

THE CATHODE-RAY TUBE AT WORK

by

JOHN F. RIDER

AUTHOR OF

*Perpetual Trouble Shooter's Manual, Servicing
Superheterodynes, Automatic Frequency Control
Systems, and other Radio Texts*

PUBLISHED BY

JOHN F. RIDER PUBLISHER, INC.

404 Fourth Avenue

New York 16, N. Y.

Copyright 1935, by
JOHN F. RIDER

All rights reserved, including that of translation
into the Scandinavian and other foreign languages

FIRST PRINTING, AUGUST, 1935
SECOND PRINTING, OCTOBER, 1935
THIRD PRINTING, JUNE, 1936
FOURTH PRINTING, APRIL, 1937
FIFTH PRINTING, DECEMBER, 1937
SIXTH PRINTING, APRIL, 1939
SEVENTH PRINTING, JULY, 1940
EIGHTH PRINTING, MAY, 1941
NINTH PRINTING, NOVEMBER, 1941
TENTH PRINTING, MARCH, 1942
ELEVENTH PRINTING, MARCH, 1942
TWELFTH PRINTING, MAY 1942
THIRTEENTH PRINTING, AUGUST, 1942
FOURTEENTH PRINTING, DECEMBER, 1942
FIFTEENTH PRINTING, FEBRUARY, 1943
SIXTEENTH PRINTING, APRIL, 1943
SEVENTEENTH PRINTING, JULY, 1943
EIGHTEENTH PRINTING, MARCH, 1944
NINETEENTH PRINTING, JUNE, 1944

In order to cooperate with the United States Government, this book has been made in strict conformity with WPB regulations of essential materials. In all other respects it is equivalent to the latest prior edition.

Printed in the United States of America

THE
CATHODE-RAY TUBE
AT WORK

Other Books
by
JOHN F. RIDER

SERVICING SUPERHETERODYNES

SERVICING RECEIVERS BY MEANS OF RESISTANCE
MEASUREMENT

PERPETUAL TROUBLE SHOOTER'S MANUAL

VOLUME III

VOLUME IV

VOLUME V

VOLUME VI

VOLUME VII

VOLUME VIII

VOLUME IX

VOLUME X

VOLUME XI

VOLUME XII

VOLUME XIII

VOLUMES I TO V ABRIDGED

AUTOMATIC RECORD CHANGERS AND RECORDERS

ALIGNING PHILCO RECEIVERS, VOLUMES I AND II

AUTOMATIC FREQUENCY CONTROL SYSTEMS

FREQUENCY MODULATION

SERVICING BY SIGNAL TRACING

THE OSCILLATOR AT WORK

THE METER AT WORK

VACUUM TUBE VOLTMETERS

AN HOUR A DAY WITH RIDER

ON

RESONANCE AND ALIGNMENT

AUTOMATIC VOLUME CONTROL

ALTERNATING CURRENTS IN
RADIO RECEIVERS

D-C. VOLTAGE DISTRIBUTION IN
RADIO RECEIVERS

A-C CALCULATION CHARTS
By R. Lorenzen

Dedicated to Janet

(3 years old)

who displayed tremendous interest
in cathode-ray oscillography by
destroying the manuscript for the
first three chapters

TABLE OF CONTENTS

Chapter I—THE THEORY OF THE TUBE—1. What the Cathode-ray Tube is and What it will do—1. Types of Cathode-ray Tubes—2. What is in the Cathode-ray Tube?—6. The Western Electric 224 Tube—7. The RCA 906 Tube—8. How the Cathode-ray Tube Works—10. Optical Analogy of Focusing—11. Focusing the RCA type Tube—14. Focusing in Other types of Tubes—17. Magnetic Focusing—19. Beam Deflection—20. Tubes with No Plates or One Pair—20. Beam Deflection in Different types of Tubes—21. Spot Positioning—30. Persistency of Vision—37. Varying Voltages Applied to Deflector Plates—41. Magnetic Deflection—44.

Chapter II—SWEEP CIRCUITS—47. Spreading the Image—48. Time Sweep Frequency Changed—52. Sweep Frequency that is Half that of Wave—55. Electronic Sweep Circuits—58. Linearity of Sweep Circuits—64. Use of 885 tube in Sweep Circuits—66. Other Types of Saw Tooth Wave Oscillators—70. 60-cycle Sweep Circuit—73. Distortion of Images Due to Non-linearity of Sweep—74.

Chapter III—A-C. VOLTAGES ON BOTH SETS OF PLATES—77. Sine Waves of Equal Frequency and Amplitude—78. Phase Relations of Two Waves—80. Development of Lissajous Figures—86. Voltages with Variable Frequency and Amplitude—90.

Chapter IV—COMMERCIAL CATHODE-RAY OSCILLOGRAPHS—93. National Union Model 3-5 Oscillograph—95. Dumont Model 145 Oscillograph—99. RCA Model TMV-122-B Oscillograph—99. Kaltman-Romander Oscillograph—103. National Oscillograph—105. Clough Brengle Model CRA Oscillograph—107. Other Oscillographs—108.

Chapter V—PRACTICAL APPLICATION OF THE CATHODE-RAY OSCILLOGRAPH—110. Spot Position—110. Spot Focusing—114. Sweep Circuit Control—117. The Sweep Frequency—118. The Synchronizing Control—119. External Synchronization—127. 60-Cycle Synchronization—128. Vertical Amplitude—129. Horizontal Amplitude—130. Distortion Due to Non-linear Sweep—131. General Operating Conditions—132. Phase Difference Measurement—133. Frequency Comparison—137. Frequency Limits—138. Frequency Standards—139. Relative Amplitude of Two Voltages—139. Interpretation of Completed Loop Patterns—141. Typical Lissajous Patterns—142. Phase Splitting Circuits—154. Linear Sweep Circuit as Frequency Standard—156. Oscillator Calibration—157. Interpreting Ratio Patterns—158. Dynamic Tube Characteristics—160. Magnetic Deflection Practice—163. Hysteresis Measurements—166. D-C Voltage Measurements—168. Sensitivity Ratings of Various Types of Cathode-ray Tubes—171. Direct Current Measurements—172. A-C. Voltmeter Applications—173. A-C. Ammeter Applications—177. Study of Waveforms—178. Complex Wave Characteristics—180. Development of Complex Waves—180. Amplifier Distortion Measurements—

185. Checking Audio Amplifier Overload—188. Checking I-F. Amplifier Overload—193. Checking Demodulator Output Waveform—198. Checking Phase Distortion—199. Checking Class "B" A-F. Amplifier—201. Distortion in Demodulator—204. Condenser Power Factor Tests—206. Phase Inversion—207. Checking Test Oscillators—209. Hum Measurements—220. Testing Tone Controls—224.

Chapter VI—ALIGNMENT OF TUNED CIRCUITS—226. The Motor Driven Frequency Modulated Oscillator—228. Electrically Operated Frequency Modulated Oscillators—233. Motor Driven Frequency Modulators—235. Relation Between Rotating Condenser and Frequency Sweep—239. Synchronizing Rotating Condenser and Horizontal Sweep—242. Single Image Motor Driven Frequency Modulator—254. Commercial Frequency Modulated R-F Oscillators—255. Rectification of the Frequency Modulated Signal—357. Resonance Curves and Coupled Circuits—261. The Dimensions of the Image—263. Connecting the Oscillograph for Visual Alignment—264. Images with Spurious Voltages—267. Excessively Strong Frequency Modulated Signal—268. Conditions of Alignment—269. Synchronization of Double Image Pattern—272. Band Width in Variable Band Width Double Image Systems—273. Constant Band Width Single Image Systems—274. Checking Effect of Damping upon Tuned Circuit Response—278.

Chapter VII—THE A-F. FREQUENCY MODULATOR—280. Determining Overall A-F Response Curves—280. Practical Applications of the A-F Frequency Modulator—282.

Chapter VIII—AUTO RADIO VIBRATOR TESTING—287. Checking Non-Synchronous Vibrators—288. Testing Synchronous Vibrators—290.

Chapter IX—TRANSMITTER ADJUSTMENT—294. Modulation Measurement and Analysis—294. Developing the Trapezoidal Pattern—297. Stopping Modulated Wave Patterns—301. Transmitter Adjustment—302. Improper Test Procedure—310.

Chapter X—OTHER APPLICATIONS OF THE CATHODE-RAY OSCILLOGRAPH—312. Beat Patterns—312. CW Reception and Detection—313. Industrial Applications—313. Other Radio Applications—314.

Appendix—315. Testing Mixer Circuits—315. Checking Test Oscillators—315. Photographing the Image—316. Simultaneous Traces—317. Articles on Cathode-Ray Oscillography—318. Dumont Model 148 Oscillograph—319. United Sound Engineering Model CR-3 Oscillograph—320. United Sound Engineering Model CR-5 Frequency-Modulated Oscillator—320. Visual Alignment at 600 KC.—320. Dayrad Series 65 Oscillograph—323. Supreme Model 555 Oscillograph—325. RCA Model TMV-122-B Oscillograph Chance—327. Hickok Model RFO-1 Oscillograph—327. Triumph Model 180 Frequency-Modulated Oscillator—329. Triumph Model 800 Oscillograph—330. RCA 913 Cathode-Ray Tube—331. Alignment of A.F.C. Circuits—332.

INTRODUCTION

The cathode-ray oscillograph is not a new device. It is years old. In fact the writer employed the instrument almost a decade ago and there were very many who employed it many years before then. However, its exploitation during the past six months removed it from the laboratory class and made it an instrument of general practical utility to an extent far greater than that which was accomplished during the past ten years. . . . Radio service technicians—design engineers—college laboratory technicians—amateur transmitter operators—have become cathode-ray oscillograph conscious. This is by no means strange, for no piece of equipment possesses the versatility and utility equal to that of this device.

While it is true that "The Cathode-Ray Tube At Work" is intended primarily for the radio servicing industry as a reference text covering the operating principles and practical applications, it is felt that the contents will be of value to the design engineer as well, for he, too, has in very many cases searched in the dark for the conclusions he hoped to reach.

This volume is not intended as an engineering text. It is intended as a practical book and should be viewed from that angle. The theory covers the principles underlying the operation of the cathode-ray tube as used in oscillographs of the type intended for general use in the radio and allied fields in connection with servicing, design research and "ham" transmitter operation and adjustment. The practical applications covered herein relate to the servicing of radio receivers and the observation of electrical phenomena associated with receiver, amplifier and transmitter components.

The subject of television has been omitted entirely, because we felt that it did not belong in this volume. However, the theory given in this text should be of some value in the effort to comprehend the operation of the cathode-ray tube in television systems. We have omitted discussion of the application of the cathode-ray tube to fields associated with radio, but far removed from receivers, amplifiers and transmitters as we consider them. We are referring to the application of the cathode-ray tube for direction finding, study of static, prevention of collision, blind flying, etc. . . .

We made brief reference to the application of the cathode-ray oscillograph to the industrial field. But as far as radio servicing is concerned, we feel that we have covered the subject as fully as it will permit, without making the text an involved engineering discussion. No doubt, revisions of this volume will take place in years to come. Changes will take place. The servicing field in particular is fast approaching an engineering status and as such will use more and more equipment originally native to the laboratory only. When that time arrives, such a volume will of necessity become more of an engineering text.

The engineer responsible for the design of cathode-ray equipment will not find much of value in this volume. This is not an apology, but a statement of fact. However, the man who is going to apply the cathode-ray oscillograph, it is hoped, will find a great deal of value.

It is our sincere wish that students will find material of value in these pages and that more and more educational institutions will find the cathode-ray oscillograph to be of value during instruction.

It may be of interest to note that all the oscillograms in this book were reproduced from unretouched photographs made in the author's Successful Servicing Laboratory.

We desire to extend our thanks for the wholehearted cooperation extended by Mr. G. C. B. Rowe and Mr. J. Avins, during the preparation of this volume.
August 13, 1935.

JOHN F. RIDER

CHAPTER I

THE THEORY OF THE TUBE

In the discussion of the cathode-ray tube during the course of this volume, it should be understood that we are referring to the types used in the commercial oscillographs of today, unless in discussion of a type, the contrary is mentioned.

What Is the Cathode-Ray Tube?

The cathode-ray tube is essentially a special type of vacuum tube, wherein electrons emitted from a cathode are concentrated into a beam, which beam is placed under the influence of electric or magnetic, or a combination of both, fields—and then caused to impinge upon a specially prepared screen, located within the tube. This screen becomes fluorescent at the point of impact of the electron beam and thus makes visible the trace of the beam in the form of a pattern or image. The persistency of the pattern is dependent upon the nature of the phenomena, i.e., if transient or recurrent. The shape of the pattern or image likewise is determined by the nature of the electric or magnetic field, which has been caused to act upon the electron beam.

Obviously, what has been said is nothing more than a very brief and general explanation of the tube, leaving much more to be said about the actual operation of the various elements within the tube and the utility of the complete cathode-ray oscillograph, wherein the cathode-ray tube is the basic unit. Much more and detailed information will follow as you progress through this volume. In order to comprehend fully the versatility of the device, it is imperative that its operation be fully understood.

What the Cathode-Ray Tube Will Do

The statements made under this heading assume that the tube is used in an oscillograph with the proper related apparatus, for as we stated in the preceding paragraph, the tube itself is but one part of the

complete device. The trace or pattern or image, which appears upon the viewing screen, provides a visual means of studying transient or recurrent electric or magnetic phenomena. The nature of the phenomena, which can be studied, is extremely diversified, due primarily to the fact that the electron beam or stream is practically free of inertia; consequently it can respond to cyclic variations from a fraction of a cycle per second to several hundred million cycles. Frankly, at the time of this writing, the tube itself is more versatile than the ingenuity of man in being able to design related equipment of equal latitude.

The tube is not limited to use only in the electrical or radio field. It can be employed for the determination and observation of physical and mechanical phenomena, by translating the physical or mechanical phenomena into electric or magnetic phenomena, which then will become visible upon the screen and be suitable for interpretation.

The ability to interpret a pattern or image into its true significance demands that the operator be familiar with the principles underlying the operation of the device or devices producing the phenomenon, as well as with the operation of the cathode-ray tube and its related apparatus comprising the oscillograph.

We shall refrain from listing specific applications of the device at this time, because detailed discussion of these applications, with illustrations, is given in subsequent chapters. To make references at this time would be so much repetition, without anything being gained. However, we feel free to speak in generalities and to say that the tube is suitable for application to the design and servicing of all types of radio receiving and transmitting apparatus, inclusive of the investigation of the performance of all of the components employed in receivers and transmitters. For that matter, we can say that it is suitable for the investigation of the performance of complete or parts of units which generate oscillations, modulate, demodulate, rectify and amplify. This about covers all of the items which are within the province of the radio serviceman, for whom this volume is primarily intended.

Types of Cathode-Ray Tubes

Speaking once more about the types of cathode-ray tubes used in the field encompassed by this volume, we find two, which while similar in many respects, particularly actual performance, have certain points of dissimilarity. One type of tube is typified by the Western Electric 224 series. This tube employs comparatively low operating voltages, between 300 and 400 volts, and has a slight gas content, using argon.

The gas employed in this tube aids in the concentration of the beam. Just what is meant by "concentration of the beam" will become evident in a subsequent paragraph. This same type of tube employs a cathode which is a part of the filament structure, as will become evident, when we show and discuss the actual components of cathode-ray tubes.

The other general type of cathode-ray tube employed in commercial oscillographs and typified by the RCA 905, 906, 907 and 908 and National Union and other makes of similar tubes, operates at a higher voltage and higher vacuum without any gas content. In these tubes, the cathode is a separate structure, indirectly heated by the heater.

It is obvious from the foregoing that cathode-ray tubes differ in operating potential. As a result of this difference in operating potentials, and other related controlling factors, cathode-ray tubes have what is known as different degrees of sensitivity. This would be somewhat like the different degrees of power output with different types of amplifying tubes, except that in the cathode-ray tube, the degree of sensitivity determines the size of the image appearing upon the screen with respect to the amplitude of the electric or magnetic field required to influence the beam. Perhaps this may be clarified if we stated that one tube may require a deflecting voltage of 40 volts to produce a one-inch image on the viewing screen, whereas a less sensitive tube may require a deflecting voltage of 75 volts to produce an image one inch long upon the viewing screen. In the cases cited, the deflecting voltage is secured from the source being investigated. A similar difference in sensitivity exists with magnetic, as well as electrostatic, deflection. (By electrostatic deflection is meant deflection due to voltage.)

Speaking about sensitivity and operating potentials, you should not take for granted that two tubes of unlike operating voltages (anode voltages) are widely different in sensitivity. A number of factors combine to produce the variation in sensitivity, so that it is possible for two tubes of unlike operating voltage, produced by two different manufacturers, to have a like rating of sensitivity. Voltage rating and position of elements influence the sensitivity rating. Just how this sensitivity is established will be shown later.

Cathode-ray tubes differ in the size of the viewing screen and also in the type of screen material used. Perhaps you have already noted that certain tubes will fluoresce green, that is, show a green image, whereas others may show a blue image or some variation of blue or green. This is a matter of the chemical composition of the preparation employed for the viewing screen, which is a coating upon the inner surface of the top-

most and widest portion of the tube. Such variations in color are photographically more or less active and certain tubes are made to fluoresce blue in order to be suitable for photographic recording of the image; that is, a photo-active image is desired. Then again, various compounds fluoresce at different rates and some screens are specially designed for the observation of high speed transients, which exist for several microseconds, whereas others require that the image be recurrent in order that it be satisfactorily visible. Certain materials, such as would be used for single high speed transients, will remain fluorescent for a short time after the impulse has passed. Generally, screens are identified as "fast" or "slow" screens; although some have been identified as general purpose screens. Composite screens are being developed. General purpose screens are used for the oscillographs being offered to the radio industry at large. These screens are photographically active. Examples of photographs taken, with data relative to type of lens, speed, focus, film, etc., will be given in the section devoted to the making of oscillograms in the Appendix. Materials used for screens are willemite, zinc silicate, cadmium tungstate, calcium tungstate and others.

Concerning the size of the viewing screen, the larger the better naturally. At the same time the larger the tube, the larger the equipment and the greater the cost and if satisfactory operation is available with the smaller tube, then there is no reason for the larger tube. Of course, for photographic purposes, the larger tube is preferable, because the image to be photographed is larger.

Referring once more to sensitivity, we are speaking about the tube itself without any related amplifiers. The introduction of the amplifiers used with cathode-ray tubes increases the sensitivity—not because the tube characteristic is altered in any way, but because the signal applied to the tube is magnified or strengthened by the amplifiers, so that a basic 1-volt signal may be raised to as high as 40 or 50 volts in the amplifiers, and then applied to the cathode-ray tube. This combination of cathode-ray tube and related amplifiers changes the sensitivity of the combination, making it much greater than with the tube alone. If the amplifiers were removed and we considered the tube alone, it would still possess the original degree of sensitivity.

Although not of the type of tube which service technicians and radio engineers may have occasion to use, it might be well to say a few words about the "cold" cathode type of cathode-ray tube. This is like the "hot" cathode type of cathode-ray tube, with which we are con-



Type 903 has a 9-inch screen and is designed for electromagnetic deflection.

Type No. 904 has a 5-inch screen and but one pair of plates, these being connected to two of three caps on the tube's side. This tube was designed for simultaneous electromagnetic and electrostatic deflection.

Type No. 905 has a 5-inch screen and two pairs of deflecting plates, which are connected to the four caps on the tube's side.

Type No. 906 has a 3-inch screen and two pairs of deflecting plates. All connections to the tube are made through the prongs on the base.

Courtesy RCA Mfg. Co., Inc.

Types No. 34-8, 54-8, 94-8 (left) have 3, 5 and 9-inch screens respectively and four deflecting plates that are connected to the terminals on the base. These are gas-focus tubes.

Types Nos. 54-8-C, 94-8-C (middle) have 5- and 9-inch screens respectively. The elements are at an angle, making the normal position of the spot at one side of the screen instead of the center.

Courtesy Allen B. DuMont Laboratories

Type No. 908 (right) has a 5-inch screen and four deflecting plates connected to prongs on the base.

Courtesy National Union Radio Corp.

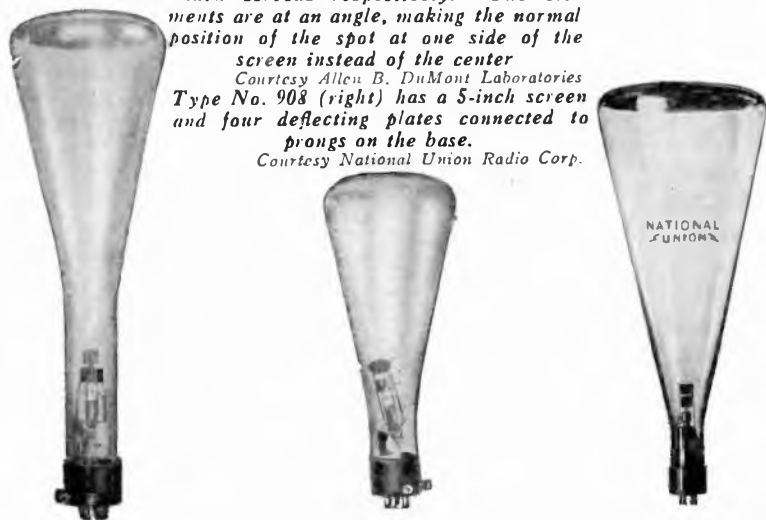

cerned, but differs in that the electron emitter, the cathode, is not heated and the electrons are drawn from the cathode by a nearby element (anode), to which has been applied a voltage of from 10,000 to 20,000 volts, which is positive with respect to the cathode. In the hot-cathode type of tube, the emitter emits electrons freely.

Some of the conventional cathode-ray tubes differ in physical dimensions and in the arrangement of connections to the various elements. Figure 1 illustrates various types of cathode-ray tubes. As is evident, some types have all the connections in the tube base, whereas others employ a tube base for certain contacts and have connecting caps on the sides of the tubes for connection to the remaining elements within the glass envelope.

What Is in the Cathode-Ray Tube?

You wonder about the structure of a cathode-ray tube. Once more we repeat that our discussion, consequently our descriptions, relate to those tubes that are used in commercial oscillographs, which employ the cathode-ray tube and which are being offered to the radio servicing industry and related industries for the work previously mentioned. We include these qualifications in order to obviate the necessity of describing other types of cathode-ray tubes, of the very high voltage variety used in other fields. It is realized that omission of such data imposes a limitation upon the utility of this volume, yet we feel that the space and time can be devoted to better advantage by elaborating about things much closer to home.

We have made reference to two major types of tubes. These are the Western Electric 224 series and the RCA 906 series and its equivalents. When speaking about types in connection with what elements are in them, we will omit the tubes which have their connections through both the side of the glass envelope and through the tube base, since the actual elements within these tubes are identical to the elements within similar tubes, wherein all connections are made through the tube base.

In the descriptions which follow, we shall merely refer to the electrodes and their general function. After these descriptions are completed, a more detailed explanation of the operation of the tube and the function of the electrodes will follow. Our reason for progressing in this manner, is that we feel that an understanding of the operation of the components of the tube will be facilitated if you compare the operation with a conventional optical system, which discussion would

be premature if introduced at this time. However, if the optical system analogy is presented after the description of the elements within the two types of tubes, the facts gleaned will be more readily associated with tube operation and action.

The Western Electric 224

Figure 2 illustrates the physical structure of the W.E. type 224 cathode-ray tube. The working elements are enclosed within a pear-shaped glass bulb about twelve inches long. All air is removed from the bulb and a certain amount of argon gas is placed within it. The purpose of this gas is to aid in the concentration of the beam.

Fig. 2. The various elements of the Western Electric type 224 cathode-ray tube are designated in the table on the right. The glass tube is first evacuated and then argon is introduced. As is explained fully in the text, this gas is an aid in concentrating the beam of electrons so that when it strikes the screen a small spot will result.

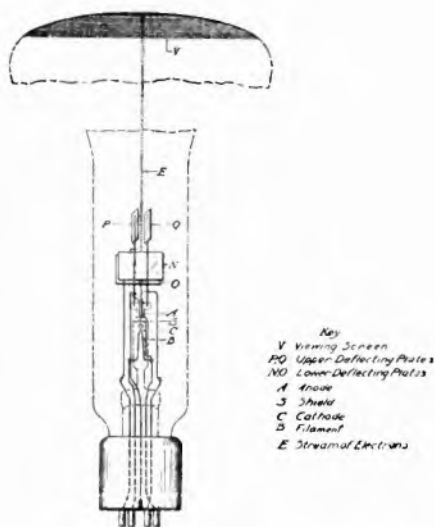

The electron stream is projected from the cathode C, which is joined to the filament. This structural arrangement causes the filament current to flow through the cathode emitter and to heat it to the state of incandescence required for satisfactory electron emission. Around the cathode is a shield S, with a tiny hole at the top, through which the electrons must pass in order to reach the elements above. Directly above the shield is the tubular anode A, through which the stream of electrons is projected towards the screen. Directly above the anode are to be found the two pairs of deflecting plates made of non-magnetic material. As is evident, these two pairs of plates are arranged so that each pair is at right angles to the other. The stream of electrons

projected from the cathode, after passing through the tubular anode, pass between these two sets of deflecting plates. If you viewed these two pairs of plates from the top and could also see the electron stream, it would appear as shown in figure 3, the stream coming

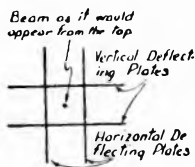

Fig. 3. If it were possible to see through the screen at the tube's end, the electron stream would appear as a small dot in the middle of a square formed by the two sets of deflection plates, on which no deflecting voltage was impressed.

through in the center of what is a small square. The fluorescent screen is spread over the inner surface of the top of the tube. So much for the arrangement of the elements within the W.E. type 224 tube.

The RCA 906 Type

Now for the arrangement of the elements in the tubes typified by the RCA 906, shown in figure 4. H is the heater. Around the heater is the cathode C. Surrounding the cathode is a shield G, with a small opening directly above the emitter portion of the cathode. This is known as the control grid. This cathode is fastened to one side of an insulating member. To the other side of this insulating member is attached another cylinder with a small aperture. This is known as anode number 1. The aperture in this anode is in line with the aperture in the grid sleeve anode. Above anode 1 is anode 2. Above the anodes are the two sets or pairs of deflecting plates. Whereas in the Western Electric tube, each pair is mounted parallel, in the RCA tube, and in some others, they are mounted in an oblique manner, although in some other tubes of this type, the two pairs of deflecting plates are mounted perpendicularly. The viewing screen is spread across the inner surface of the uppermost portion of the tube. The beam of electrons emitted from the cathode, after passing through the various electrodes, pass between the two sets of plates, as in the case of the previous type of tube. However, this statement should not be construed as being a positive statement applicable to all tubes.

In some of the higher powered tubes of this type, such as are employed in connection with the observation of high powered transient phenomena, one or both pairs of deflecting plates are adjustable from the outside. These tubes are, of course, special tubes, somewhat beyond the type in which we are interested.

There are also in use tubes similar to that illustrated in figure 4, but wherein one pair of deflecting plates are used. In some, all plates are omitted. How this arrangement is employed will be discussed after we explain the basic facts underlying the operation of the tube.

In all of the tubes, which have been mentioned up to this point, the mechanical arrangement of the electrodes is such that when the electron beam is projected to strike the viewing screen, the fluorescent spot appears in the center of the viewing screen. However, there is another type of tube, similar in electrode complement, wherein the entire assembly is definitely tilted, so that the original spot appears at one edge of the screen rather than in the exact center. This special purpose tube provides a greater operating area upon the screen for certain types of observations. Just how such a tube is beneficial at times, will become evident when we consider the practical applications.

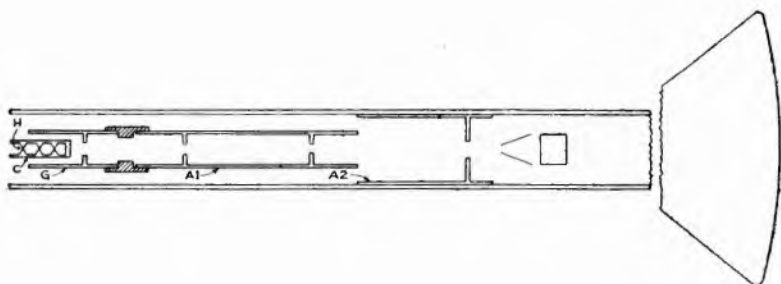

Fig. 4. In the sketch of the RCA type 906 tube the following letters indicate the various elements: H, the heater; C, cathode; G, shield grid; A1, first anode; A2, second anode. The two pairs of deflecting plates are to the right of A2. It will be noted that these plates are at an angle to the main axis of the tube. This arrangement of elements in a glass envelope or bulb constitutes what is sometimes referred to as an "electron gun."

If you review the electrode arrangement in the Western Electric type of the tube and in the RCA and equivalent types of tubes, you cannot help but note certain differences. It is true that certain electrodes appear in both types of tubes, that is, are common to both types, but there are certain differences in the number of electrodes employed in these tubes between the electron emitter and the deflecting plates. At the same time, it is imperative that you understand that both tubes will perform the same functions in cathode-ray oscillographs. You will learn in the subsequent section, how the same objective is attained in these tubes, although the number of electrodes is not the same.

How the Cathode-Ray Tube Works

As is true in any number of instances, best utilization of a piece of equipment is obtained when the operator is thoroughly familiar with the operation of the device. That is why we place such importance in knowing how the electron beam in the cathode-ray tube is controlled at the various electrodes. If the focusing of the tube and the effect of the various electrodes is fully comprehended, some of the peculiar effects encountered with these tubes will be recognized and corrective measures instituted. However, to apply the cathode-ray tube by mechanically following specific instructions, will be found to introduce myriad limitations. Consequently, we feel that it will be to your advantage if you read again and again the text relating to the basic operation of the tube itself. Assimilate this portion of this volume and you will develop a solid foundation upon which to build the structure of successful cathode-ray oscillograph application.

The focusing of the electron beam is one of the important points of information, which should be understood by the man who intends applying the tube to his work. While it is true that this is but one of the many operations relating to the application of the tube, no harm can come from thoroughly understanding what happens during the process of focusing.

Focusing of the beam is an important operation. Without it, the utility of the tube would be practically nil. The stream of electrons projected from the cathode travels in all directions from the cathode. To place it under the influence of the electric or magnetic fields, it is necessary that the emitted electrons first be concentrated into a beam and then be properly located, so that these fields be enabled to act upon the beam. Concentration into a beam is essential in order that the trace upon the viewing screen be readily distinguishable, particularly the fine variations which may appear in the pattern. Furthermore, proper acceleration of the electrons is required, so that when they strike the viewing screen, the impact will be sufficiently great to cause fluorescence. Focusing is a function of this acceleration.

If the emitted electrons are not concentrated into a beam, the image position will not be under control. Neither will it be possible for the electric or magnetic fields, whichever are used, to act uniformly and to produce an image which will be of value in studying the phenomena, unless the beam is properly focused. An incorrectly focused beam in a cathode-ray tube results in a large spot with a halo around it. In

some instances, improper focusing results in a very wide spot, which, when spread as a result of the deflection, produces extremely wide lines of non-uniform width in the pattern. Considering all of the factors, focusing of the beam should be understood.

To expedite comprehension of the focusing operation, we deem it worthwhile to present a simple optical analogy. While it is true that this analogy is more readily applicable to the RCA type of tube than to the W.E. type, it should also be remembered that it is more true with the type of tube most frequently employed in connection with radio servicing. At the same time, comprehension of the analogy is all that matters in order to facilitate the understanding of what takes place within the cathode-ray tube.

Optical Analogy of Focusing

Suppose that we consider a simple optical system, such as that shown in figure 5. The variables which present themselves in this analogy,

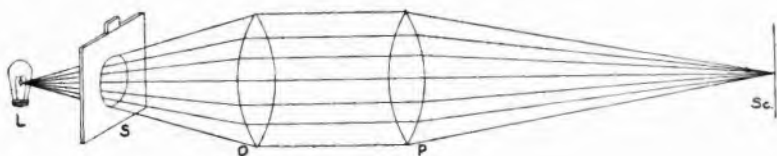

Fig. 5. A sketch of an optical system that is analogous to the elements of an RCA cathode-ray tube. L is a light source, whose output can be controlled by the variable opening of the shutter S. O and P are lenses, which concentrate the beam to a spot on the screen Sc.

are very much like the variables which are found in the RCA type of cathode-ray tube. You will realize this as we continue the discussion. This optical system consists of a source of light L, a stop, or light gate, S, two lenses, O and P, and a screen Sc.

The purpose of the system is to project the light from the lamp L upon the screen Sc, in the form of a small but intense spot of light. More than likely, you have focused the sun's rays onto your hand with a lens, and if you were of an experimental nature, one of your pranks during your youth was to start a fire by focusing or concentrating the rays from the sun onto a piece of paper. The nature of the light gate or stop, is like that of a stop on a camera; in other words, a device with an opening of variable size. By means of this device the amount of light passed from the lamp L to the lens O, is definitely under control. At the same time, we can further assume that the intensity of

the lamp, L, is also under control. In other words, a rheostat can be assumed to exist in the power supply circuit feeding the lamp.

The two lenses are of the type which will pick up the light from some source, concentrate the beam and project a pin point of light upon a screen at a definite distance from the lens. In the process of projection from lens P, the light from lens P is caused to converge into a spot upon the screen.

We stated that the objective of the system, shown in figure 5, is to project a spot of light of suitable intensity and proper size and definition, upon the screen Sc. Let us consider first, the first of these requirements, namely, the intensity of the spot. Obviously, this depends upon the amount of light available from L. If the original light source is not sufficiently luminous, all the concentration in the world is not going to produce a sufficiently luminous spot. On the other hand, while the light source may be sufficiently intense, any adjustment, as for example some setting of the stop S, which may reduce the amount of light conveyed from L to the lens O, will interfere with the intensity of the spot and if this adjustment is such that the light transferred is insufficient, the intensity level of the spot upon the screen will not be suitable. Bear in mind that at this time, we are concerned solely with the intensity or the brightness of the spot or image.

As is evident two variables are existent, which are directly associated with the intensity or luminosity of the spot. If we desire to vary the intensity of the light, we have two variable controls, either or both of which may be used. If we should decide to keep the brilliancy of the lamp L, fixed, adjustment of the opening of the stop S would give us the desired control. On the other hand, if we desired to keep the adjustment of the stop opening fixed, the filament control in the lamp circuit would give us the intensity control. Naturally, there is no reason for a dual control of the same thing, so that we can forget for the moment any variation in the brilliancy of the lamp and use only the stop opening as our intensity control. When the stop is opened wide, the full intensity is realized, because the maximum amount of light goes through. When the stop opening is closed, no light passes through. It should be understood that the only way that light from lamp L can reach lens O is through the stop S. Any setting of the stop opening, between wide open and fully closed, will provide a range of intensity.

Now for the concentration of the light into a beam, which will converge at some distance from the lens P, and become a spot upon the

screen Sc. For every lens or series of lenses, there is some point at a definite distance from the lens, where the rays of light, which are picked up by the lens, will be projected with greatest sharpness of definition. If one type of lens is employed, the projected light will be smaller than the original area of light picked up by the lens, and the rays of light can be said to have converged to a pin-point at the prescribed distance from the lens. If some other lens is used, the rays of light passing out of the lens can form an area greater than the area of light picked up by the lens, and this projected area of light will be sharply defined at a prescribed distance from the lens.

For any one set distance between the light source and the screen and suitable lenses in between, there is one setting of the lens, with respect to its position between the light and the screen, where it will project the most sharply defined area of light. This operation, or adjustment of the lens, to bring the rays of the light most sharply defined upon the screen, is known as focusing. You may recall, if you ever experimented with burning your hand or the newspaper with rays of light from the sun, that you had to shift the position of the lens until the most brilliant spot of light struck your hand or the paper. When you moved the lens you focused the light rays upon your hand or the paper.

In connection with the optical analogy offered to illustrate focusing in the cathode-ray tube, we are concerned with light rays which converge to a pin point. That is why we show the light rays in figure 5, converging to a spot upon the screen Sc. The adjustment of lenses O and P constitutes the focusing, with two variables. If lens O is fixed in position, focusing can be accomplished by moving lens P. On the other hand, if lens P, is fixed, all the focusing can be done with lens O. With lens P fixed in position, adjustment of the stop S and the lens O will result in an optimum setting, which will provide greatest intensity and greatest definition; in other words, the properly focused spot upon the screen and at the same time the spot of proper intensity. An incorrect adjustment of the stop S, with correct adjustment of lens O, will result in a properly focused spot of light upon the screen, but of insufficient luminosity or brilliance. On the other hand, correct adjustment of the stop S and incorrect adjustment of the lens O, will result in light upon the screen, but not of the correct intensity or focus. The intensity also suffers when the light is out of focus, because proper concentration does not take place. Instead of having all of the light concentrated into one spot, the number of rays picked up by the lens are diffused

over a greater portion of the screen, with reduced light at any one point.

It is significant to note that with the position of the light source *L*, the opening of stop *S* and the screen *Sc* permanently fixed, the projection of the best defined spot is determined by the relative positions of the lenses *O* and *P*. Incidentally, such focusing can be done with but a single lens in place of *O* and *P*.

Focusing the RCA Type Cathode-Ray Tube

Let us now associate figure 5 with the electrodes used in the RCA type cathode-ray tube and see how closely the optical analogy of focusing is like the electrical means employed in the tube. Examine figure 6. *H* is the heater. *C* is the cathode, which is the electron emitter and equivalent to the light source. *G* is the control grid and is the equivalent of the light gate, or stop *S*. Just why this is so will be stated later. Anode *A1* is the equivalent of lens *O* and anode *A2* is the equivalent of lens *P*. The viewing screen *Sc* is the equivalent of the screen *Sc* in figure 5.

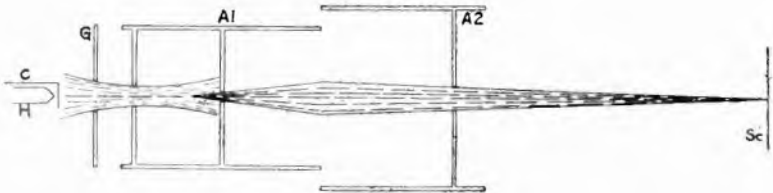

*Fig. 6. The path of the electron stream through an RCA cathode-ray tube is here shown. The heater, *H*, warms the cathode, *C*, from which the electrons are emitted. The stream is concentrated and accelerated by the two anodes, *A1* and *A2*, finally appearing as a spot on the screen, *Sc*. See Fig. 5 for optical analogy.*

The control grid *G*, which is not really a grid in the normal sense, functions as an electron gate or stop, just as the stop *S*, serves as a light gate because of the following: The electrons which are emitted from the cathode are negative particles. For any one temperature of the cathode, the maximum number of electrons are emitted by the cathode for that temperature. However, in operation, if we desire control of the intensity of the spot, we must have some means of controlling the number of electrons allowed to pass into what finally becomes the beam, it being acknowledged that the intensity of the spot upon the viewing screen is dependent upon the number of electrons in the beam, just as the intensity of the spot in the optical analogy is dependent upon the amount of light allowed to pass to the lenses.

Control of the number of electrons, which are permitted to pass

through the electron gate (control grid), is accomplished somewhat in the manner employed in the regular vacuum tube: by the application of a negative bias to the control grid, which is the electron-gate G, with the aperture directly above the emission surface of the cathode. The negative bias applied to the gate electrode repels the electrons emitted from the cathode and definitely controls the number which pass through the aperture. Reducing the bias naturally allows a greater number of electrons to pass through the aperture and thus pass under the influence of the adjacent electrode. The greater the number of electrons permitted to pass through, assuming fixed adjustment of the related electrical lens controls, A1 and A2, the greater the intensity of the spot which appears upon the viewing screen Sc.

Now, the electrons emitted from the cathode have a certain velocity, but not necessarily the velocity required. Furthermore, while some electrons will normally pass through the electron gate G, there is applied to the anode A1 a positive voltage, which tends to attract the electrons towards it, or at least accelerate the movement of the electrons through the electron gate G towards the viewing screen. The shape of the electron field at the cathode and the attracting influence of anode A1, combine to produce the initially converging force, for the width of the stream passing through the control grid (electron gate aperture) is much less than that at the cathode.

As a matter of fact this control grid electrode serves a dual purpose. The first has been explained. The second is that, as a result of the negative charge applied, it tends to stop electron emission from the outer portions of the cathode. Only the center portion, beneath the aperture, is emitting. Of course, the exact extent of this condition depends upon the bias adjustment. This electrode, in conjunction with the cathode and the first anode A1, which applies the initial acceleration force to the emitted electrons, constitutes an electronic lens. The converging influence of the combination upon the emitted electrons can be observed in figure 6.

From what has been said, it is clearly evident that the primary control of the beam is the intensity control, namely the control grid electrode bias adjustment. It stands to reason that the electron beam cannot be focused if there is no beam, which condition is created when the bias adjustment of the control grid is such that no electrons, or insufficient electrons, pass through the electron gate (control grid) aperture. On the other hand, if sufficient electrons are caused to pass through the electron gate, a spot will appear upon the screen irrespec-

tive of the adjustment of the anode A1 voltage, just as in the case of the simple optical system, shown in figure 5, where, if light is caused to pass through the stop, light will be visible upon the screen, even if the adjustment of the lens O is not correct.

In the case of the tube shown in figure 6, the voltage applied to the anode A1 is the primary focusing voltage, since the first focusing action takes place in the region of the first anode A1, as illustrated in figure 6. There is a small aperture at the end of anode A1, which is nearest anode A2. The function of A1 is to converge the initial beam for passage through this aperture. Those electrons, which are too divergent from the beam, are stopped by this aperture. A comparison between the optical system shown in figure 5 and the electrical optical system in the cathode-ray tube shown in figure 6, shows a parallel between L, S and O in figure 5 and between C, G and A1 in figure 6.

The main focusing action in the cathode-ray tube, shown in figure 6, takes place between anodes 1 and 2. A fixed high voltage is applied to the anode A2. This voltage is fixed and positive with respect to the cathode and from 4 to 5 times as great as the voltage applied to anode A1. Anode A2 voltage accelerates the electrons to the velocity required to produce fluorescence, when they strike the screen. The electrons, which pass through the beam defining aperture on A1, are brought to a focus as a result of the combined action of A1 and A2, but this time are caused to converge into a spot at a certain distance from anode A2, namely, upon the screen. Anode A2 also has a beam defining aperture, so that electrons which are too divergent from the main beam are not permitted to pass through.

You recall, during the discussion of the optical system, that lens P was fixed and that focusing was carried on by adjustment of lens O. With the position of L and the adjustment of S also fixed, it is obvious that focusing of the light upon the screen Sc is governed by the relative positions of the two lenses, O and P. The same is true in the cathode-ray tube, figure 6, but in this case, with cathode emission fixed, the focusing of the beam upon the screen is determined by the ratio of voltages applied to anodes A1 and A2. With anode A2 voltage fixed, the proper focusing adjustment is made by varying the voltage applied to anode A1.

We made the statement that if the intensity adjustment, or the bias applied to the control grid, was correct, electrons would strike the viewing screen irrespective of the setting of the anode A1 (focusing) voltage. That is true, but it is also important to remember that if the

adjustment of the control grid voltage is such that insufficient electrons are passed, or if the emission from the cathode is insufficient, variation of the focusing voltage may cause the spot to disappear from the screen. There are several possible reasons for this. One is that as a result of incorrect focusing, insufficient acceleration is given to the electrons and comparatively few reach the high voltage anode A2. Second, is the diffusion of the beam, which results in less than the required light to appear as an image.

The production of a bright and sharply defined spot upon the screen is accomplished by correctly controlling the intensity and the focusing. The size of the spot is influenced by both the intensity and the focusing controls.

Focusing in Other Types of Tubes

You may have noted that the focusing of the beam in the RCA type of tube is a result of the fields developed by the voltages applied to the anodes. In other words, the concentration of the electrons into a beam is accomplished by these fields. The Western Electric tube employs a somewhat different manner of concentration. We stated in connection with the electrode arrangement shown in figure 2, that the tube contained a cathode, a shield and an anode. In contrast to the fixed potential cathode employed in the RCA tube, the W.E. tube, figure 7, employs a variable potential cathode C. By this we mean that

Fig. 7. In a Western Electric cathode-ray tube, the cathode, C, is a part of the filament, F. This is in turn connected to the shield, G. A fixed positive voltage is applied to the anode, A, for acceleration purposes.

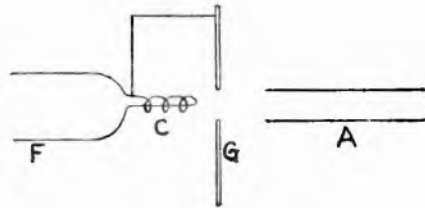

the current flowing through the cathode is varied by means of a rheostat and thereby controls the emission. The shield or electron gate G is electrically connected to the cathode at one point. The anode A is connected to a fixed voltage source, which applies a positive voltage to this electrode. Further, a certain amount of inert gas is placed within the glass envelope.

How is this tube focused? It is lacking the focusing electrode. It has the intensity control, although not in the same manner as the other

tube. The number of electrons fed into the beam or allowed to pass through the shield (electron gate) aperture is controlled by the emission of the cathode, because the shield, being joined to one side of the cathode, is maintained at a fixed potential with respect to the cathode. At the same time, the anode, being at a fixed potential, supplies the attracting influence upon the electrons to cause them to move through the shield aperture and accelerates their motion towards the screen. With these voltages fixed, the variation in temperature of the cathode, controlled by the filament resistor, varies the amount of emission, so that the intensity control is the cathode temperature control.

Now, the gas within the tube comes into action. The combination of the aperture in the shield and the tubular anode results in the projection of a stream of electrons from the cathode, through the shield aperture and through the opening in the tubular anode towards the viewing screen. An initial beam is therefore available. However, the electron stream, moving further away from the attracting force, which has caused it to converge (the tubular high voltage anode), would tend to diverge, as a result of the mutual repulsion between the electrons (negative particles) comprising the stream. Furthermore, due to the comparatively low accelerating voltage, about 300 to 400 volts, as compared with 1000 to 1300 volts in the 906 type tube, there is a greater tendency for the electron stream to spread during its passage to the viewing screen. Such spreading would be the equivalent of poor focusing, cause a large spot of insufficient brilliance, etc.

It is here that the gas content comes into play. The argon gas, which is used at low pressure, counteracts this tendency towards spreading of the stream in the following manner: A high velocity or speed is developed by the electrons which pass through the high voltage anode, as a result of the voltage applied to the anode. The molecules of gas, on the other hand, move at comparatively low velocities. When an electron strikes a molecule of gas, it knocks one or more electrons off the gas molecule, thus making the remaining nucleus a positive ion. This ion, therefore, attracts free electrons. Being comparatively heavy, with respect to the weight of the electron, and moving slowly, the positive ions stay within the limits of the initial electron stream, so that the entire stream of electrons forms a stream of positive ions. The tendency of the electrons to spread is offset by the attracting power of the positive ions, which are continually being created as a result of the bombardment of the gas molecules by the stream of electrons. Obviously, the gas is doing what was previously accomplished by the

focusing anodes and voltages, namely, concentrating the stream of electrons.

The only variable control, which is found in this type of tube, is the rheostat, controlling the cathode temperature. The adjustment of the cathode temperature, or electron emission, serves the dual purpose of controlling intensity as well as focus. Both are simultaneously accomplished, because there is a critical temperature, at which the spot upon the viewing screen is small and brilliant. If the adjustment of the cathode temperature is such that insufficient electrons are emitted, the spot will not be bright. On the other hand, if the emission is too great, the spot becomes too wide for practical use.

Some of the commercial cathode-ray tubes of the type which have separate intensity and focusing controls are equipped with but one continuously variable control on the face of the panel. This is the intensity control. The focusing control, that is, the adjustment of the accelerating anode voltage (A1 in figure 6), is a screw control on the side of the box housing the equipment. Such an arrangement is deemed advisable by some manufacturers on the ground that the focusing adjustment for any one tube is changed but little during normal operation of the tube. This is a matter of opinion and also is dependent upon the type of observation work being carried on.

Magnetic Focusing

The methods of focusing the beam, as described thus far, have employed electrostatic fields. It is also possible to focus the beam with a magnetic field. Incidentally, this reference to focusing should not be confused with the application of electrostatic or magnetic fields for the purpose of deflecting the beam during the observation of electric or magnetic phenomena. The reference to focusing is that relating to the proper concentration of the beam so as to enable the application of the deflecting voltages and to create the proper image.

In magnetic methods of focusing, powerful magnetic fields are developed by passing current through coils located outside the tube, coaxially around the tube's neck. In view of the fact that magnetic focusing is not used in the field, which is the destination of this volume, and since this volume is not intended as a text for those associated with the design of cathode-ray oscillograph apparatus, it is deemed best to make nothing more than this brief reference.

Tubes With No Plates or One Pair

There are tubes, as has been stated, which contain but one pair of deflecting plates and outside magnetic deflection coils must be employed. Then again, there are cathode-ray tubes without any deflecting plates within the glass envelope and magnetic deflection must be used. These are general descriptive references. The types of tubes, which are used in connection with radio receiver design and servicing, invariably are of the type equipped with two pairs of internal deflecting plates, and are suitable, when such is desired, for use with external magnetic deflection coils. This is the type we shall consider in this text, showing its application to radio receiver and component design and servicing. Incidentally, electrostatic deflecting plates may also be located outside the tube, but such tubes are not commonly used in the radio industry.

The Deflection of the Beam

There are two important functions performed in the cathode-ray tube oscillograph. The first is the focusing of the electron stream into a narrow concentrated beam of electrons. The second is the placement of this beam under the influence of an electric or magnetic, or combination of both, types of field, in order to secure the proper deflection of the beam. Deflection of the beam results in a pattern or image visible upon the fluorescent viewing screen, which pattern furnishes the information desired.

The illustrations showing the focusing of the electron beam create the impression that the beam is quite wide. An illustration, which would really show the properly focused beam as narrow as it really is, would make comprehension of the process of focusing much more difficult. Consequently, we show the properly focused beam much wider than it actually is within the tube. When the tube is properly operated, the beam is a very narrow pencil of electrons, which produces a spot with a diameter not greater than perhaps $\frac{1}{16}$ to $\frac{1}{8}$ of an inch. Such is the diameter of the spot found in tubes of the W.E. 224 type and the usual run of cathode-ray tubes with 3-inch diameter viewing screens. Some of the tubes with larger screens have larger spots, since the type of electrodes used are comparably larger. At any rate, the beam, when placed under the influence of the deflecting fields, should be understood to be a narrow stream of electrons. That is how we will show them.

We made the statement that two types of deflection were available; namely, electrostatic (electric) and magnetic. All of the smaller tubes

are arranged for electrostatic deflection and contain the two pairs of deflecting plates, which enable the application of deflecting fields in two directions. However, even these tubes may be used for magnetic deflection, by the location of the proper deflecting coils around the outside of the neck of the tube.

When considering the process of deflection, it is imperative that you realize several pertinent facts. These are:

1. Electrons are particles, bearing a negative charge at all times.
2. Electrons are repulsed by a negative field produced by any medium.
3. Electrons are attracted by a positive field produced by any medium.
4. The electrons which pass through the deflecting fields are in a narrow stream or beam.

In this discussion of the deflection of the beam, we will consider first the deflection with an electrostatic field and then with magnetic fields. In this connection, whatever is said, is equally applicable to the RCA type of tube and the W.E. type of tube. As far as deflection is concerned, the nature of the electron emitter and the type of accelerating anode or anodes used are of no consequence. The primary consideration is the existence of the electron stream within the deflecting field. There is a relation between the means of focusing and the strength of the deflecting field in order to produce a certain deflection, but this subject can await its discussion until the proper time. Figure 8, illustrates the beam passing through two pairs of deflecting plates on its way to the screen. There is no necessity for showing the cathode, control grid and anode structure. These can be assumed.

The position of the beam, without any voltages applied to the deflection plates, is midway between the plates, which should place the spot in the center of the viewing screen. The positioning of this spot is the same irrespective of the physical arrangement of the plates; that is, if they are perfectly straight with respect to each other, as in figure 8A, or if they are tilted as in figure 8B.

There are electrical and mechanical influences, wholly undesired, which will tilt the beam, so that it does not strike the viewing screen exactly in the middle. Incorrect positioning of the deflecting plates, static charges upon the bulb, external magnetic bodies, etc., are some of these influences. However, many of the tubes have means of positioning the beam, so that the spot impinges upon the screen at the

correct center. As a matter of fact, slight misalignment of the beam does not very greatly interfere with the operation of the tube, provided, of course, that the degree of misalignment of the spot is not

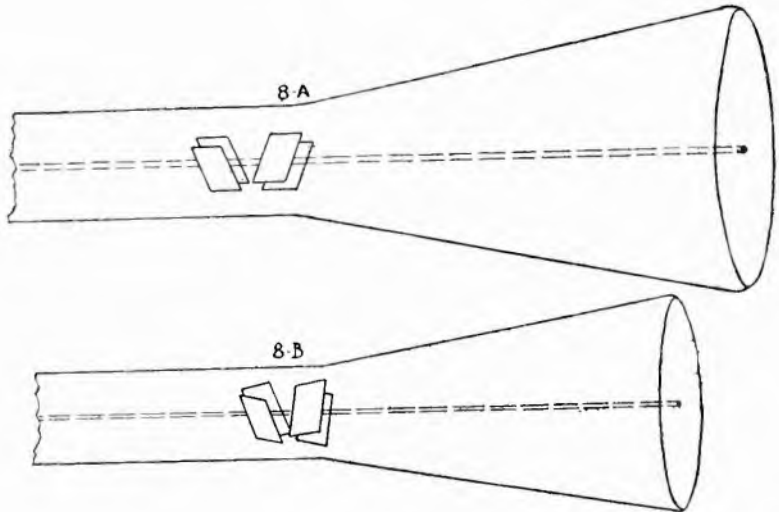

Fig. 8A shows the relative position of the deflecting plates of a Western Electric type of cathode-ray tube. Note that each pair of plates is parallel. Fig. 8B shows how the plates of an RCA tube are at an angle to each other. It should be noted that the longer sides of each pair are perpendicular in both tubes.

so great as to interfere with the image upon the screen. If sufficient screen area is available for whatever utility is expected from the tube, a slight shift in spot centering does not do a great deal of harm.

The position of the spot midway between the plates also exists if no potential difference exists between the plates. In other words, if both plates of each pair are at the same potential, the effect upon the beam is as if there were no voltage whatsoever applied to either pair of plates.

To appreciate properly what happens in the tube when a potential difference exists between the plates of each pair of deflecting plates, it is necessary to consider each pair separately. For the sake of clarity, the plates of each pair will be shown arranged parallel to each other, instead of tilted. The illustrations given in figures 9A and 9C are made in the same plane. Figure 9A shows the pair of deflecting plates which are responsible for what is generally known as the vertical deflection and figure 9C illustrates the action of the plates responsible

for the horizontal deflection. Explanations of what constitutes vertical and horizontal deflections will follow immediately after the discussion of why the deflection occurs.

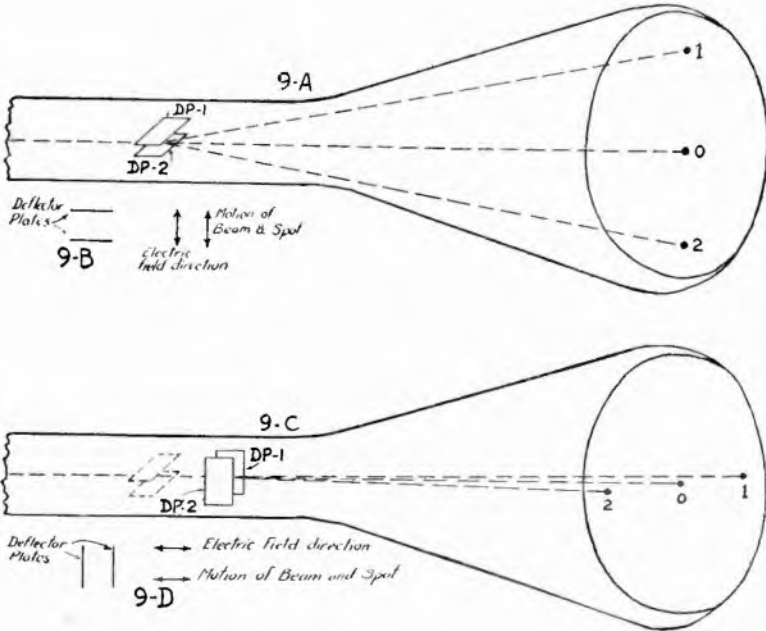

Fig. 9A shows the pair of deflecting plates that cause the electron beam to move vertically and Fig. 9C, the plates that are responsible for the horizontal movement. Figs. 9B and 9D show the direction of the electric fields and the motions of the beam for each of the two pairs of plates.

We made particular reference to the fact that the electron stream or beam consists of a bundle of moving negative charges. Also that these charges are repelled by similar negative charges or by a negative field and that they are attracted by positive charges or a positive field. Suppose then, that the beam of electrons is moving between the two deflecting plates in figure 9A. By means of the connections to these plates, it is possible to apply a positive voltage to the upper plate DP-1 and to make the lower plate DP-2 negative. With such connections, the positive charge upon the upper plate, DP-1, will attract the stream towards it, whereas the negative charge upon the lower plate, DP-2, will repel the stream, so that the entire beam will be deflected towards the upper plate, DP-1.

Now, the normal direction of the beam is as shown by the middle dotted line and the position of the spot upon the screen is O. When the difference of potential previously described exists between the plates, the beam is pulled out of line as it passes between the plates and the spot upon the screen is moved to the point indicated by the number 1, the beam being shown as a dotted line. The extent that the spot is moved up away from its normal position, or the extent of the pull upon the beam towards the upper plate DP-1, is determined by the preponderance of the positive charge upon this plate, with respect to plate DP-2. If the difference of potential existing between plates DP-1 and DP-2, with DP-1 positive, is very small, the pull upon the beam is very little, so that the spot upon the viewing screen is moved slightly up from its normal position O. However, if the difference of potential between DP-1 and DP-2, with the former positive, is very great, say several hundred volts, it is possible to deflect the beam, so that the spot moves off the screen. Obviously, such a condition is of no value, as far as utility of the tube is concerned, since with the spot off the screen, there is no indication of the degree of deflection. Consequently, each tube has its limits of deflecting voltage, so that the spot will stay on the screen.

From what has been said, it is easy to understand how calibration of a tube is possible in terms of the potential difference between plates DP-1 and DP-2, in order to move the spot a definite distance away from its normal center position.

The limitation of the movement of the spot, or the deflection of the beam, with a certain potential difference between the two plates, is presented as a result of the voltage applied to the accelerating anodes. These voltages have projected the electrons in a stream towards the screen. The velocity of these electrons in motion being very great, a certain force is necessary to deflect them or pull them away from their normal line of travel. The potential difference between the deflecting plates is the force which tends to pull the stream out of its normal axis of travel. The higher the accelerating voltage, which starts the stream in motion, the greater the force required to pull it out of line. In this connection, however, it is also necessary to understand that there are other factors present in the tube, which may offset the effect of the high accelerating voltage, so that two tubes of unlike accelerating voltage may require a like value of deflecting voltage, in order to move the beam or spot the same distance.

A certain amount of amplification in displacement on the screen is obtained as a result of the distance between the deflecting plates and the screen. In other words, the vertical movement of the beam from its normal axis at the deflecting plates is small compared with the movement at the screen. This is due to projection of the angle of displacement.

Referring once more to the deflection of the beam, one of the advantages claimed for the low-accelerating-voltage, gas-concentrated beam cathode-ray tube, such as the W.E. described herein, is the fact that a lower value of deflecting voltage is required to move the spot a predetermined distance upon the screen, than would be required with a high-vacuum, high-accelerating-voltage cathode-ray tube. However, there are certain advantages found in the high-vacuum tube which are not found in the gas-filled tube, so that it becomes a matter of personal fancy and consideration of all factors.

If now we reverse the voltage to the two deflecting plates shown in figure 9A, so that DP-1 is negative and DP-2 is positive, we have a shifting of the beam and the spot in a direction opposite to that which took place before. The basis of this shift is exactly as stated before, except that the polarity of the deflecting plates has been changed. Now, DP-2 attracts the electron beam and DP-1 repels the beam. Since the hypothetical voltage applied to the two deflecting plates is the same as before, the potential difference between the plates is the same as before and the spot moves the same distance in the opposite direction to point 2.

Whatever has been said about the relation between the potential difference between the plates and the distance the spot moves towards point 1, is wholly applicable when the spot moves to point 2. If you could visualize a device whereby the voltage applied to the two plates was automatically reversed at a very slow rate, you would see the beam shift from position 0 to position 1, back through position 0 to position 2.

At this time we want to call to your attention one very significant fact. A large number of men who have viewed the deflecting plates within a cathode-ray tube have been confused about the mode of deflection. The electric field existing between these plates is like the electric field existing between the plates of a two-plate condenser. (As a matter of fact a certain amount of capacity exists between the plates of a pair of deflecting plates.) The electric field exists perpendicular to the plane of the plates, so that the plates which are *horizontal with*

respect to the front of the tube, cause the vertical deflection. The motion of the beam is parallel with the electric field. This is shown in figure 9B. The term "vertical deflection plates" refers to the *motion given to the beam and the spot by those plates, with respect to the normal position of the tube*, and not to the orientation of the plates with respect to the normal position of the tube. As a matter of fact, the plane of the plates is at right angles to the axis of the beam and spot movement.

Now for the horizontal deflection plates. Examine figure 9C. DP-1 and DP-2 are these two plates; their position in the tube with respect to the vertical deflection plates is such that they are closer to the viewing screen. The illustration of the tube in 9C, has been shifted slightly from the normal, in order to show the shifting of the beam. If this were not done, the three positions of the beam would fall atop each other, and the three spot positions 0, 1 and 2, would be in the same straight line. The operation of these plates is like that previously mentioned; that is, attraction of the beam by the positively charged plate and repulsion of the beam by the negatively charged plate is just as in the case of the vertical deflection plates. However, in this instance, the spot moves in a plane which is at right angles to the spot motion shown in figure 9A.

If deflector plate DP-1 is positive with respect to plate DP-2, the spot would move from spot 0 to position 1, spot 0, being the normal position without any potentials applied to the deflector plates or with equal distribution of the charges to both plates. The pull towards plate DP-1 is away from the reader and is the furthestmost end on the screen. If the polarity of the charges is reversed, so that DP-2 attracts the stream, the beam is pulled towards the reader, and the spot moves to position 2. The relation between the plane of the plates, the direction of the electric field and the motion of the beam and spot is shown in figure 9D. Once again the motion of the beam is at right angles to the plane of the plates.

There are other important facts which we wish to call to your attention. The first is that the placement of the deflecting plates is such that the beam is acted upon first by the vertical deflecting plates. In other words, the first displacement of the electron beam, for normal operation of the tube, is the vertical displacement. Then the horizontal field or force acts upon the beam. The second significant fact, one which you will have occasion to remember, is that displacement of the beam from its normal axis of travel results in displacement of a SPOT.

The third significant fact is that the concentrated beam moves as a single unit. The electron stream is not broken up into groups of electrons. It is deflected as a beam, terminating in a single spot. If your imagination is sufficiently great, you can visualize deflection of a single SPOT. If you consider the screen only and forget about the deflection of the electron beam, the application of the deflection voltage causes the motion of a SPOT.

Let us carry this a bit further. Examine figure 10. The circle indicates the viewing screen. The position of the tube is such that

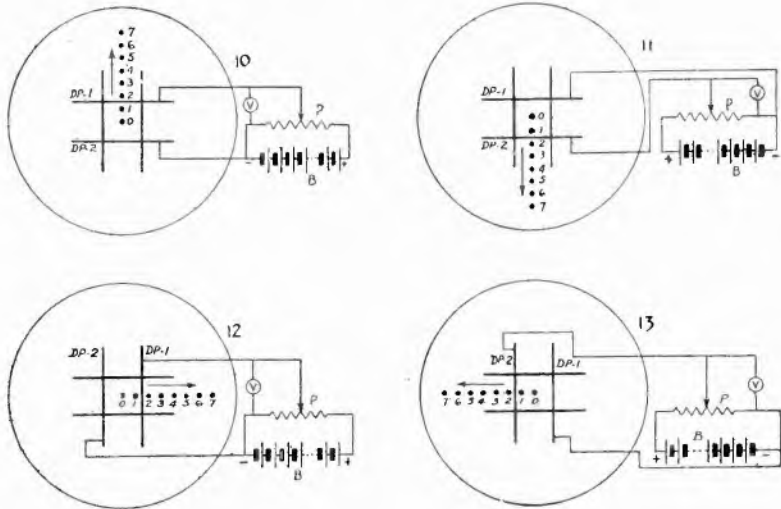

Figs. 10, 11, 12, 13. The circles indicate the viewing screen of a cathode-ray tube. The dots, numbered 0 to 7, show the successive positions of the spot formed by the electron beam when it strikes the screen and various voltages are applied to the deflecting plates, the voltages from the battery, B, being controlled by a potentiometer, P, and their values being read by the voltmeter, V.

plates DP-1 and DP-2 constitute the vertical deflectors. The other pair of plates are the horizontal deflectors, to be considered later. B is a battery of say 100 volts. P is a potentiometer, with which it is possible to apply a d-c. voltage of from 0 to 100 volts in small increments. The meter V, indicates the voltage existing across the vertical deflector plates. The voltage across V, therefore across the plates, is zero when the potentiometer control is to the extreme left, and maximum when the potentiometer control is to the extreme right.

The dots, bearing numbers from 0 to 7, indicate the relative positions of the spot. The spot, when viewed upon the screen, will move to-

wards DP-1, because that electrode is positive with respect to DP-2, for any setting of the potentiometer P, other than the zero setting. Seven uniform increases of the P adjustment will cause the shifting of the spot from 0 to position 7. If you would vary P at an extremely slow rate, you would note a steady spot, of uniform intensity and size, vary its position, although always remaining a spot, from point 0 to point 7. If you moved the potentiometer adjustment fast, a spot of light would move across the screen. If you stopped at any one point, the image upon the screen would be a stationary spot at some point, between position 0 and position 7. At no time can the spot move closer to plate DP-2 than position 0, because at no time does a difference of potential exist which makes plate DP-1 negative with respect to plate DP-2.

Suppose that we reverse the voltage, as in figure 11. Now, plate DP-1 is negative and plate DP-2 is positive. The d-c. voltage supply source is the same battery B. The voltage control unit is still the potentiometer P and the voltage indicator is the voltmeter V. Now we find that the beam and spot move towards the plate DP-2, since potential difference between the two plates is such that the electron stream is deflected towards DP-2. Since the maximum potential difference between the two plates is the same as before, the spot moves the same distance for the same swing of the potentiometer control, but in this case, the beam and spot move in the opposite direction.

It should be understood that while only seven spot positions are shown, it is conceivable that the number of spot positions is limited solely by the diameter of the spot and the potential difference existing between the two vertical deflector plates. In other words, the spot can be placed at the extreme limit of the viewing screen, which would place it at the edge of the circle. For that matter, if the deflection voltage, that is the potential difference between the two plates, is sufficiently great, the spot would be moved off the screen. Furthermore, the spot positions shown do not limit the positioning of the spot to that exact location. The blank space between the positions indicated may be occupied by a spot, if the potential difference, that is, the adjustment of the potentiometer P, is such that the voltage required to place the spot at that position exists. Each increment of voltage will move the spot to another position.

The arrows indicate the direction of the deflection. The variation of the potentiometer P, in figures 10 and 11, under normal circumstances would move the spot in a straight line from the center of the

screen to its limits. Naturally, a voltage, which tends to move the spot off the screen, is excessive, for it is only upon the screen that we see the spot, since luminosity exists only at the point where the beam of electrons strikes the fluorescent material.

What is true about the vertical deflector plates is applicable to the horizontal deflector plates, as shown in figure 12. The voltage source is the same as before. However, now the potential difference is established between the horizontal deflector plates. With DP-1 positive with respect to DP-2, the beam is going to be attracted by deflector plate DP-1 and the spot moves in the direction of the arrow. The exact positioning of the spot is determined by the potential difference as previously described. If we reverse the polarity of the voltages applied to the two horizontal deflector plates, as in figure 13, wherein DP-2 is positive with respect to DP-1, the beam will be attracted towards DP-2, and the spot will move in the direction of the arrow.

Fig. 14. By connecting one vertical deflecting plate to the mid-point of the battery and the other to the arm of a potentiometer, P, connected across the battery, the polarity of the plates may be reversed and the spot may be moved to any position in the vertical direction.

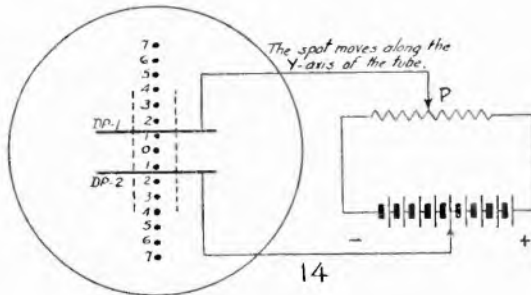

What will happen if the potential difference applied to the two vertical deflector plates undergoes a change in polarity? Suppose that we arrange a circuit such as shown in figure 14. Here the battery and potentiometer circuit is arranged so that by moving the arm of the potentiometer P, we can reverse the polarity of the voltage applied to the two deflector plates. With the potentiometer arm set to the mid-point and the battery tapped at its mid-point, the potential difference between the two plates is zero, hence the spot occupies the position designated as 0. If the arm is moved to the extreme left position, the plate DP-1 is made maximum negative with respect to DP-2, and the spot moves towards DP-2. If, however, the potentiometer arm is moved to the extreme right, DP-1 is made positive with respect to DP-2 and the spot moves towards DP-1. Therefore, by moving the

potentiometer arm between its limits we can cause the spot to move across the viewing screen in a vertical direction to limits which are prescribed by the voltage difference existing between the two plates, which limits are determined by the position of the potentiometer arm. Starting at the mid-point, the spot would move, say from 0 to 7 in the upward direction, back to 0 in the downward direction and continue downward to 7 and then return to 0, when the arm is again brought to rest at the mid-point on the potentiometer resistance. The dash-line in figure 14 represents the horizontal deflector plates.

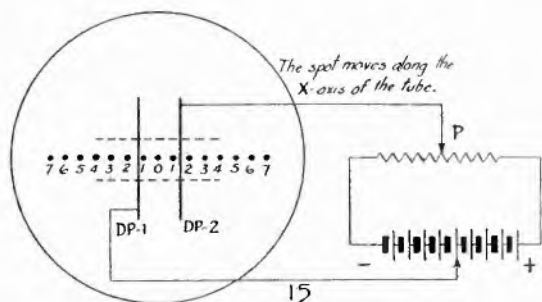

Fig. 15. The horizontal positioning of the spot is accomplished in the same way as it was moved vertically in Fig. 14. Note that in this and other figures the seven spots indicate ANY positions of the beam's trace in the directions indicated.

What is true about the vertical deflector plates is true about the horizontal deflector plates, as shown in figure 15. In figures 14 and 15, the active plates are those which are shown as solid lines. By swinging the arm of the potentiometer P, we can cause the spot to traverse the screen in the horizontal direction, as shown by the position of the dots in figure 15. Once more we repeat that the seven dots representative of spot positions do not signify that the total number of spot positions is seven each side of the 0 position. These are purely illustrative of what represents a movement of the fluorescent spot position along the horizontal axis, which incidentally is known as the "X" axis of the tube. The vertical axis, as shown in figure 14, is known as the "Y" axis of the tube.

Let us now consider the possible range of spot positioning, with respect to the complete viewing screen. Up to the present time, we have considered but one deflecting force applied to the beam which passes between the two sets of deflecting plates. From now on we shall work with two sets of deflecting voltages, one voltage applied to one set of plates and another voltage applied to the other set of plates. As before, we are employing d-c. voltages secured from batteries, with the voltage controlled by means of a potentiometer. As far as the source of voltage is concerned, the d-c. power supply can be

used with equal facility, just so long as a variable control of the actual voltage applied to the plates is available.

Suppose that we start with figure 16. Here we see two voltage sources VB and HB controlled by two potentiometers, VP and HP. The letters V and H designate vertical and horizontal in all places where they are mentioned. These voltages are applied to the vertical and horizontal deflector plates, respectively, with the polarity shown. Now, if we considered each of these separately, the influence of the voltage applied to the vertical deflector plates VDP-1 and VDP-2 would tend to cause the spot to move towards VDP-1 and occupy positions as shown by the circles marked 1V, 2V, 3V, 4V, etc., moving in the direction of the arrow marked V. If we considered the horizontal deflection separately, the position of the spot would be along the direction of the arrow H, or the circles 1H to 7H. However, both forces are acting at the same time and they are acting upon the beam at right angles to each other, so that the spot moves in accordance with the deflecting force exerted by BOTH voltages. If the voltage applied to the vertical plates is such as to move the beam to the position 1V and the voltage applied to the horizontal deflectors is such that it normally would move the beam to create a spot at 1H, the combined force shifts the spot to the position indicated by the solid dot 1. If you examine the position of this dot, you will find that displacement along the "Y"

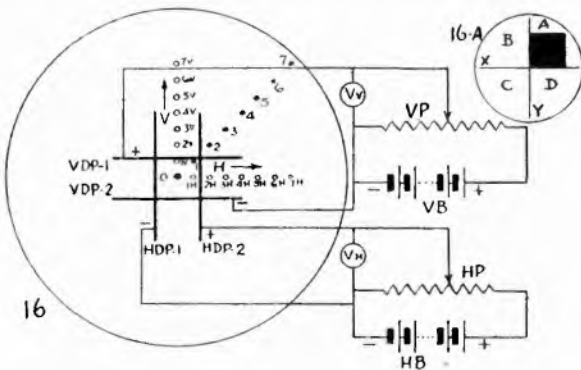

Fig. 16. Applying positive voltages to the plates VDP-1 and HDP-2 by means of the batteries and potentiometers, the beam's spot can be placed ANYWHERE in quadrant A, see Fig. 16-A. The solid spots, 1 to 7, indicate the resultant positions of the beam's spot, when acted upon by the white dots 1V to 7V and 1H to 7H respectively.

axis, that is the vertical axis, is the same as for the vertical deflection, without any horizontal deflection, and that its displacement from its

basic position along the "X" axis that is, the horizontal axis, is the same as for the horizontal deflection, without any vertical deflection. If the individual voltages, with the polarities shown are such as to cause the basic 2V and 2H deflections, the resultant deflection sets the spot at the position, solid dot 2. The same applies to the other positions of the horizontal and vertical deflections, which are productive of the solid dot positions 3 to 7.

Now, from what has been said, it should not be a difficult matter to comprehend the placement of the spot as a result of the combined deflection in any position of the quadrant A. (By quadrant is meant a fourth part of the area of a circle.) However, since the viewing screen surface is not perfectly flat and since the entire portion of the screen is not suitable for use, we have shown a square area within this quadrant as being the useful area. To expedite comprehension, see figure 21. Examine quadrant A¹. Here you find positions of the beam spot for vertical and horizontal deflecting forces, when the polarity of the voltages applied to the deflecting plates is as shown in figure 16. If the vertical deflection voltage is varied in equal steps from 1 to 7 and the horizontal deflecting voltage is kept constant at 1 unit, the spot will occupy the positions shown by the line parallel to the "Y" axis and terminating in the 1H unit designation on the "X" axis. If on the other hand, the vertical deflection is kept constant at 1 unit and the horizontal deflection is varied in steps of one unit through the illustrated range of 7 units, the spot will occupy the positions shown by the line which runs parallel to the "X" axis. For the sake of illustration, to show that the positions selected are purely arbitrary and that the spot may occupy *any* position in this quadrant, we show the position of the spot for a vertical deflection of $3\frac{1}{2}$ units and a horizontal deflection of $5\frac{1}{2}$ units. From what has been said you can understand how it is possible to show the useful area in "A" quadrant of figure 16-A, filled solid.

The selection of the quadrant "A", and the position of the spot in figures 16 and 16-A, is not one of choice or preference. It depends upon the polarity of the voltages applied to the plates. In geometry there are four quadrants in a circle. If this circle is divided by two reference lines, a vertical reference line, the "Y" axis, and a horizontal reference line, the "X" axis, four areas are available in the complete circle. One of these is the area to the right of the "Y" axis and above the "X" axis. Another is the area to the left of the "Y" axis and above the "X" axis. Still another is the area to the left of the

¹In engineering this quadrant would be designated as quadrant I. References are made to quadrants B, C and D. These are also designated as quadrants II, III and IV, respectively.

"Y" axis and below the "X" axis and the last is the area to the right of the "Y" axis and below the "X" axis. To produce a deflection in the "A" quadrant, the upper vertical deflection plate VDP-1 is positive with respect to its associated plate and the right-hand horizontal deflection plate HDP-2 is positive, with respect to its associated plate HDP-1.

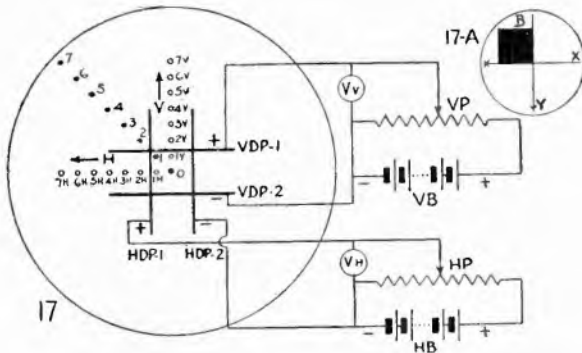

Fig. 17. Positive voltages being applied to plates VDP-1 and HDP-1 will position the spot anywhere within quadrant B, see Fig. 17-A. Note that the change effected from Fig. 16 is the reversing of the polarity of the horizontal plates.

If you now refer to figure 17 and examine the polarity of the voltages applied to the various plates, you will find that the upper vertical deflection plate VDP-1 is still positive. However, the left horizontal deflection plate HDP-1 is now positive. Displacement of the beam spot takes place exactly as before, but in this instance, the horizontal motion is towards the left horizontal deflection plate, and the resultant displacement of the vertical and horizontal voltage forces places the active area of the spot position in the "B" quadrant. This is shown in figure 17-A. The actual forces acting upon the beam are the same in figures 16 and 17, as illustrated by the identical arbitrary units indicated upon the drawing, except that the direction of the horizontal deflection is different. With the polarities shown in figure 17, the application of various d-c. voltages, will position the spots in the "B" quadrant in figures 17-A and 21.

By changing the polarity of the various voltages, we can position the beam spot below the horizontal reference line or "X" axis. This is shown in figures 18 and 18-A, where by properly arranging the polarity of the voltages applied to the deflection plates, we position the spot to the left of the vertical reference line, or "Y" axis, and below the horizontal reference line or "X" axis. This places the spot in the

"C" quadrant and the active area is indicated by the solid pattern in figure 18-A. The action of the various deflection forces is identical to that explained in connection with figure 16, except for the fact that since the polarity is different, the position of the spot will be different than in figure 16. As far as displacement of the spot is concerned with respect to the unit forces, that is the same in all cases. See figure 21.

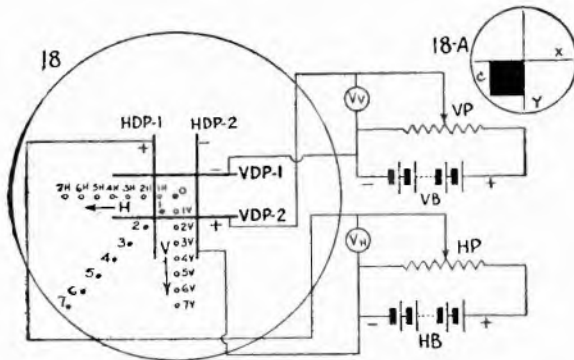

Fig. 18. To position the spot anywhere within quadrant C, the plates VDP-2 and HDP-1 are made positive with respect to their respective plates. See Fig. 18-A for the area covered in this particular case.

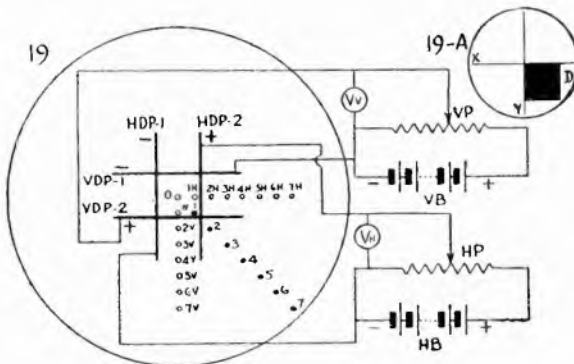

Fig. 19. The positions of the beam's spot are within quadrant D, when plates VDP-2 and HDP-2 are made positive with respect to VDP-1 and HDP-1 respectively. See Fig. 19-A for the portion of the screen covered.

You will note that to change the positioning of the spot with respect to the vertical reference lines, shown in figures 16 and 17, all that is required is the changing of the polarity of the horizontal deflection. In

other words, to swing from quadrant "A" to "B", all that is required is a change in the polarity of but one deflecting force, the horizontal deflection. To change from quadrant "B" to quadrant "C", shown in figure 18-A, the polarity of the vertical deflection is changed, whereas the horizontal deflection plate polarity remains as before. From what has been said so far, it is obvious that to position the spot below or above the horizontal reference line, or "X" axis, the vertical deflection plate polarity must be changed and to position the spot to the right or to the left of the vertical reference line, or "Y" axis, the horizontal deflection plate polarity must be changed.

Placement of the spot in the fourth or "D" quadrant is shown in figures 19, 19-A and 21. As far as the resultant displacement of the vertical and horizontal forces is concerned, that which was said in connection with figure 16 is applicable to figure 19, bearing in mind, of course, that the direction of the displacement has been changed.

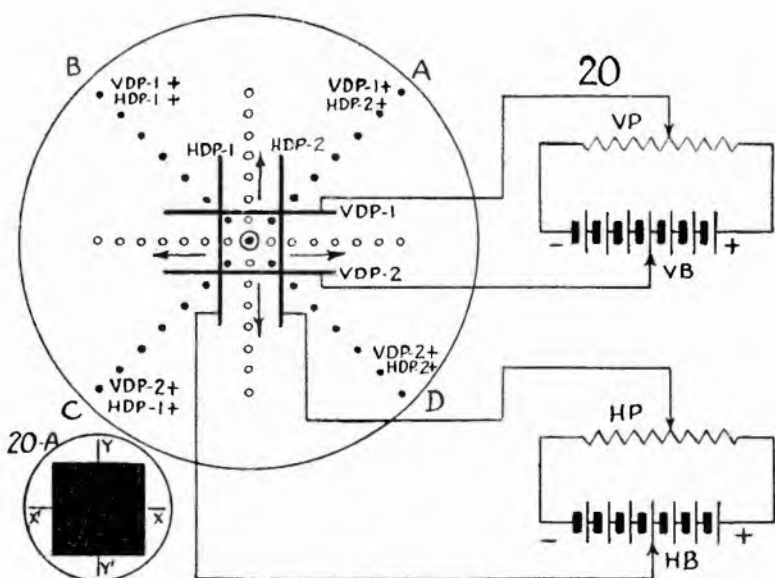

Fig. 20. Above is shown a composite diagram of Figs. 16, 17, 18 and 19. The polarities of the plates are indicated adjacent to the lines of spots, which caused them to assume the positions indicated. Fig. 20-A shows the useful area of the screen within which the beam's spot can be placed.

Consolidating figures 16, 17, 18 and 19 and also figures 16-A, 17-A, 18-A and 19-A, we obtain figure 20. This illustration shows two sources of voltages (d-c.) for the deflecting plates. Each of these

voltage sources is of the type whereby the polarity of the voltage applied to each set of deflecting plates may be changed, similar to figures 14 and 15. With proper adjustment of the potentiometers, VP (vertical plates) and HP (horizontal plates), the potential difference between each set of plates is substantially zero and the spot occupies the position indicated by the large circle with the dot in its center. Radiating from this center position are the basic vertical and horizontal deflection spot positions, indicated by circles. These spot positions exist when no other force, acting at right angles, is existent. The direction of the deflections, as has been stated upon several occasions, is dependent upon the polarity of the voltages applied to the deflector plates and the distance that the spot moves from its normal center position depends upon the potential difference between the plates. The greater this difference, the greater the distance that the spot moves from the center.

When voltages are applied simultaneously to both sets of plates so that the electric field set-up between each set of plates acts upon the beam, the displacement of the spot is determined by the two forces acting at right angles. The direction of this displacement is determined by the polarity of the voltages applied to the plates and the extent of the displacement of the spot from its normal center position is determined by the strength of the fields or forces. For uniform voltages applied to the both sets of plates with the polarity shown, the spot is caused to occupy the positions indicated by the solid dots. The position of the spot with respect to the quadrant is determined by the polarity of the voltage applied to the plates, just as in the case of the original spot position. Thus, if the vertical deflector plate VDP-1 is positive and the horizontal deflector plate HDP-2 is positive, the spot will be in quadrant A. If VDP-1 is positive and HDP-1 is made positive, the spot will be in quadrant B. If HDP-1 is positive and VDP-2 is positive, the spot will occupy a position in quadrant C. If VDP-2 is positive and HDP-2 is positive, the spot will occupy a position in quadrant D. The spot positions shown in solid dot form indicate the maximum displacement in all directions for uniform voltages applied to each set of plates. The furthestmost spot in each quadrant constitutes the four boundaries of a square, which represents the active useful area within which a spot could be positioned by the application of the proper potentials to the two sets of plates. This active area is shown by the solid portion in figure 20-A. For any voltage applied to the horizontal and vertical deflector plates, within the limits determined by

the maximum values governing the boundary of the active area, the spot would occupy some position within the solid square of figure 20-A.

If we varied potentiometer VP through its entire range and varied potentiometer HP through one-half of its range, so that horizontal deflector plate HDP-2 always remained positive with respect to its associated deflector plate HDP-1, the spot would be placed within the solid square of figure 20-A, to the right of the "Y" axis, or to the right of the line Y-Y'. If we varied the potentiometer VP through its range and varied potentiometer HP through one-half of its range, so that horizontal deflector plate HDP-1 was always positive with respect to its associated horizontal deflector plate HDP-2, the spot would be positioned within the active area to the left of the Y-Y' line, which is half of the square shown in figure 20-A. By the application of proper voltages, we can place the spot, within the upper half of the solid square shown in figure 20-A, or within the active area above the "X" axis, or above the X-X' line. The same is true of the area beneath the X-X' line. By operating both VP and HP through their complete ranges, we can cover the entire active area.

Persistency of Vision

At this time it is imperative to bring one pertinent fact to your attention. You have read repeated references to SPOT positions. While these may have appeared repetitive and perhaps superfluous, the frequent references were premeditated. We want to impress upon you that the electron beam causes a fluorescent spot to appear upon the screen at the point where the beam strikes the screen. Irrespective of the nature of the voltage impressed upon the deflecting plates, it is only a single spot which appears upon the screen. It is this SINGLE SPOT which is caused to move as a result of the deflecting voltages.

You who read this page may have seen an image upon the cathode-ray oscillograph viewing screen. Just how simple or complex the image was, you alone know. Yet, no matter how complex the image, it was made by a single spot in motion. Do not confuse the solid areas in figures 16-A, 17-A, 18-A, 19-A and 20-A as being a spreading out of the beam as a result of the deflecting voltages and the generation of a fluorescent spot which covers the active area. By proper manipulation of the two deflecting voltages shown in figures 16 and 16-A, it is possible to make the active area, shown as a solid black drawing in figure 16-A, a fluorescent area, yet it would not be due to the spreading of the beam, but to the fact that THE NATURE OF THE MANIPU-

LATION OF THE VOLTAGES WOULD BE SUCH AS TO CAUSE THE BEAM TO SHIFT ITS POSITION BY SMALL INCREMENTS AND TO PRODUCE A FLUORESCENT SPOT WHICH WOULD APPEAR PERIODICALLY AT EVERY POINT IN THAT ACTIVE AREA. THE REPEATED APPEARANCE OF THE SPOT IN EACH OF THE RESPECTIVE POSITIONS DETERMINED BY THE VOLTAGES EXISTING AT THAT INSTANT WOULD CREATE THE ILLUSION BY PERSISTENCE OF VISION, AND WHILE IT IS TRUE THAT THE FLUORESCENT SPOT EXISTS AT ANY ONE POINT FOR A VERY SMALL FRACTION OF AN INSTANT, IT SEEMS TO THE OBSERVER AS IF THE ENTIRE ACTIVE AREA IS MADE FLUORESCENT BY A SPOT SUFFICIENTLY LARGE TO COVER THE AREA.

This persistency of vision is an optical illusion, created by the limitation of the eye to respond to changes which occur faster than a certain rate. Perhaps you may recall some of your pranks of childhood. Do you remember placing some burning wood or glowing coal into a metal container, usually an old discarded canned-soup container? This container with the glowing embers was attached to a string. You would then rotate the can at the end of the string at arm's length so that it described a circle. You no doubt recall the ring of fire which was visible as this glowing can was swung around and around. The ring of fire was nothing more than an optical illusion, for you well know now that at any one moment the can was occupying some position along the circumference of the circle you described. But the speed of movement of the can and the inability of the eye to spot the can at any one position, because of its rate of travel, caused the optical illusion, described as persistence of vision. You thought you saw a ring of fire. All that you really witnessed was the movement of the glowing can from point to point along the circumference, but its course of travel appeared as a continuous circle. The every-day motion picture is an optical illusion. While the eye sees continuous motion, what really happens is the presentation of a series of still pictures, each of which is stationary for a very short time, usually $1/16$ th of a second. The eye cannot follow change at this speed, hence the motion appears continuous.

This illusion of persistency of vision (discounting screen retentivity, which shall be described elsewhere) is the basis for the observation of phenomena with the cathode-ray tube. If we arranged the two potentiometers, VP and HP in figure 20, to be motor driven over their com-

plete ranges, the entire active area shown in black, in figure 20-A, would appear fluorescent upon the viewing screen. The electron beam, displaced as a result of the voltages applied to the two sets of places, would trace and retrace a number of spots as shown in figure 21. This pattern would appear if the potentiometer were arranged to change the voltage in steps of seven units each side of the zero position. If,

Fig. 21. Although the examples of the spot's positioning are given for quadrant A, it should be understood that the same reasoning applies to any of the four quadrants. Compare this illustration with Figs. 20 and 20A.

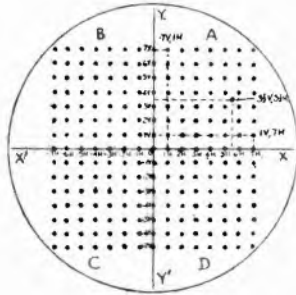

however, the voltage applied to the plates changed in very small increments, the spot would appear so close to the previous position that when recurrent at a rate, say 16 to 20 times per second, the entire active area would appear fluorescent.

By the same token, if the potentiometer P in figure 14 were motor driven, so that the spot would move faster than 16 times per second and the potentiometer unit was a continuously variable resistor, the trace of the spot would appear as a line or image, instead of a series of individual spots. The same is true of figure 15, or for that matter, any variation in position of the spot, which would occur at a rate fast enough to create the optical illusion of persistency of vision.

From what has been said and as will be shown later, you must comprehend that displacement of the electron beam results in displacement of a SINGLE SPOT and that it is this single spot, moving over the screen, which appears as the image. No matter how complex you may find the image, always remember that the pattern is being traced by a FLUORESCENT SPOT WHICH MOVES ACROSS THE SCREEN.

Referring to figure 20, if potentiometers VP and HP are varied very slowly but at a constant rate, it is possible to follow the movement of the SINGLE SPOT over the screen. With seven steps of voltage variation, the spot positions upon the screen would appear as in figure 21. With the horizontal deflection voltage kept constant, that is with HP set at one point and left there, and sufficiently rapid variation of the vertical deflection potentiometer VP, which means sufficiently rapid

variation of the vertical deflection voltage, any one of the columns of the dots, parallel to the vertical reference line, that is the "Y" axis, would appear as a straight line, instead of a series of dots. If the vertical deflection voltage were fixed and the horizontal voltage were varied at a sufficiently rapid rate and the variations made recurrent, any one of the horizontal line of columns, representative of the displacement due to the voltage applied, would appear as a straight line, instead of a series of dots.

Positioning of the Spot

From what has been said thus far, you can no doubt appreciate that by the application of a fixed voltage from a battery, it is possible to position the spot wherever desired. We have mentioned time and again that under normal conditions, with zero potential difference between the plates of each pair of deflector plates, the normal position of the spot is at the center of the screen. Now it is possible that for some reason, it may be desirable to place the normal position of the spot somewhat off-center, above or below the horizontal reference line, or "X" axis, or to the right or left of the vertical reference line, or "Y" axis. This can be done by the application of a fixed potential from a battery of the value required to position the spot as desired. This battery voltage may be a few volts, or perhaps ten or twenty volts, or as great as may be desired.

Such positioning of the spot may be employed for normal operation of the tube, that is with varying voltages applied to the tube. The positioning voltage has no bearing upon the actual application of the tube. It is used essentially to position the spot as desired. In some instances, due to a defect in the tube, stray voltages, etc., the normal position of the spot is not in the center. To center the spot properly, the positioning voltage is applied to the horizontal or vertical deflection plates, as required. The method of applying such voltages for proper positioning of the spot during application of the tube for the observation of varying voltage phenomena, is described elsewhere in this volume.

Commercial cathode-ray units are equipped with spot centering controls, known as "X" and "Y" position controls, whereby it is possible to locate properly the spot as desired. These adjustments are usually on the side or to the rear of the unit's housing and are of the screw type, since once adjusted they do not require further manipulation. They are incorporated to enable proper centering of the spot, when

tubes are changed. Often, a replacement tube may not have its deflecting plates exactly as in the tube previously used and the normal position of the beam may be slightly off center, hence the spot will be off center. Adjustment of these controls enables proper centering. In some instances, some of the units have but one adjustment, that which is along

Fig. 22. The two arrows at the upper side of the oscillograph's chassis indicate the locations of the two controls for centering the beam's spot horizontally and vertically

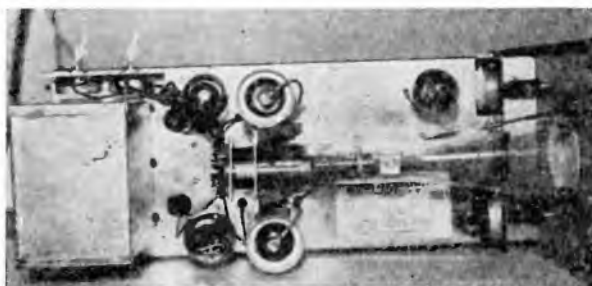

the "X" axis, but it is becoming more common to provide both centering controls. Figure 22 shows the spot positioning controls' locations on a commercial oscillograph.

Varying Voltages Applied to Deflector Plates

Up to the present time, we have devoted our attention to deflection of the electron beam by means of d-c. voltages applied to the vertical and horizontal plates. Let us now consider the application of varying voltages, such as a-c. potentials. What is the effect of such voltages when applied to the deflecting plates?

In the first place, the process of deflection is exactly as before, that is, with d-c. voltages. The displacement of the beam from its normal center position is again a function of the field strength existing between the two plates of each pair of deflection plates. However, when speaking about a-c. voltages, you have been accustomed to working with r.m.s or root mean square values, as indicated upon the every-day a-c. voltmeter. The deflection in the cathode-ray tube is determined by the peak voltage, which is 1.414 times the r.m.s value.

As in the case of the previous examples, the displacement of the spot from its normal center position is a measure of the voltage difference existing between the two plates of a pair, be they the vertical or the horizontal deflection plates. An a-c. peak voltage of 10 volts will displace the spot or deflect the beam the same distance each side of the center position, as d-c. voltage of 10 volts applied in both directions, as shown in figures 14 and 15. If the nature of the a-c. voltage is such

that the amplitude of its alternations is not equal, then the displacement of the spot both sides of the normal center position along the vertical or "Y" axis will not be the same, but will be in accordance with the peak voltage of the alternations.

There is one other significant fact which must be mentioned in connection with varying voltage applied to the deflection plates. In actual practice, the image which will appear upon the viewing screen will be a line image or pattern, because, as a general rule, the frequency of these varying voltages is too high to allow observation of the motion of the spot from point to point along the screen. However, for the sake of illustration and, we hope, clarity of comprehension, we shall employ, in a few examples, varying voltages of very low-frequency and imagine that the travel of the spot is discernible by the naked eye.

Suppose that we apply a very low-frequency a-c. voltage to the vertical deflector plates of a cathode-ray tube. Suppose that the frequency of this a-c. voltage is 1 cycle per second. This cycle is shown in figure 23. Since only one force is acting upon the electron beam,

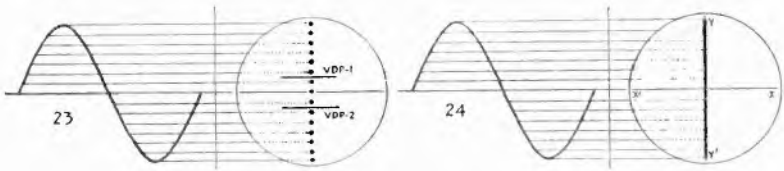

Fig. 23. The change in polarity of an a-c. voltage sine wave, when connected to the vertical deflection plates, will cause the spot to assume the positions indicated by the series of vertical dots. No voltage is impressed on the horizontal deflecting plates.

Fig. 24. The solid line along the vertical axis, Y-Y', is the actual trace made when a sine wave is impressed on the vertical deflecting plates with no voltage on the other pair of plates.

the field set up by the applied deflecting voltage is determined by the instantaneous amplitude of this applied voltage. The normal position of the spot is indicated by the dot within the circle in the center of the screen. The applied voltage starts at zero and increases in one direction until maximum is reached. We shall assume that the polarity of this alternation is such as to make VDP-1 positive with respect to VDP-2, so that the beam and spot move upward. As the voltage increases, the spot moves through the various positions shown, until it reaches its maximum position when the peak of the alternation, or half circle, is reached. Then the downward half of this alternation starts, and the spot moves downward towards its initial starting position,

which is reached when the first alternation is completed and the a-c. voltage is zero. Now the alternation starts in the opposite direction, making plate VDP-2 positive with respect to VDP-1, so that the beam is deflected downward and the spot moves in that direction. As the downward alternation increases in amplitude, the spot moves further and further away (down) from its normal center position until it reaches its furthestmost point when the peak amplitude is reached. Then as the voltage starts to decrease, that is the last quarter of the complete cycle is occurring, the spot moves back (upward) towards its initial starting point, until it is again in the middle of the screen, when the a-c. voltage is zero.

The foregoing is the basis for the line image shown in figure 24. In normal practice the frequency of the varying voltages applied to the plates is such that it is impossible to see the spot moving from point to point. Instead, the recurrent action of the a-c. voltage causes the spot to trace and retrace its path at such speed that the illusion of persistence of vision is created and we see a solid line pattern. Now, you may wonder, why the initial a-c. voltage is represented as a wave, whereas the image upon the screen is but a straight line. The reason for this is that the original voltage waveform is illustrated as possessing displacement along both the "X" and "Y" axes. In other words, the original voltage is shown as possessing amplitude with respect to time. The image upon the cathode-ray tube, however, possesses only amplitude, since the beam is displaced along its "Y" axis only. Incidentally, when operating the cathode-ray tube in practice, you will find that the image, which will appear when an a-c. voltage is applied to the vertical plates without any deflection applied to the horizontal plates, will be a single straight line, like that shown in figure 24.

What is true about the vertical plates is true about the horizontal plates. If a varying voltage of very low frequency is applied to the horizontal plates without any vertical deflection and if this frequency is sufficiently low, so that movement of the spot may be observed, we would observe the positioning of the spot as shown in figure 15. If this frequency would be too high for observation of the travel of the spot, a straight line, without any vertical displacement, would be seen upon the screen.

If you will examine figure 24, you will note that the line image appears in the center of the tube, along the "Y" axis. If desired, it is possible to place this line either to the right or to the left of the "Y" axis, by the use of a spot positioning voltage. The same is true of

the horizontal deflection. By means of a spot-positioning battery or adjustment of the spot-positioning control available with most cathode-ray units, it is possible to place the horizontal line image above or below the "X" axis.

Magnetic Deflection

All of the comments made thus far concerning deflection of the electron beam referred to the application of voltages to the deflecting plates. The beam may also be deflected by means of a magnetic field, by placing the electron beam under the influence of a magnetic field. The magnetic field is created by means of a pair of coils located outside the tube near the neck. The extent of the deflection is determined by the strength of the magnetic field, which in turn is determined by the current flowing through the deflecting coils.

In contrast to electrostatic deflection, electro-magnetic deflection does not require deflection plates. This does not mean that cathode-ray tubes, which were originally designed for electrostatic deflection and contain deflection plates, cannot be used for electro-magnetic deflection. However, the application of magnetic deflection to such tubes is not the most ideal arrangement.

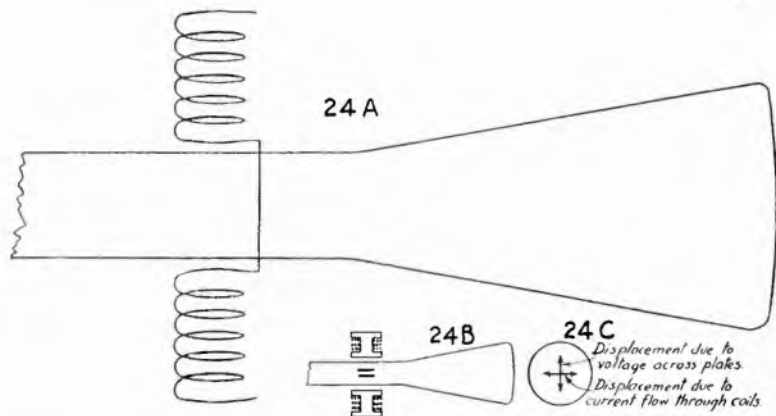

The two coils connected in series (Fig. 24A) are shown in their positions relative to the plates of the tube (Fig. 24B). The displacement of the beam due to voltage across plates is perpendicular to the displacement due to current flow through coils. (Fig. 24C.)

The fact that deflection plates are contained in the tube is of no consequence. The deflection coils are used just as if the tube did not contain any deflection plates. The deflection voltages are applied to

the coils, instead of to the plates. Deflection in each direction requires two coils, as shown in figures 24-A and 24-B. The field exists between the coils. Orientation of the coils provides deflection in the proper direction. Deflection in the vertical direction requires two coils and deflection in the horizontal direction requires another pair of coils. The action of the magnetic field upon the electron beam is at *right angles to the direction of the magnetic field*. In other words, if the direction of the magnetic field is along the "X" axis of the tube, the deflection of the beam is in the vertical direction, or along the "Y" axis. Conversely, if the direction of the magnetic field is along the "Y" axis, the displacement of the beam is along the "X" axis.

Examine figure 24-B. Note the positions of these coils. If we assume that the tube is so positioned that the face of these coils is parallel to what would be the vertical deflection plates, the flow of current through the coils would cause displacement of the spot along the "X" axis, instead of along the "Y" axis, which would be the case if a voltage were applied to the two plates. This is shown in figure 24-C. Simultaneous displacement of the beam in two directions requires four coils, arranged in two pairs of two each. The two coils of each pair are connected in series, as indicated in the case of the one pair of coils in figure 24-A.

The actual deflection of the beam can be accomplished with direct current or with alternating current. If direct current is used, the magnetic field created is constant as long as the direct current is flowing through the windings. The result is displacement of the spot to a distance determined by the strength of the current, and in a manner (not direction) which obtains when a d-c. voltage is applied to the deflection plates.

When alternating current is caused to flow through the deflection coils, the field is varying and the spot traces an image across the screen, just as if an a-c. voltage were applied to the proper set of plates to cause a trace in the same direction.

There are certain disadvantages to the use of magnetic deflection for routine operations such as we cover. First is the limitation of frequency. Coils which are suitable for deflecting the beam in high-voltage, high-vacuum tubes must of necessity have quite a large number of turns in order to provide the required number of ampere-turns, bearing in mind the relatively low signal voltages found in practice. Such coils would possess a high value of inductance and, consequently, would be suitable for use over the low audio band. At

higher frequencies, the reactance and impedance of the windings would materially impair the operation of the unit.

Deflection coils arranged in pairs and so built into a unit are available for certain uses ready to use with the usual cathode-ray tube. The neck of the cathode-ray tube slides through an opening of the housing containing the four coils, as shown in figure 24-D. A metal strap located to the rear of the housing and attached thereto can be



Fig. 24D. Magnetic deflection apparatus. The circular housing contains the four coils, which are brought close to the tube's neck when it is inserted in the opening. The lead at the rear connects the tube's base to its socket in the oscillograph so that its power supply unit can be used.

fastened around the neck of the tube, keeping it rigidly in place. The cable and plug arrangement connects the cathode-ray tube to its respective terminals at the socket contained in the conventional cathode-ray oscillograph. The connecting terminals to the deflection coils are mounted upon the coil housing.

We want to take this opportunity of stating that while we say that magnetic deflection is not as satisfactory as electrostatic deflection, we are referring in particular to the 3-inch and 5-inch tubes intended for electrostatic deflection and for applications to problems in the radio receiver field, amplifier design and servicing and for "ham" transmitter adjustment. We recognize that certain cathode-ray tubes have been designed for magnetic deflection only, such as the RCA 903, and that magnetic deflection has its field of utility, but when viewed from the practical angle, with respect to our problems, we cannot come to any but the conclusions which have been voiced.

CHAPTER II

SWEEP CIRCUITS

The greatest amount of the discussion presented thus far concerned the action of the deflecting fields upon the electron beam and the positioning of the spot. We progressed through the application of d-c. voltages to the vertical and horizontal deflection plates and have made very brief mention of the application of a varying or a-c. voltage to the deflection plates.

Now, the primary function of the cathode-ray tube as used in oscillographs employed in connection with radio receiver and amplifier design and servicing, "ham" transmitter adjustment and other related activities, is the observation of a-c. phenomena of one type or another. The first step then can well be an exposition of the spreading of the a-c. wave, so that the waveform of a-c. and pulsating currents and voltages can be examined by viewing the cathode-ray screen.

Investigation of electrical phenomena such as waveforms of voltage and current with the cathode-ray tube, requires that some means be available whereby the electron beam, which has been placed under the influence of the phenomenon to be examined or observed, will be caused to move also in accordance with a predetermined time base, because investigation of electrical waveforms can be carried out only if one can determine the variation in amplitude with respect to time. If such a time base or *sweep circuit* is available, the pattern or image is given two dimensions: one, time and the other amplitude.

The time base deflection must position the spot at a certain point upon the screen, move the spot across the screen at a definite known rate and *instantly* return to its original position to begin a new cycle. This time base is referred to as the *sweep voltage* or *sweep signal* and the rate at which it moves or sweeps across the screen is known as the *sweep frequency*. Application of the term sweep seems quite appropriate, since its action is to sweep the beam across the screen. As a general rule, the deflection representing amplitude is usually applied to

the vertical deflection plates and the deflection representative of the time is applied to the horizontal deflection plates. You can very easily comprehend the absence of the time base, by examining figure 24. While it is true that the deflecting force applied to the vertical plates is that of an a-c. voltage wave, the image upon the screen is a single straight line—of just one dimension. The time base is absent. Such would be the image for any type of waveform applied to the vertical deflection plates—until such time when a voltage providing the horizontal deflection is applied.

To reproduce the original wave shown in figure 24, it is necessary to apply to the horizontal deflection plates a voltage which will cause the electron beam and resultant spot to move in accordance with the amplitude of the wave and the instantaneous displacement with respect to time. The simplest means of illustrating this action is to apply an a-c. wave to the vertical plates and to apply a varying d-c. voltage to the horizontal plates. By arranging that the horizontal deflection takes place at a definite time rate, we establish a known time base. If this horizontal deflection be of a-c. character, and it were desired to establish a definite time base, a voltage of known frequency would be applied. However, that is for later discussion. In the meantime, let us sweep the beam across the "X" axis, by means of rotating potentiometer, thereby developing the time base.

Figure 25 illustrates a very low frequency signal, say 1-cycle, applied across the vertical deflection plates. We select this frequency because it enables observation of the motion of the spot. The horizontal voltage is developed across the potentiometer P. This potentiometer is arranged in the form of a circle with a rotating arm. You will note that contacts are provided and are numbered from plus 14 to 0 to minus 14. You will have to visualize a minute jump which the arm makes as it rotates and moves from the minus 14 to the plus 14 terminal. The spacing between these two terminals will have to be assumed to be extremely small, so that the time interval elapsing during the jump is extremely small with respect to the time interval existing when the contact arm moves between the resistance steps or taps upon the potentiometer arm. You must also assume that this contact arm is rotated by a motor at a predetermined and constant speed.

The circles shown in figure 25 for the vertical and horizontal deflections indicate the spot positions during the deflection of the beam, when only one deflection exists at one time. In other words, the column of spot positions along the "Y" axis exists without the hori-

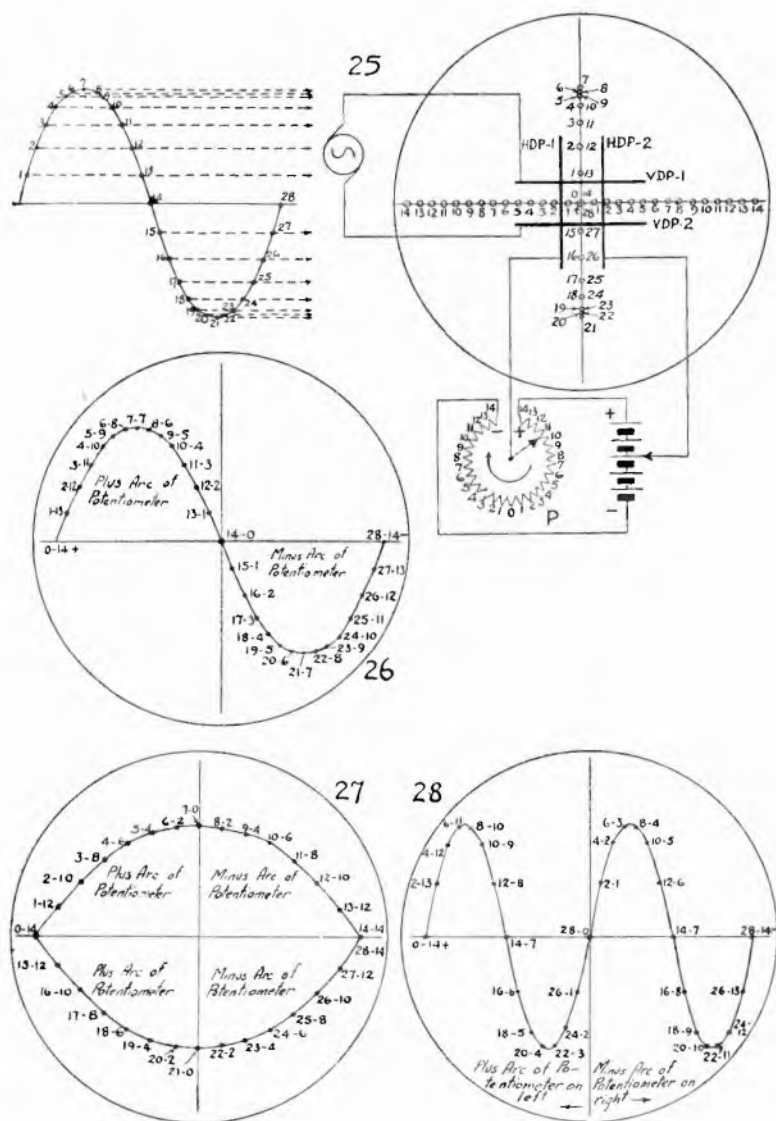

Fig. 25. The sine wave at the left is impressed on plates VDP-1 and VDP-2 by the oscillator, giving spots 0 to 28 along the Y axis. The arm of the potentiometer, P, makes one revolution in the time required to complete one cycle of the voltage impressed on the vertical plates. The spots, 14 to 0 to 14 along the X axis correspond to the points on the potentiometer. The resulting figure is shown in Fig. 26. Fig. 27 shows the trace when the potentiometer arm moves twice as fast as the wave and Fig. 28 is the figure seen when the arm moves at one-half the rate.

zontal deflection and the line of spot positions along the "X" axis exists without any vertical deflection. The reason for the uneven spacing of the circles along the vertical axis is the fact that the amplitude variations are at a sine rate. You will also note that while only seven positions of the spot are shown above and below the "X" axis along the "Y" axis, each spot other than that which indicates the peak amplitude appears twice during each half cycle. This is shown by the lines which connect the designated spots on the curve and the circles on the tube screen. The same is true for the second alternation of the cycle.

To enable closer association between the vertical and horizontal deflections, when both exist, we have numbered the vertical deflection spot positions consecutively. The numbers adjacent to the vertical column of spot positions correspond with the numbers shown upon the wave. In other words, the zero position or normal center position of the spot corresponds to numbers 0, 14 and 28 on the wave. Spot position 1 on the rising quarter of the cycle is also spot 13 on the second quarter. Spot positions 2 and 12 coincide, because they represent equal displacement from the normal position, or "X" axis. The same is true of 3 and 11, 4 and 10, 5 and 9, 6 and 8. Spot position 7 occurs just once during the half cycle, because it is the peak amplitude and the voltage causes this displacement but once during each half cycle. In the second half cycle, spot positions 15 and 27, 16 and 26, 17 and 25, 18 and 24, 19 and 23, 20 and 22 coincide. Spot position 21 occurs but once during this half cycle, because it indicates maximum displacement, which occurs only once during the half cycle.

You will further note that the horizontal deflection sweep voltage potentiometer has 14 taps each side of the zero position, between the zero point and the two positions of maximum voltage. The position of the spot upon the screen for each position of the potentiometer rotor arm is indicated by the corresponding numbers. The speed of the potentiometer rotor arm is such that a complete revolution is made in the time required to complete a cycle, so that a single cycle appears upon the screen. When this condition exists, it is said that the sweep frequency corresponds with the frequency of the signal being observed. The effects of different sweep or timing axis frequencies will be shown as we progress through this chapter. Again we want to remind you that the rotor arm on the potentiometer moves from what is indicated as minus 14 to plus 14 in an extremely short interval of time. You will learn soon just why this fact is brought to your attention.

Let us now develop the image upon the screen by combining the two deflections shown in figure 25. We shall assume that the rotor arm of the potentiometer is set at the plus 14 tap when the motor starts and that this position coincides with the start of the a-c. cycle or the 0 point on the wave. With the rotor arm at plus 14, horizontal deflection plate HDP-1 is 14 units positive and in accordance with figure 25, the beam spot at that instant has a horizontal displacement of 14 units towards HDP-1 but no vertical displacement, hence occupies the position 0-14 in figure 26. At the next instant, the rotor arm is at plus 13 tap and the voltage wave amplitude has advanced to position 1. The resultant displacement of the spot then is 1 unit up along the "Y" axis and plus 13 units along the "X" axis and the resultant spot position is shown in figure 26 as 1-13. The first of these numbers designates the vertical displacement with respect to the numbers shown in figure 25 and the second number represents the horizontal displacement due to the potentiometer voltage, with respect to the numbers indicated in figure 25.

At the next instant the potentiometer rotor arm is at plus 12 tap and the amplitude of the wave has advanced to point 2. The resultant displacement is 12 units along the horizontal axis and 2 units along the vertical axis and the resultant position of the spot is 2-12 as indicated in figure 26. The potentiometer rotor arm continues revolving and as it makes contact with taps 11, 10, 9, 8 it causes resultant displacement of the beam spot in accordance with the vertical deflection to the positions 3-11, 4-10, 5-9, 6-8 and 7-7. Now the a-c. voltage starts on its downward half of the half cycle, but the potentiometer rotor arm continues revolving and makes contact with taps 6, 5, 4, 3, 2, 1 and 0. The resultant displacement of the spot is indicated by the numbers 8-6, 9-5, 10-4, 11-3, 12-2, 13-1. At the moment when the voltage of the a-c. wave reaches the point marked 14, which is zero, the potentiometer arm has also reached the zero voltage tap, so that there is no deflecting force exerted upon the beam, hence the spot remains in its normal center position.

You now see half the wave upon the viewing screen. The upper half of the straight line image, existing when the vertical displacement is without horizontal displacement, has been spread out with a time base or sweep. Let us now develop the remaining half cycle. The lower half of the voltage wave, making VDP-2 positive with respect to VDP-1, causes the spot to move downward, below the "X" axis and the movement of the potentiometer rotor arm, past the 0 point, causes

HDP-2, to become positive with respect to HDP-1, so that the image will appear in the D quadrant, namely below the "X" axis and to the right of the "Y" axis. As the rotor arm moves to new tap 1, the voltage wave increases in the reverse direction and the resultant displacement places the spot in position 15-1 in figure 26. Further motion of the rotor arm in synchronism with the voltage wave, causes resultant spot displacements of 16-2, 17-3, 18-4, 19-5, 20-6, 21-7, 22-8, 23-9, 24-10, 25-11, 26-12, 27-13 and 28-14. The last position is zero voltage or deflection along the vertical axis, but maximum deflection along the horizontal or "X" axis.

Continued operation of the rotor and application of the voltage wave repeats the process, for, as previously stated, an extremely short interval after the spot 28-14 has been positioned, the horizontal timing voltage sweeps back to its original position of plus 14, which is in time with the start of the cycle, at point 0. This return from the maximum sweep voltage position to its original return position is known as the "return of the sweep voltage." The rate at which this return takes place is usually made to occupy a time interval which is from 1/25th to 1/100th of the time required for the completion of a single cycle.

You have seen how the time base is introduced and how what is first an image of the amplitude only (figure 25), becomes an image of the wave by simultaneously applying the vertical deflection and the horizontal time base deflection. At this point we want to mention that the time base here shown is not applied commercially with the type of apparatus described here. However, this description will serve to explain the manner in which the sweep voltage, developed by some other means, spreads the wave. It might also be well if you understood that the slow speed of the rotor arm and the very low frequency of the a-c. wave were purposely selected in order to expedite comprehension. With both frequency and potentiometer rotor speed increased, it is impossible to follow the movement of the spot, but the positioning of the spot remains the same. The image, instead of being shown as a spot, which moved from place to place, assumes the form of a solid line, of the wave shape shown.

Time Sweep Frequency Changed

The example cited, that is when just one cycle appears upon the screen, is obtained when the time sweep speed or frequency is the same as the frequency of the phenomenon being observed. What happens

if the time sweep frequency is twice as great as that of the wave being observed? . . . If it is one-half the frequency of the wave being observed? . . . Let us analyze the former. The frequency of the sweep circuit is twice the frequency of the voltage wave being examined. This means that the potentiometer rotor arm makes two revolutions during the period required to complete one cycle of the wave being observed. In the case being discussed, the potentiometer rotor arm completes two revolutions during one second. During this discussion we must assume that a certain phase condition exists between the varying d-c. voltage applied to the horizontal deflection plates and the a-c. wave applied to the vertical deflection plates. By phase relation, we mean that the potentiometer rotor arm starts moving simultaneously with the start of the a-c. wave. With the wave and the arm moving at constant frequencies, they will stay in phase.

The basic data is furnished in figure 25. For proper comprehension of what is being explained, it will be necessary to correlate figures 25 and 27. Since the potentiometer rotor moves twice as fast as the voltage wave under observation, it completes half of its complete rotation during the time that the voltage wave under observation completes one-fourth of the complete cycle. Referring to figure 25, the rotor starts moving at the plus 14 tap when the voltage wave is at zero. Since there is no vertical displacement, but there is a horizontal displacement towards HDP-1, because this plate is positive with respect to HDP-2, the resultant displacement places the spot at 0-14 in figure 27. By the time that the voltage wave has advanced to point 1 in figure 25, the rotor arm has advanced to tap 12, which represents a vertical displacement of 1 unit and a horizontal displacement of 12 units, resulting in the positioning of the spot at 1-12 in figure 27. By the time that the wave has advanced in amplitude to point 2, the rotor has moved to tap 10 and the resultant displacement is shown as 2-10 in figure 27. Maintaining the same rate of rotation, the rotor is at tap 8, when the wave amplitude has reached point 3, thus positioning the spot as 3-8 in figure 27. Continuing, the next three spots are positioned at 4-6, 5-4, 6-2, in figure 27. When the wave reaches its maximum amplitude, point 7 in figure 27, the rotor arm has reached the 0 tap. With no horizontal deflection and 7 units vertical deflection, the spot is positioned on the "Y" axis, as 7-0 in figure 27. It is evident that one-quarter cycle of the wave has been covered for one-half of the complete arc of the rotor arm.

The amplitude of the wave now decreases and passes through the

points 8, 9, 10, 11, 12, 13 and finally to 14, which is zero. At the same time, the rotor arm is advancing in its arc of travel. Having passed the zero point, it is making horizontal deflector plate HDP-2 positive with respect to HDP-1, so that the spot is positioned to the right of the "Y" axis, or vertical reference line. Furthermore, the wave is still above the "X" axis or horizontal reference line and vertical deflector plate VDP-1 is still positive with respect to VDP-2, so that the spot positions are still above the horizontal axis. During the time that the wave is passing through its second quarter cycle, the rotor arm is passing through its second half of the complete revolution and the spots are positioned at 8-2, 9-4, 10-6, 11-8, 12-10, 13-12 and as the wave reaches its zero point, designated as 14 in figure 25, the rotor arm is also at 14.

At this instant, the arm moves from minus 14 to plus 14, which means that the sweep goes back to its original starting point and makes horizontal deflection plate HDP-1 14 units positive with respect to HDP-2 and brings the spot back to the 0-14 position, as shown in figure 27. If you can view this return from minus 14 tap to the plus 14 tap upon the potentiometer rotor as taking place in an extremely small interval of time, it can be said that there is no time lost between the movement of the horizontal sweep from spot 14-14 in figure 27 to spot 0-14 in the same figure, with respect to the continued motion of the wave. According to the wave illustrated in figure 25, it now starts upon its half cycle below the zero reference line. When so doing it makes vertical deflector plate VDP-2 positive with respect to VDP-1, so that the beam is deflected towards the former plate and the spot is positioned below the "X" axis. At the same time, the rotor arm, moving on the plus side, also positions the spot to the left of the "Y" axis. By the time that the wave has increased in amplitude to point 15 in figure 25, the rotor arm has moved to tap 12 and the spot is positioned as 15-12 in figure 27. Continued operation during the same quarter cycle of the wave results in motion of the rotor arm over the entire half of the potentiometer, from plus 14 to 0 and the spot is positioned as 16-10, 17-8, 18-6, 19-4, 20-2 and 21-0. When the maximum amplitude is reached during the second alternation of the wave, the rotor arm has reached zero. Since there is no horizontal displacement and there is maximum vertical displacement, the spot is positioned on the vertical or "Y" axis. The wave now starts on its last quarter cycle, while the rotor arm starts advancing in that segment which makes horizontal deflection plate HDP-2 positive with respect to

HDP-1, so that the spot is positioned in the D quadrant. The resultant displacement causes the spot to move through positions 22-2, 23-4, 24-6, 25-8, 26-10, 27-12 and when the wave reaches its zero point, number 28 in figure 25, the rotor arm is at minus 14 and maximum horizontal displacement with zero vertical displacement positions the spot at 28-14. Continued operation repeats the cycle, and the recurrent action results in the line image shown as figure 27.

If you examine figure 27, you will see that operation of the sweep at a frequency which is twice that of the wave being observed places the alternation below the zero line, directly beneath the alternation above the zero line.

Sweep Frequency Reduced to Half That of Wave

What happens when the horizontal displacement occurs at a rate or speed which is one-half of that of the wave under observation; in other words, when the sweep frequency is one-half of the frequency of the wave under observation? Again we refer to figure 25 as the source of the basic facts. We refer you to figure 28 as the illustration of the wave when so developed. Now, the wave under observation moves twice as fast as the sweep, which means that a complete cycle will occur during the time that the rotor arm is passing through one-half of its total arc of travel. The result is the presence of two cycles upon the screen. In this connection, we want to stress that the number of cycles which appears upon the viewing screen is a function of the frequency relation between the sweep frequency and the frequency of the wave being observed, not solely that of the wave being observed. It is possible, by proper adjustment of the horizontal displacement frequency, to place but one cycle of a 5,000-cycle signal or ten cycles of a 600-cycle signal upon the screen.

Once again the rotor starts at plus 14, when the a-c. wave is at 0 in figure 25. Since the wave is moving twice as fast as the sweep, a half wave will be spread or swept by one-quarter of the arc of travel of the rotor, or one-quarter of the total sweep. This is evident in figure 28, where the wave moves through its half cycle, during the time that the sweep moves from plus 14 to the plus 7 tap. The second alternation is swept by the horizontal deflection voltage as the rotor moves from tap 7 to 0, so that the complete cycle is swept during half of the sweep cycle. The second cycle is swept by the horizontal deflection voltage, as the rotor moves through its arc in the negative side, from 0 to minus 14. The placement of the first two alternations to the

left of the "Y" axis in figure 28, is due to the fact that during this period of time, horizontal deflection plate HDP-1 (figure 25) is positive with respect to HDP-2. The second cycle appears to the right of the "Y" axis, because during this period, HDP-2 is positive with respect to HDP-1.

At this time we again repeat that the battery-potentiometer form of time base is not commonly used—that it is here employed as a means of establishing the foundation for comprehension of the means whereby the modern sweep circuits of different design provide the time base or horizontal deflection. The figures, which are shown as being developed when the sweep frequency is equal to half the frequency of the wave under observation, are applicable to all forms of sweeps of substantially linear character. The same is true of the pattern developed when the sweep frequency is twice the frequency of the wave being observed. This should be borne in mind, for, as you shall see later, modern sweep circuits are of the electron tube variety.

Perhaps it is premature to mention it at this time, but departure from linearity in the sweep circuit causes distortion of the image upon the screen. In other words, it is not a true reproduction of the actual wave applied to the deflection plates for investigation. More will be said about this subject later in the text.

Before advancing to the actual electronic means of developing the sweep voltage or time base, it might be well to consider another form of battery operated sweep voltage source, as being the electro-mechanical equivalent of the sweep used in several cathode-ray oscillographs, and different from the type previously described. In this arrangement, the normal position of the spot is off-center—as a matter of fact, it is located at one end of the tube screen along the "X" axis. The operation of this circuit is along the following lines:

A potentiometer with a continually rotating contact arm is connected across the battery B. See figure 29. The design of this potentiometer is such that the arm jumps from the minus to the plus terminal in an extremely short interval of time, with respect to the time elapsed during its rotation around the resistor portion. A separate supplementary spot-positioning battery B-1 is connected as shown, with the plus terminal joined to horizontal deflection plate HDP-2. With the polarity of the main battery B, as shown in figure 29, and with the arm set to the plus end of the potentiometer control, the action is as follows:

With the rotary arm at the plus end of the potentiometer, the beam spot is deflected towards the horizontal deflection plate HDP-2, because

of the deflecting force of the battery B-1. This positions the spot on the "X" axis, but quite distant from the exact center of the screen. Deflection plate HDP-1 is negative with respect to HDP-2. The arm starts rotating and as it moves in the direction shown, the voltage from battery B starts bucking the voltage of battery B-1, and the potential difference existing between HDP-2 and HDP-1, with the former positive with respect to the latter, becomes less and less, and the spot moves

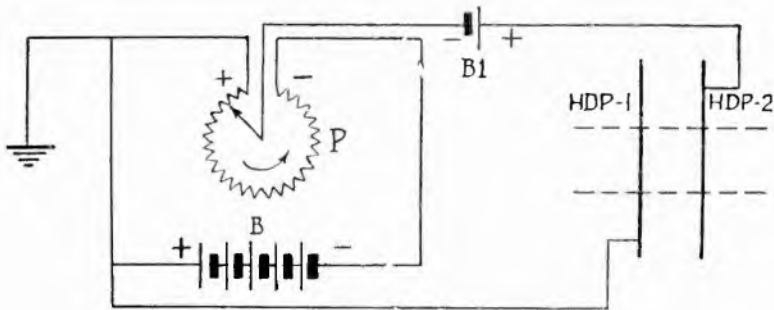

Fig. 29. An electro-mechanical equivalent of the sweep circuit used in several oscillographs. The normal position of the spot is at one side of the screen on the X axis instead of at the center.

towards the center of the screen away from plate HDP-2. As the rotor arm moves towards the minus end of the potentiometer resistance strip, the greater voltage of battery B nullifies the positive charge from battery B-1, making deflection plate HDP-2 negative with respect to plate HDP-1 and the spot moves towards HDP-1. At the instant when the rotor arm reaches the most negative point on the potentiometer resistance strip, HDP-1 is most positive with respect to HDP-2 and the beam spot has moved the greatest distance from its original position and has swept across the screen. At the next instant, an extremely small interval of time, as stated before, the arm jumps from the most negative point on the potentiometer strip to the most positive point on the strip and instantaneously returns the spot to its original starting position. The return of the spot occurs during the interval when the rotor arm shifts from the most negative to the most positive points on the potentiometer resistance strip. If the speed of rotation of the arm is sufficiently great, and the rotation is recurrent, the trace of the beam spot constitutes a single line across the screen. The return sweep, occurring at an extremely rapid rate is not visible. An example of an electronic sweep circuit, functioning in this manner, will be given later.

Electronic Sweep Circuits

There are available a number of ways of developing the sweep or time base voltage. The rotating potentiometer and battery method has been shown. There are other arrangements which employ the charge of a condenser, controlled by a breaking contact, but since these are seldom if ever used, we do not feel justified in devoting space to a discussion. Whatever space we have available can be utilized to better advantage by discussing various types of electronic sweep circuits, since they find application in modern cathode-ray oscillograph apparatus.

The most commonly used unit is what is known as a relaxation oscillator. By a relaxation oscillator is meant a generator of distorted currents in which the variations are due to the charge and discharge of a condenser through a resistor. This is in contrast with the normal signal generator, wherein anything but distorted waves are desired. Furthermore, whereas the normal electron tube oscillator develops a fundamental frequency determined by the values of capacity, inductance and resistance in the circuit and the order of the harmonics present is kept as low as possible, the relaxation oscillator's frequency is a product of the capacity and the resistance and its harmonic content is greatly desired. Generally speaking, the frequency generated by such relaxation oscillators is increased as the capacity and resistance over which the charge and discharge occur are decreased, and is decreased as the capacity and/or resistance are increased. Similar variations in fundamental frequency and, naturally, the harmonic frequencies can be developed, by varying but one of the constants, say the condenser or the resistance, with the other maintained at a constant value. The frequency varies inversely with capacity and resistance.

There are several reasons why such relaxation oscillators are better suited as time base or sweep voltage sources than other types of oscillators. The first of these is the nature of the output voltage developed by the unit. The relaxation oscillator develops an output voltage which rises slowly to maximum and then very rapidly decreases to zero, i.e., a saw-tooth wave. The rate of decrease from maximum to zero occurs in an extremely small portion of the time required for the rise to maximum. This extremely rapid decrease from maximum to zero is utilized to return the beam to its original position and, naturally, the spot to its original position. The rise in voltage constitutes the deflection field which swings the beam across the screen in the horizontal direction, along the "X" axis. The drop to zero is the return trace,

which is desired to return at such a fast rate that it produces a minimum trace upon the screen. The brilliance of the return trace depends upon the fundamental frequency, for if the fundamental frequency is very high, the return trace, while much faster than the original sweep across the screen, may still be sufficiently slow to produce a trace. The decrease from maximum voltage to zero, when returning the spot to its original starting position, is the equivalent of the movement of the potentiometer rotor in figure 29 from the extreme minus end of the resistor strip to the extreme positive end of the strip.

The second reason is that by proper design, the increase from zero to maximum of the output voltage, utilized to sweep the beam, can be made linear, so that a uniform time base is available. A supplementary reason is that a fairly wide range of fundamental frequencies may be had with comparative ease and also that synchronization between two frequencies is easily accomplished. In other words, relaxation oscillators can be stabilized and kept constant by frequencies which are multiples or submultiples of the fundamental.

Fig. 30. A glow-discharge tube used as a relaxation oscillator is here shown. The frequency can be changed by varying the d-c. voltage, the capacity or the resistance.

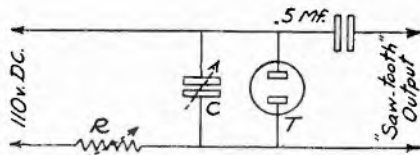

The simplest form of relaxation oscillator is the glow-discharge tube used in conjunction with a resistor and condenser and a d-c. voltage source. This is shown in schematic form in figure 30. The oscillator portion of the circuit consists of the d-c. voltage source, the variable condenser C and the glow tube, which is a neon or argon gas-filled tube of the common variety. The .5-mfd. condenser is the output condenser. According to the circuit shown, the discharge tube is connected across the frequency controlling condenser. The resistor R , being variable, also can be used to control frequency, but for the sake of illustration, we can consider the unit as being fixed in value.

Operation of the device is along the following lines: Current from the d-c. voltage source flows through the resistor, charging the condenser to a certain voltage. Normally, were it not for the presence of the glow discharge tube, the d-c. voltage would charge the condenser to its full value, but with the tube connected across the condenser, this does not occur for the following reason: These tubes contain gas. When the voltage across the two anodes of the tube reaches a certain value,

the gas within the tube ionizes, the tube flashes and becomes a conductor. When this happens—and it is an instantaneous action—the tube short circuits the condenser and dissipates its charge.

Now, it is a characteristic of such gas-filled tubes, that when ignition or ionization has occurred, it will persist for a period of time, which means that while the flashing point may be a certain voltage, once the flash has occurred it will persist, even if the voltage across the tube electrodes is somewhat reduced. However, when the voltage across the tube anodes reaches the lower critical value, ionization ceases and the tube again becomes a non-conductor and the condenser charging cycle starts all over again. Once the tube has again become a non-conductor, it will require the original upper critical voltage to cause ionization again. Thus the tube can be said to have two values of critical voltage, namely, that which will cause ionization and that which is the lower limit required to maintain ionization, once that it has been started.

The usual arrangement is to use a glow discharge tube, that has a breakdown voltage rating which is appreciably lower than the voltage of the voltage supply source, which in this case is the 110-volt d-c. line. Suppose for the sake of illustration that the tube used is rated at a critical voltage of 60 volts. When, during the initial charge cycle, the voltage across the condenser reaches 60 volts, the tube ionizes and the condenser is instantaneously discharged through the tube. When this happens, the voltage across the condenser falls to a value less than that required to keep the gas within the tube in a state of ionization and the tube again becomes an infinite resistance and the condenser starts its charging cycle.

When a system of this type is used to supply the sweep voltage or time base, the charging voltage across the condenser is used as the voltage which sweeps the beam spot across the screen and the discharge cycle is the voltage which returns the spot to its initial starting position. Consequently, the output voltage waveform of such a circuit is in effect a picture of just what is happening during the charge and discharge of the condenser. The glow-discharge tube serves the purpose of discharging the condenser at the predetermined instant. Just what this instant is in the units which are used in actual practice is a matter of design. The discharge at a certain instant, with respect to the voltage across the condenser, bears a definite relation, as will be shown, to the frequency and to the degree of linearity.

Figure 31 shows two cycles of the output voltage waveform of the neon tube oscillator illustrated in figure 30. You can, if you wish,

consider the sloping line which rises from zero to maximum as the charging cycle, since it indicates the rise in voltage across the condenser. The discharge trace is the steep drop from maximum to zero and which is barely visible. This pattern is for a 400-cycle wave, so that the duration of each cycle is about $1/400$ th of a second. You can therefore see that the duration of the discharge period is extremely small with respect to time.

The frequency of a relaxation oscillator can be varied in three ways: With the flashing voltage and the resistance constant, variation of the capacity will vary the frequency. With capacity and flashing voltage

Fig. 31. Two cycles of the voltage wave taken across the output terminals of Fig. 30. The charging portion of the cycle is the sloping line and the vertical line is the discharge from maximum voltage to zero.



constant, variation of the resistance will vary the frequency. With resistance and capacity fixed, variation of the flashing voltage will vary the frequency. The frequency variation with respect to capacity and resistance has been mentioned. The variation with respect to the flashing voltage is such that the higher the ionization or ignition or flashing voltage of the tube, the lower the frequency; and the lower the flashing voltage, the higher the frequency. Just how this is done will be shown in a subsequent paragraph.

It is relatively simple to understand why these variations in capacity, resistance and flashing voltage vary the frequency. With fixed resistance, fixed supply voltage and fixed capacity, the time required to charge the condenser to the flashing voltage of the tube is finite. If the flashing voltage is reduced, the time required to reach this value of charge or voltage across the condenser will be less, hence the number of times the condenser will reach that charge and discharge across the tube in a definite time will be greater, which means that the frequency will be higher. If the flash voltage is raised, then the period of time required to charge the condenser to the critical voltage will be longer and the number of times the condenser will reach that charge and be discharged by the tube in a definite period will be less and the frequency of the output voltage will be lower.

With a constant supply voltage source, fixed resistor and fixed flash voltage, the variation of frequency with capacity variation is due to the

time required to charge a condenser to the proper voltage. The higher the value of capacity, the greater is the time required to charge that condenser to a certain voltage, and if this certain voltage is the critical ionization voltage, the less will be the number of times that the condenser will be properly charged and discharged in a definite amount of time. This means that the frequency will be lower than if the capacity value of the condenser were smaller. The smaller the capacity, the less is the time required to charge it to a critical voltage and the more frequently will this condenser reach its proper charge and be discharged in a definite amount of time. Hence the frequency will be higher than for a condenser of greater capacity.

As far as the resistance is concerned, the greater the value of the resistor for fixed supply voltage, fixed capacity and fixed flash voltage, the longer is the time required to charge the condenser to the critical voltage. Hence the lower the number of charges and discharges in a definite period of time; consequently, the lower the frequency. The lower the value of the resistance, the more rapidly will the condenser receive its required charge in a finite time, and the greater the number of charges and discharges; hence the higher the frequency, for a definite time interval.

What is said here is applicable to all such relaxation oscillators, be they much more complicated than the one illustrated in figure 30 and when the fixed or variable resistance is replaced by some other device.

If you examine figure 31, you will of necessity note certain significant details. If you examine the portion of the cycle representing the rise in voltage or the charging period, you cannot help but note that it does not progress at a uniform rate with respect to time. In other words, the rise in voltage for each fraction of the charging cycle is not the same. The steepest portion is that which occurs as the charging cycle starts. The slope of the curve is greatest here. Then the slope becomes less and less until, when nearing the maximum amplitude (which means, approaching the critical voltage), the rise of the charge in the condenser is very little for the few moments before the maximum is reached. If this rising voltage is applied to the horizontal deflection plates so as to swing or sweep the spot across the screen, the speed of the spot across the screen would not be uniform with respect to intervals of time. The spot would move fastest at the start of its journey and gradually slow down its rate of travel as it approached the other limit of the screen. Its start of travel is the start of the charging cycle and it slows down as it approaches the other side of the screen,

because the rate of voltage increase with time (figure 31) is reduced. In sum and substance, the output voltage is not linear with respect to time.

A relaxation oscillator of this type can be used, but it would not be wholly satisfactory because it would develop a distorted image upon the screen. Nevertheless it has utility, because a certain portion of the charging cycle possesses sufficient linearity to enable examination of the pattern upon the screen, provided that a number of cycles of the wave being observed are caused to appear upon the screen. The cycle or cycles positioned near the start of the spot travel would be substantially true images of the waveform being examined.

In connection with linearity of the sweep voltage, the mode of application of the cathode-ray oscillograph to servicing, public address and "ham" transmitter adjustment, or where quantitative observations are of not prime importance, is such that a certain departure from perfect linearity is permissible. As a matter of fact the commercial cathode-ray oscillographs now available possess sweep circuits which enable observations of various kinds and are of extreme value to the industry, yet which are not 100 percent. linear. Of course, all of these are more linear than the representation in figure 31, but a departure of from 10 to as high as 20 per cent., is not sufficient to cause trouble.

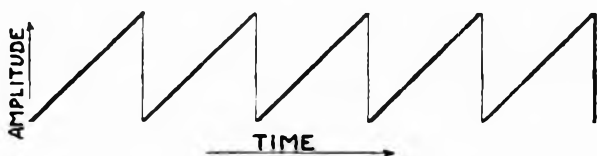

Fig. 32. The ideal saw tooth wave. Note that the charging portion of each cycle of this wave is linear, i.e. a straight line, indicating a constant increase in voltage with respect to time. The discharge from maximum to zero voltage is perpendicular, indicating an instantaneous return to the starting point.

The primary reason for the lack of linearity with the oscillator, shown in figure 30, is that the use of a fixed or even variable resistor of the common type does not keep the flow of charging current at a constant rate, which requisite must be fulfilled if linearity is to be attained. There are two simple ways of obtaining at least a close approach to linearity of the sweep voltage. One of these is commonly employed in the majority of commercial cathode-ray oscillographs. The other is used in some few isolated cases and, while somewhat more complicated, affords a closer approach to the ideal.

The ideal saw-tooth wave output of a relaxation oscillator is that shown in figure 32. This was drawn and affords a good comparison with the photograph of the neon tube oscillator output shown in figure 31. Note that the rise in voltage in figure 32 is constant with respect to time and that the discharge time is theoretically zero, since it is a straight line from maximum to minimum. The variation of the voltage increase, being a straight line, is linear, in contrast with the exponential variation of figure 31. With figure 32 as a basis, we can compare ways and means of securing the closest approach to the ideal and note the discrepancies of various forms of sweep circuits. Incidentally, very satisfactory application of the cathode-ray tube is possible with an approach to the ideal saw-tooth sweep voltage.

The most commonly used method of obtaining a fairly linear, although not really linear, sweep voltage, consists of an arrangement whereby the gas discharge tube ionizes at a certain voltage, appreciably less than the full charging voltage. Consider figure 33. Figure 33-A shows two cycles of a saw tooth wave supposedly developed by a fixed resistor-condenser-discharge tube combination, wherein the tube trips or flashes at 105 volts. The charging voltage or supply voltage is 110 volts. From what has been said, it is obvious that this type of sweep voltage would be unsatisfactory. If we consider the ordinates or vertical reference lines, as representing time; each heavy vertical line represents $1/100$ of a second. For the first $1/100$ second, the voltage rises approximately 32.5 volts. For the next, it rises about 29.5 volts. For the next, it rises about 15.5 volts. For the next, it rises about 11.5 volts. For the remaining equal time variations, this voltage rises in steps of 7.3 volts, 6.7 volts, 4.1 volts, 3.5 volts, 2 volts and 1 volt, respectively, when the tube flashes and the discharge occurs. (We are assuming an ideal case, where the discharge is instantaneous from maximum to zero. In actual practice, a certain amount of time would elapse for the discharge period, because the tube possesses resistance, even when it is ionized and the condenser possesses resistance. Also that the tube does not become a non-conductor until the voltage has reached zero. In practice this is not so, as stated earlier in the reference to the upper and lower critical values of voltage.)

It is evident that the rate of charge and voltage increase is very irregular. If we assume that this is a cycle of a 10-cycle wave, the rise in voltage mentioned before would occur in each $1/100$ of a second. Suppose that we arrange for the tube to flash at 87.7 volts. The charging voltage, resistance and capacity remain the same. The dis-

charge then occurs after an interval of $5/100$ of a second. Hence the frequency is 20 cycles. See figure 33-B. What are the effects?

They are two in number. The first is that the amplitude of the sweep voltage is reduced. The second is that the portion of the charge curve actually used is steeper than the entire curve previously used and

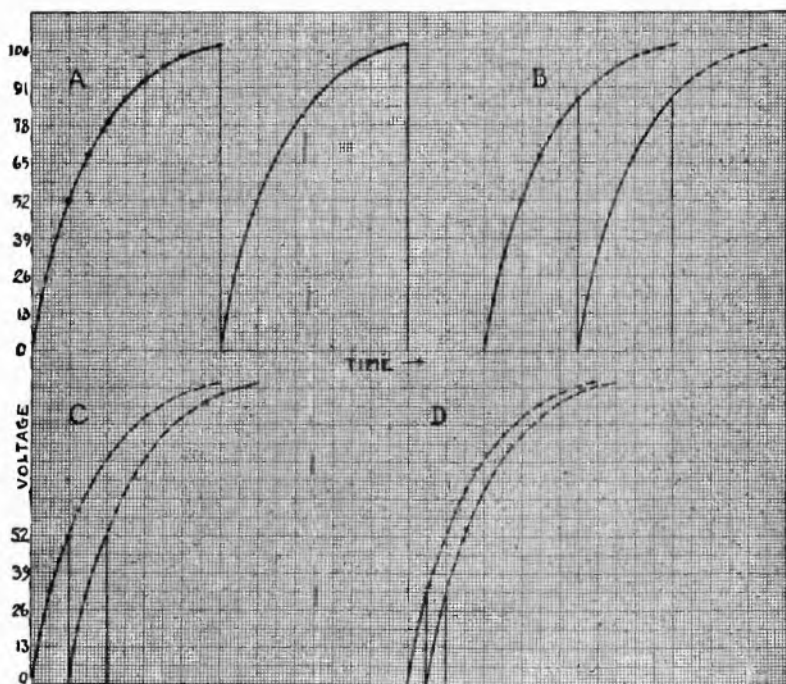

Fig. 33-A. Two cycles of a theoretical saw-tooth wave such as would be developed by a resistor-condenser-discharge tube combination with the tube tripping at 105 volts. Fig. 33-B shows the waveform when the tube flashes at 87.7 volts and Fig. 33-C shows the wave when the tube flashes at 52 volts. When the flashing voltage is reduced to 32.5 volts, Fig. 33-D, the charging portion of the wave is fairly linear.

while it is true that linearity is still far from attainment, the rate of travel of the spot across the screen will not vary as much as it did when the amplitude was greater as a result of using most of the charging voltage. It is to be understood that the rise in voltage with respect to time is not yet a close approach to being constant, but the change in speed from the start to the finish is not as great as before. From this we can gather a very important bit of information. Namely, that if any attempt is made to employ the maximum amplitude by utilizing almost

the full charging voltage, the departure from the required linearity is greatly increased. The change in frequency also brings to light the fact that under certain conditions, that is, if the adjustments of the sweep circuit change the amplitude very much, it is possible to cause a change in frequency of the sweep voltage.

Suppose that we reduce the flash voltage still more, say to 52 volts. See figure 33-C. The charge and discharge period now occurs in $2/100$ of a second. This means that the frequency of the sweep is 50 cycles. It is obvious that the slope of the voltage curve is a closer approach to the ideal straight line than the curves of either figures 33-A or 33-B. Since figure 32 shows the ideal curve, wherein we know the variation to be linear, we can take for granted, without going into a discussion of actual figures, that the condition obtained, when the flash voltage is as stated in figure 33-C, is improved over that of the other curves.

Suppose that we reduce the flash voltage still more, say to 32.5 volts, as shown in figure 33-D. The charge and discharge cycle occurs in $1/100$ of a second, hence the frequency has been increased to 100 cycles. At the same time the amplitude has also been decreased. However, we are producing what appears to be a fairly linear wave. At no time is it possible to produce a truly linear wave, unless the control of the charging current is such that the flow is kept at a constant rate during the entire charging cycle. We have seen how, by utilizing a certain portion of the complete charging voltage to constitute the charging cycle, we can definitely improve the degree of linearity. This is done in a number of instances in commercial cathode-ray oscillographs.

It might be well at this time if we made mention of the fact that the voltage values mentioned in connection with figure 33 were purely arbitrary. They do not designate the actual charging voltage values employed in commercial devices. The similarity, however, between these values and commercial equipment lies in the fact that the voltage used to charge the condenser, through whatever current limiting device is used, is much greater than the actual voltage developed across the condenser and employed to flash the gas discharge tube.

The method of employing the type 885 gas-discharge tube to provide the sweep circuit for commercial oscillographs is shown in simplified form in figure 34. This tube differs somewhat from the two-anode neon or argon gas tube. The 885 is a gas content grid controlled triode. The heater heats the cathode, which is the electron emitter, just as in the ordinary indirectly heated a-c. triode. The tube contains an inert

gas, which will ionize when the voltage between the cathode and the plate reaches a certain value. The voltage at which ionization will occur depends upon the bias applied to the grid. In other words, the flash voltage is a function of the grid voltage. With a certain negative bias applied to the control grid, the tube will flash at a certain plate voltage. This is the voltage developed across the condenser. When the flash occurs, the condenser discharges through the tube. When the voltage across the condenser is reduced to the lower critical potential of the tube, the grid again takes control and the tube becomes a non-conductor and the charging cycle starts all over again.

The potentiometer P in this case is used solely to establish the proper flash voltage to produce the most linear sweep possible. In practice P is fixed, or at least the bias voltage is fixed, so that when R and C are varied to produce the sweep voltage at the required frequencies, the sweep voltage will be linear. Some commercial units employ a potentiometer across the bias battery, in order to provide an amplitude control, whereas other commercial units employ the power supply voltage divider as the source of the bias voltage and by properly tapping this source, provide the correct bias and eliminate the potentiometer. The

Fig. 34. A simplified schematic diagram showing the use of an 885 gas discharge tube for providing a sweep circuit. This circuit is typical of those used in several commercial oscillographs.

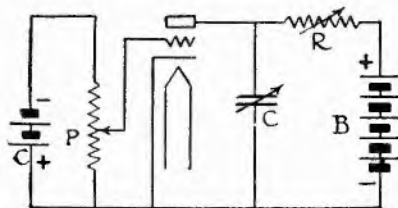

charging cycle of the system, shown in figure 34, is exactly like that of the system shown in figure 30, hence requires no detailed discussion. Some commercial oscillographs do not employ the tube as such but employ the G.E. Thyatron, known as such. However, as far as operation is concerned, both are of like character, except that the 885 type of tube is rated at a much lower plate voltage, so that its output under correct conditions is not as great as may be secured from the thyatron. We are referring to amplitude of the sweep. It is to be understood that the 885 and the tube known as the grid-controlled gas discharge thyatron are of substantially the same design.

The effect of amplitude control of the gas discharge tube, which means operation at various portions of the charging or adjustment of the flash voltage, is illustrated in figures 35, 36 and 37. Figure 35 shows the output waveform of a commercial sweep circuit which has

been adjusted to trip at a low plate voltage, which is accomplished by the application of a comparatively low value of negative grid bias. The waveform is a good approximation of the ideal. These photographs were taken by spreading one sweep circuit with another, so that a certain amount of non-linearity may appear in the photograph.

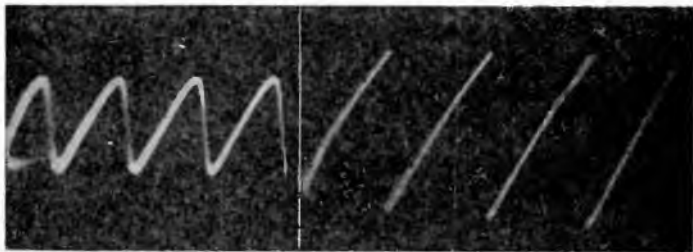

Fig. 35 (left) shows the output waveform of a sweep circuit of a commercial oscillograph with a low tripping voltage, making the charging portion of the wave fairly linear. Fig. 36 (right) shows the same wave with the amplitude control advanced, resulting in a slight departure from the good linearity of the wave of Fig. 35.

Figure 36 shows an advancement of the amplitude control; that is, the application of a higher negative bias. A bend in the upper portion of each cycle is visible. Figure 37 shows the application of the amount

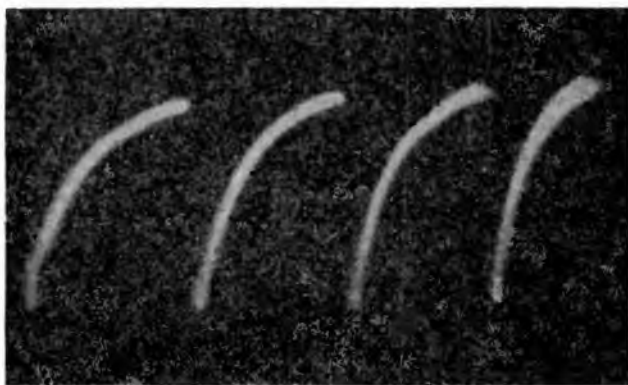

Fig. 37. This waveform is the result of applying the bias necessary to produce maximum amplitude of the sweep. Note the very definite bend in the charging portion of the cycle and the consequent non-linearity.

of bias required to produce maximum amplitude. Note how the sweep voltage has departed from the good wave shown in figure 35. It might be well to state that the sweep voltage shown as figure 37 was

not passed through any amplifiers. It is the output of the sweep oscillator, fed directly to the plates of the test oscillograph.

A modification of the relaxation oscillator shown in figure 34 is shown in figure 38. This is substantially the same as that shown in figure 34, except that a current limiting tube is used in place of the current control resistor R . Also that the unit is shown with output connections to the deflection plates of the oscillograph tube. The function of the type 34 pentode—incidentally, it is not imperative that this tube be exactly this pentode—is to keep the flow of current charging the condensers $C1$, $C2$ or $C3$, whichever is in the circuit, at a constant value during the entire charging cycle. If this is done, then the rise of the voltage is at a constant rate and the output is linear.

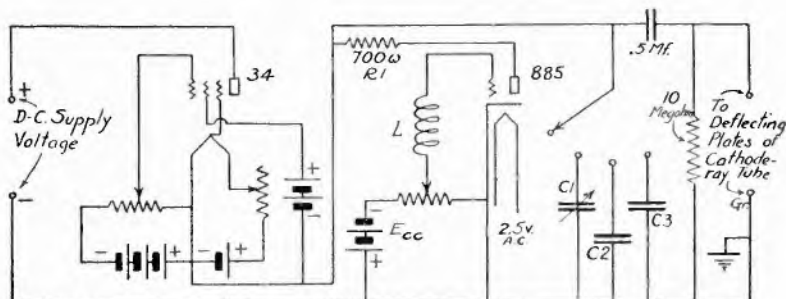

Fig. 38. The type 34 tube replaces the resistor, R , (Fig. 34) as a current limiting device in this relaxation oscillator sweep circuit. The constant current flow tends to charge whatever condenser is in the circuit at a constant rate, making the voltage rise constant thereby supplying a linear output to the deflecting plates.

This current limiting tube functions somewhat like a ballast, and, in general, sweep circuits equipped with current limiting tubes function as follows: When the d-c. voltage is first applied, no voltage exists across the frequency control condensers $C1$, $C2$ or $C3$, whichever one is in the circuit; consequently, the entire supply voltage is impressed across the plate and cathode. As the condenser begins to charge and the voltage across the condenser starts to increase, it decreases the voltage across the pentode and eventually the voltage built up across the frequency control condenser is sufficient to flash the 885 tube.

It is obvious from the wiring diagram that the voltage applied to the plate of the pentode controls the current through the pentode and the balance between the supply voltage and the voltage across the frequency control condenser results in uniform current flow through the pentode during the charging cycle. The 700-ohm fixed resistor between the

pentode and the plate of the 885 is used to limit the peak current during discharge. The coil L is a low impedance transformer winding, whereby the synchronizing signal is fed into the 885 oscillator tube.

Although not mentioned, there are definite limits to the fundamental frequency obtainable with such sweep circuits. The 885 tube used as the saw-tooth oscillator can be made to develop frequencies up to about 20,000 with comparative ease. Higher values entail problems. Commercial cathode-ray oscillographs equipped with thyratron tubes usually limit the frequency of the sweep circuit to a maximum fundamental of 15,000 cycles. No doubt higher fundamental frequencies have been obtained, but we are quoting values experienced in practice. It might also be well to state, that shielding of these circuits is required, in order that radiation of the signal into whatever unit is under test be avoided.

We made mention of the ability to synchronize such saw-tooth wave oscillators with multiples and submultiples of the frequency being generated. Such can be done by feeding into the control grid circuit of the gas filled triode a small voltage from the frequency source being observed. By feeding a pulse into the control grid circuit of the oscillator tube, this small voltage will tend to keep the frequency of the oscillator steady and unvarying. Such a signal would be fed into the circuit through the transformer winding L in figure 38 or through a condenser and resistor into the grid circuit of the system shown in figure 34. If the frequency of the saw-tooth oscillator is an exact multiple or submultiple of the frequency being observed and part of the voltage has been fed into the oscillator circuit, the two will be locked in step and the pattern will remain stationary. More data concerning such synchronization is given in connection with the practical application of the cathode-ray oscillograph.

Other Types of Saw-Tooth Wave Oscillators

There are several other types of saw-tooth wave generators. The ordinary glow-discharge tube of figure 30 used with an amplifier enables operation at a low amplitude, so as to produce a linear sweep voltage which is amplified or built up in the amplifier.

Another method of producing a saw-tooth wave is shown in figure 39. This circuit is known as a multi-vibrator, although no mechanical vibrator is used. If you examine the circuit you will see that it is

nothing more than a two-stage resistance-capacity coupled amplifier which is so arranged as to feed back upon itself. The unit is extremely rich in harmonics and has an exceptionally high range of fundamental frequencies. By proper design it is capable of generating fundamental frequencies as high as 30,000 to 40,000 cycles per second. For such high frequencies, it is necessary that all parts be of high quality and constancy, particularly the diode tube employed as a variable resistor. This circuit differs from the normal sweep, in that the voltage used to sweep the spot across the screen is the discharge of one of the condensers, rather than the charge. The diode tube used as a variable resistor provides a discharge path through which the current is independent of the voltage, so that the rate of the condenser discharge becomes uniform and a linear time axis is available.

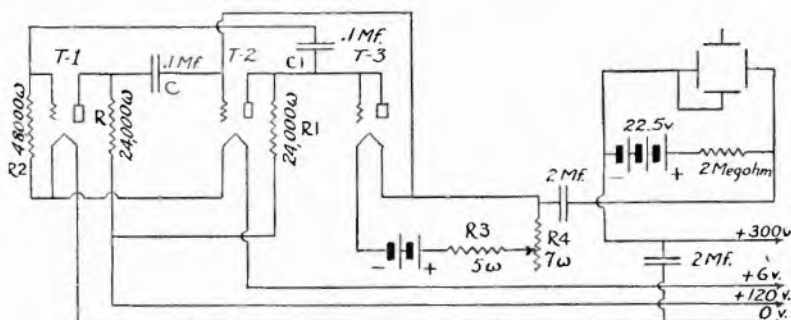

Fig. 39. Schematic diagram of the so-called multi-vibrator circuit. Note that this is nothing more than a two-stage resistance-capacity coupled amplifier arranged to feed back on itself. It is possible to generate fundamental frequencies up to 30 or 40 kilocycles.

Condensers C and C1 are alternately and very rapidly charged. Condenser C discharges through the diode tube, in which the plate current is limited by the filament temperature, hence control of the filament current of T-3 provides a wide range of frequencies. The time axis output of the unit is secured through the two 2-mfd condensers. The constants shown are those which were used by the writer for many years. The tubes originally employed were W.E. 203B for T-1 and T-2 and a 215-A for tube T-3. The circuit is adaptable to the conventional tubes, rated at from 10,000 to 20,000 ohms plate resistance. By making C and C-1, fixed condensers of from .0005 mfd. to the value shown, arranged in switch controlled steps, additional control of frequency is available. A synchronizing pulse can be fed into the circuit in series with the 48,000-ohm grid leak.

Still another form of relaxation oscillator, whereby higher sweep

frequencies are available is the ordinary oscillator circuit arranged in such manner that the grid circuit will periodically block. The discharge of the grid condenser is arranged through a diode tube with a controlled filament, so that the current through the tube is governed by the filament temperature. The filament temperature is the rough frequency adjustment and the variable grid condenser is the fine frequency adjustment.

The circuit is shown in figure 40. The oscillator is adjusted to some high frequency, say, within the broadcast band. The grid condenser, consisting of the two condensers C and C1, becomes charged. As a result of the value of the grid leak, which is the diode tube, the grid of the oscillator tube becomes highly negative and the tube blocks.

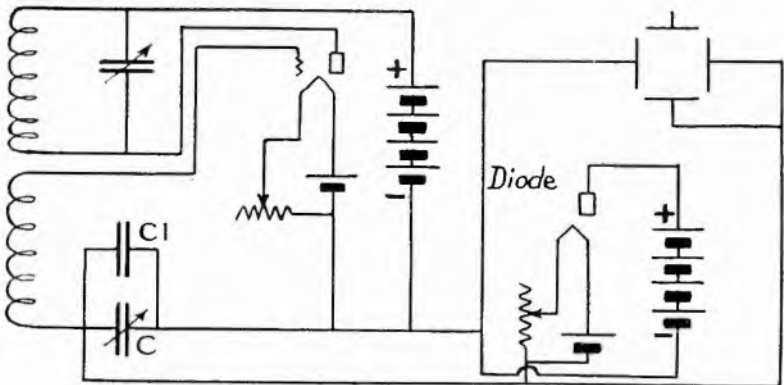

Fig. 40. This circuit is capable of producing frequencies of a fairly high order. It is an ordinary oscillator circuit so arranged that the grid circuit will block periodically. The filament temperature of the diode is the rough frequency adjustment and the condenser C is the fine frequency adjustment.

Oscillations cease. The charge which has accumulated across the condensers now leaks off through the diode tube. After a time interval, sufficient charge has leaked off, so that oscillations start again. The charge again accumulates and the process is repeated. The time interval required for the charging of the condenser can be controlled by the tuning of the resonant circuit. The period of the discharge is adjustable by means of the grid condenser and the diode tube filament resistor. The discharge curve of the grid condenser-diode tube combination is sufficiently linear to provide a satisfactory time base. However, the amplitude of this voltage may not be high enough to provide the correct width of the sweep without amplification and this is somewhat of a problem at high frequency, particularly when this frequency must

be variable. Then again, the constancy depends upon the care with which the unit is assembled and the parts employed.

60-Cycle Sweep Circuit

All of the sweep circuits mentioned thus far have been of the variable frequency type. There are found in some commercial cathode-ray oscillographs sweep circuits which are not of necessity linear sweep systems. In other words, the voltage which causes the spot to move across the screen does not vary in a linear fashion. One of these sweep circuits is the regular sine wave 60-cycle supply, or at any rate, the frequency of the supply which provides the power for the oscillograph unit. When a linear sweep is available, the utility of the rated 60-cycle sweep is

Fig. 41. The sweep of the Egert oscillograph is different from those shown before. Here the charging portion of the cycle is steep and the discharge is more gradual, both parts of the cycle being used for sweeping the spot across the screen. Compare this wave with that of Fig. 35.



comparatively small, for, as shall be shown, it possesses certain disadvantages. In the first place it can stop only one band of frequencies, those which are direct multiples or submultiples of the supply frequency and this band is of necessity limited, since the sweep frequency is fixed. Then again, it does not lend itself to very satisfactory observation of the waveform of signals which are of frequencies near these multiples or submultiples, because they cannot be made stationary. Furthermore, the rate of variation of this sweep voltage distorts the image which appears upon the screen.

However, there is another form of 60-cycle sweep circuit, which is used in the Egert oscillograph, of which a few are available. This is the discharging voltage developed across the input filter condenser in the power supply rectifier system. The nature of this voltage is shown in figure 41. The charge is fairly rapid and steep, whereas the discharge, which occurs, is more gradual. The waveshape looks like a reversed saw-tooth cycle. Since the rectifying system is a half wave affair, the sweep voltage has the frequency of the power supply. By using a small value of capacity as the load upon the rectifier, the change in voltage representing the amplitude of the sweep is made appreciable.

We have said a great deal about different types of sweep circuits—about distortion which occurs when a sweep is not linear and the need for linearity. It might be a good thing to develop several sine waves with linear and non-linear sweep voltages. These are shown in figures 42, 43, 44 and 45. Figures 42 to 44, inclusive, illustrate how a normal fairly linear sweep voltage spreads one, two and three cycles. You will note that in each and every case, there is some effect upon the shape of the developed pattern as a result of the discharge portion of

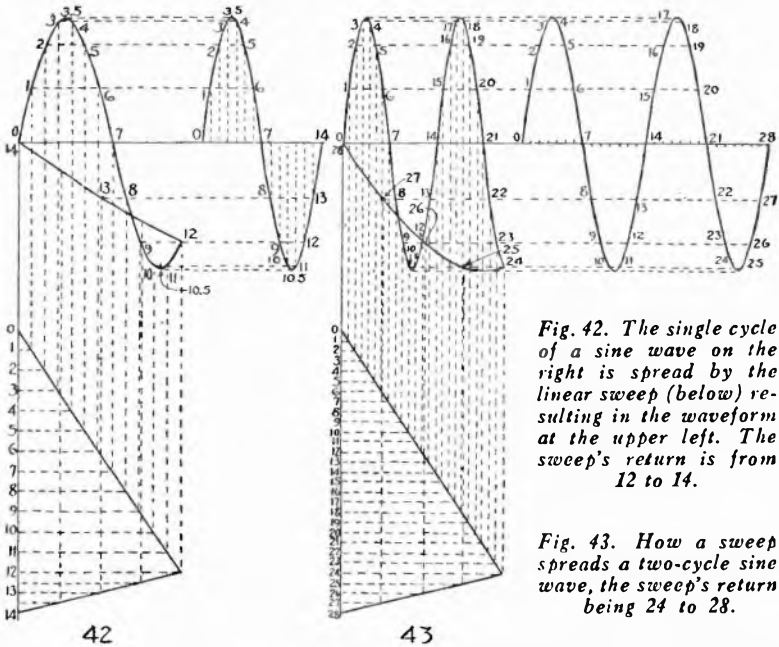
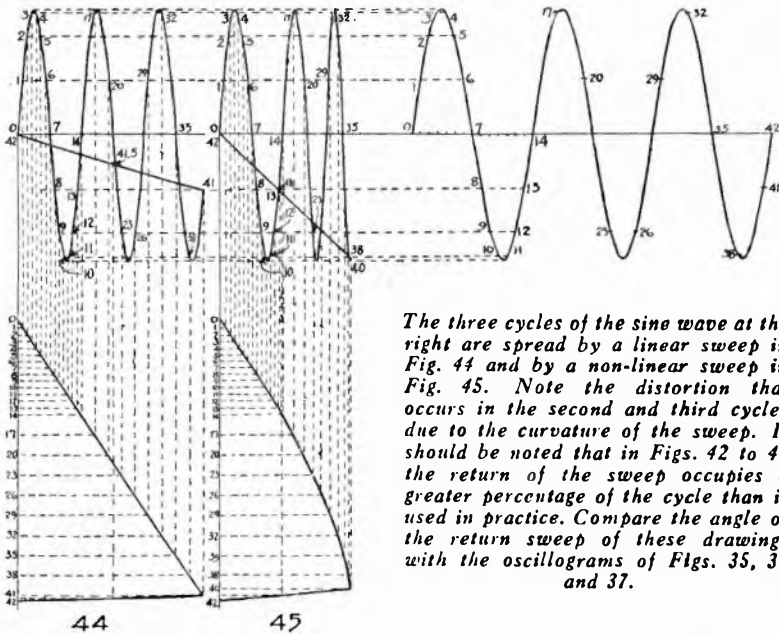

Fig. 42. The single cycle of a sine wave on the right is spread by the linear sweep (below) resulting in the waveform at the upper left. The sweep's return is from 12 to 14.

Fig. 43. How a sweep spreads a two-cycle sine wave, the sweep's return being 24 to 28.

the cycle. Its effect is greatest when a single cycle appears, because this portion of the sweep cycle takes place during a part of the waveform cycle being observed, so that there is a tendency towards distortion. However, as you see in figure 44, if three or more cycles are placed upon the screen, the first cycle is substantially an undistorted representation of the sine wave applied to the vertical deflection plates. The effect of a non-linear sweep in distorting the developed image is evident in figure 45. You can very easily imagine the effect upon a single or two-cycle images. In a single-cycle image one of the alternations would appear normal and the other half of the cycle would be crowded. In the two-cycle pattern, one of the cycles would appear normal, whereas the other would be crowded.

However, we do not want you to forget the statement made earlier in this chapter to the effect that even a non-linear sweep may enable observation of the character of a waveform, if a sufficient number of cycles are shown upon the screen. This is so, because, as you note, one portion of the non-linear sweep voltage is a fair approximation of linearity. Hence with three or four cycles upon the screen, those slightly



The three cycles of the sine wave at the right are spread by a linear sweep in Fig. 44 and by a non-linear sweep in Fig. 45. Note the distortion that occurs in the second and third cycles due to the curvature of the sweep. It should be noted that in Figs. 42 to 45 the return of the sweep occupies a greater percentage of the cycle than is used in practice. Compare the angle of the return sweep of these drawings with the oscillograms of Figs. 35, 36 and 37.

in from the position which is the start of the beam may be fairly true representations of the waveform voltage applied to the vertical deflection plates. The sweep voltage frequency in figures 42, 43, 44 and 45 has been kept constant and the voltage being observed has been changed in frequency. In practice to obtain a greater number of cycles upon the screen, for any one frequency input to the vertical deflection plates, the sweep frequency is changed.

Although we do not definitely tie in the sweep voltage shown in figures 42 to 45, inclusive, with the basic electro-mechanical sweep of figure 25, it is to be understood that the operation of the electronic sweep in tracing the pattern is like that which has been described for the electro-mechanical sweep consisting of the battery voltage and potentiometer. In the electronic sweep the trace and return of the

beam spot from one end of the screen to the other is done automatically. You should realize that the sweep voltages shown in figures 42 to 45, inclusive, are divided into uniform time intervals just as the sweep voltage in figure 25 is divided into uniform time intervals. Also that the waveforms being observed and developed upon the screen are likewise divided into uniform time intervals. The fact that a screen is not shown in figures 42 to 45, inclusive, should not confuse you. The sweep voltage is being applied to the horizontal deflection plates and the voltage to be observed is applied to the vertical deflection plates. The developed pattern is assumed to appear upon the screen.

So much for the *general discussion* of sweep circuits. The association between the basic electronic sweep circuits shown in this chapter and the commercial arrangements used in cathode-ray oscillographs will follow in a subsequent chapter.

CHAPTER III

A-C. VOLTAGES ON BOTH SETS OF PLATES

Before embarking upon the discussion of the commercial cathode-ray oscillographs and the practical application of such units, there is one very important subject which must receive attention. This is the result of applying a-c. voltages to both sets of deflector plates. In this connection one very important point comes to the fore. This is phase relation. The phase relation between the a-c. voltage applied to the vertical deflection plates and the a-c. voltage applied to the horizontal deflection plates has a tremendous effect upon the shape of the pattern which appears upon the screen. It is extremely important that you realize this qualification.

After all is said and done, the pattern which appears upon the screen is the result of displacement of the spot in two dimensions, at right angles to each other. Assuming any one value of voltage, a uniform voltage applied to both plates, the shape of the pattern is going to be determined by the phase relation between the instantaneous deflecting voltage fields. At the same time, if the phase relation is constant, the shape of the pattern is also going to be influenced by the relative amplitudes of the horizontal and vertical deflection fields.

Fortunately, certain information is possible with the cathode-ray oscillograph, even when the phase relation is unknown, despite the fact that the existing phase relation does influence the pattern. This is so, because the pattern, if understood as a pattern, conveys the information desired, despite the fact that the existing phase relation has manifested its effect. Also because the same information may be conveyed to the observer for any one of a number of different phase relations. At the same time, it is extremely valuable to comprehend the reason why the shape of the pattern is as it is.

It is also of interest to realize that simple and complex patterns result from the application of a-c. voltages to both plates. However, irrespective of the nature of the pattern, be it simple or complex, it is

important to understand that the pattern is created by the movement of a single spot—that each of the lines, no matter how many appear upon the screen, is being traced by a single spot in motion and the line or lines are the result of the recurrent tracing of that path by the moving spot.

The nature of the a-c. voltages, which are applied to the two sets of plates, is of no consequence. They can be sine waves or distorted waves. They can be modulated waves or unmodulated waves. As far as the latter two classifications are concerned, certain limitations are imposed and these relate to the ability of the amplifiers within the oscillograph to pass or amplify the voltages at these carrier frequencies. Simplest patterns appear when the simplest waves are placed upon the respective plates, and when they bear some simple relation to each other with respect to frequency. If the nature of the voltages applied to both sets, or to one set of plates, is complex, due to distortion or modulation, the resultant pattern will show the complexity of one of the voltages. Two voltages, which are of such frequency that they are not integral multiples of each other, will produce complicated patterns. So much for that. Let us now see how two simple sine waves deflect the electron beam.

Suppose that we apply two sine waves of like amplitude and like frequency, one voltage to each set of plates. The two voltages are exactly in phase. What is the final pattern upon the screen? . . . Examine figure 46. The normal position of the spot is in the center of the screen. The horizontal and vertical deflecting fields start at zero. Consequently, at the start of each voltage cycle, the deflecting force exerted by the two voltages is zero. The numbers for each spot upon the screen, in each direction, correspond with the numbers shown upon the waves. Each spot, with the exception of the zero and the peak points, has two numbers, corresponding to the two times that the spot passes through that point during each alternation. The zero point has three numbers, because the wave reaches that point three times in a complete cycle. The peak points have but one set of numbers, because the wave passes through the peak amplitude but once in each alternation. The time interval between the amplitude designations is uniform for both voltages.

At the start the spot remains at rest in the center of the screen. This is indicated as zero on figure 46-B. After the passing of the first time interval, the vertical field has a deflection of 1 unit and the horizontal field has a deflection of 1 unit, positioning the spot as 1-1

in figure 46-B. As time passes, the voltage of each wave increases and the resultant spot displacement for each time interval is shown as 2-2, 3-3, 4-4, 5-5, 6-6 and 7 in figure 46-B. Both waves now have reached their peak amplitude on the rising half of the first alternation. Now,

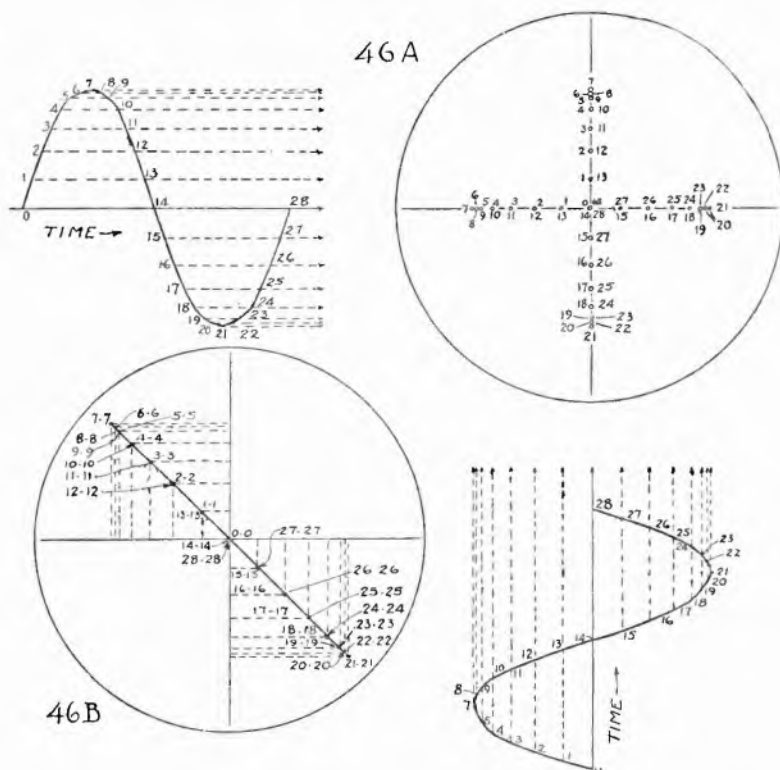

Fig. 46. The sine wave at the left is impressed on the vertical plates and the one below is impressed on the horizontal deflection plates. Each spot on the screen bears two numbers, except the peaks, as the voltage varies from zero to maximum and returns. The resulting figure is shown in Fig. 46-B. These waves are in phase.

they both decrease in amplitude at a constant rate and the spot positions pass through the same points as before, since the time interval is the same. To correspond with the spot positions shown in figure 46-A, for the second half of the first alternation, we have also numbered the resultant displacement positions of the spot to correspond. These are 8-8, 9-9, 10-10, 11-11, 12-12, 13-13, and 14 is again zero. The positioning of the spots in this quadrant is due to the polarity of the plates as a result of the voltages applied.

We now start upon the second alternation. As a result of the polarity of the respective vertical and horizontal deflecting plates, the spot now is positioned in the D or fourth quadrant. The increase in amplitude of the second alternation causes displacement equal to amplitudes indicated as 15, 16, 17, 18, 19, 20 and 21 in the vertical direction and amplitudes indicated as 15, 16, 17, 18, 19, 20 and 21 in the horizontal direction. The resultant spot positions are 15-15, 16-16, 17-17, 18-18, 19-19, 20-20 and 21-21 in figure 46-B. During the last half of the second alternation, the vertical and horizontal amplitudes decrease and they cause resultant displacement of the spot through positions 22-22, 23-23, 24-24, 25-25, 26-26, 27-27 and 28-28 in figure 46-B. As is evident, the result is a diagonal line of spots. If these two voltages are recurrent, instead of number of spots, we have an image which is a straight line.

A pattern of this type indicates certain definite conditions. First that the frequency of the two voltages applied to the vertical and horizontal plates is identical and, second, that they are exactly in phase with each other. In other words, that the instantaneous values of the two voltages are exactly alike with respect to time. A pattern of this type is independent of frequency. That is to say, such would be the pattern for any frequency, provided that both voltages were of the same frequency and exactly in phase or have a zero phase difference.

(Two voltages or currents or a voltage and a current are said to be in phase if they pass through their maximum and zero points in the same direction, at the same time.)

What other significant information can we glean from figures 46-A and 46-B? . . . In the first place, the bisection of the angles of the second and fourth quadrants by the image is attained, because the amplitude of the two deflecting fields is the same. Try to visualize the horizontal deflection equal to half of that which is shown and the vertical amplitude as shown. What would happen? Since the vertical amplitude would be the same, but the horizontal displacement would be less, the line would tend to approach the vertical reference line, the "Y" axis. If the horizontal deflection is decreased in steps, the resultant pattern would gradually approach the vertical line, until, when the horizontal deflection becomes zero, the image is a straight line along the "Y" axis. If the reverse were true, that is, the horizontal deflection is maintained constant and the vertical deflection is decreased, the line would tend to move towards the horizontal or "X" axis, until, when the vertical deflection is zero, the pattern is a straight line along the

"X" axis. In practice, variation of the horizontal or vertical amplitude controls, seems to rotate the pattern around the zero point.

The exact position of the single line pattern as it appears in the B and D quadrants (see figure 46-B) is not of great importance, for it indicates a zero phase difference as long as the pattern is a single line and is the result of the presence of both deflecting fields. The exact

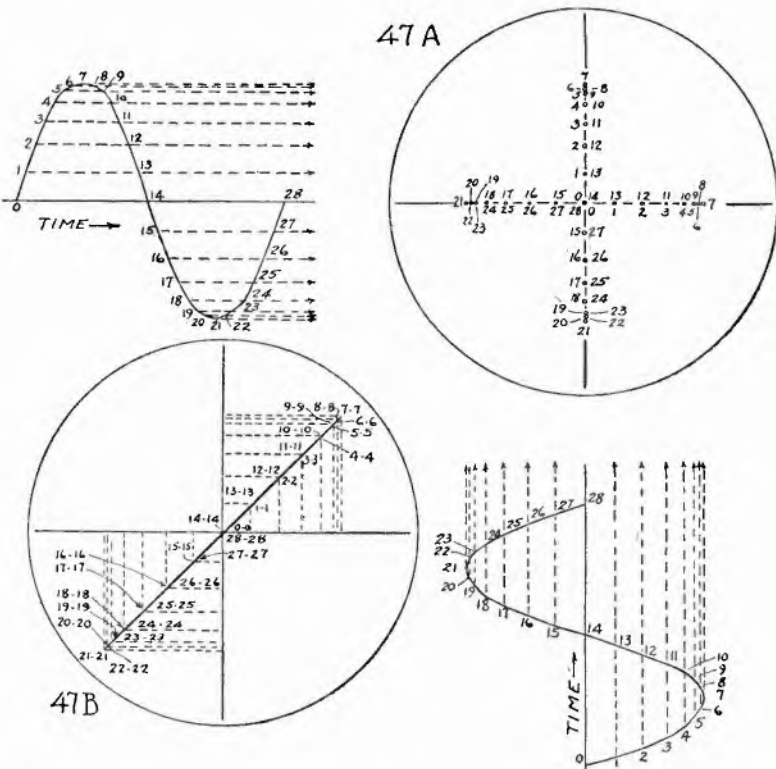

Fig. 47. The development of the resulting image seen on the screen in Fig. 47-B is the same as Fig. 46, but in this case the two sine waves impressed on the deflecting plates of the tube are 180° out of phase; hence the image slopes to the right instead of the left, as in Fig. 46.

angle is an indicator of the relative amplitudes of the two voltages applied to the plates. The fact that the image is a single line pattern is the indicator of the zero phase relation between the two voltages.

Suppose that one of the voltages is 180 degrees out of phase with the other voltage. (Two waves are said to be 180 degrees out of phase,

if they pass through their maximum and minimum points at the same time but move in opposite directions.) Suppose that the two voltages of like frequency and like amplitude shown in figure 46-A are now 180 degrees out of phase. Wave B has been turned through 180 degrees. See figure 47-A. Both voltages start at zero, but increase in amplitude in opposite directions. With the individual spot positions as shown in figure 47-A, the resultant pattern is as shown in figure 47-B. Note that the pattern now occupies space in quadrants A and C or if you designate the quadrants by numbers, in quadrants 1 and 3. What was said about amplitude variations in connection with figure 46-B is applicable to figure 47-B, except for the difference introduced by the orientation of the pattern upon the screen. A similar pattern would be obtained, if wave B had been left intact as in figure 46-A, and wave A had been changed through 180 degrees. If both waves are turned through 180 degrees, the result is the original zero degree phase difference. Exactly 180-degree phase difference is indicated only if the pattern is a single line, located in the quadrants shown. Additional details concerning the phase relation indicated by such patterns will be found in the chapter devoted to practical applications of the tube for the determination of phase relation.

The phase relation of two voltages applied to the vertical and horizontal plates, respectively, is not limited to 0 or 180 degrees. Any phase difference between 0 and 180 degrees may be recognized upon the screen. In connection with phase difference, while it is true that the complete cycle of angular rotation is 360 degrees, certain phase angle representations appear alike, when viewed upon the cathode-ray tube screen. Phase difference patterns representative of angles between 0 and 90 degrees find their duplicates in patterns which vary in phase from 270 to 360 degrees. Patterns, which vary in phase from 90 to 180 degrees, find their duplicates in patterns which vary in phase from 180 to 270 degrees. In other words, a pattern which indicates a 45-degree phase difference may also be 315 degrees; 90-degree phase shift may also be 270 degrees and 135 degrees may also be a 225-degree phase shift. For ordinary purposes, however, in connection with radio receiver, public address amplifier and "ham" transmitter adjustment, phase difference observations between 0 and 180 degrees are entirely sufficient.

Continuing with like frequency signals supplied to the two sets of deflecting plates, if these signals differ in phase by 90 degrees, the resultant pattern is a circle, providing that the amplitudes of both waves

are alike. The development of this circular pattern is shown in figure 48. Any deviation from like amplitudes results in an elliptical pattern, instead of a circle. However, the shape of the pattern cannot be confused with one of different phase difference, because the "Y" axis divides the image in two, when the exact 90-degree phase difference exists. For that matter, the "X" axis is also a bisecting line. For higher or lower values of phase difference, the image tilts one way or the other.

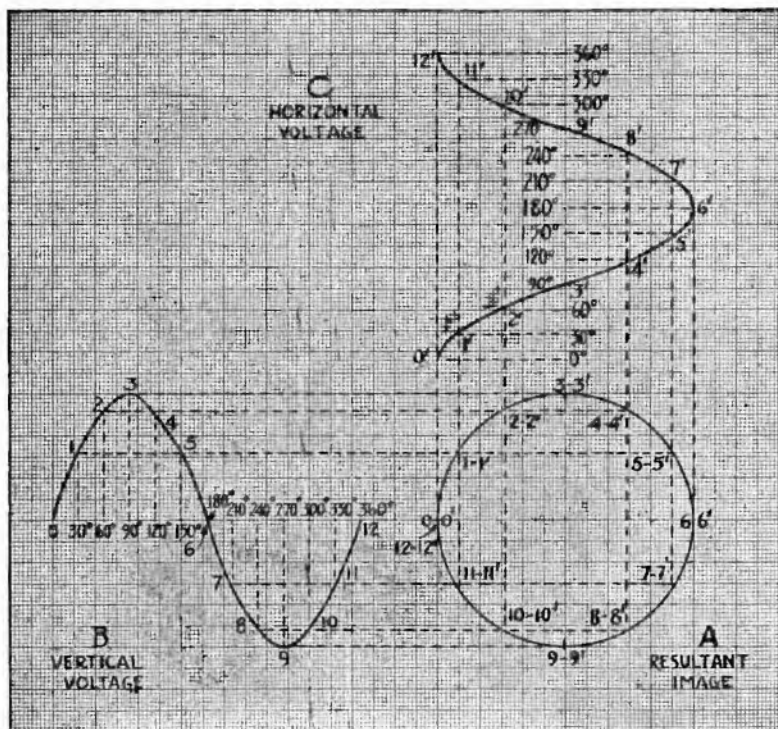

Fig. 48. The sine wave at B is 90° out of phase with the one shown at C, so that the resulting pattern is a circle. Note that the time axis here is divided into degrees of a circle instead of fractions of a second as in previous drawings.

You will note, if you examine figure 48, that the time reference line has been designated in degrees, the divisions being in uniform time of 30 degrees. This should make it easier to comprehend the resultant movement of the spot through a circle of 360 degrees. A general idea of the effect of waveshape and phase relation upon the pattern developed, when both voltages are of like amplitude, is given in figure 49.

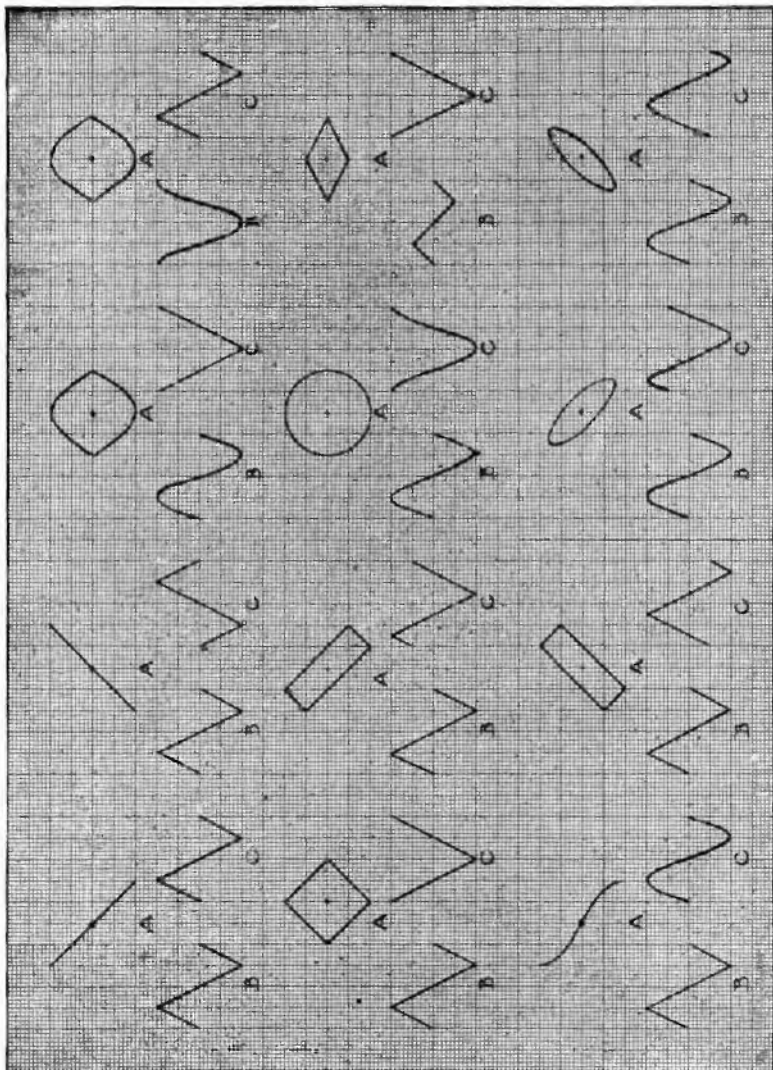

Fig. 49. In each case A is the resultant image that will appear upon the screen when the wave at B is impressed on the vertical deflecting plates and the wave at C on the horizontal plates. These waves are of equal amplitude and have the same frequency.

In each of these, A is the resultant image, B is the vertical deflection voltage and C is the horizontal deflection voltage. Furthermore, the frequency of both voltages is the same. From these patterns one can

gather an idea of the resultant pattern, under the conditions cited, when the wave shape lies between limits represented by sine waves as one limit and linear waveforms as the other limit. (The idea to present such limits was obtained from the Western Electric Bulletin No. 176.) In each case, the resultant can be computed from the two deflecting voltages, because all three patterns are based upon the same time interval and also upon a uniform amplitude basis.

Photographs of various phase relations for different kinds of deflecting voltages will be found in the chapter devoted to practical application of the cathode-ray tube.

Whether or not the patterns shown in figures 46-B, 47-B, 48 and 49 will remain stationary for any one condition, or will drift from shape to shape, that is, drift from a single line to an ellipse and to a circle and reverse, depends upon the constancy of the frequency and phase relation. If one of the frequency sources, or if the frequency of one of the deflecting voltages is continuously changing, no matter how slight this drift, the pattern will not remain stationary. It is going to be in motion and change its shape continually, because the phase relation is continually changing. Normally two signals which bear a certain phase relation to each other remain in that phase relation as long as the frequencies remain constant, and other controlling factors remain constant. The movement of a pattern resulting from the application of two frequencies, which are substantially identical, takes place at a rate equal to the difference frequency. In other words, the rate of change of a pattern through the complete 360 degrees is an indication of the frequency difference between the two frequencies.

From what has been said so far, it is evident that these patterns are suitable for frequency comparison. In other words, a stationary pattern indicative of any phase relation, and which is a single line, circle or ellipse, shows that both frequencies are identical. If one of these voltages be of known frequency and the other of an unknown frequency, the adjustment of the unknown to produce the patterns mentioned, is that for the known frequency and can be so calibrated. As a matter of fact, one of the important functions of the cathode-ray oscillograph is frequency comparison, as will be shown later. In this connection, it affords an excellent and extremely accurate means of comparing audio frequencies, which normally require very elaborate and expensive standards. By proper operation, as shall be shown, one or two audio standards of single frequencies are sufficient to calibrate a range as great as from 30 to 10,000 cycles.

The patterns formed when two varying voltages are applied to the two sets of deflecting plates, one such voltage to each set of plates, are known as Lissajous' figures. These figures can be developed under various conditions and they will assume various shapes. It is the nature of the pattern which enables its use for frequency comparison. When both voltages are sine waves, or for that matter, if both contain several harmonics, or if only one contains several harmonics, one type of pattern is developed. If one of the waves is a sine wave and the other is a saw-tooth wave, another type of pattern is developed. It might be well at this time to distinguish between Lissajous' figures, which result from the application of sine-wave voltages to both sets of plates, modulated or unmodulated, and the figure which appears when one of the voltages is a saw-tooth wave. It has been customary in the past to apply the term Lissajous' figures to those patterns which occur when two varying voltages are applied to the two plates, in any phase relation and in any frequency ratio. Also to apply the name to the pattern which appears when one of the voltages is a saw-tooth wave and the frequency ratio between the two voltages is not a simple integral ratio, with the saw-tooth voltage being the lower of the two frequencies. The reason for making this qualification is that under certain conditions, namely, when the saw-tooth voltage is of a frequency which is an exact submultiple of the other voltage, the pattern which appears upon the screen is the waveform of the other voltage. It would be incorrect to call such a pattern a Lissajous' figure.

Lissajous' figures may be of varied shapes. They may be complex or simple, depending upon the frequency ratio between the two varying voltages and the characteristics of these voltages, whether modulated or unmodulated, sine or distorted, relative amplitudes and phase relation. As a general rule, when used for the comparison of frequencies, the known and unknown signals are secured from oscillators, so that a certain type of pattern is usually developed. Fortunately, when the frequency ratio between the two voltages is higher than a certain order, a stationary pattern is not desired. Instead, a slowly changing pattern is arranged. This means that the two frequencies are not in exact ratio and a continual change in phase relation is taking place. The determination of the frequency is made during the time that the pattern is rotating very slowly. Then the exact calibration is accomplished by stopping the pattern and noting the exact setting of the oscillator being calibrated. All of this is practical data. Let us devote some attention to the development of a Lissajous' pattern.

We have shown the pattern resulting from the application of two sine waves of like frequency. Suppose that we make one frequency three times as high as the other. The exact numerical values are of no importance, just so long as the amplitude of the voltages is sufficient to cause the proper deflection, and the ratio of the two frequencies is as 3 is to 1. The higher of the two frequencies is applied to the vertical deflection plates and the lower of the two frequencies is applied to the horizontal deflection plates.

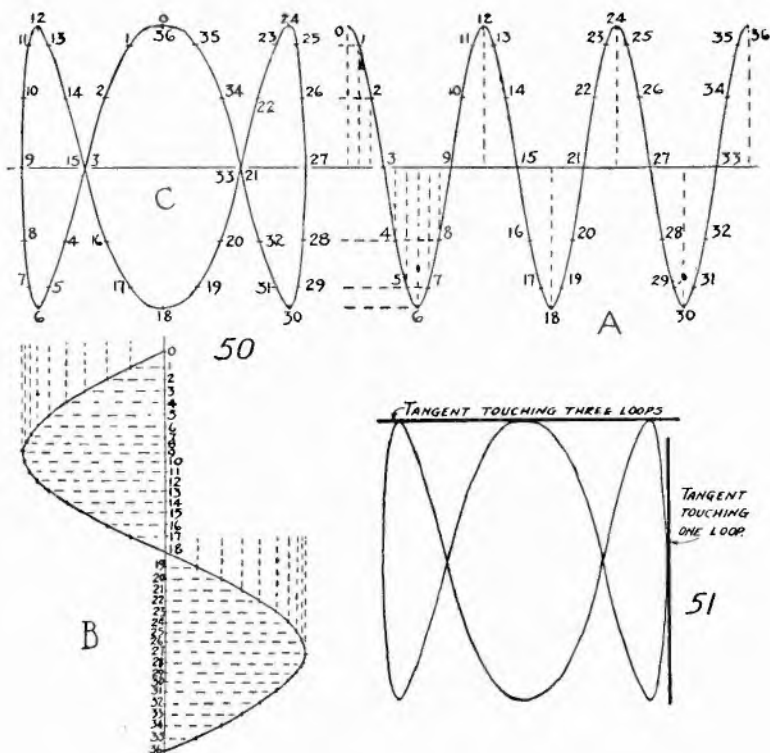

Fig. 50. The sine wave at A is three times the frequency of that at B and is 90° out of phase. Both waves are divided into equal time intervals. The numbers on the resultant image at C indicate the amplitude displacement of each wave at the same instant.

Fig. 51. By drawing tangents to the loops at the horizontal and vertical sides of the pattern and counting the number of loops that each touches, the ratio between the two frequencies impressed upon the plates of the tube can be easily found.

In figure 50, A is the vertical deflection voltage, B is the horizontal deflection voltage and C is the resultant pattern. You will note that

the two voltages are 90 degrees out of phase. Both vertical and horizontal deflection voltages are divided into the same equal time intervals. To develop the resultant pattern, you position the spot as a result of the amplitude displacement of both waves. This is indicated by the numbers. The pattern shown is quite common for various frequency ratios.

Once again we want to call to your attention that the pattern is made by a single spot which moves through these various positions. The fact that the image is in line form is due to the repeated movement of the spot through the same positions. The pattern is uniform, that is, tangents drawn to each side would produce a square. This is shown because of uniform amplitude of both of the deflecting voltages. If the vertical deflection voltage is greater than the horizontal deflection voltage, the pattern would be higher and the image formed by the intersections would be narrower. Conversely, if the horizontal voltage is greater than the vertical deflecting voltage, the pattern widens and becomes flatter.

By drawing a tangent to one vertical side of the image and one horizontal side of the image, it is possible to determine the frequency ratio. The frequency ratio is the ratio between the number of loops which touch the tangents. See figure 51. With such simple patterns, it is not necessary to draw tangents to determine the frequency ratio. The number of loops upon each side can be counted without any additional aids.

The number of patterns which may result from the application of two equal such voltages are quite numerous, and as has been stated, depend upon the phase relation. Figure 50 illustrates a pattern obtained when the two voltages are 90 degrees out of phase. Figure 52 illustrates the pattern which is produced when these two voltages are in phase. If you check the development of this pattern, you will find that certain loops are in back of others, so that only two peaks are seen, instead of the six peaks in figure 50. Peak 10 is directly behind peak 2. Peak 14 is directly behind peak 22. Peak 6, appears as a straight line at the left and peak 18 appears as a straight line at the right. To comprehend properly such Lissajous' figures, it is necessary to imagine the wave traveling around a transparent glass cylinder, through which the front and rear patterns are visible. The view obtained is the elevation or side view. At certain time intervals in a moving pattern, certain parts of the pattern would be directly behind each other, so that all parts of the wave would not be visible. This is shown later in this book.

The transition from the pattern in figure 50 to that shown in figure 52, occurs in the time required for a 90-degree travel of the wave. For the purpose of frequency comparison, phase relations other than 0 or 180 degrees are preferable. The 0-degree and 180-degree patterns

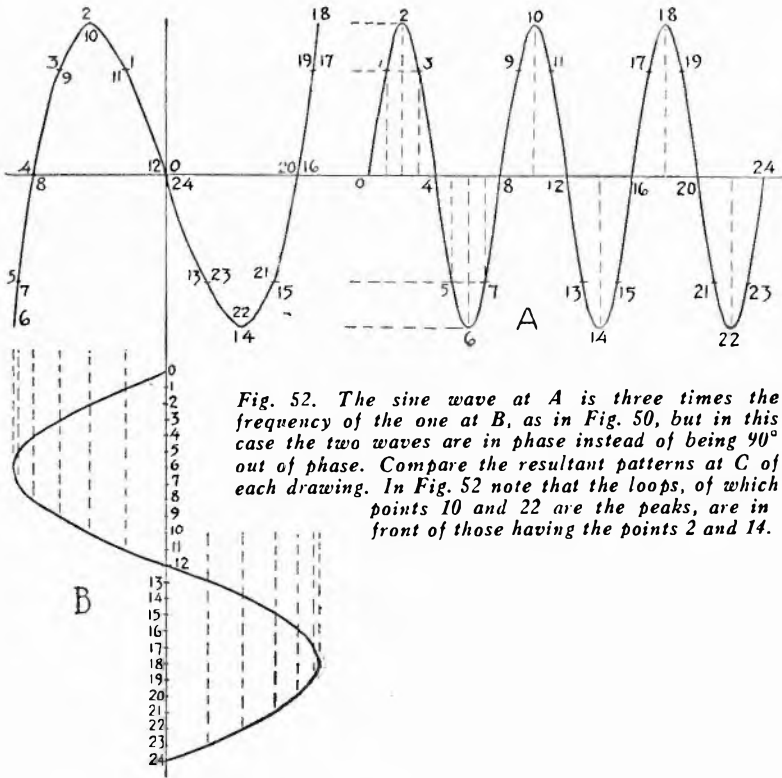

Fig. 52. The sine wave at A is three times the frequency of the one at B, as in Fig. 50, but in this case the two waves are in phase instead of being 90° out of phase. Compare the resultant patterns at C of each drawing. In Fig. 52 note that the loops, of which points 10 and 22 are the peaks, are in front of those having the points 2 and 14.

are very similar, lacking all intersections, but differ in the positions of the peaks shown in figure 52. In the 180-degree pattern, the whole image would be turned upside down. The appearance of the pattern for 90-degrees and 270 degrees is also identical, except for the fact that the image would be turned upside down. However, since the image is symmetrical, turning it upside down, would not change the appearance of the pattern. Separation of the peaks, which are directly behind each other in the 3-1 patterns for 0 and 180 degrees, is accomplished by changing one frequency very slightly. A fraction of a cycle change is sufficient to separate the peaks.

Ratios as high as 10 to 1 can be easily observed with patterns such as that shown in figure 50. In each case tangents drawn to two sides and counting the number of loops or peaks which touch these tangents will identify the frequency ratio. Such identification requires that one frequency be known and further that the plates to which this voltage has been applied, be known. The relation between the frequency of the voltage and the plates to which the voltage has been applied is important, because it places the loops along the proper axis.

Space does not permit a complete explanation with full data concerning the development of all types of Lissajous' figures. We feel that illustrations of various types of these figures, given in connection with the practical application of the tube to frequency comparison, will serve its purpose better than a detailed accounting of how the final patterns are developed. Development of the most intricate pattern progresses exactly as outlined for the simplest of patterns. However, the actual work is naturally more detailed and more intricate because of the greater number of spot positions which must be established.

As far as the positioning of the beam spot to produce any one type of pattern, it should be understood that it is applicable to all types of voltages. While it is true that the pattern resulting from a 4-3 ratio, obtained by applying two sine voltages, will differ from that developed when one of these voltages is a saw-tooth wave, the actual method of development remains the same. If you are interested in solving such a problem, draw four cycles for the vertical deflection plates and three cycles of a saw-tooth wave for the horizontal axis, employing the same time interval for both. Mark off the respective amplitudes and project the resultant spot displacement as has been done for a number of illustrations in this chapter. We take this opportunity of advising you that it will be an arduous task.

We feel that it is not necessary to advance any further with the actual development of Lissajous' figures, because far more valuable information can be conveyed by showing the types of figures which are actually experienced in practice, and explaining the applications of these figures.

Voltages with Variable Frequency and Amplitude

Before closing this chapter, we must make reference to one other combination of varying voltages applied to the two sets of deflecting plates. This is the arrangement wherein the voltage applied to the vertical deflection plates varies both in frequency and in amplitude and

wherein the horizontal voltage is a saw-tooth wave. This material is related to what takes place during visual alignment. There is much more to be said about the subject, but what is here presented should be of value in comprehending the basic development of the pattern upon the screen. Reference to the chapter devoted to the practical application of the tube for visual alignment will establish the remaining details, as they relate to the various methods in use at the time of this writing.

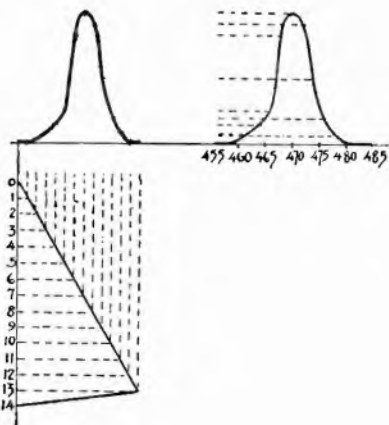

Fig. 53. The sweep frequency is such that one cycle occurs during the time that the oscillator's frequency varies from 455 to 485 kc. The tuned circuit to which this band of frequencies is applied is resonant at 470 kc. The frequency response curve taken across the detector load appears at the right and its image, as seen on the screen is at the left, above the sweep.

Examine figure 53. Let us assume that an oscillator is arranged to vary in frequency of output from 455 kc. to 485 kc., once each second. The signal from this oscillator is applied to a detector tube through a tuned circuit. This tuned circuit is made resonant to a frequency of 470 kc., which is the mean frequency of the band covered by the continuously variable oscillator. There is supplied to the detector tube a signal voltage, which varies in amplitude with the response characteristic of the tuned circuit. As a result the rectified voltage across the detector load varies in accordance with the response characteristic of the tuned circuit. If this voltage is applied to the vertical deflection plates of the cathode-ray tube, it is the equivalent of applying to these plates a voltage which varies in amplitude at a definite rate, namely, the rate at which the oscillator covers the frequency band specified. The sweep frequency is adjusted so that one full sweep cycle takes place during the oscillator frequency change over the band. The result is that the sweep voltage displaces the spot in one direction (horizontal) and the signal voltage applied to the vertical plates displaces the spot in the other direction (vertically). The resultant displacement of this

spot develops the resonance curve. The pattern is stationary, because the sweep is in step with the frequency variation and the position of the spot is recurrent during each cycle.

Actual visual alignment devices employ this basis of developing the resonance curve. There are, of course, certain differences between the design of the practical units and the explanation here given, but the basis of operation, as here presented, is substantially that experienced in practice. Although this reference and explanation covers what is the i-f. band, let it be known that it is applicable to the r-f. band and also to the a-f. band. As far as the latter is concerned, the shape of the resonance curve differs, as a result of the difference between an a-f. system response characteristic and an i-f. or r-f. system response characteristic, but the basis of operation remains unchanged. What has been said, as will be shown later, is applicable to all types of frequency modulator circuits and to single and double pattern systems.

CHAPTER IV

COMMERCIAL CATHODE-RAY OSCILLOGRAPHS

We now are ready to consider the structure of the cathode-ray oscillographs offered for commercial use. Let it be known that it is our intention to discuss those devices which are being offered for use by the radio servicing industry for radio receiver design and servicing, public address design and servicing and to the amateur radio fraternity, for the adjustment of "ham" transmitters. There are in use a large number of cathode-ray units intended for the industrial field and college laboratories. In many respects these devices are like the ones to be described in the pages following, but since we are catering to a limited field, we deem it best to devote very little space to the application of the tube to fields and industries other than those named. At the same time, we recognize that many of the industrial applications are similar to those found in our fields, because the method of utilizing the cathode-ray tube is to convert mechanical and other physical impulses into electrical impulses and to interpret the cathode-ray tube image accordingly. As such we hope that some of the information contained in this volume will be of value to the men, who will employ the cathode-ray tube in the industrial field.

To analyze properly the structure of the commercial cathode-ray oscillographs available at this writing, for use in the fields named, we must of necessity classify the instruments in basic types. Perhaps others may not agree with our method of classification, but since no definite standard classification is available, we take the liberty of establishing our own.

1. The basic unit is the cathode-ray tube with its power supply.
2. An elaboration upon this basic unit, which forms class 2, the most popular is the cathode-ray tube with its power supply and to which has been added amplifiers for the vertical and horizontal deflection plates and a linear (saw-tooth oscillator) sweep circuit

These are the two basic divisions. Elaboration upon basic units 1 and 2, are accomplished in several ways, dependent upon the nature of the service involved. Basic unit 1 can be converted into basic unit 2, thereby greatly expanding upon its field of application, by the addition of the component circuits stated.

Elaboration upon basic unit 2, is also possible by the addition of some means, generally known as a frequency modulated multi-wave-band oscillator covering the i-f. and broadcast band, sometimes the high frequency band, whereby a frequency modulated signal is available. (By frequency modulated signal is meant a constant voltage output which changes over a pre-determined frequency band, as a result of some action associated with the oscillator, or as a result of a separate unit intended to perform that function.) This is the unit intended for visual alignment work.

Investigation of the cathode-ray instrument market brings to light the fact that certain instruments intended solely for such visual alignment and not possessing controlled sweep circuits, are available. It is possible that this type of unit constitutes a third classification, but we feel that it is not justified. Recognizing the tremendous versatility of the cathode-ray tube as used in basic unit 2, the addition of equipment for alignment is just an expansion of its functions, particularly so when a unit, such as that stated as basic unit 2, can be expanded to include alignment by means of simple external equipment. Consequently, we openly state that it is preferable to expand basic unit 2 to include alignment than to expand a cathode-ray system, developed solely for alignment, to include the functions and capabilities of the tube equipped with power supply, amplifiers and linear sweep circuit. We make this statement with the full knowledge that it is possible that several visual alignment cathode-ray units, intended solely for such work may make their appearance upon the market. As such, they fill only one need. When expanded upon, as stated before, the ease of operation, so much required, is not achieved.

It is true that certain types of units of limited utility are suitable, if they fill certain needs—when it is definitely known that the needs considered are all which will ever be required. Thus, the basic unit 1 is suitable for the modulation percentage checking of transmitters, without any additional equipment. But as will be shown later in this volume, there is much more to the adjustment of a "ham" transmitter than merely determining the percentage of modulation, so that basic unit 2, is by far preferable.

No serviceman, after analyzing the servicing field, can say that the only function he can see for the cathode-ray tube is its use for visual alignment. With this thought in mind, we will embark upon the discussion of the various types of cathode-ray oscillograph units available in this country and the structure of each. It is not the purpose of this volume to compare the merits of each of the instruments described herein. All that we shall do is to discuss the structure of each. Decision to buy one or the other must come from the prospective purchaser. The only aid we can give is to describe the operating capabilities of the devices presented.

It might be well at this time to call to your attention something which you may or may not notice as you examine the wiring diagrams of the commercial units. The examples of spot displacement, cited in an earlier chapter, showed all four deflecting plates free and with separate connections. This is contrary to the electrical connections actually found in the usual run of three and five-inch tubes. As a general rule, one plate of each set is joined to the other and connected to anode number 2, so as to keep these two plates at ground potential. This gives rise to a slight amount of distortion of the pattern, in the form of a departure from a perfect square when equal amplitude voltages are applied to the two sets of plates. However, this amount of distortion in no way interferes with the normal operation of the tube when making tests of the type outlined in this volume.

National Union Model 3-5 Cathode-Ray Oscillograph

Various views of this unit are given in figure 54. The schematic wiring diagram is given in figure 55. Referring to the mechanical structure of the device, the unit will accommodate either a 3-inch or a 5-inch tube. The major variable operating controls are located upon the front of the panel and the switching controls, to be outlined, are located in the rear of the metal housing. Incidentally, the construction just mentioned is undergoing a change during this writing. Advice has been received that the connecting terminals, now located upon the rear, will be mounted in front with the variable controls.

Referring to the variable controls, they consist of a rough frequency adjustment of the linear sweep circuit; a fine frequency adjustment of the same circuit and an amplitude control, whereby the length of the sweep beam across the screen is controlled. Also a synchronizing control, for synchronizing the sweep voltage with the frequency of the voltage under observation and the control which adjusts the intensity of the

spot. A spot positioning control, operating along the "X" axis is mounted on one side and is accessible through a hole in the housing. From information gathered at the time of this writing, the new units will also

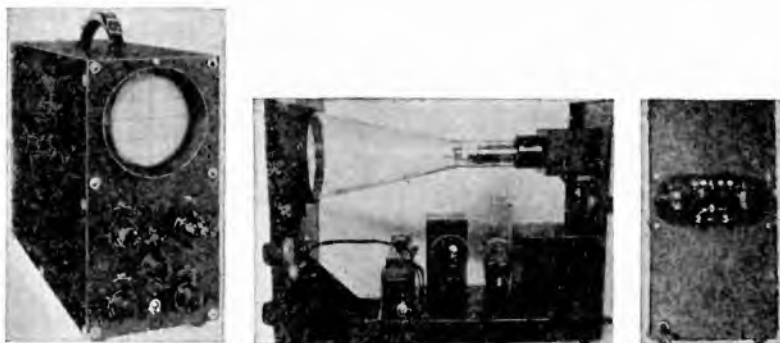

Photograph at left courtesy National Union Radio Corp.

Fig. 54. Left, panel of the National Union oscillograph. The cross-section lines are ruled on a transparent shield that clamps over the screen of the tube. Middle, chassis showing the 5-inch cathode-ray tube in position. Right, rear panel to which connections are made to the deflecting plates.

possess a "Y" axis positioning control. A focusing control is also available through the side of the metal housing. It controls the anode number 1 voltage.

Referring to the schematic wiring diagram, the unit consists of the cathode-ray tube, a full-wave rectifier power supply for all of the voltages, a thyratron sweep circuit oscillator and two single stage resistance-capacity coupled audio amplifiers. By means of pin plugs and pin jacks, designated as A, D, S, D and A upon the wiring diagram, it is possible to arrange the single stage amplifiers in such manner that voltages to be observed and applied to the vertical and horizontal plates, are amplified. These amplifiers are rated at a voltage step-up of 35 for each stage. It is possible, if so desired, to feed the sweep circuit through one amplifier to the horizontal plates. It is also possible to connect the sweep circuit directly to the horizontal deflection plates; in which case, both amplifiers may be connected in cascade to amplify the signal being applied to the vertical deflection plates.

By means of these pin jacks, plugs and terminals, direct connection may be made to the horizontal and vertical deflection plates without passing through the amplifiers or without involving the sweep circuit. Each of the amplifiers is independent of the other, so that either one may be used in connection with the horizontal or vertical deflection voltages, without making it necessary to employ the other amplifier.

Provision is made by means of the connecting terminals to employ internal or external synchronizing pulses. According to the manufacturer's rating, the amplifiers used in the unit are linear from 20 to 100,000 cycles. The range of the linear sweep circuit, according to the manufacturer is such that frequencies up to 20,000 may be studied. (Editor's Note. By using the 5-inch tube, frequencies up to about 100,000 cycles have been studied, although a more reasonable limit would be about 80,000 to 90,000 cycles.)

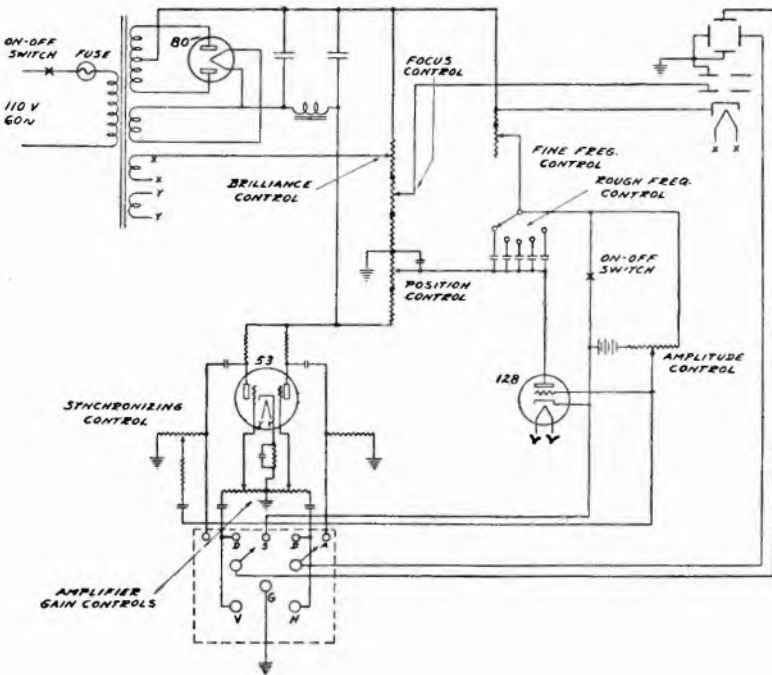

Fig. 55. The schematic diagram of the National Union Model 3-5 oscillograph. The terminals within the dotted square and the two amplifier gain controls are on the rear of the instrument.

Perhaps it would be well to say a few words about the sweep circuit used in this instrument. When this sweep voltage is applied to the horizontal deflection plates without going through the amplifier, the position of the spot, with the amplitude control set at minimum, is to the extreme right end of the screen. As the amplitude control is varied, the spot moves towards the left and the sweep voltage results in a line, which can be lengthened until it extends across the screen. The

operation of this system, may prove puzzling, hence this short description. When the unit is placed into operation with the sweep amplitude control set to minimum, the potentiometer adjustment across the thyatron control grid bias battery is such that the tube is fully ionized and is, in effect, short circuiting the frequency control condensers. With the horizontal deflection connection plug in the pin-jack S, the thyatron cathode potential is approximately that of the plate and since the free horizontal deflection plate is joined to the cathode, this plate is positive with respect to its associated horizontal plate and the beam is deflected towards the free plate and away from the center of the screen. During this state, the voltage developed across the frequency control condensers is substantially zero. It is conceivable that a small amount of voltage is being built up across these condensers, or that the amplitude of the sweep voltage is a finite value, rather than zero, but it is more convenient to think of the sweep voltage at zero, since the spot is not moving at all and does not appear to be larger than originally adjusted with the focusing control.

As the amplitude control is varied, a higher voltage is necessary between the thyatron plate and cathode, in order that the tube trip or flash. This means that a finite value of voltage is being built up across the frequency control condensers. As a result of the electrical connection of the free horizontal plate to the cathode of the thyatron and since the cathode is connected to what is the negative side of the frequency control condensers, the voltage developed across the frequency control condensers nullifies a portion of the original potential difference existing between the two horizontal plates. Also since the free horizontal plate now is not at the same positive potential with respect to its associated plate, the spot moves away a certain distance from the free plate. With this adjustment of the amplitude control, the tube trips at a definite rate and each time that it flashes, it returns the spot to its original starting position. As the voltage builds up across the frequency control condensers, the spot again moves across the screen. This is repeated and the result is a line part way across the screen representative of the sweep voltage.

As the amplitude control is increased, a greater value of voltage builds up across the frequency control condensers and the spot is moved further across the screen and away from its original position, thus making the sweep voltage line longer. To aid in the movement of the spot past the center of the screen, the thyatron plate receives a positive voltage as a result of its junction on the power supply voltage

divider. The sum total result is that by means of the sweep circuit amplitude control, it is possible, as has been stated, to increase the sweep voltage until the line spreads across the entire screen. This sweep circuit has its potentiometer sweep analogy in the sweep circuit shown in figure 29.

As is the case with all thyratron circuits, the linearity of the sweep voltage is influenced by the amplitude. The lower the amplitude, the more linear the saw-tooth wave output. More about this later. Referring to the amplifiers, both have variable gain controls. Synchronization of the sweep voltage and the voltage waveform being observed is accomplished by feeding a small portion of the voltage fed to the vertical deflection plates into the control grid of the thyratron. A potentiometer controls the magnitude of this synchronizing pulse, obtainable internally or externally. The letters V, H and G designate the terminals; for the free vertical plate as V, for the free horizontal plate as H and the common ground as G.

In the operation of the sweep circuit, the rough frequency adjustment is accomplished by varying the condensers, five being used and selected by means of a switch. Fine frequency control is accomplished by varying the resistor in series with the frequency control condenser bank. As has been stated in connection with sweep circuits earlier in this text, adjustment of the amplitude control has an effect upon the frequency, so that when any adjustment is made upon the amplitude control to spread the image, a supplementary adjustment will be required in order to stop the image, so that it is stationary upon the screen. The fine frequency control is used for this purpose. The instrument does not contain a sinusoidal sweep.

Much more can be said about the synchronization control, but perhaps it is best to wait until we discuss the practical application of these devices, since the effect of the synchronization adjustment is general with respect to all units which possess such a control.

Dumont 145 Cathode-Ray Oscillograph

The details given in connection with the National Union model 3-5 cathode-ray oscillograph are applicable in their entirety to the Dumont model 145 instrument. See Appendix for Dumont Model 148 Oscillograph.

RCA Model TMV-122-B Cathode-Ray Oscillograph

Various views of this unit are shown in figure 56. The schematic wiring diagram is shown in figure 57. As far as components are con-

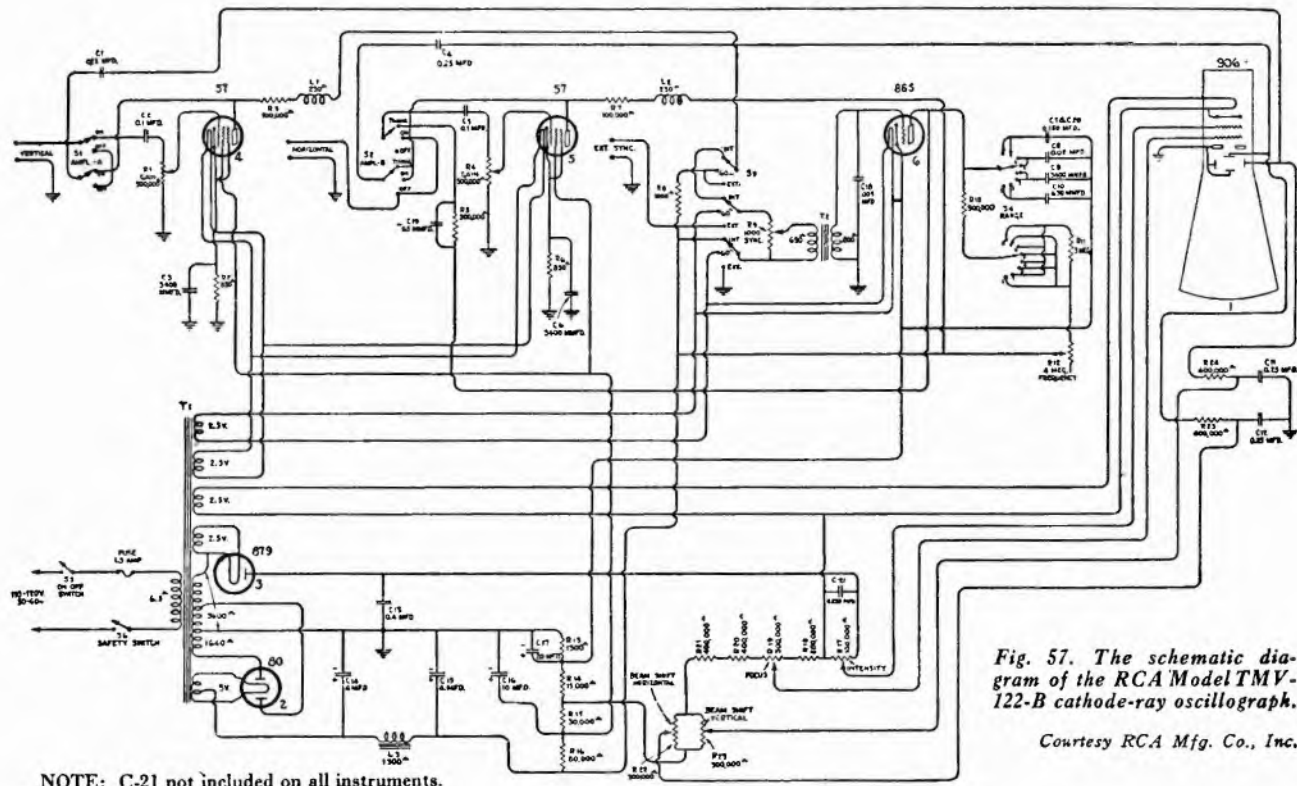

Fig. 57. The schematic diagram of the RCA Model TMV-122-B cathode-ray oscillograph.

Courtesy RCA Mfg. Co., Inc.

cerned, the instrument consists of a type 885 grid controlled gas triode, which is in effect a thyratron, as the saw-tooth wave-time axis oscillator, two individual resistance-capacity coupled amplifiers, a two-tube rectifying system, one tube functioning as a full-wave rectifier supplying the plate and grid voltages for the two amplifiers and the other tube functioning as a half-wave rectifier supplying the various operating potentials required for the 906 cathode-ray tube.

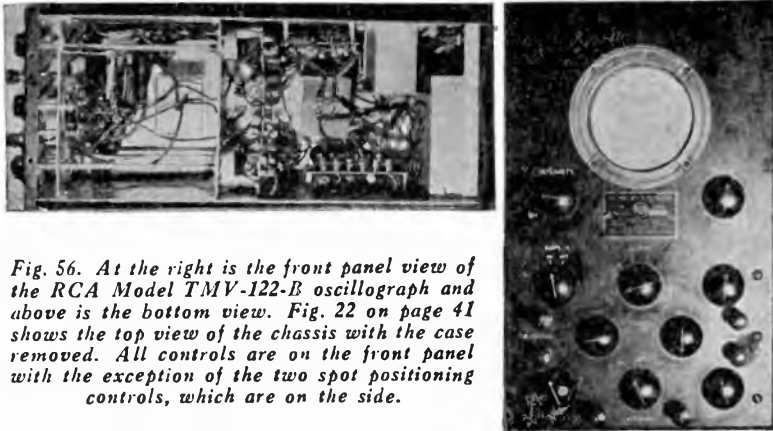

Fig. 56. At the right is the front panel view of the RCA Model TMV-122-B oscillograph and above is the bottom view. Fig. 22 on page 41 shows the top view of the chassis with the case removed. All controls are on the front panel with the exception of the two spot positioning controls, which are on the side.

All of the continuously variable controls are mounted upon the front of the panel. The spot positioning controls for the "X" and "Y" axes are accessible through holes in the side of the metal housing. Referring to the controls on the front of the panel, they are the spot intensity control, the spot focusing control, on and off control for the vertical deflection plate amplifier, gain control for the vertical deflection plate amplifier, on and off control for the horizontal deflection plate amplifier, which also controls the connection of the sweep circuit to the horizontal deflection plate amplifier, rough frequency adjustment control, fine frequency adjustment control, gain control for the horizontal deflection plate amplifier, switch for selecting the internal or external synchronization pulse and synchronization control. Also the terminals for the horizontal and vertical deflection plates and external synchronization pulse.

Referring to the schematic wiring diagram, the type 879 tube is used as the half-wave rectifier. The type 80 tube is the full wave rectifier. The type 885 tube is the time axis voltage oscillator. The two type 57 tubes are the individual amplifiers. A 3-inch type 906 tube is used as

the cathode-ray tube. There are several significant features which must be brought to your attention. Selection of the amplifiers is done by means of switches. Provision is made to feed the vertical deflection voltage through an amplifier or to the vertical plates without the amplifier. However, at no time is direct connection to the plates available without entering the chassis. A 0.25-mfd. condenser is connected into the circuit lead to the vertical plates. This condenser is in the circuit, with or without the amplifier. The same is true of the horizontal deflection plate input circuit. The input systems of the two amplifiers have a blocking condenser of 0.1 mfd. in each grid lead. The gain control is in the grid circuit of each of the amplifier tubes.

The sweep circuit is tied in with the horizontal deflection plate amplifier, so that whenever the sweep circuit is used, its output voltage is amplified by the horizontal deflection plate amplifier. Whenever the switch is set for internal synchronization, a portion of the signal voltage at the plate of the vertical deflection plate amplifier is fed into the grid circuit of the sweep oscillator. The amplitude of the synchronization pulse is controlled by means of a 1000-ohm gain control potentiometer across the input of the synchronizing pulse transformer. Internal synchronization cannot be used, unless the vertical deflection plate amplifier also is used. The external synchronization pulse may be applied with or without the vertical deflection plate amplifier in use.

It is possible that if you try to correlate the four frequency condensers, shown in the schematic wiring diagram, with the eight terminals used for the rough frequency control, that confusion may arise. A variation in frequency is accomplished by automatically switching different values of fixed resistance into each of the condenser circuits. The rough frequency control gang switch is in two sections. The first, third, fifth and seventh positions place the fixed condensers into the circuit in series with the fine frequency control variable. This takes care of four of the eight positions. The second, fourth, sixth and eighth positions of the switch connect a fixed resistor in series with the rough frequency control condensers, which combination in turn is connected in series with the fine frequency control resistor. This takes care of the remaining four tap positions. The design of the unit is such that each position of the switch changes the frequency of the sweep in such manner that multiples of the lowest frequency are available, and with sufficient synchronization, the image remains locked and all that varies is the number of cycles appearing upon the screen. The basic equivalent of this sweep circuit is that shown in figure 34.

You will note in the diagram that the amplitude of the sweep voltage is controlled by the horizontal deflection plate amplifier. The amplitude of the actual sweep voltage developed in the timing axis tube is definitely fixed, by means of a fixed bias between the cathode and the ground, which is the return position of the thyatron control grid. The free vertical and the free horizontal deflection plates are connected to ground through a 400,000-ohm resistor in each leg, which joins the voltage divider. This minimizes the collection of a charge upon either set of plates, when only one set is actually in use. It is significant to know that the impedance of the synchronizing circuit input is very low, so that proper provision must be made, when connecting the high side of this circuit to the external synchronizing signal source, not to load the circuit supplying the signal. The ground in the system is common to all of the circuits. The 60-cycle synchronizing pulse is secured from a 2.5-volt winding upon the power transformer.

Kaltman-Romander Cathode-Ray Oscillograph

Various views of this instrument are shown in figure 58. The connecting terminals to the horizontal and vertical deflection plates and



Fig. 58. Above is the panel view of the Kaltman-Romander oscillograph and on the right is the side view, showing the locations of the various batteries.

external synchronizing signal, are located in the rear of the housing. All of the other variable controls, inclusive of the switches, are located on the front panel.

The schematic wiring diagram of the unit is shown in figure 59. There are five tubes in the complete instrument. They are the 906 3-inch cathode-ray tube, a type 81 as a half-wave rectifier to supply the anode voltages to the cathode-ray tube, a type 80 full-wave rectifier which supplies the plate voltage for the sweep circuit, a type 885

thyatron and a type 34 pentode, used as the constant current tube in the sweep circuit. The knobs upon the panel control the rough adjustment of the linear sweep frequency, the fine adjustment of the sweep frequency, the amplitude of the linear sweep, the degree of synchronization, the intensity of the signal voltage applied to the horizontal deflection plates, the intensity of the signal applied to the vertical deflection plates, the spot intensity, spot focus, selection of

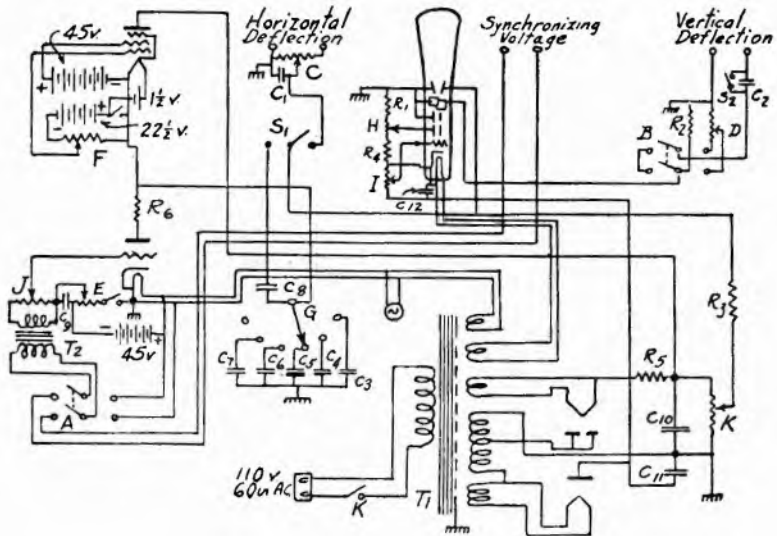

Fig. 59. The schematic diagram of the Kaltman-Romander oscillograph.

internal or external synchronization, direct connection to the vertical deflection plates, connection to the vertical deflection plates through a series condenser, exclusion of the vertical deflection plate potentiometer, internal or external sweep voltage to the horizontal deflection plates and on-off switch. This unit does not incorporate amplifiers for the horizontal or vertical deflection plates.

The screen and control grid voltages for the constant current control tube in the sweep circuit are secured from batteries. Battery form of supply is used for the filament current of this tube. A battery form of supply is used for the control grid of the 885 thyatron. The synchronization control potentiometer is located in the secondary circuit of the input transformer, but the impedance of this input circuit is still comparatively low, about 1,000 ohms.

The design of the sweep circuit used in this unit is substantially the same as that illustrated in figure 38. There is no means of positioning the spot along the "X" or "Y" axis.

National Cathode-Ray Oscillograph

This is what may be classed as being a "basic" unit. Several views are shown in figure 60. The schematic is given in figure 61. Con-

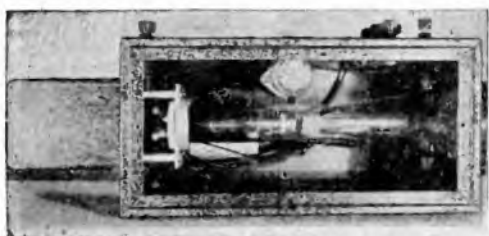
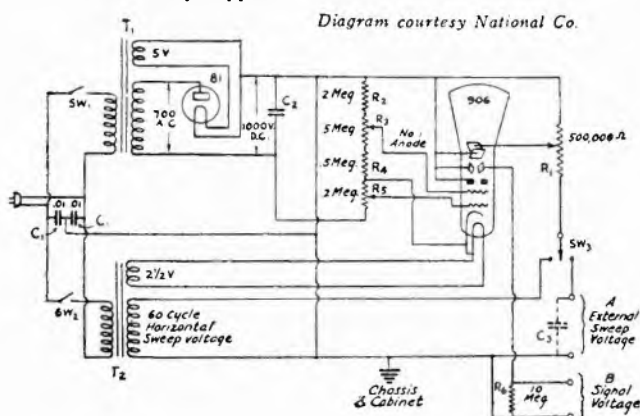

Fig. 60. Above is shown the interior of the National oscillograph and on the right is the panel view with the 3-inch screen of the cathode-ray tube.

Fig. 61. Below is the schematic diagram of the National oscillograph. No sweep is provided except the 60-cycle sinusoidal voltage from the power transformer. Other types of sweeps must be externally supplied.



controls are mounted upon the front of the housing and upon the right side. The spot intensity and spot focusing controls are mounted upon the front panel; also the power supply switch. The horizontal and vertical deflection plate connection posts are mounted on the side; also the potentiometer controlling the amplitude of the voltage supplied to the horizontal plates. The unit is equipped with a 60-cycle

sinusoidal sweep, which can be placed into or taken out of the circuit by means of a switch located on the side of the housing. This same switch makes provision for the connection of an external sweep to the horizontal deflection plates. The sinusoidal sweep voltage is secured from a winding upon the power transformer, hence the frequency of the voltage supplied by this winding is that of the power supply voltage. Two tubes are used in this instrument, namely the 906 3-inch type cathode-ray tube and an 81 half-wave rectifier, supplying the anode and control voltages for the cathode-ray tube. This unit is not equipped with a linear time axis oscillator. Direct connection to the horizontal and vertical plates is available through the terminal posts. There is no means of positioning the spot along either the "X" or "Y" axis.

Clough Brengle CRA Cathode-Ray Oscilloscope

The schematic wiring diagram of this unit is shown in figure 62. Six tubes are used. These are the 906 3-inch cathode-ray tube, an 81 as a half-wave rectifier for the cathode-ray tube anode and control voltages, an 80 as a full-wave rectifier supplying the amplifier voltages, an 885 tube as the timing axis voltage oscillator, a 2A5 as the timing axis voltage amplifier and a 57 as the amplifier for the signal voltage fed to the vertical deflection plates. Variable controls are available for the spot intensity, spot focus, spot positioning along the "X" and "Y" axis, including or excluding the vertical deflection amplifier, gain control for the vertical deflection, gain control for the horizontal deflection, rough linear sweep frequency adjustment, fine linear sweep frequency adjustment, synchronization pulse amplitude, and choice of internal, external or 60-cycle synchronization pulse. Synchronization between the sweep and the voltage applied to the vertical deflection plates is available, with or without the vertical deflection amplifier in the circuit. The amplifier, which is used to amplify the linear sweep voltage, is not available for separate use in connection with application of a voltage, other than the sweep, to the horizontal deflection plates.

The timing axis oscillator is of the type shown in figure 34, with the addition of an amplifier. The actual amplitude of the sweep voltage, developed by the timing axis oscillator, is fixed, as the result of a fixed bias. The variation in sweep voltage amplitude is achieved by varying the intensity of the amplified sweep voltage. The amplitude of the synchronizing pulse is governed by a potentiometer across the secondary of the input transformer. The primary winding of this trans-

former is not grounded. However, the impedance of this input circuit is comparatively low, so that care must be taken when connecting this circuit to an external source of synchronizing pulse. Photographic views of the unit are shown in figure 63.



Fig. 63. On the left is the panel view of the Clough Brengle oscillograph. Provision is made for using either a 3-inch or 5-inch cathode-ray tube. Above is the top view of the chassis.

Photo at left courtesy Clough Brengle Co.

According to the manufacturer's rating, the linear sweep circuit has a frequency range of from about 20 to 15,000 cycles as fundamental frequencies. As such, with about 6 cycles on the screen, observation of frequencies up to about 90,000 cycles is possible.

Other Cathode-Ray Oscillographs

There are available a number of other cathode-ray oscillograph units, produced by manufacturers not mentioned. The exact nature of these units is not known, but from available information, we can hazard the statement that they do not depart from what constitutes the features of the instruments described thus far. There may be slight variations, but as a general rule, recognizing existing requirements, most of the devices within a certain price class, are very similar in unit design, components and capabilities. One of the prominent manufacturers of oscillographs, intended for laboratory and industrial work, but whose units are not described herein because the data was not available, is General Radio Co. The absence of schematic and other data is due primarily to the fact that it was not supplied. The other schematics shown were supplied with the equipment which was purchased for use in connection with the preparation of this volume in the Successful Servicing Laboratory, owned by the publishers of this volume.

It is necessary at this time to call your attention to the fact that we consider alignment operations as just another practical application of the cathode-ray oscillograph, hence we will describe the cathode-ray instruments, intended solely for alignment or the development of response curves, when we discuss the development of response curves. Furthermore, since any one of the cathode-ray oscillographs described thus far can be used for the development of a response curve by the addition of other equipment, we shall show and discuss those units, when we apply the cathode-ray oscillograph to alignment operations.

CHAPTER V

PRACTICAL APPLICATION OF THE CATHODE-RAY OSCILLOGRAPH

Practical applications of the cathode-ray oscillograph, there are plenty. To present a list of its practical uses and to enumerate again these units in connection with the actual work, would be just so much duplication. Accordingly, we shall omit the usual list and consider each application in turn.

When talking about certain operating characteristics of cathode-ray oscillographs, we must take for granted that you who read these pages possess the type of equipment which is covered by this text. Of course, it is possible that the unit you own or operate may not be as versatile as that which we discuss. In that event a portion of what is said in these pages will apply to your equipment and you will be familiar with what other effects are experienced or introduced as a result of the manipulation of the controls existing in more elaborate equipment. However, there are certain subjects which can be discussed with total freedom, since they encompass operating features common to all types of cathode-ray oscillographs.

In as much as the general operation of the instruments is generally useful information, we shall start the discussion of practical applications by describing those points which come under the general operation category.

Spot Position

Spot positioning is a very important operation. While it is true that tubes should be manufactured in such manner that the normal position of the spot is in the center of the screen, certain slight discrepancies may arise, which will cause the spot to be off-center. This may be experienced when cathode-ray tubes are changed, or as a result of aging of the spot positioning resistors, or perhaps imperfect adjustment during some test. Unless the tube is so designed, that the normal position of the spot is off center (which is not the case in units now being sold), the first adjustment is the correct positioning of the

spot. If the unit on hand does not include spot positioning controls, then some other means, to be mentioned later, must be used. In the meantime, we shall assume that spot positioning controls are available.

The spot can be moved in two directions, vertically and horizontally across the tube. Figure 64 illustrates nine positions of the spot upon the cathode-ray screen. You will note a slight halo around the spot. This indicates an incorrect adjustment, as will be described later. However we deliberately made the spot larger than normal and exposed the film for a long time in order to bring out the full limits of the tube screen. Consider these illustrations from the angle of spot position only and not from the size of focus of the spot. These position adjustments were obtained by varying the vertical and horizontal spot position controls. Of these nine, only one is the correct position, and that is figure A. All the other pictures indicate location of the spots in incorrect positions.

Location of the spot in the correct position is important, because it influences the placement of the image upon the screen. The screen is not a perfectly flat surface and with the spot off-center, examination of a waveform, which may not have equal amplitudes for its positive and negative alternations, may place one portion of the image off the screen. Then again, spot positioning is also important, in order to permit the viewing of just such an image which does not have equal amplitudes both sides of the zero line. Whereas under one condition, the spot must be in the center of the screen, in the other, it may be necessary to move the spot above or below the center along the "Y" axis.

Often, when viewing resonance curves, when a comparison of amplitude is being made, the spot may move off the screen at the peak point. To bring the image within the screen limits the spot would be moved down from the center, along the "Y" axis. For an inverted resonance curve, with the conditions cited, the spot would be moved up from the exact center, along the "Y" axis. However, normal operation requires exact centering. After each change, for certain types of test, the spot should be moved back to its original position.

Whatever the type of cathode-ray instrument, the horizontal and vertical plates must be connected to ground, when adjusting the spot position. This ground can be effected by connecting a 500,000-ohm resistor between the free vertical deflecting plate and ground and a similar resistor between the free horizontal plate and ground. Instruments, which are equipped with gain control in both deflecting

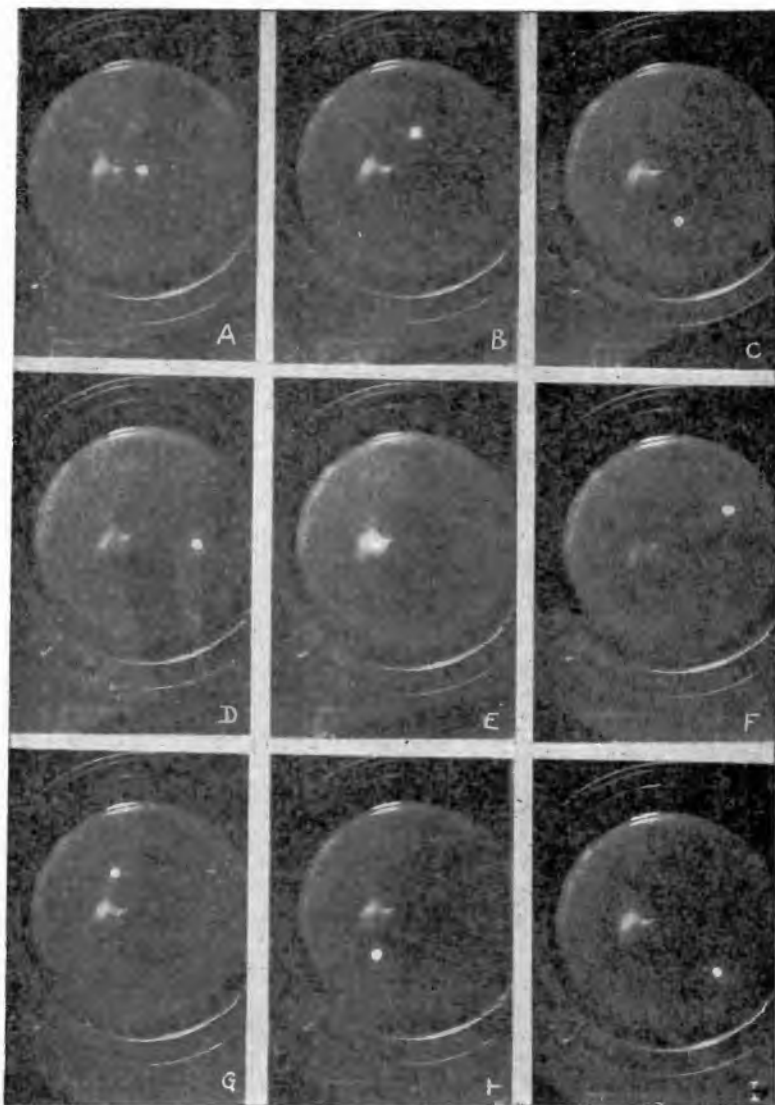

Fig. 64. A shows the correct position of the spot at the screen's center. B, C, D and E show the spot above, below, to the right and to the left of the center respectively. The spot in E happened to coincide with the reflection of the light on the external surface of the tube. F, G, H and I show the spot in the different quadrants. It should be noted that the size of the spot was made very large intentionally and it was too intense, as is evidenced by the halo surrounding it.

plate circuits, automatically are connected to ground. However, units which are arranged in such manner that direct connection is possible to the plates of the cathode-ray tube, require such grounding resistors. If the plates are allowed to float, they will collect electrical charges, which will interfere with correct positioning of the spot.

Referring to figure 64, A is the correct position. In B, the spot has been moved up along the "Y" axis. In C, the spot has been moved down along the "Y" axis. In D, the spot has been moved to the right along the "X" axis. In E, the spot has been moved to the left along the "X" axis. In F, the spot has been moved into the first quadrant, to the right of the vertical reference line and above the horizontal reference line. In G the spot is in the second quadrant, to the left of the vertical reference line and above the horizontal reference line. In H, the spot is in the third quadrant, below the horizontal reference line and to the left of the vertical reference line. In I, the spot has been moved to the fourth quadrant, to the right of the vertical reference line and below the horizontal reference line.

There are several ways of positioning the spot when the normal voltage divider adjustments are not available. The old suggestion to position the spot by means of an external magnet, placed near the deflecting plates on the outside of the tube is not satisfactory, because it distorts the image formed when the spot is made to move. For that matter, such a condition must be guarded against. Time and again, an external field may cause the spot to be out of position. To insure against such action, the metal case housing the cathode-ray unit, must be grounded. If the tube is used without a metal housing or shield, it should be kept away from all steel or from units which develop strong, magnetic fields, unless, of course, a test is being made, which requires that a strong magnetic field act upon the spot.

A fairly satisfactory method of centering the spot, when the proper controls are not available, is to sweep a horseshoe magnet back and forth across the tube, near the plates. By properly orienting the magnet with respect to the plate and noting the movement of the spot, correct placement will be achieved. The magnet need not be closer than perhaps six inches from the tube. The average horseshoe magnet about 3 inches long is big and powerful enough. It may be necessary to place the magnet closer to the tube. Experience will indicate the correct distance. As a general rule, the amount of correction required is not very great, for a fairly high degree of uniformity exists between tubes. The magnet should be moved past the tube, parallel with the

neck of the tube and then the change in spot position noted.

Take care that such a remedy is applied, only when it is needed. Make certain that the off-center position of the spot is not due to circuit adjustment, as, for example, in the National Union instrument, the normal position of the spot, when the sweep is in operation and adjusted to minimum amplitude, is at the extreme right hand side of the viewing screen.

The use of a biasing battery in the vertical or horizontal deflection plate circuit is quite in order. The battery is connected into the free deflection plate lead. However, this battery can be utilized only if direct connection to the plates is possible. If a blocking condenser is used in the circuit, the battery biasing arrangement cannot be employed. The amount of voltage required for the battery is dependent upon the amount of spot position shift desired. The battery voltage may be controlled with a potentiometer. The complete biasing voltage source in series with a 3.0 or 5.0 megohm resistor may be connected between the free deflecting plate and the ground plate. The signal voltage to be observed or applied across the same set of plates, then is applied to the cathode-ray tube in normal fashion. The high resistance in series with the battery serves to maintain the input impedance of the biased set of plates at a reasonably high value. The circuit which supplies the signal voltage to be observed is connected across the free plate and the grounded plate. This signal feed circuit may incorporate the blocking condenser if desired. Since most of the commercial units incorporate blocking condensers, it will be necessary to make proper contact inside the unit, in order to apply the biasing voltage.

Spot Focusing

We have made reference to the fact that the spot intensity or brilliancy and focus influenced the detail of the image appearing upon the screen. Once the spot has been properly centered, which operation need be carried out but once for each tube, the next item is the focusing and brilliancy adjustment. As a general rule, for any one focus adjustment arrived at in conjunction with the brilliancy adjustment, it is necessary to operate but one control, to maintain the same detail of image. This is true for certain periods of time. Naturally, as the tube ages, the emission characteristic varies and the rectifier tube emission varies, so that both brilliancy or intensity and focus controls must be readjusted.

Figure 65 shows three photographs of spot images. A is the cor-

rect spot size, attained by proper adjustment of the intensity and focus controls. Note that the spot is uniformly round, without any jagged edges. B shows a spot which is out of focus. Note that the spot is somewhat elliptical and has a slight fringe. C shows a spot which

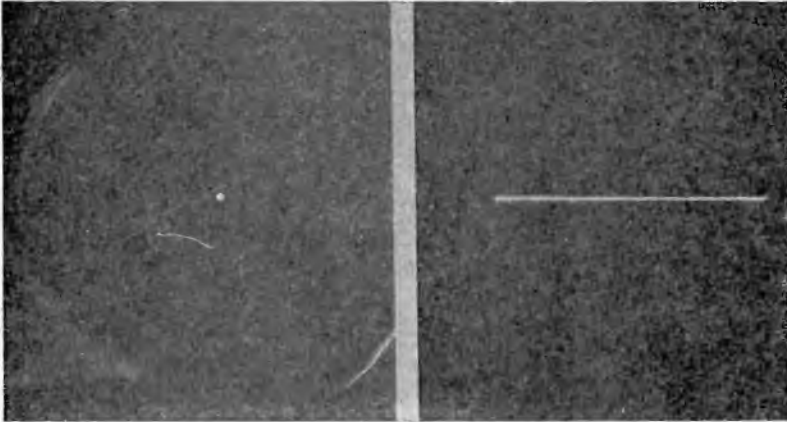

Fig. 65-A. Left. The proper size of the spot. Note that it is round and has smooth edges. Fig. 66-A. Right. The line resulting when a voltage is impressed on the horizontal deflecting plates. Note that it is uniform in thickness.

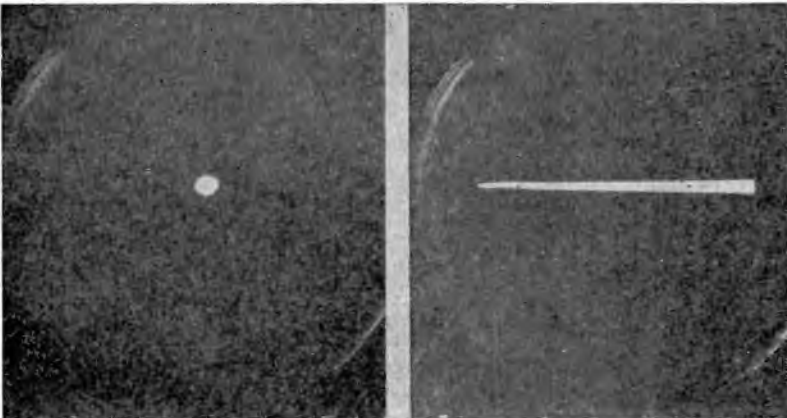

Fig. 65-B. The spot is here out of focus, evidenced by its elliptical shape. Fig. 66-B shows the resulting line when this spot is spread across the screen. Note its non-uniformity of thickness.

is too intense. You can see the halo around the spot. The effect that the intensity and focusing adjustment has upon the image is shown in figure 66. A voltage was applied to the horizontal deflection plates,

for each of the conditions shown in figure 65. A is the line developed when the spot is correctly focused and of proper intensity. As a matter of fact, it is necessary to readjust slightly the intensity control when the spot is spread into a line or image, to maintain the intensity of

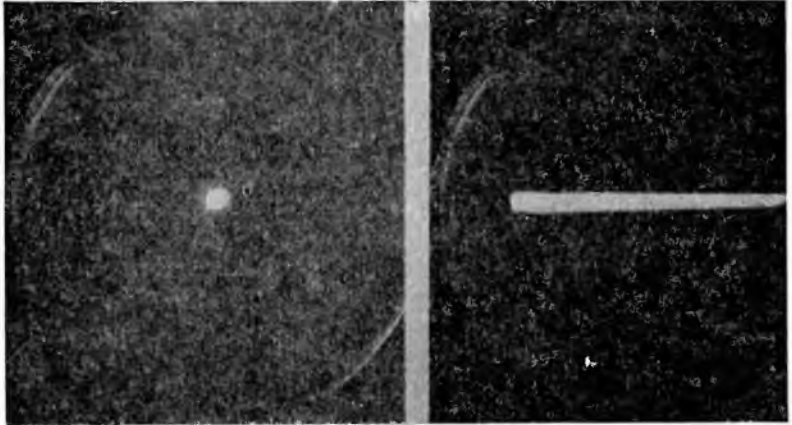

Fig. 65-C. Here the intensity control was too far advanced, this being evidenced by the halo around the spot. Fig. 66-C. The spot of Fig. 65-C shows a trace that is broad at one end and narrow at the other.

the spot. This is so because the spot is in motion. Note that the intensity of the line is uniform, its width is even throughout its length and that the width is equal to the diameter of the spot. Actually, correct intensity and focusing produces a spot which is about $1/64$ or perhaps $1/32$ inch in diameter.

The out of focus adjustment, shown in figure 65-B, develops a line which is wider at one end than at the other. Improper intensity and focusing adjustments may switch the wide portion from the right side to the left side, but one side will always be wider than the other. Excessive intensity is indicated in figure 66-C. Note the ragged edges and the excessive width of the line. Such a spot adjustment would kill all detail in a pattern.

As far as intensity adjustment is concerned for any one correct focus adjustment, let it be known that the minimum brilliancy consistent with ease of examination of the image, is the best adjustment. Of course, if the image is to be photographed, as we have done, then far more brilliancy is required. Nothing is gained, when viewing the image with the eye, by making the image very brilliant. As a matter of fact, a stationary image of excessive brightness is apt to damage the screen of the tube, if the image is allowed to stay on the screen for

too long a time. A single brilliant spot should not be allowed to stay on the screen for too long a time. It will burn the screen and that part of the screen will thereafter not fluoresce as brilliantly as the balance of the screen.

Sweep Circuit Control

The oscillograph is valuable because it enables observation of various alternating phenomena. One of the reasons why such observation is possible is that the device provides a time base. In the majority of cathode-ray tube instruments, the greater majority at that, this time base is of a variable frequency. In a few isolated cases, the time base is the 60-cycle supply. Since this type of time base, and we are speaking about what is known as the 60-cycle sweep, is of very little, if any value, we do not deem it worthwhile to devote space to it as a sweep circuit. Instead it shall be considered as just a sinusoidal wave applied to the horizontal plates in connection with the development of Lissajous' figures. . . . Do not confuse this reference to a 60-cycle sine wave sweep with a 60-cycle synchronizing pulse, which will be discussed in a subsequent paragraph. The two are very definitely different, although the original signal is secured from the same place. In the immediate paragraphs to follow, we shall dwell upon what has been presented as being the linear sweep or timing axis.

There are numerous pertinent facts relating to the operation of a sweep circuit which you should know and understand. The frequency relation between the sweep circuit voltage and the voltage being observed or to be observed, has very much to do with the ease of making such observations. If it is necessary to make photographic records of the pattern upon the screen, even greater stress must be placed upon proper application of the sweep system. As we stated in a preceding paragraph, the amplitude of the sweep voltage has a bearing upon the shape of the image and it is necessary for the person, who is using the equipment, to understand the nature of the circuit employed in the instrument, so that he can employ the device to greatest advantage and with greatest accuracy.

Subsequent paragraphs will be devoted to what can be generally called "the ways and means of developing waveform images upon the screen." However, we hasten to say that this discussion will not include what is really the interpretation of waveforms. That will follow later. Before walking, we crawl. So it is with the operation of the oscillograph, for if the proper means are not employed when

establishing the wave upon the screen, the imperfect shape of the wave, due perhaps to improper handling of the instrument, may result in false conclusions. You may find it necessary, as we progress through this discussion, to refer back to some of the earlier diagrams showing the development of waves of various types by means of spot position.

As has been stated earlier in this chapter, linear sweep circuits, used in modern cathode-ray oscillographs, are of the variable frequency type. As a result of the controls available upon the panel, it is possible to select any one frequency within the range of the device and to produce a sweep voltage, or timing axis voltage, of the pre-determined frequency. In as much as these sweep circuits are only partly calibrated, a rough and fine frequency adjustment is available. The band selection is made by means of the rough adjustment and the final adjustment to the required frequency is made by means of the fine control, which, as has been shown, is a resistance of one type or another, which controls the rate of charge in one type of sweep circuit and the rate of discharge in another type of sweep circuit. The process of distinguishing whether the charge or discharge portion of the cycle is being used for the sweep, is nothing more than an examination of the circuit being used. As a matter of fact, knowledge of this type is not essential to the proper application of the instrument.

The Sweep Frequency

The frequency selected for the sweep circuit usually is a sub-multiple of the frequency of the voltage wave to be observed. In other words, the frequency of sweep circuit is less than the frequency of the voltage wave to be examined. The result is that several cycles of the wave to be observed are developed on the screen. Of course, it is not imperative that several cycles be developed upon the screen. One cycle would do, but since better judgment of the true shape of the wave under examination is possible when several cycles, say two or three or three or four, are upon the screen, the sweep frequency is varied until this number of cycles appear upon the screen. Irrespective of what the frequency of the wave to be observed, providing that it is within the limits of the cathode-ray oscillograph, which means about 100,000 cycles with today's equipment, the number of cycles which appear upon the screen vary directly in proportion with the integral ratio between the frequency of the wave being observed and the sweep frequency. If the wave being observed is at 5000 cycles and the sweep fre-

quency is 1000 cycles, five cycles will appear upon the screen. If the sweep frequency is 2500 cycles, two cycles appear upon the screen. If the sweep frequency is 500 cycles, ten cycles will appear upon the screen. If the sweep frequency is 5000 cycles, one cycle will appear upon the screen.

Now, it is important to understand that some form of pattern will exist upon the screen for all ratios between the sweep frequency and the frequency of the wave to be examined. However, the nature of these patterns is too complicated to be of any value and, as a general rule, the patterns are moving. To establish the waveshape of the voltage applied to the vertical deflection plates, it is necessary that the pattern appearing upon the screen be the simplest showing the wave shape. Such a pattern is established when the relation between the sweep frequency and the frequency of the voltage under observation, is a simple integral ratio — and not a fractional ratio. When this simple ratio exists, such as 2-1, 3-1, 4-1, 5-1, etc. and the lower frequency is that of the sweep circuit, the maze of lines moving across the screen will develop into a simple waveform. Whether or not this wave will be sine or distorted, depends upon a number of factors, which need not be discussed at this time. At any rate, the pattern desired is that which has a single line waveform of one or more cycles.

The greater the ratio between the sweep frequency and the frequency of the voltage under observation, the greater the number of lines which appear in the pattern, during the time that a fractional ratio exists between the two frequencies. However, as the sweep frequency is changed and approaches that value which provides the simple integral ratio, the number of lines in the pattern becomes less and less, until a single line waveform pattern appears. This adjustment is reached by manipulating the fine frequency control.

The Synchronizing Control

Before showing you examples of various patterns, we want to remind you of the synchronizing control, which is also available on the majority of cathode-ray oscillographs. This part of the instrument is the means whereby the image upon the screen is kept stationary for observation. What is accomplished, as a result of the synchronization adjustment, is that the sweep frequency is "locked in step" with the frequency of the signal being observed. This is done by feeding a small portion of the voltage to be observed, which has been applied to the vertical plates, to the input circuit of the timing axis or sweep voltage oscillator tube. These pulses will maintain the frequency of

the sweep oscillator at the setting made to develop the proper image. As stated before, one of the properties of a relaxation oscillator, such as is used to produce the timing axis, is to keep step with a frequency which is applied to the input circuit of the oscillator. The sweep oscillator will keep step with this synchronizing pulse, be the pulse a sub-multiple or a multiple of the frequency of the sweep oscillator. This locks the image and it stands stationary upon the screen.

Hence, after the preliminary adjustment of the sweep frequency to produce the required pattern, the synchronizing control is manipulated so as to keep the image stationary upon the screen. For operation of the type being described, the synchronizing selector switch would be set to the "internal" position. Just what is meant by this internal position can be gleaned by examination of the RCA, National Union or Clough-Brengle oscillograph circuits. In the first unit you will find that a portion of the signal voltage, developed across the vertical deflection plate amplifier, is fed to the synchronizing circuit of the sweep oscillator. In the case of the other two units, you will find that a portion of the signal voltage fed to the free vertical deflection plate is also fed to the synchronizing circuit of the sweep oscillator. At times, a slight readjustment of the fine frequency control is required after the synchronizing control is manipulated. This is so because of the change in frequency of oscillations created in the sweep circuit, as a result of the application of the synchronizing pulse. The greater the amount of synchronization voltage, as determined by the setting of the control, which usually is a potentiometer, the greater the effect upon the frequency of the sweep circuit. At times, as shall be shown, the degree of synchronization also influences the shape of the pattern.

It is necessary that you understand the operation of the synchronizing adjustment, otherwise you will find it extremely difficult to produce a stationary pattern upon the screen. The frequency adjustment of the sweep circuit, when correct, will stop the image, but the image will not stand stationary, because of slight drift in the source of the voltage being observed and in the relaxation oscillator. But when the sweep has been synchronized with the voltage under observation, the pattern will remain stationary despite slight changes in frequency of the voltage being observed, because these changes in frequency, being transmitted to the relaxation oscillator tube, also tend to change slightly the relaxation oscillation, and thus keep the sweep circuit in step with the frequency being observed.

Let us now assume the application of a 700-cycle sine wave voltage

to the vertical plates. This figure is mentioned because it happened to be the frequency used to make the photographs which follow. With the synchronization control advanced somewhat beyond its minimum setting and the rough adjustment of the linear sweep frequency set to around 700 and then followed by the manipulation of the fine adjustment until a single line pattern appears, we develop an image such as

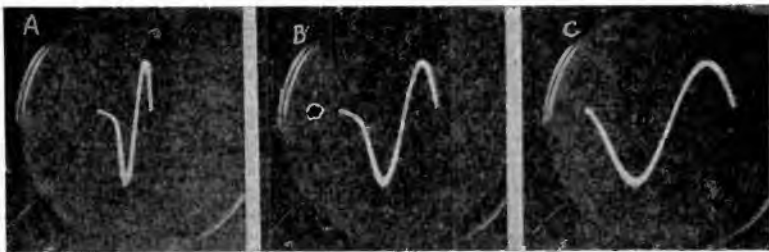

Fig. 67. The sine-wave voltage impressed on the vertical plates and the sweep voltage are both 700 cycles, resulting in the appearance of a single cycle on the screen. In A and B, the sweep amplitude is insufficient to give a true image; whereas in C the wave is spread out enough to present a substantially undistorted image.

in figure 67-A. This is a single cycle of the 700-cycle voltage applied to the vertical plates. The sweep and signal frequencies are the same. Obviously, it is not the most perfect looking wave. The image stands still. There are several reasons why a perfectly symmetrical wave is not upon the screen. One of these is the amplitude of the sweep. The second is that the sweep is not absolutely linear and tends to distort a single cycle. Also there exists too much synchronization; that is, the synchronization control is advanced too far. Also there is imperfect phase relation between sweep and signal. With this single cycle upon the screen, we can experiment with the action of the sweep amplitude. We increase the sweep amplitude control. In the unit we were using, the sweep amplitude control was the horizontal deflection plate amplifier. The actual sweep voltage developed by the thyratron was fixed in amplitude. The amplitude variation was accomplished by the amplifier gain control. The amplitude is increased and the image shown in figure 67-A now looks like 67-B. The fact that the return trace is not in the middle of the pattern is due to the phase relation between the sweep and signal voltages. The phase can be altered by slowly adjusting the fine frequency control.

We now reduce the frequency of the sweep circuit and after a number of complex images appear, we develop three cycles upon the screen.

The sweep amplitude adjustment is the same as it was for figure 67-C. The three cycles are shown in figure 68-A. It now is possible to judge the character of the wave. We reduce the amplitude of the sweep voltage by varying the amplifier control. The vertical deflection plate amplifier has not been changed, as is shown by the uniform vertical amplitude. The new image appears as in figure 68-B. If you compare figures 68-A and 68-B, you will note that the rounded tops of the sine waves appear more pointed in figure 68-B. The reason for that is the reduced sweep amplitude. It is possible to judge the character of the wave by examining figure 68-B, but not so well as in figure 68-A. Obviously, a certain sweep amplitude is required for the development of an image which is suitable for inspection.



Fig. 68. The sweep amplitude of A is the same as that in Fig. 67-C, but the sweep frequency has been reduced so that three cycles appear on the screen. When the amplitude of the sweep is reduced, as in B, the peaks of the waves become sharp and make it difficult to get a true idea of the wave's shape. In C the sweep frequency has been further reduced with the result that the peaks are more pointed than in B.

We reduce the sweep frequency still further and we now have 8 cycles upon the screen, as in figure 68-C. The character of the wave can be judged by examining this image, but not so well as in figure 68-A, hence we come to the conclusion that between three and four cycles upon the screen is most satisfactory for wave form examination.

What information can we glean from the images shown in figures 67-A to C and 68-A to C? First, that the greater the number of cycles upon the screen, the more crowded the image; that is, the closer is one cycle to the other and the more difficult is it to examine the character of the wave. A rounded peak looks like a sharp peak, when the cycles are crowded. Second, that it is difficult to judge a wave by looking at one cycle, so that more than one cycle should be placed upon the screen. Third, that irrespective of the number of cycles shown upon the screen, the width of the image is determined by the sweep amplitude. Fourth, that by varying the sweep frequency, we can vary the number of cycles

upon the screen. We hasten to add, that the character of the sweep circuit which produced these waveforms is fairly linear. The effect of non-linearity, as a result of increased amplitude will be shown later.

Suppose that the synchronization control is not properly adjusted. There are two conditions of incorrect adjustment: insufficient synchronization, in which case the image will not be stationary, and over synchronization, which will distort the pattern somewhat and also change the frequency of the sweep. Neither one of these adjustments is correct. Insufficient synchronization is due to insufficient voltage fed into the sweep circuit oscillator. Over-synchronization is caused by excessive voltage fed into the sweep circuit oscillator. Both are, as a rule, due to incorrect adjustment of the synchronization potentiometer. It is also necessary that you realize that the synchronization voltage adjustment is influenced by the sweep amplitude adjustment, when using a sweep circuit, which has as its amplitude control a unit which actually increases the amplitude of the sweep voltage out of the relaxation oscillator tube. As this voltage is increased, it may be necessary to advance the synchronization control, thereby the synchronization voltage, in order to keep the image "locked."

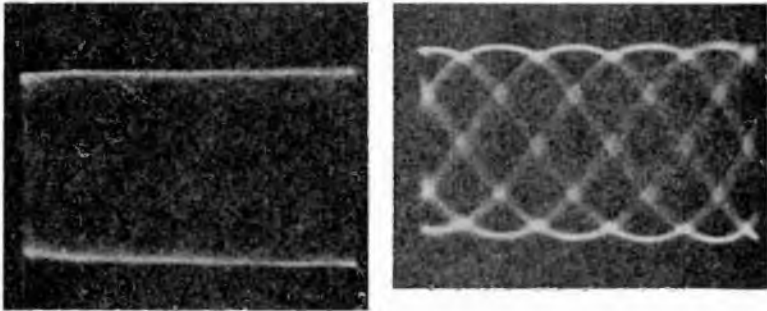

Fig. 69, left, Fig. 70, right. Two examples of patterns that are under-synchronized. The fine lines in Fig. 69 can be seen to follow the usual outline of a sine wave. This can be readily seen in Fig. 70.

As a general rule, the greatest variation in the image takes place when the image is under-synchronized. Then the pattern drifts. Of course, this is a matter of design of the instrument. An example of a complex image which is under-synchronized and which has become steady after synchronization, is shown in figures 69 and 70. Two more examples are given in figures 71 and 72. The images in figures 70

and 72 are still not perfectly synchronized. Correct synchronization adjustment comes with experience, because it is a variable and is often-times closely allied with other controls in the unit. Not that this latter condition is desired, but it is an actual condition in practice.

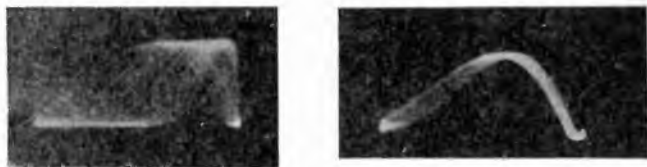

Fig. 71, left, Fig. 72, right. The pattern shown in Fig. 72 resulted from adjusting the synchronization control a trifle after the pattern in Fig. 71 was photographed. The pattern in Fig. 72 is still under-synchronized.

Referring once more to images appearing upon the screen as a result of the relation between the sweep frequency and the frequency of the voltage to be examined, we have considered sweep frequencies lower than the frequency of the voltage applied to the vertical deflection plates. Suppose that we consider the reverse, where the sweep frequency is higher than the signal frequency. The patterns resulting from such conditions are seldom experienced in practice, because they have no real value. However, since the image may appear, you might just as well be familiar with its appearance.

The image which appears when the sweep frequency is twice the signal frequency. (See figure 27 for graphic example.) Under ideal

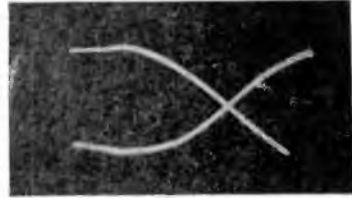

Fig. 73. The image resulting when the sweep frequency is twice the frequency of the wave being observed. Compare Fig. 27. Such a pattern is difficult to stop on the screen, as the points are moving on the fastest portion of the cycle. The top and bottom halves of the wave should coincide.

conditions, which are quite difficult to attain, because it is necessary to get two points, moving at the most rapid rate during a cycle, to coincide, the image which appears upon the screen is shown in figure 73. The two half cycles should coincide. The open gap between the two ends resulted from imperfect timing of the photograph, although quite some time was spent trying to secure a perfect pattern. The most common type of pattern which appears when the sweep frequency is two times that of the voltage being observed is that shown in figure 74. This

differs from figure 73 in but one respect: namely, phase relation between the sweep voltage and the voltage being observed. The appearance of a pattern, that of figure 74, when it is not stationary, or when

Fig. 74. When the sweep frequency is twice that of the wave being observed, the pattern at the right most commonly appears on the screen. This differs from the image of Fig. 73 because of a different phase relation.



it is moving, because of some slight discrepancy of the sweep frequency or under-synchronization, is shown in figures 75 and 76.

An example of what is really a useless pattern for the observation of wave shape is shown in figure 77. The sweep frequency is four



Fig. 75, left, Fig. 76, right. The stationary pattern of Fig. 74 is here shown when the sweep frequency is not properly adjusted. These two patterns resulted from varying the synchronizing control slightly.

times as great as the frequency of the voltage applied to the vertical plates. Patterns of this type are valuable for frequency calibration, which subject will receive proper attention later, but as far as waveform checking is concerned, such patterns are of little use. To examine

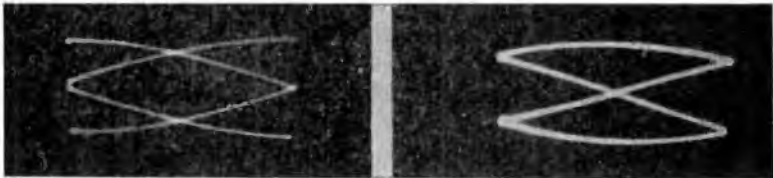

Fig. 77. The sweep frequency is four times the signal's frequency in both patterns. While these two patterns are useless for studying the character of the waveform, they can be used for frequency calibration.

properly the waveform of the 160-cycle signal, the correct adjustment of the sweep frequency would be about 40 cycles. The patterns shown in figure 77 were obtained with just enough synchronization to keep

them stationary long enough to photograph. For visual observation of waveform the image can be moving slowly, so that even less synchronization can be used. An idea of what happens when too much synchronization voltage is applied to the patterns of figure 77 is shown in figure 78. Note how the sides have been pulled in.



Fig. 78. By applying too much synchronization to the pattern of Fig. 77, the image at the left was obtained. Note that the pattern is no longer symmetrical.

A better idea of what happens when the synchronizing voltage is too great is shown in figures 79 and 80. Figure 79 shows a single cycle stopped by applying the synchronizing voltage. The application of the maximum synchronizing voltage available changed the pattern to that shown in figure 80, an excellent case of distortion.

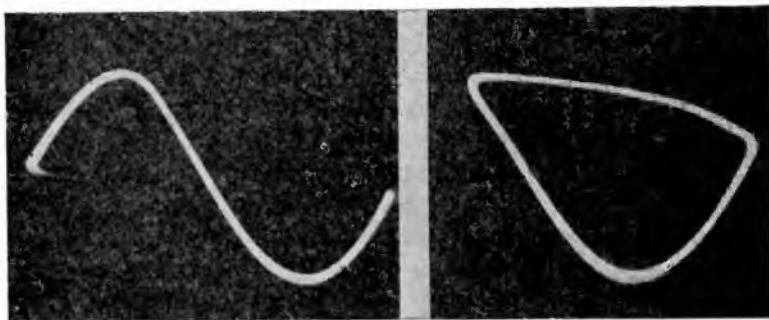

Fig. 79, left, Fig. 80, right. The proper amount of synchronizing voltage was applied to get the single cycle of Fig. 79. When the maximum amount of synchronizing voltage was applied, the distorted figure of Fig. 80 resulted.

The various illustrations offered in connection with the development of a wave upon the screen employed a sine-wave voltage applied to the vertical plates. This voltage may be distorted without changing matters in the slightest. This is shown in figure 81, which picture illustrates two cycles of a distorted wave. Actually this is the waveform of the voltage developed by one of the generators used in our laboratory. Varying the length of the sweep would close the pattern or open the pattern still more. The width of the alternations would be greater or smaller, depending upon the manipulation of the sweep amplitude con-

trol, assuming that this adjustment did not vary the linearity of the sweep voltage. The sweep frequency used to produce figure 81 was about 30 cycles. An example of incorrect frequency adjustment of the sweep circuit is shown in figure 82. The pattern also shows over-synchronization, evidenced by the fact that the terminations of the two-line

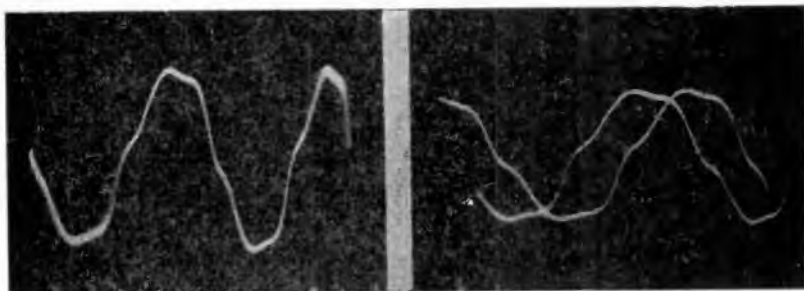

Fig. 81, left, Fig. 82, right. Even though the wave impressed on the vertical plates of the cathode-ray tube is distorted, as in Fig. 81, the same need for proper synchronization exists. Improper adjustment of the synchronizing control is responsible for the pattern of Fig. 82

pattern are not beneath each other. A slight variation of the sweep frequency produced the image shown in figure 81. The vertical amplitude in figure 82 is slightly less than that of the image in figure 81.

External Synchronization

All of the patterns shown thus far were synchronized, when so stated, by adjusting the synchronizing control switch or circuit to internal synchronization. Similar patterns would be developed if the switch were adjusted to external synchronization. However, in this case, it would be necessary to connect the external synchronization terminals upon the cathode-ray tube unit to the source of the voltage, which supplies the vertical deflection plates.

Normally, one would imagine that the two terminals provided for the external synchronization voltage input could be connected across the voltage source feeding the signal to the vertical deflection plates. Such is not the case, because of the very low input impedance of the synchronizing circuit. Accordingly, when connecting the "high" terminal of the synchronizing circuit to the voltage source, insert a 50,000 or 100,000-ohm resistor in series. The ground terminal can be connected to the grounded side of the voltage source. In the event that the arrangement of grounds is such that a common lead cannot be used, a condenser may be connected into the circuit. In the event that the use

of a 50,000 or 100,000-ohm resistor does not supply sufficient synchronization voltage, use a lower value, but bear in mind that the input impedance of the synchronizing circuit is comparatively low.

60-Cycle Synchronization

It is customary to provide a 60-cycle synchronizing signal with cathode-ray tube units. This voltage is selected by means of the switch which controls the source of the synchronizing signal; that is, whether it is "internal," "external" or "60-cycle." The 60-cycle voltage is secured from some part of the power supply system. It is necessary to understand that this 60-cycle voltage is not the sweep voltage. All it does is to actuate the sweep oscillator, depending upon the frequency setting, to generate saw tooth pulses, which are multiples or sub-multiples of 60 cycles or whatever the frequency of the power supply operating the cathode-ray tube unit may be.

Reference has been made to the fact that some oscillographs contain a 60-cycle or so called "harmonic" sweep. It should be understood that

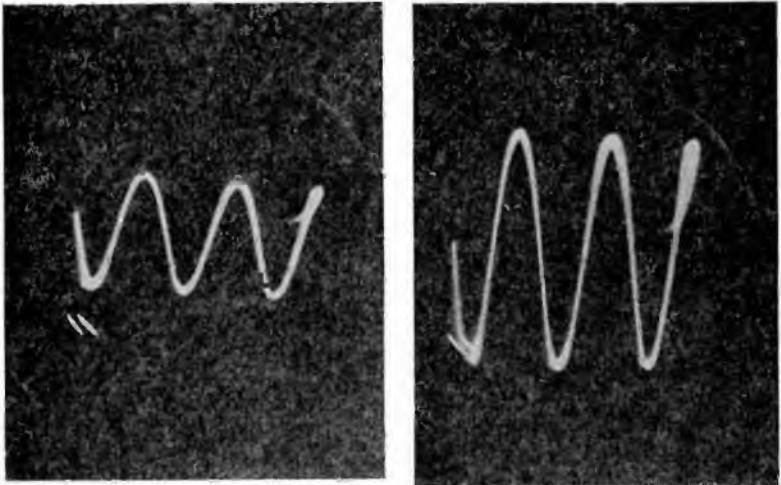

Fig. 83, left, Fig. 84, right. The vertical amplitude in Fig. 83 is correct for observation of the waveshape. The same wave was photographed for Fig. 84, but the vertical deflection plate voltage was increased to such an extent that one peak of the wave is blurred as it touches the rounded portion of the screen.

this arrangement possesses a limited utility in that it can not be used for the examination of waves other than those at frequencies which are multiples or sub-multiples of 60 cycles. Even at these frequencies, ex-

amination of the wave form is extremely difficult and the ordinary linear sweep is greatly to be preferred. However, in large communities, which maintain an accurate check on the power frequency, the harmonic sweep can conveniently be used as a frequency standard for calibration work at audio frequencies. Bear in mind that while the average power frequency over a period of time is kept at a high degree of accuracy, the frequency at any given time may be off to an appreciable degree.

Vertical Amplitude

The various images shown thus far were made with the vertical amplitude of the proper level to place the image in the center of the

Fig. 85. The same wave as was shown in Figs. 83 and 84 is illustrated at the right. When this photograph was made the vertical amplitude voltage was increased so that the peaks of the wave were entirely off the screen, and the pattern is useless for observation of the shape of the wave.

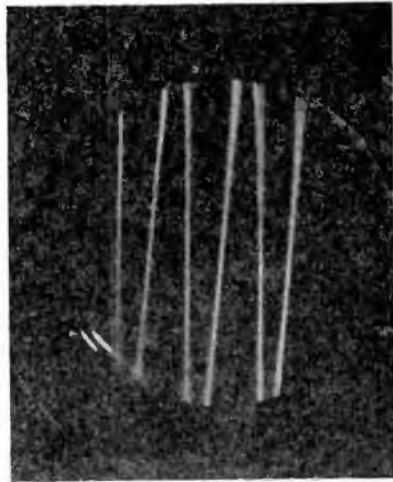

screen. It is quite natural to assume that such would be done in practice. Excessive amplitude of the vertical voltage will cause the image to be partly on and partly off the screen. The peaks of the waves will be off the screen. As a matter of fact, if the vertical amplitude adjustment is such that the peaks of the wave are located at the boundaries of the tube screen, these peak images will be distorted, blurred and hard to distinguish. These facts are shown in figures 83, 84 and 85. The image shown in figure 83 is ample for all observation. The adjustment of the vertical deflection plate voltage was increased too much and the pattern shown in figure 84 resulted. The peaks of the wave are at the boundaries of the tube and are blurred. Figure 85 shows the peaks off the screen.

It is difficult to designate the correct size of the image. That is up to the operator and is also limited by the intensity of the original voltage. At times the gain in the amplifier, contained in the cathode-ray tube unit, is not sufficient to produce an image which is more than perhaps .5 or .75-inch high. Unless additional amplification is used, one will have to be satisfied with an image of such vertical proportions. There are times when even this amplitude is not available.

A certain relation exists between the adjustment of the vertical deflection voltage gain control, or vertical amplitude, and the synchronization adjustment. This is so in every one of the cathode-ray tube units adjusted for internal synchronization. The reason is easy to understand when you examine the wiring diagram. The synchronization voltage is secured from either the plate circuit of the vertical deflection amplifier or from the vertical deflection plate circuit of the cathode-ray tube. As such, the higher the level of the vertical deflection voltage, as determined by the setting of the vertical deflection amplifier gain control, the greater the synchronization voltage, for any one adjustment of the synchronization control. That is why you may find that when the synchronization control has been advanced beyond its minimum setting, an adjustment of the vertical deflection amplifier gain control acts upon the degree of synchronization.

Horizontal Amplitude

Although we have made mention of the horizontal amplitude with respect to the number of cycles which appear upon the screen and the



Fig. 86, left, Fig. 87, right. The same wave is shown in both illustrations with the same vertical deflection voltage applied. The horizontal deflection voltage has been increased in Fig. 87, so that the wave appears to be much flatter.

relation between this number and the ease of examining a waveform or image, whatever it may portray, we did not state that excessive amplitude in the horizontal direction, when the vertical deflection is not very great, will change the apparent shape of the pattern. Examine figures 86 and 87. Figure 86 shows a pattern of a small vertical deflection voltage and small horizontal deflection voltage. The sine

character of the wave form is evident. In figure 87, the vertical deflection voltage was maintained constant, but the horizontal deflection (sweep amplitude gain control) was increased. Note how much flatter the wave *appears*. Accordingly, it is obvious that an optimum setting between the horizontal deflection, or sweep amplitude gain control, and the vertical deflection gain control is necessary in order to cause no apparent distortion of the image.

Distortion Due to Non-linear Sweep Voltage

We have shown a graphic example of how a non-linear sweep voltage distorts the image upon the screen. The distortion takes the form



Fig. 88, left, Fig. 88-A, right. The sweep of Fig. 88 is almost a straight line and so a sine wave swept by such a linear wave will be undistorted, as that shown in Fig. 88-A. The curvature of the left-hand trace of Fig. 88 is due to the curvature of the tube's viewing screen.

of non-uniform spreading of the wave along the horizontal axis. A sine wave spread by a linear sweep voltage (see figure 88) appears like that shown in figure 88-A. The same vertical deflection voltage when



Fig. 89, left, Fig. 90, right. The same wave as shown in Fig. 88-A is shown in Fig. 90 when spread across the screen with a non-linear sweep, as illustrated in Fig. 89. Note how the right side of the image is crowded due to the non-linearity of the sweep.

spread by a non-linear sweep voltage, such as that shown in figure 89, appears as shown in figure 90. If you examine figure 90, you will note that the right-hand portion of the image corresponds to the top of the charging cycle, where the rate of charge is the slowest, resulting

in a slowing down of the movement of the spot across the screen. The spot is sweeping from the left side to the right side of the screen to trace the pattern and the return trace is from right to left, as is evident in the photograph.

Distortion of this type does not cause a great deal of confusion when examining a sine wave, since the wave itself is not distorted. However, in the event that a distorted wave is spread by a non-linear sweep, the pattern does not show the extent of the distortion present in the wave in the proper perspective. The portion of the pattern, which is spread more than the other, tends to flatten peaks, due to the presence of the harmonic frequencies which constitute the distortion, and the portion of the wave which is crowded also disguises the presence of the distortion. The greater the extent of non-linearity of the sweep voltage, the greater is this effect.

Such distortion also occurs when the sweep voltage is of sinusoidal character, as for example with the 60-cycle sine wave sweep mentioned earlier in the text, and when the frequency of the voltage being observed is not a multiple or sub-multiple of 60 cycles. As a sweep voltage, the 60-cycle sinusoidal wave is of very little, if any, value. Under certain conditions, as will be shown later, the use of the sinusoidal sweep voltage results in the development of a Lissajous figure.

General Signal Voltage Considerations

A more detailed resumé of this subject is given in the discussion concerning the use of the cathode-ray tube as a voltmeter.

General Operating Considerations

It might be well to make brief mention of a few pertinent points which are of interest in connection with all types of practical applications of the cathode-ray tube.

If either the vertical or horizontal pair of deflection plates is not in use, the free plates should be grounded, thus obviating the possibility of stray charges accumulating upon the plates of the free pair and influencing the beam and pattern.

The free plate of either the vertical or horizontal deflection plates, when connected to the associated amplifier and not in use, should be placed at zero potential by grounding the input circuit of the amplifier connected to the unused deflection plate. If this is not done, the input circuit to the amplifier may pick up stray voltages and cause a spurious deflection in the related direction.

If the saw tooth sweep is in operation and the vertical deflection plates are connected to the input amplifier, but not to a source of signal voltage, stray voltage patterns may appear upon the screen and will give misleading indications, unless the reason for their appearance is recognized.

The ground terminal upon the cathode-ray tube unit should be connected to some grounded point in the operating circuit.

Phase Difference Measurement

There are a number of tests which require that the phase relation between two voltages or a current and voltage be established. There are various ways in which this information can be gleaned, but no one is as handy as the cathode-ray oscillograph, for it enables practically instantaneous determination by examination of the pattern which appears upon the screen. An idea of the development of phase difference or phase relation patterns can be had by reference to figures 46 to 48 inclusive. A phase difference pattern is a Lissajous figure for a 1-1 ratio.

The 1-1 frequency ratio obtains, because a single source of signal voltage is used; that is, the frequency of the signal applied to the vertical plates is the same as the frequency of the signal applied to the horizontal deflection plates. Hence, the ratio of the two voltages acting at right angles upon the beam is as 1 is to 1.

For phase difference tests, several of which will be shown during the discussion of the practical applications of the cathode-ray tube, the sweep circuit is not used. By means of the various controls available upon the cathode-ray oscillograph unit, one of the signal voltages is applied to the vertical plates through or around the related amplifier, depending upon the intensity of the voltage, and the other voltage is applied to the horizontal deflection plates, through or around its associated amplifier. See figure 92. It is best, in order to interpret the image correctly without involving the action of the amplifiers, to use amplifiers in the vertical and horizontal deflection circuits, or to leave them out of both circuits. If an amplifier is used in one of these circuits, it is necessary to recognize the existence and presence of this amplifier, when finally interpreting the pattern upon the screen.

The following illustrations are given solely for reference purposes and for what possible value they may have in connection with phase difference measurements. A phase difference image may assume any one of a number of shapes, ranging from a straight line tilted to the right

or to the left, through a series of ellipses, with varied degrees of eccentricity, to a circle. The range of phase angles represented by this range of patterns is from 0 to 360 degrees. This range of patterns is shown in figure 91. These patterns, with particular reference to the degree of tilt and the phase angle, apply for equal amplitudes of the voltages applied to the vertical and horizontal deflection plates, respectively; naturally, for equal frequencies as well.

Since phase angle tests are made with a single source of voltage, the frequency of the voltage applied to both sets of deflection plates is constant and the phase difference is constant, at whatever value it may be. Consequently, the pattern will remain stationary. It is, of course,

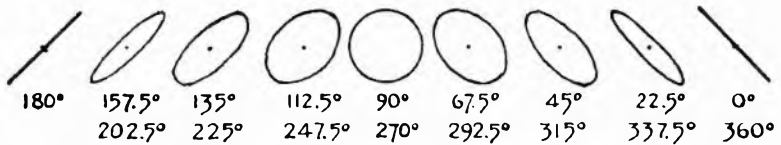

Fig. 91. Various patterns that indicate different angles of phase difference.

possible that the exact phase difference for any one condition may be different from the values specified for the patterns shown in figure 91, so that the actual shape of an ellipse may indicate a greater or lesser degree of eccentricity. Be that as it may, any phase pattern for equal vertical and horizontal voltages, which may appear upon the screen, will be found within the limits specified in the illustrations.

A similar range of patterns holds true for unequal amplitudes for the vertical and horizontal voltages, but the exact appearance of phase diagrams with unequal voltage amplitudes, with respect to the tilt of the pattern, will be different from those for equal vertical and horizontal voltage conditions. This is shown in the figure 93 series of illustrations, soon to be discussed.

The nature of the phase diagram is not influenced by the degree of purity of the voltage or current wave. While it is true, as you will see later, that the presence of distortion influences the exact appearance of the pattern, the pattern obtained, when all supplementary influences are eliminated, is the same for a sine wave or a distorted wave.

You will find numerous references to these phase diagrams as you progress through this volume. You will also find supplementary diagrams, as related to frequency comparison, under that heading, elsewhere in this chapter. For simplest determination and interpretation of the pattern, the horizontal and vertical deflection voltages

should be so adjusted that the amplitudes of the two deflections is the same in each direction. This is accomplished by adjusting, first one deflection to a definite known length, according to any standard of measurement, which may be an ordinary ruler. Then the deflection voltage is removed from that set of plates *without changing the gain*

Fig. 92. The schematic diagram on the right indicates the manner in which two voltages, E-1 and E-2, are connected to the deflection plates of the tube so that the phase difference between them may be found.

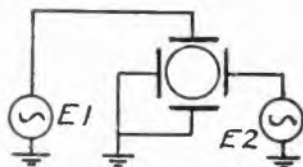

control, and the amplitude of the deflection in the other direction is made equal to the first. See figure 92. One voltage is applied to one set of plates and the other voltage in quadrature is applied to the other set of plates.

Several examples of actual phase difference or phase angle patterns or images, which appear upon the cathode-ray tube's viewing screen, are shown in figures 93-A to 93-H. You will note two types of

Fig. 93-A, left, Fig. 93-B, right. A phase difference of 180° exists in both patterns. That of A is for equal amplitudes of horizontal and vertical voltage, while that of B has a greater vertical deflection voltage.

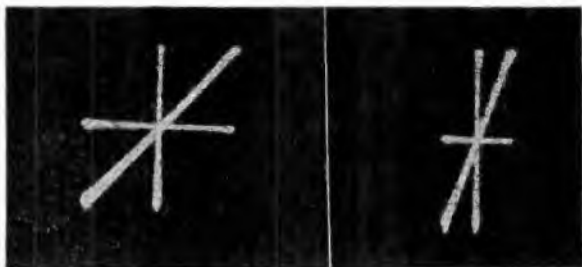

illustrations in this group. One type shows the vertical and horizontal reference lines as well as the phase difference pattern. The other group shows only the phase diagram, that is, the actual pattern, as it appears upon the screen. The illustrations with the "Y" and "X" axes and the phase diagram are triple exposures and were made to show the change in the resultant pattern as the consequence of a change in the amplitude of the vertical and horizontal voltages. The "Y" and "X" axes, in this case, are really the two voltages, photographed separately as individual deflections. The phase diagram is the resultant of the two deflections. At the same time, these two deflections serve well as reference lines.

You will have no trouble noting how the tilt of the phase pattern changes when one of the amplitudes is changed. The triple exposures

were made in the following manner: One voltage was applied, say to the vertical plates. The result was a line. This was photographed. The film was allowed to remain in the camera. Then the voltage was applied to the horizontal plates and the vertical deflection was removed and the film was again exposed, but remained in the camera. Then



Fig. 93-C, left, Fig. 93-D, right. A phase difference of 0° exists between the two voltages. In C equal amplitudes on both axes give the pattern a 45° angle with the horizontal, but when the horizontal

amplitude is increased, as in D, then the pattern approaches the X-axis.

the horizontal and vertical voltages were simultaneously applied to the tube and the phase difference image developed. This was photographed and the result is shown.

Figure 93-A indicates a 180-degree phase difference, with equal horizontal and vertical amplitudes of voltage. The same phase difference, but with the vertical deflection greater than the horizontal deflec-



Fig. 93-E, left, Fig. 93-F, right. Pattern for a phase difference of about 45° . Both E and F are the same pattern, but the X and Y axes were omitted from F.

tion, is shown in figure 93-B. Note how the phase image has moved up towards the vertical reference line or "Y" axis. Figure 93-C shows the image for 0-degree phase difference, with equal amplitudes along the vertical and horizontal axes. Figure 93-D is for the same phase difference, but the horizontal voltage was greater than the vertical deflection voltage. Note how the phase diagram has shifted towards the horizontal or "X" axis.

As stated earlier in this volume, the orientation of these phase diagrams depends upon the polarity of the respective voltages. The positioning of the images, for the phase angles stated, is that to be found in existing commercial cathode-ray tube oscillographs, wherein one plate of each pair is connected to a common ground within the unit. The plates which are grounded are the same in all of the tubes

offered to the radio industry, with 3 and 5-inch screens, inclusive of the W.E. 224. In this connection we exclude the General Radio tube, which has individual connections to each of the four plates, comprising the two pairs of deflection plates. Furthermore, the orientation is to be found in existing equipment, when the positioning of the tube is according to normal practice.

A phase difference of slightly more than 45 degrees is indicated in figures 93-E and 93-F. The former illustration also shows the two

*Fig. 93-G, left,
Fig. 93-H, right.
Pattern for a
phase difference
of approximately
135°. The pattern
of H is the same
as that of G with-
out the horizontal
and vertical refer-
ence axes.*

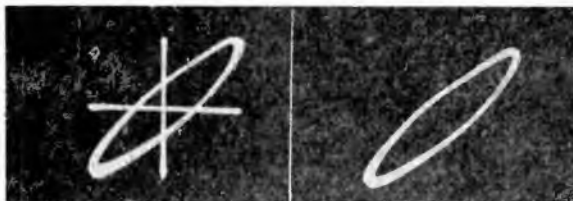

reference voltage lines and the resultant image, whereas the latter shows only the image which is seen upon the screen. Figures 93-G and 93-H show the same phase pattern, with and without the reference voltage lines, for a phase difference of slightly less than 135 degrees.

So much for stationary phase difference patterns or images. You will have occasion to examine many more, as related to certain specific applications and to refer to those shown in figure 91 and in the 93 series.

Frequency Comparison

Herein lies one of the very valuable functions of the cathode-ray tube, namely, the comparison of two frequencies. This can be carried out to a very high degree of accuracy, The comparison of two frequencies or the calibration of an unknown by means of a known frequency, is carried out by interpreting the Lissajous figure which is created when two alternating voltages are applied to the vertical and horizontal deflection plates, respectively. Just how these images or patterns are produced, by the combined action of these two voltages upon the electron beam, was described briefly in connection with figures 50, 51 and 52. In connection with the discussion of this subject at this time, we shall give details as to how such calibration is carried out and furnish a number of reference patterns, which should prove of value during actual operation. However, before starting upon the actual interpretation of the patterns, it might be well to furnish a few

pertinent facts pertaining to the application of the cathode-ray tube oscillograph to this type of work.

Frequency Limits

As a general rule, frequency comparison or frequency calibration with the cathode-ray tube is usually applied to frequencies from 0 to about 100,000 cycles. Not that the cathode-ray tube is encumbered by this figure as its upper limit, but rather because this figure is the upper limit of amplifiers, which can develop sufficient voltage to provide suitable deflection upon the screen. As a matter of fact, the frequency limit of the conventional cathode-ray tube for the purpose of frequency comparison is about 100,000,000 cycles, but it is not used at such high frequencies, because suitable means of providing the correct deflections, required for proper interpretation of the image, is not available. Consequently, we can say that the frequency limit is determined by the ability to provide suitably high voltages for the vertical and horizontal deflection plates. If at any one point of utility, the related amplifiers can provide sufficient vertical and horizontal deflection voltages up to 100,000 cycles, the frequency limit at that point of operation is 100,000 cycles. If somewhere else, amplifiers are available which will provide sufficient voltage from the known and unknown frequency sources up to 1,000,000 cycles, then the frequency limit is 1,000,000 cycles. The fact that the oscillators or signal generators are capable of developing test voltages up into the 5.0 to 10.0-megacycle band is of no consequence, unless these signals are of sufficient voltage to provide a suitable deflection upon the tube's screen. The frequency limit of the cathode-ray tube is the ability of the electron beam to follow the variations of the field.

Generally, it is necessary to work through amplifiers. Up to about 200,000 cycles can be handled by the amplifiers contained in cathode-ray oscillographs, although they are rated at only 100,000 cycles. The gain of the amplifier falls off above 100,000 cycles, but sufficient gain is still available at 200,000 cycles to enable satisfactory operation. With special amplifiers of the resistance-capacity coupled type, such as we have used in our laboratory, operation up to about 800,000 cycles is conveniently possible. With high gain tuned-radio-frequency amplifiers, operation up to the several megacycles is possible, so that coverage of from 0 to several million cycles is available to the man who is sufficiently interested.

As far as audio-frequency work is concerned, that is extremely simple,

incidentally, we feel that the variable audio-frequency oscillator is going to play an extremely important part in servicing of the future.

Frequency Standards

In order to be able to compare two frequencies, one must be known and the known one, naturally, becomes the standard. This standard should be an oscillator of one type or another, be it a vacuum tube oscillator, simple or elaborate, an electrically driven tuning fork, with output circuit connections, etc. The range of the oscillator used as a standard is not so important, provided that its highest frequency is at least one-tenth of the highest frequency to be calibrated upon the unknown. Thus, with a single 1000 cycle standard, it is possible to calibrate a range of from 100 to 10,000 cycles.

If the standard is continuously variable and has a range fully as great as the supposed range of the unknown or uncalibrated oscillator, calibration is greatly simplified. At any rate, known standard oscillators are a better source than the a-c. line. The 60-cycle power supply makes a perfect standard,—*if one knows definitely the exact frequency at the time of measurement.* . . . The power supply frequency usually is constant, but not suitable for use as a standard because of its instantaneous changes and the lack of knowledge of the exact frequency at the time that its value is thought to be 60 cycles and set up as a standard.

Under certain conditions, the linear sweep circuit in the cathode-ray oscillograph may be used as a standard, but only after certain frequency settings of this system have been definitely established and are accurately known. The use of the linear sweep as a frequency standard will be described later but its use as such is not recommended.

Sine waves, distorted waves and modulated waves may be used during such frequency comparison, but not with equal facility. The greatest ease of interpretation, which means the most rapid and accurate operation, will occur when two sine-wave voltages are being compared for frequency determination. Photographic examples of these three will be shown and you will have the opportunity to judge for yourself. What has been said is particularly true when complex ratios are involved; that is, when the two frequencies bear some fractional relation to each other, and not far removed from an integral ratio.

Relative Amplitude of the Two Voltages

Much can be said about the relative amplitudes of the two voltages applied to the vertical and horizontal deflection plates. However, effi-

cient operation is best accomplished by having the image upon the screen, formed as a result of the two voltages being compared, as large as possible, yet not too large; that is, so large that the boundaries of the pattern extend to the limits of the screen. If such is done, the edges of the pattern will be hazy and interpretation of a complex pattern will be difficult.

There is very little choice between a square pattern and a rectangular pattern; whichever suits the requirements for best interpretation should be used. The simpler the frequency ratio between the two voltages, the smaller may be the pattern. The more complex the frequency ratio between the two voltages, the larger must be the image, so as to enable visual inspection and proper interpretation. At the same time, it should also be realized that the larger the image, the less its intensity and the less distinct will be the lines, loops and intersections, all of which may be involved in making the correct interpretation. Any effort to make the image brighter may result in impairment of the focus, thus making the boundaries of the image even more indistinct and difficult to interpret.

Basic Circuit

The basic circuit utilized to produce normal Lissajous figures for frequency calibration or frequency comparison is shown in figure 94. The units are illustrated in block form. The known oscillator is the

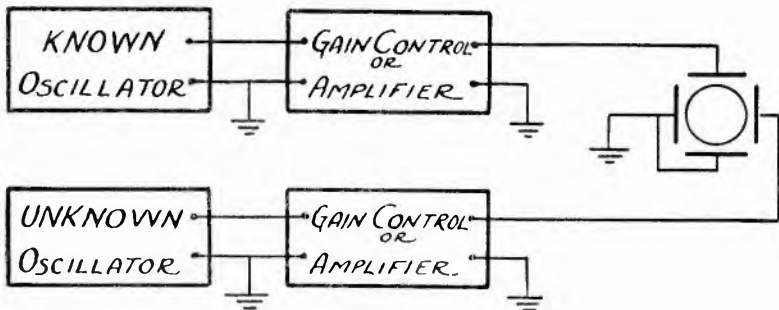

Fig. 94. The basic circuit used for producing Lissajous figures, which are used in the comparison of two frequencies or for frequency calibration.

standard. The gain control or amplifier unit can be the amplifier within the cathode-ray tube unit, or may be an external amplifier, being used to provide the required signal voltage. The standard or known frequency is applied to the vertical deflection plates. The unknown or uncalibrated oscillator also has its gain control or amplifier and the

signal is fed to the horizontal deflection plates. Whether or not external amplifiers are used, is a matter of individual need and discretion.

There are a number of circuit arrangements, in addition to that shown in figure 94, whereby Lissajous patterns are made possible. Of these, the simplest is that shown in figure 94, and incidentally, the images produced are those most commonly found to be of value during frequency comparison or calibration. The images to which we are referring are the completed loop patterns, such as was developed in figure 50. Here the loops are completed and open to view. Additional examples of such patterns will be given soon.

Under certain conditions, as for example when the frequency ratio is quite complex or when it is quite high, it is convenient to separate the front and back portions of the pattern, as a means of expediting the determination of the number of loops present in the pattern. Examples of the circuit required to produce such patterns and the means of interpreting the pattern will be given later.

There is another type of pattern, which will be discussed at greater length, wherein the loops are not completed. These will be shown, but it might be well to state at this time that these patterns are not very satisfactory for calibration work, because it is generally difficult to stop the pattern long enough to make the necessary count of loops and intersections.

Interpretation of Completed Loop Patterns

We have made mention of the means of determining the frequency ratio existing between two voltages which have been applied to the deflection plates and which have produced a completed loop pattern. This was shown in figure 51, with tangents drawn to two sides. The number of loops or peaks which touch these tangents are counted and the ratio between them is the frequency ratio between the two voltages. It may not even be necessary to draw these tangents. It is possible to determine the frequency ratio simply by counting the number of peaks or loops existing on two sides of the pattern. The important thing is to be able to recognize the existence of the loops or peaks. In certain cases, it may be necessary to vary the voltage applied to either the horizontal or vertical deflection plates, in order to bring out more clearly the existence of the loops in the pattern.

Another extremely important consideration is exact knowledge relative to the direction of the standard frequency voltage; that is, if it has been applied to the vertical plates or to the horizontal plates and

the exact frequency of the standard voltage. If these facts are not known, calibration cannot progress. The former is of particular importance, because if the standard frequency is maintained constant, the loops in the pattern will be positioned in a certain way over a certain frequency range. In other words, if the standard frequency is higher than the unknown and is applied to the vertical plates, the loops on the top of the pattern will be greater than the number of loops on either side of the pattern, until a 1-1 ratio is reached, when the image will be a circle. If the standard frequency is held constant at its original value and the unknown is advanced, the greater number of loops will appear on the side of the pattern and the smaller number of loops will appear on the top boundary of the pattern. Because of this change in the number of loops on the side or top of the pattern, it is necessary to know which plates are being supplied with the standard voltage.

A third important consideration, when working with completed loop patterns, is to make certain that all of the loops in the image are being disclosed and that none are covered by others. That is why it is best to work with a pattern which is moving very slowly. Experience is a good teacher in this respect.

So much for the general details. Elaboration upon each of these details will be made as we progress through the actual comparison of frequencies.

Typical Patterns

We have shown how the phase relation between the two voltages influences the shape of the pattern. The development of the two images for the identical frequency ratios in figures 50 and 52 show how it is possible for a person to become confused and at the same time how different patterns may indicate the same frequency ratio.



Fig. 95. A, left, B, right. Both patterns show a 1-1 ratio between the frequencies. The phase difference in A is 180° and that in B is 0° .

As stated a moment ago, the most satisfactory pattern to use for frequency ratio interpretation is the one which has the uncovered completed loops. The uncovering of the loops can be accomplished by

changing the unknown frequency ever so slightly, so that the pattern is in motion. The most minute change from a stationary condition is satisfactory. Once the frequency ratio has been determined, the pattern may be stopped, irrespective of how many of the loops are covered at the instant and the calibration for the known frequency recorded. The actual frequency difference between the setting required to set the pattern into slow motion, so as to enable determination of the number of loops or peaks, and the stopping of the pattern is so little as to be entirely negligible.

The phase relation has no bearing upon the calibration, other than, as has been stated, in the production of certain patterns, which, if they

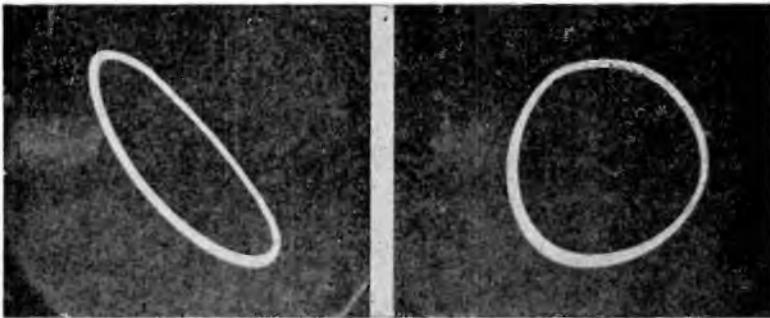

Fig. 95. C, left, D, right. Each pattern indicates a 1-1 ratio. The phase difference in C is about 45° and that in D is about 90° .

are not understood, may cause incorrect interpretation. However, if the pattern is understood, so that correct interpretation can be made, the exact phase relation indicated by the shape of the pattern is of no consequence.

The ratio indicated in the pattern is a function of the respective frequencies of the two voltages. It matters not what the exact numerical value of these frequencies, the pattern will be the same for any one particular ratio. In other words, a 1000-cycle and a 2000-cycle voltage will create a 2-1 ratio pattern and this pattern will remain the same if the two frequencies are changed to 5000 and 10,000 cycles, 2250 cycles and 4500 cycles, 50,000 and 100,000 cycles, etc. The same is true of all other ratios.

Figure 95 A, B, C and D illustrates four 1-1 ratio patterns for two sine waves of voltage. Figure 95 E, F and G indicate 1-1 ratio patterns, but with one of the voltages distorted. Such 1-1 patterns may take the form of anything between a straight or even crooked line,

through an ellipse of any degree of eccentricity, to a circle. Whether or not the pattern will remain stationary, depends upon the frequency adjustment of the two oscillators. It may be difficult to stop any pattern formed, when a standard is being compared with an unknown



Fig. 95. E, left, F, middle, G, right. The three Lissajous figures here shown indicate a 1-1 ratio. One of the voltages impressed on the plates was not a pure sine wave; hence the distortion.

oscillator, because either one of the oscillators may not be absolutely constant in its output. The drift, however, may be so small as to cause a slow change, which will not interfere with the calibration. However, you are the one to judge the degree of constancy which you want in an oscillator.

The frequency difference, existing between the two oscillators and indicated by the motion of the pattern, can be checked by timing the movement of the pattern. A complete cycle of rotation of the pattern in one second is equal to a frequency difference between the settings of the two oscillators of 1 cycle. If a complete cycle of rotation is completed in four seconds, the difference in frequency adjustment is $\frac{1}{4}$ cycle. If four complete rotations of the pattern are made in one second, the frequency difference between the two oscillators is 4 cycles.

Figures 96 A, B and C show three patterns for a 2-1 ratio, with both voltages of sine character and unmodulated. These three pat-

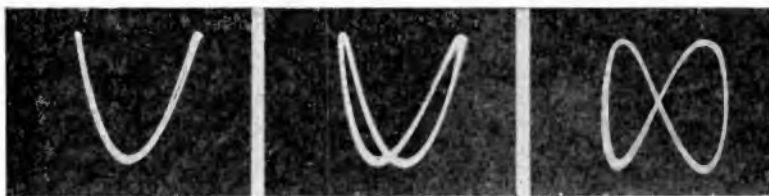

Fig. 96. A, left, B, middle, C, right. Lissajous figures showing a 2-1 ratio.

terns indicate three phase relations. These three patterns were made by causing the two oscillators to differ very slightly in frequency, so that the pattern progressed through the complete range of phase relations between 0 and 360 degrees. Figure 96-A is an example of a completed

loop pattern, but wherein one of the peaks is covered by the other and so is a poor pattern for judging frequency ratio. Figures 96-B and 96-C are suitable for frequency comparison or calibration. The similarity between figures 96-A and 96-B is quite close and you can appreciate a small lapse of time and possibly visualize how one peak has moved away from the other, thereby uncovering it.

The effect of having one of the voltages modulated is shown in figures 96-D and 96-E. These two patterns indicate a 2-1 ratio and are of the completed loop type, with the loops or peaks uncovered.

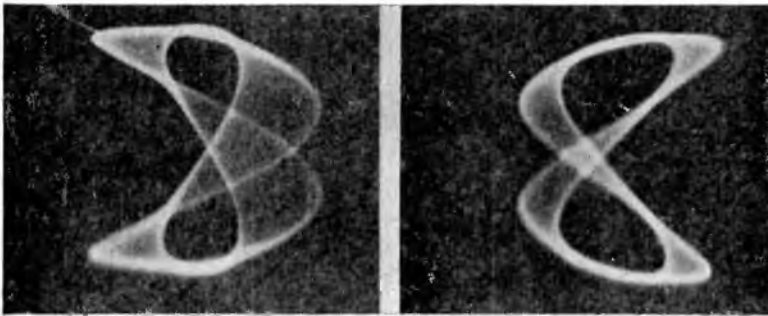

Fig. 96. D, left, E, right. A 2-1 ratio pattern obtained by impressing a 100,000-cycle sine wave modulated with 100 cycles and a 50 kc. unmodulated sine wave on the tube's plates.

Note that the modulation component does not influence the shape of the pattern, other than that the line has been spread. Incidentally, figures 96-D and 96-E are for a 100,000-cycle signal compared with a 50,000-cycle signal, with the former modulated at 400 cycles.

A better example of the range of patterns, which may be expected when the image is in motion, is illustrated in figures 97 A to G. These

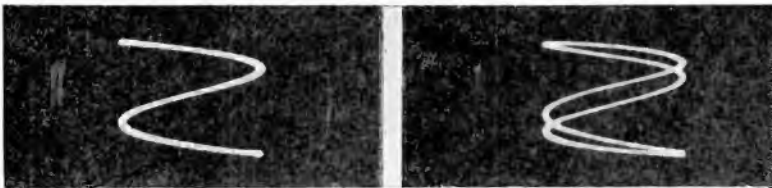

Fig. 97. A, left, B, right. A 3-1 ratio pattern is shown in both illustrations. The pattern in A was taken when the phase difference between the two voltages was 0°.

are patterns for a 3-1 ratio, with both voltages of sine character. Each of these indicates a different phase relation, the exact value of which is not important. However, it is significant to note that five of the

seven patterns are suitable for frequency comparison, because all of the loops or peaks are uncovered. Figure 97-A is like that shown in figure 52, illustrating the resultant image when two voltages are in phase and



Fig. 97. C, left, D, right. 3-1 ratio patterns obtained by using two different phase relationships.



Fig. 97. E, left, F, right. The 3-1 pattern in E was photographed with a phase difference between the waves of 90° , and that of F above 90° .

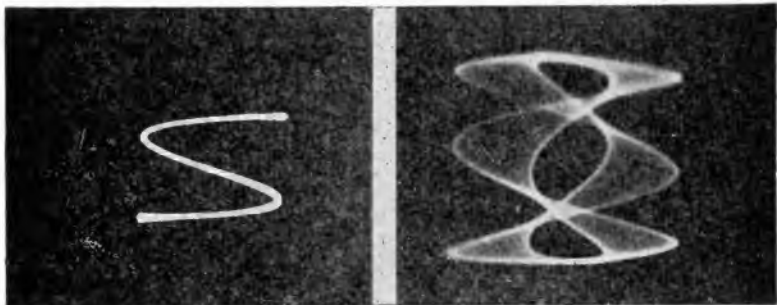

Fig. 97. G, left, H, right. The 3-1 pattern of G was made when the voltages had a phase difference of 180° . In H one of the voltages was modulated.

the frequency of one is three times the frequency of the other. Figure 97-E is like the pattern developed in figure 50, illustrating the two voltages 90 degrees out of phase. The pattern shown in figure 97-G indicates a phase difference of 180 degrees. 97-H indicates a 3-1 ratio with one of the voltages modulated.

Figure 98 illustrates a ratio of 3-2. Note three loops or peaks along one side and two loops or peaks along the adjacent side. Tangents drawn along these sides would touch the number of loops stated.

Figures 99-A and 99-B illustrate a 4-1 pattern, with both voltages sine (figure 99-A) and with one of the voltages distorted, shown in figure 99-B.

Fig. 98. A 3-2 Lissajous pattern. Note that there are two loops horizontally and three loops vertically.

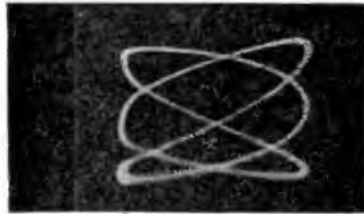

Figure 100 shows a 4-3 ratio pattern. Note the four loops on one side and the three loops on the other side. At the same time, we want to call to your attention the fact that often the loops are more distinct upon one side of the pattern than upon the other. For example, the

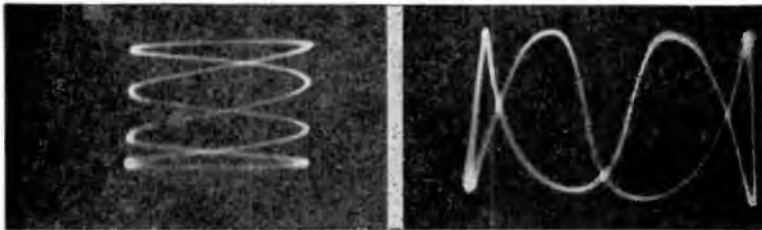
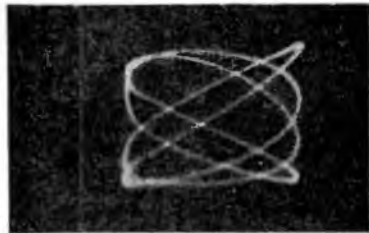

Fig. 99. A, left, B, right. Both these patterns indicate a 4-1 ratio. Both sine waves were pure when A was photographed, but one was distorted when B was taken.

four loops are more distinct upon the right side of the pattern than upon the opposite parallel side. Also that the three loops are more distinct upon the bottom side of the pattern than upon the top boundary.

Fig. 100. On the right is shown a 4-3 ratio pattern. The four loops may be easily distinguished along the right side of the figure and three loops along either the top or bottom.



Figures 101-A and 101-B illustrate 5-1 ratios, but it would be most difficult to anyone but an experienced person to determine that figure 101-B indicates a 5-1 ratio, because the loops have been covered by other loops. On the other hand, the pattern of 101-A shows all of the

loops completed and uncovered, the ideal pattern for frequency comparison.

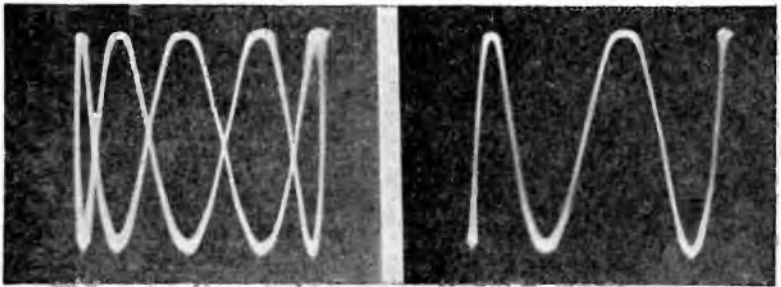

Fig. 101. A, left, B, right. Both patterns are of a 5-1 ratio. The one shown in B has its peaks coinciding.

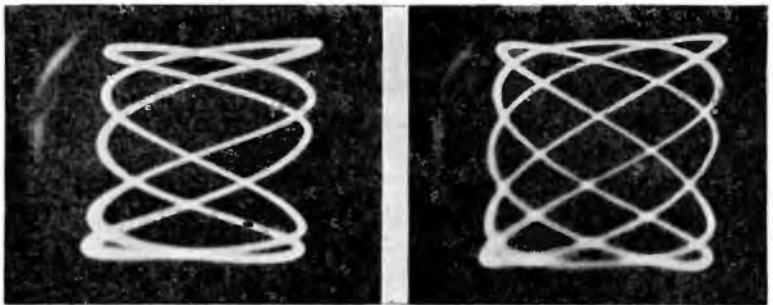

Fig. 102. A, left, B, right. The Lissajous figure in A has a ratio of 5-2 and that in B has a ratio of 5-3. Note the number of loops at the top of each figure.

Figures 102-A and 102-B illustrate 5-2 and 5-3 ratios, respectively. Figure 103 illustrates a 6-1 ratio. Figures 104-A and 104-B illustrate 6-5 ratios, with the loops covered in the former case and uncovered in the latter photograph.



Fig. 103. The ratio between the voltages impressed on the tube's plates was 6-1 when this Lissajous figure was photographed. The six loops are easily seen on the right side of the pattern.

A 7-1 ratio is shown in figure 105; a 7-2 ratio is illustrated in figure 106 and 7-3 ratio is shown in figure 107. Figures 108 and 109 illustrate ratios of 7-5 and 7-6, respectively. Note that a portion of the pattern

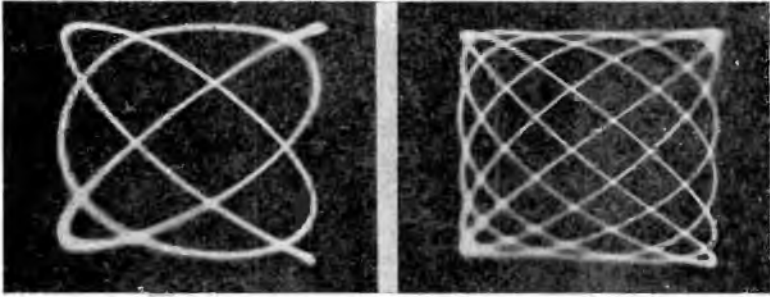

Fig. 104. A, left, B, right. Both patterns were made with a 6-5 ratio. The one shown in A was photographed when the loops were "closed" and that in B when the loops were "open."

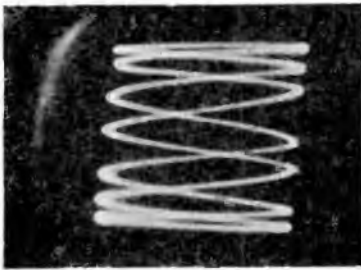

Fig. 105. A 7-1 ratio pattern.

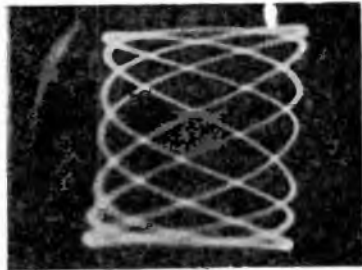

Fig. 107. A 7-3 ratio pattern.

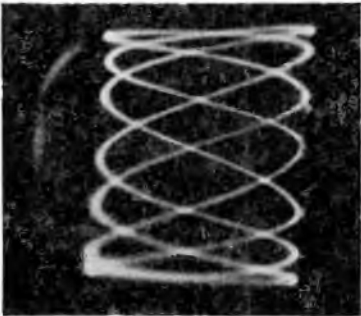

Fig. 106. A 7-2 ratio pattern.

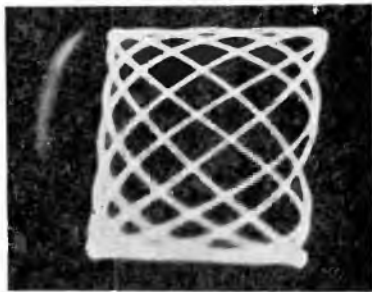

Fig. 108. A 7-5 ratio pattern.

is out of focus and that it becomes increasingly difficult to establish the identity of the frequency ratio. The bottom boundaries of both of these patterns are useless for identification of the number of loops present in the picture.

An 8-1 ratio is indicated in figure 110. Note that while the ratio is high, the pattern is still relatively simple. Compare the nature of

this pattern with the 8-3 ratio shown in figure 111-A and the 8-7 ratio illustrated in figure 111-B. Identification of the latter pattern is too complicated for ordinary frequency measurement. Extremely stable

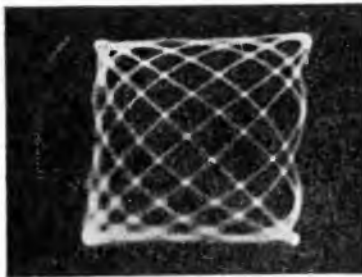

Fig. 109. A 7-6 ratio pattern.

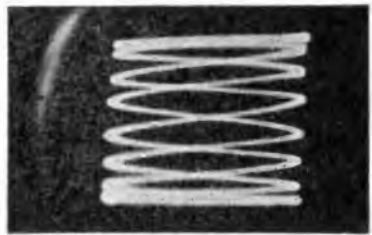

Fig. 110. An 8-1 ratio pattern.

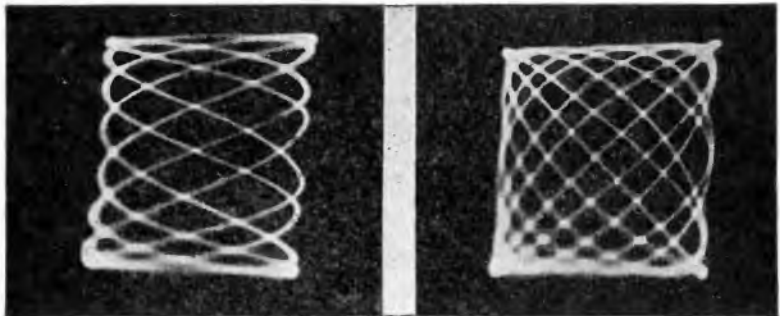

Fig. 111. A, left, B, right. The pattern in A is an 8-3 ratio and that in B is 8-7 ratio.

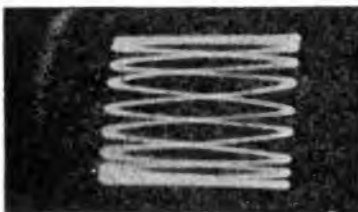

Fig. 112, above. A 9-1 ratio pattern.

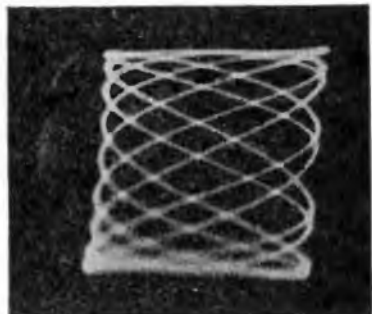

Fig. 113, right. A 9-4 ratio pattern.

oscillators must be used, if these patterns are to be identified directly upon the cathode-ray tube viewing screen. They must be stationary

for any sort of determination. There are entirely too many lines in the pattern to permit identification with the image in motion.

A 9-1 ratio is shown in figure 112. Ratios of 9-4, 9-5, 9-7 and 9-8 are shown in figures 113, 114, 115, 116, respectively. A 10-1 ratio is shown in figure 117.

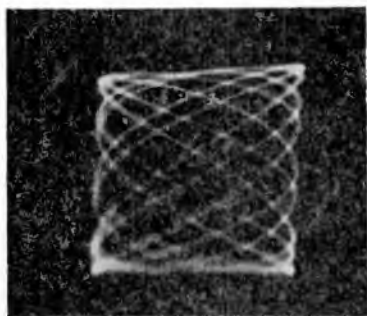

Fig. 114. A 9-5 ratio pattern.

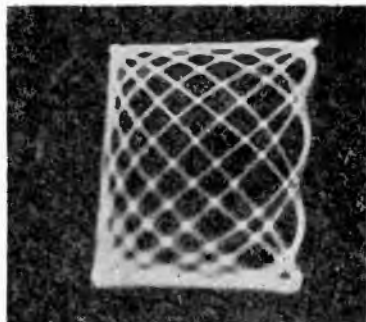

Fig. 115. A 9-7 ratio pattern.

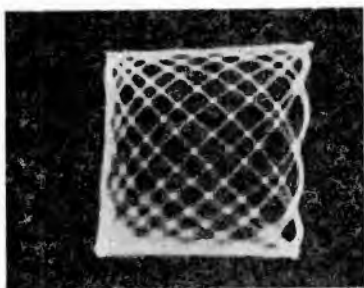

Fig. 116. A 9-8 ratio pattern.

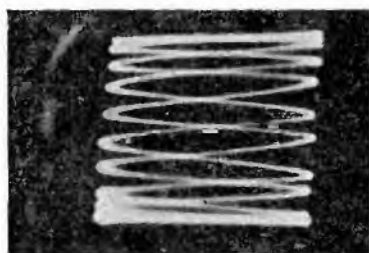

Fig. 117. A 10-1 ratio pattern.

So much for the completed loop patterns. While this by no means completes the subject of Lissajous figures used for frequency calibration, the illustrations given so far should serve as guides in establishing the ratio of patterns secured when two voltages are fed into the cathode-ray tube oscillograph in conformity with the circuit shown in figure 94. Since the majority of calibrations of oscillators are carried out with ratios of from 1-1 to 10-1, with the type of circuit shown in figure 94, we shall devote most of our attention to these completed loop patterns. The other types of patterns, which are available with the cathode-ray tube, will be discussed later in this chapter.

Proper interpretation of the frequency ratio requires more than just the knowledge of the ratio as indicated upon the screen by the loops

in the pattern. Each ratio can be interpreted two ways, namely, where one frequency is so many times higher than the standard, or is that fraction of the standard. In other words, a 3-1 ratio may mean that the standard frequency is three times as great as the unknown or is one-third the frequency of the unknown. Which case applies for any one ratio can be determined by examination of the image, assuming that the connections to the horizontal and vertical deflection plates have not been changed. The information is conveyed to the operator by the positioning of the loops upon the screen.

Let us assume that the standard frequency, adjusted to 3000 cycles, is applied to the vertical deflection plates. The unknown signal generator is connected to the horizontal deflection plates. This unit is

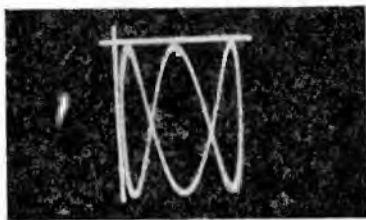

Fig. 118. The tangent that is drawn parallel to the X axis touches the loops that result from the voltage applied to the vertical plates and the tangent drawn vertically touches those loops that are produced by the voltage applied to the horizontal plates. As the former was 3000 cycles and as the figure shows a 3-1 ratio, the other voltage must be 1000 cycles.

varied until the image of figure 118 is seen upon the screen. Obviously, the ratio is 3-1, but in which direction? Is the standard higher or lower than the unknown? Let us see.

The tangent drawn parallel to the horizontal reference line or "X" axis of the tube will cut or touch the loops produced by the vertical deflection. A tangent to the pattern, drawn parallel to the vertical or "Y" axis, will cut or touch the loops due to the horizontal deflection. The voltage applied to the vertical deflection plates has caused the production of three loops, whereas the voltage applied to the horizontal plates has caused but only one loop. We know that the standard frequency, applied to the vertical plates, is 3000 cycles, hence the frequency of the standard is to the unknown as 3 is to 1, and the frequency of the unknown is 1000 cycles.

Now suppose that instead of the image shown in figure 118, we see upon the viewing screen the image shown in figure 119. Counting the number of loops, we still find a 3-1 ratio. However, a tangent drawn parallel to the "X" axis would touch but one loop, which is due to the vertical deflection. A tangent drawn parallel to the "Y" axis, however, would touch three loops, which are due to the voltage applied to the horizontal plates. There are three loops due to the

horizontal deflection voltage and only one loop due to the vertical deflection voltage. We know that the frequency of the voltage applied to the vertical deflection plates is 3000 cycles. If the horizontal deflection voltage produces three loops for the one loop due to the vertical deflection voltage, the frequency of the voltage applied to the horizontal

Fig. 119. The Lissajous pattern here shown is the reverse of that in Fig. 118. By identical reasoning, the ratio of the frequencies applied to the plates is here 1-3, instead of 3-1. The 3000-cycle wave is applied to the vertical plates, the ratio is 1-3, so the second voltage must have a frequency of 9000 cycles.

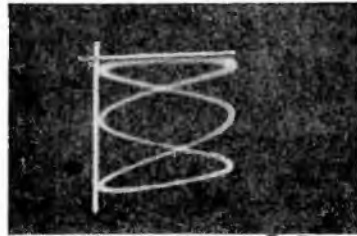

deflection plates must be three times the standard, or the frequency of the standard is to the unknown as 1 is to 3, and the frequency of the unknown is 9000 cycles.

It is evident from the foregoing, that what may be a 3-1 ratio in one case is a 1-3 ratio in another. Any one of the ratios mentioned thus far may be used to indicate that the standard frequency is higher than the unknown, by the ratio stated, or is lower than the unknown, in the ratio stated. This is why it is so important during calibration work to know the direction in which the voltage from the frequency standard is acting upon the beam.

The frequency ratios given thus far are not all which exist between any two frequencies and which produce patterns upon the viewing screen. However, more complicated ratios have very little value for calibration, because it is extremely difficult to stop the image for examination. Furthermore, there is no reason why recourse to these complicated ratios should be made when both oscillators are continuously variable through their ranges. This is so even if the oscillators are not continuously variable. If one is variable in steps and the other is continuously variable, perfect calibration will be possible by using simple integral ratios and complete elimination of complex fractional ratios.

After you have had experience viewing some of these Lissajous figures, particularly when they are in motion, you will find it much easier to comprehend just what is meant by the statement that these patterns, when viewed upon the screen, appear as if the wave were traveling around a glass cylinder.

Phase Splitting Circuits

In order to facilitate observation or to simplify the pattern, it is frequently desirable to separate the front and rear patterns. In other words, patterns, such as we have shown, can be said to have front and rear portions, which are on the same horizontal plane. That is why, under certain phase conditions, certain peaks or loops are covered by

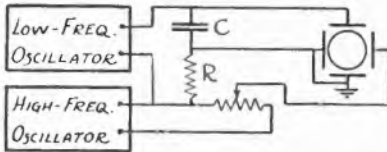

Fig. 120. This circuit is used for separating the front and rear portions of a pattern, making the interpretation of high ratio figures much simpler. For a circular pattern the reactance of C should equal resistance of R at the base frequency.

other loops. When the frequency ratio is greater than 10 to 1, comprehension of these patterns is not easy. To simplify them, or at least to make interpretation easier, the pattern can be displaced on a circle or an ellipse.

The circuit used is shown in figure 120. It is substantially the same as that used in figure 94 for securing conventional patterns, except for the addition of a phase splitting system, whereby the front and rear portions of the pattern are separated. The 10-1 pattern of figure 117 now looks like the pattern shown in figure 121. A 13-2 pattern spread out as an ellipse is shown in figure 122. A 19-2 pattern, with the front and rear traces spread, is shown in figure 123. Frankly, we



Fig. 121. A 10-1 ratio pattern. Compare Fig. 117.

Fig. 122. A 13-2 ratio pattern.

Fig. 123. A 19-2 ratio pattern.

do not feel that there is any real need for such Lissajous figures during routine frequency calibration. With careful operation with ratios up to 10-1, complete coverage can be had with a high degree of accuracy. However, we show the schematic diagram and several examples for those who may want to develop such patterns. To establish the fre-

frequency ratio of single line patterns, count the number of loops and the ratio is the number of loops to 1.

In patterns which indicate fractional ratios, count the number of loops and the number of lines of intersections made by the loops. In figures 122 and 123, there is one such line of intersections. The frequency ratio is equal to the number of loops or peaks on the circumference divided by the term (one plus the number of lines of intersections). Thus figure 122 shows a ratio of 13—2 and figure 123 shows a frequency ratio of 19 to 2.

Another form of pattern, due to N. V. Kipping, is the gear-shaped figure on a circular axis. This produces a pattern such as that shown in figure 124. The circuit is shown in figure 125. One voltage is applied across both sets of plates in quadrature, by means of the phase splitting circuit. As a result of this circuit, the beam spot traces a

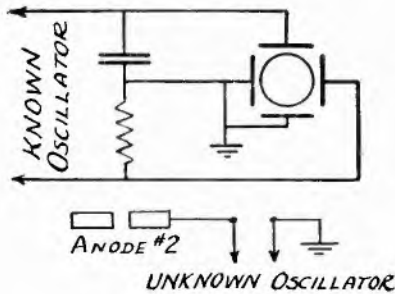

Fig. 124, above, Fig. 125, right. The circuit in Fig. 125 will produce a gear-shaped pattern like that in Fig. 124. The condenser reactance should equal the resistance for the frequency used.

circle upon the screen. The other voltage, the unknown, is connected in series with the accelerating anode (anode #2). The operation of the system is predicated upon the fact that as a result of the varying voltage in series with the fixed accelerating voltage, the anode potential will fluctuate through a maximum and minimum, in accordance with the frequency of the varying voltage. At the same time, voltage applied in quadrature to the two sets of deflection plates will cause the spot to describe a circle. The varying voltage will cause the anode potential to fluctuate a number of times (depending upon the frequency of the varying voltage) during each circulation of the spot, with the result that the final pattern will be an image which indicates the frequency ratio between the varying voltage in series with the anode and the frequency of the voltage which is causing the circular motion of the spot. If the ratio between the two is exact, the image will be stationary. If the ratio is not exact, the image will revolve.

This arrangement has several disadvantages when viewed from the

practical angle. First is the danger entailed by working around the high anode voltage found in present-day cathode-ray tube equipment. The second is that it is quite a problem to break into the finished cathode-ray oscillograph in order to make the proper contact with the circuit. The third is the defocusing effect of this varying potential, and the resultant blurring of the image. The fourth is that ample information for calibration is possible with the regular completed loop patterns.

Linear Sweep Circuit As Frequency Standard

The use of the linear sweep circuit as a frequency standard for frequency comparison or calibration is beset by so many limitations that we do not deem it worthwhile to describe the use of the patterns thus created for frequency calibration. These patterns are of the uncompleted loop, open end type. Two examples are shown in figures 126 and 127. These are created as a result of the condition that the frequency of the signal and the sweep are not exact multiples of one another. When the sweep frequency is an exact sub-multiple of the other frequency applied to the vertical plates, the pattern is the regular single line waveform, of one two or more cycles, depending upon the ratio between the sweep frequency and the other frequency. The effect of making the sweep frequency an exact multiple of the frequency being observed has been shown.

While it is true that these patterns can be used for frequency comparison, they are not worthwhile. We do not mean to assume a negative attitude, or to disparage the efforts of others who have shown such patterns for frequency comparison, but we are considering the value of a pattern from the practical as well as the technical angle. It is our belief that the use of the linear sweep circuit for frequency comparison, is not justified for the following reasons:

1. It is difficult to stop any such pattern without recourse to the synchronizing circuit. Unless the pattern is made stationary, it cannot be interpreted. When the synchronization control is applied, it is very apt to change the frequency of the sweep circuit and thereby nullify its value as a standard.
2. The possibility of errors with these uncompleted loop patterns is very much greater than with completed loop patterns, because the patterns are far more complex and require more detailed study in order to enable correct interpretation; that is, if the pattern can be made stationary, which in itself is quite a problem.

3. Linear sweep circuits contained in commercial cathode-ray units are not calibrated with sufficient accuracy to enable their use as a standard. The amount of calibration required to enable the use of the sweep for waveform observation need not be more than the knowledge concerning the range of frequencies covered by the band switch positions, but this is certainly not enough for the calibration of unknown frequencies.

For those who may desire to use some of these patterns, the frequency ratio is determined by counting the number of loops or peaks and the number of lines of intersections, and adding "one" to the number of

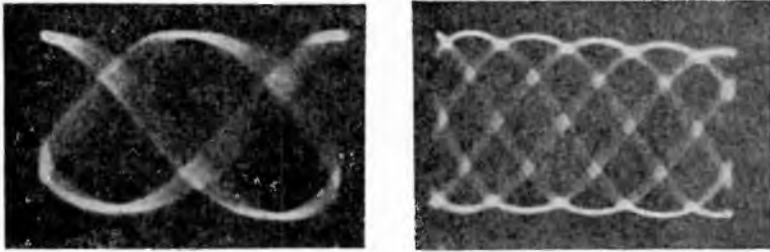

Fig. 126, left, Fig. 127, right. The pattern in Fig. 126 shows two loops and two lines of intersections. By adding one to the number of intersections, the ratio of 2-3 or 3-2 is established for the pattern. The five loops and five intersections of Fig. 127 indicates a ratio of 5-6 or 6-5, by adding one to the number of intersections.

intersections. In other words, figure 127 shows five loops and five lines of intersections. The ratio, therefore, is 6-5. Always add one to the number of lines of intersections. Figure 126 shows two loops and two lines of intersections. Adding one to the number of lines of intersections, makes the frequency ratio 3-2 or 2-3, depending upon the base frequency with respect to the frequency of the unknown oscillator. The haziness of the patterns shown in figures 126 and 127 is occasioned by the fact that the image was in motion when the photographs were made.

Oscillator Calibration

What is the exact method of calibrating an oscillator? We need not speak about the frequency ranges possible, because that subject was covered earlier in this chapter.

Two methods of calibration are possible, using the cathode-ray tube as the visual indicator. One is to adjust the known and the unknown oscillators so as to produce a 1-1 pattern upon the screen, for which ad-

justment the frequency of the unknown oscillator is equal to the known frequency of the standard oscillator. The other method is to keep the standard oscillator fixed at one frequency, say the lowest base frequency, and to vary the unknown oscillator through a range which will produce patterns of from 1-1 to 10-1 ratio, calibrating at each adjustment of the unknown, in accordance with the frequency ratio indicated upon the screen.

The former of these two methods is to be preferred. First, because it enables more accurate adjustment at each frequency, since the frequency ratio is 1-1. Second, it minimizes the error to that existent for the standard, at that one frequency. If the second method is used and the base frequency adjustment is "off," the discrepancy is carried on through each of the other calibrations based upon the original standard frequency. However, the second method is faster, in that only one oscillator is adjusted for a number of frequency calibrations. It is more economical and perhaps more common because of the minimum expense involved to secure the single frequency standard. If the first method is used, each oscillator is advanced step by step. The closer the calibration points, the greater the number of tuning changes required.

The degree of accuracy obtained is determined by two factors. First is the accuracy of the calibration of the standard oscillator for any one setting. The second is the care with which the unknown is varied in order to stop the image. Absolute accuracy of calibration is achieved when the image is stopped. However, it is possible that the drift in one or the other of the two oscillators being used will prevent the stopping of the image. At any rate a very slow drift of the pattern is permissible. The point of calibration should be set as that for which the image has stopped or is moving at the slowest speed.

The attempt to stop the image, or to bring the pattern into some even ratio, should be carried out by varying the unknown oscillator—never the standard oscillator. The standard oscillator adjustment, once fixed for any one frequency, should remain fixed.

Interpreting Ratio Patterns

Very little need be said about 1-1 ratio patterns. When these appear and are stopped, the unknown oscillator frequency is equal to the standard frequency. If full coverage of the standard and unknown oscillator ranges is carried out in this manner, there is no need for calculation of any sort. However, if the frequency calibration is carried out with ratios other than unity, some calculation is required. This cal-

ulation is not difficult. Operating in this manner, it is best to make the standard frequency, the base frequency and lower than the unknown frequency. This means that the patterns will indicate ratios, wherein the unknown frequency is the greater. Thus if a pattern indicates a 4-1 ratio, the lower frequency is the standard and the high frequency is the unknown. If the base or standard frequency for this pattern is 100 cycles, the unknown frequency, for the setting which develops the 4-1 ratio pattern is $100 \times 4/1$ or 400 cycles. In other words, the base frequency is multiplied by the numerator of the ratio fraction and the product of the two figures is divided by the denominator of the ratio fraction. Thus if the base frequency (standard) is 1200 cycles and is the lower of the two frequencies which produces the pattern, and the frequency ratio indicated by the pattern is 4-3, the frequency of the unknown for that setting is $1200 \times 4/3$ or 1600 cycles. For a base frequency of 100 cycles, the following would be the frequency of the unknown for various ratios, assuming that in all cases the base frequency is the lower of the two frequencies.

Ratio	Frequency of Unknown Oscillator
1/1	100 cycles
5/4	125
4/3	133
3/2	150
5/3	167
7/4	175
2/1	200
9/4	225
7/3	233
5/2	250
8/3	267
11/4	275
3/1	300

These thirteen patterns, produced for various base frequencies, will enable calibration in extremely small steps. Thus suppose that the thirteen ratios named have been established. By increasing the base frequency to 300 cycles, as the second adjustment, the ratios listed will provide calibration points for 300 cycles, 375 cycles, 400 cycles, 450 cycles, 500 cycles, 525 cycles, 600 cycles, 675 cycles, 700 cycles, 750 cycles, 800 cycles, 825 cycles, 900 cycles. By moving the base frequency up to 900 cycles and producing the same ratio patterns, by varying the adjustment of the oscillator being calibrated, calibration up to

2700 cycles is obtained. By advancing the base frequency up to 2700 cycles and producing the same ratio patterns, by adjusting the unknown, calibration up to 8100 cycles can be made, etc.

The frequency ratio can be expressed in two ways: as the ratio between two integers, as has been done, or as the ratio between a whole number and a fraction to unity, which requires conversion of the ratio between the two integers into the ratio between the whole number and fraction to unity. This conversion is nothing more than dividing the numerator of the integral ratio by the denominator. This is shown in the following table:

Integral Ratio	Whole Number and Fraction to Unity
1:1	1 :1
5:4	1 1/4 :1
4:3	1 1/3 :1
3:2	1 1/2 :1
5:3	1 2/3 :1
7:4	1 3/4 :1
2:1	2 :1
9:4	2 1/4 :1
7:3	2 1/3 :1
5:2	2 1/2 :1
8:3	2 2/3 :1
11:4	2 3/4 :1
3:1	3 :1

This can be carried out for any number of ratios. It is necessary that you understand that these ratios are independent of frequency, that they apply irrespective of the exact numerical value of the base frequency. In other words, a 5-4 ratio pattern may exist for a base frequency of 100 cycles, 500 cycles, 2,000 cycles, 50,000 cycles or 1,000,000 cycles, provided that the arrangement of the equipment is such that these frequencies are those for voltages which are of sufficient amplitude to act properly upon the electron beam and to cause the required pattern.

Dynamic Tube Characteristics

While it is true that the cathode-ray tube enables determination of the actual dynamic tube characteristic, we do not believe that it will ever reach any value in that direction, at least not in the service and allied fields. This is so, because the nature of the tests required upon vacuum tubes for field work is such that dynamic data is not necessary. The present day tube-checking equipment available to the service field and

to the engineer suffices for all normal purposes. However, since this volume is intended to convey information concerning the application of the cathode-ray tube, its use for determining tube characteristics must be included.

There are numerous types of tube tests which can be made with the cathode-ray oscillograph. These are grid voltage and plate current, grid voltage and plate voltage, and plate current-plate voltage tests. The tests can be made for tubes functioning as detectors, amplifiers or generators, in other words, oscillators. We have selected as an example of such application, tube characteristic tests in which are indicated the relation between a-c. grid voltage and a-c. plate voltage. As a matter of fact, this same test indicates grid voltage against plate current, because the a-c. plate voltage is taken off across a fixed resistor in the plate circuit of the tube and the a-c. voltage across this resistor is proportional to the plate current.

Fig. 128. Schematic diagram of circuit for determining the characteristics of a vacuum tube. The a-c. grid voltage actuates the horizontal plates and the a-c. plate voltage or current the vertical plates.

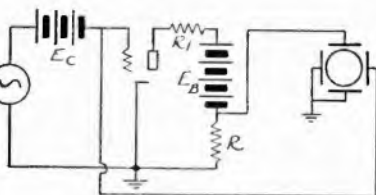

The method of making this test is to employ the a-c. grid voltage to provide the horizontal deflection and the a-c. plate voltage or plate current to provide the vertical deflection. Electrostatic deflection is used, so that the a-c. voltage developed across the resistor in the plate circuit supplies the vertical deflection voltage. The schematic wiring diagram is shown in figure 128. The oscillograph unit is adjusted to enable the application of signals to the vertical and horizontal plates. The sweep circuit is not used. Synchronization is not used. Referring to the schematic wiring diagram, E_C is the grid bias battery; E_B is the plate voltage battery; resistor R_L is the load resistor; and resistor R is a fixed 1000-ohm unit across which is developed the a-c. voltage required for the vertical deflection.

The amplifiers contained in the cathode-ray oscillograph and feeding the vertical and horizontal plates can be used. By means of the set-up shown in figure 128, it is possible to determine the effect of varying any one of the controlling factors, namely the effect of electron emission change, grid voltage, plate voltage and load-resistance change. The tube used for the tests was a type 31. Figures 129, 130

and 131 show the change in the grid voltage-plate current characteristic for constant values of grid voltage and plate voltage, but with a change in filament temperature, or electron emission. Figure 129 indicates the characteristic when the filament current or voltage is ab-



Fig. 129, left, Fig. 130, middle, Fig. 131, right. Grid voltage-plate current characteristics made by varying filament current and holding grid and plate voltages constant. Fig. 129 was made with the filament current too low. Note the lengthened curve of Fig. 130 caused by increasing the filament current. Fig. 131 shows the characteristic when the filament current was increased beyond its rated value.

normally low. Figure 130 shows an increase in filament voltage. Note how the characteristic has been made longer. In figure 131, the filament current has been increased above its rated value. Note how the useful portion of the operating curve has been lengthened and how saturation has been reduced.

An example of the effect of changing the load resistance is shown in figures 132 and 133. In figure 132, the grid voltage, filament voltage and plate voltage are maintained constant, but load resistance R_1 , in figure 128, has been reduced to zero. The only resistance remaining in the plate circuit is that of the unit R , required to provide the vertical deflection. This is a 1000-ohm unit. Figure 133 was made with conditions identical to that shown for figure 132, except that a load resistor, R_1 , has been added and is of the order of 10,000 ohms. All of these curves were made with an a-c. signal input of about 1000 cycles and of sufficient amplitude to cause saturation with a bias voltage of about -22.5 volts. The plate potential also was maintained at values lower than normal, in order to be able to show the effect of the various changes made.

Similar tests are possible upon all types of tubes. The triode here shown was selected because of its great simplicity. Any two controlling factors can be correlated by providing for the deflection of the beam at right angles, and introduction of the changes.

Magnetic deflection of the beam, described elsewhere in this volume, has been suggested in connection with the vertical deflection due to

the plate current. This is not as satisfactory as electrostatic deflection, because of the variation introduced by frequency. Such magnetic de-

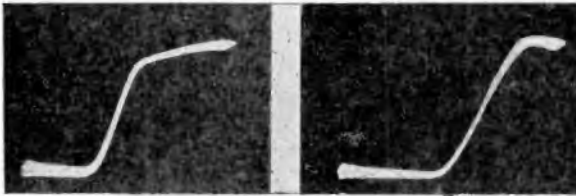

Fig. 132, left, Fig. 133, right. Tube characteristics obtained when the filament, grid and plate voltages were held constant and changes made in the load resistance, R_1 of Fig. 128. The pattern of Fig. 132 was photographed when $R_1 = 0$ and that of Fig. 133 when $R_1 = 10,000$ ohms.

flection would consist of the use of a pair of deflecting coils in place of the resistor R , shown in figure 128. These coils would be arranged to provide the vertical deflection.

Magnetic Deflection Practice

Despite what has been said about magnetic deflection, you may still feel that you wish to employ magnetic deflection along the vertical direction. Such being the case, the circuit suitable for such operation is shown in figure 134. We assume that you will feed the linear sweep

Fig. 134. Circuit for obtaining vertical displacement by magnetic deflection. Note that the two vertical plates are grounded.

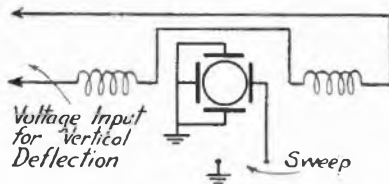

voltage, if such is used, to the horizontal deflecting plates and use a combination of magnetic and electrostatic deflection. Note that the free vertical plate is grounded. The sweep voltage connections to the horizontal plates may be made externally, if an external sweep voltage is used, or may be made internally, if an internal sweep voltage is used. In the latter event, ignore the connections shown to the horizontal plates.

When using magnetic deflection in the vertical direction, you cannot make use of the vertical deflection amplifier contained in the cathode-ray oscillograph. If amplification is required to produce the required deflection, such an amplifier must be connected between the

source of the signal voltage used for the vertical deflection and the deflecting coils.

The exact design of the deflecting coils is something into which we cannot enter. The design of the tube has a controlling influence in this connection. The magnetic sensitivity of all tubes is not alike, so that for any one voltage input, different types of coils will produce different results. The important consideration is the ampere turns. In the case of the Western Electric type 224 tube, with coils 4.3 cm. in diameter and 4. cm. apart, an anode potential of 400 volts, the magnetic sensitivity was about 1. mm. per ampere turn. At other anode potentials, the sensitivity would be different. The RCA 904 is rated at 0.8 millimeter per ampere turn at 1000 volts applied to anode #2. The coils suggested for this tube are of 15,000 turns each, air core, with a core 27 mm. by 12 mm. The length of the coil is 27 mm. and its height is 40 mm. The magnetic sensitivity rating of the RCA 906 or its equivalents, is not known. It should be understood that the ratings given herein are those contained in literature relating to the products mentioned. As stated, the design of the coils depends upon application. The coils, shown in figure 24-D, were made for the author, by Ralph R. Batcher. These coils are rated at about 15,000 turns each and 500 ohms d-c. resistance. Their size conforms with the specifications given for the coils used with the 904 tube, although we used the coils with the 906 tube.

As is to be expected, the position of the deflecting coils has a great effect upon the deflection indicated upon the screen, or the position of the trace. This effect relates to the size of the deflection as well as the direction of the deflection with respect to what is the correct deflection along the "Y" axis, assuming that the coils are being used to produce the deflection in the vertical direction.

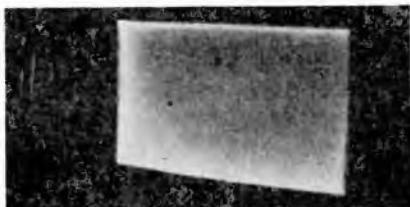

Fig. 135. Theoretically this pattern, obtained with magnetic deflection applied vertically and electrostatic deflection horizontally, should be a perfect rectangle, but it is not, due to tube distortion.

A pattern produced as a result of magnetic deflection along the vertical axis and electrostatic deflection along the horizontal axis is shown in figure 135. The solid pattern is due to the fact that the sweep frequency was made so low that many cycles of the vertical deflection

voltage appear upon the screen, to form a solid pattern. The fact that the image is not a perfect rectangle, is due to the distortion which exists in commercial tubes, wherein one of the plates of each pair of deflecting plates is connected to the anode. This is quite a commonplace action in all commercial cathode-ray tubes, not equipped with separate leads from each of the deflecting plates. It is to be found with electrostatic deflections in both directions, as well as with a combination of electrostatic and electromagnetic deflection. (Such distortion, while not a desirable feature, does not interfere with the routine operation of the tube, or at least with the routine operation of the cathode-ray oscillographs described herein.)

Fig. 136. The waveform of the voltage produced by magnetic deflection applied vertically. The frequency of the wave is the same as in Fig. 135, the horizontal sweep frequency having been changed to get two cycles on the screen.



An increase in the sweep frequency, in order to show two waveforms upon the screen, produced the pattern shown in figure 136. (The vertical deflection, that is, the voltage being observed, was applied

Fig. 137. When the coils are incorrectly positioned with respect to the horizontal, the resulting pattern on the screen will be at an angle, as is shown on the right.



Fig. 138, left. When the sweep frequency was increased after the pattern of Fig. 137 was photographed, the three cycles of the wave, shown on the left, indicate the necessity for having the deflecting coils properly oriented with respect to the sweep

through the deflecting coils.) The effect of improperly orienting the vertical deflection coils, is shown in figures 137 and 138. The former is the solid pattern, but with the deflection coils turned slightly so that the beam was deflected improperly. The tilting of the pattern, as a result of the incorrect orientation of the vertical deflecting coils, with sev-

eral cycles upon the screen, is shown in figure 138. The frequency of the voltage applied to the vertical deflection coils is the same in figures 137 and 138. The difference between the two patterns is that the sweep frequency was increased in figure 138, so that a few cycles, instead of very many cycles, appeared upon the screen.

Synchronization of the waveform under observation and the sweep frequency is possible with magnetic deflection, just as readily as with electrostatic deflection. However, it is necessary to secure the synchronizing signal from some point along the source of the vertical deflection voltage, and to adjust the synchronizing control within the cathode-ray oscillograph, to "external."

An example of the poor success which was experienced when making tube characteristic curves with magnetic deflection at a low and medium



Fig. 139, left, Fig. 140, right. The oscillogram of Fig. 139 was made at 40 cycles and that of Fig. 140 was made at 1000 cycles. The phase shift present in these patterns is clearly evident. Compare Figs. 129 to 133.

audio frequency, is shown in figures 139 and 140. Figure 139 was made at 40 cycles. The tube operating voltages were adjusted to show saturation. The phase shift indicated was corrected when so required. For similar operating voltages, but with the a-c. input voltage raised to 1000 cycles, the pattern shown in figure 140 was developed. The phase distortion due to the a-c. characteristics of the coils used is clearly evident. The tube operating characteristics, for the same tube and operating voltages but with electrostatic deflection, were shown in figures 129 to 133 inclusive.

Hysteresis Measurements

Measurement of magnetic hysteresis can be made with the cathode-ray oscillograph. The service technician will find very little opportunity

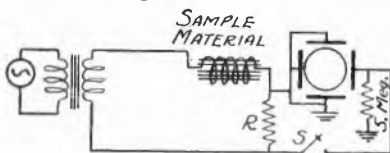

Fig. 141. The schematic diagram of the circuit used for determining the B-H curve of various open core samples of core material.

for such work, but since this volume deals with the applications of

the cathode-ray oscillograph, magnetic measurements find their place. The schematic wiring diagram employed to develop the B-H curve of various open core samples of core material is shown in figure 141. The circuit is so arranged that the flux density establishes the vertical deflection. The flux is produced by passing alternating current of the required frequency and sufficient intensity to provide a suitable field strong enough to deflect the beam. Consequently, the vertical deflection is indicative of B, or the flux density. At the same time, the circuit provides for a deflection at right angles to that of the flux density,



Figs. 142, 143, 144, 145 (reading from left to right). These hysteresis curves were made at 100 cycles. The greater the saturation, the flatter become the ends of the curve. Fig. 142 indicates the greatest saturation of these four oscillograms. Note that the area of these patterns (indicating the core loss due to hysteresis) is less than that of Fig. 147.

and which is proportional to the magnetizing field or the magnetizing current. This deflection is developed by the voltage drop across the resistor R. The magnetizing current and voltage across this resistor are in phase.

The sample core material is placed within the solenoid and held near the neck of the cathode-ray tube, with the face of the solenoid parallel to the plane of the horizontal deflection plates. Since the deflection of the beam is at right angles to the magnetic field, positioning of the testing solenoid as stated will produce the required vertical deflection. The switch numbered S is normally closed, this switch being provided, so that, if desired, the two axes may be produced upon the screen for photographic purposes. When switch S is open the vertical deflection alone is on the screen. To produce the horizontal deflection only, without the vertical deflection, switch S is closed and the solenoid and core sample are bodily removed from the tube neck.

Sample B-H curves are shown in figures 142, 143, 144, 145, 146 and 147. These are curves as they appear upon the screen, without the vertical and horizontal axes. They were made at a frequency of 100 cycles. The value of the resistor R is a function of the signal voltage available. This is so because, with limited input signal voltage, saturation of the core, indicated by departure from a straight line, is controlled

by the current limiting action of this resistor. To show the saturation, we used very low values for R , as low as 10 or 12 ohms. However, with higher values of input voltage, so that saturation can be established by varying the input signal voltage, the value of this resistor may conveniently be a 100 ohms or more.

The ideal B-H curve is a single straight line. Saturation of the core, with its detrimental effects, is indicated by the flattening of the ends of the loop, as indicated in figures 142, 143, 144 and 145. The most pronounced case of saturation, with respect to the instances being shown, is that indicated in figure 142. Cases of reduced saturation are indi-



Fig. 146, left, Fig. 147, right. The amount of saturation in these two oscillograms is appreciably less than that shown in Figs. 142 to 145. The core loss due to hysteresis, indicated by the size of the area enclosed by the curve, is fairly large in Fig. 147.



cated in figures 146 and 147. These patterns also indicate the core loss, due essentially to hysteresis. (This means the loss introduced as a result of the heat generated because of the molecular change which takes place during the process of magnetization.) The extent of this loss is indicated by the area of the loop. The greater the area of the hysteresis pattern, the greater the hysteresis loss. Thus, core loss due to hysteresis is indicated in each of the patterns, but figure 147 shows the greatest amount of core loss due to hysteresis, yet minimum amount of core saturation.

When making such magnetic measurements, the sweep circuit is not used. The cathode-ray oscillograph is adjusted so that independent voltages may be applied to the vertical and horizontal plates through the amplifiers feeding these deflection plates.

In the event that the cathode-ray oscillograph being used is not equipped with amplifiers for the two sets of deflection plates, or for either set of deflection plates, it will be necessary to apply sufficient signal voltage to the sample coil and rheostat circuits, so that suitable deflections are obtained, despite the absence of the amplifiers. The test frequency is not limited to 100 cycles. It can be whatever frequency is desired, in accordance with the requirements of the test.

D.C. Voltage Measurements

For this type of work, the cathode-ray oscillograph is essentially a high resistance voltmeter of universal range. Its adaptability to a-c. and d-c., depends upon its design. For d-c. voltage measurements, it is essential that direct connection to the deflection plates be available.

This means without any condensers or amplifiers in the circuit. The adjustment of the cathode-ray oscillograph for d-c. voltage measurements is for the application of independent voltages to either the horizontal or vertical deflection plates. The sweep circuit is not used, nor is any amplification utilized. Either set of deflection plates may be employed for d-c. voltage measurements.

It should be stated at the outset that if the oscillograph unit used for d-c. voltage measurements, contains a spot positioning circuit, this must be disconnected from the deflecting plates before making any measurements. Of course, no change is required for those oscillographs which have facilities for making direct connections to the plates and which do not have spot positioning circuits.

The indication of voltage is the distance that the spot moves from its normal no-input voltage position. In contrast to a-c. measurements, wherein a complete line appears upon the screen, the application of d-c. voltages causes the spot to move, as described in the earlier chapters of this volume.

The direction of movement of the spot from its normal center position, will depend upon the polarity of the voltage applied; that is, which of the free deflecting plates receives the positive charge. It is assumed that the grounded plates will be connected to the negative side of the d-c. voltage source being measured, and that either the free vertical or free horizontal plate will be connected to the positive side of the d-c. voltage source being measured. One set of plates is used.

The distance that the spot moves is an indication of the amount of voltage applied across the plates. How accurately you will be able to interpret the excursion of the spot in d-c. voltage measurements depends upon several factors: First, upon how accurately you can measure the distance. (A calibrated scale, with fine lines and a large number of divisions per inch, is very helpful for such observation.) The best means is to use a very fine spot, that is a very small spot, and to measure from center to center of the spot. The second controlling influence is accurate knowledge concerning the sensitivity of the tube. At best, even the manufacturer's quoted calibrations of so many volts-per-inch deflection is only an approximation. This sensitivity specification varies with the manufacturer of the cathode-ray oscillograph. It is also a function of the operating potentials, that is the voltages applied to the anode #2. Consequently, tubes of different anode voltage rating, as employed in the different commercial units, will be rated at different values of sensitivity.

The RCA cathode-ray oscillograph, which employs the 906 tube, is rated at about 72.5 volts per inch. In other words, if a d-c. voltage of 72.5 volts is applied across either set of plates, the spot will move a distance of about 1.0 inch from its normal center position. However, this calibration holds true only if the tube is being operated at the specified potentials, so that for any type of quantitative work, pre-calibration by means of known values of d-c. voltage is suggested, as a matter of fact, actually required.

Based upon this rating, it stands to reason that the cathode-ray tube is not the most satisfactory for low voltage measurements. At the same time, with definite screen limitations, it is not satisfactory for high voltage d-c. measurements unless a supplementary voltage divider is used. The use of a voltage divider, however, cancels the advantage gained by using the cathode-ray tube, namely an extremely high input resistance, so that there is no loading effect upon the voltage source. If a voltage divider is used, in order to adapt the screen limits to the voltage being measured, it must be of very high resistance, up into the megohms, in order to retain the high input impedance and freedom from loading.

Normally, only one half of the screen is available for such d-c. voltage measurement, because the spot moves away from the center. However, the complete screen can be made available, by suitably biasing the spot, so that its normal, no-test voltage input position is one limit of the screen, instead of the center.

An idea of the sensitivity of the various cathode-ray units can be had by noting the sensitivity ratings of the various cathode-ray tubes. Just how closely these ratings correspond with the actual sensitivity of the tubes, when used in the finished commercial units, is very uncertain. To establish the number of volts required to develop a 1.0-inch deflection, when the sensitivity in millimeters per volt is known, divide 25.4 by the sensitivity rating, in millimeter per volt. The ratings of some of the better known cathode-ray tubes available at the time of this writing are given herewith.

After all is said and done, we feel that the cathode-ray tube is not very well suited to replace the voltmeter. There are several reasons why we say this. The first is that the degree of accuracy available with the standard voltmeters is greater than that available with the cathode-ray oscillograph, because of the uncertainty of calibration. Second, it is easier to read low values of voltage upon a calibrated d-c. voltmeter, and the loading effect is not very great. Third, the sources which sup-

Sensitivity Ratings of Various Types of Cathode-Ray Tubes

These ratings of sensitivity obtain at specified values of anode voltage, and indicate the sensitivity with electrostatic deflection.

Manufacturer	Type	Rating mm/volt	Anode Voltage
Dumont	34, 34-8, 34-H	.38	1000
	54, 54-8, 54-H	.68	2000
	94, 94-8	.79	2000
	54-8-C	.45	1000
	94-8-C	.79	1000
	94-8-H	.85	1000
National Union	908	.38	1000
	907	.68	1000
	903	.85	1000
	907-A	.68	1000
RCA	904	.33	1000
		.11	3000
		.07	4600
	905	.38 *	1000
		.19 *	2000
		.46 **	1000
		.23 **	2000
		.33 *	1000
	906	.35 **	1000
		.38 *	1000
	907	.19 *	2000
		.46 **	1000
		.23 **	2000
		.33 *	1000
908	.41 *	800	
	.33 *	1000	
	.44 **	800	
		.35 **	1000

* This is the sensitivity rating between the two top plates, that is the top set of plates.

** This is the sensitivity rating between the two lower plates, that is, the lower set of plates.

ply high voltage, are not troubled by the loading effect of standard voltmeters, which are rated at from 1000 to 2000 ohms-per-volt.

The schematic wiring diagram for d-c. voltage tests is shown in figure 148. It is best if the voltage to be measured is caused to produce a deflection in the horizontal direction. Care must be taken when making these measurements, because one set of plates goes to ground, which would ground the negative side of the voltage source being measured. This is quite in order if that side is normally grounded, but if the entire voltage source is above ground, the condition must be recognized when making the test. Note that the unused plate is grounded.

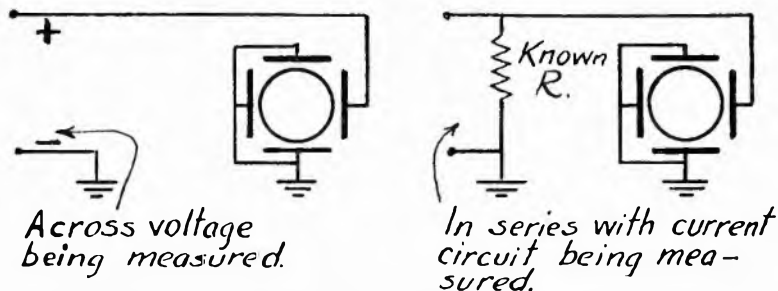

Fig. 148, left, Fig. 149, right. The schematic diagram of Fig. 148 shows the connections for making d-c. voltage readings with the cathode-ray tube. Fig. 149 shows the circuit for measuring direct current, this being calculated by Ohm's Law when the voltage drop across R is indicated on the tube's screen. Note the grounding of the vertical plates.

Direct Current Measurements

Direct current measurements are made exactly like d-c. voltage measurements. The current to be measured is caused to flow through a known resistor and the voltage drop across this resistor is measured. The current then is determined by applying Ohm's law. The circuit utilized is shown in figure 149. Unfortunately, such operation is very greatly limited by the voltage sensitivity of the tube. The use of a low value of R , whereby the insertion of this additional unit into the circuit would have very little effect upon the actual current in the circuit, is not very satisfactory, because of the low voltage developed across the resistor. In certain cases, the influence of a high value of resistance is immaterial, just as long as it is possible to determine the actual current in the circuit, so that a suitable voltage deflection is possible. However, as in the case of d-c. voltage measurements, we feel that greater satisfaction will ensue through the use of the standard direct-current indicating instruments for direct current measurement. Note that the unused plate is grounded.

A-C. Voltmeter

The cathode-ray oscillograph is far more suitable as an a-c. voltmeter than it is as a d-c. voltmeter. As a matter of fact, it is superior to the run of standard a-c. meters, but for one thing and that is calibration. If calibration can be arranged, the cathode-ray oscillograph, employed as an a-c. voltmeter, affords certain very definite advantages. One of these is the high input impedance, with minimum loading effect upon the voltage source being measured. Another is the extremely wide frequency range, which under certain conditions, can be as high as 100,000,000 cycles. A third advantage is realized when measuring low values of a-c. voltage. The amplifiers available with the cathode-ray oscillographs provide very excellent indications, with sufficiently high input resistance, so that loading of the circuits is reduced to a negligible minimum.

The image resulting from the application of an alternating voltage in one direction, that is to one set of deflecting plates, without any voltage whatsoever applied to the other plates, is a straight line. The relation between the length of this line and the voltage required to produce the line, depends upon the voltage sensitivity of the tube. Now, the voltage sensitivity identifies the magnitude of the deflection of the beam from its normal center position, in any one direction. When an a-c. voltage is applied, the excursion of the spot is in two directions, due to the change in polarity of the voltage during each cycle. Consequently, half of this line is an indicator of the voltage actually applied, because it indicates the voltage representative of one alternation. The entire line represents a voltage equal to twice the value actually applied across the plates.

The deflection of the beam, when an alternating voltage is applied, is determined by the "peak" voltage, and NOT the root-mean-square, or r.m.s. value. Because of the changing polarity of the applied voltage, the voltage indicated by the total length of the line, is the peak to peak value in each complete cycle. The actual peak voltage, therefore, indicated by the line, is the length of the line times the voltage sensitivity rating of the tube. Thus, if the length of the line is measured and found to be 2 inches and the tube is rated at 72.5 volts per inch, the approximate peak to peak voltage, being applied across the plates, is 2×72.5 or 145 volts. This is the voltage between the two peaks. Hence the peak voltage for one alternation would be exactly half of this, or the length of the line divided by two and then multiplied by the sensitivity rating of the tube, when expressed in volts per inch deflection.

The usual meters used for a-c. measurements indicate the r.m.s., or root-mean-square value, which is equal to the peak value divided by 1.414. Thus, if the peak value of voltage indicated upon the screen is 72.5 volts, the actual r.m.s. value is $72.5/1.414$ or 51.25 volts. It is necessary that you realize the relation between the length of the line upon the screen and the voltage which causes this image. To determine the r.m.s. value of voltage, you must do one of two things: Either you use only half of the total length of the line and divide by 1.414 or you use the entire length, determine the voltage between the peaks and divide by 2.828 to establish the r.m.s. value.

What has been said applies directly to the deflection plates. If the voltage being measured is applied directly to the plates, without using either the vertical or horizontal amplifiers, then the voltage measured is that which is applied. However, if one of the two other amplifiers is used, it is necessary to know the gain or amplification taking place in the amplifier. Without this information, calculation of the actual voltage being measured is impossible. In sum and substance, and this presents one of the complications besetting the use of the cathode-ray tube as an a-c. voltmeter, it is necessary that the amplifiers be calibrated. At low values of input voltage, it is possible to use the amplifier full on or wide open and to divide the voltage indicated upon the screen by the known rated gain of the amplifier. The resultant figure is an approximation of the a-c. voltage fed into the cathode-ray oscillograph. Thus, if the voltage indicated upon the screen is 51.25 volts r.m.s. and the gain of the amplifier used in the circuit is 30, the voltage fed into the amplifier is $51.25/30$ or 1.708 volt.

Once again, the use of the tube as a voltmeter depends upon the calibration, knowledge of the exact voltage sensitivity of the tube and knowledge of the gain of the amplifier, when full on and for various positions of the gain control. At the same time, it is necessary to realize that the manufacturer's rating of voltage sensitivity and amplifier gain is only an approximation. Then again, the amplifiers, when used, have very definite frequency limits. They are supposed to be linear in operation over a 20 to 100,000 cycle band, but experience shows that a variation in amplification exists around the lower and upper limits, so that if any kind of quantitative work is to be done, calibration is required. This is really unfortunate, because the cathode-ray tube as a voltmeter would be a very handy thing when working with frequencies other than the regular commercial 25 to 60-cycle band.

Speaking about frequency limitations, the amplifiers built into the

various commercial cathode-ray oscillographs are good up to about 100,000 cycles. A certain amount of gain is available upon higher frequencies, but we are tempted to say that 200,000 cycles is the top, if gain, rather than loss is desired. The previous reference to a voltage sensitivity of 72.5 volts per inch, refers specifically to the RCA TMV-122-B unit equipped with the 3-inch type 906 tube and operated at the normal potentials.

Operation at radio frequencies, or frequencies higher than 100,000 cycles, requires additional external amplifiers and we wonder, if, since these amplifiers are required, it would not be preferable to employ the old fashioned, but still reliable vacuum-tube voltmeter. After all is said and done, there are so many salient features found in the cathode-ray oscillograph, that nothing much is lost, if it cannot be used as a voltmeter.

For ordinary qualitative or comparative operations, the tube can be used as a voltmeter over a very wide frequency band and approximation of the voltage applied is possible. It is to be understood that our expressions concerning the utility of the cathode-ray tube as an a-c. voltmeter are founded upon practical experience, yet remain just our own expression, without any intent to contradict statements that the tube is suitable for calibrated voltage measurements.

When employing the tube for a-c. voltage measurements beyond the audio-frequency spectrum, it is essential to realize that the input circuits have resistance and capacity. Just what these constants are, depends upon the mode of application and the specific unit in question. The input capacity varies from 10 to 15 micromicrofarads when connection is made directly to the plates. The input resistance across the plates is about 4.0 to 5.0 megohms. These are the constants for the Dumont and National Union units mentioned in this volume. When these units are used with the associated internal amplifiers, the input capacity becomes about 20 to 30 micromicrofarads and the input resistance becomes about 400,000 to 500,000 ohms.

The RCA TMV-122-B, described herein, affords the following constants when used without the internal amplifiers: input resistance about 400,000 ohms, and input capacity about 10 micromicrofarads. With the amplifiers in use, the input resistance is 500,000 ohms and the input capacity is about 20 micromicrofarads.

When employed for a-c. voltage measurements, the cathode-ray oscillograph must be adjusted for independent voltage applicable to both sets of plates. Only one set of plates is used for making such measure-

ments. The other free plate should be grounded. What can be done is to short the input terminals to the set of plates which are not in use. The sweep circuit is not used. Neither is the synchronization control placed into operation. Either the vertical or horizontal plates can be utilized. When making such voltage tests, remember that one terminal of the cathode-ray oscillograph is grounded.

As is to be expected, all obstacles can be overcome if the desire is sufficiently strong. Calibration of the gain of the deflection amplifiers in the cathode-ray oscillograph and also of the voltage sensitivity of the tube can be carried out without very much difficulty. The 60-cycle power supply is a very satisfactory source of the test signal.

Calibration can be carried out by applying to the input circuit of cathode-ray oscillograph, through or around the amplifiers, a known a-c. voltage. This can be secured from a low voltage a-c. transformer, or direct from the power supply, with a voltage divider and voltmeter connected across the supply voltage, so as to establish definitely the magnitude of the voltage being fed into the cathode-ray tube. By feed-

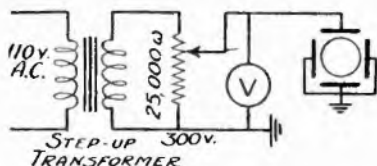

Fig. 150. Schematic diagram of the circuit used for determining the voltage sensitivity of a cathode-ray tube. This is found by measuring the length of the line on the screen, noting the voltage on V and following the directions given in the text.

ing to the plates, around the amplifier, and noting the input voltage and the length of the line upon the screen, it is possible to establish the voltage sensitivity of the tube. The circuit used for such calibration is given in figure 150. Calibration is carried out by establishing a line, say two inches long, upon the screen and noting the magnitude of the voltage (indicated upon V) required to produce this deflection. The voltage shown upon V, times 1.4 is equal to the voltage sensitivity of the tube, namely the number of volts (peak) required to produce a deflection of 1.0 inch.

Thus if the voltage (shown on V) required to produce a line 2.0 inches long is 40 volts, the voltage sensitivity of the tube is 40×1.414 or 56.56 peak volts. The relation between the length of the line and the voltage sensitivity per inch was described in a previous paragraph.

Once the voltage sensitivity has been determined, it is possible to calibrate the two deflection amplifiers, or whichever of these amplifiers is used for voltage measurement. The circuit is shown in figure 151. The voltage is secured from the 60-cycle power supply through a low

voltage step-down transformer with a 3.0 volt output. The 100 ohm potentiometer will enable variation of the voltage over a satisfactory range. The voltmeter V indicates the voltage fed into the amplifier. The amplifier should be operated wide open. The potentiometer should be adjusted until a 2-inch line appears upon the screen. The voltage sensitivity of the tube being known, the gain of the amplifier is equal to E_2 / E_1 , where E_2 is the voltage indicated upon the screen and E_1 is the voltage indicated upon the voltmeter.

Fig. 151. Schematic diagram for calibrating the gain of the amplifiers used for voltage measurements.

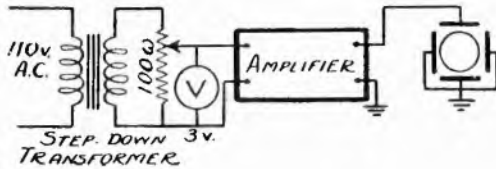

Calibration carried out in this manner at 60 cycles will be found to be substantially correct over the range of the amplifier, providing that the amplifier gain control is full on. The linearity of these amplifiers is disturbed if the gain control is not full on. This is so at frequencies higher than 10,000 cycles. If possible, with the equipment available, calibration can be carried out along similar lines at different frequencies. Furthermore, with the voltage sensitivity of the tube known, calibration of the amplifier, at various settings of the gain control, is possible, providing that it is possible to mark definitely the position of the gain control for each calibration point, so as to be able to return to that same setting in the future. Referring once more to the linearity of the amplifier, it has been our experience that variation of the gain control over a calibrated range is suitable, as has been stated, only up to about 10,000 cycles, perhaps 15,000 cycles, as the top limit.

A-C. Ammeter Applications

The cathode-ray tube can be used as an a-c. ammeter, by utilizing it as an a-c. voltmeter with an external shunt. The connection diagram

Fig. 152. Schematic diagram for using cathode-ray oscillograph as an a-c. ammeter.

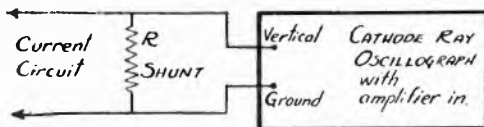

is shown in figure 152. The cathode-ray tube is arranged for independent voltages to the horizontal and vertical plates. The vertical

amplifier is used. The horizontal amplifier input post is grounded. The sweep circuit is not used.

The range of current measurements depends upon the value of the shunt R . The higher this shunt, the lower is the current range. The current flow through the shunt is established by noting the voltage indicated upon the screen and applying Ohm's law. Care must be taken when employing the cathode-ray tube in this manner, to realize that the gain control within the receiver is also shunted across the external shunt through the blocking condenser. The effect of this shunt upon the current computation is important when the external shunt is higher than 100,000 ohms. It is not of any importance when the external shunt is a low resistance unit, such as 1000 or 2000 ohms. Once more we suggest the use of the conventional current meters for current measurement, rather than the use of the oscillograph as a calibrated current indicator.

Study of Waveforms

One of the most salient features of the cathode-ray oscillograph is its ability to present waveshapes of current and voltage, for whatever type of analysis may be required. The subject of waveforms is one of extreme importance in connection with audio-frequency amplifier operation, for that matter even in connection with general receiver servicing. However, the subject of waveform analysis, when considered as a part of radio servicing, has not been received with a great deal of favor among those men who are associated with the radio service industry. The reason behind the negative attitude is quite sound, namely that the servicing group as a unit is not very familiar with waveform analysis. Admitting this to be so, we still feel that it can be remedied and that waveform analysis can be employed by the servicing group to great advantage.

Perhaps the scope of such work is limited to fairly narrow borders, yet no matter how narrow these borders, it still means advancement of the servicing industry. Proper application of the cathode-ray tube, combined with a certain amount of study, will do very much towards familiarizing the servicing industry with the significance of waveshapes, other than pure sine waves. There is much truth in the old adage that "a little knowledge is dangerous"; yet, that little knowledge judiciously applied can be very helpful. It is our intention to furnish data relative to the application of the cathode-ray tube, to show how simple facts, pertaining to waveform analysis, can be established and how this information can be used in the servicing field.

A complex wave differs from a sine wave in that the former contains a number of different frequencies, whereas the latter is one frequency only. Furthermore, a complex wave consists of a number of sine waves. One of these sine waves is the fundamental frequency and the other sine waves are harmonics of the fundamental. The shape of the complex wave is determined by a number of different factors. First is the number of harmonics present, which may be few or many, depending upon the nature of the equipment being considered. Second is the relative amplitude of the component frequencies which comprise the complex wave. The third is the phase relation between the component frequencies. Passing a sine wave through an electrical network may cause distortion of the wave, during which process the resultant wave is no longer sine, but has become complex, because new frequencies (harmonics), not present in the original wave, have been introduced. Passing a complex wave through an electrical network may cause distortion of the wave, in three ways. One of these, known as "frequency distortion," is the unequal amplification of the respective component frequencies, so that the relative amplitudes of the component frequencies present in the original wave are different in the output from those in the input. (See the second reason concerning the nature of complex waves, as mentioned in the preceding paragraph.) The second form of distortion of a complex wave is "phase distortion," wherein the phase relation between the component frequencies has been changed. Expressed in a different manner, phase distortion arises from the fact that a difference in time exists for the passage of the various component frequencies, with respect to frequency, through the amplifier. The third form of distortion is amplitude or non-linear or harmonic distortion, wherein frequencies, not present in the input, are introduced into the signal during its passage through the network and appear in the output. All of these forms of distortion will receive proper attention in subsequent paragraphs.

The cathode-ray tube lends itself admirably to the study of the development of complex waves. It is a relatively simple manner to combine several voltages of different frequency and of sine character, to establish the resultant complex wave and to note the effect of a change in the amplitude of the component frequencies. At the same time, it is also possible to note the characteristics of complex waves with respect to the even and odd harmonics. Once again we repeat that this text and these illustrations are not offered as a complete resumé of waveform analysis for the purpose of study; they are offered merely to show **the**

individual, who is in possession of a cathode-ray tube and who is interested in the subject, how he can develop complex waves and familiarize himself with their characteristics, in accordance with certain changes. At the same time, it is possible that these lines may influence the course of instruction in class rooms.

Admittedly, the cathode-ray tube can be put to good use without this discourse upon waveform development, but if these few words help the operator understand the nature of what he sees during the practical application of the cathode-ray tube, the space devoted will have been well spent.

Complex Wave Characteristics

Complex waves have certain characteristics. Waves which have a preponderance of odd harmonics may approach either the square topped or triangular shaped variety, depending upon the phase relation existing between the fundamental and the harmonics. In connection with this reference to square top waves, it is necessary to mention that this comment should not be confused with the square top wave which is the result of imperfect vacuum tube operation, wherein the upper and lower peaks of the signal voltage cycle are cut off, as will be shown later. An example of a complex wave, which has a large number of even and odd harmonics, is the saw tooth wave shown in figures 32 and 35.

Complex waves which contain both even and odd harmonics do not possess mirror symmetry, whereas complex waves which contain odd harmonics only, do possess mirror symmetry. By mirror symmetry is meant that if the top alternation is folded down below the zero line, its appearance would be like that of the lower alternation.

Development of Complex Waves

Referring once more to the application of the cathode-ray tube for the development of complex wave images, the circuit used during this interesting operation is shown in figure 153. Three sine wave output audio oscillators, A, B, and C, each with its attenuator control, are joined in series. Each of these affords a range of audio frequencies, which may be multiples of the other, so that a range from the fundamental to the fourth harmonic is available. The amplifier in the oscillograph affords linear operation over the range of frequencies used, which is from 1000 cycles to 4000 cycles. What is shown to occur at these frequencies, occurs at other frequencies, providing that similar conditions with respect to the ratio of component frequencies and rela-

tive amplitudes, obtain. This amplifier also is free from phase distortion.

The voltage from the three oscillators, connected in series, is fed to the vertical plates of the cathode-ray oscillograph. The gain control in the unit determines the size of the image upon the screen. The synchronization control is set to "internal" and the sweep circuit is adjusted to a frequency equal to about one-fifth of the fundamental, which in our case is 200 cycles, the fundamental frequency being 1000 cycles. The gain controls associated with the three audio oscillators, provide the means of varying the amplitudes of the fundamental and harmonic frequencies.

By means of the controls, selection of one, two or three oscillators is possible, so that one, two or three voltages may be fed in series into

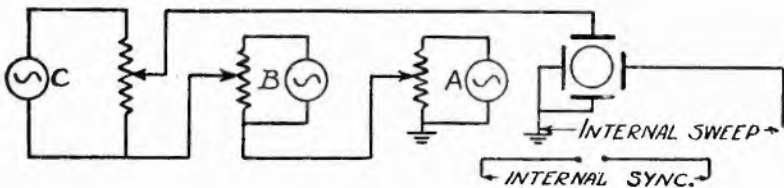

Fig. 153. Schematic diagram showing how three oscillators are in series to develop a composite wave. The lowest frequency is the fundamental and the two other waves are its harmonics.

the oscillograph. This circuit, with one possible exception, that of fixed phase relation, simulates the component sine wave voltages of a complex wave. That is to say, one of the oscillators, A, may be considered as the source of the fundamental frequency, oscillator B is the source of a harmonic and oscillator C, is the source of another harmonic. Thus if A, is adjusted to 1000 cycles, B to 3000 cycles and C to 5000 cycles, the composite wave would then consist of the fundamental of 1000 cycles, the 3rd harmonic, 3000 cycles and the fifth harmonic, 5000 cycles. For what we have in mind, we did not feel that it was necessary to use six or seven oscillators, so as to provide a much wider range of harmonics.

Figures 154, 155 and 156 illustrate a sine wave of 1000 cycles, its second harmonic of 2000 cycles and the resultant complex wave, respectively. It is to be noted, that the phase relation between the oscillator voltage is not as fixed as it would be in actual practice, but, for any one complex wave photograph, a definite phase relation exists, and it is possible that that phase relation would exist in practice. As is evident in figure 155, the amplitude of the 2000-cycle, or 2nd harmonic, voltage is almost equal to that of the fundamental, or 1000-cycle

voltage. The effect of reducing the amplitude of the 2000-cycle, or 2nd harmonic, voltage, but with practically no change in phase between the two sine waves, is illustrated in figure 157.

A change in phase relation, with the original amplitudes shown in figures 154 and 155, develops the waveform shown in figure 158. The lack of mirror symmetry is clearly evident. A reduction in the am-

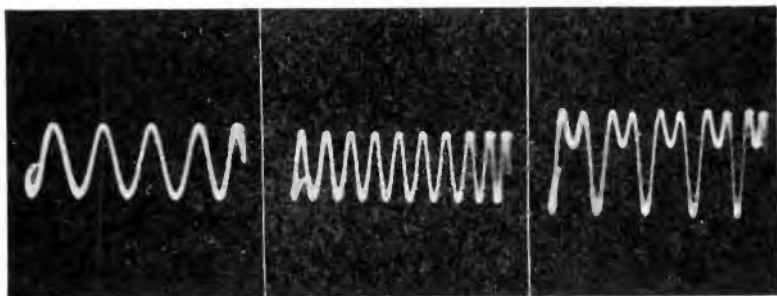

Figs. 154, left, 155, middle, 156, right. A 1000-cycle sine wave, shown in Fig. 154, and a 2000-cycle sine wave, Fig. 155, result in the composite wave, Fig. 156. Note that the 2000-cycle wave (the second harmonic of the 1000-cycle wave) is almost equal in amplitude to the fundamental frequency. Compare the amount of the dip in Fig. 156 with that of Fig. 157.

plitudes of the two component voltages and adjustment of the harmonic frequency amplitude to be equal to about half of the fundamental frequency amplitude, develops the composite wave shown in figure 159. Note that the amplitude of the 2nd harmonic, the 2000-cycle voltage, is what develops the dip in the composite wave.

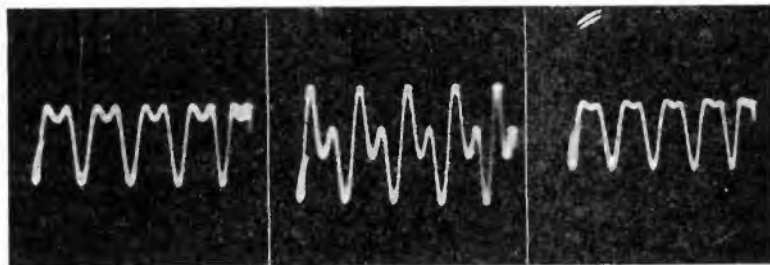

Figs. 157, left, 158, middle, 159, right. The amplitude of the wave in Fig. 155 was reduced and caused the reduction of the dip in the composite wave of Fig. 157. Compare Fig. 156. By shifting the phase between the waves of Figs. 154 and 155, the composite wave of Fig. 158 was obtained. Fig. 159 was obtained by reducing the amplitude of the wave of Fig. 154 and making that of Fig. 155 about one-half its amplitude. Compare Figs. 156 and 157.

A 400-cycle voltage and an 800-cycle voltage, with the latter frequency of an amplitude greater than the fundamental frequency (40%

cycles), if we may call it that, develops the composite wave shown in figure 162. The relative amplitudes of these two component frequencies are shown in figures 160 and 161. Figure 160 illustrates the fundamental frequency of 400 cycles and figure 161 illustrates the 800-

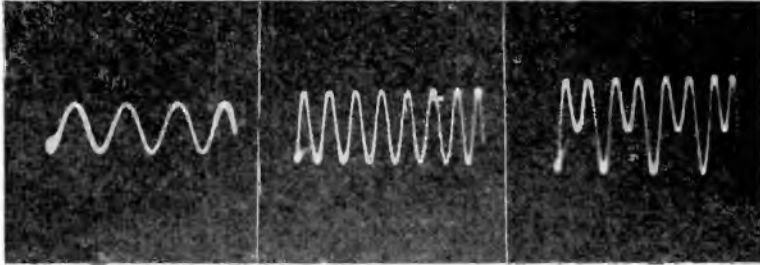

Figs. 160, left, 161, middle, 162, right. The 400-cycle wave of Fig. 160 has an amplitude smaller than its second harmonic, 800 cycles, Fig. 161, and a greater dip can be readily noted in the composite wave of Fig. 162 than those composite waves shown in earlier illustrations.

cycle voltage. Note the increase in the depth of the dip, as a consequence of the amplitude of the higher frequency.

The presence of a 1000-cycle voltage and a 3000-cycle voltage of the relative amplitudes shown in figures 163 and 164 and in a certain

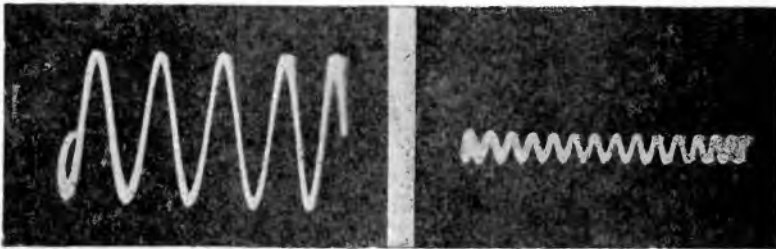

Figs. 163, left, 164, right. A 1000-cycle wave, Fig. 163, and a 3000-cycle wave were used as fundamental and third harmonic respectively to obtain the composite waves shown below.



Figs. 165, left, 166, right. The composite wave of the waves shown in Figs. 163 and 164. Note the effect on the shape of the composite wave that a shift in phase has. See Fig. 166.

phase relation, develops the composite wave shown in figure 165. With a slight shift in phase, the composite wave becomes like that shown in figure 166.

An increase in the amplitude of what would be the third harmonic, namely the 3000-cycle voltage, develops the composite wave shown in figure 167. The two component voltages, which make up this composite wave, are shown in figures 168 and 169. The relative amplitudes are as shown in the two illustrations. The phase relation is practically

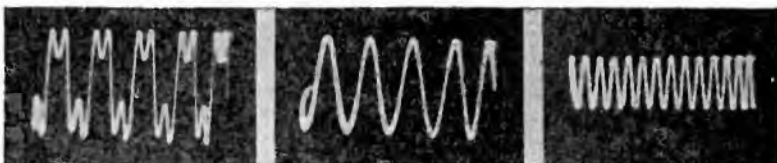

Figs. 167, left, 168, middle, 169, right. By increasing the 3000-cycle wave amplitude, Fig. 169, the composite wave of Fig. 167 is obtained. The 1000-cycle wave of Fig. 168 is the fundamental. Compare the composite wave of Fig. 166.

that which existed when figure 166 was made. Note the increased depth of the dips in both alternations as a consequence of the increased amplitude of what may be classified as the 3rd harmonic. At the same time, note the mirror symmetry of the wave.



Figs. 170, left, 171, middle, 172, right. The 1000-cycle wave, Fig. 170, is the fundamental and the 4000-cycle wave, Fig. 171, is its fourth harmonic. The composite wave is shown in Fig. 172. Compare with Fig. 167 for changes in the shape due to the substitution of the fourth for the third harmonic.

Combining two sine waves of 1000 and 4000 cycles, shown in figures 170 and 171 respectively, with the relative amplitudes shown, develops the composite wave shown in figure 172. Increasing the amplitude of the 4000-cycle voltage to that shown in figure 173, and with the amplitude indicated in figure 171, develops the composite wave shown in figure 174. A change in phase relation from that which developed the waves shown in figures 172 and 174, develops the composite wave shown in figure 175.

Combining three frequencies, 1000 cycles, 2000 cycles and 3000 cycles, with the relative voltage amplitudes as indicated in figures 176,

177 and 178 respectively, results in the composite wave shown in figure 179. This wave is developed when a certain phase relation between the various voltages exists. Any change in phase will naturally change the shape of the wave.

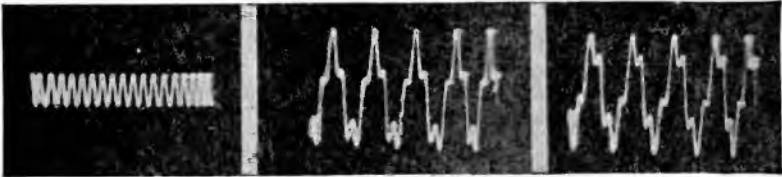

Figs. 173, left, 174, middle, 175, right. The 4000-cycle wave of Fig. 171 was increased in amplitude to that shown in Fig. 173 and the composite resulting from the waves of Figs. 170 and 173, is shown in Fig. 174. A change in the phase relation produced the composite wave of Fig. 175.

What has been shown in figures 154 and 179 inclusive should be sufficient to illustrate the application of the cathode-ray tube to the study of the development of complex waves and the study of the effect of amplitude variations. We could furnish hundreds of additional photo-

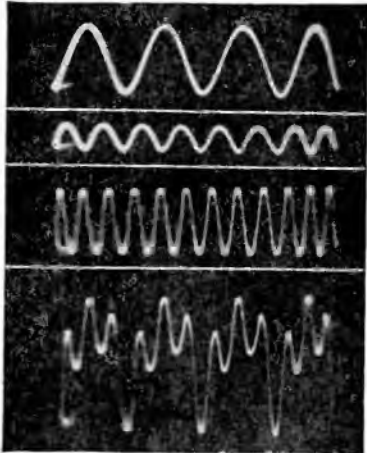

Figs. 176, 177, 178, 179, reading from top to bottom. The 1000-cycle wave of Fig. 176 is the fundamental and the 2000-cycle and 3000-cycle waves, Figs. 177 and 178, are the second and third harmonics respectively. Their composite wave, shown in Fig. 179, is for a certain phase relation, any change of which will result in a change in the shape of this composite wave.

graphs illustrating various combinations of frequency and amplitude, but we feel that the illustrations given will suffice. It is our earnest hope that service technicians who own cathode-ray oscillographs will use them for such study as well as for practical service operations.

Amplifier Distortion Measurements

The ability of the cathode-ray oscillograph to portray waveform has made the instrument of inestimable value in connection with operations

carried out upon audio amplifiers. These operations are not limited to servicing only, but are equally valuable in connection with design work. The purpose of an amplifier is to magnify the electrical equivalent of whatever impulse was fed into the unit. The prime requisite of an amplifier is to provide in its output circuit a voltage which is identical in every respect, other than amplitude, to the voltage which was fed into the amplifier. Functioning as an amplifier, the output voltage should be greater than the input voltage by an amount dependent upon the characteristics of the amplifier.

The ideal amplifier must accomplish certain ends. First it must be equally responsive to all frequencies; that is, it must amplify all frequencies within its prescribed range with equal facility. Accentuation or attenuation of certain frequencies will cause distortion, known as "frequency distortion." The ideal amplifier with a "flat" response curve is theoretically free of frequency distortion.

This ideal amplifier must not introduce frequencies which were not present in the original signal that was fed into the unit. Distortion of this type is known as amplitude, harmonic or non-linear distortion. By these terms is meant a non-linear relation between the input current or voltage and the output voltage. Such non-linearity may be due to the curvature of the characteristic of the tubes used in the amplifier or it may be due to the characteristic of the device. Non-linearity of the input circuit of a tube results when the tube grid is allowed to swing positive. Non-linearity in the plate circuit of a vacuum tube results when the operating conditions are such, with particular reference to the load impedance, that the plate voltage-plate current characteristic is curved.

The usual consequences of amplitude, harmonic or non-linear distortion is the introduction of frequencies not present in the original signal voltage fed into the amplifier or device. Such distortion need not originate in the vacuum tubes, but may also arise in iron-core transformers or inductors operated over a large amplitude of magnetization or when saturation takes place. Such amplitude distortion, due to any reason, is one of the most important problems relating to audio amplifier operation.

The third form of distortion, which may prevent correct performance of an amplifier, is "phase distortion." By phase distortion is meant a change in the phase relation of the component frequencies, during their passage through the amplifier. Expressed in another manner, phase distortion is unequal transmission with respect to time of the various fre-

quencies passing through the amplifier, so that the phase relation between two frequencies present in the output is not the same as it was when that signal voltage was fed into the amplifier. It is to be understood that such phase distortion may occur without any change in the amplitude of the component frequencies, or without the addition of any additional frequencies. Fortunately, phase distortion is not a serious matter in audio amplifiers, which are used for sound reproduction, because an appreciable change in phase may occur, without being recognized by the ear. However, amplifiers, which are being used for quantitative waveform observations, as for example with the cathode-ray oscillograph, must be free from phase distortion, otherwise the image, as seen upon the screen, is not the true picture of the wave under observation.

Each of these forms of distortion may be checked with the cathode-ray oscillograph. Frequency distortion may be determined by means of the overall response curve, developed by feeding a continuously variable frequency signal of constant voltage into the amplifier and developing the overall curve upon the screen of the cathode-ray tube. Such a test may be applied to determine the existence of frequency distortion from any cause, deliberate or otherwise. As a matter of fact, such tests are described elsewhere in this volume and are applied to establish the correct operation of those devices, which are incorporated in audio amplifiers, in order to create a certain amount of frequency distortion.

Amplitude distortion is determinable by observation of the output waveform, when a sine-wave test signal is applied to the receiver. Any condition, which will cause non-linear operation, will influence the shape of the wave and will be readily distinguished. Just how this is done will be described later.

Phase distortion is checked by feeding a complex signal voltage, wherein a definite phase relation exists between the component frequencies, and noting the output waveform. Assuming that no amplitude or frequency distortion exists, a change in waveform will be indicative of phase distortion.

Considering the forms of distortion which are actually experienced in audio frequency amplifier operation, we find that a great deal of excellent investigation can be carried on by the introduction of a sine-wave signal voltage and by observation of the output waveform and comparison between the input and output voltage waveforms. While it is true that all types of distortion are not determinable in this manner, it is fortunate, nevertheless, that such a simple means of checking affords such a wide range of applications. This is so, because it minimizes

the necessity of analysing complex waves and because it overcomes the objections of so many men who seem to feel that no information is possible, unless one is thoroughly conversant with the most complicated methods of waveform analysis.

The sum and substance of such tests is to establish the presence of distortion of one form or another. This is possible with the cathode-ray oscillograph in a manner which cannot even be approached by the older routines and it is our contention that the service technician is quite capable of establishing the reason for the distortion, if he knows that such distortion exists. We admit that the greater the knowledge concerning the operation of the components within an amplifier, the greater is the amount of information which can be gleaned oscillographically. At the same time, we also say that with such a tool available for operation, increased knowledge on the part of the operator is merely a matter of routine, for now he can establish that which he guessed at in the past. We are even tempted to say that we prefer the state, wherein the man can establish such distortion, rather than the older state, wherein amplifiers were never properly serviced, because the existing servicing equipment did not provide the means of definitely determining the presence of distortion.

The routine application of the cathode-ray oscillograph to each stage in an amplifier enables localization of the fault, even if the operator knows no more than that the departure of the image from the original sine wave indicates the presence of distortion in the specific stage of amplification under investigation. So much for that. Let us now consider various tests upon audio amplifiers.

Checking Audio Amplifier Overload

The application of signal voltages in excess of that permitted by the operating parameters of the vacuum tubes used in the amplifier, results in the creation of distortion. Such overloading, when carried beyond a certain point, becomes noticeable to the listener. However, it is possible that overloading exists, without becoming noticeable to the listener. This is so because the generation of harmonics, due to tube overloading, is a function of the amount of overloading. Departure from operation along the linear portion of the tube characteristic results in the development of harmonics. However, the amplitude of these harmonics does not reach maximum for slight overload. The greater the overload, the greater the amplitude of the harmonics, with the third harmonic occupying a very dominant position. When these harmonics

reach a certain amplitude, distortion becomes evident to the ear. Until such time, the listener would have difficulty in noting whether or not the quality has "gone bad," despite the fact that overloading exists. The cathode-ray oscillograph lends itself excellently to the determination of such overload, even the smallest amount.

The application of excessive signal voltage may result in several conditions in the vacuum tube circuit, depending entirely upon the design of the amplifying system. Under certain conditions the grid may swing positive and draw current. Under other conditions the amplitude of the input signal voltage may be sufficient to swing the grid voltage-plate current characteristic beyond the saturation point. Then again, excessive signal strength may swing the grid voltage past the cut-off point. All of these effects may be noted, by feeding a sine-wave voltage into the input circuit and noting the waveshape of the output voltage in each stage or a comparison between the input waveform and the whole amplifier output waveform.

If the overall output indicates the presence of overload, a supplementary stage-to-stage test can be applied to localize the stage at fault. Corrective remedies then can be applied.

Simultaneously, or at least with very little additional work, it is possible to arrange for a pattern which would indicate the relation between the input and output signal voltages and show overload, without the necessity of examining the waveform. For that matter, this test alone, without the waveform test, is sufficient for checking overload. To illustrate the versatility of the cathode-ray oscillograph for such work, we have made a number of overload tests of the two types mentioned. The second type of test is based upon the fact that when overload occurs, the amplifier cannot respond to the full signal voltage swing. The ease and rapidity with which such tests can be made is surprising.

The schematic arrangement is shown in figure 180. An audio oscillator of suitable frequency range and sine-wave output is the source of the test signal. Our tests were made at 1000 cycles. Any other frequency desired by the operator and within the range of the oscillator may be used. The attenuator provides control of the test signal amplitude. By means of a switch, S-1, the vertical deflection plates may be joined to the output circuit of the audio oscillator, for checking of the waveform of the test signal or for providing deflection of the beam in the vertical direction, when checking for overload. The same switch, by means of contact B, provides for the connection of the output of the

amplifier under test to the vertical deflection plates. When this circuit is used, switch S-2 is open and the regular sweep circuit in the cathode-ray oscillograph is brought into play for observation of the output waveform. When such waveform tests are made, the synchronizing circuit within the cathode-ray tube oscillograph is set to "internal." As a consequence of the design of certain cathode-ray oscillographs, the switch S-2 is found within the oscillograph.

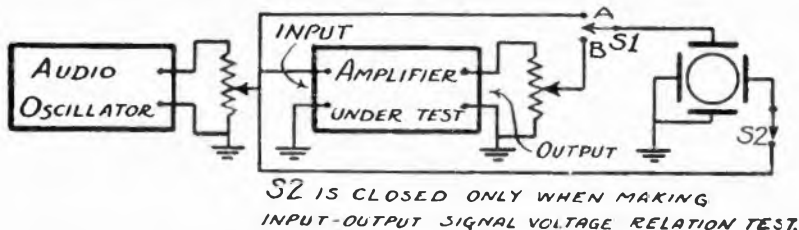

Fig. 180. Schematic diagram of apparatus for checking overload of a-f. amplifier.

With the circuit arranged in such manner (S-1 at B and S-2 closed), or the cathode-ray oscillograph connected in such manner that the input voltage causes a horizontal deflection and the output voltage causes a vertical deflection, the resultant pattern upon the screen takes the shape of what we may call the input-output signal voltage characteristic of the amplifier. If overloading is not taking place, the pattern upon the screen is a diagonal line. If overloading exists, either or both ends of the line, depending upon the amount of overloading, bends towards the horizontal. The bending of the end or ends during overload is due to the fact that the voltage in the vertical direction is not increasing during that portion of the grid swing (horizontal deflection), when overload is taking place.

The series of photographs we shall show will illustrate the input-output voltage operating characteristic and the consequent output wave-



Figs. 181, left, 182, right. The input-output voltage characteristic for distortionless operation is shown in Fig. 181. That it is distortionless is shown by the undistorted sine wave output of Fig. 182.

form, for sine-wave input. We do not think it necessary to repeat the waveform of the input voltage for each of the other sets of photographs. Let it suffice to say that a check of the input wave form was made each

time that the input signal voltage was increased. This test was purely a precautionary measure.

Figure 181 is the input-output voltage characteristic for the sine-wave output shown in figure 182. This would be the equivalent of distor-



Figs. 183, left, 184, right. When the input voltage to the amplifier was increased, the input-output signal curve ends flattened a trifle, as shown in Fig. 183. Note the departure from a true sine wave in the output waveform in Fig. 184.

tionless operation, without overload. The input voltage is increased and the input-output signal voltage characteristic shows a bending of one of the ends. The equivalent output waveform is shown in figure 184. Note the flattening of the lower half of the wave, indicating that cut-off has been reached. (The type of tube used in the first stage, cut off very rapidly.)

Increase of the signal input developed the characteristic shown in figure 185, indicating that the positive swing was excessive. A check of the waveform substantiated this conclusion, as shown in figure 186. In-



Figs. 185, left, 186, right. A further increase of input to the amplifier developed the characteristic of Fig. 185. That the positive swing was excessive was proved by the output waveform of Fig. 186.

creasing the signal input developed the input-output signal voltage characteristic shown in figure 187 and the resultant waveform is shown in figure 188.



Figs. 187, left, 188, right. Increasing the input voltage still further gave the characteristic of Fig. 187 with the corresponding square-topped wave of Fig. 188.

Such tests are very valuable in the design as well as the servicing of amplifiers, because correlation with actual voltage input and power

output would furnish definite quantitative data concerning the overload point.

A similar test applied to an audio amplifier in a receiver established the results shown in figures 189 to 194 inclusive. The set-up for the test was the same as shown in figure 180, with respect to the connections to the oscillograph. The input to the triode portion of the duo-diode-triode was of a level equal to the amplitude of the rectified signal, resulting from the transmission by a fairly powerful broadcasting station.



Figs. 189, left, 190, right. The input-output signal voltage characteristic of the a-f. amplifier of a receiver with a medium setting of the volume control, which was the diode's load, is shown in Fig. 189. The sine wave output is shown in Fig. 190.

As is happens, this triode received its bias from the diode load resistance. For a medium setting of the volume control, which was in the grid circuit of the triode portion, the resultant input-output voltage characteristic is shown in figure 189 and the sine-wave output is shown in figure 190. The frequency is 400 cycles. Advancing the volume con-



Figs. 191, left, 192, right. When the volume control was further advanced the ends of the voltage characteristic became slightly flattened, see Fig. 191, and a change from a sine wave is evident in the output wave, see Fig. 192.

trol developed the input-output voltage characteristic shown in figure 191 and the resultant waveform is shown in figure 192. Flattening of both ends of the voltage characteristic is evident and the distortion introduced is shown in the departure of the output wave from sine shape. With the volume control wide open, the resultant patterns are shown in figures 193 and 194. Investigation showed that the diode load resistance, which also functioned as the volume control, was not of the correct value to supply the required bias at the different signal input

levels. It is to be understood that when the input-output signal voltage characteristic is developed, the sweep circuit within the oscillograph is not used. Neither is it necessary to make provision for any form of synchronization.

The proper remedy for the correction of the overload condition is a matter entirely within your hands; that is the operator. Naturally the



Figs. 193, left, 194, right. The distorted characteristic curve of Fig. 193 was caused by turning the volume control on full and this, with the distorted output wave of Fig. 194, showed that something was inherently wrong in the circuit.

proper procedure will be followed. We do not think it necessary to discuss the corrective measures, in as much as that is routine service procedure and is not determined by the use of the cathode-ray oscillograph.

The mode of operation outlined as being suitable for the determination of overload in an audio amplifier is applicable to all types of amplifiers, which are supposed to operate in a linear manner, and to all stages, which are supposed to operate in a linear manner. This reference is made in order to minimize confusion when such tests are applied to a single tube of a class-B amplifier, or some type of audio amplification other than class-A. What takes place in a class-B stage of amplification is described elsewhere in this chapter.

The successful application of the cathode-ray oscillograph to the determination of distortion in amplifiers depends in a way upon the knowledge possessed by the operator, for after all is said and done, the operator must know the manner in which amplifier tubes function when used under the conditions representative of the different classifications.

Checking I-F. Amplifier Overloading

Overloading of the intermediate-frequency amplifier is a commonplace occurrence, but it is seldom recognized. Time and again service men have realized the existence of distortion in the output of a radio receiver, yet no amount of adjustment of the audio amplifier seemed to help. That is quite natural, since the distortion created as a result of the overload originates ahead of the second detector. Consequently, no

amount of adjustment in the second detector or audio amplifier circuit is of any aid.

Overloading of the i-f. amplifier system may be caused by several conditions. First is excessive signal strength for normal values of operating voltage. Such is possible with some of our high powered stations. Second is normal signal strength, but imperfect operation of the AVC voltage distribution system, wherein a leak across one of the condensers in the circuit forms a voltage divider across the AVC circuit, thus materially reducing the control voltage applied to the controlled tubes. Third, is incorrect operating potentials, which may not be easily determinable because of high resistances in the various circuits. Fourth is imperfect operation of the AVC tube. Whatever the reason, overload in the i-f. amplifier can be checked by examination of the modulated wave envelope of the i-f. signal. If desired, the rectified a-f. signal across the demodulator load may be observed at the same time. It should be understood that a conclusion drawn from the rectified a-f. signal is not enough, because, as shall be shown later, it is possible to develop distortion in the demodulator circuit, although the input to the demodulator is satisfactory in every respect. The examination of the rectified a-f. signal made concurrently with the examination of the i-f. wave envelope, is just a supplementary check.

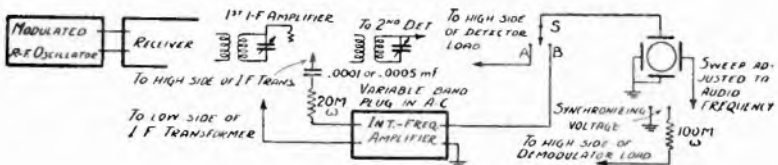

Fig. 195. Circuit for checking overloading in i-f. amplifiers.

The circuit connections for making the test are shown in figure 195. A modulated oscillator with proper carrier frequency range and with a sine-wave audio modulating signal is fed into the receiver. The level of the modulated carrier fed into the receiver approximates the normal signal, which would be encountered under different conditions in the locality where the test is made. It is necessary to check with a strong carrier in order to establish if the AVC circuits are working properly.

An i-f. amplifier, of fairly high gain and with plug-in coils so as to accommodate all intermediate frequencies, is required between the i-f. system in the receiver and the vertical deflection plates of the cathode-ray oscillograph. This amplifier is required because the vertical

deflection amplifier in the cathode-ray oscillograph is not suitable for amplification of the i-f. signal. The frequency generally is beyond the range of the oscillograph amplifier. Such a unit as used by the writer was a two-stage affair, a-c. operated, using type 58 tubes with about 250 volts upon the plate. The i-f. transformers were of the conventional variety and of the plug-in type, so that the proper transformers could be inserted for any i-f. peak called for. The coupling to the receiver i-f. amplifier was through a .0001-mfd. condenser, or a .0005-mfd. condenser, in series with a 20,000-ohm resistor. The coupling was kept loose to avoid regeneration. The lower value of capacity was used for the higher intermediate frequencies. If the intermediate frequency is less than 125,000 cycles, the oscillograph amplifier may be used and the external amplifier is not required. This low intermediate frequency is not found in many domestic American radio receivers. The amplifier mentioned, if equipped with plug-in coils covering certain fixed frequencies in the broadcast band, can be used for checking overloading in r-f. stages.

As a general rule, it is possible to check for overloading of the i-f. amplifiers by observing the modulated wave envelope out of the last i-f. transformer secondary, as applied to the input circuit of the demodulator tube. The i-f. amplifier is connected across the secondary of the i-f. transformer and not across the high side and ground, because in many circuits, the low side of the last i-f. transformer may have a high resistance in the circuit, between that point and ground. Observation of the wave envelope as stated is possible, because distortion due to overloading seldom originates in the mixer tube or ahead of that circuit. However, to make certain that overloading is taking place in the i-f. amplifier and not ahead of the i-f. system, provision is made for checking the wave envelope of the signal out of the first i-f. transformer secondary. This is a precautionary measure.

After it has been established that the signal being fed into the i-f. amplifier is satisfactory, the test amplifier is connected across the input of the demodulator tube, which, as has been stated, is the equivalent of connecting the unit across the secondary of the last i-f. transformer. This statement applies irrespective of the type of i-f. transformer; that is, if it has but two windings or if it has three windings, or is tuned or untuned.

It should be noted that whenever the oscillograph or its associated amplifier is connected across a tuned circuit in the receiver under test, the circuit must be retuned to resonance by decreasing the trimmer

capacity in the tuned circuit. It is also desirable that the leads carrying i-f. or r-f. currents be shielded and kept as short as possible.

If the i-f. amplifier is performing properly, there should be no flattening of the peaks of the modulated wave envelope, as shown in figure 196-A. The equivalent a-f. signal, as determined by connecting the vertical deflection plates of the cathode-ray oscillograph across the de-



Figs. 196-A, left, 196-B, right. When the i-f. amplifier is functioning properly, the peaks of the modulated wave envelope should not be flattened, see Fig. 196-A. The equivalent a-f. signal, taken across the demodulator load, is shown in Fig. 196-B.

modulator load, after having disconnected these plates from the test i-f. amplifier output, is shown in figure 196-B.

Overloading of the i-f. amplifier will be indicated by flattening of the peaks of the i-f. wave envelope, as shown in figures 197-A and 198-A. The extent that the peaks are cut off depends upon the degree of overloading and is determined by the reason for the overload. The degree of overload indicated in figure 198-A is greater than that indicated in figure 197-A. The equivalent a-f. signals, secured from across the demodulator load circuit, illustrate clearly the distortion introduced as a result of the i-f. overload. Note the actual loss in a-f. signal amplitude as a result of the overloaded condition indicated in figure 198-A. The signal voltage fed into the input of the i-f. circuit is substantially the same in both cases, yet the a-f. signal output is much less in figure in 198-B than in figure 197-B. The overload indicated in these illustrations was due to a leak across one of the condensers in the AVC. voltage distribution circuit, so that the proper automatic control voltage was not applied to the i-f. tubes.

When making such wave envelope observations, the voltage to be observed is applied across the vertical deflection plates and the sweep oscillator in the oscillograph is adjusted just as it would be for ordinary waveform observation. The frequency of the sweep circuit should be some submultiple of the modulation frequency; that is, the audio component of the modulated wave. To stop the image external synchron-

ization should be used and a good place to secure the synchronizing pulse is from the demodulator load circuit, which arrangement will provide the audio pulse of a frequency equal to the modulating frequency, since the rectified voltage developed across the demodulator load circuit is the audio frequency signal. A 100,000-ohm resistor should be used

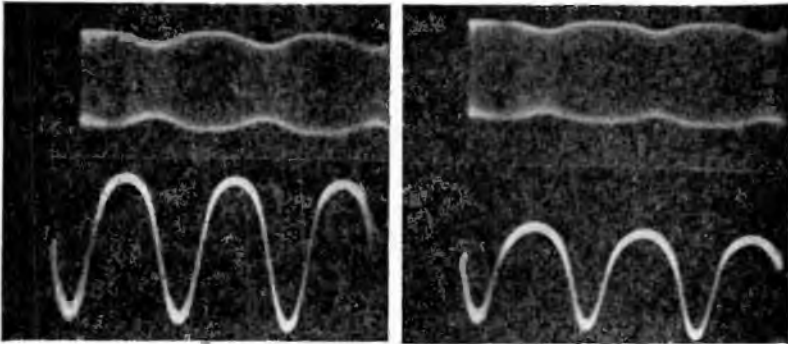

Fig. 197-A, top, Fig. 197-B, lower. The i-f. amplifier was overloaded and the modulated wave envelope appears in Fig. 197-A. Note the change in shape of the a-f. wave in Fig. 197-B from the corresponding a-f. wave in the oscillogram of Fig. 196-B.

Figs. 198-A top, 198-B, lower. The amount of overload in the i-f. amplifier was increased above that shown in Fig. 197-A and the modulated wave envelope resulting is shown in Fig. 198-A. The corresponding a-f. waveshape is shown in Fig. 198-B.

in series with the high side of the synchronizing circuit, so as not to short the demodulator load and to cut down the amplitude of the synchronizing pulse fed into the synchronizing circuit.

In the event that a triode type of demodulator or second detector is used, a condenser must be connected in series with the high side of the synchronizing circuit. A .1-mfd. condenser will be found satisfactory. As far as the vertical deflection plate circuit is concerned for the observation of the a-f. waveform, the oscillograph circuit should be checked to see that a condenser is in the "high" circuit, otherwise it will be impossible to connect the deflection plates across the load circuit of a triode demodulator, without biasing the spot away from its normal position. Switch S is set to B for the i-f. wave envelope tests and to A for the rectified a-f. waveform tests. See Fig. 195.

It is, of course, assumed that once information has been gained to the effect that overloading is taking place, that suitable effort will be made to correct the fault. It is possible that the operator, who reads these lines, may feel that the time required to make such tests is entirely out of proportion with the information gained. Such is not the case.

In the second place, the test is a necessity, for if proper service is to be rendered, overloading, resulting in distortion, cannot be tolerated, even if the customer does not notice the poor quality, because he is tone deaf or has no appreciation of music.

It is also conceivable that the operator does not possess a test signal generator which will provide a sine-wave audio signal after proper rectification. One should be secured. However, until such time, operation can be carried out by examining the audio waveform of the audio component supplied by the test oscillator and watching for any changes in the shape of this wave during its passage through the receiver. Also a test is made to determine the waveform of the modulated signal supplied by the test oscillator. This test is made in accordance with instructions given elsewhere in this chapter. Once the correct shape of the wave envelope is known, changes due to the introduction of distortion or overloading will be detected with comparative ease.

Checking Demodulator Output Waveform

The majority of modern receivers employ diode detectors of one kind or another. At any rate, the rectified signal is present across the load upon the diode circuit. To check the a-f. waveform across the diode load, use the circuit shown in figure 199. The vertical deflection

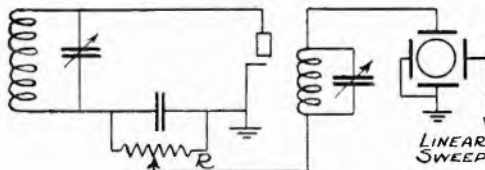
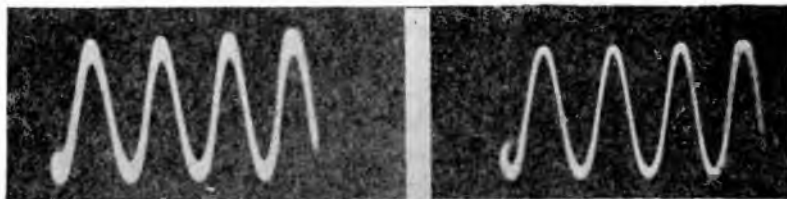

Fig. 199. Circuit for checking waveform of diode demodulator output. The trap circuit in series with R and the vertical deflection plate is to take out any r-f. that might still be present.

plates are connected across the diode load. Since operation is being carried on at an audio frequency, the vertical deflection plate amplifier can be used. The linear sweep circuit is placed in operation to spread the wave. The frequency of the sweep is adjusted in accordance with the number of cycles of the wave to be observed, which are desired upon the cathode-ray tube screen. The synchronization control is set to internal. This circuit is suitable for use with all types of diodes; that is, full wave diodes; with triodes used as diodes, with the grid and plate joined; with duo-diode triodes and pentodes, wherein only one diode plate is used in the rectifying circuit or wherein the two diodes are tied together and used as a common element.

If a triode type of demodulator is used with a resistance-coupled

load, you can use the circuit shown in figure 200. The vertical deflection plates can be connected across the grid leak of the stage following,



Figs. 199-A, left, 199-B, right. The broadness of the waveshapes in Fig. 199-A indicates that some r-f. is present in the output of the demodulator. The oscillogram in Fig. 199-B was made after filtering out the r-f. Note the difference in the peaks.

without influencing the waveform. If the input circuit to the vertical plates of the cathode-ray oscillograph contains a condenser, the vertical deflection plates can be connected between the plate of the detector or

Fig. 200. Circuit for determining waveform of triode type of demodulator output.

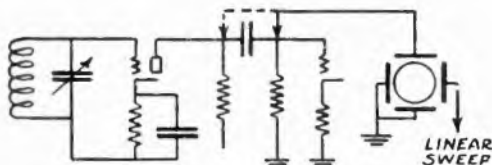

demodulator and ground. The same connections apply if the demodulator tube is transformer coupled to the audio stage following. If no condenser is in the high side of the vertical deflection plate, a .1-mfd. unit of suitable voltage rating will suffice.

Checking Phase Distortion

Phase distortion, as has been stated earlier in this volume in connection with audio amplifiers, is not of great interest in ordinary audio amplifiers employed in receivers. Yet, interest is evidenced in the subject and the following may be of benefit in connection with a means employed to check phase shift. Minimization of phase shift is accomplished when series reactance and shunt susceptances are negligible, which is seldom the case in commercial apparatus.

Phase shift or phase distortion can be checked by feeding a complex or distorted wave into a device, noting the waveshape of the input signal and noting the waveshape of the output signal. Assuming that amplitude or harmonic distortion does not exist and hoping that frequency distortion or discrimination is at a minimum, the difference between the two patterns is an indication of the extent of phase distortion.

The circuit shown in figure 201 was used for this purpose and the phase distortion was deliberately introduced by changing the value of the capacity, with the value of resistance maintained constant. The

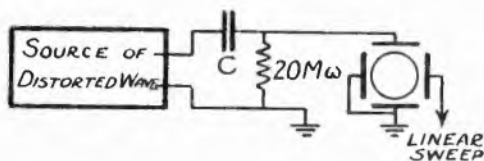

Fig. 201. Circuit for checking phase distortion.

fundamental frequency was 1000 cycles. The original wave fed into the phase distorting circuit is shown in figure 202. The coupling capacity C was made .005-mfd. and the resultant waveform is that shown in figure 203. With C changed to .01-mfd., the wave shape became



Figs. 202, left, 203, right. The original wave fed into the phase distorting circuit is shown in Fig. 202. When the condenser C (Fig. 201) was made .005 mf., the waveform of Fig. 203 resulted.

that shown in figure 204. With C changed to .05-mfd. the wave shape became that illustrated in figure 205. The gradual approach to the original waveform is evident. It was attained when C was increased to .5-mfd.

No doubt a certain amount of frequency discrimination was also present in the system, but the existence of phase distortion is shown



Figs. 204, left, 205, right. Further changes were made in the value of C of Fig. 201. When it was increased to .01 mf. the wave shown in Fig. 204 was obtained and when it was made .05 mf., the waveform of Fig. 205 was obtained. Note the similarity of this wave to the original, which is shown in Fig. 202.

nevertheless very conclusively. A very excellent method of checking phase distortion in amplifiers, known to be free from frequency dis-

crimination or frequency distortion, is to pass a fairly linear saw-tooth wave through the system and note the departure from linearity as a result of phase distortion.

When making such tests, the voltage to be observed is fed to the vertical deflection plates. The linear sweep in the oscillograph is adjusted to a frequency which will place several cycles of the desired wave upon the screen. Internal synchronization can be employed.

Having checked phase distortion, the presence of frequency distortion can be checked by making a frequency distortion test. In this connection we are very hopeful that the use of the audio-frequency modulator, described elsewhere in this volume, will be commercially developed and applied.

Checking A Class "B" Audio Amplifier

We make special reference to this type of system because of the difference in operation of certain sections, with respect to Class A am-

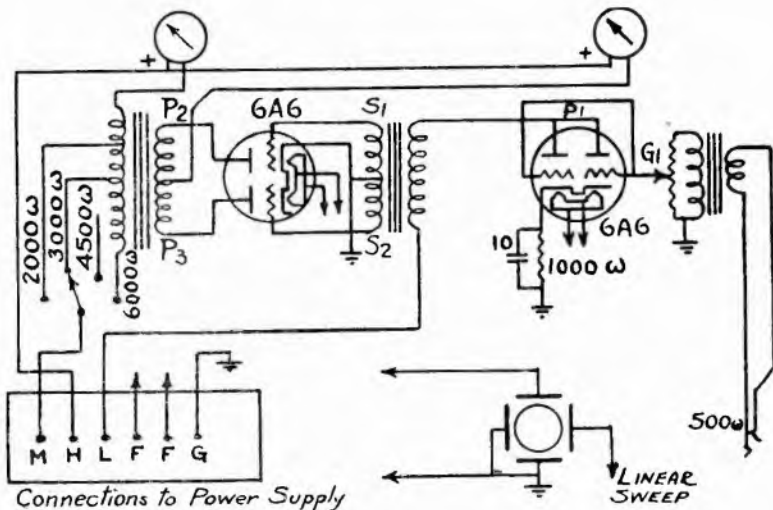

Fig. 206. A typical Class B amplifier, which can be employed either for amplification or for the modulation of a transmitter.

plifiers. An amplifier, such as we have in mind, as shown in schematic form in 206. It can be used for ordinary power amplification or for modulation of a transmitter. Forgetting its utility, what will be said about the mode of checking through the unit with a cathode-ray oscillograph is applicable to any such units. At the same time, the mode of progress is applicable to any and all types of audio amplifiers.

Referring to the schematic, the two sections of the input 6A6 tube are used in parallel as a Class A amplifier. The Class B stage consists of the two sections of a 6A6 used in push-pull. The remainder of the circuit is self-explanatory. The variable load upon the Class B stage has been arranged in order to adapt the unit to various loads and, at the same time, to show the effect of various loads. This amplifier is a part of the "ham" transmitter, which is dealt with in detail later in this volume.

The test upon the amplifier is made by connecting the cathode-ray tube across the various important points in the system, so as to determine operation, by noting the character of the signal which is passing through the system. The illustrations given herewith show the images developed by connecting the cathode-ray tube across the designated points. Such a test can be made upon an amplifier which is considered to be in good condition, as determined by voltage tests and by the



Figs. 207, left, 208, middle, 209, right. The output wave of the Class A stage is shown in Fig. 207. The input voltage wave to the Class B stage is shown in Fig. 208. The correct phase relation of 180° between the two voltages to the Class B input is indicated in Fig. 209.

way in which it operates. The identical test is applicable to an amplifier which is not operating as well as it should. The waveform test should be a routine operation, irrespective of what other tests indicate.

The cathode-ray tube is arranged so that the voltage to be observed is applied across the vertical deflection plates. The vertical deflection amplifier in the cathode-ray tube is used to adjust the amplitude of the image. The linear sweep circuit in the cathode-ray tube is adjusted to a sub-multiple of the frequency of the test signal, the exact frequency being determined by the number of cycles desired upon the screen. Internal synchronization is used. The vertical deflection terminals are joined to test leads with prods and these leads are connected across the various test points; or if desired, two clips are connected to the test leads and these clips are connected to the various test points.

The first test is the determination of the character of the test signal input into the amplifier. This is a sine wave, determined by viewing the waveform upon the screen. Assuming correct signal input, the following photographs illustrate the progress through the amplifier. Figure 207 is the waveform of the output of the Class A stage using the 6A6 tube. The test prods are joined across the plate circuit of the Class A stage. The input voltage to the Class B stage is shown in figure 208. Note that the amplitude of this voltage is lower than that of the signal across the primary of the transformer. This is quite natural, in that the input transformer feeding a Class B stage has a voltage step-down ratio. The sine character of the wave is preserved. The phase relation between the two voltages applied to the two grids of the Class B stage is determined by connecting the vertical deflection

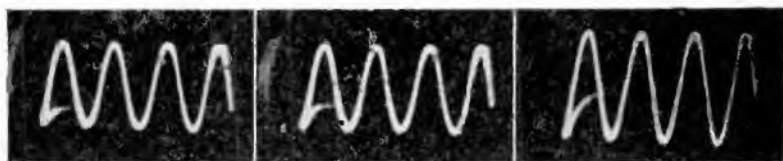

Figs. 210, left, 211, middle, 212, right. The waves of Figs. 210 and 211 were taken across each half of the input transformer of the Class B stage. It can be seen that they are identical. The voltage across the primary of the output transformer is shown in Fig. 212.

plates between S-1 and ground and the horizontal deflection plates between S-2 and ground. The linear sweep circuit in the cathode-ray tube is not used. The cathode-ray oscillograph input circuits are adjusted for independent voltages to the two sets of deflecting plates. Correct phase relation of 180 degrees should exist if proper operation of the system is to be secured. Such is found to be the case, as indicated in figure 209. The vertical and horizontal axes are shown for reference. The photograph is a triple exposure. The image which would normally appear upon the screen is the diagonal line.

A check is made to make certain that the correct voltage exists across each half of the input winding in the Class B stage, that is across S-1 and ground and across S-2 and ground. The pattern appearing upon the screen is shown in figures 210 and 211 respectively. As is to be expected in a normally operating system, they are identical.

The nature of the signal voltage across the primary of the output transformer is determined by connecting the vertical plates across P-2 and P-3 and adjusting the sweep frequency to the proper figure. The

resultant pattern is shown in figure 212. A very slight amount of distortion is indicated in the waveform, but since it is so little, it is tolerated. The waveform of the voltage appearing across the secondary circuit is shown in figure 213. It is to be understood that these tests were made with the correct load impedance in the secondary circuit of the output transformer.

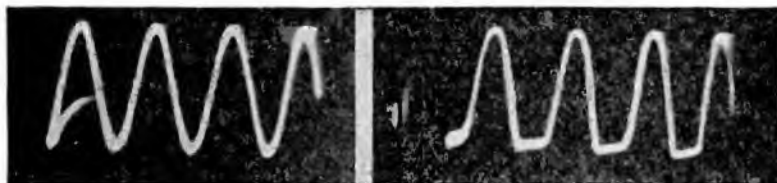

Figs. 213, left, 214, right. The waveform of the voltage across the secondary circuit is shown in Fig. 213. The waveshape of the voltage, showing cut-off, in the plate circuit of one of the sections of the 6A6 tube in the Class B stage.

In a Class B stage of amplification, zero bias is often used and the operating characteristic is such that no plate current flows, unless a signal is applied, during which time grid current also flows. However, some of the tubes used as Class B amplifiers do allow the flow of plate current with no signal input, so that for low values of signal input, each stage in the system operates as a Class A amplifier. Cut-off in a Class A stage is classified as being representative of distortion. In a Class B stage, such cut-off is quite natural, as is indicated in figure 214. This is the shape of the signal voltage in the plate circuit of one of the sections of the 6A6 in the Class B stage, with the associated grid excited. No signal was applied to the other grid. Note the cut-off. The final correct output is secured as a result of the presence of the two tubes in the stage. One tube functions over one portion of the cycle and the other tube functions over the other portion of the cycle.

Additional Class B amplifier tests are given in a subsequent section.

Distortion In Demodulator

There are occasions when distortion originates in the demodulator tube, as a result of some kind of defect. One which has been found of particular interest is given special mention at this time. Incidentally, its discovery was made during the process of servicing. During the checking of the receiver in question, it was noted that the audio signal was distorted and no amount of adjustment was of any avail. Examination of the i-f. signal envelope established that the waveshape of

the signal fed into the demodulator, which was of the diode type, was satisfactory in every respect. A test of the audio signal, resulting from rectification in the diode circuit, established that it was distorted, so that localization of the distortion in the diode circuit was accomplished.

The patterns upon the cathode-ray oscillograph screen, which disclosed the trouble, are shown in figure 215. There is no mistaking

Fig. 215. Above is shown the modulated wave as it came from the i-f. amplifier and below is an oscillogram of the a-f. wave taken across the diode demodulator output. Note the distortion in the a-f. wave, indicating that the demodulator is not functioning properly.

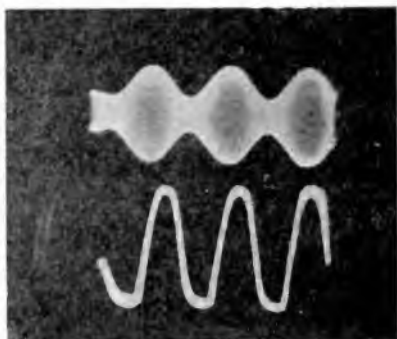

the fact that the i-f. wave envelope is satisfactory and that the rectified signal should be the original sine wave fed into the input of the receiver in the form of a modulated carrier. The distorted diode output is shown as the lower photograph.

As to the reason for the distortion, investigation disclosed that the diode load resistor, which also was the audio volume control unit, had increased in resistance value from the correct 500,000 ohms to about 3,000,000 ohms. When this unit was changed, the distortion was eliminated.

The cathode-ray oscillograph is applied in the conventional manner. The voltage to be observed is applied across the vertical plates. For observation of the i-f. waveform, it may be necessary to use the external i-f. amplifier described earlier in this chapter. However, if the intermediate frequency is not higher than 175 kc., it may be possible to use the vertical deflection amplifier in the cathode-ray unit, if such an amplifier is available. If sufficient gain is available in the i-f. amplifier in the receiver, it may be possible to feed the i-f. signal directly to the vertical plates, without passing through any amplifier.

The sweep circuit is used, that is the linear sweep, and is adjusted to a sub-multiple of the modulation component frequency, the exact frequency being dependent upon the number of cycles desired upon the viewing screen. (See the discussion concerning i-f. amplifier overload, presented earlier in this chapter.)

For observation of the rectified a-f. signal, the vertical deflection plates are connected across the demodulator load direct, or through the vertical deflection plate amplifier. The linear sweep is used and adjusted to a frequency dependent upon the number of audio cycles desired upon the screen. Either internal or external synchronization may be used.

For proper application of such tests, it is essential that the waveform of the audio signal generated by the test oscillator be known. This means that the modulated carrier wave envelope of the test signal be observed and also the audio signal be observed. Facts pertaining to such tests are given on subsequent pages.

Condenser Power Factor Tests

The cathode-ray oscillograph enables a very rapid comparative test between condensers, to determine relative power factor or losses. The circuit used for such tests is shown in figure 216. An oscillator sup-

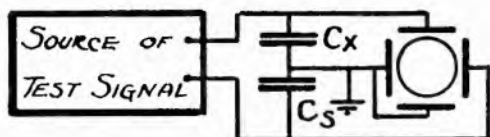

Fig. 216. Circuit for comparing power factors or losses between two condensers. C_x is the sample and C_s is the standard.

plies the test voltage at a pre-determined frequency. We used 1000 cycles. The two condensers, C_s being the standard and C_x being the unknown, are so arranged that the voltage across the sample being tested develops the vertical deflection and the current through the sample develops the deflection in the horizontal deflection, so that the current and voltage are 90 degrees apart. The linear sweep in the cathode-ray oscillograph is not used. If the oscillograph unit is equipped with amplifiers, both vertical and horizontal amplifiers should be used. If the unit is equipped with a vertical deflection amplifier only then both horizontal and vertical deflections should be secured without recourse to amplifiers in the oscillograph. One amplifier alone should not be used.

If the sample being tested is comparable in electrical efficiency with the standard, the pattern will be a straight line. The area of the pattern is proportional to the power factor of the test condenser. The greater the losses in the test condenser with respect to the standard, the greater the eccentricity of the ellipse. Photographs showing various patterns indicative of different degrees of loss in condensers compared with standard samples, are given in figures 217, 218, 219 and 220. Each increase in the area of the ellipse indicates greater losses

and higher power factor. A slight difference in electrical efficiency between the sample tested and the standard is indicated in figure 217. Increasing difference in electrical efficiency is indicated in the subsequent three photographs.



Figs. 217, 218, 219, 220, reading from left to right. Oscillograms showing varying degrees of loss and power factor in condensers. The greater the area of the ellipse, the higher the losses and the higher the power factor.

The tests need not be made at 1000 cycles. If sufficient voltage is available, the test can be made at radio frequencies, or, if desired, at commercial frequencies, such as 60 cycles.

Phase Inversion

A number of receivers, manufactured during the past two years, contain what is known as a phase inverter tube. Sometimes this tube is a separate tube and in other cases, it is one section of a dual triode. The purpose of such phase inversion is to enable push-pull amplification in the output circuit, with resistance-capacity coupling between the output tubes and the tube which feeds the output tubes. Generally speaking, push-pull amplification is not possible with resistance-coupled input, because the coupling device does not change the phase of the signal voltage, so that the two signals applied to the two grids of the output tubes are the required 180 degrees apart. Usually the push-pull input transformer accomplishes this function. Since this transformer is omitted in resistance-capacity coupled systems, a tube is used to change the phase of the signal voltage fed to one of the output tube grids. The phase inversion tube secures its signal voltage from the tube which supplies the signal voltage to the other output tube. This is shown in figure 221. T-1 is the demodulator tube or the first stage a-f. amplifier. T-2 is the phase inverter. T-3 and T-4 are the two output tubes. T-1 supplies a signal voltage to the grid of T-3 through condenser C. R is the load resistor for T-1. The signal voltage fed to T-3 is in a certain phase with respect to the a-c. voltage developed across the load resistor R. At the same time, a pre-determined portion of the signal voltage developed across R is fed to the grid of the

phase inverter tube T-2 through the condenser C-1 and resistor R-1. The operation of a vacuum tube is such that when a resistive load is used, the phase of the a-c. signal voltage in the plate circuit is 180 degrees out of phase with the a-c. signal voltage in the grid circuit.

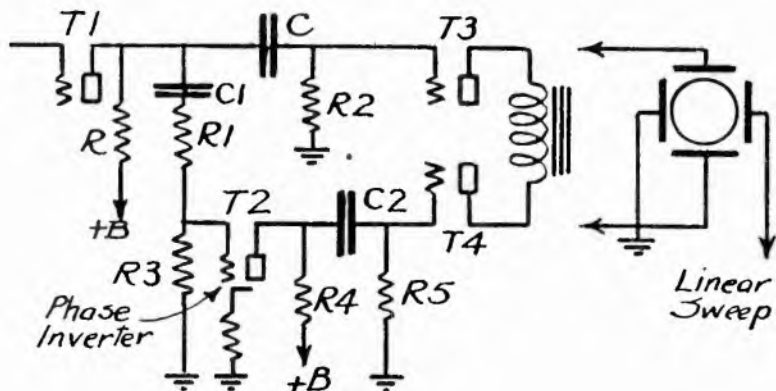

Fig. 221. Schematic diagram of an a-f. amplifier employing a phase inverter tube, which in this case is T-2. Various checks on the voltage as supplied to the output stage can be made with the cathode-ray oscillograph, as is explained in the text.

The voltage supplied to the phase inverter tube develops an a-c. voltage across the load resistor R-4. This voltage is then fed to the grid of T-4, the other output tube, through the blocking condenser C-2. Because of the action of the phase inverter tube, the phase of the voltage fed to the grid of T-4 is 180 degrees out, with respect to the signal voltage supplied to T-3. By proper selection of constants, it is assumed that the amplitude of the two voltages fed into the two output tube grid circuits is the same.

To check the operation of such a phase inversion circuit, several facts must be established. One of these is that the amplitude of the voltage output from the phase inverter tube is equal to the amplitude of the signal supplied from the other tube. The second is that phase inversion is actually taking place. As it happens, both tests can be made simultaneously, because, when making the phase inversion test, it is possible to note the amplitude of the signal voltage and compare the voltage supplied by T-1 and that supplied by the phase inverter tube.

We checked phase inversion by actually observing the waveform. A distorted wave was fed into T-1. The output wave is shown in figure 222. Note the distortion on the upper peaks. This voltage was meas-

ured across R-2. Then the vertical deflection plates were connected across R-5. The pattern resulting is shown in figure 223. Note that the pattern has been shifted through 180 degrees and that the lower peaks now show the distortion previously evident upon the upper peaks.



Figs. 222, left, 223, right. The wave shown in Fig. 222 was taken across R-2 (Fig. 221) and shows distortion deliberately introduced. When the voltage was taken across R-5, the wave of Fig. 223 was obtained. Note that the distorted peaks are now on the bottom, showing that the wave has been shifted through 180°, which is the function of the phase inverter tube.

The phase inverter tube has shifted the signal through 180 degrees, but you will also note that the amplitude of the voltage out of the phase inverter tube is not the same as that out of the supply tube T-1. This may be due to any one of a number of defects. It may be due to defects in the coupling resistor, which feeds a portion of the signal out of T-1 to the phase inverter tube; or to insufficient amplification within the phase inverter tube; or to incorrect values of the grid leaks related to the phase inverter; or to the output tube which receives its signal voltage from the phase inverter. At any rate, corrective remedies must be applied.

Another way of establishing the operation of the phase inverter tube is to develop a phase diagram, by connecting the vertical plates across the input to T-4. With a signal input into T-1 and the phase inverter tube in operation, the pattern which appears upon the screen is a single line indicating a phase difference of 180 degrees between the two voltages fed into the two output tubes. When making such tests, the oscillograph is adjusted for independent voltages to the two sets of deflection plates and the linear sweep circuit is not used.

Checking Test Oscillators

We have made mention of the fact that it is often necessary to know the character of the signal input into the receiver or amplifier being tested. If tests are to be made upon the i-f. system in the receiver, it

is essential that the character of the modulated wave output from the test oscillator being used be known. The same is true about the audio signal which is generated by the test oscillator. The character of this signal must be established, so that when waveform observations are being made in the audio system under test, the operator will know the correct shape of the wave. The ideal type of wave for most work is the sine wave, but when a perfect sine wave is not available, a close approach will do.

The rated percentage of modulation usually employed in test oscillators is 30, but investigation discloses that the percentage varies over a range in different units. However, actual percentage of modulation is not very important. The important thing is to know the character of the wave, so that operating conditions in the receiver or amplifier under test can be established. (Facts pertaining to the determination of the percentage of modulation are given elsewhere in this volume.)

The exact character of the unmodulated r-f. carrier is not of great importance, as far as servicing is concerned. The presence of harmonics in the signal will not cause any complications, providing that the test set-up is such that these harmonics will not cause beats with other signals which may be involved in the test.

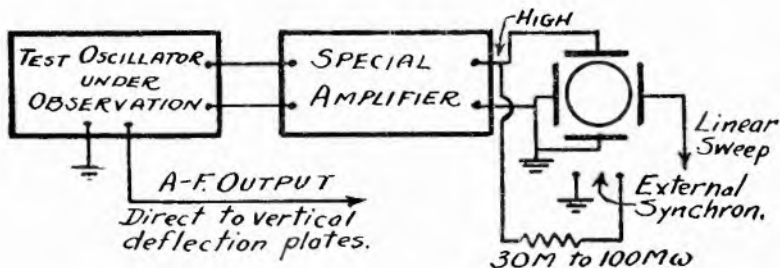

Fig. 224. Circuit used for checking the modulated and unmodulated carrier outputs and the a-f. output of a test oscillator.

The method of checking the unmodulated carrier output, modulated carrier output and audio output is shown in figure 224. For all of these tests, the voltage or waveform to be observed is applied to the vertical deflection plates. The linear sweep circuit is brought into play and external synchronization is preferred. Whether or not the unmodulated carrier can be spread so as to observe the waveform is a matter of the upper frequency limit of the sweep in the cathode-ray oscillograph. The adjustment of the sweep frequency depends upon the number of cycles desired upon the screen. When checking modu-

lated waves, the number of cycles of the modulated wave, which appears upon the screen, is determined by the ratio between the sweep frequency and the frequency of the modulating signal. When checking the audio signal waveform, that is, the modulating signal generated by the test oscillator, the number of cycles which appears upon the screen is determined by the ratio between the sweep frequency and the frequency of the audio signal, with the former being the lower of the two frequencies. The synchronizing signal is



Figs. 225, left, 226, right. A 100-kc. unmodulated carrier was fed to the special amplifier of Fig. 224 and the streaked pattern of Fig. 225 was obtained. These light and dark horizontal lines in the pattern indicate that harmonics are present in the output of the oscillator. In Fig. 226 several cycles of this output wave are shown and the irregularities of the wave can be seen to correspond with the streaks in the pattern of Fig. 225.

obtained by connecting the high side of the external synchronizing circuit to the high side of the special amplifier through a 30,000 to 100,000 ohm resistor. The higher the value of this resistor, the better, for it provides greater freedom from loading of the output circuit of the amplifier by the input circuit of the synchronizing system.

The character of an unmodulated carrier can be checked roughly by examination of the pattern formed upon the screen. Figure 225 shows the pattern resulting from the application of a 100 kc. unmodulated



Figs. 227, left, 228, right. The unmodulated 100-kc. carrier from an oscillator that is free of harmonics gives a pattern free of streaks, as is shown in Fig. 227. Several cycles of the wave, which was used to obtain the oscillogram of Fig. 227, are shown in Fig. 228.

r-f carrier to the circuit. Note the streaks in the pattern. Each of these streaks indicates a kink in the waveform of the signal and denotes that the wave is not pure, but contains harmonics. This is shown in

figure 226, where several cycles of this 100 kc. carrier voltage are spread by the sweep in the oscillograph. Note the departure of this carrier voltage waveform from the ideal sine wave.

Figure 227 shows the pattern for an unmodulated r-f. carrier of 100 kc., but which is quite free of harmonics. Note the absence of streaks in the pattern. A few cycles of this voltage are shown in figure 228. This method of judging the character of an unmodulated carrier is fast and reasonably accurate, although not necessarily quantitative with respect to the exact amount of distortion present in the voltage wave.

The modulated output waveform is checked by feeding the test oscillator output to the amplifier, as shown in figure 224. The audio signal is secured directly from the test oscillator, by connecting to the a-f. output terminals usually provided for that purpose. The vertical deflection plates are disconnected from the special amplifier used for the modulated wave envelope observations and connected to the test oscillator audio output circuit. The amplifier in the cathode-ray oscillograph can be employed for vertical amplitude control. The synchronization control upon the oscillograph can be set to internal.

It might be well, if at this time, we mentioned that a superheterodyne receiver, known to be good, can be used to check the character of the modulated wave output from the test oscillator. If such a receiver is available, you can dispense with the amplifier mentioned as being required for amplification of carrier frequencies. During the normal operation of a superheterodyne receiver, the beat frequency, that is, the i-f. signal present in the intermediate frequency amplifier, retains all the characteristics of the original modulated signal impressed across the antenna-ground terminals. This is so, despite the fact that the carrier frequency in the intermediate-frequency amplifier is not the same carrier which was originally applied to the receiver input. Any departure from regularity in the character of the modulated wave input to the receiver will be retained by the modulated i-f. signal, so that as far as observation of such a wave is concerned, it can be examined and judged by connecting the vertical deflection plates of the cathode-ray oscillograph across the output circuit of the last i-f. transformer, or across the input circuit of the demodulator.

What was said in the previous paragraph is true only when the receiver mentioned is known to operate perfectly, with total freedom from distortion, overloading and all other defects.

If we may be allowed to make a suggestion, we think that a high-gain amplifier operative over the i-f. band will be found very handy,

whereas the receiver arrangement mentioned is suitable for use over the broadcast and higher frequencies. When such a receiver is used, the test oscillator output is fed into the antenna-ground system of the receiver and the output of the standard test receiver is connected to the vertical deflection plates of the cathode-ray oscillograph.

Before discussing cathode-ray oscillograph patterns, such as you would see when making tests upon commercial service test oscillators, we feel that a few words are necessary concerning modulated wave patterns and also the audio signal voltage waveshape.

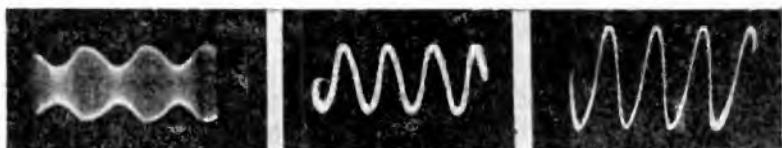

Fig. 229-A, left, Fig. 229-B, middle, Fig. 229-C, right. A. The wave envelope of the modulated output of a commercial test oscillator. B. The a-f. output of the same oscillator. C. The a-f. signal resulting from demodulation of the modulated wave shown in A.

Concerning modulated wave patterns, the design of the majority of commercial service test oscillators, with possibly one or two exceptions, is such that the modulated waveform varies with the frequency setting of the test oscillator. Recognition of this fact is important, when tests are to be made at different frequencies. This condition is illustrated in several photographs. There are a number of reasons which contribute to this condition, the major being that the amount of r-f. voltage generated at the different carrier frequencies within the range of the unit, is not constant; consequently, the relative amplitude between the a-f. and r-f. voltages is not maintained uniform. As a



Fig. 230-A, left, Fig. 230-B, middle, Fig. 230-C, right. A. The wave envelope of the modulated output of a commercial test oscillator. B. The a-f. output of the same oscillator. C. The a-f. signal resulting from demodulation of the modulated wave shown in A.

result of carrier amplitude variations over the frequency range of the unit, the percentage modulation is a variable. There are other reasons, but our function is to show the application of the cathode-ray oscillograph and not discuss the design of test oscillators.

A similar condition exists with respect to the audio-frequency signal available from the a-f. output posts in the test unit and the a-f. signal out of the demodulator tube in the receiver. Here, too, is a difference, which must be appreciated, if proper application of the cathode-ray tube is to be attained. With one or two exceptions, the a-f. output, as secured from the service test oscillator, is not of the same shape as that which is seen when the a-f. signal is checked across the demodulator load in the receiver and which is due to demodulation of the modulated carrier generated by the service test oscillator. This condition is occasioned by the fact that the character of the audio signal is changed



Fig. 231-A, left, Fig. 231-B, middle, Fig. 231-C, right. A. The wave envelope of the modulated output of a commercial oscillator. B. the a-f. output of the same oscillator. C. The a-f. signal resulting from demodulation of the modulated wave shown in A.

during the process of modulation of the carrier in the test oscillator and demodulation in the receiver. This condition is the result of the manner in which modulation of the carrier, generated by the test oscillator, is accomplished. While it is true that the shape of the audio voltage, generated by the a-f. portion of the test oscillator, remains the same at all times, (that is, independent of the carrier frequency, when that signal modulates the carrier,) the resultant wave envelope may or may not be representative of the actual modulating voltage, depending entirely upon modulating process. Then, when this modulated wave is demodulated, the resultant a-f. signal is determined by the characteristics of the modulated wave and not by the basic audio signal, which was used for modulation in the test oscillator. This, too, is shown in several photographs.

It is important to realize these facts because of the difference in the character of the audio pattern which is obtained at the test oscillator and the pattern developed across the demodulator tube in the receiver.

It would seem as if the normal run of test oscillators is not satisfactory for application with the cathode-ray oscillograph. Such is really not the case. All that is required is judicious operation of the equipment at hand and full knowledge of what must be done and what is being done. At the same time, however, we do hope that some time

in the future, when cathode-ray oscillographs will have become commonplace equipment, service test oscillators in general will operate in a manner more in keeping with the work which has to be done.

The service test oscillators now in possession of service technicians can be used for audio work, providing that the basic waveform is established by demodulation of the modulated carrier. However, if the test oscillator is equipped with audio output terminals, it is preferable to

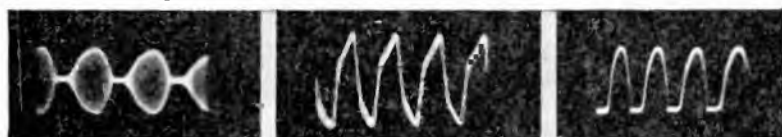

Fig. 232-A, left, Fig. 232-B, middle, Fig. 232-C, right. A. The wave envelope of the modulated output of a commercial test oscillator. B. The a-f. output of the same oscillator. C. The a-f. signal resulting from demodulation of the modulated wave shown in A.

use them as the source of audio signal voltage rather than to feed the modulated r-f. output of the test oscillator into the receiver and then use the audio signal resulting from the demodulation of the carrier. This is so because the demodulated waveform is dependent upon the frequency setting of the test oscillator. If finances permit, the most logical plan would be to get a sine-wave audio oscillator, not as elaborate as the Western Electric a-f. oscillator used for our a-f. tests, but one cheaper and of a more limited frequency range.

While it is true that the majority of test oscillators in use in the service field do not generate a sine audio wave, even after demodulation wave form observations can be made, using the cathode-ray oscillograph, if care is exercised when checking the various stages, and if the operator is familiar with what effects are introduced by certain types of defects existent in audio amplifiers. At this time, we wish to make particular reference to the fact that the present day service units, just as they are, are suitable for all forms of meter testing, such as alignment with output meter and other types of adjustments, wherein meters are used as the indicating devices. This means that men who intend buying service test oscillators may feel free to purchase present day equipment, with the knowledge that they will afford the required amount of utility.

Referring again to modulated waves, it has been found that the most important operative band, as far as application of the cathode-ray oscillograph is concerned, is the i-f. band and the broadcast band up to about 1500 kc. As it happens, the character of modulated wave en-

velopes remains substantially the same over the i-f. band and over the broadcast band, although in some instances, a change is noted at the upper and lower limits of these bands. However, application of the cathode-ray tube for tests, which involve the waveform of the modulated signal, occur at but few frequencies, so that the change in the character of the wave is not harmful, as long as it is recognized and realized when work is being done.

Checking for overload ahead of the demodulator is complicated when the normal envelope of the modulated wave has a flat top, as is the case with some test oscillators. Few suggestions can be made, other



Fig. 233. The a-f. output of a commercial test oscillator. This oscillator is also responsible for the modulated patterns shown in figures 234 to 236 inclusive.

than that another oscillator of superior design is required. It is, of course, possible to recognize the presence of such distortion, because either the positive or the negative peaks will be higher than the others, assuming that the correct output from the oscillator shows even amplitude for the peaks.

As to the frequencies used in tests which involve the modulated wave envelope, one frequency within the broadcast band is usually sufficient, so that for that one frequency, it is possible to determine

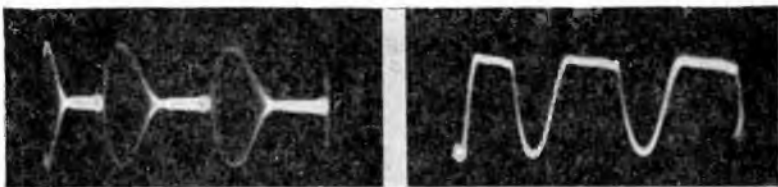

Fig. 234-A, left, Fig. 234-B, right. A. The waveform of the modulated output of a commercial test oscillator adjusted to 260 kc. B. The a-f. signal resulting from the demodulation of A.

the character of the wave envelope and the information will hold true for a band of frequencies both sides of that figure. This signal is used to check the operation of the mixer tube-oscillator system and can also be used to check the i-f. system. An average suitable frequency is about 800 kilocycles. The method of determining the operation of the mixer-oscillator, in the effort to establish distortion in that

system, is mentioned elsewhere in this volume. The character of the 800-kc. modulated signal, or for that matter any frequency within the stated broadcast band, can be established by utilizing the test receiver, as described earlier in this chapter.

Examples of the various conditions cited in connection with the testing of test oscillators is shown in figures 229 to 236 inclusive. The exact condition depicted is described in the captions.

The cathode-ray oscillograph can be applied as shown when making changes upon test oscillators in the effort to produce a unit which will



Fig. 235-A, left, Fig. 235-B, right. A. The modulated output waveform of the same oscillator used for generating waves shown in Fig. 234. The frequency here is 600 kc. B. The a-f. signal resulting from demodulation of A.



Fig. 236-A, left, Fig. 236-B, right. The same oscillator adjusted to 1000 kc. has a modulated waveform as shown in Fig. 236-A. The a-f. output resulting from the demodulation of A is shown in B.



Fig. 236-C, left, Fig. 236-D. The modulated output waveform of the same oscillator when adjusted to 1700 kc., is shown in C. The a-f. output resulting from the demodulation of C is shown in D.

be satisfactory in operation. Whether or not the average service technician or operator feels competent to make changes upon test oscillators so as to remedy defects, depends entirely upon the individual, but it stands to reason that if the knowledge possessed by the operator is sufficient, the cathode-ray oscillograph is the medium which furnishes the data relative to the efficacy of any change or adjustment, because it shows what change in output waveform has been effected.

As an example of what we have in mind, figures 237, 238 and 239 illustrate various waveforms secured from an audio oscillator, wherein



Fig. 237, left, Fig. 238, right. Two oscillograms obtained from an audio oscillator in which regeneration was excessive and a very high L-C ratio.

regeneration was excessive and the L-C ratio was very high. Reduction of the L-C ratio and regeneration resulted in the development of the sine wave shown in figure 240.

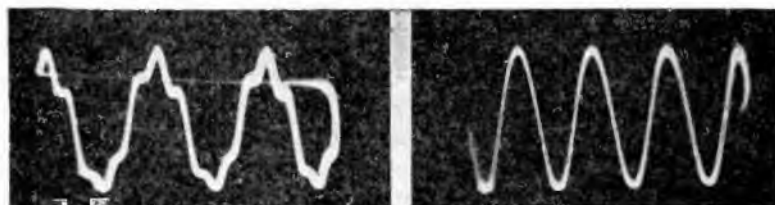

Fig. 239, left, Fig. 240, right. The oscillogram of Fig. 239 is the a-f. output of an oscillator with high L-C ratio and regeneration. The waveform of Fig. 240 is for the same oscillator when the L-C ratio and the regeneration were reduced.

An added example of the application of the cathode-ray oscillograph as the tool whereby improvements may be effected, is shown in figures 241, 242, 243 and 244. Figure 241 is the pattern upon the screen when a distorted 90-kc. unmodulated carrier is observed, with the linear sweep set to a very low frequency so that a block pattern results. As stated earlier in this volume, it is possible to distinguish distortion of the carrier wave by the character of the pattern. If it is solid, without any of the streaks of greater intensity, as appear in figure 241, the waveform usually is sine or a close approach to sine shape. The presence of the streaks indicates distortion. The wave shown in figure 241, when synchronized with the linear sweep so that a few cycles of the carrier appears upon the screen, is shown in figure 242.

Corrective remedies applied to the oscillator in the form of a load placed upon the tickler winding, so that the amount of feedback in the circuit is reduced, is shown in figures 243 and 244. The block pattern,

corresponding to the oscillograph adjustment productive of figure 241, is shown in figure 243. Note the absence of streaks in the pattern. The synchronized pattern, showing several cycles of the carrier after correction and corresponding to the adjustment of the oscillograph for

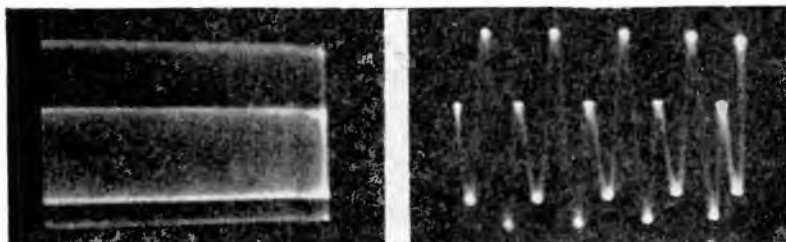

Fig. 241, left, Fig. 242, right. The light and dark streaks of the pattern in Fig. 241 indicate that the unmodulated carrier, which was 90 kc., was distorted. When the sweep frequency was increased, so that only a few cycles of this 90-kc. carrier appeared on the screen, the waveform in Fig. 242 showed the distortion that the solid pattern indicated.

figure 242, is shown in figure 244. Note the approach to what is a sine wave. Actually, the wave is not of sine character. A certain amount of distortion exists, but the oscillograph served its purpose in enabling the application of corrective remedies by indicating what was being accomplished.

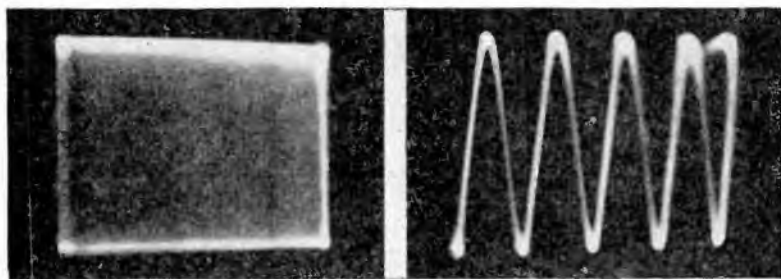

Fig. 243, left, Fig. 244, right. After corrective measures were taken with the oscillator used to generate the patterns shown in Figs. 241 and 242, the pattern of Fig. 243 indicated that distortion had been removed from the carrier, because the streaks had disappeared. The oscillogram of Fig. 244 shows the corresponding carrier wave, which has little of the distortion of Fig. 242.

Many more photographs of such work are possible, but we do not deem it necessary to consider all types of adjustments upon such units. Irrespective of the nature of the adjustment, that which has some influence upon the operation of the device and upon the output voltage or current waveform, can be checked by examination by means of the

cathode-ray oscillograph. The patterns shown in figures 242 and 244 are carrier frequencies within the intermediate frequency band and because the frequency is within the limit of the vertical deflection amplifier within the oscillograph, external amplification is not required. The output of the test oscillator, adjusted for unmodulated output, is connected across the vertical deflection plates through the amplifier.

Hum Measurements

This subject deserves discussion. Once more, we are confronted with a situation where theory does not coincide with practice because of practical limitations. The cathode-ray oscillograph lends itself well to observation of hum voltages, but only if these voltages are of a certain magnitude. This is so because of the voltage sensitivity limitation of the cathode-ray oscillograph and because of noise which is inherent in every radio receiver.

However, it is also fortunate that where hum levels are so low that they are beyond normal observation by the cathode-ray oscillograph, they are so low as not to be annoying. At least, such is generally the case.

As a means of observing the filtering action of any system, the cathode-ray oscillograph is an excellent medium. But it is necessary to realize that the average commercial cathode-ray tube, when used with the amplifiers contained within the cathode-ray oscillograph has a sensitivity of about 2.0 volts per inch, with the possible exception of one particular unit, wherein the vertical and horizontal deflection amplifiers can be connected in cascade in the vertical deflection circuit and provide a theoretical sensitivity of about .02 volt per inch. However, even in this unit, it is difficult to operate both amplifiers wide open without regeneration and noise troubles, so that the possible satisfactory maximum sensitivity is about .06 volt per inch. These voltage limitations, limit observation of hum levels to values which are within the limits of the tube, so that while the presence of reasonably large values of hum may be observed, when the hum is attenuated to a certain value as a result of the filtering action, the cathode-ray tube will not indicate its presence, because the deflection voltage is not sufficient to deflect the beam. The consequence is that we must recognize what are suitable applications of the cathode-ray tube in connection with the observation of hum voltages.

Another of the limiting factors, which must be recognized, is the noise in the receiver. As a general rule, the points across which hum

is measured are those where noise is also strong and while it is true that when the system is in normal operation, as for example in a receiver or an amplifier, the signal completely overshadows the noise, this signal is missing when the hum test is being made. Consequently, it is important to recognize that what may be classified as a hum pattern of a certain level, may be noise also. In addition, cathode-ray tubes used with amplifiers are quite sensitive to pickup, so that it is possible with the gain wide open to obtain a hum pattern upon the screen, which is really not the hum from the point being checked, but is stray line voltage picked up through induction.

We are anxious to clarify our position in making these statements. We are not repudiating statements made in manufacturers' bulletins, but are quoting from actual practical experience.

On the other hand, the cathode-ray oscillograph does perform an excellent function in locating the source of hum and the character of the voltage, when its amplitude is appreciable, as would be the case in a defective filter system. It can also be used in establishing if a carrier, or for that matter the signal, being passed through the system, is being modulated at 60 cycles, as a result of hum introduced into either the grid or plate circuits. Once again, it is necessary that the

Fig. 245. The oscillogram on the right shows a 5000-cycle note, which, being passed through an amplifier, is modulated at 60 cycles, because of unbalance in the output stage.

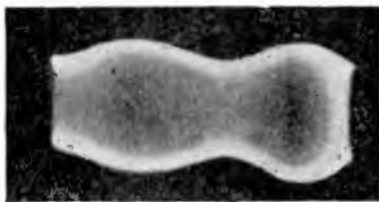

hum be of appreciable value, in order to portray its presence upon the screen. A case of such action is shown in figure 245, where a 5000-cycle note, being passed through an amplifier, is modulated at 60 cycles, as a result of unbalance in the output stage. For such tests, it is necessary that a substantial number of cycles of the signal voltage be visible upon the screen. The linear sweep frequency should be a submultiple of the hum frequency. The wavy outline of the pattern represents the hum modulation.

Where the hum is due to faulty operation of the power supply system, it can be checked, providing its amplitude is sufficiently great, by connecting the vertical deflection plates across the output of the power supply circuit. In any well filtered system, the hum level at the out-

put of the filter is so low as to cause no deflection of the beam. Hum observations are made in a manner identical to normal waveform observations, with both the linear sweep and the synchronizing control brought into operation. Ground connections must be perfect so as to avoid, or at least minimize to the greatest degree, all stray pickup. The circuit is shown in figure 246.

When checking for hum, the vertical deflection plates are connected across the point being checked. In very few, if any, cases is the cathode-ray tube suitable as a voltmeter for hum level measurements. For such work, the average 1000 ohms-per-volt rectifier type of meter is preferable.

The nature of the pattern indicative of the hum voltage may be any one of a number of types. There are so many that it is useless to show any. A controlling factor is the point at which the hum is being checked and the harmonic content.

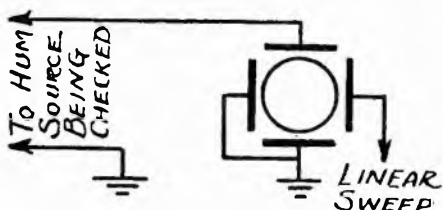

Fig. 246. The vertical plates of the cathode-ray tube are connected across the source of possible hum, for checking the presence of this interference.

Speaking about the filtering action of the units in a power supply device, figure 247 illustrates a two-section filter, which is tested along the following lines in order to establish the value of the various units: The vertical deflection plate leads, shown in figure 246, would be connected across the common connection and point 1, for the overall hum. Across points 1 and 2, would develop the a-c. voltage across the choke L-1. Across the common connection and point 2, would develop the a-c. hum voltage across the output of the first section of the filter. Across points 2 and 3, with C-1 in the circuit, would develop the a-c. voltage across the tuned choke. The effectiveness of this resonating condenser could be established by noting the character and amplitude of the voltage across L, with C-1 connected and with C-1 disconnected. The a-c. voltage across the input filter condenser can be established by connecting the vertical deflection plates across the common terminal and point 3. The hum voltage is maximum across C and minimum across C-3.

Frankly the effectiveness of the cathode-ray oscillograph in connection with hum observation is to determine whether or not the hum origi-

nates in the power supply device by checking across the output of the filter, or by checking to locate hum modulation in the grid and plate circuits of the amplifier tubes, by feeding a signal of constant frequency into the audio amplifier and observing the character of the signal voltage across the various elements in the respective grid and plate circuits.

Fig. 247. By checking across the points numbered 1, 2 and 3 in this filter circuit by means of the circuit of Fig. 246, hum can be traced to its source.

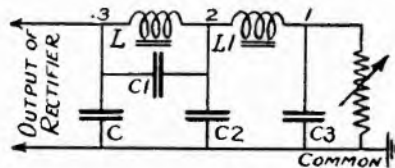

In all such work, it is advisable to determine first the shape of the a-c. power supply voltage, so that undesired pickup of the power supply voltage in place of the desired hum, will be recognized when the image is examined. The character of the hum, due to defective operation of the filter system or unbalance in an amplifying system, shows a definite departure from the conventional sine wave of a sine wave power supply or the distorted wave secured from a motor generator. This statement should not be taken as positive and applying in all cases, for in many instances stray voltages may assume all shapes, even when the stray is picked up from the line, because of the noise voltage present in the line.

To establish whether or not the hum originates at the point being checked, and is not due to stray voltage picked up by the connecting leads to the vertical deflection plates, it is best to check the ground connection and to turn off the amplifier or receiver being tested. If the image remains upon the screen when the power supply, amplifier or receiver under test has been turned off, it is obvious that the voltage, which produces the image, is a stray.

The effectiveness of the tuned section, that is the resonating condenser, shown as C-1 in figure 247, can be tested by connecting the vertical deflection plates across the output of the filter choke L, in the position occupied by C-2. In a test power supply device, figure 248 illustrates the hum voltage with C-1 disconnected. Figure 249 shows the pattern secured when the proper value of capacity was connected across the filter choke L, for the purpose of resonating the unit and thus securing maximum attenuation. Figure 250 shows the image when the capacity, used to shunt filter choke L, was too high and did not resonate the circuit to the correct frequency.

When working with such units, the pattern you may see may not

be exactly like those shown here, but no matter what the shape of the pattern, maximum attenuation will be indicated by a decrease in the amplitude of the hum voltage.

The effect of core saturation in a filter choke can be determined in similar manner. In every case where hum level is being measured, the proper condition is minimum hum. When checking for core sat-

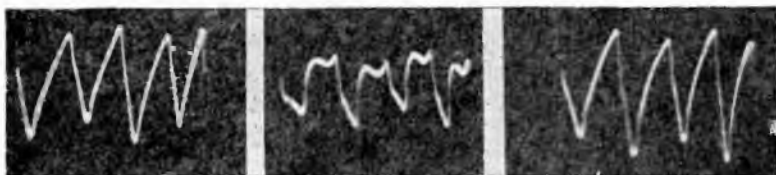

Fig. 248, left, Fig. 249, middle, Fig. 250, right. When the condenser C-1 was disconnected, see Fig. 247, the waveshape in Fig. 248 illustrates the hum voltage present. When C-1 was the correct value, the oscillogram of Fig. 249 was obtained. When C-1 was too high, the pattern of Fig. 250 resulted, as the circuit was not resonated to the right frequency.

uration, the vertical deflection plates can be connected across the output of the filter, between the negative side of the filter and the output of the filter choke being tested. A variable load resistor must be used so as to enable variation of the load current, consequently the value of the direct current flowing through the choke under test. If the choke saturates, the hum level will increase and will be indicated by a larger vertical amplitude of the image. In the event that hum is indicated by a certain wave shape, this shape will change when saturation occurs.

Testing Tone Controls

There are several ways of testing the action of a tone control in an amplifier or receiver. One of these is to note the attenuation when a number of different audio frequencies of constant amplitude or voltage are fed into the stage. When such a test is made, the cathode-ray oscillograph is being utilized solely as a voltmeter and equally satisfactory results can be secured with an output meter.

A more satisfactory, although not yet generally practical, system is to note the effect of the tone control over a continuously variable band of audio frequencies, the signal being in the form of a frequency modulated voltage. The system is described in elaborate detail in a subsequent chapter, devoted to the application of a-f. frequency modulators.

The third form of test is more of a design operation than a service operation. The information gained is that relating to the introduction of amplitude distortion, rather than frequency distortion, which is the function of the unit. In certain types of audio amplifier circuits, loading of the circuit and even tuning of the circuit occurs as the tone control is varied within its limits. Consequently, at certain frequencies, a change in wave shape, due to amplitude distortion, takes place. For tests of this type, the cathode-ray oscillograph circuit is adjusted in the manner normally used to observe waveform. The voltage to be observed is fed into the vertical plates. The horizontal plates are connected to the linear sweep circuit and internal synchronization is utilized.

Modulation Measurement

The subject is covered in detail in the chapter devoted to the adjustment of "ham" transmitters. Amplitude and trapezoid figures are shown.

CHAPTER VI

ALIGNMENT OF TUNED CIRCUITS

The alignment of a tuned circuit, so as to establish the correct resonant state by visual observation, is commonly understood to be the most valuable application of the cathode-ray oscillograph. Having read through this volume up to this point, you no doubt appreciate our statement when we say that observation of resonant circuits is but one more application of the cathode-ray instrument we are discussing. It is true, however, that, from the viewpoint of the servicing industry, it is an extremely important application. In fact, many service technicians have displayed infinitely more interest in its uses for the purpose of tuned circuit alignment than in its myriad other applications.

Just as a casual comment, let it be known, that visual curve tracing devices, such as are formed by the cathode-ray oscillograph when used for alignment operation, have been in use for some time. They are new in the radio servicing field, but have been used for a long time in manufacturing plants, in connection with production testing. While it is true that all of these commercial visual curve tracing devices were not of the cathode-ray tube variety, they were oscillographic. Incidentally, as far back as 1912, Marx and Banneitz used the cathode-ray oscillograph, with a motor driven condenser and a synchronized potentiometer-battery type of sweep, for the tracing of resonance curves. Deflection coils were used in the sweep circuit instead of deflection plates.

The production lines of many receiver manufacturers have been using the string galvanometer type of oscillograph, modernized, of course, for the alignment and testing of the various tuned circuits, which were part of the receivers being produced. Further historical background is not necessary, for after all is said and done, we are interested in that which now is available for use in the servicing field.

If we analyze the basic underlying principles of the curve tracing or visual alignment processes employed in connection with cathode-ray

tubes, we find them very much like those which apply to other applications of the cathode-ray oscillograph. It is true that there are various ways of accomplishing some of the actions which enable operation of the complete visual aligning system, but the basis of the system has already been described, although it may not have appeared as such.

If we remember that the image which appears upon the cathode-ray tube viewing screen, irrespective of its shape, is the result of a deflection of the beam by means of a varying voltage applied to the deflection plates, we have the basis for visual alignment system. This, as you know, is also the basis for the normal operations of the cathode-ray oscillograph.

There are, however, two additional considerations found in alignment systems, which are not involved in the waveform observation operations with the cathode-ray oscillograph. One of these is that instead of a fixed frequency voltage input to the device under test, as is the case when observing voltage waveforms, the frequency of the voltage input varies continuously over a predetermined band. The second consideration is that relating to the frequency of the linear sweep circuit, which is used in conjunction with alignment operations. Whereas for normal waveform observation, the frequency of the linear sweep circuit is adjusted in a certain ratio with the frequency of the voltage being observed, so as to place a certain number of cycles upon the screen, for alignment work the frequency of the linear sweep in the oscillograph is adjusted in accordance with the rate of frequency variation over the aforementioned band. The actual frequencies being produced, by whatever device is used to vary the band covered, have no bearing upon the frequency setting of the oscillograph sweep circuit. Bear these facts in mind as this discussion progresses.

A resonance curve is a graph of the voltage output of a tuned stage or tuned system with respect to frequency. The voltage output develops the vertical deflection and the variation in frequency is plotted along the horizontal axis. By synchronizing the sweep with the rate of speed of the frequency variation, time, as shown along the horizontal or "X" axis, is interpreted in frequency, because, theoretically, the rate of change in frequency is linear over whatever operating band is used. The result is that the base of the resonance curve represents frequency in equally spaced divisions, and makes possible the use of calibrated scales, graduated in kilocycles.

The above can be said to be the briefest of explanations of what goes on during visual alignment with the cathode-ray oscillograph.

Naturally, there is much more to the subject and in order to present most satisfactorily the facts of the matter, we are going to divide the subject into two parts: the frequency modulator, which is the means or device whereby the voltage fed into the tuned stage or system is made to vary continuously over the band; and second, the synchronization of the sweep circuit, so as to develop the resonance curve image.

The Motor Driven Frequency Modulated Oscillator

Since a resonance curve is an indication of the manner in which a tuned stage or system responds to an impressed voltage over a band of frequencies, one of which is the resonant frequency of the circuit, it is necessary that voltage be available at frequencies above and below the resonant frequency. The limits covered by this band, that is the number of kilocycles below the resonant frequency and the number of kilocycles above the resonant frequency, are spoken of as the "bandwidth." This test voltage, at a radio frequency or an intermediate frequency, is secured in the following manner: A constant voltage is secured from an oscillator at a fixed frequency, determined by the setting of the variable tuning condenser. This fixed frequency is really variable, since the tuning condenser is a variable, but, for the sake of clarity, we will classify it as a fixed frequency, because at any one time it is fixed as the setting of the tuning condenser remains untouched. This signal voltage at a certain frequency may be secured from a single oscillator, or may be the difference frequency or beat frequency between two oscillators, one of which is fixed tuned. Expressed in another manner, the test voltage may be the output voltage from a single oscillating system, or may be the voltage at the beat frequency resulting from the heterodyning of one oscillator with another.

Bear in mind that in both of these systems the output voltage is at a single frequency determined by the tuning. The design of these oscillators is such that the output voltage, while not substantially the same at all frequencies, is practically constant for a small band of frequencies, each side of any one setting. To secure such a test signal voltage over a band of frequencies a device known as a frequency modulator is incorporated into the system. This frequency modulator may be a mechanically operating device or may be an electrical device. In the mechanical device, a small variable condenser is connected or arranged in the tuned circuit. This condenser is continuously rotated by a small, fractional horse-power motor. As it rotates, the capacity naturally varies from minimum to maximum and back from maximum

to minimum. Since this condenser is electrically connected to the tuning condenser in the oscillator circuit, each variation in capacity varies the total tuning capacity, hence the frequency of the circuit. While the frequency modulator condenser rotates, the frequency of the oscillator is being continually varied. The width of the frequency band thus covered is a function of the circuit capacity change due to the rotation of the frequency modulator condenser and the change in frequency of the oscillator output voltage, as a result of the change in the L-C circuit.

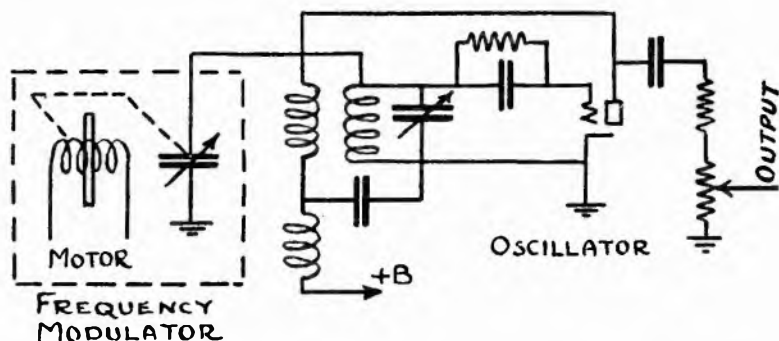

Fig. 251. Schematic diagram of a motor driven frequency modulator connected to an oscillator. The oscillator is tuned to the mean frequency of the circuit under test and the motor driven condenser varies the output frequency over a predetermined band, say 10 kc. each side of the mean frequency.

With suitable calibration it is possible to adjust the oscillator condenser to generate a fixed frequency of say 260 kc. and to cause, as a result of the capacity change in the frequency modulator condenser, a continuous variation in frequency from 250 kc. to 270 kc., thus providing a band width of 20 kc., or a 10 kilocycle variation each side of the mean or periodic frequency. (The mean frequency, which is the setting of the oscillator and which also is the resonant frequency of the circuit under test, often is referred to as the periodic frequency.) As shown in figure 251, which is a simple version of what has been said, the continuously rotating variable condenser is that contained in the frequency modulator. The condenser in the oscillator, which is of the continuously variable type, is not geared to a motor or any other form of drive. It is tuned by hand to whatever periodic frequency is desired and is operated in exactly the same manner as if there were no frequency modulator unit and a single frequency signal was desired.

Referring to figure 251, the motor and condenser shown within the dash line, comprise the frequency modulator unit. It is possible

to arrange the frequency modulator condenser with several sections, so that two ranges of capacity are available, thereby providing two band widths for any one periodic frequency. The connection between the frequency modulator condenser and the tuning condenser within the oscillator may be made in any manner which is convenient and which will remain constant. The oscillator circuit shown is by no means an example of any one commercial oscillator system. It is a simple oscillator shown solely for illustrative purposes.

The exact band width desired depends upon the nature of the tuned circuit or stage being investigated. A controlling influence is the frequency band width rating of the circuit under investigation. Fortunately, the majority of tuned circuits or stages associated with such devices, are rated at from 5 kilocycles each side of the periodic or resonant frequency to about 10 kilocycles each side of the resonant frequency, so that by arranging a system whereby these two band widths are available, complete coverage is secured, with possibly two adjustments of the frequency modulator capacity range. Whatever the band width of the frequency modulated system, it should always be at least 25 percent greater than the rated band width or band pass of the tuned circuit or system being investigated. This is desired so that the base of the resonance curve will be established as a reference point, even when circuit conditions are such that tuning is broader than normal.

We made reference to the fact that the band width achieved was a function of the relation between the total circuit capacity at any one periodic frequency setting of the tuning condenser and the change in total circuit capacity as a result of the rotation of the frequency modulator condenser. It, therefore, stands to reason that the higher the periodic frequency, or the higher the frequency setting of the oscillator circuit, the greater the band width when the frequency modulator condenser is applied. This is so because a uniform percentage change in frequency, as a result of a uniform change in circuit capacity, is greater in actual number of kilocycles, the higher the mean frequency.

It further stands to reason that the lower the basic circuit capacity, the greater the band width, when the frequency modulator condenser is set into operation. The reverse is also true. This is so, because, with a fixed maximum value for the frequency modulator condenser, the change in total circuit capacity is greater, the smaller the basic circuit capacity and naturally smaller, the greater the basic circuit capacity. It is important to remember this variation in band width

experienced with single oscillator equipment of this type, because other arrangements are also used, wherein constant band width exists upon all frequencies.

An idea of what is meant by an increase in band width with frequency is as follows: Suppose that operation of the frequency modulator condenser results in a 6-percent change in frequency at 260 kc. and at 1000 kc. In the former instance, the total band width will be 15.6 kc. or the frequency limits for a mean frequency of 260 kc., will be 252.2 kc. to 267.8 kc. When set to 1000 kc., the total band width is 60 kc. and the frequency limits would be 970 kc. and 1030 kc. Thus, the single oscillator used with a motor driven frequency modulator condenser, can be classified, for the want of a better name, as a variable band width frequency modulator.

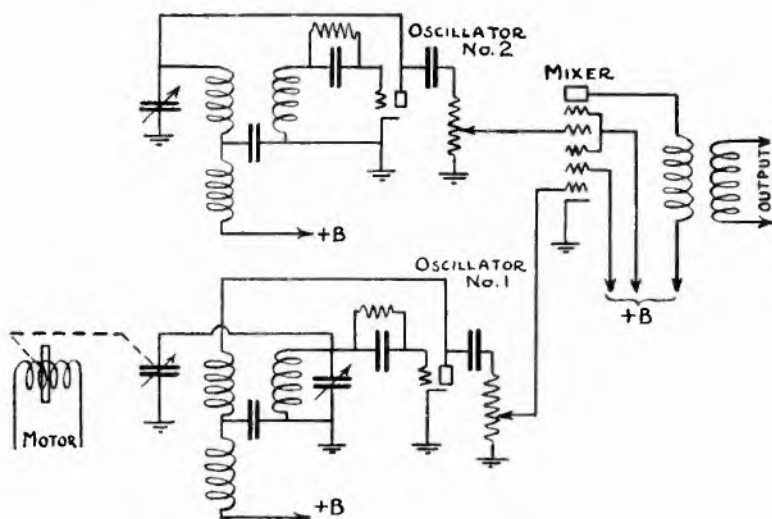

Fig. 252. Schematic diagram of a beat frequency oscillator which is frequency modulated by the motor driven variable condenser in the lower left corner of the diagram. This type of oscillator, when frequency modulated, provides a band width that is constant for any output frequency.

In contrast to the single oscillator type of frequency modulated source of test signal, there is in use the dual oscillator system, operated with a motor driven frequency modulator condenser, whereby a constant band width is secured. This is the beat frequency unit mentioned earlier in the text. Operation of the system can best be comprehended by referring to the elementary circuit shown in figure 252 and the following explanation.

The circuit consists of two oscillators, a mixer tube and the motor driven frequency modulator. One of these oscillators, say Osc. 1, is fixed tuned at some frequency, say 700 kc. Connected across the tuning condenser of this unit is the motor driven frequency modulator condenser. The capacity of the rotating condenser is so designed that when in operation, the mean frequency of the oscillator is 700 kc. and the frequency limits of the output are 690 kc. and 710 kc., a band width of 20 kc. or 10 kc. each side of the mean frequency. In effect this oscillator is a frequency modulated r-f. oscillator, fixed tuned to 700 kc. and frequency modulated over a 20 kc. band.

As is evident, provision is made to feed the frequency modulated output voltage to one section of a 6A7 tube. It is to be remembered that the circuit shown does not contain all of the frills and filters actually found in the commercial units. The circuit in figure 252 is the basic operating system. The diagrams of the commercial frequency modulated r-f. oscillators will be shown later in this chapter.

Oscillator 2 is the continuously variable frequency unit. This is the one which employs the wave changing mechanism, so that it may be tuned over the entire i-f., broadcast and high-frequency or short-wave spectrum. The tuning condenser in this unit is operated by hand, just as if it were a conventional oscillator without even the remotest association with any frequency modulating condenser. As is shown in the diagram, the output of the oscillator is fed to the mixer tube through a suitable attenuating system. The 6A7 in this case is used as a mixer tube only. One of the oscillators feeds into one of the control grids, grid number 1, and the other oscillator feeds into the other control grid, grid number 4.

Let us say that oscillator 2, the continuously variable unit, is adjusted to 960 kc. When this is done, two signals are fed into the mixer tube. One of them is of 960 kc. and the other is the 700 kc. signal frequency modulated over a 20 kc. band. These two voltages are mixed and as a result of rectification, there is present in the plate circuit of the 6A7, a voltage which varies in frequency from 250 kc. to 270 kc., or a 260 kc. signal, the beat frequency, which is frequency modulated over the 20 kc. band, or 10 kc. each side of the mean frequency. This frequency modulated signal is produced because one of the signals fed into the mixer is modulated plus and minus 10 kc. We might mention that the selection of a 20 kc. band width for the frequency modulation of the fixed oscillator, is purely illustrative. It can just as readily be 10 kc. or 30 kc.

As a result of the fixed relation between the frequency modulating condenser capacity and the circuit capacity of the fixed frequency oscillator, the band width of the frequency modulated signal is constant, at whatever the design provides. Since the beat signal retains the modulation characteristics of the modulated signal, which is mixed with the sine-wave signal, the output beat voltage, irrespective of frequency, will retain the same modulation characteristics, which in this case means modulation at plus and minus 10 kc. This is how the band width of the frequency modulated output of this dual oscillator arrangement is constant at whatever the design provides.

Electrically Operated Frequency Modulated Oscillators

In contrast to the motor driven condenser type of frequency modulator, several units are in use, wherein frequency modulation is secured without the use of a motor driven condenser. One such system is used in the Egert unit. Two oscillators are used to produce the constant band width frequency modulated signal, just as in the motor driven affair, illustrated in figure 252, except that the motor driven frequency modulating condenser is replaced by an electrical circuit.

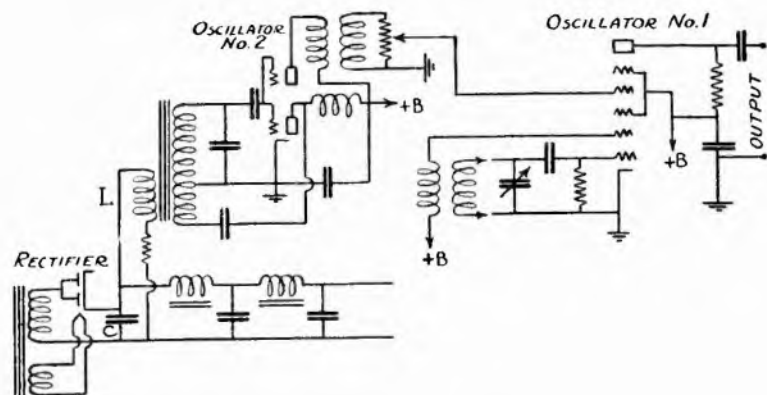

Fig. 253. Schematic diagram of a frequency modulated oscillator, wherein the spreading of the frequency over a band is accomplished by using the variation in permeability of the iron core in the No. 2 oscillator oscillation transformer.

The process of beating a variable frequency oscillator against a fixed frequency oscillator is the same. An idea of how this electrically operated type of frequency modulator develops the modulated wave can be gathered from figure 253 and the following text. The circuit shown is basic and is offered solely for illustrative purposes. The complete circuit of the Egert unit is given later in this chapter.

Oscillator number 1 is the variable frequency unit, which covers the various bands. Oscillator number 2 is the fixed frequency oscillator, which is frequency modulated over a constant band width, say 20 kilocycles. Oscillator number 1 uses the oscillator portion of a 6A7 tube. The mixer or pentode portion of this same tube receives the frequency modulated output of oscillator number 2, so that the two signals are mixed and, as a result of the rectifying action within the tube, the plate circuit contains the difference frequency modulated plus and minus 10 kc.

If you examine the wiring diagram, you will also note two significant facts: First the presence of an iron core for the oscillator number 2 coils. Second, the use of a rectifier and that a portion of the a-c. voltage present across the input condenser is fed into the oscillation transformer used in oscillator number 2.

This iron core and the rectified a-c. voltage serve to frequency modulate the output of the fixed frequency oscillator, by employing the variation in permeability of the iron core to change the frequency of the oscillations generated by oscillator number 2. The winding connected to the power supply furnishes a magnetizing current, which varies at the frequency of the a-c. voltage across condenser C. Since the rectifier is a half-wave system, this magnetizing current varies 60 times per second or at whatever the frequency of the power supply may be. By suitable design of the iron cored oscillation transformer, operation upon the straight portion of the permeability curve is secured. The normal permeability of the iron core establishes a fixed inductance for the oscillation windings and the oscillator circuit is tuned in the regular manner, except that, since a fixed tuning condenser is used, the resonant frequency is fixed and is of a single value. Now, when an a-c. voltage is established across condenser C, current will flow through coil L and the magnetizing current will change the permeability of the iron core and influence the inductance of the oscillator number 2 winding, thereby changing the frequency of the output voltage from oscillator number 2. Since the magnetizing current secured from the power supply is a varying current, the frequency of oscillator number 2 varies over a range and by designing the magnetizing current supply circuit and the iron core so that the current and the permeability varies between pre-determined limits, the frequency of oscillator number 2 will also vary between pre-determined limits. In the actual unit, the band width provided is 22 kilocycles, or 11 kilocycles each side of the mean frequency.

Since this signal is of constant band width and is fed into the mixer tube, where it beats against the variable frequency oscillator, the resultant beat frequency signal is a frequency modulated signal of the stated band width, without the use of a motor driven condenser.

Another type of r-f. frequency modulation, which is electrically operated and which does not use a motor driven frequency modulating condenser, employs the dynamic input capacity of a tube to vary the frequency of the oscillator output. According to information we can gather, a voltage secured from the 60-cycle power supply varies the operating potentials upon the auxiliary tube. The grid-to-plate capacity of a tube, being reflected across the input circuit of the same tube and being amplified to an extent determined by the operating potentials, is caused to vary over a certain range, as a result of the change in operating potential. The net result is a variation in the dynamic input capacity and since this capacity is a part of the tuning capacity, which is fixed, the frequency of the voltage generated is varied over a range determined by the change effected as a consequence of the varying operating potential. In a sense this circuit is very much like the automatic noise suppression and tone control system used in some radio receivers. Full details of the exact system are not available and we were not in possession of one of the units during the preparation of this volume.

So much for the general outline of how the frequency modulation of r-f. and i-f. test signal voltage is produced. Let us now consider the frequency modulator, which, in the case of motor driven condensers, is the unit comprised of the motor, the condenser and the synchronous pulse generator. In the case of the electrically operated frequency modulated oscillator, such as that which employs variation of the permeability of an iron core, the frequency modulator is the a-c. supply unit, the magnetizing winding and the iron core.

Motor Driven Frequency Modulators

Speaking in generalities, the motor driven frequency modulator unit, employed in connection with cathode-ray oscillographs used for alignment purposes, consists of the drive motor, the variable condenser and the synchronous pulse generator. It might be well to state that all such units do not employ synchronous pulse generators. Those which employ such a generator utilize the linear sweep circuit in the cathode-ray oscillograph to sweep the spot across the screen. Those which do not employ a synchronous pulse generator, do not use the linear

sweep in the cathode-ray oscillograph to sweep the spot across the viewing screen. Instead, a supplementary sweep circuit, associated with the motor driven condenser system, generates the voltage which sweeps the spot across the screen.

Perhaps we should mention that all reference to a frequency modulator means the unit which is responsible for the change in circuit constants so as to change the frequency. The motor driven condenser is an example of the frequency modulator. The combination of the frequency modulator and the oscillator forms what is designated as a frequency modulated r-f., i-f. or a-f. oscillator.

The circuit of the RCA TMV 128-A motor driven frequency modulator is shown in figure 254. The two condensers provide a range of

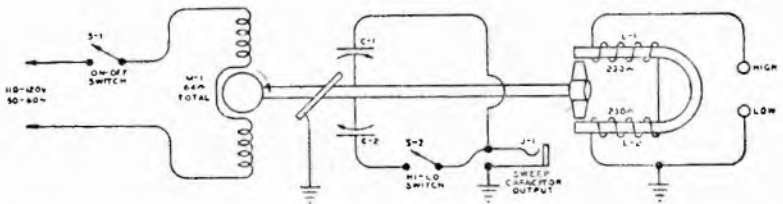

Courtesy RCA Mfg. Co., Inc.

Fig. 254. Schematic diagram of the RCA Model TMV-128-A motor driven frequency modulator.

capacity. The "Hi-Lo" switch connects one or both condensers into the circuit. When set to "Lo," one of the condensers, C-1, is in the circuit; when set to "Hi," C-2 is shunted across C-1 and the band width, for any one setting, is increased. Inclusive of the connecting cable, the capacity range for the two positions is

"Lo"	55 to 77 mmfd.
"Hi"	65 to 110 mmfd.

An armature, which rotates between the two pole pieces of an induction generator, is joined to the shaft of the condenser rotor and naturally to the shaft of the motor. This induction generator furnishes the impulse, which is fed to the linear sweep circuit within the cathode-ray oscillograph, for synchronization between the frequency modulated voltage, which is the vertical deflection, and the linear sweep voltage, which is the horizontal deflection. In this way the spot is swept across the screen at a rate in conformity with the variation in frequency, as the frequency modulating condenser rotor progresses through its arc of travel. Figure 255 illustrates two cycles of the waveform of the voltage developed by the impulse generator. This illustration may serve as reference data in the event of some trouble with the unit.

This frequency modulator is intended for use with the RCA model TMV-97-C all-wave oscillator, which is already furnished with an input jack to take the plug connection between the frequency modulator and the oscillator. However, the unit also is suitable for use with

Fig. 255. Two cycles of the waveform produced by the impulse generator, which is that part of the RCA frequency modulator that brings about synchronization between the rate of frequency modulation and the linear sweep voltage.

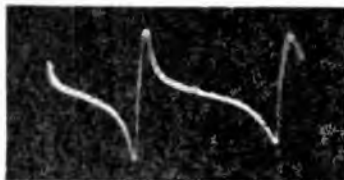

any other oscillator, providing proper connections are made. As a matter of fact, we used the unit with a number of different oscillators.

The circuit of the Clough-Brengle frequency modulator system, inclusive of the sweep used when checking alignment, is shown in figure 256. There is no provision for a change in the width of the band. The maximum amount of capacity present in the circuit is definitely fixed. Attached to the rotor is a short circuiting switch, consisting of a rotating and a stationary contact. The rotating contact makes electric

Fig. 256. The circuit of the Clough-Brengle frequency modulator. Due to the short-circuiting switch on the shaft, the sweep circuit is shorted during one half of the rotating condenser's travel.

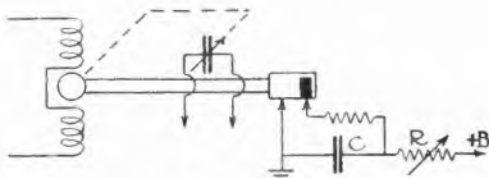

cal connection with the stationary contact during 180 degrees of the 360-degree arc made by the rotating condenser rotor. A high d-c. voltage is fed to condenser C through resistor R, charging the condenser.

The rate at which the condenser C develops the sweep voltage is not of importance providing that full charge is not reached before the contacts close. The rotating short circuiting contacts are closed during half of the arc of travel of the rotating condenser rotor, so that vertical spot displacement takes place during one half of the complete frequency modulating cycle. During the other half of the cycle there is no displacement of the beam in the horizontal direction, because the sweep voltage circuit is shorted.

This circuit arrangement is related to the proper development of the resonance curve, that is synchronization between the rate of frequency change in the oscillator circuit and the movement of the spot in the horizontal direction. Figure 257 illustrates the character of the

sweep voltage used in the Clough-Brengle model OM frequency modulated r-f. oscillator. This photograph was made by taking the voltage out of the aforementioned sweep system and observing it on another cathode-ray oscillograph.

Referring to figure 257, the jagged horizontal line represents the 180 degrees of time, during which the shorting contacts are closed.



Fig. 257. An oscillogram of the sweep voltage employed in the Clough-Brengle frequency modulator. The horizontal line represents that period of the cycle when the shorting contact is closed and the rising portion of the curve is the time when the condenser is charging.

The rising portion of the pattern is the 180 degrees of time during which the condenser charges. This image was made with the linear sweep in another cathode-ray oscillograph, adjusted to twice the frequency of the frequency modulator motor, in order to show the relative periods during a complete cycle, when the charging action and the shorting action existed. Since the horizontal axis of figure 257 represents time, you can readily see that the duration of the charging action is as long as the discharging or shorting action. Just how the synchronizing pulse previously mentioned and the sweep, now being discussed, actually function when developing resonance curves, will be shown later.

Synchronization between the sweep of the spot across the cathode-ray tube screen and the frequency change in the Egert VRO unit is accomplished by securing the sweep voltage from the source which supplies the voltage that causes the flow of the magnetizing current through the magnetizing coil. The nature of this sweep voltage can be gleaned by examination of figure 41. Synchronization is automatically accomplished, because, as a result of the circuit connections, the frequency of the modulated oscillator changes over its prescribed band during the time that the spot is sweeping across the screen. This is so during the charging as well as the discharging portion of the sweep cycle, because during the charging portion of the cycle, current is flowing through the magnetizing winding and causing the same change in frequency of the fixed oscillator output, as during the charging portion of the sweep cycle. So much for that. Let us now consider the development of the resonance curve trace upon the cathode-ray tube screen

and see how each part of the complete system contributes its share and how the patterns, which appear upon the screen, differ from one another.

Relation Between Rotating Condenser and Frequency Sweep

In order to present this subject properly for most complete comprehension, let us first establish certain facts, with which you are by this time familiar. First, that the frequency modulator, operated in conjunction with the oscillator, constitutes a source of a continuously variable frequency signal of supposedly constant amplitude or level. This is so, irrespective of the exact design of the system, that is, if it employs a single oscillator tube, or if it employs two oscillator tubes and a rectifier, so that the resultant beat signal is frequency modulated over a pre-determined and constant band width.

If we measured the voltage from a system which is supposed to provide a frequency modulated signal covering the 450 to 470 kc. band, and plotted this voltage against frequency, the resultant graph would appear like that shown in figure 258. It is possible that a slight

Fig. 258. The horizontal line of this graph indicates that the voltage output from a frequency modulated oscillator is constant over the frequency band covered.

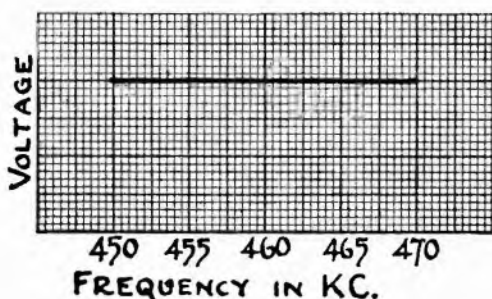

variation in voltage output may exist over the band used, but we shall assume for our discussion that the voltage output is of constant amplitude. The selection of the 450 kc. to 470 kc. band is purely illustrative. We assume that similar conditions prevail over any band width both sides of any periodic or mean frequency. It should be realized that a departure from such linearity of output will distort the final resonance curve.

We stated that the change in frequency, with motor driven condenser units, results from the change in circuit capacity. We further know that a condenser has a minimum and a maximum value of ca-

capacity, so that if such a condenser is connected in shunt with a tuning condenser in an oscillator, and since a band of frequencies are to be covered by variation of the external condenser between its minimum and maximum limits, the mean oscillator frequency will obtain for some intermediate position of the external rotating condenser. Just what the exact position of the rotor may be depends upon the design; that is, capacity variation with respect to frequency variation. Be that as it may, the fact is true that when the condenser is entirely out of mesh, the capacity is lowest and the frequency is highest and when the condenser is all in mesh, the capacity is highest and the frequency is lowest.

Now, if a condenser rotor starts rotating from its minimum capacity setting, it passes through two points of minimum capacity, a point of maximum capacity and two points of intermediate capacity for each complete revolution. This is illustrated in figures 259 A, B, C, D, and E, which show five positions of the condenser rotor within a complete

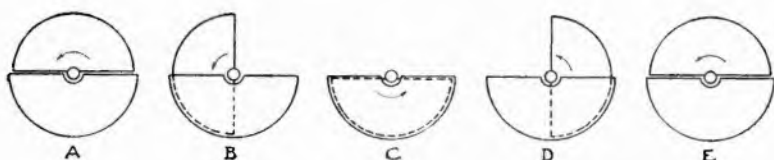

Fig. 259. Five positions of the rotating plates of a variable condenser used in a frequency modulator. When the capacity is minimum (plates unmeshed completely), the frequency is maximum and vice versa. It is essential that the plates be in positions B or D when the oscillator delivers the mean frequency of the circuit under test.

360 degree cycle. Since the mean oscillator frequency is located at the mid-point of the frequency band covered, it is obvious that the adjustment of the condenser rotor or the external capacity must be such that the complete band will be covered when the rotating condenser varies in capacity from minimum to maximum. If the fixed oscillator frequency is set to the mean value, with the external condenser at minimum or maximum, the required band width will not be obtained and the actual mean frequency will not be the desired mean frequency.

Referring once more to the illustration of the condenser rotor positions, it stands to reason that the five settings shown obtain only when rotation is started from the minimum capacity setting. If the rotor starts moving from its fully meshed position, it will complete a cycle by returning to that position, during which time the capacity will have passed through two stages of maximum, one minimum and two in-

termediate. If it starts rotating from the intermediate position, it will pass through three intermediate settings, a minimum and a maximum. Irrespective of the setting of the rotor, when the condenser rotor starts revolving, the proper band will be covered, if the adjustment of the oscillator is correct. Just how this correct adjustment is attained in actual practice will be stated later.

Referring to figure 259, if we set the frequency modulating condenser to either B or D and tune the oscillator to the mean or periodic frequency without touching the external rotating condenser, the signal frequency will be highest for the A and E settings of the rotating condenser and lowest for the C setting of this condenser. It is assumed, after correct adjustment of the oscillator condenser, that further variation of capacity and frequency results from the movement of the frequency modulating condenser rotor only. If we plot the five positions of the condenser as shown in frequency of the oscillator during one complete cycle, the graph shown in figure 260 is the result. THIS IS NOT A RESONANCE CURVE.

Fig. 260. The variation in frequency for different positions of the variable condenser in the frequency modulator is shown in the graph on the right. Note that the mean frequency—assumed to be 460 kc.—is produced when the plates of the condenser are half meshed (positions B and D, Fig. 259).

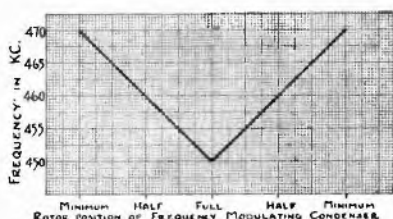

Obviously, the correct setting of the frequency modulating condenser for the correct mean frequency is about half capacity. The increase from half to maximum capacity serves to produce the change in frequency from the mean figure to the lowest frequency. The decrease from half capacity to minimum capacity serves to produce the change in output frequency from the mean frequency to the highest frequency.

Referring once more to figure 259, we note one very significant fact. This is that starting from minimum capacity and increasing to maximum over an arc of 180 degrees covers the desired frequency band—and—that the decrease in capacity from maximum to minimum over the 180 degrees of travel of the rotor, again covers the required frequency spread. Expressed differently, each 180 degree of travel of the rotor, from minimum to maximum and then from maximum to minimum, sweeps through the required frequency band, first, in one direction, then in the other direction.

Starting from minimum capacity, we find that two positions of the condenser rotor result in the same frequency. We now have an option of using these two positions or short circuiting the condenser during 180 degrees of its travel, so that the frequency is swept through the band only once in each complete arc of travel of the condenser rotor. Both of these methods are used, as you will see. The RCA frequency modulator sweeps through the band twice, whereas the Clough-Brengle unit employs the short circuiting contact and shorts the sweep during half of the complete revolution of the rotor. In other words only one half of the V shown in figure 260 is used.

Synchronizing Rotating Condenser and Horizontal Sweep

Let us now establish the relation between the frequency sweep, which is the action of the rotating condenser, and the horizontal sweep, which means the motion of the spot across the screen in the horizontal direction. Once more we have to be specific and refer to the two types of these units, that is, the nature of the patterns which result. The rotating condenser, operative over its entire arc, develops what is known as the double image type of curve. The rotating condenser, operative over half its entire arc of travel, develops the single image type of resonance curve. At the time of this writing, the former is found in the RCA unit and the latter in the Clough-Brengle unit.

Suppose that we have a condenser operative over the entire arc of travel of the rotor and, when frequency modulating an oscillator, will produce a band width of 20 kc. with 460 kc. as the mean frequency. Let us further suppose that the speed of the rotor travel is 1800 r.p.m., which is the equivalent of 30 cycles per second. During each 1/30th of a second the condenser sweeps the frequency from say 450 kc. to 470 kc. and from 470 kc. back to 450 kc. (For this illustration we assume that the rotor starts its excursion with the plates fully meshed.)

To illustrate the relation between frequency change and time, we plot the frequency variation and one cycle of the linear sweep circuit, normally adjusted to 30 cycles, which is the equivalent of saying that the sweep is synchronized with the speed of the motor. This is shown in figure 261. Note that the spot starts moving across the screen when the frequency is 450 kc. It reaches half way across the screen when the frequency is 470 kc. and continues moving towards the other limit of the screen as the frequency decreases, until, when the spot has moved across the screen, the frequency is again 450 kc. As is evident, the sweep has been synchronized with a definite mode of frequency change.

It could just as readily be synchronized with the frequency change starting at 470 kc., decreasing to 450 kc., as the spot reaches the middle of the screen, and then increasing again to 470 kc., as the spot reaches the other end of the screen. Synchronization with any other starting frequency, that is with some position of the condenser other than minimum or maximum, will interfere with the attainment of the correct pattern. This synchronization adjustment is accomplished by varying the fine sweep frequency control in the oscillograph, so that the condenser rotor may be in any position when starting. Adjustment of the fine sweep frequency control will provide the correct degree of syn-

Fig. 261. The relation between the sweep amplitude and the change in frequency of the frequency modulated oscillator is indicated in the graph. This change from 450 kc. to 470 kc. and back to 450 kc. occurs 30 times per second, therefore the sweep frequency is adjusted to 30 cycles so that the spot moves across the screen during the entire cycle of frequency modulation.

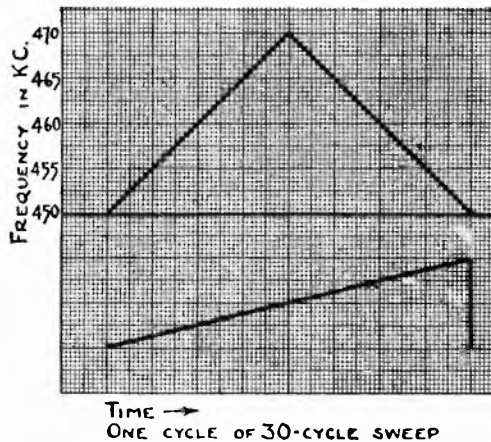

chronization. (The synchronizing pulse, secured from the impulse generator in the RCA frequency modulator unit will keep the sweep circuit in step, once the proper adjustment has been reached.)

With the motor speed constant and the linear sweep in the oscillograph constant, a definite relation between the frequency change and spot movement in the horizontal direction exists, as indicated by the dotted lines which join the sweep (time) graph and the frequency change graph. For each uniform division of time, a definite change in frequency occurs. This change in frequency is a function of the frequency modulated oscillator speed, so that it remains unchanged if the voltage is fed into a resonant circuit. Feeding the frequency modulated signal into a resonant circuit will not change the action of the sweep oscillator in the oscillograph and the movement of the spot in the horizontal direction. However, feeding the frequency modulated signal into a resonant circuit is going to provide the vertical deflection upon the oscillograph, because the output voltage of the resonant circuit is a

function of the resonance characteristic of the circuit. (The rectification process actually entailed in order to develop the resonant curve is here omitted, but will be mentioned when the complete alignment process is discussed.)

Let us now feed this frequency modulated signal into what may be classified, for the sake of illustration, a perfect resonant circuit, one which has a flat top over a 10-kilocycle band and has perfect suppression of all frequencies beyond this band. What is the nature of the pattern which will result from this combination of frequency modulated signal voltage, resonant circuit and sweep?

Examine figure 262. During the time that the condenser is rotating and changing the frequency from 450 kc. to 455 kc., the spot is moving across the screen in the horizontal direction without any vertical displacement, because the circuit into which this frequency modulated voltage is being fed prevents the flow of current. The result is a straight line, representative of the base of the resonance curve pattern between the 450 kc. and 455 kc. At 455 kc. up to 465 kc. maximum vertical deflection is obtained simultaneously with the horizontal displacement. As the rotor motion progresses and the spot moves across the screen, the vertical deflection again falls to zero and remains there while the rotor has passed through 180 degrees of rotation and is sweeping the frequency in the opposite direction, from 470 kc. downward. The circuit does not permit current to flow during the time that the frequency is changing from 465 to 470 kc. and back to 465 kc.

The spot continues to move as a result of the sweep oscillator and when the frequency again is 465 kc. maximum vertical displacement is attained. This remains so as the condenser rotor continues turning and the frequency is decreasing to 455 kc. The horizontal displacement exists simultaneously with the vertical displacement because the sweep is still causing the spot to move across the screen. As the frequency moves below 455 kc., the vertical displacement again becomes zero. When the spot reaches its limit before the return and frequency has reached the low point of 450 kc., the process is repeated.

It is evident from the illustration that the pattern which appears contains two resonance curves, one showing the response characteristic when the frequency is sweeping in one direction and the other showing the response characteristic when the frequency is sweeping in the other direction. If you examine figure 262, you will note that the sweep circuit is shown as being absolutely linear. Such an ideal case is not achieved in practice, particularly at the low frequencies which

must be used in order to synchronize the sweep with the motor speed. Actually, a slight departure from linearity exists, so that the resultant pattern, as it would appear upon the screen, would not be as perfect as is shown in figure 262. Curve B would be slightly narrower than curve A, that is to say, would be crowded slightly.

The action described in connection with figure 262 is supposed to take place within $1/30$ th of a second. It remains unchanged for any

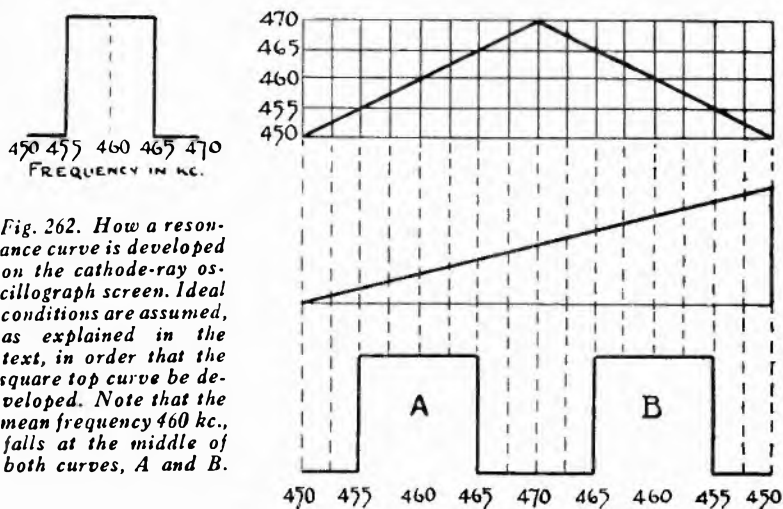
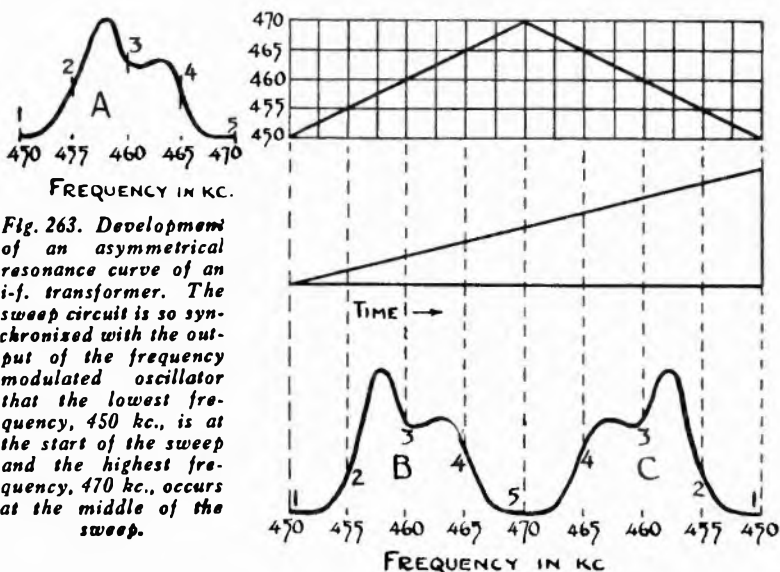

Fig. 262. How a resonance curve is developed on the cathode-ray oscillograph screen. Ideal conditions are assumed, as explained in the text, in order that the square top curve be developed. Note that the mean frequency 460 kc., falls at the middle of both curves, A and B.

duration of time, because it is recurrent, so that what is shown as being the case for $1/30$ th of a second holds true for whatever period of time is desired, just as long as the constants of the circuits involved do not change.

What is true for a square top resonance curve is true for the normal symmetrical resonance curve or for a non-symmetrical curve. It might be well, because of what may be experienced in practice, to show the construction of a non-symmetrical curve with synchronization between the sweep and the rotating rotor for frequency sweep in two directions. This reference to direction means starting of the sweep at the highest frequency or starting of the sweep at the lowest frequency. The reason for showing these two illustrations is that, sometimes, during the practical application of the device to the alignment of asymmetrical curves, the bump in the curve may be displaced from the inside to the outside, this being dependent upon how the sweep and condenser rotor travel are synchronized.

Examine figure 263. This is the characteristic of a resonated transformer used in the i-f. circuit. The frequency modulated signal is fed into this device and the sweep circuit is synchronized in such manner that the start of the sweep occurs when the frequency modulating condenser is at full capacity and the frequency is the lowest. The numbers upon curve A in figure 263 are reference figures to indicate the response of the circuit at the various frequencies. During one half of the sweep cycle, curve B is developed and during the remaining half of the sweep cycle, curve C is developed, curves B and C appearing simultaneously upon the screen. If you examine curves B and C, you



will find that they are identical, with respect to frequency response characteristic. They appear different, because the direction of the frequency sweep is different for curve C than for curve B. This you can see if you examine the frequency change during the existence of the linear sweep cycle. First, the frequency sweeps from the lowest to the highest and then from the highest to the lowest. While the response of the circuit remains the same, the appearance of the response curve has undergone a change. Curve C is curve B turned over. You will further note, for comparison with the subsequent illustration, that the maximum peaks in the curve appear at the outside of the curve, whereas the lower peaks are on the inside of each curve.

Suppose that we synchronize the linear sweep with the highest frequency; that is to say, the sweep cycle starts when the frequency modulating condenser is all out and as the sweep moves the spot across the screen, the frequency of the oscillator is being lowered. What type of curve would appear upon the screen for the same resonant circuit? Examine figure 264. The basic circuit is the same as on figure 263. Everything in the system is the same, except for the synchronization between the movement of the frequency modulating condenser and the linear sweep. Compare curves B and C in figures 263 and 264. The curves are identical, although they appear different. The two maxi-

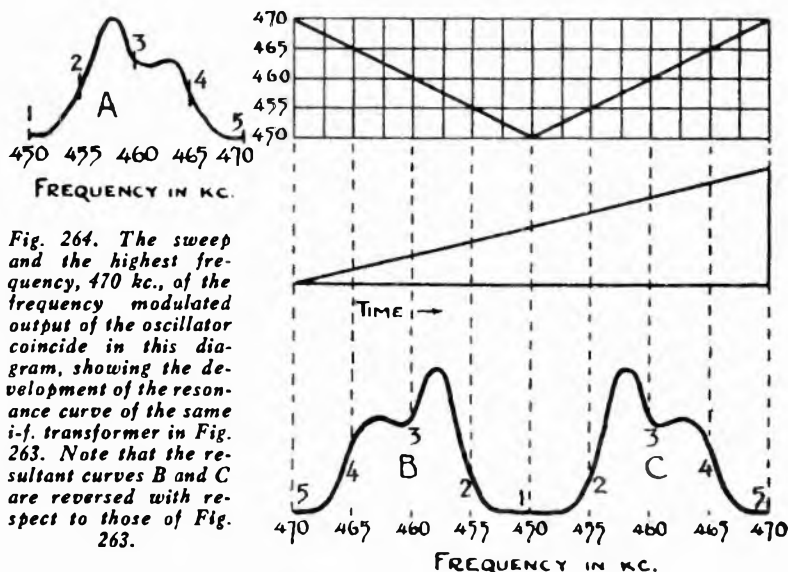

Fig. 264. The sweep and the highest frequency, 470 kc., of the frequency modulated output of the oscillator coincide in this diagram, showing the development of the resonance curve of the same i-f. transformer in Fig. 263. Note that the resultant curves B and C are reversed with respect to those of Fig. 263.

mum peaks have been transposed from the outside to the inside of the curves and the two smaller peaks have been transposed from the inside to the outside of the curves. Curve B in figure 263 is like curve C in figure 264, because the direction of the frequency sweep is the same. A similar situation exists with respect to curve C in figure 263 and curve B in figure 264.

Once again we want to make mention that the perfect linearity of the sweep, evident in figures 263 and 264, is not achieved in practice, with the result that curves C in figures 263 and 264 are more crowded; that is, the base, in each of the curves marked C, is not as wide as for curves B. As stated, this is a function of the linearity of the timing

sweep or horizontal displacement and has nothing to do with the frequency band width, which is identical for both.

Examples of such images, as seen upon the cathode-ray oscillograph viewing screen, are shown in figures 265, 266 and 267. Figure 265 illustrates the pattern which appears under the linear sweep-motor

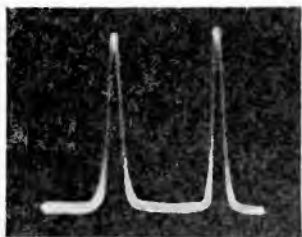

Fig. 265. An example of symmetrical resonance curves. Note that the base of the right hand curve is less wide than the one on the left. As explained in the text, this is due to the variation of the sweep from true linearity. The sweep frequency here is the same as the motor frequency.

speed frequency relations cited; the response characteristic of the circuit is symmetrical. Figures 266 and 267 illustrate the images which appear for a non-symmetrical resonance characteristic, illustrating the displacement of the peaks in accordance with the explanation which accompanied figures 263 and 264. If the curves in figure 265 are the equivalents of the curves B and C in figures 262 to 264 inclusive, then figure 268 is the response characteristic of the circuit into which was fed the signal from the frequency modulated oscillator, in order to develop the curves shown in figure 265.

If you examine figures 266 and 267, you find a great deal of similarity between the curves, which, according to the graphic illustra-



Fig. 266, left, Fig. 267, right. These oscillograms are examples of asymmetrical resonance curves, like those which were developed in Figs. 263 and 264. The differences between these curves are explained in the text.

tions of figures 262, 263 and 264, is to be expected. In actual practice, however, you may experience quite a different condition. The graphic illustrations of figures 262 to 264 cannot take into consideration such an item as regeneration, which is present to a lesser or greater degree in each radio receiver. Now, the presence of regeneration creates peculiar conditions, which are related to the direction of the

frequency sweep. In other words, the circuit acts in one manner if the signal, which is fed into the circuit, approaches the resonant frequency from one direction and acts in another manner, if the signal fed into the circuit approaches the resonant frequency from another direction.

It is very possible that the two curves created, as have been the curves of figures 266 and 267, will show differences other than those caused by non-linearity of the sweep. This is particularly true in the case of circuits which possess non-symmetrical response characteristics. These differences are that the two curves are not alike; they differ in the relative amplitude of the related peaks and overall amplitude. These variations are to the best of our knowledge a function of the direction in which the signal frequency sweep occurs. Examples of what we mean are shown in figures 269 and 270.

At this time, we want to call to your attention that alignment, using equipment of the type now being described, is seldom if ever carried



Figs. 268, left, 269, middle, 270, right. The sweep frequency used in developing the symmetrical pattern of Fig. 268 was twice the motor frequency. Compare with Fig. 265. Figs. 269 and 270 are examples of asymmetrical resonance curves. Explanation of the dissimilarity of the curves is given in the accompanying text.

out by using such dual curve images. However, we feel that you should be familiar with what is behind the appearance of such double curve images, when operating frequency modulator units which employ a rotating condenser operative over its entire arc of rotation. Furthermore, this discussion is the first step in the establishment of the resultant pattern, wherein the two curves are superimposed to form a single image, which is the usual form of image employed in alignment. We intend developing the various forms of images, before embarking upon the actual alignment operation and the discussion of what type of resonance curves are indicative of satisfactory operation.

When operating frequency modulators of the type being discussed, the correct timing sweep adjustment is twice the frequency of the rotating rotor. What happens when this adjustment exists and what is the difference between this frequency relation and that when the timing oscillator frequency is the same as the speed of the rotor? Since we

have discussed the effect of sweeping the frequency in both directions, the remainder of this discussion will relate to the change in frequency in but one direction.

Figure 271 illustrates the relation between a change in frequency from 450 kc. to 470 kc. and back to 450 kc., and the sweep frequency twice that of the condenser rotor. Whereas in figure 261, a single-cycle of the sweep existed during the complete 360 degrees of rotation of the condenser rotor, the sweep now moves the spot across the

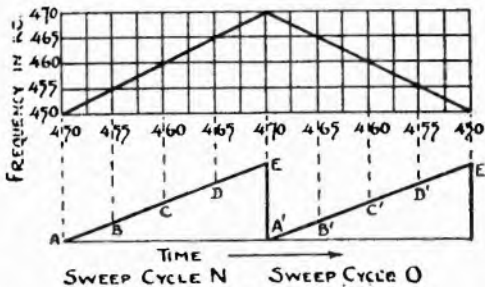

Fig. 271. The sweep frequency is here twice what it was in Fig. 261. Cycle N of the sweep spreads the frequency modulated output from 450 kc. to 470 kc. over the screen and cycle O spreads the descending part of the output. Points A to E and A' to E' coincide on the screen. See Figs. 272 to 274.

screen during 180 degrees of the condenser rotor movement, returns to its initial starting position and then again sweeps the spot across the screen during the remaining 180 degrees of rotation of the condenser. What does this mean? The answer is evident if you consider the sweep curve as being spot positions upon the screen and also examine the position of the respective dash-line perpendiculars, with respect to frequency of the oscillator signal and spot position. A and A' of the time sweep curve, represent the start of the sweep and the spot at the same position upon the screen. The same is true of B and B', C and C', D and D' and E and E'. Further analysis of figure 271 shows that spot position A represents 450 kc. and spot position A' represents 470 kc. Since they occupy the same position upon the screen, 450 and 470 kc. are in the same spot. Likewise spot B is 455 kc. and spot B' is 465 kc., and, since they occupy the same position upon the screen, 455 kc. and 465 kc. are identically located upon the screen. The 460 kc., or mean frequency position, is occupied by one frequency only. On the other hand 465 kc. and 455 kc. are in the same spot and 470 kc. and 455 kc. are likewise in the same spot. With the exception of the mean frequency position upon the screen, every spot position represents two different frequencies. One of these frequencies is due to the frequency modulation in one direction and

the other frequency is due to the frequency modulation in the other direction. This is a very important fact to remember.

From what has been said you can understand how it is possible to superimpose the resonance curve due to the voltage from the frequency modulated oscillator, when it is advancing from 450 kc. to 470 kc., upon the resonance curve due to the voltage from the frequency modulated oscillator, when it is decreasing from 470 kc. to 450 kc. Any circuit which responds in like manner for the 10-kc. band each side of the mean or periodic frequency (that is, develops like amplitudes of voltage) will result in a single curve. If for any reason the amplitude of the voltage developed in the circuit is different during the 10-kc. band below the mean frequency than above the mean frequency, a two line pattern must result. The same is true if the amplitude of the voltage developed in the circuit is greater at frequencies within the 10-kc. band above the mean or periodic frequency, than for frequencies within the 10-kc. band below the mean or periodic frequency. Let us investigate what has been said so far.

Examine figure 272. This is a photograph of a resonance curve of a circuit which is not symmetrical both sides of the mean frequency.

Fig. 272. When a circuit is not symmetrical both sides of the mean frequency a resonance curve like that on the right will result. This oscillogram really consists of two patterns that are superimposed, each being traced on the screen by alternate sweep cycles.

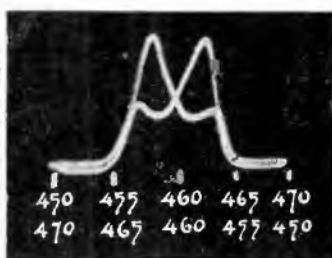

We have plotted the double frequency positions along the horizontal axis. The vertical displacement represents the voltage developed across the circuit and is responsible for the vertical deflection. The total band width is 20 kc. These double frequency positions correspond to the double frequency positions designated in figure 271. The image shown in figure 272 really consists of two curves superimposed upon each other. One of the traces is due to the sweep cycle N (figure 271) and frequency modulation in the upward direction (figure 271); the other trace is due to sweep cycle O (figure 271) and frequency modulation in the downward direction (figure 271). The width of the band passed by the circuit is fixed, so the

base of one curve coincides with the base of the other and a single trace is seen.

A peak occurs at about 457 kc. This is evident in both traces. The lower peak to the left of the center intersection is the 457 kc. position during the upward frequency modulation. The lower peak to the right of the center intersection is the 457-kc. position during the downward frequency modulation. Following along the trace due to sweep cycle N and the frequency modulation in the upward direction, we note a second and higher peak at about 463 kc. This is evident in the trace due to sweep cycle O and frequency modulation in the downward direction, that is from 470 kc. to 450 kc. The reason why these two traces cannot coincide throughout their entire length is found in the illustration. The 463-kc. spot position in sweep cycle N and during the frequency modulation in the upward direction, also is the 457-kc. spot position during the frequency modulation in the downward direction and during sweep cycle O. These two frequency settings are on opposite sides of the mean frequency of 460 kc. Since the nature of the circuit is such that the voltage developed at 457 kc. is not of the same amplitude as the voltage developed at 463 kc., the vertical displacements are not the same and the traces cannot coincide.

Another significant item can be gleaned from the pattern in figure 272. This relates to the mean frequency. All traces properly established and which intersect, do so at the mean frequency. This statement is not made with the intention of conveying the impression that all such traces intersect at 460 kc. However, they do intersect at whatever the mean frequency may be of the band being developed by the frequency modulating condenser. More about this later.

Readjustment of the circuit, so that response both sides of the stated 460-kc. mean frequency is symmetrical, develops the pattern

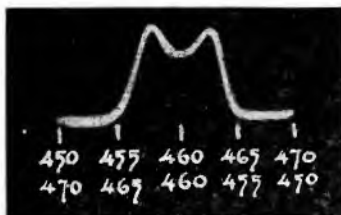

Fig. 273. The circuit used for obtaining the oscillogram of Fig. 272 was adjusted so that it was symmetrical and the resonance curve then taken. The result is shown at the left. Note that now the two curves coincide throughout.

shown in figure 273. The double frequency points are shown along the horizontal axis. The vertical displacement is in accordance with

the voltage developed across the circuit. You now note that the two traces coincide and appear as a single line trace. Examine the image and you will note that the amplitude of the peak at 457 kc. is the same as the amplitude of the peak at 463 kc., so that the vertical displacement of the spot for this dual frequency setting, in accordance with figure 271, is the same. We are referring to the 457-kc. setting during sweep cycle N, when the frequency is being modulated upward from 450 kc. to 470 kc. and the 463 kc. setting during sweep cycle O when the frequency is being modulated downward. This is the peak to the left of the dip in the curve. The peak to the right of the dip occurs during sweep cycle N, when the frequency is being modulated upward and is at 463 kc. and during sweep cycle O, when the frequency is being modulated downward and is 457 kc.

Another example of how an adjustment which develops a symmetrical pattern produces a single line trace or image, is shown in figure 274. The double frequency points are shown along the base of

Fig. 274. Another symmetrical resonance curve. The change in vertical amplitude can be seen to be the same on each side of the mean frequency, 460 kc. for corresponding frequency points on the pattern.

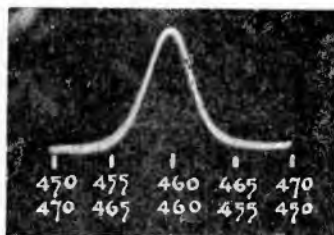

the curve. The variation in amplitude is the same both sides of the single resonant frequency, hence the spot positioning for corresponding frequencies of each pair is the same and a single line pattern appears.

The extent of the departure of the pattern or image from a single line trace depends upon the circuit being checked and the oscillator adjustment. If we assume the correct oscillator adjustment, it is possible that the base of each trace will coincide with the other, as in figure 272, and the peaks will not coincide. This may exist without requiring that the resonance characteristic of the circuit being checked contains two peaks. Then again it is possible that the peaks of the curve will coincide, but the base of one curve will not coincide with the base of the other curve. These conditions are controlled by the circuit being tested. Any factor, which will influence the circuit so that the amplitude response is not symmetrical both sides of the mean

frequency, will prevent the formation of a single line trace, because the lack of symmetry throughout the band will develop two different vertical displacements for the same spot position along the horizontal axis.

Lest some confusion exist about the spot occupying the same position at the same time for two different frequencies, let it be known that, like other optical illusions which exist when the cathode-ray tube is applied, this, too, is one of the optical illusions. There really is a time interval between the tracings of the curve for the frequency modulation in the upward direction and of the curve for the frequency modulation in the downward direction, but this time interval is very short and since the phenomenon is recurrent, the spot appears to occupy the same position.

Single Image Motor Driven Frequency Modulator

There is a great deal of similarity between this arrangement and the one just described. The greatest difference arises in the sweep circuit, in that the sweep supplies the horizontal displacement during one half of the complete cycle of rotation of the frequency modulating condenser rotor. It is necessary that you understand that the

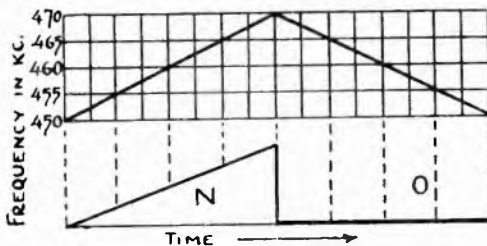

Fig. 275. During one half of each revolution of the variable condenser in the frequency modulator of Fig. 256, the sweep circuit is shorted and only cycle N spreads the resonance curve, giving a single instead of a double pattern.

circuit, which is shorted during the inactive portion of the cycle, is the sweep and **NOT THE FREQUENCY MODULATING CONDENSER**. This is shown in figure 275. Note that the timing oscillator is active only during one half of the complete cycle of the rotating frequency modulating condenser rotor. Frequency modulation of the oscillator is taking place during the complete cycle of the rotating condenser rotor, but each spot position is related to one frequency only and no matter how asymmetrical the pattern, only a single line trace appears. However, this trace is also accompanied by a vertical line, which represents the vertical displacement during that portion of the frequency modulating cycle, when there is no horizontal displacement.

Let us assume for the sake of illustration that the sweep circuit is synchronized in such manner that it shows the response curve during frequency modulation in the upward direction, from 450 kc. to 470 kc., as shown in figure 275. Horizontal displacement exists during the time that the oscillator is being frequency modulated in this di-

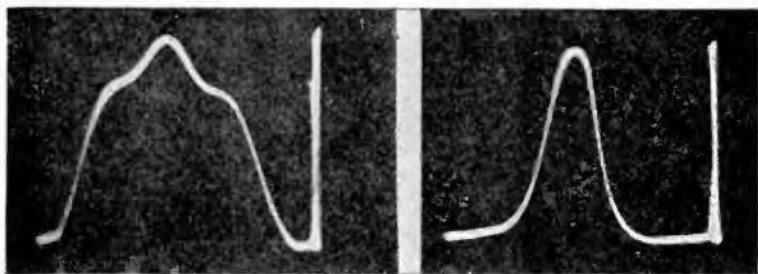

Fig. 276, left, Fig. 277 right. The resonance curve in Fig. 276 is non-symmetrical and that in Fig. 277 is symmetrical. These oscillograms were made using the frequency modulator and sweep described in Fig. 275. The vertical line on the right of each oscillogram indicates the vertical displacement due to change in frequency, but as the sweep was shorted, it is not spread across the screen.

rection. When the frequency modulating condenser rotor has reached the position where a 470-kc. signal is being generated, the shorting contacts close and there is no horizontal displacement during the time that frequency modulation takes place in the downward direction. However, voltage is established across the circuit being tested during both halves of the frequency modulation cycle. The pattern or image appearing upon the screen, when checking a non-symmetrical circuit under these conditions, is shown in figure 276.

In accordance with the specifications stated, concerning the direction of frequency modulation, the resonance curve shown in figure 276 is for this half cycle, whereas the straight line is the vertical displacement without horizontal displacement, during the O sweep cycle of figure 275. The pattern for a symmetrical circuit is shown in figure 277. You now have a picture of the manner in which the resonance curve is developed with the Clough-Brengle OM frequency modulated r-f. oscillator.

Commercial Frequency Modulated R-F. Oscillators

We have shown the schematic wiring diagram of the RCA motor driven frequency modulating condenser unit. As stated this unit can

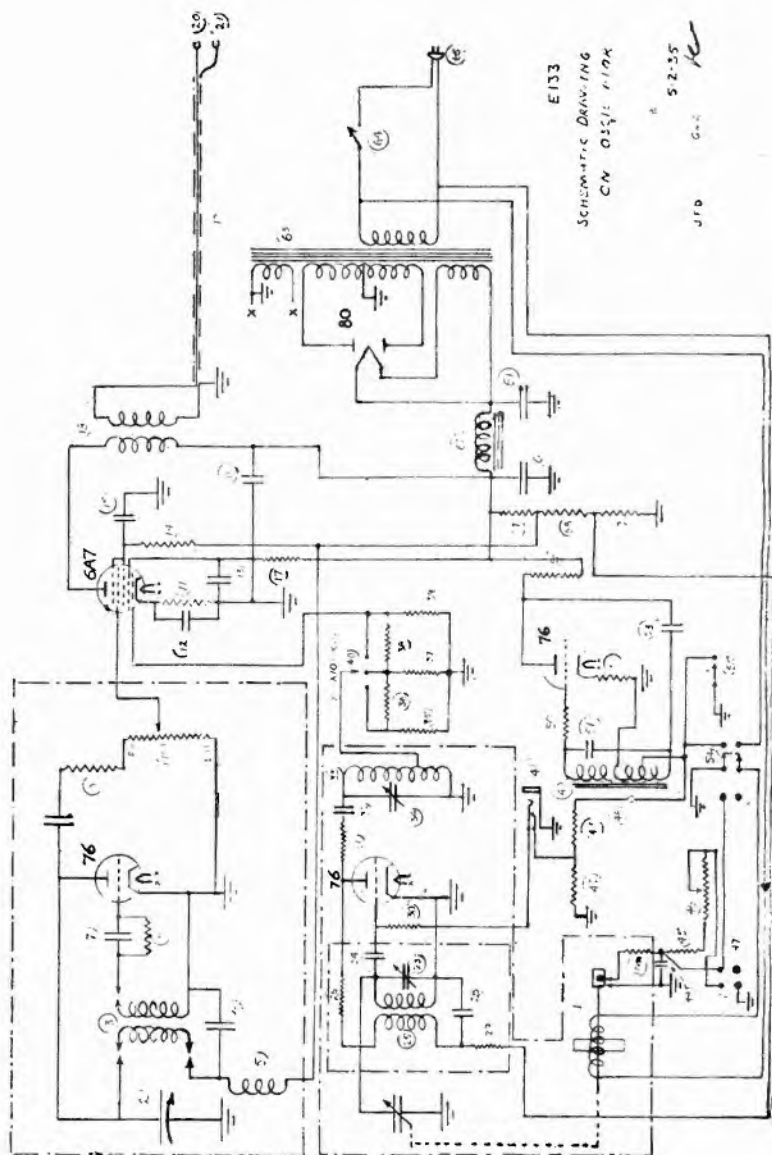

Courtesy Clough-Bregle Co.

Fig. 278. The schematic diagram of the Clough-Bregle Model OM frequency modulated r-f. oscillator. The 76 tube in the middle of the diagram is the constant frequency oscillator that is frequency modulated by the motor driven condenser at the left.

be used with any r-f. oscillator of suitable frequency range required to cover all operating bands. The Clough-Brengle OM frequency modulated r-f. oscillator is shown in figure 278. The type 76 tube nearest the 6A7 mixer is the variable band oscillator. The type 76 tube directly beneath this tube is the fixed frequency oscillator, which is frequency modulated with the motor driven condenser. The 76 tube near the bottom of the diagram is the a-f. oscillator, which is used when modulated output is required without any frequency modulation. The 80 tube is the rectifier. For panel view see figure 278-A.

The complete Egert VRO unit is shown in schematic form in figure 279. Tube T-3 is the fixed frequency oscillator, the output of which



Fig. 278-A, above. Panel view of the Clough-Brengle Model OM oscillator.



Fig. 279-A, right. Panel view of the Egert Model VRO unit.

is frequency modulated. T-5 is the variable band oscillator and also the mixer tube, supplying the constant band frequency modulated beat output signal. T-1 is the power supply for the cathode-ray tube. T-2 is the power supply for the two oscillators. T-4 is a combination detector and amplifier. Either function may be selected by means of pin-jack connections. For panel view see figure 279-A.

Both of these units can be used as variable frequency r-f. oscillators without frequency modulation. A 400-cycle tone is available in the former unit and a 60-cycle tone is available with the latter unit.

Rectification of the Frequency Modulated Signal

We believe that alignment of a radio receiver with a cathode-ray tube, in other words visual alignment, is so far superior to the normal alignment with an output meter or some other similar type of indicating instrument, that comparison is out of the question. We feel that that fact will be proved by the photographs to follow.

In order to interpret alignment patterns properly, it is essential that you understand what goes on during the process of alignment. You are familiar with the generation of the frequency modulated sig-

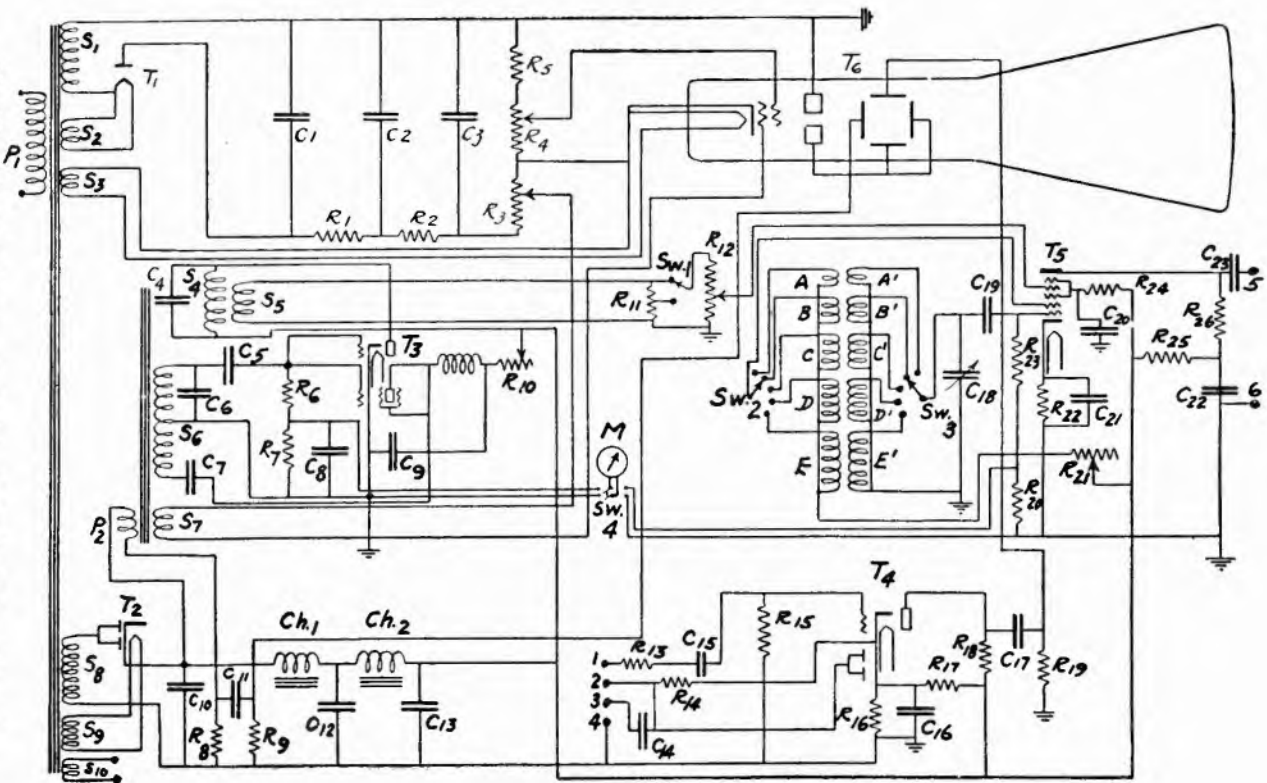

Fig. 279. Schematic diagram of the Egert Model VRO oscillograph.

nal, so that we can start our discussion with the statement that the frequency modulated signal is available from the signal generator. At the moment, the width of the band, over which the signal is modulated, is of little if any importance. If it will expedite comprehension, let us assume that the mean signal frequency lies within the intermediate band, is 460 kc., and is frequently modulated over a 10-kc. band, so that the total band width is 20 kc.

If you recall the discussion concerning the various modes of frequency modulation, you cannot help but understand that the frequency modulation takes place at an audio rate, maybe 30 cycles per second, 60 cycles per second, etc. By audio rate is meant the speed of the frequency modulating condenser rotor in such systems, or the rate at which variation of permeability occurs in systems of that type. Expressed in another manner, we can say that the mean frequency is modulated plus and minus 10 kilocycles, thirty times per second or sixty times per second, or whatever the audio rate may be, depending upon the design of the unit.

In order to develop the image upon the screen, we require deflection of the cathode-ray beam in two directions, namely vertical and horizontal. The horizontal deflection voltage is secured from the timing axis oscillator or sweep oscillator. The vertical deflection voltage is secured from the demodulator circuit in the receiver or from the detector circuit associated with the resonant circuit being checked.

In order that the vertical deflection voltage be available for application to the vertical plates of the cathode-ray tube, it is necessary to convert the radio or intermediate-frequency signal voltage from the frequency modulated oscillator into an audio voltage variation. This is done by feeding the signal voltage, developed across whatever circuit is being checked, into a detector tube and rectifying the r-f. or i-f. voltage. In other words, if a frequency modulated signal covers a band of frequencies extending from 450 kc. to 470 kc., this band of signal voltages, at each instantaneous frequency within this band, is rectified and a voltage is developed across the demodulator load or output circuit. The envelope of this rectified voltage during a complete cycle of frequency modulation is in accordance with the resonance characteristics of the resonant circuit which feeds the detector.

Examine figure 280. It is the fundamental circuit used for alignment. The frequency modulated signal is fed into the resonated system being checked. The output voltage over the frequency modu-

lated band is fed into the demodulator tube. Rectification occurs and a rectified voltage is developed across the diode load resistor. The magnitude of this voltage at any one instant during the cycle of frequency modulation is dependent upon how the resonant circuit passes the signal of that frequency. Perhaps "pass" is not the correct

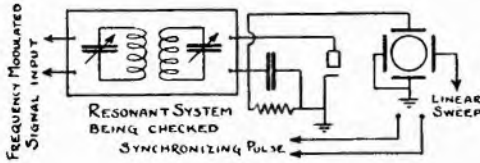

Fig. 280. Arrangement of apparatus for obtaining alignment curves. Rectification occurs in the diode and the voltage across the diode load is impressed on the vertical plates of the tube. This voltage depends on the signal voltage built up across the resonant circuit.

depends on the signal voltage built up across the resonant circuit.

term. It would be better to say that the rectified voltage at any one frequency is dependent upon the signal voltage built up across the resonant circuit or system.

Bear in mind that the voltage supplied from the frequency modulated r-f. or i-f. oscillator is of constant level over the entire band developed by the frequency modulating system. The greater the voltage built up across the resonant circuit or system and fed to the detector, the greater the rectified voltage across the demodulator load or output and the greater the deflection of the beam in the vertical direction. If the operation of the circuit is such that it will not allow the development of a voltage at frequencies between 450 kc. and 455 kc. and also between 465 kc. and 470 kc., there will be no rectified voltage available across the diode load during those instants, when the frequency of the frequency modulated oscillator is generating these frequencies. This condition will be evident upon the cathode-ray tube screen in the form of an absence of a vertical deflection for this portion of the resonance curve. If the circuit operation is such that maximum carrier voltage is built up at 460 kc., which may be the resonant frequency of the circuit, the maximum rectified voltage will be developed across the demodulator load.

The envelope of the voltage, built up across the demodulator load, varies at an audio rate, namely at the rate that the frequency modulation occurs. To keep the pattern upon the screen stationary, the horizontal deflection voltage (sweep voltage) is adjusted to synchronize with this audio rate.

You have seen frequent references in the last few paragraphs to rectification. Rectification is essential to the development of the resonance curve. This is so despite the fact that the graphic de-

scriptions given earlier in this chapter, did not involve the process of rectification. Without rectification, it is impossible to develop the resonance curve upon the cathode-ray tube screen.

The facts given here are basic and apply to all types of patterns, single and double line images and to all types of frequency modulating systems.

Resonance Curves and Coupled Circuits

Without entering upon the discussion of the theory of coupled circuits and resonance curves, we feel that certain pertinent facts should be brought to your attention, for what good they may serve during the process of practical alignment.

You have seen several examples of resonance curves upon previous pages. These may be divided into two classes; for that matter all of them may be divided into the same two classifications. These are "symmetrical" and "asymmetrical" or "non-symmetrical." By a symmetrical resonance curve is meant one which shows the same amplitude response for frequencies which are higher or lower than the mean frequency by like amounts. Another definition of a symmetrical resonance curve is one which can be cut through the middle, along its vertical axis, be folded over and have the lines coincide. Asymmetrical curves do not possess these characteristics.

Resonance curves may be of various shapes, yet be symmetrical. In other words, symmetrical resonance curves may be obtained with loosely coupled circuits, critically coupled circuits and over coupled or closely coupled circuits. Examples of symmetrical resonance curves with but one peak, two peaks and three peaks are shown in figures 281, 282, 283, and 273, the last having been shown in connection

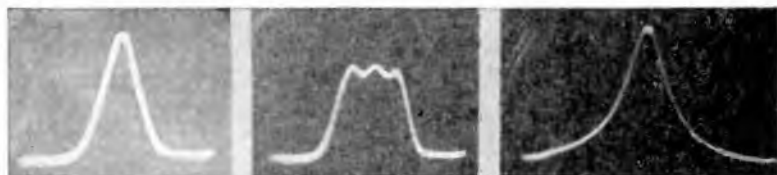

Figs. 281, left, 282, middle, 283, right. Examples of symmetrical resonance curves, having one and three peaks, are shown in Figs. 281 and 282. See Fig. 273 for a two peaked curve. The resonance curve of Fig. 283 indicates a wider band-pass than does the curve shown in Fig. 281.

with the graphic development of the resonance curve image. Asymmetrical curves, or non-symmetrical curves, may be obtained from the

same type of circuits. Examples of non-symmetrical curves are shown in figures 284 and 285. Regeneration, an extremely important factor, is responsible for the lack of symmetry in the curve of figure 285.

Recognizing the function of tuned circuits, such as are found in r-f. and i-f. amplifying systems, which are to be aligned, the first requisite is symmetry of the resonance curve and elimination of those factors which tend to prevent symmetry in response curves. These factors are



Figs. 284, left, 285, right. Two oscillograms of asymmetrical resonance curves. The lack of symmetry in the curve of Fig. 285 was caused by regeneration.

regeneration and incorrect adjustment of the coupling between the related circuits. Where coupling is fixed, which usually is the case, correct operation is secured by adjustment of the tuning of the related circuits. This fact should be borne in mind during alignment operations when basic curves are not available for comparison.

As a rule, two winding transformers develop a sharp single peak, depending upon the degree of coupling and resonance adjustment. Three winding transformers usually are closely coupled transformers and develop double or triple humped curves, depending upon the tuning and coupling adjustments. However, it is possible with a three winding transformer to develop a single peak, just as in the case of the critically coupled two winding transformer.

A high sharp peak is not always the desired adjustment. It is necessary to understand the requirement of band width. Since the transformer is supposed to pass a band of frequencies with minimum suppression, the ideal curve is the square flat-top, which cannot be accomplished in practice. However, the nearest approach is desired, consistent with maximum amplitude, thereby obtaining maximum signal transfer through the unit with minimization of sideband suppression. Symmetry of the resonance curve is a pre-requisite, as has been stated.

Another important consideration, which must be remembered, is that relating to the final resonance curve, resulting from the combination of resonated r-f. and i-f. circuits. You will note in the image photographs to be given later in this chapter, that the combination of the r-f. and i-f. circuits develops a resonance curve which is different from either of these circuits, when handled individually. Fur-

thermore, since the operating frequencies relating to the i-f. amplifier are fixed and those of the r-f. system are variable, it is necessary to consider the overall response curve with respect to the mean frequency of the signal being fed into the receiver input.

So much for the general details concerning the shape of the resonance curves. A detailed discussion is not necessary in this volume, because we must assume that the man, who intends applying the cathode-ray tube to alignment, is familiar with the shape of the curve he must develop, or at least with the general shape of the curve, with respect to the requirements of the system. The cathode-ray tube provides the picture of the actual curve and the effect of the adjustments made. That which was only a guess with meter type indicators, now can be viewed by the operator.

The Dimensions of the Image

Before discussing the various types of images, which may appear upon the screen, it might be well to make some comments concerning the dimensions of the image and their effect upon its interpretation.

It stands to reason that a fair sized image is required in order to enable proper interpretation of the information conveyed. However, it is also necessary to realize that it is possible to distort the image appearing upon the screen, by making the image too great, so that it extends beyond the curved boundaries of the screen. In addition, it is possible to distort the image by the application of an excessive voltage to the vertical deflection plates and cause overloading of the amplifier, with consequent flattening of the top of the curve. Last, but not the least important point, is distortion of the image as a result of overloading of the amplifier tubes, associated with the resonant circuits being checked. Examples of this will be given later.

Concerning the dimensions, a height not exceeding $1\frac{1}{2}$ inches, when using the 3 inch tube, is ample for examination and interpretation. The maximum length of the base line of the image should likewise not be greater than $1\frac{1}{2}$ inches. This assumes that the image is centered upon the screen.

The dimensions of the image, assuming them to be correct, do not in any way change the characteristics of the pattern. That is to say, the response characteristic of the circuit is not changed when the dimensions of the image upon the screen are changed by varying the cathode-ray tube control equipment. It is possible that the pattern may appear as if the characteristics had been changed, but no such change has actually taken place.

Since the base line of the resonance curve is determined by the frequency modulating circuit and the response characteristic of the resonant circuit being tested, increasing or decreasing the length of the base line, by varying the cathode-ray oscillograph horizontal amplifier control, does not change the ratio between the total frequency band sweep and the band passed by the resonant circuit. Expressed in another manner; if the total frequency sweep is 20 kc. and the band passed by the circuit is 5 kc. each side of the mean frequency, this relation, as shown upon the resonance curve, does not change when the horizontal sweep amplitude is changed. For any horizontal sweep amplitude, the same ratio will be found to exist in the pattern.

The same is true of the vertical displacement. Increasing the height of the peak may make it look narrower, but in reality no change has taken place. This condition can be checked by establishing the ratio between the total frequency sweep and the band passed, by measuring the line representing the total sweep and the space indicating the band passed.

This apparent change due to adjustment of the vertical and/or horizontal amplifier gain controls was mentioned earlier in this volume in connection with sine waves.

For any given resonance curve pattern, the greater the frequency band passed with respect to the total band established by the frequency modulating condenser or unit, the greater the separation between the bottom of the sloping sides of the curve. The narrower the band passed under the same conditions, the closer together will be the bottoms of the sloping sides of the curve. It is because of this relation that a "high" frequency sweep, with a much wider band width, will develop a narrow response curve; whereas a "low" frequency sweep, with a much narrower total band width, will develop a wider resonance curve, when both signals are applied to the same circuit.

Connecting the Oscillograph for Visual Alignment

There are several methods of connecting the cathode-ray oscillograph to the receiver for visual alignment. However, only one of these is really correct, in that it provides the correct pattern with freedom from distortion. With both single and double image systems of the motor driven frequency modulating condenser variety or with the electrically operated forms of frequency modulation, development of the pattern requires that an audio signal be present. This

audio signal is at the rate of frequency modulation. Certain forms of circuit connections, between the cathode-ray oscillograph and the source of the rectified signal required for alignment, introduce phase distortion of the audio signal, with the result that the resonance curve pattern is badly distorted. The image, instead of having its base upon the same horizontal plane, has one side of the base correctly placed and the other side displaced below what would normally be the correct base position.

Such distortion is introduced when the rectified signal from the receiver is fed to the oscillograph through a capacity of insufficient value, as is usually the case when the vertical deflection voltage is secured across the audio volume control and the said volume control is connected to the source of the audio signal through a blocking condenser. This system is to be found in a large number of radio receivers using diode demodulators.

A similar case of distortion occurs when the demodulator is of the triode type, with an inductive load, and the vertical deflection voltage is taken off across this inductive load. Similar distortion also occurs



Figs. 286-A, 286-B, 287-A, 287-B, from left to right. The oscillograms of Figs. 286-A and 287-A show phase distortion in single peaked and double peaked curves, respectively. Correct corresponding curves with no phase distortion are shown in Figs. 286-B and 287-B.

when a triode demodulator is used with resistance-capacity coupling between the demodulator and the subsequent amplifying tube and the vertical deflection voltage is taken off across the grid leak of the amplifier tube. These references to distortion assume that the coupling or blocking condensers, present in the circuits mentioned, are of insufficient capacity.

Examples of such phase distortion for a single peaked resonance curve and for a double peaked resonance curve are shown in figures 286-A and 287-A. The correct corresponding curves, free from phase distortion, are shown in figures 286-B and 287-B.

The most satisfactory circuit arrangement is to connect the input to the oscillograph across the diode load resistor, assuming that the demodulator is of the diode type. This connection is shown in figure

280. Supplementary AVC and audio resistor connections have been omitted from the diagram, because they have no bearing upon the operation. It is possible that the circuit found in a receiver may be slightly more complicated than that shown, having more resistors in the load circuit. Be that as it may, the vertical deflection plates should be connected across the diode load. The two curves shown in figures 286-B and 287-B were made with the signal voltage secured from across the diode load.

The three major circuit arrangements, with several possible points of connection of the vertical plates of the cathode-ray oscillograph for alignment operation, are shown in figures 288, 289 and 290.

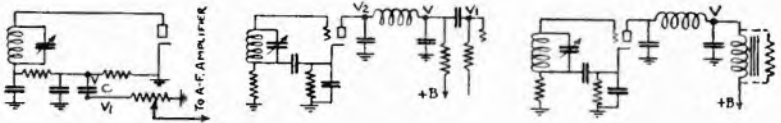

Figs. 288, left, 289, middle, 290, right. Schematic diagrams showing two types of demodulator circuits with three types of load circuits. The correct points for connecting to the deflection plates are indicated by V. The results obtained when connections are made to other points are explained in the text.

These diagrams illustrate two types of demodulator systems with three forms of load circuits. In the diode system of figure 288, connection between point V and the ground is the most preferred and provides an undistorted pattern, such as was shown in figures 286-B and 287-B. Connecting the vertical deflection plates between V1 and ground, introduces the blocking condenser and if its value is not great enough, the distortion shown in figures 286-A and 287-A is produced.

In a triode circuit with resistive load, the correct connecting point is between V and ground or across V1 and ground, providing that the blocking condenser used in the circuit is at least .5 mfd. If connection is made at point V2 instead of at V, the pattern will be fuzzy, because it will contain some of the carrier voltage.

In a triode circuit with a reactive load, the correct connecting point is at V, but it is necessary to shunt a variable resistor across the reactance in the plate circuit, or the reactive load can be temporarily disconnected and a 50,000-ohm or 100,000-ohm resistor may be inserted in its stead. If a variable resistor is connected in shunt with the reactive load to correct the phase distortion, its maximum value should be about 25,000 ohms and the resistance should be varied until the corrected pattern appears upon the screen.

What has been said about connections to various demodulator systems, applies to all the types of oscillographs or visual aligning devices, irrespective of the type of frequency modulation employed in the device.

Images With Spurious Voltages

Images may appear, which, while of the shape desired, are distorted or are not so required, because of the presence of spurious voltage. Figure 291 illustrates a correct resonance curve, but it is



Figs. 291, left, 292, right. Both the resonance curves shown here have their lines broad because of the presence of an appreciable amount of carrier voltage.

made fuzzy by the presence of carrier voltage, such as would exist if the vertical deflection plates were connected to that portion of the demodulator circuit which carried appreciable carrier current or voltage, or, if in a diode circuit, the r-f. bypass condenser, connected across the diode load resistor, were removed. Figure 292 illustrates a resonance curve of a non-symmetrical circuit, with a large amount of carrier voltage present in the rectified a-f. signal, applied to the vertical deflection plates.

The image shown in figure 293 indicates the presence of modu-

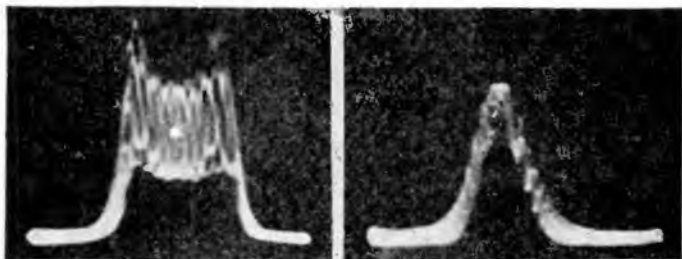

Figs. 293, left, 294, right. The output of the frequency modulated oscillator, used for making the resonance curve of Fig. 293, was also modulated at 400 cycles. The curve of Fig. 294 shows the presence of another carrier voltage that is beating against the frequency modulated signal, zero beat being at the mean frequency.

lation. In other words, the frequency modulated oscillator was operated with the modulation "on" instead of "off." Figure 294 illus-

trates the appearance of the image of a resonance curve, but which also shows the presence of another carrier voltage that is beating against the frequency modulated signal. A signal of the mean frequency found its way into the circuit being tested with the frequency modulated oscillator. Although not very clear in the photograph, the undesired signal is at zero beat at the mean frequency. An example of a similar condition, but wherein the beating signal is at zero beat several kilocycles away from the mean frequency, is shown in figure 295. Note the zero beat, indicated at both sides of the pattern. Incidentally, it is possible to determine the band width or the position of any frequency within the frequency modulated band, by feeding a known variable frequency unmodulated signal into the circuit being tested with the frequency modulated signal and cause these

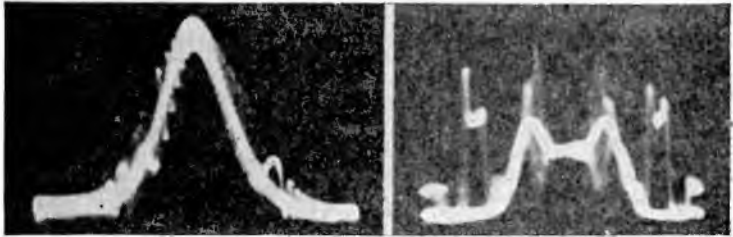

Fig. 295, left, Fig. 295-A, right. On the lower right side of the curve in Fig. 295 may be seen a large peak, which indicates the presence of some undesired frequency that is at zero beat several kilocycles away from the mean frequency. The "ghost" patterns behind the main curve in Fig. 295-A are due to the presence of a harmonic of the frequency modulated i-f. signal in the r-f. amplifier.

two to beat against each other. Since the beating oscillator frequency is known, the zero beat position upon the image spots that frequency upon the resonance curve.

A condition, which may arise during alignment of i-f. amplifiers and which interferes greatly with proper interpretation of the pattern, is indicated in figure 295-A. The "ghost" alignment patterns in the background are due to a harmonic of the frequency modulated i-f. signal feeding into the r-f. amplifier. The remedy is either to detune the receiver so that it does not respond to the harmonic or to short the oscillator section of the variable condenser while aligning the i-f. stages.

Excessively Strong Frequency Modulated Signal

The image, which appears when the frequency modulated signal fed into the circuit being tested is too strong and overloads the tubes,

is shown in figures 296, 297 and 298. Figure 296 is the correct curve with the proper amount of signal input. Figure 297 shows the effect of tube overload as stated. Note that the base of the curve now shows a change in resonance, which is more aggravated when

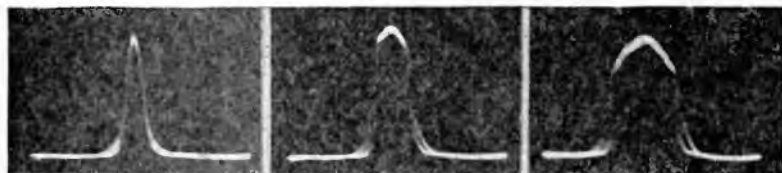

Figs. 296, left, 297, middle, 298, right. The resonance curve in Fig. 296 was made when the frequency modulated signal input to the circuit under test was the correct strength. The distortion in Fig. 297 was due to too strong a signal with resultant overloading of the tubes. Compare the spreading of the curve, indicating change in resonance when the signal is increased still further, as shown in Fig. 298.

the degree of overload is increased still more, as shown in figure 298. This is to be expected, because the presence of grid current creates a condition which is the equivalent of a load placed upon the circuit and causes a change in the resonance condition. It is interesting to note the relative amplitudes of these three images, bearing in mind that AVC was present in the circuit.

Conditions of Alignment

The condition of alignment is established by interpretation of the pattern. In the double image system, the figures of 299, 300 and 301



Figs. 299, left, 300, middle, 301, right. These resonance curves show correct alignment of a symmetrical circuit as to frequency and band width (Fig. 299), alignment at the wrong frequency, (Fig. 300), and alignment at the correct peak but improper response over the band, (Fig. 301).

indicate correct alignment of a symmetrical response circuit as to frequency and band width, alignment at the wrong frequency, and alignment at the correct peak, but improper response over the band, respectively. Additional adjustment of the circuit under test, without any change of the frequency modulator setting, resulted in the correct curve of figure 299. The correct mean frequency is indicated

in figure 300, by the point where the two curves, representative of frequency modulation in the two directions, cross each other. It is evident from figure 301 that it is possible for the peaks to coincide, but not the bases. Under certain conditions, as for example the presence of regeneration, it may be impossible to get the two bases to coincide, although the two peaks will fall atop each other. Minimization or elimination of the regeneration in the circuit is the only means of securing the required single pattern.

Under certain conditions of regeneration, the circuit may go into oscillation only when the signal frequency is being swept through in one direction, so that the pattern indicative of regeneration appears upon one side of the curve. When this is the case, the peak and one side of the two bases will coincide, whereas the other side will not coincide. This is shown in figure 302. The corrected curve with



Fig. 302, left, 303, right. The lack of symmetry in the resonance curve in Fig. 302 is due to regeneration. See Fig. 303 for the corrected curve.

minimum regeneration is shown in figure 303. Note the difference in frequency band pass of the two adjustments, bearing in mind that both were made with the same frequency modulated sweep. The two amplitudes are slightly out of proportion. Actually, that of figure 303 was smaller than that shown for 302. In order to present a satisfactory picture, we increased the vertical amplitude. A slight discrepancy in coincidence between the two bases on the right side of the curve of figure 303 is still evident.

A different effect, caused by regeneration, is shown in figure 305. The correct curve, showing the absence of regeneration, is shown in figure 304. The same circuit with a definite amount of regeneration, established the curve above in figure 305. Note that the bases coincide, whereas the peaks do not, so that in this instance the condition of alignment was changed in such manner that the resonant frequency was changed.

Another example of incorrect alignment, using the double image system and working upon closely coupled circuits productive of double peaked curves, is shown in figure 306. The bases coincide perfectly, but the peaks in the curve are not correctly established. It is necessary to equalize the two peaks so that they are of the same

amplitude. This is done by adjusting the trimmers. Regeneration in a circuit will make such equalization virtually impossible. When the bases of asymmetrical response curves coincide, the mean fre-

Figs. 304, left, 305, right. The correct resonance curve is shown in Fig. 304. In Fig. 305 the bases coincide, but the peaks do not, this being due to regeneration.

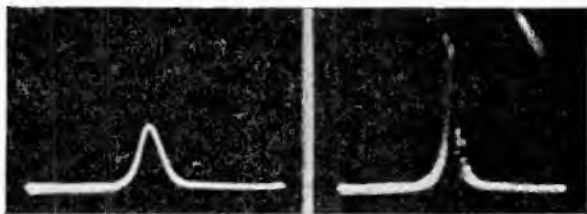

quency is indicated or spotted upon the pattern or image by the point where the two curves cross each other. A pattern of this type indicates that the response of the circuit is better to frequencies one side of the mean frequency than to frequencies on the other side of the mean frequency.

If the frequency band, which may be passed through a system, is greater than the frequency sweep, the pattern appearing upon the screen will not be complete. The base of the curve will be absent. Examine figures 307 and 308. In figure 307, the modulated frequency band sweep is about 6 kc. each side of the mean frequency,

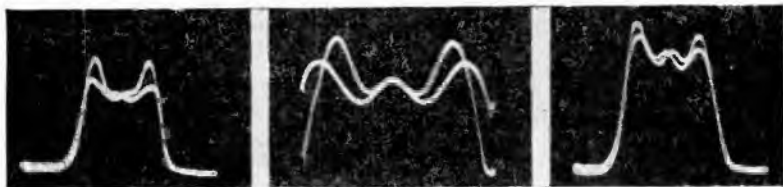

Figs. 306, left, 307, middle, 308, right. The resonance curve of Fig. 306 indicates incorrect alignment. Note that the bases of the two patterns coincide, but not the peaks. The incomplete curve in Fig. 307 was caused by the frequency band of the circuit being greater than the signal frequency sweep. The corrected condition is shown in Fig. 308.

whereas the circuit being checked, is capable of passing about 9 or 10 kc. each side of the mean frequency. The result is an uncompleted resonance curve, because at no time within the modulated frequency signal band does the circuit reject the frequency. The same system, but fed by a frequency modulated voltage which covered about 15 kc. each side of the mean frequency, developed a completed pattern. This is shown in figure 308.

The absence of a completed pattern due to insufficient signal frequency sweep is just as readily applicable to the single image system, as

to the double image system. This also applies to those units which furnish constant band width frequency modulated signals, because the completion of the pattern depends upon the operating characteristics of the resonant circuit or system, rather than upon the characteristics of the oscillator which supplies the frequency modulated signal.

Synchronization of Double Image Pattern

The degree of synchronization has a great effect upon the appearance of the finished pattern or image. This is so irrespective of the state of alignment of the circuit under test. By this we mean that the shape of the pattern is influenced by the adjustment of the synchronizing voltage control for both symmetrical and asymmetrical circuits. Figure 309 indicates the pattern for an asymmetrical response circuit.

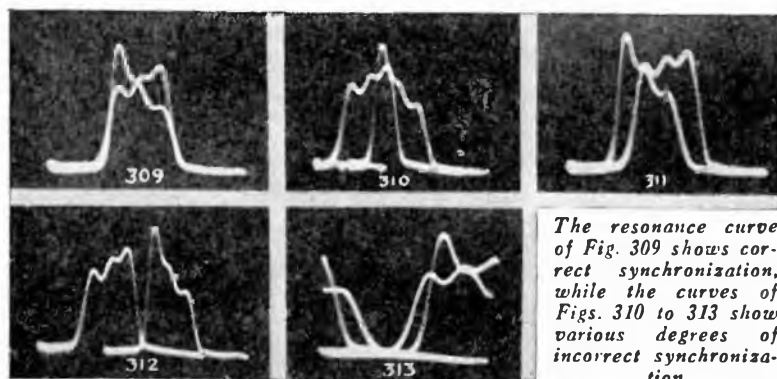

The resonance curve of Fig. 309 shows correct synchronization, while the curves of Figs. 310 to 313 show various degrees of incorrect synchronization.

As far as timing frequency (linear sweep) is concerned, the adjustment is correct as indicated by the pattern. The adjustment of the circuit trimmers for symmetrical response is another matter. The same pattern, with the synchronizing voltage control advanced too far, is shown in figure 310. The same pattern, with the linear sweep frequency slightly higher than the frequency of the frequency modulating condenser rotor, is shown in figure 313.

The effect of over-synchronization, that is adjustment of the synchronizing voltage control upon the cathode-ray oscillograph, so that a very strong synchronizing voltage is applied for a double pattern obtained when the linear sweep frequency is the same as the motor speed, is shown in figures 314 and 315. These two photographs should be compared with figures 265 and 270 respectively. An excessively strong synchronizing signal, obtained by advancing the synchronizing gain

control too far, changes the phase and frequency of the signal being generated by the linear sweep circuit. The polarity of the synchronizing pulse, obtained from the impulse generator in the frequency

Figs. 314, left, 315, right. The effect of over-synchronization is shown in these two resonance curves. Compare them with those of Figs. 265 and 270.

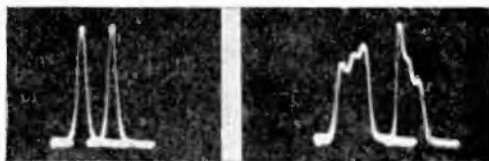

modulating unit, also is important. If the polarity is incorrect, the pattern is greatly distorted. Examples are shown in figures 316 and 317. The image shown in figure 316 is for correct polarity of the impulse generator signal and all other adjustments correct. The pattern shown in figure 317 is for the same signal under exactly the same conditions, except that the polarity of the signal obtained from the impulse generator has been reversed.

Speaking about synchronization, it might be well to remember that the synchronizing control adjustment and the fine linear sweep frequency adjustment are closely allied to each other. Correction of an incorrectly synchronized adjustment may be accomplished by varying the synchronizing voltage gain control and the fine linear sweep frequency control. The minimum setting of the synchronizing voltage gain control, consistent with satisfactory performance, is the adjustment

Figs. 316, left, 317, right. Curves showing correct and incorrect polarity of impulse generator signal appear at left and right.



to be preferred. It should also be understood that the distortion ensuing, when the synchronizing control is improperly set, applies equally to symmetrical and asymmetrical patterns.

Band Width In Variable Band Width Double Image Systems

As is stated in the heading of this paragraph, the band width indicated in the pattern depends upon the ratio of the total frequency sweep (frequency modulator) and the frequency band passed through the system under test. In frequency modulated systems, where constant band width is not secured, the total frequency sweep increases with the mean frequency. This was mentioned earlier in the text. Consequently, for normal symmetrical response of a resonant circuit, the

width of the frequency band passed with respect to the total frequency sweep, as it appears upon the screen, is going to be a function of the mean frequency.

Assuming knowledge of the total frequency sweep, the extent of the band passed by the resonant circuit can be approximated in a very simple manner. Suppose that the total frequency sweep (horizontal base line) appearing upon the screen is 1.5 inches long, as measured with a ruler. The total sweep is known to be 24 kc. With a ruler, measure the length of the indication representative of the band passed. Measure at the base of the curve or about a tenth of the way up. The ratio between the total length of the base line and the line representative of the band passed is the band passed in kilocycles. Suppose that the length of the space indicating the frequency band passed is .5 inch, or roughly one third of the total length. The total frequency band passed then is one third of the total sweep, or about 8 kc., which means 4 kc. each side of the mean frequency.

When establishing band width in double peaked systems, calculations should be made only after proper alignment has been effected. This means that both peaks are of equal amplitude and are equidistant from the center or mean frequency, which may be indicated by a depression in the curve or by a third peak. Examples of such resonance curves have been shown.

When making band width determinations, it is necessary to exercise precautions to avoid making such measurements when aligning at a harmonic of the correct mean frequency. In other words, if alignment is to be carried out at 1000 kc., the frequency modulator adjustment should be 1000 kc., not 200 kc., i.e., operating at the fifth harmonic. Such operation would tend to create the impression that the band width was much narrower than is actually the case. . . . Always align with the fundamental frequency.

Constant Band Width Single Image Systems

We have made reference to several types of constant band width single image systems. These differ from the double image arrangement previously mentioned in that the pattern upon the screen is a single image, irrespective of the nature of alignment, providing, of course, that the frequency of the oscillator is within the frequency range of the resonant circuit. As in the case of the double image system, the prime requisite during adjustment is symmetrical response for all types of resonant circuits used in radio receivers. As a general rule,

due to the constant band width of the frequency modulated signal, these systems are employed in conjunction with transparent frequency band pass calibrated scales, which are placed in front of the screen.

Since synchronization and horizontal sweep frequency adjustments are automatic in such systems, nothing along such lines can be said about the shape of the pattern, other than if a double pattern appears, the synchronizing system, whatever its type, is out of order.

Whereas the double image arrangement requires that the two curves be made to coincide, the single image system requires that the trimmer adjustments be made in accordance with whatever type of response characteristic is desired, and the calibrated scale showing kilocycle separation is used. These scales have a vertical reference line which is supposed to coincide with the mean frequency indication. The response of the circuit then is indicated by noting the shape of the curve with respect to the frequency divisions. Those items which relate to the adjustment of the circuit at hand and which were quoted in connection with double image operation apply to single image constant band width systems. Proper interpretation of the image appearing upon the screen, with respect to the calibrated scale, indicates the exact band pass at any point along the curve.

Knowing the type of resonance curve required, trimmer adjustment is carried on until the resonance curve, viewed through the transparent scale, indicates such response. Lack of symmetry is established by examination of the curve to see if, with the mean frequency coincident with the vertical reference line, the slope of the curve each side of the mean frequency reference line is uniform on both sides.

We illustrate this discussion with photographs of images which show a vertical amplitude line upon the pattern, as well as the regular response curve. This is in accordance with the data previously given. The usual run of single image systems will develop substantially identical patterns under like conditions, with the exception that the vertical amplitude line will be absent.

The connections between the receiver and the cathode-ray oscillograph using the single image type of resonance curve, are identical to those made for the double image system, and are shown in figures 280, 288, 289 and 290. The phase distortion introduced as a result of improper connections and improper values of coupling capacity as mentioned previously, applies here as well.

Incompleted patterns may be due to one of three conditions: First, that the sweep of the frequency modulated oscillator is insufficiently

wide, with respect to the band pass characteristics of the circuit. This is not a commonplace occurrence, because the band width in these constant band width systems is seldom if ever less than 15 kc. and is constant over the entire frequency spectrum, covering the i-f. and high frequency bands. In some of these systems, the band width is as high as 30 kc., so that practically every type of resonant circuit found in receivers will develop a completed pattern.

The second possible condition, illustrated in figure 318, is incorrect adjustment of the frequency modulator frequency setting, with respect to the resonant frequency of the circuit being checked. Note that



Figs. 318, left, 319, right. When the frequency modulator setting was incorrect, the curve of Fig. 318 was obtained. Overloading of the tubes in the resonated amplifier under test, caused the distortion in Fig. 319.

response is contained over one complete side-band and over a portion of the other, thus indicating that the mean frequency of the frequency modulated signal is not correct.

The third possible condition is related to the second, in that the resonant frequency of the circuit or system being checked is incorrect with respect to the mean frequency of the frequency modulated signal. The pattern shown in figure 318 would apply to this condition. Investigation of the calibration of the oscillator establishes which of these two stated conditions is the reason for the pattern. If the oscillator calibration is correct and the oscillator is correctly tuned, it stands to reason that the resonant circuit is not correctly resonated.

Overloading of the tubes associated with the resonated amplifier being tested is indicated exactly as in the case of the double image system. The peak is flattened and the lack of symmetry, due to direct current flow through the circuit, is shown by the fact that the two sides of the curve are not the same, with respect to the side band frequencies. The curve for this condition is illustrated in figure 319. Compare this curve with figures 297 and 298.

Regeneration or motor boating in an i-f. amplifier, as viewed with the single image system, is shown in figures 320, 321 and 322. The correct resonance curve for a single peak system with minimum regeneration is shown in figure 320. The same system with increased regeneration is shown in figure 321. Note the departure from lack of

symmetry; also the marked reduction in the width of the frequency band passed, and the very steep slope as resonance is approached. In the double image system, this curve would coincide at the peak, but the



Figs. 320, left, 321, middle, 322, right. A correct resonance curve for a single-peaked system with minimum regeneration is shown in Fig. 320. An increase in regeneration caused the curve to become asymmetrical, see Fig. 321. Actual generation of oscillations is indicated in Fig. 322.

bases would not coincide. The actual generation of oscillations is indicated in figure 322. Compare this pattern with a double image pattern, showing the presence of oscillations.

The resonance curve of a triple peaked circuit, such as used in an i-f. amplifier adjusted for high fidelity, is shown in figure 323. The overall response curve of the receiver at 600 kc., with the frequency

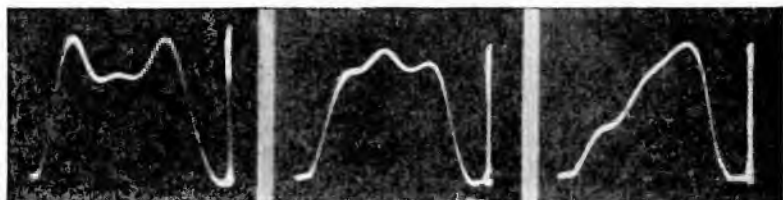

Figs. 323, left, 324, middle, 325, right. The resonance curve of a triple-peaked circuit is shown in Fig. 323. The overall response curve of the receiver is shown in Fig. 324. The curve of Fig. 325 was the result when the alignment was made with an output meter instead of an oscillograph, as was the curve of Fig. 324.

modulated signal fed into the antenna, is shown in figure 324. Note how the response curve of the r-f. system, superimposed upon the i-f. response curve, raises the gain at the mean frequency. Just as a matter of information, we show the same alignment operation, but made with an output meter, instead of the oscillograph. The overall response curve is shown in figure 325. Compare this curve with the one shown in figure 324. Note the symmetry in the latter, and the absence of symmetry in the former.

The necessity for reasonable amplitude, in order to be able to judge the characteristics of the response curve, is shown in figures 326 and 327. Note that at the low amplitude, it is difficult to establish the

width of the band actually passed by the circuit. The band seems smaller, because insufficient voltage is being built up across the circuit. The correct operation of the circuit is seen when the vertical amplitude is increased, as in figure 327.

The disfigurement of the image upon the screen, as a result of spurious signals described in connection with the double image system, is



Figs. 326, left, 327, right. The low amplitude of the curve of Fig. 326 makes interpretation of its characteristics difficult. Note the difference in Fig. 327, in which the amplitude is correct.

applicable in every respect to the signal image system. The spotting of frequencies by beating an unmodulated signal against the frequency modulated signal is accomplished in the manner originally stated. However, since a calibrated scale is used with such single image units, the frequencies can be spotted by means of the scale, so that the additional heterodyning signal is not required.

Checking Effect of Damping Upon Tuned Circuit Response

The effect of damping upon the response of a simple tuned circuit can be checked in the following manner: The circuit is shown in figure 328. The amplifier is a tuned amplifier capable of operation at the

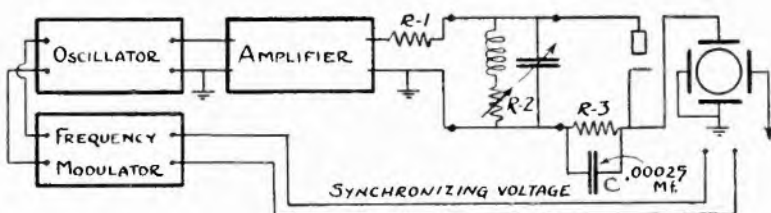
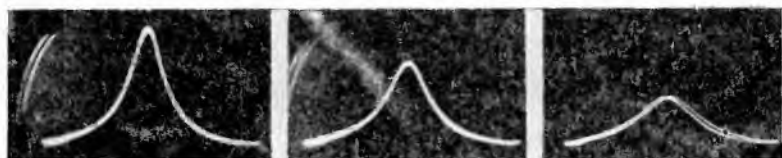

Fig. 328. Schematic diagram of the circuit for checking the effect of damping upon the response of a simple tuned circuit.

mean frequency used for checking. The values given were used at 500 kc. R-1 is a 200,000 ohm resistor, employed to minimize the shunting effect of the output circuit in the amplifier. R-2 is a variable resistance of from 0 to 14 ohms. R-3 is the diode load resistor of 500,000 ohms. The tuned circuit is that shown within the four dots. The rectifier is a conventional diode. Note that the cathode of the diode is "high." Provision was made for the addition of a shunt

resistance across the tuned circuit. When this shunt was used, $R-2$ was zero.

The six illustrations in figures 329, 330, 331, 332, 333 and 334 indicate the response under various conditions. The basic response



Figs. 329, left, 330, middle, 331, right. When $R-2$ of Fig. 328 was 0, the curve of Fig. 329 was obtained. When $R-2$ was 2 ohms and 6 ohms, the curves obtained are shown in Figs. 330 and 331, respectively.

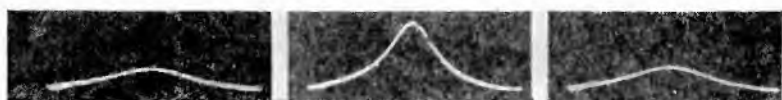

Figs. 332, left, 333, middle, 334, right. When $R-2$ of Fig. 328 was increased to 14 ohms, the curve of Fig. 332 was obtained. The effects of shunting 50,000 ohms and 20,000 ohms across the resonant circuit are shown in Figs. 333 and 334 respectively.

curve of the circuit, with a 12-kc. frequency sweep, no additional series or shunt resistor is shown in figure 329. The effect of adding 2 ohms in series is shown in figure 330. The effect of adding 6 ohms in series is shown in figure 331. The effect of adding 14 ohms in series is shown in figure 332. The effect of shunting the resonant circuit with 50,000 ohms is shown in figure 333. Note that with the coil constants used, the effect of a 50,000-ohm shunt is very much like a series resistance of 2 ohms. The effect of a 20,000-ohm shunt is shown in figure 334. The effect is very much like the insertion of a 14-ohm series resistor.

CHAPTER VII

THE A-F. FREQUENCY MODULATOR

The use of the cathode-ray tube for the determination of overall audio-frequency response curves is no innovation. As far back as 1927 Diamond and Webb pointed out the suitability of the device for the rapid determination of audio-frequency response curves and published excellent response curve oscillograms in the September 1927 issue of the *I. R. E. Proceedings*. The authors used a beat frequency oscillator, wherein the continuously variable frequency control condenser was mounted upon the shaft of the potentiometer, which, with a battery, supplied the sweep voltage. The potentiometer arm and the condenser rotor were simultaneously driven by a slow speed motor.

The a-f. frequency modulator is a device which supplies a continuously variable band of audio frequencies. In effect it is the same as the various constant band width r-f. and i-f. frequency modulators being sold for visual alignment operations, except that the mean frequency or beat frequency is zero and the frequency modulation takes place over a 10,000 or 15,000 cycle band each side of the zero beat. This signal then is rectified, so that the output of the detector is a continuously variable band of audio frequencies.

The device, which we employed in connection with the photographs shown in this volume, is illustrated graphically in figure 335. Since

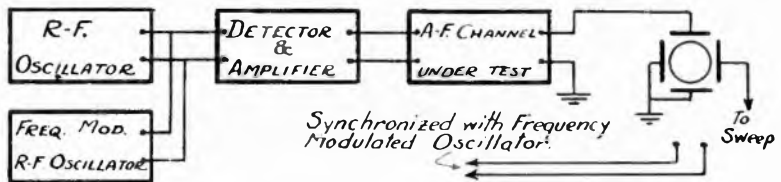
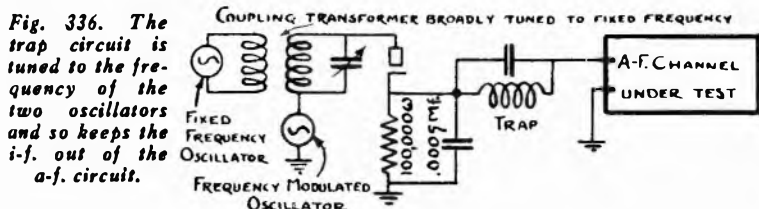

Fig. 335. Arrangement of apparatus used for the determination of overall a-f. response curves.

there is nothing very special about the circuit, it is not necessary to show schematic wiring diagrams of the respective oscillators. These

two oscillators are operated at about 200 kc. One of them is frequency modulated with a motor driven condenser, so as to supply frequency modulation over about a 10-kc. band. Because of the a. c. present in the frequency modulated unit, the supplementary diagram, shown in figure 336, is offered. The frequency modulated oscillator is grounded. In series with its output is the secondary of an i-f. trans-



former tuned to about 200 kc. or whatever the frequency being used. To this winding is coupled the primary winding, which is connected to the other oscillator. The detector is a diode tube with a 100,000-ohm load resistor, shunted with a .0005-mfd. condenser. In the output voltage supply circuit is a trap tuned roughly to the frequency of the two oscillators, namely about 200 kc. This is used to keep i-f. out of the a-f. signal. The rest is the usual routine.

Two radio-frequency oscillators, operating at about 200 kilocycles, were heterodyned to obtain an a-f. signal with zero beat as the mean frequency. To one of these oscillators was connected a motor driven condenser, such as is available for alignment work. The frequency operating conditions were so chosen that the output audio frequency varied 10,000 cycles each side of zero beat. With the equipment available the timing sweep frequency was necessarily limited to 20 cycles. Synchronization between the sweep and the a-f. signal was accomplished in the usual manner, as for i-f. alignment.

The operating parameters were so selected that the output beat signal was linear over the 10,000-cycle frequency sweep. This is not difficult of accomplishment, since the variation of 10,000 cycles at 200,000 cycles is sufficiently small so that very little departure from the actual output at 200,000 cycles occurs. The oscillogram indicating the linearity of the output voltage over the stated frequency range is shown in figure 337. The type of frequency modulation used is that which furnishes a double image, so that two types of image will be shown. One type is that which occurs when the timing frequency is the same as the speed of the frequency modulating condenser rotor and the other type is that which occurs when the timing frequency is twice the speed

of the frequency modulating condenser. A single image pattern can be obtained by making the sweep frequency inoperative during one half of the complete arc of travel of the frequency modulating condenser, as described in the chapter on r-f. and i-f. alignment. That



Fig. 337. An oscillogram of the output of the a-f. frequency modulator. Note that it is linear over the band from 0 to 10 kc.

device was not available when the photographs shown herein were made and the experiments were conducted. (See appendix.)

When the synchronization adjustment is such that the timing (sweep) frequency is equal to the frequency modulating condenser rotor speed, only one half of the entire pattern is used, as indicated. The other half of the trace is a repetition of the first in reverse order. Incidentally, due to lack of linearity of the sweep at the low frequency employed, that is between 20 and 25 cycles, the trace is not equally divided. The second trace is somewhat more crowded than the first, which condition was discussed at greater length in the preceding chapter. By properly synchronizing the timing (sweep) voltage and the rotation of the frequency modulating condenser, the zero beat or lowest frequency setting can be set at the outside limits of the pattern, so that frequency variation in the used half of the complete trace is in the normal progression from the lowest to the highest, reading from left to right. The limitation of image size, only one half of the complete trace being of utility, is not a limitation of the system, but is due essentially to the design of the device we were using. Further elaboration of design can remove one half of the trace, leaving the entire screen available for the remaining trace.

The accompanying unretouched photographs will show a few of the practical applications of this system for the purpose of noting overall audio-frequency response and the effect of any variables which influence the passage of signal voltages through the audio-frequency amplifier. The day is not far distant when this rapid method of noting the effect of tone frequency compensating circuit adjustments, tone control, low-pass and high-pass filter adjustments, etc., will be put to use. This system enables instantaneous determination of the frequency response of an audio system. The fact that our photographs show calibration at

the two extreme limits, is not an indication of the fact that the device possesses calibration limitations. With established linear frequency variation, a calibrated scale can be placed in front of the screen and all frequencies within the band, definitely spotted.

It should be noted that a linear frequency variation in general is not to be desired, but rather one that is logarithmic. This type of scale can be readily obtained by the use of properly shaped plates in the motor driven frequency modulating condenser.

Figures 338, 339 and 340 show the application of the unit to the adjustment of the 10-kc. low-pass filter found in the demodulator output circuit of one of the high fidelity receivers. The three illustrations show the filter adjusted below the correct limit, above the correct limit

Figs. 338, top, 339, middle, 340, bottom. These oscillograms show the application of the a-f. frequency modulator to the adjustment of a 10-kc. low-pass filter in the demodulator output circuit of a high-fidelity receiver. Fig. 338 shows the filter adjusted below the correct limit, Fig. 339, above the correct limit and Fig. 340, correctly tuned.

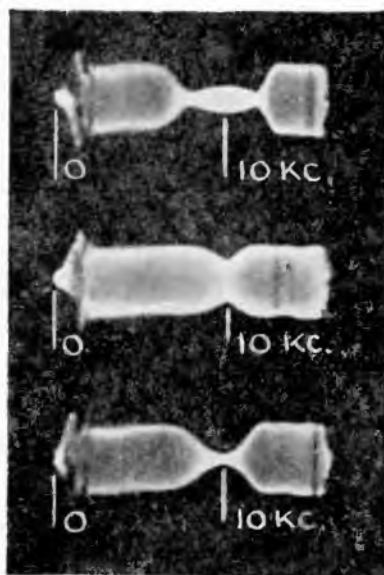

Figs. 341, below left, 342, below right. Fig. 341 indicates bass compensation and Fig. 342 indicates treble compensation.

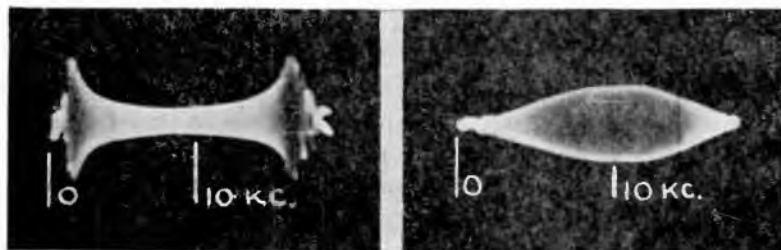

and correctly tuned. As is obvious, the effect of each adjustment is instantaneously noted.

Figures 341 and 342 indicate bass and treble compensation respectively. Note the high peaks at the low end of figure 341 and the rising



Fig. 343, left. The effect of a tone control on the a-f. response curve is shown at the left.

Figs. 344 to 348-A, below. Figs. 344 and 341 and 345 and 346 show similar conditions but different phase relations between the sweep voltage and the frequency modulated output. The action of a low-pass filter is shown in Fig. 347. The presence of a trap resonated at 6000 cycles is shown in Fig. 348 and the overall response of a good a-f. amplifier in Fig. 348-A.

a trap resonated at 6000 cycles is shown in Fig. 348 and the overall response of a good a-f. amplifier in Fig. 348-A.

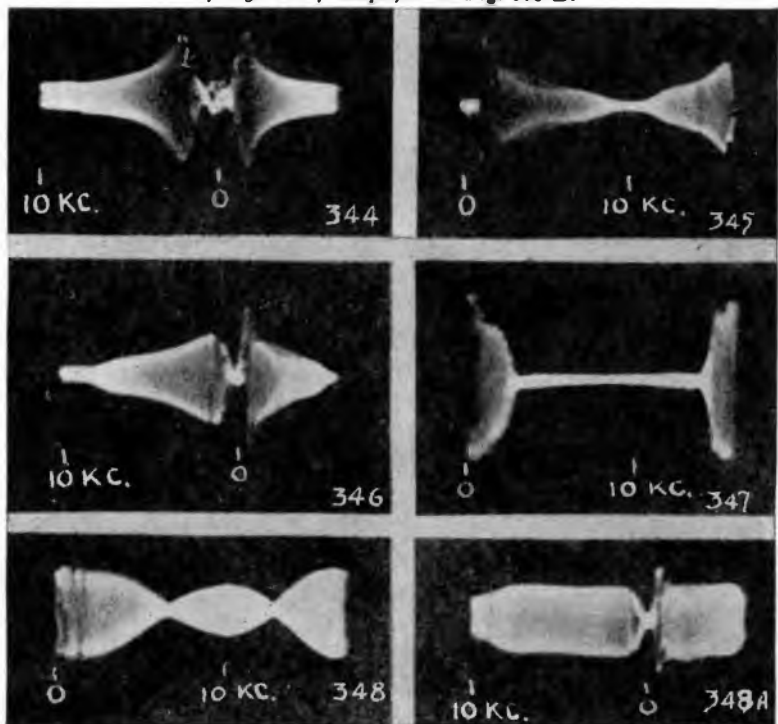

characteristic in figure 342. Incidentally, the point of zero signal voltage is indicated by a thin line and not total elimination of the line, because the motion of the spot in the horizontal direction continues even when there is no vertical displacement. The effect of a tone control upon audio response is shown in figure 343. Compensation of

the bass frequencies, shown in figure 341, is again illustrated in figure 344, but this time with the sweep voltage phased with respect to the frequency modulated output, to spot the zero beat position in the middle of the pattern. Compare figures 341 and 344. Figures 345 and 346 are for the same condition, except for different phase relation between the frequency modulating signal and the timing or sweep voltage. The pictures illustrate the response curve of an audio amplifier used in a receiver, with a .04-mfd. condenser connected across the output transformer. In figure 345 the zero beat position is at the left. In figure 346, the zero beat spot is in the middle of the trace. The action of a low-pass filter is shown in figure 347. It should be understood that all of the tests indicated were made with the constant voltage input indicated in figure 337.

The presence of a trap or filter circuit resonated to about 6000 cycles is shown in figure 348. The overall response of a well built audio frequency amplifier is shown in figure 348-A. The zero beat spot representative of the lower frequency limit is in the center of the pattern.

One deficiency present in these patterns may have come to your attention. This is the very small spread at the lower limit. In other

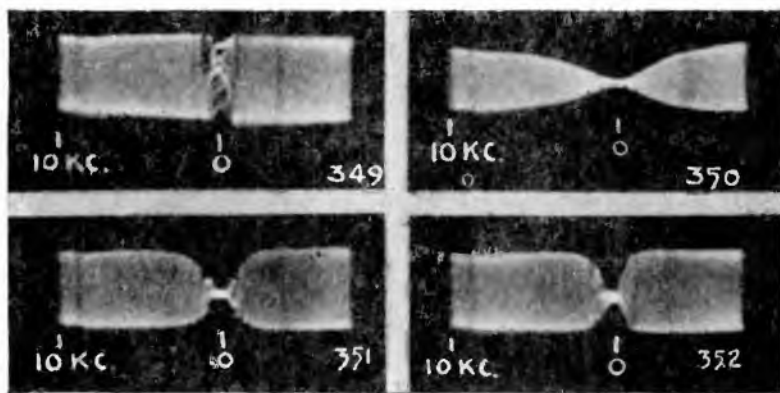

Figs. 349 to 352. These four oscillograms show the effects on the response curve of changing the blocking condenser in a resistance coupled amplifier. See text for detailed explanation.

words it is difficult to distinguish the limits between the lower limit and several hundred cycles. Elaboration of design, to spread the lower end of the frequency spectrum, is one of the required refine-

ments. As it happens it is fairly simple, being a modification of the frequency modulator condenser plates.

The effect of varying the blocking condenser, in a well built resistance coupled stage, is shown in figures 349, 350, 351 and 352. Figure 349 indicates the output with a high value of blocking condenser and is the equivalent of the input used for comparison. The frequency range is from 0 to 10,000 cycles and the zero beat spot is positioned in the middle of the pattern, so that the frequency increase is from right to left. Figure 350 shows the overall response with a .0001-mfd. blocking condenser. Figure 351 shows the overall response with a .0005-mfd. blocking condenser. Figure 352 shows the overall response with a .01-mfd. blocking condenser. The value used to develop the standard response curve of figure 349 was .25 mfd.

While we cannot speak officially, it has come to the attention of the writer, that one large concern intends manufacturing a beat frequency oscillator, which will have provision for frequency modulation, so that the type of a-f. signal described herein will be available. Perhaps by the time that cathode-ray oscillographs become general in service shops and design laboratories, such a-f. frequency modulators will be available for audio-frequency amplifier analysis and design.

CHAPTER VIII

AUTO RADIO VIBRATOR TESTING

We want to preface this chapter with the statement that the material offered herein is given simply to show the application of the cathode-ray oscillograph to the testing of auto radio vibrators. The photographs of voltage waveforms under various conditions are purely illustrative and are NOT furnished as the basis for comparison with units which are being worked upon. A certain amount of data to be found in this chapter is generally applicable and basic. There are too many variables among the large number of different kinds of vibrators to permit the presentation of specific voltage waveform oscillograms, without reference to the specific model and the conditions under which the vibrator is being employed. It is hoped, and we believe that the trust is well founded, that manufacturers of such devices, now realizing that cathode-ray oscillographic equipment is available, will furnish reference oscillograms to be used as the standards of comparison.

Proper adjustment of the contacts entails consideration of long life, as well as operating efficiency. Both of these are related to specific modes of application, with respect to the related apparatus, such as the power transformer, the load, buffer condensers, etc. Speaking in generalities, symmetry in the voltage waveform is an essential. Comparative freedom from arcing, which is productive of noise and appears in the oscillograph image as jagged streamers or off-shoots, is required. Imperfect operation, due to one cause or another, is productive of incorrect output voltage and incorrect primary current. Correction of the condition raises the output voltage to its normal value. Correlation between the nature of the image and the output voltage, as measured with a d-c. meter across the 5000-ohm load, which is the average load used when testing auto radio vibrator units, serves as a guide to attain the proper adjustment.

Speaking about symmetry in the voltage waveform, a slight departure is to be expected when checking the operation of that portion of the transformer windings which is related to the starting winding. This

winding shunts one half of the primary winding in all full wave, synchronous and non-synchronous vibrator systems.

The oscillograms we shall show will serve to illustrate how the cathode-ray oscillograph can be used to establish the effect of various adjustments, showing that various changes in adjustment and circuit constants influence the voltage waveform and proper interpretation should lead to most efficient servicing.

The schematic wiring diagram of the full-wave non-synchronous vibrator power supply units used during some of these tests is shown in figure 353. The various designations related to the transformer

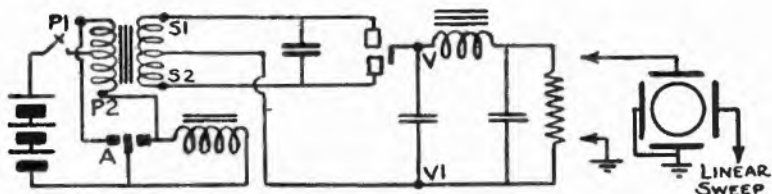
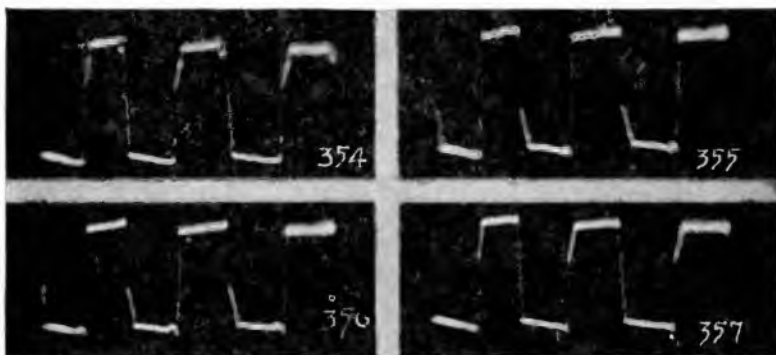

Fig. 353. Schematic diagram of a full-wave non-synchronous vibrator power supply unit.

winding represent the points to which the vertical deflection plates of the cathode-ray oscillograph were joined. The cathode-ray unit was arranged for use as a means of observing voltage waveform. The linear sweep oscillator within the unit was joined to the horizontal deflection plates in order to supply the horizontal time displacement.



Figs. 354, 355, 356, 357. Oscillograms of the voltage taken across P1 and P2 and the center tap are shown in Figs. 354 and 355. Similar oscillograms taken across S1 and S2 and the center tap are shown in Figs. 356 and 357. See Fig. 353 for points of test.

Internal synchronization was employed. Vibrator adjustments were checked by noting the voltage waveform across the various terminals

specified in the text and shown upon the diagram. The "high" terminal of the vertical deflection plates was connected to the point designated. The "low" or grounded terminal of the vertical deflection plates was connected to the associated center tap upon the identified winding or across whatever points may be specifically stated.

The waveform for the vibrator as received, when checked between P-1 and the center tap and between P-2 and the center tap, is shown in

Fig. 358. Oscillogram of voltage taken across terminals V and V1 of Fig. 353.

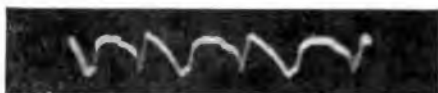

figures 354 and 355 respectively. The corresponding voltage waveforms, as checked across the secondary winding between S-1 and the center tap and between S-2 and the center tap, are shown in figures

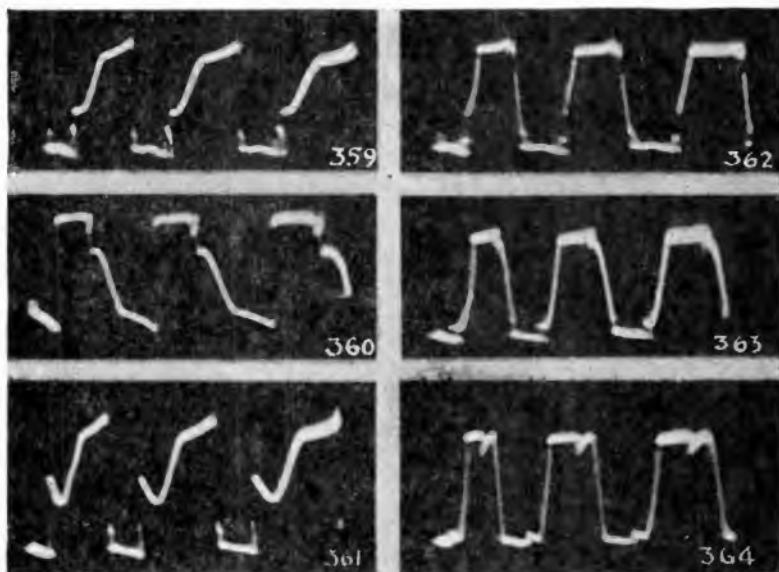

Figs. 359 to 364. Oscillograms in Figs. 359, 360 and 361 were made with the vibrator of Fig. 353 functioning as a half-wave rectifier by disconnecting contact A. Oscillogram made when contact A was restored to normal operation is shown in Fig. 362. When both contacts were opened to maximum separation, oscillograms in Figs. 363 and 364 were obtained across P1 and S1 and their respective center taps.

356 and 357 respectively. The voltage waveform between points V and V1 is shown in figure 358.

Contact A (figure 353) was disconnected making the unit a half-wave rectifier. The resultant voltage waveform between P-1 and the

center tap is shown in figure 359. The voltage across S-1 and the center tap, with contact A open circuited, is shown in figure 360. Compare figures 359 and 360.

The remaining active contact clearance or separation was increased appreciably and the resultant voltage across P-1 and the center tap is shown in figure 361. Contact A was again restored to operation, so that the unit was functioning as a full-wave rectifier and the contact separation made uniform so that symmetry was obtained. The resultant voltage waveform between points P-1 and the center tap is shown in figure 362.

Starting with the adjustment which resulted in figure 362, both contacts were opened to maximum separation. The resultant voltage waveform developed between P-1 and the center tap is shown in figure 363. The equivalent voltage across S-1 and the center tap is shown in figure 364.

The effect of resistance added into the "A" contact circuit is shown



Figs. 365, left, 366, right. Resistance was added into the "A" contact circuit of Fig. 353. Fig. 365 was made with 1 ohm in the circuit and Fig. 366 with 2 ohms.

in figures 365 and 366. The former indicates the voltage waveform with 1.0 ohm added and the latter with 2.0 ohms added.

Tests were then made upon a full-wave synchronous vibrator unit. The schematic wiring diagram is shown in figure 367. Preliminary

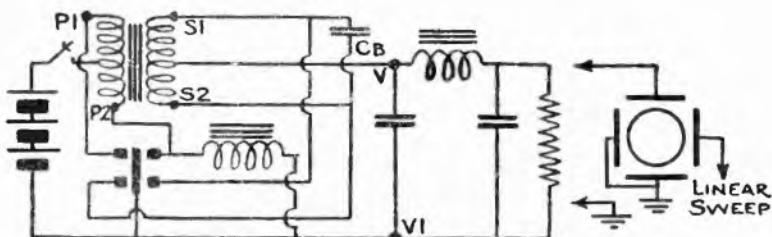

Fig. 367. Schematic diagram of full-wave synchronous vibrator.

voltage tests made upon the unit as received, resulted in the voltage waveform images shown in figures 368 and 369, across P-1 and center tap and P-2 and center tap, respectively. The equivalent voltages across

S-1 and center tap and S-2 and center tap are shown in figures 370 and 371 respectively. The voltage existing across V and V1, or at the input



Figs. 368, left, 369, right. Oscillograms of voltage taken across P1 and center tap and P2 and center tap are shown in Figs. 368 and 369 respectively.



Figs. 370, left, 371, right. Similar oscillograms taken across S1 and the center tap and S2 and the center tap are shown in Figs. 370 and 371 respectively.



Figs. 372, left, 373, right. Oscillogram of voltage taken across V and V1 is shown in Fig. 372. Fig. 373 shows the voltage across the same points, but with a shorter exposure of the photographic film. Note the transients in Fig. 372, indicated by the faint vertical lines below the wave, but not visible in Fig. 373.

of the filter system, is shown in figure 372. Figure 373 is a duplicate of figure 372, except for two items: First, figure 372 is a 3-second exposure, whereas figure 373 is a 1/2-second exposure. A transient is present in figure 373, but the "streamers" or "off-shoots", productive of r-f. interference, while visible upon the screen, did not record upon the film. The long exposure is the reason for the very thick lines in figure 372.

Maximum separation between the secondary contacts resulted in the voltage waveform image across P-1 and the center tap, shown in figure 374. Arcing occurred at the contacts named. The effect of very little spacing between the contacts is shown in figure 375. The voltage waveform was established across the same points.

Readjustment for symmetrical waveform developed the image shown in figure 376. The introduction of 0.5-ohm resistance in series with the battery, resulted in a change in the waveform of figure 376 to

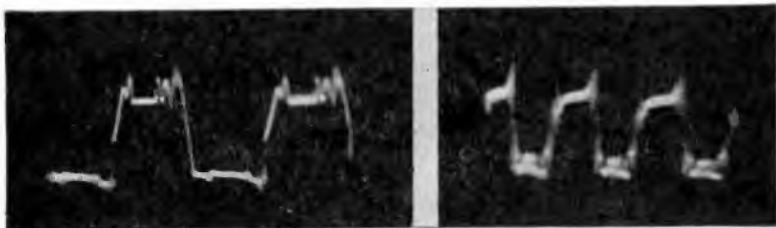

Figs. 374, left, 375, right. The effect of maximum and minimum separation between the secondary contacts is shown in Figs. 374 and 375 respectively.

that shown in figure 377. The output voltage also dropped from a normal of about 245 volts to about 150 volts. This is the voltage measured across the 5000-ohm load.



Figs. 376, left, 377, right. The oscillogram of Fig. 376 was made after the contacts had been restored to normal. When a .5-ohm resistor was connected in series with the battery, the oscillogram of Fig. 377 was obtained.

Starting with the normal adjustment of figure 376, removal of the buffer condenser developed the waveform in the primary circuit, shown in figure 378. The output voltage was 160 volts. Under the same conditions the voltage waveform of the secondary circuit was like that



Figs. 378, left, 379, right. The waveform taken in the primary circuit when the buffer condenser was removed is shown in Fig. 378. The waveform of the secondary circuit under similar conditions is shown in Fig. 379.

shown in figure 379. The excessive amount of sparking is clearly evident. With a .001-mfd. buffer condenser, the voltage rose to 170 volts, and the voltage across the secondary winding is shown in figure 380. With .005-mfd. as the buffer condenser, the voltage rose to 244 volts and the waveform is shown in figure 381.

Once more we wish to say that these oscillograms are offered purely to show the application of the cathode-ray oscillograph to the servicing and adjustment of auto-radio vibrators and not as images to be used



Figs. 380, left, 381, right. When a .001-mf. condenser was used as a buffer, the waveform of Fig. 380 was obtained. When the capacity was increased to .005 mf. the oscillogram of Fig. 381 resulted.

for comparison with what may appear upon the screen of the tube which you may be using. Of course, a certain amount of general practical data can be gathered from these pictures, but the qualifications we have mentioned still stand.

CHAPTER IX

TRANSMITTER ADJUSTMENT

The cathode-ray oscillograph is of excellent utility during the adjustment of a transmitter. While it is true that our experimental work did not cover all types of transmitters, we feel that the oscillograms presented in the following pages should serve as guides to those men, particularly the amateurs, who operate low powered "ham" transmitters and who have been interested in the application of the cathode-ray oscillograph as a means of adjusting correctly the various circuits which comprise the complete unit. For that matter, the data should also be of interest to the men who operate modulated oscillators in laboratories and who desire data concerning the various adjustments.

Modulation Measurement and Analysis

One of the most important types of information, which operators of transmitters and oscillators require, is the existing percentage of modulation, when an audio tone is superimposed upon the r-f. carrier. Furthermore, examination of the modulated wave envelope pattern can furnish a great deal of data concerning the operation of the complete unit, when interpretation is correct. There are several ways of establishing patterns which will enable the determination of the percentage of modulation.

There are three types of patterns which can be developed with ease. One of these is the modulated wave envelope showing amplitude modulation, an example of which is illustrated in figure 382. The second type of pattern is the trapezoid, showing the relation between the carrier amplitude and the modulating signal voltage amplitude, which is illustrated in figure 383. The third type of pattern, which, for the want of a better name is called a block pattern, is illustrated in figure 384. This is a photograph. It is related to the pattern showing the modulated wave envelope, except that the image is not spread by the timing wave. Instead the pattern shows streaks of varied in-

tensity, the width of which can be used to establish the percentage of modulation. The modulated wave envelope pattern of figure 382 is developed by means of the arrangement shown in figure 385. The modulated output signal voltage is secured from the source by some suit-

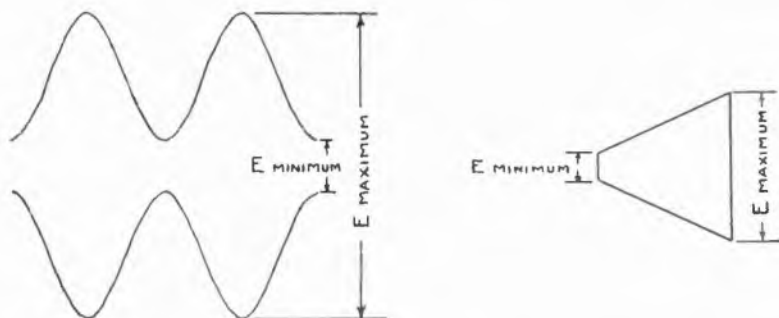

Figs. 382, left, 383, right. A modulated wave envelope showing amplitude modulation is shown in Fig. 382. A trapezoidal pattern showing the relation between the carrier amplitude and the audio signal amplitude is shown in Fig. 383.

able means of coupling, so that a reasonably strong signal is available. The modulated signal is applied to the vertical deflection plates. The cathode-ray oscillograph is adjusted as for regular waveform examination. The linear sweep circuit is used and is adjusted to some sub-



Figs. 384, left, 384-A, right. Two block patterns are here shown. That of Fig. 384 has fifty percent. modulation and that of Fig. 384-A is modulated one hundred percent.

multiple frequency of the modulation frequency. The exact sweep frequency depends upon the number of cycles of the modulated wave envelope, desired upon the screen. Internal synchronization can be used except where the percentage of modulation is very low.

Adjustment of the transmitter should be accomplished with the Class C stage working into a dummy antenna. The pick-up may be several turns of wire loosely coupled to the output tank. If sufficient voltage is not obtained, an additional Lo-C tank may be link coupled to the final tank. In any case, the r-f. voltage should be taken from the final tank with the amplifier working into a normal load.

Another consideration must be recognized. This relates to the frequency of the carrier and to the mode of connection to the vertical deflection plates. The amplifier associated with the vertical deflection plates has a definite frequency limit, which usually is 100,000 cycles. If the carrier frequency is higher than this figure, it is necessary to connect directly to the vertical deflection plate, without going through the amplifier. The low side of the signal supply circuit can be connected to any ground upon the oscillograph. Adjustment of the modulated signal pick-up may be required in order to keep the image upon the screen.

The percentage of modulation can be determined by applying the following equation:

$$\text{Percent Modulation} = \frac{E_{\text{Max}} - E_{\text{Min}}}{E_{\text{Max}} + E_{\text{Min}}} \times 100$$

in accordance with the data shown in figure 382.

The units in which E_{Max} and E_{Min} are measured are unimportant as long as they are the same for both. If E_{Max} is 2 inches and E_{Min} is .5 inch, the percentage modulation is $(2 - \frac{1}{2}) \div (2 + \frac{1}{2}) \times 100 = 60\%$. It is unnecessary to interpret the deflection on the screen in terms of actual voltage.

The trapezoidal pattern of figure 383 is established by applying the modulated r-f. signal voltage across the vertical plates and applying the

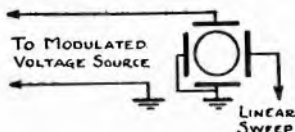

Fig. 385. The modulated wave envelope of Fig. 382 is developed with the arrangement shown on the left. For frequencies above 100 kc., it is necessary to connect directly to the free vertical plate. See text.

modulating signal voltage (audio signal) across the horizontal plates. To assure the correct trapezoidal pattern, the modulating signal should be secured from the output of the modulator stage. The circuit arrangement is shown in figure 386. As stated in connection with figure 385, it may be necessary to feed the modulated signal voltage directly to the

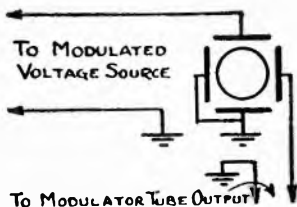

Fig. 386. The connections shown at the left are used for developing the trapezoidal patterns.

free vertical deflection plate. The audio voltage from the modulator can be applied to the horizontal deflection plates through the regular

terminals. The horizontal deflection amplifier in the cathode-ray oscillograph, if such an amplifier is available, can be used as a gain control, governing the width of the pattern.

Determination of the percentage modulation is carried out by applying the equation previously stated in accordance with the designation shown upon figure 383.

Developing the Trapezoidal Pattern

Speaking about trapezoidal patterns, it might be well to show how this type of pattern is developed. It will do much towards clarifying the reasons why certain peculiar shapes appear and just why phase

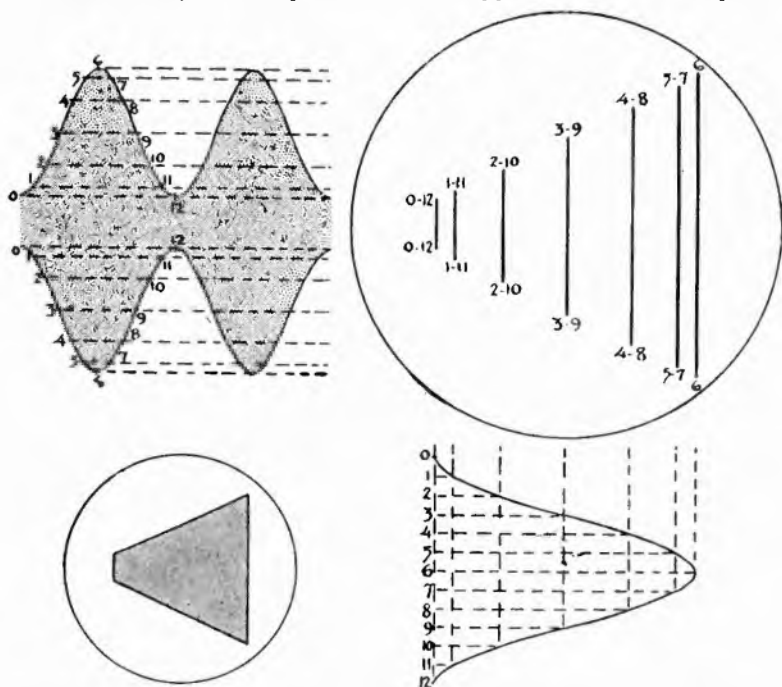

Figs. 336-A, above, 336-B, below. How a trapezoidal pattern is developed on the screen of a cathode-ray tube. The pattern enclosed in the small circle, Fig. 336-B, is what actually appears on the screen. The sweep voltage is in phase with the modulated wave.

difference between the original audio input signal and the modulation component of the modulated wave distorts the trapezoid.

We stated that the trapezoid figure establishes the relation between the modulated signal and the audio-frequency component. The vertical displacement of the spot is accomplished by the modulated carrier voltage and the horizontal displacement of the spot is accomplished by the

audio voltage, which is used to modulate the carrier. Since the rate of amplitude modulation of the carrier is at the modulating frequency and since this same frequency is used as the timing base or sweep frequency to move the spot in the horizontal direction, the two voltages are automatically synchronized and the pattern remains stationary.

Examine figure 386-A. This illustration shows two cycles of the modulated wave envelope and one cycle of the audio voltage. The numbers upon the audio outline of the modulated wave correspond with the numbers upon the audio wave, because they are identical. The negative peak of the modulated wave corresponds to the negative peak of the audio wave. Since both halves of the modulated wave are identical we can number like positions of the envelope in like manner. The horizontal displacement of the spot is accomplished, as has been stated, by the audio voltage. For the sake of illustration, we show a sine audio wave and sine modulation.

Displacement of the spot across the screen in one horizontal direction is accomplished by the change in voltage between points 1 and 6 of the audio wave. The return trace of the spot in the horizontal direction is accomplished by the change in voltage between points 6 and 12 of the audio wave, so that the completed pattern really consists of two traces, but since the displacement of the spot is occurring at a fast rate, the pattern appears as a single image. When the spot is in position O along the "X" axis, it is being displaced along the vertical or "Y" axis by the voltage difference between O-O of the modulated wave at that instant, a single line is evident upon the screen. It is to be remembered that the vertical motion of the spot takes place at the carrier frequency and it is the peak amplitude of the carrier which is determined by the audio modulation. As the horizontal displacement of the spot moves towards the other end of the screen, that is towards position 6, the peak amplitude of the modulated signal voltage is also increasing at exactly the same rate, so that as the spot reaches positions 1, 2, 3, 4, etc. along the horizontal axis, the modulated carrier voltage also reaches points, 1, 2, 3, 4, etc. and the displacement of the spot in the vertical direction is determined by the peak voltages between points 1-1, 2-2, 3-3, 4-4, etc. of the modulated wave.

It stands to reason that as the spot moves in the horizontal direction from 1 to 6, that vertical displacement will also take place for the various peak values of the modulated carrier, so that at any instant, lines, such as are shown for spot positions 1 and 2, would appear upon the screen.

As the spot moves to 6, representing the limit of the sweep in one direction, the vertical displacement corresponds to the modulated peak voltage between points 6-6 upon the modulated curve. As the spot starts moving back across the screen and reaches point 8 upon the horizontal sweep voltage curve, the vertical displacement is that due to the peak voltage between points 8-8 upon the modulated wave. This point corresponds with points 4-4. As the spot reaches point 12 along the horizontal sweep voltage curve, which is the audio voltage curve, the vertical displacement is that due to the peak voltage between 12-12. This corresponds to points 0-0. The complete cycle is repeated during the existence of the respective vertical and horizontal voltages. The result is a stationary pattern of the type shown in figure 386-B. The fact that the horizontal voltage or sweep voltage variation is not linear,

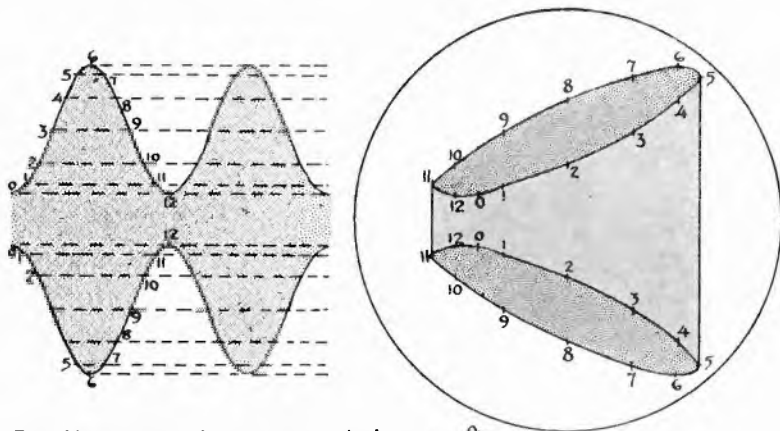
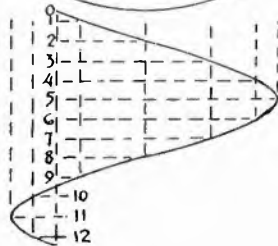

Fig. 386-C. The development of the pattern is similar to that shown in Fig. 386-A with the exception that in this case the sweep voltage is 45° out of phase with the modulated signal. This is the type of pattern obtained when the sweep voltage is taken from some part of the speech amplifier, other than the modulator tube.



but is sinusoidal, does not interfere with a linear pattern as long as the amplitude variation of the modulated signal occurs at the same rate and is of identical shape and correct phase. Provided the modulation is linear, any complex modulating wave will produce a perfect trapezoid.

We stated that the phase relation between the audio voltage used for the horizontal displacement of the spot and the modulated signal

influenced the shape of the trapezoidal pattern. This is shown in figure 386-C. The basic modulated signal is the same as in figure 386-A. However, the audio signal used for the horizontal sweep has been displaced, so that the phase relation is changed slightly. The phase loops which appear in the trapezoidal pattern are developed. This is the type of pattern which results when the audio signal for the horizontal sweep is secured from some part of the speech amplifier, other than the modulator tube. The extent of the phase difference, as indicated by the pattern, depends upon the phase displacement between the signal at the point where the voltage is secured and the signal at the output of the modulator stage. You will find several photographs upon the pages following, which show photographically the difference in the appearance of the trapezoidal image when the audio signal for the horizontal displacement is secured from the input to the speech amplifier and from the modulator. Compare these photographs with the pattern developed in figure 386-C.

Figure 386-D illustrates the development of a trapezoid pattern for a state of overmodulation. The method outlined in figures 386-A and

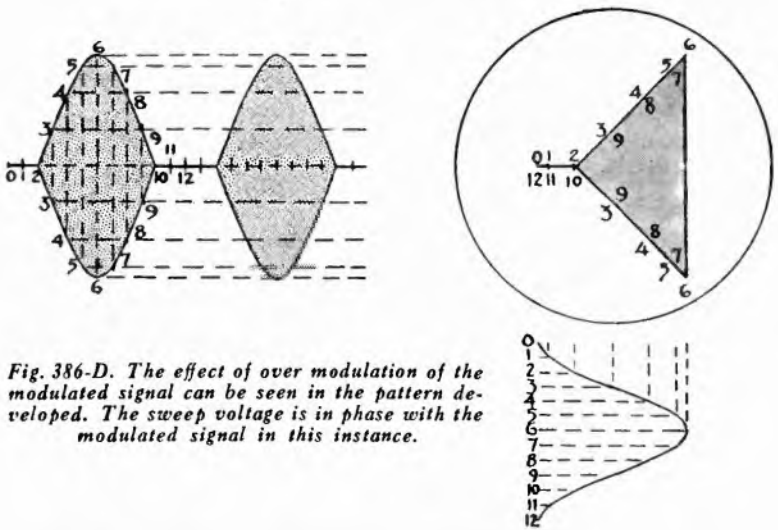

Fig. 386-D. The effect of over modulation of the modulated signal can be seen in the pattern developed. The sweep voltage is in phase with the modulated signal in this instance.

386-C are applied to figure 386-D. While a distorted signal input will not affect the linearity of the sides of the trapezoid, it will introduce a series of bright vertical bands in the pattern corresponding to the distortion present in the audio signal. Furthermore, you can appreciate the formation of various kinds of patterns indicative of the different troubles possible in a transmitter. Examples of such con-

ditions are shown in subsequent illustrations and it is hoped that the three developed trapezoidal patterns will aid in the comprehension of the photographic records here given.

Symmetry of modulation can be determined by examination of the wave envelope or trapezoidal patterns. In wave envelope patterns, the positive and negative peaks must be alike and of like height, if symmetry is maintained. The carrier height must be midway between the positive and negative audio heights. When judging trapezoidal patterns for symmetry, a horizontal reference line drawn from the mid-point of the E-Min amplitude should bisect the E-Max amplitude and both halves of the pattern, above and below this horizontal reference line, should be identical.

It might be well at this time to stress the fact that the trapezoidal pattern consists of two traces, which may or may not coincide, depending upon a number of factors. This statement is made in advance of several trapezoidal patterns which appear later and wherein the forward and return traces do not coincide.

Stopping Modulated Wave Patterns

Stopping the correct modulated wave envelope pattern with internal synchronization is a matter of correct sweep frequency adjustment and sufficient amplitude of the modulating voltage. An example of incor-



Figs. 387, left, 388, right. When the sweep voltage is incorrectly adjusted a pattern like that of Fig. 387 results. A correctly adjusted sweep voltage yielded the oscillogram of Fig. 388.

Figs. 389, left, 390, right. Distortion may be introduced in the amplifier by over-loading or rectification. A greater degree of rectification is present in the oscillogram of Fig. 390 than there is in Fig. 389.



rect frequency adjustment, that is sweep frequency adjustment, results in a pattern such as that shown in figure 387. When the correct sweep frequency adjustment is reached, in this case being a sub-multiple equal

to $\frac{1}{4}$ of the modulating frequency, the pattern of figure 387 becomes that shown in figure 388.

A perfect modulated signal, fed into the vertical amplifier of the cathode-ray oscillograph or into an external amplifier for amplification, may be distorted as a result of overloading and rectification in the amplifier. Resulting patterns appear as shown in figures 389 and 390, the latter indicating a greater degree of rectification than is shown in figure 389.

Transmitter Adjustment

The transmitter used in the tests to be described is of the "ham" type, operating at 80 meters. The circuit of the system is shown in two parts, in figures 391 and 392. The variable controls shown in the

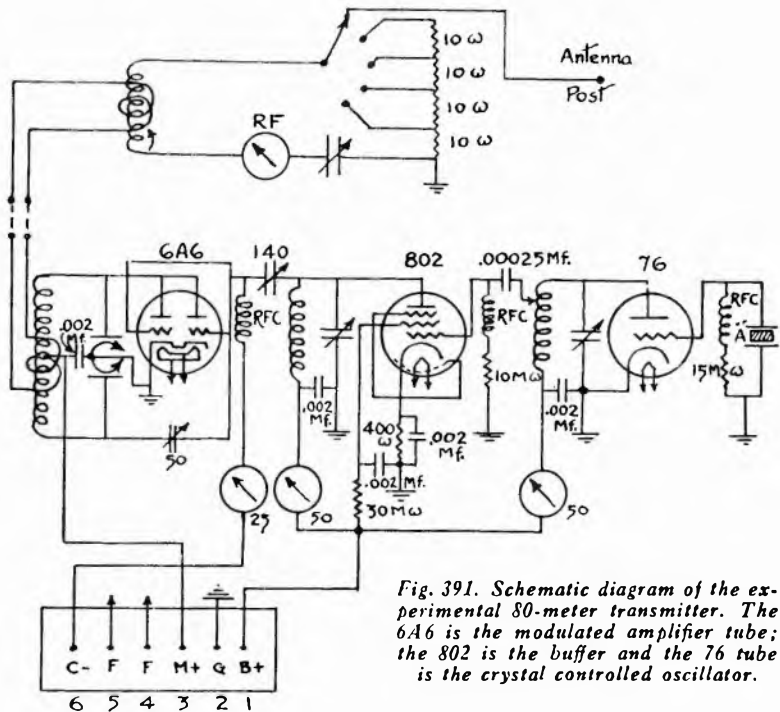

Fig. 391. Schematic diagram of the experimental 80-meter transmitter. The 6A6 is the modulated amplifier tube; the 802 is the buffer and the 76 tube is the crystal controlled oscillator.

schematics and which generally are not found in such transmitter systems, were deliberately installed in order that means be available whereby sub-normal and abnormal conditions could be introduced.

The transmitter is rated at 10 watts, 100 percent. modulation, of course variable percentage modulation is available. It is crystal con-

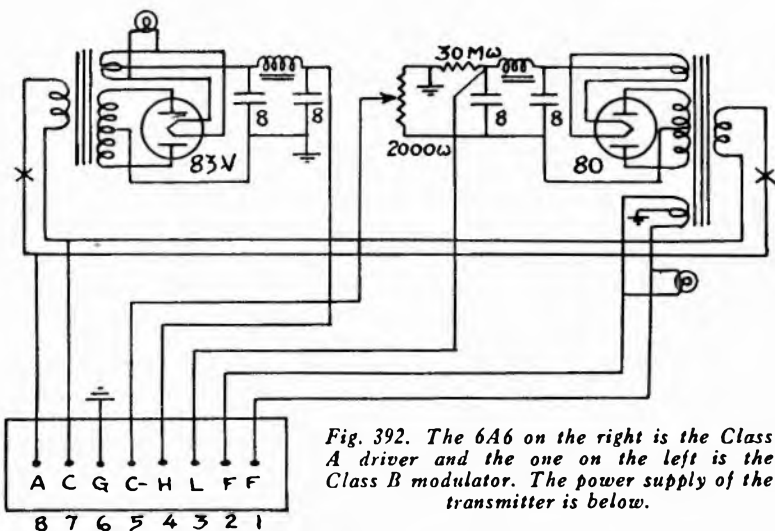
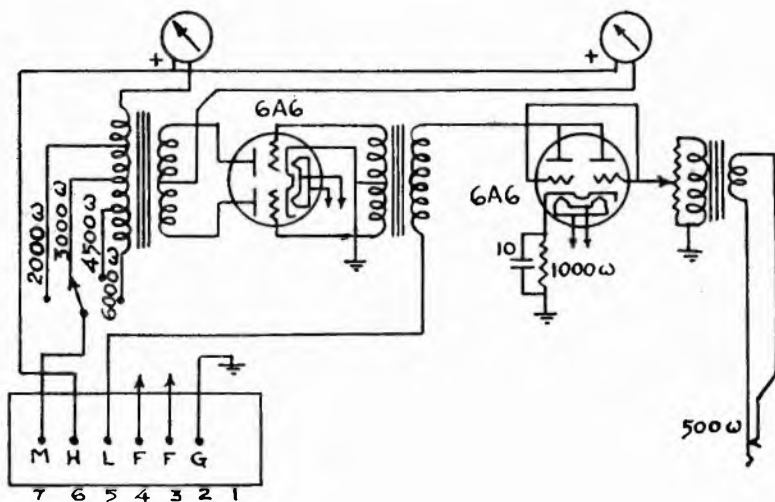
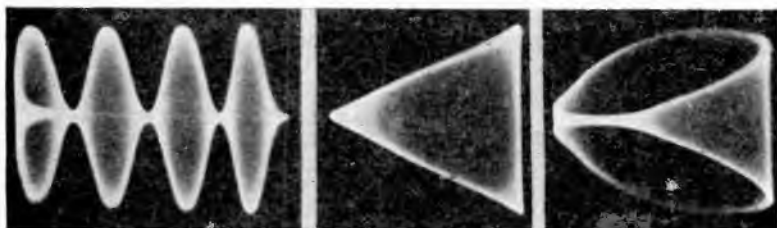

Fig. 392. The 6A6 on the right is the Class A driver and the one on the left is the Class B modulator. The power supply of the transmitter is below.

trolled, with a buffer stage and power amplifier. The modulator system employs a class A stage and a class B stage.

Tests made upon this transmitter were substantiated with experi-

ments conducted on other transmitters, so that the results shown herein can be said to be generally applicable to systems of similar design. It is, of course, necessary that you realize the actual significance of these patterns. Furthermore, that the appearance of identical patterns upon the screen in the tube, which is being employed for the adjustment of a transmitter, would require duplication of identical conditions. Consequently the patterns we show herein should be classified as patterns typical of the conditions stated. It is, therefore, possible and likely that tests made upon transmitters under similar conditions would result in patterns which would resemble those given herein, but which would not be identical. It has been our experience that the greatest resemblance would occur in the trapezoidal patterns rather than in the modulated wave envelope patterns.



Figs. 393, left, 394, middle, 395, right. The three oscillograms were made with 100 percent modulation. The pattern of Fig. 395 differs from that of Fig. 394 because of phase shift.

We start with all adjustments correct, showing the correct 100 percent modulated wave envelope and the correct trapezoidal patterns. As stated before the audio voltage for the trapezoidal pattern was secured from the output circuit of the modulator stage. These two correct patterns, to be used for comparison of shape and not amplitude, are shown in figures 393 and 394. The effect upon the trapezoidal pattern, due to phase shift, is shown in figure 395. The difference between the patterns shown in figures 394 and 395 is due to the fact that the audio voltage used for the horizontal displacement of the spot was secured from two different parts of the transmitter. The voltage for figure 394 was secured from the output of the modulator stage. The voltage for figure 395 was secured from the input to the speech amplifier. In all of the tests shown, the audio voltage was 400 cycles and of sine waveform.

From this point on, we shall show a number of oscillograms indicating different operating conditions of the transmitter. Since the

majority of the images are of the modulated wave envelope and trapezoid type, the instructions given earlier in this chapter, concerning the connection of the oscillograph to the transmitter, apply in each case. Where an audio waveform is shown, the vertical plates are connected to the source of the audio voltage and the oscillograph is adjusted for regular waveform observation* as outlined in several places of this volume. Whenever trapezoidal patterns are shown and no statement is made to the contrary, the audio voltage for the horizontal displacement is secured from the modulator stage output circuit.

Insufficient Excitation of Class C Stage

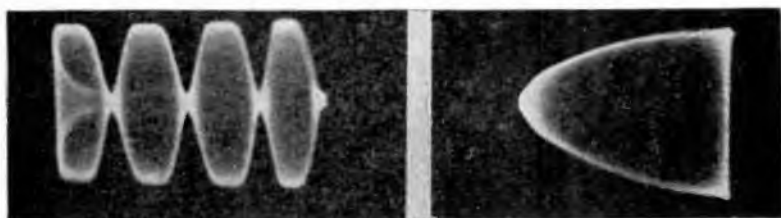

The wave envelope and trapezoid patterns indicating insufficient excitation of the Class C stage are shown in Figs. 396 (left) and 397 (right). All other operating conditions are correct. Note the clipped peaks in figure 396 and the non-linearity of the pattern in Fig. 397.

Insufficient Excitation and Overmodulation

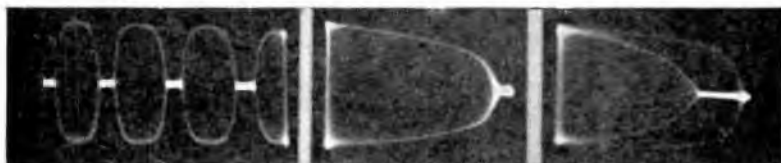

The wave envelope and trapezoid patterns are shown in Figs. 398 (left) and 399 (middle). Fig. 400 (right) shows the type of trapezoid pattern secured when the audio voltage for the horizontal displacement is secured from the input to the speech amplifier, instead of from the modulator, as in Fig. 399.

Insufficient Excitation, Overmodulation and Excessive Bias



The wave envelope and trapezoid patterns are shown in Figs. 401 (left) and 402 (right). The trapezoidal patterns afford more definite information than is evident in the modulated wave pattern.

Overmodulation

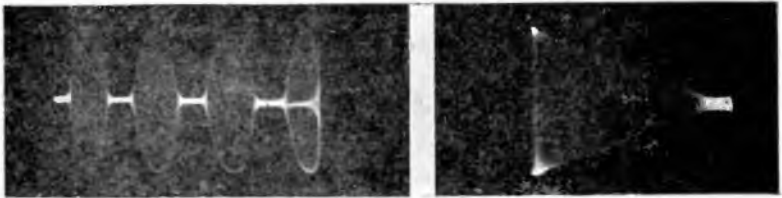

The wave envelope and trapezoidal patterns indicating overmodulation with all other conditions normal, is shown in Figs. 403 (left) and 404 (right)

Non-Linear Operating Conditions, Excessive Bias

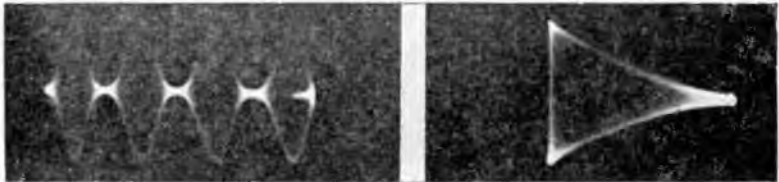

The wave envelope and trapezoidal patterns for this condition are shown in Figs. 405 (left) and 406 (right). Note that the condition is not as evident in the modulated wave pattern as in the trapezoidal pattern.

Overmodulation With Distorted Audio

The wave envelope, trapezoidal and audio patterns are shown in Figs. 407, 408 and 409. All other conditions are normal. Evidence of distortion of the audio signal is seen in the trapezoidal figure, in that the intensity of the pattern is greater in certain places than in others. Correlation between the shape of the audio voltage and the formation of the trapezoidal pattern will show that positions corresponding to the positive and negative loops, in distorted voltages of the type shown, slow down the movement of the spot and result in increased brightness of the line. We assume a sine wave input to the speech amplifier.

High Excitation, Overloaded Speech Amplifier, Insufficient Modulator Capability

Figures 410, 411 and 412 indicate a peculiar condition, one which is not often experienced in actual practice. Figure 410 shows the modulated wave. Figure 411 shows the corresponding trapezoid and figure 412 shows the audio output at the modulator. An examination of figure 410 shows that the desired 100-percent. modulation is not obtained.

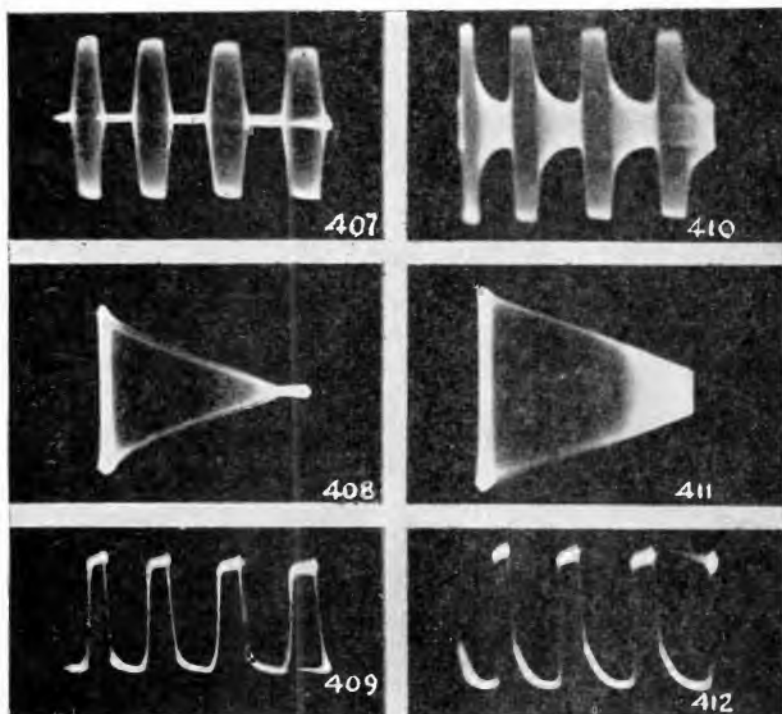

Figs. 407, 408 and 409 show the wave envelope, trapezoidal and audio patterns of an overmodulated wave with distorted audio.

Fig. 410 is the modulated wave. Fig. 411 is the corresponding trapezoid and Fig. 412 shows the modulator output. In this case observation of the modulated wave envelope indicates the existing condition more definitely than does the trapezoid.

At the same time, the speech amplifier and modulator stages are overloaded, in the effort to modulate the r-f. carrier to the full value. The trapezoidal pattern indicates that linear modulation of the carrier is being achieved. Proper adjustment of the transmitter then requires several considerations: One is reduction of the excitation, so that it is possible to cut down the gain in the speech amplifier and modulator in order to achieve distortionless output and still modulate the carrier 100 percent. The other is to keep the carrier at the high level and to make changes in the speech amplifier and modulator system. The former is true only if what we have classed here as being high excitation, actually represents an adjustment which, based upon the design of the complete transmitter, is excessive excitation. The existence of audio distortion is indicated in the trapezoid by the light and dark portions.

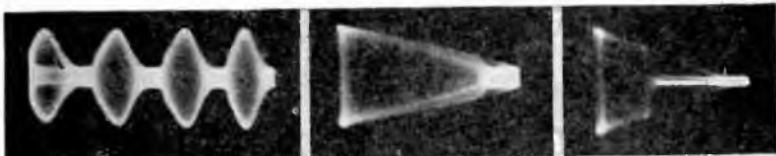

Fig. 413 (left) indicates the modulated wave during excessive regeneration and Fig. 414 (middle) shows the equivalent trapezoidal pattern. Fig. 414-A (right) is another trapezoidal pattern indicating improper neutralization adjustment.

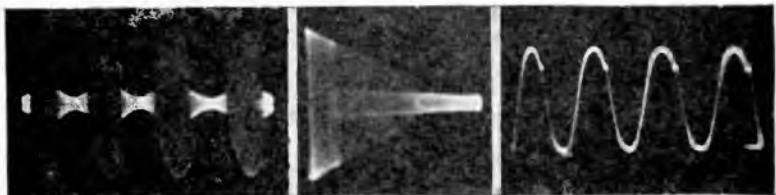

Fig. 415 (left) indicates the modulated wave. Fig. 416 (middle) shows the equivalent trapezoidal pattern and 417 (right) shows the audio wave across the modulator output. Note that the oscillation starts suddenly, persists for awhile and then dies out during each cycle. Note the resulting dip in the audio wave



Fig. 418 shows the modulated wave. Fig. 419 shows the corresponding trapezoidal pattern and Fig. 420 shows the audio wave across the modulator output during the operative condition stated. The sudden start and cessation of the uncontrolled oscillation is clearly shown in Fig. 418.

Incorrect Neutralization

The effect of incorrect neutralization is indicated in a number of oscillograms. In two cases, the modulated wave, equivalent trapezoid and the audio wave at the modulator are shown. In a third case, the modulated wave and trapezoid only are shown. These oscillograms are purely illustrative and cannot be associated with any specific adjustment other than the incorrect setting of the neutralizing control. Consequently, the value of these oscillograms is found in the information they convey concerning the general appearance of modulated waves and trapezoidal patterns during excessive regeneration in the Class C stage. See figures 413 to 420 above.

Plate Tank Tuning

The effect of tuning of the tank circuit in the plate circuit of the Class C stage is shown in figures 421, 422, 423 and 424. The modulated wave and corresponding trapezoidal patterns are shown. All other conditions were normal.

Fig. 421 shows the modulated wave for correct tuning of the plate tank. Fig. 422 shows the corresponding trapezoid. Fig. 423 shows the modulated wave for incorrect tuning of the plate tank and Fig. 424 shows the corresponding trapezoid.

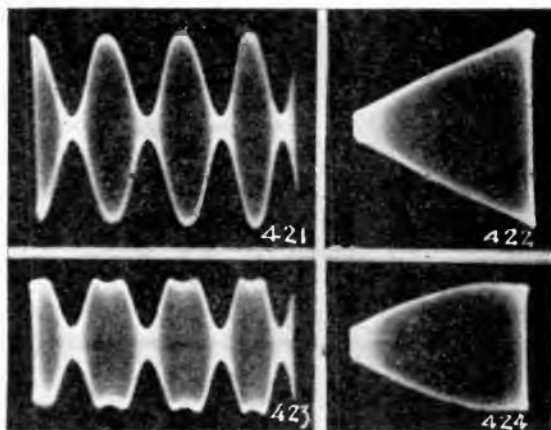

Modulation Transformer Load Adjustment

The effect of a departure from the correct impedance load upon the Class B modulator is shown in a number of illustrations. Only for the

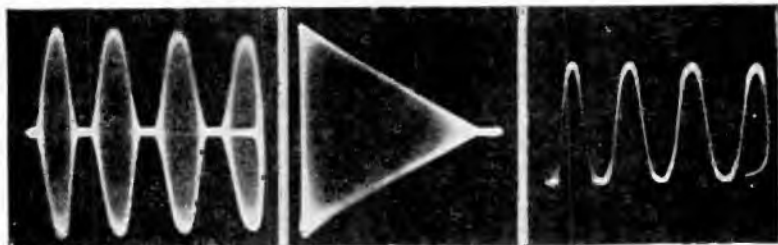

Fig. 425 (left) shows the modulated wave envelope when the modulator is matched to a 6000-ohm load. The corresponding trapezoidal pattern is shown in Fig. 426 (middle). The audio wave across the modulator load is shown in Fig. 427 (right). Compare these images with Figs. 393 and 394.

correct load impedance are proper conditions produced. Departure from the correct load impedance changes the character of the audio input and the modulated wave envelope. The standards of comparison



Fig. 428 (left) shows the modulated wave envelope when the modulator is matched to a 2000-ohm load. The corresponding trapezoidal pattern is shown in Fig. 429 (middle) and the audio voltage across the modulator load is shown in Fig. 430 (right). Compare these images with Figs. 393 and 394.



Fig. 431 (left) is an example of hum modulation of the carrier, which is modulated at 1000 cycles. Fig. 432 (right) is an example of a pattern resulting from incorrect test connections.

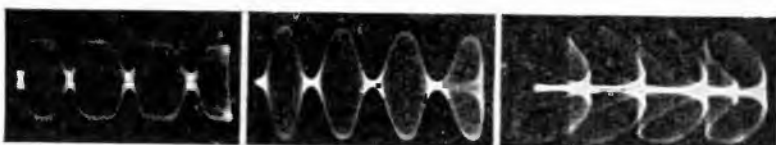

Figs. 433 (left), 434 (middle), 435 (right). When the audio leads, which were the cause of the distorted pattern of Fig. 432, were removed, the pattern of Fig. 433 was obtained, this being the correct one. Before the audio leads were removed in a similar case, the pattern of Fig. 435 was on the screen, the corrected pattern being shown in Fig. 434.

were shown in figures 393 and 394. These two illustrations show the standard and correct 100 percent. modulated wave and the corresponding trapezoidal patterns. Incorrect adjustments are shown in figures 425 to 430 inclusive. The correct load impedance is 4000 ohms. Tests were made with adjustments for a 2000-ohm load and a 6000-ohm load. All other operating values are correct.

Improper Test Procedure

An example of the pattern resulting from incorrect test connections is shown in figure 432. The oscillograph circuit was arranged to develop the modulated wave pattern. However, the audio signal was still connected to the horizontal plate binding posts, although these connections were out of the circuit, because the horizontal sweep voltage was the linear sweep voltage secured internally. Leakage between the horizontal plate terminals and the horizontal plate circuit distorted the pattern. The correct pattern developed, when the audio voltage leads, which were used to develop the trapezoidal patterns, were removed, is shown in figure 433.

Another example of a similar condition is shown in figures 434 and 435. The correct pattern is shown in figure 434. Due to the connection between the modulator plate circuit and the horizontal binding posts, leakage occurred when developing the modulated wave pattern and the distorted pattern, shown in figure 435, appeared upon the screen. When the audio leads were removed, with everything else left intact, the pattern of figure 435 changed to that shown in figure 434.

Distortion of the image is possible if, when making observations of the modulated wave, the vertical deflection amplifier is in the circuit and the gain control is not set to zero. This assumes that the modulated carrier voltage is being fed directly to the vertical deflection plate and not through the vertical amplifier. The form of distortion which occurs is lack of symmetry of the pattern, that is the positive peaks may be higher than the negative peaks, or vice-versa. The most feasible plan is to keep the amplifier in the circuit, although the signal is not being fed through the amplifier and to short circuit the amplifier input terminals.

CHAPTER X

OTHER APPLICATIONS OF THE CATHODE-RAY OSCILLOGRAPH

In line with the statement that the cathode-ray oscillograph can be used for the observation of various electrical phenomena, are observations of value in connection with the academic study of radio principles. There are a number of subjects, which require extensive descriptive discussion, particularly when variables are involved. A great deal of time can be saved by the use of the cathode-ray oscillograph to illustrate the effect of these variables upon the final pattern. Take for example the presence of two signals in an electrical circuit and the mixing of these two voltages to form a beat pattern. It is to be understood that the beat signal is not available until rectification takes place, but the beat pattern, resulting from the mixing of the two signals, can be viewed upon the cathode-ray screen.

Beat Patterns

Assume two unmodulated signals, say 1000 cycles and 1180 cycles. The two oscillator output circuits are connected in series and fed into



Figs. 436 (left), 437 (middle), 438 (right). These three oscillograms were obtained by connecting the output of two oscillators in series, each delivering a different frequency. With the sweep frequency equal to the difference frequency, the oscillogram of Fig. 436 was obtained. The oscillograms of Figs. 437 and 438 were obtained with the sweep frequency equal to one-half and one-third the difference frequency respectively.

the vertical deflection plates. The horizontal displacement is secured with the internal linear sweep oscillator, exactly as used for ordinary waveform observation.

With the sweep circuit adjusted to the difference frequency, a single beat cycle pattern appears as in figure 436. With the sweep adjusted to half the difference frequency, two cycles of the difference frequency appear as in figure 437. With the sweep frequency set to one third of the difference frequency, three cycles of the difference frequency appear upon the screen, as shown in figure 438.

CW Reception and Detection

The action taking place when a CW signal is heterodyned and rectified is shown in figures 439 and 440. Two sine waves of comparatively low frequency were used. These two were fed into a diode rec-

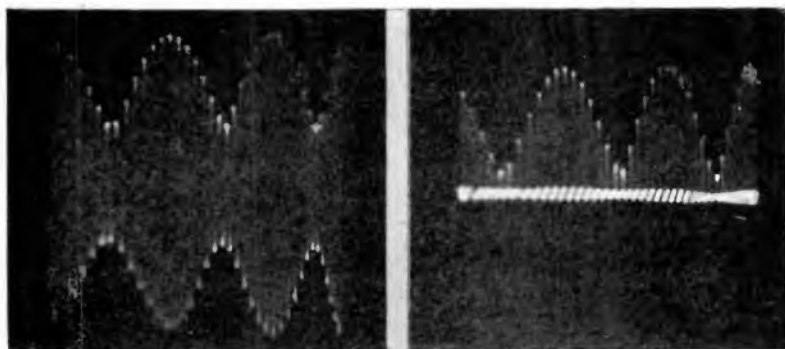

Figs. 439 (left), 440 (right). When a CW signal is heterodyned and rectified, the voltage across the detector input appears as shown in Fig. 439. The rectified voltage across the detector output is shown in Fig. 440.

tifier and the voltage across the diode load resistor was applied to the vertical deflection plates. The internal sweep circuit was adjusted as for ordinary wave form observation.

The voltage across the detector input is shown in figure 439. The rectified voltage across the output circuit of the detector is shown in figure 440. The relation between the signal amplitude and the local heterodyning oscillator voltage amplitude can be shown upon the screen by noting the amplitude of the output signal as the oscillator voltage is varied over a prescribed range.

Industrial Applications

A number of very interesting industrial applications are described in the May, 1935 issue of *Electronics*. The author is J. M. Stinchfield. In connection with such industrial applications, they employ means of converting mechanical phenomena into electrical phenomena. For ex-

ample, the cathode-ray tube can be used as a size tolerance indicator. The capacity of a supplementary condenser, which influences the frequency of an oscillator, is controlled mechanically by the device related to the thickness of the item being checked. The voltage developed by the oscillator is applied to vertical deflection plates. The length of the line is used as the guide to tolerance or the tolerance is calibrated in frequency and the frequency generated by the test oscillator is compared with a standard frequency and the drift of the pattern upon the cathode-ray screen is used as an indicator.

Pressure changes are determined by means of the cathode-ray oscillograph, by having a quartz crystal, microphone diaphragm or any other device, which can convert pressure changes into electrical impulses, feed the vertical deflection plates through an amplifier.

Clock and watches may be compared with a standard, by having the sound impulses picked up by microphones and fed into the cathode-ray tube in quadrature so as to form a Lissajous pattern.

The speed of moving contacts can be compared with standard frequencies by having the contacts close a supplementary circuit.

A series of articles discussing the application of the cathode-ray oscillograph to industrial problems is running at the time of this writing in the monthly publication *Instruments*. The author is Ralph R. Bacher.

Other Radio Applications

A very elaborate discussion of the application of the cathode-ray oscillograph for direction finding in connection with radio signals, observation and study of atmospheric signals, prevention of collisions, etc., is described in detail in "The Cathode-Ray Oscillograph In Radio Research," by R. A. Watson-Watt, published by His Majesty's Stationery Office, London, England.

APPENDIX

Testing Mixer Circuits

Reference is made on pages 216 and 217 to testing mixer systems for distortion. This can be done by using the tuned amplifier mentioned in this volume. The signal from the test oscillator is fed through the amplifier to the cathode-ray tube and the character of the modulated wave is observed. This can be done at frequencies as high as several megacycles, providing that the modulated carrier signal is fed directly to the vertical deflection plates, without passing through the vertical deflection amplifier.

Then the signal from the test oscillator is fed into the receiver and the tuned amplifier is connected across the output of the mixer tube and tuned to the intermediate frequency of the receiver. The i-f. signal then is fed to the cathode-ray tube and the modulated wave examined. The character of the signal should be the same as that which was originally secured from the test oscillator.

Checking Test Oscillators

Reference is made on pages 209 to 220 to various test oscillators. Of the various test oscillators checked, only one delivered a sine wave when the modulated wave was demodulated. Since the preparation of those pages, several additional oscillators have been checked and have been found to deliver a sine wave. One of these is shown below. Incidentally, the exploitation of the cathode-ray oscillograph has created a very definite amount of interest in the development of test oscillators intended for service operations and which deliver a sine wave when the modulated wave is demodulated.

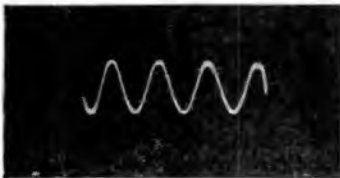

Fig. 441.



Fig. 442.

The sine wave at the left is the demodulated output of a recent commercial test oscillator. At the right is shown the audio response curve of a transformer which covers a band from 0 to 10,000 cycles. Note that one half of the pattern is here present, the other half of the trace being eliminated by shorting the sweep circuit during half of the revolution of the rotating condenser.

A-F. Frequency Modulator

In connection with the a-f. frequency modulators discussed on pages 280 to 286. the reference was made that one refinement was the removal of one of the traces of the double trace pattern, so that a greater amount of space was available upon the screen. An example of such a pattern, created by using a short circuiting contact, so that the sweep circuit was shorted during one

half of the rotating cycle of the frequency modulating condenser, is shown above. This is the response curve of an audio-frequency transformer over a 0 to 10,000 cycle band.

Photographing the Image

The following is offered to those who are interested in the photographing of the image which appears upon the cathode-ray oscillograph screen. The statements we mention are exactly in accordance with the photographing of the patterns shown in this volume and represent our experience.

It was found that practically identical results were obtained when either the RCA 906 cathode-ray tube, which fluoresces green, or the RCA 908 tube, which fluoresces blue, were used. Super-Plenachrome film pack was found to be most satisfactory as the emulsion of this film is responsive to both blue and green light.

The camera was of a standard type, with an f 4.5 lens and with a bellows long enough so that the camera could be placed from 10 to 18 inches from the cathode-ray viewing screen. Focussing of the image upon the ground glass is vital to successful photography.

Practically all the oscillograms illustrating this book were photographed with the camera stop at f 4.5, because maximum speed was highly desirable and depth of focus was of no importance. If a lens slower than f 4.5 be used, difficulty will be experienced in photographing moving patterns, because of the increased time of exposure necessary.

The image upon the screen may be photographed in daylight or in a darkened room. The choice depends upon the nature of the image, particularly, the intensity of the image. No hood is required over the cathode-ray tube. All of the photographs in this book, which show the screen, were taken in broad daylight. The determining influence is the image. If it is stationary and simple in character, it can be photographed in daylight. The other photographs shown in this volume, which appear with a solid black background, were taken in darkness. By darkness, we mean the shades were pulled down, so as to exclude the sun light. Every oscillogram shown in this volume is an unretouched photograph.

Concerning the speed of the lens, the highest speed consistent with good photography is desired. An idea of the type of image resulting from various exposure speeds can be had from the plate shown below. Six exposures were made upon the same plate, at speeds ranging from $1/25$ of a second to 3 seconds. The image was stationary and the 908 tube was used. The stop was set to 4.5. The frequency of the voltage being photographed was 1000 cycles.

As is evident the best detail is had at about $1/5$ th of a second. This checks with our experience. The majority of the photographs shown in this volume were taken at speeds ranging from $1/5$ to $1/2$ second. Those exposures which show the screen were taken at speeds of from $1/2$ second to about 1 second.

Moving patterns, unless they are moving fast, can be photographed at about $1/5$ th second with good results, providing that the intensity of the image is sufficiently great and it is properly focussed upon the camera. Such patterns were photographed in the darkened room. Proper focussing of the image upon the cathode-ray tube screen, likewise is important.

The size of the film is not very important—a convenient size is $2\frac{1}{4} \times 3\frac{1}{4}$ inches (6x9 cm.).

The camera must be mounted upon a substantial tripod if good pictures are to be secured. Enough trouble develops due to movement of the image, so that the situation should not be aggravated by having the camera move. As a matter of fact, we suspended a heavy weight from the head of the screw which mounts the camera upon the tripod, to secure rigidity.

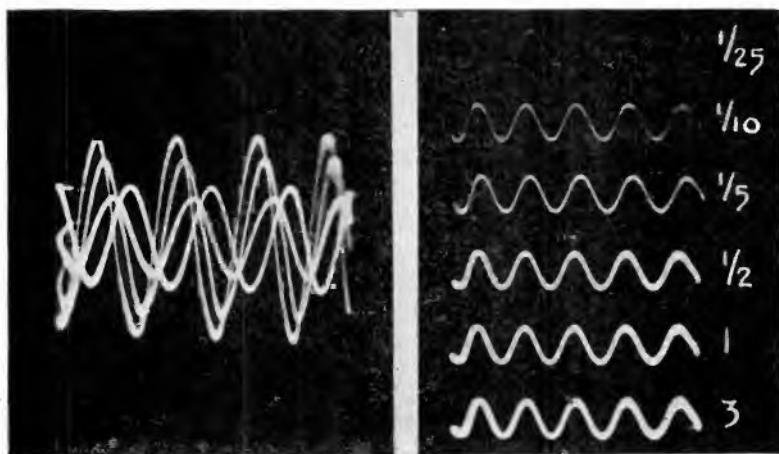

Fig. 443.

Fig. 444.

The oscillogram at the left is a quadruple exposure, each one being made at $1/5$ of a second, f 4.5. This illustrates the phase relations in a circuit containing capacity, inductance and resistance. The sweep was synchronized with the oscillator supplying the circuit. The illustration at the right shows the effect of exposure time upon the image. The numbers at the right indicate the time in seconds. The intensity and focus of the image were unchanged and the waves were positioned on the one film by elevating the lens.

Clough-Bregle Sweep

The oscillogram of figure 257 is slightly more linear than actually appears in the illustration. The state of non-linearity was augmented slightly by the fact that the other sweep which was used to spread the image was not a perfect saw tooth wave at 80 cycles.

High Frequency Sweep Circuits

A high frequency sweep circuit covering the range from about 4 to 12 megacycles is described in the June, 1935, issue of the *I. R. E. Proceedings*. The authors are T. T. Goldsmith, Jr. and L. A. Richards.

Simultaneous Traces

One of the units which has been found very helpful in connection with cathode-ray oscillographic equipment is a switching means whereby two or more voltages can be fed to the cathode-ray oscillograph for simultaneous appearance upon the screen. Actually, these patterns are not upon the screen at the same time; they appear alternately, but at such high speed that they appear to be upon the screen at the same time. Such equipment is suitable for the comparison of waveforms, phase, etc. By means of suitable biasing units within the equipment, the various images can be positioned upon the screen to suit whatever requirement exists.

One such commercial device is known as the Dumont electronic switch and consists of a switching tube, which is a multi-vibrator, and two amplifier channels, thus permitting the switching of two voltages from any source, and two patterns upon the screen. A mechanical arrangement consisting of a motor driven cam with contacts, enabling the application of three voltages from three different

sources is described in June, 1933, issue of *Electronics*. The author is C. Bradner Brown.

Signal Synchronized Sweep

A sweep circuit which will automatically synchronize with a signal over a very wide range of frequencies, is described in the May, 1935, issue of *Electronics*.

Sine Wave Relaxation Oscillator

Reference to relaxation oscillators in this volume stated that the output waveform was extremely distorted and rich in harmonics. An article describing a relaxation oscillator, which will deliver a sine wave output, is to be found in the March, 1935, issue of *Electronics*.

Checking A-F. Amplifiers

An article describing the checking of audio-frequency amplifiers with a saw tooth wave input voltage, is described in the March, 1931, issue of the *I. R. E. Proceedings*. The author is Herbert J. Reich. Distortion and phase can be determined.

Another article concerning audio amplifier checking, already mentioned in this volume, appeared in the September, 1927, issue of the *I. R. E. Proceedings*. The authors are Diamond and Webb.

Alignment

An article describing the application of the oscillograph to visual alignment appears in the October, 1932, issue of the *I. R. E. Proceedings*. The author is O. H. Schuck.

Frequency Analysis

An article describing the application of the oscillograph to the frequency analysis of a complex wave, appears in the October, 1932, issue of the *I. R. E. Proceedings*. The author is W. L. Barrow.

Resonance Curves

A method of obtaining frequency response curves with the cathode-ray oscillograph is described in the January, 1934, issue of the *I. R. E. Proceedings*. The author is Guenther Ulbricht.

DuMont 148 Cathode-Ray Oscillograph

Two views of this instrument are shown herewith. At this writing the circuit diagram of the unit is not available; in fact the information which follows was received just in time to be included in the second printing of this book.

The oscillograph employs either a type 34-H or 54-H DuMont cathode-ray tube, the former being a 3-inch and the latter a 5-inch tube. Two amplifiers, linear from 10 to 100,000 cycles, are provided. One can be used for horizontal and one for vertical deflection or the two amplifier stages can be cascaded to amplify the signal to the vertical deflection plates. When one amplifier is used the gain is approximately 25; when used in cascade, the gain is approximately 250. The amplifier gain controls have scales for the purpose of resetting and comparison.

Two views of the DuMont type 148 oscillograph. All the controls, with the exception of the spot positioning adjustments, can be seen on the front panel.



A basically new sweep design is used in this unit which has a number of advantages over previous circuits. The frequency range of the sweep is from 10 to 200,000 cycles per second, allowing both audio and radio frequency waves to be observed. A type 57 pentode is used as a current limiting tube, providing a substantially linear sweep over the entire range. The discharge tube used is a DuMont type 128 mercury vapor tube, which has a much faster de-ionization time than a gas discharge tube and increases the speed of the return trace. An important feature of this sweep circuit is that it can be synchronized with fractions of the wave as well as with multiples of the wave.

Two screw driver adjustments are provided at the side of the case for both vertical and horizontal beam-centering adjustment. A remov-

able calibrated scale, to be used in conjunction with the 54-H tube, is provided so that quantitative measurements can be made.

Reference to the illustration will show that all the controls are accessible on the front panel. These are the intensity, focus, fine and rough frequency, amplitude, vertical amplifier gain, horizontal amplifier gain, and the switching controls. It will be noted that the latter control permits six different amplifier arrangements by means of which the signal and sweep can be applied to the oscillograph plates. This is accomplished by means of a 6 position-five gang switch.

United Sound Engineering Co. CR-3 Oscillograph

This recently announced oscillograph incorporates a vertical and horizontal amplifier, a linear sweep oscillator, and both horizontal and vertical beam-centering adjustments. The frequency of the sweep oscillator is divided into eight logarithmically-spaced ranges and a control is provided for continuous variation of the sweep frequency. External, internal, or 60-cycle synchronization is available by means of a switch on the panel.

The horizontal and vertical amplifiers have identical characteristics and are linear from 15 to 100,000 cycles, being down about 20 db. at 300 kc. The range of the sweep oscillator is from 15 to 20,000 cycles. All the controls and terminals are conveniently located on the front panel. The instrument is completely a-c. operated and employs the following tubes: 906, 879, 885, 80, and two 57's.

United Sound Engineering Co. CR-5 Frequency—Modulated Oscillator

The extent of the frequency modulation in this unit is maintained approximately constant at about 20 kc. This is accomplished by varying the maximum capacity of the rotating condenser in accordance with the dial setting. An internal impulse generator provides a peaked waveform suitable for synchronization. Audio modulation is effected by means of a sine-wave oscillator, which can be used externally for audio work. Either a single or double image trace can be used.

Visual Alignment at 600 kc.

There has been some confusion as to the proper procedure to be followed in effecting the alignment of the series oscillator trimmer at the low frequency end of a band, say at 600 kc. To clear up this

matter we shall go over the procedure in some detail. To take a concrete illustration, we shall assume that the intermediate frequency is 450 kc. The first step after aligning the i-f. amplifier is to align the r-f., detector and oscillator shunt trimmers in the conventional way at the high frequency end of the broadcast band, say 1400 kc. With this completed, the signal generator (test oscillator) is set at 600 kc. and connected to the receiver antenna post. It should be understood that the frequency-modulated signal generator is producing not only 600 kc., but a band of frequencies ranging from say 585 to 615 kc. The receiver is tuned to 600 kc. and the resonance curve appears on the screen. From this point on we shall consider first the procedure when the single image system of frequency modulation is used.

In this case there will be just a single trace, the peak of which may or may not be in the center of the trace. The adjustment of the series oscillator trimmer should then be made so that the resonance curve has the greatest height, regardless of whether this maximum peak occurs in the middle of the trace. This is highly important and even though it may be necessary to change the receiver tuning slightly, the procedure is to adjust the trimmer for the greatest peak height. The significance of the peak being off center is that the calibration of the receiver is off at 600 kc. If the oscillator trimmer



Figs. 445, left, 446, middle, 447, right. Fig. 445 shows an incorrect adjustment of the padding condenser, whereas Fig. 446 shows the correct adjustment. In Fig. 447 the tuning has been changed to bring the peak to the center of the trace.

is adjusted so that the peak is in the center of the trace when the receiver and signal generator are tuned to 600 kc., then the sensitivity and selectivity of the receiver are sacrificed for the sake of an improvement in the calibration of the receiver. This is certainly an undesirable condition. Fig. 445 shows the *incorrect* adjustment which results when the peak is centered, whereas Fig. 446 shows the improvement in response which resulted when the series oscillator trimmer was adjusted for maximum height, in spite of the fact that the peak

happened to occur off the center of the trace. To bring the peak back to the center of the trace, the receiver tuning can be changed and the amount by which it must be changed to bring the peak to the center indicates how far off the receiver calibration is. Referring back to Fig. 447, the peak was brought to the center by changing the receiver tuning from 600 kc. to 595 kc. This means that the receiver calibration at 600 kc. is off by 5 kc. It should be clearly understood that the optimum adjustment is attained when the r-f. and detector stages are tuned to the incoming signal and the oscillator frequency is higher than the signal frequency by the amount of the intermediate frequency. In this case, the r-f. and detector stages are tuned to 600 kc. and the oscillator frequency is 1050 kc.

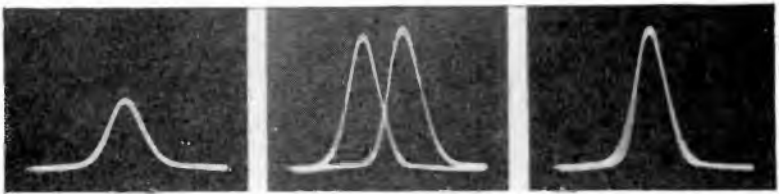

Figs. 448, left, 449, middle, 450, right. An incorrect adjustment of the series oscillator trimmer is shown in Fig. 448. Figs. 449 and 450 indicate the correct condition, the receiver tuning having been changed to obtain Fig. 450.

The procedure to be followed when the double image system is used requires further explanation. In general, a double trace will appear on the screen when the receiver and the signal generator are tuned to 600 kc. Now the important point is this: in contrast to the usual procedure, wherein the trimmer adjustments are made so as to bring the two curves into coincidence, in this case the series oscillator trimmer is adjusted for maximum output, regardless of whether this may or may not bring the two curves together. Fig. 448 shows the *incorrect* adjustment made so that the two curves are brought into coincidence. The improvement in sensitivity, when the series oscillator trimmer is adjusted so that the peak height of the curves is a maximum, is shown in Fig. 449. Note that while the curves no longer coincide, at the same time, the gain and selectivity of the receiver have been appreciably increased. The curves, of course, can be brought together by retuning the receiver. Again the amount by which it is necessary to change the receiver tuning is a measure of the extent to which the calibration is off. The appearance of the trace when the curves are brought together is shown in Fig. 450.

The Dayrad Series 65 Cathode-Ray Oscillograph

The panel view of this instrument is shown in the accompanying illustration. This oscillograph is designed to be used for visual alignment work in addition to the general uses for the oscillograph. It incorporates two audio amplifier stages, linear from 15 to 100,000 cycles which can be used to amplify the signal to both the vertical and horizontal deflection plates. Separate gain controls are provided for these amplifiers. Switches are provided for turning off the amplifiers independently of each other and for connecting the oscillograph input terminals directly to the cathode-ray tube plates or to the input of the amplifiers. In each case there is a condenser in the input circuit.

The range of the linear sweep circuit, which employs an 885 gaseous discharge tube, is from 15 to 15,000 cycles. This range is covered in eight steps, continuous coverage being obtained by means of a variable resistor. A synchronizing switch provides for internal, external and

On the right is shown the panel view of the Dayrad Series 65 Oscillograph. All the controls are on the front panel with the exception of the horizontal and vertical spot positioning controls, which are on the side of the cabinet. A 1000-cycle, frequency-modulated oscillator is incorporated in the unit.

Courtesy of The Radio Products Co.



60-cycle synchronization. The focus and intensity controls are located on the front panel; horizontal and vertical spot positioning controls are located on the side of the case.

A 1000-kc. oscillator is incorporated within the oscillograph unit, as is also a motor-driven condenser, which is used for frequency modulation. Two ranges of capacity are available by means of a switch. This motor-driven condenser unit provides a band width of 20 kc. for use in connection with visual alignment. The frequency modulator, which can also be used in conjunction with any standard test oscillator, is self contained for the 1000-kc. frequency. A fixed timing axis oscillator is used when the oscillograph is employed for visual alignment work.

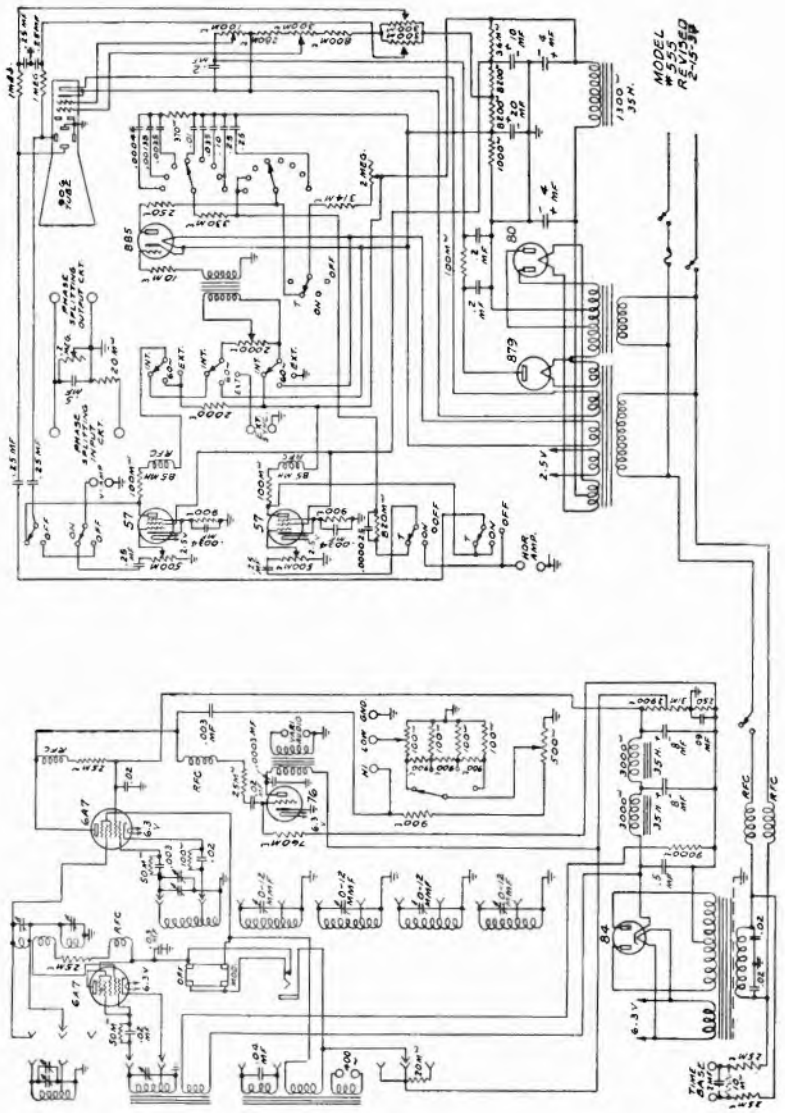

Schematic diagram of the Supreme Model 555 oscillograph. The functioning of the frequency modulator is explained on the opposite page.

This consists of a condenser charging circuit and shorting cam, which works on the same motor shaft as the frequency modulator; in this way the resonance curve is kept on the screen, regardless of shift in line voltage or change in motor speed.

Supreme Model 555 Cathode-Ray Oscillograph

This instrument is self-contained for both visual alignment work and for the usual oscillographic functions. It incorporates a signal generator, which covers the frequency range from 125 kc. to 60 mc., and which provides a frequency-modulated signal having a constant band-width over this range. Frequency modulation is effected by varying the permeability of an iron core, which is used in the tuned

The Supreme Model 555 Oscillograph has incorporated in it a signal generator with a frequency range from 125 kc. to 60 mc. There is also an a.-f. generator whose output ranges from 50 to 10,000 cycles.

Courtesy Supreme Instruments Corp.



circuit of the fixed-frequency oscillator. This is heterodyned with a variable-frequency oscillator and produces the range of frequencies mentioned above with a constant band-width of 24 kc. A transparent celluloid screen, calibrated in kc. off resonance, is provided for quantitative measurements.

The system of frequency modulation employed in this oscillograph is of interest. A 60-cycle sweep voltage is applied to the horizontal plates, and at the same time a 120-cycle current is passed through the partially-saturated iron core of the fixed-frequency oscillator which normally operates at 600 kc. This 120-cycle current is obtained from the output of a full-wave rectifier. As a result of the variation of the saturating current of the iron core, the oscillator frequency is varied from 588 kc. to 612 kc. at such a rate that the output of the oscillator sweeps through 600 kc. four times in each complete cycle of the horizontal spot movement. It follows, then, that four complete resonance curves are traced out each time the spot travels back and forth across the screen of the cathode-ray tube.

Typical resonance curves produced by this instrument are shown in the accompanying illustrations. Note that two of the resonance curves appear in the center of the screen and appear to be similar to the conventional double image patterns which appear elsewhere in this book. The two vertical lines appearing at the extremities of the pattern are in reality two additional resonance curves which appear as straight lines



The left pattern shows the circuit in resonance and that at the right, the circuit out of resonance. These oscillograms made with the Supreme 555.

because of the comparatively slow horizontal movement of the spot at the extremities of the screen. This slow movement is due to the fact that a sine-wave voltage is used for the horizontal sweep, as we mentioned above. The phasing of this 60-cycle sweep voltage is permanently adjusted at the correct value and no synchronizing adjustment is necessary when the oscillograph is used for alignment work.

It is important to note that the resonance curves which appear in the center of the screen are both due to frequency sweeping through resonance in the same direction. The fact that one image is reversed from left to right with respect to the other, is due to the fact that the spot is travelling in different directions for the two traces.

This type of double image pattern should be distinguished from the conventional type of pattern in which the two traces are due to resonance curves which are traced out by the frequency of the signal generator sweeping through resonance in different directions.

In addition to the r-f. signal generator, the oscillograph contains an audio oscillator, continuously variable from 50 to 10,000 cycles.

The oscillograph is provided with both horizontal and vertical amplifiers. The gain of these amplifiers is 40 and the frequency response is substantially flat from 20 to 90,000 cycles. The switching arrangement permits the signal under study to be fed through the amplifiers or connected directly to the plates. Each amplifier is provided with a gain control and a scale graduated in 50 divisions to facilitate comparative tests.

The range of the linear sweep circuit, which employs an 885 tube, is from 15 to 20,000 cycles. Synchronization is provided so as to

permit internal, external or 60-cycle synchronization. Included among the controls are the intensity, focus and spot positioning controls. The convenient arrangement of the controls is evident in the accompanying illustration.

Change in RCA TMV-122-B Oscillographs

The effectiveness of sweep synchronization at the higher frequencies in models bearing serial numbers up to 1000, can be improved by replacing condenser C-18 with a $\frac{1}{4}$ -watt, 10,000-ohm resistor. This condenser is easily accessible, being mounted at the end of the resistor-condenser board, which is in a vertical position near the front of the chassis. As may be seen by reference to the schematic, which appears on page 100, this condenser is shunted across the secondary of the synchronizing transformer T-2 and so tends to bypass the synchronizing voltage at the higher frequencies. There is no necessity for making this change unless the oscillograph is used at frequencies above 25 kc.

Hickok Model RFO-1 Cathode-Ray Oscillograph

The panel view and schematic of this instrument are shown in the accompanying illustrations. Designed to be used for both visual align-

On the right is the front view of the Hickok Model RFO-1 Oscillograph. The schematic diagram of this instrument will be found on the next page. In the revised model the spot positioning controls, as well as all the others, are on the front panel.

Courtesy Hickok Electrical Instrument Co.



ment and general work, this oscillograph incorporates an electronically frequency-modulated r-f. oscillator in addition to the usual features. Amplifiers which are linear to 100,000 cycles and which have a gain of 40, are included in both the horizontal and vertical deflection circuits. An 885 tube is used in the linear sweep circuit to provide a frequency range of 10 to 25,000 cycles. A synchronizing control permits

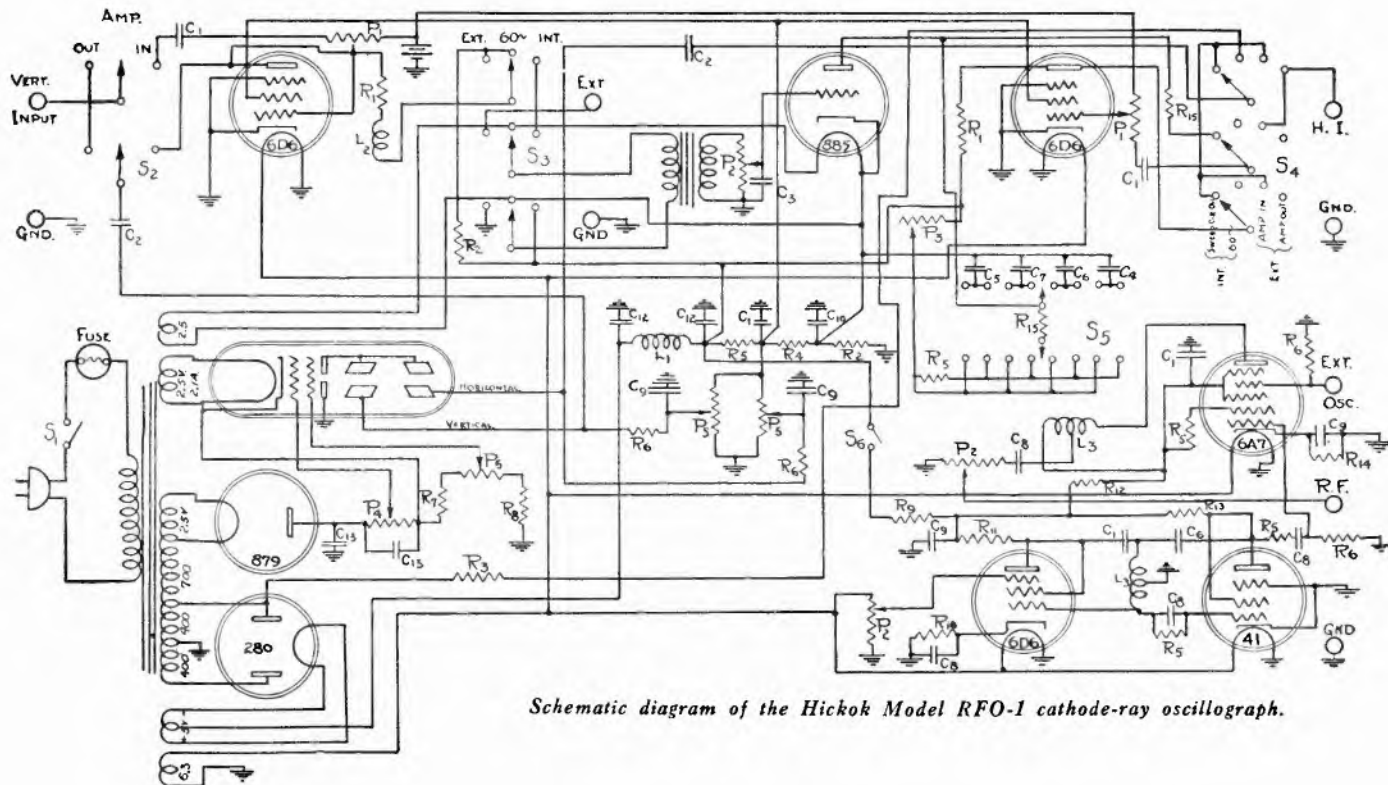

Schematic diagram of the Hickok Model RFO-1 cathode-ray oscillograph.

of either internal, external or 60-cycle synchronization. Focus and intensity controls, as well as horizontal and vertical positioning controls, are located on the front panel.

The radio-frequency section of the oscillograph unit provides a frequency-modulated output at 700 kc., the band-width being variable from 5 kc. to 30 kc. The output of this oscillator is variable up to 3 volts, and contains sufficient harmonic output to permit alignment up to 10 mc. The choice of self-contained frequency is convenient in that it permits visual alignment at both 700 kc. and at 1400 kc. This frequency-modulated oscillator can be used in conjunction with a standard test oscillator to provide a frequency-modulated signal of variable frequency by the usual heterodyne method, the extent of frequency modulation remaining constant.

The tubes used are 1-906 cathode-ray tube; 1-879 half-wave rectifier; 1-885 gaseous discharge tube; 1-6D6 as an electronic frequency modulator; 2-6D6's as horizontal and vertical deflection amplifiers; 1-41 as an r-f. oscillator.

Triumph Model 180 Frequency-Modulated Oscillator

This frequency-modulated oscillator, shown in the accompanying figure, covers the range from 100 kc. to 30 mc. and provides a band-

The range of the Triumph frequency-modulated oscillator, Model 180, is from 100 kc. to 33 mc. The frequency modulation is accomplished electronically.

Courtesy Triumph Mfg. Co.



width constant at 30 kc. over this entire range. Constant band-width is secured by heterodyning a frequency-modulated "fixed-frequency" oscillator, working at 840 kc., with a variable-frequency oscillator contained within the unit. A dual attenuator is provided for controlling both the input to and the output of the mixer tube. The frequency modulation is accomplished electronically. If a frequency-modulated signal is not desired, a switch is provided so that the instrument can be used for conventional alignment work.

Triumph Model 800 Cathode-Ray Oscillograph.

This oscillograph employs two 6C6's as vertical and horizontal amplifiers. Individual gain controls are provided, which give a maximum

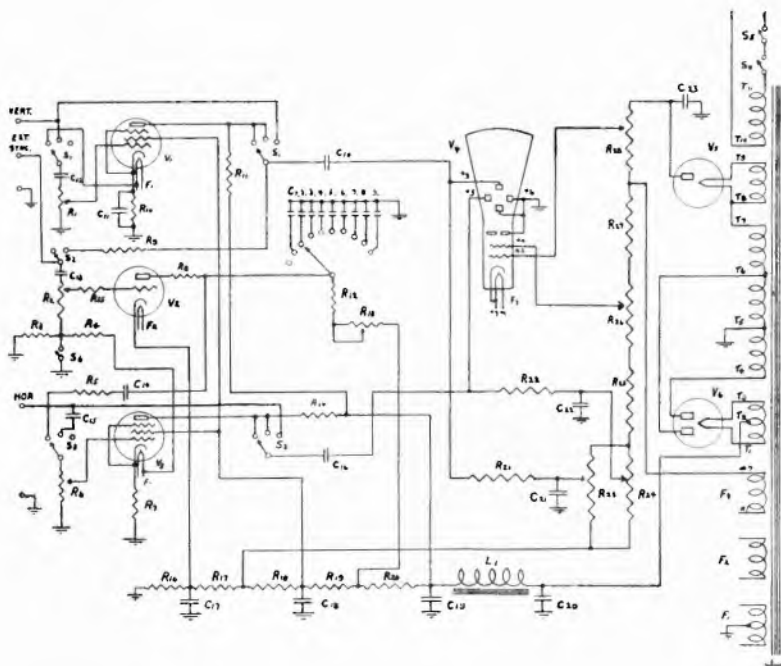

Schematic diagram of the Triumph Model 800 cathode-ray oscillograph. Note the two rectifiers, the type 879 supplying the high voltages for the cathode-ray tube, type 906, and the type 80 supplying the bias and plate voltages for the remainder of the tubes.

amplification of approximately 40. A type 80 tube is used to supply power for both amplifiers and for the linear sweep circuit, which employs an 885 tube. A type 879 rectifier supplies the high voltage requirements of the 906 cathode-ray tube.

The input impedance, when using either amplifier, is 500,000 ohms. When using the direct connection to either set of plates, the input impedance is one megohm with d-c. blocking condensers within the unit. The deflection sensitivity is 75 volts per inch or 27 rms volts per inch directly to the plates and with either the vertical or horizontal amplifiers, the sensitivity is increased to about 2 peak volts per inch or 0.7 rms volts per inch.

Included among the controls, which are arranged as shown in the

On the right is shown the Triumph Model 800 oscillograph, the schematic diagram of which appears on the opposite page. The various controls are described in the accompanying text.

Courtesy Triumph Mfg. Co.



accompanying illustration, are the following: focus, intensity, vertical selector switch (providing a 60-cycle, direct, or through amplifier connection to the vertical plates), internal-external synchronizing switch, locking control, step and vernier sweep-frequency controls, horizontal gain, vertical gain, and horizontal selector switch. The schematic is shown in the accompanying figure.

R.C.A. Type 913 Cathode-Ray Tube

A new cathode-ray tube which is characterized by its small size and low cost, has recently been announced by R.C.A. While this tube differs in construction from the larger tubes which have been previously described, the application of the tube is essentially the same. For this reason it is unnecessary for us to explain here how the tube is employed for the study of waveforms, modulation, frequency measurements, etc.

The 913 cathode-ray tube is of the high-vacuum type, utilizes the all-metal type of construction, and employs a viewing screen which has a diameter of approximately one inch as compared with the conventional tube, which has a diameter of at least three inches. It contains two sets of deflection plates which are at right angles to each other, and, as in the case of the 906, one plate in each set is tied to a common point inside the tube. The low voltage requirements of the tube are of special

interest inasmuch as a brilliant green trace is obtained at voltages as low as 250 volts.

The introduction of this tube has already greatly extended the field of application of the cathode-ray tube and promises to continue to do so. In many cases this does not mean that the larger type of cathode-ray tube will be displaced, but rather that the low cost, small size, and low voltage requirements of the 913 are making for its use in equipment which would not ordinarily employ a cathode-ray tube. In service equipment where a large image, although desirable, is not essential, the new tube is rapidly becoming an integral part of the equipment being offered to the serviceman by the instrument manufacturers. Aside from the additional saving in space and the increased portability, made possible through the use of the 913 in such equipment, the lower cost is enabling more and more servicemen to afford and enjoy the advantages and help of the cathode-ray oscillograph in diagnosing faults in radio receivers and public address equipment.

The Alignment of Automatic Frequency Control Circuits

The cathode-ray oscillograph and the frequency modulated signal generator can be used for aligning automatic frequency control circuits, and in this connection two typical oscillograms indicating correct and incorrect alignment are shown in the accompanying figure.

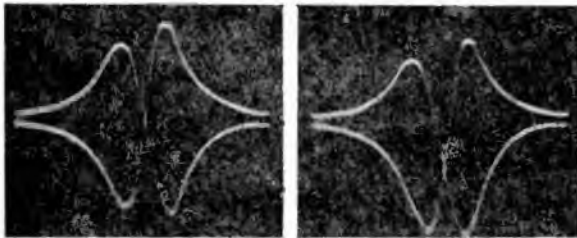

The left oscillogram shows the A.F.C. circuit in correct alignment and the other, incorrect alignment.

While it is not possible for us to go into any detail as to the various connections and considerations involved in this type of alignment work, the entire subject of automatic frequency control is fully covered in another book by this author.

INDEX

Alignment

(See Resonance Curves)

- at wrong frequency, 269
- Automatic Frequency Control, 332
- circuit connections 260, 266
- incorrect band width, 269, 271
- insufficient band pass, 271
- rectification for visual, 257
- requirements for correct, 261
- 600 kc., 320

Amplifier

- alignment of r-f. and i-f.
(See Resonance Curves)
- calibration of oscillograph gain controls, 176, 177
- checking audio overload of, 188, 189, 190, 191, 192, 193
- checking Class B, 201, 202, 203, 204
- checking frequency response of, 280-286, 315
- checking Class C (See Transmitter Adjustment)
- checking i-f. overloading, 193, 194, 195, 196, 197, 198
- checking phase inversion of, 207, 208, 209
- checking tone control action of, 224, 225, 283, 284, 315
- distortion in, 185, 186, 187, 188, 189, 190, 191, 192, 193
- effect of—on apparent waveform, 121, 128, 129, 130, 131
- horizontal deflection, 4, 93, 94, 97, 100, 101, 102, 103, 106, 107
- hum in, 220, 221, 222, 223, 224
- phase shift in, 134, 135, 136, 137, 190, 192, 193, 199, 200, 201, 318
- rectification in, 301
- sweep circuit, 100, 102, 103, 106, 107
- vertical deflection, 4, 93, 94, 97, 100, 101, 102, 103, 106, 107

Anode

- general, 4
- RCA, 8, 9, 14
- voltage in series with, 155
- Western Electric, 7, 17

Axis

- "X"—30, 32, 33, 35, 45, 50, 110, 135, 136, 152

- "Y"—30, 32, 33, 35, 45, 50, 110, 135, 136, 152

Beat patterns

312

C-W detection

313

Calibration

- AC ammeter of, 177
- AC voltmeter of, 173
- DC ammeter of, 172
- DC voltmeter of, 168
- frequency, 118, 123, 124, 125, 139, 141-160
- oscillator, 157
- of sweep as standard, 156
- voltage sensitivity, 24, 168-172, 173, 174, 175

Cathode

- cold, 1, 4, 6
- hot, 1, 2, 3, 7, 8, 9, 17

Cathode-ray tube

- Dumont, 5
- National Union, 5
- RCA, 5, 8, 331
- types, 2, 5
- Western Electric, 7

Condenser power factor

206, 207

Current measurements

- a-c., 177
- d-c., 172

Deflection

- coils, 20, 44
- direction of, 22-37, 44, 110, 113
- electrostatic, 3, 5, 7, 9, 20, 169, 170, 171, 173
- magnetic, 3, 5, 20, 44, 163, 166
- plates, 3, 5, 7, 9, 20, 26, 77, 110, 171
- sensitivity, 3, 4, 25, 171
- voltage, 3, 20, 25, 41, 48, 49, 77, 81, 83, 169, 170, 171, 173

Demodulator output

- 193, 194, 195, 196, 197, 198, 199, 213, 214, 215, 216, 217, 259, 281, 313

Demodulated wave

- 213, 214, 215, 216, 217, 313

Electric field

- direction of, 23, 25, 44

- Focusing**
 electrostatic, 10, 14, 114
 gas, 3, 10, 17
 magnetic, 10, 19
 optical analogy of, 10, 11
- Frequency**
 comparison of, 137, 142-160
 distortion, 186, 280
 limit of amplifiers, 97
 limit of sweep circuits, 70, 71, 108, 317
 standards, 73, 139, 156
- Frequency modulators (A-F)**
 280-286
- Frequency modulator (R-F)**
 constant band width type, 231, 274
 Clough-Brengle motor driven, 237
 double image, 245, 246, 247, 248, 249
 dynamic input capacity type, 235
 electrically operated, 233, 235
 iron core type, 233
 motor driven condenser, 228-233, 235
 oscillator circuits, 228, 229, 231, 233, 256, 258
 RCA modulating condenser, 236
 single image type of, 250, 254, 255, 259, 274-278
 sweep circuits used with, 237, 238
 synchronizing pulse from, 237, 242
 synchronization of, with horizontal sweep, 242-250, 272, 273
 Triumph, 329
 United Sound Engineering, 320
 variable band width type, 228, 229
- Glow tube oscillator**
 56
- Hysteresis measurement**
 166-168
- Linear time axis**
 (See Sweep Circuits)
- Lissajous figures**
 79, 81, 83, 84, 87, 89, 123-126, 132, 135-160
 amplitude of voltages, 139
 circular, 154, 155
 frequency comparison with, 137
 frequency limits, 138
 frequency standards, 139, 156
 interpreting, 141-153, 156-160
 Lissajous-Ryan patterns, 206, 207
 phase patterns, 79, 81, 83, 87, 89, 135-137, 145, 146
 phase splitting circuits, 154, 155
 power factor patterns, 206, 207
- Magnetic field**
 direction of, 44, 163, 166
- Modulation**
 (See Transmitter)
 hum, 221, 310
 percent of, 295
- Modulated waves**
 checking, in i-f. amplifiers, 194-199
 distortion of, 301
 hum in, 221
 stopping, 301, 302
 test oscillator, 209-217
- Oscillators**
 audio output of, 213, 214
 block patterns, 211, 219, 295
 distorted output from, 218, 219
 modulated output from, 213, 214, 215, 216, 217, 304-310
 multi-vibrator type, 71
 output wave correction, 218, 219
 relaxation, 59, 67, 69, 72
 sine output from, 211, 218, 219
 transmitter adjustment, 302-310
- Oscillographs**
 Clough-Brengle, 107
 Day-Rad, 323
 Dumont, 99, 319
 Egert, 257
 General Radio, 108
 Hickok, 327
 Kaltman-Romander, 103
 National, 105
 National Union, 95
 RCA, 99, 327
 Supreme, 325
 Triumph, 330
 United Sound Engineering, 320
- Peak voltage measurement**
 173
- Persistence of Vision**
 37
- Phase**
 amplitude of voltage for tests, 79-81, 135-137
 distortion, 199-201, 265
 inversion, 207-209
 measurements, 135-137
 of Lissajous pattern, 79, 81, 83, 84, 87, 89, 135-137, 145, 146
 patterns, 79, 81, 83, 84, 134-137, 142, 143, 145, 146, 190-193
 relations in amplifiers, 189-193
 relation between a-f. and modulated

- wave, 297-300, 304, 305
- relation between sweep and other voltage, 49, 79, 81, 83, 84, 124, 126, 245-250
- relation between voltages, 79, 81, 83, 84, 87, 89, 135-137, 145-146, 180-185
- shift, 166
- shift due to synchronization, 126
- splitting circuits, 154, 155
- Photography**
 - of images, 316
- Quadrants**
 - position of, 31, 39
- Regeneration**
 - in amplifiers, 270, 271, 277, 308
- Response curves**
 - A-F., 282, 283, 284, 285
 - R-F. (See Resonance curves)
- Resonance curves**
 - asymmetrical, 246, 247, 248, 249, 251, 255, 262
 - circuit connections for, 260, 266
 - conditions of alignment, 269
 - damped circuit, 279
 - determining band width of, 273
 - development of, 245, 246, 247
 - dimensions of, image, 278
 - double image, 245, 246, 247, 248, 249, 251, 267, 269, 271, 272, 273
 - double peaked, 246, 247, 248, 252, 265
 - insufficient band pass of, 271
 - not synchronized, 272, 273
 - overall receiver, 277
 - overloaded tube circuit, 269, 276
 - phase distorted, 265
 - regeneration in circuit, 262, 270, 271, 277
 - single peak, 245, 248, 249, 253, 255, 261, 265, 267, 269, 270, 271
 - square top, 245
 - symmetrical, 245, 248, 249, 252, 253, 255, 261, 265, 269, 271, 277
 - triple peak, 249, 261, 262, 277
 - with carrier voltage, 267
 - with harmonics, 268
 - with modulation on, 267
- Screen**
 - quadrants of, 31, 39
 - size of, 5
- structure of, 3
- vision, 37
- Sensitivity**
 - 3, 4, 18, 24, 168-175
- Spot intensity**
 - operation of, control, 114
 - RCA, 15
 - Western Electric, 17, 18
- Spot position**
 - 5, 8, 14, 22, 27-37, 39, 40, 44, 110-114
- Spot size**
 - 20, 110, 115
- Structure**
 - Dumont tubes, 5
 - National Union tubes, 5, 8, 9
 - RCA tubes, 5, 8, 9
 - Western Electric tubes, 7, 8
- Sweep voltage**
 - amplitude of, 68, 121, 122, 130
 - circuits, 59, 67, 69, 71, 72, 97, 100, 104, 105, 106, 256, 258
 - condenser charge, 65
 - control of, 117
 - development of, 48-52
 - distortion due to, 75, 121, 122, 126, 131
 - electronic systems for generating, 59, 67, 69, 71, 72, 97, 100, 104, 106
 - frequency modulator, 233, 236, 238-250, 254, 271, 276, 280-286, 315
 - frequency of, 70, 71, 108, 118, 317
 - frequency standard, 73, 156
 - linear, 63, 65, 68, 131
 - multi-vibrator source of, 71
 - non-linear, 61, 65, 68, 105, 131
 - patterns, 61, 63, 65, 68, 73, 238
 - potentiometer source of, 27-37, 49, 57
 - relation between other voltage and, 49, 52, 55, 74, 75, 79, 81, 83, 91, 118, 121, 122, 126, 131, 312
 - synchronization of, 123, 124, 125, 126, 127
 - tubes, 59, 67, 69, 71, 72, 97, 100, 104, 106
- Synchronization**
 - control adjustment, 119, 157, 211
 - during alignment, 236, 237, 272, 273
 - external, 127
 - in commercial units, 97, 100, 104, 106

- over, 126
 - relation to vertical amplitude, 129, 130
 - under, 123, 124, 125, 129
 - 60 cycle pulse, 128
- Transmitter**
- Adjustments of, 294-310
- Trapezoidal patterns**
- development of, 297, 299, 300
 - normal, 295, 297, 304, 309
 - overmodulation, 300, 305, 306, 307, 309
 - patterns, 295, 297, 299, 300, 304-310
 - percent modulation, 295, 296
 - phase shift in, 299, 304, 305
- Tube characteristics (dynamic)**
- electromagnetic deflection, 166
 - electrostatic deflection, 160-163
- Vibrators (auto-radio)**
- 287-293
- Voltage measurements**
- a-c., 173
 - d-c., 168
- Waveforms**
- by magnetic deflection, 163-165
 - block patterns showing, 211, 219
 - checking demodulated, 198, 199, 204, 205
 - class B operation, 204
 - Clough-Brengle sweep, 238, 317
 - complex, 178-185
 - development of, 74-76
 - distorted, 127
 - distortion in amplifiers, 185-193
 - distorted, in Lissajous patterns, 147
 - distortion of, by non-linear sweep, 75, 131
 - effect of exposure on, 317
 - horizontal amplitude, 121, 122, 130
 - hum modulation, 221
 - presence of carrier in, 199
 - power supply, 224
 - selection of sweep frequency, 118, 119, 122, 124, 125
 - showing phase distortion, 200
 - study of, 178-185
 - sweep, 61, 63, 68, 73
 - sweep circuits for studying, 47-76
 - synchronizing control, 119, 120, 123-127
 - test oscillator, 209-220
 - vertical amplitude, 128, 129
 - vibrator, 287-293

