

*Directional Antenna  
Patterns*

**by Carl E. Smith**

# *Directional Antenna Patterns*

by Carl E. Smith, E. E., President  
Cleveland Institute of Radio Electronics  
Carl E. Smith Consulting Radio Engineers

Directional Antenna System, WDOK, Cleveland, Ohio.

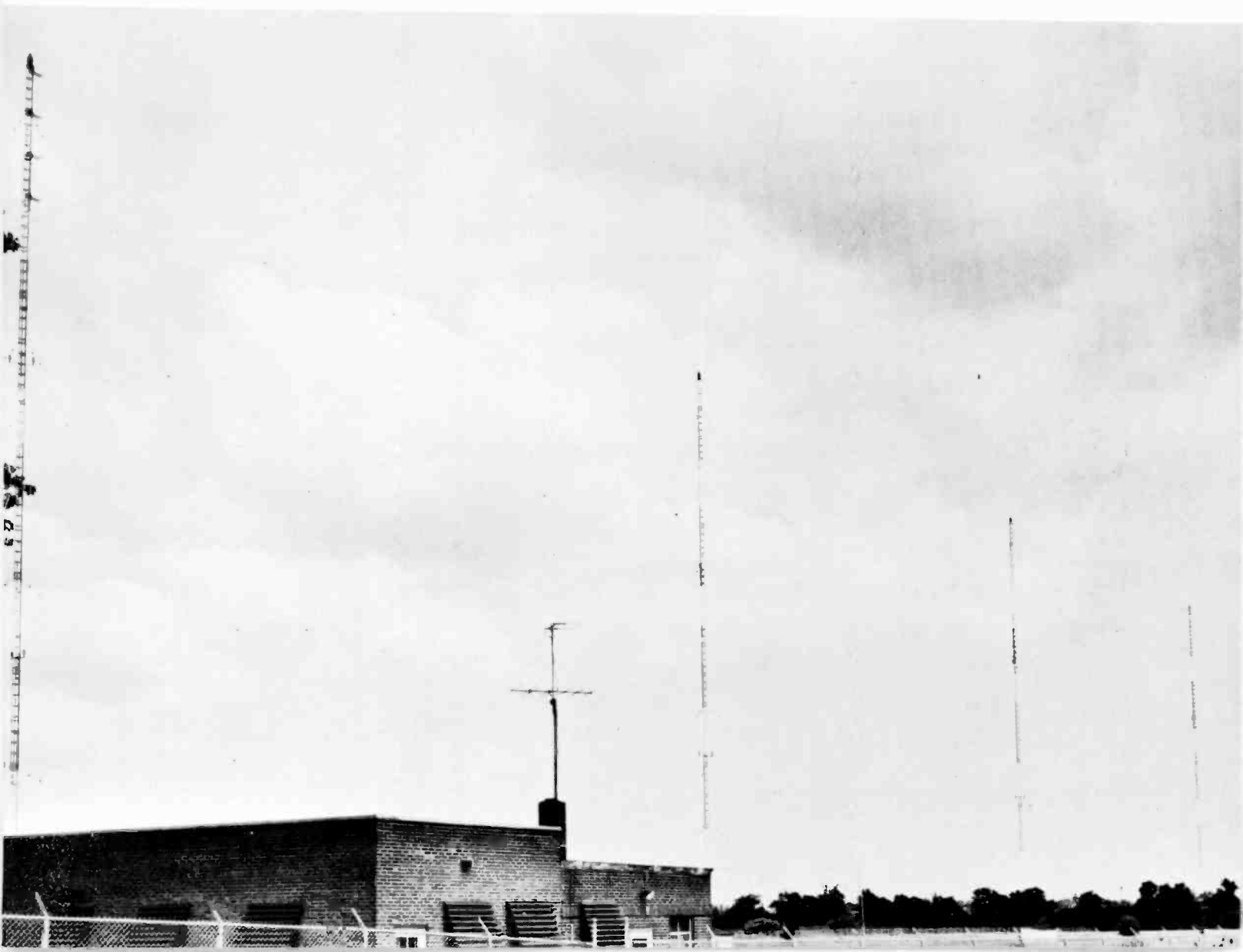

# CONTENTS

PAGE	TOPIC
iii	Preface to First Edition
iv	Preface to Second Edition

## PART

### 1

#### THEORY AND APPLICATION

1.1	1	Fundamental Properties
1.1	a	Introduction
1.1	b	Purpose
1.1	c	Control of pattern shape
1.2	d	Determination of pattern size
1.2	2	General Treatment
1.2	a	Standard reference antennas
1.8	b	Vertical radiation characteristics
1.10	c	Directivity definitions
1.15	d	Generalized equation to determine pattern shape
1.18	e	Directional antenna parameters
1.18	f	Systematization of directional antenna patterns
1.25	3	Bibliography
1.29	4	Electromechanical Calculator Photographs

## PART

### 2

#### SYSTEMATIZATION OF TWO TOWER PATTERNS

## PART

### 3

#### SYSTEMATIZATION OF THREE TOWER PATTERNS

## PREFACE TO FIRST EDITION

Directional antenna design is a specialized field of communication engineering requiring considerable mathematics and experience or education to become proficient. Furthermore, the computations in many instances become very involved and lengthy. Therefore, much time may be saved in making a design if suitable formulas and a good collection of patterns are available. The purpose of this book is to aid the design engineer by furnishing a number of useful formulas and a lengthy collection of systematized directional antenna patterns. The design formulas are supported by suitable developments since most of us do not desire to accept an unknown formula.

There is quite a wide variety of nomenclature used in directional antenna designs. Reviewing designs on file with the Federal Communications Commission reveals that practically every consultant has his own pet way of presenting the information and almost invariably uses his own variety of symbols. Recently, in collecting parameters for directional antennas from the FCC files, it was revealing to observe how difficult it was to determine some of the pertinent factors. In this book considerable thought has been given to nomenclature and in most cases the selection has been made to fit in with FCC practice, in so far as possible, and still maintain simplicity and clarity. It is hoped that some standardizations can eventually be made so everyone can speak the same language with similar symbols. The author would welcome any constructive criticisms to the nomenclature presented in this book, as well as pointing out errors which are bound to occur in a book of this nature. The book has been made loose-leafed for ease in making additions and changes.

Due to the lack of systematized directional antenna patterns an electro-mechanical calculator was constructed prior to World War II. In the fall of 1941, the machine was completed and the work was started to systematize two and three tower directional antenna patterns. The work was faithfully carried on during the war years by the operators at the WHK transmitter in Cleveland, Ohio, with the result that we now have all of the patterns that were contemplated when the systematization was started.

The electro-mechanical calculator used to systematize the patterns has proven to be a very useful instrument and with the scientific advances during the war it is hoped that a more precise machine can be constructed at an early date. In any event, it is believed, that if the patterns in this book are used merely as a guide to show trends, and not necessarily to show precise patterns, that the systematization will have served its purpose.

In the preparation of a book of this nature it is not possible to give credit to everyone involved, however, the author would like to mention some of the highlights. Mr. William G. Hutton worked with the author from the beginning of this project. In fact, at one time, the systematization project was started on his mechanical calculator and after drawing a couple of patterns it was decided that it would be quicker and easier to design a special machine to do the job.

The author wishes to give particular credit to the United Broadcasting Company and Radio Station WHK for being sympathetic to the project and furnishing the spare time help of their technicians to operate and maintain the electro-mechanical calculator. It is indeed a pleasure to mention the following men who did the bulk of the systematization work:

James Sturdevant, over 7,000 patterns.  
Charles Carment, over 800 patterns.  
P. C. Tuttle, over 800 patterns.

In preparing the text material the author wishes to give credit to the following: Edgar F. Vandivere, Engineering Department of FCC who furnished some of the basic notes for the mutual resistance method of determining pattern size; J. F. Morrison, Bell Telephone

Laboratories, for the mutual impedance data plotted in Figs. 30 and 31; William G. Hutton, for the mutual impedance data plotted in Fig. 32; Dr. Edward C. Jordan, University of Illinois, for the mutual impedance data plotted in Figs. 33 to 37; Calvin S. Warner, United Broadcasting Company, for his excellent drafting of the figures; and Mr. James Harvey, Cleveland Institute of Radio Electronics, for his patience in composing Part I.

Carl E. Smith

Cleveland, Ohio  
June, 1946

#### PREFACE TO SECOND EDITION

The second edition title has been changed from "Directional Antennas" to "Directional Antenna Patterns" since all of the directional antenna patterns have been retained and most of the "Theory and Design of Directional Antenna Systems" has been published in a companion book that is more complete and up to date than the original edition.

The first part on theory and application has been thoroughly revised to cover information not contained in the companion book, "Theory and Design of Directional Antenna Systems." The primary purpose of this section is to give

the information necessary to make the patterns more useful. The second and third parts containing the systematization of two and three tower patterns has not been altered.

Since Parts II and III represent over four man years of work, it was not practical to rerun the patterns to improve the accuracy. As stated in the first edition preface, these patterns are to be "used merely as a guide to show trends, and not necessarily to show precise patterns." The word field intensity should read field strength to conform with the IRE definition.

Carl E. Smith

Cleveland, Ohio  
January, 1958

## THEORY AND APPLICATION

## 1. FUNDAMENTAL PROPERTIES

a. Introduction. – The purpose of a radio broadcasting station is to transform sound waves into radio waves that can be picked up by radio receiving sets. The utility of this service to the public depends upon: (1) Signal Strength, (2) Program Content, and (3) System Distortion. Of these factors, the radio broadcasting station engineer is concerned with producing an intense signal that will override noise and undesired signals in the receiving sets being served and with minimizing distortion in the audio and radio facilities of the station.

The antenna is the last point in the system under the control of the radio broadcasting station. Radio waves radiated from the transmitting antenna are propagated through space to the receiving antenna. The only control over these propagated waves is the selection of the antenna site, the polarization, and the intensity of the signals leaving the transmitting antennas. The selection of the antenna site is determined by many considerations, such as; ground constants, terrain, distance and direction to the populated areas to be served, distance and direction to the areas to be protected, and last but not least is the availability of a suitable land area to install the necessary towers and ground system.

For standard broadcast stations, vertical polarization is used because of its superior ground wave propagation characteristics and the simplicity of antenna design. The intensity of the signal from the transmitting antenna, in any given direction, depends upon the output power of the transmitter and the antenna design. Since the output power is regulated by the Federal Communications Commission for the class of station involved, the only factors remaining under the engineer's

control are the antenna siting and design. These factors go hand in hand when designing directional antennas for broadcasting purposes.

b. Purpose. – Directional broadcasting antennas are required for one or more of the following reasons:

(1) Protect the service area of other broadcasting stations by causing the waves to cancel in these directions.

(2) Increase the service area of a broadcasting station, particularly in the direction of densely populated areas, by causing the waves to be reinforced in these directions.

(3) Eliminate multiple ownership problems by controlling one or more of the directional antenna patterns of radio stations owned by the same company.

(4) Control service area to minimize population lost due to interference within the normally protected contour.

c. Control of Pattern Shape. – The usual problem in broadcast practice is to mould the radiation pattern into the desired shape to cover the service areas and give the required protection to other radio stations. As a matter of economics, it is desirable to do the job with the minimum number of antennas. With severe requirements, the number of antennas must be increased until the radiation pattern can be made to conform to the required shape. As a general rule, two stations can be given the required protection with two towers; three stations can be completely protected with three towers in line or if the protection is not severe, it is possible many times to do the job with two towers. With four towers it is always possible to completely control the nulls toward four stations; however, if the job can be done

with three towers there is a saving of the cost of one tower.

In controlling the pattern shape, consideration has to first be given to fulfilling the conditions of the required protection to other radio stations in accordance with the Rules and Regulations of the Federal Communications Commission. The FCC Rules are an excellent practical guide for allocation work. The Standards of Good Engineering Practice incorporated in the Rules and Regulations was compiled by FCC from extensive data collected by its Engineering Department over a long period of time. This material is under almost constant revision as the art progresses.

The next consideration is to locate the directional antenna system so that the horizontal lobes will be directed toward the population areas to be served without having too many people within the blanket area, that is, the area near the transmitter where the signal is so strong that other radio stations cannot be received without objectionable interference and still be able to serve the business district with at least 25 millivolts per meter field strength.

d. Determination of Pattern Size. - Pattern size is determined by the class of station and efficiency of the antenna system. The power for the class of station is regulated by the Federal Communications Commission as outlined in Part 3 of the Rules and Regulations. In general, the power ranges from 50 kilowatts for clear channel stations to 5 kilowatts for regionals down to 250 watts for local stations. The predominance of directional antenna designs are for regional stations which have to protect radio stations in other regions of the country. A few are used on clear, but none on local channels.

The efficiency of the antenna system depends upon the antenna design. It is always desirable to maintain a high efficiency in order that a high percentage of the output power of the transmitter may be radiated. To do this it is sometimes necessary to use a more complicated directional antenna system to give the required degree of protection to other radio stations. In other words, a

low efficiency simple antenna system might give the required protection, but would not meet the FCC minimum requirement of 175 millivolts per meter root-mean-square unattenuated field strength for one kilowatt at one mile in the horizontal plane.

## 2. GENERAL TREATMENT

- a. Standard Reference Antennas. -  
 (1) Uniform Spherical Radiator...  
 The Uniform, Omnidirectional, or Isotropic radiator, in free space, is taken as THE Standard Reference Antenna because it has no directivity. Such an antenna is illustrated in Fig. 1. It is defined as a theoretical antenna which radiates waves having the same field strength in all directions. Actually such a radiator of radio waves cannot be realized, because all radio antennas have directional properties. In the case of the acoustic waves, this standard is represented by a sphere pulsating radially.

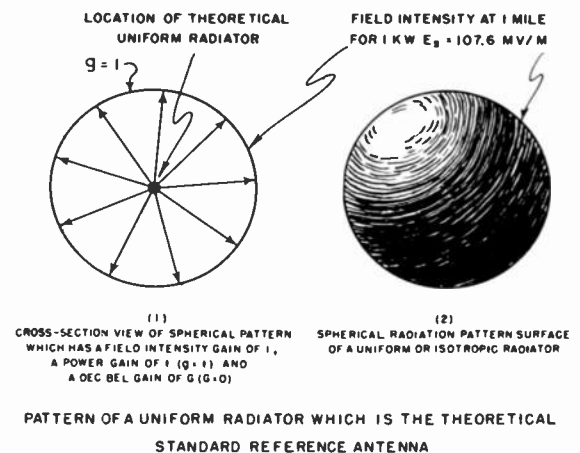

Fig. 1

For a 1 kw power source, a uniform radiator will produce a field strength of -

$$E_s = 107.6 \quad (1)$$

where  $E_s$  = millivolts per meter unattenuated field strength at one mile for one kilowatt.

This standard has come into rather common use. With this information, the figure of merit of other antennas can be compared with this basic standard. Other secondary standards for free space may be selected and used as convenience demands.

(2) Uniform Hemispherical Radiator... If a uniform radiator is placed at the surface of a perfectly conducting earth, all of the power must be radiated in the hemisphere above the surface of the earth as shown in Fig. 2. For a given power source, the power flow will have twice the intensity of a uniform radiator in free space; hence, the power gain is said to be 2. For this case, the field strength gain is  $\sqrt{2}$ , therefore, the field strength is  $107.6\sqrt{2}$  or,

$$E_s = 152.1 \quad (2)$$

where  $E_s$  = millivolts per meter unattenuated field strength at one mile for one kilowatt.

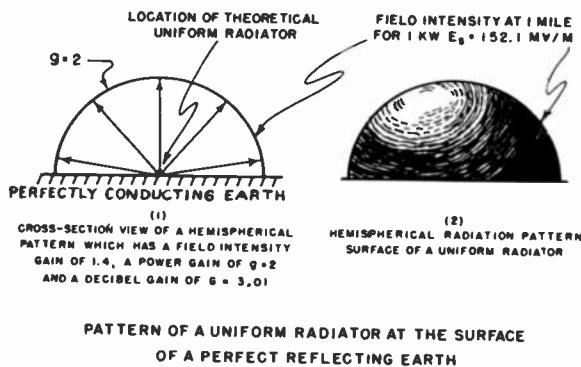

Fig. 2

At the present state of the art this antenna has only academic interest; however, it is a standard for antennas at the surface of the earth, such as radio broadcasting antennas. It is particularly useful in the computation of antenna gains. This type of antenna can be considered as a standard for determining the directivity of antennas located on the surface

of the earth.

(3) Current Element Antenna in Free Space... An electric current element in free space, sometimes referred to as an elementary doublet or dipole, consists of a very short conductor (mathematically of infinitesimal length) having a uniform current distribution. This infinitesimal antenna is universally used in developing the radiation property of an antenna of any configuration. This current element antenna is a mathematical convenience only, because such an antenna in practice for a specified field strength would require excessive transmitter power because of the high losses due to the radiation resistance being low in comparison to the loss resistance encountered in practice. The field strength at any distant point in space as shown in Fig. 3(a) is given by:

$$E = \frac{60\pi}{d\lambda} I (\delta G) \cos \Theta \quad (3)$$

or

$$= \frac{60\pi f}{dc} I (\delta G) \cos \Theta$$

where  $E$  = field strength in volts per meter at point  $P$

$$\pi = 3.1416$$

$d$  = distance in meters from current element to the point  $P$

$\lambda$  = wave length of radiated wave in meters

$f$  = frequency of current in cycles per second

$c = 3 \times 10^8$  meters per second, the velocity of light

$I$  = effective current in amperes flowing in the conductor

$\delta G$  = elementary length (or height) of conductor measured in meters

$\Theta$  = elevation angle of point  $P$  measured from a plane perpendicular to the conductor.

When this elementary antenna radiates one kilowatt of power the field strength at one mile is -



$$E = E_0 \cos \theta$$

$$= 131.8 \cos \theta$$

(4) where  $E$  = millivolts per meter unattenuated field strength at one mile for one kilowatt

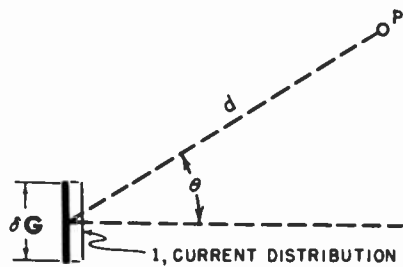

(a) ELECTRIC CURRENT ELEMENT OF LENGTH  $\delta h$  AND CARRYING CURRENT  $I$

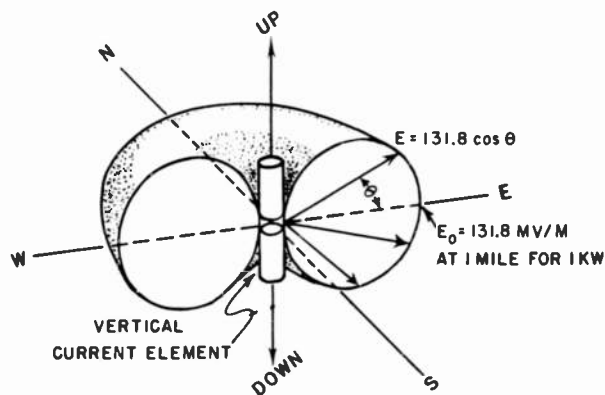

(b) SIDE CROSS-SECTION VIEW OF THE TOROIDAL RADIATION PATTERN SHOWING THE VERTICAL DIRECTIVITY.

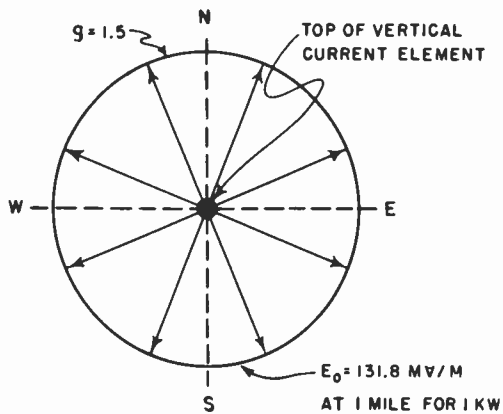

(c) HORIZONTAL CROSS-SECTION VIEW OF TOROIDAL RADIATION PATTERN SHOWING ZERO HORIZONTAL DIRECTIVITY

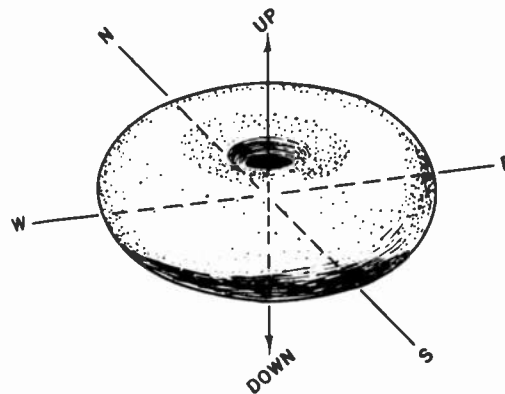

(d) SURFACE PATTERN SHOWING TOROIDAL OR DOUGHNUT SHAPE

THE RADIATION PATTERN OF A VERTICAL ELECTRIC CURRENT ELEMENT  
IN FREE SPACE

Fig. 3

$E_0$  = millivolts per meter field strength measured on a plane perpendicular to the conductor and in this case at the distance of one mile for one kilowatt of radiated power

$\theta$  = elevation angle as shown in Fig. 3(a).

The value of 131.8 is the maximum field strength and is a constant in the horizontal plane. See Fig. 3(c). This current element used as a secondary standard reference antenna is sometimes used as a secondary standard reference antenna.

(4) Vertical Current Element Antenna Over a Perfectly Conducting Earth...If a

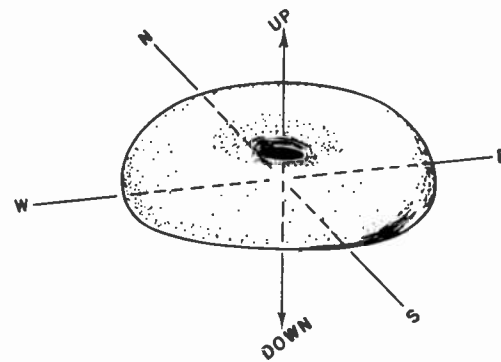
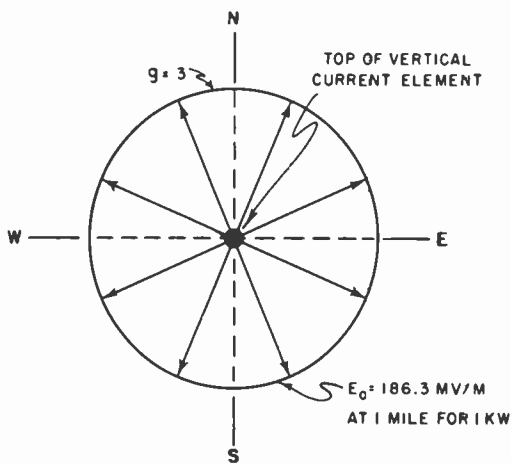
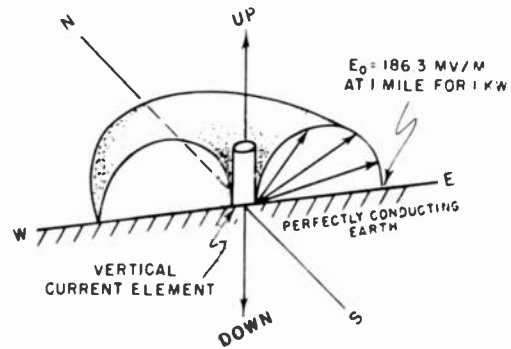
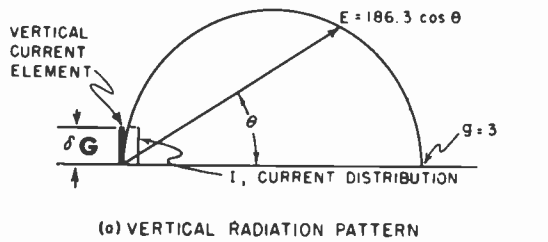

THE RADIATION PATTERN OF A VERTICAL ELECTRIC CURRENT ELEMENT OVER A PERFECTLY CONDUCTING EARTH

Fig. 4

vertical current element antenna is located at the surface of a perfect earth, the radiation will be hemispherical as shown in Fig. 4.

When this vertical current element radiates 1 kw of power the field strength at one mile is

$$E = 186.3 \cos \theta \quad (5)$$

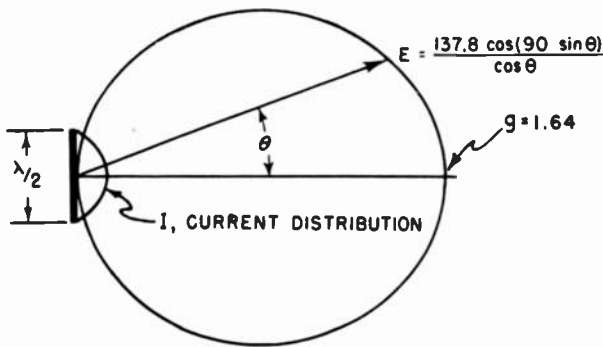

(a) VERTICAL RADIATION PATTERN

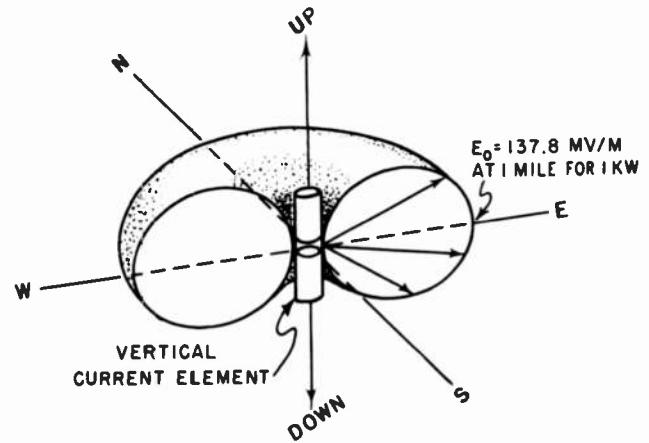

(b) SIDE CROSS-SECTION VIEW OF THE RADIATION PATTERN SHOWING THE VERTICAL DIRECTIVITY

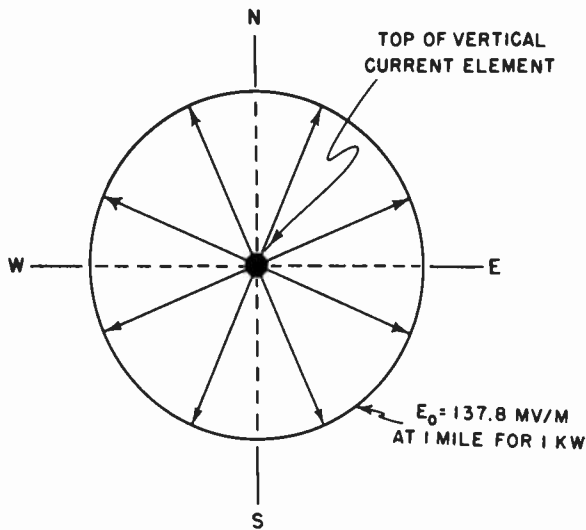

(c) HORIZONTAL CROSS-SECTION VIEW OF RADIATION PATTERN SHOWING ZERO HORIZONTAL DIRECTIVITY

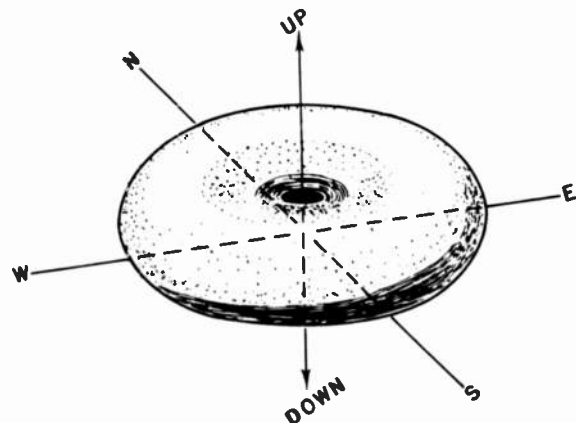

(d) SURFACE PATTERN SHOWING DOUGHNUT SHAPE

### THE RADIATION PATTERN OF A VERTICAL HALF WAVE RADIATOR IN FREE SPACE

Fig. 5

where  $E$  and  $\Theta$  are defined in Eq. (4) and Fig. 4(a).

This vertical current element antenna is sometimes used as a secondary reference antenna. It gives the vertical pattern of a zero height antenna. See Eq. (10). While one of these infinitesimal antenna itself is of

no practical value it is useful in summing up the radiation effects of antennas having practical dimensions.

(5) Half Wave Antenna in Free Space ... A half wave antenna in free space will have essentially a sinusoidal current distribution as shown in Fig. 5(a). If the radiation

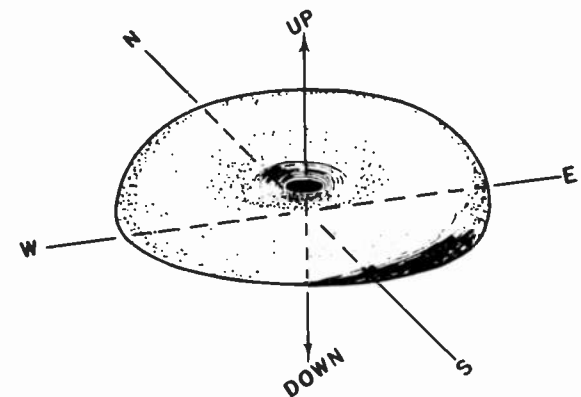
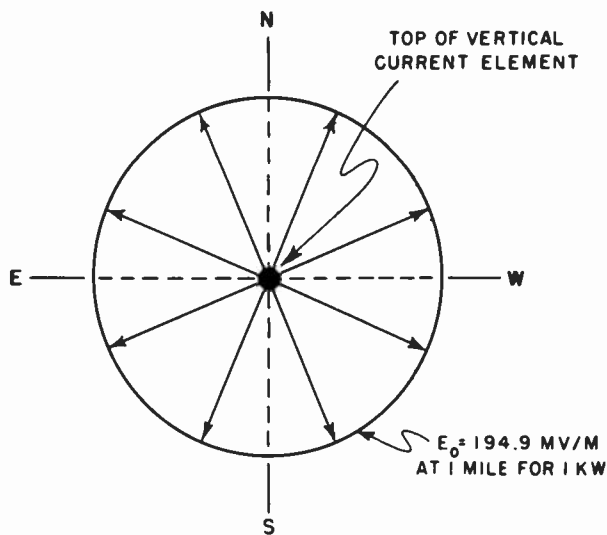
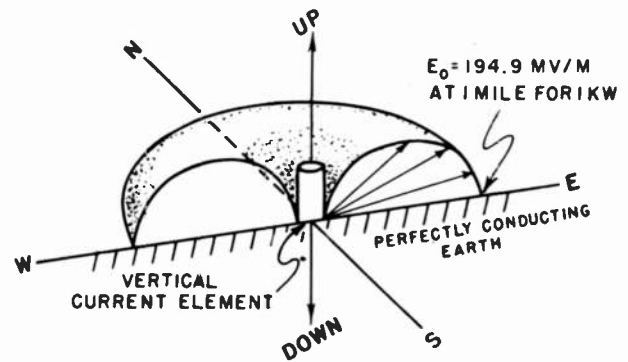
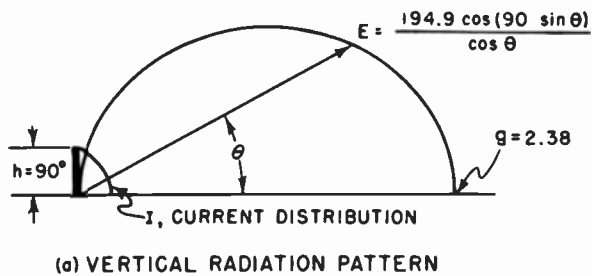

THE RADIATION PATTERN OF A VERTICAL QUARTER WAVE RADIATOR OVER A PERFECTLY CONDUCTING EARTH

Fig. 6

effects of the current elements as given in Eq. (3) are summed up for the whole antenna the field strength pattern is given by

$$E = \frac{137.6 \cos (90 \sin \Theta)}{\cos \Theta} \quad (6)$$

where  $E$  and  $\Theta$  are defined in Eq. (3) and Fig. 5(a).

This type of antenna is often used as a secondary standard reference antenna because it is a practical type of antenna that is easy to set up experimentally. For example, the Federal Communications Commission uses this standard for FM and TV Broadcast Stations.

(6) Quarter-Wave Vertical Antenna Over a Perfectly Conducting Earth... This type of antenna is very common and is often used as a secondary standard reference antenna. With a sinusoidal current distribution as shown in Fig. 6(a) the radiation pattern is given by

$$E = \frac{194.9 \cos (90 \sin \Theta)}{\cos \Theta} \quad (7)$$

where  $E$  and  $\Theta$  are defined in Eq. (3) and Fig. 6(a).

Many directional antenna arrays are designed with quarter-wave elements because of the ease of making computations in design and adjustments during the proof of performance.

(7)  $0.311\lambda$  Vertical Antenna Over a Perfectly Conducting Earth... The Federal Communications Commission at the present time uses this height antenna  $G = 111.96^\circ$  as their standard reference antenna. It at one time represented the average height of broadcast antennas in the United States. With sinusoidal current distribution the radiation pattern is given by

$$\begin{aligned} E &= 200 \frac{\cos (G \sin \Theta) - \cos G}{(1 - \cos G) \cos \Theta} \quad (8) \\ &= 319.5 \frac{\cos (111.96 \sin \Theta) + 0.3740}{\cos \Theta} \end{aligned}$$

where  $E$  and  $\Theta$  are defined in Eq. (3) and  $G = 111.96^\circ$  the height of the antenna in electrical degrees.

(8) Half-Wave Vertical Antenna Over

a Perfectly Conducting Earth... For comparison purposes it is of interest to present the radiation pattern of a half-wave antenna. With sinusoidal current distribution the radiation pattern is given by

$$\begin{aligned} E &= 236.5 \frac{\cos (G \sin \Theta) - \cos G}{(1 - \cos G) \cos \Theta} \quad (9) \\ &= 118.25 \frac{\cos (180 \sin \Theta) + 1}{\cos \Theta} \end{aligned}$$

where  $E$  and  $\Theta$  are defined in Eq. (3) and  $G = 180^\circ$  the height of the antenna in electrical degrees.

(9) Comparison of the Vertical Radiation Patterns of Primary and Secondary Standard Reference Antennas... Figure 7 gives a comparison of the radiation patterns of primary and secondary standard reference antennas. The vertical patterns are expressed in millivolts per meter at one mile for one kilowatt of input power. The field strength in millivolts per meter at one mile as a function of antenna height is given in Fig. 8.

b. Vertical Radiation Characteristics. - Already we have considered a number of vertical radiation patterns in Fig. 7. If these patterns are made equal to unity in the horizontal plane they are then known as vertical radiation characteristics. If this is done the curves of Fig. 9 result.

For a vertical antenna having a sinusoidal current distribution with a current node at the top, the vertical radiation characteristic takes on the form

$$f(\Theta) = \frac{\cos (G \sin \Theta) - \cos G}{(1 - \cos G) \cos \Theta} \quad (10)$$

where  $f(\Theta)$  = vertical radiation characteristic

$G$  = electrical height of the antenna in electrical degrees

$\Theta$  = elevation angle of the observation point measured up from the horizon in degrees.

The curves in Fig. 10 represent the solution of this equation over the most useful range of antenna heights. The vertical radiation characteristic is plotted as a function of

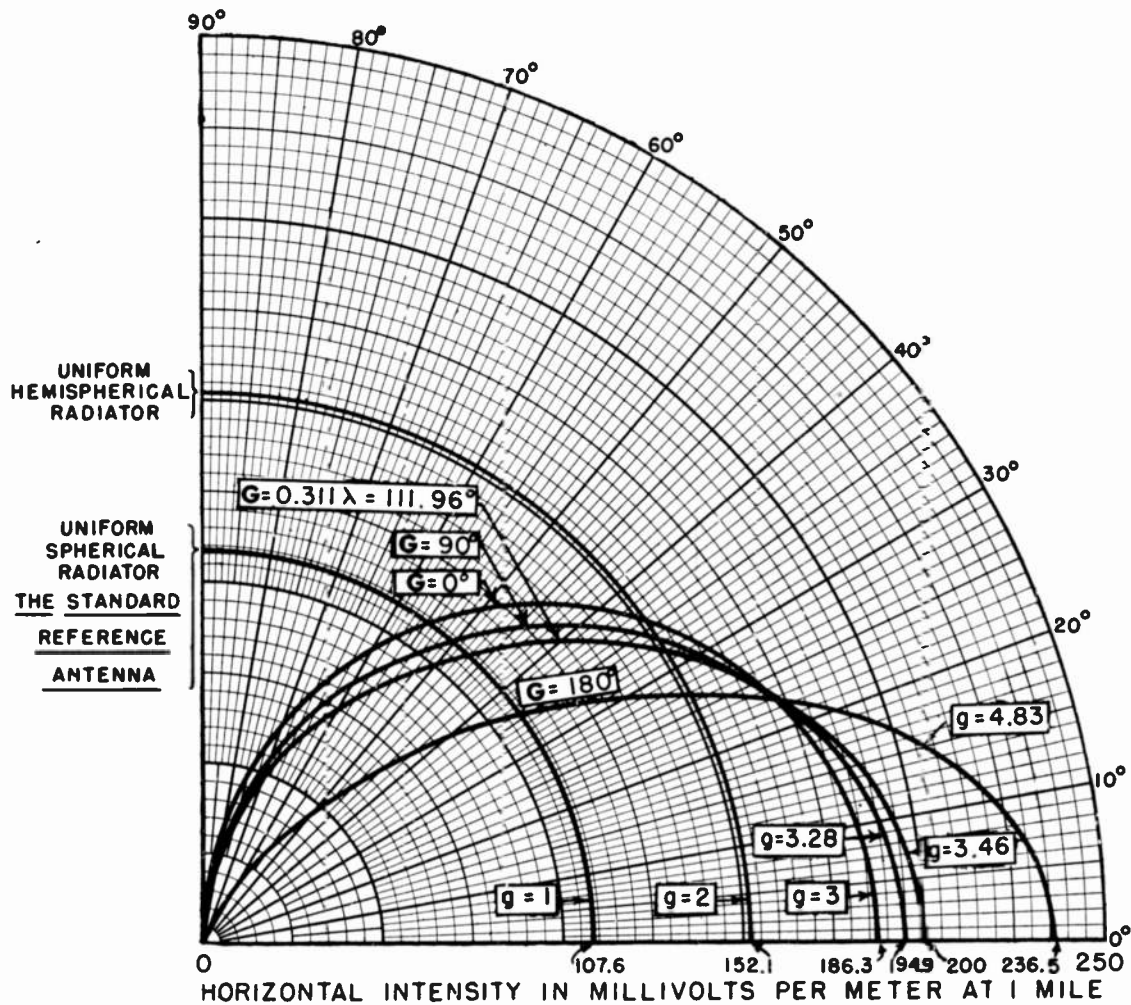

COMPARISON OF VERTICAL RADIATION PATTERN OF STANDARD REFERENCE ANTENNAS WITH A RADIATED POWER OF 1 KILOWATT

Fig. 7











elevation angle for various values of tower height. A representative set of tower heights have been selected for Fig. 10. Figure 11 represents this same information in a different form; that is, the vertical radiation characteristic is plotted as a function of electrical tower height for various values of elevation angle. In order to prevent reversals of the lines as plotted in Fig. 11, the curves are ex-

tended to negative values in Fig. 10. This merely means that the high angle lobe is of opposite phase to the low angle radiation.

The vertical radiation characteristic will be used in the generalized equation for determining the shape of the directional antenna pattern. See Eq. (15). In the horizontal plane this function reduces to unity and simplifies the design equation.

TABLE I

SUMMARY OF STANDARD REFERENCE ANTENNAS

TYPE OF ANTENNA	VERTICAL PATTERN SHAPE	MV/M FOR 1 WATT AT 1 MILE $E_0$	MV/M FOR 1 KW AT 1 MILE $E_0$	POWER GAIN $g$	db GAIN $G$	TYPE OF ANTENNA	VERTICAL PATTERN SHAPE	MV/M FOR 1 WATT AT 1 MILE $E_0$	MV/M FOR 1 KW AT 1 MILE $E_0$	POWER GAIN $g$	db GAIN $G$
UNIFORM SPHERICAL RADIATOR		3,402	107.6	1	0	UNIFORM HEMISPHERICAL RADIATOR		4,811	152.1	2	3,010
CURRENT ELEMENT		4,167	131.8	1.5	1,761	VERTICAL CURRENT ELEMENT		5,893	186.3	3	4,771
HALF WAVE ANTENNA		4,358	137.8	1,641	2,151	QUARTER WAVE VERTICAL ANTENNA		6,163	194.9	3,282	5,161
0.622 $\lambda$ ANTENNA		4,472	141.4	1,728	2,375	0.311 $\lambda$ VERTICAL ANTENNA		6,324	200	3,456	5,386
TWO END ON HALF WAVE IN PHASE ANTENNA		5,283	167.1	2,411	3,822	HALF WAVE VERTICAL ANTENNA		7,471	236.2	4,822	6,832

c. Directivity Definitions. -

(1) On the Basis of Equal Powers...

Directivity or directive gain of a given antenna can be defined as the ratio of the maximum power flow intensity to the power flow intensity of a uniform radiator when the total power output of both sources are equal. In Equation form,

$$g = \frac{P_m}{P_s} \text{ (equal powers)} \quad (11)$$

where  $g$  = directivity or power gain

$P_m$  = maximum power flow intensity from the directional antenna radiating 1 kw of power

$P_s$  = uniform power flow intensity from the standard reference antenna radiating 1 kw of power.

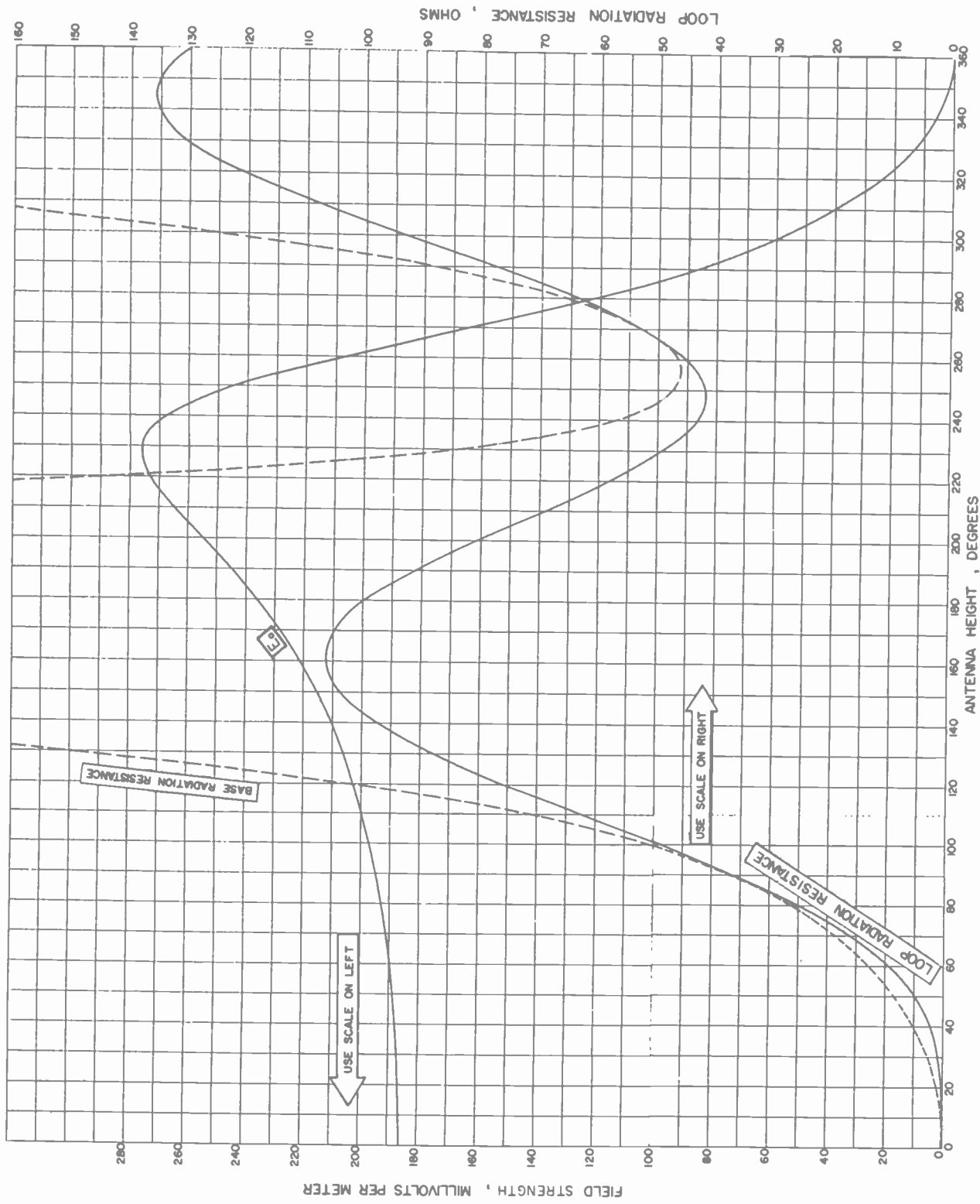

INVERSE FIELD STRENGTH AT ONE MILE FOR 1kw, LOOP AND BASE RADIATION RESISTANCE AS A FUNCTION OF TOWER HEIGHT OVER A PERFECTLY CONDUCTING EARTH

Fig. 8



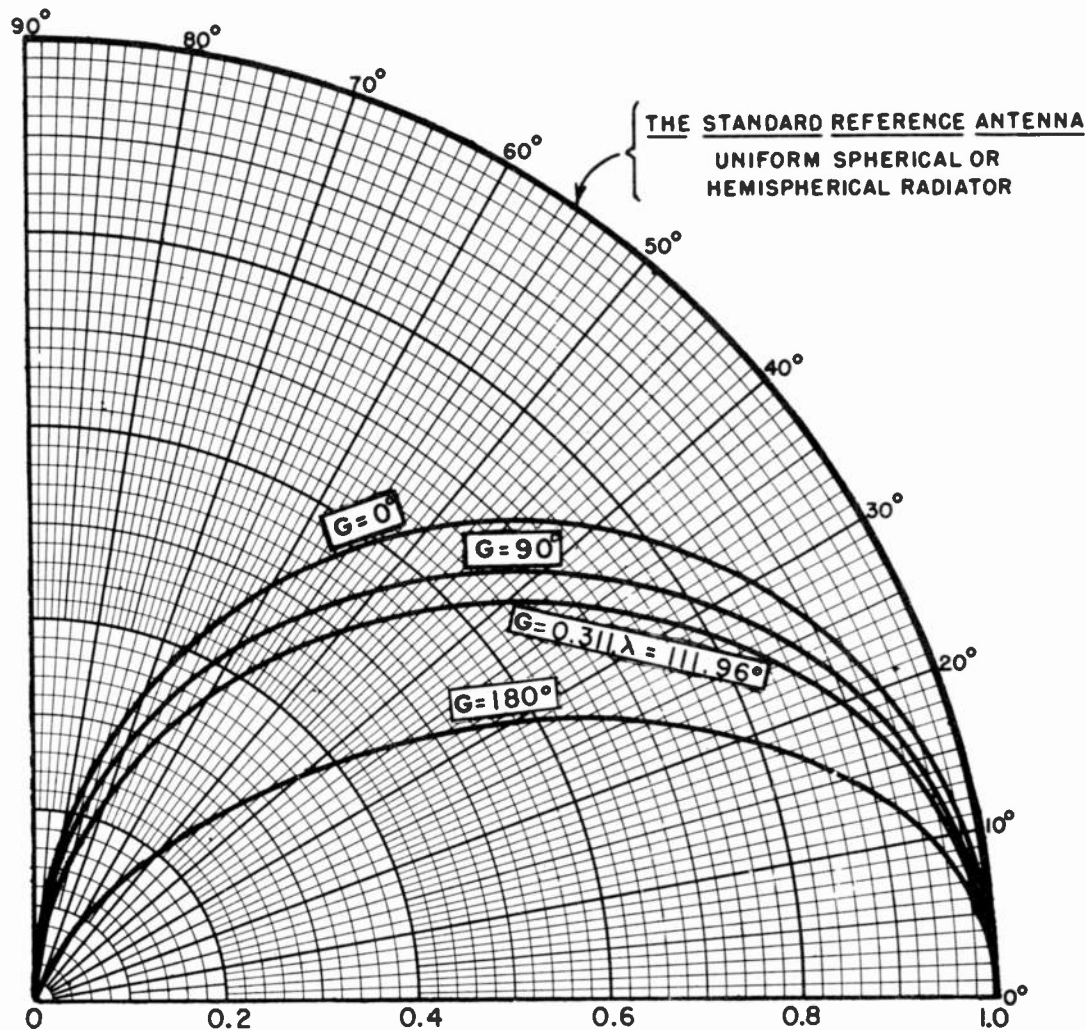

COMPARISON OF THE VERTICAL RADIATION CHARACTERISTICS FOR SEVERAL STANDARD REFERENCE ANTENNAS

Fig. 9

Or, in terms of field strengths, power gain can be determined by the following equation,

$$g = \left[ \frac{E_m}{E_s} \right]^2 \text{ (equal powers)} \quad (12)$$

where  $g$  = directivity or power gain

$E_m$  = maximum field strength in mv/m from the directional antenna at 1 mile for 1 kw of radiated power

$E_s$  = field strength (107.6 mv/m) from a uniform spherical antenna at 1 mile for 1 kw of radiated power.

(2) On Basis of Equal Field Strengths ... The directivity can also be defined by taking the ratios of the power radiated when the maximum field intensity of the directional antenna is made equal to the field strength from a uniform spherical antenna.

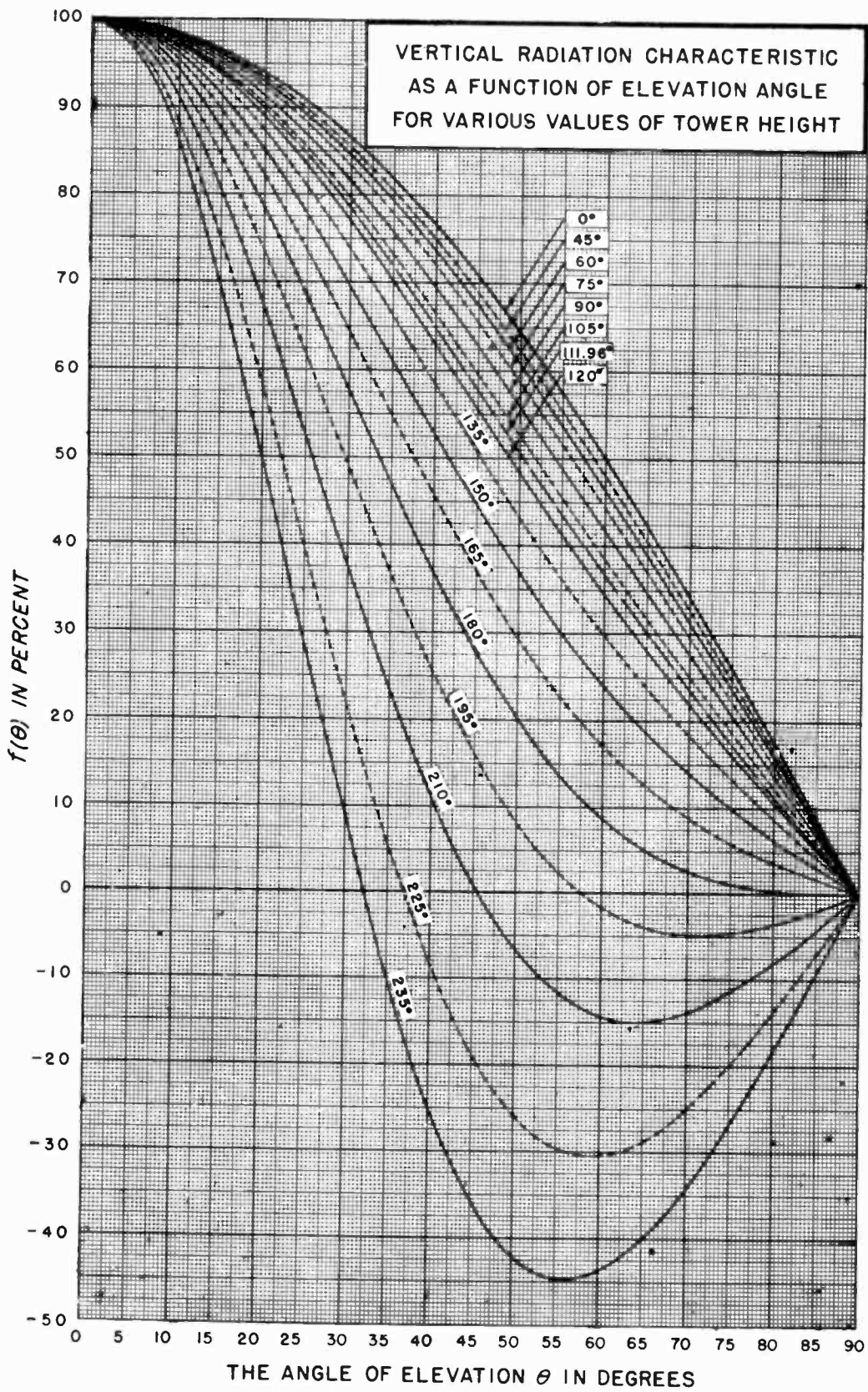
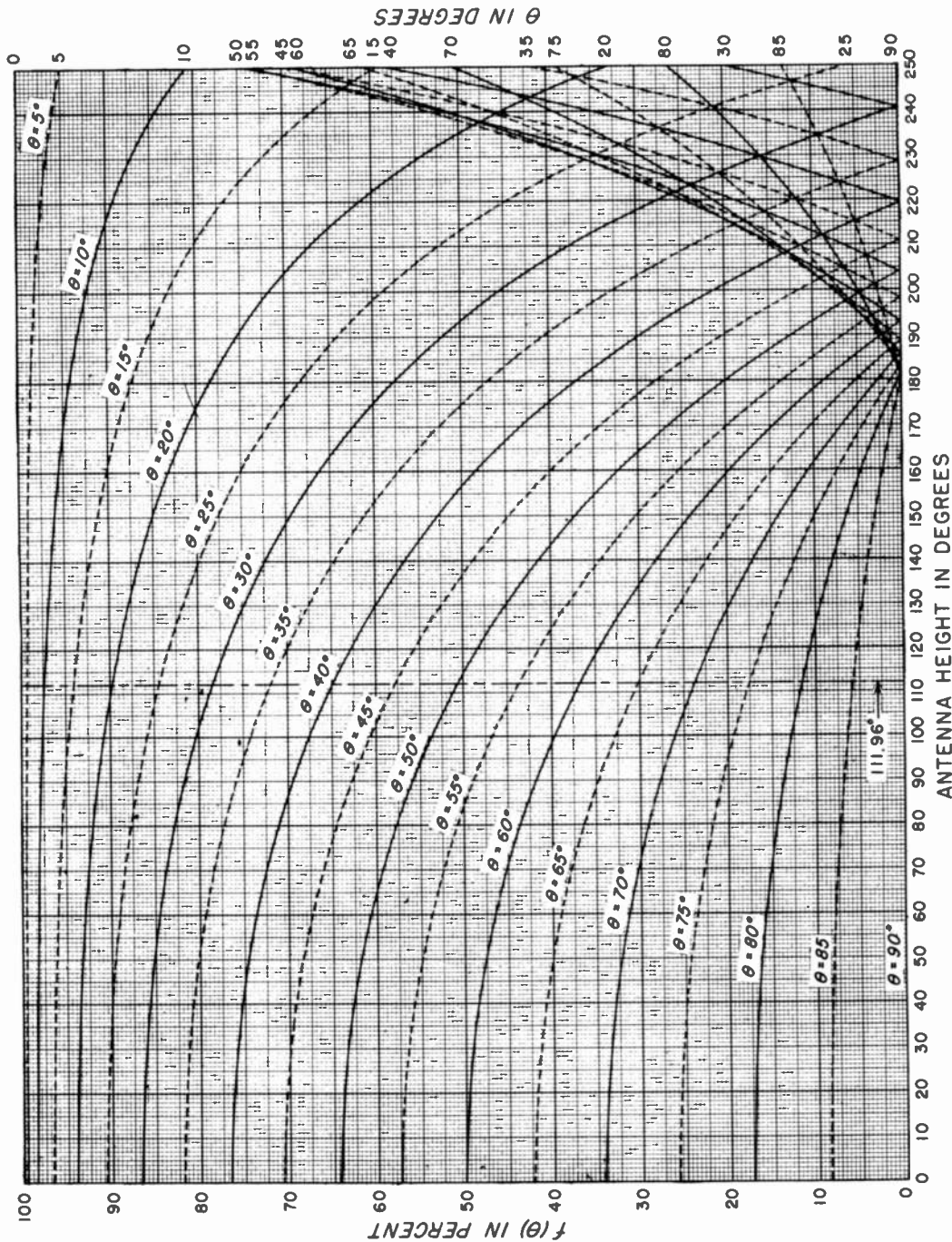

Fig. 10



VERTICAL RADIATION CHARACTERISTIC AS A FUNCTION OF ELECTRICAL TOWER HEIGHT FOR VARIOUS VALUES OF ELEVATION ANGLE

Fig. 11

In equation form,

$$g = \frac{P_S}{P_R} \text{ (equal field strengths)} \quad (13)$$

$g$  = directivity or power gain

$P_S$  = power radiated (1 kw) from a uni-

form spherical antenna to produce a given field strength of  $E_S$  (107.6 mv/m) at 1 mile

$P_R$  = power radiated from the directional antenna to produce the same given maximum field strength  $E_m$

(107.6 mv/m) at 1 mile.

To illustrate, let the field strength of a uniform hemispherical antenna be adjusted to produce 107.6 mv/m unattenuated field strength at 1 mile. The power radiated will be 500 watts; hence,

$$g = \frac{P_s}{P_r} = \frac{1.0 \text{ kw}}{0.5 \text{ kw}} = 2$$

the power gain of a uniform hemispherical antenna. In other words, twice the amount of power has to be supplied to the uniform spherical radiator to produce the same maximum field strength at one mile. In the uniform spherical radiator, the additional 500 watts is used in the other hemisphere to make the radiation pattern spherical.

(3) On Basis of Decibels... The directivity can also be computed in terms of decibels by the equation,

$$G = 10 \log g \quad (14)$$

where  $G$  = decibels directive gain

$g$  = directivity or power gain.

d. Generalized Equation to Determine Pattern Shape. - The generalized equation for a directional antenna array as given here is based upon the following assumptions:

- (1) That the antennas are over a perfectly conducting plane earth surface
- (2) That the distance from the space reference point to the observation point is great in comparison to the physical dimensions of the directional antenna array.

The generalized equation for  $n$  antennas in the directional antenna array is -

$$E = E_1 f_1(\Theta) \underline{\beta_1} + E_2 f_2(\Theta) \underline{\beta_2} + E_k f_k(\Theta) \underline{\beta_k} + \dots + E_n f_n(\Theta) \underline{\beta_n} \quad (15a)$$

By using the summation sign this equation can be written

$$E = \sum_{k=1}^n E_k f_k(\Theta) \underline{\beta_k} \quad (15b)$$

where  $E$  = the total effective field strength

vector at unit distance for the antenna array with respect to the voltage reference axis

$k$  = the  $k^{\text{th}}$  antenna in the system

$n$  = the total number of antennas in the directional-antenna array

$E_k$  = the horizontal magnitude of the field strength at unit distance produced by the  $k^{\text{th}}$  antenna

$f_k(\Theta)$  = vertical radiation characteristic of the  $k^{\text{th}}$  antenna—see Eq. (10) for a vertical thin conductor

$\Theta$  = elevation angle of the observation point measured up from the horizon

$$\beta_k = S_k \cos(\Phi_k - \Phi) \cos \Theta + \Psi_k \quad (16)$$

= phase relation of the voltage (or current) in the  $k^{\text{th}}$  antenna with respect to the voltage reference axis

$S_k \cos(\Phi_k - \Phi) \cos \Theta$  = space phasing portion of the  $\beta_k$  due to location of the  $k^{\text{th}}$  antenna

$S_k$  = electrical length of spacing of the  $k^{\text{th}}$  antenna from the space reference point

$\Phi_k$  = true horizontal azimuth, orientation of the  $k^{\text{th}}$  antenna, with respect to the space reference axis

$\Phi$  = true horizontal azimuth angle of the direction to the observation point  $P$  (measured clockwise from true north)

$\Psi_k$  = time phasing portion of  $\beta_k$  due to electrical phase angle of the voltage (or current) in the  $k^{\text{th}}$  antenna with respect to the voltage reference axis.

The generalized equation for  $n$  antennas as given in Eqs. (15a) and (15b) treats only the  $k^{\text{th}}$  antenna. All of the antennas in the directional antenna array can be handled in a sim-

ilar fashion and the vectors finally added together as indicated by the summation sign. It will be noted in this equation that the field strength vector for the  $k^{\text{th}}$  antenna has a magnitude of  $E_k$  in all directions in the horizontal plane. This magnitude is modified by the vertical radiation characteristic  $f_k(\theta)$  which corrects the magnitude of the field strength vector  $E_k$  to give the correct value of the elevation angle being considered. For simple vertical antennas Eq. (10), Figs. 10 and 11 can be used to determine the value of  $f_k(\theta)$ .

The vector field strength from the  $k^{\text{th}}$  antenna in any direction is illustrated in Fig. 12.

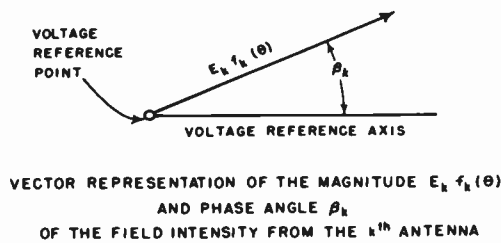
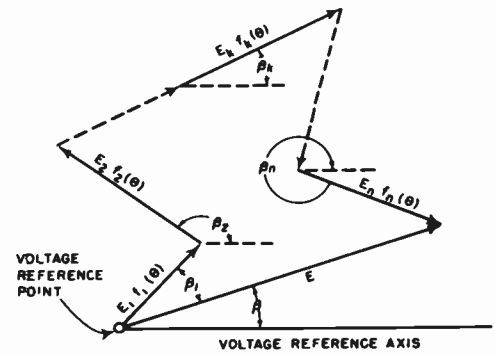

Fig. 12

It has a magnitude of  $E_k f_k(\theta)$  and makes an angle of  $\beta_k$  with respect to the voltage reference axis. The summation of these vectors for the  $n$  antennas in the directional antenna array, as indicated in Eq. (15), is illustrated in Fig. 13. The vector angles, as will be noted in the figure, are all measured from the voltage reference axis.

The angle  $\beta_k$ , of the field strength vector, as defined in Eq. (16), is a function of space phasing and time phasing. The space phasing parameters for the  $k^{\text{th}}$  antenna are illustrated in Fig. 14.

This figure illustrates that any antenna in the directional antenna array can be located with respect to the space reference axis by the true orientation angle  $\phi_k$ , and with respect to the space reference point by the distance  $S_k$ .



SUMMATION OF FIELD INTENSITY VECTORS FOR  $n$  ANTENNAS IN THE DIRECTIONAL ANTENNA ARRAY

Fig. 13

In the space phasing portion of Eq. (16), the term  $\cos \theta$  reduces to unity in the horizontal plane. In this plane the space phasing is simply the difference in distance from the observation point to the  $k^{\text{th}}$  antenna and the space reference point as shown in Fig. 15.

Since the observation point is assumed to be at a great distance, a perpendicular dropped from the  $k^{\text{th}}$  antenna to the straight line connecting the observation and reference points creates a right triangle, the side of

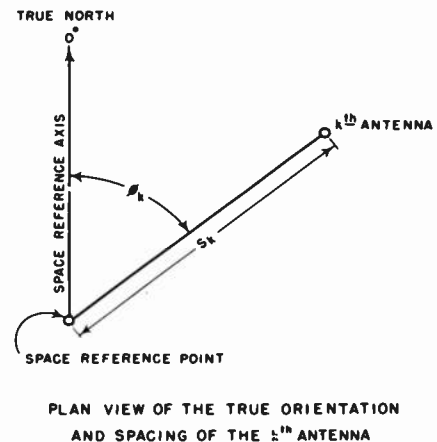

Fig. 14

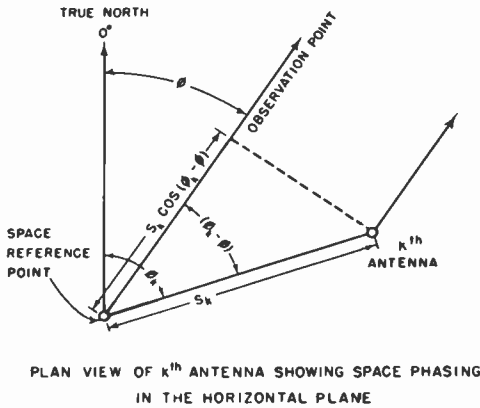

Fig. 15

which is  $S_k \cos(\phi_k - \phi)$ . This space phasing quantity is the required difference distance for any direction in the horizontal plane.

When the observation point is at some elevation angle  $\theta$  the  $k^{\text{th}}$  antenna will appear to be closer to the space reference point by the multiplying factor  $\cos \theta$ . Referring to Eq. (16) and Fig. 16, a right triangle can be formed by dropping a perpendicular to the line connecting the space reference point and the observation point.

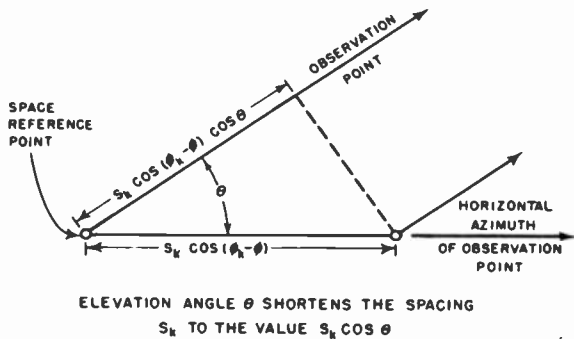

Fig. 16

The  $k^{\text{th}}$  antenna then appears to have a space phasing of  $S_k \cos(\phi_k - \phi) \cos \theta$  from the space reference point. This is the complete expression for the space phasing of any antenna in the system and for any observation point in the hemisphere.

The direction of the observation point  $P$  in terms of the true orientation  $\phi$  and elevation angle  $\theta$  is illustrated in Fig. 17. The magnitude of the total effective field strength  $E$ , as given in Eq. (15), is represented along the direction of the line from the space reference point toward the observation point  $P$ . This is for convenience in drawing polar charts.

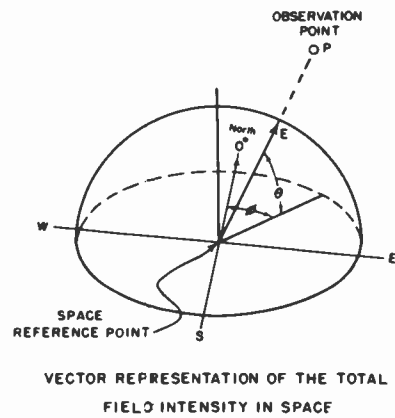

Fig. 17

Referring again to Eq. (16), it is seen that the phase angle of the voltage vector is a function of space phasing and time phasing. The space phasing, as discussed above, varies with the position of the observer, while the time phasing is a constant that is set by the phase angle of the voltage (or current) in the  $k^{\text{th}}$  antenna.

It is of interest to note that a pattern can be calculated for a given elevation angle which is equivalent to a horizontal pattern that has field strength vector magnitudes of the respective antennas equal to  $E_k f_k(\theta)$  and spacings reduced to  $S_k \cos \theta$ . This scheme of drawing patterns at the various elevation angles is a useful method for determining the

TABLE 2  
DIRECTIONAL ANTENNA PARAMETERS

Antenna No.	True Orientation $\phi^\circ$	Spacing $S^\circ$	Phasing $\Psi^\circ$	Horizontal Field Strength $E_{mv}/m$	Vertical Radiation Characteristic $f(\theta)$
1					
2					
.					
.					
.					
k					
.					
.					
.					
n					

vertical pattern of an equivalent non-directional antenna. All that is required to make this computation is to determine the root-mean-square value of the pattern for each elevation angle.

e. Directional Antenna Parameters. - In general this system specifies all of the parameters required to determine the shape and size of the directional antenna pattern. To be specific the system specifies:

- (1) The number of antennas in the directional antenna array,
- (2) The true orientation of each antenna from the space reference axis,
- (3) The spacing of each antenna from the space reference point,
- (4) The time phasing of the voltage (or current) in each antenna with respect to the voltage reference axis,
- (5) The horizontal field strength of each antenna,
- (6) The electrical height of each antenna, if a uniform cross-section tower, or the vertical radiation characteristic if it cannot be determined from Eq. (10).

The general scheme for specifying the parameters of a directional antenna system can be tabulated as shown in Table 2.

where  $k = k^{\text{th}}$  antenna in the array

$n =$  total number of antennas in the array

$\phi^\circ =$  true orientation in degrees

$S^\circ =$  spacing in degrees

$\Psi^\circ =$  phasing in degrees

$E_{mv}/n =$  horizontal field strength in millivolts per meter

$f(\theta) =$  vertical radiation characteristic

f. Systematization of Directional Antenna.

(1) General... A pattern numbering system has been devised which furnishes the antenna parameters in an orderly fashion. The first digit specifies the number of antennas in the directional antenna array. Succeeding sequences of three digits specify the orientation, spacing and phase of each antenna in the array. To simplify this numbering system, the orientation, spacing, and phase of each antenna is shifted in steps of 45 degrees. Rather than specify these steps directly in degrees, the number of degrees is divided by 45 to produce small whole numbers that can be used more conveniently in the pattern numbering system. The orientation, spacing, and phasing sequences are followed by two digit figures to specify, in percent, of the maximum lobe field strength,

the horizontal field strength from each antenna and finally the last two digits specify in percent the r-m-s field strength in the horizontal plane for the directional antenna array.

The basic idea of the pattern numbering system is illustrated in Fig. 18. Referring to this figure the first digit specifies the number of antennas and will require only 1 digit for 9 or less antennas. Each antenna in

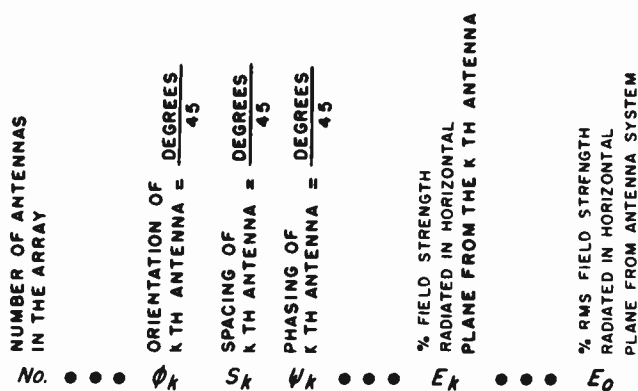

PATTERN NUMBERING SYSTEM

Fig. 18

the array will require 3 digits to specify its orientation, spacing and phase plus 2 digits to specify its field strength in percent. Finally, the r-m-s field strength will require 2 digits.

On this basis the pattern number will require,

Total number of digits in the pattern number =  $1 + 3n + 2n + 2 = 5n + 3$  (17)

where  $n$  = number of antennas in the array. However, if No. 1 antenna is placed at the

space reference point and the phase is held at zero, the first set of three digits will always be zero. Therefore, the pattern number can be reduced by three digits if No. 1 antenna is used as the reference antenna. The first set of 3 digits will then specify the orientation, spacing and phase of No. 2 antenna with respect to No. 1 antenna. Using this modification the number of digits required will be,

Total number of digits in modified pattern number =  $1 + 3(n - 1) + 2n + 2 = 5n$  (18)

where  $n$  is defined in Eq. (17). On this basis a two tower systematization will require 10 digits, a three tower systematization will require 15 digits and a four tower systematization will require 20 digits. Figure 19 illustrates respectively a two, three and four tower directional antenna array using this pattern numbering system.

(2) Systematization of Two Tower Patterns... For two towers the pattern numbering system consists of a 10 digit number as shown in Fig. 19(a) and Fig. 20.

Number 1 antenna is placed at the space reference point so its orientation, spacing and phase are zero. The orientation of No. 2 antenna is made zero or true north of No. 1 antenna for all patterns. However, its spacing is varied from 45 degrees to 1,440 degrees (from 1 to 32 in the pattern numbering system) and for each placement of No. 2 tower its phase is varied from 0 degrees to 315 degrees (from 0 to 7 in the pattern numbering system). Since the orientation of No. 2 antenna is always zero the second digit of the pattern number, which is ordinarily used to specify the orientation of No. 2 antenna, is used in this particular systematization to specify the spacings which require two digits for spacings greater than 405 degrees ( $9 \times 45 = 405$ ).

For the purpose of systematization, the magnitude of the field strength are each made equal to 50 percent of the maximum value. This results in complete nulls whenever the voltage vectors swing exactly out of phase.



The maximum field strength is 100 percent when the vectors are in phase and is represented by the outer circle of the simple polar chart. The field strength is a maximum when the two field strength vectors are exactly in phase.

In some cases, especially for very close spacings, the field strength vectors are never exactly in phase; hence, the percent field strength from each antenna must be increased above 50 percent to secure the desired 100 percent maximum value. This is illustrated by the pattern No. 2 014 129 129 69, where the percent field strength from each antenna must be 129 percent to produce a maximum field strength of 100 percent. The theoretical r-m-s value is only 69 percent.

In other cases the field strength vectors are never exactly out of phase with the result that the pattern will not have a complete null. Pattern No. 2 010 50 50 85 is an example where the minimums are very shallow.

For the two tower systematization with spacings out to four wavelengths (1440°) the number of settings of each parameter is given in Table 3.

NUMBER OF ANTENNAS IN THE SYSTEM	ORIENTATION OF NO. 2 ANTENNA =	SPACING OF NO. 2 ANTENNA =	PHASING OF NO. 2 ANTENNA =	% FIELD STRENGTH RADIATED IN HORIZONTAL PLANE FROM NO. 1 ANTENNA	% FIELD STRENGTH RADIATED IN HORIZONTAL PLANE FROM NO. 2 ANTENNA	% RMS FIELD STRENGTH RADIATED IN HORIZONTAL PLANE FROM ANTENNA SYSTEM
No.	$\phi_2$	$S_2$	$\psi_2$	$E_1$	$E_2$	$E_0$
2	0	6	7	50	50	60
	DEGREES	DEGREES	DEGREES			
	45	45	45			

TWO TOWER PATTERN NUMBERING SYSTEM

Fig. 20

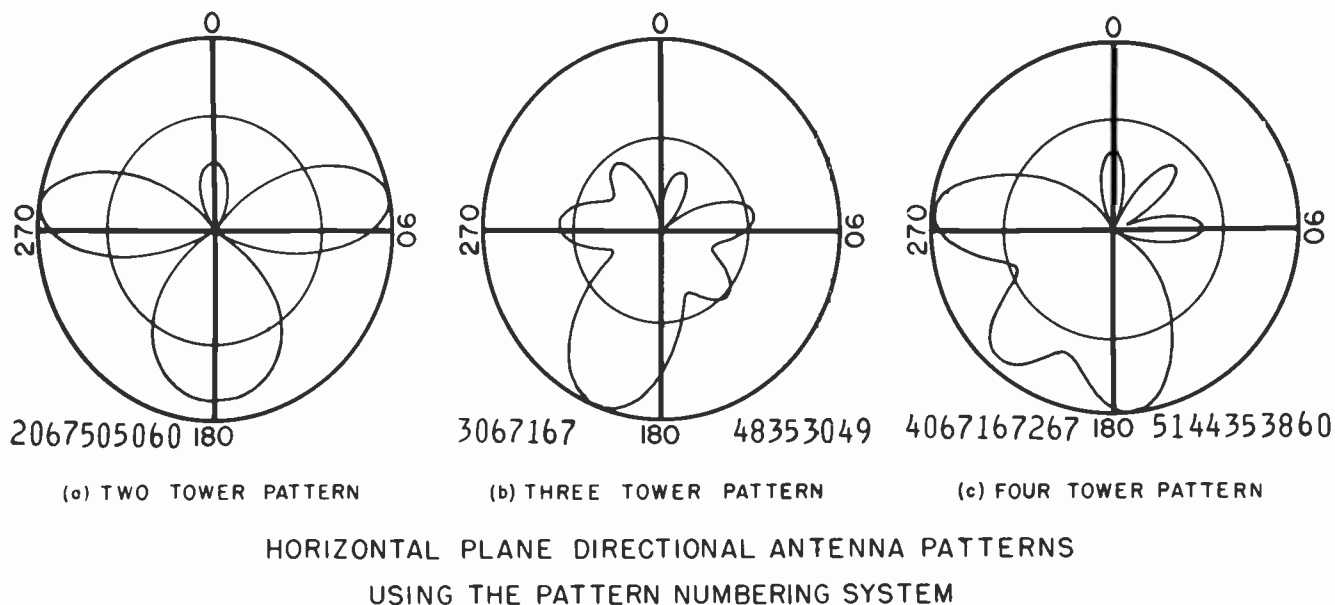

Fig. 19

TABLE 3

TWO TOWER SYSTEMATIZATION  
PARAMETER SETTINGS

Parameters	$\phi_1$	$S_1$	$\psi_1$	$\phi_2$	$S_2$	$\psi_2$
No. Settings	1	1	1	1	32	8

The product of the number of settings results in

$$\text{Number of two tower patterns} = 1 \times 1 \times 1 \times 1 \times 32 \times 8 = 256 \quad (19)$$

which is the number of patterns in the two tower systematization. This systematization is presented in PART II.

Since two tower patterns are so important in directional antenna work, particularly in multiplying patterns, a more detailed systematization has also been prepared and presented in PART II. In this more detailed systematization the spacing and phasing have been shifted in steps of only 15 degrees, thus making 13 patterns for each spacing. The numbering system has been altered to present the spacing and phasing in degrees instead of numbers which have to be multiplied by 45.

(3) Systematization of Three Tower Patterns... For three tower patterns the numbering system consists of a 15 digit number; however, for convenience this number is divided into two parts as shown in Fig. 19(b). The first part as shown in Fig. 21 gives the number of antennas in the system, followed by the orientation, spacing, and phase of the second and third antennas with respect to the first or reference antenna. This part of the number is located in the lower left hand corner of the pattern sheet.

The second part of the number as shown in Fig. 19(b) and Fig. 22 gives the magnitude of the various horizontal field intensities in percent of the maximum lobe field strength. For a three tower pattern each antenna will require two digits and finally two digits will be required for the r-m-s horizontal field intensity for the antenna array. This number is placed at the lower right hand corner of the pattern sheet.

NUMBER OF ANTENNAS IN THE SYSTEM	ORIENTATION OF NO. 2 ANTENNA = $\frac{\text{DEGREES}}{45}$	SPACING OF NO. 2 ANTENNA = $\frac{\text{DEGREES}}{45}$	PHASING OF NO. 2 ANTENNA = $\frac{\text{DEGREES}}{45}$	ORIENTATION OF NO. 3 ANTENNA = $\frac{\text{DEGREES}}{45}$	SPACING OF NO. 3 ANTENNA = $\frac{\text{DEGREES}}{45}$	PHASING OF NO. 3 ANTENNA = $\frac{\text{DEGREES}}{45}$
No. 3	$\phi_2$	$S_2$	$\psi_2$	$\phi_3$	$S_3$	$\psi_3$
3	0	6	7	1	6	7

LEFT HAND THREE TOWER PATTERN NUMBER  
GIVES ANTENNA PLACEMENT AND PHASING DATA

Fig. 21

% FIELD STRENGTH RADIATED IN HORIZONTAL PLANE FROM NO. 1 ANTENNA	% FIELD STRENGTH RADIATED IN HORIZONTAL PLANE FROM NO. 2 ANTENNA	% FIELD STRENGTH RADIATED IN HORIZONTAL PLANE FROM NO. 3 ANTENNA.	% RMS FIELD STRENGTH RADIATED IN HORIZONTAL PLANE FROM ANTENNA SYSTEM
$F_1$	$F_2$	$F_3$	$F_0$
48	35	30	49

RIGHT HAND THREE TOWER PATTERN NUMBER  
GIVES ANTENNA FIELD INTENSITY DATA IN PERCENT

Fig. 22

For the purpose of systematization of three tower patterns, No. 1 tower is located at the space reference point, then its orientation, spacing and phase can be considered zero and thus be deleted from the pattern numbering system.

Number 2 tower, for convenience, can be located due north of No. 1 tower; hence, its orientation  $\phi_2$ , will always be zero. The spacing,  $S_2$ , can be varied from 45 degrees to 360 degrees (from 1 to 8 in the pattern numbering system) and the phasing  $\psi_2$ , for each placement of the towers can be varied from 0 degrees to 315 degrees (from 0 to 7 in the pattern numbering system).

Number 3 tower orientation,  $\phi_3$ , will vary from 0 degrees to 315 degrees (0 to 7 in the pattern numbering system). The spacing,  $S_3$ , will vary from 45 degrees to 360 degrees (from 1 to 8 in the pattern numbering system). The phasing,  $\psi_3$ , for each placement of the towers will vary from 0 degrees to 315 degrees (from 0 to 7 in the pattern numbering system).

The restrictions placed on the field strength from the respective antennas is in general that they add up to produce a maximum of 100 percent in at least one direction and that they completely cancel in at least one other direction. The suggested procedure for accomplishing this is to at first make the field strength from all three antennas equal, then inspect the pattern for minimums. With the orientation that gives the lowest minimum the magnitude of the respective field strength can be adjusted for a null if possible. This is usually accomplished by increasing a field strength that produces a lower minimum. Usually a little manipulation of the field strength magnitudes and perhaps a slight change in orientation will result in the required null.

This procedure eliminates the field strength as parameters in the systematization. If this was not done the number of patterns required would soon become prohibitive. It is believed that this procedure is a good compromise because it gives complete nulls in most cases. Of course when there are several possible nulls it would be desirable to present patterns for each of them.

For the three tower systematization with spacings out to one wavelength (360°) the total number of settings is given in Table 4.

The product of the number of settings results in,

$$\text{Number of three tower settings} = 1 \times 1 \times 1 \times 8 \times 8 \times 8 \times 8 \times 8 = 32,768. \quad (20)$$

TABLE 4  
THREE TOWER SYSTEMATIZATION  
PARAMETER SETTINGS

Parameter	$\phi_1$	$S_1$	$\psi_1$	$\phi_2$	$S_2$	$\psi_2$	$\phi_3$	$S_3$	$\psi_3$
No. Settings	1	1	1	1	8	8	8	8	8

The systematization placement chart is illustrated in Fig. 23. A study of this chart and the systematization problem reveals that several things can be done to decrease the number of patterns, and thus eliminate duplications.

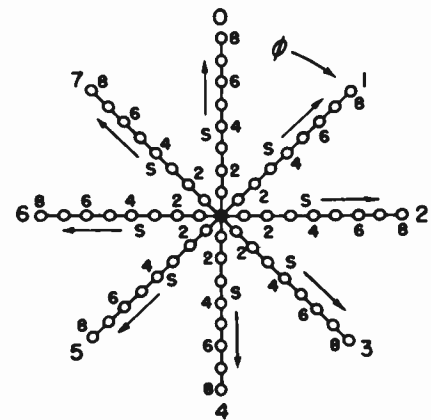

THREE TOWER SYSTEMATIZATION PLACEMENT CHART

Fig. 23

The number of patterns in the three tower systematization is decreased by

(a) Eliminating the cases where No. 3 tower falls on No. 2 tower. These cases actually result in two tower directional antenna patterns as given in Part II.

The number of patterns eliminated from the three tower systematization by using the two tower patterns is given in Table 5.

TABLE 5

NUMBER OF TWO TOWER SETTINGS  
ELIMINATED FROM THE THREE TOWER  
SYSTEMATIZATION

Parameters	$\phi_1$	$S_1$	$\psi_1$	$\phi_2$	$S_2$	$\psi_2$	$\phi_3$	$S_3$	$\psi_3$
No. Settings	1	1	1	1	1	8	1	8	8

Performing the multiplication indicated in Table 5 gives,

Number of two tower patterns eliminated  
 $= 1 \times 1 \times 1 \times 1 \times 1 \times 8 \times 1 \times 8 \times 8 = 512$  (21)

In Table 5,  $S_2$  and  $S_3$  step along together making a total of 8 settings when  $\phi_3 = 0$ .

(b) Eliminating all three tower patterns in line which are the duplicate of another placement of the towers even though the pattern is turned around 180°.

Number of three tower patterns eliminated  
 $= 84 \times 8 \times 8 = 5,376$  (22)

(c) Eliminating the cases where No. 2 and No. 3 towers have the same spacing and orientation. For this case the orientation of No. 3 tower for 225, 270 and 315 degrees which corresponds to  $\phi_3 = 5, 6$  and 7 in the pattern numbering system can be omitted from the systematization. These placements can be exactly duplicated when the orientation of No. 3 tower is 135, 90 or 45 degrees, respectively. The only difference is that the whole pattern will be rotated. This sort of restriction has been placed upon both the two and three tower systematizations when No. 2 tower was arbitrarily placed due north of No. 1 tower. It would be foolish, for example, to present all of the same two tower patterns eight times, the only difference being that the patterns would be rotated in steps of 45 degrees as the orientation of No. 2 tower is varied from 0 to 315 degrees.

Performing the indicated multiplications,

Number of three tower patterns eliminated  
 (by not using  $\phi_3 = 5, 6$  or 7 when  $S_2 = S_3$ )  
 $= 1 \times 1 \times 1 \times 1 \times 1 \times 8 \times 3 \times 8 \times 8 = 1,536$  (23)

TABLE 6

NUMBER OF THREE TOWER SETTINGS  
ELIMINATED FROM THE SYSTEMATIZA-  
TION BY NOT USING  $\phi_3 = 5, 6$  OR 7  
WHEN  $S_2 = S_3$

Parameters	$\phi_1$	$S_1$	$\psi_1$	$\phi_2$	$S_2$	$\psi_2$	$\phi_3$	$S_3$	$\psi_3$
No. Settings	1	1	1	1	1	8	3	8	8

(d) Another reduction in the total number of patterns could be achieved by eliminating all image patterns. For example, when  $S_2 = 90^\circ$  and  $S_3 = 180^\circ$  the patterns produced when  $\phi_3 = 315^\circ$  is the image of the patterns produced when  $\phi_3 = 45^\circ$ . This was not done in the systematization because of the difficulty of visualizing the shape of the image patterns, or actually having to supply a mirror with the pattern book and having to explain how to write the pattern number. The production of the image patterns was accomplished by printing image patterns and deleting the numbers. The image patterns are then presented on the left hand side of the page opposite the original set of patterns from which the images were made. The pattern number of the respective image pattern is the same as the original with the exception of the orientation. The orientation of the image pattern is such that if the systematization placement chart is folded along the north-south line through No. 1 and No. 2 towers the location of No. 3 tower for the image pattern will coincide with the location of No. 3 tower of the original pattern.

(e) The elimination of three tower patterns which are duplicates of original or image patterns but shifted in orientation amounts to 10,752 patterns. For example when  $\phi_3 = 1$  the patterns produced when  $S_2 = 1$  and  $S_3 = 2$  is the same as for the case when  $\phi_3 = 7$  with  $S_3 = 1$  and  $S_2 = 2$  with the exception that the patterns are rotated 45 degrees counterclockwise. For each value of the orientation,  $\phi = 1, 2, 3, 5, 6$  and 7, there are 28 placements that are duplications of this nature. The number of patterns eliminated are then

Number of three tower patterns eliminated by not duplicating patterns shifted in orientation  
 $= 6 \times 28 \times 8 \times 8 = 10,752$  (24)

After eliminating these various types of duplications as given in Eqs. (21), (22), (23) and (24), the resulting number of patterns is,

Substituting values,

$$32,768 - 18,176 = 14,592 \quad (25)$$

Dividing this number by 64 gives 228 pages of patterns as furnished in Part III of this book.

$$\left[ \begin{array}{l} \text{Total number of} \\ \text{patterns in the} \\ \text{systematization,} \\ \text{Eq. (20)} \end{array} \right] - \left[ \begin{array}{l} \text{Total number of} \\ \text{patterns elimi-} \\ \text{nated, Eqs. (21)} \\ \text{(22) (23) and (24)} \end{array} \right] = \left[ \begin{array}{l} \text{Total number of} \\ \text{patterns produced} \\ \text{in the three tower} \\ \text{systematization.} \end{array} \right]$$

### 3. BIBLIOGRAPHY

#### BOOKS

1. Henney, Keith, Radio engineering handbook (McGraw-Hill, New York, 1950).
2. King, Ronald W. P., The theory of linear antennas (University Press, Cambridge, Mass., 1956).
3. Kraus, John D., Antennas (McGraw-Hill, New York, 1950).
4. Laport, E. A., Radio antenna engineering (McGraw-Hill, New York, 1952).
5. Lovell, B., and J. A. Clegg, Radio astronomy (Chapman and Hall).
6. Schelkunoff S. A., and H. T. Friis, Antennas (John Wiley and Sons, New York, 1952).
7. Silver, Samuel, Microwave antenna theory and design, vol. 12, Radiation laboratory series (McGraw-Hill, New York, 1949).
8. Smith, Carl E., Theory and design of directional antennas (Cleveland Institute of Radio Electronics, Cleveland, Ohio, 1949).
9. Terman, F. E., Radio engineers handbook (McGraw-Hill, New York, 1943).
10. Williams, H. Paul, Antenna theory and design, vol. I and II (Sir Isaac Pitman and Sons, London, 1950).
11. National Association of Radio and Television Broadcasters Handbook (McGraw-Hill, New York, 1935, 1949 and new edition).
12. Standard Broadcast Allocations Maps (Mutual Broadcasting System, 1954).

#### PAPERS

1. Affanasiev, K. J., "Simplification in the consideration of mutual effects between half-wave dipoles in collinear and parallel orientations," Proc. I.R.E. 34, 635-638 (Sept. 1946).
2. Bateman, Ross; E. F. Florman, and A. Tait "A source of error in radio phase measuring systems," Proc. I.R.E. 38, 612-614 (June 1950).
3. Baum, R., "Design of directive broadband antennas," Proc. I.R.E. 34, 956-959 (Dec. 1946).

4. Brown, G. H., "Critical study of the characteristics of broadcast antennas as affected by antenna current distribution," Proc. I.R.E. 24, 48-81 (Jan. 1936).
5. Brown, G. H., "Directional antennas," Proc. I.R.E. 25, 78-145 (Jan. 1937).
6. Brown, G. H., and John G. Leitch, "The fading characteristics of the top-loaded WCAU antenna," Proc. I.R.E. 25, 583-611 (May 1937).
7. Brown, G. H., and W. C. Morrison. "The RCA antennalyzer," Broadcast News 43, 6-11 (June 1946).
8. Brownless, S. F., "Standardized transmitting aerials for medium-frequency broadcasting," Reprint from I. R. E. Australia (Nov. 1955), I.R.E. Trans. PGBTS-5, 38-51 (Sept. 1956).
9. Carter, David, "Phase centers of microwave antennas," I.R.E. Trans. AP-4, 597-600 (Oct. 1956).
10. Carter, P. S., "Circuit relations in radiating system and application to antenna problems," Proc. I.R.E. 20, 1004-1041 (June 1932).
11. Chamberlain, A. B., and W. B. Lodge, "The broadcast antenna," Proc. I.R.E. 24, 11-35 (Jan. 1936).
12. Covington, A. E., and N. W. Broten, "An interferometer for radio astronomy with a single-lobed radiation pattern," I.R.E. Trans. AP-5, 247-255 (July 1951).
13. Cox, C. R., "Mutual impedance between vertical antennas of unequal heights," Proc. I.R.E. 35, 1367-1370 (Nov. 1947).
14. Cox, C. R., "Phasing networks for broadcast arrays; graphical methods applied," Electronics 17, 120-123 (June 1944).
15. Cutler, C. C.; A. P. King, and W. E. Kock, "Microwave antenna measurements," Proc. I.R.E. 35, 1462-1471 (Dec. 1947).
16. Dewitt, J. H. Jr., and A. D. Ring, "Significant radiation from directional antennas of broadcast stations for determining sky-wave interference at short distances," Proc. I.R.E. 32, 668-673 (Nov. 1944).
17. Dolph, C. L., "A current distribution for broadside arrays which optimizes the re-

lation between beam width and side-lobe level," Proc. I.R.E. 34, 335-348 (June 1946).

18. Duttera, W. S., "Adjustment of directional antennas," Electronics 16, 91-93 (April 1943).

19. Duttera, W. S., "Design charts for phase shifting and amplitude control networks," Electronics 15, 53-55 (Oct. 1942).

20. Ebel, A. James, "Directional radiation patterns," Electronics 9, 29-30 (April 1936).

21. Eckersley, P. P.; T. L. Eckersley, and M. L. Kerke, "Design of transmitting aerials for broadcasting stations," Jour. Inst. Elec. Eng. 67, 507-520 (April 1929).

22. Everest, F. A., and W. S. Pritchett, "Horizontal polar pattern tracer for directional broadcast antennas," Proc. I.R.E. 30, 227-232 (May 1942).

23. Foster, Ronald M., "Directive diagrams for antenna arrays," Bell System Technical Journal 5, 292-307 (April 1926).

24. Friis, H. T., "A note on a simple transmission formula," Proc. I.R.E. 34, 254-256 (May 1946).

25. Gihring, H. E., and G. H. Brown, "General consideration of tower antennas for broadcast use," Proc. I.R.E. 23, 311-356 (April 1935).

26. Green, E., "Extended aerial systems; calculating the polar diagrams," Wireless Eng. 19, 195-199 (May 1942).

27. Grimm, R., "The comb antenna," Proc. I.R.E. 36, 359-362 (March 1948).

28. Guertler, Rudolf, "Impedance Transformation in folded dipoles," Proc. I.R.E. 38, 1042-1047, (Sept. 1950).

29. Hansen, W. W. and J. R. Woodyard, "New principle in directional antenna design," Proc. I.R.E. 26, 333-345, (March 1938).

30. Harmon, R. N., "Some comments on broadcast antennas," Proc. I.R.E. 24, 36-47 (Jan. 1936).

31. Harrison, C. W. Jr., "Characteristics of the two element array," Proc. I.R.E. 31, 75-78 (Feb. 1943).

32. Harrison, C. W. Jr., "Mutual impedance of antennas," Jour. Ap. Phys. 14, 306-

309 (Jan. 1943).

33. Hartig, E. O.; R. Ring; T. Morita, and D. G. Wilson, "The measurement of antenna impedance using a receiving antenna," Proc. I.R.E. 39, 1458-1460 (Nov. 1951).

34. Hansen, W. W., and L. M. Hollingsworth, "Design of flat shooting antenna arrays," Proc. I.R.E. 27, 137-143 (Feb. 1939).

35. Hutton, W. G., and R. M. Pierce, "Mechanical calculator for directional antenna patterns," Proc. I.R.E. 30, 233-237 (May 1942).

36. Jeffers, C. L., "An antenna for controlling the nonfading range of broadcasting stations," Proc. I.R.E. 36, 1426-1431 (Nov. 1948).

37. Jones, E. M. T., "An annular corrugated-surface antenna," Proc. I.R.E. 40, 721-725 (June 1952).

38. Jordan, E. C., and W. L. Everitt, "Acoustic models of radio antennas," Proc. I.R.E. 29, 186-194 (April 1941).

39. Kear, F. G., "Maintaining the directivity of antenna arrays," Proc. I.R.E. 22, 847-869 (July 1934), and vol. 22, 1313-1314 (Nov. 1934).

40. Kelvin, W., "The radiation field of an unbalanced dipole," Proc. I.R.E. 34, 440-444 (July 1946).

41. King, D. D., "Impedance measurement on transmission lines," Proc. I.R.E. 35, 509-514 (May 1947).

42. King, Howard E., "Mutual impedance of unequal length antennas in echelon," I.R.E. Trans. AP-5, 306-313 (July 1957).

43. King, R., "Coupled antennas and transmission lines," Proc. I.R.E. 31, 626-640 (Nov. 1943).

44. King, R., and C. W. Harrison Jr., "Distribution of current along a symmetrical center-driven antenna," Proc. I.R.E. 31, 548-567 (Oct. 1943), Cor. vol. 31, 697 (Dec. 1943).

45. King, R., "An improved theory of the receiving antenna," Proc. I.R.E. 40, 1113-1120 (Sept. 1952).

46. King, R., and C. W. Harrison Jr. "Mutual and self-impedance for coupled antennas," *Jour. Ap. Phys.* 15, 481-495 (June 1944).
47. King, R., and F. G. Blake Jr., "Self-impedance of a symmetrical antenna," *Proc. I.R.E.* 30, 335-349 (July 1942).
48. Kraus, J. D., "Antenna arrays with closely spaced elements," *Proc. I.R.E.* 28, 76-84 (Feb. 1940).
49. Kraus, J. D., "A helix theorem," *Proc. I.R.E.* 39, 563 (May 1951).
50. LaPaz, L., and G. A. Miller, "Optimum current distribution on vertical antennas," *Proc. I.R.E.* 31, 214-232 (May 1943).
51. Laport, E. A., "Directional antenna design," *Electronics* 9, 22-25 (April 1936).
52. McPherson, W. L., "Electrical properties of aeri-als for medium and long wave broadcasting," *Electrical Communications* 16, 306 (April 1938), and vol. 17, 44-65 (July 1938).
53. Morgan, M. G., and W. R. Evans, Jr., "Synthesis and analysis of elliptic polarization loci in terms of space-quadrature sinusoidal components," *Proc. I.R.E.* 39, 552-556 (May 1951).
54. Morita, T., "Current distribution on transmitting and receiving antennas," *Proc. I.R.E.* 38, 898-904 (Aug. 1950).
55. Morrison, J. F., and P. H. Smith, "The shunt-excited antenna," *Proc. I.R.E.* 25, 673 (July 1937).
56. Morrison, J. F., "Simple method of observing current amplitude and phase relations in antenna arrays," *Proc. I.R.E.* 25, 1310-1326 (Oct. 1937).
57. Moulton, C. H., "Signal distortion by directional broadcast antennas," *Proc. I.R.E.* 40, 575-600 (May 1952).
58. Novik, J., "Installing antenna systems for AM operations," *Broadcast News* 95, 20-26 (June 1957).
59. Papas, C. H., and R. King, "The radiation resistance of end-fire and collinear arrays," *Proc. I.R.E.* 36, 736-741 (June 1948).
60. Patrick, P. E., "The service area of medium power broadcast stations," *Proc. I.R.E.* 30, 404-410 (Sept. 1942).
61. Pistolkors, A. A., "The radiation resistance of beam antennas," *Proc. I.R.E.* 17, 562-579 (March 1929).
62. Pistolkors, A. A., "Theory of the circular diffractive antenna," *Proc. I.R.E.* 36, 56-60 (Jan. 1948).
63. Rountree, J. G., "Calculator for two-element directive arrays," *Proc. I.R.E.* 32, 760-767 (Dec. 1944).
64. Rountree, J. G., "Maintenance of directional arrays," *I.R.E. Trans. PGBTS-9*, 39-45 (Dec. 1957).
65. Rumsey, V. H.; G. A. Deschamps; M. L. Kales, and J. I. Bohner, Introduction H. G. Booker, "Techniques for handling elliptically polarized waves with special reference to antennas," *Proc. I.R.E.* 39, 533-552 (May 1951).
66. Schelkunoff, S.A., "Principal and complimentary waves in antennas," *Proc. I.R.E.* 34, 23-32 (Jan. 1946).
67. Sinclair, D. B., "Impedance measurements on broadcast antennas," *Communications* 19, 5-9 and 26-28 (July 1939).
68. Sletten, C. J.; P. Blacksmith Jr., and G. R. Forbes Jr., "New method of antenna array synthesis applied to generation of double-step patterns," *I.R.E. Trans. AP-5*, 369-373 (Oct. 1957).
69. Smeby, Lynne C., "Short antenna characteristics," *Proc. I.R.E.* 37, 1185-1194 (Oct. 1949).
70. Smith, Carl E., "Critical study of two broadcast antennas," *Proc. I.R.E.* 24, 1329-1341 (Oct. 1936).
71. Smith, Carl E., and E. L. Gove, "Electro-mechanical calculator for directional antenna patterns," *Elec. Eng.* 62, 78-82, *Trans.* 78 (Feb. 1943).
72. Smith, Carl E., "Impedance-measuring instrument," *Proc. I.R.E.* 30, 362-364 (Aug. 1942).
73. Smith, Carl E., and E. M. Johnson, "Performance of short antennas," *Proc. I.R.E.* 35, 1026-1038 (Oct. 1947).



74. Southworth, G. C., "Certain factors affecting the gain of directive antennas," Proc. I.R.E. 18, 1502-1536 (Sept. 1930).
75. Spangenberg, K., "Charts for the determination of the r-m-s value of horizontal radiation pattern of two-element broadcast arrays," Proc. I.R.E. 30, 237-240 (May 1942).
76. Spencer, R. C., "Fourier integral methods of pattern analysis," Radiation Lab. M.I.T., Rep. 762-1 (1946).
77. Sterba, E. J., "Theoretical and practical aspects of directional transmitting systems," Proc. I.R.E. 19, 1184-1215 (July 1931).
78. Storch, Leo, "Design procedures for  $\pi$ -network antenna couplers," Proc. I.R.E. 37, 1427-1432 (Dec. 1949).
79. Tai, C. T., "Coupled antennas," Proc. I.R.E. 36, 487-500 (April 1948).
80. Thompson, W. T., "Development of the general antenna array equation," Jour. Ap. Phys. 15, 420-422 (May 1944).
81. Wheeler, H. A., "The radiation resistance of an antenna in an infinite array or wave guide," Proc. I.R.E. 36, 478-487 (April 1948).
82. Williams, H. Paul, "A machine for calculating the polar diagram of an antenna system," Electrical Communication 21, 103-111 (1943).
83. Wilmotte, R. M., "Directional antennas for broadcasting," Electronics 4, 362-364 (Nov. 1932).
84. Wilmotte, R. M., "General formulas for the radiation distribution of antenna systems," Jour. Inst. Elec. Eng. 68, 1174-1190 (Sept. 1930).
85. Wilmotte, R. M., "History of the directional antenna in the standard broadcast band for purpose of protecting service area of distant stations," I.R.E. Trans. PGBTs-7, 51-55 (Feb. 1955).
86. Wilmotte, R. M., "Nature of the field in the neighborhood of an antenna," Jour. Inst. Elec. Eng. 66, 961-967 (Sept. 1928).
87. Wilmotte, R. M., "Polycasting," Proc. I.R.E. 39, 740-752 (July 1951).
88. Wolff, Irving, "Determination of the radiating system which will produce a specified directional characteristic," Proc. I.R.E. 25, 630-643 (May 1937).
89. Yaru, Nicholas, "A note on super-gain antenna arrays," Proc. I.R.E. 39, 1081-1085 (Sept. 1951).

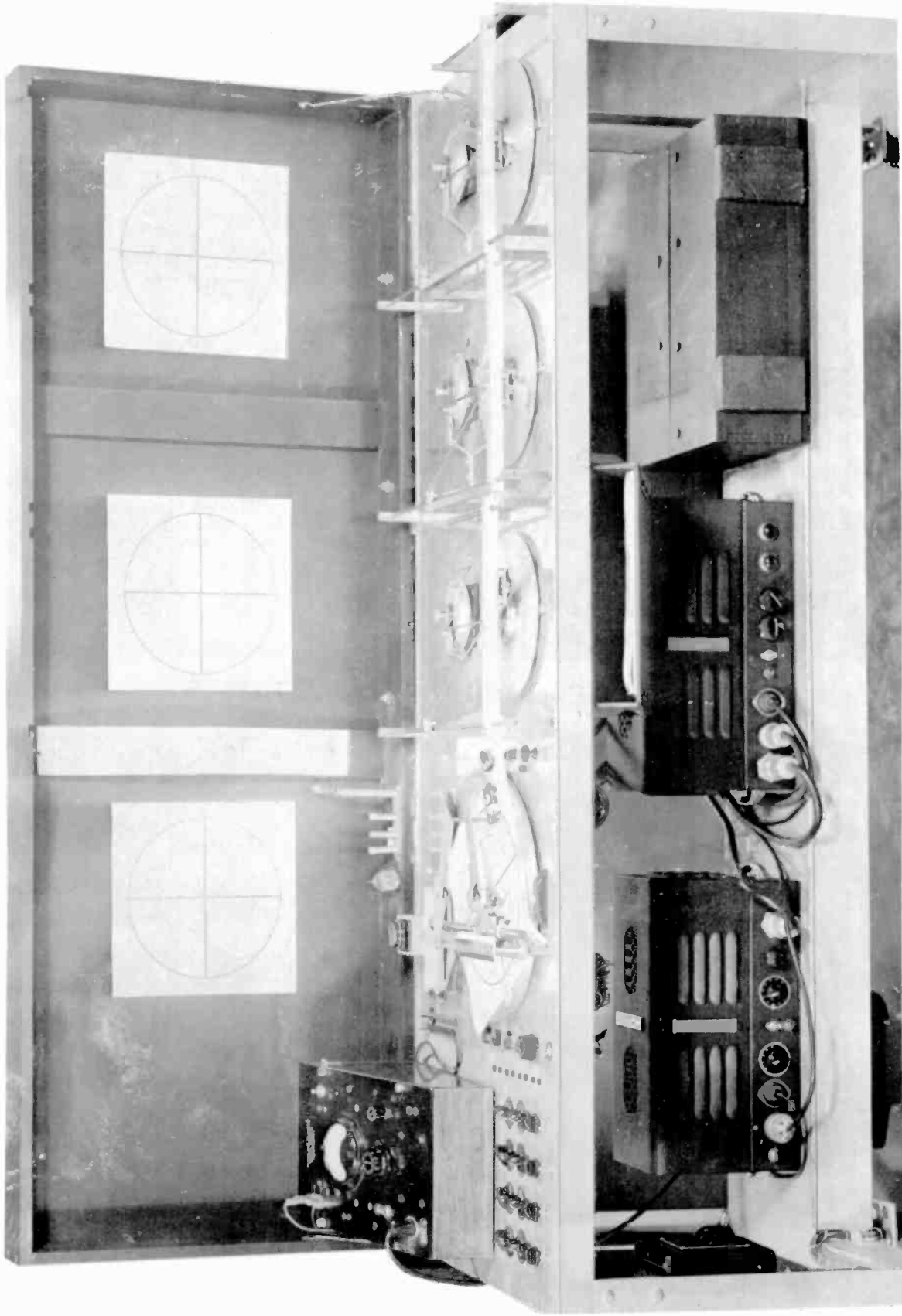

ELECTRO-MECHANICAL DIRECTIONAL ANTENNA PATTERN CALCULATOR  
FIG. A

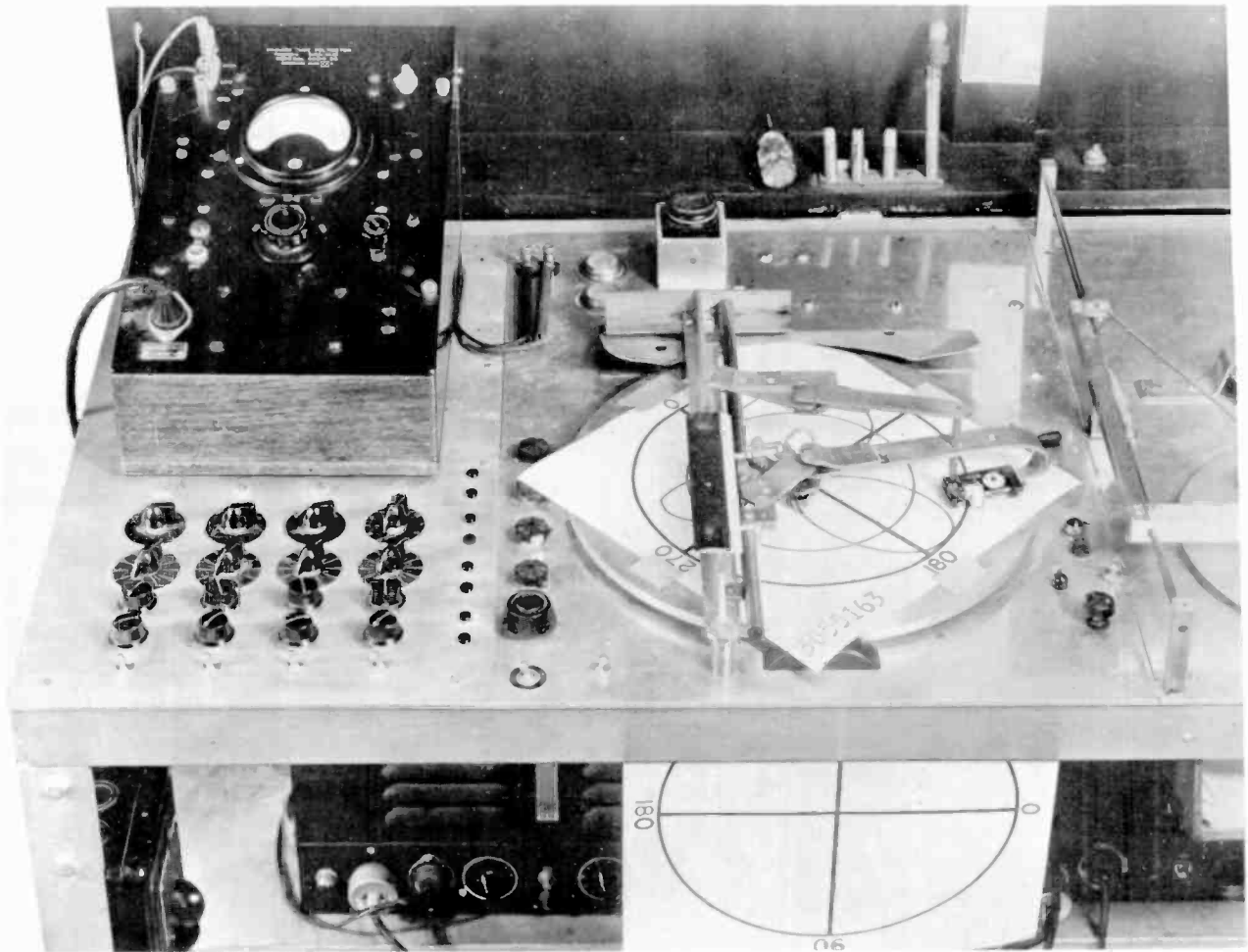

(a) MAGNITUDE CONTROL AND TURNTABLE PANELS

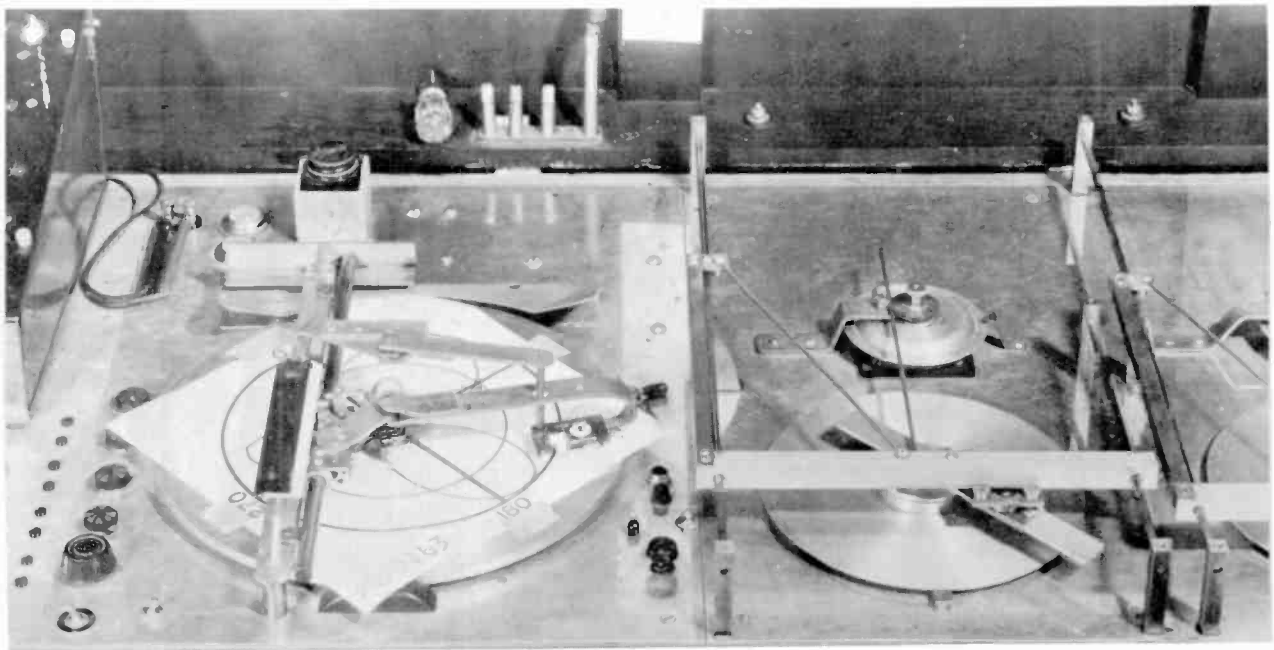

(b) TURNTABLE AND COSINE GENERATOR PANELS  
CLOSE-UP VIEWS OF CALCULATOR

FIG. B

SYSTEMATIZATION OF  
TWO TOWER PATTERNS

This section furnishes 568 patterns as described on page 1.19 of Part 1, "Theory and Application."

256 of these patterns are general patterns with spacings out to four wavelengths, while 312 are detailed patterns for spacings out to one wavelength. The general patterns are for spacings in steps of 45 degrees and phasings in steps of 45 degrees. The detailed patterns are for spacings in steps of 15 degrees and phasings in steps of 15 degrees. The phasings are only presented from 0 to 180 degrees since the same patterns, oriented 180 degrees, result for phasings from 180 degrees to 360 degrees. This is readily observed by inspecting the general patterns which present the phasings.

D i r e c t i o n a l                      A n t e n n a                      P a t t e r n s

$\psi_2$  = PHASING OF ANTENNA No. 2 IN DEGREES

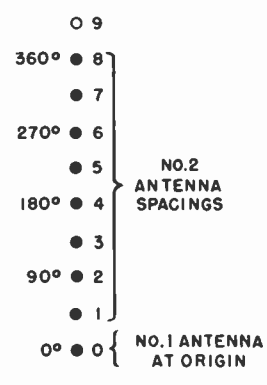
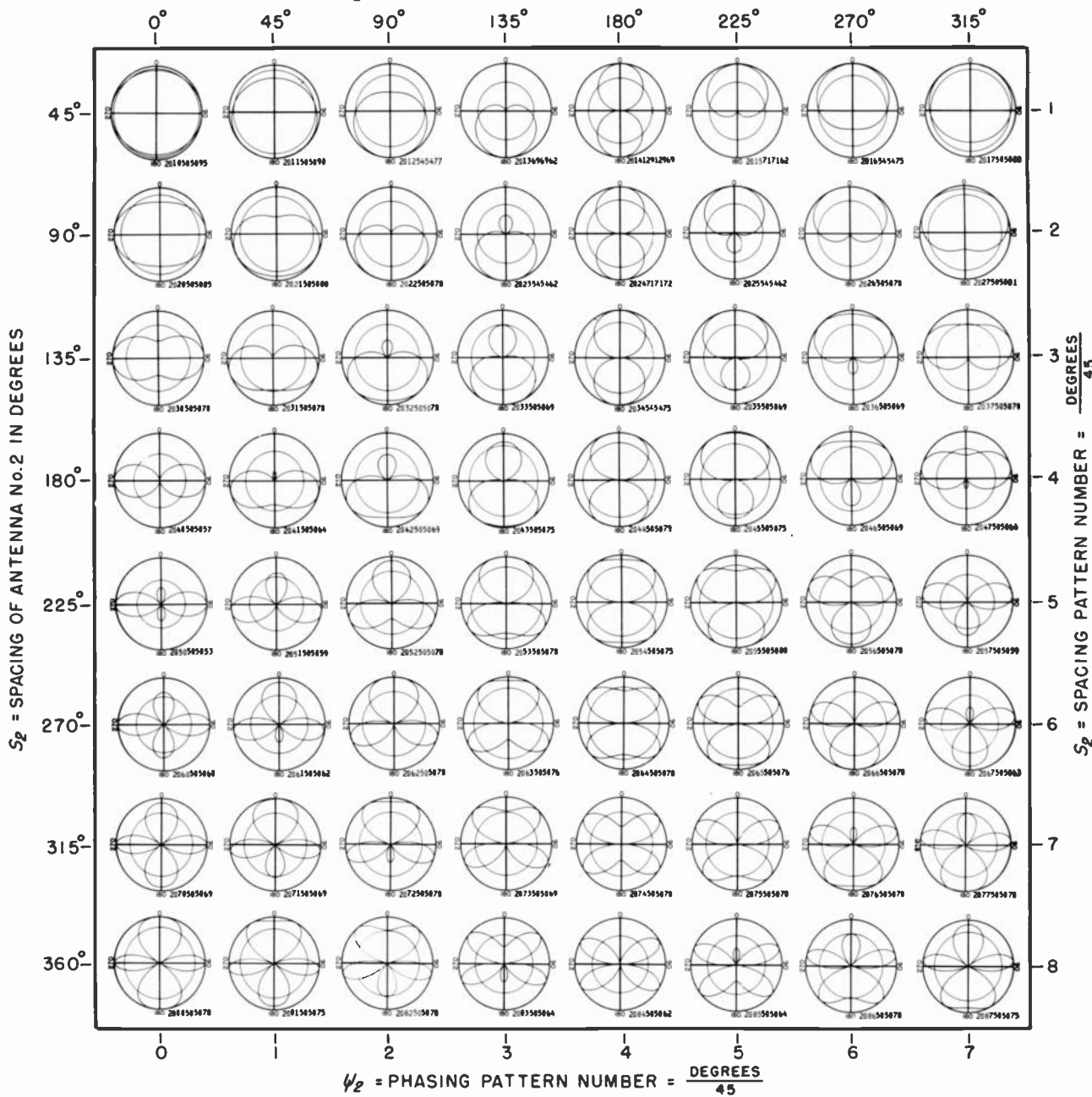

SPOTS LOCATE THE ANTENNAS FOR THIS PAGE OF PATTERNS.

NUMBER OF ANTENNAS IN THE SYSTEM.	SPACING OF NO. 2 ANTENNA = $\frac{\text{DEGREES}}{45}$	PHASING OF NO. 2 ANTENNA = $\frac{\text{DEGREES}}{45}$	% FIELD INTENSITY RADIATED IN HORIZONTAL PLANE FROM NO. 1 ANTENNA.	% FIELD INTENSITY RADIATED IN HORIZONTAL PLANE FROM NO. 2 ANTENNA.	% RMS FIELD INTENSITY RADIATED IN HORIZONTAL PLANE FROM ANTENNA SYSTEM.
No. 2	$S_2$	$\psi_2$	$E_1$	$E_2$	$E_0$
	01	0	50	50	95

PATTERN NOMENCLATURE

$\psi_2$  = PHASING OF ANTENNA No.2 IN DEGREES

2.3

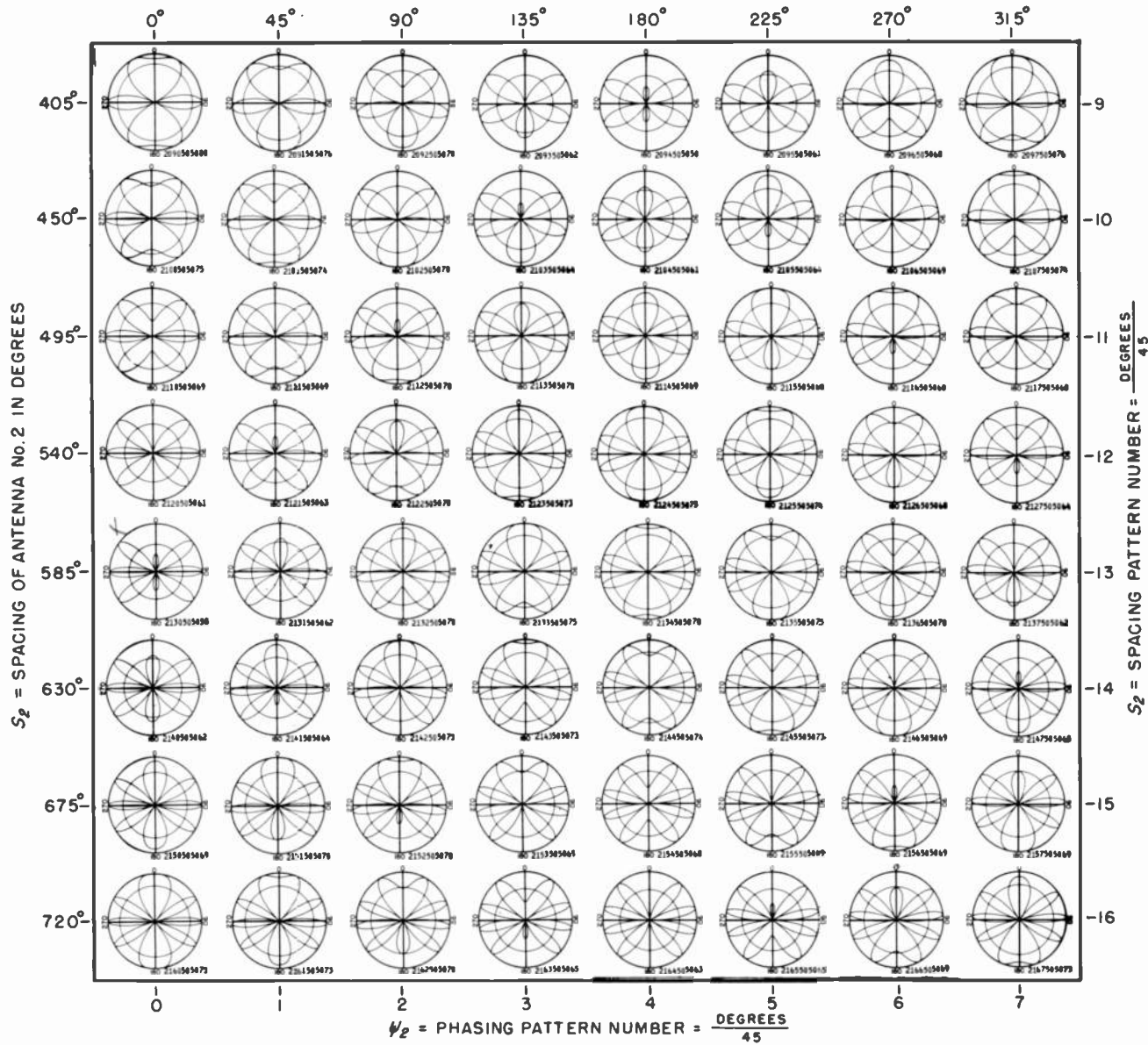

$S_2$  = SPACING OF ANTENNA No.2 IN DEGREES

$S_2$  = SPACING PATTERN NUMBER =  $\frac{\text{DEGREES}}{45}$

$\psi_2$  = PHASING PATTERN NUMBER =  $\frac{\text{DEGREES}}{45}$

- 17
  - 16
  - 15
  - 14
  - 13
  - 12
  - 11
  - 10
  - 9
  - 8
  - 1
- NO. 2 ANTENNA SPACINGS
- 0
- NO. 1 ANTENNA AT ORIGIN

NUMBER OF ANTENNAS IN THE SYSTEM.	SPACING OF NO. 2 ANTENNA = $\frac{\text{DEGREES}}{45}$	PHASING OF NO. 2 ANTENNA = $\frac{\text{DEGREES}}{45}$	% FIELD INTENSITY RADIATED IN HORIZONTAL PLANE FROM NO. 1 ANTENNA.	% FIELD INTENSITY RADIATED IN HORIZONTAL PLANE FROM NO. 2 ANTENNA.	% RMS FIELD INTENSITY RADIATED IN HORIZONTAL PLANE FROM ANTENNA SYSTEM.
No. 2	$S_2$ 09	$\psi_2$ 0	$E_1$ 50	$E_2$ 50	$E_0$ 80

PATTERN NOMENCLATURE

SPOTS LOCATE THE ANTENNAS FOR THIS PAGE OF PATTERNS.

$\psi_2$  = PHASING OF ANTENNA No. 2 IN DEGREES

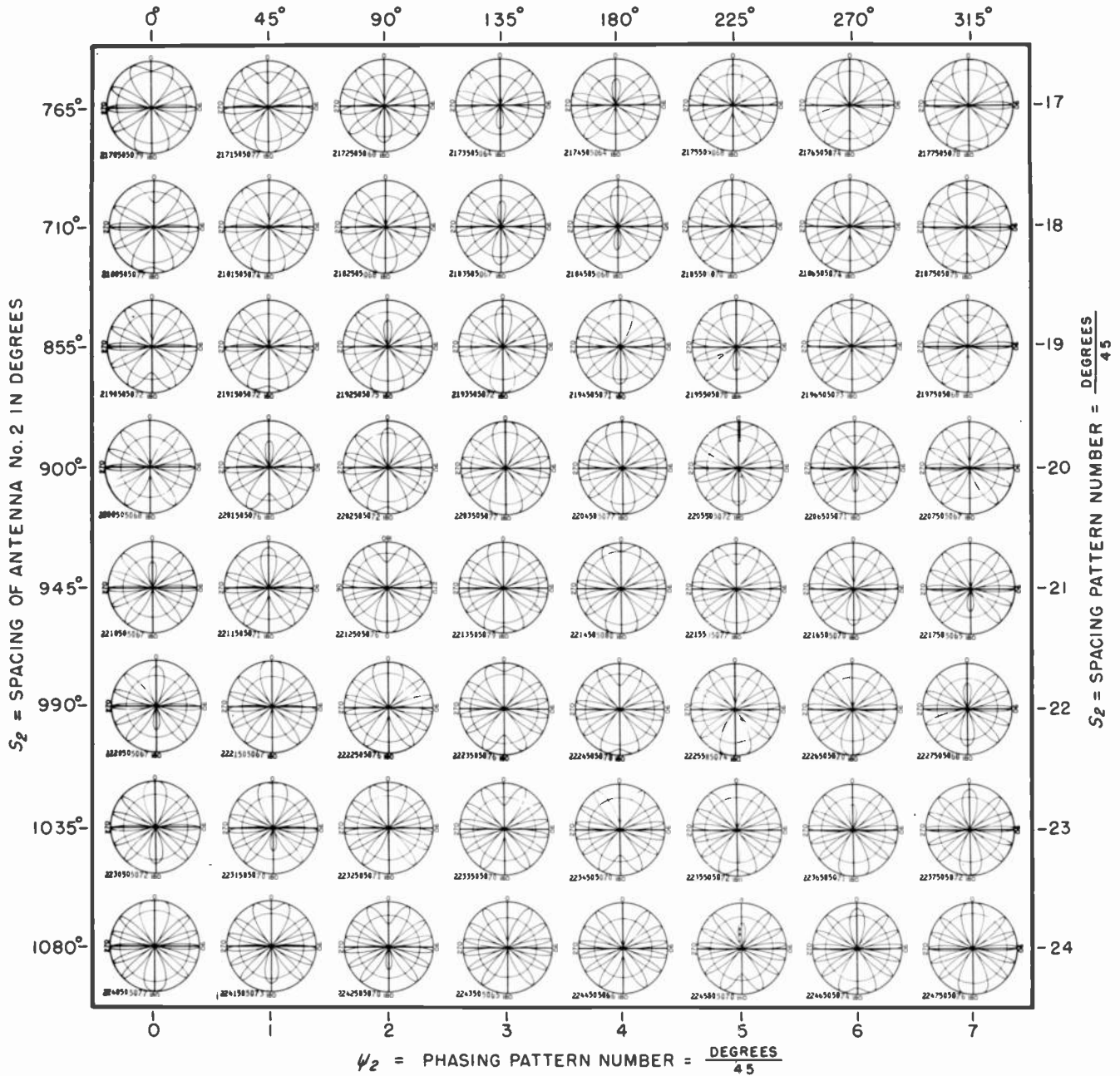

- 25
  - 24
  - 23
  - 22
  - 21
  - 20
  - 19
  - 18
  - 17
  - 16
  - 1
  - 0
- NO. 2 ANTENNA SPACINGS
- NO. 1 ANTENNA AT ORIGIN

SPOTS LOCATE THE ANTENNAS FOR THIS PAGE OF PATTERNS

NUMBER OF ANTENNAS IN THE SYSTEM.

No. 2

SPACING OF NO. 2 ANTENNA =  $\frac{\text{DEGREES}}{45}$

$S_2$  17

PHASING OF NO. 2 ANTENNA =  $\frac{\text{DEGREES}}{45}$

$\psi_2$  0

% FIELD INTENSITY RADIATED IN HORIZONTAL PLANE FROM NO. 1 ANTENNA.

$E_1$  50

% FIELD INTENSITY RADIATED IN HORIZONTAL PLANE FROM NO. 2 ANTENNA.

$E_2$  50

% RMS FIELD INTENSITY RADIATED IN HORIZONTAL PLANE FROM ANTENNA SYSTEM.

$E_0$  79

PATTERN NOMENCLATURE

$\psi_2$  = PHASING OF ANTENNA No. 2 IN DEGREES

2.5

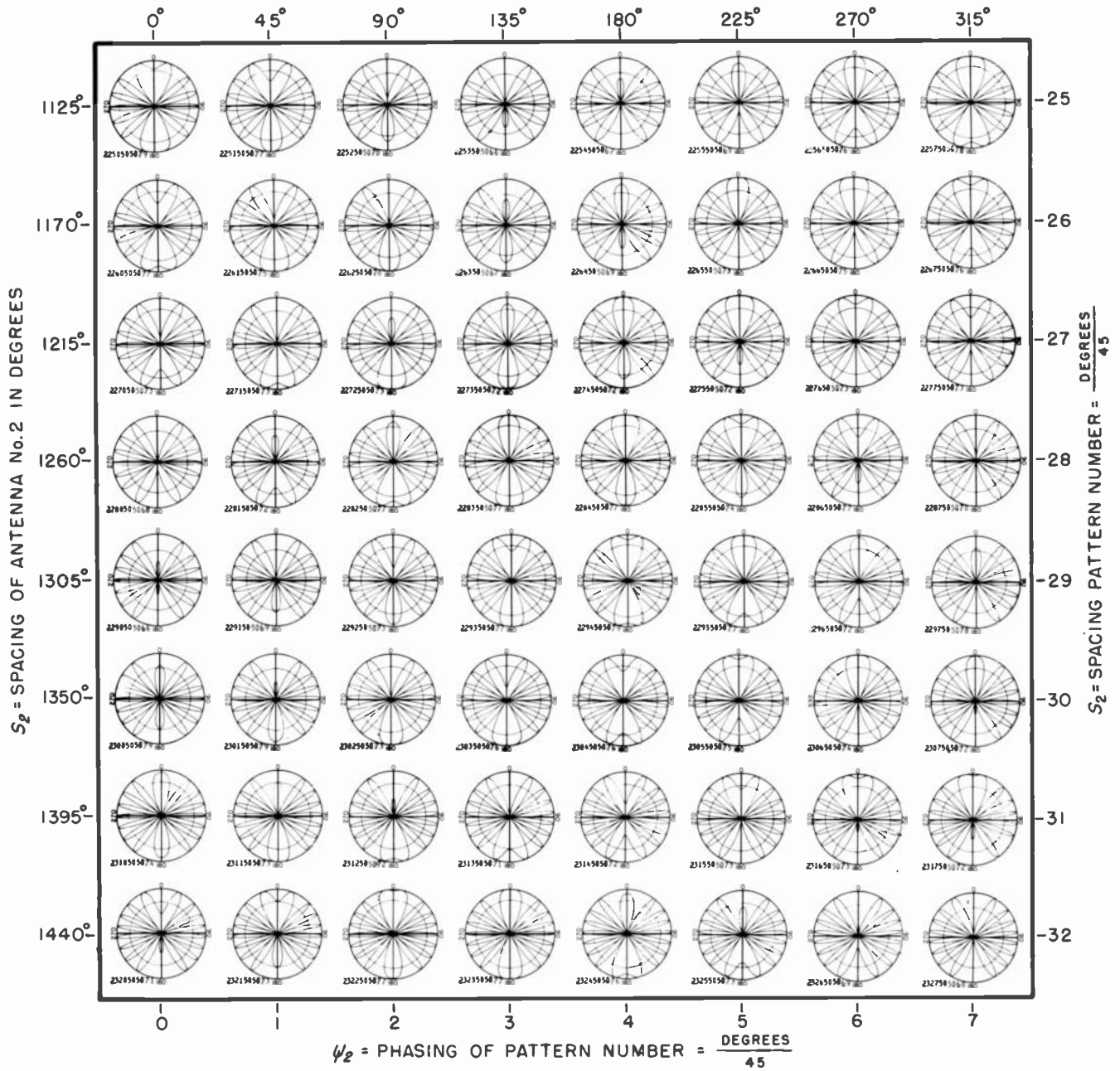

- 1440° ● 32
- 31
- 1350° ● 30
- 29
- 28
- 27
- 26
- 25
- 1080° ○ 24
- 1
- 0° ● 0

NO. 2 ANTENNA SPACINGS

NO. 1 ANTENNA AT ORIGIN

NUMBER OF ANTENNAS IN THE SYSTEM.	SPACING OF NO. 2 ANTENNA = $\frac{\text{DEGREES}}{45}$	PHASING OF NO. 2 ANTENNA = $\frac{\text{DEGREES}}{45}$	% FIELD INTENSITY RADIATED IN HORIZONTAL PLANE FROM NO. 1 ANTENNA.	% FIELD INTENSITY RADIATED IN HORIZONTAL PLANE FROM NO. 2 ANTENNA.	% RMS FIELD INTENSITY RADIATED IN HORIZONTAL PLANE FROM ANTENNA SYSTEM.
No.	$S_2$	$\psi_2$	$E_1$	$E_2$	$E_0$
2	25	0	50	50	79

SPOTS LOCATE THE ANTENNAS FOR THIS PAGE OF PATTERNS.

PATTERN NOMENCLATURE



$\psi_2 =$  PHASING OF ANTENNA No. 2 IN DEGREES

- 360°
- 345°
- 330°
- 315°
- 300
- 285
- 270
- 255
- 240
- 225
- 210
- 195
- 180
- 165
- 150
- 135
- 120
- 105
- 90
- 75
- 60
- 45
- 30
- 15
- NO. 1 ANTENNA AT ORIGIN

$S_2 =$  SPACING OF ANTENNA No. 2 IN DEGREES

$S_2 =$  SPACING OF ANTENNA No. 2 IN DEGREES

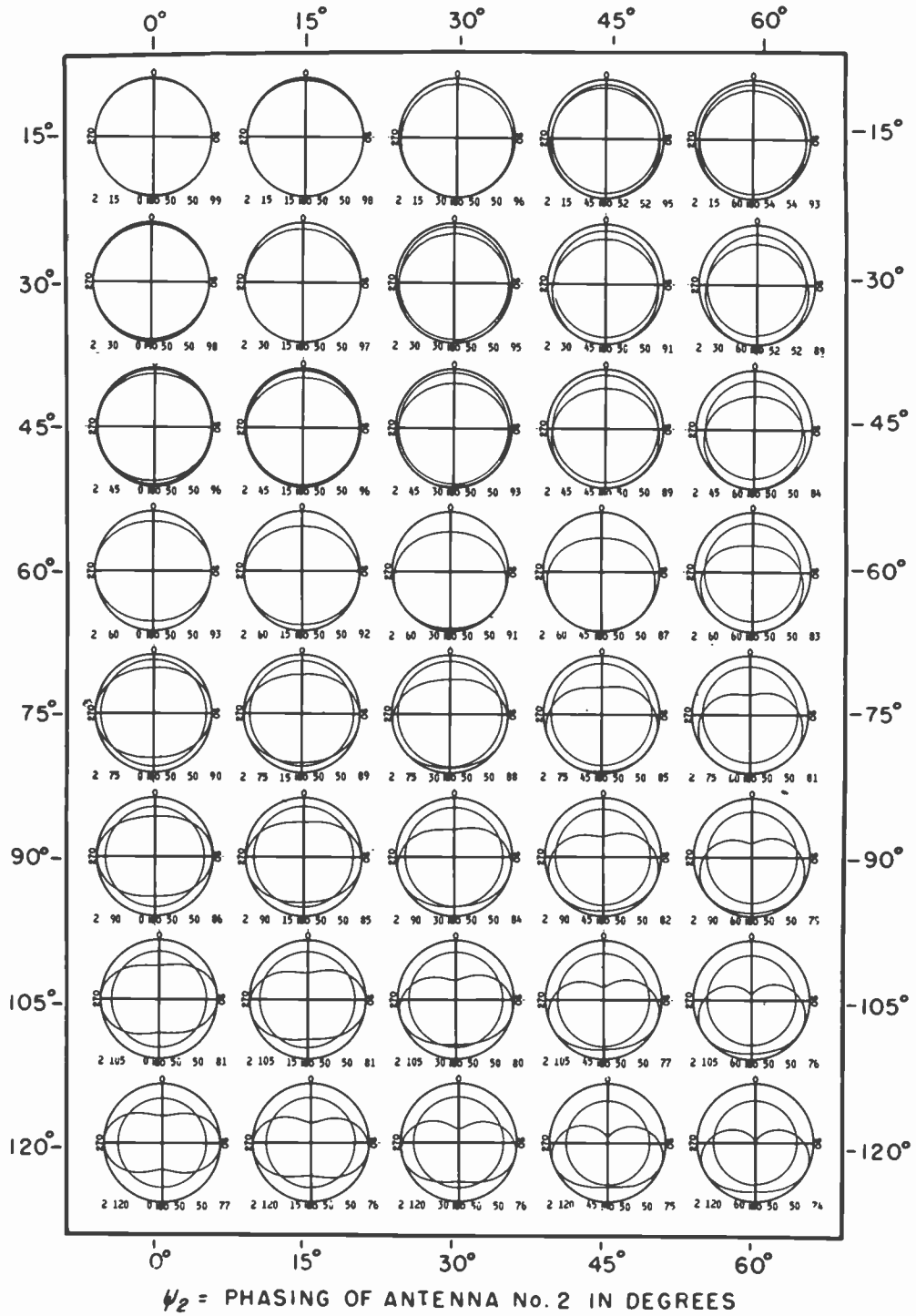

SPOTS LOCATE THE ANTENNAS FOR THIS PAGE OF PATTERNS .

$\psi_2$  = PHASING OF ANTENNA No. 2 IN DEGREES

2.7

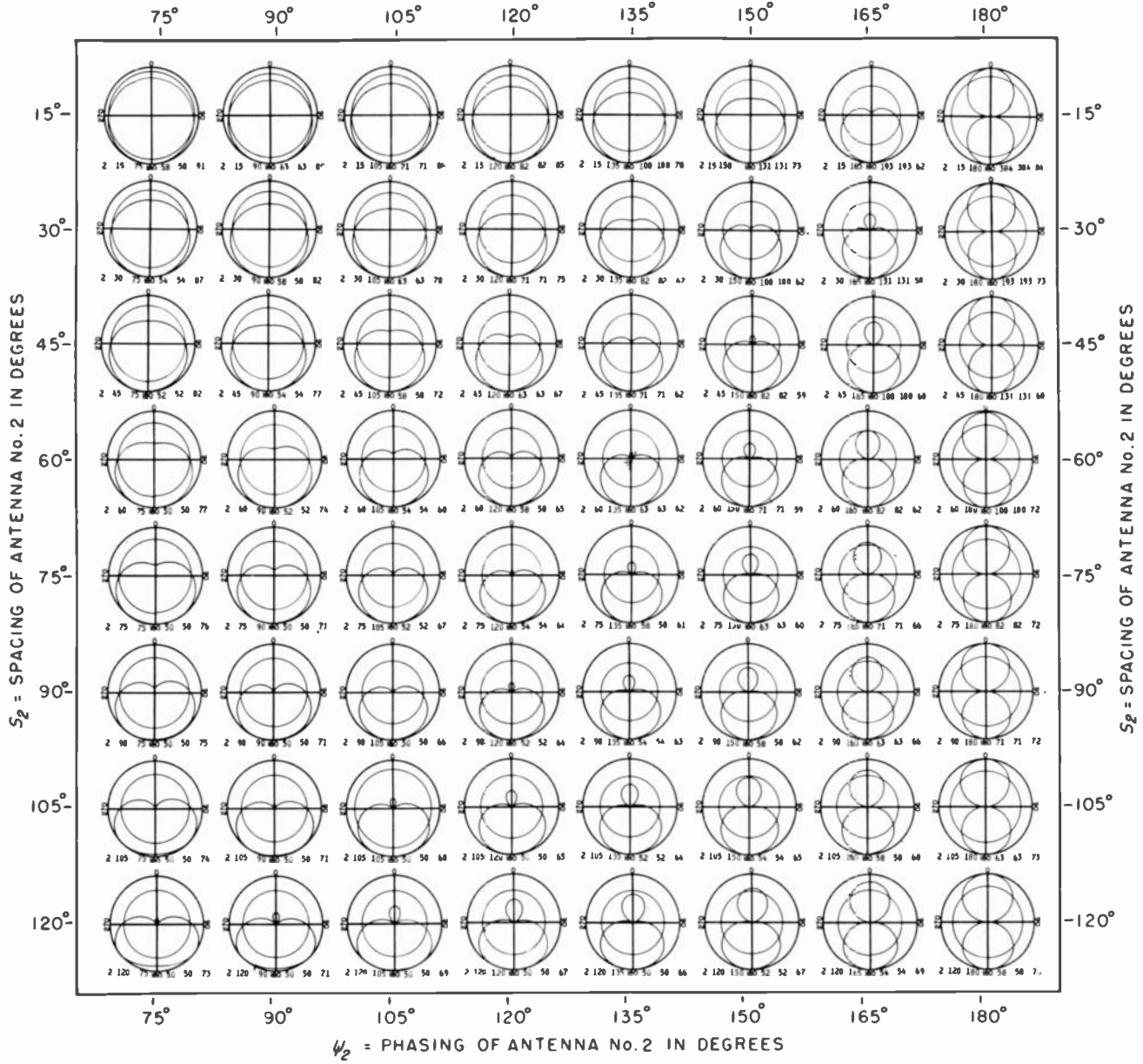

NUMBER OF ANTENNAS  
 IN THE SYSTEM  
 No. 2

SPACING OF NO. 2  
 ANTENNA IN DEGREES  
 $S_2$  15

PHASING OF NO. 2  
 ANTENNA IN DEGREES  
 $\psi_2$  75

% FIELD INTENSITY  
 RADIATED IN HORIZONTAL  
 PLANE FROM NO. 1 ANTENNA  
 $F_1$  58

% FIELD INTENSITY  
 RADIATED IN HORIZONTAL  
 PLANE FROM NO. 2 ANTENNA  
 $F_2$  58

% RMS FIELD INTENSITY  
 RADIATED IN HORIZONTAL  
 PLANE FROM ANTENNA SYSTEM  
 $F_0$  91

PATTERN NOMENCLATURE

$\psi_2 =$  PHASING OF ANTENNA No. 2 IN DEGREES

No. 2 ANTENNA SPACING IN DEGREES

- 360°
- 345°
- 330°
- 315°
- 300
- 285
- 270
- 255
- 240
- 225
- 210
- 195
- 180
- 165
- 150
- 135
- 120
- 105
- 90
- 75
- 60
- 45
- 30
- 15
- NO. 1 ANTENNA AT ORIGIN

$S_2 =$  SPACING OF ANTENNA No. 2 IN DEGREES

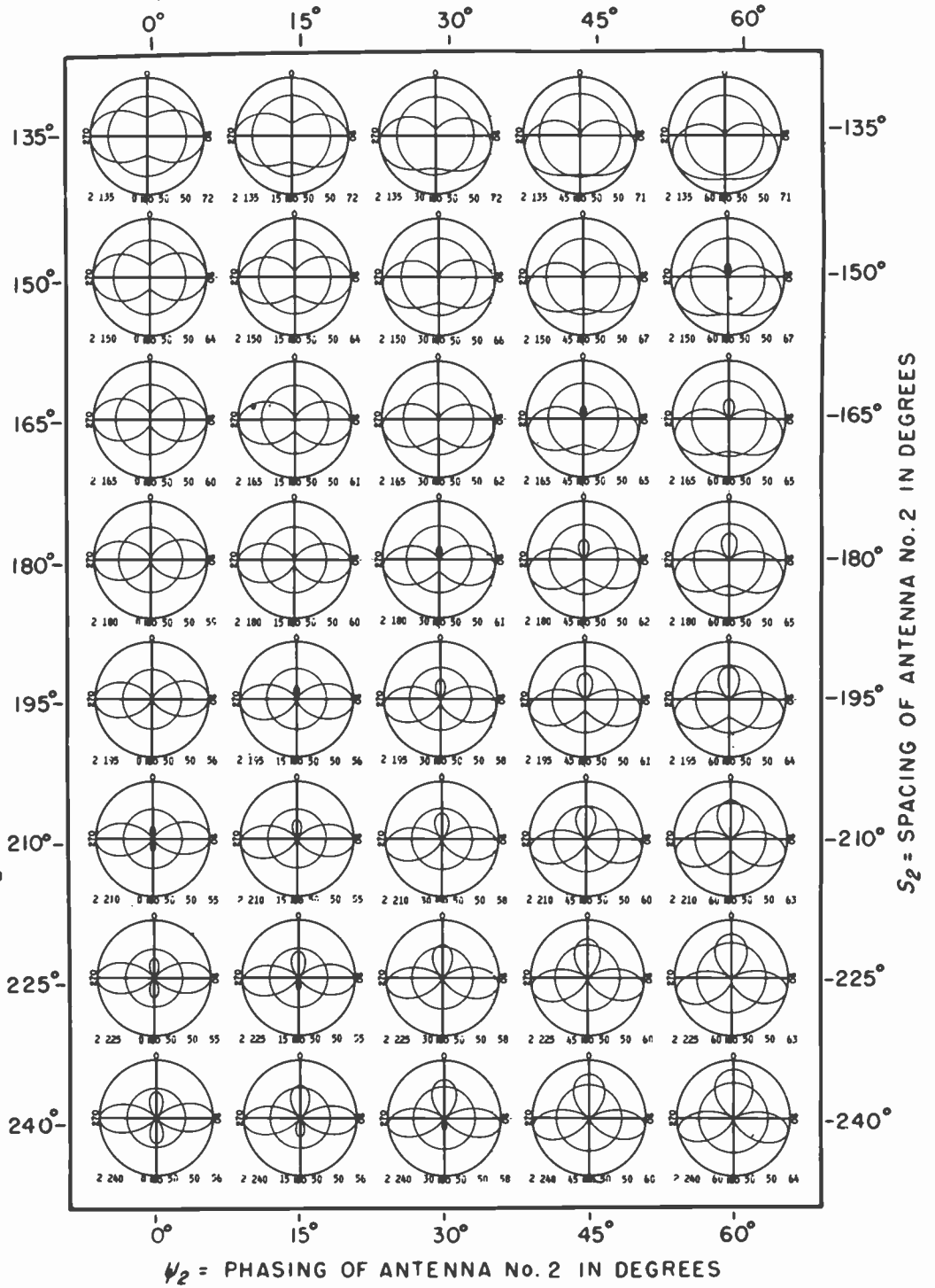

$S_2 =$  SPACING OF ANTENNA No. 2 IN DEGREES

↑  
SPOTS LOCATE THE ANTENNAS FOR THIS PAGE OF PATTERNS.

$\psi_2$  = PHASING OF ANTENNA No. 2 IN DEGREES

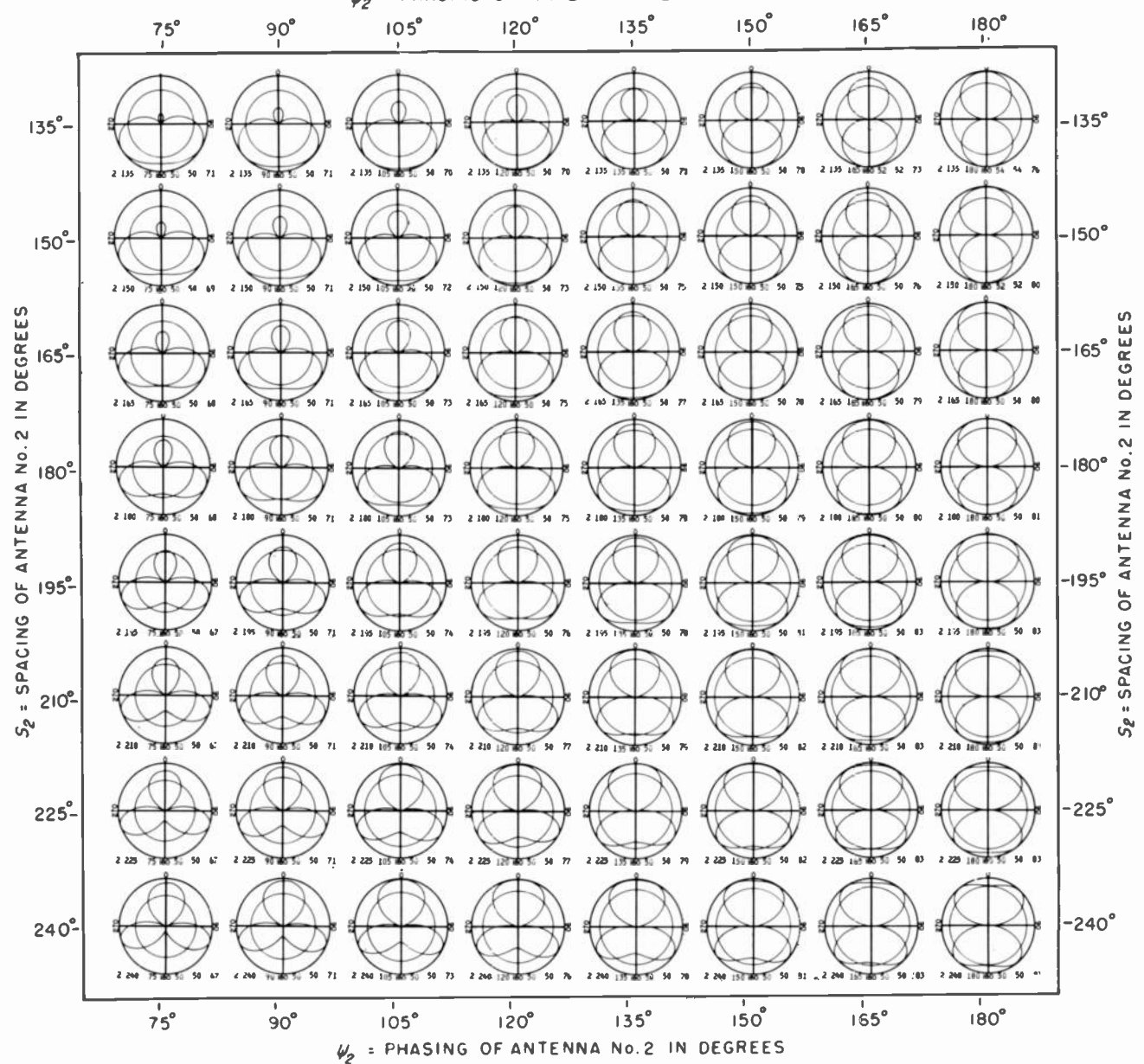

NUMBER OF ANTENNAS IN THE SYSTEM  
 No. 2  
 SPACING OF NO. 2 ANTENNA IN DEGREES  
 $S_2$  315  
 PHASING OF NO. 2 ANTENNA IN DEGREES  
 $\psi_2$  75  
 % FIELD INTENSITY RADIATED IN HORIZONTAL PLANE FROM NO. 1 ANTENNA  
 $E_1$  50  
 % FIELD INTENSITY RADIATED IN HORIZONTAL PLANE FROM NO. 2 ANTENNA  
 $E_2$  50  
 % RMS FIELD INTENSITY RADIATED IN HORIZONTAL PLANE FROM ANTENNA SYSTEM  
 $E_0$  71  
 PATTERN NOMENCLATURE

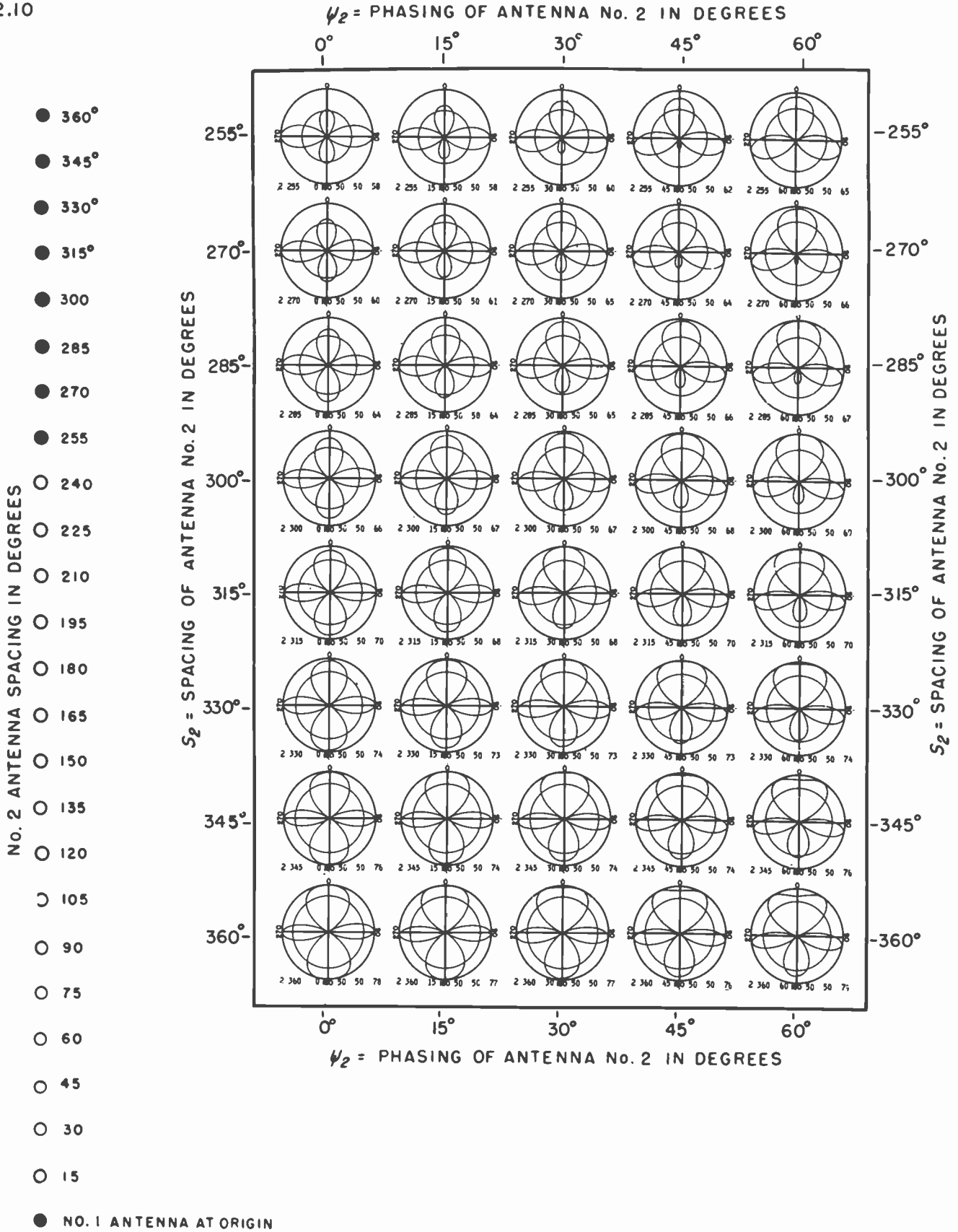

SPOTS LOCATE THE ANTENNAS FOR THIS PAGE OF PATTERNS

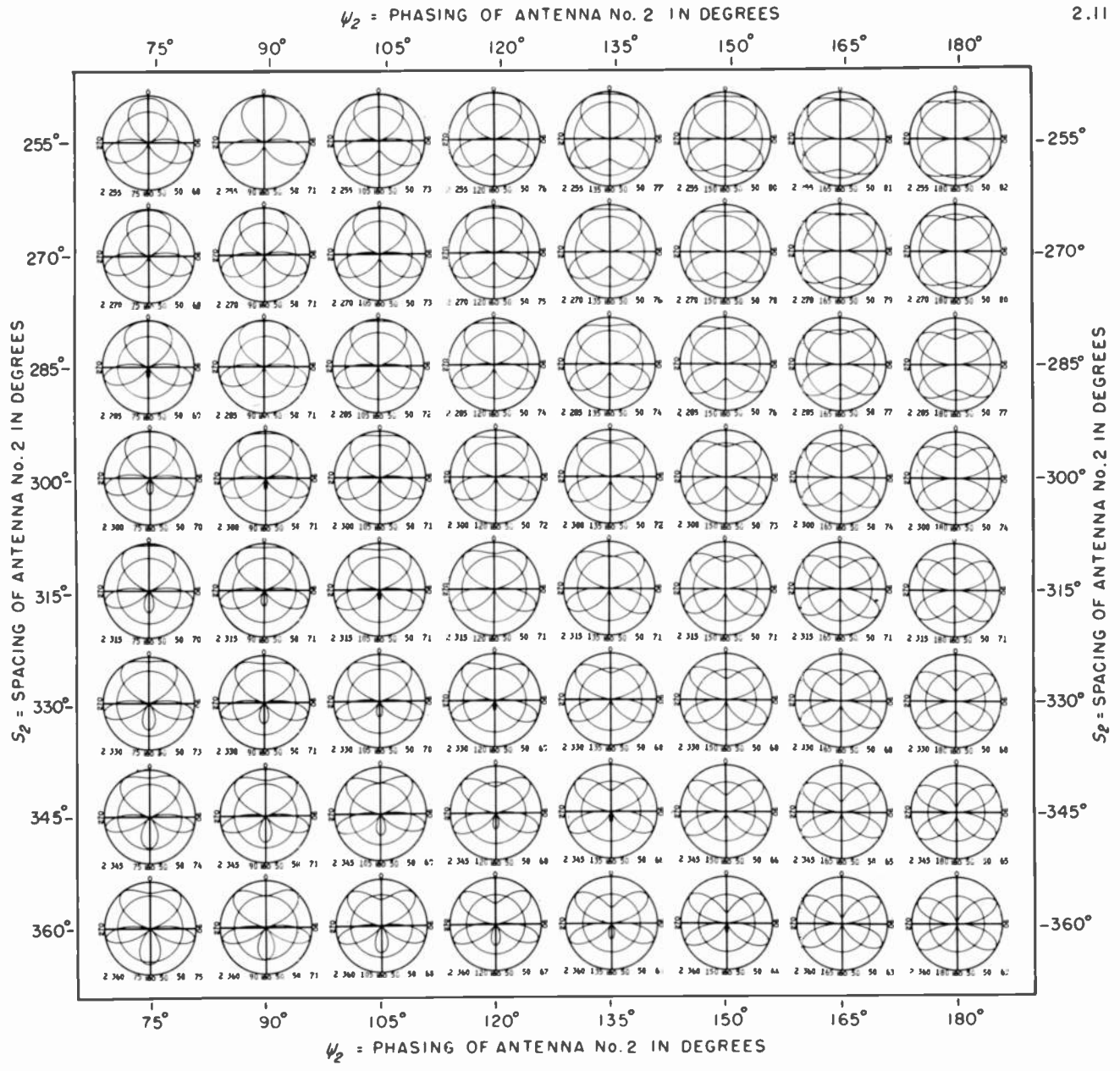

NUMBER OF ANTENNAS IN THE SYSTEM	SPACING OF NO. 2 ANTENNA IN DEGREES	PHASING OF NO. 2 ANTENNA IN DEGREES	% FIELD INTENSITY RADIATED IN HORIZONTAL PLANE FROM NO. 1 ANTENNA	% FIELD INTENSITY RADIATED IN HORIZONTAL PLANE FROM NO. 2 ANTENNA	% RMS FIELD INTENSITY RADIATED IN HORIZONTAL PLANE FROM ANTENNA SYSTEM
No.	$S_2$	$\psi_2$	$F_1$	$F_2$	$F_0$
2	255	75	50	50	68

PATTERN NOMENCLATURE

SYSTEMATIZATION OF  
THREE TOWER PATTERNS

This section furnishes 14,592 patterns, as described on page 1.20 of Part 1, "Theory and Application."

There are 228 placements (pages) of the three towers to cover spacings out to one wavelength. For each placement of the towers there are 64 different phasings presented. The field strengths were eliminated as parameters by making magnitude adjustments to give at least one maximum of 100 percent and where possible, at least one null.

D i r e c t i o n a l                      A n t e n n a                      P a t t e r n s

$\psi_3$  = PHASING OF ANTENNA No. 3 IN DEGREES

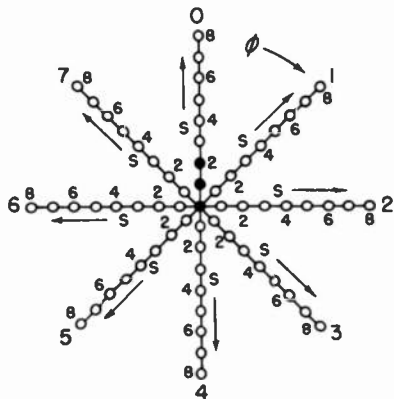
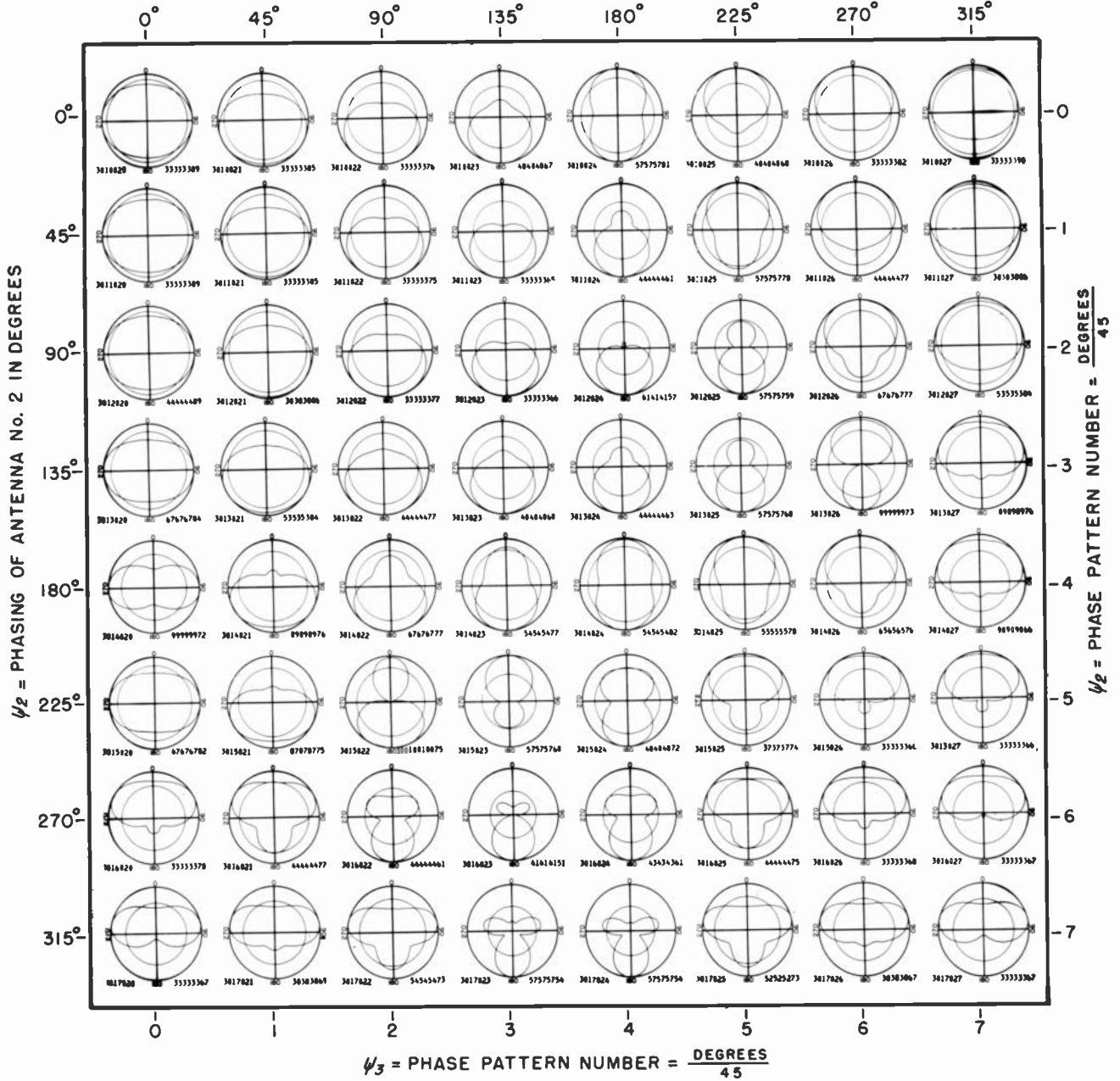

SPOTS LOCATE THE ANTENNAS FOR THIS PAGE OF PATTERNS IN THE SYSTEMATIZATION PLACEMENT CHART.

- NUMBER OF ANTENNAS IN THE SYSTEM  
No. 3
- ORIENTATION OF DEGREES / 45 NO. 2 ANTENNA =  $\psi_2$   
0
- SPACING OF DEGREES / 45 NO. 2 ANTENNA =  $S_2$   
1
- PHASING OF DEGREES / 45 NO. 2 ANTENNA =  $\psi_2$   
0
- ORIENTATION OF DEGREES / 45 NO. 3 ANTENNA =  $\psi_3$   
0
- SPACING OF DEGREES / 45 NO. 3 ANTENNA =  $S_3$   
2
- PHASING OF DEGREES / 45 NO. 3 ANTENNA =  $\psi_3$   
0

LEFT HAND PATTERN NUMBER GIVES ANTENNA PLACEMENT AND PHASING DATA.

- % FIELD INTENSITY RADIATED IN HORIZONTAL PLANE FROM NO. 1 ANTENNA.  
 $F_1$  33
- % FIELD INTENSITY RADIATED IN HORIZONTAL PLANE FROM NO. 2 ANTENNA.  
 $F_2$  33
- % FIELD INTENSITY RADIATED IN HORIZONTAL PLANE FROM NO. 3 ANTENNA.  
 $F_3$  33
- % RMS FIELD INTENSITY RADIATED IN HORIZONTAL PLANE FROM ANTENNA SYSTEM.  
 $F_0$  89

RIGHT HAND PATTERN NUMBER GIVES ANTENNA FIELD INTENSITY DATA IN PERCENT.

PATTERN NOMENCLATURE



$\psi_3$  = PHASING OF ANTENNA No. 3 IN DEGREES

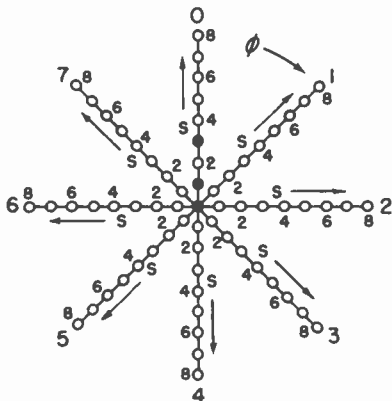
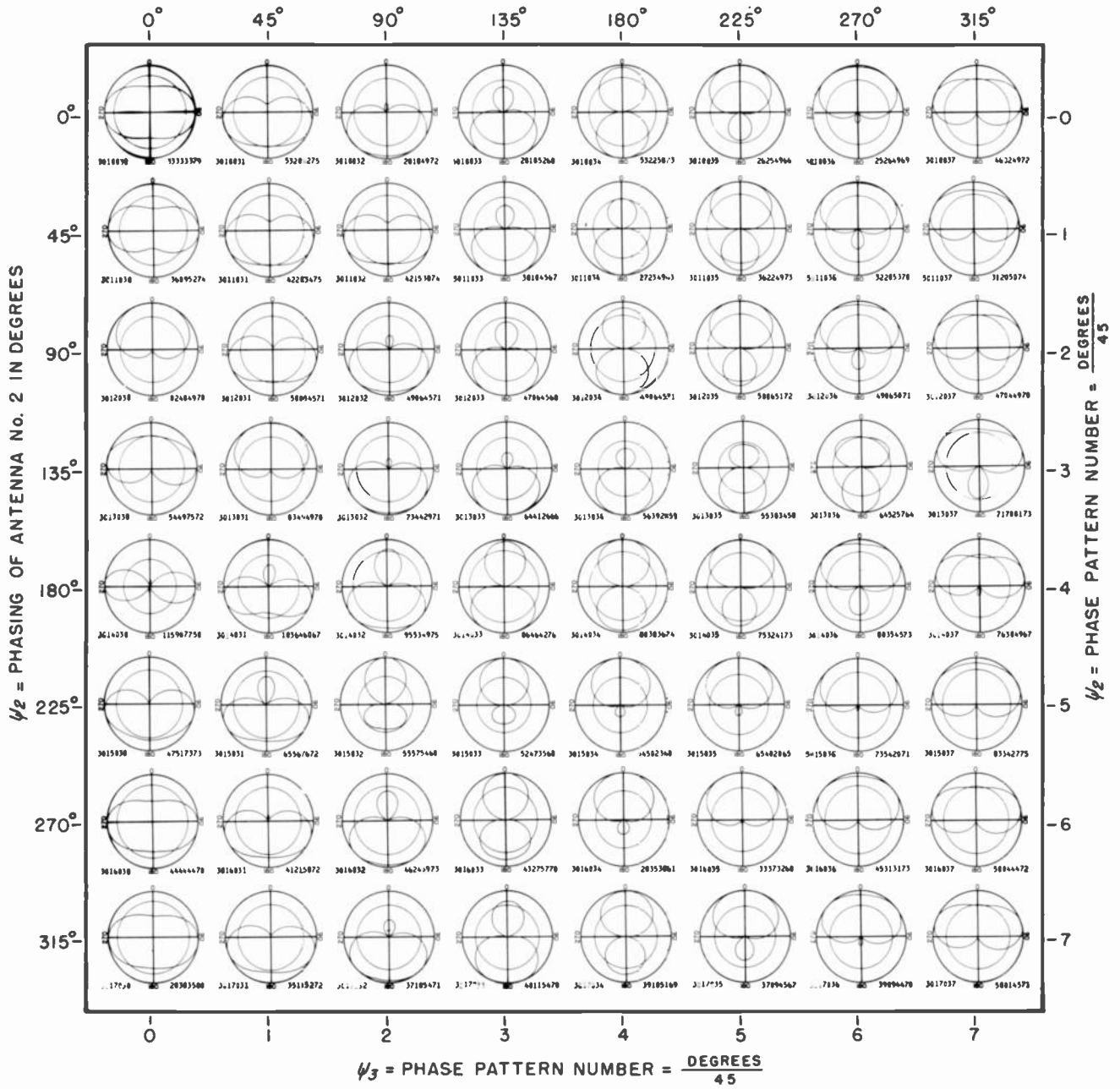

SPOTS LOCATE THE ANTENNAS FOR THIS PAGE OF PATTERNS IN THE SYSTEMIZATION PLACEMENT CHART.

$\psi_3$  = PHASE PATTERN NUMBER =  $\frac{\text{DEGREES}}{45}$

- NUMBER OF ANTENNAS IN THE SYSTEM  
No. 3
- ORIENTATION OF DEGREES NO. 2 ANTENNA =  $\frac{\text{DEGREES}}{45}$   
 $\psi_2$  0
- SPACING OF DEGREES NO. 2 ANTENNA =  $\frac{\text{DEGREES}}{45}$   
 $S_2$  1
- PHASING OF DEGREES NO. 2 ANTENNA =  $\frac{\text{DEGREES}}{45}$   
 $\psi_2$  0
- ORIENTATION OF DEGREES NO. 3 ANTENNA =  $\frac{\text{DEGREES}}{45}$   
 $\psi_3$  0
- SPACING OF DEGREES NO. 3 ANTENNA =  $\frac{\text{DEGREES}}{45}$   
 $S_3$  3
- PHASING OF DEGREES NO. 3 ANTENNA =  $\frac{\text{DEGREES}}{45}$   
 $\psi_3$  0

LEFT HAND PATTERN NUMBER GIVES ANTENNA PLACEMENT AND PHASING DATA.

- % FIELD INTENSITY RADIATED IN HORIZONTAL PLANE FROM NO. 1 ANTENNA.  
 $F_1$  33
- % FIELD INTENSITY RADIATED IN HORIZONTAL PLANE FROM NO. 2 ANTENNA.  
 $F_2$  33
- % FIELD INTENSITY RADIATED IN HORIZONTAL PLANE FROM NO. 3 ANTENNA.  
 $F_3$  33
- % RMS FIELD INTENSITY RADIATED IN HORIZONTAL PLANE FROM ANTENNA SYSTEM.  
 $F_0$  79

RIGHT HAND PATTERN NUMBER GIVES ANTENNA FIELD INTENSITY DATA IN PERCENT.

PATTERN NOMENCLATURE

$\psi_3$  = PHASING OF ANTENNA No. 3 IN DEGREES

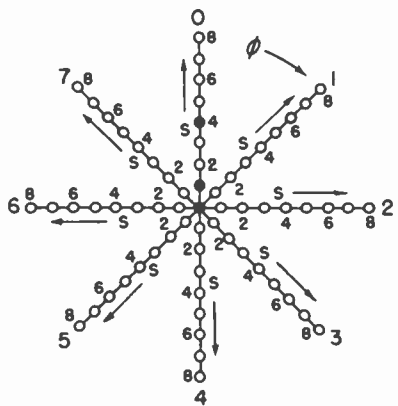
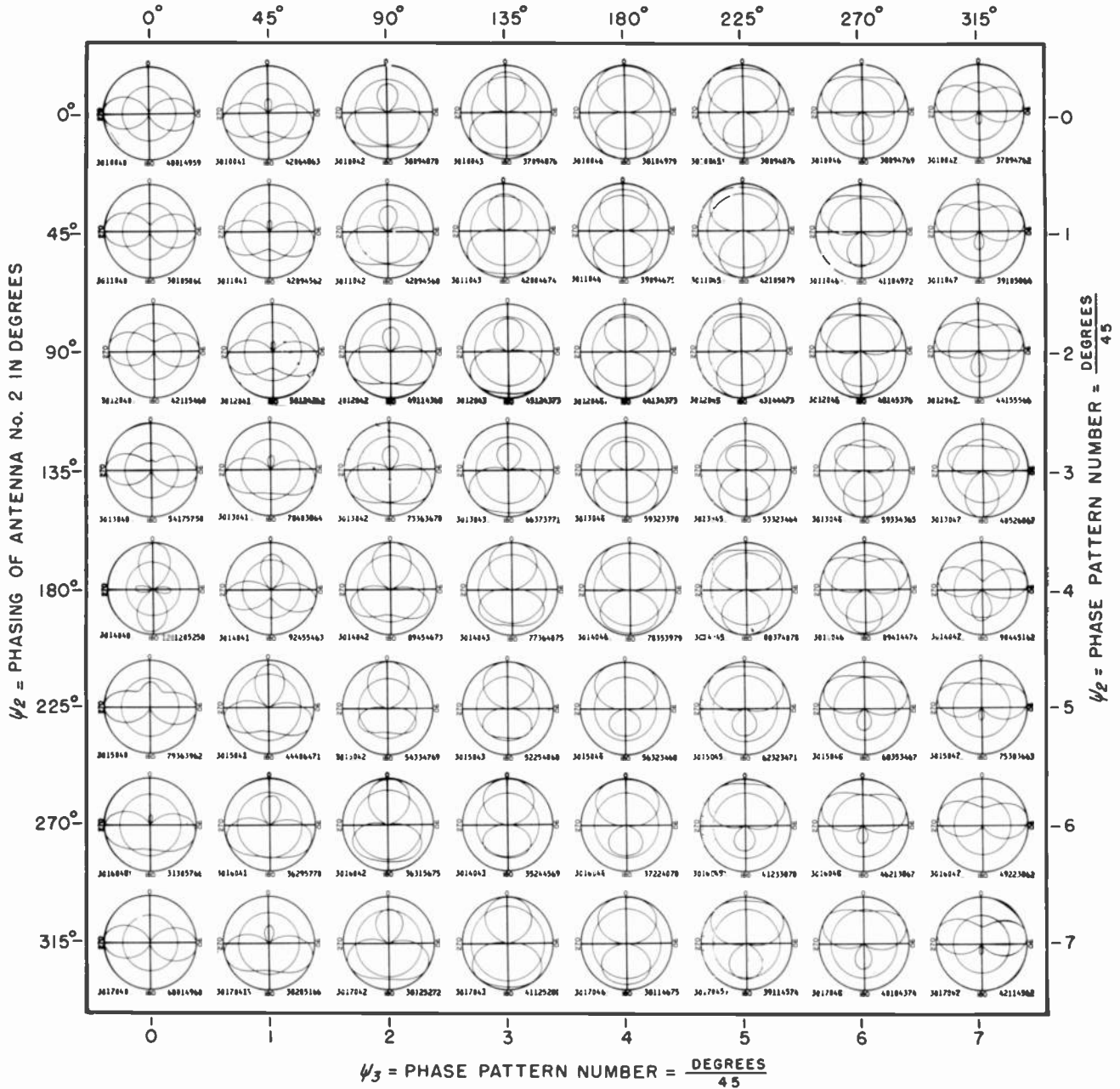

$\psi_3$  = PHASE PATTERN NUMBER =  $\frac{\text{DEGREES}}{45}$

NUMBER OF ANTENNAS IN THE SYSTEM	ORIENTATION OF NO. 2 ANTENNA = $\frac{\text{DEGREES}}{45}$	SPACING OF NO. 2 ANTENNA = $\frac{\text{DEGREES}}{45}$	PHASING OF NO. 2 ANTENNA = $\frac{\text{DEGREES}}{45}$	ORIENTATION OF NO. 3 ANTENNA = $\frac{\text{DEGREES}}{45}$	SPACING OF NO. 3 ANTENNA = $\frac{\text{DEGREES}}{45}$	PHASING OF NO. 3 ANTENNA = $\frac{\text{DEGREES}}{45}$	% FIELD INTENSITY RADIATED IN HORIZONTAL PLANE FROM NO. 1 ANTENNA.	% FIELD INTENSITY RADIATED IN HORIZONTAL PLANE FROM NO. 2 ANTENNA.	% FIELD INTENSITY RADIATED IN HORIZONTAL PLANE FROM NO. 3 ANTENNA.	% RMS FIELD INTENSITY RADIATED IN HORIZONTAL PLANE FROM ANTENNA SYSTEM.
No. 3	$\phi_2$ 0	$S_2$ 1	$\psi_2$ 0	$\phi_3$ 0	$S_3$ 4	$\psi_3$ 0	$E_1$ 48	$E_2$ 01	$E_3$ 49	$E_0$ 59

SPOTS LOCATE THE ANTENNAS FOR THIS PAGE OF PATTERNS IN THE SYSTEMATIZATION PLACEMENT CHART.

LEFT HAND PATTERN NUMBER GIVES ANTENNA PLACEMENT AND PHASING DATA.

RIGHT HAND PATTERN NUMBER GIVES ANTENNA FIELD INTENSITY DATA IN PERCENT.

PATTERN NOMENCLATURE

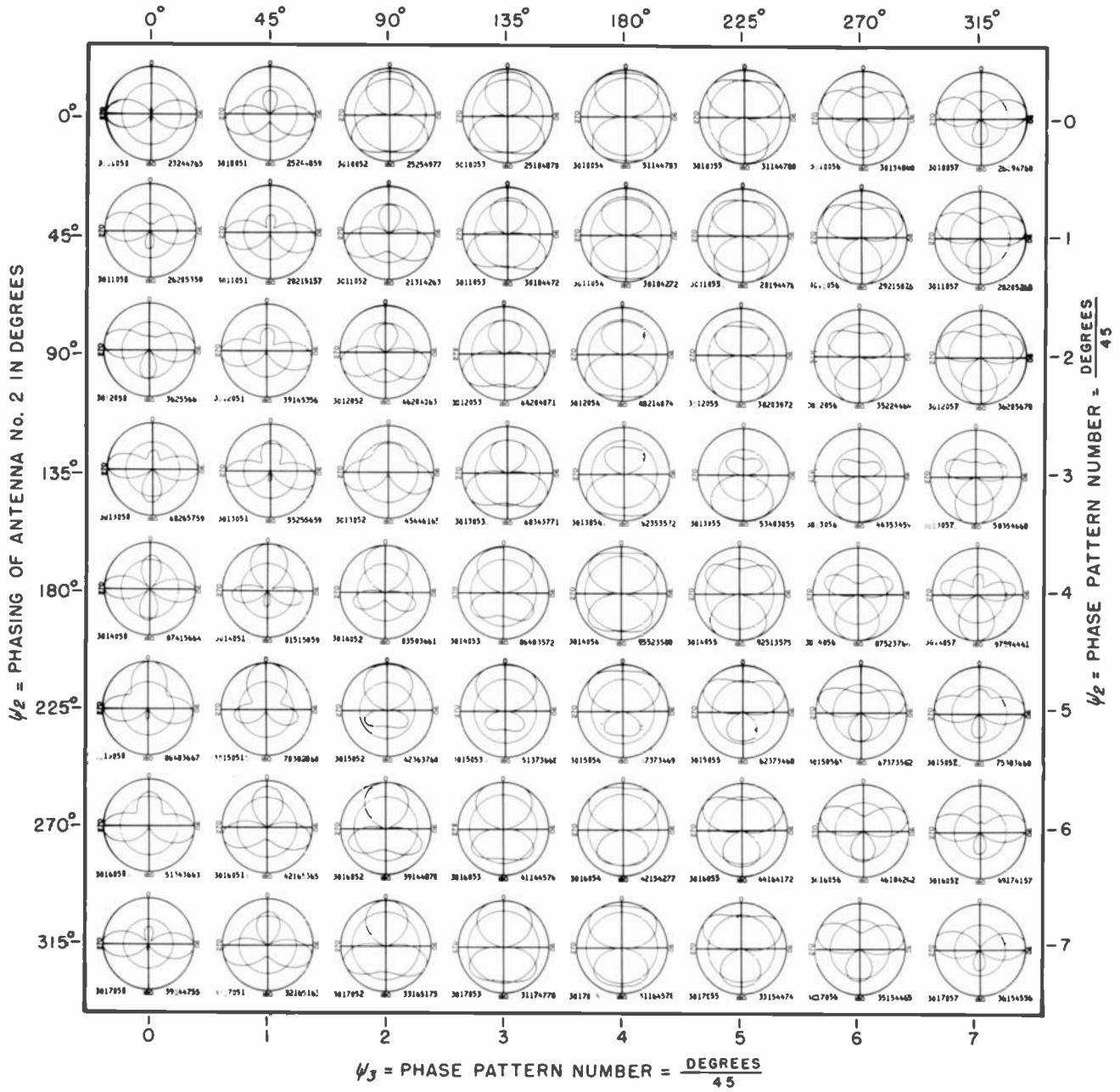

COPYRIGHT 1948 BY CARL E. SMITH  
PRINTED IN U. S. A.

CLEVELAND INSTITUTE OF RADIO ELECTRONICS  
TERMINAL TOWER, CLEVELAND 18, OHIO.

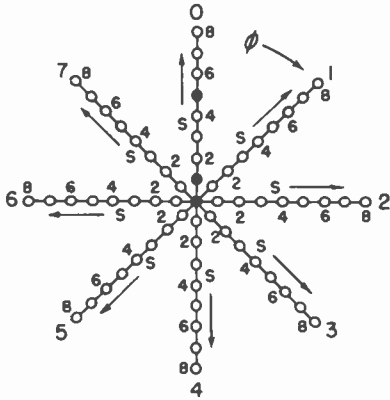

$\psi_3 = \text{PHASE PATTERN NUMBER} = \frac{\text{DEGREES}}{45}$

NUMBER OF ANTENNAS IN THE SYSTEM	ORIENTATION OF NO. 2 ANTENNA = $\frac{\text{DEGREES}}{45}$	SPACING OF NO. 2 ANTENNA = $\frac{\text{DEGREES}}{45}$	PHASING OF NO. 2 ANTENNA = $\frac{\text{DEGREES}}{45}$	ORIENTATION OF NO. 3 ANTENNA = $\frac{\text{DEGREES}}{45}$	SPACING OF NO. 3 ANTENNA = $\frac{\text{DEGREES}}{45}$	PHASING OF NO. 3 ANTENNA = $\frac{\text{DEGREES}}{45}$
No.	$\phi_2$	$S_2$	$\psi_2$	$\phi_3$	$S_3$	$\psi_3$
3	0	1	0	0	5	0

% FIELD INTENSITY RADIATED IN HORIZONTAL PLANE FROM NO. 1 ANTENNA.	% FIELD INTENSITY RADIATED IN HORIZONTAL PLANE FROM NO. 2 ANTENNA.	% FIELD INTENSITY RADIATED IN HORIZONTAL PLANE FROM NO. 3 ANTENNA.	% RMS FIELD INTENSITY RADIATED IN HORIZONTAL PLANE FROM ANTENNA SYSTEM.
$E_1$	$E_2$	$E_3$	$E_0$
23	24	47	65

LEFT HAND PATTERN NUMBER GIVES ANTENNA PLACEMENT AND PHASING DATA.

RIGHT HAND PATTERN NUMBER GIVES ANTENNA FIELD INTENSITY DATA IN PERCENT.

SPOTS LOCATE THE ANTENNAS FOR THIS PAGE OF PATTERNS IN THE SYSTEMATIZATION PLACEMENT CHART.

PATTERN NOMENCLATURE

$\psi_3$  = PHASING OF ANTENNA No. 3 IN DEGREES

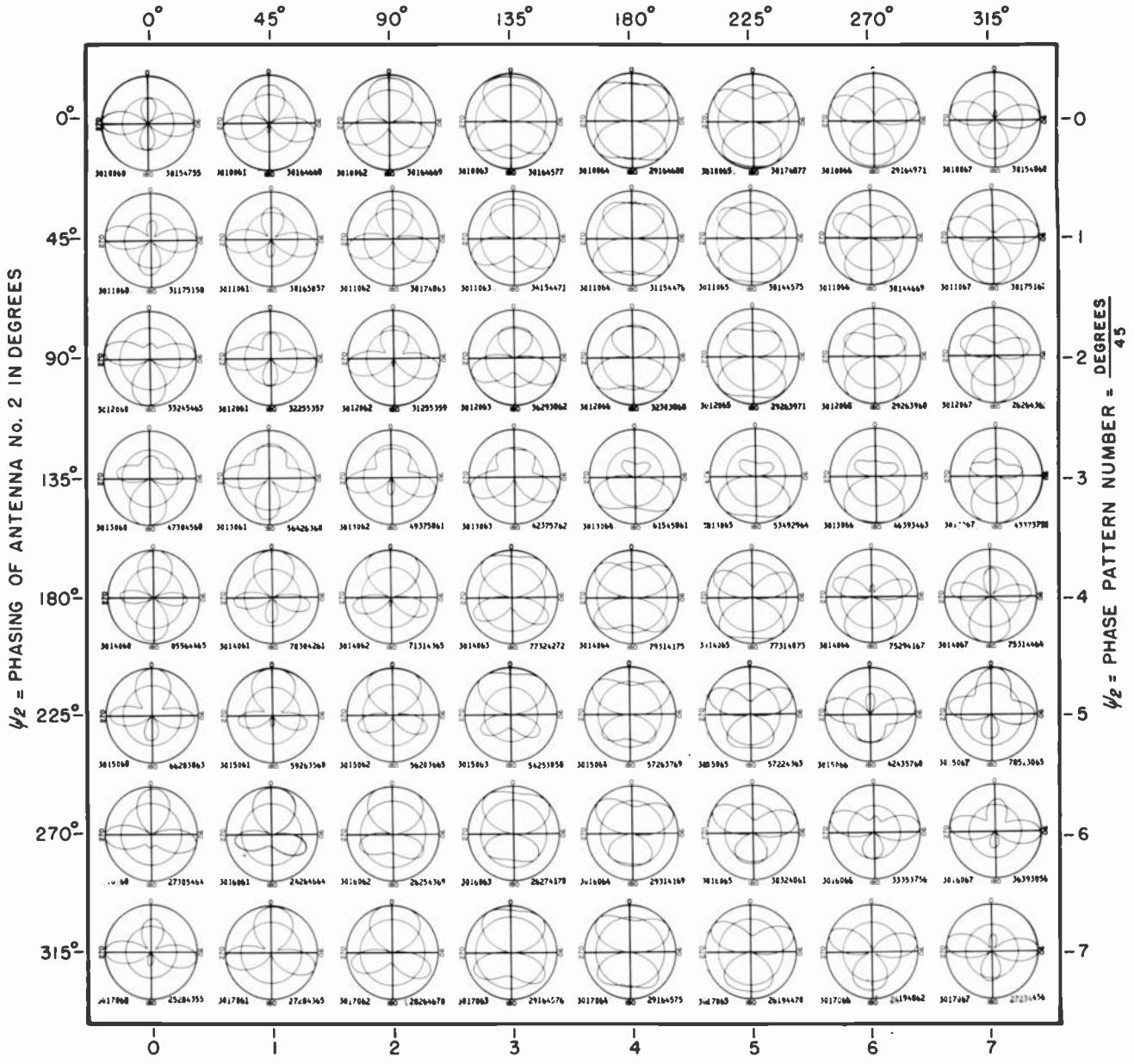

$\psi_3$  = PHASE PATTERN NUMBER =  $\frac{\text{DEGREES}}{45}$

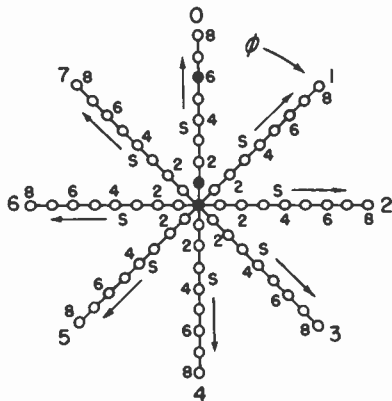

SPOTS LOCATE THE ANTENNAS FOR THIS PAGE OF PATTERNS IN THE SYSTEMATIZATION PLACEMENT CHART.

NUMBER OF ANTENNAS IN THE SYSTEM	$\frac{\text{DEGREES}}{45}$	$\frac{\text{DEGREES}}{45}$	$\frac{\text{DEGREES}}{45}$	$\frac{\text{DEGREES}}{45}$	$\frac{\text{DEGREES}}{45}$	$\frac{\text{DEGREES}}{45}$
No. 3	$\phi_2$	$S_2$	$\psi_2$	$\phi_3$	$S_3$	$\psi_3$
3	0	1	0	0	6	0

LEFT HAND PATTERN NUMBER GIVES ANTENNA PLACEMENT AND PHASING DATA.

% FIELD INTENSITY RADIATED IN HORIZONTAL PLANE FROM NO. 1 ANTENNA.	% FIELD INTENSITY RADIATED IN HORIZONTAL PLANE FROM NO. 2 ANTENNA.	% FIELD INTENSITY RADIATED IN HORIZONTAL PLANE FROM NO. 3 ANTENNA.	% RMS FIELD INTENSITY RADIATED IN HORIZONTAL PLANE FROM ANTENNA SYSTEM.
$E_1$	$E_2$	$E_3$	$E_0$
30	15	47	55

RIGHT HAND PATTERN NUMBER GIVES ANTENNA FIELD INTENSITY DATA IN PERCENT.

PATTERN NOMENCLATURE

COPYRIGHT 1948 BY CARL E. SMITH  
PRINTED IN U. S. A.

CLEVELAND INSTITUTE OF RADIO ELECTRONICS  
TERMINAL TOWER, CLEVELAND 13, OHIO.

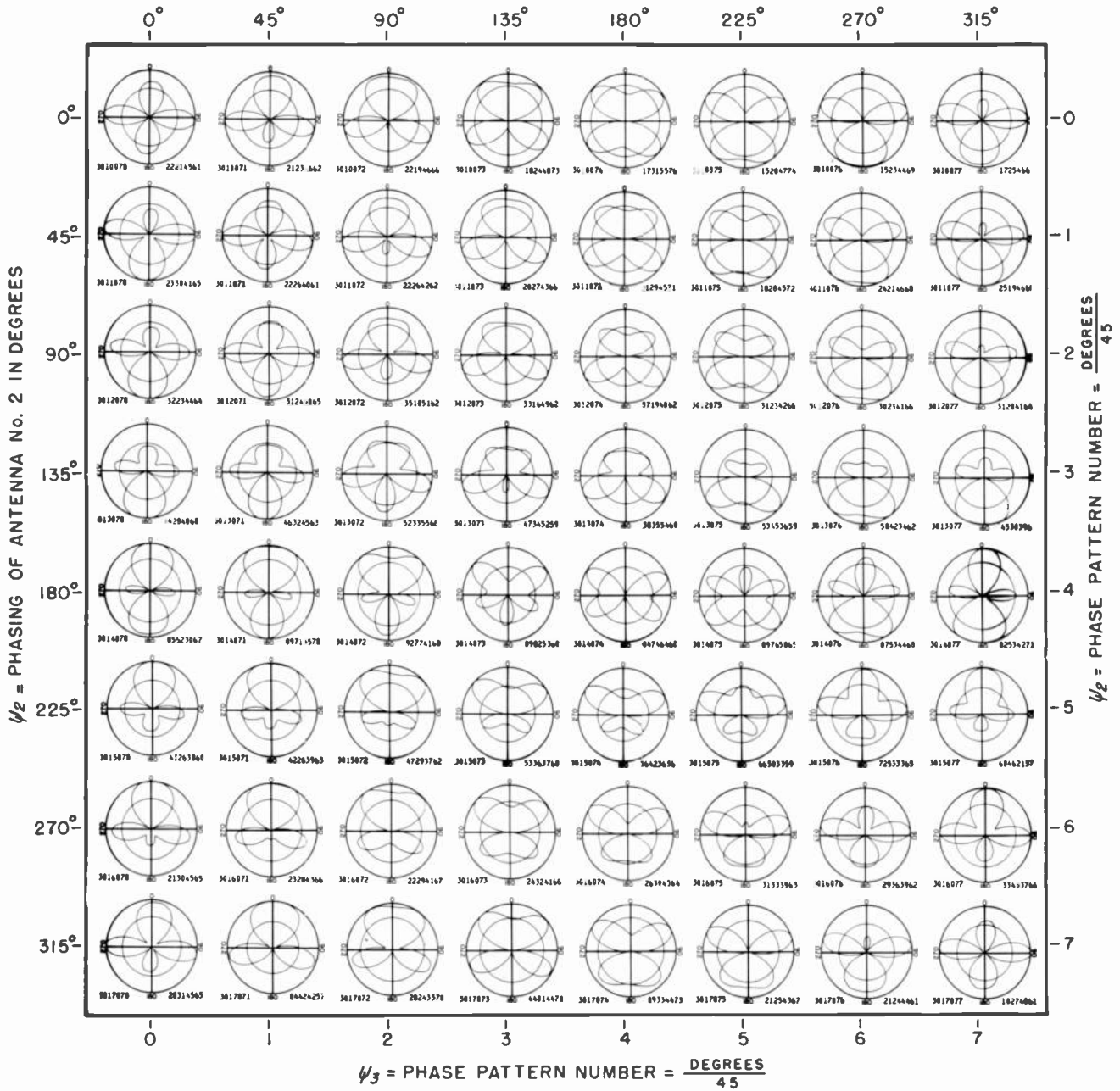

$\psi_3$  = PHASE PATTERN NUMBER =  $\frac{\text{DEGREES}}{45}$

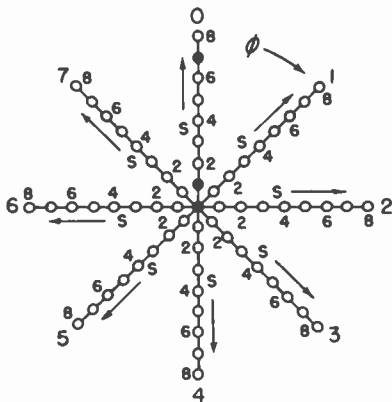

- NUMBER OF ANTENNAS IN THE SYSTEM  
No. 3
- ORIENTATION OF ANTENNA NO. 2  
 $\phi_2 = 0$
- SPACING OF ANTENNA NO. 2  
 $S_2 = 1$
- PHASING OF ANTENNA NO. 2  
 $\psi_2 = 0$
- ORIENTATION OF ANTENNA NO. 3  
 $\phi_3 = 0$
- SPACING OF ANTENNA NO. 3  
 $S_3 = 7$
- PHASING OF ANTENNA NO. 3  
 $\psi_3 = 0$

LEFT HAND PATTERN NUMBER GIVES ANTENNA PLACEMENT AND PHASING DATA.

- % FIELD INTENSITY RADIATED IN HORIZONTAL PLANE FROM NO. 1 ANTENNA.  
 $F_1 = 21$
- % FIELD INTENSITY RADIATED IN HORIZONTAL PLANE FROM NO. 2 ANTENNA.  
 $F_2 = 21$
- % FIELD INTENSITY RADIATED IN HORIZONTAL PLANE FROM NO. 3 ANTENNA.  
 $F_3 = 45$
- % RMS FIELD INTENSITY RADIATED IN HORIZONTAL PLANE FROM ANTENNA SYSTEM.  
 $F_0 = 61$

RIGHT HAND PATTERN NUMBER GIVES ANTENNA FIELD INTENSITY DATA IN PERCENT.

SPOTS LOCATE THE ANTENNAS FOR THIS PAGE OF PATTERNS IN THE SYSTEMATIZATION PLACEMENT CHART.

PATTERN NOMENCLATURE

$\psi_3$  = PHASING OF ANTENNA NO. 3 IN DEGREES

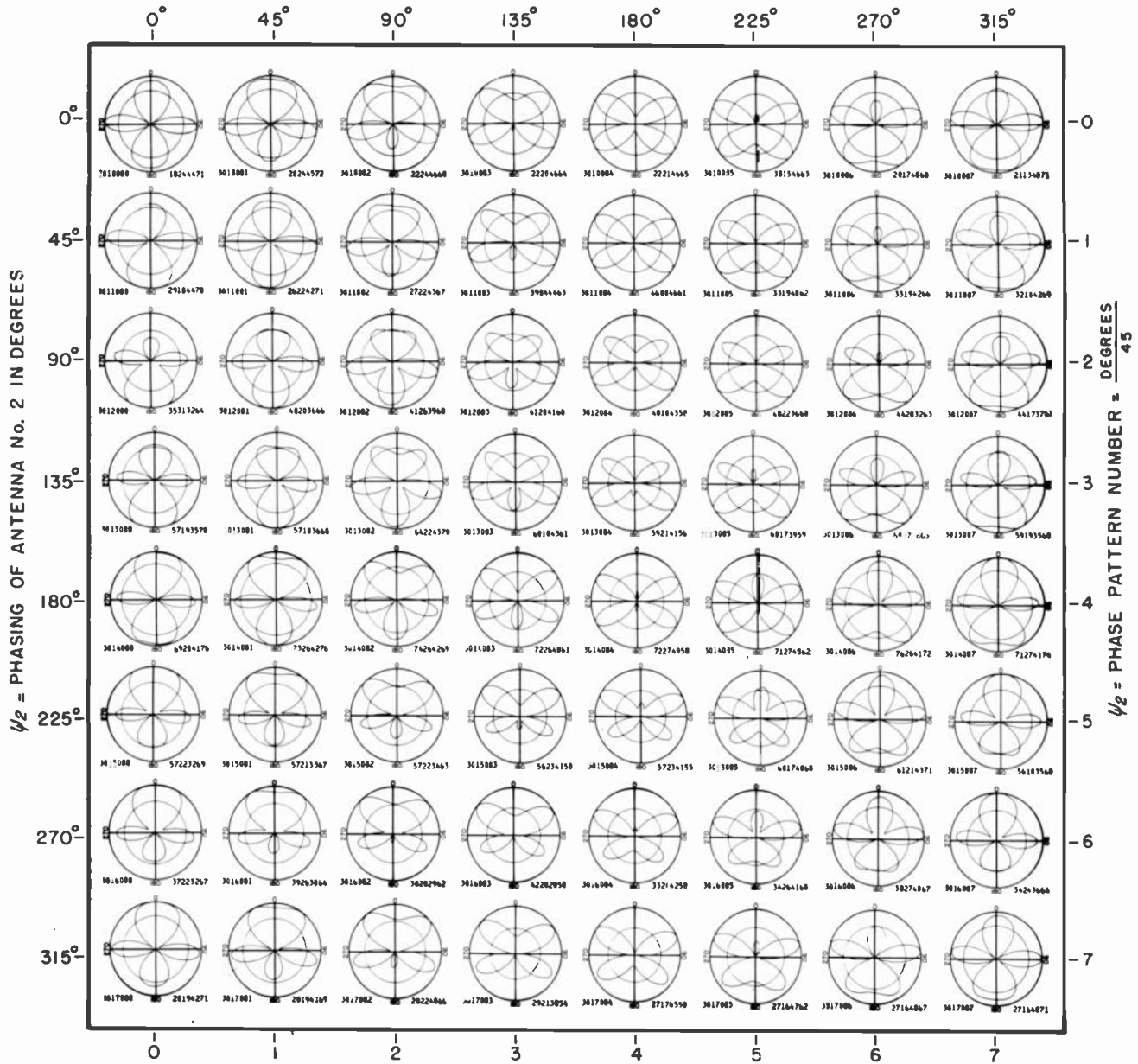

$\psi_2$  = PHASING OF ANTENNA NO. 2 IN DEGREES

$\psi_2$  = PHASE PATTERN NUMBER =  $\frac{\text{DEGREES}}{45}$

$\psi_3$  = PHASE PATTERN NUMBER =  $\frac{\text{DEGREES}}{45}$

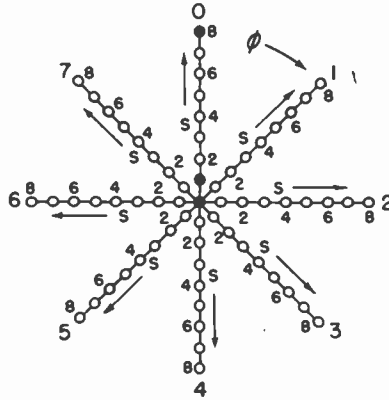

SPOTS LOCATE THE ANTENNAS FOR THIS PAGE OF PATTERNS IN THE SYSTEMATIZATION PLACEMENT CHART.

NUMBER OF ANTENNAS IN THE SYSTEM	ORIENTATION OF NO. 2 ANTENNA = $\frac{\text{DEGREES}}{45}$	SPACING OF NO. 2 ANTENNA = $\frac{\text{DEGREES}}{45}$	PHASING OF NO. 2 ANTENNA = $\frac{\text{DEGREES}}{45}$	ORIENTATION OF NO. 3 ANTENNA = $\frac{\text{DEGREES}}{45}$	SPACING OF NO. 3 ANTENNA = $\frac{\text{DEGREES}}{45}$	PHASING OF NO. 3 ANTENNA = $\frac{\text{DEGREES}}{45}$
No.	$\phi_2$	$S_2$	$\psi_2$	$\phi_3$	$S_3$	$\psi_3$
3	0	1	0	0	8	0

LEFT HAND PATTERN NUMBER GIVES ANTENNA PLACEMENT AND PHASING DATA.

% FIELD INTENSITY RADIATED IN HORIZONTAL PLANE FROM NO. 1 ANTENNA.	% FIELD INTENSITY RADIATED IN HORIZONTAL PLANE FROM NO. 2 ANTENNA.	% FIELD INTENSITY RADIATED IN HORIZONTAL PLANE FROM NO. 3 ANTENNA.	% RMS FIELD INTENSITY RADIATED IN HORIZONTAL PLANE FROM ANTENNA SYSTEM.
$E_1$	$E_2$	$E_3$	$E_0$
18	24	44	71

RIGHT HAND PATTERN NUMBER GIVES ANTENNA FIELD INTENSITY DATA IN PERCENT.

PATTERN NOMENCLATURE

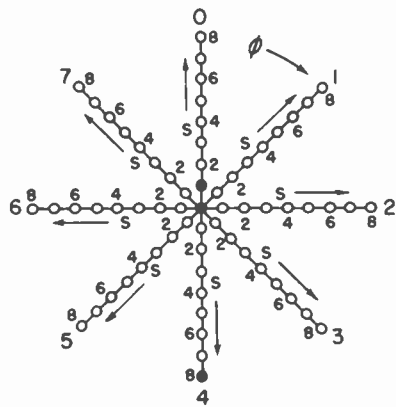
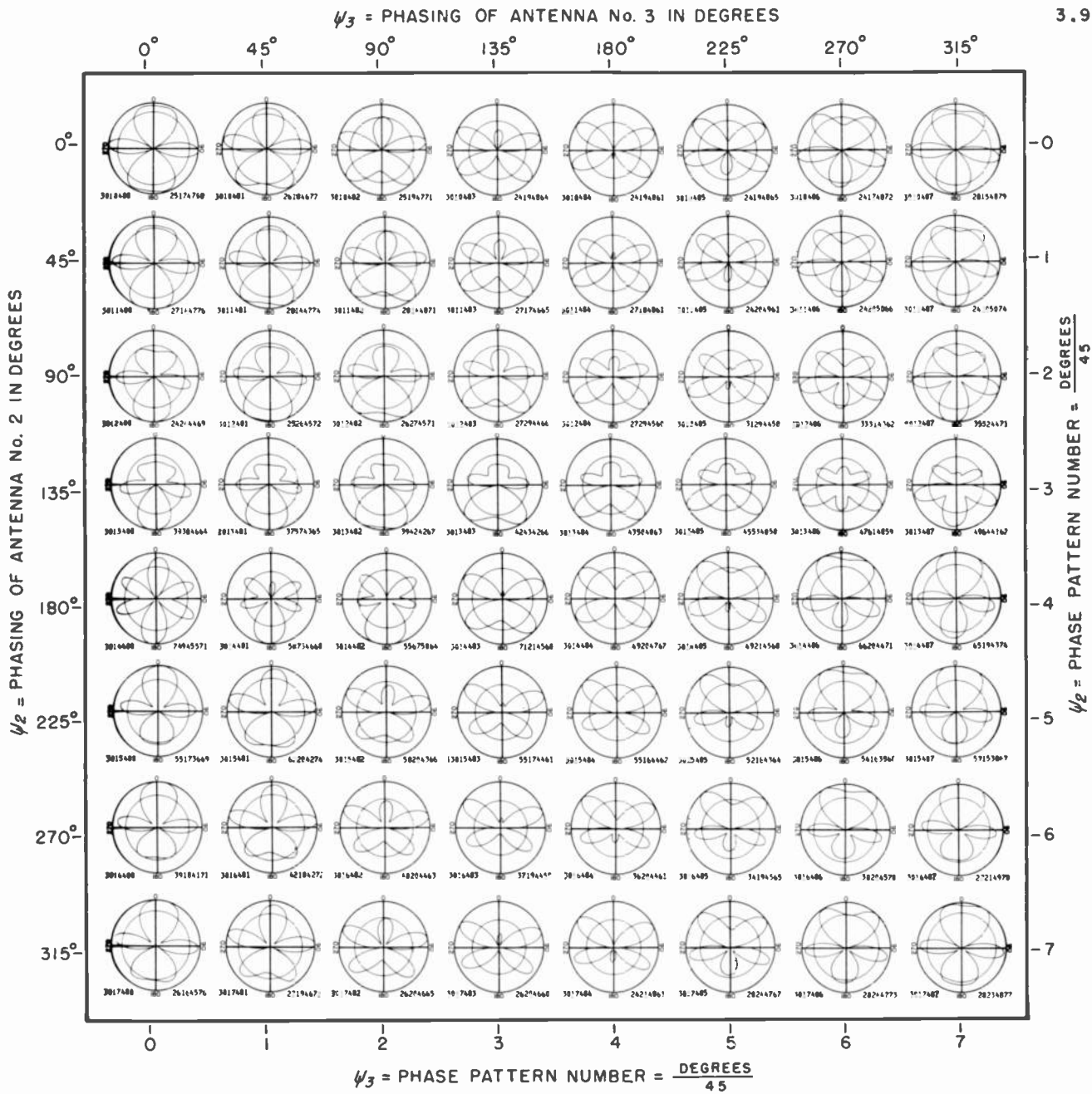

SPOTS LOCATE THE ANTENNAS FOR THIS PAGE OF PATTERNS IN THE SYSTEMATIZATION PLACEMENT CHART.

$\psi_3 = \text{PHASE PATTERN NUMBER} = \frac{\text{DEGREES}}{45}$

NUMBER OF ANTENNAS IN THE SYSTEM	ORIENTATION OF NO. 2 ANTENNA = $\frac{\text{DEGREES}}{45}$	SPACING OF NO. 2 ANTENNA = $\frac{\text{DEGREES}}{45}$	PHASING OF NO. 2 ANTENNA = $\frac{\text{DEGREES}}{45}$	ORIENTATION OF NO. 3 ANTENNA = $\frac{\text{DEGREES}}{45}$	SPACING OF NO. 3 ANTENNA = $\frac{\text{DEGREES}}{45}$	PHASING OF NO. 3 ANTENNA = $\frac{\text{DEGREES}}{45}$
No. 3	$\phi_2$	$S_2$	$\psi_2$	$\phi_3$	$S_3$	$\psi_3$
3	0	1	0	4	8	0

LEFT HAND PATTERN NUMBER GIVES ANTENNA LOCATION AND PHASING DATA.

% FIELD INTENSITY RADIATED IN HORIZONTAL PLANE FROM NO. 1 ANTENNA.	% FIELD INTENSITY RADIATED IN HORIZONTAL PLANE FROM NO. 2 ANTENNA.	% FIELD INTENSITY RADIATED IN HORIZONTAL PLANE FROM NO. 3 ANTENNA.	% RMS FIELD INTENSITY RADIATED IN HORIZONTAL PLANE FROM ANTENNA SYSTEM.
$E_1$	$E_2$	$E_3$	$E_0$
25	17	47	80

RIGHT HAND PATTERN NUMBER GIVES ANTENNA FIELD INTENSITY DATA IN PERCENT.

PATTERN NOMENCLATURE

$\psi_3 = \text{PHASING OF ANTENNA No. 3 IN DEGREES}$

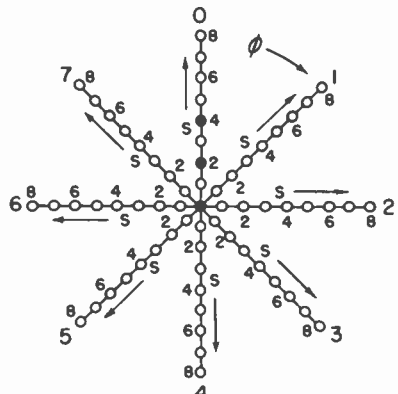
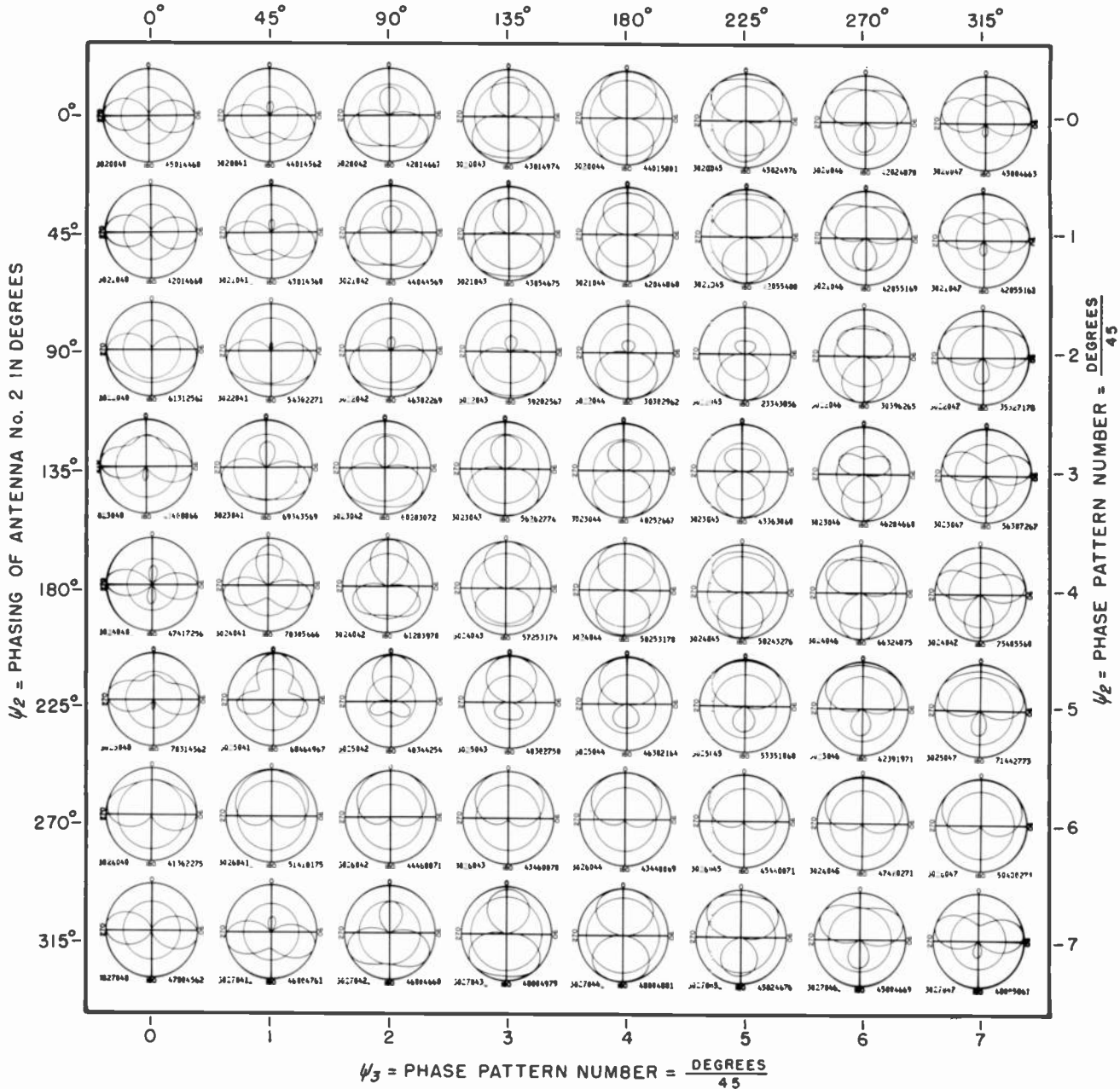

SPOTS LOCATE THE ANTENNAS FOR THIS PAGE OF PATTERNS IN THE SYSTEMATIZATION PLACEMENT CHART.

$\psi_3 = \text{PHASE PATTERN NUMBER} = \frac{\text{DEGREES}}{45}$

NUMBER OF ANTENNAS IN THE SYSTEM	ORIENTATION OF NO. 2 ANTENNA = $\frac{\text{DEGREES}}{45}$	SPACING OF NO. 2 ANTENNA = $\frac{\text{DEGREES}}{45}$	PHASING OF NO. 2 ANTENNA = $\frac{\text{DEGREES}}{45}$	ORIENTATION OF NO. 3 ANTENNA = $\frac{\text{DEGREES}}{45}$	SPACING OF NO. 3 ANTENNA = $\frac{\text{DEGREES}}{45}$	PHASING OF NO. 3 ANTENNA = $\frac{\text{DEGREES}}{45}$
No. 3	$\psi_2 = 0$	$S_2 = 2$	$\psi_2 = 0$	$\psi_3 = 0$	$S_3 = 4$	$\psi_3 = 0$

LEFT HAND PATTERN NUMBER GIVES ANTENNA PLACEMENT AND PHASING DATA.

% FIELD INTENSITY RADIATED IN HORIZONTAL PLANE FROM NO. 1 ANTENNA.	% FIELD INTENSITY RADIATED IN HORIZONTAL PLANE FROM NO. 2 ANTENNA.	% FIELD INTENSITY RADIATED IN HORIZONTAL PLANE FROM NO. 3 ANTENNA.	% RMS FIELD INTENSITY RADIATED IN HORIZONTAL PLANE FROM ANTENNA SYSTEM.
$F_1 = 45$	$F_2 = 01$	$F_3 = 44$	$F_0 = 60$

RIGHT HAND PATTERN NUMBER GIVES ANTENNA FIELD INTENSITY DATA IN PERCENT.

PATTERN NOMENCLATURE



$\psi_3$  = PHASING OF ANTENNA NO. 3 IN DEGREES

3. 11

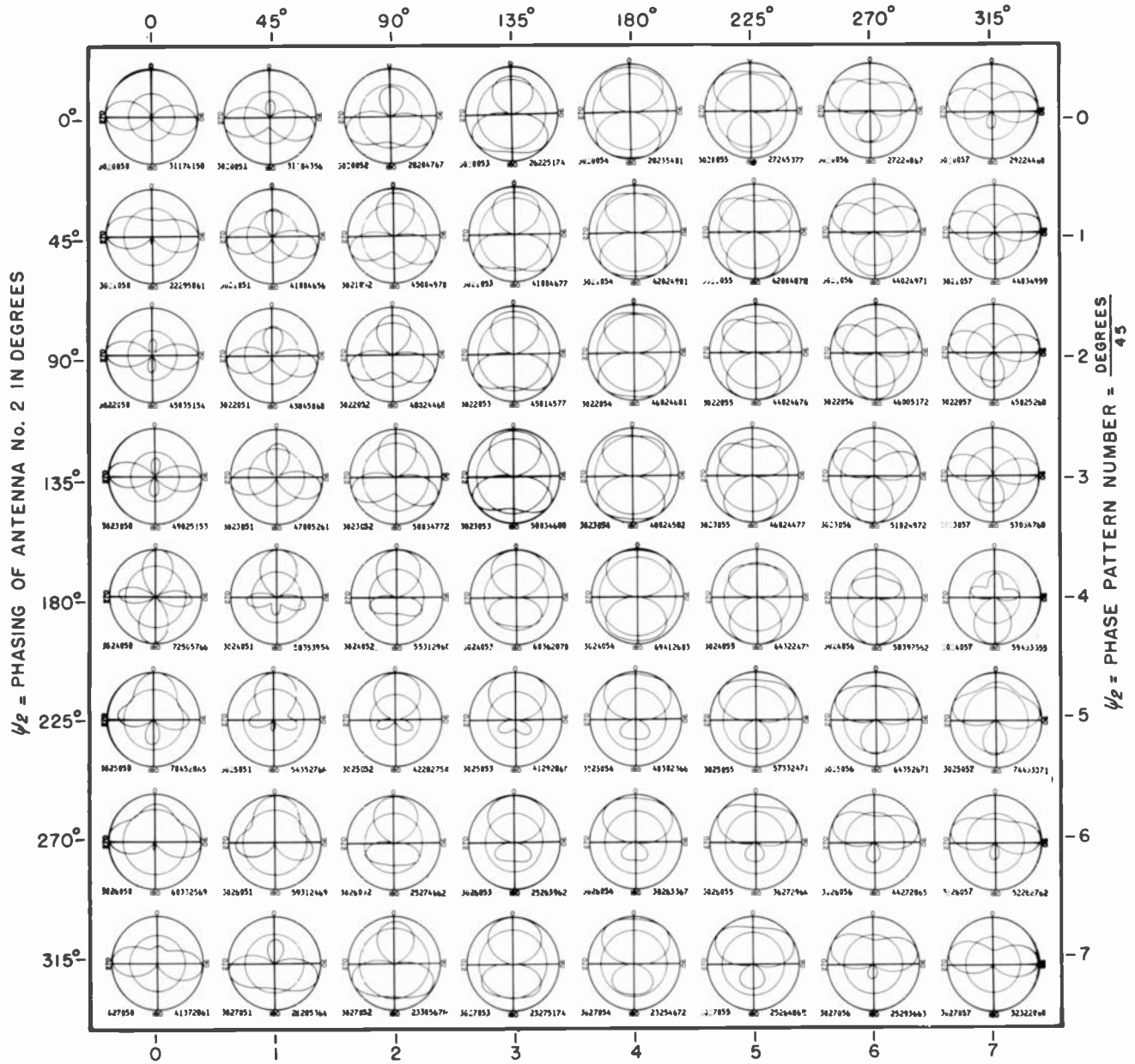

$\psi_3$  = PHASE PATTERN NUMBER =  $\frac{\text{DEGREES}}{45}$

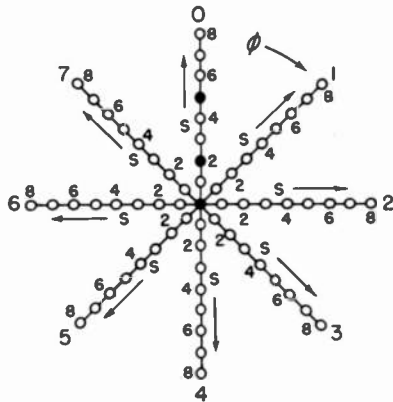

SPOTS LOCATE THE ANTENNAS FOR THIS PAGE OF PATTERNS IN THE SYSTEMATIZATION PLACEMENT CHART.

NUMBER OF ANTENNAS IN THE SYSTEM

No. 3

ORIENTATION OF NO. 2 ANTENNA =  $\frac{\text{DEGREES}}{45}$

$\phi_2$  0

SPACING OF NO. 2 ANTENNA =  $\frac{\text{DEGREES}}{45}$

$S_2$  2

PHASING OF NO. 2 ANTENNA =  $\frac{\text{DEGREES}}{45}$

$\psi_2$  0

ORIENTATION OF NO. 3 ANTENNA =  $\frac{\text{DEGREES}}{45}$

$\phi_3$  0

SPACING OF NO. 3 ANTENNA =  $\frac{\text{DEGREES}}{45}$

$S_3$  5

PHASING OF NO. 3 ANTENNA =  $\frac{\text{DEGREES}}{45}$

$\psi_3$  0

% FIELD INTENSITY RADIATED IN HORIZONTAL PLANE FROM NO. 1 ANTENNA.

% FIELD INTENSITY RADIATED IN HORIZONTAL PLANE FROM NO. 2 ANTENNA.

% FIELD INTENSITY RADIATED IN HORIZONTAL PLANE FROM NO. 3 ANTENNA.

% RMS FIELD INTENSITY RADIATED IN HORIZONTAL PLANE FROM ANTENNA SYSTEM.

$E_1$  31

$E_2$  17

$E_3$  41

$E_0$  50

LEFT HAND PATTERN NUMBER GIVES ANTENNA PLACEMENT AND PHASING DATA.

RIGHT HAND PATTERN NUMBER GIVES ANTENNA FIELD INTENSITY DATA IN PERCENT.

PATTERN NOMENCLATURE

$\psi_3 =$  PHASING OF ANTENNA No. 3 IN DEGREES

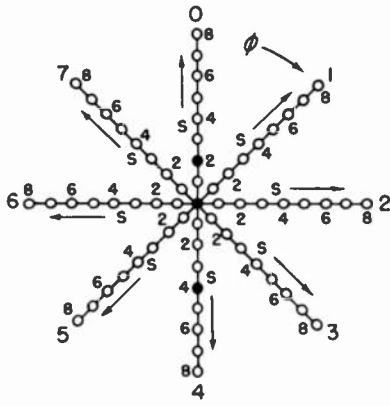
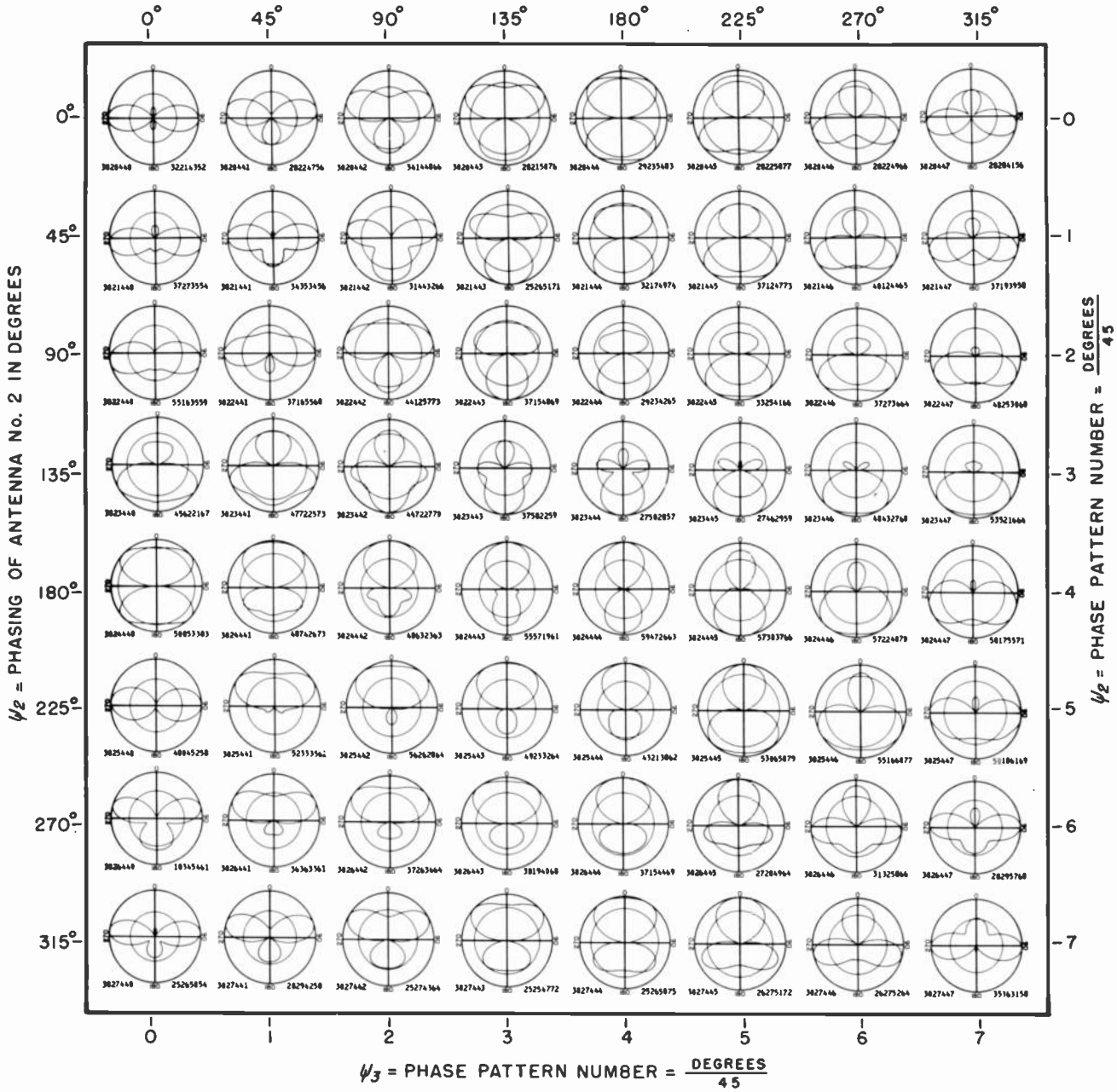

NUMBER OF ANTENNAS IN THE SYSTEM	$\phi_2$	$S_2$	$\psi_2$	$\phi_3$	$S_3$	$\psi_3$
No.	$\phi_2$	$S_2$	$\psi_2$	$\phi_3$	$S_3$	$\psi_3$
3	0	2	0	4	4	0

% FIELD INTENSITY RADIATED IN HORIZONTAL PLANE FROM NO. 1 ANTENNA.	% FIELD INTENSITY RADIATED IN HORIZONTAL PLANE FROM NO. 2 ANTENNA.	% FIELD INTENSITY RADIATED IN HORIZONTAL PLANE FROM NO. 3 ANTENNA.	% RMS FIELD INTENSITY RADIATED IN HORIZONTAL PLANE FROM ANTENNA SYSTEM.
$E_1$	$E_2$	$E_3$	$E_0$
32	21	43	52

SPOTS LOCATE THE ANTENNAS FOR THIS PAGE OF PATTERNS IN THE SYSTEMIZATION PLACEMENT CHART.

LEFT HAND PATTERN NUMBER GIVES ANTENNA PLACEMENT AND PHASING DATA.

RIGHT HAND PATTERN NUMBER GIVES ANTENNA FIELD INTENSITY DATA IN PERCENT.

PATTERN NOMENCLATURE

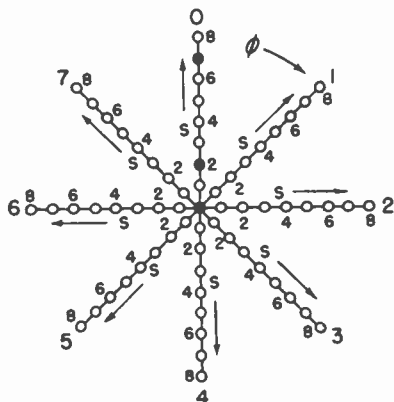
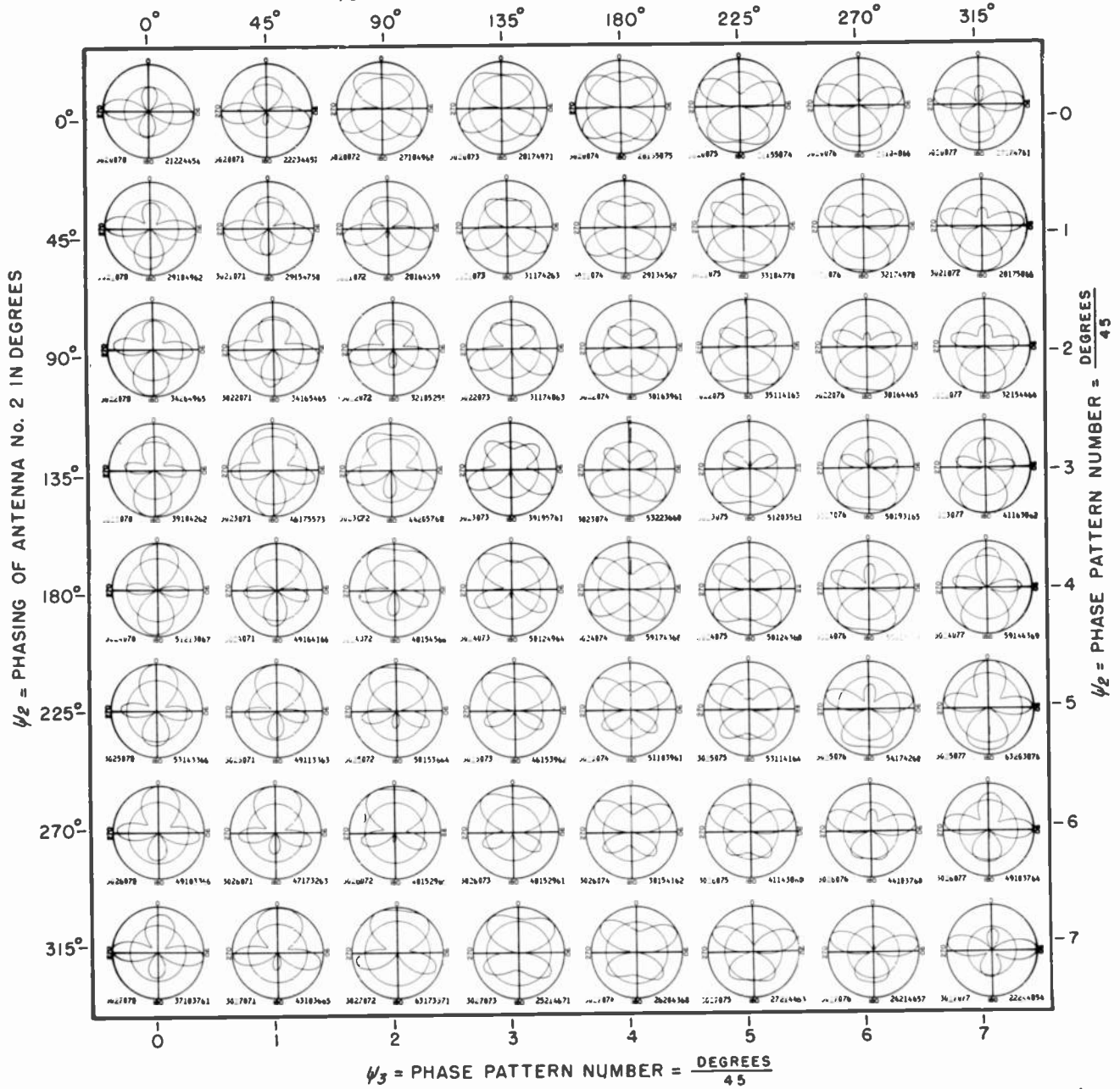

NUMBER OF ANTENNAS IN THE SYSTEM	ORIENTATION OF NO. 2 ANTENNA = $\frac{\text{DEGREES}}{45}$	SPACING OF NO. 2 ANTENNA = $\frac{\text{DEGREES}}{45}$	PHASING OF NO. 2 ANTENNA = $\frac{\text{DEGREES}}{45}$	ORIENTATION OF NO. 3 ANTENNA = $\frac{\text{DEGREES}}{45}$	SPACING OF NO. 3 ANTENNA = $\frac{\text{DEGREES}}{45}$	PHASING OF NO. 3 ANTENNA = $\frac{\text{DEGREES}}{45}$
No. 3	$\phi_2 = 0$	$S_2 = 2$	$\psi_2 = 0$	$\phi_3 = 0$	$S_3 = 7$	$\psi_3 = 0$

% FIELD INTENSITY RADIATED IN HORIZONTAL PLANE FROM NO. 1 ANTENNA.	% FIELD INTENSITY RADIATED IN HORIZONTAL PLANE FROM NO. 2 ANTENNA.	% FIELD INTENSITY RADIATED IN HORIZONTAL PLANE FROM NO. 3 ANTENNA.	% RMS FIELD INTENSITY RADIATED IN HORIZONTAL PLANE FROM ANTENNA SYSTEM.
$E_1 = 21$	$E_2 = 22$	$E_3 = 44$	$E_0 = 54$

LEFT HAND PATTERN NUMBER GIVES ANTENNA PLACEMENT AND PHASING DATA.

RIGHT HAND PATTERN NUMBER GIVES ANTENNA FIELD INTENSITY DATA IN PERCENT.

SPOTS LOCATE THE ANTENNAS FOR THIS PAGE OF PATTERNS IN THE SYSTEMIZATION PLACEMENT CHART.

PATTERN NOMENCLATURE

COPYRIGHT 1946 BY CARL E. SMITH  
PRINTED IN U. S. A.

CLEVELAND INSTITUTE OF RADIO ELECTRONICS  
TERMINAL TOWER, CLEVELAND 18, OHIO.

$\psi_3 =$  PHASING OF ANTENNA No. 3 IN DEGREES

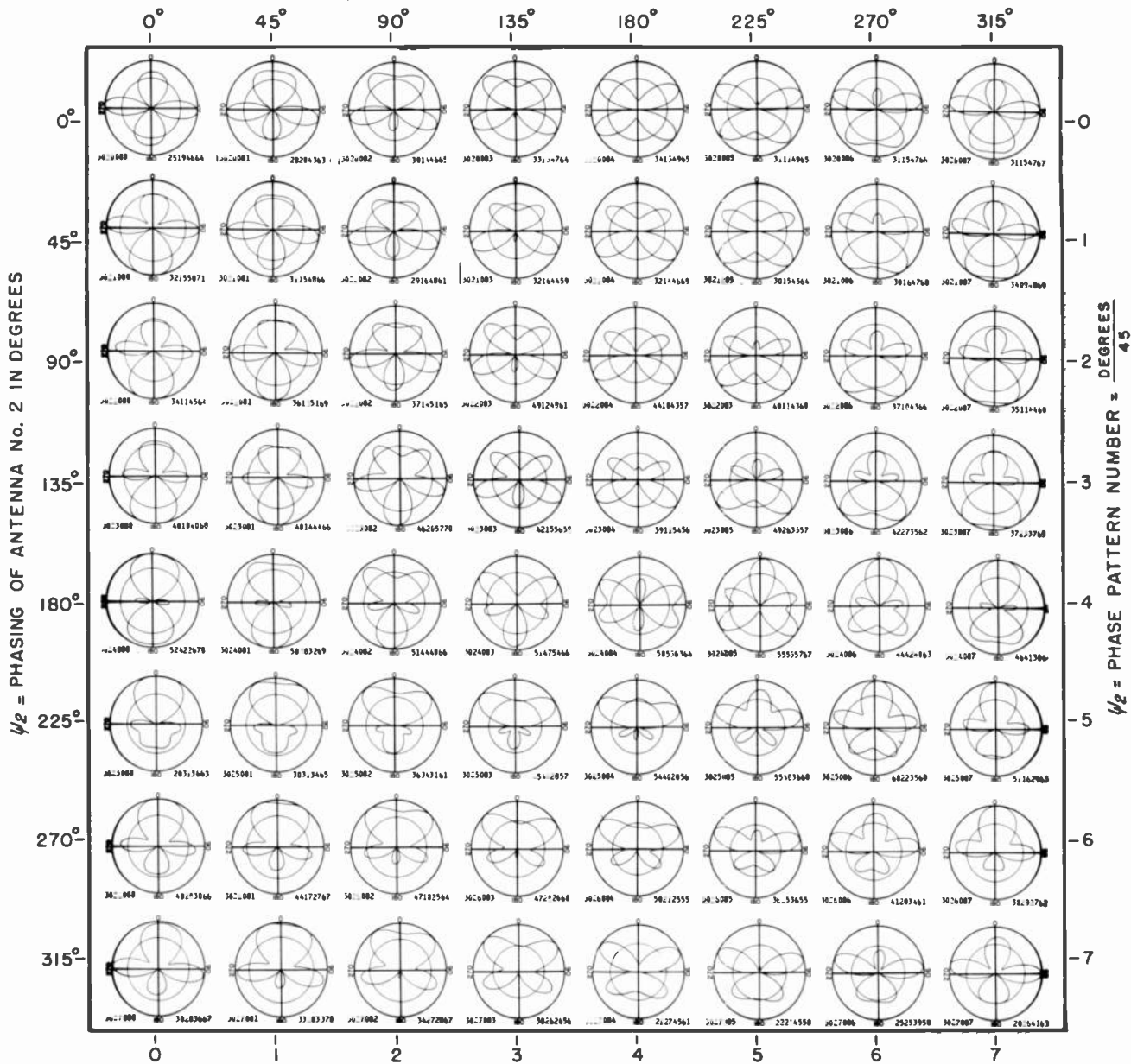

$\psi_3 =$  PHASE PATTERN NUMBER =  $\frac{\text{DEGREES}}{45}$

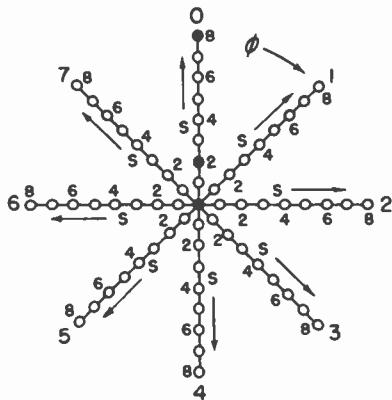

SPOTS LOCATE THE ANTENNAS FOR THIS PAGE OF PATTERNS IN THE SYSTEMATIZATION PLACEMENT CHART.

NUMBER OF ANTENNAS IN THE SYSTEM	$\frac{\text{DEGREES}}{45}$	$\frac{\text{DEGREES}}{45}$	$\frac{\text{DEGREES}}{45}$	$\frac{\text{DEGREES}}{45}$	$\frac{\text{DEGREES}}{45}$	$\frac{\text{DEGREES}}{45}$
No.	$\phi_2$	$S_2$	$\psi_2$	$\phi_3$	$S_3$	$\psi_3$
3	0	2	0	0	8	0

LEFT HAND PATTERN NUMBER GIVES ANTENNA PLACEMENT AND PHASING DATA.

% FIELD INTENSITY RADIATED IN HORIZONTAL PLANE FROM NO. 1 ANTENNA.	% FIELD INTENSITY RADIATED IN HORIZONTAL PLANE FROM NO. 2 ANTENNA.	% FIELD INTENSITY RADIATED IN HORIZONTAL PLANE FROM NO. 3 ANTENNA.	% RMS FIELD INTENSITY RADIATED IN HORIZONTAL PLANE FROM ANTENNA SYSTEM.
$E_1$	$E_2$	$E_3$	$E_0$
25	19	46	64

RIGHT HAND PATTERN NUMBER GIVES ANTENNA FIELD INTENSITY DATA IN PERCENT.

PATTERN NOMENCLATURE

$\psi_3$  = PHASING OF ANTENNA No. 3 IN DEGREES

3.15

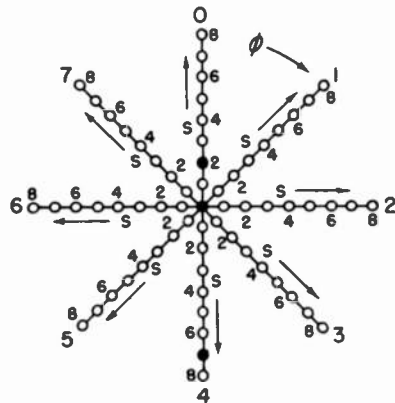
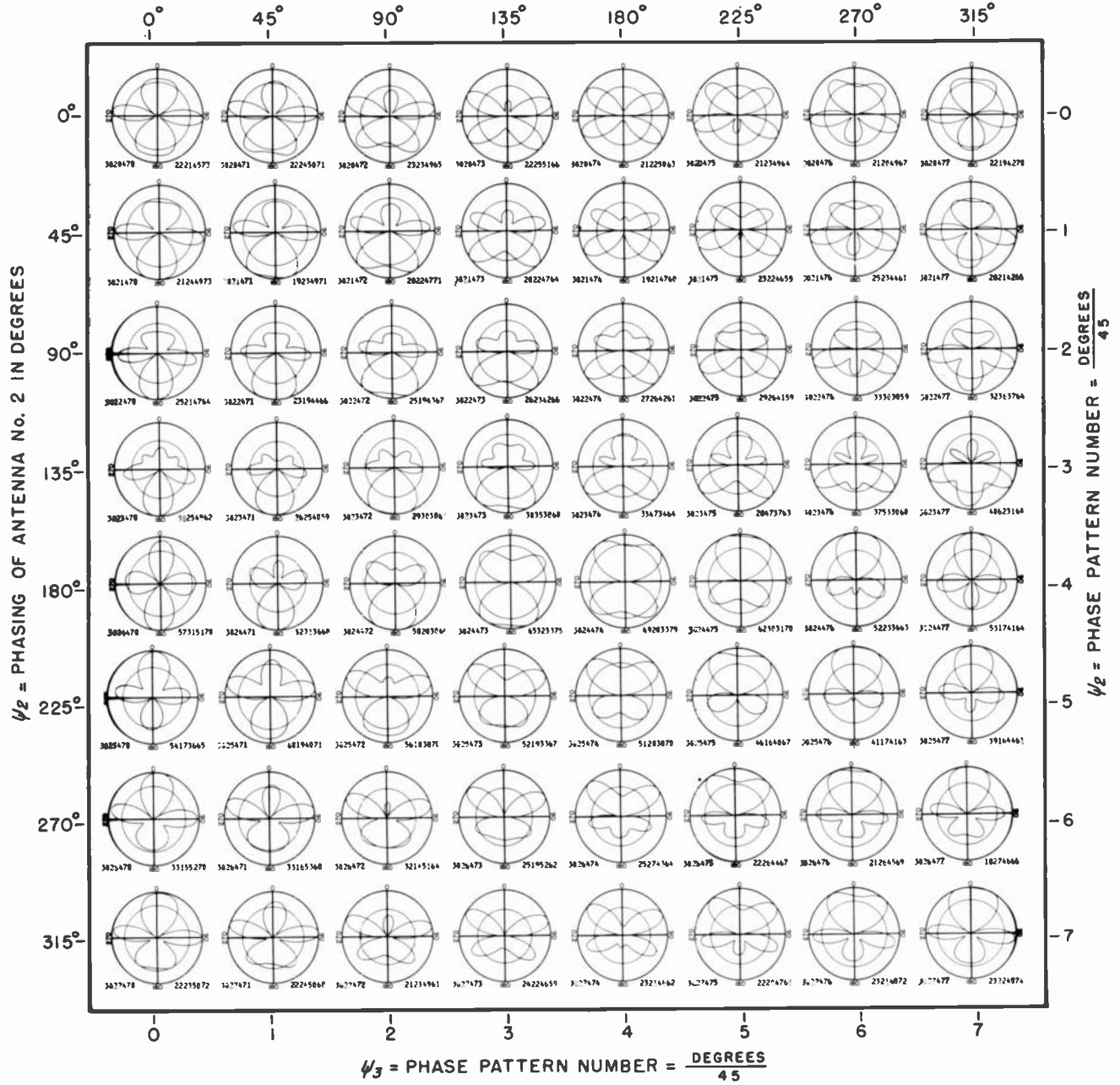

SPOTS LOCATE THE ANTENNAS FOR  
THIS PAGE OF PATTERNS IN THE  
SYSTEMATIZATION PLACEMENT CHART.

NO.	$\psi_2$	$\psi_3$
3	0	0
2	2	0
4	4	4
7	7	0

LEFT HAND PATTERN NUMBER GIVES ANTENNA  
PLACEMENT AND PHASING DATA.

$E_1$	$E_2$	$E_3$	$E_0$
22	21	45	73

RIGHT HAND PATTERN NUMBER  
GIVES ANTENNA FIELD INTENSITY  
DATA IN PERCENT.

PATTERN NOMENCLATURE

$\psi_3$  = PHASING OF ANTENNA No. 3 IN DEGREES

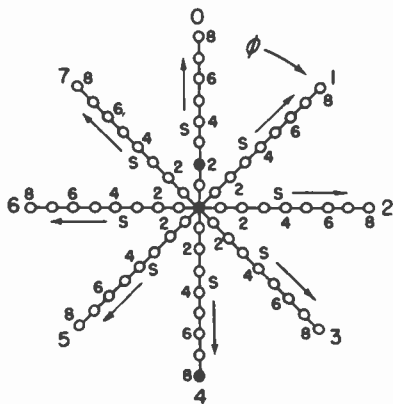
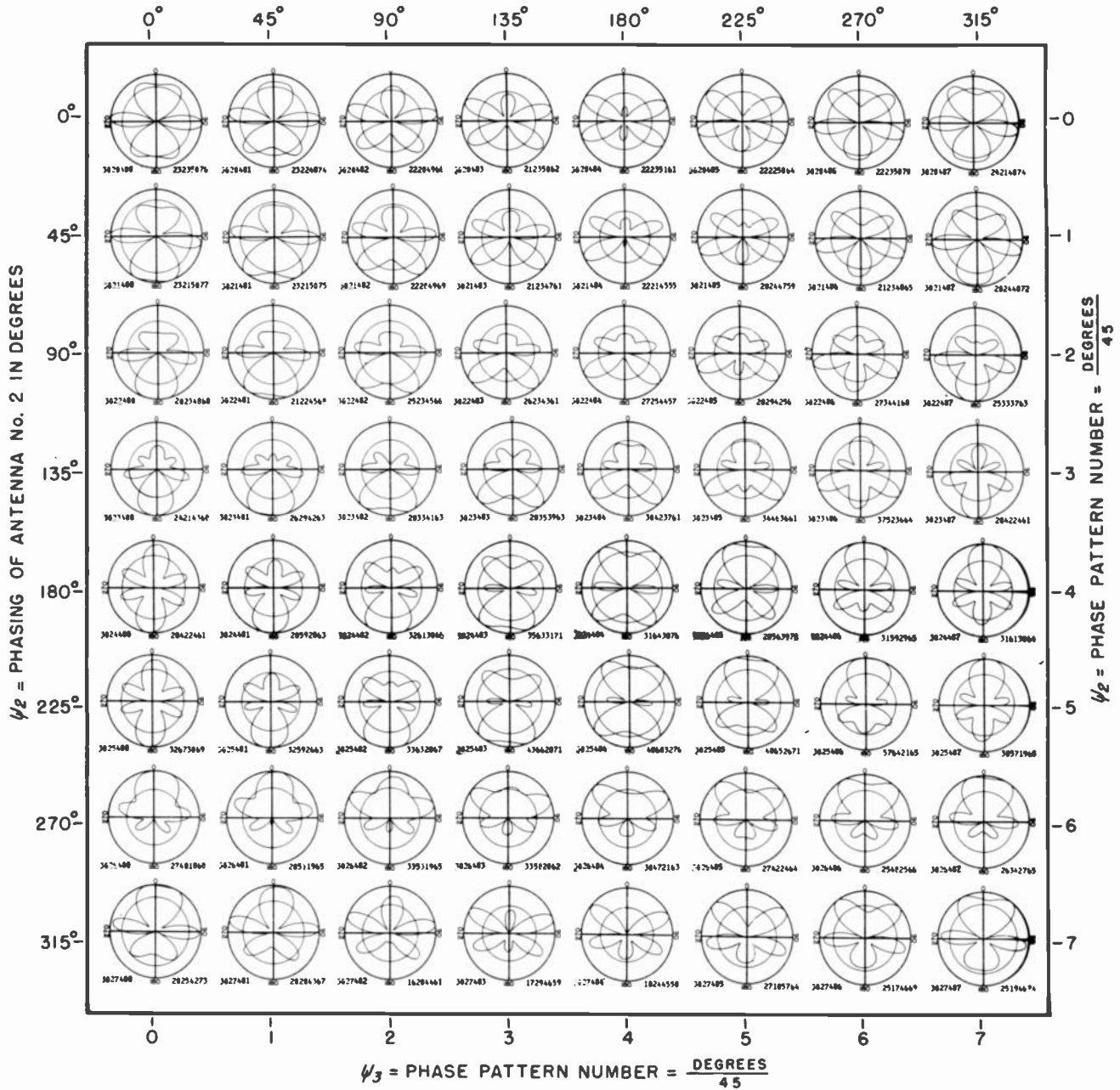

$\psi_3$  = PHASE PATTERN NUMBER =  $\frac{\text{DEGREES}}{45}$

NUMBER OF ANTENNAS IN THE SYSTEM  
No. 3

ORIENTATION OF NO. 2 ANTENNA =  $\frac{\text{DEGREES}}{45}$   
 $\phi_2$  0

SPACING OF NO. 2 ANTENNA =  $\frac{\text{DEGREES}}{45}$   
 $S_2$  2

PHASING OF NO. 2 ANTENNA =  $\frac{\text{DEGREES}}{45}$   
 $\psi_2$  0

ORIENTATION OF NO. 3 ANTENNA =  $\frac{\text{DEGREES}}{45}$   
 $\phi_3$  4

SPACING OF NO. 3 ANTENNA =  $\frac{\text{DEGREES}}{45}$   
 $S_3$  8

PHASING OF NO. 3 ANTENNA =  $\frac{\text{DEGREES}}{45}$   
 $\psi_3$  0

% FIELD INTENSITY RADIATED IN HORIZONTAL PLANE FROM NO. 1 ANTENNA.  
 $E_1$  23

% FIELD INTENSITY RADIATED IN HORIZONTAL PLANE FROM NO. 2 ANTENNA.  
 $E_2$  23

% FIELD INTENSITY RADIATED IN HORIZONTAL PLANE FROM NO. 3 ANTENNA.  
 $E_3$  50

% RMS FIELD INTENSITY RADIATED IN HORIZONTAL PLANE FROM ANTENNA SYSTEM.  
 $E_0$  76

LEFT HAND PATTERN NUMBER GIVES ANTENNA PLACEMENT AND PHASING DATA.

RIGHT HAND PATTERN NUMBER GIVES ANTENNA FIELD INTENSITY DATA IN PERCENT.

SPOTS LOCATE THE ANTENNAS FOR THIS PAGE OF PATTERNS IN THE SYSTEMATIZATION PLACEMENT CHART.

PATTERN NOMENCLATURE

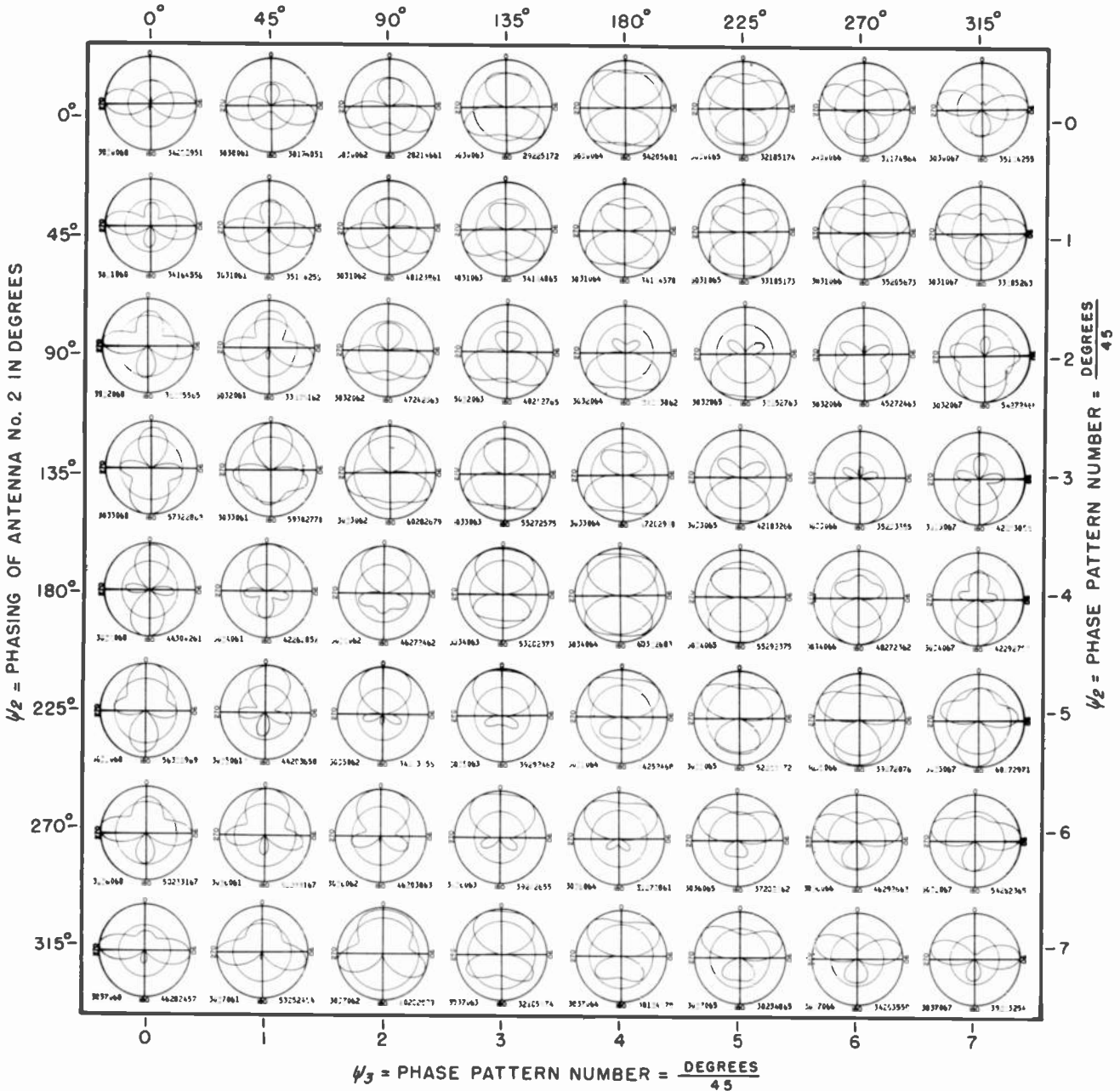

COPYRIGHT 1946 BY CARL F. SMITH  
PRINTED IN U. S. A.

CLEVELAND INSTITUTE OF RADIO ELECTRONICS  
TERMINAL TOWER, CLEVELAND 18, OHIO.

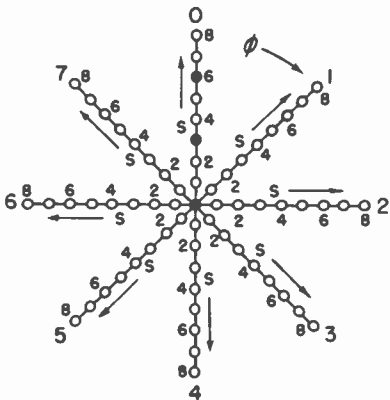

SPOTS LOCATE THE ANTENNAS FOR THIS PAGE OF PATTERNS IN THE SYSTEMATIZATION PLACEMENT CHART.

NUMBER OF ANTENNAS IN THE SYSTEM	ORIENTATION OF NO. 2 ANTENNA = $\frac{\text{DEGREES}}{45}$	SPACING OF NO. 2 ANTENNA = $\frac{\text{DEGREES}}{45}$	PHASING OF NO. 2 ANTENNA = $\frac{\text{DEGREES}}{45}$	ORIENTATION OF NO. 3 ANTENNA = $\frac{\text{DEGREES}}{45}$	SPACING OF NO. 3 ANTENNA = $\frac{\text{DEGREES}}{45}$	PHASING OF NO. 3 ANTENNA = $\frac{\text{DEGREES}}{45}$
No. 3	$\phi_2$ 0	$S_2$ 3	$\psi_2$ 0	$\phi_3$ 0	$S_3$ 6	$\psi_3$ 0

LEFT HAND PATTERN NUMBER GIVES ANTENNA PLACEMENT AND PHASING DATA.

% FIELD INTENSITY RADIATED IN HORIZONTAL PLANE FROM NO. 1 ANTENNA.	% FIELD INTENSITY RADIATED IN HORIZONTAL PLANE FROM NO. 2 ANTENNA.	% FIELD INTENSITY RADIATED IN HORIZONTAL PLANE FROM NO. 3 ANTENNA.	% RMS FIELD INTENSITY RADIATED IN HORIZONTAL PLANE FROM ANTENNA SYSTEM.
$E_1$ 34	$E_2$ 25	$E_3$ 29	$E_0$ 51

RIGHT HAND PATTERN NUMBER GIVES ANTENNA FIELD INTENSITY DATA IN PERCENT.

PATTERN NOMENCLATURE

$\psi_3$  = PHASING OF ANTENNA No. 3 IN DEGREES

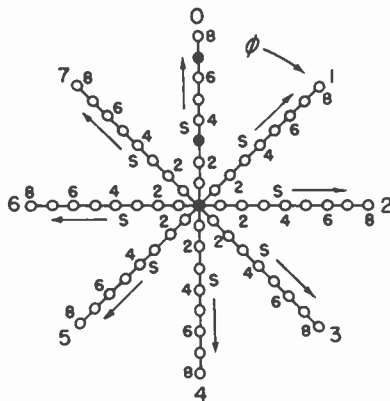
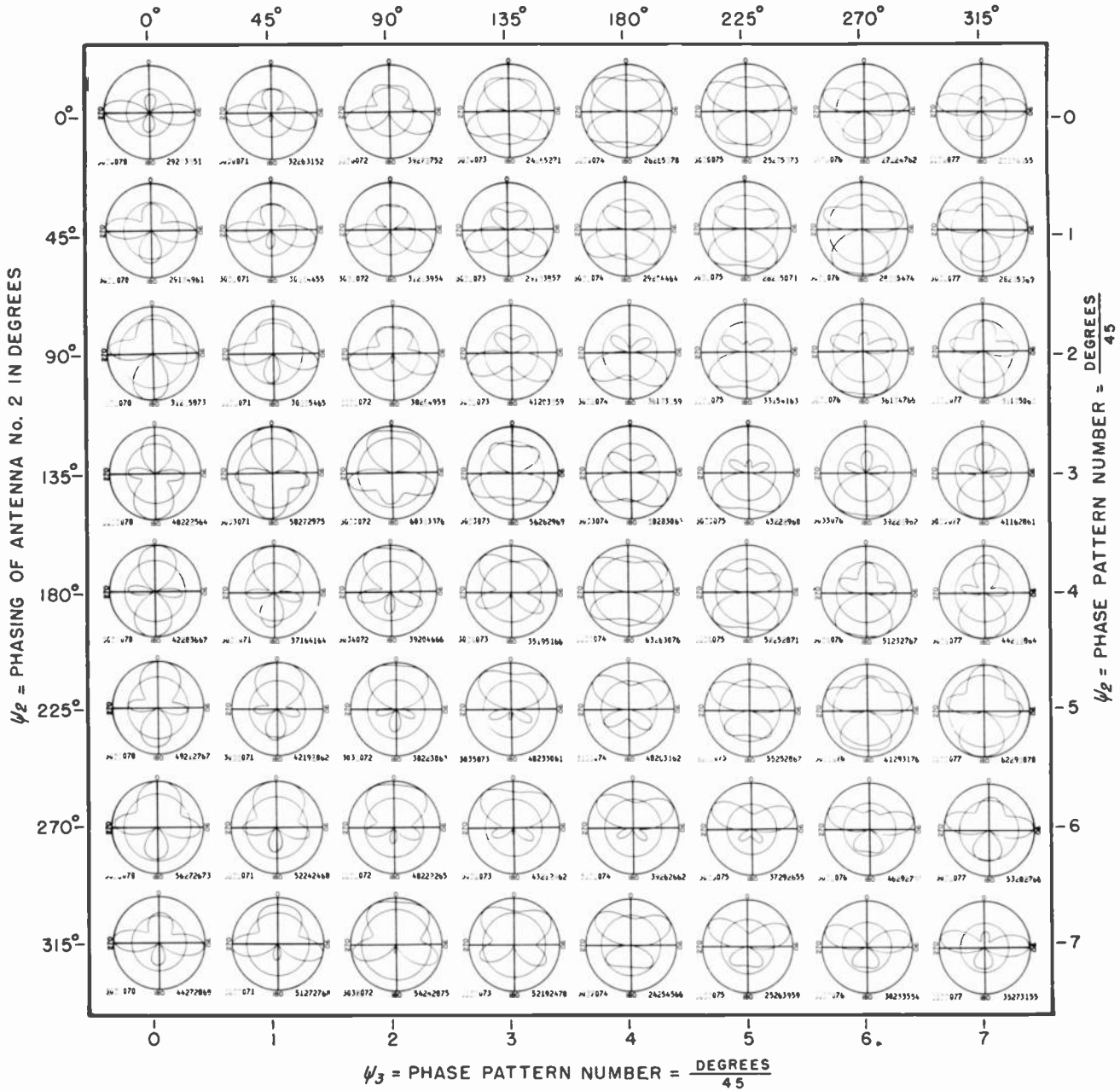

SPOTS LOCATE THE ANTENNAS FOR THIS PAGE OF PATTERNS IN THE SYSTEMIZATION PLACEMENT CHART.

NUMBER OF ANTENNAS IN THE SYSTEM	ORIENTATION OF ANTENNA = $\frac{DEGREES}{45}$	SPACING OF ANTENNA = $\frac{DEGREES}{45}$	PHASING OF ANTENNA = $\frac{DEGREES}{45}$	ORIENTATION OF ANTENNA = $\frac{DEGREES}{45}$	SPACING OF ANTENNA = $\frac{DEGREES}{45}$	PHASING OF ANTENNA = $\frac{DEGREES}{45}$
No. 3	$\phi_2$ 0	$S_2$ 3	$\psi_2$ 0	$\phi_3$ 0	$S_3$ 7	$\psi_3$ 0

LEFT HAND PATTERN NUMBER GIVES ANTENNA PLACEMENT AND PHASING DATA.

% FIELD INTENSITY RADIATED IN HORIZONTAL PLANE FROM NO. 1 ANTENNA.	% FIELD INTENSITY RADIATED IN HORIZONTAL PLANE FROM NO. 2 ANTENNA.	% FIELD INTENSITY RADIATED IN HORIZONTAL PLANE FROM NO. 3 ANTENNA.	% RMS FIELD INTENSITY RADIATED IN HORIZONTAL PLANE FROM ANTENNA SYSTEM.
$E_1$ 29	$E_2$ 24	$E_3$ 36	$E_0$ 51

RIGHT HAND PATTERN NUMBER GIVES ANTENNA FIELD INTENSITY DATA IN PERCENT.

PATTERN NOMENCLATURE



$\psi_3$  = PHASING OF ANTENNA No. 3 IN DEGREES

3.19

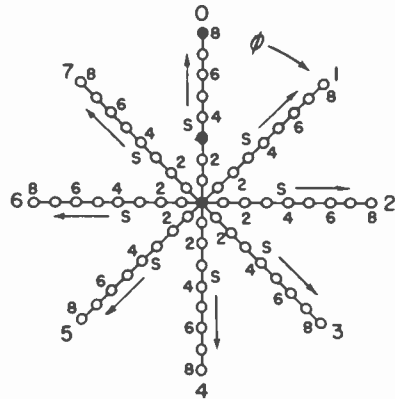
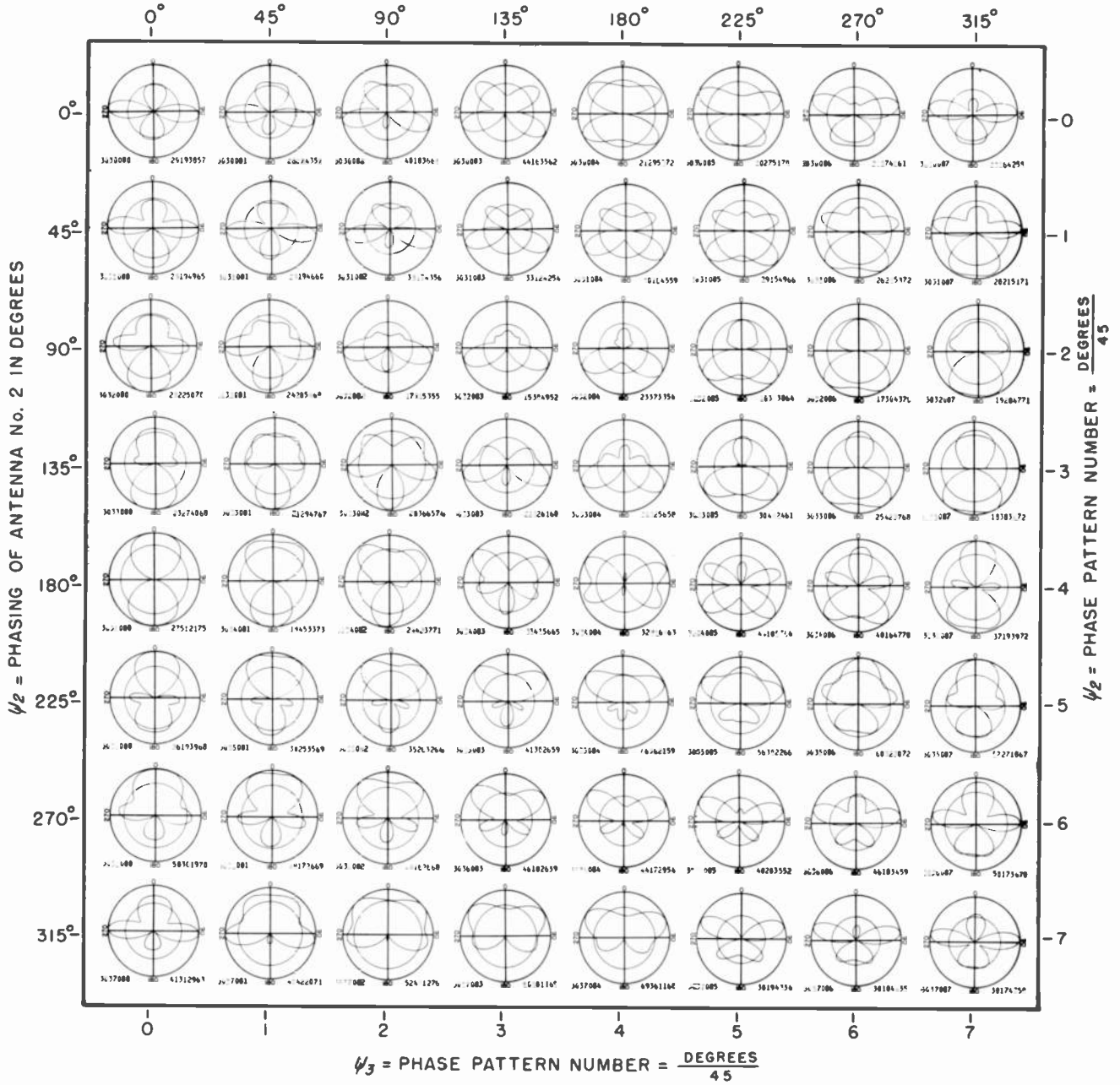

SPOTS LOCATE THE ANTENNAS FOR THIS PAGE OF PATTERNS IN THE SYSTEMATIZATION PLACEMENT CHART.

$\psi_3$  = PHASE PATTERN NUMBER =  $\frac{\text{DEGREES}}{45}$

NUMBER OF ANTENNAS IN THE SYSTEM	ORIENTATION OF NO. 2 ANTENNA = $\frac{\text{DEGREES}}{45}$	SPACING OF NO. 2 ANTENNA = $\frac{\text{DEGREES}}{45}$	PHASING OF NO. 2 ANTENNA = $\frac{\text{DEGREES}}{45}$	ORIENTATION OF NO. 3 ANTENNA = $\frac{\text{DEGREES}}{45}$	SPACING OF NO. 3 ANTENNA = $\frac{\text{DEGREES}}{45}$	PHASING OF NO. 3 ANTENNA = $\frac{\text{DEGREES}}{45}$
No.	$\phi_2$	$S_2$	$\psi_2$	$\phi_3$	$S_3$	$\psi_3$
3	0	3	0	0	8	0

LEFT HAND PATTERN NUMBER GIVES ANTENNA PLACEMENT AND PHASING DATA.

% FIELD INTENSITY RADIATED IN HORIZONTAL PLANE FROM NO. 1 ANTENNA.	% FIELD INTENSITY RADIATED IN HORIZONTAL PLANE FROM NO. 2 ANTENNA.	% FIELD INTENSITY RADIATED IN HORIZONTAL PLANE FROM NO. 3 ANTENNA.	% RMS FIELD INTENSITY RADIATED IN HORIZONTAL PLANE FROM ANTENNA SYSTEM.
$E_1$	$E_2$	$E_3$	$E_0$
29	19	38	57

RIGHT HAND PATTERN NUMBER GIVES ANTENNA FIELD INTENSITY DATA IN PERCENT.

PATTERN NOMENCLATURE

$\psi_3$  = PHASING OF ANTENNA No. 3 IN DEGREES

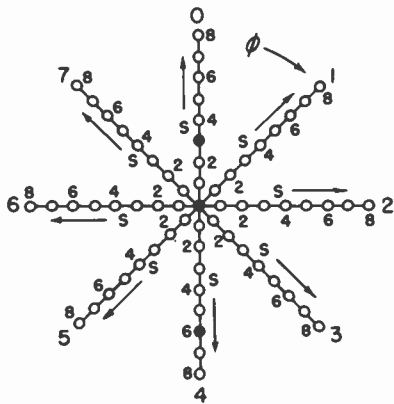
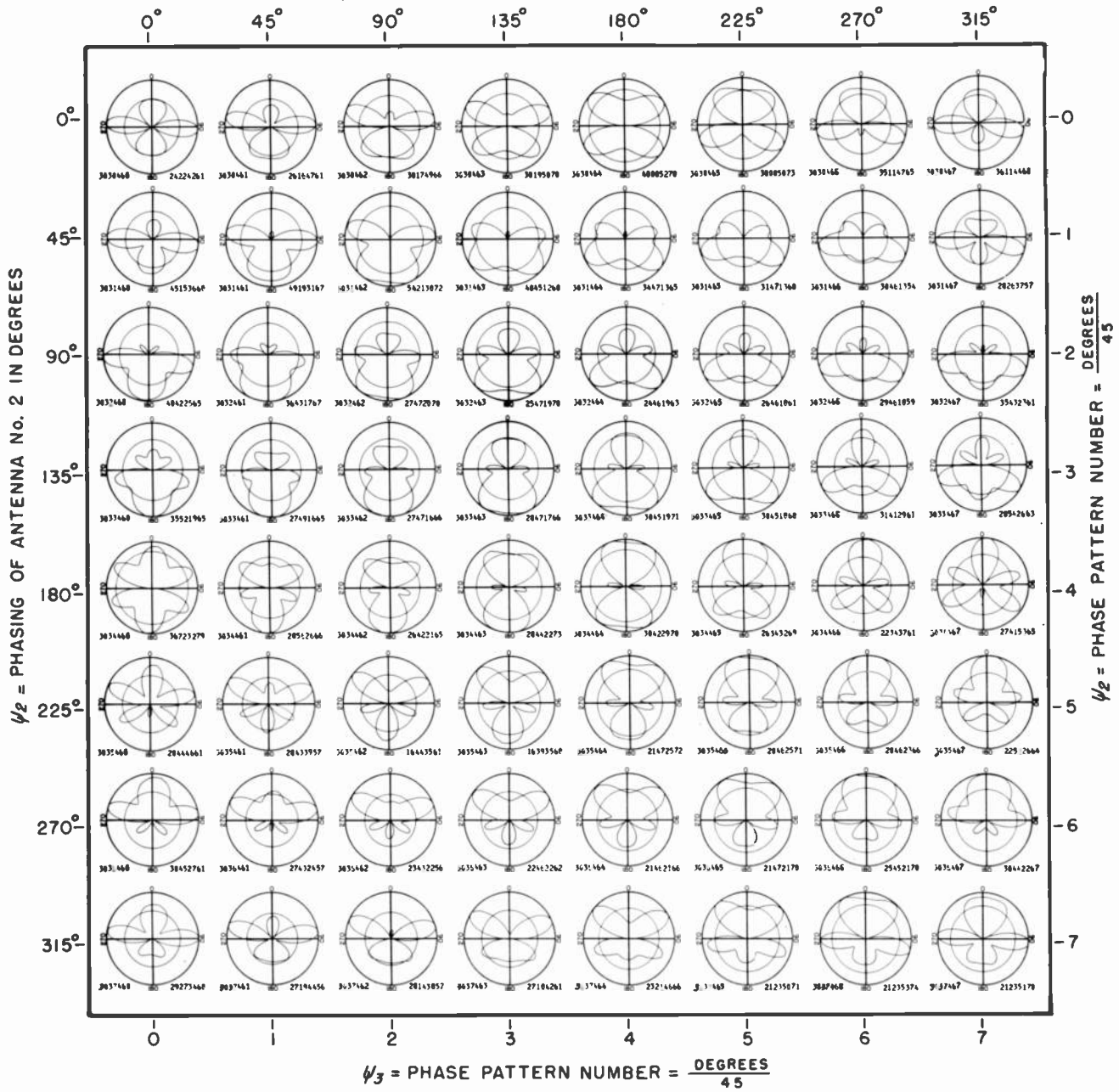

SPOTS LOCATE THE ANTENNAS FOR THIS PAGE OF PATTERNS IN THE SYSTEMATIZATION PLACEMENT CHART.

NUMBER OF ANTENNAS IN THE SYSTEM	ORIENTATION OF NO. 2 ANTENNA = $\frac{\text{DEGREES}}{45}$	SPACING OF NO. 2 ANTENNA = $\frac{\text{DEGREES}}{45}$	PHASING OF NO. 2 ANTENNA = $\frac{\text{DEGREES}}{45}$	ORIENTATION OF NO. 3 ANTENNA = $\frac{\text{DEGREES}}{45}$	SPACING OF NO. 3 ANTENNA = $\frac{\text{DEGREES}}{45}$	PHASING OF NO. 3 ANTENNA = $\frac{\text{DEGREES}}{45}$
No. 3	$\phi_2$ 0	$S_2$ 3	$\psi_2$ 0	$\phi_3$ 4	$S_3$ 6	$\psi_3$ 0

LEFT HAND PATTERN NUMBER GIVES ANTENNA PLACEMENT AND PHASING DATA.

% FIELD INTENSITY RADIATED IN HORIZONTAL PLANE FROM NO. 1 ANTENNA.	% FIELD INTENSITY RADIATED IN HORIZONTAL PLANE FROM NO. 2 ANTENNA.	% FIELD INTENSITY RADIATED IN HORIZONTAL PLANE FROM NO. 3 ANTENNA.	% RMS FIELD INTENSITY RADIATED IN HORIZONTAL PLANE FROM ANTENNA SYSTEM.
$E_1$ 24	$E_2$ 22	$E_3$ 42	$E_0$ 61

RIGHT HAND PATTERN NUMBER GIVES ANTENNA FIELD INTENSITY DATA IN PERCENT.

PATTERN NOMENCLATURE

$\psi_3$  = PHASING OF ANTENNA No. 3 IN DEGREES

3.21

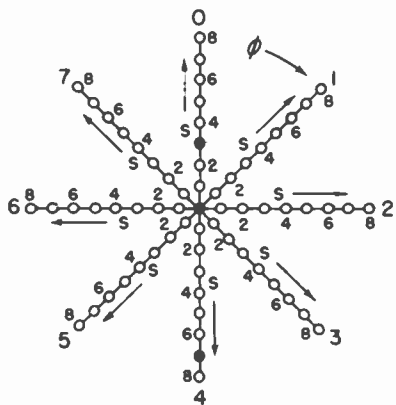
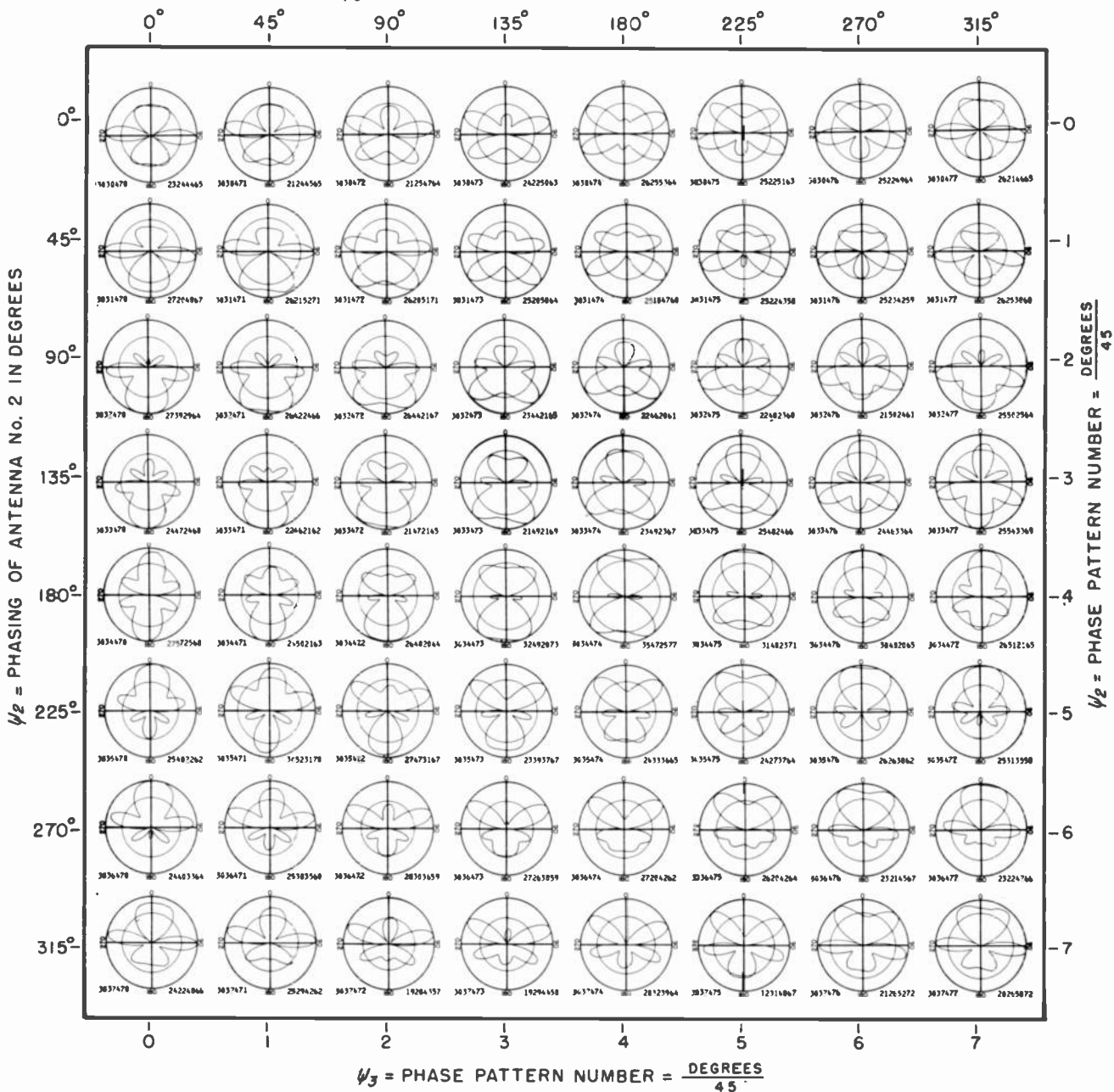

NUMBER OF ANTENNAS IN THE SYSTEM	ORIENTATION OF NO. 2 ANTENNA = $\frac{\text{DEGREES}}{45}$	SPACING OF NO. 2 ANTENNA = $\frac{\text{DEGREES}}{45}$	PHASING OF NO. 2 ANTENNA = $\frac{\text{DEGREES}}{45}$	ORIENTATION OF NO. 3 ANTENNA = $\frac{\text{DEGREES}}{45}$	SPACING OF NO. 3 ANTENNA = $\frac{\text{DEGREES}}{45}$	PHASING OF NO. 3 ANTENNA = $\frac{\text{DEGREES}}{45}$
No. 3	$\phi_2$ 0	$S_2$ 3	$\psi_2$ 0	$\phi_3$ 4	$S_3$ 7	$\psi_3$ 0

LEFT HAND PATTERN NUMBER GIVES ANTENNA PLACEMENT AND PHASING DATA.

% FIELD INTENSITY RADIATED IN HORIZONTAL PLANE FROM NO. 1 ANTENNA.	% FIELD INTENSITY RADIATED IN HORIZONTAL PLANE FROM NO. 2 ANTENNA.	% FIELD INTENSITY RADIATED IN HORIZONTAL PLANE FROM NO. 3 ANTENNA.	% RMS FIELD INTENSITY RADIATED IN HORIZONTAL PLANE FROM ANTENNA SYSTEM.
$E_1$ 23	$E_2$ 24	$E_3$ 44	$E_{RMS}$ $E_0$

RIGHT HAND PATTERN NUMBER GIVES ANTENNA FIELD INTENSITY DATA IN PERCENT.

SPOTS LOCATE THE ANTENNAS FOR THIS PAGE OF PATTERNS IN THE SYSTEMATIZATION PLACEMENT CHART.

PATTERN NOMENCLATURE

$\psi_3$  = PHASING OF ANTENNA No. 3 IN DEGREES

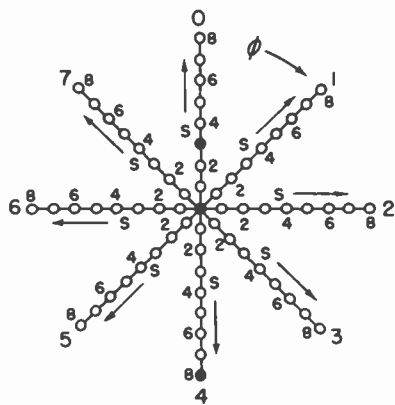
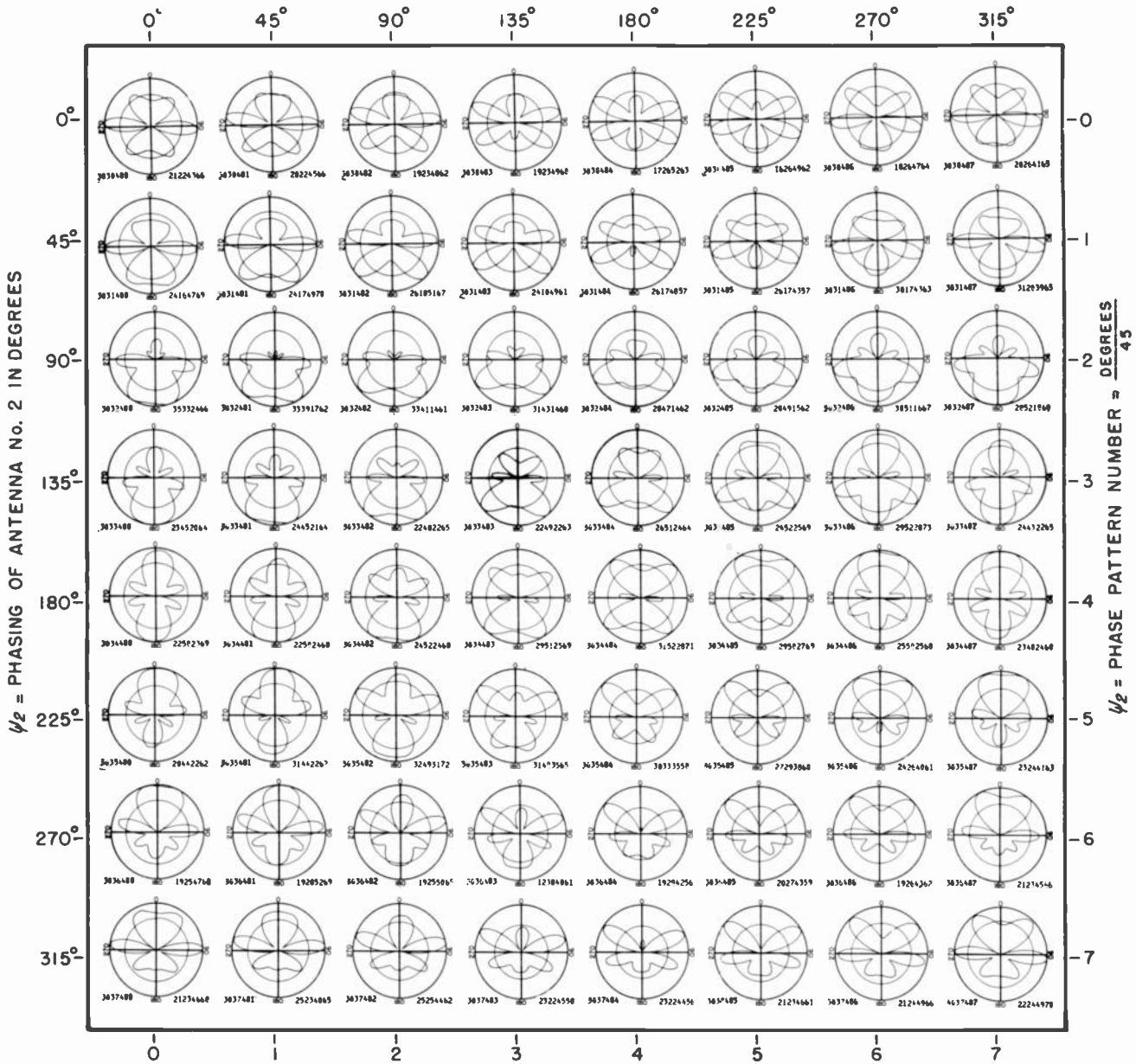

$\psi_3 = \text{PHASE PATTERN NUMBER} = \frac{\text{DEGREES}}{45}$

NUMBER OF ANTENNAS IN THE SYSTEM	ORIENTATION OF NO. 2 ANTENNA = $\frac{\text{DEGREES}}{45}$	SPACING OF NO. 2 ANTENNA = $\frac{\text{DEGREES}}{45}$	PHASING OF NO. 2 ANTENNA = $\frac{\text{DEGREES}}{45}$	ORIENTATION OF NO. 3 ANTENNA = $\frac{\text{DEGREES}}{45}$	SPACING OF NO. 3 ANTENNA = $\frac{\text{DEGREES}}{45}$	PHASING OF NO. 3 ANTENNA = $\frac{\text{DEGREES}}{45}$
No. 3	$\psi_2 = 0$	$S_2 = 3$	$\psi_2 = 0$	$\psi_3 = 4$	$S_3 = 0$	$\psi_3 = 0$

% FIELD INTENSITY RADIATED IN HORIZONTAL PLANE FROM NO. 1 ANTENNA.	% FIELD INTENSITY RADIATED IN HORIZONTAL PLANE FROM NO. 2 ANTENNA.	% FIELD INTENSITY RADIATED IN HORIZONTAL PLANE FROM NO. 3 ANTENNA.	% RMS FIELD INTENSITY RADIATED IN HORIZONTAL PLANE FROM ANTENNA SYSTEM.
$E_1 = 21$	$E_2 = 22$	$E_3 = 43$	$E_0 = 66$

SPOTS LOCATE THE ANTENNAS FOR THIS PAGE OF PATTERNS IN THE SYSTEMATIZATION PLACEMENT CHART.

LEFT HAND PATTERN NUMBER GIVES ANTENNA PLACEMENT AND PHASING DATA.

RIGHT HAND PATTERN NUMBER GIVES ANTENNA FIELD INTENSITY DATA IN PERCENT.

PATTERN NOMENCLATURE

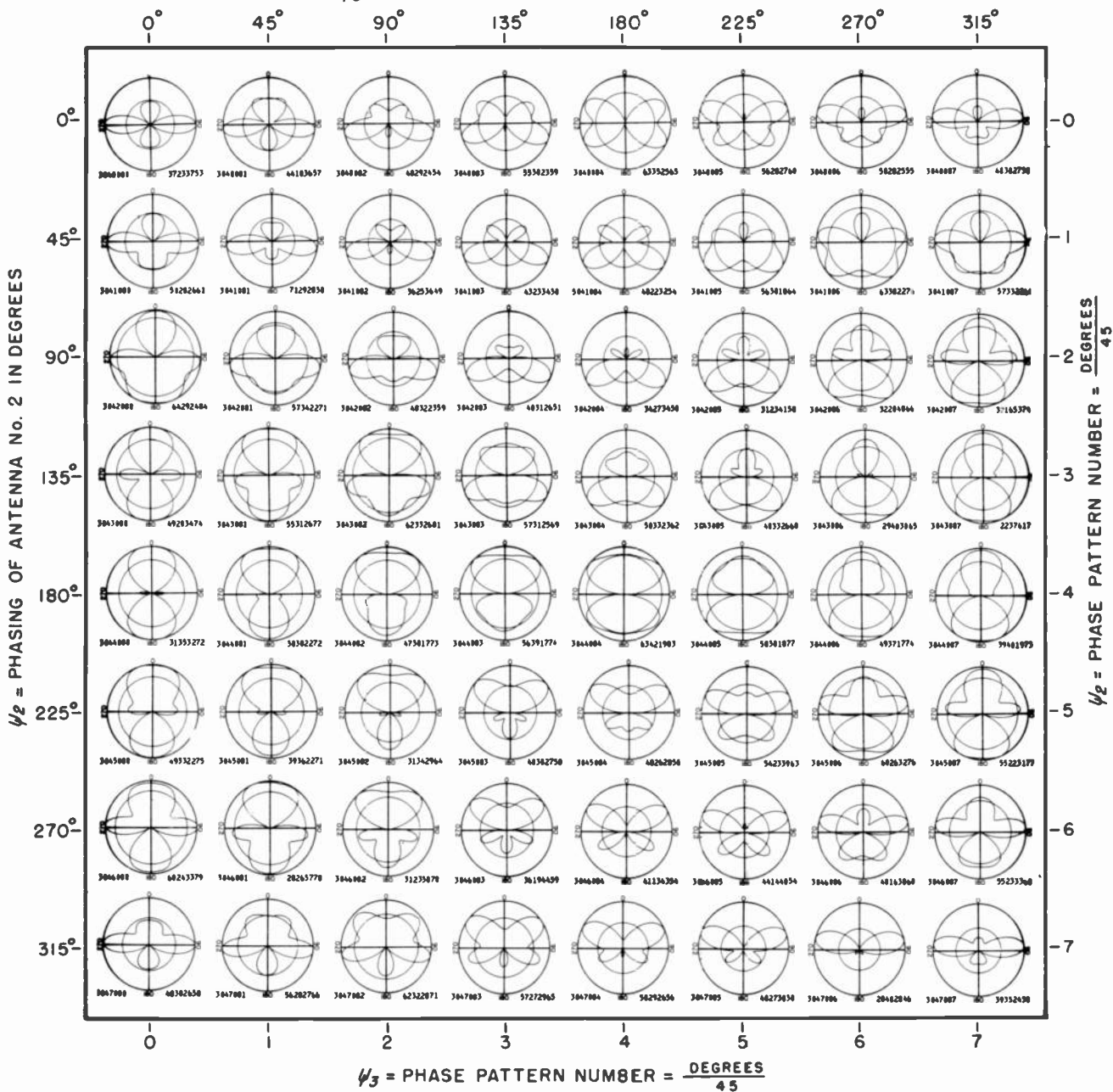

COPYRIGHT 1946 BY CARL E. SMITH  
PRINTED IN U. S. A.

CLEVELAND INSTITUTE OF RADIO ELECTRONICS  
TERMINAL TOWER, CLEVELAND 18, OHIO.

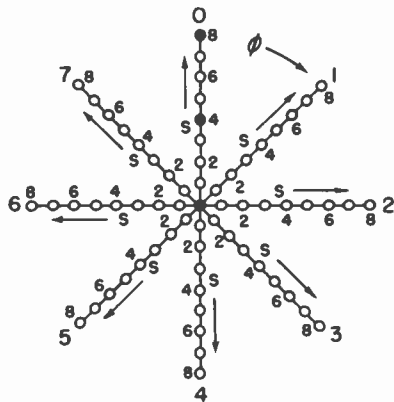

SPOTS LOCATE THE ANTENNAS FOR THIS PAGE OF PATTERNS IN THE SYSTEMATIZATION PLACEMENT CHART.

$\psi_3$  = PHASE PATTERN NUMBER =  $\frac{\text{DEGREES}}{45}$

NUMBER OF ANTENNAS IN THE SYSTEM	ORIENTATION OF NO. 2 ANTENNA = $\frac{\text{DEGREES}}{45}$	SPACING OF NO. 2 ANTENNA = $\frac{\text{DEGREES}}{45}$	PHASING OF NO. 2 ANTENNA = $\frac{\text{DEGREES}}{45}$	ORIENTATION OF NO. 3 ANTENNA = $\frac{\text{DEGREES}}{45}$	SPACING OF NO. 3 ANTENNA = $\frac{\text{DEGREES}}{45}$	PHASING OF NO. 3 ANTENNA = $\frac{\text{DEGREES}}{45}$
No. 3	$\phi_2$ 0	$S_2$ 4	$\psi_2$ 0	$\phi_3$ 0	$S_3$ 8	$\psi_3$ 0

LEFT HAND PATTERN NUMBER GIVES ANTENNA PLACEMENT AND PHASING DATA.

% FIELD INTENSITY RADIATED IN HORIZONTAL PLANE FROM NO. 1 ANTENNA.	% FIELD INTENSITY RADIATED IN HORIZONTAL PLANE FROM NO. 2 ANTENNA.	% FIELD INTENSITY RADIATED IN HORIZONTAL PLANE FROM NO. 3 ANTENNA.	% RMS FIELD INTENSITY RADIATED IN HORIZONTAL PLANE FROM ANTENNA SYSTEM.
$E_1$ 37	$E_2$ 23	$E_3$ 37	$E_0$ 53

RIGHT HAND PATTERN NUMBER GIVES ANTENNA FIELD INTENSITY DATA IN PERCENT.

PATTERN NOMENCLATURE

$\psi_3$  = PHASING OF ANTENNA No. 3 IN DEGREES

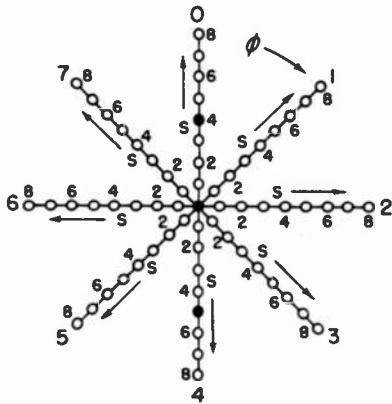
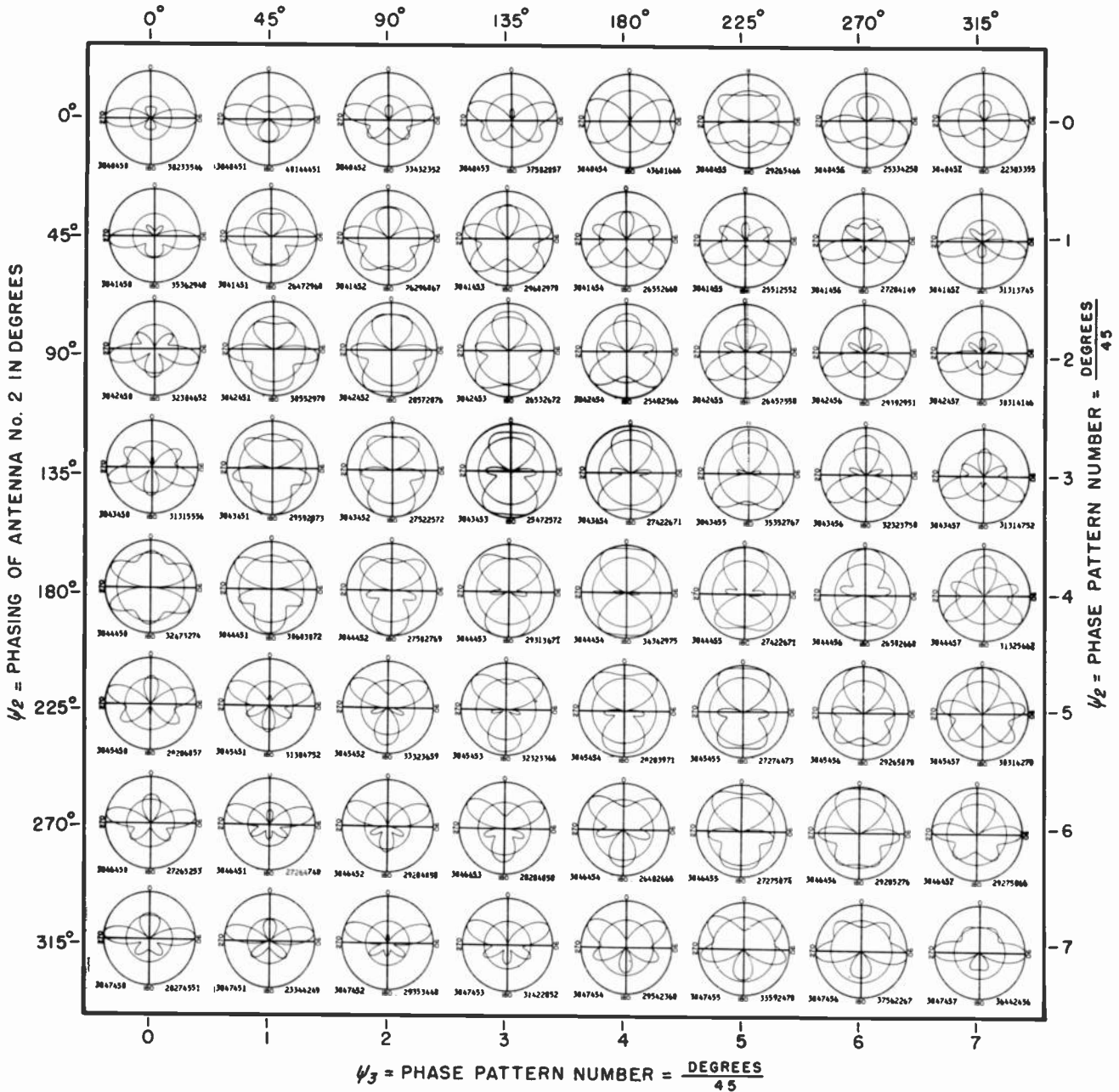

NUMBER OF ANTENNAS IN THE SYSTEM	ORIENTATION OF NO. 2 ANTENNA = $\frac{\text{DEGREES}}{45}$	SPACING OF NO. 2 ANTENNA = $\frac{\text{DEGREES}}{45}$	PHASING OF NO. 2 ANTENNA = $\frac{\text{DEGREES}}{45}$	ORIENTATION OF NO. 3 ANTENNA = $\frac{\text{DEGREES}}{45}$	SPACING OF NO. 3 ANTENNA = $\frac{\text{DEGREES}}{45}$	PHASING OF NO. 3 ANTENNA = $\frac{\text{DEGREES}}{45}$
No. 3	$\phi_2$ 0	$S_2$ 4	$\psi_2$ 0	$\phi_3$ 4	$S_3$ 5	$\psi_3$ 0

LEFT HAND PATTERN NUMBER GIVES ANTENNA PLACEMENT AND PHASING DATA.

% FIELD INTENSITY RADIATED IN HORIZONTAL PLANE FROM NO. 1 ANTENNA.	% FIELD INTENSITY RADIATED IN HORIZONTAL PLANE FROM NO. 2 ANTENNA.	% FIELD INTENSITY RADIATED IN HORIZONTAL PLANE FROM NO. 3 ANTENNA.	% RMS FIELD INTENSITY RADIATED IN HORIZONTAL PLANE FROM ANTENNA SYSTEM.
$E_1$ 38	$E_2$ 23	$E_3$ 35	$E_0$ 46

RIGHT HAND PATTERN NUMBER GIVES ANTENNA FIELD INTENSITY DATA IN PERCENT.

SPOTS LOCATE THE ANTENNAS FOR THIS PAGE OF PATTERNS IN THE SYSTEMATIZATION PLACEMENT CHART.

PATTERN NOMENCLATURE

$\psi_3$  = PHASING OF ANTENNA No. 3 IN DEGREES

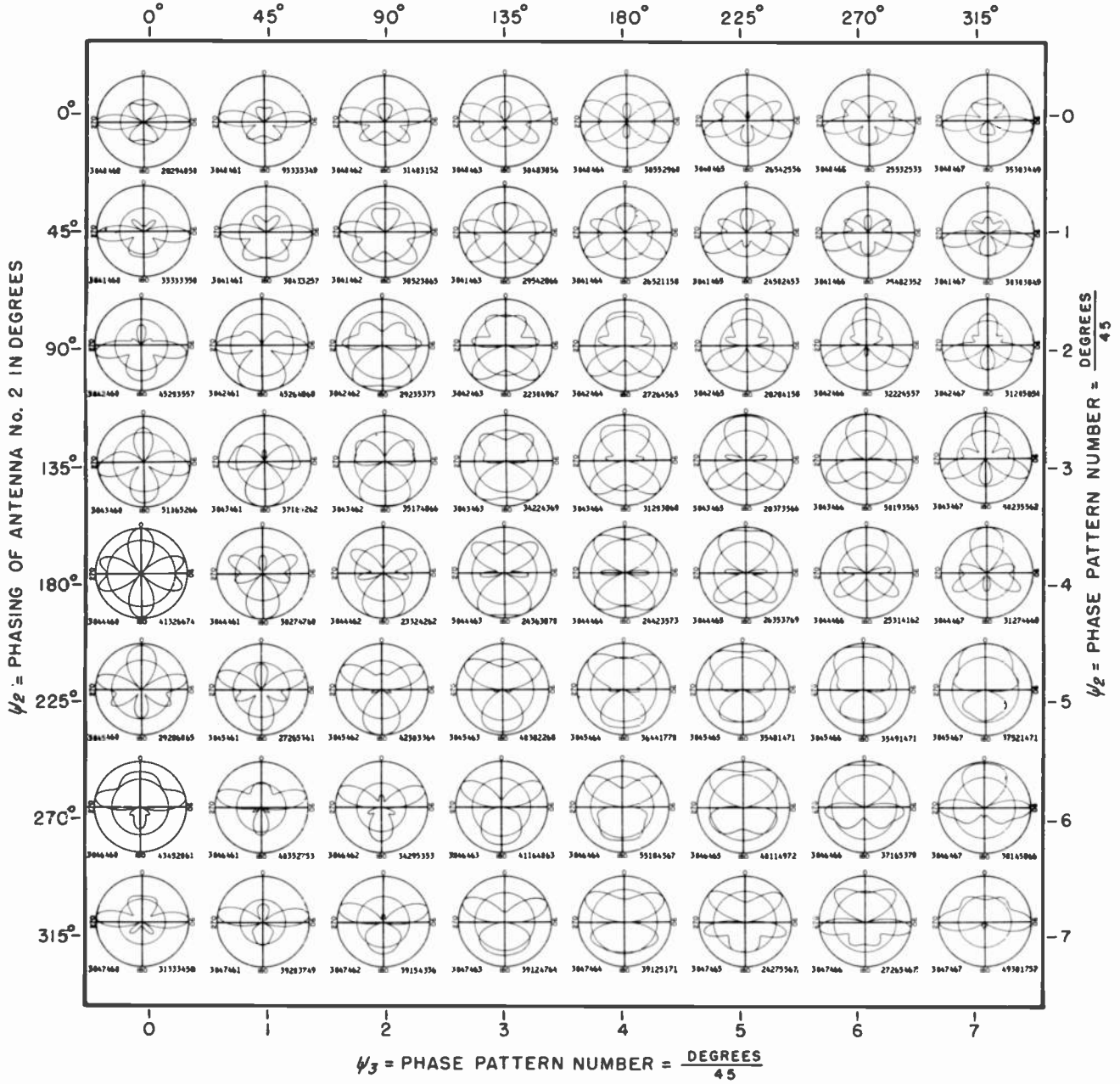

$\psi_2$  = PHASING OF ANTENNA No. 2 IN DEGREES

$\psi_2$  = PHASE PATTERN NUMBER =  $\frac{\text{DEGREES}}{45}$

$\psi_3$  = PHASE PATTERN NUMBER =  $\frac{\text{DEGREES}}{45}$

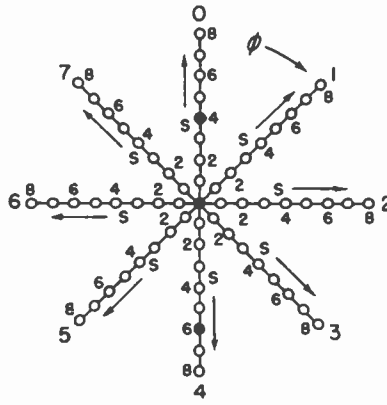

NO.	$\phi_2$	$S_2$	$\psi_2$	$\phi_3$	$S_3$	$\psi_3$
3	0	4	0	4	6	0

LEFT HAND PATTERN NUMBER GIVES ANTENNA PLACEMENT AND PHASING DATA.

$E_1$	$E_2$	$E_3$	$E_0$
28	29	40	50

RIGHT HAND PATTERN NUMBER GIVES ANTENNA FIELD INTENSITY DATA IN PERCENT.

SPOTS LOCATE THE ANTENNAS FOR THIS PAGE OF PATTERNS IN THE SYSTEMIZATION PLACEMENT CHART.

PATTERN NOMENCLATURE

$\psi_3 =$  PHASING OF ANTENNA NO. 3 IN DEGREES

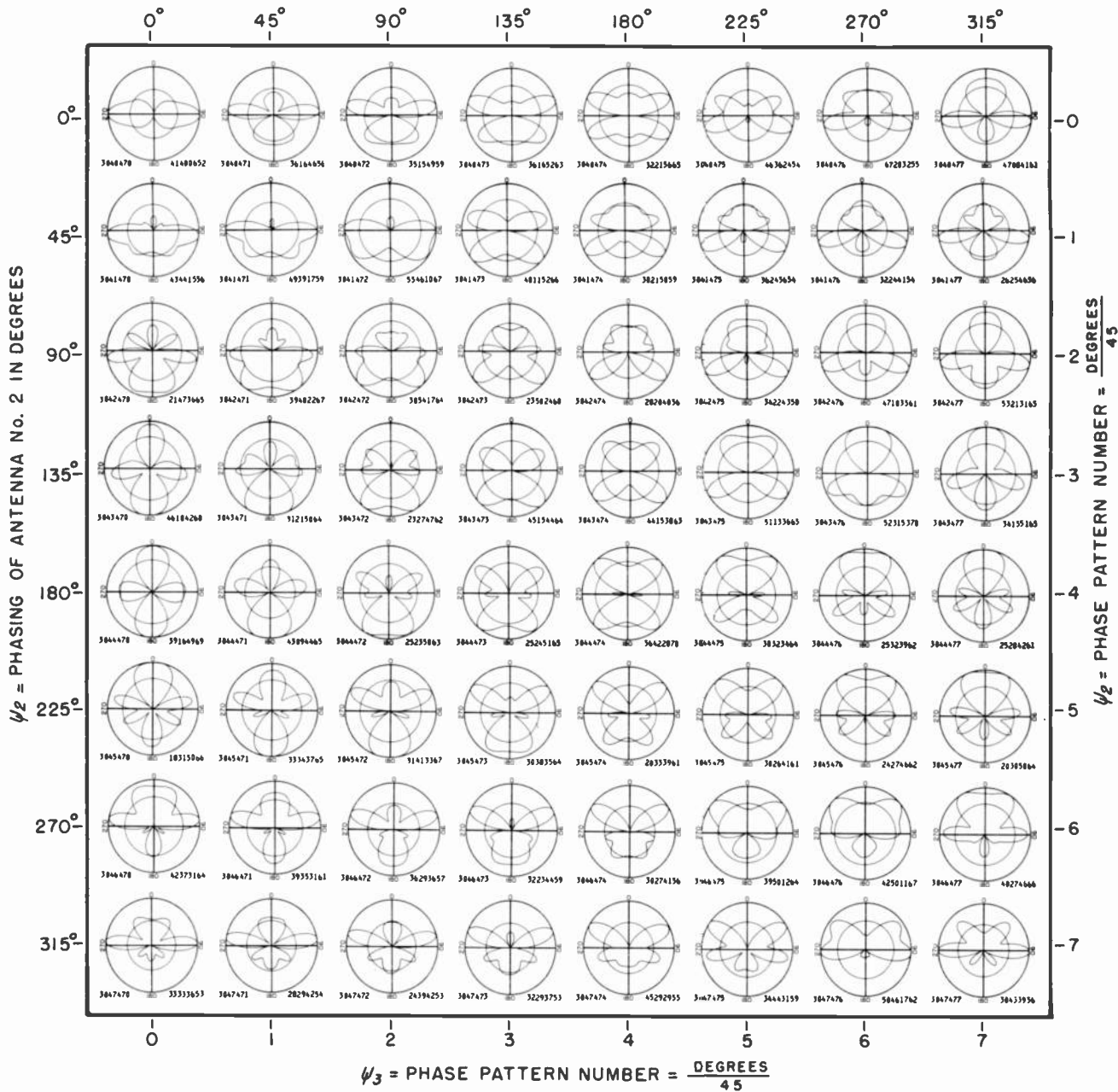

$\psi_2 =$  PHASING OF ANTENNA NO. 2 IN DEGREES

$\psi_2 =$  PHASE PATTERN NUMBER  $\times \frac{\text{DEGREES}}{45}$

$\psi_3 =$  PHASE PATTERN NUMBER  $\times \frac{\text{DEGREES}}{45}$

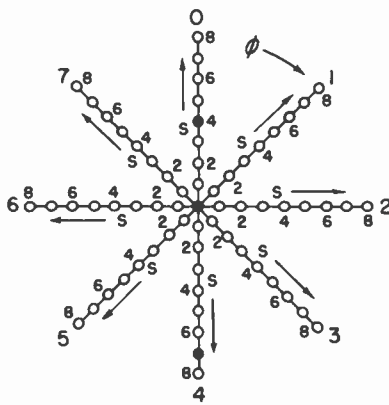

NUMBER OF ANTENNAS IN THE SYSTEM	ORIENTATION OF NO. 2 ANTENNA = $\frac{\text{DEGREES}}{45}$	SPACING OF NO. 2 ANTENNA = $\frac{\text{DEGREES}}{45}$	PHASING OF NO. 2 ANTENNA = $\frac{\text{DEGREES}}{45}$	ORIENTATION OF NO. 3 ANTENNA = $\frac{\text{DEGREES}}{45}$	SPACING OF NO. 3 ANTENNA = $\frac{\text{DEGREES}}{45}$	PHASING OF NO. 3 ANTENNA = $\frac{\text{DEGREES}}{45}$
No.	$\phi_2$	$S_2$	$\psi_2$	$\phi_3$	$S_3$	$\psi_3$
3	0	4	0	4	7	0

% FIELD INTENSITY RADIATED IN HORIZONTAL PLANE FROM NO. 1 ANTENNA.	% FIELD INTENSITY RADIATED IN HORIZONTAL PLANE FROM NO. 2 ANTENNA.	% FIELD INTENSITY RADIATED IN HORIZONTAL PLANE FROM NO. 3 ANTENNA.	% RMS FIELD INTENSITY RADIATED IN HORIZONTAL PLANE FROM ANTENNA SYSTEM.
$E_1$	$E_2$	$E_3$	$E_0$
41	48	06	52

LEFT HAND PATTERN NUMBER GIVES ANTENNA PLACEMENT AND PHASING DATA.

RIGHT HAND PATTERN NUMBER GIVES ANTENNA FIELD INTENSITY DATA IN PERCENT.

SPOTS LOCATE THE ANTENNAS FOR THIS PAGE OF PATTERNS IN THE SYSTEMATIZATION PLACEMENT CHART.

PATTERN NOMENCLATURE



$\psi_3$  = PHASING OF ANTENNA No. 3 IN DEGREES

3.27

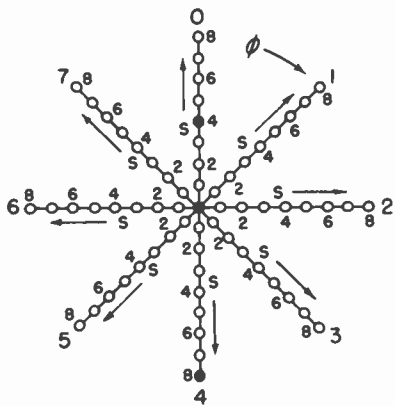
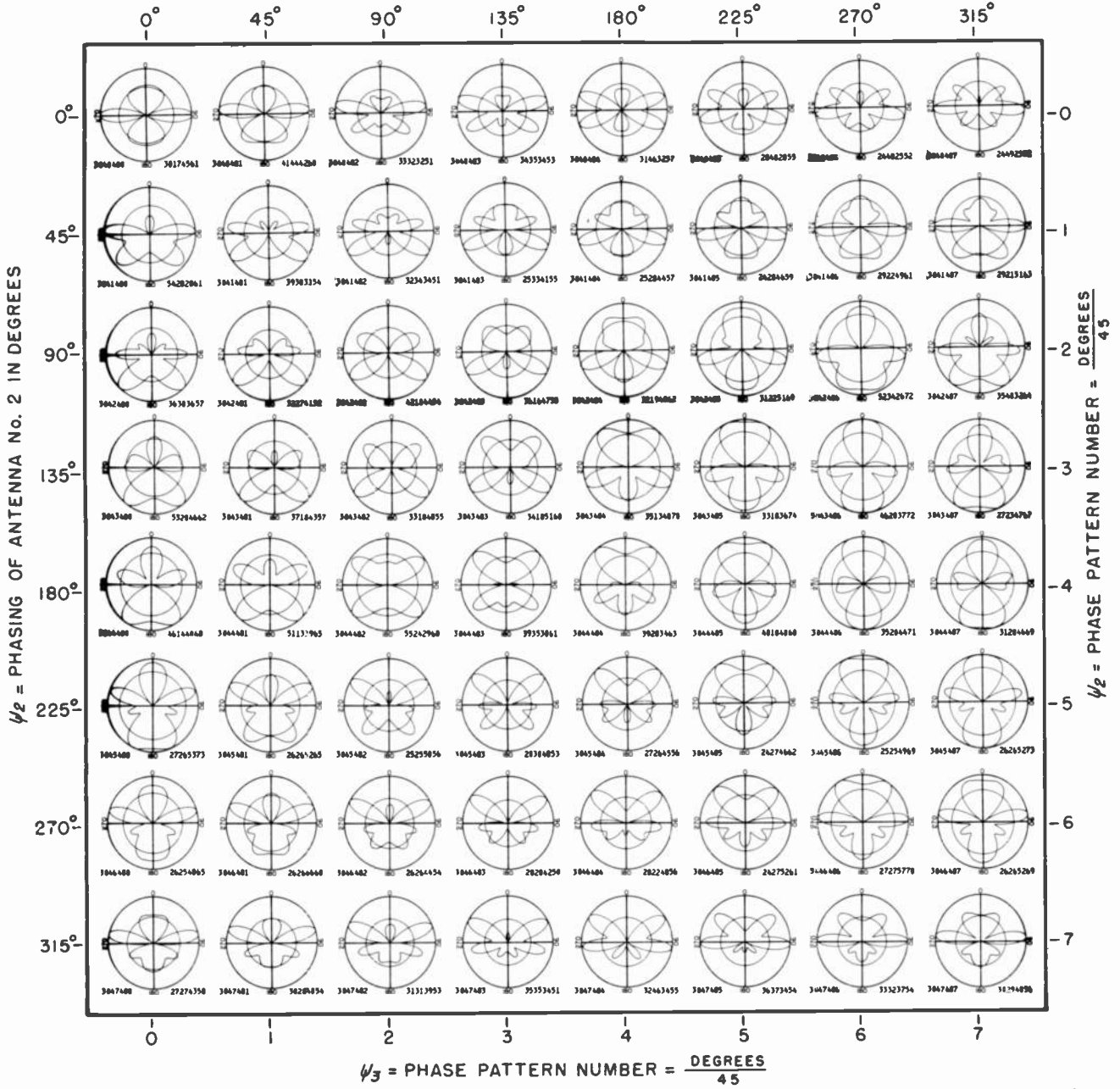

$\psi_3$  = PHASE PATTERN NUMBER =  $\frac{\text{DEGREES}}{45}$

NUMBER OF ANTENNAS IN THE SYSTEM	ORIENTATION OF NO. 2 ANTENNA = $\frac{\text{DEGREES}}{45}$	SPACING OF NO. 2 ANTENNA = $\frac{\text{DEGREES}}{45}$	PHASING OF NO. 2 ANTENNA = $\frac{\text{DEGREES}}{45}$	ORIENTATION OF NO. 3 ANTENNA = $\frac{\text{DEGREES}}{45}$	SPACING OF NO. 3 ANTENNA = $\frac{\text{DEGREES}}{45}$	PHASING OF NO. 3 ANTENNA = $\frac{\text{DEGREES}}{45}$
No. 3	$\phi_2$ 0	$S_2$ 4	$\psi_2$ 0	$\phi_3$ 4	$S_3$ 8	$\psi_3$ 0

LEFT HAND PATTERN NUMBER GIVES ANTENNA  
PLACEMENT AND PHASING DATA.

% FIELD INTENSITY RADIATED IN HORIZONTAL PLANE FROM NO. 1 ANTENNA.	% FIELD INTENSITY RADIATED IN HORIZONTAL PLANE FROM NO. 2 ANTENNA.	% FIELD INTENSITY RADIATED IN HORIZONTAL PLANE FROM NO. 3 ANTENNA.	% RMS FIELD INTENSITY RADIATED IN HORIZONTAL PLANE FROM ANTENNA SYSTEM.
$E_1$ 38	$E_2$ 17	$E_3$ 45	$E_0$ 61

RIGHT HAND PATTERN NUMBER  
GIVES ANTENNA FIELD INTEN-  
SITY DATA IN PERCENT.

SPOTS LOCATE THE ANTENNAS FOR  
THIS PAGE OF PATTERNS IN THE  
SYSTEMATIZATION PLACEMENT CHART.

PATTERN NOMENCLATURE

$\psi_3$  = PHASING OF ANTENNA No. 3 IN DEGREES

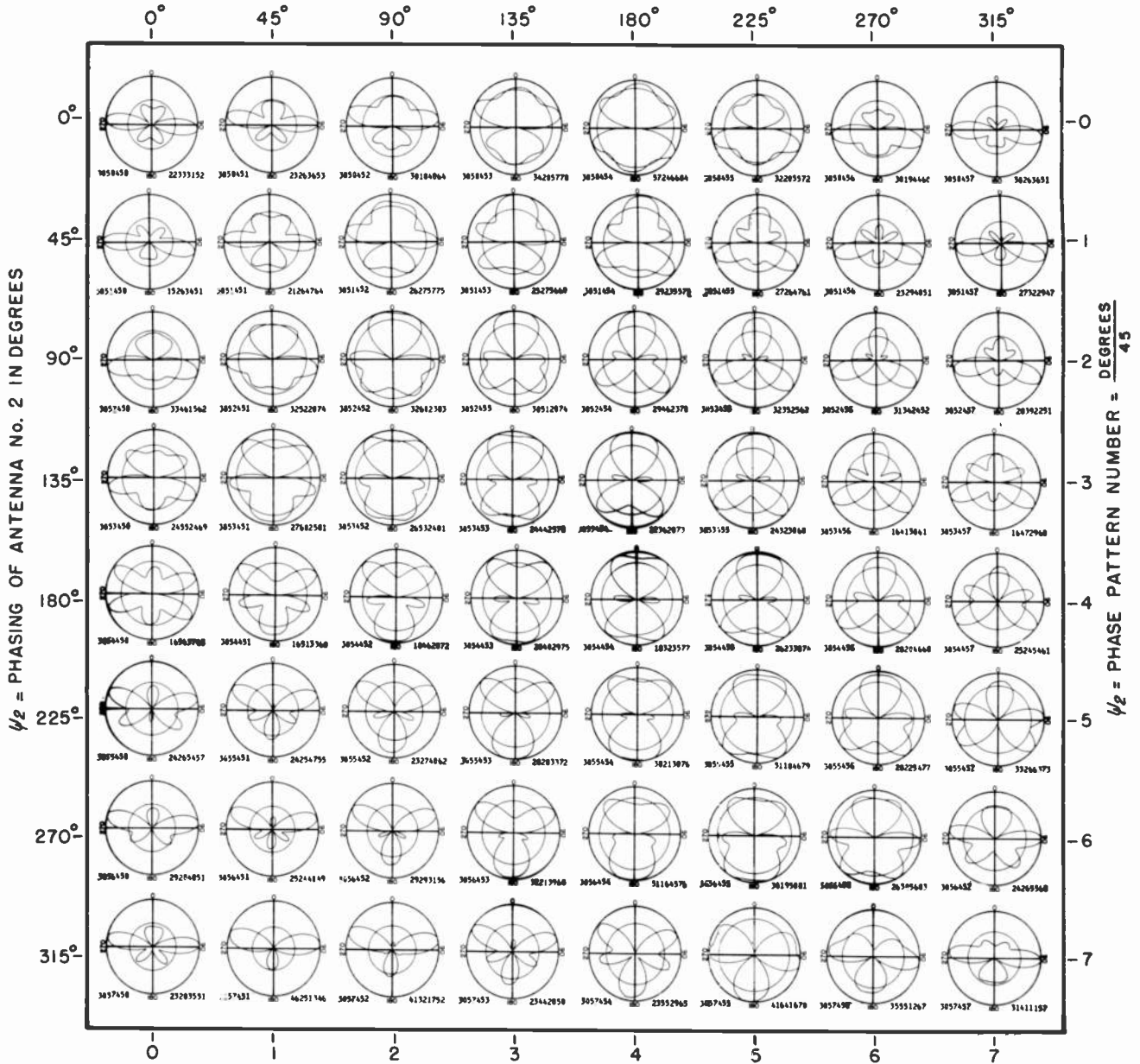

$\psi_3$  = PHASE PATTERN NUMBER =  $\frac{\text{DEGREES}}{45}$

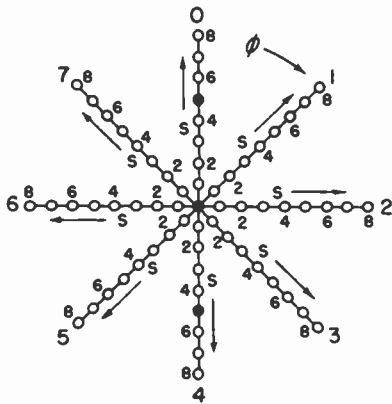

NUMBER OF ANTENNAS IN THE SYSTEM	ORIENTATION OF NO. 2 ANTENNA = $\frac{\text{DEGREES}}{45}$	SPACING OF NO. 2 ANTENNA = $\frac{\text{DEGREES}}{45}$	PHASING OF NO. 2 ANTENNA = $\frac{\text{DEGREES}}{45}$	ORIENTATION OF NO. 3 ANTENNA = $\frac{\text{DEGREES}}{45}$	SPACING OF NO. 3 ANTENNA = $\frac{\text{DEGREES}}{45}$	PHASING OF NO. 3 ANTENNA = $\frac{\text{DEGREES}}{45}$
No. 3	$\phi_2$ 0	$S_2$ 5	$\psi_2$ 0	$\phi_3$ 4	$S_3$ 5	$\psi_3$ 0

LEFT HAND PATTERN NUMBER GIVES ANTENNA PLACEMENT AND PHASING DATA.

% FIELD INTENSITY RADIATED IN HORIZONTAL PLANE FROM NO. 1 ANTENNA.	% FIELD INTENSITY RADIATED IN HORIZONTAL PLANE FROM NO. 2 ANTENNA.	% FIELD INTENSITY RADIATED IN HORIZONTAL PLANE FROM NO. 3 ANTENNA.	% RMS FIELD INTENSITY RADIATED IN HORIZONTAL PLANE FROM ANTENNA SYSTEM.
$E_1$ 22	$E_2$ 33	$E_3$ 31	$E_0$ 52

RIGHT HAND PATTERN NUMBER GIVES ANTENNA FIELD INTENSITY DATA IN PERCENT.

SPOTS LOCATE THE ANTENNAS FOR THIS PAGE OF PATTERNS IN THE SYSTEMIZATION PLACEMENT CHART.

PATTERN NOMENCLATURE

$\psi_3$  = PHASING OF ANTENNA No. 3 IN DEGREES

3.29

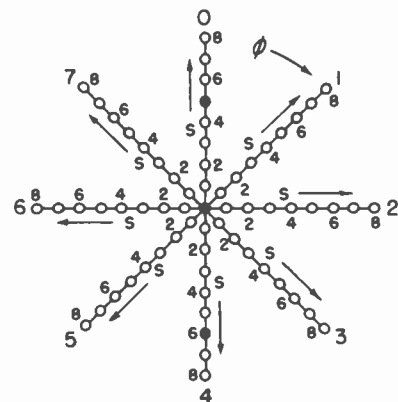
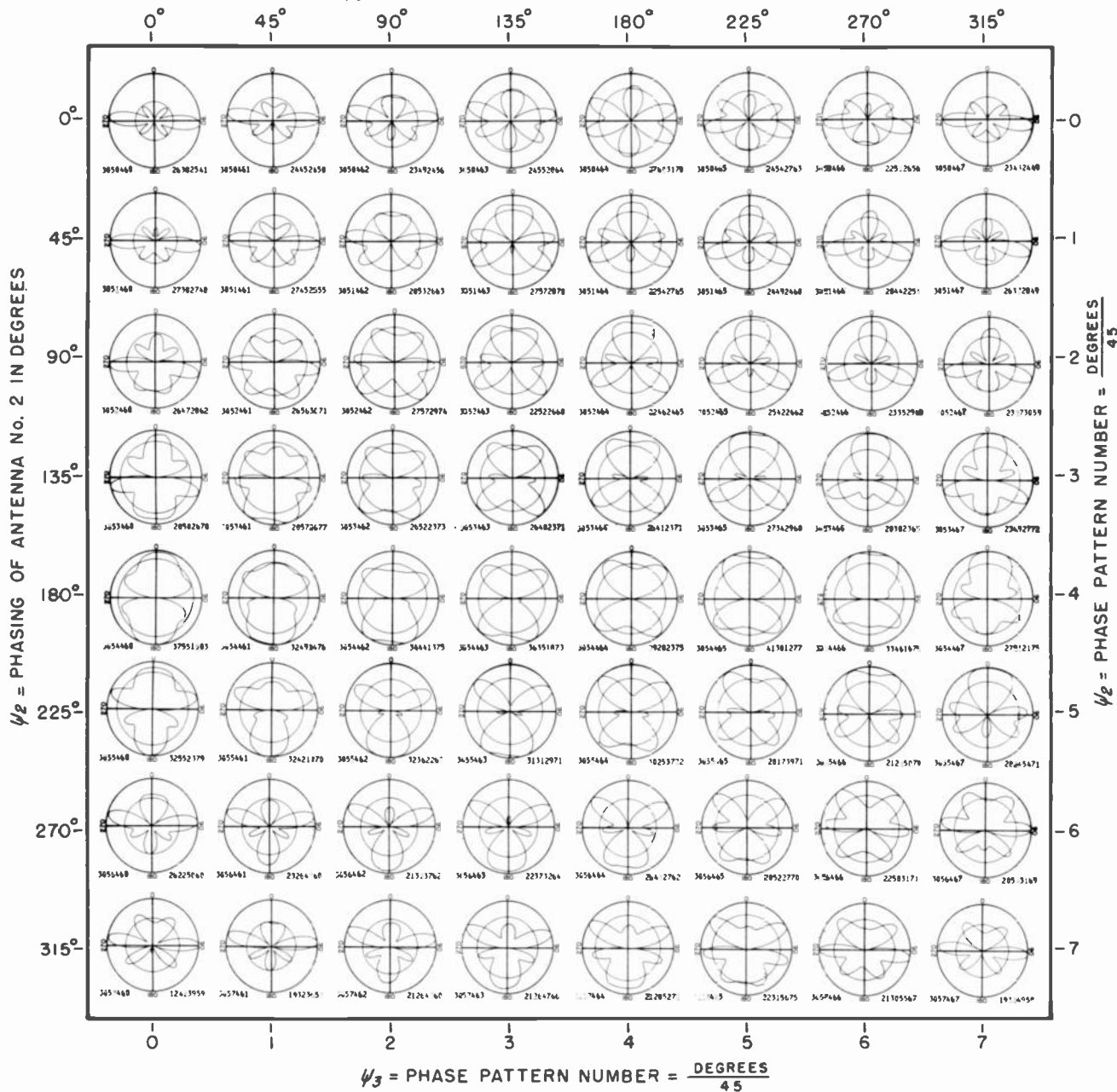

SPOTS LOCATE THE ANTENNAS FOR  
THIS PAGE OF PATTERNS IN THE  
SYSTEMATIZATION PLACEMENT CHART.

$\psi_3$  = PHASE PATTERN NUMBER =  $\frac{\text{DEGREES}}{45}$

NUMBER OF ANTENNAS  
IN THE SYSTEM  
NO. 3

ORIENTATION OF ANTENNA =  $\frac{\text{DEGREES}}{45}$   
NO. 2 ANTENNA = 0

SPACING OF ANTENNA =  $\frac{\text{DEGREES}}{45}$   
NO. 2 ANTENNA = 5

PHASING OF ANTENNA =  $\frac{\text{DEGREES}}{45}$   
NO. 2 ANTENNA = 0

ORIENTATION OF ANTENNA =  $\frac{\text{DEGREES}}{45}$   
NO. 3 ANTENNA = 4

SPACING OF ANTENNA =  $\frac{\text{DEGREES}}{45}$   
NO. 3 ANTENNA = 6

PHASING OF ANTENNA =  $\frac{\text{DEGREES}}{45}$   
NO. 3 ANTENNA = 0

% FIELD INTENSITY  
RADIATED IN HORIZONTAL  
PLANE FROM NO. 1 ANTENNA.  
 $E_1$  26

% FIELD INTENSITY  
RADIATED IN HORIZONTAL  
PLANE FROM NO. 2 ANTENNA.  
 $E_2$  38

% FIELD INTENSITY  
RADIATED IN HORIZONTAL  
PLANE FROM NO. 3 ANTENNA.  
 $E_3$  25

% RMS FIELD INTENSITY  
RADIATED IN HORIZONTAL  
PLANE FROM ANTENNA SYSTEM.  
 $E_0$  41

LEFT HAND PATTERN NUMBER GIVES ANTENNA  
PLACEMENT AND PHASING DATA.

RIGHT HAND PATTERN NUMBER  
GIVES ANTENNA FIELD INTEN-  
SITY DATA IN PERCENT.

PATTERN NOMENCLATURE

$\psi_3$  = PHASING OF ANTENNA No. 3 IN DEGREES

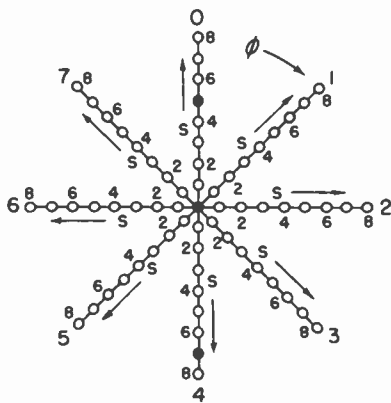
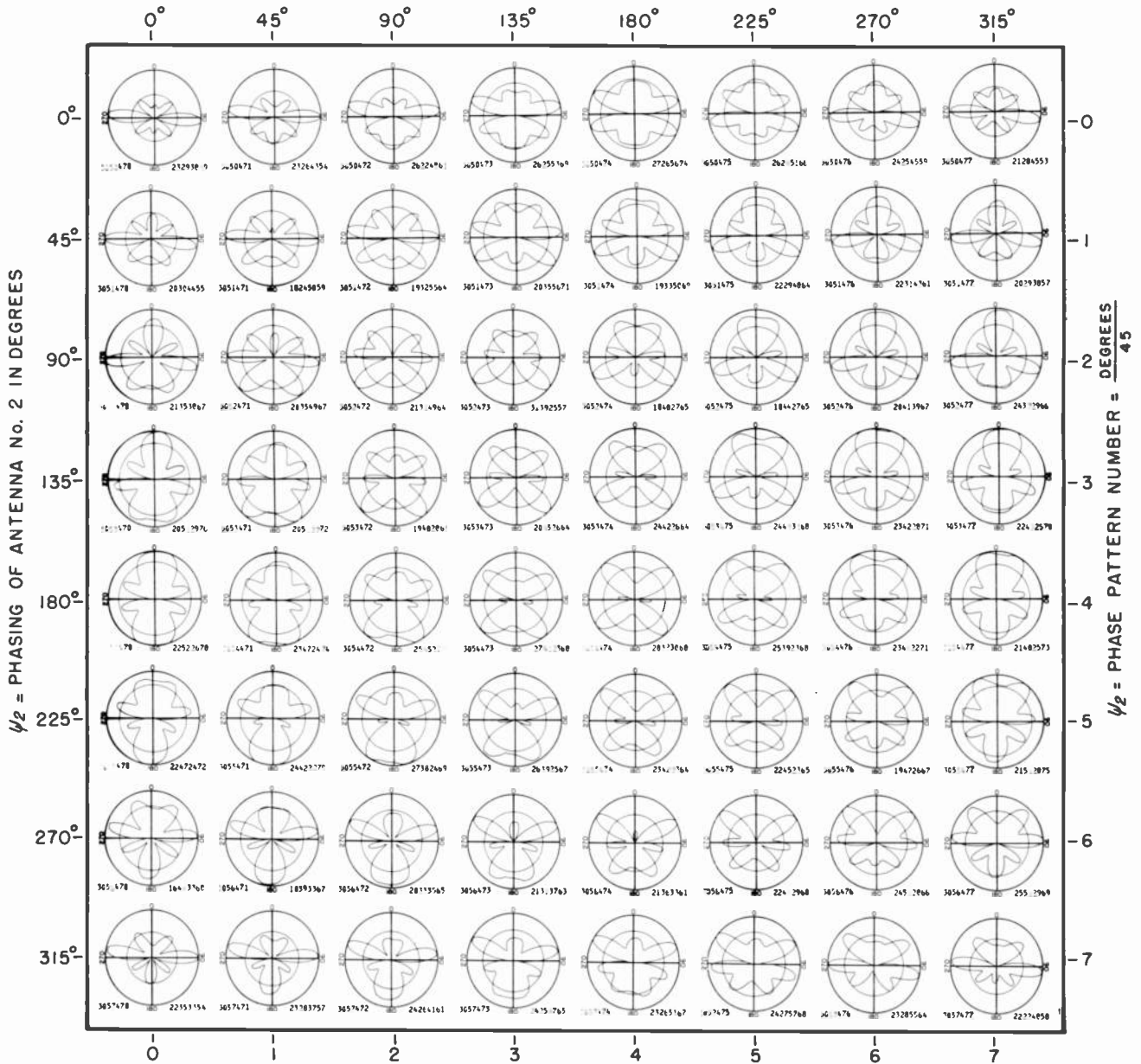

SPOTS LOCATE THE ANTENNAS FOR THIS PAGE OF PATTERNS IN THE SYSTEMATIZATION PLACEMENT CHART.

$\psi_3$  = PHASE PATTERN NUMBER =  $\frac{\text{DEGREES}}{45}$

NUMBER OF ANTENNAS IN THE SYSTEM  
No. 3

ORIENTATION OF NO. 2 ANTENNA =  $\frac{\text{DEGREES}}{45}$   
 $\phi_2$  0

SPACING OF NO. 2 ANTENNA =  $\frac{\text{DEGREES}}{45}$   
 $S_2$  5

PHASING OF NO. 2 ANTENNA =  $\frac{\text{DEGREES}}{45}$   
 $\psi_2$  0

ORIENTATION OF NO. 3 ANTENNA =  $\frac{\text{DEGREES}}{45}$   
 $\phi_3$  4

SPACING OF NO. 3 ANTENNA =  $\frac{\text{DEGREES}}{45}$   
 $S_3$  7

PHASING OF NO. 3 ANTENNA =  $\frac{\text{DEGREES}}{45}$   
 $\psi_3$  0

% FIELD INTENSITY RADIATED IN HORIZONTAL PLANE FROM NO. 1 ANTENNA.  
 $E_1$  23

% FIELD INTENSITY RADIATED IN HORIZONTAL PLANE FROM NO. 2 ANTENNA.  
 $E_2$  29

% FIELD INTENSITY RADIATED IN HORIZONTAL PLANE FROM NO. 3 ANTENNA.  
 $E_3$  38

% RMS FIELD INTENSITY RADIATED IN HORIZONTAL PLANE FROM ANTENNA SYSTEM.  
 $E_0$  49

LEFT HAND PATTERN NUMBER GIVES ANTENNA PLACEMENT AND PHASING DATA.

RIGHT HAND PATTERN NUMBER GIVES ANTENNA FIELD INTENSITY DATA IN PERCENT.

PATTERN NOMENCLATURE

$\psi_3$  = PHASING OF ANTENNA No. 3 IN DEGREES

3. 31

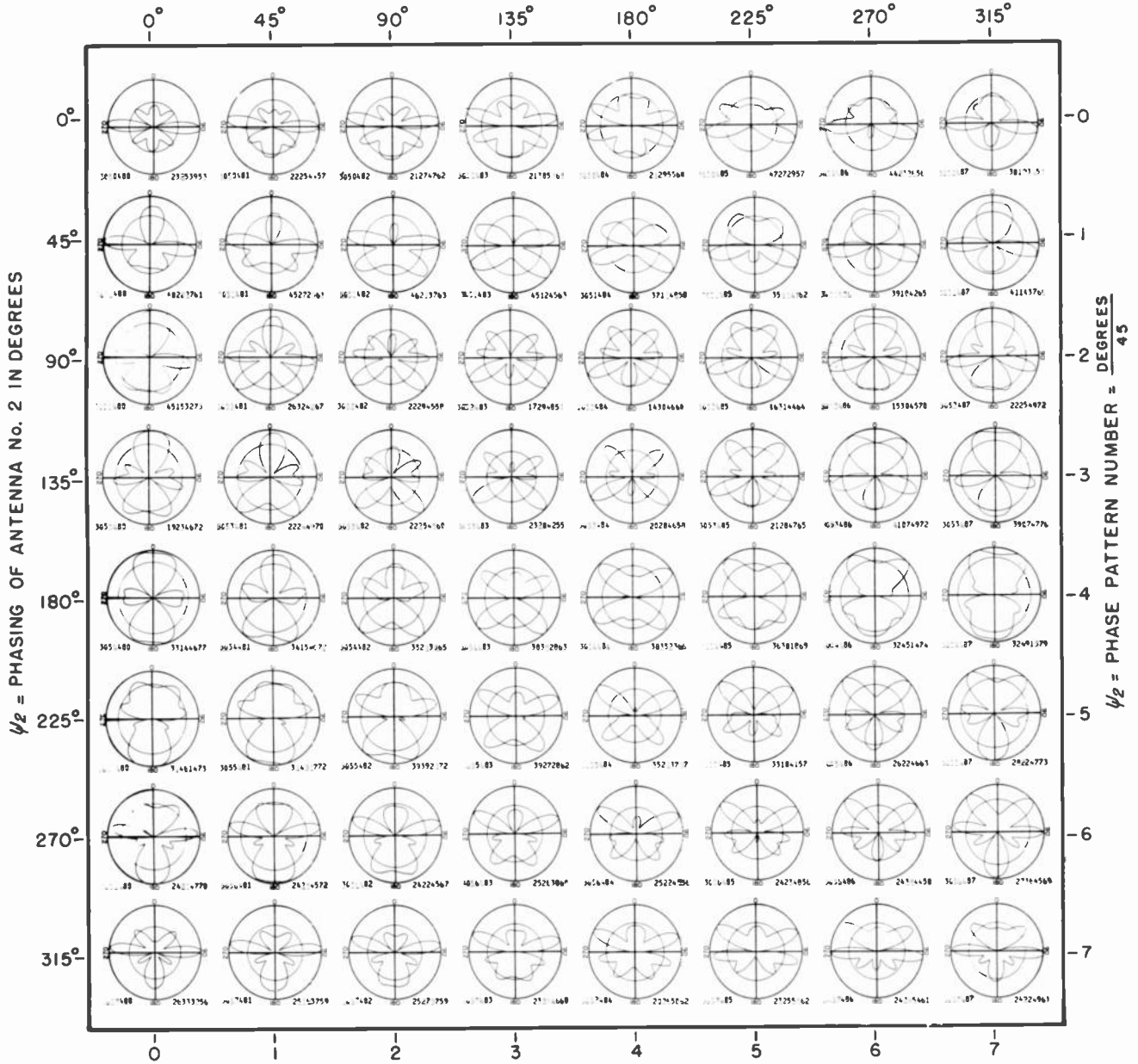

$\psi_3$  = PHASE PATTERN NUMBER =  $\frac{\text{DEGREES}}{45}$

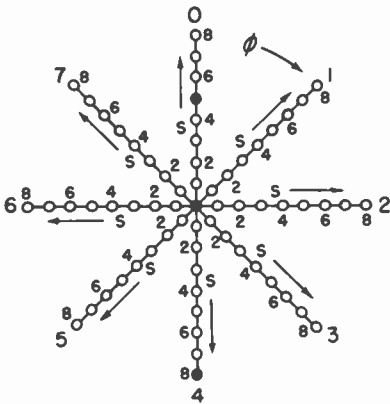

SPOTS LOCATE THE ANTENNAS FOR THIS PAGE OF PATTERNS IN THE SYSTEMATIZATION PLACEMENT CHART.

NUMBER OF ANTENNAS IN THE SYSTEM	ORIENTATION OF NO. 2 ANTENNA = $\frac{\text{DEGREES}}{45}$	SPACING OF NO. 2 ANTENNA = $\frac{\text{DEGREES}}{45}$	PHASING OF NO. 2 ANTENNA = $\frac{\text{DEGREES}}{45}$	ORIENTATION OF NO. 3 ANTENNA = $\frac{\text{DEGREES}}{45}$	SPACING OF NO. 3 ANTENNA = $\frac{\text{DEGREES}}{45}$	PHASING OF NO. 3 ANTENNA = $\frac{\text{DEGREES}}{45}$
No. 3	$\psi_2$ 0	$S_2$ 5	$\psi_2$ 0	$\psi_3$ 4	$S_3$ 8	$\psi_3$ 0

LEFT HAND PATTERN NUMBER GIVES ANTENNA PLACEMENT AND PHASING DATA.

% FIELD INTENSITY RADIATED IN HORIZONTAL PLANE FROM NO. 1 ANTENNA.	% FIELD INTENSITY RADIATED IN HORIZONTAL PLANE FROM NO. 2 ANTENNA.	% FIELD INTENSITY RADIATED IN HORIZONTAL PLANE FROM NO. 3 ANTENNA.	% RMS FIELD INTENSITY RADIATED IN HORIZONTAL PLANE FROM ANTENNA SYSTEM.
$E_1$ 23	$E_2$ 25	$E_3$ 39	$E_0$ 53

RIGHT HAND PATTERN NUMBER GIVES ANTENNA FIELD INTENSITY DATA IN PERCENT.

PATTERN NOMENCLATURE

$\psi_3$  = PHASING OF ANTENNA No. 3 IN DEGREES

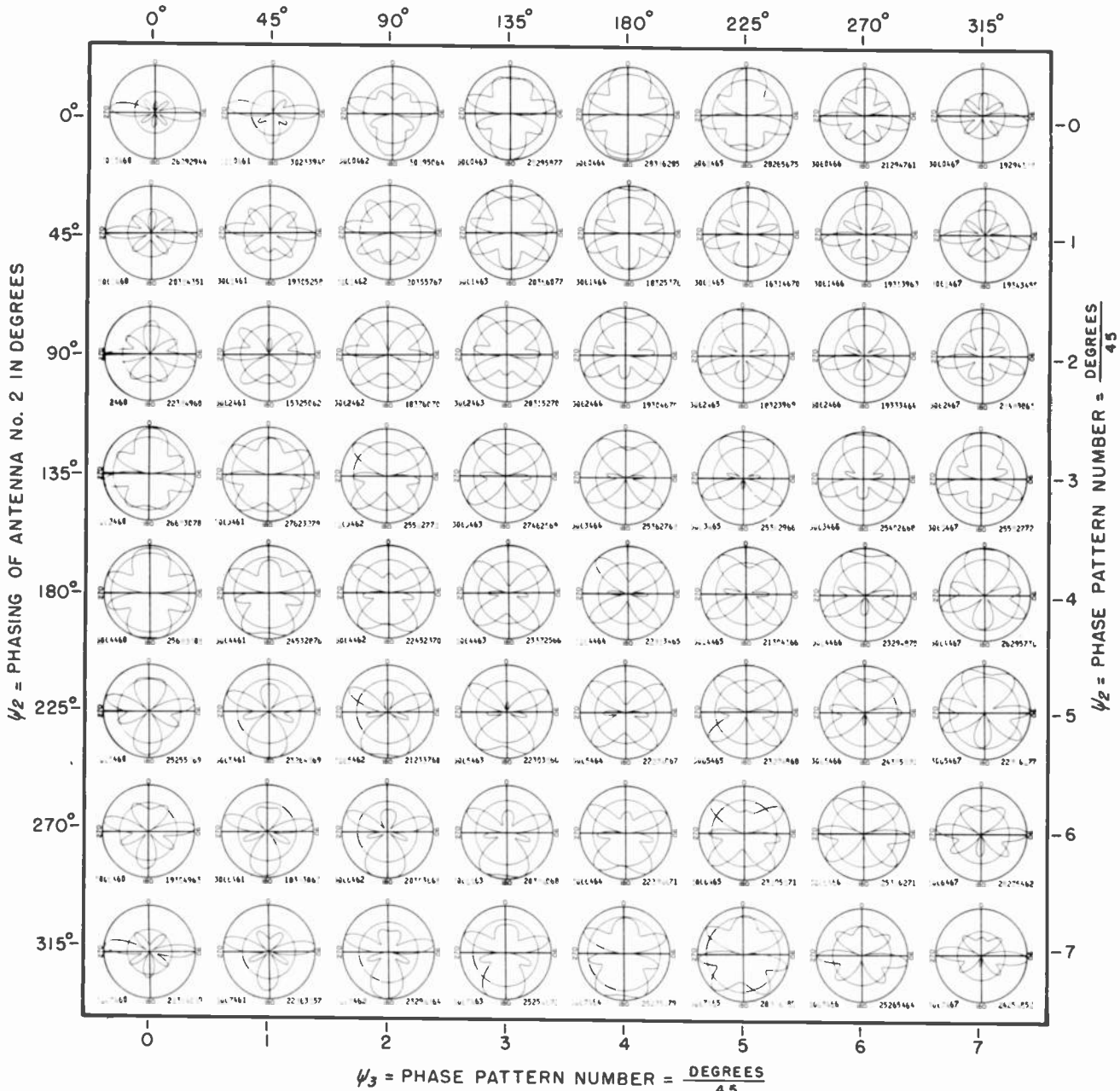

$\psi_2$  = PHASING OF ANTENNA No. 2 IN DEGREES

$\psi_2$  = PHASE PATTERN NUMBER =  $\frac{\text{DEGREES}}{45}$

$\psi_3$  = PHASE PATTERN NUMBER =  $\frac{\text{DEGREES}}{45}$

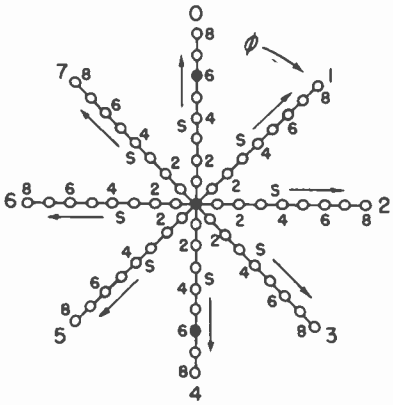

SPOTS LOCATE THE ANTENNAS FOR THIS PAGE OF PATTERNS IN THE SYSTEMATIZATION PLACEMENT CHART.

NUMBER OF ANTENNAS IN THE SYSTEM	ORIENTATION OF NO. 2 ANTENNA = $\frac{\text{DEGREES}}{45}$	SPACING OF NO. 2 ANTENNA = $\frac{\text{DEGREES}}{45}$	PHASING OF NO. 2 ANTENNA = $\frac{\text{DEGREES}}{45}$	ORIENTATION OF NO. 3 ANTENNA = $\frac{\text{DEGREES}}{45}$	SPACING OF NO. 3 ANTENNA = $\frac{\text{DEGREES}}{45}$	PHASING OF NO. 3 ANTENNA = $\frac{\text{DEGREES}}{45}$
No. 3	$\phi_2$ 0	$S_2$ 6	$\psi_2$ 0	$\phi_3$ 4	$S_3$ 6	$\psi_3$ 0

LEFT HAND PATTERN NUMBER GIVES ANTENNA PLACEMENT AND PHASING DATA.

% FIELD INTENSITY RADIATED IN HORIZONTAL PLANE FROM NO. 1 ANTENNA.	% FIELD INTENSITY RADIATED IN HORIZONTAL PLANE FROM NO. 2 ANTENNA.	% FIELD INTENSITY RADIATED IN HORIZONTAL PLANE FROM NO. 3 ANTENNA.	% RMS FIELD INTENSITY RADIATED IN HORIZONTAL PLANE FROM ANTENNA SYSTEM.
$E_1$ 26	$E_2$ 29	$E_3$ 29	$E_0$ 44

RIGHT HAND PATTERN NUMBER GIVES ANTENNA FIELD INTENSITY DATA IN PERCENT.

PATTERN NOMENCLATURE

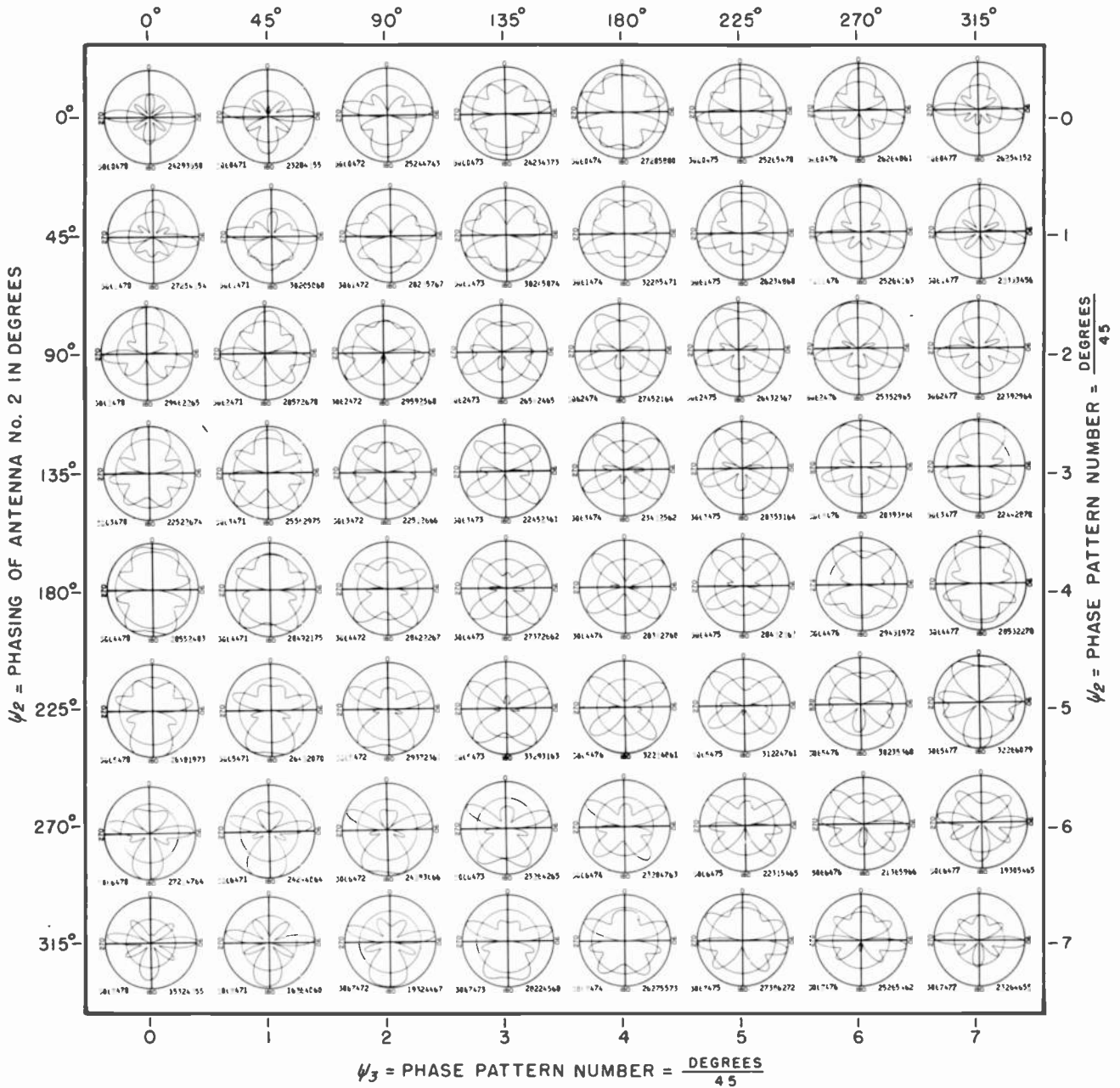

COPYRIGHT 1946 BY CARL E. SMITH  
PRINTED IN U. S. A.

CLEVELAND INSTITUTE OF RADIO ELECTRONICS  
TERMINAL TOWER, CLEVELAND 18, OHIO.

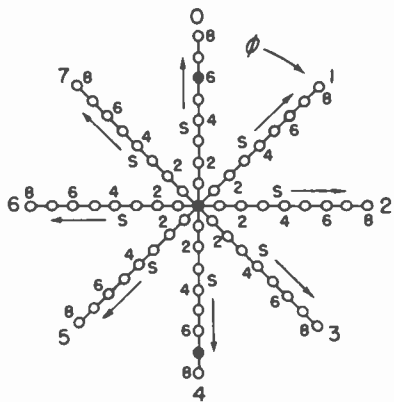

SPOTS LOCATE THE ANTENNAS FOR  
THIS PAGE OF PATTERNS IN THE  
SYSTEMATIZATION PLACEMENT CHART.

NO.	$\phi_2$	$S_2$	$\psi_2$	$\phi_3$	$S_3$	$\psi_3$
3	0	6	0	4	7	0

LEFT HAND PATTERN NUMBER GIVES ANTENNA  
PLACEMENT AND PHASING DATA.

$F_1$	$F_2$	$F_3$	$F_0$
24	29	35	50

RIGHT HAND PATTERN NUMBER  
GIVES ANTENNA FIELD INTEN-  
SITY DATA IN PERCENT.

PATTERN NOMENCLATURE

$\psi_3$  = PHASING OF ANTENNA No. 3 IN DEGREES

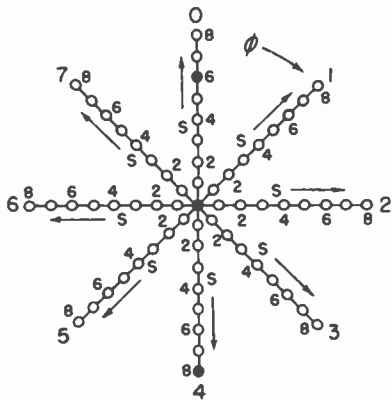
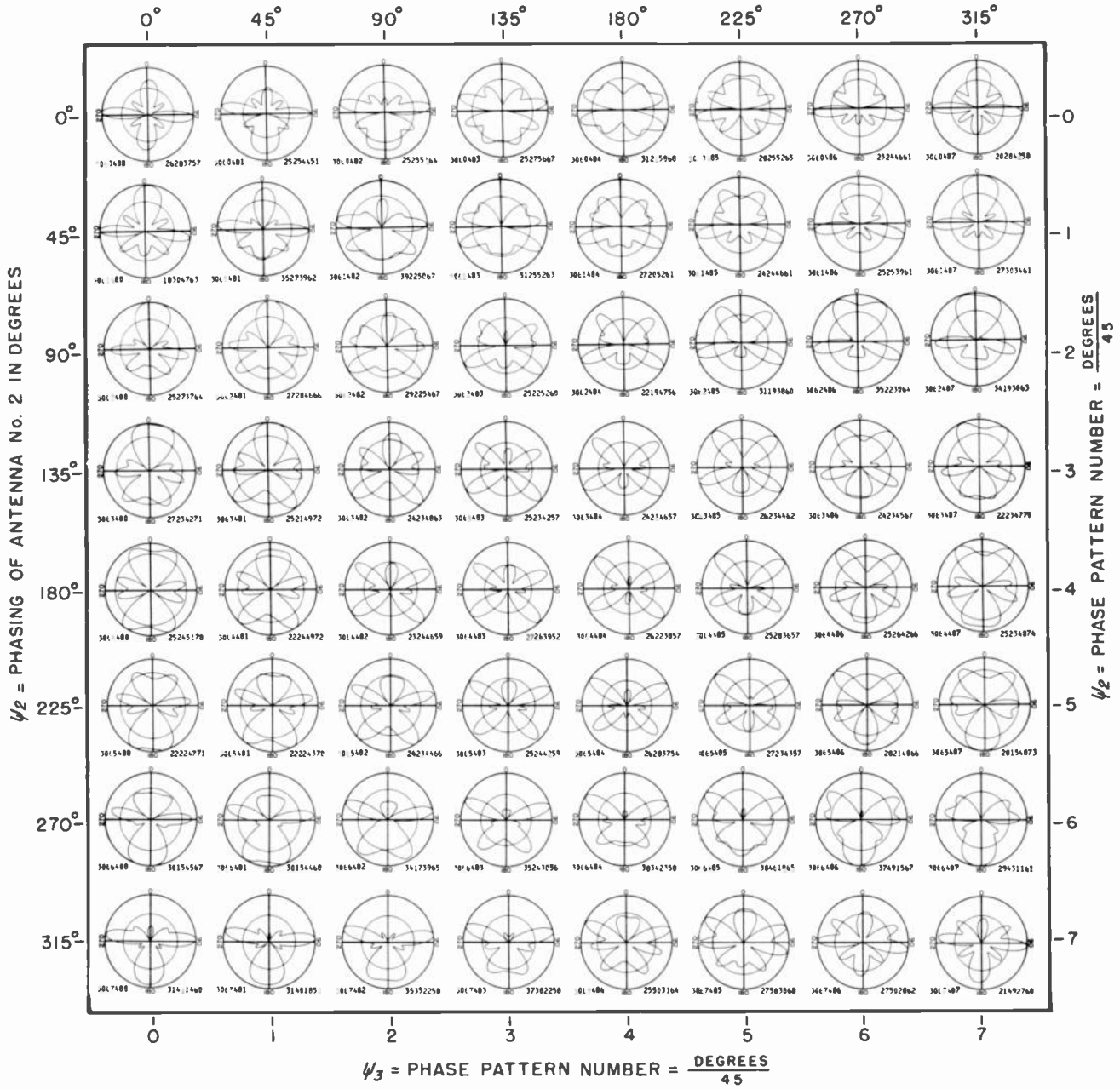

SPOTS LOCATE THE ANTENNAS FOR THIS PAGE OF PATTERNS IN THE SYSTEMATIZATION PLACEMENT CHART.

NUMBER OF ANTENNAS IN THE SYSTEM	ORIENTATION OF NO. 2 ANTENNA = $\frac{\text{DEGREES}}{45}$	SPACING OF NO. 2 ANTENNA = $\frac{\text{DEGREES}}{45}$	PHASING OF NO. 2 ANTENNA = $\frac{\text{DEGREES}}{45}$	ORIENTATION OF NO. 3 ANTENNA = $\frac{\text{DEGREES}}{45}$	SPACING OF NO. 3 ANTENNA = $\frac{\text{DEGREES}}{45}$	PHASING OF NO. 3 ANTENNA = $\frac{\text{DEGREES}}{45}$
No. 3	$\phi_2$ 0	$S_2$ 6	$\psi_2$ 0	$\phi_3$ 4	$S_3$ 8	$\psi_3$ 0

LEFT HAND PATTERN NUMBER GIVES ANTENNA PLACEMENT AND PHASING DATA.

% FIELD INTENSITY RADIATED IN HORIZONTAL PLANE FROM NO. 1 ANTENNA.	% FIELD INTENSITY RADIATED IN HORIZONTAL PLANE FROM NO. 2 ANTENNA.	% FIELD INTENSITY RADIATED IN HORIZONTAL PLANE FROM NO. 3 ANTENNA.	% RMS FIELD INTENSITY RADIATED IN HORIZONTAL PLANE FROM ANTENNA SYSTEM.
$E_1$ 26	$E_2$ 28	$E_3$ 37	$E_0$ 57

RIGHT HAND PATTERN NUMBER GIVES ANTENNA FIELD INTENSITY DATA IN PERCENT.

PATTERN NOMENCLATURE



$\psi_3$  = PHASING OF ANTENNA No. 3 IN DEGREES

3.35

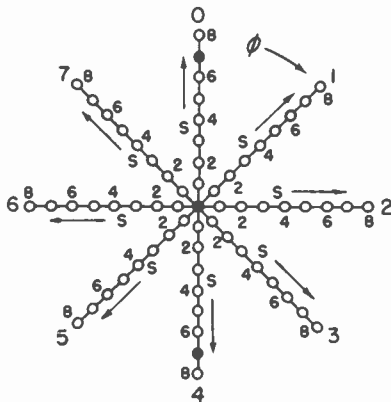
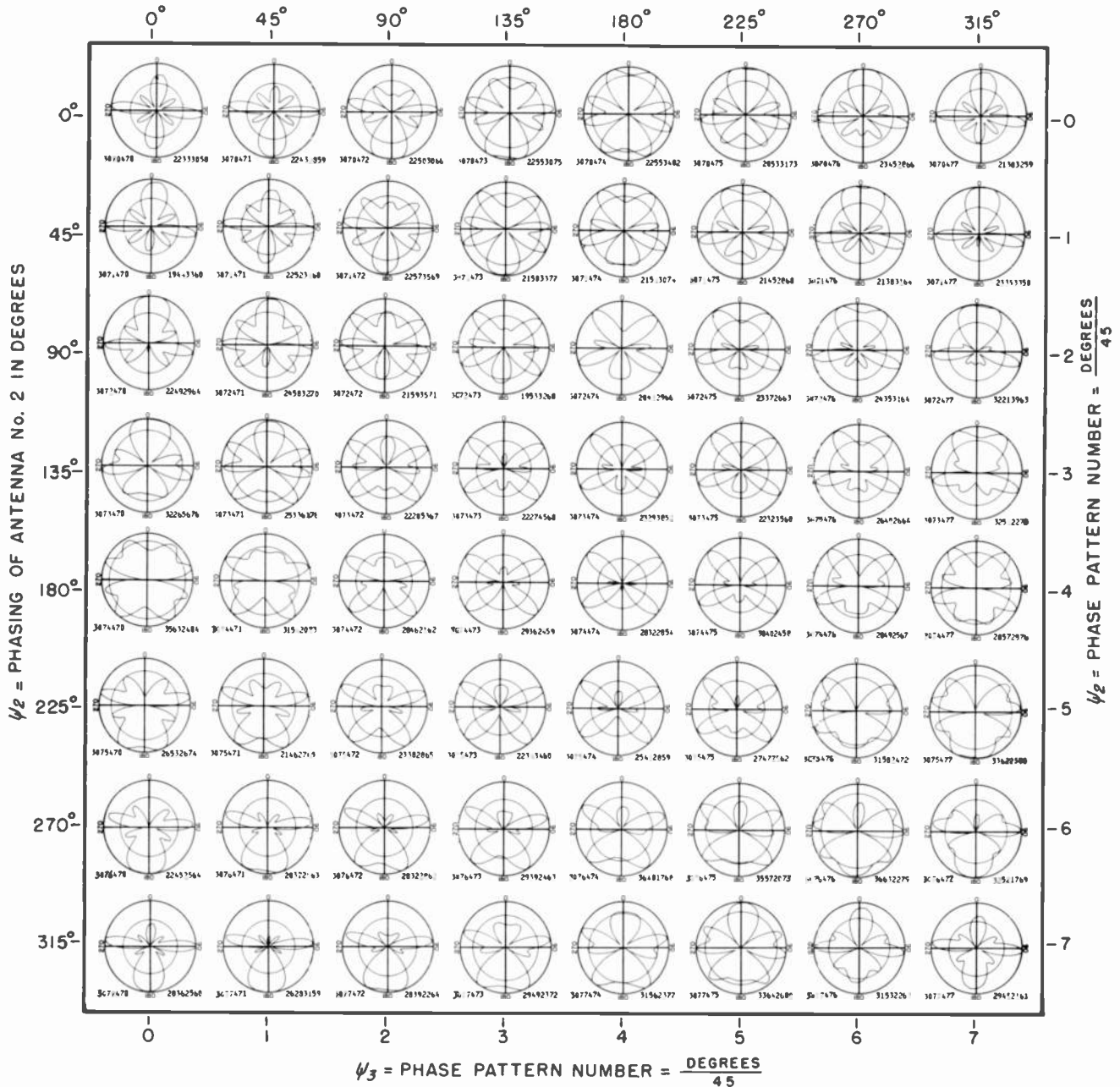

NUMBER OF ANTENNAS IN THE SYSTEM	ORIENTATION OF NO. 2 ANTENNA = $\frac{\text{DEGREES}}{45}$	SPACING OF NO. 2 ANTENNA = $\frac{\text{DEGREES}}{45}$	PHASING OF NO. 2 ANTENNA = $\frac{\text{DEGREES}}{45}$	ORIENTATION OF NO. 3 ANTENNA = $\frac{\text{DEGREES}}{45}$	SPACING OF NO. 3 ANTENNA = $\frac{\text{DEGREES}}{45}$	PHASING OF NO. 3 ANTENNA = $\frac{\text{DEGREES}}{45}$
No. 3	$\phi_2$ 0	$S_2$ 7	$\psi_2$ 0	$\phi_3$ 4	$S_3$ 7	$\psi_3$ 0

% FIELD INTENSITY RADIATED IN HORIZONTAL PLANE FROM NO. 1 ANTENNA.	% FIELD INTENSITY RADIATED IN HORIZONTAL PLANE FROM NO. 2 ANTENNA.	% FIELD INTENSITY RADIATED IN HORIZONTAL PLANE FROM NO. 3 ANTENNA.	% RMS FIELD INTENSITY RADIATED IN HORIZONTAL PLANE FROM ANTENNA SYSTEM.
$E_1$ 22	$E_2$ 33	$E_3$ 30	$E_0$ 58

SPOTS LOCATE THE ANTENNAS FOR THIS PAGE OF PATTERNS IN THE SYSTEMIZATION PLACEMENT CHART.

LEFT HAND PATTERN NUMBER GIVES ANTENNA PLACEMENT AND PHASING DATA.

RIGHT HAND PATTERN NUMBER GIVES ANTENNA FIELD INTENSITY DATA IN PERCENT.

PATTERN NOMENCLATURE

$\psi_3$  = PHASING OF ANTENNA No. 3 IN DEGREES

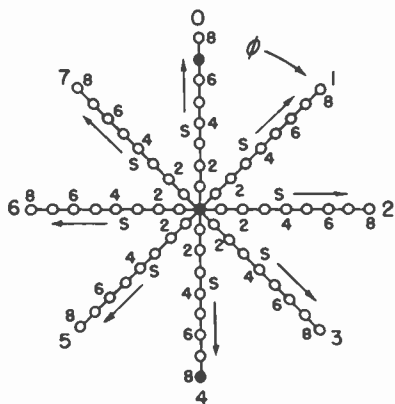
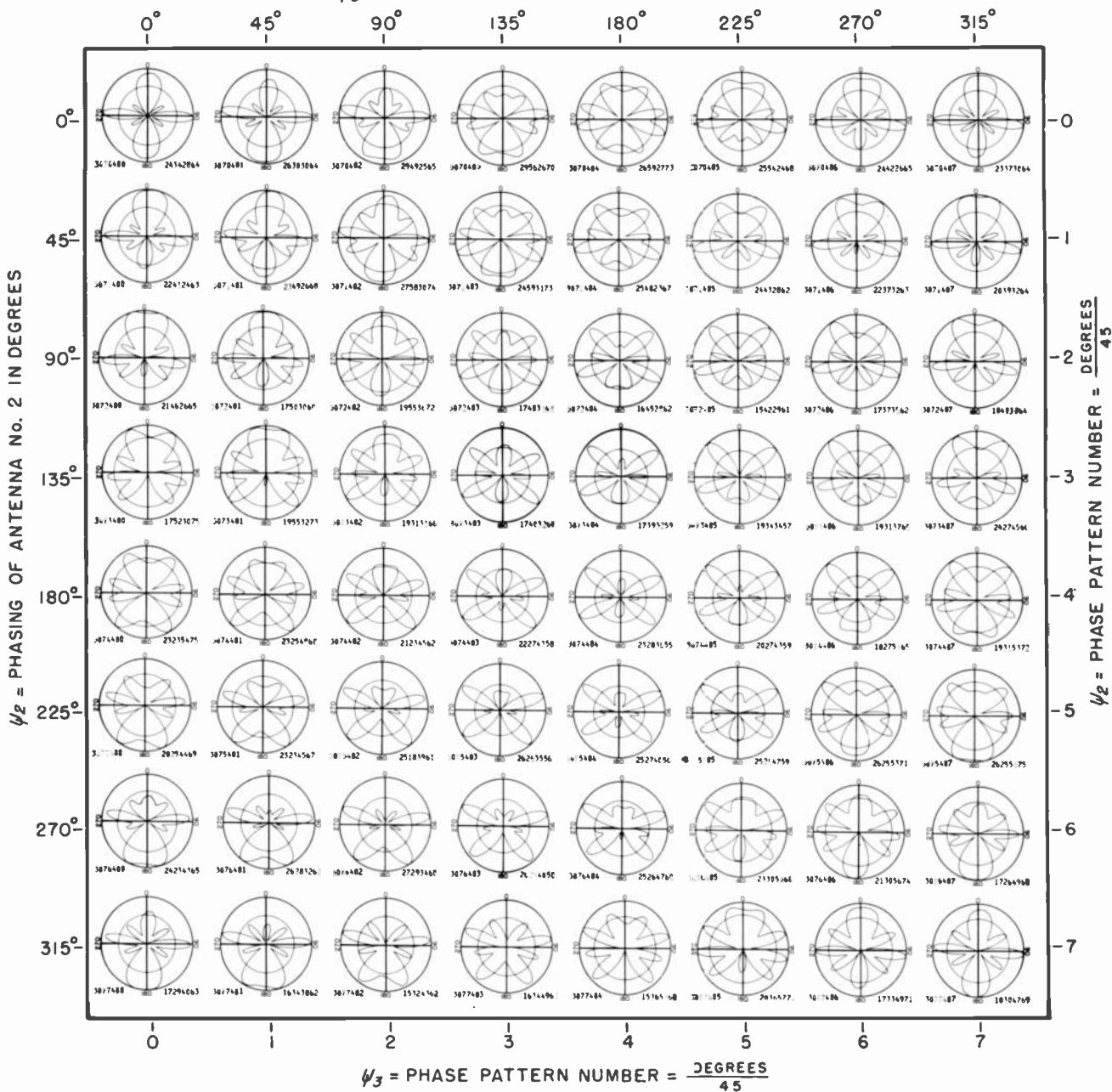

NUMBER OF ANTENNAS IN THE SYSTEM	ORIENTATION OF NO. 2 ANTENNA = $\frac{\text{DEGREES}}{45}$	SPACING OF NO. 2 ANTENNA = $\frac{\text{DEGREES}}{45}$	PHASING OF NO. 2 ANTENNA = $\frac{\text{DEGREES}}{45}$	ORIENTATION OF NO. 3 ANTENNA = $\frac{\text{DEGREES}}{45}$	SPACING OF NO. 3 ANTENNA = $\frac{\text{DEGREES}}{45}$	PHASING OF NO. 3 ANTENNA = $\frac{\text{DEGREES}}{45}$
No. 3	$\phi_2$ 0	$S_2$ 7	$\psi_2$ 0	$\phi_3$ 4	$S_3$ 8	$\psi_3$ 0

% FIELD INTENSITY RADIATED IN HORIZONTAL PLANE FROM NO. 1 ANTENNA.	% FIELD INTENSITY RADIATED IN HORIZONTAL PLANE FROM NO. 2 ANTENNA.	% FIELD INTENSITY RADIATED IN HORIZONTAL PLANE FROM NO. 3 ANTENNA.	% RMS FIELD INTENSITY RADIATED IN HORIZONTAL PLANE FROM ANTENNA SYSTEM.
$E_1$ 24	$E_2$ 34	$E_3$ 28	$E_0$ 64

LEFT HAND PATTERN NUMBER GIVES ANTENNA PLACEMENT AND PHASING DATA.

RIGHT HAND PATTERN NUMBER GIVES ANTENNA FIELD INTENSITY DATA IN PERCENT.

SPOTS LOCATE THE ANTENNAS FOR THIS PAGE OF PATTERNS IN THE SYSTEMATIZATION PLACEMENT CHART.

PATTERN NOMENCLATURE

$\psi_3 =$  PHASING OF ANTENNA No. 3 IN DEGREES

3.37

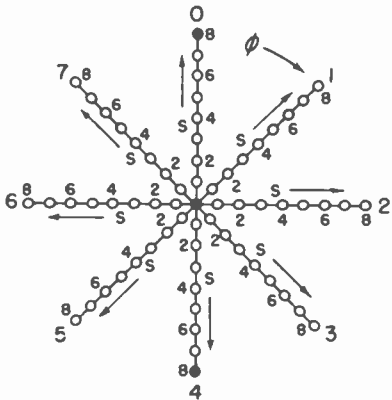
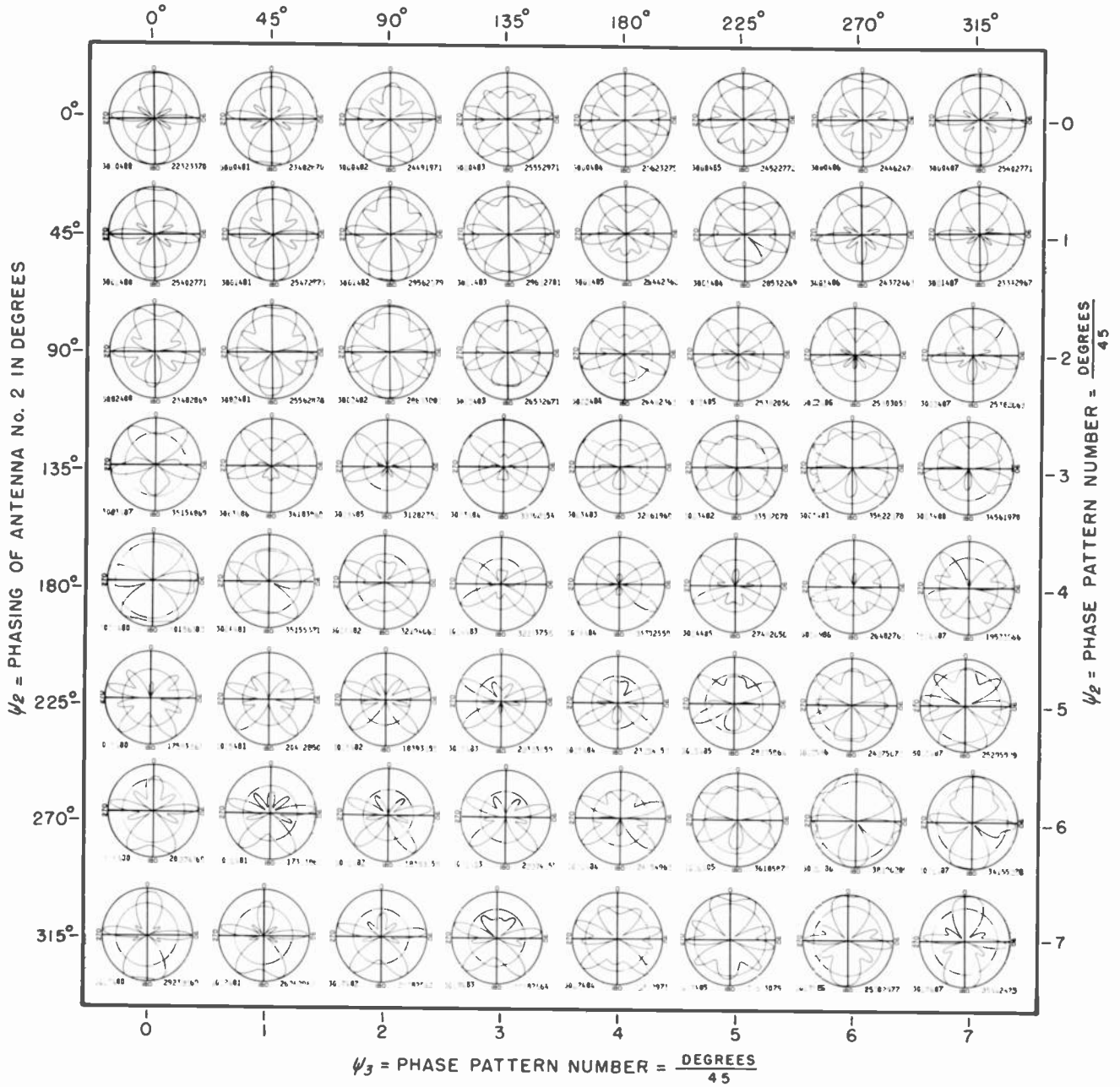

SPOTS LOCATE THE ANTENNAS FOR  
 THIS PAGE OF PATTERNS IN THE  
 SYSTEMATIZATION PLACEMENT CHART.

NUMBER OF ANTENNAS IN THE SYSTEM	ORIENTATION OF NO. 2 ANTENNA = $\frac{DEGREES}{45}$	SPACING OF NO. 2 ANTENNA = $\frac{DEGREES}{45}$	PHASING OF NO. 2 ANTENNA = $\frac{DEGREES}{45}$	ORIENTATION OF NO. 3 ANTENNA = $\frac{DEGREES}{45}$	SPACING OF NO. 3 ANTENNA = $\frac{DEGREES}{45}$	PHASING OF NO. 3 ANTENNA = $\frac{DEGREES}{45}$
No. 3	$\psi_2$ 0	$S_2$ 8	$\psi_2$ 0	$\psi_3$ 4	$S_3$ 8	$\psi_3$ 0

LEFT HAND PATTERN NUMBER GIVES ANTENNA  
 PLACEMENT AND PHASING DATA.

% FIELD INTENSITY RADIATED IN HORIZONTAL PLANE FROM NO. 1 ANTENNA.	% FIELD INTENSITY RADIATED IN HORIZONTAL PLANE FROM NO. 2 ANTENNA.	% FIELD INTENSITY RADIATED IN HORIZONTAL PLANE FROM NO. 3 ANTENNA.	% RMS FIELD INTENSITY RADIATED IN HORIZONTAL PLANE FROM ANTENNA SYSTEM.
$E_1$ 22	$E_2$ 32	$E_3$ 33	$E_0$ 70

RIGHT HAND PATTERN NUMBER  
 GIVES ANTENNA FIELD INTEN-  
 SITY DATA IN PERCENT.

PATTERN NOMENCLATURE

$\psi_3$  = PHASING OF ANTENNA No. 3 IN DEGREES

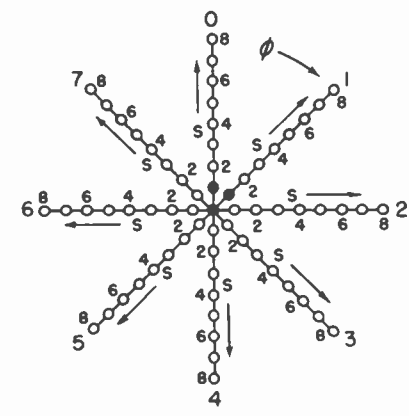
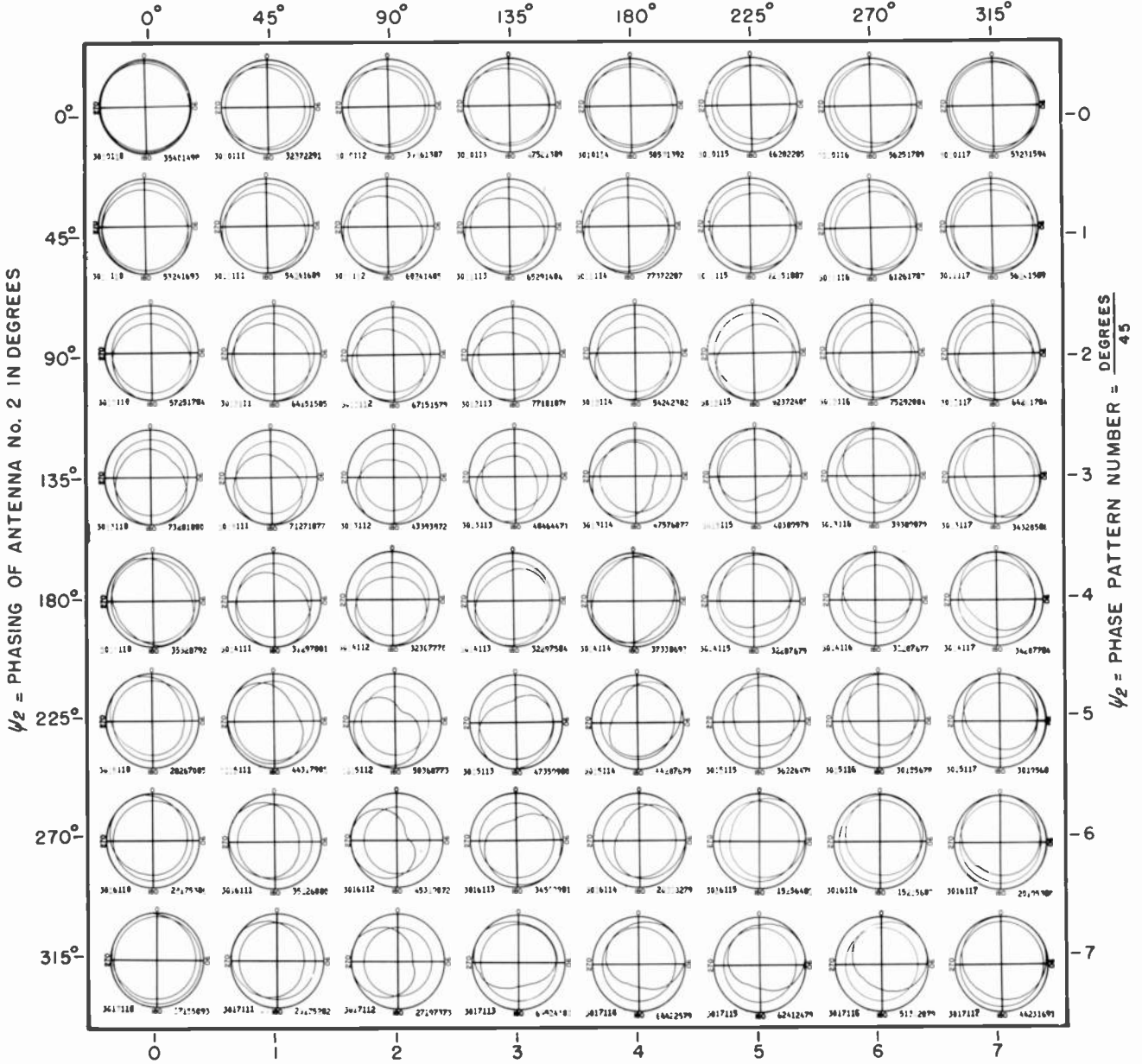

$\psi_3$  = PHASE PATTERN NUMBER =  $\frac{\text{DEGREES}}{45}$

NUMBER OF ANTENNAS IN THE SYSTEM	ORIENTATION OF NO. 2 ANTENNA = $\frac{\text{DEGREES}}{45}$	SPACING OF NO. 2 ANTENNA = $\frac{\text{DEGREES}}{45}$	PHASING OF NO. 2 ANTENNA = $\frac{\text{DEGREES}}{45}$	ORIENTATION OF NO. 3 ANTENNA = $\frac{\text{DEGREES}}{45}$	SPACING OF NO. 3 ANTENNA = $\frac{\text{DEGREES}}{45}$	PHASING OF NO. 3 ANTENNA = $\frac{\text{DEGREES}}{45}$
No. 3	$\phi_2$ 0	$S_2$ 1	$\psi_2$ 0	$\phi_3$ 1	$S_3$ 1	$\psi_3$ 0

LEFT HAND PATTERN NUMBER GIVES ANTENNA PLACEMENT AND PHASING DATA.

% FIELD INTENSITY RADIATED IN HORIZONTAL PLANE FROM NO. 1 ANTENNA.	% FIELD INTENSITY RADIATED IN HORIZONTAL PLANE FROM NO. 2 ANTENNA.	% FIELD INTENSITY RADIATED IN HORIZONTAL PLANE FROM NO. 3 ANTENNA.	% RMS FIELD INTENSITY RADIATED IN HORIZONTAL PLANE FROM ANTENNA SYSTEM.
$E_1$ 35	$E_2$ 40	$E_3$ 14	$E_0$ 98

RIGHT HAND PATTERN NUMBER GIVES ANTENNA FIELD INTENSITY DATA IN PERCENT.

SPOTS LOCATE THE ANTENNAS FOR THIS PAGE OF PATTERNS IN THE SYSTEMATIZATION PLACEMENT CHART.

PATTERN NOMENCLATURE

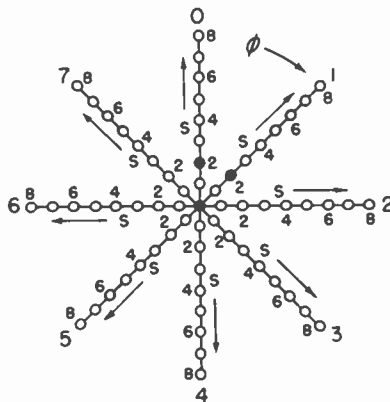
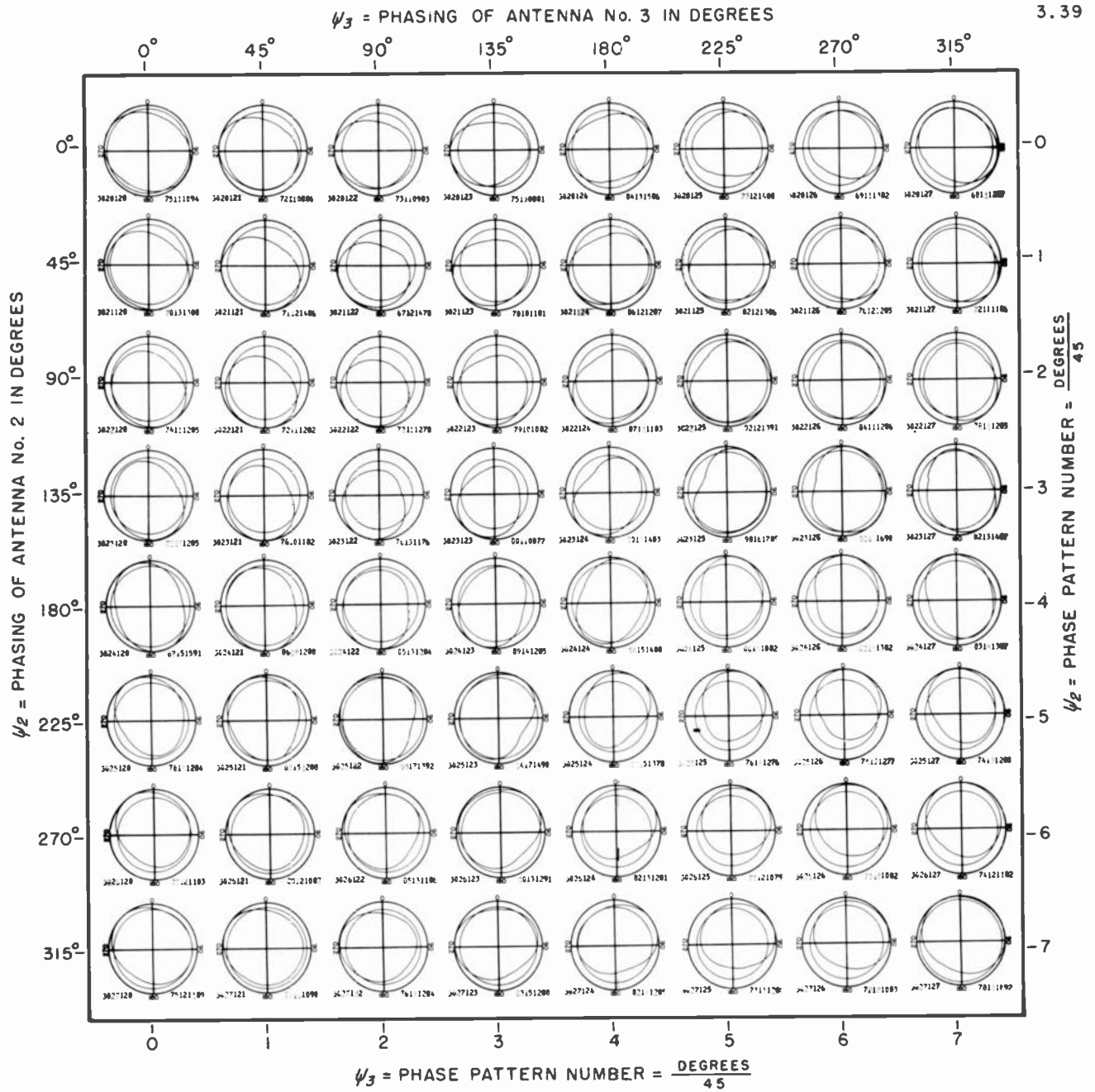

SPOTS LOCATE THE ANTENNAS FOR THIS PAGE OF PATTERNS IN THE SYSTEMATIZATION PLACEMENT CHART.

NO.	$\phi_2$	$S_2$	$\psi_2$	$\phi_3$	$S_3$	$\psi_3$
3	0	2	0	1	2	0

LEFT HAND PATTERN NUMBER GIVES ANTENNA PLACEMENT AND PHASING DATA.

$E_1$	$E_2$	$E_3$	$E_0$
75	11	10	94

RIGHT HAND PATTERN NUMBER GIVES ANTENNA FIELD INTENSITY DATA IN PERCENT.

PATTERN NOMENCLATURE

$\psi_3$  = PHASING OF ANTENNA No. 3 IN DEGREES

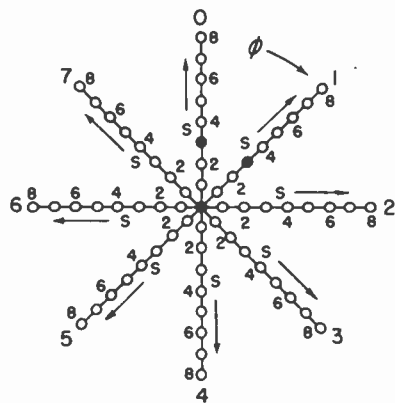
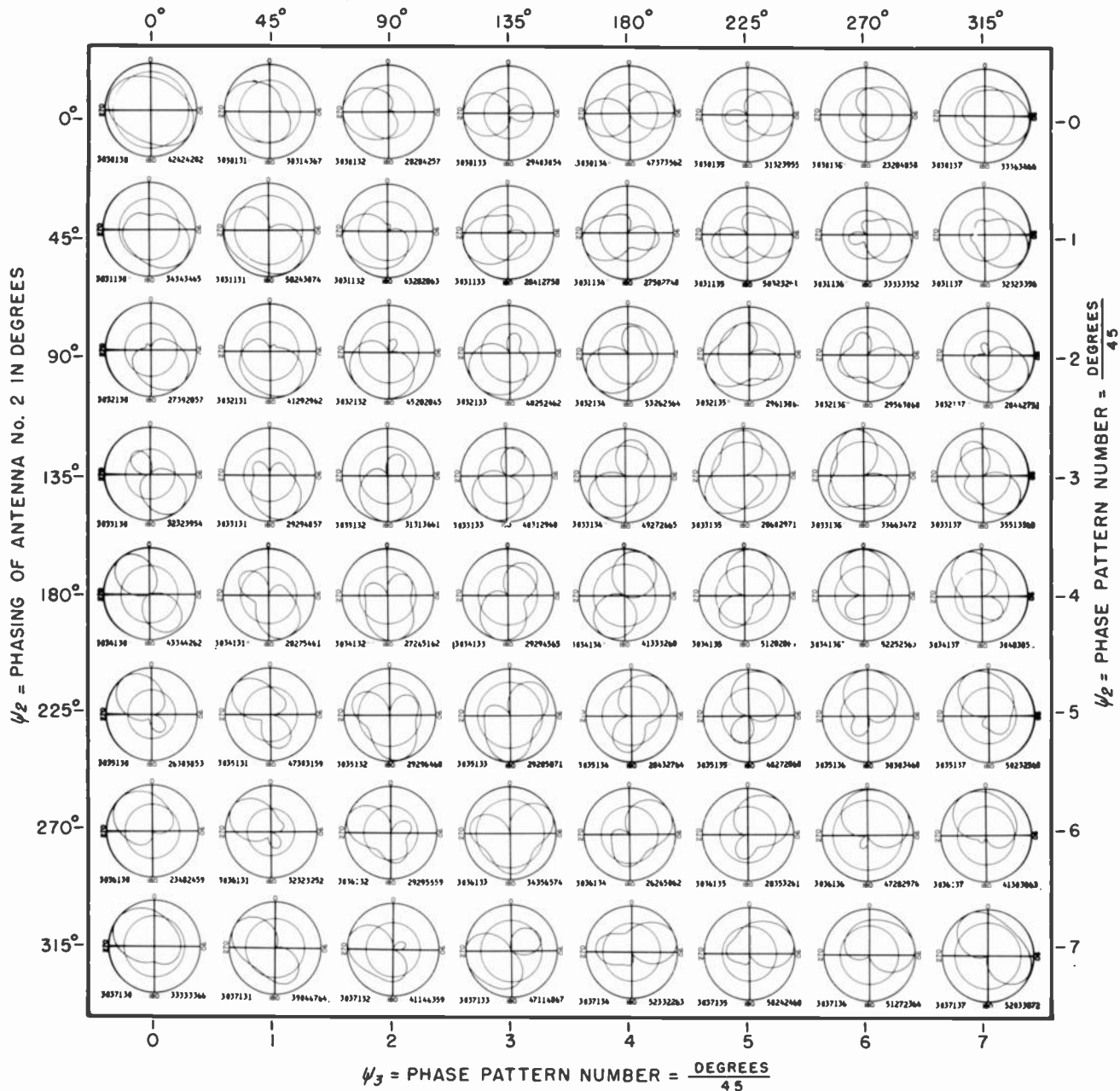

NUMBER OF ANTENNAS IN THE SYSTEM	ORIENTATION OF NO. 2 ANTENNA = $\frac{\text{DEGREES}}{45}$	SPACING OF NO. 2 ANTENNA = $\frac{\text{DEGREES}}{45}$	PHASING OF NO. 2 ANTENNA = $\frac{\text{DEGREES}}{45}$	ORIENTATION OF NO. 3 ANTENNA = $\frac{\text{DEGREES}}{45}$	SPACING OF NO. 3 ANTENNA = $\frac{\text{DEGREES}}{45}$	PHASING OF NO. 3 ANTENNA = $\frac{\text{DEGREES}}{45}$
No. 3	$\phi_2$ 0	$S_2$ 3	$\psi_2$ 0	$\phi_3$ 1	$S_3$ 3	$\psi_3$ 0

% FIELD INTENSITY RADIATED IN HORIZONTAL PLANE FROM NO. 1 ANTENNA.	% FIELD INTENSITY RADIATED IN HORIZONTAL PLANE FROM NO. 2 ANTENNA.	% FIELD INTENSITY RADIATED IN HORIZONTAL PLANE FROM NO. 3 ANTENNA.	% RMS FIELD INTENSITY RADIATED IN HORIZONTAL PLANE FROM ANTENNA SYSTEM.
$E_1$ 42	$E_2$ 42	$E_3$ 42	$E_0$ 82

SPOTS LOCATE THE ANTENNAS FOR THIS PAGE OF PATTERNS IN THE SYSTEMATIZATION PLACEMENT CHART.

LEFT HAND PATTERN NUMBER GIVES ANTENNA PLACEMENT AND PHASING DATA.

RIGHT HAND PATTERN NUMBER GIVES ANTENNA FIELD INTENSITY DATA IN PERCENT.

PATTERN NOMENCLATURE

$\psi_3$  = PHASING OF ANTENNA No. 3 IN DEGREES

3.41

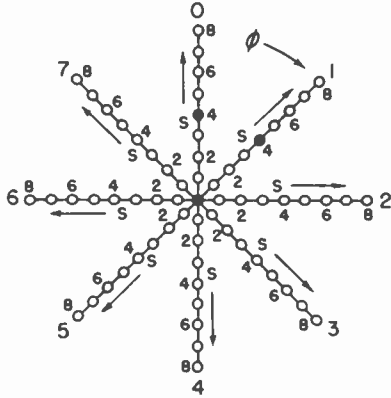
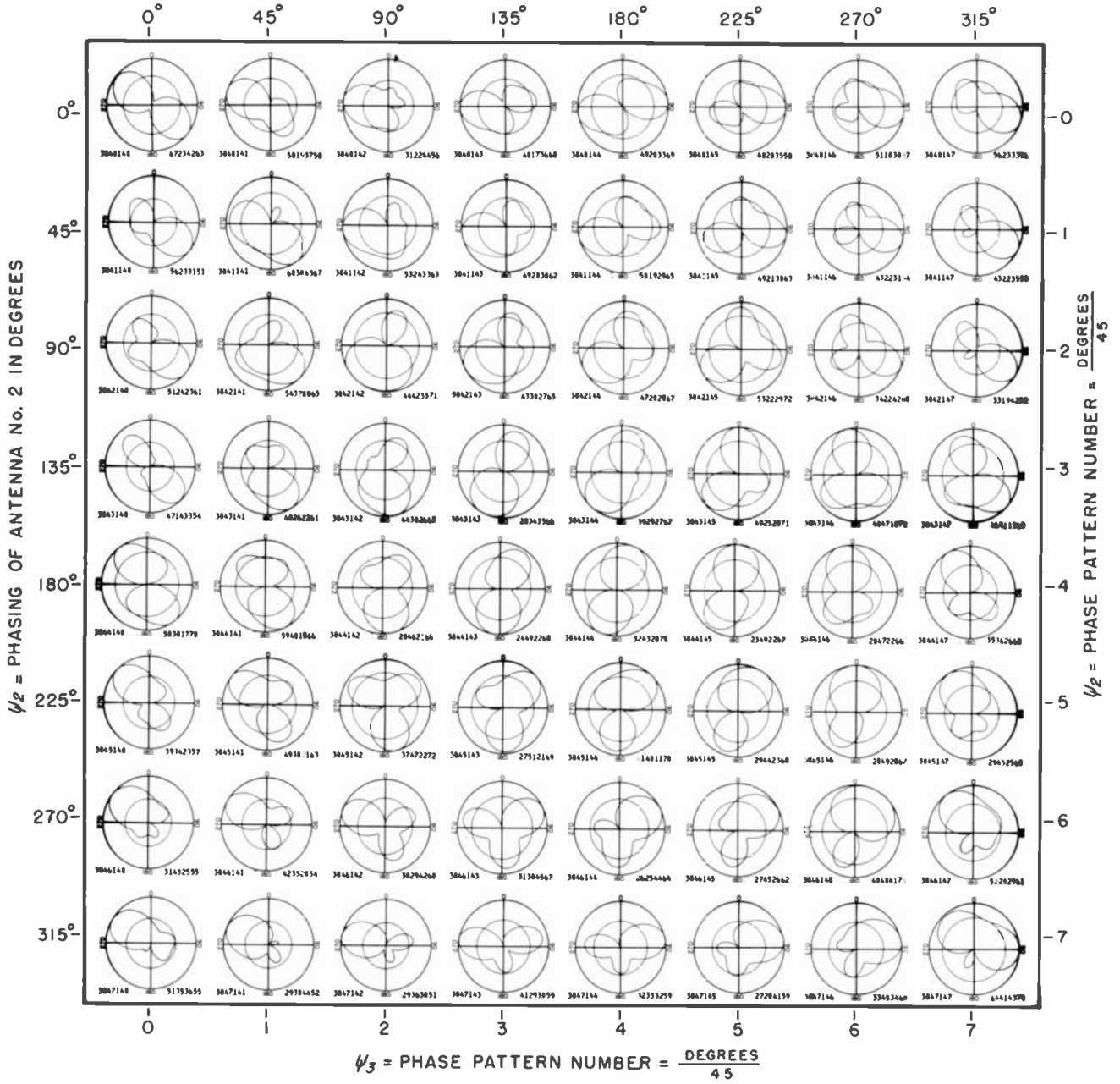

$\psi_3$  = PHASE PATTERN NUMBER =  $\frac{\text{DEGREES}}{45}$

NUMBER OF ANTENNAS IN THE SYSTEM	ORIENTATION OF NO. 2 ANTENNA = $\frac{\text{DEGREES}}{45}$	SPACING OF NO. 2 ANTENNA = $\frac{\text{DEGREES}}{45}$	PHASING OF NO. 2 ANTENNA = $\frac{\text{DEGREES}}{45}$	ORIENTATION OF NO. 3 ANTENNA = $\frac{\text{DEGREES}}{45}$	SPACING OF NO. 3 ANTENNA = $\frac{\text{DEGREES}}{45}$	PHASING OF NO. 3 ANTENNA = $\frac{\text{DEGREES}}{45}$
No.	$\phi_2$	$S_2$	$\psi_2$	$\phi_3$	$S_3$	$\psi_3$
3	0	4	0	1	4	0

LEFT HAND PATTERN NUMBER GIVES ANTENNA PLACEMENT AND PHASING DATA.

% FIELD INTENSITY RADIATED IN HORIZONTAL PLANE FROM NO. 1 ANTENNA.	% FIELD INTENSITY RADIATED IN HORIZONTAL PLANE FROM NO. 2 ANTENNA.	% FIELD INTENSITY RADIATED IN HORIZONTAL PLANE FROM NO. 3 ANTENNA.	% RMS FIELD INTENSITY RADIATED IN HORIZONTAL PLANE FROM ANTENNA SYSTEM.
$E_1$	$E_2$	$E_3$	$E_0$
67	23	42	63

RIGHT HAND PATTERN NUMBER GIVES ANTENNA FIELD INTENSITY DATA IN PERCENT.

SPOTS LOCATE THE ANTENNAS FOR THIS PAGE OF PATTERNS IN THE SYSTEMIZATION PLACEMENT CHART.

PATTERN NOMENCLATURE

$\psi_3 =$  PHASING OF ANTENNA No. 3 IN DEGREES

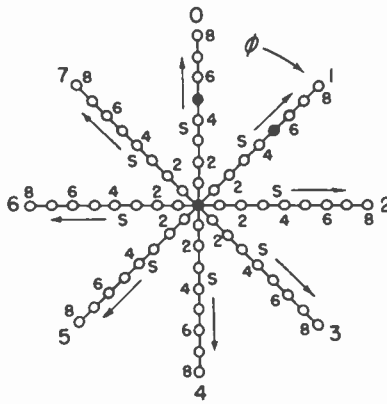
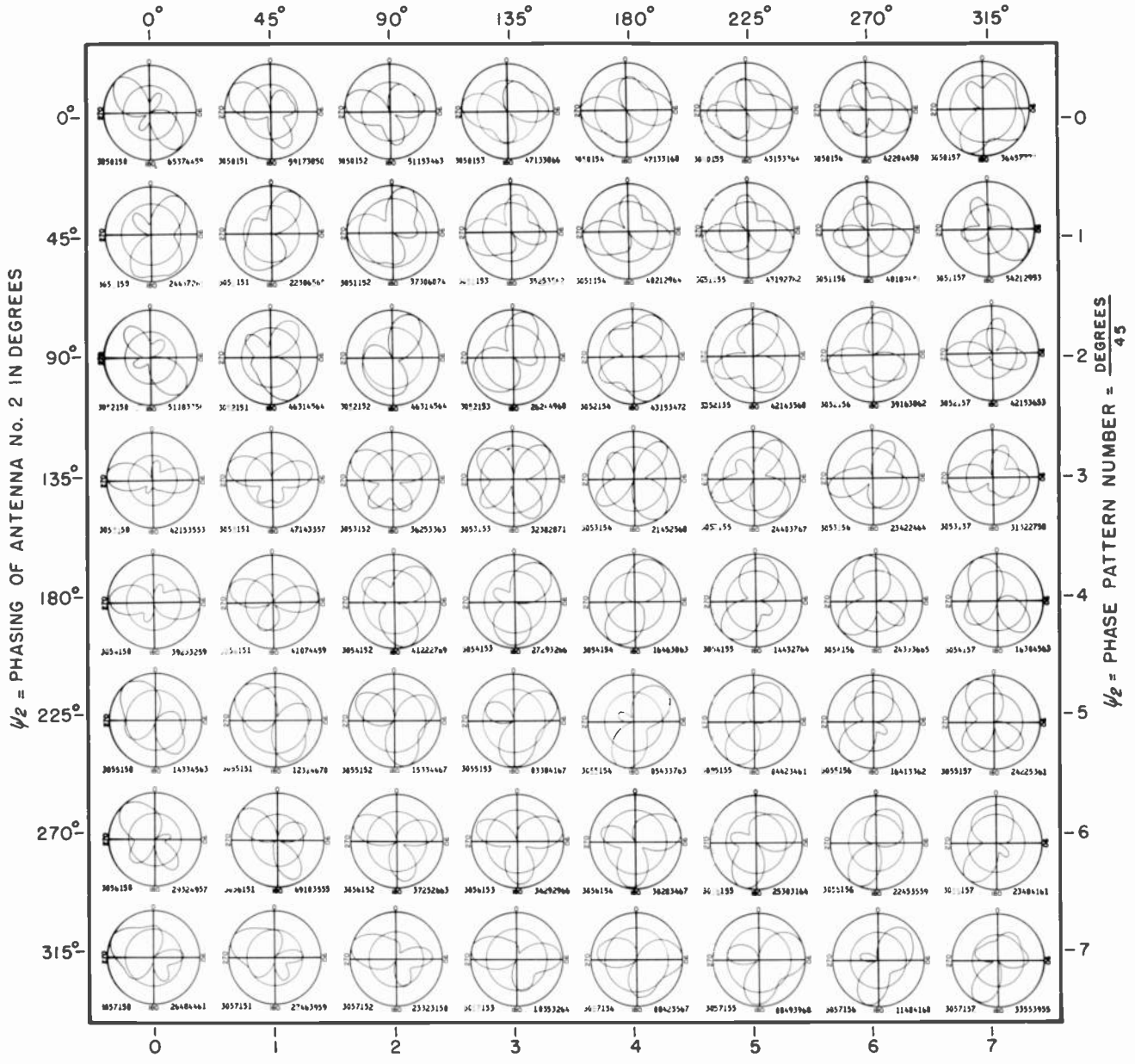

SPOTS LOCATE THE ANTENNAS FOR THIS PAGE OF PATTERNS IN THE SYSTEMATIZATION PLACEMENT CHART.

$\psi_3 =$  PHASE PATTERN NUMBER =  $\frac{\text{DEGREES}}{45}$

NUMBER OF ANTENNAS IN THE SYSTEM	ORIENTATION OF NO. 2 ANTENNA = $\frac{\text{DEGREES}}{45}$	SPACING OF NO. 2 ANTENNA = $\frac{\text{DEGREES}}{45}$	PHASING OF NO. 2 ANTENNA = $\frac{\text{DEGREES}}{45}$	ORIENTATION OF NO. 3 ANTENNA = $\frac{\text{DEGREES}}{45}$	SPACING OF NO. 3 ANTENNA = $\frac{\text{DEGREES}}{45}$	PHASING OF NO. 3 ANTENNA = $\frac{\text{DEGREES}}{45}$
No. 3	$\phi_2$ 0	$S_2$ 5	$\psi_2$ 0	$\phi_3$ 1	$S_3$ 5	$\psi_3$ 0

LEFT HAND PATTERN NUMBER GIVES ANTENNA PLACEMENT AND PHASING DATA.

% FIELD INTENSITY RADIATED IN HORIZONTAL PLANE FROM NO. 1 ANTENNA.	% FIELD INTENSITY RADIATED IN HORIZONTAL PLANE FROM NO. 2 ANTENNA.	% FIELD INTENSITY RADIATED IN HORIZONTAL PLANE FROM NO. 3 ANTENNA.	% RMS FIELD INTENSITY RADIATED IN HORIZONTAL PLANE FROM ANTENNA SYSTEM.
$E_1$ 65	$E_2$ 37	$E_3$ 64	$E_0$ 59

RIGHT HAND PATTERN NUMBER GIVES ANTENNA FIELD INTENSITY DATA IN PERCENT.

PATTERN NOMENCLATURE



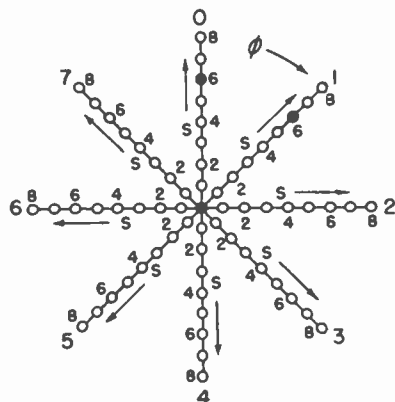
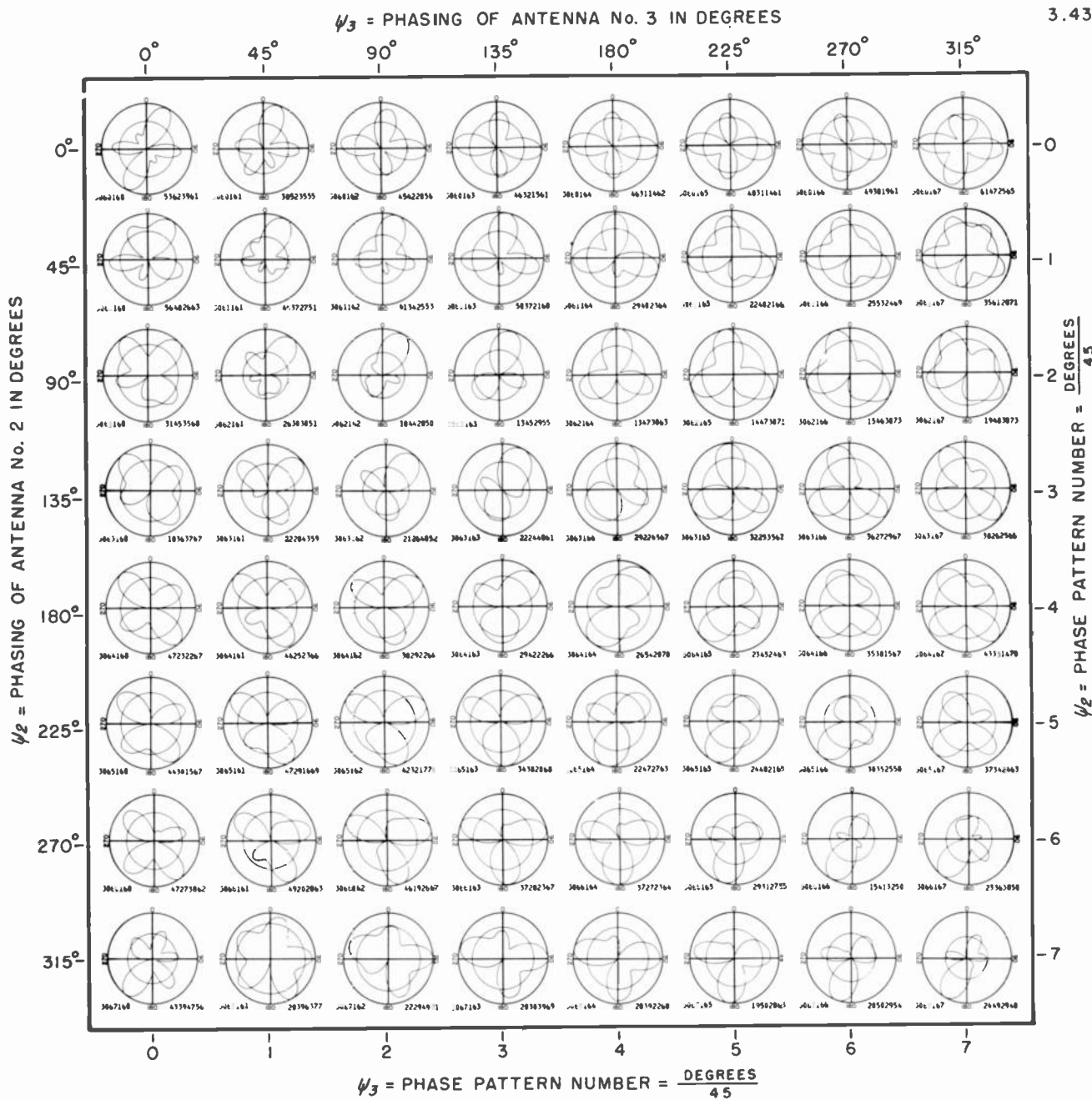

SPOTS LOCATE THE ANTENNAS FOR THIS PAGE OF PATTERNS IN THE SYSTEMATIZATION PLACEMENT CHART.

$\psi_3 = \text{PHASE PATTERN NUMBER} = \frac{\text{DEGREES}}{45}$

NUMBER OF ANTENNAS IN THE SYSTEM	ORIENTATION OF NO. 2 ANTENNA = $\frac{\text{DEGREES}}{45}$	SPACING OF NO. 2 ANTENNA = $\frac{\text{DEGREES}}{45}$	PHASING OF NO. 2 ANTENNA = $\frac{\text{DEGREES}}{45}$	ORIENTATION OF NO. 3 ANTENNA = $\frac{\text{DEGREES}}{45}$	SPACING OF NO. 3 ANTENNA = $\frac{\text{DEGREES}}{45}$	PHASING OF NO. 3 ANTENNA = $\frac{\text{DEGREES}}{45}$
No. 3	$\phi_2 = 0$	$S_2 = 6$	$\psi_2 = 0$	$\phi_3 = 1$	$S_3 = 6$	$\psi_3 = 0$

LEFT HAND PATTERN NUMBER GIVES ANTENNA PLACEMENT AND PHASING DATA.

% FIELD INTENSITY RADIATED IN HORIZONTAL PLANE FROM NO. 1 ANTENNA.	% FIELD INTENSITY RADIATED IN HORIZONTAL PLANE FROM NO. 2 ANTENNA.	% FIELD INTENSITY RADIATED IN HORIZONTAL PLANE FROM NO. 3 ANTENNA.	% RMS FIELD INTENSITY RADIATED IN HORIZONTAL PLANE FROM ANTENNA SYSTEM.
$E_1 = 53$	$E_2 = 62$	$E_3 = 39$	$E_0 = 61$

RIGHT HAND PATTERN NUMBER GIVES ANTENNA FIELD INTENSITY DATA IN PERCENT.

PATTERN NOMENCLATURE

$\psi_3 =$  PHASING OF ANTENNA No. 3 IN DEGREES

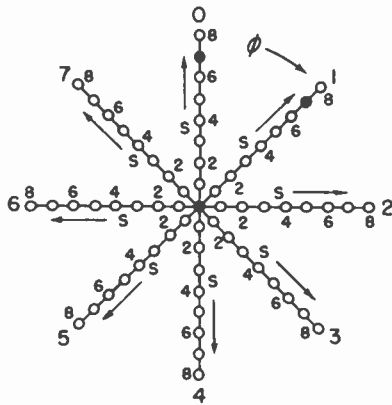
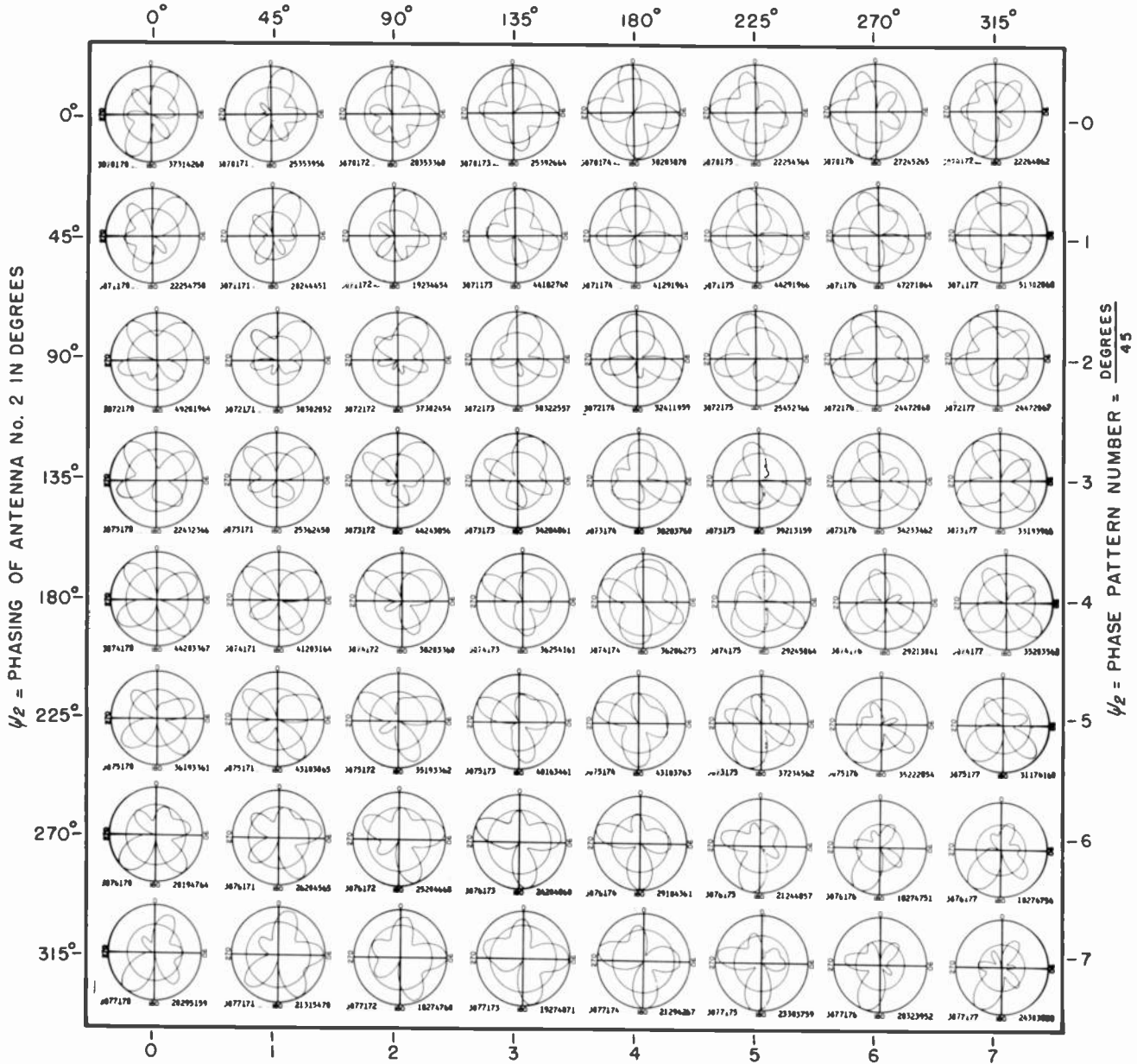

NUMBER OF ANTENNAS IN THE SYSTEM	ORIENTATION OF ANTENNA = $\frac{\text{DEGREES}}{45}$	SPACING OF ANTENNA = $\frac{\text{DEGREES}}{45}$	PHASING OF ANTENNA = $\frac{\text{DEGREES}}{45}$	ORIENTATION OF ANTENNA = $\frac{\text{DEGREES}}{45}$	SPACING OF ANTENNA = $\frac{\text{DEGREES}}{45}$	PHASING OF ANTENNA = $\frac{\text{DEGREES}}{45}$
No. 3	$\phi_2 = 0$	$S_2 = 7$	$\psi_2 = 0$	$\phi_3 = 1$	$S_3 = 7$	$\psi_3 = 0$

LEFT HAND PATTERN NUMBER GIVES ANTENNA PLACEMENT AND PHASING DATA.

% FIELD INTENSITY RADIATED IN HORIZONTAL PLANE FROM NO. 1 ANTENNA.	% FIELD INTENSITY RADIATED IN HORIZONTAL PLANE FROM NO. 2 ANTENNA.	% FIELD INTENSITY RADIATED IN HORIZONTAL PLANE FROM NO. 3 ANTENNA.	% RMS FIELD INTENSITY RADIATED IN HORIZONTAL PLANE FROM ANTENNA SYSTEM.
$E_1 = 37$	$E_2 = 31$	$E_3 = 42$	$E_0 = 60$

RIGHT HAND PATTERN NUMBER GIVES ANTENNA FIELD INTENSITY DATA IN PERCENT.

SPOTS LOCATE THE ANTENNAS FOR THIS PAGE OF PATTERNS IN THE SYSTEMIZATION PLACEMENT CHART.

PATTERN NOMENCLATURE

$\psi_3 =$  PHASING OF ANTENNA No. 3 IN DEGREES

3.45

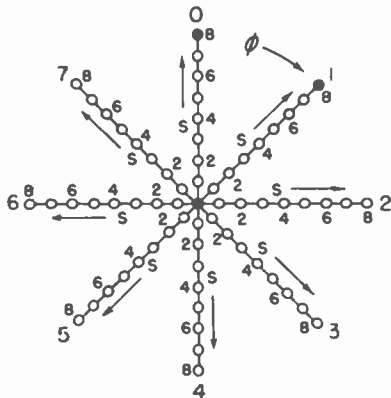
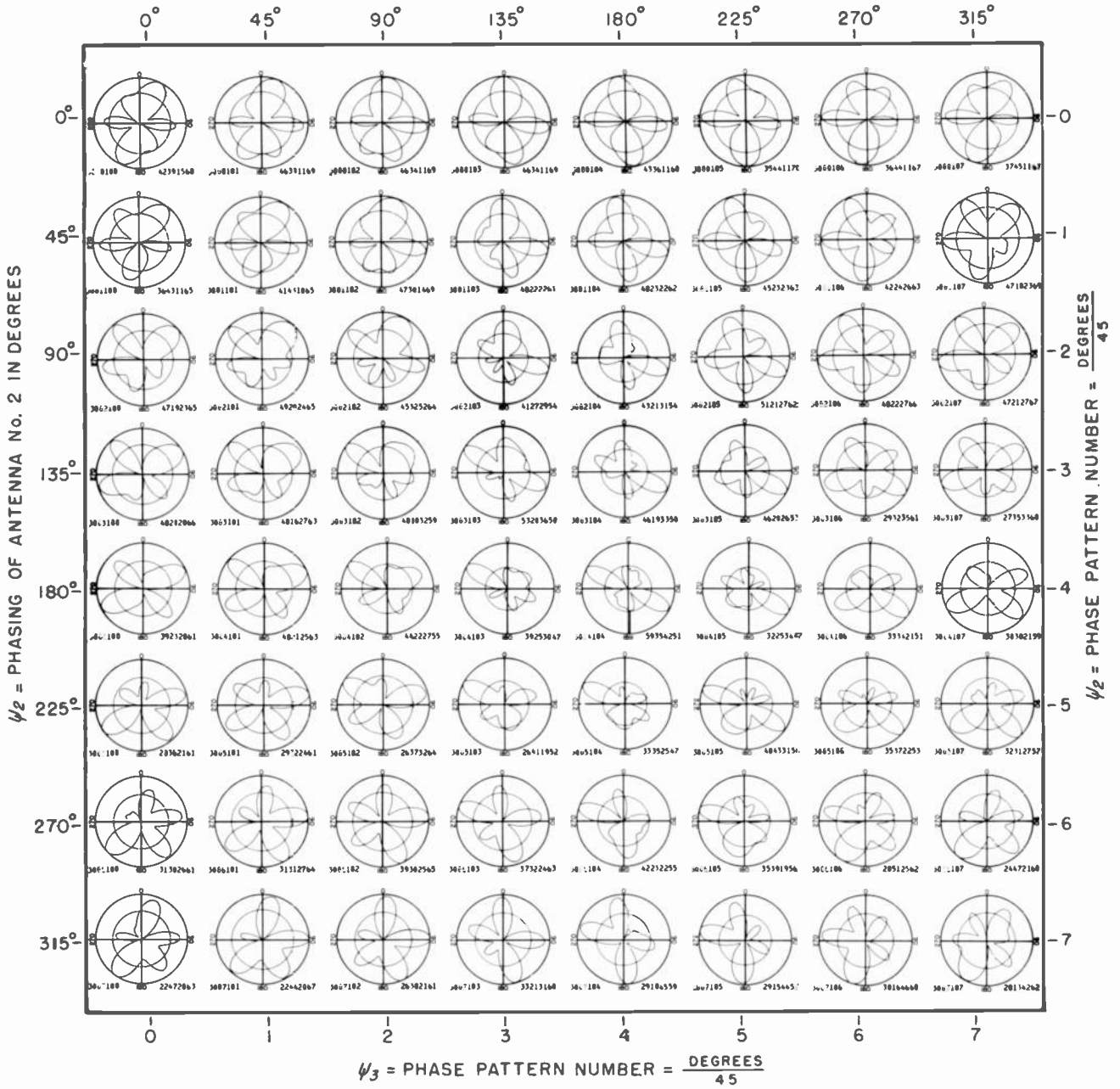

SPOTS LOCATE THE ANTENNAS FOR  
THIS PAGE OF PATTERNS IN THE  
SYSTEMATIZATION PLACEMENT CHART.

$\psi_3 =$  PHASE PATTERN NUMBER =  $\frac{DEGREES}{45}$

NO.	$\phi_2$	$S_2$	$\psi_2$	$\phi_3$	$S_3$	$\psi_3$
3	0	8	0	1	8	0

LEFT HAND PATTERN NUMBER GIVES ANTENNA  
PLACEMENT AND PHASING DATA.

	$E_1$	$E_2$	$E_3$	$E_0$
% FIELD INTENSITY RADIATED IN HORIZONTAL PLANE FROM NO. 1 ANTENNA.	42			
% FIELD INTENSITY RADIATED IN HORIZONTAL PLANE FROM NO. 2 ANTENNA.		39		
% FIELD INTENSITY RADIATED IN HORIZONTAL PLANE FROM NO. 3 ANTENNA.			15	
% RMS FIELD INTENSITY RADIATED IN HORIZONTAL PLANE FROM ANTENNA SYSTEM.				68

RIGHT HAND PATTERN NUMBER  
GIVES ANTENNA FIELD INTEN-  
SITY DATA IN PERCENT.

PATTERN NOMENCLATURE

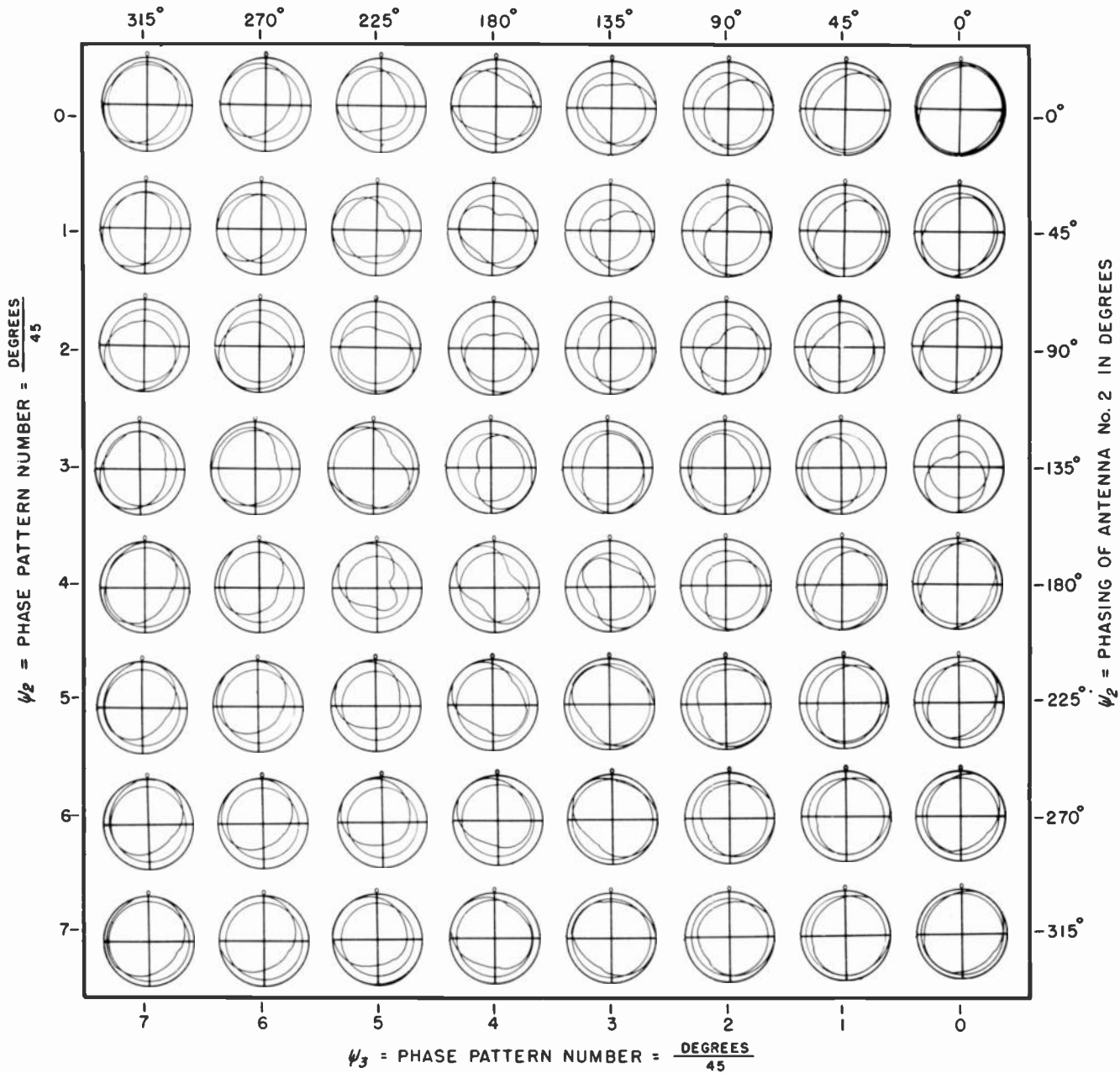

NUMBER OF ANTENNAS  
IN THE SYSTEM  
No. 3

ORIENTATION OF ANTENNA  
No. 2 ANTENNA =  $\frac{\text{DEGREES}}{45}$   
 $\phi_2$  0

SPACING OF ANTENNA  
No. 2 ANTENNA =  $\frac{\text{DEGREES}}{45}$   
 $S_2$  1

PHASING OF ANTENNA  
No. 2 ANTENNA =  $\frac{\text{DEGREES}}{45}$   
 $\psi_2$  0

ORIENTATION OF ANTENNA  
No. 3 ANTENNA =  $\frac{\text{DEGREES}}{45}$   
 $\phi_3$  7

SPACING OF ANTENNA  
No. 3 ANTENNA =  $\frac{\text{DEGREES}}{45}$   
 $S_3$  2

PHASING OF ANTENNA  
No. 3 ANTENNA =  $\frac{\text{DEGREES}}{45}$   
 $\psi_3$  0

% FIELD INTENSITY  
RADIATED IN HORIZONTAL  
PLANE FROM NO. 1 ANTENNA.  
 $E_1$  47

% FIELD INTENSITY  
RADIATED IN HORIZONTAL  
PLANE FROM NO. 2 ANTENNA.  
 $E_2$  30

% FIELD INTENSITY  
RADIATED IN HORIZONTAL  
PLANE FROM NO. 3 ANTENNA.  
 $E_3$  20

% RMS FIELD INTENSITY  
RADIATED IN HORIZONTAL  
PLANE FROM ANTENNA SYSTEM.  
 $E_0$  95

LEFT HAND PATTERN NUMBER GIVES ANTENNA  
PLACEMENT AND PHASING DATA.

RIGHT HAND PATTERN NUMBER  
GIVES ANTENNA FIELD INTEN-  
SITY DATA IN PERCENT.

PATTERN NOMENCLATURE

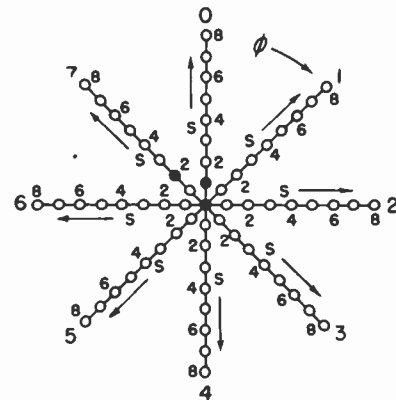

SPOTS LOCATE THE ANTENNAS FOR  
THIS PAGE OF PATTERNS IN THE  
SYSTEMATIZATION PLACEMENT CHART.

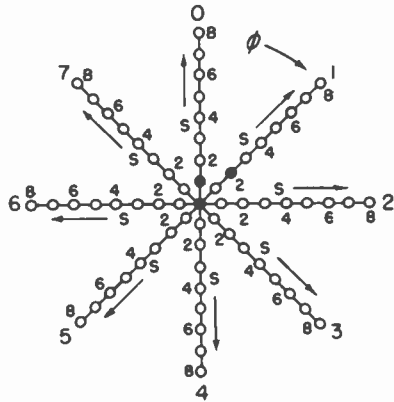
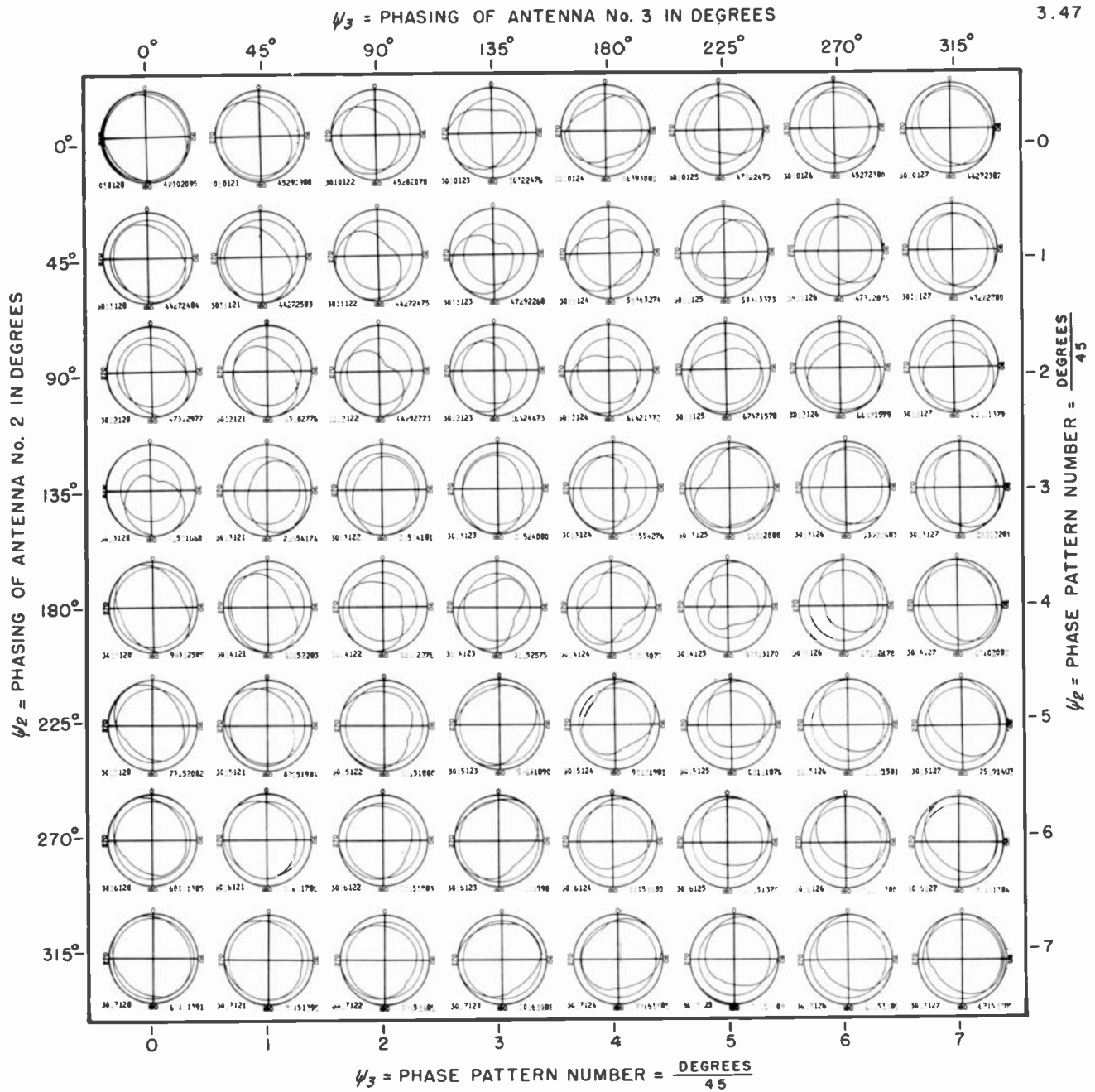

SPOTS LOCATE THE ANTENNAS FOR THIS PAGE OF PATTERNS IN THE SYSTEMATIZATION PLACEMENT CHART.

NUMBER OF ANTENNAS IN THE SYSTEM	ORIENTATION OF DEGREES / 45	SPACING OF DEGREES / 45	PHASING OF DEGREES / 45	ORIENTATION OF DEGREES / 45	SPACING OF DEGREES / 45	PHASING OF DEGREES / 45
No. 3	$\phi_2 = 0$	$S_2 = 1$	$\psi_2 = 0$	$\phi_3 = 1$	$S_3 = 2$	$\psi_3 = 0$

LEFT HAND PATTERN NUMBER GIVES ANTENNA PLACEMENT AND PHASING DATA.

% FIELD INTENSITY RADIATED IN HORIZONTAL PLANE FROM NO. 1 ANTENNA.	% FIELD INTENSITY RADIATED IN HORIZONTAL PLANE FROM NO. 2 ANTENNA.	% FIELD INTENSITY RADIATED IN HORIZONTAL PLANE FROM NO. 3 ANTENNA.	% RMS FIELD INTENSITY RADIATED IN HORIZONTAL PLANE FROM ANTENNA SYSTEM.
$F_1 = 47$	$F_2 = 30$	$F_3 = 20$	$F_0 = 95$

RIGHT HAND PATTERN NUMBER GIVES ANTENNA FIELD INTENSITY DATA IN PERCENT.

PATTERN NOMENCLATURE

$\psi_3$  = PHASING OF ANTENNA No. 3 IN DEGREES

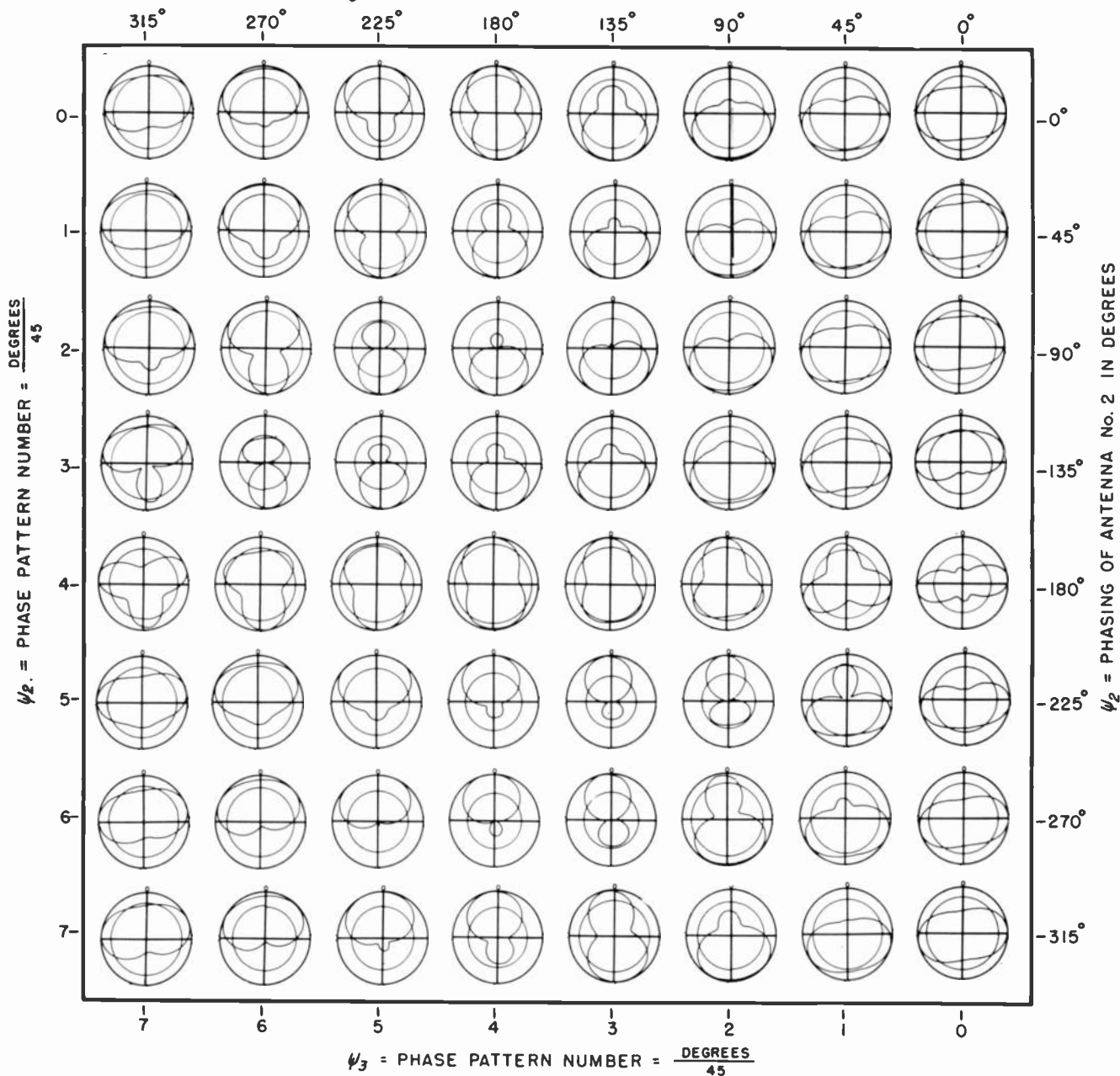

NUMBER OF ANTENNAS IN THE SYSTEM  
No. 3

ORIENTATION OF NO. 2 ANTENNA =  $\frac{\text{DEGREES}}{45}$   
No.  $\psi_2$

SPACING OF NO. 2 ANTENNA =  $\frac{\text{DEGREES}}{45}$   
No.  $S_2$

PHASING OF NO. 2 ANTENNA =  $\frac{\text{DEGREES}}{45}$   
No.  $\psi_2$

ORIENTATION OF NO. 3 ANTENNA =  $\frac{\text{DEGREES}}{45}$   
No.  $\psi_3$

SPACING OF NO. 3 ANTENNA =  $\frac{\text{DEGREES}}{45}$   
No.  $S_3$

PHASING OF NO. 3 ANTENNA =  $\frac{\text{DEGREES}}{45}$   
No.  $\psi_3$

% FIELD INTENSITY RADIATED IN HORIZONTAL PLANE FROM NO. 1 ANTENNA.  
 $E_1$

% FIELD INTENSITY RADIATED IN HORIZONTAL PLANE FROM NO. 2 ANTENNA.  
 $E_2$

% FIELD INTENSITY RADIATED IN HORIZONTAL PLANE FROM NO. 3 ANTENNA.  
 $E_3$

% RMS FIELD INTENSITY RADIATED IN HORIZONTAL PLANE FROM ANTENNA SYSTEM.  
 $E_0$

LEFT HAND PATTERN NUMBER GIVES ANTENNA PLACEMENT AND PHASING DATA.

RIGHT HAND PATTERN NUMBER GIVES ANTENNA FIELD INTENSITY DATA IN PERCENT.

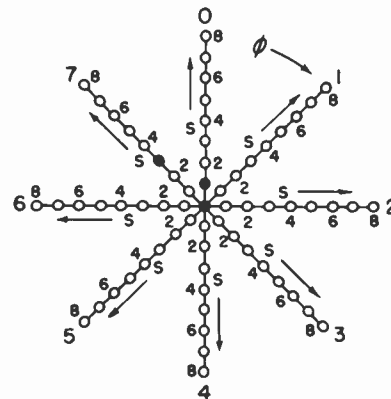

SPOTS LOCATE THE ANTENNAS FOR THIS PAGE OF PATTERNS IN THE SYSTEMATIZATION PLACEMENT CHART.

PATTERN NOMENCLATURE

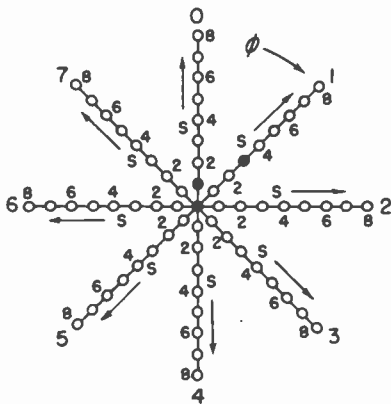
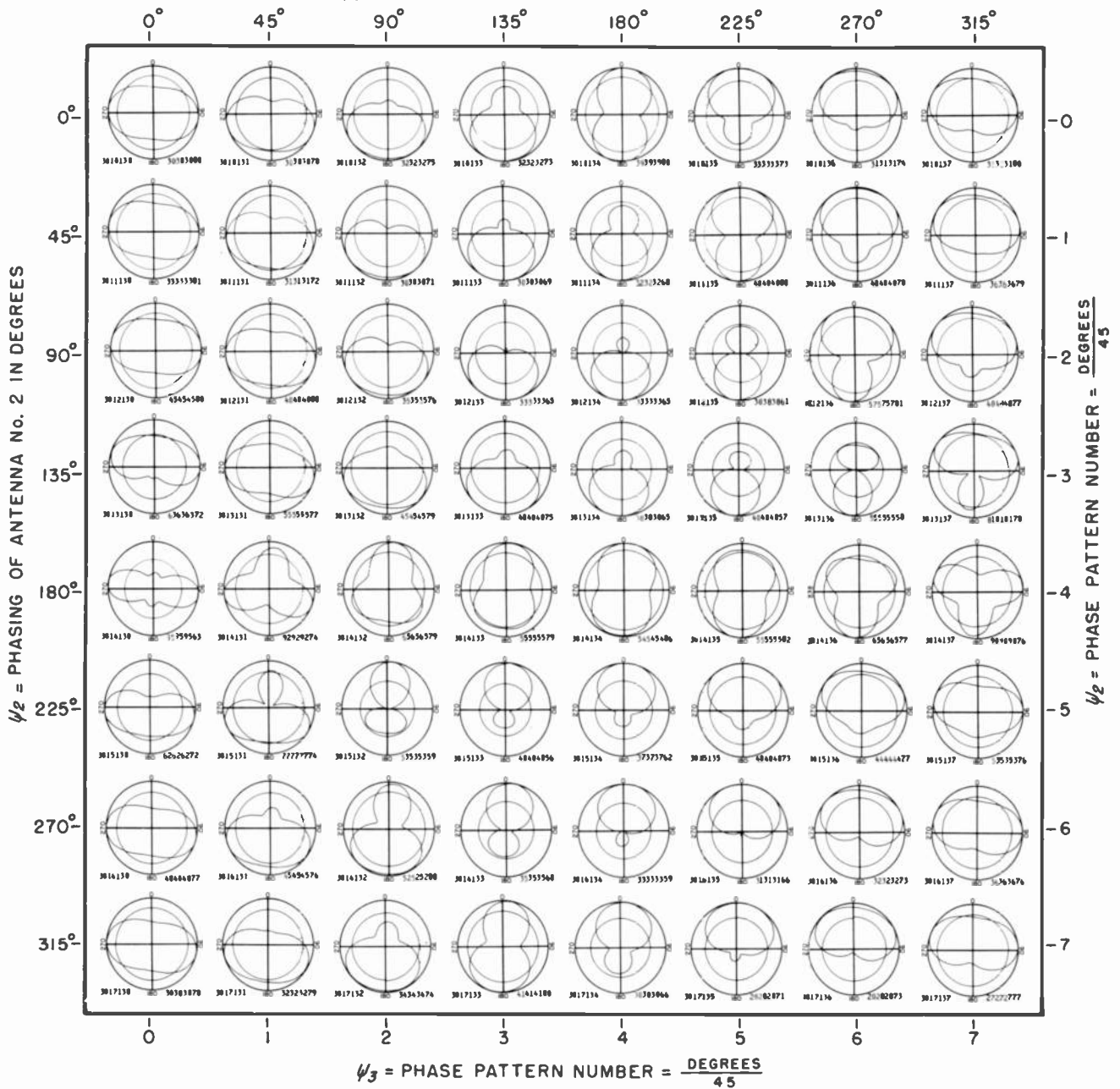

NO.	$\phi_2$	$S_2$	$\psi_2$	$\phi_3$	$S_3$	$\psi_3$
3	0	1	0	1	3	0

LEFT HAND PATTERN NUMBER GIVES ANTENNA PLACEMENT AND PHASING DATA.

$E_1$	$E_2$	$E_3$	$E_0$
30	30	30	80

RIGHT HAND PATTERN NUMBER GIVES ANTENNA FIELD INTENSITY DATA IN PERCENT.

SPOTS LOCATE THE ANTENNAS FOR THIS PAGE OF PATTERNS IN THE SYSTEMATIZATION PLACEMENT CHART.

PATTERN NOMENCLATURE

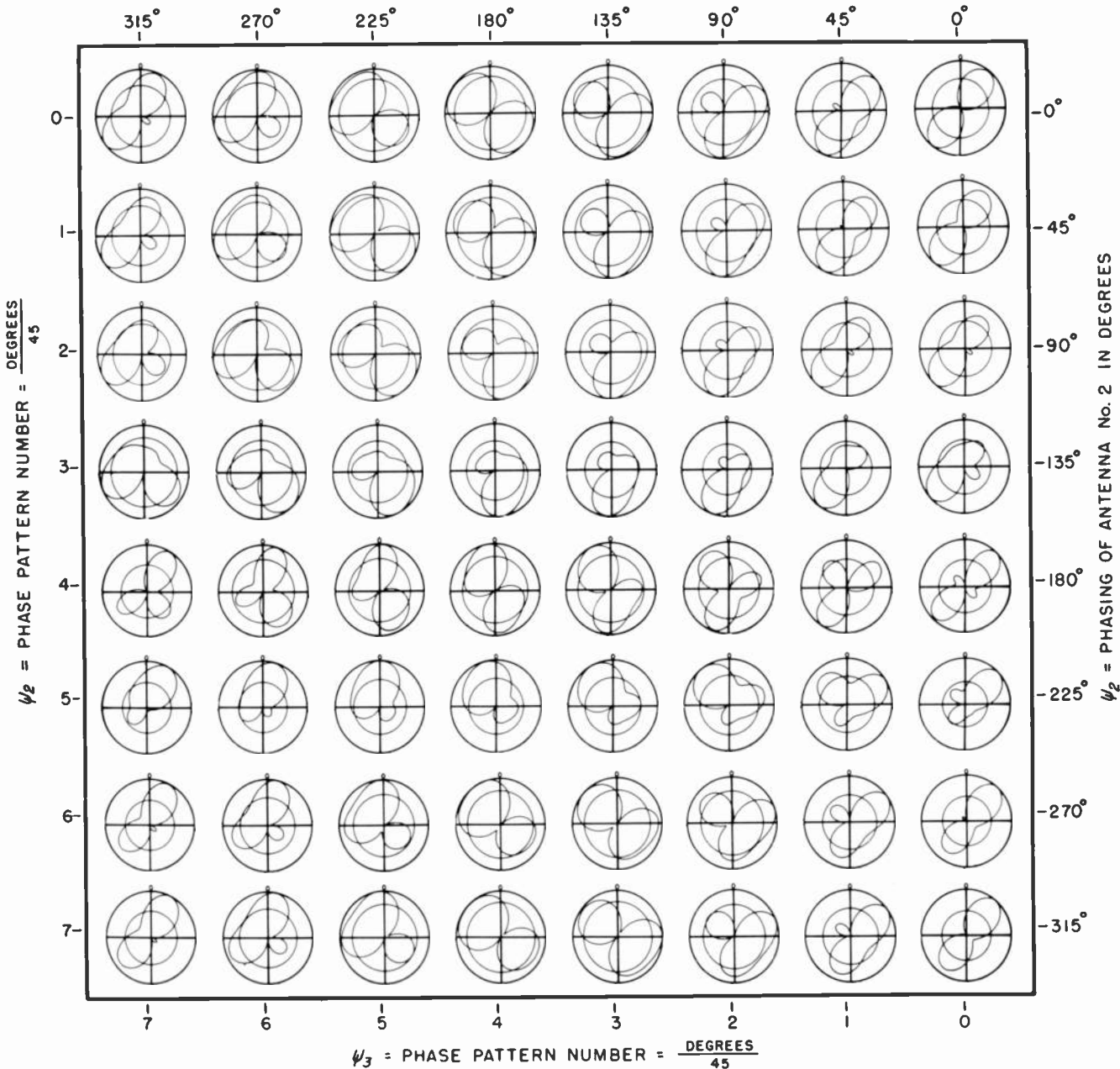

NUMBER OF ANTENNAS IN THE SYSTEM	$\psi_2 = \text{PHASE PATTERN NUMBER} = \frac{\text{DEGREES}}{45}$						
ORIENTATION OF NO. 2 ANTENNA =	$\psi_2 = \frac{\text{DEGREES}}{45}$						
SPACING OF NO. 2 ANTENNA =	$S_2 = \frac{\text{DEGREES}}{45}$						
PHASING OF NO. 2 ANTENNA =	$\psi_2 = \frac{\text{DEGREES}}{45}$						
ORIENTATION OF NO. 3 ANTENNA =	$\psi_3 = \frac{\text{DEGREES}}{45}$						
SPACING OF NO. 3 ANTENNA =	$S_3 = \frac{\text{DEGREES}}{45}$						
PHASING OF NO. 3 ANTENNA =	$\psi_3 = \frac{\text{DEGREES}}{45}$						

LEFT HAND PATTERN NUMBER GIVES ANTENNA PLACEMENT AND PHASING DATA.

% FIELD INTENSITY RADIATED IN HORIZONTAL PLANE FROM NO. 1 ANTENNA.	% FIELD INTENSITY RADIATED IN HORIZONTAL PLANE FROM NO. 2 ANTENNA.	% FIELD INTENSITY RADIATED IN HORIZONTAL PLANE FROM NO. 3 ANTENNA.	% RMS FIELD INTENSITY RADIATED IN HORIZONTAL PLANE FROM ANTENNA SYSTEM.
$F_1$	$F_2$	$F_3$	$F_0$
32	09	39	61

RIGHT HAND PATTERN NUMBER GIVES ANTENNA FIELD INTENSITY DATA IN PERCENT.

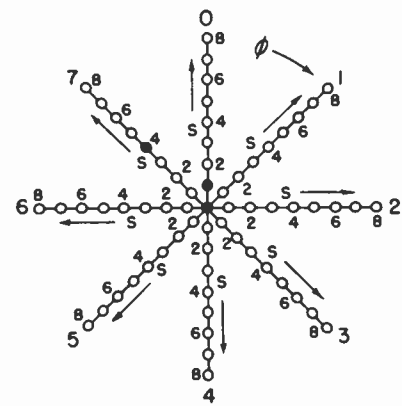

SPOTS LOCATE THE ANTENNAS FOR THIS PAGE OF PATTERNS IN THE SYSTEMATIZATION PLACEMENT CHART.

PATTERN NOMENCLATURE



$\psi_3$  = PHASING OF ANTENNA No. 3 IN DEGREES

3.51

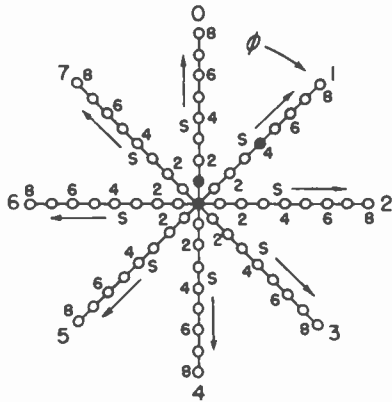
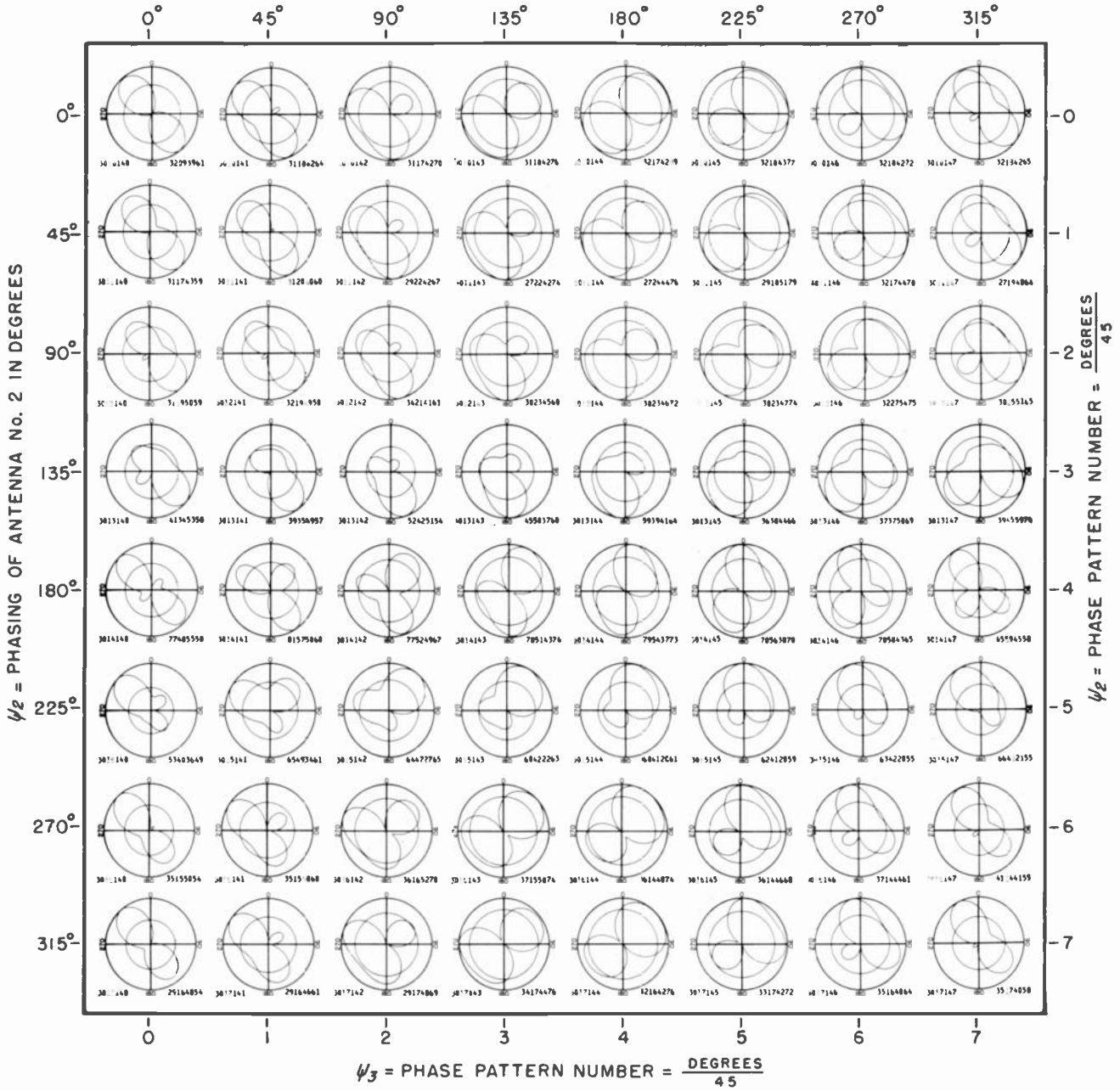

SPOTS LOCATE THE ANTENNAS FOR THIS PAGE OF PATTERNS IN THE SYSTEMATIZATION PLACEMENT CHART.

NUMBER OF ANTENNAS IN THE SYSTEM	ORIENTATION OF NO. 2 ANTENNA = $\frac{DEGREES}{45}$	SPACING OF NO. 2 ANTENNA = $\frac{DEGREES}{45}$	PHASING OF NO. 2 ANTENNA = $\frac{DEGREES}{45}$	ORIENTATION OF NO. 3 ANTENNA = $\frac{DEGREES}{45}$	SPACING OF NO. 3 ANTENNA = $\frac{DEGREES}{45}$	PHASING OF NO. 3 ANTENNA = $\frac{DEGREES}{45}$
No. 3	$\phi_2$ 0	$S_2$ 1	$\psi_2$ 0	$\phi_3$ 1	$S_3$ 4	$\psi_3$ 0

LEFT HAND PATTERN NUMBER GIVES ANTENNA PLACEMENT AND PHASING DATA.

% FIELD INTENSITY RADIATED IN HORIZONTAL PLANE FROM NO. 1 ANTENNA.	% FIELD INTENSITY RADIATED IN HORIZONTAL PLANE FROM NO. 2 ANTENNA.	% FIELD INTENSITY RADIATED IN HORIZONTAL PLANE FROM NO. 3 ANTENNA.	% RMS FIELD INTENSITY RADIATED IN HORIZONTAL PLANE FROM ANTENNA SYSTEM.
$E_1$ 32	$E_2$ 09	$E_3$ 39	$E_0$ 61

RIGHT HAND PATTERN NUMBER GIVES ANTENNA FIELD INTENSITY DATA IN PERCENT.

PATTERN NOMENCLATURE

$\psi_3$  = PHASING OF ANTENNA No. 3 IN DEGREES

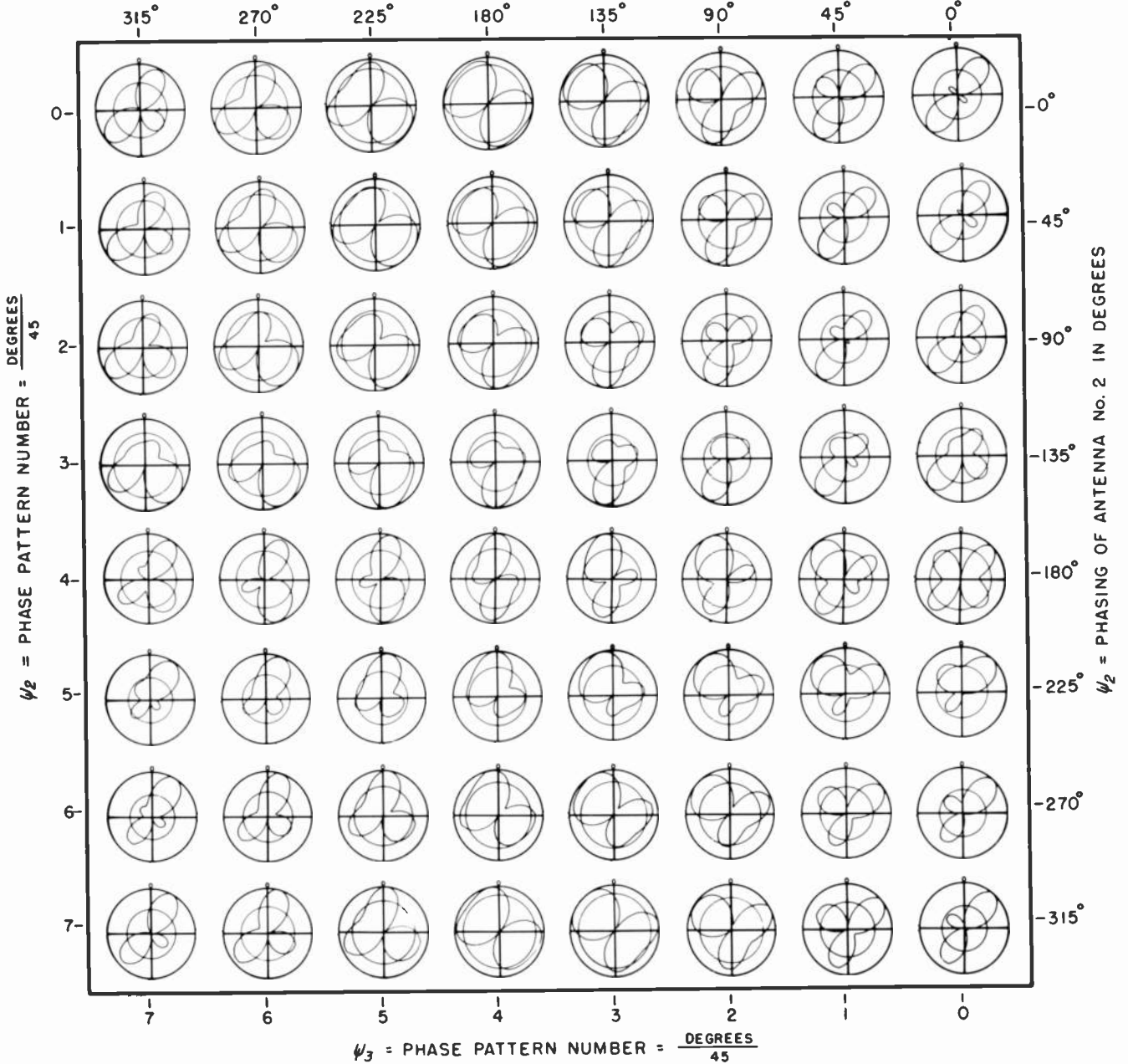

NUMBER OF ANTENNAS IN THE SYSTEM	ORIENTATION OF NO. 2 ANTENNA = $\frac{DEGREES}{45}$	SPACING OF NO. 2 ANTENNA = $\frac{DEGREES}{45}$	PHASING OF NO. 2 ANTENNA = $\frac{DEGREES}{45}$	ORIENTATION OF NO. 3 ANTENNA = $\frac{DEGREES}{45}$	SPACING OF NO. 3 ANTENNA = $\frac{DEGREES}{45}$	PHASING OF NO. 3 ANTENNA = $\frac{DEGREES}{45}$
No. $\phi_2$	$S_2$	$\psi_2$	$\phi_3$	$S_3$	$\psi_3$	
3	0	1	0	7	5	0

LEFT HAND PATTERN NUMBER GIVES ANTENNA PLACEMENT AND PHASING DATA.

% FIELD INTENSITY RADIATED IN HORIZONTAL PLANE FROM NO. 1 ANTENNA.	% FIELD INTENSITY RADIATED IN HORIZONTAL PLANE FROM NO. 2 ANTENNA.	% FIELD INTENSITY RADIATED IN HORIZONTAL PLANE FROM NO. 3 ANTENNA.	% RMS FIELD INTENSITY RADIATED IN HORIZONTAL PLANE FROM ANTENNA SYSTEM.
$F_1$	$F_2$	$F_3$	$F_0$
30	14	42	53

RIGHT HAND PATTERN NUMBER GIVES ANTENNA FIELD INTENSITY DATA IN PERCENT.

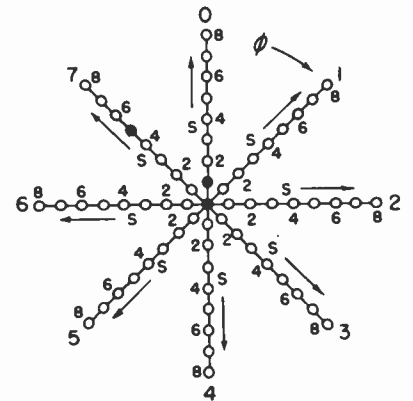

SPOTS LOCATE THE ANTENNAS FOR THIS PAGE OF PATTERNS IN THE SYSTEMATIZATION PLACEMENT CHART.

PATTERN NOMENCLATURE

$\psi_3$  = PHASING OF ANTENNA No. 3 IN DEGREES

3.53

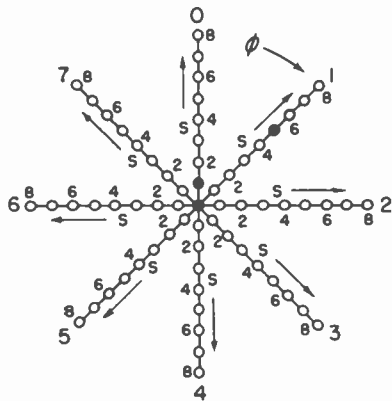
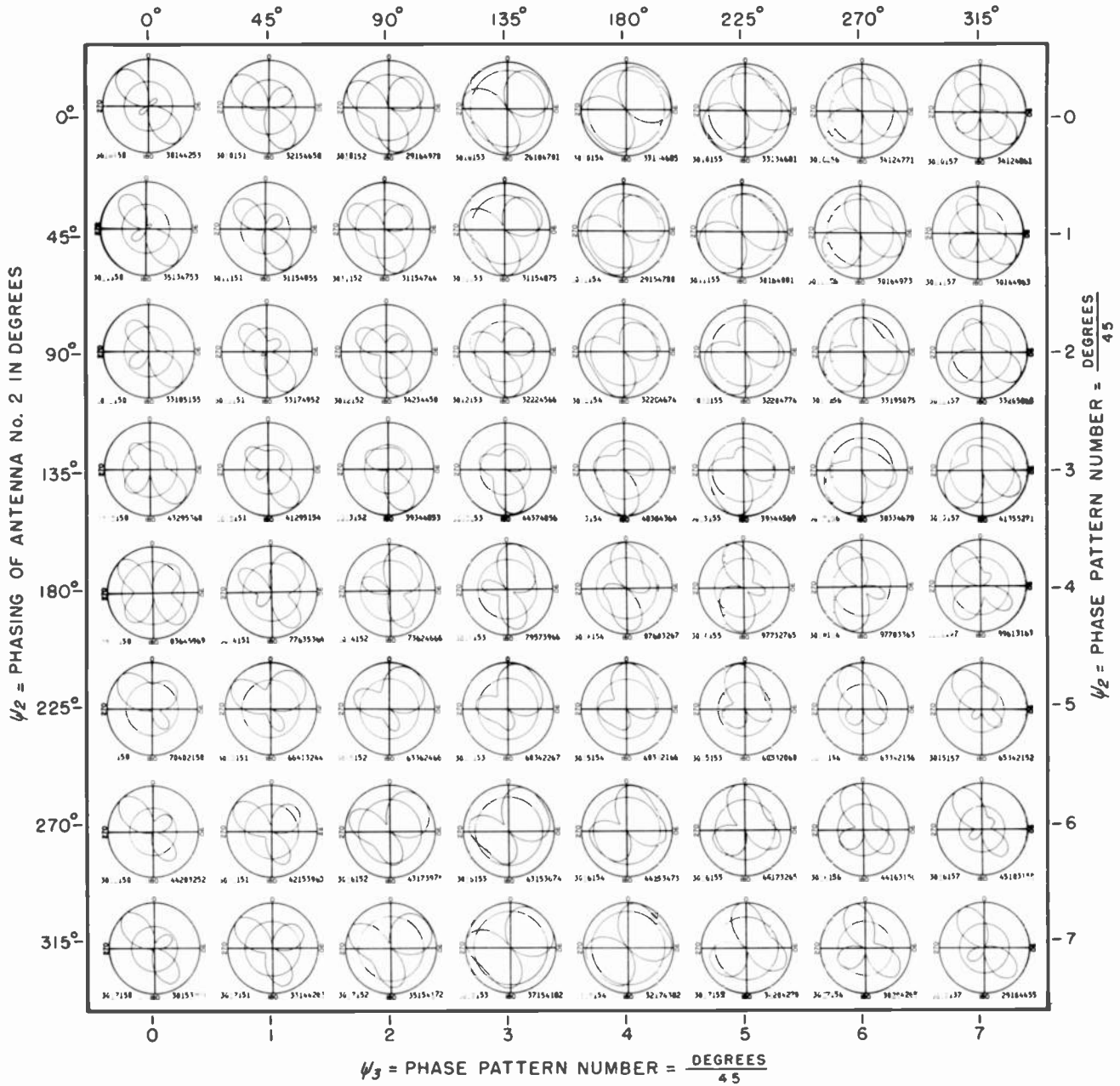

NUMBER OF ANTENNAS IN THE SYSTEM	ORIENTATION OF NO. 2 ANTENNA = $\frac{\text{DEGREES}}{45}$	SPACING OF NO. 2 ANTENNA = $\frac{\text{DEGREES}}{45}$	PHASING OF NO. 2 ANTENNA = $\frac{\text{DEGREES}}{45}$	ORIENTATION OF NO. 3 ANTENNA = $\frac{\text{DEGREES}}{45}$	SPACING OF NO. 3 ANTENNA = $\frac{\text{DEGREES}}{45}$	PHASING OF NO. 3 ANTENNA = $\frac{\text{DEGREES}}{45}$
No.	$\phi_2$	$S_2$	$\psi_2$	$\phi_3$	$S_3$	$\psi_3$
3	0	1	0	1	5	0

% FIELD INTENSITY RADIATED IN HORIZONTAL PLANE FROM NO. 1 ANTENNA.	% FIELD INTENSITY RADIATED IN HORIZONTAL PLANE FROM NO. 2 ANTENNA.	% FIELD INTENSITY RADIATED IN HORIZONTAL PLANE FROM NO. 3 ANTENNA.	% RMS FIELD INTENSITY RADIATED IN HORIZONTAL PLANE FROM ANTENNA SYSTEM.
$F_1$	$F_2$	$F_3$	$F_0$
30	14	42	53

SPOTS LOCATE THE ANTENNAS FOR THIS PAGE OF PATTERNS IN THE SYSTEMATIZATION PLACEMENT CHART.

LEFT HAND PATTERN NUMBER GIVES ANTENNA PLACEMENT AND PHASING DATA.

RIGHT HAND PATTERN NUMBER GIVES ANTENNA FIELD INTENSITY DATA IN PERCENT.

PATTERN NOMENCLATURE

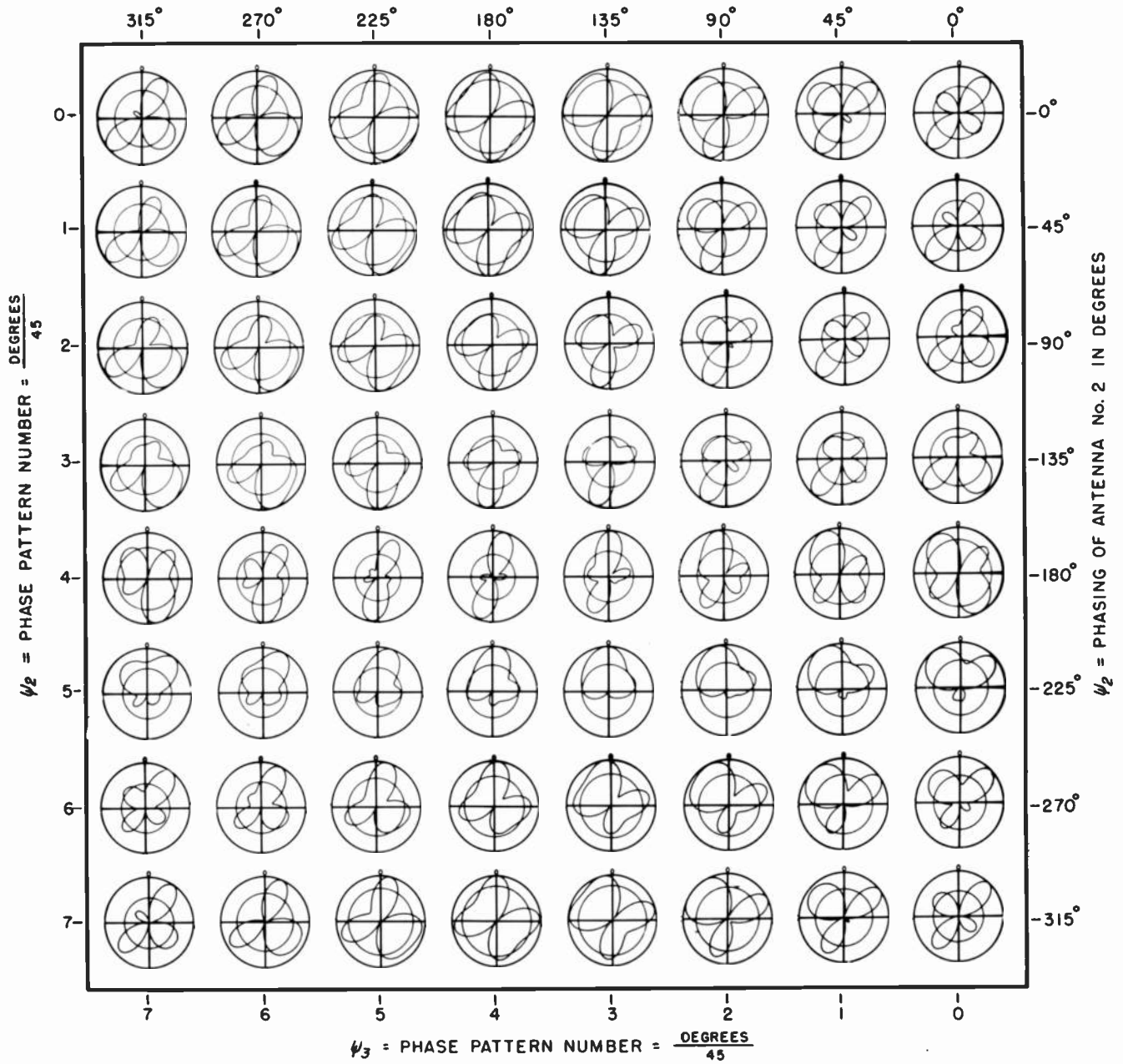

NUMBER OF ANTENNAS IN THE SYSTEM  
 NO.  $\phi_2$  3  
 ORIENTATION OF NO. 2 ANTENNA =  $\frac{\text{DEGREES}}{45}$  0  
 SPACING OF NO. 2 ANTENNA =  $\frac{\text{DEGREES}}{45}$   $S_2$  1  
 PHASING OF NO. 2 ANTENNA =  $\frac{\text{DEGREES}}{45}$   $\psi_2$  0  
 ORIENTATION OF NO. 3 ANTENNA =  $\frac{\text{DEGREES}}{45}$   $\phi_3$  7  
 SPACING OF NO. 3 ANTENNA =  $\frac{\text{DEGREES}}{45}$   $S_3$  6  
 PHASING OF NO. 3 ANTENNA =  $\frac{\text{DEGREES}}{45}$   $\psi_3$  0

LEFT HAND PATTERN NUMBER GIVES ANTENNA PLACEMENT AND PHASING DATA.

% FIELD INTENSITY RADIATED IN HORIZONTAL PLANE FROM NO. 1 ANTENNA.  $E_1$  30  
 % FIELD INTENSITY RADIATED IN HORIZONTAL PLANE FROM NO. 2 ANTENNA.  $E_2$  19  
 % FIELD INTENSITY RADIATED IN HORIZONTAL PLANE FROM NO. 3 ANTENNA.  $E_3$  48  
 % RMS FIELD INTENSITY RADIATED IN HORIZONTAL PLANE FROM ANTENNA SYSTEM.  $E_0$  58

RIGHT HAND PATTERN NUMBER GIVES ANTENNA FIELD INTENSITY DATA IN PERCENT.

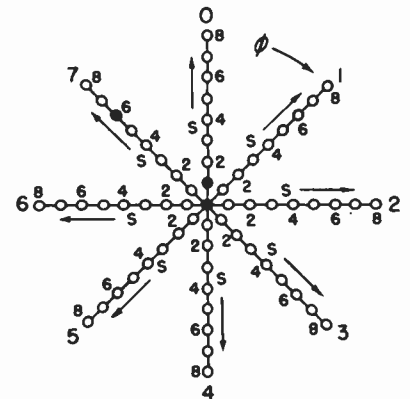

SPOTS LOCATE THE ANTENNAS FOR THIS PAGE OF PATTERNS IN THE SYSTEMATIZATION PLACEMENT CHART.

PATTERN NOMENCLATURE

$\psi_3 =$  PHASING OF ANTENNA No. 3 IN DEGREES

3.55

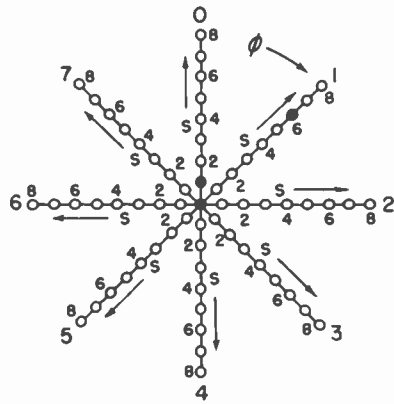
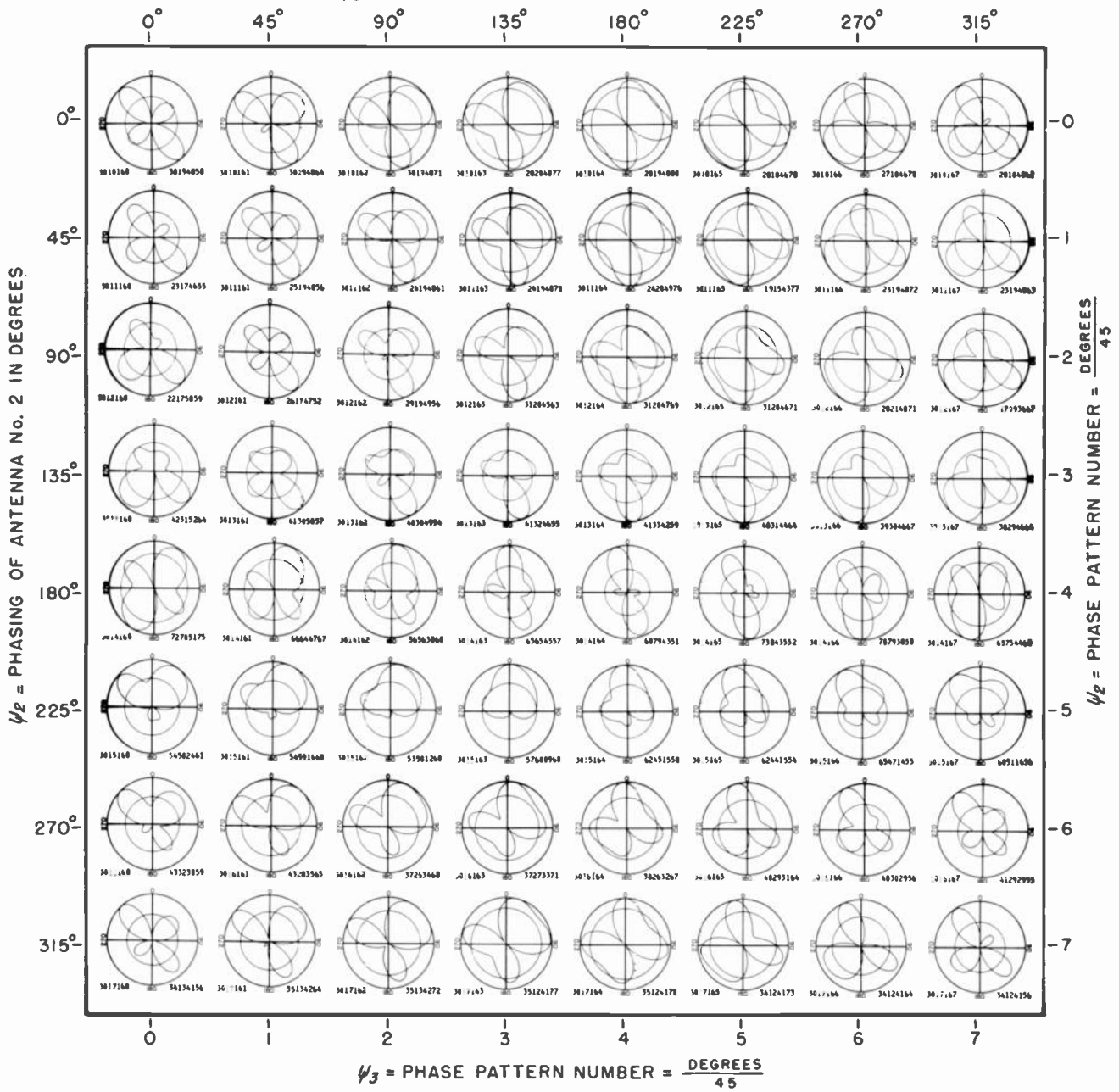

SPOTS LOCATE THE ANTENNAS FOR  
THIS PAGE OF PATTERNS IN THE  
SYSTEMATIZATION PLACEMENT CHART.

$\psi_3 =$  PHASE PATTERN NUMBER =  $\frac{\text{DEGREES}}{45}$

NUMBER OF ANTENNAS IN THE SYSTEM	ORIENTATION OF NO. 2 ANTENNA = $\frac{\text{DEGREES}}{45}$	SPACING OF NO. 2 ANTENNA = $\frac{\text{DEGREES}}{45}$	PHASING OF NO. 2 ANTENNA = $\frac{\text{DEGREES}}{45}$	ORIENTATION OF NO. 3 ANTENNA = $\frac{\text{DEGREES}}{45}$	SPACING OF NO. 3 ANTENNA = $\frac{\text{DEGREES}}{45}$	PHASING OF NO. 3 ANTENNA = $\frac{\text{DEGREES}}{45}$
No.	$\phi_2$	$S_2$	$\psi_2$	$\phi_3$	$S_3$	$\psi_3$
3	0	1	0	1	6	0

LEFT HAND PATTERN NUMBER GIVES ANTENNA  
PLACEMENT AND PHASING DATA.

% FIELD INTENSITY RADIATED IN HORIZONTAL PLANE FROM NO. 1 ANTENNA.	% FIELD INTENSITY RADIATED IN HORIZONTAL PLANE FROM NO. 2 ANTENNA.	% FIELD INTENSITY RADIATED IN HORIZONTAL PLANE FROM NO. 3 ANTENNA.	% RMS FIELD INTENSITY RADIATED IN HORIZONTAL PLANE FROM ANTENNA SYSTEM.
$F_1$	$F_2$	$F_3$	$F_0$
30	19	48	58

RIGHT HAND PATTERN NUMBER GIVES ANTENNA FIELD INTEN-  
SITY DATA IN PERCENT.

PATTERN NOMENCLATURE

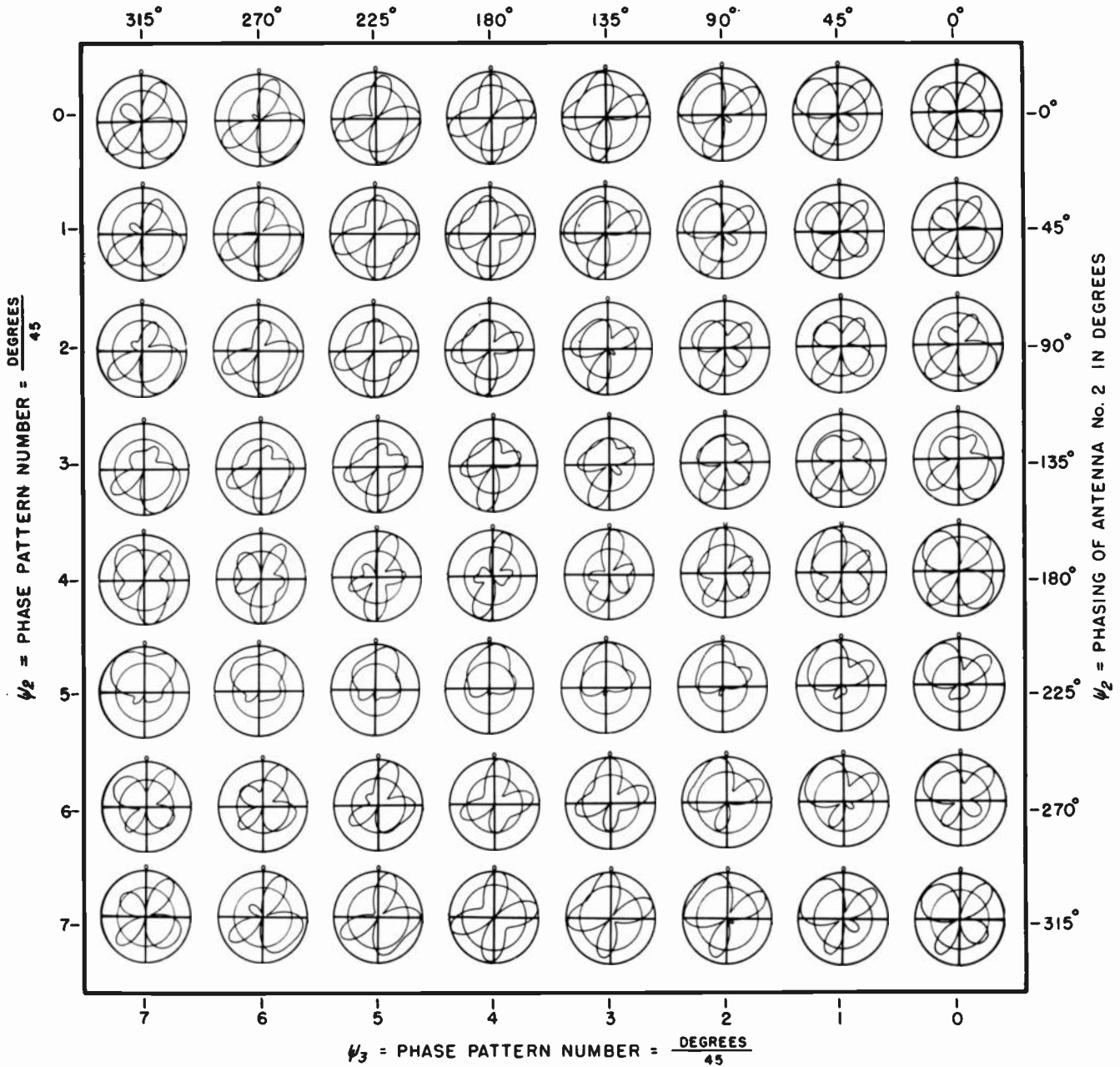

NUMBER OF ANTENNAS IN THE SYSTEM  
 No. 3

ORIENTATION OF NO. 2 ANTENNA =  $\frac{DEGREES}{45}$   
 $\phi_2$  0

SPACING OF NO. 2 ANTENNA =  $\frac{DEGREES}{45}$   
 $S_2$  1

PHASING OF NO. 2 ANTENNA =  $\frac{DEGREES}{45}$   
 $\psi_2$  0

ORIENTATION OF NO. 3 ANTENNA =  $\frac{DEGREES}{45}$   
 $\phi_3$  7

SPACING OF NO. 3 ANTENNA =  $\frac{DEGREES}{45}$   
 $S_3$  7

PHASING OF NO. 3 ANTENNA =  $\frac{DEGREES}{45}$   
 $\psi_3$  0

% FIELD INTENSITY RADIATED IN HORIZONTAL PLANE FROM NO. 1 ANTENNA.  
 $F_1$  02

% FIELD INTENSITY RADIATED IN HORIZONTAL PLANE FROM NO. 2 ANTENNA.  
 $F_2$  42

% FIELD INTENSITY RADIATED IN HORIZONTAL PLANE FROM NO. 3 ANTENNA.  
 $F_3$  48

% RMS FIELD INTENSITY RADIATED IN HORIZONTAL PLANE FROM ANTENNA SYSTEM.  
 $F_0$  63

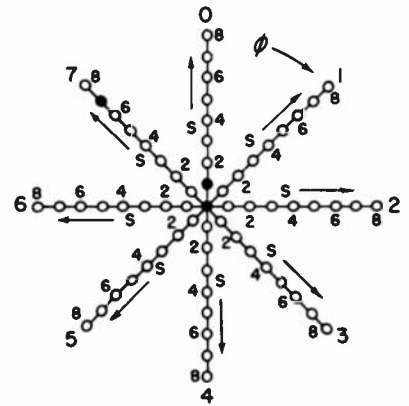

LEFT HAND PATTERN NUMBER GIVES ANTENNA PLACEMENT AND PHASING DATA.

RIGHT HAND PATTERN NUMBER GIVES ANTENNA FIELD INTENSITY DATA IN PERCENT.

SPOTS LOCATE THE ANTENNAS FOR THIS PAGE OF PATTERNS IN THE SYSTEMIZATION PLACEMENT CHART.

PATTERN NOMENCLATURE

$\psi_3$  = PHASING OF ANTENNA No. 3 IN DEGREES

3.57

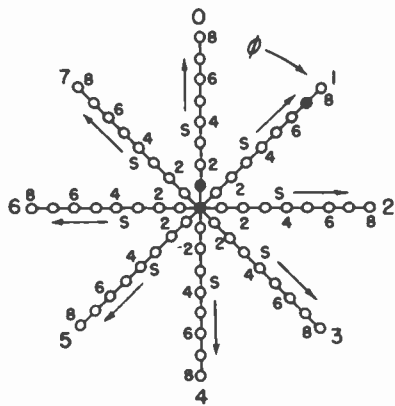
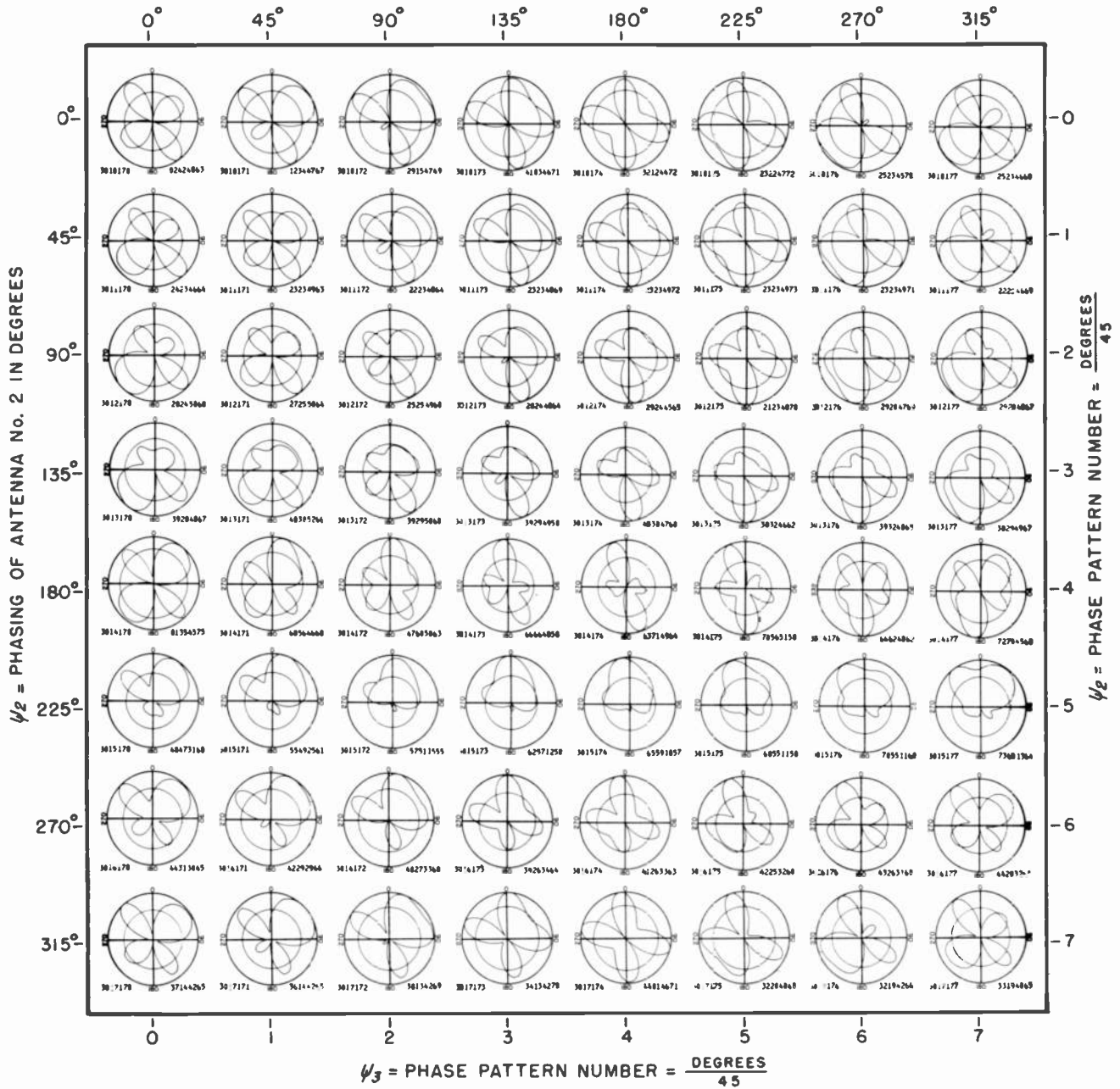

NUMBER OF ANTENNAS IN THE SYSTEM	ORIENTATION OF NO. 2 ANTENNA = $\frac{\text{DEGREES}}{45}$	SPACING OF NO. 2 ANTENNA = $\frac{\text{DEGREES}}{45}$	PHASING OF NO. 2 ANTENNA = $\frac{\text{DEGREES}}{45}$	ORIENTATION OF NO. 3 ANTENNA = $\frac{\text{DEGREES}}{45}$	SPACING OF NO. 3 ANTENNA = $\frac{\text{DEGREES}}{45}$	PHASING OF NO. 3 ANTENNA = $\frac{\text{DEGREES}}{45}$
No.	$\phi_2$	$S_2$	$\psi_2$	$\phi_3$	$S_3$	$\psi_3$
3	0	1	0	1	7	0

LEFT HAND PATTERN NUMBER GIVES ANTENNA PLACEMENT AND PHASING DATA.

% FIELD INTENSITY RADIATED IN HORIZONTAL PLANE FROM NO. 1 ANTENNA.	% FIELD INTENSITY RADIATED IN HORIZONTAL PLANE FROM NO. 2 ANTENNA.	% FIELD INTENSITY RADIATED IN HORIZONTAL PLANE FROM NO. 3 ANTENNA.	% RMS FIELD INTENSITY RADIATED IN HORIZONTAL PLANE FROM ANTENNA SYSTEM.
$F_1$	$F_2$	$F_3$	$F_0$
02	42	48	63

RIGHT HAND PATTERN NUMBER GIVES ANTENNA FIELD INTENSITY DATA IN PERCENT.

SPOTS LOCATE THE ANTENNAS FOR THIS PAGE OF PATTERNS IN THE SYSTEMATIZATION PLACEMENT CHART.

PATTERN NOMENCLATURE

$\psi_3$  = PHASING OF ANTENNA No. 3 IN DEGREES

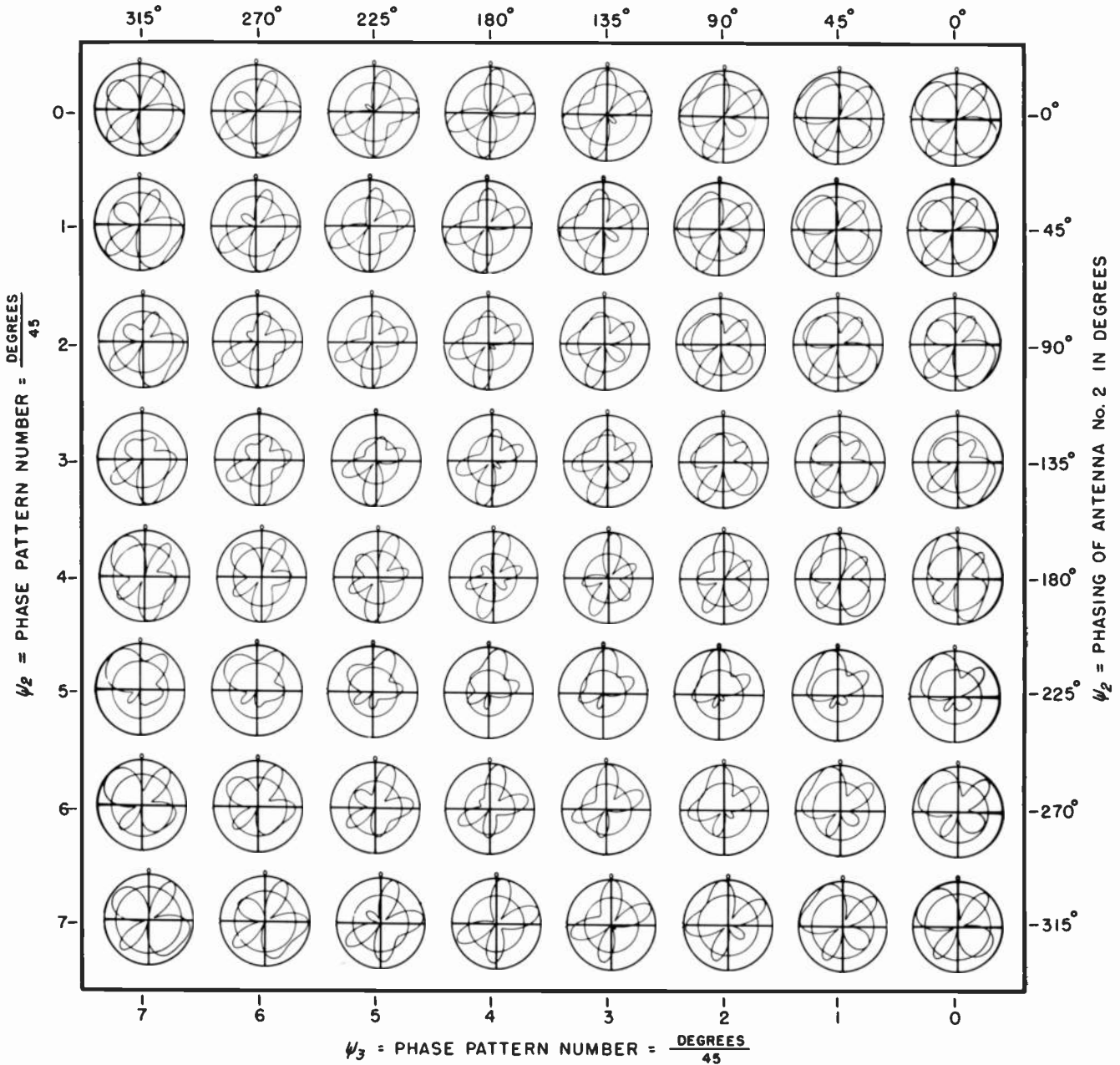

NUMBER OF ANTENNAS IN THE SYSTEM  
 ORIENTATION OF NO. 2 ANTENNA =  $\frac{\text{DEGREES}}{45}$   
 SPACING OF NO. 2 ANTENNA =  $\frac{\text{DEGREES}}{45}$   
 PHASING OF NO. 2 ANTENNA =  $\frac{\text{DEGREES}}{45}$   
 ORIENTATION OF NO. 3 ANTENNA =  $\frac{\text{DEGREES}}{45}$   
 SPACING OF NO. 3 ANTENNA =  $\frac{\text{DEGREES}}{45}$   
 PHASING OF NO. 3 ANTENNA =  $\frac{\text{DEGREES}}{45}$

% FIELD INTENSITY RADIATED IN HORIZONTAL PLANE FROM NO. 1 ANTENNA.  $F_1$   
 % FIELD INTENSITY RADIATED IN HORIZONTAL PLANE FROM NO. 2 ANTENNA.  $F_2$   
 % FIELD INTENSITY RADIATED IN HORIZONTAL PLANE FROM NO. 3 ANTENNA.  $F_3$   
 % RMS FIELD INTENSITY RADIATED IN HORIZONTAL PLANE FROM ANTENNA SYSTEM.  $F_0$

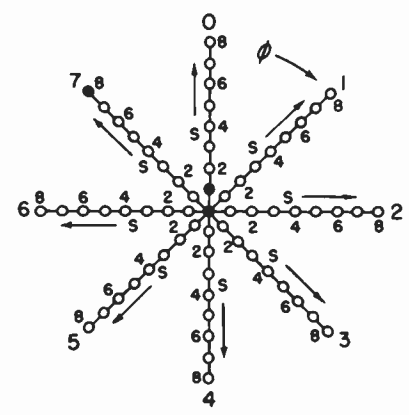

LEFT HAND PATTERN NUMBER GIVES ANTENNA PLACEMENT AND PHASING DATA.

RIGHT HAND PATTERN NUMBER GIVES ANTENNA FIELD INTENSITY DATA IN PERCENT.

SPOTS LOCATE THE ANTENNAS FOR THIS PAGE OF PATTERNS IN THE SYSTEMATIZATION PLACEMENT CHART.

PATTERN NOMENCLATURE



$\psi_3$  = PHASING OF ANTENNA No. 3 IN DEGREES

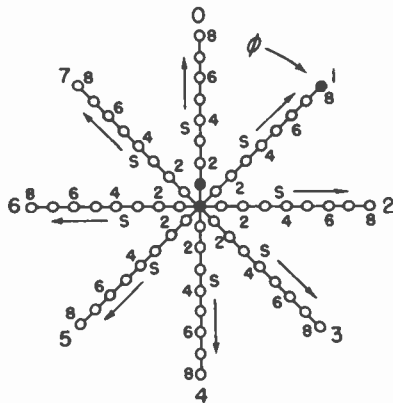
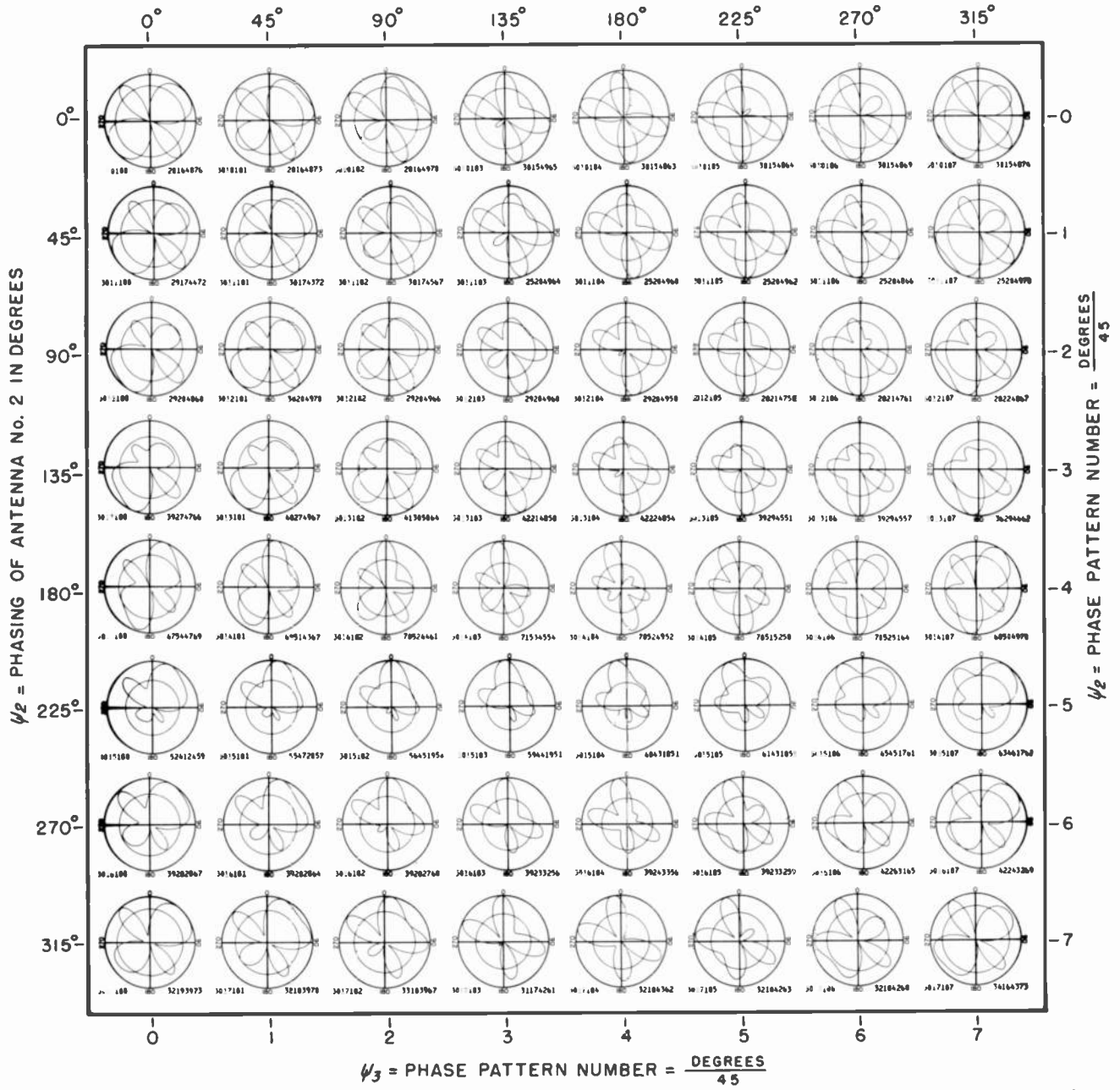

NUMBER OF ANTENNAS IN THE SYSTEM	ORIENTATION OF NO. 2 ANTENNA = $\frac{\text{DEGREES}}{45}$	SPACING OF NO. 2 ANTENNA = $\frac{\text{DEGREES}}{45}$	PHASING OF NO. 2 ANTENNA = $\frac{\text{DEGREES}}{45}$	ORIENTATION OF NO. 3 ANTENNA = $\frac{\text{DEGREES}}{45}$	SPACING OF NO. 3 ANTENNA = $\frac{\text{DEGREES}}{45}$	PHASING OF NO. 3 ANTENNA = $\frac{\text{DEGREES}}{45}$
No. 3	$\phi_2$ 0	$S_2$ 1	$\psi_2$ 0	$\phi_3$ 1	$S_3$ 8	$\psi_3$ 0

% FIELD INTENSITY RADIATED IN HORIZONTAL PLANE FROM NO. 1 ANTENNA.	% FIELD INTENSITY RADIATED IN HORIZONTAL PLANE FROM NO. 2 ANTENNA.	% FIELD INTENSITY RADIATED IN HORIZONTAL PLANE FROM NO. 3 ANTENNA.	% RMS FIELD INTENSITY RADIATED IN HORIZONTAL PLANE FROM ANTENNA SYSTEM.
$E_1$ 28	$E_2$ 16	$E_3$ 48	$E_0$ 76

SPOTS LOCATE THE ANTENNAS FOR THIS PAGE OF PATTERNS IN THE SYSTEMATIZATION PLACEMENT CHART.

LEFT HAND PATTERN NUMBER GIVES ANTENNA PLACEMENT AND PHASING DATA.

RIGHT HAND PATTERN NUMBER GIVES ANTENNA FIELD INTENSITY DATA IN PERCENT.

PATTERN NOMENCLATURE

$\psi_3$  = PHASING OF ANTENNA No. 3 IN DEGREES

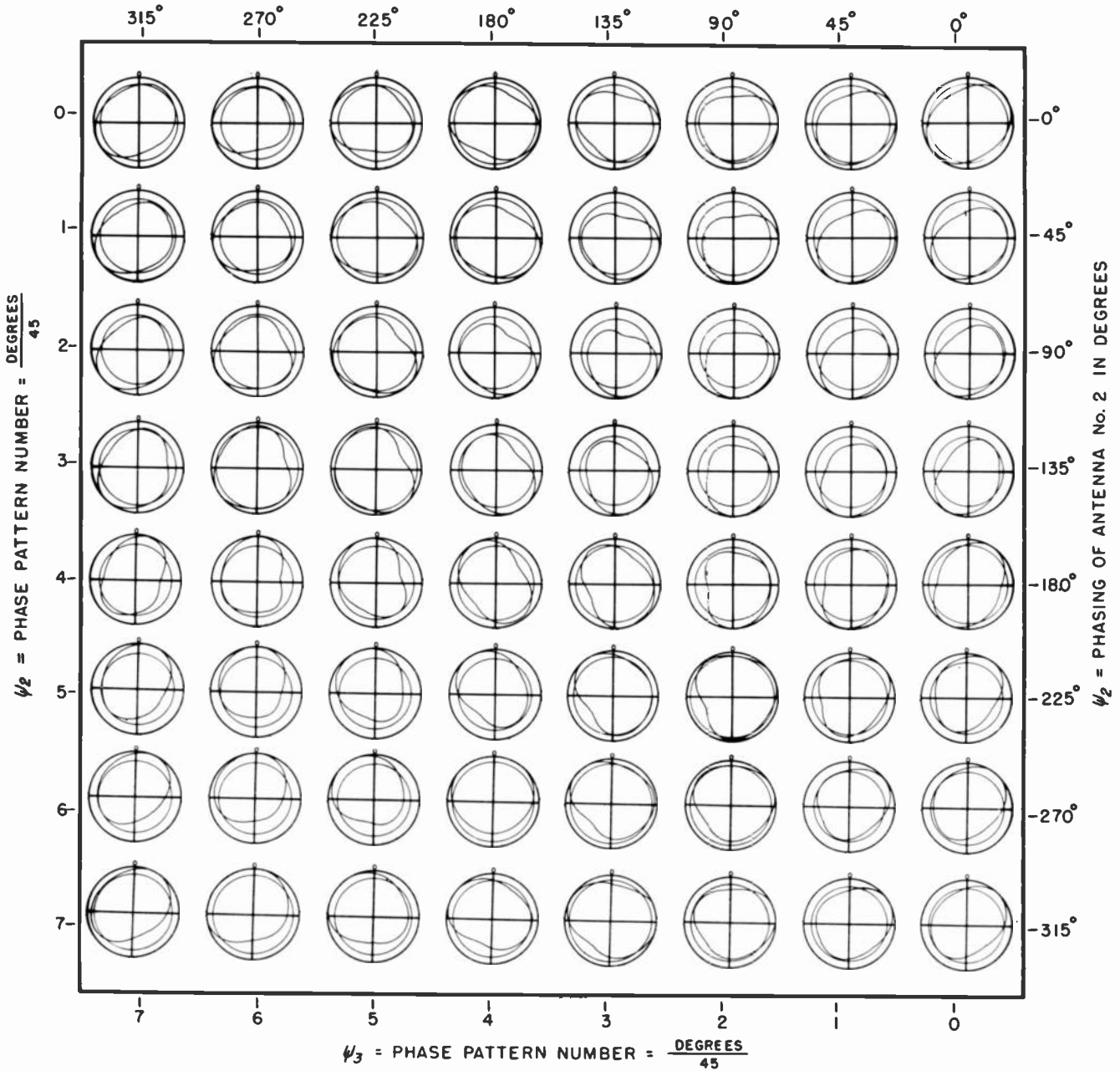

NUMBER OF ANTENNAS IN THE SYSTEM  
 No. 3

ORIENTATION OF NO. 2 ANTENNA =  $\frac{\text{DEGREES}}{45}$   
 $\psi_2$  0

SPACING OF NO. 2 ANTENNA =  $\frac{\text{DEGREES}}{45}$   
 $S_2$  2

PHASING OF NO. 2 ANTENNA =  $\frac{\text{DEGREES}}{45}$   
 $\psi_2$  0

ORIENTATION OF NO. 3 ANTENNA =  $\frac{\text{DEGREES}}{45}$   
 $\psi_3$  7

SPACING OF NO. 3 ANTENNA =  $\frac{\text{DEGREES}}{45}$   
 $S_3$  3

PHASING OF NO. 3 ANTENNA =  $\frac{\text{DEGREES}}{45}$   
 $\psi_3$  0

LEFT HAND PATTERN NUMBER GIVES ANTENNA PLACEMENT AND PHASING DATA.

% FIELD INTENSITY RADIATED IN HORIZONTAL PLANE FROM NO. 1 ANTENNA.  
 $E_1$  77

% FIELD INTENSITY RADIATED IN HORIZONTAL PLANE FROM NO. 2 ANTENNA.  
 $E_2$  12

% FIELD INTENSITY RADIATED IN HORIZONTAL PLANE FROM NO. 3 ANTENNA.  
 $E_3$  12

% RMS FIELD INTENSITY RADIATED IN HORIZONTAL PLANE FROM ANTENNA SYSTEM.  
 $E_0$  90

RIGHT HAND PATTERN NUMBER GIVES ANTENNA FIELD INTENSITY DATA IN PERCENT.

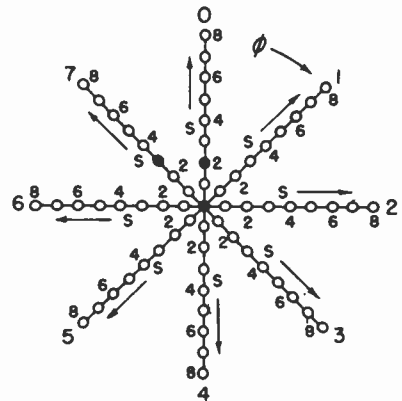

SPOTS LOCATE THE ANTENNAS FOR THIS PAGE OF PATTERNS IN THE SYSTEMATIZATION PLACEMENT CHART.

PATTERN NOMENCLATURE

$\psi_3$  = PHASING OF ANTENNA No. 3 IN DEGREES

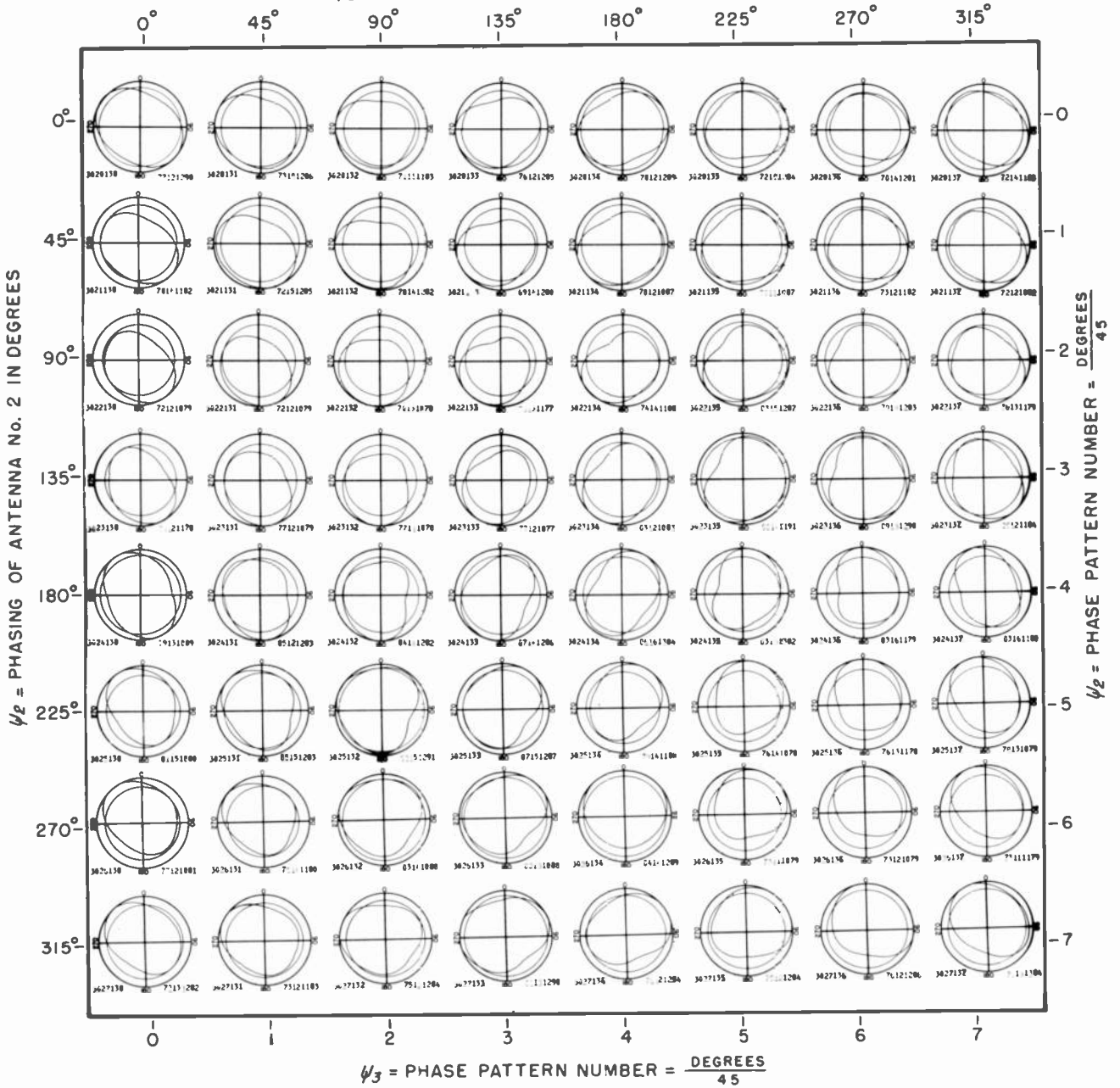

COPYRIGHT 1946 BY CARL E. SMITH  
PRINTED IN U. S. A.

CLEVELAND INSTITUTE OF RADIO ELECTRONICS  
TERMINAL TOWER, CLEVELAND 13, OHIO.

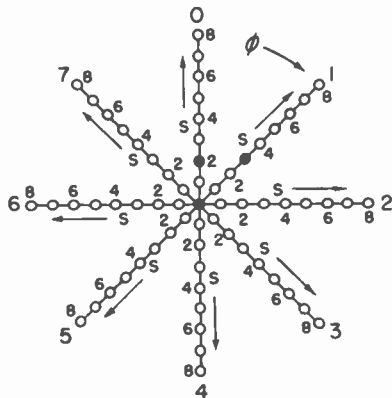

SPOTS LOCATE THE ANTENNAS FOR THIS PAGE OF PATTERNS IN THE SYSTEMATIZATION PLACEMENT CHART.

$\psi_3$  = PHASE PATTERN NUMBER =  $\frac{\text{DEGREES}}{45}$

NUMBER OF ANTENNAS IN THE SYSTEM	ORIENTATION OF NO. 2 ANTENNA = $\frac{\text{DEGREES}}{45}$	SPACING OF NO. 2 ANTENNA = $\frac{\text{DEGREES}}{45}$	PHASING OF NO. 2 ANTENNA = $\frac{\text{DEGREES}}{45}$	ORIENTATION OF NO. 3 ANTENNA = $\frac{\text{DEGREES}}{45}$	SPACING OF NO. 3 ANTENNA = $\frac{\text{DEGREES}}{45}$	PHASING OF NO. 3 ANTENNA = $\frac{\text{DEGREES}}{45}$
No. 3	$\phi_2$ 0	$S_2$ 2	$\psi_2$ 0	$\phi_3$ 1	$S_3$ 3	$\psi_3$ 0

LEFT HAND PATTERN NUMBER GIVES ANTENNA PLACEMENT AND PHASING DATA.

% FIELD INTENSITY RADIATED IN HORIZONTAL PLANE FROM NO. 1 ANTENNA.	% FIELD INTENSITY RADIATED IN HORIZONTAL PLANE FROM NO. 2 ANTENNA.	% FIELD INTENSITY RADIATED IN HORIZONTAL PLANE FROM NO. 3 ANTENNA.	% RMS FIELD INTENSITY RADIATED IN HORIZONTAL PLANE FROM ANTENNA SYSTEM.
$E_1$ 77	$E_2$ 12	$E_3$ 12	$E_0$ 90

RIGHT HAND PATTERN NUMBER GIVES ANTENNA FIELD INTENSITY DATA IN PERCENT.

PATTERN NOMENCLATURE

$\psi_3$  = PHASING OF ANTENNA No. 3 IN DEGREES

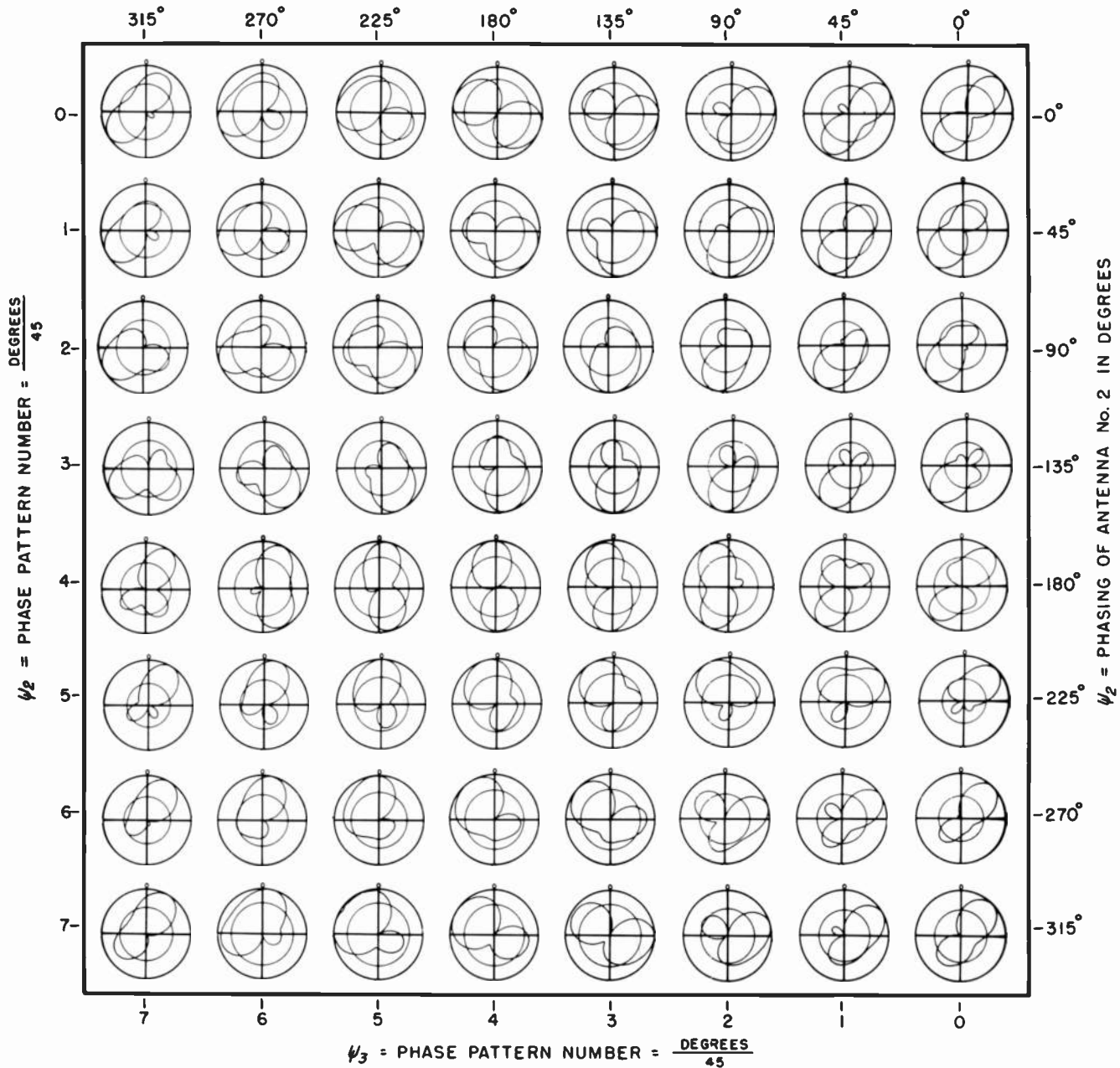

NUMBER OF ANTENNAS IN THE SYSTEM  
 NO. 3

ORIENTATION OF NO. 2 ANTENNA =  $\frac{\text{DEGREES}}{45}$   
 $\psi_2$  0

SPACING OF NO. 2 ANTENNA =  $\frac{\text{DEGREES}}{45}$   
 $S_2$  2

PHASING OF NO. 2 ANTENNA =  $\frac{\text{DEGREES}}{45}$   
 $\psi_2$  0

ORIENTATION OF NO. 3 ANTENNA =  $\frac{\text{DEGREES}}{45}$   
 $\psi_3$  7

SPACING OF NO. 3 ANTENNA =  $\frac{\text{DEGREES}}{45}$   
 $S_3$  4

PHASING OF NO. 3 ANTENNA =  $\frac{\text{DEGREES}}{45}$   
 $\psi_3$  0

% FIELD INTENSITY RADIATED IN HORIZONTAL PLANE FROM NO. 1 ANTENNA.  
 $E_1$  42

% FIELD INTENSITY RADIATED IN HORIZONTAL PLANE FROM NO. 2 ANTENNA.  
 $E_2$  17

% FIELD INTENSITY RADIATED IN HORIZONTAL PLANE FROM NO. 3 ANTENNA.  
 $E_3$  49

% RMS FIELD INTENSITY RADIATED IN HORIZONTAL PLANE FROM ANTENNA SYSTEM.  
 $E_0$  60

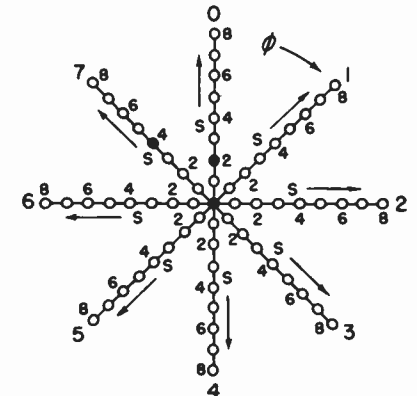

LEFT HAND PATTERN NUMBER GIVES ANTENNA PLACEMENT AND PHASING DATA.

RIGHT HAND PATTERN NUMBER GIVES ANTENNA FIELD INTENSITY DATA IN PERCENT.

SPOTS LOCATE THE ANTENNAS FOR THIS PAGE OF PATTERNS IN THE SYSTEMATIZATION PLACEMENT CHART.

PATTERN NOMENCLATURE

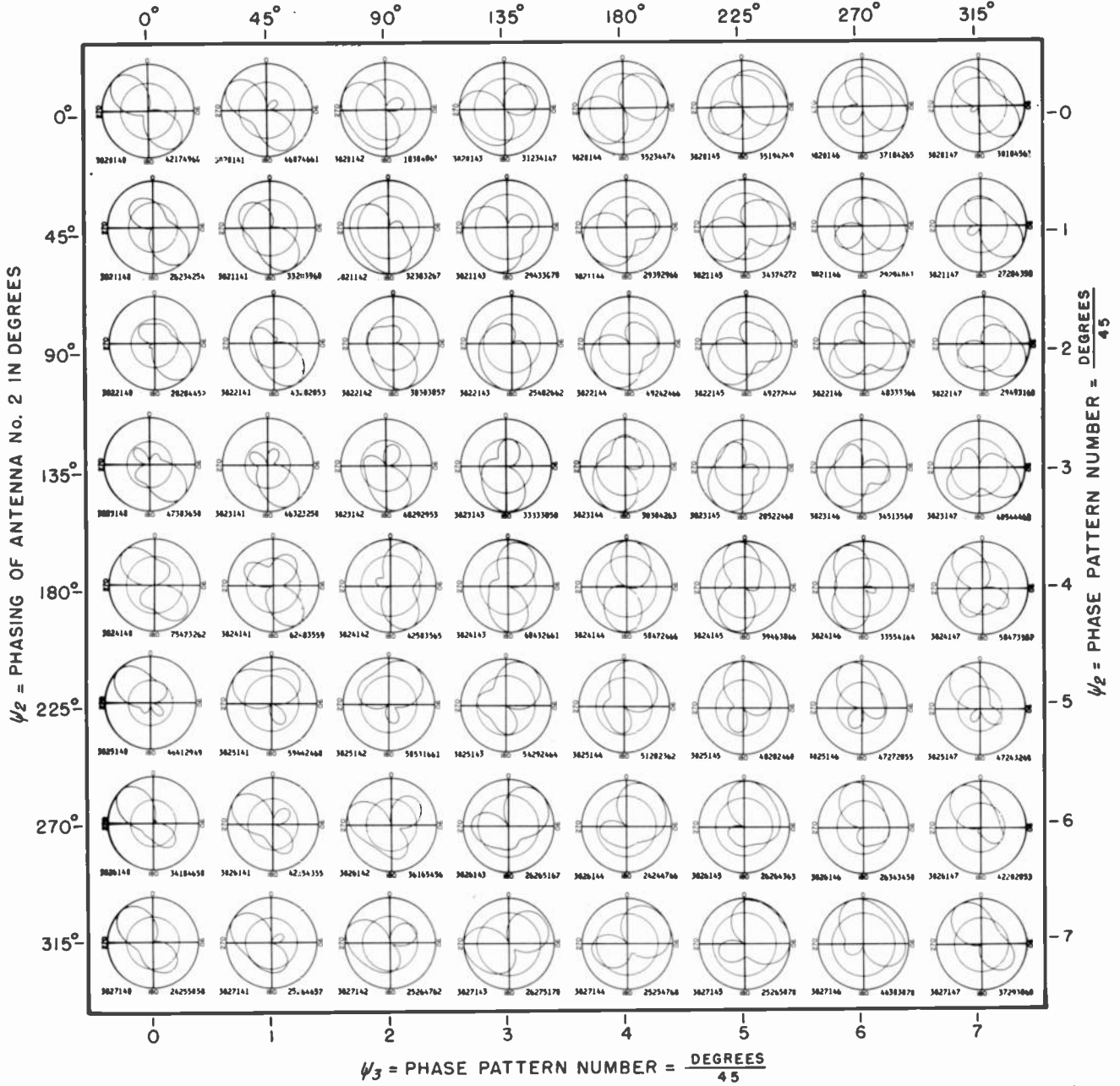

COPYRIGHT 1946 BY CARL E. SMITH  
PRINTED IN U. S. A.

CLEVELAND INSTITUTE OF RADIO ELECTRONICS  
TERMINAL TOWER, CLEVELAND 18, OHIO.

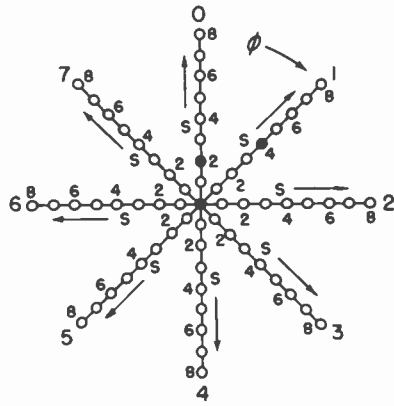

SPOTS LOCATE THE ANTENNAS FOR THIS PAGE OF PATTERNS IN THE SYSTEMATIZATION PLACEMENT CHART.

$\psi_3$  = PHASE PATTERN NUMBER =  $\frac{\text{DEGREES}}{45}$

NUMBER OF ANTENNAS IN THE SYSTEM	ORIENTATION OF NO. 2 ANTENNA = $\frac{\text{DEGREES}}{45}$	SPACING OF NO. 2 ANTENNA = $\frac{\text{DEGREES}}{45}$	PHASING OF NO. 2 ANTENNA = $\frac{\text{DEGREES}}{45}$	ORIENTATION OF NO. 3 ANTENNA = $\frac{\text{DEGREES}}{45}$	SPACING OF NO. 3 ANTENNA = $\frac{\text{DEGREES}}{45}$	PHASING OF NO. 3 ANTENNA = $\frac{\text{DEGREES}}{45}$
No. 3	$\phi_2$ 0	$S_2$ 2	$\psi_2$ 0	$\phi_3$ 1	$S_3$ 4	$\psi_3$ 0

LEFT HAND PATTERN NUMBER GIVES ANTENNA PLACEMENT AND PHASING DATA.

% FIELD INTENSITY RADIATED IN HORIZONTAL PLANE FROM NO. 1 ANTENNA.	% FIELD INTENSITY RADIATED IN HORIZONTAL PLANE FROM NO. 2 ANTENNA.	% FIELD INTENSITY RADIATED IN HORIZONTAL PLANE FROM NO. 3 ANTENNA.	% RMS FIELD INTENSITY RADIATED IN HORIZONTAL PLANE FROM ANTENNA SYSTEM.
$E_1$ 42	$E_2$ 17	$E_3$ 49	$E_0$ 60

RIGHT HAND PATTERN NUMBER GIVES ANTENNA FIELD INTENSITY DATA IN PERCENT.

PATTERN NOMENCLATURE

$\psi_3$  = PHASING OF ANTENNA No. 3 IN DEGREES

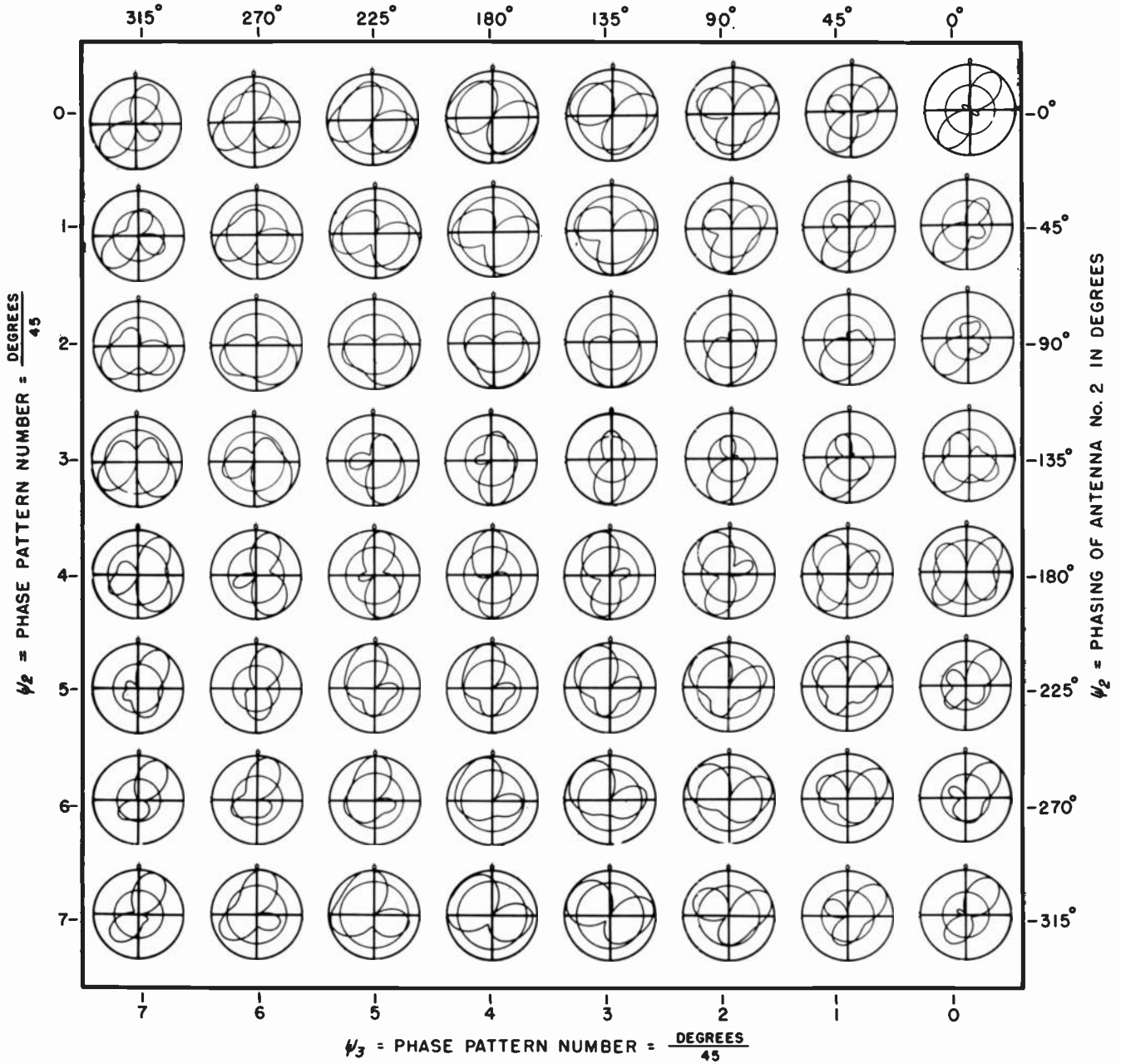

NUMBER OF ANTENNAS IN THE SYSTEM  
 No. 3

ORIENTATION OF NO. 2 ANTENNA =  $\frac{\text{DEGREES}}{45}$   
 $\psi_2$

SPACING OF NO. 2 ANTENNA =  $\frac{\text{DEGREES}}{45}$   
 $S_2$

PHASING OF NO. 2 ANTENNA =  $\frac{\text{DEGREES}}{45}$   
 $\psi_2$

ORIENTATION OF NO. 3 ANTENNA =  $\frac{\text{DEGREES}}{45}$   
 $\psi_3$

SPACING OF NO. 3 ANTENNA =  $\frac{\text{DEGREES}}{45}$   
 $S_3$

PHASING OF NO. 3 ANTENNA =  $\frac{\text{DEGREES}}{45}$   
 $\psi_3$

% FIELD INTENSITY RADIATED IN HORIZONTAL PLANE FROM NO. 1 ANTENNA.  
 $E_1$

% FIELD INTENSITY RADIATED IN HORIZONTAL PLANE FROM NO. 2 ANTENNA.  
 $E_2$

% FIELD INTENSITY RADIATED IN HORIZONTAL PLANE FROM NO. 3 ANTENNA.  
 $E_3$

% RMS FIELD INTENSITY RADIATED IN HORIZONTAL PLANE FROM ANTENNA SYSTEM.  
 $E_0$

LEFT HAND PATTERN NUMBER GIVES ANTENNA PLACEMENT AND PHASING DATA.

RIGHT HAND PATTERN NUMBER GIVES ANTENNA FIELD INTENSITY DATA IN PERCENT.

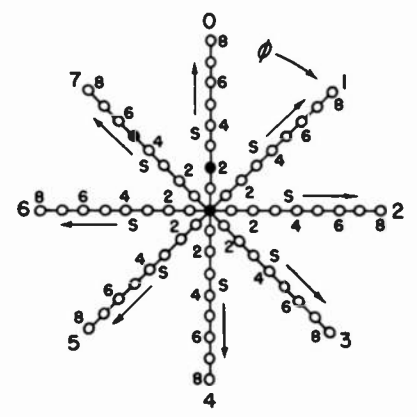

SPOTS LOCATE THE ANTENNAS FOR THIS PAGE OF PATTERNS IN THE SYSTEMIZATION PLACEMENT CHART.

PATTERN NOMENCLATURE

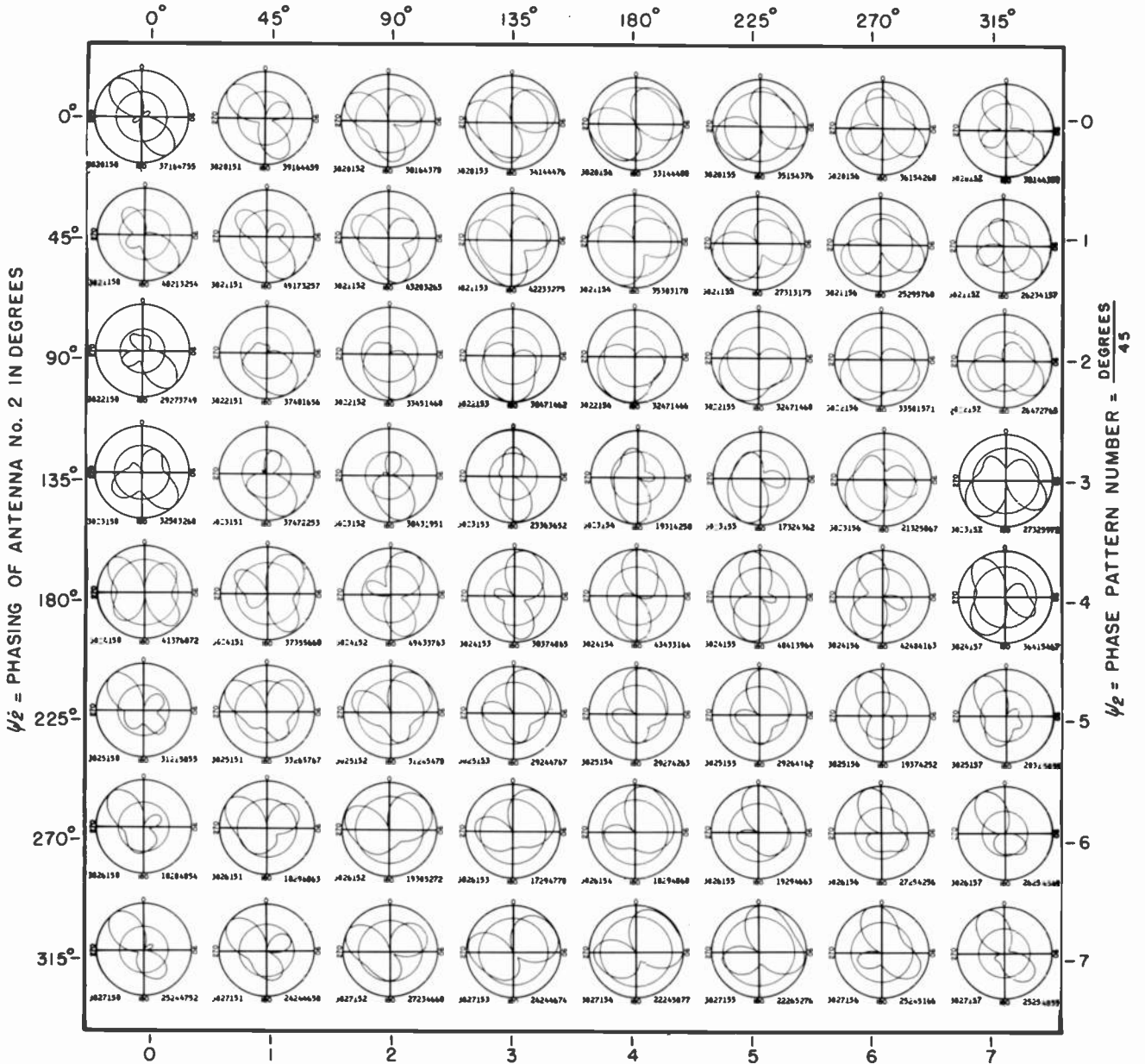

COPYRIGHT 1948 BY CARL E. SMITH  
PRINTED IN U. S. A.

CLEVELAND INSTITUTE OF RADIO ELECTRONICS  
TERMINAL TOWER, CLEVELAND 13, OHIO.

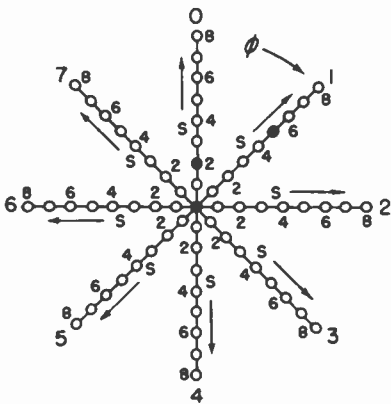

$\psi_3$  = PHASE PATTERN NUMBER =  $\frac{\text{DEGREES}}{45}$

NUMBER OF ANTENNAS IN THE SYSTEM	ORIENTATION OF NO. 2 ANTENNA = $\frac{\text{DEGREES}}{45}$	SPACING OF NO. 2 ANTENNA = $\frac{\text{DEGREES}}{45}$	PHASING OF NO. 2 ANTENNA = $\frac{\text{DEGREES}}{45}$	ORIENTATION OF NO. 3 ANTENNA = $\frac{\text{DEGREES}}{45}$	SPACING OF NO. 3 ANTENNA = $\frac{\text{DEGREES}}{45}$	PHASING OF NO. 3 ANTENNA = $\frac{\text{DEGREES}}{45}$
No. 3	$\phi_2$ 0	$S_2$ 2	$\psi_2$ 0	$\phi_3$ 1	$S_3$ 5	$\psi_3$ 0

LEFT HAND PATTERN NUMBER GIVES ANTENNA PLACEMENT AND PHASING DATA.

% FIELD INTENSITY RADIATED IN HORIZONTAL PLANE FROM NO. 1 ANTENNA.	% FIELD INTENSITY RADIATED IN HORIZONTAL PLANE FROM NO. 2 ANTENNA.	% FIELD INTENSITY RADIATED IN HORIZONTAL PLANE FROM NO. 3 ANTENNA.	% RMS FIELD INTENSITY RADIATED IN HORIZONTAL PLANE FROM ANTENNA SYSTEM.
$E_1$ 37	$E_2$ 16	$E_3$ 47	$E_0$ 55

RIGHT HAND PATTERN NUMBER GIVES ANTENNA FIELD INTENSITY DATA IN PERCENT.

SPOTS LOCATE THE ANTENNAS FOR THIS PAGE OF PATTERNS IN THE SYSTEMATIZATION PLACEMENT CHART.

PATTERN NOMENCLATURE

$\psi_3$  = PHASING OF ANTENNA No. 3 IN DEGREES

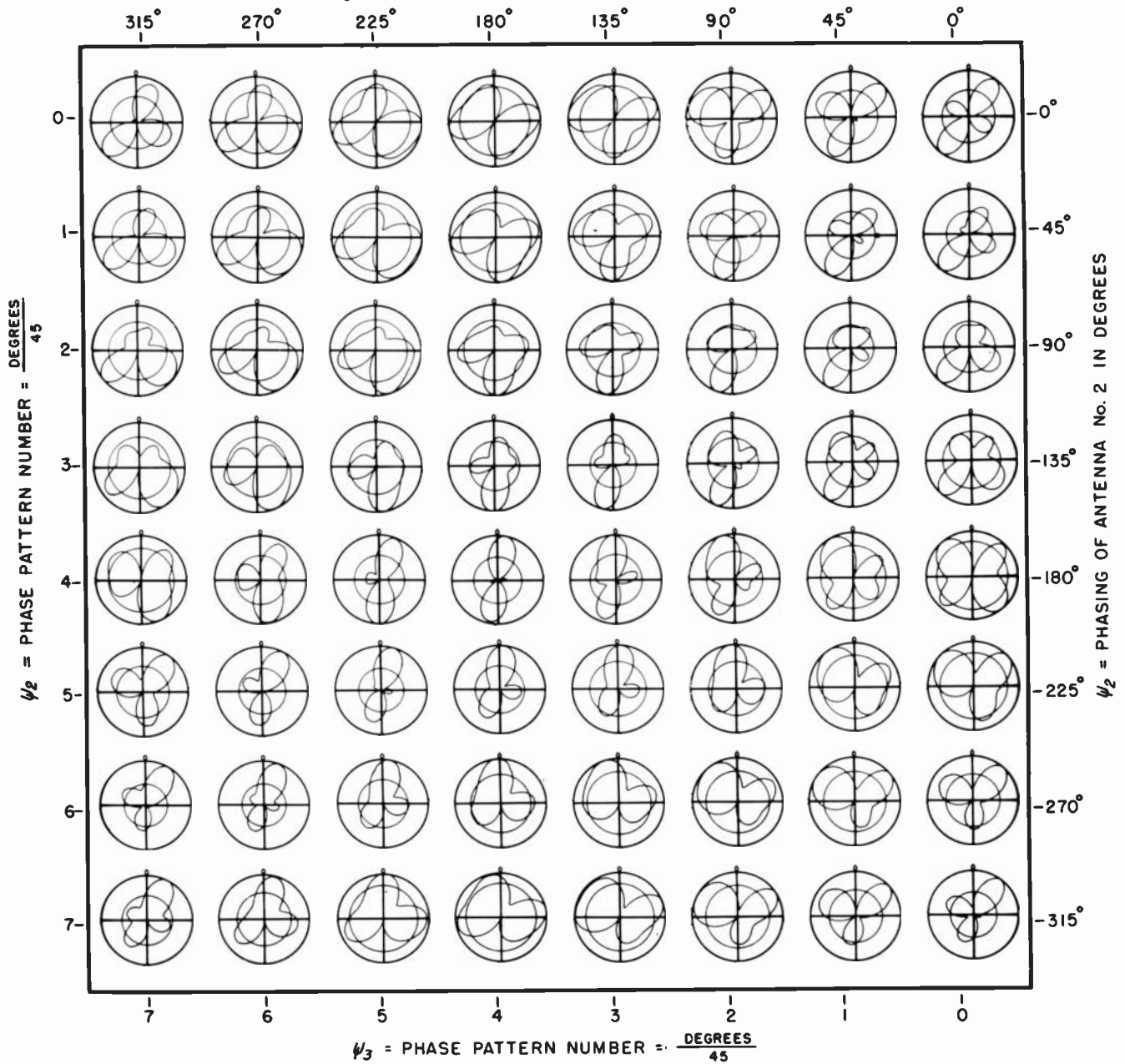

NUMBER OF ANTENNAS IN THE SYSTEM  
 NO. 3

ORIENTATION OF NO. 2 ANTENNA =  $\frac{\text{DEGREES}}{45}$   
 $\phi_2$  0

SPACING OF NO. 2 ANTENNA =  $\frac{\text{DEGREES}}{45}$   
 $S_2$  2

PHASING OF NO. 2 ANTENNA =  $\frac{\text{DEGREES}}{45}$   
 $\psi_2$  0

ORIENTATION OF NO. 3 ANTENNA =  $\frac{\text{DEGREES}}{45}$   
 $\phi_3$  7

SPACING OF NO. 3 ANTENNA =  $\frac{\text{DEGREES}}{45}$   
 $S_3$  6

PHASING OF NO. 3 ANTENNA =  $\frac{\text{DEGREES}}{45}$   
 $\psi_3$  0

LEFT HAND PATTERN NUMBER GIVES ANTENNA PLACEMENT AND PHASING DATA.

% FIELD INTENSITY RADIATED IN HORIZONTAL PLANE FROM NO. 1 ANTENNA.  
 $F_1$  37

% FIELD INTENSITY RADIATED IN HORIZONTAL PLANE FROM NO. 2 ANTENNA.  
 $F_2$  23

% FIELD INTENSITY RADIATED IN HORIZONTAL PLANE FROM NO. 3 ANTENNA.  
 $F_3$  44

% RMS FIELD INTENSITY RADIATED IN HORIZONTAL PLANE FROM ANTENNA SYSTEM.  
 $F_0$  58

RIGHT HAND PATTERN NUMBER GIVES ANTENNA FIELD INTENSITY DATA IN PERCENT.

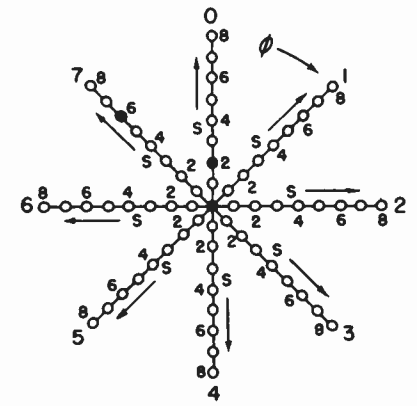

SPOTS LOCATE THE ANTENNAS FOR THIS PAGE OF PATTERNS IN THE SYSTEMATIZATION PLACEMENT CHART.

PATTERN NOMENCLATURE



$\psi_3$  = PHASING OF ANTENNA NO. 3 IN DEGREES

3.67

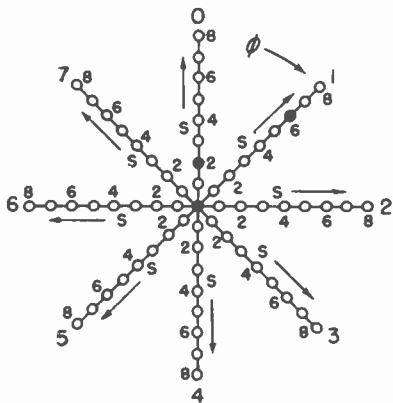
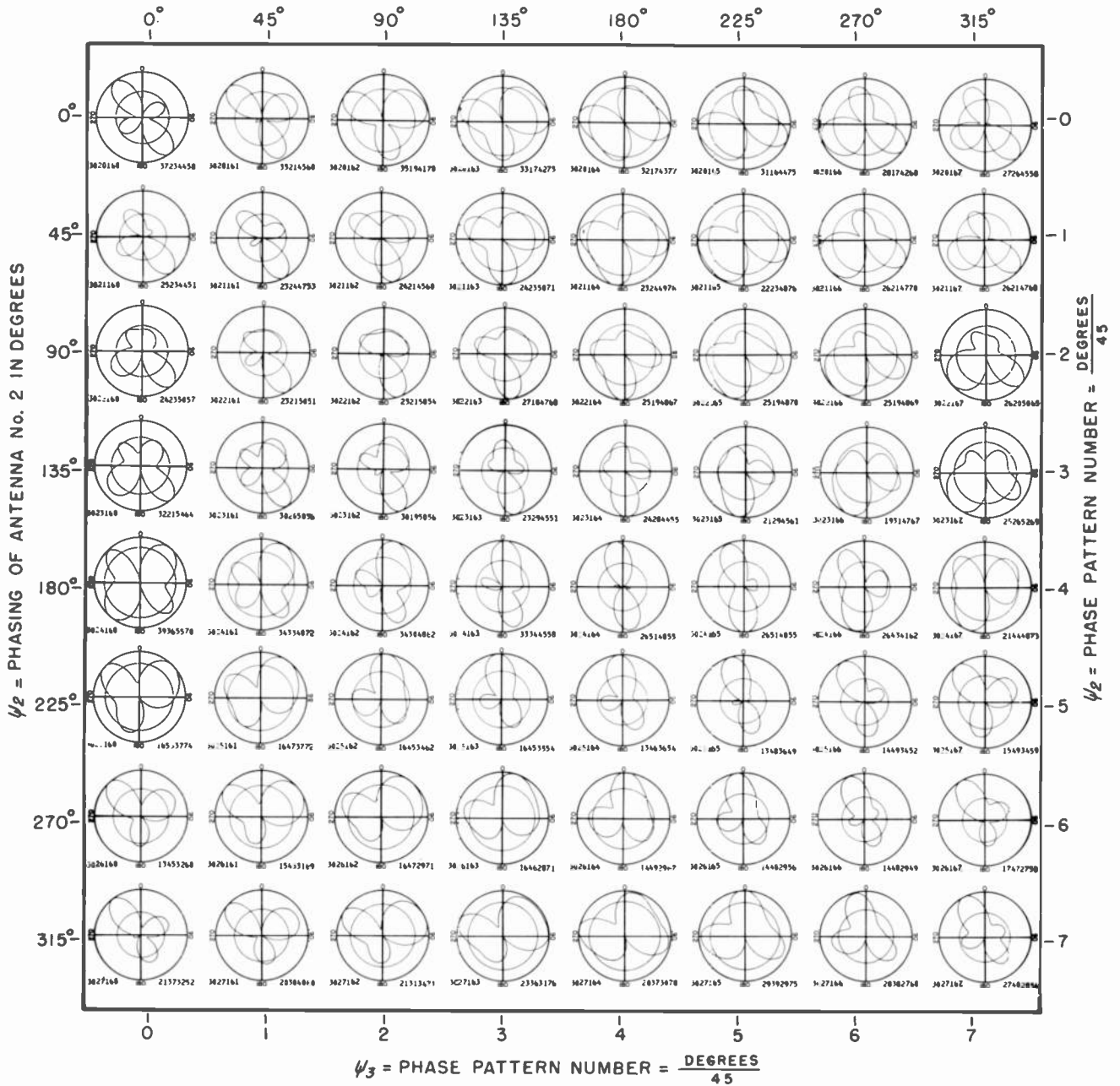

NUMBER OF ANTENNAS IN THE SYSTEM	ORIENTATION OF NO. 2 ANTENNA = $\frac{\text{DEGREES}}{45}$	SPACING OF NO. 2 ANTENNA = $\frac{\text{DEGREES}}{45}$	PHASING OF NO. 2 ANTENNA = $\frac{\text{DEGREES}}{45}$	ORIENTATION OF NO. 3 ANTENNA = $\frac{\text{DEGREES}}{45}$	SPACING OF NO. 3 ANTENNA = $\frac{\text{DEGREES}}{45}$	PHASING OF NO. 3 ANTENNA = $\frac{\text{DEGREES}}{45}$
No.	$\phi_2$	$S_2$	$\psi_2$	$\phi_3$	$S_3$	$\psi_3$
3	0	2	0	1	6	0

LEFT HAND PATTERN NUMBER GIVES ANTENNA PLACEMENT AND PHASING DATA.

% FIELD INTENSITY RADIATED IN HORIZONTAL PLANE FROM NO. 1 ANTENNA.	% FIELD INTENSITY RADIATED IN HORIZONTAL PLANE FROM NO. 2 ANTENNA.	% FIELD INTENSITY RADIATED IN HORIZONTAL PLANE FROM NO. 3 ANTENNA.	% RMS FIELD INTENSITY RADIATED IN HORIZONTAL PLANE FROM ANTENNA SYSTEM.
$E_1$	$E_2$	$E_3$	$E_0$
37	23	44	58

RIGHT HAND PATTERN NUMBER GIVES ANTENNA FIELD INTENSITY DATA IN PERCENT.

SPOTS LOCATE THE ANTENNAS FOR THIS PAGE OF PATTERNS IN THE SYSTEMATIZATION PLACEMENT CHART.

PATTERN NOMENCLATURE

$\psi_3$  = PHASING OF ANTENNA No. 3 IN DEGREES

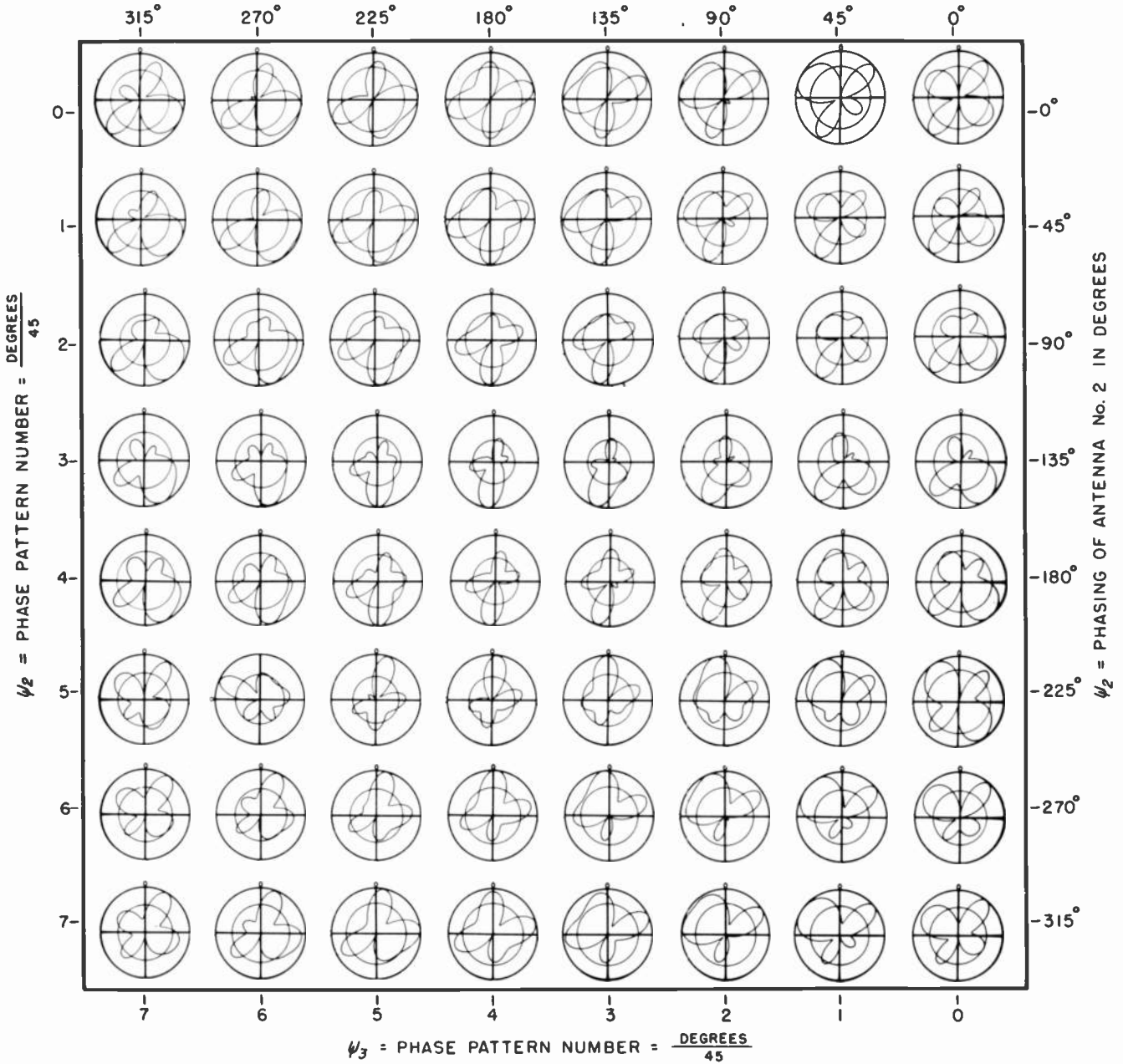

NUMBER OF ANTENNAS  
IN THE SYSTEM  
No. 3

ORIENTATION OF  
NO. 2 ANTENNA =  $\frac{\text{DEGREES}}{45}$   
 $\phi_2$  0

SPACING OF  
NO. 2 ANTENNA =  $\frac{\text{DEGREES}}{45}$   
 $S_2$  2

PHASING OF  
NO. 2 ANTENNA =  $\frac{\text{DEGREES}}{45}$   
 $\psi_2$  0

ORIENTATION OF  
NO. 3 ANTENNA =  $\frac{\text{DEGREES}}{45}$   
 $\phi_3$  7

SPACING OF  
NO. 3 ANTENNA =  $\frac{\text{DEGREES}}{45}$   
 $S_3$  7

PHASING OF  
NO. 3 ANTENNA =  $\frac{\text{DEGREES}}{45}$   
 $\psi_3$  0

% FIELD INTENSITY  
RADIATED IN HORIZONTAL  
PLANE FROM NO. 1 ANTENNA.  
 $E_1$  40

% FIELD INTENSITY  
RADIATED IN HORIZONTAL  
PLANE FROM NO. 2 ANTENNA.  
 $E_2$  16

% FIELD INTENSITY  
RADIATED IN HORIZONTAL  
PLANE FROM NO. 3 ANTENNA.  
 $E_3$  43

% RMS FIELD INTENSITY  
RADIATED IN HORIZONTAL  
PLANE FROM ANTENNA SYSTEM.  
 $E_0$  68

LEFT HAND PATTERN NUMBER GIVES ANTENNA  
PLACEMENT AND PHASING DATA.

RIGHT HAND PATTERN NUMBER  
GIVES ANTENNA FIELD INTEN-  
SITY DATA IN PERCENT.

PATTERN NOMENCLATURE

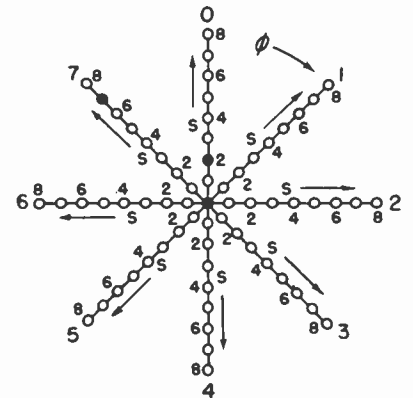

SPOTS LOCATE THE ANTENNAS FOR  
THIS PAGE OF PATTERNS IN THE  
SYSTEMATIZATION PLACEMENT CHART.

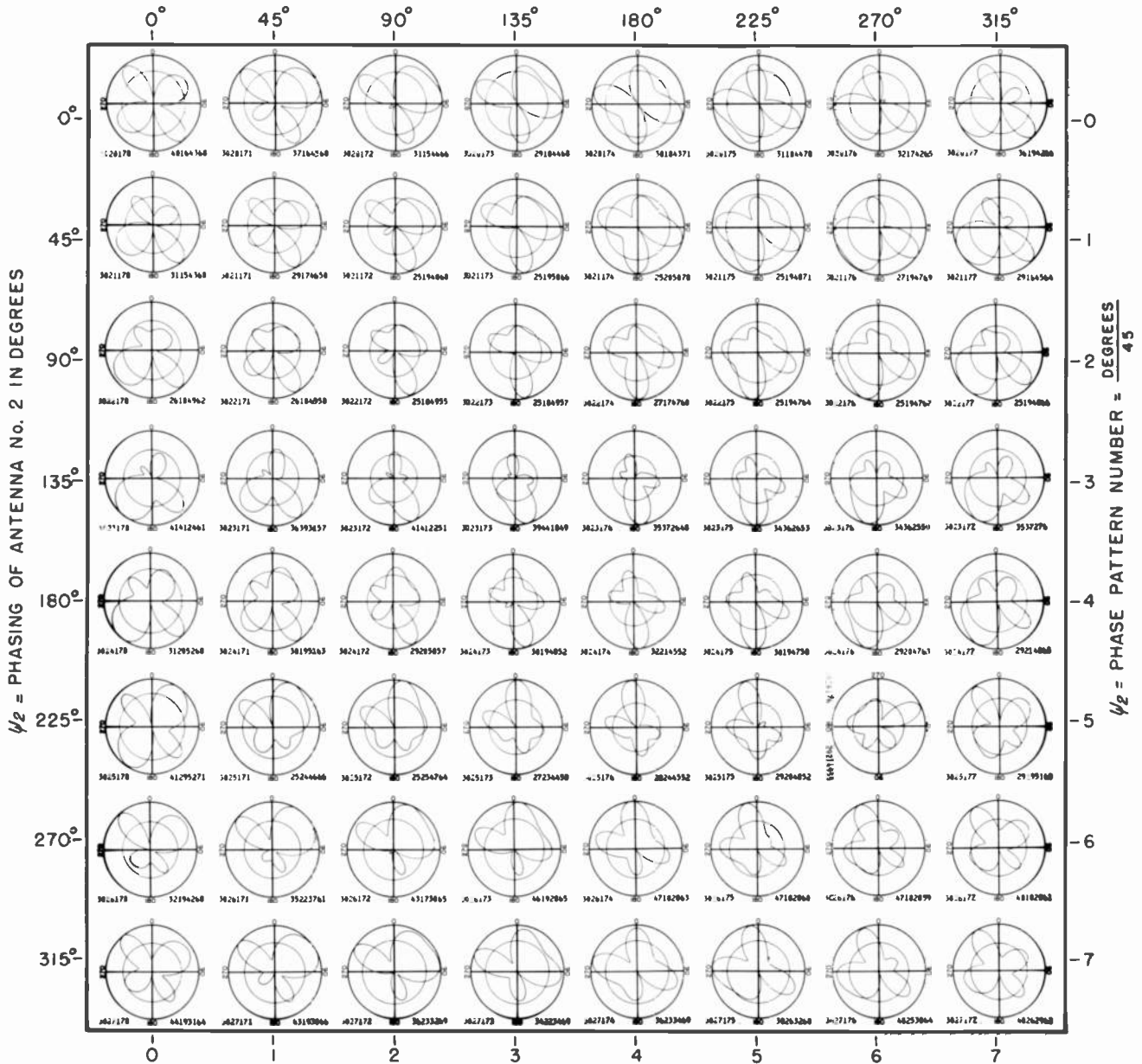

$\psi_3$  = PHASE PATTERN NUMBER =  $\frac{\text{DEGREES}}{45}$

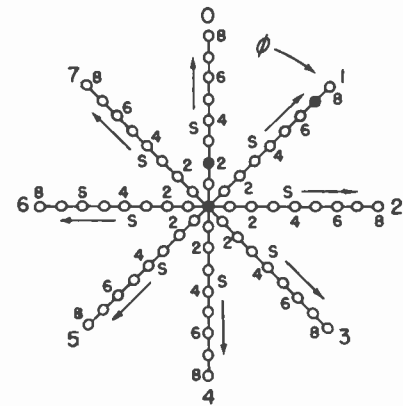

NUMBER OF ANTENNAS IN THE SYSTEM	ORIENTATION OF NO. 2 ANTENNA = $\frac{\text{DEGREES}}{45}$	SPACING OF NO. 2 ANTENNA = $\frac{\text{DEGREES}}{45}$	PHASING OF NO. 2 ANTENNA = $\frac{\text{DEGREES}}{45}$	ORIENTATION OF NO. 3 ANTENNA = $\frac{\text{DEGREES}}{45}$	SPACING OF NO. 3 ANTENNA = $\frac{\text{DEGREES}}{45}$	PHASING OF NO. 3 ANTENNA = $\frac{\text{DEGREES}}{45}$
No. 3	$\phi_2$	$S_2$	$\psi_2$	$\phi_3$	$S_3$	$\psi_3$
3	0	2	0	1	7	0

LEFT HAND PATTERN NUMBER GIVES ANTENNA PLACEMENT AND PHASING DATA.

% FIELD INTENSITY RADIATED IN HORIZONTAL PLANE FROM NO. 1 ANTENNA.	% FIELD INTENSITY RADIATED IN HORIZONTAL PLANE FROM NO. 2 ANTENNA.	% FIELD INTENSITY RADIATED IN HORIZONTAL PLANE FROM NO. 3 ANTENNA.	% RMS FIELD INTENSITY RADIATED IN HORIZONTAL PLANE FROM ANTENNA SYSTEM.
$E_1$	$E_2$	$E_3$	$E_0$
40	16	43	68

RIGHT HAND PATTERN NUMBER GIVES ANTENNA FIELD INTENSITY DATA IN PERCENT.

SPOTS LOCATE THE ANTENNAS FOR THIS PAGE OF PATTERNS IN THE SYSTEMATIZATION PLACEMENT CHART.

PATTERN NOMENCLATURE

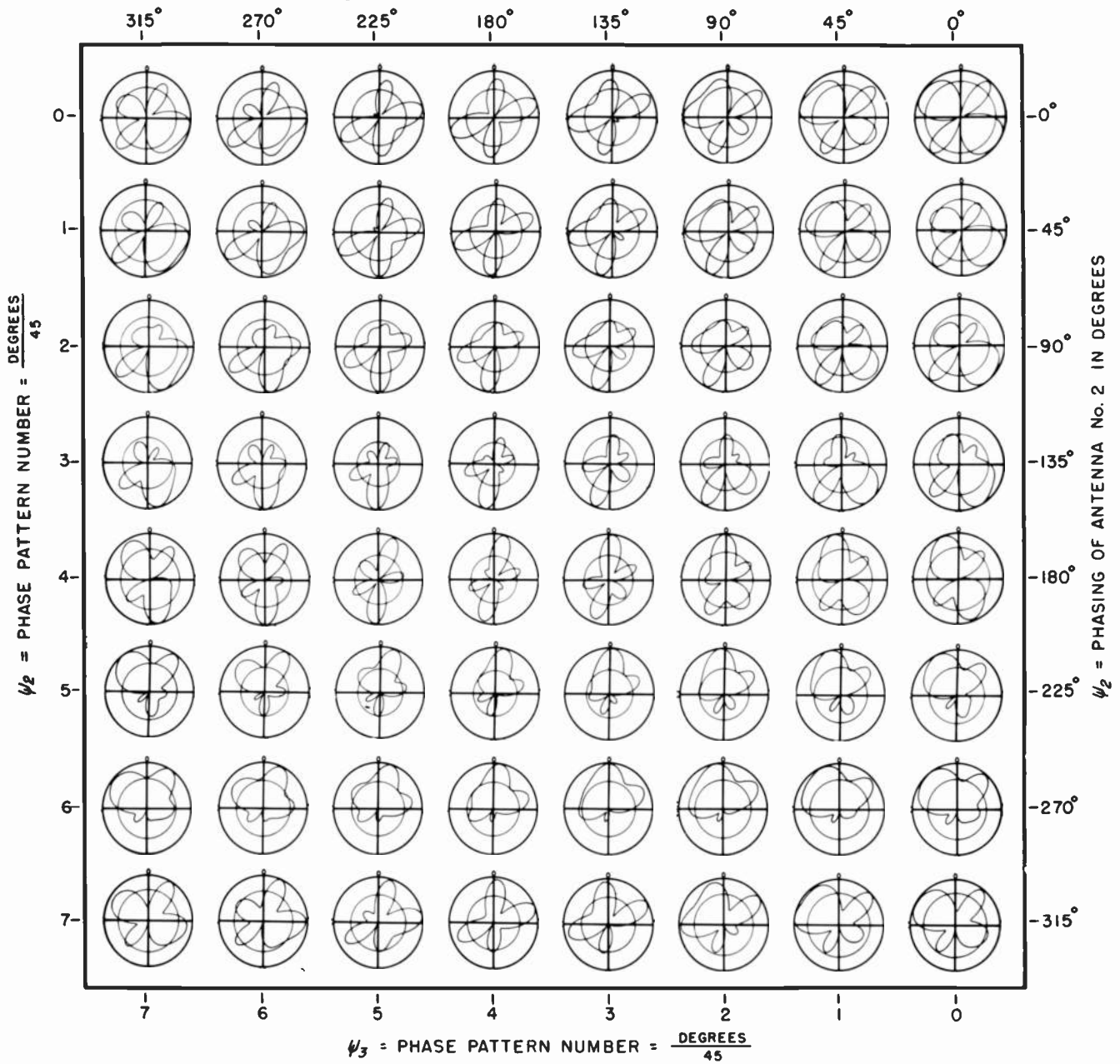

NUMBER OF ANTENNAS IN THE SYSTEM		ORIENTATION OF ANTENNA = $\frac{DEGREES}{45}$		SPACING OF ANTENNA = $\frac{DEGREES}{45}$		PHASING OF ANTENNA = $\frac{DEGREES}{45}$		ORIENTATION OF ANTENNA = $\frac{DEGREES}{45}$		SPACING OF ANTENNA = $\frac{DEGREES}{45}$		PHASING OF ANTENNA = $\frac{DEGREES}{45}$		% FIELD INTENSITY RADIATED IN HORIZONTAL PLANE FROM NO. 1 ANTENNA.		% FIELD INTENSITY RADIATED IN HORIZONTAL PLANE FROM NO. 2 ANTENNA.		% FIELD INTENSITY RADIATED IN HORIZONTAL PLANE FROM NO. 3 ANTENNA.		% RMS FIELD INTENSITY RADIATED IN HORIZONTAL PLANE FROM ANTENNA SYSTEM.	
No.	$\phi_2$	$S_2$	$\psi_2$	$\phi_3$	$S_3$	$\psi_3$	$E_1$	$E_2$	$E_3$	$E_0$											
3	0	2	0	7	8	0	43	07	46	78											

LEFT HAND PATTERN NUMBER GIVES ANTENNA PLACEMENT AND PHASING DATA.

RIGHT HAND PATTERN NUMBER GIVES ANTENNA FIELD INTENSITY DATA IN PERCENT.

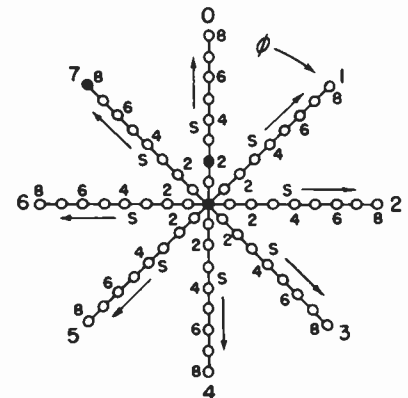

SPOTS LOCATE THE ANTENNAS FOR THIS PAGE OF PATTERNS IN THE SYSTEMATIZATION PLACEMENT CHART.

PATTERN NOMENCLATURE

$\psi_3 =$  PHASING OF ANTENNA No. 3 IN DEGREES

3.71

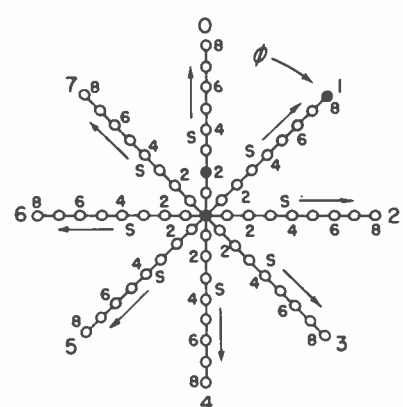
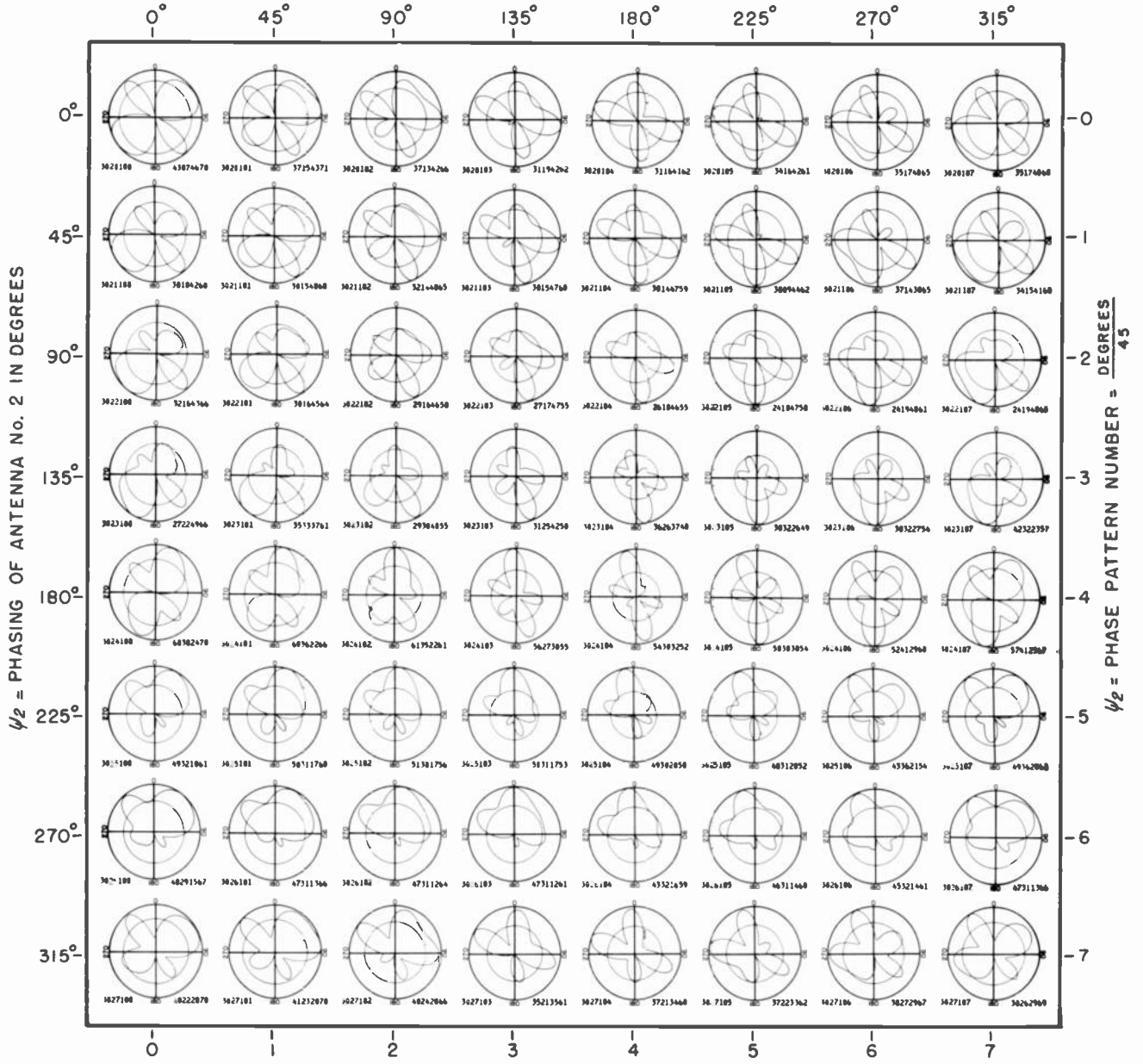

$\psi_3 =$  PHASE PATTERN NUMBER =  $\frac{\text{DEGREES}}{45}$

NUMBER OF ANTENNAS IN THE SYSTEM	ORIENTATION OF NO. 2 ANTENNA = $\frac{\text{DEGREES}}{45}$	SPACING OF NO. 2 ANTENNA = $\frac{\text{DEGREES}}{45}$	PHASING OF NO. 2 ANTENNA = $\frac{\text{DEGREES}}{45}$	ORIENTATION OF NO. 3 ANTENNA = $\frac{\text{DEGREES}}{45}$	SPACING OF NO. 3 ANTENNA = $\frac{\text{DEGREES}}{45}$	PHASING OF NO. 3 ANTENNA = $\frac{\text{DEGREES}}{45}$
No.	$\phi_2$	$S_2$	$\psi_2$	$\phi_3$	$S_3$	$\psi_3$
3	0	2	0	1	8	0

LEFT HAND PATTERN NUMBER GIVES ANTENNA PLACEMENT AND PHASING DATA.

% FIELD INTENSITY RADIATED IN HORIZONTAL PLANE FROM NO. 1 ANTENNA.	% FIELD INTENSITY RADIATED IN HORIZONTAL PLANE FROM NO. 2 ANTENNA.	% FIELD INTENSITY RADIATED IN HORIZONTAL PLANE FROM NO. 3 ANTENNA.	% RMS FIELD INTENSITY RADIATED IN HORIZONTAL PLANE FROM ANTENNA SYSTEM.
$E_1$	$E_2$	$E_3$	$E_0$
43	07	46	78

RIGHT HAND PATTERN NUMBER GIVES ANTENNA FIELD INTENSITY DATA IN PERCENT.

SPOTS LOCATE THE ANTENNAS FOR THIS PAGE OF PATTERNS IN THE SYSTEMATIZATION PLACEMENT CHART.

PATTERN NOMENCLATURE

$\psi_3$  = PHASING OF ANTENNA No. 3 IN DEGREES

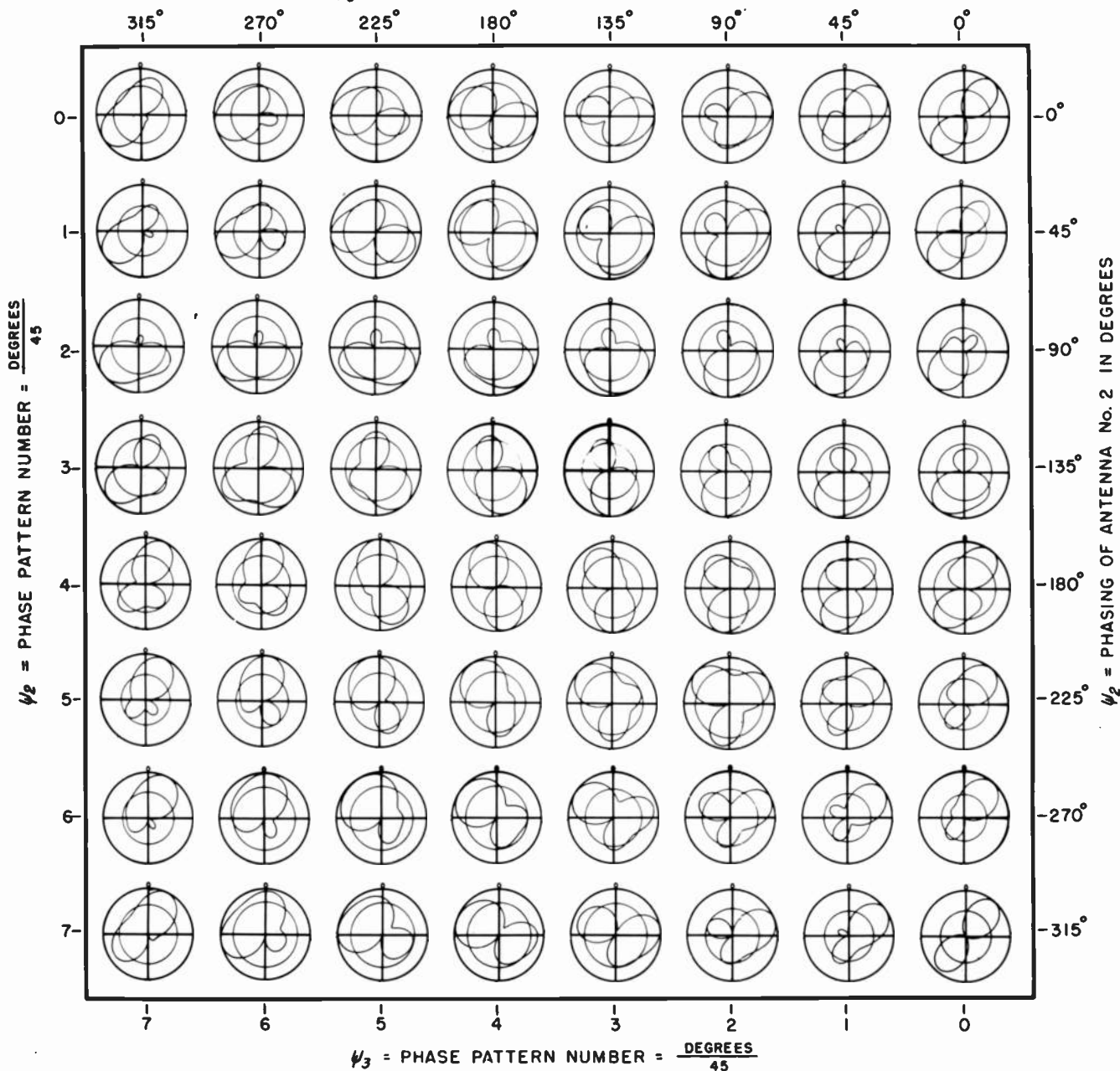

NUMBER OF ANTENNAS IN THE SYSTEM  
 $\psi_2$  = PHASE PATTERN NUMBER =  $\frac{\text{DEGREES}}{45}$

ORIENTATION OF NO. 2 ANTENNA =  $\frac{\text{DEGREES}}{45}$   
 $\psi_2$

SPACING OF NO. 2 ANTENNA =  $\frac{\text{DEGREES}}{45}$   
 $S_2$

PHASING OF NO. 2 ANTENNA =  $\frac{\text{DEGREES}}{45}$   
 $\psi_2$

ORIENTATION OF NO. 3 ANTENNA =  $\frac{\text{DEGREES}}{45}$   
 $\psi_3$

SPACING OF NO. 3 ANTENNA =  $\frac{\text{DEGREES}}{45}$   
 $S_3$

PHASING OF NO. 3 ANTENNA =  $\frac{\text{DEGREES}}{45}$   
 $\psi_3$

% FIELD INTENSITY RADIATED IN HORIZONTAL PLANE FROM NO. 1 ANTENNA.  
 $F_1$

% FIELD INTENSITY RADIATED IN HORIZONTAL PLANE FROM NO. 2 ANTENNA.  
 $F_2$

% FIELD INTENSITY RADIATED IN HORIZONTAL PLANE FROM NO. 3 ANTENNA.  
 $F_3$

% RMS FIELD INTENSITY RADIATED IN HORIZONTAL PLANE FROM ANTENNA SYSTEM.  
 $F_0$

LEFT HAND PATTERN NUMBER GIVES ANTENNA PLACEMENT AND PHASING DATA.

RIGHT HAND PATTERN NUMBER GIVES ANTENNA FIELD INTENSITY DATA IN PERCENT.

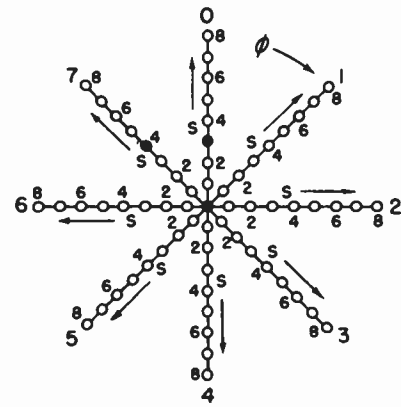

SPOTS LOCATE THE ANTENNAS FOR THIS PAGE OF PATTERNS IN THE SYSTEMIZATION PLACEMENT CHART.

PATTERN NOMENCLATURE

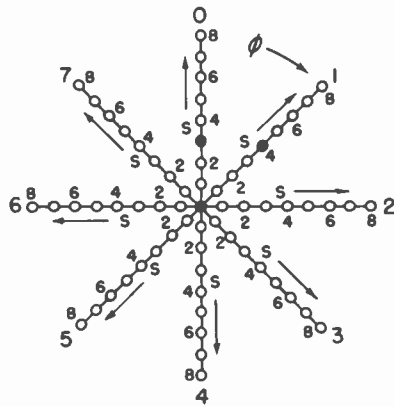
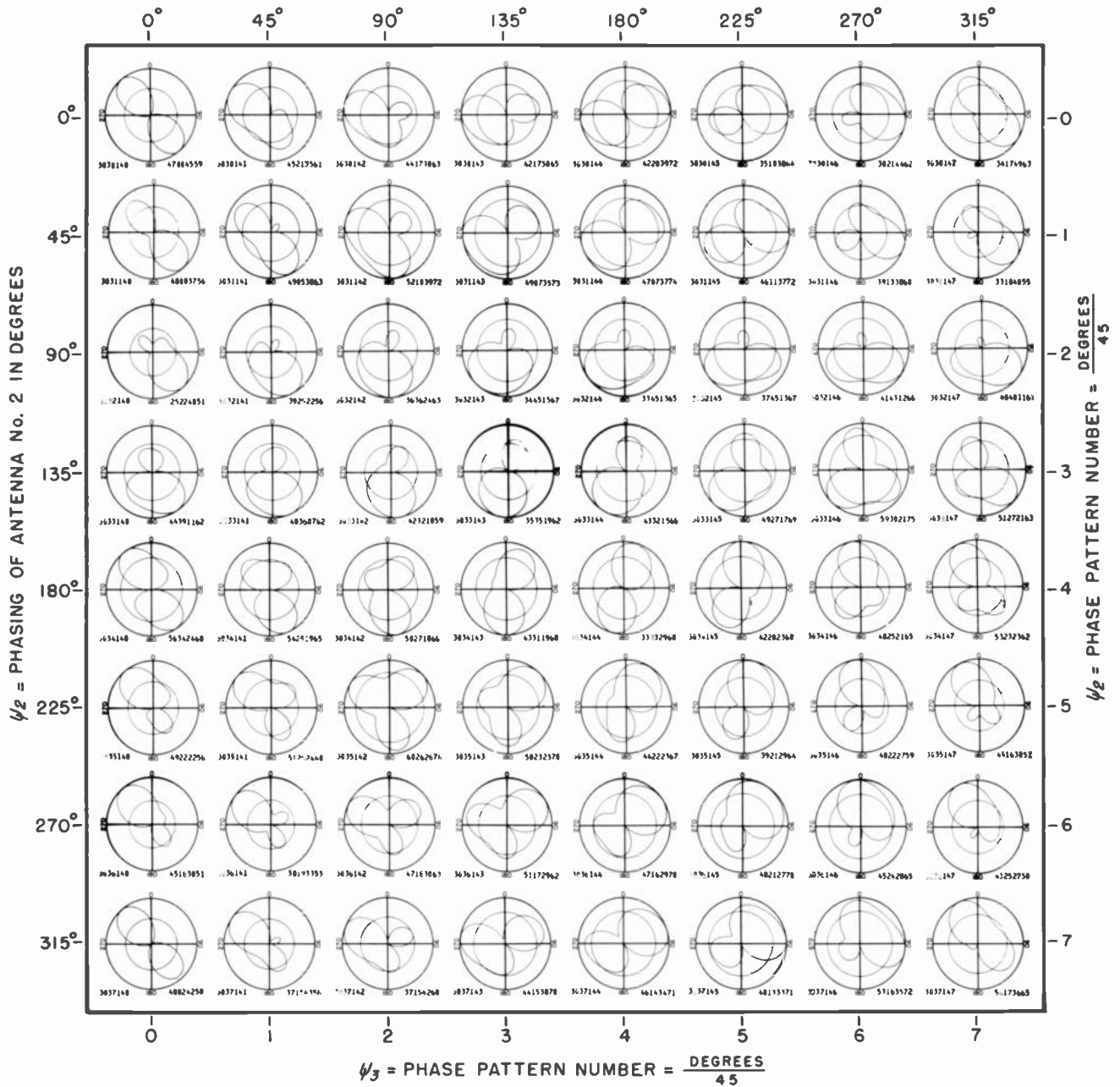

SPOTS LOCATE THE ANTENNAS FOR THIS PAGE OF PATTERNS IN THE SYSTEMATIZATION PLACEMENT CHART.

NUMBER OF ANTENNAS IN THE SYSTEM	ORIENTATION OF NO. 2 ANTENNA = $\frac{\text{DEGREES}}{45}$	SPACING OF NO. 2 ANTENNA = $\frac{\text{DEGREES}}{45}$	PHASING OF NO. 2 ANTENNA = $\frac{\text{DEGREES}}{45}$	ORIENTATION OF NO. 3 ANTENNA = $\frac{\text{DEGREES}}{45}$	SPACING OF NO. 3 ANTENNA = $\frac{\text{DEGREES}}{45}$	PHASING OF NO. 3 ANTENNA = $\frac{\text{DEGREES}}{45}$
No. 3	$\phi_2$ 0	$S_2$ 3	$\psi_2$ 0	$\phi_3$ 1	$S_3$ 4	$\psi_3$ 0

LEFT HAND PATTERN NUMBER GIVES ANTENNA PLACEMENT AND PHASING DATA.

% FIELD INTENSITY RADIATED IN HORIZONTAL PLANE FROM NO. 1 ANTENNA.	% FIELD INTENSITY RADIATED IN HORIZONTAL PLANE FROM NO. 2 ANTENNA.	% FIELD INTENSITY RADIATED IN HORIZONTAL PLANE FROM NO. 3 ANTENNA.	% RMS FIELD INTENSITY RADIATED IN HORIZONTAL PLANE FROM ANTENNA SYSTEM.
$F_1$ 47	$F_2$ 00	$F_3$ 45	$F_0$ 59

RIGHT HAND PATTERN NUMBER GIVES ANTENNA FIELD INTENSITY DATA IN PERCENT.

PATTERN NOMENCLATURE

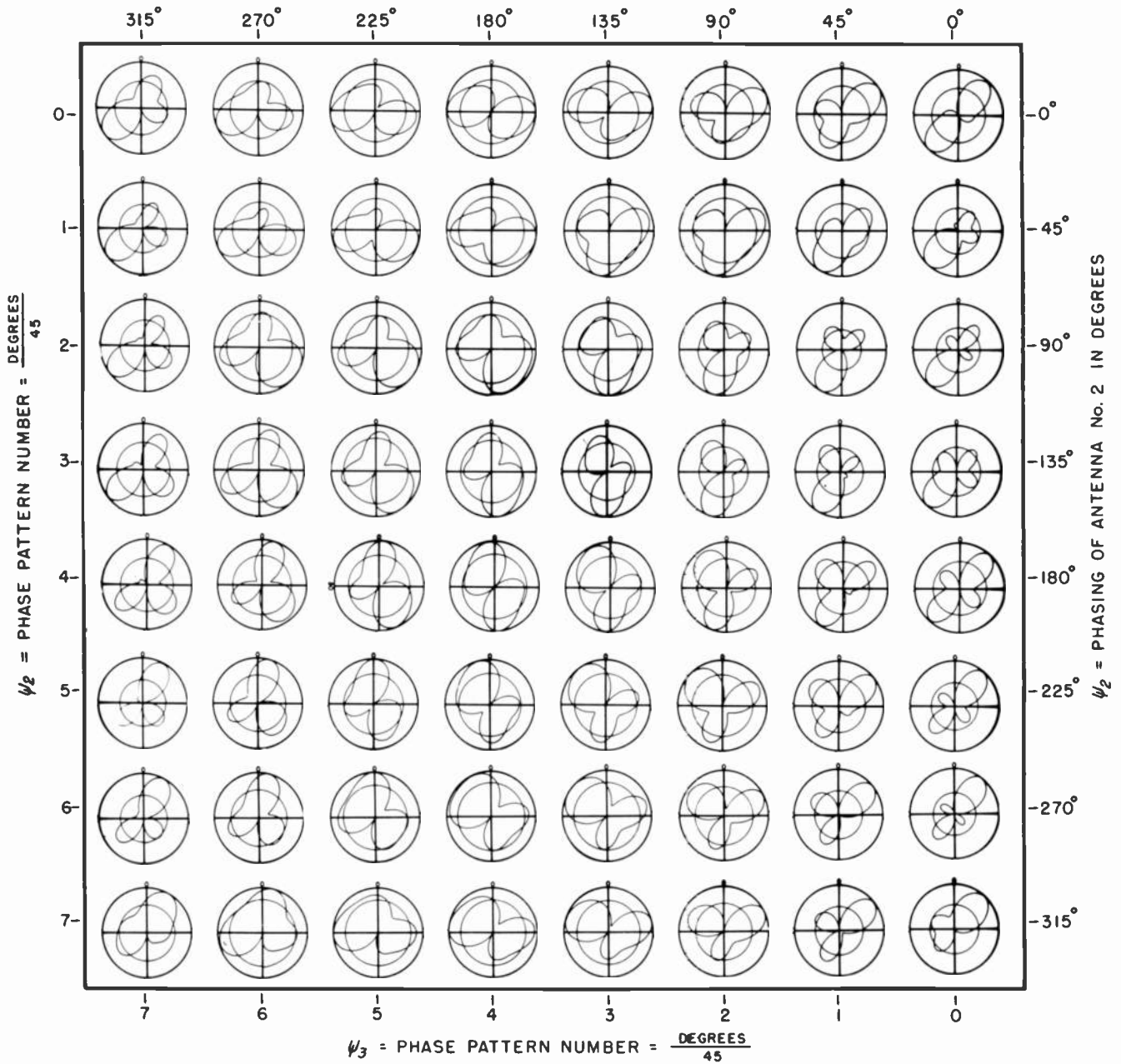

NUMBER OF ANTENNAS IN THE SYSTEM	$\psi_2 = \frac{\text{DEGREES}}{45}$	
ORIENTATION OF NO. 2 ANTENNA	$\phi_2 = \frac{\text{DEGREES}}{45}$	
SPACING OF NO. 2 ANTENNA	$S_2 = \frac{\text{DEGREES}}{45}$	
PHASING OF NO. 2 ANTENNA	$\psi_2 = \frac{\text{DEGREES}}{45}$	
ORIENTATION OF NO. 3 ANTENNA	$\phi_3 = \frac{\text{DEGREES}}{45}$	
SPACING OF NO. 3 ANTENNA	$S_3 = \frac{\text{DEGREES}}{45}$	
PHASING OF NO. 3 ANTENNA	$\psi_3 = \frac{\text{DEGREES}}{45}$	
NO.	$\phi_2$	$S_2$
3	0	3

LEFT HAND PATTERN NUMBER GIVES ANTENNA PLACEMENT AND PHASING DATA.

% FIELD INTENSITY RADIATED IN HORIZONTAL PLANE FROM NO. 1 ANTENNA.	$E_1$	51
% FIELD INTENSITY RADIATED IN HORIZONTAL PLANE FROM NO. 2 ANTENNA.	$E_2$	25
% FIELD INTENSITY RADIATED IN HORIZONTAL PLANE FROM NO. 3 ANTENNA.	$E_3$	42
% RMS FIELD INTENSITY RADIATED IN HORIZONTAL PLANE FROM ANTENNA SYSTEM.	$E_0$	60

RIGHT HAND PATTERN NUMBER GIVES ANTENNA FIELD INTENSITY DATA IN PERCENT.

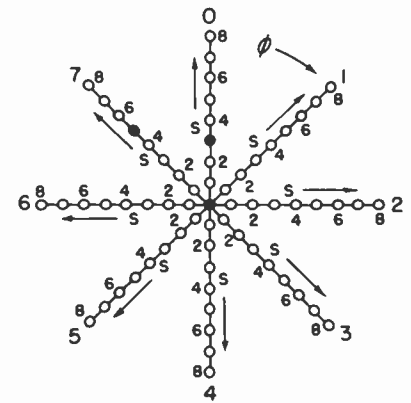

SPOTS LOCATE THE ANTENNAS FOR THIS PAGE OF PATTERNS IN THE SYSTEMATIZATION PLACEMENT CHART.

PATTERN NOMENCLATURE



$\psi_3$  = PHASING OF ANTENNA No. 3 IN DEGREES

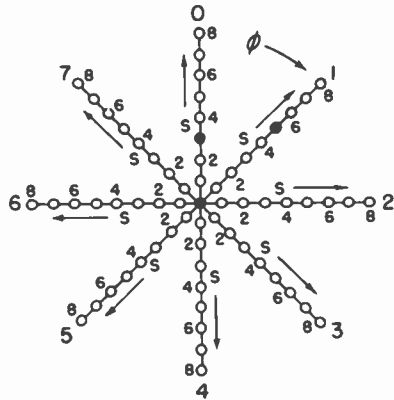
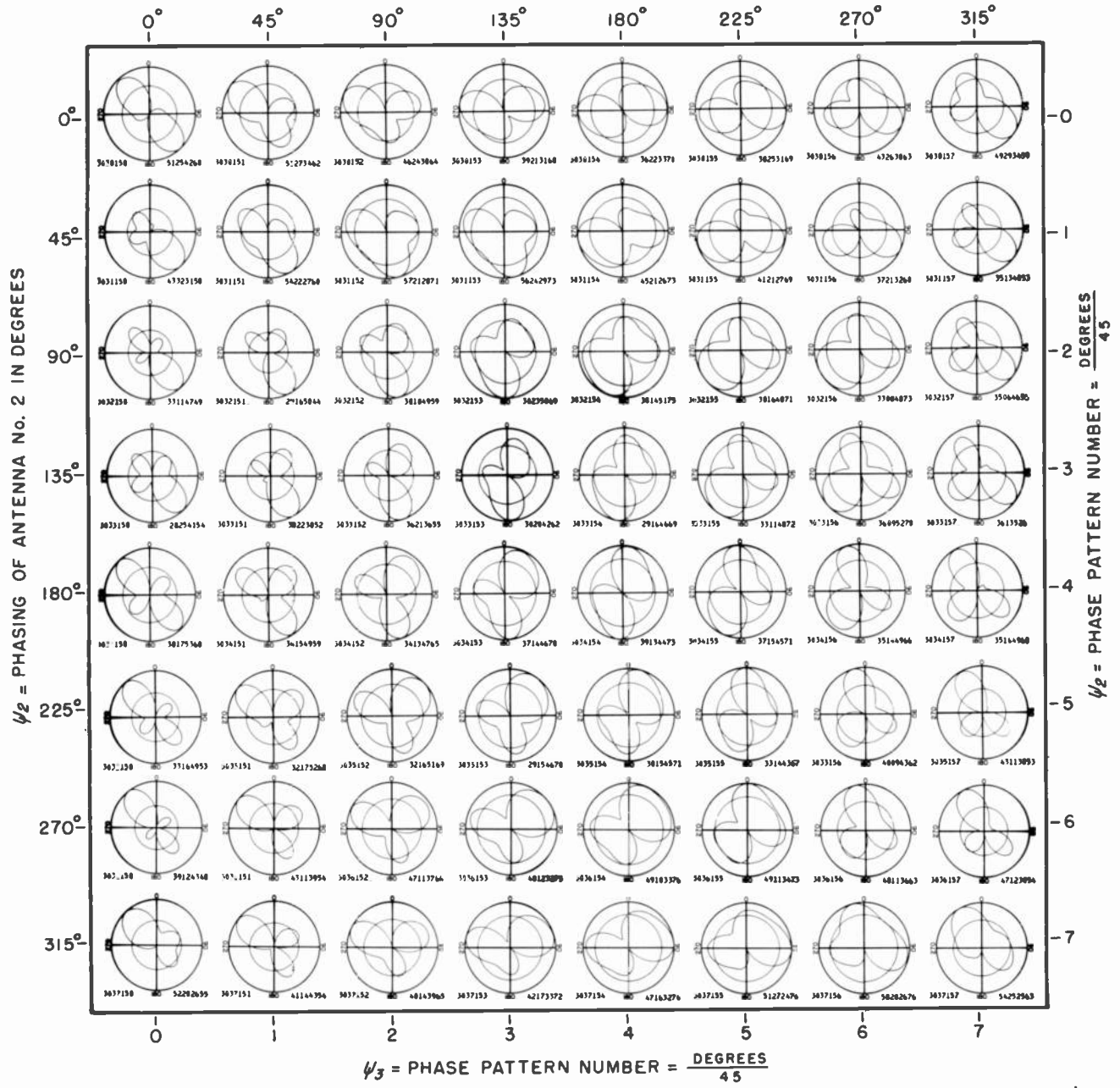

SPOTS LOCATE THE ANTENNAS FOR THIS PAGE OF PATTERNS IN THE SYSTEMATIZATION PLACEMENT CHART.

$\psi_3$  = PHASE PATTERN NUMBER =  $\frac{\text{DEGREES}}{45}$

NO.	$\phi_2$	$S_2$	$\psi_2$	$\phi_3$	$S_3$	$\psi_3$
3	0	3	0	1	5	0

LEFT HAND PATTERN NUMBER GIVES ANTENNA PLACEMENT AND PHASING DATA.

$E_1$	$E_2$	$E_3$	$E_0$
51	25	42	60

RIGHT HAND PATTERN NUMBER GIVES ANTENNA FIELD INTENSITY DATA IN PERCENT.

PATTERN NOMENCLATURE

$\psi_3$  = PHASING OF ANTENNA No. 3 IN DEGREES

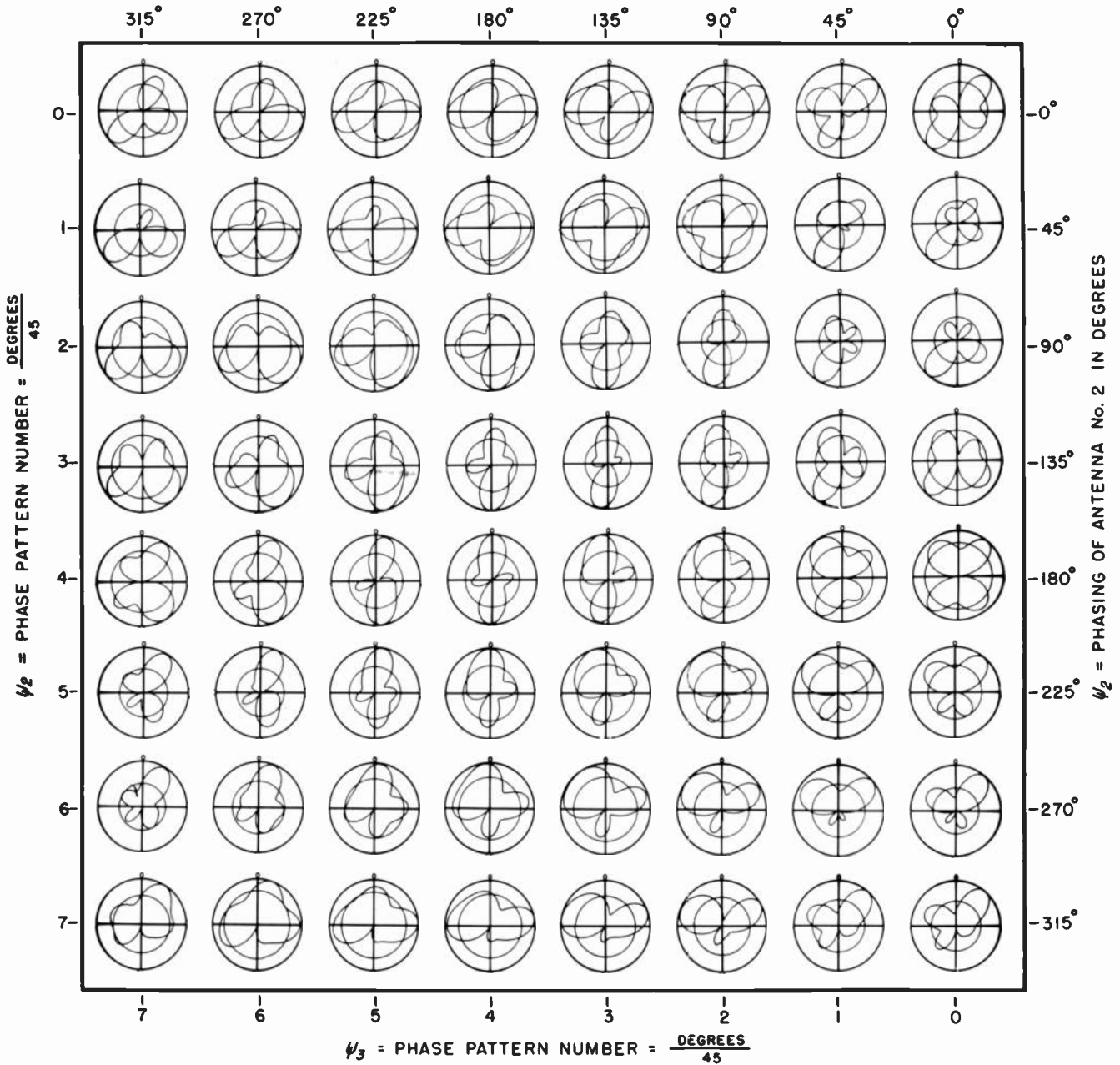

NUMBER OF ANTENNAS  
IN THE SYSTEM

No. 3

ORIENTATION OF ANTENNA No. 2  
 $\psi_2 = 0$

SPACING OF ANTENNA No. 2  
 $S_2 = 3$

PHASING OF ANTENNA No. 2  
 $\psi_2 = 0$

ORIENTATION OF ANTENNA No. 3  
 $\psi_3 = 7$

SPACING OF ANTENNA No. 3  
 $S_3 = 6$

PHASING OF ANTENNA No. 3  
 $\psi_3 = 0$

% FIELD INTENSITY RADIATED IN HORIZONTAL PLANE FROM NO. 1 ANTENNA.  
 $E_1 = 55$

% FIELD INTENSITY RADIATED IN HORIZONTAL PLANE FROM NO. 2 ANTENNA.  
 $E_2 = 29$

% FIELD INTENSITY RADIATED IN HORIZONTAL PLANE FROM NO. 3 ANTENNA.  
 $E_3 = 37$

% RMS FIELD INTENSITY RADIATED IN HORIZONTAL PLANE FROM ANTENNA SYSTEM.  
 $E_0 = 63$

LEFT HAND PATTERN NUMBER GIVES ANTENNA PLACEMENT AND PHASING DATA.

RIGHT HAND PATTERN NUMBER GIVES ANTENNA FIELD INTENSITY DATA IN PERCENT.

PATTERN NOMENCLATURE

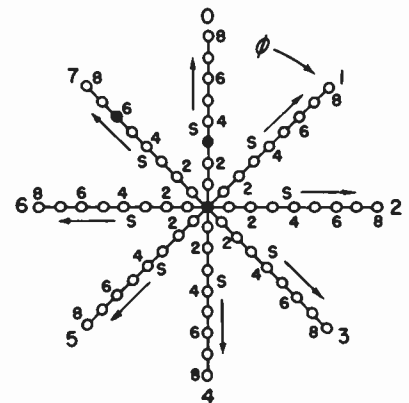

SPOTS LOCATE THE ANTENNAS FOR THIS PAGE OF PATTERNS IN THE SYSTEMIZATION PLACEMENT CHART.

$\psi_3 =$  PHASING OF ANTENNA No. 3 IN DEGREES

3.77

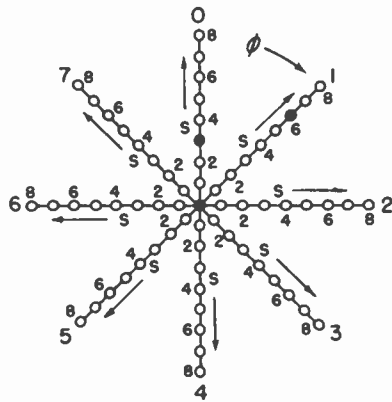
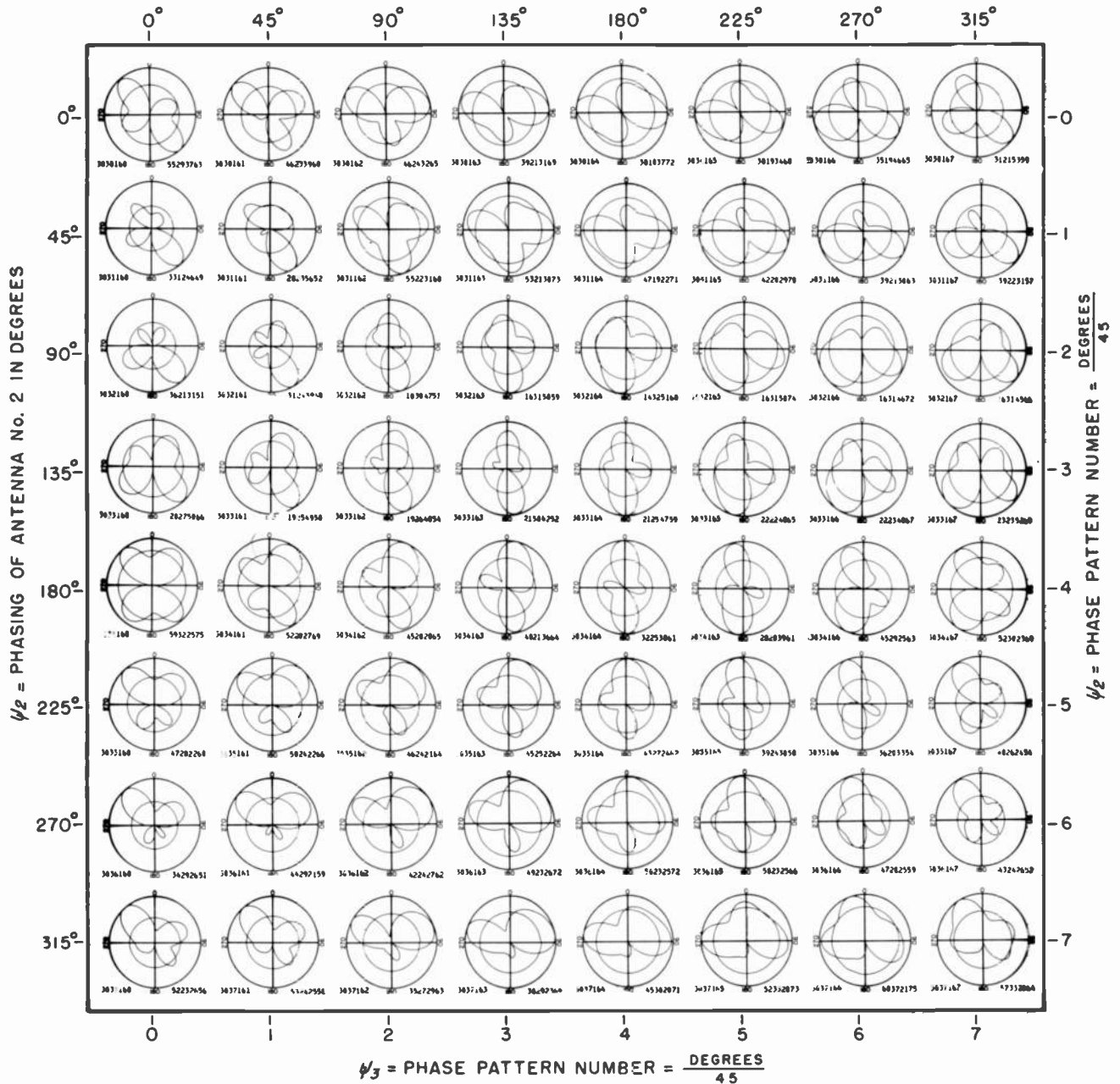

SPOTS LOCATE THE ANTENNAS FOR THIS PAGE OF PATTERNS IN THE SYSTEMIZATION PLACEMENT CHART.

NUMBER OF ANTENNAS IN THE SYSTEM	ORIENTATION OF NO. 2 ANTENNA = $\frac{\text{DEGREES}}{45}$	SPACING OF NO. 2 ANTENNA = $\frac{\text{DEGREES}}{45}$	PHASING OF NO. 2 ANTENNA = $\frac{\text{DEGREES}}{45}$	ORIENTATION OF NO. 3 ANTENNA = $\frac{\text{DEGREES}}{45}$	SPACING OF NO. 3 ANTENNA = $\frac{\text{DEGREES}}{45}$	PHASING OF NO. 3 ANTENNA = $\frac{\text{DEGREES}}{45}$
$N_0$	$\phi_2$	$S_2$	$\psi_2$	$\phi_3$	$S_3$	$\psi_3$
3	0	3	0	1	6	0

LEFT HAND PATTERN NUMBER GIVES ANTENNA PLACEMENT AND PHASING DATA.

% FIELD INTENSITY RADIATED IN HORIZONTAL PLANE FROM NO. 1 ANTENNA.	% FIELD INTENSITY RADIATED IN HORIZONTAL PLANE FROM NO. 2 ANTENNA.	% FIELD INTENSITY RADIATED IN HORIZONTAL PLANE FROM NO. 3 ANTENNA.	% RMS FIELD INTENSITY RADIATED IN HORIZONTAL PLANE FROM ANTENNA SYSTEM.
$E_1$	$E_2$	$E_3$	$E_0$
55	29	37	63

RIGHT HAND PATTERN NUMBER GIVES ANTENNA FIELD INTENSITY DATA IN PERCENT.

PATTERN NOMENCLATURE

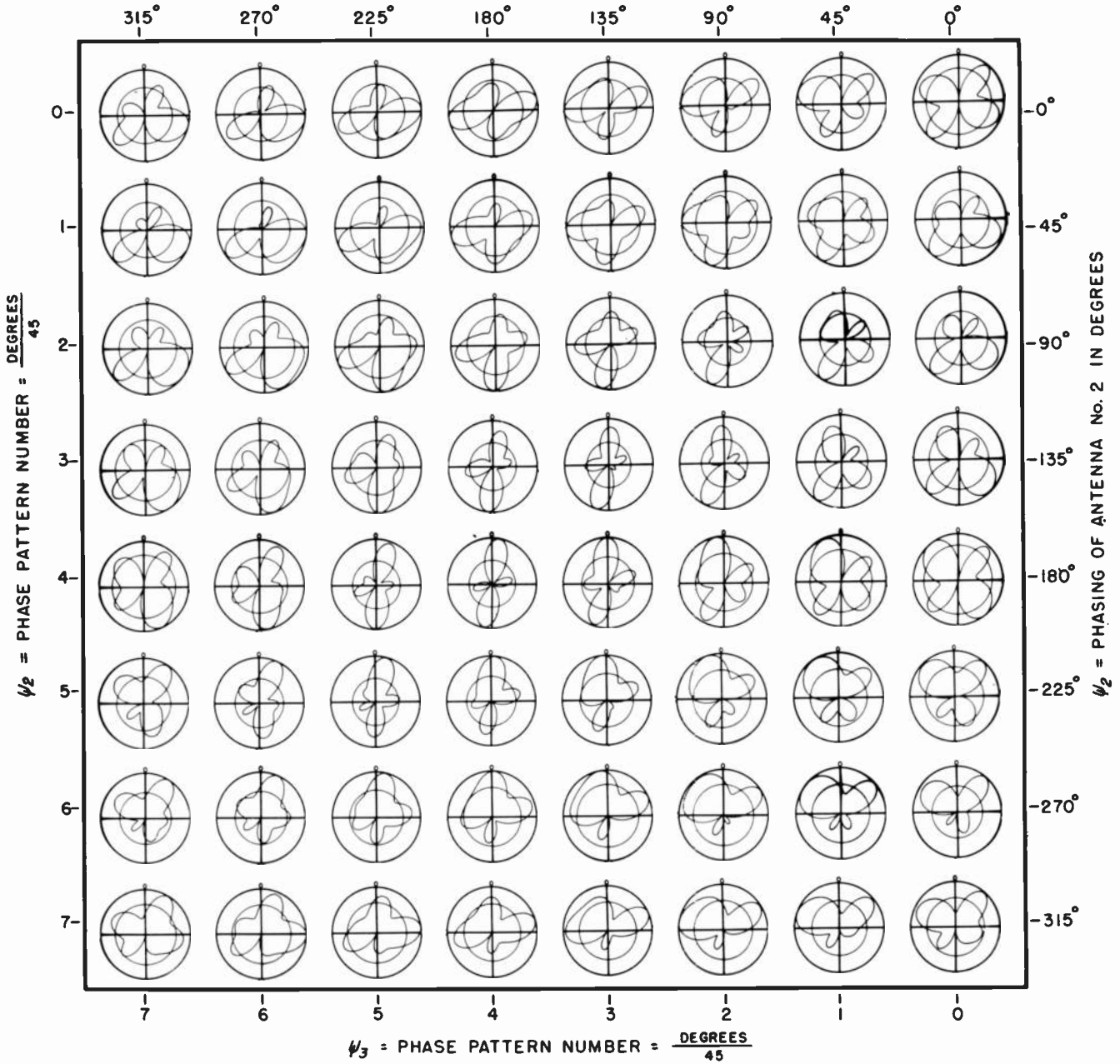

NUMBER OF ANTENNAS IN THE SYSTEM

ORIENTATION OF NO. 2 ANTENNA =  $\frac{\text{DEGREES}}{45}$

SPACING OF NO. 2 ANTENNA =  $\frac{\text{DEGREES}}{45}$

PHASING OF NO. 2 ANTENNA =  $\frac{\text{DEGREES}}{45}$

ORIENTATION OF NO. 3 ANTENNA =  $\frac{\text{DEGREES}}{45}$

SPACING OF NO. 3 ANTENNA =  $\frac{\text{DEGREES}}{45}$

PHASING OF NO. 3 ANTENNA =  $\frac{\text{DEGREES}}{45}$

% FIELD INTENSITY RADIATED IN HORIZONTAL PLANE FROM NO. 1 ANTENNA.

% FIELD INTENSITY RADIATED IN HORIZONTAL PLANE FROM NO. 2 ANTENNA.

% FIELD INTENSITY RADIATED IN HORIZONTAL PLANE FROM NO. 3 ANTENNA.

% RMS FIELD INTENSITY RADIATED IN HORIZONTAL PLANE FROM ANTENNA SYSTEM.

LEFT HAND PATTERN NUMBER GIVES ANTENNA PLACEMENT AND PHASING DATA.

RIGHT HAND PATTERN NUMBER GIVES ANTENNA FIELD INTENSITY DATA IN PERCENT.

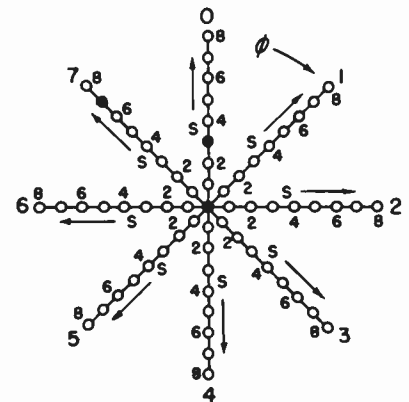

SPOTS LOCATE THE ANTENNAS FOR THIS PAGE OF PATTERNS IN THE SYSTEMATIZATION PLACEMENT CHART.

PATTERN NOMENCLATURE

LEFT HAND PATTERN NUMBER GIVES ANTENNA PLACEMENT AND PHASING DATA. RIGHT HAND PATTERN NUMBER GIVES ANTENNA FIELD INTENSITY DATA IN PERCENT.

$\psi_3$  = PHASING OF ANTENNA No. 3 IN DEGREES

3.79

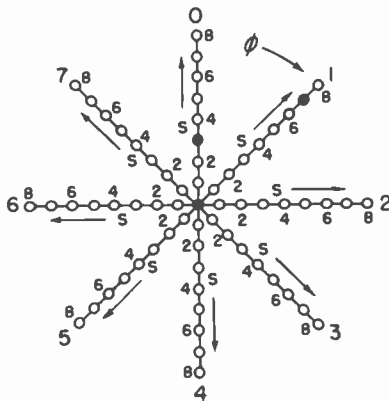
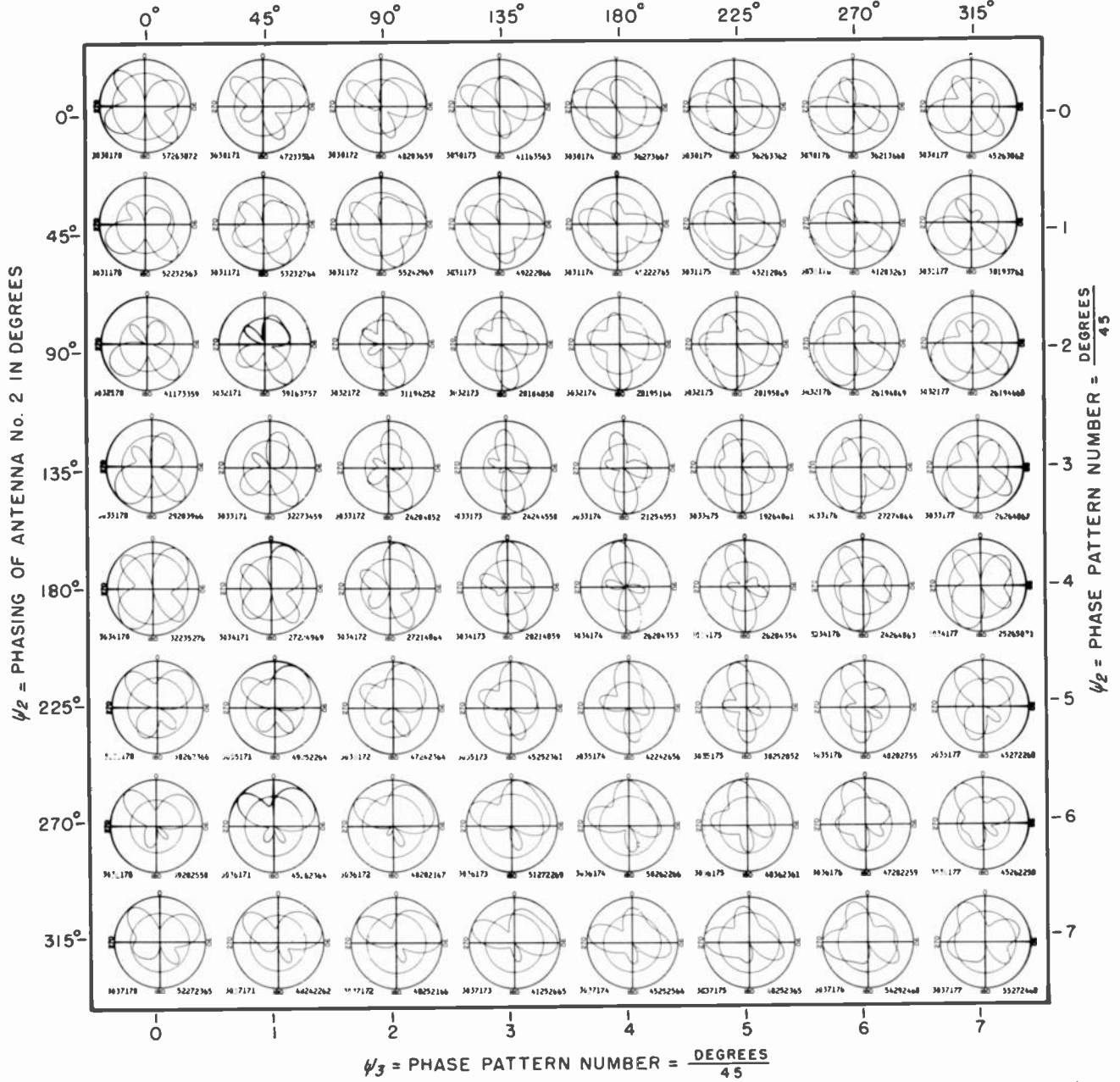

SPOTS LOCATE THE ANTENNAS FOR THIS PAGE OF PATTERNS IN THE SYSTEMATIZATION PLACEMENT CHART.

$\psi_3$  = PHASE PATTERN NUMBER =  $\frac{\text{DEGREES}}{45}$

NUMBER OF ANTENNAS IN THE SYSTEM

No. 3

ORIENTATION OF NO. 2 ANTENNA =  $\frac{\text{DEGREES}}{45}$

$\phi_2$  0

SPACING OF NO. 2 ANTENNA =  $\frac{\text{DEGREES}}{45}$

$S_2$  3

PHASING OF NO. 2 ANTENNA =  $\frac{\text{DEGREES}}{45}$

$\psi_2$  0

ORIENTATION OF NO. 3 ANTENNA =  $\frac{\text{DEGREES}}{45}$

$\phi_3$  1

SPACING OF NO. 3 ANTENNA =  $\frac{\text{DEGREES}}{45}$

$S_3$  7

PHASING OF NO. 3 ANTENNA =  $\frac{\text{DEGREES}}{45}$

$\psi_3$  0

% FIELD INTENSITY RADIATED IN HORIZONTAL PLANE FROM NO. 1 ANTENNA.

$E_1$  57

% FIELD INTENSITY RADIATED IN HORIZONTAL PLANE FROM NO. 2 ANTENNA.

$E_2$  26

% FIELD INTENSITY RADIATED IN HORIZONTAL PLANE FROM NO. 3 ANTENNA.

$E_3$  38

% RMS FIELD INTENSITY RADIATED IN HORIZONTAL PLANE FROM ANTENNA SYSTEM.

$E_0$  72

LEFT HAND PATTERN NUMBER GIVES ANTENNA PLACEMENT AND PHASING DATA.

RIGHT HAND PATTERN NUMBER GIVES ANTENNA FIELD INTENSITY DATA IN PERCENT.

PATTERN NOMENCLATURE

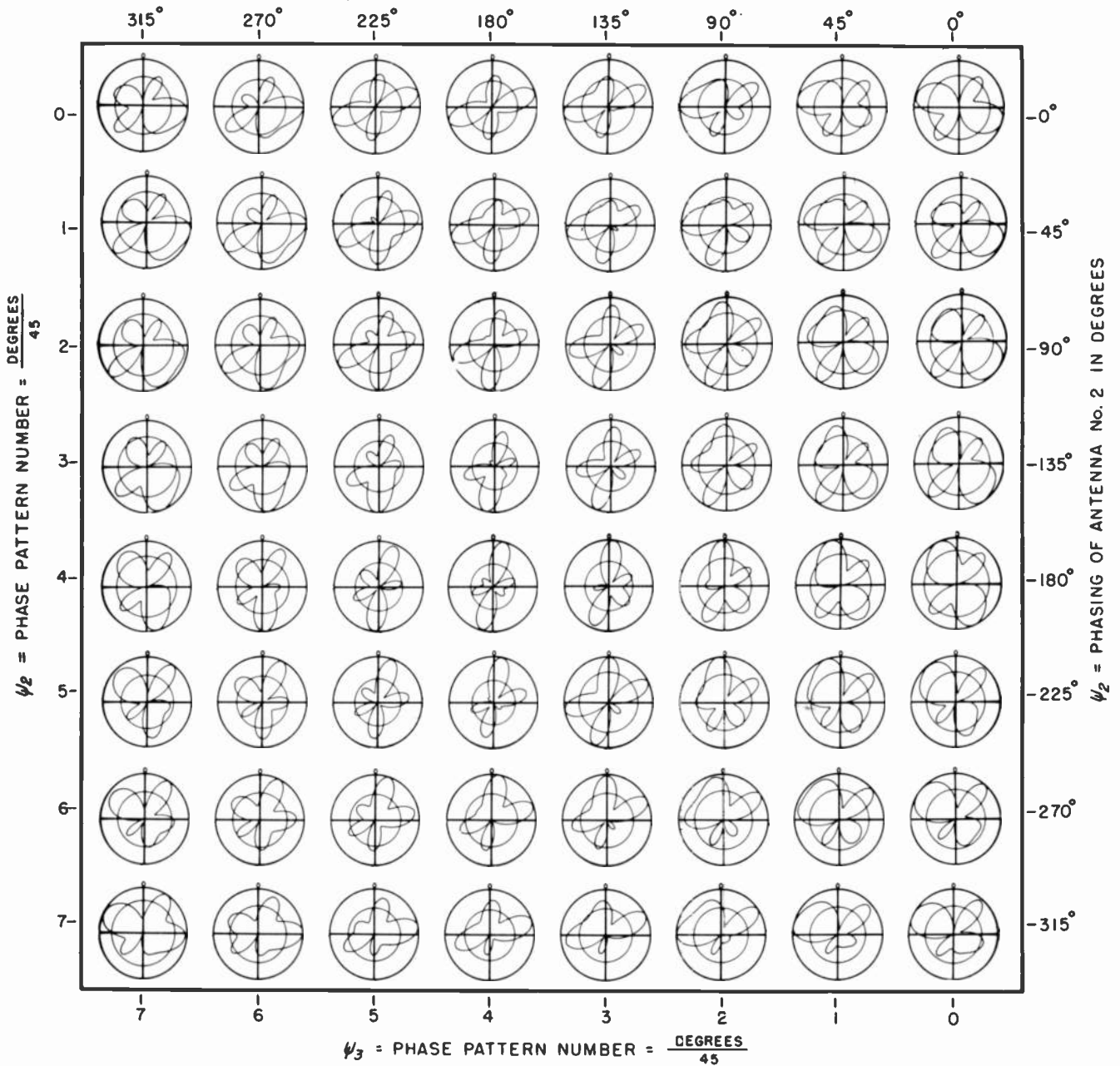

NUMBER OF ANTENNAS  
IN THE SYSTEM  
No. 3

ORIENTATION OF  
NO. 2 ANTENNA =  $\frac{\text{DEGREES}}{45}$   
 $\phi_2$  0

SPACING OF  
NO. 2 ANTENNA =  $\frac{\text{DEGREES}}{45}$   
 $S_2$  3

PHASING OF  
NO. 2 ANTENNA =  $\frac{\text{DEGREES}}{45}$   
 $\psi_2$  0

ORIENTATION OF  
NO. 3 ANTENNA =  $\frac{\text{DEGREES}}{45}$   
 $\phi_3$  7

SPACING OF  
NO. 3 ANTENNA =  $\frac{\text{DEGREES}}{45}$   
 $S_3$  8

PHASING OF  
NO. 3 ANTENNA =  $\frac{\text{DEGREES}}{45}$   
 $\psi_3$  0

% FIELD INTENSITY  
RADIATED IN HORIZONTAL  
PLANE FROM NO. 1 ANTENNA.  
 $E_1$  46

% FIELD INTENSITY  
RADIATED IN HORIZONTAL  
PLANE FROM NO. 2 ANTENNA.  
 $E_2$  27

% FIELD INTENSITY  
RADIATED IN HORIZONTAL  
PLANE FROM NO. 3 ANTENNA.  
 $E_3$  32

% RMS FIELD INTENSITY  
RADIATED IN HORIZONTAL  
PLANE FROM ANTENNA SYSTEM.  
 $E_0$  70

LEFT HAND PATTERN NUMBER GIVES ANTENNA  
PLACEMENT AND PHASING DATA.

RIGHT HAND PATTERN NUMBER  
GIVES ANTENNA FIELD INTEN-  
SITY DATA IN PERCENT.

PATTERN NOMENCLATURE

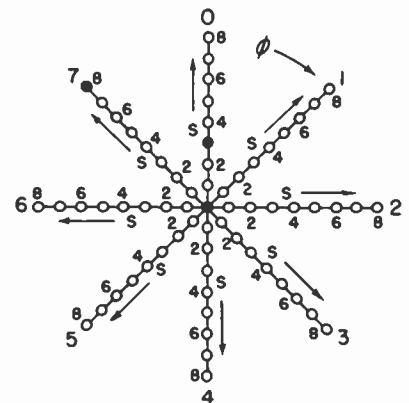

SPOTS LOCATE THE ANTENNAS FOR  
THIS PAGE OF PATTERNS IN THE  
SYSTEMATIZATION PLACEMENT CHART.

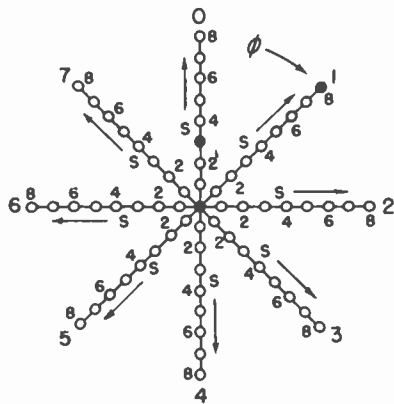
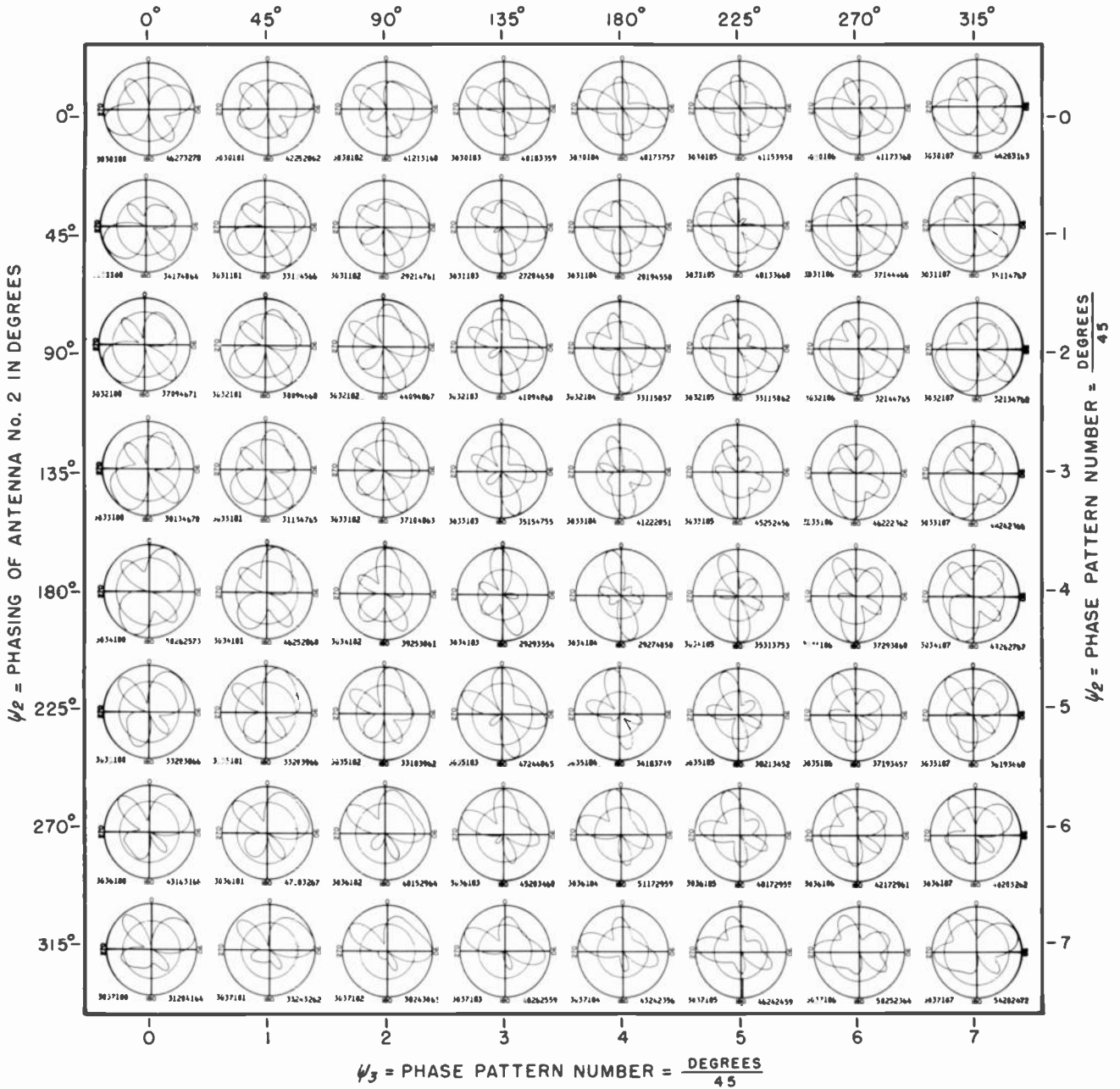

NUMBER OF ANTENNAS IN THE SYSTEM	ORIENTATION OF NO. 2 ANTENNA = $\frac{\text{DEGREES}}{45}$	SPACING OF NO. 2 ANTENNA = $\frac{\text{DEGREES}}{45}$	PHASING OF NO. 2 ANTENNA = $\frac{\text{DEGREES}}{45}$	ORIENTATION OF NO. 3 ANTENNA = $\frac{\text{DEGREES}}{45}$	SPACING OF NO. 3 ANTENNA = $\frac{\text{DEGREES}}{45}$	PHASING OF NO. 3 ANTENNA = $\frac{\text{DEGREES}}{45}$
No. 3	$\phi_2$ 0	$S_2$ 3	$\psi_2$ 0	$\phi_3$ 1	$S_3$ 8	$\psi_3$ 0

LEFT HAND PATTERN NUMBER GIVES ANTENNA PLACEMENT AND PHASING DATA.

% FIELD INTENSITY RADIATED IN HORIZONTAL PLANE FROM NO. 1 ANTENNA.	% FIELD INTENSITY RADIATED IN HORIZONTAL PLANE FROM NO. 2 ANTENNA.	% FIELD INTENSITY RADIATED IN HORIZONTAL PLANE FROM NO. 3 ANTENNA.	% RMS FIELD INTENSITY RADIATED IN HORIZONTAL PLANE FROM ANTENNA SYSTEM.
$F_1$ 46	$F_2$ 27	$F_3$ 32	$F_0$ 70

RIGHT HAND PATTERN NUMBER GIVES ANTENNA FIELD INTENSITY DATA IN PERCENT.

SPOTS LOCATE THE ANTENNAS FOR THIS PAGE OF PATTERNS IN THE SYSTEMATIZATION PLACEMENT CHART.

PATTERN NOMENCLATURE

$\psi_3$  = PHASING OF ANTENNA No. 3 IN DEGREES

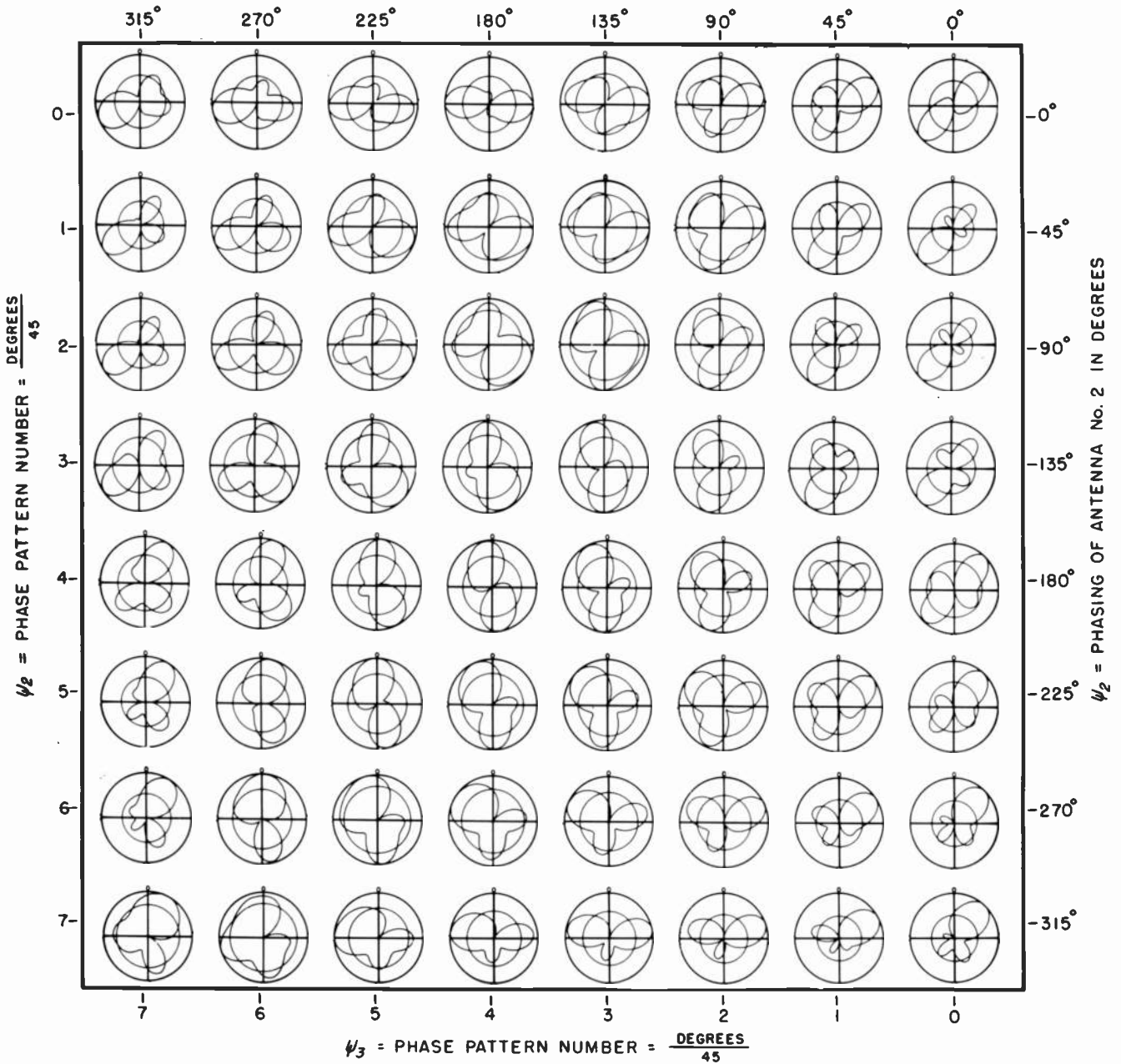

NUMBER OF ANTENNAS IN THE SYSTEM	
No.	3
ORIENTATION OF NO. 2 ANTENNA = $\frac{\text{DEGREES}}{45}$	
$\psi_2$	0
SPACING OF NO. 2 ANTENNA = $\frac{\text{DEGREES}}{45}$	
$S_2$	4
PHASING OF NO. 2 ANTENNA = $\frac{\text{DEGREES}}{45}$	
$\psi_2$	0
ORIENTATION OF NO. 3 ANTENNA = $\frac{\text{DEGREES}}{45}$	
$\psi_3$	7
SPACING OF NO. 3 ANTENNA = $\frac{\text{DEGREES}}{45}$	
$S_3$	5
PHASING OF NO. 3 ANTENNA = $\frac{\text{DEGREES}}{45}$	
$\psi_3$	0

LEFT HAND PATTERN NUMBER GIVES ANTENNA PLACEMENT AND PHASING DATA.

% FIELD INTENSITY RADIATED IN HORIZONTAL PLANE FROM NO. 1 ANTENNA.	
$E_1$	65
% FIELD INTENSITY RADIATED IN HORIZONTAL PLANE FROM NO. 2 ANTENNA.	
$E_2$	20
% FIELD INTENSITY RADIATED IN HORIZONTAL PLANE FROM NO. 3 ANTENNA.	
$E_3$	43
% RMS FIELD INTENSITY RADIATED IN HORIZONTAL PLANE FROM ANTENNA SYSTEM.	
$E_0$	55

RIGHT HAND PATTERN NUMBER GIVES ANTENNA FIELD INTENSITY DATA IN PERCENT.

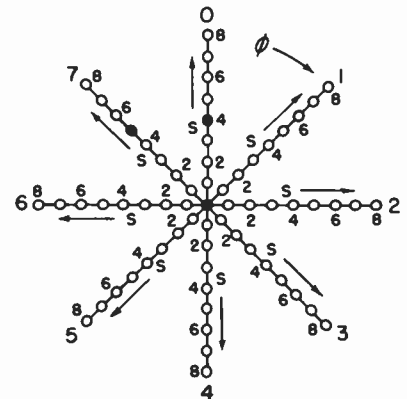

SPOTS LOCATE THE ANTENNAS FOR THIS PAGE OF PATTERNS IN THE SYSTEMIZATION PLACEMENT CHART.

PATTERN NOMENCLATURE



COPYRIGHT 1946 BY CARL E. SMITH  
PRINTED IN U. S. A.

CLEVELAND INSTITUTE OF RADIO ELECTRONICS  
TERMINAL TOWER, CLEVELAND 18, OHIO.

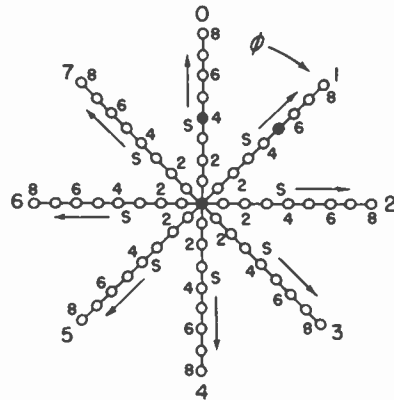
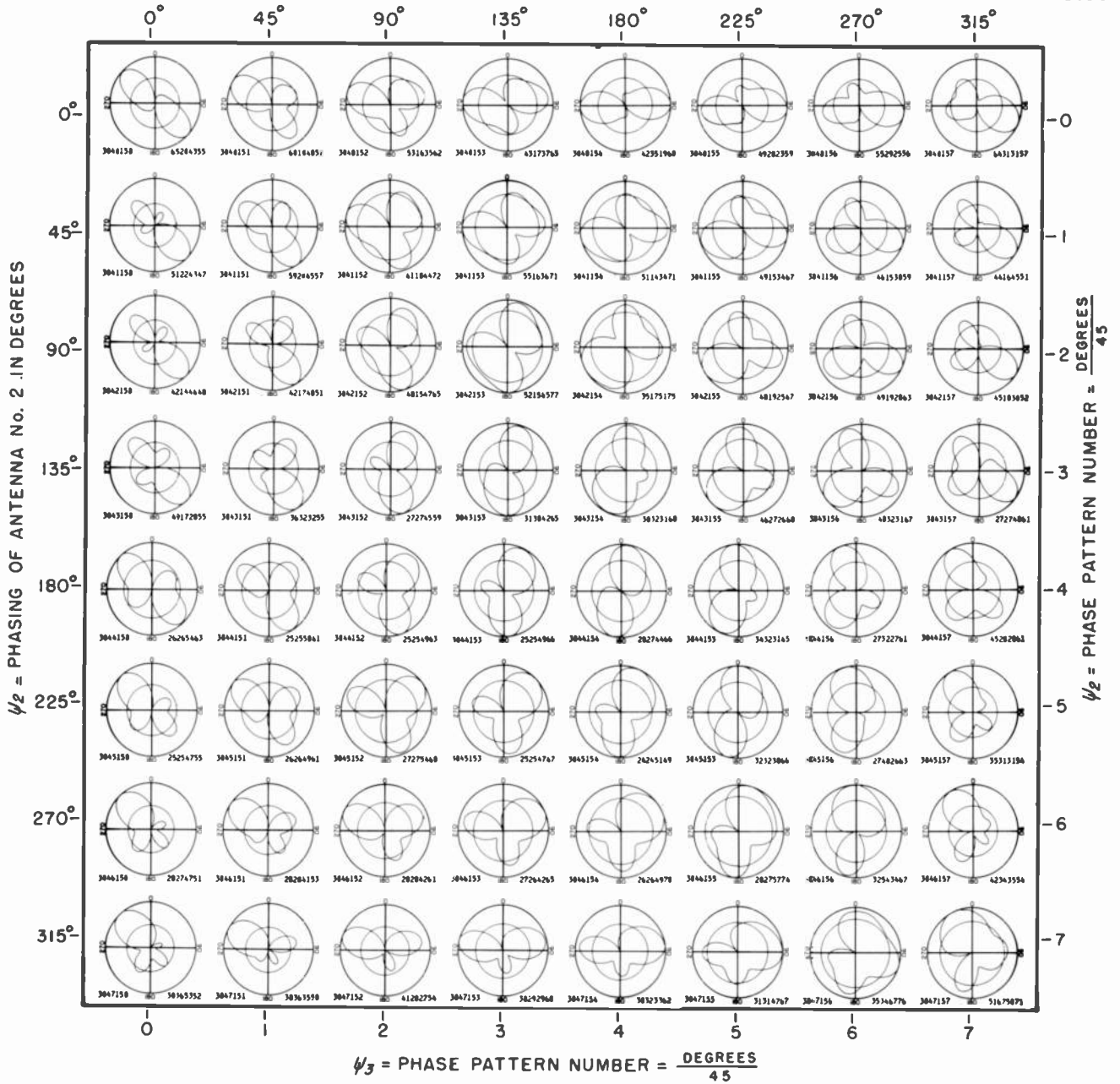

$\psi_3$  = PHASE PATTERN NUMBER =  $\frac{\text{DEGREES}}{45}$

NUMBER OF ANTENNAS  
IN THE SYSTEM

No. 3

ORIENTATION OF  
NO. 2 ANTENNA =  $\frac{\text{DEGREES}}{45}$

$\phi_2$  0

SPACING OF  
NO. 2 ANTENNA =  $\frac{\text{DEGREES}}{45}$

$S_2$  4

PHASING OF  
NO. 2 ANTENNA =  $\frac{\text{DEGREES}}{45}$

$\psi_2$  0

ORIENTATION OF  
NO. 3 ANTENNA =  $\frac{\text{DEGREES}}{45}$

$\phi_3$  1

SPACING OF  
NO. 3 ANTENNA =  $\frac{\text{DEGREES}}{45}$

$S_3$  5

PHASING OF  
NO. 3 ANTENNA =  $\frac{\text{DEGREES}}{45}$

$\psi_3$  0

% FIELD INTENSITY  
RADIATED IN HORIZONTAL  
PLANE FROM NO. 1 ANTENNA.

$F_1$  65

% FIELD INTENSITY  
RADIATED IN HORIZONTAL  
PLANE FROM NO. 2 ANTENNA.

$F_2$  20

% FIELD INTENSITY  
RADIATED IN HORIZONTAL  
PLANE FROM NO. 3 ANTENNA.

$F_3$  43

% RMS FIELD INTENSITY  
RADIATED IN HORIZONTAL  
PLANE FROM ANTENNA SYSTEM.

$F_0$  55

LEFT HAND PATTERN NUMBER GIVES ANTENNA  
PLACEMENT AND PHASING DATA.

RIGHT HAND PATTERN NUMBER  
GIVES ANTENNA FIELD INTEN-  
SITY DATA IN PERCENT.

SPOTS LOCATE THE ANTENNAS FOR  
THIS PAGE OF PATTERNS IN THE  
SYSTEMATIZATION PLACEMENT CHART.

PATTERN NOMENCLATURE

$\psi_3$  = PHASING OF ANTENNA No. 3 IN DEGREES

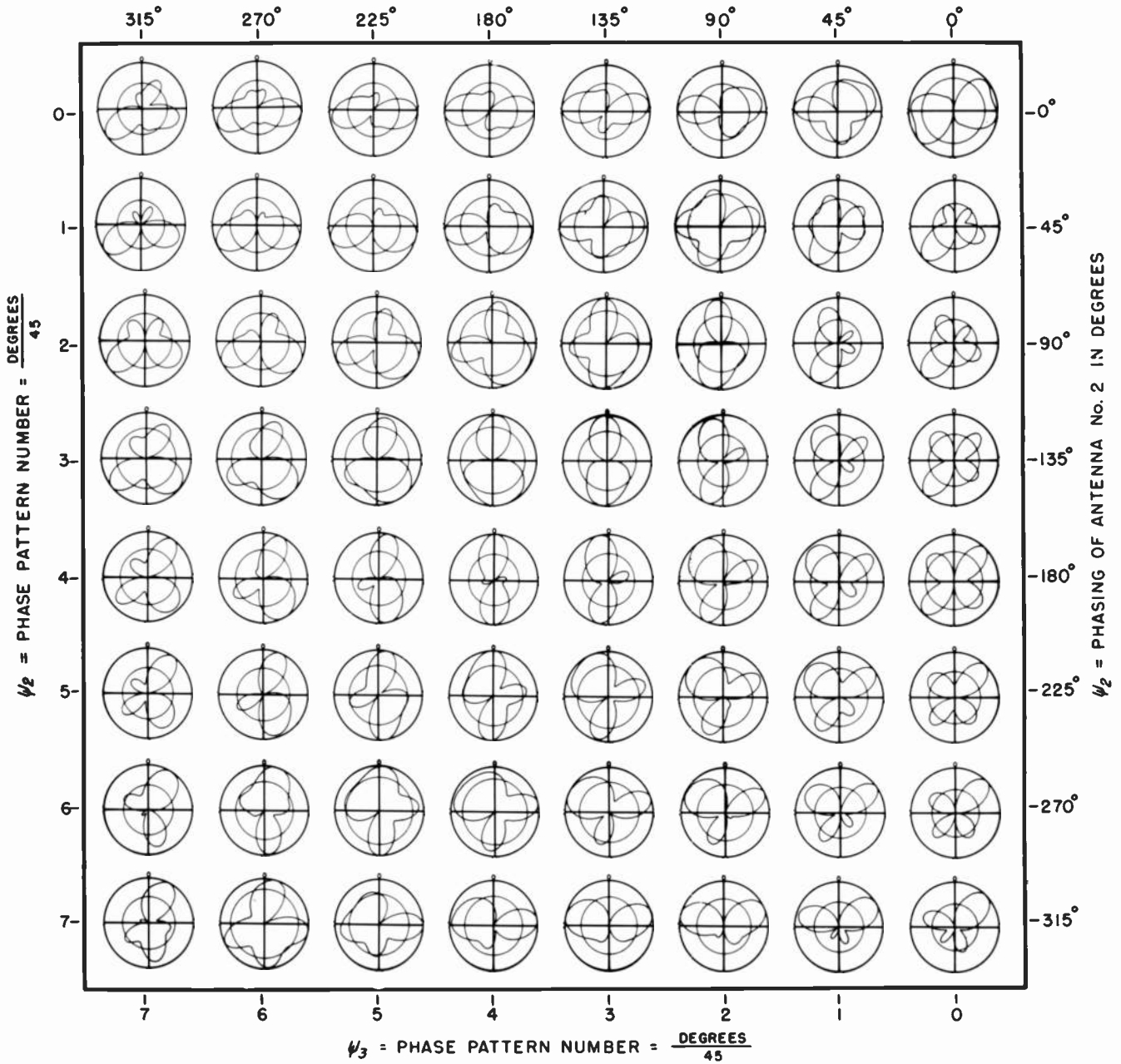

NUMBER OF ANTENNAS IN THE SYSTEM  
No. 3

ORIENTATION OF NO. 2 ANTENNA =  $\frac{\text{DEGREES}}{45}$   
 $\psi_2$  0

SPACING OF NO. 2 ANTENNA =  $\frac{\text{DEGREES}}{45}$   
 $S_2$  4

PHASING OF NO. 2 ANTENNA =  $\frac{\text{DEGREES}}{45}$   
 $\psi_2$  0

ORIENTATION OF NO. 3 ANTENNA =  $\frac{\text{DEGREES}}{45}$   
 $\psi_3$  7

SPACING OF NO. 3 ANTENNA =  $\frac{\text{DEGREES}}{45}$   
 $S_3$  6

PHASING OF NO. 3 ANTENNA =  $\frac{\text{DEGREES}}{45}$   
 $\psi_3$  0

% FIELD INTENSITY RADIATED IN HORIZONTAL PLANE FROM NO. 1 ANTENNA.  
 $E_1$  84

% FIELD INTENSITY RADIATED IN HORIZONTAL PLANE FROM NO. 2 ANTENNA.  
 $E_2$  44

% FIELD INTENSITY RADIATED IN HORIZONTAL PLANE FROM NO. 3 ANTENNA.  
 $E_3$  34

% RMS FIELD INTENSITY RADIATED IN HORIZONTAL PLANE FROM ANTENNA SYSTEM.  
 $E_0$  71

LEFT HAND PATTERN NUMBER GIVES ANTENNA PLACEMENT AND PHASING DATA.

RIGHT HAND PATTERN NUMBER GIVES ANTENNA FIELD INTENSITY DATA IN PERCENT.

PATTERN NOMENCLATURE

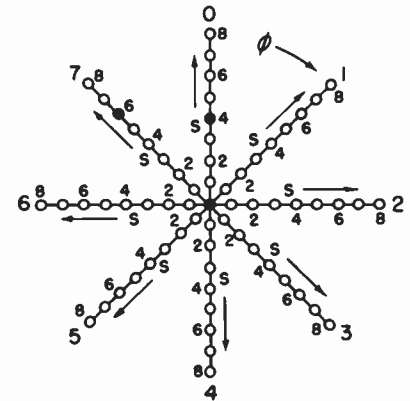

SPOTS LOCATE THE ANTENNAS FOR THIS PAGE OF PATTERNS IN THE SYSTEMIZATION PLACEMENT CHART.

$\psi_3$  = PHASING OF ANTENNA No. 3 IN DEGREES

3.85

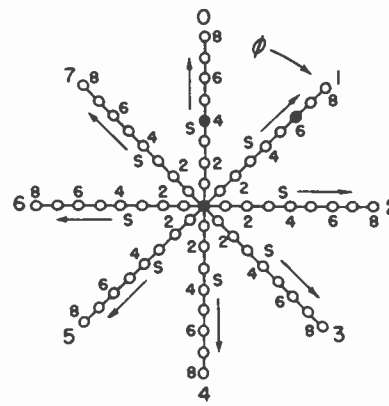
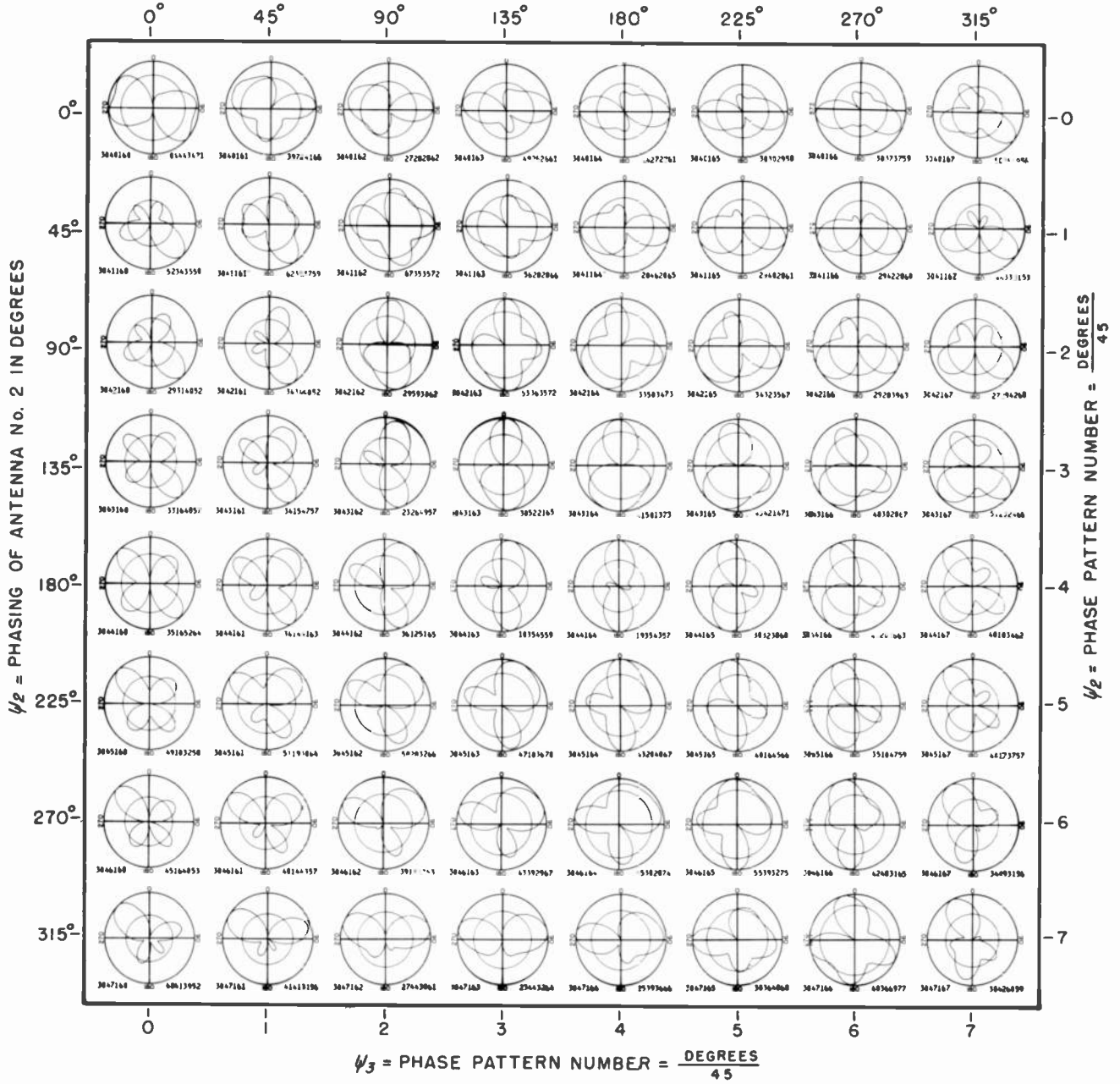

SPOTS LOCATE THE ANTENNAS FOR THIS PAGE OF PATTERNS IN THE SYSTEMATIZATION PLACEMENT CHART.

$\psi_3$  = PHASE PATTERN NUMBER =  $\frac{\text{DEGREES}}{45}$

NUMBER OF ANTENNAS IN THE SYSTEM	ORIENTATION OF NO. 2 ANTENNA = $\frac{\text{DEGREES}}{45}$	SPACING OF NO. 2 ANTENNA = $\frac{\text{DEGREES}}{45}$	PHASING OF NO. 2 ANTENNA = $\frac{\text{DEGREES}}{45}$	ORIENTATION OF NO. 3 ANTENNA = $\frac{\text{DEGREES}}{45}$	SPACING OF NO. 3 ANTENNA = $\frac{\text{DEGREES}}{45}$	PHASING OF NO. 3 ANTENNA = $\frac{\text{DEGREES}}{45}$
No. 3	$\phi_2$ 0	$S_2$ 4	$\psi_2$ 0	$\phi_3$ 1	$S_3$ 6	$\psi_3$ 0

LEFT HAND PATTERN NUMBER GIVES ANTENNA PLACEMENT AND PHASING DATA.

% FIELD INTENSITY RADIATED IN HORIZONTAL PLANE FROM NO. 1 ANTENNA.	% FIELD INTENSITY RADIATED IN HORIZONTAL PLANE FROM NO. 2 ANTENNA.	% FIELD INTENSITY RADIATED IN HORIZONTAL PLANE FROM NO. 3 ANTENNA.	% RMS FIELD INTENSITY RADIATED IN HORIZONTAL PLANE FROM ANTENNA SYSTEM.
$E_1$ 84	$E_2$ 44	$E_3$ 34	$E_0$ 71

RIGHT HAND PATTERN NUMBER GIVES ANTENNA FIELD INTENSITY DATA IN PERCENT.

PATTERN NOMENCLATURE

$\psi_3$  = PHASING OF ANTENNA No. 3 IN DEGREES

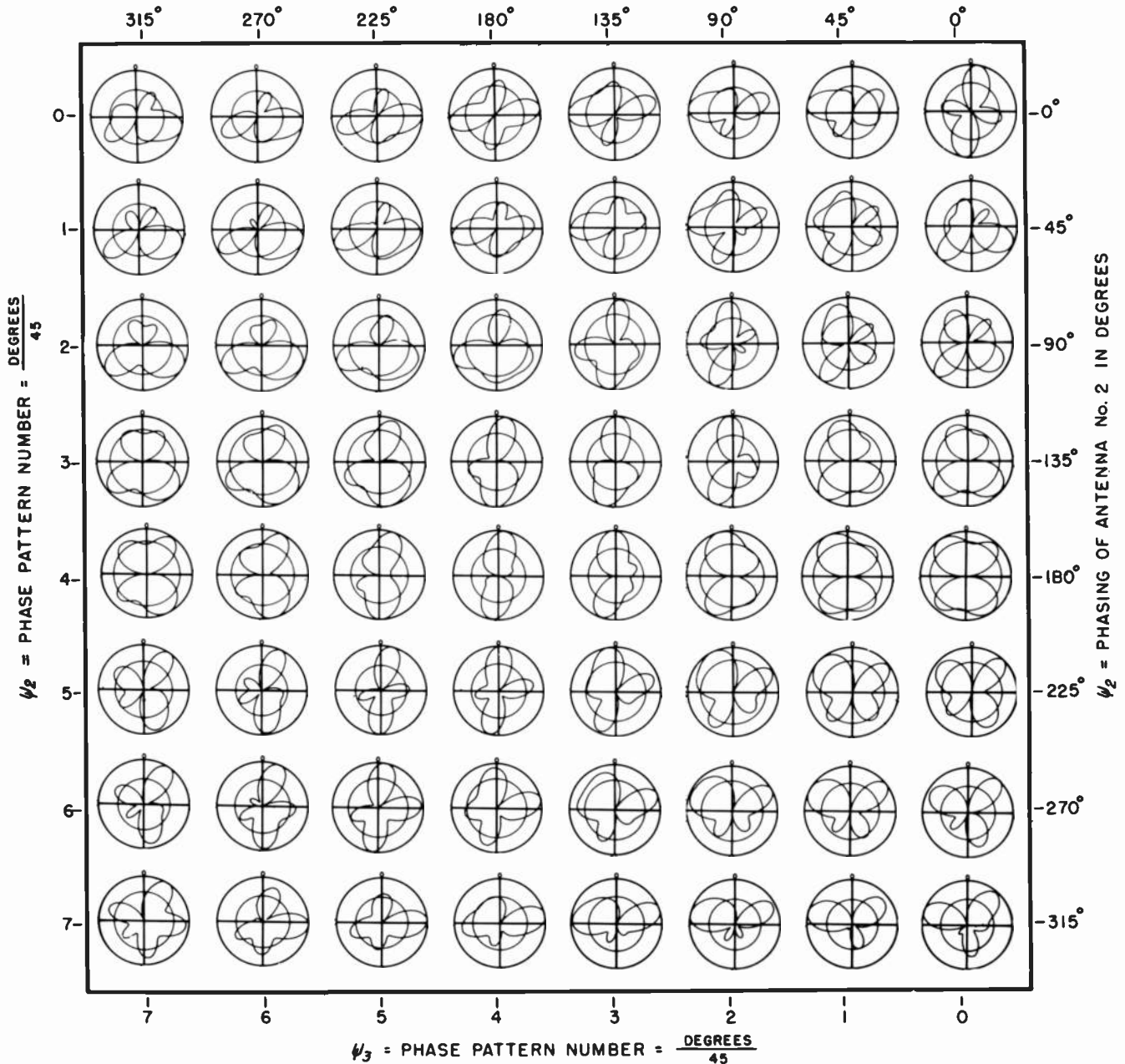

NUMBER OF ANTENNAS IN THE SYSTEM	$\psi_2 = \text{PHASE PATTERN NUMBER} = \frac{\text{DEGREES}}{45}$	
NO. 1	$\phi_2$	0
ORIENTATION OF NO. 2 ANTENNA	$\frac{\text{DEGREES}}{45}$	
NO. 2	$S_2$	4
SPACING OF NO. 2 ANTENNA	$\frac{\text{DEGREES}}{45}$	
NO. 3	$\psi_2$	0
PHASING OF NO. 2 ANTENNA	$\frac{\text{DEGREES}}{45}$	
NO. 4	$\phi_3$	7
ORIENTATION OF NO. 3 ANTENNA	$\frac{\text{DEGREES}}{45}$	
NO. 5	$S_3$	7
SPACING OF NO. 3 ANTENNA	$\frac{\text{DEGREES}}{45}$	
NO. 6	$\psi_3$	0
PHASING OF NO. 3 ANTENNA	$\frac{\text{DEGREES}}{45}$	

LEFT HAND PATTERN NUMBER GIVES ANTENNA PLACEMENT AND PHASING DATA.

% FIELD INTENSITY RADIATED IN HORIZONTAL PLANE FROM NO. 1 ANTENNA.	$E_1$	17
% FIELD INTENSITY RADIATED IN HORIZONTAL PLANE FROM NO. 2 ANTENNA.	$E_2$	67
% FIELD INTENSITY RADIATED IN HORIZONTAL PLANE FROM NO. 3 ANTENNA.	$E_3$	50
% RMS FIELD INTENSITY RADIATED IN HORIZONTAL PLANE FROM ANTENNA SYSTEM.	$E_0$	61

RIGHT HAND PATTERN NUMBER GIVES ANTENNA FIELD INTENSITY DATA IN PERCENT.

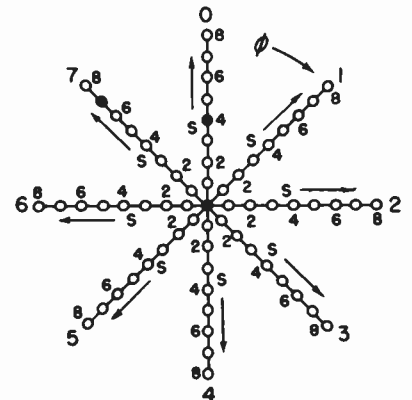

SPOTS LOCATE THE ANTENNAS FOR THIS PAGE OF PATTERNS IN THE SYSTEMATIZATION PLACEMENT CHART.

PATTERN NOMENCLATURE

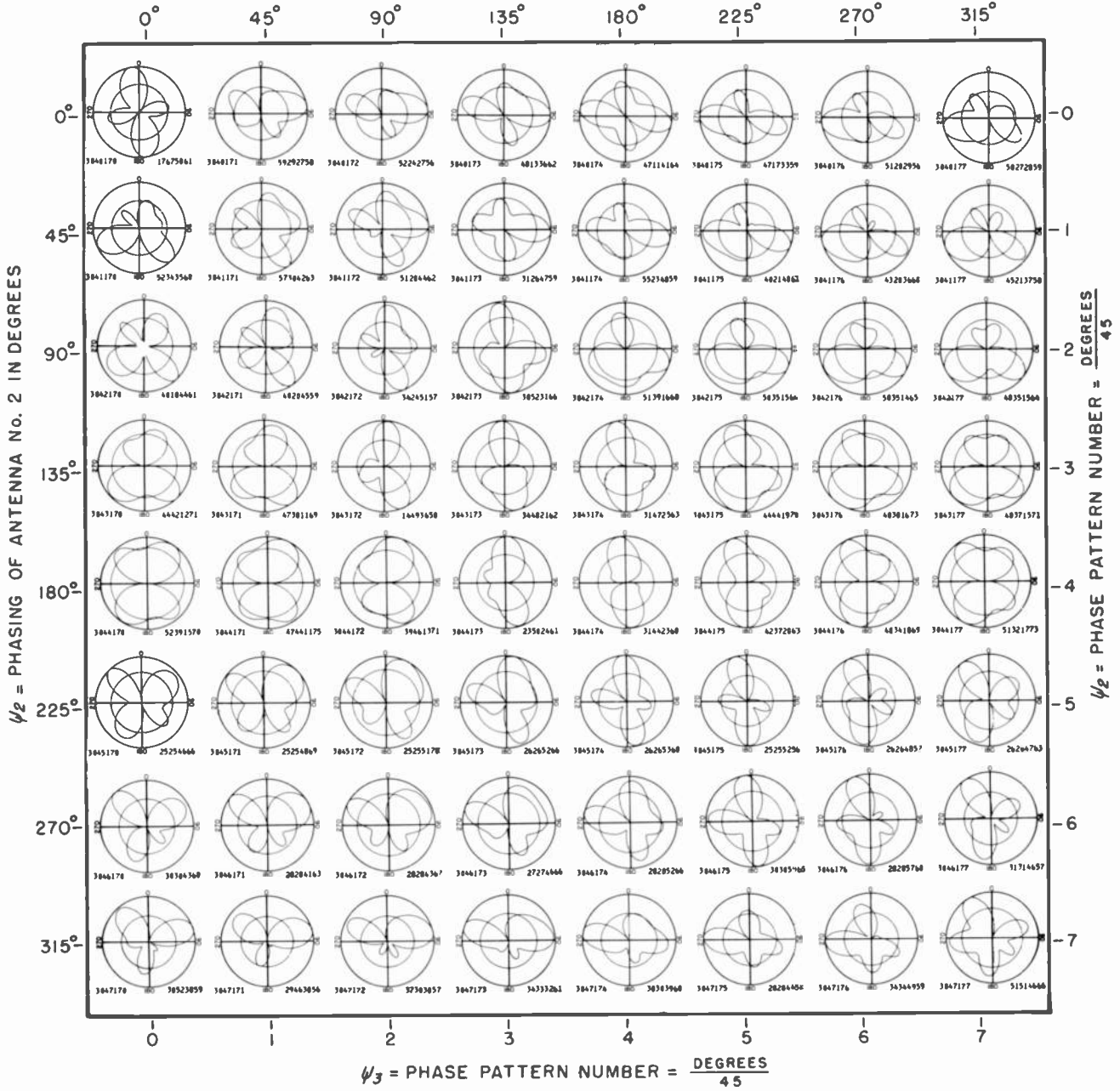

COPYRIGHT 1946 BY CARL E. SMITH  
PRINTED IN U. S. A.

CLEVELAND INSTITUTE OF RADIO ELECTRONICS  
TERMINAL TOWER, CLEVELAND 18, OHIO.

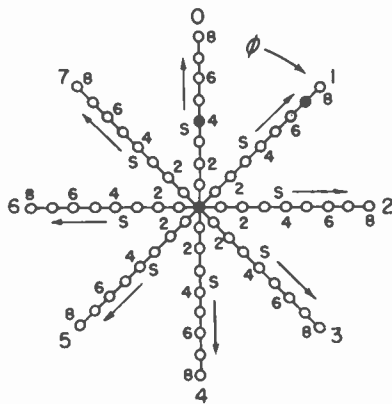

SPOTS LOCATE THE ANTENNAS FOR THIS PAGE OF PATTERNS IN THE SYSTEMATIZATION PLACEMENT CHART.

NUMBER OF ANTENNAS IN THE SYSTEM	ORIENTATION OF DEGREES / 45	SPACING OF DEGREES / 45	PHASING OF DEGREES / 45	ORIENTATION OF DEGREES / 45	SPACING OF DEGREES / 45	PHASING OF DEGREES / 45
No. 3	$\psi_2 = 0$	$S_2 = 4$	$\psi_2 = 0$	$\psi_3 = 1$	$S_3 = 7$	$\psi_3 = 0$

LEFT HAND PATTERN NUMBER GIVES ANTENNA PLACEMENT AND PHASING DATA.

% FIELD INTENSITY RADIATED IN HORIZONTAL PLANE FROM NO. 1 ANTENNA.	% FIELD INTENSITY RADIATED IN HORIZONTAL PLANE FROM NO. 2 ANTENNA.	% FIELD INTENSITY RADIATED IN HORIZONTAL PLANE FROM NO. 3 ANTENNA.	% RMS FIELD INTENSITY RADIATED IN HORIZONTAL PLANE FROM ANTENNA SYSTEM.
$E_1 = 17$	$E_2 = 67$	$E_3 = 50$	$E_0 = 61$

RIGHT HAND PATTERN NUMBER GIVES ANTENNA FIELD INTENSITY DATA IN PERCENT.

PATTERN NOMENCLATURE

$\psi_3$  = PHASING OF ANTENNA No. 3 IN DEGREES

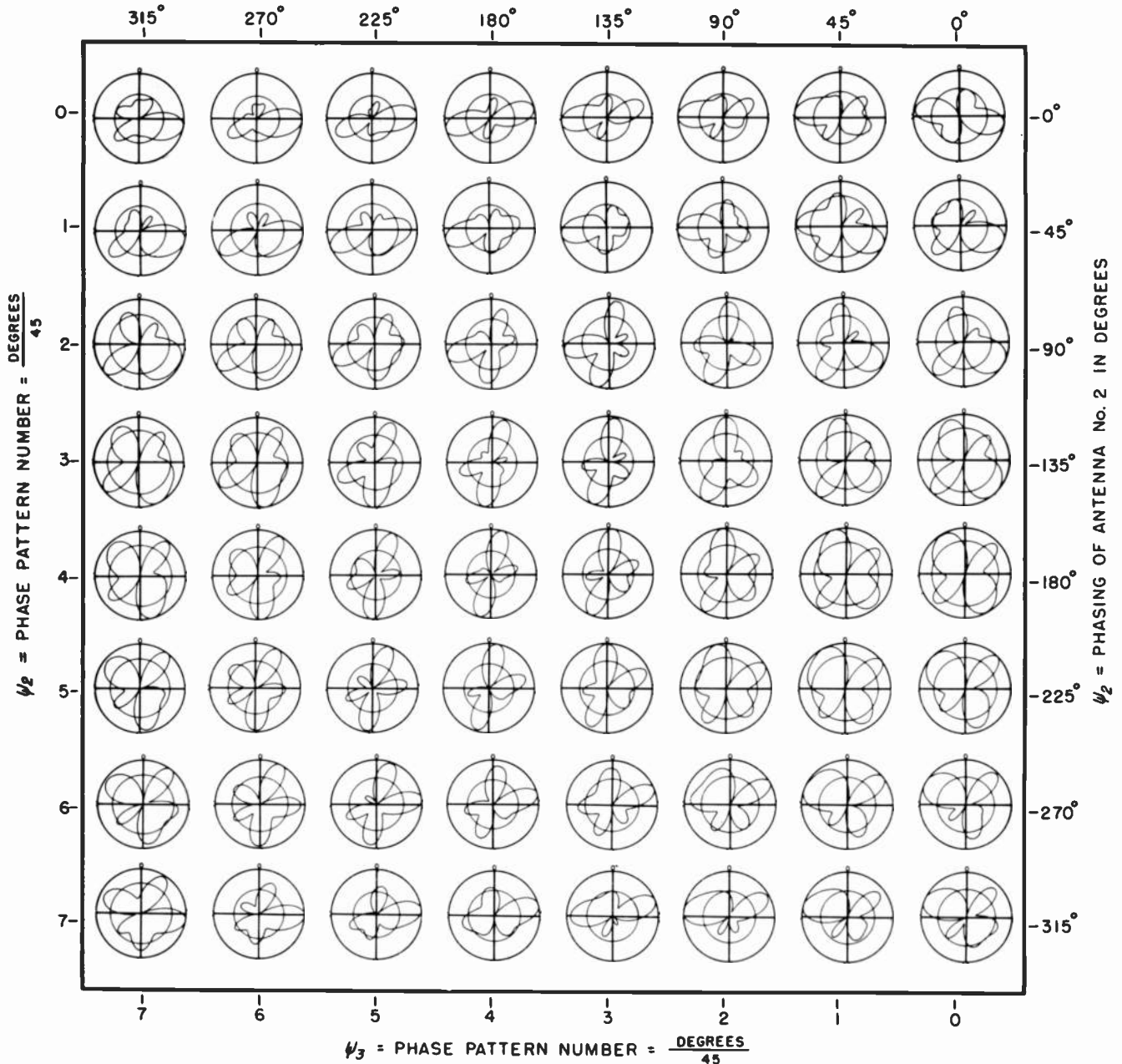

NUMBER OF ANTENNAS IN THE SYSTEM  
 NO. 3

ORIENTATION OF DEGREES ANTENNA =  $\frac{\text{DEGREES}}{45}$   
 $\phi_2$  0

SPACING OF DEGREES ANTENNA =  $\frac{\text{DEGREES}}{45}$   
 $S_2$  4

PHASING OF DEGREES ANTENNA =  $\frac{\text{DEGREES}}{45}$   
 $\psi_2$  0

ORIENTATION OF DEGREES ANTENNA =  $\frac{\text{DEGREES}}{45}$   
 $\phi_3$  7

SPACING OF DEGREES ANTENNA =  $\frac{\text{DEGREES}}{45}$   
 $S_3$  8

PHASING OF DEGREES ANTENNA =  $\frac{\text{DEGREES}}{45}$   
 $\psi_3$  0

% FIELD INTENSITY RADIATED IN HORIZONTAL PLANE FROM NO. 1 ANTENNA.  
 $F_1$  31

% FIELD INTENSITY RADIATED IN HORIZONTAL PLANE FROM NO. 2 ANTENNA.  
 $F_2$  63

% FIELD INTENSITY RADIATED IN HORIZONTAL PLANE FROM NO. 3 ANTENNA.  
 $F_3$  24

% RMS FIELD INTENSITY RADIATED IN HORIZONTAL PLANE FROM ANTENNA SYSTEM.  
 $F_0$  61

LEFT HAND PATTERN NUMBER GIVES ANTENNA PLACEMENT AND PHASING DATA.

RIGHT HAND PATTERN NUMBER GIVES ANTENNA FIELD INTENSITY DATA IN PERCENT.

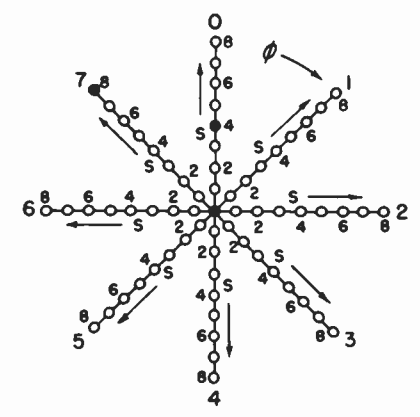

SPOTS LOCATE THE ANTENNAS FOR THIS PAGE OF PATTERNS IN THE SYSTEMATIZATION PLACEMENT CHART.

PATTERN NOMENCLATURE

$\psi_3$  = PHASING OF ANTENNA No. 3 IN DEGREES

3.89

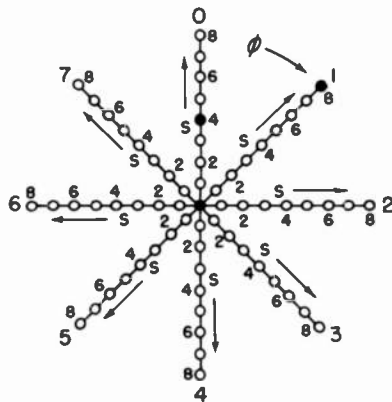
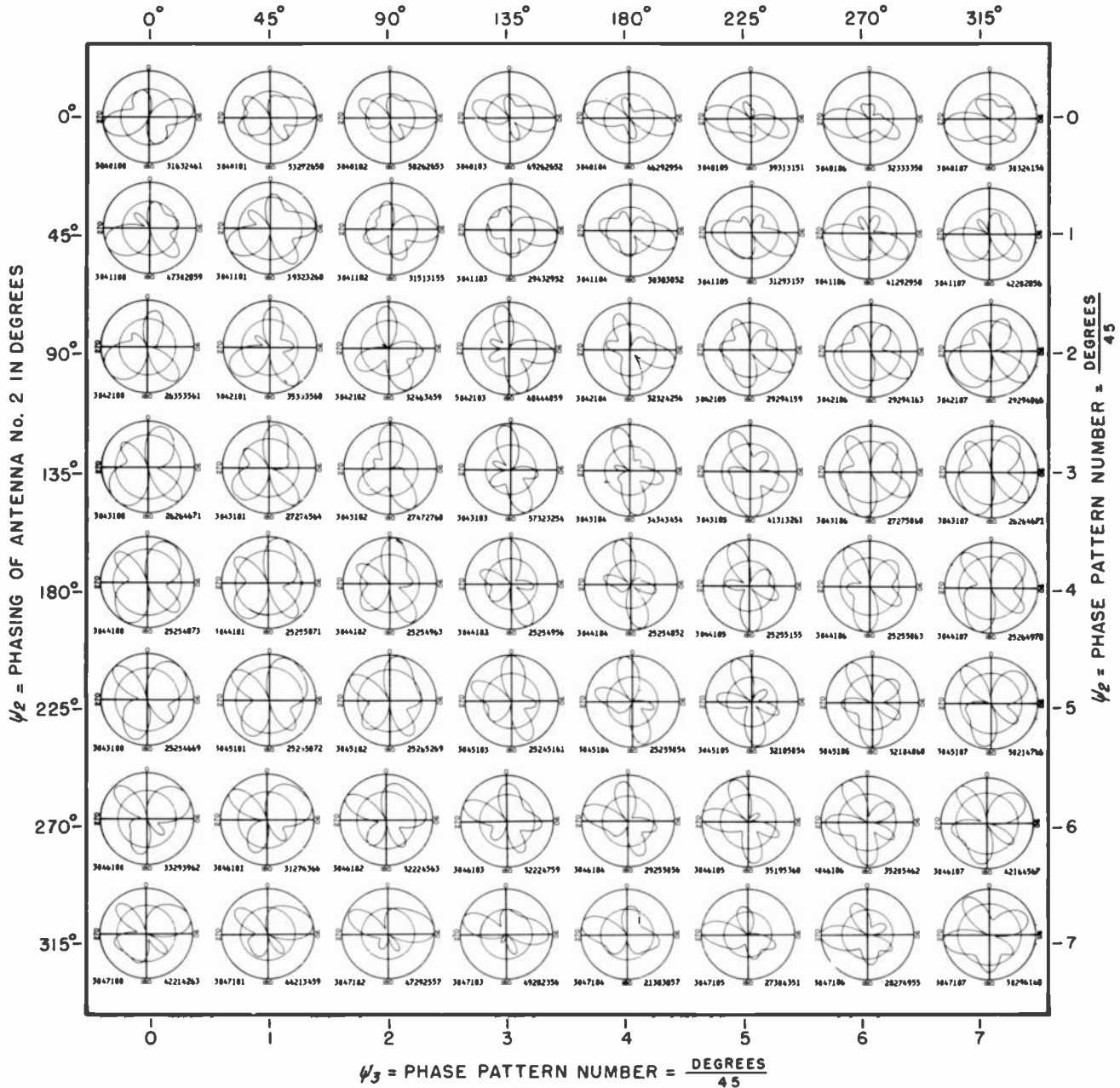

SPOTS LOCATE THE ANTENNAS FOR  
 THIS PAGE OF PATTERNS IN THE  
 SYSTEMATIZATION PLACEMENT CHART.

NO.	$\psi_2$	$S_2$	$\psi_2$	$\psi_3$	$S_3$	$\psi_3$
3	0	4	0	1	8	0

LEFT HAND PATTERN NUMBER GIVES ANTENNA  
 PLACEMENT AND PHASING DATA.

% FIELD INTENSITY RADIATED IN HORIZONTAL PLANE FROM NO. 1 ANTENNA.	% FIELD INTENSITY RADIATED IN HORIZONTAL PLANE FROM NO. 2 ANTENNA.	% FIELD INTENSITY RADIATED IN HORIZONTAL PLANE FROM NO. 3 ANTENNA.	% RMS FIELD INTENSITY RADIATED IN HORIZONTAL PLANE FROM ANTENNA SYSTEM.
$F_1$	$F_2$	$F_3$	$F_0$
31	63	24	61

RIGHT HAND PATTERN NUMBER  
 GIVES ANTENNA FIELD INTEN-  
 SITY DATA IN PERCENT.

PATTERN NOMENCLATURE

$\psi_3$  = PHASING OF ANTENNA No. 3 IN DEGREES

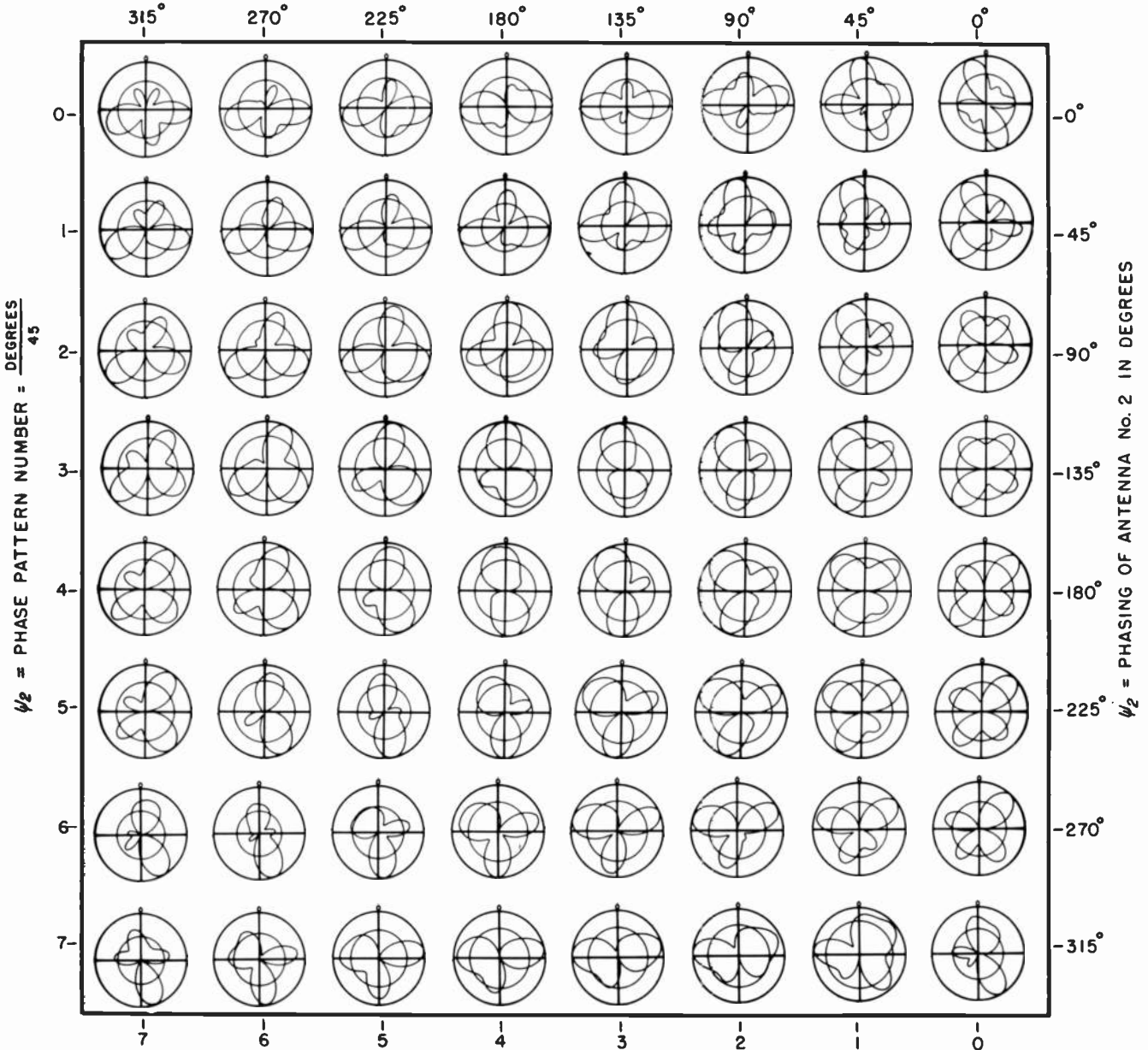

$\psi_2$  = PHASE PATTERN NUMBER =  $\frac{\text{DEGREES}}{45}$

$\psi_2$  = PHASING OF ANTENNA No. 2 IN DEGREES

$\psi_3$  = PHASE PATTERN NUMBER =  $\frac{\text{DEGREES}}{45}$

- NUMBER OF ANTENNAS IN THE SYSTEM  
No. 3
- ORIENTATION OF NO. 2 ANTENNA =  $\frac{\text{DEGREES}}{45}$   
 $\phi_2$  0
- SPACING OF NO. 2 ANTENNA =  $\frac{\text{DEGREES}}{45}$   
 $S_2$  5
- PHASING OF NO. 2 ANTENNA =  $\frac{\text{DEGREES}}{45}$   
 $\psi_2$  0
- ORIENTATION OF NO. 3 ANTENNA =  $\frac{\text{DEGREES}}{45}$   
 $\phi_3$  7
- SPACING OF NO. 3 ANTENNA =  $\frac{\text{DEGREES}}{45}$   
 $S_3$  6
- PHASING OF NO. 3 ANTENNA =  $\frac{\text{DEGREES}}{45}$   
 $\psi_3$  0

- % FIELD INTENSITY RADIATED IN HORIZONTAL PLANE FROM NO. 1 ANTENNA.  
 $E_1$  48
- % FIELD INTENSITY RADIATED IN HORIZONTAL PLANE FROM NO. 2 ANTENNA.  
 $E_2$  68
- % FIELD INTENSITY RADIATED IN HORIZONTAL PLANE FROM NO. 3 ANTENNA.  
 $E_3$  57
- % RMS FIELD INTENSITY RADIATED IN HORIZONTAL PLANE FROM ANTENNA SYSTEM.  
 $E_0$  61

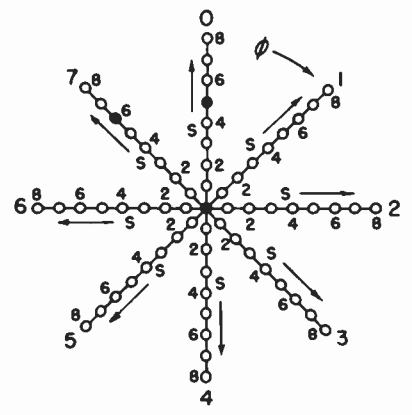

LEFT HAND PATTERN NUMBER GIVES ANTENNA PLACEMENT AND PHASING DATA.

RIGHT HAND PATTERN NUMBER GIVES ANTENNA FIELD INTENSITY DATA IN PERCENT.

SPOTS LOCATE THE ANTENNAS FOR THIS PAGE OF PATTERNS IN THE SYSTEMATIZATION PLACEMENT CHART.

PATTERN NOMENCLATURE



COPYRIGHT 1946 BY CARL E. SMITH  
PRINTED IN U. S. A.

CLEVELAND INSTITUTE OF RADIO ELECTRONICS  
TERMINAL TOWER, CLEVELAND 18, OHIO.

$\psi_3$  = PHASING OF ANTENNA No. 3 IN DEGREES

3.91

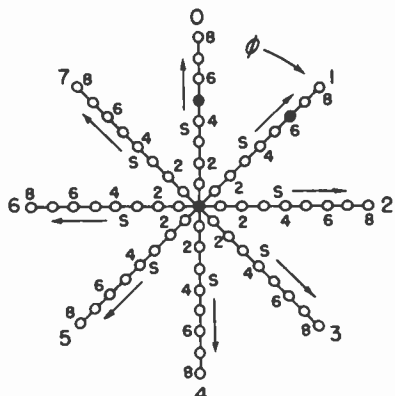
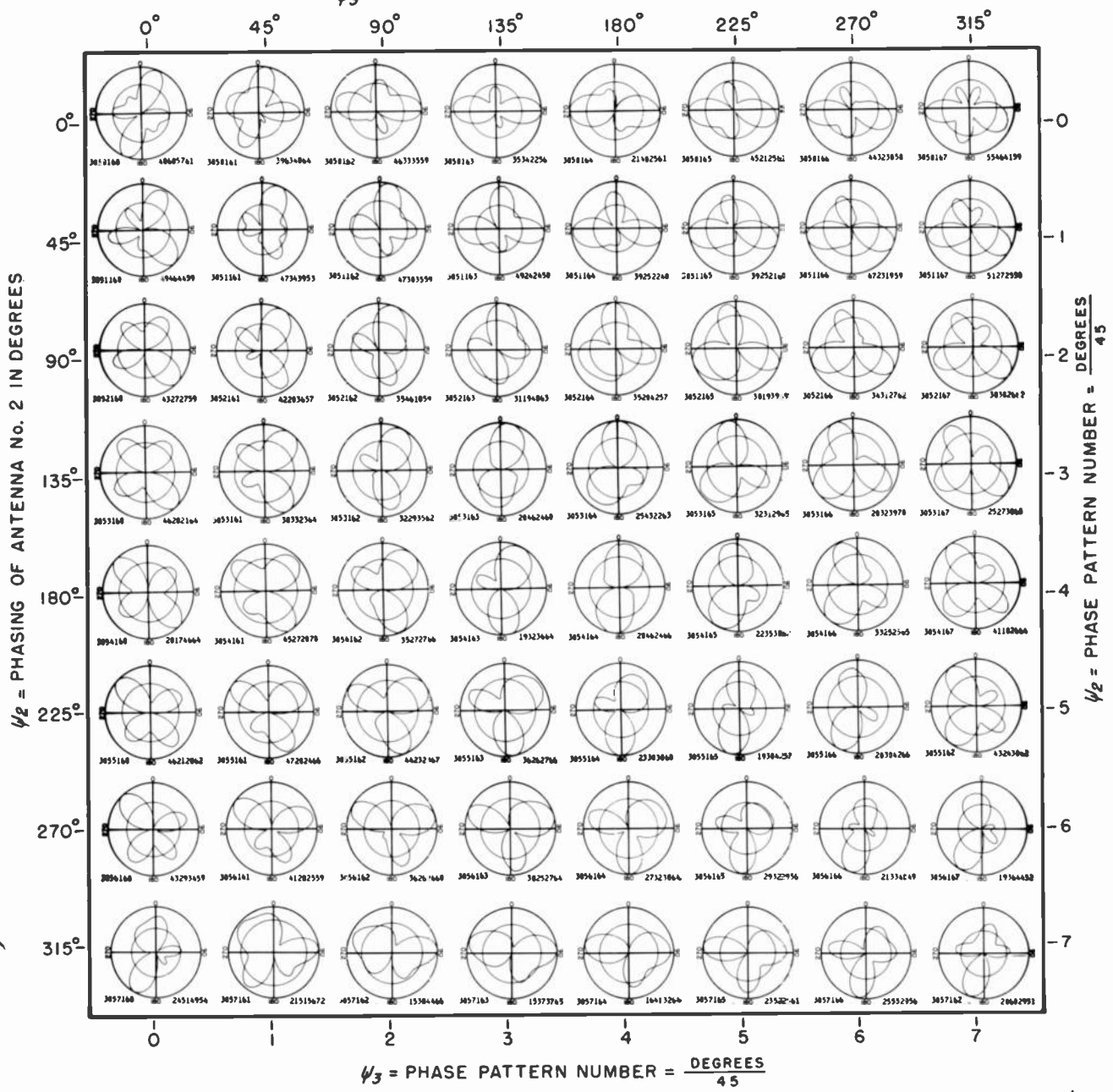

SPOTS LOCATE THE ANTENNAS FOR THIS PAGE OF PATTERNS IN THE SYSTEMATIZATION PLACEMENT CHART.

NUMBER OF ANTENNAS IN THE SYSTEM	ORIENTATION OF NO. 2 ANTENNA = $\frac{\text{DEGREES}}{45}$	SPACING OF NO. 2 ANTENNA = $\frac{\text{DEGREES}}{45}$	PHASING OF NO. 2 ANTENNA = $\frac{\text{DEGREES}}{45}$	ORIENTATION OF NO. 3 ANTENNA = $\frac{\text{DEGREES}}{45}$	SPACING OF NO. 3 ANTENNA = $\frac{\text{DEGREES}}{45}$	PHASING OF NO. 3 ANTENNA = $\frac{\text{DEGREES}}{45}$
No. 3	$\phi_2$ 0	$S_2$ 5	$\psi_2$ 0	$\phi_3$ 1	$S_3$ 6	$\psi_3$ 0

LEFT HAND PATTERN NUMBER GIVES ANTENNA PLACEMENT AND PHASING DATA.

% FIELD INTENSITY RADIATED IN HORIZONTAL PLANE FROM NO. 1 ANTENNA.	% FIELD INTENSITY RADIATED IN HORIZONTAL PLANE FROM NO. 2 ANTENNA.	% FIELD INTENSITY RADIATED IN HORIZONTAL PLANE FROM NO. 3 ANTENNA.	% RMS FIELD INTENSITY RADIATED IN HORIZONTAL PLANE FROM ANTENNA SYSTEM.
$E_1$ 48	$E_2$ 68	$E_3$ 57	$E_0$ 61

RIGHT HAND PATTERN NUMBER GIVES ANTENNA FIELD INTENSITY DATA IN PERCENT.

PATTERN NOMENCLATURE

$\psi_3$  = PHASING OF ANTENNA No. 3 IN DEGREES

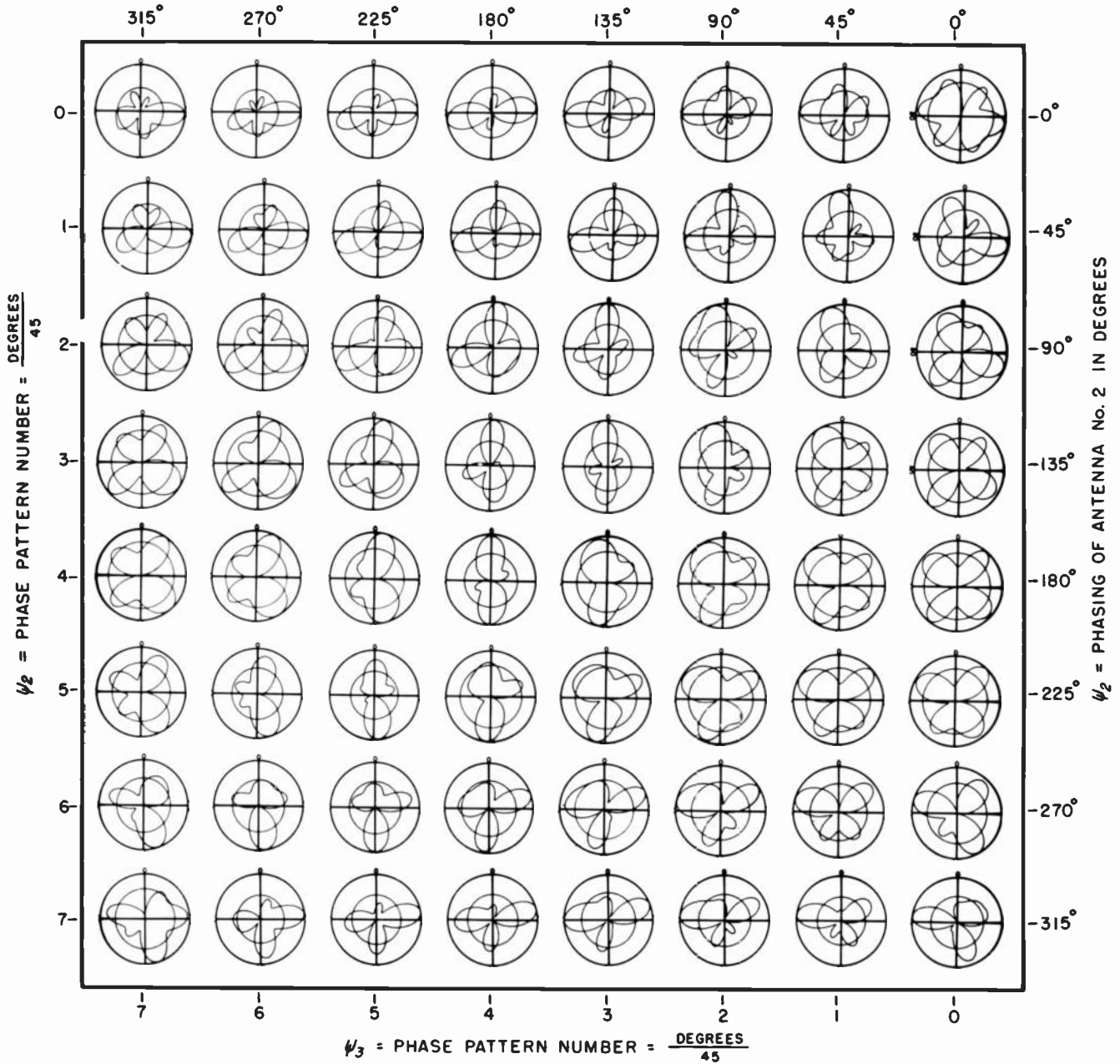

NUMBER OF ANTENNAS IN THE SYSTEM  
 No.  $\phi_2$  3  
 ORIENTATION OF NO. 2 ANTENNA =  $\frac{\text{DEGREES}}{45}$   $\psi_2$  0  
 SPACING OF NO. 2 ANTENNA =  $\frac{\text{DEGREES}}{45}$   $S_2$  5  
 PHASING OF NO. 2 ANTENNA =  $\frac{\text{DEGREES}}{45}$   $\psi_2$  0  
 ORIENTATION OF NO. 3 ANTENNA =  $\frac{\text{DEGREES}}{45}$   $\phi_3$  7  
 SPACING OF NO. 3 ANTENNA =  $\frac{\text{DEGREES}}{45}$   $S_3$  7  
 PHASING OF NO. 3 ANTENNA =  $\frac{\text{DEGREES}}{45}$   $\psi_3$  0

% FIELD INTENSITY RADIATED IN HORIZONTAL PLANE FROM NO. 1 ANTENNA.  $F_1$  72  
 % FIELD INTENSITY RADIATED IN HORIZONTAL PLANE FROM NO. 2 ANTENNA.  $F_2$  37  
 % FIELD INTENSITY RADIATED IN HORIZONTAL PLANE FROM NO. 3 ANTENNA.  $F_3$  47  
 % RMS FIELD INTENSITY RADIATED IN HORIZONTAL PLANE FROM ANTENNA SYSTEM.  $F_0$  74

LEFT HAND PATTERN NUMBER GIVES ANTENNA PLACEMENT AND PHASING DATA.

RIGHT HAND PATTERN NUMBER GIVES ANTENNA FIELD INTENSITY DATA IN PERCENT.

PATTERN NOMENCLATURE

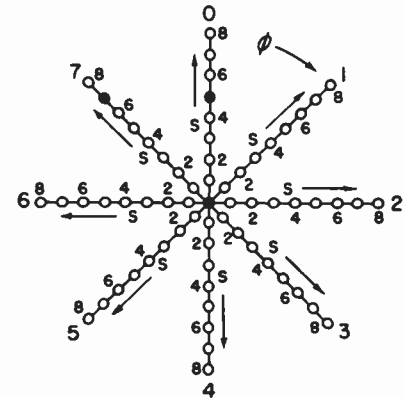

SPOTS LOCATE THE ANTENNAS FOR THIS PAGE OF PATTERNS IN THE SYSTEMIZATION PLACEMENT CHART.

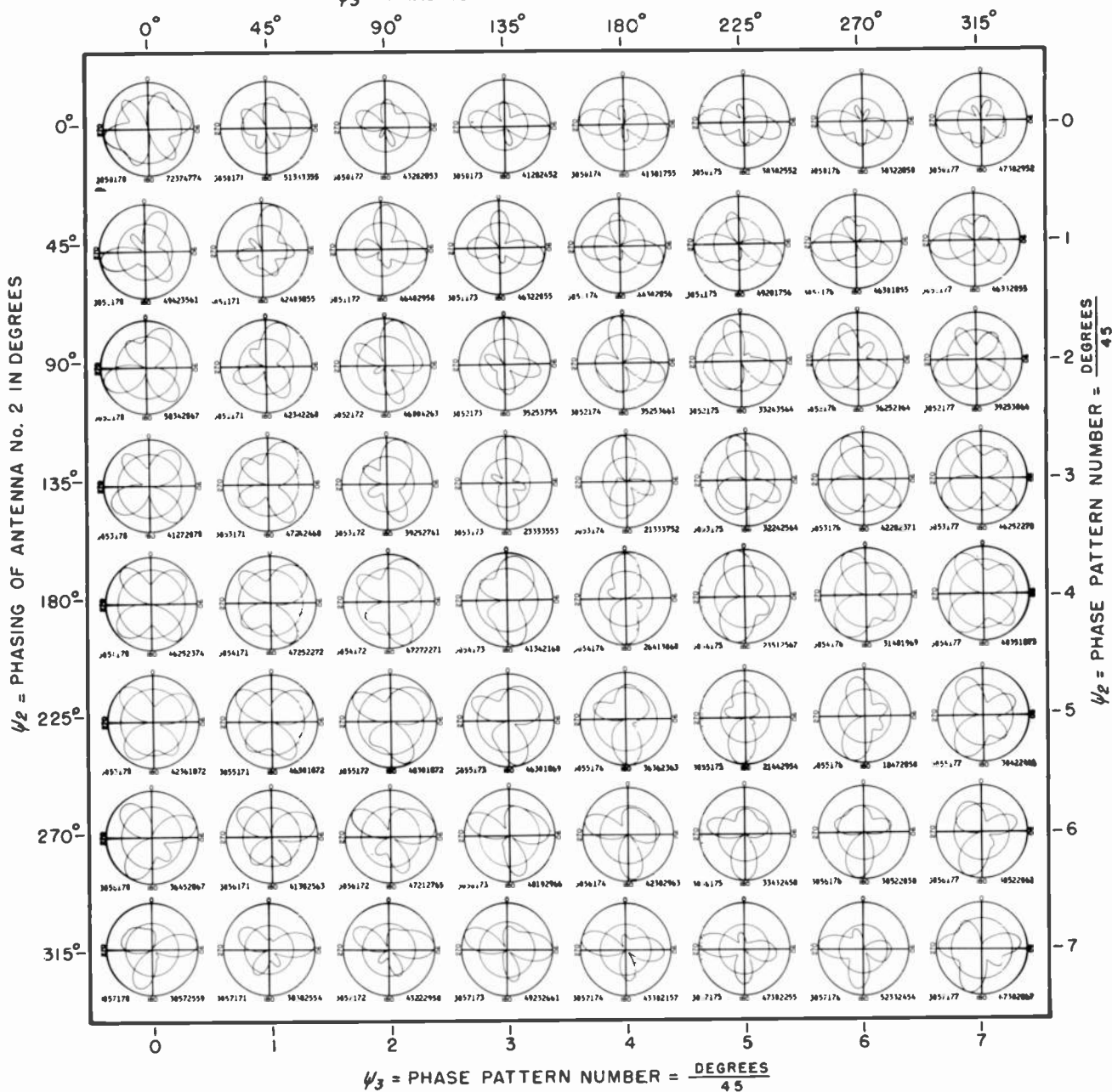

COPYRIGHT 1946 BY CARL E. SMITH  
PRINTED IN U. S. A.

CLEVELAND INSTITUTE OF RADIO ELECTRONICS  
TERMINAL TOWER, CLEVELAND 18, OHIO.

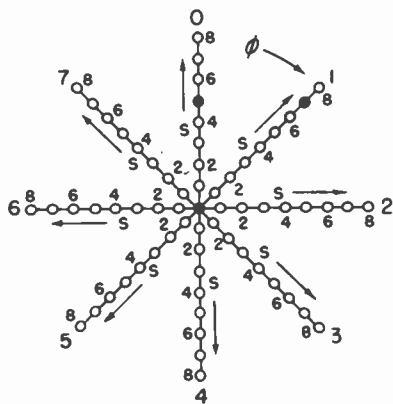

SPOTS LOCATE THE ANTENNAS FOR  
THIS PAGE OF PATTERNS IN THE  
SYSTEMATIZATION PLACEMENT CHART.

NUMBER OF ANTENNAS IN THE SYSTEM	ORIENTATION OF NO. 2 ANTENNA = $\frac{\text{DEGREES}}{45}$	SPACING OF NO. 2 ANTENNA = $\frac{\text{DEGREES}}{45}$	PHASING OF NO. 2 ANTENNA = $\frac{\text{DEGREES}}{45}$	ORIENTATION OF NO. 3 ANTENNA = $\frac{\text{DEGREES}}{45}$	SPACING OF NO. 3 ANTENNA = $\frac{\text{DEGREES}}{45}$	PHASING OF NO. 3 ANTENNA = $\frac{\text{DEGREES}}{45}$
NO.	$\phi_2$	$S_2$	$\psi_2$	$\phi_3$	$S_3$	$\psi_3$
3	0	5	0	1	7	0

LEFT HAND PATTERN NUMBER GIVES ANTENNA  
PLACEMENT AND PHASING DATA.

% FIELD INTENSITY RADIATED IN HORIZONTAL PLANE FROM NO. 1 ANTENNA.	% FIELD INTENSITY RADIATED IN HORIZONTAL PLANE FROM NO. 2 ANTENNA.	% FIELD INTENSITY RADIATED IN HORIZONTAL PLANE FROM NO. 3 ANTENNA.	% RMS FIELD INTENSITY RADIATED IN HORIZONTAL PLANE FROM ANTENNA SYSTEM.
$E_1$	$E_2$	$E_3$	$E_0$
72	37	47	74

RIGHT HAND PATTERN NUMBER  
GIVES ANTENNA FIELD INTEN-  
SITY DATA IN PERCENT.

PATTERN NOMENCLATURE

$\psi_3$  = PHASING OF ANTENNA No. 3 IN DEGREES

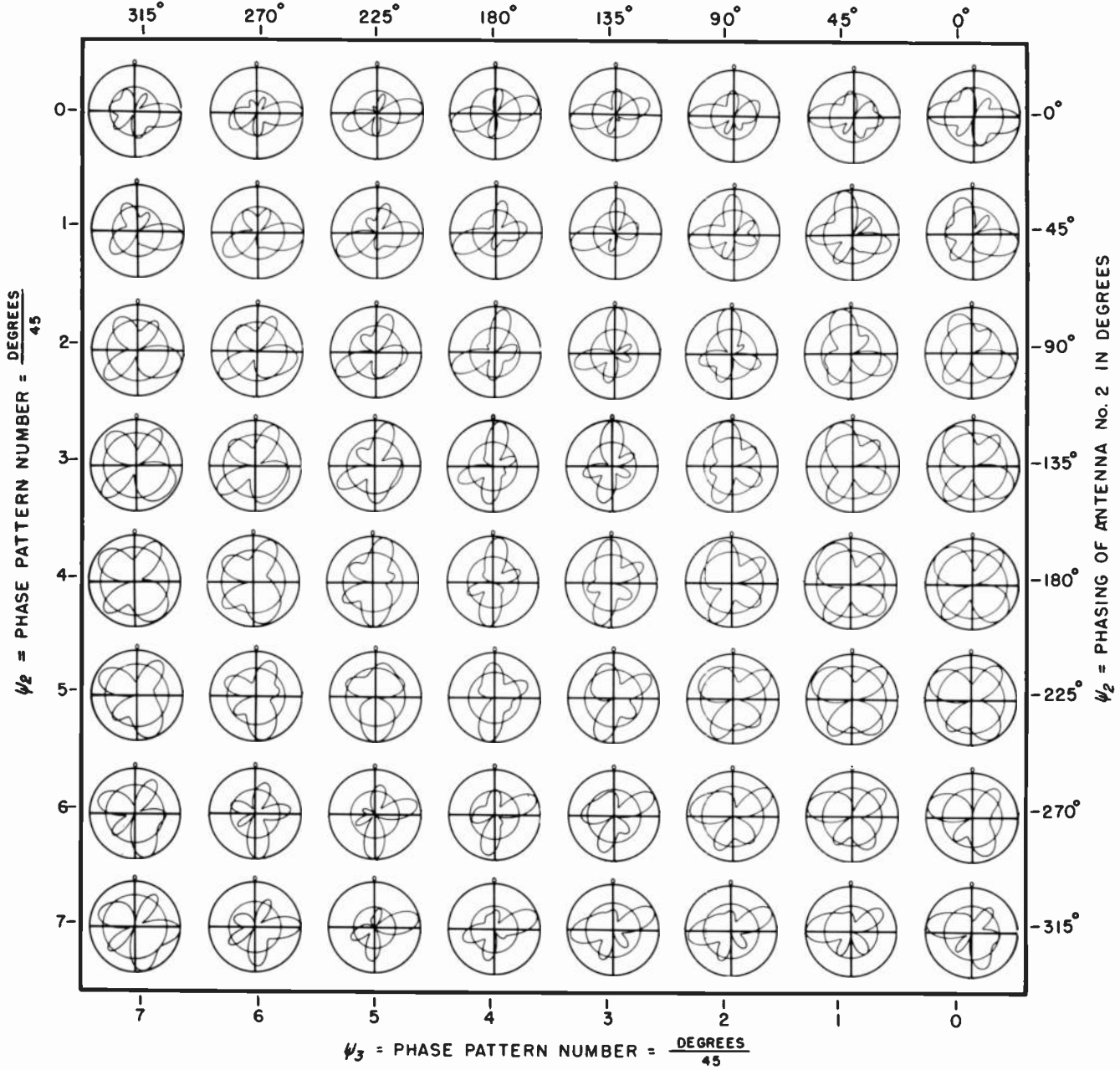

NUMBER OF ANTENNAS IN THE SYSTEM		ORIENTATION OF NO. 2 ANTENNA = $\frac{\text{DEGREES}}{45}$		SPACING OF NO. 2 ANTENNA = $\frac{\text{DEGREES}}{45}$		PHASING OF NO. 2 ANTENNA = $\frac{\text{DEGREES}}{45}$		ORIENTATION OF NO. 3 ANTENNA = $\frac{\text{DEGREES}}{45}$		SPACING OF NO. 3 ANTENNA = $\frac{\text{DEGREES}}{45}$		PHASING OF NO. 3 ANTENNA = $\frac{\text{DEGREES}}{45}$		
No.	$\phi_2$	$S_2$	$\psi_2$	$\phi_3$	$S_3$	$\psi_3$	$E_1$	$E_2$	$E_3$	$E_0$				
3	0	3	0	7	8	0	56	34	27	64				

LEFT HAND PATTERN NUMBER GIVES ANTENNA PLACEMENT AND PHASING DATA.

RIGHT HAND PATTERN NUMBER GIVES ANTENNA FIELD INTENSITY DATA IN PERCENT.

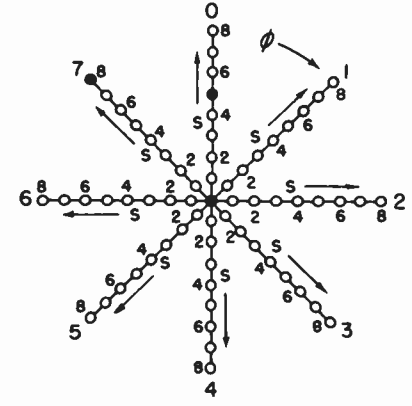

SPOTS LOCATE THE ANTENNAS FOR THIS PAGE OF PATTERNS IN THE SYSTEMIZATION PLACEMENT CHART.

PATTERN NOMENCLATURE

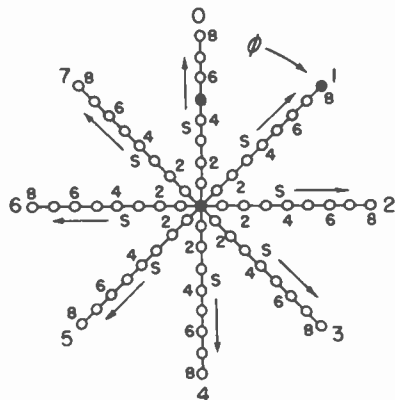
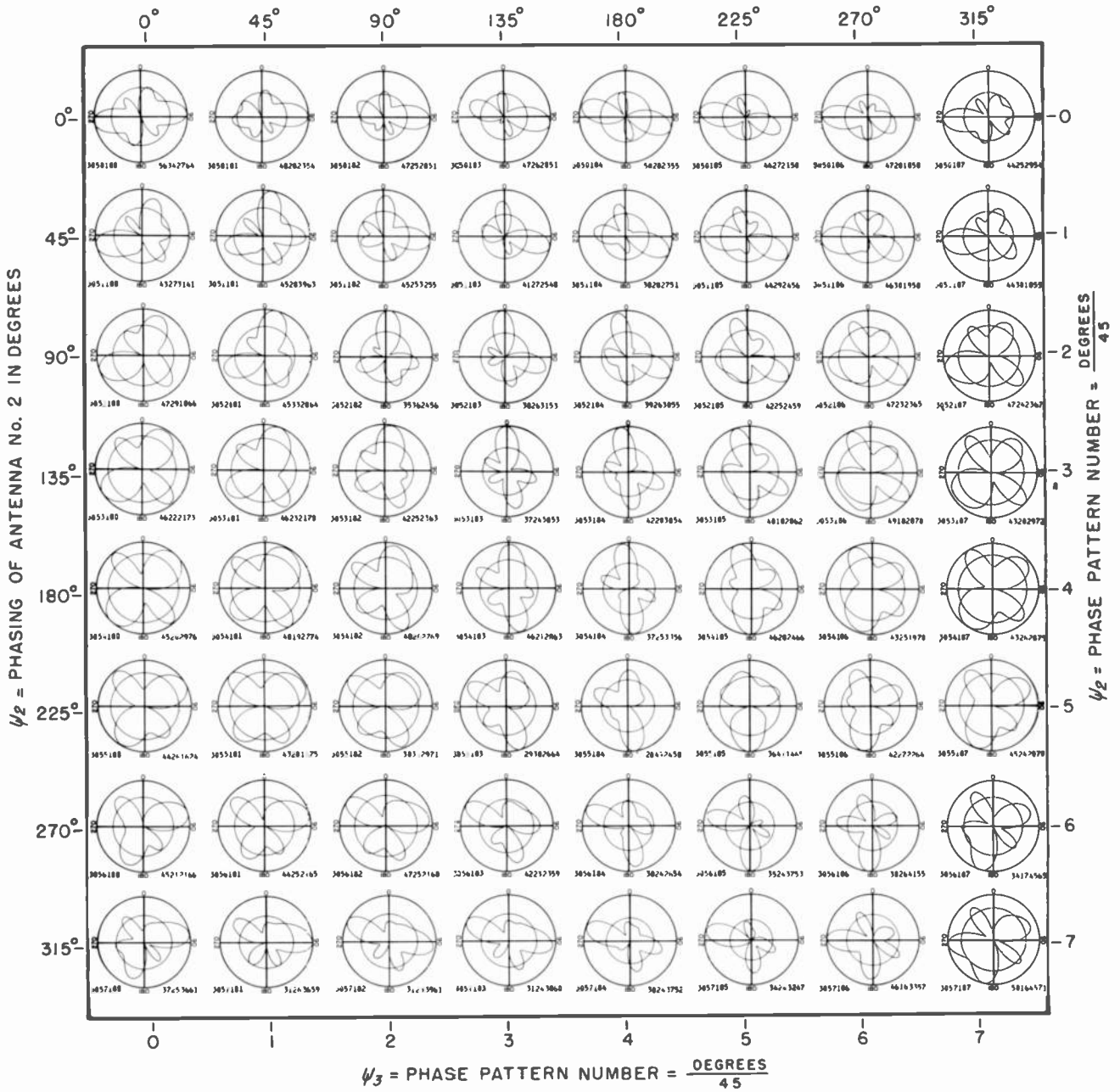

NUMBER OF ANTENNAS IN THE SYSTEM	ORIENTATION OF NO. 2 ANTENNA = $\frac{\text{DEGREES}}{45}$	SPACING OF NO. 2 ANTENNA = $\frac{\text{DEGREES}}{45}$	PHASING OF NO. 2 ANTENNA = $\frac{\text{DEGREES}}{45}$	ORIENTATION OF NO. 3 ANTENNA = $\frac{\text{DEGREES}}{45}$	SPACING OF NO. 3 ANTENNA = $\frac{\text{DEGREES}}{45}$	PHASING OF NO. 3 ANTENNA = $\frac{\text{DEGREES}}{45}$
NO. 3	$\phi_2$ 0	$S_2$ 5	$\psi_2$ 0	$\phi_3$ 1	$S_3$ 8	$\psi_3$ 0

% FIELD INTENSITY RADIATED IN HORIZONTAL PLANE FROM NO. 1 ANTENNA.	% FIELD INTENSITY RADIATED IN HORIZONTAL PLANE FROM NO. 2 ANTENNA.	% FIELD INTENSITY RADIATED IN HORIZONTAL PLANE FROM NO. 3 ANTENNA.	% RMS FIELD INTENSITY RADIATED IN HORIZONTAL PLANE FROM ANTENNA SYSTEM.
$E_1$ 56	$E_2$ 34	$E_3$ 27	$E_0$ 64

LEFT HAND PATTERN NUMBER GIVES ANTENNA PLACEMENT AND PHASING DATA.

RIGHT HAND PATTERN NUMBER GIVES ANTENNA FIELD INTENSITY DATA IN PERCENT.

SPOTS LOCATE THE ANTENNAS FOR THIS PAGE OF PATTERNS IN THE SYSTEMATIZATION PLACEMENT CHART.

PATTERN NOMENCLATURE

COPYRIGHT 1946 BY CARL E. SMITH  
PRINTED IN U. S. A.

CLEVELAND INSTITUTE OF RADIO ELECTRONICS  
TERMINAL TOWER, CLEVELAND 13, OHIO.

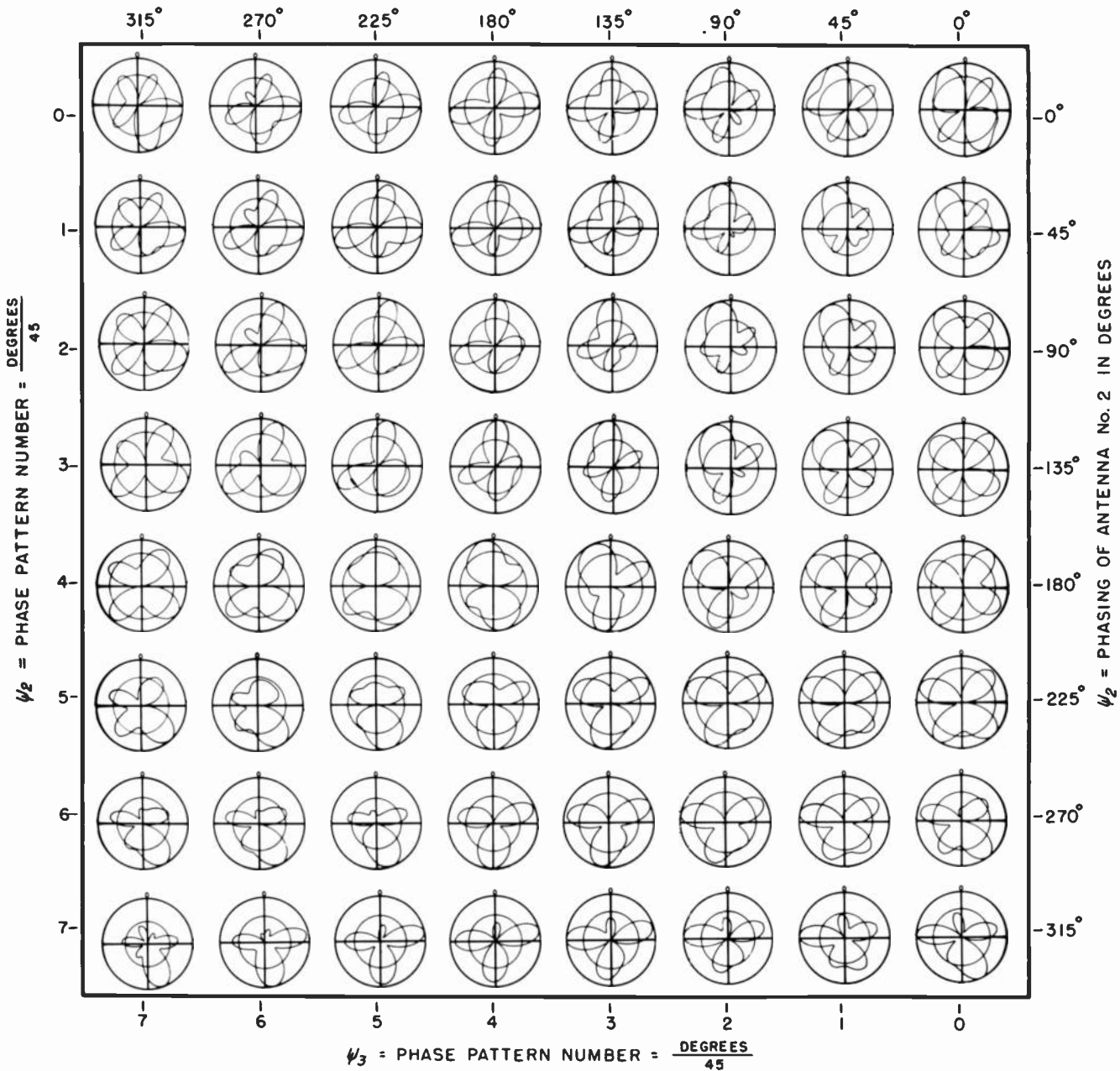

NUMBER OF ANTENNAS IN THE SYSTEM  
No. 3

ORIENTATION OF NO. 2 ANTENNA =  $\frac{\text{DEGREES}}{45}$   
 $\phi_2$  0

SPACING OF NO. 2 ANTENNA =  $\frac{\text{DEGREES}}{45}$   
 $S_2$  6

PHASING OF NO. 2 ANTENNA =  $\frac{\text{DEGREES}}{45}$   
 $\psi_2$  0

ORIENTATION OF NO. 3 ANTENNA =  $\frac{\text{DEGREES}}{45}$   
 $\phi_3$  7

SPACING OF NO. 3 ANTENNA =  $\frac{\text{DEGREES}}{45}$   
 $S_3$  7

PHASING OF NO. 3 ANTENNA =  $\frac{\text{DEGREES}}{45}$   
 $\psi_3$  0

% FIELD INTENSITY RADIATED IN HORIZONTAL PLANE FROM NO. 1 ANTENNA.  
 $F_1$  54

% FIELD INTENSITY RADIATED IN HORIZONTAL PLANE FROM NO. 2 ANTENNA.  
 $F_2$  19

% FIELD INTENSITY RADIATED IN HORIZONTAL PLANE FROM NO. 3 ANTENNA.  
 $F_3$  52

% RMS FIELD INTENSITY RADIATED IN HORIZONTAL PLANE FROM ANTENNA SYSTEM.  
 $F_0$  71

LEFT HAND PATTERN NUMBER GIVES ANTENNA PLACEMENT AND PHASING DATA.

RIGHT HAND PATTERN NUMBER GIVES ANTENNA FIELD INTENSITY DATA IN PERCENT.

PATTERN NOMENCLATURE

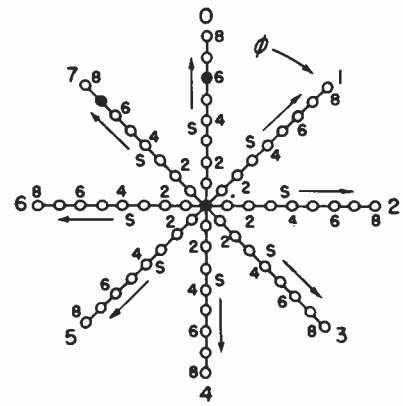

SPOTS LOCATE THE ANTENNAS FOR THIS PAGE OF PATTERNS IN THE SYSTEMIZATION PLACEMENT CHART.

$\psi_3$  = PHASING OF ANTENNA No. 3 IN DEGREES

3.97

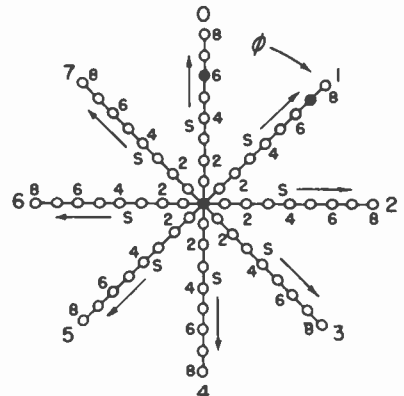
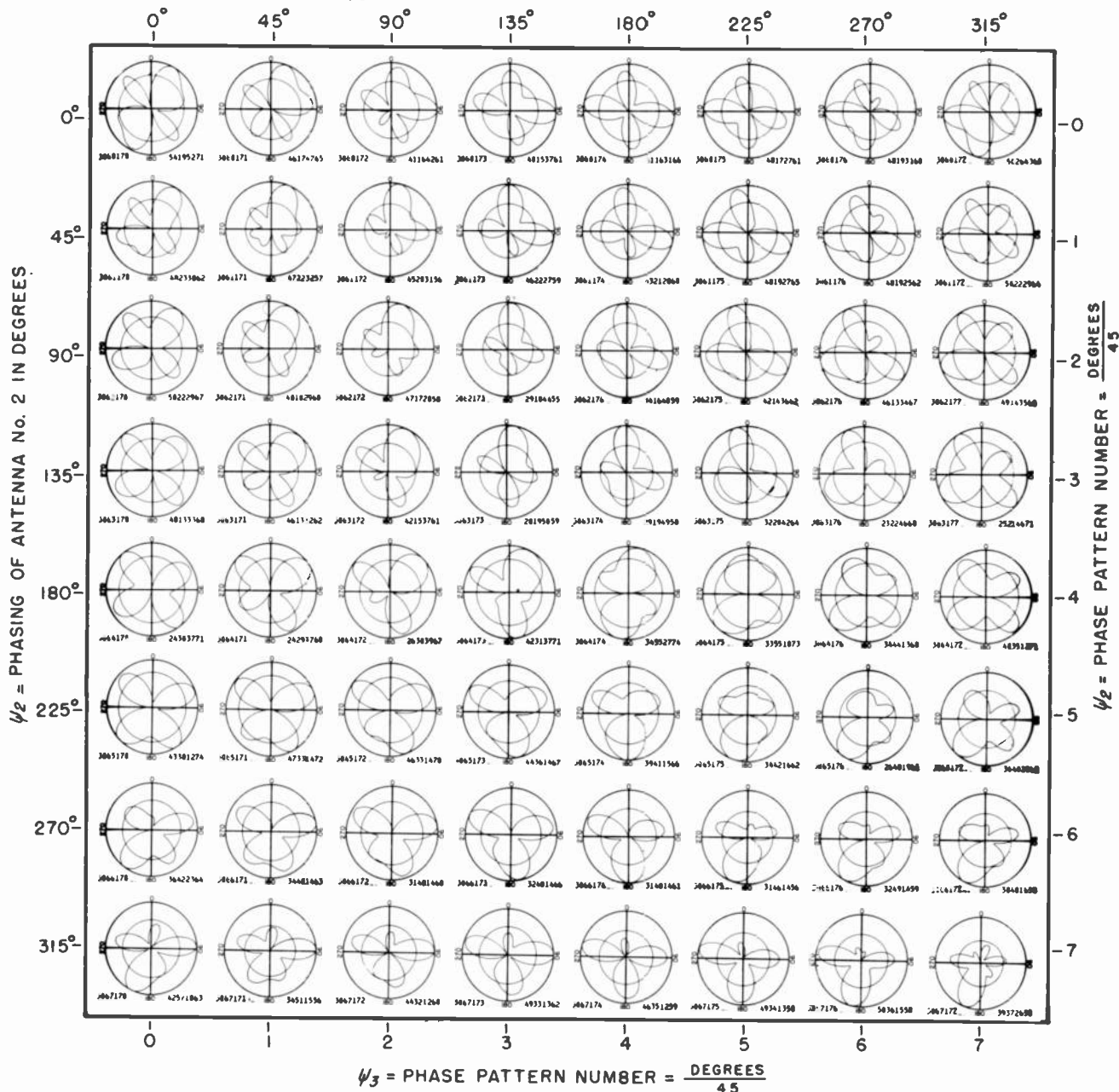

NUMBER OF ANTENNAS IN THE SYSTEM	ORIENTATION OF NO. 2 ANTENNA = $\frac{\text{DEGREES}}{45}$	SPACING OF NO. 2 ANTENNA = $\frac{\text{DEGREES}}{45}$	PHASING OF NO. 2 ANTENNA = $\frac{\text{DEGREES}}{45}$	ORIENTATION OF NO. 3 ANTENNA = $\frac{\text{DEGREES}}{45}$	SPACING OF NO. 3 ANTENNA = $\frac{\text{DEGREES}}{45}$	PHASING OF NO. 3 ANTENNA = $\frac{\text{DEGREES}}{45}$
No. 3	$\phi_2$ 0	$S_2$ 6	$\psi_2$ 0	$\phi_3$ 1	$S_3$ 7	$\psi_3$ 0

LEFT HAND PATTERN NUMBER GIVES ANTENNA PLACEMENT AND PHASING DATA.

% FIELD INTENSITY RADIATED IN HORIZONTAL PLANE FROM NO. 1 ANTENNA.	% FIELD INTENSITY RADIATED IN HORIZONTAL PLANE FROM NO. 2 ANTENNA.	% FIELD INTENSITY RADIATED IN HORIZONTAL PLANE FROM NO. 3 ANTENNA.	% RMS FIELD INTENSITY RADIATED IN HORIZONTAL PLANE FROM ANTENNA SYSTEM.
$E_1$ 54	$E_2$ 19	$E_3$ 52	$E_0$ 71

RIGHT HAND PATTERN NUMBER GIVES ANTENNA FIELD INTENSITY DATA IN PERCENT.

SPOTS LOCATE THE ANTENNAS FOR THIS PAGE OF PATTERNS IN THE SYSTEMIZATION PLACEMENT CHART.

PATTERN NOMENCLATURE

$\psi_3$  = PHASING OF ANTENNA No. 3 IN DEGREES

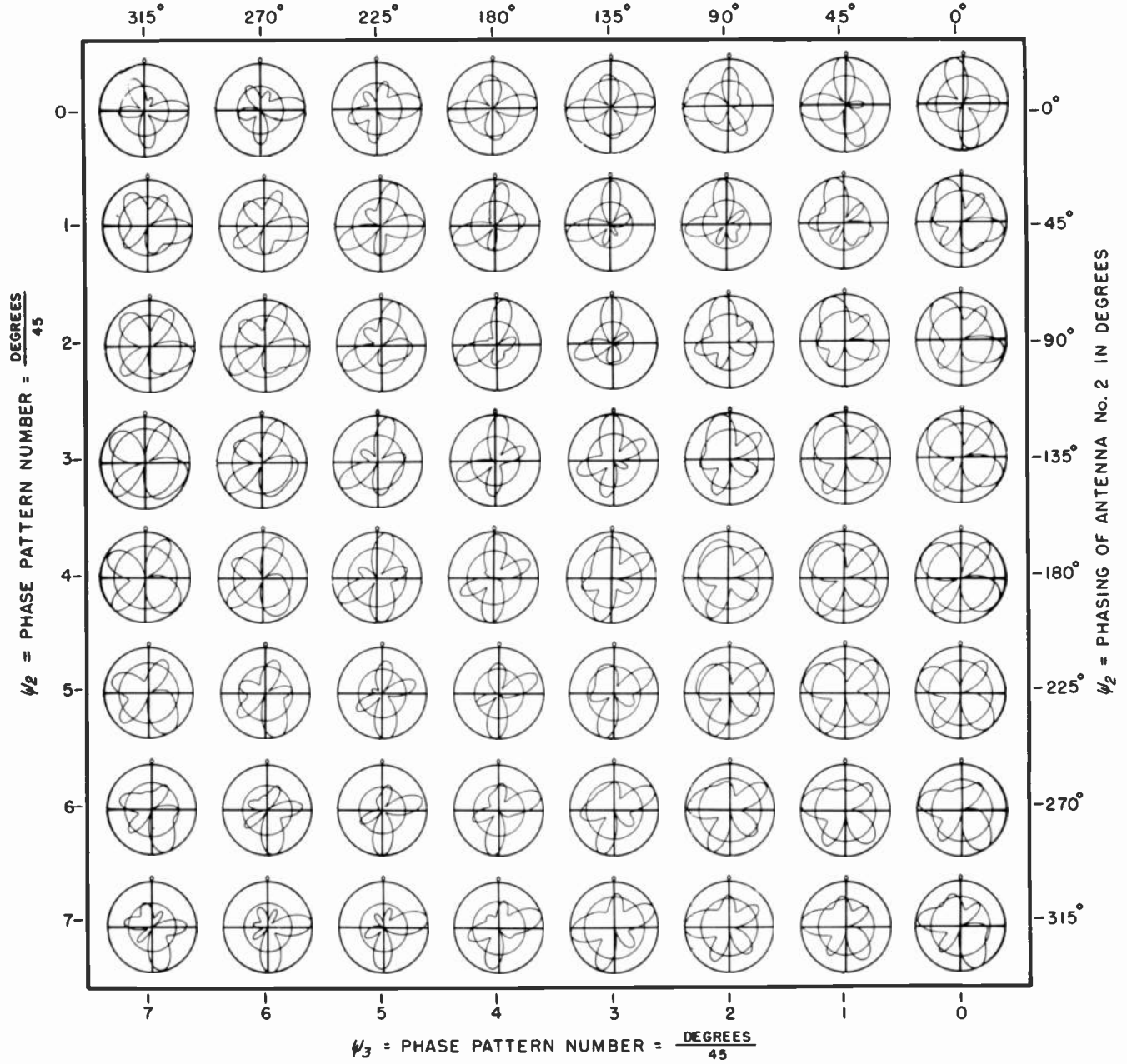

NUMBER OF ANTENNAS IN THE SYSTEM.	ORIENTATION OF NO. 2 ANTENNA = $\frac{DEGREES}{45}$	SPACING OF NO. 2 ANTENNA = $\frac{DEGREES}{45}$	PHASING OF NO. 2 ANTENNA = $\frac{DEGREES}{45}$	ORIENTATION OF NO. 3 ANTENNA = $\frac{DEGREES}{45}$	SPACING OF NO. 3 ANTENNA = $\frac{DEGREES}{45}$	PHASING OF NO. 3 ANTENNA = $\frac{DEGREES}{45}$
NO. 3	$\phi_2$ 0	$S_2$ 6	$\psi_2$ 0	$\phi_3$ 7	$S_3$ 8	$\psi_3$ 0

LEFT HAND PATTERN NUMBER GIVES ANTENNA PLACEMENT AND PHASING DATA.

% FIELD INTENSITY RADIATED IN HORIZONTAL PLANE FROM NO. 1 ANTENNA.	% FIELD INTENSITY RADIATED IN HORIZONTAL PLANE FROM NO. 2 ANTENNA.	% FIELD INTENSITY RADIATED IN HORIZONTAL PLANE FROM NO. 3 ANTENNA.	% RMS FIELD INTENSITY RADIATED IN HORIZONTAL PLANE FROM ANTENNA SYSTEM.
$E_1$ 22	$E_2$ 52	$E_3$ 40	$E_0$ 60

RIGHT HAND PATTERN NUMBER GIVES ANTENNA FIELD INTENSITY DATA IN PERCENT.

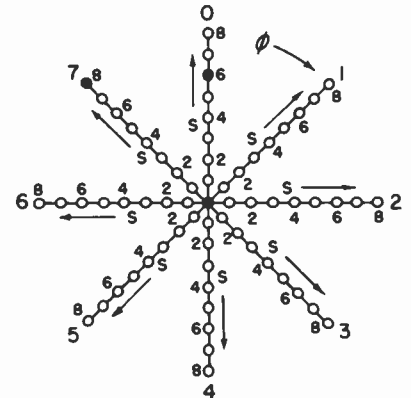

SPOTS LOCATE THE ANTENNAS FOR THIS PAGE OF PATTERNS IN THE SYSTEMATIZATION PLACEMENT CHART.

PATTERN NOMENCLATURE



$\psi_3 =$  PHASING OF ANTENNA NO. 3 IN DEGREES

3.99

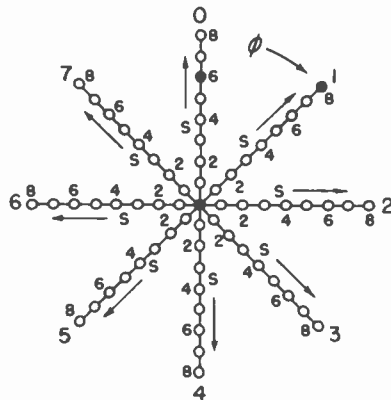
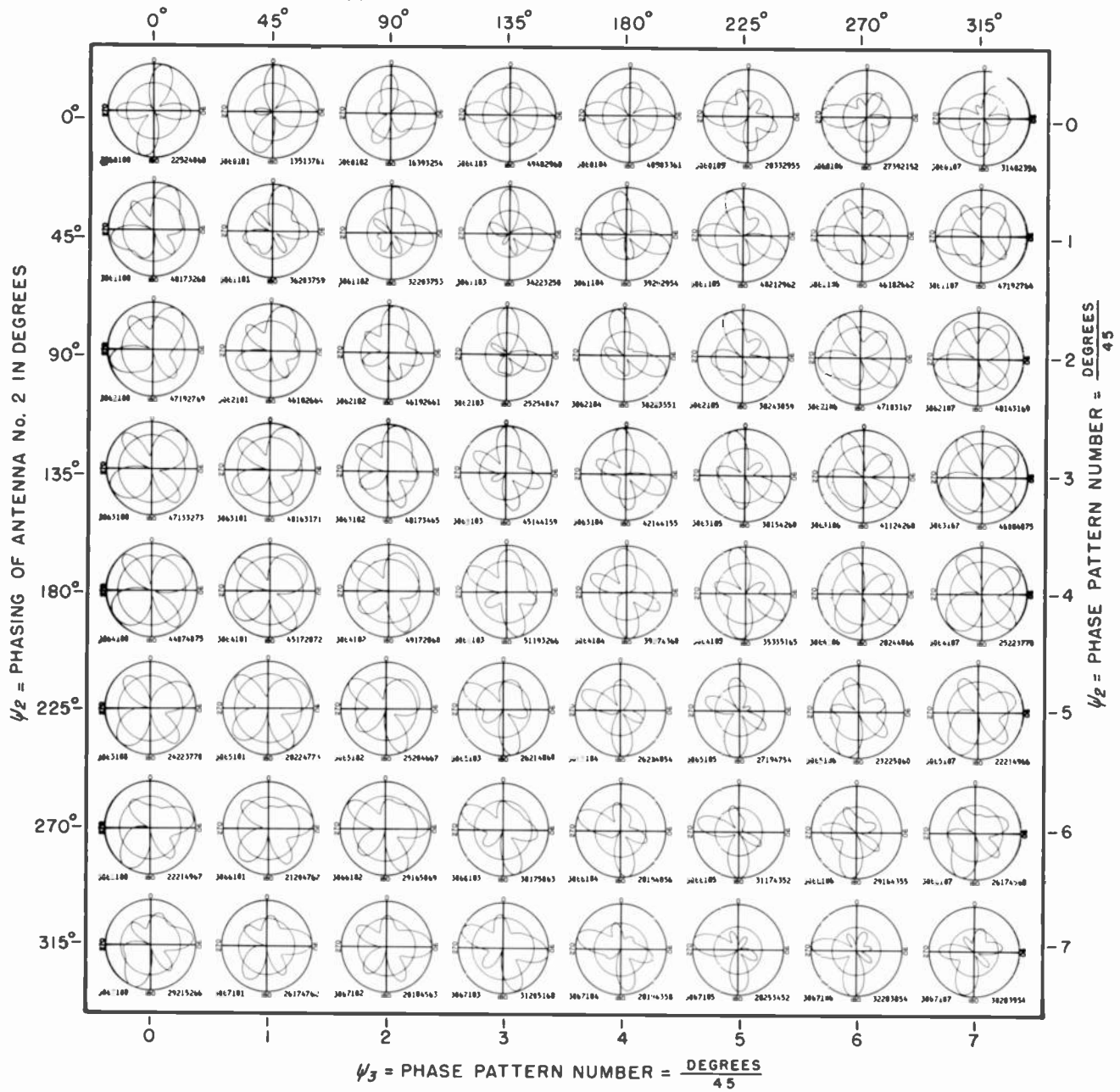

NUMBER OF ANTENNAS IN THE SYSTEM	$\psi_2 = \frac{\text{DEGREES}}{45}$	$S_2 = \frac{\text{DEGREES}}{45}$	$\psi_3 = \frac{\text{DEGREES}}{45}$	$\psi_3 = \frac{\text{DEGREES}}{45}$	$S_3 = \frac{\text{DEGREES}}{45}$	$\psi_3 = \frac{\text{DEGREES}}{45}$
No. 3	0	6	0	1	8	0

LEFT HAND PATTERN NUMBER GIVES ANTENNA PLACEMENT AND PHASING DATA.

% FIELD INTENSITY RADIATED IN HORIZONTAL PLANE FROM NO. 1 ANTENNA.	% FIELD INTENSITY RADIATED IN HORIZONTAL PLANE FROM NO. 2 ANTENNA.	% FIELD INTENSITY RADIATED IN HORIZONTAL PLANE FROM NO. 3 ANTENNA.	% RMS FIELD INTENSITY RADIATED IN HORIZONTAL PLANE FROM ANTENNA SYSTEM.
$E_1 = 22$	$E_2 = 52$	$E_3 = 40$	$E_0 = 60$

RIGHT HAND PATTERN NUMBER GIVES ANTENNA FIELD INTENSITY DATA IN PERCENT.

SPOTS LOCATE THE ANTENNAS FOR THIS PAGE OF PATTERNS IN THE SYSTEMATIZATION PLACEMENT CHART.

PATTERN NOMENCLATURE

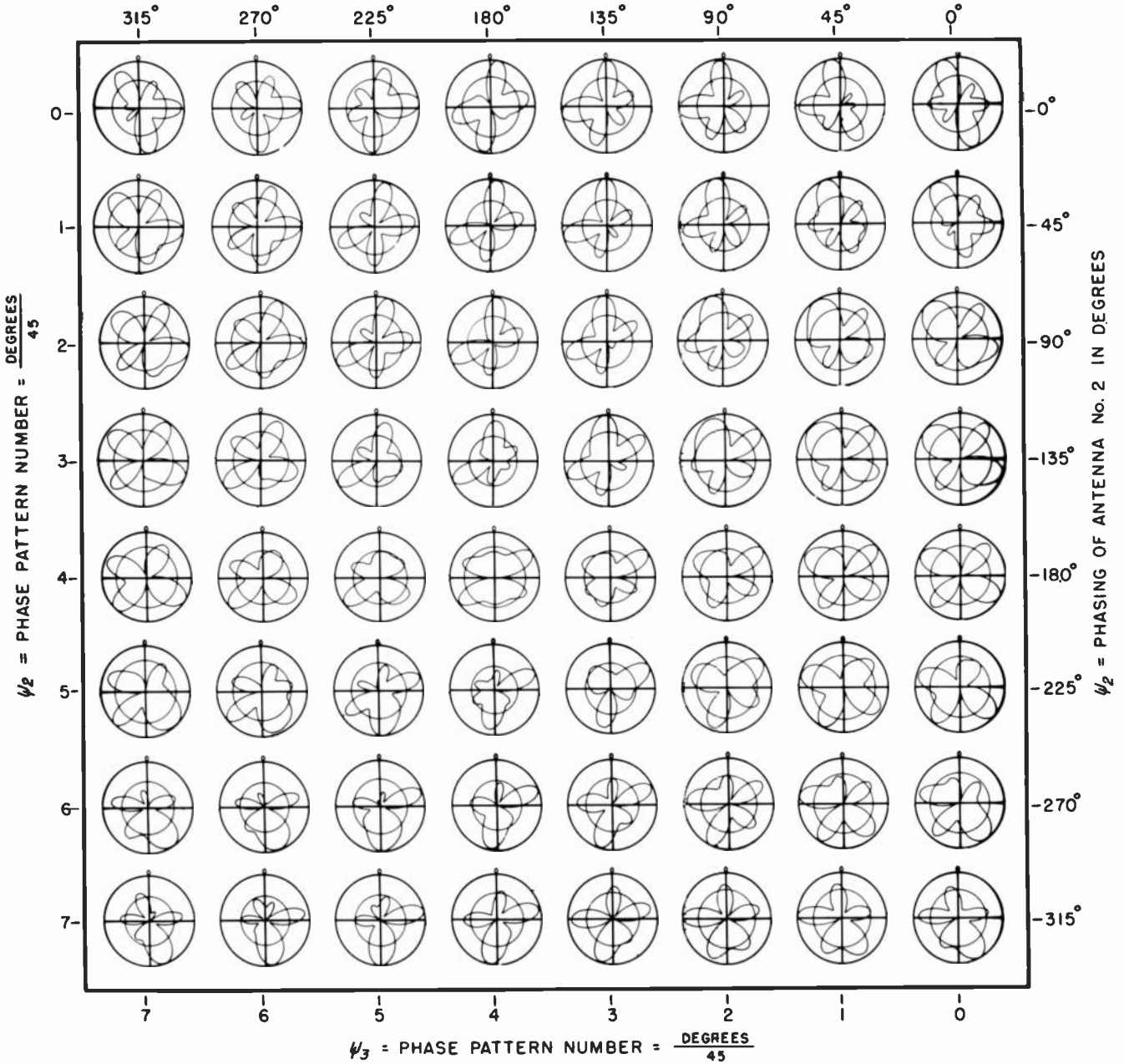

NUMBER OF ANTENNAS IN THE SYSTEM	ORIENTATION OF NO. 2 ANTENNA = $\frac{DEGREES}{45}$	SPACING OF NO. 2 ANTENNA = $\frac{DEGREES}{45}$	PHASING OF NO. 2 ANTENNA = $\frac{DEGREES}{45}$	ORIENTATION OF NO. 3 ANTENNA = $\frac{DEGREES}{45}$	SPACING OF NO. 3 ANTENNA = $\frac{DEGREES}{45}$	PHASING OF NO. 3 ANTENNA = $\frac{DEGREES}{45}$
No. 3	$\psi_2 = 0$	$S_2 = 7$	$\psi_2 = 0$	$\psi_3 = 7$	$S_3 = 8$	$\psi_3 = 0$

LEFT HAND PATTERN NUMBER GIVES ANTENNA PLACEMENT AND PHASING DATA.

% FIELD INTENSITY RADIATED IN HORIZONTAL PLANE FROM NO. 1 ANTENNA.	% FIELD INTENSITY RADIATED IN HORIZONTAL PLANE FROM NO. 2 ANTENNA.	% FIELD INTENSITY RADIATED IN HORIZONTAL PLANE FROM NO. 3 ANTENNA.	% RMS FIELD INTENSITY RADIATED IN HORIZONTAL PLANE FROM ANTENNA SYSTEM.
$E_1 = 21$	$E_2 = 31$	$E_3 = 45$	$E_0 = 61$

RIGHT HAND PATTERN NUMBER GIVES ANTENNA FIELD INTENSITY DATA IN PERCENT.

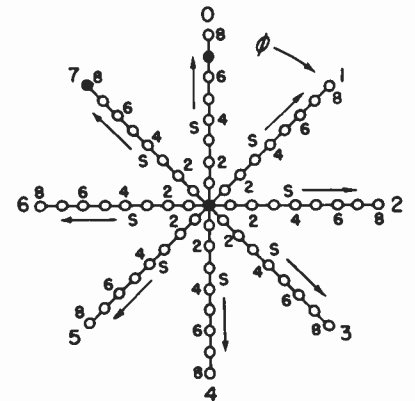

SPOTS LOCATE THE ANTENNAS FOR THIS PAGE OF PATTERNS IN THE SYSTEMATIZATION PLACEMENT CHART.

PATTERN NOMENCLATURE

$\psi_3$  = PHASING OF ANTENNA No. 3 IN DEGREES

3.101

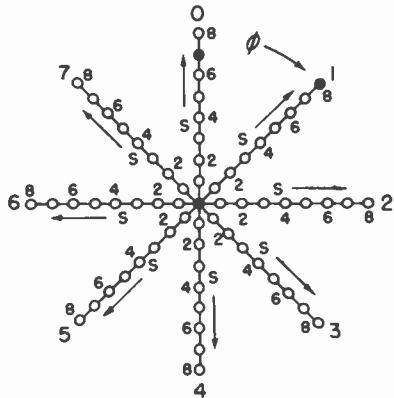
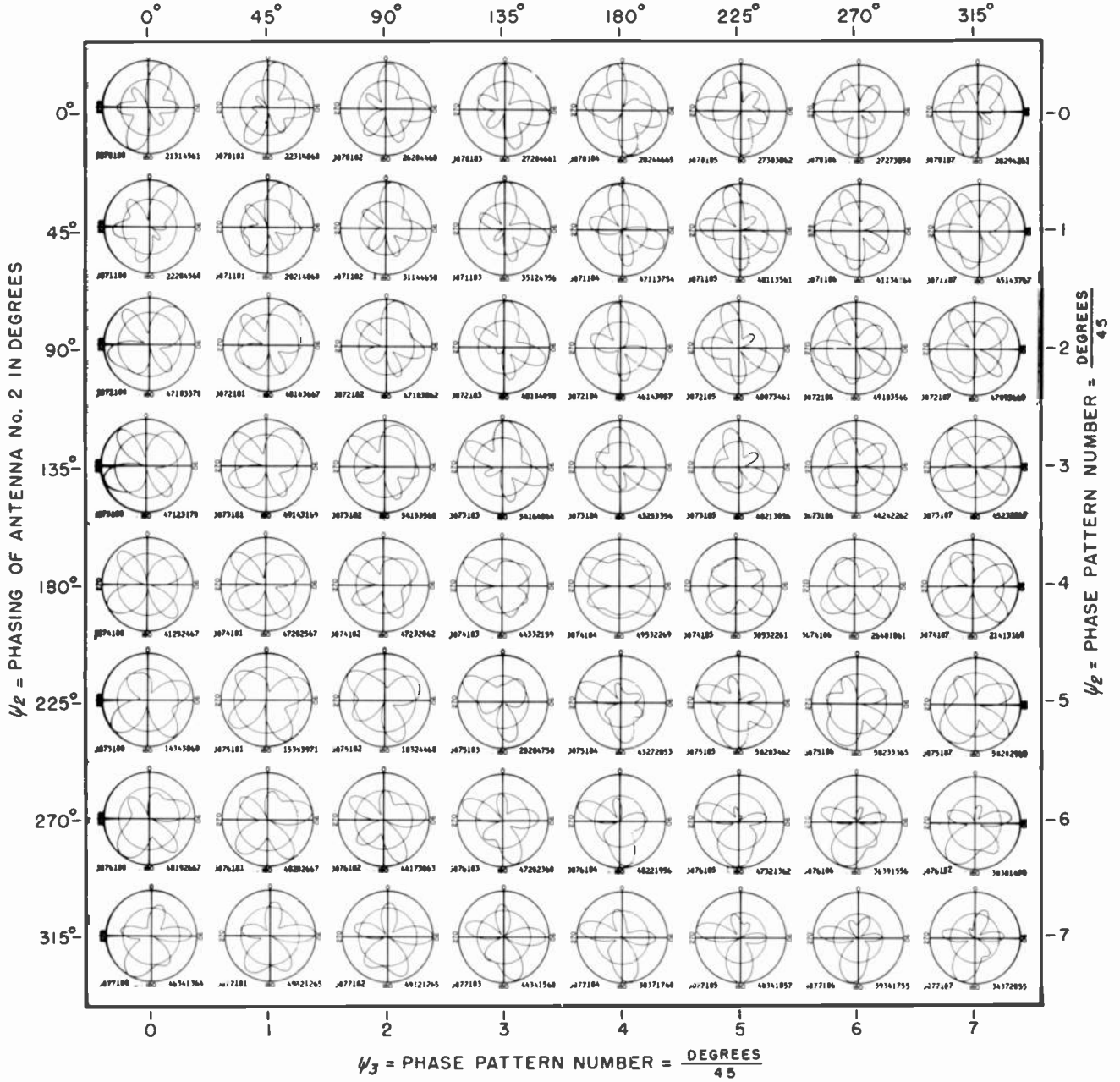

SPOTS LOCATE THE ANTENNAS FOR THIS PAGE OF PATTERNS IN THE SYSTEMATIZATION PLACEMENT CHART.

NO.	ORIENTATION OF NO. 2 ANTENNA = $\frac{\text{DEGREES}}{45}$	SPACING OF NO. 2 ANTENNA = $\frac{\text{DEGREES}}{45}$	PHASING OF NO. 2 ANTENNA = $\frac{\text{DEGREES}}{45}$	ORIENTATION OF NO. 3 ANTENNA = $\frac{\text{DEGREES}}{45}$	SPACING OF NO. 3 ANTENNA = $\frac{\text{DEGREES}}{45}$	PHASING OF NO. 3 ANTENNA = $\frac{\text{DEGREES}}{45}$
$\psi_2$	$S_2$	$\psi_2$	$\phi_3$	$S_3$	$\psi_3$	
3	0	7	0	1	8	0

LEFT HAND PATTERN NUMBER GIVES ANTENNA PLACEMENT AND PHASING DATA.

% FIELD INTENSITY RADIATED IN HORIZONTAL PLANE FROM NO. 1 ANTENNA.	% FIELD INTENSITY RADIATED IN HORIZONTAL PLANE FROM NO. 2 ANTENNA.	% FIELD INTENSITY RADIATED IN HORIZONTAL PLANE FROM NO. 3 ANTENNA.	% RMS FIELD INTENSITY RADIATED IN HORIZONTAL PLANE FROM ANTENNA SYSTEM.
$F_1$	$F_2$	$F_3$	$F_0$
21	31	45	61

RIGHT HAND PATTERN NUMBER GIVES ANTENNA FIELD INTENSITY DATA IN PERCENT.

PATTERN NOMENCLATURE

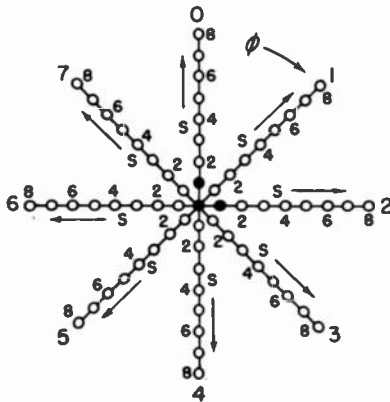
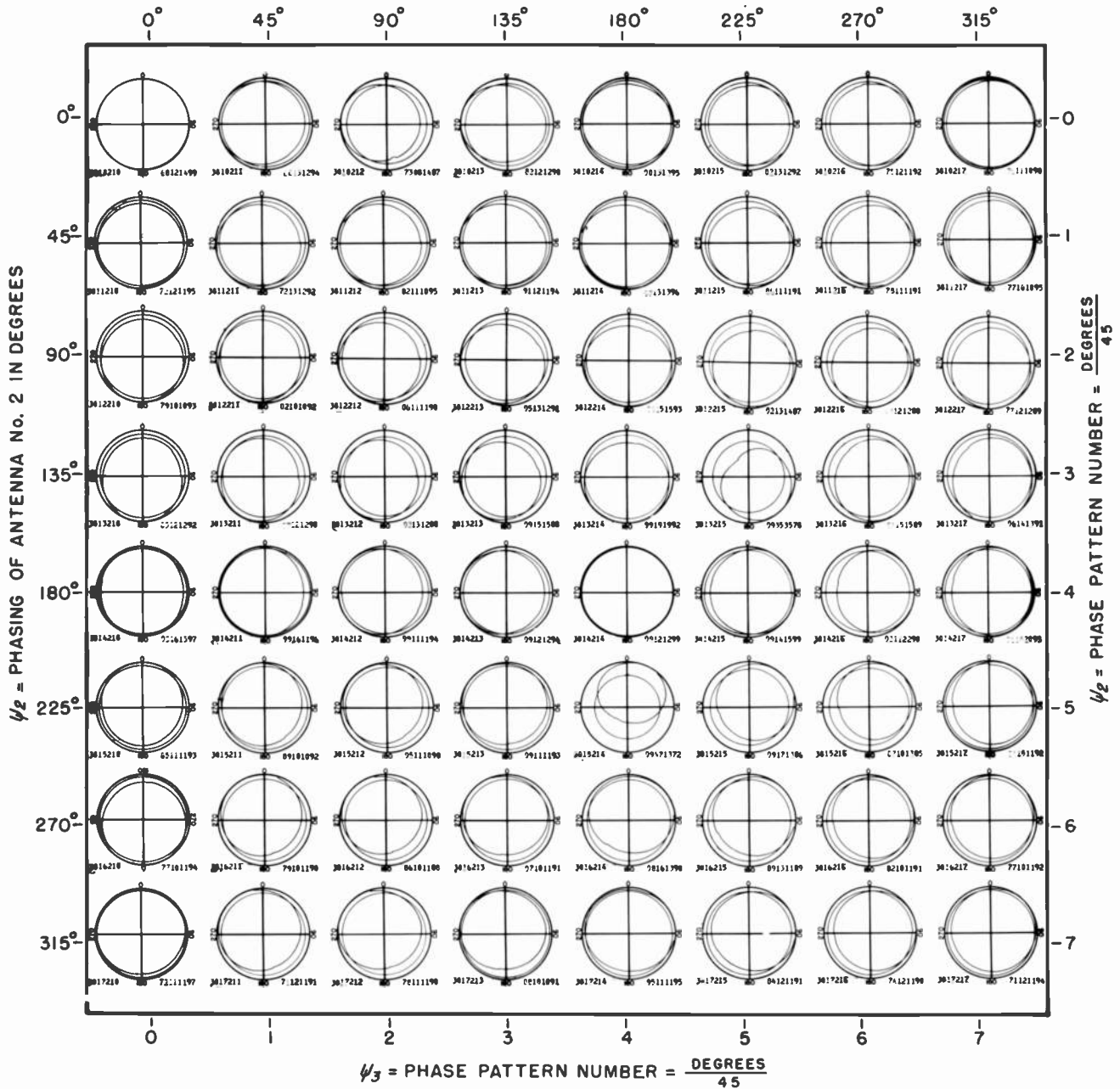

SPOTS LOCATE THE ANTENNAS FOR THIS PAGE OF PATTERNS IN THE SYSTEMATIZATION PLACEMENT CHART.

NUMBER OF ANTENNAS IN THE SYSTEM	ORIENTATION OF NO. 2 ANTENNA = $\frac{\text{DEGREES}}{45}$	SPACING OF NO. 2 ANTENNA = $\frac{\text{DEGREES}}{45}$	PHASING OF NO. 2 ANTENNA = $\frac{\text{DEGREES}}{45}$	ORIENTATION OF NO. 3 ANTENNA = $\frac{\text{DEGREES}}{45}$	SPACING OF NO. 3 ANTENNA = $\frac{\text{DEGREES}}{45}$	PHASING OF NO. 3 ANTENNA = $\frac{\text{DEGREES}}{45}$
No. 3	$\psi_2$ 0	$S_2$ 1	$\psi_2$ 0	$\psi_3$ 2	$S_3$ 1	$\psi_3$ 0

LEFT HAND PATTERN NUMBER GIVES ANTENNA PLACEMENT AND PHASING DATA.

% FIELD INTENSITY RADIATED IN HORIZONTAL PLANE FROM NO. 1 ANTENNA.	% FIELD INTENSITY RADIATED IN HORIZONTAL PLANE FROM NO. 2 ANTENNA.	% FIELD INTENSITY RADIATED IN HORIZONTAL PLANE FROM NO. 3 ANTENNA.	% RMS FIELD INTENSITY RADIATED IN HORIZONTAL PLANE FROM ANTENNA SYSTEM.
$F_1$ 68	$F_2$ 12	$F_3$ 14	$F_0$ 99

RIGHT HAND PATTERN NUMBER GIVES ANTENNA FIELD INTENSITY DATA IN PERCENT.

PATTERN NOMENCLATURE

$\psi_3$  = PHASING OF ANTENNA No. 3 IN DEGREES

3.103

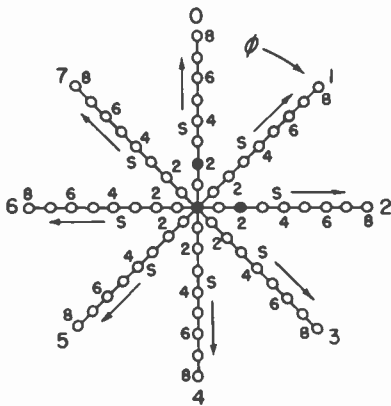
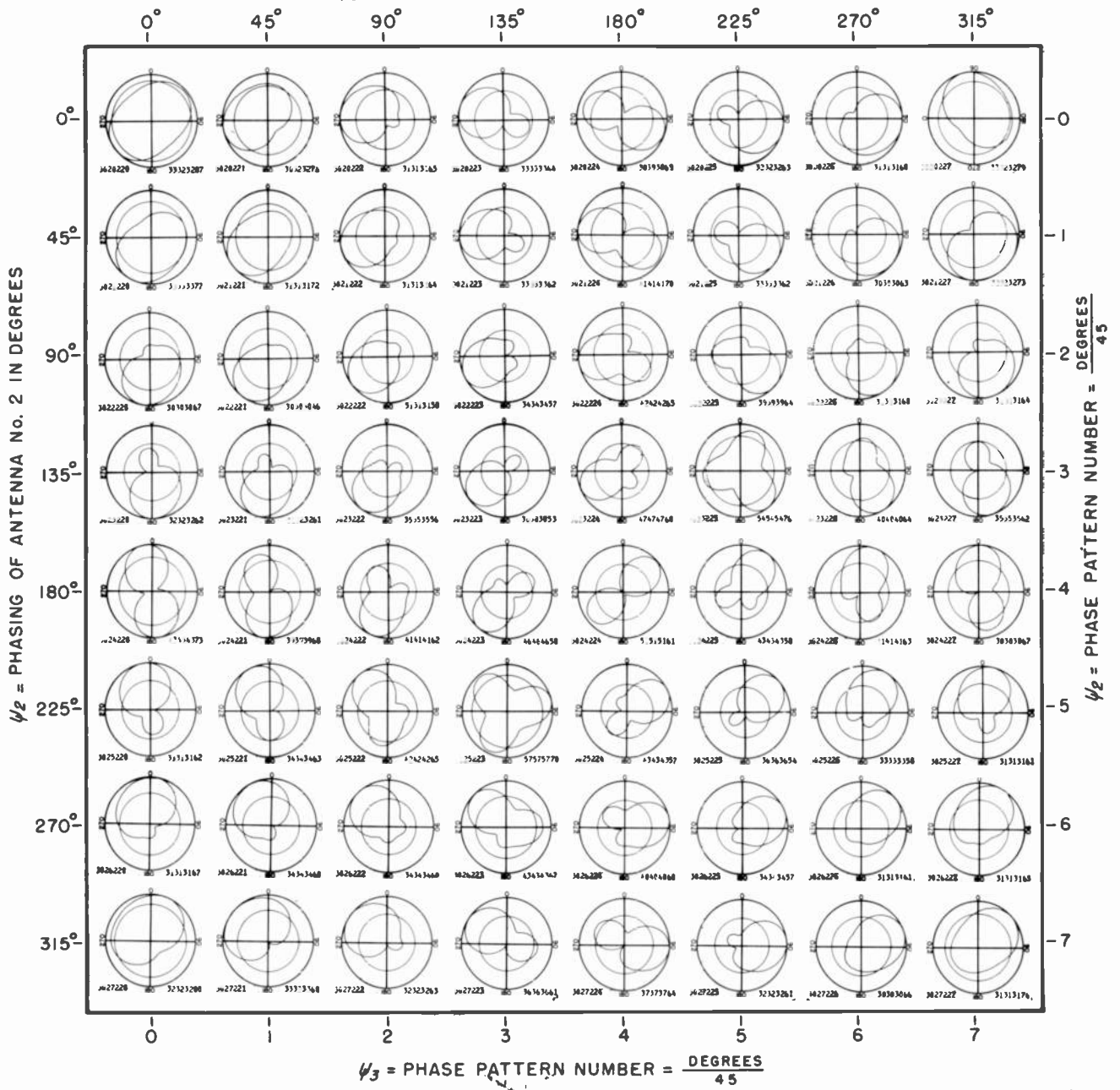

$\psi_3$  = PHASE PATTERN NUMBER =  $\frac{\text{DEGREES}}{45}$

NUMBER OF ANTENNAS IN THE SYSTEM	ORIENTATION OF NO. 2 ANTENNA = $\frac{\text{DEGREES}}{45}$	SPACING OF NO. 2 ANTENNA = $\frac{\text{DEGREES}}{45}$	PHASING OF NO. 2 ANTENNA = $\frac{\text{DEGREES}}{45}$	ORIENTATION OF NO. 3 ANTENNA = $\frac{\text{DEGREES}}{45}$	SPACING OF NO. 3 ANTENNA = $\frac{\text{DEGREES}}{45}$	PHASING OF NO. 3 ANTENNA = $\frac{\text{DEGREES}}{45}$
No.	$\phi_2$	$S_2$	$\psi_2$	$\phi_3$	$S_3$	$\psi_3$
3	0	2	0	2	2	0

% FIELD INTENSITY RADIATED IN HORIZONTAL PLANE FROM NO. 1 ANTENNA.	% FIELD INTENSITY RADIATED IN HORIZONTAL PLANE FROM NO. 2 ANTENNA.	% FIELD INTENSITY RADIATED IN HORIZONTAL PLANE FROM NO. 3 ANTENNA.	% RMS FIELD INTENSITY RADIATED IN HORIZONTAL PLANE FROM ANTENNA SYSTEM.
$E_1$	$E_2$	$E_3$	$E_0$
33	32	32	87

SPOTS LOCATE THE ANTENNAS FOR  
 THIS PAGE OF PATTERNS IN THE  
 SYSTEMIZATION PLACEMENT CHART.

LEFT HAND PATTERN NUMBER GIVES ANTENNA  
 PLACEMENT AND PHASING DATA.

RIGHT HAND PATTERN NUMBER  
 GIVES ANTENNA FIELD INTENSITY  
 DATA IN PERCENT.

PATTERN NOMENCLATURE

$\psi_3 =$  PHASING OF ANTENNA No. 3 IN DEGREES

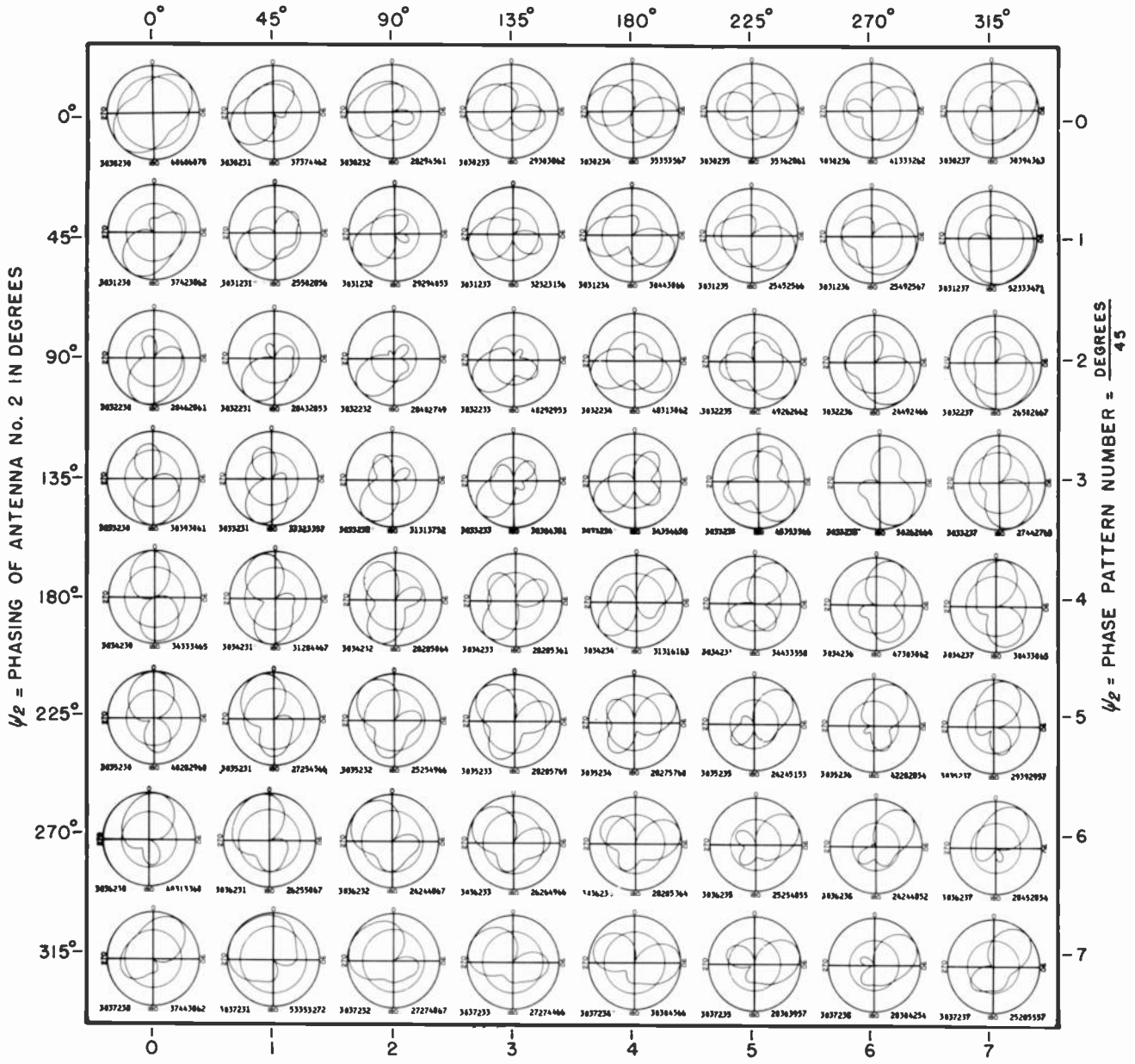

$\psi_3 =$  PHASE PATTERN NUMBER =  $\frac{\text{DEGREES}}{45}$

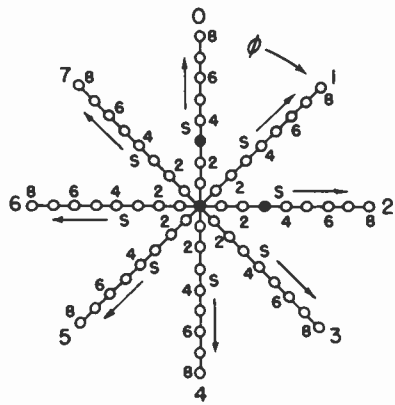

NUMBER OF ANTENNAS IN THE SYSTEM	ORIENTATION OF NO. 2 ANTENNA = $\frac{\text{DEGREES}}{45}$	SPACING OF NO. 2 ANTENNA = $\frac{\text{DEGREES}}{45}$	PHASING OF NO. 2 ANTENNA = $\frac{\text{DEGREES}}{45}$	ORIENTATION OF NO. 3 ANTENNA = $\frac{\text{DEGREES}}{45}$	SPACING OF NO. 3 ANTENNA = $\frac{\text{DEGREES}}{45}$	PHASING OF NO. 3 ANTENNA = $\frac{\text{DEGREES}}{45}$
No. 3	$\phi_2$ 0	$S_2$ 3	$\psi_2$ 0	$\phi_3$ 2	$S_3$ 3	$\psi_3$ 0

% FIELD INTENSITY RADIATED IN HORIZONTAL PLANE FROM NO. 1 ANTENNA.	% FIELD INTENSITY RADIATED IN HORIZONTAL PLANE FROM NO. 2 ANTENNA.	% FIELD INTENSITY RADIATED IN HORIZONTAL PLANE FROM NO. 3 ANTENNA.	% RMS FIELD INTENSITY RADIATED IN HORIZONTAL PLANE FROM ANTENNA SYSTEM.
$E_1$ 60	$E_2$ 60	$E_3$ 60	$E_0$ 78

LEFT HAND PATTERN NUMBER GIVES ANTENNA PLACEMENT AND PHASING DATA.

RIGHT HAND PATTERN NUMBER GIVES ANTENNA FIELD INTENSITY DATA IN PERCENT.

SPOTS LOCATE THE ANTENNAS FOR THIS PAGE OF PATTERNS IN THE SYSTEMIZATION PLACEMENT CHART.

PATTERN NOMENCLATURE

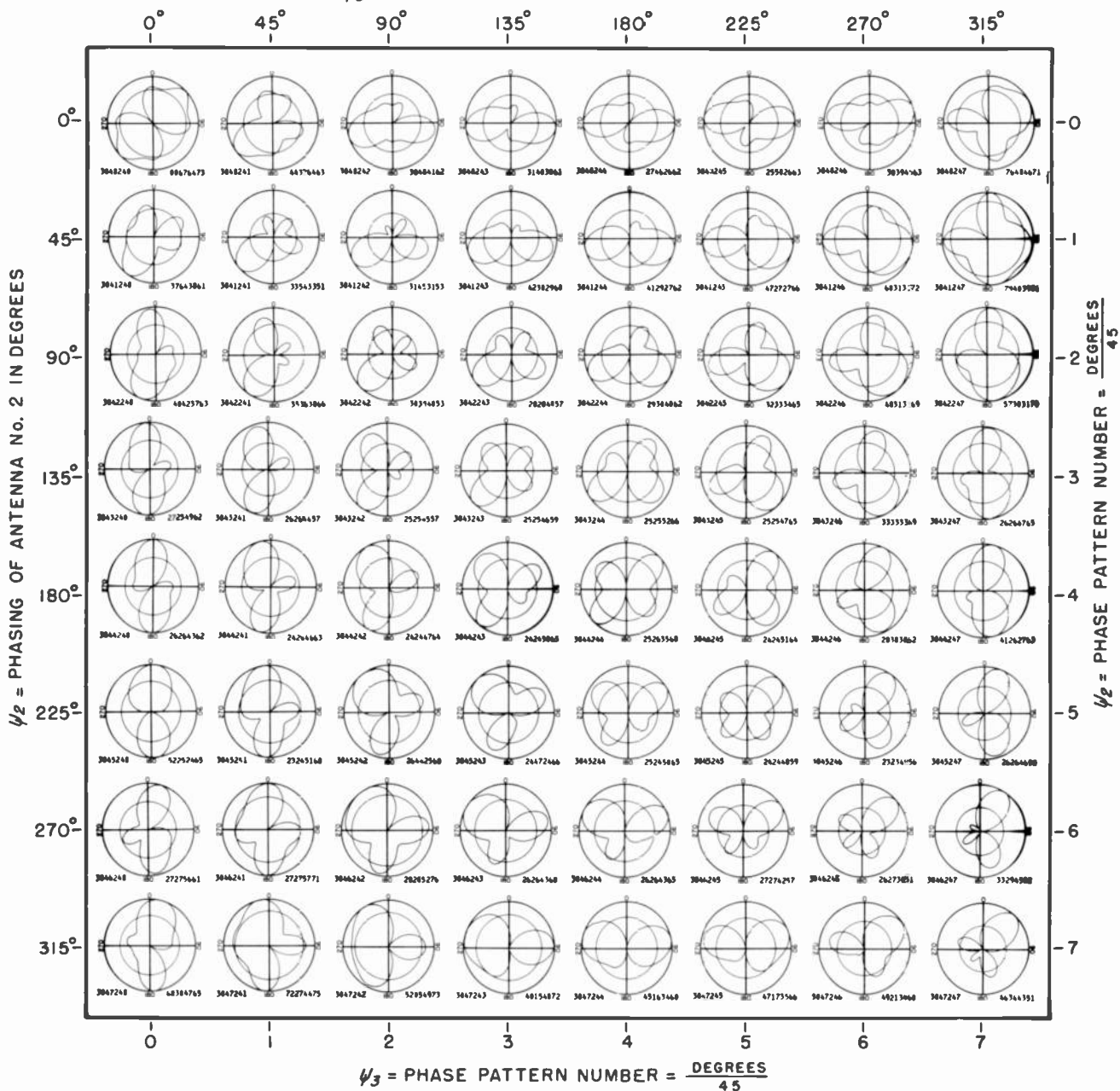

$\psi_3$  = PHASE PATTERN NUMBER =  $\frac{\text{DEGREES}}{45}$

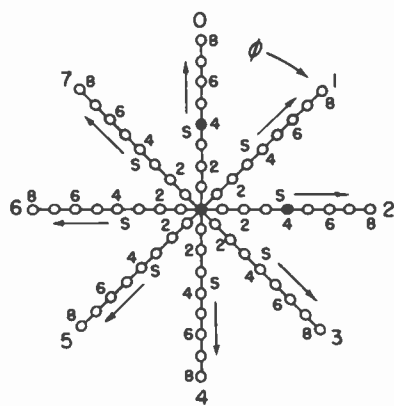

NUMBER OF ANTENNAS IN THE SYSTEM	ORIENTATION OF NO. 2 ANTENNA = $\frac{\text{DEGREES}}{45}$	SPACING OF NO. 2 ANTENNA = $\frac{\text{DEGREES}}{45}$	PHASING OF NO. 2 ANTENNA = $\frac{\text{DEGREES}}{45}$	ORIENTATION OF NO. 3 ANTENNA = $\frac{\text{DEGREES}}{45}$	SPACING OF NO. 3 ANTENNA = $\frac{\text{DEGREES}}{45}$	PHASING OF NO. 3 ANTENNA = $\frac{\text{DEGREES}}{45}$
No.	$\phi_2$	$S_2$	$\psi_2$	$\phi_3$	$S_3$	$\psi_3$
3	0	4	0	2	4	0

% FIELD INTENSITY RADIATED IN HORIZONTAL PLANE FROM NO. 1 ANTENNA.	% FIELD INTENSITY RADIATED IN HORIZONTAL PLANE FROM NO. 2 ANTENNA.	% FIELD INTENSITY RADIATED IN HORIZONTAL PLANE FROM NO. 3 ANTENNA.	% RMS FIELD INTENSITY RADIATED IN HORIZONTAL PLANE FROM ANTENNA SYSTEM.
$E_1$	$E_2$	$E_3$	$E_0$
80	67	64	73

LEFT HAND PATTERN NUMBER GIVES ANTENNA PLACEMENT AND PHASING DATA

RIGHT HAND PATTERN NUMBER GIVES ANTENNA FIELD INTENSITY DATA IN PERCENT.

SPOTS LOCATE THE ANTENNAS FOR THIS PAGE OF PATTERNS IN THE SYSTEMATIZATION PLACEMENT CHART.

PATTERN NOMENCLATURE

COPYRIGHT 1946 BY CARL E. SMITH  
PRINTED IN U. S. A.

CLEVELAND INSTITUTE OF RADIO ELECTRONICS  
TERMINAL TOWER, CLEVELAND 18, OHIO.

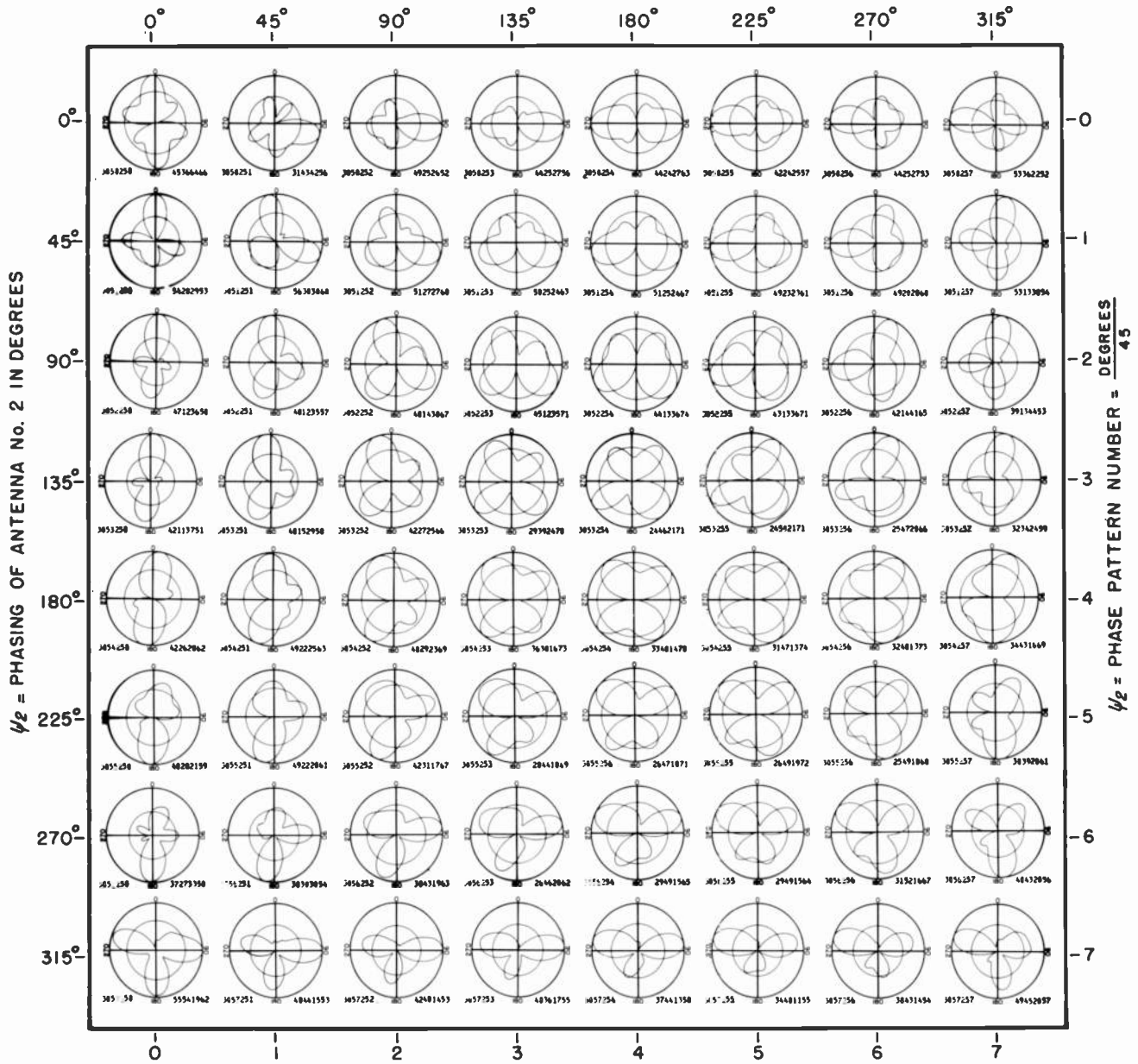

$\psi_3 = \text{PHASE PATTERN NUMBER} = \frac{\text{DEGREES}}{45}$

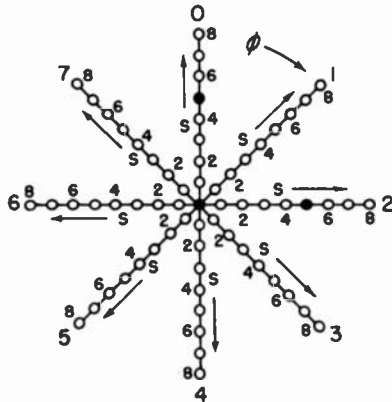

NO.	$\phi_2$	$S_2$	$\psi_2$	$\phi_3$	$S_3$	$\psi_3$
3	0	5	0	2	5	0

$E_1$	$E_2$	$E_3$	$E_0$
45	36	64	66

SPOTS LOCATE THE ANTENNAS FOR THIS PAGE OF PATTERNS IN THE SYSTEMIZATION PLACEMENT CHART.

LEFT HAND PATTERN NUMBER GIVES ANTENNA PLACEMENT AND PHASING DATA.

RIGHT HAND PATTERN NUMBER GIVES ANTENNA FIELD INTENSITY DATA IN PERCENT.

PATTERN NOMENCLATURE



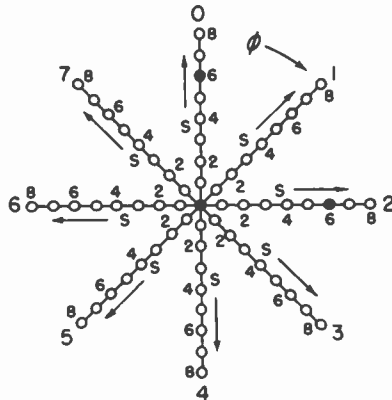
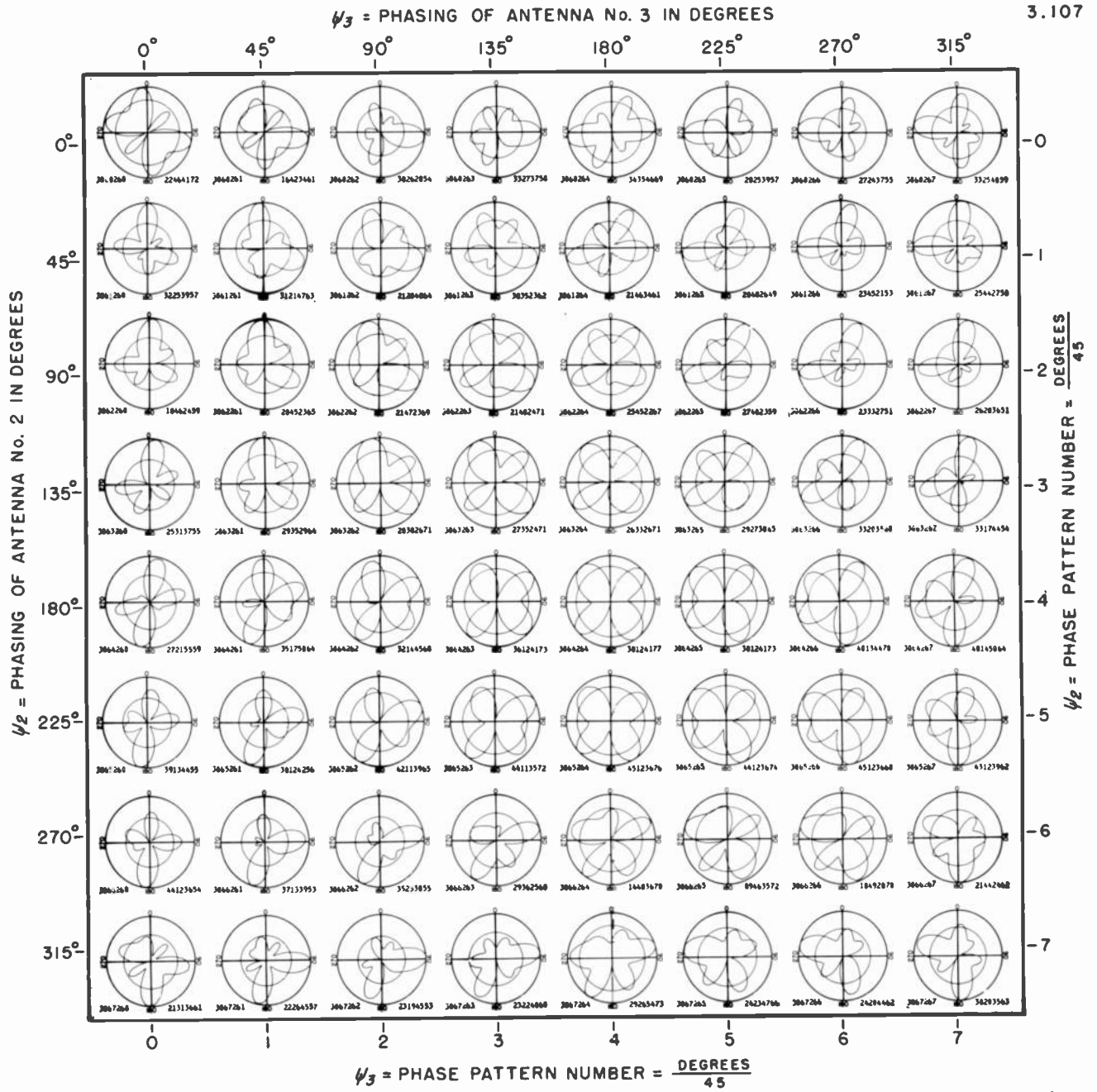

NUMBER OF ANTENNAS IN THE SYSTEM	ORIENTATION OF NO. 2 ANTENNA =	SPACING OF NO. 2 ANTENNA =	PHASING OF NO. 2 ANTENNA =	ORIENTATION OF NO. 3 ANTENNA =	SPACING OF NO. 3 ANTENNA =	PHASING OF NO. 3 ANTENNA =
No. 3	$\phi_2$	$S_2$	$\psi_2$	$\phi_3$	$S_3$	$\psi_3$
3	0	6	0	2	6	0

% FIELD INTENSITY RADIATED IN HORIZONTAL PLANE FROM NO. 1 ANTENNA.	% FIELD INTENSITY RADIATED IN HORIZONTAL PLANE FROM NO. 2 ANTENNA.	% FIELD INTENSITY RADIATED IN HORIZONTAL PLANE FROM NO. 3 ANTENNA.	% RMS FIELD INTENSITY RADIATED IN HORIZONTAL PLANE FROM ANTENNA SYSTEM.
$E_1$	$E_2$	$E_3$	$E_0$
22	46	41	72

SPOTS, LOCATE THE ANTENNAS FOR  
THIS PAGE OF PATTERNS IN THE  
SYSTEMATIZATION PLACEMENT CHART.

LEFT HAND PATTERN NUMBER GIVES ANTENNA  
PLACEMENT AND PHASING DATA.

RIGHT HAND PATTERN NUMBER  
GIVES ANTENNA FIELD INTEN-  
SITY DATA IN PERCENT.

PATTERN NOMENCLATURE

$\psi_3$  = PHASING OF ANTENNA No. 3 IN DEGREES

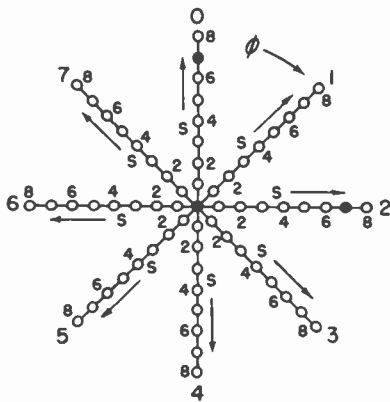
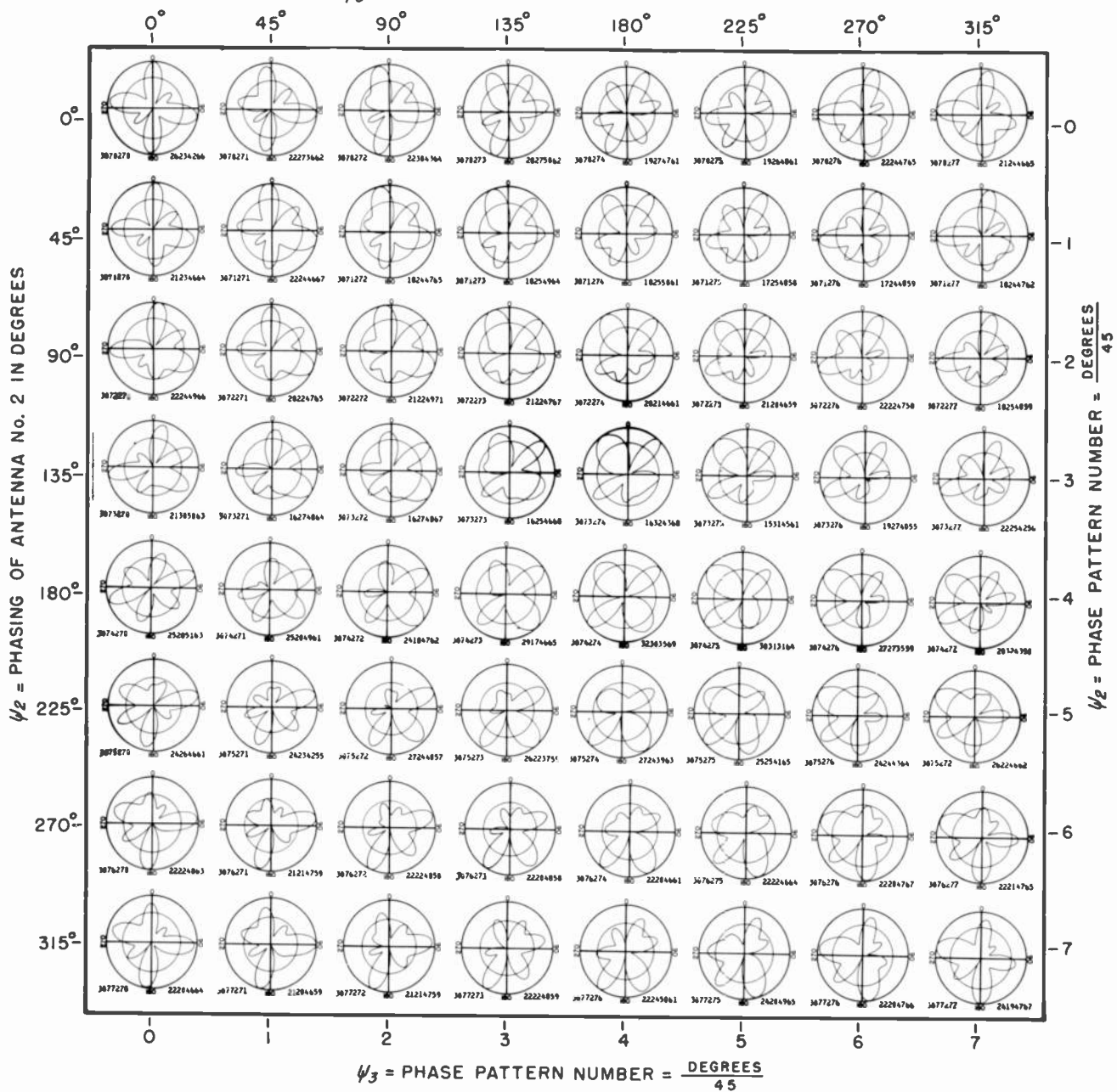

$\psi_3$  = PHASE PATTERN NUMBER =  $\frac{\text{DEGREES}}{45}$

NUMBER OF ANTENNAS IN THE SYSTEM	ORIENTATION OF NO. 2 ANTENNA = $\frac{\text{DEGREES}}{45}$	SPACING OF NO. 2 ANTENNA = $\frac{\text{DEGREES}}{45}$	PHASING OF NO. 2 ANTENNA = $\frac{\text{DEGREES}}{45}$	ORIENTATION OF NO. 3 ANTENNA = $\frac{\text{DEGREES}}{45}$	SPACING OF NO. 3 ANTENNA = $\frac{\text{DEGREES}}{45}$	PHASING OF NO. 3 ANTENNA = $\frac{\text{DEGREES}}{45}$
No. 3	$\phi_2$ 0	$S_2$ 7	$\psi_2$ 0	$\phi_3$ 2	$S_3$ 7	$\psi_3$ 0

% FIELD INTENSITY RADIATED IN HORIZONTAL PLANE FROM NO. 1 ANTENNA.	% FIELD INTENSITY RADIATED IN HORIZONTAL PLANE FROM NO. 2 ANTENNA.	% FIELD INTENSITY RADIATED IN HORIZONTAL PLANE FROM NO. 3 ANTENNA.	% RMS FIELD INTENSITY RADIATED IN HORIZONTAL PLANE FROM ANTENNA SYSTEM.
$E_1$ 26	$E_2$ 23	$E_3$ 42	$E_0$ 66

SPOTS LOCATE THE ANTENNAS FOR THIS PAGE OF PATTERNS IN THE SYSTEMATIZATION PLACEMENT CHART.

LEFT HAND PATTERN NUMBER GIVES ANTENNA PLACEMENT AND PHASING DATA.

RIGHT HAND PATTERN NUMBER GIVES ANTENNA FIELD INTENSITY DATA IN PERCENT.

PATTERN NOMENCLATURE

$\psi_3$  = PHASING OF ANTENNA NO. 3 IN DEGREES

3.109

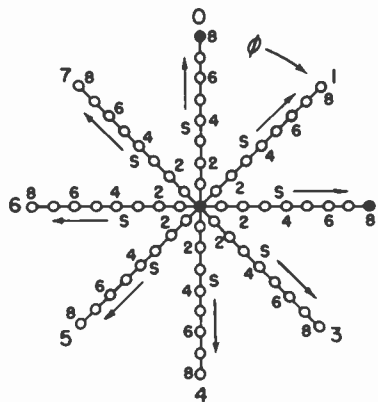
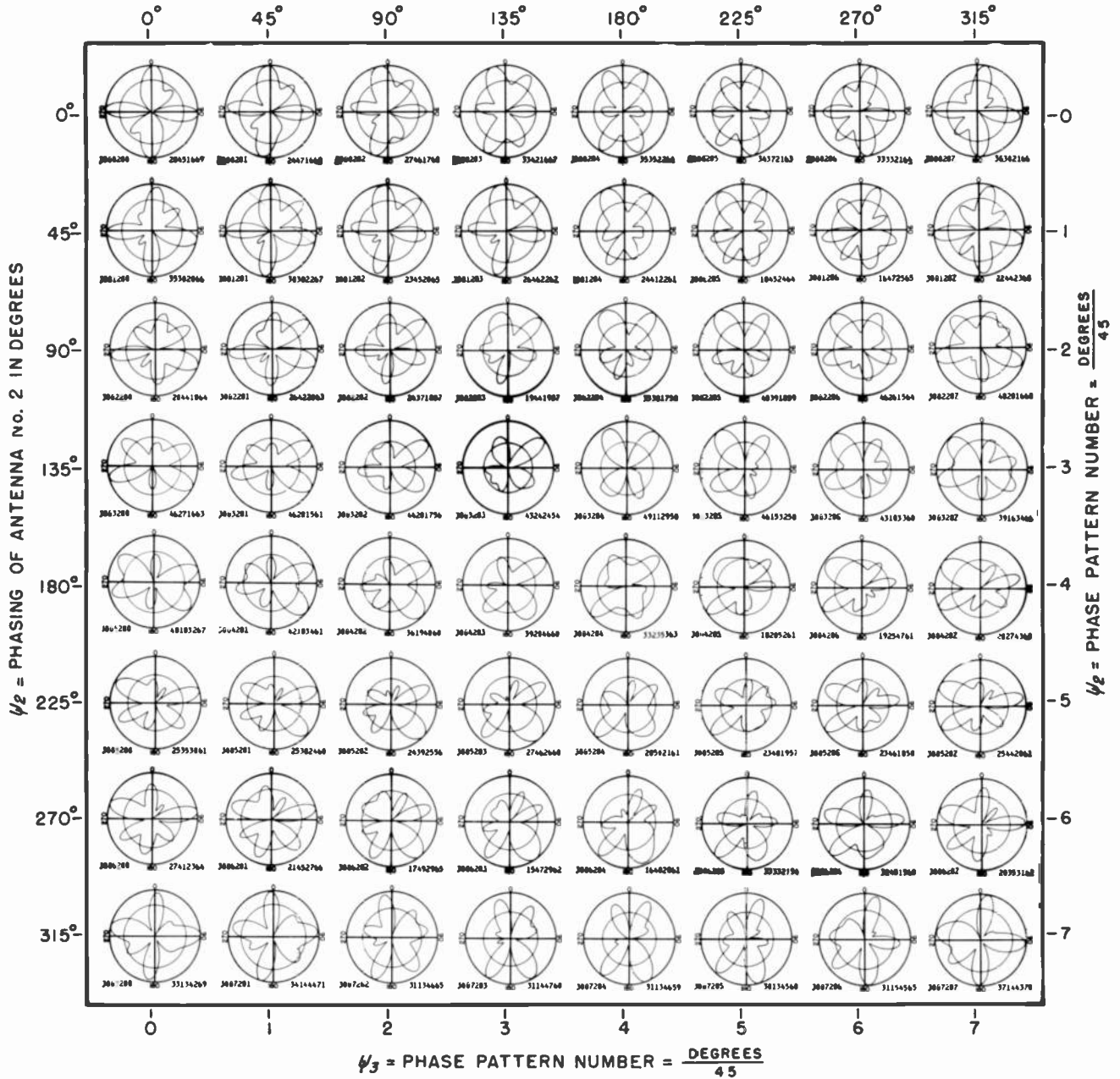

SPOTS LOCATE THE ANTENNAS FOR THIS PAGE OF PATTERNS IN THE SYSTEMATIZATION PLACEMENT CHART.

NUMBER OF ANTENNAS IN THE SYSTEM	ORIENTATION OF DEGREES / 45	SPACING OF DEGREES / 45	PHASING OF DEGREES / 45	ORIENTATION OF DEGREES / 45	SPACING OF DEGREES / 45	PHASING OF DEGREES / 45
No.	$\phi_2$	$S_2$	$\psi_2$	$\phi_3$	$S_3$	$\psi_3$
3	0	8	0	2	8	0

LEFT HAND PATTERN NUMBER GIVES ANTENNA PLACEMENT AND PHASING DATA.

% FIELD INTENSITY RADIATED IN HORIZONTAL PLANE FROM NO. 1 ANTENNA.	% FIELD INTENSITY RADIATED IN HORIZONTAL PLANE FROM NO. 2 ANTENNA.	% FIELD INTENSITY RADIATED IN HORIZONTAL PLANE FROM NO. 3 ANTENNA.	% RMS FIELD INTENSITY RADIATED IN HORIZONTAL PLANE FROM ANTENNA SYSTEM.
$E_1$	$E_2$	$E_3$	$E_0$
28	45	16	69

RIGHT HAND PATTERN NUMBER GIVES ANTENNA FIELD INTENSITY DATA IN PERCENT.

PATTERN NOMENCLATURE

$\psi_3$  = PHASING OF ANTENNA No. 3 IN DEGREES

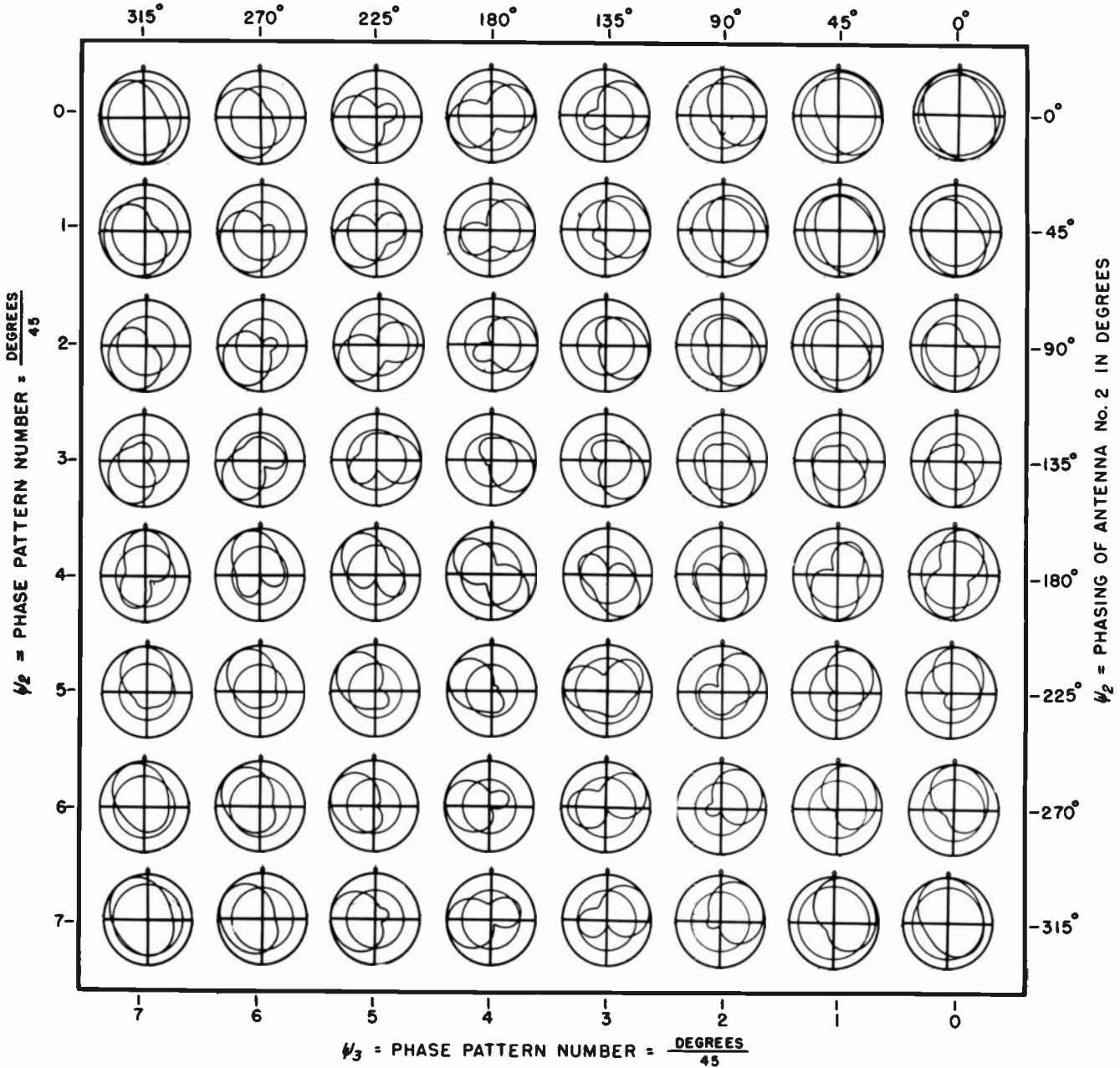

- NUMBER OF ANTENNAS IN THE SYSTEM  
No. 3
- ORIENTATION OF NO. 2 ANTENNA =  $\frac{\text{DEGREES}}{45}$   
 $\phi_2$  0
- SPACING OF NO. 2 ANTENNA =  $\frac{\text{DEGREES}}{45}$   
 $S_2$  1
- PHASING OF NO. 2 ANTENNA =  $\frac{\text{DEGREES}}{45}$   
 $\psi_2$  0
- ORIENTATION OF NO. 3 ANTENNA =  $\frac{\text{DEGREES}}{45}$   
 $\phi_3$  6
- SPACING OF NO. 3 ANTENNA =  $\frac{\text{DEGREES}}{45}$   
 $S_3$  2
- PHASING OF NO. 3 ANTENNA =  $\frac{\text{DEGREES}}{45}$   
 $\psi_3$  0

- % FIELD INTENSITY RADIATED IN HORIZONTAL PLANE FROM NO. 1 ANTENNA.  
 $F_1$  27
- % FIELD INTENSITY RADIATED IN HORIZONTAL PLANE FROM NO. 2 ANTENNA.  
 $F_2$  27
- % FIELD INTENSITY RADIATED IN HORIZONTAL PLANE FROM NO. 3 ANTENNA.  
 $F_3$  27
- % RMS FIELD INTENSITY RADIATED IN HORIZONTAL PLANE FROM ANTENNA SYSTEM.  
 $F_0$  89

LEFT HAND PATTERN NUMBER GIVES ANTENNA PLACEMENT AND PHASING DATA.

RIGHT HAND PATTERN NUMBER GIVES ANTENNA FIELD INTENSITY DATA IN PERCENT.

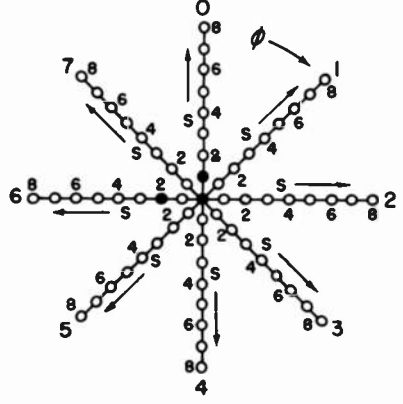

SPOTS LOCATE THE ANTENNAS FOR THIS PAGE OF PATTERNS IN THE SYSTEMATIZATION PLACEMENT CHART.

PATTERN NOMENCLATURE

$\psi_3$  = PHASING OF ANTENNA No. 3 IN DEGREES

3.111

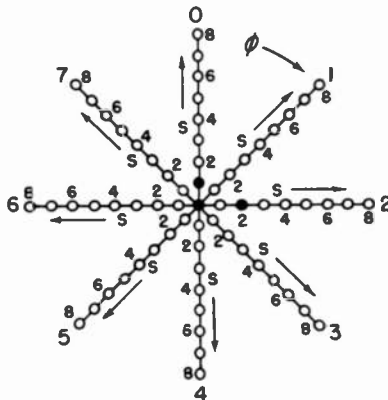
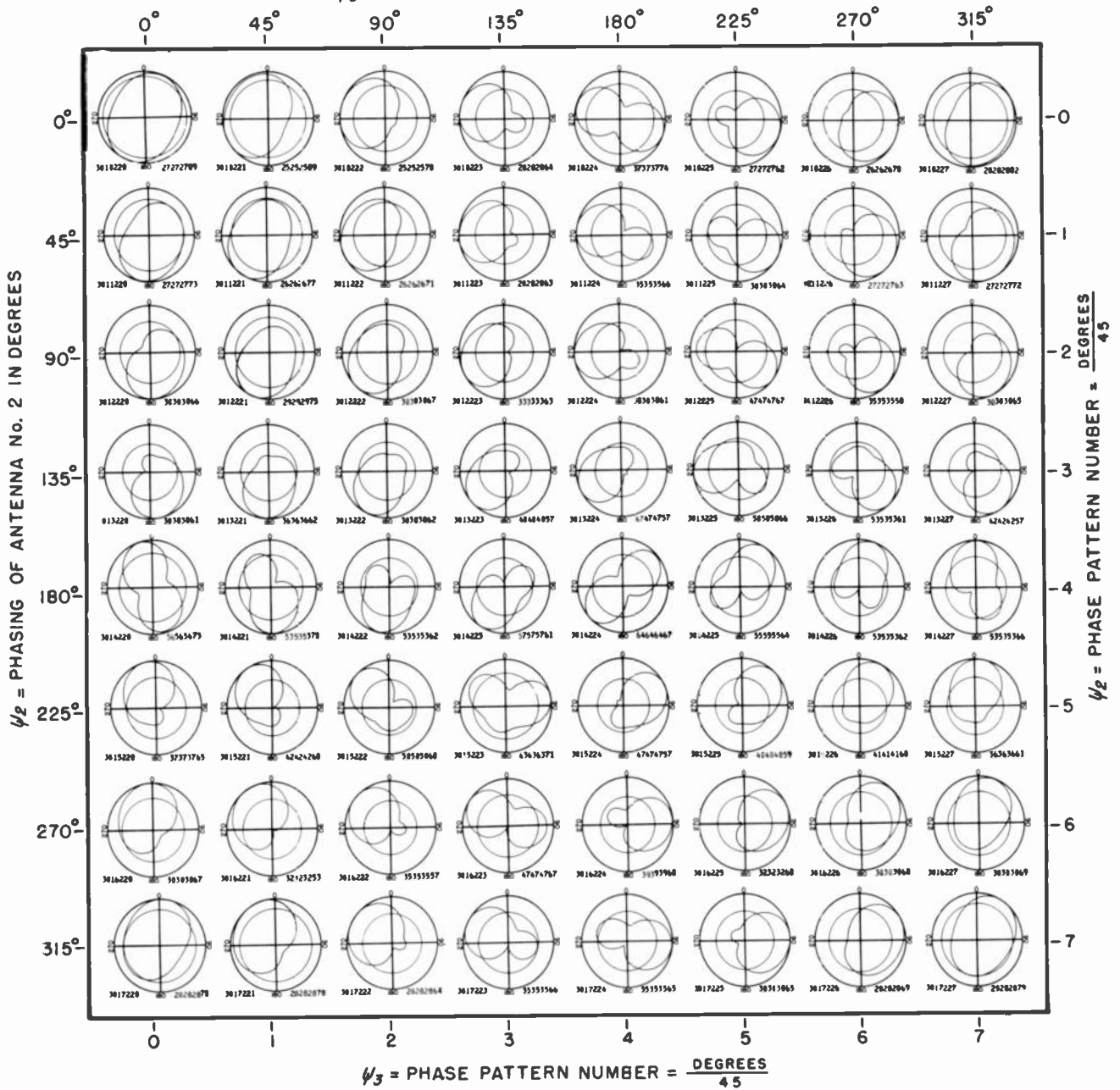

SPOTS LOCATE THE ANTENNAS FOR THIS PAGE OF PATTERNS IN THE SYSTEMATIZATION PLACEMENT CHART.

NUMBER OF ANTENNAS IN THE SYSTEM	ORIENTATION OF NO. 2 ANTENNA = $\frac{\text{DEGREES}}{45}$	SPACING OF NO. 2 ANTENNA = $\frac{\text{DEGREES}}{45}$	PHASING OF NO. 2 ANTENNA = $\frac{\text{DEGREES}}{45}$	ORIENTATION OF NO. 3 ANTENNA = $\frac{\text{DEGREES}}{45}$	SPACING OF NO. 3 ANTENNA = $\frac{\text{DEGREES}}{45}$	PHASING OF NO. 3 ANTENNA = $\frac{\text{DEGREES}}{45}$
No.	$\phi_2$	$S_2$	$\psi_2$	$\phi_3$	$S_3$	$\psi_3$
3	0	1	0	2	2	0

LEFT HAND PATTERN NUMBER GIVES ANTENNA PLACEMENT AND PHASING DATA.

% FIELD INTENSITY RADIATED IN HORIZONTAL PLANE FROM NO. 1 ANTENNA.	% FIELD INTENSITY RADIATED IN HORIZONTAL PLANE FROM NO. 2 ANTENNA.	% FIELD INTENSITY RADIATED IN HORIZONTAL PLANE FROM NO. 3 ANTENNA.	% RMS FIELD INTENSITY RADIATED IN HORIZONTAL PLANE FROM ANTENNA SYSTEM.
$E_1$	$E_2$	$E_3$	$E_0$
27	27	27	89

RIGHT HAND PATTERN NUMBER GIVES ANTENNA FIELD INTENSITY DATA IN PERCENT.

PATTERN NOMENCLATURE

$\psi_3$  = PHASING OF ANTENNA No. 3 IN DEGREES

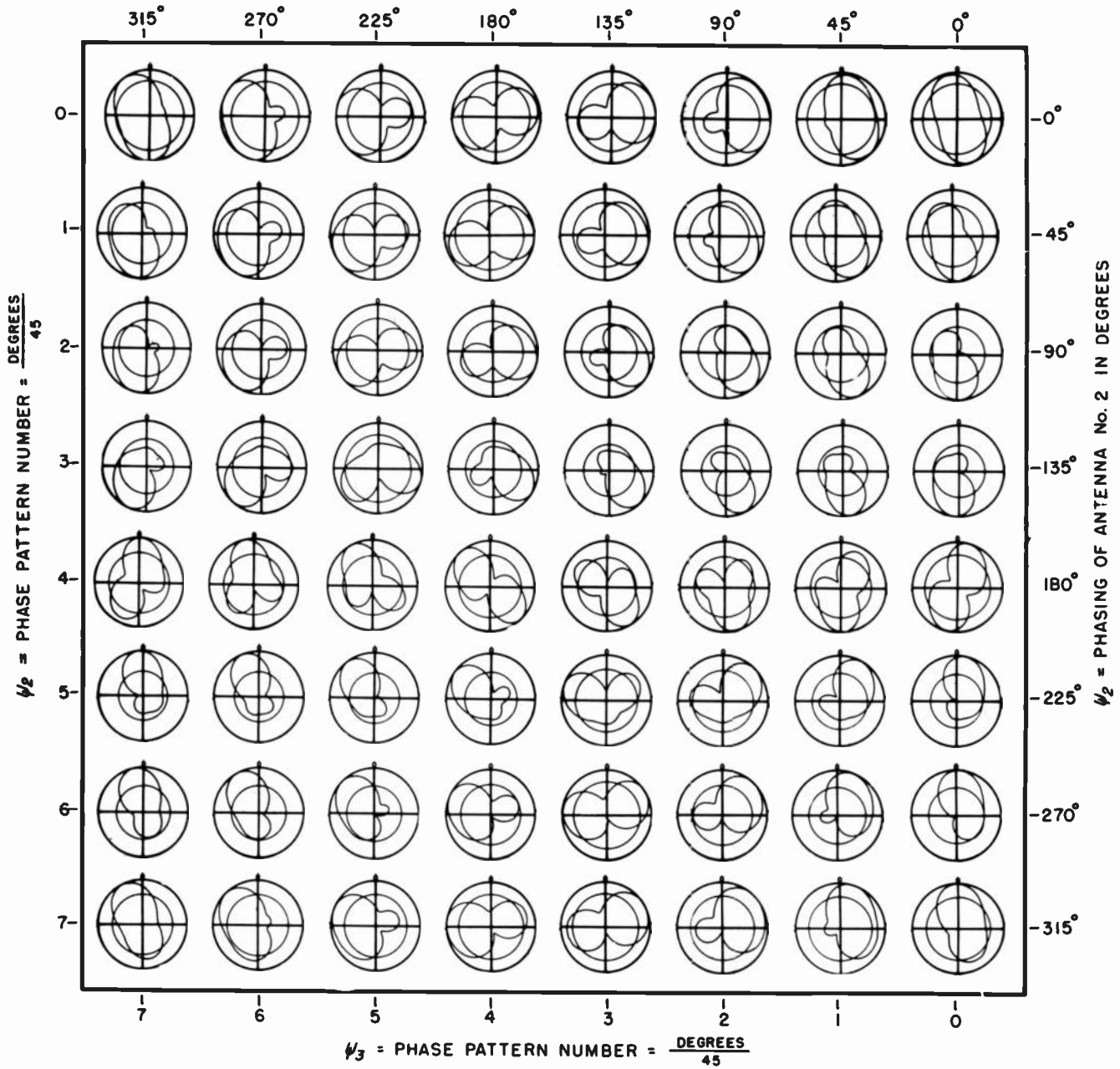

NUMBER OF ANTENNAS IN THE SYSTEM  
 No. 3

ORIENTATION OF NO. 2 ANTENNA =  $\frac{\text{DEGREES}}{45}$   
 $\psi_2$

SPACING OF NO. 2 ANTENNA =  $\frac{\text{DEGREES}}{45}$   
 $S_2$

PHASING OF NO. 2 ANTENNA =  $\frac{\text{DEGREES}}{45}$   
 $\psi_2$

ORIENTATION OF NO. 3 ANTENNA =  $\frac{\text{DEGREES}}{45}$   
 $\psi_3$

SPACING OF NO. 3 ANTENNA =  $\frac{\text{DEGREES}}{45}$   
 $S_3$

PHASING OF NO. 3 ANTENNA =  $\frac{\text{DEGREES}}{45}$   
 $\psi_3$

LEFT HAND PATTERN NUMBER GIVES ANTENNA PLACEMENT AND PHASING DATA.

% FIELD INTENSITY RADIATED IN HORIZONTAL PLANE FROM NO. 1 ANTENNA.  
 $E_1$  33

% FIELD INTENSITY RADIATED IN HORIZONTAL PLANE FROM NO. 2 ANTENNA.  
 $E_2$  33

% FIELD INTENSITY RADIATED IN HORIZONTAL PLANE FROM NO. 3 ANTENNA.  
 $E_3$  32

% RMS FIELD INTENSITY RADIATED IN HORIZONTAL PLANE FROM ANTENNA SYSTEM.  
 $E_0$  76

RIGHT HAND PATTERN NUMBER GIVES ANTENNA FIELD INTENSITY DATA IN PERCENT.

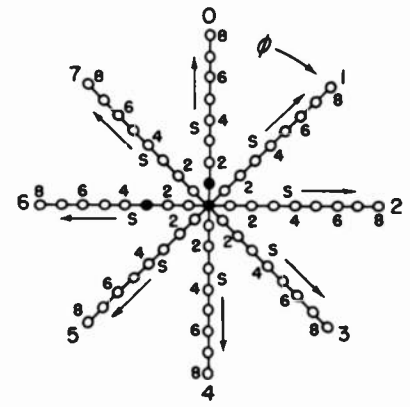

SPOTS LOCATE THE ANTENNAS FOR THIS PAGE OF PATTERNS IN THE SYSTEMATIZATION PLACEMENT CHART.

PATTERN NOMENCLATURE

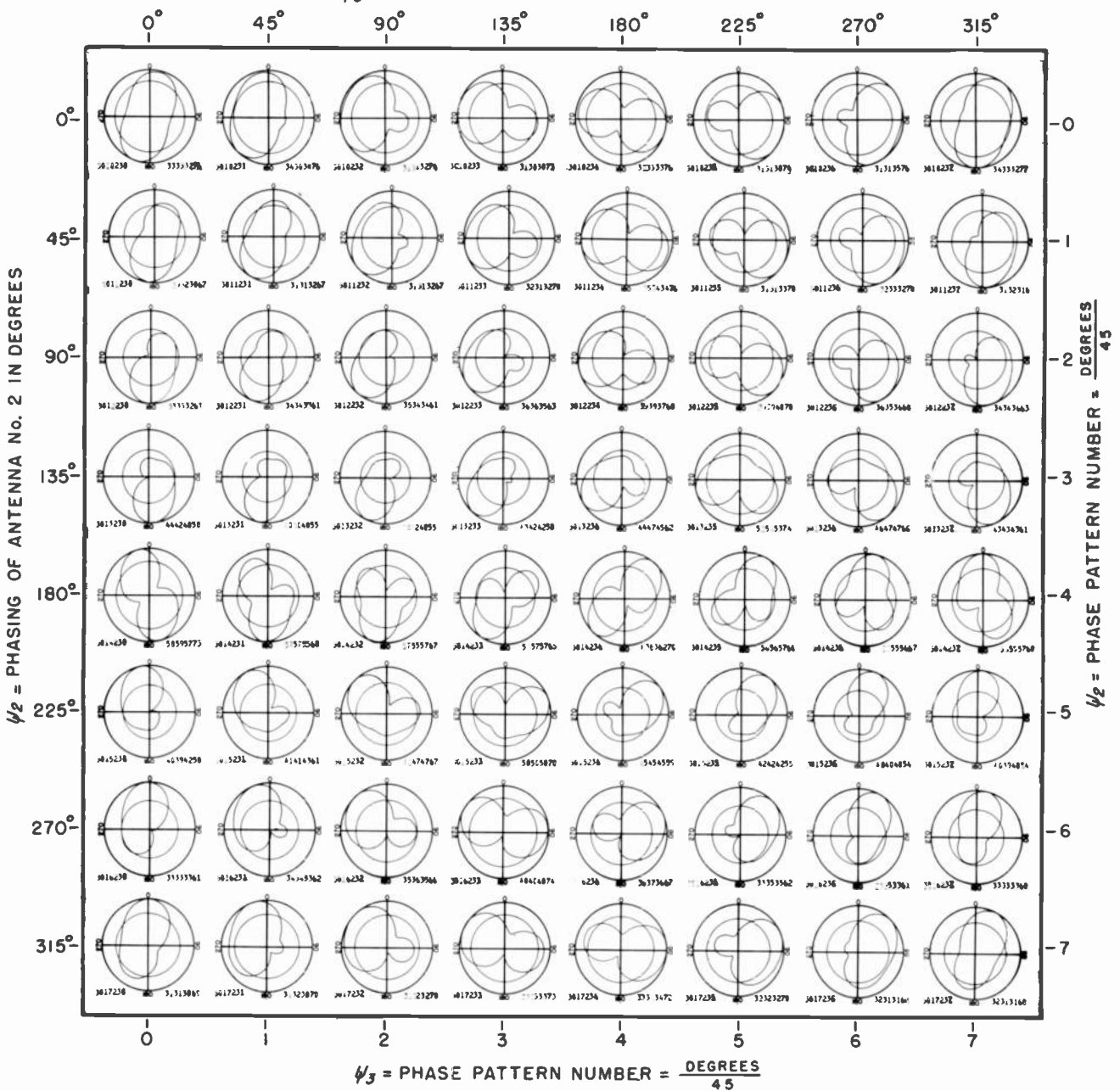

COPYRIGHT 1946 BY CARL E. SMITH  
PRINTED IN U. S. A.

CLEVELAND INSTITUTE OF RADIO ELECTRONICS  
TERMINAL TOWER, CLEVELAND 18, OHIO.

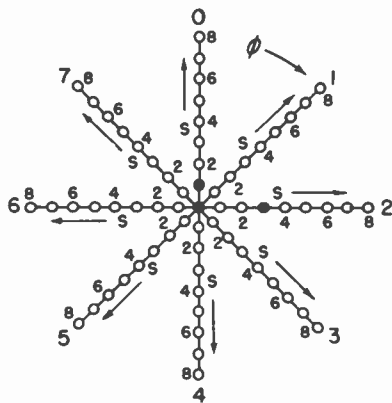

$\psi_3$  = PHASE PATTERN NUMBER =  $\frac{\text{DEGREES}}{45}$

NUMBER OF ANTENNAS IN THE SYSTEM	ORIENTATION OF NO. 2 ANTENNA = $\frac{\text{DEGREES}}{45}$	SPACING OF NO. 2 ANTENNA = $\frac{\text{DEGREES}}{45}$	PHASING OF NO. 2 ANTENNA = $\frac{\text{DEGREES}}{45}$	ORIENTATION OF NO. 3 ANTENNA = $\frac{\text{DEGREES}}{45}$	SPACING OF NO. 3 ANTENNA = $\frac{\text{DEGREES}}{45}$	PHASING OF NO. 3 ANTENNA = $\frac{\text{DEGREES}}{45}$
No.	$\phi_2$	$S_2$	$\psi_2$	$\phi_3$	$S_3$	$\psi_3$
3	0	1	0	2	3	0

LEFT HAND PATTERN NUMBER GIVES ANTENNA PLACEMENT AND PHASING DATA.

% FIELD INTENSITY RADIATED IN HORIZONTAL PLANE FROM NO. 1 ANTENNA.	% FIELD INTENSITY RADIATED IN HORIZONTAL PLANE FROM NO. 2 ANTENNA.	% FIELD INTENSITY RADIATED IN HORIZONTAL PLANE FROM NO. 3 ANTENNA.	% RMS FIELD INTENSITY RADIATED IN HORIZONTAL PLANE FROM ANTENNA SYSTEM.
$E_1$	$E_2$	$E_3$	$E_0$
33	33	32	76

RIGHT HAND PATTERN NUMBER GIVES ANTENNA FIELD INTENSITY DATA IN PERCENT.

SPOTS LOCATE THE ANTENNAS FOR THIS PAGE OF PATTERNS IN THE SYSTEMIZATION PLACEMENT CHART.

PATTERN NOMENCLATURE

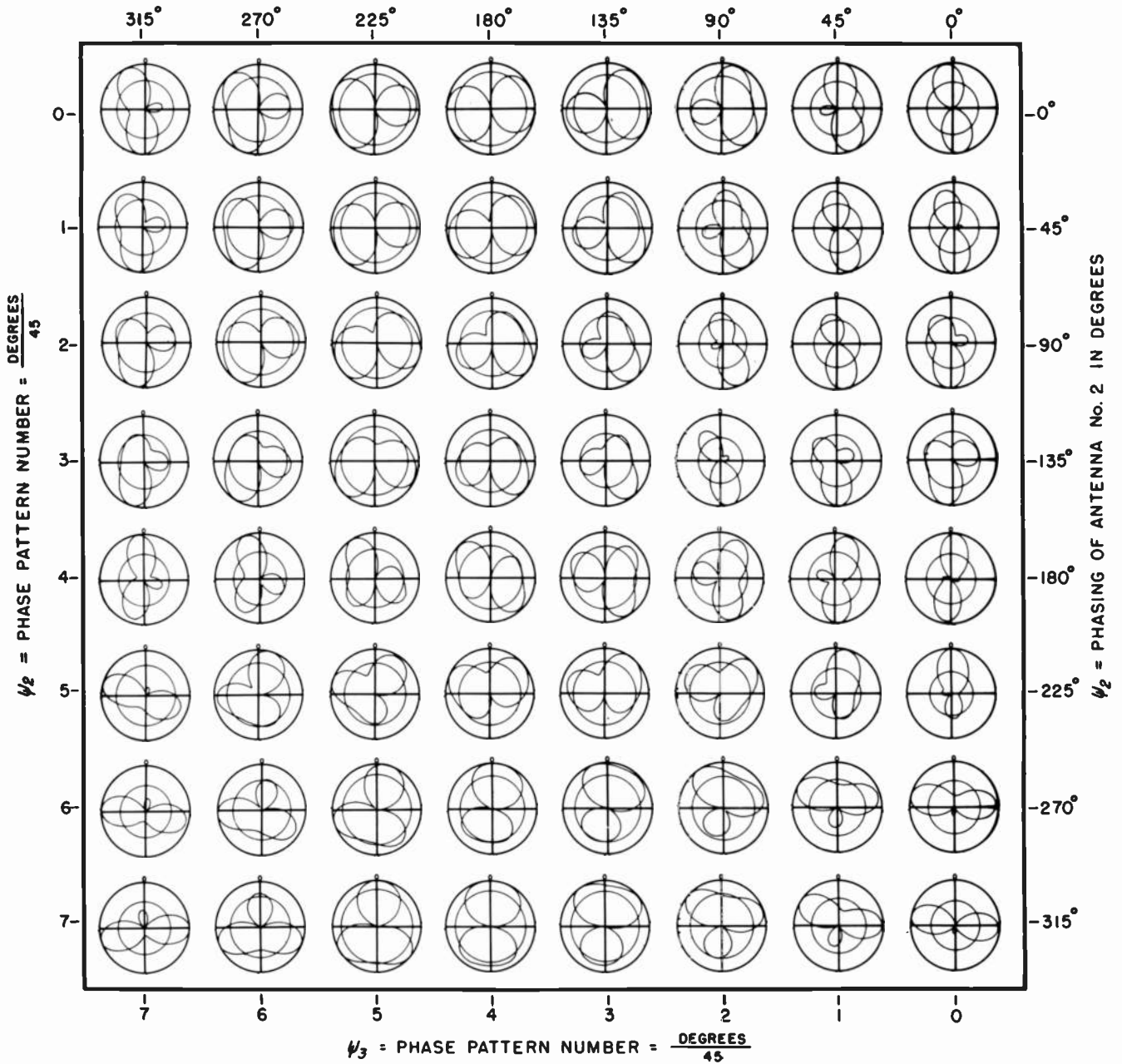

NUMBER OF ANTENNAS  
IN THE SYSTEM

No. 3

ORIENTATION OF  
NO. 2 ANTENNA =  $\frac{\text{DEGREES}}{45}$

$\phi_2$  0

SPACING OF  
NO. 2 ANTENNA =  $\frac{\text{DEGREES}}{45}$

$S_2$  1

PHASING OF  
NO. 2 ANTENNA =  $\frac{\text{DEGREES}}{45}$

$\psi_2$  0

ORIENTATION OF  
NO. 3 ANTENNA =  $\frac{\text{DEGREES}}{45}$

$\phi_3$  6

SPACING OF  
NO. 3 ANTENNA =  $\frac{\text{DEGREES}}{45}$

$S_3$  4

PHASING OF  
NO. 3 ANTENNA =  $\frac{\text{DEGREES}}{45}$

$\psi_3$  0

% FIELD INTENSITY  
RADIATED IN HORIZONTAL  
PLANE FROM NO. 1 ANTENNA.

$F_1$  25

% FIELD INTENSITY  
RADIATED IN HORIZONTAL  
PLANE FROM NO. 2 ANTENNA.

$F_2$  22

% FIELD INTENSITY  
RADIATED IN HORIZONTAL  
PLANE FROM NO. 3 ANTENNA.

$F_3$  48

% RMS FIELD INTENSITY  
RADIATED IN HORIZONTAL  
PLANE FROM ANTENNA SYSTEM.

$F_0$  58

LEFT HAND PATTERN NUMBER GIVES ANTENNA  
PLACEMENT AND PHASING DATA.

RIGHT HAND PATTERN NUMBER  
GIVES ANTENNA FIELD INTEN-  
SITY DATA IN PERCENT.

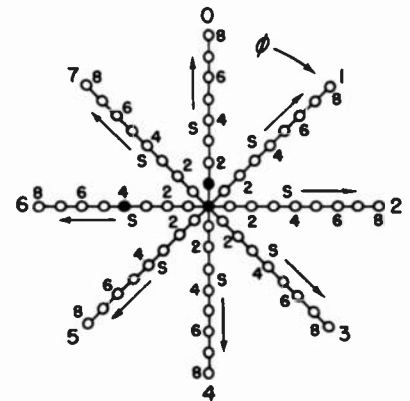

SPOTS LOCATE THE ANTENNAS FOR  
THIS PAGE OF PATTERNS IN THE  
SYSTEMATIZATION PLACEMENT CHART.

PATTERN NOMENCLATURE



$\psi_3$  = PHASING OF ANTENNA No. 3 IN DEGREES

3.115

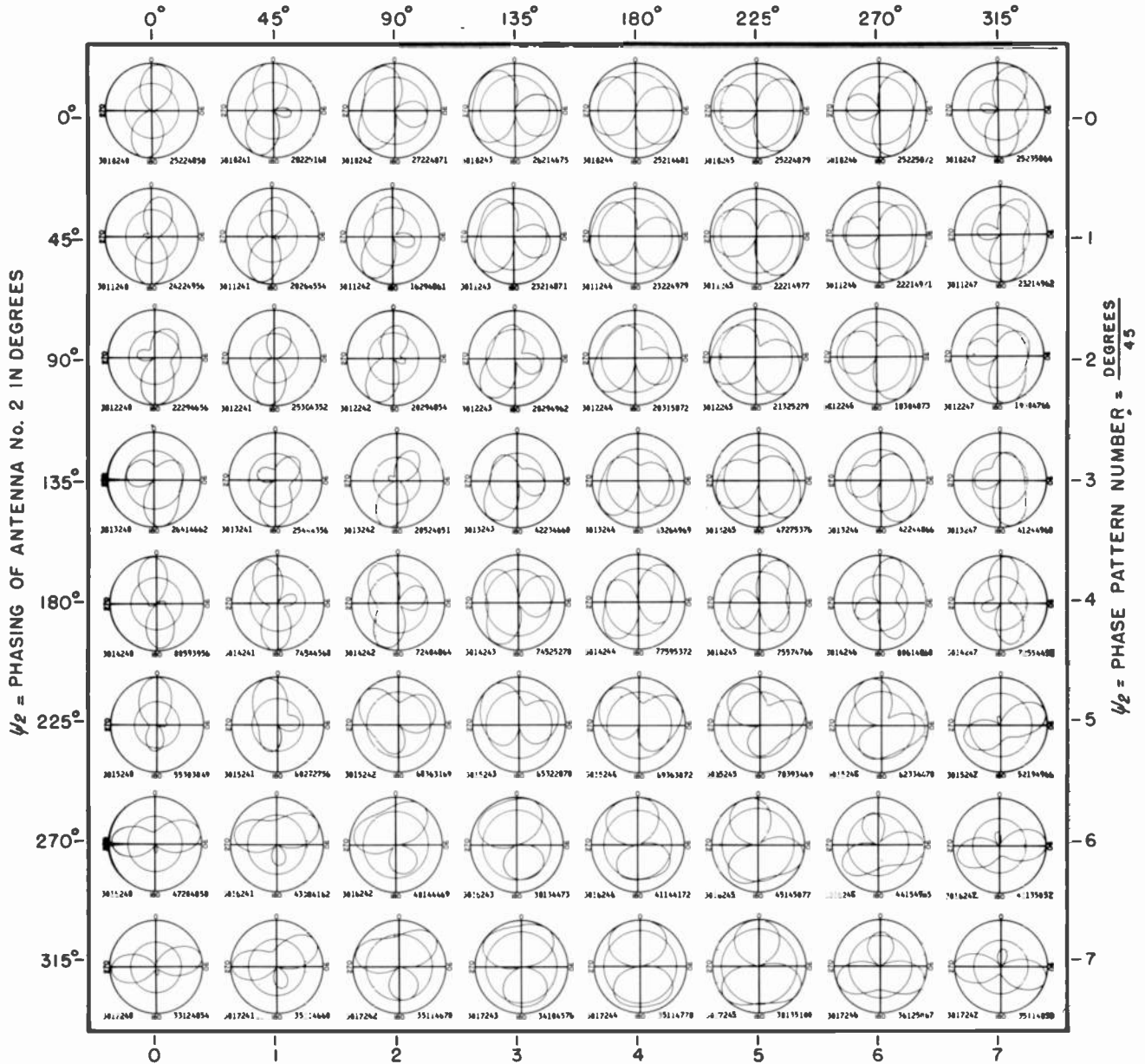

$\psi_3$  = PHASE PATTERN NUMBER =  $\frac{\text{DEGREES}}{45}$

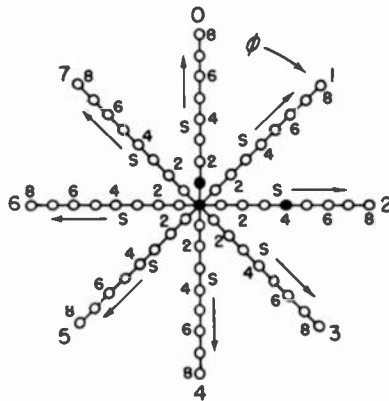

SPOTS LOCATE THE ANTENNAS FOR THIS PAGE OF PATTERNS IN THE SYSTEMATIZATION PLACEMENT CHART.

NO.	$\psi_2$	$S_2$	$\psi_2$	$\psi_3$	$S_3$	$\psi_3$
3	0	1	0	2	4	0

LEFT HAND PATTERN NUMBER GIVES ANTENNA PLACEMENT AND PHASING DATA.

$E_1$	$E_2$	$E_3$	$E_0$
25	22	48	58

RIGHT HAND PATTERN NUMBER GIVES ANTENNA FIELD INTENSITY DATA IN PERCENT.

PATTERN NOMENCLATURE

$\psi_3$  = PHASING OF ANTENNA No. 3 IN DEGREES

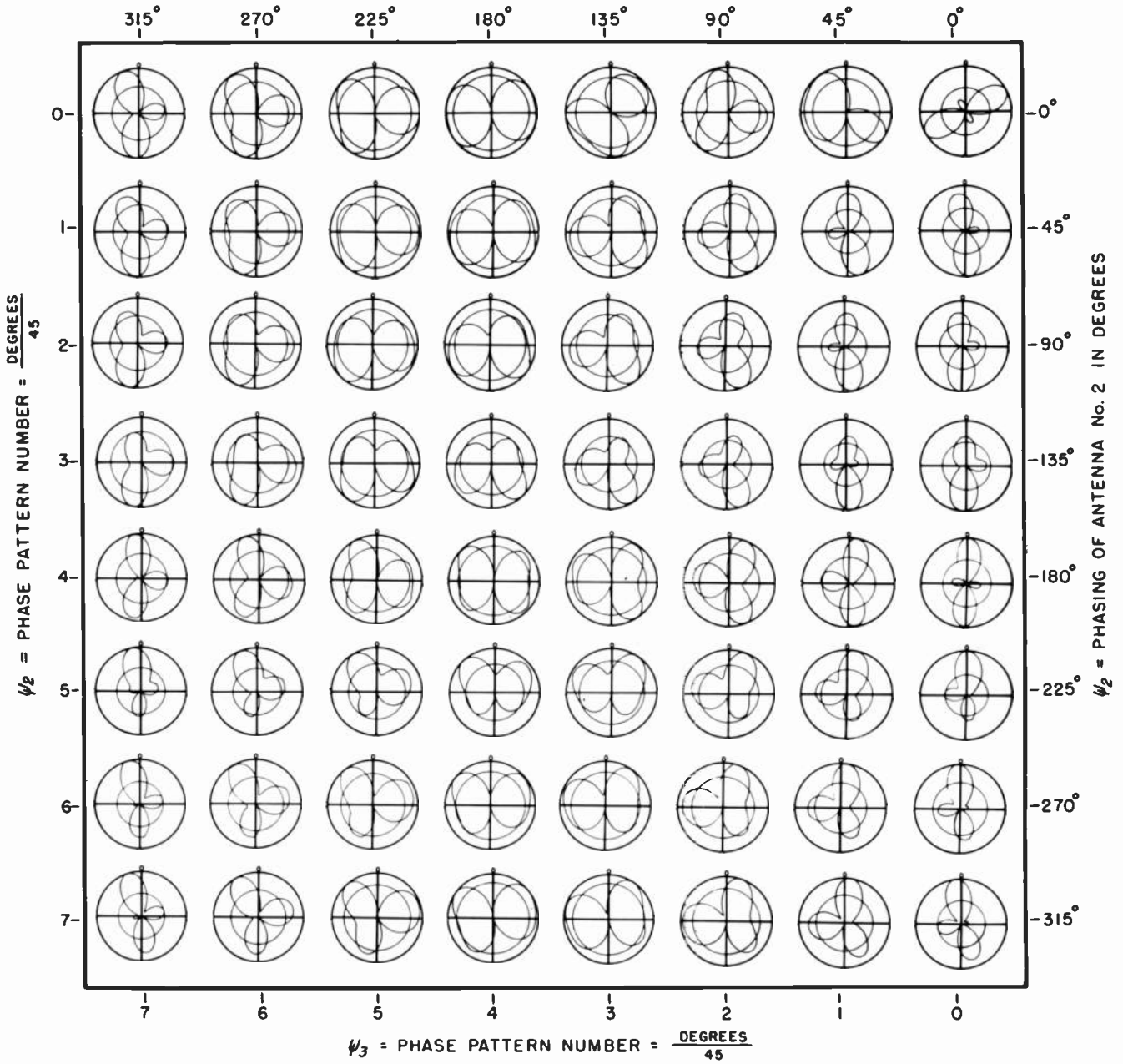

NUMBER OF ANTENNAS IN THE SYSTEM  
 ORIENTATION OF NO. 2 ANTENNA =  $\frac{\text{DEGREES}}{45}$   
 SPACING OF NO. 2 ANTENNA =  $\frac{\text{DEGREES}}{45}$   
 PHASING OF NO. 2 ANTENNA =  $\frac{\text{DEGREES}}{45}$   
 ORIENTATION OF NO. 3 ANTENNA =  $\frac{\text{DEGREES}}{45}$   
 SPACING OF NO. 3 ANTENNA =  $\frac{\text{DEGREES}}{45}$   
 PHASING OF NO. 3 ANTENNA =  $\frac{\text{DEGREES}}{45}$

LEFT HAND PATTERN NUMBER GIVES ANTENNA PLACEMENT AND PHASING DATA.

% FIELD INTENSITY RADIATED IN HORIZONTAL PLANE FROM NO. 1 ANTENNA.  $E_1$  32  
 % FIELD INTENSITY RADIATED IN HORIZONTAL PLANE FROM NO. 2 ANTENNA.  $E_2$  11  
 % FIELD INTENSITY RADIATED IN HORIZONTAL PLANE FROM NO. 3 ANTENNA.  $E_3$  47  
 % RMS FIELD INTENSITY RADIATED IN HORIZONTAL PLANE FROM ANTENNA SYSTEM.  $E_0$  52

RIGHT HAND PATTERN NUMBER GIVES ANTENNA FIELD INTENSITY DATA IN PERCENT.

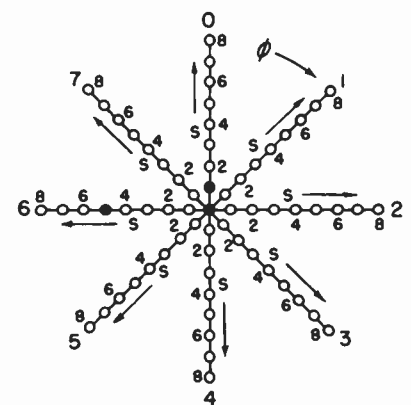

SPOTS LOCATE THE ANTENNAS FOR THIS PAGE OF PATTERNS IN THE SYSTEMIZATION PLACEMENT CHART

PATTERN NOMENCLATURE

$\psi_3$  = PHASING OF ANTENNA No. 3 IN DEGREES

3.117

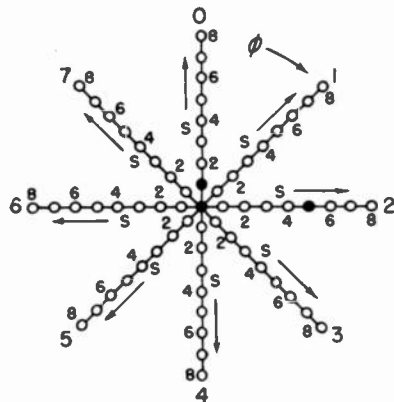
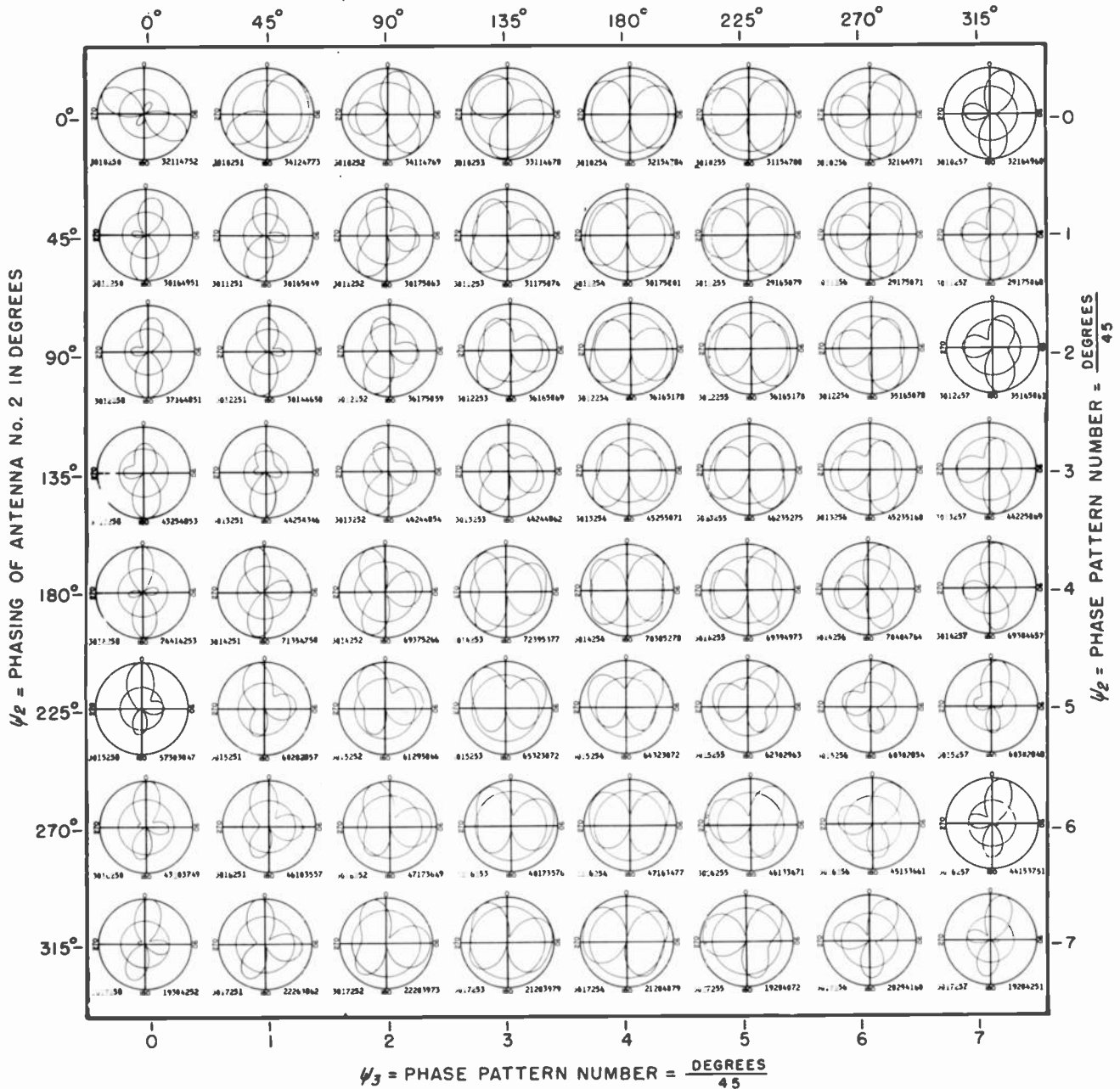

NUMBER OF ANTENNAS IN THE SYSTEM	ORIENTATION OF NO. 2 ANTENNA = $\frac{\text{DEGREES}}{45}$	SPACING OF NO. 2 ANTENNA = $\frac{\text{DEGREES}}{45}$	PHASING OF NO. 2 ANTENNA = $\frac{\text{DEGREES}}{45}$	ORIENTATION OF NO. 3 ANTENNA = $\frac{\text{DEGREES}}{45}$	SPACING OF NO. 3 ANTENNA = $\frac{\text{DEGREES}}{45}$	PHASING OF NO. 3 ANTENNA = $\frac{\text{DEGREES}}{45}$
No. 3	$\phi_2$ 0	$S_2$ 1	$\psi_2$ 0	$\phi_3$ 2	$S_3$ 5	$\psi_3$ 0

LEFT HAND PATTERN NUMBER GIVES ANTENNA PLACEMENT AND PHASING DATA.

% FIELD INTENSITY RADIATED IN HORIZONTAL PLANE FROM NO. 1 ANTENNA.	% FIELD INTENSITY RADIATED IN HORIZONTAL PLANE FROM NO. 2 ANTENNA.	% FIELD INTENSITY RADIATED IN HORIZONTAL PLANE FROM NO. 3 ANTENNA.	% RMS FIELD INTENSITY RADIATED IN HORIZONTAL PLANE FROM ANTENNA SYSTEM.
$E_1$ 32	$E_2$ 11	$E_3$ 47	$E_0$ 52

RIGHT HAND PATTERN-NUMBER GIVES ANTENNA FIELD INTENSITY DATA IN PERCENT.

SPOTS LOCATE THE ANTENNAS FOR THIS PAGE OF PATTERNS IN THE SYSTEMATIZATION PLACEMENT CHART.

PATTERN NOMENCLATURE

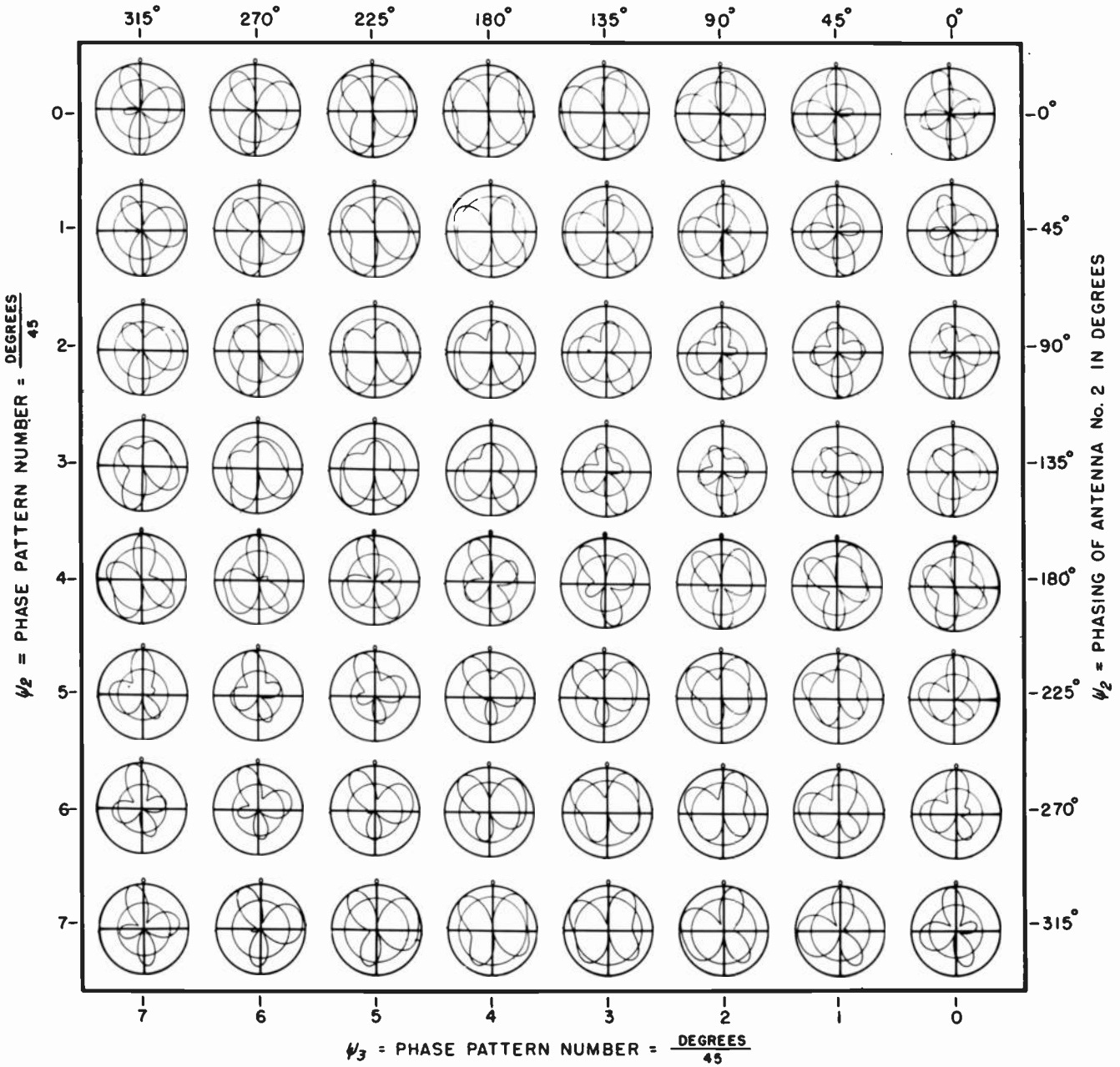

NUMBER OF ANTENNAS IN THE SYSTEM  
 NO. 3

ORIENTATION OF NO. 2 ANTENNA =  $\frac{\text{DEGREES}}{45}$   
 $\phi_2$  0

SPACING OF NO. 2 ANTENNA =  $\frac{\text{DEGREES}}{45}$   
 $S_2$  1

PHASING OF NO. 2 ANTENNA =  $\frac{\text{DEGREES}}{45}$   
 $\psi_2$  0

ORIENTATION OF NO. 3 ANTENNA =  $\frac{\text{DEGREES}}{45}$   
 $\phi_3$  6

SPACING OF NO. 3 ANTENNA =  $\frac{\text{DEGREES}}{45}$   
 $S_3$  6

PHASING OF NO. 3 ANTENNA =  $\frac{\text{DEGREES}}{45}$   
 $\psi_3$  0

LEFT HAND PATTERN NUMBER GIVES ANTENNA PLACEMENT AND PHASING DATA.

% FIELD INTENSITY RADIATED IN HORIZONTAL PLANE FROM NO. 1 ANTENNA.  
 $E_1$  06

% FIELD INTENSITY RADIATED IN HORIZONTAL PLANE FROM NO. 2 ANTENNA.  
 $E_2$  27

% FIELD INTENSITY RADIATED IN HORIZONTAL PLANE FROM NO. 3 ANTENNA.  
 $E_3$  43

% RMS FIELD INTENSITY RADIATED IN HORIZONTAL PLANE FROM ANTENNA SYSTEM.  
 $E_0$  55

RIGHT HAND PATTERN NUMBER GIVES ANTENNA FIELD INTENSITY DATA IN PERCENT.

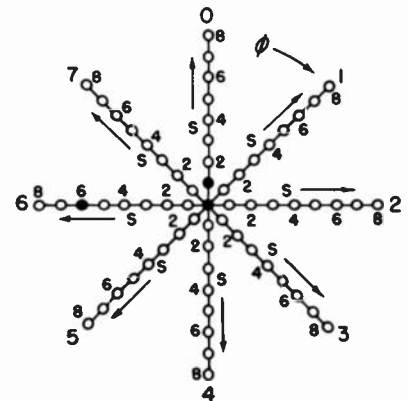

SPOTS LOCATE THE ANTENNAS FOR THIS PAGE OF PATTERNS IN THE SYSTEMATIZATION PLACEMENT CHART.

PATTERN NOMENCLATURE

$\psi_3$  = PHASING OF ANTENNA No. 3 IN DEGREES

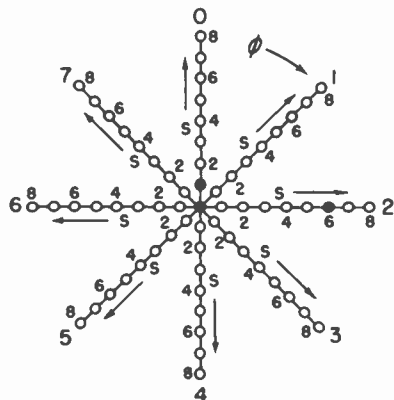
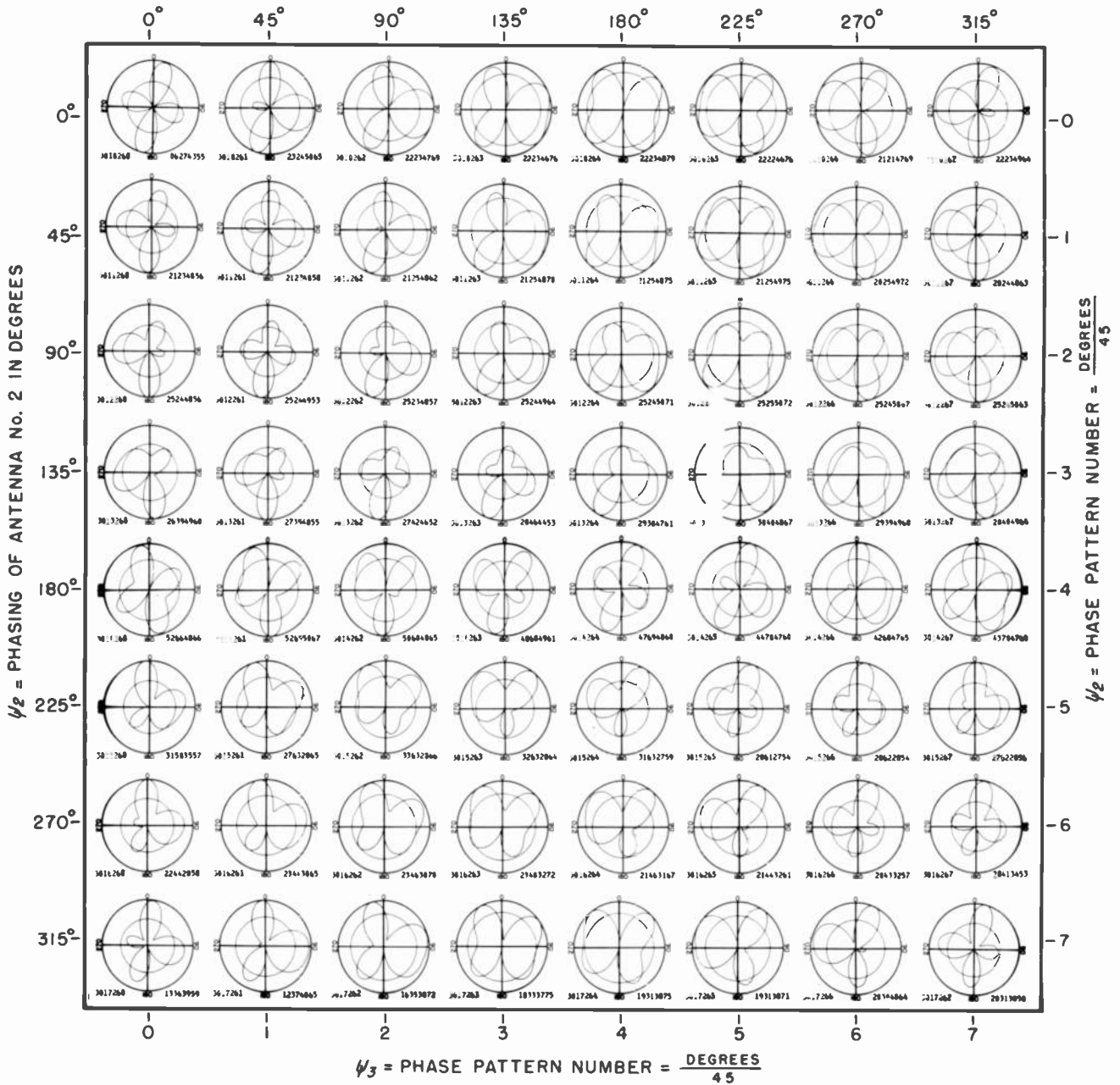

NUMBER OF ANTENNAS IN THE SYSTEM	ORIENTATION OF NO. 2 ANTENNA = $\frac{\text{DEGREES}}{45}$	SPACING OF NO. 2 ANTENNA = $\frac{\text{DEGREES}}{45}$	PHASING OF NO. 2 ANTENNA = $\frac{\text{DEGREES}}{45}$	ORIENTATION OF NO. 3 ANTENNA = $\frac{\text{DEGREES}}{45}$	SPACING OF NO. 3 ANTENNA = $\frac{\text{DEGREES}}{45}$	PHASING OF NO. 3 ANTENNA = $\frac{\text{DEGREES}}{45}$
No.	$\phi_2$	$S_2$	$\psi_2$	$\phi_3$	$S_3$	$\psi_3$
3	0	1	0	2	6	0

LEFT HAND PATTERN NUMBER GIVES ANTENNA PLACEMENT AND PHASING DATA.

% FIELD INTENSITY RADIATED IN HORIZONTAL PLANE FROM NO. 1 ANTENNA.	% FIELD INTENSITY RADIATED IN HORIZONTAL PLANE FROM NO. 2 ANTENNA.	% FIELD INTENSITY RADIATED IN HORIZONTAL PLANE FROM NO. 3 ANTENNA.	% RMS FIELD INTENSITY RADIATED IN HORIZONTAL PLANE FROM ANTENNA SYSTEM.
$E_1$	$E_2$	$E_3$	$E_0$
06	27	43	55

RIGHT HAND PATTERN NUMBER GIVES ANTENNA FIELD INTENSITY DATA IN PERCENT.

SPOTS LOCATE THE ANTENNAS FOR THIS PAGE OF PATTERNS IN THE SYSTEMATIZATION PLACEMENT CHART.

PATTERN NOMENCLATURE

$\psi_3$  = PHASING OF ANTENNA NO. 3 IN DEGREES

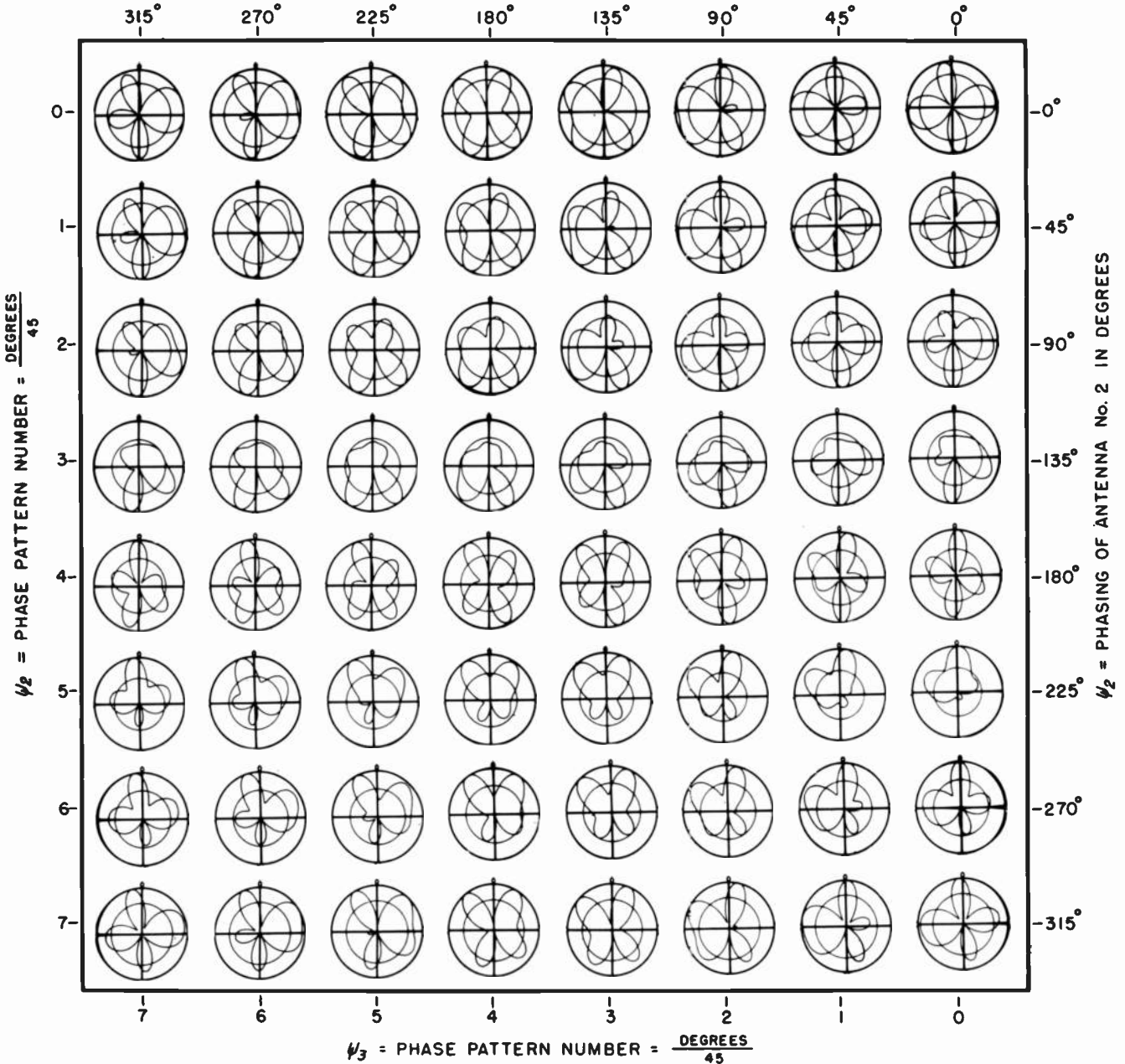

NUMBER OF ANTENNAS IN THE SYSTEM  
 NO. 3

ORIENTATION OF NO. 2 ANTENNA =  $\frac{\text{DEGREES}}{45}$   
 $\phi_2$  0

SPACING OF NO. 2 ANTENNA =  $\frac{\text{DEGREES}}{45}$   
 $S_2$  1

PHASING OF NO. 2 ANTENNA =  $\frac{\text{DEGREES}}{45}$   
 $\psi_2$  0

ORIENTATION OF NO. 3 ANTENNA =  $\frac{\text{DEGREES}}{45}$   
 $\phi_3$  6

SPACING OF NO. 3 ANTENNA =  $\frac{\text{DEGREES}}{45}$   
 $S_3$  7

PHASING OF NO. 3 ANTENNA =  $\frac{\text{DEGREES}}{45}$   
 $\psi_3$  0

% FIELD INTENSITY RADIATED IN HORIZONTAL PLANE FROM NO. 1 ANTENNA.  
 $E_1$  16

% FIELD INTENSITY RADIATED IN HORIZONTAL PLANE FROM NO. 2 ANTENNA.  
 $E_2$  31

% FIELD INTENSITY RADIATED IN HORIZONTAL PLANE FROM NO. 3 ANTENNA.  
 $E_3$  47

% RMS FIELD INTENSITY RADIATED IN HORIZONTAL PLANE FROM ANTENNA SYSTEM.  
 $E_0$  72

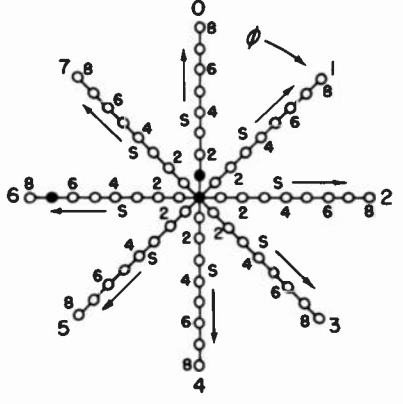

LEFT HAND PATTERN NUMBER GIVES ANTENNA PLACEMENT AND PHASING DATA.

RIGHT HAND PATTERN NUMBER GIVES ANTENNA FIELD INTENSITY DATA IN PERCENT.

SPOTS LOCATE THE ANTENNAS FOR THIS PAGE OF PATTERNS IN THE SYSTEMATIZATION PLACEMENT CHART.

PATTERN NOMENCLATURE

$\psi_3$  = PHASING OF ANTENNA No. 3 IN DEGREES

3.121

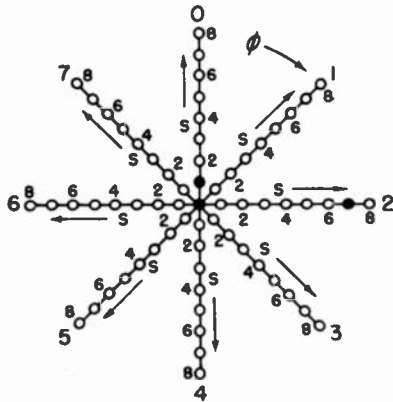
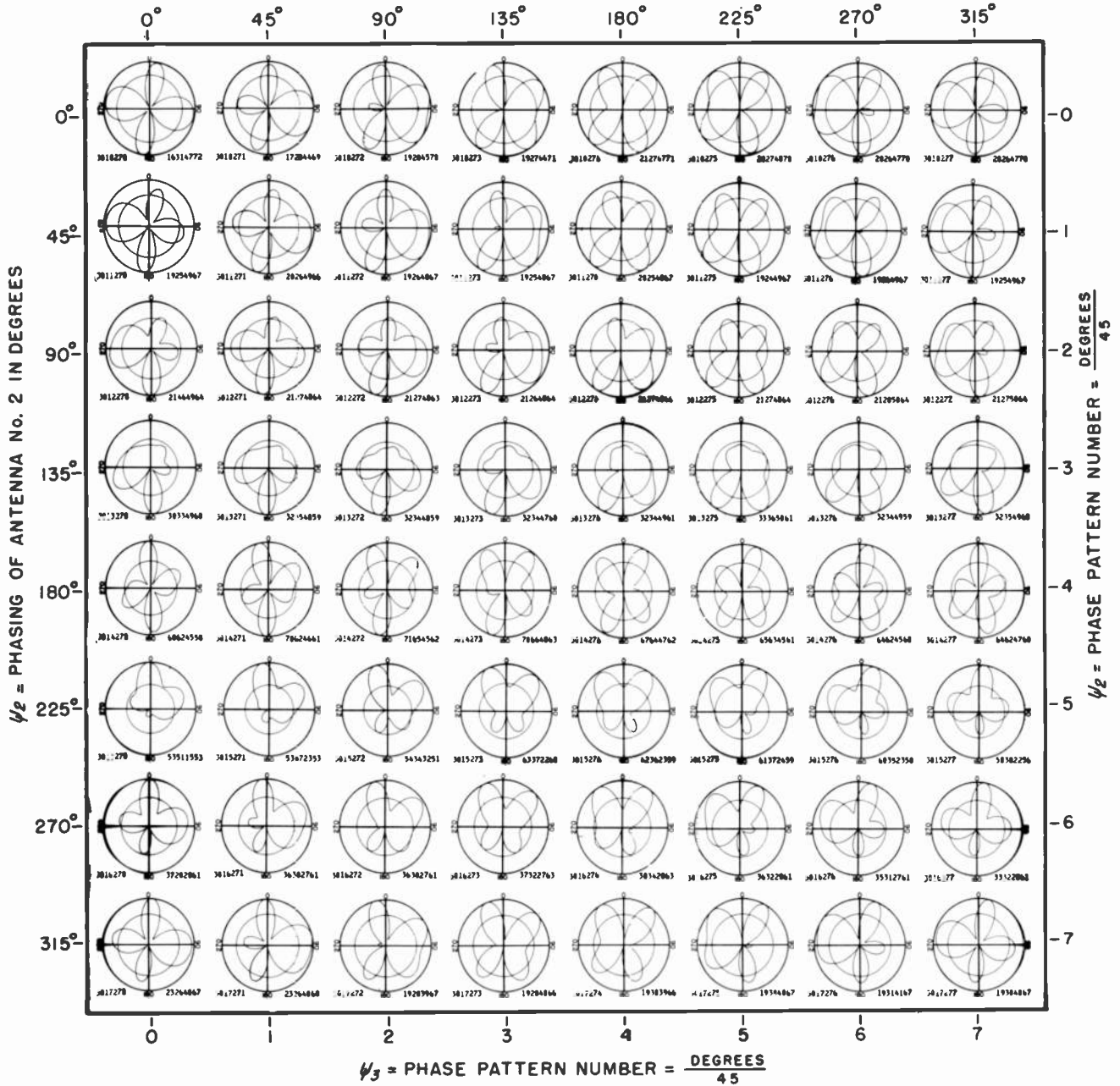

SPOTS LOCATE THE ANTENNAS FOR THIS PAGE OF PATTERNS IN THE SYSTEMATIZATION PLACEMENT CHART.

NUMBER OF ANTENNAS IN THE SYSTEM	ORIENTATION OF NO. 2 ANTENNA = $\frac{\text{DEGREES}}{45}$	SPACING OF NO. 2 ANTENNA = $\frac{\text{DEGREES}}{45}$	PHASING OF NO. 2 ANTENNA = $\frac{\text{DEGREES}}{45}$	ORIENTATION OF NO. 3 ANTENNA = $\frac{\text{DEGREES}}{45}$	SPACING OF NO. 3 ANTENNA = $\frac{\text{DEGREES}}{45}$	PHASING OF NO. 3 ANTENNA = $\frac{\text{DEGREES}}{45}$
No. 3	$\phi_2$ 0	$S_2$ 1	$\psi_2$ 0	$\phi_3$ 2	$S_3$ 7	$\psi_3$ 0

LEFT HAND PATTERN NUMBER GIVES ANTENNA PLACEMENT AND PHASING DATA.

% FIELD INTENSITY RADIATED IN HORIZONTAL PLANE FROM NO. 1 ANTENNA.	% FIELD INTENSITY RADIATED IN HORIZONTAL PLANE FROM NO. 2 ANTENNA.	% FIELD INTENSITY RADIATED IN HORIZONTAL PLANE FROM NO. 3 ANTENNA.	% RMS FIELD INTENSITY RADIATED IN HORIZONTAL PLANE FROM ANTENNA SYSTEM.
$F_1$ 16	$F_2$ 31	$F_3$ 47	$F_0$ 72

RIGHT HAND PATTERN NUMBER GIVES ANTENNA FIELD INTENSITY DATA IN PERCENT.

PATTERN NOMENCLATURE

$\psi_3$  = PHASING OF ANTENNA No. 3 IN DEGREES

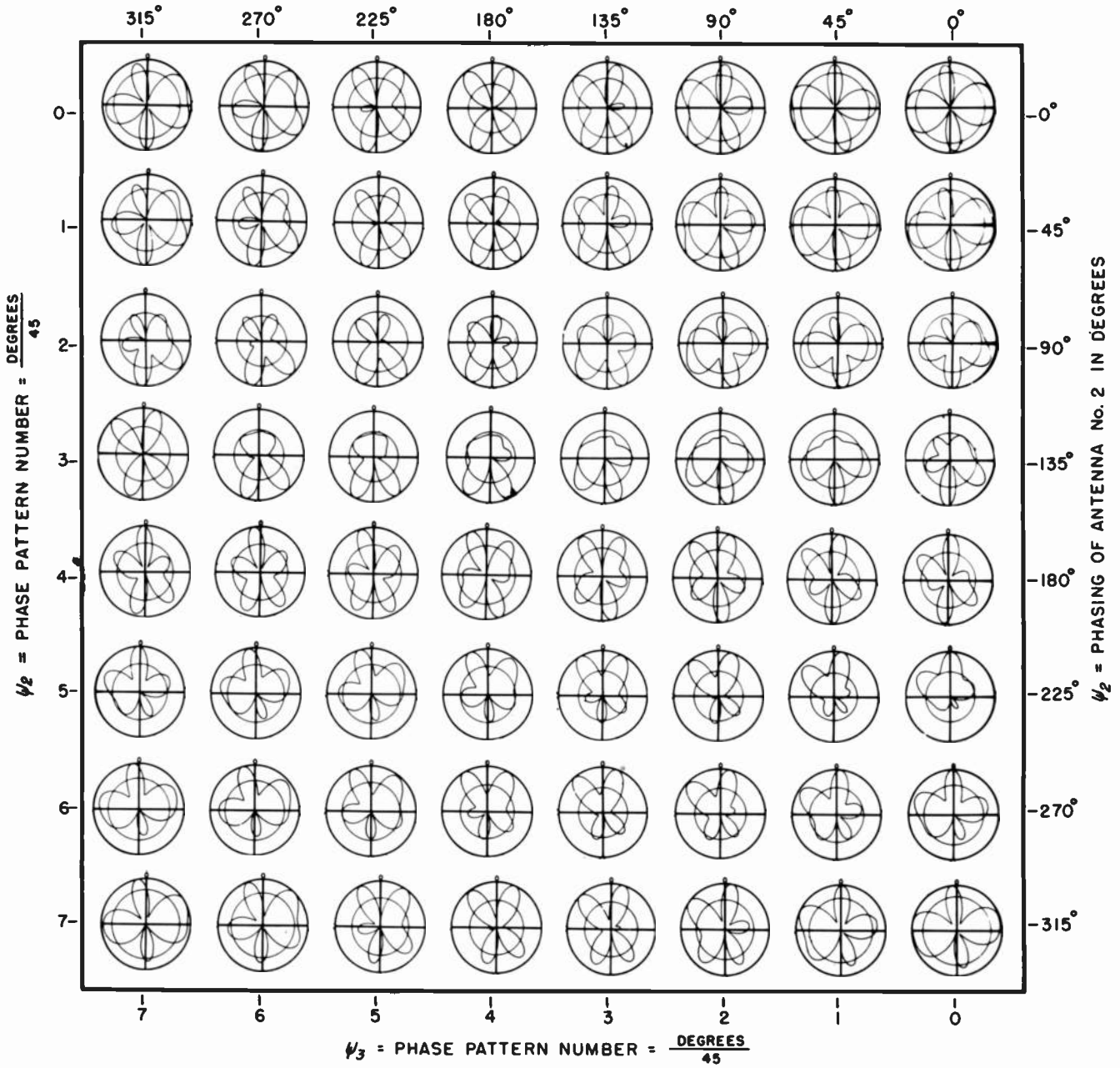

NUMBER OF ANTENNAS IN THE SYSTEM  
 NO.  $\psi_2$  = 3

ORIENTATION OF NO. 2 ANTENNA =  $\frac{\text{DEGREES}}{45}$   
 $\phi_2$  = 0

SPACING OF NO. 2 ANTENNA =  $\frac{\text{DEGREES}}{45}$   
 $S_2$  = 1

PHASING OF NO. 2 ANTENNA =  $\frac{\text{DEGREES}}{45}$   
 $\psi_2$  = 0

ORIENTATION OF NO. 3 ANTENNA =  $\frac{\text{DEGREES}}{45}$   
 $\phi_3$  = 6

SPACING OF NO. 3 ANTENNA =  $\frac{\text{DEGREES}}{45}$   
 $S_3$  = 8

PHASING OF NO. 3 ANTENNA =  $\frac{\text{DEGREES}}{45}$   
 $\psi_3$  = 0

LEFT HAND PATTERN NUMBER GIVES ANTENNA PLACEMENT AND PHASING DATA.

% FIELD INTENSITY RADIATED IN HORIZONTAL PLANE FROM NO. 1 ANTENNA.  
 $E_1$  = 28

% FIELD INTENSITY RADIATED IN HORIZONTAL PLANE FROM NO. 2 ANTENNA.  
 $E_2$  = 18

% FIELD INTENSITY RADIATED IN HORIZONTAL PLANE FROM NO. 3 ANTENNA.  
 $E_3$  = 45

% RMS FIELD INTENSITY RADIATED IN HORIZONTAL PLANE FROM ANTENNA SYSTEM.  
 $E_0$  = 78

RIGHT HAND PATTERN NUMBER GIVES ANTENNA FIELD INTENSITY DATA IN PERCENT.

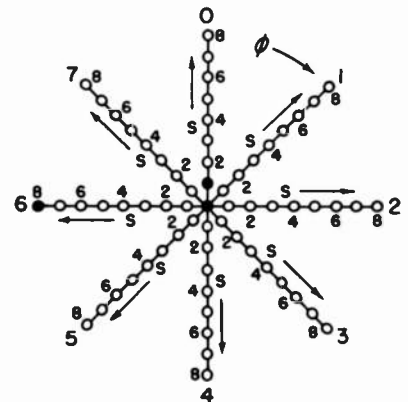

SPOTS LOCATE THE ANTENNAS FOR THIS PAGE OF PATTERNS IN THE SYSTEMATIZATION PLACEMENT CHART.

PATTERN NOMENCLATURE



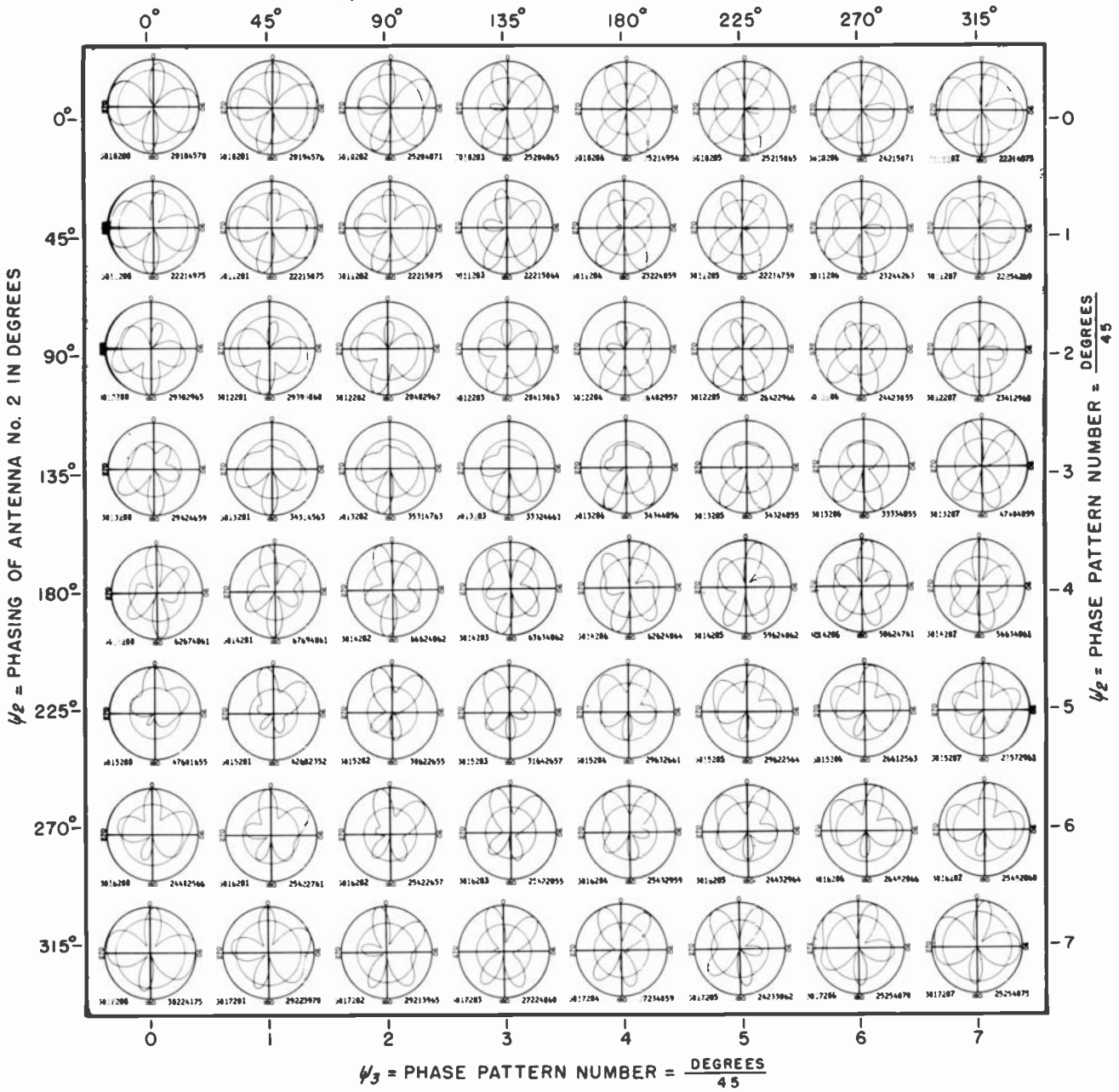

SPOTS LOCATE THE ANTENNAS FOR THIS PAGE OF PATTERNS IN THE SYSTEMATIZATION PLACEMENT CHART.

PATTERN NOMENCLATURE

LEFT HAND PATTERN NUMBER GIVES ANTENNA PLACEMENT AND PHASING DATA.

RIGHT HAND PATTERN NUMBER GIVES ANTENNA FIELD INTENSITY DATA IN PERCENT.

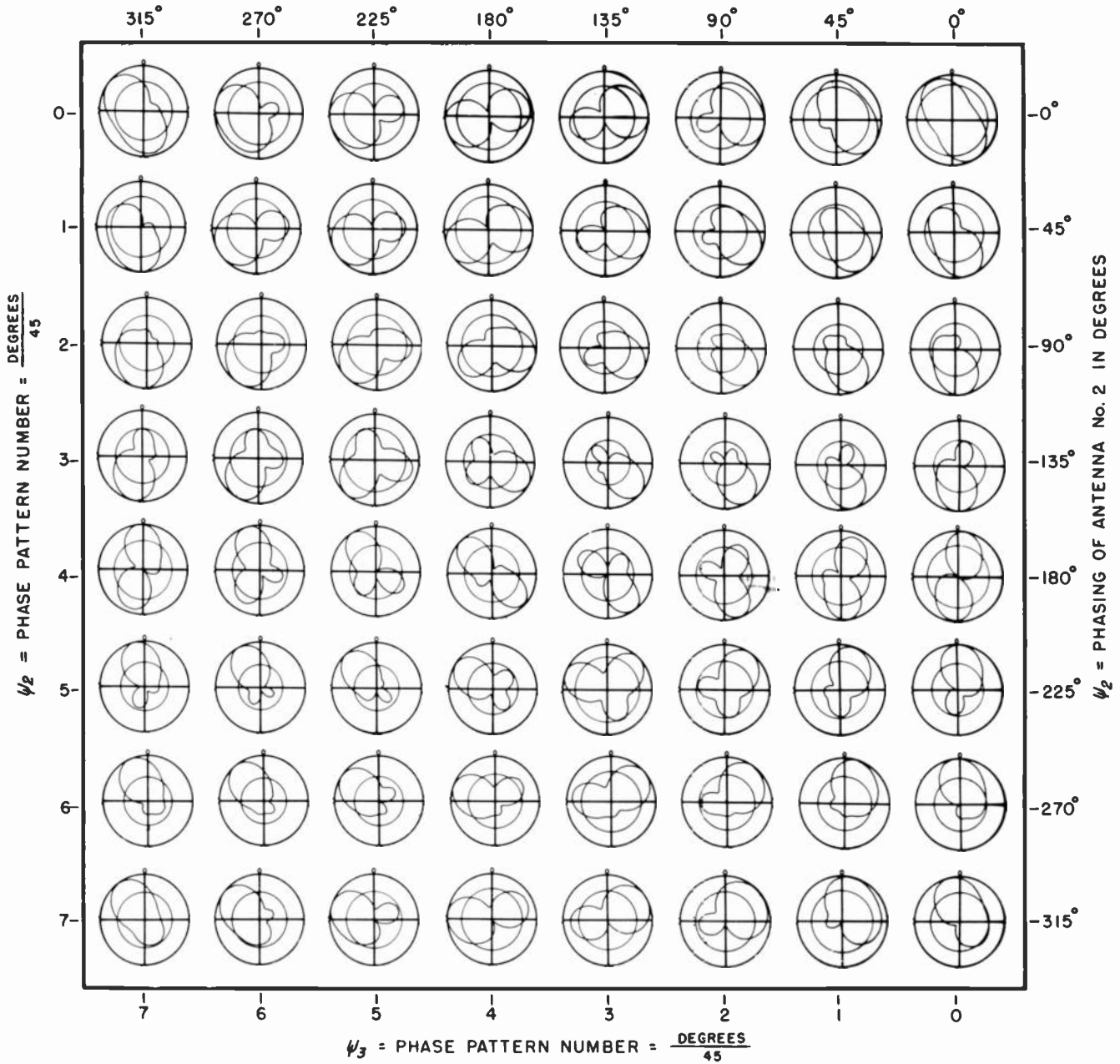

NUMBER OF ANTENNAS IN THE SYSTEM	ORIENTATION OF NO. 2 ANTENNA = $\frac{DEGREES}{45}$	SPACING OF NO. 2 ANTENNA = $\frac{DEGREES}{45}$	PHASING OF NO. 2 ANTENNA = $\frac{DEGREES}{45}$	ORIENTATION OF NO. 3 ANTENNA = $\frac{DEGREES}{45}$	SPACING OF NO. 3 ANTENNA = $\frac{DEGREES}{45}$	PHASING OF NO. 3 ANTENNA = $\frac{DEGREES}{45}$
No. 3	$\phi_2$ 0	$S_2$ 2	$\psi_2$ 0	$\phi_3$ 6	$S_3$ 3	$\psi_3$ 0

LEFT HAND PATTERN NUMBER GIVES ANTENNA PLACEMENT AND PHASING DATA.

% FIELD INTENSITY RADIATED IN HORIZONTAL PLANE FROM NO. 1 ANTENNA.	% FIELD INTENSITY RADIATED IN HORIZONTAL PLANE FROM NO. 2 ANTENNA.	% FIELD INTENSITY RADIATED IN HORIZONTAL PLANE FROM NO. 3 ANTENNA.	% RMS FIELD INTENSITY RADIATED IN HORIZONTAL PLANE FROM ANTENNA SYSTEM.
$E_1$ 39	$E_2$ 40	$E_3$ 39	$E_0$ 78

RIGHT HAND PATTERN NUMBER GIVES ANTENNA FIELD INTENSITY DATA IN PERCENT.

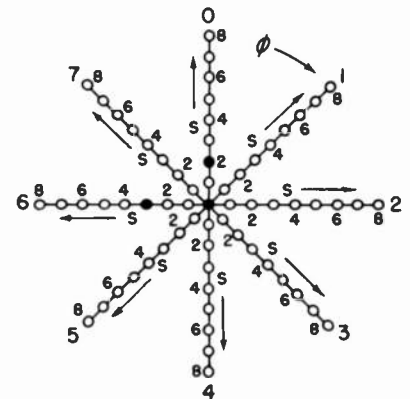

SPOTS LOCATE THE ANTENNAS FOR THIS PAGE OF PATTERNS IN THE SYSTEMATIZATION PLACEMENT CHART.

PATTERN NOMENCLATURE

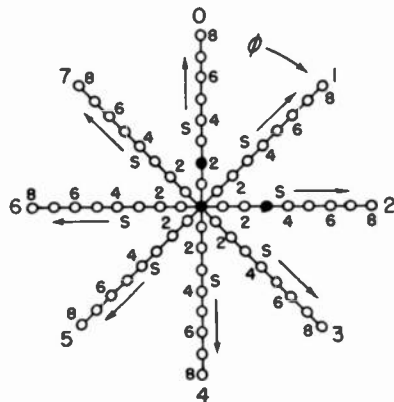
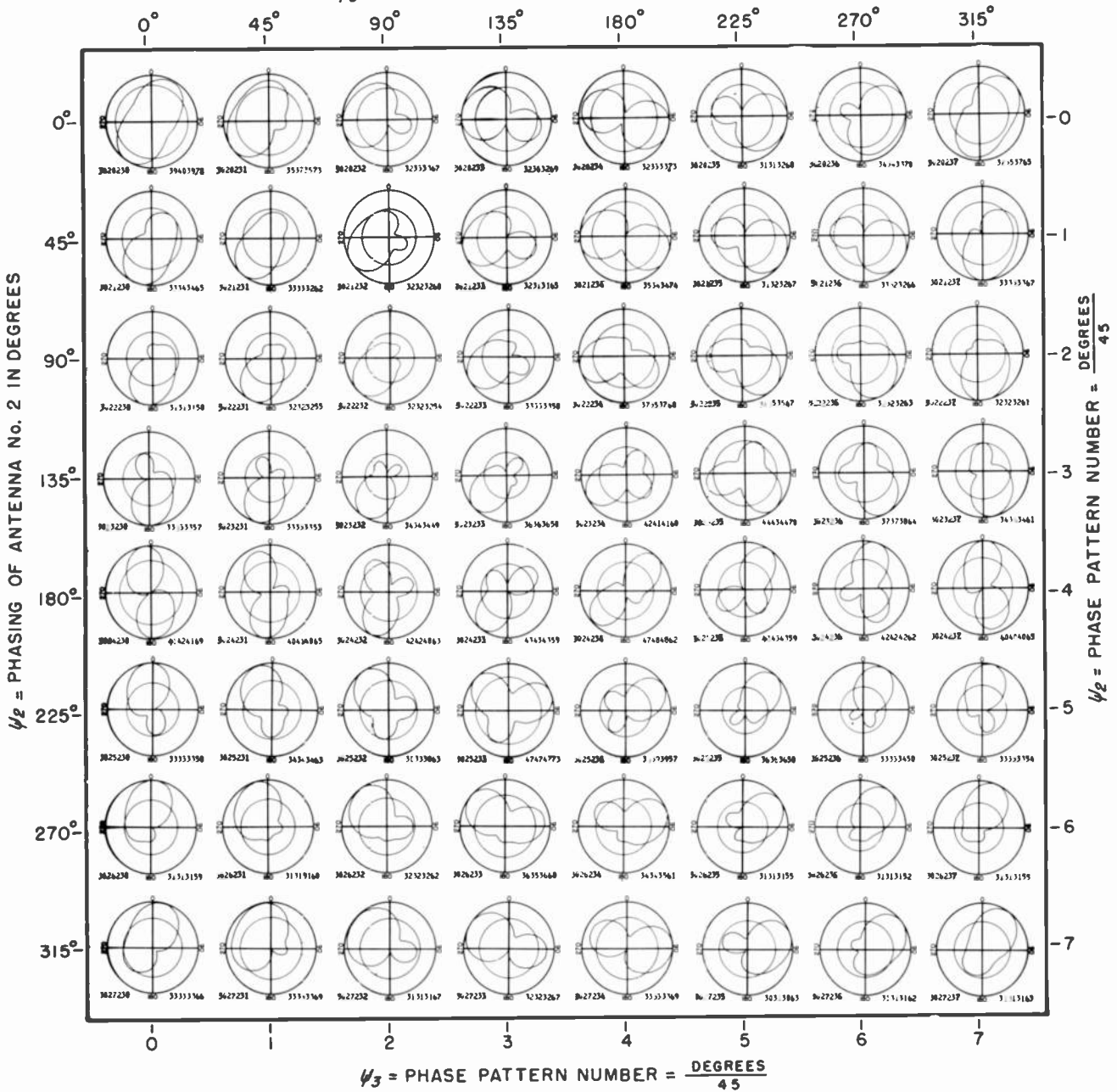

NO.	$\phi_2$	$S_2$	$\psi_2$	$\phi_3$	$S_3$	$\psi_3$
3	0	2	0	2	3	0

$F_1$	$F_2$	$F_3$	$F_0$
39	40	39	78

SPOTS LOCATE THE ANTENNAS FOR THIS PAGE OF PATTERNS IN THE SYSTEMATIZATION PLACEMENT CHART.

LEFT HAND PATTERN NUMBER GIVES ANTENNA PLACEMENT AND PHASING DATA.

RIGHT HAND PATTERN NUMBER GIVES ANTENNA FIELD INTENSITY DATA IN PERCENT.

PATTERN NOMENCLATURE

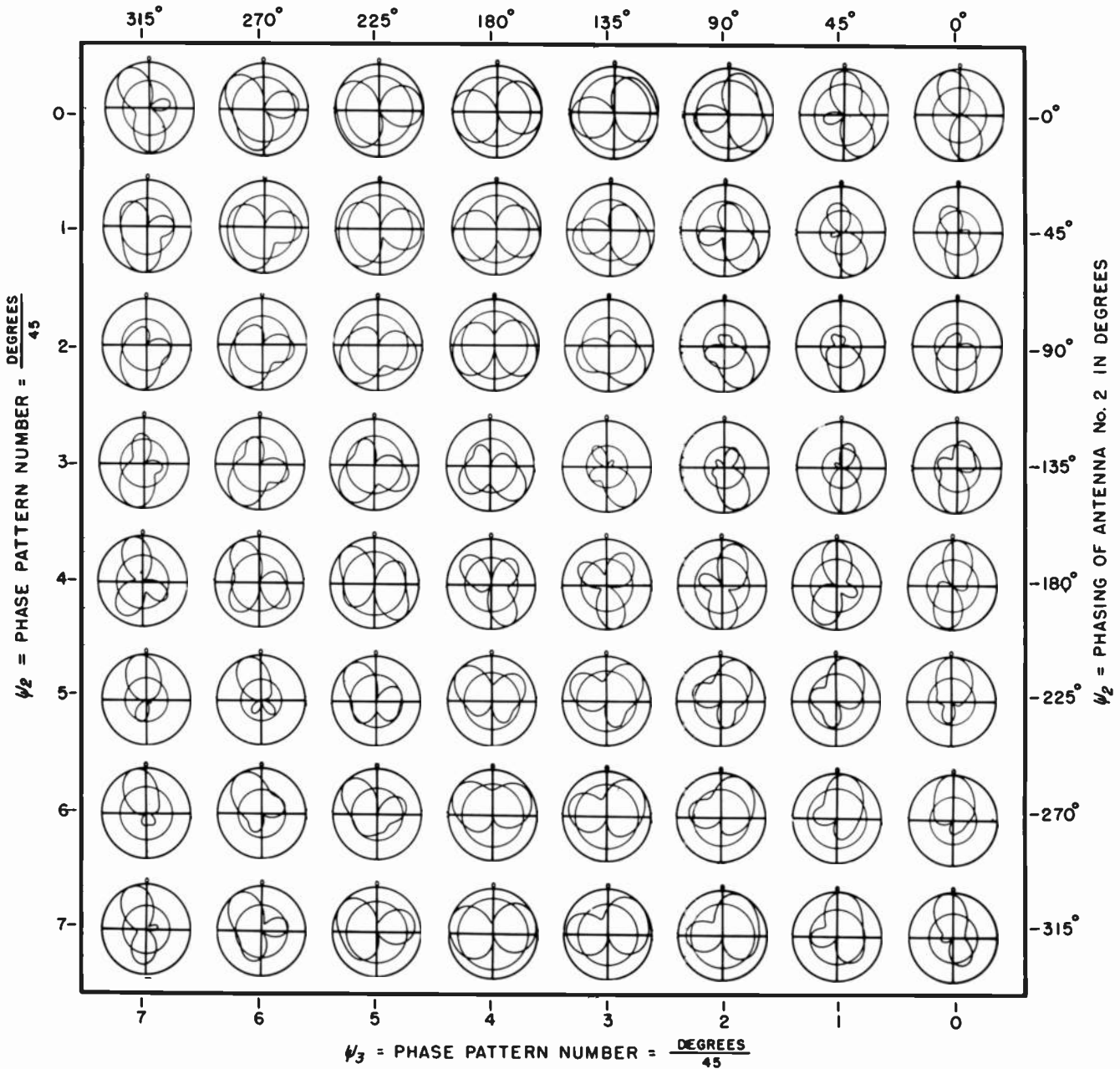

NUMBER OF ANTENNAS IN THE SYSTEM  
 No.  $\phi_2$  3

ORIENTATION OF NO. 2 ANTENNA =  $\frac{DEGREES}{45}$   
 $S_2$  0

SPACING OF NO. 2 ANTENNA =  $\frac{DEGREES}{45}$   
 $S_2$  2

PHASING OF NO. 2 ANTENNA =  $\frac{DEGREES}{45}$   
 $\psi_2$  0

ORIENTATION OF NO. 3 ANTENNA =  $\frac{DEGREES}{45}$   
 $\phi_3$  6

SPACING OF NO. 3 ANTENNA =  $\frac{DEGREES}{45}$   
 $S_3$  4

PHASING OF NO. 3 ANTENNA =  $\frac{DEGREES}{45}$   
 $\psi_3$  0

LEFT HAND PATTERN NUMBER GIVES ANTENNA PLACEMENT AND PHASING DATA.

% FIELD INTENSITY RADIATED IN HORIZONTAL PLANE FROM NO. 1 ANTENNA.  
 $E_1$  26

% FIELD INTENSITY RADIATED IN HORIZONTAL PLANE FROM NO. 2 ANTENNA.  
 $E_2$  26

% FIELD INTENSITY RADIATED IN HORIZONTAL PLANE FROM NO. 3 ANTENNA.  
 $E_3$  57

% RMS FIELD INTENSITY RADIATED IN HORIZONTAL PLANE FROM ANTENNA SYSTEM.  
 $E_0$  60

RIGHT HAND PATTERN NUMBER GIVES ANTENNA FIELD INTENSITY DATA IN PERCENT.

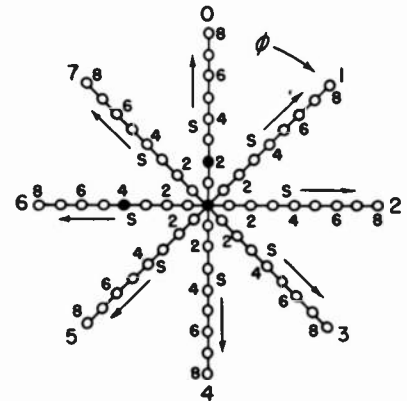

SPOTS LOCATE THE ANTENNAS FOR THIS PAGE OF PATTERNS IN THE SYSTEMIZATION PLACEMENT CHART.

PATTERN NOMENCLATURE

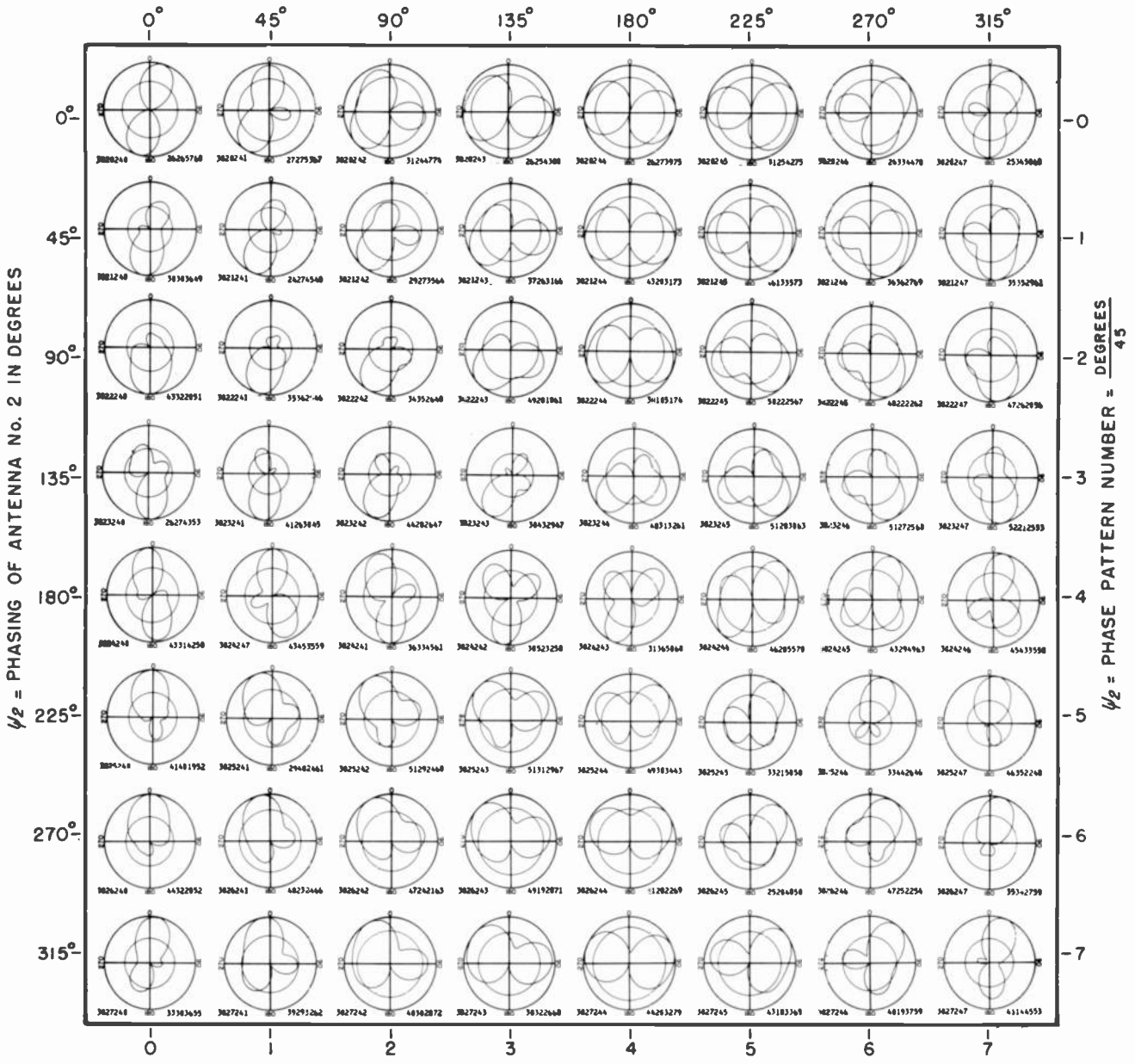

$\psi_3$  = PHASE PATTERN NUMBER =  $\frac{\text{DEGREES}}{45}$

COPYRIGHT 1946 BY CARL E. SMITH  
PRINTED IN U. S. A.

CLEVELAND INSTITUTE OF RADIO ELECTRONICS  
TERMINAL TOWER, CLEVELAND 13, OHIO.

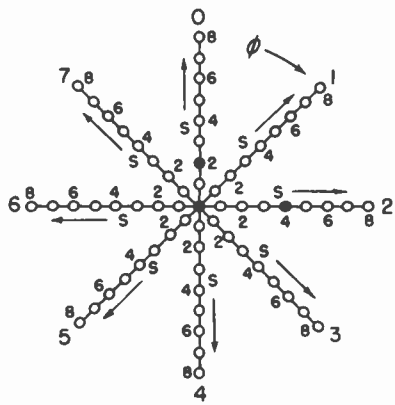

NUMBER OF ANTENNAS IN THE SYSTEM	ORIENTATION OF NO. 2 ANTENNA = $\frac{\text{DEGREES}}{45}$	SPACING OF NO. 2 ANTENNA = $\frac{\text{DEGREES}}{45}$	PHASING OF NO. 2 ANTENNA = $\frac{\text{DEGREES}}{45}$	ORIENTATION OF NO. 3 ANTENNA = $\frac{\text{DEGREES}}{45}$	SPACING OF NO. 3 ANTENNA = $\frac{\text{DEGREES}}{45}$	PHASING OF NO. 3 ANTENNA = $\frac{\text{DEGREES}}{45}$
No.	$\phi_2$	$S_2$	$\psi_2$	$\phi_3$	$S_3$	$\psi_3$
3	0	2	0	2	4	0

% FIELD INTENSITY RADIATED IN HORIZONTAL PLANE FROM NO. 1 ANTENNA.	% FIELD INTENSITY RADIATED IN HORIZONTAL PLANE FROM NO. 2 ANTENNA.	% FIELD INTENSITY RADIATED IN HORIZONTAL PLANE FROM NO. 3 ANTENNA.	% RMS FIELD INTENSITY RADIATED IN HORIZONTAL PLANE FROM ANTENNA SYSTEM.
$E_1$	$E_2$	$E_3$	$E_0$
26	26	57	60

LEFT HAND PATTERN NUMBER GIVES ANTENNA PLACEMENT AND PHASING DATA.

RIGHT HAND PATTERN NUMBER GIVES ANTENNA FIELD INTENSITY DATA IN PERCENT.

SPOTS LOCATE THE ANTENNAS FOR THIS PAGE OF PATTERNS IN THE SYSTEMATIZATION PLACEMENT CHART.

PATTERN NOMENCLATURE

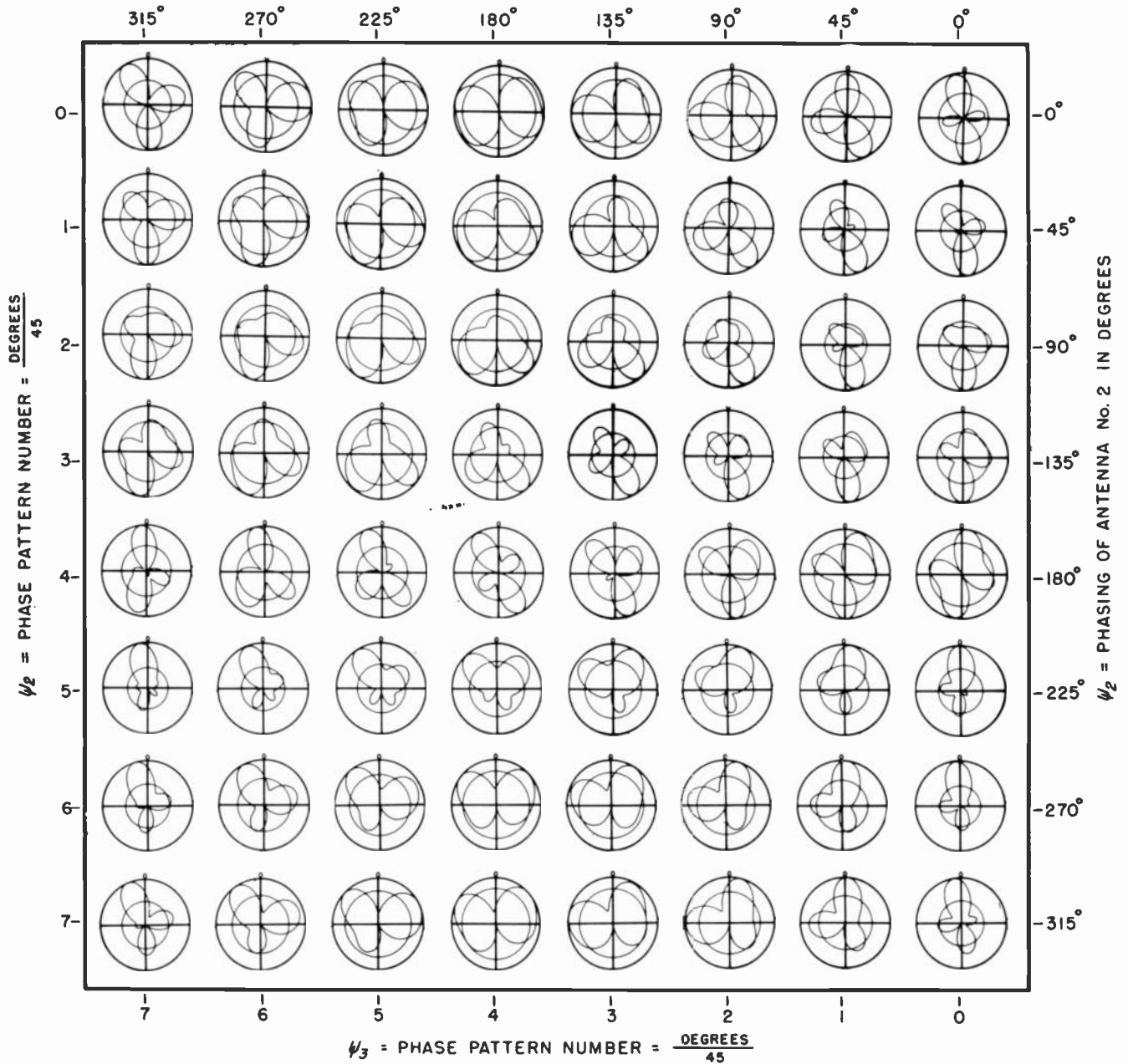

NUMBER OF ANTENNAS IN THE SYSTEM  
 NO. 3

ORIENTATION OF NO. 2 ANTENNA =  $\frac{\text{DEGREES}}{45}$   
 $\phi_2 = 0$

SPACING OF NO. 2 ANTENNA =  $\frac{\text{DEGREES}}{45}$   
 $S_2 = 2$

PHASING OF NO. 2 ANTENNA =  $\frac{\text{DEGREES}}{45}$   
 $\psi_2 = 0$

ORIENTATION OF NO. 3 ANTENNA =  $\frac{\text{DEGREES}}{45}$   
 $\phi_3 = 6$

SPACING OF NO. 3 ANTENNA =  $\frac{\text{DEGREES}}{45}$   
 $S_3 = 5$

PHASING OF NO. 3 ANTENNA =  $\frac{\text{DEGREES}}{45}$   
 $\psi_3 = 0$

% FIELD INTENSITY RADIATED IN HORIZONTAL PLANE FROM NO. 1 ANTENNA.  
 $F_1 = 37$

% FIELD INTENSITY RADIATED IN HORIZONTAL PLANE FROM NO. 2 ANTENNA.  
 $F_2 = 22$

% FIELD INTENSITY RADIATED IN HORIZONTAL PLANE FROM NO. 3 ANTENNA.  
 $F_3 = 49$

% RMS FIELD INTENSITY RADIATED IN HORIZONTAL PLANE FROM ANTENNA SYSTEM.  
 $F_0 = 56$

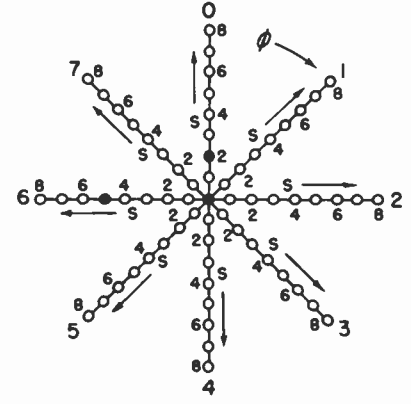

LEFT HAND PATTERN NUMBER GIVES ANTENNA PLACEMENT AND PHASING DATA.

RIGHT HAND PATTERN NUMBER GIVES ANTENNA FIELD INTENSITY DATA IN PERCENT.

SPOTS LOCATE THE ANTENNAS FOR THIS PAGE OF PATTERNS IN THE SYSTEMATIZATION PLACEMENT CHART.

PATTERN NOMENCLATURE

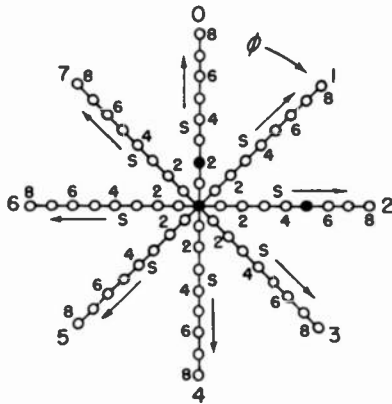
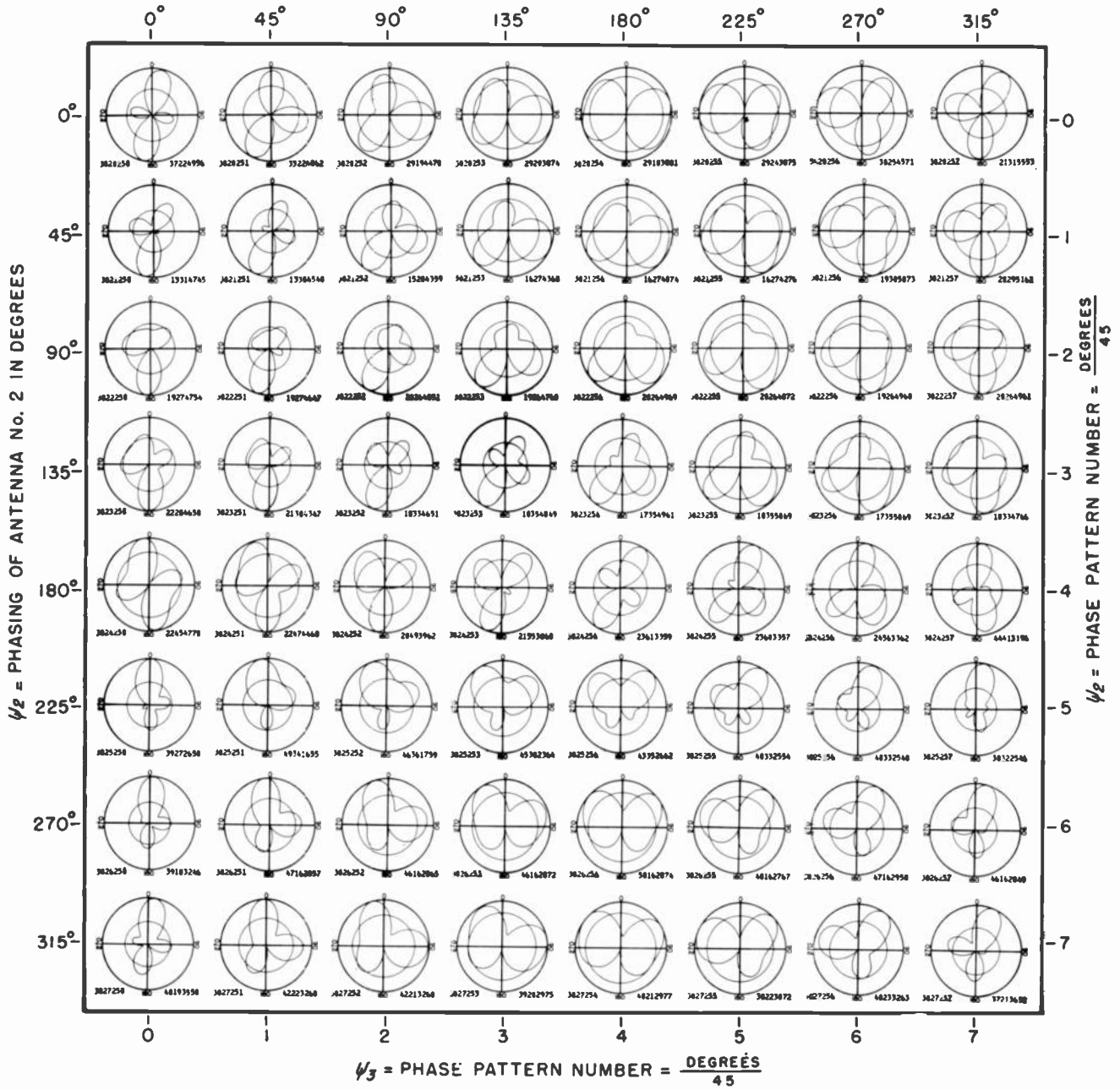

$\psi_3$  = PHASE PATTERN NUMBER =  $\frac{\text{DEGREES}}{45}$

NUMBER OF ANTENNAS IN THE SYSTEM	ORIENTATION OF NO. 2 ANTENNA = $\frac{\text{DEGREES}}{45}$	SPACING OF NO. 2 ANTENNA = $\frac{\text{DEGREES}}{45}$	PHASING OF NO. 2 ANTENNA = $\frac{\text{DEGREES}}{45}$	ORIENTATION OF NO. 3 ANTENNA = $\frac{\text{DEGREES}}{45}$	SPACING OF NO. 3 ANTENNA = $\frac{\text{DEGREES}}{45}$	PHASING OF NO. 3 ANTENNA = $\frac{\text{DEGREES}}{45}$
No.	$\phi_2$	$S_2$	$\psi_2$	$\phi_3$	$S_3$	$\psi_3$
3	0	2	0	2	5	0

% FIELD INTENSITY RADIATED IN HORIZONTAL PLANE FROM NO. 1 ANTENNA.	% FIELD INTENSITY RADIATED IN HORIZONTAL PLANE FROM NO. 2 ANTENNA.	% FIELD INTENSITY RADIATED IN HORIZONTAL PLANE FROM NO. 3 ANTENNA.	% RMS FIELD INTENSITY RADIATED IN HORIZONTAL PLANE FROM ANTENNA SYSTEM.
$E_1$	$E_2$	$E_3$	$E_0$
37	22	49	56

SPOTS LOCATE THE ANTENNAS FOR THIS PAGE OF PATTERNS IN THE SYSTEMATIZATION PLACEMENT CHART,

LEFT HAND PATTERN NUMBER GIVES ANTENNA PLACEMENT AND PHASING DATA.

RIGHT HAND PATTERN NUMBER GIVES ANTENNA FIELD INTENSITY DATA IN PERCENT.

PATTERN NOMENCLATURE

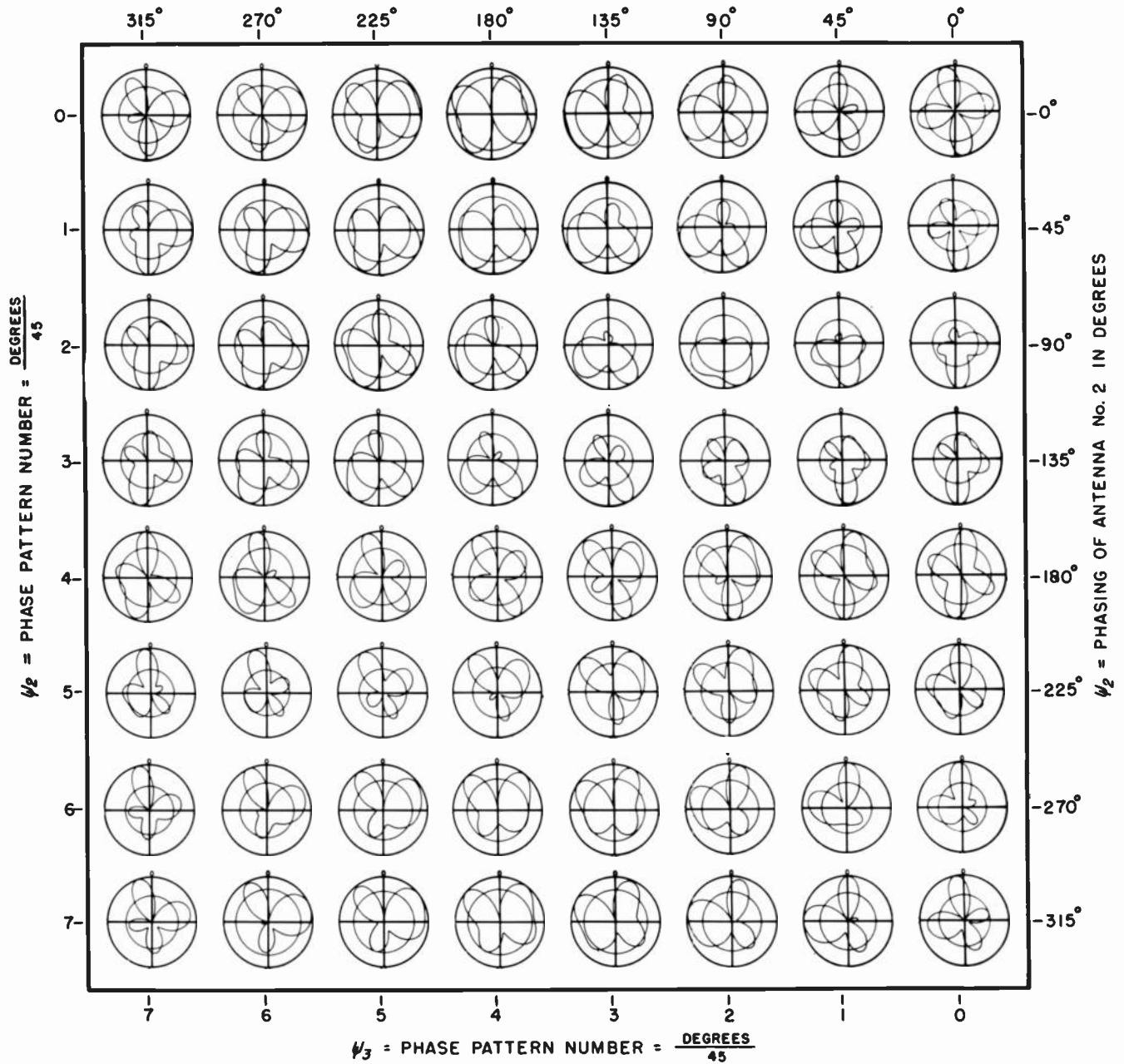

NUMBER OF ANTENNAS IN THE SYSTEM  
 NO. 3  
 0

ORIENTATION OF NO. 2 ANTENNA =  $\frac{\text{DEGREES}}{45}$   
 $\psi_2$   
 0

SPACING OF NO. 2 ANTENNA =  $\frac{\text{DEGREES}}{45}$   
 $S_2$   
 2

PHASING OF NO. 2 ANTENNA =  $\frac{\text{DEGREES}}{45}$   
 $\psi_2$   
 0

ORIENTATION OF NO. 3 ANTENNA =  $\frac{\text{DEGREES}}{45}$   
 $\psi_3$   
 6

SPACING OF NO. 3 ANTENNA =  $\frac{\text{DEGREES}}{45}$   
 $S_3$   
 6

PHASING OF NO. 3 ANTENNA =  $\frac{\text{DEGREES}}{45}$   
 $\psi_3$   
 0

LEFT HAND PATTERN NUMBER GIVES ANTENNA PLACEMENT AND PHASING DATA.

% FIELD INTENSITY RADIATED IN HORIZONTAL PLANE FROM NO. 1 ANTENNA.  
 $E_1$   
 36

% FIELD INTENSITY RADIATED IN HORIZONTAL PLANE FROM NO. 2 ANTENNA.  
 $E_2$   
 25

% FIELD INTENSITY RADIATED IN HORIZONTAL PLANE FROM NO. 3 ANTENNA.  
 $E_3$   
 51

% RMS FIELD INTENSITY RADIATED IN HORIZONTAL PLANE FROM ANTENNA SYSTEM.  
 $E_0$   
 67

RIGHT HAND PATTERN NUMBER GIVES ANTENNA FIELD INTENSITY DATA IN PERCENT.

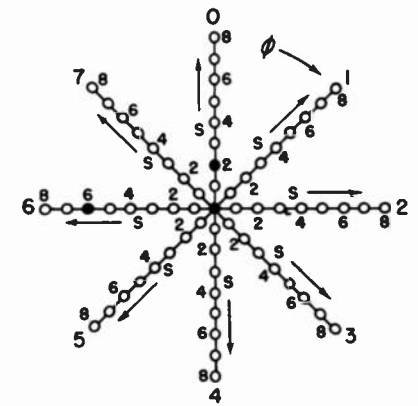

SPOTS LOCATE THE ANTENNAS FOR THIS PAGE OF PATTERNS IN THE SYSTEMATIZATION PLACEMENT CHART.

PATTERN NOMENCLATURE



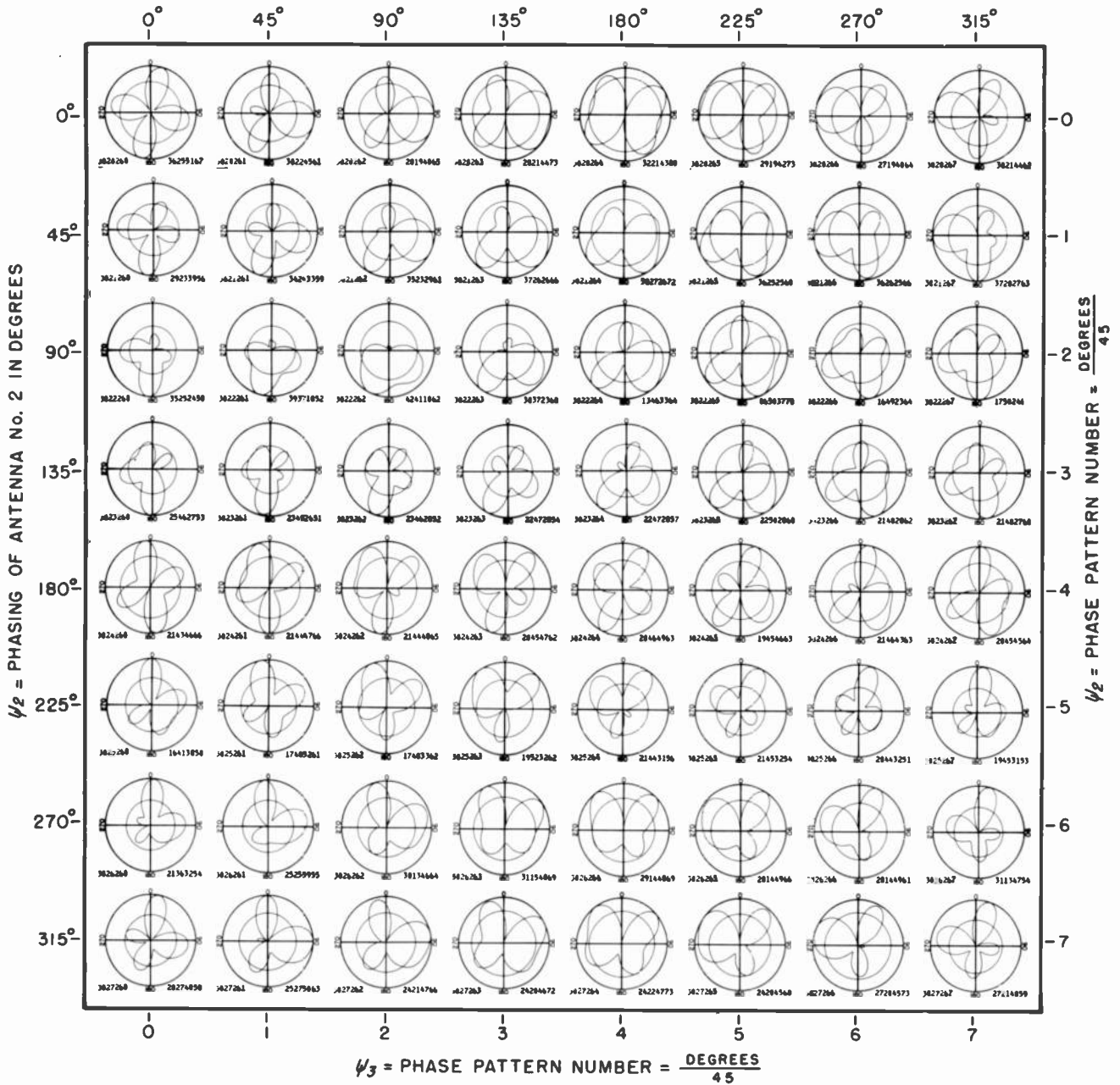

COPYRIGHT 1946 BY CARL E. SMITH  
PRINTED IN U. S. A.

CLEVELAND INSTITUTE OF RADIO ELECTRONICS  
TERMINAL TOWER, CLEVELAND 13, OHIO.

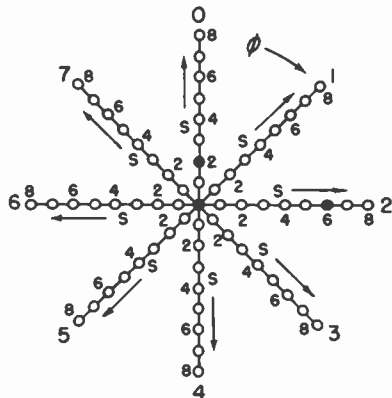

NUMBER OF ANTENNAS IN THE SYSTEM	ORIENTATION OF NO. 2 ANTENNA = $\frac{\text{DEGREES}}{45}$	SPACING OF NO. 2 ANTENNA = $\frac{\text{DEGREES}}{45}$	PHASING OF NO. 2 ANTENNA = $\frac{\text{DEGREES}}{45}$	ORIENTATION OF NO. 3 ANTENNA = $\frac{\text{DEGREES}}{45}$	SPACING OF NO. 3 ANTENNA = $\frac{\text{DEGREES}}{45}$	PHASING OF NO. 3 ANTENNA = $\frac{\text{DEGREES}}{45}$
No.	$\phi_2$	$S_2$	$\psi_2$	$\phi_3$	$S_3$	$\psi_3$
3	0	2	0	2	6	0

% FIELD INTENSITY RADIATED IN HORIZONTAL PLANE FROM NO. 1 ANTENNA.	% FIELD INTENSITY RADIATED IN HORIZONTAL PLANE FROM NO. 2 ANTENNA.	% FIELD INTENSITY RADIATED IN HORIZONTAL PLANE FROM NO. 3 ANTENNA.	% RMS FIELD INTENSITY RADIATED IN HORIZONTAL PLANE FROM ANTENNA SYSTEM.
$E_1$	$E_2$	$E_3$	$E_0$
36	25	51	67

SPOTS LOCATE THE ANTENNAS FOR  
THIS PAGE OF PATTERNS IN THE  
SYSTEMATIZATION PLACEMENT CHART.

LEFT HAND PATTERN NUMBER GIVES ANTENNA  
PLACEMENT AND PHASING DATA.

RIGHT HAND PATTERN NUMBER  
GIVES ANTENNA FIELD INTENSITY  
DATA IN PERCENT.

PATTERN NOMENCLATURE

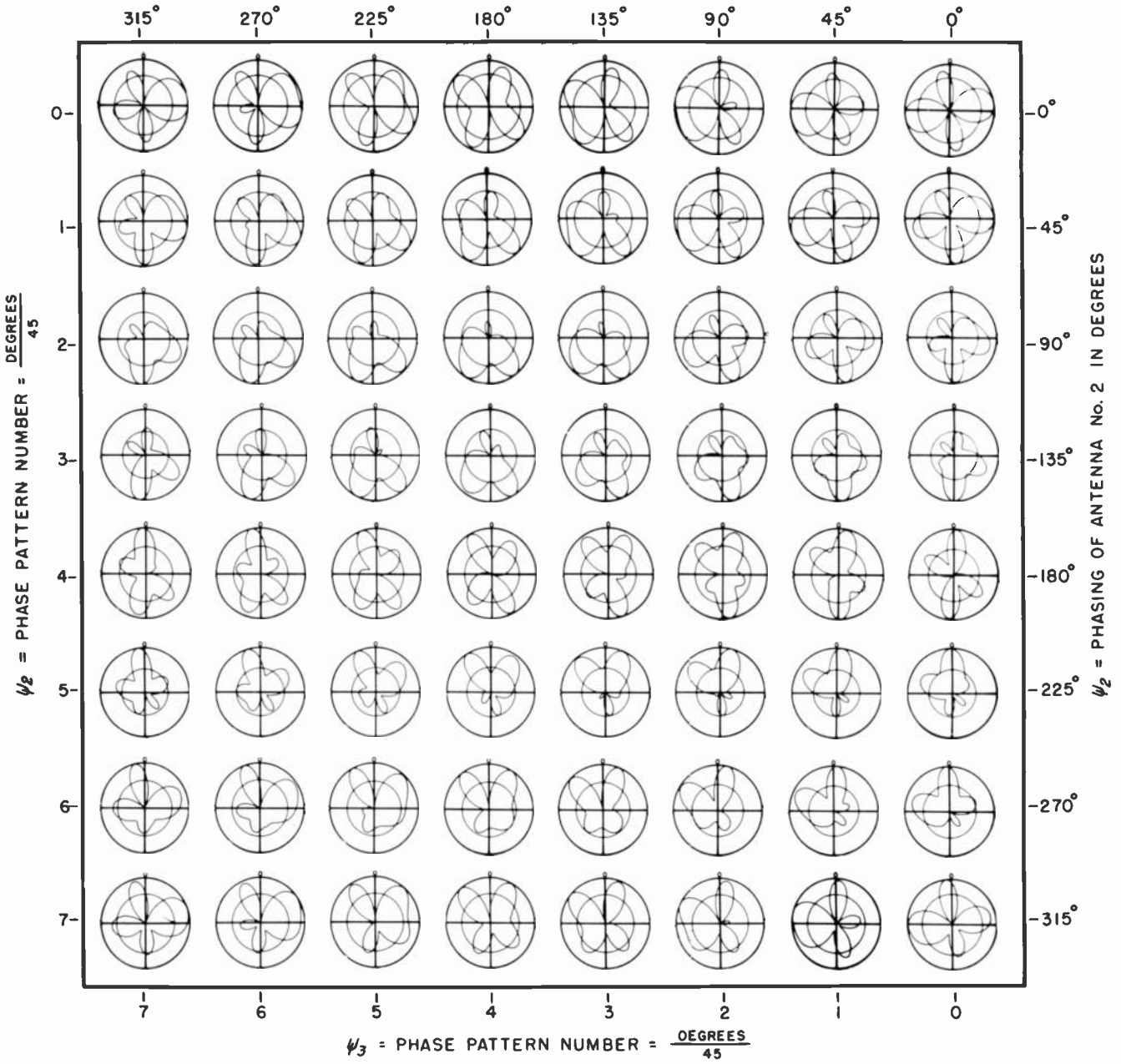

NUMBER OF ANTENNAS IN THE SYSTEM  
 No. 3

ORIENTATION OF NO. 2 ANTENNA =  $\frac{DEGREES}{45}$   
 $\phi_2$  0

SPACING OF NO. 2 ANTENNA =  $\frac{DEGREES}{45}$   
 $S_2$  2

PHASING OF NO. 2 ANTENNA =  $\frac{DEGREES}{45}$   
 $\psi_2$  0

ORIENTATION OF NO. 3 ANTENNA =  $\frac{DEGREES}{45}$   
 $\phi_3$  6

SPACING OF NO. 3 ANTENNA =  $\frac{DEGREES}{45}$   
 $S_3$  7

PHASING OF NO. 3 ANTENNA =  $\frac{DEGREES}{45}$   
 $\psi_3$  0

% FIELD INTENSITY RADIATED IN HORIZONTAL PLANE FROM NO. 1 ANTENNA.  
 $E_1$  23

% FIELD INTENSITY RADIATED IN HORIZONTAL PLANE FROM NO. 2 ANTENNA.  
 $E_2$  23

% FIELD INTENSITY RADIATED IN HORIZONTAL PLANE FROM NO. 3 ANTENNA.  
 $E_3$  41

% RMS FIELD INTENSITY RADIATED IN HORIZONTAL PLANE FROM ANTENNA SYSTEM  
 $E_0$  65

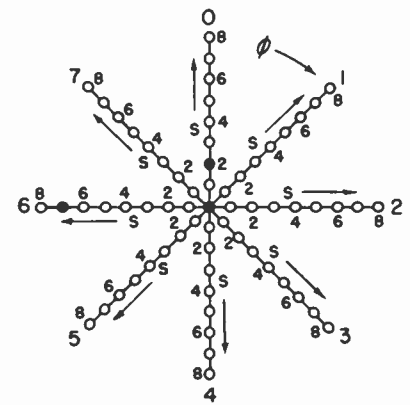

LEFT HAND PATTERN NUMBER GIVES ANTENNA PLACEMENT AND PHASING DATA.

RIGHT HAND PATTERN NUMBER GIVES ANTENNA FIELD INTENSITY DATA IN PERCENT.

SPOTS LOCATE THE ANTENNAS FOR THIS PAGE OF PATTERNS IN THE SYSTEMATIZATION PLACEMENT CHART.

PATTERN NOMENCLATURE

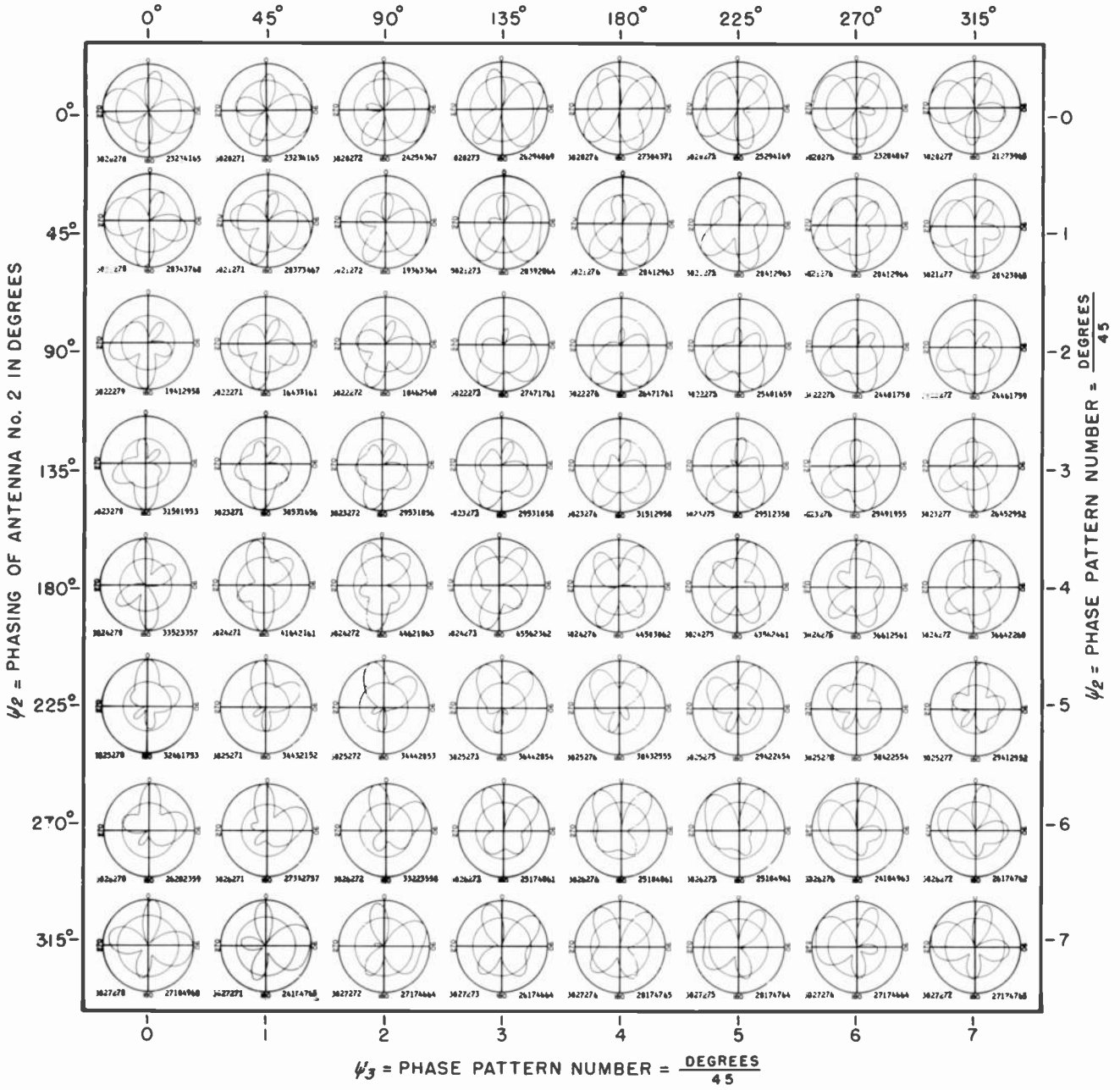

COPYRIGHT 1946 BY CARL E. SMITH  
PRINTED IN U. S. A.

CLEVELAND INSTITUTE OF RADIO ELECTRONICS  
TERMINAL TOWER, CLEVELAND 13, OHIO.

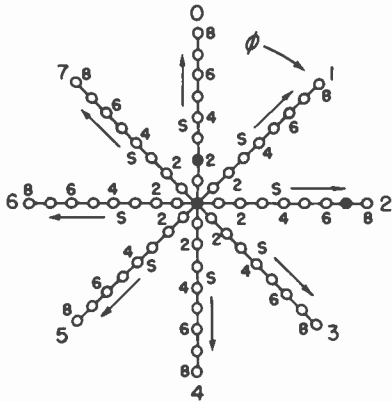

SPOTS LOCATE THE ANTENNAS FOR THIS PAGE OF PATTERNS IN THE SYSTEMATIZATION PLACEMENT CHART.

$\psi_3$  = PHASE PATTERN NUMBER =  $\frac{\text{DEGREES}}{45}$

NUMBER OF ANTENNAS IN THE SYSTEM  
No. 3

ORIENTATION OF NO. 2 ANTENNA =  $\frac{\text{DEGREES}}{45}$   
 $\phi_2$  0

SPACING OF NO. 2 ANTENNA =  $\frac{\text{DEGREES}}{45}$   
 $S_2$  2

PHASING OF NO. 2 ANTENNA =  $\frac{\text{DEGREES}}{45}$   
 $\psi_2$  0

ORIENTATION OF NO. 3 ANTENNA =  $\frac{\text{DEGREES}}{45}$   
 $\phi_3$  2

SPACING OF NO. 3 ANTENNA =  $\frac{\text{DEGREES}}{45}$   
 $S_3$  7

PHASING OF NO. 3 ANTENNA =  $\frac{\text{DEGREES}}{45}$   
 $\psi_3$  0

% FIELD INTENSITY RADIATED IN HORIZONTAL PLANE FROM NO. 1 ANTENNA.  
 $E_1$  23

% FIELD INTENSITY RADIATED IN HORIZONTAL PLANE FROM NO. 2 ANTENNA.  
 $E_2$  23

% FIELD INTENSITY RADIATED IN HORIZONTAL PLANE FROM NO. 3 ANTENNA.  
 $E_3$  41

% RMS FIELD INTENSITY RADIATED IN HORIZONTAL PLANE FROM ANTENNA SYSTEM.  
 $E_0$  65

LEFT HAND PATTERN NUMBER GIVES ANTENNA PLACEMENT AND PHASING DATA.

RIGHT HAND PATTERN NUMBER GIVES ANTENNA FIELD INTENSITY DATA IN PERCENT.

PATTERN NOMENCLATURE

$\psi_3$  = PHASING OF ANTENNA No. 3 IN DEGREES

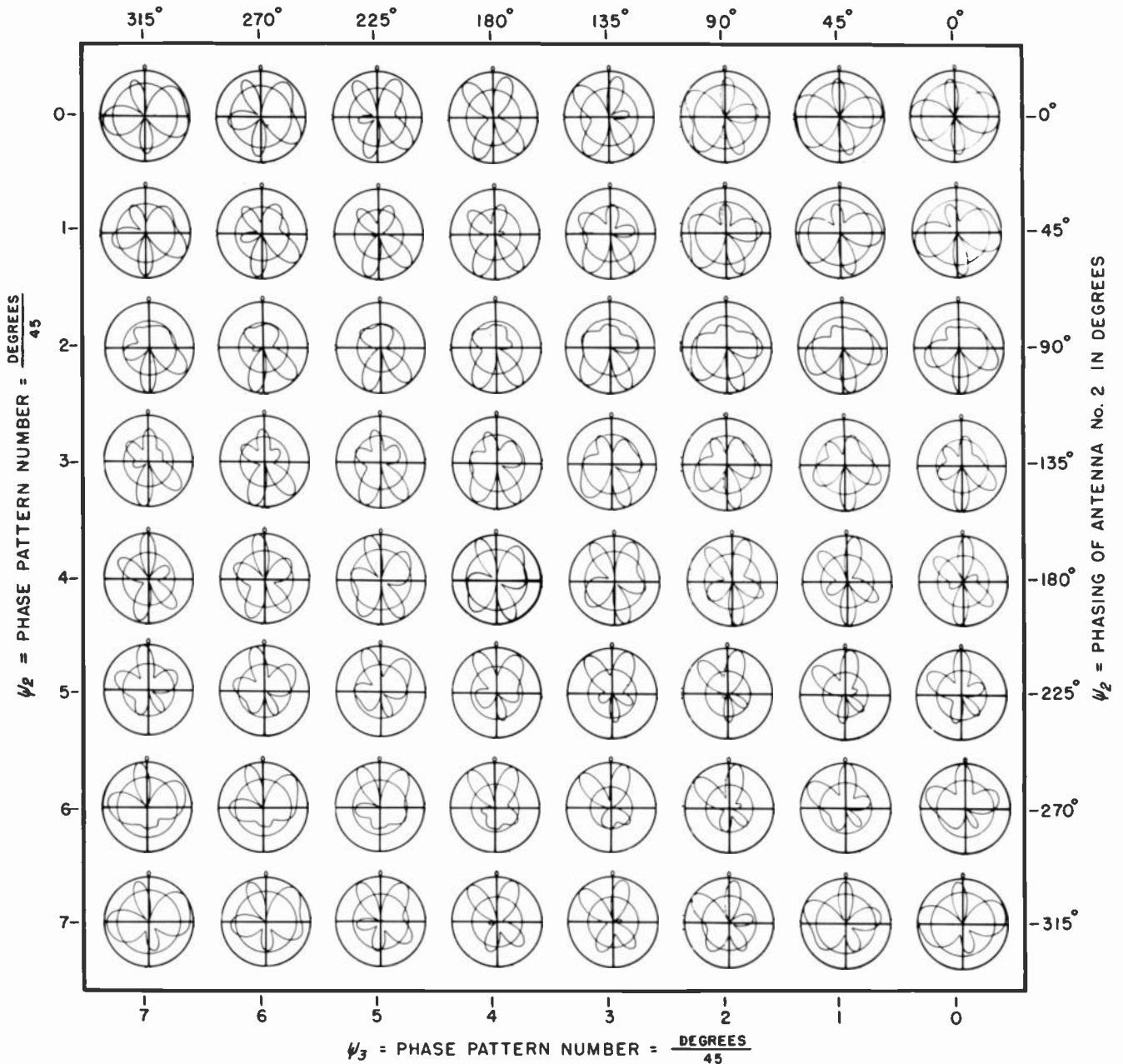

NUMBER OF ANTENNAS IN THE SYSTEM  
 No. 3

ORIENTATION OF NO. 2 ANTENNA =  $\frac{\text{DEGREES}}{45}$   
 $\psi_2 = 0$

SPACING OF NO. 2 ANTENNA =  $\frac{\text{DEGREES}}{45}$   
 $S_2 = 2$

PHASING OF NO. 2 ANTENNA =  $\frac{\text{DEGREES}}{45}$   
 $\psi_2 = 0$

ORIENTATION OF NO. 3 ANTENNA =  $\frac{\text{DEGREES}}{45}$   
 $\psi_3 = 6$

SPACING OF NO. 3 ANTENNA =  $\frac{\text{DEGREES}}{45}$   
 $S_3 = 8$

PHASING OF NO. 3 ANTENNA =  $\frac{\text{DEGREES}}{45}$   
 $\psi_3 = 0$

% FIELD INTENSITY RADIATED IN HORIZONTAL PLANE FROM NO. 1 ANTENNA.  
 $E_1 = 30$

% FIELD INTENSITY RADIATED IN HORIZONTAL PLANE FROM NO. 2 ANTENNA.  
 $E_2 = 16$

% FIELD INTENSITY RADIATED IN HORIZONTAL PLANE FROM NO. 3 ANTENNA.  
 $E_3 = 43$

% RMS FIELD INTENSITY RADIATED IN HORIZONTAL PLANE FROM ANTENNA SYSTEM.  
 $E_0 = 75$

LEFT HAND PATTERN NUMBER GIVES ANTENNA PLACEMENT AND PHASING DATA.

RIGHT HAND PATTERN NUMBER GIVES ANTENNA FIELD INTENSITY DATA IN PERCENT.

PATTERN NOMENCLATURE

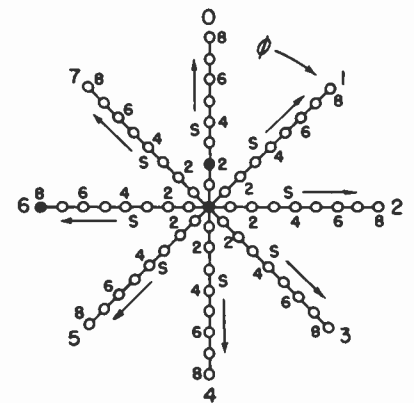

SPOTS LOCATE THE ANTENNAS FOR THIS PAGE OF PATTERNS IN THE SYSTEMATIZATION PLACEMENT CHART.

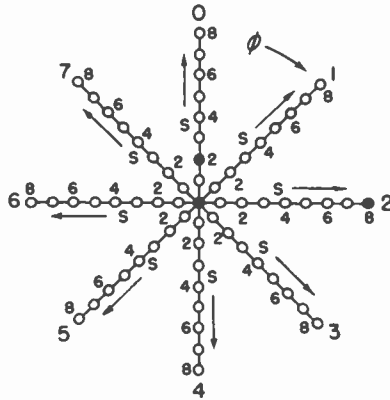
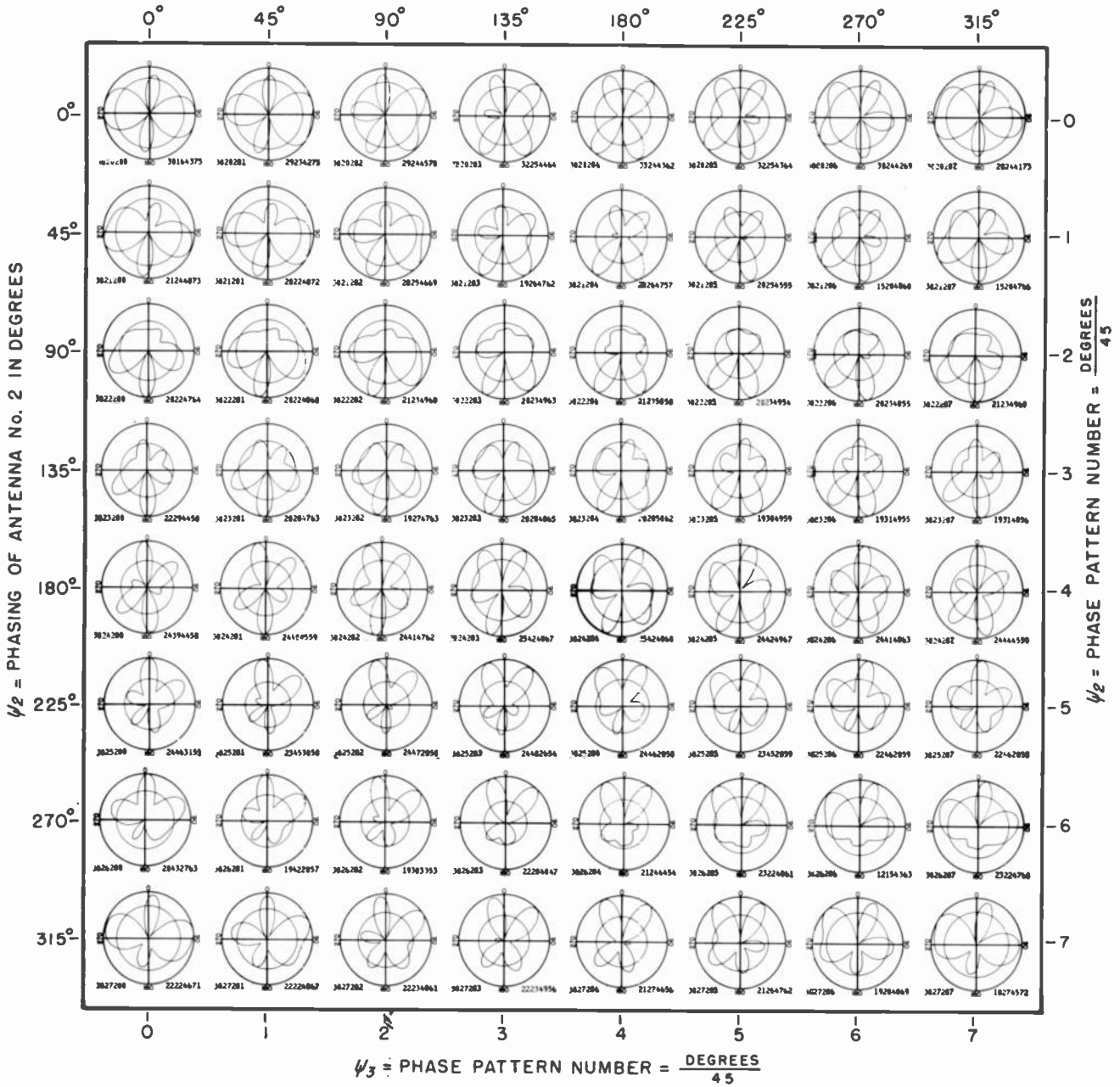

NUMBER OF ANTENNAS IN THE SYSTEM	ORIENTATION OF NO. 2 ANTENNA = $\frac{\text{DEGREES}}{45}$	SPACING OF NO. 2 ANTENNA = $\frac{\text{DEGREES}}{45}$	PHASING OF NO. 2 ANTENNA = $\frac{\text{DEGREES}}{45}$	ORIENTATION OF NO. 3 ANTENNA = $\frac{\text{DEGREES}}{45}$	SPACING OF NO. 3 ANTENNA = $\frac{\text{DEGREES}}{45}$	PHASING OF NO. 3 ANTENNA = $\frac{\text{DEGREES}}{45}$
No. 3	$\phi_2$	$S_2$	$\psi_2$	$\phi_3$	$S_3$	$\psi_3$
3	0	2	0	2	8	0

% FIELD INTENSITY RADIATED IN HORIZONTAL PLANE FROM NO. 1 ANTENNA.	% FIELD INTENSITY RADIATED IN HORIZONTAL PLANE FROM NO. 2 ANTENNA.	% FIELD INTENSITY RADIATED IN HORIZONTAL PLANE FROM NO. 3 ANTENNA.	% RMS FIELD INTENSITY RADIATED IN HORIZONTAL PLANE FROM ANTENNA SYSTEM.
$E_1$	$E_2$	$E_3$	$E_0$
30	16	43	75

LEFT HAND PATTERN NUMBER GIVES ANTENNA PLACEMENT AND PHASING DATA.

RIGHT HAND PATTERN NUMBER GIVES ANTENNA FIELD INTENSITY DATA IN PERCENT.

SPOTS LOCATE THE ANTENNAS FOR THIS PAGE OF PATTERNS IN THE SYSTEMATIZATION PLACEMENT CHART,

PATTERN NOMENCLATURE

$\psi_3$  = PHASING OF ANTENNA No. 3 IN DEGREES

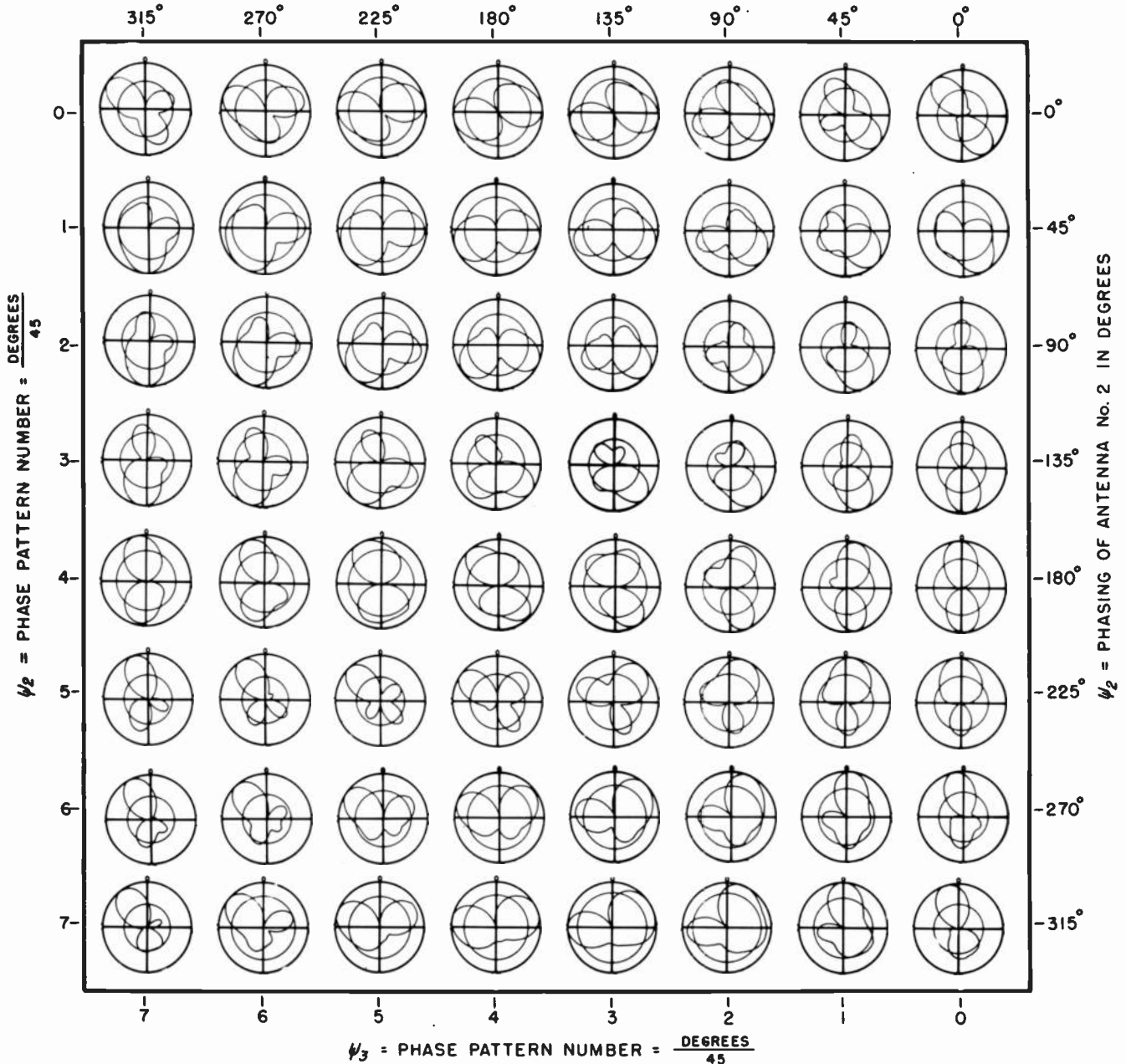

NUMBER OF ANTENNAS IN THE SYSTEM  
 No. 3

ORIENTATION OF NO. 2 ANTENNA =  $\frac{\text{DEGREES}}{45}$   
 $\psi_2$  0

SPACING OF NO. 2 ANTENNA =  $\frac{\text{DEGREES}}{45}$   
 $S_2$  3

PHASING OF NO. 2 ANTENNA =  $\frac{\text{DEGREES}}{45}$   
 $\psi_2$  0

ORIENTATION OF NO. 3 ANTENNA =  $\frac{\text{DEGREES}}{45}$   
 $\psi_3$  6

SPACING OF NO. 3 ANTENNA =  $\frac{\text{DEGREES}}{45}$   
 $S_3$  4

PHASING OF NO. 3 ANTENNA =  $\frac{\text{DEGREES}}{45}$   
 $\psi_3$  0

% FIELD INTENSITY RADIATED IN HORIZONTAL PLANE FROM NO. 1 ANTENNA.  
 $E_1$  21

% FIELD INTENSITY RADIATED IN HORIZONTAL PLANE FROM NO. 2 ANTENNA.  
 $E_2$  37

% FIELD INTENSITY RADIATED IN HORIZONTAL PLANE FROM NO. 3 ANTENNA.  
 $E_3$  63

% RMS FIELD INTENSITY RADIATED IN HORIZONTAL PLANE FROM ANTENNA SYSTEM.  
 $E_0$  57

LEFT HAND PATTERN NUMBER GIVES ANTENNA PLACEMENT AND PHASING DATA.

RIGHT HAND PATTERN NUMBER GIVES ANTENNA FIELD INTENSITY DATA IN PERCENT.

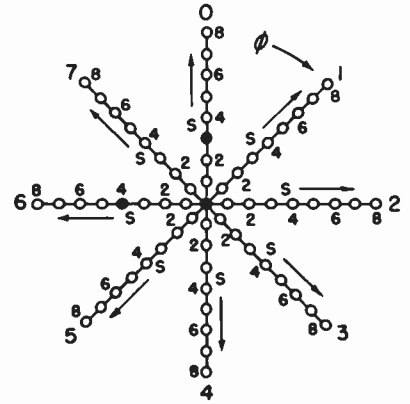

SPOTS LOCATE THE ANTENNAS FOR THIS PAGE OF PATTERNS IN THE SYSTEMATIZATION PLACEMENT CHART.

PATTERN NOMENCLATURE

$\psi_3$  = PHASING OF ANTENNA No. 3 IN DEGREES

3.137

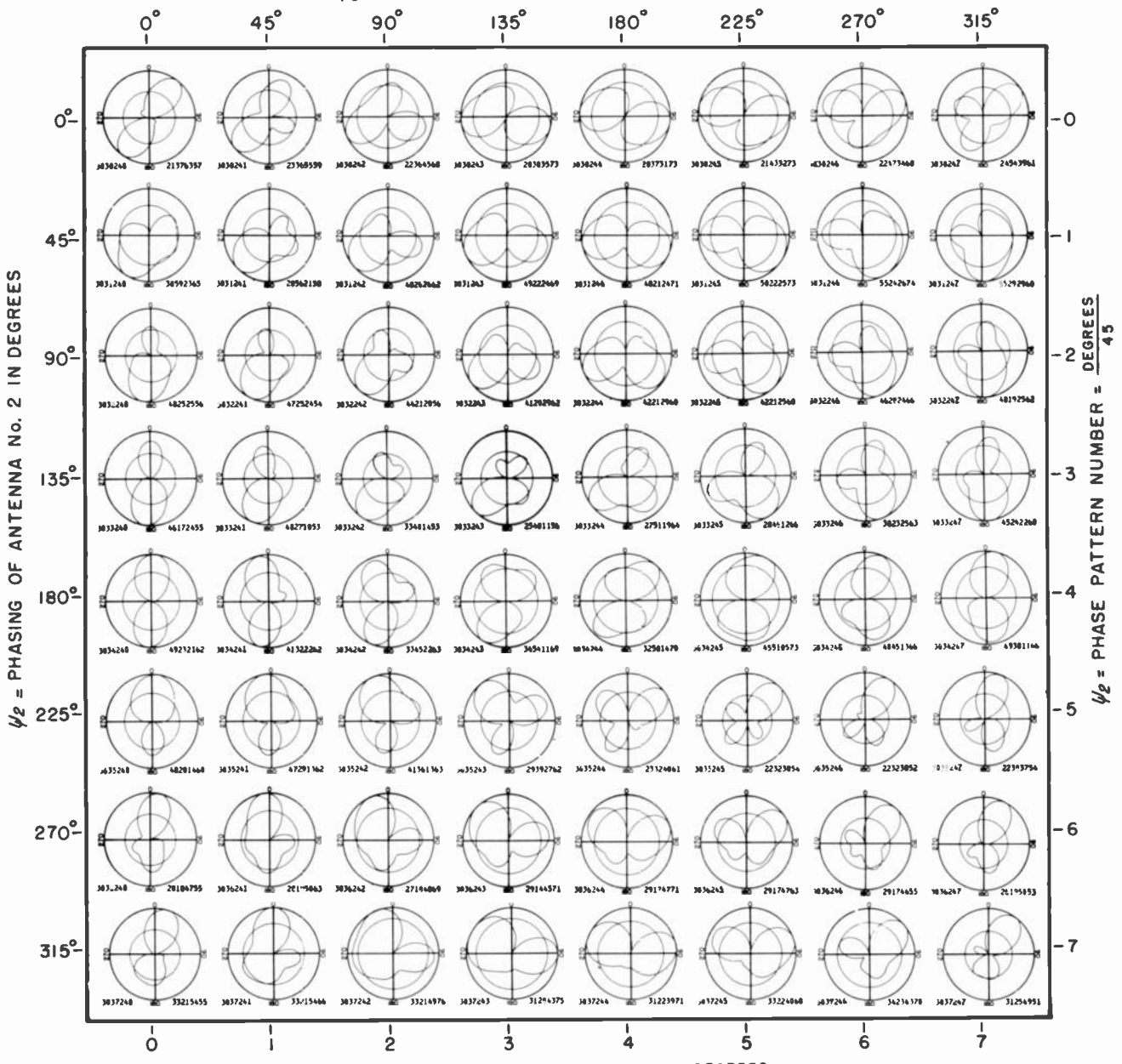

$\psi_3$  = PHASE PATTERN NUMBER =  $\frac{\text{DEGREES}}{45}$

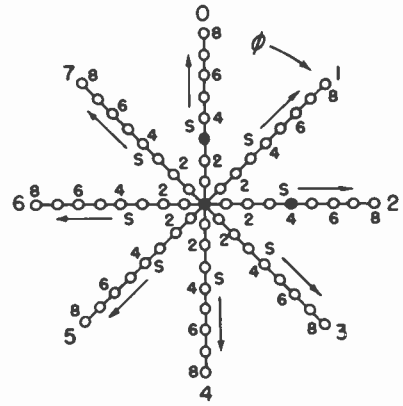

NUMBER OF ANTENNAS  
IN THE SYSTEM  
No. 3

ORIENTATION OF  
NO. 2 ANTENNA =  $\frac{\text{DEGREES}}{45}$   
 $\phi_2$  0

SPACING OF  
NO. 2 ANTENNA =  $\frac{\text{DEGREES}}{45}$   
 $S_2$  3

PHASING OF  
NO. 2 ANTENNA =  $\frac{\text{DEGREES}}{45}$   
 $\psi_2$  0

ORIENTATION OF  
NO. 3 ANTENNA =  $\frac{\text{DEGREES}}{45}$   
 $\phi_3$  2

SPACING OF  
NO. 3 ANTENNA =  $\frac{\text{DEGREES}}{45}$   
 $S_3$  4

PHASING OF  
NO. 3 ANTENNA =  $\frac{\text{DEGREES}}{45}$   
 $\psi_3$  0

% FIELD INTENSITY  
RADIATED IN HORIZONTAL  
PLANE FROM NO. 1 ANTENNA.  
 $E_1$  21

% FIELD INTENSITY  
RADIATED IN HORIZONTAL  
PLANE FROM NO. 2 ANTENNA.  
 $E_2$  37

% FIELD INTENSITY  
RADIATED IN HORIZONTAL  
PLANE FROM NO. 3 ANTENNA.  
 $E_3$  63

% RMS FIELD INTENSITY  
RADIATED IN HORIZONTAL  
PLANE FROM ANTENNA SYSTEM.  
 $E_0$  57

LEFT HAND PATTERN NUMBER GIVES ANTENNA  
PLACEMENT AND PHASING DATA.

RIGHT HAND PATTERN NUMBER  
GIVES ANTENNA FIELD INTEN-  
SITY DATA IN PERCENT.

SPOTS LOCATE THE ANTENNAS FOR  
THIS PAGE OF PATTERNS IN THE  
SYSTEMATIZATION PLACEMENT CHART.

PATTERN NOMENCLATURE

$\psi_3$  = PHASING OF ANTENNA No. 3 IN DEGREES

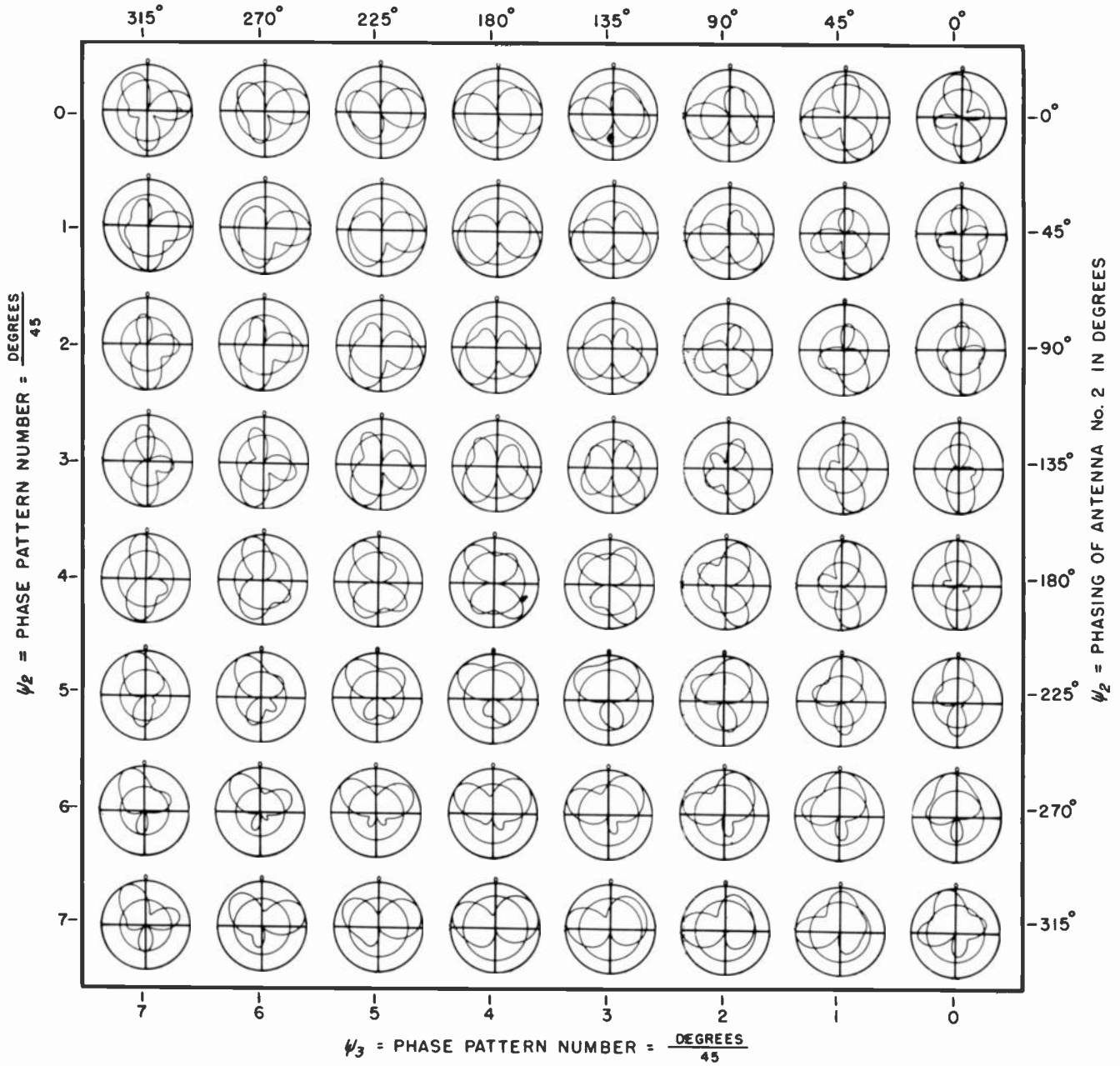

NUMBER OF ANTENNAS IN THE SYSTEM  
 NO.  $\phi_2$  3  
 ORIENTATION OF NO. 2 ANTENNA =  $\frac{\text{DEGREES}}{45}$   
 $\phi_2$  0  
 SPACING OF NO. 2 ANTENNA =  $\frac{\text{DEGREES}}{45}$   
 $S_2$  3  
 PHASING OF NO. 2 ANTENNA =  $\frac{\text{DEGREES}}{45}$   
 $\psi_2$  0  
 ORIENTATION OF NO. 3 ANTENNA =  $\frac{\text{DEGREES}}{45}$   
 $\phi_3$  6  
 SPACING OF NO. 3 ANTENNA =  $\frac{\text{DEGREES}}{45}$   
 $S_3$  5  
 PHASING OF NO. 3 ANTENNA =  $\frac{\text{DEGREES}}{45}$   
 $\psi_3$  0

LEFT HAND PATTERN NUMBER GIVES ANTENNA PLACEMENT AND PHASING DATA.

% FIELD INTENSITY RADIATED IN HORIZONTAL PLANE FROM NO. 1 ANTENNA.  
 $F_1$  45  
 % FIELD INTENSITY RADIATED IN HORIZONTAL PLANE FROM NO. 2 ANTENNA.  
 $F_2$  24  
 % FIELD INTENSITY RADIATED IN HORIZONTAL PLANE FROM NO. 3 ANTENNA.  
 $F_3$  63  
 % RMS FIELD INTENSITY RADIATED IN HORIZONTAL PLANE FROM ANTENNA SYSTEM.  
 $F_0$  62

RIGHT HAND PATTERN NUMBER GIVES ANTENNA FIELD INTENSITY DATA IN PERCENT.

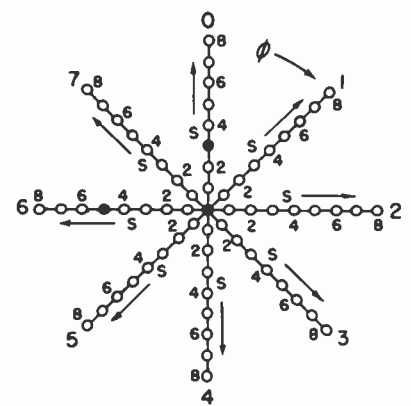

SPOTS LOCATE THE ANTENNAS FOR THIS PAGE OF PATTERNS IN THE SYSTEMATIZATION PLACEMENT CHART.

PATTERN NOMENCLATURE



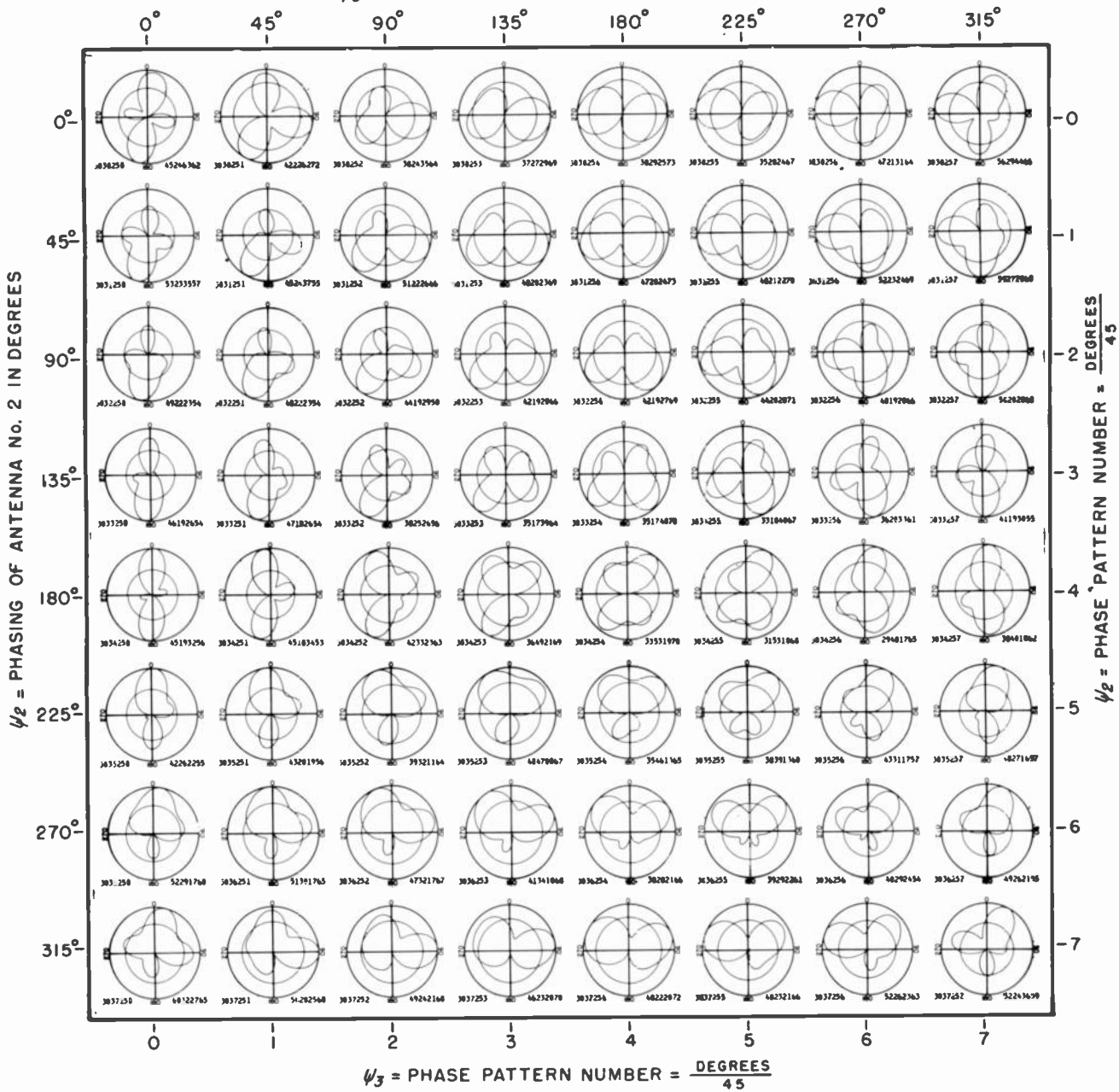

COPYRIGHT 1946 BY CARL E. SMITH  
PRINTED IN U. S. A.

CLEVELAND INSTITUTE OF RADIO ELECTRONICS  
TERMINAL TOWER, CLEVELAND 18, OHIO.

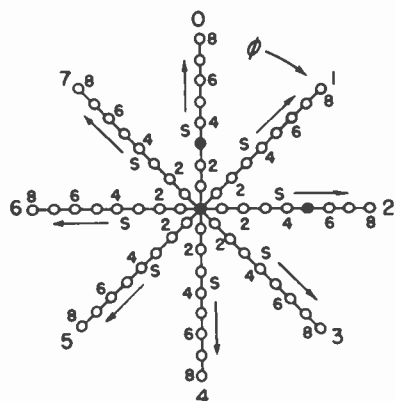

SPOTS LOCATE THE ANTENNAS FOR THIS PAGE OF PATTERNS IN THE SYSTEMATIZATION PLACEMENT CHART.

$\psi_3$  = PHASE PATTERN NUMBER =  $\frac{\text{DEGREES}}{45}$

NUMBER OF ANTENNAS IN THE SYSTEM	ORIENTATION OF NO. 2 ANTENNA = $\frac{\text{DEGREES}}{45}$	SPACING OF NO. 2 ANTENNA = $\frac{\text{DEGREES}}{45}$	PHASING OF NO. 2 ANTENNA = $\frac{\text{DEGREES}}{45}$	ORIENTATION OF NO. 3 ANTENNA = $\frac{\text{DEGREES}}{45}$	SPACING OF NO. 3 ANTENNA = $\frac{\text{DEGREES}}{45}$	PHASING OF NO. 3 ANTENNA = $\frac{\text{DEGREES}}{45}$
No. 3	$\phi_2$ 0	$S_2$ 3	$\psi_2$ 0	$\phi_3$ 2	$S_3$ 5	$\psi_3$ 0

LEFT HAND PATTERN NUMBER GIVES ANTENNA PLACEMENT AND PHASING DATA.

% FIELD INTENSITY RADIATED IN HORIZONTAL PLANE FROM NO. 1 ANTENNA.	% FIELD INTENSITY RADIATED IN HORIZONTAL PLANE FROM NO. 2 ANTENNA.	% FIELD INTENSITY RADIATED IN HORIZONTAL PLANE FROM NO. 3 ANTENNA.	% RMS FIELD INTENSITY RADIATED IN HORIZONTAL PLANE FROM ANTENNA SYSTEM.
$E_1$ 45	$E_2$ 24	$E_3$ 63	$E_0$ 62

RIGHT HAND PATTERN NUMBER GIVES ANTENNA FIELD INTENSITY DATA IN PERCENT.

PATTERN NOMENCLATURE

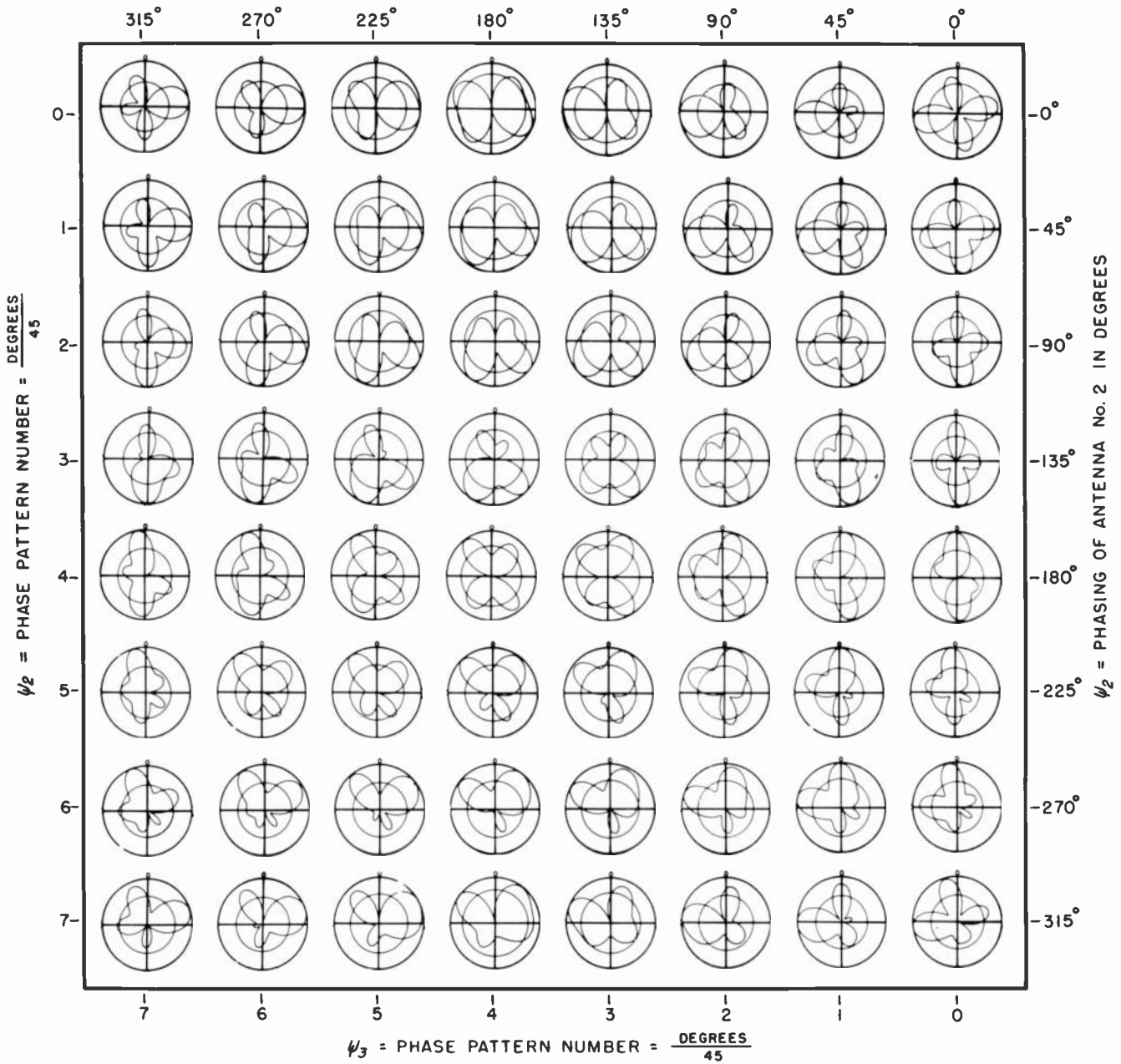

NUMBER OF ANTENNAS  
IN THE SYSTEM

No. 3

ORIENTATION OF DEGREES  
NO. 2 ANTENNA =  $\frac{\text{DEGREES}}{45}$

$\phi_2$  0

SPACING OF DEGREES  
NO. 2 ANTENNA =  $\frac{\text{DEGREES}}{45}$

$S_2$  3

PHASING OF DEGREES  
NO. 2 ANTENNA =  $\frac{\text{DEGREES}}{45}$

$\psi_2$  0

ORIENTATION OF DEGREES  
NO. 3 ANTENNA =  $\frac{\text{DEGREES}}{45}$

$\phi_3$  6

SPACING OF DEGREES  
NO. 3 ANTENNA =  $\frac{\text{DEGREES}}{45}$

$S_3$  6

PHASING OF DEGREES  
NO. 3 ANTENNA =  $\frac{\text{DEGREES}}{45}$

$\psi_3$  0

% FIELD INTENSITY  
RADIATED IN HORIZONTAL  
PLANE FROM NO. 1 ANTENNA.

$E_1$  51

% FIELD INTENSITY  
RADIATED IN HORIZONTAL  
PLANE FROM NO. 2 ANTENNA.

$E_2$  24

% FIELD INTENSITY  
RADIATED IN HORIZONTAL  
PLANE FROM NO. 3 ANTENNA.

$E_3$  45

% RMS FIELD INTENSITY  
RADIATED IN HORIZONTAL  
PLANE FROM ANTENNA SYSTEM.

$E_0$  66

LEFT HAND PATTERN NUMBER GIVES ANTENNA  
PLACEMENT AND PHASING DATA.

RIGHT HAND PATTERN NUMBER  
GIVES ANTENNA FIELD INTEN-  
SITY DATA IN PERCENT.

PATTERN NOMENCLATURE

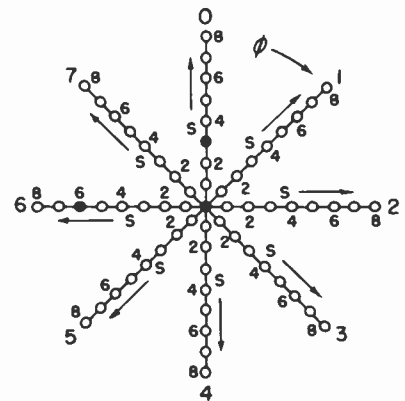

SPOTS LOCATE THE ANTENNAS FOR  
THIS PAGE OF PATTERNS IN THE  
SYSTEMATIZATION PLACEMENT CHART.

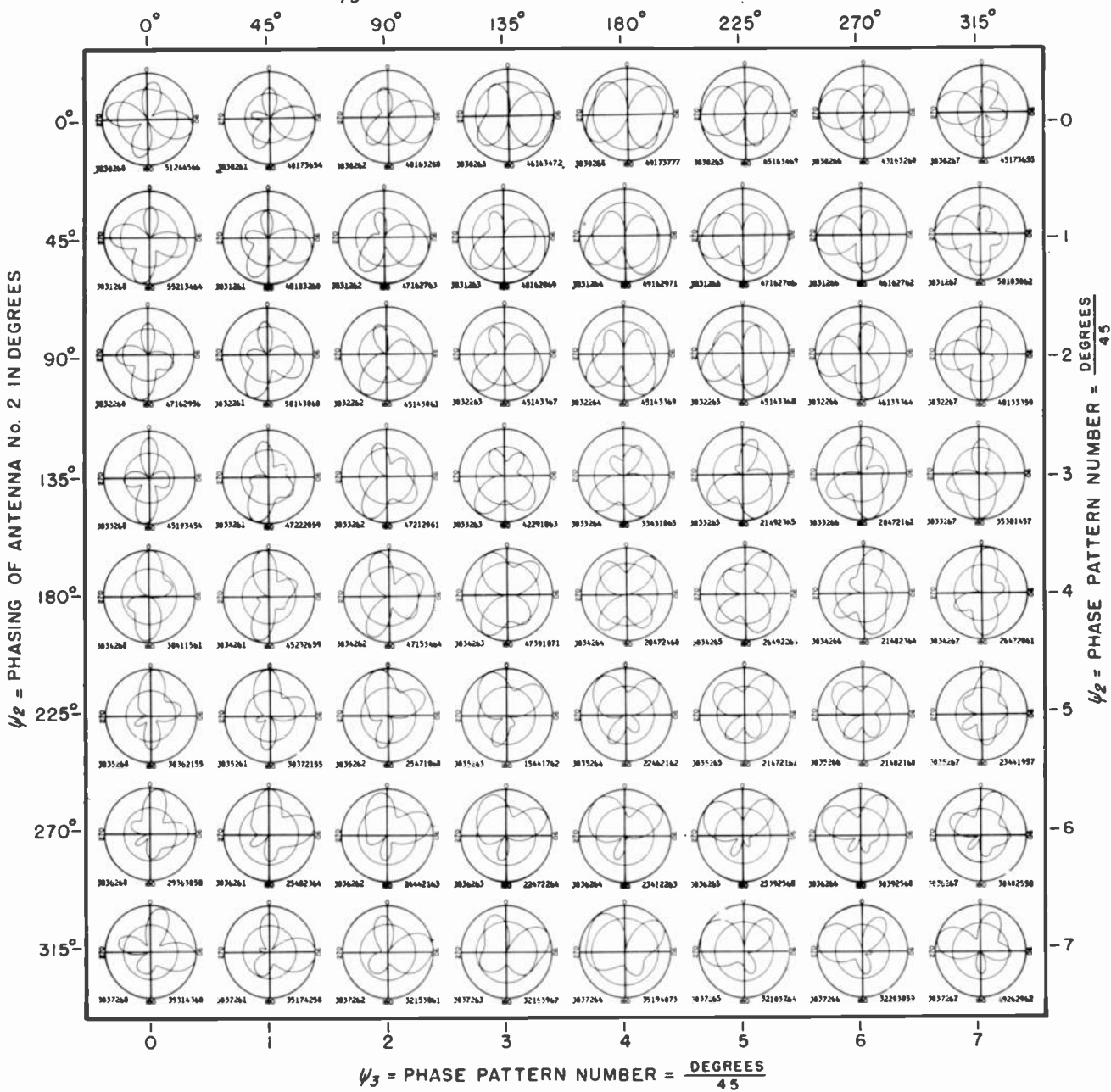

$\psi_3$  = PHASE PATTERN NUMBER =  $\frac{\text{DEGREES}}{45}$

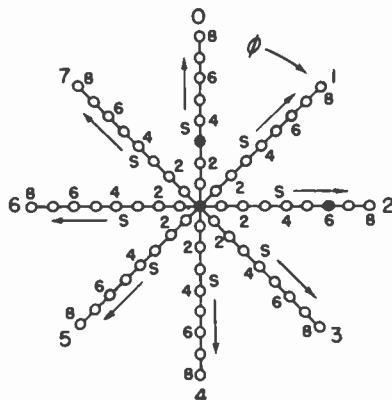

SPOTS LOCATE THE ANTENNAS FOR THIS PAGE OF PATTERNS IN THE SYSTEMATIZATION PLACEMENT CHART.

NO.	$\phi_2$	$S_2$	$\psi_2$	$\phi_3$	$S_3$	$\psi_3$
3	0	3	0	2	6	0

LEFT HAND PATTERN NUMBER GIVES ANTENNA PLACEMENT AND PHASING DATA.

% FIELD INTENSITY RADIATED IN HORIZONTAL PLANE FROM NO. 1 ANTENNA.	% FIELD INTENSITY RADIATED IN HORIZONTAL PLANE FROM NO. 2 ANTENNA.	% FIELD INTENSITY RADIATED IN HORIZONTAL PLANE FROM NO. 3 ANTENNA.	% RMS FIELD INTENSITY RADIATED IN HORIZONTAL PLANE FROM ANTENNA SYSTEM.
$E_1$	$E_2$	$E_3$	$E_0$
51	24	45	66

RIGHT HAND PATTERN NUMBER GIVES ANTENNA FIELD INTENSITY DATA IN PERCENT.

PATTERN NOMENCLATURE

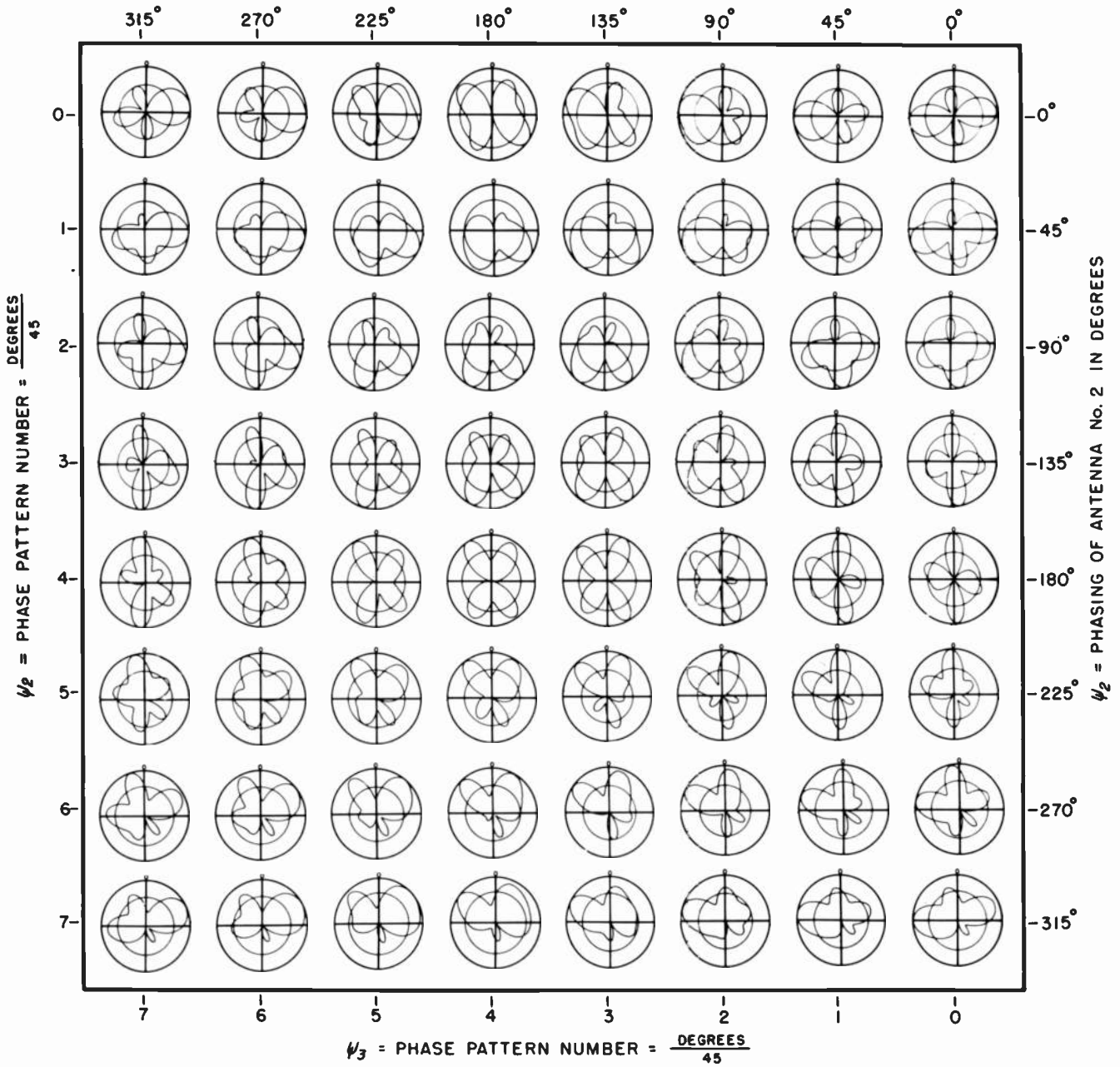

NUMBER OF ANTENNAS IN THE SYSTEM  
 No.  $\phi_2$  3  
 ORIENTATION OF NO. 2 ANTENNA =  $\frac{DEGREES}{45}$   
 SPACING OF NO. 2 ANTENNA =  $\frac{DEGREES}{45}$   
 PHASING OF NO. 2 ANTENNA =  $\frac{DEGREES}{45}$   
 ORIENTATION OF NO. 3 ANTENNA =  $\frac{DEGREES}{45}$   
 SPACING OF NO. 3 ANTENNA =  $\frac{DEGREES}{45}$   
 PHASING OF NO. 3 ANTENNA =  $\frac{DEGREES}{45}$

LEFT HAND PATTERN NUMBER GIVES ANTENNA PLACEMENT AND PHASING DATA.

% FIELD INTENSITY RADIATED IN HORIZONTAL PLANE FROM NO. 1 ANTENNA.  $E_1$  42  
 % FIELD INTENSITY RADIATED IN HORIZONTAL PLANE FROM NO. 2 ANTENNA.  $E_2$  22  
 % FIELD INTENSITY RADIATED IN HORIZONTAL PLANE FROM NO. 3 ANTENNA.  $E_3$  32  
 % RMS FIELD INTENSITY RADIATED IN HORIZONTAL PLANE FROM ANTENNA SYSTEM.  $E_0$  64

RIGHT HAND PATTERN NUMBER GIVES ANTENNA FIELD INTENSITY DATA IN PERCENT.

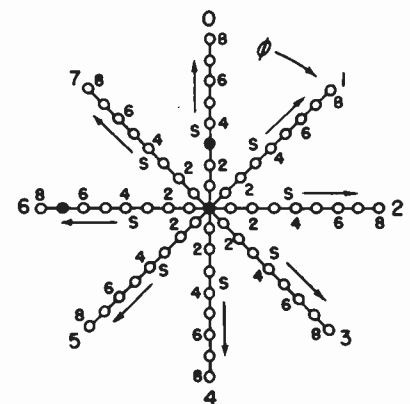

SPOTS LOCATE THE ANTENNAS FOR THIS PAGE OF PATTERNS IN THE SYSTEMIZATION PLACEMENT CHART.

PATTERN NOMENCLATURE

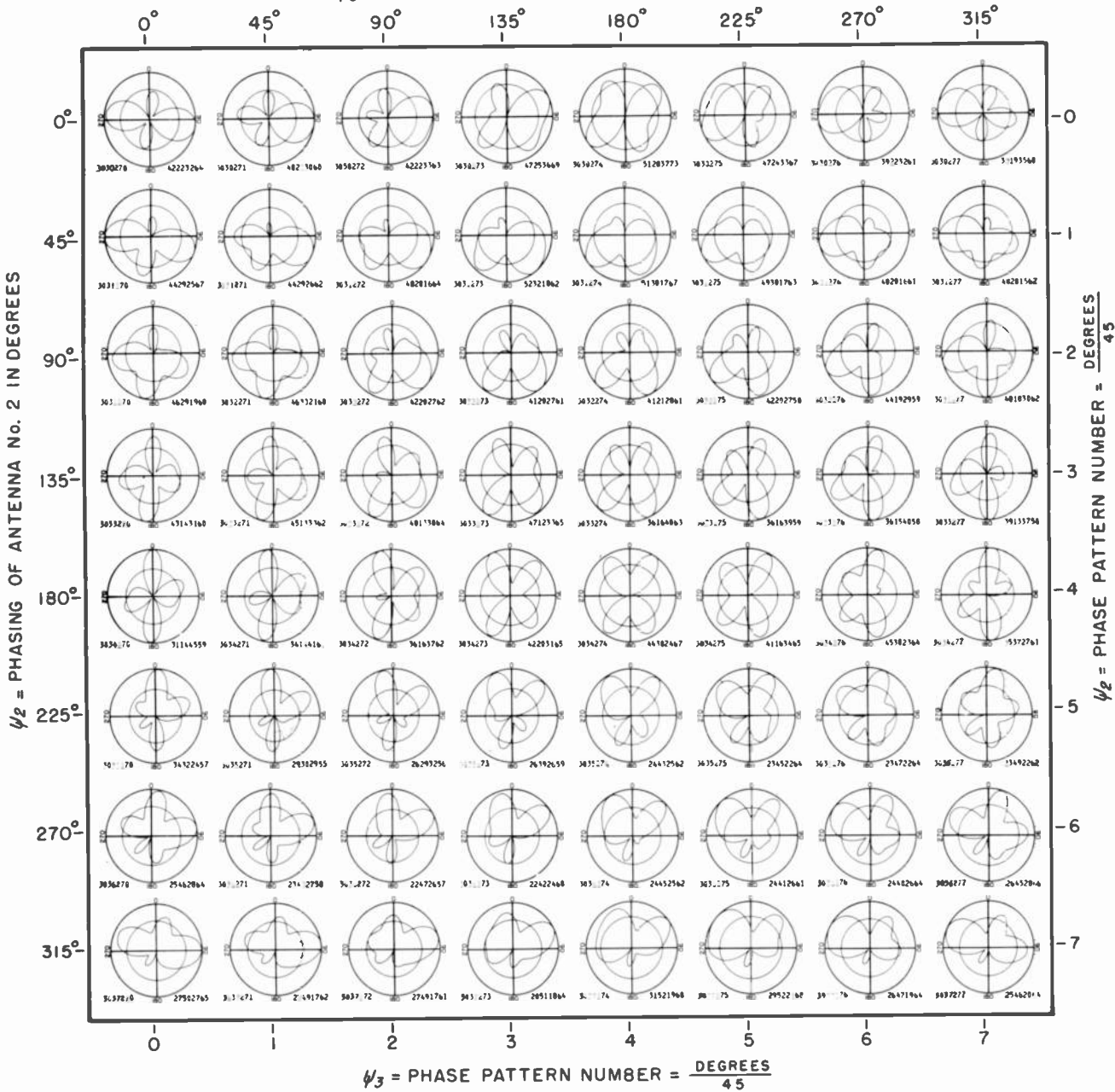

COPYRIGHT 1946 BY CARL E. SMITH  
PRINTED IN U. S. A.

CLEVELAND INSTITUTE OF RADIO ELECTRONICS  
TERMINAL TOWER, CLEVELAND 18 OHIO.

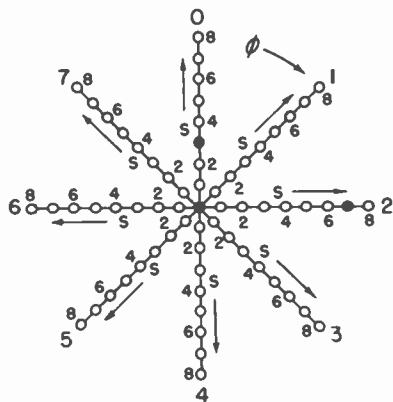

$\psi_3$  = PHASE PATTERN NUMBER =  $\frac{\text{DEGREES}}{45}$

NUMBER OF ANTENNAS IN THE SYSTEM	ORIENTATION OF NO. 2 ANTENNA = $\frac{\text{DEGREES}}{45}$	SPACING OF NO. 2 ANTENNA = $\frac{\text{DEGREES}}{45}$	PHASING OF NO. 2 ANTENNA = $\frac{\text{DEGREES}}{45}$	ORIENTATION OF NO. 3 ANTENNA = $\frac{\text{DEGREES}}{45}$	SPACING OF NO. 3 ANTENNA = $\frac{\text{DEGREES}}{45}$	PHASING OF NO. 3 ANTENNA = $\frac{\text{DEGREES}}{45}$
No. 3	$\phi_2$ 0	$S_2$ 3	$\psi_2$ 0	$\phi_3$ 2	$S_3$ 7	$\psi_3$ 0

LEFT HAND PATTERN NUMBER GIVES ANTENNA PLACEMENT AND PHASING DATA.

% FIELD INTENSITY RADIATED IN HORIZONTAL PLANE FROM NO. 1 ANTENNA.	% FIELD INTENSITY RADIATED IN HORIZONTAL PLANE FROM NO. 2 ANTENNA.	% FIELD INTENSITY RADIATED IN HORIZONTAL PLANE FROM NO. 3 ANTENNA.	% RMS FIELD INTENSITY RADIATED IN HORIZONTAL PLANE FROM ANTENNA SYSTEM.
$E_1$ 42	$E_2$ 22	$E_3$ 32	$E_0$ 64

RIGHT HAND PATTERN NUMBER GIVES ANTENNA FIELD INTENSITY DATA IN PERCENT.

SPOTS LOCATE THE ANTENNAS FOR THIS PAGE OF PATTERNS IN THE SYSTEMIZATION PLACEMENT CHART.

PATTERN NOMENCLATURE

$\psi_3$  = PHASING OF ANTENNA No. 3 IN DEGREES

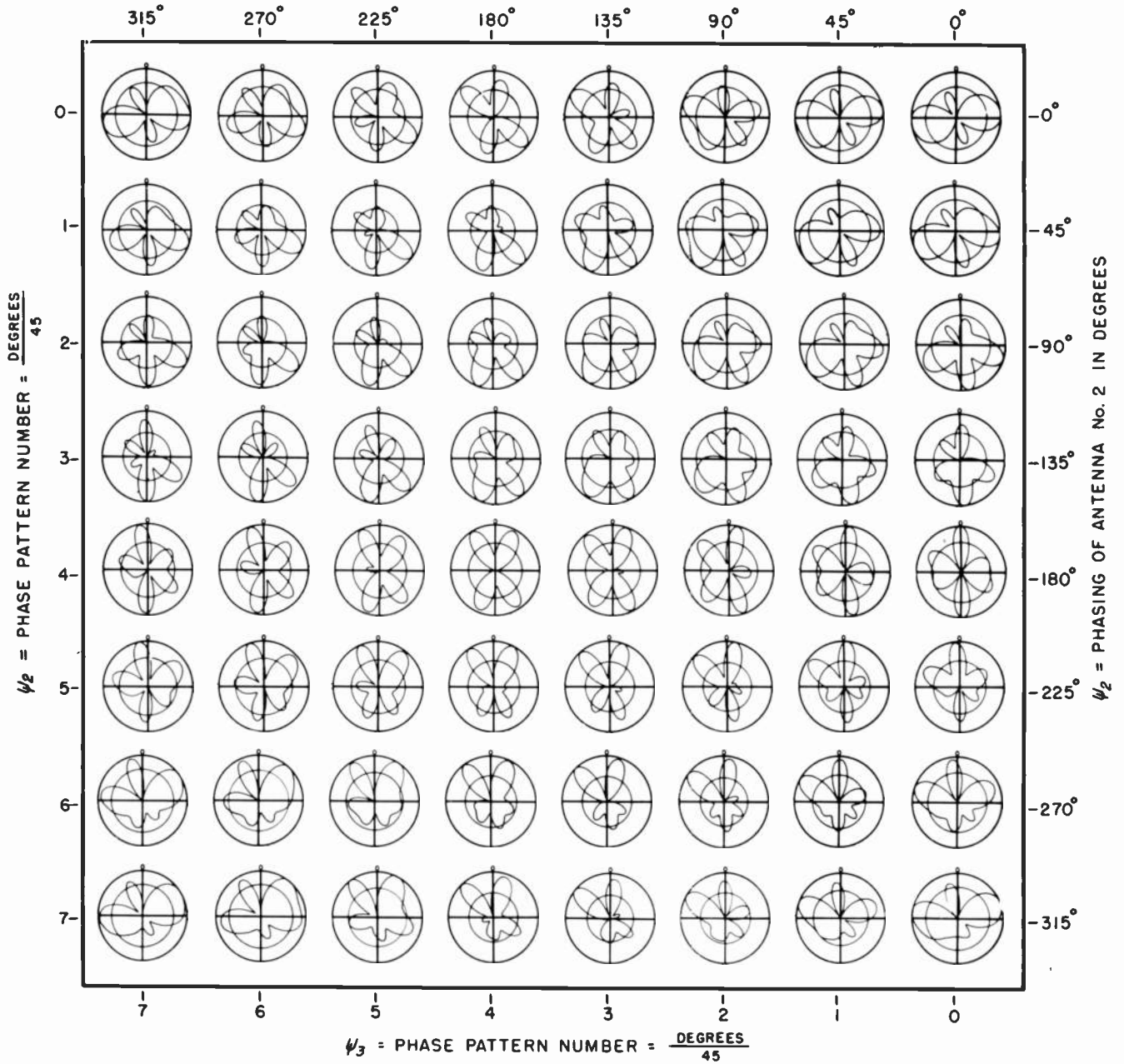

NUMBER OF ANTENNAS IN THE SYSTEM	$\psi_2 = \frac{\text{DEGREES}}{45}$	$\psi_3 = \frac{\text{DEGREES}}{45}$
ORIENTATION OF NO. 2 ANTENNA = $\frac{\text{DEGREES}}{45}$	$S_2 = \frac{\text{DEGREES}}{45}$	$S_3 = \frac{\text{DEGREES}}{45}$
SPACING OF NO. 2 ANTENNA = $\frac{\text{DEGREES}}{45}$	$\phi_2 = \frac{\text{DEGREES}}{45}$	$\phi_3 = \frac{\text{DEGREES}}{45}$
PHASING OF NO. 2 ANTENNA = $\frac{\text{DEGREES}}{45}$	$\psi_2 = \frac{\text{DEGREES}}{45}$	$\psi_3 = \frac{\text{DEGREES}}{45}$
ORIENTATION OF NO. 3 ANTENNA = $\frac{\text{DEGREES}}{45}$	$\phi_2 = \frac{\text{DEGREES}}{45}$	$\phi_3 = \frac{\text{DEGREES}}{45}$
SPACING OF NO. 3 ANTENNA = $\frac{\text{DEGREES}}{45}$	$S_2 = \frac{\text{DEGREES}}{45}$	$S_3 = \frac{\text{DEGREES}}{45}$
PHASING OF NO. 3 ANTENNA = $\frac{\text{DEGREES}}{45}$	$\psi_2 = \frac{\text{DEGREES}}{45}$	$\psi_3 = \frac{\text{DEGREES}}{45}$

LEFT HAND PATTERN NUMBER GIVES ANTENNA  
PLACEMENT AND PHASING DATA.

% FIELD INTENSITY RADIATED IN HORIZONTAL PLANE FROM NO. 1 ANTENNA.	$E_1$	21
% FIELD INTENSITY RADIATED IN HORIZONTAL PLANE FROM NO. 2 ANTENNA.	$E_2$	40
% FIELD INTENSITY RADIATED IN HORIZONTAL PLANE FROM NO. 3 ANTENNA.	$E_3$	27
% RMS FIELD INTENSITY RADIATED IN HORIZONTAL PLANE FROM ANTENNA SYSTEM.	$E_0$	64

RIGHT HAND PATTERN NUMBER  
GIVES ANTENNA FIELD INTEN-  
SITY DATA IN PERCENT.

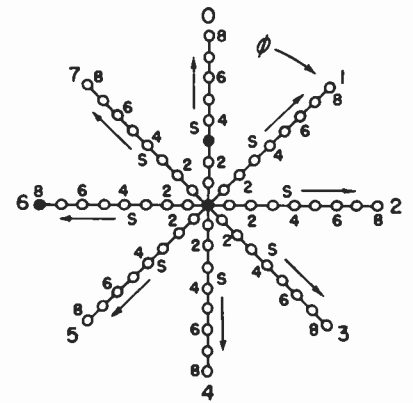

SPOTS LOCATE THE ANTENNAS FOR  
THIS PAGE OF PATTERNS IN THE  
SYSTEMATIZATION PLACEMENT CHART.

PATTERN NOMENCLATURE

$\psi_3$  = PHASING OF ANTENNA No. 3 IN DEGREES

3.145

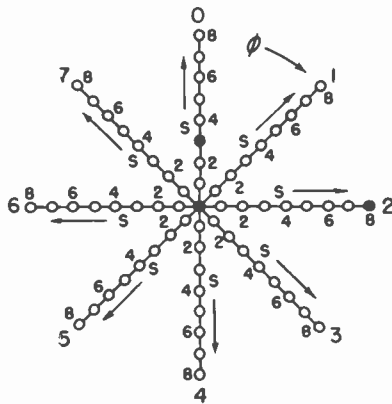
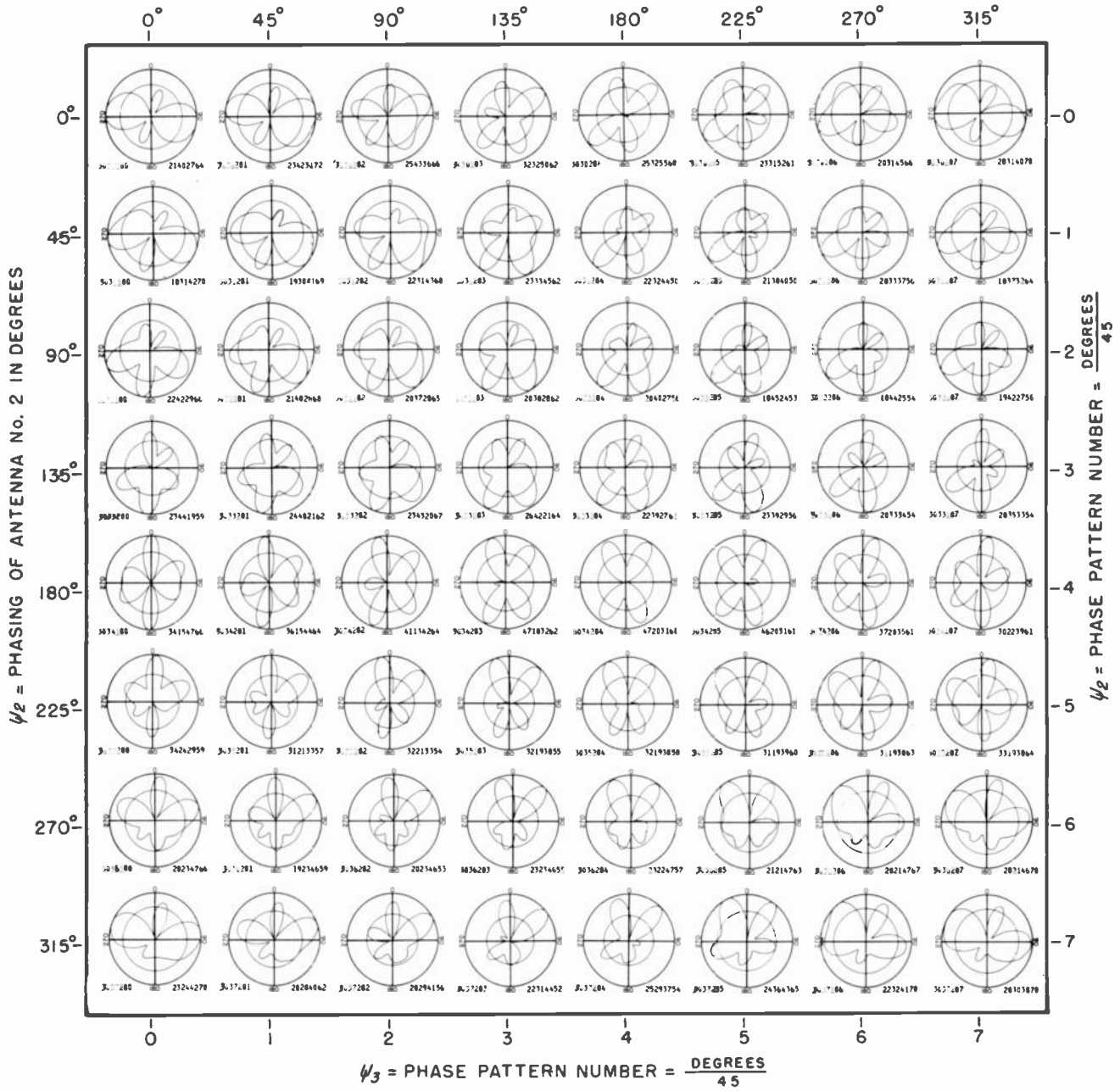

SPOTS LOCATE THE ANTENNAS FOR THIS PAGE OF PATTERNS IN THE SYSTEMIZATION PLACEMENT CHART.

$\psi_3$  = PHASE PATTERN NUMBER =  $\frac{\text{DEGREES}}{45}$

NUMBER OF ANTENNAS IN THE SYSTEM	ORIENTATION OF NO. 2 ANTENNA = $\frac{\text{DEGREES}}{45}$	SPACING OF NO. 2 ANTENNA = $\frac{\text{DEGREES}}{45}$	PHASING OF NO. 2 ANTENNA = $\frac{\text{DEGREES}}{45}$	ORIENTATION OF NO. 3 ANTENNA = $\frac{\text{DEGREES}}{45}$	SPACING OF NO. 3 ANTENNA = $\frac{\text{DEGREES}}{45}$	PHASING OF NO. 3 ANTENNA = $\frac{\text{DEGREES}}{45}$
No.	$\phi_2$	$S_2$	$\psi_2$	$\phi_3$	$S_3$	$\psi_3$
3	0	3	0	2	8	0

LEFT HAND PATTERN NUMBER GIVES ANTENNA PLACEMENT AND PHASING DATA.

% FIELD INTENSITY RADIATED IN HORIZONTAL PLANE FROM NO. 1 ANTENNA.	% FIELD INTENSITY RADIATED IN HORIZONTAL PLANE FROM NO. 2 ANTENNA.	% FIELD INTENSITY RADIATED IN HORIZONTAL PLANE FROM NO. 3 ANTENNA.	% RMS FIELD INTENSITY RADIATED IN HORIZONTAL PLANE FROM ANTENNA SYSTEM.
$F_1$	$F_2$	$F_3$	$F_0$
21	40	27	64

RIGHT HAND PATTERN NUMBER GIVES ANTENNA FIELD INTENSITY DATA IN PERCENT.

PATTERN NOMENCLATURE

$\psi_3$  = PHASING OF ANTENNA No. 3 IN DEGREES

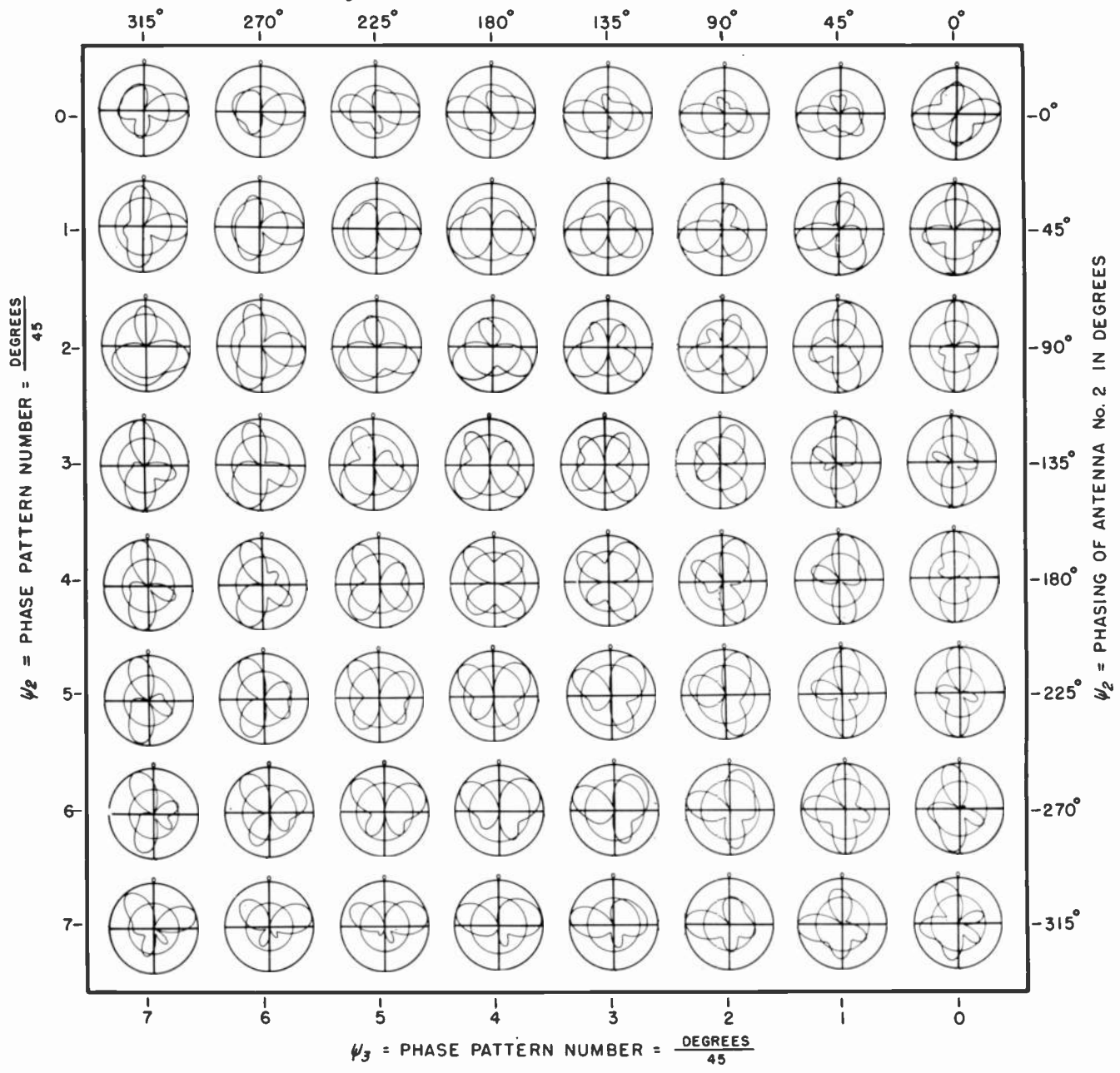

$\psi_2$  = PHASE PATTERN NUMBER =  $\frac{\text{DEGREES}}{45}$

$\psi_3$  = PHASE PATTERN NUMBER =  $\frac{\text{DEGREES}}{45}$

- NUMBER OF ANTENNAS IN THE SYSTEM  
NO. 3
- ORIENTATION OF NO. 2 ANTENNA =  $\frac{\text{DEGREES}}{45}$   
 $\phi_2$  0
- SPACING OF NO. 2 ANTENNA =  $\frac{\text{DEGREES}}{45}$   
 $S_2$  4
- PHASING OF NO. 2 ANTENNA =  $\frac{\text{DEGREES}}{45}$   
 $\psi_2$  0
- ORIENTATION OF NO. 3 ANTENNA =  $\frac{\text{DEGREES}}{45}$   
 $\phi_3$  6
- SPACING OF NO. 3 ANTENNA =  $\frac{\text{DEGREES}}{45}$   
 $S_3$  5
- PHASING OF NO. 3 ANTENNA =  $\frac{\text{DEGREES}}{45}$   
 $\psi_3$  0
- % FIELD INTENSITY RADIATED IN HORIZONTAL PLANE FROM NO. 1 ANTENNA.  
 $E_1$  75
- % FIELD INTENSITY RADIATED IN HORIZONTAL PLANE FROM NO. 2 ANTENNA.  
 $E_2$  50
- % FIELD INTENSITY RADIATED IN HORIZONTAL PLANE FROM NO. 3 ANTENNA.  
 $E_3$  46
- % RMS FIELD INTENSITY RADIATED IN HORIZONTAL PLANE FROM ANTENNA SYSTEM.  
 $E_0$  63

LEFT HAND PATTERN NUMBER GIVES ANTENNA PLACEMENT AND PHASING DATA.

RIGHT HAND PATTERN NUMBER GIVES ANTENNA FIELD INTENSITY DATA IN PERCENT.

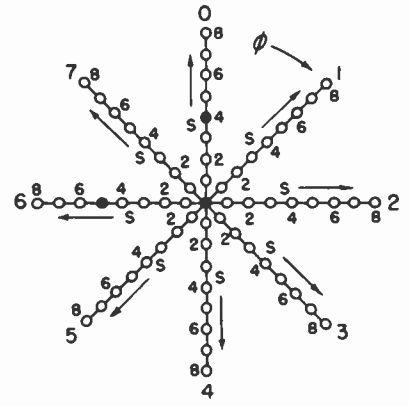

SPOTS LOCATE THE ANTENNAS FOR THIS PAGE OF PATTERNS IN THE SYSTEMATIZATION PLACEMENT CHART.

PATTERN NOMENCLATURE



$\psi_3$  = PHASING OF ANTENNA NO. 3 IN DEGREES

3.147

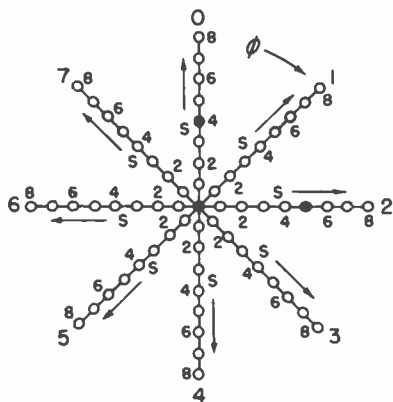
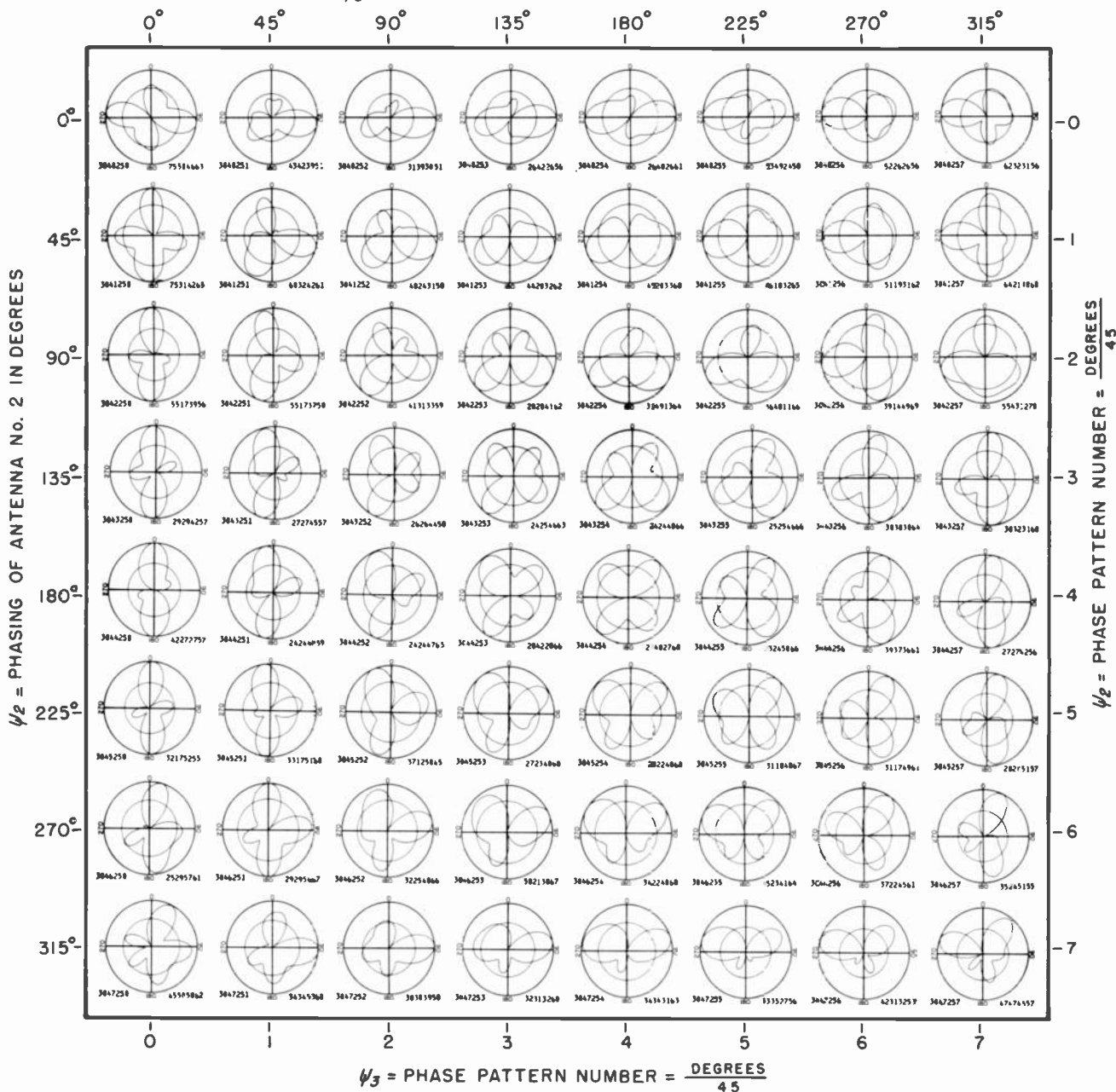

SPOTS LOCATE THE ANTENNAS FOR THIS PAGE OF PATTERNS IN THE SYSTEMATIZATION PLACEMENT CHART.

NUMBER OF ANTENNAS IN THE SYSTEM	ORIENTATION OF NO. 2 ANTENNA = $\frac{\text{DEGREES}}{45}$	SPACING OF NO. 2 ANTENNA = $\frac{\text{DEGREES}}{45}$	PHASING OF NO. 2 ANTENNA = $\frac{\text{DEGREES}}{45}$	ORIENTATION OF NO. 3 ANTENNA = $\frac{\text{DEGREES}}{45}$	SPACING OF NO. 3 ANTENNA = $\frac{\text{DEGREES}}{45}$	PHASING OF NO. 3 ANTENNA = $\frac{\text{DEGREES}}{45}$
No. 3	$\phi_2$ 0	$S_2$ 4	$\psi_2$ 0	$\phi_3$ 2	$S_3$ 5	$\psi_3$ 0

LEFT HAND PATTERN NUMBER GIVES ANTENNA PLACEMENT AND PHASING DATA.

% FIELD INTENSITY RADIATED IN HORIZONTAL PLANE FROM NO. 1 ANTENNA.	% FIELD INTENSITY RADIATED IN HORIZONTAL PLANE FROM NO. 2 ANTENNA.	% FIELD INTENSITY RADIATED IN HORIZONTAL PLANE FROM NO. 3 ANTENNA.	% RMS FIELD INTENSITY RADIATED IN HORIZONTAL PLANE FROM ANTENNA SYSTEM.
$E_1$ 75	$E_2$ 50	$E_3$ 46	$E_0$ 63

RIGHT HAND PATTERN NUMBER GIVES ANTENNA FIELD INTENSITY DATA IN PERCENT.

PATTERN NOMENCLATURE

$\psi_3$  = PHASING OF ANTENNA No. 3 IN DEGREES

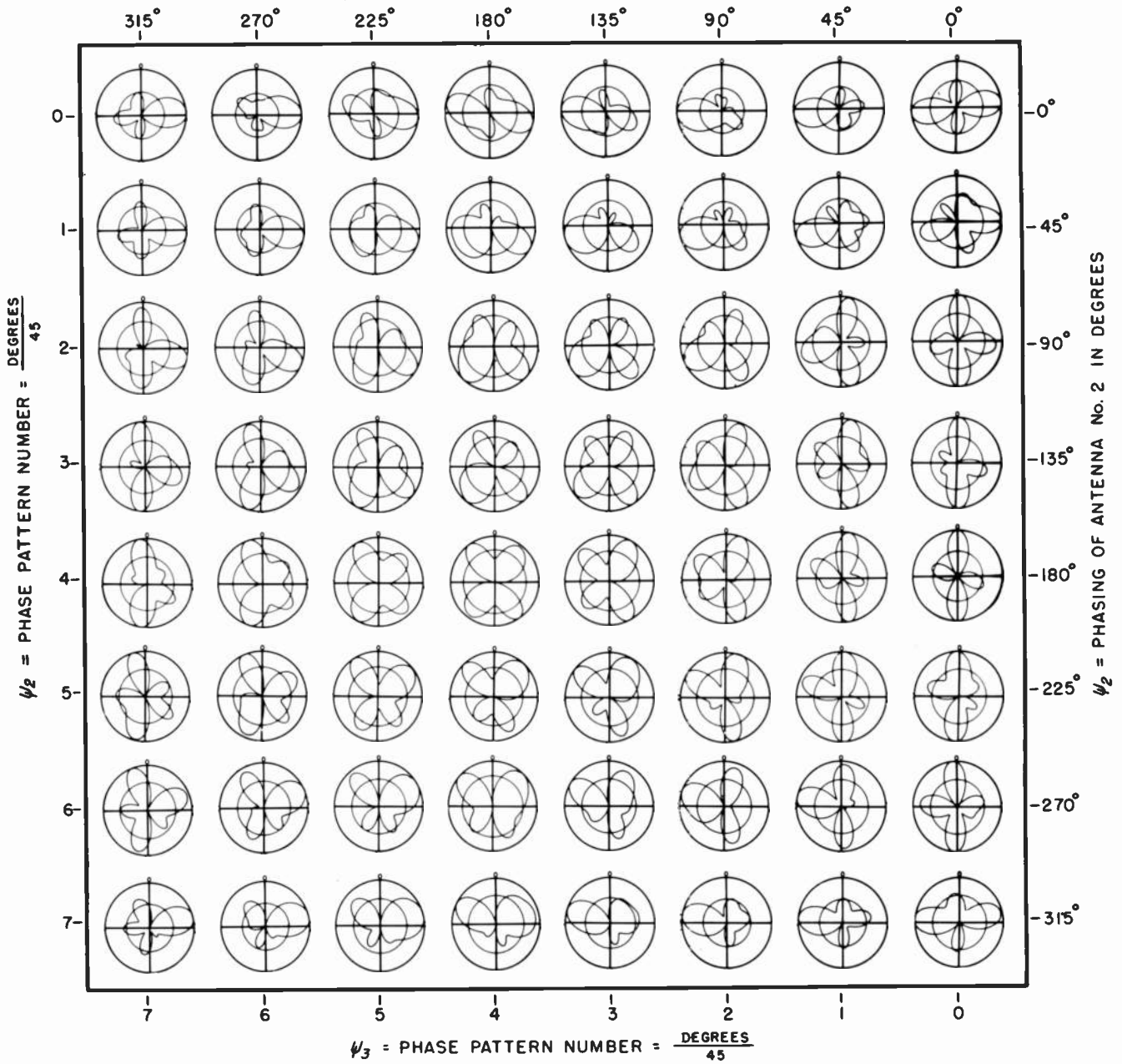

NUMBER OF ANTENNAS IN THE SYSTEM  
 NO. 3  
 3

ORIENTATION OF NO. 2 ANTENNA =  $\frac{\text{DEGREES}}{45}$   
 $\phi_2$   
 0

SPACING OF NO. 2 ANTENNA =  $\frac{\text{DEGREES}}{45}$   
 $S_2$   
 4

PHASING OF NO. 2 ANTENNA =  $\frac{\text{DEGREES}}{45}$   
 $\psi_2$   
 0

ORIENTATION OF NO. 3 ANTENNA =  $\frac{\text{DEGREES}}{45}$   
 $\phi_3$   
 6

SPACING OF NO. 3 ANTENNA =  $\frac{\text{DEGREES}}{45}$   
 $S_3$   
 6

PHASING OF NO. 3 ANTENNA =  $\frac{\text{DEGREES}}{45}$   
 $\psi_3$   
 0

LEFT HAND PATTERN NUMBER GIVES ANTENNA PLACEMENT AND PHASING DATA.

% FIELD INTENSITY RADIATED IN HORIZONTAL PLANE FROM NO. 1 ANTENNA.  
 $E_1$   
 60

% FIELD INTENSITY RADIATED IN HORIZONTAL PLANE FROM NO. 2 ANTENNA.  
 $E_2$   
 33

% FIELD INTENSITY RADIATED IN HORIZONTAL PLANE FROM NO. 3 ANTENNA.  
 $E_3$   
 33

% RMS FIELD INTENSITY RADIATED IN HORIZONTAL PLANE FROM ANTENNA SYSTEM.  
 $E_0$   
 59

RIGHT HAND PATTERN NUMBER GIVES ANTENNA FIELD INTENSITY DATA IN PERCENT.

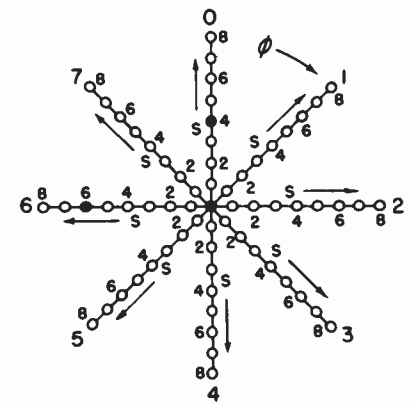

SPOTS LOCATE THE ANTENNAS FOR THIS PAGE OF PATTERNS IN THE SYSTEMATIZATION PLACEMENT CHART.

PATTERN NOMENCLATURE

$\psi_3$  = PHASING OF ANTENNA NO. 3 IN DEGREES

3.149

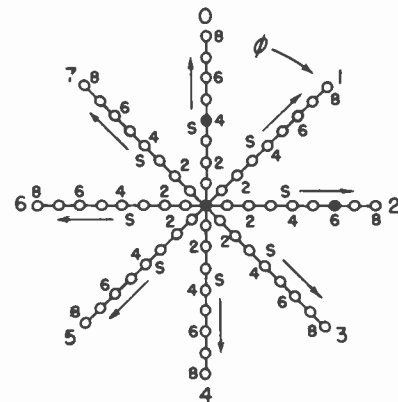
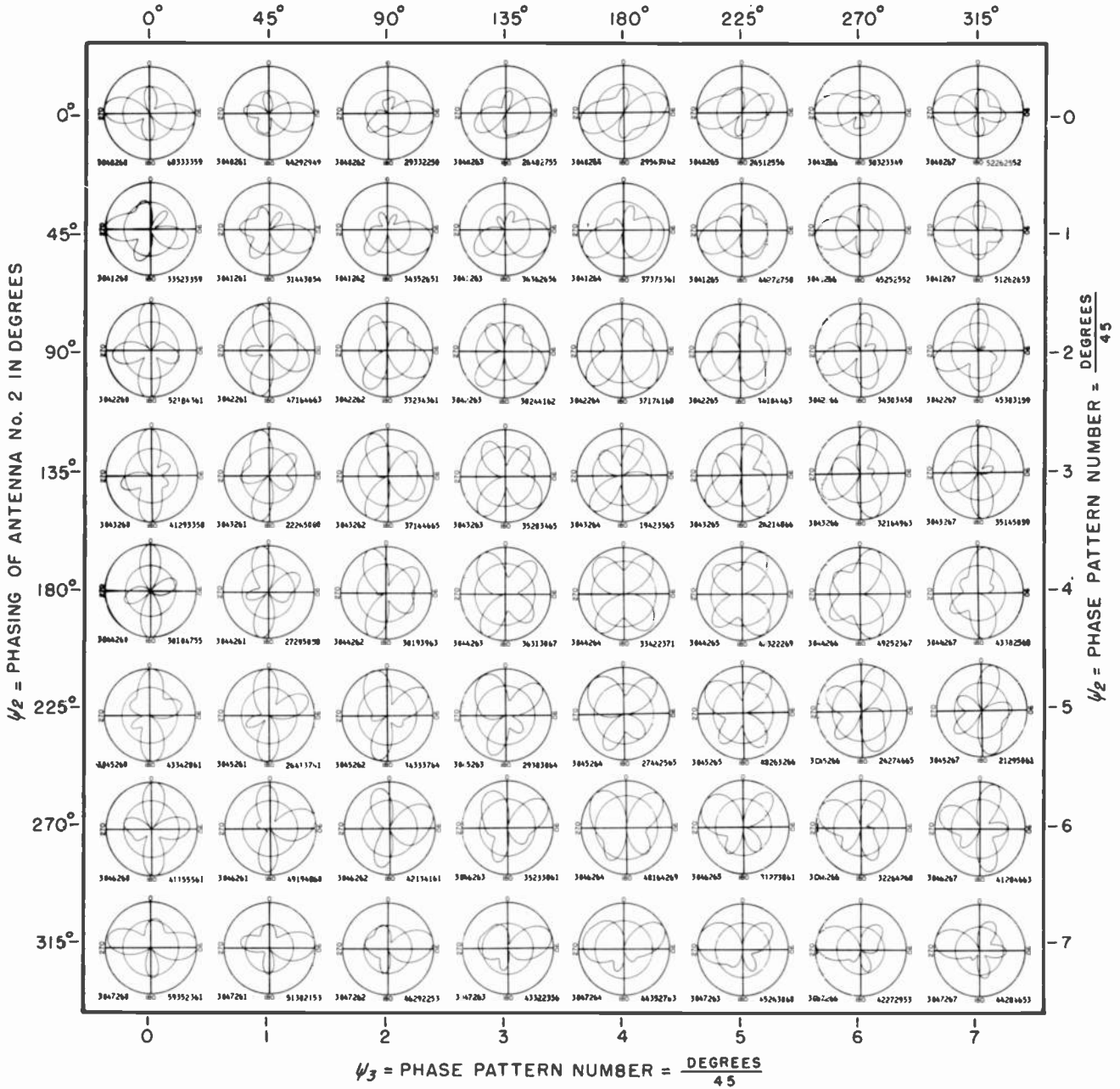

SPOTS LOCATE THE ANTENNAS FOR THIS PAGE OF PATTERNS IN THE SYSTEMATIZATION PLACEMENT CHART.

$\psi_3$  = PHASE PATTERN NUMBER =  $\frac{\text{DEGREES}}{45}$

NUMBER OF ANTENNAS IN THE SYSTEM	3
ORIENTATION OF NO. 2 ANTENNA = $\frac{\text{DEGREES}}{45}$	$\phi_2 = 0$
SPACING OF NO. 2 ANTENNA = $\frac{\text{DEGREES}}{45}$	$S_2 = 4$
PHASING OF NO. 2 ANTENNA = $\frac{\text{DEGREES}}{45}$	$\psi_2 = 0$
ORIENTATION OF NO. 3 ANTENNA = $\frac{\text{DEGREES}}{45}$	$\phi_3 = 2$
SPACING OF NO. 3 ANTENNA = $\frac{\text{DEGREES}}{45}$	$S_3 = 6$
PHASING OF NO. 3 ANTENNA = $\frac{\text{DEGREES}}{45}$	$\psi_3 = 0$

LEFT HAND PATTERN NUMBER GIVES ANTENNA PLACEMENT AND PHASING DATA.

% FIELD INTENSITY RADIATED IN HORIZONTAL PLANE FROM NO. 1 ANTENNA.	$E_1 = 60$
% FIELD INTENSITY RADIATED IN HORIZONTAL PLANE FROM NO. 2 ANTENNA.	$E_2 = 33$
% FIELD INTENSITY RADIATED IN HORIZONTAL PLANE FROM NO. 3 ANTENNA.	$E_3 = 33$
% RMS FIELD INTENSITY RADIATED IN HORIZONTAL PLANE FROM ANTENNA SYSTEM.	$E_0 = 59$

RIGHT HAND PATTERN NUMBER GIVES ANTENNA FIELD INTENSITY DATA IN PERCENT.

PATTERN NOMENCLATURE

$\psi_3$  = PHASING OF ANTENNA No. 3 IN DEGREES

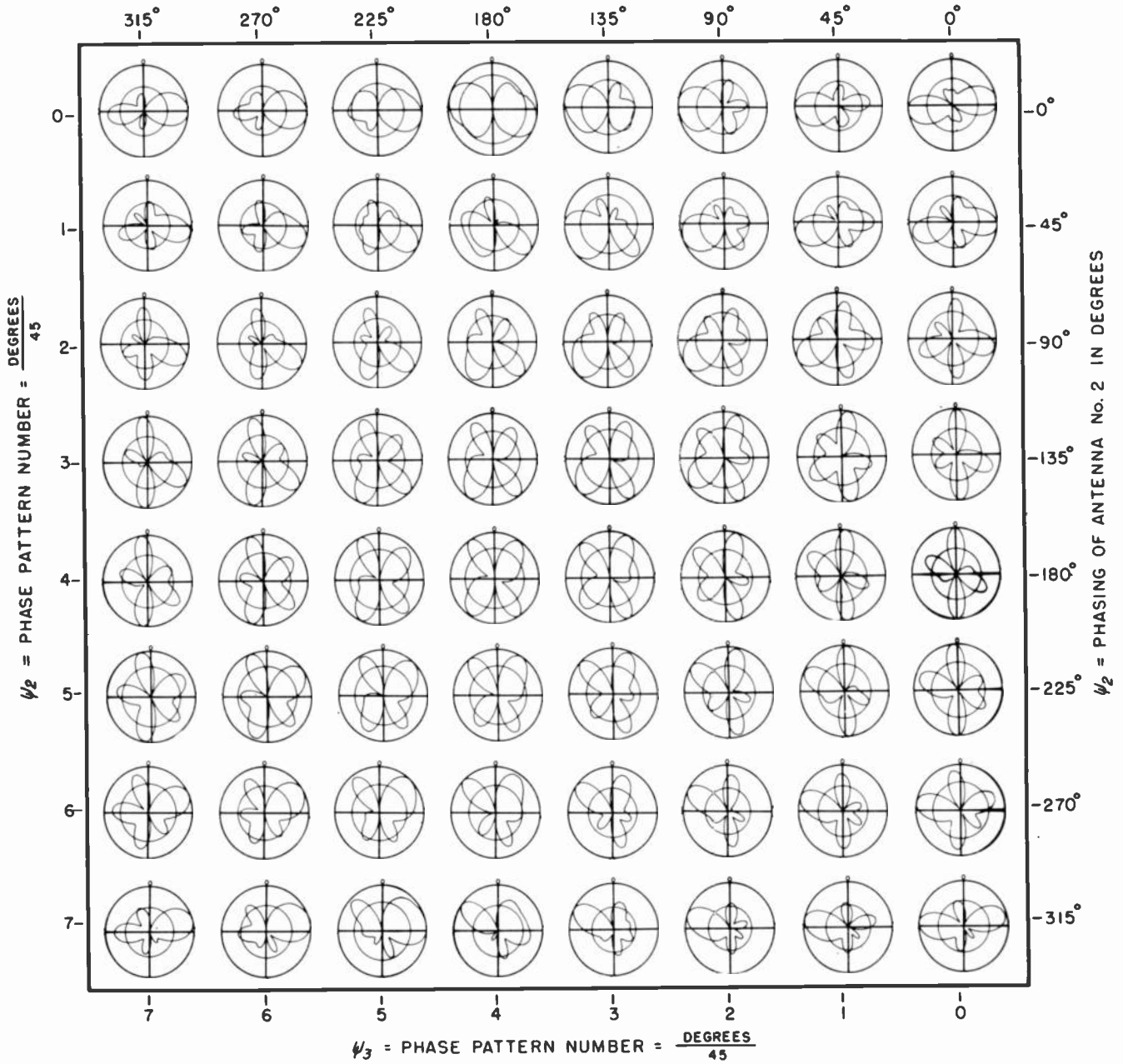

NUMBER OF ANTENNAS IN THE SYSTEM  
 NO. 3

ORIENTATION OF NO. 2 ANTENNA =  $\frac{\text{DEGREES}}{45}$   
 NO. 2 ANTENNA =  $\psi_2$

SPACING OF NO. 2 ANTENNA =  $\frac{\text{DEGREES}}{45}$   
 NO. 2 ANTENNA =  $S_2$

PHASING OF NO. 2 ANTENNA =  $\frac{\text{DEGREES}}{45}$   
 NO. 2 ANTENNA =  $\psi_2$

ORIENTATION OF NO. 3 ANTENNA =  $\frac{\text{DEGREES}}{45}$   
 NO. 3 ANTENNA =  $\phi_3$

SPACING OF NO. 3 ANTENNA =  $\frac{\text{DEGREES}}{45}$   
 NO. 3 ANTENNA =  $S_3$

PHASING OF NO. 3 ANTENNA =  $\frac{\text{DEGREES}}{45}$   
 NO. 3 ANTENNA =  $\psi_3$

LEFT HAND PATTERN NUMBER GIVES ANTENNA PLACEMENT AND PHASING DATA.

% FIELD INTENSITY RADIATED IN HORIZONTAL PLANE FROM NO. 1 ANTENNA.  
 $F_1$  36

% FIELD INTENSITY RADIATED IN HORIZONTAL PLANE FROM NO. 2 ANTENNA.  
 $F_2$  36

% FIELD INTENSITY RADIATED IN HORIZONTAL PLANE FROM NO. 3 ANTENNA.  
 $F_3$  36

% RMS FIELD INTENSITY RADIATED IN HORIZONTAL PLANE FROM ANTENNA SYSTEM.  
 $F_0$  59

RIGHT HAND PATTERN NUMBER GIVES ANTENNA FIELD INTENSITY DATA IN PERCENT.

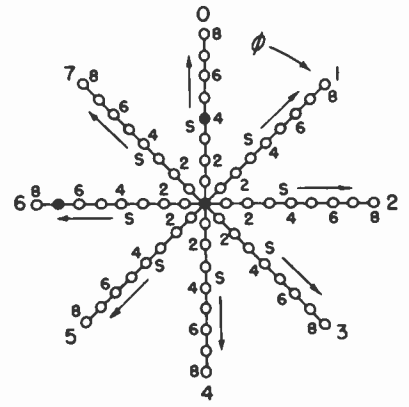

SPOTS LOCATE THE ANTENNAS FOR THIS PAGE OF PATTERNS IN THE SYSTEMATIZATION PLACEMENT CHART.

PATTERN NOMENCLATURE

$\psi_3$  = PHASING OF ANTENNA No. 3 IN DEGREES

3.151

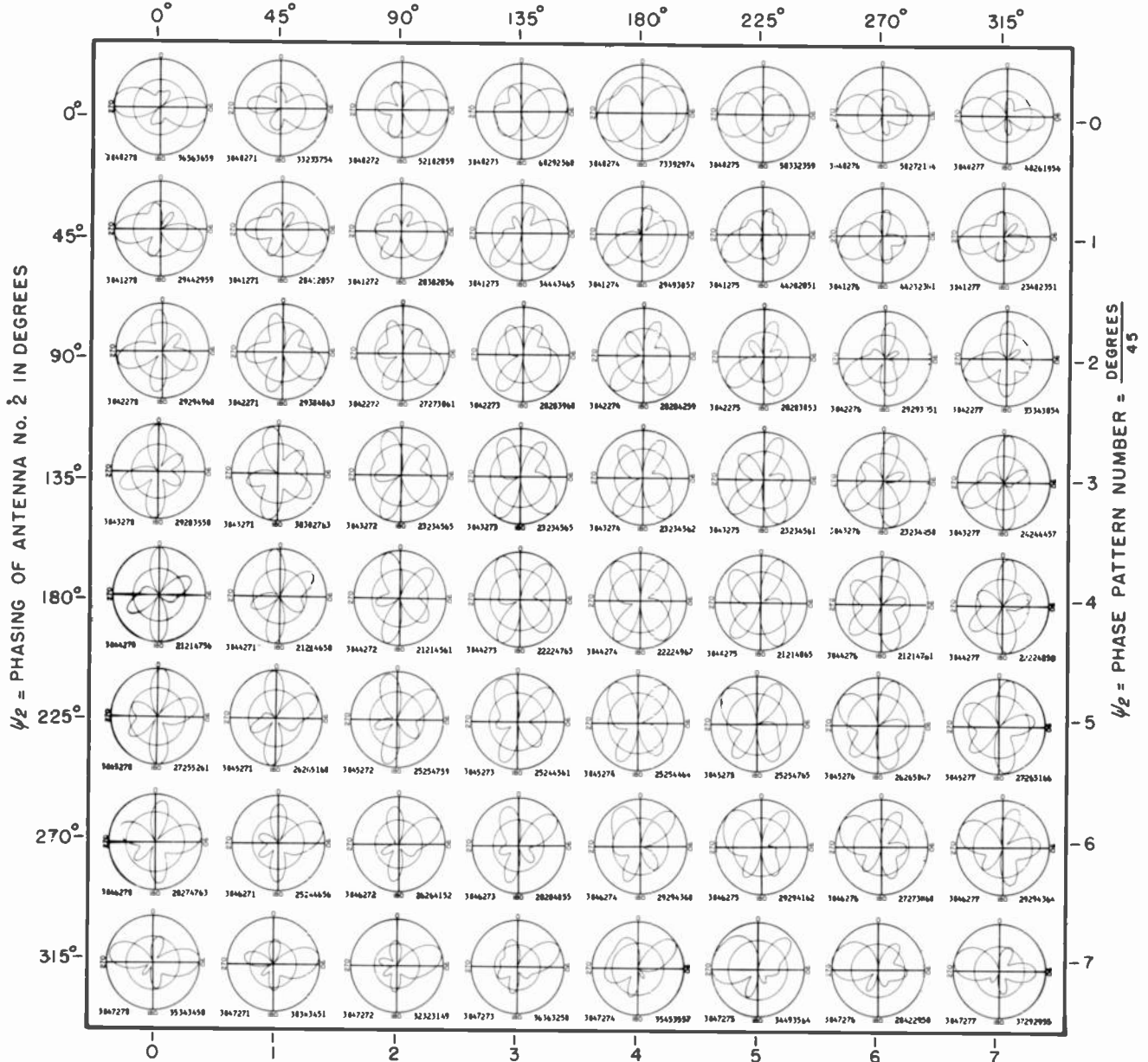

$\psi_3$  = PHASE PATTERN NUMBER =  $\frac{\text{DEGREES}}{45}$

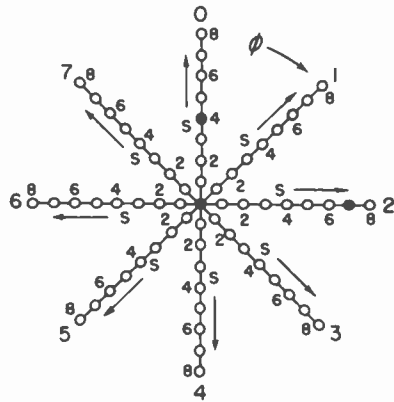

SPOTS LOCATE THE ANTENNAS FOR THIS PAGE OF PATTERNS IN THE SYSTEMIZATION PLACEMENT CHART.

NO.	$\phi_2$	$S_2$	$\psi_2$	$\phi_3$	$S_3$	$\psi_3$
3	0	4	0	2	7	0

LEFT HAND PATTERN NUMBER GIVES ANTENNA PLACEMENT AND PHASING DATA.

$E_1$	$E_2$	$E_3$	$E_0$
36	36	36	59

RIGHT HAND PATTERN NUMBER GIVES ANTENNA FIELD INTENSITY DATA IN PERCENT.

PATTERN NOMENCLATURE

$\psi_3$  = PHASING OF ANTENNA No. 3 IN DEGREES

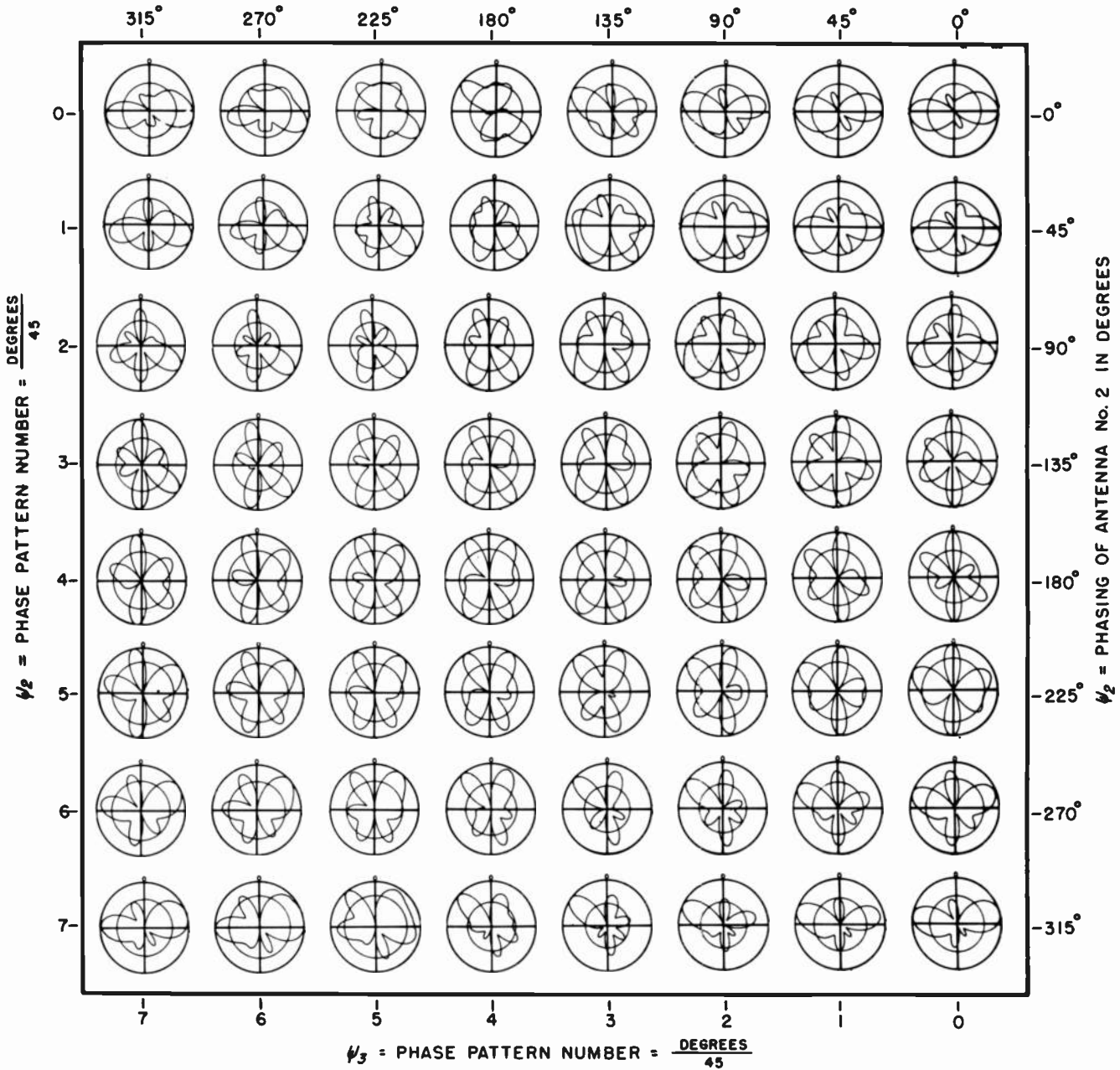

- NUMBER OF ANTENNAS IN THE SYSTEM
- ORIENTATION OF NO. 2 ANTENNA =  $\frac{DEGREES}{45}$
- SPACING OF NO. 2 ANTENNA =  $\frac{DEGREES}{45}$
- PHASING OF NO. 2 ANTENNA =  $\frac{DEGREES}{45}$
- ORIENTATION OF NO. 3 ANTENNA =  $\frac{DEGREES}{45}$
- SPACING OF NO. 3 ANTENNA =  $\frac{DEGREES}{45}$
- PHASING OF NO. 3 ANTENNA =  $\frac{DEGREES}{45}$

- % FIELD INTENSITY RADIATED IN HORIZONTAL PLANE FROM NO. 1 ANTENNA.
- % FIELD INTENSITY RADIATED IN HORIZONTAL PLANE FROM NO. 2 ANTENNA.
- % FIELD INTENSITY RADIATED IN HORIZONTAL PLANE FROM NO. 3 ANTENNA.
- % RMS FIELD INTENSITY RADIATED IN HORIZONTAL PLANE FROM ANTENNA SYSTEM.

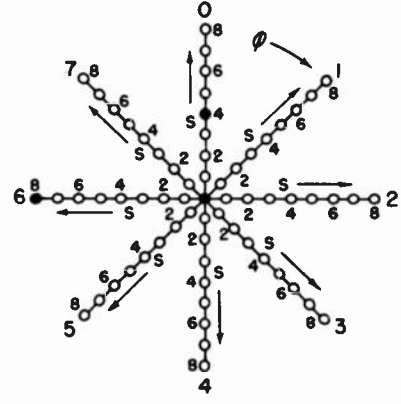

LEFT HAND PATTERN NUMBER GIVES ANTENNA PLACEMENT AND PHASING DATA.

RIGHT HAND PATTERN NUMBER GIVES ANTENNA FIELD INTENSITY DATA IN PERCENT.

SPOTS LOCATE THE ANTENNAS FOR THIS PAGE OF PATTERNS IN THE SYSTEMIZATION PLACEMENT CHART.

PATTERN NOMENCLATURE

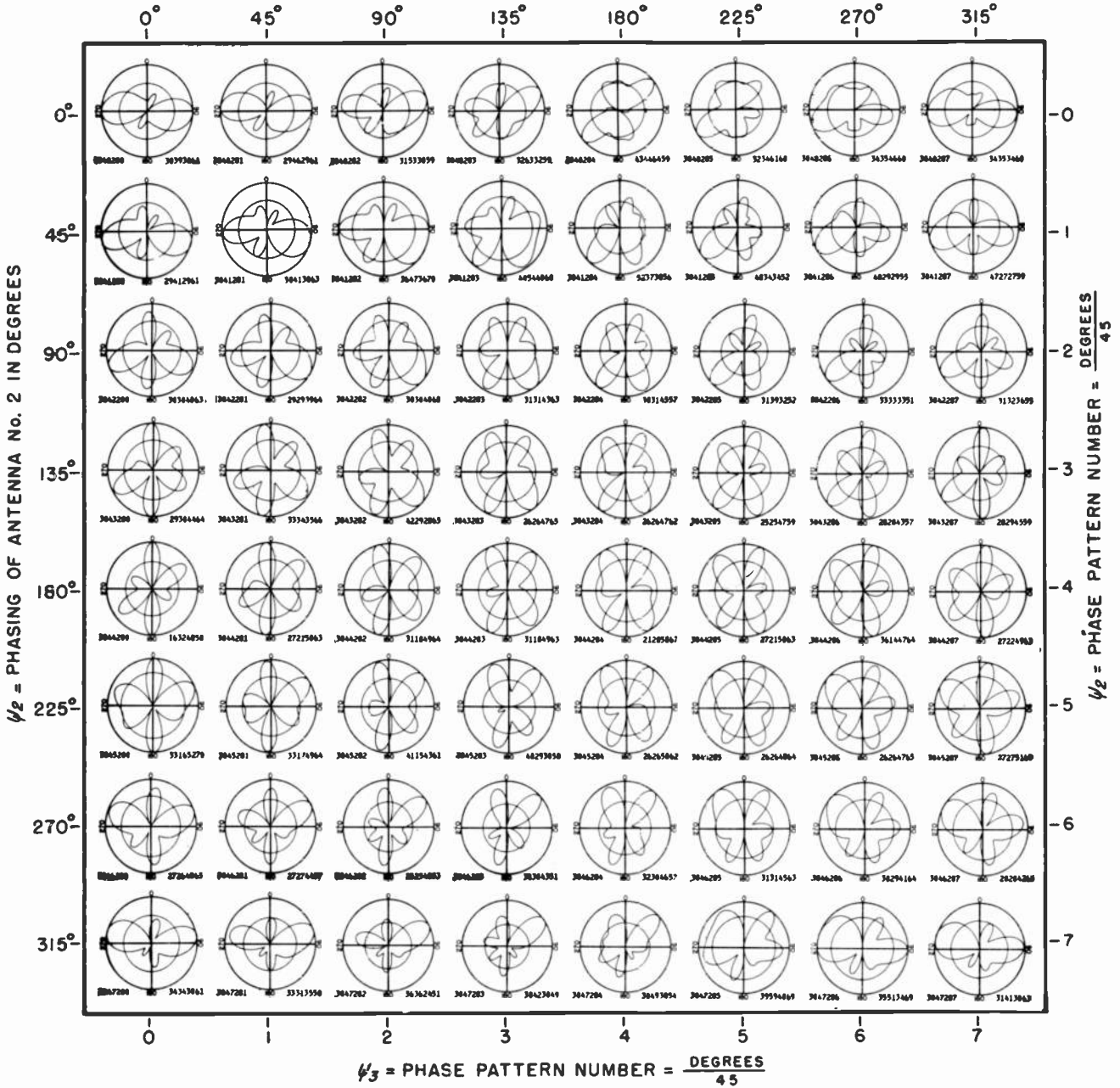

COPYRIGHT 1946 BY CARL E. SMITH  
PRINTED IN U. S. A.

CLEVELAND INSTITUTE OF RADIO ELECTRONICS  
TERMINAL TOWER, CLEVELAND 18, OHIO.

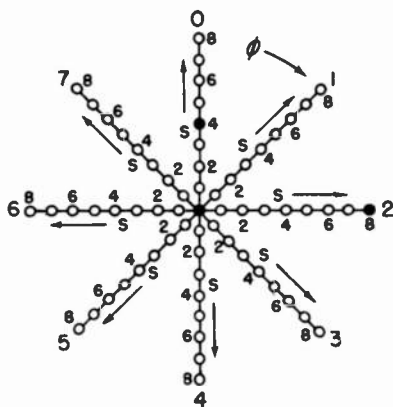

SPOTS LOCATE THE ANTENNAS FOR THIS PAGE OF PATTERNS IN THE SYSTEMATIZATION PLACEMENT CHART.

NUMBER OF ANTENNAS IN THE SYSTEM	ORIENTATION OF NO. 2 ANTENNA = $\frac{\text{DEGREES}}{45}$	SPACING OF NO. 2 ANTENNA = $\frac{\text{DEGREES}}{45}$	PHASING OF NO. 2 ANTENNA = $\frac{\text{DEGREES}}{45}$	ORIENTATION OF NO. 3 ANTENNA = $\frac{\text{DEGREES}}{45}$	SPACING OF NO. 3 ANTENNA = $\frac{\text{DEGREES}}{45}$	PHASING OF NO. 3 ANTENNA = $\frac{\text{DEGREES}}{45}$
No. 3	$\phi_2$ 0	$S_2$ 4	$\psi_2$ 0	$\phi_3$ 2	$S_3$ 8	$\psi_3$ 0

LEFT HAND PATTERN NUMBER GIVES ANTENNA PLACEMENT AND PHASING DATA.

% FIELD INTENSITY RADIATED IN HORIZONTAL PLANE FROM NO. 1 ANTENNA.	% FIELD INTENSITY RADIATED IN HORIZONTAL PLANE FROM NO. 2 ANTENNA.	% FIELD INTENSITY RADIATED IN HORIZONTAL PLANE FROM NO. 3 ANTENNA.	% RMS FIELD INTENSITY RADIATED IN HORIZONTAL PLANE FROM ANTENNA SYSTEM.
$E_1$ 30	$E_2$ 39	$E_3$ 30	$E_0$ 61

RIGHT HAND PATTERN NUMBER GIVES ANTENNA FIELD INTENSITY DATA IN PERCENT.

PATTERN NOMENCLATURE

$\psi_3$  = PHASING OF ANTENNA No. 3 IN DEGREES

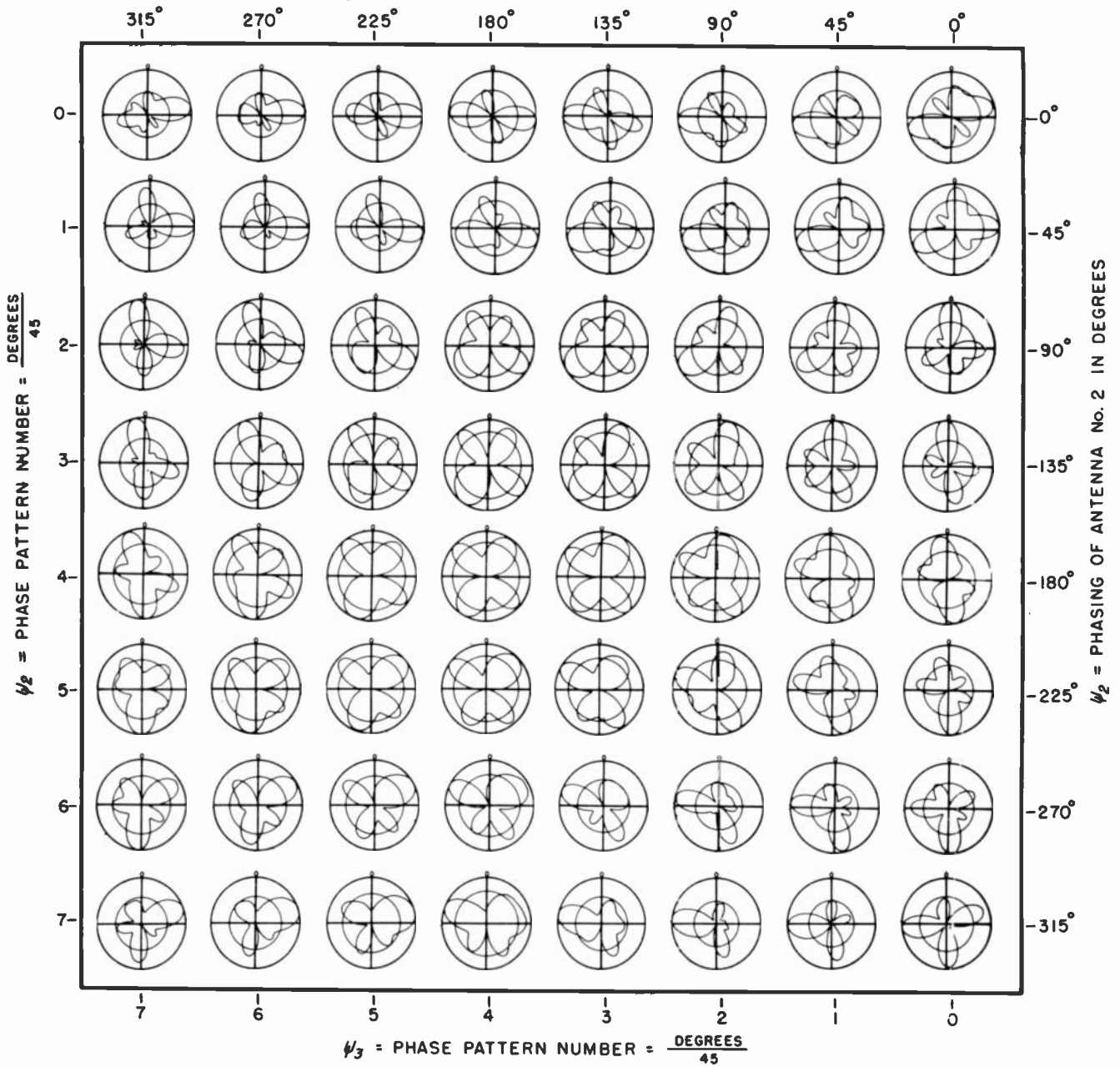

NUMBER OF ANTENNAS  
IN THE SYSTEM  
No. 3

ORIENTATION OF  
NO. 2 ANTENNA =  $\frac{\text{DEGREES}}{45}$   
 $\phi_2$  0

SPACING OF  
NO. 2 ANTENNA =  $\frac{\text{DEGREES}}{45}$   
 $S_2$  5

PHASING OF  
NO. 2 ANTENNA =  $\frac{\text{DEGREES}}{45}$   
 $\psi_2$  0

ORIENTATION OF  
NO. 3 ANTENNA =  $\frac{\text{DEGREES}}{45}$   
 $\phi_3$  0

SPACING OF  
NO. 3 ANTENNA =  $\frac{\text{DEGREES}}{45}$   
 $S_3$  6

PHASING OF  
NO. 3 ANTENNA =  $\frac{\text{DEGREES}}{45}$   
 $\psi_3$  0

% FIELD INTENSITY  
RADIATED IN HORIZONTAL  
PLANE FROM NO. 1 ANTENNA.  
 $E_1$  25

% FIELD INTENSITY  
RADIATED IN HORIZONTAL  
PLANE FROM NO. 2 ANTENNA.  
 $E_2$  40

% FIELD INTENSITY  
RADIATED IN HORIZONTAL  
PLANE FROM NO. 3 ANTENNA.  
 $E_3$  43

% RMS FIELD INTENSITY  
RADIATED IN HORIZONTAL  
PLANE FROM ANTENNA SYSTEM.  
 $E_0$  65

LEFT HAND PATTERN NUMBER GIVES ANTENNA  
PLACEMENT AND PHASING DATA.

RIGHT HAND PATTERN NUMBER  
GIVES ANTENNA FIELD INTEN-  
SITY DATA IN PERCENT.

PATTERN NOMENCLATURE

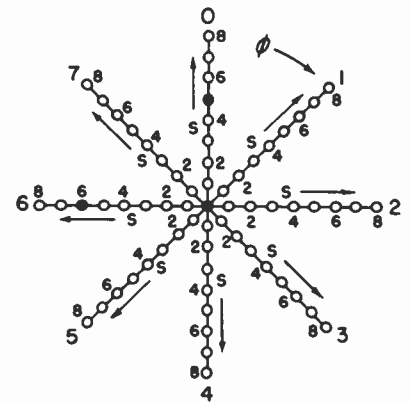

SPOTS LOCATE THE ANTENNAS FOR  
THIS PAGE OF PATTERNS IN THE  
SYSTEMATIZATION PLACEMENT CHART.



$\psi_3$  = PHASING OF ANTENNA No. 3 IN DEGREES

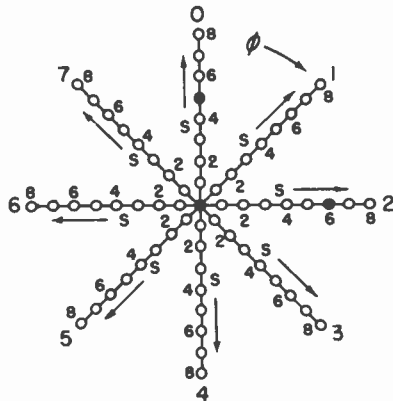
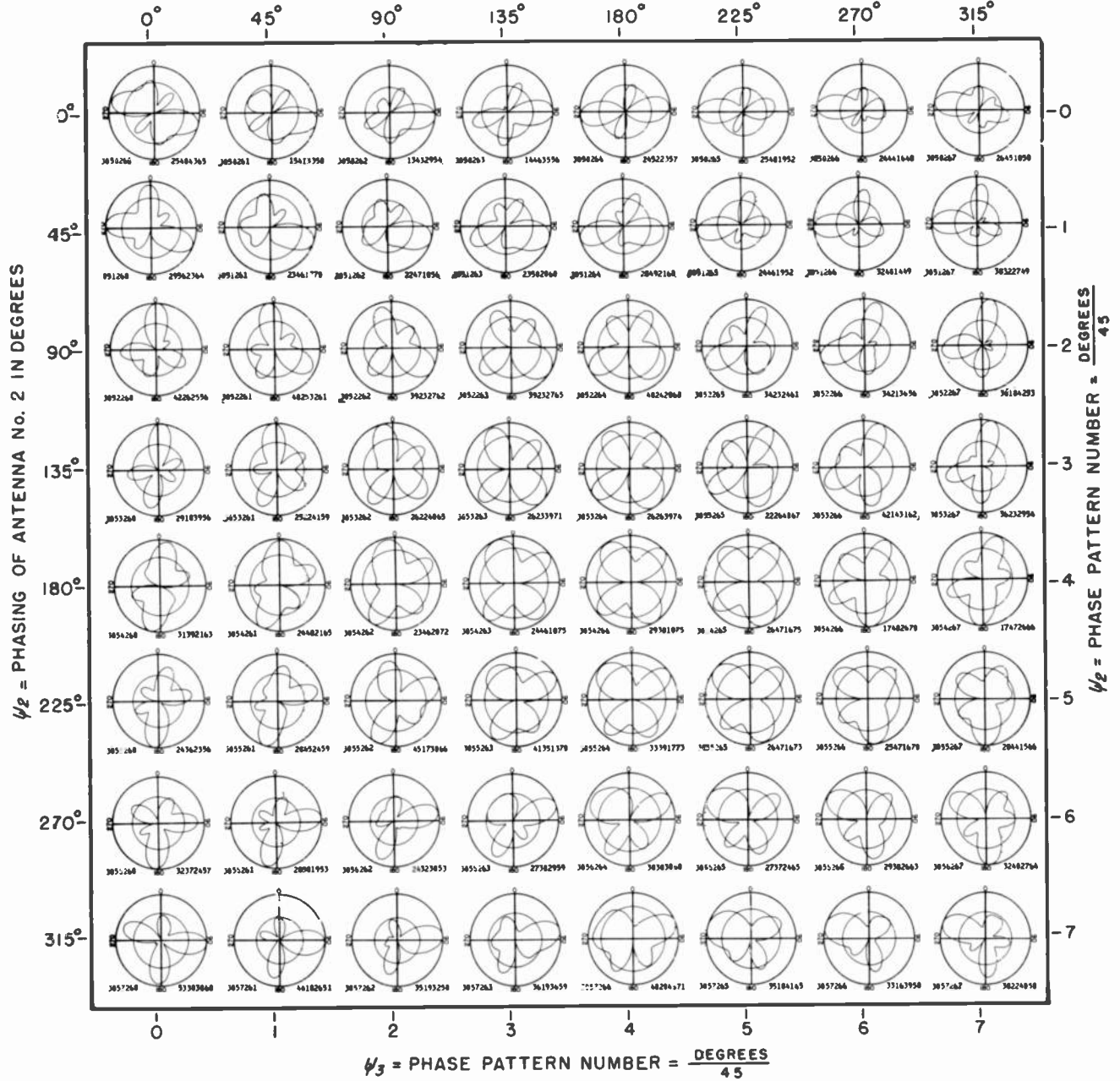

NUMBER OF ANTENNAS IN THE SYSTEM	ORIENTATION OF NO. 2 ANTENNA = $\frac{\text{DEGREES}}{45}$	SPACING OF NO. 2 ANTENNA = $\frac{\text{DEGREES}}{45}$	PHASING OF NO. 2 ANTENNA = $\frac{\text{DEGREES}}{45}$	ORIENTATION OF NO. 3 ANTENNA = $\frac{\text{DEGREES}}{45}$	SPACING OF NO. 3 ANTENNA = $\frac{\text{DEGREES}}{45}$	PHASING OF NO. 3 ANTENNA = $\frac{\text{DEGREES}}{45}$
No. 3	$\psi_2$ 0	$S_2$ 5	$\psi_2$ 0	$\psi_3$ 2	$S_3$ 6	$\psi_3$ 0

LEFT HAND PATTERN NUMBER GIVES ANTENNA  
PLACEMENT AND PHASING DATA.

% FIELD INTENSITY RADIATED IN HORIZONTAL PLANE FROM NO. 1 ANTENNA.	% FIELD INTENSITY RADIATED IN HORIZONTAL PLANE FROM NO. 2 ANTENNA.	% FIELD INTENSITY RADIATED IN HORIZONTAL PLANE FROM NO. 3 ANTENNA.	% RMS FIELD INTENSITY RADIATED IN HORIZONTAL PLANE FROM ANTENNA SYSTEM.
$E_1$ 25	$E_2$ 40	$E_3$ 43	$E_0$ 65

RIGHT HAND PATTERN NUMBER  
GIVES ANTENNA FIELD INTEN-  
SITY DATA IN PERCENT.

SPCTS LOCATE THE ANTENNAS FOR  
THIS PAGE OF PATTERNS IN THE  
SYSTEMATIZATION PLACEMENT CHART.

PATTERN NOMENCLATURE

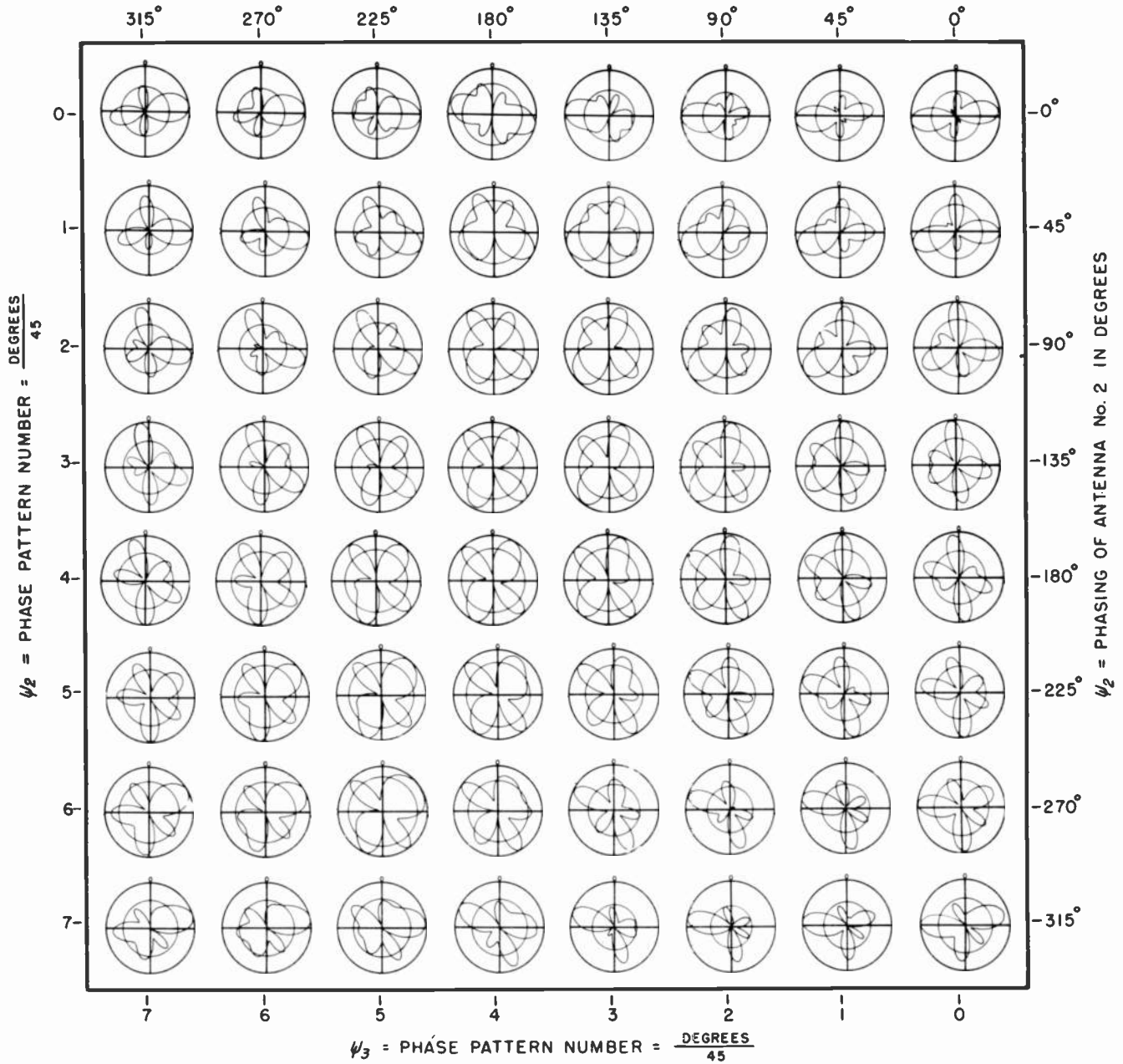

NUMBER OF ANTENNAS  
IN THE SYSTEM

No. 3

ORIENTATION OF  
NO. 2 ANTENNA =  $\frac{\text{DEGREES}}{45}$

$\phi_2$  0

SPACING OF  
NO. 2 ANTENNA =  $\frac{\text{DEGREES}}{45}$

$S_2$  5

PHASING OF  
NO. 2 ANTENNA =  $\frac{\text{DEGREES}}{45}$

$\psi_2$  0

ORIENTATION OF  
NO. 3 ANTENNA =  $\frac{\text{DEGREES}}{45}$

$\phi_3$  6

SPACING OF  
NO. 3 ANTENNA =  $\frac{\text{DEGREES}}{45}$

$S_3$  7

PHASING OF  
NO. 3 ANTENNA =  $\frac{\text{DEGREES}}{45}$

$\psi_3$  0

% FIELD INTENSITY  
RADIATED IN HORIZONTAL  
PLANE FROM NO. 1 ANTENNA.

$E_1$  38

% FIELD INTENSITY  
RADIATED IN HORIZONTAL  
PLANE FROM NO. 2 ANTENNA.

$E_2$  33

% FIELD INTENSITY  
RADIATED IN HORIZONTAL  
PLANE FROM NO. 3 ANTENNA.

$E_3$  19

% RMS FIELD INTENSITY  
RADIATED IN HORIZONTAL  
PLANE FROM ANTENNA SYSTEM.

$E_T$  55

LEFT HAND PATTERN NUMBER GIVES ANTENNA  
PLACEMENT AND PHASING DATA.

RIGHT HAND PATTERN NUMBER  
GIVES ANTENNA FIELD INTEN-  
SITY DATA IN PERCENT.

PATTERN NOMENCLATURE

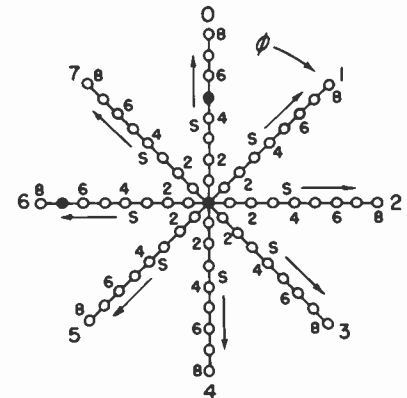

SPOTS LOCATE THE ANTENNAS FOR  
THIS PAGE OF PATTERNS IN THE  
SYSTEMATIZATION PLACEMENT CHART.

$\psi_3$  = PHASING OF ANTENNA No. 3 IN DEGREES

3.157

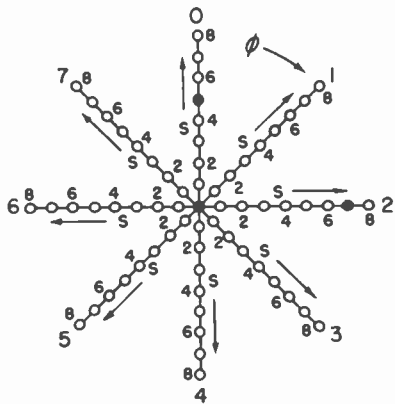
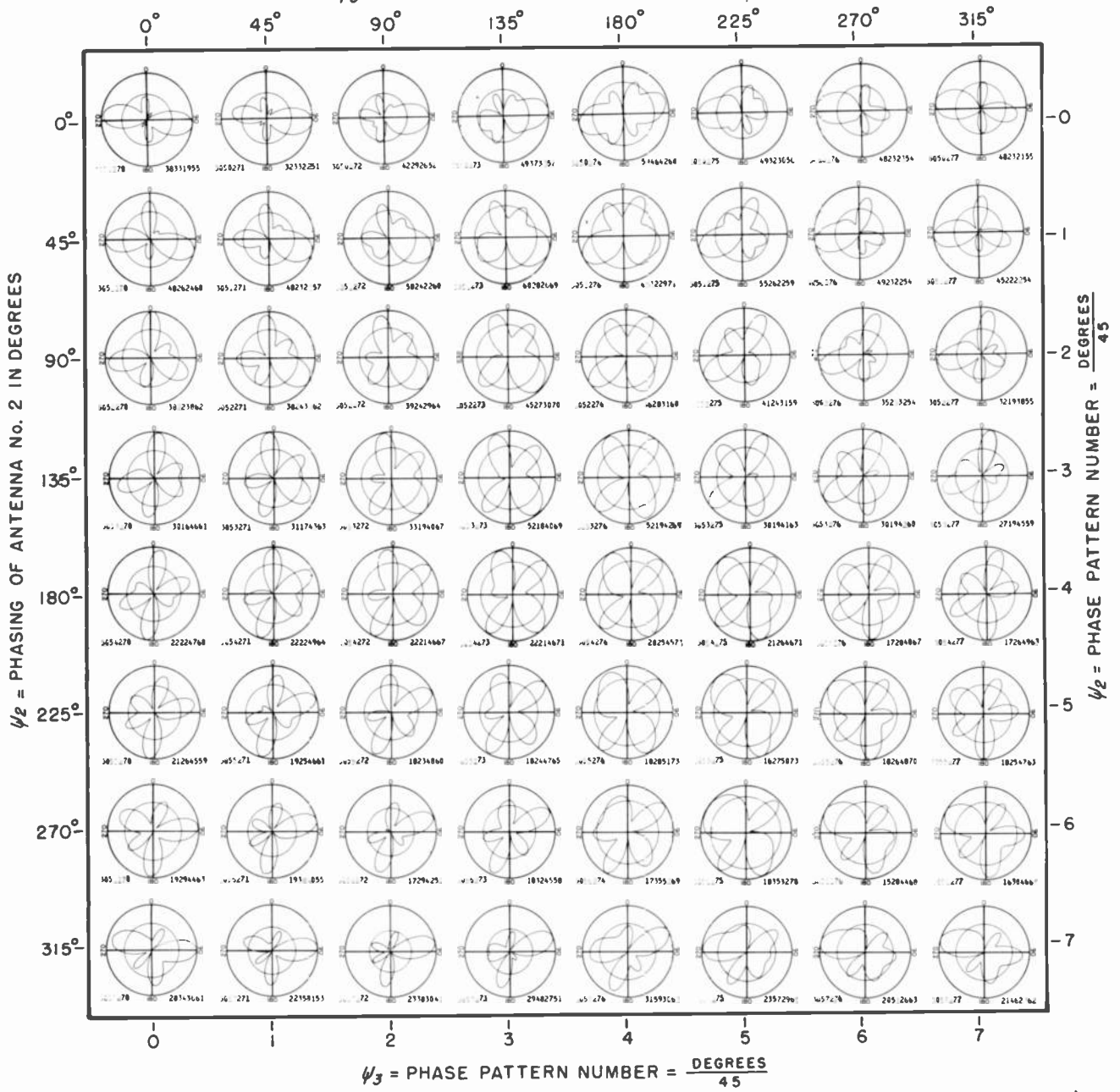

NUMBER OF ANTENNAS IN THE SYSTEM	ORIENTATION OF NO. 2 ANTENNA = $\frac{\text{DEGREES}}{45}$	SPACING OF NO. 2 ANTENNA = $\frac{\text{DEGREES}}{45}$	PHASING OF NO. 2 ANTENNA = $\frac{\text{DEGREES}}{45}$	ORIENTATION OF NO. 3 ANTENNA = $\frac{\text{DEGREES}}{45}$	SPACING OF NO. 3 ANTENNA = $\frac{\text{DEGREES}}{45}$	PHASING OF NO. 3 ANTENNA = $\frac{\text{DEGREES}}{45}$
No.	$\phi_2$	$S_2$	$\psi_2$	$\phi_3$	$S_3$	$\psi_3$
3	0	5	0	2	7	0

% FIELD INTENSITY RADIATED IN HORIZONTAL PLANE FROM NO. 1 ANTENNA.	% FIELD INTENSITY RADIATED IN HORIZONTAL PLANE FROM NO. 2 ANTENNA.	% FIELD INTENSITY RADIATED IN HORIZONTAL PLANE FROM NO. 3 ANTENNA.	% RMS FIELD INTENSITY RADIATED IN HORIZONTAL PLANE FROM ANTENNA SYSTEM.
$E_1$	$E_2$	$E_3$	$E_0$
38	33	19	55

LEFT HAND PATTERN NUMBER GIVES ANTENNA PLACEMENT AND PHASING DATA.

RIGHT HAND PATTERN NUMBER GIVES ANTENNA FIELD INTENSITY DATA IN PERCENT.

SPOTS LOCATE THE ANTENNAS FOR THIS PAGE OF PATTERNS IN THE SYSTEMIZATION PLACEMENT CHART.

PATTERN NOMENCLATURE

$\psi_3$  = PHASING OF ANTENNA No. 3 IN DEGREES

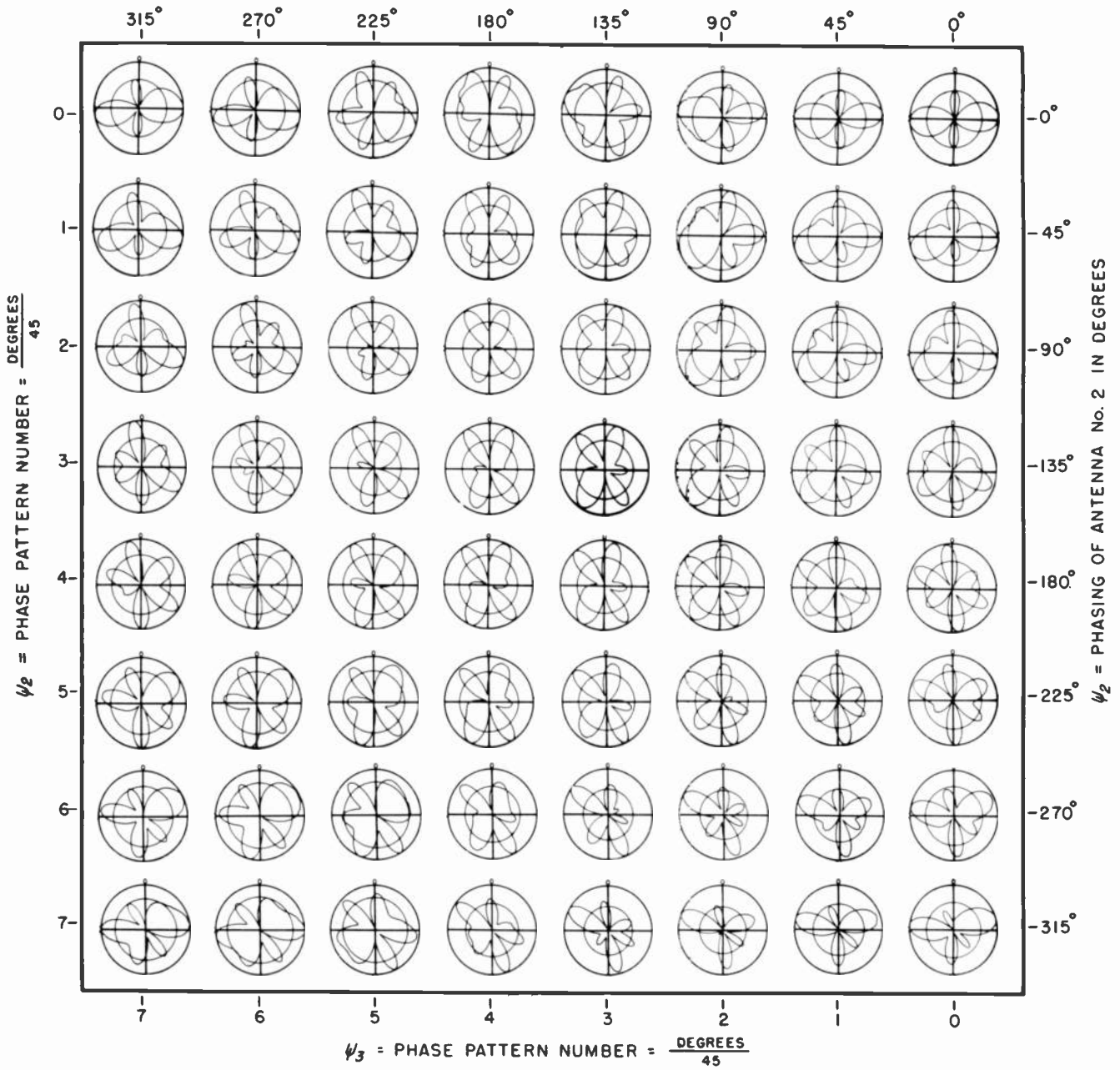

NUMBER OF ANTENNAS IN THE SYSTEM  
 NO.  $\phi_2$  3  
 ORIENTATION OF NO. 2 ANTENNA =  $\frac{\text{DEGREES}}{45}$  0  
 SPACING OF NO. 2 ANTENNA =  $\frac{\text{DEGREES}}{45}$  5  
 PHASING OF NO. 2 ANTENNA =  $\frac{\text{DEGREES}}{45}$  0  
 ORIENTATION OF NO. 3 ANTENNA =  $\frac{\text{DEGREES}}{45}$  6  
 SPACING OF NO. 3 ANTENNA =  $\frac{\text{DEGREES}}{45}$  8  
 PHASING OF NO. 3 ANTENNA =  $\frac{\text{DEGREES}}{45}$  0

LEFT HAND PATTERN NUMBER GIVES ANTENNA PLACEMENT AND PHASING DATA.

% FIELD INTENSITY RADIATED IN HORIZONTAL PLANE FROM NO. 1 ANTENNA.  $E_1$  46  
 % FIELD INTENSITY RADIATED IN HORIZONTAL PLANE FROM NO. 2 ANTENNA.  $E_2$  17  
 % FIELD INTENSITY RADIATED IN HORIZONTAL PLANE FROM NO. 3 ANTENNA.  $E_3$  26  
 % RMS FIELD INTENSITY RADIATED IN HORIZONTAL PLANE FROM ANTENNA SYSTEM.  $E_0$  63

RIGHT HAND PATTERN NUMBER GIVES ANTENNA FIELD INTENSITY DATA IN PERCENT.

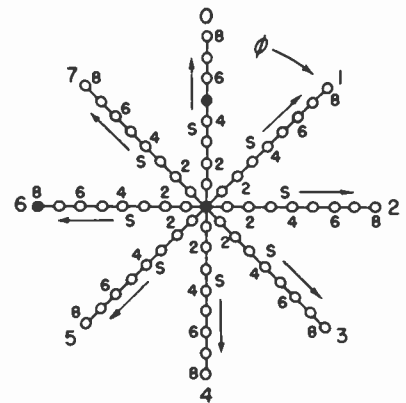

SPOTS LOCATE THE ANTENNAS FOR THIS PAGE OF PATTERNS IN THE SYSTEMIZATION PLACEMENT CHART.

PATTERN NOMENCLATURE

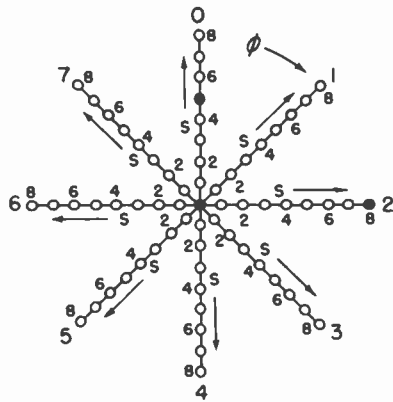
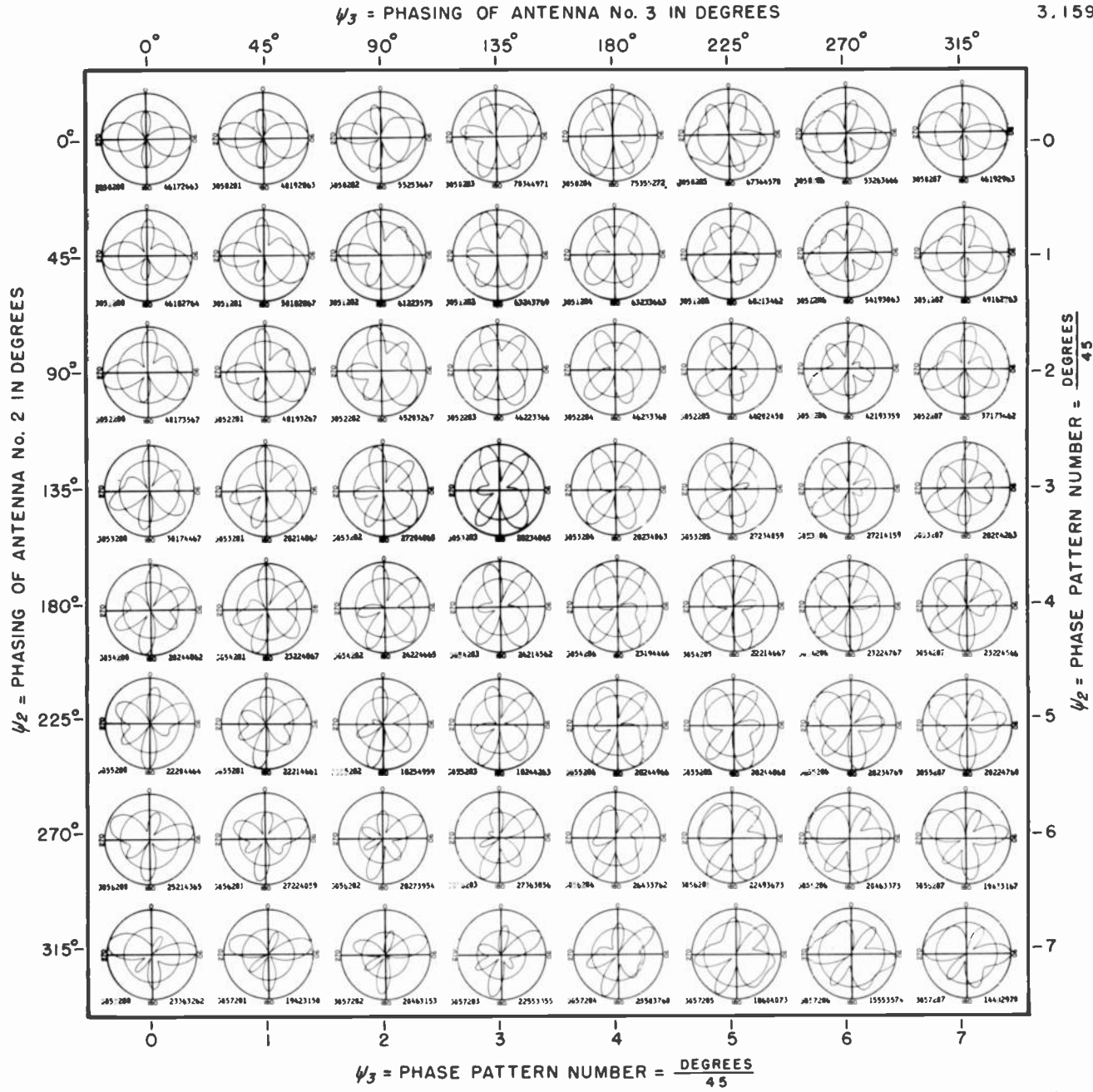

$\psi_3 = \text{PHASE PATTERN NUMBER} = \frac{\text{DEGREES}}{45}$

NUMBER OF ANTENNAS IN THE SYSTEM	ORIENTATION OF NO. 2 ANTENNA = $\frac{\text{DEGREES}}{45}$	SPACING OF NO. 2 ANTENNA = $\frac{\text{DEGREES}}{45}$	PHASING OF NO. 2 ANTENNA = $\frac{\text{DEGREES}}{45}$	ORIENTATION OF NO. 3 ANTENNA = $\frac{\text{DEGREES}}{45}$	SPACING OF NO. 3 ANTENNA = $\frac{\text{DEGREES}}{45}$	PHASING OF NO. 3 ANTENNA = $\frac{\text{DEGREES}}{45}$
No. 3	$\phi_2$ 0	$S_2$ 5	$\psi_2$ 0	$\phi_3$ 2	$S_3$ 8	$\psi_3$ 0

LEFT HAND PATTERN NUMBER GIVES ANTENNA  
PLACEMENT AND PHASING DATA.

% FIELD INTENSITY RADIATED IN HORIZONTAL PLANE FROM NO. 1 ANTENNA.	% FIELD INTENSITY RADIATED IN HORIZONTAL PLANE FROM NO. 2 ANTENNA.	% FIELD INTENSITY RADIATED IN HORIZONTAL PLANE FROM NO. 3 ANTENNA.	% RMS FIELD INTENSITY RADIATED IN HORIZONTAL PLANE FROM ANTENNA SYSTEM.
$E_1$ 46	$E_2$ 17	$E_3$ 26	$E_0$ 63

RIGHT HAND PATTERN NUMBER  
GIVES ANTENNA FIELD INTEN-  
SITY DATA IN PERCENT.

SPOTS LOCATE THE ANTENNAS FOR  
THIS PAGE OF PATTERNS IN THE  
SYSTEMATIZATION PLACEMENT CHART.

PATTERN NOMENCLATURE

$\psi_3$  = PHASING OF ANTENNA No. 3 IN DEGREES

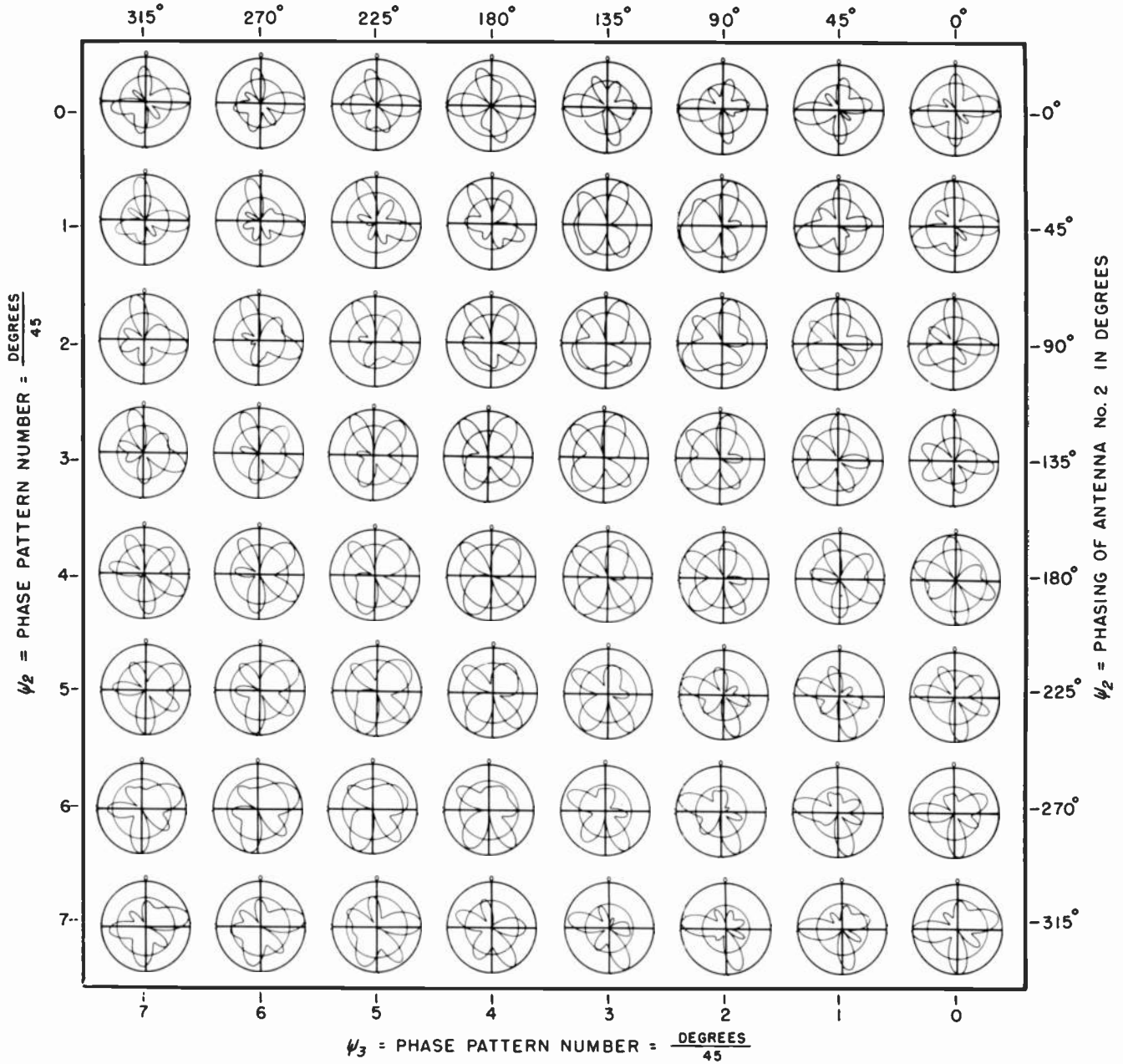

NUMBER OF ANTENNAS IN THE SYSTEM	ORIENTATION OF NO. 2 ANTENNA = $\frac{\text{DEGREES}}{45}$	SPACING OF NO. 2 ANTENNA = $\frac{\text{DEGREES}}{45}$	PHASING OF NO. 2 ANTENNA = $\frac{\text{DEGREES}}{45}$	ORIENTATION OF NO. 3 ANTENNA = $\frac{\text{DEGREES}}{45}$	SPACING OF NO. 3 ANTENNA = $\frac{\text{DEGREES}}{45}$	PHASING OF NO. 3 ANTENNA = $\frac{\text{DEGREES}}{45}$
No. 3	$\phi_2$ 0	$S_2$ 6	$\psi_2$ 0	$\phi_3$ 6	$S_3$ 7	$\psi_3$ 0

LEFT HAND PATTERN NUMBER GIVES ANTENNA PLACEMENT AND PHASING DATA.

% FIELD INTENSITY RADIATED IN HORIZONTAL PLANE FROM NO. 1 ANTENNA.	% FIELD INTENSITY RADIATED IN HORIZONTAL PLANE FROM NO. 2 ANTENNA.	% FIELD INTENSITY RADIATED IN HORIZONTAL PLANE FROM NO. 3 ANTENNA.	% RMS FIELD INTENSITY RADIATED IN HORIZONTAL PLANE FROM ANTENNA SYSTEM.
$E_1$ 31	$E_2$ 28	$E_3$ 34	$E_0$ 62

RIGHT HAND PATTERN NUMBER GIVES ANTENNA FIELD INTENSITY DATA IN PERCENT.

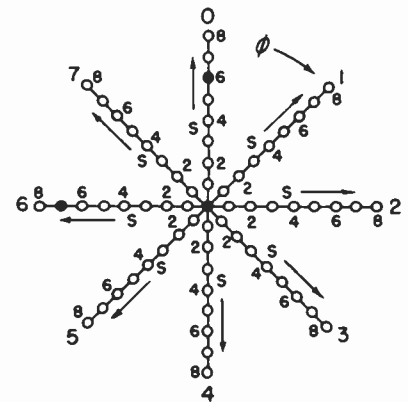

SPOTS LOCATE THE ANTENNAS FOR THIS PAGE OF PATTERNS IN THE SYSTEMATIZATION PLACEMENT CHART.

PATTERN NOMENCLATURE

$\psi_3$  = PHASING OF ANTENNA No. 3 IN DEGREES

3.161

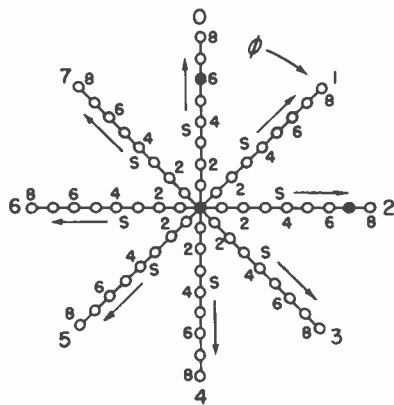
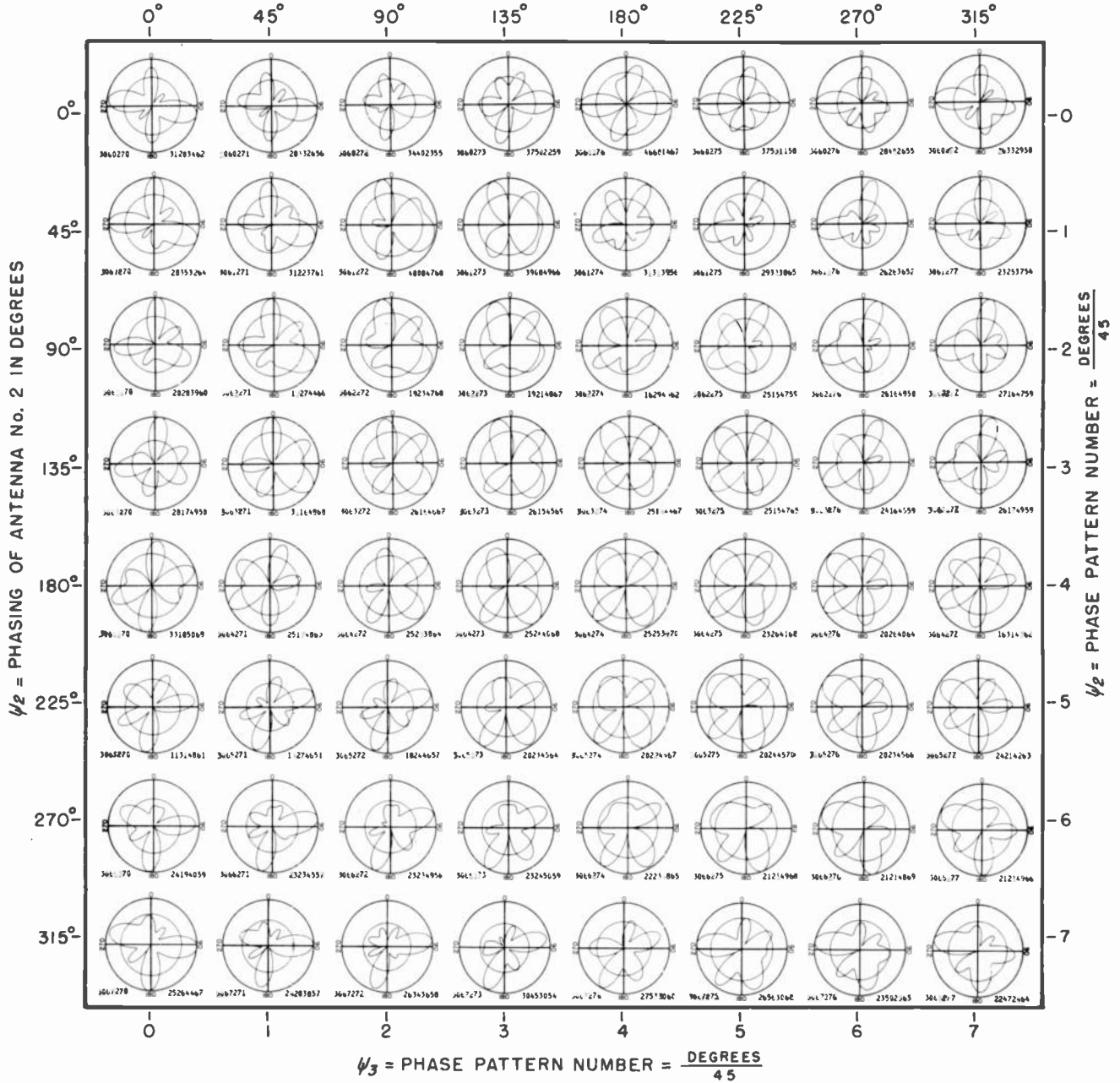

SPOTS LOCATE THE ANTENNAS FOR  
THIS PAGE OF PATTERNS IN THE  
SYSTEMATIZATION PLACEMENT CHART.

NO.	$\phi_2$	$S_2$	$\psi_2$	$\phi_3$	$S_3$	$\psi_3$
3	0	6	0	2	7	0

LEFT HAND PATTERN NUMBER GIVES ANTENNA  
PLACEMENT AND PHASING DATA.

$E_1$	$E_2$	$E_3$	$E_0$
31	28	34	62

RIGHT HAND PATTERN NUMBER  
GIVES ANTENNA FIELD INTEN-  
SITY DATA IN PERCENT.

PATTERN NOMENCLATURE

$\psi_3$  = PHASING OF ANTENNA No. 3 IN DEGREES

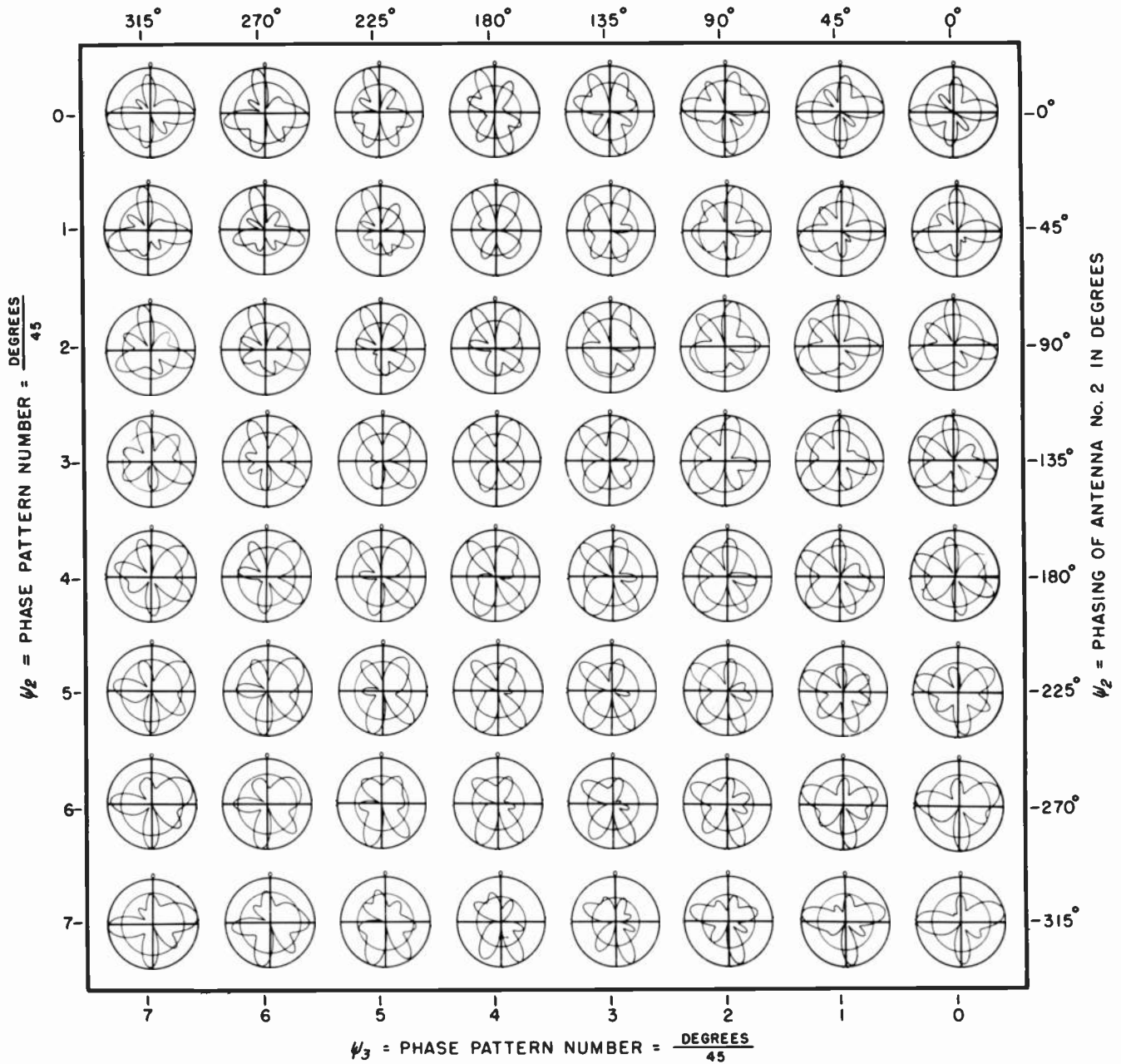

NUMBER OF ANTENNAS  
IN THE SYSTEM

No. 3

ORIENTATION OF  
NO. 2 ANTENNA =  $\frac{DEGREES}{45}$

$\phi_2$

SPACING OF  
NO. 2 ANTENNA =  $\frac{DEGREES}{45}$

$S_2$

PHASING OF  
NO. 2 ANTENNA =  $\frac{DEGREES}{45}$

$\psi_2$

ORIENTATION OF  
NO. 3 ANTENNA =  $\frac{DEGREES}{45}$

$\phi_3$

SPACING OF  
NO. 3 ANTENNA =  $\frac{DEGREES}{45}$

$S_3$

PHASING OF  
NO. 3 ANTENNA =  $\frac{DEGREES}{45}$

$\psi_3$

% FIELD INTENSITY  
RADIATED IN HORIZONTAL  
PLANE FROM NO. 1 ANTENNA.

$F_1$

% FIELD INTENSITY  
RADIATED IN HORIZONTAL  
PLANE FROM NO. 2 ANTENNA.

$F_2$

% FIELD INTENSITY  
RADIATED IN HORIZONTAL  
PLANE FROM NO. 3 ANTENNA.

$F_3$

% RMS FIELD INTENSITY  
RADIATED IN HORIZONTAL  
PLANE FROM ANTENNA SYSTEM.

$F_0$

LEFT HAND PATTERN NUMBER GIVES ANTENNA  
PLACEMENT AND PHASING DATA.

RIGHT HAND PATTERN NUMBER  
GIVES ANTENNA FIELD INTEN-  
SITY DATA IN PERCENT.

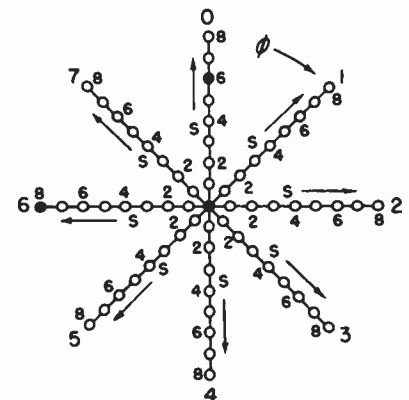

SPOTS LOCATE THE ANTENNAS FOR  
THIS PAGE OF PATTERNS IN THE  
SYSTEMATIZATION PLACEMENT CHART.

PATTERN NOMENCLATURE



$\psi_3$  = PHASING OF ANTENNA No. 3 IN DEGREES

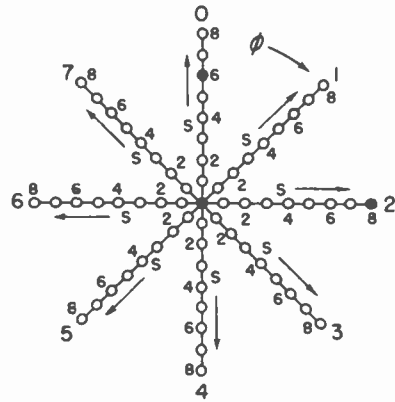
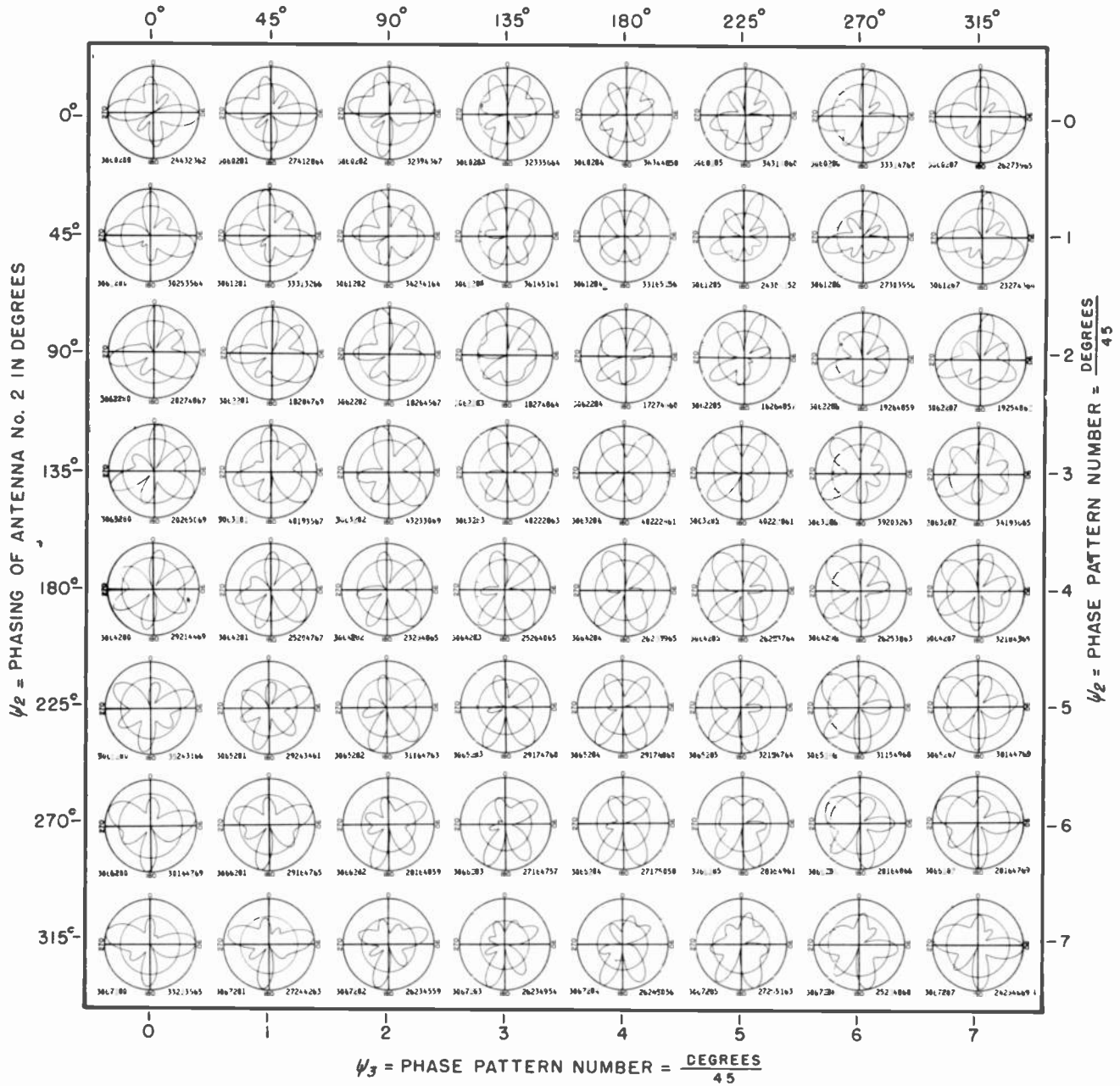

$\psi_3$  = PHASE PATTERN NUMBER =  $\frac{\text{DEGREES}}{45}$

NUMBER OF ANTENNAS IN THE SYSTEM	ORIENTATION OF NO. 2 ANTENNA = $\frac{\text{DEGREES}}{45}$	SPACING OF NO. 2 ANTENNA = $\frac{\text{DEGREES}}{45}$	PHASING OF NO. 2 ANTENNA = $\frac{\text{DEGREES}}{45}$	ORIENTATION OF NO. 3 ANTENNA = $\frac{\text{DEGREES}}{45}$	SPACING OF NO. 3 ANTENNA = $\frac{\text{DEGREES}}{45}$	PHASING OF NO. 3 ANTENNA = $\frac{\text{DEGREES}}{45}$
No. 3	$\phi_2$ 0	$S_2$ 6	$\psi_2$ 0	$\phi_3$ 2	$S_3$ 8	$\psi_3$ 0

LEFT HAND PATTERN NUMBER GIVES ANTENNA PLACEMENT AND PHASING DATA.

% FIELD INTENSITY RADIATED IN HORIZONTAL PLANE FROM NO. 1 ANTENNA	% FIELD INTENSITY RADIATED IN HORIZONTAL PLANE FROM NO. 2 ANTENNA.	% FIELD INTENSITY RADIATED IN HORIZONTAL PLANE FROM NO. 3 ANTENNA.	% RMS FIELD INTENSITY RADIATED IN HORIZONTAL PLANE FROM ANTENNA SYSTEM.
$E_1$ 24	$E_2$ 43	$E_3$ 23	$E_0$ 62

RIGHT HAND PATTERN NUMBER GIVES ANTENNA FIELD INTENSITY DATA IN PERCENT.

SPOTS LOCATE THE ANTENNAS FOR THIS PAGE OF PATTERNS IN THE SYSTEMATIZATION PLACEMENT CHART.

PATTERN NOMENCLATURE

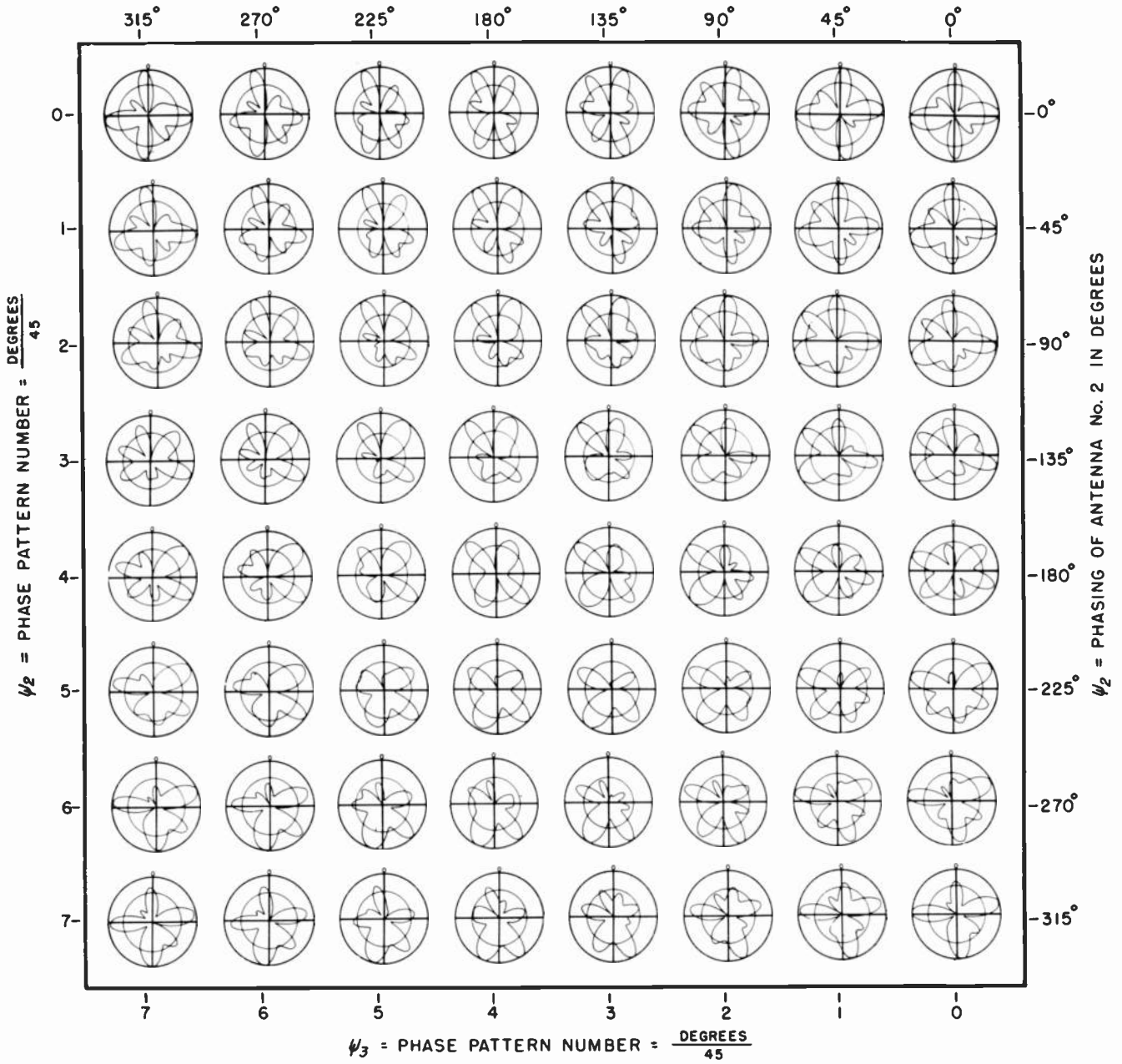

NUMBER OF ANTENNAS IN THE SYSTEM  
 NO. 3

ORIENTATION OF NO. 2 ANTENNA =  $\frac{\text{DEGREES}}{45}$   
 $\phi_2$  0

SPACING OF NO. 2 ANTENNA =  $\frac{\text{DEGREES}}{45}$   
 $S_2$  7

PHASING OF NO. 2 ANTENNA =  $\frac{\text{DEGREES}}{45}$   
 $\psi_2$  0

ORIENTATION OF NO. 3 ANTENNA =  $\frac{\text{DEGREES}}{45}$   
 $\phi_3$  6

SPACING OF NO. 3 ANTENNA =  $\frac{\text{DEGREES}}{45}$   
 $S_3$  8

PHASING OF NO. 3 ANTENNA =  $\frac{\text{DEGREES}}{45}$   
 $\psi_3$  0

LEFT HAND PATTERN NUMBER GIVES ANTENNA PLACEMENT AND PHASING DATA.

% FIELD INTENSITY RADIATED IN HORIZONTAL PLANE FROM NO. 1 ANTENNA.  
 $E_1$  27

% FIELD INTENSITY RADIATED IN HORIZONTAL PLANE FROM NO. 2 ANTENNA.  
 $E_2$  20

% FIELD INTENSITY RADIATED IN HORIZONTAL PLANE FROM NO. 3 ANTENNA.  
 $E_3$  42

% RMS FIELD INTENSITY RADIATED IN HORIZONTAL PLANE FROM ANTENNA SYSTEM.  
 $E_0$  67

RIGHT HAND PATTERN NUMBER GIVES ANTENNA FIELD INTENSITY DATA IN PERCENT.

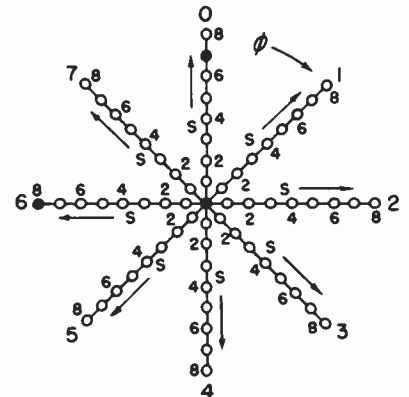

SPOTS LOCATE THE ANTENNAS FOR THIS PAGE OF PATTERNS IN THE SYSTEMATIZATION PLACEMENT CHART.

PATTERN NOMENCLATURE

$\psi_3$  = PHASING OF ANTENNA No. 3 IN DEGREES

3.165

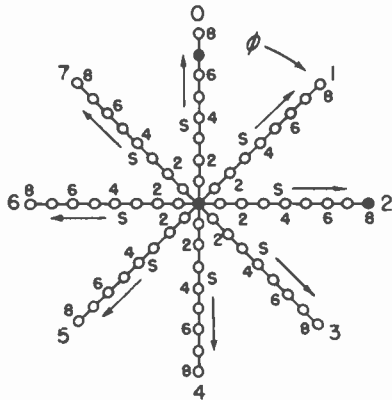
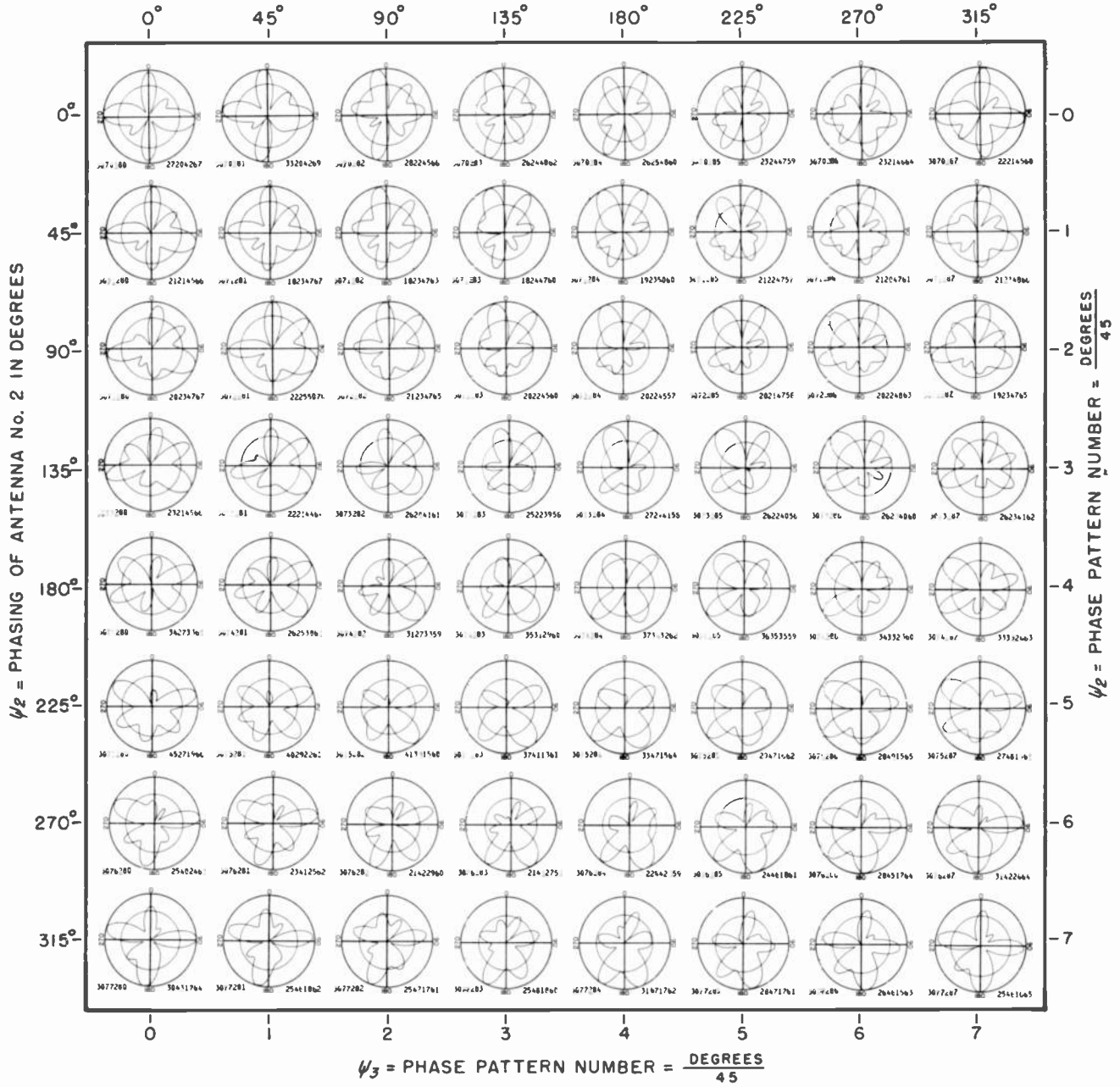

SPOTS LOCATE THE ANTENNAS FOR THIS PAGE OF PATTERNS IN THE SYSTEMATIZATION PLACEMENT CHART.

NO.	$\phi_2$	$S_2$	$\psi_2$	$\phi_3$	$S_3$	$\psi_3$
3	0	7	0	2	8	0

LEFT HAND PATTERN NUMBER GIVES ANTENNA PLACEMENT AND PHASING DATA.

$E_1$	$E_2$	$E_3$	$E_0$
27	20	42	67

RIGHT HAND PATTERN NUMBER GIVES ANTENNA FIELD INTENSITY DATA IN PERCENT.

PATTERN NOMENCLATURE

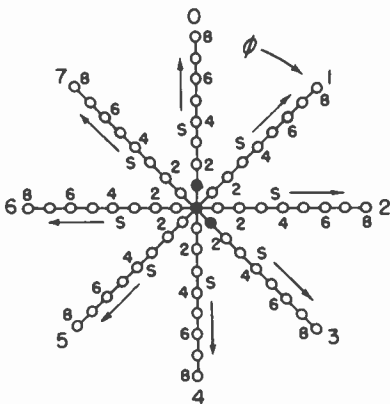
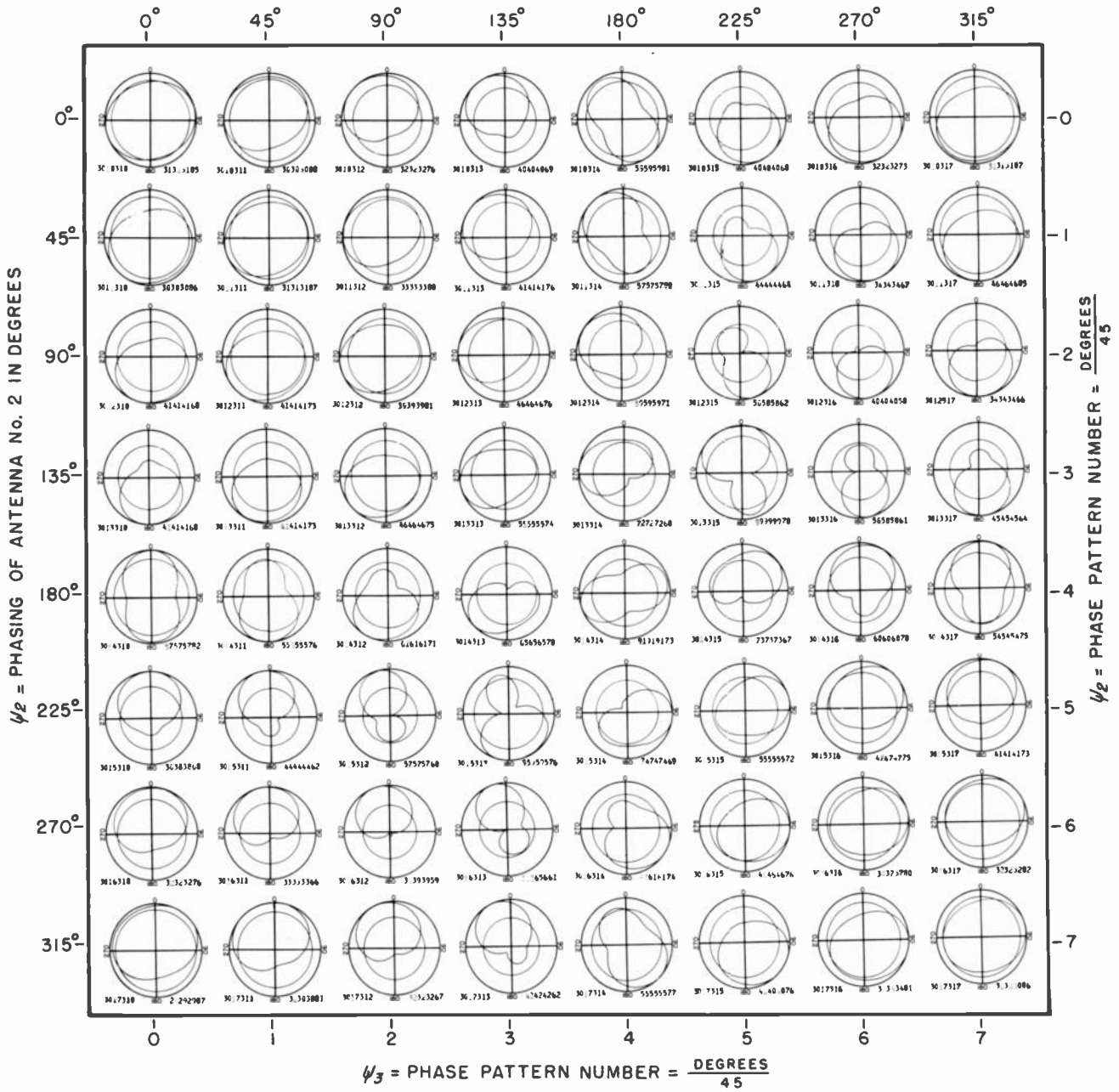

NUMBER OF ANTENNAS IN THE SYSTEM	ORIENTATION OF NO. 2 ANTENNA = $\frac{\text{DEGREES}}{45}$	SPACING OF NO. 2 ANTENNA = $\frac{\text{DEGREES}}{45}$	PHASING OF NO. 2 ANTENNA = $\frac{\text{DEGREES}}{45}$	ORIENTATION OF NO. 3 ANTENNA = $\frac{\text{DEGREES}}{45}$	SPACING OF NO. 3 ANTENNA = $\frac{\text{DEGREES}}{45}$	PHASING OF NO. 3 ANTENNA = $\frac{\text{DEGREES}}{45}$
No. 3	$\psi_2 = 0$	$S_2 = 1$	$\psi_2 = 0$	$\phi_3 = 3$	$S_3 = 1$	$\psi_3 = 0$

% FIELD INTENSITY RADIATED IN HORIZONTAL PLANE FROM NO. 1 ANTENNA.	% FIELD INTENSITY RADIATED IN HORIZONTAL PLANE FROM NO. 2 ANTENNA.	% FIELD INTENSITY RADIATED IN HORIZONTAL PLANE FROM NO. 3 ANTENNA.	% RMS FIELD INTENSITY RADIATED IN HORIZONTAL PLANE FROM ANTENNA SYSTEM.
$E_1 = 31$	$E_2 = 31$	$E_3 = 31$	$E_0 = 85$

LEFT HAND PATTERN NUMBER GIVES ANTENNA PLACEMENT AND PHASING DATA.

RIGHT HAND PATTERN NUMBER GIVES ANTENNA FIELD INTENSITY DATA IN PERCENT.

SPOTS LOCATE THE ANTENNAS FOR THIS PAGE OF PATTERNS IN THE SYSTEMATIZATION PLACEMENT CHART.

PATTERN NOMENCLATURE.

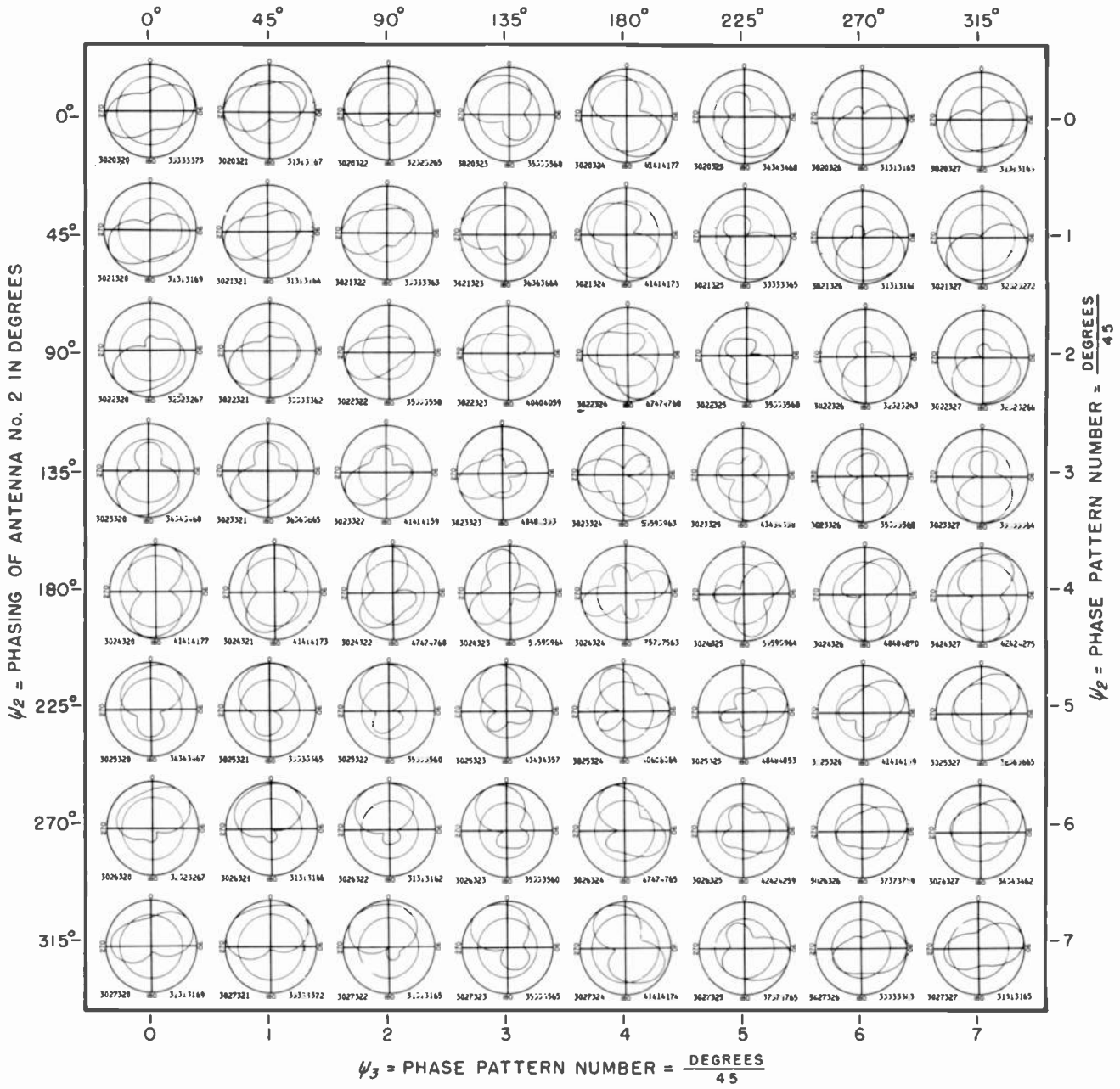

COPYRIGHT 1946 BY CARL F. SMITH  
PRINTED IN U. S. A.

CLEVELAND INSTITUTE OF RADIO ELECTRONICS  
TERMINAL TOWER, CLEVELAND 13, OHIO.

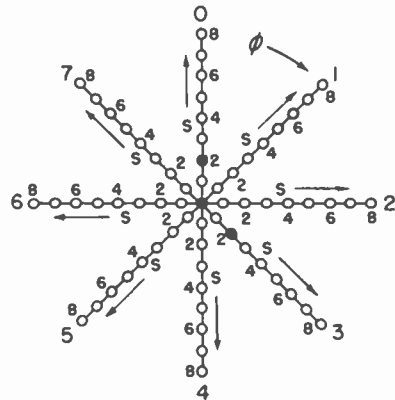

$\psi_3$  = PHASE PATTERN NUMBER =  $\frac{\text{DEGREES}}{45}$

NUMBER OF ANTENNAS IN THE SYSTEM	ORIENTATION OF NO. 2 ANTENNA = $\frac{\text{DEGREES}}{45}$	SPACING OF NO. 2 ANTENNA = $\frac{\text{DEGREES}}{45}$	PHASING OF NO. 2 ANTENNA = $\frac{\text{DEGREES}}{45}$	ORIENTATION OF NO. 3 ANTENNA = $\frac{\text{DEGREES}}{45}$	SPACING OF NO. 3 ANTENNA = $\frac{\text{DEGREES}}{45}$	PHASING OF NO. 3 ANTENNA = $\frac{\text{DEGREES}}{45}$
No. 3	$\phi_2$ 0	$S_2$ 2	$\psi_2$ 0	$\phi_3$ 3	$S_3$ 2	$\psi_3$ 0

LEFT HAND PATTERN NUMBER GIVES ANTENNA PLACEMENT AND PHASING DATA.

% FIELD INTENSITY RADIATED IN HORIZONTAL PLANE FROM NO. 1 ANTENNA.	% FIELD INTENSITY RADIATED IN HORIZONTAL PLANE FROM NO. 2 ANTENNA.	% FIELD INTENSITY RADIATED IN HORIZONTAL PLANE FROM NO. 3 ANTENNA.	% RMS FIELD INTENSITY RADIATED IN HORIZONTAL PLANE FROM ANTENNA SYSTEM.
$E_1$ 33	$E_2$ 33	$E_3$ 33	$E_0$ 73

RIGHT HAND PATTERN NUMBER GIVES ANTENNA FIELD INTENSITY DATA IN PERCENT.

SPOTS LOCATE THE ANTENNAS FOR THIS PAGE OF PATTERNS IN THE SYSTEMATIZATION PLACEMENT CHART.

PATTERN NOMENCLATURE

$\psi_3$  = PHASING OF ANTENNA No. 3 IN DEGREES

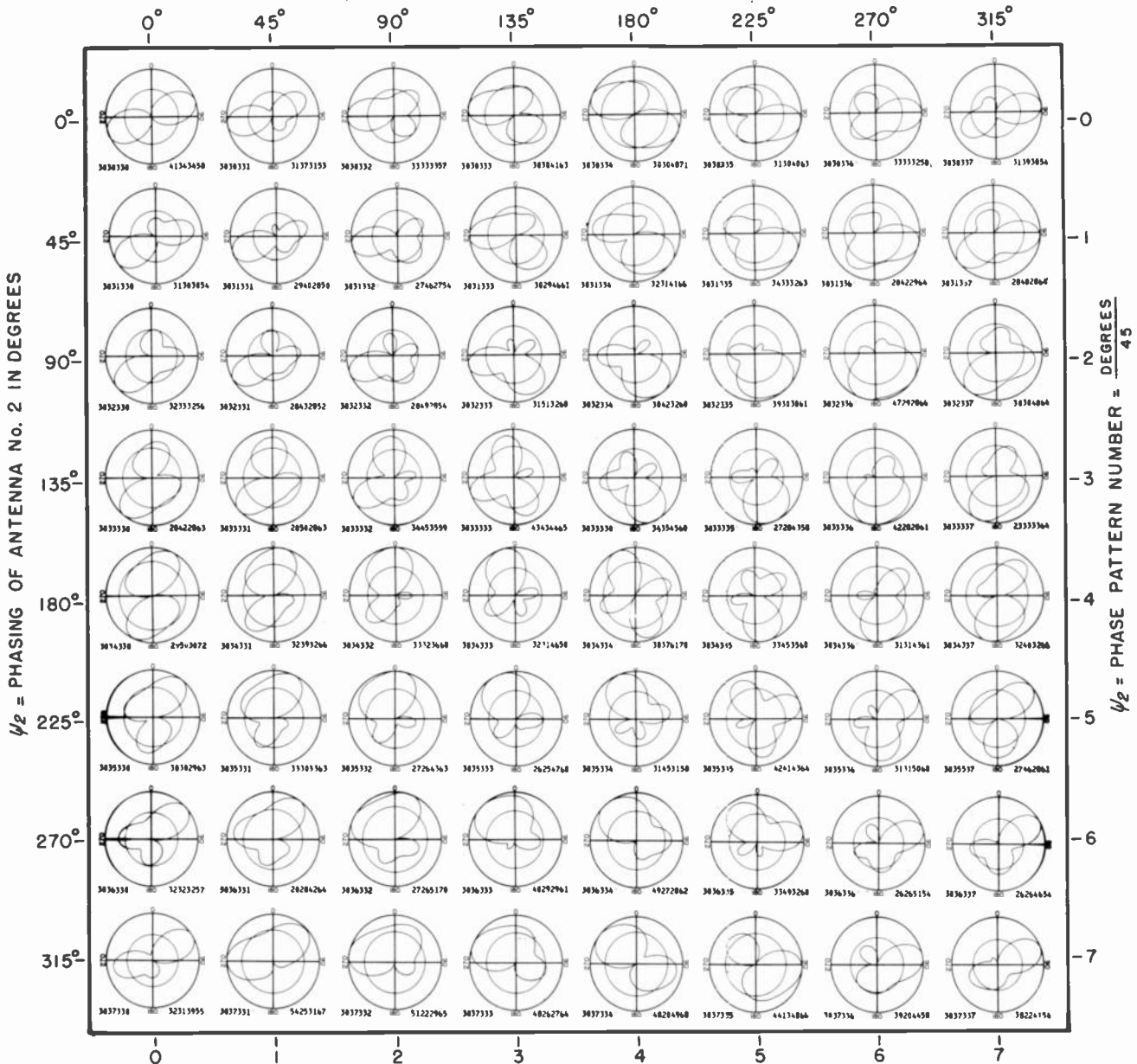

$\psi_3$  = PHASE PATTERN NUMBER =  $\frac{\text{DEGREES}}{45}$

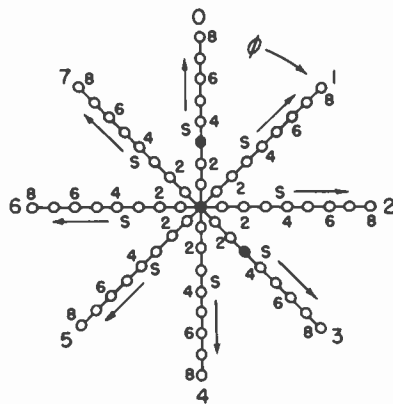

NUMBER OF ANTENNAS IN THE SYSTEM	ORIENTATION OF NO. 2 ANTENNA = $\frac{\text{DEGREES}}{45}$	SPACING OF NO. 2 ANTENNA = $\frac{\text{DEGREES}}{45}$	PHASING OF NO. 2 ANTENNA = $\frac{\text{DEGREES}}{45}$	ORIENTATION OF NO. 3 ANTENNA = $\frac{\text{DEGREES}}{45}$	SPACING OF NO. 3 ANTENNA = $\frac{\text{DEGREES}}{45}$	PHASING OF NO. 3 ANTENNA = $\frac{\text{DEGREES}}{45}$
No. 3	$\phi_2$ 0	$S_2$ 3	$\psi_2$ 0	$\phi_3$ 3	$S_3$ 3	$\psi_3$ 0

LEFT HAND PATTERN NUMBER GIVES ANTENNA PLACEMENT AND PHASING DATA.

% FIELD INTENSITY RADIATED IN HORIZONTAL PLANE FROM NO. 1 ANTENNA.	% FIELD INTENSITY RADIATED IN HORIZONTAL PLANE FROM NO. 2 ANTENNA.	% FIELD INTENSITY RADIATED IN HORIZONTAL PLANE FROM NO. 3 ANTENNA.	% RMS FIELD INTENSITY RADIATED IN HORIZONTAL PLANE FROM ANTENNA SYSTEM.
$E_1$ 41	$E_2$ 34	$E_3$ 34	$E_0$ 58

RIGHT HAND PATTERN NUMBER GIVES ANTENNA FIELD INTENSITY DATA IN PERCENT.

SPOTS LOCATE THE ANTENNAS FOR THIS PAGE OF PATTERNS IN THE SYSTEMATIZATION PLACEMENT CHART.

PATTERN NOMENCLATURE

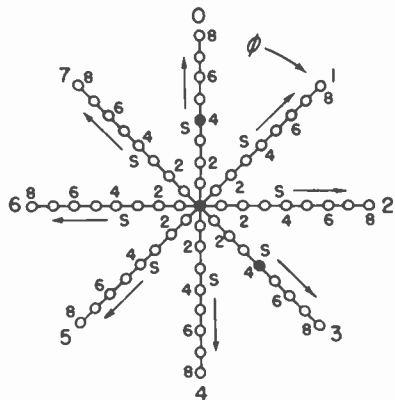
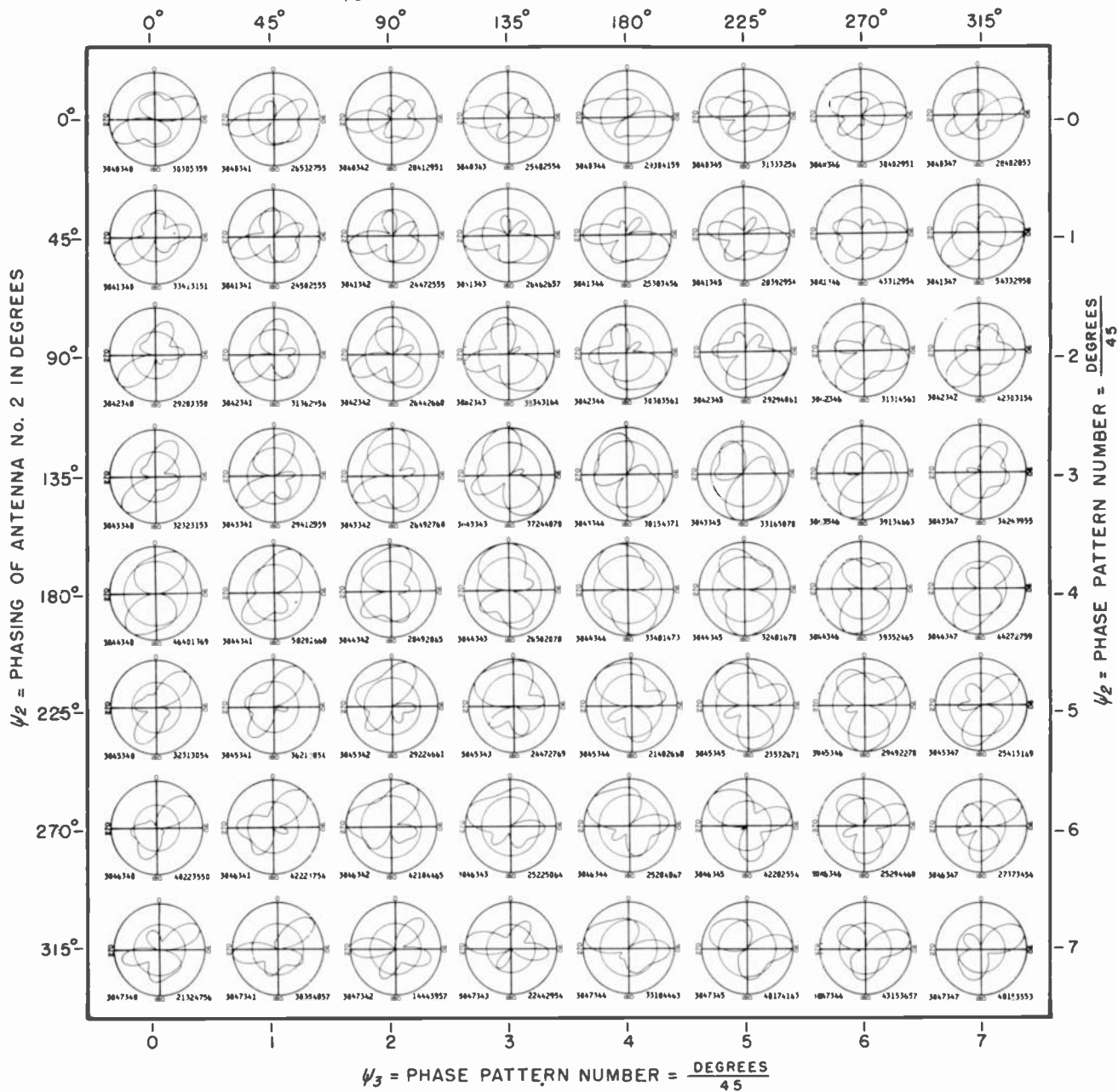

SPOTS LOCATE THE ANTENNAS FOR THIS PAGE OF PATTERNS IN THE SYSTEMATIZATION PLACEMENT CHART.

NUMBER OF ANTENNAS IN THE SYSTEM	ORIENTATION OF NO. 2 ANTENNA = $\frac{\text{DEGREES}}{45}$	SPACING OF NO. 2 ANTENNA = $\frac{\text{DEGREES}}{45}$	PHASING OF NO. 2 ANTENNA = $\frac{\text{DEGREES}}{45}$	ORIENTATION OF NO. 3 ANTENNA = $\frac{\text{DEGREES}}{45}$	SPACING OF NO. 3 ANTENNA = $\frac{\text{DEGREES}}{45}$	PHASING OF NO. 3 ANTENNA = $\frac{\text{DEGREES}}{45}$
No. 3	$\phi_2$ 0	$S_2$ 4	$\psi_2$ 0	$\phi_3$ 3	$S_3$ 4	$\psi_3$ 0

LEFT HAND PATTERN NUMBER GIVES ANTENNA PLACEMENT AND PHASING DATA.

% FIELD INTENSITY RADIATED IN HORIZONTAL PLANE FROM NO. 1 ANTENNA.	% FIELD INTENSITY RADIATED IN HORIZONTAL PLANE FROM NO. 2 ANTENNA.	% FIELD INTENSITY RADIATED IN HORIZONTAL PLANE FROM NO. 3 ANTENNA.	% RMS FIELD INTENSITY RADIATED IN HORIZONTAL PLANE FROM ANTENNA SYSTEM.
$E_1$ 30	$E_2$ 30	$E_3$ 53	$E_0$ 59

RIGHT HAND PATTERN NUMBER GIVES ANTENNA FIELD INTENSITY DATA IN PERCENT.

PATTERN NOMENCLATURE

$\psi_3 =$  PHASING OF ANTENNA No. 3 IN DEGREES

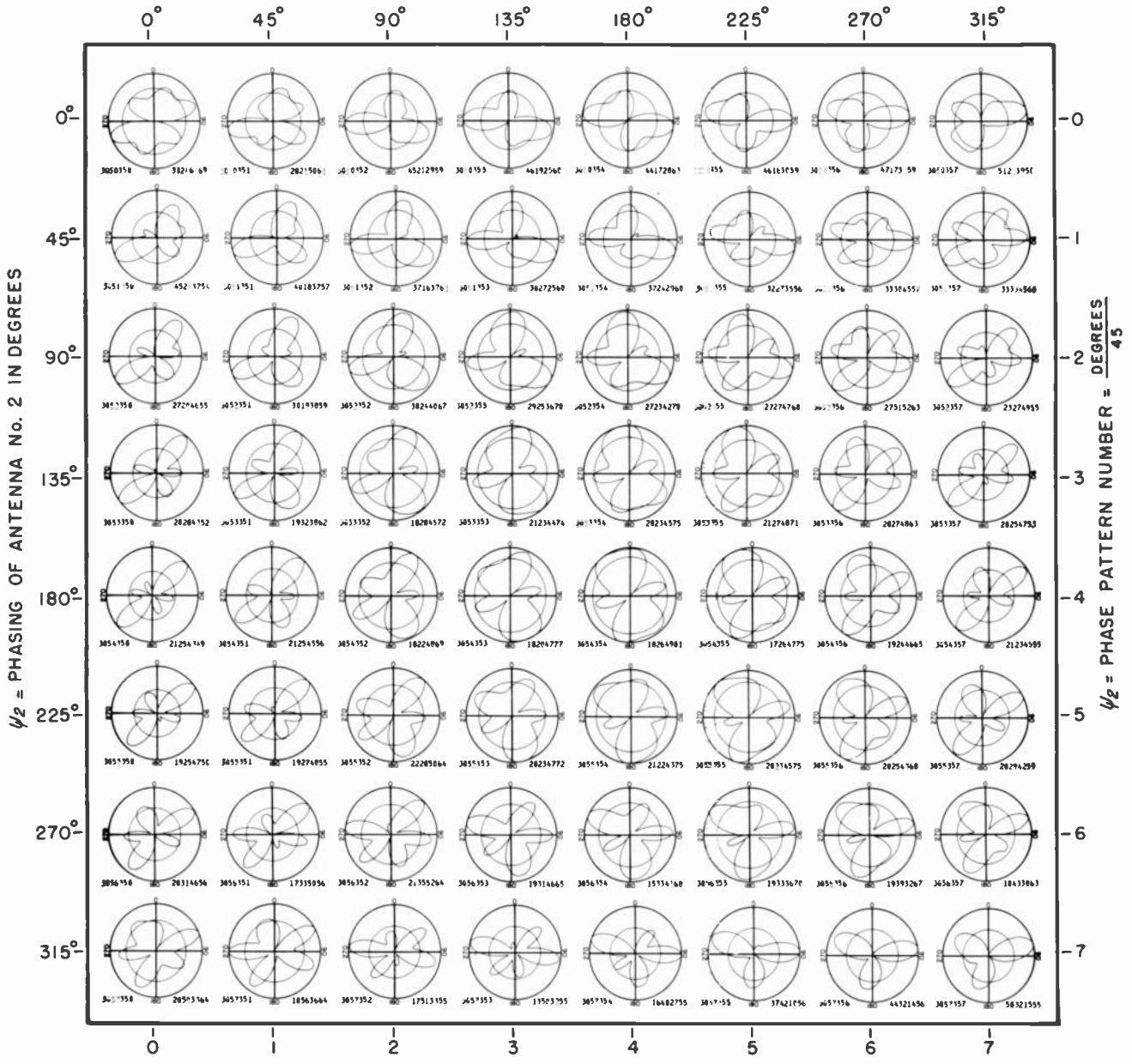

$\psi_3 =$  PHASE PATTERN NUMBER =  $\frac{\text{DEGREES}}{45}$

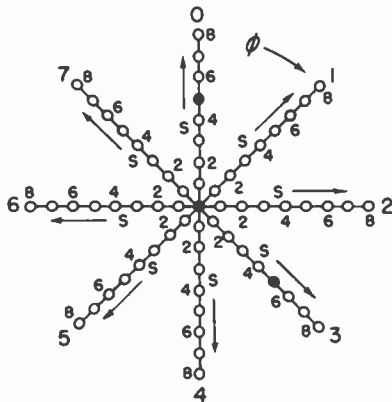

SPOTS LOCATE THE ANTENNAS FOR THIS PAGE OF PATTERNS IN THE SYSTEMIZATION PLACEMENT CHART.

NUMBER OF ANTENNAS IN THE SYSTEM	ORIENTATION OF DEGREES $\frac{\text{DEGREES}}{45}$	SPACING OF DEGREES $\frac{\text{DEGREES}}{45}$	PHASING OF DEGREES $\frac{\text{DEGREES}}{45}$	ORIENTATION OF DEGREES $\frac{\text{DEGREES}}{45}$	SPACING OF DEGREES $\frac{\text{DEGREES}}{45}$	PHASING OF DEGREES $\frac{\text{DEGREES}}{45}$
No. 3	$\phi_2$	$S_2$	$\psi_2$	$\phi_3$	$S_3$	$\psi_3$
3	0	5	0	3	5	0

LEFT HAND PATTERN NUMBER GIVES ANTENNA PLACEMENT AND PHASING DATA.

% FIELD INTENSITY RADIATED IN HORIZONTAL PLANE FROM NO. 1 ANTENNA.	% FIELD INTENSITY RADIATED IN HORIZONTAL PLANE FROM NO. 2 ANTENNA.	% FIELD INTENSITY RADIATED IN HORIZONTAL PLANE FROM NO. 3 ANTENNA.	% RMS FIELD INTENSITY RADIATED IN HORIZONTAL PLANE FROM ANTENNA SYSTEM.
$E_1$	$E_2$	$E_3$	$E_0$
30	24	61	69

RIGHT HAND PATTERN NUMBER GIVES ANTENNA FIELD INTENSITY DATA IN PERCENT.

PATTERN NOMENCLATURE



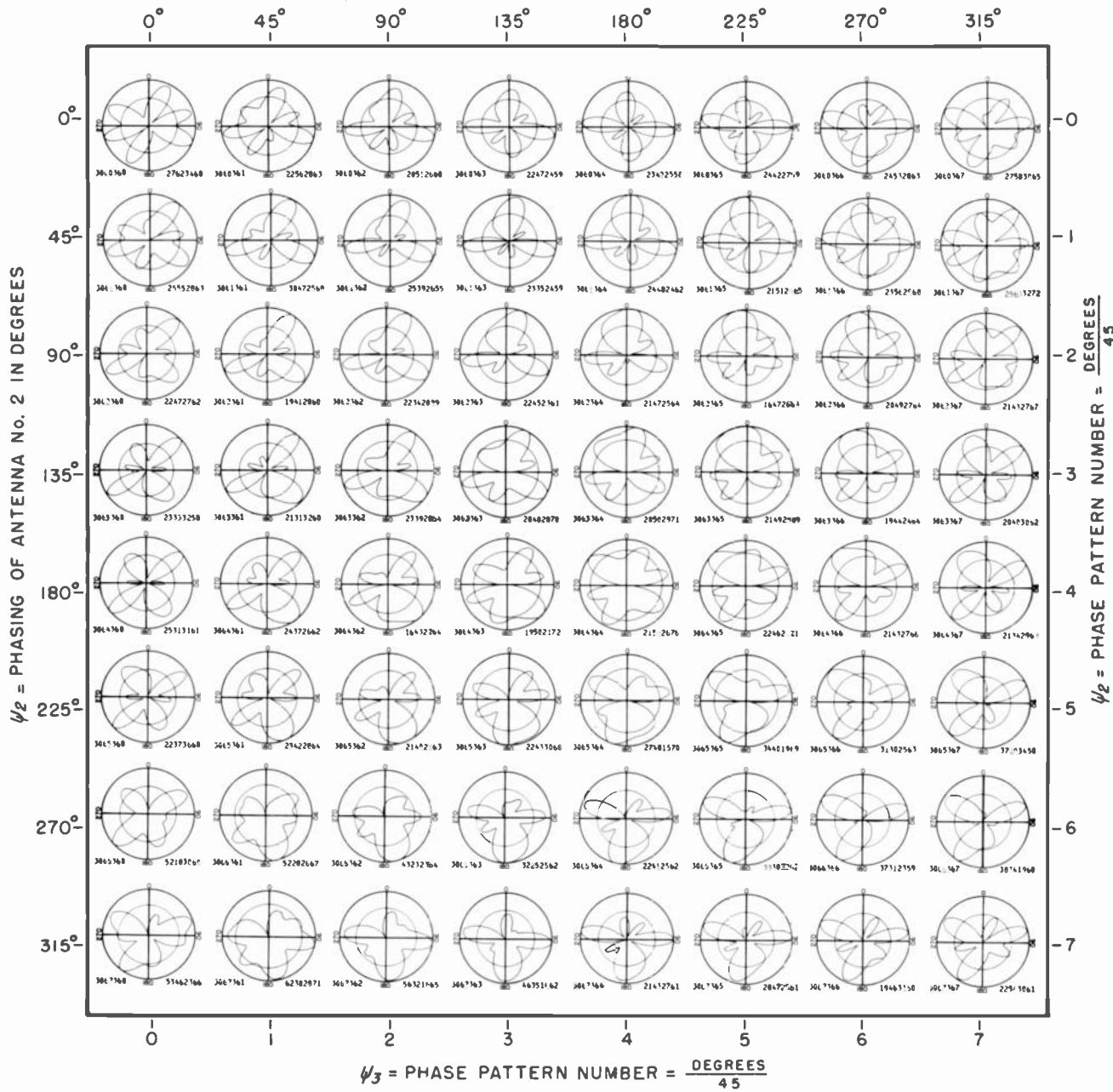

COPYRIGHT 1946 BY CARL E. SMITH  
PRINTED IN U. S. A.

CLEVELAND INSTITUTE OF RADIO ELECTRONICS  
TERMINAL TOWER, CLEVELAND 18, OHIO.

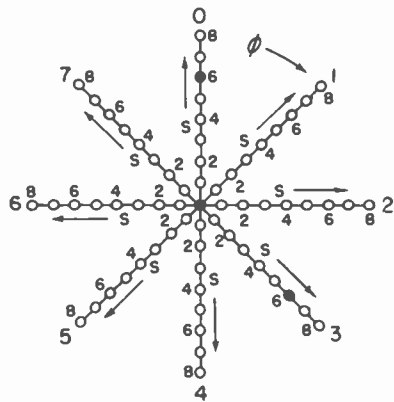

NO.	$\phi_2$	$S_2$	$\psi_2$	$\phi_3$	$S_3$	$\psi_3$
3	0	6	0	3	6	0

$E_1$	$E_2$	$E_3$	$E_0$
27	62	34	60

SPOTS LOCATE THE ANTENNAS FOR THIS PAGE OF PATTERNS IN THE SYSTEMATIZATION PLACEMENT CHART.

LEFT HAND PATTERN NUMBER GIVES ANTENNA PLACEMENT AND PHASING DATA.

RIGHT HAND PATTERN NUMBER GIVES ANTENNA FIELD INTENSITY DATA IN PERCENT.

PATTERN NOMENCLATURE

$\psi_3$  = PHASING OF ANTENNA No. 3 IN DEGREES

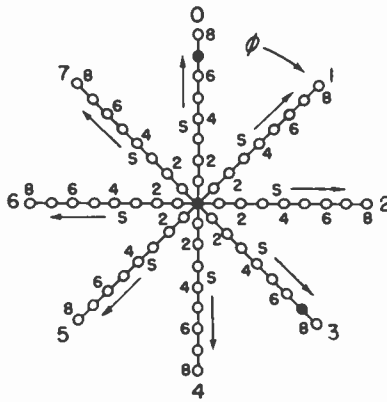
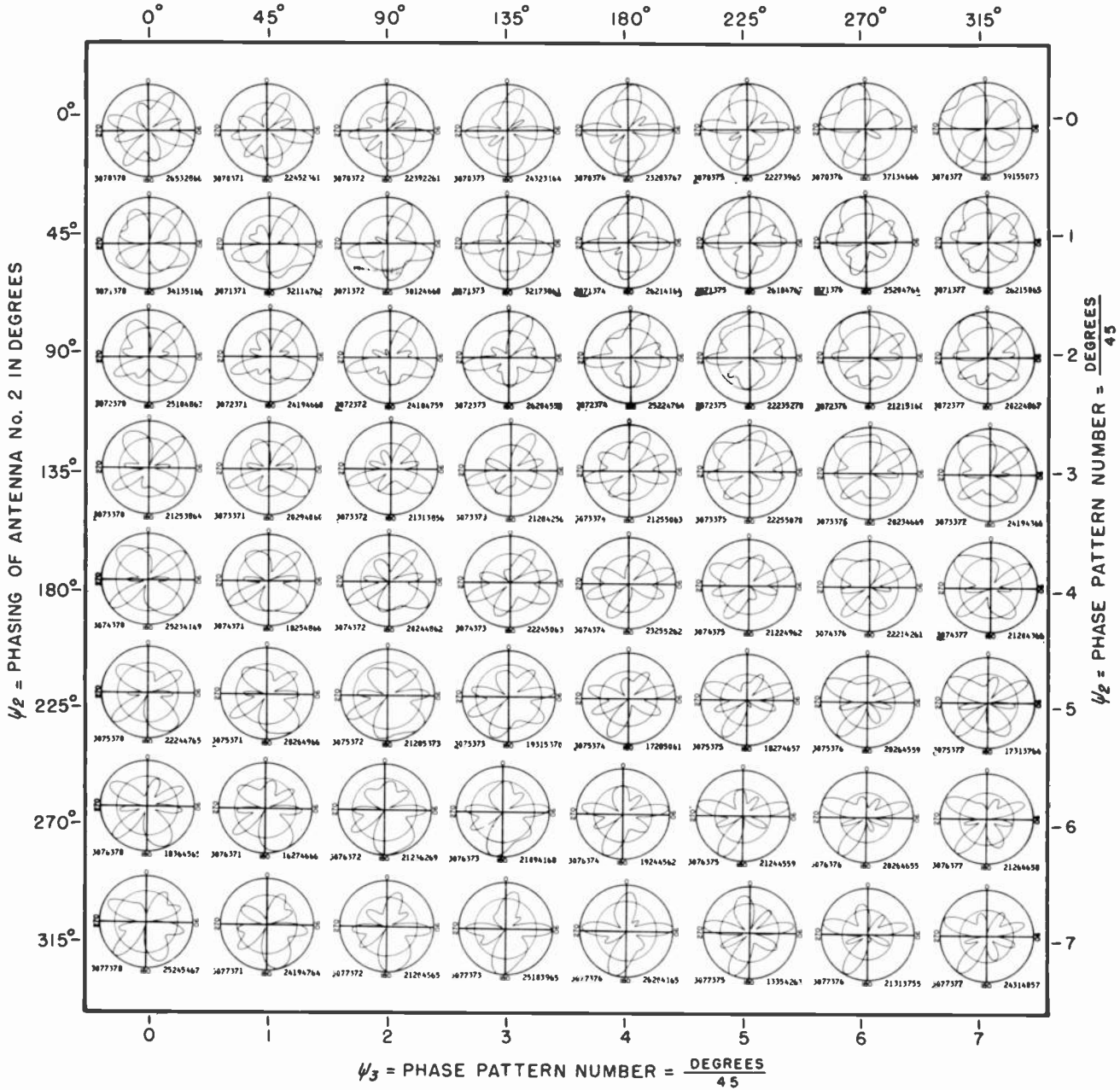

$\psi_3$  = PHASE PATTERN NUMBER =  $\frac{\text{DEGREES}}{45}$

NUMBER OF ANTENNAS IN THE SYSTEM	ORIENTATION OF NO. 2 ANTENNA = $\frac{\text{DEGREES}}{45}$	SPACING OF NO. 2 ANTENNA = $\frac{\text{DEGREES}}{45}$	PHASING OF NO. 2 ANTENNA = $\frac{\text{DEGREES}}{45}$	ORIENTATION OF NO. 3 ANTENNA = $\frac{\text{DEGREES}}{45}$	SPACING OF NO. 3 ANTENNA = $\frac{\text{DEGREES}}{45}$	PHASING OF NO. 3 ANTENNA = $\frac{\text{DEGREES}}{45}$
No. 3	$\phi_2$ 0	$S_2$ 7	$\psi_2$ 0	$\phi_3$ 3	$S_3$ 7	$\psi_3$ 0

% FIELD INTENSITY RADIATED IN HORIZONTAL PLANE FROM NO. 1 ANTENNA.	% FIELD INTENSITY RADIATED IN HORIZONTAL PLANE FROM NO. 2 ANTENNA.	% FIELD INTENSITY RADIATED IN HORIZONTAL PLANE FROM NO. 3 ANTENNA.	% RMS FIELD INTENSITY RADIATED IN HORIZONTAL PLANE FROM ANTENNA SYSTEM.
$E_1$ 26	$E_2$ 53	$E_3$ 28	$E_0$ 66

LEFT HAND PATTERN NUMBER GIVES ANTENNA PLACEMENT AND PHASING DATA.

RIGHT HAND PATTERN NUMBER GIVES ANTENNA FIELD INTENSITY DATA IN PERCENT.

SPOTS LOCATE THE ANTENNAS FOR THIS PAGE OF PATTERNS IN THE SYSTEMATIZATION PLACEMENT CHART.

PATTERN NOMENCLATURE

$\psi_3$  = PHASING OF ANTENNA No. 3 IN DEGREES

3.173

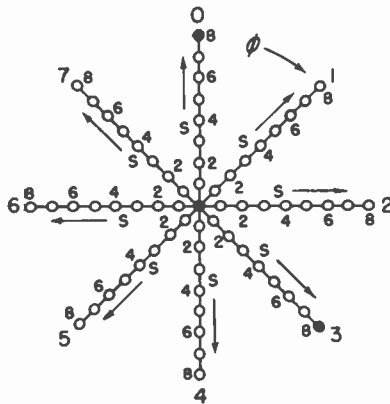
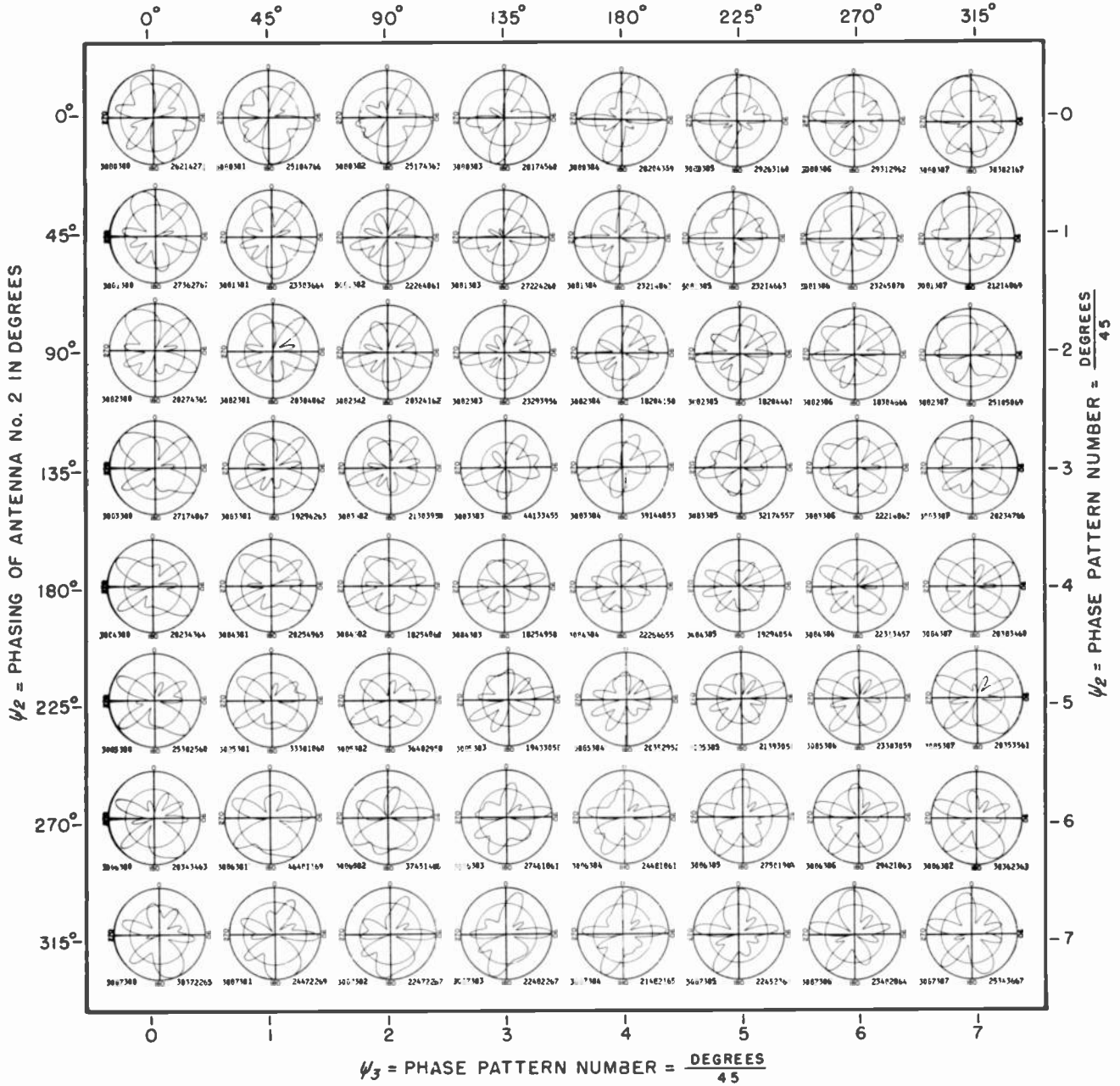

$\psi_3$  = PHASE PATTERN NUMBER =  $\frac{\text{DEGREES}}{45}$

NUMBER OF ANTENNAS IN THE SYSTEM	ORIENTATION OF NO. 2 ANTENNA = $\frac{\text{DEGREES}}{45}$	SPACING OF NO. 2 ANTENNA = $\frac{\text{DEGREES}}{45}$	PHASING OF NO. 2 ANTENNA = $\frac{\text{DEGREES}}{45}$	ORIENTATION OF NO. 3 ANTENNA = $\frac{\text{DEGREES}}{45}$	SPACING OF NO. 3 ANTENNA = $\frac{\text{DEGREES}}{45}$	PHASING OF NO. 3 ANTENNA = $\frac{\text{DEGREES}}{45}$
No.	$\phi_2$	$S_2$	$\psi_2$	$\phi_3$	$S_3$	$\psi_3$
3	0	8	0	3	8	0

% FIELD INTENSITY RADIATED IN HORIZONTAL PLANE FROM NO. 1 ANTENNA.	% FIELD INTENSITY RADIATED IN HORIZONTAL PLANE FROM NO. 2 ANTENNA.	% FIELD INTENSITY RADIATED IN HORIZONTAL PLANE FROM NO. 3 ANTENNA.	% RMS FIELD INTENSITY RADIATED IN HORIZONTAL PLANE FROM ANTENNA SYSTEM.
$F_1$	$F_2$	$F_3$	$F_0$
26	21	42	72

SPOTS LOCATE THE ANTENNAS FOR THIS PAGE OF PATTERNS IN THE SYSTEMATIZATION PLACEMENT CHART.

LEFT HAND PATTERN NUMBER GIVES ANTENNA PLACEMENT AND PHASING DATA.

RIGHT HAND PATTERN NUMBER GIVES ANTENNA FIELD INTENSITY DATA IN PERCENT.

PATTERN NOMENCLATURE

$\psi_3$  = PHASING OF ANTENNA No. 3 IN DEGREES

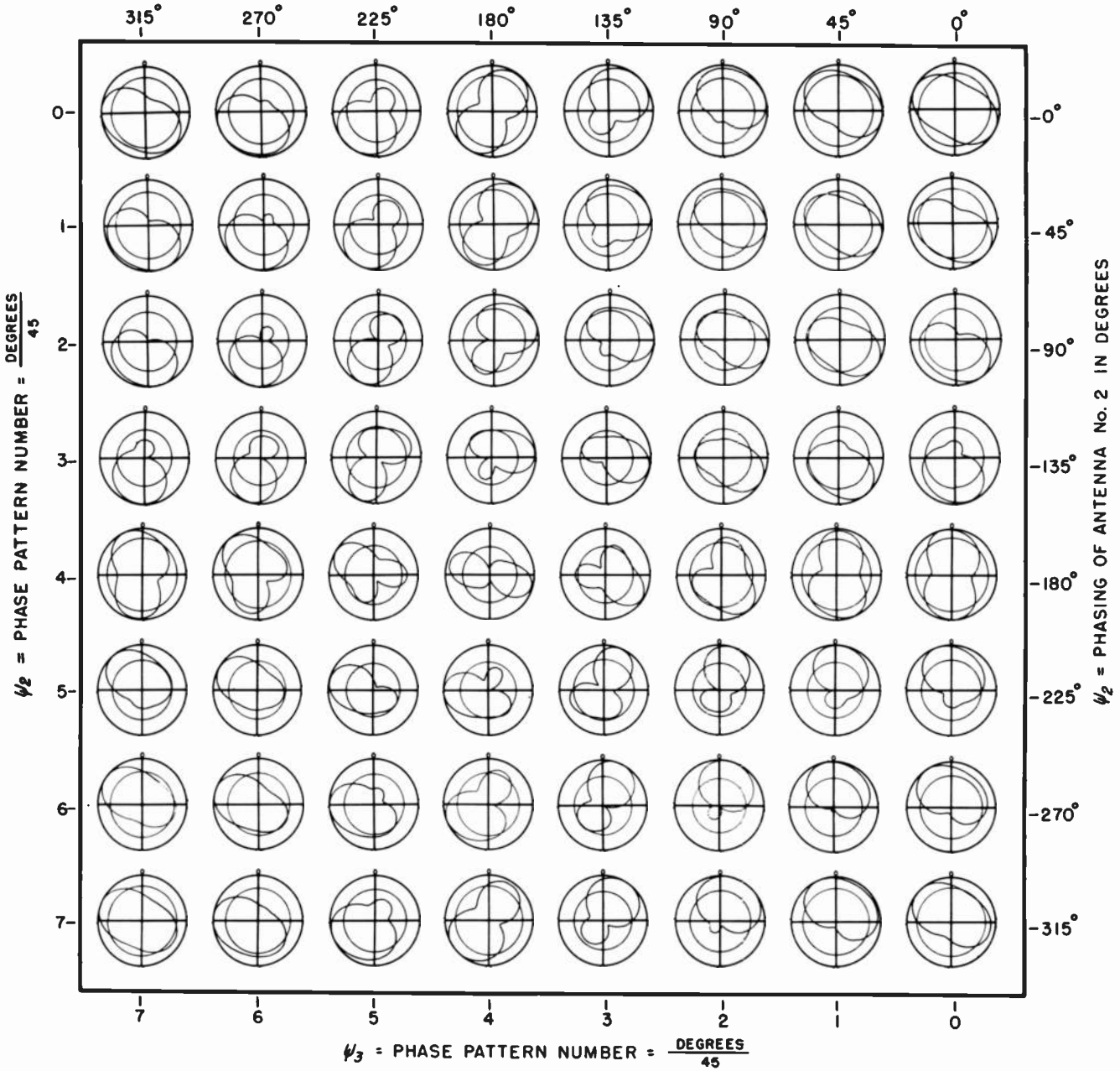

NUMBER OF ANTENNAS IN THE SYSTEM  
 No. 3  
 ORIENTATION OF NO. 2 ANTENNA =  $\frac{\text{DEGREES}}{45}$   
 $\psi_2 = 0$   
 SPACING OF NO. 2 ANTENNA =  $\frac{\text{DEGREES}}{45}$   
 $S_2 = 1$   
 PHASING OF NO. 2 ANTENNA =  $\frac{\text{DEGREES}}{45}$   
 $\psi_2 = 0$   
 ORIENTATION OF NO. 3 ANTENNA =  $\frac{\text{DEGREES}}{45}$   
 $\psi_3 = 5$   
 SPACING OF NO. 3 ANTENNA =  $\frac{\text{DEGREES}}{45}$   
 $S_3 = 2$   
 PHASING OF NO. 3 ANTENNA =  $\frac{\text{DEGREES}}{45}$   
 $\psi_3 = 0$

LEFT HAND PATTERN NUMBER GIVES ANTENNA PLACEMENT AND PHASING DATA.

% FIELD INTENSITY RADIATED IN HORIZONTAL PLANE FROM NO. 1 ANTENNA.  
 $E_1 = 29$   
 % FIELD INTENSITY RADIATED IN HORIZONTAL PLANE FROM NO. 2 ANTENNA.  
 $E_2 = 29$   
 % FIELD INTENSITY RADIATED IN HORIZONTAL PLANE FROM NO. 3 ANTENNA.  
 $E_3 = 29$   
 % RMS FIELD INTENSITY RADIATED IN HORIZONTAL PLANE FROM ANTENNA SYSTEM.  
 $E_0 = 82$

RIGHT HAND PATTERN NUMBER GIVES ANTENNA FIELD INTENSITY DATA IN PERCENT.

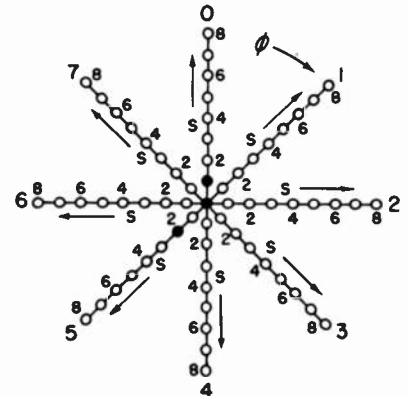

SPOTS LOCATE THE ANTENNAS FOR THIS PAGE OF PATTERNS IN THE SYSTEMATIZATION PLACEMENT CHART.

PATTERN NOMENCLATURE

$\psi_3$  = PHASING OF ANTENNA No. 3 IN DEGREES

3.175

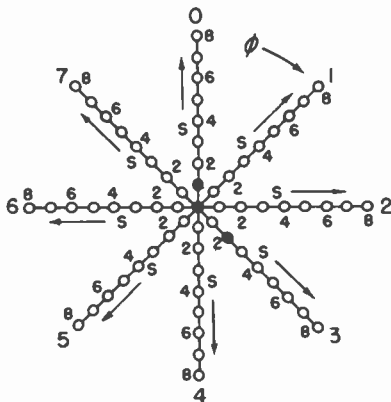
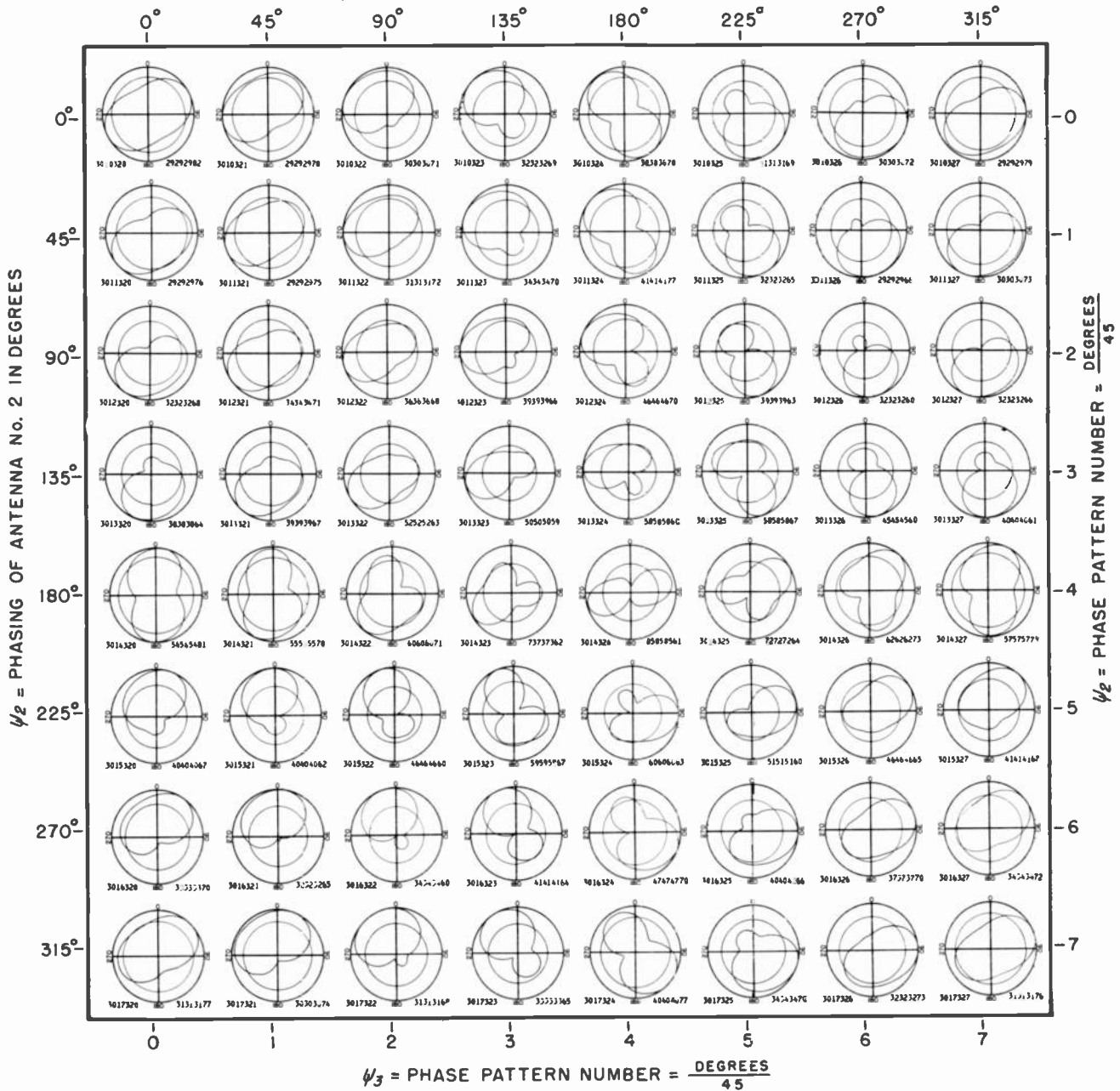

SPOTS LOCATE THE ANTENNAS FOR THIS PAGE OF PATTERNS IN THE SYSTEMATIZATION PLACEMENT CHART.

NUMBER OF ANTENNAS IN THE SYSTEM	ORIENTATION OF DEGREES / 45	SPACING OF DEGREES / 45	PHASING OF DEGREES / 45	ORIENTATION OF DEGREES / 45	SPACING OF DEGREES / 45	PHASING OF DEGREES / 45
No. 3	$\phi_2 = 0$	$S_2 = 1$	$\psi_2 = 0$	$\phi_3 = 3$	$S_3 = 2$	$\psi_3 = 0$

LEFT HAND PATTERN NUMBER GIVES ANTENNA PLACEMENT AND PHASING DATA.

% FIELD INTENSITY RADIATED IN HORIZONTAL PLANE FROM NO. 1 ANTENNA.	% FIELD INTENSITY RADIATED IN HORIZONTAL PLANE FROM NO. 2 ANTENNA.	% FIELD INTENSITY RADIATED IN HORIZONTAL PLANE FROM NO. 3 ANTENNA.	% RMS FIELD INTENSITY RADIATED IN HORIZONTAL PLANE FROM ANTENNA SYSTEM.
$E_1 = 29$	$E_2 = 29$	$E_3 = 29$	$E_0 = 82$

RIGHT HAND PATTERN NUMBER GIVES ANTENNA FIELD INTENSITY DATA IN PERCENT.

PATTERN NOMENCLATURE

$\psi_3$  = PHASING OF ANTENNA No. 3 IN DEGREES

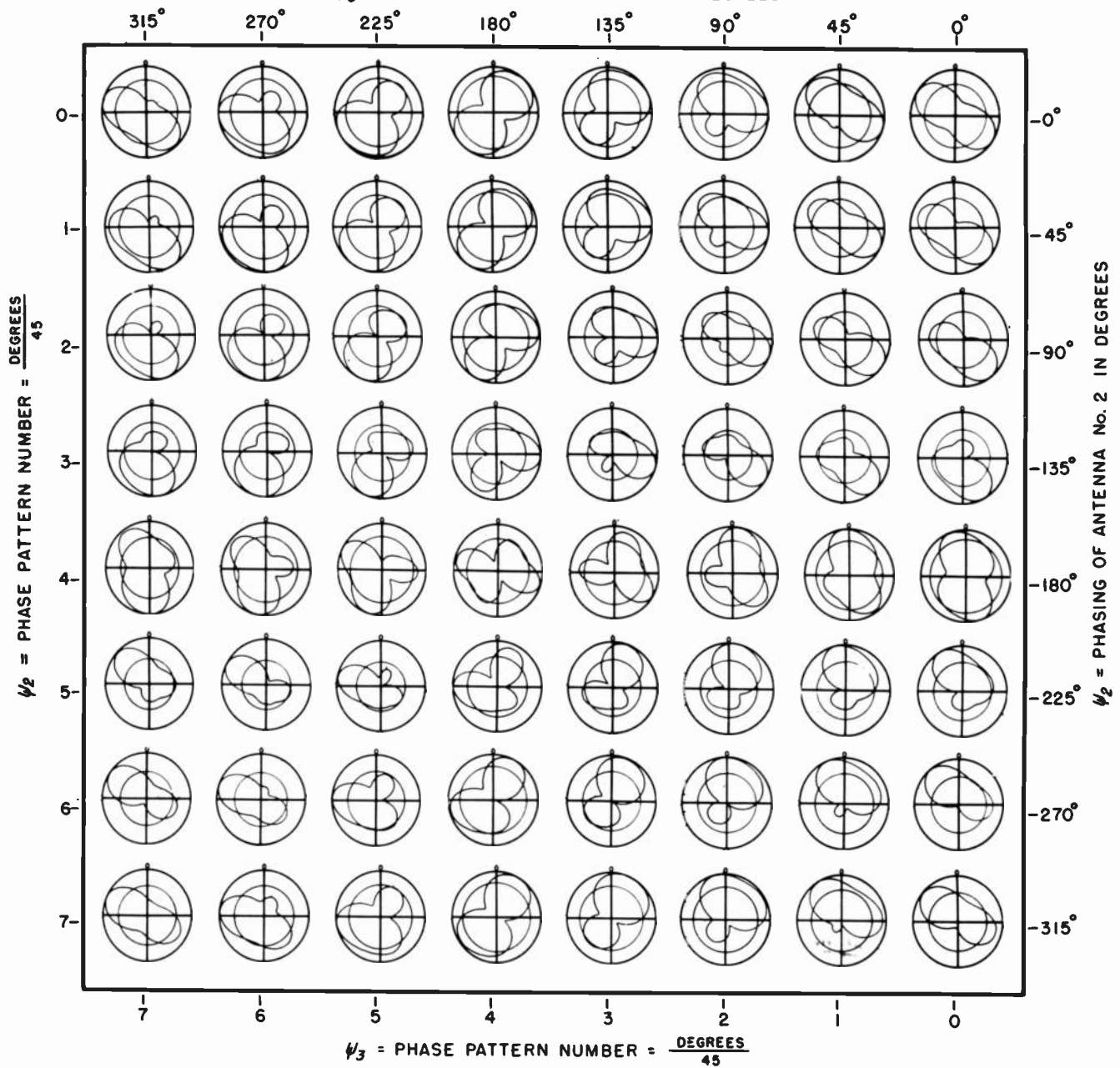

NUMBER OF ANTENNAS IN THE SYSTEM	$N$	3
ORIENTATION OF NO. 2 ANTENNA = $\frac{\text{DEGREES}}{45}$	$\phi_2$	0
SPACING OF NO. 2 ANTENNA = $\frac{\text{DEGREES}}{45}$	$S_2$	1
PHASING OF NO. 2 ANTENNA = $\frac{\text{DEGREES}}{45}$	$\psi_2$	0
ORIENTATION OF NO. 3 ANTENNA = $\frac{\text{DEGREES}}{45}$	$\phi_3$	5
SPACING OF NO. 3 ANTENNA = $\frac{\text{DEGREES}}{45}$	$S_3$	3
PHASING OF NO. 3 ANTENNA = $\frac{\text{DEGREES}}{45}$	$\psi_3$	0

% FIELD INTENSITY RADIATED IN HORIZONTAL PLANE FROM NO. 1 ANTENNA.	$F_1$	31
% FIELD INTENSITY RADIATED IN HORIZONTAL PLANE FROM NO. 2 ANTENNA.	$F_2$	31
% FIELD INTENSITY RADIATED IN HORIZONTAL PLANE FROM NO. 3 ANTENNA.	$F_3$	31
% RMS FIELD INTENSITY RADIATED IN HORIZONTAL PLANE FROM ANTENNA SYSTEM.	$F_0$	69

LEFT HAND PATTERN NUMBER GIVES ANTENNA PLACEMENT AND PHASING DATA.

RIGHT HAND PATTERN NUMBER GIVES ANTENNA FIELD INTENSITY DATA IN PERCENT.

PATTERN NOMENCLATURE

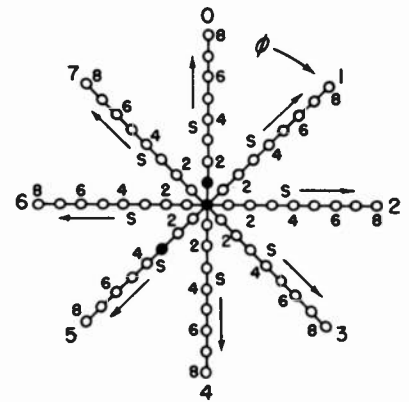

SPOTS LOCATE THE ANTENNAS FOR THIS PAGE OF PATTERNS IN THE SYSTEMIZATION PLACEMENT CHART.

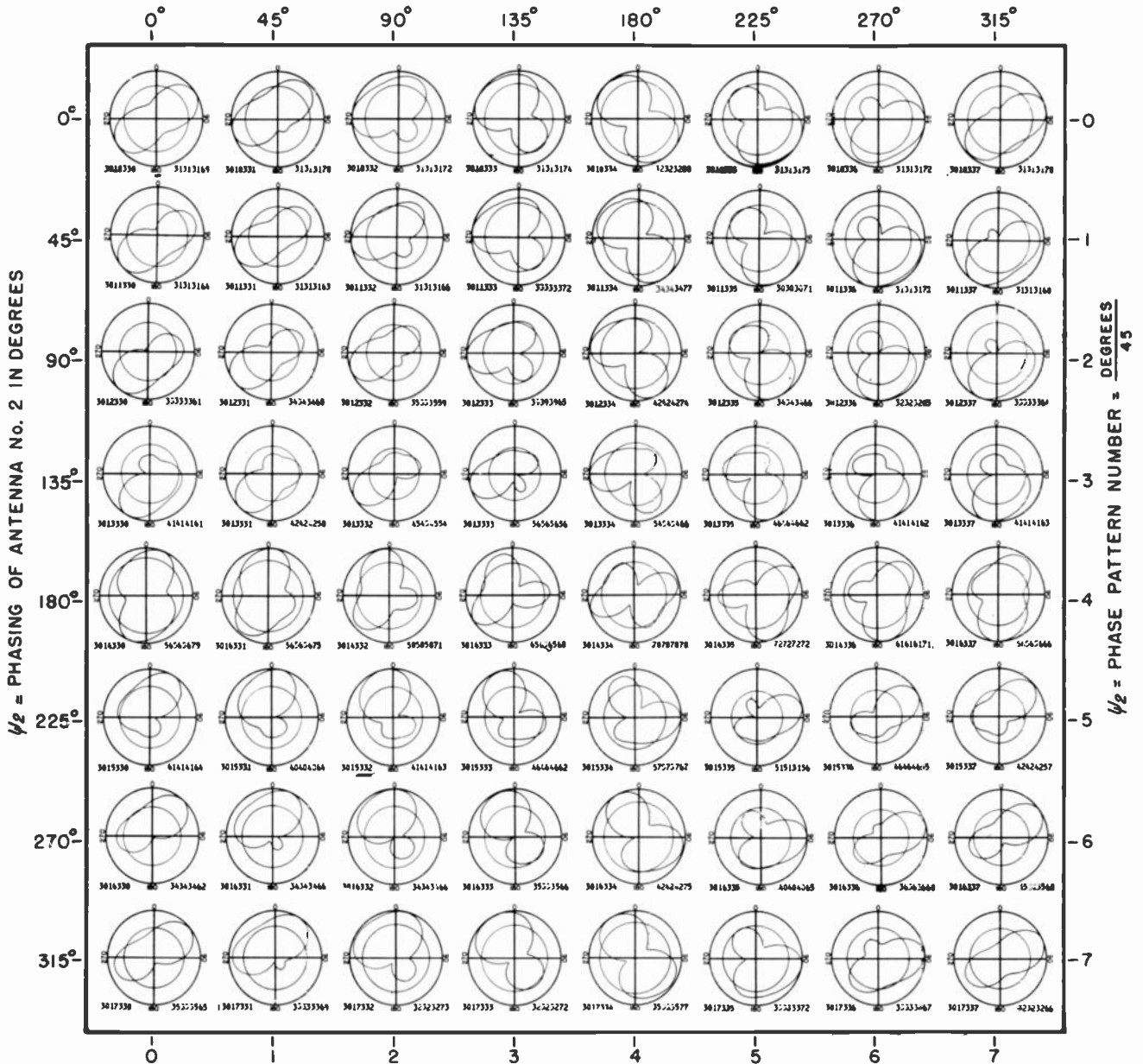

COPYRIGHT 1946 BY CARL E. SMITH  
PRINTED IN U. S. A.

CLEVELAND INSTITUTE OF RADIO ELECTRONICS  
TERMINAL TOWER, CLEVELAND 18, OHIO.

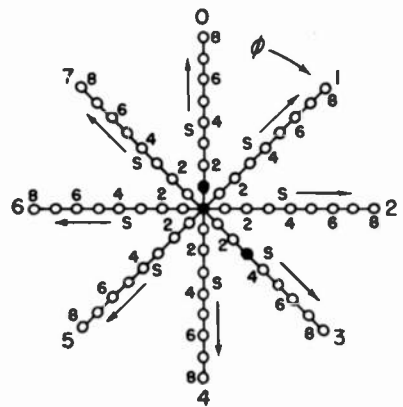

$\psi_3 = \text{PHASING OF ANTENNA No. 3 IN DEGREES} = \frac{\text{DEGREES}}{45}$

NUMBER OF ANTENNAS IN THE SYSTEM	ORIENTATION OF NO. 2 ANTENNA = $\frac{\text{DEGREES}}{45}$	SPACING OF NO. 2 ANTENNA = $\frac{\text{DEGREES}}{45}$	PHASING OF NO. 2 ANTENNA = $\frac{\text{DEGREES}}{45}$	ORIENTATION OF NO. 3 ANTENNA = $\frac{\text{DEGREES}}{45}$	SPACING OF NO. 3 ANTENNA = $\frac{\text{DEGREES}}{45}$	PHASING OF NO. 3 ANTENNA = $\frac{\text{DEGREES}}{45}$
No. 3	$\psi_2$ 0	$S_2$ 1	$\psi_2$ 0	$\psi_3$ 3	$S_3$ 3	$\psi_3$ 0

LEFT HAND PATTERN NUMBER GIVES ANTENNA PLACEMENT AND PHASING DATA.

% FIELD INTENSITY RADIATED IN HORIZONTAL PLANE FROM NO. 1 ANTENNA.	% FIELD INTENSITY RADIATED IN HORIZONTAL PLANE FROM NO. 2 ANTENNA.	% FIELD INTENSITY RADIATED IN HORIZONTAL PLANE FROM NO. 3 ANTENNA.	% RMS FIELD INTENSITY RADIATED IN HORIZONTAL PLANE FROM ANTENNA SYSTEM.
$E_1$ 31	$E_2$ 31	$E_3$ 31	$E_0$ 69

RIGHT HAND PATTERN NUMBER GIVES ANTENNA FIELD INTENSITY DATA IN PERCENT.

SPOTS LOCATE THE ANTENNAS FOR THIS PAGE OF PATTERNS IN THE SYSTEMIZATION PLACEMENT CHART.

PATTERN NOMENCLATURE

$\psi_3$  = PHASING OF ANTENNA No. 3 IN DEGREES

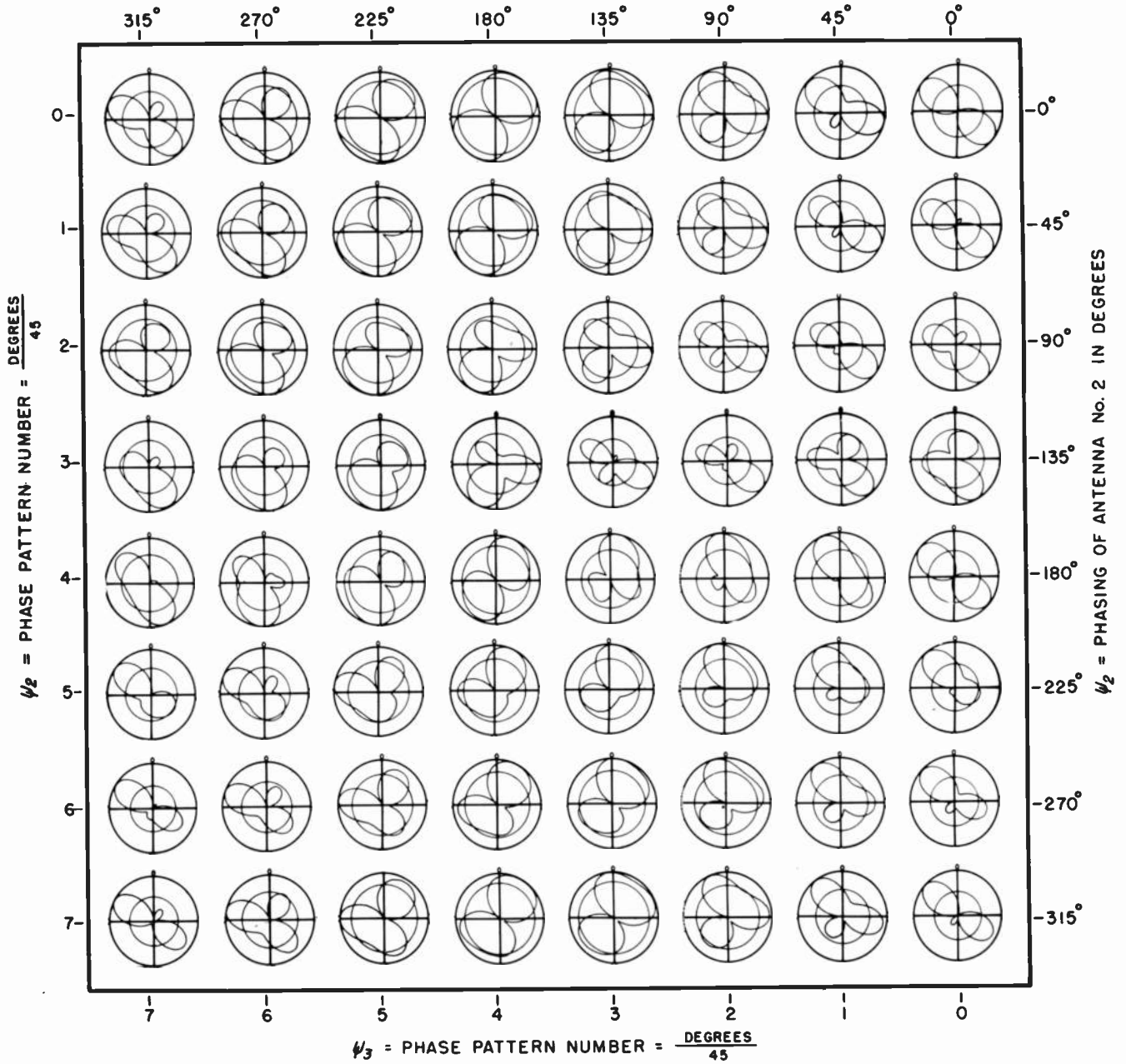

NUMBER OF ANTENNAS  
IN THE SYSTEM  
No. 3

ORIENTATION OF ANTENNA  
No. 2 ANTENNA =  $\frac{DEGREES}{45}$   
 $\phi_2$  0

SPACING OF ANTENNA  
No. 2 ANTENNA =  $\frac{DEGREES}{45}$   
 $S_2$  1

PHASING OF ANTENNA  
No. 2 ANTENNA =  $\frac{DEGREES}{45}$   
 $\psi_2$  0

ORIENTATION OF ANTENNA  
No. 3 ANTENNA =  $\frac{DEGREES}{45}$   
 $\phi_3$  5

SPACING OF ANTENNA  
No. 3 ANTENNA =  $\frac{DEGREES}{45}$   
 $S_3$  4

PHASING OF ANTENNA  
No. 3 ANTENNA =  $\frac{DEGREES}{45}$   
 $\psi_3$  0

% FIELD INTENSITY  
RADIATED IN HORIZONTAL  
PLANE FROM NO. 1 ANTENNA.  
 $E_1$  38

% FIELD INTENSITY  
RADIATED IN HORIZONTAL  
PLANE FROM NO. 2 ANTENNA.  
 $E_2$  07

% FIELD INTENSITY  
RADIATED IN HORIZONTAL  
PLANE FROM NO. 3 ANTENNA.  
 $E_3$  47

% RMS FIELD INTENSITY  
RADIATED IN HORIZONTAL  
PLANE FROM ANTENNA SYSTEM.  
 $E_0$  56

LEFT HAND PATTERN NUMBER GIVES ANTENNA  
PLACEMENT AND PHASING DATA.

RIGHT HAND PATTERN NUMBER  
GIVES ANTENNA FIELD INTEN-  
SITY DATA IN PERCENT.

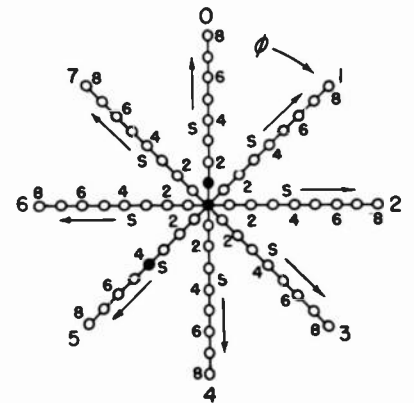

SPOTS LOCATE THE ANTENNAS FOR  
THIS PAGE OF PATTERNS IN THE  
SYSTEMATIZATION PLACEMENT CHART.

PATTERN NOMENCLATURE



$\psi_3$  = PHASING OF ANTENNA No. 3 IN DEGREES

3.179

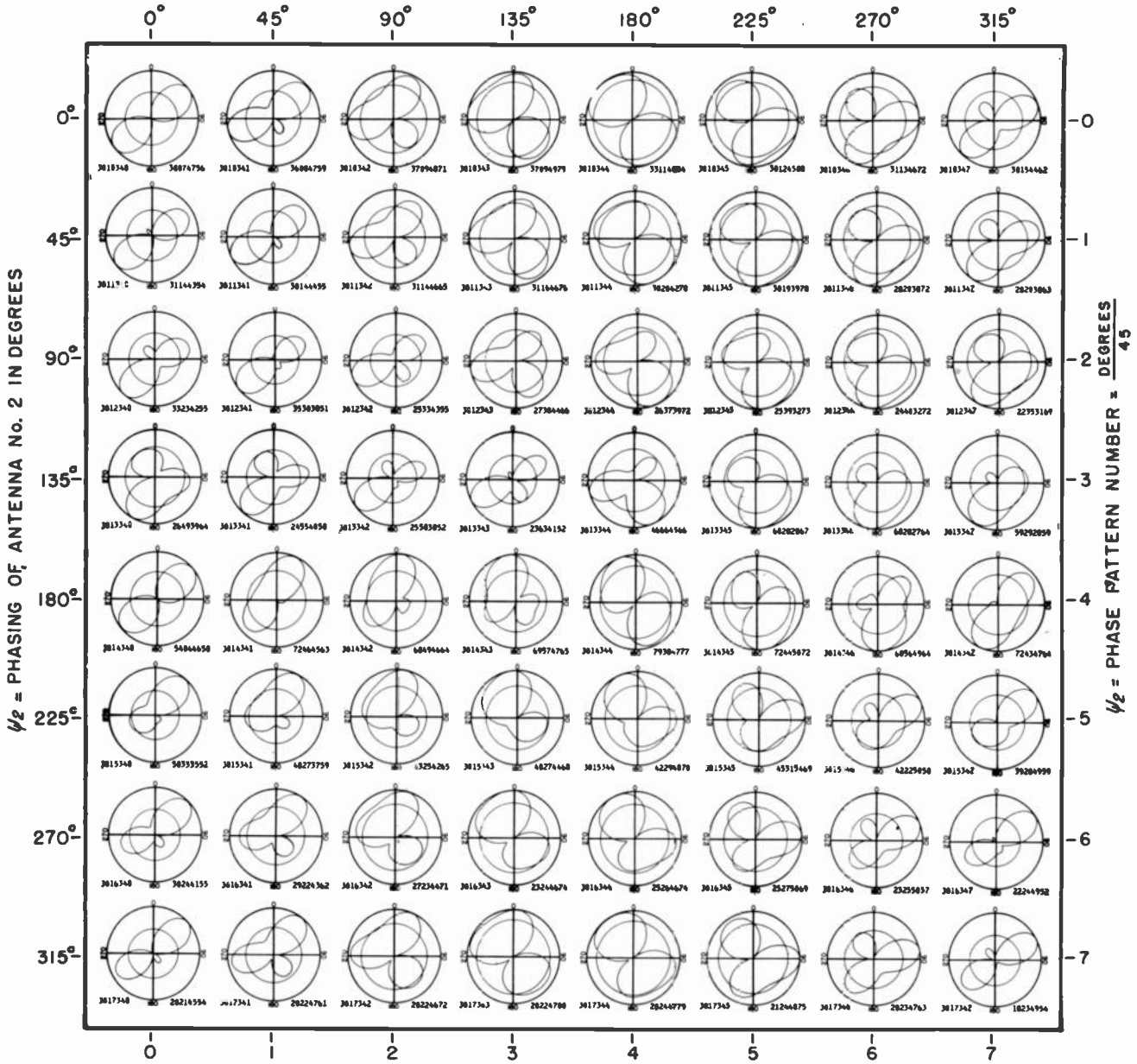

$\psi_3$  = PHASE PATTERN NUMBER =  $\frac{\text{DEGREES}}{45}$

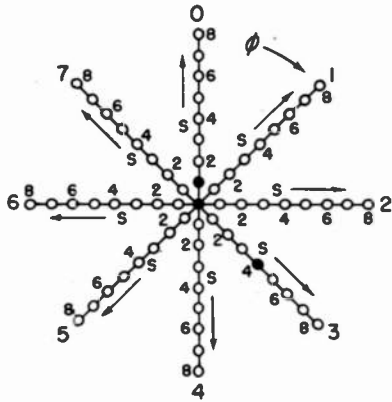

NUMBER OF ANTENNAS IN THE SYSTEM	ORIENTATION OF NO. 2 ANTENNA = $\frac{\text{DEGREES}}{45}$	SPACING OF NO. 2 ANTENNA = $\frac{\text{DEGREES}}{45}$	PHASING OF NO. 2 ANTENNA = $\frac{\text{DEGREES}}{45}$	ORIENTATION OF NO. 3 ANTENNA = $\frac{\text{DEGREES}}{45}$	SPACING OF NO. 3 ANTENNA = $\frac{\text{DEGREES}}{45}$	PHASING OF NO. 3 ANTENNA = $\frac{\text{DEGREES}}{45}$
No. 3	$\phi_2$ 0	$S_2$ 1	$\psi_2$ 0	$\phi_3$ 3	$S_3$ 4	$\psi_3$ 0

% FIELD INTENSITY RADIATED IN HORIZONTAL PLANE FROM NO. 1 ANTENNA.	% FIELD INTENSITY RADIATED IN HORIZONTAL PLANE FROM NO. 2 ANTENNA.	% FIELD INTENSITY RADIATED IN HORIZONTAL PLANE FROM NO. 3 ANTENNA.	% RMS FIELD INTENSITY RADIATED IN HORIZONTAL PLANE FROM ANTENNA SYSTEM.
$F_1$ 38	$F_2$ 07	$F_3$ 47	$F_0$ 56

SPOTS LOCATE THE ANTENNAS FOR THIS PAGE OF PATTERNS IN THE SYSTEMATIZATION PLACEMENT CHART.

LEFT HAND PATTERN NUMBER GIVES ANTENNA PLACEMENT AND PHASING DATA.

RIGHT HAND PATTERN NUMBER GIVES ANTENNA FIELD INTENSITY DATA IN PERCENT.

PATTERN NOMENCLATURE

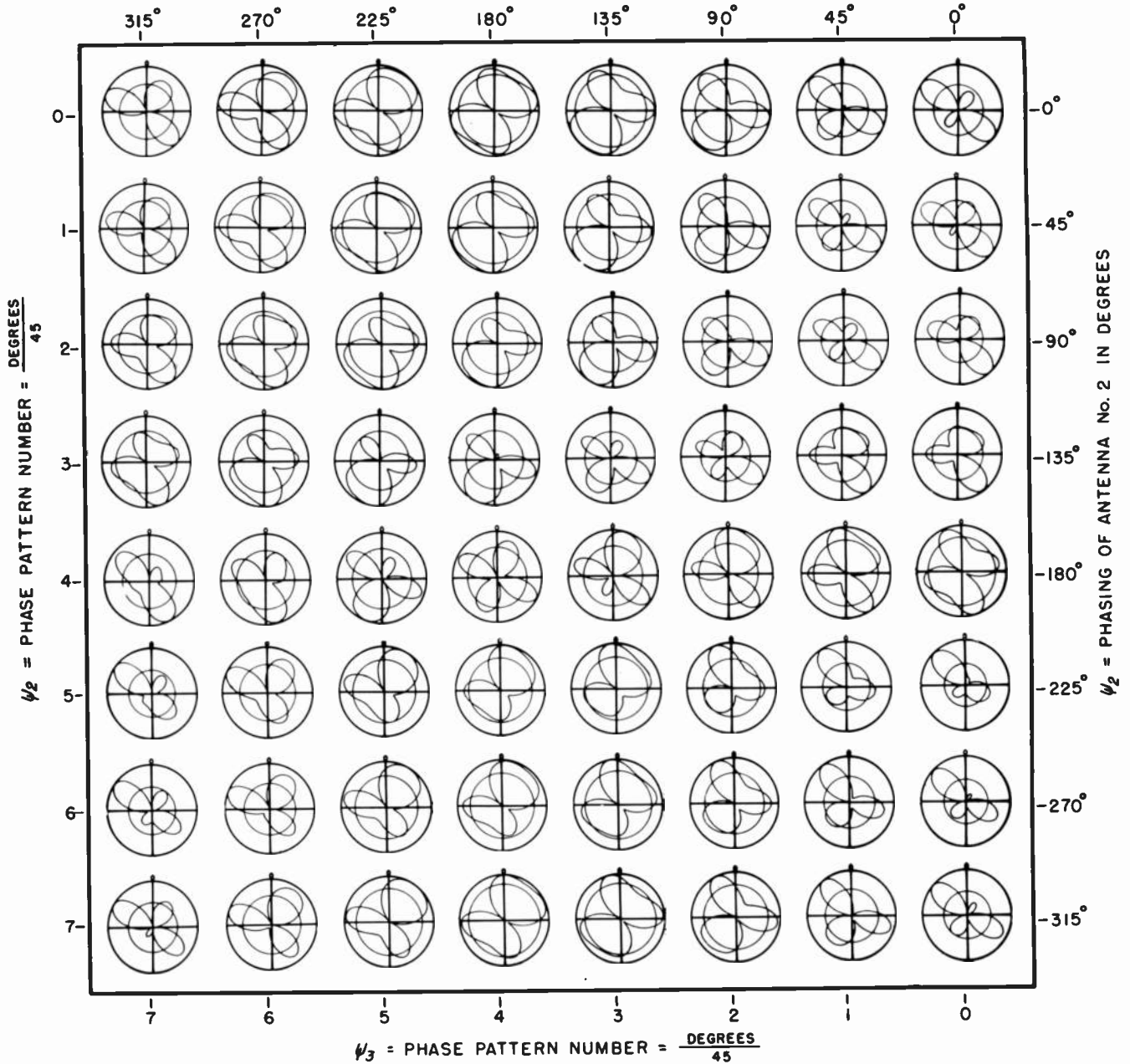

NUMBER OF ANTENNAS IN THE SYSTEM  
 No. 3

ORIENTATION OF NO. 2 ANTENNA =  $\frac{\text{DEGREES}}{45}$   
 $\phi_2$  0

SPACING OF NO. 2 ANTENNA =  $\frac{\text{DEGREES}}{45}$   
 $S_2$  1

PHASING OF NO. 2 ANTENNA =  $\frac{\text{DEGREES}}{45}$   
 $\psi_2$  0

ORIENTATION OF NO. 3 ANTENNA =  $\frac{\text{DEGREES}}{45}$   
 $\phi_3$  5

SPACING OF NO. 3 ANTENNA =  $\frac{\text{DEGREES}}{45}$   
 $S_3$  5

PHASING OF NO. 3 ANTENNA =  $\frac{\text{DEGREES}}{45}$   
 $\psi_3$  0

LEFT HAND PATTERN NUMBER GIVES ANTENNA PLACEMENT AND PHASING DATA.

% FIELD INTENSITY RADIATED IN HORIZONTAL PLANE FROM NO. 1 ANTENNA.  
 $E_1$  24

% FIELD INTENSITY RADIATED IN HORIZONTAL PLANE FROM NO. 2 ANTENNA.  
 $E_2$  20

% FIELD INTENSITY RADIATED IN HORIZONTAL PLANE FROM NO. 3 ANTENNA.  
 $E_3$  49

% RMS FIELD INTENSITY RADIATED IN HORIZONTAL PLANE FROM ANTENNA SYSTEM.  
 $E_0$  56

RIGHT HAND PATTERN NUMBER GIVES ANTENNA FIELD INTENSITY DATA IN PERCENT.

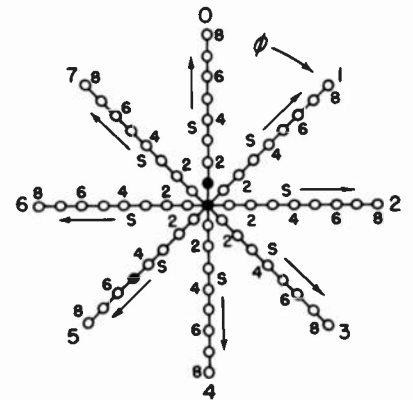

SPOTS LOCATE THE ANTENNAS FOR THIS PAGE OF PATTERNS IN THE SYSTEMIZATION PLACEMENT CHART.

PATTERN NOMENCLATURE

$\psi_3$  = PHASING OF ANTENNA No. 3 IN DEGREES

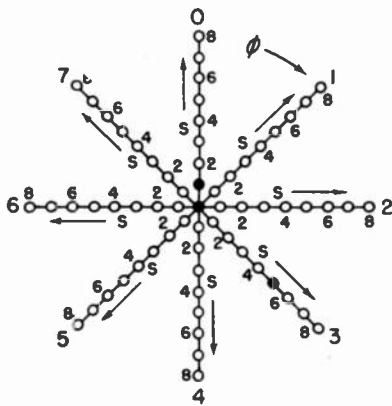
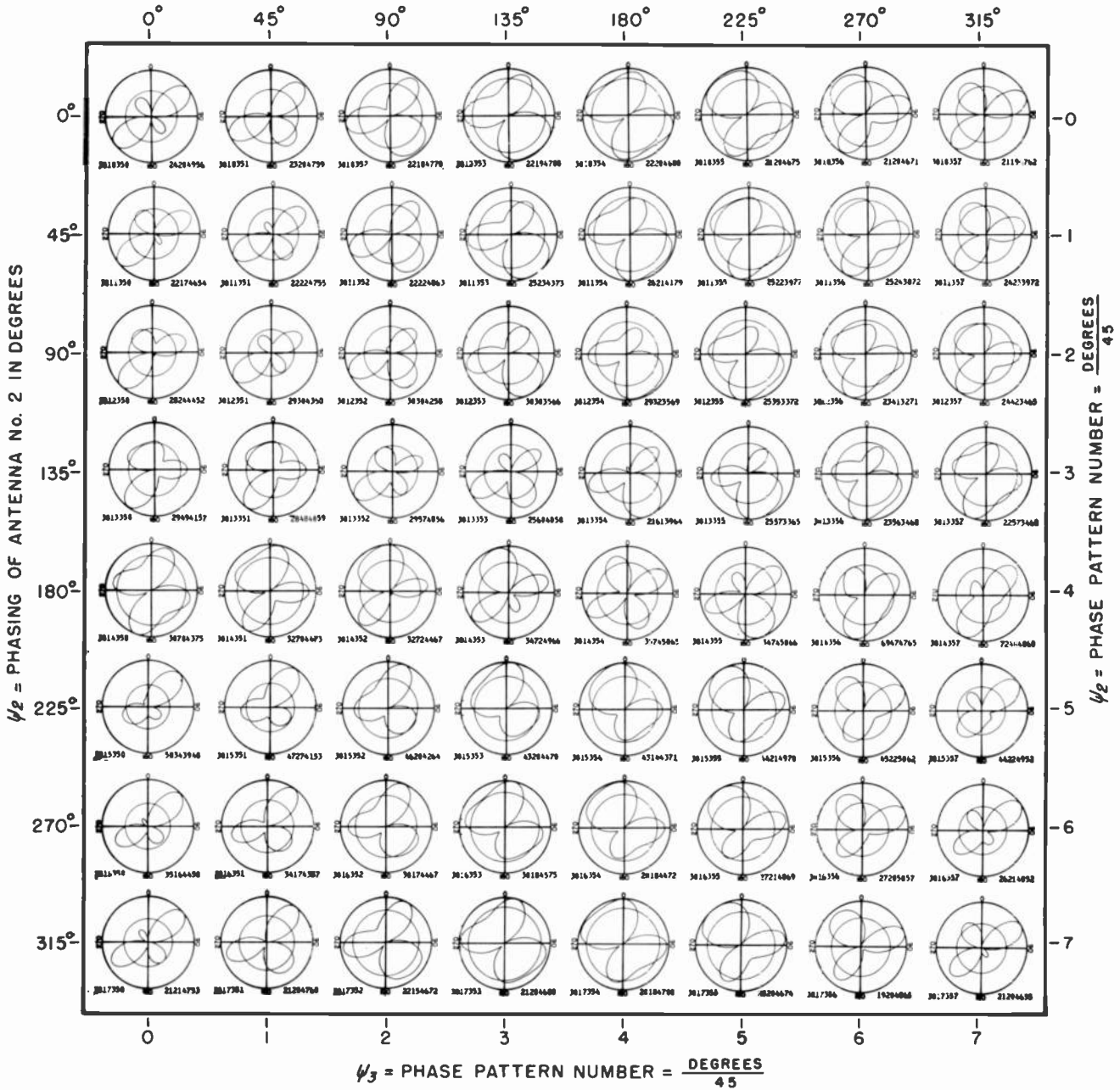

- NUMBER OF ANTENNAS IN THE SYSTEM
- ORIENTATION OF NO. 2 ANTENNA =  $\frac{\text{DEGREES}}{45}$
- SPACING OF NO. 2 ANTENNA =  $\frac{\text{DEGREES}}{45}$
- PHASING OF NO. 2 ANTENNA =  $\frac{\text{DEGREES}}{45}$
- ORIENTATION OF NO. 3 ANTENNA =  $\frac{\text{DEGREES}}{45}$
- SPACING OF NO. 3 ANTENNA =  $\frac{\text{DEGREES}}{45}$
- PHASING OF NO. 3 ANTENNA =  $\frac{\text{DEGREES}}{45}$

- % FIELD INTENSITY RADIATED IN HORIZONTAL PLANE FROM NO. 1 ANTENNA.
- % FIELD INTENSITY RADIATED IN HORIZONTAL PLANE FROM NO. 2 ANTENNA.
- % FIELD INTENSITY RADIATED IN HORIZONTAL PLANE FROM NO. 3 ANTENNA.
- % RMS FIELD INTENSITY RADIATED IN HORIZONTAL PLANE FROM ANTENNA SYSTEM.

SPOTS LOCATE THE ANTENNAS FOR THIS PAGE OF PATTERNS IN THE SYSTEMIZATION PLACEMENT CHART.

LEFT HAND PATTERN NUMBER GIVES ANTENNA PLACEMENT AND PHASING DATA.

RIGHT HAND PATTERN NUMBER GIVES ANTENNA FIELD INTENSITY DATA IN PERCENT.

PATTERN NOMENCLATURE

No.	$\psi_2$	$S_2$	$\psi_2$	$\psi_3$	$S_3$	$\psi_3$	$E_1$	$E_2$	$E_3$	$E_0$
3	0	1	0	3	5	0	24	20	49	56

$\psi_3$  = PHASING OF ANTENNA No. 3 IN DEGREES

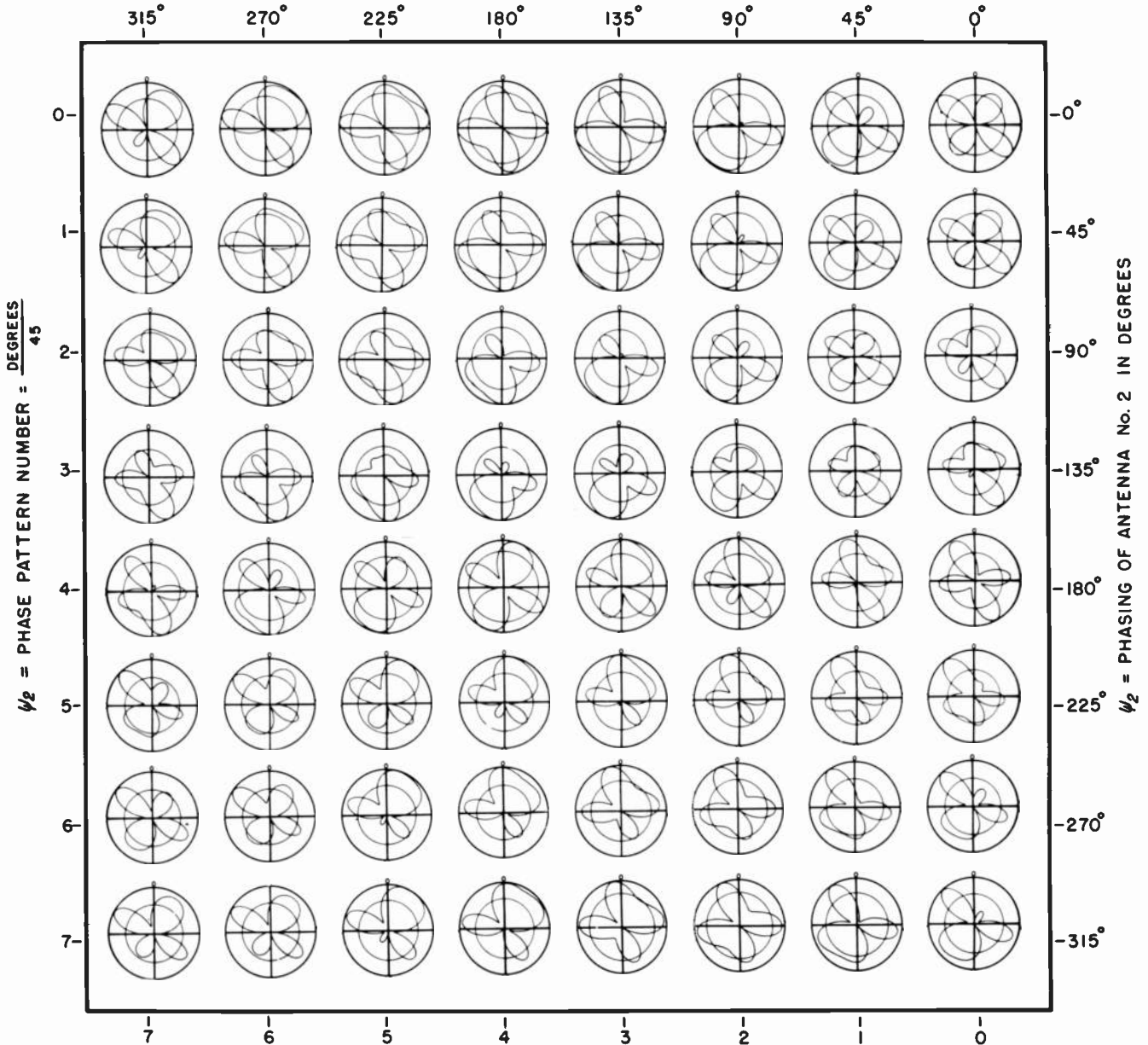

NUMBER OF ANTENNAS IN THE SYSTEM

No. 3

ORIENTATION OF NO. 2 ANTENNA =  $\frac{\text{DEGREES}}{45}$

$\phi_2$  0

SPACING OF NO. 2 ANTENNA =  $\frac{\text{DEGREES}}{45}$

$S_2$  1

PHASING OF NO. 2 ANTENNA =  $\frac{\text{DEGREES}}{45}$

$\psi_2$  0

ORIENTATION OF NO. 3 ANTENNA =  $\frac{\text{DEGREES}}{45}$

$\phi_3$  5

SPACING OF NO. 3 ANTENNA =  $\frac{\text{DEGREES}}{45}$

$S_3$  6

PHASING OF NO. 3 ANTENNA =  $\frac{\text{DEGREES}}{45}$

$\psi_3$  0

% FIELD INTENSITY RADIATED IN HORIZONTAL PLANE FROM NO. 1 ANTENNA.

$F_1$  20

% FIELD INTENSITY RADIATED IN HORIZONTAL PLANE FROM NO. 2 ANTENNA.

$F_2$  21

% FIELD INTENSITY RADIATED IN HORIZONTAL PLANE FROM NO. 3 ANTENNA.

$F_3$  48

% RMS FIELD INTENSITY RADIATED IN HORIZONTAL PLANE FROM ANTENNA SYSTEM.

$F_0$  64

LEFT HAND PATTERN NUMBER GIVES ANTENNA PLACEMENT AND PHASING DATA.

RIGHT HAND PATTERN NUMBER GIVES ANTENNA FIELD INTENSITY DATA IN PERCENT.

PATTERN NOMENCLATURE

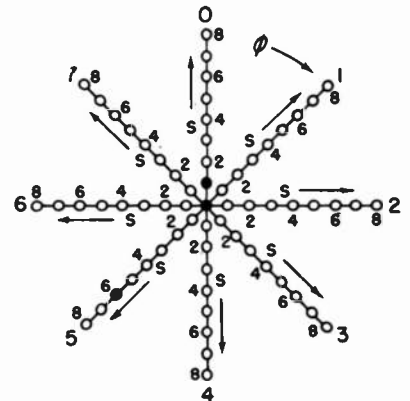

SPOTS LOCATE THE ANTENNAS FOR THIS PAGE OF PATTERNS IN THE SYSTEMATIZATION PLACEMENT CHART.

$\psi_3$  = PHASING OF ANTENNA No. 3 IN DEGREES

3.183

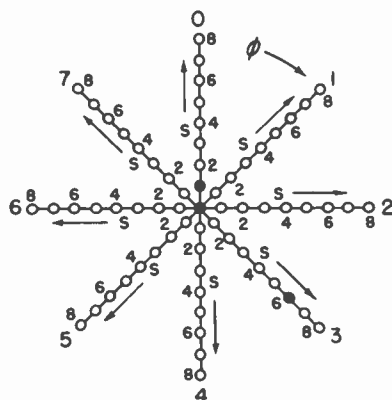
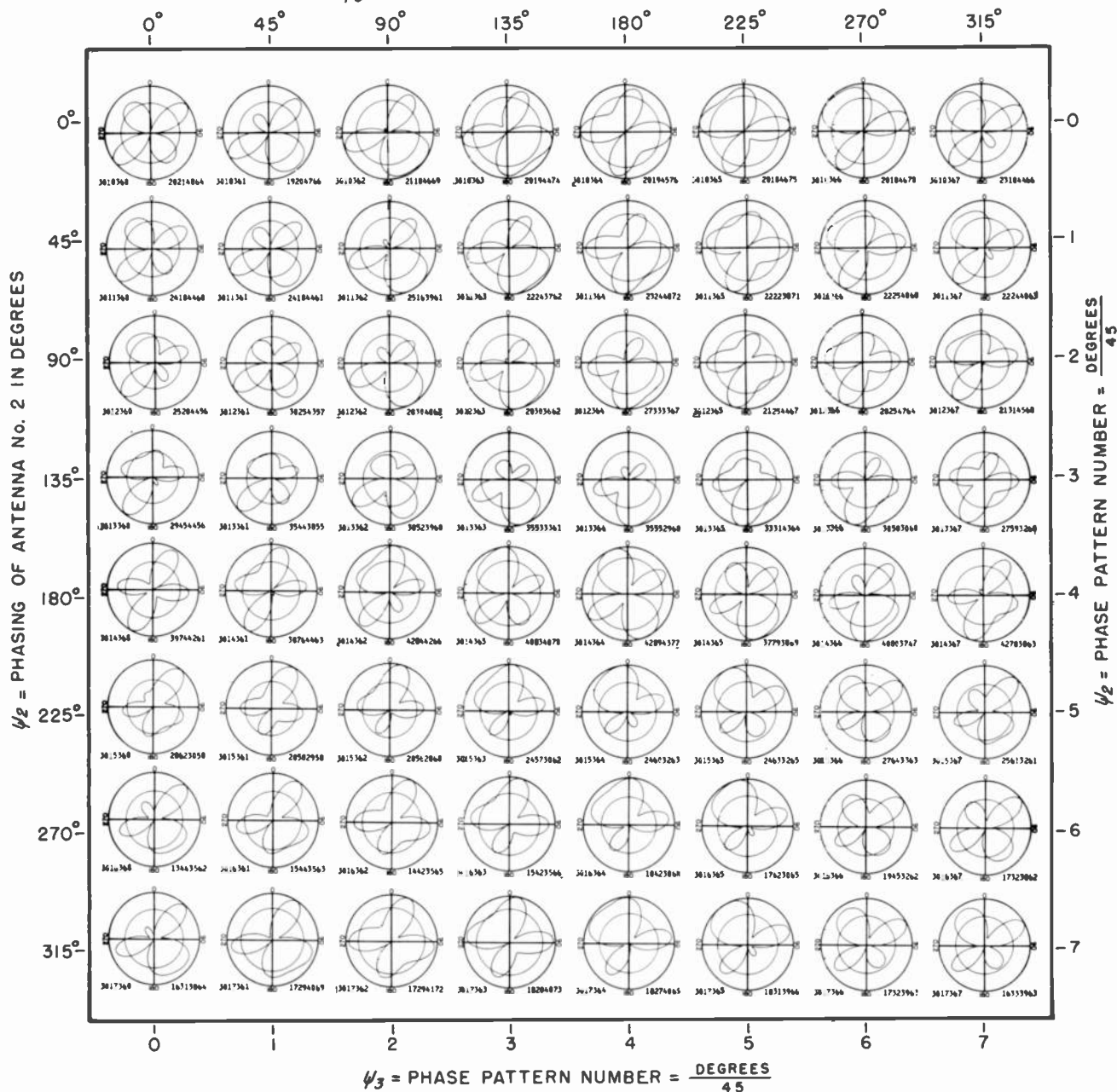

NUMBER OF ANTENNAS IN THE SYSTEM	ORIENTATION OF NO. 2 ANTENNA = $\frac{\text{DEGREES}}{45}$	SPACING OF NO. 2 ANTENNA = $\frac{\text{DEGREES}}{45}$	PHASING OF NO. 2 ANTENNA = $\frac{\text{DEGREES}}{45}$	ORIENTATION OF NO. 3 ANTENNA = $\frac{\text{DEGREES}}{45}$	SPACING OF NO. 3 ANTENNA = $\frac{\text{DEGREES}}{45}$	PHASING OF NO. 3 ANTENNA = $\frac{\text{DEGREES}}{45}$
No. 3	$\psi_2$ 0	$S_2$ 1	$\psi_2$ 0	$\psi_3$ 3	$S_3$ 6	$\psi_3$ 0

% FIELD INTENSITY RADIATED IN HORIZONTAL PLANE FROM NO. 1 ANTENNA.	% FIELD INTENSITY RADIATED IN HORIZONTAL PLANE FROM NO. 2 ANTENNA.	% FIELD INTENSITY RADIATED IN HORIZONTAL PLANE FROM NO. 3 ANTENNA.	% RMS FIELD INTENSITY RADIATED IN HORIZONTAL PLANE FROM ANTENNA SYSTEM.
$E_1$ 20	$E_2$ 21	$E_3$ 48	$E_0$ 64

SPOTS LOCATE THE ANTENNAS FOR THIS PAGE OF PATTERNS IN THE SYSTEMATIZATION PLACEMENT CHART.

LEFT HAND PATTERN NUMBER GIVES ANTENNA PLACEMENT AND PHASING DATA.

RIGHT HAND PATTERN NUMBER GIVES ANTENNA FIELD INTENSITY DATA IN PERCENT.

PATTERN NOMENCLATURE

$\psi_3$  = PHASING OF ANTENNA No. 3 IN DEGREES

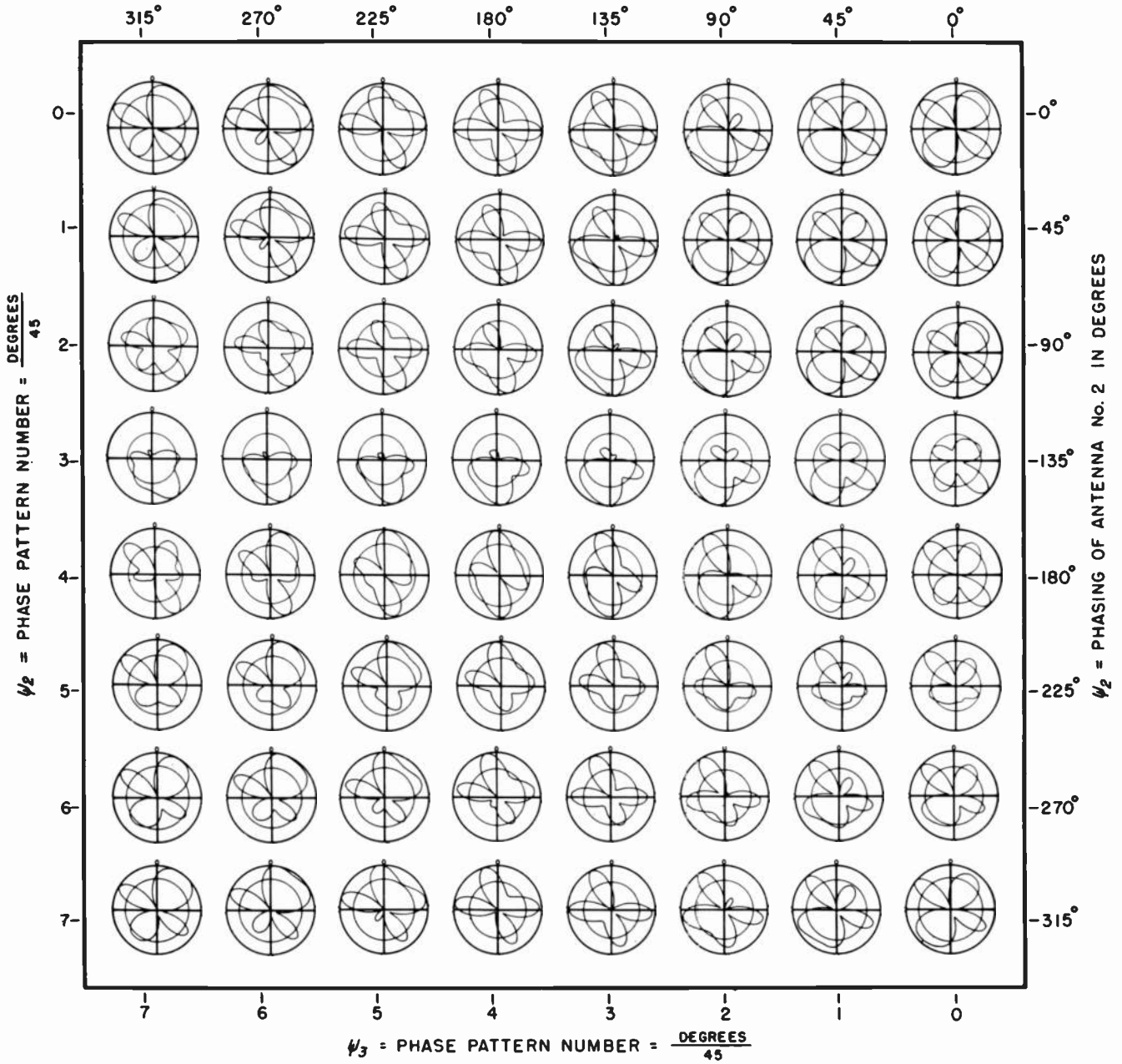

NUMBER OF ANTENNAS IN THE SYSTEM  
 $N_D = 3$

ORIENTATION OF NO. 2 ANTENNA =  $\frac{\text{DEGREES}}{45} = 0$   
 $\phi_2 = 0$

SPACING OF NO. 2 ANTENNA =  $\frac{\text{DEGREES}}{45} = 1$   
 $S_2 = 1$

PHASING OF NO. 2 ANTENNA =  $\frac{\text{DEGREES}}{45} = 0$   
 $\psi_2 = 0$

ORIENTATION OF NO. 3 ANTENNA =  $\frac{\text{DEGREES}}{45} = 5$   
 $\phi_3 = 5$

SPACING OF NO. 3 ANTENNA =  $\frac{\text{DEGREES}}{45} = 7$   
 $S_3 = 7$

PHASING OF NO. 3 ANTENNA =  $\frac{\text{DEGREES}}{45} = 0$   
 $\psi_3 = 0$

% FIELD INTENSITY RADIATED IN HORIZONTAL PLANE FROM NO. 1 ANTENNA.  
 $E_1 = 30$

% FIELD INTENSITY RADIATED IN HORIZONTAL PLANE FROM NO. 2 ANTENNA.  
 $E_2 = 15$

% FIELD INTENSITY RADIATED IN HORIZONTAL PLANE FROM NO. 3 ANTENNA.  
 $E_3 = 48$

% RMS FIELD INTENSITY RADIATED IN HORIZONTAL PLANE FROM ANTENNA SYSTEM.  
 $E_0 = 74$

LEFT HAND PATTERN NUMBER GIVES ANTENNA PLACEMENT AND PHASING DATA.

RIGHT HAND PATTERN NUMBER GIVES ANTENNA FIELD INTENSITY DATA IN PERCENT.

PATTERN NOMENCLATURE

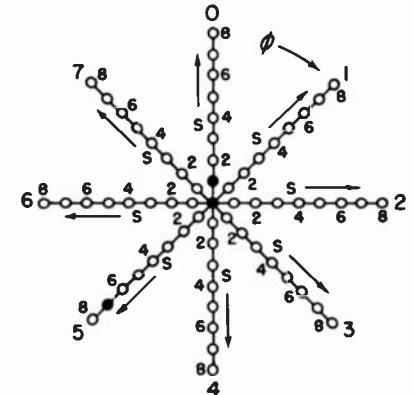

SPOTS LOCATE THE ANTENNAS FOR THIS PAGE OF PATTERNS IN THE SYSTEMATIZATION PLACEMENT CHART.

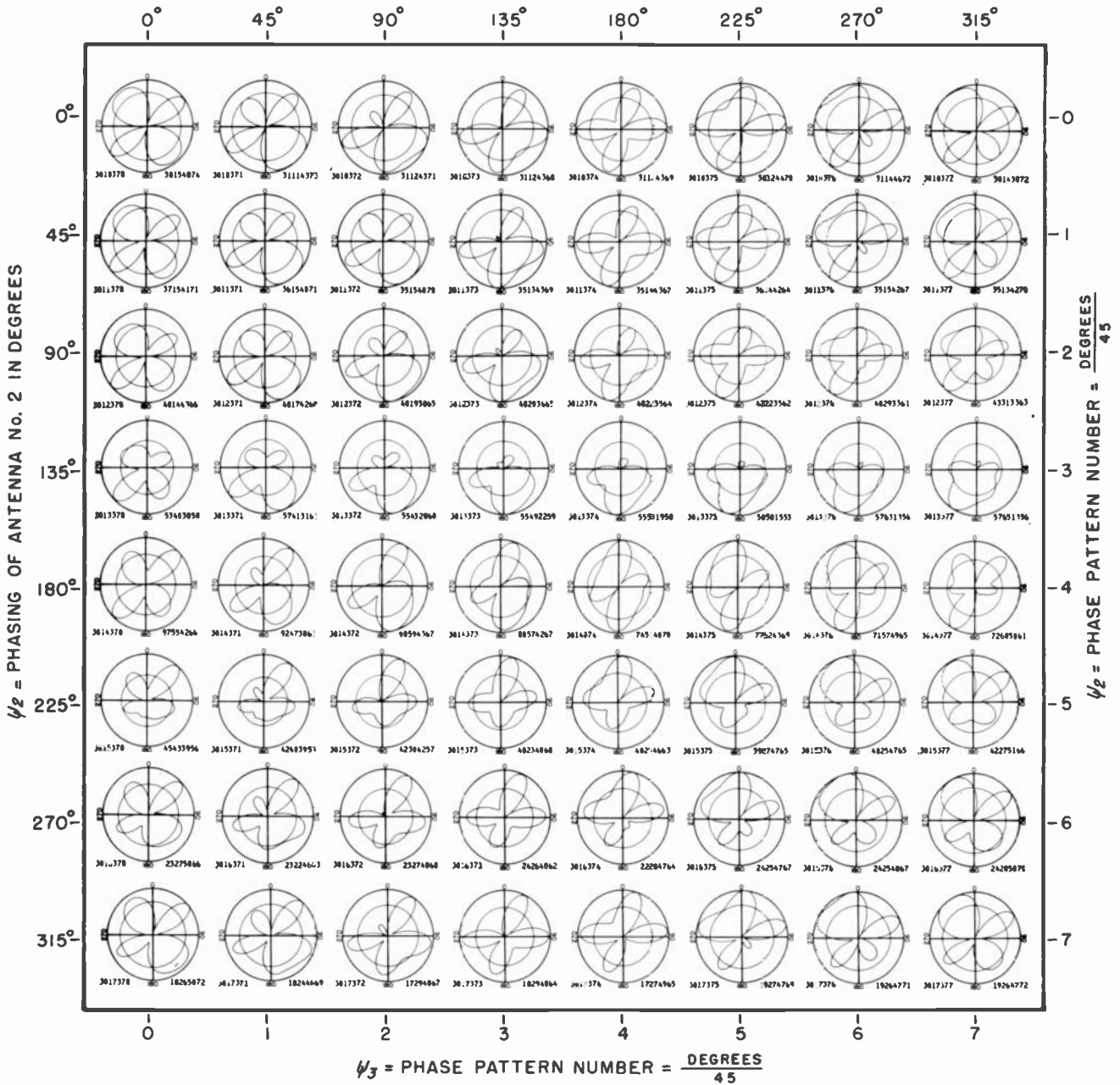

COPYRIGHT 1946 BY CARL E. SMITH  
PRINTED IN U. S. A.

CLEVELAND INSTITUTE OF RADIO ELECTRONICS  
TERMINAL TOWER, CLEVELAND 18, OHIO.

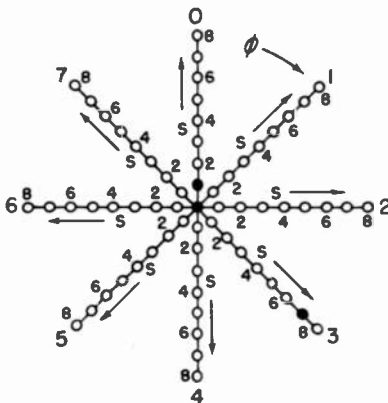

SPOTS LOCATE THE ANTENNAS FOR THIS PAGE OF PATTERNS IN THE SYSTEMATIZATION PLACEMENT CHART.

NUMBER OF ANTENNAS IN THE SYSTEM	ORIENTATION OF NO. 2 ANTENNA = $\frac{\text{DEGREES}}{45}$	SPACING OF NO. 2 ANTENNA = $\frac{\text{DEGREES}}{45}$	PHASING OF NO. 2 ANTENNA = $\frac{\text{DEGREES}}{45}$	ORIENTATION OF NO. 3 ANTENNA = $\frac{\text{DEGREES}}{45}$	SPACING OF NO. 3 ANTENNA = $\frac{\text{DEGREES}}{45}$	PHASING OF NO. 3 ANTENNA = $\frac{\text{DEGREES}}{45}$	% FIELD INTENSITY RADIATED IN HORIZONTAL PLANE FROM NO. 1 ANTENNA.	% FIELD INTENSITY RADIATED IN HORIZONTAL PLANE FROM NO. 2 ANTENNA.	% FIELD INTENSITY RADIATED IN HORIZONTAL PLANE FROM NO. 3 ANTENNA.	% RMS FIELD INTENSITY RADIATED IN HORIZONTAL PLANE FROM ANTENNA SYSTEM.
No. 3	$\phi_2$ 0	$S_2$ 1	$\psi_2$ 0	$\phi_3$ 3	$S_3$ 7	$\psi_3$ 0	$F_1$ 30	$F_2$ 15	$F_3$ 48	$F_0$ 74

LEFT HAND PATTERN NUMBER GIVES ANTENNA PLACEMENT AND PHASING DATA.

RIGHT HAND PATTERN NUMBER GIVES ANTENNA FIELD INTENSITY DATA IN PERCENT.

PATTERN NOMENCLATURE

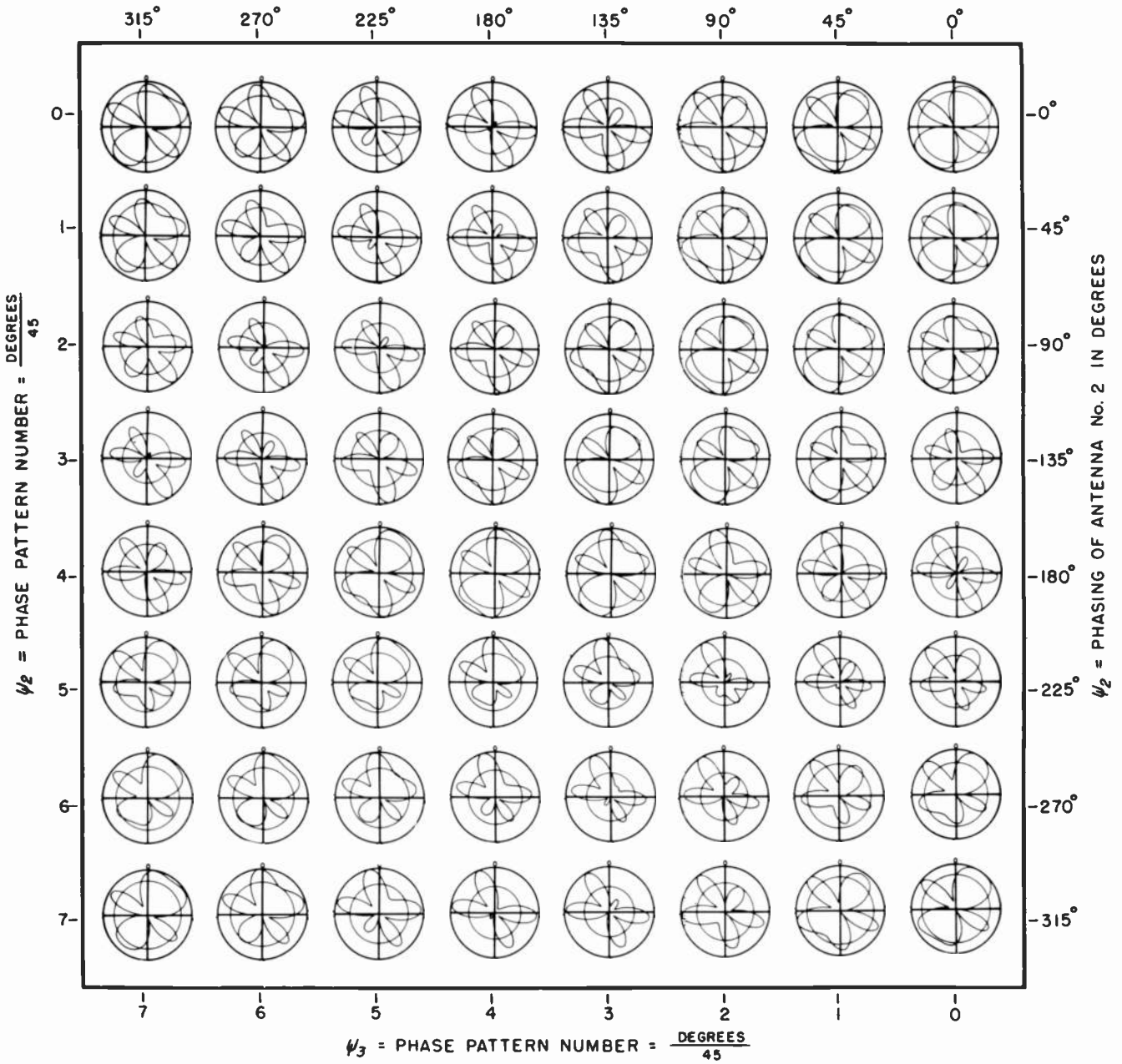

NUMBER OF ANTENNAS IN THE SYSTEM  
 NO.  $\phi_2$  3

ORIENTATION OF NO. 2 ANTENNA =  $\frac{\text{DEGREES}}{45}$   
 $\psi_2$  0

SPACING OF NO. 2 ANTENNA =  $\frac{\text{DEGREES}}{45}$   
 $S_2$  1

PHASING OF NO. 2 ANTENNA =  $\frac{\text{DEGREES}}{45}$   
 $\psi_2$  0

ORIENTATION OF NO. 3 ANTENNA =  $\frac{\text{DEGREES}}{45}$   
 $\phi_3$  5

SPACING OF NO. 3 ANTENNA =  $\frac{\text{DEGREES}}{45}$   
 $S_3$  8

PHASING OF NO. 3 ANTENNA =  $\frac{\text{DEGREES}}{45}$   
 $\psi_3$  0

LEFT HAND PATTERN NUMBER GIVES ANTENNA PLACEMENT AND PHASING DATA.

% FIELD INTENSITY RADIATED IN HORIZONTAL PLANE FROM NO. 1 ANTENNA.  
 $E_1$  19

% FIELD INTENSITY RADIATED IN HORIZONTAL PLANE FROM NO. 2 ANTENNA.  
 $E_2$  24

% FIELD INTENSITY RADIATED IN HORIZONTAL PLANE FROM NO. 3 ANTENNA.  
 $E_3$  47

% RMS FIELD INTENSITY RADIATED IN HORIZONTAL PLANE FROM ANTENNA SYSTEM.  
 $E_0$  79

RIGHT HAND PATTERN NUMBER GIVES ANTENNA FIELD INTENSITY DATA IN PERCENT.

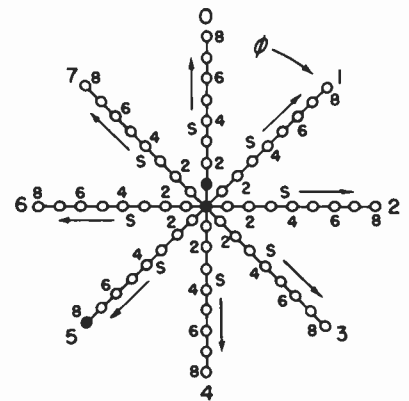

SPOTS LOCATE THE ANTENNAS FOR THIS PAGE OF PATTERNS IN THE SYSTEMATIZATION PLACEMENT CHART.

PATTERN NOMENCLATURE



$\psi_3$  = PHASING OF ANTENNA No. 3 IN DEGREES

3.187

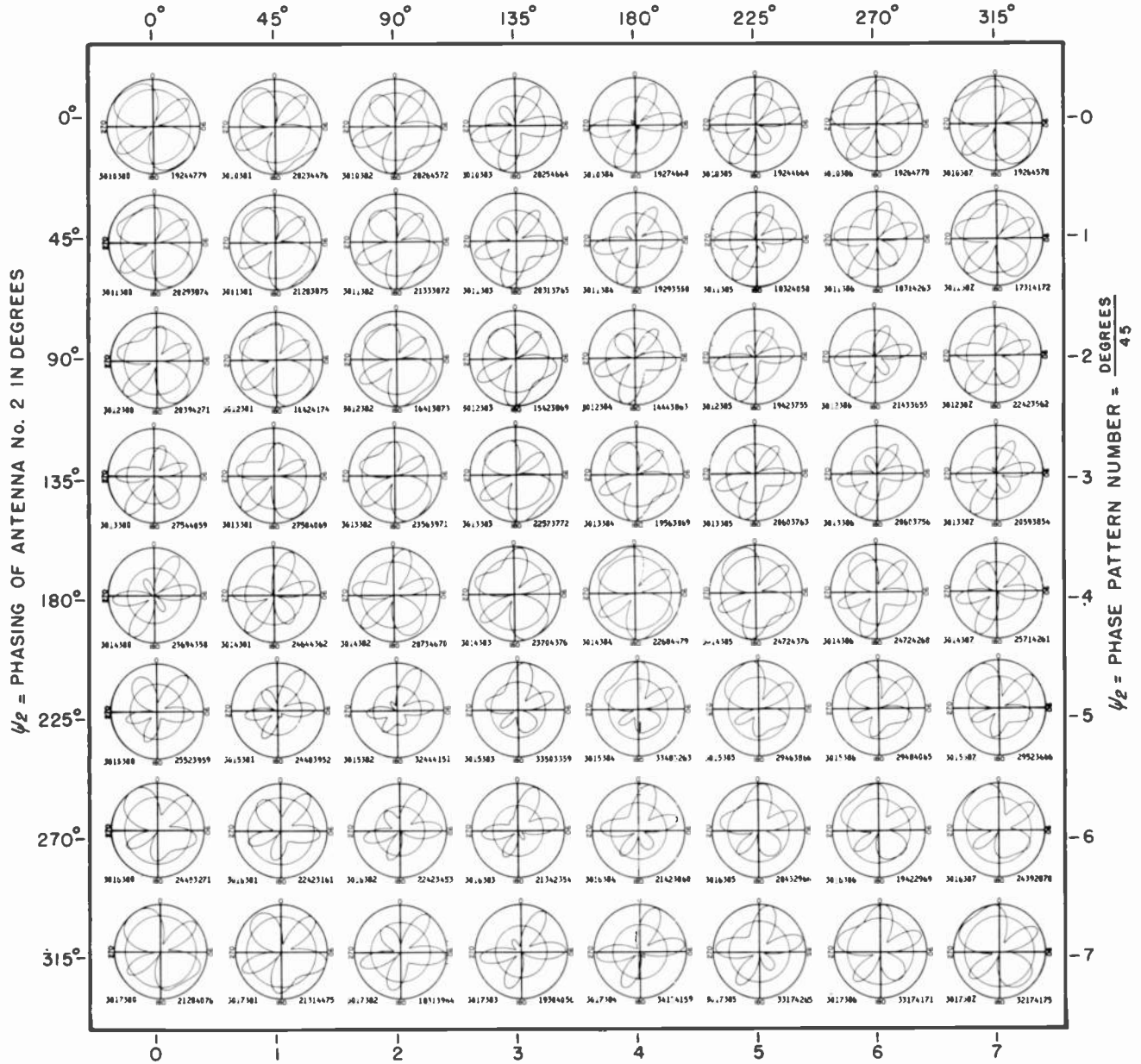

$\psi_3$  = PHASE PATTERN NUMBER =  $\frac{\text{DEGREES}}{45}$

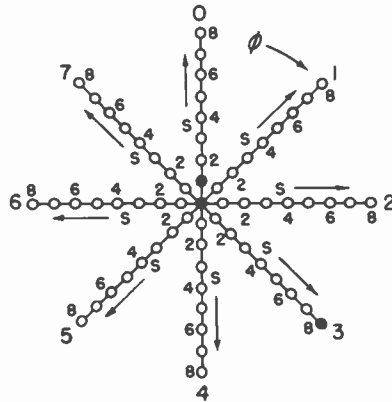

NO.	$\phi_2$	$S_2$	$\psi_2$	$\phi_3$	$S_3$	$\psi_3$
3	0	1	0	3	8	0

LEFT HAND PATTERN NUMBER GIVES ANTENNA PLACEMENT AND PHASING DATA.

$E_1$	$E_2$	$E_3$	$E_0$
19	24	47	79

RIGHT HAND PATTERN NUMBER GIVES ANTENNA FIELD INTENSITY DATA IN PERCENT.

SPOTS LOCATE THE ANTENNAS FOR THIS PAGE OF PATTERNS IN THE SYSTEMATIZATION PLACEMENT CHART.

PATTERN NOMENCLATURE

$\psi_3$  = PHASING OF ANTENNA No. 3 IN DEGREES

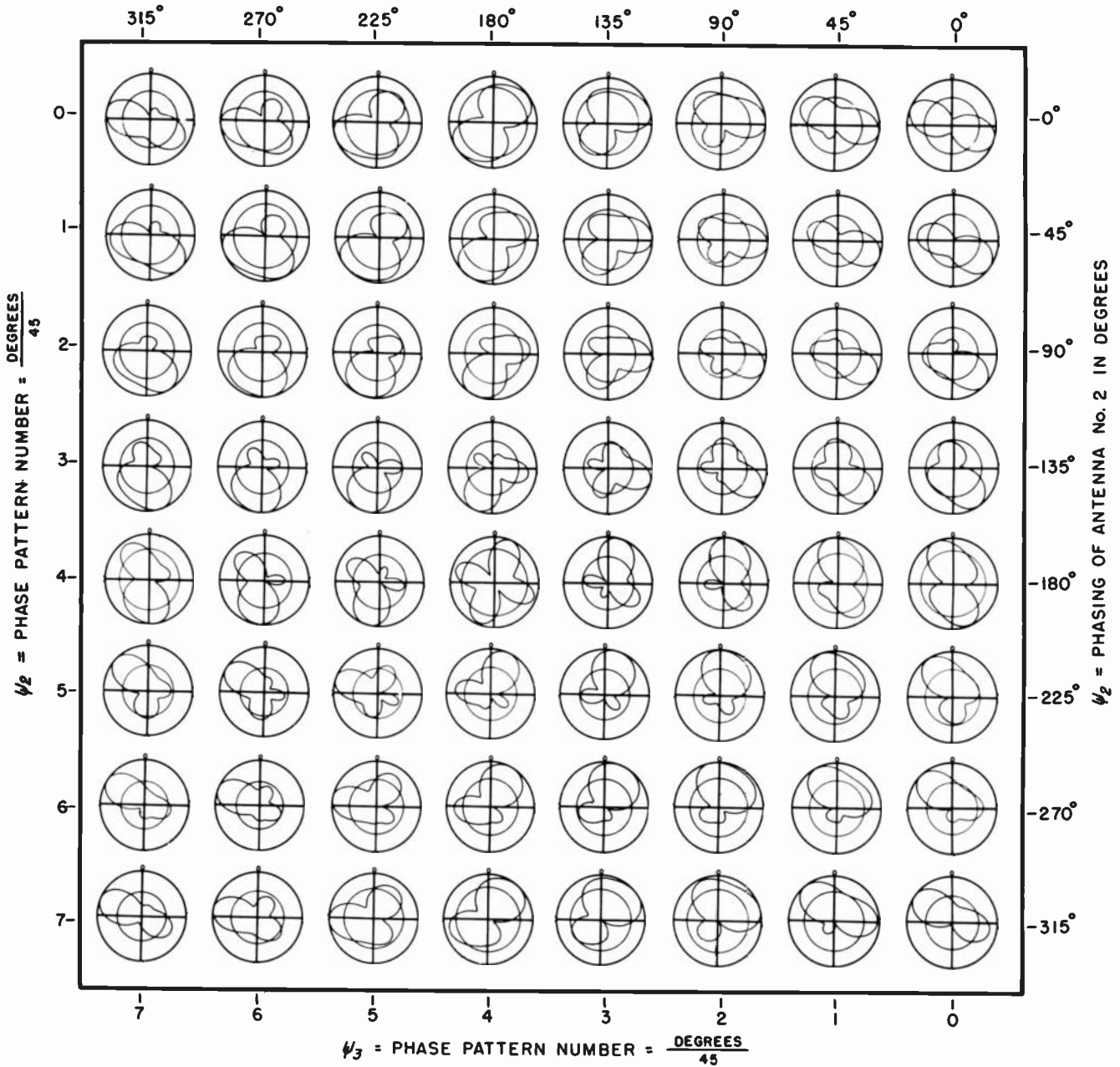

NUMBER OF ANTENNAS IN THE SYSTEM  
 $\psi_2$  = PHASE PATTERN NUMBER =  $\frac{\text{DEGREES}}{45}$

ORIENTATION OF NO. 2 ANTENNA =  $\frac{\text{DEGREES}}{45}$   
 $\phi_2$  = 0

SPACING OF NO. 2 ANTENNA =  $\frac{\text{DEGREES}}{45}$   
 $S_2$  = 2

PHASING OF NO. 2 ANTENNA =  $\frac{\text{DEGREES}}{45}$   
 $\psi_2$  = 0

ORIENTATION OF NO. 3 ANTENNA =  $\frac{\text{DEGREES}}{45}$   
 $\phi_3$  = 5

SPACING OF NO. 3 ANTENNA =  $\frac{\text{DEGREES}}{45}$   
 $S_3$  = 3

PHASING OF NO. 3 ANTENNA =  $\frac{\text{DEGREES}}{45}$   
 $\psi_3$  = 0

% FIELD INTENSITY RADIATED IN HORIZONTAL PLANE FROM NO. 1 ANTENNA.  
 $E_1$  = 33

% FIELD INTENSITY RADIATED IN HORIZONTAL PLANE FROM NO. 2 ANTENNA.  
 $E_2$  = 33

% FIELD INTENSITY RADIATED IN HORIZONTAL PLANE FROM NO. 3 ANTENNA.  
 $E_3$  = 33

% RMS FIELD INTENSITY RADIATED IN HORIZONTAL PLANE FROM ANTENNA SYSTEM.  
 $E_0$  = 62

LEFT HAND PATTERN NUMBER GIVES ANTENNA PLACEMENT AND PHASING DATA.

RIGHT HAND PATTERN NUMBER GIVES ANTENNA FIELD INTENSITY DATA IN PERCENT.

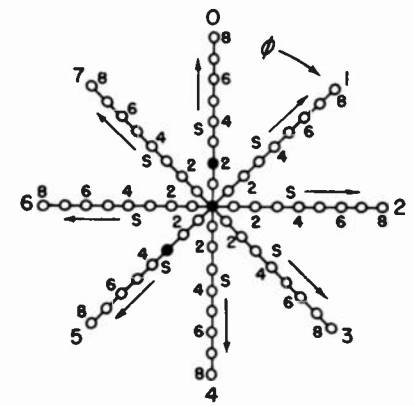

SPOTS LOCATE THE ANTENNAS FOR THIS PAGE OF PATTERNS IN THE SYSTEMATIZATION PLACEMENT CHART.

PATTERN NOMENCLATURE

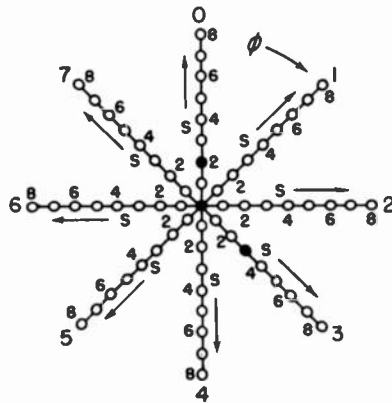
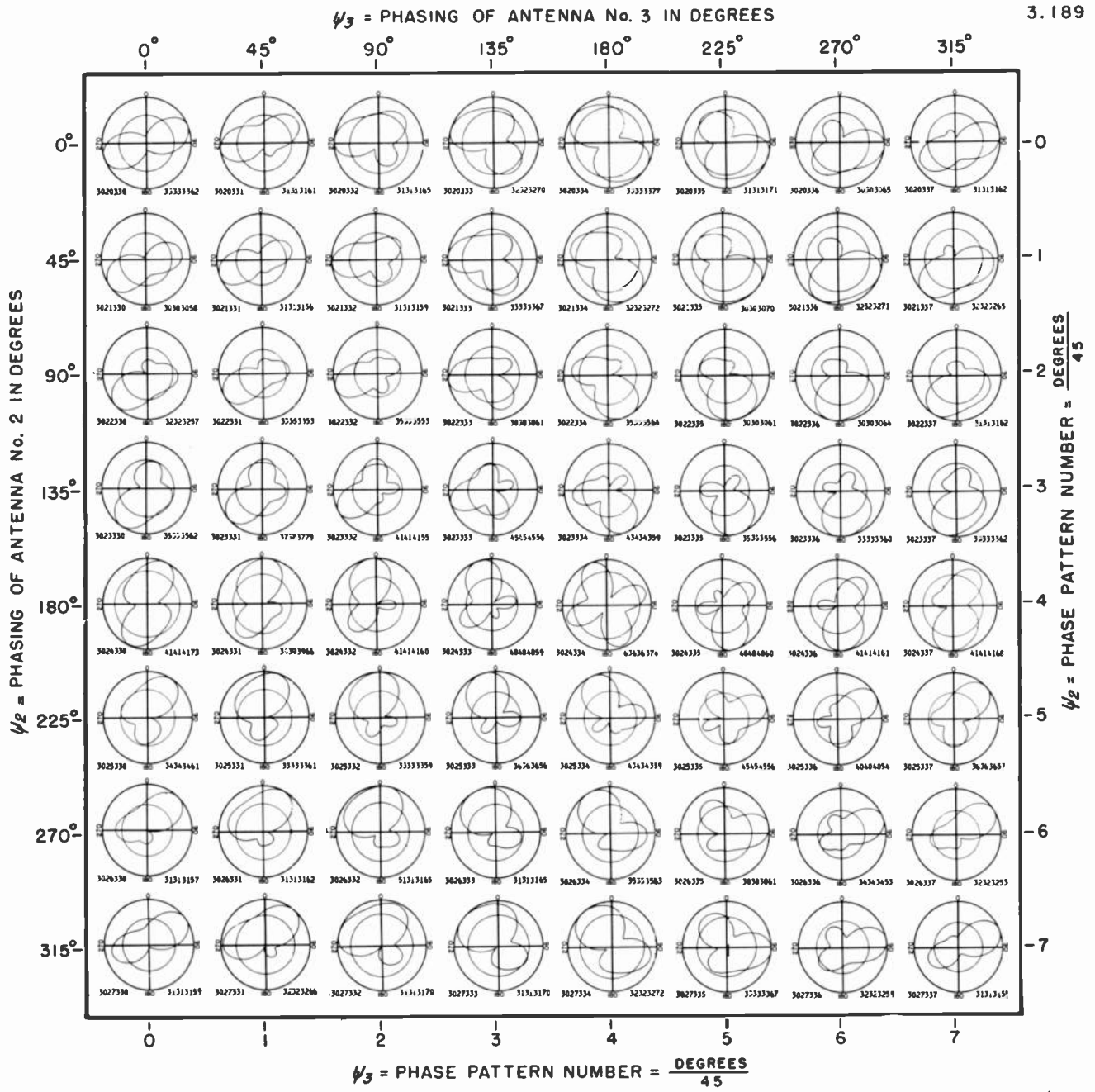

SPOTS LOCATE THE ANTENNAS FOR THIS PAGE OF PATTERNS IN THE SYSTEMATIZATION PLACEMENT CHART.

LEFT HAND PATTERN NUMBER GIVES ANTENNA PLACEMENT AND PHASING DATA.

RIGHT HAND PATTERN NUMBER GIVES ANTENNA FIELD INTENSITY DATA IN PERCENT.

PATTERN NOMENCLATURE

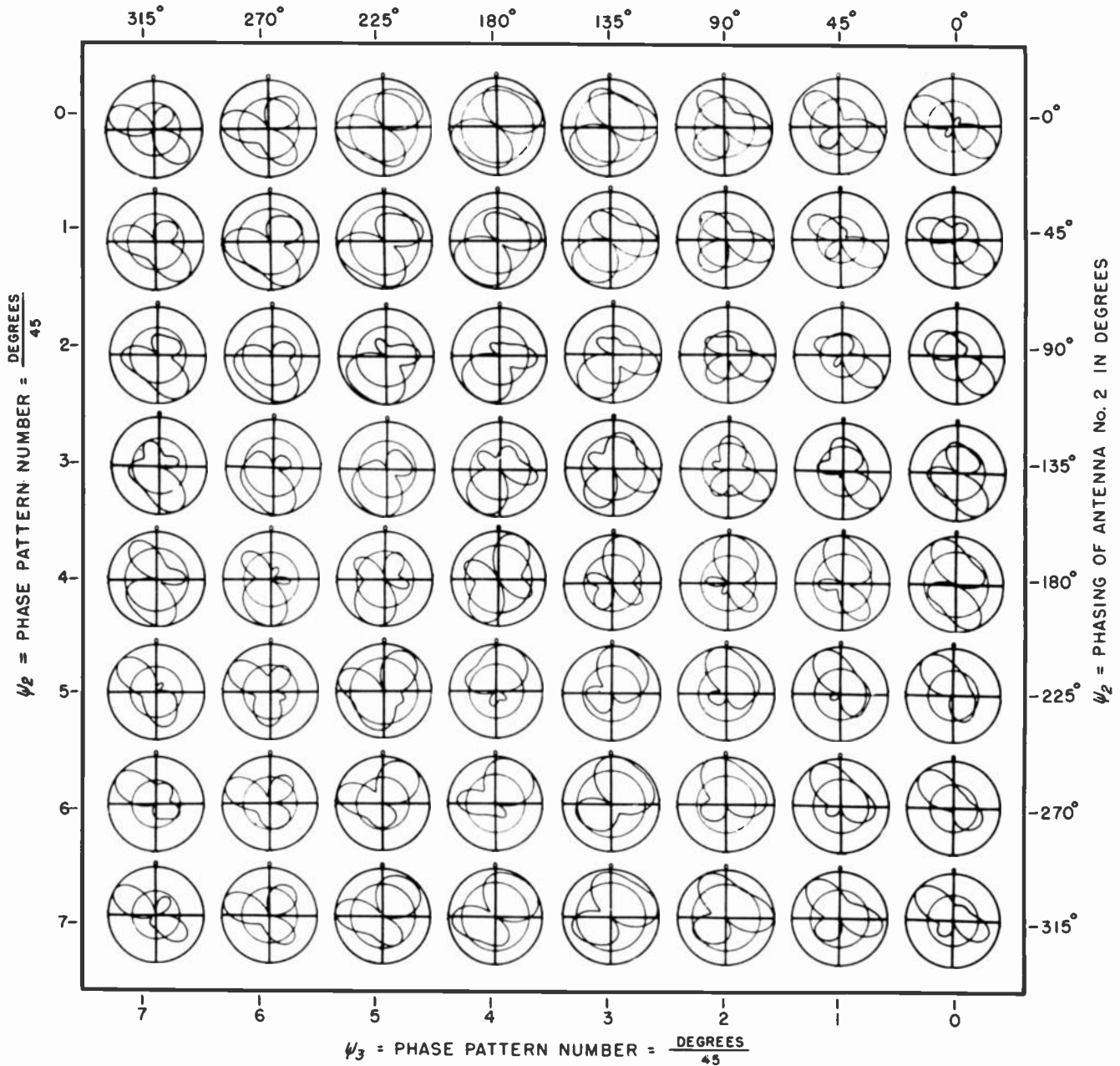

NUMBER OF ANTENNAS IN THE SYSTEM  
No. 3

ORIENTATION OF NO. 2 ANTENNA =  $\frac{\text{DEGREES}}{45}$   
 $\psi_2$  0

SPACING OF NO. 2 ANTENNA =  $\frac{\text{DEGREES}}{45}$   
 $S_2$  2

PHASING OF NO. 2 ANTENNA =  $\frac{\text{DEGREES}}{45}$   
 $\psi_2$  0

ORIENTATION OF NO. 3 ANTENNA =  $\frac{\text{DEGREES}}{45}$   
 $\psi_3$  5

SPACING OF NO. 3 ANTENNA =  $\frac{\text{DEGREES}}{45}$   
 $S_3$  4

PHASING OF NO. 3 ANTENNA =  $\frac{\text{DEGREES}}{45}$   
 $\psi_3$  0

% FIELD INTENSITY RADIATED IN HORIZONTAL PLANE FROM NO. 1 ANTENNA.  
 $E_1$  32

% FIELD INTENSITY RADIATED IN HORIZONTAL PLANE FROM NO. 2 ANTENNA.  
 $E_2$  28

% FIELD INTENSITY RADIATED IN HORIZONTAL PLANE FROM NO. 3 ANTENNA.  
 $E_3$  44

% RMS FIELD INTENSITY RADIATED IN HORIZONTAL PLANE FROM ANTENNA SYSTEM.  
 $E_0$  53

LEFT HAND PATTERN NUMBER GIVES ANTENNA PLACEMENT AND PHASING DATA.

RIGHT HAND PATTERN NUMBER GIVES ANTENNA FIELD INTENSITY DATA IN PERCENT.

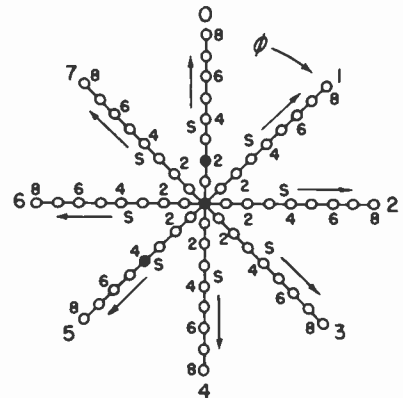

SPOTS LOCATE THE ANTENNAS FOR THIS PAGE OF PATTERNS IN THE SYSTEMATIZATION PLACEMENT CHART.

PATTERN NOMENCLATURE

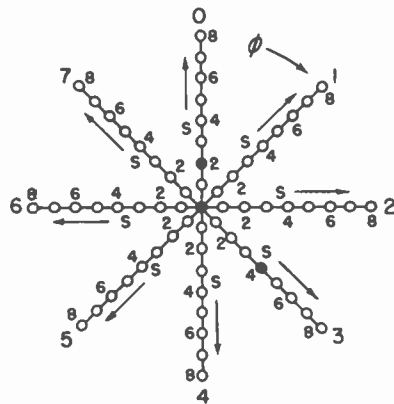
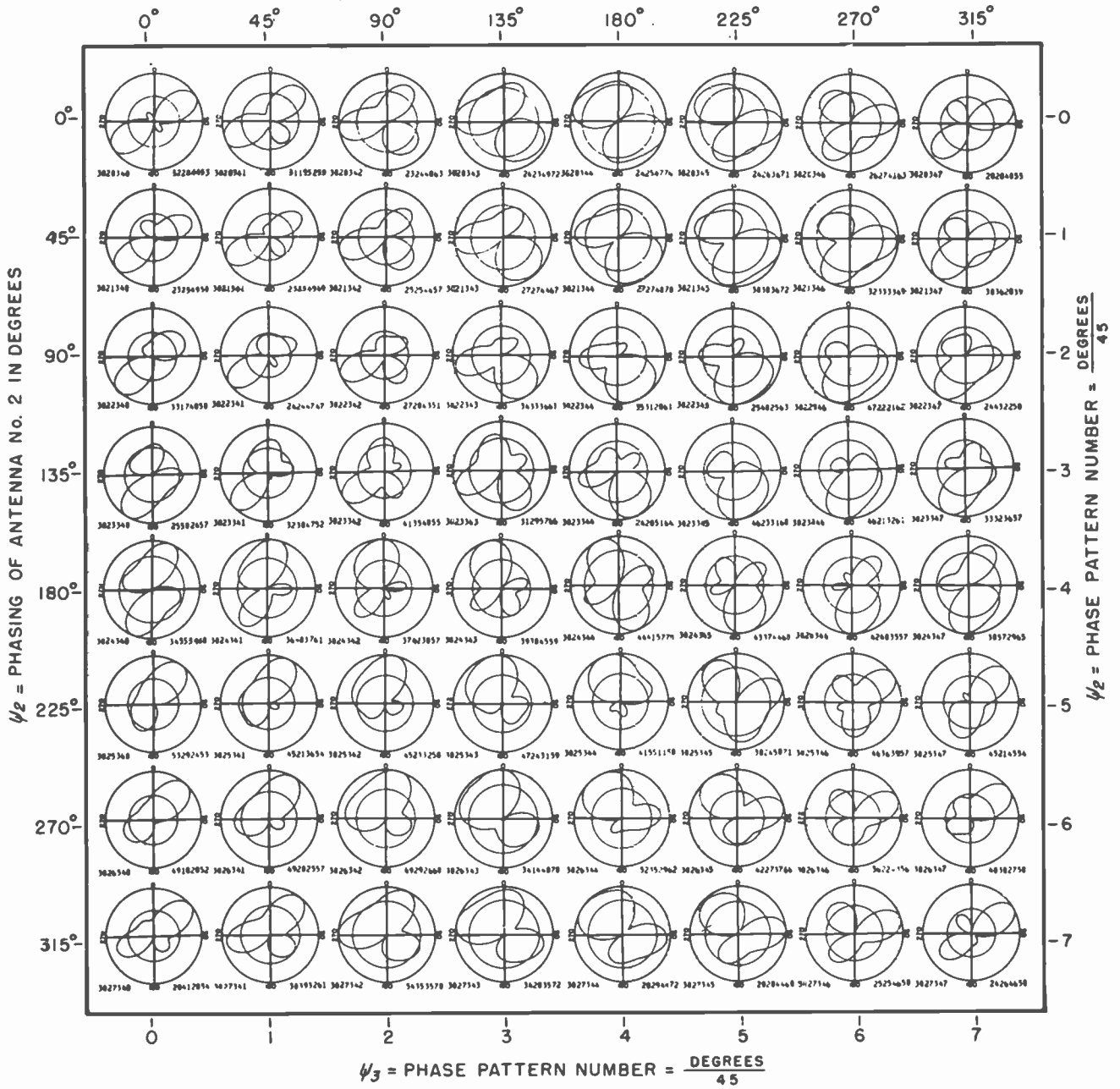

NO.	$\phi_2$	$S_2$	$\psi_2$	$\phi_3$	$S_3$	$\psi_3$
3	0	2	0	3	4	0

LEFT HAND PATTERN NUMBER GIVES ANTENNA PLACEMENT AND PHASING DATA.

	$F_1$	$F_2$	$F_3$	$F_0$
% FIELD INTENSITY RADIATED IN HORIZONTAL PLANE FROM NO. 1 ANTENNA.	32			
% FIELD INTENSITY RADIATED IN HORIZONTAL PLANE FROM NO. 2 ANTENNA.		28		
% FIELD INTENSITY RADIATED IN HORIZONTAL PLANE FROM NO. 3 ANTENNA.			44	
% RMS FIELD INTENSITY RADIATED IN HORIZONTAL PLANE FROM ANTENNA SYSTEM.				53

RIGHT HAND PATTERN NUMBER GIVES ANTENNA FIELD INTENSITY DATA IN PERCENT.

SPOTS LOCATE THE ANTENNAS FOR THIS PAGE OF PATTERNS IN THE SYSTEMATIZATION PLACEMENT CHART.

PATTERN NOMENCLATURE

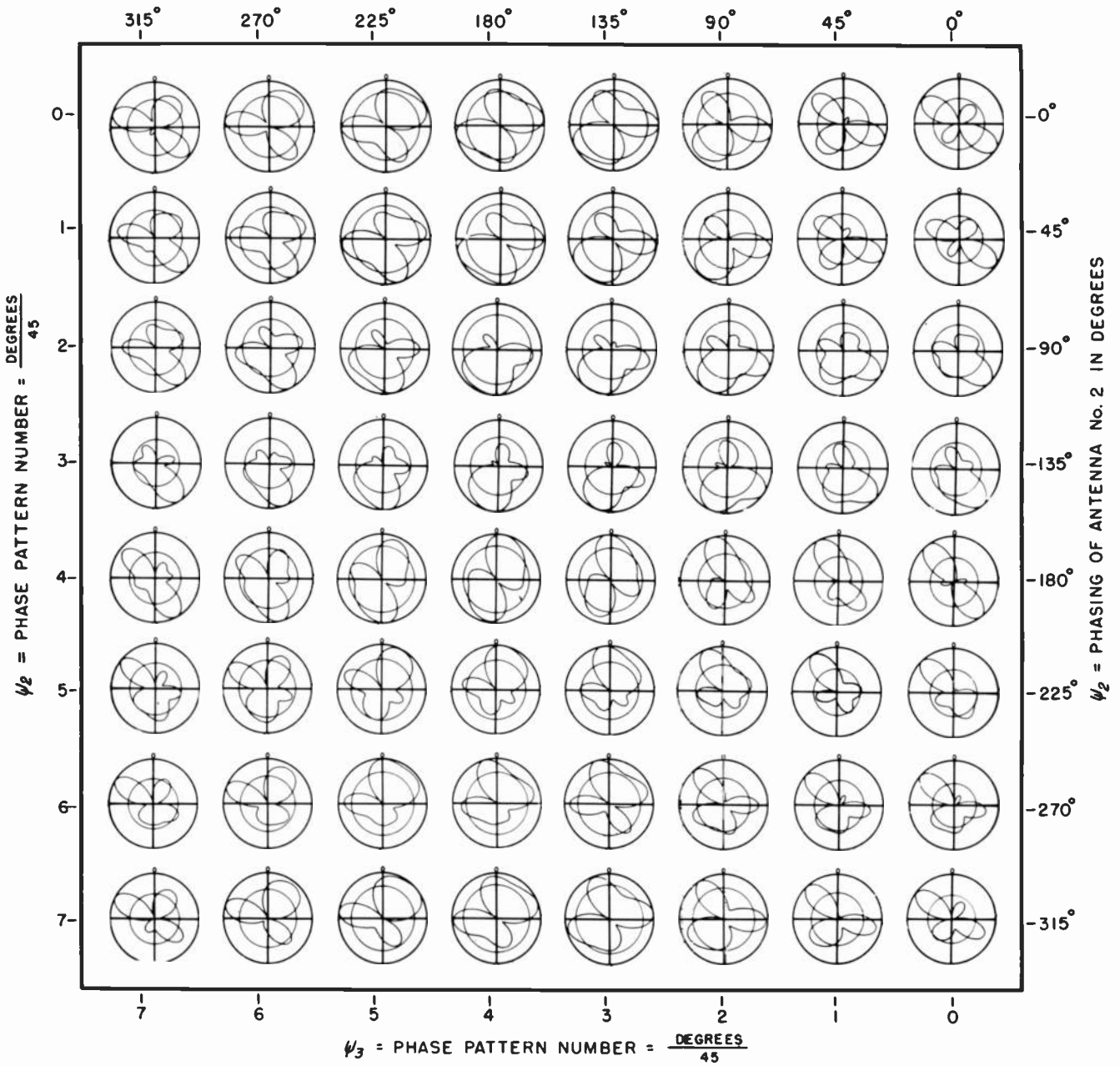

NUMBER OF ANTENNAS IN THE SYSTEM	$\psi_2 = \frac{\text{DEGREES}}{45}$	$\psi_3 = \frac{\text{DEGREES}}{45}$
ORIENTATION OF NO. 2 ANTENNA =	$\phi_2 = \frac{\text{DEGREES}}{45}$	$\phi_3 = \frac{\text{DEGREES}}{45}$
SPACING OF NO. 2 ANTENNA =	$S_2 = \frac{\text{DEGREES}}{45}$	$S_3 = \frac{\text{DEGREES}}{45}$
PHASING OF NO. 2 ANTENNA =	$\psi_2$	$\psi_3$
ORIENTATION OF NO. 3 ANTENNA =	$\phi_3 = \frac{\text{DEGREES}}{45}$	$\phi_2 = \frac{\text{DEGREES}}{45}$
SPACING OF NO. 3 ANTENNA =	$S_3 = \frac{\text{DEGREES}}{45}$	$S_2 = \frac{\text{DEGREES}}{45}$
PHASING OF NO. 3 ANTENNA =	$\psi_3 = \frac{\text{DEGREES}}{45}$	$\psi_2 = \frac{\text{DEGREES}}{45}$

LEFT HAND PATTERN NUMBER GIVES ANTENNA PLACEMENT AND PHASING DATA.

% FIELD INTENSITY RADIATED IN HORIZONTAL PLANE FROM NO. 1 ANTENNA.	$F_1$	35
% FIELD INTENSITY RADIATED IN HORIZONTAL PLANE FROM NO. 2 ANTENNA.	$F_2$	19
% FIELD INTENSITY RADIATED IN HORIZONTAL PLANE FROM NO. 3 ANTENNA.	$F_3$	44
% RMS FIELD INTENSITY RADIATED IN HORIZONTAL PLANE FROM ANTENNA SYSTEM.	$F_0$	57

RIGHT HAND PATTERN NUMBER GIVES ANTENNA FIELD INTENSITY DATA IN PERCENT.

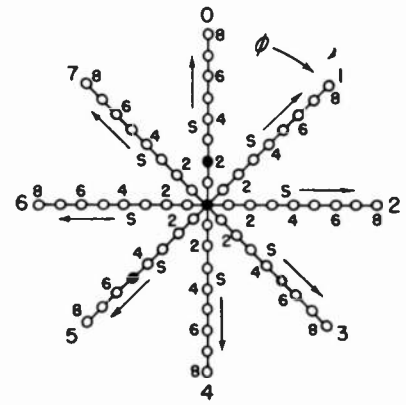

SPOTS LOCATE THE ANTENNAS FOR THIS PAGE OF PATTERNS IN THE SYSTEMATIZATION PLACEMENT CHART.

PATTERN NOMENCLATURE

$\psi_3$  = PHASING OF ANTENNA No. 3 IN DEGREES

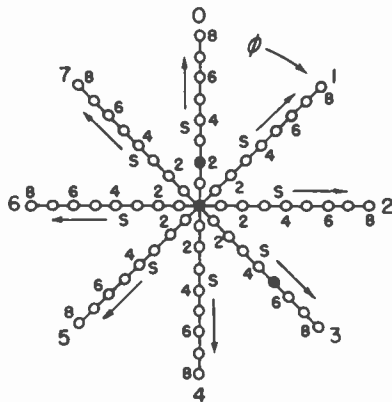
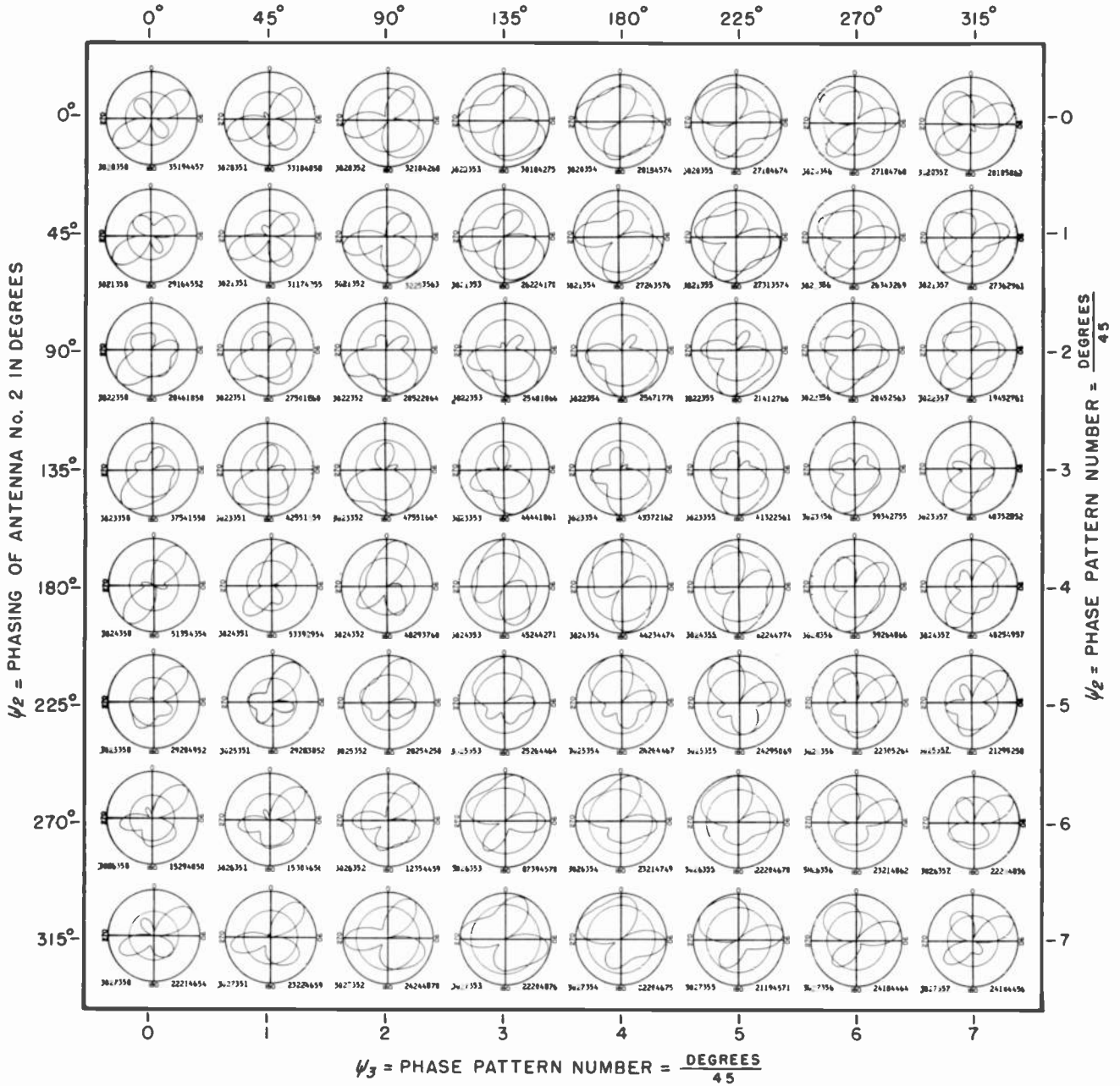

SPOTS LOCATE THE ANTENNAS FOR THIS PAGE OF PATTERNS IN THE SYSTEMATIZATION PLACEMENT CHART.

NUMBER OF ANTENNAS IN THE SYSTEM	ORIENTATION OF NO. 2 ANTENNA = $\frac{\text{DEGREES}}{45}$	SPACING OF NO. 2 ANTENNA = $\frac{\text{DEGREES}}{45}$	PHASING OF NO. 2 ANTENNA = $\frac{\text{DEGREES}}{45}$	ORIENTATION OF NO. 3 ANTENNA = $\frac{\text{DEGREES}}{45}$	SPACING OF NO. 3 ANTENNA = $\frac{\text{DEGREES}}{45}$	PHASING OF NO. 3 ANTENNA = $\frac{\text{DEGREES}}{45}$
No. 3	$\phi_2$ 0	$S_2$ 2	$\psi_2$ 0	$\phi_3$ 3	$S_3$ 5	$\psi_3$ 0

LEFT HAND PATTERN NUMBER GIVES ANTENNA PLACEMENT AND PHASING DATA.

% FIELD INTENSITY RADIATED IN HORIZONTAL PLANE FROM NO. 1 ANTENNA.	% FIELD INTENSITY RADIATED IN HORIZONTAL PLANE FROM NO. 2 ANTENNA.	% FIELD INTENSITY RADIATED IN HORIZONTAL PLANE FROM NO. 3 ANTENNA.	% RMS FIELD INTENSITY RADIATED IN HORIZONTAL PLANE FROM ANTENNA SYSTEM.
$E_1$ 35	$E_2$ 19	$E_3$ 44	$E_0$ 57

RIGHT HAND PATTERN NUMBER GIVES ANTENNA FIELD INTENSITY DATA IN PERCENT.

PATTERN NOMENCLATURE

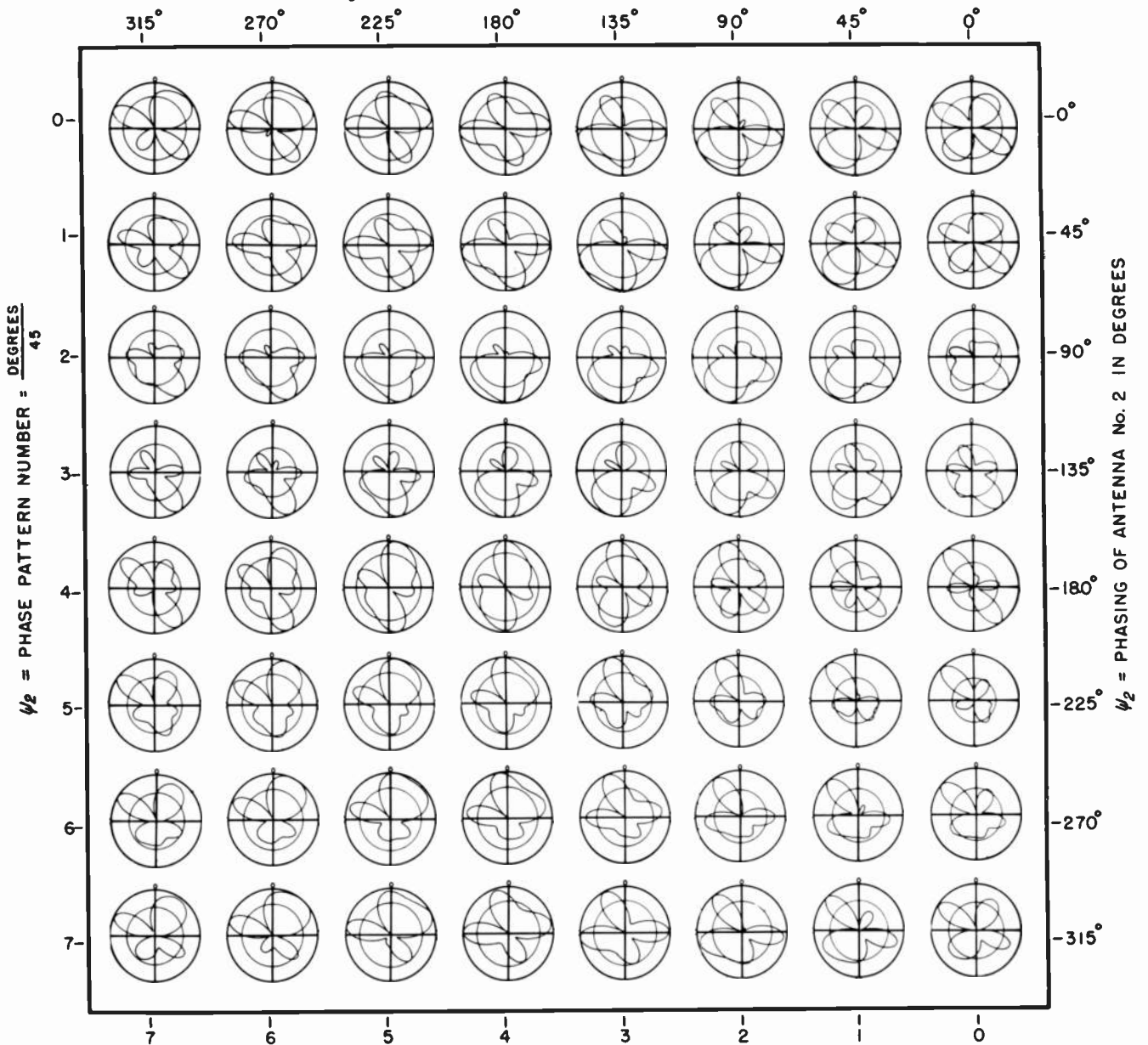

NUMBER OF ANTENNAS IN THE SYSTEM  
 No. 3

ORIENTATION OF NO. 2 ANTENNA =  $\frac{\text{DEGREES}}{45}$   
 $\psi_2$  0

SPACING OF NO. 2 ANTENNA =  $\frac{\text{DEGREES}}{45}$   
 $S_2$  2

PHASING OF NO. 2 ANTENNA =  $\frac{\text{DEGREES}}{45}$   
 $\psi_2$  0

ORIENTATION OF NO. 3 ANTENNA =  $\frac{\text{DEGREES}}{45}$   
 $\psi_3$  5

SPACING OF NO. 3 ANTENNA =  $\frac{\text{DEGREES}}{45}$   
 $S_3$  6

PHASING OF NO. 3 ANTENNA =  $\frac{\text{DEGREES}}{45}$   
 $\psi_3$  0

LEFT HAND PATTERN NUMBER GIVES ANTENNA PLACEMENT AND PHASING DATA.

% FIELD INTENSITY RADIATED IN HORIZONTAL PLANE FROM NO. 1 ANTENNA.  
 $F_1$  23

% FIELD INTENSITY RADIATED IN HORIZONTAL PLANE FROM NO. 2 ANTENNA.  
 $F_2$  22

% FIELD INTENSITY RADIATED IN HORIZONTAL PLANE FROM NO. 3 ANTENNA.  
 $F_3$  50

% RMS FIELD INTENSITY RADIATED IN HORIZONTAL PLANE FROM ANTENNA SYSTEM.  
 $F_0$  67

RIGHT HAND PATTERN NUMBER GIVES ANTENNA FIELD INTENSITY DATA IN PERCENT.

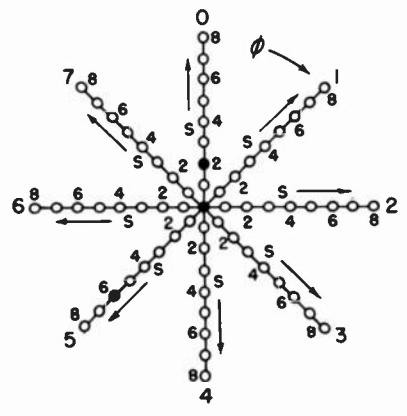

SPOTS LOCATE THE ANTENNAS FOR THIS PAGE OF PATTERNS IN THE SYSTEMATIZATION PLACEMENT CHART.

PATTERN NOMENCLATURE



$\psi_3$  = PHASING OF ANTENNA No. 3 IN DEGREES

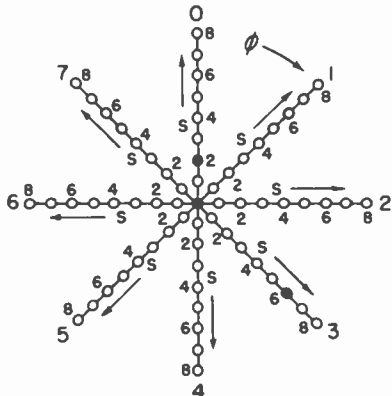
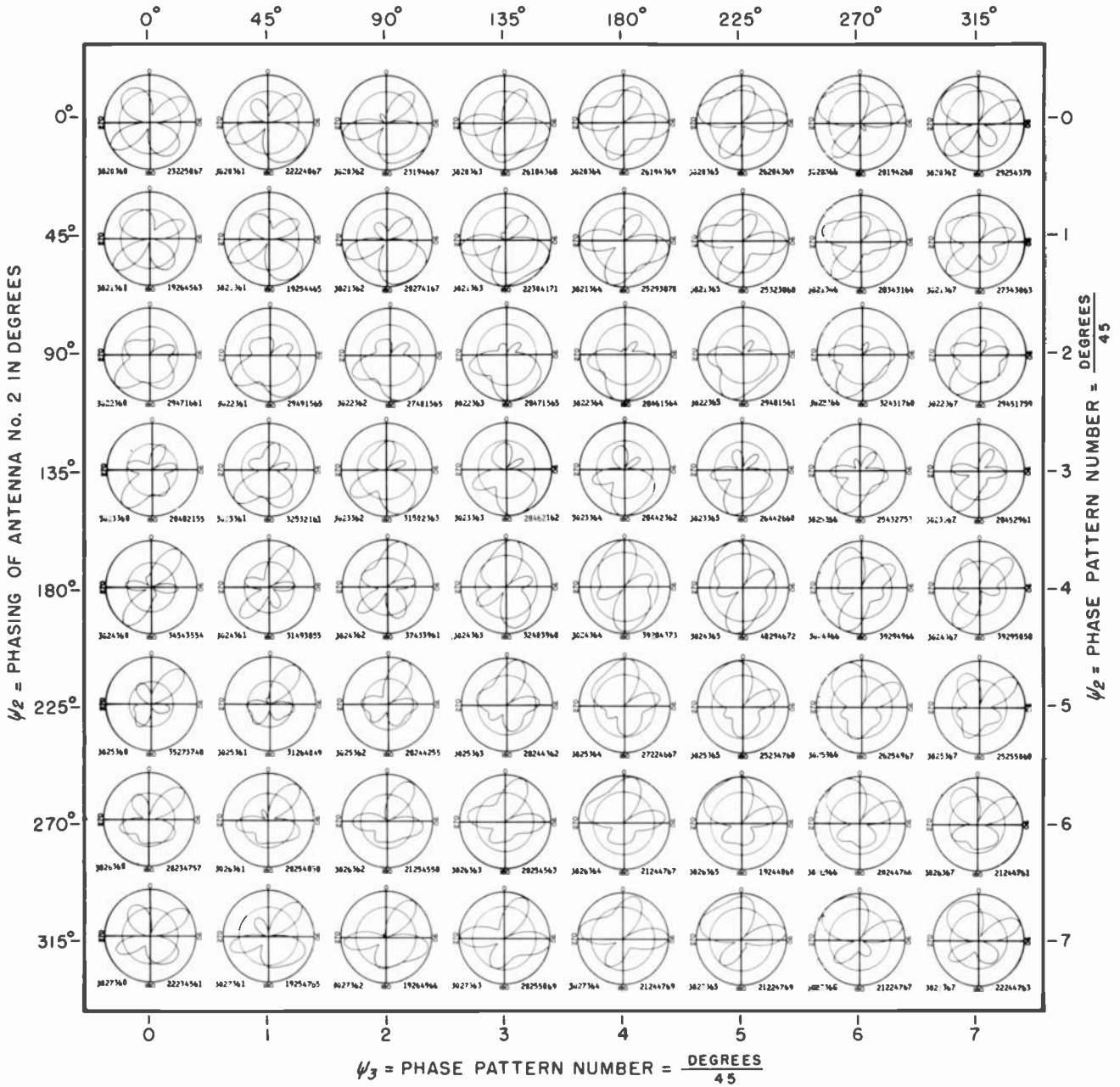

$\psi_3$  = PHASE PATTERN NUMBER =  $\frac{\text{DEGREES}}{45}$

NUMBER OF ANTENNAS IN THE SYSTEM	ORIENTATION OF NO. 2 ANTENNA = $\frac{\text{DEGREES}}{45}$	SPACING OF NO. 2 ANTENNA = $\frac{\text{DEGREES}}{45}$	PHASING OF NO. 2 ANTENNA = $\frac{\text{DEGREES}}{45}$	ORIENTATION OF NO. 3 ANTENNA = $\frac{\text{DEGREES}}{45}$	SPACING OF NO. 3 ANTENNA = $\frac{\text{DEGREES}}{45}$	PHASING OF NO. 3 ANTENNA = $\frac{\text{DEGREES}}{45}$
No. 3	$\phi_2$	$S_2$	$\psi_2$	$\phi_3$	$S_3$	$\psi_3$
3	0	2	0	3	6	0

% FIELD INTENSITY RADIATED IN HORIZONTAL PLANE FROM NO. 1 ANTENNA.	% FIELD INTENSITY RADIATED IN HORIZONTAL PLANE FROM NO. 2 ANTENNA.	% FIELD INTENSITY RADIATED IN HORIZONTAL PLANE FROM NO. 3 ANTENNA.	% RMS FIELD INTENSITY RADIATED IN HORIZONTAL PLANE FROM ANTENNA SYSTEM.
$F_1$	$F_2$	$F_3$	$F_0$
23	22	50	67

SPOTS LOCATE THE ANTENNAS FOR THIS PAGE OF PATTERNS IN THE SYSTEMATIZATION PLACEMENT CHART.

LEFT HAND PATTERN NUMBER GIVES ANTENNA PLACEMENT AND PHASING DATA.

RIGHT HAND PATTERN NUMBER GIVES ANTENNA FIELD INTENSITY DATA IN PERCENT.

PATTERN NOMENCLATURE

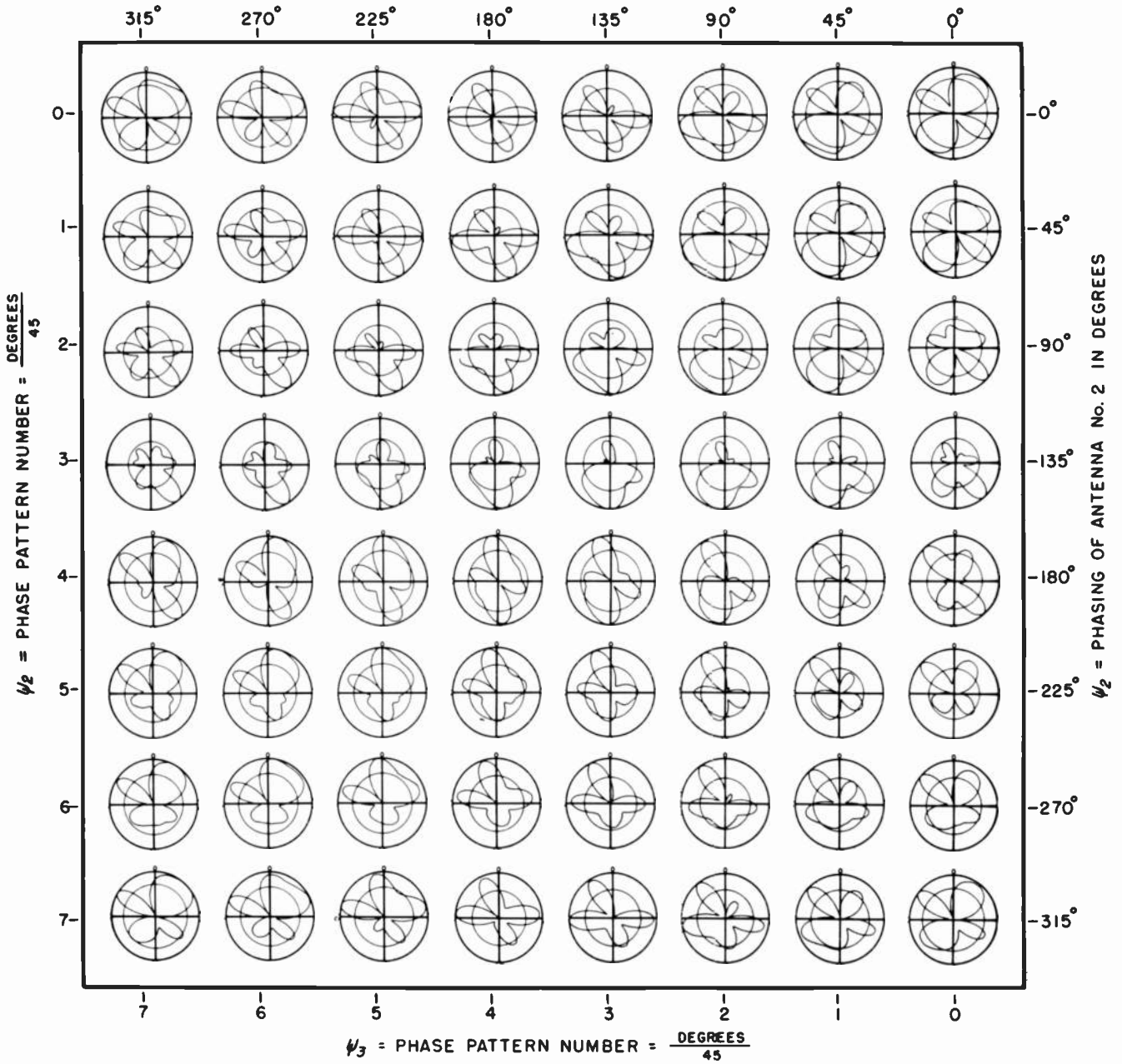

NUMBER OF ANTENNAS IN THE SYSTEM  
 No. 3

ORIENTATION OF NO. 2 ANTENNA =  $\frac{DEGREES}{45}$   
 $\phi_2$  0

SPACING OF NO. 2 ANTENNA =  $\frac{DEGREES}{45}$   
 $S_2$  3

PHASING OF NO. 2 ANTENNA =  $\frac{DEGREES}{45}$   
 $\psi_2$  0

ORIENTATION OF NO. 3 ANTENNA =  $\frac{DEGREES}{45}$   
 $\phi_3$  5

SPACING OF NO. 3 ANTENNA =  $\frac{DEGREES}{45}$   
 $S_3$  7

PHASING OF NO. 3 ANTENNA =  $\frac{DEGREES}{45}$   
 $\psi_3$  0

LEFT HAND PATTERN NUMBER GIVES ANTENNA PLACEMENT AND PHASING DATA.

% FIELD INTENSITY RADIATED IN HORIZONTAL PLANE FROM NO. 1 ANTENNA.  
 $E_1$  20

% FIELD INTENSITY RADIATED IN HORIZONTAL PLANE FROM NO. 2 ANTENNA.  
 $E_2$  26

% FIELD INTENSITY RADIATED IN HORIZONTAL PLANE FROM NO. 3 ANTENNA.  
 $E_3$  49

% RMS FIELD INTENSITY RADIATED IN HORIZONTAL PLANE FROM ANTENNA SYSTEM.  
 $E_0$  76

RIGHT HAND PATTERN NUMBER GIVES ANTENNA FIELD INTENSITY DATA IN PERCENT.

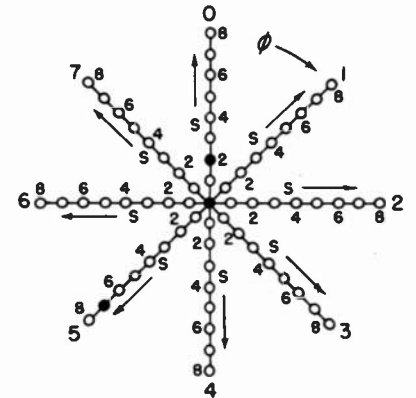

SPOTS LOCATE THE ANTENNAS FOR THIS PAGE OF PATTERNS IN THE SYSTEMATIZATION PLACEMENT CHART.

PATTERN NOMENCLATURE

CLEVELAND INSTITUTE OF RADIO ELECTRONICS  
 TERMINAL TOWER, CLEVELAND 18, OHIO.

COPYRIGHT 1946 BY CARL E. SMITH  
 PRINTED IN U. S. A.

$\psi_3$  = PHASING OF ANTENNA No. 3 IN DEGREES

3.197

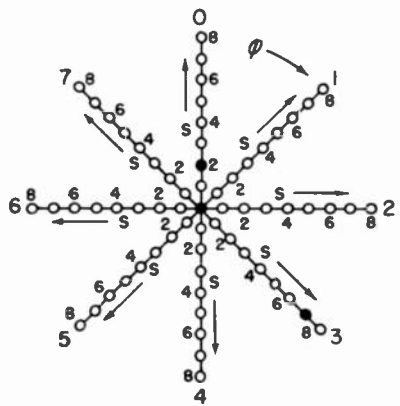
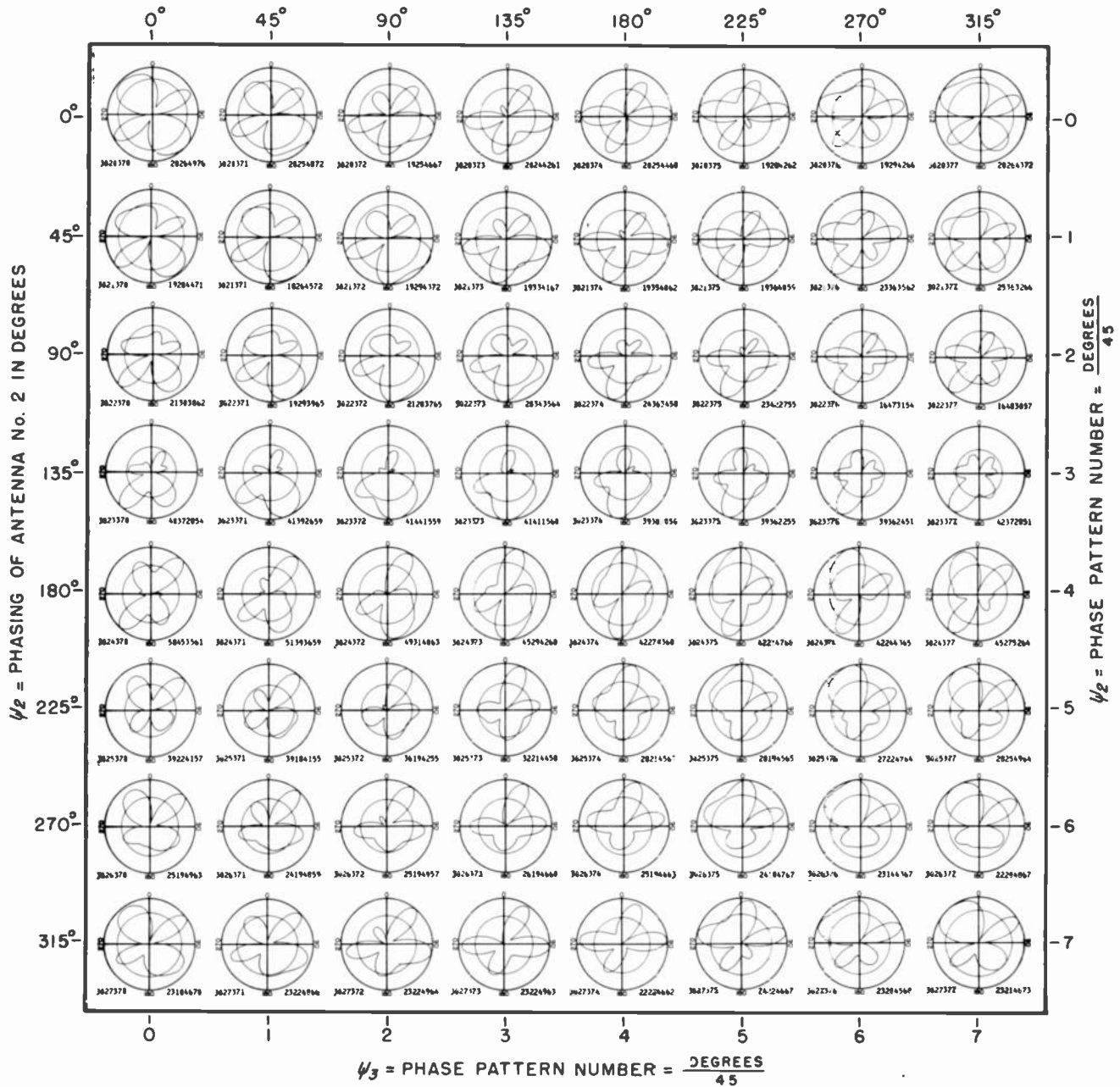

NUMBER OF ANTENNAS IN THE SYSTEM	ORIENTATION OF NO. 2 ANTENNA = $\frac{\text{DEGREES}}{45}$	SPACING OF NO. 2 ANTENNA = $\frac{\text{DEGREES}}{45}$	PHASING OF NO. 2 ANTENNA = $\frac{\text{DEGREES}}{45}$	ORIENTATION OF NO. 3 ANTENNA = $\frac{\text{DEGREES}}{45}$	SPACING OF NO. 3 ANTENNA = $\frac{\text{DEGREES}}{45}$	PHASING OF NO. 3 ANTENNA = $\frac{\text{DEGREES}}{45}$
3	$\psi_2$	$S_2$	$\psi_2$	$\psi_3$	$S_3$	$\psi_3$
0	2	0	3	7	0	

LEFT HAND PATTERN NUMBER GIVES ANTENNA PLACEMENT AND PHASING DATA.

% FIELD INTENSITY RADIATED IN HORIZONTAL PLANE FROM NO. 1 ANTENNA.	% FIELD INTENSITY RADIATED IN HORIZONTAL PLANE FROM NO. 2 ANTENNA.	% FIELD INTENSITY RADIATED IN HORIZONTAL PLANE FROM NO. 3 ANTENNA.	% RMS FIELD INTENSITY RADIATED IN HORIZONTAL PLANE FROM ANTENNA SYSTEM.
$F_1$	$F_2$	$F_3$	$F_0$
20	26	49	76

RIGHT HAND PATTERN NUMBER GIVES ANTENNA FIELD INTENSITY DATA IN PERCENT.

SPOTS LOCATE THE ANTENNAS FOR THIS PAGE OF PATTERNS IN THE SYSTEMATIZATION PLACEMENT CHART.

PATTERN NOMENCLATURE

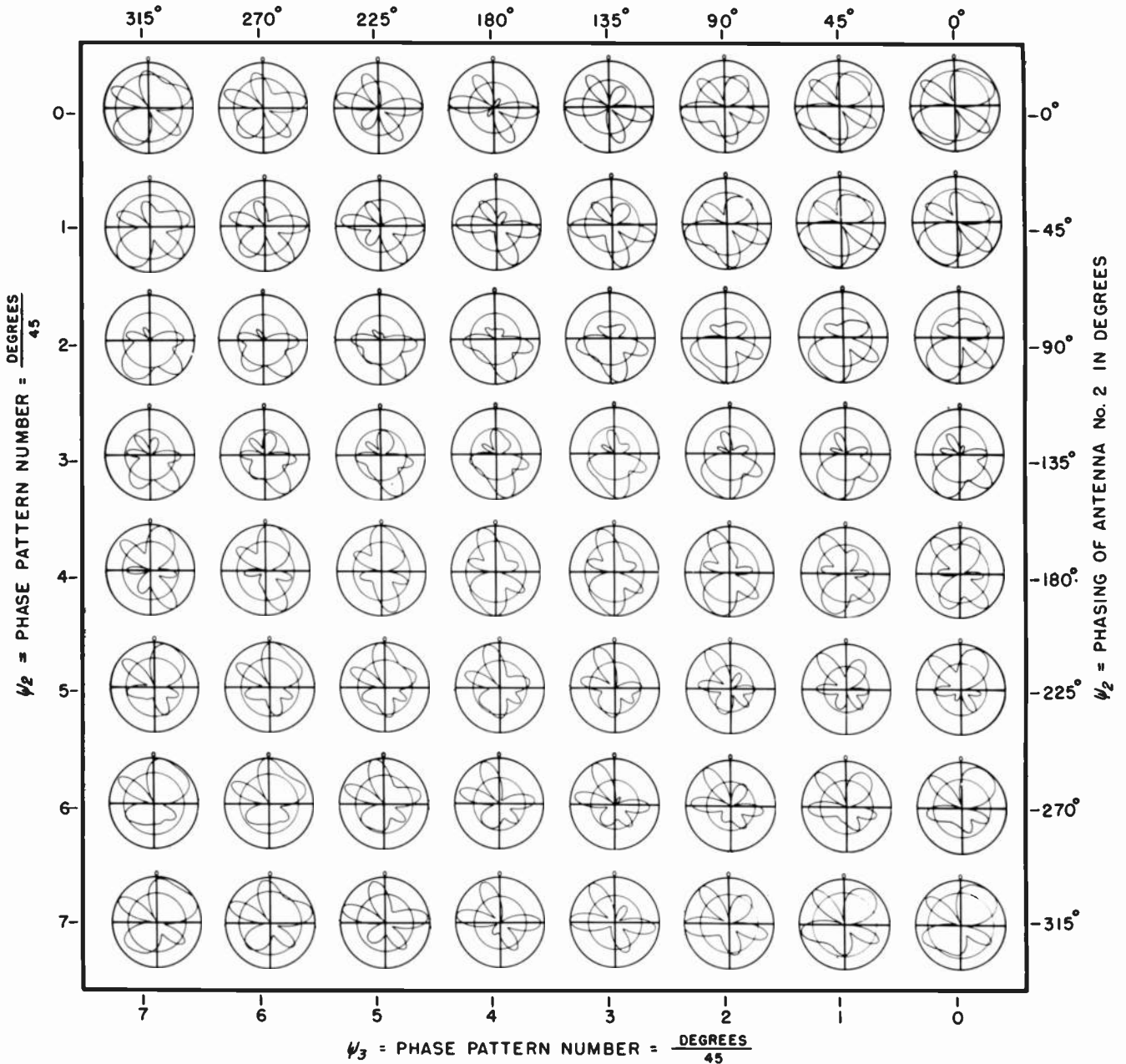

NUMBER OF ANTENNAS IN THE SYSTEM	
No. 3	0
ORIENTATION OF ANTENNAS	
$\phi_2$ NO. 2 ANTENNA = $\frac{\text{DEGREES}}{45}$	2
$S_2$ NO. 2 ANTENNA = $\frac{\text{DEGREES}}{45}$	0
$\psi_2$ NO. 2 ANTENNA = $\frac{\text{DEGREES}}{45}$	0
$\phi_3$ NO. 3 ANTENNA = $\frac{\text{DEGREES}}{45}$	5
$S_3$ NO. 3 ANTENNA = $\frac{\text{DEGREES}}{45}$	8
$\psi_3$ NO. 3 ANTENNA = $\frac{\text{DEGREES}}{45}$	0

LEFT HAND PATTERN NUMBER GIVES ANTENNA PLACEMENT AND PHASING DATA.

% FIELD INTENSITY RADIATED IN HORIZONTAL PLANE FROM NO. 1 ANTENNA.	
$F_1$	22
% FIELD INTENSITY RADIATED IN HORIZONTAL PLANE FROM NO. 2 ANTENNA.	
$F_2$	21
% FIELD INTENSITY RADIATED IN HORIZONTAL PLANE FROM NO. 3 ANTENNA.	
$F_3$	45
% RMS FIELD INTENSITY RADIATED IN HORIZONTAL PLANE FROM ANTENNA SYSTEM.	
$F_0$	77

RIGHT HAND PATTERN NUMBER GIVES ANTENNA FIELD INTENSITY DATA IN PERCENT.

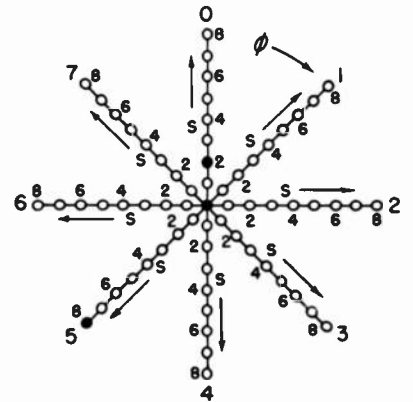

SPOTS LOCATE THE ANTENNAS FOR THIS PAGE OF PATTERNS IN THE SYSTEMATIZATION PLACEMENT CHART.

PATTERN NOMENCLATURE

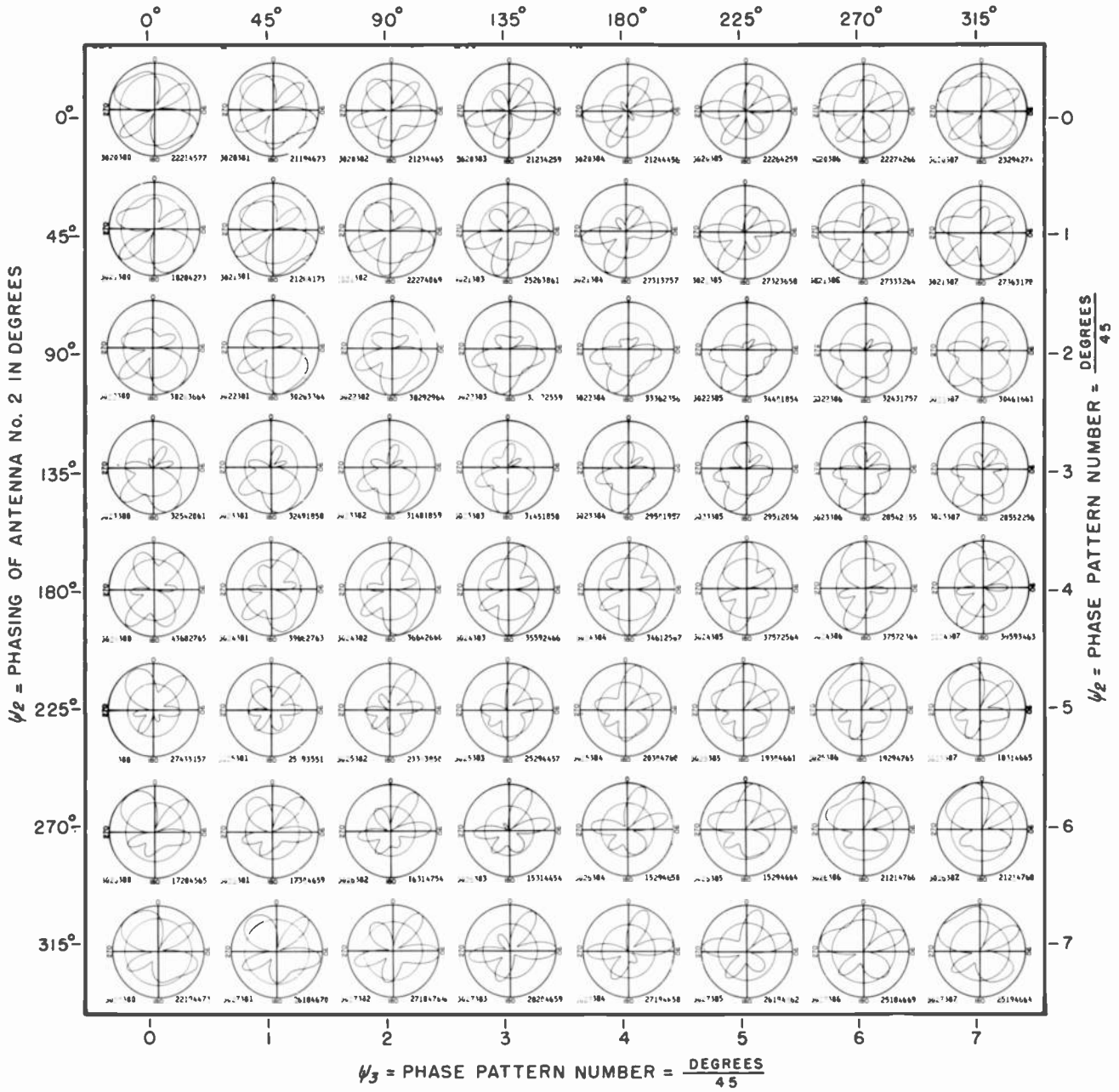

$\psi_3$  = PHASE PATTERN NUMBER =  $\frac{\text{DEGREES}}{45}$

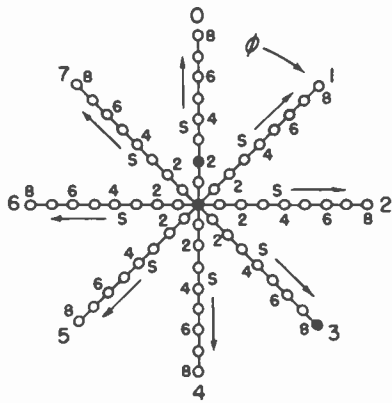

NUMBER OF ANTENNAS IN THE SYSTEM	ORIENTATION OF NO. 2 ANTENNA = $\frac{\text{DEGREES}}{45}$	SPACING OF NO. 2 ANTENNA = $\frac{\text{DEGREES}}{45}$	PHASING OF NO. 2 ANTENNA = $\frac{\text{DEGREES}}{45}$	ORIENTATION OF NO. 3 ANTENNA = $\frac{\text{DEGREES}}{45}$	SPACING OF NO. 3 ANTENNA = $\frac{\text{DEGREES}}{45}$	PHASING OF NO. 3 ANTENNA = $\frac{\text{DEGREES}}{45}$
No.	$\phi_2$	$S_2$	$\psi_2$	$\phi_3$	$S_3$	$\psi_3$
3	0	2	0	3	8	0

LEFT HAND PATTERN NUMBER GIVES ANTENNA PLACEMENT AND PHASING DATA.

% FIELD INTENSITY RADIATED IN HORIZONTAL PLANE FROM NO. 1 ANTENNA.	% FIELD INTENSITY RADIATED IN HORIZONTAL PLANE FROM NO. 2 ANTENNA.	% FIELD INTENSITY RADIATED IN HORIZONTAL PLANE FROM NO. 3 ANTENNA.	% RMS FIELD INTENSITY RADIATED IN HORIZONTAL PLANE FROM ANTENNA SYSTEM.
$E_1$	$E_2$	$E_3$	$E_0$
22	21	45	77

RIGHT HAND PATTERN NUMBER GIVES ANTENNA FIELD INTENSITY DATA IN PERCENT.

SPOTS LOCATE THE ANTENNAS FOR THIS PAGE OF PATTERNS IN THE SYSTEMIZATION PLACEMENT CHART.

PATTERN NOMENCLATURE

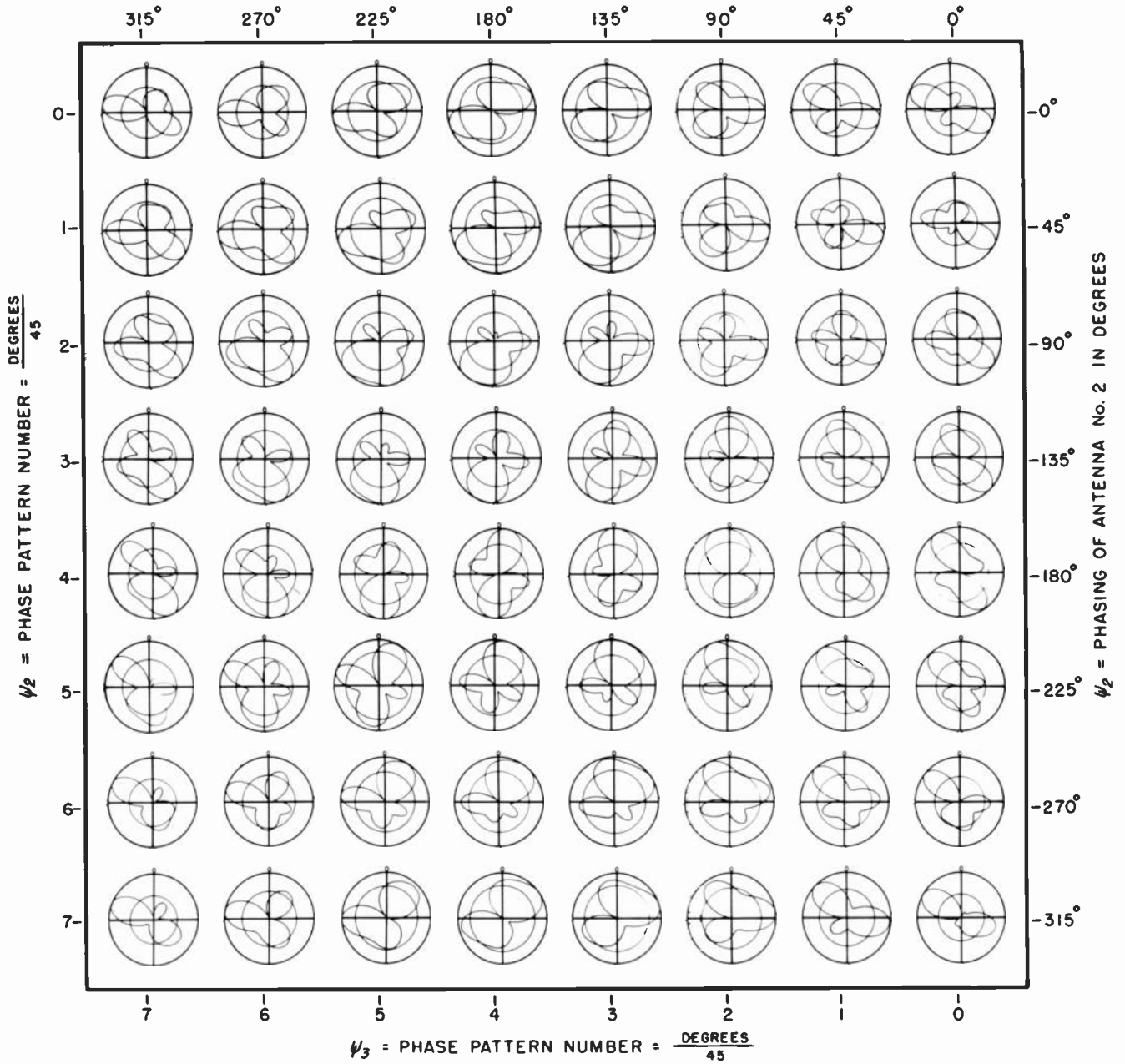

NUMBER OF ANTENNAS IN THE SYSTEM  
 ORIENTATION OF NO. 2 ANTENNA =  $\frac{\text{DEGREES}}{45}$   
 SPACING OF NO. 2 ANTENNA =  $\frac{\text{DEGREES}}{45}$   
 PHASING OF NO. 2 ANTENNA =  $\frac{\text{DEGREES}}{45}$   
 ORIENTATION OF NO. 3 ANTENNA =  $\frac{\text{DEGREES}}{45}$   
 SPACING OF NO. 3 ANTENNA =  $\frac{\text{DEGREES}}{45}$   
 PHASING OF NO. 3 ANTENNA =  $\frac{\text{DEGREES}}{45}$

% FIELD INTENSITY RADIATED IN HORIZONTAL PLANE FROM NO. 1 ANTENNA.  $E_1$  27  
 % FIELD INTENSITY RADIATED IN HORIZONTAL PLANE FROM NO. 2 ANTENNA.  $E_2$  21  
 % FIELD INTENSITY RADIATED IN HORIZONTAL PLANE FROM NO. 3 ANTENNA.  $E_3$  51  
 % RMS FIELD INTENSITY RADIATED IN HORIZONTAL PLANE FROM ANTENNA SYSTEM.  $E_0$  58

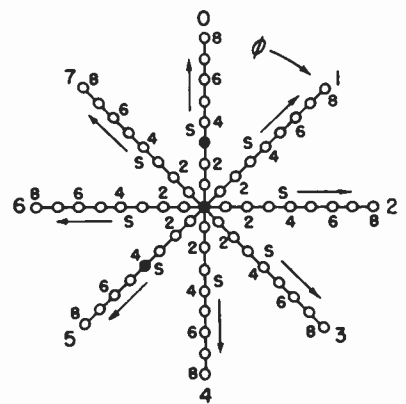

LEFT HAND PATTERN NUMBER GIVES ANTENNA PLACEMENT AND PHASING DATA.

RIGHT HAND PATTERN NUMBER GIVES ANTENNA FIELD INTENSITY DATA IN PERCENT.

SPOTS LOCATE THE ANTENNAS FOR THIS PAGE OF PATTERNS IN THE SYSTEMIZATION PLACEMENT CHART.

PATTERN NOMENCLATURE

$\psi_3$  = PHASING OF ANTENNA No. 3 IN DEGREES

3.201

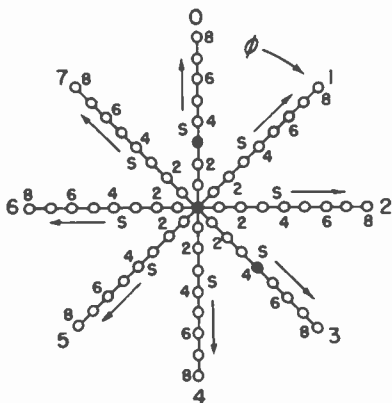
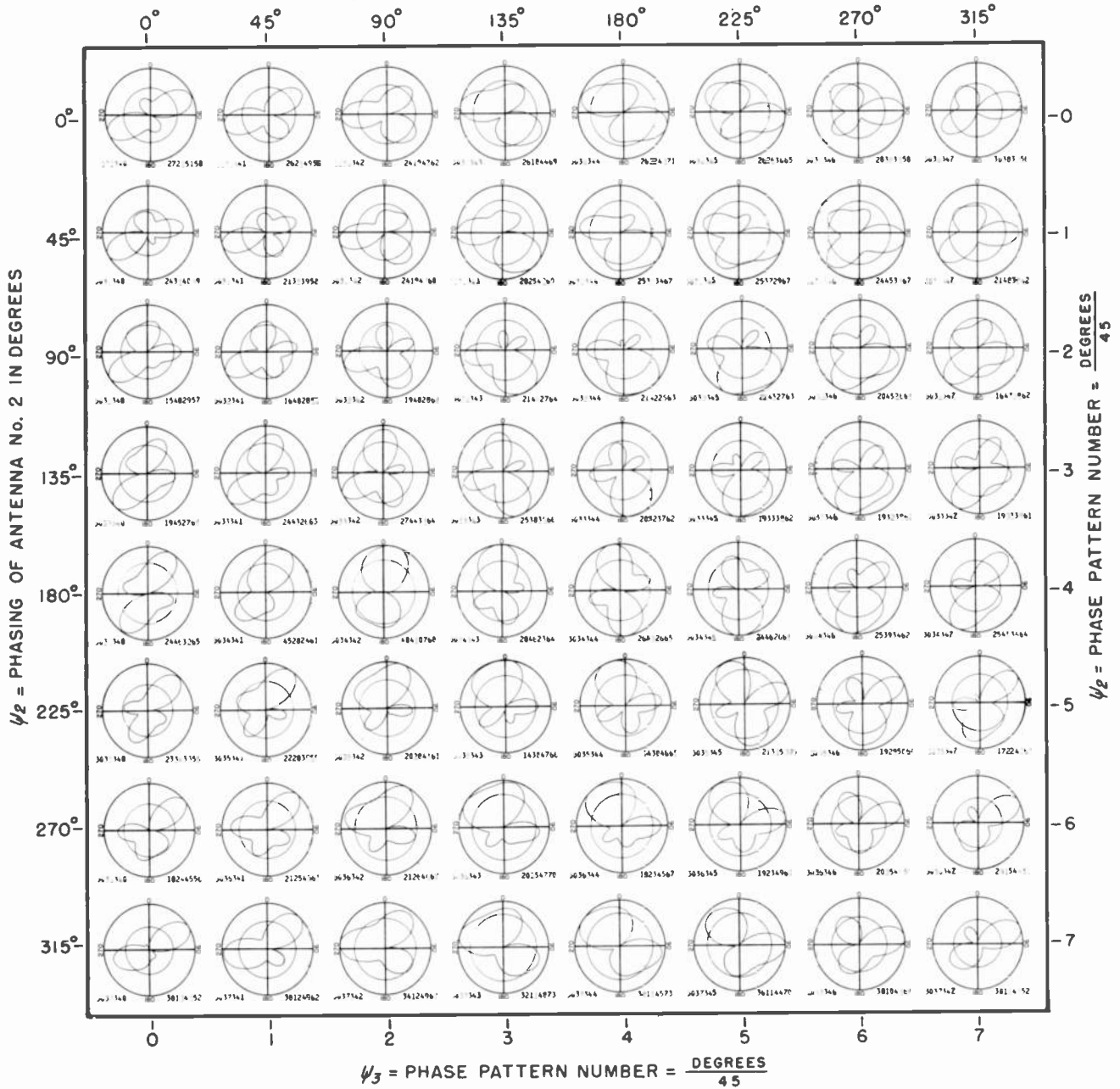

NUMBER OF ANTENNAS IN THE SYSTEM	ORIENTATION OF NO. 2 ANTENNA = $\frac{\text{DEGREES}}{45}$	SPACING OF NO. 2 ANTENNA = $\frac{\text{DEGREES}}{45}$	PHASING OF NO. 2 ANTENNA = $\frac{\text{DEGREES}}{45}$	ORIENTATION OF NO. 3 ANTENNA = $\frac{\text{DEGREES}}{45}$	SPACING OF NO. 3 ANTENNA = $\frac{\text{DEGREES}}{45}$	PHASING OF NO. 3 ANTENNA = $\frac{\text{DEGREES}}{45}$
No. 3	$\psi_2$ 0	$S_2$ 3	$\psi_2$ 0	$\psi_3$ 3	$S_3$ 4	$\psi_3$ 0

LEFT HAND PATTERN NUMBER GIVES ANTENNA  
PLACEMENT AND PHASING DATA.

% FIELD INTENSITY RADIATED IN HORIZONTAL PLANE FROM NO. 1 ANTENNA.	% FIELD INTENSITY RADIATED IN HORIZONTAL PLANE FROM NO. 2 ANTENNA.	% FIELD INTENSITY RADIATED IN HORIZONTAL PLANE FROM NO. 3 ANTENNA.	% RMS FIELD INTENSITY RADIATED IN HORIZONTAL PLANE FROM ANTENNA SYSTEM.
$E_1$ 27	$E_2$ 21	$E_3$ 51	$E_0$ 58

RIGHT HAND PATTERN NUMBER  
GIVES ANTENNA FIELD INTEN-  
SITY DATA IN PERCENT.

SPOTS LOCATE THE ANTENNAS FOR  
THIS PAGE OF PATTERNS IN THE  
SYSTEMATIZATION PLACEMENT CHART.

PATTERN NOMENCLATURE

$\psi_3$  = PHASING OF ANTENNA No. 3 IN DEGREES

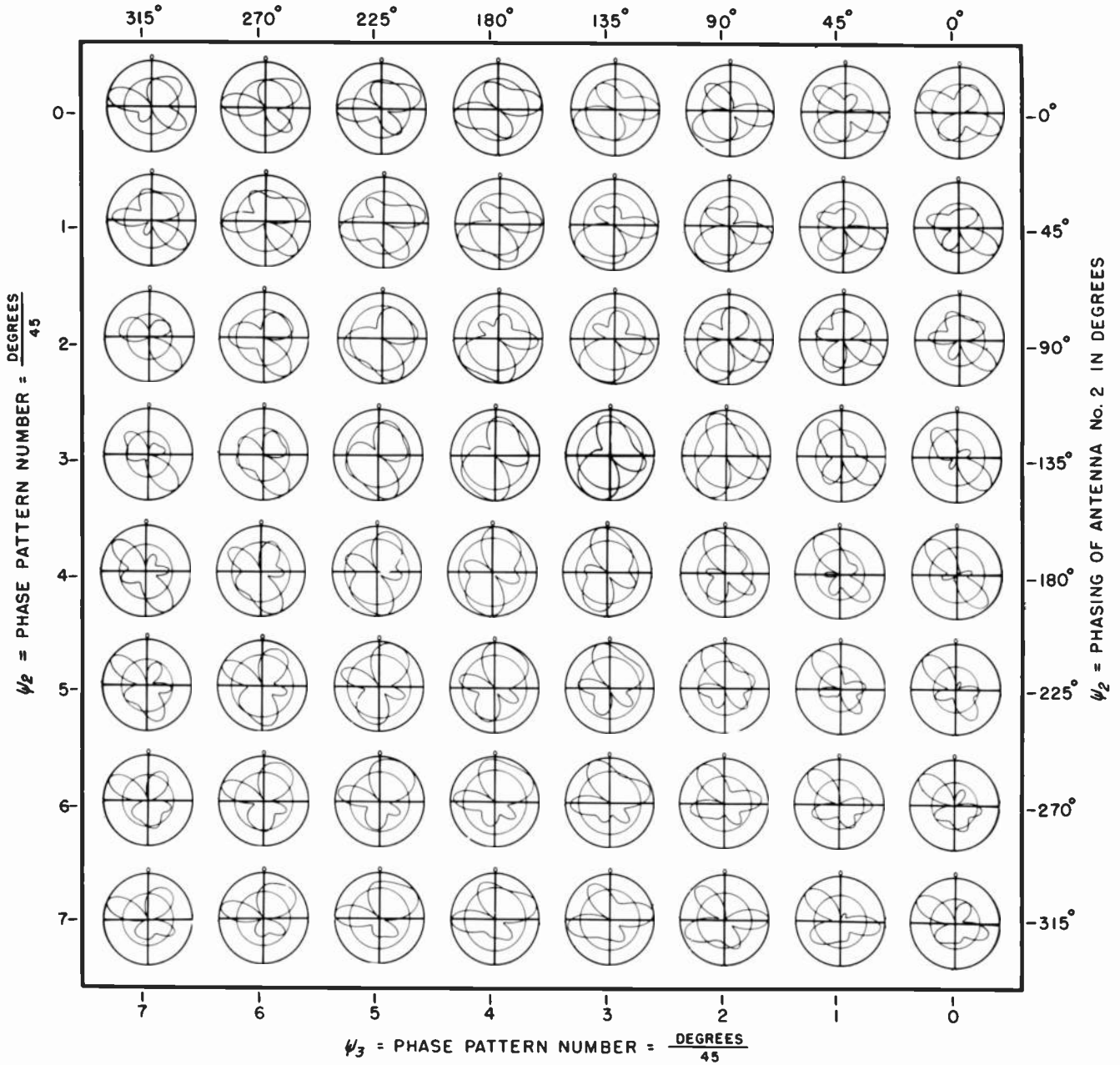

NUMBER OF ANTENNAS IN THE SYSTEM	$\psi_2 = \frac{\text{DEGREES}}{45}$	$\psi_3 = \frac{\text{DEGREES}}{45}$
ORIENTATION OF NO. 2 ANTENNA =	$S_2 = \frac{\text{DEGREES}}{45}$	$\phi_3 = \frac{\text{DEGREES}}{45}$
SPACING OF NO. 2 ANTENNA =	$\psi_2 = \frac{\text{DEGREES}}{45}$	$S_3 = \frac{\text{DEGREES}}{45}$
PHASING OF NO. 2 ANTENNA =	$\phi_2 = \frac{\text{DEGREES}}{45}$	$\psi_3 = \frac{\text{DEGREES}}{45}$
ORIENTATION OF NO. 3 ANTENNA =	$\psi_2 = \frac{\text{DEGREES}}{45}$	$\phi_3 = \frac{\text{DEGREES}}{45}$
SPACING OF NO. 3 ANTENNA =	$S_2 = \frac{\text{DEGREES}}{45}$	$S_3 = \frac{\text{DEGREES}}{45}$
PHASING OF NO. 3 ANTENNA =	$\phi_2 = \frac{\text{DEGREES}}{45}$	$\psi_3 = \frac{\text{DEGREES}}{45}$

LEFT HAND PATTERN NUMBER GIVES ANTENNA PLACEMENT AND PHASING DATA.

% FIELD INTENSITY RADIATED IN HORIZONTAL PLANE FROM NO. 1 ANTENNA.	$E_1$	22
% FIELD INTENSITY RADIATED IN HORIZONTAL PLANE FROM NO. 2 ANTENNA.	$E_2$	26
% FIELD INTENSITY RADIATED IN HORIZONTAL PLANE FROM NO. 3 ANTENNA.	$E_3$	52
% RMS FIELD INTENSITY RADIATED IN HORIZONTAL PLANE FROM ANTENNA SYSTEM.	$E_0$	62

RIGHT HAND PATTERN NUMBER GIVES ANTENNA FIELD INTENSITY DATA IN PERCENT.

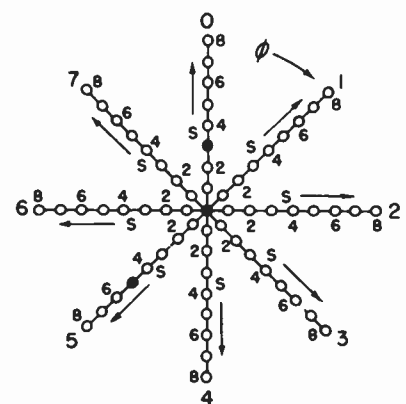

SPOTS LOCATE THE ANTENNAS FOR THIS PAGE OF PATTERNS IN THE SYSTEMATIZATION PLACEMENT CHART.

PATTERN NOMENCLATURE



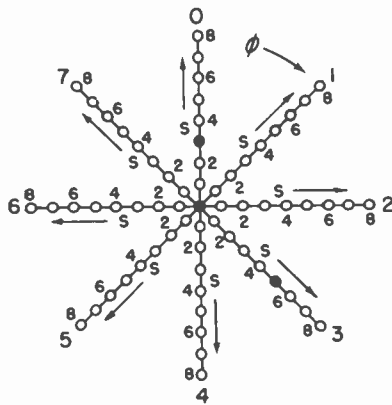
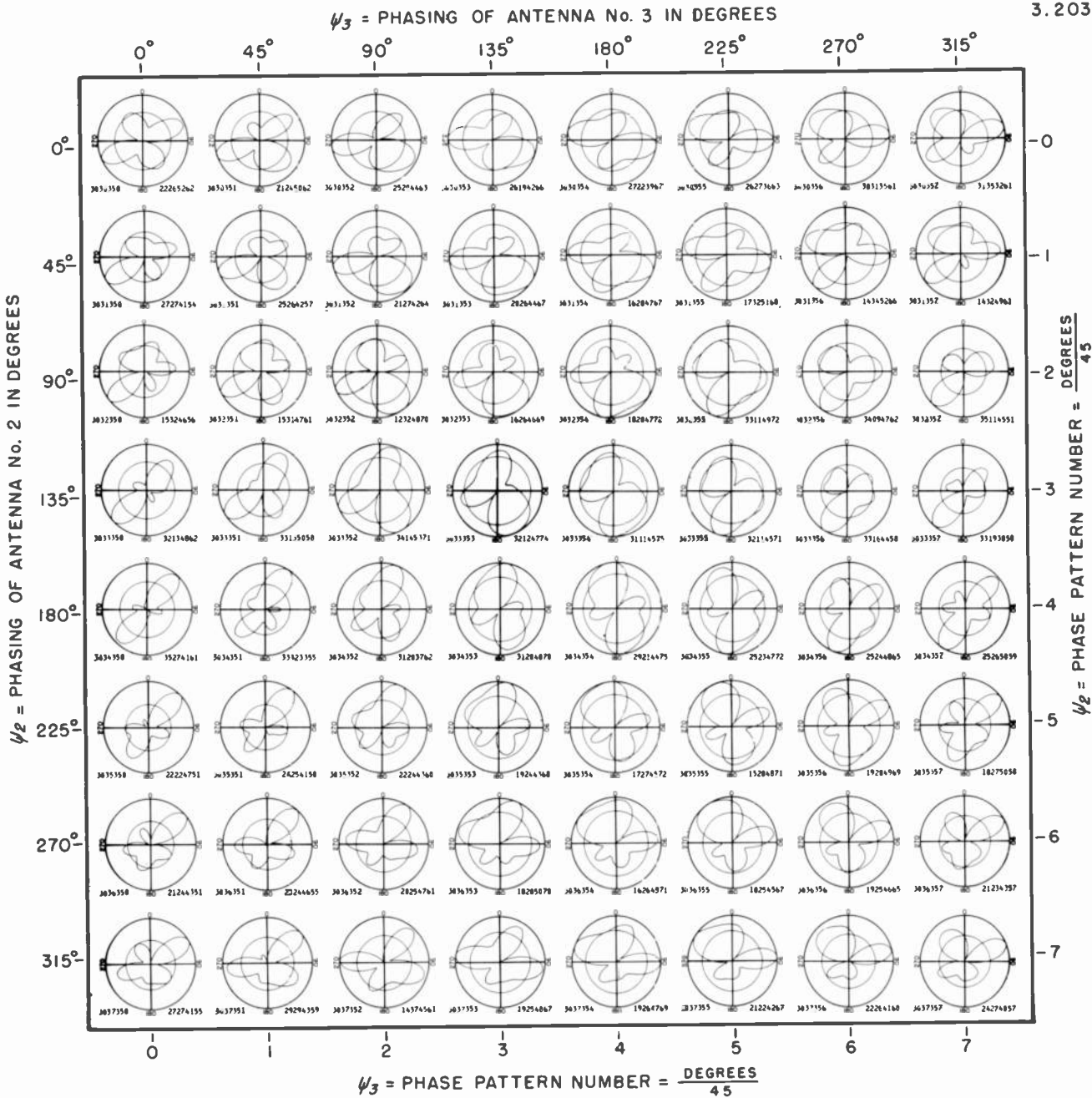

SPOTS LOCATE THE ANTENNAS FOR THIS PAGE OF PATTERNS IN THE SYSTEMATIZATION PLACEMENT CHART.

NUMBER OF ANTENNAS IN THE SYSTEM	ORIENTATION OF NO. 2 ANTENNA = $\frac{\text{DEGREES}}{45}$	SPACING OF NO. 2 ANTENNA = $\frac{\text{DEGREES}}{45}$	PHASING OF NO. 2 ANTENNA = $\frac{\text{DEGREES}}{45}$	ORIENTATION OF NO. 3 ANTENNA = $\frac{\text{DEGREES}}{45}$	SPACING OF NO. 3 ANTENNA = $\frac{\text{DEGREES}}{45}$	PHASING OF NO. 3 ANTENNA = $\frac{\text{DEGREES}}{45}$
No 3	$\phi_2$ 0	$S_2$ 3	$\psi_2$ 0	$\phi_3$ 3	$S_3$ 5	$\psi_3$ 0

LEFT HAND PATTERN NUMBER GIVES ANTENNA PLACEMENT AND PHASING DATA.

% FIELD INTENSITY RADIATED IN HORIZONTAL PLANE FROM NO. 1 ANTENNA.	% FIELD INTENSITY RADIATED IN HORIZONTAL PLANE FROM NO. 2 ANTENNA.	% FIELD INTENSITY RADIATED IN HORIZONTAL PLANE FROM NO. 3 ANTENNA.	% RMS FIELD INTENSITY RADIATED IN HORIZONTAL PLANE FROM ANTENNA SYSTEM.
$F_1$ 22	$F_2$ 26	$F_3$ 52	$F_0$ 62

RIGHT HAND PATTERN NUMBER GIVES ANTENNA FIELD INTENSITY DATA IN PERCENT.

PATTERN NOMENCLATURE

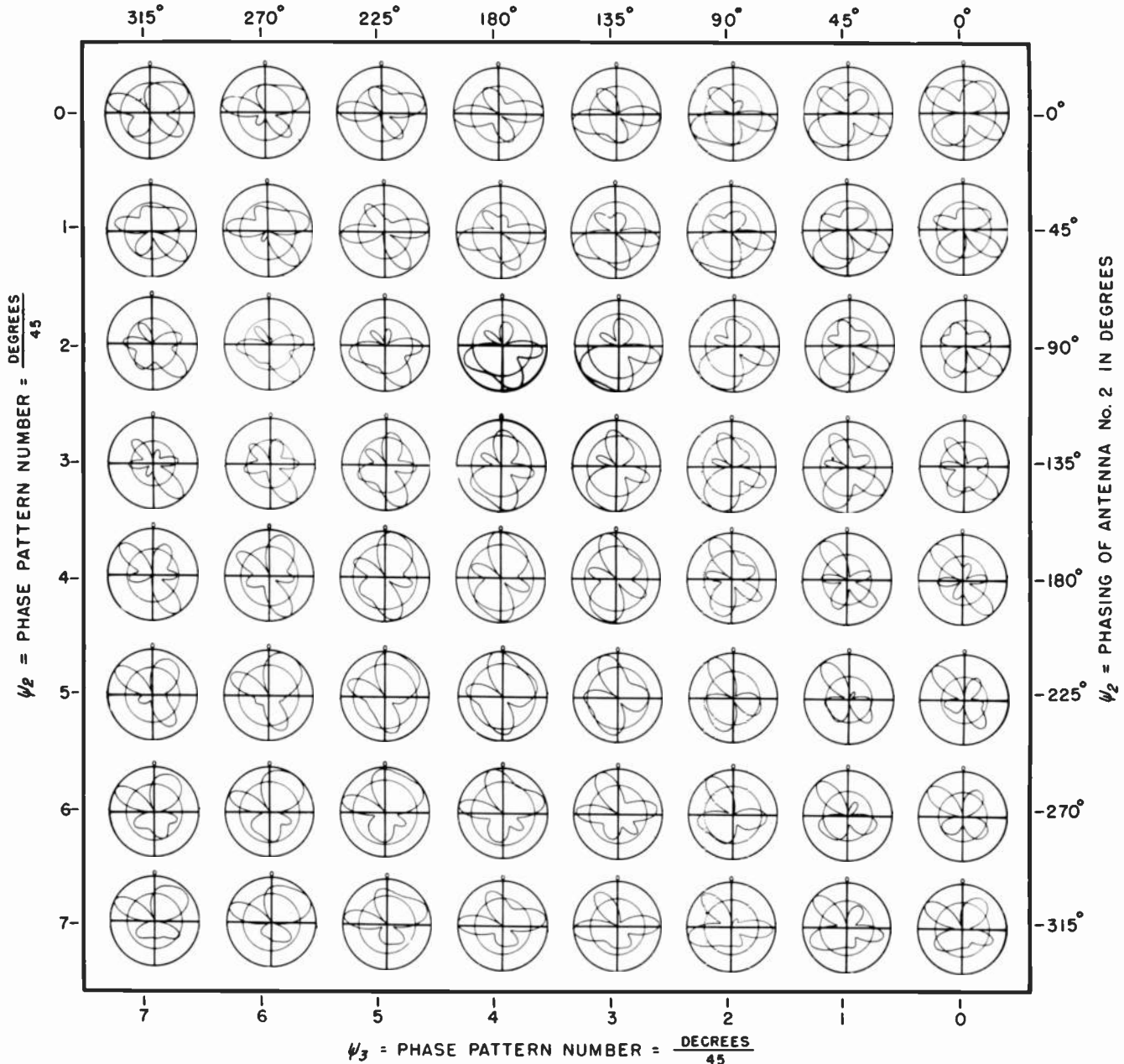

NUMBER OF ANTENNAS IN THE SYSTEM  
 NO. 3  
 ORIENTATION OF NO. 2 ANTENNA =  $\frac{\text{DEGREES}}{45}$   
 $\phi_2$  0  
 SPACING OF NO. 2 ANTENNA =  $\frac{\text{DEGREES}}{45}$   
 $S_2$  3  
 PHASING OF NO. 2 ANTENNA =  $\frac{\text{DEGREES}}{45}$   
 $\psi_2$  0  
 ORIENTATION OF NO. 3 ANTENNA =  $\frac{\text{DEGREES}}{45}$   
 $\phi_3$  5  
 SPACING OF NO. 3 ANTENNA =  $\frac{\text{DEGREES}}{45}$   
 $S_3$  6  
 PHASING OF NO. 3 ANTENNA =  $\frac{\text{DEGREES}}{45}$   
 $\psi_3$  0

% FIELD INTENSITY RADIATED IN HORIZONTAL PLANE FROM NO. 1 ANTENNA.  
 $E_1$  26  
 % FIELD INTENSITY RADIATED IN HORIZONTAL PLANE FROM NO. 2 ANTENNA.  
 $E_2$  24  
 % FIELD INTENSITY RADIATED IN HORIZONTAL PLANE FROM NO. 3 ANTENNA.  
 $E_3$  51  
 % RMS FIELD INTENSITY RADIATED IN HORIZONTAL PLANE FROM ANTENNA SYSTEM.  
 $E_0$  71

LEFT HAND PATTERN NUMBER GIVES ANTENNA PLACEMENT AND PHASING DATA.

RIGHT HAND PATTERN NUMBER GIVES ANTENNA FIELD INTENSITY DATA IN PERCENT.

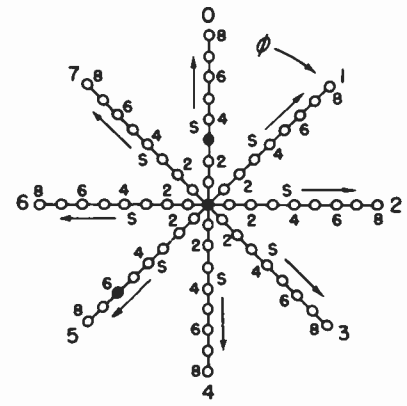

SPOTS LOCATE THE ANTENNAS FOR THIS PAGE OF PATTERNS IN THE SYSTEMATIZATION PLACEMENT CHART.

PATTERN NOMENCLATURE

$\psi_3$  = PHASING OF ANTENNA No. 3 IN DEGREES

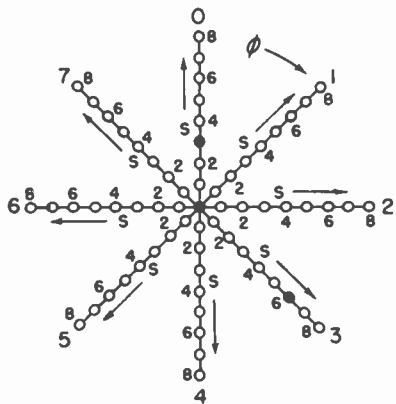
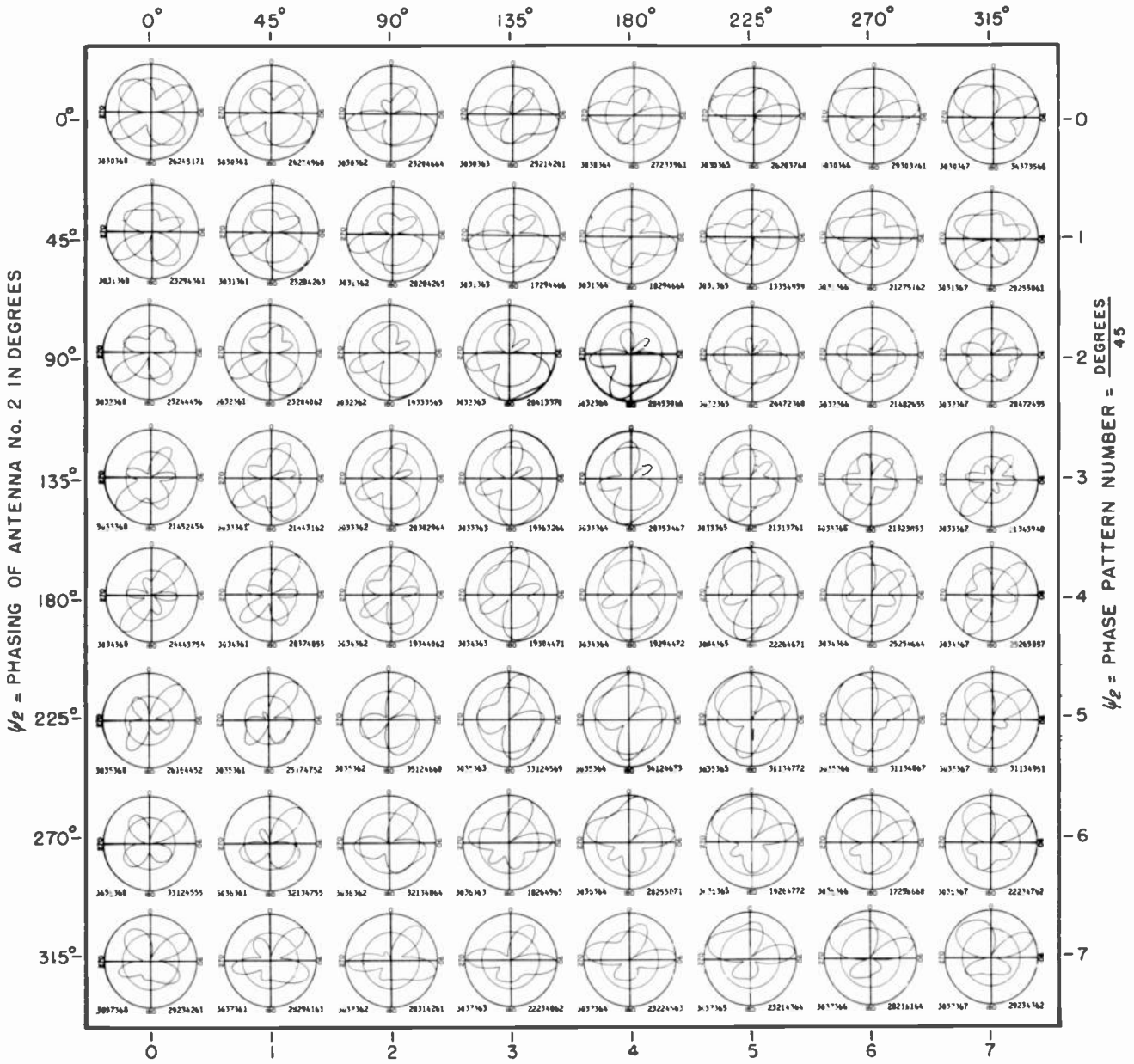

SPOTS LOCATE THE ANTENNAS FOR  
 THIS PAGE OF PATTERNS IN THE  
 SYSTEMATIZATION PLACEMENT CHART.

$\psi_3$  = PHASE PATTERN NUMBER =  $\frac{\text{DEGREES}}{45}$

NUMBER OF ANTENNAS IN THE SYSTEM	ORIENTATION OF NO. 2 ANTENNA = $\frac{\text{DEGREES}}{45}$	SPACING OF NO. 2 ANTENNA = $\frac{\text{DEGREES}}{45}$	PHASING OF NO. 2 ANTENNA = $\frac{\text{DEGREES}}{45}$	ORIENTATION OF NO. 3 ANTENNA = $\frac{\text{DEGREES}}{45}$	SPACING OF NO. 3 ANTENNA = $\frac{\text{DEGREES}}{45}$	PHASING OF NO. 3 ANTENNA = $\frac{\text{DEGREES}}{45}$
No. 3	$\phi_2$ 0	$S_2$ 3	$\psi_2$ 0	$\phi_3$ 3	$S_3$ 6	$\psi_3$ 0

LEFT HAND PATTERN NUMBER GIVES ANTENNA  
 PLACEMENT AND PHASING DATA.

% FIELD INTENSITY RADIATED IN HORIZONTAL PLANE FROM NO. 1 ANTENNA.	% FIELD INTENSITY RADIATED IN HORIZONTAL PLANE FROM NO. 2 ANTENNA.	% FIELD INTENSITY RADIATED IN HORIZONTAL PLANE FROM NO. 3 ANTENNA.	% RMS FIELD INTENSITY RADIATED IN HORIZONTAL PLANE FROM ANTENNA SYSTEM.
$F_1$ 26	$F_2$ 24	$F_3$ 51	$F_0$ 71

RIGHT HAND PATTERN NUMBER  
 GIVES ANTENNA FIELD INTEN-  
 SITY DATA IN PERCENT.

PATTERN NOMENCLATURE

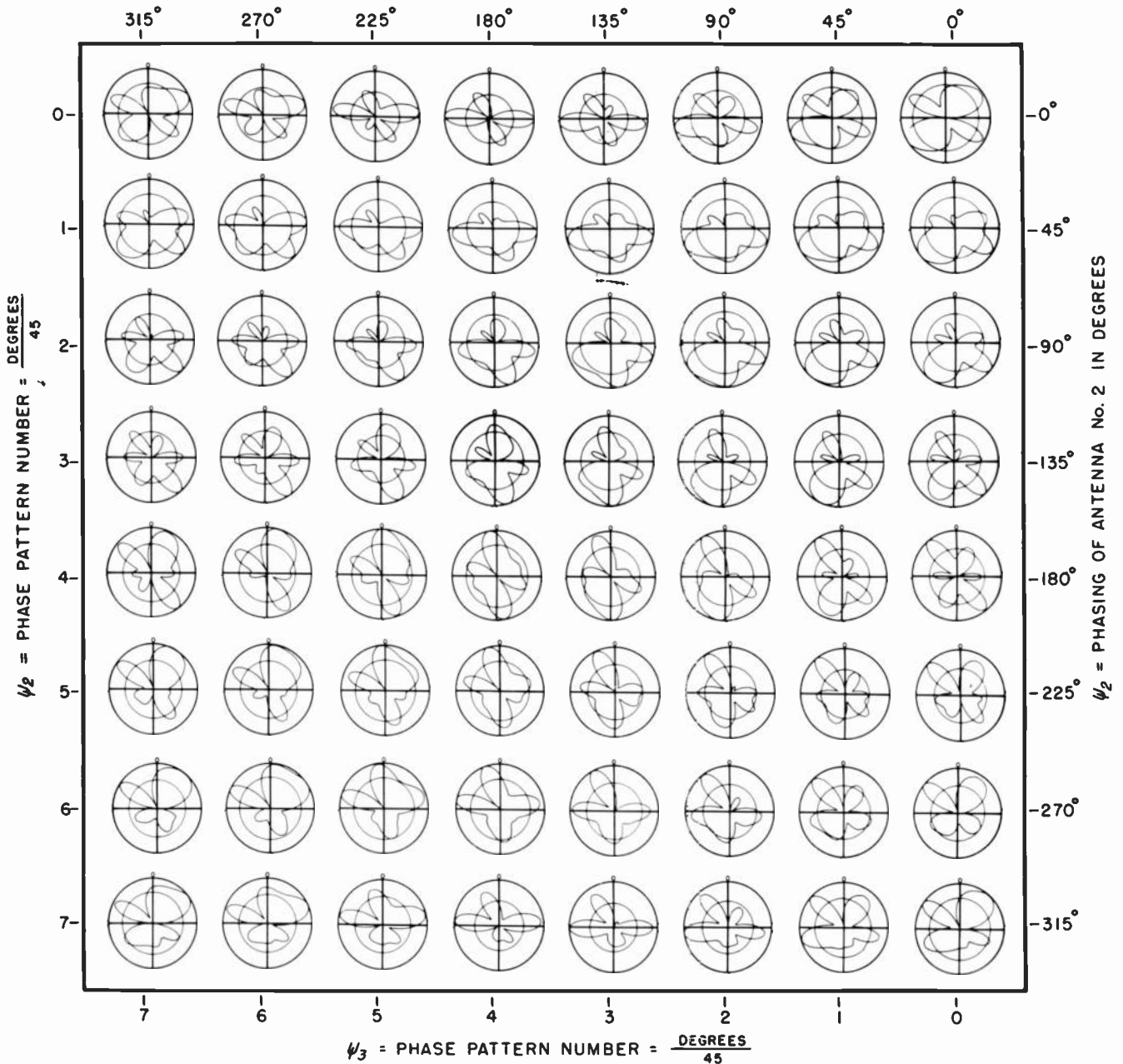

$\psi_2$  = PHASE PATTERN NUMBER =  $\frac{\text{DEGREES}}{45}$

$\psi_2$  = PHASING OF ANTENNA No. 2 IN DEGREES

$\psi_3$  = PHASE PATTERN NUMBER =  $\frac{\text{DEGREES}}{45}$

NUMBER OF ANTENNAS IN THE SYSTEM	ORIENTATION OF NO. 2 ANTENNA = $\frac{\text{DEGREES}}{45}$	SPACING OF NO. 2 ANTENNA = $\frac{\text{DEGREES}}{45}$	PHASING OF NO. 2 ANTENNA = $\frac{\text{DEGREES}}{45}$	ORIENTATION OF NO. 3 ANTENNA = $\frac{\text{DEGREES}}{45}$	SPACING OF NO. 3 ANTENNA = $\frac{\text{DEGREES}}{45}$	PHASING OF NO. 3 ANTENNA = $\frac{\text{DEGREES}}{45}$	% FIELD INTENSITY RADIATED IN HORIZONTAL PLANE FROM NO. 1 ANTENNA.	% FIELD INTENSITY RADIATED IN HORIZONTAL PLANE FROM NO. 2 ANTENNA.	% FIELD INTENSITY RADIATED IN HORIZONTAL PLANE FROM NO. 3 ANTENNA.	% RMS FIELD INTENSITY RADIATED IN HORIZONTAL PLANE FROM ANTENNA SYSTEM.
No. 3	$\phi_2$ 0	$S_2$ 3	$\psi_2$ 0	$\phi_3$ 5	$S_3$ 7	$\psi_3$ 0	$E_1$ 25	$E_2$ 25	$E_3$ 51	$E_0$ 74

LEFT HAND PATTERN NUMBER GIVES ANTENNA PLACEMENT AND PHASING DATA.

RIGHT HAND PATTERN NUMBER GIVES ANTENNA FIELD INTENSITY DATA IN PERCENT.

PATTERN NOMENCLATURE

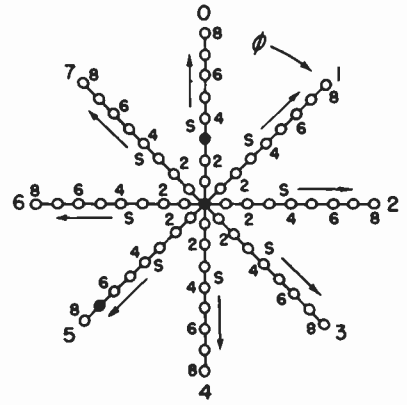

SPOTS LOCATE THE ANTENNAS FOR THIS PAGE OF PATTERNS IN THE SYSTEMIZATION PLACEMENT CHART.

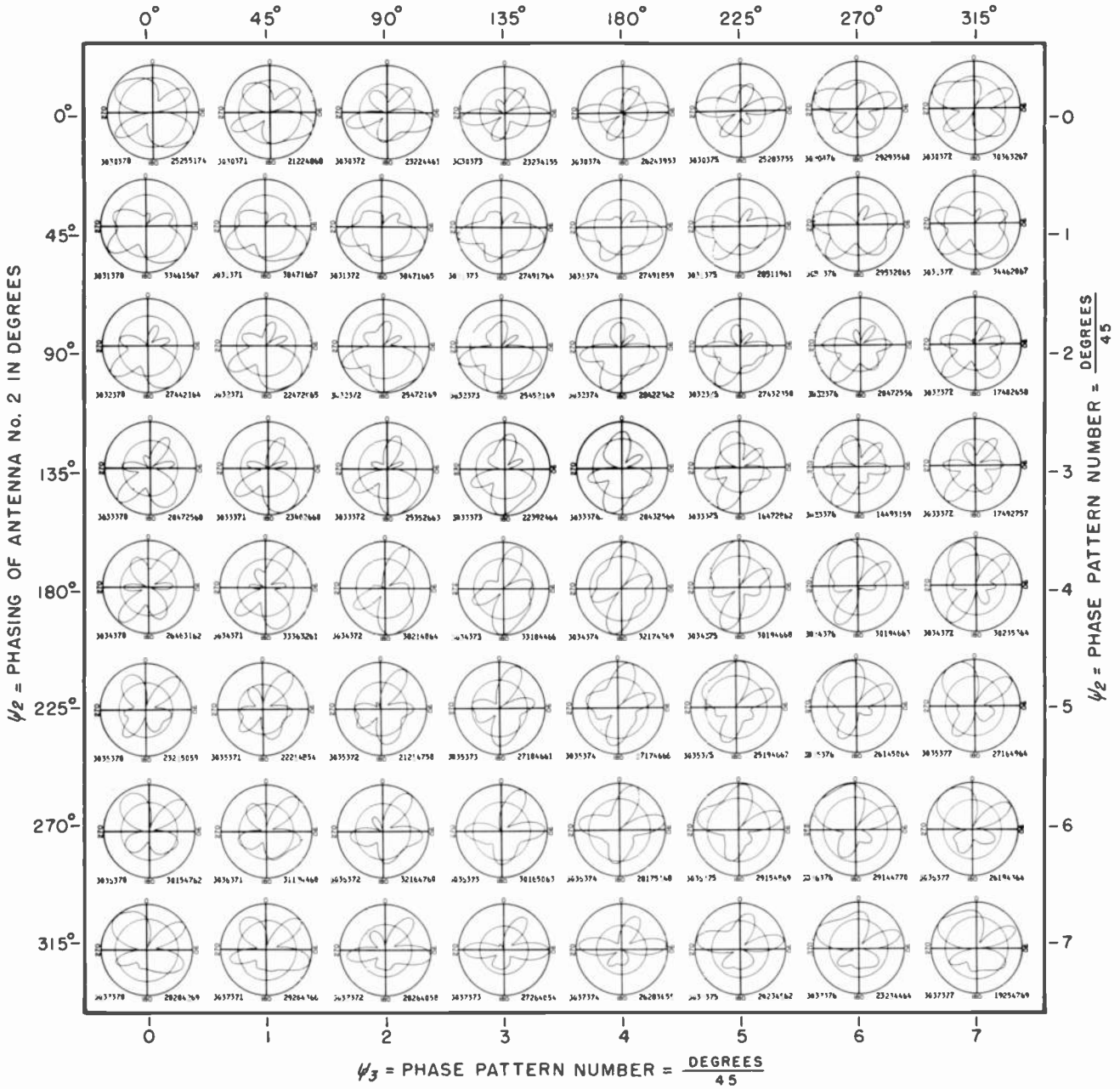

COPYRIGHT 1946 BY CARL E. SMITH  
PRINTED IN U. S. A.

CLEVELAND INSTITUTE OF RADIO ELECTRONICS  
TERMINAL TOWER, CLEVELAND 13, OHIO.

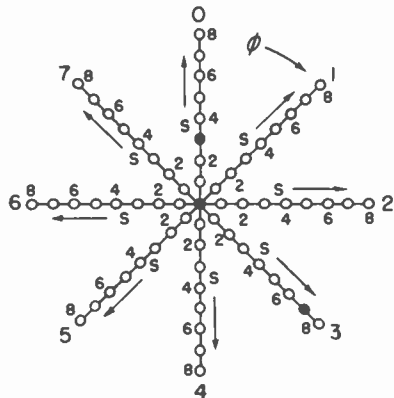

SPOTS LOCATE THE ANTENNAS FOR THIS PAGE OF PATTERNS IN THE SYSTEMATIZATION PLACEMENT CHART.

NUMBER OF ANTENNAS IN THE SYSTEM	ORIENTATION OF NO. 2 ANTENNA = $\frac{\text{DEGREES}}{45}$	SPACING OF NO. 2 ANTENNA = $\frac{\text{DEGREES}}{45}$	PHASING OF NO. 2 ANTENNA = $\frac{\text{DEGREES}}{45}$	ORIENTATION OF NO. 3 ANTENNA = $\frac{\text{DEGREES}}{45}$	SPACING OF NO. 3 ANTENNA = $\frac{\text{DEGREES}}{45}$	PHASING OF NO. 3 ANTENNA = $\frac{\text{DEGREES}}{45}$
No. 3	$\phi_2$ 0	$S_2$ 3	$\psi_2$ 0	$\phi_3$ 3	$S_3$ 7	$\psi_3$ 0

LEFT HAND PATTERN NUMBER GIVES ANTENNA PLACEMENT AND PHASING DATA.

% FIELD INTENSITY RADIATED IN HORIZONTAL PLANE FROM NO. 1 ANTENNA.	% FIELD INTENSITY RADIATED IN HORIZONTAL PLANE FROM NO. 2 ANTENNA.	% FIELD INTENSITY RADIATED IN HORIZONTAL PLANE FROM NO. 3 ANTENNA.	% RMS FIELD INTENSITY RADIATED IN HORIZONTAL PLANE FROM ANTENNA SYSTEM.
$E_1$ 25	$E_2$ 25	$E_3$ 51	$E_0$ 74

RIGHT HAND PATTERN NUMBER GIVES ANTENNA FIELD INTENSITY DATA IN PERCENT.

PATTERN NOMENCLATURE

$\psi_3$  = PHASING OF ANTENNA No. 3 IN DEGREES

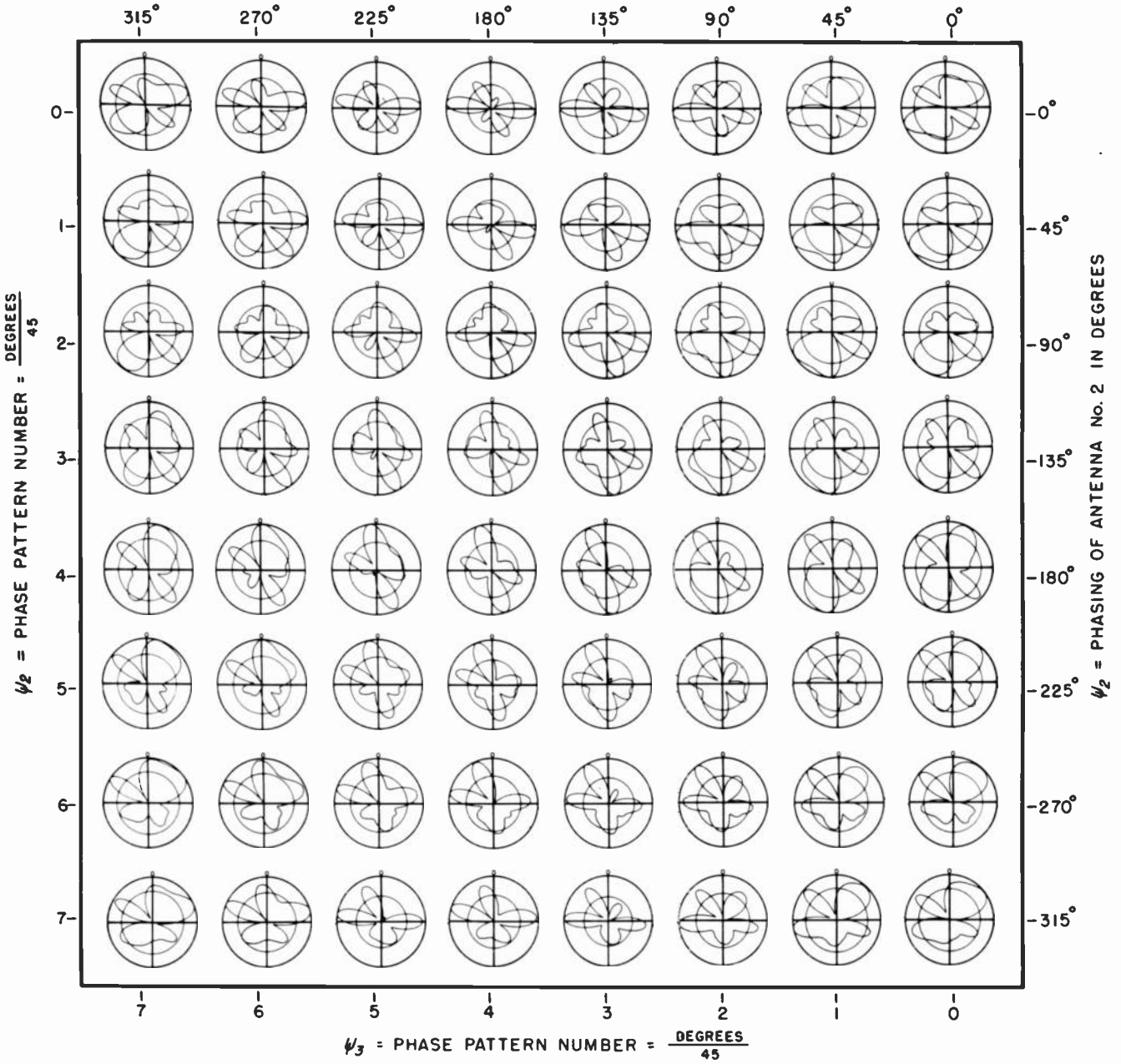

NUMBER OF ANTENNAS IN THE SYSTEM  
 No. 3 = 3

ORIENTATION OF NO. 2 ANTENNA =  $\frac{\text{DEGREES}}{45}$   
 $\psi_2 = 0$

SPACING OF NO. 2 ANTENNA =  $\frac{\text{DEGREES}}{45}$   
 $S_2 = 3$

PHASING OF NO. 2 ANTENNA =  $\frac{\text{DEGREES}}{45}$   
 $\psi_2 = 0$

ORIENTATION OF NO. 3 ANTENNA =  $\frac{\text{DEGREES}}{45}$   
 $\psi_3 = 5$

SPACING OF NO. 3 ANTENNA =  $\frac{\text{DEGREES}}{45}$   
 $S_3 = 8$

PHASING OF NO. 3 ANTENNA =  $\frac{\text{DEGREES}}{45}$   
 $\psi_3 = 0$

% FIELD INTENSITY RADIATED IN HORIZONTAL PLANE FROM NO. 1 ANTENNA.  
 $E_1 = 20$

% FIELD INTENSITY RADIATED IN HORIZONTAL PLANE FROM NO. 2 ANTENNA.  
 $E_2 = 26$

% FIELD INTENSITY RADIATED IN HORIZONTAL PLANE FROM NO. 3 ANTENNA.  
 $E_3 = 47$

% RMS FIELD INTENSITY RADIATED IN HORIZONTAL PLANE FROM ANTENNA SYSTEM.  
 $E_0 = 71$

LEFT HAND PATTERN NUMBER GIVES ANTENNA PLACEMENT AND PHASING DATA.

RIGHT HAND PATTERN NUMBER GIVES ANTENNA FIELD INTENSITY DATA IN PERCENT.

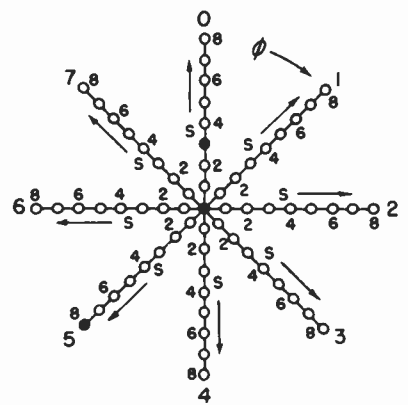

SPOTS LOCATE THE ANTENNAS FOR THIS PAGE OF PATTERNS IN THE SYSTEMATIZATION PLACEMENT CHART.

PATTERN NOMENCLATURE

$\psi_3 =$  PHASING OF ANTENNA No. 3 IN DEGREES

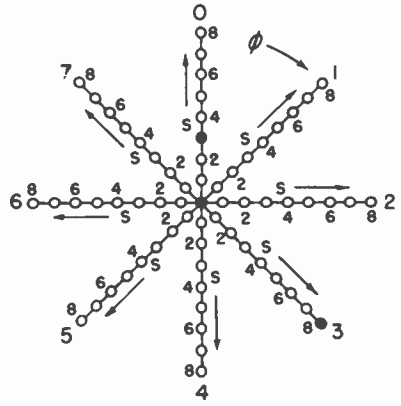
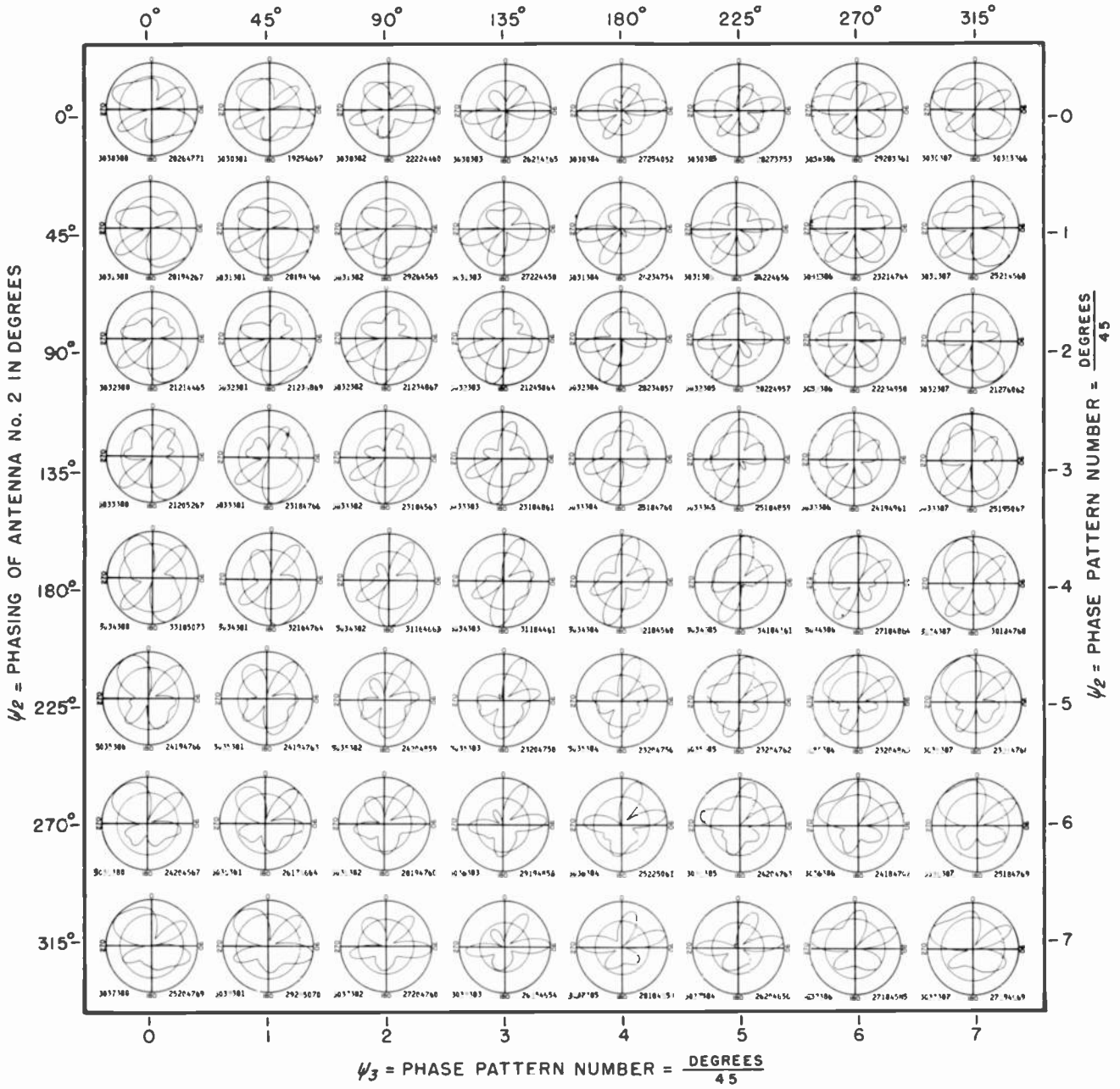

NUMBER OF ANTENNAS IN THE SYSTEM	ORIENTATION OF NO. 2 ANTENNA = $\frac{\text{DEGREES}}{45}$	SPACING OF NO. 2 ANTENNA = $\frac{\text{DEGREES}}{45}$	PHASING OF NO. 2 ANTENNA = $\frac{\text{DEGREES}}{45}$	ORIENTATION OF NO. 3 ANTENNA = $\frac{\text{DEGREES}}{45}$	SPACING OF NO. 3 ANTENNA = $\frac{\text{DEGREES}}{45}$	PHASING OF NO. 3 ANTENNA = $\frac{\text{DEGREES}}{45}$
No. 3	$\psi_2 = 0$	$S_2 = 3$	$\psi_2 = 0$	$\psi_3 = 3$	$S_3 = 8$	$\psi_3 = 0$

LEFT HAND PATTERN NUMBER GIVES ANTENNA PLACEMENT AND PHASING DATA.

% FIELD INTENSITY RADIATED IN HORIZONTAL PLANE FROM NO. 1 ANTENNA.	% FIELD INTENSITY RADIATED IN HORIZONTAL PLANE FROM NO. 2 ANTENNA.	% FIELD INTENSITY RADIATED IN HORIZONTAL PLANE FROM NO. 3 ANTENNA.	% RMS FIELD INTENSITY RADIATED IN HORIZONTAL PLANE FROM ANTENNA SYSTEM.
$E_1 = 20$	$E_2 = 26$	$E_3 = 47$	$E_0 = 71$

RIGHT HAND PATTERN NUMBER GIVES ANTENNA FIELD INTENSITY DATA IN PERCENT.

SPOTS LOCATE THE ANTENNAS FOR THIS PAGE OF PATTERNS IN THE SYSTEMATIZATION PLACEMENT CHART.

PATTERN NOMENCLATURE

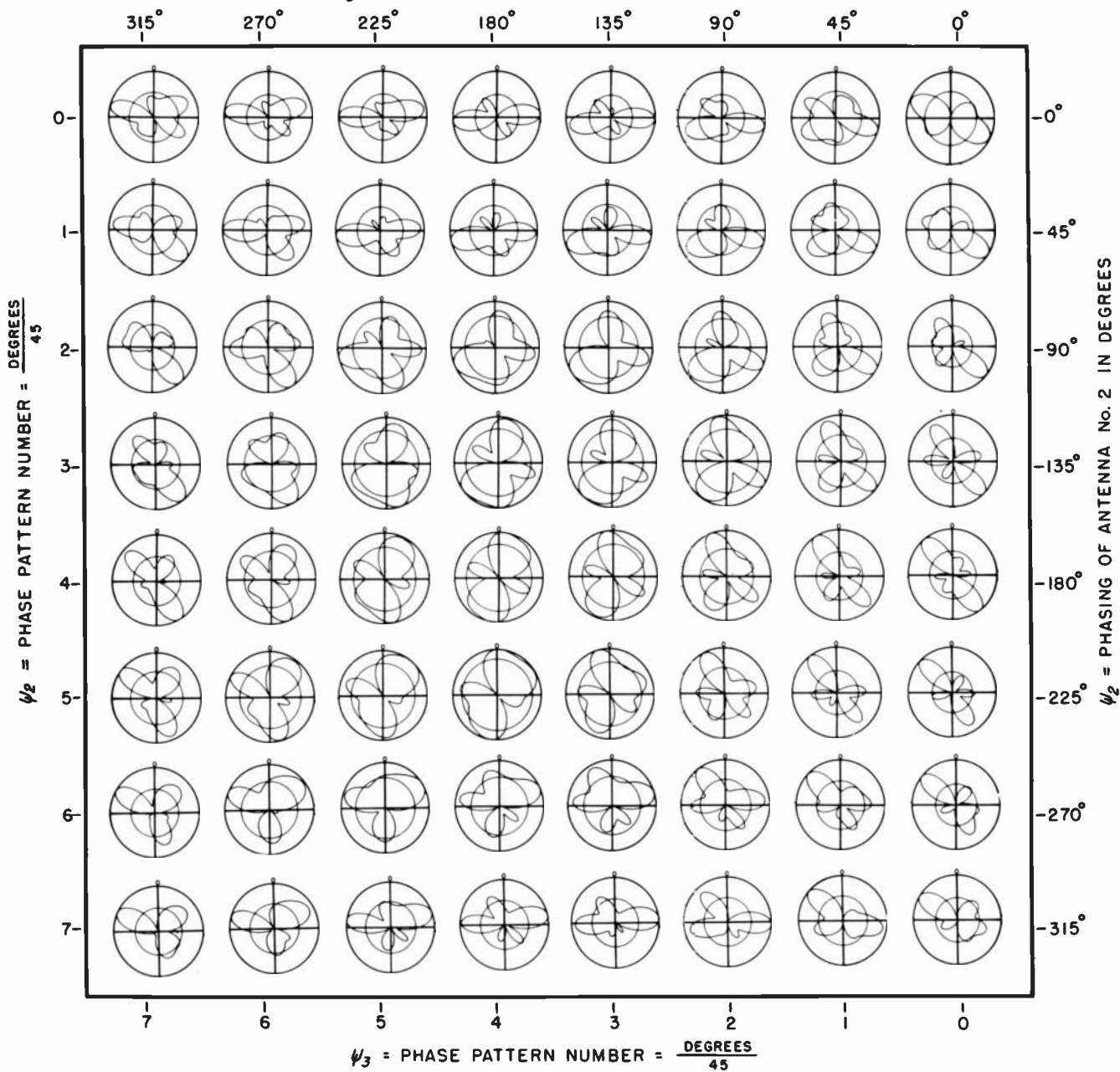

NUMBER OF ANTENNAS IN THE SYSTEM  
 NO. 3  
 ORIENTATION OF NO. 2 ANTENNA =  $\frac{\text{DEGREES}}{45}$   
 $\phi_2$  0  
 SPACING OF NO. 2 ANTENNA =  $\frac{\text{DEGREES}}{45}$   
 $S_2$  4  
 PHASING OF NO. 2 ANTENNA =  $\frac{\text{DEGREES}}{45}$   
 $\psi_2$  0  
 ORIENTATION OF NO. 3 ANTENNA =  $\frac{\text{DEGREES}}{45}$   
 $\phi_3$  5  
 SPACING OF NO. 3 ANTENNA =  $\frac{\text{DEGREES}}{45}$   
 $S_3$  5  
 PHASING OF NO. 3 ANTENNA =  $\frac{\text{DEGREES}}{45}$   
 $\psi_3$  0

LEFT HAND PATTERN NUMBER GIVES ANTENNA PLACEMENT AND PHASING DATA.

% FIELD INTENSITY RADIATED IN HORIZONTAL PLANE FROM NO. 1 ANTENNA.  
 $E_1$  63  
 % FIELD INTENSITY RADIATED IN HORIZONTAL PLANE FROM NO. 2 ANTENNA.  
 $E_2$  31  
 % FIELD INTENSITY RADIATED IN HORIZONTAL PLANE FROM NO. 3 ANTENNA.  
 $E_3$  30  
 % RMS FIELD INTENSITY RADIATED IN HORIZONTAL PLANE FROM ANTENNA SYSTEM.  
 $E_0$  59

RIGHT HAND PATTERN NUMBER GIVES ANTENNA FIELD INTENSITY DATA IN PERCENT.

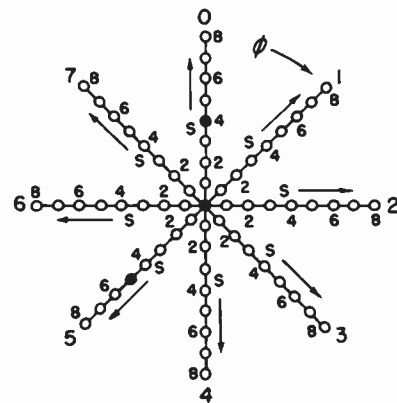

SPOTS LOCATE THE ANTENNAS FOR THIS PAGE OF PATTERNS IN THE SYSTEMATIZATION PLACEMENT CHART.

PATTERN NOMENCLATURE



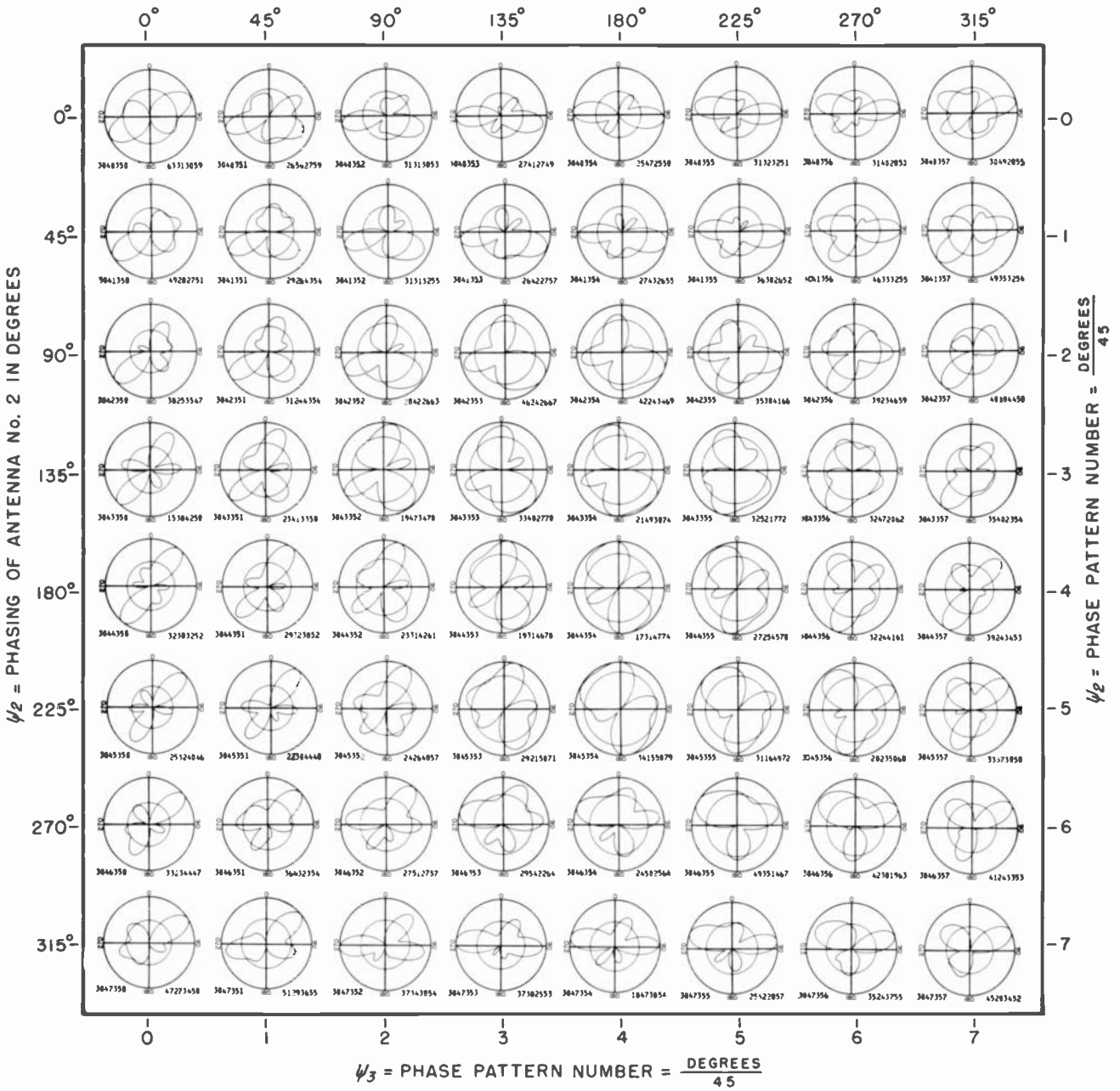

$\psi_3$  = PHASE PATTERN NUMBER =  $\frac{DEGREES}{45}$

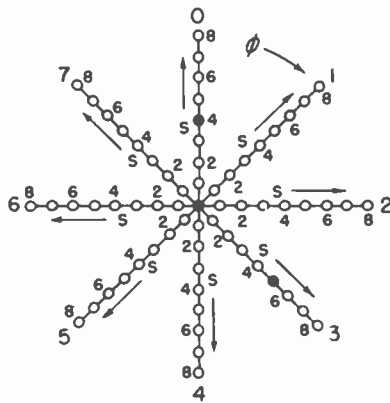

NUMBER OF ANTENNAS IN THE SYSTEM	ORIENTATION OF NO. 2 ANTENNA = $\frac{DEGREES}{45}$	SPACING OF NO. 2 ANTENNA = $\frac{DEGREES}{45}$	PHASING OF NO. 2 ANTENNA = $\frac{DEGREES}{45}$	ORIENTATION OF NO. 3 ANTENNA = $\frac{DEGREES}{45}$	SPACING OF NO. 3 ANTENNA = $\frac{DEGREES}{45}$	PHASING OF NO. 3 ANTENNA = $\frac{DEGREES}{45}$
No. 3	$\phi_2$ 0	$S_2$ 4	$\psi_2$ 0	$\phi_3$ 3	$S_3$ 5	$\psi_3$ 0

% FIELD INTENSITY RADIATED IN HORIZONTAL PLANE FROM NO. 1 ANTENNA.	% FIELD INTENSITY RADIATED IN HORIZONTAL PLANE FROM NO. 2 ANTENNA.	% FIELD INTENSITY RADIATED IN HORIZONTAL PLANE FROM NO. 3 ANTENNA.	% RMS FIELD INTENSITY RADIATED IN HORIZONTAL PLANE FROM ANTENNA SYSTEM.
$E_1$ 63	$E_2$ 31	$E_3$ 30	$E_0$ 59

LEFT HAND PATTERN NUMBER GIVES ANTENNA PLACEMENT AND PHASING DATA.

RIGHT HAND PATTERN NUMBER GIVES ANTENNA FIELD INTENSITY DATA IN PERCENT.

SPOTS LOCATE THE ANTENNAS FOR THIS PAGE OF PATTERNS IN THE SYSTEMATIZATION PLACEMENT CHART.

PATTERN NOMENCLATURE

$\psi_3$  = PHASING OF ANTENNA No. 3 IN DEGREES

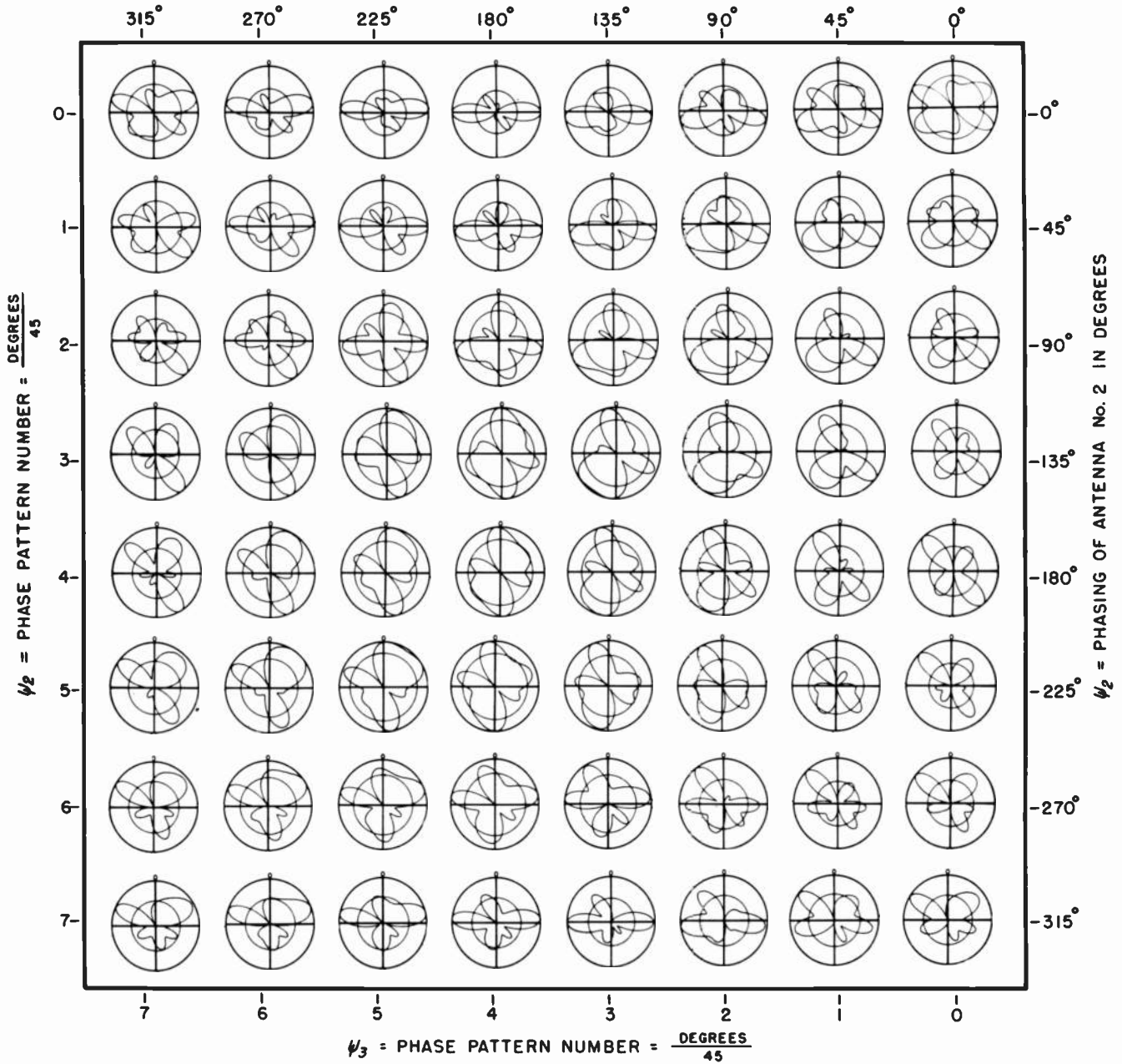

NUMBER OF ANTENNAS IN THE SYSTEM  
 No. 3

ORIENTATION OF NO. 2 ANTENNA =  $\frac{\text{DEGREES}}{45}$   
 $\phi_2$  0

SPACING OF NO. 2 ANTENNA =  $\frac{\text{DEGREES}}{45}$   
 $S_2$  4

PHASING OF NO. 2 ANTENNA =  $\frac{\text{DEGREES}}{45}$   
 $\psi_2$  0

ORIENTATION OF NO. 3 ANTENNA =  $\frac{\text{DEGREES}}{45}$   
 $\phi_3$  5

SPACING OF NO. 3 ANTENNA =  $\frac{\text{DEGREES}}{45}$   
 $S_3$  6

PHASING OF NO. 3 ANTENNA =  $\frac{\text{DEGREES}}{45}$   
 $\psi_3$  0

LEFT HAND PATTERN NUMBER GIVES ANTENNA PLACEMENT AND PHASING DATA.

% FIELD INTENSITY RADIATED IN HORIZONTAL PLANE FROM NO. 1 ANTENNA.  
 $E_1$  32

% FIELD INTENSITY RADIATED IN HORIZONTAL PLANE FROM NO. 2 ANTENNA.  
 $E_2$  59

% FIELD INTENSITY RADIATED IN HORIZONTAL PLANE FROM NO. 3 ANTENNA.  
 $E_3$  32

% RMS FIELD INTENSITY RADIATED IN HORIZONTAL PLANE FROM ANTENNA SYSTEM.  
 $E_0$  69

RIGHT HAND PATTERN NUMBER GIVES ANTENNA FIELD INTENSITY DATA IN PERCENT.

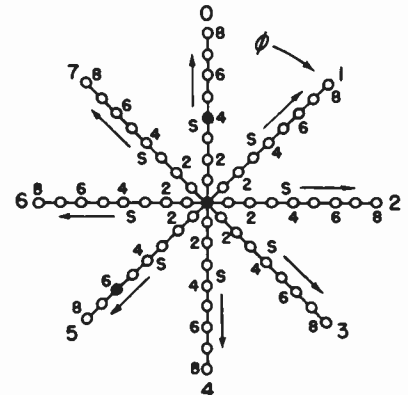

SPOTS LOCATE THE ANTENNAS FOR THIS PAGE OF PATTERNS IN THE SYSTEMIZATION PLACEMENT CHART.

PATTERN NOMENCLATURE

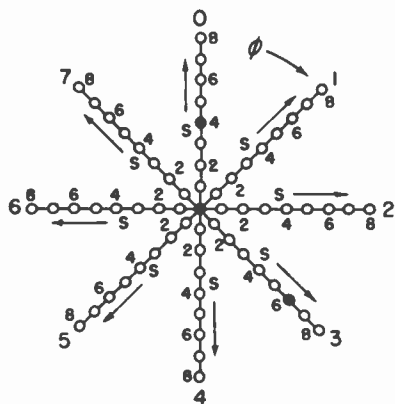
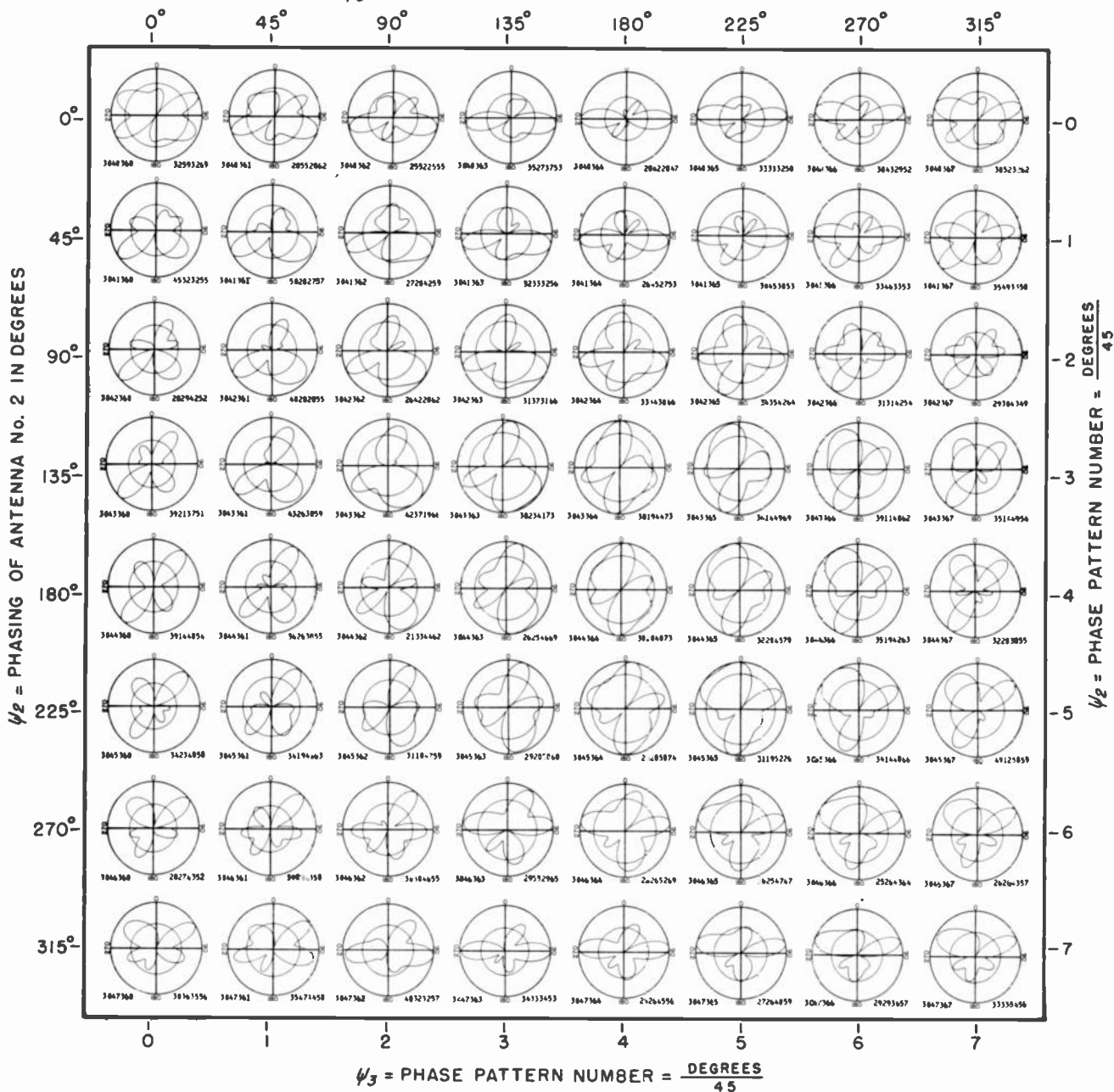

NUMBER OF ANTENNAS IN THE SYSTEM	ORIENTATION OF NO. 2 ANTENNA = $\frac{\text{DEGREES}}{45}$	SPACING OF NO. 2 ANTENNA = $\frac{\text{DEGREES}}{45}$	PHASING OF NO. 2 ANTENNA = $\frac{\text{DEGREES}}{45}$	ORIENTATION OF NO. 3 ANTENNA = $\frac{\text{DEGREES}}{45}$	SPACING OF NO. 3 ANTENNA = $\frac{\text{DEGREES}}{45}$	PHASING OF NO. 3 ANTENNA = $\frac{\text{DEGREES}}{45}$
No.	$\phi_2$	$S_2$	$\psi_2$	$\phi_3$	$S_3$	$\psi_3$
3	0	4	0	3	6	0

% FIELD INTENSITY RADIATED IN HORIZONTAL PLANE FROM NO. 1 ANTENNA.	% FIELD INTENSITY RADIATED IN HORIZONTAL PLANE FROM NO. 2 ANTENNA.	% FIELD INTENSITY RADIATED IN HORIZONTAL PLANE FROM NO. 3 ANTENNA.	% RMS FIELD INTENSITY RADIATED IN HORIZONTAL PLANE FROM ANTENNA SYSTEM.
$E_1$	$E_2$	$E_3$	$E_0$
32	59	32	69

SPOTS LOCATE THE ANTENNAS FOR THIS PAGE OF PATTERNS IN THE SYSTEMATIZATION PLACEMENT CHART.

LEFT HAND PATTERN NUMBER GIVES ANTENNA PLACEMENT AND PHASING DATA.

RIGHT HAND PATTERN NUMBER GIVES ANTENNA FIELD INTENSITY DATA IN PERCENT.

PATTERN NOMENCLATURE

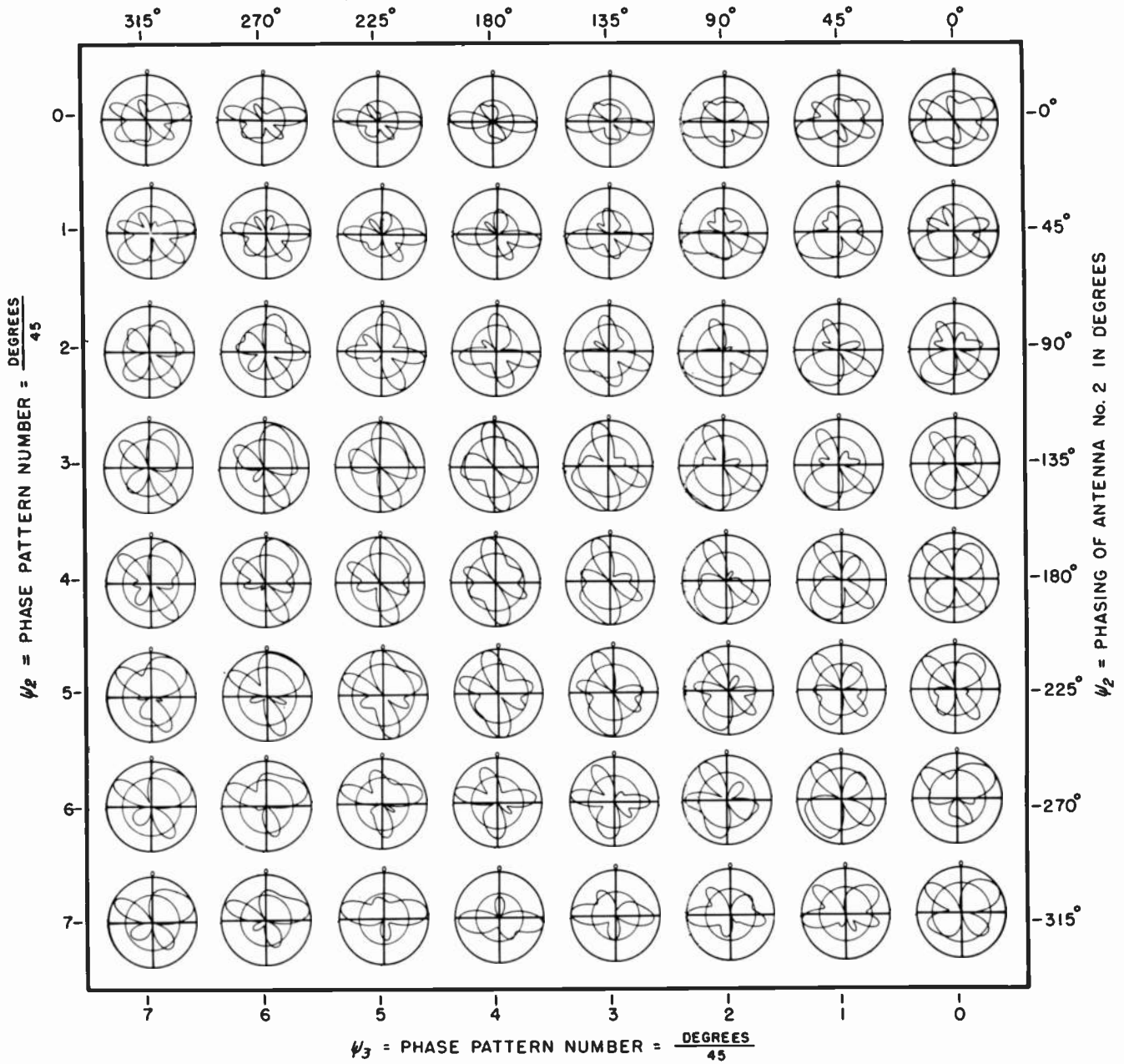

NUMBER OF ANTENNAS IN THE SYSTEM  
 No. 3

ORIENTATION OF NO. 2 ANTENNA =  $\frac{\text{DEGREES}}{45}$   
 $\psi_2 = 0$

SPACING OF NO. 2 ANTENNA =  $\frac{\text{DEGREES}}{45}$   
 $S_2 = 4$

PHASING OF NO. 2 ANTENNA =  $\frac{\text{DEGREES}}{45}$   
 $\psi_2 = 0$

ORIENTATION OF NO. 3 ANTENNA =  $\frac{\text{DEGREES}}{45}$   
 $\psi_3 = 5$

SPACING OF NO. 3 ANTENNA =  $\frac{\text{DEGREES}}{45}$   
 $S_3 = 7$

PHASING OF NO. 3 ANTENNA =  $\frac{\text{DEGREES}}{45}$   
 $\psi_3 = 0$

LEFT HAND PATTERN NUMBER GIVES ANTENNA PLACEMENT AND PHASING DATA.

% FIELD INTENSITY RADIATED IN HORIZONTAL PLANE FROM NO. 1 ANTENNA.  
 $E_1 = 30$

% FIELD INTENSITY RADIATED IN HORIZONTAL PLANE FROM NO. 2 ANTENNA.  
 $E_2 = 55$

% FIELD INTENSITY RADIATED IN HORIZONTAL PLANE FROM NO. 3 ANTENNA.  
 $E_3 = 30$

% RMS FIELD INTENSITY RADIATED IN HORIZONTAL PLANE FROM ANTENNA SYSTEM.  
 $E_0 = 64$

RIGHT HAND PATTERN NUMBER GIVES ANTENNA FIELD INTENSITY DATA IN PERCENT.

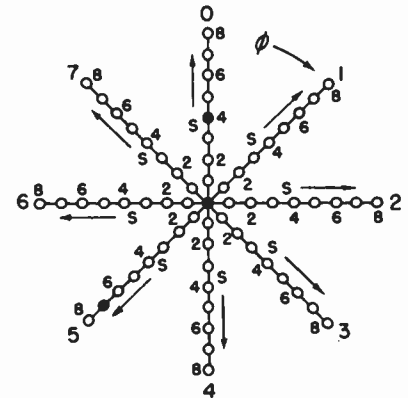

SPOTS LOCATE THE ANTENNAS FOR THIS PAGE OF PATTERNS IN THE SYSTEMIZATION PLACEMENT CHART.

PATTERN NOMENCLATURE

$\psi_3 =$  PHASING OF ANTENNA No. 3 IN DEGREES

3.215

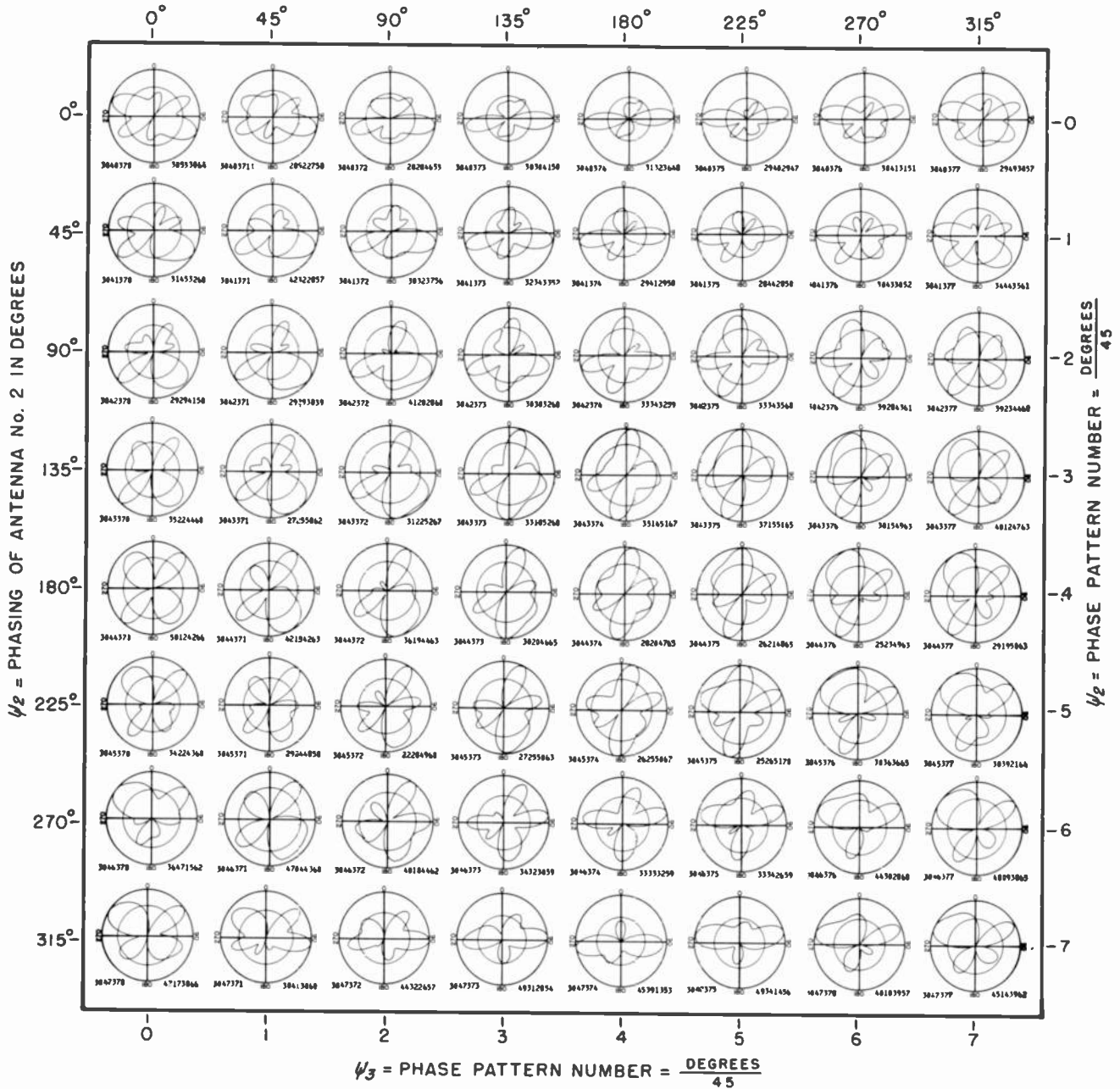

$\psi_2 =$  PHASING OF ANTENNA No. 2 IN DEGREES

$\psi_2 = \frac{\text{DEGREES}}{45}$

$\psi_3 =$  PHASE PATTERN NUMBER =  $\frac{\text{DEGREES}}{45}$

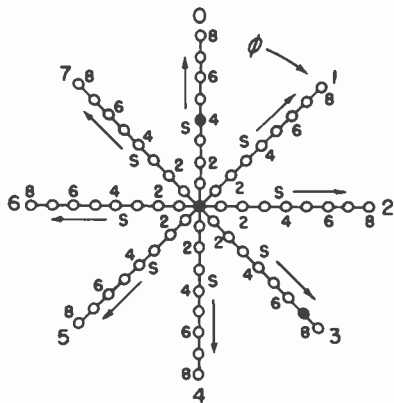

SPOTS LOCATE THE ANTENNAS FOR THIS PAGE OF PATTERNS IN THE SYSTEMATIZATION PLACEMENT CHART.

NUMBER OF ANTENNAS IN THE SYSTEM	ORIENTATION OF NO. 2 ANTENNA = $\frac{\text{DEGREES}}{45}$	SPACING OF NO. 2 ANTENNA = $\frac{\text{DEGREES}}{45}$	PHASING OF NO. 2 ANTENNA = $\frac{\text{DEGREES}}{45}$	ORIENTATION OF NO. 3 ANTENNA = $\frac{\text{DEGREES}}{45}$	SPACING OF NO. 3 ANTENNA = $\frac{\text{DEGREES}}{45}$	PHASING OF NO. 3 ANTENNA = $\frac{\text{DEGREES}}{45}$
No. 3	$\psi_2 = 0$	$S_2 = 4$	$\psi_2 = 0$	$\psi_3 = 3$	$S_3 = 7$	$\psi_3 = 0$

LEFT HAND PATTERN NUMBER GIVES ANTENNA PLACEMENT AND PHASING DATA.

% FIELD INTENSITY RADIATED IN HORIZONTAL PLANE FROM NO. 1 ANTENNA.	% FIELD INTENSITY RADIATED IN HORIZONTAL PLANE FROM NO. 2 ANTENNA.	% FIELD INTENSITY RADIATED IN HORIZONTAL PLANE FROM NO. 3 ANTENNA.	% RMS FIELD INTENSITY RADIATED IN HORIZONTAL PLANE FROM ANTENNA SYSTEM.
$E_1 = 30$	$E_2 = 55$	$E_3 = 30$	$E_0 = 64$

RIGHT HAND PATTERN NUMBER GIVES ANTENNA FIELD INTENSITY DATA IN PERCENT.

PATTERN NOMENCLATURE

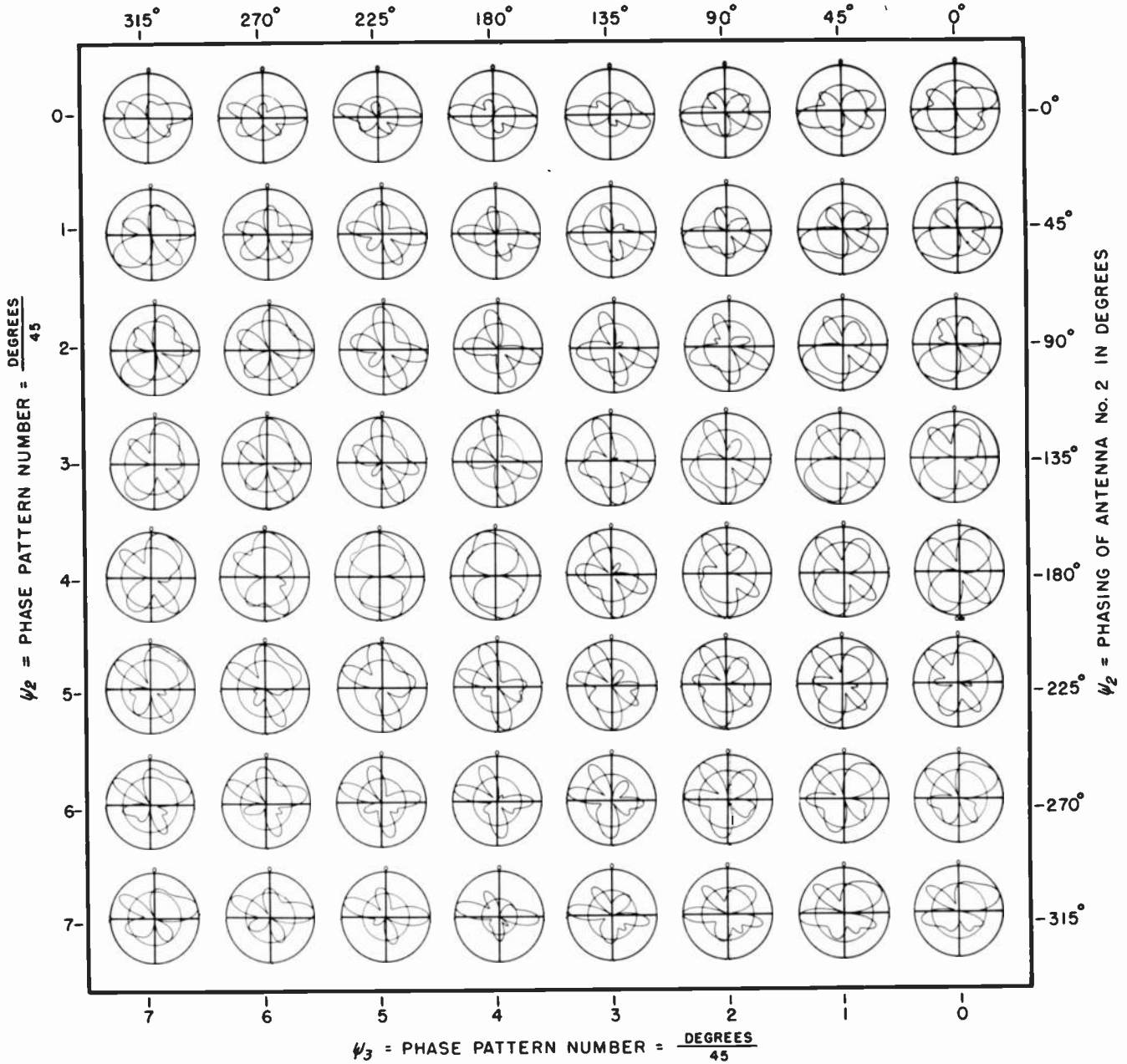

NUMBER OF ANTENNAS IN THE SYSTEM	$\psi_2 = \text{PHASE PATTERN NUMBER} = \frac{\text{DEGREES}}{45}$	$\psi_3 = \text{PHASE PATTERN NUMBER} = \frac{\text{DEGREES}}{45}$
No. 3	0	0
ORIENTATION OF NO. 2 ANTENNA = $\frac{\text{DEGREES}}{45}$	$S_2 = \text{SPACING OF NO. 2 ANTENNA} = \frac{\text{DEGREES}}{45}$	$S_3 = \text{SPACING OF NO. 3 ANTENNA} = \frac{\text{DEGREES}}{45}$
0	4	8
PHASING OF NO. 2 ANTENNA = $\frac{\text{DEGREES}}{45}$	$\psi_2 = \text{PHASING OF NO. 2 ANTENNA} = \frac{\text{DEGREES}}{45}$	$\psi_3 = \text{PHASING OF NO. 3 ANTENNA} = \frac{\text{DEGREES}}{45}$
0	0	0
ORIENTATION OF NO. 3 ANTENNA = $\frac{\text{DEGREES}}{45}$	$\psi_3 = \text{PHASING OF NO. 3 ANTENNA} = \frac{\text{DEGREES}}{45}$	$E_1 = \%$ FIELD INTENSITY RADIATED IN HORIZONTAL PLANE FROM NO. 1 ANTENNA.
5	5	53
SPACING OF NO. 3 ANTENNA = $\frac{\text{DEGREES}}{45}$	$S_3 = \text{SPACING OF NO. 3 ANTENNA} = \frac{\text{DEGREES}}{45}$	$E_2 = \%$ FIELD INTENSITY RADIATED IN HORIZONTAL PLANE FROM NO. 2 ANTENNA.
8	8	28
PHASING OF NO. 3 ANTENNA = $\frac{\text{DEGREES}}{45}$	$\psi_3 = \text{PHASING OF NO. 3 ANTENNA} = \frac{\text{DEGREES}}{45}$	$E_3 = \%$ FIELD INTENSITY RADIATED IN HORIZONTAL PLANE FROM NO. 3 ANTENNA.
0	0	25
		$E_0 = \%$ RMS FIELD INTENSITY RADIATED IN HORIZONTAL PLANE FROM ANTENNA SYSTEM.
		63

LEFT HAND PATTERN NUMBER GIVES ANTENNA PLACEMENT AND PHASING DATA.

RIGHT HAND PATTERN NUMBER GIVES ANTENNA FIELD INTENSITY DATA IN PERCENT.

PATTERN NOMENCLATURE

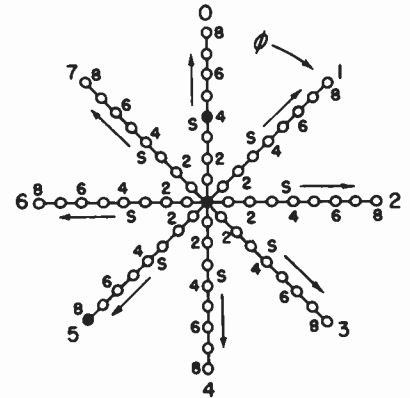

SPOTS LOCATE THE ANTENNAS FOR THIS PAGE OF PATTERNS IN THE SYSTEMATIZATION PLACEMENT CHART.

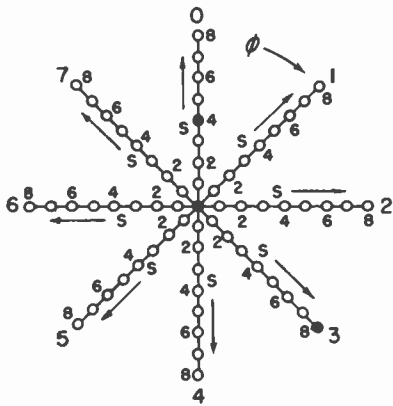
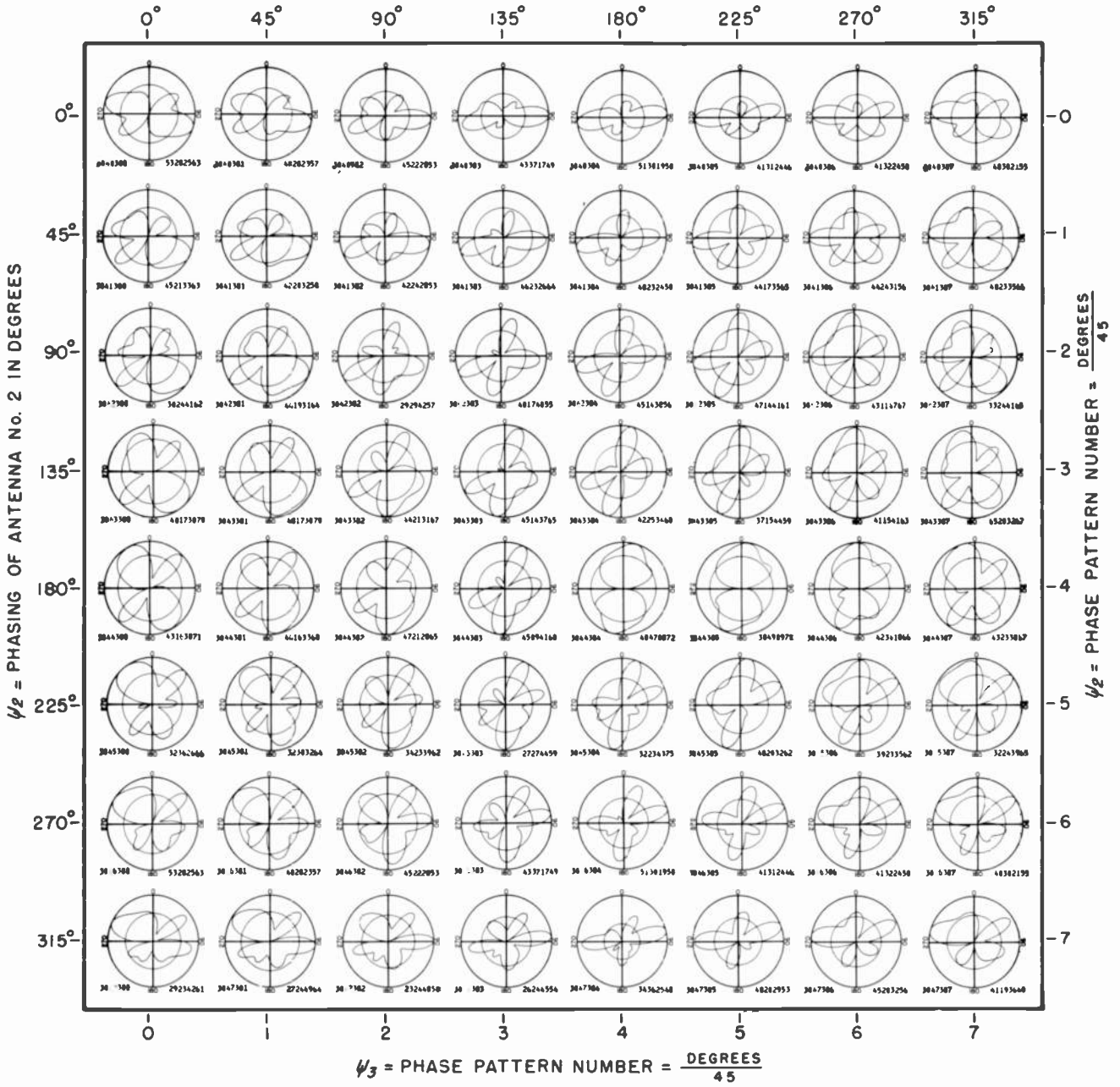

$\psi_3$  = PHASE PATTERN NUMBER =  $\frac{\text{DEGREES}}{45}$

NUMBER OF ANTENNAS IN THE SYSTEM	ORIENTATION OF NO. 2 ANTENNA = $\frac{\text{DEGREES}}{45}$	SPACING OF NO. 2 ANTENNA = $\frac{\text{DEGREES}}{45}$	PHASING OF NO. 2 ANTENNA = $\frac{\text{DEGREES}}{45}$	ORIENTATION OF NO. 3 ANTENNA = $\frac{\text{DEGREES}}{45}$	SPACING OF NO. 3 ANTENNA = $\frac{\text{DEGREES}}{45}$	PHASING OF NO. 3 ANTENNA = $\frac{\text{DEGREES}}{45}$
No. 3	$\phi_2$ 0	$S_2$ 4	$\psi_2$ 0	$\phi_3$ 3	$S_3$ 8	$\psi_3$ 0

% FIELD INTENSITY RADIATED IN HORIZONTAL PLANE FROM NO. 1 ANTENNA.	% FIELD INTENSITY RADIATED IN HORIZONTAL PLANE FROM NO. 2 ANTENNA.	% FIELD INTENSITY RADIATED IN HORIZONTAL PLANE FROM NO. 3 ANTENNA.	% RMS FIELD INTENSITY RADIATED IN HORIZONTAL PLANE FROM ANTENNA SYSTEM.
$E_1$ 53	$E_2$ 28	$E_3$ 25	$E_0$ 63

LEFT HAND PATTERN NUMBER GIVES ANTENNA PLACEMENT AND PHASING DATA.

RIGHT HAND PATTERN NUMBER GIVES ANTENNA FIELD INTENSITY DATA IN PERCENT.

SPOTS LOCATE THE ANTENNAS FOR THIS PAGE OF PATTERNS IN THE SYSTEMATIZATION PLACEMENT CHART.

PATTERN NOMENCLATURE

$\psi_3$  = PHASING OF ANTENNA No. 3 IN DEGREES

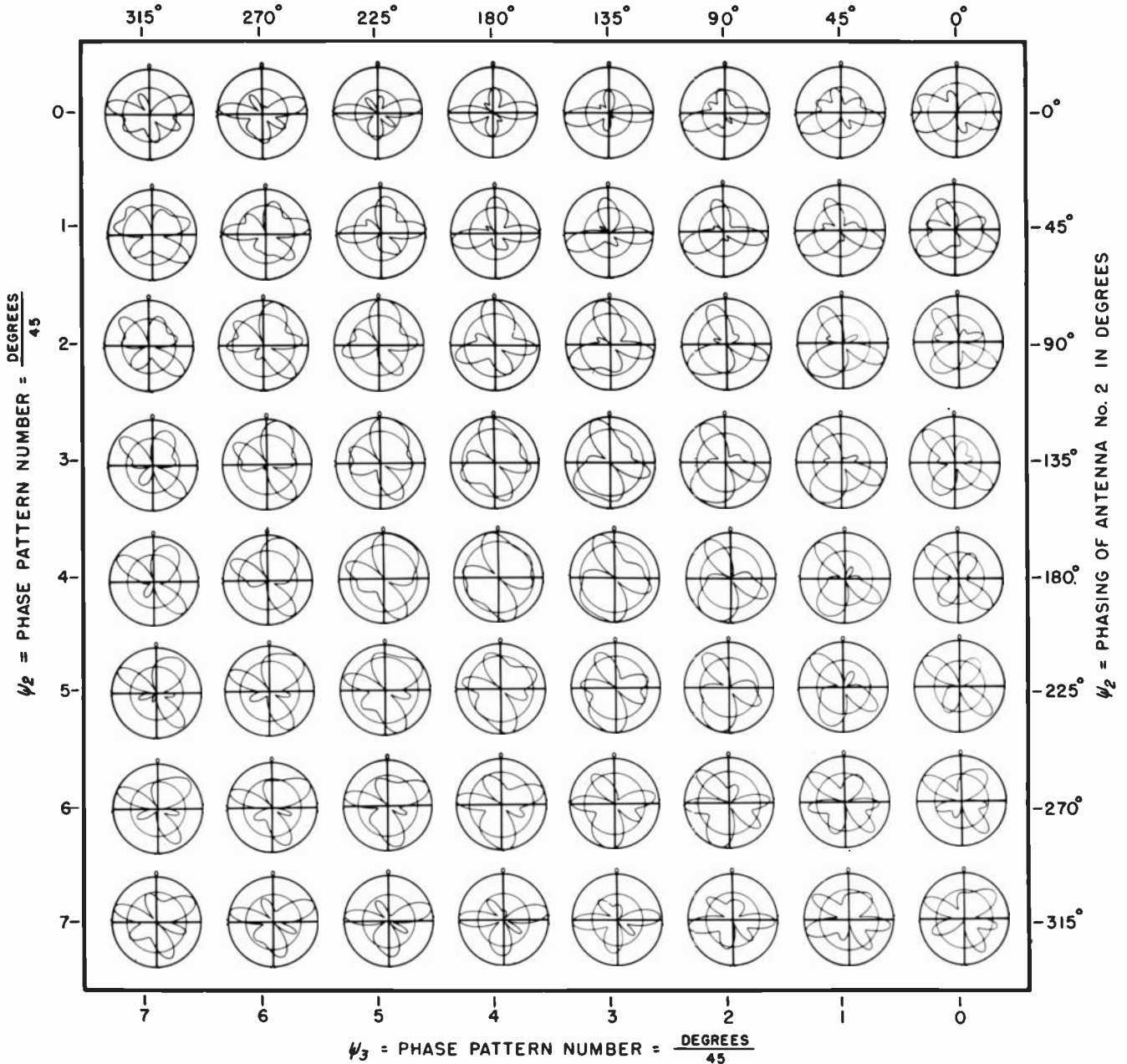

NUMBER OF ANTENNAS NO. IN THE SYSTEM	ORIENTATION OF NO. 2 ANTENNA = $\frac{\text{DEGREES}}{45}$	SPACING OF NO. 2 ANTENNA = $\frac{\text{DEGREES}}{45}$	PHASING OF NO. 2 ANTENNA = $\frac{\text{DEGREES}}{45}$	ORIENTATION OF NO. 3 ANTENNA = $\frac{\text{DEGREES}}{45}$	SPACING OF NO. 3 ANTENNA = $\frac{\text{DEGREES}}{45}$	PHASING OF NO. 3 ANTENNA = $\frac{\text{DEGREES}}{45}$
No. 3	$\phi_2$ 0	$S_2$ 5	$\psi_2$ 0	$\phi_3$ 5	$S_3$ 6	$\psi_3$ 0

LEFT HAND PATTERN NUMBER GIVES ANTENNA PLACEMENT AND PHASING DATA.

% FIELD INTENSITY RADIATED IN HORIZONTAL PLANE FROM NO. 1 ANTENNA.	% FIELD INTENSITY RADIATED IN HORIZONTAL PLANE FROM NO. 2 ANTENNA.	% FIELD INTENSITY RADIATED IN HORIZONTAL PLANE FROM NO. 3 ANTENNA.	% RMS FIELD INTENSITY RADIATED IN HORIZONTAL PLANE FROM ANTENNA SYSTEM.
$E_1$ 53	$E_2$ 47	$E_3$ 25	$E_0$ 64

RIGHT HAND PATTERN NUMBER GIVES ANTENNA FIELD INTENSITY DATA IN PERCENT.

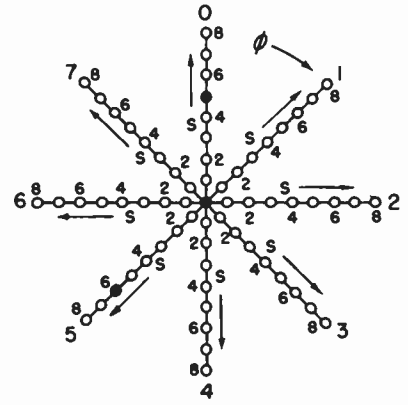

SPOTS LOCATE THE ANTENNAS FOR THIS PAGE OF PATTERNS IN THE SYSTEMATIZATION PLACEMENT CHART.

PATTERN NOMENCLATURE



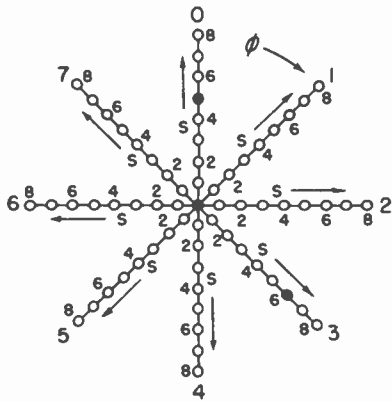
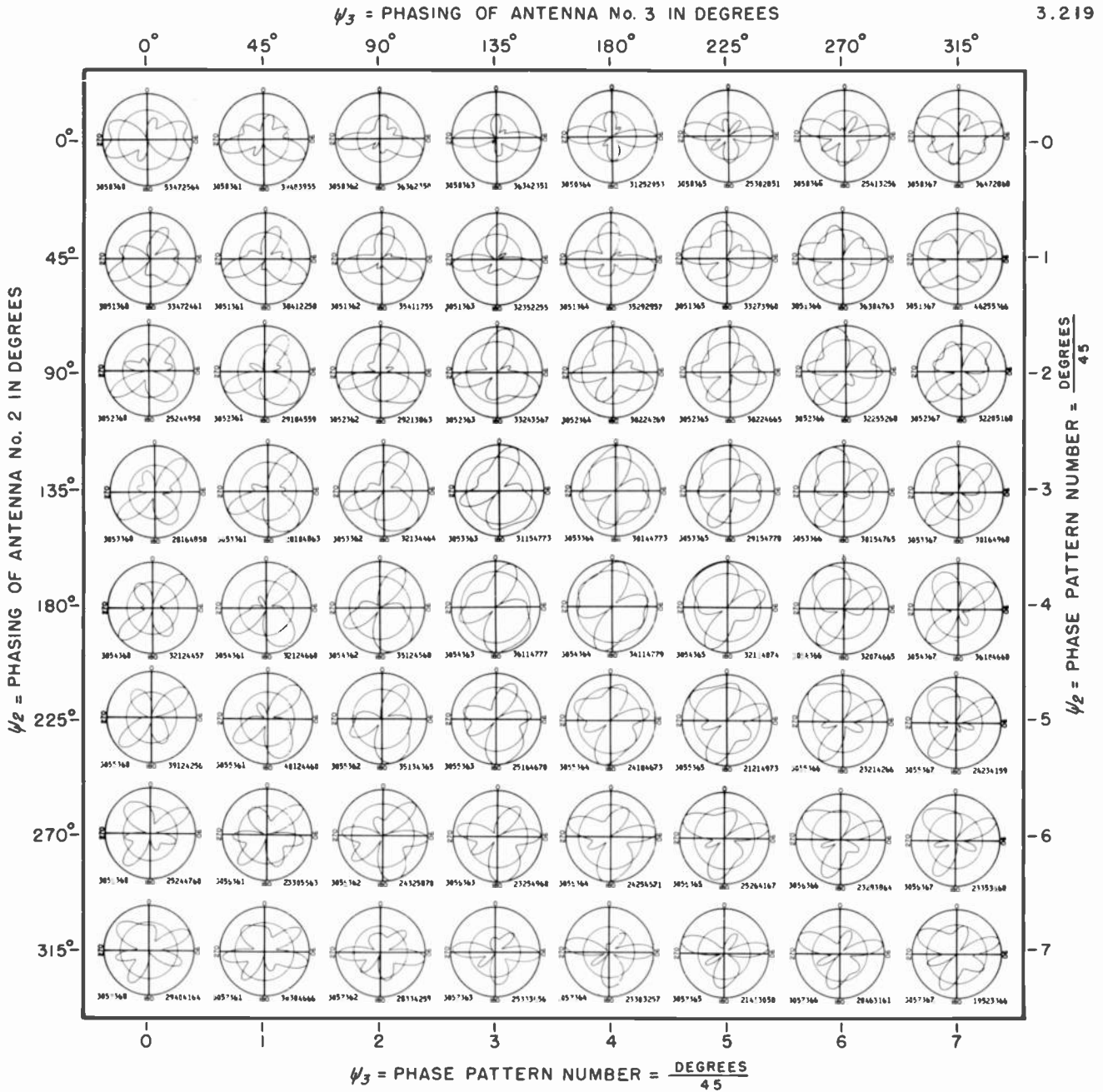

SPOTS LOCATE THE ANTENNAS FOR THIS PAGE OF PATTERNS IN THE SYSTEMATIZATION PLACEMENT CHART.

NUMBER OF ANTENNAS IN THE SYSTEM	ORIENTATION OF NO. 2 ANTENNA = $\frac{\text{DEGREES}}{45}$	SPACING OF NO. 2 ANTENNA = $\frac{\text{DEGREES}}{45}$	PHASING OF NO. 2 ANTENNA = $\frac{\text{DEGREES}}{45}$	ORIENTATION OF NO. 3 ANTENNA = $\frac{\text{DEGREES}}{45}$	SPACING OF NO. 3 ANTENNA = $\frac{\text{DEGREES}}{45}$	PHASING OF NO. 3 ANTENNA = $\frac{\text{DEGREES}}{45}$
No. 3	$\psi_2 = 0$	$S_2 = 5$	$\psi_2 = 0$	$\psi_3 = 3$	$S_3 = 6$	$\psi_3 = 0$

LEFT HAND PATTERN NUMBER GIVES ANTENNA PLACEMENT AND PHASING DATA.

% FIELD INTENSITY RADIATED IN HORIZONTAL PLANE FROM NO. 1 ANTENNA.	% FIELD INTENSITY RADIATED IN HORIZONTAL PLANE FROM NO. 2 ANTENNA.	% FIELD INTENSITY RADIATED IN HORIZONTAL PLANE FROM NO. 3 ANTENNA.	% RMS FIELD INTENSITY RADIATED IN HORIZONTAL PLANE FROM ANTENNA SYSTEM.
$E_1 = 53$	$E_2 = 47$	$E_3 = 25$	$E_0 = 64$

RIGHT HAND PATTERN NUMBER GIVES ANTENNA FIELD INTENSITY DATA IN PERCENT.

PATTERN NOMENCLATURE

$\psi_3$  = PHASING OF ANTENNA No. 3 IN DEGREES

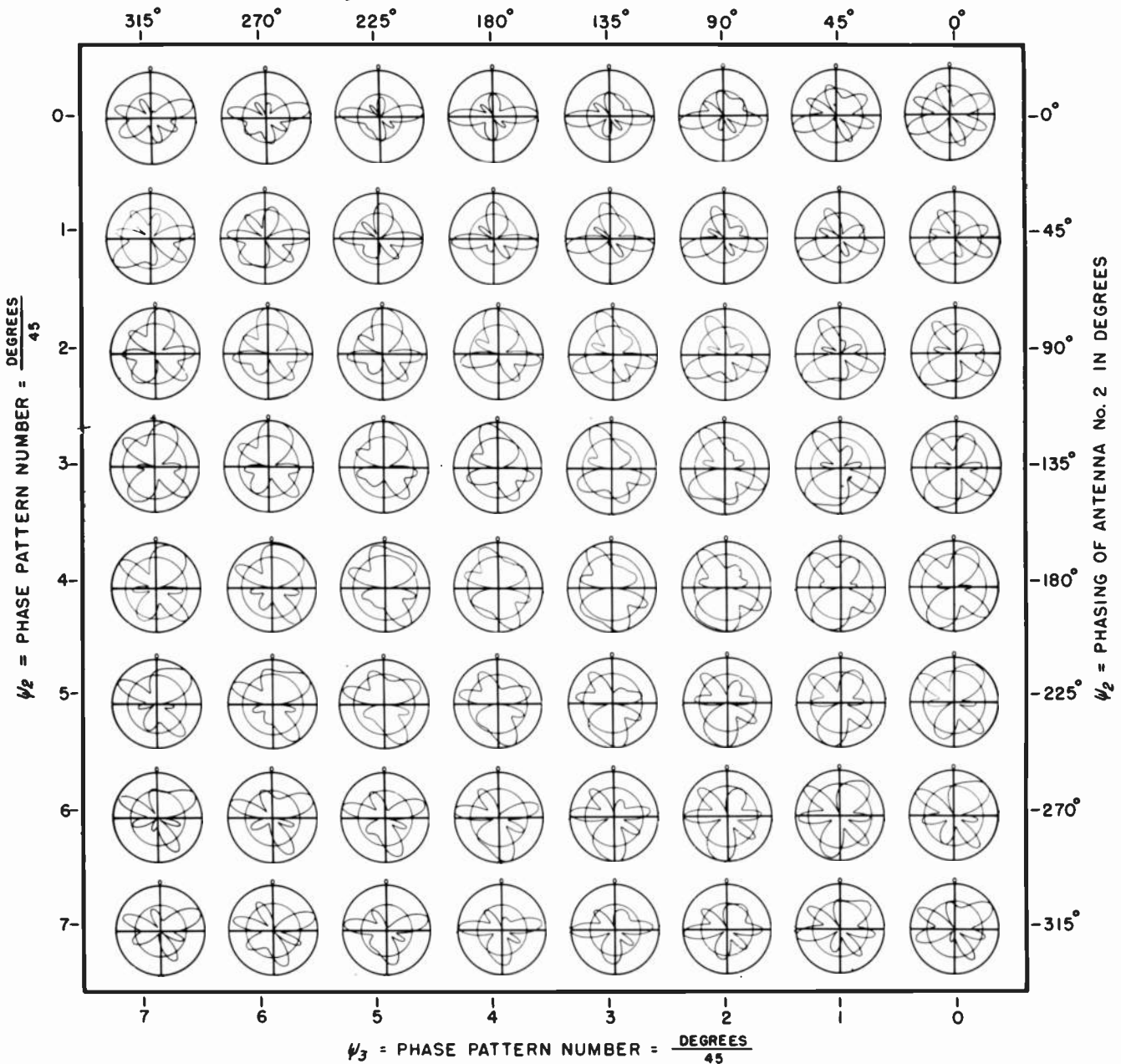

NUMBER OF ANTENNAS IN THE SYSTEM	$\psi_2 = \text{PHASE PATTERN NUMBER} = \frac{\text{DEGREES}}{45}$	
No. 3	$\phi_2$	0
ORIENTATION OF NO. 2 ANTENNA	$\frac{\text{DEGREES}}{45}$	
No. 5	$S_2$	5
SPACING OF NO. 2 ANTENNA	$\frac{\text{DEGREES}}{45}$	
No. 0	$\psi_2$	0
PHASING OF NO. 2 ANTENNA	$\frac{\text{DEGREES}}{45}$	
No. 5	$\phi_3$	5
ORIENTATION OF NO. 3 ANTENNA	$\frac{\text{DEGREES}}{45}$	
No. 7	$S_3$	7
SPACING OF NO. 3 ANTENNA	$\frac{\text{DEGREES}}{45}$	
No. 0	$\psi_3$	0
PHASING OF NO. 3 ANTENNA	$\frac{\text{DEGREES}}{45}$	

% FIELD INTENSITY RADIATED IN HORIZONTAL PLANE FROM NO. 1 ANTENNA.	$F_1$	16
% FIELD INTENSITY RADIATED IN HORIZONTAL PLANE FROM NO. 2 ANTENNA.	$F_2$	53
% FIELD INTENSITY RADIATED IN HORIZONTAL PLANE FROM NO. 3 ANTENNA.	$F_3$	34
% RMS FIELD INTENSITY RADIATED IN HORIZONTAL PLANE FROM ANTENNA SYSTEM.	$F_0$	62

LEFT HAND PATTERN NUMBER GIVES ANTENNA PLACEMENT AND PHASING DATA.

RIGHT HAND PATTERN NUMBER GIVES ANTENNA FIELD INTENSITY DATA IN PERCENT.

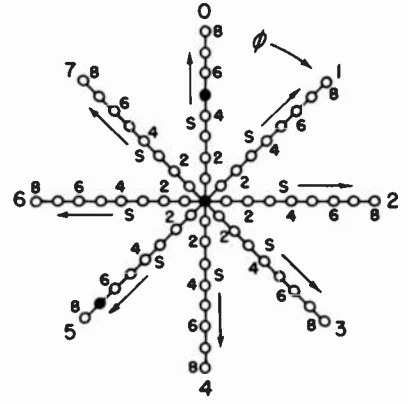

SPOTS LOCATE THE ANTENNAS FOR THIS PAGE OF PATTERNS IN THE SYSTEMATIZATION PLACEMENT CHART.

PATTERN NOMENCLATURE

$\psi_3$  = PHASING OF ANTENNA No. 3 IN DEGREES

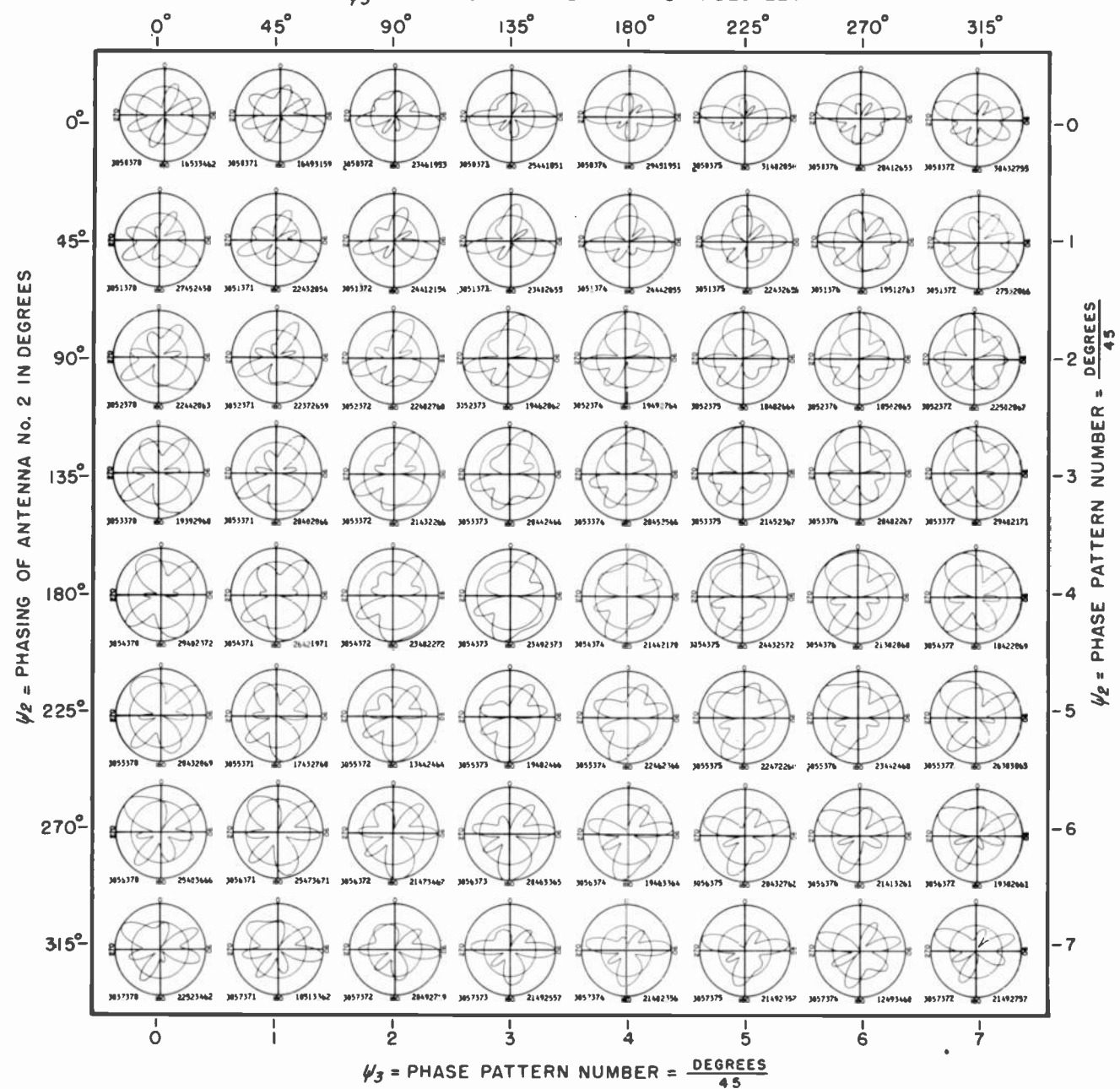

$\psi_2$  = PHASING OF ANTENNA No. 2 IN DEGREES

$\psi_2$  = PHASE PATTERN NUMBER =  $\frac{\text{DEGREES}}{45}$

$\psi_3$  = PHASE PATTERN NUMBER =  $\frac{\text{DEGREES}}{45}$

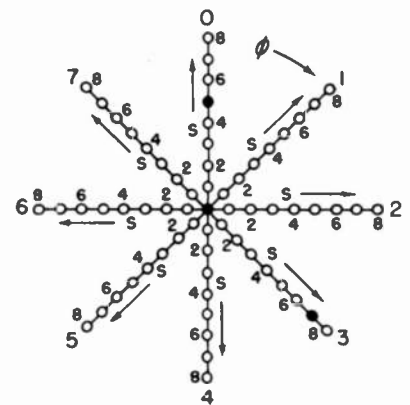

SPOTS LOCATE THE ANTENNAS FOR THIS PAGE OF PATTERNS IN THE SYSTEMIZATION PLACEMENT CHART.

NUMBER OF ANTENNAS IN THE SYSTEM	$N_0$	3
ORIENTATION OF NO. 2 ANTENNA = $\frac{\text{DEGREES}}{45}$	$\psi_2$	0
SPACING OF NO. 2 ANTENNA = $\frac{\text{DEGREES}}{45}$	$S_2$	5
PHASING OF NO. 2 ANTENNA = $\frac{\text{DEGREES}}{45}$	$\psi_2$	0
ORIENTATION OF NO. 3 ANTENNA = $\frac{\text{DEGREES}}{45}$	$\psi_3$	3
SPACING OF NO. 3 ANTENNA = $\frac{\text{DEGREES}}{45}$	$S_3$	7
PHASING OF NO. 3 ANTENNA = $\frac{\text{DEGREES}}{45}$	$\psi_3$	0

LEFT HAND PATTERN NUMBER GIVES ANTENNA PLACEMENT AND PHASING DATA.

% FIELD INTENSITY RADIATED IN HORIZONTAL PLANE FROM NO. 1 ANTENNA.	$F_1$	16
% FIELD INTENSITY RADIATED IN HORIZONTAL PLANE FROM NO. 2 ANTENNA.	$F_2$	53
% FIELD INTENSITY RADIATED IN HORIZONTAL PLANE FROM NO. 3 ANTENNA.	$F_3$	34
% RMS FIELD INTENSITY RADIATED IN HORIZONTAL PLANE FROM ANTENNA SYSTEM.	$F_0$	62

RIGHT HAND PATTERN NUMBER GIVES ANTENNA FIELD INTENSITY DATA IN PERCENT.

PATTERN NOMENCLATURE

$\psi_3$  = PHASING OF ANTENNA No. 3 IN DEGREES

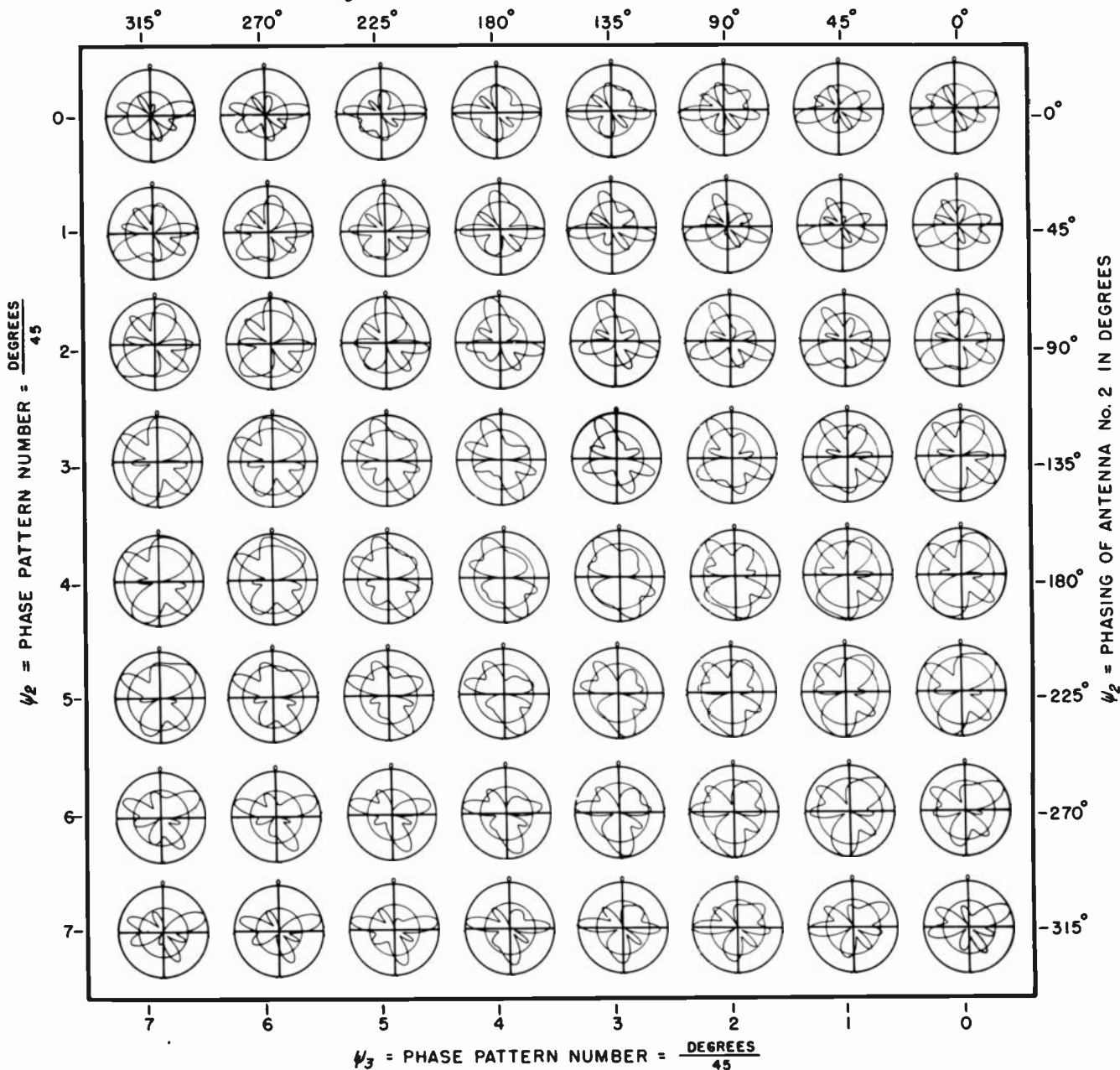

NUMBER OF ANTENNAS IN THE SYSTEM		ORIENTATION OF ANTENNA No. 2		SPACING OF ANTENNA No. 2		PHASING OF ANTENNA No. 2		ORIENTATION OF ANTENNA No. 3		SPACING OF ANTENNA No. 3		PHASING OF ANTENNA No. 3	
No.	$\phi_2$	$S_2$	$\psi_2$	$\phi_3$	$S_3$	$\psi_3$							
3	0	5	0	5	8	0							

% FIELD INTENSITY RADIATED IN HORIZONTAL PLANE FROM ANTENNA		% RMS FIELD INTENSITY RADIATED IN HORIZONTAL PLANE FROM ANTENNA SYSTEM	
Antenna	Intensity (%)	System	Intensity (%)
No. 1	22	$E_0$	53
No. 2	50		
No. 3	29		

LEFT HAND PATTERN NUMBER GIVES ANTENNA PLACEMENT AND PHASING DATA.

RIGHT HAND PATTERN NUMBER GIVES ANTENNA FIELD INTENSITY DATA IN PERCENT.

**PATTERN NOMENCLATURE**

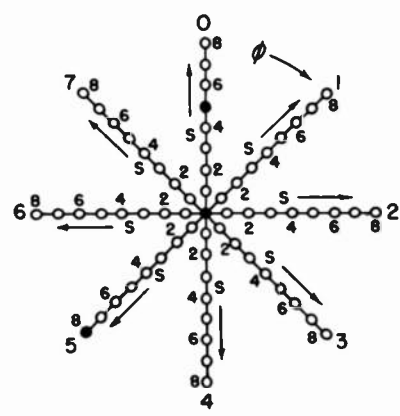

SPOTS LOCATE THE ANTENNAS FOR THIS PAGE OF PATTERNS IN THE SYSTEMIZATION PLACEMENT CHART.

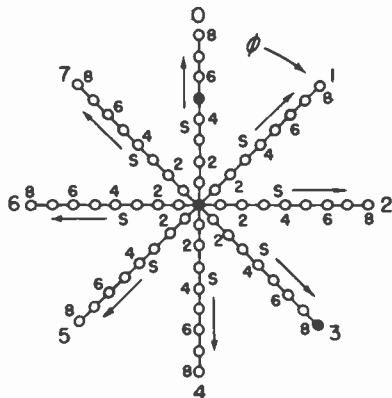
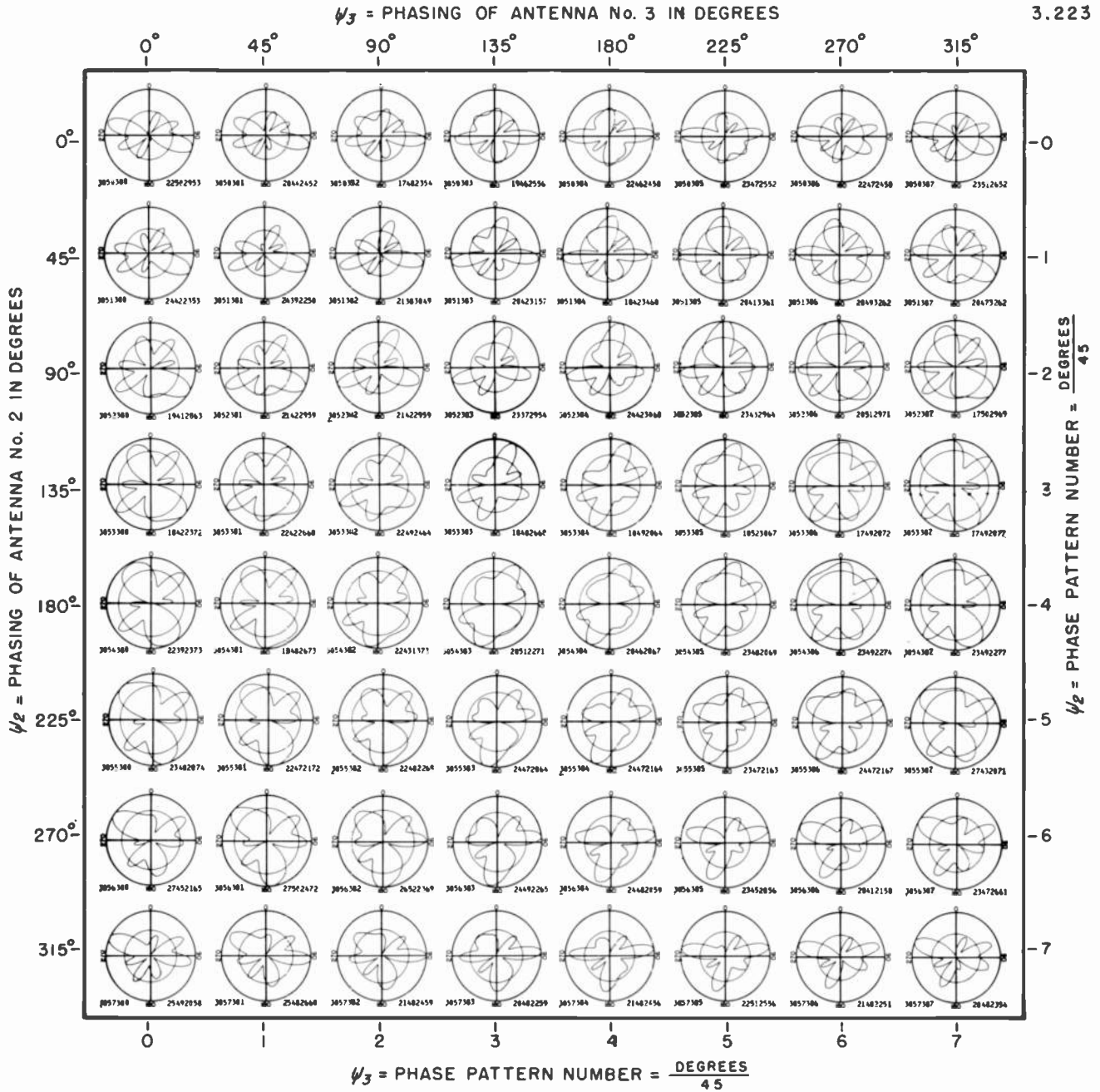

SPOTS LOCATE THE ANTENNAS FOR THIS PAGE OF PATTERNS IN THE SYSTEMATIZATION PLACEMENT CHART.

$\psi_3 = \text{PHASE PATTERN NUMBER} = \frac{\text{DEGREES}}{45}$

NUMBER OF ANTENNAS IN THE SYSTEM	ORIENTATION OF NO. 2 ANTENNA = $\frac{\text{DEGREES}}{45}$	SPACING OF NO. 2 ANTENNA = $\frac{\text{DEGREES}}{45}$	PHASING OF NO. 2 ANTENNA = $\frac{\text{DEGREES}}{45}$	ORIENTATION OF NO. 3 ANTENNA = $\frac{\text{DEGREES}}{45}$	SPACING OF NO. 3 ANTENNA = $\frac{\text{DEGREES}}{45}$	PHASING OF NO. 3 ANTENNA = $\frac{\text{DEGREES}}{45}$
NO. 3	$\phi_2$ 0	$S_2$ 5	$\psi_2$ 0	$\phi_3$ 3	$S_3$ 8	$\psi_3$ 0

LEFT HAND PATTERN NUMBER GIVES ANTENNA PLACEMENT AND PHASING DATA.

% FIELD INTENSITY RADIATED IN HORIZONTAL PLANE FROM NO. 1 ANTENNA.	% FIELD INTENSITY RADIATED IN HORIZONTAL PLANE FROM NO. 2 ANTENNA.	% FIELD INTENSITY RADIATED IN HORIZONTAL PLANE FROM NO. 3 ANTENNA.	% RMS FIELD INTENSITY RADIATED IN HORIZONTAL PLANE FROM ANTENNA SYSTEM.
$E_1$ 22	$E_2$ 50	$E_3$ 29	$E_0$ 53

RIGHT HAND PATTERN NUMBER GIVES ANTENNA FIELD INTENSITY DATA IN PERCENT.

PATTERN NOMENCLATURE

$\psi_3$  = PHASING OF ANTENNA No. 3 IN DEGREES

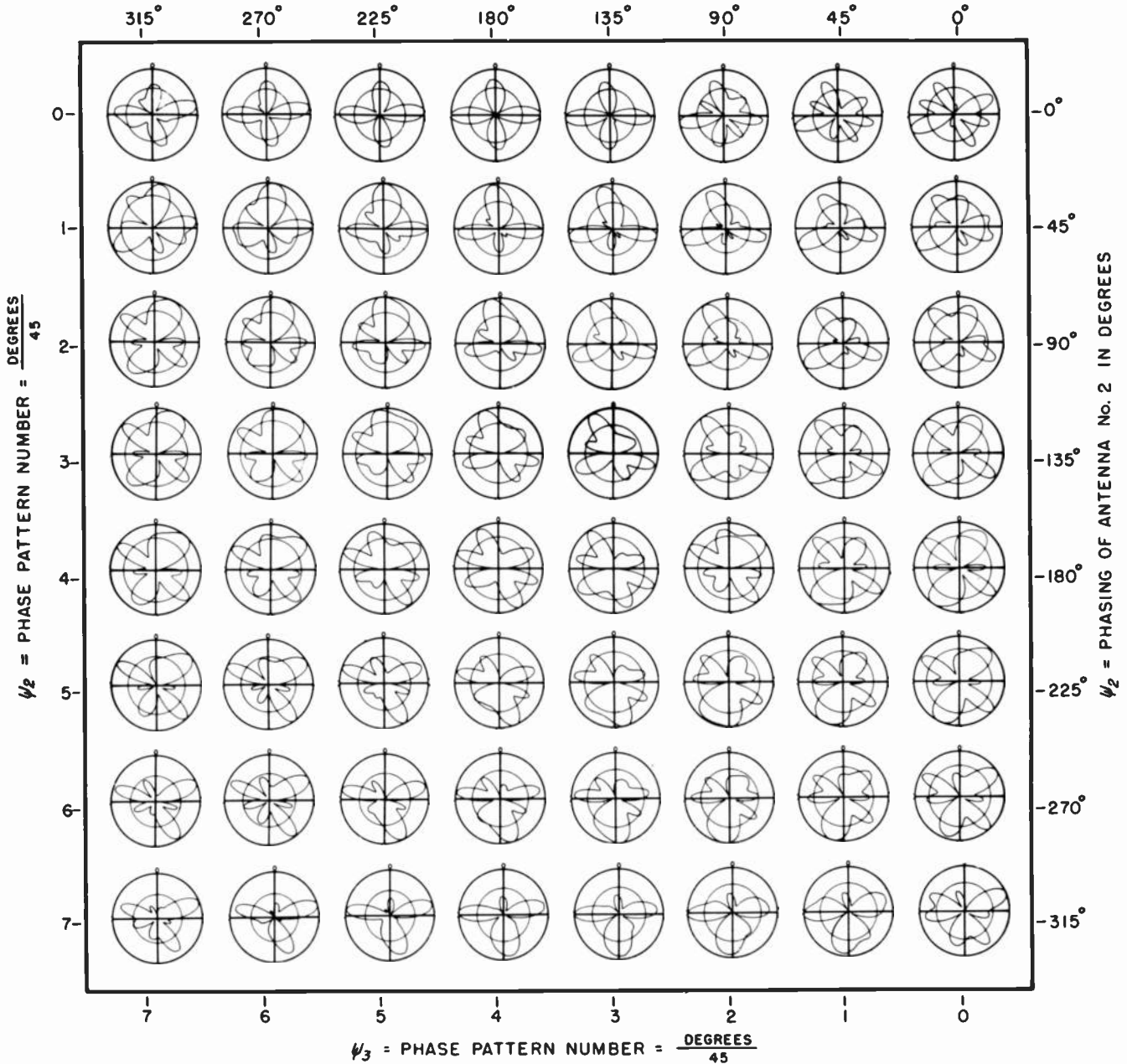

NUMBER OF ANTENNAS IN THE SYSTEM  
 NO. 2 ANTENNA =  $\frac{\text{DEGREES}}{45}$   
 SPACING OF NO. 2 ANTENNA =  $\frac{\text{DEGREES}}{45}$   
 PHASING OF NO. 2 ANTENNA =  $\frac{\text{DEGREES}}{45}$   
 ORIENTATION OF DEGREES NO. 3 ANTENNA =  $\frac{\text{DEGREES}}{45}$   
 SPACING OF NO. 3 ANTENNA =  $\frac{\text{DEGREES}}{45}$   
 PHASING OF NO. 3 ANTENNA =  $\frac{\text{DEGREES}}{45}$

% FIELD INTENSITY RADIATED IN HORIZONTAL PLANE FROM NO. 1 ANTENNA.  $E_1$   
 % FIELD INTENSITY RADIATED IN HORIZONTAL PLANE FROM NO. 2 ANTENNA.  $E_2$   
 % FIELD INTENSITY RADIATED IN HORIZONTAL PLANE FROM NO. 3 ANTENNA.  $E_3$   
 % RMS FIELD INTENSITY RADIATED IN HORIZONTAL PLANE FROM ANTENNA SYSTEM.  $E_0$

LEFT HAND PATTERN NUMBER GIVES ANTENNA PLACEMENT AND PHASING DATA.

RIGHT HAND PATTERN NUMBER GIVES ANTENNA FIELD INTENSITY DATA IN PERCENT.

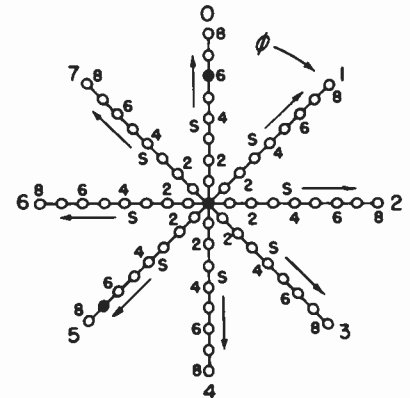

SPOTS LOCATE THE ANTENNAS FOR THIS PAGE OF PATTERNS IN THE SYSTEMIZATION PLACEMENT CHART.

PATTERN NOMENCLATURE

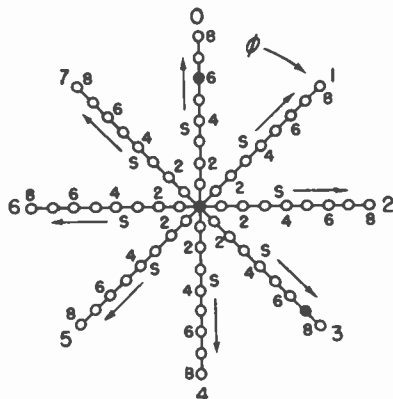
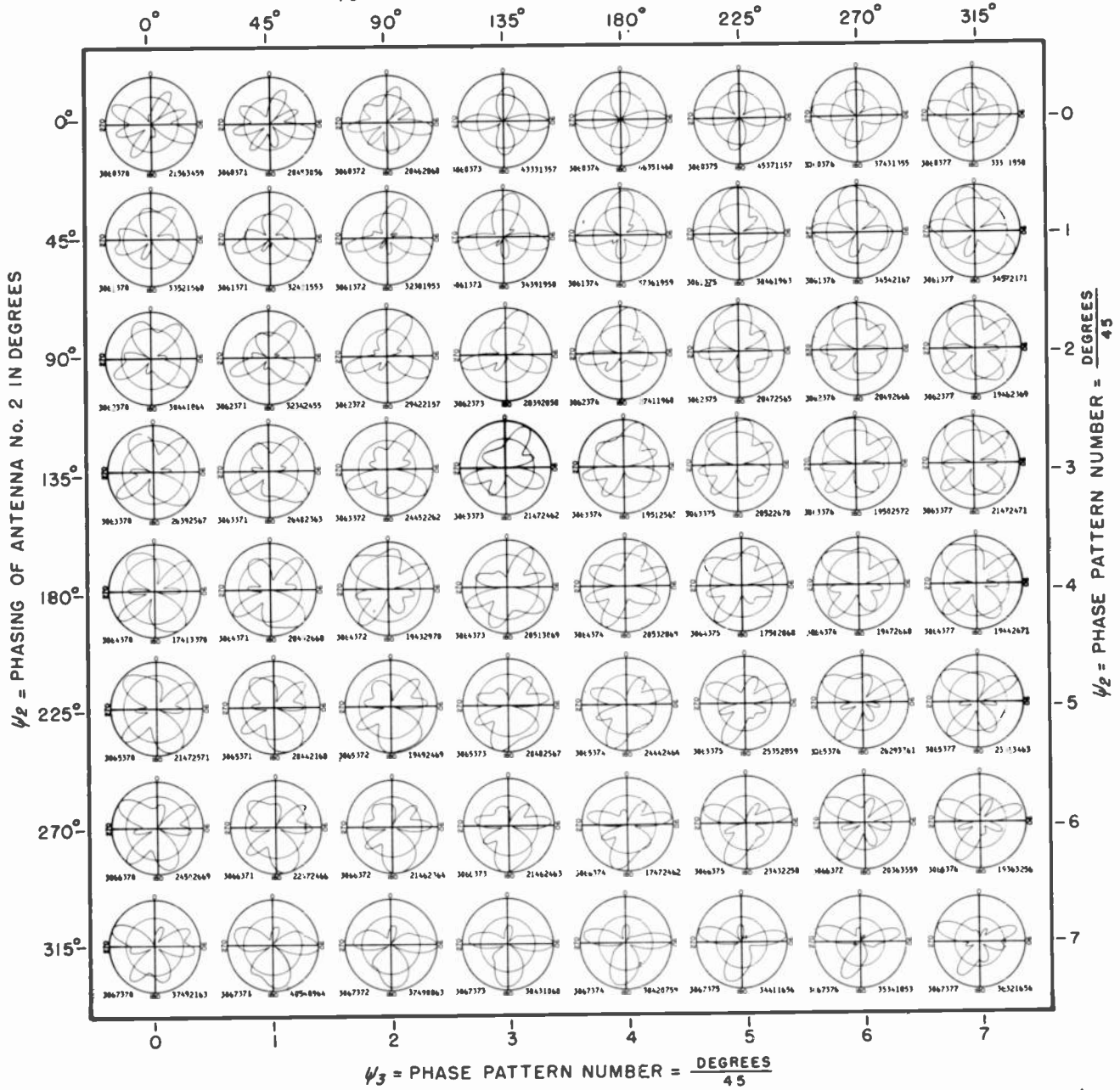

NUMBER OF ANTENNAS IN THE SYSTEM	ORIENTATION OF NO. 2 ANTENNA = $\frac{\text{DEGREES}}{45}$	SPACING OF NO. 2 ANTENNA = $\frac{\text{DEGREES}}{45}$	PHASING OF NO. 2 ANTENNA = $\frac{\text{DEGREES}}{45}$	ORIENTATION OF NO. 3 ANTENNA = $\frac{\text{DEGREES}}{45}$	SPACING OF NO. 3 ANTENNA = $\frac{\text{DEGREES}}{45}$	PHASING OF NO. 3 ANTENNA = $\frac{\text{DEGREES}}{45}$
No. 3	$\phi_2$ 0	$S_2$ 6	$\psi_2$ 0	$\phi_3$ 3	$S_3$ 7	$\psi_3$ 0

% FIELD INTENSITY RADIATED IN HORIZONTAL PLANE FROM NO. 1 ANTENNA.	% FIELD INTENSITY RADIATED IN HORIZONTAL PLANE FROM NO. 2 ANTENNA.	% FIELD INTENSITY RADIATED IN HORIZONTAL PLANE FROM NO. 3 ANTENNA.	% RMS FIELD INTENSITY RADIATED IN HORIZONTAL PLANE FROM ANTENNA SYSTEM.
$E_1$ 21	$E_2$ 56	$E_3$ 34	$E_0$ 59

LEFT HAND PATTERN NUMBER GIVES ANTENNA PLACEMENT AND PHASING DATA.

RIGHT HAND PATTERN NUMBER GIVES ANTENNA FIELD INTENSITY DATA IN PERCENT.

SPOTS LOCATE THE ANTENNAS FOR THIS PAGE OF PATTERNS IN THE SYSTEMATIZATION PLACEMENT CHART.

PATTERN NOMENCLATURE

$\psi_3$  = PHASING OF ANTENNA No. 3 IN DEGREES

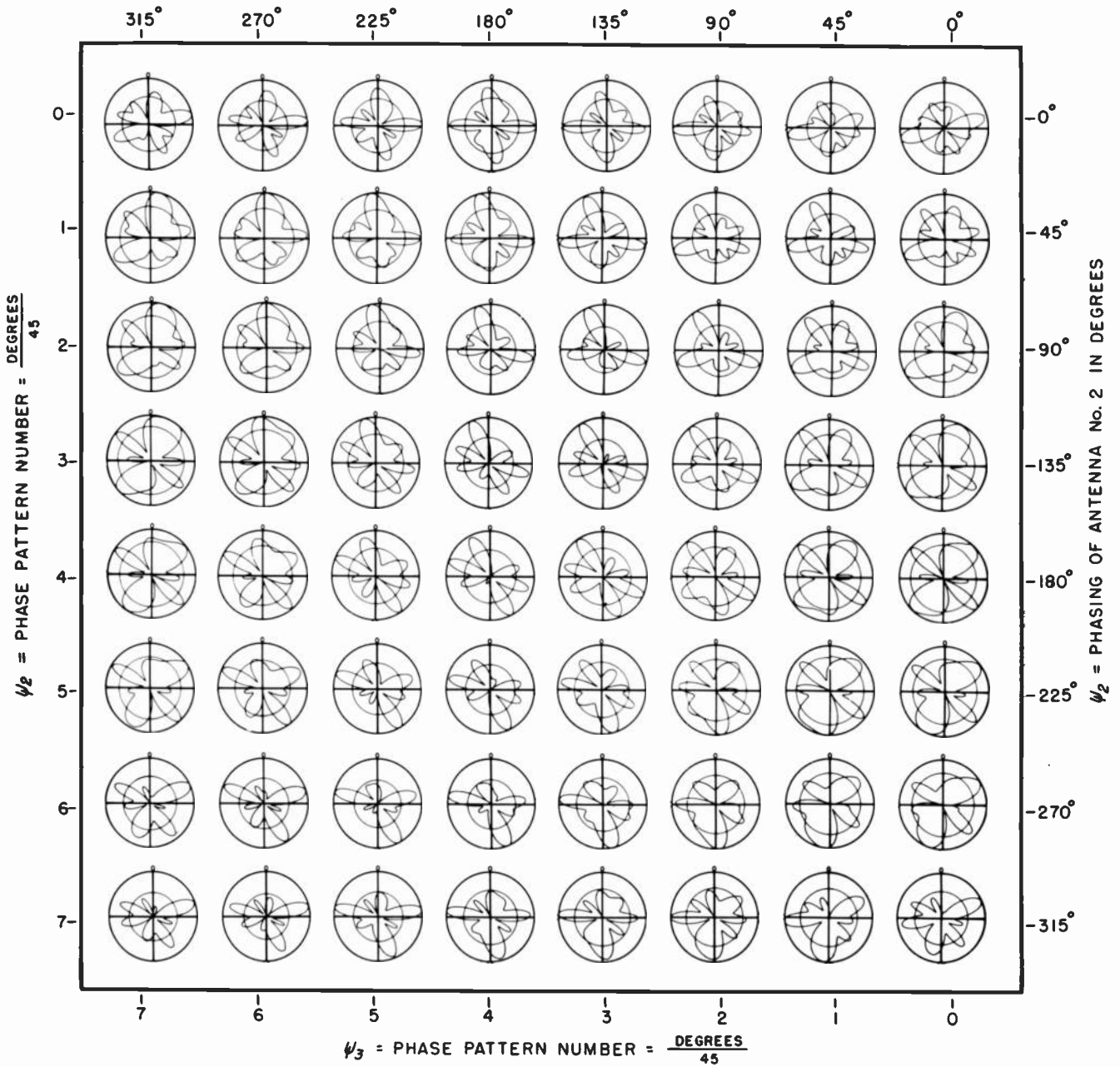

NUMBER OF ANTENNAS IN THE SYSTEM  
No. 3

ORIENTATION OF ANTENNA No. 2 ANTENNA =  $\frac{\text{DEGREES}}{45}$   
 $\phi_2$  0

SPACING OF ANTENNA No. 2 ANTENNA =  $\frac{\text{DEGREES}}{45}$   
 $S_2$  6

PHASING OF ANTENNA No. 2 ANTENNA =  $\frac{\text{DEGREES}}{45}$   
 $\psi_2$  0

ORIENTATION OF ANTENNA No. 3 ANTENNA =  $\frac{\text{DEGREES}}{45}$   
 $\phi_3$  5

SPACING OF ANTENNA No. 3 ANTENNA =  $\frac{\text{DEGREES}}{45}$   
 $S_3$  8

PHASING OF ANTENNA No. 3 ANTENNA =  $\frac{\text{DEGREES}}{45}$   
 $\psi_3$  0

% FIELD INTENSITY RADIATED IN HORIZONTAL PLANE FROM NO. 1 ANTENNA.  
 $E_1$  28

% FIELD INTENSITY RADIATED IN HORIZONTAL PLANE FROM NO. 2 ANTENNA.  
 $E_2$  52

% FIELD INTENSITY RADIATED IN HORIZONTAL PLANE FROM NO. 3 ANTENNA.  
 $E_3$  21

% RMS FIELD INTENSITY RADIATED IN HORIZONTAL PLANE FROM ANTENNA SYSTEM.  
 $E_0$  58

LEFT HAND PATTERN NUMBER GIVES ANTENNA PLACEMENT AND PHASING DATA.

RIGHT HAND PATTERN NUMBER GIVES ANTENNA FIELD INTENSITY DATA IN PERCENT.

PATTERN NOMENCLATURE

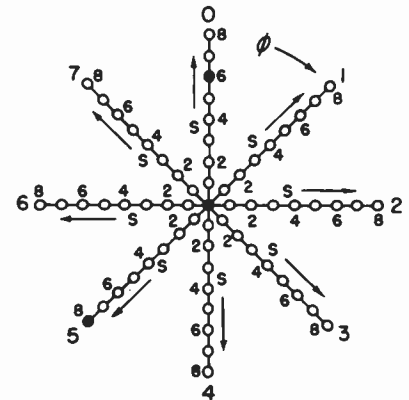

SPOTS LOCATE THE ANTENNAS FOR THIS PAGE OF PATTERNS IN THE SYSTEMIZATION PLACEMENT CHART.



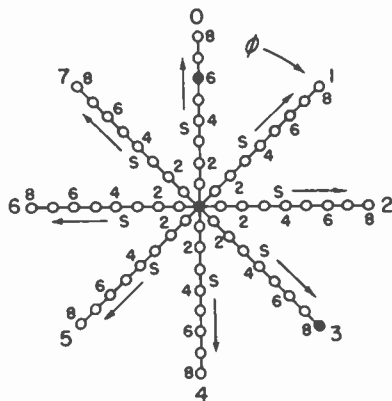
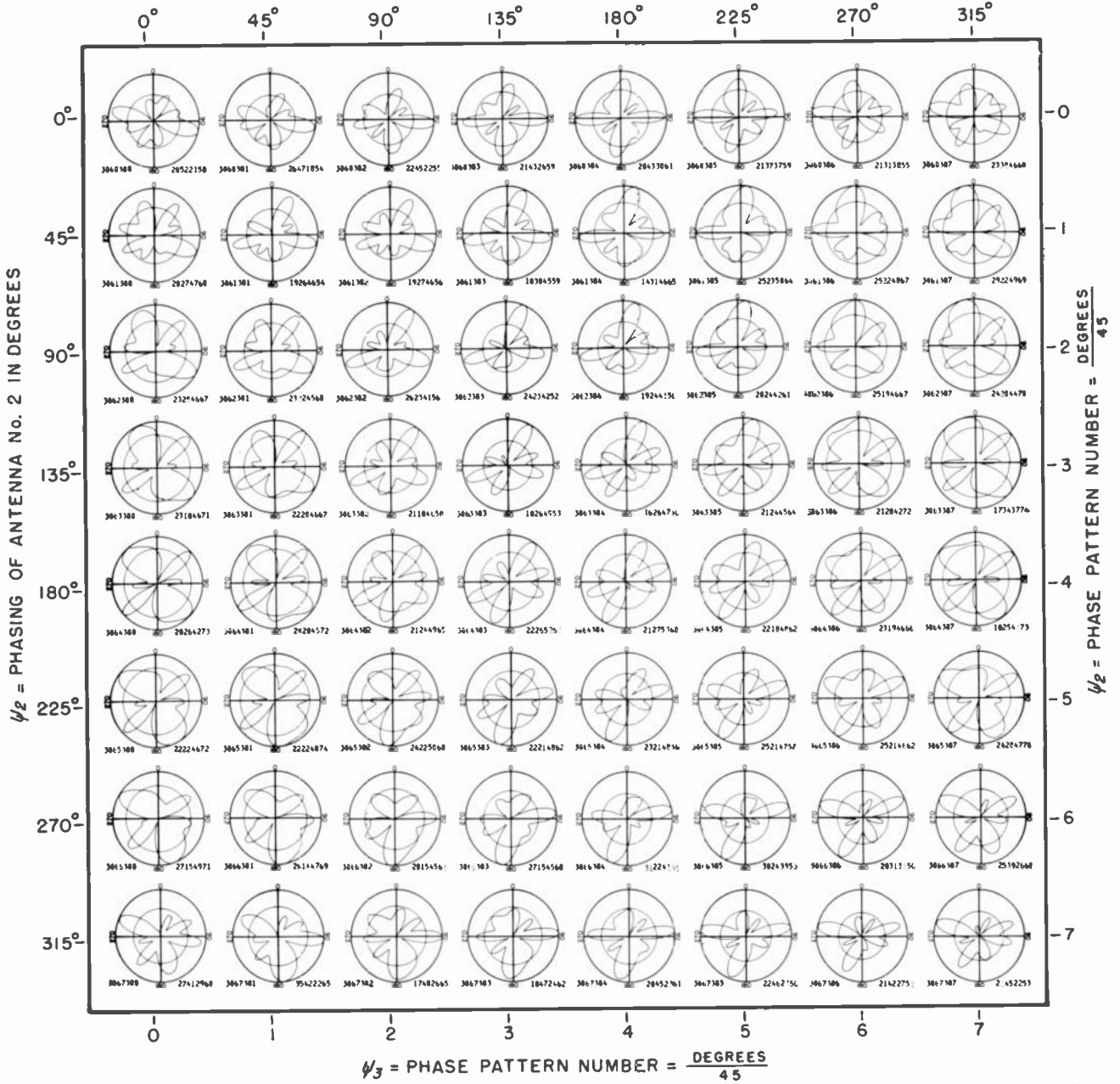

NUMBER OF ANTENNAS IN THE SYSTEM	ORIENTATION OF DEGREES $\frac{\text{DEGREES}}{45}$	SPACING OF DEGREES $\frac{\text{DEGREES}}{45}$	PHASING OF DEGREES $\frac{\text{DEGREES}}{45}$	ORIENTATION OF DEGREES $\frac{\text{DEGREES}}{45}$	SPACING OF DEGREES $\frac{\text{DEGREES}}{45}$	PHASING OF DEGREES $\frac{\text{DEGREES}}{45}$
NO. 3	$\phi_2$	$S_2$	$\psi_2$	$\phi_3$	$S_3$	$\psi_3$
3	0	6	0	3	8	0

LEFT HAND PATTERN NUMBER GIVES ANTENNA PLACEMENT AND PHASING DATA.

% FIELD INTENSITY RADIATED IN HORIZONTAL PLANE FROM NO. 1 ANTENNA.	% FIELD INTENSITY RADIATED IN HORIZONTAL PLANE FROM NO. 2 ANTENNA.	% FIELD INTENSITY RADIATED IN HORIZONTAL PLANE FROM NO. 3 ANTENNA.	% RMS FIELD INTENSITY RADIATED IN HORIZONTAL PLANE FROM ANTENNA SYSTEM.
$E_1$	$E_2$	$E_3$	$E_0$
28	52	21	58

RIGHT HAND PATTERN NUMBER GIVES ANTENNA FIELD INTENSITY DATA IN PERCENT.

PATTERN NOMENCLATURE

SPOTS LOCATE THE ANTENNAS FOR THIS PAGE OF PATTERNS IN THE SYSTEMATIZATION PLACEMENT CHART.

$\psi_3$  = PHASING OF ANTENNA No. 3 IN DEGREES

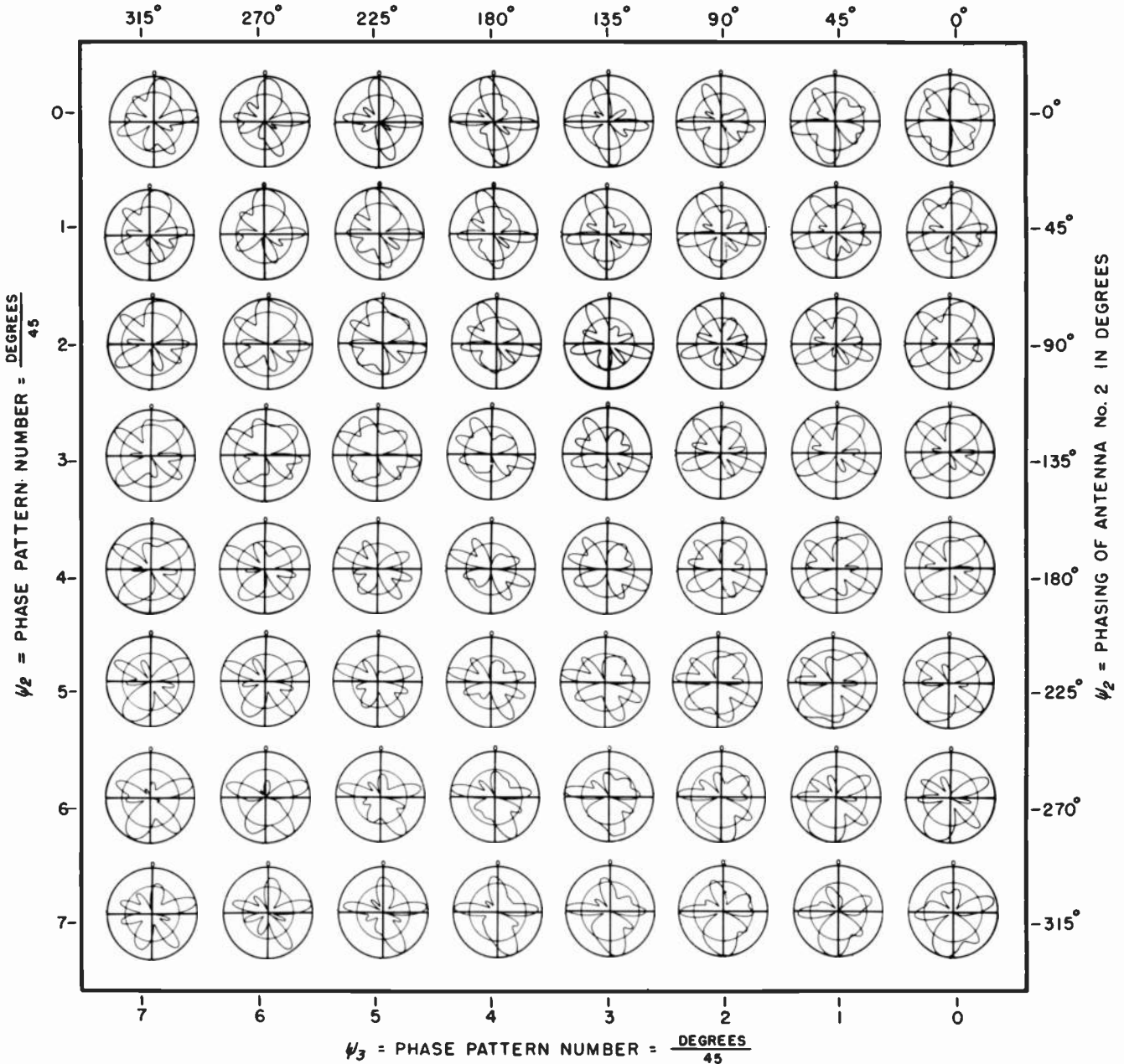

NUMBER OF ANTENNAS  
IN THE SYSTEM

No. 3

ORIENTATION OF  
NO. 2 ANTENNA =  $\frac{\text{DEGREES}}{45}$

$\psi_2$  0

SPACING OF  
NO. 2 ANTENNA =  $\frac{\text{DEGREES}}{45}$

$S_2$  7

PHASING OF  
NO. 2 ANTENNA =  $\frac{\text{DEGREES}}{45}$

$\psi_2$  0

ORIENTATION OF  
NO. 3 ANTENNA =  $\frac{\text{DEGREES}}{45}$

$\psi_3$  5

SPACING OF  
NO. 3 ANTENNA =  $\frac{\text{DEGREES}}{45}$

$S_3$  8

PHASING OF  
NO. 3 ANTENNA =  $\frac{\text{DEGREES}}{45}$

$\psi_3$  0

% FIELD INTENSITY  
RADIATED IN HORIZONTAL  
PLANE FROM NO. 1 ANTENNA.

$F_1$  29

% FIELD INTENSITY  
RADIATED IN HORIZONTAL  
PLANE FROM NO. 2 ANTENNA.

$F_2$  20

% FIELD INTENSITY  
RADIATED IN HORIZONTAL  
PLANE FROM NO. 3 ANTENNA.

$F_3$  45

% RMS FIELD INTENSITY  
RADIATED IN HORIZONTAL  
PLANE FROM ANTENNA SYSTEM.

$F_0$  70

LEFT HAND PATTERN NUMBER GIVES ANTENNA  
PLACEMENT AND PHASING DATA.

RIGHT HAND PATTERN NUMBER  
GIVES ANTENNA FIELD INTEN-  
SITY DATA IN PERCENT.

PATTERN NOMENCLATURE

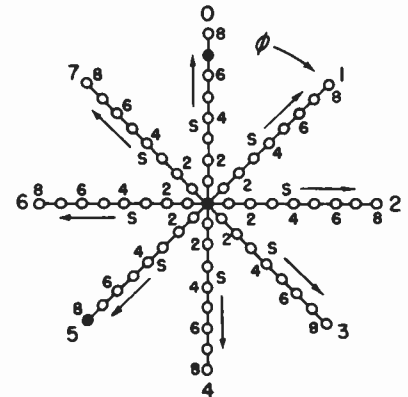

SPOTS LOCATE THE ANTENNAS FOR  
THIS PAGE OF PATTERNS IN THE  
SYSTEMATIZATION PLACEMENT CHART.

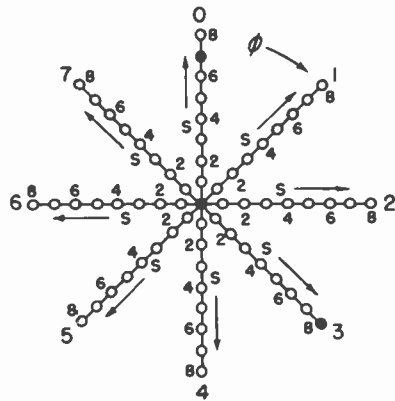
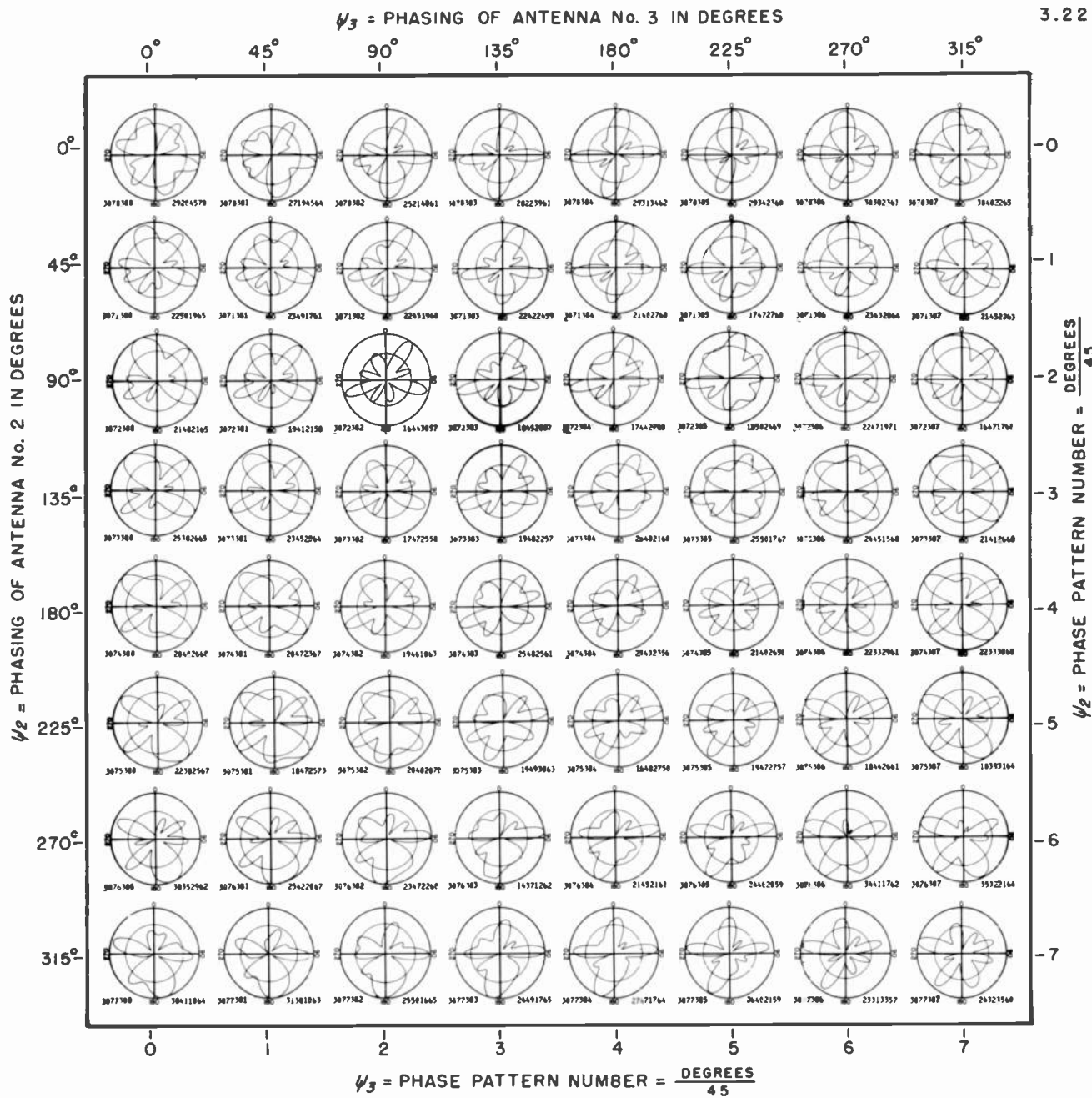

SPOTS LOCATE THE ANTENNAS FOR THIS PAGE OF PATTERNS IN THE SYSTEMATIZATION PLACEMENT CHART.

$\psi_3 = \text{PHASE PATTERN NUMBER} = \frac{\text{DEGREES}}{45}$

NUMBER OF ANTENNAS IN THE SYSTEM	ORIENTATION OF NO. 2 ANTENNA = $\frac{\text{DEGREES}}{45}$	SPACING OF NO. 2 ANTENNA = $\frac{\text{DEGREES}}{45}$	PHASING OF NO. 2 ANTENNA = $\frac{\text{DEGREES}}{45}$	ORIENTATION OF NO. 3 ANTENNA = $\frac{\text{DEGREES}}{45}$	SPACING OF NO. 3 ANTENNA = $\frac{\text{DEGREES}}{45}$	PHASING OF NO. 3 ANTENNA = $\frac{\text{DEGREES}}{45}$
No.	$\phi_2$	$S_2$	$\psi_2$	$\phi_3$	$S_3$	$\psi_3$
3	0	7	0	3	8	0

LEFT HAND PATTERN NUMBER GIVES ANTENNA PLACEMENT AND PHASING DATA.

% FIELD INTENSITY RADIATED IN HORIZONTAL PLANE FROM NO. 1 ANTENNA.	% FIELD INTENSITY RADIATED IN HORIZONTAL PLANE FROM NO. 2 ANTENNA.	% FIELD INTENSITY RADIATED IN HORIZONTAL PLANE FROM NO. 3 ANTENNA.	% RMS FIELD INTENSITY RADIATED IN HORIZONTAL PLANE FROM ANTENNA SYSTEM.
$E_1$	$E_2$	$E_3$	$E_0$
29	20	45	70

RIGHT HAND PATTERN NUMBER GIVES ANTENNA FIELD INTENSITY DATA IN PERCENT.

PATTERN NOMENCLATURE

*Directional Antenna  
Patterns*

**by Carl E. Smith**