

Radio Handbook

A HANDBOOK OF REFERENCE

FOR

Those Interested in the
Radio Art

BY

International Correspondence
Schools

SCRANTON, PA.

1st Edition, 20th Thousand, 3d Impression

SCRANTON, PA.

INTERNATIONAL TEXTBOOK COMPANY

1924

COPYRIGHT, 1923, BY
INTERNATIONAL TEXTBOOK COMPANY
COPYRIGHT IN GREAT BRITAIN
ALL RIGHTS RESERVED
Printed in U. S. A.

PRESS OF
INTERNATIONAL TEXTBOOK COMPANY
SCRANTON, PA.

85297

PREFACE

The publishers have endeavored to compile in this Radio Handbook such information as will be of value to persons engaged in radio work. This important branch of the art of communication has a wonderful future of usefulness in the development of many lines of activity. A considerable portion of the Radio Handbook is devoted to explanations, in simple language, of the theories underlying the action of the apparatus used in radio practice. The developments of the future are based on a clear conception of the action of the present devices and circuits.

The following subjects are treated: The fundamental principles of electricity and magnetism; batteries; generators; motors; radio devices, their connections, and operation; radio transmitting and receiving stations; radio measurements; radio experiments; radio formulas; telegraphic code and code practice; radio license regulations; national code for radio apparatus; definitions of radio terms; tables of special application to radio apparatus, also tables of data of general engineering value, including trigonometric tables and tables showing the square, cube, square root, cube root, and the reciprocal of any number. A very complete index serves as an aid to ready reference.

Among the many to whom the Radio Handbook should be of service are navigation officers; port captains; employes at life saving stations; operators at radio compass stations; employes of the

weather bureau; foresters; prospectors; farmers; aviators; and the large army of amateurs who operate receiving stations. The radio experimenter will find data of service in checking the operating conditions of existing apparatus and in constructing new devices.

The Radio Handbook was compiled by Mr. Harry F. Dart, E. E., and was technically edited and printed under the direction of Francis H. Doane, Principal of our School of Electrical Engineering.

INTERNATIONAL CORRESPONDENCE SCHOOLS

April, 1923

Scranton, Pa.

INDEX

A

- "A" battery, 233
- Abbreviations, Codes of, 416
- A B C code, 417
- Accumulator, 98
- Air gap, 90
- Airplane antennas, 81
- Alexanderson alternator, 139, 258
- Alternating current, 13
- A.-C. supply for receiving sets, 348
- A.-C. supply for sending sets, 351
- Alternation, 14
- Alternator, Alexanderson, 139, 258
 - Elementary revolving-armature, 133
 - 500-cycle revolving-armature, 134
 - inductor, 500-cycle, 136
 - inductor, 100,000-cycle, 138
 - inductor, Principle of, 136
 - Revolving-field, 128
 - sets at telephone transmitting stations, 273
 - Single-phase, 132
 - Undamped-wave stations using, 259
- Alternators, General theory of, 126
- American Morse code, 405
- Ammeter for power circuit, 7
- Ammeters, 7
 - Expansion type of, 7
 - for radio circuits, 7
 - Hot-wire type of, 7
- Ampere, Definition of, 7
- Amplification factor, 395
 - Radio and audio, 337
- Amplifier action of three-element electron tube, 237
- Amplifiers, A u d i o - f r e q u e n c y, 331
 - Classification and types of, 325
 - Inductively coupled, 330, 332
 - Large-capacity, 339
 - Radio-frequency, 327
 - Resistance-coupled, 327, 331
 - Transformer-coupled, 328, 332
- Angles, Measure of, 454
- Anode, 95
- Antenna circuit, coupled, 250
 - circuit, Tuning the, 296
 - Coil, 78
 - Definition of, 73
 - Directly excited, 249
 - Fan-type, 77
 - Indirectly excited, 250
 - insulators, 88
 - Inverted L-type, 75
 - masts, 87
 - modifications, 79
 - Multiple-section, 76
 - properties, Measurement of, 384

- Antenna, Range of, 87
 Resistance of, 82
 spreaders, 88
 systems, 73
 T-type, 75
 towers, 87
 Umbrella-type, 76
 Vertical wire, 74
 Antennas, Airplane, 81
 coil, Characteristics of, 511
 Properties of, 82
 Wave-length of flat top, 510
 Arc, Direct-current, 187
 generators, Factors affecting the frequency of, 190
 generator, General principles of, 186
 Oscillating, 187
 Poulsen, 186
 telephone transmitter, 275
 Arcs, Measure of, 454
 Armstrong super-regenerative circuit, 377
 three-tube circuit, 380
 two-tube circuit, 378
 Arrester, 90
 Artificial magnet, 16
 Asembling of storage battery, 106
 Atmospherics, 4
 Audio frequency, 15
 frequency amplifiers, 331
 frequency transformers, 66
 oscillator, 201
 Autodyne reception, 320
 Autotransformer, 54
 Avoirdupois weight, 454

 B
 B. & S. copper-wire gauge, 487
 "B" battery, 233
 Back electromotive force, 161
 voltage, 161
 Batteries, Electric, 94
 Batteries, General classification, construction, and operation of storage, 98
 Battery chargers of various types, 120
 Effect on an electron tube of a plate, 219
 Beat-current reception of signals, 315
 Bipolar generators, 145
 Broad wave, Effect on a receiving station of transmitting on a, 249
 Buzzer, 312
 1,000-cycle oscillator, 201
 Special testing, 201
 Testing, 199
 transmitter, 253
 Uses of, 199

 C
 "C" battery, 303
 Capacity measurements with wavemeters, 356
 of condensers, 43
 Unit of, 40
 Carborundum-crystal receiving set, 294
 detector, 177
 Carrier current, 273
 Cascade amplification, 337
 Cathode, 95
 Cells, Dry, 96
 Storage, 98
 Wet, 95
 Centigrade and Fahrenheit degrees, 500
 Centimeter of capacity, 40
 Centimeters of inductance, 34
 Changing the wave-length, 86, 281
 Characteristics of coil antennas, 511
 of three-element tube, 394
 of two-element tube, 390
 Charges, Electron theory applied to, 3

- Charges, Electrostatic, 1
 Charging panel, 119
 storage batteries, 117
 Chemical rectifiers, 120
 Choke coils, 36
 Chopper, 313
 Cipher, A B C code, 417
 Circuit-breakers, 164
 -interrupting devices, 312
 Multiple, 29
 Series, 29
 Super-regenerative, 377
 Circuits, Calculation of
 frequency of, 83
 Coupled, 49
 Oscillating, 46
 Parallel, 29
 Receiving, 284
 Regenerative, 398
 Resistance of, 20
 transmitting, Damped-
 wave, 246
 Circular measure, 488
 Code, International, 407
 Learning the, 415
 Morse, 407
 Phillips punctuation, 408
 practice apparatus, 411
 practice with key, 414
 Codes, 405
 of abbreviations, 416
 Secret, 417
 Coil antenna, 78
 antenna, Direction find-
 ing by a, 91
 antennas, Characteristics
 of, 511
 Coils, Induction, 68
 Commercial receiving sets,
 365
 Commutation, 142
 Commutator, 142
 Care of, 154
 Compass, 16
 Compound generator, 148
 -wound generator, Auto-
 matic regulation of a,
 149
 Compounding, 149
 Condenser, Definition of, 40
 Plates of, 40
 Telephone, 291
 Condensers, Capacity of, 43
 Coupling, 295
 Fixed, 42
 in parallel, 44
 in series, 44
 Variable, 41
 Condensive coupling, 51
 reactance, 44
 Conductors, 15
 in parallel groups, Re-
 sistance of, 30
 C.-W. receiving sets, 311
 C.-W. station with chopper,
 271
 C.-W. stations, 258
 C.-W. system, 245
 C.-W. transmitting circuit,
 Combination, 269
 Construction of lead-sul-
 phuric-acid cell, 99
 Continuous waves, 245
 Control devices for D.-C.
 motors, 161
 Conventional signals, 409
 symbols for radio devices,
 422
 Conversion factors, 448
 Copper wire, Resistance
 variation with fre-
 quency, 494
 wire tables, 487
 Copperclad wire, 494
 Coulomb, 6
 Counter electromotive
 force, 161
 Counterpoise, 74
 Coupled circuits, 49
 Coupling, Condensive, 51
 devices, 52
 Direct, 51
 Inductive, 49
 Variation of, 61
 Crystal detectors, 174
 Crystals, Galena, 175
 Cube root, 464
 root, Examples of, 484
 root table, 466
 Cubes, 466

- Cubes, Examples of, 486
 Cubic measure, 454
 Current, Alternating, 13
 Carrier, 273
 curves, 306
 Definition of, 4
 Direct, 13
 Pulsating, 13, 144
 Saturation, 221
 Single-phase, 132
 Unit of, 7
 Currents, Direction of, 5
 Curves, Received-current, 300
 Cycle, 14
- D**
- Damped-wave electron-tube detector sets, 301
 wave transmitting circuits, 246
 waves, 245
 Decimal equivalents of parts of 1 inch, 457
 Decrement measurement with wavemeter, 359
 Decimeter, 362
 Definitions of radio terms, 425
 Degrees, Centigrade and Fahrenheit, 500
 Depolarizer, 96
 Depolarizing agents, 96
 Detector action of three-element electron tube, 233
 Carborundum, 177
 characteristics, Summary of, 179
 Electrolytic, 179
 Galena, 175
 Lenzite and cerusite, 177
 Perikon, 177
 Silicon-antimony, 177
 Three-element tube, 303
 Two-element tube, 301
 Zincite and bornite, 177
 Detectors, Crystal, 174
 Direct-coupled receiving sets, 288
 Direct coupling, 51
 current, 13
 -current arc, 187
 -current generators, 142
 -current machine, Operation of, 153
 -current motors, 150
 Direction finding by a coil antenna, 91
 Directly excited antenna, 249
 Dielectric, Definition of, 40
 Dot, dash, and space, Length of, 409
 Double-slide tuner, 288
 Dry cells, 96
 cells, General uses of, 98
 measure, 454
 Dynamic electricity, 4
 Dynamos, 142
- E**
- Effect of plate battery, 219
 Electric batteries, 94
 circuits, 20
 current, 4
 power, Unit of, 12
 work, Unit of, 12
 Electrical and radio formulas, 400
 terms, 1
 units and measuring devices, 6
 Electricity, Dynamic, 4
 Quantity of, 6
 Static, 1
 Electrolytic detector, 179
 interrupter, 72
 Electromagnetic effect, 31
 field, 31
 Electromagnets, 33
 Electromotive force, 5
 force, Unit of, 11
 Electron, Definition of, 3
 theory, 216
 theory applied to charges, 3
 -tube detector sets, Damped-wave, 301

- Electron-tube radio-telephone transmitters, 277
 -tube transmitters, 263
 tube, Two-element, 218
 tubes, 216
 Electrons, Movement of, 229
 Electrostatic charges, 1
 laws, 2
 Electrostatically coupled receiving set, 295
 End-turn losses, 86
 Ether, 244
 Evolution, 464
 Exciter, 128
 Expansion-type ammeters, 7
- F**
- Fahrenheit degrees, 500
 Fan-type antenna, 77
 Farad, 40
 Federal Jr. receiver, 375
 Feed-back coupling, 242
 Field coils, 145
 coils and connections, 155
 Electromagnetic, 31
 excitation, Methods of, 146
 frame, 145
 -magnet cores, 145
 rheostat, 146
 Filament battery, 233
 Filter, High-pass, 343
 Low-pass, 344
 Filters, Application of, 345
 General use of, 341
 Main types of, 341
 Necessity for, 345
 tuned in receiving sets, 346
 Fire regulations, Underwriters', 441
 Fixed condensers, 42
 Flat spiral-coil transformers, 60
 -top antennas, Wave-lengths of, 510
 Formulas, Electrical and radio, 400
- Frequencies, Common, 14
 Frequency, Audio, 15
 Radio, 15
 wave-length, and oscillation constant, 500
 Fundamental principles of three-element electron tube, 225
 Fuses, 164
- G**
- Galena crystals, 175
 Galvanic battery, 94
 Galvanometer, 10
 General conversion factors, 448
 operating instructions for storage batteries, 117
 Generator, Accumulatively compounded, 149
 and motor rotation, Relation of, 152
 Armature of, with several coils, 144
 Compound, 148
 Differentially compounded, 149
 Flat-compounded, 149
 parts, 145
 Separately-excited, 146
 Series, 147
 Shunt, 146
 Generators and motors, 126
 arc, General principles of, 186
 Bipolar, 145
 Direct-current, 142
 direct-current, Inspection of, 153
 Government license, Operator's, 440
 station license, 438
 Grades of licenses, 441
 Grebe receiving set, 365
 Grid battery, 303
 condenser and leak, Action of, 310
 condenser with three-element tube, 307
 leak, 308

- Grid modulation, 277
 of electron tube, 225
 Ground switch, 89
- H**
- Hard tube, 379
 Helical-coil transformers, 58
 Henry, 33
 Hertzian waves, 181
 Heterodyne reception, 317
 High-frequency resistance measurements, 387
 -pass filter, 343
 Honeycomb-coil data, 512
 coils, 37
 Hot-wire ammeters, 7
 Hydrometer, 104
- I**
- Impedance, 45
 Inch, Decimal equivalents of parts of, 457
 Indirectly excited antenna, 250
 Inductance coil, Standard, 37
 coil, Variable, 37
 Definition of, 33
 devices, 36
 measurements with wave-meters, 357
 Unit of, 33
 Induction coils, 68
 Inductive reactance, 36
 Inductively coupled amplifiers, 330, 332
 coupled receiving set, 292
 Inductor alternator, 100,000-cycle, 138
 alternator, 500-cycle, 136
 alternator, Principle of, 136
 Insulating materials, Properties of, 494
 Insulators, 15
 Antenna, 88
 International abbreviations, 419
- International ohm, 23
 Interrupter, Explanation of the action of an electrolytic, 72
 Mechanical, 72
 Mercury, 72
 Interstage transformers, 66
 Invention and evolution, 464
 Ion, Definition of, 187
 Ionization, 187
- K**
- Key, Code practice with, 414
 Method of holding, 412
 radio, Large-capacity, 195
 radio, Small-capacity, 194
 Relay, 196
 spring, Adjustment of, 413
 Keys, radio, General uses of, 193
 Troubles of, 198
 Kilowatt, 12
 -hour, 13
- L**
- L-type antenna, 75
 Laws, Electrostatic, 2
 Lead burning, 111
 Lead-in, 75, 89
 -sulphuric-acid cell, Construction of, 99
 Learning to receive, 415
 License, Government station, 438
 Manufacturer's, 437
 Operator's government, 440
 regulations, Radio, 437
 Licenses, Grades of, 441
 Lightning arrester, 90
 Linear measure, 453
 Lines of force, 18
 Liquid measure, 455
 Loading coil, 296
 coil, Definition of, 86

- Loading coils, Wave-length of, 513
 Lodestone, 16
 Logarithms, 506
 Loud speakers, 214
 Low-pass filter, 344
- M**
- Magnavox, 214
 Magnetic attractions and repulsions, 17
 field, 18
 flux, Building up a, 147
 force, 18
 rectifier, 121
 substances, 18
 Magnetism, 16
 Residual, 19, 71
 Magnetos, 145
 Magnets, Artificial, 16
 North pole of, 17
 Permanent, 16
 South pole of, 17
 Manufacturer's license, 437
 Masts, Antenna, 87
 Measure, Circular, 488
 Cubic, 454
 Dry, 454
 Linear, 453
 Liquid, 455
 of angles or arcs, 454
 Square, 453
 Measurement of antenna properties, 384
 Measurements of high-frequency resistance, 387
 Measures, 453
 of capacity, Metric, 456
 of length, Metric, 455
 of surface, Metric, 456
 of volume, 456
 of weight, Metric, 456
 Measuring capacity with wavemeter, 356
 decrement with wavemeter, 359
 devices, Electrical, 6
 inductance with wavemeter, 357
 Measuring natural wave-length with wavemeter, 358
 Mechanical interrupter, 72
 rectifier, 121
 Megohm, 23
 Mercury interrupter, 72
 Meters, Watt-hour, 12
 Metric system, 455
 Microfarad, 40
 Microhenry, 34
 Microhm, 23
 Micro-microfarad, 40
 Microphones, 204
 Milliammeter, 10
 Millihenry, 34
 Modulated signals, Receiving, 322
 Modulation, 271
 Grid, 277
 Plate, 277
 transmission, 269
 Modulator, 244
 Morse code, 407
 Motor action of conductor flux, 150
 and generator rotation, Relation of, 152
 direct-current, Reversal of rotation of, 152
 electromotive force, 161
 generator set, 500-cycle alternator and direct-current motor, 158
 -generator set, Simple type of, 157
 -generator sets, General principles of, 156
 -generator sets, Uses of, 156
 -speed regulation, 166
 starter, 162
 starter, Single-step automatic, 166
 starter, Three-step, automatic, 167
 Starting a, 165
 Stopping a, 165
 Motors, Direct-current, 150

- Motors**, direct-current
 Classification of, 153
 direct-current, Inspection of, 153
Multiple-section antenna, 76
- N**
- Natural magnet**, 16
 wave-length, Calculation of, 84
 wave-lengths of flat-top antennas, 510
Negative resistance, 377
Nickel-iron-alkaline cell,
 Advantages and applications of, 115
 -iron-alkaline cell, Assembly of, 112
 -iron-alkaline cell, Capacity of, 113
 -iron-alkaline cell, changing electrolyte of, 116
 -iron-alkaline cell, Charging of, 116
 -iron-alkaline cell, Efficiency of, 114
 -iron-alkaline cell, Plates of, 111
 -iron-alkaline cell, Repairs to, 117
 -iron-alkaline cell, Separators and electrolyte of, 113
 -iron-alkaline cell, Special precautions for, 116
 -iron-alkaline cell, Voltage of, 114
- O**
- Ohm**, International, 23
Ohm's law, 24
Open spark gap, 182
Operating a sending station, 283
Operation of direct-current machines, 153
Operator's government license, 440
Oscillating arc, 187
Oscillating arc, Undamped-wave stations using, 260
 circuit coupled to antenna, 250
 circuits, 46
Oscillation, frequency, and wave-length constant, 500
 transformers, Purpose of, 57
Oscillations, Production of, 46
Oscillator action of three-element electron tube, 239
Audio, 201
Overloads, 154
- P**
- Pancake coils**, 60
Parts of 1 inch, Decimal equivalents of, 457
Perikon detector, 177
Phillips punctuation code, 408
Plate battery, 233
 modulation, 277
Polarization, 95
Pole faces, 145
 pieces, 145
 shoes, 145
Positive resistance, 377
Potentiometer, 294
Poulsen arc, 186
Power-buzzer transmitter, 253
 transformers, 52
Primary battery, 94
Properties of insulating materials, 494
Protective devices, 164
Pulsating current, 13, 144
Push-pull amplifier, 339
- Q**
- Quenched spark gap**, 183
- R**
- Radiation resistance**, 82

- Radio and audio amplification, Circuit connections for, 337
 devices, 171
 experiments, 384
 formulas, 400
 frequency, 15
 -frequency amplifiers, 327
 -frequency transformers, 67
 keys, 193
 license regulations, 437
 receiving circuits, 284
 receiving transformers, 61
 symbols, 422
 telegraphic abbreviations, 419
 telephone sets using alternators, 273
 terms, Definitions of, 425
 transmitters, Explanation of the action of, 204
 transmitting transformers, 56
 Radiola Sr. receiver, 373
 Range of antenna, 87
 Rating of telephone receivers, 213
 Reactance, Condensive, 44
 Inductive, 36
 Received-current curves, 300
 Receiver horn, 214
 Receivers, Telephone, 209
 Receiving circuits, Radio, 284
 modulated signals, 322
 set, Carborundum-crystal, 294
 set, Electrostatically coupled, 295
 set, Federal Jr., 375
 set, Grebe, 365
 set, Inductively coupled, 292
 set, Radiola Sr., 373
 set, Tuning a, 297
 set, Tuning antenna-circuits of, 296
 Receiving set, Westing-house RA, 370
 set with tuned oscillating circuit, 290
 sets, Calibration of, 362
 sets, Commercial, 365
 sets, Crystal-detector, 284
 sets, Direct-coupled, 288
 sets, Inductively coupled, 292
 sets, Telephone, 322
 sets, Telephones in antenna circuit, 286
 sets, Undamped-wave, 311
 sets, Vacuum-tube, 301
 sets with A.-C. supply, 348
 sets with tuned antenna, 287
 stations, Regulations for, 442
 telephone signals, 322
 transformer, Complete, 65
 transformers, Radio, 61
 undamped-wave telegraph signals, 311
 Reception, Autodyne, 320
 Beat-current, 315
 Heterodyne, 317
 Reciprocals, 466
 Examples of, 487
 Rectifier, Mechanical, 121
 Tungar, 123
 Rectifiers, Chemical, 120
 Tube, 123
 Regenerative circuit, 323
 receiver, Operation of, 398
 Regulation, Motor-speed, 166
 Regulations for receiving stations, 442
 for transmitting stations, 444
 Radio license, 437
 Underwriters' fire, 441
 Relation of generator and motor rotation, 152
 Relay key, 196
 Residual magnetism, 19, 71

- Resistance-coupled amplifiers, 327, 331
 devices, 21
 measurements, High-frequency, 387
 Negative, 377
 of antenna, 82
 of conductors in parallel groups, 30
 Positive, 377
 Radiation, 82
 Unit of, 23
 variation with frequency, 494
- Resonance, 46
- Reversal of rotation of direct-current motor, 152
- Revolving-field alternator, 128
- Rheostat, Field, 146
- Rheostats, 22
- Rotary spark gap, 184
- Rotor, Definition of, 126
- S**
- Saturation current, 221
- Secondary cells, 98
- Secret codes, 417
- Seebeck effect, 172
- Self-heterodyne reception, 320
 -inductance, Definition of, 33
- Sending set with voltage transformer, 248
 sets, Autotransformer coupling of antenna of, 250
 sets, Directly coupled antenna of, 247
 sets, Transformer coupling of antenna of, 250
 sets with A.-C. supply, 351
 sets with direct-current supply, 254
 station, Operating a, 283
 stations, Wave curves at, 254
- Separately excited generator, 146
- Series generator, 147
- Shape of received-current waves, 299
- Shunt, 30
 generator, 146
- Silicon-antimony detector, 177
- Single-phase alternator, 132
 -phase current, 132
 slide tuner, 288
 -step automatic motor starter, 166
- Skin effect, 25
- Space charge effect, 222
- Spark gap, Open, 182
 gap, Quenched, 183
 gap, Rotary, 184
 gap, Synchronous, 252
 gaps, Nature of, 180
 gaps, Nature of discharge of, 181
 gaps, Operation of, 180
 gaps, Types of, 182
- Sparking distances, 499
 distances in air, 186
- Special international Morse code signals, 409
 letters, 409
- Specific gravity, 104
- Spreaders, Antenna, 88
- Square measure, 453
 root, 464
 root, Examples of, 484
 root table, 466
- Squares, 466
 Examples of, 485
- Standard inductance coil, 37
- Starting a motor, 165
 box, Simple type of, 162
 resistance, Purpose of, 162
 rheostat, 162
- Static, 4
 electricity, 1
- Station license, Government, 438

- Stations, Undamped-wave, 258
- Stator, Definition of, 126
- Stopping a motor, 165
- Storage batteries, 98
- batteries, Charging, 117
- batteries, Charging panel for, 119
- batteries, Charging, through lamps, 118
- batteries, Charging, through resistors, 117
- batteries, General operating instructions for, 117
- batteries, Normal voltage of, 102
- battery, Capacity of, 106
- battery, Efficiency of, 106
- battery, Initial charge of, 108
- battery, Polarity of, 107
- battery, Putting out of commission, 110
- battery, Regular charge of, 108
- battery, Returning to commission, 110
- cells, 98
- Strays, 4
- Super-regenerative circuit, Armstrong, 377
- Switches on receiving transformers, 62
- Symbols, Radio, 422
- Synchronous spark gap, 252
- T**
- Tables and data, 448
- Copper wire, 488
- Trigonometric, 459
- Telephone apparatus, 204
- circuits, Grid modulation of, 278
- circuits, Plate modulation of, 279
- receivers, 209
- receivers, Rating of, 213
- Telephone receivers, Standard type of, 210
- receivers, Watch-case type of, 211
- signals, Receiving, 322
- transmitter, Arc, 275
- transmitters, 204
- transmitters, Electron-tube, 277
- transmitting circuits, 271
- Telephony, Definition of, 204
- Temperature, 499
- coefficient, Definition of, 27
- coefficients of copper resistance, 28
- Terms, Electrical, 1
- radio, Definitions of, 425
- Thermocouple materials, 173
- Thermoelectric couples, 171
- force, 171
- force, Application of, 173
- Three-element electron tube, 225
- element electron tube, Amplifier action of, 237
- element electron tube, Characteristic curves of, 231
- element electron tube, Detector action of, 233
- element electron tube, Modulator action of, 244
- element electron tube, Oscillator action of, 239
- element tube, Characteristics of, 394
- element tube detector, 303
- element tube with grid battery, 303
- element tube with grid condenser, 307
- element tubes, Commercial types of, 226
- step automatic motor starter, 167
- Tikker, 314

- Toll charges, 422
 Torque, 150
 Towers, Antenna, 87
 Transformer-coupled amplifiers, 328, 332
 Transformers, Audio-frequency, 66
 Cooling of, 55
 Core-type, 54
 Flat-spiral coil, 60
 Helical-coil, 58
 Interstage, 66
 oscillation, Purpose of, 57
 Power, 52
 Radio-frequency, 67
 Radio receiving, 61
 Radio transmitting, 56
 Shell-type, 54
 Special types of, 66
 Transmitter, Capacitive, 209
 Electrolyte-type, 208
 Granular-carbon, 206
 Power-buzzer, 253
 Solid-back, 207
 telephone, Arc, 275
 Variable-resistance type, 204
 Transmitters, Telephone and radio, 204
 telephone, Electron-tube, 277
 Transmitting circuits, Damped-wave, 246
 stations, General features relating to the classification of, 244
 stations, Regulations for, 444
 transformers, Radio, 56
 Trigonometric functions, 457
 tables, 459
 Triode, 225, 303
 Troubles on direct-current machines, 154
 Troy weight, 454
 Tube rectifiers, 123
 Tuned filter in receiving sets, 346
 Tuner, Double-slide, 288
 Single-slide, 288
 Tungar rectifier, 123
 Tuning a receiving set, 297
 coils, 61
 coils, Dimensions of, 513
 set with wavemeter, 362
 the antenna circuit, 296
 Two-element electron tube, 218
 -element tube, Characteristic curves of, 220
 -element tube, Characteristics of, 390
 -element tube detector, 301
 -element tube, Elementary principles of, 218
 -element tube, Uses of, 223
 Types of antennas, 74
- U**
- Umbrella-type antenna, 76
 Undamped-wave receiving sets, 311
 -wave stations with alternator, 259
 -wave stations with electron-tube oscillators, 263
 -wave stations with oscillating arc, 260
 -wave telegraph stations, 258
 waves, 245
 Underwriters' fire regulations, 441
 Unit of resistance, 23
 Units, Electrical, 6
- V**
- Vacuum-tube amplifier, 237
 -tube detector, 233
 -tube oscillator, 239
 -tube receiving sets, 301
 -tube transmitters, 263

Vacuum tubes, 216
 Variable condensers, 41
 Variation of coupling, 61
 Variometer, 38
 used as tuner, 288
 Volt, 11
 Voltage, 11
 and current curves, 306
 Voltaic battery, 94
 Voltmeters, 11

W

Watt, 12
 -hour, 12
 -hour meters, 12
 Wave, Broad, 249
 -length, Changing, 86,
 281
 -length, frequency, and
 oscillation constant, 500
 -length measurement with
 wavemeter, 358
 -length ranges of various
 tuning coils, 513
 -lengths of flat-top an-
 tennas, 510
 shapes in various cir-
 cuits, 254
 train, 256
 Wavemeter, Definition of,
 283
 for tuning sets, 362

Wavemeters for measuring
 capacity, 356
 for measuring decre-
 ment, 359
 for measuring induc-
 tance, 357
 for measuring w a v e-
 length, 358
 Principles and uses of,
 352
 Types of, 353
 Uses of, 356
 Waves, Continuous, 245
 Damped, 245
 Modulated, 272
 Undamped, 245
 Weight, Avoirdupois, 454
 Troy, 454
 Weights and measures, 453
 Westinghouse RA receiv-
 ing set, 370
 Wet cells, 95
 Wire, Copperclad, 494
 gauges, Brown & Sharpe,
 487

Y

Yoke, 145

Z

Zincite and bornite de-
 tector, 177

RADIO HANDBOOK

ELECTRICAL TERMS

INTRODUCTION

Electricity manifests itself as an *electric charge*, or as an *electric current*. An electric charge is an accumulation of *static electricity*, or electricity at rest, which causes it to be given the name of *electrostatic charge*. This kind of electricity is contrasted with an electric current, which is electricity in motion. Because of similarity in the characteristics of both an electrostatic charge and an electric current, the ultimate cause of both is supposed to be the same, as will be shown later. In general, only the electrical terms and the principles of their direct application, or relation, to radio will be considered under the heading Electrical Terms.

STATIC ELECTRICITY ELECTROSTATIC CHARGES

Electrostatic charges, or *electric charges*, as they are frequently called, may be produced by rubbing a glass rod with silk, or by rubbing a rod of sealing wax with flannel. The rubbing operation causes the rod in either case to be electrified. If a light pith ball supported by a thread is brought near the rod electrified by either means, the

ball will be attracted toward the charged rod, and will take the position shown in Fig. 1.

If the pith ball is allowed to touch the charged glass rod, some of the charge will pass from the rod on to the pith ball, and the ball will be suddenly repelled. The pith ball then has a charge like that on the glass rod, and the ball will tend to move out of the field of the glass rod. If, however, the charged wax rod is brought near the charged pith ball, the ball will be

attracted toward the wax rod.

Similarly, were the unelectricified pith ball touched by the wax rod, the charged pith ball would be repelled by the wax rod and attracted by the glass rod.

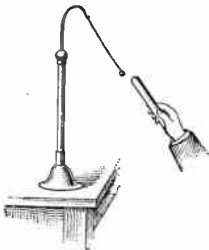

FIG. 1

This action demonstrates that there are two kinds of electric charges, to which the names *positive* and *negative* have been applied. The charge developed on glass when it is rubbed with silk is arbitrarily called positive, and that developed on the wax, being just the opposite, is called negative. Al-

though only one kind of charge was present on either charged rod, neither charge could be developed without the development of the other charge; in this case, the charge of opposite sign resides on the cloth with which the rod was rubbed. The piece of silk has a negative charge and the piece of flannel a positive charge. Likewise, if equal and opposite charges are combined, the effect of each is neutralized.

ELECTROSTATIC LAWS

The following laws apply to electrostatic charges:

1. When two dissimilar unelectricified substances are rubbed together, one assumes a positive and the other a negative charge.

2. An unelectrified body on coming into contact with an electrified body becomes electrified with a charge similar to that on the electrified body.

3. Similarly charged bodies repel each other; dissimilarly charged bodies attract each other.

ELECTRON THEORY APPLIED TO CHARGES

The charges on bodies, and many other electrical phenomena, may be explained by the electron theory. An *atom* is the smallest part into which matter may be divided by chemical means. An *electron* is a minute particle of negative electricity, and represents the smallest known component of matter. It is conceded that all atoms consist of a mass, or nucleus, of positive electricity and that each atom of any particular substance has a definite number of electrons associated with it. The electrons from different materials are all alike, and cannot act chemically with other electrons. Electrons are nothing but definite amounts, or packages, of electricity, and are always the same. They are many thousands of times smaller than atoms. The constants of the electron are: radius= 1.9×10^{-13} centimeter; mass= 8.8×10^{-28} gram; charge= 1.59×10^{-19} coulomb. Some of these values are under discussion, but they are sufficiently accurate to show the minuteness of the electron and its properties.

Normally an atom has enough electrons collected around it so that its positive charge is neutralized or balanced, and it exerts no influence on its surroundings. A positively charged body has a deficiency of electrons, and tries to draw to it any electrons that may come within its neighborhood. A negatively charged body has a superfluity of electrons, and consequently tends to reject or push away any excess electrons that may be near it. The body with the negative charge will, however, try to move toward a positively charged body, due to the law that unlike charges attract. The space surrounding a charged body constitutes an electric field, and another charged body in this field tends to be moved; away, if it has a like charge, or closer, if it has an unlike charge.

STATIC, OR STRAYS

Ordinarily the electric charges are not visible, but if a very large number of them are accumulated, they may produce a group of fiery sharp points accompanied by an audible crackling sound. If very large, the accumulation may produce an electric spark several inches long. From this analogy it seems that the charges on drops of rainwater and moisture in the air combine to form the immense charges necessary to produce lightning flashes. Similarly, the smaller charges residing on the moisture in the air, even with a clear sky, are sufficiently strong to produce considerable interference in radio receiving sets, which is commonly designated as *static*, *strays*, or *atmospherics*. This is supported by the fact that during the summer months when the static effects are greatest, there is a much higher humidity, that is, more moisture in the air, than in the other months of the year. In the damp atmosphere of the tropical regions, there is a great deal more static than elsewhere. Even though a lightning discharge occurs at some distance, there may be a considerable disturbance produced in the receiving set by induction. This apparently occurs even when the lightning discharge is beyond a visible range. Means for reducing the effect of static will be considered later.

DYNAMIC ELECTRICITY**ELECTRIC CURRENT**

An electric current is a flow of electricity, and manifests its presence by the magnetic or heating effects it produces. Just as water can be forced through a pipe and made to do work, so can electricity be forced through a wire and made to do work. The exact nature of an electric current is rather speculative, but under the electron theory it is considered that electrons in motion constitute an electric current. More will be

said about this later. Due to the small charge carried by each electron, it is necessary that an immense number of them pass any particular point per unit of time to produce an appreciable current. The electrons act like messengers to carry the electricity in small packages from place to place.

ELECTROMOTIVE FORCE

The factor causing the flow of electricity is called the *electromotive force* (often written e. m. f.) and it is correct to say that an electromotive force establishes an electric current. The flow of electricity, or electric current, in a wire depends upon the electromotive force causing it just as the rate at which water flows through a pipe depends upon the pressure behind it. The electromotive force may be produced by an electric battery or a suitable machine, several types of which will be discussed later.

From the viewpoint of the electron theory, it may be considered that a wire is made up of many atoms with their attendant electrons in rapid promiscuous motion. When an electromotive force is applied at the ends of the wire, the electrons move along the wire due to the influence of the charges which may be considered as established by the electromotive force. The flow of electrons, each carrying a small charge of electricity, establishes an electric current. One theory is that the electrons migrate along the wire to carry the charges, while another theory is that the charges are relayed from electron to electron. It seems that both actions take place as multitudes of electrons move back and forth very rapidly, and there is a very slow drift of the electrons as a whole.

DIRECTION OF CURRENT

The *direction of flow of electricity* is not definitely known. For convenience, it has been agreed that the electrical condition called positive represents a higher electromotive force than that called negative, and that

electricity tends to flow from a positively to a negatively electrified body. Positive and negative are represented by the signs + and - respectively, and electricity is said to flow from + to -.

The flow of electrons constituting a current is thought to be influenced by the electromotive force, and the direction in which the electrons migrate has been proved to be from a point of negative potential to a point of positive potential.

The direction of the flow of electrons is apparently in direct opposition to the assumed direction of the flow of electricity. It is the universal practice to consider an electric current as passing from a position of positive potential to one of negative potential, and the flow of electrons is known to be in just the *opposite* direction. It is, however, entirely possible that the current is actually in the assumed direction, and not in the direction of the flow of electrons.

ELECTRICAL UNITS AND MEASURING DEVICES

QUANTITY OF ELECTRICITY

Electricity is measured by its effects, or the work it does; the greater the effect, or the work done, the greater is the quantity of electricity. When electricity flows through the electrolyte of an electric cell, for example, some of the liquid is decomposed into gases, and the greater the quantity of electricity, the larger is the formation of the gases. When electricity is caused to flow through an electrolyte containing a metal in solution, some of the metal is deposited on one of the electrodes, the amount being proportional to the quantity of electricity.

The *coulomb* is the unit of quantity of electricity, and is the quantity that deposits a certain amount (.01725 grain) of metallic silver from a carefully prepared electrolyte containing silver dissolved in nitric acid.

This statement is true regardless of the time required for making the deposit.

CURRENT

The *ampere* (abbreviated amp.) is the practical unit of the rate of flow of electricity, or the *unit current*, and is the rate when 1 coulomb flows each second; that is, *amperes equal coulombs per second*. The value, or strength, of an electric current is practically always expressed in amperes. This unit expresses the flow of a definite quantity of electricity per second. One *milliampere* is $\frac{1}{1,000}$ ampere; 1,000 milliamperes equal 1 ampere. One *microampere* is $\frac{1}{1,000,000}$ ampere, or $\frac{1}{1,000}$ milliampere.

AMMETERS

Ammeter for Power Circuit.—In practical work, electric current is measured by means of an instrument called an ammeter, of which Fig. 2 shows one type commonly used in lighting and power circuits. The ammeter is connected in series in the circuit by inserting the ends of conductors in the openings in the two binding posts and clamping them with the thumbscrews at the tops of the posts.

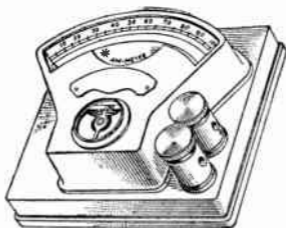

FIG. 2

The current in the circuit causes the pointer to deflect over the scale to a figure indicating the strength of current in amperes.

Ammeters for Radio Circuits.—Ammeters of the *expansion type*, or, as sometimes called, of the *hot-wire type*, are often used for measuring current in radio cir-

cuits. The action of the instrument is based on the heating effect of a current in a conductor, and the change of length of the conductor with its change of temperature. The heat developed in a given conductor is proportional to the square of the current, and the length of the conductor increases or decreases with an increase or decrease of the temperature. The square of a number is the product obtained by multiplying the number by itself. For example, the square of 4 is 16, or 4 multiplied by 4; or the square of 25 is 25 multiplied by 25, equals 625.

Fig. 3 shows the principle of expansion ammeters. The wire by means of which the current is to be measured is kept taut between two fixed points *a* and *b* by spring *c*; a pointer attached to the wire at *d* moves over a scale marked so as to indicate the current being

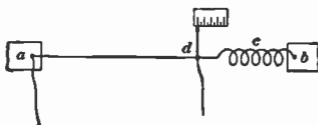

FIG. 3

measured. An increase of the current in the wire causes the wire to lengthen, the spring takes up the slack, and the pointer moves along the scale

toward the right. With a steady current, the pointer comes to rest at some point and a reading may be taken. If the current decreases, the wire contracts and the pointer is moved toward the left to a new position. In commercial instruments, means are provided so that a slight change in the length of the conductor causes a considerable change in the position of the pointer.

Instruments of the expansion type are made for measuring current or voltage on either direct-current or alternating-current circuits. An external shunt is used with a switchboard ammeter above 5-ampere capacity and an internal resistance for voltmeters reading up to 150 volts.

A commercial type of hot-wire or expansion-type ammeter is shown in Fig. 4. The heater wire is located under the scale, so it cannot be seen in this illustration.

As the length of the wire changes with temperature, its length changes whether this temperature is due to that in the room or to the current under observation.

It is necessary, therefore, to provide a correcting device, so that the needle can be set over its zero position before taking a reading, in order that the deflection shall read the true current. A knob *n* enables this correction to be made by shifting one supporting post in

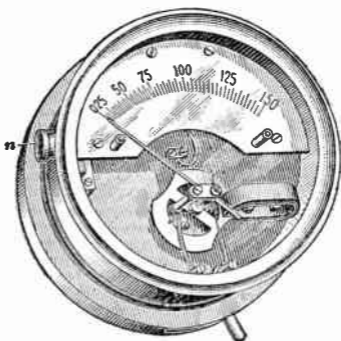

FIG. 4

the proper direction. This particular instrument was designed for mounting on the front of a panel and

therefore has the terminals on the back side.

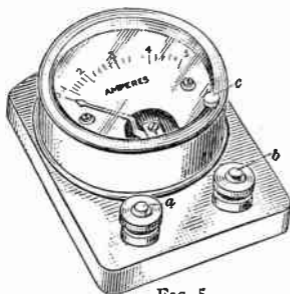

FIG. 5

Another design of expansion-type ammeter is shown in Fig. 5. This is a so-called portable type, and has its two terminals at *a* and *b*. An adjusting knurled screw at *c* permits of any necessary correction for shift in position of the needle due to changes in room temperature. It is well

to remember that this type of instrument is equally accurate on direct- or alternating-current circuits of

any frequency. The heater wire in this particular instrument is made of platinum ribbon. The scale is not uniform, that is, the divisions near the lower range of the scale are much smaller than those near the upper limit. These instruments may also be obtained in cases suitable for mounting on the front of a panel, or for mounting so that the face is flush with the panel.

Where larger ranges of values are desired, it is necessary to use a *shunt*. The shunt is a low-resistance path connected across the ammeter terminals so that only a fractional part of the current goes through the ammeter. The instrument must be calibrated with the shunt in place

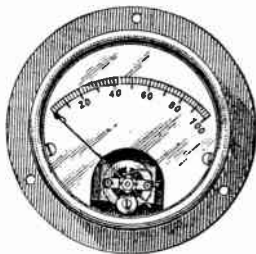

FIG. 6

by comparing its readings with those of a standard instrument or one that can be relied upon. For use in radio work, the shunt must be of special design else it will give erroneous readings under some conditions.

A *milliammeter* operating on a somewhat different principle is shown in Fig. 6. Briefly stated, its principle is: a short low-resistance wire carries the current to be measured. Against this wire is soldered a thermocouple which is heated by any current in the main wire. The principle of a thermocouple will be described under that heading. The electromotive force produced by the heating of the thermocouple is utilized to actuate a sensitive current-indicating instrument, often called a *galvanometer*. The scale of this galvanometer may be calibrated to read directly the current in the main wire in amperes or smaller units. The scale in this case will be congested near the lower values of current. For some uses, which will be mentioned later, the square of the current is desired. If the instrument is so calibrated, a uniform scale, as shown in Fig. 6, will obtain. This type of instru-

ment may be made very sensitive, and seldom needs a zero correction. It may be obtained in a portable, front-of-panel, or flush type of case. The latter type is shown in Fig. 6.

ELECTROMOTIVE FORCE

The *volt* is the practical unit of electromotive force, and is the electromotive force that will cause electricity to flow at the rate of 1 ampere through a circuit with a resistance of 1 ohm. Because of the name of its unit, electromotive force is commonly called *voltage*.

VOLTMETERS

In practical work, voltage is measured by an instrument called a *voltmeter*. One common type is shown in

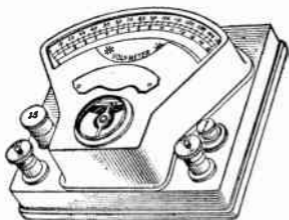

FIG. 7

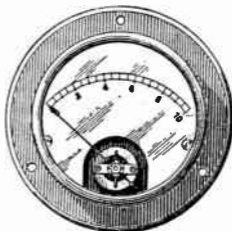

FIG. 8

Fig. 7. A voltmeter should be connected across a circuit, and will then indicate the electromotive force between the points on the line to which it is connected.

In the electric system, the flow of electricity through the circuit is due to the electromotive force applied to the terminals of the circuit. This electrical pressure forces a current against the resistance offered by the wires and other devices connected in the circuit. The current through the voltmeter causes a deflection of its needle over a scale marked in volts. The electromotive

force may be supplied by an electric battery or some other source of electric power.

A smaller voltmeter, but one capable of giving very good results, is shown in Fig. 8. This instrument is about 3 inches across the face and a little over 1 inch in depth. It may be obtained for widely different scale ranges, and in several different styles of cases. This and the preceding type of voltmeter are suitable for use on direct-current circuits only.

If the resistance of a circuit remains the same and the electromotive force applied to its terminals is increased, the current will be increased. A decrease of the electromotive force will result in a decrease of current. If the electromotive force remains constant and the resistance of the circuit is increased, the current will be decreased; when the resistance is decreased, the current will be increased.

ELECTRIC POWER

The *watt* is a unit of electric power and represents a certain amount of work done in a unit of time. In any direct-current circuit, the power in watts equals the product of the current in amperes and the electromotive force in volts, effective in that circuit.

The *kilowatt* (often written kw.) is also a unit of electric power in extensive use. One kilowatt equals 1,000 watts, the larger unit being used when measuring large amounts of power. No practical device for measuring the power in radio circuits has been developed.

ELECTRIC WORK

The *watt-hour* is a direct measure of electric work and equals 1 watt of power maintained for 1 hour. As this unit combines the elements of both rate and time, it is adapted to the measurement of the supply of electricity, that is, electric work or energy.

Special electric meters are made which measure the amount of electric work or energy furnished by a circuit, and are commonly called *watt-hour meters*. As the

name suggests, the reading may be in watt-hours, although the *kilowatt-hour* (1,000 watt-hours) is the unit generally employed for commercial purposes. The kilowatt-hour is often written kw.-hr.

OTHER TERMS

DIRECT AND ALTERNATING CURRENTS

Electric currents are of two general classes, *direct current* and *alternating current*, these names being to a large extent descriptive of the chief characteristic of the class to which each applies. A direct current is a flow of electricity always in the same direction. The flow of electricity from a battery is a direct current, and as it is unvarying so long as the circuit is unchanged it is further designated as a *continuous direct current*. The current from most machines which generate direct currents have small variations or

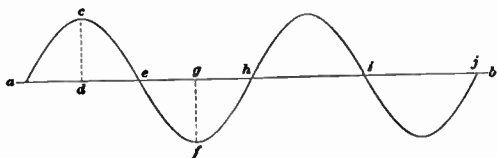

FIG. 9

pulsations due to inherent characteristics of the design and construction, and the current, strictly speaking, should be called a *pulsating direct current*. In most electric work the pulsations from a direct-current machine are insignificant, but in some phases of radio work, the ripples may be so objectionable as to prevent the use of a generator unless special auxiliary devices are used.

An *alternating current* is a flow of electricity that reverses in direction usually at periodic intervals.

Two such reversals or alternations of the current constitute a *cycle*. The *frequency* of an alternating current is expressed as the number of cycles per second. A representation of an alternating current is made in Fig. 9. Let the line *ab* represent an axis or reference line. Start at any instant of time, as at *a*, and let the current be zero. As time progresses, indicated by spaces to the right of *a*, the current gradually increases in a positive direction, indicated by this portion of the curve being located above the axis, until the curve reaches a maximum value at *c*. At this instant the current has the positive value *cd*. The current then starts to decrease until it reaches *e*, at which point it has zero value, that is, there is no flow of electricity for a brief instant of time. There is then a flow of electricity in the opposite direction until it reaches the maximum value *fg*, equal in value to the maximum positive value *cd*. Negative values are located below the axis. The current then approaches zero and reaches it at point *h*.

This cycle of events is repeated through another period of time to give the curve through point *i* and up to *j*. The portions of the curve *ace*, *efh*, etc., form *alternations* of current, and two successive alternations such as between *a* and *h*, or *h* and *b*, form *cycles* of current. If this were a 60-cycle current, the time of each cycle or rather the duration of each cycle would be $\frac{1}{60}$ of a second. The number of alternations per second would be twice the frequency, or, in this case, 120 per second.

COMMON FREQUENCIES

American commercial alternators deliver alternating currents at 60 or 25 cycles per second. Some machines are in use which deliver alternating currents at frequencies of 500 and 900 in certain kinds of radio work. For another branch of radio work, machines giving frequencies of 100,000 and even 200,000 are used. The special features and uses of these machines are considered under their proper headings.

Frequencies below 10,000 down to about 32 are audible

to the human ear, hence are known as *audio frequencies*. Some individuals can hear sounds at frequencies above 10,000 but this value is generally considered as a good arbitrary limit. The frequencies commonly used in radio communication lie above 10,000 and are called *radio frequencies*. Frequencies below 15,000 are seldom used in radio, as frequencies below this value give poorer results.

CONDUCTORS AND INSULATORS

A good *conductor* of electricity is a substance that will offer very little opposition to the flow of electricity through it. Materials vary in their ability to conduct electricity, some being very much better conductors than others.

Among such materials, arranged in order with the best conducting material first, are silver, copper, gold, aluminum, zinc, brass, phosphor-bronze, platinum, tin, nickel, lead, German silver, steel, iron, mercury, carbon, and water. Silver and gold are too expensive to be generally used for electric conductors. Copper, being plentiful and comparatively cheap, is in very general use, and aluminum is also much employed, particularly where light weight is important.

An *insulator* is a non-conductor which offers so much opposition to the flow of electricity that practically no current can pass through it. Among the best known insulating materials are glass, porcelain, rubber, mica, ebonite, dry paraffined wood, paper, vulcanized fiber, asbestos, pure asphalt, air, and oils. Insulators are used to support conductors and to keep the electricity confined to the wires intended for it. For example, telegraph, telephone, and electric-light wires on poles are fastened to glass or porcelain insulators.

It is important to remember that as all materials conduct electricity to a certain extent, it is impossible to divide them absolutely into groups of conductors and insulators; but for practical purposes they may be so divided, as the resistance of a good insulator is several million times that of a good conductor.

MAGNETS AND MAGNETISM

Kinds of Magnets.—A *natural magnet* is a piece of ore (a natural substance containing a mineral) that has the property of attracting pieces of iron, steel, and a few other metals. This ore was first discovered in the province of Magnesia, Asia Minor; the peculiar property was therefore called *magnetism*, and the name *magnet* was applied to a piece of ore possessing the property.



FIG. 10

Later the discovery was made that if such magnets were suspended so that they could turn freely, all would come to rest in positions pointing north and south. Small bars of the ore were thus used to guide ships over the seas. They were therefore called *lodestone* (leading stone), a name that is also applied to the ore. These lodestones were thus the forerunners of the modern compass.

A bar or needle of hardened steel rubbed with a lodestone acquires properties similar to those possessed by the lodestone, and is called an *artificial magnet*. Artificial magnets that retain their magnetic characteristics for a considerable period of time, are called *permanent magnets*. Fig. 10 shows a common form of permanent magnet, consisting of a bar of steel bent into the shape of a horseshoe and then hardened and magnetized. A piece of soft iron called an *armature*, or *keeper*, placed across the two free ends helps to retain the magnetism. Artificial magnets are also made in the form of straight bars. Magnets of this type are sometimes used in small electrical machines and devices.



FIG. 11

A *compass* consists of a magnetized steel needle, Fig. 11, resting on a fine point so as to turn freely in a horizontal plane. When not in the vicinity of iron, steel, or other magnets, the needle will come to rest with one end

pointing toward the north and the other toward the south. The end pointing northwards is called the *north pole*, and the opposite end is called the *south pole*.

Magnetic Attractions and Repulsions.—If one end of a bar magnet is brought near a compass needle, as in Fig. 12, the needle will be deflected from its north-and-south position, one end being attracted by the permanent magnet and the other repelled. If the other end of the bar magnet is presented to the compass needle, the end of the needle which was formerly attracted will be repelled. If the magnet is dipped into iron filings, the filings are attracted toward the two ends and adhere there in tufts, while near the center of the bar there is no attrac-

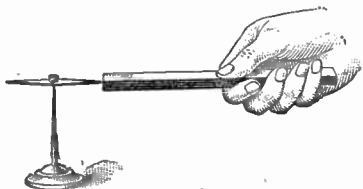

FIG. 12

tion and the filings will not adhere there. If one end of the magnetized bar is brought near a piece of soft iron, the iron will be attracted, and, if not too heavy, will be lifted by the magnet, and adhere to it. Both ends of the bar magnet will exhibit exactly the same attraction toward the piece of soft iron.

The two ends of the bar magnet, although acting alike in attracting iron filings and pieces of soft iron, must be in some way different from each other, since one end will attract only the north pole of the compass needle, and the other end will attract only the south pole. If the ends of the bar magnet are marked by the letters *N* and *S* to identify the north and south poles, and the magnet is again presented to the compass needle, it will be found that the north pole of the magnet attracts the

south pole of the compass needle and repels the north pole, and that the south pole of the magnet attracts the north pole of the needle and repels the south pole. These experiments show the general law applying to all magnets, that *like magnetic poles repel each other while unlike poles attract each other.*

Magnetic substances are those substances that are capable of being attracted by a magnet. Iron and its alloys are the principal ones, but nickel and cobalt possess mild magnetic properties. Nearly all other materials are unaffected by magnetic influences, and are called *non-*

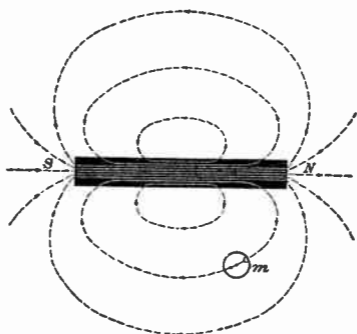

FIG. 13

magnetic. Non-magnetic materials allow a magnetic field to be established through their body practically the same as it would be were the material not present.

The space surrounding a magnet in which any magnetic substance will be attracted or repelled is its *magnetic field*, or simply its *field*. Magnetic attractions and repulsions are found to act in definite directions, and along imaginary lines, called lines of *magnetic force*, or also *lines of force*.

The direction of lines of force in a magnetic field can

be tested by means of a small, freely suspended magnet, as the needle of a compass. The needle always turns until the direction of the lines of force within its body coincides with the direction of the lines of force in the field, as at *m*, Fig. 13. The north pole of the needle always points in the direction of the lines of force. Lines of force are usually represented by dotted lines, and their direction by arrowheads on the dotted lines.

If a bar magnet is surrounded by air, the magnetic forces act in curved paths, connecting the poles, as indicated in Fig. 13, in which only a few lines of force are represented. The common assumption is that the forces act from a north pole and toward a south pole; that is, the lines of force pass out from the north pole, through the surrounding air, in at the south pole, and through the magnet to the north pole. This is called the *direction of the lines of force*, and the complete path is called the *magnetic circuit*. The total magnetism, or all the lines of force collectively surrounding a magnet, is called the flux of a magnet, or the *magnetic flux*.

Residual magnetism is the magnetism remaining in iron or steel after the magnetizing influence is no longer active. These two materials differ in their ability to retain magnetism, hard steel being much more retentive than iron, especially if the iron is of a soft grade. Very soft iron, although easily magnetized, will retain none of its magnetism after the magnet or other magnetizing source is removed. Poor grades of iron—that is, iron that is neither pure nor very soft—will retain some magnetism after the magnetizing source is removed, behaving in this respect somewhat like steel. Hard steel is difficult to magnetize to a high degree, but retains a large portion of its magnetism after the magnetizing force is removed.

ELECTRIC CIRCUITS

DEFINITIONS OF CIRCUIT TERMS

An *electric circuit* is a conductor, or a combination of conductors, through which electricity may flow. A circuit may, and generally does, include a source of electromotive force, and often includes devices for utilizing the electrical energy, or for storing it. Such a circuit is *closed*, or *made*, when it is continuous so that electricity may flow from a given point around the whole path and back to the starting point. The circuit is *broken*, or *open*, when it forms an incomplete conducting path, effectually preventing the flow of electricity.

An electric circuit is said to be *grounded* when part of it is connected with the earth by a conductor. This term is also frequently used to designate a circuit which has a *ground return*, that is, part of the circuit includes a path through the earth. Such circuits are sometimes used in telegraph practice. The more common practice, however, is to use circuits formed entirely of metal conductors, which may be designated as *metallic circuits*. There is usually less loss of energy over metallic circuits than over those of which the earth forms a part.

PROPERTIES OF A CIRCUIT

RESISTANCE

Even through the best conductors there is some opposition to the flow of electricity. This tendency of all substances to resist the passage of electricity is known as *resistance*. In general, conductors have low resistance, and insulators have comparatively high resistance. Resistance manifests itself by causing a dissipation or loss of electrical energy, which is, in most cases, undesirable. Some electromotive force is, therefore, expended in sending a current through the conductors used to connect

the devices in a circuit. The electrical resistance corresponds with the friction or resistance offered to the flow of water through a pipe.

From the viewpoint of the electron theory, it is considered that conductors are made up of atoms whose electrons are more free to move about than are those in insulators. Under the influence of an electromotive force, the electrons tend to move along the conductor, but have multitudes of collisions with the atoms which make up the conductor. This hindrance to the free motion of the electrons constitutes the resistance effect, and manifests itself by the heating of the conductor. As the vibrating motion of the atoms increases with a rise in temperature, the collisions between the electrons and atoms increase in frequency, and there is then a greater hindrance to the electron flow. With a larger current in the conductor, there is a larger electron movement with a consequent increased agitation of the atoms caused by their increased bombardment. This results in heating of the conductor, which increases with an increase of current.

If large amounts of power are to be transferred over long distances, it is desirable that low-resistance conductors be used. Copper and aluminum, both of which possess low resistance and are quite cheap, are commonly employed in this work. Many times it is desirable to use a device possessing considerable resistance, either as a heater or to control the flow of electricity to some other electrical device. Alloys, or combinations of several metals, are commonly used in this work, although iron wire or even long lengths of cast iron are used if large amounts of power must be absorbed.

RESISTANCE DEVICES

A type of resistance unit often used in radio practice is shown in Fig. 1. It is designed for mounting on a panel as indicated at *a*, with the knob *b* projecting on the front. A shaft from *b* comes through the panel to *c* and is fastened to a slider *d* which moves over a consider-

able length of resistance wire e . One terminal is provided at f , the other terminal being connected to the sliding contact d by suitable means. The amount of resistance wire included between d and f determines the effective resistance of the *rheostat*. This device is commonly used to decrease the voltage of the source of current, so that only a safe current may pass through the apparatus in use. In this type of apparatus the resistance may be made to be continuously variable and in practically infinitely small steps, a desirable feature in some radio work. Devices for accomplishing the same results in slightly different designs of apparatus are very common.

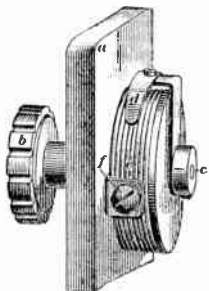

FIG. 1

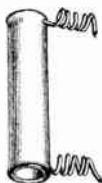

FIG. 2

Sometimes it is not necessary or desirable to change the resistance after the resistance device has been inserted. Such a unit is shown in Fig. 2, and it will maintain its constant resistance indefinitely unless abused. The conductor, in this case a long length of very fine high-resistance wire, is wound on an insulating tube and afterwards covered with an insulating and heat conducting material. This protective coating, often of enamel, prevents decomposition of the resistance material, and accidental contact with the live conductors. The coiled wires at the ends are for connecting the unit to the desired circuit, or apparatus.

UNIT OF RESISTANCE

The practical unit of electrical resistance is the *international ohm*. The international ohm is the resistance offered to the passage of an unvarying current by a column of mercury 106.3 centimeters (41.85 inches) high and weighing 14.4521 grams (.50973 oz.) at a temperature of 0° C. This standard is of interest only in making accurate scientific measurements. For general practical work, use is made of instruments that indicate either the resistance in ohms, or other measurements from which the resistance can be calculated. For very small resistances, the millionth part of an ohm is used as a unit, and is called the *microhm*; for high resistances a million-ohm unit is used, and is called the *megohm*.

The resistance of a conductor depends on the material of which it is made, on the size and shape of the conductor, and to some extent on the frequency of the current. With direct current, the last factor is eliminated. The characteristic property of the material is called its *resistivity*, and is given for different materials in a table elsewhere in this handbook.

The resistance to direct current is calculated by the formula

$$R = \rho \frac{l}{a}$$

in which ρ = ordinary, or volume, resistivity; l = length of conductor; a = cross-section of conductor; and R = resistance to direct current.

This formula will give the resistance in ohms when the dimensions of the conductor and its material are known. The relation may be expressed in the following manner: If the length of a conductor be doubled, its resistance will be doubled; if its length be halved, its resistance will be halved; an increase in the length of a conductor or a decrease in its diameter will cause an increase in its resistance; a decrease in the length or increase in the diameter will cause a decrease in its resistance.

OHM'S LAW

The relation between the current, electromotive force, and the resistance, is expressed by *Ohm's law*. The substance of the law has been given in the statement that the flow of electricity increases with increased electromotive force, and decreases with increased resistance. In problems, current is commonly expressed in amperes, electromotive force in volts, and resistance in ohms. Ohm's law may be written in the following three forms:

Rule I.—*Amperes equal volts divided by ohms.*

Rule II.—*Volts equal the product of amperes times ohms.*

Rule III.—*Ohms equal volts divided by amperes.*

These relations stated as formulas give: $I = \frac{E}{R}$,

$E = IR$, and $R = \frac{E}{I}$, where I = current in amperes, E = electromotive force in volts, and R = resistance in ohms. If there is in the circuit more than one source of electromotive force, the value of the resultant electromotive force must be used in these formulas. Furthermore, if the circuit contains inductance or capacity, the formulas are not applicable to variable, or alternating, currents.

If a given conductor offers a resistance of 2 ohms to a current of 1 ampere, it offers the same resistance to a current of 10 amperes, provided the temperature of the conductor is not changed. Hence, the resistance of a given conductor at a given temperature is always the same, irrespective of the strength of the current or the electromotive force of the current. The resistance of a conductor is a property of the conductor itself, depending on its dimensions, the material of which it is made, and its temperature; the resistance will remain the same, no matter what the value of the current through the conductor, provided the temperature is not allowed to change. In most cases, however, an increase of the current will cause an increase in the temperature of a conductor, because it is not usual to provide special precautions for

keeping the temperature constant. Under such circumstances a change in current would cause a change in resistance.

SKIN EFFECT

When a conductor is acted on by an electromotive force, the current is not established instantly throughout the cross-section of the conductor, but is created at the surface first, and then diffuses inwards. This surface concentration, which is usually called *skin effect*, is not noticeable on direct currents, nor usually on commercial power circuits, as the phenomenon is very rapid, and only a very short interval of time is required for the current distribution over the cross-section to become uniform. As the current springs into existence at the outer edge and diffuses inwards, it will take a longer time for the attainment of the final steady state with a conductor of large cross-section than for one of relatively smaller section.

With a moderately low-frequency alternating current in a large conductor, the current may reverse before the current distribution has become uniform. This means that part of the central core of the conductor does not carry current, and in so far as its electrical properties are concerned, some of the core might be eliminated. In fact, this very thing is done under some conditions in cable practice, when the core is made of hemp rope or other non-conducting material. The result of the skin effect is to increase the resistance of the conductor on alternating current to a value higher than its direct-current resistance. In commercial power work this increase of resistance is seldom greater than one or two per cent., but it might easily exceed these values, were no precautions taken.

With a high frequency, say above 50,000, the time interval between reversals of the current is much reduced, and consequently the current can penetrate to only a very small depth. The skin effect may easily be so great that the resistance of a single solid conductor is only

slightly less than that of a thin tube with the same outside dimensions. This means that the high-frequency resistance of the conductor is several times its direct-current value. If the wire is only a few inches long, this higher resistance may not be objectionable, but it becomes of paramount importance in long conductors. As is the case with other resistances, the skin effect is manifested by the increased heat loss that it causes in the current-carrying part of the conductor.

In addition to the cross-section of the conductor, the skin effect always depends upon the factor $\sqrt{\frac{2\mu f}{\rho}}$, where μ = permeability of the material; f = frequency of the current; and ρ = volume resistivity, in microhm-centimeters. This illustrates that the skin effect in good conductors is greater than in wires of high resistivity, other things being equal.

A very important term in the above factor is μ , or the permeability. This causes the skin effect of the conductors made of magnetic material to show an exaggerated increase of resistance with an increase of the frequency. The permeability of copper is 1, hence this term does not affect copper conductors.

For a straight cylindrical wire, the increase of resistance due to skin effect may be easily obtained. The value $x = \pi d \sqrt{\frac{2\mu f}{\rho}}$, where π is 3.1416, and d is the diameter of the wire in centimeters. By reference to a table given in the back of this volume, the ratio of $\frac{R}{R_0}$ may be obtained for the calculated value of x . The value R is the resistance at the high frequency f , while R_0 is the direct-current resistance. When this ratio is known, the increase in resistance, in per cent., or the actual resistance in ohms, at the desired frequency may be obtained.

The high-frequency resistance when current-carrying conductors are close together, is higher than when they are separated at least several centimeters. The proximity

of the conductors causes a still further segregation of the current, or perhaps a bunching of current on one part of the circumference, with the result that the conductor exhibits a still higher resistance than that attributable to skin effect. This feature becomes important in coils where the turns are quite close together, and is more noticeable in multi-layer short coils than in long single-layer coils. It is practically impossible to calculate the increased resistance that may occur in coils, because of the many factors to be considered.

Where high-frequency currents only are to be carried, it is often economical to use metal tubing instead of solid rods. Another method of reducing the amount of waste material is to increase the surface of the material by using many fine insulated wires bunched together. Ordinary bunching or twisting of the uninsulated wires does not suffice, as those not on the outside are really not effective in reducing the skin effect. A very moderate insulation between wires, such as enamel or a cotton covering, will reduce the skin effect a great deal. Some advantage is gained by using smaller individual wires, but smaller than No. 38 B. & S. gauge is not practical. The best method is to combine the strands in a sort of hollow basket weave, taking care that each strand takes up successively all possible positions in the cross-section.

TEMPERATURE COEFFICIENT

The change in the resistance of a substance per ohm per degree change of temperature is the *temperature coefficient*. If R_1 is the resistance of a piece of wire at any temperature t_1 , and a is the temperature coefficient of the substance at that temperature, its resistance R_2 at a higher temperature t_2 may be calculated by the formula

$$R_2 = R_1 (1 + a t)$$

where t is the difference in temperature between t_1 and t_2 .

If the resistance R_3 at a lower temperature t_3 is desired,

$$R_3 = R_1 (1 - a t)$$

where a is, as before, the temperature coefficient at the starting temperature, or in this case at the temperature t_1 .

The value of the temperature coefficient a taken from any table must be for Fahrenheit or centigrade scales, whichever is used to express the temperature change.

The Standards of the American Institute of Electrical Engineers specify that the temperature coefficient of copper for centigrade degrees shall be deduced from the relation of 1 divided by the sum of 234.5 and the value of the starting temperature under consideration. Thus, if a temperature rise from, say, 40° C. to 60° C. is to be considered, the value of a would be $\frac{1}{234.5 + 40} = \frac{1}{274.5} = .00364$. This value of a would then be used in the formula for temperature increase, and the value for t would be the difference between 60 and 40, or 20.

With a temperature decrease from 60° to 40° centigrade, the value of a at the starting temperature, 60°, would be obtained as given previously. This would be $\frac{1}{234.5 + 60} = .0034$, which is a in the formula for temperature decrease where t is the 20-degree temperature change.

TEMPERATURE COEFFICIENTS OF COPPER RESISTANCE

| Temperature of the Conductor in Degrees C. at Which the Starting Resistance is Measured. | Increase in Resistance of Copper per Degree C., per Ohm of Starting Resistance. |
|--|---|
| 0 | .00427 |
| 5 | .00418 |
| 10 | .00409 |
| 15 | .00401 |
| 20 | .00393 |
| 25 | .00385 |
| 30 | .00378 |
| 35 | .00371 |
| 40 | .00364 |
| 45 | .00358 |
| 50 | .00351 |
| 55 | .00345 |
| 60 | .00340 |

SERIES GROUPING

Electric conductors, sources of electromotive force, or devices using electricity, may be connected in several ways. A *series* circuit is formed when the connections of its parts are such as to provide only one continuous path for the flow of electricity. All the electricity must pass through each conductor, making the current equal in each of the conductors. For example, Fig. 3 represents a closed series circuit from cell B through $c-r_1-c-r_2-d$ and through cell B . The cell, conductors, and resistances

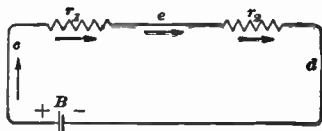

FIG. 3

are in series, because they are in one path; the same current exists in all of them, and its direction is indicated by the arrows.

Fig. 3 serves to show the usual, or conventional, method of representing resistances, which is by the sharp-pointed wavy line as shown at r_1 and r_2 . The resistance of several conductors or resistances connected in series is equal to the sum of the resistances of the conductors and resistance devices. In the above circuit, if the resistance of the battery and conductors were neglected, the resistance would be

$$R = r_1 + r_2$$

If it was desired to include the resistance of the conductors and the battery, their resistances would merely be added to the others, since all are in series. It is well to note that the current in any part of a series circuit is the same as in any other part.

PARALLEL GROUPING

Divided Circuits.—Conductors are connected in *parallel*, or *multiple*, when so joined that each will carry part of the total current in the circuit of which they are branches.

Fig. 4 shows a closed circuit consisting of a source of electromotive force, and conductors *a*, *b*, *c*, and *d*. Conductors *b* and *c* afford two current paths between conductors *a* and *d*, and are therefore in parallel. Either path *b* or *c* could be broken without interfering with the flow of electricity through the remaining path, because each is independent of the other. The arrows indicate the direction of the current with normal circuit conditions.

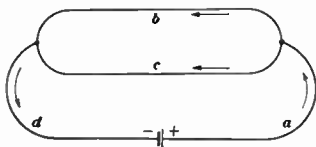

FIG. 4

Each branch is a *shunt* of the other, or *in shunt* with it, and the two together form a *divided circuit*. A circuit shunted by a low-resistance conductor is

said to be *short-circuited* by it, and the shunt in such case may be called a *short circuit*, or simply a *short*.

Resistance of Conductors in Parallel Groups.—In Fig. 4, the two paths *b* and *c* together are larger, and hence lower in resistance, than either path would be alone. Joining in parallel two conductors of the same material and of the same size and length is equivalent to making one conductor twice as large as either one of the two joined, and doubling the size of the conductor divides its resistance by two. The joint resistance *R* of any number of resistances *r*₁, *r*₂, etc., in parallel, may be determined by the following formula, in the denominator of which there should be as many terms as there are resistances in parallel:

$$R = \frac{1}{\frac{1}{r_1} + \frac{1}{r_2} + \frac{1}{r_3} + \frac{1}{r_4} + \text{etc.}}$$

This formula applies whether the individual resistances are of equal values or not.

When electric cells or other sources of electromotive force are connected in series, their voltages add algebrai-

cally. That is, all acting in one direction are added, while those acting in the opposite direction are subtracted.

Parallel connection of sources of electromotive force should only be made of devices possessing equal voltages and then only so as to assist the current output for the combination of devices, cells, and conductors.

With parallel connection of the cells, all of the positive terminals should be connected together and all of the negative terminals connected together, and these two common points used as the regular terminals. The open-circuited voltage of the battery will then be that of any one of the cells. The current capacity of the battery, however, will be increased over that of one cell.

ELECTROMAGNETIC EFFECT

There is a magnetic field set up in the medium surrounding a conductor carrying electricity. This field is strongest at the surface of the conductor and grows weaker toward the center of the wire, at which point it is zero. This field is often represented by *lines of force* which, if the conductor is isolated, form concentric circles about the conductor, as indicated in Fig. 5. Here the conductor is threaded through a piece of cardboard, and iron filings are used to indicate the presence of the lines of force. The filings arrange themselves as concentric circles throughout the length of the conductor.

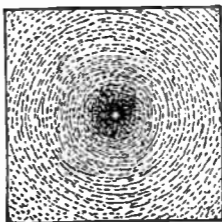

FIG. 5

Since this magnetic field is due to an electric current, it is often called an *electromagnetic field*, and it acts on a compass just like the field of a permanent magnet. With a current-carrying conductor held over a compass, as indicated in Fig. 6, the needle will be deflected as

shown by the curved arrows. This is true only with the current in the direction indicated by the long straight arrow. If the conductor is moved to a position below

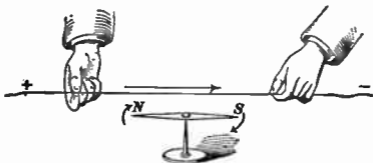

FIG. 6

the compass, the needle will reverse its direction of movement.

The direction of the magnetic lines of force may be determined by the following rule: Grasp the conductor with the right hand with the extended thumb pointing in the direction of the current; the lines of force of the magnetic field are then in the direction in which the fingers point, in circles whose planes are perpendicular to the wire.

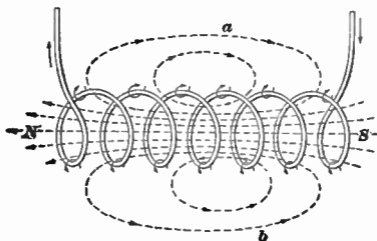

FIG. 7

A much stronger magnetic field may be secured by winding the current-carrying conductor into a coil. Fig. 7 represents such a condition, and illustrates how the lines

of force of the individual turns combine to form larger loops *a* or *b* enclosing several or all of the turns. The lines of force within the coil are roughly parallel to the axis or center line of the coil, while outside they pass from the north pole around in large loops to the south pole. The north pole is the one toward which the extended thumb points when the coil is grasped by the right hand with the fingers pointing in the direction of the current in the conductors.

Current-carrying coils are often used as *electromagnets*, as by this means very strong and easily controlled fields may be obtained. The amount of flux (designated by ϕ) is dependent upon the magnetic field intensity, area, and the magnetic permeability. The latter term shows that materials, such as iron which has a high permeability, increase the flux in an electromagnet coil. For this reason an iron core is always used in electromagnets.

INDUCTANCE

Coils of wire are also frequently used for the *inductance* which they possess. The inductance of a coil, or of a straight conductor to a smaller extent, is that property by virtue of which it is capable of storing up energy in electromagnetic form. The inductance of any conductor depends upon the amount of flux linked with that circuit. This magnetic flux may be due to a current in the conductor under consideration or to the flux produced by a current in another circuit. The *self-inductance* of a circuit is the inductance produced by the current in that circuit setting up a magnetic flux which links some part of the circuit. The magnitude of the effect of self-induction depends upon the shape and size of the magnetic circuit, and is a constant for a given circuit if the surrounding medium has a constant permeability.

UNIT OF INDUCTANCE

The unit of inductance is the *henry*. An inductance of 1 henry exists in a circuit when a current changing at a

rate of 1 ampere per second induces an electromotive force of 1 volt in the circuit. As the henry is quite large, the one-thousandth part of it, or the millihenry, is frequently used. The millihenry = $\frac{1}{1,000}$ or 10^{-3} henry.

The microhenry = $\frac{1}{1,000,000}$, or 10^{-6} henry. Inductances may also be measured in *centimeters* of inductance, one millihenry being equal to 1,000,000 centimeters of inductance.

If I is the current in amperes, T the number of turns in a coil, ϕ the number of lines of force due to the coil, then the inductance of the coil in henrys is

$$L = \frac{\phi T}{10^8 I}$$

The inductance in henrys of a coil containing no iron may be computed by the formula

$$L = \frac{4\pi T^2 A}{10^9 l}$$

in which T is the number of turns in the coil, A is its mean area in square centimeters, and l is its length in centimeters. For a cylindrical coil whose mean area is πr^2 , the formula reduces to

$$L = \frac{3,948 r^2 T^2}{10^{11} l}$$

If the radius r and the length of the coil l are given in inches, then the inductance in henrys is

$$L = \frac{10,028 r^2 T^2}{10^{11} l}$$

These two formulas are strictly true only for a long coil in which the length is twenty or more times the diameter, and the depth of winding is small compared to the mean radius. However, they may be used to determine approximately the inductance of any ordinary solenoid containing no magnetic material.

It should be understood that the lines of flux about a coil are invisible, in fact do not exist as such, but lines are merely convenient ways of representing the direction and paths of the magnetic flux. The medium surrounding the coil is placed under a magnetic strain and the field remains fixed or constant so long as the current does not change. No energy is required to maintain the field, and when the electromotive force producing the field is removed, all of the energy required to establish the magnetic field is returned to the electrical circuit.

If a bar magnet be inserted into or withdrawn from a coil the terminals of which are connected with a sensitive current-indicating device, a deflection will be obtained while the magnet is in motion. A similar current indication will be obtained if the coil is moved with respect to the magnet. If the magnet is moved into the coil, the deflection due to the current will be in a certain direction. If the magnet is moved out of the coil, the deflection will be in the opposite direction. This is the principle upon which electric generators and motors operate. A more complete discussion of this subject is given elsewhere in this volume. It should be noted that relative motion is necessary for this form of electric generation. The lines of force from the magnet cutting the coil are the real factor causing the generation of electricity.

As the inductance of a coil represents a magnetic strain in the field about the coil, energy must be used to produce this field, and place it in its stressed condition. When a direct current is sent through a coil, the current at the instant of closing the switch is limited by the resistance of the conductor and by the inductance of the coil. The space about the coil soon becomes magnetized, and the current, for the fixed voltage, after a short interval of time, is limited only by the resistance of the conductor.

If an equal voltage from an alternating-current supply system is impressed on the circuit, it will be found that the current will be somewhat less than when a direct-current

supply was used. The inductance of the coil has been effective in forestalling the complete establishment of an electromagnetic field during the individual alternations of current, and the current has not had a chance to reach the same values as it did when a direct current was employed.

INDUCTIVE REACTANCE

The property of the magnetic characteristics of a coil that impedes the passage of an alternating current is

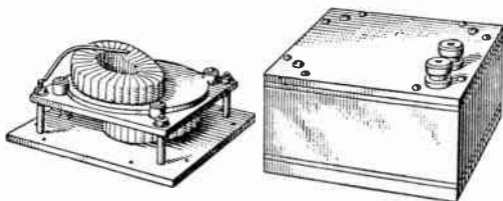

FIG. 8

called its *inductive reactance*, and it is measured in ohms. The reactance may be calculated by the formula

$$X_l = 2\pi fL,$$

where X_l is the reactance in ohms, π equals 3.1416, f is the frequency, and L is the inductance in henrys. The reactance represents an opposition to the passage of an alternating current in addition to that offered by the regular resistance, but the reactance of itself does not produce any energy loss in the circuit.

INDUCTANCE DEVICES

Choke Coils.—The preceding formula shows that the reactance of a coil depends largely upon the frequency and that it increases with the frequency. Coils with an iron core have more reactance than air-core coils of the

same size, due to their larger inductance. In some cases coils are used which have little reaction or opposition to the passage of low-frequency currents, but form an effective barrier to currents at relatively higher frequencies, because of their greater reactance at those frequencies. Such coils are called *choke coils*, and may easily be made by winding many turns of fine wire on an iron core.

Standard Inductance Coil.—A standard of inductance is shown in Fig. 8. The coils are wound of strands of insulated wire so that they are accurate on any frequency. The winding is in two sections which are arranged so that there is very little external field, hence no effect is caused by external influences. Care is also taken that there is no magnetic material in the mountings. They must also be securely wound and fixed in place after setting to the desired value. The whole is mounted in a substantial case to protect the coils from dirt and injury.

Variable Inductance Coil.

A type of inductance coil which is extensively used in radio sending work is shown in Fig 9. The winding *a* is mounted on a cylindrical frame *b*. Each turn in this case is brought out to a terminal *c* to which connection may be easily made by connectors *d*. These are arranged so that they can be slipped over the different plugs, and the number of turns in use can be readily changed.

Honeycomb Coils.—A long piece of wire may be formed into a short coil possessing large inductance, by the type of winding indicated in Fig. 10. It will be noticed that there is considerable space between adjacent turns of wire and that the wires of one layer lie at an angle with those in the adjacent layer. The capacity

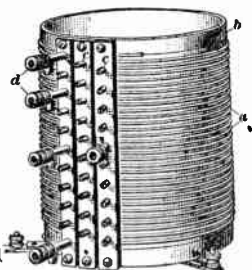

FIG. 9

effect of one wire upon those adjoining is thus reduced and it is entirely practicable to construct coils of this type with several layers of conductor. On account of the open type of construction, they are sometimes called *honeycomb-wound coils*, and are sold under several trade names. They are customarily furnished with leads from the ends of the winding, which starts at the center and is gradually built up to the desired thickness layer by layer.

Variometer.—The usual purpose of changing the number of turns used in coils of receiving transformers is to change their inductance. Another method by which this may be accomplished consists in dividing the winding into two sections and then placing these sections so that the inductance may be changed by altering their relative positions.



FIG. 10

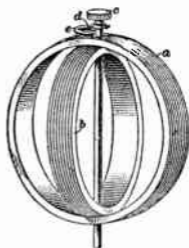

FIG. 11

In Fig. 11 is shown the operating principle of a device commonly called a *variometer*, for varying the inductance of a circuit. The outer coil *a* is usually stationary and the inner coil *b* is so mounted that it may be rotated within coil *a*. The knob *c* is on the end of a shaft that passes through both coils and supports the inner coil. The movable coil rotates when the shaft is turned, and the angle between the two coils is thus changed. A pointer *d* and scale *e* indicate the angular relation between the two coils.

As indicated in Fig. 11, the wire is wound on forms that are sections of the surfaces of spheres. In this manner the two coils may be of almost the same diameter and yet the inner coil may be freely rotated. The number of turns of wire used will depend upon the design and the size of the winding space available. In actual practice the coils are often wound on short cylindrical tubes. In such a case, however, the diameter of the inner tube must be much smaller than that of the outer one in order to allow the movable coil to be rotated. In other cases the outer winding is placed on a cylindrical tube and the inner one is on a spherical surface.

The stationary and the movable coils are connected in series and the variometer may be connected in any desired circuit. When the coils are in parallel positions and are connected so that electricity flows through them in the same direction, the lines of force which they establish act in the same direction, and the coils have practically no effect on each other. In this position the inductance of the device is at its maximum, as the lines of force of both coils are added directly. When the inner coil is turned to some other position, its lines of force move also and do not act completely in unison with the flux set up by the outer coil, but at an angle with it. The effect of a portion of the total number of lines of force is thus lost and the inductance of the device is decreased. Continued rotation of the inner coil will decrease the inductance more and more until the position is reached in which the two coils are parallel and opposing each other. If then the two coils are equal, the inductance of the device will be nearly zero, as the lines of force of the two coils will tend to neutralize each other.

A distinct advantage of this type of construction is that a continuous variation of inductance may be made over the whole range of values obtainable with this device. When complicated switch arrangements are used, the inductance is usually variable by steps of one turn of the

winding. As commonly used, the variometer is made in small sizes and is depended upon to give a small range of gradual inductance variation.

CONDENSER

An electric *condenser* is formed by two conductors or two groups of conductors separated by some insulating medium, usually called a *dielectric*. Such a device apparently has the ability to store up a large quantity of electrical energy in an electrostatic form, hence the name. The conducting elements are commonly called *plates*, as they are usually made in the form of large flat surfaces.

Capacity (*C*) is comparable to the capacity of a bottle containing air. The addition of a given amount of air will raise the pressure more or less, and the amount of air required to produce a certain pressure in the bottle may be taken as the measure of the capacity of the bottle. This capacity is analogous to the electrostatic capacity of a condenser, which is measured by the quantity of electricity with which it must be charged in order to raise its electrical potential from zero to unity.

UNIT OF CAPACITY

The *unit of capacity* is the *farad*. A condenser has a capacity of 1 farad when 1 coulomb is required to raise its potential from zero to 1 volt. Since the farad is very large, its millionth part, or the *microfarad*, is generally used as the practical unit. The microfarad = $\frac{1}{1,000,000}$, or 10^{-6} farads. The *micro-microfarad* is equal to $\frac{1}{1,000,000}$ microfarad. Another unit of capacity, sometimes used, is the *centimeter of capacity*, which is one nine hundred thousandth of a microfarad ($\frac{1}{900,000}$ microfarad). One centimeter of capacity is approximately equal to 1.11 micro-microfarads.

CONDENSER DEVICES

The condenser shown in Fig. 12 serves to illustrate the principle involved. The two conducting plates *a* and *b* are quite close together, and the intervening air forms the dielectric. As soon as the circuit is closed through the battery, there will be a flow of electricity into the condenser. The flow will be at a maximum value upon closing the circuit and then will rapidly fall off so that after a fraction of a second the flow will practically have ceased and the condenser will be charged. With the battery connected as shown, plate *a* will receive a positive charge, and plate *b* a negative charge.

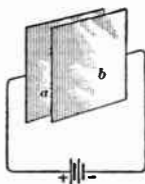
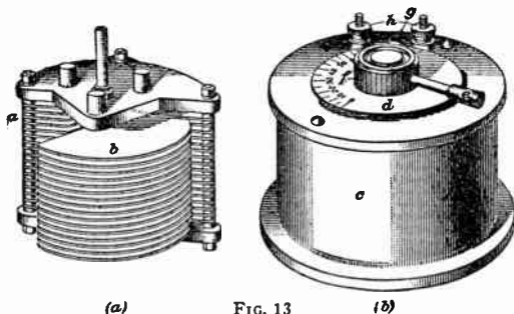

FIG. 12

Variable Condensers.—A commercial condenser unit is shown in Fig. 13 (*a*), which shows the plates, while view (*b*) gives an illustration of the complete unit. The set of plates *a*, view (*a*), are rigidly mounted and remain



(a)

FIG. 13

(b)

stationary. The plates *b* are mounted on a movable axis so that they may be swung into the spaces between the stationary plates. Both sets are semi-circular. With plates *b*

only partly interleaved between the stationary ones, the capacity of the condenser is small, while with the plates *b* in between those of *a*, the exposed surfaces are a maximum and the capacity of the condenser is a maximum.

In Fig. 13 (*b*) the condenser unit is mounted inside a suitable case *c*. The case affords considerable protection to the condenser from the effect of outside influences and tends to make its readings more reliable. The scale *d* in this case is mounted on the condenser shaft and rotates with it.

An extension handle *e* attached to the knob *f* provides an easy method of making fine settings of the condenser as it is easier to move a handle of this form a very small amount than it is to turn a knob a like amount. Readings of the angular position of the movable plates are made between a pointer *g* mounted on the case and the movable scale *d*. Two terminals *h* are provided, one being connected to the group of stationary plates and the other, through a flexible conductor, to the movable set of plates.

Fixed Condensers.—Some types of fixed condensers are formed of either square or circular aluminum plates which remain fixed in their relative positions. The air forms



FIG. 14

the dielectric. Groups are formed by connecting alternate plates, which sets then form the two plates of the condenser. This construction is commonly used in the case of standard condensers that must be very accurate and of unvarying capacity.

The usual fixed condenser is made with a solid dielectric. Under these conditions the plates are separated by the dielectric material itself, hence the plates do not require enough mechanical strength to make them self-supporting. They remain fixed in place after the con-

denser is once assembled, and so are made of very thin sheets of conductor. Such a condenser is shown in Fig. 14. This condenser has mica sheets as a dielectric and is used in sending sets. A condenser of this type will withstand a very high voltage, and for a given volume will store a comparatively large amount of energy. The aluminum protective case *a* forms one terminal. The other terminal is shown at *b* and is mounted on the cover *c* made of insulating material. Heavy lugs on the case serve as supports for mounting the condenser.

CAPACITY OF CONDENSERS

If a difference of potential of E volts exists across the terminals of a condenser of C farads capacity, then the charge of Q coulombs in the condenser may be calculated from the formula

$$Q = CE$$

from which

$$C = \frac{Q}{E}$$

and

$$E = \frac{Q}{C}$$

The capacity of a condenser is given by the formula

$$C \text{ (microfarads)} = \frac{885 K a}{d \times 10^{10}}$$

in which K is the inductivity of the dielectric between the tin-foil or metal plates; a is the area in square centimeters of all the dielectric material actually between and separating the condenser plates; and d is the average thickness in centimeters of the dielectric material. If there are n insulating layers, each of area s , then $a = ns$.

When a and d are given in square inches and inches, respectively, the formula becomes

$$C \text{ (microfarads)} = \frac{2,248 K a}{d \times 10^{10}}$$

The capacity of a condenser is therefore dependent on the dielectric material, its area, and its thickness. By reference to the table of inductivities given in this volume the inductivity or dielectric power of many

materials may be obtained. There are many materials which so far as the capacity is concerned are much better than air, but they have objections which preclude their use in many cases.

It should be noted that the quantity of electricity that may be stored in a condenser is controlled by the voltage across its plates, but this does not affect the actual capacity. There is some capacity between neighboring wires, but, due to the small size of the plates or wires and the relatively large spacing, this feature is often negligible. In coils, where adjacent turns are quite close together, the capacity is ordinarily small. With high frequencies, however, this capacity effect may introduce serious complications and produce unlooked for results.

Condensers in Parallel.—When two or more condensers are connected in parallel, the joint capacity C is equal to the sum of their capacities, that is, $C=C_1+C_2+C_3+$ etc.

Condensers in Series.—When two or more condensers $C_1, C_2, C_3,$ etc. are joined in series, their joint capacity C is equal to the reciprocal of the sum of their reciprocals, that is,

$$C = \frac{1}{\frac{1}{C_1} + \frac{1}{C_2} + \frac{1}{C_3} + \text{etc.}}$$

There are as many terms in the denominator as there are condensers connected in series. For example, the capacity of four condensers of 2, 4, 5, and 8 microfarads capacity connected in series is calculated as follows:

$$\frac{1}{2} + \frac{1}{4} + \frac{1}{5} + \frac{1}{8} = 1.075, \text{ and } \frac{1}{1.075} = .93 \text{ microfarad.}$$

CONDENSIVE REACTANCE

The opposition or reactance of a condenser to an alternating current is called the *capacitive* or *condensive reactance* as distinct from the inductive reactance of a coil. Expressed as a formula it is

$$X_c = \frac{1}{2\pi f C}$$

where X_c is the condensive reactance in ohms, f is the frequency, and C is the capacity in farads. The reactance of a condenser, therefore, decreases with an increase of frequency, which is just the opposite to the action of an inductance. It follows then, that the reactance effect of a coil in an alternating-current circuit may be completely annulled by connecting a condenser of equal reactance in series in the circuit.

IMPEDANCE

The total opposition to the passage of an alternating electric current through a circuit is grouped under the head of *impedance*. The impedance includes the effect of the resistance, inductance coil, and condenser, if all are present. In a series circuit the impedance Z may be expressed as

$$Z = \sqrt{R^2 + \left(2\pi fL - \frac{1}{2\pi fC}\right)^2}$$

where R is the resistance and the other terms of the equation represent the inductive reactance and the capacitive reactance.

Such a circuit is represented in Fig. 15, where a is the resistance connected in series with the inductance coil b and the condenser c . These are considered as connected across a source of alternating current at d . To calculate the alternating current in the circuit, Ohm's law should be changed to

$$I = \frac{E}{Z}$$

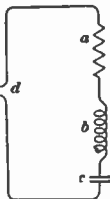

FIG. 15

where Z is the preceding value of impedance in ohms. On a direct-current circuit, there would be a flow of electricity until the condenser became charged, then the current would cease.

As has been stated, the reactance of a coil may be annulled by that of a condenser in series, providing the reactances are equal. This would be expressed as

$$2\pi fL = \frac{1}{2\pi fC}$$

When these two terms are equal they will cancel in the equation for the impedance Z , leaving $Z = \sqrt{R^2 + 0} = R$. Such a circuit would offer exactly the same opposition to an alternating current as it would to a direct current, namely, the direct-current resistance of the component devices and of the circuit connections. There would be no impedance except the resistance effect so far as an electromotive force connected across the circuit would be concerned, although the coil and condenser would still possess their individual reactances.

When the inductive and condensive reactances are equal and their effects are neutralized, the circuit is said to be in a state of *resonance*. This condition is frequently required in radio circuits and the preceding formulas show how easily it can be obtained. It is important to note that the state of resonance critically depends upon the frequency, and if the frequency changes, either L or C , or both, must be changed to secure a new resonance point. Theoretically it is possible to use any combination of values of L and C to secure resonance on any given frequency. Also, if a circuit is free to oscillate electrically, the frequency of the oscillating current will depend upon the values of L and C .

OSCILLATING CIRCUITS

PRODUCTION OF OSCILLATIONS

A charged condenser may be removed from the charging source, and will hold its charge for some time. It may be discharged by connecting the two plates by a wire. If one end of the wire were connected to one plate and the free end brought near the second plate, a spark would be seen to jump across the gap just before the wire touched the plate. A current-indicating device in series with the wire would show the passage of a considerable amount of electricity. When the spark ceases, the condenser will be found completely discharged.

The short duration of the spark makes it appear that there is only one rush of current, but as a matter of fact there are several such passages of current in a very short time; this is known as an *oscillatory discharge*. The charge on the positive plate rushes through the wire and onto the other plate, which becomes positive and discharges back into the first plate. At each passage of the current some energy is given up in the light, heat, and sound of the spark, and in the resistances of the wire and of the spark. This dissipation of energy soon uses up the electricity stored in the condenser and the oscillations cease. With a given charge in the condenser, the number of oscillations depends directly on the resistance of the path between the plates. With the usual case of a fairly low-resistance wire, there will be several cycles of current, each of smaller amplitude than the preceding one, until the current ceases altogether. This dying out of a current is commonly called *damping*. If the condenser plates are connected by a high resistance, such as a wet string, the discharge may take place so slowly that no reversal of current will occur.

With an inductance coil connected in series with a charged condenser to form a local circuit, very good control of the number of oscillations may be obtained, as well as of their frequency. By adjusting the reactances of the inductance and capacity to suitable values, the current may be made to oscillate many times before it dies out. Here, as elsewhere, the resistance in the circuit, or any added resistance, materially affects the damping of the oscillatory current. In general, the resistance and capacity tend to dampen the current rapidly while the inductance tends to prolong it. In order to have feeble damping, which is usually desired, there must be a high value of inductance in the circuit and low values of resistance and capacity.

The frequency of the oscillatory current established in a circuit which is free to oscillate is

$$f = \frac{1}{2\pi} \sqrt{\frac{1}{LC} - \frac{R^2}{4L^2}}$$

If the resistance is zero, the formula reduces to

$$f = \frac{1}{2\pi\sqrt{LC}}$$

In an oscillatory circuit, it has been stated, the resistance tends to damp out the oscillations. If the resistance exceeds a certain value in proportion to the other factors in the circuit, the circuit may not oscillate. Expressed as a formula the condition is, if R is greater than

$2\sqrt{\frac{L}{C}}$ the circuit will not oscillate. However, if R is

less than $2\sqrt{\frac{L}{C}}$ there will be an oscillatory discharge current from the condenser.

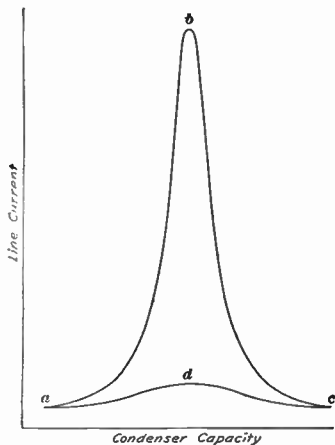

FIG. 1

The effect of resonance in a series circuit and the effect of the resistance are shown in Fig. 1.

At a , with a certain condenser setting below resonance, the alternating current through the series of devices is small. As the capacity setting is increased, the line current increases until point b is reached, at which point the inductive and condensive

reactances balance, and the current is limited by the total resistance present in the circuit. If the condenser effect is increased, the current rapidly decreases, showing that the impedance of the combination is again

larger than at resonance. At c the current will have been reduced to about its value at a . Beyond the limits of a and c the current will likewise be small. The current axis starts at zero on the figure, but the condenser settings were taken only for values near the resonance condition. With a relatively higher resistance in series with the same inductance and capacity, a resonance point will be found with the same value of capacity as before, as indicated at d . The resistance is then so large that it limits the maximum value of the current to a greater extent than formerly. It was considered that the inductance of the coil was kept constant while the curves in this figure were obtained.

COUPLED CIRCUITS

INDUCTIVE COUPLING

As has been stated, an electromagnetic field is established around a coil carrying an electric current. This is represented in Fig. 2 (a), where a battery a is connected through a switch b to a coil cd . At the instant of closing the switch there is a flow of electricity through the circuit in the direction indicated by the arrows near the battery. Simultaneously lines of force will start out from the coil, their direction being indicated by the arrowheads placed at various points. If another coil, such as ef , is in the vicinity, it will be cut by the lines of force, and an electromotive force will be induced in it. This electromotive force will cause a flow of electricity in the coil and its external circuit if the terminals of the coil ef are connected by a conductor. While the current in the first, or *primary*, coil is increasing, the current in the second, or *secondary*, coil will be in the direction indicated by the straight arrow near the right side of view (a). As soon as steady conditions obtain in the primary circuit, the lines of force of the flux will remain fixed. There will then be no electromotive force induced in the secondary and no current therein.

When the key is opened as indicated at *b* in view (*b*), the current through the primary coil stops, and the electromagnetic field starts to collapse. Some of the lines of force again cut the secondary coil, but in an opposite direction. The electromotive force and resulting secondary current are the reverse of their former values, the

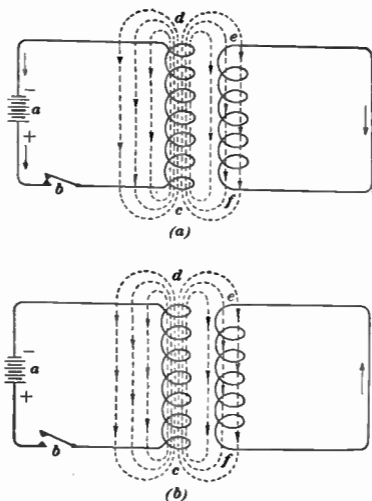

FIG. 2

current being as indicated by the arrow at the right side of view (*b*). As soon as the flux in the primary shall have died to zero there will be no more cutting of the secondary coil, and its current will be zero. The preceding type of coupling is known as *inductive coupling*, since it makes use of the inductance coils.

DIRECT COUPLING

Direct coupling is represented in Fig. 3, with *a* the common coil acting simultaneously as a primary and a secondary winding, or, in effect, as an autotransformer to couple two tuned circuits. It acts as a primary for the circuit through coil *b* and condenser *c* which is excited by an alternating current introduced at *d*. The secondary circuit includes the coil *e* and condenser *f* in addition to the inductance effect of coil *a*.

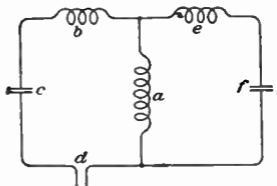

FIG. 3

At any instant there is electricity flowing from both side circuits into one end of the coil *a* and out at the other end. The action is therefore different than if coil *a* were eliminated, as then there would at any instant be a flow of electricity in one direction or the other through the circuit *c-b-e-f*. Coil *a* performs the actual transfer of energy between the primary and secondary circuits, and must be considered when obtaining the natural period of oscillation of both the primary and secondary circuits.

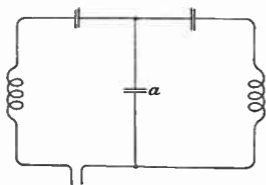

FIG. 4

CONDENSIVE COUPLING

The transfer of energy between tuned circuits may also be accomplished by using a common condenser, as represented in Fig. 4. Here the transfer is by electrostatic means, while in the case indicated by Fig. 3 it is by electromagnetic means. The condenser *a*, Fig. 4, has an effect on the natural period of each of the two oscillating

circuits, and must be considered in calculating their periods. This type of coupling is known by the name of *condensive coupling*.

COUPLING DEVICES

POWER TRANSFORMERS

The principle of coupling is used to a large extent in transformers. In a transformer the primary winding receives a certain amount of energy, and through the action of lines of force this energy is transferred to the secondary coil. In order that most of the flux from the primary shall cut the secondary in order to produce a large transfer of energy, such devices are often made with short coils placed close together, or with relatively long coaxial coils. Such a device cannot be used on a direct-current system, but with an alternating-current supply, the current is continually reversing, and an electromotive force of equal frequency with that of the primary coil will be induced in the secondary coil.

If the number of turns in the primary and secondary are the same, the voltage and current of the two coils will be the same except for the small losses caused by the transfer of energy between circuits. The ratio of transformation follows the law

$$E_2 = \frac{N_2}{N_1} E_1$$

where E_1 and E_2 are the primary and secondary voltages, and N_1 and N_2 are the primary and secondary turns, respectively. The current follows a similar law, but with different ratios, as

$$I_2 = \frac{N_1}{N_2} I_1$$

where I_1 and I_2 are the currents in the primary and secondary windings, respectively. These formulas show that the voltage or current may be changed to nearly any desired values, by changing the ratio of turns.

Since the power in both circuits must be the same, except for the transformation losses,

$$E_1 I_1 = E_2 I_2$$

where the symbols have their former values. This also follows from the theory of the conservation of energy, namely, that energy cannot be created or destroyed. To reduce the losses, iron-core transformers are often used in low-frequency circuits, thus insuring a greater flux linkage.

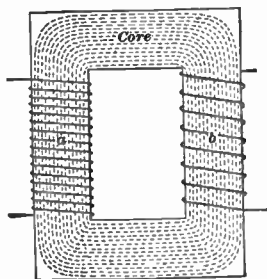

FIG. 5

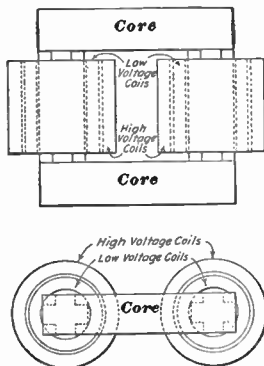

FIG. 6

The essential parts of a transformer are shown in Fig. 5, and consist of two coils *a* and *b* wound on an iron core. When one of the coils, for example *a*, is connected with a source of alternating voltage, this coil becomes the primary and receives energy, at some particular voltage, from the source. By means of the magnetic action of the alternating magnetic flux, indicated by dotted lines in the figure, the voltage of the primary coil is transformed into another voltage, which is made available at the ends of the secondary winding *b*. The windings are insulated from each other, hence the transfer of energy is by the magnetic flux linking the two windings.

The core-type transformer consists of a single magnetic circuit of square, rectangular, or cruciform cross-section, with a rectangular opening, or *window*, to accommodate the windings. The windings, which are usually of cylindrical shape, are placed on the two legs of the mag-

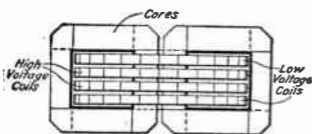
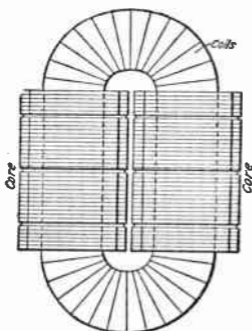

FIG. 7

The windings on the shell-type transformer are usually of so-called *pancake* construction, shown in Fig. 7, the groups of high- and low-voltage coils being so arranged as to give the best operating characteristics.

Autotransformer.—An autotransformer is a transformer having but one winding, which serves both for the primary and secondary coils. Fig 8 shows the general arrangement; *A* represents the laminated iron core on which are wound two coils *t*, *t'* connected in series so that they

netic circuit, entirely surrounding them. Relative positions of the windings and core are shown in Fig. 6. The low-voltage coils, unless large and heavy connections prevent, are usually placed next to the core, and the high-voltage coils are external and concentric with them.

The **shell-type transformer**, Fig. 7, is distinguished by a divided magnetic circuit, all coils being on one leg. The middle leg is usually divided, as shown, virtually making two core-type magnetic circuits in multiple.

practically form one coil. The primary line wires are connected to the terminals a , b , and the secondary line wires to c , a . The ratio of the secondary potential E to the primary potential E_p depends on the ratio of the number of turns t' to the total number of turns between a and b . For example, if t' is one-third the total number of turns, the voltage E_s will be about one-third the line voltage and the current taken from the secondary will be about three times that drawn from the line wires. The secondary terminals may be connected to points anywhere along the coil.

The chief advantage of the autotransformer lies in the saving effected by the combination of the primary and secondary windings. The electrical connection between the high- and low-voltage coils is very undesirable in practice, on account of the liability of getting a high voltage impressed on the low-voltage windings because of faults in the windings or in the external circuits.

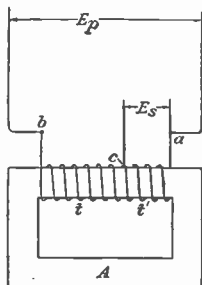

FIG. 8

Cooling.—Heat is developed when there is current in one or both of the windings of the transformer. The losses causing this heating are brought about chiefly by losses due to resistance in the windings and to the rapid reversals of magnetic flux in the iron core. When the transformer is operating under rated load, the losses may be considerable and in large units special means must be provided for preventing overheating of the coil windings. The maximum capacity of a transformer is the maximum load it can carry without developing heat enough to injure the insulating material. This capacity can, therefore, be increased by employing means to cool the transformer. Among the common methods of cooling are *self-cooling*, *air-blast cooling*, and *oil cooling*.

Self-cooled transformers are those of small capacity and dimensions in which the ratio of the exposed surface of the active materials to the volume of the materials is so large that no special means of cooling are considered necessary. The cooling is effected by natural air-currents created by the difference in temperature of the windings and the surrounding air, and by direct radiation. In the air-blast cooled transformer, which is usually of the shell type, the heat is carried away by air-currents forced through

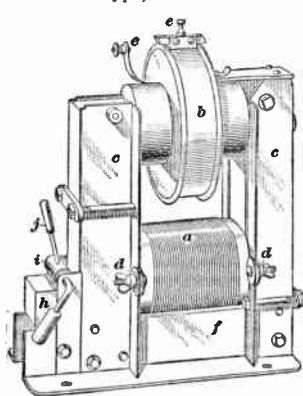

FIG. 9

ducts in the windings and core. Oil-cooled transformers, especially in the larger sizes, are extensively used. The cores and coils of such devices are submerged in oil, which transfers heat from the windings to the outer tank. In addition to carrying away heat, the oil serves as an insulator between the various windings, and between the windings and the core.

RADIO TRANSMITTING TRANSFORMERS

A transformer used in some small-power radio sending installations is shown in Fig. 9. This transformer is designed to receive energy from the usual power-supply line, and to deliver it at a much higher voltage to the oscillating circuit. A simplified diagram of the same transformer is given in Fig. 10, with the same reference letters. The primary winding *a*, secondary coil *b*, and the common magnetic circuit *c* comprise the usual transformer elements. Suitable primary terminals *d* and sec-

ondary terminals *e* afford connections to the power supply circuit and output lines.

In many cases it is desirable to change the power output of the transformer. This is readily accomplished by providing a magnetic shunt as shown at the left side of Fig. 10. The shunt path for the flux is through the iron core *f* and the air gap *g*. This air gap may be completely closed by the tongue or armature *h*, its position being controlled by the small gear-wheel *i* to which the handle *j* is fastened. The gear-wheel *i* meshes with teeth on the tongue *h* and thus, when rotated, moves the tongue into or out of the air gap.

When the tongue fills the air gap, there is a closed magnetic circuit through the iron core *f* in shunt with the one through coil *b*. As there is considerable opposition to the establishing of flux through coil *b* when it is loaded, most of the flux will follow the path through the core *f*. Withdrawing the tongue a short distance places an air gap in the flux path through *f*. The air gap offers greater opposition to the establishment of the flux than does the path formed entirely of

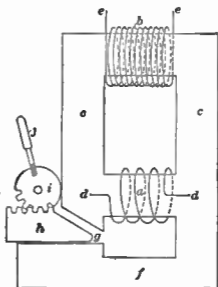

FIG. 10

iron, therefore some of the flux will shift from path *f* to path *c*. Continued withdrawal of the tongue increases the length of the air gap until it reaches such a value that practically all of the flux follows path *c*. The output is then a maximum and nearly all the flux which is produced is utilized in useful output. Other means may be used for changing the length of the air gap, but the principle is the same in any type. In any transformer employing the variable magnetic shunt, the input current will also decrease with decreases of output.

Purpose of Oscillation Transformers.—The high-frequency alternating currents, or oscillations, as they are

sometimes called, are usually produced in circuits especially arranged for this purpose. These oscillating currents are then transferred to the antenna for sending by means of an *oscillation transformer*. Ordinary iron-core transformers do not permit high-frequency currents to pass through them readily, hence the necessity for air-core transformers with proper characteristics. Devices serving the same purpose, and in almost a similar manner, are used in radio receiving work. In this case they are commonly called *receiving transformers*, although other names such as *tuners* and *couplers* are less frequently applied.

Helical-Coil Transformers.—In Fig. 11 is shown a common type of oscillation transformer which is used in many

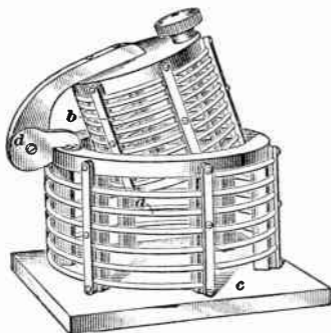

FIG. 11

medium-power stations. The larger helical winding *a* is customarily the primary, or the one which receives the energy from the generating devices, although the coils may be used interchangeably. An alternating current in coil *a* sets up lines of force which interlink the windings of the secondary coil

b and establish high-frequency currents within it. The secondary, which is also a helical winding, is connected in series with the antenna system, hence the energy of the oscillating current is transferred to the radiating system, and sent out into space.

The whole device is mounted on an insulating base *c*. Insulating posts serve to support the windings and to keep

the turns of wire in their proper relative positions. The windings of the transformer shown are made of heavy copper wire. Adjustment is provided by means of a hinge joint *d* which allows the secondary coil to be moved over a considerable range of positions with respect to the primary. When the coil *b* is moved away from coil *a* there will be fewer lines of force cutting it, hence the energy transmitted to the secondary will be smaller.

In order to change the number and the positions of the turns of the primary and secondary coils that are active, clips similar to the one shown in Fig. 12 are attached to the ends of the wires leading to the transformer. These connectors are clipped onto the turns at the proper points to produce the electrical effects desired.



FIG. 12

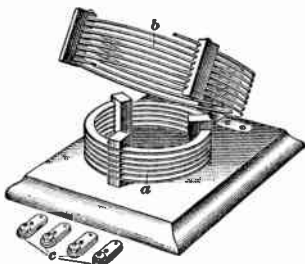

FIG. 13

To reduce the losses due to skin effect, it is desirable to use flat strips of copper or copper ribbon instead of round copper wire. The oscillation transformer shown in Fig. 13 has both its primary winding *a* and secondary winding *b* made of flat copper strips. Unlike the previous type, the secondary winding is larger in diameter than the stationary primary coil. As in the preceding case, the secondary is hinged at one edge. The principle of operation is not changed by this different arrangement of the coils. The small clips shown at *c* enable the circuit wires to be connected to the windings at any desired points.

Flat Spiral-Coil Transformer.—Another type of construction is shown in Fig. 14, in which the two coils *a* and *b* are each wound in the shape of a flat spiral, which gives rise to the name of *flat spiral-coil transformer*. The conductors are flat copper strips, which are set in grooves in radial insulating supports. Mounting blocks

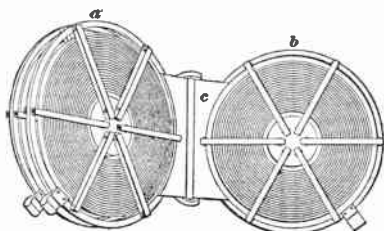

FIG. 14

and a hinge arrangement *c* permit the coils to be placed in different relative positions. When they are near together, practically all the lines of force established by one coil will cut the other and a maximum of energy will be transmitted from one coil to the other.

As the coils are separated, the transferred energy will decrease considerably, and when the coils are at right angles very little energy will be transferred. As the coils are identical, either may be used as the primary and the other as the secondary. Clips are provided for connecting to the conductors at any desired points. Quite accurate adjustments may be made between the two circuits including these coils by changing their relative positions. The flat-spiral coils are also known as *pancake coils*.

Instead of the coils being hinged, these flat coils may be mounted on a common axis along which they may be moved. The coils remain parallel during the complete range of adjustments; the distance between the two coils determines the amount of energy transferred from one to the other. The principle of operation is nearly the

same as in the preceding case, as the greater the distance between the coils the smaller will be the number of lines of force linking the secondary, and the smaller will be the energy transferred.

For the best operating conditions, it is preferable to have the primary and secondary windings made up of separate coils. In some installations a single flat-spiral or helical type of coil serves both as the primary and secondary. Its action may be compared with that of an autotransformer. Clips are attached at the proper points on the coil to give the desired ratios of energy transformation.

Variation of the Coupling.—A method for varying continuously the coupling between two circuits is indicated in Figs. 15 and 16. Fig. 15 shows a simple oscillation transformer of helical coils closely coupled. Nearly all the lines of force of one coil interlink with the windings of the other. When one of the coils is moved to one

side as shown by Fig. 16, many of the lines of force do not interlink and the coupling is considerably reduced. Intermediate settings give uniformly variable change in the linking of the lines of force with the two coils. This method of variation is also applicable to the pancake type of

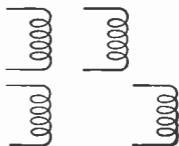

FIG. 15

FIG. 16

coil. The foregoing method of varying the coupling has not come into general use in the United States, although it has been successfully applied in other countries.

RADIO RECEIVING TRANSFORMERS

Receiving Transformers.—The amount of energy transferred and radiated from sending stations is quite large, a fact which necessitates the use of rather large windings in the oscillation transformer. The amount of energy handled by a receiving set is in all cases very small. For the transfer of this energy from the antenna circuit to the actual receiving devices it is common practice to use an oscillation transformer. As the energy is so

minute, the windings are constructed of many turns of very fine wire. In most cases the wires are insulated by cotton or silk covering, although it is possible to wind them in such a way that an insulating air space will be left between adjacent turns.

Simple Receiving Transformers.—A quite simple receiving transformer, or tuning coil, as it is sometimes called, is shown in Fig. 17. The primary coil, shown at *a*, is connected directly in the antenna circuit. The sec-

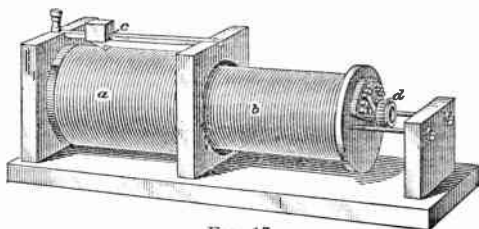

FIG. 17

ondary coil *b* is of a smaller diameter and may be moved into or out of coil *a* by sliding along stationary rods which support it. By this means the amount of coupling may be varied over a considerable range.

A slider *c* may be moved along coil *a*, and it makes contact with the individual turns of the wire. The slider makes electrical contact between the wire which it touches and the terminal on the rod on which the slider operates. Only those turns of the primary coil which are connected between the wire with which the slider makes contact, and the end of the coil which is connected to the antenna circuit, carry the antenna current. The action of switch *d* is explained later.

Switches Used on Receiving Transformers.—The action of the slider on the primary coil is indicated by Fig. 18. The coil *a* is shown diagrammatically, as is also the rod *b* carrying the slider *c*. If the antenna circuit is now con-

nected to terminals *b* and *d*, only the portion *de* of the entire length *df* of coil *a* will carry the antenna current and be effective in establishing lines of force. A larger or smaller number of turns of the primary may be used by moving the slider to the right or left respectively.

A different type of switch arrangement is that used on coil *b* and shown at *d* in Fig. 17. Fig. 19 illustrates the connections for such a switch. The main coil is shown at *a* and the switch proper at *b*. Taps 1, 2, 3, 4, and 5 are connected by suitable leads to such points on the coil that equal numbers of turns are included between adjacent contact points. The wire which carries the secondary current is that included between the point with which the switch point makes contact and the fixed terminal *c* that is connected to the receiving devices. In this case, the portion of coil *cd* between *c* and *e* is the part which actually carries the secondary current. The circuit is completed through the lead to switch point 3, and then through the switch *b* to the other terminal of the receiving devices.

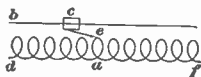

FIG. 18

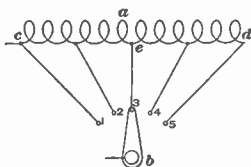

FIG. 19

The number of turns in which current is established may be increased or decreased by moving the switch to the right or left respectively. Every change of position of the switch connects or disconnects several turns of wire, the number depending upon the total number of turns in the coil and the number of contact points.

The arrangement shown in Fig. 20 permits adjustments by individual turns over the complete range of the primary coil. Switch *a* makes contact with points between each of which are connected ten turns of wire. The adjustment of switch *b* is over points which are connected

by leads to adjacent turns on a section of the coil *c*. Fig. 20 does not show ten turns between adjacent points of switch *a*, but assuming this condition, then the setting shown would be such that fifty-five turns would receive

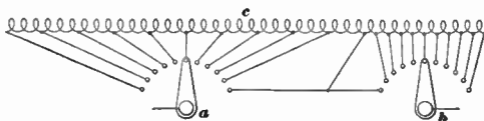

FIG. 20

the antenna current. The current enters at switch *a*, passes through the portion of the coil connected between the switches, and out at switch *b*. For a preliminary rough setting, switch *a* would be placed on a point near the desired value and the final and more careful adjustment would be made by changing switch *b* to the proper contact point.

Other switch arrangements for accomplishing the adjustment by single turns are possible and are in successful use. A careful inspection will usually reveal the method of operation. In some cases numbers are stamped near the switch points which refer to the number of turns of wire connected in the circuit when the switch is on that contact point.

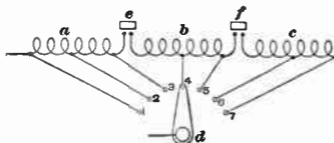

FIG. 21

It is often desirable to use only one set of coils for all radio receiving work. This necessitates the use of rather long coils of wire for the complete range of variations desired.

It has been found in practice that the turns of a coil which are not used take considerable energy from the useful portion and thus prove a detriment to the receiving system. In case only a small portion of the coil is actually used and the coil is very large,

the above consideration is very important. The means often taken to prevent this loss are represented in Fig. 21. The coil is divided up into three sections *a*, *b*, and *c*, and a switch *d* of regular design makes contact with several switch points, which are in turn connected to the coil by short leads. Switches *e* and *f* serve to connect the short coil sections in series when it is desired to use more than one section.

If it is desired to use only a short length of coil, switches *e* and *f* are opened and the blade of switch *d* is placed on the proper point 1, 2, or 3. The coils *b* and *c* being totally disconnected from the circuit, have no effect on coil *a*, hence cannot produce any losses. If a larger coil is desired it is only necessary to close switch *e* and

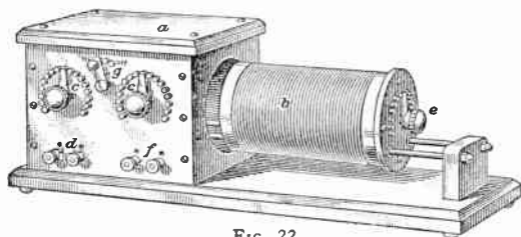

FIG. 22

move the blade of switch *d* over to points 4 or 5. When it is necessary to use all the turns of wire, switches *e* and *f* are closed and the blade of switch *b* is placed on point 7. The losses caused by turns which do not carry any current are often termed *end-turn* losses. A switch such as has just been described for sectionalizing a large coil, is called an *end-turn* switch.

Complete Type of Receiving Transformer.—A receiving oscillation transformer combining several refinements of design is shown in Fig. 22. The box *a* houses the primary coil, thereby affording considerable protection from reckless handling. The secondary coil *b* may

be moved into or out of the primary on the sliders which both support and guide the movable coil. The double-switch arrangement *c* permits adjustments of the number of primary turns by single steps, or turns, by the method which has already been described. These switches are connected to the two terminals at *d*, one of which provides a ground connection, the other one being for the attachment of the antenna lead-in.

Should a high-voltage discharge come in on the aerial wires, it would readily pass across the short air gap between the terminals at *d* and discharge harmlessly to the ground, thus protecting the transformer. A simple switch *e* permits adjustment of the number of secondary turns actually connected in that portion of the circuit. Connection between the secondary coil *b* and the secondary terminals at *f* is made by means of flexible conductors. An end-turn switch *g* divides the primary into two sections, one of which may be disconnected, when it is not required, in order to minimize end-turn losses.

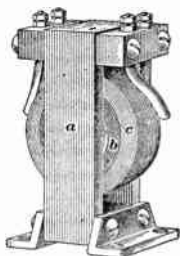

FIG. 23

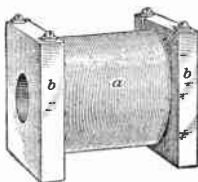

FIG. 24

Special Types of Transformers.—In some radio work it is necessary that energy be transferred between circuits of the receiving set. These circuits sometimes carry audio-frequency and sometimes radio-frequency currents, and, due to the characteristics of the circuits, must have a high impedance. This latter property is secured by making the windings of a very large number of turns

of fine wire closely wound together. Such a transformer for audio- or low-frequency currents is shown in Fig. 23. The shell-type iron core *a* provides a good path for the magnetic flux which interlinks both windings. The primary coil *b* is wound next to the core, and the secondary coil *c* nearly surrounds the primary. For some purposes the ratio of the number of primary turns to secondary turns is one to one, while in others it may be as high as ten to one. Three to one is a very common ratio in radio circuits.

For radio-frequency work it is generally more desirable to use an air-core type of transformer as shown in Fig. 24. The secondary *a* surrounds the primary, which is not visible. End-pieces at *b* afford protection to the winding, as well as form supports for the ends of the windings. Where several such transformers are used, it is well to see that they are not located so that the magnetic flux set up by one affects any of the windings of the others.

It is generally a waste of time and effort to try to make an individual transformer of either of the two types just mentioned. The ones purchased are made of thousands of turns of very fine wire, so fine that it is very desirable to use machine winding. The number of turns to use and the design and material of which the iron core is made, if there is one, are very important points to consider.

If an air-core coil is to be constructed, it is well to make several coils of different numbers of turns of wire and to try them out until the best combination is secured. The wire may be No. 40 B. & S. gauge cotton-covered. It may be wound on spools with a winding space about $\frac{5}{8}$ inch in diameter by $\frac{3}{8}$ inch long. The spool may be turned from hard rubber or bakelite or even fiber. The spools with the wire wound on them are placed end to end in operation, and after satisfactory results are secured the best two spools are mounted in position.

INDUCTION COILS

An *induction coil* is an apparatus depending on the principle of mutual induction for producing a pulsating or an alternating current of electricity. Induction coils consist essentially of two coils, primary and secondary, wound around a core consisting of a bundle of iron wires. In Fig. 25, the secondary coil *S* is composed of a large number of turns of fine insulated wire, while the primary coil *P* contains only a few turns of heavy insulated wire.

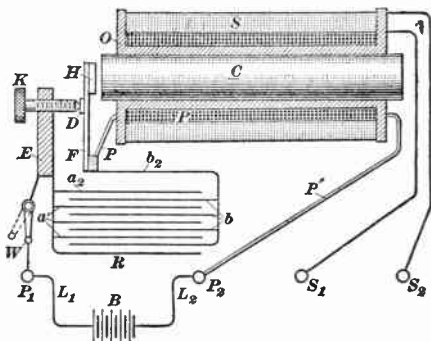

FIG. 25

Both coils are wound on a spool *O* of insulating material fitting over the iron core *C*.

The primary circuit is automatically opened and closed at *D* in the following manner: A spring *F* tends to keep the circuit closed between a platinum contact piece *D* attached to the spring *F* and the contact screw *K*. As soon, however, as the circuit is closed by the action of the spring, the current from the battery *B* begins to circulate through the primary coil *P* around the core *C*, thereby magnetizing the core and causing it to attract the iron armature *H*, thus breaking the primary circuit

between D and the point of the adjustable screw K . On opening the circuit between D and K , the magnetic flux of the core begins to decrease, the spring once more closes the circuit, and the entire operation is again repeated. These actions take place in rapid succession, a large number of times a second, constantly producing a change in the number of lines of force passing through the core and thereby inducing a current in the secondary coil. A switch W connects the post E with the terminal P_1 , and the terminals P_1 and P_2 are joined to the battery B through leads L_1 and L_2 . The terminals S_1 and S_2 of the secondary coil are not, for the present, connected with each other; the secondary coil is therefore open.

A condenser R consisting of two sets of plates a and b is connected across the break in the primary circuit and allows the magnetism of the core to decrease much more rapidly when the circuit is broken than if the condenser were not used. When the primary circuit is opened, its self-inductance tends to keep the current passing across the break in the form of a spark; but when a condenser is used, this current charges the condenser instead of producing a spark across the break. After the current has charged the condenser, the latter immediately discharges through the circuit $a_2-E-W-P_1-B-P_2$ -wire P' -primary coil P -wire P_2 and back to the condenser R . This current, being in the direction opposite to the current due to the battery B , demagnetizes the iron core with great rapidity and thus produces an extremely high electromotive force in the secondary coil. At first, the electromotive force of self-induction establishes the current that charges the condenser. When the condenser discharges, the voltage of discharge is sufficiently high to overcome the opposing electromotive force of the battery and to force a small instantaneous current through the battery and the primary coil against the resistance of these devices.

The spark at D is very much less with this condenser than it would be without it. By trial a condenser of proper capacity may be selected so that it is possible

practically to interrupt the current and reduce the magnetism of the core to zero almost instantaneously. In this way the maximum induction is produced in the secondary coil with a given current in the primary coil.

When electricity starts to flow in the primary circuit, the self-inductance of the coil causes a rather gradual increase in the current strength in the primary circuit, and, consequently, the induced electromotive force in the secondary coil is comparatively small. When the primary circuit is broken, however, the current not only almost instantly decreases from its maximum value to zero, but it is quickly followed by the reverse current from the condenser; consequently, a very intense electromotive force is produced in the secondary winding. Therefore, the tendency is to induce a very much greater current in the secondary winding in one direction than in the other. In most induction coils, a spark gap in the circuit of the secondary winding gives this winding a very high resistance; for this reason, the electromotive force induced in the secondary coil, when the primary circuit is made, may be too weak to produce a spark, that is, a current, across the air gap. Hence, there may be no current in the secondary winding when the current in the primary is made. However, when the primary circuit is broken, the electromotive force induced in the secondary is usually sufficient to force a current across the air gap. As a result, a current may be produced practically in one direction only in the secondary winding. There is, of course, always a tendency to produce a current in both directions and doubtless there is a current in both directions in many cases.

The more turns that the secondary coil contains, the more turns will be exposed to the effects of the inductive influences of the primary coil. The electromotive force developed in the secondary coil would, up to a certain limit, increase in direct proportion to the increased number of turns that are wound in the same space on the bobbin; but as the total power in watts developed in the secondary coil cannot be increased without increasing

the power supplied to the primary, an increase in voltage can be obtained, with constant output, only at the expense of a decrease in current strength. Increasing the sectional area and decreasing the length of the wire in the secondary coil will decrease its voltage and increase its amperage for a given output.

Comparisons Between Various Coils.—When coils are mentioned, it is customary simply to state their sparking distance, say 8, 10, or 12 inches, or whatever the same may be. This gives no idea whatever of the real power of the coil. It is necessary to know not only the pressure indicated by the sparking distance, but also the strength of the current and the number of sparks produced per second. Two coils may be made to give exactly the same length of spark, but the sparks may be of a very different nature. In one case the spark may be thick and intensely white, and in the other thin and bluish. The former coil is the more powerful and the more expensive to build. To produce the larger current through the secondary circuit necessary to establish the thick spark, the parts of the induction coil must be made heavier, thereby increasing the expense for material and possibly raising the cost for labor.

A straight iron core is always used in induction coils, for when the current in the primary is broken, the magnetic flux falls from its maximum value, not to zero, but to a value known as the *residual magnetism*. This value in an open magnetic circuit is much less than in a closed magnetic circuit, so when the primary current is suddenly reduced to zero, the magnetism drops quicker in an open magnetic circuit than in a closed one. As the electromotive force in the secondary is proportional to the rapidity of the reduction in the magnetic flux, it is greater with a straight core than with a complete circuit of iron.

For the iron core, properly annealed No. 24 B. & S. gauge iron wire is the most suitable, though No. 18 and No. 20 give satisfactory results and are used oftener. If one end of the core is used to operate the circuit-

breaking device, it is filed smooth, but the other end may be left rough.

Types of Interrupters.—The *mechanical interrupter* shown in Fig. 25 is fairly satisfactory for low-power coils. It is not readily adjustable to different frequencies, as the vibrating hammer *H* has a natural vibration frequency, and also possesses considerable inertia. If the current through the primary is very large or the primary voltage is high, it is good practice to interrupt the primary circuit at point *D* in oil. This procedure assists the condenser in preventing the formation of an arc when the circuit is periodically opened.

Mercury interrupters are made which depend upon the breaking up of a stream of mercury to interrupt the primary circuit. A motor is frequently used to operate a paddle-wheel arrangement whereby interruptions in the mercury stream are produced. This type of interrupter has given good results in many cases, but has not come into general use.

Electrolytic interrupters depend for their operation upon electrolytic action. The anode, which is in the primary circuit, consists of a short length of fine platinum wire projecting from a porcelain tube into the electrolyte of dilute sulphuric acid. The cathode is usually a lead plate immersed in the electrolyte. When the current reaches a certain value, the resistance at the anode is increased by the formation of gas between the platinum wire and the electrolyte. The circuit is practically opened by the gas formation, which now disappears because of the interruption of the circuit. The circuit is then reestablished and the cycle is repeated. Adjustment of the frequency is accomplished by varying the length of the platinum wire exposed to the electrolyte. Because of the characteristics of the current interruptions, there is no sparking and no condensers are necessary. With the electrolytic interrupter, it is possible to obtain much higher frequencies than with the mechanical type, for the reason that there are no moving parts.

ANTENNA SYSTEMS

PRINCIPLE OF ANTENNA'S EFFECT

An *antenna*, or aerial, consists of one or more wires suitably arranged to radiate or receive energy in the form of electromagnetic waves. Consider a simple type with a conductor reaching for some distance above and below a source of very high-frequency current, such as an alter-

nator. The two wires *ab* and *cd*, Fig. 1, in conjunction with the air which forms the dielectric, act as a condenser, and can store up considerable energy. This energy forms in loops extending out from the wires as indicated by the dash lines, called electric lines of force. The alternator is represented at *e* by a conventional symbol. Simultaneous with the electric lines there is a combination of magnetic lines, indicated by dotted lines, established at right angles to the axis of the conductors. These lines merely represent the approximate path of some of the lines of force, and it should be remembered that there are actually more lines present than are indicated, and that they are distributed on all sides of the conductors.

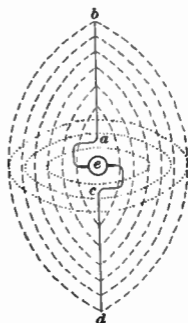

FIG. 1

These lines are established with each building up of the current in the antenna, and usually extend for some distance from the actual wire network. When the current dies down these fields start to collapse, and would do so in a very short time. If, however, the current be reversed rapidly enough it may start to establish a new set of electric and magnetic fields around the antenna

system, but in a direction opposite to the former condition, as the current is now reversed. This new system will repel the lines of force of the old fields with the result that they will be sent outwards from the antenna, causing a wave disturbance in the *ether* quite like that caused by the dropping of a stone in a pool of water. Approximately the reverse action takes place in a receiving antenna which intercepts the advancing waves and conducts the energy to some sort of receiving device.

TYPES OF ANTENNAS

VERTICAL-WIRE ANTENNA

Because of constructional advantages it is usually handier to place the alternator, or other means for obtaining a high frequency in the antenna, near the ground. If the lower wire of the type that has been illustrated were omitted, the capacity effect would be reduced, and very little radiation would be secured. By connecting the lower terminal of the alternator to a good ground connection, there will be a good capacity effect between the upper wire and the earth. This will work very well as a transmitting antenna and this method forms the basis of most of the present-day types. The elevated wire, which is usually supported by a tower, is, strictly speaking, the antenna. Where a wire network is used for the other plate of the condenser, instead of a ground, it is often called a *counterpoise*.

The vertical-wire aerial has the advantage over some other types in that it will send electrical waves in every direction with equal strength. It is also able to receive disturbances from any direction with equal facility, which is in some cases a very desirable feature. This type of antenna is not commonly used because of the fact that a very high vertical supporting structure is necessary. It has been found that other less expensive types will give very satisfactory results, and in some cases even more desirable operating conditions.

INVERTED-L-TYPE ANTENNA

The inverted-L-type antenna is one in which the upper part of the conductor is placed in an approximately horizontal position, and the general appearance is that of an inverted L as shown in Fig. 2. The instruments for sending or receiving would be connected at *a*. This is a somewhat cheaper type to install than the vertical-wire type. For much receiving work it seems to be desirable to make the antenna at least 40 to 60 feet high and as long as possible up to 250 or 300 feet.

Good signals can usually be obtained with antennas of smaller dimensions. In receiving work this type is not very directional, although it will receive signals from the end opposite the free end, that is, from the left in the

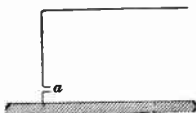

FIG. 2

illustration, somewhat better than from the opposite direction. Sending antennas in which the flat part is several times the height, seem to have pronounced directional features in a direction opposite the free end. Where the flat top is of about the same dimension as the height the directional effect is not large.

If it is impossible to make the antenna as long as desired, the capacity effect and receiving ability may be increased by using two or more wires in parallel. They should be spaced from 2 to 4 or even 6 feet apart, and it is seldom economical to use more than four. This expedient is more often followed in sending antennas than in those used only for the reception of signals, as the former require much more careful design and construction.

T-TYPE ANTENNA

The T-type antenna is quite commonly used on ship-board because of constructional features. The ends of the flat top are supported by masts, and a *lead-in*, the name applied to the wire from the elevated network to the receiving set, is brought from the middle of the

antenna. Such an antenna is indicated in Fig. 3 with provision for connecting in a sending or receiving set at *a*. This antenna is somewhat directional in a vertical plane through the horizontal wire, or to the right and left in the illustration.

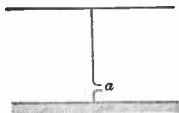

FIG. 3

MULTIPLE-SECTION ANTENNA

A type of antenna that has been and is now used in some long-distance transmitting stations has several *multiple sections* which are carefully tuned. The main features are indicated in Fig. 4, with the high-frequency alternator at *a*. The rather long flat top is connected to ground at several points through large inductance coils *b*, *c*, *d*, *e*, and *f*. The action simulates several vertical antennas, which, being in parallel or multiple, have a lower ground resistance. By properly adjusting the coils in the various branches, maximum radiation may be obtained. By unbalancing the adjustments, fairly

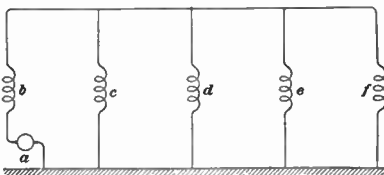

FIG. 4

good directional properties may be obtained, but apparently with higher loss, or, rather, less effective output.

UMBRELLA-TYPE ANTENNA

The umbrella type of antenna, shown in Fig. 5, has several radiating wires resembling in arrangement the ribs of an umbrella. A lead-in wire *a* connects at the

top with the antenna wires, and with the set at *b*. The black dots on the wires are used to represent insulators placed at the ends of the conducting wires. From the lower ends of the antennas guy ropes are stretched to stakes in the ground. These serve both to keep the antenna fixed and to support the mast in a vertical position. This type of antenna is not directional, and generally has six or eight wires in the elevated network. The antenna wires should not make an angle of less than 50 to 60 degrees with the mast or the radiation will

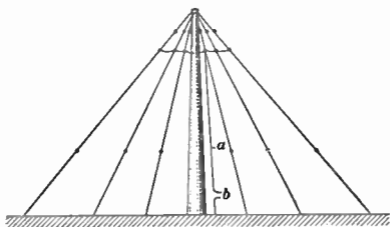

FIG. 5

be decreased. Also, the antenna wires should not come too near the ground, say about half-way, for best operation, especially in transmission. If the conductors come too near the ground, much of the radiated energy is fed into the ground instead of into the ether.

FAN-TYPE ANTENNA

The fan-type antenna is a modification of the single vertical wire and of the umbrella types. It usually consists of several wires spreading from a point near the ground into a large vertical fan shape. A common support across the top holds all of the conductors in position. The wires are all in one plane, but it is not very directional. This is a very good type of antenna, particularly for transmitting purposes. The cost of the

relatively high supporting towers seems to be an obstacle in its use.

COIL ANTENNA

The coil, or loop, type of antenna is formed of several closed turns of wire with the radio equipment connected directly in the circuit, as at *a* in Fig. 6. It is made of one or more turns of wire, from four to ten turns being the more common. Where several turns are used, it is desirable that they should not be placed too close together, else there will be an objectionably high capacity effect between turns. The coil antenna is very directional in the plane of the loop, which feature is one of its chief advantages. Unless made in awkwardly large sizes it is not very good as a transmitter, hence is little used in transmitting stations.

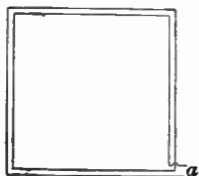

FIG. 6

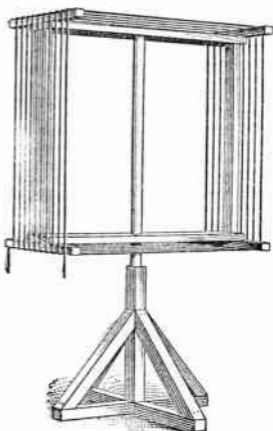

FIG. 7

The loop antenna, because of its comparatively small size, is often mounted on a framework which may be rotated in a vertical plane. Such an arrangement is shown in Fig. 7, the loop proper being mounted on a pedestal. If one edge of the loop is pointed toward the

sending station, the antenna will pick up signals from that station with maximum intensity. If the loop be rotated away from the maximum position, the signals from that station will gradually grow weaker, until when the plane of the loop is at right angles with the intercepted signals, no sound will be obtained. This is because the advancing wave front cuts both sides of the loop simultaneously and the induced electromotive forces neutralize each other. While the loop is lined up to receive signals from one station the interference caused by other stations off to either side is not very great since the loop receives poorly from the sides. Of course, if a powerful set were nearby it might produce considerable interference from any position of the loop, but the interference with a loop antenna would very probably be less than with any other type of aerial. The interference from static, which apparently comes from various directions is usually reduced, due in part undoubtedly to the directional properties of the coil.

The amount of energy received by a coil antenna is often very small, but, because of its greater freedom from interference, its energy may usually be amplified or strengthened enough to give louder and clearer signals than can be received by any other type of antenna.

ANTENNA MODIFICATIONS

A modification of the vertical-wire antenna is the so-called tree type, where a conductor or lead-in is connected with the upper part of a tree. The tree juices seem to act as a fair conducting system and the top of the tree then forms a condenser plate. While this method of reception is undoubtedly novel, little else can be said for it. The tree actually plays a part, as experiments have shown that signals of equal strength were not received when the wire was disconnected from the tree trunk.

A single-wire type, using a conducting wire on each side of the receiving or sending set, can be used in various positions. The wires may be stretched out along

the fore and aft decks of a submarine with lead-ins taken in through the conning tower. Also a cut may be made in an insulated wire fence and a receiving set inserted to complete the circuit. One of the sides will act as the antenna, and the other as a counterpoise, but this should not be expected to give the most satisfactory signals.

A similar principle has been applied with lengths of insulated wire laid on top of or buried a few inches in the earth. Reception is often possible a short distance below the surface of the earth, as the radio disturbances pass through the ether and also through the earth adjacent to the surface. It is claimed that signals received over a buried antenna are particularly free from static disturbances, but the signals themselves are also quite weak. Some experiments on submarines have given good results, as they have been able to receive long-distance messages even when submerged to a distance of 10 to 20 feet.

A cage type of antenna has about eight wires arranged around the circumference of a circle of approximately 8 to 10 inches in diameter. This produces a fairly large capacity effect, and also a relatively low radiation resistance, a term which will be discussed later. The several wires are rigidly supported in place by ring insulators, and the whole forms very much the appearance of a long cylindrical cage. It is supported at the ends, and is often used with the main part nearly vertical. The lead-in is taken off at one end. The constants of this antenna are not as variable as are those of some other types. Antennas of this type are largely used where space is limited, as on shipboard.

The electric-light wires entering a house are sometimes used to bring in the radio impulses to a receiving set. As these wires are usually elevated for some distance outside the house, they should form good antennas. In many lighting systems one wire is grounded at the power house or along the line. This wire, in general, will not work so well as will the other one. This can best be determined by test. The electric-light supply

wire must never be connected directly to the receiving set, but should be connected through a good condenser, of small capacity. The condenser forms a barrier to the low-frequency, power-supply current, but offers little opposition to the radio-frequency currents. This type of antenna has too large losses, when used to radiate energy, to permit of its use in an ordinary sending set. The ground connection from the set may be made in the usual manner.

When a receiving set is within a very few miles of a powerful sending or broadcasting station nearly any large conducting surface may be used for an antenna. Bed springs, fire escapes, metallic clothes lines, or lengths of wire lying on the ground have brought in admirably clear messages. Even the capacity effect obtained by a person grasping a short wire from the antenna terminal of the set between the fingers will serve as an antenna to pick up perfectly clear signals from a short distance. For long-distance work, however, the best antenna is none too good, and an outdoor aerial is practically a necessity.

AIRPLANE ANTENNAS

Several types of antennas have been used on airplanes. A trailing wire with a weight at the end to keep it taut has been much employed. The framework is carefully bonded, or electrically connected, together to form a counterpoise. The antenna hangs below the body of the airship in a curved trailing position, and is a very efficient transmitting and receiving aerial. The antenna is somewhat directional in the direction of flight. The main objection to this type of antenna, and a serious one, is that the long length of wire, 200 to 300 feet, is in the way in landing and in rapid maneuvering. Coils of various types and mounted in all available positions give good results, but are handicapped by the limitation of size and range. They can be used with the machine on the ground, which is an advantage in some cases where a forced landing has been made in an inaccessible place.

PROPERTIES OF ANTENNAS

RESISTANCE EFFECTS

The main dissipation of energy, and the one which is desired, is radiation to the surrounding ether. The radiation of energy is always measured, or indicated, by the current in the antenna, as there are no suitable devices or means for measuring the power output. The power output or radiation is often considered as a resistance loss, or the power is considered as being used up in *radiation resistance*. This is a fictitious term and is often taken as the resistance that would use up an equal amount of energy. Although it is often spoken of as a loss, in the strict sense it is not a loss, as it represents the real useful output of the antenna. The amount of power radiated depends upon the shape of the antenna system, and is proportional to the square of the maximum current in the antenna, and inversely proportional to the square of the wave-length of the oscillating current.

There is some dissipation of power due to the actual resistance of the antenna wires, lead-in, ground connection, etc. This resistance loss is rather hard to determine accurately, as the current in various parts of the circuit is not known. The skin effect of all the conductors carrying current enters in, but this is usually a small part of the loss. As has been mentioned, the antenna acts very much like a condenser. If there is a poor dielectric in the space between the antenna and ground, such as trees, buildings, or high vegetation, there is an appreciable loss in this manner. Even the antenna supports may take considerable energy from the system. This last loss will be particularly bad in a transmitting antenna, although it will affect the receiving ability of an antenna to a degree which cannot be disregarded.

Since the antenna produces a magnetic field and an electrostatic field it must have the means for establishing them. This means that the antenna possesses inductance and condenser effects in addition to the resistance effects.

This implies that the antenna as a unit may form a local oscillating circuit whose frequency or wave-length will depend upon the relative values of these properties. This is exactly what does happen, and is usually very important. As has been mentioned, the transfer of energy by coupling is a maximum when the circuits are tuned to the same frequency. This applies to antennas even though they are separated by thousands of miles. An induction coil is usually connected in series with the antenna, and energy is taken from the antenna by coupling the receiving set to the induction coil. If the number of turns in use in the coil is made variable by means of a slider, the total inductance in the antenna can be changed to the proper value to put the antenna in resonance with the desired sending antenna for the reception of signals with maximum strength.

NATURAL WAVE-LENGTH

Calculation of Frequency.—The frequency, or natural period of a circuit, when the inductance and capacity are concentrated, is given by the formula

$$f = \frac{1}{2\pi\sqrt{LC}}$$

In an antenna these properties are not concentrated, and the inductance is particularly distributed. A close approximation is obtained by using $\frac{1}{3}$ of the total antenna inductance as the equivalent concentrated inductance. This gives

$$f = \frac{1}{2\pi\sqrt{\left(L + \frac{L_a}{3}\right)C_a}}$$

where L is the inductance of the tuning or other coil in the antenna possessing concentrated inductance, L_a is the total inductance of the antenna only, and C_a is the capacity of the antenna.

Calculation of Wave-Length.—From the formula for frequency, an approximation of the natural wave-length of the antenna may be obtained. Represent the wave-length in meters (1 meter = 3.3 feet) by λ , then

$$\lambda = 1,884 \sqrt{\left(L + \frac{L_a}{3}\right) C_a}$$

when the inductances are in microhenrys, and the capacity is in microfarads. The inductance and capacity of an antenna may be measured by methods described elsewhere in this volume.

The length of the radiated wave depends upon many features of design, construction, and location of the antenna. Among the specific factors controlling or affecting the wave-length may be mentioned: vertical and horizontal dimensions of antenna, type of construction, length and ohmic resistance of lead-in wire, length and ohmic resistance of ground wire, effectiveness of ground connection, number of wires in the aerial and their spacing, the proximity of absorbing mediums, and the effectiveness of the insulation of the conductors from their supports. Comparatively simple devices for measuring the wave-length are on the market, and represent the only reliable means for determining the wave-length of a particular radiated wave. By their use the so-called natural wave-length of an antenna may be determined. These devices will be described under another heading.

As an antenna will radiate a larger amount of the energy supplied to it when its natural wave-length is near that of the transmitted wave, it becomes desirable that the wave-length be known. This is rather hard to predetermine accurately when building a particular station. Methods will be explained later by which small changes in the natural wave-length may be accomplished.

The wave-length is not such an important factor in the design of an antenna used only for receiving radio messages. In case the antenna is used for both sending and receiving, it is designed primarily for the sending

qualities, as these are usually the more important. It will then usually be suitable for receiving purposes especially for working with other stations operating on nearly the same wave-length. Signals may be received on very small antenna systems, but they are apt to be quite feeble. In general, a large aerial will bring in much stronger signals than a small one, and apparently with no loss in accuracy or readableness.

The natural wave-length of a vertical or flat-top antenna may be calculated, but with only rough approximation to accuracy, as follows:

Add the average height of the antenna to the horizontal length, both measured in feet. Multiply the sum by 4.2, and to get the natural wave-length, expressed in meters, divide the product by 3.3. In the case of the vertical-wire type of antenna, use the total height. This is the same as saying that the natural wave-length is slightly greater than the combined height and horizontal length of the antenna measured in meters.

The natural wave-length of a vertical-wire aerial is slightly less than the value obtained by the foregoing rule, while the calculated value for the umbrella-type aerial and others having large tops is apt to be rather low.

In the L and T types of antennas of moderate sizes, the number of wires in the flat-top part is not very important unless they are widely spaced, say about 10 feet. When such large spacing is used, the natural wave-length is increased by the addition of wires to the flat-top part. Trees and buildings in the vicinity, and especially below the antenna, tend to increase the wave-length to some extent. Results obtained by the above rules are not apt to be so accurate as those obtained by the use of a good wavemeter.

An antenna for transmitting purposes usually must operate over a short range of wave-lengths, and is carefully designed to have the proper values of inductance and capacity such that its natural period is near the specified range. Auxiliary devices tend to decrease

the useful output of the antenna, so are used as little as possible in sending stations. Conditions do arise, however, when it is necessary to change the wave-length, and special means must be employed. Due to the high voltages encountered, the apparatus may be rather expensive, especially if of special design. The following methods of changing the wave-length of an antenna apply in general to both sending and receiving systems, but there are natural limits to the range over which the natural wave-length may be changed.

CHANGING THE WAVE-LENGTH

A condenser in series with the antenna will reduce the natural wave-length of the antenna. A condenser when so used is ordinarily connected between the set and ground, although its effect will be the same if it is connected in the lead-in wire near the set. Such a series condenser is shown at *a* in Fig. 8. Tuning over a limited range of wave-lengths may be obtained by using a variable antenna condenser, and, in general, the smaller the capacity, the shorter the wave-length.

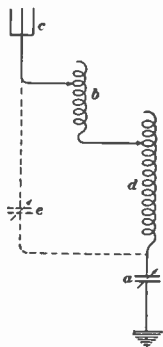

FIG. 8

The period of an antenna may be increased by inserting an inductance coil *b* in series with the antenna *c* and the regular tuning coil *d*. As this tends to produce losses or an extra load in the antenna, such a coil is often called a *loading coil*. If coil *d* had a sufficient number of turns they could be used to increase the inductance and consequently the wave-length of the antenna circuit. Extra turns on a coil, however, produce losses of various kinds which are termed *end-turn losses*. For this reason, coils should be used that do not have a

large number of unused turns of wire. Coil *b* is indicated as being a variable inductance, but this is not absolutely necessary, as fine adjustments of wave-lengths may be made by the slider on coil *d*.

Condenser *a* could be removed from the circuit or its effect eliminated by a short-circuiting switch while using the antenna on long wave-lengths. The wave-length may also be increased by using a shunt condenser, indicated by the dotted lines near *c*. As this permits some of the energy to go around coil *d* without doing any useful work, it is an objectionable method.

RANGE OF AN ANTENNA

It is very difficult to specify the range of an antenna, or of a sending or receiving set for that matter. There are many factors to be taken into consideration beside merely the physical dimensions of the elevated wire network. Antennas of the same design and dimensions often do not work equally well, and any one antenna is often subject to considerable variation. However, there are many cases of apparent signal variation which cannot by any means be attributed to the antenna, but rather to some force in nature. Too much emphasis cannot be placed upon the necessity for a good ground connection. Perhaps the ground lead and ground connection account for as much trouble in radio stations as any other factor. Even if it does not prevent operation, it may cause relatively large losses. As good results should not be expected on a small indoor antenna as on an outdoor one of proper design but it does not follow that an excessively large antenna will operate satisfactorily on short-wave work, for such is not the case.

AUXILIARY DEVICES

The antenna is supported by towers or masts of suitable strength to support the maximum load to which they may be subjected. In localities subject to sleet storms this load may be quite large. Wood is often used

for masts of the smaller sizes, but iron- and steel-tower construction is preferable and more economical in the large stations. When metal towers are used they should be insulated from ground at their bases. In any case suitable guying should be provided to enable the mast to withstand high winds and other atmospheric disturbances. Insulators should be placed at intervals in the guy wires to prevent the loss of energy through leakage.

It is very important that an antenna should be rigidly supported so that it may not come in accidental contact with power or light wires carrying current at a dangerously high voltage. Considerable interference is liable to result also, if the antenna runs close to such lines for an appreciable part of its length.

The wires are kept a suitable distance apart by a rigid mounting on supports called *spreaders*, which are commonly made of wood. Insulators are often placed between the ends of the wires and the spreaders supporting them. The spreaders, in turn, are supported on masts which elevate them to the proper height. Connection between the spreader and the mast should be



FIG. 9

made by means of good insulators; the type shown in Fig. 9 is very good for that purpose. As their prime purpose is to prevent leakage of antenna current to the ground, they must be of ample dimensions to meet the given operating conditions.

In antennas used only for receiving it is quite satisfactory to use shorter insulators, for example, those about 3 inches long. They should in any case, be of a material that does not absorb moisture, which would ruin their insulating properties. These insulators should be placed about 5 to 10 feet from the rigid end supports.

The conductor system from the elevated antenna system to the receiving set is frequently designated as the lead-in. In the vertical-wire type of antenna there

is no special lead-in, although the end of the antenna lead near the receiver set may be called the lead-in. The lead-in may be made by bunching the antenna conductors, if there is more than one, and bringing them all direct to the set, or a single conductor of large cross-section may be used. It preferably should not be placed on a wall, but should take a free air route from the antenna to the set, and need not be of insulated wire.



FIG. 10

The lead-in should connect to the blade of a single-pole, double-throw knife switch of a design similar to that shown in Fig. 10. If local fire underwriters' regulations require it, this switch should be mounted 5 inches from the wall by pedestal supports. The base must not be of slate, as this material absorbs considerable water. Asbestos board is frequently used in this connection. This type of switch is not generally used in large stations, as those better suited to their purpose, and of special design, are usually employed.

When the set is not in use, the ground switch should be thrown so as to connect the antenna to the ground lead. This should be of heavy copper, well insulated, and if regulations require it, must be outside of the building, and possibly 5 inches from the wall. Less than No. 14 B. & S. gauge copper wire, or less than No. 17 B. & S. gauge copper-covered steel wire, should not be used. It should run in a direct path to the ground, with as few sharp bends as possible.

The ground, or earth, connection is important. A large sheet of copper, zinc, or copper mesh buried some feet below the surface of the earth is usually sufficient. Many metal rods driven into the ground, or a network of buried wires also form good ground systems. The buried con-

ductors should be deep enough so that they are in damp earth at all times. In some cases it has been found desirable to bury a considerable quantity of charcoal with the ground conductors to help the retention of moisture near them. Where the soil is dry or sandy, it is often preferable to construct the ground system a few inches above the earth, and insulated therefrom, to form a counterpoise.

In cities it is quite common practice to run the ground wire to a metal pipe of the water system. If this is done care should be taken to see that a very good contact is made between the wire and the pipe. It is also best to connect onto the street side of water meters, if there is one in the line, as they sometimes have an insulating joint. Couplings in the pipe are not any too good electrically as a general rule. If clamps on the pipe are used they should be carefully installed in order to make good electrical contact. A coat of rust is apt to form under them, which may act as a partial insulator. All connections should be well soldered whenever possible.

In some cases it is permissible to use a lightning arrester, instead of a ground switch with a receiving set. Such an arrester is shown in Fig. 11. It has terminals at the end, one of which goes to the antenna and the other to the ground. Inside of the main body are two small metal disks separated about $\frac{3}{4}$ of an inch. The gap is in a vacuum. This allows any large charge on the antenna to discharge across the gap and pass harmlessly to ground.

Mounting the gaps in a partial vacuum is desirable as the device will operate on a lower voltage, and the disks are not so apt to be injured by a discharge. A protective covering protects the unit from moisture when it is

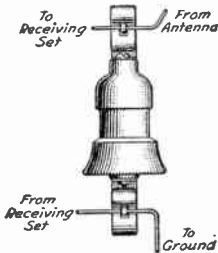

FIG. 11

mounted outdoors, as is sometimes recommended. In other styles the gap is in special rarefied gases, while sometimes only a plain spark gap is used.

Fig. 12 shows a single-wire antenna with its auxiliary equipment. The ground switch is thrown upwards in position for signals to be carried from the antenna

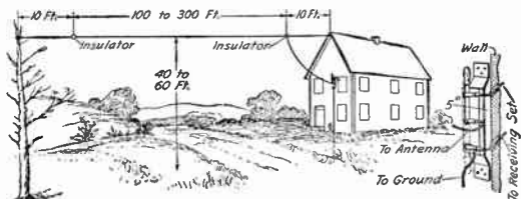

FIG. 12

through the receiving set and thence to ground. The lead-in from the switch to the set must be insulated from the wall by a bushing. A long tube of electrose, or other composition material may be used, with the lead-in wire inside the tube. Porcelain tubes are not recommended as they take up moisture.

DIRECTION FINDING BY A COIL ANTENNA

A coil antenna will receive signals with much greater strength when they come from stations in the plane of the coil than from any other direction. So reliable is this directional property of a coil antenna on the reception of short wave-lengths and for relatively short distances, that this type of antenna is successfully used in the guiding of ships and airplanes, especially during times of low visibility. This use has given rise to the name of *radio compass*, a term which is highly descriptive. Steering may be accomplished by keeping a bearing with

the coil antenna of the vessel on a fixed station which is transmitting continuously. Two or more radio compass stations may be used to obtain the location of a sending station with a very close degree of accuracy. The United States Government has established several such stations along the coast particularly for the use of ships during weather of low visibility.

A ship located at *a*, Fig. 13, requests its bearings from the compass stations *b* and *c*, and starts sending signals. The operator at station *b* turns his coil antenna until he obtains the direction of the line *ad*, and sends the reading to the ship's operator, usually



FIG. 13

so many degrees from the geographic north in a clockwise direction. As this station is located on a peninsula, the operator at *b* is unable to tell in which direction the ship lies; that is, whether the ship is in direction *a* or *d* from him. The operator of the ship, knowing the position of station *b*, would locate the line *ad* on a map, or, if he knew his position with respect to *b*, he would need to draw in the lower part of the line only. As a ship station could not lie on the land side of the station *c*, the exact direction of the ship from this station may be obtained by the operator at *c*. With the data sent by the operators at *b* and *c*, the navigation officer on the ship at *a* is able to determine his exact location from the intersection of the lines *ad* and *ac*.

This is a very accurate method for ships to get bearings, and their regular radio apparatus is all that is necessary. It is rather expensive, and the number of bearings which can be given per hour is decidedly limited, especially around busy ports. As the readings must be handled several times there is also considerable chance for error.

The recent tendency is to place the compass station

on board the vessel, and to use simple transmitting stations at strategic points on shore or on lightships. These stations transmit signals which are easily distinguishable by one not familiar with the telegraph code. The navigating officer may take bearings himself, and as often as he deems necessary. He may even use one station near his port as a bearing station, and from some distance at sea, lay his course directly for it. In case of disaster to another ship, he could get the location of that vessel, or rather its direction, and could proceed toward it immediately. Actual location readings by this method do not seem to be so accurate as when determined by land stations, but the accuracy is well within the limits by which a ship can hold its course. The land station, where it only transmits, need not have a skilled operator. Locations at sea may be obtained over a greater distance when the compass is on shipboard than when on land.

As the signal strength is a maximum when the plane of the coil cuts the sending station, so is it a minimum when the plane of the loop is at right angles to the direction of the sending station. In many installations, the minimum setting is taken instead of the maximum, as the ear can better differentiate small changes in the strength of signal when that signal is very weak than when the signal is very loud. Long wave-length signals are not nearly so accurate in this work as are short wave-length signals, so the latter are always used. Also, continuous wave signals tend to set up interference bands which often make readings inaccurate. Spark signals are thoroughly reliable and are always used.

ELECTRIC BATTERIES

PRIMARY CELLS

GENERAL THEORY

A *primary, voltaic, or galvanic, cell*, as it is variously called, is an apparatus for converting chemical energy directly into electrical energy. The cell consists of two conducting elements immersed in a solution that acts chemically on one element only or on one more than on the other. If the two elements or *poles* of the cell are joined by a continuous metallic wire or circuit, electricity will flow in one direction through the metallic circuit as long as the circuit remains complete, or closed, provided the chemical action is sufficient to maintain the electromotive force. Two or more cells used in a group form a *battery*, although the term battery is often applied to single cells.

While a knowledge of the chemical actions that occur in cells is interesting and necessary for a thorough understanding of the theory of cells, it involves a knowledge of chemistry that is not really necessary for those having only to consider the proper application of the various kinds of cells and their care.

In general, it may be considered that the electrolyte is divided into very small electric charges, which combine to produce the electric current observed in the circuit connecting the poles. The cell is said to be *charged* when it is in condition to deliver its full rated amount of electrical energy. Primary cells are fully charged just as manufactured. The electrolyte deteriorates, or loses its strength, as energy is given up, and the cell is said to be *discharged* when it can furnish no more electrical energy.

Some forms of primary cells may, when exhausted, be more or less *recharged* by passing through them, in the direction opposite to the current they produce, a current from some external source. As the amount of energy

which the primary cell will give up after recharge is very small compared with the amount required to recharge the cell, this is not considered good practice.

A simple primary cell is shown in Fig. 1, with the two plates or elements partly immersed in the electrolyte. Zinc is the metal most commonly used for the element of the primary cell to be consumed, and either copper or carbon for the element that is not attacked. The electrode from which electricity enters the electrolyte is the *anode*, and the electrode toward which electricity flows in the electrolyte is the *cathode*; thus, the electrode with the negative terminal is the anode, and the electrode with the positive terminal, the cathode. The current passes into the cell through the anode and passes out to the external circuit through the cathode.

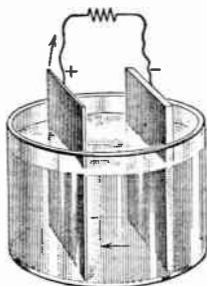

FIG. 1

Many different electrolytes are used in primary cells, the materials used depending largely upon the service for which the cell is intended. The simplest electrolyte is salt water, or water with a little acid added, although this can hardly be said to be commercially practicable. The zinc electrode is eaten away by the electrolyte, which also changes its nature in the process. Cells with liquid electrolytes were, and still are to some extent, used in telegraph offices. The care required to keep them clean and their bulk have caused their discontinuance in many lines of work. They are known as *wet cells*.

Polarization and Depolarization.—During decomposition of the electrolyte, free hydrogen is liberated near the cathode, and, if not removed, collects on the cathode in bubbles of gas. The formation of hydrogen is disadvantageous, as it forms in a layer on the surface of the cathode, enormously increasing the internal resistance of

the cell, and diminishing the current that the electromotive force of the cell can send through any given external resistance. The formation of hydrogen on the surface of the cathode is known as *polarization*, and its removal, by any means, mechanical or chemical, is called *depolarization*; the agent used is called the *depolarizer*.

Depolarizing Agents.—Various mechanical and physical devices for depolarizing cells have been used. The cathode has been arranged to be agitated in the liquid, or to be entirely removed from the liquid at intervals. The cathodes, and, in some instances, both electrodes have been made in the form of disks, dipped to about half their diameter into the electrolyte; on rotating the disks, the hydrogen is prevented from remaining on the cathode by its motion. Such devices are commercially of little value, especially as chemical depolarizers may be more easily used.

The depolarization by chemical means may be accomplished by surrounding the cathode with a solid or liquid substance, with which free hydrogen may combine. This combination usually merely disposes of the hydrogen and prevents the bad effects of a deposit on the cathode. Under these circumstances the compound formed at the cathode is usually water, the depolarizer being a substance rich in oxygen, with which the hydrogen combines.

DRY CELLS

The name *dry cells* is applied to cells in which the electrolyte is carried in the pores of some absorbent material, or combined with some gelatinous substance, so that the cell may be placed in any position without spilling the liquid. These cells are usually made with zinc and carbon elements. The zinc usually forms the outside of the cell, being made into a cylindrical can; in the center of this is the carbon, surrounded by its depolarizing compound. The space between the elements is filled with some absorbent material, such as mineral wool, asbestos, sawdust, blotting paper, etc., and the

whole, including the depolarizer, is then soaked in the electrolyte; or, the electrolyte is mixed with a hot solution of some gelatinous body, such as Irish moss, which mixture is poured into the cell; on cooling, it forms a soft jelly. The first-mentioned method of preparation is most used. It is quite necessary for dry cells to have a depolarizer, as otherwise they would have to be made open to allow the hydrogen gas to pass off. This would also allow the small content of water to evaporate. To prevent this latter action, these cells are sealed with a resinous compound. To insulate the cell, the zinc is covered with paste-board.

Fig. 2 shows the cross-section of a dry cell such as has just been described. The zinc container *a* forms the anode, or negative terminal, of the cell, with a connector at *j*. The cathode, or positive terminal, is a carbon rod *b*, placed in the center of the can with a connector at *i*. The electrolyte in this case is a solution of sal ammoniac, part of which is absorbed by a pulp-board lining *c*, and the mixture *d* is of powdered carbon and manganese dioxide. The latter is the depolarizing agent. The cell is closed by a water-tight seal *e* that is separated from the lining *c* by a layer of corrugated paper *f*, which is prevented from adhering to the seal by a layer of fine sand *g*. A layer of sawdust *h* separates the corrugated paper from the lining *c*. The purpose of the corrugated paper is to serve as a cushion between the seal and the mixture, thus allowing for any expansion or contraction in the cell.

There are many modifications in the general arrangement and kinds of materials which are used, but the fundamental principles remain the same. Dry cells are manufactured in very compact units for pocket flash-

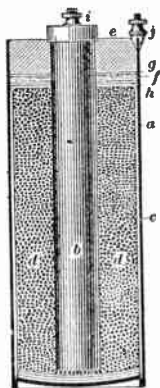

FIG. 2

lights and for certain wireless applications where a relatively high voltage is required with only a very small current output.

GENERAL USES

Some types of wet cells are more economical than dry cells, and provide a limited amount of electrical energy at a very reasonable cost. Dry cells are very convenient, readily portable, of small bulk, and relatively cheap as compared with wet cells. The advantages mentioned have offset the disadvantage that this type of cell cannot be economically refilled or recharged. The result is that dry cells have largely replaced wet cells in many lines of work. Even the best dry cells will not usually remain in good condition longer than three years, while the poorer ones depreciate in much less time. Dry cells should be kept in a cool dry place whenever possible. The internal resistance of fresh dry cells varies from .1 to .7 ohm and the electromotive force from 1.3 to 1.6 volts. Dry cells of ordinary size should not be used where a steady current exceeding about .2 ampere is required or they will have a short useful life. Dry cells find their greatest usefulness in intermittent service and in furnishing a fairly high voltage with small current consumption.

STORAGE CELLS

GENERAL CLASSES

The *storage cell*, *secondary cell*, or *accumulator*, as it is variously called, is fundamentally the same as a primary cell, but different in this respect, that when discharged, either wholly or partly, the storage cell can be restored or recharged by passing current through it in the reverse direction for a sufficient length of time. The material of the electrodes that undergoes chemical changes during charge and discharge, called the *active material*, is generally supported on the surface or in the openings, or pockets, of a conducting framework, called a *grid*. The

grid with its active material is called a *plate*. Each electrode in a storage cell consists of a plate or of a group of plates connected in parallel. The plates of the positive electrode alternate with those of the negative, in order to provide the shortest path for the current through the electrolyte. The two outside plates are negative since there is one more negative plate than positive plate. Two types of commercial storage cells are in use: the *lead-sulphuric-acid cell*, sometimes called simply the *lead cell*, and the *nickel-iron-alkaline cell*, known also as the *nickle-iron*, or *Edison, cell*. The names, with the exception of Edison, are derived from the chemical natures of the electrodes and electrolytes.

THE LEAD-SULPHURIC-ACID CELL

Construction.—In the lead-sulphuric-acid cell the grids, both positive and negative, are of lead or of lead-antimony alloy. The electrolyte is a solution of sulphuric acid, formed by mixing 1 part of pure concentrated acid with 2.5 parts, by weight (4.5 parts by volume), of distilled water. The specific gravity of the electrolyte—that is, the ratio of the weight of a given volume of electrolyte to that of an equal volume of water—is about 1.2. Two fundamental, or general, types of plates have been developed for use in the lead cell: the *Planté*, or formed, plate, and the *Faure*, or pasted, plate.

The *Planté* plate, so called after its inventor, Gaston Planté, consists of a sheet or a grid of pure lead, usually ribbed or corrugated, in order to increase the superficial area. By an electrolytic process, the active material is formed on the surface of the plate from the metal composing the plate. This type of plate is rather heavy and costly, but is very durable. The formed-plate cell is commonly used in stationary batteries for heavy service and where durability is of primary importance.

The *Faure* plate, invented at practically the same time by Faure in France and by Brush in the United States, consists of a grid provided with ribs, openings, or

pockets, to which is applied the active material in the form of a paste consisting of red lead for the positive plate and of litharge for the negative. After the paste has set, the red lead of the positives is changed to lead peroxide and the litharge of the negatives to pure sponge lead by passing current through them in the proper direction in the forming bath of dilute sulphuric acid. The pasted type of plate is almost exclusively used in portable cells, where weight and space are of more importance than durability.

An external view of a portable storage battery, which is also a good example of the lead-sulphuric-acid cell, is shown in Fig. 3. The battery consists of three cells *a*, *b*, and *c*, that are contained in a wooden box. The cells are electrically connected by two conductors *d* and *e* that connect the positive terminal of each cell with the negative terminal of the next. The terminals of the battery are shown at *f* and *g*.

The construction of the ordinary type of storage battery is shown in Fig. 4, which shows one cell of the battery cut in two crosswise, exposing to view the various parts. The elements of each cell are contained in a semiflexible rubber jar *a* that carries the plates *b* and *c* on supports *d* and thus provides a space in the bottom of the jar for any sediment from the plates. Like plates, that is, either the positive or the negative plates of a cell, are connected at each end, as shown at *e* and *f*, and a terminal from each set of plates is brought up through the top of the battery. In the cell shown, one terminal *g* is a battery terminal while the other terminal *h* is connected to the adjoining cell. When the cell is in working condition, the electrolyte, which consists of sulphuric acid and water, should fill the jar high enough to cover the plates, or, when the cell is freshly filled, up to the first cover *i*. Provision is made by means of a removable plug *j* for the addition of water at regular intervals as the water in the electrolyte evaporates. The plug contains a small hole that serves as a vent, through which liberated gases may escape. An expansion chamber *k* is

provided in the upper part of the cell for changes in the volume of the electrolyte during charging or discharging. A top cover *l* of polished hard rubber is placed over the expansion chamber and sealed acid-tight. The outer

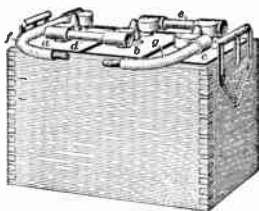

FIG. 3

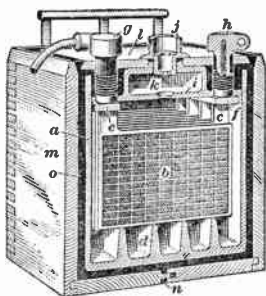
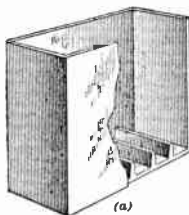

FIG. 4

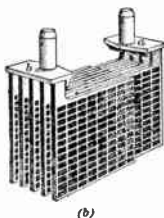

FIG. 5

wooden box *m* is provided with an expansion joint *n* to allow for any changes in its volume. A plastic sealing compound *o* surrounds the rubber containing jar between it and the box, and acts as a cushion. The wooden separators, which are placed between the adjacent plates, are hidden from view by the plates. These prevent the posi-

tive and negative plates from touching each other and thus short-circuiting the cell and rendering it inoperative.

A part sectional view of the rubber containing jar used in a battery of this type is shown in Fig. 5 (a). One side of the jar is shown partly removed in order to expose to view the supports on which the elements rest. A detailed view of the plates, arranged as they are in the cell, is shown in Fig. 5 (b). The like plates of each cell are connected by means of connecting straps *a* and *b*, to which straps the terminal posts are attached. The outline of the framework of the plates in which the lead paste is pressed can be seen. One of the separators, which for this particular battery are made of wood, is shown in view (c). In some makes of batteries porous

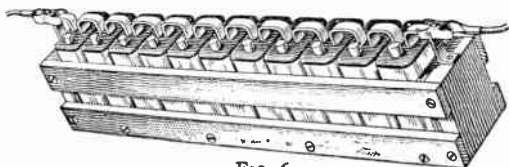

FIG. 6

rubber separators, or both wooden and rubber separators, are used. The rubber separators would, in the latter case, be placed between the wooden separators and the positive plates, as the rubber separators might embed themselves into the soft sponge lead if placed adjacent to the negative plates.

Fig. 6 shows a type of storage battery often used as the *B* battery in radio receiving sets. For this purpose a high voltage is desired with a very small current output. The cells are often assembled in units or racks with 11 cells connected in series and the voltage of the battery is 22 volts, approximately.

Normal Voltage.—The normal discharge voltage of a storage battery is usually taken as 2 volts per cell, this being about the average voltage delivered during the

normal discharge of a cell, as shown by Fig. 7, which represents typical charge and discharge curves for a lead-plate cell. For instance, the normal discharge voltage of a three-cell storage battery is 6 volts, although the actual value of the voltage of the battery, when fully charged, is approximately 1 volt higher. Storage batteries are generally designated by their normal voltages, as, for instance, a 6-volt battery, a 12-volt battery, a 16-volt battery, and so on. When the voltage has dropped to about 1.7 per cell, the battery should be

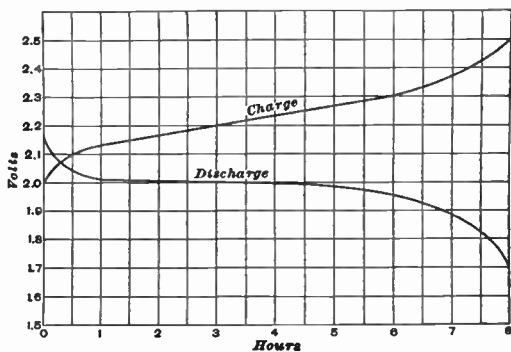

FIG. 7

recharged, because it retains only a comparatively small amount of electrical energy at this pressure and the voltage drops rapidly during discharge after getting below 1.7. The life of the battery is shortened by discharging below 1.7 volts per cell. The voltage usually remains fairly constant for a discharge at normal rate, but drops off rapidly if the battery is discharged at a more rapid rate. However accurate the voltage readings, they should not be the only factor on which the state of charge or discharge of a cell is based.

The value of the time or voltage may be easily obtained from Fig. 7, when the value of one of these factors is known. For instance, if the voltage at any particular time is desired, the proper value in hours is obtained on the lower horizontal scale. Then by following the vertical line above that point until it cuts the proper curve, and tracing from that point horizontally to the left until the vertical scale is reached, the voltage value can be read. Suppose it is desired to know the voltage after the cell has discharged for 3 hours. Follow the vertical line above 3 until it cuts the discharge curve. Then, follow the horizontal line to the left and it will show that this line cuts the vertical scale at 2 and the voltage is therefore 2.

If the voltage impressed on the cell after the cell has been charged for 3 hours is desired, it is necessary to follow the vertical line above 3 until it cuts the charge curve. Following the horizontal line to the left scale shows that the corresponding charging voltage is 2.2.

Specific Gravity.—The specific gravity of a substance is the quotient obtained by dividing the weight of a given volume of the substance by the weight of the same volume of some other substance used as a standard. Pure water is usually taken as the standard for solids and liquids. It will be noted that the strength, or specific gravity, of the electrolyte decreases during discharge and increases during charge, and furnishes an indication of the state of discharge of the cell. A fully-charged cell should show a specific gravity of the electrolyte of from 1.275 to 1.300. The cell is practically discharged when the specific gravity is as low as 1.150, and recharge should be started as soon as possible. In practice the specific gravity is often used as a whole number. For example, a specific gravity of 1.275 is often called simply twelve seventy-five.

The *hydrometer* is used for measuring specific gravities of electrolytes, and may be obtained with numbered scales ranging from 1.100 to 1.300. The hydrometer sinks into the liquid, and the reading is taken on the scale at the

level of the top of the electrolyte. A convenient device is the *hydrometer syringe*, Fig. 8, which consists of a rubber bulb provided with a glass barrel containing the hydrometer. The electrolyte is drawn up into the barrel until the hydrometer floats, when the reading may be taken, and the electrolyte then returned to the cell. The hydrometer test represents one of the most accurate methods of determining the condition of a cell, and is the one used most.

Another type of hydrometer syringe has three balls, each of different specific gravity. A white ball has the same specific gravity as does the electrolyte when fully charged, so just floats when this condition obtains. If the electrolyte is partly discharged, its specific gravity is less than the white ball, and the ball sinks. A green ball has about the same specific gravity as does the electrolyte of a cell with about half charge. With charges less than one-half the green ball sinks. A red ball has a specific gravity slightly higher than that of a completely discharged cell. The red ball will sink, therefore, when the cell is completely discharged. This may be summed up by saying that: if only the white ball sinks the battery is well charged, if the white and green ones both sink the charge is low, while if all three sink the battery is discharged. The colors of the balls serve as means of identification. If the balls were all of one color, but of different specific gravities, the sinking of one would indicate that the battery was well charged; the sinking of two, that the charge was low; and the sinking of all three would show that the battery was completely discharged. The indications of such a device are not nearly so accurate as are those of a graduated hydrometer, but the test is somewhat simpler to make.

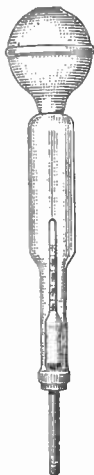

FIG. 8

It is not good practice to test the condition of a battery by temporarily connecting the terminals by a short wire and noting the spark produced when the connection is broken. The wire short-circuits the battery and the short circuit will probably injure the plates. The practice is to be strongly condemned.

Assembling.—Special instructions are furnished by the manufacturers for assembling and connecting up the cells of a battery. The following are the more important precautions to be observed:

The positive and negative groups should first be assembled in the containers and connected up before the electrolyte is put in, the positive terminal of each cell being connected to the negative terminal of the adjacent cell. The wooden separators should be kept wet until they are placed in position in the cells, and the electrolyte should then be added before the separators are allowed to dry.

Electrolyte of the proper density for immediate use is usually furnished. If strong acid (oil of vitriol, or 1.800 specific-gravity sulphuric acid) is obtained, it must be diluted with pure water before being poured into the cells. This diluting, or breaking down, of strong acid must be done with great care, as a large amount of heat is developed during the operation. *Never add the water to the acid*, as this will produce dangerous sputtering. Add the acid to the water very slowly, especially when a glass vessel is used, in order to avoid cracking the glass with excessive heat, and stir constantly during the process. Allow the mixture to cool before putting it into the cells.

Capacity of Storage Batteries.—The *capacity* of a storage battery is usually stated in units called *ampere-hours*. An ampere-hour is a current of one ampere maintained for one hour; hence, the capacity of a battery in ampere-hours is found by multiplying the number of amperes of current delivered by the number of hours during which the current passes. For instance, a storage battery that is capable of discharging 5 amperes of current

continuously for a period of 8 hours has a capacity of $5 \times 8 = 40$ ampere-hours; in like manner, one that will deliver a current of 10 amperes for a period of 12 hours has a capacity of 120 ampere-hours, etc. The *rate of discharge* of a battery is often referred to in terms of hours. In the examples just given, the batteries are said to be discharged at the 8- and 12-hour rates, respectively. The ampere-hour capacity varies with the rate of discharge, being less at high rates than at low rates. The term *efficiency* applies to the ratio of energy output to energy input. Under usual conditions, the efficiency of a battery that is fully charged and subsequently completely discharged, varies from 70 to 80 per cent. The output of a battery depends upon several variable characteristics of its make-up, each of which may cause an appreciable variation in its efficiency. Under favorable operating conditions, where the battery is only partly discharged and soon recharged, the efficiency may be over 90 per cent.

The size of storage battery to use depends largely upon the rate of current output required, and the frequency between charges. If a relatively large output is required it is desirable to use a fairly large battery, while if charging facilities are not convenient, one does not like to take the battery to be recharged too often. The 60-ampere-hour battery is one very largely used in radio work where a current of 1 to 3 amperes is required. For some radio work a current of less than .1 ampere is required. Some storage cells of very small capacity have been designed especially for this class of work. They possess small elements made up in miniature sizes, and sell for a much lower price than the large batteries. They may be recharged in the usual manner, and are convenient when used in large radio stations where dry cells would have a short life. They have found a large field of application in research laboratories.

Polarity.—Before connecting a battery to the charging circuit, the polarity (positive or negative) of each of

the two conductors of the charging circuit must be determined. If there is any doubt as to this, a simple test may be made by connecting two wires, one to each conductor of the supply circuit, with enough resistance in series to limit the current to about 1 ampere or less, and then dipping the two wires in a vessel of acidulated water or in water in which a small amount of common salt has been dissolved, the ends of the wires being kept about an inch apart. The wire from which bubbles of gas are given off more freely is connected to the negative side of the circuit. The positive terminal of the battery must then be connected to the positive conductor of the circuit, and the negative terminal to the negative conductor. The positive terminal of a stationary battery may be distinguished by the dark-brown color of the plates to which it is connected, the negative terminal being connected to the slate-gray plates. The terminals of portable batteries, in which the cells are sealed, preventing inspection of the plates, are usually marked for polarity. If they are not marked, a voltmeter may be used or the test just described may be employed.

Initial Charge.—Immediately after assembling and as soon as possible after the electrolyte has been put into the cells, charging should be started and continued at its normal charging rate with as little interruption as possible, for a period of from 35 to 60 hours, depending on the type of plate. Special instructions are furnished by the manufacturers.

Regular Charge.—A regular charge is given to the battery as frequently as may be necessary to restore the energy taken out on discharge. This regular charge can be given at the normal rate throughout; but if it is necessary to hasten the charge, a much higher rate can be used at the beginning, provided the rate is reduced from time to time to prevent violent gassing and to keep the temperature of the cells below 110° F. The regular charge should be continued until the specific gravity of the pilot cell is from 3 to 5 points below the maximum

reached on the preceding overcharge. All the cells should then be gassing moderately, but not so freely as at the end of overcharge.

When a battery has been completely discharged, the charge should be started as promptly as possible. Long standing in a discharged condition tends to produce a hard and crystalline form of lead sulphate on the plates that will reduce their capacity temporarily. This sulphate may not cause permanent injury, because it can be decomposed by a long overcharge at low rate.

The most reliable indication of a complete charge in a lead cell is the fact that the voltage and specific gravity have reached a maximum and become stationary for 15 minutes to $\frac{1}{2}$ hour, the charging current being kept constant. These final values of voltage and specific gravity are not always the same, the voltage varying with the temperature, the rate of charge, the type of plates, and the age of the battery; and the specific gravity with the temperature, the height of the electrolyte, and the amount of acid lost by spilling, gassing, or combining with sediment in the bottom of the cell.

Toward the end of the charge the cells will gas very freely, an indication in a healthy cell that the charge is nearing completion. While portable cells in sealed rubber jars are being charged, the soft-rubber stoppers in the covers should be removed and the cover of the battery box or compartment should be left open.

It should always be borne in mind that the gases, oxygen and hydrogen, given off by a battery toward the end of charge form an explosive mixture. The battery room or compartment should therefore be freely ventilated at such times, and exposed flame should be absolutely kept away.

The electrolyte should be kept above the tops of the plates by filling the cells with chemically pure water from time to time. The local supply of city water is not sufficiently pure, and the use of distilled water is strongly recommended in all cases. Water for filling cells should be stored and handled in wooden, earthen-

ware, or glass vessels; the use of vessels made of iron or other metals should be avoided. Under normal conditions of temperature and ventilation, filling and inspection once a week are sufficient. The acid in the electrolyte does not evaporate, and during normal operation should never be added to the cells except by special instructions from the manufacturer.

Putting Battery Out of Commission.—If the use of the battery is to be discontinued entirely for a period not longer than 9 months and it is not practical to charge at least once a month, care should be taken that an overcharge is given just before the idle period. Water should be added to the cells during the overcharge so that the gassing will insure thorough mixing. The level of the electrolyte should be about $\frac{1}{4}$ inch from the top of the jars. After the overcharge is completed, the operator should be sure that all the cell covers are in place and the battery fuses removed. Though not likely, the level of the electrolyte may, owing to excessive evaporation during the idle period, fall below the top of the plates; if this should occur, water must be added to keep them covered; if in a place where freezing is apt to occur, the electrolyte should be stirred after adding the water to insure thorough mixing.

When a battery is stored, it should be put in a cool place but not allowed to freeze. A battery that is completely discharged will freeze at about 20° above zero, Fahrenheit, while one having a specific gravity of 1.210 will freeze at 20° below zero, Fahrenheit.

Returning Battery to Commission.—If, in taking a battery out of service, the electrolyte has not been withdrawn, the battery can be returned to service by adding water, if needed, to the cells and overcharging the battery until the specific gravity of the electrolyte has ceased to rise during a period of 5 hours.

If the battery has been standing without electrolyte, new wooden separators should be installed and the cells then filled with electrolyte of 1.210 specific gravity. If the old electrolyte has been saved, only enough new

electrolyte is added to replace any loss. The battery is then charged for 35 hours at the normal rate, or for a proportionately longer time at a lower rate. If the specific gravity of the electrolyte is low after the first charge, it should be restored to standard by the addition of acid.

Lead Burning.—In making joints between lead and lead, repairing tank linings, etc., solder cannot be used, because it is subject to attack and corrosion by acid. For such work, a process called *lead burning* is employed, requiring a blowpipe with a flame produced by the admixture of hydrogen and air under pressure. Ordinary illuminating gas is sometimes used instead of hydrogen, but the hydrogen flame is hotter and more effective. In lead burning, no flux of any kind is used, but the surfaces to be joined

are partly fused with the blowpipe and the space between is filled by melting down a strip of lead, drop by drop.

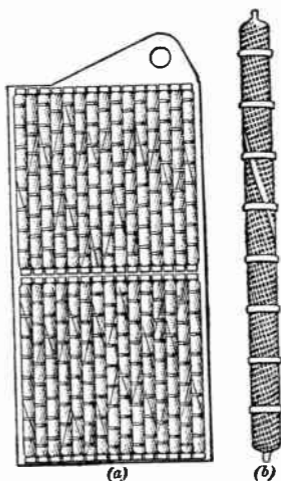

FIG. 9

THE NICKEL-IRON-ALKALINE CELL

Plates.—The positive plate, Fig. 9 (a), of the nickel-iron cell consists of a number of hollow tubes, or pencils, of perforated steel, nickel-plated, supported vertically in a nickel-plated steel grid. The pencils, Fig. 9 (b), are made of steel ribbon wound spirally with overlapping riveted seams, and are reinforced at intervals by steel

bands. The active material consists of nickel peroxide and flake nickel tamped into the tube in alternate layers, the flake nickel being added to decrease the internal resistance.

The negative plate, Fig. 10, consists of rectangular pockets of perforated nickel-plated steel supported in a

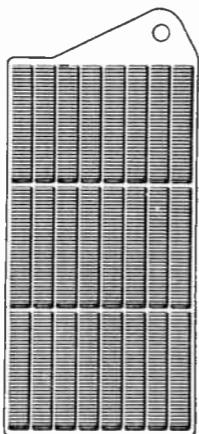

FIG. 10

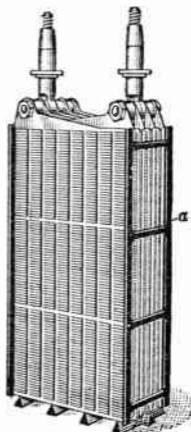

FIG. 11

nickel-plated steel grid, the pockets being filled with finely divided iron oxide, which is reduced to metallic iron by the initial charge.

Assembly.—As in the lead cell, the positive and negative plates of the nickel-iron cell alternate, with negative plates outside, there being one more negative than positive plate. The plates of each cell are assembled into positive and negative groups by bolting the corresponding lugs together and to the terminal posts by means of steel connector rods with clamping nuts at

each end, the plate lugs being spaced apart by steel washers. All steel parts are nickel-plated. Fig. 11 shows the plates of one cell when assembled.

Separators and Electrolyte.—The plates are separated from each other by vertical strips of hard rubber, square in section, inserted with their vertical edges against the plates, as shown in Fig. 12, which is a view of a cell from above. Sheets of hard rubber are inserted between the outside negative plates and the jar, and hard-rubber bridges *a*, Fig. 11, notched to receive the vertical edges of the plates, serve to separate these edges from the sides of the jar. The plates rest on hard-rubber bridges on the bottom of the jar, as shown in the same figure.

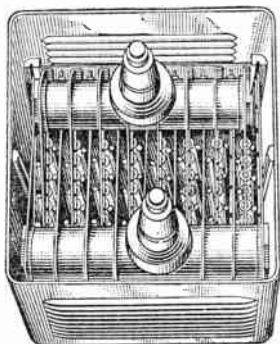

FIG. 12

The electrolyte is a dilute (21 per cent.) solution of potassium hydrate (caustic potash), the specific gravity of which is approximately 1.200. A small amount of lithia (lithium hydroxide) is added.

Container.—The container of the nickel-iron cell is a box made of nickel-plated sheet steel, corrugated to give added stiffness, the cover being welded on after the element is in place. The two terminal posts *a* and *b*, Fig. 13, pass through circular openings provided with rubber bushings. Another opening in the cover, used for filling the cell, is closed by a spring cap containing a valve *c* that allows the gases to escape during charge, but excludes the external air.

Capacity.—The rated capacity of the nickel-iron

cell is based on a 5-hour discharge rate. The actual capacity in ampere-hours, however, is but little affected by variation of discharge rate, provided no limit is set to the final voltage. In order to obtain maximum

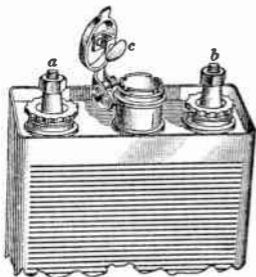

FIG. 13

ampere-hour capacity from a battery when it is discharged at one of the higher rates, the final voltage must drop to a point too low for many classes of service.

Though the rated capacity is obtained by charging at the normal 5-hour rate for about 7 hours, it is possible, by giving the cells an excessive overcharge (16 hours at normal rate),

to obtain on the subsequent discharge an increase in capacity of about 25 per cent. The excess is therefore obtained at a sacrifice in efficiency.

Voltage.—The open-circuit voltage of the nickel-iron cell is 1.5 approximately when fully charged, and the average discharge voltage 1.2. After a substantial discharge, the open-circuit voltage is restored only very slowly, and never completely until a freshening charge has been given.

In Fig. 14 are curves that show charge and discharge voltages of the nickel-iron cell at normal rate. The discharge curve, as shown, is carried to .9 volt, though the normal-rate discharge is seldom carried below 1 volt in practice. The manufacturers recommend providing a charging voltage of 1.85 per cell.

Efficiency.—The efficiency of the nickel-iron cell is lower than that of the lead cell under similar conditions. Not only is the difference in voltage between charge and discharge proportionately greater in the nickel-iron cell, but the efficiency is low on account of

the gassing that occurs during the entire charging period. An efficiency of 50 to 60 per cent. in commercial operation is about as high as can be expected, and this figure may be reduced if an attempt is made to utilize the maximum capacity of the battery.

Advantages and Applications.—The principal advantages of the nickel-iron cell are durability, mechanical ruggedness, and ability to withstand neglect and abuse without injury. Life curves published by the manufacturers as a result of laboratory tests show a maximum of 1,100 complete cycles of charge and discharge. The cell is not injured by standing in a discharged condition, nor by excessive overcharge, provided excessive temperature is avoided. At low rates of discharge, the nickel-iron cell is much lighter than the lead cell for the same watt-hour output; but this difference in weight disappears as the rate of discharge increases, on account of the proportionately lower voltage of the nickel-iron

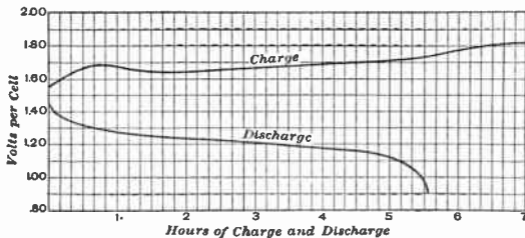

FIG. 14

cell. The Edison cell is, therefore, best adapted for service at low discharge rates where the cost of charging current is low, where light weight is important, and where indifferent care and attention are given. On the other hand, the nickel-iron cell is not well adapted for high rates of discharge, nor for service in which the cost of

charging current is high, nor where a battery must retain its charge for a long period of time without recharging.

Charging.—The state of charge of the nickel-iron cell cannot be determined by the density of the electrolyte, which does not change. Neither is the cell voltage or the amount of gassing a reliable guide. The only practicable method is to measure the output and input in ampere-hours, either by noting the rate in amperes and the time or by means of an ampere-hour meter. The manufacturers recommend a charge of 7 hours at normal rate after a discharge of 5 hours at the same rate, which is equivalent to 40 per cent. overcharge, in ampere-hours. The cell temperature should not be allowed to exceed 120° F.

The method of operation best adapted to the nickel-iron cell is that in which partial, or *boosting*, charges are given in the intervals between partial discharges. Boosting charges are particularly advantageous where the rate of discharge is sufficiently high to produce excessive polarization drop. The boosting charge quickly restores the cell voltage to normal, where otherwise it would remain abnormally low.

Changing Electrolyte.—The electrolyte in nickel-iron cells gradually deteriorates, owing to the absorption of carbonic-acid gas from the air. Deterioration, however, cannot be absolutely prevented, and although this gas does not permanently injure the plates, it reduces the capacity of the cells temporarily. About once in 6 months the electrolyte should be completely renewed.

Water that is to be used for filling the cells must be protected from exposure to the air for any considerable length of time, because water absorbs carbon dioxide (carbonic-acid gas) from the air. The local water supply, or even rainwater, which is very nearly pure, cannot safely be used for filling; distilled water protected from exposure to the air is generally necessary.

Special Precautions.—The containers of nickel-iron cells, being of metal, must be carefully insulated from each other and must be kept clean. The wooden crates

in which the cells are supported, as well as the sides and floor of the battery compartment, must be kept clean and dry for the same reason. If the insulation between cells becomes defective from any cause, a small leakage of current will, by electrolytic action, puncture the steel containers.

The nickel-iron cell is gassing more or less at all times, whether charging, discharging, or standing on open circuit. These gases (oxygen and hydrogen) produce an explosive mixture. Care must therefore be taken to guard against bringing an exposed flame or producing an electric spark in the vicinity of the cells, unless the ventilation is very thorough.

Repairs.—The covers of nickel-iron cells are welded in place after the cells are assembled. The plates cannot readily be removed from the containers, and whenever repairs are required it is necessary to return the cells to the factory for this purpose.

GENERAL OPERATING INSTRUCTIONS

Charging Storage Batteries.—Before a storage battery will deliver a current, it is necessary to bring its active materials to the proper condition for generating electricity by charging it, that is, by passing through it an electric current obtained from some outside source. The current used in charging a battery must be a direct current, as an alternating current would merely charge and discharge the battery because of the rapid reversals of current. After a battery is properly charged, it will deliver a direct current when connected in a closed circuit; the length of time that the current will pass depends on the ampere-hour capacity of the battery and the amperage of the current. The rate at which a storage battery will discharge depends on the resistance of the external circuit, and can be changed by varying the resistance.

Charging Through Resistors.—A charging resistor is connected as at *r*, Fig. 15, where the voltage of the charging source is greater than that required for the number of cells in series. The resistor in this case may

be adjusted to give any desired resistance within its range when connected in a circuit. In such cases, the voltage of the charging source should be slightly in excess of the voltage of the battery at the end of the charge; the resistor serves to reduce this voltage to that required at the beginning of the charge, and the resistance is gradually cut out as the charge proceeds, thus compensating for the increase of battery voltage.

Charging Through Lamps.—Fig. 16 shows a method of connecting a battery to charge from a 110-volt cir-

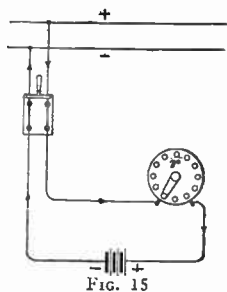

FIG. 15

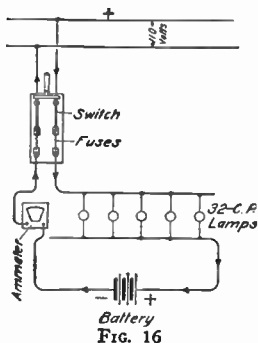

FIG. 16

cuit through five 110-volt incandescent lamps connected in parallel. The groups of lamps and the group of cells are connected in series across the line wire of the charging circuit. The voltage across the group of cells will be less than the line voltage because of the voltage expended in forcing current through the lamp bank. The current consumption of the lamps will then determine the charging current. The charging current passes through the switch, the right fuse, the lamp, the battery, the ammeter, the left fuse, and the switch. The lamps may be connected in either lead to the battery. If, in the arrangement shown in the figure, there are 25 cells in

series, having a voltage between 55 and 65 while charging, the voltage across the lamps will be between 55 and 45, or about half the normal lamp voltage. Only half the normal amount of current will then be transmitted through the lamps, provided their resistance remains constant. But the resistance of a carbon-filament lamp increases as the amount of current through it decreases while the resistance of a tungsten filament decreases as the current is reduced, and allowance must be made for this. The charging current is best determined by connecting an ammeter in series in the circuit.

The approximate number of either tungsten-filament or carbon-filament lamps required for the charging lamp bank may be found by multiplying the charging rate in amperes by the line voltage and dividing the product by the watt consumption per lamp. For example, if 40-watt lamps are to be used, with a voltage of 110 and a charging current of 8 amperes, the results would be $\frac{8 \times 110}{40} = \frac{880}{40} = 22$ lamps. If the battery has a considerable number of cells in series, a few more lamps should be used, as the voltage across the lamp bank will be considerably less than 110 because of the opposing voltage of the battery.

Charging Panel.—A very well designed panel outfit, with switching and testing apparatus included, is shown in Fig. 17. This small switchboard is particularly designed as one to be installed on ships, provision being made for charging a set of storage batteries from the direct-current supply, usually available on board steamships. Should the ship's power fail from any cause, the battery may be used to furnish power to operate the radio equipment, so that communication and the sending of distress signals may not be interrupted or prevented. The necessary apparatus and devices for performing the various switching operations and for protection to the several circuits are conveniently mounted on the panel. The panel is often made of marble or slate, as these materials are good insulators and present a good appearance.

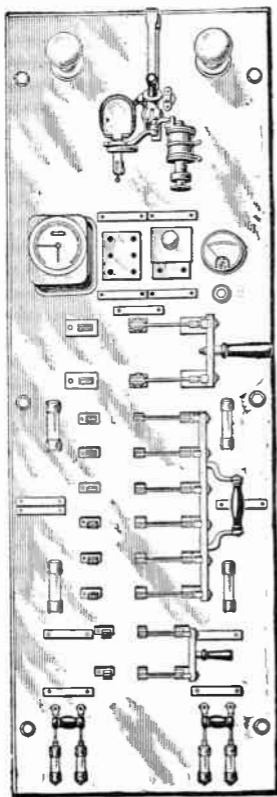

FIG. 17

Chemical Rectifiers.—

The chemical type of rectifier is suitable for charging rather high-voltage storage batteries that do not have a very large ampere-hour capacity. The current from this type of rectifier used commercially is much less than one ampere, but is very satisfactory for charging 20- or 22.5-volt storage batteries used in some branches of radio work. One type of chemical rectifier depends for its action on the fact that electricity will flow in only one direction between aluminum and certain other metals through the electrolyte in which the electrodes are immersed.

If an aluminum rod or post is partly immersed in a solution of ammonium phosphate or of common borax, and if another metal such as lead is used for the containing vessel for the solution, electricity may flow from the lead to the aluminum, but cannot flow in the opposite direction. While the aluminum is positive,

a large number of small bubbles of gas are formed around the rod and act as an insulator preventing the flow of electricity. When the lead is positive these bubbles are not formed between the electrolyte and either metal so electricity can flow through the device.

A method of connecting a chemical rectifier for charging a storage battery *a* of 20 to 60 volts, is indicated in Fig. 18. The aluminum rod *b* of the rectifier is mounted so as to project a short distance into the electrolyte contained in the lead jar or cup *c*. An ordinary 40-watt electric lamp *d* is connected in series in the line to reduce the voltage and also limit the current. This arrangement is suitable for connecting across a 110-volt alternating-current supply line, although it may be used on lines whose voltage is 10 or 15 volts

from this value. It is desirable to install a fuse and a double-pole, single-throw knife switch in the supply line for additional protection and convenience.

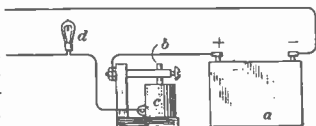

FIG. 18

It should be noted that the + terminal of the battery is connected to the aluminum rod so that the battery may receive a charging current. The current supplied to the battery when only one rectifier is used is a pulsating direct current coming in at every other half-cycle.

Mechanical Rectifier.—A *mechanical*, or *magnetic*, *rectifier* may be used for charging storage batteries from an alternating-current supply line. One type of such device is shown in Fig. 19. The plug *a* is connected to the two ends of the primary coil of a transformer *b*. The plug may be screwed into a socket of an alternating-current lighting circuit. Two battery terminals are shown at *c*. One, usually colored red, leads from the center point of the secondary coil of the transformer to the positive terminal of the battery to be charged. The two ends of

the secondary coil are connected to the contacts *d* and *e*. The negative terminal of the storage battery is connected through an ammeter *f* to an armature spring *g*. The ammeter *f* indicates the rate at which the battery is being charged. A pilot lamp may be inserted in the socket *h* to indicate when the charging set is in use.

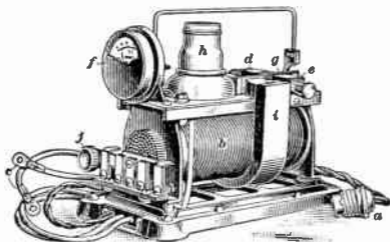

FIG. 19

A permanent magnet is shown at *i*; the poles of this magnet are placed on either side of the armature spring *g*. The armature spring is magnetized from the core of the transformer *b*; therefore, the left end of the spring is alternately north and south. The spring will be attracted toward the pole of the permanent magnet which is of opposite polarity to that of the spring at any given instant. The armature spring carries two copper contacts which alternately press against the stationary carbon contacts *d* and *e*. Contact is made to the carbon contact that is connected to what is at that instant the negative side of the secondary coil. Current thus passes from the middle point of the secondary coil through the battery, the ammeter, the armature spring, the negative stationary contact to the negative end of the secondary coil. First one half and then the other half of the secondary coil furnishes current to the battery. If the positions of the contacts are properly adjusted by the adjusting screws at their ends, the

armature spring will keep in step with the alternations of the alternating current and the battery will receive a pulsating direct current. If a low-voltage battery is to be charged, switch j is thrown to the right, if a high-voltage battery, the switch j is thrown to the left.

The closing of these contacts is so timed as to rectify each negative half-wave, thus producing a pulsating direct voltage and current, as represented in Fig. 20. Here, line $a b$ represents zero voltage and line $c d$ the battery voltage. Only the rectified voltage above the battery voltage is effective in charging the storage battery; that is, only the portion represented by the curves above line $c d$ is useful in charging the storage battery. The contacts are, therefore, timed to be closed at instants corresponding to points c and f , and to break at instants corresponding to points e and d . If either pair of contacts were closed at points below the battery voltage, the battery would tend to discharge through the rectifier. The period of time represented by the space $e f$ elapses between the instant that contact is broken on one side of the line and made on the other by the vibrating armature. The humps or pulsations prevent the use of the rectifier to furnish direct current for a radio set where the current must be continuous or unvarying. The pulsations do not affect the battery, as it can charge from the pulsating current practically as well as from an unvarying

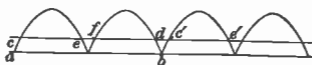

FIG. 20

current. It is not possible to use a battery in a radio set while on charge, as the pulsations produce objectionable noises in the set.

Tube Rectifiers.—A bulb, or tube, filled with an inert gas, such as argon, and containing a hot and a cold electrode, may be used as a rectifier for changing alternating current to direct current. Fig. 21 shows one type, known as the *tungar rectifier*, with the upper protective cover

removed. This device consists essentially of a rectifier bulb *a*; a compensator *b*; a fuse and receptacle *c*; alternating-current leads *d*; and direct-current leads *e*. The bulb is shown separately in Fig. 22. The cathode *a* is a tungsten filament which is heated by alternating current

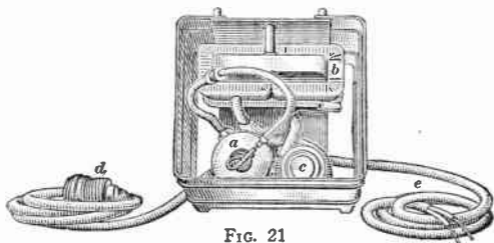

FIG. 21

taken from the compensator. The anode *b* consists of a piece of graphite.

The connections of the rectifier are indicated in Fig. 23. When the plug is connected to an alternating-current circuit, usually of 110 volts, the compensator winding is excited and a low electromotive force is applied to the filament. The effect of the heated filament on the gas is to make the gas conductive for a flow of electricity from the anode to the cathode when the filament is negative as compared to the graphite electrode. On the other half-wave of the cycle when the filament is positive as compared with the graphite electrode, the gas is non-conductive and current cannot pass between the two electrodes, therefore electricity can flow in only one direction through the bulb, from the anode to the cathode.

When a storage battery is connected to the direct-current leads, current can pass from what is at a given instant the positive lead of the alternating-current circuit, through the storage battery, the anode, the conducting gas in the bulb, the cathode and to some point on the compensator winding which at that instant is negative as

compared to the positive lead that is directly connected to the battery.

At the instant when the red lead, Fig. 23, is connected to the negative side of the alternating-current circuit, current cannot pass through the bulb. In the particular device shown only alternate half-waves of the alternating-current cycle are utilized. The battery cannot discharge through the rectifier bulb when the alternating-current circuit is open, because the gas is not conductive when the filament is cold.

To use the rectifier, the alternating-current leads are connected to an alternating-current circuit of suitable voltage and the other leads to the storage battery. This type of rectifier is made in several sizes to charge storage batteries of different current capacities and voltages. In some

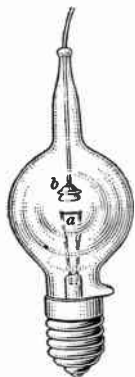

FIG. 22

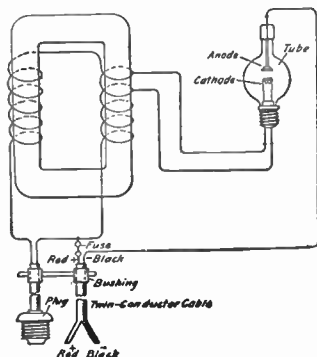

FIG. 23

types, voltage adjustments covering a considerable range can be made through taps to the compensator. Care should be taken that the voltage of the battery to be charged is less than the voltage that can be delivered to the direct-current leads by the action of the rectifier.

GENERATORS AND MOTORS

ALTERNATORS

GENERAL THEORY

The **alternator** is one of the simplest machines for the transfer of mechanical energy into electrical energy. The alternator generates an alternating electromotive force by what is commonly called *electromagnetic induction*. When an electric conductor is moved across a magnetic flux, or a magnetic flux cuts across a conductor, an electromotive force is induced, or generated, in the conductor. Most of the modern alternators have revolving magnets which produce a revolving flux, and an electromotive force is generated by the action of the flux cutting across conductors mounted on a stationary frame. In some cases the *active* conductors are rotated past stationary magnets, thereby cutting magnetic flux. In either case, the stationary frame is called the *stator*, and the rotating element is called the *rotor*.

No electromotive force will be generated if both the flux and the conductor are stationary or if the motion of the conductor or the flux is such that the conductor does not cut across the flux or the flux cut across the conductor.

The conductor *a b*, Fig. 1 (*a*), is moved toward the right across the magnetic flux of the permanent magnet, as indicated by the full-line horizontal arrow. The direction of the inducing flux is downwards, as shown by the arrowheads on the dotted vertical lines. An electromotive force is set up in the conductor in such a direction that the current established will always produce a conductor flux that agrees in direction with the inducing flux on the side of the conductor that first comes in contact with the inducing flux and is opposite in direction on the other side of the conductor. This fact holds true whether the conductor or the flux is the moving element. The direc-

tion of the conductor flux is indicated by the arrowheads on the curved lines surrounding $a b$. The direction of the electromotive force, as well as that of the current in this case, is from a to b in the conductor, as indicated by the arrowheads on the circuit wires. The flux is more dense ahead of the conductor than behind it because of the relation between the direction of the inducing flux and that of the conductor flux.

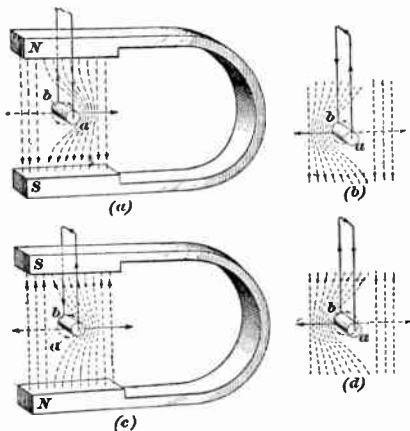

FIG. 1

The direction of the induced electromotive force in any case where the relative direction of the movement of the flux and of the conductor is known may be determined by considering which side of the conductors has the denser flux. The direction of the circular conductor flux on that side agrees with the direction of the inducing flux, and the direction of the induced electromotive force is determined from the relation of the conductor current and its flux.

The conductor $a b$, Fig. 1 (b), is moved toward the left and the induced electromotive force is from b to a . In (c) a conductor is represented as moving to the right in a field in which the direction of the flux is vertically upwards. The direction of the induced electromotive force is from b to a . In (d) the conductor is moved toward the left in the same field, and the direction of the induced electromotive force is from a to b .

It should be noted that when either the direction of the motion of the conductor or the direction of the flux is reversed, the direction of the electromotive force is reversed, as in views (a) and (b) or in (a) and (c); but, when both the direction of the flux and the direction of the motion of the conductor are reversed, the direction of the induced electromotive force remains unchanged, as in views (a) and (d) or in (b) and (c). The straight dotted arrows relate to the direction of the movement of the conductor when considered as a motor conductor.

REVOLVING-FIELD ALTERNATOR

Fig. 2 (a) shows an elementary *alternator* having a two-pole, *revolving-field* rotor a mounted within a stator b . The rotor is assumed to revolve in a clockwise direction as indicated by the long curved arrows. The active windings, in which alternating electromotive forces are generated, are distributed in slots in the inner cylindrical surface of the stator, the stator and its windings being known as the *armature*. For simplicity only one coil of a single turn is shown, consisting of active conductors c and d and connecting wires on the front and back of the stator. Connections on the rear of the machine are indicated by dotted lines.

The *exciter* e is a small direct-current generator, such as is described later, often mounted on the end of the rotor shaft and turning with it. In other cases the exciter is separately mounted and driven by a belt from the alternator shaft, or an independent direct-current supply system may be used for exciting several alternators in a large station.

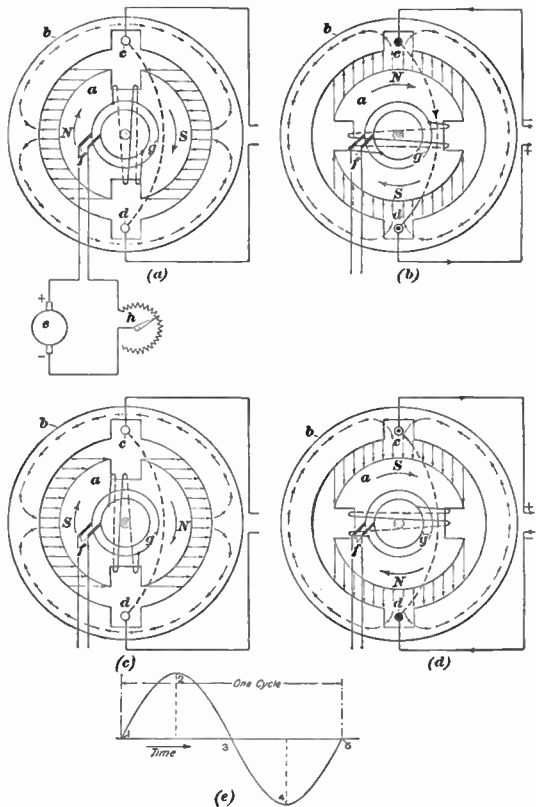

FIG. 2

Direct current for exciting the field-magnet winding, which with the core forms an electromagnet with poles of special shape, is transmitted to the rotor from the exciter through two stationary brushes *f* and two slip rings *g*, the latter mounted on and revolving with the rotor. The polarity of the field magnets and the general distribution of the fluxes in the magnetic circuits of the machine are indicated in view (*a*), which represents the magnetic field flux as uniformly distributed in the air gap. In actual electrical machines the flux distribution is usually not so uniform. In order to avoid confusion, only two lines of force and their directions are shown in the stator by the short-curved arrows, although there are many lines of force in all parts of the stator.

As the rotor turns, the flux cuts across the stationary active conductors on the stator and an electromotive force is generated in them except when the rotor is in the position shown in views (*a*) and (*c*). At these positions the fluxes are parallel to horizontal planes through conductors *c* and *d*, and no electromotive force is established, as the fluxes do not cut across either *c* or *d*.

With the rotor in the positions indicated in views (*b*) and (*d*), the fluxes from the poles are cutting across the conductors at maximum rate, therefore the maximum values of electromotive forces are generated; but it should be noted that in (*b*) the flux from the north pole cuts across conductor *c* and in (*d*) the flux entering the south pole cuts across this same conductor. The electromotive forces induced in these two positions are in opposite directions, as the electromotive force must always agree with the principles concerning the relative motion of the conductor and flux given previously.

The conductors *c* and *d* are so placed and connected that the electromotive forces generated in them act in unison, or series, to send current through the coil and the external circuit when a load is connected to the terminals of the generator. In actual alternators many conductors are coiled together and connected in series to give a higher voltage than would be generated by a

coil of one single turn. Other coils are ordinarily distributed around the stator, thus considerably increasing the output of the machine.

Fig. 2 (*e*) indicates very closely the rise and fall of an alternating electromotive force or current established by an alternator of the type shown. The vertical distances between the base line 1-5 and points 1, 2, 3, 4, and 5 on the curve correspond to the values of the electromotive forces generated at positions of the rotor shown in (*a*), (*b*), (*c*), and (*d*), point 5 referring also to the position shown in (*a*). The direction of the current in the coil and the external circuit at position (*b*) is assumed, simply for the purposes of comparison, to be positive, represented by the curve at point 2 above the base line in view (*e*). A negative value could have been assigned to this electromotive force if desired.

Starting with point 1 of view (*e*) and with the position of the rotor as shown in (*a*), the field flux begins to cut the armature conductors *c* and *d* at an angle as the rotor is turned. Due to the relative direction of the flux and the position of the conductor, the rate of cutting the lines of force of the flux is low, as indicated by the portion of the curve in (*e*) just to the right of point 1. As rotation of the rotor continues, the lines of force of the flux cut across the conductors at a higher rate and the generated electromotive force increases at a corresponding rate. This increase will continue until the rotor has reached the position shown in (*b*), when the electromotive force will have attained its maximum value as shown by point 2 in (*e*).

As rotation continues from position (*b*), the rate at which the lines of force of the flux cut across the conductors gradually decreases until position (*c*) is reached, and the electromotive force generated during this movement will be as shown by the curve in (*e*) from point 2 to 3. This portion of the wave from 1 to 3 represents an *alternation*.

Continued motion of the rotor will produce an alternation similar to the one just generated, but of opposite

polarity. In the preceding case the flux from a north pole cuts conductor *c*, while now flux that enters a south pole cuts that conductor. According to the principles shown in Fig. 1, the generated electromotive force is in the opposite direction to that just produced. This will give the wave shown in Fig. 2 (*e*) from point 3 through negative maximum at point 4, and back to zero at point 5. It should be noted that at both points 1 and 5 the electrical conditions are the same, and the position of the rotor is shown in view (*a*). Another complete revolution of the rotor would produce another curve exactly similar to (*e*).

A complete set of positive and negative values of electromotive force or current in any conductor is, as has been mentioned previously, called a cycle. The curve shown in (*e*) represents a cycle, which is made up of two alternations. The frequency, as has been defined, is the number of cycles through which the electromotive force or current passes in one second. The shape of the curve generated under the above conditions is a sine curve, and is so represented in view (*e*). The current being directly dependent upon the voltage, varies according to the same laws, and would also be represented by a sine wave.

The machine shown in Fig. 2 is known as a *single-phase alternator*, as it generates a single wave of current. The current generated by such a machine and represented as a single curve such as shown in (*e*), is called a *single-phase current*. In other electrical work machines are used which generate two-, or three-, or occasionally six-phase current. The principle of their operation is quite similar to that already described.

The value of the electromotive force generated by an alternator depends upon the speed of the rotor, the number of conductors in series and their distribution between any two terminals, and the total flux from all poles. In practice it is usually undesirable to increase the voltage of the alternator by increasing the speed of the rotor. Increasing the strength of the current in the coils of an electromagnet increases the amount of flux set up by the

magnet. The rheostat h in Fig. 2 (a), which contains an adjustable resistance, controls the current through the field windings of the rotor. The current furnished by the exciter e may be increased by decreasing the resistance of h , or decreased by increasing the resistance that is active in the rheostat. With an increase of field current, the field flux is increased, and as a result the generated electromotive force is also greater on account of the larger number of lines of force which cut the armature conductors.

ELEMENTARY REVOLVING-ARMATURE ALTERNATOR

An elementary type of *revolving-armature alternator* is shown in Fig. 3. A soft-iron armature core a on a shaft b carries on its convex surface conductors at c and d and revolves between magnetic poles N and S so that the conductors cut the flux of the magnetic poles. Electromotive forces are generated in these *active conductors*, which are connected by other conductors to the slip rings e and f . Stationary brushes g and h , which

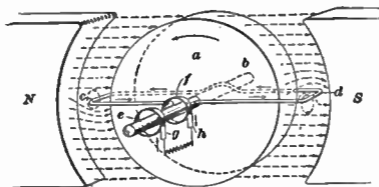

FIG. 3

bear on the rings, serve to connect the armature conductors with an external circuit.

With a counter-clockwise direction of armature rotation and the flux in the direction indicated, the electromotive force in c is toward the front, and in d toward the rear of the armature. The principles of electromagnetic induction, as explained in connection with Fig. 1, should be

applied to the conditions of Fig. 3. The two conductors are so connected across the back of the armature that the two electromotive forces act in series to force current through the circuit. The shape of the current wave will be a sine curve similar to that shown in Fig. 2 (*e*).

THE 500-CYCLE REVOLVING-ARMATURE ALTERNATOR

A section through the revolving armature and stationary field frame of an alternator used in the generation of 500-cycle alternating voltage is shown in Fig. 4 (*a*). The armature of the same machine is shown separately in view (*b*.) It will be seen that there are many coils *a* on the armature *b* of this machine. The slip rings at *c* serve to make electrical connection to the external circuit by means of brushes, which in the assembled machine bear on, and make contact with, the slip rings. View (*c*) shows the iron field frame *d* with the pole projections carrying the field coils *e*. The field coils are separately excited by direct current. The large number of poles combined with the high rotative speed of the armature serves to produce a voltage of rather high frequency.

The magnetic circuit of the alternator shown in Fig. 4 is of rather unusual construction, in that there are twice as many field poles as there are field coils. For explanation, a simple electromagnet in the shape of a horseshoe may be considered. If equal windings are placed on both legs and energized by a current, poles will be formed near the ends of the core when the coils are energized. If only one coil is energized by the same current, poles will be established as before, but as there are now only one-half as many active turns of wire, the strength of the poles will be approximately one-half their former value. If all the winding were placed on one leg of the core, the magnetic flux produced when the coil is energized would be only slightly less than that originally established by the two separate windings.

In the case of the alternator shown in Fig. 4 this principle is applied, as every alternate pole is energized though

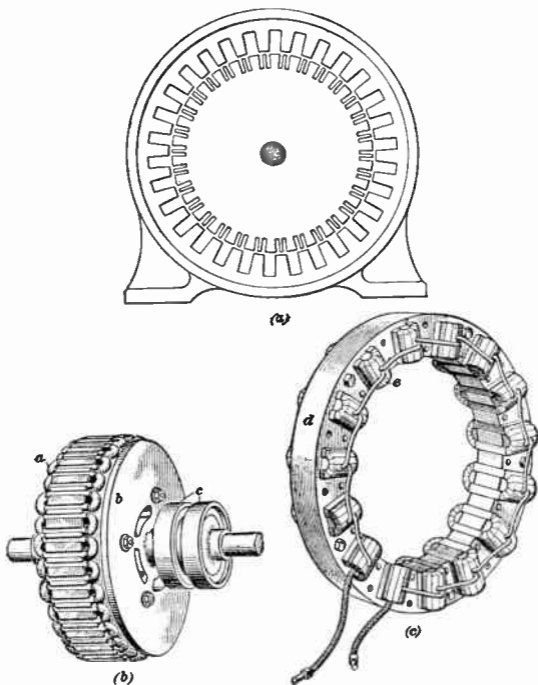

FIG. 4

the magnetizing action of the windings on adjacent poles, a feature which seemed desirable in the design of this machine. A *consequent pole* is formed when the flux through the pole is due to the combined magnetizing effects of the two field windings of two adjacent magnetic circuits.

In actual machines the magnetic field is usually produced by electromagnets excited by windings on the pole projections. The windings are usually equally divided among all the poles, but practically the same results are obtained by placing larger windings on one-half of the poles as mentioned above. In the alternator shown in Fig. 4, the arrangement of placing the field windings on alternate poles saves space and reduces manufacturing expenses.

PRINCIPLE OF THE INDUCTOR ALTERNATOR

Magnetism may be established through iron much more readily than through air. Consequently when iron is placed in the air gap of a magnetic circuit, the number of lines of force will be greatly increased. Withdrawing the iron will cause the flux to decrease to its former value. As changes of flux take place through the whole of the magnetic circuit, an electromotive force will be induced in a coil surrounding the magnetic circuit by what is known as *induction*. If the iron is periodically inserted into and withdrawn from the magnetic field, an alternating current will be established in the coil surrounding the magnetic circuit.

Such, briefly, is the principle of the *inductor alternator*, in which both the field frame and armature are stationary. Changes in the number of lines of force cutting the armature coils are produced by rapidly passing sections of iron through portions of the magnetic circuit. The lengths of the iron sections are such as to close the magnetic circuit, except for small mechanical clearances, between moving parts. Large variations in the number of lines of force, evident as pulsations in the flux, generate alternating voltages at rather high frequency.

THE 500-CYCLE INDUCTOR ALTERNATOR

Fig. 5 shows a type of 500-cycle alternator made by the Crocker-Wheeler Company. The field winding *a*, view (*a*), consists of a large stationary coil and is in a plane at right angles, or perpendicular, to the shaft. The

flux produced when the coil is energized passes from one end of the rotor *b*, view (b), to the other end, and

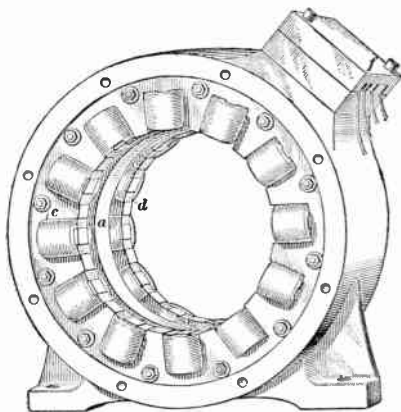

(a)

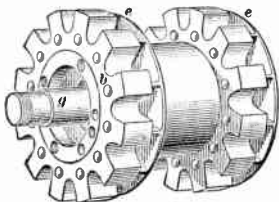

(b)

FIG. 5

returns through the outer shell of the stator, thus forming a closed magnetic loop. The armature windings are in two groups of twelve coils each, one group being

shown at *c* and the other at *d*, view (*a*). The coils are mounted on inwardly projecting sections of iron and are all connected in series, thus giving a high generated electromotive force. The magnetic flux follows the iron of the twelve teeth to their ends in preference to passing through the air spaces between the teeth. When the projections on the rotor are directly opposite the armature projections, maximum flux will be established, as the magnetic circuit is nearly all iron. When rotation brings the long air space, or gap, opposite an armature projection, the flux is considerably decreased because of the increased length of the air path in the magnetic circuit. The constantly varying field flux induces an alternating voltage of high frequency in the armature coils.

The projections on both the rotor and armature are made up of thin sheets of iron insulated from each other by shellac, forming what are known as *laminations*. This tends to prevent excessive heating which would be caused by local currents established in the iron if the projections were of solid iron.

The disks *e*, view (*b*), with the radial blades act as fans and help keep a current of air circulating over the armature and field windings. All current-carrying conductors heat to some extent due to energy losses, and if not properly cooled, their insulation may be injured by overheating. This is especially true of windings which are partly enclosed, in which case some means of insuring a circulation of cooling air must be provided.

This alternator does not require slip rings, as external connections may be made directly to the stationary windings, leads being brought out at *f*. Two plates support bearings for the shaft *g*, and are shown and described more completely under the discussion of motor-generator sets.

THE 100,000-CYCLE INDUCTOR ALTERNATOR

Alternators have been constructed which furnish 100,000- or, in some cases, 200,000-cycle alternating voltages. For the generation of voltages at these excessively

high frequencies, special construction and design features must be followed. As the inductor alternator may be made without rotating windings, which is a distinct advantage in securing mechanical strength and ruggedness, that type is commonly used. Several machines of the inductor type designed for very high frequencies have been developed.

The *Alexanderson alternator*, so named from its designer, has been successfully operated for the generation of voltages at 100,000 and 200,000 cycles. The field and armature windings are stationary and properly mounted with respect to the magnetic circuit. A rotor of magnetic material with numerous radial slots cut near its outer edge, produces many changes in the flux of the magnetic circuit per revolution, thereby generating in the stationary armature coils a voltage of very high frequency.

The general arrangement of the elementary parts of an Alexanderson alternator is shown in Fig. 6 (a), which represents a radial section from the center of the shaft to the outside of the machine. The magnetic circuit is energized by the current in two coils *a*, each extending completely around the inside circumference of the outer frame of the machine. In some machines when the stator frame is in two parts a slightly different arrangement of field coils has been developed. The field coils receive exciting current from an external direct-current source. The armature windings located as shown at *b* are wound, as represented in view (b), in zigzag formation in open slots around the whole circumference of the machine. This type of construction is necessary in view of the large number of active conductors (in some cases 600) which must be placed in a rather limited space. The rotor *c*, view (a), a portion of which is shown in view (c), is made of very high grade steel, carefully machined and balanced. Radial slots are cut near the outer edge of the rotor, and filled with some non-magnetic material. This makes the face of the rotor smooth, which, at the high rotative speed, is very essential in preventing excessive windage losses.

The magnetic flux, tending, as always, to follow the path of least opposition, will be tufted or bunched through the spokes of the rotor. The non-magnetic filling of the rotor slots between the spokes will act practically the same as air so far as its influence on the field flux is concerned. As changes in the number of lines of force occur with the passing of the rotor teeth or spokes, the recurring increase and decrease of field flux must necessarily cut the armature conductors and generate voltages in them. The conductors are so spaced that as the flux is increasing near one conductor, it is decreasing near the one next to it, and so on around the armature. Thus the electromotive forces generated by the different conductors can be combined to give the desired value of voltage. As the changes in the values of the magnetic fluxes affecting the armature conductors are made very rapidly, a high-frequency voltage is generated. In some installations the alternator armature windings are connected to a transformer and the voltage for the wireless system taken from the high-voltage coils of this device.

The rotor bearings at *d*, Fig. 6 (*a*), are lubricated by oil, supplied by a positive-feed oiling system. It is imperative that oil be kept supplied to the bearings, otherwise they would soon burn out.

The portion of the magnetic circuit near the armature conductors is made up of laminated iron to prevent local currents being set up by the rapid changes of flux. In larger capacity machines these local currents may cause considerable heating. In some machines of this type, cooling is effected by water circulating through pipes placed near the armature conductors.

These machines are usually driven by high-speed alternating-current or direct-current motors equipped with special apparatus to give them constant speed with fluctuating load. An enclosed gearing is usually employed between the motor and alternator to give a high rotative speed to the alternator rotor. The speed of the rotor is usually at least 2,000 revolutions per minute, and in some cases is as high as 20,000 revolutions per minute. Whe-

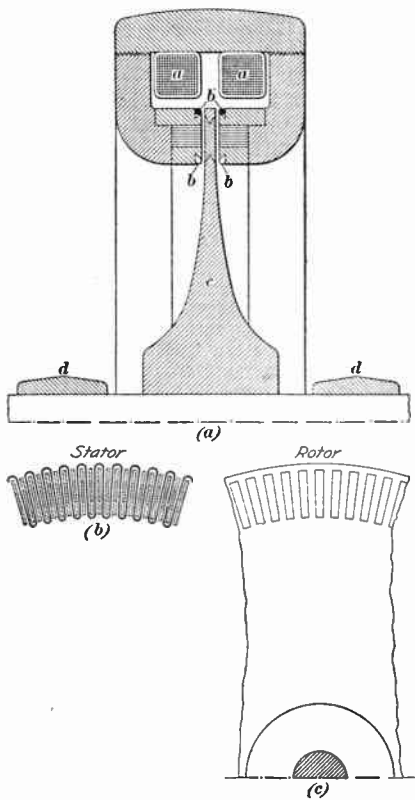

FIG. 6

a rotor with several hundred spokes is used, it is quite possible to generate an alternating voltage of exceedingly high frequency.

DIRECT-CURRENT GENERATORS COMMUTATION

Elementary Generator.—A *direct-current generator*, or *dynamo*, is a device for converting mechanical energy into electrical energy in such manner as to produce a flow of electricity in one direction through the external circuit that is connected to the machine. An elementary direct-current generator is shown in Fig. 7. The armature, indicated at *a*, is supported within the space between the poles *N* and *S* by the shaft *b*. When the generator is in action, voltages are generated in armature conductors *c* and *d* since these conductors cut up or down across the lines of force between the poles. The windings of the field coils are not indicated in Fig. 7.

The voltage, or electromotive force, generated in the armature conductors is an alternating one, since each conductor cuts down and then up across the same group of lines of force, thus causing a reversal in the direction of its generated electromotive force. The alternating voltage is changed to direct voltage, as far as the external circuit is concerned, by a rectifying device called a *commutator*. The action of a commutator in producing a direct voltage from an alternating one is known as *commutation*.

The simple commutator shown in Fig. 7 consists of two semicircular bars *e* and *f* mounted near, but not touching, each other on the shaft *b* and insulated from it. Conductor *c* is connected to bar *e* and conductor *d* to bar *f*. The brushes *g* and *h* serve to connect the external circuit with the commutator. As the shaft turns counter-clockwise, brush *g*, view (*a*), makes contact with bar *e*, and brush *h* with bar *f*.

The electromotive force generated in the turn, as soon as the conductors start to cut across the lines of

force, causes a flow of electricity out through the bar *e*, the *positive brush g*, the external circuit, and into the armature by means of the *negative brush h* and bar *f*. At the end of the first quarter revolution the positions of the armature conductors *c* and *d*, the positions of the commutator bars, and the direction of the current are as indicated in (b). At the end of the second quarter, the conductors *c* and *d* are generating no electromotive

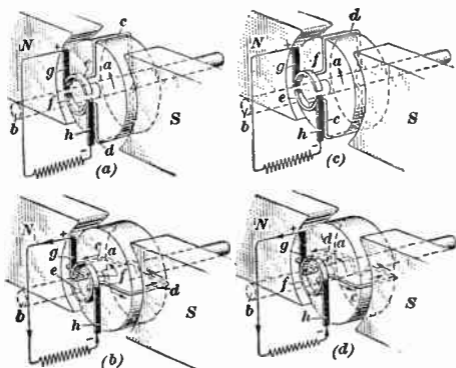

FIG. 7

force and the bars are just reversing their connections to the brushes, as indicated in (c). At this time there is no current in the circuit. During the third and fourth quarters, the bar *f*, view (d), is in contact with the positive brush *g* and bar *e* is in contact with the negative brush *h*. The direction of current in conductors *c* and *d* is indicated by the arrows. At the end of the fourth quarter, the conductors are again in the positions shown in (a), and the commutator bars are about to reverse their connections with the brushes.

As indicated by the arrows near conductors *c* and *d*, views (*b*) and (*d*), the direction of current in each conductor is reversed because the direction of motion of the conductors with reference to the flux is changed; but commutation serves to keep the current uniform in direction in the external circuit.

The alternating voltage generated in a conductor on the armature would be represented by a sine curve if the flux were uniformly distributed in the air gap. The commutator serves to produce in the external circuit a pulsating electromotive force which in turn produces a pulsating direct current of the shape shown in Fig. 8.

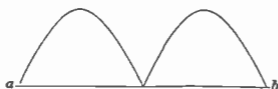

FIG. 8

The voltage or current in the external circuit starts at zero, rises to a maximum value, decreases to zero, and repeats this

action as long as the circuit is active, the current being in the positive direction at all times with respect to the reference line *a b*.

A current changing in value in the general manner indicated in Fig. 8 is called a *pulsating current*. The term, as ordinarily employed, refers to a direct current that varies in magnitude through a regular series of changes between maximum and minimum values; the minimum value may or may not be zero.

Armature With Several Coils.—The variations of the current, as indicated in Fig. 8, are due to the armature having only a single turn of wire. In an actual armature, there are many coils and commutator bars. The conductors of a few coils are passing through positions in which little or no electromotive force is generated in them, and their connections to the brushes are then reversed; but there are always a number of coils connected in series in the two or more parallel paths between the positive and negative sets of brushes. Therefore, the direct electromotive force impressed on the external cir-

cuit does not fall to zero, as indicated in Fig. 8, but assumes a nearly constant value for all positions of the armature conductors during a revolution. The action of a coil of several turns connected in series is identical with that of a single turn, except that the electromotive force is increased in proportion to the number of turns in the coil.

GENERATOR PARTS

The purpose of the electromagnets that form the field magnets of an electric generator is to establish a magnetic flux. Some types of small direct-current generators have only two pole pieces, and these are known as *bipolar generators*. In some very small generators, called *magnets*, the exciting magnetic flux is furnished by one or more permanent magnets, and in such a case no windings are placed on the field magnets.

The dotted lines, Fig. 9, indicate, in a conventional manner, the magnetic circuits of the field-magnet frame and armature core of a four-pole generator. The *field-magnet cores*, or *pole pieces*, are shown at *a* and the *field frame*, or *yoke*, at *b*. The broadened ends of the pole pieces are called *pole shoes*, and the surfaces of the shoes near the *air gaps c* between the pole pieces and the *armature core d* are called *pole faces*. The *field coils*, or *magnetizing coils*, are shown at *e*.

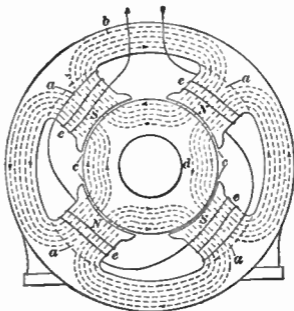

FIG. 9

The field coils, field-magnet cores, pole shoes, and the yoke, taken collectively, are called the *field of the machine*.

The field-magnet cores, pole shoes, air gaps, armature core, and field yoke, taken collectively, form the *magnetic circuits of the machine*.

When the current in the exciting coils is in the direction indicated by the arrowheads, the polarity of the pole faces is as indicated by the letters *N* and *S* and the paths of the magnetic fluxes are as indicated by the dotted lines. The field frame, field-magnet cores, pole shoes, and the armature core are made of very soft iron or of steel.

METHODS OF FIELD EXCITATION

Separately-Excited Generator.—Generators may be classified according to the method employed to *energize*, or *excite* the field coils. In a *separately-excited generator*, the current for energizing the field coils is provided from a source external to the generator.

The exciting coils are placed on the field-magnet cores and are connected to a battery or to another direct-current generator. Brushes bear on the commutator and serve to rectify the electromotive forces induced in the moving armature conductors and to impress it on the external circuit. The value of the generated electromotive force may be varied by changing the speed of the armature or by changing the value of the magnetic flux. The latter change may be effected by means of a variable resistance in the field circuit, or by changing the electromotive force causing the exciting current.

Shunt Generator.—Another type of machine is called a *self-excited shunt generator*, or simply a *shunt generator*, from the fact that the exciting current is provided by the generator itself. The exciting circuit is connected across the bushes on the armature and is in *shunt*, or parallel, with the external circuit of the machine. A shunt, in its broad sense, refers to a side path; when applied to an electric circuit, it refers to a side path between two points already connected by another path.

A resistance device, called a *field rheostat*, is included in the exciting circuit and serves to adjust the exciting

current and thus regulate the electromotive force generated by the armature conductors.

The field coils of a shunt generator are formed of many turns of fine copper wire, and the individual coils are connected in series, but this group of coils is connected in shunt with the armature. The resistance of the exciting circuit is high and only a very small part of the current from the armature is required to energize the field magnet.

Building Up a Magnetic Flux.—In order that a self-exciting machine may start to generate, some residual magnetism is required in the field of the generator. The frame of even a new machine is often slightly magnetized, but if it is not magnetized sufficiently, or if it is of incorrect polarity, the field coils may be separately excited temporarily from another generator or from a few cells of a battery. The shunt circuit is then disconnected from the separate source and connected to the brushes of its own armature.

The slight electromotive force generated by the armature will establish a current in the exciting circuit. This will increase the inducing flux, resulting in an increase of electromotive force and further building up of the exciting current and the flux. A point of balance of the electrical and magnetic effects is finally obtained where the generated electromotive force and the exciting current become constant for existing conditions of operation. The operation of setting up the magnetic flux is termed *picking up*, or *building up*, the flux.

Series Generator.—Another type of self-exciting machine is the series generator. The exciting coils are connected in series with the armature and the external circuit. No electromotive force, except the slight value due to residual magnetism, is generated in the armature unless the external circuit is closed and a current is established throughout the circuit. The electromotive force generated depends on the value of the current in the circuit, which consists of the field coils, the armature, and the external circuit. The field coils on this

type of machine are formed of a conductor of comparatively large sectional area, and each coil has comparatively few turns.

Compound Generator.—Automatic regulation of the electromotive force of a generator may be effected by a combination of shunt- and series-field coils forming part of a *compound-wound generator*, connections for which

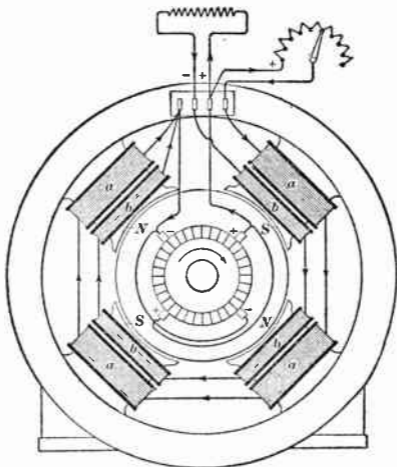

FIG. 10

are shown in Fig. 10. The shunt coils are shown at *a* and the series coils at *b*.

In a generator as usually connected, the magnetizing forces of the shunt coils *a* and the series coils *b* act in unison to set up fluxes in the cores of the main field magnets. When the generator is running, but is not connected to the external circuit, the magnetizing forces of

the shunt coils *a* produce the main flux of the magnetic field of the machine. When the external circuit is closed, current is established in the series coils *b* and the fluxes in the cores of the main field magnets are increased and a higher electromotive force is generated. If the load on the generator increases still further, the exciting current through the series coils increases, thus building up the fluxes in the magnet cores and causing a higher electromotive force to be generated. This higher electromotive force is desired because of the increased drop in volts necessary to force the larger load current through the armature, the external circuit, and the series-field coils. The generated electromotive force may be adjusted by means of the field rheostat in the circuit of the shunt-field coils.

Compounding.—The preceding method of regulating the electromotive force of the generator is called *compounding*. A machine is *flat-compounded* when the magnetizing force of the series coils is adjusted so that the voltage at the generator terminals remains practically constant for all loads. It is said to be *overcompounded* when the voltage at the terminals rises with the load so that some distant point on the external circuit may have nearly constant voltage for all loads.

In an *accumulatively compounded generator*, the shunt coils and series coils are so connected to their respective circuits that they act in unison to establish the inducing flux and thus to increase the generated electromotive force as the load increases.

In a *differentially compounded generator*, the connections of the shunt and series coils are such that the flux of the series coils acts in opposition to, or *bucks*, that of the shunt coils. Generators of this kind are used in automobiles and to a limited extent in wireless work. If the speed of a variable-speed generator exceeds a given value, the electromotive force at the terminals does not increase, because of the bucking effect of the series coils.

DIRECT-CURRENT MOTORS

DEVELOPMENT AND DIRECTION OF TURNING FORCE

Motor Action of Conductor Flux.—A *motor* may be defined as a machine for converting electrical energy into mechanical energy. The turning effort, or *torque*, which maintains rotation of the armature, is established by the interaction of the fluxes of the field magnets and the fluxes set up by the currents in the armature conductors. While the torque for each conductor is usually small, the torque for the whole armature consisting of many conductors may be very large.

Fig. 11 shows one arrangement of conductors on an armature intended for a four-pole motor. The active conductors, indicated by small circles, lie in slots in the armature core and are connected across the back of the core by wires indicated by dotted lines and to the commutator at the front of the core by wires indicated by solid lines. One-turn coils are shown, but usually a coil consists of a number of turns. A solid black circle indicates that the current in the conductor is away from the observer and a circle with a dot in its center means that the current is toward the observer. White circles indicate little or no current because of commutation. Arrows near the pole faces indicate the direction of the field flux, and a loop with arrowheads drawn around one pair of armature conductors opposite each pole face indicates the paths of the flux set up by current in these conductors. To avoid confusion of lines, only a few paths for conductor flux are shown. The denser flux on the side of each conductor, where the directions of the conductor and field fluxes agree, tends to move all conductors so as to cause counter-clockwise rotation of the armature, as indicated by the curved arrow near the brushes *A* and *B*. The direction of motor action is also indicated by the straight dotted arrows in the group of sketches used in the

discussion of the direction of the electromotive force generated in a conductor, under a preceding heading.

As the armature rotates, successive commutator bars slide under the brushes so as to reverse the direction of current in each conductor while the conductor is passing through the neutral space between the tips of

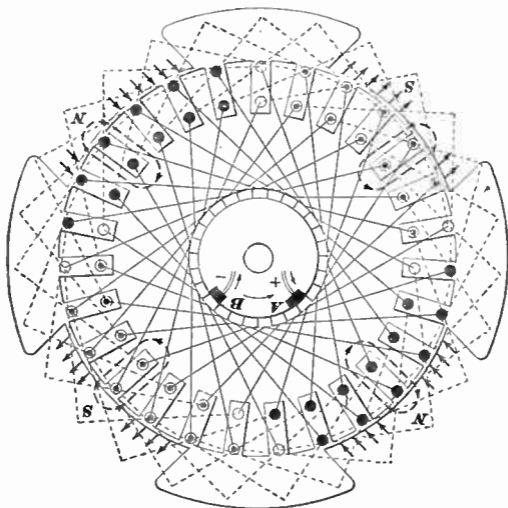

FIG. 11

adjacent pole pieces. The actions occurring at the commutator of a direct-current motor are exactly the reverse of those occurring in a direct-current generator commutator. Direct current comes to the motor commutator but is *rectified*, or *commutated*, into alternating current before reaching the armature conductors. The commutator serves to make the necessary current reversals,

so that at all times the conductors adjacent to north poles carry current in one direction and the conductors adjacent to south poles carry current in the opposite direction, as indicated in Fig. 11. The reaction between the flux of the poles and the conductor flux thus maintains the torque that keeps the armature in motion.

Relation of Generator and Motor Rotation.—If a machine that has been operating as a shunt-wound generator is operated as a shunt-wound motor, the polarity of the circuit wires and the connections between the circuit and the machine being unchanged, the armature will rotate as a motor in the same direction as it did as a generator. Current now passes into the armature at the positive motor brushes, which are the same as the generator positive brushes. This causes a reversal of the direction of the current in the armature windings. The direction of the flux around a motor conductor near a north pole is opposite to that around a similarly placed generator conductor. The polarity of the pole pieces remains unchanged, because each end of the field-coil circuit is connected to a circuit wire of the same polarity as before. As far as magnetic interaction between field flux and conductor flux is concerned, the motor armature would rotate in the opposite direction from that of a generator armature, but it must be remembered that the generator armature is driven by a steam engine or other prime mover in a direction against this magnetic force, therefore the armature of the motor or of the generator will rotate in the same direction under the assumed conditions.

Reversal of Rotation.—If the current in either the field coils or the armature of a direct-current motor is reversed, the direction of rotation will be reversed; but if the current in both the field coils and the armature be reversed, the direction of motion will remain unchanged. Reversing the line connections to the terminals of a direct-current motor simply reverses the current through both the armature circuit and the field coils and does not change the direction of rotation.

In order to reverse a direct-current motor, either the armature terminals must be interchanged, so as to reverse the current through the armature only, or the current through the field coils only must be reversed.

Motor Classification.—According to field winding, all direct-current motors are in three classes, namely, *shunt*, *series*, and *compound*, where these terms imply the same type of field-coil connections as were given in the discussion of the subject of direct-current generators. Shunt-wound motors start and operate with current input proportional to the torque, or turning effort, and run at practically constant speed at all loads. The current input to a series motor varies less than directly proportional to the torque and the speed varies widely with varying load. For example, at twice full-load torque, a shunt motor requires approximately twice full-load current and operates at only a trifle below its full-load speed, while a series motor requires considerably less than twice full-load current, but operates at much below full-load speed. Compound-wound motors have characteristics intermediate between those of shunt and series motors, resembling most closely the one that its predominant field winding most nearly resembles.

OPERATION OF DIRECT-CURRENT MACHINES

Inspection.—Direct-current generators and motors have many features in common; in fact, they are sometimes used interchangeably. A brief consideration of the operation and care of direct-current machines will apply to both generators and motors. Dynamo-electric machines and all devices connected with their operation or regulation should be kept scrupulously clean. No copper or carbon dust, dirt, grease, or oil should be allowed to remain on any part of the machine. Each part should be systematically examined, and cleaned, or repaired if necessary, at regular intervals. Connections should not

he allowed to come loose, thereby producing a possible source of serious trouble.

Heating of the Armature.—An armature should run without undue heating; if it heats so as to smoke or give off an odor, the machine should be stopped at once and the cause of the heating located and the trouble remedied. Heating may be caused by damp insulation, which, as a general rule, is shown by steaming, and may be remedied by baking the armature in an oven. *Overloads*, that is, loads greater than the rating of the machine, tend to heat the armature excessively, due to no fault of the machine.

If, instead of the whole armature running hot, the heat is confined to one or two coils, there is probably a *short circuit* either in a coil or between the two commutator bars to which the ends of the coil connect. If a short-circuited coil is run in a fully excited field, it will soon burn out. Repair of the defective coil should be made before using the machine again. By an *open circuit* in the armature is meant a break in one of the armature wires or its connections. Excessive current may burn off one of the wires or a bruise of some kind may nick a wire so that the normal load, or perhaps less, burns it off. This condition would be manifested by excessive sparking at the commutator and by a slightly decreased output. An inspection would probably locate the open-circuited coil and suggest a method of repair.

Care of the Commutator.—The commutator is usually made of copper bars insulated from each other by thin strips of mica or mica composition. Brushes of carbon or, in some cases, copper press on the commutator and serve to conduct current from the commutator to the external circuit. A moderate amount of sparking at the commutator is not very objectionable, but if it becomes sufficient in amount or in duration to blacken or roughen the commutator bars, the cause should be located and the fault corrected. Numerous small white sparks, evenly distributed along the edge of the brush and producing no distinguishable noise, usually work little injury.

Too large a load on the machine will often cause sparking, which in many cases may be lessened by shifting the brushes. In any case, the brushes should be so located that they reverse the connections to the armature conductors when they are cutting minimum flux. If the brushes are in good condition, make good contact, and are properly set, very little sparking should be evident. Large sparks under such conditions would tend to indicate trouble in the armature. In some cases the commutator does not wear down smoothly and will require resurfacing either by fine sandpaper or by machining. Emery paper must not be used on the brushes or the commutator, as emery is a conductor and may cause short circuits between adjacent commutator bars. Moreover, particles of emery sticking to the face of the brush, being more gritty than sand, will scratch the commutator.

Field Coils and Connections.—The field coils are stationary, are usually well protected, and are not apt to cause a great deal of trouble. In installation, or assembly, the field windings may be connected incorrectly, but the proper connections for correct polarity of the pole pieces can be easily found experimentally.

The magnetic circuit of the generator may lose its residual magnetism. in which case it is probable that the armature voltage will not build up, or if it does, it is apt to be wrong for the proper direction of rotation. In either case, the machine should be shut down, and the field circuit disconnected. A low voltage, taken from the circuit of a direct-current generator or from a battery consisting of a few primary or secondary cells, is applied to the terminals of the field-coil circuit. The positive terminal of the source is connected to what should be the positive terminal of the field circuit and the corresponding negative terminals also connected. The current will set up a flux in the magnetic circuit of the generator and when the exciting circuit is opened, a residual magnetism of proper polarity should be established. The positive terminal of the field circuit should

now be connected to the positive brush and the negative terminal of the field circuit to the negative brush. The armature should be driven at full normal speed and in the proper direction to cause the brushes assumed to be positive to be really so.

An *open* in the field circuit of either a generator or a motor may cause serious trouble. Frequent inspection and tightening of terminals will usually prevent this trouble.

Grounds.—The armature or field windings may become grounded on the armature core or on the frame of the machine. This condition should be corrected when found. Grounds are apt to cause considerable loss of power, and will constitute a short circuit if the windings are grounded at two or more points. The frame is often grounded intentionally by means of a high resistance in order to prevent the possibility of shock to any one coming in contact with the frame. The high resistance may under some conditions limit the current should one of the windings become grounded. The high resistance between the frame and ground permits any static charges, such as are caused by the friction of the belt on the pulley, to be conducted to the ground.

MOTOR-GENERATOR SETS

GENERAL PRINCIPLES AND USES

A *motor-generator set* is a combination of a motor coupled to one or more generators. The machines are connected by mechanical means and may be mounted on one base, but the armature windings with their corresponding field windings are entirely distinct. They may be merely two commercial machines whose shafts are connected by a coupling, or, for compactness, they may be of special design with both armatures mounted on a short shaft supported by one bearing at each end.

Motor-generator sets are commonly used for the following purposes: to change alternating current to direct

current, or vice versa; to change direct current from one voltage to another; and to change alternating current at one frequency to alternating current at some other frequency. These changes are in some cases necessary, for example, where electricity of one voltage or frequency is available, but some other value is required. The motor may be designed to operate satisfactorily on the available source of electricity and the generator may be designed to furnish current which will meet the particular requirements, such as high-frequency current for radio use.

SIMPLE MOTOR-GENERATOR SET

In its simplest form the motor-generator consists of a shunt-wound, direct-current motor driving an alternator excited by the same direct-current supply. Fig. 12

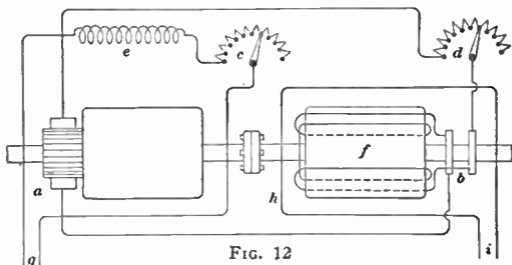

FIG. 12

shows such a combination with a motor *a* driving the alternator *b*, which is of the revolving-field type. Rheostats *c* and *d* serve to regulate the amount of current through the motor field *e* and alternator field *f*, respectively. Direct current is supplied to the motor through leads *g*, and alternating current is taken from the alternator armature, of which only one turn *h* is indicated, by means of leads or terminals *i*. The frequency of the alternating current will depend upon the design of the alternator and the speed of rotation.

When used in radio work the alternator must often operate under conditions which fluctuate from no load to full load with manipulation of the sending key. These large variations of output cause sudden changes in the amount of power required and tend to cause appreciable changes in the motor speed. To secure more uniform speed, it is desirable to use a compound-wound motor whose speed remains nearly constant with load variations. The only change required in Fig. 12 to adapt it to represent this type of machine would be the addition of a motor field winding in series with the motor armature which would oppose the action of the shunt winding. Increase of armature current with increase of load would decrease the resulting field flux, thereby maintaining the speed constant. This would keep the frequency of the alternating current at a constant value, which is very desirable in radio work.

Alternators to be used in motor-generator sets may be of the revolving-armature type as well as of the revolving-field type. The operation and results are practically the same in either case. When the alternator is of the revolving-armature type, a field winding connected in series with the motor armature may be placed on the alternator so as to aid the field flux established by the field cores of the winding on these same field cores that is in parallel with the motor armature. Decrease of speed with increased load is accompanied by an increase of current in the series winding on the field cores of the alternator. This in turn increases the field flux of the alternator and the alternator voltage is kept nearly constant.

A 500-CYCLE REVOLVING-ARMATURE ALTERNATOR CONNECTED TO A DIRECT-CURRENT MOTOR

A motor-generator set for furnishing 500-cycle alternating current from a direct-current supply is shown in Fig. 13. The frame *a*, view (*a*), of the machine is provided with screens over the ventilating open-

ings to permit air circulation and prevent to a large extent the entrance of injurious substances. The rotor, view (b), is arranged with the motor armature *b* and the alternator armature *c* mounted very close together forming a compact unit. The motor-armature coils are connected to the commutator *d*, which, by means of

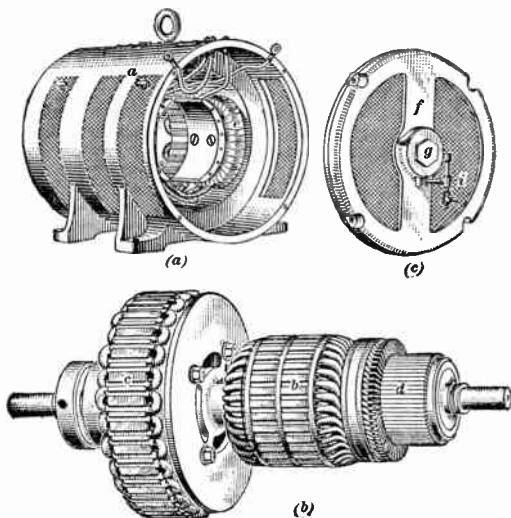

FIG. 13

brushes and leads, completes the path for current from the source of supply. The motor-field windings *e*, view (a), serve to energize the field circuit. The revolving-armature alternator has already been described under that heading. There is an *end plate f*, view (c), at each end of the frame which carries bearing *g* for the rotor shaft. A small oil gauge *i* shows the height of oil available

for lubrication of the bearings. Supports for the motor and alternator brushes are carried on the inside of the end plates at their proper ends. The end plates are also closed by means of screens. The units comprising a motor-generator set need not differ materially from those same machines when used individually.

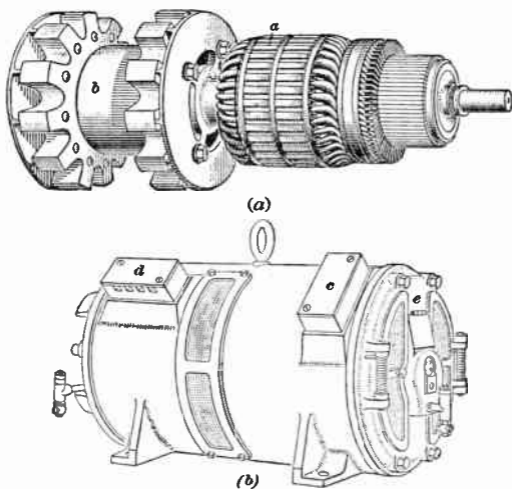

FIG. 14

A 500-CYCLE INDUCTOR ALTERNATOR OPERATED BY A DIRECT-CURRENT MOTOR

Fig. 14 shows a direct-current motor directly mounted on the same shaft with an inductor alternator. When operated at its proper speed, the alternator furnishes 500-cycle alternating current. The direct-current motor armature *a*, view (a), with its field winding presents no

marked variation from the usual construction. The characteristics of the inductor-alternator rotor *b* with its proper armature and field windings were stated under a previous heading.

The assembled machine is shown in view (*b*) with exits for the direct-current leads at *c* and for the alternating-current leads at *d*. The end plate *e* at the direct-current motor end is shown properly mounted on, and fastened to, the frame. The brushes and brush holders are mounted on the inside of the end plate and the brushes bear on the commutator of the motor. The ventilating openings of this machine are protected by wire screens. The motor-generators illustrated in Figs. 13 and 14 are made by the Crocker-Wheeler Company.

CONTROL DEVICES FOR DIRECT-CURRENT MOTORS

COUNTER ELECTROMOTIVE FORCE

When an armature conductor is forced by motor action to move across the flux of the field magnets, an electromotive force is generated in it. This electromotive force is usually called *counter electromotive force*, but it is also known as *motor electromotive force*, *back electromotive force*, and *back voltage*.

An armature has but a very low resistance—a fraction of an ohm in many cases—and if the armature is clamped so that it cannot rotate and the full voltage of the line is then impressed on its terminals, the windings would probably be damaged by the resulting large current.

If the armature is free to rotate, the counter electromotive force established in the active conductors acts in direct opposition to the impressed electromotive force from the power circuit, and thus limits the current. As the speed increases, the counter electromotive force increases and the armature finally reaches such a speed that the opposing action of the counter electromotive force is such that just enough current is taken by the

motor to develop the required torque. In the case of a shunt motor, if the load changes, the speed varies slightly and there is automatically established a new value of the counter electromotive force that is suitable for the new value of the current required for the motor load.

The pressure that is actually effective in forcing current through the armature is the difference between the impressed electromotive force and the counter electromotive force. This difference is usually only a few volts, because the ohmic resistance of the armature is so low that only a low effective voltage is required to force the necessary current through the windings.

PURPOSE OF STARTING RESISTANCE

In starting very small motors, the voltage of the line may be impressed directly on the armature terminals, because these armatures have a comparatively high ohmic resistance. In larger motors, the impressed voltage is adjusted to a lower value for starting by the insertion in the armature circuit of an adjustable resistance, called a *starting box*, *starting rheostat*, or *motor starter*. As the speed and counter electromotive force of the armature increases, the resistance of the rheostat is gradually cut out of circuit until, finally, the armature is connected directly across the line wires.

With smaller rheostats, the face plates, on which are mounted the arms and contacts by means of which resistance sections are cut into or out of circuit, are placed on the front of the box containing the resistance coils or grids. With larger rheostats, the face plates may be mounted on a switchboard and the resistance sections installed separately.

STARTING BOX OF SIMPLE TYPE

Fig. 15 shows one type of motor starter connected to a motor and its power circuit. This box has four terminals for connections to external circuits. A protective coil *a* is mounted on the face plate. This coil will

hold switch lever *b* when the lever is at its on-position. The lever is shown in its off-position. The connection to the positive line is then open and the motor is at rest. To start the motor, switch *c* is closed, thus connecting the starter to the line, and the switch lever is moved to the right, making contact with button *d*. The shunt-field circuit of the motor is then energized. At the same time the armature circuit is closed through the resistor sections *e*. The current established will depend on the voltage and on the resistance active in the motor starter and of the rest of the armature circuit. Under normal conditions there will be sufficient current

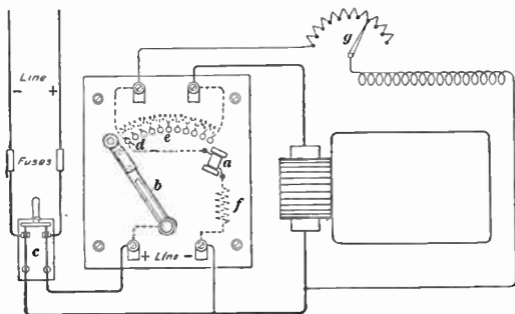

FIG. 15

so that the armature will start to rotate and a counter electromotive force will then be established in the armature conductors. In case of a heavy load on the motor, the lever may move over two or three contact buttons before the motor starts.

Further movement of the lever reduces the active resistance in the starter and the motor armature comes up to normal speed. At the extreme right-hand position of the lever, all of the resistor sections are cut out of the armature circuit and the armature is connected

directly across the power circuit. This is the normal running position of the lever.

The holding coil *a* in series with a resistor *f* and the armature-starting resistors to the left of lever *b*, when the lever is at its on-position, is connected across the circuit. The resistors *c* have a very low resistance as compared to the resistance of coil *a* and resistor *f*. The coil holds the lever in its on-position, but if the power circuit is opened, the magnet *a* releases the lever and a spring carries it back to its off-position. The motor stops and must be started again when the line is in operating condition.

Speed control is accomplished by changing the active resistance of the field rheostat *g*. A change in the current in the field circuit changes the field flux and this affects the speed that is required to generate the proper value of the counter electromotive force for the given load conditions. It is important when connecting up a starting box that all connections be made exactly as specified for proper starting and operation of the motor. The terminals on the box are usually designated by names or letters representing the correct circuit connections for each terminal.

PROTECTIVE DEVICES

Fuses.—In addition to the protective devices mounted on the face plate of a starter, such as the low-voltage release coil *a*, Fig. 15, fuses and, in some cases, circuit-breakers are also installed in the motor circuit, usually near the main switch. *Fuses* are short pieces of metal that will melt at a comparatively low temperature. They are usually encased in a fiber tube and installed in the incoming line as shown in Fig. 15. The fuses will carry the normal current for the motor indefinitely, but will melt and open the circuit in case the current exceeds a safe value. A new fuse must then be installed.

Circuit-Breakers.—Where overloads are of frequent occurrence, a special type of switch, known as a *circuit-breaker*, is often installed, in some cases in addition to

the main switch and in others in place of the main switch. The switch blade is closed against spring pressure and is held closed by a catch. A coil connected in series in the circuit connected through the breaker actuates a trip which releases the catch when the current exceeds a predetermined value. The switch blade opens the circuit very quickly, thereby affording the necessary protection for the motor. The main advantage of the circuit-breaker is that the switch arm may be easily closed, which will place the circuit in operating condition without the expense and delay occasioned by the renewal of fuses. The circuit-breaker can also be *tripped*, or opened, by hand, thus serving both for overload protection and as a line switch.

STARTING AND STOPPING A MOTOR

Starting a motor with a starter like that shown in Fig. 15 is accomplished by first closing the line switch and then moving the starting lever over the row of resistance contacts, frequently called *steps*, or *points*. The movement should be slow enough to allow the motor speed to accelerate smoothly. On the point at the extreme right, the lever is held by the low-voltage retaining magnet; this is the point on which the lever remains while the motor is running and is therefore called the *running point*. The lever will not remain at rest on any intermediate point and must not be held there longer than necessary for the speed to pick up.

Stopping a motor with the starter illustrated is generally best accomplished by opening the line switch, or circuit-breaker. A circuit-opening device should be a part of every motor installation. When the switch is opened, the motor speed and the counter electromotive force will decrease. The current in the low-voltage release magnet, now due to the counter electromotive force, will soon be so low that the magnet will release the rheostat switch lever which will then return to off-position.

MOTOR-SPEED REGULATION

Changes in the speed of a direct-current motor can be effected by changing the impressed voltage at the motor brushes or by changing the field strength of the motor. In either case, the motor speed automatically changes enough to keep the difference between the impressed volts and the counter volts at the value necessary for the torque. Speed-regulating devices for controlling the speed by varying the voltage impressed on the brushes are the same in appearance and in general design as motor-starting devices, the chief difference being that the contacts and resistors of regulating devices are generally larger, better to withstand the more severe service of some or all of them remaining in circuit for long periods of time. The resistors of motor starters are selected to carry a large current during only the short period required to accelerate the motor speed. In most cases these resistors would be overheated and possibly ruined if left in the circuit too long, that is, if too much time is taken to start, or if used to control the speed.

The more common and desirable method is to secure speed control by a field rheostat as indicated in Fig. 15. The field rheostat is usually placed near the operator so that he may have direct control of the speed of the motor.

SINGLE-STEP AUTOMATIC STARTER

The starting device may also be of the *automatic motor-starter* type, in which case the switching is done automatically, each operation cutting out a section of resistance when the motor speed has accelerated to the proper point.

The automatic starter shown in Fig. 16 is of the *single-step* type, as there is only one resistance step to be cut out of the circuit when starting. The single-step starter is satisfactory when used with motors of rather low power output, as they will readily reach full speed, especially when starting without load. Closing the line switch *a* serves to establish a current through the motor

armature b which is limited in value by the current-limiting resistance c . As the speed of the motor increases, the counter electromotive force of the armature increases. The coil d is connected in shunt across the brushes and hence the voltage across the coil is the same as that across the motor. When there is sufficient current in the coil, plunger e is drawn up and the resistance c is short-circuited by the bar across contacts f and g , thereby placing full line voltage on the motor. Simultaneously with the rise of the plunger, the key h moves upward placing resistance i in series with coil d , which operation

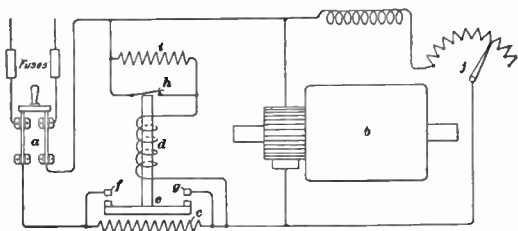

FIG. 16

decreases the current through this branch circuit. The smaller current through the coil is sufficient to hold the plunger in position, and reduces the likelihood of the coil becoming overheated.

Speed adjustment of the motor is by variation of the field current through changes in the field rheostat j . Opening the line switch stops the motor and the plunger drops, due to gravity, to its proper position for the succeeding start.

THREE-STEP AUTOMATIC STARTER

A complete circuit diagram for a *three-step automatic motor starter* connected to a motor-generator set is shown in Fig. 17. The apparatus mounted in the box a is designated as the motor starter, while that at b is an

overload relay serving as auxiliary protective apparatus. When the line switch *c* is closed as shown and the operator's control switch *d* is open, a circuit is completed from the positive line through the shunt-field rheostat *e*, shunt-field winding *f*, and overload coil *g* of the overload relay, to the negative side of the direct-current supply line. The motor field *f* is now energized.

If the machine is to stand idle for some time the main-line switch should be opened, but it is normally left closed. The current in the shunt field is usually small and the power loss is not objectionable when operating intermittently in view of the better starting and stopping characteristics obtained.

To start the motor-generator set, the operator closes the control switch *d*. This operation closes a circuit starting with the positive line, through resistance *h* and coil *i* to the lower contact of the overload relay and its lever *j*, then through control switch *d*, and back to the negative line. The current through coil *i* draws up the plunger *k* which makes contact with point *l*, between which point and points *m*, *n*, and *o* are connected the resistance units of the three steps. The rotor will now start due to current through the circuit from the positive line to point *o*, through the resistance units, point *l*, plunger *k* and flexible connection *p* to the positive armature connection, thence from the negative armature connection through coil *g*, to the negative side of the line. Further movement of the plunger *k* cuts out the three resistance steps and the motor attains full speed. The rapidity of stepping up of the plunger is controlled by the adjusting point of the resistance *h*. When the movement of *k* is completed, the shunt around *h* is opened automatically making the holding current through coil *i* small. The motion of the plunger *k* is steadied by the action of a piston in a vacuum chamber and this action permits a slow regular advance. After the plunger brings the motor up to full speed on point *o*, it also makes contact with point *q*. A circuit is now established through the alternator field winding as follows: the positive line to point *o*,

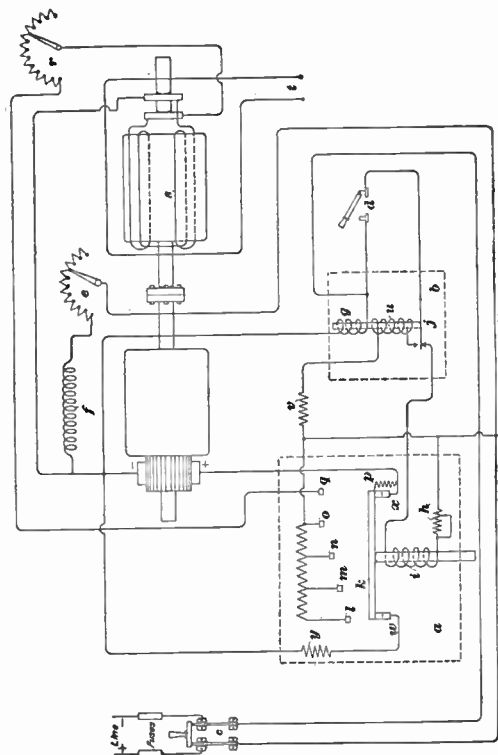

FIG. 17

through plunger *k* to point *q*, thence through the alternator-field rheostat *r* to the inner slip ring, through field windings *s* and outer slip ring to coil *g* and negative line.

Speed control of the motor, and consequently of the frequency of the alternator, is accomplished by varying the motor-field rheostat *e*. The alternator-field rheostat *r* serves to control the current through the alternator field *s* and the voltage at the terminals *t*.

The weight of the plunger inside coils *g* and *u* of the overload relay normally keeps the lever of switch *j* down against the lower contact. The control circuit is then complete and is in its normal operating condition. Should the current through coil *g* become excessively large, due to overload or other unnatural condition, the iron plunger will be drawn up, by increased electromagnetic action, thus opening the lower switch contact of *j* and closing the upper contact of the same switch. Opening the lower contact of *j* opens the circuit through coil *i*. The plunger *k* then falls and opens the motor armature circuit. The closing of the upper contact of switch *j* energizes coil *u* in the circuit established through the positive line, resistance *v*, coil *u*, upper contact of switch *j*, control switch *d*, and to the negative side of the supply line. This serves to hold the lever *j* on its upper contact until control switch *d* or switch *c* is opened, thus preventing restarting until the trouble can be investigated and corrected.

When the control switch *d* is opened to stop the motor, the coil *i* is deenergized and plunger *k* opens the armature circuit in practically the same way as has just been described. In either case plunger *k* falls across contacts *w* and *x* and makes a low-resistance path between them. A circuit is now closed through the positive armature terminal, contact *x*, plunger *k*, contact *w*, resistance *y*, to the negative armature terminal. As the motor field is excited and the armature will continue to rotate due to inertia, an electromotive force will be generated, sending considerable current through the resistance *y*. This will provide a dragging load on the motor armature and bring

it to a quick stop, so that the operator may begin receiving very soon after he quits sending. The three-step starter is particularly desirable in starting large motors, and in giving an acceleration more uniform and steady than would be possible if fewer steps were used.

The current through the control switch *d*, Fig. 17, is only enough to excite the coils *i* and *u* and is so small that an ordinary snap switch or push-button switch can be used. The switch can be located at any convenient point near to or remote from the starter. For example, such a starter can be located near its motor and controlled by means of a small hand-operated switch some distance away. Closing the switch causes the relays to operate and start the motor; opening the switch causes the relays to open and stop the motor.

MISCELLANEOUS RADIO DEVICES

GENERAL INTRODUCTION

Some of the many devices used in radio practice do not fall under any of the general headings which are discussed elsewhere, so are grouped under this one heading. Because they are thus grouped does not reflect on their value, as the principles of practically all of them have done, and still are doing, their share in the constant advance of the radio art. In fact, some of these devices may be said to be essential parts of some forms of radio sets, while others, perhaps not so essential, have been of great value in radio communication.

THERMOELECTRIC COUPLES

Development of Thermoelectric Force.—A *thermoelectric force* is developed by the contact of two dissimilar metals, and it varies not only with the kinds of metals and the physical condition of each but also with their temperature.

A *thermoelectric couple* is a combination of metals joined together that is capable of producing with proper heat treatment a thermoelectric force. That a voltage is developed by heating a contact of two dissimilar metals may be shown in the following way: Solder or other-

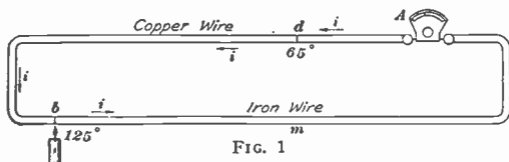

wise join together a copper and an iron wire, as shown at *d* and *b*, Fig. 1, and include somewhere in the circuit an instrument *A* that will detect or measure an electric current and also indicate its direction. If the junction *b* is heated to a temperature of 125° and the junction *d* is kept at the temperature of the room, say 65° , then the instrument *A* will show that electricity flows from the copper wire across the hot junction *b* to the iron wire, through the iron wire and the instrument *A* to the junction *d*, then across this junction to the copper wire, as indicated by the small arrows *i*.

If the junction *b* is cooled below the other parts of the circuit, the flow of electricity will be in the opposite direction, or from the iron through the contact *b* to the copper wire, etc., that is, in the opposite direction to the arrows *i*. In either case, energy in the form of heat is converted into energy in the form of electricity. This phenomenon is known as the *Scebeck effect*, after the man who discovered it.

In general, the thermoelectromotive force is larger in proportion as the difference of temperature increases. The current produced in a given circuit will be proportional to the difference in temperature between the two junctions, provided the mean temperature of the two junctions has remained the same or nearly the same.

If two dissimilar substances are joined at one point and the two free ends connected by a third substance, for instance, a long copper wire, the thermoelectromotive force developed will be exactly the same as if the two substances were connected directly together without the third substance, provided the two free ends that are joined to the copper are at the same temperature.

Thermocouple Materials.—In one type of construction, the thermocouple elements are made of constantan and iron, and constantan and platinum. A somewhat different type of construction gave good results when tellurium was used with either constantan or platinum. The voltage produced by the thermocouple is at best only a few millivolts, which may be slightly increased by enclosing the heater wire and couple in a vacuum. Should the element be burned out by an excessively large current it is not so easily repaired when in a vacuum, so this procedure is not always used.

Application of Thermoelectric Force.—The construction features of a sensitive radio-milliammeter are indicated in Fig. 2. A wire *a b* carries the current under observation, and is heated by the passage of that current. A thermocouple rests on or near this wire at *c*, and is heated by the current in wire *a b*. The couple *c* is connected with a very sensitive direct-current voltmeter *d*, as the voltage of the thermocouple depends only upon the fact that it is heated, and the direction of the current in *a b* does not affect it. The voltmeter *d* is usually calibrated to read the current in the heater wire direct in amperes or some related values, such as milliamperes. As the thermocouple element is very small, it can follow the changes in the main current, if any, thereby giving good readings. The device is not appreciably affected by local room temperatures, so may be used to give readings continuously without correction. The whole unit is fre-

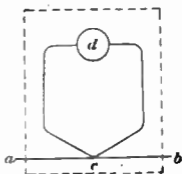

FIG. 2

quently mounted inside a single case, as indicated by the dotted lines, to present a better appearance. If desired, several couples may be used with one voltmeter, it being necessary to have a separate calibration curve with each thermocouple. This type of instrument can be made with extremely low ranges and of low resistance, two very desirable features in some phases of radio measurements.

Practically the only other commercial use of thermoelectric currents is in determining very high and very low temperatures. Strangely enough, here again the thermocouple element is coupled to a direct-current instrument, and although the voltage of the thermocouple is the factor actually read, the scale of the voltmeter may be calibrated to read the temperature of the junction directly in degrees.

CRYSTAL DETECTOR

A *crystal rectifier*, or as it is more commonly called, a *crystal detector*, is a device for changing an alternating current into a pulsating direct current. This rectification may not be complete, but for practical considerations it is generally considered that a good rectifier passes only the positive, or the negative, pulses of current. The operation is based on the unilateral, or one-way, conductivity of some crystals, which allows them to pass a much larger current in one direction than in the other. The application of crystal rectifiers to the detection of radio signals will be considered further on.

It has been found that contact between a metal point and almost any metallic crystal or between two such crystals may possess very good rectifying properties. The contact point seems to present a very high resistance to the passage of a current in one direction, while it offers but little opposition to the current in the opposite direction. Also, different points on any one crystal possess this rectifying property in varying degrees. By trial it should be possible to find some points on the crystal which are much more sensitive than others, and

one of the sensitive points should be used while receiving messages.

GALENA CRYSTALS

Characteristic curves indicating voltage and current conditions for a typical galena crystal are given in Fig. 3. Curve *a a* indicates these conditions when contact is made at a sensitive point on the crystal. Curve *b b* indicates the conditions when the contact is made at a point that is much less sensitive. The relative values of the currents for the two points when positive or negative voltages are applied are the important points to be brought out by Fig. 3, not the actual values of either the voltages or of the currents.

The voltage scale might cover an operating range of two volts positive to two volts negative on the right and left respectively of the zero voltage point marked *o* in the figure.

It is well to keep in mind that it is the difference between the two currents which determines the rectifying power or effectiveness of the crystal.

With equal positive and negative alternating voltages impressed on the crystal, as indicated by *o c* and *o d*, there will be good rectification if the contact is on a sensitive spot. The current produced by the voltage *o c* is *c e*, while that produced by the equal negative voltage is only a relatively small current as shown by *d f*. The positive pulses of current will be allowed to pass through the crystal without much opposition, while the

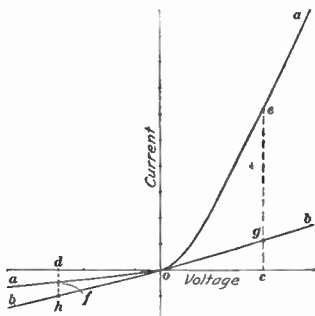

FIG. 3

negative pulses of current will be almost choked out. The corresponding currents produced on the poor point by the alternating voltages are shown as *c g* and *d h*. It is seen that the currents produced by the positive and negative voltages are approximately equal, a condition not conducive to good rectifier action.

A detector employing a galena crystal is shown in Fig. 4. The crystal *a* is mounted rigidly in a containing cup through which electrical connection is made to one of



FIG. 4

the terminals. The lower end of the small coil spring *b* presses against the crystal and makes contact with it. The metal spring is supported and adjusted by a handle *c*, which, being mounted in a ball-and-socket joint, permits a very large range of adjustment. In this manner the contact point may be placed on nearly any desired spot on the surface of the crystal. The supporting post *d* provides a mounting for the handle and also completes the electrical path between the metal contact point and the remaining terminal. The glass tube *c* is used to protect the rather delicate parts from injury, particularly from moisture. The whole device is mounted upon a suitable base *f* of insulating material.

Galena crystals possess the general characteristics of sensitiveness, but a sensitive point is sometimes hard to find and does not remain in good condition for a very long time. The metal point should be small and exert a light pressure against the galena crystal. A satisfactory arrangement is shown in Fig. 4, in which the point is an extension of the phosphor-bronze coil spring *b*. A good galena crystal will give very clear and very strong signals.

SILICON-ANTIMONY DETECTOR

A detector for radio use may be formed by a silicon crystal with an antimony crystal pressing against it. The rectifier action occurs at the contact between the point of the antimony crystal and the silicon crystal. It has been found that this combination of minerals will operate satisfactorily and that such a detector will maintain a sensitive setting under the influence of high voltages from the antenna due to static. The contact point of antimony is not necessarily pointed sharply, as such a point is hard to maintain, and the operation is usually satisfactory with a rather blunt crystal.

ZINCITE AND BORNITE

Another combination that has come into considerable use is that employing zincite and bornite crystals. The detector is quite frequently arranged, as in the antimony-silicon combination, with the zincite stationary and the bornite mounted on a movable arm. The detector will give very good results, is rather easily set, and will maintain a sensitive setting for a reasonable length of time. Other crystals and combinations of crystals have been used as detectors.

SOME OTHER CRYSTALS

Lenzite and cerusite have also been used as detector crystal materials to a limited extent. The perikon detector, formed of zincite and chalcopyrite, is suited for use where it is subjected to jarring, since this detector has nearly uniform characteristics over its entire surface. All of the crystals which have been mentioned work very well without a battery, hence are simple to operate.

CARBORUNDUM CRYSTAL

The carborundum crystal is of the same material as that of which carborundum abrasive wheels are made. Experiments have proved that for best operation the contact should be made by means of a metal point very firmly pressed against the crystal. For this reason a steel needle,

such as is used on a phonograph, will prove entirely satisfactory, and it should be forced against the crystal with considerable pressure.

The main characteristic of the carborundum crystal is that signals may be received from nearly any point on the surface at which good contact is made, and the detector will keep its setting for some time. The signals are usually not so strong as when some other detectors are used, but the reliability feature does much to commend it. Another point which adds to the reliability of the carborundum crystal is the fact that its rectifying qualities are not injured by dirt, successful operation continuing as long as the needle makes a firm contact with the crystal. In many cases, satisfactory operation has been obtained by using a wide spring which exerts a heavy pressure against the highest point on the crystal.

A characteristic curve of a carborundum crystal would look very much like that of the galena crystal, except that with a carborundum crystal the curves do not have the pronounced bend near the value of zero voltage. The bend in the characteristic curve of a carborundum crystal is usually to the right of the natural zero point. The portion of the curve where it passes through zero approaches a straight line, therefore, if an alternating voltage is applied to the crystal, there will be comparatively little difference between the current established by the positive half wave and that established by the negative half wave. The rectification will be poor. In order that the alternating voltage may work on the bend of the curve, a battery of from 1 to 2 volts is placed across the crystal in such manner that the current line established by this voltage crosses the characteristic curve near the bend. If an alternating voltage is now impressed on the crystal, the alternating voltage when of one polarity is able to force more current through the crystal than when the polarity is opposite. The rectification is then good. In practice, this refinement is not often used, because of its inconvenience.

ELECTROLYTIC DETECTOR

The electrolytic detector has fallen into disuse in the United States, but is widely used in some European countries with excellent results. It consists of a small glass cup containing an electrolyte of a dilute solution of nitric or sulphuric acid. One terminal is formed by a platinum plate in the electrolyte. The other terminal is made by a minute platinum wire about .0001 inch in diameter inserted in the electrolyte for only an exceedingly short distance. A battery is connected across these elements so that the positive terminal of the battery goes to the fine point while the negative terminal is connected with the larger platinum plate. The external receiving circuit is also connected across these two points. The battery tends to send a current through the electrolyte, and this current causes a decomposition of the electrolyte and a film of bubbles of gas to collect around the fine positive wire. Current in one direction is passed without much hindrance, while a current in the opposite direction is checked to a large extent. An alternating current will then be rectified, as one-half of the pulsation, either positive or negative, will be allowed to pass while the opposite pulsations will be rejected. The electrolytic detector requires rather sensitive voltage adjustments and also a careful adjustment of the fine point that barely projects into the electrolyte.

SUMMARY OF DETECTOR CHARACTERISTICS

A detector that will give the strongest possible signals and that possesses a high degree of reliability is usually desired. By this is meant that the detector should be of such a nature that it can be easily and quickly set in operation, and that it will hold its setting for a reasonable length of time. To be satisfactory, a detector should give an accurate rectification of the signals, without unnecessarily decreasing their strength. A crystal that will fulfil all these requirements has not been found, although several materials have come into general use that operate quite satisfactorily. As particular characteristics fit a

detector to operate more satisfactorily under certain conditions than others, it is desirable to select the type of detector which will give the best results under existing conditions.

SPARK GAPS

GENERAL FEATURES

A *spark gap* as used in radio practice is a device that will complete a circuit in the power-supply line of a radio set or in an oscillating circuit under proper conditions, and later will open the circuit at that point, thereby helping in the formation of high-frequency oscillating currents. The successful performance of the duties of the spark gap has a direct relation to the amount of radiation that may be secured from the antenna, and, consequently, the distance over which communication may be established. Spark gaps were formerly used in a larger percentage of the sending stations than they are at the present time. The type of signal radiated is apt to cause interference and it is not adapted to radio telephony, so has a tendency to be superseded by other devices.

Operation.—In a general way, the operation of a spark gap is as follows: An alternating electromotive force is applied to the terminals of the spark gap at a frequency of 60 to 900 cycles. The spark gap includes a short air gap between the conducting terminals across which the voltage is impressed. When the voltage reaches a certain high value, it will rupture the air and a spark discharge will take place. When the proper devices are connected in a circuit with the spark gap, the spark discharge will be at radio frequency, and the energy may be transmitted to an antenna and radiated into space. The main requirements of a spark gap may be stated as follows and the operation should be in the sequence given: It must keep the circuit open until the proper voltage is impressed upon its terminals; it should offer a rather low resistance path for the spark discharge that gives rise to the radio-frequency oscillations; and it should reestablish

its original conditions immediately upon cessation of the discharge.

When the above conditions are fulfilled, communication between stations will be at its best and the strength of the signals will be a maximum. When the gap is not operating properly, there will be a large loss of energy in the gap itself, and the range of communication will be greatly reduced. Certain characteristics of the circuits are apt to cause considerable interference by an improperly adjusted spark gap, or one that does not operate correctly under existing conditions.

Nature of Spark Discharge.—A spark discharge is usually caused by an oscillatory current and hence produces an oscillatory magnetic field around the spark and around the conductors connected on each side of the spark gap. This magnetic field increases in strength as the current increases, and decreases as the current decreases. Consequently the magnetic field has the same frequency as the oscillating current and is proportional to it in strength. Such rapid changes in the magnetic field surrounding the oscillating current produce disturbances that are supposed to travel as waves through space. These *electro-magnetic waves*, which are also called *Hertzian waves*, may be produced with such energy as to travel long distances. These are generally supposed to be the waves that establish radio communication from station to station. It has also been proved that electromagnetic waves travel through space with the same velocity as light, although they have a different frequency of vibration.

Just before a spark passes between two conductors separated by air or other dielectric, the dielectric is electrically strained; that is, an electric disturbance or displacement is produced in the surrounding region. Moreover, about the same kind of an electrostatic field is set up by this disturbance as the magnetic field set up by a current of electricity, except that the line of force of the electrostatic and electromagnetic fields are at right angles to each other. When the spark does pass, an

oscillating current is established and an oscillating magnetic field is set up around the path of the current as an axis. This field restores part of its energy to the circuit as the current dies away, and part is doubtless radiated into space.

When a voltage difference is equalized by a sudden discharge, the electric tension in the dielectric is relieved, and displacement currents, or electric waves, are said to be sent out into space. As a result of the electrostatic and electromagnetic disturbances, whether they are distinct or are one and the same phenomenon, disturbances in the form of waves are sent out into space in all directions; hence the energy due to these waves that is received at various distances decreases rapidly as the distance from the originating point increases.

TYPES OF SPARK GAPS

Open Spark Gap.—A rather simple type of open spark gap is shown in Fig. 5. The air gap proper is formed between the electrodes *a* and *b*. Electrode *a* is securely

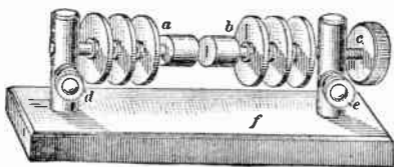

FIG. 5

fastened to its supporting post, while *b* is mounted on the end of a long screw terminating in a knob *c* so that the distance between the electrodes, and the length of the gap, may be varied. The supporting posts carry terminals *d* and *e* to which the circuit connections are made. The posts are mounted on an insulating base *f*. It should be noted that there are three flanges near the back end of the electrodes. These are not always supplied, but are useful in keeping the electrodes cool as they present a

large cooling surface to the air. The spark gap performs its function better if kept cool by some such means, or if it shows a tendency to overheat, a blast of air may be directed across the electrodes.

Copper cannot be used for electrode material as it tends to form an arc or actually to burn. Zinc is very largely used, as it does not arc, and has a very long life if the gap is properly adjusted. Monel metal, which is a combination of nickel, copper, and other materials, is also used. The spark gap forms an insulating section until the air between the electrodes is actually broken down by the electromotive force between them. Under this condition the air is a fairly good conductor and remains so until the current has fallen to a fairly low value.

When adjusting a spark gap of this type it is well to remember that the electrodes should not be separated so as to draw the longest possible spark, hoping thereby to obtain a larger amount of radiation. Instead, the spark gap should be adjusted so that a strong fat spark is produced. If the gap is too long, sparks will not pass, or only at very irregular intervals. If the gap is too short it will have a tendency to form an arc which will burn away the electrodes. The length of gap is controlled by the available voltage of the power supply, the ability of the condenser to withstand the voltage, and the desirability of securing uniform spark discharges. The gap length to use in any given case may best be determined by trial.

Quenched Spark Gap.—The operation of a spark gap may be improved to a large extent by using several short gaps in series instead of a single long gap. The quenched spark gap consists of several circular copper plates of special design, a few of which are shown in Fig. 6. The sparking surface *a* is very smooth and varies from $\frac{1}{2}$ to 1 inch in diameter, depending upon the amount of energy that the gap must handle. These plates are placed together in series with their sparking surfaces adjacent, and are separated at *b* by mica or fiber washers *c*

which insulate the plates and keep the sparking surface at the proper distance. A circular groove *d* is cut in each of the plates surrounding the sparking surface, so that the inner edge of the washer extends over it, thus preventing the spark from forming across the edge of the washer, which would soon carbonize the washers and cause a short circuit between the plates. The sides of

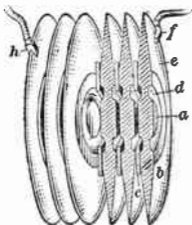

FIG. 6

the insulating rings *c* are coated when assembling, with shellac or some similar substance, and the whole set is clamped together, forming air-tight chambers for the spark discharges. The gaps being entirely enclosed, operate with very little noise and may be placed quite close to the rest of the set with no discomfort to the operator. Extensions, or fins, *e* on the outer edges of the copper plate form excellent radiators and dissipate the heat rapidly. The larger sizes of quenched spark gaps have a blast of air playing over the outside fins *e*.

The immediate quenching of the spark is brought about partly by the fact that the oscillatory discharge occurs in an air-tight chamber, and partly by the good cooling effect obtained by distributing the discharge among a number of relatively small gaps. This gap gives a high, clear spark note, and has been used in many up-to-date installations. Any number of plates may be connected in series, the number used depending upon the set with which the gap is to be operated. In many cases a permanent connection is made to one end of the gap, and the other terminal is arranged to connect any desired number of gaps by means of a suitable clamp which may be attached to the fin of any of the plates as indicated at *f* and *h*.

Rotary Spark Gap.—A rotary spark gap is one with one or more rotating electrodes, the movements of the

electrodes assisting materially in keeping the sparking surfaces cool and in controlling the discharge. Fig. 7 shows a rotary spark gap with its small driving motor. The main part of the rotor *a* is of cast copper with broad thin teeth formed on its outer edge. These teeth in their rotation pass very close to the stationary electrodes *b* and *c* which also form terminals to the external circuit. When the teeth are opposite the stationary electrodes, as shown, the air gap is very short.

A rather low voltage impressed across the terminals will establish a spark across the air gaps. If the rotor is turned a short distance the length of the air gap will be rapidly increased until it becomes sufficient to extinguish the spark. Continued rotation will bring the next pair of teeth opposite the electrodes and permit another short period of spark discharges. There will be a spark discharge every time the teeth pass the stationary electrodes and the resulting tone of the set will depend directly upon the speed of rotation of the rotor. The shape of

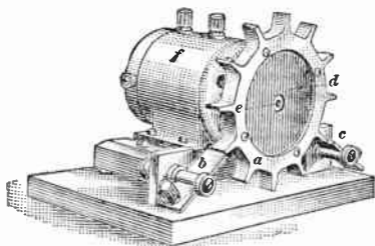

FIG. 7

the teeth is such that they blow a current of air over the electrodes *b* and *c* to keep them cool. The rapid lengthening of the air gap just after the spark starts, causes the spark to be suppressed in a very short time, which is a very desirable characteristic in a spark gap.

The rotor *a* of Fig. 7 is mounted on a disk of insulat-

ing material d and rotates with it. An extension e of the shaft of the motor f provides a support for the rotating disk. The speed of the motor may be varied over certain limits to produce a good tone for the spark gap.

In many cases the rotary spark gap is mounted on the end of the alternator shaft, thereby eliminating the cost of a separate motor. By proper adjustment of the rotor of the spark gap, the discharge may be made to occur at the moment of the maximum values of the positive and negative waves of the alternating current. This regular occurrence of the discharges produces a pure musical tone, when used on a high-frequency alternator.

SPARKING DISTANCES IN AIR

If the voltage across a spark gap is steadily increased, it will be found that the spark occurs at some definite value of voltage. This may be repeated, and the voltage at break-down will be found to check very closely each time. The distance between the gap electrodes is the main factor controlling the voltage at which the gap will break down, although the shape of the electrodes has some influence. For instance, a gap with large spherical electrodes will require a much higher break-down voltage than will one with needle-point electrodes. With the irregular-shaped electrodes used in radio practice, it is very difficult to give tables covering all cases. Tables of sparking voltages with some certain types of electrodes are given in the latter part of this volume.

ARC GENERATORS

GENERAL PRINCIPLES

The *arc* system for generating high-frequency undamped waves has been used in many stations, with considerable success. This is frequently called the *Poulsen arc*, as it was invented by Valdemar Poulsen. Many refinements have been added since its original introduc-

tion. This device is especially applicable to medium and high-power work, in which fields it finds its greatest usefulness.

DIRECT-CURRENT ARC

The fundamental part of an arc set is the electric arc which is instrumental in producing the high-frequency oscillations. When an electron is taken from or added to a neutral atom or molecule, the charged particle thus formed is called an *ion*. This process is known as *ionization*. The particle will have a negative charge if one or more electrons are added to the formerly neutral body, and a positive charge if one or more electrons are removed.

Ionization may be set up by heat vibration as well as by other means. When the two conducting electrodes *a* and *b*, Fig. 8, are brought together, a current is established, the surface contact heated, and ionization of the air between the electrodes produced. The liberated ions act as carriers of electricity and a current can pass from one electrode to the other even when these are separated a short distance. The high temperature of the arc produces incandescence of the particles of matter in and near the ends of the electrodes and thus a glow of light. The flow of ions produces a current-carrying path of rather low resistance between the electrodes. An excessively large current is prevented by the introduction of the variable resistance *c* between the direct-current generator *d* and the arc.

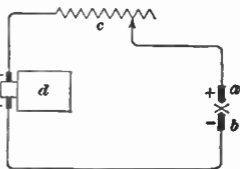

FIG. 8

THE OSCILLATING ARC

An arrangement of apparatus that will establish an oscillating arc was developed by Poulsen and consists essentially of a direct-current arc shunted by a tuned oscillating circuit. When the electrodes forming the ter-

minals of the arc are connected to a source of direct current, a high-frequency alternating current will be established in the oscillating circuit. Fig. 9 shows the fundamental connections of the arc and its shunt circuit. The electrodes, usually of copper and carbon, are shown at *a* and *b*; a variable resistance at *c* and an inductance coil at *d*, both in the generator circuit; an electromagnet in two sections at *e*; a variable condenser at *f*; a variable inductance coil at *g*; and a direct-current generator at *h*. The oscillating circuit consists of the condenser *f* and the inductance coil *g* and forms a shunt across the terminals of the arc.

When a direct current passes between the electrodes, thus forming an arc, a voltmeter connected across the

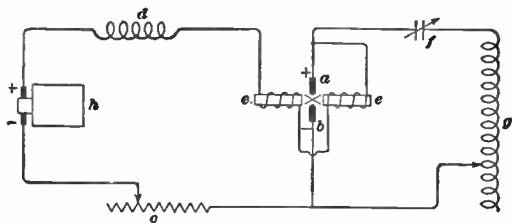

FIG. 9

electrodes will indicate a certain voltage. If, with fixed electrodes, the current through the arc is increased, greater ionization of the air is produced, the cross-sectional area of the arc is increased, and the resistance offered to the passage of current reduced to such an extent that the voltage across the electrodes is reduced. If the current through the arc is reduced, the voltage across the electrodes is increased. An inductance coil in a circuit in which the voltage is variable tends to delay changes in the current beyond what would occur with the inductance coil omitted. Both of these effects are important when considering the operation of the oscillating arc.

The arc electrodes are first connected to the generator with the oscillatory circuit disconnected. The electrodes are placed in contact and then separated, thus starting the arc. The oscillatory circuit is then connected to the electrodes. As soon as this circuit is completed, the condenser begins to accumulate a charge, the left plate being positive since it is connected through coils *c* and *d* to the positive brush of the generator. Since the oscillatory circuit is in shunt with the arc, and the inductance coil *d* in the generator circuit tends to keep the generator current constant, the oscillatory circuit now takes from the arc some of the current that formerly passed through it. The current through the arc decreases, the voltage across the electrodes increases, and this increase in voltage aids in giving the condenser a higher charge than it would otherwise take.

The inductance coil *g* causes the highest point of the charging current in the condenser to take place a short time after the voltage across the electrodes has risen to its maximum value. When the condenser is fully charged no current passes through the oscillatory circuit and the arc carries the normal full current of the generator. The arc voltage resumes its previous value and for a very short interval of times does not vary.

Because of the inductance and arc effects just mentioned, the voltage of the condenser rises temporarily to such a value that it is higher than the voltage of the supply circuit. The condenser, therefore, starts to discharge a current through the arc from *a* to *b*, the current established by the condenser being in the opposite direction from that of its charging current. The discharge current through the arc is, therefore, in the same direction as that supplied by the direct-current generator. The current through the arc is increased, the voltage across the electrodes is decreased, and this decrease helps the condenser in sending current through the arc.

The inductance coil *g* in the oscillatory circuit causes the current in the condenser to be prolonged over what it would be if this coil were omitted. The discharge cur-

rent will, therefore, continue past the point at which it would cease if the circuit had no inductance. As a result, the condenser accumulates a charge opposite in polarity to its former charge; the right-hand plate of the condenser *f* now becomes positive. As the charging of the condenser with its new polarity nears its end, the accompanying current through the arc and the oscillatory circuit dies out, and with normal conditions restored in the arc, the voltage of the arc rises and resumes its usual value.

The voltage of the condenser under the new conditions discharges a current from *b* to *a*. This discharge current neutralizes part or all of the generator current in the arc, thus raising the voltage across the electrodes. When the oscillating arc is properly tuned, the arc may be temporarily extinguished and the voltage from the generator sends a charging current into the condenser *f* in such direction as to make the left-hand plate positive again. This cycle of charges and discharges takes place continuously and an alternating current of high frequency is, therefore, established in the oscillating circuit.

FACTORS AFFECTING THE FREQUENCY

If the discharge current from the condenser is of such value that it is equal to or greater than the arc current, it will stop the current through the arc when the condenser current is equal to and opposes the generator current. When this condition is reached, the whole device is operating properly, and will continue indefinitely to do so. As this operation is dependent upon the values of inductance and

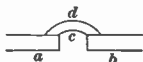

FIG. 10

capacity in the oscillating circuit, variable condensers and variable inductance coils are commonly installed, so that the circuit may be readily tuned. As soon as the arc is stopped, the supply voltage alone charges the condenser. The charge continues until the condenser has voltage sufficient to break down the arc gap and reestablish the arc. This cycle of events

recurs at very frequent intervals and the time during which there is no current through the arc is actually very minute.

Fig. 10 represents the two electrodes of the arc at *a* and *b*. The arc may be considered as established along some path between the electrodes, as at *c*, not considering the action of the electromagnets *e*, Fig. 9. When these magnets are energized by current from the generator, the stream of ions is forced to some position as at *d*, Fig. 10. The length of the arc is very much increased, and hence the magnets can stop, or blow out, the arc quite readily when the current in the oscillating circuit nearly if not entirely neutralizes the normal direct current in the arc. It is very important, in order to obtain a uniformly steady wave, that the arc be broken each time before there is enough voltage to start another one, or at least that the current in the arc be reduced an amount sufficient to cause the oscillating action to be continuous.

The operation of the arc, when establishing a radio-frequency current, is largely dependent upon the deionization of the space between the electrodes at an exceedingly rapid rate as soon as the current through the arc dies out. Several methods may be employed to deionize this space, and, when properly applied, the arc will oscillate steadily at a rate of several thousand oscillations per second. The tuning of the oscillating circuit by means of the variable condenser and variable inductance coil is an important factor in determining the frequency of the oscillations.

The flow of ions is affected by a magnetic field. A magnetic flux at right angles to the path of the current in the arc acts to distort the path of the flow of ions. This helps to break the arc and also prevents, for the required time, the reestablishment of another arc. If the ions were allowed to remain in the space around and between the electrodes, the voltage of the supply circuit might be able to establish another arc before the condenser had stored up a sufficient charge.

The chamber surrounding the electrodes is entirely

enclosed. Hydrogen gas has been found to assist materially in dispersing the ions of the arc; therefore, a gas containing hydrogen is placed in the chamber. Illuminating, or coal, gas is often used for this purpose, but as considerable foreign matter is also introduced, the chamber may require frequent cleaning to remove the soot accumulation. Another method that has met with considerable success is the introduction of some substance that contains a large amount of hydrogen. Either kerosene, alcohol, or ether is a suitable material, and the hydrogen is liberated by the intense heat of the arc. Provisions are usually made for introducing a small amount of liquid into the chamber continuously. Only a very few drops are required from time to time to supply the chamber with a sufficient amount of hydrogen gas.

The positive electrode, also called the anode, is made of copper, and is hollow. Water running through the interior of this electrode keeps it comparatively cool, and prevents it from being rapidly burned up by the intense heat of the arc. The negative electrode, or cathode, is of carbon and its supporting sleeve is frequently water-cooled to keep the temperature down. The cooling of the electrodes helps to disperse the ions and thus to quench the arc. In some cases the electrodes are placed in horizontal positions.

In order that the carbon electrode may be worn away uniformly, a small electric motor geared down to obtain a relatively low speed may be used for rotating the carbon electrode. The gap between the two electrodes may be adjusted by an extension handle, the latter being placed in such a position that it is within easy reach of the operator. In large apparatus the arc chamber is usually water-cooled to remove much of the heat generated by the arc.

The electromagnet windings, being mounted on iron cores, act as impedance, or choke, coils. Such coils do not offer any opposition to direct current other than that furnished by the resistance of the wire. Their opposition to current at radio frequency is strong enough to

prevent the passage of such a current, and the high-frequency oscillating current established by the arc in the tuned circuit is effectually prevented from passing through the direct-current generator.

The strength of the magnetic field is usually made variable by switches which short-circuit some of the turns. The turns which are short-circuited do not receive any current and, therefore, do not establish a magnetic flux. When the frequency is high, the magnets should be strong in order to remove very rapidly the ions from the vicinity of the electrodes. With a lower frequency there is more time between the successive arcs, and the field strength of the magnets need not be so great.

KEYS AND BUZZERS

GENERAL USES OF KEYS

The signals transmitted in telegraph systems consist of proper groups of current impulses. A *key* is the device used in telegraphy to open and close the electric circuit and thus form the current impulses that are transmitted through the line. The current impulses acting on the receiving device produce the signals or dots and dashes of the various codes. The receiving operator translates the signal combinations into the proper characters, or they may be recorded on some type of *automatic recorder* and later transcribed into message form.

Keys such as are used in wire telegraphy are satisfactory in radio work where the current to be broken is not too large. The current used in wire telegraphy is very small, and the *contact points* which actually make and break the circuit are correspondingly small. The interrupted current in radio practice is often many times greater than that used in wire telegraphy, hence larger contact points are necessary.

The downward stroke of the key is often called the *make*, and the upward stroke, the *break*, referring, of course, to the making and breaking of the circuit. The

contacts on most good keys were formerly made of platinum, because of the ability of that metal to resist better than most other metals the corroding and fusing action of the electric arc that is always formed at the break. The scarcity of platinum and consequent advance in price has been instrumental in causing the adoption of silver as the metal from which the contact points are made. Silver contacts must be larger than those of platinum for the same current capacity, as the former do not stand up quite as well as the latter. When the silver contact points are properly designed and of ample size, they have been found to give good service. Various other metals are used for contacts in the many different types of keys, and are listed under numerous trade names.

SMALL-CAPACITY RADIO KEY

A type of key suitable for use in small-power radio stations is shown in Fig. 11. It will be noted that the key as a whole is of rather rugged construction, so it may stand up well under rough usage. The lever *a* carries a comparatively large contact point at *b* which closes the circuit through a stationary contact point just below *b*. The base *c* is made of bakelite dilecto, which material has been found entirely satisfactory for that purpose. The lower stationary contact is connected



FIG. 11

directly to one of the binding posts by a conductor underneath the base. The circuit from the upper contact at *b* is through the lever, thence through a flexible copper braid *d* and a connection under the base to the other binding post. The reason for using the copper braid is

that a low-resistance connection is assured between the lever and the binding post. With fairly large currents it is not considered good practice to rely on the path through the trunnion screws, which act as pivots to the key lever, and the trunnion mounting, as that path is liable to give trouble if it carries a large current.

LARGE-CAPACITY RADIO KEY

A key of somewhat similar design is shown in Fig. 12. The lever *a* carries a very large contact *b*, indicating that this key is designed for interrupting quite large

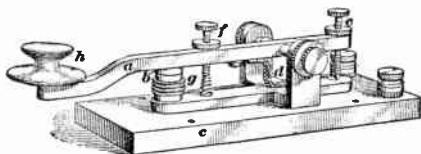

FIG. 12

currents. The base *c* is made of bakelite dilecto, with countersunk screw holes to hold screws for fastening the base to a table. A heavy copper braid *d* is provided to carry current from or to the lever arm. The length of the air gap between the contacts may be adjusted by screw *e*. The rapidity with which the lever opens the circuit depends largely upon the setting of screw *f*, acted upon by the spring immediately below it. The gap must be opened far enough to break the circuit completely, and the more rapidly this is done the better.

The contact points are apt to become heated to a considerable extent when the key is used to carry and interrupt large currents. Making these points of large dimensions assists materially in the dissipation of the heat produced. In this key auxiliary cooling flanges *g* are provided which offer a large cooling surface and are, therefore, instrumental in radiating a large part of the heat. Keeping the contact points at a fairly low tem-

perature has been found helpful in breaking the arc quickly. The handle *h* of the key is fitted with a safety disk to prevent the operator's hand from accidentally touching the metal lever.

RELAY KEY

A *relay key* is an electromagnet so arranged that movements of its armature open and close an electric circuit. This circuit may or may not be separate electrically from the circuit that supplies current to the winding of the relay. The electromagnet is usually so constructed

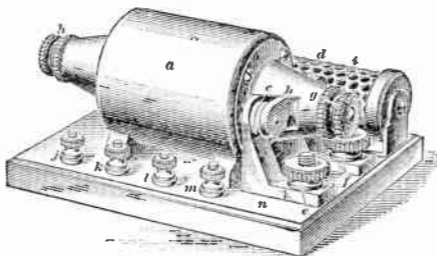

FIG. 13

that it operates with a very low current and a hand-operated control key can be used with safety to control the low-voltage, low-current exciting circuit. The armature of the relay is capable of controlling a circuit of such voltage and current as to make it undesirable to use a hand-operated key. In many cases it is desirable to control the main circuit by a control key placed some distance from the relay key, thus making it unnecessary to extend the main-circuit wiring to the point of control.

The circuit including the operating key and relay winding is called a *local*, or *auxiliary*, circuit, to distinguish it from the main circuit, which is controlled by the armature of the relay.

A relay key such as used in radio telegraphy is shown in Fig. 13. Fig. 14 shows a wiring diagram of this relay key connected to the operating key of the local circuit. Corresponding parts of the device are lettered in a similar manner in both figures. In Fig. 13 the relative positions of the parts of the device are shown, and in Fig. 14 the wiring within the protecting shells is indicated. The electromagnet is shown at *a* and the iron plunger at *b*. When the coil *a* is excited, the plunger *b*

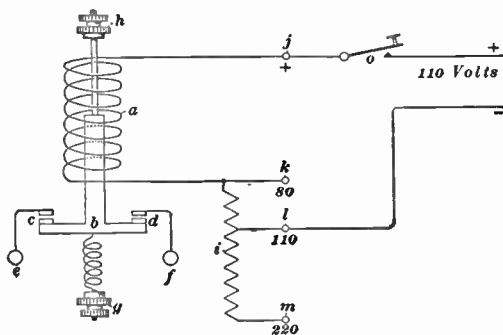

FIG. 14

is drawn into the coil and the contact points at *c* and *d* are closed. These main contact points are connected to binding posts *e* and *f* which serve as terminals for the heavy-current circuit from point *e* through *c*, *b*, and *d* to terminal *f*. It should be noted that there are two points at which the circuit is opened and closed. This arrangement insures a more rapid break and also reduces sparking and heating by dividing the arc. Thus, a larger current may be interrupted than would be possible if a single contact were used.

A spring connected to the adjusting and locking nuts

at g is placed under tension when the plunger is drawn up to close the circuit, and promptly withdraws the plunger when the coil a is deenergized. The distance to which the plunger is *withdrawn* depends upon the adjustment of the nuts at h which screw on an extension of the plunger core. The air gaps at c and d need only open far enough to insure that the arc will be suppressed with every opening of the contact points. Also, the tension of the spring should not be so great that the plunger does not have time to close the main contacts before coil a is demagnetized during rapid sending.

A resistance coil i permits the use of this relay key on several different operating voltages. The positive side of the control circuit is connected to terminal j , and the negative side to the proper one of the terminals k , l , and m . The coil itself may be operated satisfactorily on 80 volts, but for higher voltages it is necessary to use all or part of resistance i . No special internal connections are necessary for operation at the higher voltages; it is merely necessary to connect the line to the terminals marked for that particular voltage. The device is mounted on an insulating base n and makes a very compact unit, as shown in Fig. 13. Fig. 14 shows how a small key o is connected in series with coil a , the whole being connected for operation from a 110-volt, direct-current supply circuit. Closing key o excites coil a which attracts plunger b , thereby closing the circuit between terminals e and f .

TROUBLES OF KEYS

When a key, on rising, does not break the circuit, it is said to *stick*. This sticking may be due to any one of several causes. The principal cause is the fusing action of the electric spark at the contact point, but it may be caused by metallic dust collected on and bridging over the contact points, or by an improper adjustment that causes the points to come together improperly and bind. The contact points, therefore, should be kept clean by drawing between them a piece of hard, clean paper or fine emery cloth, or they may be rubbed very gently with

a very fine file and then wiped clean. Frequent use of the file or emery paper, however, should be avoided.

Pivot, or trunnion, screws often become loose and cause trouble; to prevent this they should be kept as tight as is consistent with a free and easy movement of the key. Loose connections are frequently the cause of poor and irregular signals, but with frequent inspections little trouble should be experienced from this source.

BUZZERS

A *buzzer* is an electromagnetic device that emits a buzzing sound when current is established through it. The tone is similar to that produced in a telephone receiver by radio signals and it is, therefore, common practice to use a buzzer in learning the International code. There is a considerable difference between the sound of the buzzer

and that of a sounder, but a professional telegraph operator can usually receive radio signals after a short period of practice. The ordinary buzzer resembles the sounder in that an electromagnet, when excited, attracts an armature of rather light weight. The buzzer, however, is provided with a circuit-breaking device which breaks up the received current into still smaller impulses, thereby causing a rapid vibration of the armature.

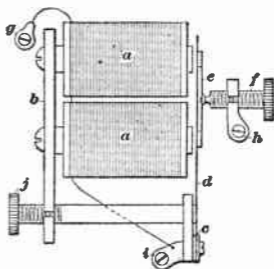

FIG. 15

causing a rapid vibration of the armature.

Small Testing Buzzer.—Fig. 15 shows the arrangement and connections of the parts of a buzzer of a type often used in small radio testing sets. Fig. 16 shows an assembled view. Similar reference letters apply to both figures. The magnet windings are shown at *a* and their iron cores are supported rigidly by the iron yoke *b*. A

support *c* holds firmly one end of the vibrator spring, or armature, *d*. The armature near its free end carries a small spring *e* at the center of which a contact point is mounted. When the buzzer magnets are decenergized, this contact is pressed against the contact mounted at the end of screw *f*. The main terminals of the buzzer are shown at *g* and *h* and an auxiliary terminal at *i*.

Adjustment of screw *j*, which presses against the armature *d* near its fixed end, changes the tone of the buzzer. Adjustment of screw *f* serves to make up for the gradual burning of the contacts and to a certain extent changes

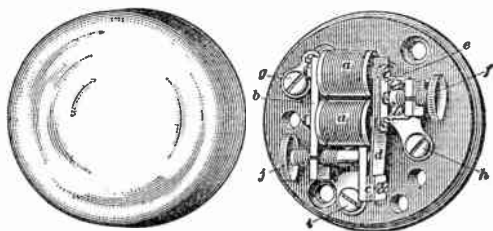

FIG. 16

the frequency of the vibrations of the armature. The holes in the supports for screws *f* and *j* are made slightly small; slots are cut to the holes and when the screws are inserted, a tight fit is assured which is relied upon to hold the screws in adjustment without the use of locknuts.

The operation of the buzzer is independent of the direction of the current through its windings. The current enters, say at *g*, and passes through the device by way of the magnet windings *a*-mounting *c*-the spring *d*-spring *e*-contact point on spring *e*-point and body of screw *f*-through mounting of screw *f*, and out at terminal *h*. As soon as current is established through coils *a*, the armature *d* is drawn toward the magnets. This movement of the armature causes the contact points to separate and open the circuit between *e* and *f*. The opening of the

circuit cuts off the current and the armature is released. The springiness of armature *d* causes its free end to fly back and the circuit is reestablished through the contact points. This cycle of events is rapidly repeated and the vibration of the armature gives rise to the audible buzzing sound. Due to the light weight of the vibrating parts, the tone of the buzzer is quite high, and closely resembles that given out by a radio receiving set.

A terminal *i* may be used in connection with terminal *h* in case it is desired to connect only the circuit-breaking part of the buzzer in another circuit for special testing or other purposes. It is, however, necessary to energize the magnets *a* through terminals *g* and *h*. The various parts of the buzzer are mounted on an insulating base shown in Fig. 16. Suitable holes are provided for mounting screws and for the entrance of connecting wires to the buzzer terminals when the cover is in place. A metal cover serves to provide mechanical protection to the device and also adds to its appearance.

There is, apparently, considerable variation between the types of buzzers made by the various manufacturers, but the difference is chiefly one of design and in the arrangement of parts. The fundamental principle of operation remains the same in all of them, despite the particular advantages of certain types. Numerous devices are in common use, by means of which the emitted tone of the buzzer may be varied until it gives out a clear high-frequency signal.

Special Testing Buzzer.—A special type of buzzer, which is capable of delivering an alternating current of constant frequency is desirable in many radio and other electrical measurements. A 1,000-cycle oscillator which gives an alternating-current wave of very good shape is shown in Fig. 17. A wiring diagram using similar reference letters is given in Fig. 18, which also shows some parts not illustrated in Fig. 17. The terminals at *a* should be connected to a 6-volt, direct-current supply, preferably a 6-volt storage battery. The switch *b* has an *on* and *off* position, which means that the buzzer is operative and

inoperative with the switch in those two respective positions. One output line is connected to the terminal marked *zero*. The other output line would be connected to the proper terminal, depending upon the amount of output current desired; namely, *low* if small output, *medium* if a normal output, and on *high* if the maximum output current is desired.

The tuning fork *c* is of hardened steel which has been adjusted to vibrate at a frequency or natural period of 1,000 times per second. It is quite similar to those used

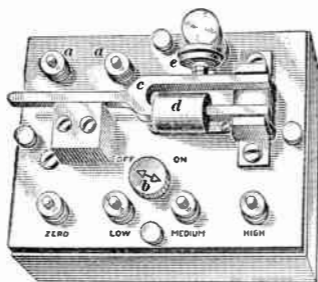

FIG. 17

in physical laboratories or by piano tuners, and produces a musical tone when vibrating. The tuning fork is rigidly supported at its base and is magnetized by a direct current in the field coil *d*. A carbon-granule transmitter button *e*, such as is described later, is mechanically connected to one tine of the tuning fork. The variable resistance of this device under vibrations from the fork performs the function of the circuit-opening contact on simpler buzzers and assists in maintaining oscillations.

The button *e* is in series with the frame of the tuning fork and with the primary coil *f* of an input transformer. The pulsating direct current in the primary coil induces an alternating current in the secondary coil *g* of the

input transformer. This alternating current passes through the armature coil *h* of the tuning fork and the primary coil *i* of the output transformer. The action of the alternating current in coil *h* is to establish poles of alternate polarity at the ends of the armature. The poles of the tuning fork, which are of fixed polarity, are attracted by the constantly changing poles of the armature, and the

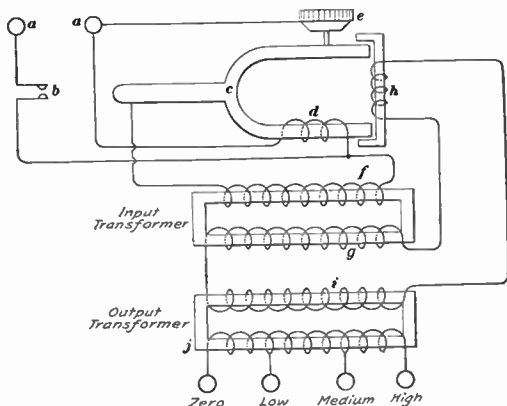

FIG. 18

tuning fork is maintained in vibration. The alternating current in coil *i* induces an alternating current in the secondary coil *j*. The frequency of this current depends on the rate of vibration of the tuning fork.

This oscillator is able to start and operate continuously without attention, so it may be located at some distance if the small volume of sound which it produces is undesirable. There are no adjustments, and the state of charge or discharge of the supply battery or any other factor cannot change the frequency of the output current.

TELEPHONE APPARATUS

GENERAL FEATURES

Telephony is the art of transmitting sounds between distant points by means of fluctuations of an electric current. This definition applies to both wire telephony and radio telephony, the carrying mediums being electric conductors in the first case and the ether in the second case. For the purpose of telephony, sound may be said to be the sensation produced by vibration of the air on the ear drum. When one person talks with another the speaker sets in motion a series of air waves which when striking against the delicate membrane of the listener's ear produce the sensation called *sound*. In electric telephony the transmission of sound is accomplished by making one plate, or diaphragm, at the sending station, take up, or respond to, the wave of the sound to be transmitted, and causing, by electric means, another diaphragm at the receiving end of the system to vibrate as nearly as possible in exact accordance with the first, thus reproducing the original sound.

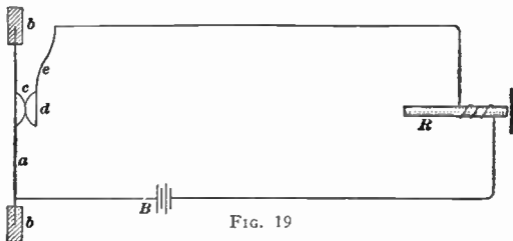

FIG. 19

TELEPHONE AND RADIO TRANSMITTERS

Variable-Resistance Type.—A *telephone transmitter* is an instrument that takes up the vibrations of the sound to be transmitted, and causes corresponding fluctuations

of electric current in the circuit of which it is a part. The action of the instrument usually employed as a standard telephone transmitter is such as to alter the resistance of the circuit and thus produce variations in the strength of the current. The instrument is very sensitive and for that reason is often called a *microphone*.

The resistance between two bodies in light contact can be made to vary by slight changes in the pressure applied to the bodies. Such a transmitter, since it does not generate an electromotive force, must necessarily contain a source of electromotive force connected in the transmitter circuit. The device acts as a valve, or throttle, controlling the current in that circuit. Though all conductors possess the

property of giving a variable contact resistance with changing pressure to a certain extent, it has been found to be greatest in carbon.

A transmitter depending upon the variable-contact resistance principle is indicated in Fig. 19. A diaphragm *a* supported in a stationary ring *b* carries a carbon button *c* against which another carbon button *d*, mounted on a spring *e*, is lightly pressed. The two carbon buttons form part of an electric circuit, which also includes a battery *B* and a telephone receiver *R*. The pressure between the buttons is light, so that small variations in the pressure cause large variations in the resistance of the contact. Sound waves striking against the diaphragm

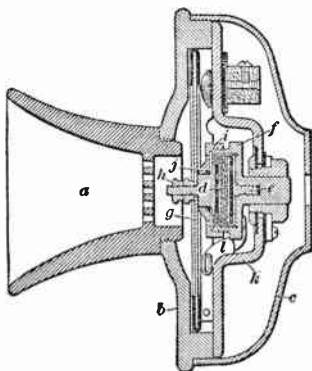

FIG. 20

cause it to vibrate; these vibrations vary the resistance of the loose contact, and, therefore, the line current is varied accordingly, and the diaphragm of the telephone receiver is thus made to vibrate in unison with the transmitter diaphragm.

The variable-resistance transmitter in its most common form is the *granular-carbon transmitter*, in which vibrations of the diaphragm increase and decrease the pressure on a chamber of carbon particles, or granules,

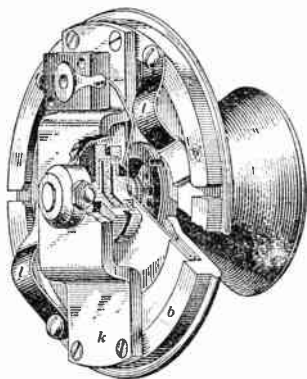

FIG. 21

thus varying the resistance of a multitude of loose contacts. The construction as actually used in practice is shown in the sectional view of Fig. 20 and the three-quarter rear view of Fig. 21. The hard-rubber mouth-piece *a*, Fig. 20, is threaded to engage a screw-thread on the internal ring of the front covering *b*, which fits into the outer rim of the shell *c*. The front and rear carbon disks, which form the *electrodes*, or main contact surfaces, are shown in heavy black on either side of the granular carbon *d*. The rear electrode is soldered to a brass disk having a small projecting shaft *e* that is screwed into the bottom, or rear, of the brass cup *f*. The front electrode is attached to a brass disk from which a threaded stud passes through the diaphragm *g* to permit of the front electrode being clamped rigidly to the diaphragm by means of the two small nuts *h*. The cup *f* containing the

thus varying the resistance of a multitude of loose contacts. The construction as actually used in practice is shown in the sectional view of Fig. 20 and the three-quarter rear view of Fig. 21. The hard-rubber mouth-piece *a*, Fig. 20, is threaded to engage a screw-thread on the internal ring of the front covering *b*, which fits into the outer rim of the shell *c*. The front and rear carbon disks, which form the *electrodes*,

granular carbon is closed by a mica washer which is clamped to the cup by a threaded ring *i* and to the front electrode plate by a threaded ring *j*. Therefore, the only relative motion possible between the two electrodes is that permitted by the flexing of this mica washer. The washer serves to close the carbon chamber, thus preventing the granular carbon from falling out and moisture from getting in, and at the same time provides the necessary play between the electrodes. The cup *f*, the electrodes, granular carbon, front electrode plate, mica washer, and clamping rings are assembled at the factory and form the variable-resistance part of the transmitter. This entire structure is fastened to the bridge *k* of both figures, which in turn is attached to the front piece *b*. The fact that the rear electrode is rigidly supported is responsible for the name *solid back*, which is often applied to this type of transmitter.

Two steel springs *l* are fastened to the case so that their free ends, which are provided with insulating cushions of soft rubber, rest upon the diaphragm. By reducing the flexibility of the diaphragm, they eliminate to a large extent the confusion of sounds that would otherwise result from its free movement.

Among the many kinds of carbon-granule transmitters on the market, nearly all employ the foregoing principles, although they may appear different because of different designs adopted by the manufacturers. The variation in resistance of this type of transmitter is undoubtedly due more to variation in contact area of the surfaces of the individual granules and electrodes than to any compression within the carbon itself. The common transmitters used in wire telephony are designed for a current of about .1 ampere, and have a resistance of about 50 to 100 ohms with the diaphragm at rest. If the current is increased too much, the carbon granules will overheat and may even fuse together, rendering the device worthless until the mass is replaced with new granules.

For use where a larger current is handled, as in some

radio work, carbon-granule transmitters of special design have been made capable of carrying .5 ampere. Their steady resistance is in the neighborhood of 10 to 20 ohms. Using two or more similar transmitters in parallel offers a partial solution as the current will divide and should not be excessively large in any one transmitter. Some speaking-tube arrangement must be devised to divide equally the sound energy among the various transmitters. Artificial cooling by air or water also permits a larger current to be sent through the microphone without overheating the granules.

Other Types of Transmitters.—Transmitters have been designed to carry large currents. Such transmitters depend upon changing the cross-sectional area of a current path through an electrolyte. In one system, a stream of falling water forms part of the transmitting circuit. By a rather sensitive and complicated arrangement of parts, any sound waves striking a diaphragm cause changes in the diameter of the water column. This changes the resistance of the path and consequently of the transmitting circuit, so that the necessary current fluctuations are produced.

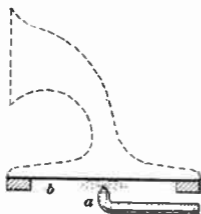

FIG. 22

In another arrangement, a jet of electrolyte under low pressure, impinges against the under side of a horizontal diaphragm as indicated in Fig. 22. The distance between the jet *a* and the diaphragm *b* should not be very large. A mouth-piece could be mounted as indicated by the dotted line.

When the diaphragm vibrates under the influence of a sound wave the cross-sectional area of the jet of water between the nozzle *a* and the diaphragm changes and the electrical resistance also varies. This principle is made use of in the transmitting circuit in the usual manner.

A transmitter that has met with limited use employs the capacity variation effect between two plates to produce the electrical disturbances. The device is really a condenser, and as one of the plates is put into motion by the sound waves the capacity of the condenser is changed. The change in capacity is used as a factor to control the output current, instead of a change in resistance as with the preceding types.

TELEPHONE RECEIVERS

Fundamental Forms.—In its simplest form, the telephone receiver, as shown in Fig. 23, consists of a thin, soft-iron diaphragm *P* mounted close to but not touching one pole of the permanent magnet *N S*. A fine wire *C* is coiled around one end of the magnet

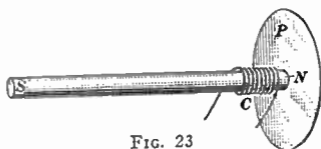

FIG. 23

and the terminals of this coil are connected directly in the circuit in which the instrument is to be used. The diaphragm is rigidly supported at its outer edge, but the center portion will be curved slightly toward the magnet because of the attraction between the diaphragm and the magnet. If a current is sent through the coil in such a direction that the lines of force set up by it coincide with those of the permanent magnet, the strength of the magnet will be increased and the diaphragm will be drawn closer to the pole. If, however, a current is sent through the coil in such a direction as to set up lines of force opposing those of the magnet, the strength of the magnet will be diminished and the diaphragm will spring farther from the pole.

If a current that varies in value but is always in the same direction is sent through the coil, the lines of force induced in the magnet will increase while the current is increasing, and decrease while the current is decreasing.

Thus, a varying pull on the diaphragm will cause vibrations that will be in harmony with the changes in current whether the lines induced by the coil are in the same direction as those of the magnet or not.

If the current is an alternating one, that is, one that is first in one direction and then in the other, the lines set up in the magnet will change their direction every time the current changes its direction. They will thus, while in one direction, add to the strength of the magnet; and while in the other direction, diminish it, producing a varying pull on the diaphragm.

The telephone receiver is affected by the fluctuating currents corresponding to sound waves and translates

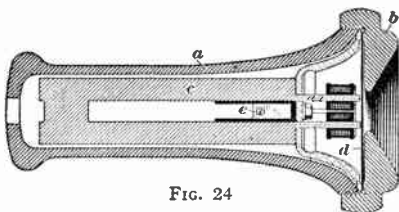
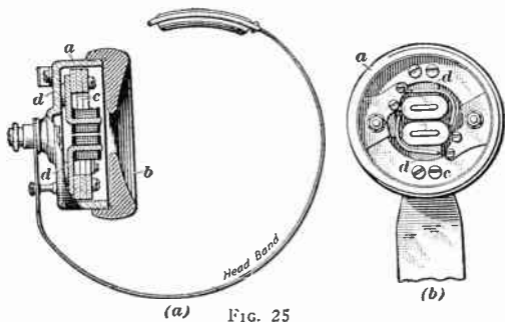

FIG. 24

these currents into distinguishable sounds. The diaphragm of this simple device, like the diaphragm of the reproducer of a phonograph, is capable of emitting the most complex sounds; in fact, it is capable of imitating with a fair degree of accuracy practically all of the sounds of the human voice, of musical instruments, or other sounds made up of many complicated wave combinations.

Standard Type.—A cross-sectional view of a standard type of telephone receiver is shown in Fig. 24. A barrel or shell *a* is used to protect the component parts of the receiver, and may be made of some insulating material or in some cases is made of metal finished with an enamel coating. The ear piece *b* screws onto the shell and serves to cover the diaphragm end of the receiver except for a small hole in its center through which sound

waves are permitted to escape. The permanent magnet *c* is U-shaped, and has both poles projecting close to the diaphragm *d* to give as strong a pull as possible. The pole projections carry the windings, which are equally distributed between the two coils, and which are connected to the terminals at *e*, only one of which is shown. Bringing both poles of the permanent magnet close to the diaphragm increases the number of lines of force effective on the diaphragm and increases considerably the sensitiveness of the receiving unit.



(a) FIG. 25

Watch-Case Type.—The construction of a compact form of telephone receiver, known as the *watch-case* receiver, is shown in Fig. 25; view (a) shows a section and view (b) shows the end with the ear piece and diaphragm removed. When the receiver is equipped with a head band, as shown in view (a), it forms a *head set*, a name which is applied whether one or two receiver units are used. Although the principle of operation is the same as in the larger hand receiver, the construction and design is necessarily varied to decrease both the size and the weight. The shell *a* consists of a case, usually of metal, threaded externally to engage an internal screw-thread

on the hard-rubber ear piece *b*. The magnets are built up of flat steel rings *c*, so magnetized that the opposite sides of their circumferences are of different polarities. The L-shaped pole pieces *d*, which reach nearly to the diaphragm and carry the magnet coils, are attached to the north and south poles of the steel rings. In many cases the magnets are not made of complete rings, but are approximately half circles. The extensions carrying



FIG. 26

the coils are then fastened to the ends of the permanent magnet. The diaphragm is of thin iron and is clamped between the body *a* of the shell and the ear cap *b*.

A receiver set using two watch-case receiver units is shown in Fig. 26. This particular type has a piece of soft iron mounted between the poles so that it is acted on by their magnetic field. The coil of wire carrying the received current is so located that it moves the iron armature in a manner corresponding to the current

changes. The armature is connected by levers to a light diaphragm, often of mica, which is controlled by the armature to produce sound waves in the air. The lightness of the moving parts causes this receiver to be responsive to very weak signals.

In some instruments of this general type an adjusting screw is provided so that the sensitiveness of the signals may be controlled to a certain extent. For instance, if it is desired to weaken the signals, the armature is withdrawn from the magnets by the screw arrangement. Also, the tone or sound of the two receiver units may be exactly balanced for best operation. If no screw adjustment is furnished, the two receiver units should be adjusted at the factory so that the tone of each is the same.

Rating.—Telephone receivers are usually rated according to their total resistance, the value being expressed in ohms. As used in wire telephony, the resistance usually lies between 10 and 100 ohms, although higher values are used under some circumstances. In radio practice it is considered desirable to use receivers of high resistance in order to balance more nearly the high resistance of other parts of the receiving circuit. As devices of relatively high resistance are commonly used, the resistance of telephone receivers is usually around 2,000 or 3,000 ohms. In some low-resistance receiving sets, which are usually so specified, the low-resistance telephones are preferred.

In order to obtain the desired electromagnetic pull, it is necessary to use many turns of wire on the coils. The space for the windings is limited; therefore, a very fine wire is used which makes a high-resistance coil. It is difficult to determine the number of turns of wire used in a telephone receiver, after it is assembled, hence rating by turns is not used. The resistance, however, is in a fair measure related to the length of wire and consequently to the number of turns, and, being readily obtained at any time, the resistance is customarily used for rating purposes. Telephone receivers of 2,000 ohms

will be found well adapted to ordinary radio work, although in case a particular set is used, the recommendation of the manufacturer should be sought and followed.

Receiver Horn.—The ordinary type of watch-case receiver does not move a very large volume of air, and the amount of sound which it produces is quite small. By attaching a horn of some type on the front of the receiver, the vibrating diaphragm is forced to move a much larger volume of air with the result that the signals are audible over a greater distance. In other words, the vibrating diaphragm is made to do more work.



FIG. 27

A cast aluminum horn of special design for such use is illustrated in Fig. 27. The horn is provided with two arms terminating in soft-rubber caps over which the ordinary pair of double receivers clamp. The diaphragms then set the whole column of air in the horn in vibration with the result that the signals may be heard by several people in a room of moderate size.

Use has been made of a single receiver unit clamped on to the small end of an old-style automobile or phonograph horn. Special devices have been introduced for connecting a receiver unit with the tone arm of a cabinet phonograph, with very good results. It is important that for best results there should be a firm connection between the receiver unit or units and the horn attachment. Otherwise much of the energy is lost.

Loud Speakers.—Where it is desired to make the signals or message loud enough for a large group of people to hear, it is necessary to use a special type of receiver unit known as the *loud speaker*. It is generally not very different from the other type of receiver in its receiving qualities, but, of course, requires more power or stronger signals to operate it. Additional apparatus is generally

required to provide signals of the desired strength, although some receiving circuits give a signal strong enough to operate a loud-speaker receiver without any auxiliaries.

The general external appearance of a satisfactory type of loud speaker is indicated in Fig. 28. The operating mechanism is enclosed at the base, and the diaphragm opens into the horn, which is of fairly large dimensions. In order that the message may not have a metallic or tin-pan sound, the tendency is to make the horn of wood, fiber, or some other non-metallic material. It should be carefully designed to give a clear sound without distortion.

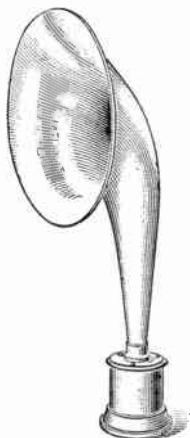

FIG. 28

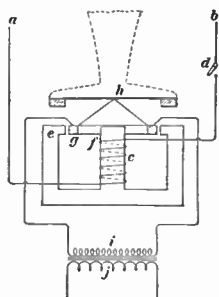

FIG. 29

The essential parts and their arrangement in one type of loud speaker are shown in Fig. 29. The terminals *a* and *b* connect with a coil *c* which carries current from a 6-volt storage battery when switch *d* is closed. The current through the coils makes a strong electromagnet of the iron core on which it is wound, and a very strong magnetic flux is established between *e*, which is a circular

pole, and the center pole *f*. The lines of force converge from the round outside pole *e* toward the middle or centrally located pole *f*. A coil *g* of many turns of wire is mounted so as to move in this magnetic field, and is connected mechanically with the diaphragm *h* so as to move it simultaneously. Coil *g* carries the received current which is obtained from the secondary coil *i* of a transformer. The primary coil of the transformer is shown at *j*. The primary coil is called the *input* and receives the strong current signals from the receiving set. This current, representing considerable electrical energy, is transferred to coil *g* by transformer action. The current pulsations set up magnetic fields of varying direction and intensity which act upon the steady magnetic field produced by coil *c*. Coil *g* is thereby compelled to move in accordance with these current variations and audible sounds are produced by the diaphragm *h*. The electrical energy is transferred into mechanical energy at the diaphragm, and the diaphragm by moving the column of air in the horn is able to reproduce sounds of the most complex nature with practically no distortion. In the smaller sized instruments it is possible to use a strong permanent magnet to produce the steady magnetic field. Such an arrangement is used in the type illustrated in Fig. 28. Even then the loud speaker is rather expensive.

ELECTRON TUBES

ELECTRON THEORY

The elements of any material are in continual motion at the ordinary temperature. If heat is applied to a liquid, such as water, the agitated and rapid motion of the particles is increased. If the heating is continued long enough, particles of the water attain a sufficient velocity to break through the *surface tension*, or mutual tendency to cling together, and form steam. The steam represents a certain amount of energy and can be used in many ways.

In metals the surface tension is very strong and they boil or evaporate at very high temperatures. Associated with the atoms, however, are the electrons, which have a rate of travel much higher than the atoms have. Before the material has reached a sufficient temperature to cause the atoms to break through the surface tension of the metal, the electrons may reach a state where they start evaporating or passing out from the structure of their parent metal. It can be safely assumed that the material was in a fairly stable state of equilibrium, and that the atoms have a certain number of electrons associated with them such that the atom exhibits practically a neutral state. In other words, the nucleus of the atom which has a positive charge is about neutralized by the negatively charged electrons associated with the atom. When some of the electrons are freed, however, the parent atoms have a positive charge remaining on them and tend to draw back the negatively charged electrons. Thus many of the electrons are undoubtedly attracted back into the metal, but many wander away and are lost, so far as the parent atom is concerned.

A very convenient way to heat a metal is to form it in a fine wire and pass an electric current through it. The energy expended in overcoming the resistance of the wire will heat it, and by controlling the current the temperature of the wire may be maintained at the desired value. A very slight trace of oxygen, one of the elements present in the air, has been found to prevent the liberation of electrons. Also, at the high temperature necessary, the wire would rapidly oxidize or decompose, just as an electric light filament will almost immediately burn up when a current is sent through it after the glass bulb has been broken. For these and other reasons, the wire, commonly called a *filament*, is placed in a high-vacuum bulb, usually of glass, or at least in one in which there is only an inert gas, such as argon, which does not decompose the filament nor affect the emission of electrons.

Filaments made of tungsten have been much used, as

have also been filaments made of platinum-iridium and coated with barium and strontium oxides. The coating in the latter case increases the electron emission very much. Other materials, such as a small amount of thorium in a tungsten filament, increase the emission considerably, and are used in some types of tubes.

TWO-ELEMENT ELECTRON TUBE

ELEMENTARY PRINCIPLE

The electrons each carry a minute charge of electricity, and if a fairly large number of them impinge on a metal plate inside of the tube, there will be a flow of electricity. The metal plate should be connected with the filament through a very sensitive ammeter which will indicate the passage of an electric current. If the added element, called the *plate*, is connected to the negative end of the filament—that is, the end of the filament connected to the negative terminal of the battery—only a small current indication can be obtained, and this only if the filament is heated to such a high temperature that an excess of electrons is emitted and caused to settle on the plate quite by accident. It should be noted that in this case the plate is negative with respect to most of the filament, and in fact may tend to repel the negative electrons. If a very large number of electrons are given off by the filament, however, many may accidentally collide with the plate. For most considerations, however, the current when the plate is connected to the negative terminal may be regarded as zero.

If the plate is connected to the positive filament terminal, the plate will be positive with respect to most of the filament. The positive potential on the plate will attract some of the negatively charged electrons, and a current indication will result. The connections are indicated in Fig. 1, where *a* represents the bulb, or tube; *b*, the heated filament; *c*, the filament battery; *d*, the relatively cold plate; and *e*, the sensitive ammeter. The condition shown is with the plate connected to the positive

terminal of the battery *c*. The condition for little or no current flow would occur with the lead from *e* connected to the negative terminal of the battery *c*. A tube that has both a filament and a plate element is known as a *two-element electron tube*.

EFFECT OF PLATE BATTERY

With the condition shown in Fig. 1 there is only a very small current through the plate circuit, as only a small percentage of the electrons ever reach the plate, most of them falling back into the fields of the atoms. If a battery is connected in the plate circuit so as to give the plate a higher positive potential with respect to the filament, many if not all of the emitted electrons will be attracted to the plate, and a quite large plate current will result. A diagram of such a connection

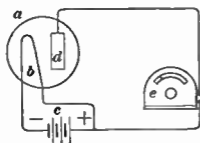

FIG. 1

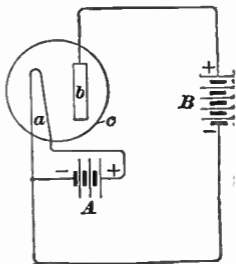

FIG. 2

is given in Fig. 2, where *a* represents the filament and *b* the plate element. The filament-heating, or filament-current, battery, is designated by *A*, which is more or less standard practice, as this is frequently called the *A* battery. The plate battery is commonly called the *B* battery, and that designation is used here.

If the plate, or *B*, battery is reversed so as to make the plate negative with respect to the filament there will be no plate current, as the negative potential of the plate will repel the electrons emitted by the filament. It is

thus seen that electricity cannot flow from the plate toward the filament, as there are no electrons passing that way to carry the component charges.

CHARACTERISTICS OF THE TWO-ELEMENT TUBE

The emission of a definite number of negatively charged electrons per unit of time occurs with certain characteristics of the operating circuits. The main factors governing the rate at which electrons are emitted are, the surface area of the filament, the temperature of the filament, and the material of which it is constructed. In any tube, as manufactured, practically the only factor which can be varied is the filament temperature, this being dependent on, and controlled by, the filament current. For any given filament temperature a definite number of electrons per unit of time is given off. If the plate voltage is made sufficiently high, practically all of the liberated electrons will go to the plate and through the

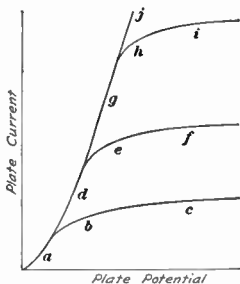

FIG. 3

circuit back to the filament, and a further rise of plate voltage will fail to increase the plate current, as there are no more free or available electrons.

The variation of the plate current with different plate voltages and different temperatures of the filament is shown in Fig. 3. Part *a* of curve *a b c* occurs while there is an increase of plate current with every increase of plate voltage, indicating that not all of the emitted electrons are drawn over to the plate, but that many are reentering the filament. Near *b*, practically all of the emitted electrons are drawn over to the plate, and very nearly the maximum plate current will be established. The plate-current value corresponding with point *b* is

called the *saturation current*. As nearly all of the emitted electrons are drawn over to the plate when the saturation point is reached, a further increase of plate voltage cannot cause an appreciable increase in the plate current. This is indicated by the nearly flat portion of the curve near *c*.

If, however, the filament temperature is raised, electrons are given off at a higher rate, as indicated by the curve through *a* and *d*, before the plate current is limited by a new and larger saturation current at point *e*. Beyond point *e* and toward *f*, further increase of plate potential can cause but a very small increase in the plate current. A further rise in filament temperature will give the curve through points *g*, *h*, and *i*. It is possible that a plate-current curve may be obtained, as that through *a*, *d*, *g*, and *j*, such that no saturation value is reached within the safe operating limits of the tube. Data for the curves shown in Fig. 3 could be taken by reading the plate current for different values of plate voltage while the filament current was maintained constant. Other curves would be taken by changing the filament current to the desired value and repeating the run.

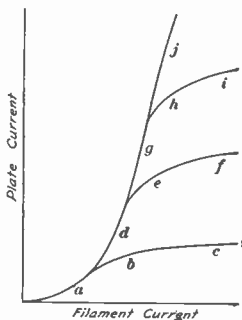

FIG. 4

A set of curves of somewhat the general shape of those in Fig. 3, but exhibiting entirely different characteristics of the tube, are given in Fig. 4. These curves represent changes of plate current with variation in the filament current, each being taken with the plate voltage maintained at a constant value. The first part of each curve follows the same law, so they all coincide over part *a*. With a rather low plate voltage, all of the emitted

electrons will be attracted to the plate until some point as *b* is reached. The events happening in the tube must now be considered. As has been frequently mentioned, there is an emission of negatively charged electrons from the filament, which emission increases as the temperature of the filament is raised. These negative charges of electricity can be considered as forming a cloud just beyond the surface of the filament, just as steam particles congregate near the surface of water. If the plate voltage is high enough, it will attract all of the freed electrons immediately after they leave the filament. For any definite plate voltage, there is a corresponding maximum plate current, depending upon the resistance of the plate circuit. It is well to remember that the voltage between the filament and plate and the corresponding plate current determines the resistance between these elements. The plate resistance will be considered more fully under another heading. The maximum plate current, which has just been mentioned, requires a definite rate of emission of electrons from the filament which pass to the plate.

Suppose that the filament is heated to such a temperature that there is an excess of emitted electrons. Only enough electrons will be attracted to the plate to supply the maximum plate current, and this number will exactly neutralize the plate voltage. The excess of electrons will then congregate near the filament and wander aimlessly around since there is no plate voltage tending to attract them. Some of the electrons will undoubtedly go back into the filament. The large cloud of negatively charged electrons produces what is known as a *space-charge* effect. Since like charges repel, the cloud of negative electrons tends to prevent the emission of any more negative electrons, or, if they are emitted, exerts an influence to send them back into the filament. Point *b*, Fig. 4, on the characteristic curve, represents the point at which the space charge comes into play for that particular value of plate voltage. At this point just enough electrons are emitted to supply the plate current, and, strictly speaking, the space-charge effect is just ready

to start. If the filament current, which is here considered as it is impossible to get the filament temperature satisfactorily, is raised to increase the electron emission, there is very little further increase of plate current, as shown by the nearly flat line *c*.

With a higher voltage on the plate, the plate current will follow curve *a d c f* until a new space-charge point at *c* is reached, after which the plate current is more nearly constant. Raising the plate potential to a still higher value gives a considerably larger plate current, as indicated by the curve through *a, d, g, h,* and *i*. The curve through *a, d, g,* and *j* was secured by using such a high plate potential that the corresponding space-charge effect was not reached within the operating limits of the tube. In some tubes the space-charge effect does not make a sharply defined effect at a particular point. This will cause the curves to have a gradual bending over near this point rather than a sharp change in direction of the curve. These curves were taken from tests on a tungsten-filament tube. The plate-current scales in all cases start at zero, but the filament-current scale starts at the value of filament current at which appreciable emission occurs, in general at about three-fourths of the rated normal filament current.

USES OF TWO-ELEMENT TUBES

The chief use of the two-element tube is as a rectifier, and it has been used in the detection of minute radio currents, and in the rectification of relatively large amounts of alternating current into a direct current. In some cases, the tube is highly evacuated, that is, the vacuum in it is made very complete, and the plate or output current depends upon the actual electron flow, while in others the tube is not so highly evacuated. In the latter case, the gas is ionized by collision with the particles, or ions, which are disrupted. The negative electrons are freed and rush over to the plate, while the positive nuclei are hurled against the filament. This bombardment of the small and hot filament results in a

rapid decomposition of the filament, and unless of large size it is soon burned out. Sometimes the tube is not highly evacuated and the gas remaining in the tube is that which is ionized, while at other times an inert gas, such as argon at low pressure, is introduced after all of the air has been removed. The tubes with some air remaining in them cannot be used on such high voltages as can the other types, as the high potential is more apt to spark across between adjacent parts of the elements when some air is present. Descriptions and connection

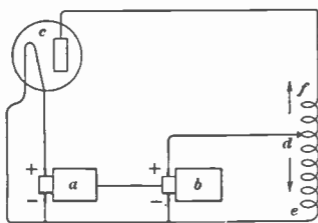

FIG. 5

of such a set is shown in Fig. 5. This arrangement has been used on generators for mounting on airplanes, where the speed is subject to wide variations as the generators are driven by means of fans. The two generator armatures *a* and *b* are shown separately, but they might be wound on a common armature core. Armature *a* supplies current for heating the filament of the tube *c*. Armature *b* has a main field coil between *d* and *e* and a differential, or bucking field coil, between *d* and *f*. With normal operation, there is a flow of electricity through the main field winding *de*, in the direction of the arrow, which excites the armature and causes it to generate the desired voltage. There is also a small flow of electricity in the plate circuit of the tube in the direction indicated by the arrow near *f*. This current establishes a small bucking field in *df*.

diagrams of the two-element tube in some of its various uses are given elsewhere.

Another interesting and practical application of the two-element tube is to control the voltage of small generators.

A wiring diagram

This action reduces the generated voltage to some extent, but is a feature of the design of the generator. Now suppose the speed of both armatures is increased. This tends to increase the terminal voltage of each armature. This increase of voltage at the terminals of *a* sends a larger current through the filament of the tube, and the plate current is immediately increased. This increased plate current increases the field of coil *df* which bucks the field of *dc* to a greater extent. The armature *b* will then be rotating faster than previously, but in a weaker magnetic field with the result that its terminal voltage will remain nearly unchanged. Energy may then be taken from the terminals of *b* with the assurance that the voltage will remain practically constant.

THREE-ELEMENT ELECTRON TUBE FUNDAMENTAL PRINCIPLES

The *three-element electron tube* has, in addition to the filament and plate, a third electrode, which from its appearance is called the *grid*. The grid is always placed between the filament and the plate, as its operation or effect is then at its best. It is usually made of a mesh-work, or grid, of fine wires connected together, although some manufacturers have made the grid of solid plate with many slots stamped out. It has been found that the maximum effect can be produced by constructing the filament as a central unit for the liberation of electrons, and practically enclosing it with the grid, which is in turn surrounded by the plate. Some effect from the grid can be secured by placing it on the opposite side of the filament from the plate or even by placing the grid outside of the plate, but neither of these methods has been used commercially.

In considering the two-element tube, it was noted that the filament gave off a very large number of electrons and, unless the plate had a high positive charge with respect to the filament, many of these emitted

electrons returned to the positively charged atoms which they had just left. By using a high positive-plate voltage many of these electrons were induced to travel to the plate, thereby establishing a plate current. This plate current depended upon the filament temperature, plate voltage, and, under certain conditions, indirectly upon the saturation current and space-charge effect. Any factor that will increase the flow of electrons will increase the plate current, and, conversely, any factor that will decrease the flow of electrons will diminish the plate current. The *grid*, or third element, by virtue of its strategic location, can control the plate current over a wide range of values with the expenditure of very little energy.

COMMERCIAL TYPES OF THREE-ELEMENT TUBES

A type of three-element electron tube is shown in Fig. 6. The V-shaped filament *a*, made of a twisted strip of platinum-iridium covered with barium and strontium oxides, is mounted in the central portion of the tube. On each side of the filament is placed one of the two sections of the grid *b*. Outside of the grid *b* are mounted the two sections of the plate *c*. The grid is of a cage-like structure and made of punched steel sheets. The plate sections are made of corrugated steel sheets, supported at the bottom by the glass base *d*, and clamped at the top about a small block *e* of insulating material. The top of the grid is supported by this block, and the bottom by a lead-in wire through the glass base. The filament is held taut by a small spring-wire hook which is fastened to the insulating block *e*. The glass base *d* supports and keeps the three elements in their proper relative positions. Better utilization of the liberated electrons is obtained by constructing the grid and the plate in two sections and mounting them so that the heated filament is nearly enclosed, than when the plate and the grid are in single sections and off to one side of the filament. The metal base *f* with its locking pin *g* fits into a socket made for this purpose, and locks securely in position. By

means of spring contacts in the socket, connection is made with the three elements in the tube through the four external contact pins *h*. Two of these projections are connected to the filament inside of the tube, another one is connected to the grid, and the fourth one connects to the plate. A high vacuum is maintained around the three elements within the glass tube *i*.

Another type of tube using a slightly different style of construction is shown in Fig. 7. In view (a) the glass bulb has been broken away and the plate element removed. The filament *a* is rigidly supported by posts of heavy wire so as to form an isosceles triangle. There is no particular reason for mounting the filament in this shape except for convenience. The top support is insulated, the terminals of the filament being at its bottom supports. The grid *b* is in the form of a flattened helix, and is rigidly supported along each edge. The grid then forms a cage-like structure all around the filament, except that the ends are open. The grid can thereby have nearly absolute control over the passage of electrons away from the filament. View (b) differs from view (a) only in that it shows the plate element *c* in place. It is formed of a flattened metal cylinder and placed so as practically to enclose both the filament and grid elements. Ears on the plate are fastened to rigid supporting posts. All of the supports of the three elements are embedded

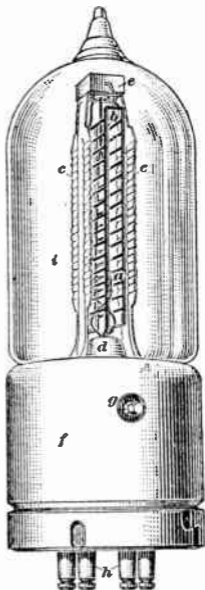

FIG. 6

in a glass post as shown at *d*, view (*c*). In view (*c*) the glass bulb is in place and the arrangement of parts is indicated. One of the support wires from the grid, one from the plate, and two from the filament go through the glass base and are connected to the four contact pins at the bottom of the tube. Only three of the contact pins are visible in any one of the three views. Before the glass bulb is mounted on the base *e*, view (*c*),

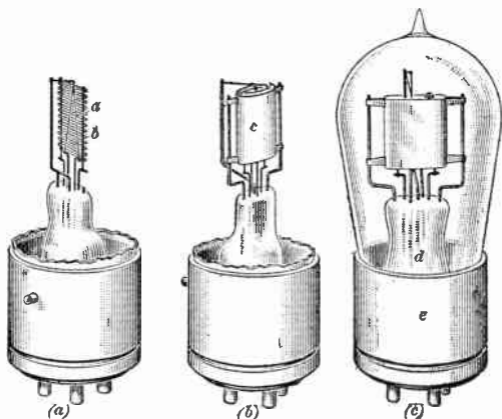

FIG. 7

a small tube is left projecting at the opposite end. A vacuum pump is connected to this tube, and as much of the air as possible is pumped out. The tube is then heated and allowed to seal shut. With even the best vacuum pumps there are thousands of molecules of air left in the tube. Some material is usually placed in the tube during manufacture which will take up the free gas and thus prevent it from producing undesirable results in the tube.

Some types of tubes have different styles of construction than that just described. For some cases a trace or definite small amount of air is desirable in the electron tubes. Inert gases have also been used. These features will be considered under separate headings.

MOVEMENT OF THE ELECTRONS

The essential parts of a three-electrode tube are indicated in Fig. 8, which is merely diagrammatical. The filament *a* is relatively close to the grid wires *b*, beyond which is the plate *c*. Suppose that one of the electrons is represented at positions *d*, *e*, and *f*, and another electron at position *g*. It should be understood, however, that there are practically a countless number of electrons in the same neighborhood. The electron

represented at *d* has just been emitted by the filament and is subject to any of the forces that may act upon it. The positive charge remaining on the filament may try to reclaim it. If there are a large number of electrons in its vicinity or to its right, their negative or space-charge effect may tend to repel it back to the filament. If the



FIG. 8

plate voltage is sufficiently high and there are not too many other electrons, the electron at *d* will be attracted to the plate immediately. Finally, suppose that there is a charge on the grid *b*. If this charge is positive with respect to the filament, the electron at *d* will start toward that charge, or, in this case, toward the grid. As the electron moves to the right it comes under the influence of the predominating field of the plate. At position *e* the electron will be under the influence of two fields, that of the grid, and the much stronger one of the plate. The influence of the plate will predominate and the electron will pass through the grid mesh to some position as at *f*. At this position, the strong force due to the plate voltage causes the electron to travel to the plate *c* at a high rate of speed.

An electron that had reached the position shown at g would be acted on by the same fields as is the electron at e , but it is not probable that g could change its course to avoid colliding with the grid wire. In fact the number colliding with the grid wires is surprisingly small with the grid and plate voltage commonly employed. The electrons which collide with the grid establish a current in that circuit just as much as do those which collide with the plate. However, the grid current does not produce any useful output, but as it does take electrons which might go toward establishing a plate current, it is generally considered objectionable. Occasionally conditions arise under which it is desirable that the grid take current, and these cases will be mentioned as they arise. In any case, the grid current seldom exceeds one-tenth of the plate current, and is usually much smaller.

The grid voltage is relatively low so that its current will not be large. Often the grid potential is zero or slightly negative, and it is still effective in giving the electrons a good start toward the plate. Perhaps the best way to look at it is as follows: With the grid maintained at a zero voltage, it is still positively charged with respect to the negatively charged electrons. Also, the space-charge effect is neutralized to a greater or less degree by the fixed grid potential. It should be remembered that the relative value of the changes is the important point, and that, although the grid may be at zero potential with respect to the filament, it is still in a condition to attract the electrons, but with not so great a force as when the grid is more positive. The same idea obtains when the grid is slightly negative; that is, the more negative electrons are attracted toward the grid and then handed over to the plate field. As the grid is made more and more negative, the flow of electrons will diminish until at some negative value of grid voltage the flow of electrons to the plate will cease altogether. This decrease of electrons will cause a corresponding decrease of plate current, and when the flow of electrons stops,

the plate current will be zero. Except for some electrons that wander away, there will be no appreciable emission from the filament with the more negative grid potentials. As the grid voltage was reduced from a positive voltage to zero, the grid current also decreased. In most tubes the grid current reaches zero about the time the grid voltage becomes zero. With zero or negative values of grid voltage, the grid current will be zero.

The grid acts on the electrons like a gate or valve to control their flow. By increasing the positive grid voltage or decreasing the negative grid voltage the plate current is increased, and by decreasing the positive grid voltage or increasing the negative grid voltage the plate current may be decreased. This change is a very sensitive one and takes place within certain limits. The chief feature of the three-element tube is the fact that large changes of plate current may be secured by relatively small changes in grid voltage.

CHARACTERISTIC CURVES

Characteristic curves of a three-element tube illustrate many of the actions that have just been described. A set of these curves is given in Fig. 9, where curve *a* represents the plate current for different values of grid voltage while the plate voltage and filament current are maintained constant. At the lower left end of curve *a* the plate current becomes zero. This is the value of grid volts, as determined on the grid-voltage scale, at which the flow of electrons to the plate is stopped by the negative grid potential. As the grid reaches positive values of potential and these are increased beyond that point, the plate current keeps increasing, this increase being along a straight line for a considerable part of the range. At a relatively high positive value of the grid potential, the plate current begins to drop off and finally reaches a maximum. This is indicated by the bending over of the curve at the upper right end, and represents the saturation current under those conditions. If the grid voltage is still further increased, the plate current may,

under proper conditions, begin to decrease, due to the fact that the grid takes electrons and establishes a larger grid current. Curve *a* was obtained by maintaining the plate voltage constant and reading the plate current as affected by several values of grid potential.

Curves *b* and *c* indicate the variations of plate current under the preceding conditions, but with higher values of plate voltage, curve *c* having a plate voltage somewhat higher than *b*. It should be noted that the general shape of the curves is about the same as for the lower voltage,

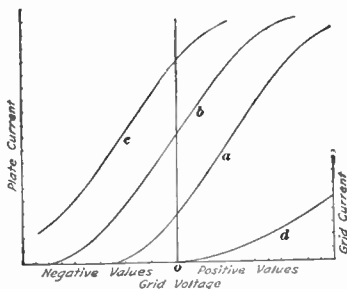

FIG. 9

the main difference being that they have been displaced bodily to the left. All of these curves presume a constant filament temperature. Extreme plate voltages below curve *a* and above curve *c* will produce rather irregular curves which may or may not resemble the curves obtained over the usual operating range.

The corresponding values of grid current are shown in curve *d*, which strictly relates to the values indicated by curve *a*. However, as the grid current is only slightly less for the higher values of plate voltage used when determining curves *b* and *c*, separate grid-current curves are not drawn. The grid current comes to zero at about

the time the grid voltage reaches zero, and remains zero for negative values of grid voltage. As the grid voltage is raised, that is, made more positive, the grid current increases. If the grid voltage is nearly as high as the plate voltage, the grid, in spite of its small surface area, may attract many of the electrons as they pass by and establish a grid current nearly as large as the plate current. This would be an extreme case, however. The grid-current scale is in general much smaller than the plate-current scale; for example, each division of the grid-current scale might represent a current one-third as large as that represented by the divisions of the plate-current scale.

DETECTOR ACTION

A circuit to illustrate the rectifying action of a three-element tube as a detector is shown in Fig. 10. The conventional symbol for a three-element tube at *a* represents the filament at the left by a nearly closed loop, the grid in the middle by a zigzag line, and the plate at the right by a small rectangle.

The battery for heating the filament is often called the *A* battery and is so indicated in the figure.

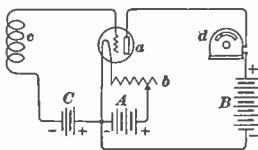

FIG. 10

The plate and the grid batteries, or *B* and *C* batteries, respectively, are frequently designated by those letters. A filament rheostat *b* is used to adjust the filament temperature to the desired value. For a detector tube, the adjustment of the filament rheostat should be very accurate and sensitive, particularly in the so-called gas tubes. At *c* is a coil which might be the secondary of a transformer, but here is represented as a means for impressing an alternating potential on the grid. A sensitive current-indicating device is represented at *d*, which, in an actual set, might be the telephone receivers.

The elimination of the filament-control rheostat has been secured in one type of set by using a *ballast lamp*. This lamp has a filament of iron wire so proportioned that with a very small change in the specified current, its resistance will change a great deal. The ballast lamp is connected in series with the filament of the electron tube whose current it is desired to keep constant. If the supply voltage, from a storage battery, is normal and the proper ballast lamp is used, the filament current will be at its correct value. As the battery voltage drops while the cells are discharging, the current output tends to decrease. However, as soon as the slight decrease in current occurs, there is a decrease in the resistance of the ballast lamp, so the result is that the filament current can decrease only a very slight amount.

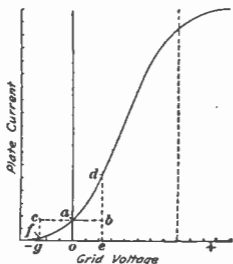

FIG. 11

If the battery is fully charged, its voltage is higher than normal, and it tends to send a large current through the filament circuit. This large current increases the resistance of the ballast lamp, and the filament current is kept very close to its normal value. This method of filament current control must necessarily have some current variation over the extreme range of charge and

discharge of the storage battery, but gives a very good method of control without any attention whatever.

The curve, Fig. 11, is one of the characteristic curves of a three-element tube. Assume that it is one in which the zero grid-voltage line cuts the curve near the lower bend as at *a*. With an alternating voltage from coil *c* of Fig. 10 impressed on the grid, there will be equal values of the grid voltage *ab* and *ac*, Fig. 11, impressed on each side of the point of zero voltage.

line at b just above point d . Suppose there is an incoming signal impressed on the grid. It is assumed that there is zero grid potential from d to e followed by four cycles of alternating current from e to f , and then there is zero grid potential again from f to g . From d to e the plate current has the value $d b$ and is constant as indicated by the horizontal line from b to h . The four cycles of alternating current e to f now act to produce the pulsating waves in the plate circuit as indicated in the horizontal space from h to i . The pulsating plate current has raised the average value of the plate current to the level of i , or the plate current during this time is given by the value $i j$. This will give an indication on any current-indicating device in the plate circuit. As soon as the pulsating current stops at i , the plate current drops to the level of its original value at k and continues at that value for a time corresponding with $f g$.

In the preceding case the use of a suitable C battery has been assumed. The C battery, as illustrated in Fig. 10, may be a few small dry cells, as it is not required to furnish an appreciable current. The purpose of the C battery is primarily to obtain such a condition that detector action takes place on the lower bend of the characteristic curve. If it does not take place on a bend of the curve, equal changes of grid potential will not produce unequal changes of plate current and no detector action can result. By using a proper value of C battery, operation at the best point on the characteristic curve may be assured. It may so happen that the inherent characteristics of the tube are such that it operates satisfactorily without a C battery.

It is rather important that the grid should be maintained at a negative potential with respect to the filament, as the grid can then take no current, hence can cause no loss. A negative potential can be applied to the grid in other ways than that just described, and some of them will be given in connection with the descriptions of actual receiving circuits.

AMPLIFIER ACTION

It has been seen that with certain voltage variations applied to the grid of a three-electrode electron tube, there are much larger changes of plate current, and consequently of plate voltage, produced in the plate or output circuit. If the operation of the tube is on the straight part of its characteristic curve, that is, between the bends, the voltage curve for the output circuit will in general outline resemble that of the input voltage, but will be much greater. The three-element electron tube with its auxiliary devices is then known as an *amplifier*, as it magnifies, or strengthens, the input signals many fold. A circuit to illustrate this principle is given in Fig. 13. The incoming signal, alternating or otherwise, is applied to the grid of tube *a* by coil *b*. The output circuit includes the *B* battery, current-indicating device *c*, and high resistance *d*, all in series in the plate circuit. The current changes produced by the grid potential variations are indicated by the sensitive ammeter or other current-indicating device *c*. By sending this current through the high resistance *d* there will be a large voltage drop across this part of the circuit which may be used in any of the ways desired in radio practice.

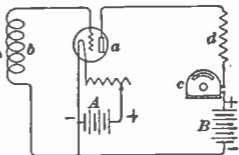

FIG. 13

The current changes produced by the grid potential variations are indicated by the sensitive ammeter or other current-indicating device *c*. By sending this current through the high resistance *d* there will be a large voltage drop across this part of the circuit which may be used in any of the ways desired in radio practice.

By substituting a known voltage from a direct-current source in place of coil *b*, Fig. 13, and varying this voltage by steps over its positive and negative values, readings of the ammeter *c* may be obtained, that, when plotted, will produce the characteristic curve a portion of which—through *a*, *b*, and *c*—is shown in Fig. 14. Consider the case where the zero-voltage line cuts the characteristic curve at its mid-point *b*. If an alternating voltage, as indicated between *d* and *e*, is now impressed on the grid, it will cause the tube to operate over the part of the characteristic curve between *a* and *c*, and since it is

on the straight part of the curve, the two parts $b c$ and $a b$ will be equal. The positive impulse $b f$ will therefore produce a plate-current change $f c$, and the equal negative impulse $b g$ will produce a plate-current change $g a$ equal and opposite to $f c$. These plate-current changes will combine to produce a pulsating plate current, as shown between h and i , of a form that is, in general,

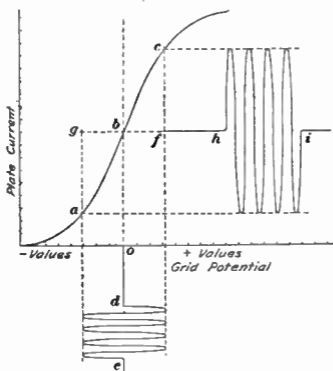

FIG. 14

but that differs in amplitude. When this output current is sent through a high resistance in the plate circuit, there is a much larger voltage available than that originally impressed on the grid.

The basic principle of the amplifier is that equal changes in voltage impressed on the grid produce equal changes in the plate circuit. This does not imply that the amplitude of the changes in the grid voltage is the same as the amplitude of the changes in the plate current. If the amplitude of the impressed voltage is too great, operation may take place well up on the bend of the characteristic curve. If there is no distortion produced thereby, and there should be very little unless the voltage is excessive, there is no objection to this feature, except that the tube will not be operating very efficiently. Similarly, if only small voltages are impressed on the grid, the amplification may be perfect, but the output will be small compared to the power expended. It is well to

remember that the *A*, or filament, battery actually supplies the electron charges present in the tube; that the plate, or *B*, battery attracts them; and that the grid, or *C*, battery, if one is used, has an indirect control over them by determining the active portion of the characteristic curve. Actual wiring diagrams of various practical types of radio amplifiers will be given under the heading Amplifiers. An amplifier tube should give a voltage amplification of from 5 to 25 times, although the latter figure is seldom realized in practice. A decided advantage of the electron-tube amplifier is that its operation is entirely electrical, and there is no time lag between the input and output currents. The electron-tube amplifier may be designed to amplify alternating currents of any frequency, and in some special work has been used on direct currents to amplify any changes which might occur.

OSCILLATOR ACTION

The three-electrode electron tube, when connected in circuits of special types, has proved to be a very reliable *oscillator*, that is, it is capable of establishing and maintaining an alternating current of constant frequency. For such purpose it has found a very large field, and is the source of power for many low- and medium-sized sending sets using continuous or undamped waves. Although practical uses do not require it, the electron tube may be made to establish alternating currents of any frequency within the range of one cycle per second up to several million in a like interval of time. When the circuit auxiliary to the tube is once adjusted, it will continue to oscillate at that frequency without attention. The type of tube suitable for detector or amplifier use may be used as an oscillator or, in fact, generator, but for large power output an oscillator tube of special design should be used.

The basic principle of the tube when operating as an oscillator depends upon its amplifying properties. If a correct portion of every oscillation produced in the plate circuit is fed back into the grid circuit in the proper time

relation, the pulsating-current wave generated in the plate circuit will be continuous.

Fig. 15 shows a simple circuit arrangement for producing an alternating current by the use of an electron tube *a*. The condenser *b* and inductance *c*, which form an oscillating circuit, are given such values that their natural period of vibration corresponds with the desired frequency. The inductance, or capacity, or both, may be made variable, if it is desired to change the frequency of the current. An inductance coil *d* is coupled to coil *c*, and thus receives some energy from the oscillating circuit. The degree of coupling must be such that the feeble currents in the grid circuit will, when amplified, maintain the current variations and cause the plate oscillations to be continuous. When the electrical properties are once established, the tube will oscillate for a considerable time with very little variation. Due to the stable frequency of oscillation, the electron tube is largely used as a producer of continuous waves to be used in accurate radio measurements. The condenser *e* is not always used, but when installed it provides a good path for the oscillating current in the plate circuit. This current then does not have to pass through a rather high resistance *B* battery. The established current may be used in another circuit by coupling another coil to coil *c*, or to any other coil placed in the oscillating circuit.

The inductance or coupling coils *c* and *d* must be connected so that the oscillations in the grid circuit assist those in the plate circuit. These coils need not be very large, as only a small amount of energy is transferred. In some cases it may be possible to wind both coils on a common supporting core, but in that case it would be impossible to vary the coupling.

The original electrical disturbance in the oscillating circuit might be due to an electron discharge in the tube, which might be caused by a change in the capacity of the circuit, or by a slight rush of current produced by closing the circuit of the *A* or *B* battery. Through the action of the coils *c* and *d* the grid voltage is affected.

The amplitude of the first cycle on starting might be quite small, but the cumulative effect of the feedback action would cause successive waves to be larger until a balance was reached. At this point the energy generated would just maintain a current of a certain strength, and a pure unvarying wave of alternating current would be produced in coil *d* or any other coil in a circuit coupled to the plate circuit. The actual operation of the tube is quite like its action as a regenerative amplifier, as it actually amplifies the small amount of energy transferred to the grid circuit from the plate circuit.

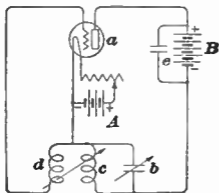

FIG. 15

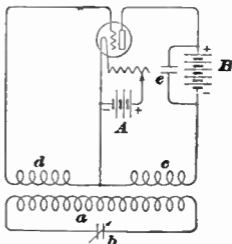

FIG. 16

The oscillating circuit may be entirely separate, and be connected to the grid and plate circuits by inductance coils, as is represented in Fig. 16. The oscillating circuit formed by the inductance coil *a* and condenser *b* controls the oscillations of the current established in the plate circuit as in the preceding case. An inductance coil *c* is coupled to the oscillating circuit, and by transformer action transfers the current to the inductance coil *a* and its connected circuit. By means of an inductance coil *d* an electromotive force is impressed on the grid of the electron tube which causes an oscillating current to be established in the plate circuit, but with a greater amplitude. The condenser *e* provides a good path for the oscillating current in the plate circuit to pass around the *B* battery.

One of the best oscillator circuits, so far as ease of adjustment and simplicity are concerned, is the one shown in Fig. 17. The single coil is divided into two sections by the contacts *a*, *b*, and *c*. Point *b* should be adjustable so that the ratio of the number of turns in the plate and grid circuits may be changed. It will be found that a setting not far from the center will be generally satisfactory. With various settings of *b* the condenser *d* should be varied until the tube starts to oscillate. Where large changes in the generated frequency are desired, it may be best to vary the total number

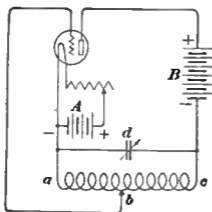

FIG. 17

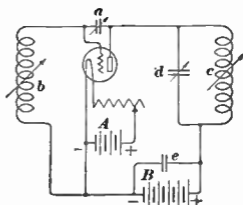

FIG. 18

of turns in the inductance coil by moving the connection at *a* or *c*. The oscillating current is established in the tuned circuit through the coil *a b c* and condenser *d*. If trouble is experienced, it might be well to use separate coils for the inductances *a b* and *b c* and to couple these sections together loosely.

A condenser may be used to form an electrostatic coupling or feed-back arrangement between the plate and grid circuits. Such an arrangement is shown in Fig. 18, where *a* is the coupling condenser. The inductances *b* and *c* should be approximately equal and variable, and not coupled to each other. A condenser at *d* adds a very desirable refinement as regards tuning for securing maximum output. A small condenser *e* is inserted to act as a by-pass for the high-frequency currents around the

B battery. The frequency of the alternating current is determined chiefly by the values of the inductances *b* and *c* and by the setting of the condensers *a* and *d*.

It is very difficult to give design data for oscillators. This is due to the fact that the oscillation of a tube depends upon several variable factors. The value of the *B*-battery voltage is important, and quite different for different tubes. The voltage of this battery is, in general, quite high, as a relatively large plate current is desired when oscillations are sent out.

One of the simple tests to determine when an audio-frequency tube is oscillating, is to couple a coil of a few turns of wire to some part of the oscillating circuit, and listen to the induced current with a set of telephone receivers. If the frequency is above audibility this method is not applicable. By listening to a pair of telephone receivers while the terminals are tapped to some of the circuit connections, it is usually possible to tell when a tube is oscillating, as clicks will be heard at the moment of contact and release.

In the case of radio frequencies a short gap in the oscillating circuit will often show when the tube is oscillating. For this test unfasten the lead to the condenser and slowly pull the connecting wire away from the condenser terminal. While there is still a minutely short gap, there should be a fine spark which will die out as the gap length is increased. This is only a rough test. The most sensitive and absolute test is by placing in the oscillating circuit a sensitive radio ammeter, which will deflect when an oscillating current is established. Often when the tube is oscillating at audio frequencies, and occasionally when at higher frequencies, an appreciable buzz or hum can be heard from the oscillating circuit. In some cases, this seems to be due to loose condenser plates which vibrate so as to produce sound waves very much after the manner of a telephone receiver.

MODULATOR ACTION

In addition to generating or producing power, the three-electrode electron tube may be used as a *modulator*, in which capacity it changes or modifies an alternating current as required. In doing this the modulator tube often acts as an absorber of power, thereby performing just the opposite of its generator or amplifier function. The principle of the modulator tube is that it acts on the grid or plate of another tube, generally an oscillator tube, to change its output current. Since the modulator tube is nearly always used in complete transmitting circuits, its description is given further on under the heading Modulation Transmission.

TRANSMITTING STATIONS

GENERAL FEATURES

Radio communication depends upon the travel of radio-frequency waves from an antenna at the sending, or transmitting, station to suitable equipment at the receiving station that will render these signals intelligible. The transmitting station must comprise, essentially, a source of electrical energy, means for converting this energy into a form capable of being radiated and of traveling long distances through the *ether*, a device or means for impressing the signal or message on this energy, and an antenna system. Successful short-range transmitting stations have been made of only a few well-designed pieces of apparatus, while others, equally successful in the long-distance work for which they were built, have required an enormous outlay of essential and auxiliary apparatus.

The requirements of the converted energy in order that it may be readily radiated are, briefly, it must be at a very high radio frequency, and the voltage should be high. The current should be fairly large, but this affects the range of transmission rather more than the

radiating property. As the radiation is proportional to the square of the frequency of the oscillating current, it is important that the frequency be high.

Radio communication, considered from the standpoint of the nature of the waves by which communication is established between stations, may be divided into two classes. In the class employing *damped waves*, a series of wave-trains is sent out, each of which trains consists of a group of damped radio-frequency waves. The term *damped* as used here means that the succeeding waves in the short wave-trains are of decreasing amplitude. Practically, there may be any number of waves in each train, although United States Government regulations prohibit the use of radio signals with less than about 23 waves per train. These waves are not usually continuous; that is, the trains do not ordinarily overlap, or even join their neighbors. In the second class, employing *undamped waves*, use is made of radio-frequency waves, which, if the signal did not prevent, would form a continuous series of waves of constant amplitude, representing a true alternating current. As the generated wave is continuous, this system is also known as a *continuous-wave system*, frequently abbreviated to a C.-W. system.

In the early days of radio communication, the various spark systems of damped-wave signaling provided practically the only satisfactory method of producing radio-frequency current oscillations; hence this system was in almost universal use. With the development of the art, and by the application of new principles, several devices have been produced which enable radio communication to be established by using continuous alternating currents of exceptionally high frequency. The use of damped waves at the present time, particularly in small power sets, is due largely to the fact that such transmitting apparatus may be constructed and operated very conveniently and cheaply.

There is apt to be some interference on wave-lengths near the main one for which the set is tuned, where

damped waves are used, as in practice there seems to be some change in frequency as well as in amplitude during the wave-trains. Also, the radiating system is idle for a part of the time as there is normally an interval of inactivity between the wave-trains, that is, they do not overlap.

The following are some of the advantages of the undamped-wave radio system: As waves of constant amplitude and frequency are used, tuning at the receiving station can be made very sharp, and on one definite wave-length. Interference at other stations is also a minimum, because of the single frequency of the radiated wave. As the radiating system receives a continuous supply of energy, the amount of energy radiated is a maximum for steady conditions. The tone of the received signals may, in most undamped-wave systems, be controlled by the receiving operator. By manipulation he can make the tone of the desired station distinguishable from others that may be interfering, and may even be able to use a pitch that is easily distinguishable from atmospheric disturbances. Furthermore, the continuous-wave system is essential to radio telephony.

DAMPED-WAVE TRANSMITTING CIRCUITS

The individual trains of damped high-frequency waves which form the basis of damped-wave radio are usually produced by the discharge of a condenser in a circuit containing inductance. The condenser is discharged by placing it in series with a spark gap and impressing a voltage that is high enough to break down the spark gap in order to produce an oscillatory current in the condenser circuit. Sometimes the high voltage is produced by means other than the accumulation of the energy on the condenser. It is essential that the oscillating current either be produced in the antenna system or be produced in a circuit coupled to the antenna circuit so that it may be radiated.

SIMPLE SENDING SET

A very simple type of sending station is represented by the circuit diagram shown in Fig. 1. The parts of the circuit and devices used are indicated by the conventional symbols, which are largely used in radio practice, and are described and illustrated elsewhere. The first step in the operation of the station would be the closing of key *a*. As soon as the voltage of the alternator *b* reaches a sufficient value, the spark gap *c* will break down, and an oscillatory discharge will take place across the gap electrodes. The frequency of the discharge will depend primarily upon the inductance and capacity of the antenna system. This oscillatory discharge will produce a strong effect on the antenna system *d* and, due to the high frequency of the oscillating discharge, a considerable amount of energy will be radiated out into the ether. The number of oscillations in each discharge will be quite small, and will in any case depend upon the electrical characteristics of the set as a whole, as will also the damping, or decrease of the successive waves in a train. If the spark gap is properly adjusted, there will be a spark discharge for every half-cycle of the alternator, and the number of wave-trains per second will be equal to twice the alternator frequency. A succession of groups of damped oscillations will be produced in the antenna circuit, and, as long as the key is closed, a series of damped-wave trains will be radiated into space. By proper manipulation of the sending key, the dots and dashes of the radio-telegraph code are produced, dashes consisting of a longer series of wave-trains than do the dots.

A marked disadvantage of using an alternator connected directly across a spark gap in the antenna is the fact that an alternator of very high voltage must be used in order to obtain an appreciable amount of energy

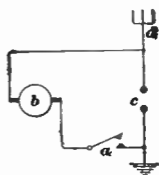

FIG. 1

radiation. This is rather objectionable from an operating point of view, as it is a source of danger to the operator. From a constructional point of view it is not desirable, because it requires a machine of special design. The arrangement is also very inefficient as a radiator, and is not used in practice.

SENDING SET WITH VOLTAGE TRANSFORMER

An alternator of fairly low voltage may be used as the source of energy in the sending set illustrated in Fig. 2. The primary winding *a* of an iron-core voltage transformer is connected in series with the alternator *b* and key *c*. The secondary winding *d* of the transformer is connected across the spark gap *e*, which in

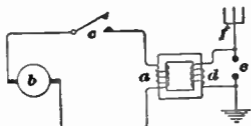

FIG. 2

turn is connected between the antenna *f* and ground. When the key is closed, a current of low voltage and rather low frequency passes through the primary winding of the transformer, and induces a current of the same frequency, but at a higher voltage, in the secondary winding. The action taking place in the secondary circuit is quite similar to that which has been described, in that the high voltage will cause the spark gap to break down and a wave-train of high-frequency oscillations will be produced for every half-cycle of the alternator current.

The use of a step-up voltage transformer gives a much larger radiation output and range for the set than is otherwise attainable, as it is possible to impress several thousand volts across the antenna system. The lower voltage of the primary circuit is an advantage as the alternator need not be designed and constructed to generate such high voltages, as would otherwise be necessary.

With manipulation of the sending key, the machine is

required to furnish full load at one instant, and no load at the next, with consequent wide variation in speed caused by the sudden and large change of output. As a relief measure, the sending key may be shunted by a resistance. When the key is opened, the primary circuit will still be closed through the auxiliary resistance by extra contact points on the key. The resistance should be of such a value that it will decrease the voltage in the secondary circuit to such an extent as to prevent a discharge across the spark gap. Although more energy is taken from the generator with no increase in radiation, this arrangement is desirable as it causes the transmitted signals to have greater uniformity; this is a feature of importance to the receiving operator.

The length of the wave radiated into the ether depends upon the electrical characteristics of the circuit in which the high-frequency oscillations are produced. In the sets which have just been described, no means of adjustment are provided in the antenna circuit, and consequently signals of only one wave-length can be transmitted. As the two main features affecting the wave-length are the inductance and capacity of the oscillating circuit, the introduction of devices possessing these properties will change the oscillating period of the antenna circuit, and, consequently, the length of the emitted wave. Connecting either an inductance coil or a condenser between the antenna and the ground will give the desired result, the size of the device used depending upon the change required.

The systems that have been described make use of a spark gap connected directly in series in the antenna system, and across the power-supply circuit. For these reasons the antenna circuit is said to be *directly excited*, that is, the high-frequency oscillations are both produced in, and radiated by, this circuit. The spark gap introduces a high resistance in the antenna circuit, which causes a very rapid damping of the trains of oscillating high frequency waves. The wave radiated in such a case is very *broad*, that is, the receiving station may pick up

the incoming signals over a considerable range of wave-length adjustments. This would prevent other stations, operating on nearly the same wave-length, from tuning out undesirable signals. By the method just described a low number of oscillations results from a spark discharge, and the use of this type of apparatus has been prohibited. In order to produce a wave that will not have such high-damping characteristics, the oscillatory discharge is produced in a local circuit in which the operating conditions may be more easily and accurately controlled. The high-frequency currents are then transferred to the antenna system from the *indirect excitation circuit* by means of a transformer.

OSCILLATING CIRCUIT COUPLED TO ANTENNA

The sending circuit of Fig. 3 differs from the preceding ones in that here the oscillating circuit is coupled to the antenna.

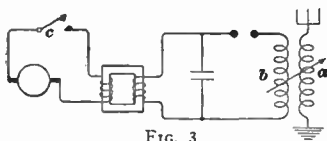

FIG. 3

An inductance coil *a* in the antenna circuit is so placed as to cut the lines of force established by coil *b* of the oscillating circuit. The induc-

tance coil *b* then acts as the primary and coil *a* as the secondary of an oscillation transformer. Energy is transferred from the oscillating circuit to the antenna, or radiating, circuit by induction. The antenna circuit will readily receive a large part of the energy from the closed oscillating circuit, if the product of the inductance and capacity of the one is approximately equal to that of the other. If these products are not nearly equal, very little energy will be transferred. In other words, the natural frequency or period of oscillation of the two circuits must be the same, or approximately so.

The power-supply circuit of Fig. 3 includes an operating key *c* used to open or close the circuit through the

primary coil of the power transformer. Transmission of waves is established only when the key is closed. A key is sometimes used in series in the field circuit of the alternator to interrupt the current in that circuit, instead of breaking the rather large current in the power circuit. In this latter case, however, the action is somewhat sluggish, as the field must be built up and decreased with each closing and opening of the key, resulting in a slow sending speed. A relay key in the alternator circuit will usually produce the best results where large currents are to be interrupted; satisfactory operation with a relay key has even been obtained by connecting it in the secondary circuit of the transformer.

It is perfectly feasible to use a commercial alternator delivering 25- or 60-cycle current as the source of energy; in fact, many stations are operated with energy at one of these frequencies received from a local electric central station. If a spark gap of the ordinary type is used in the oscillating circuit, the tone of that station as heard in a receiving set will be very poor and it will be difficult to receive messages. A rotary spark gap should be used, giving somewhere between 500 and 1,000 spark discharges per second. While this does not give a pure musical note in the receiving set, it is of a good audio frequency and is readily copied.

Alternators are manufactured which deliver 500- or 900-cycle currents. With such alternators the frequency of the spark discharge is quite good, and an ordinary spark gap may be used in the oscillating circuit. The tone produced is naturally musical, but if the spark gap is not properly adjusted, the note may become ragged or rough. For best operation, the use of a rotary spark gap is recommended, as the interruption of the energy supplied to the oscillating circuit is very rapid and positive.

In many instances the rotor of the spark gap is mounted on an extension of the alternator shaft, and rotates with it, thus eliminating the necessity for using a separate machine to drive the gap rotor. The stationary

electrodes are placed in such positions that a spark discharge will occur the instant the maximum value of each alternating voltage wave is reached. This type of spark gap is sometimes known as a *synchronous spark gap*, as its frequency of interruption is related to the frequency of the current. The note produced by this gap is more clear and musical than that produced by a spark gap operating at some other speed. The latter practice is, however, justified in case two or more stations are to be operating simultaneously on nearly the same wave-lengths, as the signals of the different stations may then be distinguished from each other. The quenched spark gap will also operate quite satisfactorily with the 500- and 900-cycle sources of current.

If the source of energy is a commercial supply line, it is customary to use an iron-core transformer of the usual type to step up the voltage from that of the supply circuit to several thousand volts. If the frequency is 500 or 900 cycles or thereabout, iron-core transformers are likewise used, but they must be of special design or trouble will be experienced with overheating. Due to the characteristics of iron-core transformers, they cannot be used on radio-frequency power circuits, and air-core transformers must be used. Such a transformer is represented by coils *a* and *b* in Fig. 3, its purpose being to transfer the high-frequency currents from the oscillating circuit to the antenna, and simultaneously to raise the voltage to some extent. Some means of varying the number of turns of wire effective in the primary and secondary circuits as well as for varying the coupling between them is usually provided in air-core transformers, although such has not been indicated in some of the figures.

AUTOTRANSFORMER COUPLING BETWEEN OSCILLATING AND ANTENNA CIRCUITS

The use of an air-core autotransformer between the oscillating and antenna circuits gives quite good operating characteristics. Such an arrangement is represented

in Fig. 4, in which the inductance coil *a* is the auto-transformer. Sliding contacts at *b* and *c* permit changes in the number of turns of wire included in the primary and secondary circuits, respectively.

The coupling between these circuits cannot be changed except for the small amount made possible by using different turns of wire on

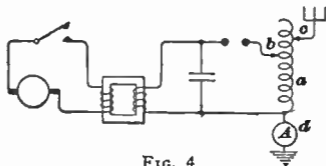

FIG. 4

the transformer. This constitutes the chief objection to the adoption of the autotransformer for this use, although it is employed in some small-range sets.

An expansion-type ammeter *d* may be included in the antenna circuit of this sending set. It is usually located between the lower end of the autotransformer and the ground. A reading of the ammeter gives indirectly an indication of the amount of energy radiated by the set, but does not directly do so because the instrument does not indicate watts, or power output.

POWER-BUZZER TRANSMITTER

A very simple transmitting set utilizing a battery as the direct-current source of energy is represented in

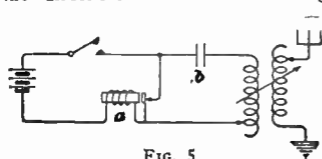

FIG. 5

Fig. 5. The high-frequency buzzer *a* may be one of ordinary design operating with a few dry cells. The capacity of the condenser *b* need not

be large. The range of this set is necessarily rather limited, but for that very reason is recommended for communication with near-by stations. The power required and interference produced are both a minimum.

ARRANGEMENT FOR USING A DIRECT-CURRENT SUPPLY

When only direct current is available, a motor-generator set may be used to convert the energy into alternating current of suitable frequency for the operation of any of the sending sets which have been described. Another arrangement is to use an induction or spark coil with its primary or input winding connected in the supply line. The vibrator on the coil, or any other circuit interrupter, may be used to open and close the supply circuit, so that a pulsating current passes through the primary winding. This pulsating current establishes an alternating electromotive force in the secondary winding which is impressed on the oscillating circuit. The current is changed in the oscillating circuit so as to have radio frequency which is suitable for transmission. For short distances and where interference is not a consideration, the secondary of the induction coil has been connected across the spark gap which formed a part of the antenna circuit, resulting in the arrangement of an antenna circuit very similar to Fig. 2. A sending key is commonly connected in the primary circuit.

WAVE SHAPES IN VARIOUS CIRCUITS

A consideration of the shapes of the various current waves in the different circuits may help to make clear the changes and steps through which the energy must pass before it is finally radiated out into space. The shapes of the waves in the various circuits are shown in Fig. 6, the curves being given in consecutive order. The curve in view (a) represents the shape of the current-supply wave, which in this case has been assumed to be from a 500-cycle alternator. The voltage curve would also have a similar shape. The curves in views (b) and (c), which are drawn to different scales but have identical values, indicate the shape of the wave across the spark gap, while the curve in view (d) shows the shape of the wave in the antenna circuit. The reason for duplicating the curve of the wave across the spark gap is so

that in the following explanation the curves of views (a) and (b) and the curves of views (c) and (d) may be readily compared.

Only one complete cycle of the 500-cycle supply current is represented in view (a), Fig. 6. If when the current is at some point near its maximum value, as at *a*,

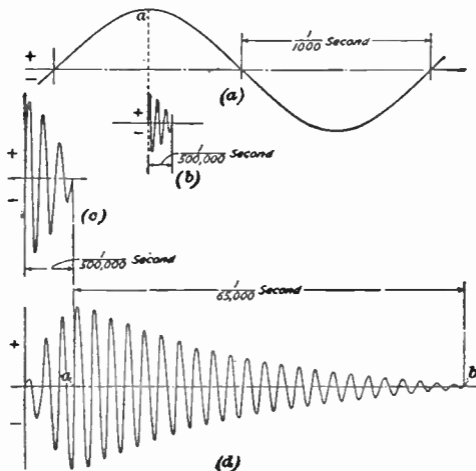

FIG. 6

view (a), the electrodes of the synchronous spark gap are opposite each other, the voltage will break down the gap, and a high-frequency spark discharge will take place. The energy furnished by the alternator has been stored up in the condenser of the oscillating circuit, and is now permitted to discharge, thus producing a high-frequency current in that circuit. With continued movement of the rotor, the gap rapidly lengthens, and inter-

rupts the spark after a very few oscillations have occurred, in this case three. The oscillations occur very rapidly, the frequency of a 200-meter wave, which is quite common, being equal to 1,500,000 cycles per second. The total time for the three cycles represented in view (b) is thus very short, in fact much shorter than is indicated by the relative lengths of the curves, views (a) and (b). However, for purposes of explanation, the relation is sufficiently accurate. The three high-frequency waves constituting the oscillatory discharge are commonly called a *wave-train*, which term has been used before in this same connection. For convenience, only three cycles are here represented; in practice, however, the train usually consists of a greater number of waves.

The tone of the spark may be varied by changing the number of points at which the spark gap discharges. For example, if a discharge occurs at every other peak of the impressed voltage wave, the tone will be decidedly different than that of a spark discharge occurring at every maximum point on that same wave. When a 60-cycle source of supply is used, it is necessary to produce several spark discharges for each voltage cycle in order to secure a fairly high tone. In this case the spark may occur when the condenser is only partly charged, or possibly not charged at all, with the result that the spark tone will be rather rough and hard to read at the receiving set.

The train of waves shown in view (d), Fig. 6, is dependent on the train of waves of view (c). The train of waves of view (c) represents the high-frequency current established in the oscillating circuit by the discharge of the condenser across the spark gap. This current induces lines of force around the inductance coil forming a part of its circuit, which lines of force interlink with the inductance coil of the antenna circuit. The energy is rapidly transferred from the oscillating circuit to the antenna circuit, as is shown by the high damping of the curve, view (c), and the correspondingly rapid increase of the curve, view (d). It should be noted

that the first three cycles of the curve, view (*d*), increase at approximately the same rate as that at which the curve, view (*c*), is decreased. At point *a*, view (*d*), the energy in the oscillating circuit has been removed, and the spark gap ceases to pass sparks. It should be noted that point *a*, view (*d*), is directly below the right end of the train of waves, view (*c*). The open spark gap prevents transfer of energy back from the antenna circuit to the oscillating circuit, which would cause losses. Most of the energy is then radiated, while some is used up in overcoming the various circuit losses.

The antenna current reaches its highest point on the wave close to point *a*, view (*d*), Fig. 6. This current is now free to oscillate at the natural frequency of the antenna as determined by its electrical properties. From point *a* the amplitude of the oscillations gradually decreases to point *b*, due to the radiation of energy into the ether and to losses in the antenna system caused by the resistance of the antenna. If properly designed, the resistance of the antenna should be quite low, and the losses from this source will be low. It is an established fact that all the energy cannot be radiated instantly; in fact, it is desirable that the radiation be prolonged over several cycles. If radiation were extremely rapid, the emitted wave would be broad and considerable interference would be produced. By using a feebly damped wave, however, such as the curve in view (*d*), very sharp tuning may be obtained and interference with neighboring stations is reduced. For this reason, the United States Government has specified that no sending station may operate with a highly damped wave. The minimum number of cycles allowed per wave-train is 23, as shown by the complete waves between *a* and *b*, view (*d*). In order to be within the law, most stations use a larger number of waves to a train than required by the government.

In order to determine the location of point *b*, view (*d*), it is necessary to establish a certain relation between the height of the wave at the maximum point and the height

of the wave at a point where the wave-train is practically damped out. In practical work this is considered to be the point at which the amplitude of a wave is $\frac{1}{100}$ part of that of the wave at the maximum point. The number of waves in a train of this kind is very difficult to determine and there is seldom need of knowing it in practical work, as long as the conditions comply with government regulations.

UNDAMPED-WAVE TELEGRAPH SENDING CIRCUITS

GENERAL CONSIDERATIONS

Undamped waves, as has been mentioned, form an important branch of radio transmitting systems. Ordinarily, the waves are merely interrupted at intervals to form dots and dashes of the telegraph code. Thus a short series of complete cycles of alternating current comprises a dot, while a longer series would represent a dash. In other cases, the output current is *modulated* so that a simpler type of receiving set may be used to pick up the messages, and tuning is in general simpler. Both of these methods are described. There are three main ways of producing undamped-wave radio currents; namely, with a very high-frequency alternator, with the oscillating arc, and by the electron-tube oscillator. All three are used in medium and large-powered stations, while the electron-tube generator is without a rival in the smaller-sized sets, say below the 2-kilowatt size.

ALEXANDERSON ALTERNATOR

The *Alexanderson alternator* is an alternator of very high frequency, and the generated energy may be radiated direct from the antenna as produced. This type of alternator has been described under a previous heading. Considerable expense is attached to the installation of this set, partly on account of the large amount of auxiliary apparatus required. Great success has accom-

panied the use of this equipment, and it is one of the most important and common machines used in long-distance radio communication.

Alternator in Antenna Circuit.—As the Alexanderson alternator generates voltage waves at radio frequency, it may be connected directly in the antenna circuit, as indicated at *a* in Fig. 7. The antenna is tuned to a wave-length corresponding with the frequency of the alternator by varying the number of turns of the inductance coil *b* which are actually connected in the antenna circuit. A wide variation is not usually necessary or indeed desirable in the large power stations using this type of equipment as they are ordinarily designed to operate on one particular wave-length. As the electrical characteristics

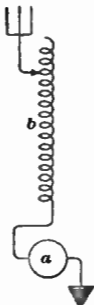

FIG. 7

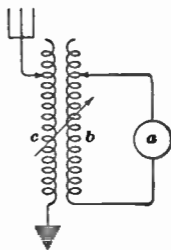

FIG. 8

of the apparatus at the sending station may vary, some slight change may be necessary from time to time to keep the station operating on the desired wave-length.

Alternator Coupled to the Antenna.—Inductive coupling of the radio-frequency alternator *a* to the antenna, using an air-core transformer, is shown in Fig. 8. This circuit arrangement is practically identical with the preceding one, but is preferable in many cases, as more accurate tuning of the radiating system with the frequency of the alternator may be secured by adjustment of the primary winding *b* and the secondary *c*. When it becomes desirable to decrease the radiated energy, the coupling between the coils *b* and *c* is decreased. Detailed connections are not shown in either case, as they vary

considerably in the different stations in order to conform with local conditions

Sending Key.—The key for interrupting the generated wave and producing thereby the required dots and dashes for telegraphic signaling, is preferably connected in the field circuit of the alternator. The small field current may easily be interrupted, and this, by deenergizing the magnetic circuit intermittently, causes dots and dashes of the code to be produced and ultimately radiated. By using special sending and receiving devices, operation with the Alexanderson alternator has been successfully carried on at speeds up to 200 words per minute.

Constant-Speed Motor.—As the wave-length changes to some extent with variation in the frequency, it is important that the alternator's speed be kept constant. In most of the installations the alternator is driven by an electric motor so arranged and controlled as to give a very uniform speed, even when the sending key is being operated. Positive drive is assured through a high-ratio gear connected between the machines so as to run the alternator at a speed several times greater than that of the motor. By this means the speed of the motor may be kept fairly low, and a machine of special design to withstand the terrific speed of the alternator is not required.

OTHER TYPES OF ALTERNATORS

Other types of alternators with auxiliary apparatus and circuits ingeniously applied have been used in radio communication, but have met with only limited adoption. The circuit arrangements are, in general, very complicated. It is highly probable that with further development some of these machines may be more commonly used, and become active competitors of the alternator just mentioned.

ARC OSCILLATING CIRCUIT COUPLED TO THE SENDING ANTENNA

A circuit much used in high-powered arc stations is shown in Fig. 9, in which the arc oscillating circuit is

coupled to the antenna circuit. The high-frequency generating circuit is not unlike the ones which have been described. By means of an air-core transformer, the radio-frequency currents are transferred to the antenna circuit. The capacity of the latter circuit is furnished by the condenser effect of the antenna and ground. The inductance a is made variable, so this circuit may be tuned to the wave-length of the oscillating circuit. Where large currents are radiated it is desirable to produce dots and dashes by some means other than actually interrupting the circuit. Key b is connected around a few turns

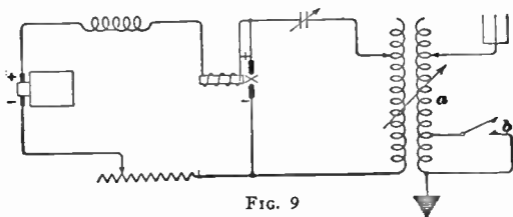

FIG. 9

of the secondary of the transformer, and short-circuits them when in its closed position. The antenna circuit is then tuned to radiate at the desired wave-length, with the key down. When it is open, the aerial circuit is out of tune with the primary winding, and only a portion of the generated energy is transferred to the antenna circuit. What energy is radiated, is at a different wave-length than the one on which communication is established, and does not bother the receiving station. This extra wave is, however, apt to cause interference to other stations which may happen to be operating on wave-lengths near the value of this secondary wave. This system of producing signals is sometimes called the *detuning method*, and is often used in large power stations in which the high-frequency current is established by means other than arc sets.

ARC CONNECTED IN ANTENNA CIRCUIT

A method of connecting an arc set to an antenna where only relatively low power is used, is represented in Fig. 10. The arc is connected directly in the antenna

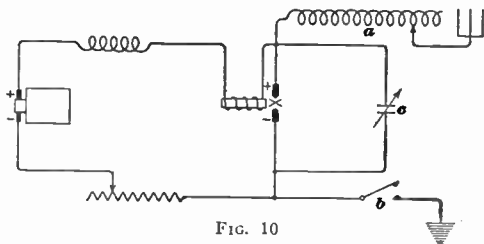

FIG. 10

circuit, and the radio-frequency oscillations are established directly therein. As in the preceding case, the capacity in the oscillating circuit is due to the condenser action between the aerial and the ground. The inductance a is variable and the wave-length of the radiated energy is determined largely by its setting. The key b is connected directly in the ground circuit, and this circuit is completed only when the key is down. In order that the arc may operate continuously, it is shunted by a condenser c , which serves to maintain the high-frequency oscillations. This condenser helps to boost the strength of the signals when the arc is under normal operation.

Although the arc is operating all the time, energy is radiated only when the key b is closed. The key could be connected so as to short-circuit some of the turns of the inductance instead of opening the ground connection. Tuning should then be made so that the correct wave-length would be radiated with the key closed. Nearly full power would be radiated with the key either open or closed, and the arc would be in continuous operation.

Under this condition no shunt condenser c would be required.

ELECTRON-TUBE OSCILLATORS

Electron tubes are used for the production of continuous, or undamped, currents at radio frequency. The same type of tube may be used in either transmitting or receiving circuits, but for large outputs tubes of special design should be used. Many tubes will heat up due to the losses occurring in them when operating, and a blast of air must be directed across them to keep them reasonably cool. The principle of operation of electron tubes when used as oscillators has been treated under a preceding heading.

Elementary Circuit Arrangements.—In Fig. 11, coil a is in the plate circuit, the inductance coil b is in the antenna circuit, and coil c is in the grid circuit. If the coils a and c of the elementary oscillating three-element electron tube are coupled to the antenna coil b in the manner indicated, a radio-frequency current will be established in the

antenna circuit. A small oscillation produced in the grid circuit will produce a greater change of current in the plate circuit, including the coil a . This coil, being coupled to the inductance coil b , produces oscillations in the

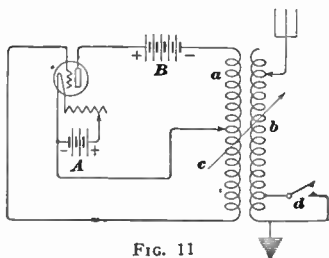

FIG. 11

coil b which react upon coil c in the grid circuit. The feed-back then serves further to amplify or increase the oscillations in the antenna circuit and to maintain them.

As only the antenna circuit is a tuned circuit, and oscillating at the desired radio frequency, the radiated

wave is very sharp. The frequency of the alternating current finally established depends primarily upon the tuning of the antenna circuit, although it is important that the coupling between the antenna coil *b* and the other coils *a* and *c* should be adjusted for the desired amount of energy to be transferred.

A key, located as at *d*, may be used to send telegraphic code signals. The antenna is tuned to radiate signals of the desired wave-length with the key closed. Opening the sending key introduces a few additional turns into the antenna circuit, and energy is radiated but on a different wave-length. Operation seems to be best with this arrangement, although some interference is produced by

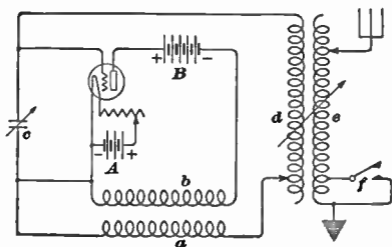

FIG. 12

the useless radiated energy. The key may be so located as to interrupt the antenna current, by opening the circuit, in which case good results may be expected. Placing the key in some part of the tube circuits is not satisfactory, as the action is sluggish and the radiated wave is apt to be ragged.

Coupled Oscillating Circuit.—A somewhat different circuit arrangement using an electron tube as an oscillator to produce undamped waves is indicated in Fig. 12. A fundamental requirement for the successful operation of this circuit is that the coupling between coils *a* and *b* must be quite close, that is, the coils must be brought

close together, so that a large amount of the energy in the plate circuit is fed back to the grid circuit. When the varying electromotive force obtained from coil *b* is more than enough to sustain oscillations in the oscillating circuit *a c d*, this circuit may be used as a source of sustained waves.

As the principle of operation of the oscillating circuit is somewhat different from some others, it will be explained briefly. The instant all the circuits are closed, starting with no voltage on the grid, there will be a current in the plate circuit which starts at zero and increases. The current through coil *b* induces an electromotive force in coil *a* such that one of its terminals is positive and the other terminal is negative. The positive terminal being connected to the grid places a positive voltage on the grid which causes the current in the plate circuit to increase at a still faster rate. This increasing action is cumulative, and would continue indefinitely were there not some factors to limit it. In this case a limit is reached when the quantity of negative charges, or electrons, flowing in the tube from filament to plate becomes so great that a larger number cannot flow. This is the phenomenon described as *saturation* of the tube.

As the limiting point is approached, the increase in the current in the plate circuit becomes less rapid, a condition which causes the voltage at the terminals of coil *a* to decrease and a smaller electromotive force will be applied to the grid. A point is then reached where there is no further increase in the current in the plate circuit. At this instant, with a steady current through coil *b*, there will be no voltage induced in coil *a* and consequently none applied to the grid. The current in the plate circuit then decreases in order to come down to its normal value for zero grid voltage.

With a decreasing current through coil *b*, there will be an electromotive force induced in coil *a* which is in a direction opposite to that induced when the current in coil *b* was increasing, that is, the terminal which was

positive is now negative and the other terminal is positive. The negative voltage applied to the grid causes the current in the plate circuit to be decreased at an increasingly faster rate, this in turn causing a still greater negative voltage to be applied to the grid. This decreasing action tends to continue indefinitely, but a limit is reached when the plate current reaches zero. Therefore, as the limiting point is approached, the decrease in the current in the plate circuit becomes less rapid, which causes the voltage induced in coil *a* to decrease, and a smaller electromotive force to be applied to the grid. A point is then reached when there is no further decrease in the current in the plate circuit, the grid then being at zero voltage. The plate current then increases in order to reach its normal value with zero grid voltage.

A complete cycle of changes of current in the oscillating circuit has been completed and the action continues during the operation of the tube. Thus, there is a voltage at the terminals of coil *a* which is continuously oscillating between positive and negative values. The coil *a* is included in the circuit *a c d*; therefore, there is an oscillating current set up in this circuit whose frequency depends upon the amount of inductance and capacity in the circuit; that is, the frequency depends upon the inductance and capacity properties of *a*, *c*, and *d*.

All that is necessary to use this arrangement for transmitting sustained wave signals is to couple coil *d* to a coil *e* forming part of an antenna circuit. A transmitting key could be located as shown at *f* to send out signals on the desired wave-length.

Generator in Plate Circuit.—Another complete circuit arrangement for transmitting undamped waves by means of an electron tube is indicated in Fig. 13. As in other cases, the plate circuit is coupled to the grid circuit through coils *a* and *b*, and supplies the latter with energy. The oscillating circuit, consisting of *b*, *c*, and *d*, is coupled to the antenna coil *e*, producing undamped oscillations therein. The coil *f*, which is short-circuited by a sending

key g , is represented as being separate from coil e , although this is not always the case, it being feasible to have the sending key short-circuit a few turns of any coil in the antenna circuit.

A small direct-current generator h is used in place of a B battery, for the reason that a much higher voltage and a much larger power output are necessary in the plate circuit of an electron tube used for transmitting than is required in the plate circuit of one used for receiving. A generator is usually a better

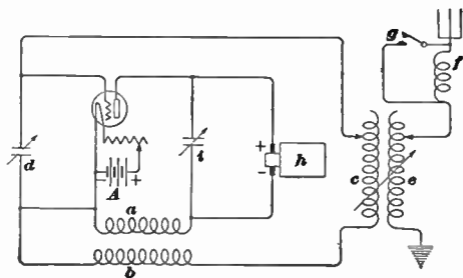

FIG. 13

device than a battery to provide a high electromotive force. The condenser i , shown connected in parallel with the generator, is for the purpose of providing a good path around the generator for the rapidly pulsating current in the plate circuit, as the generator windings offer high opposition to the pulsating current.

The production of a greater amount of power may be secured by connecting two or more tubes in parallel; that is, all the grid terminals would be connected to a common terminal, and all the plate terminals to a common terminal, and then these common points would be connected in the circuit just as if they were the terminals of a single tube. The filament terminals are also connected in parallel with a separate control resistance in

each filament circuit, so that the filament current of each tube may be accurately adjusted to its best operating value. This will help compensate for any differences in the operating characteristics of the tubes. It has not been found satisfactory to connect the filaments of tubes in series, especially power tubes, as the plate current of some of the tubes may cause a larger current in the filament circuit of some tubes. This would be due to the combination of the plate current with the filament current, which, in power tubes, is fairly large when compared with the filament current.

Another distinctive type of connection is indicated in Fig. 14. Here the plate circuit is coupled to the grid circuit by means of a condenser *a* instead of by inductance coils. The condenser acts, as did the coils of previous cases, to transfer some of the plate-circuit energy back to the grid circuit. The frequency of the oscillations

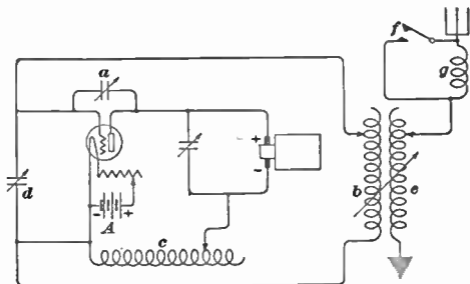

FIG. 14

depends on the values of the inductances *b* and *c*, and capacities *a* and *d*. As before, energy is transferred to the antenna by means of inductance coils *b* and *e* which are coupled together. A key *f* is shown arranged to short-circuit a small coil *g* consisting of a number of turns connected in the antenna circuit.

Modulation Transmission.—As was briefly mentioned, the output current from an undamped-wave source may be modulated so that it may be received more easily and with simpler equipment. A regular electron-tube oscillator is shown in Fig. 15, with the addition of apparatus capable of modulating the output current. A local circuit consisting of a key *a*, buzzer *b*, and battery *c*, is connected through the primary coil *d* and secondary coil *e* of an iron-core transformer to an oscillating-tube circuit. When the key is closed, the buzzer will operate and an interrupted current will be established in the local circuit. By transformer action of coils *d* and *e* these current variations act on the grid of the tube *f*, and change or modulate the generated current. The modulated current is then emitted and with suitable

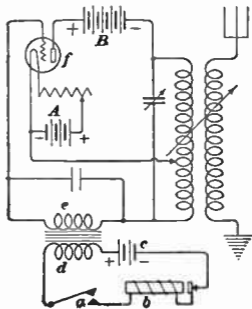

FIG. 15

apparatus at the receiving end a tone very similar to that of the buzzer will be heard. The principle of the modulation of the radiated current is very similar to that which will be explained under radio telephony.

Combination Circuit.—A circuit permitting operation on either one of three methods is given in Fig. 16. When the switch *a* is in the position shown, the antenna circuit may be opened or closed at key *b*. During the intervals while key *b* is closed, the set will oscillate with the antenna circuit forming the real oscillating circuit. Short series of waves of radio-frequency current will therefore be radiated while the key is down and all will be quiet while the key is open.

If switch *a* is moved so as to make contact with point *c*, the antenna circuit will be completed through

the inductance coil *d*. The set will oscillate continuously, but at a different wave-length when the key *b* is open than when it is closed. When the key *b* is closed, the length of the radiated wave is less than when the key is open, as then the added inductance is short-circuited and is ineffective. The third position of the switch *a*, namely, on point *c*, controls the third system of operation. When the switch *a* is on position *c*, the antenna is connected to ground through the *A* battery and the windings of buzzer *f*. The impedance of this path to ground

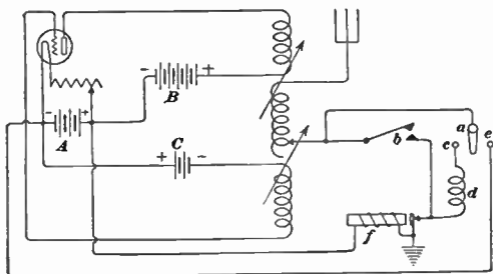

FIG. 16

is, however, so high to radio-frequency currents that the set cannot oscillate. In the two previous methods of transmission, the buzzer has been inoperative, and the antenna circuit was completed through the armature resting on its back contact point. When the key *b* is closed, switch *a* being in contact with *e*, the buzzer will operate continuously through the circuit consisting of the *A* battery, buzzer *f*, switch *b*, switch *a*, contact *e*, back to the *A* battery. The set will oscillate during the intervals of time that the buzzer armature rests against its back stop. The set oscillates and radiates several cycles, or a train, of radio-frequency, alternating-current waves while the key *b* is depressed.

Other Modulators Applied to Continuous-Wave Sets.

The buzzer may be used as a modulator to best advantage on low-power sets where the current to be interrupted is not large. A circuit-interrupting device, known as a *chopper*, may be used at the sending station to break up the continuous waves into trains or groups in order to make them audible with any type of receiving set. The chopper merely opens and closes some part of the radiating circuit at audio-frequency times per second, and is usually motor driven. It may be applied to stations of practically all sizes, although the larger stations seldom use any interrupting or modulating devices.

UNDAMPED-WAVE TELEPHONE SENDING CIRCUITS**GENERAL PRINCIPLES**

Radio telephony is the transmission of speech or other intelligible sounds by means of radio waves. In wire telephony the current-carrying medium is a metal conductor, while in radio telephony there is no visible connection between communicating stations. The electric waves in both wire and radio telephony are changed into audible sounds by means of suitable receiving apparatus; the sounds heard at the telephone receiver correspond with those at the transmitter in the sending station.

In radio telephony, changes in the resistance or capacity of a circuit caused by sound waves striking the diaphragm of a transmitter in that circuit are used to modify the amplitude of the oscillations of a radio-frequency current. These modified oscillations are transmitted from station to station and, by the aid of suitable apparatus at the receiving station, telephone receivers reproduce the sounds made at the transmitting station.

Modulation is the act of varying the amplitude of radio-frequency oscillations by the action of the audio-frequency changes established by the transmitter. In undamped-wave radio telegraphy, the outgoing oscillations

are either interrupted, detuned, or modulated enough to produce dots and dashes of the telegraphic code. The outgoing oscillations in radio telephony are merely modu-

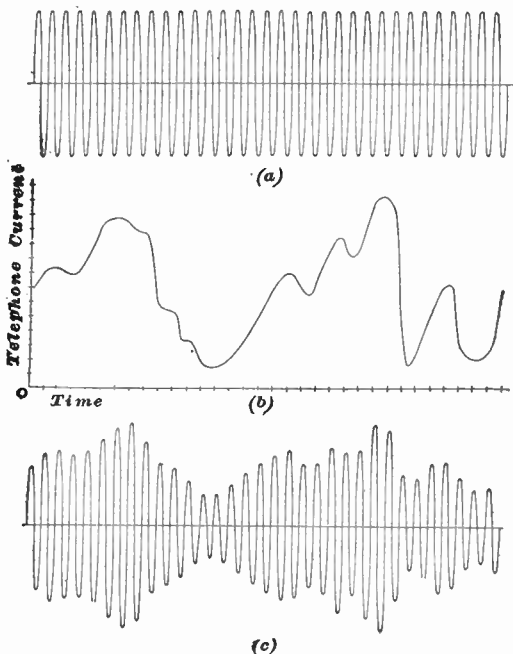

FIG. 17

lated, or their outlines changed, to correspond with the original sound disturbances.

Three methods for producing undamped waves of radio

frequency, namely, by the use of the alternator, the arc, and the electron-tube oscillator, have been described, and any one of these may be employed for producing the radio-frequency carrier current.

In Fig. 17 (a) is represented an undamped wave of radio-frequency current such as would be produced by any of the devices just mentioned. View (b) represents, approximately, the variation in current in a circuit consisting of a telephone transmitter in action, a battery, and connecting wires. The current waves, view (b), as produced by the human voice are, in general, of irregular form. When the oscillations, view (a), are modulated, or modified, by methods explained later, the outline of the modulated radio-frequency wave thus formed, view (c), assumes the general wave shape of the audio-frequency wave shown in view (b), but the high-frequency oscillations with modified amplitudes are still retained.

The undamped radio-frequency current, view (a), before modulation is sometimes called a *carrier current*, but the modulated radio-frequency current is the one actually transmitted. Its frequency is high enough to produce radio disturbances in the ether which will carry well and thus render communication over long distances possible.

ALTERNATOR SETS

A connection for modulating the current of a small radio-frequency alternator is given in Fig. 18. The simple antenna circuit includes the variable or tuning inductance *a*, the alternator *b*, and the telephone transmitter *c* all connected in series. When the diaphragm of the telephone transmitter is at rest, the alternator delivers a current of radio frequency and constant amplitude to the antenna. In order that the output current shall be a maximum, the antenna circuit should be tuned to resonance for the operating frequency of the alternator. When the transmitter unit is spoken into, its resistance undergoes large changes. As the telephone transmitter also carries the antenna current, the change in resistance

of the transmitter will cause modulation of the output current. The transmitter must be of special design as it has to carry a very large current.

The circuit of Fig. 19 is somewhat different in that only the alternator *a* is in series with the tuning inductance *b* in the antenna circuit. Both of these devices are in parallel with a condenser type of telephone transmitter *c*, or perhaps a better way to look at it, is that the capacity of the telephone transmitter is in parallel with the capacity effect of the antenna. With the condenser

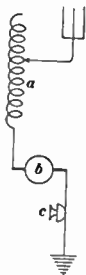

FIG. 18

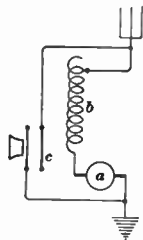

FIG. 19

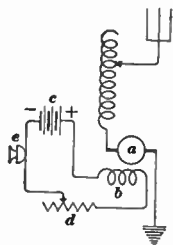

FIG. 20

diaphragm at rest, the set generates and radiates a radio-frequency current of unvarying amplitude. When the transmitter *c* is spoken into, the diaphragm is moved back and forth by the sound waves and the capacity effect of the transmitter plates is altered. This change of capacity detunes the antenna system according to the sound waves striking the diaphragm and thus produces modulation of the generated wave before it is radiated. The changes of capacity in the transmitter are apt to be small, and for best results the capacity of the antenna should also be reasonably small. In an actual transmitter the plates are placed very close together.

In Fig. 20 the alternator *a* is connected directly in the antenna circuit, and its field-coil winding is shown at *b*.

The field coil receives a direct current to excite the alternator from the battery *c*. The field circuit also includes the resistance *d* and telephone transmitter *e*. The resistance *d* is used only to adjust the field current to some fixed value. As the telephone transmitter is spoken into, its resistance varies and the current through the field circuit changes. The changes of field current produce like changes in the electromotive force of the alternator, with the result that the output antenna current is modulated in accordance with the sound waves striking the transmitter diaphragm. The transmitter need not be of particularly large current-carrying capacity as it carries only the relatively small field current. The field should not be excited by too strong a current, else the current changes cannot produce good modulation. If the current changes as produced by the transmitters of the preceding cases are not great enough, special amplifying means may be applied. The large companies use more complicated apparatus and circuit connections, with some gain in operating efficiency.

ARC TRANSMITTER

The arc set *a* shown in Fig. 21 operates in the manner previously described to produce an undamped alternating-current wave of radio frequency. These oscillations in the inductance coil *b* are transferred by induction to coil *c* in the antenna circuit. An ordinary telephone transmitter *d*, when spoken into, produces variations in the resistance of its local circuit in accord with the changes in the sound waves impressed upon the diaphragm.

The inductance in the direct-current circuit supplying the arc tends to maintain the high-frequency current in the coil *c* as well as that in the other portions of the antenna circuit at nearly constant values when the transmitter is inactive. The telephone-transmitter circuit is coupled to coil *c* by coil *e* and, therefore, even when the transmitter is inactive, takes away a very small amount of the energy supplied to coil *c* by coil *b*. The amount of the energy taken by the telephone-transmitter circuit

depends on the resistance of this circuit. When the transmitter is active, the resistance of its circuit is varied and a variable amount of energy is supplied to it by coil *c*. Most of the remaining energy of coil *c* is radiated from the antenna circuit to the ether and the amount radiated is variable because of the variable amount of energy absorbed from coil *c* by the telephone-transmitter circuit. The amplitude of the radio-frequency oscillations is decreased when the amount of energy absorbed is increased, and the amplitude of the oscillations is increased when the amount of energy absorbed is decreased. The energy radiated to the ether is thus modulated in accor-

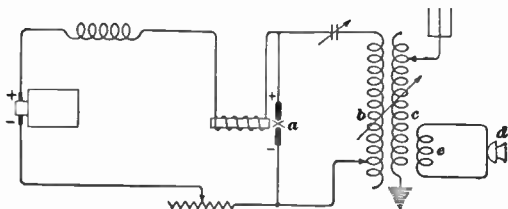

FIG. 21

dance with the sound waves impressed on the transmitter diaphragm.

The arc set is represented in this case merely as a typical oscillator, and is largely used in this connection. The high-frequency alternator or electron-tube oscillator may be employed in place of the arc generator, but the more common practice in regard to transmitter modulation is to use an electron-tube modulator.

Although the transmitter circuit, Fig. 21, is shown coupled to the antenna circuit, such is not always the case. In practice, the transmitter may be coupled to other parts of the oscillating circuit, or even connected directly in series at certain places. For instance, a large current-carrying transmitter might be included in the

antenna circuit, or several transmitters of the usual type could be connected in parallel in the same part of the circuit.

As the current variations produced by the ordinary type of transmitter are often quite small, an amplifier is sometimes used to strengthen the variations before they are combined with the carrier current. It is impracticable to consider all the possible ways in which the audio-frequency waves are actually impressed on the carrier current. The fundamental principle to be applied is that the audio- and the radio-frequency currents must act to form a radio-frequency current that carries the characteristics of the original sound wave; the exact method by which this is accomplished is unimportant, so far as the radiated wave is concerned.

ELECTRON-TUBE, RADIO-TELEPHONE TRANSMITTERS

The electron tube, as has been explained, is a very good generator of sustained alternating currents of radio frequency. This current may be modulated in two general ways before being radiated by the antenna; namely, by *grid* and by *plate modulation*. The principle of each will be explained in the order mentioned.

In Fig. 22 is illustrated the circuit connections in the case where the telephone transmitter *a* is coupled to the grid circuit of tube *b* by an iron-core transformer *c*. When the transmitter diaphragm is at rest, the tube is oscillating and delivers a continuous alternating current to the antenna system. When the transmitter *a* is spoken into, current variations are produced in its local circuit which induce varying electromotive forces at the secondary terminals of transformer *c*. This varying voltage is impressed on the grid and thereby modulates the generated high-frequency current in accord with the original sound impulses. This type of connection possesses the decided advantage that the transmitter unit may be of very small size, and grid control is used in many radio-telephone stations.

A somewhat different connection and principle is shown in Fig. 23, as one of the tubes acts to take current away from the main oscillating tube. The modulator, or robbing tube, *a* controls the plate current of the oscillating tube *b*. The filaments of the similar three-element electron tubes are connected in series, and supplied with current from a common *A* battery, which is controlled by an adjustable rheostat *c*. Likewise a common *B* battery furnishes a voltage for both plates in parallel. A *C* battery in the grid circuit of the modulator tube places a negative electromotive force on the grid. A slightly negative

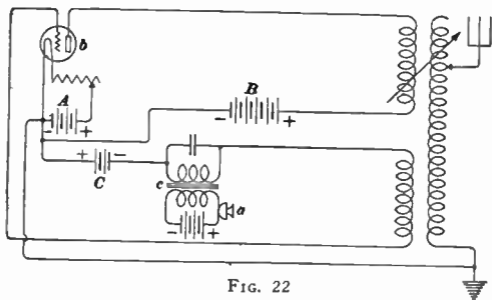

FIG. 22

voltage is given to the grid of the oscillator tube *b* by the connection through a high resistance *d* to the negative terminal of the *B* battery. These negative voltages have been found necessary in order to force the tubes to operate steadily, and without distorting the signals. This is a very important feature in clear radio telephony.

A transmitter *e* with a local battery *f* is included in the circuit of the primary *g* of a transformer, whose secondary is at *h*. It is well to keep in mind the important fact that the electron flow is from the filament to the plate, while the plate current is assumed to be in just the opposite direction. The current from the positive terminal of the *B* battery passes through an inductance coil *i*,

and then divides and passes to the two plates. The inductance coil i , which has an iron core to increase its effect, maintains the current through itself practically constant.

A very irregular pulsating current is produced in the transmitter circuit when the diaphragm intercepts sound waves. By transformer action these pulsations are transferred to coil h , and then to the grid of the modulator tube a . If the effect of the voltage generated in the secondary coil h by the action of the transmitter is, at a

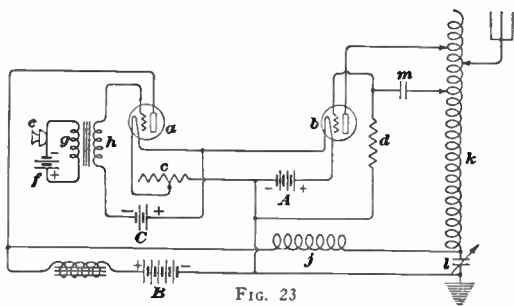

FIG. 23

given instant, such as to decrease the negative charge on the grid as compared to its condition when the transmitter was inactive, the plate current in the modulator tube will be increased because of the lessened opposing action of the negatively charged grid. The flow of electrons is thereby increased, therefore the plate current is increased. The B battery furnishes a nearly constant current, and if the plate current of tube a is increased, less current can pass to the plate circuit of the oscillator tube b . The plate circuit of the oscillator tube is connected to the antenna circuit, and when its plate current is decreased, the amplitude of the radio-frequency oscillations radiated by the antenna is decreased.

If the action of the transmitter circuit is, at a given instant, to increase the negative charge on the grid of the modulator tube *a*, the opposing action of the grid will be increased, the flow of electrons decreased, and, therefore, the plate current of tube *a* decreased. Because of the nearly constant current supplied by the *B* battery, more current will pass to the plate circuit of the oscillator tube *b*, and the amplitude of the radiated oscillations will be increased.

It is convenient to consider the variations of the grid voltage of the modulator tube as changing the resistance of the path between the plate and the filament in the tube. This change in the resistance causes a change in the division of current supplied to tubes *a* and *b* from the common *B* battery.

It should be noted that any sound intercepted by the transmitter does not alter the frequency of, but modulates the outline of, the radio-frequency oscillations. The modulation of the wave preserves the general characteristics of the original sound impressed on the transmitter.

The action of the inductance coil *i* prevents the audio-frequency plate-current pulsations of tube *a* from passing into the *B* battery, hence they follow the path through coil *j* to the plate of the oscillating tube. The coil *j*, which has less inductance than coil *i*, offers very little impedance or opposition to the audio-frequency variations, but quite effectually prevents the radio-frequency currents from leaving the antenna circuit and becoming lost. The antenna coil *k* is equipped with several adjustable contacts. Tuning of the antenna proper is made by varying the contact of the movable antenna terminal. The antenna condenser *l* is variable by steps for adjustments on short wave-lengths. Portions of coil *k* are used in conjunction with condenser *l* to form the oscillating circuit of the generator tube *b*. The grid of tube *b* in connection with the other portions of the oscillator-tube circuit enables the tube to establish a radio-frequency current. Condenser *m* prevents a shunt circuit for direct current between *d* and *k*, which are connected

to opposite terminals of the *B* battery, but allows an oscillating current from the antenna inductance coil *k* to pass to the grid of tube *b*.

It is advantageous to use two similar tubes in the preceding circuit so that *complete* modulation may be secured. That is, the modulator tube then brings the amplitude of the oscillating current to zero at one instant, then to double its steady value at the next instant. In this way very good use is made of the carrier current. If the transmitter unit is incapable of producing large enough current variation to give complete modulation, it may be necessary to send this current through an amplifying device before it is fed to the modulator tube. This principle can be applied to other types of modulation which require large currents to produce modulation.

A telegraph key and buzzer, or key and chopper, in series may be used in place of the telephone type of transmitter in most of the previous circuits. It is found that the range secured by this means is often much greater, even as much as three times, due in large part to the more complete modulation obtained by these devices. Also, faint telegraph signals are apparently easier to receive accurately than are weak telephone messages.

CHANGING THE WAVE-LENGTH

The wave-length is dependent upon the values of the inductance and the capacity of the circuit, which explains the reason for making the inductance and the capacity in the oscillating circuit variable. Adjustments are made so as to give the values that will produce a radiated wave of the desired length. Varying the length of the spark gap or coupling changes the wave-length to only a slight extent, if at all. A more important consideration is that if the coupling is too close a broad wave will be radiated, which, due to the consequent interference produced, will be very undesirable. This method of producing a broad wave finds practical application in the case of distress

signals emanating from a ship station, which signals have absolute precedence over all other radio communication. Here the operator desires to attract complete attention, which he does by using close coupling and maximum power. If, after a reasonable time, the operator called does not answer, any one reasonably close may reply. All other stations must preserve absolute silence until the transfer of distress messages has been completed.

As sending stations are required by common courtesy to radiate only enough energy to establish satisfactory communication, it is necessary that the output be decreased when working with near-by stations. One of the most convenient methods of accomplishing this is by decreasing the coupling between the windings of the high-frequency transformer. Another fairly common method is to decrease the input to the power transformer by decreasing the voltage applied thereto. An objection to the latter method, which is not true of the former, is that it is usually necessary to change the adjustments of the various tuning devices after any changes of voltage have been made.

A condenser may be required to decrease the wave-length to the desired value, and it is connected in series with the antenna circuit. The opposite effect is produced by using inductance or loading coils, as the natural period of the antenna is increased by the addition of inductance to its circuit. This is in addition to the inductance of the coupling transformer. More often, especially in short-wave work, condensers are needed to decrease the wave-length of the radiating system. This condenser may or may not be so arranged that its capacity is adjustable. Due to the very high voltages impressed across the plates, a dielectric that will withstand a high electrical strain is required. In the earlier types of stations, extensive use was made of condensers with glass dielectrics, either in the form of jars or flat plates. This form of condenser was rather bulky and subject to frequent puncture by high-voltage surges, which would render it useless. It has largely been superseded by the

smaller sized and more rugged condensers using mica or oil as the dielectric. Where space is not an object, air condensers may be used, the air in some instances being placed under pressure, the better to withstand high voltages. In a few cases the capacity may be arranged to be varied by changing the external circuit connections, but this is inconvenient as compared with the facility with which the inductance may be varied in a transmitting circuit.

OPERATING A SENDING STATION

The smooth operation of stations depends on the correct adjustment of the apparatus. In some sets very few adjustments of the apparatus can be made, while in the more elaborate sets many adjustments are possible. The procedure to be followed can only be determined by carefully noting the instructions furnished by the manufacturer. In the absence of such instructions, the following general suggestions are of value.

A careful inspection of the wiring and connections is desirable in every case, and is necessary if the operator is not familiar with that particular style of apparatus. This will often prevent damage to expensive equipment as well as protect the operator. If the source of energy is a power line or a storage battery, it is necessary to see that whichever is used is properly connected. If an alternator or other electrical apparatus, such as a rotary spark gap, must be started, this should be done at the outset. When these devices are operating properly, the key may be closed and the oscillating circuit tuned to the proper wave-length, the antenna circuit being opened or else very loosely coupled. A *wavemeter* is a device by means of which the length of a radio-frequency wave may be measured, and will be described later. The wavemeter is loosely coupled to the oscillating circuit, which circuit is then tuned to the desired wave-length by varying its capacity and inductance. For this operation the wavemeter is set at the desired wave-length, and the adjustments in the oscillating circuit are made until

maximum response is observed in the wavemeter. The high-frequency oscillating circuit is then generating a wave of the desired length.

The next step is to adjust the coupling between the oscillating and the antenna circuits to some medium value, and the antenna circuit is then tuned to the desired wave-length. This is accomplished by varying the inductance in the antenna circuit until an ammeter or other current-indicating device in that circuit gives a maximum indication. If the current indication is nearly constant for a considerable variation of inductance, it means that the emitted wave is very broad or that transmission is on more than one wave-length. The coupling should be decreased until it is certain that transmission is being effected on a single wave-length, or if this is not practicable both the circuits under consideration should be adjusted until such conditions are reached.

It is desirable to make still further adjustments in order to secure maximum current in the antenna. The length of the spark gap should be varied until the antenna-current indication is maximum, and the spark tone is good and clear. It is also of benefit to again test the adjustments of the coupling and of the condenser and inductance coils to be sure that operation is at its best.

RADIO RECEIVING CIRCUITS

DAMPED-WAVE, CRYSTAL-DETECTOR RECEIVING SETS

GENERAL FEATURES

The production of damped-wave radio telegraph signals has been considered in detail, as well as the type of signal radiated by the antenna system. These signals travel from the sending station equally well in all directions, except for the directional effect of some types of antennas, and the interference of conducting substances. The waves are able to follow the gradual curvature of the

earth quite readily, but cannot easily adapt themselves to the rough outlines of intervening high hills and mountains. The presence of such obstacles between stations will seriously interfere with communication, particularly if they are near either of the stations. In most cases, the amount of energy radiated into space is not exceptionally large and only a fractional part of this energy can be collected at any distant point. The ever decreasing amplitudes of the waves necessitates the use of a sensitive receiving device, particularly when the stations are some thousands of miles apart.

For this purpose an antenna system is erected in a favorable location to intercept the high-frequency radio waves. These waves induce currents in the aerial which are exactly similar to those emitted by the sending station, although they are necessarily of much smaller amplitude. The receiving antenna should be tuned to the same wave-length as that of the radio signals which are to be received, because the strength of the induced current will be larger when the natural period of the receiving antenna system is the same as that of the sending antenna. So important is this fact, that it is usually impossible to receive any signals unless these circuits are properly tuned.

All circuits capable of receiving damped-wave radio-telegraph signals depend upon rectification of the received signal unless this signal is strong enough to give a current indication on a sensitive ammeter. This condition is practically never realized in practice and is not particularly desirable. The receiving circuit must also include a means for making the signal intelligible, and telephone receivers of some type are almost universally used. Experiments have been made on the ability to receive signals by taste, but it does not seem practical. In some large stations the signals are recorded on tape with ink recorders, and the message is later transcribed by reading from the tape. Briefly, a receiving set may be said to comprise a means of tuning to the incoming signal, a rectifier device, and generally a pair of telephone receivers.

The two main classes of rectifiers are some type of crystal detector, and the three-electrode electron tube. Practically all of the circuits that may be used to receive damped-wave telegraph signals may be used to receive undamped-wave signals that have been modulated or interrupted, such as by a buzzer, or even to receive radio telephone messages.

RECEIVER SET IN ANTENNA CIRCUIT

A receiving method of limited application is shown in Fig. 1. The crystal detector *a* is in series with the telephone receivers *b* and both are connected directly in the antenna circuit. As has been explained, the detector readily permits the passage of current in one direction and prevents current in the opposite direction. If it were not for the detector, no sound would be produced by the high-frequency alternating current in the tele-



FIG. 1

phone receivers. This may be explained as follows: The radio-frequency alternating current in the electromagnet windings of the receiver attracts the diaphragm first in one direction and then in the other so rapidly that the diaphragm cannot respond to give audible sounds. The several rectified impulses in one wave-train, however, act upon the diaphragm successively in one direction, and combine to produce one vibration or movement of the diaphragm resulting in a click. A series of these clicks, due to successive wave-trains, follow each other in rapid succession, producing a note in the receiver. The dots and dashes of the telegraph code may thus be produced; a short series of clicks represents a dot, while a longer series represents a dash. With the arrangement shown, the resistance of the telephone receivers must be kept low, so as not to limit the current unnecessarily.

The detector and telephone receivers might be replaced for some purposes by a current-indicating device, such as a sensitive ammeter. The ammeter would then give a visible deflection of short or long duration correspond-

ing with the dots and dashes of the telegraph code. The ammeter is, however, not applicable to radio telephony, and is so sluggish and insensitive on telegraph signals that it is not ordinarily used in communication work.

SETS WITH TUNED ANTENNA

The main objection to a set using only a detector and telephone receivers in the antenna circuit is that the set cannot be tuned to different wave-lengths. The natural wave-length is fixed by the inductance and capacity of the antenna system, and operation, such as it is, is best on that one wave-length. Such an arrangement is very inefficient as a receiver, even when the stations are relatively close together.

The capacity of an antenna is usually quite large, while its inductance may be rather small. A very considerable change of wave-length may be made by placing a variable inductance coil in the antenna circuit, thus permitting accurate adjustments of the wave-length of the antenna in order to obtain sharper tuning. Such an arrangement is shown in Fig. 2, with the variable inductance coil *a*, the detector *b*, and telephone receivers *c*, all connected in series between the aerial and the ground.



FIG. 2

The action of the detector is identical with that of the detectors previously described. A click is produced in the receivers for every high-frequency wave-train. Introducing a condenser between the inductance coil and the detector renders the tuning sharper, and also decreases the length of the radio wave that may be received satisfactorily. The chief advantage of the tuned antenna lies in the fact that its natural period of vibration may be changed to correspond with that of the sending antenna. Under this condition, the current established in the receiving antenna is maximum, and the received signals will be clearer.

In order that the strength of the received signals may

be as great as possible, it is desirable that the resistance of the antenna circuit be kept low. Fig. 3 shows the telephone receivers connected in parallel with the detector; this reduces the resistance of the antenna circuit from what it was with the series arrangement of detector and receivers. Not much improvement in the tuning qualities of the antenna circuit is accomplished by the parallel arrangement.

The action of the receiving apparatus may be explained as follows: The wave-trains from the sending station tend to establish an alternating current in the wires of the antenna and its connections. Current can pass through the detector only in one direction due to its unidirectional feature. Very little current at radio frequency can pass through the telephone receivers because of their high impedance. Assume that the detector is so connected that the current passes from the earth upwards through the crystal detector to the antenna, but the return current is practically blocked. The rectified oscillations accumulate, therefore, in the form of a charge on the

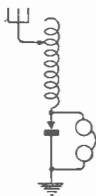

FIG. 3

antenna wires. When this charge is sufficiently high, the antenna discharges through the receivers to the ground, producing a single click for one wave-train and a signal for a series of trains.

DIRECT-COUPLED RECEIVING SETS

Definition.—Receiving sets that use an autotransformer to form the coupling between the primary and secondary circuits are said to be direct-coupled. These sets are commonly known either as a *single-slide tuner* or as a *double-slide tuner*. The autotransformer as used in practice consists essentially of an inductance coil with one common terminal and one or two movable contact points. As the main purpose of the sliding contact is to vary the inductance, it is often possible to use a *variometer* to perform this function, either wholly or in part.

Detector and Telephone Receiver in Series in the Secondary Circuit.—The resistance of a detector is usually quite high, as is also that of the telephone receivers. An arrangement in which both these devices are removed from the antenna circuit and transferred to a shunt circuit is indicated in Fig. 4. The inductance coil *a* is the only device connected between the antenna and ground; the series arrangement of the detector *b* and the telephone receivers *c* is in parallel with a portion of the inductance coil. For clearness of explanation the antenna circuit may be called the primary, and the circuit consisting of

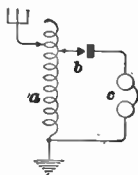

FIG. 4

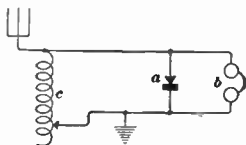

FIG. 5

the detector, telephone receivers, and part of the auto-transformer, the secondary.

The rectifying action of the detector converts the incoming radio-frequency alternating current into a pulsating current capable of energizing the telephone receivers to produce sound signals. A movable contact on the coil permits tuning of the natural wave-length of the primary to that of the incoming wave. A similar contact in the secondary circuit provides a means for tuning this circuit to that same wave-length. This principle corresponds exactly with that used in the sending station in which, as previously explained, the energy transfer from one circuit to another is found to be greatest when the two circuits are tuned to the same wave-length.

Detector and Telephone Receivers in Parallel in the Secondary Circuit.—In Fig. 5, the detector *a* and the

telephone receivers *b* are connected in parallel across a portion of the inductance coil. The action is to a certain extent similar to that in the set shown in Fig. 3. During the period of a cycle when the current at radio frequency passes from the antenna to the ground, Fig. 5, comparatively little of this current can pass through the detector because of its unidirectional feature, or through the receivers because of their very considerable impedance to the passage of a high-frequency current. Most of the current, therefore, will pass through the inductance coil. During the alternate half-cycle, current can readily pass from the ground to the antenna through the detector. As these half-waves of current are stronger than the other half-waves, the receiving system will accumulate a charge of a given polarity, and, when the charge is of sufficient value, it will send a current through the receivers, thus producing a click. It has been assumed that the crystal detector is so connected as to fulfil this condition, although in practice the connections of the detector may be reversed and current caused by the voltage of the other half-waves will then pass readily through the crystal detector. It should be noted that there is only one contact slider on the tuning coil *c*. This makes one less adjustment, as the amount of inductance in both the antenna circuit and detector circuit is changed simultaneously. Tuning is not apt to be as sharp as may be secured by the double-slide tuner shown in Fig. 4. A variometer, which allows of a variation of inductance within itself, might be used in place of coil *c*, Fig. 5, with practically as good results.

Tuned Oscillating Circuit.—Better adjustments of the set may be secured by connecting a variable condenser *a*, Fig. 6, in parallel with the portion of the autotransformer that is used as a secondary. The set may then be tuned with greater accuracy and thus better selectivity may be obtained. The antenna and primary circuit are tuned to the wave-length of the incoming high-frequency currents. The closed oscillating circuit consisting of the secondary coil and the condenser may be adjusted for both in-

ductance and capacity; therefore, the secondary circuit may be tuned to the wave-length of the primary. With suitable adjustments the oscillations in the secondary may be made to have considerable amplitude, thus producing a high impressed voltage on the condenser. Part of the energy of the secondary oscillating circuit affects the shunt detector circuit and the current is rectified by the crystal detector in order to produce a sound in the receivers.

Telephone Receivers Shunted by a Condenser.—The sound in the telephone receivers is frequently improved by shunting them with a condenser, as represented at *a* in Fig. 7. A fixed condenser of small capacity will serve

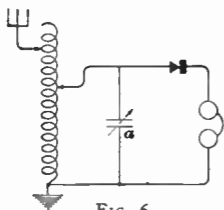

FIG. 6

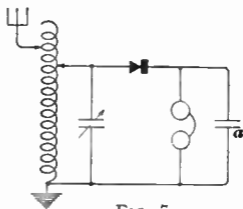

FIG. 7

this purpose. In all other respects this circuit is similar to that in Fig. 6. This addition could be applied to the arrangement shown in Fig. 4 with good results. During the period when electricity flows through the detector. Fig. 7, the voltage is applied across the telephone receivers, and also across the condenser in parallel with them. The short interval between the rectified half-waves of the high-frequency incoming signals is thus smoothed over by the condenser, which gives up to the receivers energy received during the previous half-wave pulsation. The action of the receivers is thereby strengthened.

The receiver leads, as used in practical work, consist of two long conductors bound quite close together by an insulating covering. The wires in the leads thus give a

condenser effect in parallel with the receivers and by their natural action in some cases possess sufficient capacity to obviate the necessity for using a special or separate condenser. In many instances an apparent advantage is gained by making the shunt condenser variable, although this is not always true.

Simple Variometer Set.—A variometer may be used where particularly selective tuning is not required, and where short-wave signals are to be received from near-by stations. A diagram of such a set is given in Fig. 8, where *a* is the variometer, which often consists of two windings wound on forms so as to form parts of spheres, one within the other. Quite

accurate adjustment of the total inductance can be made, but this feature is not so important in this circuit connection as in some others.

INDUCTIVELY COUPLED RECEIVING SET

An *inductively coupled receiving set* makes use of separate coils in the antenna and oscillating circuits, the action being quite similar to that which has been described relating to the transfer of energy from one circuit to another by induction. The use of such an arrangement is illustrated in Fig. 9, in which the two inductance coils *a* and *b* form simply the primary and secondary, respectively, of an air-core receiving transformer. In other respects this arrangement of circuits and apparatus is identical with that of Fig. 7.

As ordinarily constructed, one or both of the coils,

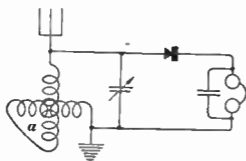

FIG. 8

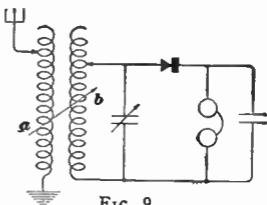

FIG. 9

Fig. 9, are mounted on movable supports and their relative positions may be changed as desired. A very important advantage of this type of mounting is the coupling adjustment provided. The preliminary tuning is often made with the coupling between the coils very close, as in that condition the receiving set will respond to any radio waves whose wave-length is approximately that of the tuned wave-length. As soon, however, as the desired station is heard, the coupling between the inductance coils is made looser, but not to such an extent as to cause the signals to be very weak. The set is then finally and accurately tuned to conform to the conditions established by the change that has been made in the coupling. This will probably cause the strength of the received signals to decrease somewhat from their original strength, but the elimination or tuning out of undesirable stations in many cases renders this procedure highly desirable.

Many experiments and trials indicate that the interference caused by static may be very materially reduced by using loose coupling. In many instances decided relief has been obtained by this means, the received signals coming in very clear after this remedy has been applied.

The various types of receiving transformers that may be used have been described in considerable detail. Many of them are particularly adapted to close coupling work, while others permit of very loose coupling between the two windings. The advent of coils wound with several layers of wire makes the coils much shorter and is really responsible for the practice of loose coupling. This system is especially applicable to honeycomb-wound coils; it is entirely feasible in many cases to use a coupling length of 6 to 8 inches between the coils, while satisfactory reception has been obtained with the coils separated as far as 18 inches. For this unusual receiving work, the conditions must be exceptionally good. As long as enough lines of force from the primary cut the secondary coil to induce audible signals, the operation will be satisfactory.

The primary coil is sometimes wound on a long form in the usual manner, and a few turns, say eight, are wound on another small short cylinder. This coil is then mounted inside the primary on an axis so that it may be turned through at least 90 degrees in its relation to the axis of the main coil. When the axis of the small secondary coil is parallel to that of the main coil, the coupling is a maximum, and when the axis of the small coil is at right angles with the primary, no current will be induced in the secondary. Intermediate positions give the desired amount of coupling between the antenna and local oscillating circuits.

If more inductance is needed in the oscillating circuit than that of the small coil, it is entirely feasible to use another inductance coil for this purpose, but it should not be coupled to the antenna circuit. The tendency for most operators is to use too much coupling, when only a small amount is really necessary.

CARBORUNDUM CRYSTAL RECEIVING SET

As has been mentioned, some types of crystals, especially carborundum, may operate best with a small constant potential of about 2 volts impressed across their terminals. A circuit with such provision is given in Fig. 10. The battery *a* has a high resistance *b* connected across its terminals, as only a small current is required. The resistance has a movable contact point, and by moving this slider, the voltage impressed on the crystal may be varied to

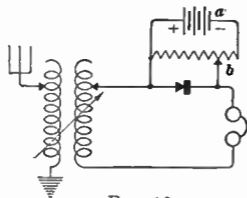

FIG. 10

the value that gives the strongest signals. The resistance connected across a battery and equipped with a slider so that the voltage impressed on another circuit may be varied from zero to the full potential of the battery, is known as a *potentiometer*. This principle

has other uses in radio work. The other features of the set are similar to those already described.

ELECTROSTATICALLY COUPLED RECEIVING SET

A circuit employing *electrostatic coupling*, or coupling through condensers, is represented in Fig. 11. The two condensers *a* and *b* are known as *coupling condensers*.

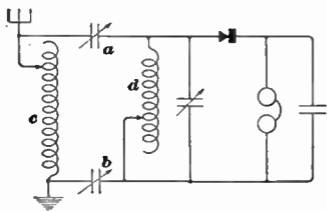

FIG. 11

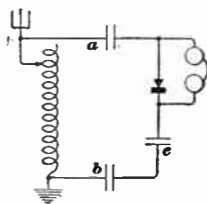

FIG. 12

Coils *c* and *d* are so placed that the lines of force of one coil do not interlink the other coil, hence they do not furnish any coupling; they are used solely to change the inductance of their respective circuits. The only change of coupling between the antenna and oscillating circuits is that afforded by varying the two condensers *a* and *b*, which are usually mounted on one shaft, thus rotating together to produce equal capacity changes. It is claimed that this circuit arrangement affords very good reception of signals and the coupling adjustments may be made easily and rapidly.

An electrostatically coupled receiver, which is very simple both in circuit arrangement and operation, is shown in Fig. 12. If the coupling condensers *a* and *b* are of medium capacity they need not be variable, and the only adjustment will be that provided by the inductance coil. Extreme simplicity is thus secured, but partly at the expense of selectivity, the receiving set having a tendency to respond to a wide variety of wave-lengths. It is customary to make the two condensers *a* and *b* of

the same capacity, but if b is made somewhat larger than a an extra condenser, as indicated at c , may be eliminated. This circuit arrangement with only one tuning adjustment is particularly useful where quick tuning is required and only small interference is likely to be encountered.

TUNING THE ANTENNA CIRCUIT

Methods for adapting the circuit of Fig. 9 to the reception of either very long or very short radio waves are indicated in Fig. 13. The primary winding a is the one effective in transferring energy to the secondary coil in the oscillating circuit. The primary coil possesses a large inductance. The addition of a so-called *loading coil* b ,

which is merely a variable inductance coil, serves to increase the natural wave-length of the antenna, the change produced being directly dependent upon the amount of inductance actually in use. The natural wave-length of the antenna may also be increased by the use of a

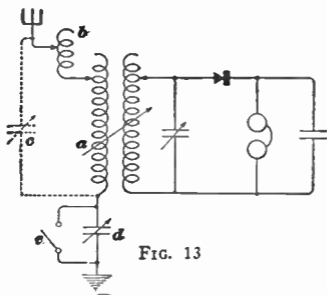

FIG. 13

variable condenser c connected in parallel with whatever inductance may be used, as represented by the dotted line in Fig. 13. A variable condenser of small capacity is sometimes used in this manner to provide a means for making very fine and accurate adjustments of tuning of the antenna system.

For decreasing the natural wave-length of an antenna system, a variable condenser is usually connected in series in the antenna circuit as shown at d . A short-circuiting switch e is normally closed when the condenser d is not required, the condenser then producing no effect on the

wave-length. When an antenna is constructed, it is so designed that its natural wave-length will be near that on which the most of its intended radio communication will be conducted. One of the means described above is then used to secure any other necessary wave-lengths. The use of auxiliary devices is objectionable, in that additional losses are introduced into the receiving set with a consequent decrease in the strength of the signals received. Such apparatus, however, is often necessary, as it provides a simple and effective means for securing a desired wave-length beyond the range possible with a particular set. The use of condensers and inductance coils to modify the natural wave-length of an antenna is limited; it is not practical to add sufficient inductance to more than double the natural wave-length, nor to use a series condenser that will decrease the natural wave-length by more than one-half. These methods, within limits, may be applied to any type of receiving antenna system with equal success. The changes described are applied only when necessary, and when the range of the set is not exceeded; that is, it would be futile to change the antenna's wave-length to respond to signals that the receiving set could not handle.

TUNING A RECEIVING SET

The great variety of receiving sets makes it difficult to formulate definite rules for tuning and for operation that will apply in all cases. Instructions are generally furnished by the manufacturer relating to the operation of the set supplied, and these should be followed to obtain good results.

The following suggestions apply in many cases, but the operator should modify these to suit his apparatus and the operating conditions. The set illustrated by Fig. 9 is to be considered and it is desired to tune the apparatus so as to receive signals from some particular station.

If the wave-length of the sending station is known and the proper setting of the receiving set for that

wave-length has been ascertained, the problem is very much simplified, as the setting may be made direct. A small adjustment, particularly of the coupling, while signals are being received may help to make them more clear and distinct.

If the approximate setting is not known, the two inductance windings should first be coupled closely, as then the set will respond to radio waves even if not tuned to the exact wave-length of the station sending the message that is to be received. Arbitrary settings of the primary inductance are then made and the secondary inductance and capacity are slowly varied over the range of their scales. In many cases in which accurate tuning is required, a very small variation of any of the settings will throw the set out of tune, and cause the signals of the sending station to be lost. It is, therefore, important that the adjustments be made gradually, and not so fast that the correct point may be passed over unawares.

Sometimes two separate settings of the receiving set will give clear signals. This usually indicates that the energy from the sending station is being emitted on two distinct wave-lengths. This condition cannot be remedied at the receiving station; but it is desirable to select the wave-length that gives the clearest signals.

SETTING THE CRYSTAL DETECTOR

For the best reception of radio signals, it is important that the crystal detector be set on a sensitive point. If signals can be easily tuned in from the antenna, the detector may be adjusted from point to point until a satisfactory response is given. In many cases, however, no response can be obtained until the detector is on a sensitive spot even if the remainder of the receiving set is perfectly tuned. This is particularly true of weak signals from remote stations. If the detector point is set in a haphazard way, considerable time may be lost in trying to pick up or tune in a transmitting station. It is, therefore, sometimes desirable to test for a sensitive spot on the crystal before receiving radio signals.

A method of energizing the antenna for the purpose of testing the detector is indicated in Fig. 14. A circuit including a small buzzer *a* operated by a battery *b* is loosely coupled with the antenna system by means of coils *c* and *d*. When key *e*, which may be a push button, is closed, the buzzer produces a pulsating current in coil *c* and by induction an alternating current is established in coil *d* and in the antenna circuit. A small current will then be established in the receiving circuit by induction

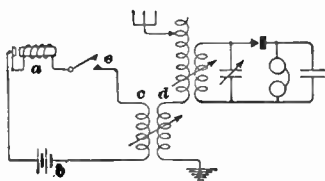

FIG. 14

from the antenna circuit. The position of the detector point is changed several times until the sound produced by the buzzer comes in clear and strong. The setting of the detector is then on

a sensitive spot, which will also respond to radio signals, and the usual tuning may be completed. As soon as a good point on the detector is found, the buzzer is stopped by opening its circuit at *e*, as its continued operation would only produce interference.

SHAPE OF CURRENT WAVES

Fig. 15 shows, with approximate accuracy, the forms of the current waves in the parts of the receiving set. In practice, there is considerable variation in the form of these waves. Only a few waves per train of the antenna current are indicated in view (a). There are actually many more, their number depending upon the kind of wave intercepted by the aerial and, to a limited extent, on the characteristics of the receiving set. A little time is required for the current in the antenna to reach maximum value; therefore, the first two cycles are shown as of less amplitude than the ones immediately following them. The radio-frequency oscillations are now

transferred from the antenna circuit to the oscillating circuit, Fig. 9, by induction.

Voltage wave-trains, of the general form shown in Fig. 15 (a), are impressed on the circuit containing the detector and the telephone receivers, Fig. 9. The detector offers very high resistance to the passage of current in one direction and low resistance to the passage of current in the other direction.

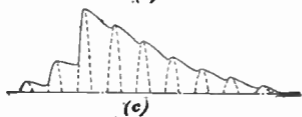
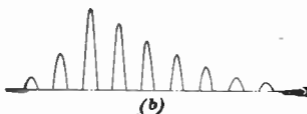
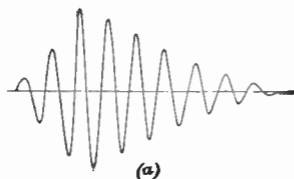

FIG. 15

Unidirectional current impulses, Fig. 15 (b), are, therefore, established in the telephone circuit by the alternating voltages induced in the secondary coil *b*, Fig. 9. Because of the rapidity of the impulses, the diaphragm cannot vibrate in unison, but the effect of a group of impulses is to attract the diaphragm toward its magnet and to release the diaphragm when the impulses cease. The diaphragm produces a click for each train of waves,

and a musical tone for a series of trains.

The condenser that shunts the telephone receivers is charged during the intervals of time that electricity flows through the detector, and discharges a current through the receivers during the intervals when the detector blocks a flow of electricity. The action of the condenser causes the forces acting on the receiver diaphragms to be more nearly continuous and thus improves the tone of the receivers. The curve repre-

sented as a heavy solid line in Fig. 15 (c) indicates approximately the rise and fall of the current in the receivers for each incoming wave-train. The peaks of the curve are due to the impulses of current direct from the detector. The portion of the curve between the peaks represents the current supplied to the receivers by the discharge of the condenser. The dotted curves are used merely to indicate how the solid-line curve is derived from view (b).

In Fig. 15, the upper part of the wave-train, that is, the part above the horizontal axis, is indicated as the part affecting the receivers; the lower part of the wave-train could, however, be used. The portion that is effective depends on the manner of connecting the detector in its circuit; it is not important which part of the wave is used.

DAMPED-WAVE, ELECTRON-TUBE DETECTOR SETS

GENERAL CONSIDERATIONS

Both the two- and three-element electron tubes possess excellent rectifying properties. These tubes may, therefore, be used in the reception of damped-wave telegraph signals, and also for receiving certain classes of undamped-wave signals. In general, it may be stated that the electron tube, and especially the three-element tube with its auxiliary apparatus, could be introduced successfully into most of the crystal-detector receiving circuits in place of the crystal-detector unit. The crystal detector in its rectifying action uses up some of the received energy. The electron-tube detector does not do this to such a large extent, and may even strengthen or amplify the signals as it passes on its way to the telephone receivers.

TWO-ELEMENT TUBE AS DETECTOR

One type of radio receiving circuit using a two-element electron tube is shown in Fig. 16, the two elements

being the filament *a* and the plate *b*. The current from the *A* battery, which heats the filament, may be adjusted by means of the filament rheostat *c*, changes being made until the operation is most satisfactory. The remainder of the circuit represents a common radio receiving cir-

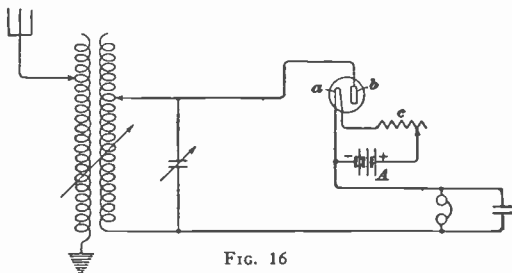

FIG. 16

cuit, and differs only from a receiving set using a crystal detector in that that device is replaced by the electron tube and its auxiliary apparatus. The electron tube, however, acts as a simple detector, and the operation is not unlike that obtained by the use of any other good detector. The fact that a flow of electricity can pass through the space between the plate and filament in only one direction, gives rise to its use as a detector in the reception of damped-wave radio signals.

In the circuit arrangement shown in Fig. 16, there is no *B* battery connected across the plate and filament, the voltage changes being due to the incoming signals collected by the antenna system and transferred to the oscillating circuit. When a high-frequency wave-train is established across the plate circuit, the plate is made alternately positive and negative with respect to the filament. Therefore, a flow of electricity is established from the plate to the filament only during the brief time that the plate is positive. The telephone receivers being in series in this circuit are also energized by the rectified

current, very much as they are with the other types of detectors.

THREE-ELEMENT TUBE WITH GRID BATTERY

The three-element electron tube shown in Fig. 17 makes use of the *A*, *B*, and *C* batteries in its detector action. The small condenser *a* shunting the telephone receivers *b* performs its usual function, namely, that of smoothing out the radio-frequency pulsations to help produce audible clicks in the telephone receivers for the passage of each wave-train. The *C* battery with the resistance and slider *e* forms a potentiometer. By changing the position of the movable contact point along the resistance *e*, the effective voltage of the *C* battery applied to the grid may be varied over its complete range of positive and negative values. The *C* battery is used to move the vertical voltage line to such a location that it will cut the characteristic curve of the tube near its top or bottom bend. If the properties of the tube are such that the natural

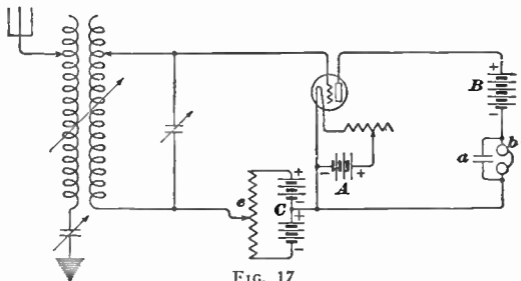

FIG. 17

zero grid-voltage line comes near the middle of the characteristic curve, the movable contact point on resistance *e* would be changed toward the negative voltage end to move the vertical-voltage line to a new position. The new vertical-voltage line is properly a zero-voltage:

line to incoming oscillations, although it may be considerably removed from the natural zero-voltage position, for that tube, by the action of the *C* battery. A positive grid voltage might be applied by the *C* battery instead of a negative one, in which case the vertical-voltage line would cut the characteristic curve at some higher value near the upper bend. In this case, however, the negative part of the alternating current wave will be passed more readily than will the positive portion, but this difference will not be noticeable in the received signals. However, it is not desirable to operate near the top part of the curve, else the positive grid will take some of the electrons that belong to the plate. It might also happen,

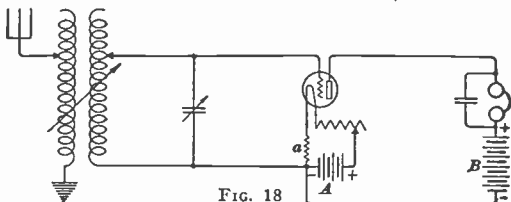

FIG. 18

in fact occasionally does, that the natural-zero grid-voltage line comes on a bend of the characteristic curve, thereby removing the necessity for a *C* battery. The sole purpose of the *C* battery is, therefore, to control the location of the vertical-voltage line, which, after the *C* battery voltage is once adjusted properly, becomes the zero grid-voltage line, so far as the operating characteristics of the detector tube are concerned.

The same effect may be secured by the arrangement shown in Fig. 18. The added resistance *a* in the filament lead causes a voltage drop at that point, and, since the grid is connected between the resistance *a* and the *A* battery, it will always be at a lower potential than the filament. If the resistance of *a* is, say, 1 ohm, and the filament current is 1 ampere, there will be a drop of

1 volt across the resistance a , and the end toward the A battery will be more negative than the end connected to the filament. Under this particular condition the grid will be 1 volt negative with respect to the filament. This method gets rid of an extra C battery, and will be satisfactory on most tubes, but is not adjustable.

Some types of so-called gas, or soft, tubes require a very accurate and frequent adjustment of grid potential, which may be done in any of the ways that have been described. Since the adjustment of these tubes is usually very critical, it is not usually desirable to employ the fixed resistance just described. Sometimes a high resistance is connected across the A battery, and by means of a slider this is used as a potentiometer. This arrangement does not permit of adjustments to give a negative potential on the grid, but does seem to work very well with many of the detector tubes on the market. As the grid takes practically no current, very small dry cells will give a long life in this service.

In some receiving sets the B battery and telephone receivers are interchanged from their relative positions as shown in the plate circuit of Fig. 17. This latter arrangement indicated in Fig. 18 seems particularly useful where a storage battery is used for the B battery. With the negative terminal of the B battery connected next to the filament, this point could be connected to ground with no serious results. The arrangement shown in Fig. 17 is perhaps as much used as any; but if one does not work, others should be tried until best results are obtained. This interchangeability of the B battery and the telephone receivers holds, in general, for most of the plate-circuit connections that are to be described. It may be advantageous to connect the telephone condenser across both the receivers and the B battery as indicated further on in Fig. 31. This is not, however, always an improvement, but both methods may be tried and compared.

VOLTAGE AND CURRENT CURVES

Curves showing the shape of the current waves active in the various circuits of the receiving circuits already described are given in Fig. 19. View (a) represents the shape of either the voltage or the current waves of the

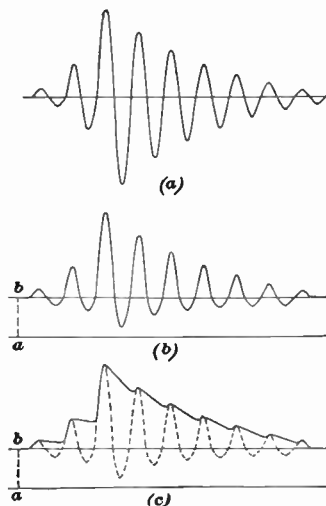

FIG. 19

incoming damped radio-frequency signals just as intercepted by the antenna and impressed on the receiving circuit; the horizontal line represents the axis of the curve. View (b) shows the plate-current curve as affected by the action of the alternating or pulsating voltage applied to the grid circuit. View (c) further shows that the positive impulses of the grid voltage cause greater changes in the plate current than do the negative impulses. When the electron tube is connected in a receiving circuit, the

actual plate-current curve is more apt to be similar to that represented by the curve of view (c).

If the vertical-voltage line intersects the characteristic curve near the center, the alternating-grid voltage will produce equal plate-current changes with equal positive and negative impulses. One set of pulsations will then largely neutralize the other, and no detector action will

be accomplished by the tube. The values a b shown on views (b) and (c) represent the value of the normal current in the plate circuit, and the changes caused by the variations of the grid voltage are impressed on it, giving the curves of varied shapes as shown.

Only one wave-train is given in Fig. 19, but this operation is repeated for every wave-train, succeeding ones being connected by the constant values a b of plate current passing during the brief intervals of quiet. The dotted waves in view (c) are the same as the solid-line

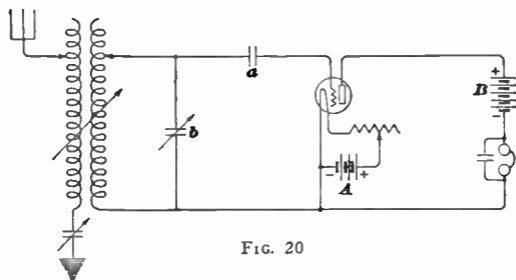

FIG. 20

curve of view (b); they are used merely to show the derivation of the plate-current curve that is drawn as a heavy line, view (c).

THREE-ELEMENT TUBE WITH GRID CONDENSER

Another method of using a three-element electron tube as a detector is shown in Fig. 20. This circuit differs from circuits using a grid battery in that the C battery is omitted and a condenser a of small capacity is connected in the grid circuit of the tube. A condenser connected in such a location is very commonly called a *grid condenser*. This condenser does not permit a direct current to pass through it, hence no constant voltage can be impressed on the grid as in the former condition. For any given value of filament temperature and plate

voltage a constant current will pass through the plate circuit, its value depending primarily upon the characteristics of the tube. When a wave-train of radio frequency is impressed upon the oscillating circuit, the condenser *b* in that circuit becomes alternately positive and negative, due to the oscillatory current set up in that circuit. This changing voltage charges the grid positively and negatively through the grid condenser *a*. Each time the grid becomes positive, some of the electrons will flow from the filament to the grid, but during the negative half-cycle no electrons will be attracted to the grid. Neither will the electrons that have been accumulated be liberated from the grid during the period of negative charge. The successive positive charges impressed on the grid by the condenser *a* will produce a cumulative effect which results in the grid becoming negatively charged from the electrons it has attracted. This accumulated negative charge on the grid opposes the flow of electrons from the filament to the plate by adding its effect to the opposing space-charge effect, and the plate current is, therefore, decreased during the remainder of the wave-train.

In order that the grid may be in its original condition, that is, with no charge, upon the arrival of the following wave-train, it is necessary to remove the negative charge from the grid. If the grid condenser has a poor dielectric, this charge may leak off to the filament through the dielectric and the secondary winding of the oscillation transformer. In some cases the charge very probably leaks off through the grid supports, or if there is some gas in the tube, this gas may form the conducting medium. When the tube has a very high vacuum, an artificial means for insuring a leakage path for the grid charge may be provided by shunting the grid condenser *a*, Fig. 21, by a high resistance, such as is represented at *b*. A resistance used in this manner is commonly called a *grid leak*, and may be anywhere from 500,000 to 2,000,000 ohms. Although the high resistance is often of fixed value, it is sometimes very desirable to

use one that is variable, as fine tuning of the set may often be assisted by making changes in the value of this resistance.

Practically the same results may be attained by connecting the grid leak between the grid terminal *c* and the negative filament terminal *d*, as then the charge can leak off directly to the filament and be dissipated. As only one main charge is accumulated for each wave-train, the radio-frequency oscillations will be converted into audio-frequency impulses, and thus produce audible signals in

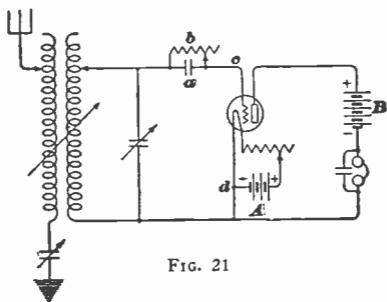

FIG. 21

the telephone receivers. It should be noted that when a grid condenser is used, no *C* battery is required. This feature, together with the fact that the operation will be satisfactory at practically any point on the characteristic curve of the tube, is a point decidedly in favor of this circuit arrangement. With some types of tubes and the grid-condenser connection, the signals are much louder when the common terminal of the grid circuit and of the plate circuit is connected to the positive terminal of the *A* battery than when connected to the negative terminal as shown at *d*. The best method depends upon the shape of the characteristic curves and the inherent characteristics of the tube.

ACTION OF GRID CONDENSER AND LEAK

The action of the grid condenser and grid leak in producing conditions on the grid which cause the grid to give an audible current impulse in the telephone receivers is somewhat different from its action with a grid battery.

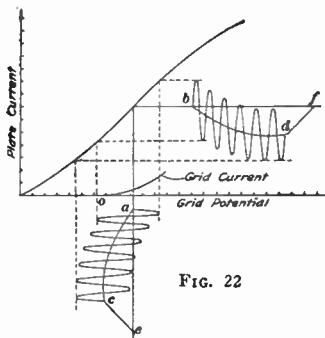

FIG. 22

With the grid potential indicated by the position of the vertical line through *a* acting on the characteristic curve of Fig. 22, there will be a corresponding plate current as indicated by the position of the horizontal line through *b*. Suppose that six cycles of undamped alternating voltage

are impressed on the grid as shown between *a* and *c*. These six cycles of current might be received from a continuous-wave transmitting set which used a chopper or buzzer to break up the signal into short trains. A train of damped-wave signals could be used here, but the undamped wave shows some of the principles more clearly.

The signal voltage as impressed on the grid is really symmetrical with and extends along the straight vertical line through *a*. The negative impulses, to the left, do not affect the grid as much as do the positive impulses. The positive impulses attract a supply of electrons to the grid and it gradually assumes a negative charge. The several cycles of alternating current between *a* and *c*, therefore, represent the actual voltage changes through which the grid goes.

This action may also be explained by referring to the

grid-current curve, and considering the operation to be on a bend of that curve. Positive impulses will cause a large increase in grid current compared to the relatively small decrease in grid current when the grid becomes negative. The net result of this is an accumulation of electrons on the grid. Thus it is seen that the average value of the grid potential is decreased according to the heavy line between *a* and *c*.

During this change, simultaneous changes have occurred in the plate circuit as shown between *b* and *d*. The plate current has been decreased by the signal and now stands at *d*. With stoppage of the impressed current at *c*, the charge on the grid passes off through the grid leak and the grid resumes its normal value as at *e*. The plate current also comes to normal at point *f*, and remains constant until another signal is received. The change of plate current which actually produces a click in the telephone receivers is indicated by the heavy line through *b*, *d*, and *f*, which represents the average value of the plate current.

As has been mentioned, rectification may take place over any part of the characteristic curve, and the effect of a wave-train is always a momentary decrease in the plate current. No difference is discernible, however, between the sounds in the telephone receivers, whether the current impulses increase or decrease the magnetic pull on the diaphragm.

RECEIVING UNDAMPED-WAVE TELE- GRAPH SIGNALS

GENERAL CONSIDERATIONS

Undamped-wave radio telegraph signals are not capable of producing signals when received on the usual type of damped-wave receiving apparatus unless they have been interrupted or modulated at the sending station. Cases coming under this latter group will be considered later. Suppose an undamped-wave signal is being received in a crystal detector. There is a very large number of

cycles of radio-frequency current in either a dot or a dash of the telegraph code. This current would be rectified as usual, but the receiver diaphragm would be drawn up at the start of the wave-train and released at the end. This would not produce a buzzing sound nor even a good receiving sound in the telephone receivers, and it is doubtful if any sound would be heard. If, however, this wave-train is broken up or its form changed, it can be made intelligible.

CIRCUIT-INTERRUPTING DEVICES

Buzzer.—One method of receiving and detecting sustained waves is indicated in Fig. 23. Here the arrangement of circuits is exactly the same as for receiving

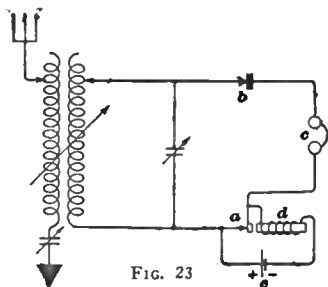

FIG. 23

damped-wave signals, except that a circuit-interrupting device *a* has been inserted in series with the detector *b* and telephone receivers *c*. The interrupter forms part of an electric buzzer *d*, whose operating circuit is also shown connected to its

own local battery *e*. The buzzer operates at its normal audio frequency, and the vibrating armature periodically opens and closes the circuit through the detector *b* and telephone receivers *c*.

The action of breaking the circuit cuts up the received radio-frequency waves into groups of a few high-frequency oscillations, with quiet intervals separating the periods during which current is passing in the circuit. As has been explained, a detector rectifies any alternating-current wave passing through it, and would in this case

pass a pulsating current through its circuit were it not for the buzzer. As the circuit is opened at intervals by the buzzer, the rectified pulsations of current that remain will be grouped into short wave-trains. These grouped current pulsations passing through the coils of the telephone receivers will act upon their diaphragms, for, although the individual pulsations are at a high frequency, they are all in one direction, and thus their combined action is to hold the diaphragms in their active positions during each group of pulsations. The diaphragms will resume their normal positions during the intervals between wave-trains. These groups of pulsations occurring at audio frequency give audible signals, a long series of groups representing a dash, and a short series of groups representing a dot in the telegraphic code.

Chopper.—Undamped waves may be received by connecting a *chopper* in the detector and receiver circuit of a damped-wave receiving set. This will result in the circuit arrangement indicated in Fig. 24. The chopper normally consists of a toothed wheel *a*, and a brush or contact point *b* which touches the teeth momentarily as they pass. A motor rotates the toothed wheel at a fair rate of speed, and the teeth make brief periodical contact with the brush *b*. During the period of contact, the oscillating circuit, consisting of the inductance *c* and the condenser *d*, is connected to the circuit through the detector *e* and the telephone receivers *f* just as in a damped-wave set. As was the case there, a small condenser shunting the telephone receivers, as at *g*, may be used to smooth out and assist in receiving the high-frequency pulsations.

Here as in other continuous-wave systems, the oscillating circuit receives undamped radio-frequency signals. As long as the teeth of *a* do not touch the brush *b* the receiver circuit is open and no signal is heard. When the contact points close the receiver and detector circuit, a few cycles of radio-frequency current are allowed to pass from the oscillating circuit. However, the detector performs its rectifying action and allows only a pulsating

current to pass through the telephone receivers. These few pulsations of current, which pass during the contact period, produce one click in the telephone receivers. The frequency of the opening and closure of the detector and receiver circuit, and, consequently, the tone of the received signal, may be controlled to a large extent by regulating the speed of the chopper wheel. The note produced by the telephone receivers is not quite so uniform nor so easy to receive as in some other receiving systems.

Tikker.—The *tikker* depends upon a make-and-break contact to produce audible signals from undamped waves. In one form it uses the circuit of Fig. 25, which is quite similar to that of Fig. 24. A grooved wheel *a*, Fig. 25, forms one side of the contact and is rotated by a motor. A spring *b* presses into the groove of wheel *a* and makes a sliding and imperfect contact. The minute irregularities in the wheel open and close the contact very frequently, producing a series of breaks between the oscillating cir-

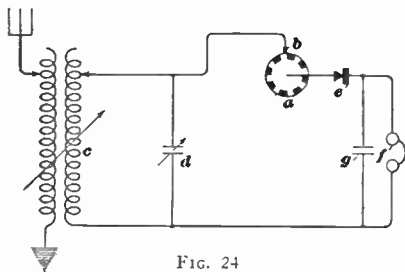

FIG. 24

cuit and the detector and receiver circuit very similar to that of the chopper. A small condenser *c* shunting the telephone receivers *d* will help in the reception of the high-frequency impulses.

In the reception of high-frequency signals corresponding to the shorter wave-lengths, it seems desirable to use

the detector indicated at *e*, Fig. 25. On the lower frequencies, it is quite feasible to eliminate the detector, but a much larger condenser must be used at *c*. The rotation of the wheel *a* must also be increased, and this increase will cause a more frequent closure and opening of its circuit. The inductance *f* and condenser *g* store up

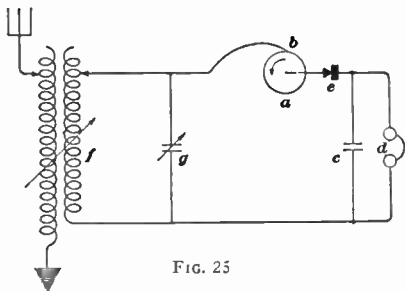

FIG. 25

considerable energy while the receiver and condenser circuit is open at the tikker. This energy is instantly transferred in bulk to the large condenser *c* while the tikker contact is closed. This contact opens in time to prevent condenser *c* from discharging back through the oscillating circuit, and the charge is therefore expended in producing a click in the telephone receivers. The irregular contact of the tikker, and the consequent non-uniform charges on condenser *c*, produces a tone neither uniform nor musical. More pronounced makes and breaks are obtained by rotating the wheel against the contact point, as shown by the arrow in the figure.

BEAT-CURRENT RECEPTION

Two undamped-current waves of different frequencies are indicated in Fig. 26 (*a*) and (*b*). When these two waves are combined into one wave by adding the instan-

taneous values of the two separate waves, taking into consideration their positive and negative relations, the resulting wave will be similar in form to that shown in view (c). This wave is an indication of what is known as a *beat current*. The amplitudes of the individual alternations of the beat current are not uniform. Periodi-

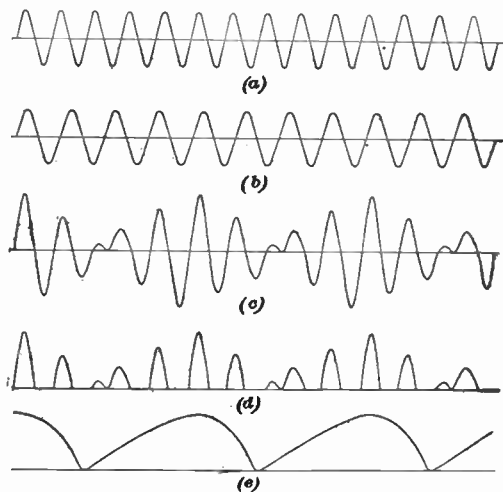

FIG. 26

cal increases and decreases of amplitude are formed by the addition of the two separate waves. Maximum points are due to the addition of two simultaneous maximum values in the same direction, and minimum points are due to two simultaneous zero values or to the addition of two simultaneous maximum values, one of which is positive and the other negative. The amplitudes of the waves between the maximum and the minimum points

depend upon the simultaneous individual values and their positive or negative relations.

The time between any two maximum points on the beat-current wave is much longer than the time occupied by one cycle of either of the two separate waves. The beat current when rectified, view (d), and further modified by the action of the telephone receivers and their condenser produces a periodic current of audio frequency, view (e). In radio practice the difference between the two currents is often made 1,000 cycles as this produces a note in the telephone receiver which is easy to read. Thus, if the frequency of the received signal was 150,000, the frequency of the locally generated oscillation could be 149,000 or 151,000.

HETERODYNE RECEPTION

Alternating-Current Generator.—The *heterodyne* method of receiving depends on the principle of superimposing upon the incoming undamped high-frequency wave a similar wave of a slightly different frequency. Fig. 27 shows one arrangement of circuits for heterodyne reception. A small alternating-current generator is shown at *a*. The primary coil *b* and the secondary coil *c* of a transformer serve to couple the generator and antenna circuits.

Suppose the incoming high-frequency current to be that represented by Fig. 26 (a) and the alternating current of another frequency supplied to the antenna circuit by the generator to be that shown in view (b), then the combined current, or beat current, in the antenna circuit may be indicated by view (c). The beat current in coil *d*, Fig. 27, produces a current of similar wave shape in the oscillating circuit consisting of the secondary coil *e* and the condenser *f*. The electron tube *g* rectifies the beat current, Fig. 26 (c), into the form shown in view (d). The current represented by view (d) is seen to be made up of high-frequency pulsations of current, but divided into beats or groups by their large and small amplitudes. This rectified current in the plate circuit of tube *g*, Fig. 27, operates the telephone

receivers *h*, and also charges the shunt condenser *i* during the time of each short series of high-frequency current pulsations, or with each beat. The shunt condenser helps to smooth out the rapid pulsations impressed on the telephone receivers, causing the current to assume the general form shown in Fig. 26 (*e*), and this current produces a click in the receivers for each pulsation of the beat current. The diaphragms of the telephone receivers will not act quickly enough to respond to the individual radio-

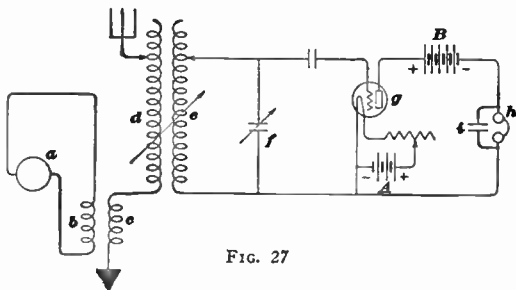

FIG. 27

frequency pulsations, but will produce audible sounds when a current represented by the audio-frequency wave, view (*c*), passes through the coils of the telephone receivers.

The beat frequency depends directly upon the difference between the frequencies of the component waves; that is, if there is very little difference between the received and applied frequencies, the beat frequency will be low, while, if there is a large difference, the beat will be high. The frequency of the received wave is, therefore, fixed for any given conditions, but by varying the frequency of the local applied current, the beat frequency may readily be controlled. In this manner sharp tuning is possible, and many interfering stations may be easily tuned out. It should be noted that a crystal

detector or some other form of rectifier might be used in place of the electron-tube detector; the action of the tube in this arrangement being simply to rectify the beat current caused by the interference of the two high-frequency oscillations.

To supply this current, the alternator for generating the local oscillations might just as well be connected to the local oscillating circuit, through coil *e*, Fig. 27, as to the antenna circuit. The principle of operation would

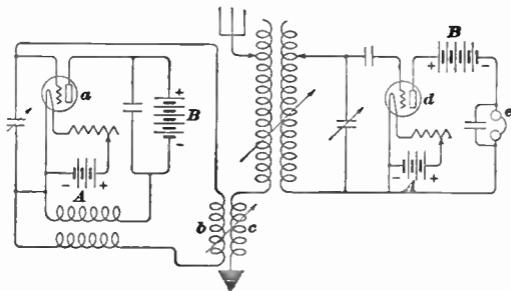

FIG. 28

remain the same as previously described. This method of receiving signals tends to amplify the signals or make them stronger, as the local energy is added to the incoming signals to produce the effective beat current. The coupling between coils *b* and *c* should be of such value as to induce a current in the antenna about equal to that received from the sending station.

The beat and consequent audio-frequency current pulsations of Fig. 26 will be received only while both of the component high-frequency currents are established. The antenna, Fig. 27, will receive its high-frequency current from the sending station only while that station is sending out the dot-and-dash signals. During the intervals or spaces between these elements of the signals there

will be only the locally generated high-frequency current in the receiving set. This radio-frequency current is, however, unable to produce any audible signals of itself and is used up in the receiving set as waste energy. It is also important that the local oscillating current be established before the incoming signals can be received.

Electron-Tube Generator.—The heterodyne method of receiving undamped radio signals may be used with an electron tube acting as a generator. Fig. 28 shows such an arrangement in which tube *a* and its associated circuits act as the generator of a radio-frequency current. Through the action of the transformer coils *b* and *c*, this current is transferred to the antenna circuit where it is combined with the current of the incoming wave to form a beat current. The receiving circuit including the electron tube *d* is of the type commonly employed for damped waves. The signals reaching the tube *d* are carried by the beat current. The tube rectifies the beat current and the rectified current operates the telephone receiver *e*.

AUTODYNE RECEPTION

Instead of using two tubes as in the preceding case, one electron tube may be used to perform the complete operation of receiving and detecting the incoming undamped radio-frequency oscillations. This is known as the *autodyne* method, which, briefly stated, is the system of using one tube to function as a generator of high-frequency current oscillations as well as to function as a rectifier for the beat current.

Fig. 29 shows a circuit diagram based on the autodyne method. The pulsating current of the plate circuit is transferred by the feed-back method to the oscillating circuit through the action of coils *a* and *b*. The coupling between these coils should be rather close for successful operation, and the various adjustments in the coupled circuit must be accurately made. In other respects the principle of operation is not unlike the heterodyne method of reception.

The signals as received by an antenna are at best very

weak, hence the amount of energy required to produce local oscillations of equal strength is consequently small. It is important when using the heterodyne method of reception, that a local current of approximately equal amplitude be combined with the incoming antenna current. This is also applicable to the autodyne method of reception, but as the oscillating current is necessarily small in this case, it is not apt to need special attention. Where sensitive adjustment of the detector tube is necessary, it may be desirable to use a separate tube to pro-

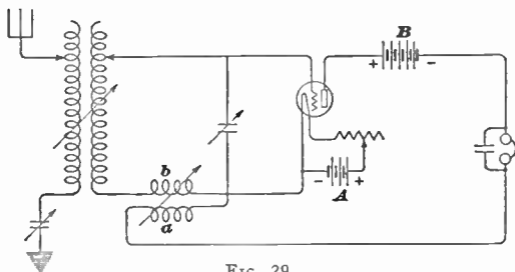

FIG. 29

duce the local oscillations and *couple* its output to the grid circuit of the detector tube.

In the autodyne circuit the three-element electron tube is exhibiting three of its important functions, namely, those of acting as oscillator, detector, and to some extent as an amplifier, and these all simultaneously. The principle of feeding some of the plate current back to the grid could probably be applied with advantage to other circuits using the three-element tube, especially those using one or more stages of radio-frequency amplification.

RECEIVING UNDAMPED-WAVE MODULATED SIGNALS

Undamped-wave, radio-telegraph signals which have been modulated, or, what amounts to the same thing, which have been cut up into short wave-trains, may be received with any good damped-wave receiving set. This type of set is in general simpler to operate than those used in the reception of undamped-wave telegraph signals, which is the main reason for the desirability of modulating the radiated waves in some manner. As was described and illustrated under the discussion of radio telephony, use is made of an undamped wave modulated so that the outline of the radiated wave corresponds to a large extent with the original sound wave. If the modulated current, either for telegraph or telephone communication, is passed through a rectifier at the receiving station, one-half of the energy pulsations will be prevented from

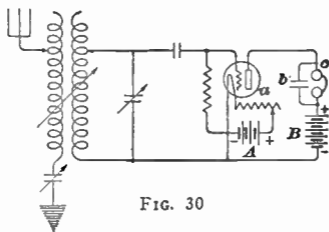

FIG. 30

passing through the telephone receivers, and a pulsating current will result. The radio-frequency, carrier-current pulsations will be vibrating too fast to affect the telephone receivers. The component of audio-frequency current

which was used at the sending station will however affect the telephone receivers to reproduce the original sound impulses.

It will be noted that the receiving set suitable for the reception of radio telephone messages is the ordinary damped-wave receiver circuit using a crystal or electron-tube detector. A suitable circuit connection is shown

in Fig. 30, which follows the usual type of arrangement with a three-element electron tube *a* as the detector. The capacity of condenser *b* shunting the telephone receivers *c*, should be small so as not to distort the received signal pulsations.

In the more common systems of radio-telephone modulation, the oscillating current is not varied over a larger range than from zero to approximately twice its normal

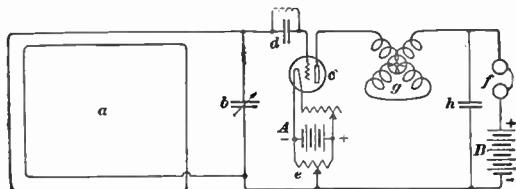

FIG. 31

value. It is possible, and it is in practical operation with some long-wave length sets, to over-modulate the current. The envelope or modulating outline which starts, say, on the positive side of the axis, may even cross the axis and form the outline of the radio-frequency current in the opposite direction or on the negative side of the axis, recrossing the axis as often as may be necessary to produce greater modulation. To receive the message from such a modulated current, it is necessary to use a form of beat reception. A locally-generated current that is identical with the radio-frequency carrier current is bucked against the incoming wave and neutralizes the carrier waves. The audio-frequency component is then sent through the telephone receivers. It is very difficult to adjust the frequency and phase or time relation of the local high-frequency current, especially on the short-wave lengths where the frequency is exceptionally high.

A circuit employing several distinctive features is shown in Fig. 31. A coil or loop antenna is represented at *a* and has a tuning condenser *b* by which this local

circuit may be tuned to the incoming signals. The electron tube *c* has a grid condenser *d* and operates as a detector. Across the *A* battery is a resistance *e* of perhaps 200 to 300 ohms used as a potentiometer. By moving the slider across the potentiometer resistance, a very accurate adjustment of the voltage effective on the grid may be secured, which on some tubes will result in increased sensitiveness. The plate circuit, besides its usual *B* battery and telephone receivers *f* has a variometer *g* or some other type of continuously variable inductance. By varying the inductance of this device, the plate circuit may be tuned into resonance with the input or grid circuit and the plate circuit will feed back energy into the grid circuit. The feed-back may be due in part to radiation or coupling effect direct from the plate circuit to the grid circuit, but the larger effect is that due to the coupling in the form of the tube capacities. The capacity effect between the filament and grid is, in an actual tube, coupled with the capacity effect between the filament and plate, and couples the grid and plate circuits together. This capacity effect is usually small, even in poorly designed tubes, but becomes a very important consideration when receiving the exceptionally high-frequency currents of the short-wave-length signals. The telephone condenser *h* may include the *B* battery so as to give a good path for the radio-frequency currents in the plate circuit.

The set, Fig. 31, may be used with a regular type of elevated antenna by removing the coil antenna *a* and substituting an outside antenna with primary and secondary windings of a receiving transformer. The secondary of this transformer is then connected in place of coil *a*, or directly across the condenser *b*. The range of this circuit connection is not large, although a regenerative or feed-back receiver will have a greater range or give louder signals than the simpler detector circuits. The coil antenna is also a rather limiting factor as it only intercepts a small amount of energy if of small size. It may be, however, that some of the advantages of the loop

antenna will more than compensate for its disadvantages and limitations of range.

OTHER POSSIBLE ARRANGEMENTS

Many other circuit arrangements than those just described are possible, some extremely simple, and others needlessly complicated. The receiving sets put up by different manufacturers naturally differ largely as to the arrangement of apparatus, the adjustments provided, and as to the number and quality of the component devices.

The particular receiving set to use in any case depends, to a very large extent, upon the purpose for which the station is to be used. If long-distance receiving is to be attempted, the currents handled will be very minute and the receiving set must be exceptionally well designed and assembled. In many cases one type of receiving circuit may work very well on one particular antenna system, while if used on some other one, satisfactory reception may be impossible. This is usually considered to be due to characteristics of the antenna rather than to faults in the set itself. In any case, whether reception is good or poor, it is advisable to try various arrangements and electrical connections of the apparatus with a view of obtaining the most satisfactory arrangements possible with the given equipment. Circuits radically different from those illustrated may be found that will give excellent signals with a particular or special type of aerial.

AMPLIFIERS

CLASSIFICATION AND TYPES

Amplifiers, as has been mentioned, are pieces of apparatus for increasing the voltage or current that is supplied to them. Their most frequent use is in the amplification of weak signals as received from distant stations, but they are also often used in sending sets in various ways. The ability of the three-element electron

tube to amplify currents of any frequency without distortion makes its use exclusive or without a rival in this field.

The principle of all amplifiers is that a small change of voltage impressed on the grid of a three-element tube produces large current changes in the plate circuit which accurately follow the changes in the impressed voltage. The principle of the amplifier action of a three-element electron tube was described under that heading. Here consideration will be given chiefly to the application of amplifiers to radio circuits, and to the auxiliary apparatus required.

Amplification may take place at radio frequencies or at audio frequencies. In the former case the signal is sent through the amplifier and then through the detector and telephone receivers, or the received energy may be detected first and then amplified at audio frequencies. It is also possible, and frequently practiced, to amplify the signals at radio frequency to some extent, rectify them in a detector to audio frequency, and then further amplify them at this audio frequency. A more recent development, which produces excellent results, is to reduce the radio-frequency signal to some lower radio frequency, and then rectify and amplify it in other steps. The advantages of each method of amplification will be considered separately.

Where more than one tube is used, such as a detector and an amplifier tube or two amplifier tubes, it is necessary to use some method of coupling. The methods of coupling come under three headings, although there are some modifications of the main types of coupling. These three are the resistance, transformer, and the inductive types of coupling. These different types of coupling will be, for the most part, illustrated with detector apparatus, as they are most frequently used in that connection. Most of them may be used as amplifiers for other purposes by merely making proper connections to the grid as the input circuit, and to the plate as the output circuit.

RADIO-FREQUENCY AMPLIFIERS

RESISTANCE COUPLING

Connections for a resistance-coupled amplifier are given in Fig. 1. The two tubes *a* and *b* amplify the signal just as it is received and a detector tube *c* is then used to rectify the signal. In this case an autodyne connection is shown capable of receiving undamped-wave telegraph signals. A regular type of detector tube for damped-wave signals might be used, or even a crystal detector, although it appears that the amplifying stages might rectify such signals to some extent. The resistances *d* and *c* are the real amplifying resistances. It is important for high-frequency work that these resistances should not have appreciable inductance or capacity effect, hence high-resistance carbon rods are sometimes used. There is some loss in these resistances and the voltages of the *B* batteries must be higher for successful operation than with some other methods of coupling. The

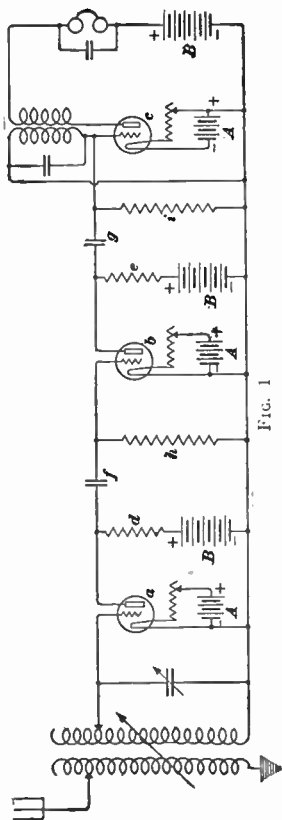

FIG. 1

condensers f and g , which need not be large, prevent the establishment of a fixed positive potential on the grid by the B battery of the preceding tube. It is general practice to use common A and B batteries for all tubes, although in some cases it seems to be better to use a separate B battery on the detector tube. The grid leaks h and i permit the charges accumulated on the grids to leak off.

A feature of importance in radio-frequency amplification by any method of coupling, and especially on wave-lengths below 600 meters where the frequency becomes high, is the feed-back caused by the grid and plate capacity effects. As has been mentioned, there is only a small capacity effect between the filament and grid, and the filament and plate, but this is of utmost importance in high-frequency work. Sometimes a set will amplify very well on long wave-lengths but fail absolutely on the shorter wave-lengths, due entirely to the tube capacity effects. One method of reducing this effect is to design the electron tube so that its internal capacity effects are reduced to a minimum. Such tubes have been used on the radio-frequency amplification of short-wave messages with excellent results.

TRANSFORMER COUPLING

Two stages of transformer-coupled amplifiers feeding into a crystal detector are shown in Fig. 2. Tubes a and b receive the radio-frequency energy, and after amplifying it at radio frequency pass it on to the crystal detector circuit where it is rendered intelligible. The transformer c has its primary connected in series with the B battery of the first tube, and its secondary impresses the voltage induced in it on the grid of tube b . The voltage is further amplified and is transferred through the primary and secondary of transformer d which with condenser e form a local oscillating circuit. The signal acts on the crystal detector f and the telephone receivers g to produce audible signals. The connection wire h helps to steady the operation of the tubes.

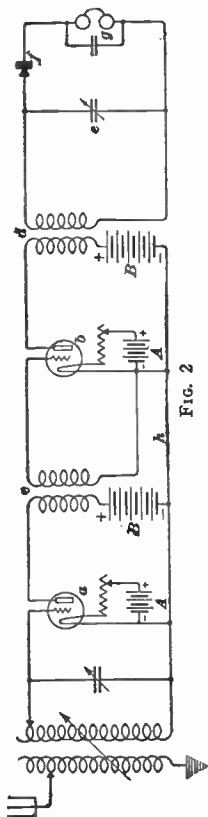

FIG. 2

To reduce the capacity of the coils of the transformer, the windings are made of very fine wire. To prevent the tube from oscillating, some expedients may be used to produce high losses. The transformer may be wound on an iron core, and the losses in this iron will generally prevent oscillation, but will also decrease the output to some extent. The winding may be of resistance wire, which also increases the losses. A small positive potential applied to the grid will usually prevent the tube from oscillating, but at the expense of reduced output.

It should be understood that every inductance coil, and transformer winding, for that matter, has a natural period of its own. If the signal is near that frequency, it may be amplified very well by the circuit assembly, while other frequencies may be poorly amplified. When several amplifiers are used as in the preceding case, it is well to use transformers of different characteristics, so that this tendency to amplify signals of any particular frequency more than others is minimized. This may very well be accomplished by using transformers made by different manufacturers in the various steps.

INDUCTIVE COUPLING

The amplifier tube *a* and the detector tube *b* of Fig. 3 are coupled by a common inductance coil *c*, which gives this method of coupling the name of inductive coupling. The condition will first be considered without the condenser *d*. An entirely feasible connection results if the condenser is omitted. Without this condenser, the coupling coil might be considered an autotransformer; at least in effect. This coil is then occupying the position of the resistance unit in the resistance type of coupling. In fact, the impedance of coil *c* represents its real amplifying property. The condenser *e* prevents the establishment

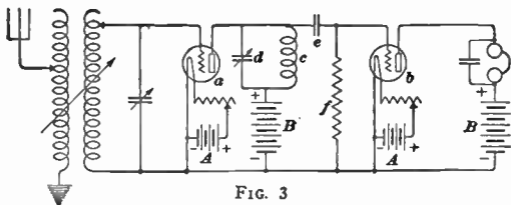

FIG. 3

on the grid of tube *b* of a potential by the *B* battery of tube *a*. The grid leak *f* is then necessary so that a large negative charge shall not accumulate on the grid of tube *b* to stop operation. Tube *b* acts as a regular detector tube.

When the condenser *d* is used, the local circuit consisting of the inductance *c* and the condenser *d* may be tuned and the set will amplify signals of that particular wave-length particularly well. This arrangement is frequently used where it is desired to reduce the interference from signals on other wave-lengths. It is in general better to use a large value of capacity in the condenser *d* and a small inductance in coil *c*. This type of coupling does not require as high a *B* battery voltage as does the resistance type, since there is less loss in the coupling device.

AUDIO-FREQUENCY AMPLIFIERS

RESISTANCE COUPLING

A diagram of connections for using an audio-frequency amplifier using resistance coupling is shown in Fig. 4. The resistance unit a of several thousand ohms forms the coupling medium between the detector tube b and the real amplifier tube c . The arrangement is a little different from that of the radio-frequency, resistance-coupled amplifier, shown in Fig. 1, but the difference is not

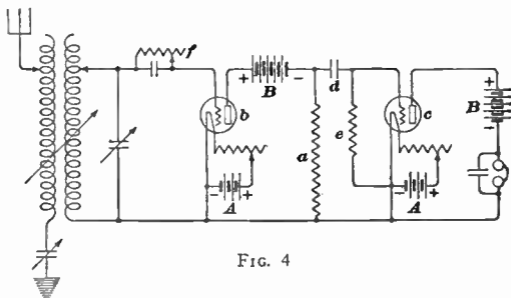

FIG. 4

as great as it may appear. For example, the B battery of tube b , Fig. 4, might be placed below the resistance a , or rather between resistance a and the conductor connecting the negative terminals of the A batteries. Any changes of current strength in the plate circuit of the first tube will be communicated to the grid of the second tube, where the current impulses will be amplified.

A condenser d prevents the establishment of a direct current in the grid circuit of the amplifier tube c and consequent interference with the flow of electrons therein. The introduction of the condenser d in the grid circuit necessitates the use of a grid-leak resistance e of rather high value to prevent the accumulation of an excessive

negative charge on the grid. The grid leak e is connected directly across the grid and filament terminals in this case instead of directly across the condenser, as is the case with the grid leak f . No material difference in the operation of the two methods of connection is usually evident, and although they may be considered interchangeable, the method in which the resistance shunts the condenser is the more commonly used. The coupling resistance a is usually several thousand ohms. The B battery required with this type of coupling is practically the same as that required with any other type of coupling. As this type of coupling is entirely independent of the frequency of the current, it amplifies signals of all frequencies equally well, and without distortion. It does not in general give so high a degree of amplification as do some other types of coupling, but is comparatively inexpensive.

TRANSFORMER COUPLING

Transformer coupling for the amplification of currents at audio frequencies is shown in principle in Fig. 5. This differs from some connections in that only one common A battery and B battery are used. One common resistance a serves to vary the voltage applied to the filaments, and both filaments receive the same voltage. Using two rheostats, one for each filament, has certain advantages, as the voltage, and consequently the filament current, of each electron tube, may be independently controlled. This is particularly desirable in case the characteristics of the two tubes are somewhat different, as is often the case in commercial tubes used as detectors and amplifiers. Another change in the circuit is the addition of the grid condenser b to the grid circuit of the detector tube. The grid leak c is often added, when the grid condenser is used, for the purpose, as has been explained, of allowing the charge on the grid to leak off to the filament, so as to maintain stable operating conditions. The telephone receivers are shown at d and the condenser shunting them at e .

As the plate current is directly dependent upon the flow of electrons in the tube, any change in this flow will affect the plate current. As has been explained, the detection and amplification of the radio signals depend wholly upon this principle. The strength of the signals may be controlled over a considerable range by changing the filament temperature through changes in the filament current. Thus if the signals from a nearby station come in very strong, the electron flow may be decreased, and the signals will still be strong enough for the operator to receive them satisfactorily. Burning the filament at the lower temperature possesses the advantage that decom-

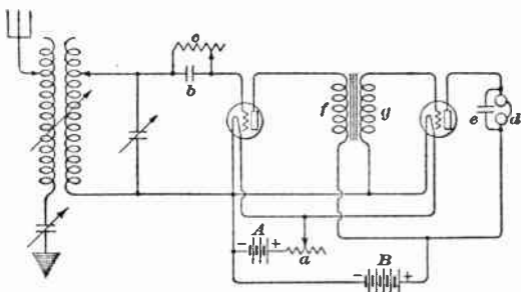

FIG. 5

position is not so rapid, and its life is much longer. Similarly, burning the filament at a higher temperature, or so that it glows brighter, will increase the electron flow, and the incoming signals will be amplified to a greater degree. This holds true over narrow limits, and should not be carried to such an extent as to burn out the filament. Some change in the degree of amplification of the signals may be accomplished by varying the voltage of the *B* battery, but, while this is important with some types of tubes, it is not commonly used as better control is furnished by the *A* battery.

A steady direct current from the *B* battery in passing through the primary coil *f* of the transformer does not induce any current in the secondary coil *g*. This is according to the principle of transformer action, that only a varying current in one winding induces a current in the other winding. It is therefore impossible for the steady current to be transferred from one circuit to another, although the alternating-current signals pass through with very little opposition.

The ratio of numbers of turns of wire in coils *f* and *g* varies considerably, but is usually somewhat less than one to ten; very frequently a ratio of one to three is employed. Good operation has been secured by using air-core coils of many turns instead of iron-core coils. It is important that these coils have a very great number of turns for best operation, and, to reduce the bulk, they are commonly made of fine wire. Very close coupling between the coils is desirable, especially where air-core coils are used. It may sometimes be advantageous to use an air gap in the iron core to stabilize the system. As only a minute current is carried, the power lost in these transformers is usually negligible. It is very probable that some of the radio-frequency currents get over into the grid of the amplifier tube and are there further rectified. This, however, is not considered an objection. It is well to try the effect of an auxiliary condenser between the upper terminals of coils *f* and *g*, as it is sometimes possible to improve reception and amplification in this manner.

In some cases a *C* battery may be used on the amplifier tube, and when this is done it is connected between the filament and the grid in a manner similar to that previously illustrated and described for the detector alone. A *C* battery is seldom used on amplifier tubes, as only those whose characteristic curves fulfil the required conditions are selected for this use. When trying to pick up a station, the filament is usually burned at some high value of current, and when sharper tuning is being made the filament current may be

decreased. This procedure very frequently leads to an appreciable elimination of some of the interference from other stations.

The circuit of Fig. 6 is, in general, similar to the circuit of Fig. 5, but the transformer with primary coil *a* and secondary coil *b* has a tuned secondary circuit. A small condenser *c* across the secondary coil permits tuning this part of the circuit, with the result that the amplifier is more selective. With the tuned transformer, the

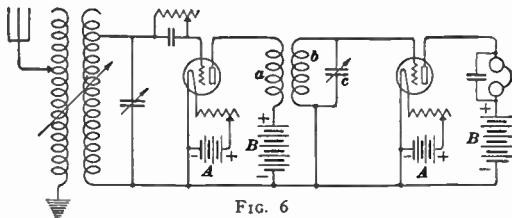

FIG. 6

ratio of turns is often one to one. In this case, as well as in all others where there are coils possessing inductance in the coupling circuits, it is well to use coils whose natural period is quite different from the frequency of the currents which are to be amplified.

INDUCTIVE COUPLING

Fig. 7 represents a detector tube *a* with two stages of audio-frequency amplification in tubes *b* and *c*. The inductive coupling between tubes *a* and *b* is through the coil *d* which is shunted by the condenser *e*. The condenser permits tuning the local circuit through the inductance *d* and condenser *e* to the frequency of the signal that it is desired to receive. The set may therefore be made very selective, and this property will be increased by using a large value of capacity and a small inductance. For broad tuning, the opposite is true; namely, the inductance should be large and the capacity

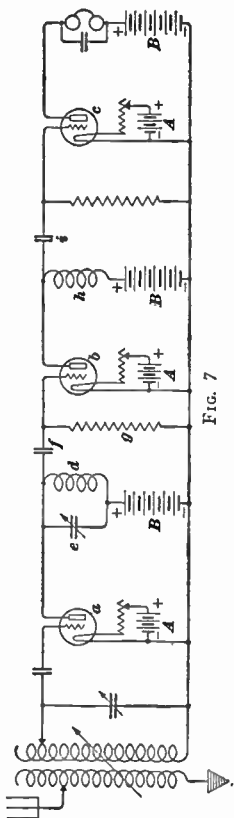

FIG. 7

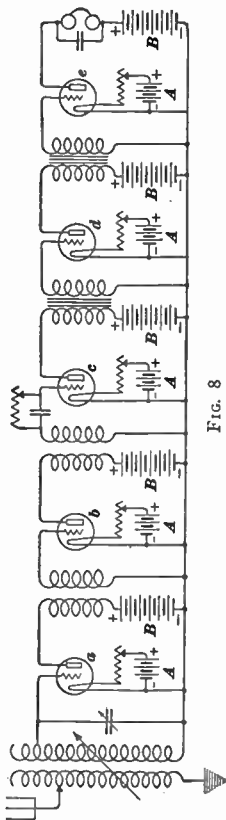

FIG. 8

small. The condenser f merely insulates the grid for a steady current and the resistance g permits any negative charge on the grid to leak off.

The coupling between tubes b and c is slightly different in that no condenser is used across the inductance h . It may be, however, that there is considerable capacity effect between the turns of wire of this coil, which will give virtually the same result as if a condenser were installed. This is undesirable, as then the set will amplify signals well on one frequency, but be a poor amplifier on other frequencies or wave-lengths. The grid condenser i acts as in the previous case. The coil h normally has an air core but if an iron-core coil is used, the condenser i must have a large capacity and will then assist the coupling. These methods of coupling give good series amplification and there also seems to be some series detector action.

RADIO- AND AUDIO-FREQUENCY AMPLIFICATION

AMPLIFIERS IN CASCADE CONNECTIONS

When a large degree of amplification is desired, the natural tendency is merely to connect more amplifiers in series, or in *cascade*, as it is called. This works very well for two stages of audio-frequency amplification, or for three stages of radio-frequency amplification. If more tubes are added to either method it will generally be found that the set tends to oscillate very easily, due to the interaction or feed-back between the output and input circuits. One expedient is shown in Fig. 8, where two stages of radio-frequency amplification are produced by tubes a and b , the signal is then rectified by the detector tube c to an audio frequency, which is further amplified in stages d and e . This gives excellent results, as there are not the reactions between the steps of audio- and radio-frequency stages of amplification that there are between several stages all operating at or near one frequency.

It is possible to use a common *A* battery for all of the tubes, but it is very desirable to use a separate control rheostat for each tube. It is not very good practice to connect all of the filaments in series, because of the different current taken by each for best operation. Only parallel connection of the filaments is recommended. The *B* batteries should be separate or individual for the most quiet operation. At least the *B* battery for the audio-frequency stages should be separate from those used on the radio-frequency stages. Also the *B* battery voltage should increase as the signal strength increases, or, in other words, the voltage of the *B* battery of tube *c* should be higher than the *B* battery voltage of the preceding tube *d*, and so on, down the line.

Much of the noise produced in amplifiers seems to be due to effects between adjacent tubes. If they are shielded by a sheet of tin, which is connected to ground or to the negative terminal of the *A* battery, much quieter operation should result. Also all of the connecting wires between the various stages should be as short as possible, and it is well to see that the coupling devices between the various stages do not react upon each other. Coupling transformers are shown in Fig. 8, but any of the standard types of coupling may be used, depending upon the use to which the set will be put.

An advantage in amplifying the signal, at least to some extent, before it is rectified, is the fact that, in general, detectors will operate better under that condition. The rectifying power of most detectors depends upon the square of the voltage, that is, the product of the voltage by itself. By amplifying the signal before passing it through the detector, its voltage is raised several times; the rectification is also much improved. A crystal detector has been very successfully operated as a rectifier of the current from a two-stage, radio-frequency amplifier and the current was further amplified at audio frequency. The circuit of Fig. 8 may be used to receive undamped-wave telegraph signals by connecting in circuit an interrupter or a beat-reception device.

As has been stated, it is very difficult to amplify radio-frequency currents through more than two or three stages without getting real noisy effects. This is particularly true on wave-lengths of 600 meters and less where the frequency is 500,000 cycles per second and over. One novel way of getting around this difficulty is to reduce the exceptionally high-frequency current to a lower frequency in some of the stages, say 50,000 cycles per second, which is further amplified and then rectified in the usual manner. Briefly stated, this is accomplished by causing a 50,000-cycle beat current by using a locally generated current and the heterodyne or autodyne method of combining it with the incoming signal. This 50,000-cycle beat current is then amplified and passed on, perhaps not as a pure sine wave of alternating current. After further amplification, this signal is sent through an ordinary detector set, if a damped wave or modulated type of undamped wave; or through a circuit interrupter and detector, if an undamped wave. Since the stages of the 50,000-cycle amplification and the detector unit always operate on one frequency, they may be made highly selective for maximum amplification, and their adjustment need not then be changed. The high-frequency current combined with the incoming signal might be produced by an electron-tube oscillator.

LARGE-CAPACITY AMPLIFIER

A special type of amplifier sometimes used is shown in Fig. 9. Tube *a* is connected in the usual manner while tube *b* is connected to be operative when tube *a* is not. The input or primary winding *c* supplies current to both coils *d* and *e* simultaneously. The connections of *d* and *e* with their tubes are such that when the upper terminal of *d* is positive, its grid is positive, and the upper terminal of coil *e* is likewise positive, but the terminal of coil *e* that is connected to the grid is negative at that instant. Thus while the grid of tube *a* is positive, that tube is delivering a large current through coil *f*, and the grid of tube *b* being negative,

that tube cannot deliver any current through its plate coil g . The current in f then induces a current in the output coil h which is proportional to the amplifying power of tube a .

As the current in coil c dies down, the plate currents of tubes a and b buck each other as each induces a current in coil h , that from coil f being in one direction, and that from coil g being in just the opposite direction. When there is no voltage induced in coils d and e , the plate currents exactly neutralize and there is no resulting

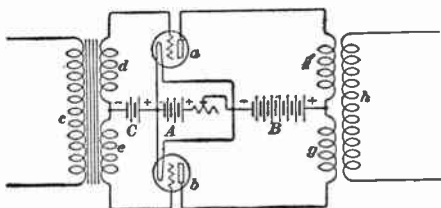

FIG. 9

current induced in coil h . It is important for proper operation that the two tubes be identical in all respects.

With the reversal of current in coil c , the voltages induced in coils d and e will be in directions opposite to their former ones, and the grid of tube b will become positive while the grid of tube a becomes negative. The positive potential on the grid of tube b will produce a large plate current in that tube, which current is also established through coil g . This change of current will induce a current in coil h opposite to the one induced by coil f . When the current in coil c reaches its maximum negative value, the current induced in coil h will be proportional to the full amplifying power of tube b . Thus the current variation produced in the output coil h is somewhat greater than the amplifying power of one tube, and exceptional clarity of speech reproduction is

secured. This type of connection seems to be most applicable to the output of loud-speaking receivers and to use in line-wire repeaters where it is desired to amplify the signals for further transmission along the line.

FILTERS

GENERAL USE OF FILTERS

Filters are used for eliminating currents of frequencies either higher or lower than some specified value. They consist, in general, of some electrical devices connected in the line which tend to prevent the passage of currents of the undesired frequency, but which do not offer much opposition to the passage of currents at the desired frequency. Other electrical devices are also included that will provide a path so these undesirable currents can easily return to their source. The principles of filters are often used in other electrical applications than radio work, such as in telephone lines where currents of interfering undesirable frequencies are blocked out of the telephone apparatus by filters of proper design.

MAIN TYPES OF FILTERS

As has been mentioned, condensers prevent the passage of a direct current, and offer much less opposition to the passage of an alternating current. This opposition is somewhat reduced the higher the frequency; that is, a condenser offers a little more opposition to a current of low frequency than it does to one of relatively higher frequency. If, then, several condensers are connected in a line as shown at *a, b, c, d, e, f,* and *g,* in Fig. 1, a low-frequency current will be blocked out to a considerable extent, while a high-frequency current can pass with much less opposition. Now that the low-frequency currents have been stopped they must be gotten rid of.

An inductance coil offers an opposition to the passage of an alternating current and this depends directly upon the frequency of the current. Thus, the opposition of a coil possessing inductance is many times greater to a high-frequency current than it is to one of relatively low frequency. Suppose there are two possible paths for a mixture of alternating currents to pass through, and that one is through condensers and the other is through inductance coils. The various currents, which as always are seeking the path of least resistance or opposition, will each select the path which they can get through the easiest. The high-frequency currents will naturally select the condenser route, while the low-

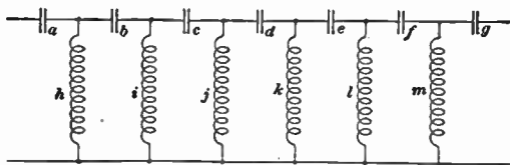

FIG. 1

frequency currents will take the path through the inductances.

If the inductance coils *h*, *i*, *j*, *k*, *l*, and *m*, Fig. 1, are connected across the line, the low-frequency currents which were temporarily held up by the condensers, can find an easy path across to the other line wire and thus complete the circuit back to the source of the currents. The high-frequency currents continue to pass on through the condensers and on into the desired apparatus, as that is still their easiest path. The action of this filter then depends upon a combination of effects that may be summed up as follows: A low-frequency current, which may be assumed at any instant to be coming in on the upper left line wire, will try to get through the condensers in that line, but due to their bucking effect and

at in farads, and f is the frequency above which frequencies will be greatly reduced, if not eliminated. The values of L and C to use may be calculated as in the preceding case. It is rather desirable to reduce the size of the inductance coil, particularly in this case, so it will be of small size with a fairly low resistance.

It may be well to review the fact that filters offer some opposition to currents of all frequencies. This is unavoidable, but by proper design currents of any specified frequency may be decreased in value much more than are the others. There is a gradual change between the frequencies of currents which are blocked out and those which are passed, but this change may be made more sharp to some extent by increasing the number of sections. It is not generally desirable to use more than six or seven sections, but too few sections should also not be used.

APPLICATION OF FILTERS

NECESSITY FOR FILTERS IN RADIO CIRCUITS

The types of filters which have just been described are particularly useful in telephone work. The principles, as explained, apply to radio circuits, and some illustrations of such circuits will be given. It is not very desirable to use several sections of filters directly in a receiving circuit, but modified arrangements of filters are often very useful.

Some kinds of static disturbances occur on several wave-lengths or frequencies at once. By filtering out currents at other frequencies than that of the desired signal, much of the annoying static effects may be overcome. This filter, if properly proportioned, can also eliminate many of the telegraph signals at other frequencies if they are not too strong. At any rate the filter can act to make the desired signals on any particular frequency relatively stronger than they were when received.

In small and medium-sized stations storage batteries are the most common source of filament current, although

some tubes are made with which dry cells give a good life when supplying the filament current. Dry cells or storage cells may be used in the plate circuit, depending somewhat on the amount of plate current required. The filament of an electron tube, especially tubes used in receiving, is so small that it will heat up and cool off appreciably with the current changes if heated by an alternating current. It is possible to receive signals by this method, but they will be accompanied by a very disagreeable humming noise which has a complex pitch related to the frequency of the alternating-current supply, unless special apparatus is used. It is often impossible to obtain the high direct-current potential required for the plate circuit, especially in transmitting sets, and a rectifier combined with a filter system provides an easy means for obtaining such a voltage from an alternating-current supply circuit. Very often the expense of a suitable filter system for this use is too high to justify its adoption. Even when suitable filament and plate voltage may be obtained from a direct-current source, it is often necessary to adopt a filter system in order to eliminate the hum which would otherwise be caused by the small pulsations of even a supposedly constant-voltage generator.

RECEIVING SET USING A TUNED FILTER

A type of filter that will cut out, to a very high degree, objectionable low- and high-frequency waves is shown diagrammatically in Fig. 3, in connection with a two-stage amplifier and a detector unit. The amplifier tubes *a* and *b* feed the current amplified at radio frequency into the usual detector tube *c*. Resistance couplings are shown at *d* and *e*. For convenience, only the filter action between tubes *a* and *b* will be given in detail, although it applies to both stages of amplification. A condenser *f* prevents the passage of direct current from the *B* battery of tube *a* through the circuit from *g* to *h*. Condenser *f* may be fairly large so as not to hinder the passage of the alternating currents of high frequencies.

strongly amplified, and the components of other frequencies only mildly present or even suppressed.

The usual grid condenser is shown at *k*, Fig. 3, with the grid leak *l*. A small resistance to give a negative voltage on the grid of tube *b* is shown at *m* and in the corresponding locations on the other tube circuits. This type of filter should not be used for separating high-frequency, damped-wave signals, as the tube is liable to oscillate with the natural frequency of the local circuit *j* and *i*, excited by the impulses of such signals.

If the condenser *j* and inductance coil *i*, Fig. 3, are replaced by a pure resistance, a type of filter is obtained

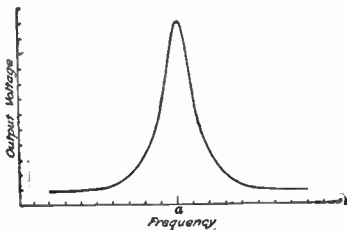

FIG. 4

that will eliminate all undesirable low frequencies. This filter can be used with damped as well as undamped waves, with the resistance connected between points *g* and *h*. It has proved satisfactory to make the total reactance of

the condensers *f* and *k* for the desired signal frequency about one-fifth of the resistance between *g* and *h*.

RECEIVING SET USING ALTERNATING-CURRENT SUPPLY

A complete three-element, electron-tube detector circuit using alternating current throughout is given in Fig. 5. The tube *a* acts as a detector while the two-element electron tubes *b* and *c* act as rectifiers to impress a high unidirectional voltage on the plate of tube *a*. The power supply is received on the primary coil *d* of the iron-core transformer, at probably 110 volts, although any lighting voltage may be used with a proper number of turns in

this coil. There are three secondary coils, each with such a number of turns that it has the desired voltage available at its terminals. Coil *e* delivers the current to heat the filament of the detector tube *a* which otherwise acts in the manner previously described. Coil *f* furnishes the filament current to the two two-element tubes *b* and *c*. The filaments of these tubes are in series.

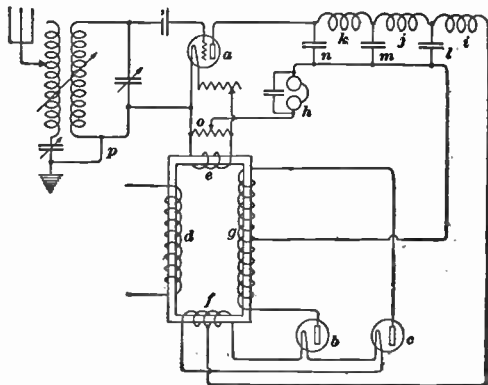

FIG. 5

Coil *g*, in two sections, impresses a voltage on the plates of the rectifier tubes *b* and *c*. These two tubes are connected so that their plates are alternately positive and negative. When the plate of either tube *b* or *c* is positive, there is a plate voltage established through that tube, which is impressed on the plate of tube *a* and a plate current through tube *a* is established. This rectified current is a pulsating direct current that may produce very disagreeable noises in the telephone receivers *h*. By using a filter system of several inductance coils *i*, *j*, and *k* in series in the plate circuit, and condensers *l*, *m*, and *n*

across that circuit, much of this disturbance will be eliminated or at least prevented from affecting the signal received in the telephone receivers.

It is necessary to connect a resistance o across the filament transformer winding e . This resistance with a slider acts as a potentiometer and the plate circuit is connected to the filament circuit at this point. Operation may be improved by connecting the grid lead to this slider also. The slider should be set at the electrical center of the resistance o . Were it not at the exact electrical center, the voltage of the plate would be unbalanced during alternate half-cycles. A lead may be taken from the mid-point of coil e to accomplish the same result. This is what was done in the case of coil f to reduce the unbalanced effect. If it is desired to use the alternating current to furnish the filament current only, the tubes b and c , coils f and g , and the filter system comprising i , j , k , l , m , and n may be entirely eliminated. It will be necessary to use a battery of some type to furnish the necessary plate potential, but there is apt to be a slight humming sound in the receivers. It is desirable to connect the set to ground through some connection such as p to safeguard the operator should something go wrong with the power supply circuit.

In a receiving set where radio-frequency and audio-frequency amplifications are used, large grid condensers and grid leaks are sometimes connected in the grid circuits of the radio-frequency amplifier tubes, while 9-volt C batteries are used in the audio-frequency stages. A crystal detector may be used between the radio- and audio-frequency stages.

Another method of receiving signals by operating the receiving set with alternating current is by the use of tubes which, besides the ordinary elements, have sleeves, or cylinders, over the filaments. The filament of such a tube is heated from a local alternating-current source, which indirectly heats the sleeve surrounding the filament. The emission of electrons from the sleeve is

fairly constant and with a suitable *B* battery, a constant current may be maintained in the plate circuit. The *B* battery may be eliminated by rectifying the alternating current by means of the filament and sleeve which act as the two electrodes of a two-element tube.

SENDING SET USING ALTERNATING-CURRENT SUPPLY

A complete circuit diagram for a radio-telephone sending set is shown in Fig. 6. The two-element tubes *a* and *b* act as rectifiers, one for each alternate pulsation of the supply current. The three-element electron tube *c* acts as a modulator, while another three-element tube *d* acts as an oscillator of undamped radio-frequency currents. The primary coils of the power-supply transformers are not shown. The three secondary coils *e*, *f*, and *g* could all be mounted on one iron core, using one primary coil, or they could be mounted with separate primaries. In any case the secondary coils must have a number of turns which will give the desired voltage at their terminals. It is generally preferable

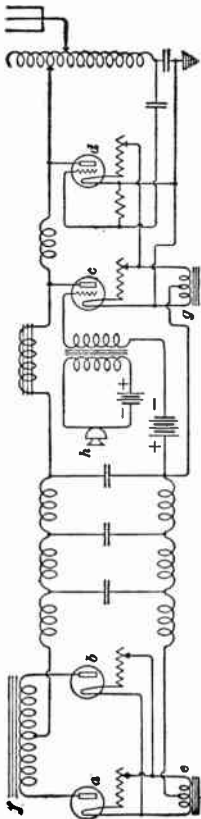

FIG. 6

to use a separate filament control rheostat for each of the tubes.

The coil *e* merely sends a current through the filaments of the two rectifier tubes *a* and *b*. The secondary coil *f* makes the plates of the rectifier tubes *a* and *b* alternately positive and negative. This plate voltage establishes a current through tubes *c* and *d*, first from tube *a* then from tube *b* and so on with alternations of the power-supply voltage.

The filter system consisting of the several condensers and inductance coil units smoothes out the rectified alternating current so that a fairly steady voltage is impressed on the plates of the modulator and oscillator tubes. The secondary winding *g* supplies heating currents to the filaments of the modulator and oscillator tubes. A telephone transmitter *h*, with its auxiliaries, acts in conjunction with the tube *c* to modulate the radio-frequency current generated by the oscillator tube *d*. This was explained in detail when considering this subject under a previous heading.

WAVEMETERS

PRINCIPLES AND USES

A wavemeter is a device for measuring the length of a current wave in a radio circuit. It may also be used to compare inductances and capacities, measure decrement, and for some other radio measurements. When equipped with a buzzer, the wavemeter may be used in accurate work as a generator of currents of known frequency. It primarily indicates frequency, but is commonly calibrated to read the wave-length of the oscillating current, or period, in meters (1 meter = 39.37 inches). A wavemeter might be calibrated to read the wave-length in feet or any other convenient unit.

A wavemeter consists essentially of a simple oscillatory circuit containing an inductance coil and a condenser in series with another device to indicate a current in the

circuit, or the voltage across some part of the circuit. To allow the period of the wavemeter to be changed, either the condenser or inductance coil is arranged so that its properties may be changed, or sometimes both are variable. For convenience and accuracy, the condenser is usually made variable, and a number of inductance coils of fixed values are provided. Each coil in connection with the variable condenser gives readings of wave-lengths over a limited range, and by interchanging coils of proper values, a large range of wave-lengths may be measured with a minimum of equipment.

TYPES OF WAVEMETERS

A simple wavemeter circuit is illustrated in Fig. 1 with the current-indicating device *a* connected in series with the inductance coil *b* and condenser *c*. The inductance coil consists of several turns of wire of low resistance and preferably of a stranded type to reduce this effect. The coil is coupled loosely with the circuit carrying the current under observation, and the condenser is varied until the current-indicating device gives a maximum deflection. When this condition obtains, the two circuits are in resonance, and the current in the wavemeter is limited only by the resistance of its local circuit. For

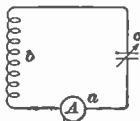

FIG. 1

this reason the resistance in the wavemeter circuit should be kept low, so that a large deflection of the current-indicating instrument may be secured. Under conditions of resonance the wave-length in meters is given by

$$\lambda = 1,885 \sqrt{LC}$$

where *L* is the inductance in microhenrys, and *C* is the capacity in microfarads.

With *L* and *C* in henrys and farads, respectively, the frequency *f* expressed in cycles per second is given by

$$f = \frac{1}{2\pi \sqrt{LC}}$$

To be useful, the values of L and C of the wavemeter must be known, or, what amounts to the same thing, its calibration curve must be known. A standard coil and condenser may be used and the natural wave-length calculated from the known values of inductance and capacity. The values of inductance and capacity may be determined by measurements, or may be calculated quite accurately from the physical dimensions of the inductance coil and condenser.

A suitable current-indicating device could be a small electric-light bulb, the kind used in flashlights being quite satisfactory. The light will glow at its maximum brightness when the tuned wave-length of the wavemeter circuit corresponds with that of the sending circuit, this condition indicating resonance between the two circuits. A very sensitive expansion type of ammeter connected in series in the wavemeter circuit, or a thermocouple with an ammeter as its current-indicating device, are in more common use than a lamp, particularly in case the current indications are weak or when very accurate measurements are to be made.

In the operation of this type of wavemeter, the inductance coil b , Fig. 1, is so placed that its turns of wire are close to an inductance coil in the circuit under test. Lines of force from the excited coil energize the wavemeter coil and establish a current therein. This current also passes through the condenser and current-indicating device and the capacity of the condenser is adjusted until the current is observed to be a maximum. A setting should finally be secured so that further turning of the condenser handle in either direction of rotation, so as to vary the capacity even slightly, will cause a *decrease* in the current. If no such position can be found, but instead, a considerable range of capacity adjustment gives a uniformly large current indication, the coupling between the inductance coil of the wavemeter and the inductance coil of the circuit under test should be decreased until one clearly defined maximum current reading is obtained.

When the received energy is very small, a circuit

arrangement as shown in Fig. 2 is usually preferred. The inductance coil *a* and the variable condenser *b* are connected in series, and the oscillating circuit thus formed offers a low resistance to the passage of the induced current. The condenser is shunted by a crystal detector *c* and telephone receivers *d* in series. Sounds are produced in the receivers by the rectifying action of the crystal detector in a manner similar to that which has been described in connection with receiving sets. Resonance between the circuit under measurement and the wavemeter is determined by the maximum strength of signal produced in the telephone receivers. By the use of telephone receivers, indications of very weak waves may be read accurately. A great advantage of this set is that

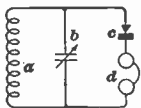

FIG. 2

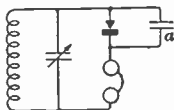

FIG. 3

it is very rugged, there being no sensitive current-measuring instruments to be injured by rough handling. This is one of the most common wavemeter circuits used in practice. As there is apt to be some capacity effect between the wires to the detector and telephone receivers, these connections should be made as short as possible. If there is an appreciable capacity effect here, the wavemeter should be calibrated with these devices connected.

The addition of a small fixed condenser shunting the crystal detector only has been found to give much stronger signals than otherwise would be obtained. Such a circuit is represented in Fig. 3, the addition of the condenser *a* being the only difference between Fig. 3 and Fig. 2. Fig. 3 represents about as sensitive a wavemeter connection as can be used. It should be understood that the crystal detector and telephone receivers in wavemeters can be used only when the exciting cur-

rent is a damped-wave, or modulated continuous-wave signal.

As the resistance of many current-indicating devices, which may be used, is often very high, it is occasionally desirable that they be removed from the oscillating circuit. Also if the current induced in the wavemeter circuit is large, it may be necessary to use a separate circuit for

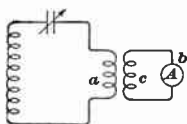

FIG. 4

the sensitive ammeter so that it may not be injured. This is accomplished, as indicated in Fig. 4. The primary winding *a* of a small oscillating transformer is connected in the tuned wavemeter circuit. The wavemeter should be calibrated with at least this coil in place, and preferably also with the secondary circuit, including the ammeter *b* and secondary winding *c*, in place.

The coupling between these two circuits should be as loose as possible consistent with the production of a good value of current in the secondary circuit. No particular advantage is gained by placing the combination of a crystal detector and telephone receivers in the secondary circuit in place of the sensitive ammeter. In fact, with such an arrangement the operation is apt to be poorer than when they are connected according to Fig. 2 or Fig. 3.

USES OF WAVEMETERS

MEASUREMENT OF CAPACITY

To measure the capacity of a condenser, it is convenient to combine the unknown capacity with a known inductance to form an oscillating circuit. This oscillating circuit is then excited by some source of electricity, and by coupling a wavemeter to this circuit, the natural period of the oscillating circuit may be obtained. Such a circuit combination is shown in Fig. 5, with the unknown condenser *a* in combination with the known inductance *b*

excited by the buzzer *c* and its auxiliary battery *d*. The wavemeter *e* is loosely coupled to the inductance *b*, and, while the buzzer is operating, the wavemeter may be set to resonance with the oscillating circuit. The capacity of condenser *a*, in microfarads, may then be obtained directly by the formula

$$C = \frac{\lambda^2}{3,553,000 L}$$

where λ is the wave-length, in meters, as ordinarily read by a wavemeter, and L is the known inductance, in microhenrys. This inductance may be a standard of inductance, or if it is unknown its inductance may be calculated from its dimensions and other characteristics.

MEASUREMENT OF INDUCTANCE

The inductance can best be measured by using a known capacity, and connecting the inductance coil and the condenser so as to form an oscillating circuit. This oscillating circuit may be excited by a buzzer circuit as indicated in Fig. 5. A wavemeter may be used to obtain the

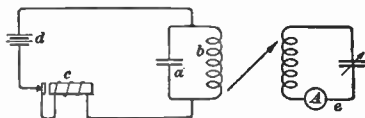

FIG. 5

natural period or wave-length of the oscillating circuit in meters. This wave-length λ , in meters, may then be used to obtain L in microhenrys, in the formula

$$L = \frac{\lambda^2}{3,553,000 C}$$

where C is the known capacity, in microfarads. The capacity should preferably be a known standard condenser, but its capacity may be closely calculated from its dimensions and other physical properties. If the coil has considerable capacity effect between adjacent turns of wire,

the value of inductance determined by the formula will not be so accurate, and a much more complicated measurement is necessary for extremely accurate work. The coupling between the oscillating circuit and the wavemeter should be kept loose so that the natural, or free, period of the oscillating circuit cannot be affected by the period of the wavemeter circuit.

MEASUREMENT OF NATURAL WAVE-LENGTH OF AN ANTENNA

In order to measure the natural wave-length of an antenna system without radiating a large amount of energy, a very simple arrangement, as shown in Fig. 6, may be used. A regular wavemeter circuit is excited by a small buzzer *a*, which in turn is operated by a battery *b*. A small push button *c*, or other type of switch, closes the buzzer circuit when so desired. Each current

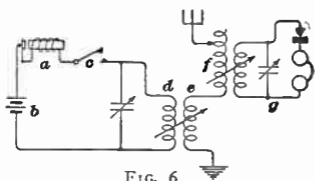

FIG. 6

impulse through the buzzer circuit establishes a high-frequency current in the oscillating circuit connected to the buzzer circuit, whose wave-length depends upon the values of inductance and capacity in the oscillating circuit.

By means of inductance coils, as *d* and *e*, this energy is transferred to the antenna and sets up a wave therein. If the inducing wave is near the antenna's natural period, and the coupling is not too close, the length of the wave set up in the antenna will depend upon the inductance and capacity of the antenna. In case the natural wave-length of the antenna is desired, the inductance of coil *e* should be small so as not to change the characteristics of the antenna circuit when it is removed after completion of the testing. Coil *d* may be coupled directly to the antenna inductance *f*, instead of using an extra coil *e*

with the consequent liability of changing the natural wave-length of the antenna.

If a wavemeter g is coupled to coil f , the length of the wave that is established in the antenna may be determined. To be certain that the wave-length measured is that of the antenna, care should be taken that the wavemeter is coupled only with coil f , and that it is as far from coil d as possible.

MEASUREMENT OF DECREMENT OF THE RADIATED WAVE

As has been explained, the amplitudes of the succeeding cycles of current in a damped wave gradually diminish as the energy is used up, as, for example, by resistance in the circuit. In any separately-excited oscillatory circuit there is some resistance and inductance so that any current that may be established in that circuit gradually dies down. The greater the resistance and the smaller the inductance, the greater is the damping of the oscillating current, and the faster the oscillations decrease. The relation between the amplitudes of the succeeding waves in a train is such that the ratio of the maximum value of the amplitude of any wave to the value of the amplitude of the following wave is a constant. For convenience in mathematical theory, the decrease is expressed by the natural logarithmic relation between successive maximum values. The number obtained in this manner is known as the *logarithmic decrement*. This is usually called merely the *decrement*, and the decrement may, for all practical purposes, be considered as a number indicating, or bearing a relation to, the rate of decrease of a wave train. The decrement of a circuit is also spoken of, but this merely refers to the damping effect which that circuit tends to produce on an oscillatory current established in that circuit.

The *reactance-variation* method for obtaining the decrement is very simple, and may be performed by using an ordinary wavemeter, and making a short calculation. In the first place, the wavemeter for this use should have

for a current-indicating instrument one that gives indications and readings proportional to the square of the current. The ammeters generally supplied with good commercial wavemeters are of this type. The simple wavemeter circuit of Fig. 1 is preferable in this measurement. Only enough coupling to a coil of one or two turns in the antenna circuit should be made to give a fairly large deflection on the ammeter when the wavemeter is in resonance with the radiated wave. This will give a maximum point as indicated at *a* in Fig. 7. In any practical case the ammeter reading and the condenser setting, in degrees or other convenient uniform divisions, are made and plotted as one

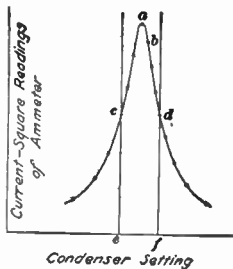

FIG. 7

point of what might be called a resonance curve. The condenser setting is then changed a small amount, say increased, and the new smaller ammeter reading is plotted against this condenser setting to give another point such as *b*. This is done for several points, the ammeter reading being plotted against the condenser setting each time until the curve has become almost horizontal. The condenser setting is then moved to position *a* and several points are taken in the opposite direction, each ammeter reading being plotted against the corresponding condenser setting. A curve is then drawn through these various points, and should have the general appearance of the curve previously referred to.

The decrement of the radiated wave may be calculated directly from this curve. The formula to use is

$$\delta' = \pi \left(\frac{C_2 - C_1}{C_2 + C_1} \right) - \delta$$

where δ' is the desired decrement, δ is the decrement of the wavemeter, and the value of C_1 and C_2 are par-

ticular condenser settings from the resonance curve. In practice, especially in damped-wave work, the wavemeter decrement is usually negligible, and the last term in the above formula may be dropped, as is done in the following explanation. The values of C_1 and C_2 are the condenser settings at c and d , Fig. 7, on either side of resonance at which the ammeter reading is exactly one-half its maximum value at resonance, C_1 being the value below resonance and C_2 the value above resonance. These values are then substituted in the formula which will give the decrement of the radiated wave. The value π in the formula is the usual one of 3.1416.

The preceding explanation may be illustrated by an example. Suppose the maximum current, at a on the resonance curve of Fig. 7, was 8 units, then each of the one-half values would come at 4 units, as at c and d . Vertical lines are drawn through these two lines so as to cut the condenser-setting scale at corresponding points, namely, e and f . These two points are the desired values of C_1 and C_2 , respectively. Suppose these values had been 4.0 and 4.4, respectively, then using them in the formula would give

$$\begin{aligned} \delta' &= \pi \left(\frac{C_2 - C_1}{C_2 + C_1} \right) = 3.1416 \left(\frac{4.4 - 4.0}{4.4 + 4.0} \right) \\ &= 3.1416 \left(\frac{.4}{8.4} \right) \\ &= .15 \end{aligned}$$

This value is well below the United States Government regulation which specifies that decrements greater than .2 shall not be used, on account of the interference caused to other stations. A low decrement also indicates that the set is properly adjusted and operating at its best.

If the condenser is of the usual type, that is, has semi-circular plates, the capacity is proportional to the scale reading in degrees except near the extreme lower values, and the scale reading at the one-half maximum current points may be used in the preceding formula without the actual condenser capacity being known. It is very

important that the distance of the wavemeter from the part of the circuit to which it is coupled should not be changed during the test, else the results will not be so accurate.

An instrument based upon the principles just described for measuring the decrement is known as the *decrementer*. One common type is really a modified form of wavemeter and is so calibrated that by making a setting at the point of one-half maximum current *below* the point of resonance, the decrement may be read directly from the scale when the pointer is moved to the setting for one-half maximum current *above* the point of resonance. No calculations are required, and its operation is very simple, and reliable.

There are several other methods of obtaining the decrement, most of them involving a more complex method. Since the decrement is a damping of the current caused by the electrical properties of the circuit, it is possible to calculate the decrement from these properties. One of the best formulas for calculating the decrement is

$$\delta = 3.1416 R \sqrt{\frac{C}{L}}$$

where R is the resistance in ohms, C is the capacity in microfarads, and L is the inductance in microhenrys.

TUNING A SET WITH A WAVEMETER

Resonance curves, as obtained by a wavemeter, of the energy in the antenna of a damped-wave transmitting set are particularly useful in showing that the various circuits are properly tuned and that they are coupled together by the best amounts. Here as elsewhere, the wavemeter should be coupled only close enough so that a good deflection of the ammeter may be secured. Also the position of the wavemeter should not be altered while taking readings for a given coupling. The ammeter need not be of the current-square type; any sensitive ammeter on which reliable readings can be taken will answer.

Suppose a curve with two peaks, such as a and b in

Fig. 8, is obtained by taking simultaneous readings of the indications of the ammeter and of the condenser setting. The readings of the condenser settings are used in this case as of wave-lengths instead of as capacity values, as some points can be more clearly explained by this means. The double-peaked wave indicates that one or both of two things are the trouble. It tends to show that the coupling is too close between the circuit in which

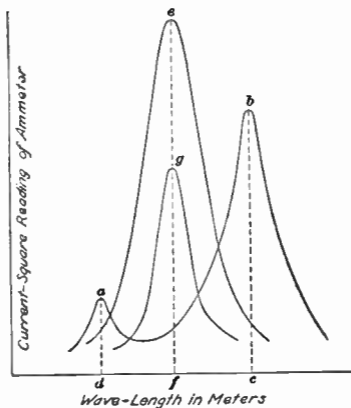

FIG. 8

the radio-frequency oscillations are induced and the antenna circuit, and that these two circuits are not in resonance with each other. The larger peak in any resonance curve generally refers to the circuit to which the wavemeter is coupled. In this case peak *b* shows that the antenna is tuned to the wave-length *c*, while the local oscillating circuit is apparently tuned to the shorter wave-length *d*. Much of the energy is radiated at the wave-length *c*, but there is also a considerable amount

radiated at the wave-length d . If it is desired to communicate with any particular receiving set, it should be tuned to the wave-length c for maximum signals. All of the energy radiated at the wave-length d is then wasted, and moreover produces considerable interference to other stations trying to communicate on wave-length d .

It should be noted that there is some energy radiated at all wave-lengths between c and d , as indicated by the fact that the resonance curve between these points does not come to zero. Also for a band of a few meters on each side of these two wave-lengths there is considerable energy radiated. There is thus a very wide band of wave-lengths over which other stations would have difficulty in communicating, because of the interference from this one station.

A curve with one sharply defined maximum, as e , indicates that the local oscillating and the antenna circuits are in resonance, and that they are coupled properly to give a maximum amount of energy radiation on the wave-length f . In any actual set, it might be well to try slightly smaller and larger amounts of coupling to see that the maximum possible current is being transferred to the antenna circuit. This single maximum resonance curve might be obtained from the previous condition of poor tuning by changing the wave-length of both the local oscillating and antenna circuits to the value f and correcting the coupling to give a maximum energy transfer. It should be noted that the maximum e of the single-peaked curve is higher above the reference axis than either of the maximum points on the double-peaked curve, indicating that more energy is actually radiated when the set is properly tuned. This is an important advantage of using proper tuning and coupling in the sending set, besides the advantage that it reduces the interference to other stations.

The resonance curve does not come to zero right next to the wave-length f , but the radiated energy, even with most careful tuning and coupling, covers a small band of wave-lengths. The width of this band depends upon many

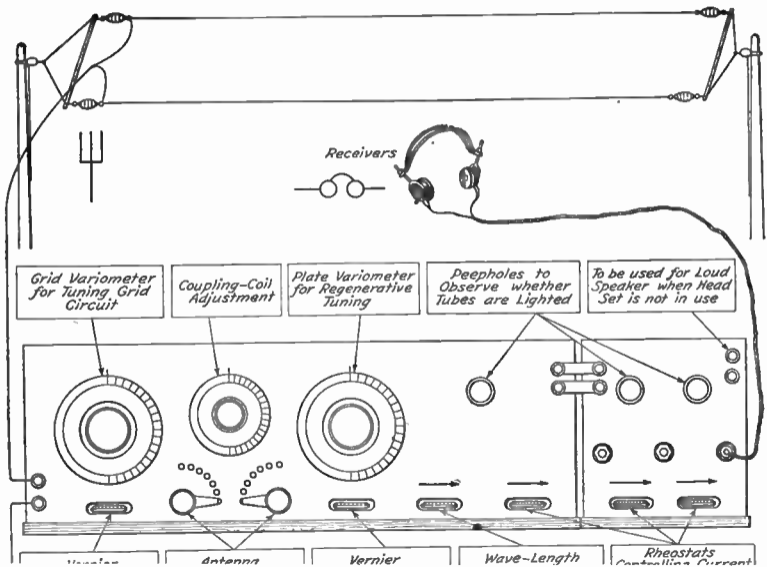

Receivers

Grid Variometer
for Tuning Grid
Circuit

Coupling-Coil
Adjustment

Plate Variometer
for Regenerative
Tuning

Peepholes to
Observe whether
Tubes are Lighted

To be used for Loud
Speaker when Head
Set is not in use

Vacuum

Antenna

Vernier

Wave-Length

Rheostats
Controlling Current

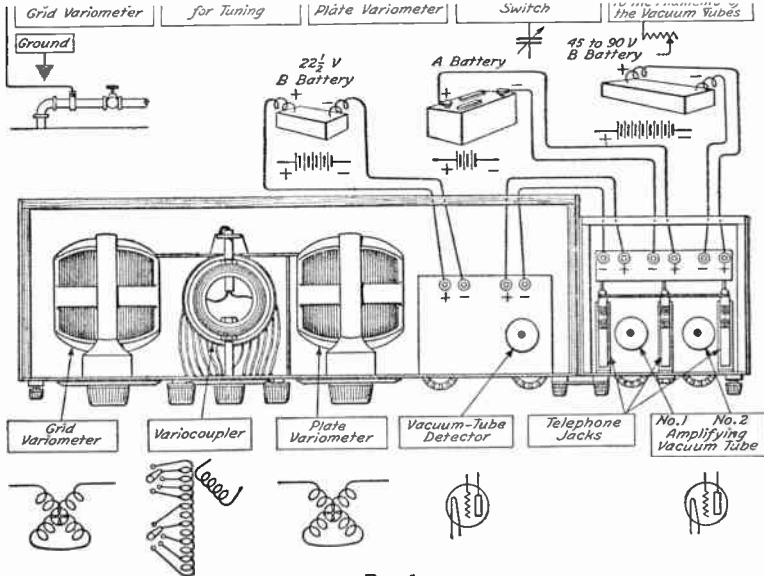
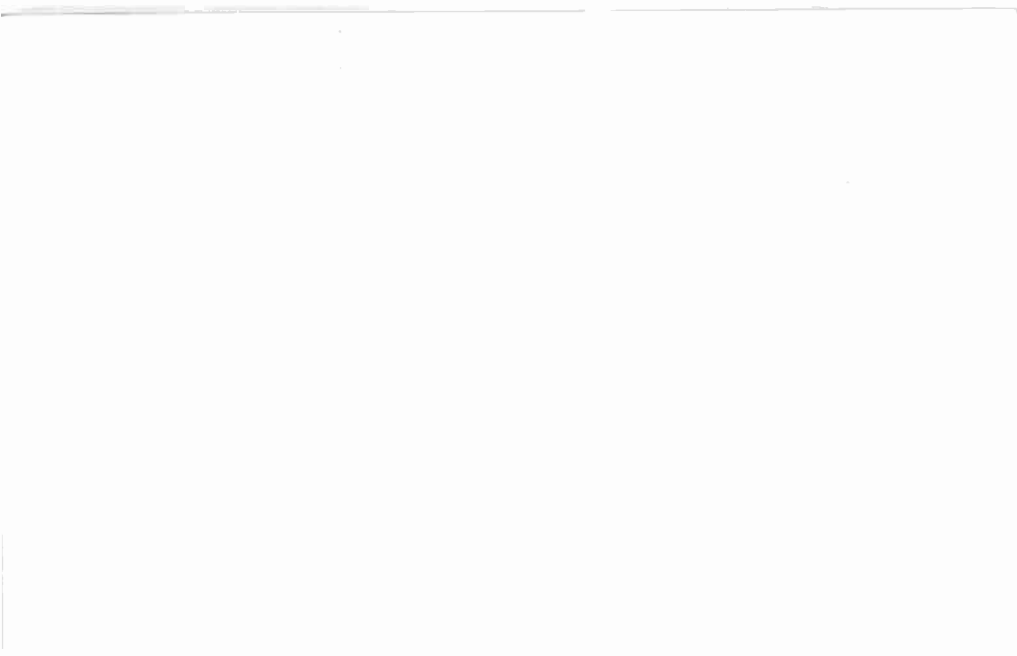

FIG. 1



features of the design, arrangement, and adjustment of the sending set. Any other stations that desire to communicate in this locality should use a wave-length at least far enough from f so that they do not pick up considerable interference from the wave-length band of this station. The wave-length band required by an undamped-wave station is, in general, very narrow, and two or even more stations can successfully operate on the wave-length band ordinarily required by a damped-wave spark set.

A curve of relatively small maximum value, as g , obtained on the same sending set, indicates that the coupling is very loose between the antenna and the local oscillating circuit in which the radio-frequency currents are generated. The width of the wave-length band is small, and interference to other stations is consequently reduced. For communication over short distances, it is desirable for powerful sending stations to reduce their coupling so that a great deal of useless energy shall not be radiated. Such loose coupling is not desirable in long-distance work, as the radiated energy, and consequently the range, is only a part of its possible value.

COMMERCIAL RECEIVING SETS

GREBE SHORT-WAVE REGENERATIVE RECEIVER

The Grebe short-wave regenerative receiver, which is illustrated in Fig. 1, is designated by the manufacturer as type CR-8, while the amplifier unit is known as the RORK unit. This circuit is also put up in other mountings, and its operation is then practically the same as will be given here. In Fig. 1 the various parts are labeled.

In Fig. 2 is shown a wiring diagram for the set shown in Fig. 1. The terminal a , Fig. 2, connects with the antenna lead-in, while the ground terminal b connects with the ground lead. The grid variometer c is used to change

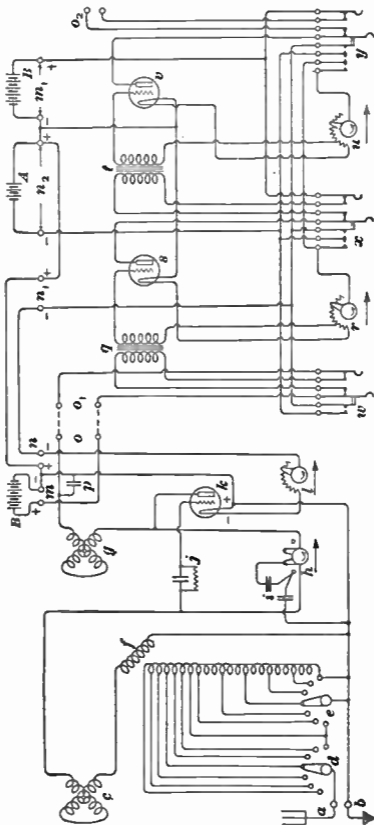

FIG. 2

the inductance in the grid circuit, so this circuit may be tuned to the incoming wave. Just below each variometer dial, Fig. 1, on the front of the panel is a vernier attachment by which fine adjustments of the variometer inductance may be made for accurate wave-length settings. The switches *d* and *e*, Fig. 2, control the amount of primary inductance which is actually connected in the antenna circuit. When the proper inductance is obtained, the antenna is tuned to the wave-length of the desired signal. As the set is actually constructed, there are 2 turns of wire between each of the 7 contact points of switch *d*, and 10 between each of the 7 contact points of switch *e*. The secondary coil *f* is mounted at one end of the primary coil and the amount of coupling between these two coils depends upon the angle through which coil *f* is turned with respect to the primary. The scale on the dial of this part, Fig. 1, is calibrated to read from 0 with minimum coupling, to 50 with maximum coupling. The plate variometer *g*, Fig. 2, permits tuning of the plate circuit to resonance with the grid circuit for the regenerative condition. A vernier beneath the dial of this device, Fig. 1, affords fine adjustments of the plate-circuit inductance. A wave-length adjustment switch, Fig. 1, and *h*, Fig. 2, connects the condensers *i*, so as to increase the wave-length of the set when rotated to the right. The grid condenser and grid leak *j* are shown only in Fig. 2, as they are mounted in the lower part of the set. The three-element electron tube *k* acts as a detector. The filament current of the detector tube is controlled by the filament rheostat *l*. On the panel, Fig. 1, an arrow is shown indicating the direction in which the switch knob should be moved to increase the filament current. The plate-battery terminals *m*, Fig. 2, are for connection to a 22½-volt *B* battery. The filament-battery terminals *n* are for the connection of a battery to light the filament of the detector tube. The two terminals *o* are for the connection of the telephone receivers, or, as in this case, to the terminals *o*₁ of an amplifier set. A small condenser *p* acts as a telephone condenser, and as a by-pass around the

plate battery and telephone receivers for the feed-back current.

When the two-stage amplifier is used, the terminals o of the receiver are connected to the input terminals o_1 . The terminals n may be connected directly to a battery, or else to the external battery terminals n_1 , which are provided for this purpose. The terminals n_1 are wired to the filament-battery terminals n_2 , that are connected to the proper A battery, generally of the 6-volt type. A 45- to 90-volt B battery is connected to the terminals m_1 to give a high plate potential to the amplifier tubes. If desired, taps may be taken off this battery at the 22½-volt point to get the proper potential for connection to m .

The audio-frequency transformer q and the filament rheostat r operate the first amplifier tube s . Another similar transformer t and rheostat u control the second amplifier tube v . The transformers are mounted under the battery-terminal board, so are not visible. The three jacks, w , x , and y are connected so that they automatically make proper circuit connections for receiving on any stage with the insertion of a telephone receiver plug, and open the filament circuits of any tubes that are not in use. Briefly stated, the insertion of the telephone plug connects the receiving apparatus to the left of that plug and jack, and open-circuits that to the right to prevent losses. For example, when a telephone receiver plug is inserted into the jack x , the filament of the first amplifier tube s is lighted, and the telephone receivers are connected in the plate circuit of tube s , instead of the transformer t . The filament of tube v is not lighted by inserting the plug in jack x . Inserting the telephone receiver plug in jack y connects in both stages of amplification in full. If it is desired to use a loud speaker it is necessary to insert a telephone plug into the jack y just far enough to close the filament contacts, and connect the loud speaker to the terminals at o_2 .

After making the connections indicated in the figure to the auxiliary apparatus and devices, it is always well to check the battery leads to see that they are connected

to the proper terminals and that the polarities are not reversed. The tubes should not be inserted until the rheostats *l*, *r*, and *u* are all turned so as to open their respective circuits. These rheostats are then turned until the tubes receive their normal filament current, which on most tubes corresponds with a setting marked on the rheostat.

To tune the receiver to a given wave-length, the antenna inductance switches *d* and *e* and the grid variometer *c* must all be adjusted to that wave-length, and the wave-length switch arrangement *h* must be set in the position indicating the upper limit of the wave-length band in use. On the panel of the set, Fig. 1, numbers representing the number of turns in the antenna circuit are usually placed opposite the contacts of the antenna inductance switches, indicated by *d* and *e*, Fig. 2. Divide the wave-length desired by 14 to find the approximate number of turns to use in the antenna inductance. The proper setting of the grid variometer *c*, Fig. 2, for a given wave-length may be found by referring to a chart furnished with the set giving the setting of the dial for various wave-lengths. The plate variometer *g* controls the regenerative action, and its best setting for spark signals is determined by advancing the dial until the signal is of maximum strength but without distortion. For continuous- or undamped-wave signals, the dial must be advanced still farther, that is, until oscillations occur, a condition easily recognized by a soft hissing sound in the telephone receivers. The coupler should be set so that the dial reading is 50 for rough, or preliminary, tuning, and finally varied to tune out interfering signals. As many signals are not audible until the regenerative action takes place, it is advisable to adjust the grid and plate variometers simultaneously until good signals are heard, and make final adjustment of the antenna inductance for maximum signal strength, that is, until the oscillations are stopped. A final adjustment may be made by using the vernier adjustment on the grid variometer, and by correcting the coupling by tuning coil *f*.

If the exact wave-length is not known, tuning should be started by setting the coupler dial at 50. Make an approximate adjustment of the antenna inductance switches *d* and *e* to a wave-length slightly higher than is expected. Using both hands, simultaneously rotate the grid and plate variometers over their entire ranges, and with such a ratio as to keep these circuits on the verge of oscillating. When the desired signal has been located, rotate the coupler dial toward the zero setting until the signal is barely audible and readjust the antenna inductance until oscillations cease. It is desirable to make a final adjustment of the coupler coil.

The telephone plug may be inserted in any of the jacks that will give sufficiently loud signals. If adjustment of the plate variometer in this set fails to produce regeneration, adjust the filament current or the plate voltage, or both. If adjustment of the plate variometer produces regeneration but no appreciable increase in signal strength, readjust the antenna inductance, or coupling, or both, if need be. Trouble may most often be caused by faulty connections, poor contact between the tube and the contact springs, defective or run-down batteries, or defective electron tubes. Many of the noises caused by these faults persist after the antenna is disconnected, and may be eliminated by tightening and checking binding posts and connections, cleaning the contacts with sandpaper, or replacing defective batteries or tubes.

WESTINGHOUSE REGENERATIVE RECEIVER AND AMPLIFIER

The Westinghouse tuner, type RA, and an electron-tube detector and two-stage amplifier unit, type DA, are illustrated in Figs. 3 and 4. The tuner unit, when used alone or with the DA unit, employs the single-circuit principle, that is, there is one coil which acts as both primary and secondary tuning coil. All connections, except for the telephone receivers, are made on the back of the units.



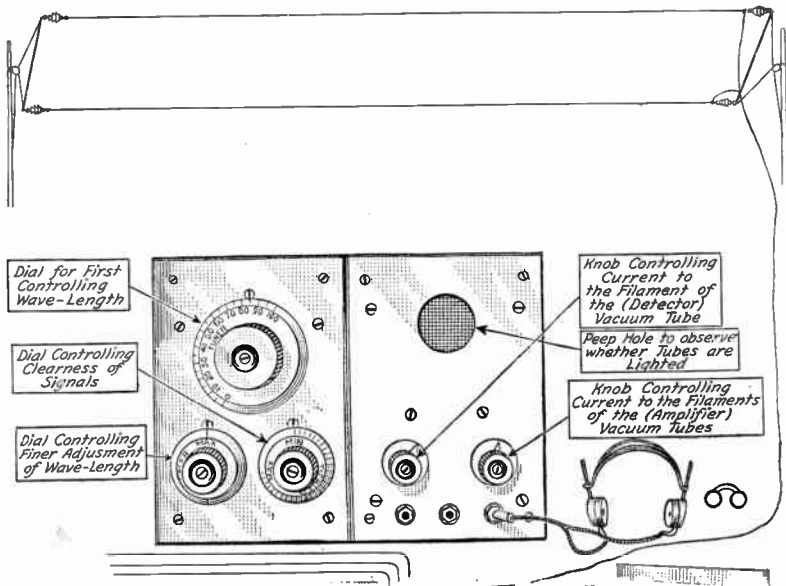

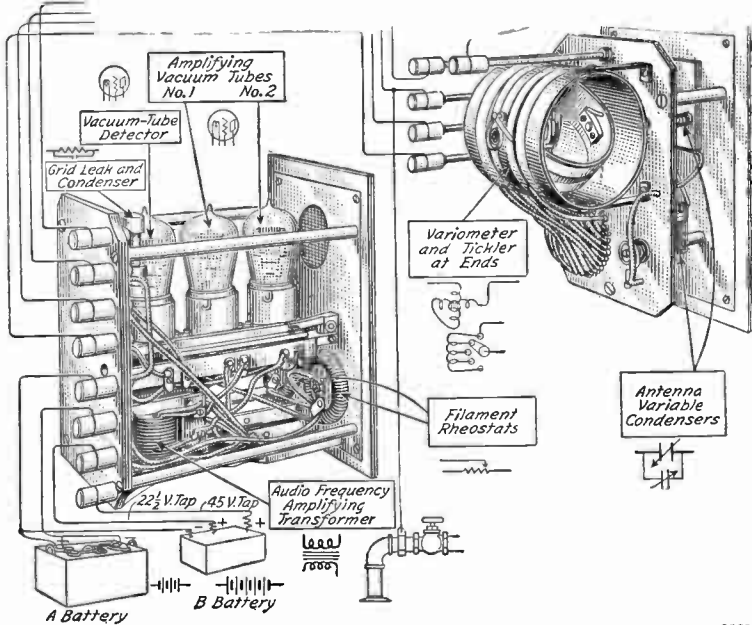

FIG. 3

1. The first part of the document discusses the importance of maintaining accurate records of all transactions and activities. It emphasizes the need for transparency and accountability in financial reporting.

2. The second part of the document outlines the various methods and techniques used to collect and analyze data. It highlights the importance of using reliable sources and ensuring the accuracy of the information gathered.

3. The third part of the document focuses on the interpretation and analysis of the collected data. It discusses the various statistical and analytical tools used to identify trends and patterns in the data.

4. The fourth part of the document discusses the implications of the findings and the potential impact of the research. It highlights the need for further research and the importance of sharing the results with the relevant stakeholders.

5. The fifth part of the document provides a conclusion and summarizes the key findings of the study. It emphasizes the importance of ongoing monitoring and evaluation to ensure the continued relevance and effectiveness of the research.

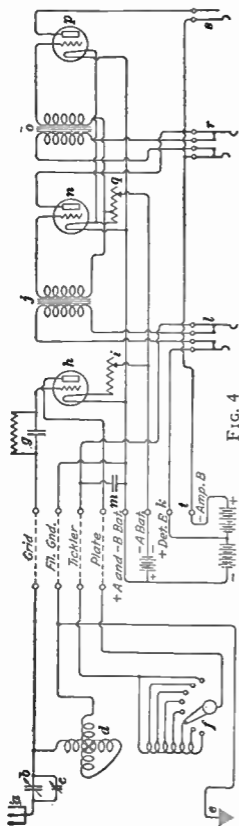

FIG. 4

The antenna terminal *a*, Fig. 4, also connects to a variable condenser *b* which is mounted on the tuner shaft, and turns with that dial. A small vernier condenser *c* is connected around the larger condenser *b* and permits of fine tuning to the desired signals. A variometer *d* is mounted on the back end of the tuner shaft. The condenser and variometer are mounted so that their capacity and inductance, respectively, are increased simultaneously and are a maximum with the dial setting at 100, its highest reading. These properties are reduced on the lower dial settings. Variometer *d* is the one which acts as an autotransformer to transfer energy from the antenna circuit to the receiver circuit proper. The ground connection is made at *e*, and the metallic shield on the back of the panel, which prevents disturbance from outside capacity effects, is also grounded at the same point.

The tickler coil *f* in the set consists of turns of wire wound quite close to some of the tuning inductance, and performs its regenerative ac-

tion by feeding back some of the plate-circuit energy into the input circuit. The amount of energy fed back into the input circuit is varied by changing the number of turns of this coil which carry current by a switch arrangement. The connections between the units are made as indicated by the dotted lines, and the terminals are represented in the same relative positions as they occupy when the panel is looked at from the front of the set

The grid leak and grid condenser *g* help the detector tube *h* to perform its rectifying action. The filament rheostat *i* controls the filament current of the detector tube *h*. The plate circuit of the detector tube includes the tickler coil and also the primary of the transformer *j* and a 22½-volt *B* battery whose positive terminal is connected at *k*, and its negative terminal connects to the filament circuit. A jack *l* permits the connection of the telephone receivers in the plate circuit of the detector tube in place of the primary of *j*. A condenser *m* forms a high-frequency shunt for the feed-back current around the *B* battery and the primary of *j* or the telephone receivers if they are connected in place of *j*. The first amplifier tube *n* is connected to the transformer *o* so as to feed its amplified energy into the second amplifier tube *p*. A common rheostat *q* controls the current to both of the amplifier tubes in parallel. Telephone receivers may be plugged into the plate circuit of the first amplifier tube at jack *r*, which operation automatically disconnects the primary of the transformer *o*. Telephone receivers may be connected in the plate circuit of the second amplifier tube by plugging into jack *s*. The negative terminal of the 45- to 90-volt *B* battery for the amplifier tubes connects to the filament circuit, while the positive terminal connects to terminal *t*.

Tuning should be done by moving the tuner dial over its full range of values while listening in. The dial should be moved very slowly so as not to pass over any signals coming in on a sharp wave-length. In this, as in other regenerative sets, the presence of a continuous-wave signal,

or message, is indicated by a sharp whistling sound as the wave-length position is passed over. When such a position is located, the dial should be returned to that point, and fine tuning made for the signal by varying the vernier condenser. Preliminary tuning of some stations seems to be easier with the tickler on its zero position, while others are more easily picked up with higher settings of the dial. After the signal has been picked up, different settings of the tickler should be tried, making a readjustment of the vernier condenser each time.

The tuner unit, type RA, may be used with a crystal detector and telephone receivers connected across the terminals marked *Grid* and *Fil.* The antenna and ground connections are made to the terminals so labeled. The set then operates as a crystal detector set, and only the tuner dial and vernier condenser affect the tuning. The tickler coil is not used when the set is used with a crystal detector.

Where still greater selectivity is desired, another unit may be added to make a two-circuit arrangement. This unit has a variometer and condenser similar in design and tuning to those in the RA unit. There is an antenna terminal and a ground terminal, and only one tuning dial on this unit, which is placed next to the RA unit, and on its left. The antenna and ground terminals on the RA unit are connected together through a condenser, and both units are tuned nearly simultaneously. After tuning is accomplished, the coupling may be reduced by moving the antenna-circuit tuning unit away from the RA unit as far as consistent with the reception of good signals.

RADIOLA SR. RECEIVER

The Radiola Sr. receiving set, shown in Fig. 5, is designed to use a WD-11 three-element electron tube as the detector element. Current obtained from a single No. 6 dry cell will heat the filament of this tube sufficiently, with a reasonable life for both the tube and the dry cell. The main receiving circuit is a special form of the single

circuit, arranged so as to require a minimum number of adjustments. It is adapted for receiving on the shorter wave-lengths only.

The circuit arrangement of the Radiola Sr. receiver is shown in Fig. 6. Corresponding devices and terminals

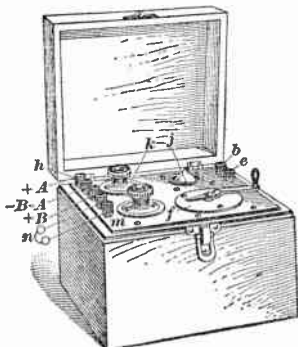

FIG. 5

are lettered similarly in Figs. 5 and 6 so that reference may easily be made to either figure when reading the explanation. The antenna *a* is connected to terminal *b* for receiving on wave-lengths from 350 to 500 meters. This lead has a condenser *c*, which is larger than the condenser *d* connected in the lead from *e*. The antenna is connected to terminal *e* for the reception of signals on wave-lengths below 350 meters. The antenna circuit includes the variometer *f* and fixed inductance coil *g* as well as the ground connection at *h*. The antenna inductance is varied by turning the variometer *f*, which is done by moving a tuning handle on top of the case, Fig. 5. The usual grid condenser and grid leak *i*, Fig. 6, are connected in the grid circuit of the tube *j*. The filament current is controlled by a rheostat *k*, and the single dry cell is shown at *l*. The connections of the *A* battery in an actual set are indicated by *-A* and *+A*, Fig. 5. The plate variometer *m* is coupled to the input coil *g* for the regenerative feed-back of energy. This variometer has a dial on top of the panel called the tickler. The telephone receivers *n* and the *B* battery are shunted by the small fixed condenser *o*, Fig. 6, to provide a complete path in

the plate circuit for the regenerative radio-frequency currents.

Tuning should be done with the antenna connected to the terminal corresponding with the wave-length over which signals are expected. The filament of the tube should be just sufficiently heated, as burning it too brightly reduces its life materially. With the tickler *m*, Fig. 5, set on its zero position move the tuning handle *f* slowly over its range of values. Adjust it to best position then in-

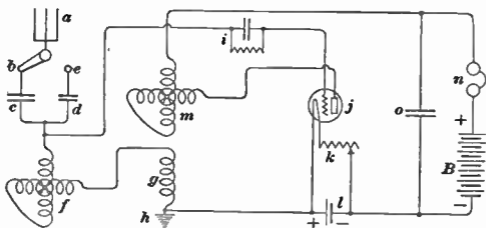

FIG. 6

crease tickler until maximum strength of undistorted signal is obtained. If the tickler is increased too much, telephone signals will lose their natural tone qualities.

FEDERAL JR. CRYSTAL RECEIVER

The Federal Jr. crystal receiver shown in Fig. 7 is a very simple type of receiver unit. As the name implies, it uses a crystal detector to perform its rectifying action, and gives good results over comparatively short distances. There are no batteries to maintain, and the tuning to desired signals is very easy. The set is of rugged construction, and should last indefinitely with reasonable care.

The ground connection is made to the terminal marked No. 1 on the top of the panel, Fig. 7. The antenna

lead-in *a* is connected to either terminal No. 2 or No. 3 as marked on the panel, depending upon the natural wave-

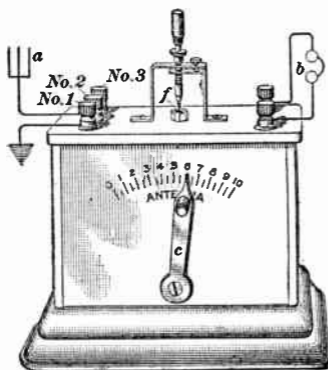

FIG. 7

length of the antenna and the wave-length to be received. For broadcast and other short-wave reception, connection should be made to terminal No. 2, although with some types and sizes of antennas the connection to binding post No. 3 will give stronger signals. In general, terminal No. 3 is only used for long-wave ship and commercial stations, although these stations may be received on No. 2 if the antenna is long and low. The telephone receivers *b*, Figs. 7 and 8, are connected to the two terminals provided for that purpose at the end of the case opposite the antenna and ground connections. When the antenna is connected to terminal No. 3, a direct connection is made to the slider *c*, Fig. 8, on the tuner coil *d*. The position of the slider is controlled by a pointer and handle mounted on one side of the case as shown at *c*, Fig. 7. A similar pointer and handle mounted on the opposite side of the case

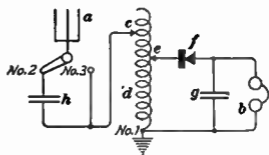

FIG. 8

moves another slider *c*, Fig. 8, which presses on the same tuner coil *d*. Slider *e* is connected with the crystal detector *f*, which then connects with the telephone receivers *b* and a telephone shunt condenser *g*. Terminal No. 2 connects with the slider *c* through a condenser *h*, which makes this connection more suitable for short-wave work.

For first trial in tuning the set, the antenna wire may be connected to the binding post No. 3, and the detector control lever or pointer should be set at about the middle of its scale. The crystal detector is then adjusted by bringing the fine wire point into light contact with the crystal itself. The antenna control or pointer is then moved over its range of values until signals are heard. Further adjustment is then made of the crystal detector setting, and of the detector and antenna controls. If the signals are those of a short wave-length station, the antenna connection should be changed to terminal No. 2 and the antenna and detector controls carefully readjusted. For fine tuning and to reduce interference from other stations, the detector control should be moved down its scale a short distance and the antenna control readjusted to bring in the desired signal. This procedure may be carried through several steps until either the interfering signal is eliminated or until the desired signal strength is seriously reduced. The set will keep in tune with the station indefinitely, but the crystal detector may need occasional resetting.

THE ARMSTRONG SUPER-REGENERATIVE CIRCUIT

POSITIVE AND NEGATIVE RESISTANCE

The Armstrong super-regenerative circuit is a refinement of the regenerative circuit which allows of very great amplification of signals. When using a regenerative circuit, it may be observed that the signals continue to increase as the regeneration increases, and that the maximum possible strength comes just before the tube starts to

oscillate. The signals apparently increase, too, as the tube oscillates, but the oscillating current is so great that it makes the signals inaudible, or at least they cannot be picked out.

The ordinary circuit possesses resistance, which causes an absorption of energy and a decrease or damping effect on any oscillation started in that circuit. This will be distinguished as a positive resistance in this discussion. If a circuit combination is such as to be a source of energy, or if oscillations in it increase in amplitude, due to circuit conditions, instead of decrease, that circuit acts as though it possessed a property just the opposite of positive resistance, or what may be called negative resistance. Between these two conditions may be found one at which a properly arranged circuit does not seem to possess any positive and negative resistance; that is, an oscillation of any particular frequency when once started in that circuit will continue indefinitely.

As has been intimated, the amplification of an electron tube and its auxiliary circuit is greatest when the oscillating condition obtains. Under this condition an oscillation would increase rapidly in strength, being limited by the power capacity of the tube. Briefly stated, the Armstrong super-regenerative circuit periodically produces the positive and negative resistance conditions, leaving the circuit with a positive resistance the larger part of the time, so as to control the amplification of signals. This is accomplished by impressing an alternating current on the tube or circuit; the frequency of this current should be just above the audibility limit. This oscillating current should preferably be obtained from a separate or auxiliary tube that has a circuit so arranged as to generate an alternating current of, say, about 20,000 cycles per second.

CIRCUIT ARRANGEMENTS

Two-Tube Circuit.—The antenna connection *a* and ground connection *b* on the two-tube circuit of Fig. 9 may be connected to a loop if desired instead of to the antenna and ground. If the set is close to the sending

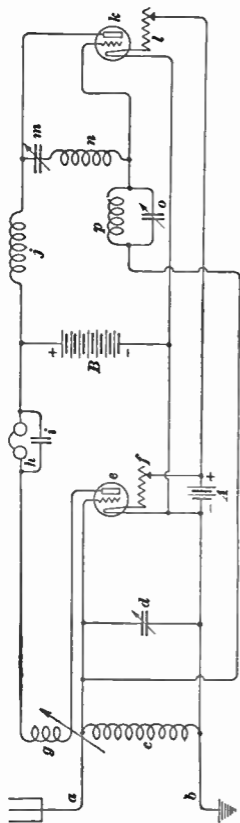

FIG. 9

station, it may be possible to get loud signals without any connection on terminal *b*, or possibly with none on *a* and *b*. The coil *c* may be a honeycomb or duolateral coil of 35 to 50 turns or any other type of coil possessing the necessary inductance. At *d* is a variable air condenser with a maximum capacity of .0005 microfarad. The electron tube *e* should be *hard*, that is, it should have a very high degree of vacuum, so that a high plate potential may be safely applied. The filament current supplied by the *A* battery is controlled by a rheostat at *f*. A coil *g* of 75 to 100 turns, of honeycomb or equivalent construction, is very closely coupled to the coil *c*. The telephone receivers *h* are shunted by the fixed telephone condenser *i* of .001- to .005-microfarad capacity to afford a by-pass for the radio-frequency currents in this circuit. The *B* battery should be at least 100 volts, or higher, as the signals will, in general, be stronger the higher the voltage. On most types

of tubes it is not safe to go above 200 to 250 volts on the plate. The honeycomb coil j should have 1,500 turns, or an equivalent inductance. The electron tube k and rheostat l are of the type already mentioned. The variable condenser m has a maximum capacity of .001 microfarad. The inductance coil n may very well be a honeycomb coil of 400 turns. A variable condenser o of .001 microfarad maximum capacity is connected in parallel with a honeycomb coil p of 1,250 turns. Coils j , n , and p are not in inductive relation to each other, in fact it is important to mount them in such a manner that no induction from one to the other can take place.

The tuning of the set is much more critical than on the simpler fundamental regenerative circuits. In the usual regenerative circuit, loose feed-back coupling would be used, but such is not the case here, as coils c and g are very closely coupled. The various condensers form the active members to be varied to secure proper tuning. For preliminary work, condenser m should be set at maximum. In some cases coil n may be replaced by one of 250 turns, but a 400-turn coil should be tried first. It may be well to vary the filament currents of the two tubes, not that any actual tuning is accomplished thereby, but it may give the two tubes their proper relative output currents for successful operation. If the circuit seems totally dead, that is, no high-frequency hum is heard, it is well to check carefully all connections. Grid or C batteries of 2 to 6 volts may be necessary and should be connected between the grid terminals of the tube and the other apparatus in the grid circuit so as to make the grids negative.

Three-Tube Circuit.—The three-tube circuit of Fig. 10 is very efficient as far as amplification is concerned and is quite easy to operate. The loop connected at a and b , for broadcasting reception might be of 8 turns of wire spaced $\frac{1}{2}$ inch apart on a square wooden frame 3 feet on a side. Antenna and ground connections may be made to points a and b , respectively. The coil c should have about 25 or 35 turns or in some cases 50 turns. The tuning con-

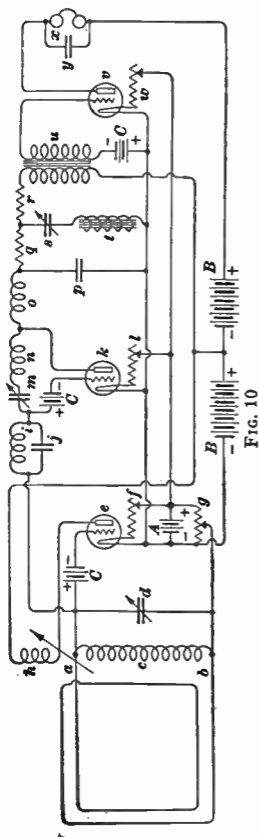

FIG. 10

denser d should be variable and have a maximum capacity of .001 microfarad. The electron tube at e should be *hard*, that is, one possessing a very good vacuum. The A battery supplies the filament current for the tube, the amount of current used being controlled by the rheostat f . The grid, or C , battery may consist of a few small-sized dry cells connected so as to give the grid a negative potential of from 2 to 10 volts, depending upon the type of tube in use. The grid battery may not be needed if a 200- or 400-ohm potentiometer g is used. Also, in other types of tubes, in fact with most commercial types, the grid battery may be set at the proper value, thereby eliminating the necessity for the potentiometer. The honeycomb coil h should have 75 to 100 turns, or, roughly, twice as many as coil c to which it is coupled. The honeycomb coil i of 1,250 turns and its condenser j of .001-microfarad maximum capacity control the frequency of the positive and negative resistance

reversals of the amplifier circuit of tube *e*. The primary function of tube *k* is to generate the high-frequency oscillations which are impressed on the circuit of the main amplifying tube *e*. The filament current of tube *k* is controlled by the rheostat *l*. This tube may also need a few small cells to give the grid a negative voltage. The condenser *m* with a maximum capacity of .001 microfarad, in series with a honeycomb coil *n* of 300, or preferably 400, turns, forms a coupling between the grid and the plate circuits of tube *k*. The honeycomb coil *o* has 1,500 turns, and is mounted so as not to be inductive to either coil *i* or *n*. The .005 microfarad condenser *p* is not variable. The two resistances *q* and *r* each have values of 12,000 ohms and the resistance wire should be wound so that these devices are non-inductive. The condenser *s* should have a maximum capacity of .001 to .005 microfarad. The iron-core choke coil *t* should have an inductance of .1 to .2 henry. A Ford spark coil serves very well or a coil may be wound of 650 turns of No. 26 or 27 B. & S. gauge silk-covered magnet wire on a $\frac{3}{4}$ -inch square core of thin sheets of iron. The resistances *q* and *r*, the condenser *s*, and the inductance *t* form a filter and their purpose is to keep the high-pitch hum out of the telephone receivers. The audio-frequency transformer *u* is of the usual type and gives good results in this connection. The *C* battery in the amplifying circuit may or may not be necessary, depending upon the type of amplifier tube used at *v*. The filament current of this tube is controlled by the rheostat *w*. The telephone receivers *x* should be paralleled by a fixed condenser *y* of .001- or .002-microfarad capacity. The voltage of the B battery for the first two tubes should be from 100 to 150 volts, while by using 100 more for the final amplifier tube a total voltage of 200 to 250 is impressed on the final tube.

The tube *e* and its auxiliary circuits, consisting of coils *h* and *c* and the condenser *d*, is the tube in which the high amplification takes place. The tube *k* with its auxiliary apparatus performs the function of making the resistance of the first amplifier circuit alternately positive and nega-

five. The oscillating current from this tube should be at about the upper range of audibility, say about 20,000 cycles per second. The filter system comprising the two resistances q and r and the condenser s and the inductance t connected across their mid-point will prevent this high-frequency current from producing objectionable sounds in the receivers, and from feeding so much energy into the tube v as to stop its functioning. It may be well to leave out the filter system until the set has been put in working order. The amplifying transformer u and tube v act as any ordinary audio-frequency amplifier, to increase the output signal strength.

It will probably be necessary to do considerable experimenting with the various adjustments before the best results will be obtained. As a general procedure, the condenser d should be varied to see if some indication of a signal may be obtained. Coils c and h should be closely coupled, and a pair of telephone receivers, connected for testing across condenser m , should give a hissing sound if the set is working at all. If no sound is heard, it is advisable to check all connections, and see that the battery polarities are not reversed. It may be necessary to reverse the connections to coil h so it will have the proper relation to coil c . The condensers j and m require an adjustment to give the loudest signal, and when properly adjusted need not be changed except for a casual check to see that they have not been disturbed. The condenser s requires no further adjustment when once properly set. After the set is operating, it may be well to experiment with the C , or grid, batteries until the best value is obtained for the particular tubes in use.

RADIO EXPERIMENTS

EXPERIMENT NO. 1—MEASUREMENT OF THE PROPERTIES OF AN ANTENNA

Object.—To determine, (a) the natural wave-length, inductance, and capacity of an antenna, and, (b) to determine the resistance and decrement of an antenna.

List of Apparatus for (a).—Buzzer, Fig. 1, wavemeter *a*, variable inductance *b* which has approximately about as much inductance as is possessed by the antenna, and an aperiodic, or untuned, detector circuit *c*.

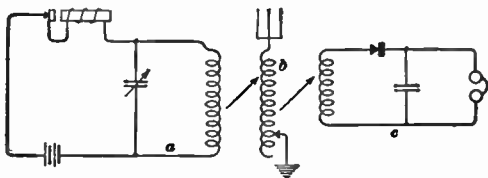

FIG. 1

Discussion of (a).—The wavemeter *a* must be calibrated with the buzzer so that the wave-length of the oscillating current can be read from the setting of the condenser. Couple the antenna loading inductance coil *b* loosely to the inductance coil of the wavemeter. The aperiodic or non-oscillatory detector circuit *c* is responsive to all wave-lengths, which is the most convenient arrangement to use in this experiment. A circuit that must be tuned with each wave-length change may be used. The detector circuit is loosely coupled to coil *b* of the antenna circuit, and the detector circuit is placed so that no energy can get directly from the wavemeter to the detector circuit.

Start the buzzer so it will excite the wavemeter, and set its condenser so the wavemeter will oscillate at some arbitrary or convenient value. Tune the antenna circuit to resonance with the wavemeter by adjusting the inductance of coil *b* and listening to the sound produced in the telephone receivers of the detector circuit *c*. This sound will be a maximum when the antenna is in resonance with the wavemeter circuit if the conditions mentioned have been fulfilled. The wave-length of the antenna circuit may then be read directly from the setting of the wavemeter condenser. The amount of inductance *b* connected in the circuit is also read for this setting. If no suitable variable inductance is available, several coils, each of fixed known inductance, such as honey-comb coils, may be connected in various series combinations to give a considerable range of inductance.

Repeat this procedure for from six to ten values of wave-length, choosing values over a fairly wide range. Square each of the values of wave-length reading, and plot the values of squared wave-lengths against the readings of inductance.

These values should lie on a straight line as indicated in the upper right-hand portion of Fig. 2. The straight line should be extended so as to intersect the wave-length squared axis at *a* and the added-inductance axis at *b*. The value *oa* then represents the square of the natural wave-length of the antenna itself. For instance, if the value *oa* was 360,000, this number would be the square of the natural wave-length, or taking the square root of 360,000, which is 600, would give a natural wave-

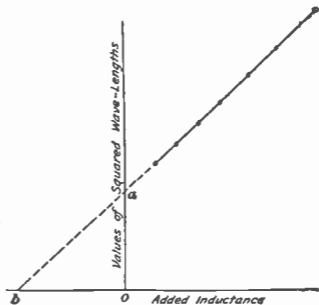

FIG. 2

length of the antenna of 600 meters. The intercept of the straight line with the added inductance axis determines the inductance of the antenna only. The numerical value of $o b$ is the negative of the high-frequency inductance of the antenna. Thus, if the value as read on the scale to the left of o is -65 microhenrys, it would mean that the inductance of the antenna is 65 microhenrys.

The capacity of the antenna may be obtained from the formula, which is also given elsewhere, that the wave-length expressed in meters, is $\lambda = 1,885 \sqrt{L C}$ where L is the inductance in microhenrys, and C is the capacity in microfarads. This may also be written as

$$C = \frac{\lambda^2}{3,553,000 \times L}$$

where the terms have merely been interchanged to some extent.

As an example, the values of wave-length and inductance which were previously assumed may be used. This would give

$$C = \frac{(300)^2}{3,553,000 \times 65} = .00039 \text{ microfarad.}$$

The inductance and capacity values as obtained by the above method are somewhat different from their audio-frequency values. In fact the inductive reactance of an

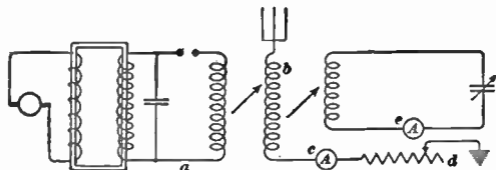

FIG. 3

antenna is generally negligible at audio frequencies, while the capacity effect may change only slightly.

List of Apparatus for (b).—Sending set *a*, Fig. 3, with its auxiliary apparatus, antenna coil *b* made of a few turns

of low-resistance wire, sensitive expansion-type ammeter c , non-inductive resistance d , and a wavemeter e .

Discussion of (b).—The coupling between the sending set and the coil b in the antenna should be only enough to give a good deflection of ammeter c when the resistance of d is zero. The current reading is noted and, without changing the sending circuit, enough resistance is added at d to bring the antenna current to one-half its former value, as noted by ammeter c . The resistance added at d is then very close to the antenna resistance in ohms, if a regular open spark gap is used in the sending set.

The decrement δ may be obtained, approximately, from the values of R , the antenna resistance, L , and C by using the formula

$$\delta = 3.1416 R \sqrt{\frac{C}{L}}$$

where R is the antenna resistance in ohms; C is the antenna capacity in microfarads; and L is the antenna inductance in microhenrys.

The antenna resistance R may also be obtained by determining the decrement of the antenna. A quenched spark gap should be used in the sending set, and the decrement should be obtained by using the wavemeter e to determine the decrement, as is described elsewhere. The antenna resistance R may then be obtained from the formula

$$R = \frac{\delta}{3.1416 R \sqrt{\frac{C}{L}}}$$

where the terms δ , R , C , and L have the meanings specified in the preceding paragraphs.

EXPERIMENT NO. 2—HIGH-FREQUENCY RESISTANCE MEASUREMENTS

Object.—To measure the high-frequency resistance of a simple coil and the variation of this resistance with change in frequency.

List of Apparatus.—Electron tube oscillator *a*, Fig. 4, or other source of radio-frequency, undamped current, wavemeter *b*, inductance coil under test *c*, a variable condenser *d* of fairly large capacity and low losses, expansion-type ammeter *e*, and a non-inductive resistance *f* variable either continuously or in small steps.

Discussion.—Throughout this experiment the current delivered by the oscillator circuit must be kept at a constant value. The value of the current may be checked by the ammeter connected in the circuit of the oscillator tube. It may be necessary to use a variable resistance in series with the ammeter to control this current. The wave-

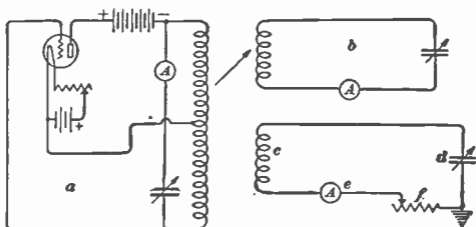

FIG. 4

meter *b* is loosely coupled to the oscillator circuit when it is desired to take readings of the wave-length or frequency. The coupling between the oscillator coil and coil *c* should not be changed after the coupling has been adjusted to give a fairly large deflection on ammeter *e*. A ground connection should be made as indicated at one end of *f* in order to eliminate undesirable capacity effects.

Cut out all the resistance of *f* and start the oscillating circuit *a* operating. Tune the circuit that is under test to resonance with the impressed frequency by varying the capacity of condenser *d*. The condition of resonance is indicated by the maximum reading on the ammeter *e*. The current should be read and recorded for this adjustment. The resistance under this condition is composed

of that of the coil c , a very small amount of resistance due to the ammeter and condenser, and of the connecting wires between these devices which are in series. Ordinarily the resistance of all but the coil is negligibly small, so they will be omitted here.

Then insert enough of the resistance f into the circuit to reduce the current, as indicated by the ammeter e , to one-half its former value. That is, the new current I bears the relation to I_1 , the current of resonance, that is expressed by the formula, $I = \frac{1}{2}I_1$. The units for expressing the current values are unimportant if both I and I_1 are given in the same units. When the preceding relation of currents I and I_1 is fulfilled, the added resistance R is equal to the total resistance of the coil at this frequency.

The frequency is obtained from the reading of the wavemeter b . From the wavemeter reading of the wave-length, in meters, the frequency may be obtained directly from a table given in this book, or the frequency f in cycles per second may be calculated from the formula,

$$f = \frac{300,000,000}{\lambda}$$

where the wave-length λ is given in its usual form in meters.

Vary the frequency of the source over several values or settings, taking care that the oscillating current is not greatly changed from its original value. By the method just given, determine the resistance of the coil at each of the different frequency settings. These points, or readings of resistance, may be plotted to give a curve of the general shape shown in Fig. 5. The fact that the curve tends to bend upwards shows that the resistance increases at a faster rate than does the frequency. This illustrates, to some extent at least, the presence of skin effect which tends to increase the effective resistance of any conductor as the frequency of the current it is carrying is raised.

It should be noted that, although the frequency comes to zero, if the curve is extended, the resistance never

reaches zero. This value of resistance oa corresponds with the direct-current resistance of the coil and, by subtracting this value from the resistance value at any

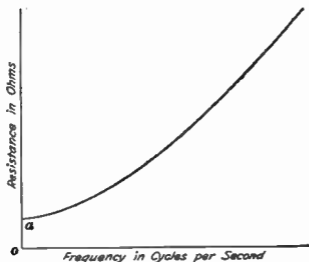

FIG. 5

frequency, the increase of resistance can be determined. The direct-current resistance oa , as obtained from the curve, may be checked by connecting a battery and ammeter in series across the coil. If the voltage of the battery is known, the resistance can be calculated from that value and the value

of current as read on the ammeter, by using Ohm's law. This is explained in detail elsewhere, and the resistance obtained by this method and the value oa should check each other very closely.

EXPERIMENT NO. 3—CHARACTERISTICS OF A TWO-ELEMENT ELECTRON TUBE

Object.—To investigate the characteristics of a two-element electron tube.

List of Apparatus.—Two, or three-element electron tube a , Fig. 6, filament rheostat b , filament ammeter c , plate milliammeter or ammeter d , plate potential voltmeter e , and the necessary A and B batteries, the B battery equipped with a potentiometer or taps between cells for securing various plate voltages.

Discussion.—This, as well as the succeeding experiments, may be conducted on tubes of various sizes and types. In any case it is necessary to use instruments, such as ammeters, milliammeters, and voltmeters, and A and B batteries, of such range that readable deflections may be

obtained. The range of the meters in particular should not be too small or they are liable to be burned out. If the experiment is to be carried above the safe range of operation of any instrument or meter, such apparatus should be removed from the circuit before it is damaged. If a three-element tube is used in this particular experiment, its grid should be connected to the positive terminal of the *A* battery, else it is liable to collect a negative charge from the accumulation of electrons striking it.

Adjust the filament current of tube *a* to somewhat below its normal or rated value. This may be done by increasing the resistance of rheostat *b* which is connected in the circuit, and noting the indication of ammeter *c*. With the slider of the plate-battery potentiometer at the top so that there is no *B*-battery voltage impressed on the plate, as indicated by the voltmeter *e*, there should be no appreciable plate current through the milliammeter *d*.

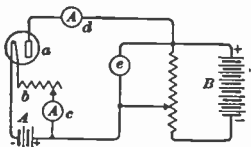

FIG. 6

If the potentiometer slider is moved down a short distance, a positive potential is applied to the plate of the tube, and there will be a flow of negatively charged electrons established from the filament to the plate. This plate current increases with every increase of voltage as indicated by part *a* of curve *abc*, Fig. 7. Near *b* the curve starts to bend over, indicating the approach to complete saturation-current effect. The curve becomes nearly horizontal between points *b* and *c*. Nearly all of the electrons emitted by the filament are drawn across to the plate. The value of plate current corresponding to point *b* is known as the *saturation* current for those conditions, and any further increase in plate voltage can produce but little increase in plate current, as is manifested by the fact that the remainder of the curve is nearly horizontal. It is generally possible to get some increase of plate current by using

large plate voltages, but even then the increase is relatively small. It has been assumed that the filament current was kept constant at its original setting throughout the reading of values for this curve.

If the filament current is raised, electrons are given off at a higher rate, as indicated by the curve through *a* and *d*, before the plate current is limited by a new and larger saturation current at point *e*. Beyond *e* and toward *f*, further increase of plate potential can cause but a very small increase in the plate current. A further rise in

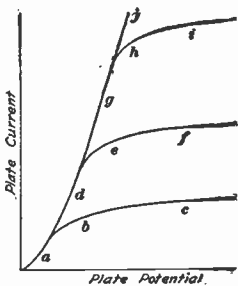

FIG. 7

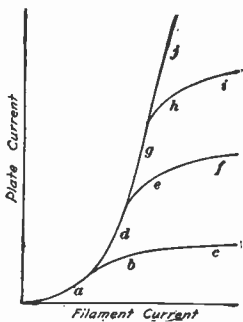

FIG. 8

filament temperature will give the curve through points *g*, *h*, and *i*. It is possible that a plate-current curve may be obtained, such as that through *a*, *d*, *g*, and *j*, such that no saturation value is reached within the safe operating limits of the tube. These curves indicate that the saturation current for each higher value of filament current is greater than for any preceding lower filament-current test. The curve through *j* shows that in this case there were more electrons given off than could be attracted by the plate at the voltage of the plate battery, and saturation current was not reached. As this curve forms a sort

of limiting curve, and there are no curves to the left of it, this curve is sometimes called an *envelope curve*.

A set of curves of somewhat the same appearance, but indicating somewhat different conditions, is given in Fig. 8. The plate voltage is set at some fairly low value, and kept constant, while the filament current is raised from a value at which no electrons are emitted to as high as it is safe to go. The plate current will rise fairly rapidly while the plate voltage is high enough to attract all of the emitted electrons direct to the plate. As the filament temperature and current are raised, there is an increase of electrons and they become so numerous that the plate voltage available cannot attract them all. The plate current then starts to drop off at *a* and has become practically constant by the time the filament current reaches *b*, due to space-charge effect. This space-charge effect is due to a sort of negatively charged cloud hovering near the filament which is made up of the negative electrons wandering about the filament in excess of those necessary to establish the plate current. As the filament temperature is increased, the plate current, as indicated between *b* and *c*, remains practically constant and the space-charge effect becomes greater.

With a higher value of plate potential, the space-charge effect does not begin to show up until a higher plate current indicated just above *d* is reached, and does not greatly limit the plate current until a practically constant value is reached at *e*. A considerably larger filament current at *f* produces but a small increase in the plate current. A still higher plate voltage, as shown by the curve through *g*, *h*, and *i* shows that a correspondingly higher plate current at *h* is reached before the space-charge effect is great enough to limit the plate current. The curve through *j* shows that the conditions of the test did not produce a space-charge effect, and the curve is also an envelope, or limiting, curve.

EXPERIMENT NO. 4—CHARACTERISTICS OF A THREE-ELEMENT TUBE

Object.—To determine the amplifying power μ_o , and the internal plate-circuit resistance R_p of a three-element electron tube under various operating conditions.

List of Apparatus.—Alternator *a*, Fig. 9, of 1,000-cycle frequency; variable resistances *b* and *c*; three-element electron tube *d* to be tested; resistance *e* variable from 0 to 20,000 ohms; two single-pole, single-throw switches *f* and *g*; telephone receivers *h*; filament-current ammeter *i*; fila-

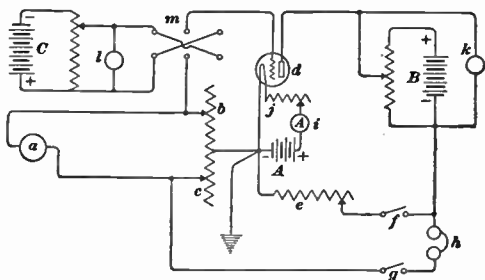

FIG. 9

ment-current rheostat *j*; plate-potential voltmeter *k*; grid-potential voltmeter *l*; two-pole, reversing switch *m*; *A*, *B*, and *C* batteries to give a full operating range of values, the last two equipped with potentiometers to get any desired value of voltage.

Discussion.—The amount of apparatus shown in the diagram is more than is absolutely necessary, and much of the apparatus is really quite simple. Instead of an alternator *a*, it is possible to use a type of 1,000-cycle audio oscillator capable of giving an alternating-current output. The resistances *b* and *c* may be made from a

straight piece of German silver resistance wire fastened onto some sort of a calibrated scale reading in, say, centimeters. The resistance between the center point and each of the two sliders, one at each end, should be measured so that the resistance can be read with the sliders in any position. Switches f and g may be omitted and the circuit opened and closed at these points as required by fastening or unfastening the connecting wires. The voltmeters k and l may be omitted, if not available, as they are not necessary to the performance of most of the experiment. For some parts of the experiment at least one voltmeter is necessary, and it can be used in either circuit as desired. If the B -battery voltage is too high for the available voltmeter, it is possible to get a good reading of the total voltage by reading the voltage across each of several sections and adding these readings together. The potentiometers across the B and the C batteries are not necessary if connection for variable voltage may be made between adjacent cells. The potentiometers, if used, should have resistances of several hundred ohms each so as not to discharge the batteries too rapidly. The reversing switch m is hardly essential, as the connecting wires going to the C battery may be disconnected and reversed as required to give a positive or negative grid potential.

Close switch g and open switch f . Adjust the filament current and plate voltage to normal values for tube d , and start alternator a . Adjust the resistance of b and c , which can be designated by r_1 and r_2 respectively, by moving the sliders, until no sound is heard in the telephone receivers h . Under this condition of balance, the amplifying factor μ_o of the tube has the value $\mu_o = \frac{r_1}{r_2}$, the values of r_1 and r_2 being expressed in ohms. Hold the filament current constant at normal value, and determine the value of μ_o for various values of grid potential. This will give the μ_o curve shown in Fig. 10, which shows that the amplification is greatest at a grid voltage just about at or slightly less than zero. It is well to remember

that commercial electron tubes may differ widely from one another, and that their characteristic curves may not bear a close resemblance.

A characteristic plate-current curve *a* is shown in Fig. 10 to verify the findings of the μ_0 curve. The zero grid-voltage line

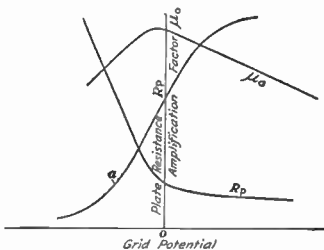

FIG. 10

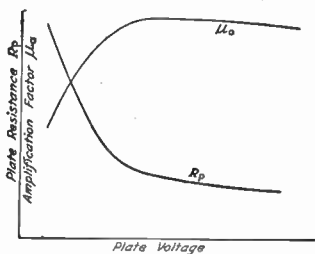

FIG. 11

cuts the characteristic curve *a* on the steep part of the curve which is the best part of the characteristic curve on which to get good amplification. However, the zero grid-voltage line is nearer the upper bend of the characteristic curve, and for best operation this grid-voltage line should be midway between the bends on the characteristic curve. This may be accomplished by applying a small negative potential to the grid of the tube. This checks the μ_0 curve which indicated that a small negative

potential applied to the grid would give the greatest amplification for that tube.

The characteristic curve *a* could be obtained by using the connections of Fig. 9, with slight changes which apply only to this part of the test. Alternator *a* may be inoperative or removed from the circuit, and the telephone re-

ceivers h are disconnected by opening switch g . Resistances b and c are made equal to zero and switch f is closed. By connecting a low-range milliammeter between the B battery and the plate of tube d , the plate current may be read for various positive and negative values of grid voltage, and curve a , Fig. 10, plotted.

Connect alternator a and the telephone receivers h . Hold the filament current and the grid potential constant, and determine values of μ_o for various plate voltages. This will give the μ_o curve of Fig. 11. From this curve it is seen that the operation of the tube is poor if the plate voltage is too low. A test might also be made of μ_o while only the filament current is varied. This generally shows very little variation of μ_o over the possible operating range of filament current.

Now close the switch f , Fig. 9, and make the resistances b and c about equal. Adjust the resistance R of the rheostat e until silence is secured in the telephone receivers. It will generally be necessary to make changes in the resistance of b and c , designated as r_1 and r_2 respectively, to secure silence. The internal plate resistance, designated as R_p , Figs. 10 and 11, may be determined from the formula

$$R_p = \left(\frac{r_1}{r_2} \mu_o - 1 \right) R$$

where the resistances are all in ohms and μ_o is in units. For a good amplifying tube, R_p should be a few thousand ohms at its lowest value. Values of R_p obtained for a typical tube are given in Fig. 10, for various grid voltages. The values become excessively high at the negative grid potentials, but this is seldom important, as amplifier tubes do not generally have an appreciable fixed grid potential.

Values of R_p obtained while only the plate potential was varied are indicated by curve R_p , Fig. 11. Here the plate resistance gets very high with low plate voltage, but changes very little over the important range of plate voltages.

EXPERIMENT NO. 5—REGENERATIVE RECEIVER CIRCUIT AND OPERATION

Object.—To study the connections of a simple regenerative receiver circuit, and its operation, and the effect of varying the voltage of the filament, plate, and grid batteries.

List of Apparatus.—Three-element electron tube *a*, Fig 12, filament-current control reostat *b*, antenna *c*, antenna inductance coil *d*, antenna condenser *e* for short wave-length work, receiver inductance *f* coupled to *d*, receiver tuning condenser *g*, grid condenser *h*, grid leak *i*, switch *j* to cut out the grid condenser and leak resistance,

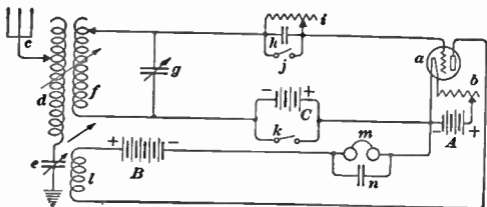

FIG. 12

a switch *k* to cut out the grid battery when it is not desired (disconnect *C* battery), regenerative feed-back coil *l* loosely coupled to *f*, telephone receivers *m*, telephone-receiver shunt condenser *n*, and the necessary *A*, *B*, and *C* batteries.

Discussion.—Some of the tests described here can be applied to nearly any type of receiving set, and should give information as to the best conditions of operation of the whole set. The connection diagram used here is only one of many possible satisfactory ones, and it is generally well to try different circuit connections. If it is not desirable to make all of the tests given here some of the apparatus needed for those tests may be omitted. It

may be desirable to find the effect of various plate and grid voltages, in which case it will be necessary to have these potentials easily changeable. This may be done by using high resistance potentiometers or by merely taking off taps from the battery so as to include the proper number of cells in the circuit.

The condenser e is used only when waves that have a wave-length shorter than the natural wave-length of the antenna are to be received. The inductance coil l , called a tickler coil, has variable mutual inductance with coil f and is directly effective in feeding enough plate current into the grid circuit to cause the tube to oscillate. The grid condenser h may have a capacity effect of about .001 microfarad. The grid leak i may have a resistance in the neighborhood of 1 megohm, or, in other words, 1,000,000 ohms. For this experiment several grid leaks may be used, or binding posts may be mounted about an inch apart and pencil lines between these points used for different resistances. By using lines of different weight and width, the one giving best results for the tube under test can be determined. The condenser n shunting the telephones has a capacity effect of .001 microfarad or greater. An amplifier set may be connected in place of the telephone receivers m and condenser n , if the received signals are very weak.

Disconnect the C battery and close switch k . See that switch j is open, and set the filament current at near its normal value. It is very desirable to have an ammeter in the filament circuit so that the safe operating filament current may not be exceeded, and so that good operating conditions may be reproduced. Couple coil l closely enough to coil f so that the tube current starts to oscillate, as may be noted by the increased intensity of sound in the telephone receivers. If the set is tuned to any incoming signals, it should be noted that the signal strength keeps increasing until it is drowned out by the stronger oscillating current in the tube circuit. Under this condition the sound, especially of radio telephone messages, is apt to be badly distorted. Only enough coupling be-

tween coils *l* and *f* should be used to give good clear signals of maximum strength. Some retuning is generally necessary as the regeneration is increased.

The effects produced by varying any one or a combination of factors may now be studied, attention being paid as to whether the signal strength is increased or decreased. If the change is such as to vary the wave-length of the local receiving circuit, it should be restored by retuning with condenser *g*, to get a fair comparison. For example, various grid-leak resistances, other values of filament current, or higher and lower plate voltages might be used to determine their effect on the signal strength. The disconnecting of the grid leak or the condenser shunting the telephones will generally result in much poorer reception than when they are properly connected.

The relative merits of a grid condenser and the grid, or *C*, battery may be determined for the tube and circuit under test by connecting first one and then the other in the grid circuit. After the intensity of the signal produced by the grid condenser and grid-leak combination has been noted, switch *j* should be closed, and after switch *k* is opened, the *C* battery is connected in the grid circuit. It will usually be found that there is at least one value of *C*-battery potential which will give the loudest sound in the telephone receivers.

ELECTRICAL AND RADIO FORMULAS

Impedance of inductive circuit:

$$Z = \sqrt{R^2 + (\omega L)^2}$$

where *Z*=impedance, in ohms; *R*=resistance, in ohms; *L*=inductance, in henrys; and $\omega = 2\pi f$, or $2 \times 3.1416 \times$ the frequency, in cycles per second.

Impedance of simple series circuit, containing resistance, inductance, and capacity.

$$Z = \sqrt{R^2 + \left(\omega L - \frac{1}{\omega C}\right)^2}$$

where Z is the impedance, in ohms; R =resistance, in ohms; $\omega = 2 \times 3.1416 \times$ frequency; L =inductance, in henrys; and C =capacity, in farads.

Current in simple series circuit:

$$I = \frac{E}{\sqrt{R^2 + \left(\omega L - \frac{1}{\omega C}\right)^2}}$$

where I =current, in amperes; E =electromotive force, in volts; R =resistance, in ohms; L =inductance, in henrys; C =capacity, in farads; and $\omega = 2 \times 3.1416 \times$ frequency.

Capacity between two parallel plates:

$$C = .0885 \frac{SA}{t}$$

where C =capacity, in micromicrofarads; S =specific inductive capacity for dielectric material as given in the latter portion of this book; A =area of each plate of the condenser, in square centimeters; and t =thickness of the dielectric material, in centimeters.

Capacity of condenser of N plates, alternate plates being connected in parallel:

$$C = .0885 \frac{S(N-1)A}{t}$$

where the factors have the value given under the preceding formula and N =the actual total number of condenser plates.

Capacity of a variable condenser with semicircular plates:

$$C = .1390 \frac{S(N-1)(r_1^2 - r_2^2)}{t}$$

where C =capacity, in micromicrofarads; S =specific inductive capacity of dielectric; N =total number of plates; r_1 =outside radius of the plates, in centimeters; r_2 =the inner radius of the plates, usually very small; and t =the thickness of the dielectric, in centimeters.

Capacity of single horizontal wire, earth forms the other plate:

$$C = .5562 \frac{l}{l_n \frac{2h}{r}}$$

where C =capacity, in micromicrofarads; l =length of the wire, in centimeters; h =height of wire, in centimeters; r =radius of wire, in centimeters; and l_n =natural logarithm of the number following that sign or of $\frac{2h}{r}$.

Austin's formula for the capacity of a flat-top antenna:

$$C = 1.1124 \left(36 \sqrt{A} + 7.97 \frac{A}{h} \right)$$

where C =capacity, in micromicrofarads; A =over-all area of flat top of antenna, in square meters; and h =average, or mean, height of antenna, in meters.

Inductance of a single horizontal wire:

$$L = .002 l \left(l_n \frac{2h}{r} + \frac{1}{4} \right)$$

where L =inductance, in microhenrys; l =length of the wire, in centimeters; h =height of the wire above the earth, in centimeters; r =radius of the wire, in centimeters; and l_n =the natural logarithm of the fraction following that sign, or of $\frac{2h}{r}$.

Inductance of a single circular turn of round wire:

$$L = .01257 R \left[\left(1 + \frac{r^2}{8R^2} \right) l_n \frac{8R}{r} + \frac{r^2}{24R^2} - 1.75 \right]$$

where L =inductance, in microhenrys; R =radius of coil, in centimeters; r =radius of wire, in centimeters; and l_n =the natural logarithm of $\frac{8R}{r}$.

Inductance of a single-layer solenoid, closely wound:

$$L = \frac{.03948 R^2 n^2}{l} K$$

where L =inductance in microhenrys; R =distance from axis of the coil to the center of any wire, or the radius of the coil, in centimeters; n =number of turns of the winding; l =length of winding along coil, in centimeters; and K =a value depending upon $\frac{2R}{l}$ that may be obtained from the accompanying table.

TABLE FOR VALUES OF K

| $\frac{2R}{l}$ | K | $\frac{2R}{l}$ | K |
|----------------|-------|----------------|------|
| .00 | 1.000 | 0.95 | .700 |
| .05 | .979 | 1.00 | .688 |
| .10 | .959 | 1.10 | .667 |
| .15 | .939 | 1.20 | .648 |
| .20 | .920 | 1.40 | .612 |
| .25 | .902 | 1.60 | .580 |
| .30 | .884 | 1.80 | .551 |
| .35 | .867 | 2.00 | .526 |
| .40 | .850 | 2.50 | .472 |
| .45 | .834 | 3.00 | .429 |
| .50 | .818 | 3.50 | .394 |
| .55 | .803 | 4.00 | .365 |
| .60 | .789 | 4.50 | .341 |
| .65 | .775 | 5.00 | .320 |
| .70 | .761 | 6.00 | .285 |
| .75 | .748 | 7.00 | .258 |
| .80 | .735 | 8.00 | .237 |
| .85 | .723 | 9.00 | .219 |
| .90 | .711 | 10.00 | .203 |

Power input to a condenser:

$$P = 0.5 \times 10^{-6} N C E^2$$

where P =power input, in watts; N =number of charges or discharges per second; C =capacity, in microfarads; and E =electromotive force, in volts.

Energy associated with an inductance:

$$W = \frac{1}{2} L I^2$$

where W =energy, in joules; L =inductance, in henrys; and I =the current, in amperes.

Wave-length for resonance of a loaded antenna:

$$\lambda = 1,885 \sqrt{C \left(L + \frac{L_1}{3} \right)}$$

where λ =wave-length, in meters; C =capacity, in microfarads for uniform voltage or low-frequency capacity; L =inductance, in microhenrys for uniform current or low-

frequency inductance; and L_1 =the inductance of the loading coil, in microhenrys.

Radiation resistance of an antenna:

$$R_r = 1,580 \left(\frac{h}{\lambda} \right)^2$$

Where R_r =radiation resistance, in ohms; h =height from ground to center of antenna capacity, in meters; and λ =the wave-length of the antenna, in meters.

Natural frequency of a simple series circuit:

$$f = \frac{1}{2 \times 3.1416} \sqrt{\frac{1}{CL} - \frac{R^2}{4L^2}}$$

where f =frequency, in cycles per second; C =capacity, in microfarads; L =the inductance, in microhenrys; and R =the total resistance, in ohms.

Logarithmic decrement of any alternating-current circuit:

$$\delta = .00167 \frac{R\lambda}{L}$$

where δ =logarithmic decrement; R =resistance of antenna or circuit, in ohms; λ =wave-length of antenna or circuit, in meters; and L =inductance of antenna or circuit, in microhenrys

Again:

$$\delta = 3.1416 R \sqrt{\frac{C}{L}}$$

where the terms are the same as have previously been given, and C =capacity of antenna or circuit, in microfarads.

Fundamental wave-length:

$$\lambda = \frac{V}{f}$$

where λ =wave-length, in meters; V =the velocity of electromagnetic waves which is 300,000,000 meters per second; and f =frequency, in cycles per second.

Resonance wave-length of a coil and condenser circuit:

$$\lambda = 1,885 \sqrt{LC}$$

where λ =wave-length, in meters; L =inductance, in microhenrys; and C =capacity, in microfarads.

NOTE.—This formula is only approximately correct when applied to an antenna.

CODES

TELEGRAPH CODE SYSTEMS

MORSE CODE

Telegraph codes consist of *characters* formed by combinations of dots, dashes, and spaces, which represent letters, numerals, and punctuation marks. These characters are sent by one operator to the other by means of electric impulses. With the aid of suitable apparatus, the receiving operator hears the incoming signals and is then able to reproduce the original message. The characters representing letters, figures, and punctuation marks for the International Morse code, the Morse code, and the Phillips punctuation code, which is used as a part of the Morse code, are to be found under the heading Code Charts.

The **Morse code** of characters came into general use in wire telegraphy shortly after the establishment of that means of communication. In this system, which is also called the *American Morse code*, some of the characters are made with so-called *spaces* which are a part of the group signal, and are essential in distinguishing those characters. The use of spaced letters in this system occasionally leads to errors in the transmission of messages, as the parts of those letters are apt to be divided into two letters, or two letters composed of a small number of signals may be combined unintentionally to form a single letter. This does not imply that no mistakes are made when other codes are used, but rather that they are apt to be more common in the Morse for the reason given. It is usually somewhat more difficult to learn a code with spaced letters than one which does not have any spaces as part of the letter characters. The *Phillips punctuation code* has superseded the punctuation characters of the Morse code as it is much more complete and systematic.

INTERNATIONAL MORSE CODE

The International Morse code is a modified form of the Morse code in which no spaced characters are used, except in the character for the period. This alphabet is also commonly called the *Continental*, and the *Universal code*, and has come into extensive use in some fields.

The International Morse code is used all over the world for radio and submarine telegraphy, and for wire telegraphy in almost every country except the United States, Canada, and parts of Australia. It is superior for signaling through long submarine cables, as some of the recording devices used in that work do not give accurate signals when used with spaced letters.

The Morse code, owing to the fact that there are fewer dashes in its characters, is about 5 per cent. more rapid than the International Morse code. The latter is, however, preferable for several reasons and would doubtless have been adopted in the United States if the Morse alphabet had not already obtained such extensive use among telegraph operators.

The only codes that are in general use are the Morse and the International Morse. Either of these codes may be used in wire or radio telegraphy, yet each has been adopted in certain particular fields. In some fields, such as railroad work where both wire and radio systems are employed and the Morse code is used in the wire system, it is sometimes convenient to use the Morse code also for the radio system.

CODE CHARTS

Code charts are introduced at this point in the text so that reference may be easily made to them in connection with the suggestions for sending the characters. The code charts include the characters and figures of the International and the American Morse codes; the characters for punctuation marks of the International Morse code, the Phillips code, and special International Morse code signals.

CODES

ALPHABETS

| LETTERS | INTERNATIONAL MORSE | MORSE |
|---------|---------------------|-----------|
| A | · — | · — |
| B | — · · · | — · · · |
| C | — — — · | — · · · |
| D | — — · · | — · · · |
| E | — | — |
| F | · · — — | · — · — |
| G | — — — · | — — — · |
| H | · · · · | · · · · |
| I | · · | · · |
| J | · — — — — | · — — — — |
| K | — · — — | — · — — |
| L | · — — · | — — — |
| M | — — — | — — — |
| N | — · | — · |
| O | — — — | — — — |
| P | · — — — · | · — · — · |
| Q | — — — · — | — — — · |
| R | · — — · | · — · — |
| S | · · · | · · · |
| T | — | — |
| U | · · — | · · — |
| V | · · · — | · · — — |
| W | · — — — | · — — — |
| X | — · — — · | — · — — · |
| Y | — — — — · | — · — — · |
| Z | — — — · · | — · — — · |
| & | · · · · | · · · · |

NUMERALS

| FIGURES | INTERNATIONAL MORSE | MORSE |
|---------|---------------------|-----------|
| 1 | — — — — — | — — — — — |
| 2 | · — — — — | · — — — — |
| 3 | · · — — — | · · — — — |
| 4 | · · · — — | · · · — — |
| 5 | · · · · | · · · · |
| 6 | — · — — — | — · — — — |
| 7 | — · — — · | — · — — · |
| 8 | — — — — · | — — — — · |
| 9 | — — — — — | — — — — — |
| 0 | — — — — — | — — — — — |

PUNCTUATION MARKS, ETC.

| CHARACTERS | INTERNATIONAL MORSE | PHILLIPS PUNCTUATION USED WITH MORSE CODE |
|---------------------------|---------------------|--|
| . Period | | ..- - |
| : Colon | --- - | ..- - |
| ; Semicolon | --- - | ..- - |
| , Comma | --- - | ..- - |
| ? Interrogation | | ..- - |
| ! Exclamation | --- - | ..- - |
| Fraction line | --- - | ..- - |
| — Dash | --- - | ..- - |
| - Hyphen | --- - | ..- - |
| ' Apostrophe | --- - | ..- - |
| Underline (or Italics) | | ..- - |
| End of underline | | ..- - |
| (Parenthesis (start) | --- - | ..- - |
|) End of parenthesis | --- - | ..- - |
| " Quotation marks (start) | --- - | ..- - |
| " End of quotation | --- - | ..- - |
| = Double dash (or break) | --- - | ..- - |

PHILLIPS PUNCTUATION USED
WITH MORSE CODE

K O

S I

{ E
U T

D X

H X

Q X

U X

U J

P N

P Y

Q N

Q J

B K

SPECIAL INTERNATIONAL MORSE CODE SIGNALS**CONVENTIONAL SIGNALS**









| | |
|--|-----------|
| Attention call, to precede every transmission | — — — — — |
| Position report (to precede all position messages) | — — — — — |
| General inquiry call | — — — — — |
| From (de) | — — — — — |
| Invitation to transmit (go ahead) | — — — — — |
| Warning (high power) | — — — — — |
| Wait | — — — — — |
| Understand | — — — — — |
| Error (series of dots) | — — — — — |
| Received (O. K.) | — — — — — |
| Transmission finished (end of work) | — — — — — |
| End of each message (cross) | — — — — — |
| Distress call | — — — — — |

SPECIAL LETTERS

| | |
|-------------------------------|-----------|
| Ä (German) | — — — — — |
| Á or Å (Spanish-Scandinavian) | — — — — — |
| CH (German-Spanish) | — — — — — |
| Ê (French) | — — — — — |
| Ñ (Spanish) | — — — — — |
| Ö (German) | — — — — — |
| Û (German) | — — — — — |

LENGTH OF DOT, DASH, AND SPACE

In all codes, the dot is taken as the unit by which the lengths of the dashes and spaces are measured. The generally accepted relative lengths of the different dashes and spaces, some of which are used only in the Morse code, are as follows:

| SIGNAL | | DURATION OF SIGNAL |
|--|---|--------------------|
| Dot |  | 1 unit |
| The dash |  | 3 units |
| The long dash (<i>l</i>)..... |  | 6 units |
| The extra dash (naught)..... |  | 9 units |
| Space between parts of a character |  | 1 unit |
| Space in spaced characters..... |  | 2 units |
| Space between characters..... |  | 3 units |
| Space between words..... |  | 5 units |

The dot, which also represents the character *e*, is made by a single instantaneous downward stroke of the key followed immediately by an upward stroke. The actual time required in making the dot will vary with the speed of signaling, but it is important that the relative lengths of the dots, dashes, and spaces should remain constant. There are four lengths of spaces and three of dashes, or, including the dot, four.

A dash, or the letter *t*, is made by holding the key down as long as it takes to make 3 dots. This should be timed so that the duration of the signal transmitted is actually 3 times as long as that sent as a dot. The space, or interval, of time between characters should equal 3 units. It will then be exactly like the dash in length of time. The space between words or groups of characters should be made equal to 5 units. This spacing is very distinct and enables the operator to separate the letter and number groups of characters very readily even when receiving code words such as are used often for secret communications.

Some characters which are used only in the Morse code have special lengths of dashes and spaces. A long dash is used to represent the letter *l*, and is made 6 units long. an extra long dash, normally 9 units in length, designates the figure 0 (naught). However, in practice, the *l* and the 0 are often made 5 and 7 units long, respectively.

In many cases the *l* and the *0* (naught) are made the same; occurring alone, the long dash would be read as *l*, but when found among figures it would be translated as *0* (naught).

The space in the *spaced letters* of the Morse code, *C, O, R, Y, Z, &*, is 2 units long, or just double that ordinarily used between the elements of a letter. In case the receiving is rather poor, it is sometimes difficult to distinguish the 2- and 3-unit spaces because of the relatively small difference between them.

CODE PRACTICE APPARATUS

An inexpensive outfit particularly suitable for practice in learning the radio code is the combination of a buzzer *a* and a key *b* properly connected to a primary cell *c*, as shown in Fig. 1. The buzzer will operate as long as the key handle is depressed, dots and dashes of the telegraph code being produced by holding this key depressed for relatively short and long periods. The judgment of an

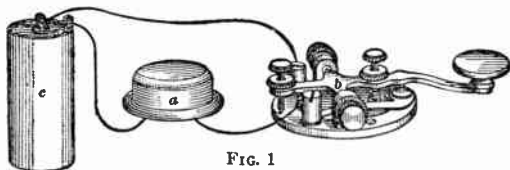

FIG. 1

inexperienced sender should not be relied upon as to the accuracy of the signals which he makes. He may, to his own satisfaction, be sending perfect code signals, but it may be impossible for any one to read them.

Instruction in code practice is usually given by an experienced operator who sends the code characters. The student listens to the signals and endeavors to write the letters and figures corresponding to the characters sent by

the operator. In order to give better practice it is desirable that the persons be located in different rooms or even in separate houses, and that all communication between them should be by means of the code signals. This may easily be accomplished by connecting two keys, two buzzers, and a battery in series in a circuit connecting the two stations. It is necessary in this case to use keys with short-circuiting switches, such as regular wire-telegraph keys. This short-circuiting switch must be closed at one station when the other is sending, otherwise the circuit would be open at two places, and no signals could be transmitted. In case a key with a short-circuiting switch is not available, a good expedient is to short-circuit the terminals of the key which is not used by a short length of wire. When operating properly, both buzzers respond to current impulses caused by the closing of one key.

The use of telephone receivers for the reception of radio signals is quite common. In order to give practice in this method of receiving, it is customary to use telephone receivers for the later portion of the training period, if not exclusively. They also help to exclude outside sounds by being held against the ears, which enables the person receiving to concentrate on the incoming signals.

METHOD OF HOLDING KEY

The first step in learning to send telegraph characters is to develop complete control of the hand. The key should be located on the table in such a position that when the hand is placed on the key, the arm will assume the normal writing position. This arrangement will be much less tiring than if the hand and arm were placed in an unnatural position. A good position for holding the key is shown in Fig. 2; it is the one adopted by many of the most speedy and perfect operators. Rest the first finger on the top, near the edge, of the key button, with the thumb and the second finger against the opposite edges, as shown. Curve the first and the second finger so

as to form the quarter section of a circle. Avoid straightness or rigidity of these fingers and the thumb. Partly close the third and the fourth fingers.

Many operators prefer to rest both the first and second fingers upon the key handle or button, with the thumb and third finger pressing lightly upon opposite sides of the button. This method is perhaps preferable, especially in the operation of large keys. The thumb and fingers should always remain in contact with the handle, but still must be kept flexible enough to form a sort of spring action between the rigid key and the hand. The elbow should rest easily on the table

at all times, and the wrist should be elevated from the table and be perfectly flexible. The key is operated by a free and easy motion of the whole



FIG. 2

forearm rather than by motion of the wrist alone. The motion should be directly up and down, avoiding all side pressure. When the proper swing is acquired, the forearm moves freely in conjunction with the wrist and fingers. The grasp on the button should be moderately firm, but not rigid. Grasping the knob tightly will quickly tire the hand and destroy control of the key, causing what is termed telegraphers' cramp.

ADJUSTMENT OF KEY SPRING

In the matter of adjusting the spring of the key, there is considerable difference of opinion. It is a good rule to avoid too much force or too light a touch, and to strive for a medium firm closing of the key. It is not the heavy pressure on the key, but the evenness of the stroke that constitutes good sending. A few of the very fastest senders use very stiff springs, while many other fast senders use springs that are barely strong enough to keep the weight of the key from closing the contacts. Some

operators even use a spring which will not of itself open the key, in which case the thumb must be used to raise the key. A moderate amount of play and a medium pressure of the spring should be used by the beginner unless he has good reason to believe another adjustment more suitable.

CODE PRACTICE WITH THE KEY

Begin the use of the key by making dashes in succession, first at the rate of about one a second, and then gradually increasing to two or three. Care should be taken to make the break between the dashes quite short, for there is always a tendency to make too large a space between dashes, and this should be guarded against.

The dots should be made as regularly as possible, and at the rate of about five a second, and the speed increased with practice; but, no matter how fast the dots are made, they should be regular, definite, and uniform. Sending is not merely making the dots and dashes as arranged on the code chart. It involves the accurate timing of the dot and dash signals, and of the spaces and intervals between individual elements of the characters.

The code may be learned by starting with characters represented by the least number of dots or dashes. Progress then is continued through the code, starting with the simpler combinations and advancing through the more complex characters until finally all can be made with equal ease. The beginner should start by making the letters *e*, *t*, *i*, and *m* correctly, after which the slightly more difficult combinations, as *n*, *a*, *s*, *h*, *o*, and *r*, should be taken up and mastered. Practice in sending words made up of groups of these letters would help to fix the groups in mind. The practice with the simpler characters helps to some extent to master the more complex ones. The student can easily assemble the letters made up of simple dot and dash combinations into short words. Practice with short word groups, such as *at*, *me*, *bat*, *dot*, *eat*, *him*, *date*, *met*, *tie*, *moose*, and *home*, followed by the more advanced word groups, will be the plan to follow in this method.

LEARNING TO RECEIVE

To learn to receive, it is necessary to have another person manipulate the key, or an automatic sending device to produce the characters, for one cannot read by sound from his own sending. It is very desirable that the sender should be able to make the signals distinctly and correctly, otherwise it will be very difficult, if not impossible, for the learner to understand the signals. However, two beginners can get good practice by taking turns at sending and receiving, each correcting the faults of the other.

There is considerable variation in the tone of different stations, depending largely on the type of transmitting apparatus. This is found to give very little trouble in actual practice. In fact this feature is in many cases desirable, as it enables an operator to distinguish between separate stations which may be operating at the same time. The sounds produced by the buzzer depend upon the length of the signal and the length of the spaces, or intervals between signals. The sounder used in wire telegraphy is different, in that the letter or character is determined solely by the time or times the lever strikes the bottom and top stops, and the duration of time between these clicks. No sound is emitted excepting at the beginning and end of the dot or dash. The buzzer, on the other hand, operates throughout the length of the dot or dash, and, for that reason, is in many cases, easier to read.

A learner should begin to read by sound by receiving letters and copying them. He should continue this exercise until each letter is instantly recognized. It is not well for a beginner to wait for whole words; each letter should be written down as soon as it is received, for if he waits for the whole word he is apt to become confused and fail to get the word, thus causing him to guess at it. He should learn to listen and write at the same time, and after he is proficient in receiving and writing letters he should practice on words and sentences. The speed of receiving and copying should be gradually increased until both can be done rapidly.

The beginner should study thoroughly the International

Morse alphabet and memorize it perfectly before making an attempt to copy from a sounder or an automatic transmitting device. Many learners require a longer time than others to become fair operators on account of failure to understand and memorize the proper signal combinations representing the telegraph characters. In some cases, it may assist the beginner to copy every other word of the message from a fast sender. This will give very good practice, and the number of letters received may be increased until all are copied correctly.

An operator should learn to copy that which is sent him as far behind transmission as possible. Although this will be hard to do, especially at the beginning, because it divides the attention and requires the exercise of memory, it must be accomplished before one can become a good receiver of rapid sending. The beginner will find it difficult at first to keep one or two words behind, but improvement will come by practice.

CODES OF ABBREVIATIONS

A telegraph code of abbreviations is a system of abbreviations, or a sort of shorthand applied to a means of communication. It usually consists of single letters and a combination of two or more letters, which arbitrarily represent figures, words, and phrases. Words and phrases in very common use are represented by single letters or short combination of letters. In some cases, the communication companies, to save time, and for their own convenience transfer the message into code form. Because of the difficulty in memorizing a long list of abbreviations, the code message is usually recorded just as it is sent, no effort being made to copy the matter in full wording as it comes in. The message is later transcribed from the record and put out in regular message form.

These codes have come into very extensive use in wire telegraphy, especially in newspaper reporting. Such codes enable a person to send a rather long message in a few word groups, thereby reducing the cost considerably, as

charges can be collected only on the material sent. If desired, the message can be made relatively secret.

Several code systems have come into use, and by employing one of them it is possible to send a message very economically and with a fair degree of secrecy. One extensive and complete system arranged for the use of the public is called the A B C code. By its use, a long message can be transmitted in a few words, and the cost of a message, which might otherwise be very expensive, can be made quite reasonable. It is published in book form, and both the sender and receiver must have a copy of the same code book, for the various communication companies will not form or translate the message. Each page in the book is divided into three columns. In the first column are figures from 1 to 99,999, inclusive; in the second column are words or combinations of letters arranged alphabetically; and in the third column are placed the words, phrases, or sentences that the numbers and words in the first and second columns respectively represent. For example, suppose the body of a message to be cabled is as follows: *Tugs now assisting; we write you full particulars*, in which the important words are *tugs* and *write*. Looking these up in the code book, the lines containing them will be found to be:

| | | |
|--------|-----------------|--|
| 14,643 | <i>Turtle</i> | <i>Tug(s) now assisting</i> |
| 15,419 | <i>Worthily</i> | <i>I (we) write you full particulars</i> |

The body of the message may then be written *Turtle Worthily*. The person receiving this message would then look up in his code book the meaning of the two words *turtle* and *worthily* and thus learn the meaning of the message. In this way, instead of eight words, only two have to be transmitted and paid for.

Cipher A B C Code.—Any one, by using this code, can arrange a *secret and private cipher*. To do this, he should

take ten letters, or, preferably, a ten-letter word in which the same letter does not occur more than once, such as the word *Cumberland*, and number each letter as follows:

| | | | | | | | | | |
|----------|----------|----------|----------|----------|----------|----------|----------|----------|----------|
| <i>c</i> | <i>u</i> | <i>m</i> | <i>b</i> | <i>e</i> | <i>r</i> | <i>l</i> | <i>a</i> | <i>n</i> | <i>d</i> |
| 1 | 2 | 3 | 4 | 5 | 6 | 7 | 8 | 9 | 0 |

In the first column of the code book, opposite the two phrases "Tug(s) now assisting" and "I (we) write you full particulars," are the two numbers 14,643 and 15,419, respectively. In the word "Cumberland," *c* represents the numeral 1, *u* the numeral 2, *m* the numeral 3, and so on. Thus, the number 14,643 is represented by the group of letters *cbrbm*, and the number 15,419 by *cebcn*. On the message blank, the sender using this cipher code would write, as the body of the message, the two following combinations of letters, for they are not apt to be words: *cbrbm* and *cebcn*.

These letters would be transmitted by the operator, in groups exactly as written, and the person to whom the message was addressed would first translate it into the two numbers 14,643 and 15,419 by means of the private code word "Cumberland" and the numerals corresponding to each letter in this word. Then, by looking up these numbers in the code book, the correct meaning would be obtained. Only the parties knowing what numeral corresponds to each letter in the code word can interpret the message.

If the code runs up to 99,999, that is, five figures, each combination of letters transmitted should contain five letters, and, therefore, if the number contains less than five figures, ciphers must be prefixed to make five figures. This is necessary, to avoid the risk of a wrong grouping of the letters by either the sending or receiving operator. For instance, suppose the word *best* were to be sent. In the code book would be found:

| | | |
|-------|------------------|-------------|
| 1,734 | <i>Becalming</i> | <i>Best</i> |
|-------|------------------|-------------|

**INTERNATIONAL RADIOTELEGRAPHIC CONVENTION LIST OF ABBREVIATIONS
TO BE USED IN RADIO COMMUNICATION—(Continued)**

| Abbrevia- tion | Question | Answer or Notice |
|-------------------|--|---|
| QRT | Shall I stop sending?..... | Stop sending. |
| QRU | | I have nothing for you. |
| QRV | Are you ready?..... | I am ready. All right now. |
| QRW | Are you busy?..... | I am busy (or: I am busy with.....) |
| QRX | Shall I stand by?..... | Please do not interfere. |
| QRY | Shall I stand by?..... | Stand by. I will call you when re- quired. |
| QRZ | When will be my turn?..... | Your turn will be No..... |
| QSA | Are my signals weak? | Your signals are weak. |
| QSB | Are my signals strong?..... | Your signals are strong. |
| QSC | { Is my tone bad?..... | The tone is bad. |
| QSD | { Is my spark bad?..... | The spark is bad. |
| QSF | Is my spacing bad?..... | Your spacing is bad. |
| QSG | What is your time?..... | My time is..... |
| QSH | Is transmission to be in alternate or- der or in series?..... | Transmission will be in alternate order. |
| QSI | | Transmission will be in series of 5 messages. |
| QSK | | Transmission will be in series of 10 messages. |
| QSL | What rate shall I collect for?..... | Collect..... for..... |
| QSM | Is the last radiogram canceled?..... | The last radiogram is canceled. |

| | | |
|------|---|---|
| QSL | Did you get my receipt?..... | Please acknowledge. |
| QSM | What is your true course?..... | My true course is.....degrees. |
| QSN | Are you in communication with land?. | I am not in communication with land. |
| QSO | Are you in communication with any ship or station (or: with.....)?.... | I am in communication with..... (through.....). |
| QSP | Shall I inform.....that you are calling him? | Inform.....that I am calling him. |
| QSQ | Is.....calling me?..... | You are being called by..... |
| QSR | Will you forward the radiogram?..... | I will forward the radiogram. |
| QSS | Are my signals fading?..... | Your signals are fading. |
| QST | Have you received the general call?.. | General call to all stations. |
| QSU | Please call me when you have finished (or: at.....o'clock)? | Will call when I have finished. |
| *QSV | Is public correspondence being handled? | Public correspondence is being handled. Please do not interfere. |
| QSW | Shall I increase my spark frequency?... | Increase your spark frequency. |
| QSX | Shall I decrease my spark frequency?. | Decrease your spark frequency. |
| QSY | Shall I send on a wave-length of... meters?..... | Let us change to the wave-length of.....meters. |
| QSZ | | Send each word twice. I have difficulty in receiving you. |
| QTA | | Repeat the last radiogram. |
| QTC | Have you anything to transmit?..... | I have something to transmit. |
| QTE | What is my true bearing?..... | Your true bearing is....degrees from.... |
| QTF | What is my position?..... | Your position is...latitude..longitude. |

*Public correspondence is any radio work, official or private, handled on commercial wave-lengths.

When an abbreviation is followed by a mark of interrogation, it refers to the question indicated for that abbreviation.

Now, 1,734 has only four figures in it, but five must be used. This is accomplished by prefixing a cipher to the set, which would give 01,734, and, by referring to the private cipher, the corresponding combination of letters to be sent would be *dclmb*.

Toll Charges.—The company operating any station usually has certain rules concerning the counting of characters and words in determining the charge for the service. The operator accepting the message must determine the number of words or groups of characters on which the charge is based. In many cases a fee is charged for part or all of the address and signature as well as for the main part of the message. It is especially important that each letter, figure, and punctuation mark be transmitted exactly as it is written by the sender.

International Abbreviations.—The United States Government has entered into an agreement with other large governments of the world in adopting a certain list of abbreviations to be used in International Radio Communication.

Slight revisions and additions are made from time to time to meet the requirements arising from change of conditions.

















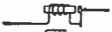



The distinct advantage of such a list of abbreviations is that it permits the exchange of ideas and information among persons who speak different languages. The well-known radio signal, *S O S*, used as a ship distress call, is, perhaps, the best illustration of the convenience of such a code. These abbreviations are in common use at nearly all radio stations.

CONVENTIONAL SYMBOLS FOR RADIO DEVICES

The symbols indicated in the accompanying table are very generally used in illustrations that refer to radio apparatus and circuits. Their use greatly simplifies the drawing of illustrations and tends to promote uniformity.

CONVENTIONAL SYMBOLS FOR RADIO DEVICES

| | |
|--|--|
| Crossed wires not joined | |
| Joined electrical conductors | |
| Resistance (not variable) | |
| Variable resistance | |
| Fixed inductance | |
| Inductance, variable or adjustable | |
| Inductance, iron core | |
| Coupled coils, air, or oscillation transformer; also, mutual inductances | |
| Coupled coils, with variable coupling | |
| Variometer | |
| Iron core or power transformer | |
| Condenser, fixed | |
| Variable condenser | |
| Antenna | |
| Coil aerial | |
| Ground connection | |
| Ammeter | |

| | |
|---------------------------|---|
| Crystal detector |  |
| Telephone transmitter |  |
| Telephone receivers |  |
| Loud speaker |  |
| Spark gap |  |
| Quenched gap |  |
| Buzzer |  |
| Electron tube, 2-element |  |
| Electron tube, 3-element |  |
| Battery |  |
| Generator, direct current |  |
| Alternator |  |
| Arc, oscillating |  |
| Enclosed fuse |  |
| Signaling key |  |
| Switches: | |
| Single-pole, single-throw |  |
| Single-pole, double-throw |  |
| Double-pole, single-throw |  |
| Double-pole, double-throw |  |
| Reversing |  |

DEFINITIONS OF RADIO TERMS

Air Condenser.—A condenser having air as its dielectric material.

Alternating Current.—A current that periodically reverses in direction, such as that from an alternator.

Alternation.—An alternation of current is one-half cycle, or the rise and fall of a current in one direction.

Alternator.—An electrical generator for producing alternating currents.

Ammeter.—An instrument for measuring electric current intensity in a circuit when connected in series in that circuit.

Ampere.—The standard electrical unit of current is the ampere, and it is the current established in a circuit of 1-ohm resistance by an electromotive force of 1 volt.

Ampere-Hour.—The ampere-hour is the unit for expressing the quantity of electricity passing through the circuit under test, when a current of 1 ampere is established in a circuit for a period of 1 hour.

Amplifier.—An amplifier is a device or arrangement which augments, or strengthens, feeble oscillations to increase their indications and tone.

Amplitude.—The amplitude of a wave is a measure of the maximum deviation from its zero or normal axis.

Antenna.—An antenna consists of a conductor or a system of conductors designed for radiating or absorbing the energy of radio waves, depending on whether the station is transmitting or receiving, respectively.

Antenna Resistance.—Antenna resistance is the opposition offered to the electric current by all of the electrical properties of the antenna.

Antenna Switch.—A switch connected in the antenna lead-in circuit to open and close the connection to the set.

Aperiodic Circuit.—An aperiodic circuit is a circuit which has such electrical properties or adjustments that it does not oscillate electrically.

Arc.—An arc is formed by the passage of an electric current through a gas or vapor, the conductivity of which is mainly due to the ionization of that gas or vapor.

Armature.—The armature of a generator comprises the active conductors in which electromotive forces are induced, together with their supporting framework. The armature of a motor comprises the active conductors which by the action of their lines of force tend to rotate the armature conductors and their supporting framework.

Atmospheric Absorption.—Atmospheric absorption is the part of the total loss caused by atmospheric conductivity.

Attenuation.—Attenuation is the decrease, with distance from the source, of the magnitude or amplitude of any electric or magnetic wave.

Audio Frequency.—An audio frequency is one capable of producing sound in the human ear, and in radio practice is considered to be all frequencies between 20 cycles per second to 10,000 cycles per second.

Battery.—A battery is a combination of two or more electric cells.

Battery Charger.—A battery charger is any device for charging a storage battery.

Buzzer.—A buzzer is an electromagnetic device which has a vibrating member for opening and closing its own electrical circuit.

Capacity.—The capacity of a condenser, or, better, its *capacitance*, is a measure of the amount of electrical energy which the condenser can store up.

Capacity Reactance.—Capacity reactance is the opposition offered by a condenser to an alternating current.

Change-Over Switch.—A change-over switch is a special switch arranged to shift the antenna connection from the sending to the receiving apparatus and vice versa.

Choke Coil.—A choke coil is a coil so wound as to possess a large choking, or self-inductance, effect to the passage of an alternating current.

Chopper.—A chopper is a device for rapidly opening and closing a circuit.

Circuit.—A circuit consists of any path through which an electric current is or may be established.

Circuit-Breaker.—A circuit-breaker is a special type of switch so arranged as to open a circuit rapidly and without injury to itself.

Clamp.—A clamp is a device to hold a wire in electrical connection with a pipe, although it has other uses.

Clip.—A clip is a form of snap fastener for making electrical connections that must be frequently changed.

Close Coupling.—Close coupling means the condition in which two coils are placed in close magnetic proximity to each other.

Coil Antenna.—A coil antenna is one in which the wires of the antenna are in the form of a coil or loop.

Condenser.—A condenser is an electrical device for storing up electrical energy. It usually consists of two conducting surfaces separated by an insulating medium, called the dielectric.

Conductivity.—The conductivity of a substance is a measure of its current-carrying power.

Conductor.—A conductor is a substance that offers a relatively small opposition to the passage of an electric current; that is, it has low resistance.

Continuous Waves.—Continuous waves are a series of waves or cycles of current all of which have a constant or unvarying amplitude. Sometimes abbreviated C. W.

Conventional Symbols.—Conventional symbols are sets of easily drawn representations adopted to indicate various pieces of apparatus.

Coulomb.—The coulomb is the quantity of electricity or the charge transmitted in 1 second by a current of 1 ampere.

Counterpoise.—A counterpoise is a system of electrical conductors used to complete the antenna capacity effect in place of the usual ground connection.

Coupler.—A coupler is a device for the transfer of the energy of radio oscillations from one circuit to another.

Coupling.—Coupling refers to the amount of flux linkage of one coil with another.

Crystal Detector.—A crystal detector is a form of detector making use of the contact between a metal point and any one of certain metallic crystals, for the detector action.

Cycle.—A cycle of current is one complete set of one positive and one negative alternation of current.

Damped Wave.—A damped wave consists of a series of oscillations or cycles of current of gradually decreasing amplitude.

Decremeter.—A decremeter is an instrument for measuring directly the logarithmic decrement of a circuit or of a train of electromagnetic waves.

Detector.—A detector is any device which converts or rectifies high-frequency oscillations into a pulsating direct current.

Dielectric.—A dielectric is an insulating substance that allows electrostatic induction to act across it, as the insulating medium between the plates of a condenser.

Direct Current.—A direct current is a current that does not reverse; that is, the flow of electricity is always in one direction.

Dry Cell.—A dry cell is a type of primary cell in which the electrolyte is in the form of a paste.

Electrical Oscillation.—An electrical oscillation is a complete cycle of high-frequency current.

Electromagnetic Lines of Force.—Electromagnetic lines of force are the lines of force existing about an electromagnet and a current-carrying conductor.

Electrolytic Detector.—An electrolytic detector is one consisting of a fine platinum wire projecting a very short distance into an electrolyte.

Electron.—An electron is the smallest known part of matter and is an extremely minute but very active particle or charge of negative electricity.

Electron Tube.—An electron tube is a special type of radio device whose operation depends primarily upon a flow of electrons from one element to another.

Electromotive Force.—An electromotive force is the voltage or electrical pressure that causes electricity to flow in a circuit.

Ether.—The ether is a name given to a medium that is supposed to permeate all space and matter and to be the medium for the transmission of heat, light, and radio waves.

Expansion-Type Ammeter.—An expansion-type ammeter is one which depends for its operation upon the expansion of a piece of metal when it is heated by an electric current.

Farad.—The farad is the unit of capacity and represents the charge in a condenser when an electromotive force of 1 volt will place into it an electric charge of 1 coulomb.

Field.—The field of a generator or motor is the name given to the part of the electrical system which establishes an electromagnetic field effect.

Field Rheostat.—The field rheostat is a variable resistance placed in series in the field circuit of a generator or motor to control the field current and consequently the strength of the electromagnetic field.

Filament.—A filament is an electrically heated fine wire sealed in a glass bulb, and it forms one element of an electron tube.

Filament Battery.—A filament battery is a low-voltage battery used to send a current through the filament of an electron tube to heat it.

Fixed Condenser.—A fixed condenser is one whose plates are stationary and whose capacity cannot be changed.

Flux.—By the flux of a coil is meant the electromagnetic lines of force produced by a current in that coil.

Frequency.—The frequency of a current is the number f complete cycles of current occurring in 1 second.

Fuse.—A fuse is an element of a circuit designed to melt or dissipate and to open the circuit at a predetermined value of current. The fuse protects the circuit from the destroying effects of excessively high currents.

Galena.—Galena is a natural crystalline structure of lead sulphide which makes one of the most sensitive materials for crystal detectors.

Generator.—An electric generator is a device or machine for converting mechanical energy into electrical energy.

Grid.—The grid of an electron tube is the name given to the element which has that appearance, and which controls the flow of electrons away from the filament.

Grid Battery.—The grid battery is the name given to a battery that is sometimes connected in the grid circuit of a three-element electron tube.

Grid Condenser.—A condenser connected so as to give its charge to the grid of an electron tube is commonly called a grid condenser.

Grid Leak.—Grid leak is a name applied to a very high resistance often connected from the grid to the filament of an electron tube which permits any negative charge that may accumulate on the grid to leak off.

Ground.—A ground is an electrical connection with earth or water.

Ground Switch.—A ground switch is a switch so connected that it can connect the antenna direct to ground for protection in lightning storms.

Ground Wire.—A ground wire is the wire connecting the ground switch or radio set to ground.

Henry.—A henry is the unit of inductance, and a circuit has an inductance of 1 henry when a current changing at the rate of 1 ampere per second produces a back electromotive force of 1 volt.

Honeycomb Coil.—A honeycomb coil is an inductance coil so wound that it appears to have a cellular or honeycomb construction.

Hydrometer.—A hydrometer is a device for conveniently measuring the specific gravity of the electrolyte in a storage cell to give an indication of the state of charge of the battery.

Impedance.—The impedance is the total opposition of a circuit to the passage of an alternating current.

Inductance.—The inductance of a circuit is its property that allows it to store up electrical energy in electromagnetic form.

Interrupted Continuous Wave.—This is the name applied to a continuous wave that is interrupted, as by a chopper, before it is sent out. It consists of a series of wave-trains, each cycle, however, having the same current amplitude. It is sometimes abbreviated I. C. W.

Insulator.—An insulator is any material that presents such a high opposition to a flow of electricity that there is not a perceptible flow through that material.

Key.—A key is a special form of switch arranged for rapid operation to form dots and dashes of the telegraph codes.

Knob.—A knob is a form of circular handle usually mounted on the end of a shaft to make it easy to turn the shaft.

Lead-in.—The lead-in is the electrical conductor forming the connection between the antenna proper and the station apparatus.

Lightning.—Lightning is a violent electrical discharge between clouds or a cloud and earth, caused by a great difference of potential.

Lightning Arrester.—A lightning arrester is a device for protecting a circuit or apparatus from lightning and other excessively high voltages.

Loading Coil.—A loading-coil is a coil possessing inductance connected in a circuit to increase its period of oscillation.

Logarithmic Decrement.—The logarithmic decrement of a damped wave is expressed mathematically by the natural logarithm of the ratio of the amplitude of one oscillation to that of the next one in the same direction.

Loose Coupling.—Two coils are said to possess loose coupling when only a small part of the flux set up by one links the other coil.

Loud Speaker.—Loud speaker is the name given to a special type of telephone receiver capable of giving very loud signals or sounds.

Megohm.—A megohm is a resistance of 1,000,000 ohms.

Meter.—The meter is the unit of length in the metric system, largely used in European countries, and corre-

sponds to a length of 39.37 inches. An instrument or means for measuring some quantity, as a voltmeter.

Microfarad.—A microfarad is a capacity of $\frac{1}{1,000,000}$ of a farad, and is a very convenient division of the large unit.

Milliampere.—A milliampere is a current of the strength of $\frac{1}{1,000}$ of an ampere.

Motor.—A motor is an electrical machine for converting electrical energy into mechanical energy.

Motor-Generator Set.—A motor-generator set consists of a motor and generator connected together and used to deliver electrical energy of the desired kind.

Mutual Inductance.—Mutual inductance is the term applied to designate the inductance produced by a current change in one of two independent circuits which react upon each other.

Ohm.—An ohm is the unit of resistance, and may be defined as the resistance that will allow 1 ampere of current to pass under the pressure due to an electromotive force of 1 volt.

Oscillation Transformer.—An oscillation transformer is a special open type of transformer primarily used for transferring fairly large amounts of oscillating energy from one circuit to another.

Oscillatory Circuit.—An oscillatory circuit is one which offers very little opposition to the establishment of an oscillating current of the frequency to which it is tuned.

Panel.—A panel is a heavy sheet of insulating material on which electrical apparatus is mounted.

Parallel Connection.—A parallel connection of electrical devices or circuits is one in which the current divides, only a part of the total current passing through each device.

Period.—The period of an alternating current is the time required for one cycle to pass through a complete set of positive and negative values.

Plate.—The plate of an electron tube is the positively charged plate-like element which collects the electrons emitted by the filament.

Plate Battery.—The plate battery is the one connected in the plate circuit of an electron tube to give the plate element its high positive charge.

Plate Circuit.—The plate circuit of an electron tube includes all the devices connected directly in the external circuit between the filament and the plate elements.

Potentiometer.—A potentiometer is an arrangement for securing any desired voltage by utilizing the voltage drop across the required portion of a current-carrying resistance.

Primary Cell.—A primary cell is a type of cell whose voltage is directly due to the chemical decomposition of matter.

Primary Coil.—A primary coil is the input winding of a transformer.

Quenched Spark Gap.—A quenched spark gap is one arranged and designed so as to put out, or quench, the spark very quickly.

Radiation.—Radiation means the sending of energy from a source; it is considered here as the sending or radiating of energy from the antenna in the form of electromagnetic waves.

Radio Communication.—Radio communication is the science of transmitting and receiving knowledge by so-called radio means.

Radio Compass.—The name radio compass is frequently applied to a small coil antenna and receiving set when this arrangement is used for taking direction bearings.

Radio Frequency.—Currents of a frequency above 10,000 cycles per second are said to have a radio frequency, as currents of this frequency and higher are easily radiated by an antenna.

Receiving Station.—A receiving station is a radio station equipped with suitable apparatus for receiving radio messages.

Rectifier.—A rectifier is any device for converting an alternating current into a pulsating direct current.

Regenerative Circuit.—A regenerative circuit is an electron-tube circuit in which additional amplification is produced by feeding back some of the energy in the plate circuit into the grid circuit.

Resistance.—Resistance is the opposition to the passage of a direct current or low-frequency alternating current by any substance or material.

Resistivity.—The resistivity of any material is a measure of its resistance or opposition to the flow of electricity.

Resonance.—Two circuits are in resonance if they are in tune with each other, that is, if the products of the inductance and capacity of each are equal.

Rheostat.—A rheostat is a resistance device, usually variable. A device possessing resistance is also called a resistor.

Scale.—A scale is a series of divisions arranged to give numerical readings of the setting of the device to which it is connected.

Secondary.—The secondary of a transformer is the output winding.

Self-Inductance.—Self-inductance is the property of an electrical circuit which tends to prevent any change in the current established in the conductor.

Sending Station.—A sending station is a station equipped with apparatus for producing and radiating radio messages.

Series Connection.—In the series connection of electrical apparatus or circuits all of the current passes through each of the devices in succession or one after the other.

Slider.—A slider is a movable contact usually arranged to move along an electrical device to change the effect of its electrical properties.

Socket.—A socket is a receptacle, or support, into which some piece of apparatus may be inserted for convenient connection to a circuit or circuits.

Solder.—Solder is an alloy or mixture of lead and tin; it has a low melting point.

Soldering Flux.—Soldering flux is a chemical prepara-

tion to assist in cleaning the surfaces to be soldered, and to help the solder to stick properly.

Spark.—A spark is an arc of very short duration.

Spark Gap.—A spark gap is made of special terminals or electrodes designed to permit spark discharges to take place across the air gap between the terminals without injury, and for only a very short period of time.

Specific Inductive Capacity.—The specific inductive capacity of a substance is a direct measure of its ability to store up electrical energy when used as a dielectric material in a condenser.

Specific Gravity.—The specific gravity of any substance is its weight in proportion to that of an equal volume of water.

Starting Box.—A starting box is an adjustable resistance designed and used to control the flow of electricity into a motor during the starting period.

Static.—Static is an electrical disturbance caused by atmospheric charges collecting on the antenna.

Storage Cell.—A storage cell is a type of cell in which the chemical changes of discharge may be reversed by an electric current to recharge the cell to its original condition.

Switch.—A switch is a device for making, breaking, or changing the connections in an electric circuit.

Synchronous Spark Gap.—A synchronous spark gap is a spark gap that is operated by a special type of motor. The spark gap opens the circuit always at the same portion of the current wave.

Telegraph Code.—A telegraph code is a code of dot and dash combinations arranged to form letters, figures, and other symbols for rapid telegraphic communication.

Telephone Jack and Plug.—A telephone jack is a special type of connection device into which a telephone plug may be inserted to make an electrical connection.

Telephone Receivers.—Telephone receivers are reproducing devices capable of transferring current variations into sound impulses of like variation.

Telephone Transmitter.—A telephone transmitter refers,

strictly speaking, to a device for converting sound pulsations or variations into electric-current variations with the same features preserved.

Thermo-ammeter.—A thermo-ammeter is an ammeter operated by the thermoelectric effect caused by the current under observation.

Thermoelectric Effect.—The thermoelectric effect is the voltage effect generated at the terminals of a junction of two dissimilar metals and is greater with some metals than with others.

Tickler.—A tickler is the name sometimes applied to the coil in the plate circuit used to feed some of the energy back into the grid circuit.

Transformer.—A transformer is a device for transferring energy from one circuit to another.

Tuned Circuit.—A circuit is said to be tuned when its natural period of oscillation is the same as that of some other circuit to which it is coupled.

Tuning.—Tuning is the operation of adjusting any circuit to be in electrical resonance with any other circuit or circuits.

Variable Condenser.—A variable condenser is one whose electrical capacity may be changed or varied.

Variocoupler.—A variocoupler is composed of a set of coils, generally so arranged as to make it possible to vary the coupling between different circuits.

Variometer.—A variometer consists of two coils which may be placed in such relative positions that the inductance effects of each winding may be made to assist or practically neutralize each other.

Volt.—A volt is the unit of electromotive force and is the electrical pressure required to send a current of 1 ampere through a resistance of 1 ohm.

Voltmeter.—A voltmeter is a device for measuring electromotive force in volts.

Watt.—A watt is the unit of electrical power, and represents the product of current and electromotive force.

Wave Changer.—A transmitting device for rapidly and positively changing the radiated wave-length.

Wave-Length.—The wave-length is the distance between two corresponding points on succeeding waves.

Wavemeter.—A wavemeter is a device arranged and calibrated to read the length of a radiated wave directly in meters.

Wave-Train.—A wave-train is a short series of cycles of alternating current interrupted or separated by quiet periods.

Wire.—A wire is a slender rod or filament of drawn metal.

Wire Gauge.—A wire gauge is a system of wire sizes arranged for the convenient designation of wires of various diameters.

Wiring Diagram.—A wiring diagram is a sketch or figure showing where wire connections are to be made in a circuit.

RADIO LICENSE REGULATIONS

WHEN A MANUFACTURER'S LICENSE IS REQUIRED

Broad basic United States patents have been granted on many types of radio circuits and principles as well as on special radio devices. Some of the holders of these patents have sold the right to manufacture either a limited or unlimited number of devices under their patents. The person selling this right to manufacture apparatus under, or otherwise permit a manufacturer to make use of, his patent, is said to have granted that manufacturer a license, which should be made up in approved legal form.

Any one making apparatus or employing principles covered by a United States patent, or by a foreign patent that has been properly entered in the United States Patent Office, makes himself liable to legal proceedings, and heavy damages have been frequently obtained for violation of the patent rights held by another party. Due to the expense involved, legal proceedings are

seldom brought against an individual who uses the principles covered by a patent, if such is confined to his personal use. If it is desired to manufacture and sell apparatus covered by a patent, it is necessary to secure a license from the holder of the patent. After the patent has expired it is common property and is no longer a restriction on any one.

WHEN A GOVERNMENT STATION LICENSE IS REQUIRED

The United States Government requires that a sending station be licensed. The conditions are such that, in practice, all radio transmitting stations must have a Government license before they can be operated. The form of the license states the purpose of the station, whether amateur or commercial, and a licensed operator is required to be in charge when transmission is going on. The United States Government does not require that stations have a license which are used for receiving radio messages only. A complete summary of the radio laws of the United States is contained in the pamphlet, *Radio Communication Laws of the United States*, a copy of which may be obtained direct from the Government Printing Office, Washington, D. C., at a nominal cost. There is no charge collected for any form of United States radio license. Some cities require an inspection and approval of radio sets, particularly as regards the electrical safety of sending stations, but this is independent of the Government regulations.

In Canada, a station that is used only for receiving, must have a Government license as also must a sending station. Detailed information may be secured by inquiry to the Deputy Minister of the Naval Service, Ottawa, Ontario.

The United States Government further requires that persons desiring to operate a licensed sending station must have an operator's license of proper form. This covers several features which are given in detail in the radio pamphlet previously referred to, of which a summary fol-

laws. Any one may receive radio messages, but the Government Regulations specifically provide that the contents of any message directed to a specific person or persons may not be divulged or published unlawfully, under penalty of the law.

STATION LICENSE

Applications for station and operator's licenses of all kinds or grades should be sent to the Radio Inspector of the district in which the station or applicant is located, or, in case this is not known, to the Department of Commerce, Bureau of Navigation, Washington, D. C. All applications should be on forms supplied by the radio inspection service on application to any Radio Inspector, and should be carefully filled out in all details.

The United States Government regulations relative to transmitting stations are as follows:

"A person, company, or corporation within the jurisdiction of the United States shall not use or operate any apparatus for radio communication as a means of commercial intercourse among the several states, or with foreign nations, or upon any vessel of the United States engaged in interstate or foreign commerce, or for the transmission of radiograms or signals the effect of which extends beyond the jurisdiction of the State or Territory in which the same are made, or where interference would be caused thereby with the receipt of messages from beyond the jurisdiction of the said State or Territory, except under and in accordance with a license, revocable for cause, in that behalf granted by the Secretary of Commerce upon application therefor; but nothing in this Act shall be construed to apply to the transmission and exchange of radiograms or signals between points situated in the same State: *Provided*, that the effect thereof shall not extend beyond the jurisdiction of the said State or interfere with the reception of radiograms or signals from beyond said jurisdiction; and a license shall not be required for the transmission or exchange of radiograms or signals by or on behalf of the Government of the

United States, but every Government station on land or sea shall have special call letters designated and published in the list of radio stations of the United States by the Department of Commerce."

Call letters consisting generally of a number and two or three letters are issued to the station when the application for a license is approved. These form a convenient means of identifying calls for and from any particular station. The use of false call letters is prohibited. Station licenses can be issued only to persons who are citizens of the United States, its territories and dependencies.

Most of the *general amateur stations* are permitted to use a power input of 1 kilowatt on any wave-length not in excess of 200 meters. Some *special amateur stations* are permitted to transmit on wave-lengths up to 375 meters. *Experimental stations* of radio schools and colleges are generally allowed greater power and longer wave-lengths. *Commercial* and *ship stations* have a power rating and use wave-lengths assigned to their particular classes of service.

OPERATOR'S LICENSE

A person of any age, sex, or nationality may make application for an operator's license. This application should be on a form, which will be supplied by the Radio Inspector, and all blanks should be filled in. The license for some classes or grades is granted temporarily until an examination on code speed can be given. In the higher grades, especially the commercial ones, the examination must be taken before the license can be issued, and in addition to testing the sending and receiving speed, some questions are given on the theory and practice of radio, and some on the applicant's knowledge of the radio regulations of the United States and of the International Radiotelegraphic Convention. All operators are required to take a binding oath of secrecy.

Following is a list of various grades of operators' licenses. Certain grades are issued only under special

conditions; for others, an operator is required to be able to send and receive not less than a certain specified number of 5-letter words per minute in International Morse or American Morse. In the list the number required is mentioned following each class.

GRADES OF LICENSES

Commercial extra first: 30 of International Morse and 25 of American Morse.

Commercial first: 20 of International Morse.

Commercial second: 12 of International Morse.

Commercial cargo: required to understand usual distress signals:

Commercial temporary permit: issued temporarily to skilled ship operators.

Experiment and instruction: a special grade for investigators and experimenters.

Amateur first: 10 International Morse, but no examination.

Complete details of the requirements for any grade may be obtained from the pamphlet previously mentioned.

TENTATIVE REGULATIONS OF THE NATIONAL BOARD OF FIRE UN- DERWRITERS FOR RADIO SIGNALING APPARATUS

The following regulations were issued to secure field experience in advance of consideration of them as a revision of Rule 86 in the National Electrical Code. These rules do not apply to radio equipment installed on ship-board. When radio equipment is set up, all wiring pertaining thereto must conform to the general requirements of the National Electrical Code for the class of work installed and to the following additional specifications.

RECEIVING STATIONS

ANTENNA

a. Antenna outside of buildings shall not cross over or under electric light or power wires of any circuit of more than 600 volts, or railway trolley or feeder wires, nor shall it be so located that a failure of either antenna or of the above-mentioned electric light or power wires can result in a contact between the antenna and such electric light or power wires.

Antenna shall be constructed and installed in a strong and durable manner and shall be so located as to prevent accidental contact with light and power wires by sagging or swinging.

Splices and joints in the antenna span, unless made with approved clamps or splicing devices, shall be soldered.

Antennae installed inside of buildings are not covered by the above specifications.

LEAD-IN WIRES

b. Lead-in wires shall be of copper, approved copper-clad steel, or other approved metal which will not corrode excessively, and in no case shall they be smaller than No. 14 B. & S. gauge except that approved copper-clad steel not less than No. 17 B. & S. gauge may be used.

Lead-in wires on the outside of buildings shall not come nearer than 4 inches to electric light and power wires unless separated therefrom by a continuous and firmly fixed non-conductor that will maintain permanent separation. The non-conductor shall be in addition to any insulation on the wire.

Lead-in wires shall enter building through a non-combustible, non-absorptive insulating bushing.

PROTECTIVE DEVICE

c. Each lead-in wire shall be provided with an approved protective device properly connected and located (inside or outside the building) as near as practicable to the point

where the wire enters the building. The protector shall not be placed in the immediate vicinity of easily ignitable stuff, or where exposed to inflammable gases, or dust, or flyings of combustible materials.

The protective device shall be an approved lightning arrester which will operate at a potential of 500 volts or less.

The use of an antenna grounding switch is desirable, but does not obviate the necessity for the approved protective device required in this section. The antenna grounding switch if installed shall, in its closed position, form a shunt around the protective device.

(Suggested change). Fuses are not required, but if used must not be placed in the circuit from the antenna through the protective device to ground.

PROTECTIVE GROUND WIRE

d. The ground wire may be bare or insulated and shall be of copper or approved copper-clad steel. If of copper, the ground wire shall be not smaller than No. 14 B. & S. gauge, and if of approved copper-clad steel it shall be not smaller than No. 17 B. & S. gauge. The ground wire shall be run in as straight a line as possible to a good permanent ground. Preference shall be given to water piping. Gas piping shall not be used for grounding protective devices. Other permissible grounds are grounded steel frames of buildings or other grounded metallic work in the building and artificial grounds such as driven pipes, plates, cones, etc.

The ground wire shall be protected against mechanical injury. An approved ground clamp shall be used wherever the ground wire is connected to pipes or piping.

WIRES INSIDE BUILDINGS

e. Wires inside buildings shall be securely fastened in a workmanlike manner and shall not come nearer than 2 inches to any electric light or power wire unless separated therefrom by some continuous and firmly fixed non-conductor making a permanent separation. This non-

conductor shall be in addition to any regular insulation on the wire. Porcelain tubing or approved flexible tubing may be used for encasing wires to comply with this rule.

RECEIVING EQUIPMENT GROUND WIRE

f. The ground conductor may be bare or insulated and shall be of copper, approved copper-clad steel, or other approved metal which will not corrode excessively under existing conditions, and in no case shall the ground wire be less than No. 14 B. & S. gauge, except that approved copper-clad steel not less than No. 17 B. & S. gauge may be used.

The ground conductor may be run inside or outside of building. When receiving equipment ground wire is run in full compliance with rules for Protective Ground Wire, in Section *d*, it may be used as the ground conductor for the protective device.

TRANSMITTING STATIONS

ANTENNA

g. Antenna outside of buildings shall not cross over or under electric light or power wires of any circuit of more than 600 volts, or railway trolley or feeder wires, nor shall it be so located that a failure of either the antenna or the above-mentioned electric light or power wires can result in a contact between the antenna and such electric light or power wires.

Antenna shall be constructed and installed in a strong and durable manner and shall be so located as to prevent accidental contact with light and power wires by sagging or swinging.

Splices and joints in the antenna span shall, unless made with approved clamps or splicing devices, be soldered.

LEAD-IN WIRES

h. Lead-in wires shall be of copper, approved copper-clad steel or other metal which will not corrode exces-

sively, and in no case shall they be smaller than No. 14 B. & S. gauge.

Antenna and counterpoise conductors and wires leading therefrom to ground switch, where attached to buildings, must be firmly mounted 5 inches clear of the surface of the building, on non-absorptive insulating supports such as treated wood pins or brackets equipped with insulators having not less than 5-inch creepage and air-gap distance to inflammable or conducting material. Where desired, approved suspension type insulators may be used.

i. In passing the antenna or counterpoise lead-in into the building a tube or bushing of non-absorptive insulating material shall be used and shall be installed so as to have a creepage and air-gap distance of at least 5 inches to any extraneous body. If porcelain or other fragile material is used it shall be installed so as to be protected from mechanical injury. A drilled window pane may be used in place of bushing provided 5-inch creepage and air-gap distance is maintained.

PROTECTIVE GROUNDING SWITCH

j. A double-throw knife switch having a break distance of 4 inches and a blade not less than $\frac{1}{8}$ inch by $\frac{1}{2}$ inch shall be used to join the antenna and counterpoise lead-ins to the ground conductor. The switch may be located inside or outside the building. The base of the switch shall be of non-absorptive insulating material. Slate base switches are not recommended. This switch must be so mounted that its current-carrying parts will be at least 5 inches clear of the building wall or other conductors and located preferably in the most direct line between the lead-in conductors and the point where ground connection is made. The conductor from grounding switch to ground connection must be securely supported.

PROTECTIVE GROUND WIRE

k. Antenna and counterpoise conductors must be effectively and permanently grounded at all times when station is not in actual operation (unattended) by a con-

ductor at least as large as the lead-in, and in no case shall it be smaller than No. 14 B. & S. gauge copper or approved copper-clad steel. This ground wire need not be insulated or mounted on insulating supports. The ground wire shall be run in as straight a line as possible to a good permanent ground. Preference shall be given to water piping. Gas piping shall not be used for the ground connection. Other permissible grounds are the grounded steel frames of buildings and other grounded metal work in buildings and artificial grounding devices such as driven pipes, plates, cones, etc. The ground wire shall be protected against mechanical injury. An approved ground clamp shall be used wherever the ground wire is connected to pipes or piping.

OPERATING GROUND WIRE

l. The radio operating ground conductor shall be of copper strip not less than $\frac{3}{8}$ inch wide by $\frac{1}{16}$ inch thick, or of copper or approved copper-clad steel having a periphery, or girth (around the outside), of at least $\frac{3}{4}$ inch (for example, a No. 2 B. & S. gauge wire) and shall be firmly secured in place throughout its length. The radio operating ground conductor shall be protected and supported similar to the lead-in conductors.

OPERATING GROUND

m. The operating ground conductor shall be connected to a good permanent ground. Preference shall be given to water piping. Gas piping shall not be used for ground connections. Other permissible grounds are grounded steel frames of buildings or other grounded metal work in the building and artificial grounding devices such as driven pipes, plates, cones, etc.

POWER FROM STREET MAINS

n. When the current supply is obtained direct from street mains, the circuit shall be installed in approved metal conduit, armored cable or metal raceways.

If lead-covered wire is used it shall be protected

throughout its length in approved metal conduit or metal raceways.

PROTECTION FROM SURGES, ETC.

o. In order to protect the supply system from high-potential surges and kick-backs there must be installed in the supply line as near as possible to each radio-transformer, rotary spark gap, motor in generator set and other auxiliary apparatus, one of the following:

1. Two condensers (each of not less than $\frac{1}{2}$ microfarad capacity and capable of withstanding 600-volt test) in series across the line and mid-point grounded; across (in parallel with) each of these condensers shall be connected a shunting fixed spark gap capable of not more than $\frac{1}{8}$ -inch separation.

2. Two vacuum-tube type protectors in series across the line with the mid-point grounded.

3. Non-inductively wound resistors, connected across the line with mid-point grounded.

4. Electrolytic lightning arresters, such as the aluminum-cell type.

In no case shall the ground wire of surge and kick-back protective devices be run in parallel with the operating ground wire when within a distance of 30 feet.

The ground wire of the surge and kick-back protective devices shall not be connected to the operating ground or ground wire.

SUITABLE DEVICES

p. Transformers, voltage reducers, keys, and other devices employed shall be of types suitable for radio operation.

TABLES AND DATA

GENERAL CONVERSION FACTORS

In order to use the following table for converting from one unit to another the conversion factors are used as given; for example, to change 10 centimeters to inches would give $10 \times .3937 = 3.937$ inches. To change 10 inches to centimeters the conversion factor for centimeters is used as a divisor to give $10 \div .3937 = 25.40$ centimeters. It is better to use the direct conversion factor for all transfers, or to change 10 inches to centimeters use the value $10 \times 2.54 = 25.40$ centimeters. The units that are to be converted are given in an alphabetical order, so as to be located more readily.

Acres $\times .4047 =$ hectares

Acres $\times 43,560 =$ square feet

Ampere-hours $\times 3,600 =$ coulombs

British thermal units $\times 10,551 \times 10^6 =$ ergs

British thermal units $\times 778.3 =$ foot-pounds

British thermal units $\times 252.2 =$ gram-calories

British thermal units $\times 1,055 =$ joules

British thermal units $\times 107.6 =$ kilogram-meters

British thermal units $\times .2931 =$ watt-hours

British thermal units per minute $\times 17.57 =$ watts

Bushels $\times 1.244 =$ cubic feet

Bushels $\times 35.24 =$ liters

Bushels $\times 2150 =$ cubic inches

(Centigrade degrees $\times 1.8$) $+ 32^\circ =$ Fahrenheit temperature

Centimeters $\times .3937 =$ inches

Centimeters $\times .01 =$ meters

Centimeters $\times 10 =$ millimeters

Centimeters $\times 393.7 =$ mils

Centimeters of inductance $\times 10^{-9} =$ henrys

Centimeters (capacity) $\times 1.1 \times 10^{-12} =$ farads

Centimeters $\times 1.1 =$ micro-microfarads

Centimeters per second $\times 1.969 =$ feet per minute

Circular mils $\times 5.067 \times 10^{-6} =$ square centimeters

| | | |
|---------------------------|--------------------------------|---------------------------|
| Circular mils | $\times 7.854 \times 10^{-7}$ | = square inches |
| Circular mils | $\times .7854$ | = square mils |
| Cubic centimeters | $\times .061$ | = cubic inches |
| Cubic feet | $\times 28,317$ | = cubic centimeters |
| Cubic feet | $\times 1,728$ | = cubic inches |
| Cubic feet | $\times .02832$ | = cubic meters |
| Cubic feet | $\times .03704$ | = cubic yards |
| Cubic feet | $\times 7.481$ | = gallons |
| Cubic feet | $\times 28.317$ | = liters |
| Cubic inches | $\times 16.387$ | = cubic yards |
| Cubic inches | $\times 5.787 \times 10^{-4}$ | = cubic feet |
| Cubic inches | $\times 1.639 \times 10^{-6}$ | = cubic meters |
| Cubic inches | $\times 4.329 \times 10^{-3}$ | = gallons |
| Cubic inches | $\times .0164$ | = liters |
| Cubic meters | $\times 10^6$ | = cubic centimeters |
| Cubic meters | $\times 35.314$ | = cubic feet |
| Cubic meters | $\times 1,000$ | = liters |
| Cubic yards | $\times 27$ | = cubic feet |
| Cubic yards | $\times .765$ | = cubic meters |
| Cubic yards | $\times 202$ | = gallons |
| Degrees (angle) | $\times .01745$ | = radians |
| Ergs | $\times 9.486 \times 10^{-11}$ | = British thermal units |
| Ergs | $\times 10^{-7}$ | = joules |
| (Fahrenheit degrees - 32) | $\times \frac{5}{9}$ | = centigrade temperature |
| Farads | $\times 10^6$ | = microfarads |
| Farads | $\times .9 \times 10^{12}$ | = centimeters of capacity |
| Farads | $\times 10^{12}$ | = micro-microfarads |
| Farads | $\times 10^9$ | = milli-microfarads |
| Fathoms | $\times 6$ | = feet |
| Feet | $\times .167$ | = fathoms |
| Feet | $\times 12$ | = inches |
| Feet | $\times .3048$ | = meters |
| Feet | $\times .3333$ | = yards |
| Feet per minute | $\times .508$ | = centimeters per second |
| Foot-pounds | $\times .1383$ | = kilogram-meters |
| Foot-pounds | $\times 1.285 \times 10^{-3}$ | = British thermal units |
| Foot-pounds per minute | $\times 3.03 \times 10^{-4}$ | = horsepower |
| Foot-pounds per minute | $\times .0226$ | = watts |
| Gallons | $\times 3,785$ | = cubic centimeters |

| | | |
|---|-----------------------------|-------|
| Gallons $\times .1337$ | = cubic feet | r t } |
| Gallons $\times 231$ | = cubic inches | |
| Gallons $\times 4.951 \times 10^{-3}$ | = cubic yards | |
| Gallons (U. S.) $\times 3.785$ | = liters | |
| Gallons (British) $\times 4.543$ | = liters | |
| Grains (troy) $\times 1$ | = grains (avoirdupois) | |
| Grains (troy) $\times .0648$ | = grams | |
| Grams $\times 980.7$ | = dynes | |
| Grams $\times 15.43$ | = grains (troy) | |
| Grams $\times .035274$ | = ounces (avoirdupois) | |
| Grams $\times .03215$ | = ounces (troy) | |
| Grams $\times 2.205 \times 10^{-3}$ | = pounds (avoirdupois) | |
| Gram-calories $\times 3.965 \times 10^{-3}$ | = British thermal units | |
| Gram-calories $\times 4.184$ | = joules | |
| Grams per cubic centimeter $\times .03613$ | = pounds per cubic inch | |
| Hectares $\times 2.471$ | = acres | |
| Hectares $\times 10,000$ | = square meters | |
| Henrys $\times 10^9$ | = centimeters of inductance | |
| Henrys $\times 10^6$ | = microhenrys | |
| Henrys $\times 1,000$ | = millihenrys | |
| Horsepower $\times .7457$ | = kilowatts | |
| Horsepower $\times 33,000$ | = foot-pounds per minute | |
| Horsepower-hours $\times 2.684 \times 10^6$ | = joules | |
| Hours $\times 60$ | = minutes | |
| Hours $\times 3600$ | = seconds | |
| Inches $\times 2.54$ | = centimeters | |
| Inches $\times 1,000$ | = mils | |
| Inches $\times 254 \times 10^2$ | = microns | |
| Joules $\times 9.476 \times 10^{-4}$ | = British thermal units | |
| Joules $\times 10^7$ | = ergs | |
| Joules $\times .7376$ | = foot-pounds | |
| Joules $\times .239$ | = gram-calories | |
| Joules $\times 2.778 \times 10^{-7}$ | = watt-hours | |
| Kilogram-meters $\times .009293$ | = British thermal units | |
| Kilogram-meters $\times 7.233$ | = foot-pounds | |
| Kilograms $\times 1,000$ | = grams | |
| Kilograms $\times 2.2046$ | = pounds (avoirdupois) | |
| Kilometers $\times .54$ | = knots | |
| Kilometers $\times 1,000$ | = meters | |

| | | |
|--------------------------------------|-------------------------------|---------------------------------------|
| Kilometers | $\times .62137$ | = miles |
| Kilowatts | $\times 1.341$ | = horsepower |
| Kilowatts | $\times 1,000$ | = watts |
| Knots | $\times 1.853$ | = kilometers |
| Knots | $\times 1.152$ | = miles |
| Knots per hour | $\times 1.152$ | = miles per hour |
| Liters | $\times .02838$ | = bushels |
| Liters | $\times 1,000$ | = cubic centimeters |
| Liters | $\times .03531$ | = cubic feet |
| Liters | $\times 61.02$ | = cubic inches |
| Liters | $\times 1.308 \times 10^{-3}$ | = cubic yards |
| Liters | $\times 10^{-3}$ | = cubic meters |
| Liters | $\times .2642$ | = gallons (U. S.) |
| Liters | $\times 1.0567$ | = quarts (liquid) |
| Liters | $\times .908$ | = quarts (dry) |
| \log_n , or \log_e , of a number | $\times .4343$ | = \log_{10} of that number |
| \log_n of a number | $\times 2.303$ | = \log_n , or the natural logarithm |
| Megohms | $\times 10^6$ | = ohms |
| Meters | $\times 100$ | = centimeters |
| Meters | $\times 3.2808$ | = feet |
| Meters | $\times 39.37$ | = inches |
| Meters | $\times 10^{-3}$ | = kilometers |
| Meters | $\times 1,000$ | = millimeters |
| Meters | $\times 1.0936$ | = yards |
| Microfarads | $\times 10^{-6}$ | = farads |
| Microhenrys | $\times 10^{-6}$ | = henrys |
| Microhms | $\times 10^{-6}$ | = ohms |
| Micro-microfarads | $\times 10^{-12}$ | = farads |
| Micro-microfarads | $\times .9$ | = centimeters of capacity |
| Microns | $\times 3937 \times 10^{-8}$ | = inches |
| Miles (statute) | $\times 5,280$ | = feet |
| Miles (nautical) | $\times 6,086$ | = feet |
| Miles | $\times 1.60934$ | = kilometers |
| Miles | $\times .8684$ | = knots |
| Miles per hour | $\times .8684$ | = knots per hour |
| Miles per minute | $\times 88$ | = feet per second |
| Milliamperes | $\times 10^{-3}$ | = amperes |
| Milligrams | $\times 10^{-3}$ | = grams |
| Millihenrys | $\times 10^{-3}$ | = henrys |

| | | |
|------------------------|-------------------------------|------------------------------|
| Millimeters | $\times .1$ | = centimeters |
| Millimeters | $\times 39.37$ | = mils |
| Milli-microfarads | $\times 10^{-9}$ | = farads |
| Mils | $\times .00254$ | = centimeters |
| Mils | $\times .001$ | = inches |
| Mils | $\times .0254$ | = millimeters |
| Ohms | $\times 10^{-6}$ | = megohms |
| Ounces (avoirdupois) | $\times 28.35$ | = grams |
| Ounces (troy) | $\times 31.103$ | = grams |
| Ounces (avoirdupois) | $\times .0625$ | = pounds |
| Pounds | $\times 453.59$ | = grams |
| Pounds | $\times .4536$ | = kilograms |
| Pounds | $\times 16$ | = ounces (avoirdupois) |
| Pounds (avoirdupois) | $\times 7,000$ | = grains |
| Pounds of water | $\times .1198$ | = gallons |
| Pounds per cubic foot | $\times 16.02$ | = kilograms per cubic meter |
| Pounds per square foot | $\times 4.883$ | = kilograms per square meter |
| Quarts (liquid) | $\times .9463$ | = liters |
| Radians | $\times 57.3$ | = degrees (angular) |
| Square centimeters | $\times .155$ | = square inches |
| Square centimeters | $\times 10^{-6}$ | = square meters |
| Square feet | $\times 144$ | = square inches |
| Square feet | $\times \frac{1}{9}$ | = square yards |
| Square inches | $\times 1,273,240$ | = circular mils |
| Square inches | $\times 6.4516$ | = square centimeters |
| Square inches | $\times 6.944 \times 10^{-3}$ | = square feet |
| Square inches | $\times 10^6$ | = square mils |
| Square kilometers | $\times .3861$ | = square miles |
| Square meters | $\times 10^{-4}$ | = hectares |
| Square meters | $\times 1.196$ | = square yards |
| Square miles | $\times 27,880,000$ | = square feet |
| Square miles | $\times 2.59$ | = square kilometers |
| Square millimeters | $\times 1,973$ | = circular mils |
| Square millimeters | $\times 1.55 \times 10^{-3}$ | = square inches |
| Square mils | $\times 1.273$ | = circular mils |
| Square mils | $\times 10^{-6}$ | = square inches |
| Square yards | $\times 9$ | = square feet |
| Square yards | $\times .8361$ | = square meters |
| Tons (long) | $\times 2,240$ | = pounds |

- Tons (metric) $\times 1,000$ = kilograms
- Tons (metric) $\times 2,204.6$ = pounds
- Tons (metric) $\times 1.1023$ = tons (short)
- Tons (short) $\times 907.2$ = kilograms
- Tons (short) $\times 2,000$ = pounds
- Watts $\times .05692$ = British thermal units per minute
- Watts $\times 44.26$ = foot-pounds per minute
- Watts $\times 1.341 \times 10^{-3}$ = horsepower
- Watts $\times 10^{-3}$ = kilowatts
- Watt-hours $\times 3.411$ = British thermal units
- Watt-hours $\times 10^{-3}$ = kilowatt-hours
- Yards $\times 3$ = feet
- Yards $\times 36$ = inches
- Yards $\times .9144$ = meters
- Yards $\times 91.44$ = centimeters

WEIGHTS AND MEASURES

LINEAR MEASURE

- 12 inches (in.)..... = 1 foot.....ft.
- 3 feet..... = 1 yard.....yd.
- 5½ yards..... = 1 rod.....rd.
- 40 rods..... = 1 furlong.....fur.
- 8 furlongs..... = 1 mile.....mi.

| <i>in.</i> | <i>ft.</i> | <i>yd.</i> | <i>rd.</i> | <i>fur.</i> | <i>mi.</i> |
|------------|------------|------------|------------|-------------|------------|
| 36 = | 3 = | 1 | | | |
| 198 = | 16.5 = | 5.5 = | 1 | | |
| 7,920 = | 660 = | 220 = | 40 = | 1 | |
| 63,360 = | 5,280 = | 1,760 = | 320 = | 8 = | 1 |

SQUARE MEASURE

- 144 square inches (sq. in.)... = 1 square footsq. ft.
 - 9 square feet..... = 1 square yardsq. yd.
 - 30½ square yards..... = 1 square rodsq. rd.
 - 160 square rods..... = 1 acre.....A.
 - 640 acres..... = 1 square milesq. mi.
- | | | | | | |
|----------------|-----------|----------------|----------------|----------------|----------------|
| <i>sq. mi.</i> | <i>A.</i> | <i>sq. rd.</i> | <i>sq. yd.</i> | <i>sq. ft.</i> | <i>sq. in.</i> |
| 1 = | 640 = | 102,400 = | 3,097,600 = | 27,878,400 = | 4,014,489,600 |

CUBIC MEASURE

| | | |
|---|----------------------|--------------|
| 1,728 cubic inches (cu. in.) | = 1 cubic foot |cu. ft. |
| 27 cubic feet | = 1 cubic yard |cu. yd. |
| 128 cubic feet | = 1 cord |cd. |
| 24½ cubic feet | = 1 perch |P. |
| 1 cu. yd. = 27 cu. ft. = 46,656 cu. in. | | |

MEASURE OF ANGLES OR ARCS

| | | |
|--------------------------------------|---------------------------------|-----------|
| 60 seconds (") | = 1 minute |' |
| 60 minutes | = 1 degree |° |
| 90 degrees | = 1 rt. angle or quadrant |L |
| 360 degrees | = 1 circle |cir. |
| 1 cir. = 360° = 21,600' = 1,296,000" | | |

AVOIRDUPOIS WEIGHT

| | | |
|--|-------------------------|------------|
| 437.5 grains (gr.) | = 1 ounce |oz. |
| 16 ounces | = 1 pound |lb. |
| 100 pounds | = 1 hundredweight |cwt. |
| 20 cwt., or 2,000 lb. | = 1 ton |T. |
| 2,240 lb. | = 1 long ton |L. T. |
| 1 T. = 20 cwt. = 2,000 lb. = 32,000 oz. = 14,000,000 gr. | | |
| The avoirdupois pound contains 7,000 gr. | | |

TROY WEIGHT

| | | |
|---------------------------------------|-----------------------|-----------|
| 24 grains (gr.) | = 1 pennyweight |pwt. |
| 20 pennyweights | = 1 ounce |oz. |
| 12 ounces | = 1 pound |lb. |
| 1 lb. = 12 oz. = 240 pwt. = 5,760 gr. | | |

DRY MEASURE

| | | |
|---------------------------------|------------------|----------|
| 2 pints (pt.) | = 1 quart |qt. |
| 8 quarts | = 1 peck |pk. |
| 4 pecks | = 1 bushel |bu. |
| 1 bu. = 4 pk. = 32 qt. = 64 pt. | | |

The U. S. bushel contains 2,150.42 cu. in. = approximately 1½ cu. ft. The British bushel contains 2,218.19 cu. in.

TA

VOT LAND)

| |
|-----------------------|
|pt. |
|qt. |
|gal. |
|bbl. |
| l. hhd. |
| 4 pt. = 2,016 gi. |
| .134 cu. ft., nearly. |

| | |
|-----------------|--------------------------|
| eter....cu. cm. | sity, 1 cu. ft. weighs |
| er....cu. dm. | o. |
|cu. m. | ater is considered equal |
| | $\frac{1}{3}$ lb. |

C SYSTEM

.....cl.
dl.
l.
Dl.
Hl.
Kl.
 l. dm.

.....cg.
dg.
g.
Dg.
Hg.
Kg.
T.

er
of
t

on the meter, which, according to the Metric Survey Report of 1884, is the value commonly used is 39.37 in. The U. S. government has adopted the following principal units—the *meter*, the *liter* (properly the *gramme liter*), the *gram*, the units of length, capacity, and weight, respectively. Multiples of these units are given, to the names of the principal units the *deca* (10), *hecto* (100), and *kilo* (1,000); the subdivisions, are obtained by prefixing the Latin *deca* ($\frac{1}{10}$), *hecto* ($\frac{1}{100}$), and *milli* ($\frac{1}{1000}$). These prefixes apply to the entire system. The abbreviations of the units and their multiples begin with a small letter, and the multiples begin with a capital letter.

MEASURES OF LENGTH

| | | |
|------------------------|---------------------|-----|
|meters (mm.)..... | = 1 centimeter..... | cm. |
|meters..... | = 1 decimeter..... | dm. |
|meters..... | = 1 meter..... | m. |
|meters..... | = 1 decameter..... | Dm. |
|meters..... | = 1 hectometer..... | Hm. |
|meters..... | = 1 kilometer..... | Km. |

MEASURES OF SURFACE (I)

100 square millimeters

(sq. mm.)..... = 1 square ce

100 square centimeters... = 1 square de

100 square decimeters.... = 1 square met

MEASURES OF VOLUME

1,000 cubic millimeters

(cu. mm.)..... = 1 cubic centim

1,000 cubic centimeters... = 1 cubic decime

1,000 cubic dccimeters... = 1 cubic meter...

MEASURES OF CAPACITY

10 milliliters (ml.)..... = 1 centiliter...

10 centiliters..... = 1 deciliter...

10 deciliters..... = 1 liter.....

10 liters..... = 1 decaliter....

10 decaliters..... = 1 hectoliter....

10 hectoliters..... = 1 kiloliter.....

The liter is equal to the volume occupied by 1 cu

MEASURES OF WEIGHT

10 milligrams (mg.)..... = 1 centigram.....

10 centigrams..... = 1 decigram.....

10 decigrams..... = 1 gram.....

10 grams..... = 1 decagram.....

10 decagrams..... = 1 hectogram.....

10 hectograms..... = 1 kilogram.....

1,000 kilograms..... = 1 ton.....

The gram is the weight of 1 cu. cm. of pure distilled wa
 at a temperature of 39.2° F.; the kilogram is the weight
 1 liter of water; the ton is the weight of 1 cu. m. of wate

DECIMAL EQUIVALENTS OF PARTS OF ONE INCH

| | | | | | | | |
|-------|---------|-------|---------|-------|---------|-------|---------|
| 1-64 | .015625 | 17-64 | .265625 | 33-64 | .515625 | 49-64 | .765625 |
| 1-32 | .031250 | 9-32 | .281250 | 17-32 | .531250 | 25-32 | .781250 |
| 3-64 | .046875 | 19-64 | .296875 | 35-64 | .546875 | 51-64 | .796875 |
| 1-16 | .062500 | 5-16 | .312500 | 9-16 | .562500 | 13-16 | .812500 |
| 5-64 | .078125 | 21-64 | .328125 | 37-64 | .578125 | 53-64 | .828125 |
| 3-32 | .093750 | 11-32 | .343750 | 19-32 | .593750 | 27-32 | .843750 |
| 7-64 | .109375 | 23-64 | .359375 | 39-64 | .609375 | 55-64 | .859375 |
| 1-8 | .125000 | 3-8 | .375000 | 5-8 | .625000 | 7-8 | .875000 |
| 9-64 | .140625 | 25-64 | .390625 | 41-64 | .640625 | 57-64 | .890625 |
| 5-32 | .156250 | 13-32 | .406250 | 21-32 | .656250 | 29-32 | .906250 |
| 11-64 | .171875 | 27-64 | .421875 | 43-64 | .671875 | 59-64 | .921875 |
| 3-16 | .187500 | 7-16 | .437500 | 11-16 | .687500 | 15-16 | .937500 |
| 13-64 | .203125 | 29-64 | .453125 | 45-64 | .703125 | 61-64 | .953125 |
| 7-32 | .218750 | 15-32 | .468750 | 23-32 | .718750 | 31-32 | .968750 |
| 15-64 | .234375 | 31-64 | .484375 | 47-64 | .734375 | 63-64 | .984375 |
| 1-4 | .250000 | 1-2 | .500000 | 3-4 | .750000 | 1 | 1 |

TRIGONOMETRIC FUNCTIONS

The accompanying table contains the natural sines, cosines, tangents, and cotangents of angles from 0° to 90° . Angles less than 45° are given in the first column at the left-hand side of the page, and the names of the functions are given at the top of the page; angles greater than 45° appear at the right-hand side of the page, and the names of the functions are given at the bottom. Thus, the second column contains the sines of angles less than 45° and the cosines of angles greater than 45° ; the sixth column contains the cotangents of angles less than 45° and the tangents of angles greater than 45° . To find the function of an angle less than 45° , look in the column of angles at the left of the page for the angle, and at the top of the page for the name of the function; to find a function of an angle greater than 45° , look in the column at the right of the page for the angle and at the bottom of the page for the name of the function. The successive angles differ by an interval of $10'$; they increase downwards in the left-hand column and upwards in the right-hand column. Thus, for angles less than 45° read down from top of page, and for angles greater than 45° read up from bottom of page.

The third, fifth, seventh, and ninth columns, headed d , contain the differences between the successive functions; for

example, the sine of $32^\circ 10'$ is .5324 and the sine of $32^\circ 20'$ is .5348, as given in the second column, page 26; the difference is $.5348 - .5324 = .0024$, and the 24 is written in the third column, just opposite the space between .5324 and .5348. In like manner, the differences between the successive tabular values of the tangents are given in the fifth column, those between the cotangents in the seventh column, and those for the cosines in the ninth column. These differences in the functions correspond to a difference of $10'$ in the angle; thus, when the angle $32^\circ 10'$ is increased by $10'$, that is, to $32^\circ 20'$, the increase of the sine is .0024, or, as given in the table, 24. In the tabular difference, no attention is paid to the decimal point, it being understood that the difference is merely the number obtained by subtracting the last two or three figures of the smaller function from those of the larger. These differences are used to obtain the sines, cosines, etc. of angles not given in the table; for example, to find the tangent of $27^\circ 34'$ find in the table the tangent of $27^\circ 30'$, .5206, and (in column 5) the difference for $10'$, 37. Difference for $1'$ is $37 \div 10 = 3.7$, and difference for $4'$ is $3.7 \times 4 = 14.8$. Adding this difference to the value of the $\tan 27^\circ 30'$, gives

$$\begin{array}{r} \tan 27^\circ 30' = .5206 \\ \text{difference for } 4' = \quad 14.8 \\ \hline \end{array}$$

$$\tan 27^\circ 34' = .52208, \text{ or } .5221, \text{ to four places.}$$

Since only four decimal places are retained, the 8 in the fifth place is dropped and the figure in the fourth place is increased by 1, because 8 is greater than 5.

To avoid multiplication, the column of proportional parts, headed P. P., at the extreme right of the page, is used. At the head of each table in this column is the difference for $10'$, and below are the differences for any intermediate number of minutes from $1'$ to $9'$. In the above example, the difference at $27^\circ 30'$ for $10'$ was 37; looking in the table with 37 at the head, the difference opposite 4 is 14.8; that opposite 7 is 25.9; and so on. For want of space, the differences for the cotangents for angles less than 45° (or the tangents of angles greater than 45°) have been omitted from the tables of proportional parts. The use of these functions should be

| | | | | | | | | | | P. P. | | | | | |
|----|----|--------|----|--------|----|--------|------|--------|----|-------|----|-----------|-----------|-----------|-----|
| ° | ' | Sin. | d. | Tan. | d. | Cot. | d. | Cos. | d. | | | | | | |
| 9 | 0 | 0.1564 | | 0.1584 | | 6.3138 | | 0.9877 | | 0 | 81 | | | | |
| | 10 | 0.1593 | 29 | 0.1614 | 30 | 6.1970 | 1168 | 0.9872 | 5 | 50 | | | | | |
| | 20 | 0.1622 | 28 | 0.1644 | 29 | 6.0844 | 1086 | 0.9868 | 5 | 40 | | | | | |
| | 30 | 0.1650 | 29 | 0.1673 | 30 | 5.9758 | 1050 | 0.9863 | 5 | 30 | | 32 | 31 | 30 | |
| | 40 | 0.1679 | 29 | 0.1703 | 30 | 5.8708 | 1014 | 0.9858 | 5 | 20 | | 1 | 3.2 | 3.1 | 3.0 |
| | 50 | 0.1708 | 28 | 0.1733 | 30 | 5.7694 | 981 | 0.9853 | 5 | 10 | | 2 | 6.4 | 6.2 | 6.0 |
| 10 | 0 | 0.1736 | | 0.1763 | | 5.6713 | | 0.9848 | 5 | 0 | 80 | | | | |
| | 10 | 0.1765 | 29 | 0.1793 | 30 | 5.5764 | 949 | 0.9843 | 5 | 50 | | | | | |
| | 20 | 0.1794 | 28 | 0.1823 | 30 | 5.4845 | 919 | 0.9838 | 5 | 40 | | | | | |
| | 30 | 0.1822 | 29 | 0.1853 | 30 | 5.3955 | 890 | 0.9833 | 5 | 30 | | | | | |
| | 40 | 0.1851 | 29 | 0.1883 | 31 | 5.3093 | 862 | 0.9827 | 5 | 20 | | | | | |
| | 50 | 0.1880 | 28 | 0.1914 | 30 | 5.2257 | 836 | 0.9822 | 5 | 10 | | | | | |
| 11 | 0 | 0.1908 | | 0.1944 | | 5.1446 | | 0.9816 | 6 | 0 | 79 | | | | |
| | 10 | 0.1937 | 29 | 0.1974 | 30 | 5.0658 | 788 | 0.9811 | 5 | 50 | | | | | |
| | 20 | 0.1965 | 28 | 0.2004 | 31 | 4.9894 | 764 | 0.9805 | 6 | 40 | | | | | |
| | 30 | 0.1994 | 28 | 0.2035 | 30 | 4.9152 | 742 | 0.9799 | 6 | 30 | | | | | |
| | 40 | 0.2022 | 29 | 0.2067 | 30 | 4.8430 | 722 | 0.9793 | 6 | 20 | | | | | |
| | 50 | 0.2051 | 28 | 0.2095 | 31 | 4.7729 | 701 | 0.9787 | 6 | 10 | | | | | |
| 12 | 0 | 0.2079 | | 0.2126 | | 4.7046 | | 0.9781 | 6 | 0 | 78 | | | | |
| | 10 | 0.2108 | 29 | 0.2156 | 30 | 4.6382 | 664 | 0.9775 | 6 | 50 | | | | | |
| | 20 | 0.2136 | 28 | 0.2186 | 31 | 4.5736 | 646 | 0.9769 | 6 | 40 | | | | | |
| | 30 | 0.2164 | 29 | 0.2217 | 30 | 4.5107 | 629 | 0.9763 | 6 | 30 | | | | | |
| | 40 | 0.2193 | 28 | 0.2247 | 31 | 4.4494 | 613 | 0.9757 | 6 | 20 | | | | | |
| | 50 | 0.2221 | 29 | 0.2278 | 31 | 4.3897 | 597 | 0.9750 | 7 | 10 | | | | | |
| 13 | 0 | 0.2250 | | 0.2309 | | 4.3315 | | 0.9744 | 6 | 0 | 77 | | | | |
| | 10 | 0.2278 | 28 | 0.2339 | 30 | 4.2747 | 568 | 0.9737 | 7 | 50 | | | | | |
| | 20 | 0.2306 | 28 | 0.2370 | 31 | 4.2193 | 554 | 0.9730 | 7 | 40 | | | | | |
| | 30 | 0.2334 | 29 | 0.2401 | 31 | 4.1653 | 540 | 0.9724 | 6 | 30 | | | | | |
| | 40 | 0.2363 | 28 | 0.2432 | 30 | 4.1126 | 527 | 0.9717 | 7 | 20 | | | | | |
| | 50 | 0.2391 | 28 | 0.2462 | 31 | 4.0611 | 515 | 0.9710 | 7 | 10 | | | | | |
| 14 | 0 | 0.2419 | | 0.2493 | | 4.0108 | | 0.9703 | 7 | 0 | 76 | | | | |
| | 10 | 0.2447 | 29 | 0.2524 | 31 | 3.9617 | 491 | 0.9696 | 7 | 50 | | | | | |
| | 20 | 0.2476 | 28 | 0.2555 | 31 | 3.9136 | 481 | 0.9689 | 7 | 40 | | | | | |
| | 30 | 0.2504 | 28 | 0.2586 | 31 | 3.8667 | 469 | 0.9681 | 8 | 30 | | | | | |
| | 40 | 0.2532 | 28 | 0.2617 | 31 | 3.8208 | 459 | 0.9674 | 7 | 20 | | | | | |
| | 50 | 0.2560 | 28 | 0.2648 | 31 | 3.7760 | 448 | 0.9667 | 7 | 10 | | | | | |
| 15 | 0 | 0.2588 | | 0.2679 | | 3.7321 | | 0.9659 | 8 | 0 | 75 | | | | |
| | 10 | 0.2616 | 28 | 0.2711 | 32 | 3.6891 | 430 | 0.9652 | 7 | 50 | | | | | |
| | 20 | 0.2644 | 28 | 0.2742 | 31 | 3.6470 | 421 | 0.9644 | 8 | 40 | | | | | |
| | 30 | 0.2672 | 28 | 0.2773 | 32 | 3.6059 | 411 | 0.9636 | 8 | 30 | | | | | |
| | 40 | 0.2700 | 28 | 0.2805 | 32 | 3.5656 | 403 | 0.9628 | 8 | 20 | | | | | |
| | 50 | 0.2728 | 28 | 0.2836 | 31 | 3.5261 | 395 | 0.9621 | 7 | 10 | | | | | |
| 16 | 0 | 0.2756 | | 0.2867 | | 3.4874 | | 0.9613 | 8 | 0 | 74 | | | | |
| | 10 | 0.2784 | 28 | 0.2899 | 32 | 3.4495 | 379 | 0.9605 | 8 | 50 | | | | | |
| | 20 | 0.2812 | 28 | 0.2931 | 31 | 3.4124 | 371 | 0.9596 | 9 | 40 | | | | | |
| | 30 | 0.2840 | 28 | 0.2962 | 32 | 3.3759 | 365 | 0.9588 | 8 | 30 | | | | | |
| | 40 | 0.2868 | 28 | 0.2994 | 32 | 3.3402 | 357 | 0.9580 | 8 | 20 | | | | | |
| | 50 | 0.2896 | 28 | 0.3026 | 32 | 3.3052 | 350 | 0.9572 | 9 | 10 | | | | | |
| 17 | 0 | 0.2924 | | 0.3057 | | 3.2709 | | 0.9563 | 9 | 0 | 73 | | | | |
| | 10 | 0.2952 | 27 | 0.3089 | 32 | 3.2371 | 338 | 0.9555 | 8 | 50 | | | | | |
| | 20 | 0.2979 | 28 | 0.3121 | 32 | 3.2041 | 330 | 0.9546 | 9 | 40 | | | | | |
| | 30 | 0.3007 | 28 | 0.3153 | 32 | 3.1716 | 325 | 0.9537 | 9 | 30 | | | | | |
| | 40 | 0.3035 | 27 | 0.3185 | 32 | 3.1397 | 319 | 0.9528 | 9 | 20 | | | | | |
| | 50 | 0.3062 | 27 | 0.3217 | 32 | 3.1084 | 313 | 0.9520 | 8 | 10 | | | | | |
| 18 | 0 | 0.3090 | | 0.3249 | | 3.0777 | | 0.9511 | 9 | 0 | 72 | | | | |
| | | Cos. | d. | Cot. | d. | Tan. | d. | Sin. | d. | ' | ° | | | | |
| | | | | | | | | | | | | P. P. | | | |

| | | | | | | | | | | P. P. | | | |
|----|----|--------|----|--------|----|--------|-----|--------|----|-------|------|------|------|
| ° | ' | Sin. | d. | Tan. | d. | Cot. | d. | Cos. | d. | | | | |
| 18 | 0 | 0.3090 | | 0.3249 | | 3.0777 | | 0.9511 | | 0 72 | | | |
| | 10 | 0.3118 | 28 | 0.3291 | 32 | 3.0475 | 302 | 0.9502 | 9 | 50 | | | |
| | 20 | 0.3145 | 27 | 0.3314 | 33 | 3.0178 | 297 | 0.9492 | 10 | 40 | | | |
| | 30 | 0.3173 | 28 | 0.3346 | 32 | 2.9887 | 287 | 0.9483 | 9 | 30 | | | |
| | 40 | 0.3201 | 28 | 0.3378 | 33 | 2.9600 | 281 | 0.9474 | 9 | 20 | | | |
| | 50 | 0.3228 | 27 | 0.3411 | 33 | 2.9319 | 277 | 0.9467 | 10 | 10 | | | |
| 19 | 0 | 0.3256 | | 0.3443 | | 2.9042 | | 0.9455 | | 0 71 | | | |
| | 10 | 0.3283 | 28 | 0.3476 | 32 | 2.8770 | 272 | 0.9446 | 9 | 50 | | | |
| | 20 | 0.3311 | 27 | 0.3508 | 33 | 2.8502 | 268 | 0.9436 | 10 | 40 | | | |
| | 30 | 0.3338 | 27 | 0.3541 | 33 | 2.8239 | 263 | 0.9426 | 10 | 30 | | | |
| | 40 | 0.3365 | 28 | 0.3574 | 33 | 2.7980 | 259 | 0.9417 | 9 | 20 | | | |
| | 50 | 0.3393 | 27 | 0.3607 | 33 | 2.7725 | 255 | 0.9407 | 10 | 10 | | | |
| 20 | 0 | 0.3420 | | 0.3640 | | 2.7475 | | 0.9397 | | 0 70 | | | |
| | 10 | 0.3448 | 28 | 0.3673 | 33 | 2.7228 | 247 | 0.9387 | 10 | 50 | | | |
| | 20 | 0.3475 | 27 | 0.3706 | 33 | 2.6985 | 243 | 0.9377 | 10 | 40 | | | |
| | 30 | 0.3502 | 27 | 0.3739 | 33 | 2.6746 | 239 | 0.9367 | 11 | 30 | | | |
| | 40 | 0.3529 | 28 | 0.3772 | 33 | 2.6511 | 235 | 0.9356 | 10 | 20 | | | |
| | 50 | 0.3557 | 27 | 0.3805 | 34 | 2.6279 | 232 | 0.9346 | 10 | 10 | | | |
| 21 | 0 | 0.3584 | | 0.3839 | | 2.6051 | | 0.9336 | | 0 69 | | | |
| | 10 | 0.3611 | 27 | 0.3872 | 33 | 2.5826 | 228 | 0.9325 | 11 | 50 | | | |
| | 20 | 0.3638 | 27 | 0.3906 | 33 | 2.5605 | 225 | 0.9315 | 10 | 40 | | | |
| | 30 | 0.3665 | 27 | 0.3939 | 34 | 2.5386 | 221 | 0.9304 | 11 | 30 | | | |
| | 40 | 0.3692 | 27 | 0.3973 | 34 | 2.5172 | 219 | 0.9293 | 11 | 20 | | | |
| | 50 | 0.3719 | 27 | 0.4006 | 34 | 2.4960 | 214 | 0.9283 | 10 | 10 | | | |
| 22 | 0 | 0.3746 | | 0.4040 | | 2.4751 | | 0.9272 | | 0 68 | | | |
| | 10 | 0.3773 | 27 | 0.4074 | 34 | 2.4545 | 209 | 0.9261 | 11 | 50 | | | |
| | 20 | 0.3800 | 27 | 0.4108 | 34 | 2.4342 | 206 | 0.9250 | 11 | 40 | | | |
| | 30 | 0.3827 | 27 | 0.4142 | 34 | 2.4142 | 203 | 0.9239 | 11 | 30 | | | |
| | 40 | 0.3854 | 27 | 0.4176 | 34 | 2.3945 | 200 | 0.9228 | 12 | 20 | | | |
| | 50 | 0.3881 | 26 | 0.4210 | 35 | 2.3750 | 197 | 0.9216 | 12 | 10 | | | |
| 23 | 0 | 0.3907 | | 0.4245 | | 2.3559 | | 0.9205 | | 0 67 | | | |
| | 10 | 0.3934 | 27 | 0.4279 | 35 | 2.3369 | 191 | 0.9205 | 11 | 50 | | | |
| | 20 | 0.3961 | 26 | 0.4314 | 34 | 2.3183 | 190 | 0.9194 | 12 | 40 | | | |
| | 30 | 0.3987 | 27 | 0.4348 | 35 | 2.2998 | 186 | 0.9182 | 11 | 30 | | | |
| | 40 | 0.4014 | 27 | 0.4383 | 34 | 2.2817 | 185 | 0.9171 | 12 | 20 | | | |
| | 50 | 0.4041 | 26 | 0.4417 | 35 | 2.2637 | 181 | 0.9159 | 12 | 10 | | | |
| 24 | 0 | 0.4067 | | 0.4452 | | 2.2460 | | 0.9147 | | 0 66 | | | |
| | 10 | 0.4094 | 27 | 0.4487 | 35 | 2.2286 | 177 | 0.9135 | 12 | 50 | | | |
| | 20 | 0.4120 | 26 | 0.4522 | 35 | 2.2113 | 174 | 0.9124 | 11 | 40 | | | |
| | 30 | 0.4147 | 26 | 0.4557 | 35 | 2.1943 | 173 | 0.9112 | 12 | 30 | | | |
| | 40 | 0.4173 | 26 | 0.4592 | 36 | 2.1775 | 170 | 0.9100 | 12 | 20 | | | |
| | 50 | 0.4200 | 27 | 0.4628 | 36 | 2.1609 | 168 | 0.9088 | 13 | 10 | | | |
| 25 | 0 | 0.4226 | | 0.4663 | | 2.1445 | | 0.9075 | | 0 65 | | | |
| | 10 | 0.4253 | 26 | 0.4699 | 36 | 2.1283 | 164 | 0.9063 | 12 | 50 | | | |
| | 20 | 0.4279 | 26 | 0.4734 | 35 | 2.1123 | 162 | 0.9051 | 13 | 40 | | | |
| | 30 | 0.4305 | 26 | 0.4770 | 36 | 2.0965 | 160 | 0.9038 | 12 | 30 | | | |
| | 40 | 0.4331 | 27 | 0.4806 | 36 | 2.0809 | 158 | 0.9026 | 13 | 20 | | | |
| | 50 | 0.4358 | 27 | 0.4841 | 35 | 2.0655 | 156 | 0.9013 | 12 | 10 | | | |
| 26 | 0 | 0.4384 | | 0.4877 | | 2.0503 | | 0.8998 | | 0 64 | | | |
| | 10 | 0.4410 | 26 | 0.4913 | 36 | 2.0353 | 152 | 0.8988 | 13 | 50 | | | |
| | 20 | 0.4436 | 26 | 0.4950 | 36 | 2.0204 | 150 | 0.8975 | 13 | 40 | | | |
| | 30 | 0.4462 | 26 | 0.4986 | 36 | 2.0057 | 149 | 0.8962 | 13 | 30 | | | |
| | 40 | 0.4488 | 26 | 0.5022 | 37 | 1.9912 | 147 | 0.8949 | 13 | 20 | | | |
| | 50 | 0.4514 | 26 | 0.5059 | 36 | 1.9768 | 145 | 0.8936 | 13 | 10 | | | |
| 27 | 0 | 0.4540 | | 0.5095 | | 1.9626 | | 0.8923 | | 0 63 | | | |
| | | | | | | | 142 | 0.8910 | 13 | | | | |
| | | | | | | | | | | P. P. | | | |
| | | | | | | | | | | 1 | 37 | 38 | 35 |
| | | | | | | | | | | 2 | 8.7 | 3.6 | 8.5 |
| | | | | | | | | | | 3 | 7.4 | 7.2 | 7.0 |
| | | | | | | | | | | 4 | 11.1 | 10.8 | 10.5 |
| | | | | | | | | | | 5 | 14.8 | 14.4 | 14.0 |
| | | | | | | | | | | 6 | 18.5 | 18.0 | 17.5 |
| | | | | | | | | | | 7 | 22.2 | 21.6 | 21.0 |
| | | | | | | | | | | 8 | 25.9 | 25.2 | 24.5 |
| | | | | | | | | | | 9 | 29.6 | 28.8 | 28.0 |
| | | | | | | | | | | | 33.3 | 32.4 | 31.5 |
| | | | | | | | | | | 0 70 | | | |
| | | | | | | | | | | 1 | 34 | 33 | 32 |
| | | | | | | | | | | 2 | 3.4 | 3.3 | 3.2 |
| | | | | | | | | | | 3 | 6.8 | 6.6 | 6.4 |
| | | | | | | | | | | 4 | 10.2 | 9.9 | 9.6 |
| | | | | | | | | | | 5 | 13.6 | 13.2 | 12.8 |
| | | | | | | | | | | 6 | 17.0 | 16.5 | 16.0 |
| | | | | | | | | | | 7 | 20.4 | 19.8 | 19.2 |
| | | | | | | | | | | 8 | 23.8 | 23.1 | 22.4 |
| | | | | | | | | | | 9 | 27.2 | 26.4 | 25.6 |
| | | | | | | | | | | | 30.6 | 29.7 | 28.8 |
| | | | | | | | | | | 0 68 | | | |
| | | | | | | | | | | 1 | 28 | 27 | 26 |
| | | | | | | | | | | 2 | 2.8 | 2.7 | 2.6 |
| | | | | | | | | | | 3 | 5.6 | 5.4 | 5.2 |
| | | | | | | | | | | 4 | 8.4 | 8.1 | 7.8 |
| | | | | | | | | | | 5 | 11.2 | 10.8 | 10.4 |
| | | | | | | | | | | 6 | 14.0 | 13.5 | 13.0 |
| | | | | | | | | | | 7 | 16.8 | 16.2 | 15.6 |
| | | | | | | | | | | 8 | 19.6 | 18.9 | 18.2 |
| | | | | | | | | | | 9 | 22.4 | 21.6 | 20.8 |
| | | | | | | | | | | | 25.2 | 24.3 | 23.4 |
| | | | | | | | | | | 0 67 | | | |
| | | | | | | | | | | 1 | 13 | 12 | |
| | | | | | | | | | | 2 | 1.3 | 1.3 | |
| | | | | | | | | | | 3 | 2.6 | 2.4 | |
| | | | | | | | | | | 4 | 3.9 | 3.6 | |
| | | | | | | | | | | 5 | 4.2 | 4.8 | |
| | | | | | | | | | | 6 | 6.5 | 6.0 | |
| | | | | | | | | | | 7 | 7.8 | 7.2 | |
| | | | | | | | | | | 8 | 9.1 | 8.4 | |
| | | | | | | | | | | 9 | 10.4 | 9.6 | |
| | | | | | | | | | | | 11.7 | 10.8 | |
| | | | | | | | | | | 0 66 | | | |
| | | | | | | | | | | 1 | 11 | 10 | 9 |
| | | | | | | | | | | 2 | 1.1 | 1.0 | 0.9 |
| | | | | | | | | | | 3 | 2.2 | 2.0 | 1.8 |
| | | | | | | | | | | 4 | 3.3 | 3.0 | 2.7 |
| | | | | | | | | | | 5 | 4.4 | 4.0 | 3.6 |
| | | | | | | | | | | 6 | 5.5 | 5.0 | 4.5 |
| | | | | | | | | | | 7 | 6.6 | 6.0 | 5.4 |
| | | | | | | | | | | 8 | 7.7 | 7.0 | 6.3 |
| | | | | | | | | | | 9 | 8.8 | 8.0 | 7.2 |
| | | | | | | | | | | | 9.9 | 9.0 | 8.1 |
| | | | | | | | | | | 0 65 | | | |
| | | | | | | | | | | P. P. | | | |

avoided, if possible, since the differences change very rapidly, and the computation is therefore likely to be inexact.

In finding the functions of an angle, note carefully whether the difference obtained from the table of proportional parts is to be added or subtracted, by observing whether the function is increasing or decreasing as the angle increases. For example, the sine of 21° is .3584, and the following sines, reading downwards, are .3611, .3638, etc. The sine of $21^\circ 6'$ is greater than that of 21° , and the difference for $6'$ must be added. On the other hand, the cosine of 21° is .9336, and the following cosines, reading downwards, are .9325, .9315, etc.; that is, as the angle grows larger the cosine decreases, and the difference obtained for any angle between 21° and $21^\circ 10'$, say $21^\circ 6'$, must be subtracted from the cosine of 21° .

Suppose the function, i. e., the sine, cosine, tangent, or cotangent is given and the corresponding angle is to be found; for example, find the angle whose sine is .4943. First find in the second column the sine next *smaller* than .4943, which is .4924, and the difference for $10'$ is 26. The angle corresponding to .4924 is $29^\circ 30'$. Subtracting the .4924 from .4943, the first remainder is 19; in the table of proportional parts under 26, the part next lower than this difference, is 18.2, opposite which is $7'$. Subtracting 18.2 from 19 leaves .8 as the second remainder. In the table under 26 is found 7.8, which with its decimal point moved one place to the left is nearest to the second remainder, and opposite 7.8 is 3, which indicates $.3'$ or $18''$. Hence, the angle is $29^\circ 30' + 7' + 18'' = 29^\circ 37' 18''$.

INVOLUTION AND EVOLUTION

By means of the following table, the square, cube, square root, cube root, and reciprocal of any number may be obtained correct always to five significant figures, and in the majority of cases correct to six significant figures.

In any number, the figures beginning with the first digit* at the left and ending with the last digit at the right, are

*Ciphers (used merely to locate the decimal point) are not digits.

called the *significant figures* of the number. Thus, the number 405,800 has the four significant figures 4, 0, 5, 8; and the *significant part* of the number is 4058. The number .000090067 has five significant figures, 9, 0, 0, 6, 7, and the significant part is 90067. *All numbers that differ only in the position of the decimal point have the same significant figures and the same significant part.* For example, .002103, 21.03, 21,030, and 210,300 have the same significant figures 2, 1, 0, and 3, and the same significant part 2103.

The *integral part* of a number is the part to the left of the decimal point.

Square and Cube Roots.—If the given number contains less than four significant figures, the required root can be found in the table, the square root under \sqrt{n} , or $\sqrt{10n}$, and the cube root under $\sqrt[3]{n}$, $\sqrt[3]{10n}$, or $\sqrt[3]{100n}$, according to the number of significant figures in the integral part of the number. Thus, $\sqrt{3.14} = 1.772$; $\sqrt{31.4} = \sqrt{10} \times \sqrt{3.14} = 5.60357$; $\sqrt[3]{3.14} = 1.46434$; $\sqrt[3]{31.4} = \sqrt[3]{10} \times \sqrt[3]{3.14} = 3.15484$; $\sqrt[3]{314} = \sqrt[3]{100} \times \sqrt[3]{3.14} = 6.79688$.

In order to locate the decimal point, the given number must be pointed off into periods of two figures each for square root and three figures each for cube root, beginning always at the decimal point. Thus, for square root: 12703, 1'27'03; 12.703, 12.70'30; 220000, 22'00'00; .000442, .00'04'42; and for cube root: 3141.6, 3'141.6; 67296428, 67'296'428; .0000000217, .000'000'021'700, etc.

There are as many figures in the root preceding the decimal point as there are periods preceding the decimal point in the given number; if the number is entirely decimal, the root is entirely decimal, and there are as many ciphers following the decimal point in the root as there are cipher periods following the decimal point in the given number.

Applying this rule, $\sqrt{220000} = 469.04$, $\sqrt{.000442} = .021024$, $\sqrt[3]{518000} = 80.3113$, and $\sqrt[3]{.000073} = .0418$.

If the number has more than three significant figures, point off the number into periods, place a decimal point between the first and second periods of the significant part of the number, and proceed as in the following examples:

| n | n^2 | n^3 | \sqrt{n} | $\sqrt{10n}$ | $\sqrt[3]{n}$ | $\sqrt[3]{10n}$ | $\sqrt[4]{100n}$ | $\frac{1}{n}$ |
|------|--------|---------|------------|--------------|---------------|-----------------|------------------|---------------|
| 1.01 | 1.0201 | 1.03030 | 1.00499 | 3.17805 | 1.00332 | 2.16159 | 4.65701 | .990099 |
| 1.02 | 1.0404 | 1.06121 | 1.00995 | 3.19374 | 1.00662 | 2.16870 | 4.67233 | .980392 |
| 1.03 | 1.0609 | 1.09273 | 1.01489 | 3.20936 | 1.00990 | 2.17577 | 4.68755 | .970874 |
| 1.04 | 1.0816 | 1.12486 | 1.01980 | 3.22490 | 1.01316 | 2.18278 | 4.70267 | .961539 |
| 1.05 | 1.1025 | 1.15763 | 1.02470 | 3.24037 | 1.01640 | 2.18976 | 4.71769 | .952381 |
| 1.06 | 1.1236 | 1.19102 | 1.02956 | 3.25576 | 1.01961 | 2.19669 | 4.73262 | .943396 |
| 1.07 | 1.1449 | 1.22504 | 1.03441 | 3.27109 | 1.02281 | 2.20358 | 4.74746 | .934579 |
| 1.08 | 1.1664 | 1.25971 | 1.03923 | 3.28634 | 1.02599 | 2.21042 | 4.76220 | .925928 |
| 1.09 | 1.1881 | 1.29508 | 1.04403 | 3.30151 | 1.02914 | 2.21722 | 4.77686 | .917431 |
| 1.10 | 1.2100 | 1.33100 | 1.04881 | 3.31662 | 1.03228 | 2.22398 | 4.79142 | .909091 |
| 1.11 | 1.2321 | 1.36763 | 1.05357 | 3.33167 | 1.03540 | 2.23070 | 4.80590 | .900901 |
| 1.12 | 1.2544 | 1.40493 | 1.05830 | 3.34664 | 1.03850 | 2.23738 | 4.82028 | .892857 |
| 1.13 | 1.2769 | 1.44290 | 1.06301 | 3.36155 | 1.04158 | 2.24402 | 4.83459 | .884956 |
| 1.14 | 1.2996 | 1.48154 | 1.06771 | 3.37639 | 1.04464 | 2.25062 | 4.84881 | .877193 |
| 1.15 | 1.3225 | 1.52088 | 1.07238 | 3.39116 | 1.04769 | 2.25718 | 4.86294 | .869565 |
| 1.16 | 1.3456 | 1.56090 | 1.07703 | 3.40588 | 1.05072 | 2.26370 | 4.87700 | .862069 |
| 1.17 | 1.3689 | 1.60161 | 1.08167 | 3.42053 | 1.05373 | 2.27019 | 4.89097 | .854701 |
| 1.18 | 1.3924 | 1.64303 | 1.08628 | 3.43511 | 1.05672 | 2.27664 | 4.90487 | .847458 |
| 1.19 | 1.4161 | 1.68516 | 1.09087 | 3.44964 | 1.05970 | 2.28305 | 4.91868 | .840336 |
| 1.20 | 1.4400 | 1.72800 | 1.09545 | 3.46410 | 1.06266 | 2.28943 | 4.93242 | .833333 |
| 1.21 | 1.4641 | 1.77156 | 1.10000 | 3.47851 | 1.06560 | 2.29577 | 4.94609 | .826446 |
| 1.22 | 1.4884 | 1.81585 | 1.10454 | 3.49285 | 1.06853 | 2.30208 | 4.95968 | .819672 |
| 1.23 | 1.5129 | 1.86087 | 1.10905 | 3.50714 | 1.07144 | 2.30835 | 4.97319 | .813008 |
| 1.24 | 1.5376 | 1.90662 | 1.11355 | 3.52136 | 1.07434 | 2.31459 | 4.98663 | .806452 |
| 1.25 | 1.5625 | 1.95313 | 1.11803 | 3.53553 | 1.07722 | 2.32080 | 5.00000 | .800000 |
| 1.26 | 1.5876 | 2.00038 | 1.12250 | 3.54965 | 1.08008 | 2.32697 | 5.01330 | .793651 |
| 1.27 | 1.6129 | 2.04838 | 1.12694 | 3.56371 | 1.08293 | 2.33310 | 5.02653 | .787402 |
| 1.28 | 1.6384 | 2.09715 | 1.13137 | 3.57771 | 1.08577 | 2.33921 | 5.03968 | .781250 |
| 1.29 | 1.6641 | 2.14669 | 1.13578 | 3.59166 | 1.08859 | 2.34529 | 5.05277 | .775194 |
| 1.30 | 1.6900 | 2.19700 | 1.14018 | 3.60555 | 1.09139 | 2.35134 | 5.06580 | .769231 |
| 1.31 | 1.7161 | 2.24809 | 1.14455 | 3.61939 | 1.09418 | 2.35735 | 5.07875 | .763359 |
| 1.32 | 1.7424 | 2.29997 | 1.14891 | 3.63318 | 1.09696 | 2.36333 | 5.09164 | .757576 |
| 1.33 | 1.7689 | 2.35264 | 1.15326 | 3.64692 | 1.09972 | 2.36928 | 5.10447 | .751880 |
| 1.34 | 1.7956 | 2.40610 | 1.15758 | 3.66060 | 1.10247 | 2.37521 | 5.11723 | .746269 |
| 1.35 | 1.8225 | 2.46038 | 1.16190 | 3.67423 | 1.10521 | 2.38110 | 5.12993 | .740741 |
| 1.36 | 1.8496 | 2.51546 | 1.16619 | 3.68782 | 1.10794 | 2.38696 | 5.14256 | .735294 |
| 1.37 | 1.8769 | 2.57135 | 1.17047 | 3.70135 | 1.11064 | 2.39280 | 5.15514 | .729927 |
| 1.38 | 1.9044 | 2.62807 | 1.17473 | 3.71484 | 1.11334 | 2.39861 | 5.16765 | .724638 |
| 1.39 | 1.9321 | 2.68562 | 1.17898 | 3.72827 | 1.11602 | 2.40439 | 5.18010 | .719425 |
| 1.40 | 1.9600 | 2.74400 | 1.18322 | 3.74166 | 1.11869 | 2.41014 | 5.19249 | .714286 |
| 1.41 | 1.9881 | 2.80322 | 1.18743 | 3.75500 | 1.12135 | 2.41587 | 5.20483 | .709220 |
| 1.42 | 2.0164 | 2.86329 | 1.19164 | 3.76829 | 1.12399 | 2.42156 | 5.21710 | .704225 |
| 1.43 | 2.0449 | 2.92421 | 1.19583 | 3.78153 | 1.12662 | 2.42724 | 5.22932 | .699301 |
| 1.44 | 2.0736 | 2.98598 | 1.20000 | 3.79473 | 1.12924 | 2.43288 | 5.24148 | .694444 |
| 1.45 | 2.1025 | 3.04863 | 1.20416 | 3.80789 | 1.13185 | 2.43850 | 5.25359 | .689655 |
| 1.46 | 2.1316 | 3.11214 | 1.20830 | 3.82099 | 1.13445 | 2.44409 | 5.26564 | .684932 |
| 1.47 | 2.1609 | 3.17652 | 1.21244 | 3.83406 | 1.13703 | 2.44966 | 5.27763 | .680272 |
| 1.48 | 2.1904 | 3.24179 | 1.21655 | 3.84708 | 1.13960 | 2.45520 | 5.28957 | .675676 |
| 1.49 | 2.2201 | 3.30795 | 1.22066 | 3.86005 | 1.14216 | 2.46072 | 5.30146 | .671141 |
| 1.50 | 2.2500 | 3.37500 | 1.22474 | 3.87298 | 1.14471 | 2.46621 | 5.31329 | .666667 |

| n | n^2 | n^3 | \sqrt{n} | $\sqrt{10n}$ | $\sqrt[3]{n}$ | $\sqrt[3]{10n}$ | $\sqrt[3]{100n}$ | $\frac{1}{n}$ |
|------|--------|---------|------------|--------------|---------------|-----------------|------------------|---------------|
| 1.51 | 2.2801 | 3.44795 | 1.22882 | 3.88587 | 1.14725 | 2.47168 | 5.32507 | .662252 |
| 1.52 | 2.3104 | 3.51181 | 1.23288 | 3.89872 | 1.14978 | 2.47713 | 5.33680 | .657895 |
| 1.53 | 2.3409 | 3.58158 | 1.23693 | 3.91152 | 1.15230 | 2.48255 | 5.34848 | .653595 |
| 1.54 | 2.3716 | 3.65226 | 1.24097 | 3.92428 | 1.15480 | 2.48794 | 5.36011 | .649351 |
| 1.55 | 2.4025 | 3.72388 | 1.24499 | 3.93700 | 1.15729 | 2.49332 | 5.37169 | .645161 |
| 1.56 | 2.4336 | 3.79642 | 1.24900 | 3.94968 | 1.15978 | 2.49866 | 5.38321 | .641026 |
| 1.57 | 2.4649 | 3.86989 | 1.25300 | 3.96232 | 1.16225 | 2.50399 | 5.39469 | .636943 |
| 1.58 | 2.4964 | 3.94431 | 1.25698 | 3.97492 | 1.16471 | 2.50930 | 5.40612 | .632911 |
| 1.59 | 2.5281 | 4.01968 | 1.26095 | 3.98748 | 1.16717 | 2.51458 | 5.41750 | .628931 |
| 1.60 | 2.5600 | 4.09600 | 1.26491 | 4.00000 | 1.16961 | 2.51984 | 5.42884 | .625000 |
| 1.61 | 2.5921 | 4.17328 | 1.26886 | 4.01248 | 1.17204 | 2.52508 | 5.44012 | .621118 |
| 1.62 | 2.6244 | 4.25153 | 1.27279 | 4.02492 | 1.17446 | 2.53030 | 5.45136 | .617284 |
| 1.63 | 2.6569 | 4.33075 | 1.27671 | 4.03733 | 1.17687 | 2.53549 | 5.46256 | .613497 |
| 1.64 | 2.6896 | 4.41094 | 1.28062 | 4.04969 | 1.17927 | 2.54067 | 5.47370 | .609756 |
| 1.65 | 2.7225 | 4.49213 | 1.28452 | 4.06202 | 1.18167 | 2.54582 | 5.48481 | .606061 |
| 1.66 | 2.7556 | 4.57430 | 1.28841 | 4.07431 | 1.18405 | 2.55095 | 5.49586 | .602410 |
| 1.67 | 2.7889 | 4.65746 | 1.29228 | 4.08656 | 1.18642 | 2.55607 | 5.50688 | .598802 |
| 1.68 | 2.8224 | 4.74163 | 1.29615 | 4.09878 | 1.18878 | 2.56116 | 5.51785 | .595238 |
| 1.69 | 2.8561 | 4.82681 | 1.30000 | 4.11096 | 1.19114 | 2.56623 | 5.52877 | .591716 |
| 1.70 | 2.8900 | 4.91300 | 1.30384 | 4.12311 | 1.19348 | 2.57128 | 5.53966 | .588235 |
| 1.71 | 2.9241 | 5.00021 | 1.30767 | 4.13521 | 1.19582 | 2.57631 | 5.55050 | .584795 |
| 1.72 | 2.9584 | 5.08845 | 1.31149 | 4.14729 | 1.19815 | 2.58133 | 5.56130 | .581395 |
| 1.73 | 2.9929 | 5.17772 | 1.31529 | 4.15933 | 1.20046 | 2.58632 | 5.57205 | .578035 |
| 1.74 | 3.0276 | 5.26802 | 1.31909 | 4.17133 | 1.20277 | 2.59129 | 5.58277 | .574713 |
| 1.75 | 3.0625 | 5.35938 | 1.32288 | 4.18330 | 1.20507 | 2.59625 | 5.59344 | .571429 |
| 1.76 | 3.0976 | 5.45178 | 1.32665 | 4.19524 | 1.20736 | 2.60118 | 5.60408 | .568182 |
| 1.77 | 3.1329 | 5.54523 | 1.33041 | 4.20714 | 1.20964 | 2.60610 | 5.61467 | .564972 |
| 1.78 | 3.1684 | 5.63975 | 1.33417 | 4.21900 | 1.21192 | 2.61100 | 5.62523 | .561798 |
| 1.79 | 3.2041 | 5.73534 | 1.33791 | 4.23084 | 1.21418 | 2.61588 | 5.63574 | .558659 |
| 1.80 | 3.2400 | 5.83200 | 1.34164 | 4.24264 | 1.21644 | 2.62074 | 5.64622 | .555556 |
| 1.81 | 3.2761 | 5.92974 | 1.34536 | 4.25441 | 1.21869 | 2.62558 | 5.65665 | .552486 |
| 1.82 | 3.3124 | 6.02857 | 1.34907 | 4.26615 | 1.22093 | 2.63041 | 5.66705 | .549451 |
| 1.83 | 3.3489 | 6.12849 | 1.35277 | 4.27785 | 1.22316 | 2.63522 | 5.67741 | .546448 |
| 1.84 | 3.3856 | 6.22950 | 1.35647 | 4.28952 | 1.22539 | 2.64001 | 5.68775 | .543478 |
| 1.85 | 3.4225 | 6.33163 | 1.36015 | 4.30116 | 1.22760 | 2.64479 | 5.69802 | .540541 |
| 1.86 | 3.4596 | 6.43486 | 1.36382 | 4.31277 | 1.22981 | 2.64954 | 5.70827 | .537634 |
| 1.87 | 3.4969 | 6.53920 | 1.36748 | 4.32435 | 1.23201 | 2.65428 | 5.71848 | .534759 |
| 1.88 | 3.5344 | 6.64467 | 1.37113 | 4.33590 | 1.23420 | 2.65900 | 5.72865 | .531915 |
| 1.89 | 3.5721 | 6.75127 | 1.37477 | 4.34741 | 1.23639 | 2.66371 | 5.73879 | .529101 |
| 1.90 | 3.6100 | 6.85900 | 1.37840 | 4.35890 | 1.23856 | 2.66840 | 5.74890 | .526316 |
| 1.91 | 3.6481 | 6.96787 | 1.38203 | 4.37035 | 1.24073 | 2.67307 | 5.75897 | .523560 |
| 1.92 | 3.6864 | 7.07789 | 1.38564 | 4.38178 | 1.24289 | 2.67773 | 5.76900 | .520833 |
| 1.93 | 3.7249 | 7.18906 | 1.38924 | 4.39318 | 1.24505 | 2.68237 | 5.77900 | .518135 |
| 1.94 | 3.7636 | 7.30138 | 1.39284 | 4.40454 | 1.24719 | 2.68700 | 5.78896 | .515464 |
| 1.95 | 3.8025 | 7.41488 | 1.39642 | 4.41588 | 1.24933 | 2.69161 | 5.79889 | .512821 |
| 1.96 | 3.8416 | 7.52954 | 1.40000 | 4.42719 | 1.25146 | 2.69620 | 5.80879 | .510204 |
| 1.97 | 3.8809 | 7.64537 | 1.40357 | 4.43847 | 1.25359 | 2.70078 | 5.81865 | .507614 |
| 1.98 | 3.9204 | 7.76239 | 1.40712 | 4.44972 | 1.25571 | 2.70534 | 5.82848 | .505051 |
| 1.99 | 3.9601 | 7.88060 | 1.41067 | 4.46094 | 1.25782 | 2.70989 | 5.83827 | .502513 |
| 2.00 | 4.0000 | 8.00000 | 1.41421 | 4.47214 | 1.25992 | 2.71442 | 5.84804 | .500000 |

| n | n^2 | n^3 | \sqrt{n} | $\sqrt{10 n}$ | $\sqrt[3]{n}$ | $\sqrt[3]{10 n}$ | $\sqrt[3]{100 n}$ | $\frac{1}{n}$ |
|------|--------|---------|------------|---------------|---------------|------------------|-------------------|---------------|
| 2.01 | 4.0401 | 8.12060 | 1.41774 | 4.48330 | 1.26202 | 2.71893 | 5.85777 | .497512 |
| 2.02 | 4.0804 | 8.24241 | 1.42127 | 4.49444 | 1.26411 | 2.72343 | 5.86746 | .495050 |
| 2.03 | 4.1209 | 8.36543 | 1.42478 | 4.50555 | 1.26619 | 2.72792 | 5.87713 | .492611 |
| 2.04 | 4.1616 | 8.48966 | 1.42829 | 4.51664 | 1.26827 | 2.73239 | 5.88677 | .490196 |
| 2.05 | 4.2025 | 8.61513 | 1.43178 | 4.52769 | 1.27033 | 2.73685 | 5.89637 | .487805 |
| 2.06 | 4.2436 | 8.74182 | 1.43527 | 4.53872 | 1.27240 | 2.74129 | 5.90594 | .485437 |
| 2.07 | 4.2849 | 8.86974 | 1.43875 | 4.54973 | 1.27445 | 2.74572 | 5.91548 | .483092 |
| 2.08 | 4.3264 | 8.99891 | 1.44222 | 4.56070 | 1.27650 | 2.75014 | 5.92499 | .480769 |
| 2.09 | 4.3681 | 9.12933 | 1.44568 | 4.57165 | 1.27854 | 2.75454 | 5.93447 | .478469 |
| 2.10 | 4.4100 | 9.26100 | 1.44914 | 4.58258 | 1.28058 | 2.75893 | 5.94392 | .476191 |
| 2.11 | 4.4521 | 9.39393 | 1.45258 | 4.59347 | 1.28261 | 2.76330 | 5.95334 | .473934 |
| 2.12 | 4.4944 | 9.52813 | 1.45602 | 4.60435 | 1.28463 | 2.76766 | 5.96273 | .471698 |
| 2.13 | 4.5369 | 9.66360 | 1.45945 | 4.61519 | 1.28665 | 2.77200 | 5.97209 | .469484 |
| 2.14 | 4.5796 | 9.80034 | 1.46287 | 4.62601 | 1.28866 | 2.77633 | 5.98142 | .467290 |
| 2.15 | 4.6226 | 9.93838 | 1.46629 | 4.63681 | 1.29066 | 2.78065 | 5.99073 | .465116 |
| 2.16 | 4.6656 | 10.0777 | 1.46969 | 4.64758 | 1.29266 | 2.78495 | 6.00000 | .462963 |
| 2.17 | 4.7089 | 10.2183 | 1.47309 | 4.65833 | 1.29465 | 2.78924 | 6.00925 | .460830 |
| 2.18 | 4.7524 | 10.3602 | 1.47648 | 4.66905 | 1.29664 | 2.79352 | 6.01846 | .458718 |
| 2.19 | 4.7961 | 10.5035 | 1.47986 | 4.67974 | 1.29862 | 2.79779 | 6.02765 | .456621 |
| 2.20 | 4.8400 | 10.6480 | 1.48324 | 4.69042 | 1.30059 | 2.80204 | 6.03681 | .454546 |
| 2.21 | 4.8841 | 10.7939 | 1.48661 | 4.70106 | 1.30258 | 2.80628 | 6.04594 | .452489 |
| 2.22 | 4.9284 | 10.9410 | 1.48997 | 4.71169 | 1.30452 | 2.81051 | 6.05505 | .450451 |
| 2.23 | 4.9729 | 11.0896 | 1.49332 | 4.72229 | 1.30648 | 2.81472 | 6.06413 | .448431 |
| 2.24 | 5.0176 | 11.2394 | 1.49666 | 4.73286 | 1.30843 | 2.81892 | 6.07318 | .446429 |
| 2.25 | 5.0625 | 11.3906 | 1.50000 | 4.74342 | 1.31037 | 2.82311 | 6.08220 | .444444 |
| 2.26 | 5.1076 | 11.5432 | 1.50333 | 4.75395 | 1.31231 | 2.82728 | 6.09120 | .442478 |
| 2.27 | 5.1529 | 11.6971 | 1.50665 | 4.76445 | 1.31424 | 2.83145 | 6.10017 | .440529 |
| 2.28 | 5.1984 | 11.8524 | 1.50997 | 4.77493 | 1.31617 | 2.83560 | 6.10911 | .438597 |
| 2.29 | 5.2441 | 12.0090 | 1.51327 | 4.78539 | 1.31809 | 2.83974 | 6.11803 | .436681 |
| 2.30 | 5.2900 | 12.1670 | 1.51658 | 4.79583 | 1.32001 | 2.84387 | 6.12693 | .434783 |
| 2.31 | 5.3361 | 12.3264 | 1.51987 | 4.80625 | 1.32192 | 2.84798 | 6.13579 | .432900 |
| 2.32 | 5.3824 | 12.4872 | 1.52315 | 4.81664 | 1.32382 | 2.85209 | 6.14463 | .431035 |
| 2.33 | 5.4289 | 12.6493 | 1.52643 | 4.82701 | 1.32572 | 2.85618 | 6.15345 | .429185 |
| 2.34 | 5.4756 | 12.8129 | 1.52971 | 4.83735 | 1.32761 | 2.86026 | 6.16224 | .427350 |
| 2.35 | 5.5225 | 12.9779 | 1.53297 | 4.84768 | 1.32950 | 2.86433 | 6.17101 | .425532 |
| 2.36 | 5.5696 | 13.1443 | 1.53623 | 4.85798 | 1.33139 | 2.86838 | 6.17975 | .423729 |
| 2.37 | 5.6169 | 13.3121 | 1.53948 | 4.86826 | 1.33326 | 2.87243 | 6.18846 | .421941 |
| 2.38 | 5.6644 | 13.4813 | 1.54272 | 4.87852 | 1.33514 | 2.87646 | 6.19715 | .420168 |
| 2.39 | 5.7121 | 13.6519 | 1.54596 | 4.88876 | 1.33700 | 2.88049 | 6.20582 | .418410 |
| 2.40 | 5.7600 | 13.8240 | 1.54919 | 4.89898 | 1.33887 | 2.88450 | 6.21447 | .416667 |
| 2.41 | 5.8081 | 13.9975 | 1.55242 | 4.90918 | 1.34072 | 2.88850 | 6.22308 | .414938 |
| 2.42 | 5.8564 | 14.1725 | 1.55563 | 4.91935 | 1.34257 | 2.89249 | 6.23168 | .413223 |
| 2.43 | 5.9049 | 14.3489 | 1.55885 | 4.92950 | 1.34442 | 2.89647 | 6.24025 | .411523 |
| 2.44 | 5.9536 | 14.5268 | 1.56205 | 4.93964 | 1.34626 | 2.90044 | 6.24880 | .409836 |
| 2.45 | 6.0025 | 14.7061 | 1.56525 | 4.94975 | 1.34810 | 2.90439 | 6.25732 | .408163 |
| 2.46 | 6.0516 | 14.8869 | 1.56844 | 4.95984 | 1.34993 | 2.90834 | 6.26583 | .406504 |
| 2.47 | 6.1009 | 15.0692 | 1.57162 | 4.96991 | 1.35176 | 2.91227 | 6.27431 | .404858 |
| 2.48 | 6.1504 | 15.2530 | 1.57480 | 4.97996 | 1.35358 | 2.91620 | 6.28276 | .403226 |
| 2.49 | 6.2001 | 15.4383 | 1.57797 | 4.98999 | 1.35540 | 2.92011 | 6.29119 | .401606 |
| 2.50 | 6.2500 | 15.6250 | 1.58114 | 5.00000 | 1.35721 | 2.92402 | 6.29961 | .400000 |

| n | n^2 | n^3 | \sqrt{n} | $\sqrt[3]{10n}$ | $\sqrt[3]{n}$ | $\sqrt[3]{10n}$ | $\sqrt[3]{100n}$ | $\frac{1}{n}$ |
|------|--------|---------|------------|-----------------|---------------|-----------------|------------------|---------------|
| 2.51 | 6.3001 | 15.8133 | 1.58430 | 5.00999 | 1.35902 | 2.92791 | 6.30799 | .398406 |
| 2.52 | 6.3504 | 16.0030 | 1.58745 | 5.01996 | 1.36082 | 2.93179 | 6.31636 | .396825 |
| 2.53 | 6.4009 | 16.1943 | 1.59060 | 5.02991 | 1.36262 | 2.93567 | 6.32470 | .395257 |
| 2.54 | 6.4516 | 16.3871 | 1.59374 | 5.03984 | 1.36441 | 2.93953 | 6.33303 | .393701 |
| 2.55 | 6.5025 | 16.5814 | 1.59687 | 5.04975 | 1.36620 | 2.94338 | 6.34133 | .392157 |
| 2.56 | 6.5536 | 16.7772 | 1.60000 | 5.05964 | 1.36798 | 2.94723 | 6.34960 | .390625 |
| 2.57 | 6.6049 | 16.9746 | 1.60312 | 5.06952 | 1.36976 | 2.95106 | 6.35786 | .389105 |
| 2.58 | 6.6564 | 17.1735 | 1.60624 | 5.07937 | 1.37153 | 2.95488 | 6.36610 | .387597 |
| 2.59 | 6.7081 | 17.3740 | 1.60935 | 5.08920 | 1.37330 | 2.95869 | 6.37431 | .386100 |
| 2.60 | 6.7600 | 17.5760 | 1.61245 | 5.09902 | 1.37507 | 2.96250 | 6.38250 | .384615 |
| 2.61 | 6.8121 | 17.7796 | 1.61555 | 5.10882 | 1.37683 | 2.96629 | 6.39068 | .383142 |
| 2.62 | 6.8644 | 17.9847 | 1.61864 | 5.11859 | 1.37859 | 2.97007 | 6.39883 | .381679 |
| 2.63 | 6.9169 | 18.1914 | 1.62173 | 5.12835 | 1.38034 | 2.97385 | 6.40696 | .380228 |
| 2.64 | 6.9696 | 18.3997 | 1.62481 | 5.13809 | 1.38208 | 2.97761 | 6.41507 | .378788 |
| 2.65 | 7.0225 | 18.6096 | 1.62788 | 5.14782 | 1.38383 | 2.98137 | 6.42316 | .377359 |
| 2.66 | 7.0756 | 18.8211 | 1.63095 | 5.15752 | 1.38557 | 2.98511 | 6.43123 | .375940 |
| 2.67 | 7.1289 | 19.0342 | 1.63401 | 5.16720 | 1.38730 | 2.98885 | 6.43928 | .374532 |
| 2.68 | 7.1824 | 19.2488 | 1.63707 | 5.17687 | 1.38903 | 2.99257 | 6.44731 | .373134 |
| 2.69 | 7.2361 | 19.4651 | 1.64012 | 5.18652 | 1.39076 | 2.99629 | 6.45531 | .371747 |
| 2.70 | 7.2900 | 19.6830 | 1.64317 | 5.19615 | 1.39248 | 3.00000 | 6.46330 | .370370 |
| 2.71 | 7.3441 | 19.9025 | 1.64621 | 5.20577 | 1.39419 | 3.00370 | 6.47127 | .369004 |
| 2.72 | 7.3984 | 20.1236 | 1.64924 | 5.21536 | 1.39591 | 3.00739 | 6.47922 | .367647 |
| 2.73 | 7.4529 | 20.3464 | 1.65227 | 5.22494 | 1.39761 | 3.01107 | 6.48715 | .366300 |
| 2.74 | 7.5076 | 20.5708 | 1.65529 | 5.23450 | 1.39932 | 3.01474 | 6.49507 | .364964 |
| 2.75 | 7.5625 | 20.7969 | 1.65831 | 5.24404 | 1.40102 | 3.01841 | 6.50296 | .363636 |
| 2.76 | 7.6176 | 21.0246 | 1.66132 | 5.25357 | 1.40272 | 3.02206 | 6.51083 | .362319 |
| 2.77 | 7.6729 | 21.2539 | 1.66433 | 5.26308 | 1.40441 | 3.02571 | 6.51868 | .361011 |
| 2.78 | 7.7284 | 21.4850 | 1.66733 | 5.27257 | 1.40610 | 3.02934 | 6.52652 | .359712 |
| 2.79 | 7.7841 | 21.7176 | 1.67033 | 5.28205 | 1.40778 | 3.03297 | 6.53434 | .358423 |
| 2.80 | 7.8400 | 21.9520 | 1.67332 | 5.29150 | 1.40946 | 3.03659 | 6.54213 | .357142 |
| 2.81 | 7.8961 | 22.1880 | 1.67631 | 5.30094 | 1.41114 | 3.04020 | 6.54991 | .355872 |
| 2.82 | 7.9524 | 22.4258 | 1.67929 | 5.31037 | 1.41281 | 3.04380 | 6.55767 | .354610 |
| 2.83 | 8.0089 | 22.6652 | 1.68226 | 5.31977 | 1.41448 | 3.04740 | 6.56541 | .353357 |
| 2.84 | 8.0656 | 22.9063 | 1.68523 | 5.32917 | 1.41614 | 3.05098 | 6.57314 | .352113 |
| 2.85 | 8.1225 | 23.1491 | 1.68819 | 5.33854 | 1.41780 | 3.05456 | 6.58084 | .350877 |
| 2.86 | 8.1796 | 23.3937 | 1.69115 | 5.34790 | 1.41946 | 3.05813 | 6.58853 | .349650 |
| 2.87 | 8.2369 | 23.6399 | 1.69411 | 5.35724 | 1.42111 | 3.06169 | 6.59620 | .348432 |
| 2.88 | 8.2944 | 23.8879 | 1.69706 | 5.36658 | 1.42276 | 3.06524 | 6.60385 | .347222 |
| 2.89 | 8.3521 | 24.1376 | 1.70000 | 5.37587 | 1.42440 | 3.06878 | 6.61149 | .346021 |
| 2.90 | 8.4100 | 24.3890 | 1.70294 | 5.38516 | 1.42604 | 3.07232 | 6.61911 | .344828 |
| 2.91 | 8.4681 | 24.6422 | 1.70587 | 5.39444 | 1.42768 | 3.07585 | 6.62671 | .343643 |
| 2.92 | 8.5264 | 24.8971 | 1.70880 | 5.40370 | 1.42931 | 3.07936 | 6.63429 | .342466 |
| 2.93 | 8.5849 | 25.1538 | 1.71172 | 5.41295 | 1.43094 | 3.08287 | 6.64185 | .341297 |
| 2.94 | 8.6436 | 25.4122 | 1.71464 | 5.42218 | 1.43257 | 3.08638 | 6.64940 | .340136 |
| 2.95 | 8.7025 | 25.6724 | 1.71756 | 5.43139 | 1.43419 | 3.08987 | 6.65693 | .338983 |
| 2.96 | 8.7616 | 25.9343 | 1.72047 | 5.44059 | 1.43581 | 3.09336 | 6.66444 | .337838 |
| 2.97 | 8.8209 | 26.1981 | 1.72337 | 5.44977 | 1.43743 | 3.09684 | 6.67194 | .336700 |
| 2.98 | 8.8804 | 26.4636 | 1.72627 | 5.45894 | 1.43904 | 3.10031 | 6.67942 | .335571 |
| 2.99 | 8.9401 | 26.7309 | 1.72916 | 5.46809 | 1.44065 | 3.10378 | 6.68688 | .334448 |
| 3.00 | 9.0000 | 27.0000 | 1.73205 | 5.47723 | 1.44225 | 3.10723 | 6.69433 | .333333 |

| n | n^2 | n^3 | \sqrt{n} | $\sqrt[10]{n}$ | $\sqrt[3]{n}$ | $\sqrt[5]{10n}$ | $\sqrt[7]{100n}$ | $\frac{1}{n}$ |
|------|---------|---------|------------|----------------|---------------|-----------------|------------------|---------------|
| 3.01 | 9.0601 | 27.2709 | 1.73494 | 5.48635 | 1.44385 | 3.11068 | 6.70176 | .332226 |
| 3.02 | 9.1204 | 27.5436 | 1.73781 | 5.49645 | 1.44545 | 3.11412 | 6.70917 | .331126 |
| 3.03 | 9.1809 | 27.8181 | 1.74069 | 5.50454 | 1.44704 | 3.11755 | 6.71657 | .330033 |
| 3.04 | 9.2416 | 28.0945 | 1.74356 | 5.51362 | 1.44863 | 3.12098 | 6.72395 | .328947 |
| 3.05 | 9.3025 | 28.3726 | 1.74642 | 5.52268 | 1.45022 | 3.12440 | 6.73132 | .327869 |
| 3.06 | 9.3636 | 28.6520 | 1.74929 | 5.53173 | 1.45180 | 3.12781 | 6.73866 | .326797 |
| 3.07 | 9.4249 | 28.9344 | 1.75214 | 5.54076 | 1.45338 | 3.13121 | 6.74600 | .325733 |
| 3.08 | 9.4864 | 29.2181 | 1.75499 | 5.54977 | 1.45496 | 3.13461 | 6.75331 | .324675 |
| 3.09 | 9.5481 | 29.5036 | 1.75784 | 5.55878 | 1.45653 | 3.13800 | 6.76061 | .323625 |
| 3.10 | 9.6100 | 29.7910 | 1.76068 | 5.56776 | 1.45810 | 3.14138 | 6.76790 | .322581 |
| 3.11 | 9.6721 | 30.0802 | 1.76352 | 5.57674 | 1.45967 | 3.14475 | 6.77517 | .321543 |
| 3.12 | 9.7344 | 30.3713 | 1.76635 | 5.58570 | 1.46123 | 3.14812 | 6.78242 | .320513 |
| 3.13 | 9.7969 | 30.6643 | 1.76918 | 5.59464 | 1.46279 | 3.15148 | 6.78966 | .319489 |
| 3.14 | 9.8596 | 30.9591 | 1.77200 | 5.60357 | 1.46434 | 3.15484 | 6.79688 | .318471 |
| 3.15 | 9.9225 | 31.2559 | 1.77482 | 5.61249 | 1.46590 | 3.15818 | 6.80409 | .317460 |
| 3.16 | 9.9856 | 31.5545 | 1.77764 | 5.62139 | 1.46745 | 3.16152 | 6.81128 | .316456 |
| 3.17 | 10.0489 | 31.8550 | 1.78045 | 5.63028 | 1.46899 | 3.16485 | 6.81846 | .315457 |
| 3.18 | 10.1124 | 32.1574 | 1.78326 | 5.63915 | 1.47054 | 3.16817 | 6.82562 | .314465 |
| 3.19 | 10.1761 | 32.4618 | 1.78606 | 5.64801 | 1.47208 | 3.17149 | 6.83277 | .313480 |
| 3.20 | 10.2400 | 32.7680 | 1.78885 | 5.65685 | 1.47361 | 3.17480 | 6.83990 | .312500 |
| 3.21 | 10.3041 | 33.0762 | 1.79165 | 5.66569 | 1.47515 | 3.17811 | 6.84702 | .311527 |
| 3.22 | 10.3684 | 33.3862 | 1.79444 | 5.67450 | 1.47668 | 3.18140 | 6.85412 | .310559 |
| 3.23 | 10.4329 | 33.6983 | 1.79722 | 5.68331 | 1.47820 | 3.18469 | 6.86121 | .309598 |
| 3.24 | 10.4976 | 34.0122 | 1.80000 | 5.69210 | 1.47973 | 3.18798 | 6.86829 | .308642 |
| 3.25 | 10.5625 | 34.3281 | 1.80278 | 5.70088 | 1.48125 | 3.19125 | 6.87534 | .307692 |
| 3.26 | 10.6276 | 34.6460 | 1.80555 | 5.70964 | 1.48277 | 3.19452 | 6.88239 | .306749 |
| 3.27 | 10.6929 | 34.9658 | 1.80831 | 5.71839 | 1.48428 | 3.19779 | 6.88942 | .305812 |
| 3.28 | 10.7584 | 35.2876 | 1.81108 | 5.72713 | 1.48579 | 3.20104 | 6.89643 | .304878 |
| 3.29 | 10.8241 | 35.6129 | 1.81384 | 5.73585 | 1.48730 | 3.20429 | 6.90344 | .303951 |
| 3.30 | 10.8900 | 35.9370 | 1.81659 | 5.74456 | 1.48881 | 3.20753 | 6.91042 | .303030 |
| 3.31 | 10.9561 | 36.2647 | 1.81934 | 5.75326 | 1.49031 | 3.21077 | 6.91740 | .302115 |
| 3.32 | 11.0224 | 36.5944 | 1.82209 | 5.76194 | 1.49181 | 3.21400 | 6.92436 | .301205 |
| 3.33 | 11.0889 | 36.9260 | 1.82483 | 5.77062 | 1.49330 | 3.21723 | 6.93130 | .300300 |
| 3.34 | 11.1556 | 37.2597 | 1.82757 | 5.77927 | 1.49480 | 3.22044 | 6.93823 | .299401 |
| 3.35 | 11.2225 | 37.5954 | 1.83030 | 5.78792 | 1.49629 | 3.22365 | 6.94515 | .298508 |
| 3.36 | 11.2896 | 37.9331 | 1.83303 | 5.79655 | 1.49777 | 3.22686 | 6.95205 | .297619 |
| 3.37 | 11.3569 | 38.2728 | 1.83576 | 5.80517 | 1.49926 | 3.23005 | 6.95894 | .296736 |
| 3.38 | 11.4244 | 38.6145 | 1.83848 | 5.81378 | 1.50074 | 3.23325 | 6.96582 | .295858 |
| 3.39 | 11.4921 | 38.9582 | 1.84120 | 5.82237 | 1.50222 | 3.23643 | 6.97268 | .294985 |
| 3.40 | 11.5600 | 39.3040 | 1.84391 | 5.83095 | 1.50369 | 3.23961 | 6.97953 | .294118 |
| 3.41 | 11.6281 | 39.6518 | 1.84662 | 5.83952 | 1.50517 | 3.24278 | 6.98637 | .293255 |
| 3.42 | 11.6964 | 40.0017 | 1.84932 | 5.84808 | 1.50664 | 3.24595 | 6.99319 | .292398 |
| 3.43 | 11.7649 | 40.3536 | 1.85203 | 5.85662 | 1.50810 | 3.24911 | 7.00000 | .291545 |
| 3.44 | 11.8336 | 40.7076 | 1.85472 | 5.86515 | 1.50957 | 3.25227 | 7.00680 | .290698 |
| 3.45 | 11.9025 | 41.0636 | 1.85742 | 5.87367 | 1.51103 | 3.25542 | 7.01358 | .289855 |
| 3.46 | 11.9716 | 41.4217 | 1.86011 | 5.88218 | 1.51249 | 3.25856 | 7.02035 | .289017 |
| 3.47 | 12.0409 | 41.7819 | 1.86279 | 5.89067 | 1.51394 | 3.26169 | 7.02711 | .288184 |
| 3.48 | 12.1104 | 42.1442 | 1.86548 | 5.89915 | 1.51540 | 3.26482 | 7.03385 | .287356 |
| 3.49 | 12.1801 | 42.5085 | 1.86815 | 5.90762 | 1.51685 | 3.26795 | 7.04058 | .286533 |
| 3.50 | 12.2500 | 42.8750 | 1.87083 | 5.91608 | 1.51829 | 3.27107 | 7.04730 | .285714 |

| n | n^2 | n^3 | \sqrt{n} | $\sqrt{10n}$ | $\sqrt[3]{n}$ | $\sqrt[3]{10n}$ | $\sqrt[3]{100n}$ | $\frac{1}{n}$ |
|------|---------|---------|------------|--------------|---------------|-----------------|------------------|---------------|
| 3.51 | 12.3201 | 43.2436 | 1.87350 | 5.92453 | 1.51974 | 3.27418 | 7.05400 | .284900 |
| 3.52 | 12.3904 | 43.6142 | 1.87617 | 5.93236 | 1.52118 | 3.27729 | 7.06070 | .284091 |
| 3.53 | 12.4609 | 43.9870 | 1.87883 | 5.94138 | 1.52262 | 3.28039 | 7.06738 | .283286 |
| 3.54 | 12.5316 | 44.3619 | 1.88149 | 5.94979 | 1.52406 | 3.28348 | 7.07404 | .282486 |
| 3.55 | 12.6025 | 44.7389 | 1.88414 | 5.95819 | 1.52549 | 3.28657 | 7.08070 | .281690 |
| 3.56 | 12.6736 | 45.1160 | 1.88680 | 5.96657 | 1.52692 | 3.28965 | 7.08734 | .280999 |
| 3.57 | 12.7449 | 45.4993 | 1.88944 | 5.97495 | 1.52835 | 3.29273 | 7.09397 | .280112 |
| 3.58 | 12.8164 | 45.8827 | 1.89209 | 5.98331 | 1.52978 | 3.29580 | 7.10059 | .279330 |
| 3.59 | 12.8891 | 46.2683 | 1.89473 | 5.99166 | 1.53120 | 3.29887 | 7.10719 | .278552 |
| 3.60 | 12.9600 | 46.6560 | 1.89737 | 6.00000 | 1.53262 | 3.30193 | 7.11379 | .277778 |
| 3.61 | 13.0321 | 47.0459 | 1.90000 | 6.00833 | 1.53404 | 3.30498 | 7.12037 | .277008 |
| 3.62 | 13.1044 | 47.4379 | 1.90263 | 6.01664 | 1.53545 | 3.30803 | 7.12694 | .276243 |
| 3.63 | 13.1769 | 47.8321 | 1.90526 | 6.02495 | 1.53686 | 3.31107 | 7.13349 | .275482 |
| 3.64 | 13.2496 | 48.2285 | 1.90788 | 6.03324 | 1.53827 | 3.31411 | 7.14004 | .274725 |
| 3.65 | 13.3225 | 48.6271 | 1.91050 | 6.04152 | 1.53968 | 3.31714 | 7.14657 | .273973 |
| 3.66 | 13.3956 | 49.0279 | 1.91311 | 6.04979 | 1.54109 | 3.32017 | 7.15309 | .273224 |
| 3.67 | 13.4689 | 49.4309 | 1.91572 | 6.05805 | 1.54249 | 3.32319 | 7.15960 | .272480 |
| 3.68 | 13.5424 | 49.8360 | 1.91833 | 6.06630 | 1.54389 | 3.32621 | 7.16610 | .271739 |
| 3.69 | 13.6161 | 50.2434 | 1.92094 | 6.07454 | 1.54529 | 3.32922 | 7.17258 | .271003 |
| 3.70 | 13.6900 | 50.6530 | 1.92354 | 6.08276 | 1.54668 | 3.33222 | 7.17905 | .270270 |
| 3.71 | 13.7641 | 51.0648 | 1.92614 | 6.09098 | 1.54807 | 3.33522 | 7.18552 | .269542 |
| 3.72 | 13.8384 | 51.4788 | 1.92873 | 6.09918 | 1.54946 | 3.33822 | 7.19197 | .268817 |
| 3.73 | 13.9129 | 51.8951 | 1.93132 | 6.10737 | 1.55085 | 3.34120 | 7.19841 | .268097 |
| 3.74 | 13.9876 | 52.3136 | 1.93391 | 6.11555 | 1.55223 | 3.34419 | 7.20483 | .267380 |
| 3.75 | 14.0625 | 52.7344 | 1.93649 | 6.12372 | 1.55362 | 3.34716 | 7.21125 | .266667 |
| 3.76 | 14.1376 | 53.1574 | 1.93907 | 6.13188 | 1.55500 | 3.35014 | 7.21765 | .265957 |
| 3.77 | 14.2129 | 53.5826 | 1.94165 | 6.14003 | 1.55637 | 3.35310 | 7.22405 | .265252 |
| 3.78 | 14.2884 | 54.0102 | 1.94422 | 6.14817 | 1.55775 | 3.35607 | 7.23043 | .264550 |
| 3.79 | 14.3641 | 54.4399 | 1.94679 | 6.15630 | 1.55912 | 3.35902 | 7.23680 | .263852 |
| 3.80 | 14.4400 | 54.8720 | 1.94936 | 6.16441 | 1.56049 | 3.36198 | 7.24316 | .263158 |
| 3.81 | 14.5161 | 55.3063 | 1.95192 | 6.17252 | 1.56186 | 3.36492 | 7.24950 | .262467 |
| 3.82 | 14.5924 | 55.7430 | 1.95448 | 6.18061 | 1.56322 | 3.36786 | 7.25584 | .261780 |
| 3.83 | 14.6689 | 56.1819 | 1.95704 | 6.18870 | 1.56459 | 3.37080 | 7.26217 | .261097 |
| 3.84 | 14.7456 | 56.6231 | 1.95959 | 6.19677 | 1.56595 | 3.37373 | 7.26848 | .260417 |
| 3.85 | 14.8225 | 57.0666 | 1.96214 | 6.20484 | 1.56731 | 3.37666 | 7.27479 | .259740 |
| 3.86 | 14.8996 | 57.5125 | 1.96469 | 6.21289 | 1.56866 | 3.37958 | 7.28108 | .259067 |
| 3.87 | 14.9769 | 57.9606 | 1.96723 | 6.22093 | 1.57001 | 3.38249 | 7.28736 | .258398 |
| 3.88 | 15.0544 | 58.4111 | 1.96977 | 6.22896 | 1.57137 | 3.38540 | 7.29363 | .257732 |
| 3.89 | 15.1321 | 58.8639 | 1.97231 | 6.23699 | 1.57271 | 3.38831 | 7.29989 | .257069 |
| 3.90 | 15.2100 | 59.3190 | 1.97484 | 6.24500 | 1.57406 | 3.39121 | 7.30614 | .256410 |
| 3.91 | 15.2881 | 59.7765 | 1.97737 | 6.25300 | 1.57541 | 3.39411 | 7.31238 | .255755 |
| 3.92 | 15.3664 | 60.2363 | 1.97990 | 6.26099 | 1.57675 | 3.39700 | 7.31861 | .255102 |
| 3.93 | 15.4449 | 60.6985 | 1.98242 | 6.26897 | 1.57809 | 3.39988 | 7.32483 | .254453 |
| 3.94 | 15.5236 | 61.1630 | 1.98494 | 6.27694 | 1.57942 | 3.40277 | 7.33104 | .253807 |
| 3.95 | 15.6025 | 61.6299 | 1.98746 | 6.28490 | 1.58076 | 3.40564 | 7.33723 | .253165 |
| 3.96 | 15.6816 | 62.0991 | 1.98997 | 6.29285 | 1.58209 | 3.40851 | 7.34342 | .252525 |
| 3.97 | 15.7609 | 62.5709 | 1.99249 | 6.30079 | 1.58342 | 3.41138 | 7.34960 | .251889 |
| 3.98 | 15.8404 | 63.0448 | 1.99499 | 6.30872 | 1.58475 | 3.41424 | 7.35576 | .251256 |
| 3.99 | 15.9201 | 63.5212 | 1.99750 | 6.31664 | 1.58608 | 3.41710 | 7.36192 | .250627 |
| 4.00 | 16.0000 | 64.0000 | 2.00000 | 6.32456 | 1.58740 | 3.41995 | 7.36806 | .250000 |

| n | n^2 | n^3 | \sqrt{n} | $\sqrt[10]{n}$ | $\sqrt[3]{n}$ | $\sqrt[3]{10n}$ | $\sqrt[3]{100n}$ | $\frac{1}{n}$ |
|------|---------|---------|------------|----------------|---------------|-----------------|------------------|---------------|
| 4.01 | 16.0801 | 64.4812 | 2.00250 | 6.33246 | 1.58872 | 3.42280 | 7.37420 | .249377 |
| 4.02 | 16.1604 | 64.9648 | 2.00499 | 6.34035 | 1.59004 | 3.42564 | 7.38032 | .248756 |
| 4.03 | 16.2409 | 65.4508 | 2.00749 | 6.34823 | 1.59136 | 3.42848 | 7.38644 | .248139 |
| 4.04 | 16.3216 | 65.9393 | 2.00998 | 6.35610 | 1.59267 | 3.43131 | 7.39254 | .247525 |
| 4.05 | 16.4025 | 66.4301 | 2.01246 | 6.36396 | 1.59399 | 3.43414 | 7.39864 | .246914 |
| 4.06 | 16.4836 | 66.9234 | 2.01494 | 6.37181 | 1.59530 | 3.43697 | 7.40472 | .246305 |
| 4.07 | 16.5649 | 67.4191 | 2.01742 | 6.37966 | 1.59661 | 3.43979 | 7.41080 | .245700 |
| 4.08 | 16.6464 | 67.9173 | 2.01990 | 6.38749 | 1.59791 | 3.44260 | 7.41686 | .245098 |
| 4.09 | 16.7281 | 68.4179 | 2.02237 | 6.39531 | 1.59922 | 3.44541 | 7.42291 | .244499 |
| 4.10 | 16.8100 | 68.9210 | 2.02485 | 6.40312 | 1.60052 | 3.44822 | 7.42896 | .243902 |
| 4.11 | 16.8921 | 69.4265 | 2.02731 | 6.41093 | 1.60182 | 3.45102 | 7.43499 | .243309 |
| 4.12 | 16.9744 | 69.9345 | 2.02978 | 6.41872 | 1.60312 | 3.45382 | 7.44102 | .242718 |
| 4.13 | 17.0569 | 70.4450 | 2.03224 | 6.42651 | 1.60441 | 3.45661 | 7.44703 | .242131 |
| 4.14 | 17.1396 | 70.9579 | 2.03470 | 6.43428 | 1.60571 | 3.45939 | 7.45304 | .241546 |
| 4.15 | 17.2225 | 71.4734 | 2.03715 | 6.44205 | 1.60700 | 3.46218 | 7.45904 | .240964 |
| 4.16 | 17.3056 | 71.9913 | 2.03961 | 6.44981 | 1.60829 | 3.46496 | 7.46502 | .240385 |
| 4.17 | 17.3889 | 72.5117 | 2.04206 | 6.45755 | 1.60958 | 3.46773 | 7.47100 | .239808 |
| 4.18 | 17.4724 | 73.0346 | 2.04450 | 6.46529 | 1.61086 | 3.47050 | 7.47697 | .239234 |
| 4.19 | 17.5561 | 73.5601 | 2.04695 | 6.47302 | 1.61215 | 3.47327 | 7.48292 | .238664 |
| 4.20 | 17.6400 | 74.0880 | 2.04939 | 6.48074 | 1.61343 | 3.47603 | 7.48887 | .238095 |
| 4.21 | 17.7241 | 74.6185 | 2.05183 | 6.48845 | 1.61471 | 3.47878 | 7.49481 | .237530 |
| 4.22 | 17.8084 | 75.1514 | 2.05426 | 6.49615 | 1.61599 | 3.48154 | 7.50074 | .236967 |
| 4.23 | 17.8929 | 75.6870 | 2.05670 | 6.50385 | 1.61726 | 3.48428 | 7.50666 | .236407 |
| 4.24 | 17.9776 | 76.2250 | 2.05913 | 6.51153 | 1.61853 | 3.48703 | 7.51257 | .235849 |
| 4.25 | 18.0625 | 76.7656 | 2.06155 | 6.51920 | 1.61981 | 3.48977 | 7.51847 | .235294 |
| 4.26 | 18.1476 | 77.3088 | 2.06398 | 6.52687 | 1.62108 | 3.49250 | 7.52437 | .234742 |
| 4.27 | 18.2329 | 77.8545 | 2.06640 | 6.53452 | 1.62234 | 3.49523 | 7.53025 | .234192 |
| 4.28 | 18.3184 | 78.4028 | 2.06882 | 6.54217 | 1.62361 | 3.49796 | 7.53612 | .233645 |
| 4.29 | 18.4041 | 78.9536 | 2.07123 | 6.54981 | 1.62487 | 3.50068 | 7.54199 | .233100 |
| 4.30 | 18.4900 | 79.5070 | 2.07364 | 6.55744 | 1.62613 | 3.50340 | 7.54784 | .232558 |
| 4.31 | 18.5761 | 80.0630 | 2.07605 | 6.56506 | 1.62739 | 3.50611 | 7.55369 | .232019 |
| 4.32 | 18.6624 | 80.6216 | 2.07846 | 6.57267 | 1.62865 | 3.50882 | 7.55953 | .231483 |
| 4.33 | 18.7489 | 81.1827 | 2.08087 | 6.58027 | 1.62991 | 3.51153 | 7.56535 | .230947 |
| 4.34 | 18.8356 | 81.7465 | 2.08327 | 6.58787 | 1.63116 | 3.51423 | 7.57117 | .230415 |
| 4.35 | 18.9225 | 82.3129 | 2.08567 | 6.59545 | 1.63241 | 3.51692 | 7.57698 | .229885 |
| 4.36 | 19.0096 | 82.8819 | 2.08806 | 6.60303 | 1.63366 | 3.51962 | 7.58279 | .229358 |
| 4.37 | 19.0969 | 83.4535 | 2.09045 | 6.61060 | 1.63491 | 3.52231 | 7.58858 | .228833 |
| 4.38 | 19.1844 | 84.0277 | 2.09284 | 6.61816 | 1.63616 | 3.52499 | 7.59436 | .228311 |
| 4.39 | 19.2721 | 84.6045 | 2.09523 | 6.62571 | 1.63740 | 3.52767 | 7.60014 | .227790 |
| 4.40 | 19.3600 | 85.1840 | 2.09762 | 6.63325 | 1.63864 | 3.53035 | 7.60590 | .227273 |
| 4.41 | 19.4481 | 85.7661 | 2.10000 | 6.64078 | 1.63988 | 3.53302 | 7.61166 | .226757 |
| 4.42 | 19.5364 | 86.3509 | 2.10238 | 6.64831 | 1.64112 | 3.53569 | 7.61741 | .226244 |
| 4.43 | 19.6249 | 86.9383 | 2.10476 | 6.65582 | 1.64236 | 3.53835 | 7.62315 | .225734 |
| 4.44 | 19.7136 | 87.5284 | 2.10713 | 6.66333 | 1.64359 | 3.54101 | 7.62888 | .225225 |
| 4.45 | 19.8025 | 88.1211 | 2.10950 | 6.67083 | 1.64483 | 3.54367 | 7.63461 | .224719 |
| 4.46 | 19.8916 | 88.7165 | 2.11187 | 6.67832 | 1.64606 | 3.54632 | 7.64032 | .224215 |
| 4.47 | 19.9809 | 89.3146 | 2.11424 | 6.68581 | 1.64729 | 3.54897 | 7.64603 | .223714 |
| 4.48 | 20.0704 | 89.9154 | 2.11660 | 6.69328 | 1.64851 | 3.55162 | 7.65172 | .223214 |
| 4.49 | 20.1601 | 90.5188 | 2.11896 | 6.70075 | 1.64974 | 3.55426 | 7.65741 | .222717 |
| 4.50 | 20.2500 | 91.1250 | 2.12132 | 6.70820 | 1.65096 | 3.55689 | 7.66309 | .222222 |

| n | n^2 | n^3 | \sqrt{n} | $\sqrt[3]{10n}$ | $\sqrt[3]{n}$ | $\sqrt[3]{10n}$ | $\sqrt[3]{100n}$ | $\frac{1}{n}$ |
|------|---------|---------|------------|-----------------|---------------|-----------------|------------------|---------------|
| 4.51 | 20.3401 | 91.7339 | 2.12368 | 6.71565 | 1.65219 | 3.55953 | 7.66877 | .221730 |
| 4.52 | 20.4304 | 92.3454 | 2.12603 | 6.72309 | 1.65341 | 3.56215 | 7.67443 | .221239 |
| 4.53 | 20.5209 | 92.9597 | 2.12838 | 6.73053 | 1.65462 | 3.56478 | 7.68009 | .220751 |
| 4.54 | 20.6116 | 93.5767 | 2.13073 | 6.73795 | 1.65584 | 3.56740 | 7.68573 | .220264 |
| 4.55 | 20.7025 | 94.1964 | 2.13307 | 6.74537 | 1.65706 | 3.57002 | 7.69137 | .219780 |
| 4.56 | 20.7936 | 94.8188 | 2.13542 | 6.75278 | 1.65827 | 3.57263 | 7.69700 | .219298 |
| 4.57 | 20.8849 | 95.4440 | 2.13776 | 6.76018 | 1.65948 | 3.57524 | 7.70262 | .218813 |
| 4.58 | 20.9764 | 96.0719 | 2.14009 | 6.76757 | 1.66069 | 3.57785 | 7.70824 | .218331 |
| 4.59 | 21.0681 | 96.7026 | 2.14243 | 6.77495 | 1.66190 | 3.58045 | 7.71384 | .217865 |
| 4.60 | 21.1600 | 97.3360 | 2.14476 | 6.78233 | 1.66310 | 3.58305 | 7.71944 | .217391 |
| 4.61 | 21.2521 | 97.9722 | 2.14709 | 6.78970 | 1.66431 | 3.58564 | 7.72503 | .216920 |
| 4.62 | 21.3444 | 98.6111 | 2.14942 | 6.79706 | 1.66551 | 3.58823 | 7.73061 | .216450 |
| 4.63 | 21.4369 | 99.2528 | 2.15174 | 6.80441 | 1.66671 | 3.59082 | 7.73619 | .215983 |
| 4.64 | 21.5296 | 99.8973 | 2.15407 | 6.81175 | 1.66791 | 3.59340 | 7.74175 | .215517 |
| 4.65 | 21.6225 | 100.545 | 2.15639 | 6.81909 | 1.66911 | 3.59598 | 7.74731 | .215054 |
| 4.66 | 21.7156 | 101.195 | 2.15870 | 6.82642 | 1.67030 | 3.59856 | 7.75286 | .214592 |
| 4.67 | 21.8089 | 101.848 | 2.16102 | 6.83374 | 1.67150 | 3.60113 | 7.75840 | .214123 |
| 4.68 | 21.9024 | 102.503 | 2.16333 | 6.84105 | 1.67269 | 3.60370 | 7.76394 | .213675 |
| 4.69 | 21.9961 | 103.162 | 2.16564 | 6.84836 | 1.67388 | 3.60626 | 7.76946 | .213220 |
| 4.70 | 22.0900 | 103.823 | 2.16795 | 6.85565 | 1.67507 | 3.60883 | 7.77498 | .212766 |
| 4.71 | 22.1841 | 104.487 | 2.17025 | 6.86294 | 1.67626 | 3.61138 | 7.78049 | .212314 |
| 4.72 | 22.2784 | 105.154 | 2.17256 | 6.87023 | 1.67744 | 3.61394 | 7.78599 | .211864 |
| 4.73 | 22.3729 | 105.824 | 2.17486 | 6.87750 | 1.67863 | 3.61649 | 7.79149 | .211417 |
| 4.74 | 22.4676 | 106.496 | 2.17715 | 6.88477 | 1.67981 | 3.61904 | 7.79697 | .210971 |
| 4.75 | 22.5625 | 107.172 | 2.17945 | 6.89202 | 1.68099 | 3.62158 | 7.80245 | .210526 |
| 4.76 | 22.6576 | 107.850 | 2.18174 | 6.89928 | 1.68217 | 3.62412 | 7.80793 | .210084 |
| 4.77 | 22.7529 | 108.531 | 2.18403 | 6.90652 | 1.68334 | 3.62665 | 7.81339 | .209644 |
| 4.78 | 22.8484 | 109.215 | 2.18632 | 6.91375 | 1.68452 | 3.62919 | 7.81885 | .209205 |
| 4.79 | 22.9441 | 109.902 | 2.18861 | 6.92098 | 1.68569 | 3.63171 | 7.82429 | .208763 |
| 4.80 | 23.0400 | 110.592 | 2.19089 | 6.92820 | 1.68687 | 3.63424 | 7.82974 | .208333 |
| 4.81 | 23.1361 | 111.285 | 2.19317 | 6.93542 | 1.68804 | 3.63676 | 7.83517 | .207900 |
| 4.82 | 23.2324 | 111.980 | 2.19545 | 6.94262 | 1.68920 | 3.63928 | 7.84059 | .207469 |
| 4.83 | 23.3289 | 112.679 | 2.19773 | 6.94982 | 1.69037 | 3.64180 | 7.84601 | .207039 |
| 4.84 | 23.4256 | 113.380 | 2.20000 | 6.95701 | 1.69154 | 3.64431 | 7.85142 | .206612 |
| 4.85 | 23.5225 | 114.084 | 2.20227 | 6.96419 | 1.69270 | 3.64682 | 7.85683 | .206186 |
| 4.86 | 23.6196 | 114.791 | 2.20454 | 6.97137 | 1.69386 | 3.64932 | 7.86222 | .205761 |
| 4.87 | 23.7169 | 115.501 | 2.20681 | 6.97854 | 1.69503 | 3.65182 | 7.86761 | .205339 |
| 4.88 | 23.8144 | 116.214 | 2.20907 | 6.98570 | 1.69619 | 3.65432 | 7.87299 | .204918 |
| 4.89 | 23.9121 | 116.930 | 2.21133 | 6.99285 | 1.69734 | 3.65682 | 7.87837 | .204499 |
| 4.90 | 24.0100 | 117.649 | 2.21359 | 7.00000 | 1.69850 | 3.65931 | 7.88374 | .204082 |
| 4.91 | 24.1081 | 118.371 | 2.21585 | 7.00714 | 1.69965 | 3.66179 | 7.88909 | .203666 |
| 4.92 | 24.2064 | 119.095 | 2.21811 | 7.01427 | 1.70081 | 3.66428 | 7.89445 | .203252 |
| 4.93 | 24.3049 | 119.823 | 2.22036 | 7.02140 | 1.70196 | 3.66676 | 7.89979 | .202840 |
| 4.94 | 24.4036 | 120.554 | 2.22261 | 7.02851 | 1.70311 | 3.66924 | 7.90513 | .202429 |
| 4.95 | 24.5025 | 121.287 | 2.22486 | 7.03562 | 1.70426 | 3.67171 | 7.91046 | .202020 |
| 4.96 | 24.6016 | 122.024 | 2.22711 | 7.04273 | 1.70540 | 3.67418 | 7.91578 | .201613 |
| 4.97 | 24.7009 | 122.763 | 2.22935 | 7.04982 | 1.70655 | 3.67665 | 7.92110 | .201207 |
| 4.98 | 24.8004 | 123.506 | 2.23159 | 7.05691 | 1.70769 | 3.67911 | 7.92641 | .200803 |
| 4.99 | 24.9001 | 124.251 | 2.23383 | 7.06399 | 1.70884 | 3.68157 | 7.93171 | .200401 |
| 5.00 | 25.0000 | 125.000 | 2.23607 | 7.07107 | 1.70998 | 3.68403 | 7.93701 | .200000 |

| n | n^2 | n^3 | \sqrt{n} | $\sqrt{10n}$ | $\sqrt[3]{n}$ | $\sqrt[3]{10n}$ | $\sqrt[3]{100n}$ | $\frac{1}{n}$ |
|------|---------|---------|------------|--------------|---------------|-----------------|------------------|---------------|
| 5.01 | 25.1001 | 125.752 | 2.23830 | 7.07814 | 1.71112 | 3.68649 | 7.94229 | .199601 |
| 5.02 | 25.2004 | 126.506 | 2.24054 | 7.08520 | 1.71225 | 3.68894 | 7.94757 | .199203 |
| 5.03 | 25.3009 | 127.264 | 2.24277 | 7.09225 | 1.71339 | 3.69138 | 7.95285 | .198807 |
| 5.04 | 25.4016 | 128.024 | 2.24499 | 7.09930 | 1.71452 | 3.69383 | 7.95811 | .198413 |
| 5.05 | 25.5025 | 128.788 | 2.24722 | 7.10634 | 1.71566 | 3.69627 | 7.96337 | .198020 |
| 5.06 | 25.6036 | 129.554 | 2.24944 | 7.11337 | 1.71679 | 3.69871 | 7.96863 | .197629 |
| 5.07 | 25.7049 | 130.324 | 2.25167 | 7.12039 | 1.71792 | 3.70114 | 7.97387 | .197239 |
| 5.08 | 25.8064 | 131.097 | 2.25389 | 7.12741 | 1.71905 | 3.70358 | 7.97911 | .196850 |
| 5.09 | 25.9081 | 131.872 | 2.25610 | 7.13442 | 1.72017 | 3.70600 | 7.98434 | .196461 |
| 5.10 | 26.0100 | 132.651 | 2.25832 | 7.14143 | 1.72130 | 3.70843 | 7.98957 | .196078 |
| 5.11 | 26.1121 | 133.433 | 2.26053 | 7.14843 | 1.72242 | 3.71085 | 7.99479 | .195695 |
| 5.12 | 26.2144 | 134.218 | 2.26274 | 7.15542 | 1.72355 | 3.71327 | 8.00000 | .195313 |
| 5.13 | 26.3169 | 135.006 | 2.26495 | 7.16240 | 1.72467 | 3.71566 | 8.00520 | .194932 |
| 5.14 | 26.4196 | 135.797 | 2.26716 | 7.16938 | 1.72579 | 3.71810 | 8.01040 | .194553 |
| 5.15 | 26.5225 | 136.591 | 2.26936 | 7.17635 | 1.72691 | 3.72051 | 8.01559 | .194175 |
| 5.16 | 26.6256 | 137.388 | 2.27156 | 7.18331 | 1.72802 | 3.72292 | 8.02078 | .193798 |
| 5.17 | 26.7289 | 138.188 | 2.27376 | 7.19027 | 1.72914 | 3.72532 | 8.02596 | .193424 |
| 5.18 | 26.8324 | 138.992 | 2.27596 | 7.19722 | 1.73025 | 3.72772 | 8.03113 | .193050 |
| 5.19 | 26.9361 | 139.798 | 2.27816 | 7.20417 | 1.73137 | 3.73012 | 8.03629 | .192678 |
| 5.20 | 27.0400 | 140.608 | 2.28035 | 7.21110 | 1.73248 | 3.73251 | 8.04145 | .192308 |
| 5.21 | 27.1441 | 141.421 | 2.28254 | 7.21803 | 1.73359 | 3.73490 | 8.04660 | .191939 |
| 5.22 | 27.2484 | 142.237 | 2.28473 | 7.22496 | 1.73470 | 3.73729 | 8.05175 | .191571 |
| 5.23 | 27.3529 | 143.056 | 2.28692 | 7.23187 | 1.73580 | 3.73968 | 8.05689 | .191205 |
| 5.24 | 27.4576 | 143.878 | 2.28910 | 7.23878 | 1.73691 | 3.74206 | 8.06202 | .190840 |
| 5.25 | 27.5625 | 144.703 | 2.29129 | 7.24569 | 1.73801 | 3.74443 | 8.06714 | .190476 |
| 5.26 | 27.6676 | 145.532 | 2.29347 | 7.25259 | 1.73912 | 3.74681 | 8.07226 | .190114 |
| 5.27 | 27.7729 | 146.363 | 2.29565 | 7.25948 | 1.74022 | 3.74918 | 8.07737 | .189753 |
| 5.28 | 27.8784 | 147.198 | 2.29783 | 7.26636 | 1.74132 | 3.75158 | 8.08248 | .189394 |
| 5.29 | 27.9841 | 148.036 | 2.30000 | 7.27324 | 1.74242 | 3.75392 | 8.08758 | .189036 |
| 5.30 | 28.0900 | 148.877 | 2.30217 | 7.28011 | 1.74351 | 3.75629 | 8.09267 | .188679 |
| 5.31 | 28.1961 | 149.721 | 2.30434 | 7.28697 | 1.74461 | 3.75865 | 8.09776 | .188324 |
| 5.32 | 28.3024 | 150.569 | 2.30651 | 7.29383 | 1.74570 | 3.76100 | 8.10284 | .187970 |
| 5.33 | 28.4089 | 151.419 | 2.30868 | 7.30068 | 1.74680 | 3.76336 | 8.10791 | .187617 |
| 5.34 | 28.5156 | 152.273 | 2.31084 | 7.30753 | 1.74789 | 3.76571 | 8.11298 | .187266 |
| 5.35 | 28.6225 | 153.130 | 2.31301 | 7.31437 | 1.74898 | 3.76806 | 8.11804 | .186916 |
| 5.36 | 28.7296 | 153.991 | 2.31517 | 7.32120 | 1.75007 | 3.77041 | 8.12310 | .186567 |
| 5.37 | 28.8369 | 154.854 | 2.31733 | 7.32803 | 1.75116 | 3.77275 | 8.12814 | .186220 |
| 5.38 | 28.9444 | 155.721 | 2.31948 | 7.33485 | 1.75224 | 3.77509 | 8.13319 | .185874 |
| 5.39 | 29.0521 | 156.591 | 2.32164 | 7.34167 | 1.75333 | 3.77744 | 8.13822 | .185529 |
| 5.40 | 29.1600 | 157.464 | 2.32379 | 7.34847 | 1.75441 | 3.77976 | 8.14325 | .185185 |
| 5.41 | 29.2681 | 158.340 | 2.32594 | 7.35527 | 1.75549 | 3.78210 | 8.14828 | .184843 |
| 5.42 | 29.3764 | 159.220 | 2.32809 | 7.36206 | 1.75657 | 3.78442 | 8.15329 | .184502 |
| 5.43 | 29.4849 | 160.103 | 2.33024 | 7.36885 | 1.75765 | 3.78675 | 8.15831 | .184162 |
| 5.44 | 29.5936 | 160.989 | 2.33238 | 7.37564 | 1.75873 | 3.78907 | 8.16331 | .183824 |
| 5.45 | 29.7025 | 161.879 | 2.33452 | 7.38241 | 1.75981 | 3.79139 | 8.16831 | .183486 |
| 5.46 | 29.8116 | 162.771 | 2.33666 | 7.38918 | 1.76088 | 3.79371 | 8.17330 | .183150 |
| 5.47 | 29.9209 | 163.667 | 2.33880 | 7.39594 | 1.76196 | 3.79603 | 8.17829 | .182815 |
| 5.48 | 30.0304 | 164.567 | 2.34094 | 7.40270 | 1.76303 | 3.79834 | 8.18327 | .182482 |
| 5.49 | 30.1401 | 165.469 | 2.34307 | 7.40945 | 1.76410 | 3.80065 | 8.18824 | .182149 |
| 5.50 | 30.2500 | 166.375 | 2.34521 | 7.41620 | 1.76517 | 3.80295 | 8.19321 | .181818 |

| n | n^2 | n^3 | \sqrt{n} | $\sqrt{10n}$ | $\sqrt[3]{n}$ | $\sqrt[3]{10n}$ | $\sqrt[3]{100n}$ | $\frac{1}{n}$ |
|------|---------|---------|------------|--------------|---------------|-----------------|------------------|---------------|
| 5.51 | 30.3601 | 167.284 | 2.34734 | 7.42294 | 1.76624 | 3.80526 | 8.19818 | .181488 |
| 5.52 | 30.4704 | 168.197 | 2.34947 | 7.42967 | 1.76731 | 3.80756 | 8.20318 | .181159 |
| 5.53 | 30.5809 | 169.112 | 2.35160 | 7.43640 | 1.76838 | 3.80986 | 8.20808 | .180832 |
| 5.54 | 30.6916 | 170.031 | 2.35372 | 7.44312 | 1.76944 | 3.81115 | 8.21303 | .180505 |
| 5.55 | 30.8025 | 170.954 | 2.35584 | 7.44983 | 1.77051 | 3.81444 | 8.21797 | .180180 |
| 5.56 | 30.9136 | 171.880 | 2.35797 | 7.45654 | 1.77157 | 3.81673 | 8.22290 | .179856 |
| 5.57 | 31.0249 | 172.809 | 2.36008 | 7.46324 | 1.77263 | 3.81902 | 8.22783 | .179533 |
| 5.58 | 31.1364 | 173.741 | 2.36220 | 7.46994 | 1.77369 | 3.82130 | 8.23275 | .179212 |
| 5.59 | 31.2481 | 174.677 | 2.36432 | 7.47663 | 1.77475 | 3.82358 | 8.23766 | .178891 |
| 5.60 | 31.3600 | 175.616 | 2.36643 | 7.48331 | 1.77581 | 3.82586 | 8.24257 | .178571 |
| 5.61 | 31.4721 | 176.558 | 2.36854 | 7.48999 | 1.77686 | 3.82814 | 8.24747 | .178253 |
| 5.62 | 31.5844 | 177.504 | 2.37065 | 7.49667 | 1.77792 | 3.83041 | 8.25237 | .177936 |
| 5.63 | 31.6969 | 178.454 | 2.37276 | 7.50333 | 1.77897 | 3.83268 | 8.25726 | .177620 |
| 5.64 | 31.8096 | 179.406 | 2.37487 | 7.50999 | 1.78003 | 3.83495 | 8.26215 | .177305 |
| 5.65 | 31.9225 | 180.362 | 2.37697 | 7.51665 | 1.78108 | 3.83721 | 8.26703 | .176991 |
| 5.66 | 32.0356 | 181.321 | 2.37908 | 7.52330 | 1.78213 | 3.83948 | 8.27190 | .176678 |
| 5.67 | 32.1489 | 182.284 | 2.38118 | 7.52994 | 1.78318 | 3.84174 | 8.27677 | .176367 |
| 5.68 | 32.2624 | 183.250 | 2.38328 | 7.53658 | 1.78422 | 3.84400 | 8.28164 | .176056 |
| 5.69 | 32.3761 | 184.220 | 2.38537 | 7.54321 | 1.78527 | 3.84625 | 8.28649 | .175747 |
| 5.70 | 32.4900 | 185.193 | 2.38747 | 7.54983 | 1.78632 | 3.84850 | 8.29134 | .175439 |
| 5.71 | 32.6041 | 186.169 | 2.38956 | 7.55645 | 1.78736 | 3.85075 | 8.29619 | .175131 |
| 5.72 | 32.7184 | 187.149 | 2.39165 | 7.56307 | 1.78840 | 3.85300 | 8.30103 | .174825 |
| 5.73 | 32.8329 | 188.133 | 2.39374 | 7.56968 | 1.78944 | 3.85524 | 8.30587 | .174520 |
| 5.74 | 32.9476 | 189.119 | 2.39583 | 7.57628 | 1.79048 | 3.85748 | 8.31069 | .174216 |
| 5.75 | 33.0625 | 190.109 | 2.39792 | 7.58288 | 1.79152 | 3.85972 | 8.31552 | .173913 |
| 5.76 | 33.1776 | 191.103 | 2.40000 | 7.58947 | 1.79256 | 3.86196 | 8.32034 | .173611 |
| 5.77 | 33.2929 | 192.100 | 2.40208 | 7.59605 | 1.79360 | 3.86419 | 8.32515 | .173310 |
| 5.78 | 33.4084 | 193.101 | 2.40416 | 7.60263 | 1.79463 | 3.86642 | 8.32995 | .173010 |
| 5.79 | 33.5241 | 194.105 | 2.40624 | 7.60920 | 1.79567 | 3.86865 | 8.33476 | .172712 |
| 5.80 | 33.6400 | 195.112 | 2.40832 | 7.61577 | 1.79670 | 3.87088 | 8.33955 | .172414 |
| 5.81 | 33.7561 | 196.123 | 2.41039 | 7.62234 | 1.79773 | 3.87310 | 8.34434 | .172117 |
| 5.82 | 33.8724 | 197.137 | 2.41247 | 7.62889 | 1.79876 | 3.87532 | 8.34913 | .171821 |
| 5.83 | 33.9889 | 198.155 | 2.41454 | 7.63544 | 1.79979 | 3.87754 | 8.35390 | .171527 |
| 5.84 | 34.1056 | 199.177 | 2.41661 | 7.64199 | 1.80082 | 3.87975 | 8.35868 | .171233 |
| 5.85 | 34.2225 | 200.202 | 2.41868 | 7.64853 | 1.80185 | 3.88197 | 8.36345 | .170940 |
| 5.86 | 34.3396 | 201.230 | 2.42074 | 7.65506 | 1.80288 | 3.88418 | 8.36821 | .170649 |
| 5.87 | 34.4569 | 202.262 | 2.42281 | 7.66159 | 1.80390 | 3.88639 | 8.37297 | .170358 |
| 5.88 | 34.5744 | 203.297 | 2.42487 | 7.66812 | 1.80492 | 3.88859 | 8.37772 | .170068 |
| 5.89 | 34.6921 | 204.336 | 2.42692 | 7.67463 | 1.80595 | 3.89082 | 8.38247 | .169779 |
| 5.90 | 34.8100 | 205.379 | 2.42899 | 7.68115 | 1.80697 | 3.89300 | 8.38721 | .169492 |
| 5.91 | 34.9281 | 206.425 | 2.43105 | 7.68765 | 1.80799 | 3.89520 | 8.39194 | .169205 |
| 5.92 | 35.0464 | 207.475 | 2.43311 | 7.69415 | 1.80901 | 3.89739 | 8.39667 | .168919 |
| 5.93 | 35.1649 | 208.528 | 2.43516 | 7.70065 | 1.81003 | 3.89958 | 8.40140 | .168634 |
| 5.94 | 35.2836 | 209.585 | 2.43721 | 7.70714 | 1.81104 | 3.90177 | 8.40612 | .168350 |
| 5.95 | 35.4025 | 210.645 | 2.43926 | 7.71362 | 1.81206 | 3.90396 | 8.41083 | .168067 |
| 5.96 | 35.5216 | 211.709 | 2.44131 | 7.72010 | 1.81307 | 3.90615 | 8.41554 | .167785 |
| 5.97 | 35.6409 | 212.776 | 2.44336 | 7.72658 | 1.81409 | 3.90833 | 8.42025 | .167504 |
| 5.98 | 35.7604 | 213.847 | 2.44540 | 7.73305 | 1.81510 | 3.91051 | 8.42494 | .167224 |
| 5.99 | 35.8801 | 214.922 | 2.44745 | 7.73951 | 1.81611 | 3.91269 | 8.42964 | .166945 |
| 6.00 | 36.0000 | 216.000 | 2.44949 | 7.74597 | 1.81712 | 3.91487 | 8.43433 | .166667 |

| n | n^2 | n^3 | \sqrt{n} | $\sqrt{10 n}$ | $\sqrt[3]{n}$ | $\sqrt[3]{10 n}$ | $\sqrt[3]{100 n}$ | $\frac{1}{n}$ |
|------|---------|---------|------------|---------------|---------------|------------------|-------------------|---------------|
| 6.01 | 36.1201 | 217.082 | 2.45153 | 7.75242 | 1.81813 | 3.91704 | 8.43901 | .166589 |
| 6.02 | 36.2404 | 218.167 | 2.45357 | 7.75887 | 1.81914 | 3.91921 | 8.44369 | .166113 |
| 6.03 | 36.3609 | 219.256 | 2.45561 | 7.76531 | 1.82014 | 3.92138 | 8.44836 | .165639 |
| 6.04 | 36.4816 | 220.349 | 2.45764 | 7.77174 | 1.82115 | 3.92355 | 8.45303 | .165163 |
| 6.05 | 36.6025 | 221.445 | 2.45967 | 7.77817 | 1.82215 | 3.92571 | 8.45769 | .164689 |
| 6.06 | 36.7236 | 222.545 | 2.46171 | 7.78460 | 1.82316 | 3.92787 | 8.46235 | .164217 |
| 6.07 | 36.8449 | 223.649 | 2.46374 | 7.79102 | 1.82416 | 3.93003 | 8.46700 | .163745 |
| 6.08 | 36.9664 | 224.756 | 2.46577 | 7.79744 | 1.82516 | 3.93219 | 8.47165 | .163274 |
| 6.09 | 37.0881 | 225.867 | 2.46779 | 7.80385 | 1.82616 | 3.93434 | 8.47629 | .162804 |
| 6.10 | 37.2100 | 226.981 | 2.46982 | 7.81025 | 1.82716 | 3.93650 | 8.48093 | .162334 |
| 6.11 | 37.3321 | 228.099 | 2.47184 | 7.81665 | 1.82816 | 3.93865 | 8.48556 | .161866 |
| 6.12 | 37.4544 | 229.221 | 2.47386 | 7.82304 | 1.82915 | 3.94079 | 8.49018 | .161399 |
| 6.13 | 37.5769 | 230.346 | 2.47588 | 7.82943 | 1.83015 | 3.94294 | 8.49481 | .161132 |
| 6.14 | 37.6996 | 231.476 | 2.47790 | 7.83582 | 1.83115 | 3.94508 | 8.49942 | .160666 |
| 6.15 | 37.8225 | 232.608 | 2.47992 | 7.84219 | 1.83214 | 3.94722 | 8.50404 | .160202 |
| 6.16 | 37.9456 | 233.745 | 2.48193 | 7.84857 | 1.83313 | 3.94936 | 8.50864 | .160238 |
| 6.17 | 38.0689 | 234.885 | 2.48395 | 7.85493 | 1.83412 | 3.95150 | 8.51324 | .160275 |
| 6.18 | 38.1924 | 236.029 | 2.48596 | 7.86130 | 1.83511 | 3.95363 | 8.51784 | .161812 |
| 6.19 | 38.3161 | 237.177 | 2.48797 | 7.86766 | 1.83610 | 3.95576 | 8.52243 | .161551 |
| 6.20 | 38.4400 | 238.328 | 2.48998 | 7.87401 | 1.83709 | 3.95789 | 8.52702 | .161290 |
| 6.21 | 38.5641 | 239.483 | 2.49199 | 7.88036 | 1.83808 | 3.96002 | 8.53160 | .161031 |
| 6.22 | 38.6884 | 240.642 | 2.49399 | 7.88670 | 1.83906 | 3.96214 | 8.53618 | .160772 |
| 6.23 | 38.8129 | 241.804 | 2.49600 | 7.89303 | 1.84005 | 3.96426 | 8.54075 | .160514 |
| 6.24 | 38.9376 | 242.971 | 2.49800 | 7.89937 | 1.84103 | 3.96639 | 8.54532 | .160256 |
| 6.25 | 39.0625 | 244.141 | 2.50000 | 7.90569 | 1.84202 | 3.96850 | 8.54988 | .160000 |
| 6.26 | 39.1876 | 245.314 | 2.50200 | 7.91202 | 1.84300 | 3.97062 | 8.55444 | .159744 |
| 6.27 | 39.3129 | 246.492 | 2.50400 | 7.91833 | 1.84398 | 3.97273 | 8.55899 | .159490 |
| 6.28 | 39.4384 | 247.673 | 2.50599 | 7.92465 | 1.84496 | 3.97484 | 8.56354 | .159236 |
| 6.29 | 39.5641 | 248.858 | 2.50799 | 7.93095 | 1.84594 | 3.97695 | 8.56808 | .158983 |
| 6.30 | 39.6900 | 250.047 | 2.50998 | 7.93725 | 1.84691 | 3.97906 | 8.57262 | .158730 |
| 6.31 | 39.8161 | 251.240 | 2.51197 | 7.94355 | 1.84789 | 3.98116 | 8.57715 | .158479 |
| 6.32 | 39.9424 | 252.436 | 2.51396 | 7.94984 | 1.84887 | 3.98326 | 8.58168 | .158228 |
| 6.33 | 40.0689 | 253.636 | 2.51595 | 7.95613 | 1.84984 | 3.98536 | 8.58620 | .157978 |
| 6.34 | 40.1956 | 254.840 | 2.51794 | 7.96241 | 1.85082 | 3.98746 | 8.59072 | .157729 |
| 6.35 | 40.3225 | 256.048 | 2.51992 | 7.96869 | 1.85179 | 3.98956 | 8.59524 | .157480 |
| 6.36 | 40.4496 | 257.259 | 2.52190 | 7.97496 | 1.85276 | 3.99165 | 8.59975 | .157233 |
| 6.37 | 40.5769 | 258.475 | 2.52389 | 7.98123 | 1.85373 | 3.99374 | 8.60425 | .156986 |
| 6.38 | 40.7044 | 259.694 | 2.52587 | 7.98749 | 1.85470 | 3.99583 | 8.60875 | .156740 |
| 6.39 | 40.8321 | 260.917 | 2.52784 | 7.99375 | 1.85567 | 3.99792 | 8.61325 | .156495 |
| 6.40 | 40.9600 | 262.144 | 2.52982 | 8.00000 | 1.85664 | 4.00000 | 8.61774 | .156250 |
| 6.41 | 41.0881 | 263.375 | 2.53180 | 8.00625 | 1.85760 | 4.00208 | 8.62222 | .156006 |
| 6.42 | 41.2164 | 264.609 | 2.53377 | 8.01249 | 1.85857 | 4.00416 | 8.62671 | .155763 |
| 6.43 | 41.3449 | 265.848 | 2.53574 | 8.01873 | 1.85953 | 4.00624 | 8.63118 | .155521 |
| 6.44 | 41.4736 | 267.090 | 2.53772 | 8.02496 | 1.86050 | 4.00832 | 8.63566 | .155280 |
| 6.45 | 41.6025 | 268.336 | 2.53969 | 8.03119 | 1.86146 | 4.01039 | 8.64012 | .155039 |
| 6.46 | 41.7316 | 269.586 | 2.54165 | 8.03741 | 1.86242 | 4.01246 | 8.64459 | .154799 |
| 6.47 | 41.8609 | 270.840 | 2.54362 | 8.04363 | 1.86338 | 4.01453 | 8.64904 | .154560 |
| 6.48 | 41.9904 | 272.098 | 2.54558 | 8.04984 | 1.86434 | 4.01660 | 8.65350 | .154321 |
| 6.49 | 42.1201 | 273.359 | 2.54755 | 8.05605 | 1.86530 | 4.01866 | 8.65795 | .154083 |
| 6.50 | 42.2500 | 274.625 | 2.54951 | 8.06226 | 1.86626 | 4.02073 | 8.66239 | .153846 |

| n | n^2 | n^3 | \sqrt{n} | $\sqrt[10]{n}$ | $\sqrt[3]{n}$ | $\sqrt[4]{10n}$ | $\sqrt[5]{100n}$ | $\frac{1}{n}$ |
|------|---------|---------|------------|----------------|---------------|-----------------|------------------|---------------|
| 6.51 | 42.3801 | 275.894 | 2.55147 | 8.06846 | 1.86721 | 4.02279 | 8.66683 | .153610 |
| 6.52 | 42.5104 | 277.168 | 2.55343 | 8.07465 | 1.86817 | 4.02485 | 8.67127 | .153374 |
| 6.53 | 42.6409 | 278.445 | 2.55539 | 8.08084 | 1.86912 | 4.02690 | 8.67570 | .153139 |
| 6.54 | 42.7716 | 279.726 | 2.55734 | 8.08703 | 1.87008 | 4.02896 | 8.68012 | .152905 |
| 6.55 | 42.9025 | 281.011 | 2.55930 | 8.09321 | 1.87103 | 4.03101 | 8.68455 | .152672 |
| 6.56 | 43.0336 | 282.300 | 2.56125 | 8.09938 | 1.87198 | 4.03306 | 8.68896 | .152439 |
| 6.57 | 43.1649 | 283.593 | 2.56320 | 8.10555 | 1.87293 | 4.03511 | 8.69338 | .152207 |
| 6.58 | 43.2964 | 284.890 | 2.56515 | 8.11172 | 1.87388 | 4.03715 | 8.69778 | .151976 |
| 6.59 | 43.4281 | 286.191 | 2.56710 | 8.11788 | 1.87483 | 4.03920 | 8.70219 | .151745 |
| 6.60 | 43.5600 | 287.496 | 2.56905 | 8.12404 | 1.87578 | 4.04124 | 8.70659 | .151515 |
| 6.61 | 43.6921 | 288.805 | 2.57099 | 8.13019 | 1.87672 | 4.04328 | 8.71098 | .151286 |
| 6.62 | 43.8244 | 290.118 | 2.57294 | 8.13634 | 1.87767 | 4.04532 | 8.71537 | .151057 |
| 6.63 | 43.9569 | 291.434 | 2.57488 | 8.14248 | 1.87862 | 4.04735 | 8.71976 | .150830 |
| 6.64 | 44.0896 | 292.755 | 2.57682 | 8.14862 | 1.87956 | 4.04939 | 8.72414 | .150602 |
| 6.65 | 44.2225 | 294.080 | 2.57876 | 8.15475 | 1.88050 | 4.05142 | 8.72852 | .150376 |
| 6.66 | 44.3556 | 295.408 | 2.58070 | 8.16088 | 1.88144 | 4.05345 | 8.73289 | .150150 |
| 6.67 | 44.4889 | 296.741 | 2.58263 | 8.16701 | 1.88239 | 4.05548 | 8.73726 | .149925 |
| 6.68 | 44.6224 | 298.078 | 2.58457 | 8.17313 | 1.88333 | 4.05750 | 8.74162 | .149701 |
| 6.69 | 44.7561 | 299.418 | 2.58650 | 8.17924 | 1.88427 | 4.05953 | 8.74598 | .149477 |
| 6.70 | 44.8900 | 300.763 | 2.58844 | 8.18535 | 1.88520 | 4.06155 | 8.75034 | .149254 |
| 6.71 | 45.0241 | 302.112 | 2.59037 | 8.19146 | 1.88614 | 4.06357 | 8.75469 | .149031 |
| 6.72 | 45.1584 | 303.464 | 2.59230 | 8.19756 | 1.88708 | 4.06558 | 8.75904 | .148810 |
| 6.73 | 45.2929 | 304.821 | 2.59422 | 8.20366 | 1.88801 | 4.06760 | 8.76338 | .148588 |
| 6.74 | 45.4276 | 306.182 | 2.59615 | 8.20975 | 1.88895 | 4.06961 | 8.76772 | .148368 |
| 6.75 | 45.5625 | 307.547 | 2.59808 | 8.21584 | 1.88988 | 4.07163 | 8.77205 | .148148 |
| 6.76 | 45.6976 | 308.916 | 2.60000 | 8.22192 | 1.89081 | 4.07364 | 8.77638 | .147929 |
| 6.77 | 45.8329 | 310.289 | 2.60192 | 8.22800 | 1.89175 | 4.07564 | 8.78071 | .147711 |
| 6.78 | 45.9684 | 311.668 | 2.60384 | 8.23408 | 1.89268 | 4.07765 | 8.78503 | .147493 |
| 6.79 | 46.1041 | 313.047 | 2.60576 | 8.24015 | 1.89361 | 4.07965 | 8.78935 | .147275 |
| 6.80 | 46.2400 | 314.432 | 2.60768 | 8.24621 | 1.89454 | 4.08166 | 8.79366 | .147069 |
| 6.81 | 46.3761 | 315.821 | 2.60960 | 8.25227 | 1.89546 | 4.08365 | 8.79797 | .146843 |
| 6.82 | 46.5124 | 317.215 | 2.61151 | 8.25833 | 1.89639 | 4.08565 | 8.80227 | .146628 |
| 6.83 | 46.6489 | 318.612 | 2.61343 | 8.26438 | 1.89732 | 4.08765 | 8.80657 | .146413 |
| 6.84 | 46.7856 | 320.014 | 2.61534 | 8.27043 | 1.89824 | 4.08964 | 8.81087 | .146199 |
| 6.85 | 46.9225 | 321.419 | 2.61725 | 8.27647 | 1.89917 | 4.09164 | 8.81516 | .145985 |
| 6.86 | 47.0596 | 322.829 | 2.61916 | 8.28251 | 1.90009 | 4.09362 | 8.81945 | .145773 |
| 6.87 | 47.1969 | 324.243 | 2.62107 | 8.28855 | 1.90102 | 4.09561 | 8.82373 | .145560 |
| 6.88 | 47.3344 | 325.661 | 2.62298 | 8.29458 | 1.90194 | 4.09760 | 8.82801 | .145349 |
| 6.89 | 47.4721 | 327.083 | 2.62488 | 8.30060 | 1.90286 | 4.09958 | 8.83229 | .145138 |
| 6.90 | 47.6100 | 328.509 | 2.62679 | 8.30662 | 1.90378 | 4.10157 | 8.83656 | .144928 |
| 6.91 | 47.7481 | 329.939 | 2.62869 | 8.31264 | 1.90470 | 4.10355 | 8.84082 | .144718 |
| 6.92 | 47.8864 | 331.374 | 2.63059 | 8.31865 | 1.90562 | 4.10552 | 8.84509 | .144509 |
| 6.93 | 48.0249 | 332.813 | 2.63249 | 8.32466 | 1.90653 | 4.10750 | 8.84934 | .144300 |
| 6.94 | 48.1636 | 334.255 | 2.63439 | 8.33067 | 1.90745 | 4.10948 | 8.85360 | .144092 |
| 6.95 | 48.3025 | 335.702 | 2.63629 | 8.33667 | 1.90837 | 4.11145 | 8.85785 | .143885 |
| 6.96 | 48.4416 | 337.154 | 2.63818 | 8.34266 | 1.90928 | 4.11342 | 8.86210 | .143678 |
| 6.97 | 48.5809 | 338.609 | 2.64008 | 8.34865 | 1.91019 | 4.11539 | 8.86634 | .143472 |
| 6.98 | 48.7204 | 340.068 | 2.64197 | 8.35464 | 1.91111 | 4.11736 | 8.87058 | .143267 |
| 6.99 | 48.8601 | 341.532 | 2.64386 | 8.36062 | 1.91202 | 4.11932 | 8.87481 | .143062 |
| 7.00 | 49.0000 | 343.000 | 2.64575 | 8.36660 | 1.91293 | 4.12129 | 8.87904 | .142857 |

| n | n^2 | n^3 | \sqrt{n} | $\sqrt{10n}$ | $\sqrt[3]{n}$ | $\sqrt[3]{10n}$ | $\sqrt[4]{100n}$ | $\frac{1}{n}$ |
|------|---------|---------|------------|--------------|---------------|-----------------|------------------|---------------|
| 7.01 | 49.1401 | 344.472 | 2.64764 | 8.37257 | 1.91384 | 4.12325 | 8.88327 | .142653 |
| 7.02 | 49.2804 | 345.948 | 2.64953 | 8.37534 | 1.91475 | 4.12521 | 8.88749 | .142150 |
| 7.03 | 49.4209 | 347.429 | 2.65141 | 8.38451 | 1.91566 | 4.12716 | 8.89171 | .142248 |
| 7.04 | 49.5616 | 348.914 | 2.65330 | 8.39047 | 1.91657 | 4.12912 | 8.89592 | .142046 |
| 7.05 | 49.7025 | 350.403 | 2.65518 | 8.39643 | 1.91747 | 4.13107 | 8.90013 | .141844 |
| 7.06 | 49.8436 | 351.896 | 2.65707 | 8.40238 | 1.91838 | 4.13303 | 8.90434 | .141643 |
| 7.07 | 49.9849 | 353.393 | 2.65895 | 8.40833 | 1.91929 | 4.13498 | 8.90854 | .141443 |
| 7.08 | 50.1264 | 354.895 | 2.66083 | 8.41427 | 1.92019 | 4.13695 | 8.91274 | .141243 |
| 7.09 | 50.2681 | 356.401 | 2.66271 | 8.42021 | 1.92109 | 4.13887 | 8.91693 | .141044 |
| 7.10 | 50.4100 | 357.911 | 2.66458 | 8.42615 | 1.92200 | 4.14082 | 8.92112 | .140845 |
| 7.11 | 50.5521 | 359.425 | 2.66646 | 8.43208 | 1.92290 | 4.14276 | 8.92531 | .140647 |
| 7.12 | 50.6944 | 360.944 | 2.66833 | 8.43801 | 1.92380 | 4.14470 | 8.92949 | .140449 |
| 7.13 | 50.8369 | 362.467 | 2.67021 | 8.44393 | 1.92470 | 4.14664 | 8.93367 | .140253 |
| 7.14 | 50.9796 | 363.994 | 2.67208 | 8.44985 | 1.92560 | 4.14858 | 8.93784 | .140056 |
| 7.15 | 51.1225 | 365.526 | 2.67395 | 8.45577 | 1.92650 | 4.15051 | 8.94201 | .139860 |
| 7.16 | 51.2656 | 367.062 | 2.67582 | 8.46168 | 1.92740 | 4.15245 | 8.94618 | .139665 |
| 7.17 | 51.4089 | 368.602 | 2.67769 | 8.46759 | 1.92829 | 4.15438 | 8.95034 | .139470 |
| 7.18 | 51.5524 | 370.146 | 2.67955 | 8.47349 | 1.92919 | 4.15631 | 8.95450 | .139276 |
| 7.19 | 51.6961 | 371.695 | 2.68142 | 8.47939 | 1.93008 | 4.15824 | 8.95866 | .139082 |
| 7.20 | 51.8400 | 373.248 | 2.68328 | 8.48528 | 1.93098 | 4.16017 | 8.96281 | .138889 |
| 7.21 | 51.9841 | 374.805 | 2.68514 | 8.49117 | 1.93187 | 4.16209 | 8.96696 | .138696 |
| 7.22 | 52.1284 | 376.367 | 2.68701 | 8.49706 | 1.93277 | 4.16402 | 8.97110 | .138504 |
| 7.23 | 52.2729 | 377.933 | 2.68887 | 8.50294 | 1.93366 | 4.16594 | 8.97524 | .138313 |
| 7.24 | 52.4176 | 379.503 | 2.69072 | 8.50882 | 1.93455 | 4.16786 | 8.97938 | .138122 |
| 7.25 | 52.5625 | 381.078 | 2.69258 | 8.51469 | 1.93544 | 4.16978 | 8.98351 | .137931 |
| 7.26 | 52.7076 | 382.657 | 2.69444 | 8.52056 | 1.93633 | 4.17169 | 8.98764 | .137741 |
| 7.27 | 52.8529 | 384.241 | 2.69629 | 8.52643 | 1.93722 | 4.17361 | 8.99176 | .137552 |
| 7.28 | 52.9984 | 385.828 | 2.69815 | 8.53229 | 1.93810 | 4.17552 | 8.99588 | .137363 |
| 7.29 | 53.1441 | 387.420 | 2.70000 | 8.53815 | 1.93899 | 4.17743 | 9.00000 | .137174 |
| 7.30 | 53.2900 | 389.017 | 2.70185 | 8.54400 | 1.93988 | 4.17934 | 9.00411 | .136986 |
| 7.31 | 53.4361 | 390.618 | 2.70370 | 8.54985 | 1.94076 | 4.18125 | 9.00822 | .136799 |
| 7.32 | 53.5824 | 392.223 | 2.70555 | 8.55570 | 1.94165 | 4.18315 | 9.01233 | .136612 |
| 7.33 | 53.7289 | 393.833 | 2.70740 | 8.56154 | 1.94253 | 4.18506 | 9.01643 | .136426 |
| 7.34 | 53.8756 | 395.447 | 2.70924 | 8.56738 | 1.94341 | 4.18696 | 9.02053 | .136240 |
| 7.35 | 54.0225 | 397.065 | 2.71109 | 8.57321 | 1.94430 | 4.18886 | 9.02462 | .136054 |
| 7.36 | 54.1696 | 398.688 | 2.71293 | 8.57904 | 1.94518 | 4.19076 | 9.02871 | .135870 |
| 7.37 | 54.3169 | 400.316 | 2.71477 | 8.58487 | 1.94606 | 4.19266 | 9.03280 | .135685 |
| 7.38 | 54.4644 | 401.947 | 2.71662 | 8.59069 | 1.94694 | 4.19455 | 9.03689 | .135501 |
| 7.39 | 54.6121 | 403.583 | 2.71846 | 8.59651 | 1.94782 | 4.19644 | 9.04097 | .135318 |
| 7.40 | 54.7600 | 405.224 | 2.72029 | 8.60233 | 1.94870 | 4.19834 | 9.04504 | .135135 |
| 7.41 | 54.9081 | 406.869 | 2.72213 | 8.60814 | 1.94957 | 4.20023 | 9.04911 | .134953 |
| 7.42 | 55.0564 | 408.518 | 2.72397 | 8.61394 | 1.95045 | 4.20212 | 9.05318 | .134771 |
| 7.43 | 55.2049 | 410.172 | 2.72580 | 8.61974 | 1.95132 | 4.20400 | 9.05725 | .134590 |
| 7.44 | 55.3536 | 411.831 | 2.72764 | 8.62554 | 1.95220 | 4.20589 | 9.06131 | .134409 |
| 7.45 | 55.5025 | 413.494 | 2.72947 | 8.63134 | 1.95307 | 4.20777 | 9.06537 | .134228 |
| 7.46 | 55.6516 | 415.161 | 2.73130 | 8.63713 | 1.95395 | 4.20965 | 9.06942 | .134048 |
| 7.47 | 55.8009 | 416.833 | 2.73313 | 8.64292 | 1.95482 | 4.21153 | 9.07347 | .133869 |
| 7.48 | 55.9504 | 418.509 | 2.73496 | 8.64870 | 1.95569 | 4.21341 | 9.07752 | .133690 |
| 7.49 | 56.1001 | 420.190 | 2.73679 | 8.65448 | 1.95656 | 4.21529 | 9.08156 | .133511 |
| 7.50 | 56.2500 | 421.875 | 2.73861 | 8.66025 | 1.95743 | 4.21716 | 9.08560 | .133333 |

| n | n^2 | n^3 | \sqrt{n} | $\sqrt[3]{n}$ | $\sqrt[4]{n}$ | $\sqrt[5]{n}$ | $\frac{1}{n}$ | |
|------|---------|---------|------------|---------------|---------------|---------------|---------------|---------|
| 7.51 | 56.4001 | 423.565 | 2.74044 | 8.66603 | 1.95830 | 4.21904 | 9.08964 | .133156 |
| 7.52 | 56.5504 | 423.529 | 2.74226 | 8.67179 | 1.95917 | 4.22091 | 9.09367 | .132979 |
| 7.53 | 56.7009 | 423.953 | 2.74408 | 8.67756 | 1.96004 | 4.22278 | 9.09770 | .132802 |
| 7.54 | 56.8516 | 424.661 | 2.74591 | 8.68332 | 1.96091 | 4.22465 | 9.10173 | .132626 |
| 7.55 | 57.0025 | 430.369 | 2.74773 | 8.68907 | 1.96177 | 4.22651 | 9.10575 | .132450 |
| 7.56 | 57.1536 | 432.081 | 2.74955 | 8.69483 | 1.96264 | 4.22838 | 9.10977 | .132275 |
| 7.57 | 57.3049 | 433.798 | 2.75136 | 8.70057 | 1.96350 | 4.23024 | 9.11378 | .132100 |
| 7.58 | 57.4564 | 435.520 | 2.75318 | 8.70632 | 1.96437 | 4.23210 | 9.11779 | .131928 |
| 7.59 | 57.6081 | 437.245 | 2.75500 | 8.71206 | 1.96523 | 4.23396 | 9.12180 | .131752 |
| 7.60 | 57.7600 | 438.976 | 2.75681 | 8.71780 | 1.96610 | 4.23582 | 9.12581 | .131579 |
| 7.61 | 57.9121 | 440.711 | 2.75862 | 8.72353 | 1.96696 | 4.23768 | 9.12981 | .131406 |
| 7.62 | 58.0644 | 442.451 | 2.76043 | 8.72926 | 1.96782 | 4.23954 | 9.13380 | .131234 |
| 7.63 | 58.2169 | 444.195 | 2.76225 | 8.73499 | 1.96868 | 4.24139 | 9.13780 | .131062 |
| 7.64 | 58.3696 | 445.944 | 2.76405 | 8.74071 | 1.96954 | 4.24324 | 9.14179 | .130890 |
| 7.65 | 58.5225 | 447.697 | 2.76586 | 8.74643 | 1.97040 | 4.24509 | 9.14577 | .130719 |
| 7.66 | 58.6756 | 449.455 | 2.76767 | 8.75214 | 1.97126 | 4.24694 | 9.14976 | .130546 |
| 7.67 | 58.8289 | 451.218 | 2.76948 | 8.75785 | 1.97211 | 4.24879 | 9.15374 | .130378 |
| 7.68 | 58.9824 | 452.985 | 2.77128 | 8.76356 | 1.97297 | 4.25063 | 9.15771 | .130209 |
| 7.69 | 59.1361 | 454.757 | 2.77308 | 8.76926 | 1.97383 | 4.25248 | 9.16169 | .130039 |
| 7.70 | 59.2900 | 456.533 | 2.77489 | 8.77496 | 1.97468 | 4.25432 | 9.16566 | .129870 |
| 7.71 | 59.4441 | 458.314 | 2.77669 | 8.78066 | 1.97554 | 4.25616 | 9.16962 | .129702 |
| 7.72 | 59.5984 | 460.100 | 2.77849 | 8.78635 | 1.97639 | 4.25800 | 9.17359 | .129534 |
| 7.73 | 59.7529 | 461.890 | 2.78029 | 8.79204 | 1.97724 | 4.25984 | 9.17754 | .129366 |
| 7.74 | 59.9076 | 463.685 | 2.78209 | 8.79773 | 1.97809 | 4.26168 | 9.18150 | .129199 |
| 7.75 | 60.0625 | 465.484 | 2.78388 | 8.80341 | 1.97895 | 4.26351 | 9.18545 | .129032 |
| 7.76 | 60.2176 | 467.289 | 2.78568 | 8.80909 | 1.97980 | 4.26534 | 9.18940 | .128866 |
| 7.77 | 60.3729 | 469.097 | 2.78747 | 8.81476 | 1.98065 | 4.26717 | 9.19335 | .128700 |
| 7.78 | 60.5284 | 470.911 | 2.78927 | 8.82043 | 1.98150 | 4.26900 | 9.19729 | .128535 |
| 7.79 | 60.6841 | 472.729 | 2.79106 | 8.82610 | 1.98234 | 4.27083 | 9.20123 | .128370 |
| 7.80 | 60.8400 | 474.552 | 2.79285 | 8.83176 | 1.98319 | 4.27266 | 9.20516 | .128205 |
| 7.81 | 60.9961 | 476.380 | 2.79464 | 8.83742 | 1.98404 | 4.27448 | 9.20910 | .128041 |
| 7.82 | 61.1524 | 478.212 | 2.79643 | 8.84308 | 1.98489 | 4.27631 | 9.21303 | .127877 |
| 7.83 | 61.3089 | 480.049 | 2.79821 | 8.84873 | 1.98573 | 4.27813 | 9.21695 | .127714 |
| 7.84 | 61.4656 | 481.890 | 2.80000 | 8.85438 | 1.98658 | 4.27995 | 9.22087 | .127551 |
| 7.85 | 61.6225 | 483.737 | 2.80179 | 8.86002 | 1.98742 | 4.28177 | 9.22479 | .127389 |
| 7.86 | 61.7796 | 485.588 | 2.80357 | 8.86566 | 1.98826 | 4.28359 | 9.22871 | .127227 |
| 7.87 | 61.9369 | 487.443 | 2.80535 | 8.87130 | 1.98911 | 4.28540 | 9.23262 | .127065 |
| 7.88 | 62.0944 | 489.304 | 2.80713 | 8.87694 | 1.98995 | 4.28722 | 9.23653 | .126904 |
| 7.89 | 62.2521 | 491.169 | 2.80891 | 8.88257 | 1.99079 | 4.28903 | 9.24044 | .126743 |
| 7.90 | 62.4100 | 493.039 | 2.81069 | 8.88819 | 1.99163 | 4.29084 | 9.24433 | .126582 |
| 7.91 | 62.5681 | 494.914 | 2.81247 | 8.89382 | 1.99247 | 4.29265 | 9.24823 | .126422 |
| 7.92 | 62.7264 | 496.793 | 2.81425 | 8.89944 | 1.99331 | 4.29446 | 9.25213 | .126263 |
| 7.93 | 62.8849 | 498.677 | 2.81603 | 8.90505 | 1.99415 | 4.29627 | 9.25602 | .126103 |
| 7.94 | 63.0436 | 500.566 | 2.81780 | 8.91067 | 1.99499 | 4.29807 | 9.25991 | .125945 |
| 7.95 | 63.2025 | 502.460 | 2.81957 | 8.91628 | 1.99582 | 4.29987 | 9.26380 | .125786 |
| 7.96 | 63.3616 | 504.358 | 2.82135 | 8.92188 | 1.99666 | 4.30168 | 9.26768 | .125628 |
| 7.97 | 63.5209 | 506.262 | 2.82312 | 8.92749 | 1.99750 | 4.30348 | 9.27156 | .125471 |
| 7.98 | 63.6804 | 508.170 | 2.82489 | 8.93308 | 1.99833 | 4.30528 | 9.27544 | .125313 |
| 7.99 | 63.8401 | 510.082 | 2.82666 | 8.93868 | 1.99917 | 4.30707 | 9.27931 | .125156 |
| 8.00 | 64.0000 | 512.000 | 2.82843 | 8.94427 | 2.00000 | 4.30887 | 9.28318 | .125000 |

| n | n^2 | n^3 | \sqrt{n} | $\sqrt[10]{n}$ | $\sqrt[3]{n}$ | $\sqrt[10]{10n}$ | $\sqrt[3]{100n}$ | $\frac{1}{n}$ |
|------|---------|---------|------------|----------------|---------------|------------------|------------------|---------------|
| 8.01 | 64.1601 | 513.922 | 2.83019 | 8.94986 | 2.00083 | 4.31066 | 9.28704 | .124844 |
| 8.02 | 64.3204 | 515.850 | 2.83196 | 8.95545 | 2.00167 | 4.31246 | 9.29091 | .124688 |
| 8.03 | 64.4809 | 517.782 | 2.83373 | 8.96103 | 2.00250 | 4.31425 | 9.29477 | .124533 |
| 8.04 | 64.6416 | 519.718 | 2.83549 | 8.96660 | 2.00333 | 4.31604 | 9.29862 | .124378 |
| 8.05 | 64.8025 | 521.660 | 2.83725 | 8.97218 | 2.00416 | 4.31783 | 9.30248 | .124224 |
| 8.06 | 64.9636 | 523.607 | 2.83901 | 8.97775 | 2.00499 | 4.31961 | 9.30633 | .124070 |
| 8.07 | 65.1249 | 525.558 | 2.84077 | 8.98332 | 2.00582 | 4.32140 | 9.31018 | .123916 |
| 8.08 | 65.2864 | 527.514 | 2.84253 | 8.98888 | 2.00664 | 4.32318 | 9.31402 | .123762 |
| 8.09 | 65.4481 | 529.475 | 2.84429 | 8.99444 | 2.00747 | 4.32497 | 9.31786 | .123609 |
| 8.10 | 65.6100 | 531.441 | 2.84605 | 9.00000 | 2.00830 | 4.32675 | 9.32170 | .123457 |
| 8.11 | 65.7721 | 533.412 | 2.84781 | 9.00555 | 2.00912 | 4.32853 | 9.32553 | .123305 |
| 8.12 | 65.9344 | 535.387 | 2.84956 | 9.01110 | 2.00995 | 4.33031 | 9.32936 | .123153 |
| 8.13 | 66.0969 | 537.368 | 2.85132 | 9.01665 | 2.01078 | 4.33208 | 9.33319 | .123001 |
| 8.14 | 66.2596 | 539.353 | 2.85307 | 9.02219 | 2.01160 | 4.33386 | 9.33702 | .122850 |
| 8.15 | 66.4225 | 541.343 | 2.85482 | 9.02774 | 2.01242 | 4.33563 | 9.34084 | .122699 |
| 8.16 | 66.5856 | 543.338 | 2.85657 | 9.03327 | 2.01325 | 4.33741 | 9.34466 | .122549 |
| 8.17 | 66.7489 | 545.339 | 2.85832 | 9.03881 | 2.01407 | 4.33918 | 9.34847 | .122399 |
| 8.18 | 66.9124 | 547.343 | 2.86007 | 9.04434 | 2.01489 | 4.34095 | 9.35229 | .122249 |
| 8.19 | 67.0761 | 549.353 | 2.86182 | 9.04986 | 2.01571 | 4.34272 | 9.35610 | .122100 |
| 8.20 | 67.2400 | 551.368 | 2.86356 | 9.05539 | 2.01653 | 4.34448 | 9.35990 | .121951 |
| 8.21 | 67.4041 | 553.388 | 2.86531 | 9.06091 | 2.01735 | 4.34625 | 9.36370 | .121803 |
| 8.22 | 67.5684 | 555.412 | 2.86705 | 9.06642 | 2.01817 | 4.34801 | 9.36751 | .121655 |
| 8.23 | 67.7329 | 557.442 | 2.86880 | 9.07193 | 2.01899 | 4.34977 | 9.37130 | .121507 |
| 8.24 | 67.8976 | 559.476 | 2.87054 | 9.07744 | 2.01980 | 4.35153 | 9.37510 | .121359 |
| 8.25 | 68.0625 | 561.516 | 2.87228 | 9.08295 | 2.02062 | 4.35329 | 9.37889 | .121212 |
| 8.26 | 68.2276 | 563.560 | 2.87402 | 9.08845 | 2.02144 | 4.35505 | 9.38268 | .121065 |
| 8.27 | 68.3929 | 565.609 | 2.87576 | 9.09395 | 2.02225 | 4.35681 | 9.38646 | .120919 |
| 8.28 | 68.5584 | 567.664 | 2.87750 | 9.09945 | 2.02307 | 4.35856 | 9.39024 | .120773 |
| 8.29 | 68.7241 | 569.723 | 2.87924 | 9.10494 | 2.02388 | 4.36032 | 9.39402 | .120627 |
| 8.30 | 68.8900 | 571.787 | 2.88097 | 9.11043 | 2.02469 | 4.36207 | 9.39780 | .120482 |
| 8.31 | 69.0561 | 573.856 | 2.88271 | 9.11592 | 2.02551 | 4.36382 | 9.40157 | .120337 |
| 8.32 | 69.2224 | 575.930 | 2.88444 | 9.12140 | 2.02632 | 4.36557 | 9.40534 | .120192 |
| 8.33 | 69.3889 | 578.010 | 2.88617 | 9.12688 | 2.02713 | 4.36732 | 9.40911 | .120048 |
| 8.34 | 69.5556 | 580.094 | 2.88791 | 9.13236 | 2.02794 | 4.36907 | 9.41287 | .119904 |
| 8.35 | 69.7225 | 582.183 | 2.88964 | 9.13783 | 2.02875 | 4.37081 | 9.41663 | .119761 |
| 8.36 | 69.8896 | 584.277 | 2.89137 | 9.14330 | 2.02956 | 4.37255 | 9.42039 | .119617 |
| 8.37 | 70.0569 | 586.376 | 2.89310 | 9.14877 | 2.03037 | 4.37430 | 9.42414 | .119474 |
| 8.38 | 70.2244 | 588.480 | 2.89482 | 9.15423 | 2.03118 | 4.37604 | 9.42789 | .119332 |
| 8.39 | 70.3921 | 590.590 | 2.89655 | 9.15969 | 2.03199 | 4.37778 | 9.43164 | .119190 |
| 8.40 | 70.5600 | 592.704 | 2.89828 | 9.16515 | 2.03279 | 4.37952 | 9.43539 | .119048 |
| 8.41 | 70.7281 | 594.823 | 2.90000 | 9.17061 | 2.03360 | 4.38126 | 9.43913 | .118906 |
| 8.42 | 70.8964 | 596.948 | 2.90172 | 9.17606 | 2.03440 | 4.38299 | 9.44287 | .118765 |
| 8.43 | 71.0649 | 599.077 | 2.90345 | 9.18150 | 2.03521 | 4.38473 | 9.44661 | .118624 |
| 8.44 | 71.2336 | 601.212 | 2.90517 | 9.18695 | 2.03601 | 4.38646 | 9.45034 | .118483 |
| 8.45 | 71.4025 | 603.351 | 2.90689 | 9.19239 | 2.03682 | 4.38819 | 9.45407 | .118343 |
| 8.46 | 71.5716 | 605.496 | 2.90861 | 9.19783 | 2.03762 | 4.38992 | 9.45780 | .118203 |
| 8.47 | 71.7409 | 607.645 | 2.91033 | 9.20326 | 2.03842 | 4.39165 | 9.46152 | .118064 |
| 8.48 | 71.9104 | 609.800 | 2.91204 | 9.20869 | 2.03923 | 4.39338 | 9.46525 | .117925 |
| 8.49 | 72.0801 | 611.960 | 2.91376 | 9.21412 | 2.04003 | 4.39511 | 9.46897 | .117786 |
| 8.50 | 72.2500 | 614.125 | 2.91548 | 9.21954 | 2.04083 | 4.39683 | 9.47268 | .117647 |

| n | n^2 | n^3 | \sqrt{n} | $\sqrt{10n}$ | $\sqrt[3]{n}$ | $\sqrt[3]{10n}$ | $\sqrt[3]{100n}$ | $\frac{1}{n}$ |
|------|---------|---------|------------|--------------|---------------|-----------------|------------------|---------------|
| 8.51 | 72.4201 | 616.295 | 2.91719 | 9.22497 | 2.04163 | 4.39855 | 9.47640 | .117509 |
| 8.52 | 72.5904 | 618.470 | 2.91890 | 9.23038 | 2.04243 | 4.40028 | 9.48011 | .117371 |
| 8.53 | 72.7609 | 620.650 | 2.92062 | 9.23580 | 2.04323 | 4.40200 | 9.48381 | .117233 |
| 8.54 | 72.9316 | 622.836 | 2.92233 | 9.24121 | 2.04402 | 4.40372 | 9.48752 | .117096 |
| 8.55 | 73.1025 | 625.026 | 2.92404 | 9.24662 | 2.04482 | 4.40543 | 9.49122 | .116959 |
| 8.56 | 73.2736 | 627.222 | 2.92575 | 9.25203 | 2.04562 | 4.40715 | 9.49492 | .116822 |
| 8.57 | 73.4449 | 629.423 | 2.92746 | 9.25743 | 2.04641 | 4.40887 | 9.49861 | .116686 |
| 8.58 | 73.6164 | 631.629 | 2.92916 | 9.26283 | 2.04721 | 4.41058 | 9.50231 | .116550 |
| 8.59 | 73.7881 | 633.840 | 2.93087 | 9.26823 | 2.04801 | 4.41229 | 9.50600 | .116414 |
| 8.60 | 73.9600 | 636.056 | 2.93258 | 9.27362 | 2.04880 | 4.41400 | 9.50969 | .116279 |
| 8.61 | 74.1321 | 638.277 | 2.93428 | 9.27901 | 2.04959 | 4.41571 | 9.51337 | .116144 |
| 8.62 | 74.3044 | 640.504 | 2.93598 | 9.28440 | 2.05039 | 4.41742 | 9.51705 | .116009 |
| 8.63 | 74.4769 | 642.736 | 2.93769 | 9.28978 | 2.05118 | 4.41913 | 9.52073 | .115875 |
| 8.64 | 74.6496 | 644.973 | 2.93939 | 9.29516 | 2.05197 | 4.42084 | 9.52441 | .115741 |
| 8.65 | 74.8225 | 647.215 | 2.94109 | 9.30054 | 2.05276 | 4.42254 | 9.52808 | .115607 |
| 8.66 | 74.9956 | 649.462 | 2.94279 | 9.30591 | 2.05355 | 4.42425 | 9.53175 | .115473 |
| 8.67 | 75.1689 | 651.714 | 2.94449 | 9.31128 | 2.05434 | 4.42595 | 9.53542 | .115340 |
| 8.68 | 75.3424 | 653.972 | 2.94618 | 9.31665 | 2.05513 | 4.42765 | 9.53908 | .115207 |
| 8.69 | 75.5161 | 656.235 | 2.94788 | 9.32202 | 2.05592 | 4.42935 | 9.54274 | .115075 |
| 8.70 | 75.6900 | 658.503 | 2.94958 | 9.32738 | 2.05671 | 4.43105 | 9.54640 | .114943 |
| 8.71 | 75.8641 | 660.776 | 2.95127 | 9.33274 | 2.05750 | 4.43274 | 9.55006 | .114811 |
| 8.72 | 76.0384 | 663.055 | 2.95296 | 9.33809 | 2.05828 | 4.43444 | 9.55371 | .114679 |
| 8.73 | 76.2129 | 665.339 | 2.95466 | 9.34345 | 2.05907 | 4.43614 | 9.55736 | .114548 |
| 8.74 | 76.3876 | 667.628 | 2.95635 | 9.34880 | 2.05986 | 4.43783 | 9.56101 | .114417 |
| 8.75 | 76.5625 | 669.922 | 2.95804 | 9.35414 | 2.06064 | 4.43952 | 9.56466 | .114286 |
| 8.76 | 76.7376 | 672.221 | 2.95973 | 9.35949 | 2.06143 | 4.44121 | 9.56830 | .114155 |
| 8.77 | 76.9129 | 674.526 | 2.96142 | 9.36483 | 2.06221 | 4.44290 | 9.57194 | .114025 |
| 8.78 | 77.0884 | 676.836 | 2.96311 | 9.37017 | 2.06299 | 4.44459 | 9.57557 | .113895 |
| 8.79 | 77.2641 | 679.151 | 2.96479 | 9.37550 | 2.06378 | 4.44627 | 9.57921 | .113766 |
| 8.80 | 77.4400 | 681.472 | 2.96648 | 9.38083 | 2.06456 | 4.44796 | 9.58284 | .113636 |
| 8.81 | 77.6161 | 683.798 | 2.96816 | 9.38616 | 2.06534 | 4.44964 | 9.58647 | .113507 |
| 8.82 | 77.7924 | 686.129 | 2.96985 | 9.39149 | 2.06612 | 4.45133 | 9.59009 | .113379 |
| 8.83 | 77.9689 | 688.465 | 2.97153 | 9.39681 | 2.06690 | 4.45301 | 9.59372 | .113250 |
| 8.84 | 78.1456 | 690.807 | 2.97321 | 9.40213 | 2.06768 | 4.45469 | 9.59734 | .113122 |
| 8.85 | 78.3225 | 693.154 | 2.97489 | 9.40744 | 2.06846 | 4.45637 | 9.60095 | .112994 |
| 8.86 | 78.4996 | 695.506 | 2.97658 | 9.41276 | 2.06924 | 4.45805 | 9.60457 | .112867 |
| 8.87 | 78.6769 | 697.864 | 2.97825 | 9.41807 | 2.07002 | 4.45972 | 9.60818 | .112740 |
| 8.88 | 78.8544 | 700.227 | 2.97993 | 9.42338 | 2.07080 | 4.46140 | 9.61179 | .112613 |
| 8.89 | 79.0321 | 702.595 | 2.98161 | 9.42868 | 2.07157 | 4.46307 | 9.61540 | .112486 |
| 8.90 | 79.2100 | 704.969 | 2.98329 | 9.43398 | 2.07235 | 4.46474 | 9.61900 | .112360 |
| 8.91 | 79.3881 | 707.348 | 2.98496 | 9.43928 | 2.07313 | 4.46642 | 9.62260 | .112233 |
| 8.92 | 79.5664 | 709.732 | 2.98664 | 9.44458 | 2.07390 | 4.46809 | 9.62620 | .112108 |
| 8.93 | 79.7449 | 712.122 | 2.98831 | 9.44987 | 2.07468 | 4.46976 | 9.62980 | .111982 |
| 8.94 | 79.9236 | 714.517 | 2.98998 | 9.45516 | 2.07545 | 4.47142 | 9.63339 | .111857 |
| 8.95 | 80.1025 | 716.917 | 2.99166 | 9.46044 | 2.07622 | 4.47309 | 9.63698 | .111732 |
| 8.96 | 80.2816 | 719.323 | 2.99333 | 9.46573 | 2.07700 | 4.47476 | 9.64057 | .111607 |
| 8.97 | 80.4609 | 721.734 | 2.99500 | 9.47101 | 2.07777 | 4.47642 | 9.64415 | .111483 |
| 8.98 | 80.6404 | 724.151 | 2.99666 | 9.47629 | 2.07854 | 4.47808 | 9.64774 | .111359 |
| 8.99 | 80.8201 | 726.573 | 2.99833 | 9.48156 | 2.07931 | 4.47974 | 9.65132 | .111235 |
| 9.00 | 81.0000 | 729.000 | 3.00000 | 9.48683 | 2.08008 | 4.48140 | 9.65489 | .111111 |

| n | n^2 | n^3 | \sqrt{n} | $\sqrt{10n}$ | $\sqrt[3]{n}$ | $\sqrt[3]{10n}$ | $\sqrt[3]{100n}$ | $\frac{1}{n}$ |
|------|---------|---------|------------|--------------|---------------|-----------------|------------------|---------------|
| 9.01 | 81.1801 | 731.433 | 3.00167 | 9.49210 | 2.08085 | 4.48306 | 9.65847 | .110988 |
| 9.02 | 81.3604 | 733.871 | 3.00335 | 9.49737 | 2.08162 | 4.48472 | 9.66204 | .110865 |
| 9.03 | 81.5409 | 736.314 | 3.00500 | 9.50263 | 2.08239 | 4.48638 | 9.66561 | .110742 |
| 9.04 | 81.7216 | 738.763 | 3.00666 | 9.50789 | 2.08316 | 4.48803 | 9.66918 | .110620 |
| 9.05 | 81.9025 | 741.218 | 3.00832 | 9.51315 | 2.08393 | 4.48968 | 9.67274 | .110497 |
| 9.06 | 82.0836 | 743.677 | 3.00998 | 9.51840 | 2.08470 | 4.49134 | 9.67630 | .110375 |
| 9.07 | 82.2649 | 746.143 | 3.01164 | 9.52365 | 2.08546 | 4.49299 | 9.67986 | .110254 |
| 9.08 | 82.4464 | 748.613 | 3.01330 | 9.52890 | 2.08623 | 4.49464 | 9.68342 | .110132 |
| 9.09 | 82.6281 | 751.089 | 3.01496 | 9.53415 | 2.08699 | 4.49629 | 9.68697 | .110011 |
| 9.10 | 82.8100 | 753.571 | 3.01662 | 9.53939 | 2.08776 | 4.49794 | 9.69052 | .109890 |
| 9.11 | 82.9921 | 756.058 | 3.01828 | 9.54463 | 2.08852 | 4.49959 | 9.69407 | .109770 |
| 9.12 | 83.1744 | 758.551 | 3.01993 | 9.54987 | 2.08929 | 4.50123 | 9.69762 | .109649 |
| 9.13 | 83.3569 | 761.048 | 3.02159 | 9.55510 | 2.09005 | 4.50288 | 9.70116 | .109529 |
| 9.14 | 83.5396 | 763.552 | 3.02324 | 9.56033 | 2.09081 | 4.50452 | 9.70470 | .109409 |
| 9.15 | 83.7225 | 766.061 | 3.02490 | 9.56556 | 2.09158 | 4.50616 | 9.70824 | .109290 |
| 9.16 | 83.9056 | 768.575 | 3.02655 | 9.57079 | 2.09234 | 4.50780 | 9.71177 | .109170 |
| 9.17 | 84.0889 | 771.095 | 3.02820 | 9.57601 | 2.09310 | 4.50945 | 9.71531 | .109051 |
| 9.18 | 84.2724 | 773.621 | 3.02985 | 9.58123 | 2.09386 | 4.51108 | 9.71884 | .108933 |
| 9.19 | 84.4561 | 776.152 | 3.03150 | 9.58645 | 2.09462 | 4.51272 | 9.72236 | .108814 |
| 9.20 | 84.6400 | 778.688 | 3.03315 | 9.59166 | 2.09538 | 4.51436 | 9.72589 | .108696 |
| 9.21 | 84.8241 | 781.230 | 3.03480 | 9.59687 | 2.09614 | 4.51599 | 9.72941 | .108578 |
| 9.22 | 85.0084 | 783.777 | 3.03645 | 9.60208 | 2.09690 | 4.51763 | 9.73293 | .108460 |
| 9.23 | 85.1929 | 786.330 | 3.03809 | 9.60729 | 2.09765 | 4.51926 | 9.73645 | .108342 |
| 9.24 | 85.3776 | 788.889 | 3.03974 | 9.61249 | 2.09841 | 4.52089 | 9.73996 | .108225 |
| 9.25 | 85.5625 | 791.453 | 3.04138 | 9.61769 | 2.09917 | 4.52252 | 9.74348 | .108108 |
| 9.26 | 85.7476 | 794.023 | 3.04302 | 9.62289 | 2.09992 | 4.52415 | 9.74699 | .107991 |
| 9.27 | 85.9329 | 796.598 | 3.04467 | 9.62808 | 2.10068 | 4.52578 | 9.75049 | .107875 |
| 9.28 | 86.1184 | 799.179 | 3.04631 | 9.63328 | 2.10144 | 4.52740 | 9.75400 | .107759 |
| 9.29 | 86.3041 | 801.765 | 3.04795 | 9.63846 | 2.10219 | 4.52903 | 9.75750 | .107643 |
| 9.30 | 86.4900 | 804.357 | 3.04959 | 9.64365 | 2.10294 | 4.53065 | 9.76100 | .107527 |
| 9.31 | 86.6761 | 806.954 | 3.05123 | 9.64883 | 2.10370 | 4.53228 | 9.76450 | .107411 |
| 9.32 | 86.8624 | 809.558 | 3.05287 | 9.65401 | 2.10445 | 4.53390 | 9.76799 | .107296 |
| 9.33 | 87.0489 | 812.166 | 3.05450 | 9.65919 | 2.10520 | 4.53552 | 9.77148 | .107181 |
| 9.34 | 87.2356 | 814.781 | 3.05614 | 9.66437 | 2.10595 | 4.53714 | 9.77497 | .107066 |
| 9.35 | 87.4225 | 817.400 | 3.05778 | 9.66954 | 2.10671 | 4.53876 | 9.77846 | .106952 |
| 9.36 | 87.6096 | 820.026 | 3.05941 | 9.67471 | 2.10746 | 4.54038 | 9.78195 | .106838 |
| 9.37 | 87.7969 | 822.657 | 3.06105 | 9.67988 | 2.10821 | 4.54199 | 9.78543 | .106724 |
| 9.38 | 87.9844 | 825.294 | 3.06268 | 9.68504 | 2.10896 | 4.54361 | 9.78891 | .106610 |
| 9.39 | 88.1721 | 827.936 | 3.06431 | 9.69020 | 2.10971 | 4.54522 | 9.79239 | .106496 |
| 9.40 | 88.3600 | 830.584 | 3.06594 | 9.69536 | 2.11045 | 4.54684 | 9.79586 | .106383 |
| 9.41 | 88.5481 | 833.238 | 3.06757 | 9.70052 | 2.11120 | 4.54845 | 9.79933 | .106270 |
| 9.42 | 88.7364 | 835.897 | 3.06920 | 9.70567 | 2.11195 | 4.55006 | 9.80280 | .106157 |
| 9.43 | 88.9249 | 838.562 | 3.07083 | 9.71082 | 2.11270 | 4.55167 | 9.80627 | .106045 |
| 9.44 | 89.1136 | 841.232 | 3.07246 | 9.71597 | 2.11344 | 4.55328 | 9.80974 | .105932 |
| 9.45 | 89.3025 | 843.909 | 3.07409 | 9.72111 | 2.11419 | 4.55488 | 9.81320 | .105820 |
| 9.46 | 89.4916 | 846.591 | 3.07571 | 9.72625 | 2.11494 | 4.55649 | 9.81666 | .105708 |
| 9.47 | 89.6809 | 849.278 | 3.07734 | 9.73139 | 2.11568 | 4.55809 | 9.82012 | .105597 |
| 9.48 | 89.8704 | 851.971 | 3.07896 | 9.73653 | 2.11642 | 4.55970 | 9.82357 | .105485 |
| 9.49 | 90.0601 | 854.670 | 3.08058 | 9.74166 | 2.11717 | 4.56130 | 9.82703 | .105374 |
| 9.50 | 90.2500 | 857.375 | 3.08221 | 9.74679 | 2.11791 | 4.56290 | 9.83048 | .105263 |

| n | n^2 | n^3 | \sqrt{n} | $\sqrt{10n}$ | $\sqrt[3]{n}$ | $\sqrt[3]{10n}$ | $\sqrt[3]{100n}$ | $\frac{1}{n}$ |
|-------|---------|---------|------------|--------------|---------------|-----------------|------------------|---------------|
| 9.51 | 90.4401 | 860.085 | 3.08389 | 9.75192 | 2.11865 | 4.56450 | 9.83392 | .105158 |
| 9.52 | 90.6304 | 862.801 | 3.08545 | 9.75705 | 2.11940 | 4.56610 | 9.83737 | .105042 |
| 9.53 | 90.8209 | 865.523 | 3.08707 | 9.76217 | 2.12014 | 4.56770 | 9.84081 | .104932 |
| 9.54 | 91.0116 | 868.251 | 3.08869 | 9.76729 | 2.12088 | 4.56930 | 9.84425 | .104822 |
| 9.55 | 91.2025 | 870.984 | 3.09031 | 9.77241 | 2.12162 | 4.57089 | 9.84769 | .104712 |
| 9.56 | 91.3936 | 873.723 | 3.09192 | 9.77753 | 2.12236 | 4.57249 | 9.85113 | .104603 |
| 9.57 | 91.5849 | 876.467 | 3.09354 | 9.78264 | 2.12310 | 4.57408 | 9.85456 | .104493 |
| 9.58 | 91.7764 | 879.218 | 3.09516 | 9.78775 | 2.12384 | 4.57568 | 9.85799 | .104384 |
| 9.59 | 91.9681 | 881.974 | 3.09677 | 9.79285 | 2.12458 | 4.57727 | 9.86142 | .104275 |
| 9.60 | 92.1600 | 884.736 | 3.09839 | 9.79796 | 2.12532 | 4.57886 | 9.86485 | .104167 |
| 9.61 | 92.3521 | 887.504 | 3.10000 | 9.80306 | 2.12605 | 4.58045 | 9.86827 | .104059 |
| 9.62 | 92.5444 | 890.277 | 3.10161 | 9.80816 | 2.12679 | 4.58203 | 9.87169 | .103950 |
| 9.63 | 92.7369 | 893.056 | 3.10322 | 9.81326 | 2.12753 | 4.58362 | 9.87511 | .103842 |
| 9.64 | 92.9296 | 895.841 | 3.10483 | 9.81835 | 2.12826 | 4.58521 | 9.87853 | .103734 |
| 9.65 | 93.1225 | 898.632 | 3.10644 | 9.82344 | 2.12900 | 4.58679 | 9.88195 | .103627 |
| 9.66 | 93.3156 | 901.429 | 3.10805 | 9.82853 | 2.12974 | 4.58838 | 9.88536 | .103520 |
| 9.67 | 93.5089 | 904.231 | 3.10966 | 9.83362 | 2.13047 | 4.58996 | 9.88877 | .103413 |
| 9.68 | 93.7024 | 907.039 | 3.11127 | 9.83870 | 2.13120 | 4.59154 | 9.89217 | .103306 |
| 9.69 | 93.8961 | 909.853 | 3.11288 | 9.84378 | 2.13194 | 4.59312 | 9.89558 | .103199 |
| 9.70 | 94.0900 | 912.673 | 3.11448 | 9.84886 | 2.13267 | 4.59470 | 9.89898 | .103093 |
| 9.71 | 94.2841 | 915.499 | 3.11609 | 9.85393 | 2.13340 | 4.59628 | 9.90238 | .102987 |
| 9.72 | 94.4784 | 918.330 | 3.11769 | 9.85901 | 2.13414 | 4.59786 | 9.90578 | .102881 |
| 9.73 | 94.6729 | 921.167 | 3.11929 | 9.86408 | 2.13487 | 4.59943 | 9.90918 | .102775 |
| 9.74 | 94.8676 | 924.010 | 3.12090 | 9.86914 | 2.13560 | 4.60101 | 9.91257 | .102669 |
| 9.75 | 95.0625 | 926.859 | 3.12250 | 9.87421 | 2.13633 | 4.60258 | 9.91596 | .102564 |
| 9.76 | 95.2576 | 929.714 | 3.12410 | 9.87927 | 2.13706 | 4.60416 | 9.91935 | .102459 |
| 9.77 | 95.4529 | 932.575 | 3.12570 | 9.88433 | 2.13779 | 4.60573 | 9.92274 | .102354 |
| 9.78 | 95.6484 | 935.441 | 3.12730 | 9.88939 | 2.13852 | 4.60730 | 9.92612 | .102250 |
| 9.79 | 95.8441 | 938.314 | 3.12890 | 9.89444 | 2.13925 | 4.60887 | 9.92950 | .102145 |
| 9.80 | 96.0400 | 941.192 | 3.13050 | 9.89949 | 2.13997 | 4.61044 | 9.93288 | .102041 |
| 9.81 | 96.2361 | 944.076 | 3.13209 | 9.90454 | 2.14070 | 4.61200 | 9.93626 | .101937 |
| 9.82 | 96.4324 | 946.966 | 3.13369 | 9.90959 | 2.14143 | 4.61357 | 9.93964 | .101833 |
| 9.83 | 96.6289 | 949.862 | 3.13528 | 9.91464 | 2.14216 | 4.61513 | 9.94301 | .101729 |
| 9.84 | 96.8256 | 952.764 | 3.13688 | 9.91968 | 2.14288 | 4.61670 | 9.94638 | .101626 |
| 9.85 | 97.0225 | 955.672 | 3.13847 | 9.92472 | 2.14361 | 4.61826 | 9.94975 | .101523 |
| 9.86 | 97.2196 | 958.585 | 3.14006 | 9.92975 | 2.14433 | 4.61983 | 9.95311 | .101420 |
| 9.87 | 97.4169 | 961.505 | 3.14166 | 9.93479 | 2.14506 | 4.62139 | 9.95648 | .101317 |
| 9.88 | 97.6144 | 964.430 | 3.14325 | 9.93982 | 2.14578 | 4.62295 | 9.95984 | .101215 |
| 9.89 | 97.8121 | 967.362 | 3.14484 | 9.94485 | 2.14651 | 4.62451 | 9.96320 | .101112 |
| 9.90 | 98.0100 | 970.299 | 3.14643 | 9.94987 | 2.14723 | 4.62607 | 9.96655 | .101010 |
| 9.91 | 98.2081 | 973.242 | 3.14802 | 9.95490 | 2.14795 | 4.62762 | 9.96991 | .100908 |
| 9.92 | 98.4064 | 976.191 | 3.14960 | 9.95992 | 2.14867 | 4.62918 | 9.97326 | .100807 |
| 9.93 | 98.6049 | 979.147 | 3.15119 | 9.96494 | 2.14940 | 4.63073 | 9.97661 | .100705 |
| 9.94 | 98.8036 | 982.108 | 3.15278 | 9.96995 | 2.15012 | 4.63229 | 9.97996 | .100604 |
| 9.95 | 99.0025 | 985.075 | 3.15436 | 9.97497 | 2.15084 | 4.63384 | 9.98331 | .100503 |
| 9.96 | 99.2016 | 988.048 | 3.15595 | 9.97998 | 2.15156 | 4.63539 | 9.98665 | .100402 |
| 9.97 | 99.4009 | 991.027 | 3.15753 | 9.98499 | 2.15228 | 4.63694 | 9.98999 | .100301 |
| 9.98 | 99.6004 | 994.012 | 3.15911 | 9.98999 | 2.15300 | 4.63849 | 9.99333 | .100200 |
| 9.99 | 99.8001 | 997.003 | 3.16070 | 9.99500 | 2.15372 | 4.64004 | 9.99667 | .100100 |
| 10.00 | 100.000 | 1000.00 | 3.16228 | 10.0000 | 2.15443 | 4.64159 | 10.0000 | .100000 |

Square Root.—EXAMPLE.—(a) $\sqrt{3.1416} = ?$ (b) $\sqrt{2342.9} = ?$

SOLUTION.—(a) In this case, the decimal point need not be moved. In the table under n^2 find $3.1329 = 1.77^2$ and $3.1684 = 1.78^2$, one of these numbers being a little less and the other a little greater than the given number 3.1416. The first three figures of the required root are 177. $31,684 - 31,329 = 355$ is the first difference; $31,416$ (the number itself) $- 31,329 = 87$ is the second difference. $87 \div 355 = .245$, or .25, which gives the fourth and fifth figures of the root. Hence, $\sqrt{3.1416} = 1.7725$.

(b) Pointing off and placing the decimal point between the first and second periods, the number appears 23.4290. Under n^2 find $23.4256 = 4.84^2$ and $23.5225 = 4.85^2$. The first three figures of the root are 484. The first difference is $235,225 - 234,256 = 969$; the second difference is $234,290 - 234,256 = 34$; $34 \div 969 = .035$, or .04, which gives the fourth and fifth figures of the root. Since the integral part of the number $23'42.9$ contains two periods, the integral part of the root contains two figures, or $\sqrt{2342.9} = 48.404$.

Cube Root.—EXAMPLE.—(a) $\sqrt[3]{.0000062417} = ?$

(b) $\sqrt[3]{50932676} = ?$

SOLUTION.—(a) Pointed off, the number appears .000'006'241'700, and with the decimal point placed between the first and second periods of the significant part, gives 6.2417. Under n^3 find $6.22950 = 1.84^3$ and $6.33163 = 1.85^3$. The first three figures of the root are 1.84. The first difference is 10,213, and the second difference is 1,220; $1,220 \div 10,213 = .119$, or .12, which gives the fourth and fifth figures. There is one cipher period after the decimal point in the number; hence, $\sqrt[3]{.0000062417} = .018412$.

(b) Replace all after the sixth figure with ciphers, making the sixth figure 1 greater when the seventh figure is 5 or greater; that is, $\sqrt[3]{50932700}$ and $\sqrt[3]{50932676}$ will be the same. Placing the decimal point between the first and second periods gives 50.9327. Under n^3 find $50.6530 = 3.70^3$ and $51.0648 = 3.71^3$. The first three figures of the root are 370.

The second difference $2,797 \div$ the first difference, $4,118 = .679$ or $.68$. Hence, $\sqrt[3]{50932676} = 370.68$.

Squares.—If the given number contains less than four significant figures, the significant figures of the square or cube can be found under n^2 or n^3 opposite the given number under n . The decimal point can be located by the fact that if the column headed $\sqrt{10n}$ is used, the square will contain twice as many figures as the number to be squared, while if the column headed \sqrt{n} is used, the square will contain twice as many figures as the number to be squared, less 1. If the number contains an integral part, the principle is applied to the integral part only; if the number is wholly decimal, the square will have twice as many ciphers, or twice as many plus 1, following the decimal point as in the number itself, depending on whether $\sqrt{10n}$ or \sqrt{n} column is used.

To square a number containing more than three significant figures, place the decimal point between the first and second significant figures and find in the column headed \sqrt{n} or $\sqrt{10n}$ two consecutive numbers, one a little greater and the other a little less than the given number. The remainder of the work is exactly as described for extracting roots. The square will contain twice as many figures as the number itself, or twice as many less 1, according to whether the column headed $\sqrt{10n}$ or \sqrt{n} is used. The number of ciphers following the decimal point in the square of a number wholly decimal is indicated in the same way.

EXAMPLE 1.—(a) $273.42^2 = ?$ (b) $.052436^2 = ?$

SOLUTION.—(a) Placing the decimal point between the first and second significant figures, the number is 2.7342 , which occurs between $2.73313 = \sqrt{7.47}$ and $2.73496 = \sqrt{7.48}$, found under \sqrt{n} . The first three figures of the square are 747 . The second difference $107 \div$ the first difference $183 = .584$, or $.58$. Hence, $273.42^2 = 74,758$.

(b) With the position of the decimal point changed, the number is 5.2436 , which is between $5.23450 = \sqrt{2.74}$ and $5.24404 = \sqrt{2.75}$, both under $\sqrt{10n}$. The first three significant figures of the root are 2.74 and the second difference

910 \div the first difference $954 = .953$, or $.95$, the next two figures. The number has one cipher following the decimal point, and the column headed $\sqrt[3]{10n}$ is used; hence, $.052436^3 = .0027495$.

Cubes.—To cube a number, proceed in the same way, but use a column headed $\sqrt[3]{n}$, $\sqrt[3]{10n}$, or $\sqrt[3]{100n}$. If the number contains an integral part, the number of figures in the integral part of the cube will be three times as many as in the given number if the column headed $\sqrt[3]{100n}$ is used; it will be three times as many less 1 if the column headed $\sqrt[3]{10n}$ is used; and it will be three times as many less 2 if the column headed $\sqrt[3]{n}$ is used. If the number is wholly decimal, the number of ciphers following the decimal point in the cube will be three times, three times plus 1, or three times plus 2, as many as in the given number, depending on whether $\sqrt[3]{100n}$, $\sqrt[3]{10n}$, or $\sqrt[3]{n}$ column is used.

EXAMPLE 2.—(a) $129.684^3 = ?$ (b) $7.6442^3 = ?$ (c) $.032425^3 = ?$

SOLUTION.—(a) With the position of the decimal point changed, the number 1.29684 is between $1.29664 = \sqrt[3]{2.18}$ and $1.29862 = \sqrt[3]{2.19}$, found under $\sqrt[3]{n}$. The second difference $20 \div$ the first difference $198 = .101+$, or $.10$. Hence, the first five significant figures are 21810; the number of figures in the integral part of the cube is $3 \times 3 - 2 = 7$; and $129.684^3 = 2,181,000$, correct to five significant figures.

(b) 7.64420 occurs between $7.64032 = \sqrt[3]{446}$ and $7.64603 = \sqrt[3]{447}$. The first difference is 571; the second difference is 388; and $388 \div 571 = .679+$, or $.68$. Hence, the first five significant figures are 44668; the number of ciphers following the decimal point is $3 \times 0 = 0$; and $7.6442^3 = 446.68$, correct to five significant figures.

(c) 3.2425 falls between $3.24278 = \sqrt[3]{10 \times 3.41}$ and $3.23961 = \sqrt[3]{10 \times 3.40}$. The first difference is 317; the second difference is 289; $289 \div 317 = .911+$, or $.91$. Hence, the first five significant figures are 34091; the number of ciphers following the decimal point is $3 \times 1 + 1 = 4$; and $.032425^3 = .000034091$, correct to five significant figures.

Reciprocals.—The table also gives the reciprocals of all numbers expressed by three significant figures correct to six significant figures. The number of ciphers following the decimal point in the reciprocal of a number is 1 less than the number of figures in the integral parts of the number; and if the number is entirely decimal, the number of figures in the integral part of the reciprocal is 1 greater than the number of ciphers following the decimal point in the number. For example, the reciprocal of $3370 = .000296736$ and of $.00348 = 287.356$.

The following examples show the process when the number contains more than three significant figures:

EXAMPLE.—The reciprocal (a) of $379.426 = ?$ (b) of $.0004692 = ?$

SOLUTION.—(a) $.379426$ falls between $.378788 = \frac{1}{2.64}$ and $.380228 = \frac{1}{2.63}$. The first difference is $380,228 - 378,788 = 1,440$; the second difference is $380,228 - 379,426 = 802$; $802 \div 1,440 = .557$, or $.56$. Hence, the first five significant figures are 26356 , and the reciprocal of 379.426 is $.0026356$, to five significant figures.

(b) $.469200$ falls between $.469484 = \frac{1}{2.13}$ and $.467290 = \frac{1}{2.14}$. The first difference is $2,194$; the second difference is 284 ; $284 \div 2,194 = .129$, or $.13$. Hence, $\frac{1}{.0004692} = 2,131.3$, correct to five significant figures.

COPPER WIRE TABLES

BROWN & SHARPE COPPER WIRE GAUGES

Sizes of Wire.—Unfortunately, various standards of wire gauges have been adopted by different manufacturers, with the result that there is a lack of uniformity in this direction, which frequently causes confusion. The standards by which the various sizes of wire are designated are usually termed *wire gauges*. In each gauge, a particular number refers to a wire having a certain diameter. The size of wire generally decreases as the gauge number increases, but the law by which this

decrease occurs is not the same in the different gauges. In the United States, copper wire is usually designated by the Brown & Sharpe, or American, wire gauge, which is generally termed B. & S. G.

Circular Measure.—A method that is extensively used for designating the size of a wire is to express its diameter in *mils* and the square of its diameter in *circular mils*. A mil is a unit of length used in measuring the diameter of wires, and is equal to $\frac{1}{1000}$ inch; that is, 1 mil = .001 inch.

If the diameter of a wire is given in mils, the square of this number represents its circular mils. For instance, if a wire has a diameter of 80 mils, it will have $80 \times 80 = 6,400$ circular mils. It is quite common to state that the sectional area of a wire is a certain number of circular mils; this invariably means the square of the diameter expressed in circular mils.

The diameter multiplied by itself and by .7854 gives the area of a circular wire in square inches when its diameter is expressed in inches. Multiplying .7854 by the number of circular mils and dividing the result by 1,000,000 gives the sectional area in square inches, when the number of circular mils in a wire are known.

Wire Table.—The size, resistance, and weight of average commercial copper for the commonly used sizes of wire are given in an accompanying table of Standard Annealed Copper Wire. The values are those given in a working table published by the United States Bureau of Standards, and have been commonly accepted in the United States. The values in this table are approximate, but are sufficiently accurate for practically all electrical calculations.

The ohms per 1,000 feet given in the table represent the resistance of 1,000 feet of wire of that particular size at the designated temperature (Fahrenheit). The resistance of 1 foot of conductor would be obtained by dividing the value as given by 1,000. Similarly, the weight of 1 foot of wire would be found by dividing the pounds per 1,000 feet by 1,000. The values of circular mils given in the third column should be the square of the diameter of the wire in mils as given in the second column. Any instances where the values in the third column are not the exact squares of those given in the second

STANDARD ANNEALED COPPER WIRE

| Size of Wire B. & S. Gauge | Diameter of Wire Mils | Circular Mils | Ohms per 1,000 Feet at 77° F. | Pounds per 1,000 Feet |
|----------------------------------|-----------------------------|------------------|-------------------------------------|--------------------------|
| 0000 | 460 | 212,000 | .0500 | 641 |
| 000 | 410 | 168,000 | .0630 | 508 |
| 00 | 365 | 133,000 | .0795 | 403 |
| 0 | 325 | 106,000 | .100 | 319 |
| 1 | 289 | 83,700 | .126 | 253 |
| 2 | 258 | 66,400 | .159 | 201 |
| 3 | 229 | 52,600 | .201 | 159 |
| 4 | 204 | 41,700 | .253 | 126 |
| 5 | 182 | 33,100 | .319 | 100 |
| 6 | 162 | 26,300 | .403 | 79.5 |
| 7 | 144 | 20,800 | .508 | 63.0 |
| 8 | 128 | 16,500 | .641 | 50.0 |
| 9 | 114 | 13,100 | .808 | 39.6 |
| 10 | 102 | 10,400 | 1.02 | 31.4 |
| 11 | 91 | 8,230 | 1.28 | 24.9 |
| 12 | 81 | 6,530 | 1.62 | 19.8 |
| 13 | 72 | 5,180 | 2.04 | 15.7 |
| 14 | 64 | 4,110 | 2.58 | 12.4 |
| 15 | 57 | 3,260 | 3.25 | 9.86 |
| 16 | 51 | 2,580 | 4.09 | 7.82 |
| 17 | 45 | 2,050 | 5.16 | 6.20 |
| 18 | 40 | 1,620 | 6.51 | 4.92 |
| 19 | 36 | 1,290 | 8.21 | 3.90 |
| 20 | 32 | 1,020 | 10.4 | 3.09 |
| 21 | 28.5 | 810 | 13.1 | 2.45 |
| 22 | 25.3 | 642 | 16.5 | 1.94 |
| 23 | 22.6 | 509 | 20.8 | 1.54 |
| 24 | 20.1 | 404 | 26.2 | 1.22 |
| 25 | 17.9 | 320 | 33.0 | .970 |
| 26 | 15.9 | 254 | 41.6 | .769 |
| 27 | 14.2 | 202 | 52.5 | .610 |
| 28 | 12.6 | 160 | 66.2 | .484 |
| 29 | 11.3 | 127 | 83.4 | .384 |
| 30 | 10.0 | 101 | 105 | .304 |
| 31 | 8.9 | 79.7 | 133 | .241 |
| 32 | 8.0 | 63.2 | 167 | .191 |
| 33 | 7.1 | 50.1 | 211 | .152 |
| 34 | 6.3 | 39.8 | 266 | .120 |
| 35 | 5.6 | 31.5 | 335 | .0954 |
| 36 | 5.0 | 25.0 | 423 | .0757 |
| 37 | 4.5 | 19.8 | 533 | .0600 |
| 38 | 4.0 | 15.7 | 673 | .0476 |
| 39 | 3.5 | 12.5 | 848 | .0377 |
| 40 | 3.1 | 9.9 | 1,070 | .0299 |

INSULATED COPPER WIRE

| Size B. & S. Gauge | Ohms per 1,000 Feet | Single-Cotton Covered | | | Double-Cotton Covered | | |
|--------------------------|------------------------|--------------------------------|-----------------------------|-----------------------------|--------------------------------|--------------------------------|-----------------------------|
| | | Outside Diameter in Mils | Turns per Linear Inch | Pounds per 1,000 Feet | Outside Diameter in Mils | Turns per Linear Inch | Pounds per 1,000 Feet |
| 0000 | .0500 | 467 | 2.14 | | 477 | 2.10 | |
| 000 | .0630 | 418 | 2.39 | | 428 | 2.34 | |
| 00 | .0795 | 373 | 2.68 | | 382 | 2.62 | |
| 0 | .100 | 334 | 3.00 | | 343 | 3.00 | |
| 1 | .126 | 300 | 3.33 | | 308 | 3.25 | |
| 2 | .159 | 267 | 3.75 | | 275 | 3.64 | |
| 3 | .201 | 239 | 4.18 | | 248 | 4.03 | |
| 4 | .253 | 214 | 4.67 | | 222 | 4.51 | |
| 5 | .319 | 192 | 5.21 | | 200 | 5.00 | |
| 6 | .403 | 170 | 5.88 | | 175 | 5.62 | |
| 7 | .508 | 153 | 6.54 | | 160 | 6.25 | |
| 8 | .641 | 136 | 7.35 | 50.6 | 142 | 7.05 | 51.2 |
| 9 | .808 | 121 | 8.26 | 40.2 | 127 | 7.87 | 40.6 |
| 10 | 1.02 | 108 | 9.25 | 31.9 | 113 | 8.85 | 32.2 |
| 11 | 1.28 | 97 | 10.3 | 25.3 | 102 | 9.80 | 25.6 |
| 12 | 1.62 | 87 | 11.5 | 20.1 | 92 | 10.9 | 20.4 |
| 13 | 2.04 | 78 | 12.8 | 16.0 | 82 | 12.2 | 16.2 |
| 14 | 2.58 | 70 | 14.3 | 12.7 | 74 | 13.5 | 12.9 |

| | | | | | | | |
|----|-------|------|------|------|------|------|------|
| 15 | 3.25 | 63 | 15.9 | 10.1 | 67 | 14.9 | 10.3 |
| 16 | 4.09 | 56 | 17.9 | 8.03 | 60 | 16.7 | 8.21 |
| 17 | 5.16 | 50 | 20.0 | 6.40 | 54 | 18.5 | 6.54 |
| 18 | 6.51 | 45 | 22.2 | 5.08 | 49 | 20.4 | 5.24 |
| 19 | 8.21 | 41 | 24.4 | 4.04 | 45 | 22.2 | 4.22 |
| 20 | 10.4 | 37 | 27.0 | 3.22 | 41 | 24.4 | 3.37 |
| 21 | 13.1 | 33.5 | 29.9 | 2.56 | 38.0 | 26.3 | 2.69 |
| 22 | 16.5 | 29.5 | 33.9 | 2.05 | 33.3 | 30.0 | 2.17 |
| 23 | 20.8 | 26.6 | 37.6 | 1.64 | 30.6 | 32.7 | 1.73 |
| 24 | 26.2 | 34.1 | 41.5 | 1.30 | 28.1 | 35.6 | 1.40 |
| 25 | 33.0 | 21.9 | 45.7 | 1.04 | 25.9 | 38.6 | 1.13 |
| 26 | 41.6 | 19.9 | 50.2 | .834 | 23.9 | 41.8 | .914 |
| 27 | 52.5 | 18.2 | 55.0 | .660 | 22.2 | 45.1 | .756 |
| 28 | 66.2 | 16.6 | 60.2 | .533 | 20.6 | 48.6 | .608 |
| 29 | 83.4 | 15.3 | 65.4 | .426 | 19.3 | 51.9 | .489 |
| 30 | 105 | 14.0 | 71.4 | .340 | 18.0 | 55.6 | .400 |
| 31 | 133 | 12.9 | 77.5 | .276 | 16.9 | 59.2 | .326 |
| 32 | 167 | 12.0 | 83.4 | .223 | 16.0 | 62.9 | .270 |
| 33 | 211 | 11.1 | 90.0 | .182 | 15.1 | 66.2 | .227 |
| 34 | 266 | 10.3 | 97.1 | .148 | 14.3 | 70.0 | .193 |
| 35 | 335 | 9.6 | 104 | .120 | 13.6 | 73.5 | .160 |
| 36 | 423 | 9.0 | 111 | .099 | 13.0 | 77.0 | .136 |
| 37 | 533 | 8.5 | 118 | .082 | 12.5 | 80.0 | .120 |
| 38 | 673 | 8.0 | 125 | .070 | 12.0 | 83.3 | .105 |
| 39 | 848 | 7.4 | 135 | .060 | 11.5 | 87.0 | .094 |
| 40 | 1,070 | 7.1 | 141 | .052 | 11.1 | 90.9 | .084 |

INSULATED COPPER WIRE

| Size B. & S. Gauge | Enamel Wire | | | Single-Silk Covered | | | Double-Silk Covered | | |
|--------------------------|-------------------------------------|--------------------------------|--------------------------------|-------------------------------------|--------------------------------|--------------------------------|-------------------------------------|--------------------------------|--------------------------------|
| | Outside Diam- eter in Mils | Turns per Linear Inch | Pounds per 1,000 Feet | Outside Diam- eter in Mils | Turns per Linear Inch | Pounds per 1,000 Feet | Outside Diam- eter in Mils | Turns per Linear Inch | Pounds per 1,000 Feet |
| 8 | 130.6 | 7.7 | 50.6 | | | | | | |
| 9 | 116.5 | 8.6 | 40.2 | | | | | | |
| 10 | 104.0 | 9.6 | 31.8 | | | | | | |
| 11 | 92.7 | 10.8 | 25.3 | | | | | | |
| 12 | 82.8 | 12.1 | 20.1 | | | | | | |
| 13 | 74.0 | 13.5 | 15.90 | | | | | | |
| 14 | 66.1 | 15.1 | 12.60 | | | | | | |
| 15 | 59.1 | 16.9 | 10.00 | | | | | | |
| 16 | 52.8 | 18.9 | 7.930 | 52.8 | 18.9 | 7.89 | 54.6 | 18.3 | 8.00 |
| 17 | 47.0 | 21.3 | 6.275 | 47.3 | 21.1 | 6.26 | 49.1 | 20.4 | 6.32 |
| 18 | 42.1 | 23.8 | 4.980 | 42.4 | 23.6 | 4.97 | 44.1 | 22.7 | 5.02 |
| 19 | 37.7 | 26.5 | 3.955 | 37.9 | 26.4 | 3.94 | 39.7 | 25.2 | 3.99 |
| 20 | 33.7 | 29.7 | 3.135 | 34.0 | 29.4 | 3.13 | 35.8 | 28.0 | 3.17 |

| | | | | | | | | | |
|----|------|------|-------|------|------|------|------|------|------|
| 21 | 30.2 | 33.1 | 2.490 | 30.5 | 32.8 | 2.49 | 32.3 | 31.0 | 2.52 |
| 22 | 26.9 | 37.2 | 1.970 | 27.3 | 36.6 | 1.98 | 29.1 | 34.4 | 2.01 |
| 23 | 24.1 | 41.5 | 1.565 | 24.6 | 40.7 | 1.57 | 26.4 | 37.9 | 1.59 |
| 24 | 21.5 | 46.5 | 1.245 | 22.1 | 45.3 | 1.25 | 23.9 | 41.8 | 1.27 |
| 25 | 19.2 | 52.1 | .988 | 19.9 | 50.3 | .994 | 21.7 | 46.1 | 1.02 |
| 26 | 17.1 | 58.5 | .785 | 17.9 | 55.9 | .791 | 19.7 | 50.8 | .810 |
| 27 | 15.3 | 65.4 | .622 | 16.2 | 61.8 | .628 | 18.0 | 55.6 | .645 |
| 28 | 13.6 | 73.5 | .494 | 14.6 | 68.5 | .498 | 16.4 | 61.0 | .514 |
| 29 | 12.2 | 82.0 | .392 | 13.3 | 75.2 | .397 | 15.1 | 66.2 | .413 |
| 30 | 10.9 | 91.7 | .311 | 12.0 | 83.3 | .316 | 13.8 | 72.5 | .333 |
| 31 | 9.7 | 103 | .247 | 10.9 | 91.7 | .252 | 12.7 | 78.7 | .268 |
| 32 | 8.7 | 115 | .196 | 9.9 | 101 | .210 | 11.8 | 84.8 | .217 |
| 33 | 7.7 | 130 | .155 | 9.1 | 110 | .161 | 10.9 | 91.7 | .175 |
| 34 | 6.9 | 145 | .123 | 8.3 | 121 | .129 | 10.1 | 99.0 | .141 |
| 35 | 6.2 | 161 | .098 | 7.6 | 132 | .104 | 9.4 | 106 | .113 |
| 36 | 5.5 | 180 | .078 | 7.0 | 143 | .082 | 8.8 | 114 | .092 |
| 37 | 4.9 | 204 | .062 | 6.5 | 154 | .066 | 8.3 | 121 | .074 |
| 38 | 4.4 | 227 | .049 | 6.0 | 167 | .053 | 7.8 | 128 | .062 |
| 39 | 3.9 | 256 | .039 | 5.5 | 180 | .042 | 7.3 | 137 | .050 |
| 40 | 3.5 | 286 | .031 | 5.1 | 196 | .035 | 6.9 | 145 | .043 |

column are due to the fact that the values in the third column are calculated from more nearly accurate values than those given in the second column.

VARIATION OF RESISTANCE WITH FREQUENCY FOR COPPER WIRE

This table gives the ratio of the resistance of straight copper wire with alternating currents of various frequencies to the value of the resistance with direct current. Multiplying the direct-current resistance by the factor found opposite that size of wire in this table and in the column of the desired frequency, will give the resistance that that copper wire offers to an alternating current of the frequency under consideration.

HARD-DRAWN COPPERCLAD AND COPPER WIRE

Copperclad wires of various kinds have a steel core and a thin outside covering of copper. The copper may be poured, while melted, around the steel ingot or casting, and allowed to cool. The copper and steel are thus firmly fastened together and when drawn into wire there will be a good coating of copper over the full length of steel. The copper acts as a protecting coating to the steel, which will not rust when so protected. The electrical resistance of the copperclad steel wire thus formed is somewhat higher than that of solid copper of the same outside diameter, but the mechanical strength of the copperclad steel wire is considerably greater than that of the solid copper wire. The copperclad steel wire is also somewhat cheaper than solid copper wire of the same size. Due to skin effect, only the outside of a conductor carries high-frequency current, so the electrical resistance of copperclad steel wire may not be appreciably greater than that of solid copper when carrying radio-frequency currents. The accompanying table of Hard-Drawn Copperclad and Copper Wire is for one particular kind of copperclad steel wire that is widely used, and shows a good comparison of this wire with commercial copper. The resistances given in this table are all direct-current values. The "30% copperclad" means that the average conductivity of this grade of copperclad steel wire is 30% that of solid copper, or that its direct-current resistance is very close to $3\frac{1}{3}$ times that

VARIATION OF RESISTANCE WITH FREQUENCY FOR COPPER WIRE

| Diameter of Wire | | Frequency, in Cycles per Second | | | | | |
|------------------|------|---------------------------------|-------|-------|--------|---------|-----------|
| Millimeters | Mils | 60 | 100 | 1,000 | 10,000 | 100,000 | 1,000,000 |
| | .05 | | | | | | 1.001 |
| | .10 | | | | | 1.001 | 1.008 |
| | .25 | | | | | 1.003 | 1.247 |
| | .50 | | | | 1.001 | 1.047 | 2.240 |
| | 1.0 | | | | 1.008 | 1.503 | 4.19 |
| | 2.0 | | | 1.001 | 1.120 | 2.756 | 8.10 |
| | 3.0 | | | 1.006 | 1.437 | 4.00 | 12.0 |
| | 4.0 | | | 1.021 | 1.842 | 5.24 | 17.4 |
| | 5.0 | | 1.001 | 1.047 | 2.240 | 6.49 | 19.7 |
| | 7.5 | 1.001 | 1.002 | 1.210 | 3.22 | 7.50 | 29.7 |
| | 10 | 1.003 | 1.008 | 1.503 | 4.19 | 12.7 | 39.1 |
| | 15 | 1.016 | 1.038 | 2.136 | 6.14 | 18.8 | |
| | 20 | 1.044 | 1.120 | 2.756 | 8.10 | 25.2 | |
| | 25 | 1.105 | 1.247 | 3.38 | 10.1 | 28.3 | |
| | 40 | 1.474 | 1.842 | 5.24 | 17.4 | | |
| | 100 | 3.31 | 4.19 | 13.7 | 39.1 | | |

HARD-DRAWN COPPERCLAD AND COPPER WIRE

496

TABLES AND DATA

| Size B. & S. Gauge | Average Weight Pounds per 1,000 Feet | | Average Breaking Load Pounds | | Average Resistance Ohms per 1,000 Feet at 68° F. | | |
|--------------------------|---|--------|---------------------------------|--------|---|------------|--------|
| | Copperclad | Copper | Copperclad | Copper | 30% | 40% | Copper |
| | | | | | Copperclad | Copperclad | |
| 0000 | 585 | 641 | 9,850 | 8,140 | .165 | .124 | .0495 |
| 000 | 467 | 508 | 8,280 | 6,730 | .208 | .156 | .0624 |
| 00 | 370 | 403 | 6,845 | 5,540 | .262 | .197 | .0787 |
| 0 | 293 | 319 | 5,695 | 4,520 | .331 | .248 | .0993 |
| 1 | 231 | 253 | 4,800 | 3,680 | .421 | .316 | .126 |
| 2 | 184 | 201 | 3,975 | 3,000 | .531 | .398 | .159 |
| 3 | 146 | 159 | 3,200 | 2,440 | .670 | .503 | .201 |
| 4 | 116 | 126 | 2,610 | 1,970 | .884 | .633 | .253 |
| 5 | 92 | 100 | 2,190 | 1,590 | 1.06 | .799 | .320 |
| 6 | 73 | 79.5 | 1,800 | 1,280 | 1.34 | 1.01 | .403 |
| 7 | 58 | 63.0 | 1,450 | 1,030 | 1.69 | 1.27 | .508 |
| 8 | 46 | 50.0 | 1,200 | 828 | 2.13 | 1.60 | .641 |
| 9 | 37 | 39.6 | 970 | 663 | 2.69 | 2.02 | .808 |
| 10 | 29 | 31.4 | 800 | 528 | 3.39 | 2.55 | 1.02 |
| 11 | 23 | 24.9 | 645 | 423 | 4.28 | 3.21 | 1.29 |
| 12 | 18 | 19.8 | 520 | 337 | 5.39 | 4.05 | 1.62 |
| 13 | 14.38 | 15.7 | 415 | 268 | 6.80 | 5.11 | 2.04 |
| 14 | 11.55 | 12.4 | 330 | 214 | 8.58 | 6.44 | 2.58 |
| 15 | 8.99 | 9.86 | 275 | 170 | 10.8 | 8.13 | 3.25 |
| 16 | 7.23 | 7.82 | 210 | 135 | 13.7 | 10.2 | 4.10 |
| 17 | 5.68 | 6.20 | 170 | 108 | 17.2 | 12.9 | 5.17 |
| 18 | 4.45 | 4.92 | 140 | 86 | 21.7 | 16.3 | 6.51 |
| 19 | 3.54 | 3.90 | 110 | 68 | 27.4 | 20.5 | 8.21 |
| 20 | 2.80 | 3.09 | 90 | 54 | 34.5 | 25.9 | 10.4 |

PROPERTIES OF ELECTRICAL MATERIALS

| Material | Component Materials | Specific Resistance Microhms per Cubic Centi- meter at 20° C. | Temperature Coefficient at 20° C. | Specific Gravity (Referred to Water) | Tensile Strength Pounds per Square Inch | Melting Point Degrees C. |
|--------------------------|--------------------------|--|---|---|--|--------------------------------|
| Aluminum, commercial.. | 97.5% Pure | 2.828 | .0039 | 2.70 | 30,000 | 659 |
| Brass..... | 66% Cu + 34% Tin | 7.0 | .002 | 8.6 | 70,000 | 900 |
| Carbon..... | Lamp filament | 4000 | -.0003 | | | |
| Constantan, or Advance.. | 60% Cu + 40% Ni | 49 | .00001 | 8.9 | 120,000 | 1,190 |
| Copper..... | Annealed | 1.724 | .00393 | 8.89 | 30,000 | 1,083 |
| Copper..... | Hard-drawn | 1.771 | .00382 | 8.89 | 60,000 | 1,083 |
| German silver..... | 18% Ni + Cu + Zn | 33 | .0004 | 8.4 | 150,000 | 1,100 |
| Gold..... | 99.9% Pure | 2.44 | .00342 | 19.3 | 20,000 | 1,063 |
| Ideal, or Eureka..... | Resistance wire, Cu + Ni | 49 | .00001 | 8.9 | 120,000 | 1,190 |
| Iron..... | 99.98% Pure | 10 | .005 | 7.8 | | 1,530 |
| Lead..... | Pure | 22 | .0039 | 11.4 | 3,000 | 327 |
| Mercury..... | Pure | 95.78 | .00089 | 13.546 | 0 | - 38.9 |
| Molybdenum..... | Drawn | 5.7 | .0033 | 9.0 | | 2,535 |
| Nichrome..... | Resistance wire | 100. | .0004 | 8.2 | 150,000 | 1,500 |
| Nickel..... | Electrolytic | 7.8 | .006 | 8.9 | 120,000 | 1,452 |
| Phosphor-bronze..... | | 7.8 | .0018 | 8.9 | 25,000 | 750 |
| Platinum..... | Pure | 10. | .003 | 21.4 | 50,000 | 1,755 |
| Silver..... | 99.98% pure | 1.629 | .0038 | 10.5 | 42,000 | 960 |
| Steel..... | E. B. B. | 10.4 | .005 | 7.7 | 53,000 | 1,510 |
| Steel..... | Manganese | 70 | .001 | 7.5 | 230,000 | 1,260 |
| Tantalum..... | | 15.5 | .0031 | 16.6 | | 2,900 |
| Tin..... | | 11.5 | .0012 | 7.3 | 4,000 | 232 |
| Tungsten..... | Drawn | 5.51 | .0045 | 19.0 | 500,000 | 3,400 |
| Zinc..... | | 5.8 | .0037 | 7.1 | 10,000 | 419 |

of solid copper of the same outside dimensions. The 40% grade has a direct-current resistance very nearly $2\frac{1}{2}$ times as great as that of a copper wire of the same size.

ELECTRICAL PROPERTIES OF COMMON INSULATING MATERIALS

The values of specific inductive capacity, given in this table, are subject to some variation due to the different qualities and grades of the materials put out by various manufacturers. Imperfections and various grades of materials cause the variations in dielectric strength given under that heading. The dielectric strength is, in general, greater per mil for thin pieces of material or air than for thicker sections. Dampness reduces the dielectric strength of many materials to a considerable extent.

| Material | Megohms per Centimeter Cube | Specific Inductive Capacity | Dielectric Strength A.-C. Volts per Mil |
|---------------------------------|--------------------------------------|-----------------------------------|--|
| Air, atmospheric pressure..... | | 1.00 | 10-75 |
| Air, pressure 100 atmospheres.. | | 1.05 | higher |
| Air, vacuum .001 mm. pressure. | | .94 | lower |
| Asbestos..... | | 2.5-3.0 | |
| Bakelite..... | 2×10^4 | 4.0-8.8 | 200-1,100 |
| Celluloid..... | | 4.2-16. | 400-900 |
| Fiber, treated..... | | | 700-1,100 |
| Glass..... | 2×10^7 | 3.5-10 | 150-300 |
| Ice..... | | 3.0 | |
| Marble..... | | 8-9 | 50-100 |
| Mica..... | 2×10^{11} | 2.5-7.5 | 700-1,500 |
| Molded composition..... | | | 40-360 |
| Oils..... | | 2.0-4.8 | 100-400 |
| Paper, dry..... | | 1.5-4.6 | 100-230 |
| Paraffin..... | 1×10^{10} | 1.7-2.5 | 200-300 |
| Porcelain..... | 3×10^8 | 4.4-6.8 | 30-120 |
| Rubber..... | | 2-4 | 250-500 |
| Rubber, hard..... | 1×10^{12} | 2-3.5 | 500-1,500 |
| Shellac..... | | 3-4 | |
| Varnished cambric..... | | 3.5-5.5 | 500-1,300 |
| Water (18° C.)..... | | 81.07 | |
| Wood, dried..... | | 2.5-7.5 | 10-50 |

**NUMBER OF VOLTS REQUIRED TO PRODUCE A SPARK
BETWEEN BALLS IN AIR**

| Length of Spark Gap in | | Diameter of the Balls | | |
|------------------------|--------|-----------------------|--------------------|--------------------|
| Centi- meters | Inches | 1 Cm. =.3937 In. | 2 Cm. =.787 In. | 6 Cm. =2.36 In. |
| | | Volts | Volts | Volts |
| .02 | .0079 | 1,560 | 1,530 | |
| .04 | .0157 | 2,460 | 2,430 | |
| .06 | .0236 | 3,300 | 3,240 | |
| .08 | .0315 | 4,050 | 3,990 | |
| .10 | .0394 | 4,800 | 4,800 | 4,500 |
| .20 | .0787 | 8,400 | 8,400 | 7,800 |
| .30 | .1181 | 11,400 | 11,400 | 10,800 |
| .40 | .1575 | 14,400 | 14,400 | 13,500 |
| .50 | .1969 | 17,100 | 17,100 | 16,500 |
| .60 | .2362 | 19,500 | 19,800 | 19,500 |
| .70 | .2756 | 21,600 | 22,500 | 22,500 |
| .80 | .3150 | 23,400 | 24,900 | 26,100 |
| .90 | .3543 | 24,600 | 27,300 | 29,000 |
| 1.00 | .3937 | 25,500 | 29,100 | 32,700 |

TEMPERATURE

The temperature of a body is its degree of sensible heat. For the measurement of temperatures there are three kinds of thermometers: the Fahrenheit, abbreviated F. or Fahr., commonly used in America; the centigrade, abbreviated C. or Cent., used in France and by scientists everywhere; and the Réaumur, abbreviated R. or Réau., used in Germany.

| <i>Standard Points</i> | <i>Degrees F.</i> | <i>Degrees C.</i> | <i>Degrees R.</i> |
|--|-------------------|-------------------|-------------------|
| Boiling point of water at sea level; i. e., pressure = 1 atmosphere..... | 212 | 100 | 80 |
| Melting point of ice..... | 32 | 0 | 0 |
| Absolute zero, i. e., the total absence of heat; theoretical only..... | -400 | -273 | -219 |

Between boiling point and freezing point = 180° F. = 100° C.
= 80° R.

$$\text{Temp. F.} = \frac{9}{5} \text{Temp. C.} + 32^{\circ} = \frac{9}{4} \text{Temp. R.} + 32^{\circ}.$$

$$\text{Temp. C.} = \frac{5}{9} (\text{Temp. F.} - 32^{\circ}) = \frac{5}{4} \text{Temp. R.}$$

$$\text{Temp. R.} = \frac{4}{9} (\text{Temp. F.} - 32^{\circ}) = \frac{4}{5} \text{Temp. C.}$$

CENTIGRADE AND FAHRENHEIT DEGREES

| Deg. C. | Deg. F. | Deg. C. | Deg. F. | Deg. C. | Deg. F. | Deg. C. | Deg. F. |
|------------|------------|------------|------------|------------|------------|------------|------------|
| 0 | 32.0 | 26 | 78.8 | 51 | 123.8 | 76 | 168.8 |
| 1 | 33.8 | 27 | 80.6 | 52 | 125.6 | 77 | 170.6 |
| 2 | 35.6 | 28 | 82.4 | 53 | 127.4 | 78 | 172.4 |
| 3 | 37.4 | 29 | 84.2 | 54 | 129.2 | 79 | 174.2 |
| 4 | 39.2 | 30 | 86.0 | 55 | 131.0 | 80 | 176.0 |
| 5 | 41.0 | 31 | 87.8 | 56 | 132.8 | 81 | 177.8 |
| 6 | 42.8 | 32 | 89.6 | 57 | 134.6 | 82 | 179.6 |
| 7 | 44.6 | 33 | 91.4 | 58 | 136.4 | 83 | 181.4 |
| 8 | 46.4 | 34 | 93.2 | 59 | 138.2 | 84 | 183.2 |
| 9 | 48.2 | 35 | 95.0 | 60 | 140.0 | 85 | 185.0 |
| 10 | 50.0 | 36 | 95.8 | 61 | 141.8 | 86 | 186.8 |
| 11 | 51.8 | 37 | 98.6 | 62 | 143.6 | 87 | 188.6 |
| 12 | 53.6 | 38 | 100.4 | 63 | 145.4 | 88 | 190.4 |
| 13 | 55.4 | 39 | 102.2 | 64 | 147.2 | 89 | 192.2 |
| 14 | 57.2 | 40 | 104.0 | 65 | 149.0 | 90 | 194.0 |
| 15 | 59.0 | 41 | 105.8 | 66 | 150.8 | 91 | 195.8 |
| 16 | 60.8 | 42 | 107.6 | 67 | 152.6 | 92 | 197.6 |
| 17 | 62.6 | 43 | 109.4 | 68 | 154.4 | 93 | 199.4 |
| 18 | 64.4 | 44 | 111.2 | 69 | 156.2 | 94 | 201.2 |
| 19 | 66.2 | 45 | 113.0 | 70 | 158.0 | 95 | 203.0 |
| 20 | 68.0 | 46 | 114.8 | 71 | 159.8 | 96 | 204.8 |
| 21 | 69.8 | 47 | 116.6 | 72 | 161.6 | 97 | 206.6 |
| 22 | 71.6 | 48 | 118.4 | 73 | 163.4 | 98 | 208.4 |
| 23 | 73.4 | 49 | 120.2 | 74 | 165.2 | 99 | 210.2 |
| 24 | 75.2 | 50 | 122.0 | 75 | 167.0 | 100 | 212.0 |
| 25 | 77.0 | | | | | | |

WAVE-LENGTH, FREQUENCY, AND OSCILLATION CONSTANT

The relation between the free wave-length in meters, the frequency in cycles per second, and the oscillation constant

(LC) of circuits is given in the accompanying table. The oscillation constant (LC) represents the product of inductance in microhenrys and capacity in microfarads for a circuit of a given wave-length or frequency. The use of the table may best be illustrated by examples.

EXAMPLE 1.—What is the frequency of an alternating current whose measured wave-length is 1,200 meters?

SOLUTION.—Opposite the value 1,200 meters in the table is the value 250,000, which means that the frequency of the current is 250,000 cycles per second.

EXAMPLE 2.—What is the natural wave-length of a circuit composed of an inductance of 135 microhenrys in series with a condenser of .003-microfarad capacity?

SOLUTION.—The product of the inductance and capacity values is $135 \times .003 = .405$, which can be called the oscillation constant (LC). Opposite this value of LC in the table will be found the value of 1,200 meters, which represents the free wave-length of an oscillatory current in this circuit.

EXAMPLE 3.—What value of capacity must be connected in series with an inductance of 25 microhenrys in order to tune the circuit to 200 meters?

SOLUTION.—Find opposite 200 meters the LC value .01126 which is the oscillation constant. Divide this value of LC by 25, and the quotient .00045 is the required capacity in microfarads.

EXAMPLE 4.—Find the inductance that must be placed in series with a condenser of .0025 microfarad in order that the circuit shall have a natural wave-length of, or be in resonance with a wave of, 360 meters.

SOLUTION.—From the table, the oscillation constant, or LC , value corresponding with 360 meters is .03648. Divide this by .0025, the capacity of the condenser in microfarads, and the desired inductance is 14.6 microhenrys.

**WAVE-LENGTH, FREQUENCY, AND OSCILLATION
CONSTANT**

| Wave- Length Meters | Frequency | <i>L C</i> | Wave- Length Meters | Frequency | <i>L C</i> |
|---------------------------|-------------|------------|---------------------------|-----------|------------|
| 1 | 300,000,000 | .0000003 | 180 | 1,667,000 | .009120 |
| 2 | 150,000,000 | .0000011 | 185 | 1,622,000 | .009634 |
| 3 | 100,000,000 | .0000025 | 190 | 1,579,000 | .01016 |
| 4 | 75,000,000 | .0000045 | 195 | 1,538,000 | .01071 |
| 5 | 60,000,000 | .0000070 | 200 | 1,500,000 | .01126 |
| 6 | 50,000,000 | .0000101 | 205 | 1,463,000 | .01183 |
| 7 | 42,860,000 | .0000138 | 210 | 1,429,000 | .01241 |
| 8 | 37,500,000 | .0000180 | 215 | 1,395,000 | .01301 |
| 9 | 33,333,000 | .0000228 | 220 | 1,364,000 | .01362 |
| 10 | 30,000,000 | .0000282 | 225 | 1,333,000 | .01425 |
| 15 | 20,000,000 | .0000634 | 230 | 1,304,000 | .01489 |
| 20 | 15,000,000 | .0001126 | 235 | 1,277,000 | .01555 |
| 25 | 12,000,000 | .0001760 | 240 | 1,250,000 | .01622 |
| 30 | 10,000,000 | .0002533 | 245 | 1,225,000 | .01690 |
| 35 | 8,571,000 | .0003448 | 250 | 1,200,000 | .01760 |
| 40 | 7,500,000 | .0004503 | 255 | 1,177,000 | .01831 |
| 45 | 6,667,000 | .0005700 | 260 | 1,154,000 | .01903 |
| 50 | 6,000,000 | .0007039 | 265 | 1,132,000 | .01977 |
| 55 | 5,454,000 | .0008519 | 270 | 1,111,000 | .02052 |
| 60 | 5,000,000 | .001014 | 275 | 1,091,000 | .02129 |
| 65 | 4,615,000 | .001188 | 280 | 1,071,000 | .02207 |
| 70 | 4,286,000 | .001378 | 290 | 1,034,500 | .02366 |
| 75 | 4,000,000 | .001583 | 295 | 1,017,000 | .02450 |
| 80 | 3,750,000 | .001801 | 300 | 1,000,000 | .02533 |
| 85 | 3,529,000 | .002034 | 310 | 967,700 | .02705 |
| 90 | 3,333,000 | .002280 | 320 | 937,500 | .02883 |
| 95 | 3,158,000 | .002541 | 330 | 909,100 | .03066 |
| 100 | 3,000,000 | .002816 | 340 | 882,400 | .03255 |
| 105 | 2,857,000 | .003105 | 350 | 857,100 | .03448 |
| 110 | 2,727,000 | .003404 | 360 | 833,300 | .03648 |
| 115 | 2,609,000 | .003721 | 370 | 810,800 | .03854 |
| 120 | 2,500,000 | .004052 | 380 | 789,500 | .04065 |
| 125 | 2,400,000 | .004397 | 390 | 769,200 | .04277 |
| 130 | 2,308,000 | .004757 | 400 | 750,000 | .04503 |
| 135 | 2,222,000 | .005130 | 410 | 731,700 | .04733 |
| 140 | 2,144,000 | .005518 | 420 | 714,300 | .04966 |
| 145 | 2,069,000 | .005919 | 430 | 697,700 | .05204 |
| 150 | 2,000,000 | .006335 | 440 | 681,800 | .05446 |
| 155 | 1,935,000 | .006760 | 450 | 666,700 | .05700 |
| 160 | 1,875,000 | .007204 | 460 | 652,200 | .05960 |
| 165 | 1,818,000 | .007662 | 470 | 638,300 | .06219 |
| 170 | 1,765,000 | .008134 | 480 | 625,000 | .06485 |
| 175 | 1,714,000 | .008620 | 490 | 612,200 | .06759 |

**WAVE-LENGTH, FREQUENCY, AND OSCILLATION
CONSTANT—(Continued)**

| Wave- Length Meters | Frequency | L C | Wave- Length Meters | Frequency | L C |
|---------------------------|-----------|--------|---------------------------|-----------|-------|
| 500 | 600,000 | .07039 | 930 | 322,600 | .2434 |
| 510 | 588,200 | .07327 | 940 | 319,100 | .2487 |
| 520 | 576,900 | .07606 | 950 | 315,100 | .2541 |
| 530 | 566,000 | .07905 | 960 | 312,500 | .2595 |
| 540 | 555,600 | .08208 | 970 | 309,300 | .2647 |
| 550 | 545,400 | .08519 | 980 | 306,100 | .2704 |
| 560 | 535,700 | .08836 | 990 | 303,100 | .2759 |
| 570 | 526,300 | .09139 | 1,000 | 300,000 | .2816 |
| 580 | 517,200 | .09467 | 1,010 | 297,000 | .2870 |
| 590 | 508,500 | .09801 | 1,020 | 294,100 | .2927 |
| 600 | 500,000 | .1014 | 1,030 | 291,300 | .2986 |
| 610 | 491,800 | .1047 | 1,040 | 288,400 | .3045 |
| 620 | 483,900 | .1082 | 1,050 | 285,700 | .3105 |
| 630 | 476,200 | .1117 | 1,060 | 283,600 | .3161 |
| 640 | 468,700 | .1154 | 1,070 | 280,400 | .3222 |
| 650 | 461,500 | .1188 | 1,080 | 277,800 | .3283 |
| 660 | 454,500 | .1225 | 1,090 | 275,200 | .3345 |
| 670 | 447,800 | .1263 | 1,100 | 272,700 | .3404 |
| 680 | 441,200 | .1302 | 1,110 | 270,300 | .3467 |
| 690 | 434,800 | .1341 | 1,120 | 267,900 | .3531 |
| 700 | 428,600 | .1378 | 1,130 | 265,500 | .3595 |
| 710 | 422,500 | .1419 | 1,140 | 263,100 | .3660 |
| 720 | 416,700 | .1459 | 1,150 | 260,900 | .3721 |
| 730 | 411,000 | .1501 | 1,160 | 258,600 | .3787 |
| 740 | 405,400 | .1540 | 1,170 | 256,400 | .3853 |
| 750 | 400,000 | .1583 | 1,180 | 254,200 | .3921 |
| 760 | 394,800 | .1626 | 1,190 | 252,100 | .3988 |
| 770 | 389,600 | .1668 | 1,200 | 250,000 | .4052 |
| 780 | 384,600 | .1712 | 1,210 | 247,900 | .4121 |
| 790 | 379,800 | .1758 | 1,220 | 245,900 | .4190 |
| 800 | 375,000 | .1801 | 1,230 | 243,900 | .4260 |
| 810 | 370,400 | .1847 | 1,240 | 241,900 | .4326 |
| 820 | 365,900 | .1893 | 1,250 | 240,000 | .4397 |
| 830 | 361,400 | .1941 | 1,260 | 238,100 | .4469 |
| 840 | 357,100 | .1985 | 1,270 | 236,200 | .4541 |
| 850 | 352,900 | .2034 | 1,280 | 234,400 | .4610 |
| 860 | 348,800 | .2082 | 1,290 | 232,600 | .4683 |
| 870 | 344,800 | .2132 | 1,300 | 230,800 | .4757 |
| 880 | 340,900 | .2179 | 1,310 | 229,000 | .4831 |
| 890 | 337,100 | .2229 | 1,320 | 227,300 | .4906 |
| 900 | 333,300 | .2280 | 1,330 | 225,600 | .4978 |
| 910 | 329,700 | .2332 | 1,340 | 223,900 | .5053 |
| 920 | 326,100 | .2381 | 1,350 | 222,200 | .5130 |

**WAVE-LENGTH, FREQUENCY, AND OSCILLATION
CONSTANT—(Continued)**

| Wave- Length Meters | Frequency | <i>L C</i> | Wave- Length Meters | Frequency | <i>L C</i> |
|---------------------------|-----------|------------|---------------------------|-----------|------------|
| 1,360 | 220,600 | .5208 | 1,790 | 167,600 | .9018 |
| 1,370 | 218,900 | .5281 | 1,800 | 166,700 | .9120 |
| 1,380 | 217,400 | .5359 | 1,810 | 165,700 | .9223 |
| 1,390 | 215,800 | .5438 | 1,820 | 164,800 | .9327 |
| 1,400 | 214,300 | .5518 | 1,830 | 163,900 | .9425 |
| 1,410 | 212,800 | .5598 | 1,840 | 163,000 | .9530 |
| 1,420 | 211,300 | .5674 | 1,850 | 162,200 | .9634 |
| 1,430 | 209,800 | .5755 | 1,860 | 161,300 | .9741 |
| 1,440 | 208,300 | .5837 | 1,870 | 160,400 | .9841 |
| 1,450 | 206,900 | .5919 | 1,880 | 159,600 | .9948 |
| 1,460 | 205,500 | .5998 | 1,890 | 158,700 | 1.006 |
| 1,470 | 204,100 | .6081 | 1,900 | 157,900 | 1.016 |
| 1,480 | 202,700 | .6165 | 1,910 | 157,100 | 1.027 |
| 1,490 | 201,300 | .6250 | 1,920 | 156,300 | 1.038 |
| 1,500 | 200,000 | .6335 | 1,930 | 155,400 | 1.049 |
| 1,510 | 198,700 | .6416 | 1,940 | 154,600 | 1.060 |
| 1,520 | 197,400 | .6502 | 1,950 | 153,800 | 1.071 |
| 1,530 | 196,100 | .6590 | 1,960 | 153,100 | 1.081 |
| 1,540 | 194,800 | .6677 | 1,970 | 152,300 | 1.092 |
| 1,550 | 193,600 | .6760 | 1,980 | 151,500 | 1.104 |
| 1,560 | 192,300 | .6849 | 1,990 | 150,800 | 1.115 |
| 1,570 | 191,100 | .6938 | 2,000 | 150,000 | 1.126 |
| 1,580 | 189,900 | .7028 | 2,050 | 146,300 | 1.183 |
| 1,590 | 188,700 | .7118 | 2,100 | 142,900 | 1.241 |
| 1,600 | 187,500 | .7204 | 2,150 | 139,500 | 1.301 |
| 1,610 | 186,300 | .7295 | 2,200 | 136,400 | 1.362 |
| 1,620 | 185,200 | .7387 | 2,250 | 133,300 | 1.425 |
| 1,630 | 184,100 | .7480 | 2,300 | 130,400 | 1.489 |
| 1,640 | 182,900 | .7573 | 2,350 | 127,700 | 1.555 |
| 1,650 | 181,800 | .7662 | 2,400 | 125,000 | 1.622 |
| 1,660 | 180,700 | .7756 | 2,450 | 122,500 | 1.690 |
| 1,670 | 179,600 | .7852 | 2,500 | 119,000 | 1.760 |
| 1,680 | 178,600 | .7946 | 2,550 | 117,700 | 1.831 |
| 1,690 | 177,500 | .8037 | 2,600 | 115,400 | 1.903 |
| 1,700 | 176,500 | .8134 | 2,650 | 113,200 | 1.977 |
| 1,710 | 175,400 | .8231 | 2,700 | 111,100 | 2.052 |
| 1,720 | 174,400 | .8329 | 2,750 | 109,100 | 2.129 |
| 1,730 | 173,400 | .8422 | 2,800 | 107,100 | 2.207 |
| 1,740 | 172,400 | .8520 | 2,850 | 105,300 | 2.287 |
| 1,750 | 171,400 | .8620 | 2,900 | 103,500 | 2.366 |
| 1,760 | 170,500 | .8720 | 2,950 | 101,700 | 2.450 |
| 1,770 | 169,400 | .8821 | 3,000 | 100,000 | 2.533 |
| 1,780 | 168,500 | .8916 | 3,100 | 96,770 | 2.705 |

WAVE-LENGTH, FREQUENCY, AND OSCILLATION
CONSTANT—(Continued)

| Wave- Length Meters | Frequency | <i>L C</i> | Wave- Length Meters | Frequency | <i>L C</i> |
|---------------------------|-----------|------------|---------------------------|-----------|------------|
| 3,200 | 93,750 | 2.883 | 7,500 | 40,000 | 15.83 |
| 3,300 | 90,910 | 3.066 | 7,600 | 39,470 | 16.26 |
| 3,400 | 88,240 | 3.255 | 7,700 | 38,960 | 16.68 |
| 3,500 | 85,910 | 3.448 | 7,800 | 38,460 | 17.14 |
| 3,600 | 83,330 | 3.648 | 7,900 | 37,980 | 17.56 |
| 3,700 | 81,080 | 3.854 | 8,000 | 37,500 | 18.01 |
| 3,800 | 78,950 | 4.065 | 8,100 | 37,040 | 18.47 |
| 3,900 | 76,920 | 4.277 | 8,200 | 36,590 | 18.93 |
| 4,000 | 75,000 | 4.503 | 8,300 | 36,140 | 19.41 |
| 4,100 | 73,170 | 4.733 | 8,400 | 35,710 | 19.85 |
| 4,200 | 71,430 | 4.966 | 8,500 | 35,290 | 20.34 |
| 4,300 | 69,770 | 5.204 | 8,600 | 34,880 | 20.82 |
| 4,400 | 68,180 | 5.446 | 8,700 | 34,480 | 21.32 |
| 4,500 | 66,670 | 5.700 | 8,800 | 34,090 | 21.79 |
| 4,600 | 65,220 | 5.960 | 8,900 | 33,710 | 22.29 |
| 4,700 | 63,830 | 6.219 | 9,000 | 33,330 | 22.80 |
| 4,800 | 62,500 | 6.485 | 9,100 | 32,970 | 23.32 |
| 4,900 | 61,220 | 6.759 | 9,200 | 32,610 | 23.81 |
| 5,000 | 60,000 | 7.039 | 9,300 | 32,260 | 24.34 |
| 5,100 | 58,820 | 7.327 | 9,400 | 31,910 | 24.87 |
| 5,200 | 57,690 | 7.606 | 9,500 | 31,590 | 25.41 |
| 5,300 | 56,600 | 7.905 | 9,600 | 31,250 | 25.95 |
| 5,400 | 55,560 | 8.208 | 9,700 | 30,930 | 26.47 |
| 5,500 | 54,550 | 8.519 | 9,800 | 30,610 | 27.04 |
| 5,600 | 53,570 | 8.836 | 9,900 | 30,310 | 27.59 |
| 5,700 | 52,630 | 9.139 | 10,000 | 30,000 | 28.16 |
| 5,800 | 51,720 | 9.467 | 10,500 | 28,570 | 31.05 |
| 5,900 | 50,850 | 9.801 | 11,000 | 27,270 | 34.04 |
| 6,000 | 50,000 | 10.14 | 11,500 | 26,090 | 37.21 |
| 6,100 | 49,180 | 10.47 | 12,000 | 25,000 | 40.52 |
| 6,200 | 48,550 | 10.82 | 12,500 | 24,000 | 43.97 |
| 6,300 | 47,620 | 11.17 | 13,000 | 23,080 | 47.57 |
| 6,400 | 46,870 | 11.54 | 13,500 | 22,220 | 51.30 |
| 6,500 | 46,150 | 11.88 | 14,000 | 21,440 | 55.18 |
| 6,600 | 45,450 | 12.25 | 14,500 | 20,690 | 59.19 |
| 6,700 | 44,780 | 12.63 | 15,000 | 20,000 | 63.35 |
| 6,800 | 44,120 | 13.02 | 15,500 | 19,350 | 67.60 |
| 6,900 | 43,480 | 13.41 | 16,000 | 18,750 | 72.04 |
| 7,000 | 42,860 | 13.78 | 16,500 | 18,180 | 76.62 |
| 7,100 | 42,250 | 14.19 | 17,000 | 17,650 | 81.34 |
| 7,200 | 41,670 | 14.59 | 17,500 | 17,140 | 86.20 |
| 7,300 | 41,100 | 15.01 | 18,000 | 16,670 | 91.20 |
| 7,400 | 40,540 | 15.40 | 18,500 | 16,220 | 96.34 |

**WAVE-LENGTH, FREQUENCY, AND OSCILLATION
CONSTANT—(Continued)**

| Wave- Length Meters | Frequency | <i>L C</i> | Wave- Length Meters | Frequency | <i>L C</i> |
|---------------------------|-----------|------------|---------------------------|-----------|------------|
| 19,000 | 15,790 | 101.64 | 25,000 | 12,000 | 175.97 |
| 19,500 | 15,380 | 107.06 | 26,000 | 11,540 | 190.26 |
| 20,000 | 15,000 | 112.56 | 27,000 | 11,110 | 205.20 |
| 21,000 | 14,290 | 124.12 | 28,000 | 10,710 | 220.70 |
| 22,000 | 13,640 | 136.24 | 29,000 | 10,350 | 236.63 |
| 23,000 | 13,040 | 148.93 | 30,000 | 10,000 | 253.32 |
| 24,000 | 12,500 | 162.18 | | | |

LOGARITHMS

Much time can be saved in the solution of some mathematical problems by the use of common logarithms, and some formulas are based on their use. The common logarithm of a number is the power to which 10 must be raised in order to obtain that number. The word logarithm is abbreviated log; for example, $\log 100 = 2$, because $10^2 = 100$; $\log 1,000 = 3$, because $10^3 = 1,000$; $\log 10,000 = 4$, because $10^4 = 10,000$. The logarithms of most numbers contain decimals: for example, $\log 31.6 = \frac{2}{3}$, or 1.5, because $10^{\frac{2}{3}}$, or $10^{1.5}$, or $\sqrt[3]{10^3} = 31.6$; $\log 21.55 = \frac{1}{3}$, or 1.333 because $10^{\frac{1}{3}}$, or $10^{1.333} = 21.55$; $\log 20 = 1.301$, because $10^{1.301} = 20$.

The part of a logarithm to the left of the decimal point is called the *characteristic*, and the part to the right of the decimal point is called the *mantissa*. For example, in 1.301 ($\log 20$), 1 is the characteristic and .301 is the mantissa.

Rule.—For a number greater than 1, the characteristic is one less than the number of figures to the left of the decimal point in the number.

Thus $\log 300 = 2.477$, of which the characteristic 2 is one less than the number of figures in 300; $\log 21.55 = 1.333$, of which the characteristic 1 is one less than the number of figures in 21; $\log 10,000 = 4$, which is one less than the number of figures in 10,000. Logarithms of perfect powers of 10 have no mantissas.

Mantissas for logarithms of numbers from 1 to 999 can be found directly from the accompanying table. The first two

COMMON LOGARITHMS

| N | 0 | 1 | 2 | 3 | 4 | 5 | 6 | 7 | 8 | 9 |
|----|-----|-----|-----|-----|-----|-----|-----|-----|-----|------|
| 10 | 000 | 004 | 009 | 013 | 017 | 021 | 025 | 029 | 033 | 037 |
| 11 | 041 | 045 | 049 | 053 | 057 | 061 | 064 | 068 | 072 | 076 |
| 12 | 079 | 083 | 086 | 090 | 093 | 097 | 100 | 104 | 107 | 111 |
| 13 | 114 | 117 | 121 | 124 | 127 | 130 | 134 | 137 | 140 | 143 |
| 14 | 146 | 149 | 152 | 155 | 158 | 161 | 164 | 167 | 170 | 173 |
| 15 | 176 | 179 | 182 | 185 | 188 | 190 | 193 | 196 | 199 | 201 |
| 16 | 204 | 207 | 210 | 212 | 215 | 217 | 220 | 223 | 225 | 228 |
| 17 | 230 | 233 | 236 | 238 | 241 | 243 | 246 | 248 | 250 | 253 |
| 18 | 255 | 258 | 260 | 262 | 265 | 267 | 270 | 272 | 274 | 276 |
| 19 | 279 | 281 | 283 | 286 | 288 | 290 | 292 | 294 | 297 | 299 |
| 20 | 301 | 303 | 305 | 307 | 310 | 312 | 314 | 316 | 318 | 320 |
| 21 | 322 | 324 | 326 | 328 | 330 | 332 | 334 | 336 | 338 | 340 |
| 22 | 342 | 344 | 346 | 348 | 350 | 352 | 354 | 356 | 358 | 360 |
| 23 | 362 | 364 | 365 | 367 | 369 | 371 | 373 | 375 | 377 | 378 |
| 24 | 380 | 382 | 384 | 386 | 387 | 389 | 391 | 393 | 394 | 396 |
| 25 | 398 | 400 | 401 | 403 | 405 | 407 | 408 | 410 | 412 | 413 |
| 26 | 415 | 417 | 418 | 420 | 422 | 423 | 425 | 427 | 428 | 430 |
| 27 | 431 | 433 | 435 | 436 | 438 | 439 | 441 | 442 | 444 | 446 |
| 28 | 447 | 449 | 450 | 452 | 453 | 455 | 456 | 458 | 459 | 461 |
| 29 | 462 | 464 | 465 | 467 | 468 | 470 | 471 | 473 | 474 | 476 |
| 30 | 477 | 479 | 480 | 481 | 483 | 484 | 486 | 487 | 489 | 490 |
| 31 | 491 | 493 | 494 | 496 | 497 | 498 | 500 | 501 | 502 | 504 |
| 32 | 505 | 507 | 508 | 509 | 511 | 512 | 513 | 515 | 516 | 517 |
| 33 | 519 | 520 | 521 | 522 | 524 | 525 | 526 | 528 | 529 | 530 |
| 34 | 531 | 533 | 534 | 535 | 537 | 538 | 539 | 540 | 542 | 543 |
| 35 | 544 | 545 | 547 | 548 | 549 | 550 | 551 | 553 | 554 | 555 |
| 36 | 556 | 558 | 559 | 560 | 561 | 562 | 563 | 565 | 566 | 567 |
| 37 | 568 | 569 | 571 | 572 | 573 | 574 | 575 | 576 | 577 | 579 |
| 38 | 580 | 581 | 582 | 583 | 584 | 585 | 587 | 588 | 589 | 590 |
| 39 | 591 | 592 | 593 | 594 | 595 | 597 | 598 | 599 | 600 | 601 |
| 40 | 602 | 603 | 604 | 605 | 606 | 607 | 609 | 610 | 611 | 612 |
| 41 | 613 | 614 | 615 | 616 | 617 | 618 | 619 | 620 | 621 | 622 |
| 42 | 623 | 624 | 625 | 626 | 627 | 628 | 629 | 630 | 631 | 632 |
| 43 | 634 | 635 | 636 | 637 | 638 | 639 | 640 | 641 | 642 | 643 |
| 44 | 643 | 644 | 645 | 646 | 647 | 648 | 649 | 650 | 651 | 652] |
| 45 | 653 | 654 | 655 | 656 | 657 | 658 | 659 | 660 | 661 | 662 |
| 46 | 663 | 664 | 665 | 666 | 667 | 667 | 668 | 669 | 670 | 671 |
| 47 | 672 | 673 | 674 | 675 | 676 | 677 | 678 | 679 | 679 | 680 |
| 48 | 681 | 682 | 683 | 684 | 685 | 686 | 687 | 688 | 688 | 689 |
| 49 | 690 | 691 | 692 | 693 | 694 | 695 | 695 | 696 | 697 | 698 |

COMMON LOGARITHMS—(Continued)

| N | 0 | 1 | 2 | 3 | 4 | 5 | 6 | 7 | 8 | 9 |
|----|-----|-----|-----|-----|-----|-----|-----|-----|-----|-----|
| 50 | 699 | 700 | 701 | 702 | 702 | 703 | 704 | 705 | 706 | 707 |
| 51 | 708 | 708 | 709 | 710 | 711 | 712 | 713 | 713 | 714 | 715 |
| 52 | 715 | 717 | 718 | 719 | 719 | 720 | 721 | 722 | 723 | 723 |
| 53 | 724 | 725 | 726 | 727 | 728 | 728 | 729 | 730 | 731 | 732 |
| 54 | 732 | 733 | 734 | 735 | 736 | 736 | 737 | 738 | 739 | 740 |
| 55 | 740 | 741 | 742 | 743 | 744 | 744 | 745 | 746 | 747 | 747 |
| 56 | 748 | 749 | 750 | 751 | 751 | 752 | 753 | 754 | 754 | 755 |
| 57 | 756 | 757 | 757 | 758 | 759 | 760 | 760 | 761 | 762 | 763 |
| 58 | 763 | 764 | 765 | 766 | 766 | 767 | 768 | 769 | 769 | 770 |
| 59 | 771 | 772 | 772 | 773 | 774 | 775 | 775 | 776 | 777 | 777 |
| 60 | 778 | 779 | 780 | 780 | 781 | 782 | 782 | 783 | 784 | 785 |
| 61 | 785 | 786 | 787 | 787 | 788 | 789 | 790 | 790 | 791 | 792 |
| 62 | 792 | 793 | 794 | 794 | 795 | 796 | 797 | 797 | 798 | 799 |
| 63 | 799 | 800 | 801 | 801 | 802 | 803 | 803 | 804 | 805 | 806 |
| 64 | 806 | 807 | 808 | 808 | 809 | 810 | 810 | 811 | 812 | 812 |
| 65 | 813 | 814 | 814 | 815 | 816 | 816 | 817 | 818 | 818 | 819 |
| 66 | 820 | 820 | 821 | 822 | 822 | 823 | 823 | 824 | 825 | 825 |
| 67 | 826 | 827 | 827 | 828 | 829 | 829 | 830 | 831 | 831 | 832 |
| 68 | 833 | 833 | 834 | 834 | 835 | 836 | 836 | 837 | 838 | 838 |
| 69 | 839 | 839 | 840 | 841 | 841 | 842 | 843 | 843 | 844 | 844 |
| 70 | 845 | 846 | 846 | 847 | 848 | 848 | 849 | 849 | 850 | 851 |
| 71 | 851 | 852 | 852 | 853 | 854 | 854 | 855 | 856 | 856 | 857 |
| 72 | 857 | 858 | 859 | 859 | 860 | 860 | 861 | 862 | 862 | 863 |
| 73 | 863 | 864 | 865 | 865 | 866 | 866 | 867 | 867 | 868 | 869 |
| 74 | 869 | 870 | 870 | 871 | 872 | 872 | 873 | 873 | 874 | 874 |
| 75 | 875 | 876 | 876 | 877 | 877 | 878 | 879 | 879 | 880 | 880 |
| 76 | 881 | 881 | 882 | 883 | 883 | 884 | 884 | 885 | 885 | 886 |
| 77 | 887 | 887 | 888 | 888 | 889 | 889 | 890 | 890 | 891 | 892 |
| 78 | 892 | 893 | 893 | 894 | 894 | 895 | 895 | 896 | 897 | 897 |
| 79 | 898 | 898 | 899 | 899 | 900 | 900 | 901 | 901 | 902 | 903 |
| 80 | 903 | 904 | 904 | 905 | 905 | 906 | 906 | 907 | 907 | 908 |
| 81 | 909 | 909 | 910 | 910 | 911 | 911 | 912 | 912 | 913 | 913 |
| 82 | 914 | 914 | 915 | 915 | 916 | 916 | 917 | 918 | 918 | 919 |
| 83 | 919 | 920 | 902 | 921 | 921 | 922 | 922 | 923 | 923 | 924 |
| 84 | 924 | 925 | 925 | 926 | 926 | 927 | 927 | 927 | 928 | 929 |
| 85 | 929 | 930 | 930 | 931 | 931 | 932 | 932 | 933 | 933 | 934 |
| 86 | 935 | 935 | 936 | 936 | 937 | 937 | 938 | 938 | 939 | 939 |
| 87 | 940 | 940 | 941 | 941 | 942 | 942 | 943 | 943 | 943 | 944 |
| 88 | 945 | 945 | 945 | 946 | 946 | 947 | 947 | 948 | 948 | 949 |
| 89 | 949 | 950 | 950 | 951 | 951 | 952 | 952 | 952 | 953 | 954 |

COMMON LOGARITHMS—(Continued)

| N | 0 | 1 | 2 | 3 | 4 | 5 | 6 | 7 | 8 | 9 |
|----|-----|-----|-----|-----|-----|-----|-----|-----|-----|-----|
| 90 | 954 | 955 | 955 | 956 | 956 | 957 | 957 | 958 | 958 | 959 |
| 91 | 959 | 960 | 960 | 960 | 861 | 861 | 962 | 962 | 963 | 963 |
| 92 | 964 | 964 | 965 | 965 | 966 | 966 | 967 | 967 | 968 | 968 |
| 93 | 968 | 969 | 969 | 970 | 970 | 971 | 971 | 972 | 972 | 973 |
| 94 | 973 | 974 | 974 | 975 | 975 | 975 | 976 | 976 | 977 | 977 |
| 95 | 978 | 978 | 979 | 979 | 980 | 980 | 980 | 981 | 981 | 982 |
| 96 | 982 | 983 | 983 | 984 | 984 | 985 | 985 | 985 | 986 | 986 |
| 97 | 987 | 987 | 988 | 988 | 989 | 989 | 989 | 990 | 990 | 991 |
| 98 | 991 | 992 | 992 | 993 | 993 | 993 | 994 | 994 | 995 | 995 |
| 99 | 996 | 996 | 997 | 997 | 997 | 998 | 998 | 999 | 999 | 000 |

RATIO OF HIGH-FREQUENCY RESISTANCE TO DIRECT-CURRENT RESISTANCE FOR SKIN-EFFECT FORMULA

| τ | $\frac{R}{R_0}$ | x | $\frac{R}{R_0}$ | x | $\frac{R}{R_0}$ |
|--------|-----------------|------|-----------------|-------|-----------------|
| 0 | 1.0000 | 5.2 | 2.114 | 14.0 | 5.209 |
| .5 | 1.0003 | 5.4 | 2.184 | 14.5 | 5.386 |
| .6 | 1.0007 | 5.6 | 2.254 | 15.0 | 5.562 |
| .7 | 1.0012 | 5.8 | 2.324 | 16.0 | 5.915 |
| .8 | 1.0021 | 6.0 | 2.394 | 17.0 | 6.268 |
| .9 | 1.0034 | 6.2 | 2.463 | 18.0 | 6.621 |
| 1.0 | 1.005 | 6.4 | 2.533 | 19.0 | 6.974 |
| 1.1 | 1.008 | 6.6 | 2.603 | 20.0 | 7.328 |
| 1.2 | 1.011 | 6.8 | 2.673 | 21.0 | 7.681 |
| 1.3 | 1.015 | 7.0 | 2.743 | 22.0 | 8.034 |
| 1.4 | 1.020 | 7.2 | 2.813 | 23.0 | 8.387 |
| 1.5 | 1.026 | 7.4 | 2.884 | 24.0 | 8.741 |
| 1.6 | 1.033 | 7.6 | 2.954 | 25.0 | 9.094 |
| 1.7 | 1.042 | 7.8 | 3.024 | 26.0 | 9.447 |
| 1.8 | 1.052 | 8.0 | 3.094 | 28.0 | 10.15 |
| 1.9 | 1.064 | 8.2 | 3.165 | 30.0 | 10.86 |
| 2.0 | 1.078 | 8.4 | 3.235 | 32.0 | 11.57 |
| 2.2 | 1.111 | 8.6 | 3.306 | 34.0 | 12.27 |
| 2.4 | 1.152 | 8.8 | 3.376 | 36.0 | 12.98 |
| 2.6 | 1.201 | 9.0 | 3.446 | 38.0 | 13.69 |
| 2.8 | 1.256 | 9.2 | 3.517 | 40.0 | 14.40 |
| 3.0 | 1.318 | 9.4 | 3.587 | 42.0 | 15.10 |
| 3.2 | 1.385 | 9.6 | 3.658 | 44.0 | 15.81 |
| 3.4 | 1.456 | 9.8 | 3.728 | 46.0 | 16.52 |
| 3.6 | 1.529 | 10.0 | 3.799 | 48.0 | 17.22 |
| 3.8 | 1.603 | 10.5 | 3.975 | 50.0 | 17.93 |
| 4.0 | 1.678 | 11.0 | 4.151 | 60.0 | 21.47 |
| 4.2 | 1.752 | 11.5 | 4.327 | 70.0 | 25.00 |
| 4.4 | 1.826 | 12.0 | 4.504 | 80.0 | 28.54 |
| 4.6 | 1.899 | 12.5 | 4.680 | 90.0 | 32.07 |
| 4.8 | 1.971 | 13.0 | 4.856 | 100.0 | 35.61 |
| 5.0 | 2.043 | 13.5 | 5.033 | | |

**APPROXIMATE NATURAL WAVE-LENGTHS OF FLAT-
TOP ANTENNAS**

INVERTED L-TYPE, 4-WIRE ANTENNAS

| Horizontal Length Feet | Wave-Lengths in Meters for the Following Heights, in Feet, to the Flat-Top Portion | | | | |
|------------------------|--|-----|-----|-----|-----|
| | 30 | 40 | 60 | 80 | 100 |
| 30 | 69 | 81 | 108 | 134 | 158 |
| 40 | 81 | 95 | 122 | 146 | 172 |
| 50 | 95 | 109 | 134 | 160 | 186 |
| 60 | 108 | 121 | 148 | 173 | 199 |
| 70 | 121 | 133 | 161 | 188 | 212 |
| 80 | 133 | 147 | 174 | 199 | 225 |
| 90 | 146 | 159 | 187 | 212 | 240 |
| 100 | 159 | 172 | 200 | 226 | 252 |
| 110 | 171 | 185 | 213 | 240 | 265 |
| 120 | 184 | 199 | 226 | 252 | 279 |

T-TYPE, 4-WIRE ANTENNAS

| Horizontal Length Feet | Wave-Lengths in Meters for the Following Heights, in Feet, to the Flat-Top Portion | | | | |
|------------------------|--|-----|-----|-----|-----|
| | 30 | 40 | 60 | 80 | 100 |
| 60 | 77 | 92 | 124 | 152 | 180 |
| 80 | 92 | 106 | 139 | 166 | 196 |
| 100 | 106 | 121 | 154 | 181 | 211 |
| 120 | 121 | 136 | 169 | 198 | 228 |
| 140 | 135 | 150 | 184 | 215 | 243 |
| 160 | 149 | 165 | 198 | 229 | 259 |
| 180 | 163 | 179 | 213 | 245 | 275 |
| 200 | 178 | 194 | 229 | 260 | 291 |
| 220 | 192 | 209 | 244 | 276 | 306 |
| 240 | 206 | 224 | 257 | 291 | 322 |

figures of the number are in the first column of the table, the third figure at the head of the column, and the figures of the mantissa in the body of the table. In finding the mantissa for the logarithm of a number, only the first three figures of the num-

ber need be considered for present purposes, and the decimal point can be disregarded. If the fourth figure is 5 or greater, the third figure should be increased by 1. The decimal point must be considered in determining the characteristic, as before stated.

For example, to find the mantissa of log 370 look in the first column for 37 and in line with it in the column headed 0 find

CHARACTERISTICS OF COIL ANTENNAS

| Length of Each Side Feet | Total Number of Turns | Spacing of Wires, in Inches | Inductance, in Microhenrys | Capacity of Coil, in Microfarads | Fundamental Wave-Length, in Meters |
|--------------------------|-----------------------|-----------------------------|----------------------------|----------------------------------|------------------------------------|
| 8 | 3 | .50 | 96 | .000075 | 160 |
| 6 | 4 | .25 | 124 | .000066 | 170 |
| 4 | 6 | .25 | 154 | .000055 | 174 |
| 3 | 8 | .125 | 193 | .000049 | 183 |

RANGES OF 5-FOOT COILS, WITH WIRES SPACED .5 INCH

| Turns on Loop | Wave-Length Range Using Condensers of Following Ranges of Capacity, in Microfarads | |
|---------------|--|------------------|
| | .00065 to .00004 | .0014 to .000045 |
| 4 | 200 to 400 | 380 to 650 |
| 8 | 350 to 700 | 400 to 950 |
| 16 | 500 to 1,000 | 675 to 2,300 |

RANGES OF 4-FOOT COILS WITH WIRES SPACED 1 INCH

| Turns on Loop | Wave-Length Range Using Condensers of the Following Ranges of Capacity, in Microfarads | |
|---------------|--|------------------|
| | .0006 to .00004 | .0014 to .000045 |
| 4 | 150 to 300 | 180 to 500 |

the number 568. By placing a decimal point before this number and prefixing the characteristic 2, log 370 is found to be 2.568. To find log 37.26 look for log 373 in the column headed 3 and in line with 37. The number there found is 572 and the characteristic is 1 which is one less than the number of figures in the integral part of the number 37.26. Logarithms obtained in this way are accurate enough for the purpose herein required.

In some work it is handier to deal with another set of logarithms, known as the Napierian, or natural, logarithms. The base of this system is 2.7183 instead of the 10 used in the common system. The natural logarithm of a number may be obtained by multiplying the common logarithm of the number by 2.303. When the natural logarithm is known, this number or value may be multiplied by .4343 to get the common logarithm of the number.

**APPROXIMATE WAVE-LENGTH OF 4-FOOT COIL
ANTENNAS WITH VARIOUS VALUES OF CON-
DENSER CAPACITY ACROSS THE COIL
TERMINALS**

| Number of Turns | Condenser Capacity, in Microfarads | | | | | | Distribution in Slots $\frac{1}{2}$ Inch Apart |
|-----------------------|------------------------------------|-------|--------|--------|--------|--------|--|
| | .00005 | .0001 | .0005 | .001 | .002 | .003 | |
| 1 | | 65 | 128 | 178 | 250 | 310 | 1 turn per slot |
| 3 | 130 | 155 | 290 | 400 | 550 | 675 | 1 turn per slot |
| 6 | 230 | 280 | 500 | 710 | 1,000 | 1,200 | 1 turn per slot |
| 12 | 430 | 490 | 920 | 1,250 | 1,700 | 2,050 | 1 turn per slot |
| 24 | 760 | 880 | 1,600 | 2,100 | 3,000 | 3,600 | 1 turn per slot |
| 48 | 1,550 | 1,775 | 3,150 | 4,300 | 6,000 | 7,000 | 2 turns per slot |
| 72 | 2,200 | 2,650 | 4,800 | 6,400 | 8,800 | 11,000 | 3 turns per slot |
| 120 | 3,930 | 4,500 | 7,900 | 10,000 | 14,700 | 17,700 | 5 turns per slot |
| 240 | 7,600 | 9,000 | 15,650 | 20,500 | 27,200 | 32,900 | 10 turns per slot |

HONEYCOMB-COIL DATA

The accompanying table lists the common sizes of honeycomb coils, by specifying the number of turns of wire in the coil. Such coils are generally made up with an inside diameter

DIMENSIONS OF TUNING COILS FOR VARIOUS RANGES OF WAVE-LENGTHS

| Coil Diameter Inches | | Wire Size B. & S. Gauge D. S. C. | | Total Length of Coil Inches | | Turns on Each Coil | | Loading Coil Dimensions Inches | | | |
|-------------------------|-----|--|----|-----------------------------------|-----|-----------------------|-----|---|---|--------|----|
| | | | | | | | | Diameter | | Length | |
| P | S | P | S | P | S | P | S | P | S | P | S |
| 5 | 4 | 24 | 28 | 4 | 4 | 152 | 212 | | | | |
| 5 | 4 | 24 | 28 | 4 | 6 | 152 | 318 | | | | |
| 5 | 4 | 24 | 28 | 4 | 8 | 152 | 424 | 5 | | 4 | |
| 7 | 6 | 24 | 28 | 14 | 14 | 532 | 742 | | | | |
| 7 | 6 | 24 | 28 | 14 | 14 | 532 | 742 | 7 | 6 | 24 | 24 |
| 4 | 3.5 | 26 | 32 | 5.5 | 5.5 | 247 | 380 | (Time-Signal Tuner, $\lambda = 2,500$ meters) | | | |
| 3.5 | 3 | 24 | 28 | 3 | 3 | 114 | 159 | | | | |
| 3.5 | 3 | 26 | 30 | .26 | .45 | 12 | 30 | (Suitable for 200-meter reception) | | | |

| Wire Data for Loading Coils | | | | Wave-Length of S Coil With Following Capacities in Microfarads in Shunt | | Wave-Length of P Coil With Antennas of Following Capacities in Microfarads | | Total Inductance in Microhenrys | |
|-----------------------------|-------|---------------------------|----|--|--------|---|--------|------------------------------------|-----------|
| Number of Turns | | Size, B. & S. D. S. C. | | .0001 | .0005 | .0004 | .001 | P | S |
| P | S | P | S | | | | | | |
| | | | | 1,050 | 2,350 | 1,810 | 2,862 | 2,307.5 | 3,102.6 |
| | | | | 1,360 | 3,040 | 1,810 | 2,862 | 2,307.5 | 5,200.0 |
| | | 24 | | 1,605 | 3,620 | 2,557 | 4,050 | 4,615.0 | 7,372.6 |
| | | | | 3,250 | 7,270 | 5,330 | 8,495 | 20,316.6 | 29,782.5 |
| 152 | | | | 7,200 | 16,100 | 9,150 | 14,470 | 58,936.2 | 114,536.0 |
| | | 24 | 32 | 1,546 | 3,460 | 2,182 | 3,450 | 3,350.0 | 6,737.5 |
| 923 | 1,856 | | | 682 | 1,525 | 1,090 | 1,755 | 867.7 | 1,309.0 |
| | | | | 200+ | | 200+ | | 31.15 | 121.4 |

of 2 inches, a width of 1 inch, and an outside diameter varying from $2\frac{1}{2}$ inches to $4\frac{1}{2}$ inches, depending upon the number of turns. All of the inductance and capacity values in this table are subject to some variation due to differences in design and construction by various manufacturers. A commercial condenser of maximum capacity of .001 microfarad generally has a minimum capacity close to .0001 microfarad, hence the wave-length values under these two column headings represent approximately the wave-length range which may be obtained by this coil and a .001-condenser combination in practice. It is better to use a condenser and a wave-length higher than the natural one of the coil, as best results can then be obtained and tuning is possible to other wave-lengths.

HONEYCOMB-COIL DATA

| Number of Turns on Coil | Size of Wire. B. & S. Gauge | Inductance in Millihenrys | Distributed Capacity in Micromicrofarads | Natural Wave-Length in Meters | Wave-Lengths With the Following Shunt-Condenser Capacities | | | |
|-------------------------|-----------------------------|---------------------------|--|-------------------------------|--|--------|--------|-------|
| | | | | | Microfarads | | | |
| | | | | | .001 | .0005 | .00025 | .0001 |
| 25 | 24 | .038 | 26.8 | 60 | 372 | 267 | 193 | 131 |
| 35 | 24 | .076 | 30.8 | 91 | 528 | 378 | 277 | 188 |
| 50 | 24 | .150 | 36.4 | 139 | 743 | 534 | 391 | 270 |
| 75 | 24 | .315 | 28.6 | 179 | 1,007 | 770 | 560 | 379 |
| 100 | 24 | .585 | 36.1 | 274 | 1,470 | 1,055 | 771 | 532 |
| 150 | 24 | 1.29 | 21.3 | 313 | 2,160 | 1,546 | 1,110 | 746 |
| 200 | 25 | 2.27 | 18.9 | 391 | 2,870 | 2,050 | 1,470 | 980 |
| 250 | 25 | 4.20 | 22.9 | 585 | 3,910 | 2,800 | 2,020 | 1,355 |
| 300 | 25 | 6.60 | 19.0 | 669 | 4,900 | 3,490 | 2,510 | 1,670 |
| 400 | 25 | 10.5 | 17.4 | 806 | 6,160 | 4,400 | 3,160 | 2,095 |
| 500 | 25 | 18.0 | 17.3 | 1,052 | 8,070 | 5,750 | 4,140 | 2,740 |
| 600 | 28 | 37.5 | 19.2 | 1,600 | 11,600 | 8,300 | 5,980 | 3,980 |
| 750 | 28 | 49.0 | 18.3 | 1,785 | 13,300 | 9,500 | 6,830 | 4,540 |
| 1,000 | 28 | 85.3 | 16.8 | 2,260 | 17,600 | 12,500 | 9,000 | 5,950 |
| 1,250 | 28 | 112.0 | 15.5 | 2,490 | 20,100 | 14,300 | 10,250 | 6,780 |
| 1,500 | 28 | 161.5 | 15.8 | 3,000 | 24,200 | 17,200 | 12,350 | 8,150 |

Radio Communication

WORDS now leap through the uncharted spaces "down between the worlds" at the rate of 186,000 miles a second. Not content with the conquest of the earth, the sea and the air, man reaches out and harnesses the limitless expanses of ether mantling the universe, making it serve him. This is the nearest approach as yet of mortals to the realms of the Infinite. Recent achievements in Radio Telephony might be unbelievable were not the phenomena right here in our midst. We rub our eyes and pinch ourselves to see whether we are still alive or on some far off celestial sphere in the world beyond.

At the burial of the Unknown Soldier in Arlington Cemetery, November 11, 1921, suitable transmitting apparatus was installed in the Cemetery Amphitheater. President Harding's oration, the songs, the prayers, and the commitment service of Bishop Brent were heard, as though they were present, by an appreciative and reverent throng in San Francisco, 3,400 miles away.

James Miller, over in Scotland 3,500 miles distant, hears Hugh Robinson in Keyport, N. J., who is in radio communication with a friend only a short distance away.

An admiring mother out in Indiana sits in her home and hears distinctly every word of a sermon delivered by her distinguished minister son in New York City.

The great Paris railway sta-

tion, the Gare du Nord, holds conversation with rapidly moving French railway trains. Passengers on a vessel hundreds of miles at sea dance by music transmitted from shore. The Western Electric Company from its transmitting station at Deal Beach, N. J., has talked to Paris and Honolulu.

The possibilities of radio communication almost dwarf the imagination and stifle conjecture.

A gigantic industry, absorbing wealth, interest, aspiration, and achievement from hundreds of thousands has flung itself with startling force into our midst. As with all great undertakings, the big rewards will come first to those who are trained to realize on its opportunities—to get in on the ground floor. The International Correspondence Schools are now ready to help you meet these fundamental requirements.



WIRELESS!

Be a wireless expert. Study at home in spare time. Get a good job at a good salary. Wonderful opportunity to get in on the ground floor of a fast-growing profession. Easy, fascinating, profitable.

Mark and mail the coupon and let us send you details of the I.C.S. Radio Operator's Course.

..... **TEAR OUT HERE**

INTERNATIONAL CORRESPONDENCE SCHOOLS

Box 1709, Scranton, Pa.

Without cost or obligation, please send me complete information about the subject before which I have marked an X.

- | | |
|---|--|
| <input type="checkbox"/> WIRELESS | <input type="checkbox"/> ADVERTISING |
| <input type="checkbox"/> Drafting | <input type="checkbox"/> Salesmanship |
| <input type="checkbox"/> Mechanical Engineering | <input type="checkbox"/> BOOKKEEPING |
| <input type="checkbox"/> Civil Engineering | <input type="checkbox"/> Civil Service |
| <input type="checkbox"/> SURVEYING | <input type="checkbox"/> Railway Mail Clerk |
| <input type="checkbox"/> ARCHITECTURE | <input type="checkbox"/> Traffic Management |
| <input type="checkbox"/> Electrical Engineering | <input type="checkbox"/> Business Management |
| <input type="checkbox"/> CHEMISTRY | <input type="checkbox"/> Cert. Pub. Accountant |
| <input type="checkbox"/> Automobiles | <input type="checkbox"/> Stenography |
| <input type="checkbox"/> Airplane Engines | <input type="checkbox"/> Good English |

Name.....

Address.....

Occupation.....

