

REFERENCE DATA  
*for*  
RADIO ENGINEERS

*Federal Telephone and Radio Corporation*

67 Broad Street



New York, N. Y.

REFERENCE DATA  
*for*  
RADIO ENGINEERS



Published by the  
*Federal Telephone and Radio Corporation*  
an associate of  
International Telephone and Telegraph Corporation

67 Broad Street



New York 4, N. Y.

Copyright 1943 by  
Federal Telephone and Radio Corporation  
Printed in the U. S. A.  
First Edition

---

First Printing August, 1943  
Second Printing October, 1943  
Third Printing March, 1944  
Fourth Printing August, 1944

## FOREWORD

Appreciating the present special need for radio reference data in compact, convenient form, the Federal Telephone and Radio Corporation presents "Reference Data for Radio Engineers" as an aid to radio research, development, production and operation. In selecting material for the book, the aim was to provide for the requirements of the engineer as well as the practical technician. Hence, more fundamental data are included than are usually found in a concise radio handbook in order to fill a gap that has existed in the past between the handbook and the standard radio engineering text book. Special effort also was directed to making the material useful both in the laboratory and in the field.

The present book was compiled under the direction of the Federal Telephone and Radio Laboratories in collaboration with other associate companies of the International Telephone and Telegraph Corporation. This group of companies (including their predecessors) possesses experience gained throughout the world over a period of many years in the materialization of important radio projects.

In the United States the Federal Telephone and Radio Corporation and its predecessor companies have pioneered in radio and its allied fields. Following several years of development consummated in 1911, commercial radio telegraph services were inaugurated, making practical use for the first time in America of Poulsen's high efficiency arc generator for the production of sustained or undamped waves. Dr. Lee de Forest, while employed by Federal as Consulting Engineer and Physicist during the years 1911-12-13, did much of his work on fundamental applications of his invention of the three element vacuum tube. During the period 1912-1918, Federal supplied many high power transmitters to the U. S. Navy, including the 1000-kw installation at Bordeaux (France). Commercial development of the Marine Radio Direction Finder was completed in 1924 and, in 1937, the RC-5 Radio Compass, which was the first automatic direction finder with 360° indication ever installed in an airplane, was introduced into the United States.

A radio airplane landing system, variously designated as the Civil Aeronautics Administration, Indianapolis, or I. T. & T. Instrument Landing System, has been adopted as standard for important airports throughout the country. Additional contributions in the short and ultra-short wave field comprise radio ranges, highly efficient FM and other ultra-high frequency antennas, and the design of a short wave broadcast transmitter powered at 200 kw.

Achievements of special present significance, originating from basic research in fields allied to communications, include the introduction into the United States in 1938 of the Selenium Rectifier; the development of high tension and high frequency "Intelin" cables; and a process for the thin case hardening of metals utilizing energy in the megacycle frequency range.

For the initiation, proposal, development and delivery of a completely integral marine radio equipment for cargo and passenger vessels, in the form of a Marine Radio Unit, the Maritime Commission in 1942 awarded the Maritime "M" to the Radio Division of the Federal Telephone and Radio Corporation. In 1943, for great accomplishment in the development of war equipment, the Laboratories Division of the Federal Telephone and Radio Corporation was awarded the Army-Navy "E".

In countries other than the United States, contributions by International Telephone and Telegraph associates also are numerous. Mention should be made of single-sideband short wave radiotelephony, demonstrated as early as 1930-31 between Buenos Aires and Madrid, and between Madrid and Paris. In 1931, transmissions on approximately 1600 mc (18 cm wavelength) with very sharp beams were achieved across the English Channel; shortly thereafter the Anglo-French Micro-Ray Link was established commercially. Prominent among medium and short wave broadcasters of the highest powers are the 120-kw Prague transmitter and one of the most recent BBC Empire transmitters rated at 100 kw to 130 kw, as well as the Paris 30-kw Eiffel Tower television transmitter.

Acknowledgement is gratefully made to another International Telephone and Telegraph associate company, Standard Telephones and Cables, Ltd., London, for its book, "Reference Data for Radio Engineers", distribution of which was warmly welcomed in Great Britain. The present book partly parallels the British reference but contains considerable additional data and material specifically selected for the use of American engineers.

For advice and suggestions in connection with the present book, acknowledgement is due to members of the technical staff of I. T. & T. System companies in New York City and Newark, N. J., particularly to E. M. Deloraine, Director of Federal Telephone and Radio Laboratories, and to Haraden Pratt, Vice President and Chief Engineer of Mackay Radio. Others who made valuable contributions include A. Alford, H. Busignies, G. Chevigny, D. D. Grieg, A. G. Kandoian, E. Labin and E. M. Ostlund of the F. T. & R. Laboratories, C. V. Litton, W. W. Macalpine, G. T. Royden, A. J. Warner and J. E. Yarmack, of the F. T. & R. Corporation, C. E. Scholz of Mackay Radio, A. M. Stevens of the I.T. & T. Corporation, and G. H. Gray and F. J. Mann of the International Standard Electric Corporation.

H. H. BUTTNER

*Chairman, Radio Reference Book Committee*

*Vice-President, Federal Telephone and Radio Corporation*

H. T. KOHLHAAS, *Editor*

*Editor of Electrical Communication*

## CONTENTS

### *Foreword*

### *General Engineering Tables*

Conversion Table . . . . .	11
Fractions of an Inch with Metric Equivalents . . . . .	12
Copper Wire Table . . . . .	13
Copperweld Wire: Mechanical and Electrical Properties . . . . .	14
Standard Stranded Copper Conductors . . . . .	15
Screw Head Styles and Method of Length Measurement . . . . .	15
Standard Machine Screw Data—Chart for Hole Sizes . . . . .	16

### *Engineering and Material Data*

Insulating Materials . . . . .	17
Plastics: Trade Names . . . . .	18
Physical Constants of Various Metals . . . . .	19
Fusing Currents of Wire . . . . .	21
Melting Points of Solder . . . . .	21
Temperature Chart of Heated Metals . . . . .	22
Spark Gap Voltages . . . . .	23
Thermocouples and Their Characteristics . . . . .	24
Characteristics of Typical Thermocouples . . . . .	25
Head of Water and Approximate Discharge Rate . . . . .	26
Wind Velocities and Pressures . . . . .	27
Weather Data . . . . .	27
Temperature Extremes . . . . .	27
Precipitation Extremes . . . . .	27
World Temperatures . . . . .	28
World Precipitation . . . . .	29
Principal Power Supplies in Foreign Countries . . . . .	30
Audible Spectrum . . . . .	33
Ether Spectrum . . . . .	34
Radio Frequency Classifications . . . . .	34

### *Audio and Radio Design—General*

Condenser Color Code . . . . .	35
Resistor Color Code . . . . .	36
Standard Color Coding for Resistors . . . . .	37
Inductance Charts for Single Layer Solenoids . . . . .	39
Copper Wire Coil Data . . . . .	42
Reactance Charts . . . . .	43
Time Constants for Series Circuits . . . . .	47
Impedance Formulas . . . . .	50
Network Theorems . . . . .	54
Electrical Circuit Formulas . . . . .	55
Attenuators . . . . .	65
Filter Networks . . . . .	70

## **Rectifiers**

Special Connections and Circuit Data for Typical Rectifiers . . . . .	72
Selenium Rectifiers . . . . .	75

## **Vacuum Tubes and Amplifiers**

Vacuum Tube Design . . . . .	79
Nomenclature . . . . .	79
Coefficients . . . . .	80
Terminology . . . . .	80
Formulas . . . . .	81
Electrode Dissipation Data . . . . .	82
Filament Characteristics . . . . .	83
Ultra-High Frequency Tubes . . . . .	84
Vacuum Tube Amplifier Design . . . . .	88
Classification . . . . .	88
General Design . . . . .	88
Graphical Methods . . . . .	92
Resistance Coupled Audio Amplifier Design . . . . .	101
Negative Feedback . . . . .	102
Distortion . . . . .	103
Army and Navy Preferred List of Vacuum Tubes . . . . .	103
Cathode Ray Tubes, Approximate Formulas . . . . .	104

## **Telephone Transmission**

Power Ratio, Voltage Ratio, Decibel Table . . . . .	106
Transmission Line Data and Constants . . . . .	107

## **Radio Frequency Transmission Lines**

Transmission Line Data . . . . .	113
Surge Impedance of Uniform Lines . . . . .	114
Transmission Line Types and Their Characteristic Impedance . . . . .	116
Impedance Matching with Shorted Stub . . . . .	117
Impedance Matching with Open Stub . . . . .	117
Wave Guides and Resonators . . . . .	118

## **Radio Propagation and Antennas**

Field Strength of Radiation from an Antenna . . . . .	127
Field Strength from an Elementary Dipole . . . . .	127
Ultra-Short Wave Propagation . . . . .	131
Line of Sight Transmission Distance . . . . .	132
Reflection Coefficient of Plane Radio Waves from Surface of the Sea . . . . .	132
Distance Ranges of Radio Waves . . . . .	133
Radio Transmission and the Ionosphere . . . . .	139
Time Interval between Transmission and Reception of Reflected Signal . . . . .	142
Linear Radiators . . . . .	143
Maxima and Minima of Radiation—Single-Wire Radiator . . . . .	144



Antenna Arrays . . . . .	144
Radiation Pattern of Several Common Types of Antennas . . . . .	147
Radiation Pattern of Multi-Element Linear Broadside Array . . . . .	148
Radiation Pattern of Multi-Element Binomial Broadside Array . . . . .	149
Frequency Tolerances . . . . .	150
<b>Noise and Noise Measurement</b>	
Wire Telephony . . . . .	153
Radio . . . . .	156
<b>Non-Sinusoidal Waveforms</b>	
Relaxation Oscillators . . . . .	157
Electronic Differentiation Methods . . . . .	159
Fourier Analysis of Recurrent Waveforms . . . . .	160
Analyses of Commonly Encountered Waveforms . . . . .	165
<b>Dimensional Expressions . . . . .</b>	
	171
<b>Greek Alphabet . . . . .</b>	
	171
<b>Mathematical Formulas and General Information</b>	
Miscellaneous Data . . . . .	172
Mensuration Formulas . . . . .	172
Formulas for Complex Quantities . . . . .	173
Algebraic and Trigonometric Formulas . . . . .	173
Approximations for Small Angles . . . . .	175
Quadratic Equation . . . . .	175
Arithmetical Progression . . . . .	175
Geometrical Progression . . . . .	175
Combinations and Permutations . . . . .	175
Binomial Theorem . . . . .	175
Maclaurin's Theorem . . . . .	175
Trigonometric Solution of Triangles . . . . .	176
Complex Hyperbolic and Other Functions . . . . .	176
Great Circle Calculations . . . . .	179
<b>Mathematical Tables</b>	
Logarithms of Numbers and Proportional Parts . . . . .	181
Natural Trigonometric Functions for Decimal Fractions of a Degree . . . . .	183
Logarithms of Trigonometric Functions for Decimal Fractions of a Degree . . . . .	187
Exponentials ( $e^a$ and $e^{-a}$ ) . . . . .	191
Natural or Napierian Logarithms . . . . .	192
Hyperbolic Sines . . . . .	194
Hyperbolic Cosines . . . . .	195
Hyperbolic Tangents . . . . .	196
Bessel Functions . . . . .	197

# Reference Data for Radio Engineers

## CONVERSION TABLE

To Convert	Into	Multiply by	Conversely Multiply by
Acres	Square feet	43,560	$2.296 \times 10^{-5}$
Atmospheres	Cms. of mercury	76	0.01316
Atmospheres	Inches of mercury	29.92	0.03342
Atmospheres	Kilograms per sq. meter	10,332	$9.678 \times 10^{-5}$
Atmospheres	Pounds per sq. inch	14.70	0.06804
B.T.U.	Foot-pounds	777.97	0.0012854
Calories (large)	Kilogram-meters	426.85	0.00234
Centigrade	Fahrenheit	$(C^{\circ} \times 9/5) + 32$	$(F^{\circ} - 32) \times 5/9$
Cubic inches	Cubic centimeters	16.39	$6.102 \times 10^{-3}$
Cubic inches	Cubic feet	$5.787 \times 10^{-4}$	1728
Cubic inches	Cubic meters	$1.639 \times 10^{-5}$	61,023
Cubic inches	Cubic yards	$2.143 \times 10^{-3}$	46,656
Cubic inches	Gallons	$4.329 \times 10^{-3}$	231
Dynes	Pounds	$7.233 \times 10^{-5}$	13,826
Ergs	Foot-pounds	$7.3756 \times 10^{-8}$	$1.3558 \times 10^7$
Gallons (U.S.)	Gallons (British)	0.83268	1.20094
Grams	Dynes	980.665	0.0010197
Grams	Grains	15.432	0.0648
Grams	Kilograms	$10^{-3}$	$10^3$
Grams	Ounces (avoir.)	0.03527	28.35
Grams	Pounds	0.07093	14.10
Grams	Pounds	$2.205 \times 10^{-3}$	453.6
Grams per centimeter	Lbs. per in.	$5.600 \times 10^{-2}$	178.6
Grams per c.c.	Lbs. per cu. in.	0.03613	27.680
Grams per sq. cm.	Lbs. per sq. ft.	2.0481	0.4883
Horsepower	B.T.U. per min.	42.40	0.02357
Horsepower	Foot-pounds per min.	33,000	$3.030 \times 10^{-5}$
Horsepower	Kg. calories per min.	10.68	0.09358
Inches	Centimeters	2.540	0.3937
Inches	Feet	$8.333 \times 10^{-2}$	12
Inches	Miles	$1.578 \times 10^{-5}$	$6.336 \times 10^4$
Inches	Mils	$10^3$	$10^{-3}$
Inches	Yards	$2.778 \times 10^{-2}$	36
Inches of mercury (0°C.)	Lbs. per sq. in.	0.49116	2.0360
Joules	Ergs	$10^7$	$10^{-7}$
Kilograms	Tons (2000 lbs.)	0.001102	907.185
Kilometers	Miles	0.62137	1.6094
Kilowatt-hours	B.T.U.	3413	$2.930 \times 10^{-4}$
Kilowatt-hours	Foot-pounds	$2.656 \times 10^8$	$3.766 \times 10^{-7}$
Kilowatt-hours	Horsepower-hours	1.341	0.7455
Kilowatt-hours	Joules	$3.6 \times 10^6$	$2.778 \times 10^{-7}$
Kilowatt-hours	Kilogram-calories	860	$1.163 \times 10^{-3}$
Kilowatt-hours	Kilogram-meters	$3.672 \times 10^5$	$2.723 \times 10^{-6}$
Liters	Cubic centimeters	$10^3$	$10^{-3}$
Liters	Cubic inches	61.02	0.0164
Liters	Cubic meters	$10^{-3}$	$10^3$
Liters	Cubic yards	$1.308 \times 10^{-3}$	764.6
Liters	Gallons (U.S.)	0.26418	3.783
Liters	Pints (liq.)	2.1134	0.4732
Meters	Centimeters	100	0.01
Meters	Feet	3.2808	0.3048
Meters	Inches	39.37	0.0254
Meters	Kilometers	$10^{-3}$	$10^3$
Meters	Miles	$6.214 \times 10^{-4}$	$1.609 \times 10^3$
Meters	Yards	1.094	0.9144
Meters per min.	Centimeters per sec.	1.667	0.6000
Meters per min.	Feet per min.	3.281	0.3048
Meters per min.	Kilometers per hour	0.06	16.67

## CONVERSION TABLE—Continued

To Convert	Info	Multiply by	Conversely Multiply by
Meters per min.	Miles per hour	0.03728	26.82
Miles (nautical)	Feet	6080.2	$1.6447 \times 10^{-1}$
Miles (nautical)	Miles (statute)	1.1516	0.86836
Miles (statute)	Feet	5280	$1.894 \times 10^{-4}$
Miles (statute)	Yards	1760	$5.682 \times 10^{-4}$
Miles per hour	Feet per min.	88	0.01136
Miles per hour	Feet per sec.	1.467	0.6818
Miles per hour	Knots	0.8684	1.152
Pounds	Pounds (weight)	0.03108	32.174
Square inches	Circular mils	$1.273 \times 10^6$	$7.854 \times 10^{-7}$
Square inches	Square centimeters	6.452	0.1550
Square inches	Square feet	$6.944 \times 10^{-3}$	144
Square inches	Square mils	$10^4$	$10^{-8}$
Square inches	Square yards	$7.716 \times 10^{-4}$	1296
Square meters	Square feet	10.7639	0.0929
Square miles	Square kilometers	2.590	0.3861
Tonnes	Tons (2000 lbs.)	1.1023	0.9072
Watts	B.T.U. per minute	0.05688	17.58
Watts	Ergs per second	$10^7$	$10^{-7}$
Watts	Foot-pounds per min.	44.27	0.022597
Watts	Horsepower	$1.341 \times 10^{-3}$	745.7
Watts	Kilogram-calories per min.	0.01433	69.77

## FRACTIONS OF AN INCH WITH METRIC EQUIVALENTS

Fractions of an Inch		Decimals of an Inch	mm.	Fractions of an Inch		Decimals of an Inch	mm.
$\frac{1}{16}$	$\frac{1}{64}$	.0156	0.397	$\frac{17}{32}$	$\frac{33}{64}$	.5156	13.097
	$\frac{2}{64}$	.0313	0.794		$\frac{34}{64}$	.5313	13.494
$\frac{1}{8}$	$\frac{3}{64}$	.0469	1.191	$\frac{9}{16}$	$\frac{35}{64}$	.5469	13.891
	$\frac{4}{64}$	.0625	1.588		$\frac{36}{64}$	.5625	14.288
$\frac{3}{16}$	$\frac{5}{64}$	.0781	1.984	$\frac{10}{16}$	$\frac{37}{64}$	.5781	14.684
	$\frac{6}{64}$	.0938	2.381		$\frac{38}{64}$	.5938	15.081
$\frac{1}{4}$	$\frac{7}{64}$	.1094	2.778	$\frac{5}{8}$	$\frac{39}{64}$	.6094	15.478
	$\frac{8}{64}$	.1250	3.175		$\frac{40}{64}$	.6250	15.875
$\frac{5}{16}$	$\frac{9}{64}$	.1406	3.572	$\frac{21}{32}$	$\frac{41}{64}$	.6406	16.272
	$\frac{10}{64}$	.1563	3.969		$\frac{42}{64}$	.6563	16.669
$\frac{3}{8}$	$\frac{11}{64}$	.1719	4.366	$\frac{11}{16}$	$\frac{43}{64}$	.6719	17.066
	$\frac{12}{64}$	.1875	4.763		$\frac{44}{64}$	.6875	17.463
$\frac{7}{16}$	$\frac{13}{64}$	.2031	5.159	$\frac{23}{32}$	$\frac{45}{64}$	.7031	17.859
	$\frac{14}{64}$	.2188	5.556		$\frac{46}{64}$	.7188	18.256
$\frac{1}{2}$	$\frac{15}{64}$	.2344	5.953	$\frac{3}{4}$	$\frac{47}{64}$	.7344	18.653
	$\frac{16}{64}$	.2500	6.350		$\frac{48}{64}$	.7500	19.050
$\frac{9}{16}$	$\frac{17}{64}$	.2656	6.747	$\frac{5}{8}$	$\frac{49}{64}$	.7656	19.447
	$\frac{18}{64}$	.2813	7.144		$\frac{50}{64}$	.7813	19.844
$\frac{5}{8}$	$\frac{19}{64}$	.2969	7.541	$\frac{13}{16}$	$\frac{51}{64}$	.7969	20.241
	$\frac{20}{64}$	.3125	7.938		$\frac{52}{64}$	.8125	20.638
$\frac{11}{16}$	$\frac{21}{64}$	.3281	8.334	$\frac{27}{32}$	$\frac{53}{64}$	.8281	21.034
	$\frac{22}{64}$	.3438	8.731		$\frac{54}{64}$	.8438	21.431
$\frac{3}{4}$	$\frac{23}{64}$	.3594	9.128	$\frac{7}{8}$	$\frac{55}{64}$	.8594	21.828
	$\frac{24}{64}$	.3750	9.525		$\frac{56}{64}$	.8750	22.225
$\frac{13}{16}$	$\frac{25}{64}$	.3906	9.922	$\frac{29}{32}$	$\frac{57}{64}$	.8906	22.622
	$\frac{26}{64}$	.4063	10.319		$\frac{58}{64}$	.9063	23.019
$\frac{7}{8}$	$\frac{27}{64}$	.4219	10.716	$\frac{15}{8}$	$\frac{59}{64}$	.9219	23.416
	$\frac{28}{64}$	.4375	11.113		$\frac{60}{64}$	.9375	23.813
$\frac{15}{16}$	$\frac{29}{64}$	.4531	11.509	$\frac{31}{32}$	$\frac{61}{64}$	.9531	24.209
	$\frac{30}{64}$	.4688	11.906		$\frac{62}{64}$	.9688	24.606
$\frac{1}{2}$	$\frac{31}{64}$	.4844	12.303	—	$\frac{63}{64}$	.9844	25.003
	$\frac{32}{64}$	.5000	12.700		1.0000	25.400	

## COPPER WIRE TABLE†

Amer. Wire Gauge A.W.G. (B&S)	Birm. Wire Gauge B.W.G.	Imperial or British Std. S.W.G.	ENGLISH UNITS			METRIC UNITS		
			Diam. in Inches	Weight Lbs. per Wire Mile	Resist. Ohms per Wire Mile 20° C (68° F)	Diam. in mm.	Weight Kg. per Wire Km.	Resist. Ohms per Wire Km. 20° C
—	—	—	.1968	618	1.415	5.0	174.0	.879
—	—	—	.1940	600	1.458	4.928	169.1	.905
—	—	6	.1920	589.2	1.485	4.875	166.2	.922
—	—	—	.1855	550	1.590	4.713	155.2	.987
5	7	—	.1819	528.9	1.654	4.620	149.1	1.028
—	—	—	.1800	517.8	1.690	4.575	146.1	1.049
—	—	—	.1771	500	1.749	4.5	141.2	1.086
—	—	7	.1762	495.1	1.769	4.447	140.0	1.098
—	—	—	.1679	450	1.945	4.260	127.1	1.208
—	—	—	.1650	435.1	2.011	4.190	123.0	1.249
6	8	—	.1620	419.5	2.086	4.115	118.3	1.296
—	—	8	.1600	409.2	2.139	4.062	115.3	1.328
—	—	—	.1582	400	2.187	4.018	113.0	1.358
—	—	—	.1575	395.3	2.213	4.0	111.7	1.373
—	—	—	.1480	350.1	2.500	3.760	98.85	1.552
7	9	—	.1443	332.7	2.630	3.665	93.78	1.634
—	—	9	.1440	331.4	2.641	3.658	93.40	1.641
—	—	—	.1378	302.5	2.892	3.5	85.30	1.795
—	—	—	.1370	300	2.916	3.480	84.55	1.812
—	10	—	.1341	287.0	3.050	3.405	80.95	1.893
—	—	—	.1285	263.8	3.317	3.264	74.37	2.061
8	—	10	.1280	261.9	3.342	3.252	73.75	2.077
—	—	—	.1251	250	3.500	3.180	70.50	2.173
—	—	—	.1181	222.8	3.930	3.0	62.85	2.440
9	—	—	.1144	209.2	4.182	2.906	58.98	2.599
—	—	—	.1120	200	4.374	2.845	56.45	2.718
—	12	—	.1090	189.9	4.609	2.768	53.50	2.862
—	—	12	.1040	172.9	5.063	2.640	48.70	3.144
*10	—	—	.1019	165.9	5.274	2.588	46.77	3.277
—	—	—	.0984	154.5	5.670	2.5	43.55	3.520
—	—	—	.0970	150	5.832	2.460	42.30	3.620
—	*14	—	.0830	110.1	7.949	2.108	31.03	4.930
*12	—	—	.0808	104.4	8.386	2.053	29.42	5.211
—	14	—	.0801	102.3	8.556	2.037	28.82	5.315
—	—	—	.0788	99.10	8.830	2.0	27.93	5.480
*13	—	—	.0720	82.74	10.58	1.828	23.33	6.571
*14	—	—	.0641	65.63	13.33	1.628	18.50	8.285
*16	—	—	.0508	41.28	21.20	1.291	11.63	13.17
*19	—	—	.0359	20.58	42.51	.912	5.802	26.42
*22	—	—	.0253	10.27	85.24	.644	2.894	52.96
*24	—	—	.0201	6.46	135.5	.511	1.820	84.21
*27	—	—	.0142	3.22	271.7	.360	.908	168.9

† For additional data on copper wire see page 42.

\* When used in cable, weight and resistance of wire should be increased about 3% to allow for increase due to twist.

## SOLID COPPERWELD WIRE—MECHANICAL AND ELECTRICAL PROPERTIES

Size AWG	Diam. Inch	CROSS SECT. AREA		WEIGHT			RESISTANCE OHMS/1000' AT 68° F.		BREAKING LOAD, LBS.		ATTENUATION—DB PER MILE*				Characteristic Impedance	
		Cir. Mils	Square Inch	Lbs. per 1000'	Lbs. per Mile	Feet per Lb.	40%	30%	40% Conduct.	30% Conduct.	40% Cond.		30% Cond.		40%	30%
											Dry	Wet	Dry	Wet		
4	.2043	41,740	.03278	115.8	611.6	8.63	.6337	.8447	3,541	3,934	—	—	—	—	—	—
5	.1819	33,100	.02600	91.86	485.0	10.89	.0260	.7990	1,065	3,250	—	—	—	—	—	—
6	.1620	26,250	.02062	72.85	384.6	13.73	1.008	1.343	2,433	2,680	.078	.086	.103	.109	650	686
7	.1443	20,820	.01635	57.77	305.0	17.31	1.270	1.694	2,011	2,207	.093	.100	.122	.127	685	732
8	.1285	16,510	.01297	45.81	241.9	21.83	1.602	2.136	1,660	1,815	.111	.118	.144	.149	727	787
9	.1144	13,090	.01028	36.33	191.8	27.52	2.020	2.693	1,368	1,491	.132	.138	.169	.174	776	852
10	.1019	10,380	.008155	28.81	152.1	34.70	2.527	3.396	1,130	1,231	.156	.161	.196	.200	834	920
11	.0907	8,234	.006467	22.85	120.6	43.76	3.212	4.28	896	975	.183	.188	.228	.233	910	1013
12	.0808	6,530	.005129	18.12	95.68	55.19	4.05	5.40	711	770	.216	.220	.262	.266	1000	1120
13	.0720	5,178	.004067	14.37	75.88	69.59	5.11	6.81	490	530						
14	.0641	4,107	.003225	11.40	60.17	87.75	6.44	8.59	400	440						
15	.0571	3,257	.002558	9.038	47.72	110.6	8.12	10.83	300	330						
16	.0508	2,583	.002028	7.167	37.84	139.5	10.24	13.65	250	270						
17	.0453	2,048	.001609	5.684	30.01	175.9	12.91	17.22	185	205						
18	.0403	1,624	.001276	4.507	23.80	221.9	16.28	21.71	153	170						
19	.0359	1,288	.001012	3.575	18.87	279.8	20.53	27.37	122	135						
20	.0320	1,022	.0008023	2.835	14.97	352.8	25.89	34.52	100	110						
21	.0285	810.1	.0006363	2.248	11.87	444.8	32.65	43.52	73.2	81.1						
22	.0253	642.5	.0005046	1.783	9.413	560.9	41.17	54.88	58.0	64.3						
23	.0226	509.5	.0004001	1.414	7.465	707.3	51.92	69.21	46.0	51.0						
24	.0201	404.0	.0003173	1.121	5.920	891.9	65.46	87.27	36.5	40.4						
25	.0179	320.4	.0002517	.889	4.695	1,125	82.55	110.0	28.7	32.1						
26	.0159	254.1	.0001996	.705	3.723	1,418	104.1	138.8	23.0	25.4						
27	.0142	201.5	.0001583	.559	2.953	1,788	131.3	175.0	18.2	20.1						
28	.0126	159.8	.0001255	.443	2.342	2,255	165.5	220.6	14.4	15.9						
29	.0113	126.7	.0000996	.352	1.857	2,843	208.7	278.2	11.4	12.6						
30	.0100	100.5	.0000789	.279	1.473	3,586	263.2	350.8	9.08	10.0						
31	.0089	79.70	.0000626	.221	1.168	4,521	331.9	442.4	7.20	7.95						
32	.0080	63.21	.0000496	.175	.926	5,701	418.5	557.8	5.71	6.30						
33	.0071	50.13	.0000394	.139	.734	7,189	527.7	703.4	4.53	5.00						
34	.0063	39.75	.0000312	.110	.582	9,065	665.4	887.0	3.59	3.97						
35	.0056	31.52	.0000248	.087	.462	11,430	839.0	1119	2.85	3.14						
36	.0050	25.00	.0000196	.069	.366	14,410	1058	1410	2.26	2.49						
37	.0045	19.83	.0000156	.055	.290	18,180	1334	1778	1.79	1.98						
38	.0040	15.72	.0000123	.044	.230	22,920	1682	2243	1.42	1.57						
39	.0035	12.47	.00000979	.035	.183	28,900	2121	2828	1.13	1.24						
40	.0031	9.89	.00000777	.027	.145	36,440	2675	3566	.893	.986						

Note: Copperweld wire in sizes from No. 25 to No. 40 may be difficult to obtain at present due to a shortage of facilities for making these smaller sizes.  
\* DP Insulators, 12-Inch Wire Spacing, 1000 cycles.

## STANDARD STRANDED COPPER CONDUCTORS A.W.G. GAUGE

Circular Mils	A.W.G. Gauge	Number of Wires	Individual Wire Dia. Inches	Cable Dia. Inches	Area Square Inches	Weight Lbs. Per 1000 Ft.	Weight Lbs. Per Mile	*Maximum Resist. Ohms/1000' At 20°C
211,600	4/0	19	.1055	.528	0.1662	653.3	3,450	.05093
167,800	3/0	19	.0940	.470	0.1318	518.1	2,736	.06422
133,100	2/0	19	.0837	.419	0.1045	410.9	2,170	.08097
105,500	1/0	19	.0745	.373	0.08286	325.7	1,720	.1022
83,690	1	19	.0664	.332	0.06573	258.4	1,364	.1288
66,370	2	7	.0974	.292	0.05213	204.9	1,082	.1624
52,630	3	7	.0867	.260	0.04134	162.5	858.0	.2048
41,740	4	7	.0772	.232	0.03278	128.9	680.5	.2582
33,100	5	7	.0688	.206	0.02600	102.2	539.6	.3256
26,250	6	7	.0612	.184	0.02062	81.05	427.9	.4105
20,820	7	7	.0545	.164	0.01635	64.28	339.4	.5176
16,510	8	7	.0486	.146	0.01297	50.98	269.1	.6528
13,090	9	7	.0432	.130	0.01028	40.42	213.4	.8233
10,380	10	7	.0385	.116	0.008152	32.05	169.2	1.038
6,530	12	7	.0305	.0915	0.005129	20.16	106.5	1.650
4,107	14	7	.0242	.0726	0.003226	12.68	66.95	2.624
2,583	16	7	.0192	.0576	0.002029	7.975	42.11	4.172
1,624	18	7	.0152	.0456	0.001275	5.014	26.47	6.636
1,022	20	7	.0121	.0363	0.0008027	3.155	16.66	10.54

\*The resistance values in this table are trade maxima for soft or annealed copper wire and are higher than the average values for commercial cable. The following values for the conductivity and resistivity of copper at 20° centigrade were used:

Conductivity in terms of International Annealed Copper Standard    98.16%  
Resistivity in lbs. per mile-ohm    891.58

The resistance of hard drawn copper is slightly greater than the values given, being about 2% to 3% greater for sizes from 4/0 to #20 AWG.

### MACHINE SCREW HEAD STYLES

and

### METHOD OF LENGTH MEASUREMENT

#### STANDARD

FLAT



OVAL



ROUND



FILLISTER



#### SPECIAL

WASHER



OVAL BINDING



FILLISTER BINDING



FLAT TOP BINDING



STRAIGHT SIDE BINDING



## STANDARD MACHINE SCREW DATA AND CHART FOR HOLE SIZES \*

Size and No. Th'ds.	SCREW			HEAD					HEX. NUT			WASHER			CLEARANCE DRILL		
	O. D.	Depth of Th'd.	Root Dio.	ROUND		FLAT	FILLISTER		Across Flat	Across Corner	Thickness	O. D.	I.D.	Thickness	Close Fit No.   Dia.	Med. Fit & Max. Tol. Bet. Holes No.   Dio.	Free Fits & Max. Tol. Bet. Holes No.   Dio.
				Min. O. D.	Max. Height	Max. O. D.	Min. O. D.	Max. Height									
				Min. O. D.	Max. Height	Max. O. D.	Min. O. D.	Max. Height									
2-56	.086	.0116	.0591	.146	.070	.172	.124	.055	.187	.217	.062	3/16	.105	.020	44-.086	41-.096	
3-48	.099	.0135	.0677	.169	.078	.199	.145	.063	.187	.217	.062	3/16	.105	.020	39-.0995	±.004	±.110
4-40	.112	.0162	.0747	.193	.086	.225	.166	.072	.250	.289	.078	5/16	.120	.025	33-.113	±.005	±.128
5-40	.125	.0162	.0877	.217	.095	.252	.187	.081	.250	.289	.078	3/8	.140	.032	30-.128	±.006	±.144
6-32	.138	.0203	.0974	.240	.103	.279	.208	.089	.250	.289	.078	5/8	.150	.026	28-.140	29-.136 ±.004	27-.144 ±.007
									.312	.361	.109	3/8	.150	.032	23-.154	±.006	18-.169 ±.013
8-32	.164	.0203	.1234	.287	.119	.332	.250	.106	.250	.289	.078	7/8	.170	.032	18-.169	15-.180 ±.006	12-.189 ±.010
									.375	.433	.125	1 1/8	.170	.036			
10-32	.190	.0203	.1494	.334	.136	.385	.292	.123	.312	.361	.109	7/8	.195	.036	10-.193	5-.205 ±.006	2-.221 ±.013
									.375	.433	.125	1 1/8	.195	.040			
12-24	.216	.0271	.1619	.382	.152	.438	.334	.141	.375	.433	.125	3/8	.228	.060	2-.221	B-.238 ±.009	E-.250 ±.015
									.437	.505	.125	5/8	.228	.060			
1/4-20	.250	.0325	.185	.443	.174	.507	.389	.163	.437	.505	.125	3/4	.260	.040	F-.257	1-.272 ±.009	1-.290 ±.018
									.500	.577	.156	1 1/8	.260	.051			
											.156						
5/16-18	.312	.0361	.2403	.557	.214	.636	.490	.205	.562	.650	.218	3/8	11/16	.064	O-.316	R-.339 ±.011	T-.358 ±.021
												7/8	1 1/8	.064			
3/8-16	.375	.0406	.2938	.670	.254	.762	.590	.246	.625	.722	.250	7/8	.385	.064	V-.377	Z-.413 ±.017	1/8-.437 ±.029
												1	.385	.081			
1/2-14	.437	.0464	.3447						.750	.866	.250	1 1/8	3/8	.081	39-453	15/16-.468 ±.013	3/8-.500 ±.029
3/4-13	.500	.0500	.4001						.875	1.010	.500	1 3/8	5/8	.091	48-516	1 1/8-.531 ±.013	1/2-.562 ±.029

\* All dimensions in inches.

## INSULATING MATERIALS

Material	Dielectric Constant at 1 Megacycle	Dielectric Strength kv/mm*	Resistivity Ohms-cm 25° C.	Power Factor at 1 Megacycle	Material	Dielectric Constant at 1 Megacycle	Dielectric Strength kv/mm*	Resistivity Ohms-cm 25° C.	Power Factor at 1 Megacycle
Aniline formaldehyde resin	3.38	> 24	> 10 <sup>13</sup>	0.006	Marble, Italian	—	—	10 <sup>11</sup>	—
Bakelite					Methyl Methacrylate	2.8-3.3	20	10 <sup>16</sup>	0.015-0.03
cotton fabric base	4.5-7	6-16	10 <sup>16</sup> -10 <sup>13</sup>	.02-.08	Mica	2.5-7	50-220	2x10 <sup>17</sup>	.0001-.001
glass fabric base	3.7-4.5	18-26	—	.01-.02	Micanite (non-flexible grade)	7	—	3x10 <sup>9</sup>	0.0018
mineral filler	4.5-20	10-16	10 <sup>9</sup> -10 <sup>11</sup>	.005-0.1	Mycalex	8.5	—	10 <sup>13</sup>	0.022
macerated fabric	4.5-6	6-18	10 <sup>9</sup> -10 <sup>11</sup>	.04-0.1	Nylon	3.6	—	10 <sup>12</sup>	—
no filler	4-5.5	16-19	1.5x10 <sup>13</sup>	.015-.04	Oil, Paraffin	2.2-4.7	16-21	—	—
paper base (laminated)	3.6-5.5	10-23	10 <sup>16</sup> -10 <sup>13</sup>	.02-.08	Ozokerite	2.2	4-6	4.5x10 <sup>14</sup>	—
wood flour filler	4.5-8	12-19	10 <sup>16</sup> -10 <sup>13</sup>	.035-0.1	Paper-paraffined	2.0-2.6	50	—	—
Casein	6.15-6.8	16-28	—	0.052	Paper-varnished	—	10-25	—	—
Cellulose Acetate (high acetyl content)	4.4-5.3 (60 cycles)	14-18	—	0.01-0.02 (60 cycles)	Paraffin	2.1-2.5	8-12	10 <sup>16</sup> -10 <sup>19</sup>	.0003 (at 900 cycles)
Cellulose Acetate moulding	3.2-6.2	14-36	.7-1.4x10 <sup>13</sup>	.01-.05	Polyethylene	2.2	—	10 <sup>17</sup>	0.0006
Cellulose Acetate sheet	3-5	12-32	(5-30)x10 <sup>13</sup>	.04-.09	Polyisobutylene	2.5	—	10 <sup>16</sup>	0.0005
Cellulose Acetabutyrate	3.2-6.2	10-16	.7-1.4x10 <sup>13</sup>	0.01-0.05	Polystyrene	2.5-2.6	20-28	10 <sup>17</sup> -10 <sup>20</sup>	.0002-.0004
Chlorinated Rubber	3 (60 cycles)	90	2.5x10 <sup>13</sup>	0.006	Polyvinyl Chloride (plasticized)	6.5-12 (at 60 cycles)	24-80	.8-2.6x10 <sup>14</sup>	0.08-0.12 (at 60 cycles)
Dilactene 100	3.6-3.7	16-25	—	.006	Porcelain	5.5-7	—	5x10 <sup>8</sup>	.005-.015 Rises rapidly at H.F.
Ebonite	2.8	30-110	10 <sup>16</sup>	.0062	Parcelain Unglazed	—	—	3x10 <sup>14</sup>	—
Empire Cloth	2	8-30	10 <sup>9</sup> -10 <sup>8</sup>	Poor	Quartz	4.7	—	10 <sup>14</sup> -10 <sup>18</sup>	.00015
Ethyl Cellulose	2.0-3.0	—	10 <sup>15</sup>	0.007-0.03	Rubber	2-3.5	16-50	—	—
Fibre-Red	2.5-5	2	5x10 <sup>9</sup>	—	Rubber, Hard	3	10-35	10 <sup>12</sup> -10 <sup>15</sup>	.003-.008
Fibre-Phenol	6	—	Varies	Poor	Shellac	2.9-3.7	—	10 <sup>16</sup>	—
Fuller (or Press) Board	3-5	4-30	—	—	Slate	6-7.4	—	10 <sup>4</sup> -10 <sup>8</sup>	Poor
Glass	5.4-9.9	30-150	—	—	Steatite	6.1	—	10 <sup>14</sup> -10 <sup>13</sup>	.002
Glass Plate	—	—	2x10 <sup>13</sup>	—	Trolitul (German polystyrene)	2.2-2.3	20-28	10 <sup>20</sup>	.0002
Glass Pyrex	4.5	—	10 <sup>14</sup>	.0006-.01	Urea-formaldehyde Resin (cellulose filled)	6.6-7.7	26-29	10 <sup>12</sup> -10 <sup>13</sup>	0.027-0.035
Gutta Percha	3.1-4.9 (at 1000 cycles)	8-20	5x10 <sup>14</sup> or 15	.01-.03 (at 1000 cycles)	Urea Melamine Formaldehyde Resin (cellulose filled)	11.5-11.6 (at 60 cycles)	1.3	—	0.15-0.17 (at 60 cycles)
Halowax (saturant)	4.9-5.5	—	10 <sup>12</sup> -10 <sup>14</sup>	.0005-.002	Vinyl Chloride-acetate (Vinylite) no filler	3.0-3.4	16-20	> 10 <sup>14</sup>	0.01-.02
Intelin IN4.5	2.40-2.44	10-14	Above 10 <sup>15</sup>	.0007	Vinylidene Chloride	3-5	20	10 <sup>14</sup> -10 <sup>16</sup>	0.03-.05
Isolanite	6	—	2.75x10 <sup>14</sup>	.0018 After conditioning in water	Wood	2.5-7.7	—	—	—
Isomerized Rubber	2.7 (at 60 cycles)	—	5-7x10 <sup>16</sup>	0.002	Wood, Paraffined Mahog.	—	—	4x10 <sup>13</sup>	—
Ivory	—	—	2x10 <sup>8</sup>	—	Wood, Bakelized	—	—	7x10 <sup>4</sup>	Poor
Morble	8	—	10 <sup>4</sup> -10 <sup>8</sup>	Poor	Wood, Teak (waxed-oiled)	—	—	10 <sup>2</sup> -10 <sup>5</sup>	—

To convert kilovolts per millimeter to volts per mil, multiply by 25.4



## PLASTICS: TRADE NAMES

Trade Name	Composition	Trade Name	Composition
Acryloid . . . . .	Methacrylate Resin	Melmac . . . . .	Melamine Formaldehyde
Alvar . . . . .	Polyvinyl Acetal	Micarta . . . . .	Phenol Formaldehyde (Lamination)
Amerith . . . . .	Cellulose Nitrate	Monsanto . . . . .	Cellulose Nitrate
Ameroid . . . . .	Casein	Monsanto . . . . .	Polyvinyl Acetals
Bakelite . . . . .	Phenol Formaldehyde	Monsanto . . . . .	Cellulose Acetate
Bakelite . . . . .	Urea Formaldehyde	Monsanto . . . . .	Phenol Formaldehyde
Bakelite . . . . .	Cellulose Acetate	Nitron . . . . .	Cellulose Nitrate
Bakelite . . . . .	Polystyrene	Nixonoid . . . . .	Cellulose Nitrate
Beetle . . . . .	Urea Formaldehyde	Nixonite . . . . .	Cellulose Acetate
Butacite . . . . .	Polyvinyl Butyral	Nylon . . . . .	Super Polyamide
Butvar . . . . .	Polyvinyl Butyral	Opalon . . . . .	Phenol Formaldehyde
Catalin . . . . .	Phenol Formaldehyde—Cast	Plaskon . . . . .	Urea Formaldehyde
Celluloid . . . . .	Cellulose Nitrate	Plastacele . . . . .	Cellulose Acetate
Crystalite . . . . .	Acrylate and Methacrylate Resin	Plexiglas . . . . .	Acrylate and Methacrylate Resin
Dilectene 100 . . . . .	Aniline Formaldehyde Synthetic Resin	Ptioform . . . . .	Rubber Derivative
Distrene . . . . .	Polystyrene	Protectoid . . . . .	Cellulose Acetate
Durez . . . . .	Phenol Formaldehyde	Prystal . . . . .	Phenol Formaldehyde
Durite . . . . .	Phenol Formaldehyde	Pyralin . . . . .	Cellulose Nitrate
Durite . . . . .	Phenolic Furfural	Resinox . . . . .	Phenol Formaldehyde
Ethocel . . . . .	Ethylcellulose	Rezoglaz . . . . .	Polystyrene
Ethocel PG . . . . .	Ethylcellulose	Rhodolene M . . . . .	Polystyrene
Ethofoil . . . . .	Ethylcellulose	Ronilla L . . . . .	Polystyrene
Fibestos . . . . .	Cellulose Acetate	Saflex . . . . .	Polyvinyl Butyral
Formica . . . . .	Phenol Formaldehyde (Lamination)	Saran . . . . .	Polyvinylidene Chloride
Formvar . . . . .	Polyvinyl Formal	Styraflex . . . . .	Polystyrene
Gelva . . . . .	Polyvinyl Acetate	Styron . . . . .	Polystyrene
Gemstone . . . . .	Phenol Formaldehyde	Super Styrex . . . . .	Polystyrene
Heresite . . . . .	Phenol Formaldehyde	Tenite . . . . .	Cellulose Acetate
Indur . . . . .	Phenol Formaldehyde	Tenite II . . . . .	Cellulose Acetate Butyrate
Intelin IN 45 . . . . .	Polystyrene	Textolite . . . . .	Various
Koroseal . . . . .	Modified Polyvinyl Chloride	Tornesit . . . . .	Rubber Derivative
Loalain . . . . .	Polystyrene	Trolitul . . . . .	Polystyrene
Lucite . . . . .	Methyl Methacrylate Resin	Vec . . . . .	Polyvinylidene Chloride
Lumarith . . . . .	Cellulose Acetate	Victron . . . . .	Polystyrene
Lumarith X . . . . .	Cellulose Acetate	Vynlite A . . . . .	Polyvinyl Acetate
Lustron . . . . .	Polystyrene	Vynlite Q . . . . .	Polyvinyl Chloride
Makalot . . . . .	Phenol Formaldehyde	Vynlite V . . . . .	Vinyl Chloride-Acetate Copolymer
Marblette . . . . .	Phenol Formaldehyde—Cast	Vynlite X . . . . .	Polyvinyl Butyral

## PHYSICAL CONSTANTS OF VARIOUS METALS\*

Annealed Copper = 10.4 ohms, circular mils per foot at 20°C

The absolute resistivity of copper in both c.g.s. and English system of units is given in two equations.

$$= 1.7241 \times 10^{-6} \text{ ohm-cm at } 20^\circ \text{ C., or}$$

$$1 \text{ ohm-cm} = 6.02 \times 10^6 \text{ ohm circular mils per foot.}$$

Material	Relative Resistance	Temp. Co-eff. of Resistivity $\alpha$ 1/°C	Specific Gravity	Co-efficient of Thermal Cond. K cal/sec/°C/cm.	Specific Heat. s cal/gm/°C
Copper annealed	1.00	.00393	8.89	.918	.0921
hard drawn	1.03	.00382	8.89		
Advance	28.45	.00001	8.90		
Aluminum	1.64	.0034	2.70	0.5	.214
Antimony	24.21	.0036	6.6	.04	.05
Arsenic	19.33	.0042	5.73		.078
Bismuth	69.8	.004	9.8	.018	.029
Brass	4.06	.002	8.6	.204	.092
Cadmium	4.41	.0038	8.6	.22	.055
Calido	58.1	.0004	8.2		
Climax	50.5	.0007	8.1		
Cobalt	5.70	.0033	8.71		.100
Constantan	28.45	.00001	8.9	.054	.100
Eureka	28.45	.00001	8.9		
Excello	53.4	.00016	8.9		
Gas Carbon	2900	-.0005			.204
German Silver					
18% Nickel	19.17	.0004	8.4	.07	.095
Gold	1.416	.0034	19.3	.70	.0312
Ideal	28.45	.00001	8.9		
Iron, pure	5.81	.005	7.8	.161	.107
Lead	12.78	.0039	11.4	.083	.0306
Magnesium	2.67	.004	1.74	.376	.246
Manganin	25.6	.00001	8.4	.152	.096
Mercury	55.6	.00089	13.55	.015	.0333
Molybdenum drawn	3.31	.004	9.0	.346	.065
Monel metal	24.4	.002	8.9		
Nichrome	58.1	.0004	8.2		
Nickel	4.53	.006	8.9	.142	.105
Palladium	6.39	.0033	12.2	.168	.053
Phosphor-Bronze	4.52	.0018	8.9		
Platinum	5.81	.003	21.4	.166	.0324
Silver	0.924	.0038	10.5	1.00	.056
Steel E.B.B.	6.05	.005	7.7	.115	.110
Steel B.B.	6.92	.004	7.7	.115	.110
Steel, Siemens Martin	10.45	.003	7.7	.115	.110
Steel, manganese	40.6	.001	7.5	.115	.110
Tantalum	9.00	.0031	16.6	.130	.036
Therlo	27.3	.00001	8.2		
Tin	8.72	.0042	7.3	.155	.054
Tungsten, drawn	3.25	.0045	19	.476	.034
Zinc	3.36	.0037	7.1	.265	.093

\*For definitions of physical constants see page 20.

## DEFINITIONS OF PHYSICAL CONSTANTS IN PRECEDING TABLE

The preceding table of relative resistances gives the ratio of the resistance of any material to the resistance of a piece of annealed copper of identical physical dimensions and temperature.

I. The resistance of any substance of uniform cross-section is proportional to the length and inversely proportional to the cross-sectioned area.

$R = \frac{\rho l}{A}$ , where  $\rho$  = resistivity, the proportionality constant,

$l$  = length,  $A$  = cross-sectional area,  $R$  = resistance in ohms.

If  $l$  and  $A$  are measured in centimeters,  $\rho$  is in ohm-centimeters.

If  $l$  is measured in feet, and  $A$  in circular mils,  $\rho$  is in ohm-circular mils per foot.

II. The temperature co-efficient of resistivity gives the ratio of the change in resistivity due to a change in temperature of  $1^\circ \text{C}$  relative to the resistivity at  $20^\circ \text{C}$ . The dimensions of this quantity are ohms per  $^\circ \text{C}$  per ohm or  $1/^\circ \text{C}$ .

The resistance at any temperature is:—

$$R = R_0 (1 + \alpha T).$$

$R_0$  = resistance at  $0^\circ$  in ohms.

$T$  = temperature in degrees centigrade.

$\alpha$  = temperature co-efficient of resistivity  $1/^\circ \text{C}$ .

III. The specific gravity of a substance is defined as the ratio of the weight of a given volume of the substance to the weight of an equal volume of water.

In the c.g.s. system, the specific gravity of a substance is exactly equal to the weight in grams of one cubic centimeter of the substance.

IV. Co-efficient of thermal conductivity is defined as the amount of heat in calories transferred across the face of a unit cube in one second when the temperature difference between the opposite faces is maintained at one degree centigrade.

$$H = \frac{KA\Delta T\Delta t}{l}$$

$H$  = total transferred heat in calories

$A$  = area of cross-section in sq. cm.

$l$  = length in cm.

$\Delta T$  = change in temperature in  $^\circ \text{C}$ .

$\Delta t$  = time interval in seconds.

$K$  = co-efficient of thermal conductivity in cal/sec/ $^\circ \text{C}$ /cm.

V. Specific heat is defined as the number of calories required to heat one gram of a substance one degree Centigrade.

$H = ms\Delta T$  or change in heat.  $m$  = mass in grams.

$\Delta T$  = temp. change  $^\circ \text{C}$ .  $s$  = specific heat in cal/gm/ $^\circ \text{C}$ .

## FUSING CURRENTS OF WIRE

Table giving the diameters of wires of various materials which will be fused by a current of given strength.

Amperes	DIAMETERS OF WIRES, Inches								
	Copper	Alumi-num	Plati-num	German silver	Plati-noid	Iron	Tin	Tin-lead alloy	Lead
1	0.0021	0.0026	0.0033	0.0033	0.0035	0.0047	0.0072	0.0083	0.0081
2	0.0034	0.0041	0.0053	0.0053	0.0056	0.0074	0.0113	0.0132	0.0128
3	0.0044	0.0054	0.007	0.0069	0.0074	0.0097	0.0149	0.0173	0.0168
4	0.0053	0.0065	0.0084	0.0084	0.0089	0.0117	0.0181	0.021	0.0203
5	0.0062	0.0076	0.0098	0.0097	0.0104	0.0136	0.021	0.0243	0.0236
10	0.0098	0.012	0.0155	0.0154	0.0164	0.0216	0.0334	0.0386	0.0375
15	0.0129	0.0158	0.0203	0.0202	0.0215	0.0283	0.0437	0.0506	0.0491
20	0.0156	0.0191	0.0246	0.0245	0.0261	0.0343	0.0529	0.0613	0.0595
25	0.0181	0.0222	0.0286	0.0284	0.0303	0.0398	0.0614	0.0711	0.069
30	0.0205	0.025	0.0323	0.032	0.0342	0.045	0.0694	0.0803	0.0779
35	0.0227	0.0277	0.0358	0.0356	0.0379	0.0498	0.0769	0.089	0.0864
40	0.0248	0.0303	0.0391	0.0388	0.0414	0.0545	0.084	0.0973	0.0944
45	0.0268	0.0328	0.0423	0.042	0.0448	0.0589	0.0909	0.1052	0.1021
50	0.0288	0.0352	0.0454	0.045	0.048	0.0632	0.0975	0.1129	0.1095
60	0.0325	0.0397	0.0513	0.0509	0.0542	0.0714	0.1101	0.1275	0.1237
70	0.036	0.044	0.0568	0.0564	0.0601	0.0791	0.122	0.1413	0.1371
80	0.0394	0.0481	0.0621	0.0616	0.0657	0.0864	0.1334	0.1544	0.1499
90	0.0426	0.052	0.0672	0.0667	0.0711	0.0935	0.1443	0.1671	0.1621
100	0.0457	0.0558	0.072	0.0715	0.0762	0.1003	0.1548	0.1792	0.1739
120	0.0516	0.063	0.0814	0.0808	0.0861	0.1133	0.1748	0.2024	0.1964
140	0.0572	0.0798	0.0902	0.0895	0.0954	0.1255	0.1937	0.2243	0.2176
160	0.0625	0.0763	0.0986	0.0978	0.1043	0.1372	0.2118	0.2452	0.2379
180	0.0676	0.0826	0.1066	0.1058	0.1128	0.1484	0.2291	0.2652	0.2573
200	0.0725	0.0886	0.1144	0.1135	0.121	0.1592	0.2457	0.2845	0.276
225	0.0784	0.0958	0.1237	0.1228	0.1309	0.1722	0.2658	0.3077	0.2986
250	0.0841	0.1028	0.1327	0.1317	0.1404	0.1848	0.2851	0.3301	0.3203
275	0.0897	0.1095	0.1414	0.1404	0.1497	0.1969	0.3038	0.3518	0.3417
300	0.097	0.1161	0.1498	0.1487	0.1586	0.2086	0.322	0.3728	0.3617

From "Overhead Systems Handbook," N.E.L.A., 1927.

## MELTING POINTS OF SOLDER

Pure Alloys		Melting Points	
Per Cent Tin	Per Cent Lead	Degrees Centigrade	Degrees Fahrenheit
100		232	450
90	10	213	415
80	20	196	385
70	30	186	367
65	35	181	358
60	40	188	370
50	50	212	414
40	60	238	460
30	70	257	496
20	80	290	554
10	90	302	576
	100	327	620

# TEMPERATURE CHART OF HEATED METALS

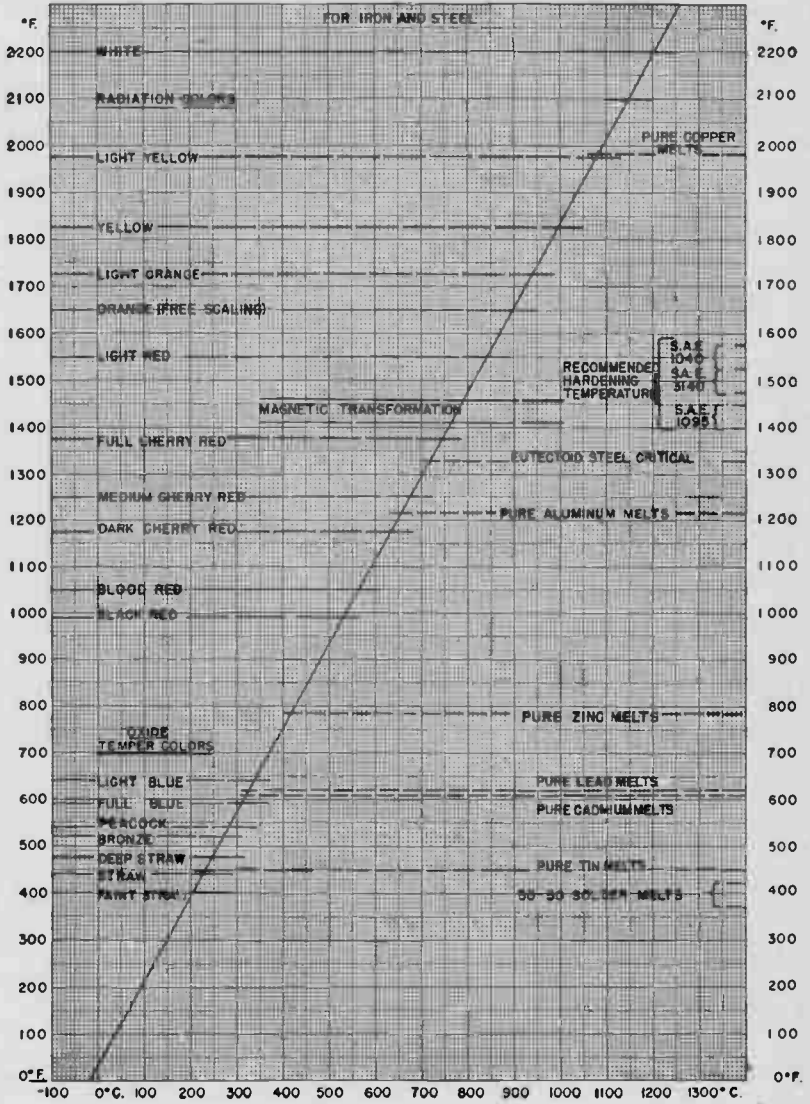

### SPARK GAP VOLTAGES

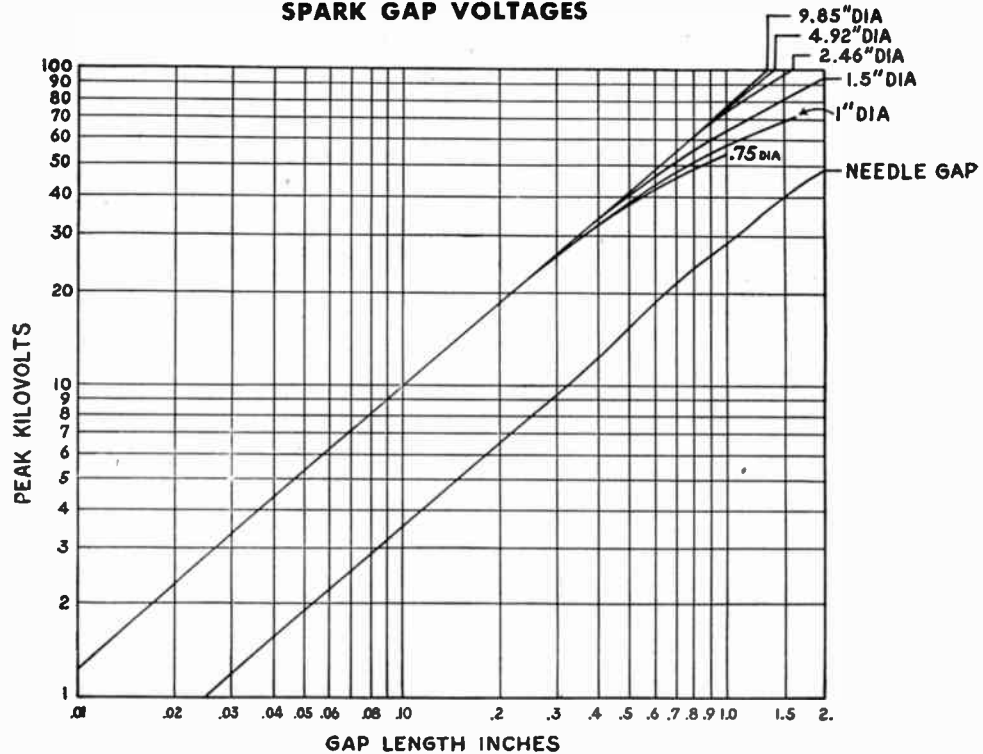

SPARK OVER VOLTAGE  
25° C. 760 M.M.

## THERMOCOUPLES AND THEIR CHARACTERISTICS

Type	Copper/Constantan	Iron/Constantan	Chromel/Constantan	Chromel/Alumel	Platinum/Platinum Rhodium (10)	Platinum/Platinum Rhodium (13)	Carbon/Silicon Carbide
Composition, %	100Cu 99.9Cu 54Cu 46Ni 55Cu 45Ni 60Cu 40Ni	100Fe 55Cu 44Ni .5Mn + Fe, Si	90Ni 10Cr 55Cu 45Ni	90Ni 10Cr 89.6Ni 8.9Cr 89Ni 10Cr 95Ni 2Al 2Mn 1Si 97Ni 3Al + Si 94Ni 2Al 1Si 2.5Mn 0.5Fe 89Ni 9.8Cr 1Fe 0.2Mn	Pt. 90Pt 10Rh	Pt 87Pt 13Rh	C SIC
Range of Application, °C.	-250 to +600	-200 to +1050	0 to 1100	0 to 1100	0 to 1550		to 2000
Resistivity, micro-ohm-C.M.	1.75 49	10 49	70 49	70 29.4	10 21		
Temperature Coefficient of resistivity, °C.	.0039 .00001	.005 .00001	.00035 .0002	.00035 .000125	.0030 .0018		
Melting Temperature, °C.	1085 1190	1535 1190	1400 1190	1400 1430	1735 1700		3000 2700
E.M.F. in mV ref. junction at 0°C.	100°C. 4.24mV. 200 9.06 300 14.42	100°C. 5.28mV. 200 10.78 400 21.82 600 33.16 800 45.48 1000 58.16	100°C. 6.3mV. 200 13.3 400 28.5 600 44.3	100°C. 4.1 mV. 200 8.13 400 16.39 600 24.90 800 33.31 1000 41.31 1200 48.85 1400 55.81	100°C. 0.643mV. 200 1.436 400 3.251 600 5.222 800 7.330 1000 9.569 1200 11.924 1400 14.312 1600 16.674	100°C. 0.646mV. 200 1.464 400 3.398 600 5.561 800 7.927 1000 10.470 1200 13.181 1400 15.940 1600 18.680	1210°C. 353.6mV. 1300 385.2 1360 403.2 1450 424.9
Influence of Temperature and gas atmosphere	Subject to oxidation and alteration above 400°C. due Cu, above 600° due constantan wire. Ni-plating of Cu tube gives protection, in acid-containing gas. Contamination of Cu affects calibration greatly. Resistance to oxid. atm. good. Resistance to reducing atm. good. Requires protection from acid fumes.	Oxidizing and reducing atm. have little effect on accuracy. Best used in dry atm. Resistance to oxidation good to 400°C. Resistance to reducing atm. good. Protect from oxygen, moisture, sulphur.	Chromel attacked by sulphurous atm. Resistance to oxidation good. Resistance to reducing atm. poor.	Resistance to oxidizing atm. very good. Resistance to reducing atm. poor. Affected by sulphur, reducing or sulphurous gas, SO <sub>2</sub> and H <sub>2</sub> S.	Resistance to oxidizing atm. very good. Resistance to reducing atm. poor. Susceptible to chemical alteration by As, Si, P vapor in reducing gas (CO <sub>2</sub> , H <sub>2</sub> , H <sub>2</sub> S, SO <sub>2</sub> ). Pt corrodes easily above 1000°. Used in gas-tight protecting tube.		Used as tube element. Carbon sheath chemically inert.
Particular Applications	Low temperature, industrial. Internal combustion engine. Used as a tube element for measurements in steam line.	Low temperature, industrial. Steel annealing, boiler flues, tube stills. Used in reducing or neutral atm.		Used in oxidizing atm. Industrial. Ceramic kilns, tube stills, electric furnaces.	International Standard 630 to 1065°C	Similar to Pt/pRh(10) but has higher e.m.f.	Steel furnace and ladle temperatures. Laboratory measurements.

## CHARACTERISTICS OF TYPICAL THERMOCOUPLES

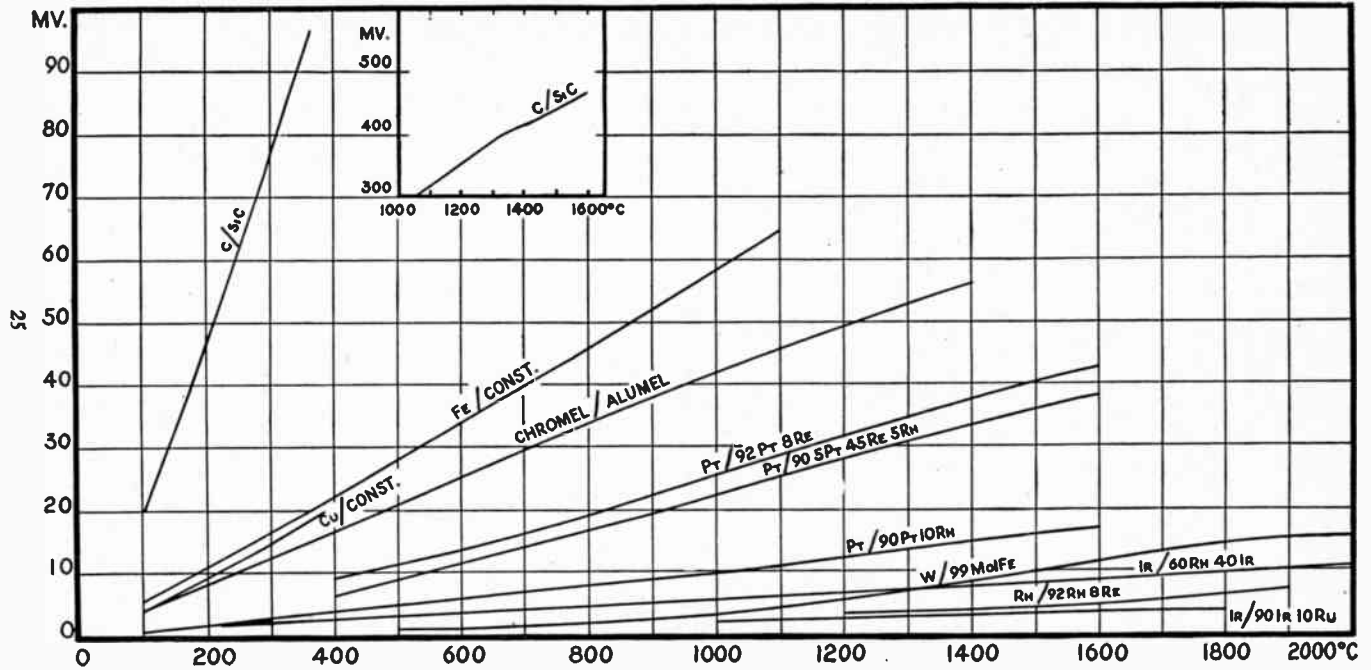



## HEAD OF WATER IN FEET AND APPROXIMATE DISCHARGE RATE

**TABLE I**

Discharge in gallons per minute through 1,000 ft. pipe line of  $\frac{1}{2}$ " to 6" bore with average number of bends and fittings. For other pipe lengths see Table II.

Head of Fall in Feet	DISCHARGE IN GALLONS PER MINUTE											
	$\frac{1}{2}$ "	$\frac{3}{4}$ "	1"	$1\frac{1}{4}$ "	$1\frac{1}{2}$ "	2"	$2\frac{1}{2}$ "	3"	$3\frac{1}{2}$ "	4"	5"	6"
1	.19	.54	1.11	1.96	3.09	6.34	11.07	17.41	25.58	35.79	62.57	98.72
2	.28	.77	1.59	2.76	4.36	8.96	15.61	24.62	36.15	50.56	88.39	139.31
4	.40	1.09	2.25	3.92	6.17	12.73	22.10	34.95	51.28	71.58	124.90	196.54
6	.48	1.33	2.75	4.78	7.55	15.49	27.02	42.63	62.69	87.67	152.52	241.39
9	.59	1.63	3.36	5.86	9.26	19.09	33.27	52.36	76.98	107.48	187.35	295.43
12	.68	1.89	3.90	6.77	10.69	21.98	38.43	60.53	88.87	123.70	216.17	342.27
16	.79	2.17	4.48	7.82	12.37	25.34	44.31	69.77	102.56	142.91	249.80	395.11
20	.89	2.44	5.02	8.74	13.81	28.34	49.48	77.94	114.57	159.73	279.82	440.74
25	.98	2.73	5.61	9.78	15.50	31.70	55.36	87.19	127.30	178.94	312.24	493.59
30	1.08	2.98	6.14	10.71	16.93	34.59	60.65	95.47	139.31	195.75	342.27	540.42
40	1.25	3.46	7.10	12.37	19.58	40.23	70.01	110.49	162.13	225.78	395.11	624.49
50	1.39	3.86	7.94	13.81	21.86	44.92	78.30	122.50	180.14	252.20	441.95	697.75
75	1.71	4.72	9.73	16.93	26.78	54.88	95.96	150.12	220.97	309.84	541.62	855.07
100	1.98	5.46	11.23	19.58	30.81	63.41	110.72	174.14	255.80	357.88	625.69	987.17
150	2.44	6.71	13.81	23.90	37.83	77.94	139.19	213.77	314.65	439.54	765.00	1,214.15
200	2.80	7.71	15.85	27.62	43.59	89.59	156.12	246.19	361.48	505.60	883.89	1,394.29
250	3.13	8.65	17.77	30.81	48.88	100.52	175.34	276.22	404.72	565.64	989.57	1,564.82
500	4.43	12.25	25.10	43.71	69.05	141.71	247.39	390.31	571.65	801.03	1,397.89	2,209.73

26

**TABLE II**

Multiplication factor to be applied to Table I for pipe lengths other than 1,000 ft.

Length in feet.....	50	100	150	200	300	400	500	750	1,000	1,250	1,500
Factor.....	4.47	3.16	2.58	2.237	1.827	1.580	1.414	1.154	1.0	.895	.817
Length in feet.....	1,750	2,000	2,500	3,000	4,000	5,000	7,500	10,000	5 mi.	10 mi.	50 mi.
Factor.....	.756	.707	.633	.577	.500	.447	.365	.316	.195	.138	.0616

**Example:** Required—approximate discharge of a line of piping 4" bore, 5,000 feet long, under 30 foot head.  
 Approximate discharge for the 1,000 foot line from Table I = 195.75 gallons per minute. Factor from Table II = .447.  
 $\therefore$  Approximate discharge = 195.75 x .447 = 87.5

### DISSIPATION AND TEMPERATURE RISE OF COOLING WATER

$$P = 0.01844 Q (T_2 - T_1)$$

Where Q = flow in gallons per min.,  $T_2$  and  $T_1$  = outlet and inlet temperature in  $^{\circ}$ C,  
 P = power in kilowatts.

## WIND VELOCITIES AND PRESSURES

Indicated Velocities Miles per Hour $V_i$ *	Actual Velocities Miles per Hour $V_a$	CYLINDRICAL SURFACES	FLAT SURFACES
		Pressure Lbs. per Sq. Ft. Projected Areas $P = 0.0025 V_a^2$	Pressure Lbs. per Sq. Ft. $P = 0.0042 V_a^2$
10	9.6	0.23	0.4
20	17.8	0.8	1.3
30	25.7	1.7	2.8
40	33.3	2.8	4.7
50	40.8	4.2	7.0
60	48.0	5.8	9.7
70	55.2	7.6	12.8
80	62.2	9.7	16.2
90	69.2	12.0	20.1
100	76.2	14.5	24.3
110	83.2	17.3	29.1
120	90.2	20.3	34.2
125	93.7	21.9	36.9
130	97.2	23.6	39.7
140	104.2	27.2	45.6
150	111.2	30.9	51.9
160	118.2	34.9	58.6
170	125.2	39.2	65.7
175	128.7	41.4	69.5
180	132.2	43.7	73.5
190	139.2	48.5	81.5
200	146.2	53.5	89.8

\*As measured with a cup anemometer, these being the average maximum for a period of five minutes

## WEATHER DATA

Compiled from "Climate and Man", Yearbook of Agriculture, U. S. Dept. of Agriculture, U. S. Govt. Printing Office, Washington, D. C., 1941.

### TEMPERATURE EXTREMES

#### United States

Lowest Temperature —66° F. Riverside Range Station, Wyoming (Feb. 9, 1933)  
 Highest Temperature 134° F. Greenland Ranch, Death Valley, California (July 10, 1933)

#### Alaska

Lowest Temperature —78° F. Fort Yukon (Jan. 14, 1934)  
 Highest Temperature 100° F. Fort Yukon

#### World

Lowest Temperature —90° F. Verkhoyansk, Siberia (Feb. 5 and 7, 1892)  
 Highest Temperature 136° F. Azizio, Libya, North Africa (Sept. 13, 1922)  
 Lowest Mean Temperature (annual) —14° F. Fromheim, Antarctica  
 Highest Mean Temperature (annual) 86° F. Massawa, Eritreo, Africa

### PRECIPITATION EXTREMES

#### United States

Wettest State Louisiana—average annual rainfall 55.11 in.  
 Driest State Nevada—average annual rainfall 8.81 in.  
 Maximum Recorded New Smyrna, Fla., Oct. 10, 1924—23.22 in. in 24 hours  
 Minimum Recorded Bagdad, Calif., 1909-1913—3.93 in. in 5 years  
 Greenland Ranch, Calif.—1.35 in. annual average

#### World

Maximum Recorded Cherrapunji, India, Aug. 1841—241 in. in 1 month  
 (Average annual rainfall of Cherrapunji is 426 in.)  
 Bagui, Luzon, Philippines, July 14-15, 1911—46 in. in 24 hours  
 Minimum Recorded Wadi Halfa, Anglo-Egyptian Sudan and Awon, Egypt are in the "rainless" area; average annual rainfall is too small to be measured.

## WORLD TEMPERATURES

	Max. ° F.	Min. ° F.
<b>NORTH AMERICA</b>		
Alaska . . . . .	100	-78
Canada . . . . .	103	-70
Canal Zone . . . . .	97	63
Greenland . . . . .	86	-46
Mexico . . . . .	118	11
U. S. A. . . . .	134	-66
West Indies . . . . .	102	45
<b>SOUTH AMERICA</b>		
Argentina . . . . .	115	-27
Bolivia . . . . .	82	25
Brazil . . . . .	108	21
Chile . . . . .	99	19
Venezuela . . . . .	102	45
<b>EUROPE</b>		
British Isles . . . . .	100	4
France . . . . .	107	-14
Germany . . . . .	100	-16
Iceland . . . . .	71	-6
Italy . . . . .	114	4
Norway . . . . .	95	-26
Spain . . . . .	124	10
Sweden . . . . .	92	-49
Turkey . . . . .	100	17
U. S. S. R. . . . .	110	-61
<b>ASIA</b>		
Arabia . . . . .	114	53
China . . . . .	111	-10
East Indies . . . . .	101	60
French Indo-China . . . . .	113	33
India . . . . .	120	-19
Iraq . . . . .	123	19
Japan . . . . .	101	-7
Malay States . . . . .	97	66
Philippine Islands . . . . .	101	58
Siam . . . . .	106	52
Tibet . . . . .	85	-20
Turkey . . . . .	111	-22
U. S. S. R. . . . .	109	-90
<b>AFRICA</b>		
Algeria . . . . .	133	1
Anglo-Egyptian Sudan . . . . .	126	28
Angola . . . . .	91	33
Belgian Congo . . . . .	97	34
Egypt . . . . .	124	31
Ethiopia . . . . .	111	32
French Equatorial Africa . . . . .	118	46
French West Africa . . . . .	122	41
Italian Somaliland . . . . .	93	61
Libya . . . . .	136	35
Morocco . . . . .	119	5
Rhodesia . . . . .	103	25
Tunisia . . . . .	122	28
Union of South Africa . . . . .	111	21
<b>AUSTRALASIA</b>		
Australia . . . . .	127	19
Hawaii . . . . .	91	51
New Zealand . . . . .	94	23
Samoa Islands . . . . .	96	61
Solomon Islands . . . . .	97	70

## WORLD PRECIPITATION

TERRITORY	HIGHEST AVERAGE				LOWEST AVERAGE				YEARLY Average In.
	Jan. In.	April In.	July In.	Oct. In.	Jan. In.	April In.	July In.	Oct. In.	
<b>NORTH AMERICA</b>									
Alaska	13.71	10.79	8.51	22.94	.15	.13	.93	.37	43.40
Canada	8.40	4.97	4.07	6.18	.48	.31	1.04	.73	26.85
Canal Zone	3.74	4.30	16.00	15.13	.91	2.72	7.28	10.31	97.54
Greenland	3.46	2.44	3.27	6.28	.35	.47	.91	.94	24.70
Mexico	1.53	1.53	13.44	5.80	.04	.00	.43	.35	29.82
U. S. A.									29.00
West Indies	4.45	6.65	5.80	6.89	.92	1.18	1.53	5.44	49.77
<b>SOUTH AMERICA</b>									
Argentina	6.50	4.72	2.16	3.35	.16	.28	.04	.20	16.05
Bolivia	6.34	1.77	.16	1.42	3.86	1.46	.16	1.30	24.18
Brazil	13.26	12.13	10.47	6.54	2.05	2.63	.01	.05	55.42
Chile	11.78	11.16	16.63	8.88	.00	.00	.03	.00	46.13
Venezuela	2.75	6.90	6.33	10.44	.02	.61	1.87	3.46	40.01
<b>EUROPE</b>									
British Isles	5.49	3.67	3.78	5.57	1.86	1.54	2.38	2.63	36.16
France	3.27	2.64	2.95	4.02	1.46	1.65	.55	2.32	27.48
Germany	1.88	2.79	5.02	2.97	1.16	1.34	2.92	1.82	26.64
Iceland	5.47	3.70	3.07	5.95	5.47	3.70	3.07	5.59	52.91
Italy	4.02	4.41	2.40	5.32	1.44	1.63	.08	2.10	29.74
Norway	8.54	4.13	5.79	8.94	1.06	1.34	1.73	2.48	40.51
Spain	2.83	3.70	2.05	3.58	1.34	1.54	.04	1.77	22.74
Sweden	1.52	1.07	2.67	2.20	.98	.78	1.80	1.60	18.12
Turkey	3.43	1.65	1.06	2.52	3.43	1.65	1.06	2.52	28.86
U. S. S. R.	1.46	1.61	3.50	2.07	.49	.63	.20	.47	18.25
<b>ASIA</b>									
Arabia	1.16	.40	.03	.09	.32	.18	.02	.09	3.05
China	1.97	5.80	13.83	6.92	.15	.61	5.78	.67	50.63
East Indies	18.46	10.67	6.54	10.00	7.48	2.60	.20	.79	78.02
French Indo-China	.79	4.06	12.08	10.61	.52	2.07	9.24	3.67	65.64
India	3.29	33.07	99.52	13.83	.09	.06	.47	.00	75.18
Iraq	1.37	.93	.00	.08	1.17	.48	.00	.05	6.75
Japan	10.79	8.87	9.94	7.48	2.06	2.83	5.02	4.59	70.18
Malay States	9.88	7.64	6.77	8.07	9.88	7.64	6.77	8.07	95.06
Philippine Islands	2.23	1.44	17.28	10.72	.82	1.28	14.98	6.71	83.31
Siam	.33	1.65	6.24	8.32	.33	1.65	6.24	8.32	52.36
Turkey	4.13	2.75	1.73	3.34	2.05	1.73	.21	.93	25.08
U. S. S. R.	1.79	2.05	3.61	4.91	.08	.16	.10	.06	11.85
<b>AFRICA</b>									
Algeria	4.02	2.06	.35	3.41	.52	.11	.00	.05	9.73
Anglo-Egyptian Sudan	.08	4.17	7.87	4.29	.00	.00	.00	.00	18.27
Angola	8.71	5.85	.00	3.80	.09	.63	.00	.09	23.46
Belgian Congo	9.01	6.51	.13	2.77	3.69	1.81	.00	1.88	39.38
Egypt	2.09	.16	.00	.28	.00	.00	.00	.00	3.10
Ethiopia	.59	3.42	10.98	3.39	.28	3.11	8.23	.79	49.17
Fr. Equatorial Africa	9.84	13.42	6.33	13.58	.00	.34	.04	.86	57.55
French West Africa	.10	1.61	8.02	1.87	.00	.00	.18	.00	19.51
Italian Somaliland	.00	3.66	1.67	2.42	.00	3.60	1.67	2.42	17.28
Libya	3.24	.48	.02	1.53	2.74	.18	.00	.67	13.17
Morocco	3.48	2.78	.07	2.47	1.31	.36	.00	.23	15.87
Rhodesia	8.40	.95	.04	1.20	5.81	.65	.00	.88	29.65
Tunisia	2.36	1.30	.08	1.54	2.36	1.30	.08	1.54	15.80
Union of South Africa	6.19	3.79	3.83	5.79	.06	.23	.27	.12	26.07
<b>AUSTRALASIA</b>									
Australia	15.64	5.33	6.57	2.84	.34	.85	.07	.00	28.31
Hawaii	11.77	13.06	9.89	10.97	3.54	2.06	1.04	1.97	82.43
New Zealand	3.34	3.80	5.55	4.19	2.67	2.78	2.99	3.13	43.20
Samoa Islands	18.90	11.26	2.60	7.05	18.90	11.26	2.60	7.05	118.47
Solomon Islands	13.44	8.24	6.26	7.91	13.44	8.24	6.26	7.91	115.37

## PRINCIPAL POWER SUPPLIES IN FOREIGN COUNTRIES

### NOTES

Where both a-c and d-c are available, an asterisk (\*) indicates the type of supply and voltage predominating. Where approximately equal quantities of a-c and d-c are available, an asterisk precedes each of the principal voltages. Voltages and frequencies are listed in order of preference.

The electrical authorities of Great Britain have adopted a plan of unifying electrical distribution systems. The standard potential for both a-c and d-c supplies will be 230 volts. Systems using other voltages will be changed over. The standard a-c frequency will be 50 cycles.

### CAUTION

The listings in these tables represent types of electrical supplies most generally used in particular countries. For power supply characteristics of particular cities of foreign countries, refer to the country section of "World Electrical Markets", a publication of the U. S. Department of Commerce, Bureau of Foreign and Domestic Commerce, Washington, D. C. In cases where definite information relative to specific locations is necessary, the Electrical Division of the above-named Bureau should be consulted.

TERRITORY	D. C. VOLTS	A. C. VOLTS	FREQUENCY
<b>NORTH AMERICA</b>			
Alaska		110, 220	60
British Honduras	110		
Canada	110	*110, 150, 115, 230	60, 25
Costa Rica	110	*110	60
Cuba	110, 220	*110, 220	60
Dominican Republic	110	*110, 220	60
Guatemala	220, 125	*110, 220	60, 50
Haiti		110, 220	60, 50
Honduras	110, 220	*110, 220	60
Mexico	110, 220	*110, 125, 115, 220, 230	60, 50
Newfoundland		110, 115	50, 60
Nicaragua	110	*110	60
Panama (Republic)		110, 220	60, 50
Panama (Canal Zone)		110	25
Puerto Rico	110, 220	*110	60
Salvador	110, 220	*110	60
Virgin Islands	110, 220		

## PRINCIPAL POWER SUPPLIES IN FOREIGN COUNTRIES—Cont'd

TERRITORY	D. C. VOLTS	A. C. VOLTS	FREQUENCY
<b>WEST INDIES</b>			
Bahamas Is.		115	60
Barbadas		110	50
Bermuda		110	60
Curacao		127	50
Jamaica		110	50
Martinique	110	*110	40, 60
Trinidad		110, 220	60
<b>SOUTH AMERICA</b>			
Argentina	*220	*220, 225	50, 60, 43
Bolivia	110	*110, 220	50, 60
Brazil		127, 120, 220	
Chile	220, 110	*220	50, 60
Colombia		*110, 220, 150	60, 50
Ecuador		110	60, 50
Paraguay	*220	220	50
Peru	220, 110	*220, 110	60, 50
Uruguay	220	*220	50
Venezuela	110, 220	*110	60
<b>EUROPE</b>			
Albania	220	*220, 125, 150	50
Austria	220, 110, 150	*220, 120, 127, 110	50
Azores	220	220	50
Belgium	220, 110, 120	*220, 127, 110, 115, 135	50, 40
Bulgaria	220, 120	*220, 120, 150	50
Cyprus (Br.)	*220	110	50
Czechoslovakia	220, 120, 150, 110	*220, 110, 115, 127	50, 42
Denmark	220, 110	*220, 120, 127	50
Estonia	*220, 110	220, 127	50
Finland	*120, 220, 110	220, 120, 115, 110	50
France	110, 220, 120, 125	*110, 115, 120, 125, 220, 230	50, 25
Germany	220, 110, 120, 250	*220, 127, 120, 110	50, 25
Gibraltar	440	*110	76
Greece	*220, 110, 150	*127, 110, 220	50
Hungary	220, 110, 120	*100, 105, 110, 220, 120	42, 50
Iceland		220	50
Irish Free State	*220	*220, 200	50
Italy	110, 125, 150, 220, 250, 160	*150, 125, 120, 110, 115, 120, 260, 220, 135	42, 50, 45
Latvia	220, 110	*220, 120	50
Lithuania	220, 110	*220	50
Malta		105	100
Monaco		110	42
Netherlands	220	220, 120, 127	50
Norway	220	*220, 230, 130, 127, 110, 120, 150	50
Poland	220, 110	*220, 120, 110	50
Portugal	220, 150, 125	*220, 110, 125	50, 42
Romania	*220, 110, 105, 120	120, 220, 110, 115, 105	50, 42
Russia	220, 110, 120, 115, 250	*120, 110, 220	50
Spain	*110, 120, 115, 105	*120, 125, 150, 110, 115, 220, 130	50
Sweden	220, 110, 120, 115, 250	*220, 127, 110, 125	50, 20, 25
Switzerland	220, 120, 110, 150	*120, 220, 145, 150, 110, 120	50, 40
Turkey	110, 220	*220, 110	50
United Kingdom	230, 220, 240	*230, 240, others	50, 25, 40
Yugoslavia	110, 120	*120, 220, 150	50, 42

**PRINCIPAL POWER SUPPLIES IN FOREIGN COUNTRIES—Cont'd**

TERRITORY	D. C. VOLTS	A. C. VOLTS	FREQUENCY
<b>ASIA</b>			
Arabia		230	50
British Malaya			
Fed. Malay States		230	50, 60, 40
Non-Fed. Malay States	230		
Straits Settlements	*230	230	50
North Borneo		110	60
Ceylon	220	230	50, 60
China	220, 110	*110, 200, 220	50, 60, 25
Hawaii		110, 220	60, 25
India	220, 110, 225, 230, 250	230, 220, 110, others	50, 25
Fr. Inda China	110, 120, 220, 240	*120, 220, 110, 115, 240	50
Iran (Persia)	220, 110	220	50
Iraq	*220, 200	220, 230	50
Japan	100	*100, 110	50, 60
Manchuria		110	60, 50, 25
Palestine		220	50
Philippine Islands		220	60
Syria		110, 115, 220	50
Siam		100	50
Turkey	220, 110	*220, 110	50
<b>AFRICA</b>			
Angola (Port.)		110	50
Algeria	220	*115, 110, 127	50
Belgian Congo		220	60
British West Africa	*220	230	50
British East Africa	*220	240	50
Canary Islands	110	*127, 110	50
Egypt	220	200, 110, 220, 110	50, 40
Ethiopia (Abyssinia)		220, 250	50
Italian Africa			
Cyrenaica	150	*110, 150	50
Eritrea		127	50
Libya (Tripoli)		125, 110, 270	50, 42, 45
Somaliland	120	*230	50
Morocco (Fr.)	110	115, 110	50
Morocco (Spanish)	200	*127, 110, 115	50
Madagascar (Fr.)		120	50
Senegal (Fr.)	230	120	50
Turisia		110	50
Union of South Africa	220, 230, 240, 110	*220, 230, 240	50
<b>OCEANIA</b>			
<b>Australia</b>			
New South Wales	*240	*240	50
Victoria	230	*230	50
Queensland	220, 240	*240	50
South Australia	200, 230, 220	*200, 230, 240	50
West Australia	*220, 110, 230	250	40
Tasmania		*240	50
New Zealand	230	*230	50
Fiji Islands	240, 110, 250		
Society Islands		120	60
Samoa		110	50





# THE ETHER SPECTRUM

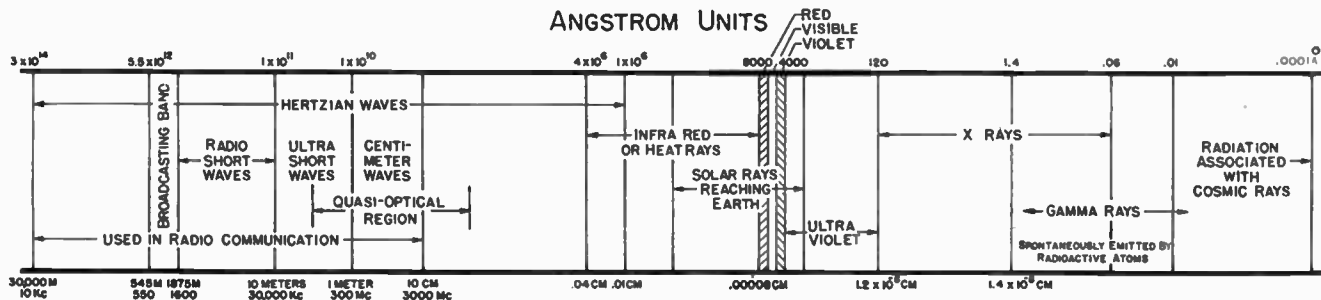

Compiled from Electronics Spectrum Chart.

34

## RADIO FREQUENCY CLASSIFICATIONS \*

Frequency in Kilocycles	Designations	Abbreviations
10 — 30	Very Low	VLF
30 — 300	Low	LF
300 — 3,000	Medium	MF
3,000 — 30,000	High	HF
30,000 — 300,000	Very High	VHF
300,000 — 3,000,000	Ultra High	UHF
3,000,000 — 30,000,000	Super High	SHF

\* Official FCC designation, March 2, 1943.

## CONDENSER COLOR CODE

Radio Manufacturers Association Standard

Color	Significant Figure	Decimal Multiplier	Tolerance %	Voltage Rating (Volts)
Black.....	0	1	—	—
Brown.....	1	10	1	100
Red.....	2	100	2	200
Orange.....	3	1000	3	300
Yellow.....	4	10,000	4	400
Green.....	5	100,000	5	500
Blue.....	6	1,000,000	6	600
Violet.....	7	10,000,000	7	700
Gray.....	8	100,000,000	8	800
White.....	9	1,000,000,000	9	900
Gold.....	—	0.1	5	1000
Silver.....	—	0.01	10	2000
No Color.....	—	—	20	500

If one row of three colored markers appears on the capacitor, the voltage rating is 500 volts and the capacitance is expressed to two significant figures in micromicrofarads as follows, usual tolerance being  $\pm 20\%$ :

First dot on left, first significant figure  
 Second dot, second significant figure  
 Third dot, decimal multiplier

*Example:*

1st Dot	2nd Dot	3rd Dot	Cap. $\mu\mu\text{f}$
Brown	Black	Brown	100
Red	Green	Brown	250
Orange	Black	Red	3000

If two rows of three colored markers appear on the capacitor, then the top row represents the significant figures, read from left to right; the bottom row indicates the decimal multiplier, tolerance, and voltage rating, read from right to left. Capacitance is in micromicrofarads.

*Example:*

TOP ROW			BOTTOM ROW			Description
Left	Center	Right	Right	Center	Left	
Brown	Black	—	Brown	Green	Blue	100 $\mu\mu\text{f}$ , $\pm 5\%$ , 600 volts
Brown	Red	Green	Brown	Red	Gold	1250 $\mu\mu\text{f}$ , $\pm 2\%$ , 1000 volts
Green	Blue	Green	Brown	Red	Blue	5650 $\mu\mu\text{f}$ , $\pm 2\%$ , 600 volts

If the capacitor is approximately circular two groups of colored bands are used, one group made up of wide bands and the other of narrow bands. When the capacitor is viewed with the wide bands on the right, the wide bands indicate the significant figures read from left to right; the narrow bands indicate the decimal multiplier, tolerance, and voltage rating, from right to left, respectively.

*Example:*

NARROW BANDS			WIDE BANDS			Description
Left	Center	Right	Right	Center	Left	
Blue	Green	Brown	Brown	Black	—	100 $\mu\mu\text{f}$ , $\pm 5\%$ , 600 volts
Gold	Red	Brown	Brown	Red	Green	1250 $\mu\mu\text{f}$ , $\pm 2\%$ , 1000 volts
Blue	Red	Brown	Green	Blue	Green	5650 $\mu\mu\text{f}$ , $\pm 2\%$ , 600 volts

## RESISTOR COLOR CODE

Radio Manufacturers Association Standard

Color	Significant Figure	Decimal Multiplier	Tolerance
Black.....	0	1	—
Brown.....	1	10	—
Red.....	2	100	—
Orange.....	3	1000	—
Yellow.....	4	10,000	—
Green.....	5	100,000	—
Blue.....	6	1,000,000	—
Violet.....	7	10,000,000	—
Gray.....	8	100,000,000	—
White.....	9	1,000,000,000	—
Gold.....	—	0.1	± 5%
Silver.....	—	0.01	± 10%
No Color.....	—	—	± 20%

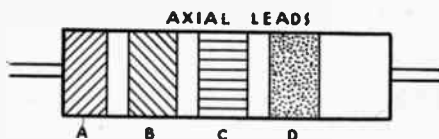
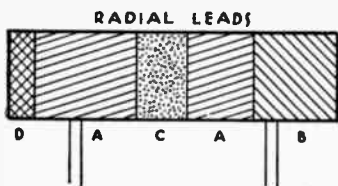

RADIAL LEADS	AXIAL LEADS	COLOR
Body A	Band A	indicates first significant figure of resistance value in ohms.
End B	Band B	indicates second significant figure.
Band C or Dot	Band C	indicates decimal multiplier.
Band D	Band D	if any, indicates tolerance in per cent about nominal resistance value. If no color appears in this position, tolerance is 20%.

## STANDARD COLOR CODING FOR RESISTORS

Preferred Values of Resistance (ohms)			Old Standard Resistance Values (ohms)	Resistance Designation			Preferred Values of Resistance (ohms)			Old Standard Resistance Values (ohms)	Resistance Designation					
±20% D=no col.	±10% D=silver	±5% D=gold		A	B	C	±20% D=no col.	±10% D=silver	±5% D=gold		A	B	C			
		51	50	Green	Black	Black	1000	1000	1000	1000	Brown	Black	Red			
		56		Green	Brown	Black					1100	Brown	Brown	Red		
	56	62		Green	Blue	Black					1200	Brown	Red	Red		
68	68	68	75	Blue	Red	Black	1500	1500	1500	1500	Brown	Orange	Red			
		75		Blue	Gray	Black					1500	Brown	Green	Red		
		82		Violet	Green	Black					1600	Brown	Blue	Red		
	82	91	100	Gray	Red	Black	2200	2200	2200	2200	Brown	Gray	Red			
100	100	100		White	Brown	Black					2000	Red	Black	Red		
		110		Brown	Black	Brown					2200	Red	Red	Red		
		120	Brown	Brown	Brown	2400	Red	Yellow	Red							
	120	130	150	Brown	Red	Brown	3300	3300	3300	3300	Red	Green	Red			
150	150	150		Orange	Orange	Brown					2700	2700	3000	Orange	Violet	Red
		160		Brown	Green	Brown					3000	3000	3000	Orange	Black	Red
		180	Brown	Blue	Brown	3300	3300	3300	Orange	Orange	Red					
	180	200	200	Brown	Gray	Brown	3900	3900	3900	3900	Orange	Blue	Red			
220	220	200		Red	Black	Brown					3600	3600	3900	Orange	White	Red
		220		Red	Red	Brown					3900	3900	4000	Yellow	Black	Red
		240	Red	Yellow	Brown	4300	4300	4700	Yellow	Orange	Red					
	270	270	250	Red	Green	Brown	4700	4700	4700	4700	Yellow	Violet	Red			
330	330	300		Red	Violet	Brown					5000	5000	5000	Green	Black	Red
		330		Orange	Black	Brown					5100	5100	5600	Green	Brown	Red
			Orange	Orange	Brown	5600	5600	5600	Green	Blue	Red					
		360	350	Orange	Green	Brown	6800	6800	6800	6800	Blue	Blue	Red			
		390		Orange	Blue	Brown					6200	6200	6800	Blue	Red	Red
	390	390		Orange	White	Brown					6800	6800	7500	Blue	Gray	Red
		430	400	Yellow	Black	Brown	8200	8200	8200	8200	Violet	Green	Red			
		470		Yellow	Orange	Brown					9100	9100	10,000	Gray	Red	Red
470	470	470		Green	Green	Brown					10,000	10,000	10,000	White	Brown	Black
				500	Yellow	Violet	Brown	10,000	10,000	11,000	Brown	Black	Orange			
				510	Green	Black	Brown	12,000	12,000	12,000	Brown	Brown	Orange			
	560	560	600	Green	Brown	Brown	15,000	15,000	15,000	15,000	Brown	Red	Orange			
		620		Green	Blue	Brown					13,000	13,000	13,000	Brown	Orange	Orange
		680		Blue	Black	Brown					15,000	15,000	15,000	Brown	Green	Orange
		680	750	Blue	Red	Brown	18,000	18,000	18,000	18,000	Brown	Blue	Orange			
680	680	680		Blue	Red	Brown					16,000	16,000	16,000	Brown	Blue	Orange
		750		Blue	Gray	Brown					18,000	18,000	18,000	Brown	Gray	Orange
		820	Violet	Green	Brown	20,000	20,000	20,000	Red	Black	Orange					
	820	910	750	Gray	Red	Brown	22,000	22,000	22,000	22,000	Red	Red	Orange			
				White	Brown	Brown					24,000	24,000	24,000	Red	Yellow	Orange

## STANDARD COLOR CODING FOR RESISTORS—continued

Preferred Values of Resistance (ohms)			Old Standard Resistance Values (ohms)	Resistance Designation			Preferred Values of Resistance (ohms)			Old Standard Resistance Values (ohms)	Resistance Designation		
±20% D=no cal.	±10% D=silver	±5% D=gold		A	B	C	±20% D=no cal.	±10% D=silver	±5% D=gold		A	B	C
			<b>25,000</b>	Red	Green	Orange			510,000		Green	Brown	Yellow
	27,000	27,000		Red	Violet	Orange		560,000	560,000		Green	Blue	Yellow
		30,000	<b>30,000</b>	Orange	Black	Orange				<b>600,000</b>	Blue	Black	Yellow
33,000	33,000	33,000		Orange	Orange	Orange			620,000		Blue	Red	Yellow
		36,000		Orange	Blue	Orange	680,000	680,000	680,000		Blue	Gray	Yellow
	39,000	39,000		Orange	White	Orange			750,000	<b>750,000</b>	Violet	Green	Yellow
		43,000	<b>40,000</b>	Yellow	Black	Orange		820,000	820,000		Gray	Red	Yellow
47,000	47,000	47,000		Yellow	Orange	Orange		910,000	910,000		White	Brown	Yellow
		51,000	<b>50,000</b>	Yellow	Violet	Orange	1.0 Meg.	1.0 Meg.	1.0 Meg.	<b>1.0 Meg.</b>	Brown	Black	Green
		56,000		Green	Black	Orange			1.1 Meg.		Brown	Brown	Green
		56,000		Green	Brown	Orange			1.2 Meg.		Brown	Red	Green
		62,000	<b>60,000</b>	Green	Blue	Orange	1.5 Meg.	1.5 Meg.	1.3 Meg.	<b>1.5 Meg.</b>	Brown	Orange	Green
		68,000		Blue	Black	Orange			1.5 Meg.		Brown	Green	Green
68,000	68,000	68,000		Blue	Red	Orange			1.6 Meg.		Brown	Blue	Green
		75,000	<b>75,000</b>	Blue	Gray	Orange			1.8 Meg.		Brown	Gray	Green
		82,000		Violet	Green	Orange			2.0 Meg.	<b>2.0 Meg.</b>	Red	Black	Green
		82,000		Gray	Red	Orange	2.2 Meg.	2.2 Meg.	2.2 Meg.		Red	Red	Green
		91,000		White	Brown	Orange			2.4 Meg.		Red	Yellow	Green
100,000	100,000	100,000	<b>100,000</b>	Brown	Black	Yellow			2.7 Meg.		Red	Violet	Green
		110,000		Brown	Brown	Yellow			3.0 Meg.	<b>3.0 Meg.</b>	Orange	Black	Green
		120,000	<b>120,000</b>	Brown	Red	Yellow	3.3 Meg.	3.3 Meg.	3.3 Meg.		Orange	Orange	Green
		130,000		Brown	Orange	Yellow			3.6 Meg.		Orange	Blue	Green
150,000	150,000	150,000	<b>150,000</b>	Brown	Green	Yellow			3.9 Meg.		Orange	White	Green
		160,000		Brown	Blue	Yellow			3.9 Meg.		Yellow	Black	Green
		180,000		Brown	Gray	Yellow			4.3 Meg.	<b>4.0 Meg.</b>	Yellow	Orange	Green
		200,000	<b>200,000</b>	Red	Black	Yellow			4.7 Meg.		Yellow	Violet	Green
220,000	220,000	220,000		Red	Red	Yellow	4.7 Meg.	4.7 Meg.	4.7 Meg.	<b>5.0 Meg.</b>	Green	Black	Green
		240,000		Red	Yellow	Yellow			5.1 Meg.		Green	Brown	Green
		270,000	<b>250,000</b>	Red	Green	Yellow			5.6 Meg.		Green	Blue	Green
		300,000		Red	Violet	Yellow			5.6 Meg.		Green	Blue	Green
		300,000	<b>300,000</b>	Orange	Black	Yellow			6.2 Meg.	<b>6.0 Meg.</b>	Blue	Black	Green
		330,000		Orange	Orange	Yellow	6.8 Meg.	6.8 Meg.	6.8 Meg.		Blue	Red	Green
		360,000		Orange	Blue	Yellow			6.8 Meg.		Blue	Gray	Green
	390,000	390,000		Orange	White	Yellow			7.5 Meg.	<b>7.0 Meg.</b>	Violet	Black	Green
		430,000	<b>400,000</b>	Yellow	Black	Yellow			8.2 Meg.		Violet	Green	Green
		470,000		Yellow	Orange	Yellow			8.2 Meg.	<b>8.0 Meg.</b>	Gray	Black	Green
470,000	470,000	470,000		Yellow	Violet	Yellow			9.1 Meg.		Gray	Red	Green
			<b>500,000</b>	Green	Black	Yellow			10 Meg.	<b>9.0 Meg.</b>	White	Black	Green
									10 Meg.		White	Brown	Green
									10 Meg.	<b>10 Meg.</b>	Brown	Black	Blue

## INDUCTANCE CHARTS FOR SINGLE-LAYER SOLENOIDS†

Two charts are used for determining the number of turns and the size of wire to be used in order to obtain a given inductance on a given winding form.

In Chart A the variables are  $n$ , the number of turns, and  $\frac{l}{d}$  the ratio of winding length to winding diameter. The ratio of inductance to diameter of winding  $\left(\frac{L}{d}\right)$  is used as a parameter.

The curves were computed from the expression given in Circular 74 of the U. S. Bureau of Standards,\* which, using the terminology of the chart, may be written,

$$L = \frac{.02508 n^2 d^2}{l} K \quad (1)$$

where  $L$  is the inductance in  $\mu h$

$K$  is Nagaoka's constant

and  $d$  and  $l$  are in inches.

For a given inductance the number of turns is then,

$$n = \sqrt{\left(\frac{L}{d}\right) \left(\frac{l}{d}\right) (39.88) \left(\frac{1}{K}\right)} \quad (2)$$

This form of the expression is particularly convenient because, in designing coils, the engineer usually starts with a given coil form  $\left(\frac{l}{d} \text{ known}\right)$  and needs a given inductance  $L$   $\left(\frac{L}{d} \text{ easily calculated}\right)$ .

Since Nagaoka's constant depends on the ratio  $\frac{l}{d}$ , the use of this ratio for the horizontal scale makes all the curves parallel, so that, in plotting them, only one curve need be calculated. The other can be drawn from a template.

For interpolating between curves, a logarithmic scale covering one decade of  $\frac{L}{d}$  is shown at the right of the chart.

Chart B is plotted from standard winding data published by wire manufacturers (see page 42).

### EXAMPLE

As an example of the use of these charts, consider the problem of

† Courtesy of General Radio Co.

\* "Radio Instruments and Measurements," p. 252.

# INDUCTANCE CHARTS FOR SINGLE-LAYER SOLENOIDS—Cont'd

CHART A

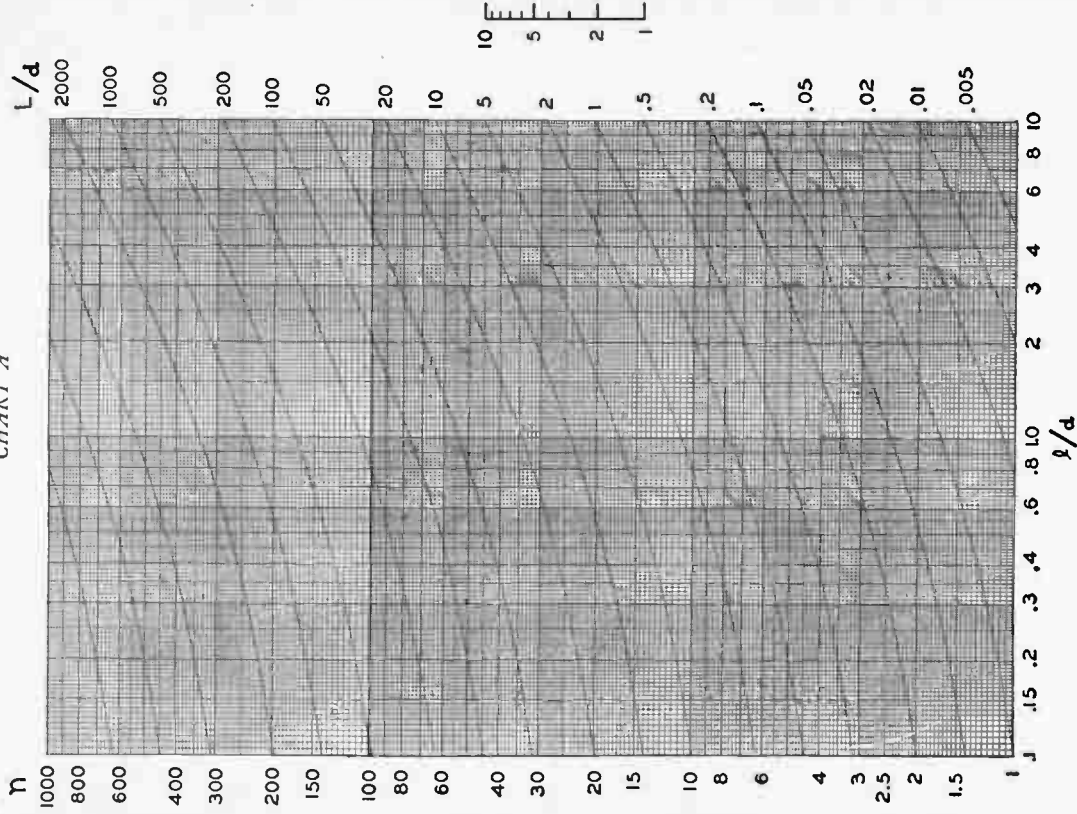

**INDUCTANCE CHART FOR SINGLE-LAYER SOLENOIDS—Cont'd**  
 designing a coil of  $100 \mu h$  inductance on a winding form two inches in diameter, with an available winding length of two inches. The quantity  $\frac{l}{d}$  is unity and  $\frac{L}{d}$  is 50. Entering the chart at  $\frac{L}{d} = 50$  and following down the curve to the vertical line  $\frac{l}{d} = 1$ , we find that  $n$ , as indicated by the lefthand vertical scale, is 54 turns.

The winding length of two inches is equivalent to 27 turns per linear inch, close wound. The second chart shows that No. 18 enamel or single-silk, No. 20 double-silk, or single-cotton-or No. 22 double-cotton-covered wire would be used close wound. No. 25 bare wire, double spaced, could also be used.

CHART B

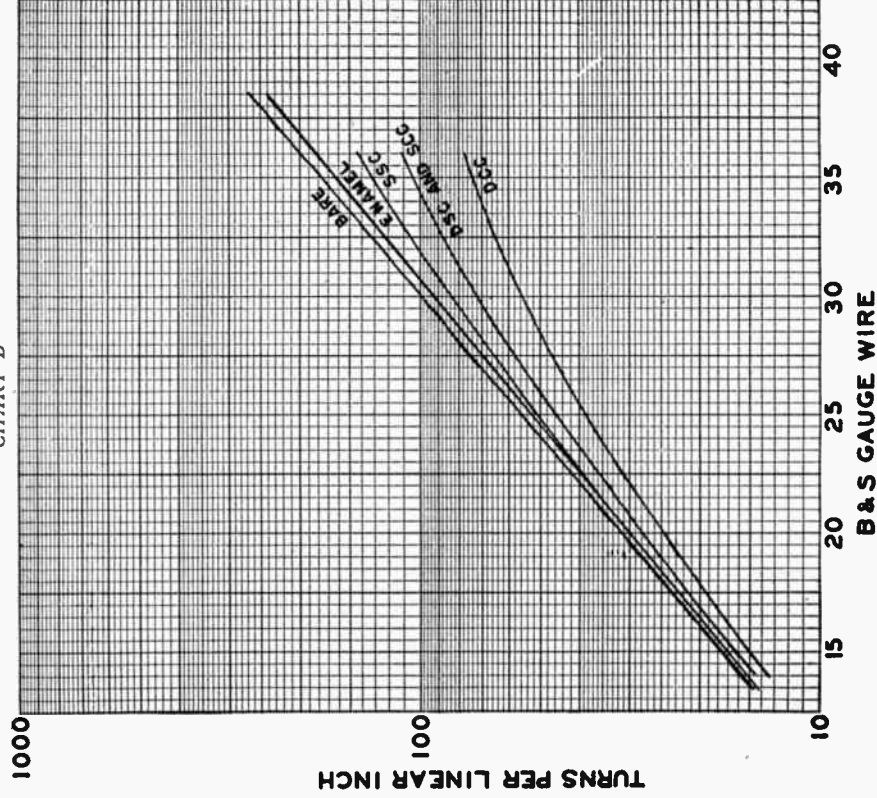



### COPPER WIRE COIL DATA

B. & S. Gauge	Diam. in Mils.	Area Circular Mils.	Turns per Linear Inch				Turns per Square Inch			Feet per Pound		Ohms per 1000 ft. 25° C.	Current Carrying Capacity at 1500 Cm. per Amp.	Diam. in m.m.	Nearest British S.W.G. No.
			Enamel	S.C.C.	D.S.C.	D.C.C.	S.C.C.	Enamel	D.C.C.	Bare	D.C.C.				
16	50.82	2583	18.9	17.9	18.2	16.5	321	348	260	127.9	119.3	4.016	1.7	1.291	18
17	45.26	2048	21.2	19.8	20.2	18.2	397	437	316	161.3	150.0	5.064	1.3	1.150	18
18	40.30	1624	23.7	22.0	22.5	20.0	493	548	378	203.4	188	6.385	1.1	1.024	19
19	35.89	1288	26.5	24.4	25.0	22.0	592	681	455	256.5	237	8.051	.86	.9116	20
20	31.96	1022	29.4	27.0	27.7	24.1	775	852	545	323.4	298	10.15	.68	.8118	21
21	28.46	810.1	33.1	29.8	30.7	26.3	940	1065	650	407.8	370	12.80	.54	.7230	22
22	25.35	642.4	37.0	33.5	34.1	29.5	1150	1340	865	514.2	461	16.14	.43	.6438	23
23	22.57	509.5	41.4	36.9	37.5	32.1	1400	1665	1030	648.4	584	20.36	.34	.5733	24
24	20.10	404.0	46.5	40.6	41.4	34.9	1700	2100	1215	817.7	745	25.67	.27	.5106	25
25	17.90	320.4	52.0	44.6	45.6	37.8	2060	2630	1420	1031	903	32.37	.21	.4547	26
26	15.94	254.1	58.4	49.0	50.0	40.9	2500	3320	1690	1300	1118	40.81	.17	.4049	27
27	14.20	201.5	65.3	53.4	54.9	44.0	3030	4145	1945	1639	1422	51.47	.13	.3606	29
28	12.64	159.8	73.5	58.4	60.2	47.3	3670	5250	2250	2067	1759	64.90	.11	.3211	30
29	11.26	126.7	81.9	63.2	65.3	50.5	4300	6510	2560	2607	2207	81.83	.084	.2859	31
30	10.03	100.5	92.5	68.9	71.4	54.0	5040	8175	2930	3287	2534	103.2	.067	.2546	33
31	8.928	79.70	103	74.6	77.5	57.4	5920	10200	3330	4145	2768	130.1	.053	.2268	34
32	7.950	63.21	114	80.0	83.3	60.6	7060	12650	3720	5227	3137	164.1	.042	.2019	36
33	7.080	50.13	129	86.2	90.0	64.1	8120	16200	4140	6591	4697	206.9	.033	.1798	37
34	6.305	39.75	144	92.5	97.0	67.5	9600	19950	4595	8310	6168	260.9	.026	.1601	38
35	5.615	31.52	161	99.9	104	70.9	10900	25000	5070	10480	6737	329.0	.021	.1426	38-39
36	5.000	25.00	181	111	111	76.9	12200	31700	5550	13210	7877	414.8	.017	.1270	39-40
37	4.453	19.83	204	117	117	80.0	—	39600	6045	16660	9309	532.1	.013	.1131	41
38	3.965	15.72	227	125	125	83.3	—	49100	6510	21010	10666	659.6	.010	.1007	42
39	3.531	12.47	256	133	133	86.9	—	62600	6935	26500	11907	831.8	.008	.0897	43
40	3.145	9.88	285	140	140	90.0	—	77600	7450	33410	14222	1049	.006	.0799	44

## REACTANCE CHARTS\*

CHART A—1 to 1000 cycles

CHART B—1 kc to 1000 kc

CHART C—1 mc to 1000 mc

The three charts on pages 44, 45, and 46 give the relationships of capacitance, reactance, and frequency. Any one value may be determined in terms of the other two by use of a straight edge laid across the correct chart for the frequency under consideration. The example below gives the method of using the charts.

*Example:* Given a capacitance of  $0.01 \mu\text{f}$ , find the reactance at a frequency of 400 cycles. Placing a straight edge through these respective values (Chart A), the desired result is read on the reactance scale as 40,000 ohms. Since the straight edge intersects the inductance scale at 15.8 henries, the chart indicates that this value of inductance has a reactance of 40,000 ohms at 400 cycles per second.

The chart also gives the values of  $L$  and  $C$  that resonate at a given frequency, in the example at 400 cycles, since  $X_L = X_C$  at resonance in most radio circuits.

---

\*Charts courtesy of Hygrade Sylvania Corp.

# REACTANCE CHART A

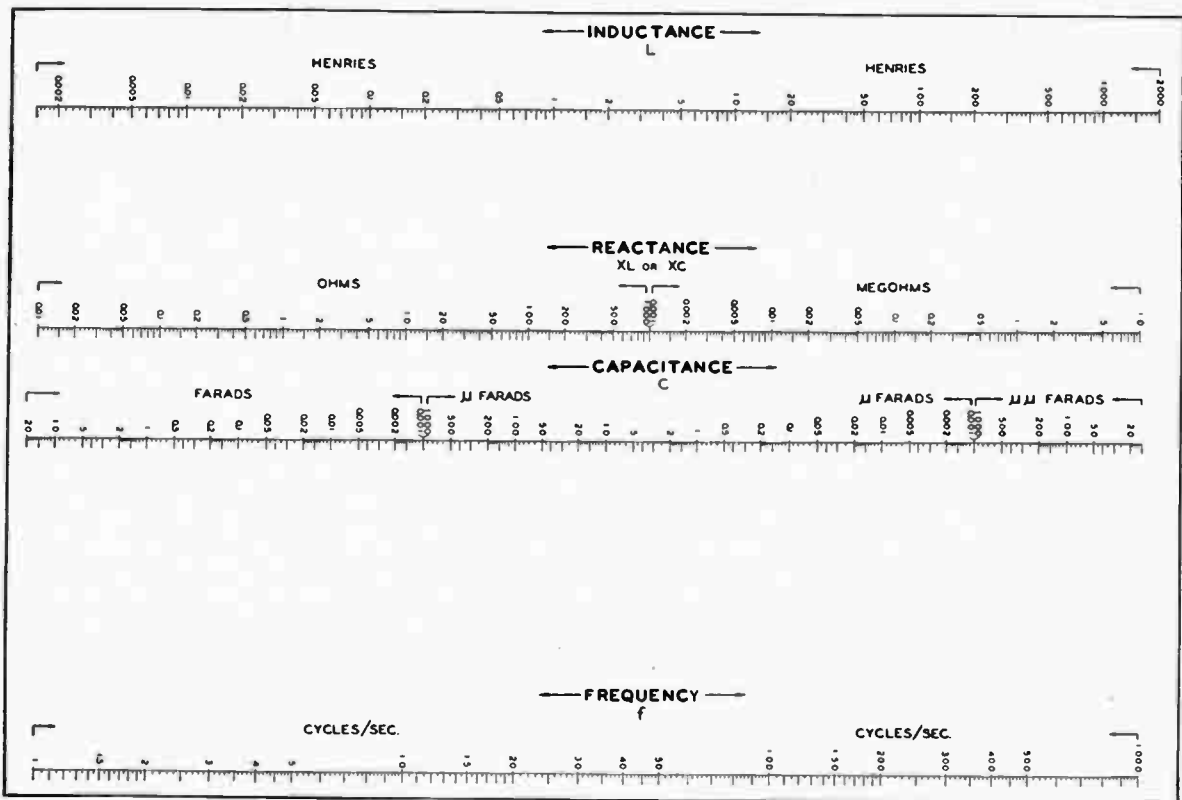

# REACTANCE CHART B

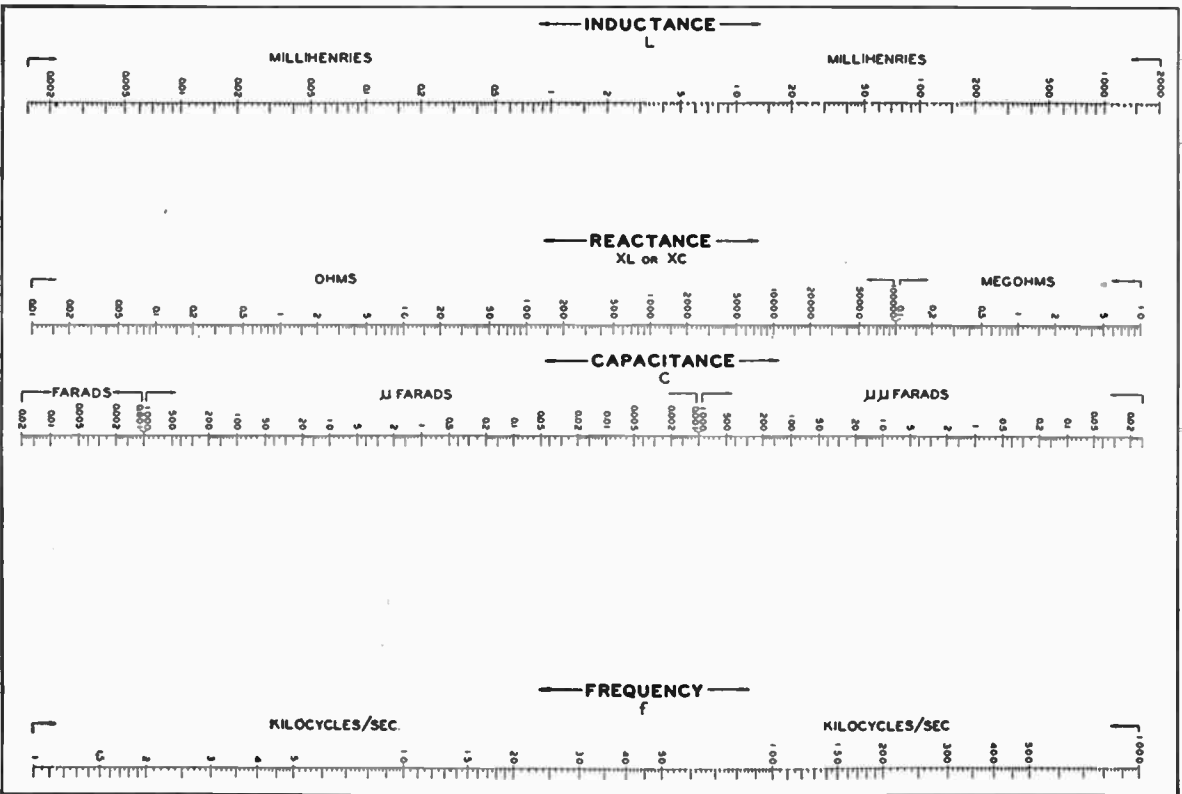

# REACTANCE CHART C

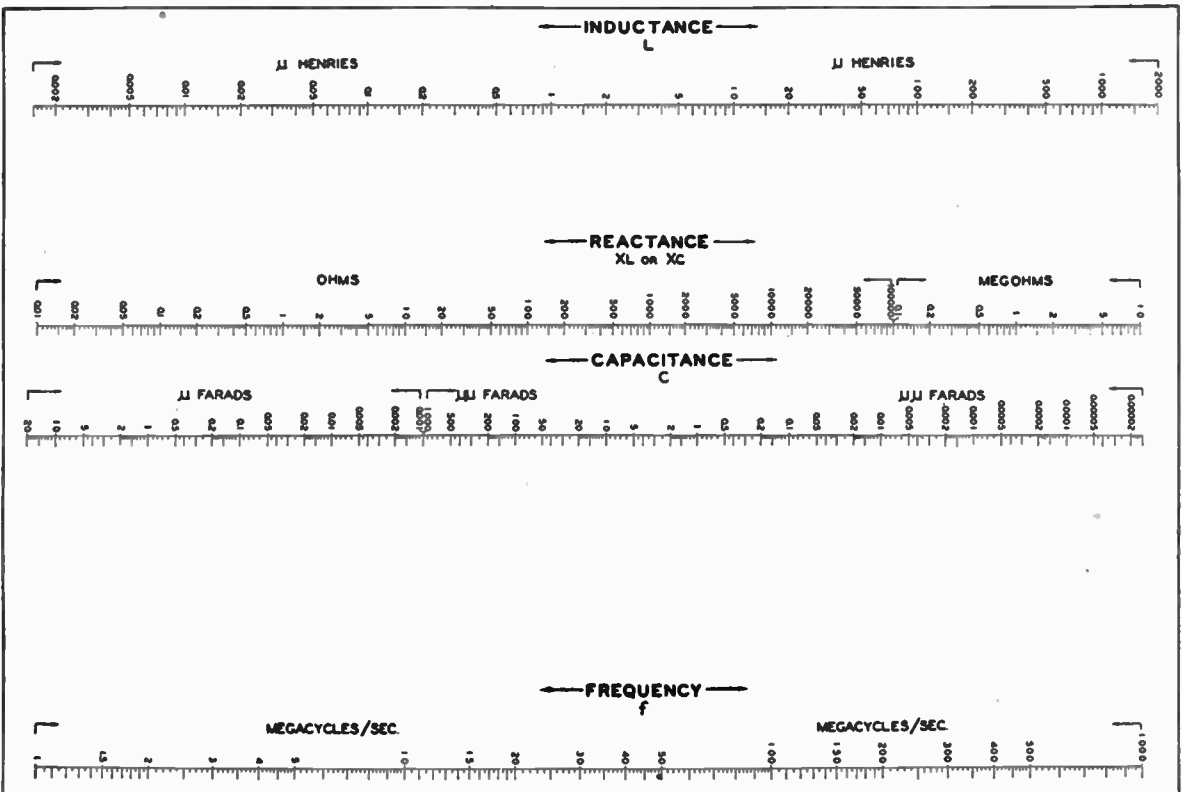

## TIME CONSTANTS FOR SERIES CIRCUITS\*

CHART I —0.1 Cycles/Sec. to 100 kc/Sec.

CHART II—10 Cycles/Sec. to 10 mc/Sec.

The two charts on pages 48 and 49 provide data for finding the time constant of a network for a series circuit. Time constant for either resistance-capacitance series networks or inductance-resistance series networks can be found. The example below gives the method of using the charts.

*Example:* Given a resistance of 0.1 megohm in series with a capacitance  $0.25 \mu f$ , find the time constant of the network. Placing a straight edge through these respective values (using resistance scale No. 2 and capacitance scale No. 2), the time constant scale is intersected at 0.025 seconds and the frequency scale at 40 cycles/sec.

The time constant scale gives the interval of time necessary for the current to rise, or decay, to within  $\frac{1}{e}$  of the steady state value (approximately 63% of its final value). The frequency scale reads the highest frequency at which 63.2% of the exciting voltage can be developed across the network.

*Formulas:* In a resistance-capacitance series network, the time constant is defined by:  $T$  (seconds) =  $R$  (ohms)  $\times$   $C$  (farads)

In an inductance-resistance series network, the time constant is defined by:  $T$  (seconds) =  $\frac{L \text{ (henrys)}}{R \text{ (ohms)}}$

---

\*Charts courtesy of Hygrade Sylvania Corp.

# TIME CONSTANTS FOR SERIES CIRCUITS—Continued

CHART 1



$$T = CR$$

$$T = \frac{L}{R}$$

$$F = \frac{1}{T}$$

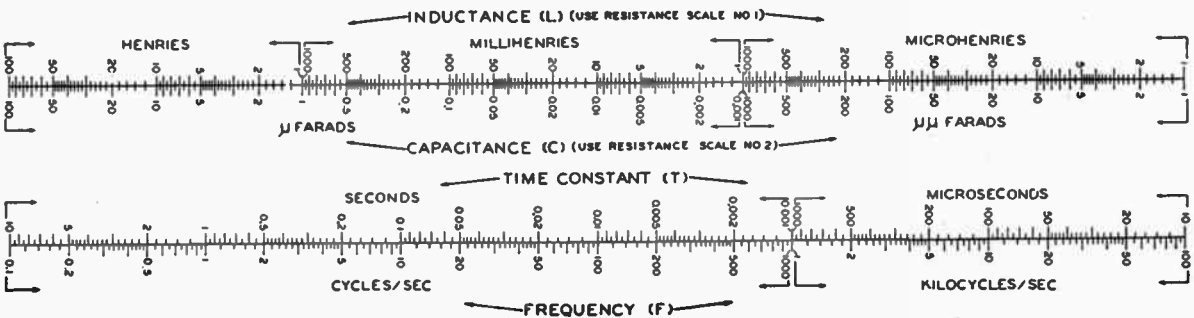





## IMPEDANCE FORMULAS

IMPEDANCE  $Z = R + jX$  ohms

PHASE ANGLE  $\phi = \tan^{-1} \frac{X}{R}$

PHASE ANGLE of the Admittance



MAGNITUDE  $|Z| = [R^2 + X^2]^{\frac{1}{2}}$  ohms

ADMITTANCE  $Y = \frac{1}{Z}$  mhos

is  $-\tan^{-1} \frac{X}{R}$

50

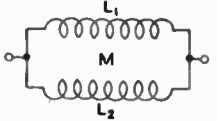
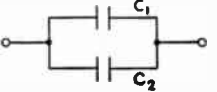
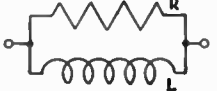
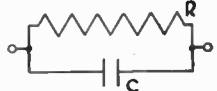
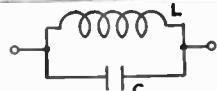
DIAGRAM	IMPEDANCE	MAGNITUDE	PHASE ANGLE	ADMITTANCE
	$R$	$R$	$0$	$\frac{1}{R}$
	$j\omega L$	$\omega L$	$+\frac{\pi}{2}$	$-j \frac{1}{\omega L}$
	$-j \frac{1}{\omega C}$	$\frac{1}{\omega C}$	$-\frac{\pi}{2}$	$j\omega C$
	$j\omega (L_1 + L_2 \pm 2M)$	$\omega (L_1 + L_2 \pm 2M)$	$+\frac{\pi}{2}$	$-j \frac{1}{\omega (L_1 + L_2 \pm 2M)}$
	$-j \frac{1}{\omega} \left( \frac{1}{C_1} + \frac{1}{C_2} \right)$	$\frac{1}{\omega} \left( \frac{1}{C_1} + \frac{1}{C_2} \right)$	$-\frac{\pi}{2}$	$j\omega \frac{C_1 C_2}{C_1 + C_2}$
	$R + j\omega L$	$[R^2 + \omega^2 L^2]^{\frac{1}{2}}$	$\tan^{-1} \frac{\omega L}{R}$	$\frac{R - j\omega L}{R^2 + \omega^2 L^2}$
	$R - j \frac{1}{\omega C}$	$\frac{1}{\omega C} [1 + \omega^2 C^2 R^2]^{\frac{1}{2}}$	$-\tan^{-1} \frac{1}{\omega C R}$	$\frac{R + j \frac{1}{\omega C}}{R^2 + \frac{1}{\omega^2 C^2}}$
	$j \left( \omega L - \frac{1}{\omega C} \right)$	$\left( \omega L - \frac{1}{\omega C} \right)$	$\pm \frac{\pi}{2}$	$j \frac{\omega C}{1 - \omega^2 LC}$
	$R + j \left( \omega L - \frac{1}{\omega C} \right)$	$\left[ R^2 + \left( \omega L - \frac{1}{\omega C} \right)^2 \right]^{\frac{1}{2}}$	$\tan^{-1} \frac{\left( \omega L - \frac{1}{\omega C} \right)}{R}$	$\frac{R - j \left( \omega L - \frac{1}{\omega C} \right)}{R^2 + \left( \omega L - \frac{1}{\omega C} \right)^2}$

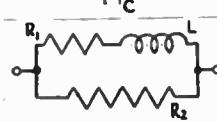
	$\frac{R_1 R_2}{R_1 + R_2}$	$\frac{R_1 R_2}{R_1 + R_2}$	0	$\left(\frac{1}{R_1} + \frac{1}{R_2}\right)$
	$j\omega \left[ \frac{L_1 L_2 - M^2}{L_1 + L_2 \mp 2M} \right]$	$\omega \left[ \frac{L_1 L_2 - M^2}{L_1 + L_2 \mp 2M} \right]$	$+\frac{\pi}{2}$	$-j \frac{1}{\omega} \left[ \frac{L_1 + L_2 \mp 2M}{L_1 L_2 - M^2} \right]$
	$-j \frac{1}{\omega (C_1 + C_2)}$	$\frac{1}{\omega (C_1 + C_2)}$	$-\frac{\pi}{2}$	$j\omega (C_1 + C_2)$
	$\omega L R \left[ \frac{\omega L + jR}{R^2 + \omega^2 L^2} \right]$	$\frac{\omega L R}{[R^2 + \omega^2 L^2]^{\frac{1}{2}}}$	$\tan^{-1} \frac{R}{\omega L}$	$\frac{1}{R} - j \frac{1}{\omega L}$
	$\frac{R (1 - j\omega C R)}{1 + \omega^2 C^2 R^2}$	$\frac{R}{[1 + \omega^2 C^2 R^2]^{\frac{1}{2}}}$	$-\tan^{-1} \omega C R$	$\frac{1}{R} + j\omega C$
	$j \frac{\omega L}{1 - \omega^2 L C}$	$\frac{\omega L}{1 - \omega^2 L C}$	$\pm \frac{\pi}{2}$	$j \left( \omega C - \frac{1}{\omega L} \right)$
	$\frac{\frac{1}{R} - j \left( \omega C - \frac{1}{\omega L} \right)}{\left( \frac{1}{R} \right)^2 + \left( \omega C - \frac{1}{\omega L} \right)^2}$	$\left[ \left( \frac{1}{R} \right)^2 + \left( \omega C - \frac{1}{\omega L} \right)^2 \right]^{\frac{1}{2}}$	$\tan^{-1} R \left( \frac{1}{\omega L} - \omega C \right)$	$\frac{1}{R} + j \left( \omega C - \frac{1}{\omega L} \right)$
	$R_2 \frac{R_1 (R_1 + R_2) + \omega^2 L^2 + j\omega L R_2}{(R_1 + R_2)^2 + \omega^2 L^2}$	$R_2 \left[ \frac{R_1^2 + \omega^2 L^2}{(R_1 + R_2)^2 + \omega^2 L^2} \right]^{\frac{1}{2}}$	$\tan^{-1} \frac{\omega L R_2}{R_1 (R_1 + R_2) + \omega^2 L^2}$	$\frac{R_1 (R_1 + R_2) + \omega^2 L^2 - j\omega L R_2}{R_2 (R_1^2 + \omega^2 L^2)}$

### IMPEDANCE FORMULAS—Continued

IMPEDANCE  $Z = R + jX$  ohms

PHASE ANGLE  $\phi = \tan^{-1} \frac{X}{R}$

PHASE ANGLE of the Admittance

MAGNITUDE  $|Z| = [R^2 + X^2]^{\frac{1}{2}}$  ohms

ADMITTANCE  $Y = \frac{1}{Z}$  mhos

is  $-\tan^{-1} \frac{X}{R}$

52

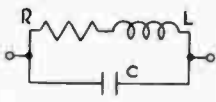
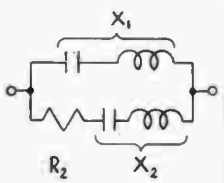
	IMPEDANCE	$\frac{R + j\omega [L(1 - \omega^2 LC) - CR^2]}{(1 - \omega^2 LC)^2 + \omega^2 C^2 R^2}$
	MAGNITUDE	$\left[ \frac{R^2 + \omega^2 L^2}{(1 - \omega^2 LC)^2 + \omega^2 C^2 R^2} \right]^{\frac{1}{2}}$
	PHASE ANGLE	$\tan^{-1} \frac{\omega [L(1 - \omega^2 LC) - CR^2]}{R}$
	ADMITTANCE	$\frac{R - j\omega [L(1 - \omega^2 LC) - CR^2]}{R^2 + \omega^2 L^2}$
	IMPEDANCE	$X_1 \frac{X_1 R_2 + j [R_2^2 + X_2 (X_1 + X_2)]}{R_2^2 + (X_1 + X_2)^2}$
	MAGNITUDE	$X_1 \left[ \frac{R_2^2 + X_2^2}{R_2^2 + (X_1 + X_2)^2} \right]^{\frac{1}{2}}$
	PHASE ANGLE	$\tan^{-1} \frac{R_2^2 + X_2 (X_1 + X_2)}{X_1 R_2}$
	ADMITTANCE	$\frac{R_2 X_1 - j (R_2^2 + X_2^2 + X_1 X_2)}{X_1 (R_2^2 + X_2^2)}$

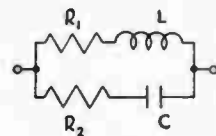

IMPEDANCE

$$\frac{R_1 R_2 (R_1 + R_2) + \omega^2 L^2 R_2 + \frac{R_1}{\omega^2 C^2}}{(R_1 + R_2)^2 + \left(\omega L - \frac{1}{\omega C}\right)^2} + j \frac{\omega L R_2^2 - \frac{R_1^2}{\omega C} - \frac{L}{C} \left(\omega L - \frac{1}{\omega C}\right)}{(R_1 + R_2)^2 + \left(\omega L - \frac{1}{\omega C}\right)^2}$$

MAGNITUDE

$$\left[ \frac{(R_1^2 + \omega^2 L^2) \left(R_2^2 + \frac{1}{\omega^2 C^2}\right)}{(R_1 + R_2)^2 + \left(\omega L - \frac{1}{\omega C}\right)^2} \right]^{\frac{1}{2}}$$

PHASE ANGLE

$$\tan^{-1} \left[ \frac{\omega L R_2^2 - \frac{R_1^2}{\omega C} - \frac{L}{C} \left(\omega L - \frac{1}{\omega C}\right)}{R_1 R_2 (R_1 + R_2) + \omega^2 L^2 R_2 + \frac{R_1}{\omega^2 C^2}} \right]$$

ADMITTANCE

$$\frac{R_1 + \omega^2 C^2 R_1 R_2 (R_1 + R_2) + \omega^4 L^2 C^2 R_2}{(R_1^2 + \omega^2 L^2) (1 + \omega^2 C^2 R_2^2)} + j \omega \left[ \frac{C R_1^2 - L + \omega^2 L C (L - C R_2^2)}{(R_1^2 + \omega^2 L^2) (1 + \omega^2 C^2 R_2^2)} \right]$$

IMPEDANCE

$$\frac{R_1 R_2 (R_1 + R_2) + R_1 X_2^2 + R_2 X_1^2}{(R_1 + R_2)^2 + (X_1 + X_2)^2} + j \frac{R_1^2 X_2 + R_2^2 X_1 + X_1 X_2 (X_1 + X_2)}{(R_1 + R_2)^2 + (X_1 + X_2)^2}$$

MAGNITUDE

$$\left[ \frac{(R_1^2 + X_1^2)(R_2^2 + X_2^2)}{(R_1 + R_2)^2 + (X_1 + X_2)^2} \right]^{\frac{1}{2}}$$

PHASE ANGLE

$$\tan^{-1} \frac{R_1^2 X_2 + R_2^2 X_1 + X_1 X_2 (X_1 + X_2)}{R_1 R_2 (R_1 + R_2) + R_1 X_2^2 + R_2 X_1^2}$$

ADMITTANCE

$$\frac{R_1 (R_2^2 + X_2^2) + R_2 (R_1^2 + X_1^2)}{(R_1^2 + X_1^2) (R_2^2 + X_2^2)} - j \frac{X_1 (R_2^2 + X_2^2) + X_2 (R_1^2 + X_1^2)}{(R_1^2 + X_1^2) (R_2^2 + X_2^2)}$$

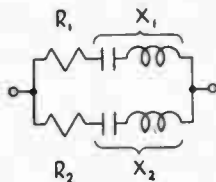

## NETWORK THEOREMS

### *Reciprocity Theorem*

If an E.M.F. of any character whatsoever located at one point in a network produces a current at any other point in the network, the same E.M.F. acting at the second point will produce the same current at the first point.

### *Thévenin's Theorem*

If an impedance  $Z$  is connected between two points of a network, the resulting steady-state current  $I$  through this impedance is the ratio of the p.d.  $V$  between the two points prior to the connection of  $Z$ , and the sum of the values of (1) the connected impedance  $Z$ , and (2) the impedance  $Z_1$  of the network measured between the two points:

$$I = \frac{V}{Z + Z_1}$$

### *Principle of Superposition*

The current which flows at any point in a network composed of constant resistances, inductances, and capacitances, or the p.d. which exists between any two points in such a network, due to the simultaneous action of a number of E.M.F.'s distributed in any manner throughout the network, is the sum of the component currents at the first point, or the component p.d.'s between the two points, which would be caused by the individual E.M.F.'s acting alone. (Applicable to E.M.F.'s of any character.)

In the application of this theorem, it is to be noted that: for any impedance element  $Z$  through which flows a current  $I$ , there may be substituted a virtual source of voltage of value  $-ZI$ .

## ELECTRICAL CIRCUIT FORMULAS

### 1. Self Inductance of a Straight Round Wire

At zero or very low frequency

$$L_0 = 0.002 l \left[ 2.303 \log_{10} \frac{4l}{d} - 1 + \frac{\mu}{4} \right] \text{ microhenries}$$

If  $\frac{2l}{d} < 1000$ , add term  $\frac{d}{2l}$  within bracket.

At infinite or very high frequency

$$L_\infty = 0.002 l \left[ 2.303 \log_{10} \frac{4l}{d} - 1 \right]$$

where  $l$  = length in cm.  
 $d$  = diameter in cm.  
 $\mu$  = permeability.

For nonmagnetic wires,  $\mu = 1$ .

### 2. Inductance of a Single Layer Coil

For coils of the proportions normally used in radio work, an accuracy of approximately one percent is given by the formula:

$$L = N^2 \frac{r^2}{9r + 10l} \text{ microhenries}$$

where  $l$  and  $r$  are the mean length and radius of the coil in inches;  $N$  is the total number of turns.

In the use of various charts, tables, and "calculators" for designing inductors, the following relationships are useful in extending the range of the devices. They apply to coils of any type or design.

(a) If all the dimensions are held constant the inductance is proportional to  $N^2$ .

(b) If the proportions of the coil remain unchanged, then for a given number of turns the inductance is proportional to the dimensions of the coil. A coil with all dimensions  $m$  times those of a given coil (having the same number of turns) has  $m$  times the inductance. That is, inductance has the dimensions of "length".

## ELECTRICAL CIRCUIT FORMULAS—Continued

### 3. Capacitance of a Parallel Plate Capacitor

$$C = 0.0885 K \frac{(N - 1)A}{t} \text{ micromicrofarads}$$

where  $A$  = area of plates in square cm.  
 $N$  = number of plates  
 $t$  = thickness of dielectric in cm.  
 $K$  = dielectric constant.

### 4. Reactance of an Inductor

$$X = 2\pi fL \text{ ohms}$$

where  $f$  = frequency in cycles per second  
 $L$  = inductance in henries

or  $f$  in kc and  $L$  in mh; or  $f$  in megacycles and  $L$  in  $\mu h$ .

### 5. Reactance of a Capacitor

$$X = \frac{-1}{2\pi fC} \text{ ohms}$$

where  $C$  = capacitance in farads.

This may be written

$$X = \frac{-159.2}{fC} \text{ ohms}$$

where  $f$  and  $C$  are kc and  $\mu f$  respectively; or  $f$  and  $C$  are megacycles and milli-microfarads (.001  $\mu f$ ) respectively.

### 6. Impedance of a Series Circuit of Resistance, Capacitance and Inductance

$$Z = R + jX = \sqrt{R^2 + X^2} / \tan^{-1} \frac{X}{R}$$

where  $X = \omega L - \frac{1}{\omega C}$

## ELECTRICAL CIRCUIT FORMULAS—Continued

### 7. Resonant Frequency of a Series Tuned Circuit

$$f = \frac{1}{2\pi\sqrt{LC}} \text{ cycles per second}$$

where  $L$  is in henries and  $C$  in farads.

This may be written

$$LC = \frac{25,330}{f^2}$$

where  $f$ ,  $L$  and  $C$  are in kc, mh and milli-microfarads (.001  $\mu f$ ) respectively; or in megacycles,  $\mu h$  and  $\mu\mu f$  respectively.

### 8. Wavelength and Frequency

$$f\lambda = 3 \times 10^{10} \text{ cm. per second (velocity of light)}$$

where  $f$  is in cycles per second;  $\lambda$  is in cm.

### 9. Dynamic Resistance of a Tuned Circuit at Resonance

$$r = \frac{X^2}{R} = \frac{L}{CR} \text{ ohms}$$

where  $X^2 = (\omega L)^2 = \left(\frac{1}{\omega C}\right)^2$  and  $R$  is the total series resistance in ohms.  $L$  is in henries and  $C$  is in farads.

### 10. Q of a Reactor

The reactor may be considered either as a reactance  $X_1$ , with series resistance  $R_1$  or as a reactance  $X_2$  with shunt resistance  $R_2$

Then

$$Q = \frac{|X_1|}{R_1} = \frac{R_2}{|X_2|}$$

Except for very low  $Q$ ,  $X_1 = X_2$ .



## ELECTRICAL CIRCUIT FORMULAS—Continued

### 11. Parallel Impedances

If  $Z_1$  and  $Z_2$  are the two impedances which are connected in parallel, then the resultant impedance is

$$Z = \frac{Z_1 Z_2}{Z_1 + Z_2}$$

Given one impedance  $Z_1$  and the desired resultant impedance  $Z$ , the other impedance is

$$Z_2 = \frac{Z Z_1}{Z_1 - Z}$$

### 12. Impedance of a Two-Mesh Network

Let  $Z_{11}$  = impedance determined for first circuit or mesh (with the second mesh open circuited)

$Z_{22}$  = impedance determined for second mesh (with the first mesh open circuited)

$Z_{12}$  = mutual impedance between the two meshes, *i.e.*, the open circuit voltage appearing in either mesh when unit current flows in the other mesh.  $Z_{12}$  may be resistive, reactive, or complex.

Then the impedance looking into the first mesh is

$$Z_1' = Z_{11} - \frac{Z_{12}^2}{Z_{22}}$$

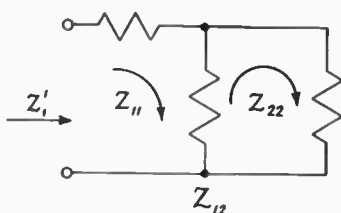

When  $Z_{12} = jX_{12}$  and  $Z_{11} = R_{11} + jX_{11}$ ;  $Z_{22} = R_{22} + jX_{22}$ , then

$$Z_1' = R_1' + jX_1' = R_{11} + jX_{11} + \frac{X_{12}^2}{R_{22}^2 + X_{22}^2} (R_{22} - jX_{22})$$

For a transformer with tuned secondary and negligible primary resistance

$$Z_1' = R_1' + jX_1' = \frac{X_{12}^2}{R_{22}} + jX_{11}$$

## ELECTRICAL CIRCUIT FORMULAS—Continued

### 13. Currents in a Two-Mesh Network

$$i_1 = \frac{e_1}{Z_1'}$$

$$= e_1 \frac{Z_{22}}{Z_{11}Z_{22} - Z_{12}^2}$$

$$i_2 = e_1 \frac{Z_{12}}{Z_{11}Z_{22} - Z_{12}^2}$$

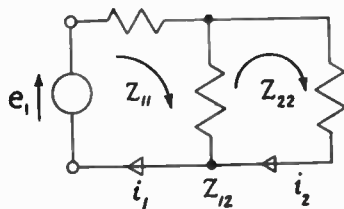

where the various symbols have the same significance as in the preceding section.

### 14. Power Transfer Between Two Impedances Connected Directly

Let  $Z_1 = R_1 + jX_1$  be the impedance of the source,

and  $Z_2 = R_2 + jX_2$  be the impedance of the load.

The maximum power transfer occurs when

$$R_2 = R_1 \quad \text{and} \quad X_2 = -X_1.$$

The reflection loss due to connecting any two impedances directly is

$$\frac{I_2}{I} = \frac{|Z_1 + Z_2|}{2\sqrt{R_1 R_2}}$$

In decibels:

$$N = 20 \log_{10} \frac{|Z_1 + Z_2|}{2\sqrt{R_1 R_2}}$$

$I_2$  = current which would flow in  $Z_2$  were the two impedances connected through a perfect impedance matching network.

$I$  = current which flows when the impedances are connected directly.

### 15. Power Transfer Between Two Meshes Coupled Reactively

In the general case  $X_{11}$  and  $X_{22}$  are not equal to zero, and  $X_{12}$

may be any reactive coupling.

When only one of the quantities  $X_{11}$ ,  $X_{22}$  and  $X_{12}$  can be

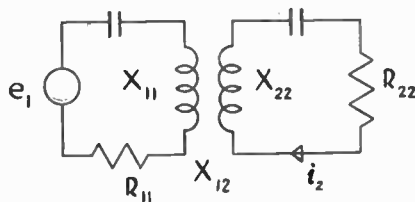

## ELECTRICAL CIRCUIT FORMULAS—Continued

varied, the best power transfer under the circumstances is given by:

$$\text{For } X_{22} \text{ variable: } X_{22} = \frac{X_{12}^2 X_{11}}{R_{11}^2 + X_{11}^2} \quad (\text{Zero reactance looking into load circuit})$$

$$\text{For } X_{11} \text{ variable: } X_{11} = \frac{X_{12}^2 X_{22}}{R_{22}^2 + X_{22}^2} \quad (\text{Zero reactance looking into source circuit})$$

$$\text{For } X_{12} \text{ variable: } X_{12}^2 = \sqrt{(R_{11}^2 + X_{11}^2)(R_{22}^2 + X_{22}^2)}$$

When two of the three quantities can be varied, a perfect impedance match is attained and maximum power is transferred when

$$X_{12}^2 = \sqrt{(R_{11}^2 + X_{11}^2)(R_{22}^2 + X_{22}^2)}$$

and  $\frac{X_{11}}{R_{11}} = \frac{X_{22}}{R_{22}}$  (Both circuits of same Q or phase angle).

For perfect impedance match the current is

$$i_2 = \frac{e_1}{2\sqrt{R_{11}R_{22}}} \bigg/ \tan^{-1} \frac{R_{11}}{X_{11}}$$

In the most common case the circuits are tuned to resonance:  $X_{11} = 0$  and  $X_{22} = 0$ . Then  $X_{12}^2 = R_{11}R_{22}$  for perfect impedance match.

### 16. Optimum Coupling Between Two Circuits Tuned to the Same Frequency

From the last result in the preceding section, maximum power transfer (or an impedance match) is obtained for

$$\omega^2 M^2 = R_1 R_2$$

where  $M$  is the mutual inductance between the circuits,  $R_1$  and  $R_2$  are the resistances of the two circuits.

### 17. Coefficient of Coupling

By definition, coefficient of coupling  $k$  is

$$k = \frac{M}{\sqrt{L_1 L_2}}$$

where  $M$  = mutual inductance,  
 $L_1$  and  $L_2$  are the inductances of the two coupled circuits.

## ELECTRICAL CIRCUIT FORMULAS—Continued

Coefficient of coupling is a geometrical property, being a function of the proportions of the configuration of coils, including their relationship to any nearby objects which affect the field of the system. As long as these proportions remain unchanged, the coefficient of coupling is independent of the physical size of the system, and of the number of turns of either coil.

### 18. Selectivity of Several Single Tuned Circuits in Cascade

When  $n$  identical resonant circuits are coupled by tubes, the width of the resonance curve is given to a close approximation by:

$$\frac{\Delta f_{\beta}}{f_0} = \frac{1}{Q} \sqrt{\left(\frac{E_0}{E_{\beta}}\right)^{2/n} - 1}$$

where  $f_0$  = resonant frequency of circuits.

$\Delta f_{\beta}$  = band width between frequencies where  $E_{\beta} = \beta E_0$ .

$E_0$  = voltage across final tuned circuit at  $f_0$ .

$E_{\beta}$  = voltage across final tuned circuit at

frequencies  $\left(f_0 \pm \frac{\Delta f_{\beta}}{2}\right)$ : Input voltage assumed to be kept constant over frequency band.

$Q$  is value for each resonant circuit.

For a single circuit, when  $\beta = 0.707$

$$\frac{\Delta f}{f_0} = \frac{1}{Q}$$

### 19. Peak Separation of Two Overcoupled Tuned Circuits

With each circuit independently tuned to  $f_0$ , the separation  $\Delta f$  between the two peaks is given to a close approximation by:

$$\frac{\Delta f}{f_0} = \sqrt{k^2 - \frac{1}{2} \left( \frac{1}{Q_1^2} + \frac{1}{Q_2^2} \right)}$$

where  $k$  = coefficient of coupling =  $\frac{X_{12}}{\sqrt{X_1 X_2}}$

$Q_1$  and  $Q_2$  are the  $Q$ 's of the first and second tuned circuits, respectively.

$X_1$  and  $X_2$  are the inductive (or capacitive) reactances

## ELECTRICAL CIRCUIT FORMULAS—Continued

in the two circuits. (Note that  $X_1$  and  $X_2$  are not necessarily equal.)

For identical circuits this reduces to

$$\frac{\Delta f}{f_0} = \sqrt{k^2 - \frac{1}{Q^2}} = \frac{\sqrt{X_{12}^2 - R^2}}{X}$$

where  $R$  = equivalent series resistance of each circuit.

$X$  = inductive reactance in each circuit.

The peaks, for the general case, converge to a single peak when the quantity under the radical sign becomes equal to zero. Then:

$$k^2 = \frac{1}{2} \left( \frac{1}{Q_1^2} + \frac{1}{Q_2^2} \right)$$

Compare this with the value of  $k^2$  for optimum coupling (refer to sections 16 and 17), *viz.*,

$$k^2 = \frac{1}{Q_1 Q_2}$$

When the quantity under the radical sign is negative, the expression is imaginary. Only one peak exists.

### 20. Selectivity of Several Pairs of Coupled Tuned Circuits in Cascade

When  $m$  pairs of tuned circuits are coupled by tubes between each successive pair, the width of the resonance curve is given to a close approximation by the following formula. This is for the case where the two peaks have just converged to a single peak, for which

$$k^2 = \frac{1}{2} \left( \frac{1}{Q_1^2} + \frac{1}{Q_2^2} \right)$$

Then,

$$\frac{\Delta f_{\beta}}{f_0} = \frac{\sqrt{2}}{2} \left( \frac{1}{Q_1} + \frac{1}{Q_2} \right) \sqrt{\left( \frac{E_0}{E_{\beta}} \right)^{2/m} - 1}$$

The two circuits of a pair need not be identical, but it is assumed that both are tuned to  $f_0$ . See section 18 above on  $n$  single tuned circuits for explanation of symbols. Comparison with the formula of that

## ELECTRICAL CIRCUIT FORMULAS—Continued

section shows that the width of the resonance curve for  $m = n/2$  pairs of circuits is  $\sqrt{2}$  times the width for  $n$  single circuits, except near the center frequency  $f_0$ .

Certain approximations have been made in order to simplify the results presented in this and the two preceding sections. In most actual applications of the types of circuits treated, the error involved is negligible from a practical standpoint. Over the narrow frequency band in question, it is assumed that:

- (1) The reactance around each circuit is equal to  $2aX_0$ , where

$$a = \frac{f - f_0}{f_0} \quad \text{and} \quad X_0 = 2\pi f_0 L = \frac{1}{2\pi f_0 C}$$

- (2) The resistance of each circuit is constant and equal to  $\frac{X_0}{Q}$
- (3) The mutual reactance between the two circuits of a pair is constant.
- (4) The voltage  $E_\beta$  across the last circuit is  $X_0 i$ , where  $i$  is the current in that circuit.

### 21. Relationships Between a Reactance Shunted by a Resistance and the Equivalent Series Circuit

Let the network in question be the reactance  $X_2$  shunted by the resistance  $R_2$ . The terminals present an impedance which may be considered as consisting of a reactance  $X_1$  in series with a resistance  $R_1$ .

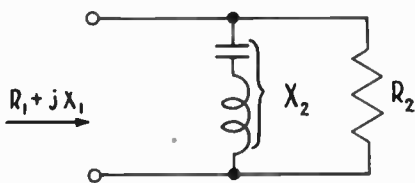

Then

$$R_1 = R_2 \frac{X_2^2}{X_2^2 + R_2^2} = R_2 \frac{1}{Q^2 + 1} \quad (1)$$

$$X_1 = X_2 \frac{R_2^2}{X_2^2 + R_2^2} = X_2 \frac{Q^2}{Q^2 + 1} \quad (2)$$

## ELECTRICAL CIRCUIT FORMULAS—Continued

From which

$$X_2 = \pm R_2 \sqrt{\frac{R_1}{R_2 - R_1}} = \frac{R_1 R_2}{X_1} = \frac{X_1^2 + R_1^2}{X_1} \quad (3)$$

$$R_2 = \frac{X_1^2 + R_1^2}{R_1} \quad (4)$$

Note that

$$R_1 R_2 = X_1 X_2 = Z^2 \quad (5)$$

where  $Z^2$  is the square of the magnitude of the impedance of the network:

$$Z^2 = R_1^2 + X_1^2 = \frac{X_2^2 R_2^2}{X_2^2 + R_2^2} \quad (6)$$

From equation (5):

$$\frac{X_1}{R_1} = \frac{R_2}{X_2} \quad (7)$$

It is thus rigorous to define  $Q$  as the absolute value of either of these ratios, as (7) holds for all values of  $X_2$ ,  $R_2$  and the corresponding  $X_1$ ,  $R_1$ .

Two special cases of importance may be cited:

- (a) A reactance with  $Q$  not too small (In the following expression the error is 1 percent for  $Q = 10$  and decreases rapidly as  $Q$  increases)

$$R_1 = \frac{X_2^2}{R_2} \quad \text{and} \quad X_1 = X_2 \quad (8)$$

- (b) A resistance with a small reactive component

$$R_1 = R_2 \quad \text{and} \quad X_1 = \frac{R_2^2}{X_2} \quad (9)$$

## ATTENUATORS

An attenuator is a network designed to introduce a known loss when working between resistive impedances  $Z_1$  and  $Z_2$  to which the input and output impedances of the attenuator are matched. Either  $Z_1$  or  $Z_2$  may be the source and the other the load. The attenuation of such networks expressed as a power ratio is the same regardless of the direction of working.

Three forms of resistance network which may be conveniently used to realize these conditions are shown below. These are the T section, the  $\pi$  section, and the Bridged-T section. Equivalent balanced sections also are shown.

Methods are given for the computation of attenuator networks, the hyperbolic expressions giving rapid solutions with the aid of tables of hyperbolic functions.

In the formulas:

$Z_1$  and  $Z_2$  are the terminal impedances (resistive) to which the attenuator is matched.

$N$  is the ratio of the power absorbed by the attenuator from the source to the power delivered to the load.

$$\text{Attenuation in decibels} = 10 \log_{10} N$$

$$\text{Attenuation in nepers} = \theta = \frac{1}{2} \log_e N$$

$$1 \text{ decibel} = 0.1151 \text{ neper}$$

$$1 \text{ neper} = 8.686 \text{ decibels}$$

### ATTENUATOR NETWORK DESIGN

#### 1. T and H Networks

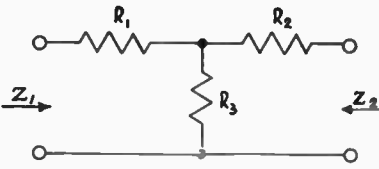

Unbalanced T

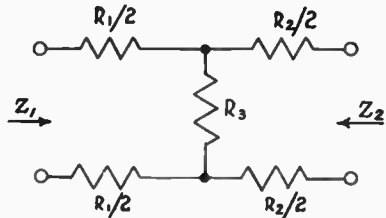

Balanced H

$$R_3 = \sqrt{Z_1 Z_2} \operatorname{cosech} \theta \quad \text{or}$$

$$R_3 = \frac{2\sqrt{N Z_1 Z_2}}{N - 1}$$

$$R_1 = Z_1 \coth \theta - R_3 \quad \text{or}$$

$$R_1 = Z_1 \left( \frac{N + 1}{N - 1} \right) - R_3$$

$$R_2 = Z_2 \coth \theta - R_3 \quad \text{or}$$

$$R_2 = Z_2 \left( \frac{N + 1}{N - 1} \right) - R_3$$



## ATTENUATORS—Continued

Particular Cases:

(a)  $Z_1 = Z_2 = Z$ . Here:

$$R_3 = Z \operatorname{cosech} \theta \quad \text{or} \quad R_3 = \frac{2Z\sqrt{N}}{N-1}$$

$$R_1 = R_2 = Z \operatorname{coth} \theta - R_3 \quad \text{or} \quad R_1 = R_2 = Z \left( \frac{N+1}{N-1} \right) - R_3$$

(b) Minimum Loss pad matching  $Z_1$  to  $Z_2$  ( $Z_1 > Z_2$ )

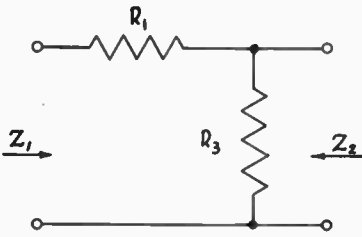

Unbalanced

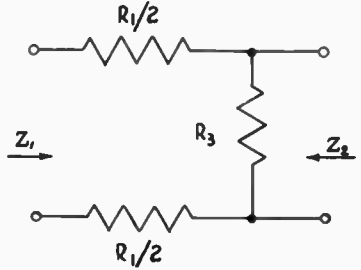

Balanced

Here:  $R_2 = 0$ ;  $R_1$  and  $R_3$  as for the general case.

Minimum attenuation in nepers,  $\theta = \cosh^{-1} \sqrt{\frac{Z_1}{Z_2}}$

Minimum power ratio, 
$$N = \frac{2Z_1}{Z_2} \left[ 1 + \sqrt{1 - \frac{Z_2}{Z_1}} \right] - 1$$

### 2. $\pi$ and $O$ Networks

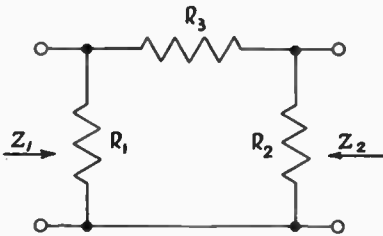

Unbalanced  $\pi$

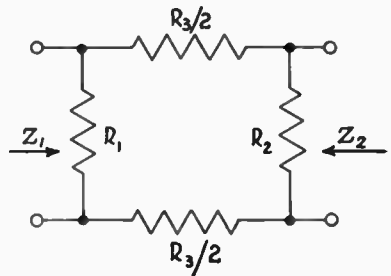

Balanced  $O$

## ATTENUATORS—Continued

$$R_3 = \sqrt{Z_1 Z_2} \sinh \theta \quad \text{or} \quad R_3 = \frac{N-1}{2} \sqrt{\frac{Z_1 Z_2}{N}}$$

$$\frac{1}{R_1} = \frac{1}{Z_1 \tanh \theta} - \frac{1}{R_3} \quad \text{or} \quad \frac{1}{R_1} = \frac{1}{Z_1} \left( \frac{N+1}{N-1} \right) - \frac{1}{R_3}$$

$$\frac{1}{R_2} = \frac{1}{Z_2 \tanh \theta} - \frac{1}{R_3} \quad \text{or} \quad \frac{1}{R_2} = \frac{1}{Z_2} \left( \frac{N+1}{N-1} \right) - \frac{1}{R_3}$$

Particular Cases:

(a)  $Z_1 = Z_2 = Z$ . Here:

$$R_3 = Z \sinh \theta \quad \text{or} \quad R_3 = \frac{(N-1)Z}{2\sqrt{N}}$$

$$\frac{1}{R_1} = \frac{1}{R_2} = \frac{1}{Z \tanh \theta} - \frac{1}{R_3} \quad \text{or} \quad \frac{1}{R_1} = \frac{1}{R_2} = \frac{1}{Z} \left( \frac{N+1}{N-1} \right) - \frac{1}{R_3}$$

(b) Minimum Loss pad matching  $Z_1$  to  $Z_2$  ( $Z_1 > Z_2$ ). Here  $R_1$  becomes infinite and the networks reduce to the same configurations as those of the minimum loss T or H pads.

### 3. Bridged T and Bridged H Networks

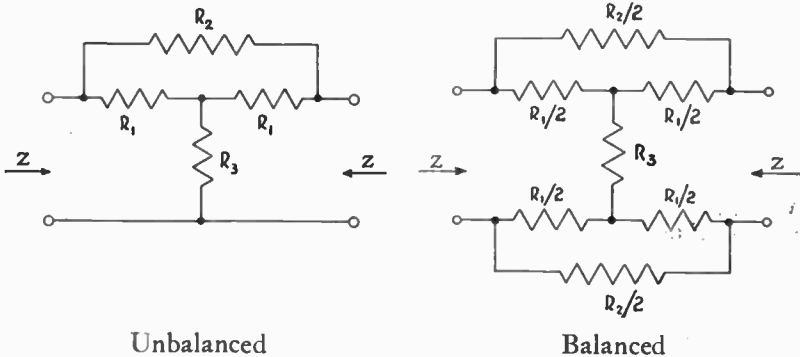

This network is designed to operate only between equal resistive terminal impedances  $Z$ . It is a useful form because only two variable elements are required.

$$R_1 = Z$$

$$R_2 = Z(\sqrt{N} - 1)$$

$$R_3 = \frac{Z}{(\sqrt{N} - 1)}$$

## ATTENUATORS—Continued

### *Effect of Incorrect Load Impedance on Operation of an Attenuator*

In the applications of attenuators the question frequently arises as to the effect upon the input impedance and the attenuation by the use of a load impedance which is different from that for which the network was designed. The following results apply to all resistive networks which, when operated between resistive impedances  $Z_1$  and  $Z_2$ , present matching terminal impedances  $Z_1$  and  $Z_2$  respectively. The results may be derived in the general case by the application of the network theorems, and may be readily confirmed mathematically for simple specific cases such as the T section.

For the designed use of the network, let:

$Z_1$  = input impedance of properly terminated network.

$Z_2$  = load impedance which properly terminates the network.

$N$  = power ratio from input to output.

$K$  = current ratio from input to output.

$$K = \frac{i_1}{i_2} = \sqrt{\frac{NZ_2}{Z_1}} \quad \text{(different in the two directions of operation except when } Z_2 = Z_1\text{).}$$

For the actual conditions of operation, let

$$(Z_2 + \Delta Z_2) = Z_2 \left( 1 + \frac{\Delta Z_2}{Z_2} \right) = \text{actual load impedance}$$

$$(Z_1 + \Delta Z_1) = Z_1 \left( 1 + \frac{\Delta Z_1}{Z_1} \right) = \text{resulting input impedance}$$

$$(K + \Delta K) = K \left( 1 + \frac{\Delta K}{K} \right) = \text{resulting current ratio.}$$

While  $Z_1$ ,  $Z_2$  and  $K$  are restricted to real quantities by the assumed nature of the network,  $\Delta Z_2$  is not so restricted, *e.g.*,

$$\Delta Z_2 = \Delta R_2 + j\Delta X_2$$

As a consequence  $\Delta Z_1$  and  $\Delta K$  can become imaginary or complex.  $\Delta Z_2$  is not restricted to small values.

The results for the actual conditions are

$$\frac{\Delta Z_1}{Z_1} = \frac{2 \frac{\Delta Z_2}{Z_2}}{2N + (N-1) \frac{\Delta Z_2}{Z_2}}$$

and

$$\frac{\Delta K}{K} = \left( \frac{N-1}{2N} \right) \frac{\Delta Z_2}{Z_2}$$

### ATTENUATORS—Continued

Certain special cases may be cited:

(a) For small  $\frac{\Delta Z_2}{Z_2}$ :

$$\frac{\Delta Z_1}{Z_1} = \frac{1}{N} \frac{\Delta Z_2}{Z_2}$$

$$\text{or } \Delta Z_1 = \frac{1}{K^2} \Delta Z_2$$

(b) Short circuited output:

$$\frac{\Delta Z_1}{Z_1} = \frac{-2}{N+1}$$

$$\text{or input impedance} = \left( \frac{N-1}{N+1} \right) Z_1 = Z_1 \tanh \theta$$

where  $\theta$  is the designed attenuation in nepers.

(c) Open circuited output:

$$\frac{\Delta Z_1}{Z_1} = \frac{2}{N-1}$$

$$\text{or input impedance} = \left( \frac{N+1}{N-1} \right) Z_1 = Z_1 \coth \theta$$

(d) For  $N = 1$  (possible only when  $Z_1 = Z_2$  and directly connected):

$$\frac{\Delta Z_1}{Z_1} = \frac{\Delta Z_2}{Z_2} \quad \text{and} \quad \frac{\Delta K}{K} = 0$$

(e) For large  $N$ :

$$\frac{\Delta K}{K} = \frac{1}{2} \frac{\Delta Z_2}{Z_2}$$

## FILTER NETWORKS

### GENERAL—Combination of filter elements

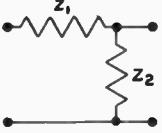
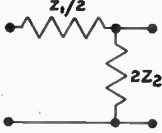
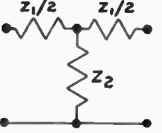
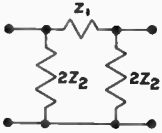
Configuration	Half Section	Full "T" Section	Full "π" Section
			

### LOW PASS

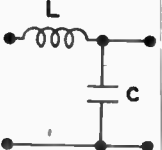
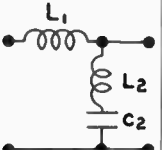
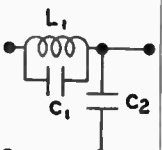
Type	Configuration	Series Arm	Shunt Arm	Notations
Constant "k"		$L = \frac{R}{\pi f_c}$	$C = \frac{1}{\pi f_c R}$	$f_c =$ cutoff frequency
Series "m" Derived		$L_1 = mL$	$L_2 = \frac{1 - m^2}{4m} L$ $C_2 = mC$	$f_\infty =$ freq. of peak atten. $m = \sqrt{1 - \left(\frac{f_0}{f_\infty}\right)^2}$
Shunt "m" Derived		$L_1 = mL$ $C_1 = \frac{1 - m^2}{4m} C$	$C_2 = mC$	$R =$ nominal terminating resistance

## FILTER NETWORKS—Continued

### HIGH PASS

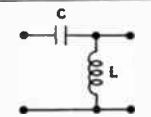
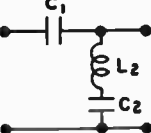
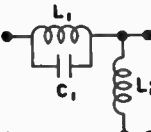
Type	Configuration	Series Arm	Shunt Arm	Notations
Constant "K"		$C = \frac{1}{4\pi f_c R}$	$L = \frac{R}{4\pi f_c}$	$f_c =$ cutoff frequency
Series "m" Derived		$C_1 = \frac{C}{m}$	$L_2 = \frac{L}{m}$ $C_2 = \frac{4m}{1-m^2} C$	$f_\infty =$ freq. of peak attenuation $m = \sqrt{1 - \left(\frac{f_\infty}{f_0}\right)^2}$
Shunt "m" Derived		$C_1 = \frac{C}{m}$ $L_1 = \frac{4m}{1-m^2} L$	$L_2 = \frac{L}{m}$	$R =$ nominal terminating resistance

### BAND PASS

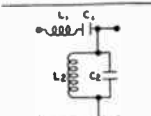
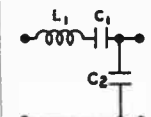
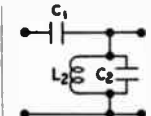
Type	Configuration	Series Arm	Shunt Arm	Notations
Constant "K"		$L_1 = \frac{R}{\pi(f_2 - f_1)}$ $C_1 = \frac{f_2 - f_1}{4\pi f_1 f_2 R}$	$L_2 = \frac{f_2 - f_1}{4\pi f_1 f_2} R$ $C_2 = \frac{1}{\pi(f_2 - f_1) R}$	$f_2 =$ upper cutoff frequency $f_1 =$ lower cutoff frequency
Three Element Series Type		$L_1 = \frac{R}{\pi(f_2 - f_1)}$ $C_1 = \frac{f_2 - f_1}{4\pi f_1^2 R}$	$C_2 = \frac{1}{\pi(f_1 + f_2) R}$	$R =$ nominal terminating resistance
Three Element Shunt Type		$C_1 = \frac{f_1 + f_2}{4\pi f_1 f_2 R}$	$L_2 = \frac{f_2 - f_1}{4\pi f_1 f_2} R$ $C_2 = \frac{f_1}{\pi f_2 (f_2 - f_1) R}$	

### BAND ELIMINATION

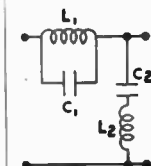



Type	Configuration	Series Arm	Shunt Arm	Notations
Constant "K"		$L_1 = \frac{f_2 - f_1}{\pi f_1 f_2} R$ $C_1 = \frac{1}{4\pi(f_2 - f_1) R}$	$L_2 = \frac{R}{4\pi(f_2 - f_1)}$ $C_2 = \frac{f_2 - f_1}{\pi f_1 f_2 R}$	$f_2 =$ upper cutoff frequency $f_1 =$ lower cutoff frequency $R =$ nominal terminating resistance

## SPECIAL CONNECTIONS AND CIRCUIT

Type	Single Phase Full Wave	Single Phase Bridge Cct.	4 Phase Star 2 Phase Supply	Double 2 Phase with Bal. Coil 2 Phase Supply
<b>SECONDARIES</b>  <b>CIRCUITS</b>  <b>PRIMARIES</b>				
RECTIFIER PHASE	2	2	4	4
NO. OF TUBES	2	4	4	4
NO. OF PHASES OF SUPPLY	1	1	2	2
TRANSF. SEC. VOLTAGE PER LEG	1.11 ( $\frac{1}{2}$ section)	1.11 (whole)	0.785	1.11
TRANSF. PRI. VOLTAGE	1.11	1.11	0.785	1.11
TRANSF. SEC. CURRENT PER LEG	0.707	1	0.500	0.354
TRANSF. PRI. CURRENT PER LEG	1	1	0.707	0.500
TRANSF. SEC. K.V.A.	1.57	1.11	1.57	1.57
TRANSF. PRI. K.V.A.	1.11	1.11	1.11	1.11
AVER. OF PRI. AND SEC. K.V.A.	1.34	1.11	1.34	1.34
PEAK INVERSE TUBE VOLTAGE	3.14	1.57	2.22	3.14
CURRENT PER TUBE	0.707	0.707	0.500	0.354
PEAK CURRENT PER TUBE	1.00	1.00	1.00	0.50
VOLTAGE RIPPLE FREQ.	2f	2f	4f	4f
RIPPLE VOLTAGE	0.483	0.483	0.098	0.098
RIPPLE PEAKS REFERENCE TO AVG. DC AS AXIS	+0.363 -0.637	0.363 0.637	0.111 0.215	0.111 0.215
LINE VOLTAGE	1.11	1.11	0.785	1.11
LINE CURRENT	1.00	1.00	0.707	0.50
LINE POWER FACTOR	0.90	0.90	0.90	0.90
FREQ. OF BAL. COIL VOLTAGE				2f
BALANCE COIL VOLTAGE				
PEAK BAL. COIL VOLTAGE				
BALANCE COIL K.V.A.				

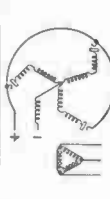
Values of voltage and current are RMS unless otherwise stated; they are given in terms of the average d-c values. The kilovolt amperes

## DATA FOR TYPICAL RECTIFIERS

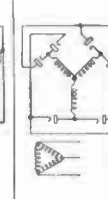
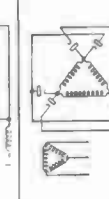
3 Phase Star	3 Phase Broken Star	6 Phase Star 3 Phase Supply	6 Phase Broken Star 3 Phase Supply	Double 3 Phase with Balance Coil	3 Phase Full Wave Single Y	3 Phase Full Wave Delta
						
3	3	6	6	6	6	6
3	3	6	6	6	6	6
3	3	3	3	3	3	3
0.855	0.985	0.740	0.428 (Per section of leg)	0.855	0.428	0.742
0.855	(1 1/2 leg .493) 0.855	0.740	0.428	0.855	0.428	0.742
0.577	0.577	0.408	Inner sect. 0.577	0.289	0.816	0.471
			Outer sect. 0.408			
0.471	0.408	0.577	0.816	0.408	0.816	0.816
1.48	1.71	1.81	1.79	1.48	1.05	1.05
1.21	1.21	1.28	1.05	1.05	1.05	1.05
1.35	1.46	1.55	1.42	1.26	1.05	1.05
2.09	2.09	2.09	2.09	2.42	1.05	1.05
0.577	0.577	0.408	0.408	0.289	0.577	0.577
1.00	1.00	1.00	1.00	0.50	1.00	1.00
3f	3f	6f	6f	6f	6f	6f
0.183	0.183	0.042	0.042	0.042	0.042	0.042
0.209	0.209	0.0472	0.0472	0.0472	0.0472	0.0472
0.395	0.395	0.0930	0.0930	0.0930	0.0930	0.0930
0.855	0.855	0.740	0.0428	0.855	0.428	0.742
0.817	0.707	0.817	1.41	0.707	1.41	1.41
0.826	0.955	0.955	0.955	0.955	0.955	0.955
				3f		
				0.356		
				0.605		
				0.178		

are in terms of d-c kilowatt output. For details refer Proc. I. R. E. Vol. 19 No. 1, January 1931, page 78, "Polyphase Rectification."



## SIX PRINCIPAL CIRCUITS OF SELENIUM RECTIFIERS





CIRCUIT		1-PHASE HALF WAVE (1-PHASE HALF WAVE)			1-PHASE BRIDGE (1-PHASE BRIDGE)			1-PHASE FULL WAVE (1-PHASE CENTER TAP)			3 PHASE STAR (3-PHASE HALF WAVE)			3 PHASE FULL WAVE "Y" OR "Δ" (3-PHASE BRIDGE)			6 PHASE STAR (3-PHASE CENTER TAP)		
SECONDARY OF TRANSFORMER AND RECTIFIER CONNECTIONS.																			
SECTION OF CIRCUIT		A	B	C	A	B	C	A	B	C	A	B	C	A	B	C	A	B	C
CURRENT FACTOR	TYPE OF LOAD																		
	RESISTIVE OR INDUCTIVE	1.8	1.8	1.8	1.15	.8	1.15	.8	.8	1.15	.65	.65	1.06	.85	.60	1.00	.46	.46	1.00
	CAPACITIVE OR BATTERY	2.5	2.5	2.5	1.7	1.2	1.6	1.2	1.2	1.8	.70	.70	1.08	.86	.61	1.02	.48	.48	1.02
OUTPUT VOLTAGE WAVE SHAPE	RESISTIVE OR INDUCTIVE LOAD																		
	CAPACITIVE LOAD																		
THEORETICAL RIPPLES IN % OF FUNDAMENTAL A.C.		121			48.3			48.3			18.3			4.2			4.2		

Figure 1—Six principal circuits of Selenium Rectifiers and their wave shapes under resistive, inductive or capacitive loads. Also, percentage of ripples in each circuit. The a-c input current in r.m.s. value in each section (A, B and C) is determined by multiplying the rectified output current in arithmetical value by resistive, inductive, capacitive, or battery load current factors,

## SELENIUM RECTIFIERS

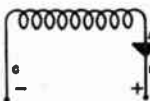
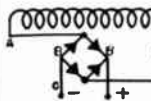
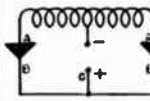
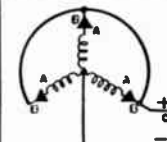
Selenium Rectifiers consist of one or several stacks assembled from selenium plates, usually arranged into one of the circuits illustrated in Fig. 1. Seven basic sizes of selenium plates and their rating are listed in Fig. 2. If the plates (Fig. 3) are spaced wider than those shown in Fig. 2, or are equipped with cooling fins (Fig. 4), the current ratings of the same seven basic plates are increased.

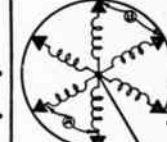
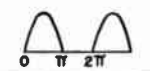
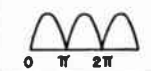
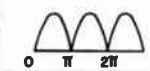
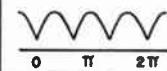
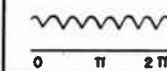
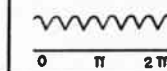
The design of Selenium Rectifiers is consummated by means of formulas and design constants tabulated in Fig. 5 and dynamic characteristics shown in Fig. 6 for direct value design method, applicable only to single phase bridge or center tap circuits and for resistive or inductive loads. For all other circuits and loads, the relative value method using the ratios  $F_v$  and  $N$  of Fig. 7 is usually employed. Upon selecting the proper current-carrying capacity plate (derated if necessary for higher ambient temperatures—see upper part of Fig. 8), the total d-c output is divided by the rated current of the selected plate. This current per plate divided by the rated current per basic plate gives quantity  $N$ . The corresponding  $F_v$  for the required circuit and load is then read off Fig. 7.  $F_v$  multiplied by  $F_a$  of the plate in question gives  $dv$  to be used in the design formulas.

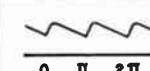
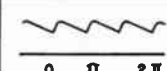
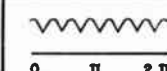
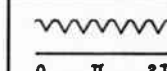
Plate Type No.	Diameter of Plates	Maximum Number of Plates per Stack	Max. R.M.S. Reverse Voltage per Plate	Single Phase Rectifiers			Three Phase Rectifiers			Rating of Plates Used as D.C. Valves	
				Half Wave	Bridge	Center Tap	Half Wave	Bridge	Center Tap		
	Inches			Volts	D.C. Amperes						Amperes
1	$\frac{3}{4}$	36	18	.04	.075	.075	.10	.11	.13	.06	15
2	1	36	18	.075	.15	.15	.20	.225	.27	.12	15
3	$1\frac{1}{4}$	36	18	.15	.30	.30	.40	.45	.55	.23	15
4	$1\frac{3}{4}$	40	18	.30	.60	.60	.80	.90	1.1	.45	15
5	$2\frac{1}{4}$	40	18	.60	1.2	1.2	1.6	1.8	2.2	.90	15
6	$3\frac{1}{4}$	40	16	1.2	2.4	2.4	3.2	3.6	4.5	1.8	12
7	$4\frac{1}{4}$	40	14	2.0	4.0	4.0	5.3	6.0	7.5	3.1	12

Figure 2—Current and Voltage Ratings of Seven Basic Selenium Plates used in Narrow Spacing Stack Assemblies feeding Resistive or Inductive Loads under conditions of 35° C Ambient Temperature and continuous duty. For Battery-charging or Condenser Loads, these ratings are reduced 20 per cent. For Temperature higher than 35° C, ratings are reduced in accordance with Fig. 8.

## SELENIUM RECTIFIERS—Continued

Plate Type No.	Diameter of Plates	Maximum Number of Plates per Stack	Selenium Plate No. Used (See Fig. 2)	Max. R.M.S. Reverse Voltage per Plate	Single Phase Rectifiers			Three Phase Rectifiers			Rating of Plates Used as D.C. Valves	
					Half Wave	Bridge	Center Tap	Half Wave	Bridge	Center Tap	Amperes	Volts
	Inches	Volts	D.C. Amperes									
20	1	28	2	18	.11	.22	.22	.29	.33	.4	.17	15
21	1 3/8	28	3	18	.23	.45	.45	.6	.67	.82	.34	15
10	1 3/8	28	4	18	.39	.78	.78	1.0	1.1	1.4	.58	15
11	2 3/8	28	5	18	.78	1.6	1.6	2.1	2.3	2.8	1.2	15
14	3 3/8	28	6	16	1.5	3.1	3.1	4.1	4.6	5.8	2.4	12
18	4 3/8	28	7	14	2.6	5.2	5.2	6.9	7.8	9.7	4.0	12

Figure 3—Current and Voltage Ratings of Six Selenium Plates (Fig. 2 less No. 1 plate) used in Wide Spacing Assemblies. Other conditions the same as those for Seven Basic Plates in Fig. 2.

Plate Type No.	Size of Cooling Fins	Maximum Number of Plates per Stack	Selenium Plate No. Used (See Fig. 2)	Max. R.M.S. Reverse Voltage per Plate	Single Phase Rectifiers			Three Phase Rectifiers			Rating of Plates Used as D.C. Valves	
					Half Wave	Bridge	Center Tap	Half Wave	Bridge	Center Tap	Amperes	Volts
	Inches	Volts	D.C. Amperes									
9	2 5/8 D.	28	4	18	.58	1.1	1.1	1.5	1.7	2.1	.87	15
12	3 5/8 D.	28	5	18	.90	1.8	1.8	2.4	2.7	3.3	1.4	15
13	4 5/8 D.	28	5	18	1.1	2.2	2.2	2.9	3.3	4.0	1.7	15
15	4 5/8 D.	28	6	16	1.8	3.5	3.5	4.6	5.2	6.5	2.7	12
16	4 5/8 D.	24	6	16	1.9	3.8	3.8	5.0	5.6	7.0	2.9	12
17	6 x 6	28	6	16	2.7	5.4	5.4	7.2	8.1	10.0	4.1	12
19	6 x 6	28	7	14	3.7	7.4	7.4	9.8	11.1	13.3	5.7	12
8	8 x 8	28	7	14	5.0	10.0	10.0	13.0	15.0	18.0	7.5	12

Figure 4—Current and Voltage Ratings of Eight Selenium Plate Assemblies using Basic Plates Nos. 4, 5, 6, and 7 and Cooling Fins of Different Sizes. Other conditions the same as in Figs. 2 and 3.

Formula No.	Formula	No. of Phase	Circuit Type	$k_1$	$n$	$k_2$
1	$V_{ac} = k_1 V_{dc} + k_2 n dv$	1	Half Wave	2.3	$\frac{V_{ac}}{V_p}$	1
2	$n = \frac{k_1 V_{dc}}{V_p - 2 dv}$	1	Bridge	1.15	$\frac{V_{ac}}{V_p}$	2
3	$V_{ac} = \frac{V_b}{\sqrt{2}} + k_2 n dv$	1	Center Tap	1.15	$\frac{2 V_{ac}}{V_p}$	1
4	$n = \frac{V_b}{V_p}$	3	Half Wave	.855	$\frac{\sqrt{3} V_{ac}}{V_p}$	1
5	$n = \frac{V_b / \sqrt{2}}{V_p - 2 dv}$	3	Bridge	.74	$\frac{V_{ac}}{V_p}$	2
6	$I_m = \sqrt{\frac{A}{A+P}} \times I_{max}$	3	Center Tap	.74	$\frac{2 V_{ac}}{V_p}$	1

Figure 5—Selenium Rectifier Design Formulas in left-hand table: 1st formula is most

## SELENIUM RECTIFIERS—Continued

commonly used in computing the required a-c voltage to give the necessary d-c output. The 3rd formula serves the same purpose in battery charging applications. The 6th formula is used in computing continuous current rating  $I_m$  when maximum current is drawn during the operating period A and between inoperative intervals P, both expressed in the same units of time and whenever A is not greater than time constant of the plate (approximately 5 or 8 minutes). The 2nd, 4th and 5th formulas are for computing n, number of plates in series to take care of voltage. Either 4th or 5th, whichever gives greater value, is used in battery charging.  $V_b$  is battery voltage, i.e., product of number of cells and the required voltage per cell;  $dv$  is voltage drop per plate in RMS value obtainable from Figs. 6 and 7.

Design Constants in right-hand table:  $k_1$ =form factor;  $k_2$ =circuit factor;  $V_D$ =maximum voltage per plate;  $V_{a0}$ =phase voltage, except three phase bridge where it is line voltage;  $n$ =number of plates in series, for checking purposes after exact computations by formulas.

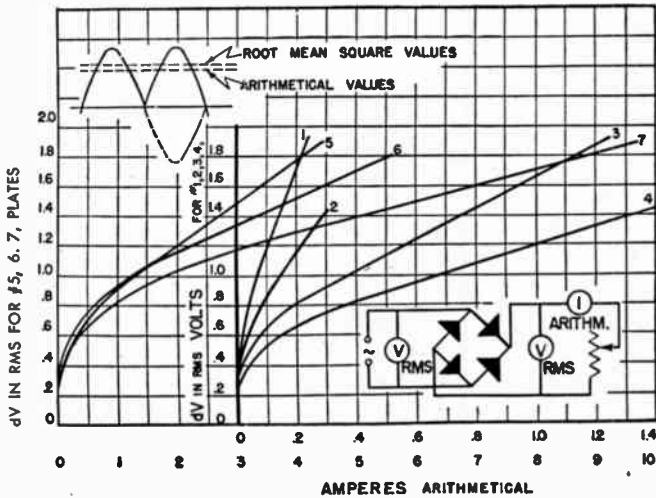
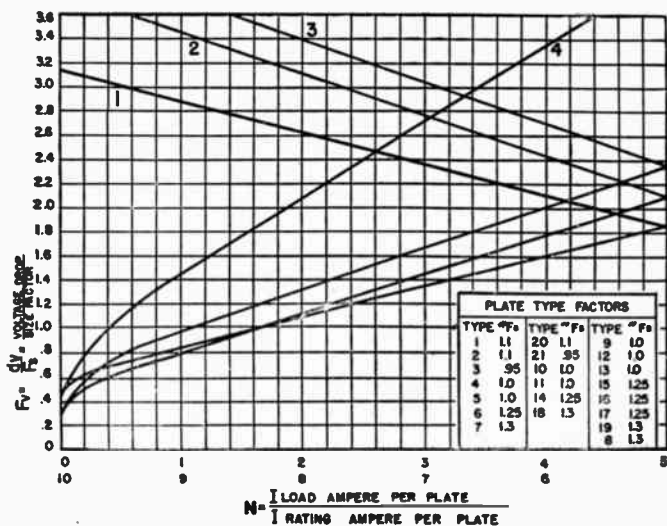

Figure 6—Rectification Characteristics of Seven Basic Plates ( $\frac{3}{4}$ , 1,  $1\frac{1}{8}$ ,  $1\frac{3}{4}$ ,  $2\frac{5}{8}$ ,  $3\frac{3}{8}$  and  $4\frac{3}{8}$  inch Diameter) Used in the Direct Method Design of Single Phase Bridge and Center Tap Rectifiers for Inductive and Resistive Loads. The voltage drop  $dv$  per plate, plotted as ordinates, is one-half of the difference between the r.m.s. values at input and output sides of the rectifier.

## SELENIUM RECTIFIERS—Continued



1. Direct Current Circuits. 2. 3 Phase, Bridge, Center Tap, All Loads. 3. 3 Phase, Half Wave, All Loads. 1 Phase, Half Wave, Bridge, Center Tap, Resistive or Inductive Loads. 4. 1 Phase, Half Wave, Bridge, Center Tap, Capacitive or Battery Loads.

Figure 7—Dynamic characteristics used in computing the necessary a-c voltage and number of series plates by means of relative value method.  $F_v$  is relative value of  $dv$  and  $F_s$  is plate type factor.

AMBIENT TEMPERATURE RANGE—°C.		35-40	40-45	45-50	50	50-55	55-60	60
Current Rating—Per Cent of Normal		83	67	47	64	47	30	47
Voltage Rating—Per Cent of Normal		100	100	100	80	80	80	60

°C.	0	1	2	3	4	5	6	7	8	9
+50	122.0	123.8	125.6	127.4	129.2	131.0	132.8	134.6	136.4	138.2
40	104.0	105.8	107.6	109.4	111.2	113.0	114.8	116.6	118.4	120.2
30	86.0	87.8	89.6	91.4	93.2	95.0	96.8	98.6	100.4	102.2
20	68.0	69.8	71.6	73.4	75.2	77.0	78.8	80.6	82.4	84.2
10	50.0	51.8	53.6	55.4	57.2	59.0	60.8	62.6	64.4	66.2
0	32.0	33.8	35.6	37.4	39.2	41.0	42.8	44.6	46.4	48.2
0	+32.0	30.2	28.4	26.6	24.8	23.0	21.2	19.4	17.6	15.8
-10	+14.0	12.2	10.4	8.6	6.8	5.0	3.2	+1.4	-0.4	-2.2
-20	-4.0	5.8	7.6	9.4	11.2	13.0	14.8	16.6	18.4	20.2
-30	-22.0	23.8	25.6	27.4	29.2	31.0	32.8	34.6	36.4	38.2
-40	-40.0	41.8	43.6	45.4	47.2	49.0	50.8	52.6	54.4	56.2
-50	-58.0	59.8	61.6	63.4	65.2	67.0	68.8	70.6	72.4	74.2

For Interpolation	°C. 0.1	0.2	0.3	0.4	0.5	0.6	0.7	0.8	0.9	1.0
	°F. 0.18	0.36	0.54	0.72	0.90	1.08	1.26	1.44	1.62	1.80

Figure 8—Under no conditions should the temperature of the Selenium Plates exceed 75° C. If the expected ambient is above 35° C, the current and, for still higher temperatures, the voltage rating of the plate should be reduced as shown in upper section of this table. The lower part of the table gives temperature conversion data from degrees Centigrade to degrees Fahrenheit.

## VACUUM TUBE DESIGN

### *Vacuum Tube Nomenclature*

I.R.E. standard symbols (Electronics Standards, 1938)

- $e_o$  Instantaneous total grid voltage
- $e_b$  Instantaneous total plate voltage
- $i_o$  Instantaneous total grid current
- $i_b$  Instantaneous total plate current
- $E_o$  Average value of grid voltage
- $E_b$  Average value of plate voltage
- $I_o$  Average value of grid current
- $I_b$  Average value of plate current
- $e_g$  Instantaneous value of varying component of grid voltage
- $e_p$  Instantaneous value of varying component of plate voltage
- $i_g$  Instantaneous value of varying component of grid current
- $i_p$  Instantaneous value of varying component of plate current
- $E_g$  Effective value of varying component of grid voltage
- $E_p$  Effective value of varying component of plate voltage
- $I_g$  Effective value of varying component of grid current
- $I_p$  Effective value of varying component of plate current
- $I_F$  Filament or heater current
- $I_b$  Total electron emission (from cathode)
- $r_1$  External plate load resistance
- $C_{gp}$  Grid-plate direct capacitance
- $C_{gk}$  Grid-cathode direct capacitance
- $C_{pk}$  Plate-cathode direct capacitance
- $\theta_p$  Plate current conduction angle
- $r_p$  Internal variational (AC) plate resistance
- $R_b$  Internal total (DC) plate resistance

Superscripts  $M$  preceding symbols (for example  ${}^M E_p$ ) indicate maximum values.

## VACUUM TUBE DESIGN—Continued

### Vacuum Tube Coefficients

Amplification Factor  $\mu$ : Ratio of incremental plate voltage to control-electrode voltage change at a fixed plate current with constant voltage on other electrodes.

$$\mu = \left[ \frac{\partial e_b}{\partial e_{c1}} \right]_{\substack{I_b \\ E_{c2} \text{-----} E_{cn}}} \left. \vphantom{\left[ \frac{\partial e_b}{\partial e_{c1}} \right]} \right\} \text{constant}$$

$r_1 = 0$

Transconductance: Ratio of incremental plate current to control-electrode voltage change at constant voltage on other electrodes. When electrodes are plate and control-grid the ratio is the *Mutual Conductance*  $g_m$  of the tube.

$$g_m = \left[ \frac{\partial i_b}{\partial e_{c1}} \right]_{E_b, E_{c2} \text{-----} E_{cn}} \text{constant}$$

$r_1 = 0$

Variational (AC) Plate Resistance  $r_p$ : The ratio of incremental plate voltage to current change at constant voltage on other electrodes.

$$r_p = \left[ \frac{\partial e_b}{\partial i_b} \right]_{E_{c1} \text{-----} E_{cn}} \text{constant}$$

$r_1 = 0$

Total (DC) Plate Resistance  $R_p$ : Ratio of total plate voltage to current for constant voltage on other electrodes.

$$R_p = \left[ \frac{e_b}{i_b} \right]_{E_{c1} \text{-----} E_{cn}} \text{constant}$$

$r_1 = 0$

### Vacuum Tube Terminology

Control Grid: Electrode to which plate current-controlling signal voltage is applied.

Space-charge Grid: Electrode, usually biased to constant positive voltage, placed adjacent to cathode to reduce current limiting effect of space charge.

Suppressor Grid: Grid placed between two electrodes to suppress conduction of secondary electrons from one to the other.

Screen Grid: Grid placed between anode and control-grid to reduce the capacitive coupling between them.

## VACUUM TUBE DESIGN—Continued

**Primary Emission:** Thermionic emission of electrons from pure metal or emissive layer.

**Secondary Emission:** Emission, usually of electrons, from a surface by direct impact, not thermal action, of electronic or ionic bombardment.

**Total Emission ( $I_a$ ):** Maximum (saturated, temperature-limited) value of electron current which may be drawn from a cathode. "Available Total Emission" is that peak value of current which may safely be drawn.

**Transfer Characteristic:** Relation, usually graphical, between voltage on one electrode and current to another, voltages on all other electrodes remaining constant. Examples:  $(i_b - e_c)e_b = \text{constant}$  curves and the so-called "positive-grid" characteristic  $(i_c - e_b)e_c = \text{constant}$  curves.

**Electrode Characteristic:** A relation, usually graphical, between the voltage on and current to a tube electrode, all other electrode voltages remaining constant. Examples:  $(i_b - e_b)e_c = \text{constant}$  curves.

**Composite-Diode Lines:** Relation, usually two curves, of the currents flowing to the control grid and the anode of a triode as a function of the equal voltage applied to them (grid-plate tied).

**Critical Grid Voltage:** Instantaneous value of grid voltage (with respect to cathode) at which anode current conduction is initiated through a gas tube.

**Constant Current Characteristics:** Relation, usually graphical, between the voltages on two electrodes, for constant specified current to one of them and constant voltages on all other electrodes. Examples:  $(e_c - e_b)i_b = \text{constant}$  curves.

### **Vacuum Tube Formulas\***

For unipotential cathode and negligible saturation of cathode emission:

	<i>Parallel Plane Cathode and Plate</i>	<i>Cylindrical Cathode and Plate</i>
Diode Plate Current (amperes)	$G_1 e_b^{3/2}$	$G_1 e_b^{3/2}$
Triode Plate Current (amperes)	$G_2 \left( \frac{e_b + \mu e_c}{1 + \mu} \right)^{3/2}$	$G_2 \left( \frac{e_b + \mu e_c}{1 + \mu} \right)^{3/2}$

\*Note: These formulas are based on theoretical considerations and do not provide accurate results for practical structures; however, they give a fair idea of the relationship between the tube geometry and the constants of the tube.



### VACUUM TUBE DESIGN—Continued

Diode Perveance, $G_1$	$2.3 \times 10^{-6} \frac{A_b}{d_b^2}$	$2.3 \times 10^{-6} \frac{A_b}{\beta^2 d_b^2}$
Triode Perveance, $G_2$	$2.3 \times 10^{-6} \frac{A_b}{d_c d_t}$	$2.3 \times 10^{-6} \frac{A_b}{\beta^2 d_b d_c}$
Amplification Factor	$\frac{2.7 d_c \left( \frac{d_b}{d_c} - 1 \right)}{\rho \log \frac{\rho}{2 \pi r_g}}$	$\frac{2 \pi d_c}{\rho} \frac{\log \frac{d_b}{d_c}}{\log \frac{\rho}{2 \pi r_g}}$
Mutual Conductance	$g_m = \frac{\mu}{r_p}$	

In above:

$A_b$  = anode area,  $\text{cm}^2$

$d_b$  = anode-cathode distance, cm

$d_c$  = grid-cathode distance, cm

$\beta$  = geometrical constant, a function of ratio of anode to cathode radius;

$\beta^2 \cong 1$  for  $\frac{r_h}{r_k} > 10$

$\rho$  = pitch of grid wires, cm

$r_g$  = grid wire radius, cm

$r_b$  = anode radius, cm

$r_k$  = cathode radius, cm

### **Electrode Dissipation Data**

Tube performance is limited by electrode dissipation. In turn tube dissipation is limited by the maximum safe operating temperatures of the glass-to-metal seals (approx. 200°C.), glass envelope, and tube electrodes. Thus excessive dissipation may result in breakage, loss of vacuum and destruction of the tube.

Typical operating data for common types of cooling are roughly as follows:

Type	Average Cooling Surface Temperature° C.	Specific Dissipation Watts / $\text{Cm}^2$ of Cooling Surface	Cooling Medium Supply
Radiation	400-1000	4-10	
Water	30-60	30-110	0.25-0.5 gals./min./KW
Forced-Air	150-200	0.5-1	75-150 cu. ft./min./KW

## VACUUM TUBE DESIGN—Continued

The operating temperature of radiation cooled anodes for a given dissipation is determined by the relative total emissivity of their material. Thus, graphite electrodes which approach black body radiation conditions operate at the lower temperature range indicated, while untreated tantalum and molybdenum work at relatively high temperatures.

In computing cooling medium flow, a minimum velocity sufficient to insure turbulent flow at the dissipating surface must be maintained.

In the case of water and forced-air cooled-tubes, the figures above apply to clean cooling surfaces, and may be reduced to a small fraction of these values by heat insulating coatings such as mineral scale or dust. Cooling surfaces should thus be closely observed and cleaned periodically.

### *Vacuum Tube Filament Characteristics*

Typical data on the three types of cathodes most used are given below:

<i>Type</i>	<i>Efficiency MA/watt</i>	<i>Specific Emission I<sub>a</sub> Amps./Cm<sup>2</sup></i>	<i>Operating Temperature Degs. Kelvin</i>	<i>Ratio Hot-to-Cold Resistance</i>
Pure Tungsten (W)	5-10	0.25-0.7	2500-2600	14:1
Thoriated Tungsten (ThW)	40-100	0.5-3	1950-2000	10:1
Oxide Coated (B <sub>a</sub> C <sub>a</sub> Sr)	50-150	0.5-2.5	1100-1250	2.5 to 5.5:1

In the cases of thoriated tungsten and oxide coated filament tubes, the emission data vary widely between tubes around the approximate range indicated in the table. The figures for specific emission refer to the peak or saturated value which is usually several times the total available value for these filaments. Instantaneous peak current values drawn during operation should not exceed the published available emission figure for the given tube.

Thoriated tungsten and oxide coated type filaments should be operated close to the specified published excitation currents and voltages. Deviation from these values, particularly in the case of oxide coated filaments, will result in rapid destruction of the cathode surface.

In the case of pure tungsten, the filament may be operated over a considerable temperature range. It should be borne in mind, however,

## VACUUM TUBE DESIGN—Continued

that the total filament emission current available varies closely as the seventh power of the filament voltage. Likewise, the expected filament life is critically dependent upon the operating temperature, an increase of 5% over the rated operating filament voltage producing a reduction of 50% in rated tube life. Where the full normal temperature cathode emission is not required, a corresponding increase in operating life may be secured by operation of a pure tungsten filament below rated filament voltage.

From the above tabulated values of hot-to-cold resistance, it may be seen that a very high heating current may be drawn by a cold filament, particularly one of the tungsten type. In order to avoid destruction by mechanical stresses which are proportional to  $I^2$ , it is imperative to limit the current to a safe value, say 150% of normal hot value for large tubes and 250% for medium types. This may be accomplished by resistance and time delay relays, high reactance transformers or regulators.

In a case where severe overload has temporarily impaired the emission, of a thoriated tungsten filament, the activity can sometimes be restored by operating the filament, with anode and grid voltages at zero, at 30% above the normal filament voltages for 10 minutes, and then at normal filament voltage for 20-30 minutes.

## ULTRA-HIGH FREQUENCY TUBES

Tubes for *UHF* application differ widely in design among themselves and from those for lower frequencies. They may be classified according to principle of operation as follows:

- (1) Negative grid tubes
  - (2) Positive grid tubes
  - (3) Velocity modulated tubes
  - (4) Magnetrons
- (1) *Negative grid tubes* for efficient *UHF* operation require:
- (a) Low interelectrode capacitance
  - (b) Low lead inductance
  - (c) Short electron transit time
  - (d) Low dielectric losses
  - (e) Relatively high cathode emission

## ULTRA-HIGH FREQUENCY TUBES—Continued

Conditions (b) and (c) lead to small tubes and close electrode spacings, in opposition to requirements (a), (d) and (e). Accordingly, the peak voltage and plate current, electrode dissipation and hence maximum possible power output decrease with increasing frequency. In case of receiving tubes not dissipation limited, small size structures with low transit time result permitting operation to about 3000 megacycles. Use of tubes in lumped constant resonant circuits leads to direct limitation of operating frequency by (a) and (b) since

$$f = \frac{1}{2\pi\sqrt{LC}}$$

Using linear resonant circuits such as parallel or concentric lines, the upper frequency attainable is limited by the interelectrode capacitance since

$$f_{\max} = \frac{10^6}{2\pi C Z_o \tan \frac{2\pi l}{\lambda}}$$

where  $f_{\max}$  = maximum operating frequency in megacycles per second

$C$  = shunt capacitance in  $\mu\mu f$  across open end of shorted section line

$l$  = minimum line length in cms.

where  $l < \frac{\lambda}{4}$

$Z_o$  = line surge impedance, ohms

Transit time of electrons from cathode to grid, and grid to anode must be less than approximately one-fifth of a period at the operating frequency. Larger values reduce operating efficiency, increase internal tube losses and may result in destructive cathode bombardment, due to the arriving electrons becoming out of phase with the accelerating alternating grid and plate voltages.

The effect of transit time limitation in an amplifier is to increase the input shunt conductance between grid and cathode. As this conductance has been found to vary with the square of the frequency, a very rapid reduction in amplification takes place in the vicinity of the upper frequency limit of a tube. The effect of transit time on the input capacitance is small.

## ULTRA-HIGH FREQUENCY TUBES—Continued

In negative grid as well as all other *UHF* tube types, conductor and dielectric resistances must be reduced to a minimum by design and choice of materials inasmuch as skin-effect and dielectric polarization losses rapidly become excessive.

High specific cathode emission per unit area is necessary for appreciable output as the tube dimensions are decreased. A higher available total emission is also required since, for lower permissible plate voltages and load impedances, higher peak currents are drawn.

In contrast to negative grid tubes, transit time is taken advantage of in the operation of positive grid and velocity-modulated tubes and magnetrons.

(2) *Positive grid or brake-field tubes* in which an oscillating space charge is produced by acceleration of electrons through a positive grid toward a negative reflecting anode have been used for production of wavelengths down to one centimeter. Low power output and efficiency and poor frequency stability has hitherto limited their wide application.

(3) *Velocity-modulated tubes* utilize the accelerating and retarding action of alternating electrode voltages on a transit-time limited electron beam to vary the space charge density of the latter. After increase of this "bunching" effect by passage through a field-free "drift tube", the beam is passed between the plates of an appropriately tuned resonant cavity from which output power of fundamental frequency is taken off. Several types of amplifiers and oscillators utilize this principle of operation, of which some such as the reflex "Klystron" having a single cavity resemble the brake-field type tube. A maximum efficiency of about 50 percent may be obtained by this principle although the actual efficiency obtained in the frequency range around 10 centimeters is only a few percent.

(4) The *magnetron* may be considered as another form of velocity-modulated tube in which the electron stream instead of being accelerated linearly is given a circular trajectory by means of a transverse magnetic field. Energy from this beam is not lost directly to an

## ULTRA-HIGH FREQUENCY TUBES—Continued

acceleration electrode at DC potential as in the linear case and accordingly a higher operating efficiency may be obtained. Usually acceleration and retardation of the rotary beam is accomplished by one or more pairs of electrodes associated with one or more resonant circuits.

Wavelengths down to a centimeter are produced by the so-called "first order" ( $n = 1$ ) oscillations generated in a magnetron having a single pair of plates. Relatively low efficiency and power output are obtained in this mode of operation. Design formulas relating dimensions, D.C. anode voltage, magnetic field strength and output frequency for this case are obtained from the basic relation for electron

angular velocity  $\omega_m = H \frac{e}{m}$ :

$$\lambda = \frac{10700}{H}$$

$$E_b = 0.022 r_b^2 \left[ 1 - \left( \frac{r_k}{r_b} \right)^2 \right]^2 H^2$$

where  $H$  = field intensity in gauss

$E_b$  = D.C. accelerating voltage in volts

$\lambda$  = generated wavelengths, cms.

$r_b$  = anode radius, cms.

$r_k$  = cathode radius, cms.

Higher order oscillations of the magnetron may be obtained at high outputs and efficiencies exceeding that of the linear velocity modulated tubes.

## VACUUM TUBE AMPLIFIER DESIGN

### *Vacuum Tube Amplifier Classification*

It is common practice to differentiate between types of vacuum tube circuits, particularly amplifiers, on the basis of the operating regime of the tube.

**Class A:** Grid bias and alternating grid voltages such that plate current flows continuously throughout electrical cycle ( $\theta_p = 360$  degrees).

**Class AB:** Grid bias and alternating grid voltages such that plate current flows appreciably more than half but less than entire electrical cycle ( $360^\circ > \theta_p > 180^\circ$ ).

**Class B:** Grid bias close to cut-off such that plate current flows only during approximately half of electrical cycle ( $\theta_p \cong 180^\circ$ ).

**Class C:** Grid bias appreciably greater than cut-off so that plate current flows for appreciably less than half of electrical cycle ( $\theta_p < 180^\circ$ ).

A further classification between circuits in which positive grid current is conducted during some portion of the cycle, and those in which it is not, is denoted by subscripts 2 and 1, respectively. Thus a class  $AB_2$  amplifier operates with a positive swing of the alternating grid voltage such that positive electronic current is conducted, and accordingly in-phase power is required to drive the tube.

### *General Design*

In selecting a tube for a given application or, conversely, of the circuit constants to obtain optimum results with a given tube, a two-step process is frequently convenient, namely:

- (1) Preliminary estimate on the basis of maximum published tube ratings and output requirements, and,
- (2) After tentative selection of tube type, graphic determination of detailed performance constants such as voltages, currents, harmonic distortion, etc., from accurate published tube characteristics. This procedure is conveniently applicable to high as well as low power amplifiers and oscillators although, in the case of receiving and small power output tubes, experimental methods are largely used.

## VACUUM TUBE AMPLIFIER DESIGN—Continued

### TABLE I

Typical Amplifier Operating Data (Max. signal conditions—per tube)

	Class A	Class B A-F (P.P.)	Class B R-F	Class C R-F
Plate Efficiency, $\eta$ %	20 - 30	35 - 65	60 - 70	65 - 85
Peak instantaneous to D.C. plate current ratio $M_{i_b}/I_b$	1.5 - 2	3.1	3.1	3.1 - 4.5
R.M.S. alternating to D.C. plate current ratio, $I_p/I_b$	0.5 - 0.7	1.1	1.1	1.1 - 1.2
R.M.S. alternating to D.C. plate voltage ratio, $E_p/E_b$	0.3 - 0.5	0.5 - 0.6	0.5 - 0.6	0.5 - 0.6
D.C. to peak instantaneous grid current, $I_c/M_{i_o}$		0.25 - 0.1	0.25 - 0.1	0.15 - 0.1

Table I gives correlating data for typical operation of tubes in the various amplifier classifications. From this table, knowing the maximum ratings of a tube, the maximum power output, currents, voltages and corresponding load impedance may be estimated. Thus, taking for example, a type F-124-A water-cooled transmitting tube as a class C RF power amplifier and oscillator—the constant current characteristics of which are shown in Fig. 1 published maximum ratings are as follows:

D.C. plate voltage, $E_b$	20,000 volts
D.C. grid voltage, $E_o$	3,000 volts
D.C. plate current, $I_b$	7 amperes
R.F. grid current, $I_g$	50 amperes
Plate input, $P_i$	135,000 watts
Plate dissipation, $P_p$	40,000 watts

Maximum conditions may be estimated as follows:

For  $\eta = 75\%$   $P_i = 135,000$  watts  $E_b = 20,000$  volts,

Power Output,  $P_o = \eta P_i = 100,000$  watts

Average D.C. plate current,  $I_b = P_i/E_b = 6.7$  amps.

From tabulated typical ratio  $M_{i_b}/I_b = 4$ , instantaneous peak plate current  $M_{i_b} = 4 I_b = 27$  amps.

The R.M.S. alternating plate current component, taking ratio  $I_p/I_b = 1.2$ ,  $I_p = 1.2 I_b = 8$  amps.

The R.M.S. value of the alternating plate voltage component from the ratio  $E_p/E_b = 0.6$  is  $E_p = 0.6 E_b = 12,000$  volts.



## VACUUM TUBE AMPLIFIER DESIGN—Continued

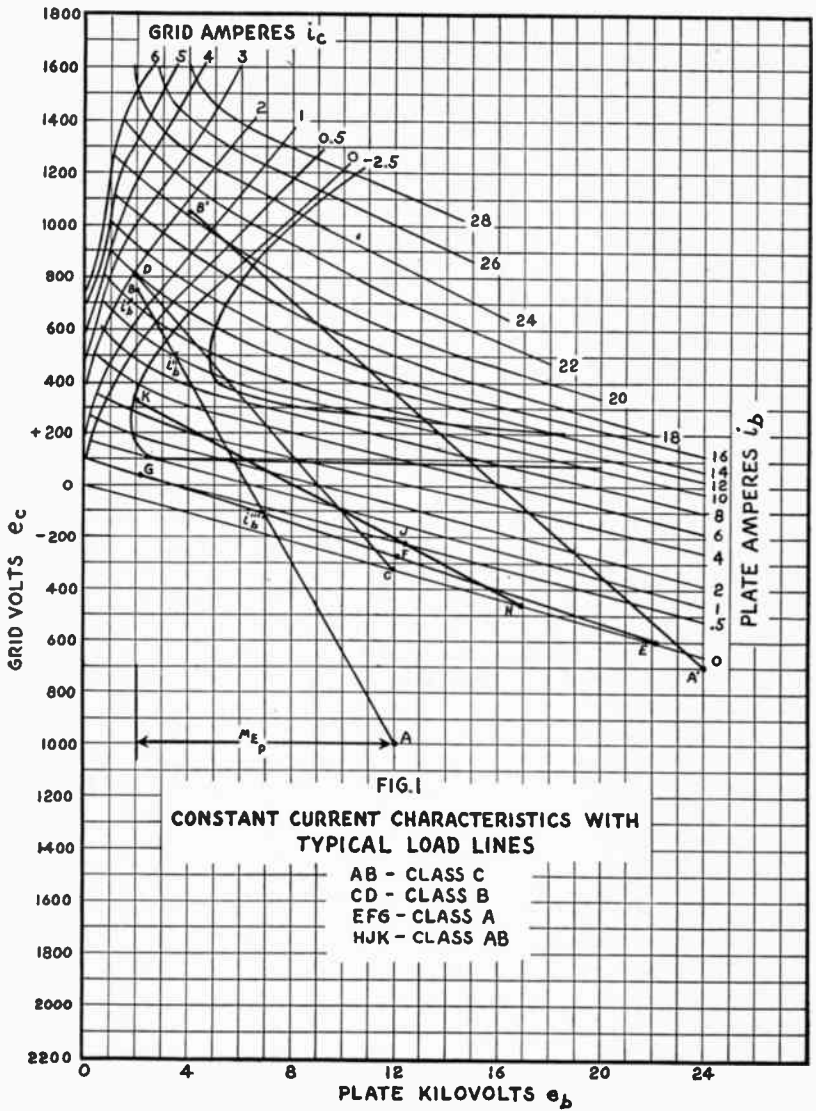

Figure 1—Constant Current Characteristics with Typical Load Lines  
AB—Class C, CD—Class B, EFG—Class A, and HJK—Class AB.

## VACUUM TUBE AMPLIFIER DESIGN—Continued

The approximate operating load resistance  $r_1$  is now found from

$$r_1 = E_p/I_p = 1500 \text{ ohms.}$$

An estimate of the grid drive power required may be obtained by reference to the constant current characteristics of the tube and determination of the peak instantaneous positive grid current  ${}^M i_g$  and the corresponding instantaneous total grid voltage  ${}^M e_g$ . Taking the value of grid bias  $E_c$  for the given operating condition, the peak A.C. grid drive voltage is

$${}^M E_g = ({}^M e_g - E_c)$$

from which the peak instantaneous grid drive power

$${}^M P_o = {}^M E_g {}^M i_g$$

An approximation to the average grid drive power,  $P_g$ , necessarily rough due to neglect of negative grid current, is obtained from the typical ratio,  $I_c/{}^M i_g = 0.2$  of D.C. to peak value of grid current, giving

$$P_g = I_c E_g = 0.2 {}^M i_g E_g \text{ watts.}$$

Plate dissipation  $P_p$  may be checked with published values since  $P_p = P_i - P_o$ .

It should be borne in mind that combinations of published maximum ratings as well as each individual maximum rating must be observed. Thus, for example in this case, the maximum D.C. plate operating voltage of 20,000 volts does not permit operation at the maximum D.C. plate current of 7 amps. since this exceeds the maximum plate input rating of 135,000 watts.

Plate load resistance  $r_1$  may be connected directly in the tube plate circuit, as in the resistance-coupled amplifier, through impedance matching elements as in AF transformer-coupling, or effectively represented by a loaded parallel resonant circuit as in most radio frequency amplifiers. In any case, calculated values apply only to effectively resistive loads, such as are normally closely approximated in radio frequency amplifiers. With appreciably reactive loads, operating currents and voltages will in general be quite different and their precise calculation is quite difficult.

The physical load resistance present in any given set-up may be measured by AF or RF bridge methods. In many cases, the proper value of  $r_1$  is ascertained experimentally as in RF amplifiers which are tuned to the proper minimum D.C. plate current. Conversely, if the circuit is to be matched to the tube,  $r_1$  is determined directly as in a resistance coupled amplifier or as

$$r_1 = N^2 r_s$$

in the case of a transformer coupled stage, where  $N$  is the primary to secondary voltage transformation ratio. In a parallel resonant circuit in which the output resistance  $r_s$  is connected directly in one of the resistance legs,

## VACUUM TUBE AMPLIFIER DESIGN—Continued

$$r_1 = X^2/r_s = L/Cr_s = QX,$$

where  $X$  is the leg reactance at resonance (ohms).

$L$  and  $C$  are leg inductance (henries) and capacitance (farads), respectively,  $Q = X/r_s$ .

The above method gives useful approximate results. When accurate operating data are required, as for instance for the layout of large equipment, more precise methods of calculation must be used. The graphical methods listed in the next section are convenient and rapid and give close approximations of actual operating values.

### Graphical Methods

Because of the non-linear nature of tube characteristics, graphical methods are resorted to for accurate determination of tube operating data. Examples of such methods are given below.

A comparison of the operating regimes of class A, AB, B and C amplifiers is given in the constant current characteristics graph of Fig. 1. The lines corresponding to the different classes of operation are each the locus of instantaneous grid  $e_s$  and plate  $e_b$  voltages, corresponding to their respective load impedances.

For radio frequency amplifiers and oscillators having tuned circuits giving an effective resistive load, plate and grid tube and load alternating voltages are sinusoidal and in phase (disregarding transit time), and the loci become straight lines.

For amplifiers having non-resonant resistive loads, the loci are in general non-linear except in the distortionless case of linear tube characteristics (constant  $r_p$ ) for which they are again straight lines.

Thus, for determination of RF performance, the constant-current chart is convenient. For solution of AF problems, however, it is more convenient to use the ( $i_b - e_c$ ) transfer characteristics of Fig. 2 on which a dynamic load line may be constructed.

Methods for calculation of the most important cases are given below.

*Class C RF Amplifier or Oscillator*—Draw straight line from  $A$  to  $B$  (Fig. 1) corresponding to chosen DC operating plate and grid voltages, and to desired peak alternating plate and grid voltage excursions. The projection of  $AB$  on the horizontal axis thus corresponds to  ${}^m E_p$ . Using Chaffee's 11-point method of harmonic analysis, lay out on  $AB$  points:

$$e'_p = {}^m E_p$$

$$e''_p = 0.866 {}^m E_p$$

$$e'''_p = 0.5 {}^m E_p$$

# VACUUM TUBE AMPLIFIER DESIGN—Continued

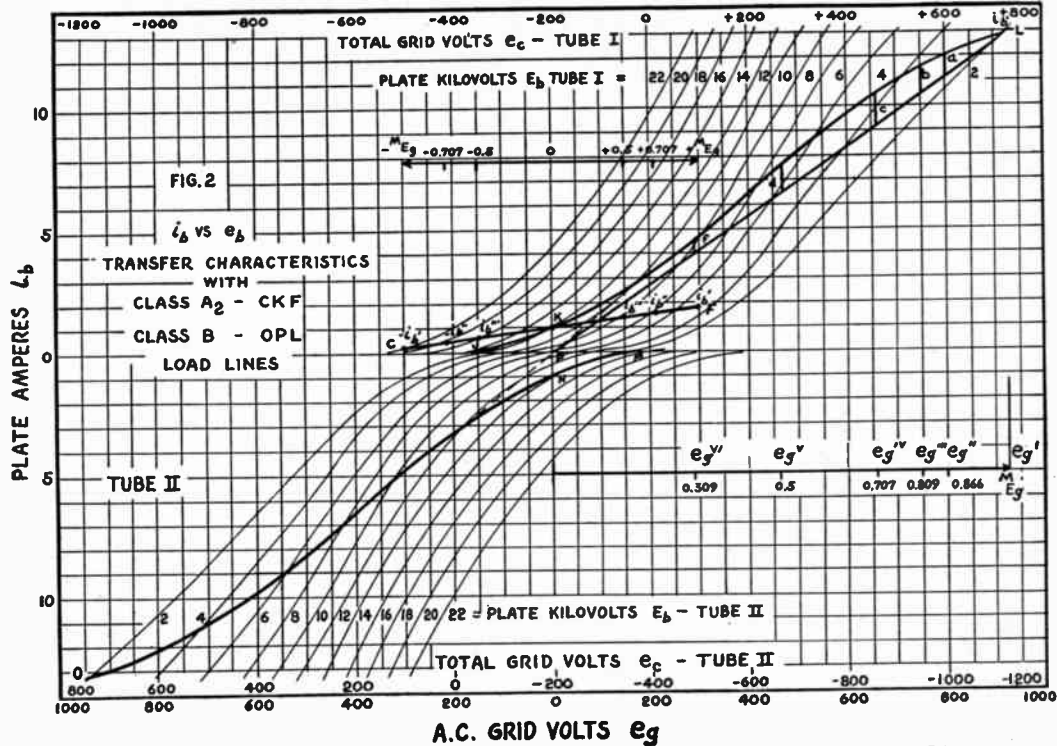

Figure 2— $i_b$  vs  $e_b$  Transfer Characteristics with Class A<sub>2</sub>—CKF, Class B—OPL Load Lines.

## VACUUM TUBE AMPLIFIER DESIGN—Continued

to each of which correspond instantaneous plate currents  $i'_b$ ,  $i''_b$  and  $i'''_b$  and instantaneous grid currents  $i'_c$ ,  $i''_c$  and  $i'''_c$ . The operating currents are obtained from the following expressions:

$$I_b = \frac{1}{12} [i'_b + 2 i''_b + 2 i'''_b]$$

$$I_c = \frac{1}{12} [i'_c + 2 i''_c + 2 i'''_c]$$

$${}^m I_p = \frac{1}{6} [i'_b + 1.73 i''_b + i'''_b]$$

$${}^m I_g = \frac{1}{6} [i'_c + 1.73 i''_c + i'''_c].$$

Substitution of the above in the following give the desired operating data.

$$\text{Power Output, } P_o = \frac{{}^m E_p {}^m I_p}{2}$$

$$\text{Power Input, } P_i = E_b I_b$$

$$\text{Average Grid Excitation Power} = \frac{{}^m E_g {}^m I_g}{2}$$

$$\text{Peak Grid Excitation Power} = {}^m E_g i'_c$$

$$\text{Plate Load Resistance, } r_1 = \frac{{}^m E_p}{{}^m I_p}$$

$$\text{Grid Bias Resistance, } R_c = \frac{E_c}{I_c}$$

$$\text{Plate Efficiency, } \eta = \frac{P_o}{P_i}$$

$$\text{Plate Dissipation, } P_p = P_i - P_o$$

The above procedure may also be applied to plate modulated class C amplifiers. Taking the above data as applying to carrier conditions, the analysis is repeated for  ${}^{\text{crest}} E_b = 2E_b$  and  ${}^{\text{crest}} P_o = 4P_o$  keeping  $r_1$  constant. After a cut and try method has given a peak solution, it will often be found that combination fixed and self grid biasing as well as grid modulation is indicated to obtain linear operation.

To illustrate the preceding exposition, a typical amplifier calculation is given below:

Operating Requirements (carrier condition)

$$E_b = 12,000 \text{ volts}$$

$$P_o = 25,000 \text{ watts}$$

$$\eta = 75\%$$

Preliminary Calculation (refer to Table II)

## VACUUM TUBE AMPLIFIER DESIGN—Continued

### TABLE II

Class C RF Amplifier Data 100% Plate Modulation

SYMBOL	PRELIMINARY		DETAILED	
	CARRIER		CARRIER	CREST
$E_b$ (volts)	12,000		12,000	24,000
${}^m E_p$ (volts)	10,000		10,000	20,000
$E_o$ (volts)			-1000	-700
${}^m E_g$ (volts)			1740	1740
$I_b$ (amps)	2.9		2.8	6.4
${}^m I_p$ (amps)	4.9		5.1	10.2
$I_o$ (amps)			0.125	0.083
${}^m I_g$ (amps)			0.255	0.183
$P_i$ (watts)	35,000		33,600	154,000
$P_o$ (watts)	25,000		25,500	102,000
$P_g$ (watts)			220	160
$\eta$ (per cent)	75		76	66
$r_i$ (ohms)	2060		1960	1960
$R_o$ (ohms)			7100	7100
$E_{co}$ (volts)			-110	-110

Since  $E_p/E_b = 0.6$

$$E_p = 0.6 \times 12,000 = 7200 \text{ volts}$$

and  ${}^m E_p = 1.41 \times 7200 = 10,000 \text{ volts.}$

From  $I_p = P_o/E_p$

$$I_p = \frac{25,000}{7200} = 3.48 \text{ amperes}$$

and  ${}^m I_p = 4.9 \text{ amperes.}$

For  $I_p/I_b = 1.2$

$$I_b = 3.48 / 1.2 = 2.9 \text{ amperes}$$

and  $P_i = 12,000 \times 2.9 = 35,000 \text{ watts.}$

Also  $\frac{{}^m i_b}{I_b} = 4.5$

giving  ${}^m i_b = 4.5 \times 2.9 = 13.0 \text{ amperes.}$

Finally  $r_i = E_p/I_p = \frac{7200}{3.48} = 2060 \text{ ohms.}$

### Complete Calculation

Layout carrier operating line,  $AB$ , on constant current graph, Fig. 1, using values of  $E_b$ ,  ${}^m E_p$  and  ${}^m i_b$  from preliminary calculated data.

## VACUUM TUBE AMPLIFIER DESIGN—Continued

Operating carrier bias voltage,  $E_c$ , is chosen somewhat greater than twice cutoff value, 1000 volts, to locate point  $A$ .

The following data are taken along  $AB$ :

$$\begin{array}{lll} i_b' = 13 \text{ amps} & i_c' = 1.7 \text{ amps} & E_c = -1000 \text{ volts} \\ i_b'' = 10 \text{ amps} & i_c'' = -0.1 \text{ amps} & e_o' = 740 \text{ volts} \\ i_b''' = 0.3 \text{ amps} & i_c''' = 0 \text{ amps} & {}^mE_p = 10,000 \text{ volts} \end{array}$$

From the formulas complete carrier data as follows are calculated:

$${}^mI_p = \frac{1}{6} [13 + 1.73 \times 10 + 0.3] = 5.1 \text{ amps}$$

$$P_o = \frac{10,000 \times 5.1}{2} = 25,500 \text{ watts}$$

$$I_b = \frac{1}{12} [13 + 2 \times 10 + 2 \times 0.3] = 2.8 \text{ amps}$$

$$P_i = 12,000 \times 2.8 = 33,600 \text{ watts}$$

$$\eta = \frac{25,500}{33,600} \times 100 = 76 \text{ per cent}$$

$$r_1 = \frac{10,000}{5.1} = 1960 \text{ ohms}$$

$$I_o = \frac{1}{12} [1.7 + 2(-0.1)] = 0.125 \text{ amps}$$

$${}^mI_g = \frac{1}{6} [1.7 + 1.7(-0.1)] + 0.255 \text{ amps}$$

$$P_g = \frac{1740 \times 0.255}{2} = 220 \text{ watts}$$

Operating data at 100% positive modulation crests are now calculated knowing that here

$$E_b = 24,000 \text{ volts}$$

$$r_1 = 1960 \text{ ohms}$$

and for undistorted operation

$$P_o = 4 \times 25,500 = 102,000 \text{ watts}$$

$${}^mE_p = 20,000 \text{ volts}$$

The crest operating line,  $A'B'$ , is now located by trial so as to satisfy the above conditions, using the same formulas and method as for the carrier condition.

It is seen that in order to obtain full crest power output, in addition

## VACUUM TUBE AMPLIFIER DESIGN—Continued

to doubling the alternating plate voltage, the peak plate current must be increased. This is accomplished by reducing the crest bias voltage with resultant increase of current conduction period but lower plate efficiency.

The effect of grid secondary emission to lower the crest grid current is taken advantage of to obtain the reduced grid resistance voltage drop required. By use of combination fixed and grid resistance bias proper variation of the total bias is obtained. The value of grid resistance required is given by

$$R_c = \frac{-[E_c - \text{crest} E_c]}{I_c - \text{crest} I_c}$$

and the value of fixed bias by

$$E_{cc} = E_c - (I_c R_c)$$

Calculations at carrier and positive crest together with the condition of zero output at negative crest give sufficiently complete data for most purposes. If accurate calculation of AF harmonic distortion is necessary the above method may be applied to the additional points required.

*Class B RF Amplifiers.*—A rapid approximate method is to determine by inspection from the tube ( $i_b - e_b$ ) characteristics the instantaneous current,  $i'_b$ , and voltage,  $e'_b$ , corresponding to peak alternating voltage swing from operating voltage,  $E_b$ .

$$\text{AC Plate Current, } {}^M I_p = \frac{i'_b}{2}$$

$$\text{DC Plate Current, } I_b = \frac{i'_b}{\pi}$$

$$\text{AC Plate Voltage, } {}^M E_p = E_b - e'_b$$

$$\text{Power Output, } P_o = \frac{(E_b - e'_b) i'_b}{4}$$

$$\text{Power Input, } P_i = \frac{E_b i'_b}{\pi}$$

$$\text{Plate Efficiency, } \eta = \frac{\pi}{4} \left( 1 - \frac{e'_b}{E_b} \right)$$

Thus  $\eta \cong 0.6$  for the usual crest value of  ${}^M E_p \cong 0.8 E_b$ .



### VACUUM TUBE AMPLIFIER DESIGN—Continued

The same method of analysis used for the class C amplifier may also be used in this case. The carrier and crest condition calculations, however, are now made from the same  $E_b$ , the carrier condition corresponding to an alternating voltage amplitude of  $\frac{M E_p}{2}$  such as to give the desired carrier power output.

For greater accuracy than the simple check of carrier and crest conditions, the RF plate currents  ${}^M I'_{p1}$ ,  ${}^M I''_{p1}$ ,  ${}^M I'''_{p1}$ ,  ${}^M I^o_{p1}$ ,  $-{}^M I'''_{p1}$ ,  $-{}^M I''_{p1}$ , and  $-{}^M I'_{p1}$  may be calculated for seven corresponding selected points of the AF modulation envelope  $+{}^M E_g$ ,  $+0.707 {}^M E_g$ ,  $+0.5 {}^M E_g$ ,  $0$ ,  $-0.5 {}^M E_g$ ,  $-0.707 {}^M E_g$  and  $-{}^M E_g$  where the negative signs denote values in the negative half of the modulation cycle. Designating

$$\begin{aligned} S' &= {}^M I'_{p1} + (-{}^M I'_{p1}) \\ D' &= {}^M I'_{p1} - (-{}^M I'_{p1}), \text{ etc.}, \end{aligned}$$

the fundamental and harmonic components of the output AF current are obtained as

$${}^M I_{p1} = \frac{S'}{4} + \frac{S''}{2\sqrt{2}} \text{ (fundamental)}$$

$${}^M I_{p2} = \frac{5 D'}{24} + \frac{D''}{4} - \frac{D'''}{3}$$

$${}^M I_{p3} = \frac{S'}{6} - \frac{S'''}{3}$$

$${}^M I_{p4} = \frac{D'}{8} - \frac{D''}{4}$$

$${}^M I_{p5} = \frac{S'}{12} - \frac{S''}{2\sqrt{2}} + \frac{S'''}{3}$$

$${}^M I_{p6} = \frac{D'}{24} - \frac{D''}{4} + \frac{D'''}{3}$$

This detailed method of calculation of AF harmonic distortion may, of course, also be applied to calculation of the class C modulated amplifier, as well as to the class A modulated amplifier.

*Class A and AB AF Amplifiers*—Approximate formulas assuming linear tube characteristics:

$$\text{Maximum Undistorted Power Output, } {}^M P_o = \frac{{}^M E_p {}^M I_p}{2}$$

### VACUUM TUBE AMPLIFIER DESIGN—Continued

when Plate Load Resistance,  $r_1 = r_p \left[ \frac{E_c}{\frac{M E_p}{\mu} - E_c} - 1 \right]$

and Negative Grid Bias,  $E_c = \frac{M E_p}{\mu} \left( \frac{r_1 + r_p}{r_1 + 2r_p} \right)$

giving Maximum Plate Efficiency,  $\eta = \frac{M E_p M I_p}{8 E_b I_b}$

Max. Maximum Undistorted Power Output  ${}^{MM}P_o = \frac{M E_p^2}{16 r_p}$

when  $r_1 = 2 r_p$

$$E_c = \frac{3 M E_p}{4 \mu}$$

An exact analysis may be obtained by use of a dynamic load line laid out on the transfer characteristics of the tube. Such a line is *CKF* of Fig. 2 which is constructed about operating point *K* for a given load resistance  $r_1$  from the following relation:

$$i_b^S = \frac{e_b^R - e_b^S}{r_1} + i_b^R$$

where

*R*, *S*, etc., are successive conveniently spaced construction points.

Using the seven point method of harmonic analysis, plot instantaneous plate currents  $i'_b, i''_b, i'''_b, I_b, -i''_b, -i'_b$  and  $-i'_b$  corresponding to  $+M E_g, +0.707M E_g, +0.5M E_g, 0, -0.5M E_g, -0.707M E_g,$  and  $-M E_g$ , where 0 corresponds to the operating point *K*. In addition to the formulas given under class B RF amplifiers:

$$I_b \text{ average} = I_b + \frac{D'}{8} + \frac{D''}{4}$$

from which complete data may be calculated.

*Class AB and B AF Amplifiers* — Approximate formulas assuming linear tube characteristics give (referring to Fig. 1, line *CD*) for a class B AF amplifier:

$${}^M I_p = i'_b$$

## VACUUM TUBE AMPLIFIER DESIGN—Continued

$$P_o = \frac{{}^m E_p {}^m I_p}{2}$$

$$P_i = \frac{2}{\pi} E_b {}^m I_p$$

$$\eta = \frac{\pi}{4} \frac{{}^m E_p}{E_b}$$

$$R_{pp} = 4 \frac{{}^m E_p}{i'_b} = 4r_1$$

Again an exact solution may be derived by use of the dynamic load line  $JKL$  on the  $(i_b - e_c)$  characteristic of Fig. 2. This line is calculated about the operating point  $K$  for the given  $r_1$  (in the same way as for the class A case). However, since two tubes operate in phase opposition in this case, an identical dynamic load line  $MNO$  represents the other half cycle, laid out about the operating bias abscissa point but in the opposite direction (see Fig. 2).

Algebraic addition of instantaneous current values of the two tubes at each value of  $e_c$  gives the composite dynamic characteristic for the two tubes  $OPL$ . Inasmuch as this curve is symmetrical about point  $P$  it may be analyzed for harmonics along a single half curve  $PL$  by the Mouromtseff 5-point method. A straight line is drawn from  $P$  to  $L$  and ordinate plate current differences  $a, b, c, d, f$  between this line and curve, corresponding to  $e''_g, e'''_g, e^{IV}_g, e^V_g$  and  $e^{VI}_g$ , are measured. Ordinate distances measured upward from curve  $PL$  are taken positive. Fundamental and harmonic current amplitudes and power are found from the following formulas:

$${}^m I_{p1} = i'_b - {}^m I_{p3} + {}^m I_{p5} - {}^m I_{p7} + {}^m I_{p9} - {}^m I_{p11}$$

$${}^m I_{p3} = 0.4475 (b + f) + \frac{d}{3} - 0.578 d - \frac{1}{2} {}^m I_{p5}$$

$${}^m I_{p5} = 0.4 (a - f)$$

$${}^m I_{p7} = 0.4475 (b + f) - {}^m I_{p3} + 0.5 {}^m I_{p5}$$

$${}^m I_{p9} = {}^m I_{p3} - \frac{2}{3} d$$

$${}^m I_{p11} = 0.707c - {}^m I_{p3} + {}^m I_{p5}$$

Even harmonics are not present due to dynamic characteristic symmetry. The DC current and power input values are found by the 7-point analysis from curve  $PL$  and doubled for two tubes.

## RESISTANCE COUPLED AUDIO AMPLIFIER DESIGN

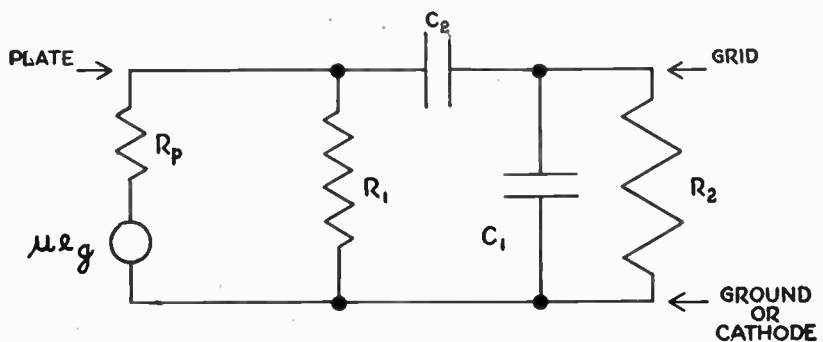

Stage gain at—

$$\text{medium frequencies} = A_m = \frac{\mu R}{R + R_p}$$

$$\text{high frequencies} = A_h = \frac{A_m}{\sqrt{1 + \omega^2 C_1^2 r^2}}$$

$$\text{low frequencies*} = A_l = \frac{A_m}{\sqrt{1 + \frac{1}{\omega^2 C_2^2 \rho^2}}}$$

$$\text{Where } R = \frac{R_1 R_2}{R_1 + R_2}$$

$$r = \frac{R R_p}{R + R_p}$$

$$\rho = R_2 + \frac{R_1 R_p}{R_1 + R_p}$$

$\mu$  = amplification factor of tube

$\omega = 2\pi \times \text{frequency}$

$R_1$  = plate load resistance (ohms)

$R_2$  = grid leak resistance (ohms)

$R_p$  = a-c plate resistance (ohms)

$C_1$  = total shunt capacity (farads)

$C_2$  = coupling capacity (farads)

Given  $C_1$ ,  $C_2$ ,  $R_2$ , and  $X$  = fractional response required:

$$\text{At highest frequency } r = \frac{\sqrt{1 - X^2}}{\omega C_1 X}$$

$$R = \frac{r R_p}{R_p - r}$$

$$R_1 = \frac{R R_2}{R_2 - R}$$

$$\text{At lowest frequency* } C_2 = \frac{X}{\omega \rho \sqrt{1 - X^2}}$$

\*Note: The low frequency stage gain also is affected by the values of the cathode by-pass condenser and the screen by-pass condenser.

## NEGATIVE FEEDBACK

The following quantities are functions of frequency with respect to magnitude and phase:

$E, N,$  and  $D$  = signal, noise, and distortion output voltage with feedback

$e, n,$  and  $d$  = signal, noise, and distortion output voltage without feedback

$\mu$  = voltage amplification of amplifier at a given frequency

$\beta$  = fraction of output voltage fed back; for usual negative feedback:  $\beta$  is negative

$\phi$  = phase shift of amplifier and feedback circuit at a given frequency

The total output voltage with feedback is

$$E + N + D = e + \frac{n}{1 - \mu\beta} + \frac{d}{1 - \mu\beta} \quad (1)$$

It is assumed that the input signal to the amplifier is increased when negative feedback is applied, keeping  $E = e$ .

$(1 - \mu\beta)$  is a measure of the amount of feedback. By definition, the amount of feedback expressed in decibels is

$$20 \log_{10} |1 - \mu\beta| \quad (2)$$

$$\text{Voltage gain with feedback} = \frac{\mu}{1 - \mu\beta} \quad (3)$$

$$\text{and change of gain} = \frac{1}{1 - \mu\beta} \quad (4)$$

If the amount of feedback is large, i.e.,  $-\mu\beta \gg 1$ , the voltage gain becomes  $-\frac{1}{\beta}$  and so is independent of  $\mu$ .

In the general case when  $\phi$  is not restricted to 0 or  $\pi$

$$\text{the voltage gain} = \frac{\mu}{\sqrt{1 + |\mu\beta|^2 - 2|\mu\beta|\cos\phi}} \quad (6)$$

$$\text{and change of gain} = \frac{1}{\sqrt{1 + |\mu\beta|^2 - 2|\mu\beta|\cos\phi}} \quad (7)$$

Hence if  $|\mu\beta| \gg 1$ , the expression is substantially independent of  $\phi$ .

On the polar diagram relating  $(\mu\beta)$  and  $\phi$  (Nyquist diagram), the system is unstable if the point  $(1, 0)$  is enclosed by the curve.

## DISTORTION

A rapid indication of the harmonic content of an alternating source is given by the Distortion Factor which is expressed as a percentage.

$$\text{Distortion Factor} = \frac{\sqrt{\text{Sum of squares of amplitudes of harmonics}}}{\sqrt{\text{Square of amplitude of fundamental}}} \times 100\%$$

If this factor is reasonably small, say less than 10%, the error involved in measuring it as

$$\sqrt{\frac{\text{Sum of squares of amplitudes of harmonics}}{\text{Sum of squares of amplitudes of fundamental and harmonics}}} \times 100\%$$

is only small. This latter is measured by the Distortion Factor Meter.

### ARMY-NAVY PREFERRED LIST OF RADIO ELECTRON TUBES

RECEIVING

15 FEBRUARY 1944

Filament Voltage	Diodes	Diode Triodes	Triodes	Twin Triodes	Pentodes		Converters	Power Output	Indicators	Rectifiers	Miscellaneous
					Remote	Sharp					
1.4	1A3	1LH4	1LE3	3A5 3B7 1291	174	1L4 1LN5 1S5	11C6 1R5	3A4 3D6 1299 3S4			Crystals 1N218
5.0										5U4G 5Y3GT	1N23 1N27
6.3	6AL5 6H6* 559 9006	6AO6 65O7* 6SR7*	2C22 2C26 6C4 6J4 6J5* 7E5/1201 9002	6J6 6SL7GT 6SN7GT	65G7* 6SK7* 9003	6AC7* 6AG5 6AG7* 6AK5 6SH7* 6SJ7* 7W7 9001	6SA7*	6G6G 6L6GA 6N7GT/G 6V6GT/G 6Y6G	6E5	6X5GT/G 1005	Phototubes 918 927  Voltage Regulators
12.6	12H6*	12SQ7* 12SR7*	12J5GT	12SL7GT 12SN7GT	12SG7* 12SK7*	12SH7* 12SJ7*	12SA7*	12A6*	1629		OB3/VR-90 OC3/VR-105 OD3/VR-153
25 and above								25L6GT/G 28D7	991	25Z6GT/G	

TRANSMITTING

MISCELLANEOUS

Triodes	Tetrodes	Twin Tetrodes	Pentodes	Rectifiers			Clipper Tubes	Gas Switching	Cathode Ray	
				Vacuum	Gas	Grid Control				
2C26	801A	5D21	3E29	2E22	2X2	4B25	3C23	73	1832/532A	2AP1
2C44	809	7158	815	803	3B24	83	3C31/C18	719A	471A	3BP1
6C21	811	807	8298	837	5R4GY	866A/866	C58		532	3DP1
15E	826	813	832A		371B	872A/872	8B4			3FP7
VT127A	833A	814			705A		2050			5CP1
3278	838	1625			836					5CF7
434A	1626				1616					5FF7
446A	8025				8016					5JP1
527	8014A				8020					7BP7
530	8025									12DP7 12GP7

\*Where direct interchangeability is assured "GT" and "L" counterparts of the preferred metal tubes may be used. *Miscellaneous tubes (shown in italics) shall be used only when essential to Service requirements.*

## CATHODE RAY TUBES, APPROXIMATE FORMULAS

### **Electrostatic Deflection**

is proportional to deflection voltage,

is inversely proportional to accelerating voltage,

is at right angles to the plane of the plates and toward the more positive plate:

$$D = \frac{E_d L l}{2E_a A}$$

where  $D$  = deflection  
 $E_d$  = deflection voltage  
 $E_a$  = accelerating voltage  
 $A$  = separation of plates  
 $l$  = length of plates  
 $L$  = length from center of plates to screen  
 $D, A, l, L$  are all in the same units

### **Electromagnetic Deflection**

is proportional to flux or current in coil,

is inversely proportional to the square root of the accelerating voltage,

is at right angles to the direction of the field:

$$D = \frac{.37LIH}{\sqrt{E_a}} \quad \text{or, assuming no leakage,} \quad D = \frac{.37LNI}{\sqrt{E_a}}$$

where

$D$  = deflection in cm.

$L$  = length in cm. between screen and point where beam enters deflecting field

$l$  = length of deflection field in cm.

$H$  = flux density in gauss

$E_a$  = accelerating voltage

$NI$  = deflecting coil ampere turns

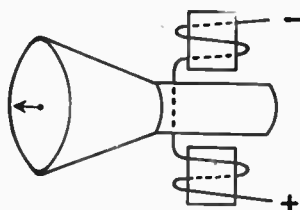

### **Deflection Sensitivity**

is linear up to frequency where phase of deflecting voltage begins to reverse before electron has reached end of deflecting field. Beyond this frequency, sensitivity drops off reaching zero and then passing

## CATHODE RAY TUBES—Continued

through a series of maxima and minima as  $n = 1, 2, 3 \dots$ . Each succeeding maximum is of smaller magnitude.

$$D_{\text{zero}} = n \lambda \left( \frac{v}{c} \right)$$

$$D_{\text{max}} = (2n - 1) \left( \frac{\lambda}{2} \right) \left( \frac{v}{c} \right)$$

$D$  = deflection

$v$  = electron velocity

$c$  = speed of light ( $3 \times 10^{10}$  cm/sec)

### Electron Velocity

for accelerating voltages up to 10,000.

$$v \text{ (km/sec)} = 593 \sqrt{E_a}$$

Beyond 10,000 volts apply Einstein's correction for the increase in mass of the electron.

### Earth's Magnetic Field

Maximum .6 Gauss vertical (Canada)

.4 Gauss horizontal (Philippine Islands)

At New York City .17 Gauss horizontal

### Magnetic Focusing

There is more than one value of current that will focus.

Best focus is at minimum value.

For an average coil  $IN = 220 \sqrt{\frac{V_o d}{f}}$

$IN$  = ampere turns

$V_o$  = Kv. accelerating voltage

$d$  = mean diameter of coil

$f$  = focal length

A well designed, shielded coil will require less ampere turns.

Example of good shield design

$$X = \frac{d_1}{20}$$

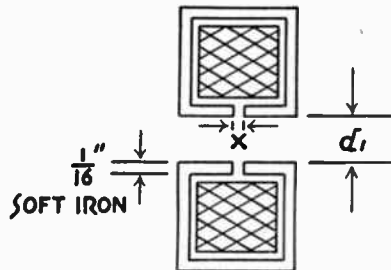



## POWER RATIO, VOLTAGE RATIO AND DECIBEL TABLE

The decibel, abbreviated db, is a unit used to express the difference in power level which exists at two points in a network:

$$\text{The number of db} = 10 \log_{10} \frac{P_1}{P_2}$$

It is also used to express voltage and current ratios:

$$\text{The number of db} = 20 \log_{10} \frac{V_1}{V_2} = 20 \log_{10} \frac{I_1}{I_2}$$

Strictly, it can be used to express voltage and current ratios only when the two points at which the voltages or currents are in question have identical impedances.

Power ratio	Voltage and Current ratio	Decibels	Power ratio	Voltage and Current ratio	Decibels
1.0233	1.0116	0.1	19.953	4.4668	13.0
1.0471	1.0233	0.2	25.119	5.0119	14.0
1.0715	1.0315	0.3	31.623	5.6234	15.0
1.0965	1.0471	0.4	39.811	6.3096	16.0
1.1220	1.0593	0.5	50.119	7.0795	17.0
1.1482	1.0715	0.6	63.096	7.9433	18.0
1.1749	1.0839	0.7	79.433	8.9125	19.0
1.2023	1.0965	0.8	100.00	10.0000	20.0
1.2303	1.1092	0.9	158.49	12.589	22.0
1.2589	1.1220	1.0	251.19	15.849	24.0
1.3183	1.1482	1.2	398.11	19.953	26.0
1.3804	1.1749	1.4	630.96	25.119	28.0
1.4454	1.2023	1.6	1000.0	31.623	30.0
1.5136	1.2303	1.8	1584.9	39.811	32.0
1.5849	1.2589	2.0	2511.9	50.119	34.0
1.6595	1.2882	2.2	3981.1	63.096	36.0
1.7328	1.3183	2.4	6309.6	79.433	38.0
1.8198	1.3490	2.6	10 <sup>4</sup>	100.000	40.0
1.9055	1.3804	2.8	10 <sup>4</sup> × 1.5849	125.89	42.0
1.9953	1.4125	3.0	10 <sup>4</sup> × 2.5119	158.49	44.0
2.2387	1.4962	3.5	10 <sup>4</sup> × 3.9811	199.53	46.0
2.5119	1.5849	4.0	10 <sup>4</sup> × 6.3096	251.19	48.0
2.8184	1.6788	4.5	10 <sup>5</sup>	316.23	50.0
3.1623	1.7783	5.0	10 <sup>5</sup> × 1.5849	398.11	52.0
3.5480	1.8836	5.5	10 <sup>5</sup> × 2.5119	501.19	54.0
3.9811	1.9953	6.0	10 <sup>5</sup> × 3.9811	630.96	56.0
5.0119	2.2387	7.0	10 <sup>5</sup> × 6.3096	794.33	58.0
6.3096	2.5119	8.0	10 <sup>6</sup>	1,000.00	60.0
7.9433	2.8184	9.0	10 <sup>7</sup>	3,162.3	70.0
10.0000	3.1623	10.0	10 <sup>8</sup>	10,000.0	80.0
12.589	3.5480	11.0	10 <sup>9</sup>	31,623.0	90.0
15.849	3.9811	12.0	10 <sup>10</sup>	100,000.0	100.0

TO CONVERT—

DECIBELS TO NEPERS MULTIPLY BY 0.115129

NEPERS TO DECIBELS MULTIPLY BY 8.68591

Where the power ratio is less than unity, it is usual to invert the fraction and express the answer as a decibel loss.

**TELEPHONE TRANSMISSION LINE DATA**  
**Characteristics of Standard Types of Aerial Wire Telephone Circuits**  
**At 1000 Cycles Per Second**

107

Type of Circuit	Gauge of Wires (mils)	Spacing of Wires (in.)	CONSTANTS PER LOOP MILE				PROPAGATION CONSTANT				LINE IMPEDANCE				Wave- Length Miles	Velocity Miles Per Second	Transmission Equivalent db Per Mile
			R Ohms	L Henrys	C μF	G M.MHO	Polar		Rectangular		Polar		Rectangular				
							Magni- tude	Angle Degrees +	α	β	Magni- tude	Angle Deg. —	R Ohms	X Ohms —			
			Non-Pole Pair Phys.	165	8	4.11	.00311	.00996	.14	.0353	83.99	.00370	.0351	565			
Non-Pole Pair Side	165	12	4.11	.00337	.00915	.29	.0352	84.36	.00346	.0350	612	5.35	610	57	179.5	179,500	.0300
Pole Pair Side	165	18	4.11	.00364	.00863	.29	.0355	84.75	.00325	.0353	653	5.00	651	57	178.0	178,000	.0282
Non-Pole Pair Phan.	165	12	2.06	.00208	.01514	.58	.0355	85.34	.00288	.0354	373	4.30	372	28	177.5	177,500	.0250
Non-Pole Pair Phys.	128	8	6.74	.00327	.00944	.14	.0358	80.85	.00569	.0353	603	8.97	596	94	178.0	178,000	.0494
Non-Pole Pair Side	128	12	6.74	.00353	.00871	.29	.0356	81.39	.00533	.0352	650	8.32	643	94	178.5	178,500	.0462
Pole Pair Side	128	18	6.74	.00380	.00825	.29	.0358	81.95	.00502	.0355	693	7.72	686	93	177.0	177,000	.0436
Non-Pole Pair Phan.	128	12	3.37	.00216	.01454	.58	.0357	82.84	.00445	.0355	401	6.73	398	47	177.0	177,000	.0386
Non-Pole Pair Phys.	104	8	10.15	.00340	.00905	.14	.0367	77.22	.00811	.0358	644	12.63	629	141	175.5	175,500	.0704
Non-Pole Pair Side	104	12	10.15	.00366	.00837	.29	.0363	77.93	.00760	.0355	692	11.75	677	141	177.0	177,000	.0660
Pole Pair Side	104	18	10.15	.00393	.00797	.29	.0365	78.66	.00718	.0358	730	10.97	717	139	175.5	175,500	.0624
Non-Pole Pair Phan.	104	12	5.08	.00223	.01409	.58	.0363	79.84	.00640	.0357	421	9.70	415	71	176.0	176,000	.0556

- NOTES: 1. All values are for dry weather conditions.  
2. All capacity values assume a line carrying 40 wires.  
3. Resistance values are for temperature of 20° C. (68° F.).  
4. DP (Double Petticaot) Insulators assumed for all 12" and 18" spaced wires—CS (Special Glass with Steel Pin) Insulators assumed for all 8" spaced wires.

**TELEPHONE TRANSMISSION LINE DATA—Continued**  
**Line Parameters of Open-Wire Pairs**  
**DP (Double Petticoat) Insulators—12-inch spacing**

Frequency Cycles/Sec.	RESISTANCE OHMS PER LOOP MI.			INDUCTANCE HENRY PER LOOP MI.			LEAKANCE MICROMHOS PER LOOP MI.: 165, 128 OR 104 MIL	
	165 mil	128 mil	104 mil	165 mil	128 mil	104 mil	Dry	Wet
0	4.02	6.68	10.12	0.00337	0.00353	0.00366	0.01	2.5
500	4.04	6.70	10.13	0.00337	0.00353	0.00366	0.15	3.0
1000	4.11	6.74	10.15	0.00337	0.00353	0.00366	0.29	3.5
2000	4.35	6.89	10.26	0.00336	0.00353	0.00366	0.57	4.5
3000	4.71	7.13	10.43	0.00335	0.00352	0.00366	0.85	5.5
5000	5.56	7.83	10.94	0.00334	0.00352	0.00366	1.4	7.5
10000	7.51	9.98	12.86	0.00331	0.00349	0.00364	2.8	12.1
20000	10.16	13.54	17.08	0.00328	0.00346	0.00361	5.6	20.5
30000	12.19	16.15	20.42	0.00326	0.00344	0.00359	8.4	28.0
40000	13.90	18.34	23.14	0.00326	0.00343	0.00358	11.2	35.0
50000	15.41	20.29	25.51	0.00325	0.00343	0.00357	14.0	41.1
infl.				0.00321	0.00337	0.00350		

**Capacitance on 40-Wire Lines**

	microfarad per loop mile		
	165 mil	128 mil	104 mil
In space	0.00898	0.00855	0.00822
On 40-wire line, dry	0.00915	0.00871	0.00837
On 40-wire line, wet (approx.)	0.00928	0.00886	0.00850

**Primary Parameters of Open-Wire Non-Pole Pairs**  
**53 Pairs CS Insulators per Mile—8-inch Spacing**  
**Temperature 68° F., 98 Per Cent Conductivity Copper**

Frequency kc/Sec.	RESISTANCE OHMS PER LOOP MI.			INDUCTANCE MILLIHENRIES PER LOOP MI.			LEAKANCE MICROMHOS PER LOOP MI.: 165, 128 OR 104 MIL	
	165 mil	128 mil	104 mil	165 mil	128 mil	104 mil	Dry	Wet
0.0	4.104	6.280	10.33	3.11	3.27	3.40		
1.0	4.186	6.872	10.36	3.10	3.26	3.40	0.052	1.75
2.0	4.416	7.018	10.47	3.10	3.26	3.40		
3.0	4.761	7.243	10.62	3.09	3.26	3.40		
5.0	5.606	7.918	11.11	3.08	3.25	3.40	0.220	3.40
10.0	7.560	10.05	12.98	3.04	3.23	3.38	0.408	5.14
20.0	10.23	13.63	17.14	3.02	3.20	3.35	0.748	8.06
50.0	15.50	20.41	25.67	2.99	3.16	3.31	1.69	15.9
100.0	21.45	28.09	35.10	2.98	3.15	3.29	3.12	27.6
200.0	29.89	38.93	48.43	2.97	3.14	3.28		
500.0	46.62	60.53	74.98	2.96	3.13	3.27		
1000.0	65.54	84.84	104.9	2.96	3.12	3.26		
infl.				2.95	3.11	3.24		

**Capacitance on 40-Wire Lines**

	microfarad per loop mile		
	165 mil	128 mil	104 mil
0.01003	0.00951	0.00912	for dry weather
0.00978	0.00928	0.00888	capacitance in space (no insulators)

## TELEPHONE TRANSMISSION LINE DATA—Continued

### Attenuation of 12-Inch Spaced Open-Wire Pairs

#### TOLL AND DP (DOUBLE PETTICOAT) INSULATORS

Size Wire	ATTENUATION IN DB PER MILE					
	.165"		.128"		.104"	
	Dry	Wet	Dry	Wet	Dry	Wet
Frequency Cycles/Sec.						
20	.0127	.0279	.0163	.0361	.0198	.0444
100	.0231	.0320	.0318	.0427	.0402	.0535
500	.0288	.0367	.0445	.0530	.0620	.0715
1000	.0300	.0387	.0464	.0557	.0661	.0760
2000	.0326	.0431	.0486	.0598	.0686	.0804
3000	.0360	.0485	.0511	.0642	.0707	.0845
5000	.0439	.0598	.0573	.0748	.0757	.0938
7000	.051	.070	.064	.085	.082	.103
10000	.061	.085	.076	.102	.093	.120
15000	.076	.108	.094	.127	.111	.147
20000	.088	.127	.108	.150	.129	.173
30000	.110	.161	.135	.188	.159	.216
40000	.130	.192	.158	.223	.185	.254
50000	.148	.220	.179	.253	.209	.287

#### CS (SPECIAL GLASS WITH STEEL PIN) INSULATORS

20	.0126	.0252	.0162	.0326	.0197	.0402
100	.0230	.0303	.0317	.0406	.0401	.0509
500	.0286	.0348	.0441	.0510	.0618	.0693
1000	.0296	.0364	.0458	.0532	.0655	.0735
2000	.0318	.0399	.0475	.0561	.0676	.0767
3000	.0346	.0437	.0495	.0593	.0694	.0797
5000	.0412	.0531	.0547	.0668	.0731	.0856
7000	.048	.061	.062	.075	.078	.093
10000	.057	.072	.071	.087	.088	.104
15000	.068	.087	.086	.105	.104	.123
20000	.078	.099	.099	.121	.119	.141
30000	.096	.121	.120	.146	.145	.171
40000	.111	.138	.138	.166	.166	.195
50000	.125	.153	.154	.184	.185	.215

### Attenuation of 8-Inch Spaced Open-Wire Pairs

#### CS INSULATORS

Size Wire	ATTENUATION IN DB PER MILE					
	.165"		.128"		.104"	
	Dry	Wet	Dry	Wet	Dry	Wet
Frequency Cycles/Sec.						
10000	.063	.074	.079	.090	.095	.109
20000	.084	.101	.104	.124	.127	.145
30000	.101	.124	.125	.150	.151	.177
50000	.129	.161	.159	.194	.190	.228
70000	.150	.194	.185	.232	.222	.270
100000	.178	.236	.220	.280	.262	.325
120000	.195	.261	.240	.310	.286	.359
140000	.211	.285	.259	.337	.308	.390
150000	.218	.296	.268	.350	.317	.403

**TELEPHONE TRANSMISSION LINE DATA—Continued**  
**Characteristics of Standard (Toll) Types of Paper Cable Telephone Circuits**  
**At 1000 Cycles Per Second**

110

Type of Circuit	Wire Gauge A.W.G.	Type of Loading	Code Number of Loading Coils	Spacing of Load Coils, Miles	Load Coil Constants Per Load Section		Constants Assumed to be Distributed Per Loop Mile				Propagation Constant				Line Impedance				Wave-Length Miles	Coils Per Wave-Length	Velocity Loads Per Second	Velocity Miles Per Second	Cut-off Frequency $f_c$ (Approximate)	Standard Transmission Equivalent db Per Mil.	
					R Ohms	L Henrys	R Ohms	L Henrys	C $\mu F$	G M.MHO	Polar		Rectangular		Polar		Rectangular								
											Magni- tude	Angle Deg. +	$\alpha$	$\beta$	Magni- tude	Angle Deg. -	R Ohms	X Ohms							
Side	19	N.L.S.	—	—	—	—	85.8	.001	.062	1.5	.1830	46.88	.1249	.1338	470.1	42.80	344.9	319.37	46.93	—	—	48930	—	1.08	
"	19	H-31-S	P-4	1.135	3.0	.031	88.4	.028	.062	1.5	.2768	76.65	.0644	.2692	711.0	13.24	692.1	162.77	23.33	20.55	20552	23327	6670	.56	
"	19	H-44-S	P-2 & P-3	1.135	4.4	.044	89.7	.040	.062	1.5	.3222	80.07	.0556	.3174	827.5	9.72	815.6	139.64	19.79	17.43	17434	19787	5600	.46	
"	19	H-172-S	P-1	1.135	13.6	.172	97.8	.152	.062	1.5	.6112	86.97	.0324	.6104	1569.9	2.62	1568.0	77.10	10.29	9.06	9065	10289	2800	.28	
"	16	N.L.S.	—	—	—	—	42.1	.001	.062	1.5	.1288	49.13	.0842	.0974	330.7	40.85	250.9	215.39	64.51	—	—	64506	—	.73	
"	16	H-31-S	P-4	1.135	3.0	.031	44.7	.023	.062	1.5	.2658	82.78	.0335	.2637	682.6	7.02	677.5	83.45	23.82	20.99	20885	23820	6670	.29	
"	16	H-44-S	P-2 & P-3	1.135	4.4	.044	48.0	.040	.062	1.5	.3153	84.70	.0291	.3140	809.9	5.08	806.7	71.69	20.00	17.62	17621	20000	5600	.25	
"	16	H-172-S	P-1	1.135	13.6	.172	54.1	.152	.062	1.5	.6102	88.27	.0184	.6099	1567.1	1.51	1566.7	41.25	10.30	9.07	9072	10297	2800	.16	
"	13	N.L.S.	—	—	—	—	21.9	.001	.062	1.5	.0942	52.89	.0568	.0751	241.9	36.89	193.5	145.21	83.61	—	—	83610	—	.19	
"	13	H-245-S	582-A	1.135	29.5	.245	47.9	.217	.062	1.5	.7286	68.88	.0142	.7285	1871.0	0.90	1871.0	29.29	8.62	7.60	7596	8620	2400	.12	
"	13	M-174-S	584-A	1.66	27.7	.174	38.6	.106	.062	1.5	.5095	88.23	.0157	.5093	1309.0	1.55	1308.0	35.36	12.33	7.43	7429	12330	2400	.14	
Phantom	19	N.L.P.	—	—	—	—	42.9	.0007	.100	2.4	.1646	47.78	.1106	.1219	262.1	41.97	194.8	175.23	51.53	—	—	51525	—	.96	
"	19	H-18-P	P-4	1.135	1.5	.018	44.2	.017	.100	2.4	.2694	78.65	.0530	.2641	429.0	11.14	420.9	82.98	23.78	20.95	20950	23778	6990	.48	
"	19	H-25-P	P-2 & P-3	1.135	2.2	.025	44.8	.023	.100	2.4	.3082	81.28	.0468	.3046	490.7	8.51	485.3	72.59	20.82	18.16	18164	20616	5900	.41	
"	19	H-63-P	P-1	1.135	6.2	.063	48.4	.056	.100	2.4	.4722	85.97	.0332	.4710	751.9	3.81	750.3	49.96	13.33	11.76	11746	13332	3700	.29	
"	16	N.L.P.	—	—	—	—	21.0	.0007	.100	2.4	.1161	50.02	.0748	.0890	184.8	38.98	143.7	116.29	70.60	—	—	70604	—	.65	
"	16	H-18-P	P-4	1.135	1.5	.018	22.3	.017	.100	2.4	.2560	83.72	.0280	.2545	407.7	6.06	405.4	43.04	24.68	21.74	21740	24680	6990	.24	
"	16	H-25-P	P-2 & P-3	1.135	2.2	.025	22.9	.023	.100	2.4	.3031	85.39	.0244	.3021	482.6	4.40	481.2	36.97	20.79	18.32	18320	20790	5900	.21	
"	16	H-63-P	P-1	1.135	6.2	.063	26.5	.058	.100	2.4	.4706	87.78	.0186	.4702	749.3	2.05	748.9	26.74	13.36	11.77	11767	13355	3700	.16	
"	16	H-155-P	P-7	1.135	12.4	.155	31.9	.137	.100	2.4	.7353	68.83	.0148	.7352	1171.0	0.96	1171.0	19.48	8.54	7.53	7526	8642	2400	.13	
"	13	N.L.P.	—	—	—	—	10.9	.0007	.100	2.4	.0859	55.09	.0492	.0705	136.8	33.91	113.5	76.32	89.14	—	—	89136	—	.43	
"	13	H-155-P	611	1.135	14.8	.155	23.9	.137	.100	2.4	.7351	89.10	.0116	.7350	1170.5	0.69	1170.0	14.03	8.54	7.53	7528	8540	2400	.10	
Physical	16	B-22	626	0.568	1.25	.022	43.1	.040	.062	1.5	.3150	85.02	.0273	.3139	809.1	4.76	806.3	67.10	20.01	35.26	35260	20010	11000	—	.24

**TELEPHONE TRANSMISSION LINE DATA—Continued**  
**Characteristics of Standard (Exchange) Types of Paper Insulated Telephone**  
**Cable Circuits at 1000 Cycles / Sec.**

Wire Gauge A. W. G.	Code No.	Type of Loading	Loop Mile Constants		Propagation Constant				Mid-Section Characteristic Impedance				Wave Length Miles	Velocity Mi/Sec.	Cut-off Freq.	Atten. db/mile		
			C $\mu$ F	G mhas X 10 <sup>-6</sup>	Polar		Rectangular		Polar		Rectangular							
					Mag.	Angle (Deg.)	$\alpha$	$\beta$	Mag.	Angle (Deg.)	Z <sub>01</sub>	Z <sub>02</sub>						
26	BST ST	NL	.083	1.6					910				20.4	20,400	—	2.9		
		NL	.069	1.6	.439	45.30	.307	.310	1007	44.5	719	706			—	2.67		
24	DSM ASM	NL	.085	1.9					725				25.0	25,000	—	2.3		
		NL	.075	1.9	.355	45.53	.247	.251	778	44.2	558	543			14.9	14,900	3100	1.31
		M88	.075	1.9	.448	70.25	.151	.421	987	23.7	904	396			12.7	12,700	3700	1.13
		H88	.075	1.9	.512	75.28	.130	.495	1160	14.6	1122	292			9.3	9,270	5300	0.86
		B88	.075	1.9	.684	81.70	.099	.677	1532	8.1	1515	215			7.05	7,050	4000	0.48
22	CSA	NL	.083	2.1	.297	45.92	.207	.213	576	43.8	416	399	29.4	29,400	—	1.80		
		M88	.083	2.1	.447	76.27	.106	.434	905	13.7	880	214	14.5	14,500	2900	0.92		
		H88	.083	2.1	.526	80.11	.0904	.519	1051	9.7	1040	177	12.1	12,100	3500	0.79		
		H135	.083	2.1	.644	83.50	.0729	.640	1306	6.3	1300	144	9.8	9,800	2800	0.63		
		B88	.083	2.1	.718	84.50	.0689	.718	1420	5.3	1410	130	8.75	8,750	5000	0.60		
		B135	.083	2.1	.890	86.50	.0549	.890	1765	3.3	1770	102	7.05	7,050	4000	0.48		
19	CNB DNB	NL	.085	1.6					400				45.7	45,700	—	1.23		
		NL	.066	1.6	.188	47.00	.128	.138	453	42.8	333	308			16.6	16,600	3200	1.12
		M88	.066	1.6	.383	82.42	.0505	.380	950	8.9	939	146			13.7	13,700	3900	0.38
		H88	.066	1.6	.459	84.60	.0432	.459	1137	5.2	1130	103			11.0	11,000	3200	0.30
		H135	.066	1.6	.569	86.53	.0345	.570	1413	4.0	1410	99			9.7	9,700	2800	0.27
		H175	.066	1.6	.651	87.23	.0315	.651	1643	3.3	1640	95			9.8	9,800	5500	0.30
		B88	.066	1.6	.641	86.94	.0342	.641	1565	2.8	1560	77			9.8	9,800	5500	0.30
16	NH	NL	.064	1.5	.133	49.10	.0868	.1004	320	40.6	243	208	62.6	62,600	—	0.76		
		M88	.064	1.5	.377	85.88	.0271	.377	937	4.6	934	76	16.7	16,700	3200	0.24		
		H88	.064	1.5	.458	87.14	.0238	.458	1130	2.8	1130	55	13.7	13,700	3900	0.21		

## TELEPHONE TRANSMISSION LINE DATA—Continued

### Primary Parameters and Propagation Constants of 16 and 19-Gauge Standard Toll Cable—Loop Mile Basis Non-Loaded—Temperature 55° F.

#### 16-GAUGE

Frequency kc./Sec.	Resistance Ohms/Mi.	Inductance Milli- Henries/Mi.	Conductance M.Mho/Mi.	Capacitance $\mu$ F/Mi.	Attenuation db per Mi.	Phase Shift Radians per Mi.	Characteristic Impedance Ohms
1	40.1	1.097	1	0.0588	.69	.09	255—j215
2	40.3	1.095	2	0.0588	.94	.14	190—j141
3	40.4	1.094	4	0.0587	1.05	.19	170—j108
5	40.7	1.092	8	0.0588	1.15	.28	154—j71
10	42.5	1.085	19	0.0587	1.30	.54	142—j42
20	47.5	1.066	49	0.0585	1.54	1.01	137—j23
30	53.5	1.046	83	0.0584	1.77	1.49	135—j17
50	66.5	1.013	164	0.0582	2.25	2.43	133—j13
100	91.6	0.963	410	0.0580	3.30	4.71	129—j9
150	111.0	0.934	690	0.0578	4.17	6.94	127—j7

#### 19-GAUGE

1	83.6	1.108	1	0.0609	1.05	0.132	345—j316
2	83.7	1.108	3	0.0609	1.44	0.190	254—j215
3	83.8	1.107	4	0.0609	1.73	0.249	215—j170
5	84.0	1.106	9	0.0609	2.02	0.347	181—j121
10	85.0	1.103	22	0.0608	2.43	0.584	153—j72
20	88.5	1.094	56	0.0607	2.77	1.07	141—j41
30	93.5	1.083	98	0.0606	3.02	1.56	137—j29
50	105.4	1.062	193	0.0604	3.53	2.55	134—j20
100	136.0	1.016	484	0.0601	4.79	4.94	131—j13
150	164.4	0.985	830	0.0599	6.01	7.27	129—j10

### Primary Parameters of Shielded 16-Gauge Spiral-Four Toll-Entrance Cable—Loop Mile Basis Non-Loaded—Temperature 70° F.

#### Side Circuit

Frequency kc./Sec.	Resistance Ohms/Mi.	Inductance Milli-Henries/Mi.	Conductance Mhos/Mi. $\times 10^{-6}$	Capacitance $\mu$ F/Mi.
0.4	43.5	1.913	0.02	0.0247
0.6	43.5	1.907	0.04	0.0247
0.8	43.6	1.901	0.06	0.0247
1.0	43.9	1.891	0.08	0.0247
2	44.2	1.857	0.20	0.0247
3	45.2	1.821	0.32	0.0247
5	49.0	1.753	0.53	0.0247
10	55.1	1.626	1.11	0.0247
20	61.6	1.539	2.49	0.0247
30	66.1	1.507	3.77	0.0247
40	71.0	1.490	5.50	0.0247
60	81.5	1.467	8.80	0.0247
80	90.1	1.450	12.2	0.0247
100	97.8	1.438	15.81	0.0247
120	104.9	1.429	19.6	0.0247
140	111.0	1.421	23.3	0.0247
200	127.3	1.411	35.1	0.0246
250	137.0	1.408	46.0	0.0246
300	149.5	1.406	56.5	0.0246
350	159.2	1.405	67.8	0.0246

For a description and illustration of this type cable see Kendall and Affel, "A Twelve-Channel Carrier Telephone System for Open-Wire Lines," B.S.T.J., January 1939, pp. 129-131.

## RF TRANSMISSION LINE DATA

For uniform transmission lines:

$$Z_o = \sqrt{\frac{L}{C}}$$

$$L = 1016 \sqrt{\epsilon} Z_o$$

$$C = 1016 \frac{\sqrt{\epsilon}}{Z_o}$$

$$\frac{V}{c} = \frac{1}{\sqrt{\epsilon}}$$

$$Z_s = Z_o \frac{Z_r + j Z_o \tan l^\circ}{Z_o + j Z_r \tan l^\circ}$$

$$Z_s = \frac{Z_o^2}{Z_r} \quad \text{for } l^\circ = 90^\circ \text{ (quarter wave)}$$

$$Z_{ss} = +j Z_o \tan l^\circ$$

$$Z_{so} = -\frac{j Z_o}{\tan l^\circ}$$

$$l^\circ = 360 \frac{l}{\lambda}$$

$$\lambda = \lambda_o \left( \frac{V}{c} \right)$$

Where

$L$  = inductance of transmission line in micro micro henries per foot

$C$  = capacity of transmission line in micro micro farads per foot

$V$  = velocity of propagation in transmission line } same units

$c$  = velocity of propagation in free space

$Z_s$  = sending end impedance of transmission line in ohms

$Z_o$  = surge impedance of transmission line in ohms

$Z_r$  = terminating impedance of transmission line in ohms

$l^\circ$  = length of line in electrical degrees

$l$  = length of line

$\lambda$  = wavelength in transmission line } same units

$\lambda_o$  = wavelength in free space

$\epsilon$  = dielectric constant of transmission line medium

= 1 for air

$Z_{ss}$  = sending end impedance of transmission line  
shorted at the far end (in ohms)

$Z_{so}$  = sending end impedance of transmission line  
open at the far end (in ohms)



# RF TRANSMISSION LINE DATA—Continued

## Surge Impedance of Uniform Lines—0 to 210 Ohms

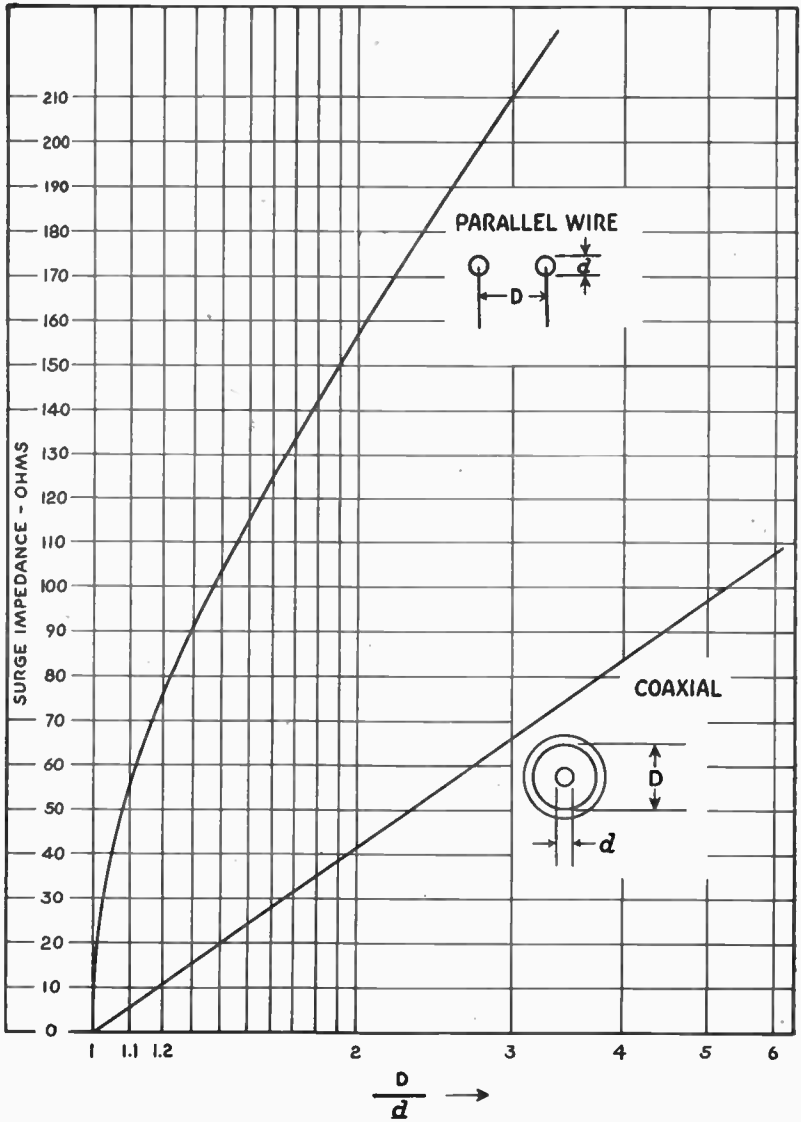

**RF TRANSMISSION LINE DATA—Continued**  
**Surge Impedance of Uniform Lines—0 to 700 Ohms**

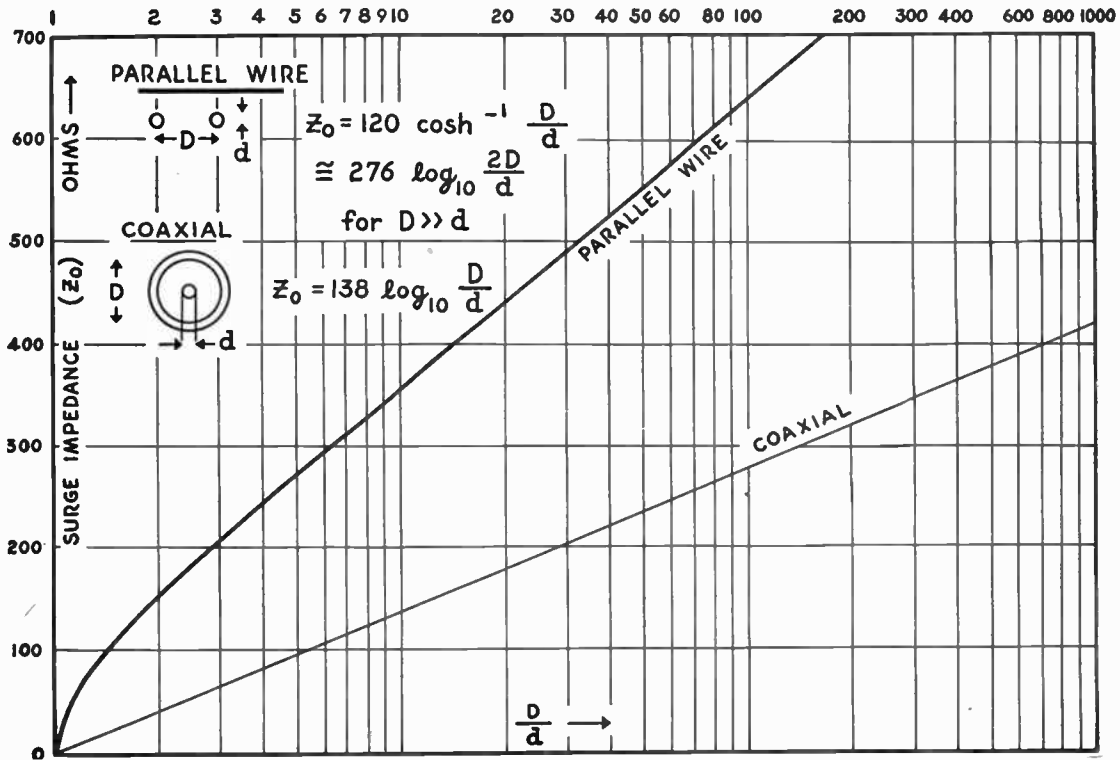

RF TRANSMISSION LINE DATA—Continued

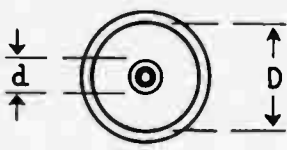
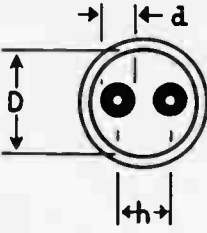
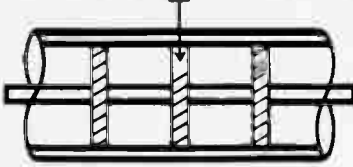
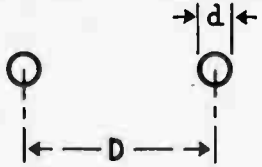
TYPE OF LINE	CHARACTERISTIC IMPEDANCE
<p>SINGLE COAXIAL LINE</p>  <p>(A)</p>	$Z_0 = \frac{138}{\sqrt{\epsilon}} \log_{10} \frac{D}{d}$ <p><math>\epsilon</math> = DIELECTRIC CONSTANT = 1 IN AIR</p>
<p>BALANCED SHIELDED LINE</p>  <p>(B)</p>	<p>FOR <math>D \gg d, h \gg d</math></p> $Z_0 \cong \frac{276}{\sqrt{\epsilon}} \log_{10} \left[ 2v \frac{1-\epsilon^2}{1+\epsilon^2} \right]$ $\epsilon = \frac{h}{D}$ $v = \frac{h}{d}$
<p>BEADS - DIELECTRIC <math>\epsilon_1</math></p>  <p>(C)</p>	<p>FOR CASES (A) AND (B)</p> <p>IF CERAMIC BEADS ARE USED AT FREQUENT INTERVALS - CALL NEW SURGE IMPEDANCE <math>Z_0'</math></p> $Z_0' = \frac{Z_0}{\sqrt{\epsilon + \frac{\epsilon_1 - \epsilon}{s} w}}$
<p>OPEN TWO-WIRE LINE</p>  <p>(D)</p>	$Z_0 = 120 \cosh^{-1} \frac{D}{d}$ $\cong 276 \log_{10} \frac{2D}{d}$

## RF TRANSMISSION LINE DATA—Continued

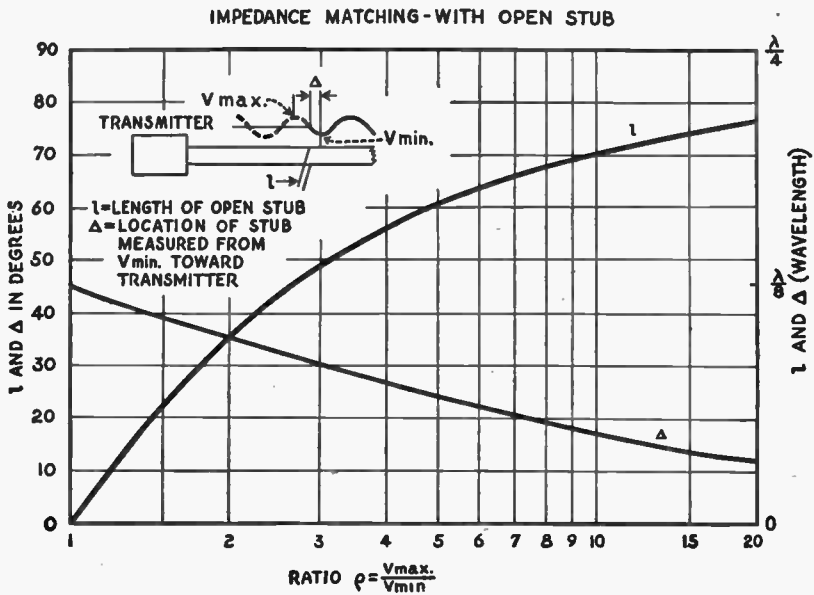
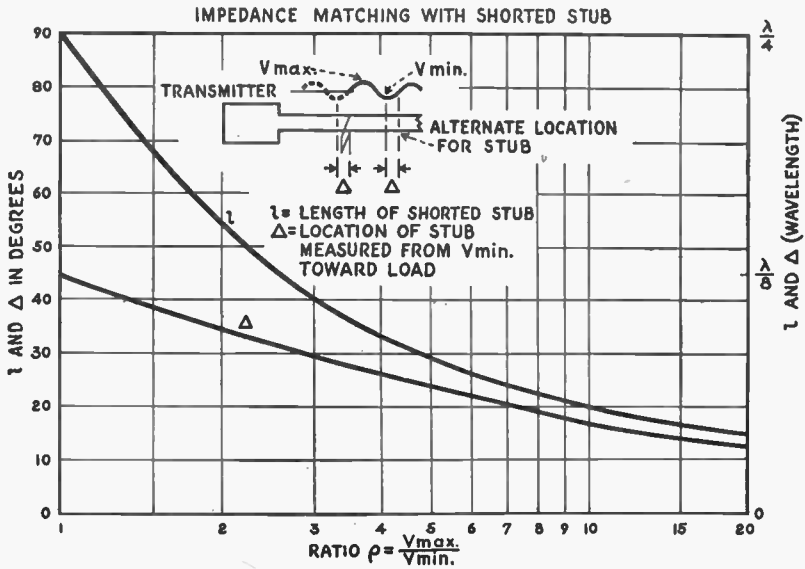

## RF TRANSMISSION LINE DATA—Continued

### *Attenuation of Transmission Lines at Ultra High Frequencies*

$$A = 4.35 \frac{R_t}{Z_0} + 2.78 \sqrt{\epsilon} p F$$

Where

$A$  = attenuation in decibels per 100 feet

$R_t$  = total line resistance in ohms per 100 feet

$p$  = power factor of dielectric medium

$F$  = frequency in megacycles

### *Resistance of Transmission Lines at Ultra High Frequencies*

$$R_t = 0.1 \left( \frac{1}{d} + \frac{1}{D} \right) \sqrt{F} \quad \text{for coaxial copper line}$$

$$= \frac{.2}{d} \sqrt{F} \quad \text{for open two-wire copper line}$$

Where

$d$  = diameter of conductors (center conductor for the coaxial line) in inches.

$D$  = diameter of inner surface of outer coaxial conductor in inches.

## WAVE GUIDES AND RESONATORS

### *Propagation of Electro-Magnetic Waves in Hollow Wave Guide*

At ultra-high frequencies, energy can be propagated within a hollow metallic tube if certain necessary conditions are fulfilled. Using a system of Cartesian co-ordinates as a basis of discussion, the electric and magnetic field vectors may be described by their  $x$ ,  $y$ , and  $z$  components. In general, all six quantities can exist simultaneously, but there are two particular types of transmission of special interest:

- (1)  $H$  waves, also called transverse electric (TE) waves, characterized by  $E_z \equiv 0$  where  $z$  is in the direction of propagation.
- (2)  $E$  waves, also called transverse magnetic (TM) waves, characterized by  $H_z \equiv 0$ .

Solution of the field equations admits of a two-fold infinity of answers which satisfy the differential equation. These solutions are characterized by the integers  $m, n$ , which take on values from zero or one to infinity. Only a certain number of these different  $m, n$  modes will be propagated, depending upon the dimensions of the guide and the frequency of the excitation. For each mode there is a definite lower limit or cut-off frequency, below which it is incapable of being propagated. Thus, a wave guide is seen to exhibit definite properties of a high pass filter.

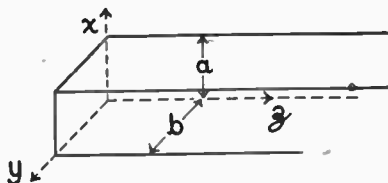

## WAVE GUIDES AND RESONATORS—Continued

### Rectangular Wave Guides

Cross sectional dimensions  $a, b$

TM waves ( $E$  waves)

$$E_{z_{n,m}} = A \sin \frac{n \pi x}{a} \sin \frac{m \pi y}{b} \epsilon^{-\Gamma_{n,m} z} \quad n, m = 1, 2, 3, \dots$$

TE waves ( $H$  waves)

$$H_{z_{n,m}} = B \cos \frac{n \pi x}{a} \cos \frac{m \pi y}{b} \epsilon^{-\Gamma_{n,m} z} \quad n, m = 0, 1, 2, 3, \dots$$

(0,0 inadmissible)

where  $A$  &  $B$  are constants;  $\Gamma_{n,m}$  = propagation constant;  $m$  and  $n$  are integers.

For every combination of values of  $m$  and  $n$  there is a possible solution. Only those solutions actually exist which satisfy the following relation.

$$f > \frac{c}{2 \pi \sqrt{\epsilon \mu}} \sqrt{\left(\frac{n \pi}{a}\right)^2 + \left(\frac{m \pi}{b}\right)^2}, f > \frac{c k_{n,m}}{2 \pi \sqrt{\epsilon \mu}}, f > f_{n,m},$$

where the right hand member is the cut-off frequency

$$\text{and } k_{n,m}^2 = \left(\frac{n \pi}{a}\right)^2 + \left(\frac{m \pi}{b}\right)^2$$

This is a design equation, giving the proper dimensions of a wave guide capable of passing the wanted modes at the frequency  $f$ .

The wave length within a wave guide will always be greater than the wave length in an unbounded medium for the same frequency.

$$\lambda_{g_{n,m}} = \frac{\lambda_0}{\sqrt{1 - \left(\frac{n \lambda_0}{2a}\right)^2 - \left(\frac{m \lambda_0}{2b}\right)^2}} \quad \text{where } \lambda_{g_{n,m}} = \text{wave length in the guide for the } n, m \text{ mode. } \lambda_0 \text{ is wavelength in free space.}$$

Because  $\lambda_g$  is always greater than  $\lambda_0$ , the phase velocity in the guide is always greater than in an unbounded medium.

With  $\epsilon, \mu = 1$ , the phase velocity and group velocity are related by the following

$$u = \frac{c^2}{v} \quad \text{where } u = \text{group velocity, the velocity of propagation of the energy; } v = f \lambda_g, \text{ phase velocity.}$$

It is seen from the above that if  $v > c$  in all cases, then invariably  $u < c$ , i.e., the energy cannot be transmitted at a speed greater than the velocity of light.

## WAVE GUIDES AND RESONATORS—Continued

### Cylindrical Wave Guides

The usual co-ordinate system is  $\rho, \theta, z$ .  $\rho$  is in radial directions;  $\theta$  is the angle;  $z$  is in the longitudinal direction.

TM waves ( $E$  waves)  $H_z \equiv 0$

$$E_z = A J_n(k_{n,m} \rho) \cos n \theta e^{-\Gamma_{n,m} z}$$

By the boundary conditions,  $E_z = 0$  when  $\rho = a$ , the radius. Thus, the only permissible values of  $k$  are those for which  $J_n(k_{n,m} a) = 0$  because  $E_z$  must be zero at the boundary.

The numbers  $m, n$  take on all integral values from zero to infinity. The waves are seen to be characterized by two numbers,  $m$  and  $n$ , where  $n$  gives the order of the Bessel functions, and  $m$  gives the order of the root of  $J_n(k_{n,m} a)$ . The Bessel function has an infinite number of roots, so that there are an infinite number of  $k$ 's which make  $J_n(k_{n,m} a) = 0$ .

The other components of the electric vector  $E_\theta$  and  $E_\rho$  are related to  $E_z$ , as are  $H_\theta$  and  $H_\rho$ .

TE waves ( $H$  waves)  $E_z \equiv 0$

$$H_z = B J_n(k_{n,m} \rho) \cos n \theta e^{-\Gamma_{n,m} z}$$

$H_\rho, H_\theta, E_\rho, E_\theta$ , are all related to  $H_z$ .

Again  $n$  takes on integral values from zero to infinity. The boundary condition  $E_\theta = 0$  when  $\rho = a$  applies. To satisfy this condition  $k$  must be such as to make  $J'_n(k_{n,m} a)$  equal to zero where the superscript indicates the derivative of  $J_n(k_{n,m} a)$ . It is seen that  $m$  takes on values from 1 to infinity since there are an infinite number of roots of  $J'_n(k_{n,m} a)$ .

For cylindrical wave guides, the cut-off frequency for the  $m, n$  mode is

$$f_{c,n,m} = \frac{c k_{n,m}}{2 \pi}$$

where  $c$  = velocity of light and  $k_{n,m}$  is evaluated from the roots of the Bessel functions.

$$k_{n,m} = \frac{u_{n,m}}{a} \text{ or } \frac{u'_{n,m}}{a}$$

where  $a$  = radius of guide or pipe and  $u_{n,m}$  is the root of the particular Bessel function of interest (or its derivative).

The wavelength in the guide is

$$\lambda_g = \frac{2 \pi}{\sqrt{\left(\frac{2 \pi}{\lambda_0}\right)^2 - k_{n,m}^2}}$$

where  $\lambda_0$  is the wavelength in an unbounded medium.

## WAVE GUIDES AND RESONATORS—Continued

The following tables are useful in determining the values of  $k$ . For  $H$  waves the roots  $U'_{n,m}$  of  $J'_n(U) = 0$  are given in the following table, and the corresponding  $k_{n,m}$  values are  $\frac{U'_{n,m}}{a}$

$n \backslash m$	0	1	2
1	3.832	1.841	3.054
2	7.016	5.332	6.705
3	10.173	8.536	9.965

For  $E$  waves the roots  $U_{n,m}$  of  $J_n(U) = 0$  are given in the following table, and the corresponding  $k_{n,m}$  values are  $\frac{U_{n,m}}{a}$

$n \backslash m$	0	1	2
1	2.405	3.832	5.135
2	5.520	7.016	8.417
3	8.654	10.173	11.620

Where  $n$  is the order of the Bessel function and  $m$  is the order of the root.

### Attenuation Coefficients

All the attenuation coefficients contain a common coefficient

$$\alpha_0 = \frac{1}{4} \sqrt{\frac{\mu_2 \epsilon_1}{\sigma_2 \mu_1}}$$

$\epsilon_1, \mu_1$  dielectric constant and magnetic permeability for the insulator.

$\sigma_2, \mu_2$  electric conductivity and magnetic permeability for the metal.

For air and copper  $\alpha_0 = 0.35 \times 10^{-9}$  nep. per cm

or  $0.3 \times 10^{-3}$  db per km

The following table summarizes some of the most important formulas. The dimensions  $a, b$  are measured in *centimeters*.



**WAVE GUIDES AND RESONATORS—Continued**  
**Table of Cut-off Wavelengths and Attenuation Factors**

	Coaxial Cable ( $a, b$ )	Rectangular Pipe $a, b$ $H_{0,m}$	Circular Pipe of Radius $a$		
			$E_0$	$H_1$	$H_0$
Cut-off Wave-length $\lambda_{c_m} = \frac{c}{f_m}$	0	$\frac{2b}{m}$	$2.613a$	$3.412a$	$1.640a$
Attenuation Factor $= \alpha$	$\alpha_0 \sqrt{f} \frac{\left(\frac{1}{a} + \frac{1}{b}\right)}{\log \frac{b}{a}}$	$\frac{4}{b} \alpha_0 A \left(\frac{b}{2a} + \frac{f_m^2}{f^2}\right)$	$\frac{2}{a} \alpha_0 A$	$\frac{2}{a} \alpha_0 A \left(0.415 + \frac{f_m^2}{f^2}\right)$	$\frac{2}{a} \alpha_0 A \left(\frac{f_m}{f}\right)^2$

Where  $f_m =$  cut-off frequency  $A = \frac{\sqrt{f}}{\sqrt{1 - \left(\frac{f_m}{f}\right)^2}}$

## WAVE GUIDES AND RESONATORS—Continued

### Resonant Cavities

A cavity resonator is essentially a closed metallic tank in which electric and magnetic fields are excited and which oscillate at one or many of the proper frequencies of the system. One type of resonant cavity is a hollow rectangular or cylindrical pipe, closed at both ends by metallic sheet or pistons.

Resonance occurs when  $l = p \frac{\lambda}{2}$

where  $p$  is an integer

$l$  = length of resonator

$\lambda$  = wavelength in the resonator which is different from the wavelength in an unbounded medium.

The wavelength in the resonator is given by:

$$\left(\frac{\lambda_0}{\lambda}\right)^2 = 1 - k^2_{n,m} \frac{\lambda^2_0}{4\pi^2}$$

$\lambda_0$  = wavelength in unbounded medium;

$$k^2_{n,m} = \frac{\pi^2 n^2}{a^2} + \frac{\pi^2 m^2}{b^2} \text{ for a rectangular cavity of dimensions } a \text{ and } b.$$

$k_{n,m}$  is given by the Bessel roots for cylindrical cavities (see section on wave guides).

The free space wavelength, corresponding to the wavelength in the resonator, is given by

$$\lambda_{0,n,m,p} = \frac{2}{\sqrt{\frac{k^2_{n,m}}{\pi^2} + \frac{p^2}{l^2}}} \quad n, m, p \text{ are integers.}$$

For TM waves  $p = 0, 1, 2 \dots$  For TE waves  $p = 1, 2$ , but not zero.

### Rectangular Resonators—Edges of Length $a, b$

The resonant frequencies are given by

$$f_{n,m,p} = \frac{c}{\lambda_{0,n,m,p}}$$

$$f_{n,m,p} = \frac{c}{2} \sqrt{\frac{n^2}{a^2} + \frac{m^2}{b^2} + \frac{p^2}{l^2}} \quad \text{where only one of the three integers } n, m, p \text{ can be zero.}$$

## WAVE GUIDES AND RESONATORS—Continued

**Cubic Box,  $a = b = l$ .**

The fundamental vibration  
( $m = 1 \quad n = 1 \quad p = 0$ ) is

$$f_{1,1,0} = \frac{c}{a\sqrt{2}}$$

**Cylindrical Resonators—Circular Section of  
Radius  $a$  and Length  $l$**

Resonant frequencies are

$$f_{n,m,p} = \frac{c}{\lambda_{0,n,m,p}} = \frac{c}{2} \sqrt{\frac{k_{n,m}^2}{\pi^2} + \frac{p^2}{l^2}}$$

where for TM, or  $E$ , modes,  $k_{n,m} = \frac{U_{n,m}}{a}$  and  $U_{n,m}$  is the  $m$ 'th root of  $J_n(U)$  and for TE, or  $H$ , modes,  $k_{m,n} = \frac{U'_{n,m}}{a}$  and  $U'_{n,m}$  is the  $m$ 'th root of  $J'_n(U)$ .

Lowest modes of oscillation are

$$f_{E_{0,1,0}} = \frac{c}{2\pi a} (2.405)$$

$n = 0 \quad m = 1 \quad p = 0$

$$f_{H_{1,1,1}} = \frac{c}{2} \sqrt{\left(\frac{1.841}{\pi a}\right)^2 + \frac{1}{l^2}}$$

$n = 1 \quad m = 1 \quad p = 1$

**Spherical Resonators—Radius  $a$**

Resonant frequencies are given by

$$f_{n,m} = \frac{cU_{n,m}}{2\pi a}$$

where for TE ( $H$ ) modes

$$U_{1,1} = 4.5; \quad U_{2,1} = 5.8; \quad U_{1,2} = 7.64$$

## WAVE GUIDES AND RESONATORS—Continued

and for TM ( $E$ ) modes

$$U'_{1,1} = 2.75$$

The most important mode is  $E_{1,1}$  which yields

$$\lambda_0 = 2.28a.$$

**Attenuations suffered by each of the more common types of waves in a hollow copper pipe 5 inches in diameter.**

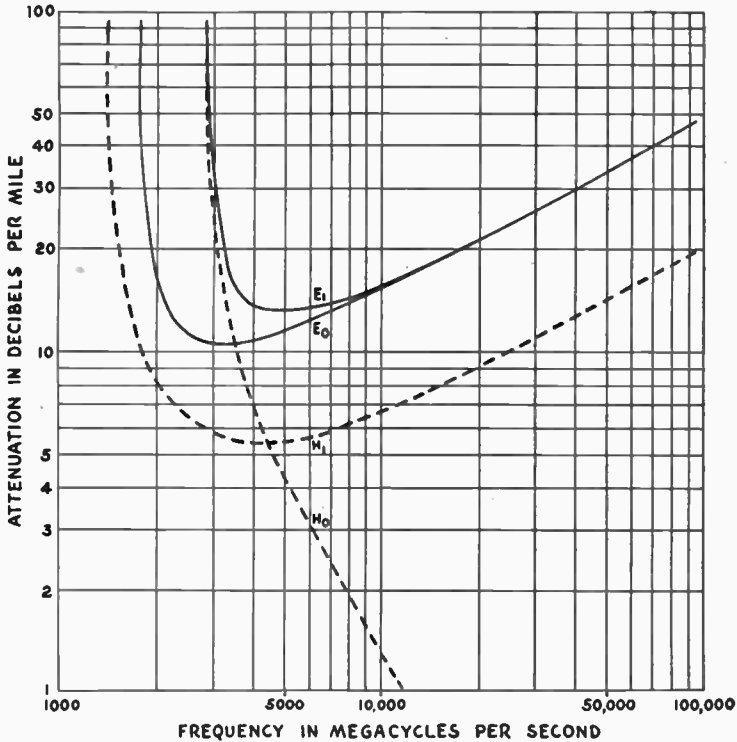



*Courtesy of Bell System Technical Journal*

## WAVE GUIDES AND RESONATORS—Continued

### Some Characteristics of Various Types of Resonators

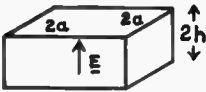
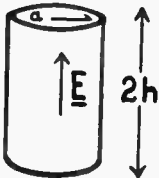
( $\delta$  is the skin depth)

	Square Prism	Circular Cylinder	Sphere
			
$\lambda$ (Wavelength)	$2\sqrt{2}a$	$2.61a$	$2.28a$
$Q$	$\frac{0.353\lambda}{\delta} \frac{1}{1 + \frac{1.177\lambda}{h}}$	$\frac{0.383\lambda}{\delta} \frac{1}{1 + \frac{.192\lambda}{h}}$	$0.318 \frac{\lambda}{\delta}$

### Additional Q Factors for Some Important Cases

		$Q$ Factor
Cylindrical Resonators of Circular Cross Section	$E_0$	$\frac{\pi a}{2\alpha_0 C} \sqrt{f}$
	$H_0$	$\frac{\pi a}{2\alpha_0 C} \sqrt{f} \left(\frac{f}{f_m}\right)^2$
	$H_1$	$\frac{\pi a}{2\alpha_0 C} \sqrt{f} \left[ \frac{1}{0.418 + \left(\frac{f_m}{f}\right)^2} \right]$
Spherical Cavity	Magn. 1.1	$0.725 \frac{\mu_1}{\mu_2} \times \frac{a}{\delta}$

Where

$$\delta = \frac{1}{2\pi \sqrt{\sigma_2 \mu_2 f}}$$

$$\alpha_0 = \frac{1}{4} \sqrt{\frac{\mu_2 \epsilon_1}{\sigma_2 \mu_1}}$$

$\sigma_2$  = conductivity of metal  
 $\mu_1$  = permeability of insulator  
 $\mu_2$  = permeability of metal  
 $f$  = frequency  
 $\epsilon_1$  = dielectric constant of insulator  
 $f_m$  = cut-off frequency  
*All Quantities in E.M.U.*

## FIELD STRENGTH OF RADIATION FROM AN ANTENNA

Vertical component of electric field at distances up to a few kilometers. Effect of image is included.

$$\epsilon = \frac{3.77IH}{\lambda r} \times 10^5$$

where  $\epsilon$  = field strength in microvolts per meter

$I$  = current in amperes at base of antenna

$H$  = effective height of antenna

$\lambda$  = wavelength ( $H$  and  $\lambda$  in the same units)

$r$  = distance in kilometers from antenna to point where  $\epsilon$  is required

Effective Height of an antenna which is short compared to a wavelength is roughly one third to one half of the actual height of the vertical portion of the antenna.

Effective height of a loop antenna

$$H = 2\pi n \frac{A}{\lambda}$$

where  $H$  = effective height at wavelength  $\lambda$

$A$  = mean area per turn of loop

$n$  = number of turns

$H$  and  $\lambda$  in same units (say meters) and

$A$  is square of that unit (say square meters).

## FIELD STRENGTH FROM AN ELEMENTARY DIPOLE\*

In order to obtain an advantageous representation of the field at a distance from an elementary dipole, its location is assumed to be at the center of a sphere (see Fig. 1). Its axis,  $PP'$ , is called the polar line, and the great circle,  $QQ'$ , the equator of the dipole so that circles such as  $PMP'$  become meridians. The *magnetic field* then is *tangent to a parallel of latitude* and the *electric field* is the *meridian* of the point under consideration.

Using polar coordinates,  $\epsilon_\theta$ ,  $\epsilon_r$  and  $h$  are shown in Fig. 1 with positive values indicated by the arrows. Calling  $c$  the speed of light,  $r$  and  $\theta$ , respectively, the distance  $OM$ , and the complementary angle of the latitude,  $POM$ , measured positively from  $P$  towards  $M$ , and letting

$$\alpha = \frac{2\pi}{\lambda} \quad \omega t - \alpha r = v$$

\*Extract from "Radio-Electricité Générale" by R. Mesny.

## FIELD STRENGTH FROM AN ELEMENTARY DIPOLE—Continued

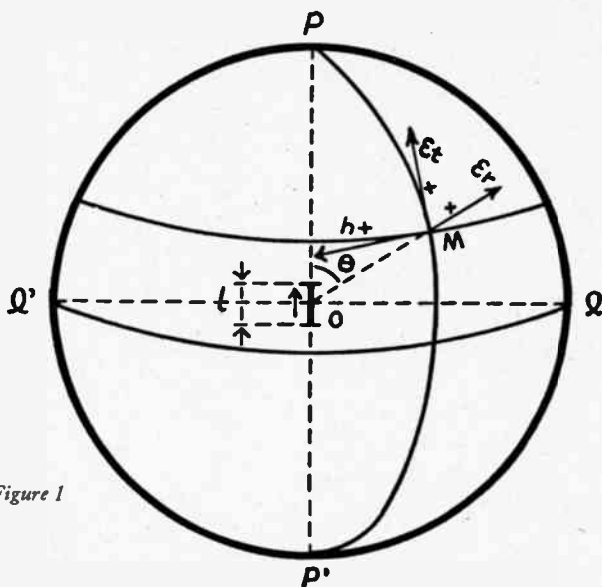

Figure 1

the result expressed in electromagnetic units is (in vacuum):

$$\left. \begin{aligned} \epsilon_r &= -\frac{c\lambda I}{\pi} \frac{\cos\theta}{r^3} (\cos v - \alpha r \sin v) \\ \epsilon_\theta &= +\frac{c\lambda I}{2\pi} \frac{\sin\theta}{r^3} (\cos v - \alpha r \sin v - \alpha^2 r^2 \cos v) \\ h &= -lI \frac{\sin\theta}{r^2} (\sin v - \alpha r \cos v) \end{aligned} \right\} I$$

These formulas are valid for the elementary dipole at a distance which is large compared with the dimensions of the dipole, the length of which is assumed to be very small. They correspond to a dipole isolated in free space. If the dipole is placed vertically on a plane of infinite conductivity, its image should be taken into account, thus doubling the above values.

### Field of an Elementary Dipole at a Great Distance

When the distance  $r$  with respect to the wavelengths is great, as is generally the case in radio applications, the product  $\alpha r = 2\pi \frac{r}{\lambda}$  is large so that lower powers in  $\alpha r$  can be neglected; the radial electric

## FIELD STRENGTH FROM AN ELEMENTARY DIPOLE—Continued

field  $\epsilon_r$  then becomes negligible with respect to the tangential field  $\epsilon_t$  and  $\epsilon_r=0$

$$\left. \begin{aligned} \epsilon_t &= -\frac{2\pi c l I}{\lambda r} \sin \theta \cos (\omega t - \alpha r) \\ h &= -\frac{\epsilon_t}{c} \end{aligned} \right\} \text{II}$$

The disposition of the field at a great distance is therefore very simple: *The electric field is tangent to the meridian and the magnetic field to the parallel of latitude; these two fields are in phase and their values at any instant are in the ratio  $c$ .*

The variation of their amplitude as a function of  $\theta$  is indicated in Fig. 2. Their relative positions are given by the three finger rule (left hand).

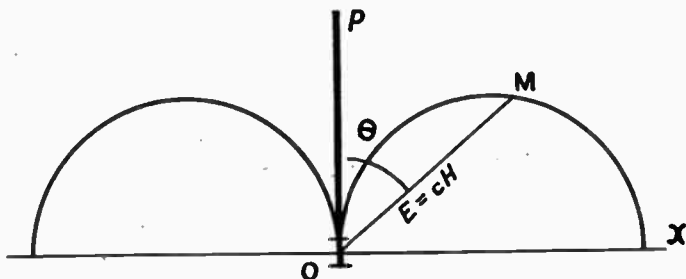

Figure 2

### Field of an Elementary Dipole at a Short Distance

In the vicinity of the dipole,  $\alpha r$  is very small and only the first terms between parentheses remain. It is easily seen that the electric field is then the one that may be deduced through the use of electrostatic formulas from the electric charges accumulated at both ends of the dipole; also, the magnetic field results from the application to the current,  $i$ , of the law of Laplace for a direct current.

The ratio between the radial and tangential field is then:

$$\frac{\epsilon_r}{\epsilon_t} = -2 \cot \theta.$$

Hence, the radial field at short distance has a magnitude of the same order as the tangential field. These two fields are in opposition.

Further the ratio of the magnetic and electric tangential field is

$$\frac{h}{\epsilon_t} = -\frac{\alpha r}{c} \frac{\sin \nu}{\cos \nu}$$

The magnitude of the magnetic field at short distance is therefore extremely small with respect to that of the tangential electric field,



## FIELD STRENGTH FROM AN ELEMENTARY DIPOLE—Continued

relatively to their relationship at great distances. These two fields are in quadrature. Thus, at short distance, the effect of a dipole on an open circuit is much greater than on a closed circuit as compared with the effect at remote points.

In order to obtain the e.m.f. induced by a plane wave in an element of wire, use is often made of the magnetic flux cut by this element of wire in unit time; the second of the formulas, group II, justifies this practice. Here, however, this procedure is impracticable since the speed of displacement of the magnetic field is not  $c$ ; the equation consequently does not apply.

TABLE I

$r/\lambda$	$1/\alpha r$	$A_r$	$\varphi_r$	$A_t$	$\varphi_t$	$A_h$	$\varphi_h$
0.01	15.9	4,028	3°6	4,012	3°6	253	93°6
0.02	7.96	508	7°2	500	7°3	64.2	97°2
0.04	3.98	65	14°1	61	15°0	16.4	104°1
0.06	2.65	19.9	20°7	17.5	23°8	7.67	110°7
0.08	1.99	8.86	26°7	7.12	33°9	4.45	116°7
0.10	1.59	4.76	32°1	3.52	45°1	2.99	122°1
0.15	1.06	1.66	42°3	1.14	83°1	1.56	132°3
0.20	0.80	0.81	51°5	0.70	114°0	1.02	141°5
0.25	0.64	0.47	57°5	0.55	133°1	0.75	147°5
0.30	0.56	0.32	62°0	0.48	143°0	0.60	152°0
0.35	0.45	0.23	65°3	0.42	150°1	0.50	155°3
0.40	0.40	0.17	68°3	0.37	154°7	0.43	158°3
0.45	0.35	0.134	70°5	0.34	158°0	0.38	160°5
0.50	0.33	0.106	72°3	0.30	160°4	0.334	162°3
0.60	0.265	0.073	75°1	0.26	164°1	0.275	165°1
0.70	0.228	0.053	77°1	0.22	166°5	0.234	167°1
0.80	0.199	0.041	78°7	0.196	168°3	0.203	168°7
0.90	0.177	0.032	80°0	0.175	169°7	0.180	170°0
1.00	0.159	0.026	80°9	0.157	170°7	0.161	170°9
1.20	0.133	0.018	82°4	0.132	172°3	0.134	172°4
1.40	0.114	0.013	83°5	0.114	173°5	0.114	173°5
1.60	0.100	0.010	84°3	0.100	174°3	0.100	174°3
1.80	0.088	0.008	84°9	0.088	174°9	0.088	174°9
2.00	0.080	0.006	85°4	0.080	175°4	0.080	175°4
2.50	0.064	0.004	86°4	0.064	176°4	0.064	176°4
5.00	0.032	0.001	88°2	0.032	178°2	0.032	178°2

### Field of an Elementary Dipole at Intermediate Distance

At intermediate distance, say between .04 and 1.2 wavelengths, one should take into account all the terms of the formulas of group I. This case occurs, for instance, when studying the reactions between adjacent antennae. To calculate the fields, it is convenient to transform the equations as follows:

$$\left. \begin{aligned} \epsilon_r &= -2\alpha^2 c I \cos \theta & A_r \cos (v + \varphi_r) \\ \epsilon_t &= \alpha^2 c I \sin \theta & A_t \cos (v + \varphi_t) \\ h &= \alpha^2 I \sin \theta & A_h \cos (v + \varphi_h) \end{aligned} \right\} \text{ III}$$

## FIELD STRENGTH FROM AN ELEMENTARY DIPOLE—Continued

$$\left. \begin{aligned} \text{where } A_r &= \frac{\sqrt{1+(\alpha r)^2}}{(\alpha r)^3} & \tan \varphi_r &= \alpha r \\ A_t &= \frac{\sqrt{1-(\alpha r)^2+(\alpha r)^4}}{(\alpha r)^3} & \cot \varphi_r &= \frac{1}{\alpha r} - \alpha r \\ A_h &= \frac{\sqrt{1+(\alpha r)^2}}{(\alpha r)^2} & \cot \varphi_h &= -\alpha r. \end{aligned} \right\} \text{IV}$$

Values of  $A$ 's and  $\varphi$ 's are given in Table I as a function of the ratio between the distance  $r$  and the wavelength  $\lambda$ . The second column contains values of  $\frac{1}{\alpha r}$  which would apply if the fields  $\epsilon_t$  and  $h$  behaved

the same as at great distances.

The above outline concerns electric dipoles. It also can be applied to magnetic dipoles, *i.e.*, by installing the loop perpendicular to the PP' line at the center of the sphere. In this case, the vector  $h$  of Fig. 1 becomes  $\epsilon$ , the electric field;  $\epsilon_t$  becomes the magnetic tangential field, and  $\epsilon_r$  the radial magnetic field.

In the case of a magnetic dipole, the table showing the variations of the field in the vicinity of the dipole can also be used.  $A_r$  is then the coefficient for the radial magnetic field,  $A_t$  is the coefficient for the tangential magnetic field; and  $A_h$  is the coefficient for the electric field;  $\varphi_r$ ,  $\varphi_t$ , and  $\varphi_h$  are the phase angles corresponding to the above coefficients.

### ULTRA-SHORT WAVE PROPAGATION

For propagation over a path within the range of optical visibility, the field strength is given approximately by

$$E = \frac{88 \sqrt{W}}{\lambda D^2} h_T h_R \text{ volts/meter}$$

where  $W$  = watts radiated  
 $h_T$  = height of transmitting aerial in meters  
 $h_R$  = height of receiving aerial in meters  
 $\lambda$  = wavelength in meters  
 $D$  = distance in meters

Allowing for the refractive effect of the atmosphere, the "optical range" for aerial heights  $h_T$  and  $h_R$  is approximately

$$D_{\text{opt.}} = 4130 [\sqrt{h_T} + \sqrt{h_R}]$$

where all dimensions are in meters.

If the refractive effect of the atmosphere is ignored, the "optical range" is reduced to the "geometric" range given by

$$D_{\text{geom.}} = 3550 [\sqrt{h_T} + \sqrt{h_R}]$$

The above formula holds good for both vertical and horizontal polarization. It assumes that the aerials are half-wave dipoles, and both  $h_T$  and  $h_R$  are not less than a half-wavelength and that  $h_T h_R < < \lambda D$ .

## ULTRA-SHORT WAVE PROPAGATION LINE OF SIGHT TRANSMISSION DISTANCE

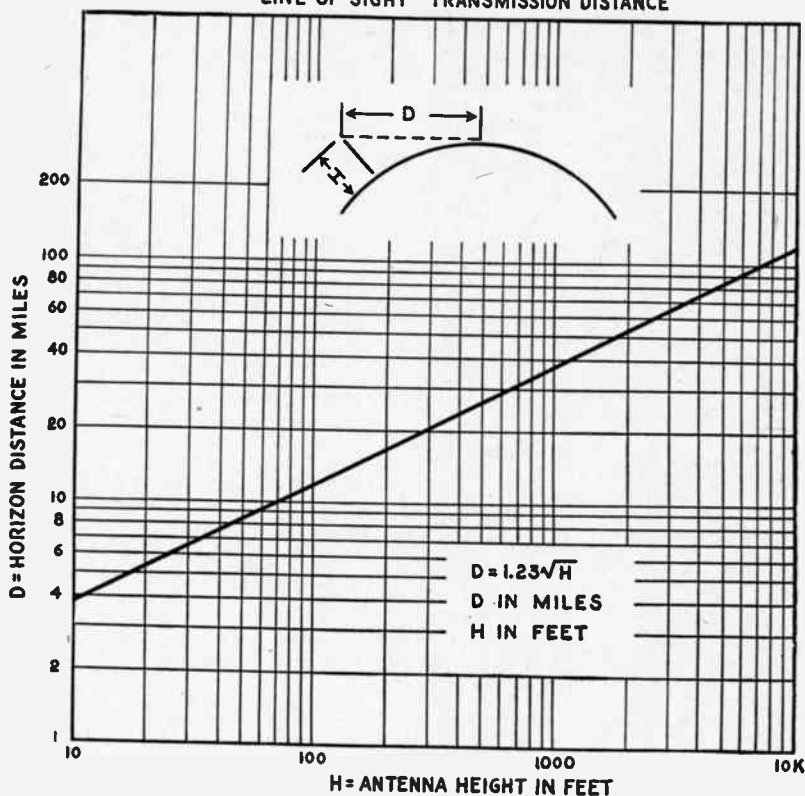

## REFLECTION COEFFICIENT OF PLANE RADIO WAVES FROM SURFACE OF THE SEA

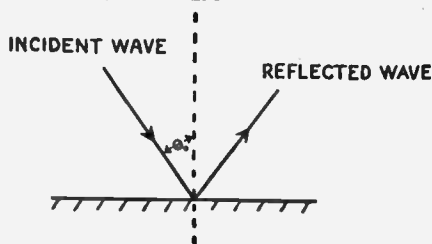
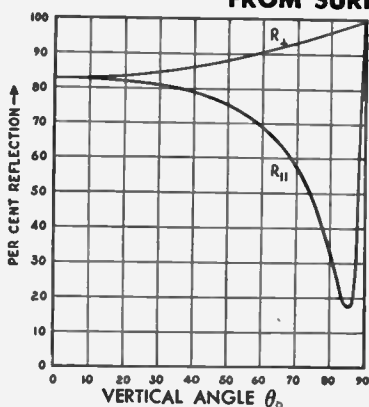

The curve  $R_{\perp}$  corresponds to polarization perpendicular to the plane of incidence (horizontal polarization); curve  $R_{\parallel}$  to polarization parallel to the plane of incidence. Valid for frequencies below 1 megacycle.

Curves from "Electromagnetic Theory," by J. A. Stratton, McGraw-Hill Book Co.

## DISTANCE RANGES OF RADIO WAVES\*

The following four charts show the limits of distance for the periods indicated over which practical radiotelegraph communication is possible. They are based on the lowest field intensity which permits practical reception in the presence of average background interference or noise. For the broadcast frequencies this does not mean satisfactory program reception. The limiting field intensity is different at different frequencies and times. The following table gives limiting field intensity values typical of those used in determining the distance ranges. This assumes the use of a good receiving set.

	0.1 mc	1.0 mc	5.0 mc	10.0 mc
Summer day	60 $\mu\text{v}/\text{m}$	10 $\mu\text{v}/\text{m}$	10 $\mu\text{v}/\text{m}$	3 $\mu\text{v}/\text{m}$
Summer night	100	50	15	1
Winter day	25	1	2	1
Winter night	35	5	1	1

When atmospherics ("static") or other sources of interference are great, *e.g.*, in the tropics, larger received field intensities are required and the distance ranges are less. The graphs assume the use of one kilowatt radiated power, and non-directional antennas. For greater power the distance ranges will be somewhat greater. For transmission over a given path, received intensity is proportional to the square root of radiated power, but there is no simple relation between distance range and either radiated power or received field intensity.

The day graphs are based on noon conditions and the night graphs on midnight conditions. In a general way, progressive change occurs from one to the other, but with some tendency for day conditions to persist through dusk, and night conditions through dawn. The conditions of spring and autumn are intermediate between those of summer and winter, autumn resembling winter somewhat more than summer.

The graphs are based principally upon data for the latitude of Washington, but serve as a guide for transmission anywhere in the temperate zones. They are not as accurate for polar or equatorial latitudes.

In general, the distance ranges for paths which lie partly in day and partly in night portions of the globe are intermediate between those shown in the day and night graphs, for the range of frequencies which can be used both day and night. For paths which cross the sunset line in summer, the usable frequencies will be about the same as the usable summer day frequencies. For paths across the sunset line in winter, the usable frequencies will be a little higher than the night

\* Extracted from U. S. Dept. of Commerce, National Bureau of Standards, Letter Circular LC 615.

## DISTANCE RANGES OF RADIO WAVES—Continued

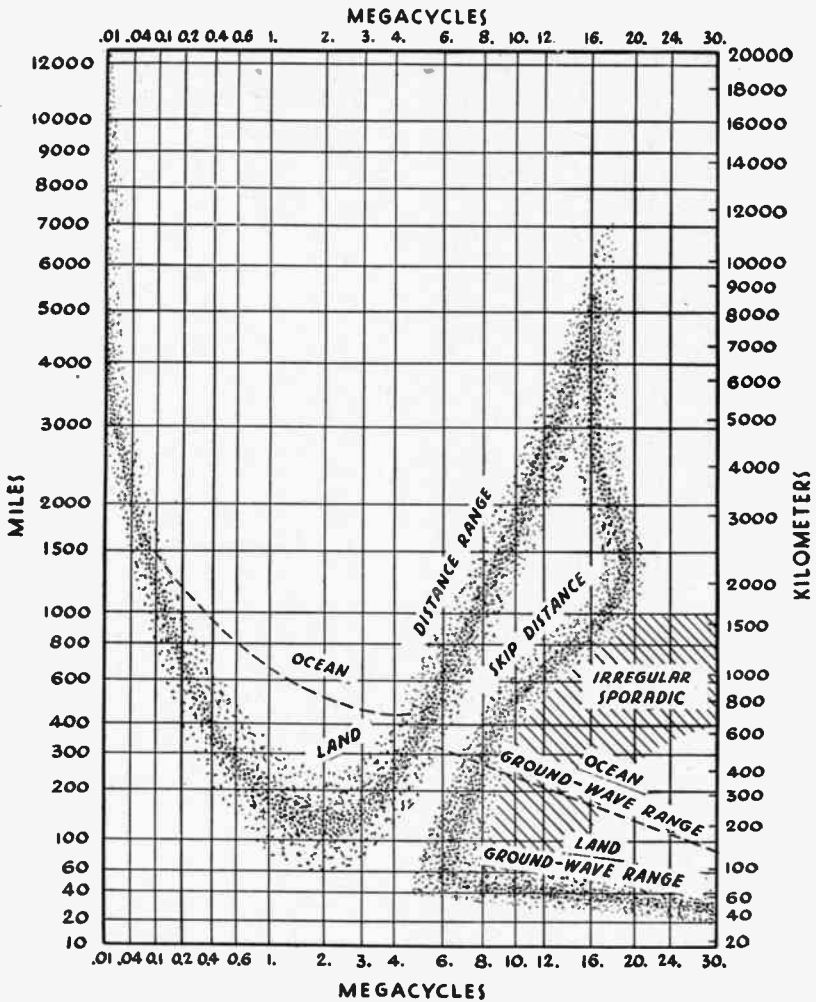

SUMMER DAY—Figure 1

frequencies shown in the graphs. For transmissions across the sunrise line, both summer and winter, the usable frequencies will be a little lower than the night frequencies shown in the graphs. Frequently the conditions of the ionosphere on the light and dark sides of sunrise

## DISTANCE RANGES OF RADIO WAVES—Continued

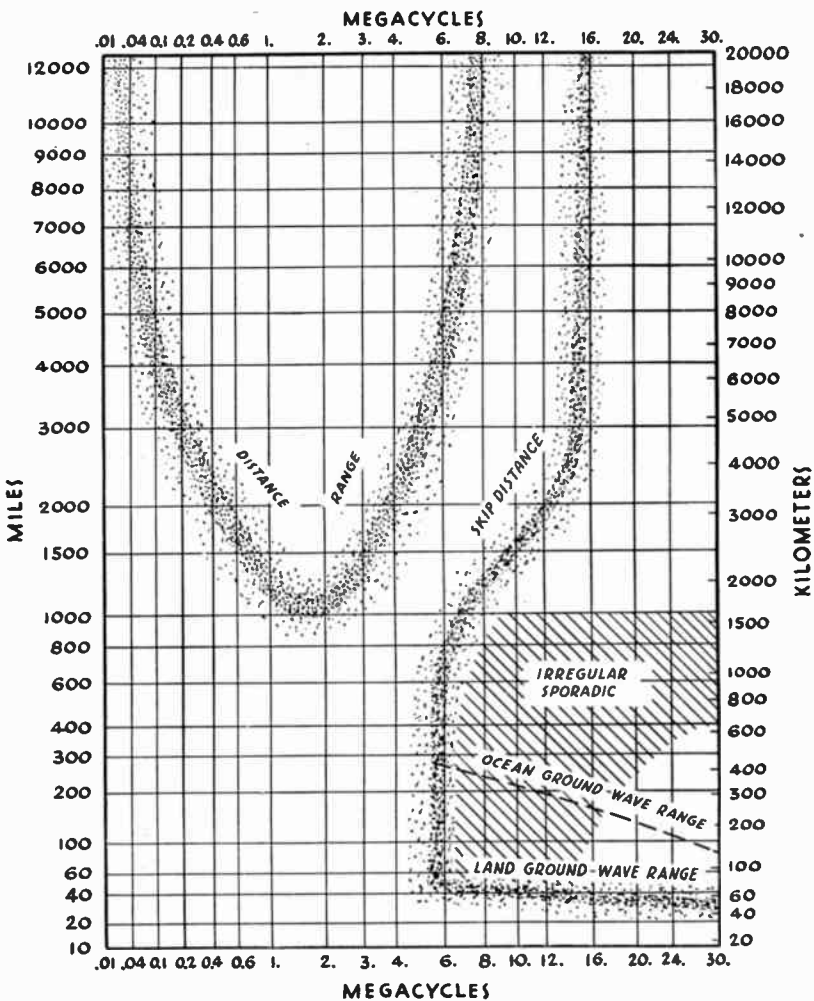

SUMMER NIGHT—Figure 2

are widely different. Under such conditions it is often so difficult to transmit across the sunrise line that it is almost a barrier to high-frequency radio communication.

The graphs give distance ranges for the year 1941 only. They

## DISTANCE RANGES OF RADIO WAVES—Continued

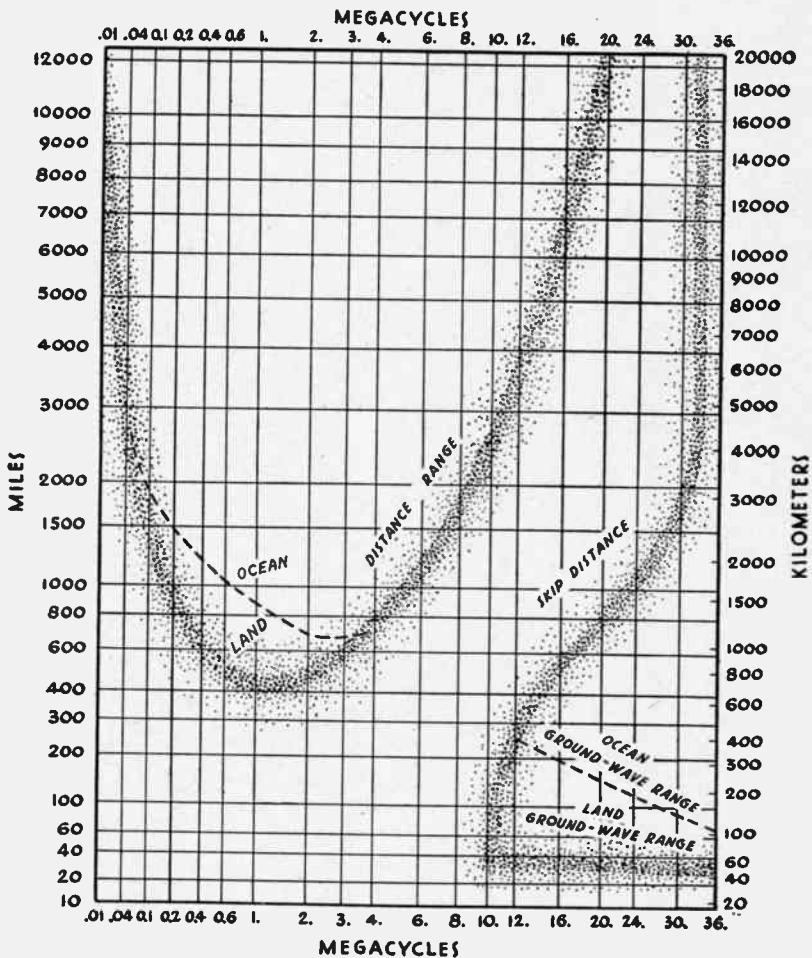

WINTER DAY—Figure 3

change from year to year because of changes of ionization in the ionosphere. These changes are caused by the changing ultraviolet radiation from the sun in an approximate eleven-year cycle. The graphs therefore require revision each year.

The distance ranges given in the graphs are the distances for good

## DISTANCE RANGES OF RADIO WAVES—Continued

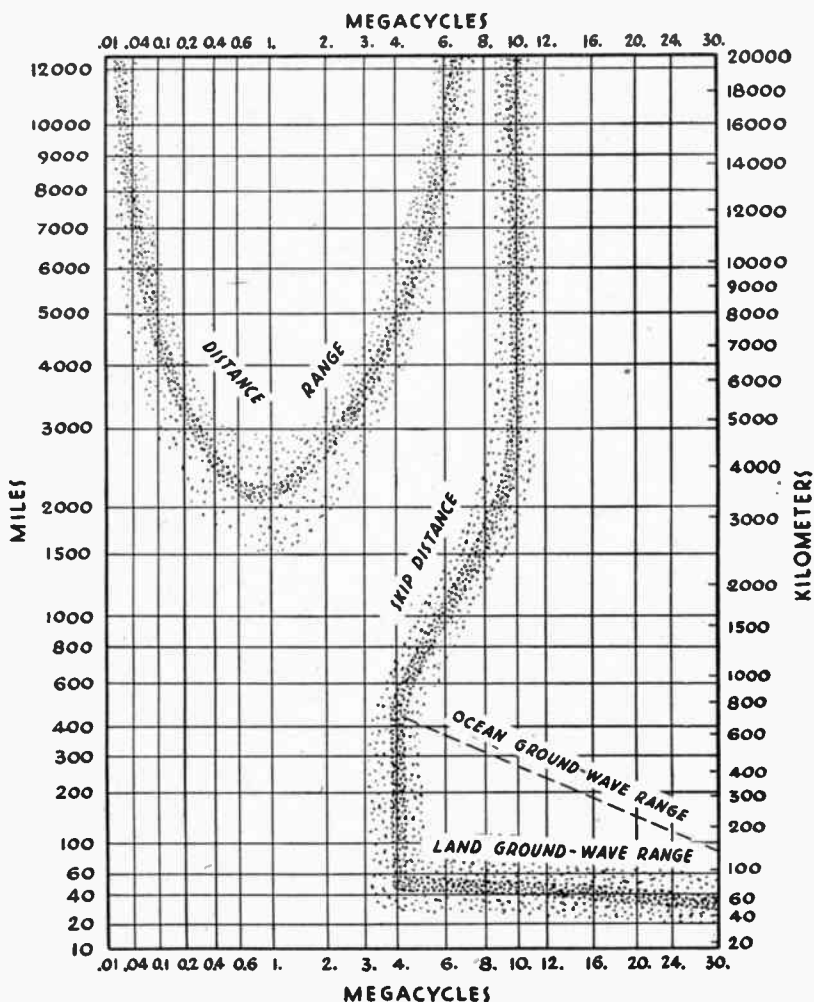

WINTER NIGHT—Figure 4

intelligible reception; they are not the limits of distance at which interference can be caused. A field intensity sufficient to cause troublesome interference may be produced at a much greater distance than the maximum distance of reliable reception.





## RADIO TRANSMISSION AND THE IONOSPHERE

In local radio broadcasting, as is well known, electrical impulses set up by an antenna travel close to the earth's surface with rapidly decreasing energy as the distance increases. For distances of 150 miles or over, transmission must occur by way of the ionosphere.

A cross section of the ionospheric radio reflection layers and the ionospheric structure of particular interest to the radio engineer may be visualized in an elementary way from Figs. 1 and 2. The latter is drawn to scale so that the angles of reflection of radio waves from the layers may be estimated correctly.

### *D Layer*

The D layer (Fig. 1) at the altitude of 40 km. is located at a height corresponding very nearly to the upper part of the ozone region. This is the layer from which the very low-frequency or long radio waves of 20 to 550 kc. are reflected. Such frequencies were used almost exclusively in the earlier days of communication across the Atlantic. Communication conditions at these frequencies are unusually stable but, since attenuation increases rapidly with wave length, very high powers were necessary to cover great distances.

### *E Layer*

The height of the E layer or Kennelly-Heaviside region may be placed at about 100 km. This layer reflects all broadcast frequencies from 500 to 1500 kc. and represents a source of reception of commercial broadcast programs over distances of several hundred miles.

Unfortunately, due to sunlight, the E layer becomes so heavily ionized in the daytime that most of these broadcast waves are absorbed. Thus it is only after dark, when the de-ionizing process has set in, that the critical number of ions exists for proper reflection and "good reception" is obtained at long distances.

### *F Layer*

This layer, 200 km. above the earth, reflects short radio waves that pass through the E layer; that is, waves of frequencies from 1500 to 30,000 kc. Within this range, because of reflections from the F layer, radio transmissions are practicable day or night over thousands of miles with moderate power.

Because of the ionizing effect of the sun's rays the height of the F layer varies over a considerable range from day to night and from

# RADIO TRANSMISSION AND THE IONOSPHERE—Continued

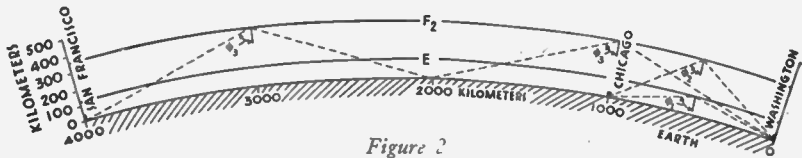

Figure 2

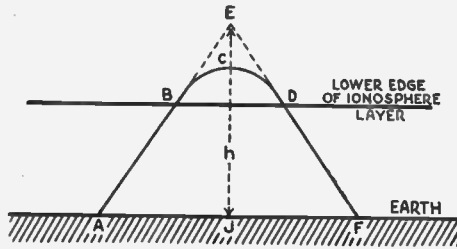

Figure 3

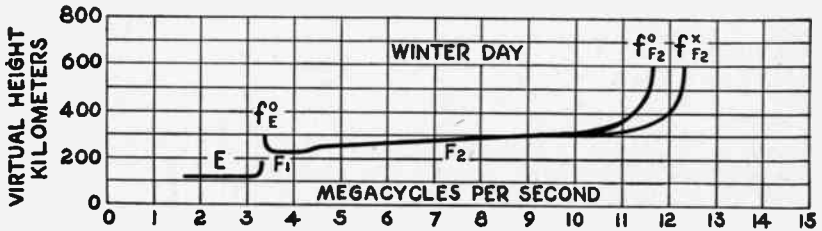

Figure 4

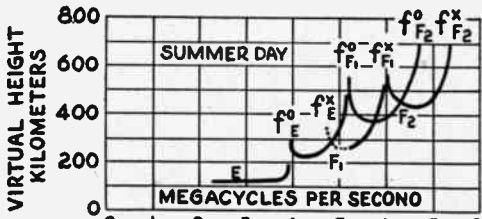

Figure 5

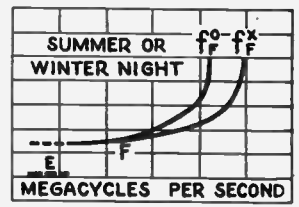

Figure 6

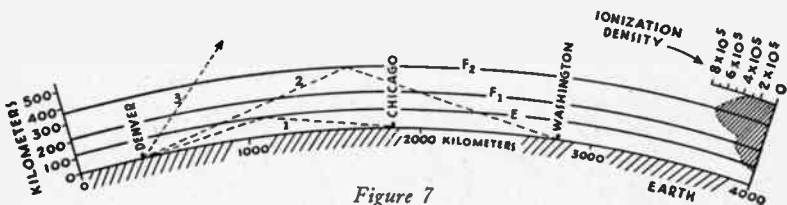

Figure 7

Figures from Department of Commerce Letter Circular, LC-614.

## RADIO TRANSMISSION AND THE IONOSPHERE—*Continued*

season to season. This layer actually splits into two regions during the day, the  $F_1$  layer and the  $F_2$  layer. Conditions for maximum transmission depend on how the radio waves are reflected and the occurrence of interference from two systems of reflection.

### *Ionosphere Characteristics*

Since each ionospheric layer possesses a certain thickness as well as ionization density, it is necessary to define the sense in which the term, height, is used. When a ray or train of waves is reflected by a layer, it is slowed down as soon as it starts to penetrate the layer. The process of reflection thus goes on from the place at which the waves enter the layer until they have been fully turned down and leave the layer. It is illustrated for oblique incidence by Fig. 3. The time of transmission along the actual path BCD in the ionized layer is, for the simple case, the same as would be required for transmission along the path BED if no ionized particles were present. The height  $H$  from the ground to E, the intersection of the two projected straight parts of the path, is called the virtual height of the layer.

The highest frequency at which waves sent vertically upward are received back from the layer is the critical frequency of that layer. Typical results of such measurements are illustrated in Figs. 4\*, 5 and 6 for different times of year, day and night. They show critical frequencies as sharp increases in virtual height. Knowing the critical frequency, one can calculate the number of ions per unit volume in the upper atmosphere, an important factor in forecasting radio conditions.

### *Applications to Radio Transmission*

Fig. 2 illustrates the radio wave path in the case of a double-hop transmission between Washington, D. C., and San Francisco; Fig. 7 illustrates a single-hop transmission between Washington, D. C., and Denver. For information on ionospheric disturbances and the calculation of maximum working frequencies, reference may be made to the Department of Commerce Letter Circular, LC-614, dated October 23, 1940, and the papers cited therein.

\*Fig. 4 (similarly in Figs. 5 and 6) indicates excessive retardation in the waves near the critical frequency, i.e., rise of the curves near the critical frequency. Also, at the right of the curves, two critical frequencies are shown for the  $F_2$  layer. This indicates double refraction of the waves due to the earth's magnetic field, yielding two components of different polarization, i.e., the ordinary and extraordinary wave  $F_2^0$  and  $F_2^x$ , respectively. In the case of the E layer the ordinary wave usually predominates, the extraordinary wave being too weak to affect radio reception. At Washington, the critical frequency of the extraordinary wave is about 750 kc/s higher than the ordinary wave for frequencies of 4000 kc/s or over. Present customary practice is to report critical frequency measurements on the basis of ordinary wave values.

## TIME INTERVAL BETWEEN TRANSMISSION AND RECEPTION OF REFLECTED SIGNAL

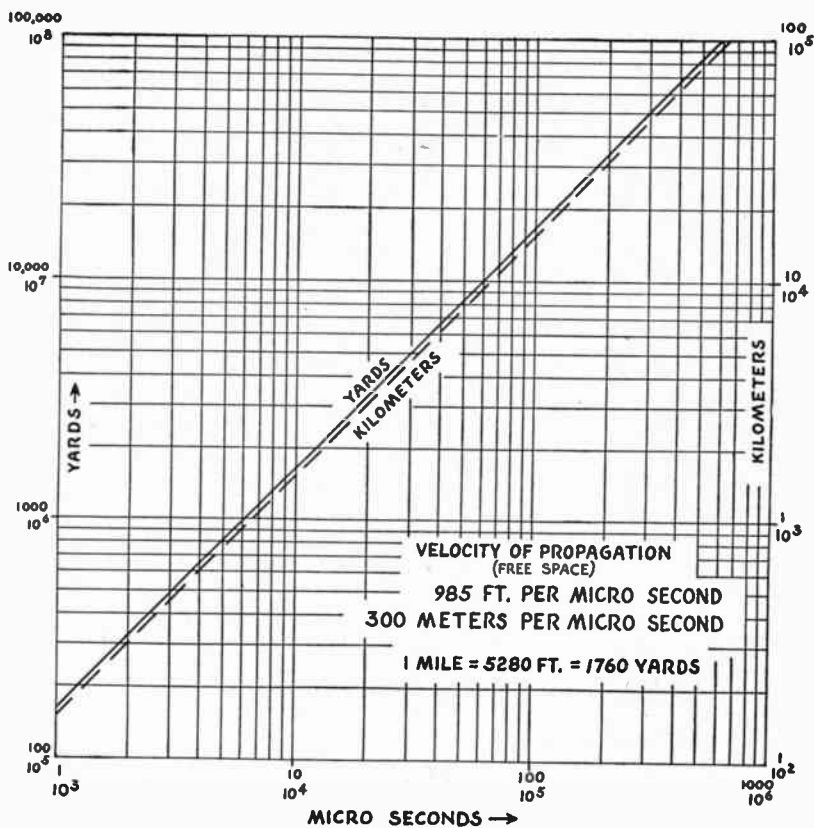

## LINEAR RADIATORS

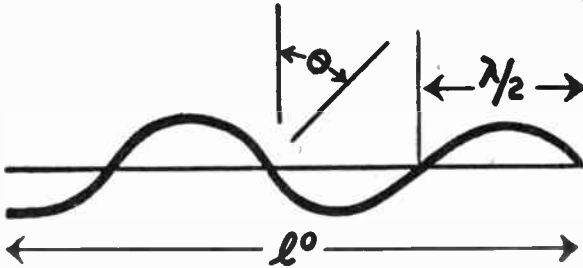

CONFIGURATION (Length of Radiator)	EXPRESSION FOR INTENSITY $F(\theta)$
Half Wave	$\frac{\cos\left(\frac{\pi}{2} \sin \theta\right)}{\cos \theta}$
Any Odd Number of Half Waves	$\frac{\cos\left(\frac{l^0}{2} \sin \theta\right)}{\cos \theta}$
Any Even Number of Half Waves	$\frac{\sin\left(\frac{l^0}{2} \sin \theta\right)}{\cos \theta}$
Any Length	$\frac{1}{\cos \theta} \left[ 1 + \cos^2 l^0 + \sin^2 \theta \sin^2 l^0 - 2 \cos(l^0 \sin \theta) \cos l^0 - 2 \sin \theta \sin(l^0 \sin \theta) \sin l^0 \right]^{\frac{1}{2}}$

$l^0$  = Length of radiator in electrical degrees, energy to flow from left-hand end of radiator.

## LINEAR RADIATORS—Continued

### Maxima and Minima of Radiation— Single Wire Radiator

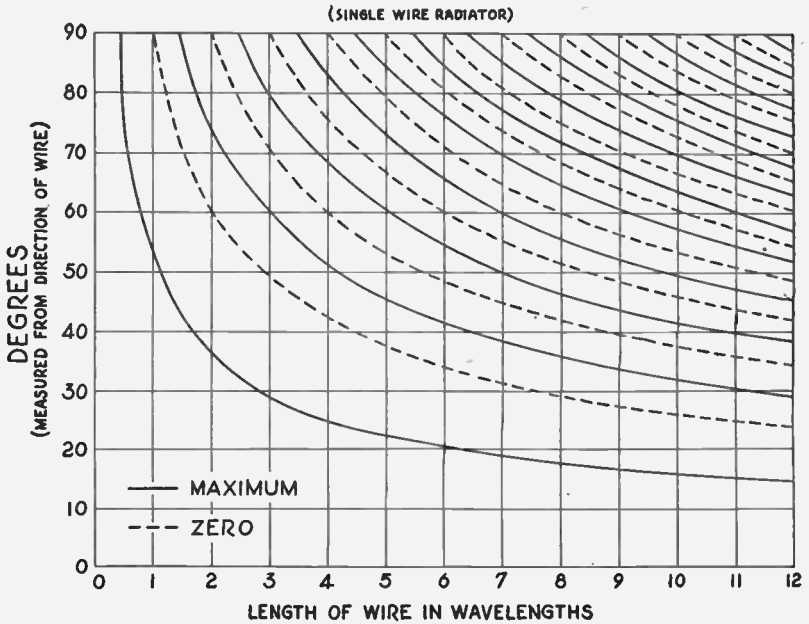

### ANTENNA ARRAYS

The basis for all directivity control in antenna arrays is wave interference. By providing a large number of sources of radiation it is possible with a fixed amount of power to greatly reinforce radiation in a desired direction, *i.e.*, by suppressing the radiation in undesired directions.

One of the most important arrays is the linear multi-element array where a large number of equally spaced antenna elements are fed equal currents in phase to obtain maximum directivity in the forward direction. Chart II gives expressions for the radiation pattern of several particular cases and the general case of any number of broad-side elements.

In this type of array, a great deal of directivity may be obtained. A large number of minor lobes, however, are apt to be present and they may be undesirable under some conditions, in which case a type of array, called the Binomial array, may be used. Here again all the radiators are fed in phase but the current is not distributed equally between the array elements, the center radiators in the array being fed more current than the outer ones. Chart III shows the configura-

## ANTENNA ARRAYS—Continued

tion and general expression for such an array. In this case the configuration is made for a vertical stack of loop antennas in order to obtain single lobe directivity in the vertical plane. If such an array were desired in the horizontal plane, say  $n$  dipoles end to end, with the specified current distribution the expression would be

$$F(\theta) = 2^{n-1} [\cos(\frac{\pi}{2} \sin \theta) / \cos \theta] \cos^{n-1} (1/2 S^\circ \sin \theta).$$

The term binomial results from the fact that the current intensity in the successive array elements is in accordance with the binomial expansion  $(1+1)^{n-1}$ , where  $n$  is the number of elements.

### Examples of Use of Charts I, II, and III.\*

**Problem 1** Find horizontal radiation pattern of four colinear horizontal dipoles, spaced successively  $\frac{\lambda}{2}$  ( $180^\circ$ ).

**Solution** From Chart II radiation from four radiators spaced  $180^\circ$  is given by

$$F(\theta) = A \cos(180^\circ \sin \theta) \cos(90^\circ \sin \theta).$$

From Chart I, the horizontal radiation of a dipole is given by

$$A = K \frac{\cos(\frac{\pi}{2} \sin \theta)}{\cos \theta}$$

therefore, the total radiation

$$F(\theta) = K \left[ \frac{\cos(\frac{\pi}{2} \sin \theta)}{\cos \theta} \right] \cos(180^\circ \sin \theta) \cos(90^\circ \sin \theta)$$

**Problem 2** Find vertical radiation pattern of four horizontal dipoles, stacked one above the other, spaced  $180^\circ$  successively.

**Solution** From Chart II we obtain the general equation of four radiators, but since the spacing is vertical, the expression should be in terms of vertical angle  $\beta$ .

$$F(\beta) = A \cos(180^\circ \sin \beta) \cos(90^\circ \sin \beta).$$

From Chart I we find the vertical radiation from a horizontal dipole (in the perpendicular bisecting plane) is non-directional. Therefore the vertical patterns

$$F(\beta) = K(1) \cos(180^\circ \sin \beta) \cos(90^\circ \sin \beta)$$

\*Charts located on pages 147, 148, and 149.



## ANTENNA ARRAYS—Continued

**Problem 3** Find horizontal radiation pattern of group of dipoles in problem 2.

**Solution** From Chart I.

$$F(\theta) = K \frac{\cos\left(\frac{\pi}{2} \sin \theta\right)}{\cos \theta} \cong K \cos \theta$$

**Problem 4** Find the horizontal radiation pattern of stack of five loops spaced  $\frac{2}{3} \lambda$  ( $240^\circ$ ) one above the other, all currents equal in phase and amplitude.

**Solution** From Chart II, using vertical angle because of vertical stacking,

$$F(\beta) = A \frac{\sin [5(120^\circ) \sin \beta]}{\sin (120^\circ \sin \beta)}$$

From Chart I, we find  $A$  for a horizontal loop in the vertical plane

$$A = F(\beta) = K \cos \beta$$

Total radiation pattern

$$F(\beta) = K \cos \beta \frac{\sin [5(120^\circ) \sin \beta]}{\sin (120^\circ \sin \beta)}$$

**Problem 5** Find radiation pattern (vertical directivity) of the five loops in problem 4, if they are used in binomial array. Find also current intensities in the various loops.

From Chart III





$$F(\beta) = K \cos \beta [\cos^4(120^\circ \sin \beta)]$$

(all terms not functions of vertical angle  $\beta$  combined in constant  $K$ .)

Current distribution  $(1+1)^4 = 1+4+6+4+1$ , which represent the current intensities of successive loops in the array.

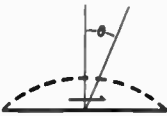
## ANTENNA ARRAYS—Continued

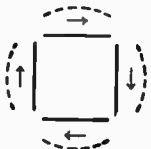
**Chart I**  
**RADIATION PATTERN OF SEVERAL**  
**COMMON TYPES OF ANTENNAS**

Type of Radiator	Current Distribution	DIRECTIVITY	
		Horizontal $F(\theta)$	Vertical $F(\beta)$
Half Wave Dipole		$F(\theta) = K \frac{\cos(\frac{\pi}{2} \sin \theta)}{\cos \theta} \cong K \cos \theta$	$F(\beta) = K(1)$
Shortened Dipole		$F(\theta) \cong K \cos \theta$	$F(\beta) = K(1)$
Horizontal Loop		$F(\theta) \cong K(1)$	$F(\beta) = K \cos \beta$
Horizontal Turnstile	 $i_1$ and $i_2$ phased $90^\circ$	$F(\theta) \cong K'(1)$	$F(\beta) \cong K'(1)$



$\theta$  = Horizontal Angle Measured from Perpendicular Bisecting Plane

$\beta$  = Vertical Angle Measured from Horizon

$K$  and  $K'$  are Constants and  $K' \cong .7K$

**ANTENNA ARRAYS—Continued**  
**Chart II**

LINEAR MULTI-ELEMENT ARRAY  
BROADSIDE DIRECTIVITY

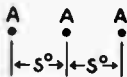
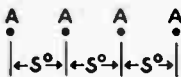
CONFIGURATION OF ARRAY	EXPRESSION FOR INTENSITY
	$A \{1\}$
	$2A \left[ \cos \left( \frac{s^\circ}{2} \sin \theta \right) \right]$
	$A + 2A \left[ \cos (s^\circ \sin \theta) \right]$
	$4A \left[ \cos (s^\circ \sin \theta) \cos \left( \frac{s^\circ}{2} \sin \theta \right) \right]$
<p align="center"><b>M RADIATORS</b> <b>(GENERAL CASE)</b></p>	$A \frac{\sin \left( m \frac{s^\circ}{2} \sin \theta \right)}{\sin \left( \frac{s^\circ}{2} \sin \theta \right)}$
<p align="center"> <math>A = 1</math> FOR HORIZONTAL LOOP, VERTICAL DIPOLE  <math>A = \frac{\cos \left( \frac{\pi}{2} \sin \theta \right)}{\cos \theta}</math> FOR HORIZONTAL DIPOLE  <math>s^\circ =</math> SPACING OF SUCCESSIVE ELEMENTS              IN DEGREES         </p>	

**ANTENNA ARRAYS—Continued**  
**Chart III**

DEVELOPMENT OF BINOMIAL ARRAY

CONFIGURATION OF ARRAY

EXPRESSION FOR INTENSITY

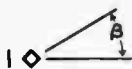

$$\cos \beta \left( 1 \right)$$

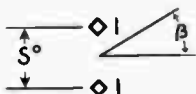

$$2 \cos \beta \left[ \cos \left( \frac{S^\circ}{2} \sin \beta \right) \right]$$

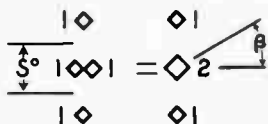

$$2^2 \cos \beta \left[ \cos^2 \left( \frac{S^\circ}{2} \sin \beta \right) \right]$$

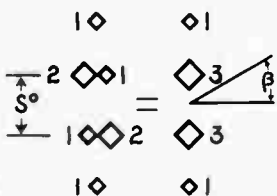

$$2^3 \cos \beta \left[ \cos^3 \left( \frac{S^\circ}{2} \sin \beta \right) \right]$$

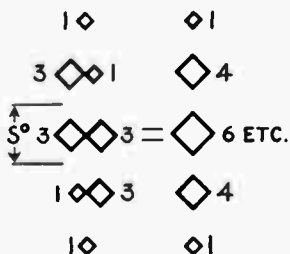

$$2^4 \cos \beta \left[ \cos^4 \left( \frac{S^\circ}{2} \sin \beta \right) \right]$$

AND IN GENERAL:

$$2^{n-1} \cos \beta \left[ \cos^{n-1} \left( \frac{S^\circ}{2} \sin \beta \right) \right]$$

WHERE  $n$  IS THE NUMBER  
OF LOOPS IN THE ARRAY

## FREQUENCY TOLERANCES†

(Cairo Revision, 1938)

1. The frequency tolerance is the maximum permissible separation between the actual frequency of an emission and the frequency which this emission should have (frequency notified or frequency chosen by the operator).

2. This separation results from the following errors:

(a) Error made when the station was calibrated; this error presents a semi-permanent character.

(b) Error made during use of the station (error variable from one transmission to another and resulting from actual operating conditions: ambient temperature, voltage of supply, antenna, skill of the operator, et cetera). This error, which is usually small in other services, is particularly important in the case of mobile stations.

(c) Error due to slow variations of the frequency of the transmitter during a transmission.

*Note:* In the case of transmissions without a carrier wave, the preceding definition applies to the frequency of the carrier wave before its suppression.

3. In the case of ship stations, the reference frequency is the frequency on which the transmission begins, and the figures appearing in the present table, marked by an asterisk, refer only to frequency separations observed during a ten-minute period of transmission.

4. In the frequency tolerance, modulation is not considered.

†Reproduced from "Treaty Series No. 948, Telecommunication—General Radio Regulations (Cairo Revision, 1938) and Final Radio Protocol (Cairo Revision, 1938) annexed to the Telecommunication Convention (Madrid, 1932) Between the United States of America and Other Powers", Appendix 1, pp. 234, 235 and 236, United States Government Printing Office, Washington, D. C. References refer to this publication.

## FREQUENCY TOLERANCES—Continued

FREQUENCY BANDS (wavelengths)	TOLERANCES	
	Transmitters in service now and until January 1, 1944, after which date they will conform to the tolerances indicated in column 2	New transmitters installed beginning January 1, 1940
	Column 1	Column 2
<b>A. From 10 to 550 kc (30,000 to 545 m):</b>		
(a) Fixed stations . . . . .	0.1%	0.1%
(b) Land stations . . . . .	0.1%	0.1%
(c) Mobile stations using frequencies other than those of bands indicated under (d) . . . . .	0.5%	0.1%
(d) Mobile stations using frequencies of the bands 110-160 kc (2,727 to 1,875 m), 365-515 kc (822 to 583 m)† . . . . .	0.5%*	0.3%*
(e) Aircraft stations . . . . .	0.5%	0.3%
(f) Broadcasting . . . . .	50 Cycles	20 cycles
<b>B. From 550 to 1,500 kc (545 to 200 m):</b>		
(a) Broadcasting stations . . . . .	50 cycles	20 cycles
(b) Land stations . . . . .	0.1%	0.05%
(c) Mobile stations using the frequency of 1,364 kc (220 m) . . . . .	0.5%	0.1%
<b>C. From 1,500 to 6,000 kc (200 to 50 m):</b>		
(a) Fixed stations . . . . .	0.03%	0.01%
(b) Land stations . . . . .	0.04%	0.02%
(c) Mobile stations using frequencies other than those of bands indicated in (d):		
1,560 to 4,000 kc (192.3 to 75 m) . . . . .	0.1%*	0.05%*
4,000 to 6,000 kc (75 to 50 m) . . . . .	0.04%	0.02%
(d) Mobile stations using frequencies within the bands:		
4,115 to 4,165 kc (72.90 to 72.03 m) . . . . .	} 0.1%*	0.05%*
5,500 to 5,550 kc (54.55 to 54.05 m) . . . . .		0.025%
(e) Aircraft stations . . . . .	0.05%	0.025%
(f) Broadcasting:		
between 1,500 and 1,600 kc (200 and 187.5 m) . . . . .	50 cycles	20 cycles
between 1,600 and 6,000 kc (187.5 and 50 m) . . . . .	0.01%	0.005%

† It is recognized that a great number of spark transmitters and simple self-oscillator transmitters exist in this service which are not able to meet these requirements.

\* See preamble, under 3.

## FREQUENCY TOLERANCES—Continued

FREQUENCY BANDS (wavelengths)	TOLERANCES	
	Transmitters in service now and until January 1, 1944, after which date they will conform to the tolerances indicated in column 2	New transmitters installed beginning January 1, 1940
	Column 1	Column 2
<b>D. From 6,000 to 30,000 kc (50 to 10 m):</b>		
(a) Fixed stations . . . . .	0.02%	0.01%
(b) Land stations . . . . .	0.04%	0.02%
(c) Mobile stations using frequencies other than those of bands indicated under (d) . . . . .	0.04%	0.02%
(d) Mobile stations using frequencies within the bands:		
6,200 to 6,250 kc (48.39 to 48 m) . . . . .	} 0.1%*	} 0.05%*
8,230 to 8,330 kc (36.45 to 36.01 m) . . . . .		
11,000 to 11,100 kc (27.27 to 27.03 m) . . . . .		
12,340 to 12,500 kc (24.31 to 24 m) . . . . .		
16,460 to 16,660 kc (18.23 to 18.01 m) . . . . .		
22,000 to 22,200 kc (13.64 to 13.51 m) . . . . .		
(e) Aircraft stations . . . . .	0.05%	0.025%
(f) Broadcasting stations . . . . .	0.01%	0.005%

\* See preamble, under 3.

*Note 1*—The administrations shall endeavor to profit by the progress of the art in order to reduce frequency tolerances progressively.

*Note 2*—It shall be understood that ship stations working in shared bands must observe the tolerances applicable to land stations and must conform to article 7, ¶21 (2) (a). [No. 186].

*Note 3*—Radiotelephone stations with less than 25 watts power, employed by maritime beacons for communications with beacons isolated at sea, shall be comparable, with reference to frequency stability, to mobile stations indicated in C above.

*Note 4*—Ships equipped with a transmitter, the power of which is under 100 watts, working in the band of 1,560–4,000 kc (192.3–75 m), shall not be subject to the stipulations of column 1.

## NOISE AND NOISE MEASUREMENT

### I—WIRE TELEPHONY

#### *Definitions:*

The following definitions are based upon those given in the Proceedings of the 10th Plenary Meeting (1934) of the *Comite Consultatif International Telephonique (C.C.I.F.)*.

(Note: The unit in which noise is expressed in many of the European countries differs from the two American standards, the "noise unit" and the "db above reference noise." The European unit is referred to as the "Psophometric Electromotive Force".)

*Noise* is a sound which tends to interfere with a correct perception of vocal sounds, desired to be heard in the course of a telephone conversation.

It is customary to distinguish between—

- (1) *Room noise*: Noise present in that part of the room where the telephone apparatus is used;
- (2) *Frying noise* (transmitter noise): Noise produced by the microphone, manifest even when conversation is not taking place;
- (3) *Line noise*: All noise electrically transmitted by the circuit, other than room noise and frying noise.

#### *Psophometric Electromotive Force*

In the case of a complete telephone connection the interference with a telephone conversation produced by extraneous currents may be compared with the interference which would be caused by a parasitic sinusoidal current of 800 cycles per second. The strength of the latter current, when the interference is the same in both cases, can be determined.

If the receiver used has a resistance of 600 ohms and a negligible reactance (if necessary it should be connected through a suitable transformer), the psophometric electromotive force at the end of a circuit is defined as twice the voltage at 800 cycles per second, measured at the terminals of the receiver under the conditions described.

The psophometric electromotive force is therefore the electromotive force of a source having an internal resistance of 600 ohms and zero internal reactance which, when connected directly to a standard receiver of 600 ohms resistance and zero reactance, produces the same sinusoidal current at 800 cycles per second as in the case with the arrangements indicated above.



## NOISE AND NOISE MEASUREMENT—Continued

An instrument known as the "psophometer" has been designed. When connected directly across the terminals of the 600 ohm receiver, it gives a reading of  $\frac{1}{2}$  of the psophometric electromotive force for the particular case considered.

In a general way, the term *psophometric voltage* between any two points refers to the reading on the instrument when connected to these two points.

If, instead of a complete connection, only a section thereof is under consideration, the psophometric electromotive force with respect to the end of that section is defined as twice the psophometric voltage measured at the terminals of a pure resistance of 600 ohms, connected at the end of the section, if necessary through a suitable transformer.

The C. C. I F. have published a Specification for a psophometer which is included in Volume II of the Proceedings of the Tenth Plenary Meeting in 1934. An important part of this psophometer is a filter network associated with the measuring circuit whose function is to "weight" each frequency in accordance with its interference value relative to a frequency of 800 cycles.

### Noise Levels

The amount of noise found on different circuits, and even on the same circuit at different times, varies through quite wide limits. Further, there is no definite agreement as to what constitutes a "quiet" circuit, a "noisy" circuit, etc. The following values should therefore be regarded merely as a rough indication of the general levels which may be encountered under the different conditions:

	db above Ref. Noise
Open Wire Circuit—Quiet	20
Average	35
Noisy	50
Cable Circuit — Quiet	15
Average	25
Noisy	40

### Relationship of European and American Noise Units

The psophometric E.M.F. can be related to the American units: the "Noise Unit," and the "Decibel above Reference Noise."

The following chart shows this relationship together with correction factors for psophometric measurements on circuits of impedance other than 600 ohms.

## NOISE AND NOISE MEASUREMENT—Continued

### Relationship of European and American Noise Units

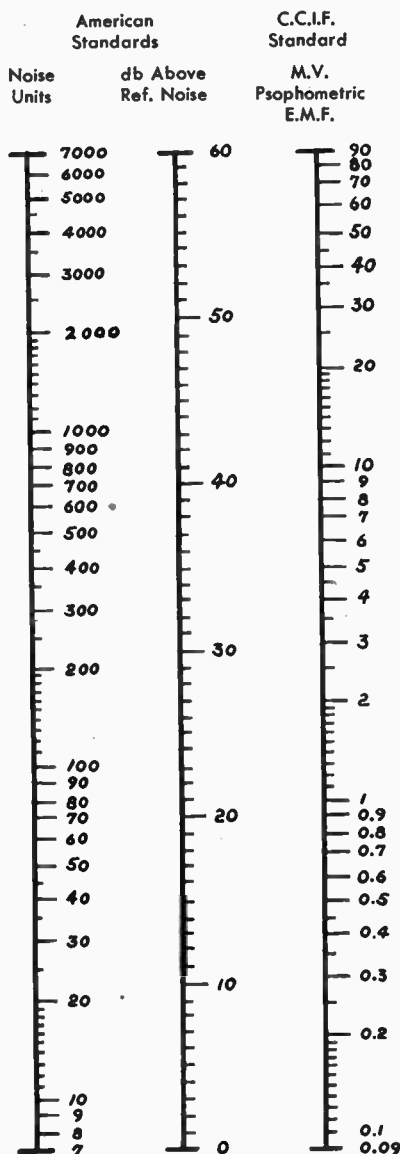

1. The relationship of N.U.'s to db's above reference noise is obtained from technical report No. 1B-5 of the joint sub committee on development and research of the Bell Telephone System and the Edison Electric Institute.

2. The relationship of db's above reference noise to psophometric E.M.F. is obtained from the Proceedings of C.C.I.F. 1934.

3. The C.C.I.F. expresses noise limits in terms of the psophometric E.M.F. for a circuit of 600 ohms resistance and zero reactance, terminated in a resistance of 600 ohms. Measurements made in terms of the potential difference across the terminations, or on circuits of impedance other than 600 ohms should be corrected as follows:—

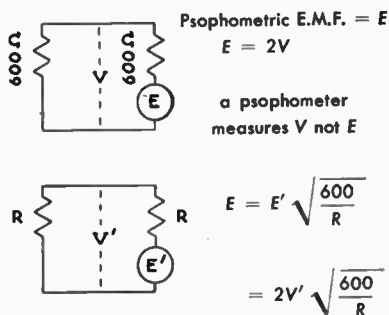

4. Reference Noise—with respect to which the American noise measuring set is calibrated—is a 1000 cycles per second tone 90 db below 1 milliwatt.

## NOISE AND NOISE MEASUREMENT—Continued

### II—RADIO

Radio telephone links, connecting land line networks, using double sideband modulation with directional antennas and optimum frequencies, require a radio signal field strength of from 25 to 35 db above one microvolt per meter and a signal-to-noise ratio at the land line terminal, i.e., the telephone toll board, of from 30 to 40 db for a high grade commercial channel, or, as classified in international service, a "merit four" circuit.

The signal or noise level in the antenna is expressed in db above or below one microvolt per meter as measured by a calibrated field strength set using a half wave vertical antenna at the operating wave length of the circuit under consideration. The signal or noise level at the line terminal is expressed in db measured above or below one milliwatt (sine wave) in an impedance of 600 ohms.

Noise fields for optimum frequency vary generally from 10 to 20 db below one microvolt per meter.

With noise levels and equipment as above, a field strength of 15 to 25 db above one microvolt per meter will give a fair grade of commercial service, corresponding to a "merit three" circuit, while fields of 7.5 to 15 db will give fair to poor service, corresponding to a "merit two" circuit. These figures assume good antenna front to back ratios, antenna gains of 12 to 15 db compared to a half wave element at the operating frequency, and receiver noise levels 50 db below the normal output.

For single sideband radio telephone circuits, the above field strengths can be lowered by from 6 to 10 db for the same grade of commercial service.

Privacy systems, room noise, microphones and language difficulties all serve to degrade the service and necessitate above average signal-to-noise ratios in order to render an average service of the grade specified. Modern high grade radio telephone channels using noise suppressors, compressors, automatic gain controls, etc., maintain a high signal-to-noise ratio, the noise level being subject to further control either through correct frequency selection or the application of power amplifiers at the transmitter.

A voice controlled noise reducer with limited and controlled action can, if placed in the receiving circuit between the radio receiver and the terminal, improve the signal to noise an average of 10 db.

For radio telegraph aural reception, noise levels equal to or above the signal levels are permissible. For tape recording and teletype or teleprinter reception, fields and signal-to-noise ratios comparable to those of telephone circuits are necessary. Diversity reception is the best remedy for fading; two antennas spaced about 10 wave lengths apart will eliminate 90% of the deep fading.

## RELAXATION OSCILLATORS

### Gas Tube Oscillator

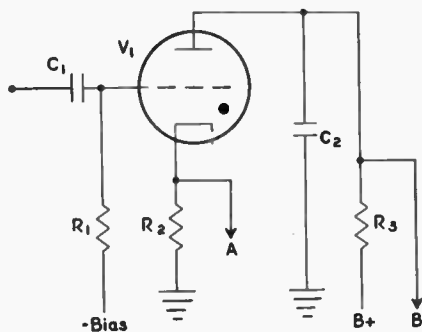

$A$  = Pulse Output  
 $B$  = Sawtooth Output

#### Typical Circuit

$V_1 = 884$   
 $C_1 = .05$  mfd.  
 $C_2 = .05$  mfd.  
 $R_1 = 100,000 \Omega$   
 $R_2 = 500 \Omega$   
 $R_3 = 100,000 \Omega$

Frequency Controlling Elements  $C_2, R_3$

### Feedback Relaxation Oscillator

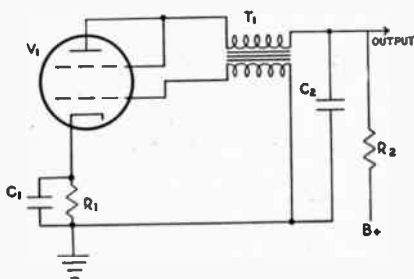

#### Typical Circuit

$V_1 = 6F6$   
 $T_1 = 3:1$  Audio Trans.  
 0.3 hry. pri.  
 $R_1 = 100,000 \Omega$   
 $R_2 = 5000 \Omega$   
 $C_1 = 1$  mfd.  
 $C_2 = .1$  mfd.

Frequency Controlling Elements  $C_2, R_2$

### Blocking Oscillator

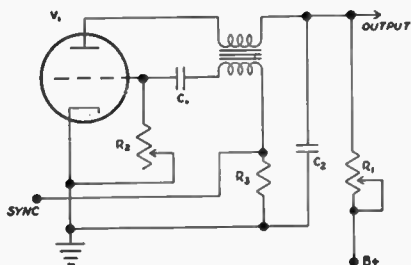

#### Typical Circuit

$V_1 = 6J5$   
 $C_1 = .01$  mfd.  
 $C_2 = .25$  mfd.  
 $R_1 = 1$  meg.  $\Omega$   
 $R_2 = 1$  meg.  $\Omega$   
 $R_3 = 1000 \Omega$

Frequency Controlling Elements  $R_1, C_2, R_2$

## RELAXATION OSCILLATORS—Continued

### Squegging Oscillator

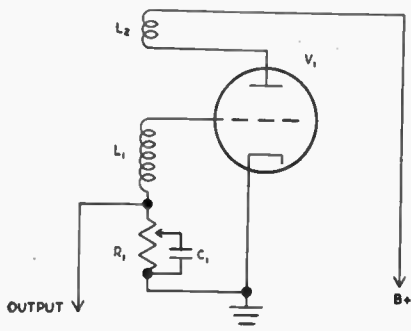

Typical Circuit

$$V_1 = 6J5$$

$L_1$  } Tightly Coupled  
 $L_2$  }

$$R_1 = 500,000 \Omega$$

$$C_1 = .01 \text{ mfd.}$$

Frequency Controlling Elements  $R_1, C_1$

### Multivibrator

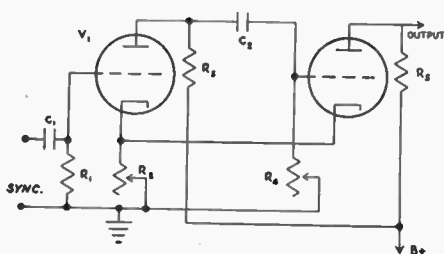

Typical Circuit

$$V_1 = 6F8$$

$$R_1 = 100,000 \Omega$$

$$R_2 = 1000 \Omega$$

$$R_3 = 25,000 \Omega$$

$$R_4 = 250,000 \Omega$$

$$R_5 = 25,000 \Omega$$

$$C_1 = .01 \text{ mfd.}$$

$$C_2 = 250 \text{ mmfd.}$$

Frequency Controlling Elements  $R_1, R_2, R_4, C_2$

### Vander Pol Oscillator

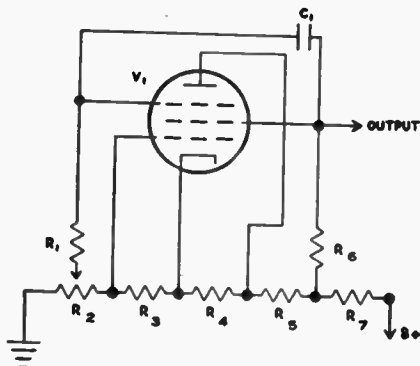

Typical Circuit

$$V_1 = 6SJ7$$

$$R_1 = 100,000 \Omega$$

$$R_2 = 500 \Omega$$

$$R_3 = 100 \Omega$$

$$R_4 = 3,000 \Omega$$

$$R_5 = 10,000 \Omega$$

$$R_6 = 25,000 \Omega$$

$$R_7 = 25,000 \Omega$$

Frequency Controlling Elements  $R_1, R_6, C_1, (Also B+)$

## ELECTRONIC DIFFERENTIATION METHODS

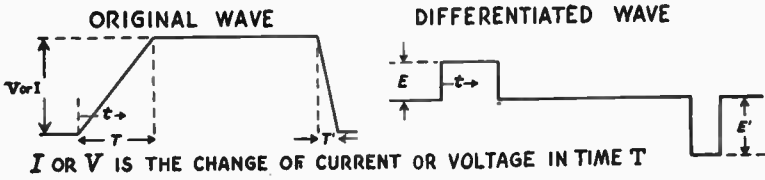

Type	Basic Method	Design Formula	Typical Circuit
I Self-Inductance	<p style="text-align: center;">CONSTANT CURRENT SOURCE</p>	$E = \frac{LI}{T}$	
II Mutual Inductance	<p style="text-align: center;">CONSTANT CURRENT SOURCE</p>	$E = \frac{MI}{T}$	
III RC Method		$E = \frac{VRC}{T} \left( 1 - e^{-\frac{t}{RC}} \right)$	

## ELECTRONIC DIFFERENTIATION METHODS—Continued

### Methods I and II

- (a) Current  $I$  should be a replica of the input voltage wave-form  $V$ .
- (b) The voltage  $V$  must be substantially independent of the back EMF developed by the inductance  $L$ .
- (c) The output shunt impedance placed across  $E$  should be high compared to the network impedance.
- (d) The resonant period associated with the inductance caused by shunting circuit capacities should be at least one-third the build-up time  $T$ .

### Method III

- (a) Voltage  $V$  must be obtained from a low impedance source.
- (b) The RC product should be one-fiftieth of the build-up time  $T$  or smaller.
- (c) The output voltage  $E$  should not react back on the input voltage  $V$ .
- (d) The impedance into which the differentiator circuit works should be large compared with  $R$ . If this impedance is resistive it should be included as part of  $R$  (This also applies to the input source impedance.)

## FOURIER ANALYSIS OF RECURRENT WAVEFORMS

### General Formulas

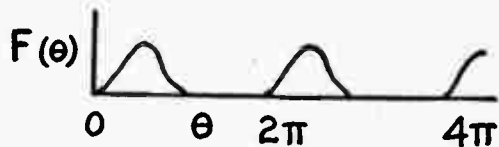

$$(1) F(\theta) = \frac{A_0}{2} + A_1 \sin \theta + A_2 \sin 2\theta + \dots + A_n \sin n\theta \\ + B_1 \cos \theta + B_2 \cos 2\theta + \dots + B_n \cos n\theta$$

Formula (1) may be written:

$$(2) F(\theta) = \frac{A_0}{2} + C_1 \cos(\theta - \phi_1) + C_2 \cos(2\theta - \phi_2) + \dots \\ + C_n \cos(n\theta - \phi_n)$$

Where:

$$(3) C_n = \sqrt{A_n^2 + B_n^2}$$

$$(4) \phi_n = \arctan \frac{A_n}{B_n}$$

## FOURIER ANALYSIS OF RECURRENT WAVEFORMS — *Continued*

The coefficients  $A_n$  and  $B_n$  are determined by the following formulas:

$$(5) \quad A_n = \frac{1}{\pi} \int_{-\pi}^{\pi} F(\theta) \sin n \theta \, d\theta$$

$$(6) \quad B_n = \frac{1}{\pi} \int_{-\pi}^{\pi} F(\theta) \cos n \theta \, d\theta$$

By a change of limits (5) and (6) may also be written:

$$(7) \quad A_n = \frac{1}{\pi} \int_0^{2\pi} F(\theta) \sin n \theta \, d\theta$$

$$(8) \quad B_n = \frac{1}{\pi} \int_0^{2\pi} F(\theta) \cos n \theta \, d\theta$$

If the function  $F(\theta)$  is an odd function, that is:

$$(9) \quad F(\theta) = -F(-\theta)$$

the coefficients of all the cosine terms ( $B_n$ ) of equation (6) become equal to zero.

Similarly if the function  $F(\theta)$  is an even function, that is:

$$(10) \quad F(\theta) = F(-\theta)$$

the coefficients of all the sine terms ( $A_n$ ) of equation (5) become equal to zero.

If the function to be analysed is thus a symmetrical function defined by either equation (9) or (10) the function should be disposed about the zero axis and an analysis obtained by means of equations (5) or (6) for the simplest solution.



## FOURIER ANALYSIS OF RECURRENT WAVEFORMS — *Continued*

### Graphical Solution:

If the function to be analysed is not known analytically, a solution of the Fourier integral may be approximated by graphical means.

The period of the function is divided into a number of ordinates as indicated by the graph.

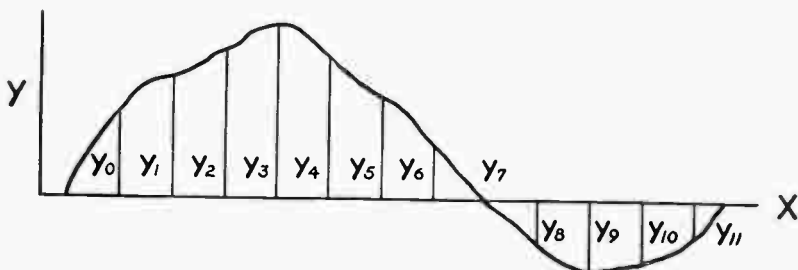

The values of these ordinates are recorded and the following computations made:

$$(11) \quad \begin{array}{cccccccc} & Y_0 & Y_1 & Y_2 & Y_3 & Y_4 & Y_5 & Y_6 \\ & & Y_{11} & Y_{10} & Y_9 & Y_8 & Y_7 & & \\ \text{Sum} & S_0 & S_1 & S_2 & S_3 & S_4 & S_5 & S_6 \\ \text{Difference} & & d_1 & d_2 & d_3 & d_4 & d_5 & & \end{array}$$

The sum terms are arranged as follows:

$$(12) \quad \begin{array}{cccc} S_0 & S_1 & S_2 & S_3 \\ S_6 & S_5 & S_4 & \\ \hline \text{Sum} & \overline{S_0} & \overline{S_1} & \overline{S_2} & \overline{S_3} \\ \text{Difference} & D_0 & D_1 & D_2 & \end{array} \quad (13) \quad \begin{array}{cc} \overline{S_0} & \overline{S_1} \\ \overline{S_2} & \overline{S_3} \\ \hline \overline{S_7} & \overline{S_8} \end{array}$$

The difference terms are as follows:

$$(14) \quad \begin{array}{ccc} d_1 & d_2 & d_3 \\ d_5 & d_4 & \\ \hline \text{Sum} & \overline{S_4} & \overline{S_5} & \overline{S_6} \\ \text{Difference} & \overline{D_3} & \overline{D_4} & \end{array} \quad (15) \quad \begin{array}{cc} \overline{S_4} & \overline{D_0} \\ \overline{S_6} & \overline{D_2} \\ \hline \overline{D_5} & \overline{D_6} \end{array}$$

## FOURIER ANALYSIS OF RECURRENT WAVEFORMS — Continued

The coefficients of the Fourier series (1) are now obtained as follows:

$$(16) \quad A_0 = \frac{\overline{S}_7 + \overline{S}_8}{12}$$

$$(17) \quad A_1 = \frac{\overline{D}_0 + 0.866 \overline{D}_1 + 0.5 \overline{D}_2}{6}$$

$$(18) \quad A_2 = \frac{\overline{S}_0 + 0.5 \overline{S}_1 - 0.5 \overline{S}_2 - \overline{S}_3}{6}$$

$$(19) \quad A_3 = \frac{\overline{D}_6}{6}$$

$$(20) \quad A_4 = \frac{\overline{S}_0 - 0.5 \overline{S}_1 - 0.5 \overline{S}_2 + \overline{S}_3}{6}$$

$$(21) \quad A_5 = \frac{\overline{D}_0 - 0.866 \overline{D}_1 + 0.5 \overline{D}_2}{6}$$

$$(22) \quad A_6 = \frac{\overline{S}_7 - \overline{S}_8}{12}$$

Also:

$$(23) \quad B_1 = \frac{0.5 \overline{S}_4 + 0.866 \overline{S}_5 + \overline{S}_6}{6}$$

$$(24) \quad B_2 = \frac{0.866 (\overline{D}_3 + \overline{D}_4)}{6}$$

$$(25) \quad B_3 = \frac{\overline{D}_5}{6}$$

$$(26) \quad B_4 = \frac{0.866 (\overline{D}_3 - \overline{D}_4)}{6}$$

$$(27) \quad B_5 = \frac{0.5 \overline{S}_4 - 0.866 \overline{S}_5 + \overline{S}_6}{6}$$

## ANALYSES OF COMMONLY ENCOUNTERED WAVEFORMS

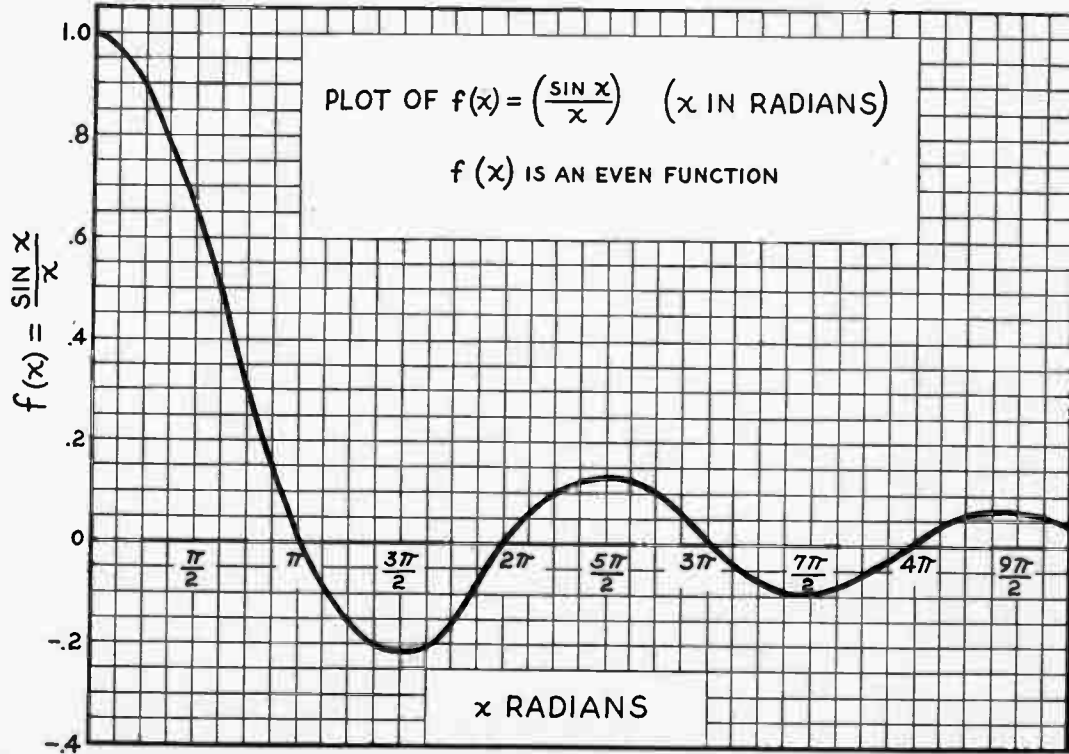

## ANALYSES OF COMMONLY ENCOUNTERED WAVEFORMS

The following analyses include the coefficients of the Fourier Series for all harmonics ( $n^{\text{th}}$  order). By the use of the graph for the  $\left(\frac{\sin x}{x}\right)$  function, page 164, the amplitude coefficients may be evaluated in a simple manner.

The symbols used are defined as follows:

- $A$  = pulse amplitude
- $T$  = periodicity
- $d$  = pulse width
- $f$  = pulse build-up time
- $r$  = pulse decay time
- $n$  = order of harmonic
- $C_n$  = amplitude of  $n^{\text{th}}$  harmonic
- $\theta_n$  = phase angle of  $n^{\text{th}}$  harmonic

$$A_{\text{av}} = \text{average value of function} = \frac{1}{T} \int_0^T F(t) dt$$

$$A_{\text{rms}} = \text{root-mean square value of function} = \sqrt{\frac{1}{T} \int_0^T [F(t)]^2 dt}$$

### 1. Rectangular Wave

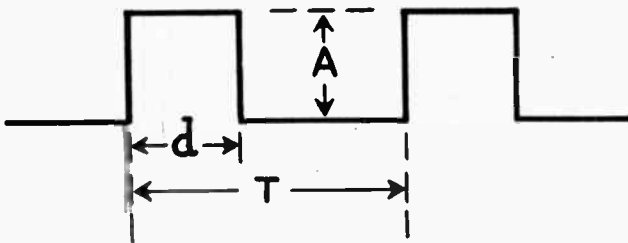

$$A_{\text{av}} = \frac{Ad}{T}$$

$$A_{\text{rms}} = A \sqrt{\frac{d}{T}}$$

$$C_n = 2 A_{\text{av}} \left[ \frac{\sin \frac{n \pi d}{T}}{\frac{n \pi d}{T}} \right]$$

## ANALYSES OF COMMONLY ENCOUNTERED WAVEFORMS—Cont.

### 2. Symmetrical Trapezoid Wave

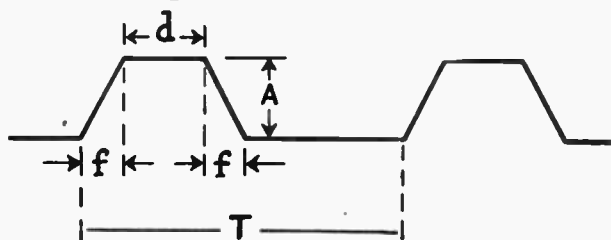

$$A_{av} = A \frac{(f + d)}{T}$$

$$A_{rms} = A \sqrt{\frac{2f + 3d}{3T}}$$

$$C_n = 2 A_{av} \left[ \frac{\sin \frac{n \pi f}{T}}{\frac{n \pi f}{T}} \right] \left[ \frac{\sin \frac{n \pi (f + d)}{T}}{\frac{n \pi (f + d)}{T}} \right]$$

### 3. Unsymmetrical Trapezoid Wave

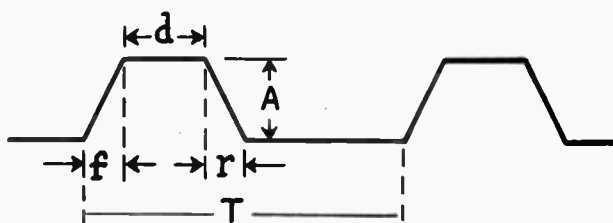

$$A_{av} = \frac{A}{T} \left[ \frac{f}{2} + \frac{r}{2} + d \right]$$

$$A_{rms} = A \sqrt{\frac{f + r + 3d}{3T}}$$

If  $f \cong r$

$$C_n = 2 A_{av} \left[ \frac{\sin \frac{n \pi f}{T}}{\frac{n \pi f}{T}} \right] \left[ \frac{\sin \frac{n \pi (f + d)}{T}}{\frac{n \pi (f + d)}{T}} \right] \left[ \frac{\sin \frac{n \pi (r - f)}{T}}{\frac{n \pi (r - f)}{T}} \right]$$

## ANALYSES OF COMMONLY ENCOUNTERED WAVEFORMS—Cont.

### 4. Isoles Triangle Wave

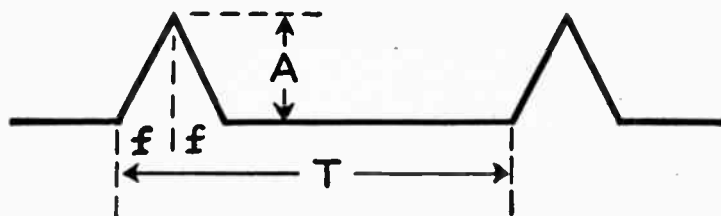

$$A_{av} = \frac{Af}{T}$$

$$A_{rms} = A \sqrt{\frac{2f}{3T}}$$

$$C_n = 2 A_{av} \left[ \frac{\sin \frac{n \pi f}{T}}{\frac{n \pi f}{T}} \right]^2$$

### 5. Clipped Sawtooth Wave

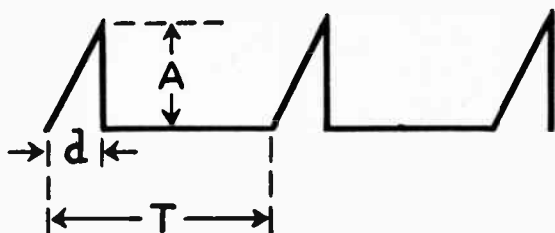

$$A_{av} = \frac{Ad}{2T}$$

$$A_{rms} = A \sqrt{\frac{d}{3T}}$$

$$C_n = \frac{AT}{2 \pi^2 n^2 d} \left[ 2 \left( 1 - \cos \frac{2 \pi n d}{T} \right) + \frac{4 \pi n d}{T} \left( \frac{\pi n d}{T} - \sin \frac{2 \pi n d}{T} \right) \right]^2$$

If  $d$  is small

$$C_n = \frac{2 A_{av}}{\frac{\pi n d}{T}} \left[ \frac{\sin \frac{\pi n d}{T}}{\frac{\pi n d}{T}} - 1 \right]$$

## ANALYSES OF COMMONLY ENCOUNTERED WAVEFORMS—Cont.

### 6. Sawtooth Wave

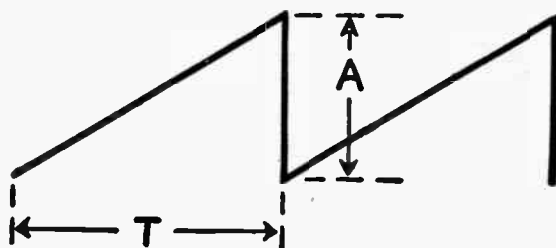

$$A_{av} = \frac{A}{2}$$

$$A_{rms} = \frac{A}{\sqrt{3}}$$

$$C_n = -\frac{2 A_{av}}{n \pi} \cos(n \pi)$$

### 7. Sawtooth Wave

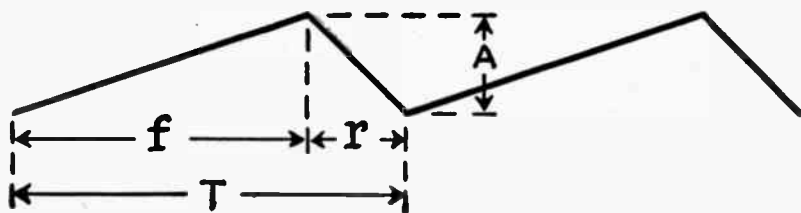

$$A_{av} = \frac{A}{2}$$

$$A_{rms} = \frac{A}{\sqrt{3}}$$

$$C_n = \frac{2 A_{av} T}{\pi^2 n^2 f \left(1 - \frac{f}{T}\right)} \sin \frac{\pi f}{T}$$

## ANALYSES OF COMMONLY ENCOUNTERED WAVEFORMS—Cont.

### 8. Fractional Sine-Wave

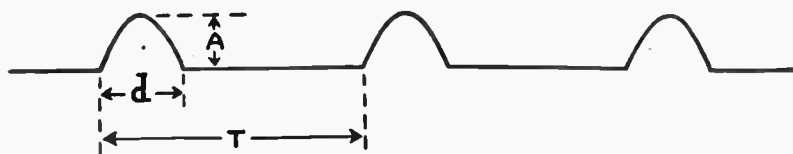

$$A_{av} = \frac{A \left( \sin \frac{\pi d}{T} - \frac{\pi d}{T} \cos \frac{\pi d}{T} \right)}{\pi \left( 1 - \cos \frac{\pi d}{T} \right)}$$

$$A_{rms} = \frac{A}{\left( 1 - \cos \frac{\pi d}{T} \right)}$$

$$C_n = \frac{A_{av} \frac{\pi d}{T}}{n \left( \sin \frac{\pi d}{T} - \frac{\pi d}{T} \cos \frac{\pi d}{T} \right)} \left[ \frac{\sin (n-1) \frac{\pi d}{T}}{(n-1) \frac{\pi d}{T}} - \frac{\sin (n+1) \frac{\pi d}{T}}{(n+1) \frac{\pi d}{T}} \right]$$

### 9. Half Sine-Wave

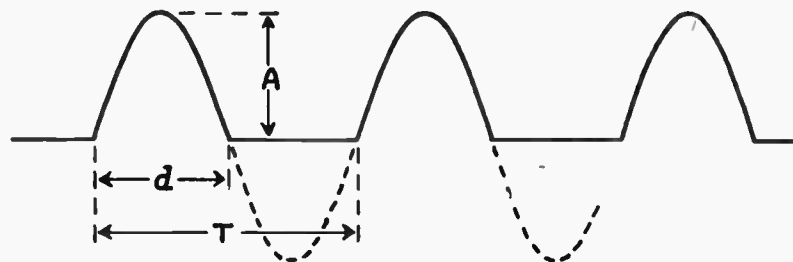

$$A_{av} = \frac{2A}{\pi} \frac{d}{T}$$

$$A_{rms} = A \sqrt{\frac{d}{2T}}$$

$$C_n = \frac{\pi}{2} A_{av} \left[ \frac{\sin \frac{\pi}{2} \left( 1 - \frac{2nd}{T} \right)}{\frac{\pi}{2} \left( 1 - \frac{2nd}{T} \right)} + \frac{\sin \frac{\pi}{2} \left( 1 + \frac{2nd}{T} \right)}{\frac{\pi}{2} \left( 1 + \frac{2nd}{T} \right)} \right]$$



## ANALYSES OF COMMONLY ENCOUNTERED WAVEFORMS—Cont.

### 10. Full Sine-Wave

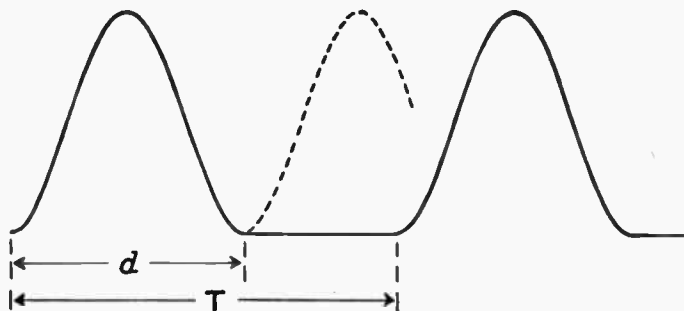

$$A_{av} = \frac{Ad}{2T}$$

$$A_{rms} = \frac{A}{2} \sqrt{\frac{3d}{T}}$$

$$C_n = A_{av} \left[ 2 \frac{\sin\left(n\pi\frac{d}{T}\right)}{n\pi\frac{d}{T}} + \frac{\sin\pi\left(1-n\frac{d}{T}\right)}{\pi\left(1-n\frac{d}{T}\right)} + \frac{\sin\pi\left(1+n\frac{d}{T}\right)}{\pi\left(1+n\frac{d}{T}\right)} \right]$$

### 11. Critically Damped Exponential Wave



$$f(t) = \frac{A\epsilon}{f} t \epsilon^{-\frac{t}{f}} \quad \text{where } \epsilon = 2.718$$

for  $T > 10f$

$$A_{av} = \frac{A\epsilon f}{T}$$

$$A_{rms} = \frac{A\epsilon}{2} \sqrt{\frac{f}{T}}$$

$$C_n = 2 A_{av} \left[ \frac{1}{1 + \left(\frac{2\pi n f}{T}\right)^2} \right] = 2 A_{av} \cos^2 \frac{\theta_n}{2}$$

$$\frac{\theta_n}{2} = \tan^{-1} \left( \frac{2\pi n f}{T} \right)$$

## DIMENSIONAL EXPRESSIONS

Units in five systems. Multiply by F to convert to practical units.

Quantity	F (E.M.U.)	F (E.S.U.)	Unrationalized F (MKS)	Rationalized F (MKS)	Practical
e.m.f.	$10^{-8}$	300	1	1	volt
potential gradient	$10^{-9}$	300	$10^{-2}$	$10^{-2}$	volt per cm
resistance	$10^{-9}$	$9 \times 10^{11}$	1	1	ohm
resistivity	$10^{-9}$	$9 \times 10^{11}$	$10^2$	$10^2$	ohm-cm
charge	10	$1/3 \times 10^{-9}$	1	1	coulomb
current	10	$1/3 \times 10^{-9}$	1	1	ampere
electric flux	10	$1/3 \times 10^{-9}$	1	$4\pi$	coulomb
flux density	10	$1/3 \times 10^{-9}$	$10^{-2}$	$4\pi \times 10^{-2}$	coulomb per sq. cm
current density	10	$1/3 \times 10^{-9}$	$10^{-2}$	$4\pi \times 10^{-2}$	amp. per sq. cm
capacitance	$10^9$	$1/9 \times 10^{-11}$	1	1	farad
relative dielectric constant	1	1	1	1	numeric
absolute dielectric constant of free space	$9 \times 10^{20}$	1	$9 \times 10^{-9}$	$36\pi \times 10^{-9}$	
relative permeability	1	1	1	1	numeric
absolute permeability of free space	1	$9 \times 10^{20}$	$10^7$	$\frac{1}{4}\pi \times 10^7$	
m.m.f.	1		$10^{-1}$	$4\pi \times 10^{-1}$	gilbert
magnetic field	1		$10^{-2}$	$4\pi \times 10^{-2}$	oersted or gilbert per cm
strength magnetic flux	1		$10^8$	$10^8$	maxwell
flux density	1		$10^4$	$10^4$	gauss
reluctance	1		$10^{-9}$	$4\pi \times 10^{-9}$	nameless unit
inductance	$10^{-9}$	$9 \times 10^{11}$	1	1	henry

## GREEK ALPHABET

$\alpha$	A	Alpha	$\nu$	N	Nu
$\beta$	B	Beta	$\xi$	$\Xi$	Xi
$\gamma$	Γ	Gamma	o	O	Omicron
$\delta$	Δ	Delta	$\pi$	Π	Pi
$\epsilon$	E	Epsilon	$\rho$	Ρ	Rho
$\zeta$	Z	Zeta	$\sigma$	Σ	Sigma
$\eta$	H	Eta	$\tau$	Τ	Tau
$\theta$	Θ	Theta	v	Υ	Upsilon
ι	I	Iota	$\varphi$	Φ	Phi
$\kappa$ (or small capital K)	K	Kappa	$\chi$	Χ	Chi
$\lambda$	Λ	Lambda	$\psi$	Ψ	Psi
$\mu$	M	Mu	$\omega$	Ω	Omega

## MISCELLANEOUS DATA

1 cubic foot of water at 4°C (weight) . . . . .	62.4 lb.
1 foot of water at 4°C (pressure) . . . . .	0.43352 lb./in. <sup>2</sup>
Velocity of light in vacuum . . . . .	186,284 mi./sec.
Velocity of sound in dry air at 20°C . . . . .	1129 ft./sec.
Degree of longitude at equator . . . . .	69.17 miles
Acceleration due to gravity, <i>g</i> , at sea-level, 40° N. Latitude (N. Y.) . . . . .	32.1578 ft./sec. <sup>2</sup>
$\sqrt{2g}$ . . . . .	8.02 ft./sec. <sup>2</sup>
1 atmosphere . . . . .	14.696 lb./in. <sup>2</sup>
1 inch of mercury . . . . .	1.133 ft. water
1 inch of mercury . . . . .	0.4912 lb./in. <sup>2</sup>
1 radian . . . . .	$180^\circ \div \pi = 57.3^\circ$
360 degrees . . . . .	$2\pi$ radians
$\pi$ . . . . .	3.1416
Sine 1' . . . . .	0.0002929

## MENSURATION FORMULAS

Area of triangle	=	Base $\times$ $\frac{1}{2}$ height
Area of ellipse	=	major axis $\times$ minor axis $\times$ .7854
Area of parabola	=	base $\times$ $\frac{2}{3}$ perpendicular height
Area of plane surface	=	sum of mid. ords. $\times$ width <i>d</i> (approx.) or ( $2n$ strips)

Let  $h_0, h_1, h_2, \dots, h_n$  be the measured lengths of a series of equidistant parallel chords, and let  $d$  be their distance apart, then the area enclosed by any boundary is given approximately as follows:

$$A = \frac{1}{3} d [(h_0 + h_n) + 4 (h_1 + h_3 + \dots + h_{n-1}) + 2 (h_2 + h_4 + \dots + h_{n-2})]$$

(Simpson's Rule, where  $n$  is even).

Area of circle	=	$\pi r^2$
Surface area of sphere	=	$4\pi r^2$
Volume of sphere	=	$\frac{4\pi r^3}{3}$
Side of square	=	.707 diagonal of square
Volume of pyramid or cone	=	Area of base $\times$ $\frac{1}{3}$ of height

## FORMULAS FOR COMPLEX QUANTITIES

$$(A + jB)(C + jD) = (AC - BD) + j(BC + AD)$$

$$\frac{A + jB}{C + jD} = \frac{AC + BD}{C^2 + D^2} + j \frac{BC - AD}{C^2 + D^2}$$

$$\frac{1}{A + jB} = \frac{A}{A^2 + B^2} - j \frac{B}{A^2 + B^2}$$

$$A + jB = \rho (\cos \theta + j \sin \theta)$$

$$\sqrt{A + jB} = \pm \sqrt{\rho} \left( \cos \frac{\theta}{2} + j \sin \frac{\theta}{2} \right)$$

where  $\rho = \sqrt{A^2 + B^2}$ ;  $\cos \theta = \frac{A}{\rho}$

$$\sin \theta = \frac{B}{\rho}$$

$$e^{j\theta} = \cos \theta + j \sin \theta$$

$$e^{-j\theta} = \cos \theta - j \sin \theta$$

## ALGEBRAIC AND TRIGONOMETRIC QUANTITIES

$$1 = \sin^2 A + \cos^2 A = \sin A \operatorname{cosec} A = \tan A \cot A = \cos A \sec A$$

$$\text{Sine } A = \frac{\cos A}{\cot A} = \frac{1}{\operatorname{cosec} A} = \cos A \tan A = \sqrt{1 - \cos^2 A}$$

$$\text{Cosine } A = \frac{\sin A}{\tan A} = \frac{1}{\sec A} = \sin A \cot A = \sqrt{1 - \sin^2 A}$$

$$\text{Tangent } A = \frac{\sin A}{\cos A} = \frac{1}{\cot A} = \sin A \sec A$$

$$\text{Cotangent } A = \frac{1}{\tan A} \qquad \text{Secant } A = \frac{1}{\cos A}$$

$$\text{Cosecant } A = \frac{1}{\sin A}$$

$$\sin(A \pm B) = \sin A \cos B \pm \cos A \sin B$$

$$\tan(A \pm B) = \frac{\tan A \pm \tan B}{1 \mp \tan A \tan B}$$

## ALGEBRAIC AND TRIGONOMETRIC FORMULAS—Continued

$$\cos (A \pm B) = \cos A \cos B \mp \sin A \sin B$$

$$\cot (A \pm B) = \frac{\cot A \cot B \mp 1}{\cot B \pm \cot A}$$

$$\sin A + \sin B = 2 \sin \frac{1}{2} (A + B) \cos \frac{1}{2} (A - B)$$

$$\sin^2 A - \sin^2 B = \sin (A + B) \sin (A - B)$$

$$\tan A \pm \tan B = \frac{\sin (A \pm B)}{\cos A \cos B}$$

$$\sin A - \sin B = 2 \cos \frac{1}{2} (A + B) \sin \frac{1}{2} (A - B)$$

$$\cos A + \cos B = 2 \cos \frac{1}{2} (A + B) \cos \frac{1}{2} (A - B)$$

$$\cot A \pm \cot B = \frac{\sin (B \pm A)}{\sin A \sin B}$$

$$\cos B - \cos A = 2 \sin \frac{1}{2} (A + B) \sin \frac{1}{2} (A - B)$$

$$\sin 2A = 2 \sin A \cos A \qquad \cos 2A = \cos^2 A - \sin^2 A$$

$$\cos^2 A - \sin^2 B = \cos (A + B) \cos (A - B)$$

$$\tan 2A = \frac{2 \tan A}{1 - \tan^2 A}$$

$$\sin \frac{1}{2} A = \pm \sqrt{\frac{1 - \cos A}{2}} \qquad \cos \frac{1}{2} A = \pm \sqrt{\frac{1 + \cos A}{2}}$$

$$\tan \frac{1}{2} A = \frac{\sin A}{1 + \cos A} \qquad \sin^2 A = \frac{1 - \cos 2A}{2}$$

$$\cos^2 A = \frac{1 + \cos 2A}{2} \qquad \tan^2 A = \frac{1 - \cos 2A}{1 + \cos 2A}$$

$$\frac{\sin A \pm \sin B}{\cos A + \cos B} = \tan \frac{1}{2} (A \pm B)$$

$$\frac{\sin A \pm \sin B}{\cos B - \cos A} = \cot \frac{1}{2} (A \mp B)$$

Angle	0	30°	45°	60°	90°	180°	270°	360°
Sin .. ..	0	½	½√2	½√3	1	0	-1	0
Cos .. ..	1	½√3	½√2	½	0	-1	0	1
Tan .. ..	0	⅓√3	1	√3	±∞	0	±∞	0

### APPROXIMATIONS FOR SMALL ANGLES

$$\sin \theta = (\theta - \theta^3/6 \dots) \quad \theta \text{ in radians}$$

$$\tan \theta = (\theta + \theta^3/3 \dots) \quad \theta \text{ in radians}$$

$$\cos \theta = (1 - \theta^2/2 \dots) \quad \theta \text{ in radians}$$

$$\text{Versine } \theta = 1 - \cos \theta$$

$$\sin 14\frac{1}{2}^\circ = \frac{1}{4}$$

$$\sin 20^\circ = \frac{11}{32}$$

### QUADRATIC EQUATION

$$\text{If } ax^2 + bx + c = 0, \text{ then } x = \frac{-b \pm \sqrt{b^2 - 4ac}}{2a}$$

### ARITHMETICAL PROGRESSION

$$S = n(a + l) / 2 = n[2a + (n - 1)d] / 2$$

where

$a$  = first term;  $l$  = last term;  $n$  = number of terms;  $S$  = sum;  
 $d$  = common difference.

### GEOMETRICAL PROGRESSION

Let  $r$  = common ratio, then

$$S = \frac{a(r^n - 1)}{r - 1} = \frac{a(1 - r^n)}{1 - r}$$

### COMBINATIONS AND PERMUTATIONS

The number of combinations of  $n$  things  $r$  at a time =  ${}_n C_r = \frac{n!}{r!(n-r)!}$

The number of permutations of  $n$  things  $r$  at a time =  ${}_n P_r$ .

$${}_n P_n = n(n-1)(n-2) \dots 3 \cdot 2 \cdot 1 = n!$$

$${}_n P_r = n(n-1)(n-2) \dots (n-r+1).$$

### BINOMIAL THEOREM

$$(a \pm b)^n = a^n \pm na^{n-1}b + \frac{n(n-1)}{2!} a^{n-2}b^2 \pm \frac{n(n-1)(n-2)}{3!} a^{n-3}b^3 + \dots$$

### MACLAURIN'S THEOREM

$$f(x) = f(0) + xf'(0) + \frac{x^2}{1 \cdot 2} f''(0) + \dots$$

## TRIGONOMETRIC SOLUTION OF TRIANGLES

*Right Angled Triangles (Right Angle at C)*

$$\sin A = \cos B = \frac{a}{c}$$

$$\tan A = \frac{a}{b} \quad B = 90^\circ - A$$

$$\text{vers } A = 1 - \cos A = \frac{c-b}{c}$$

$$c = \sqrt{a^2 + b^2}$$

$$b = \sqrt{c^2 - a^2} = \sqrt{(c+a)(c-a)}$$

$$\text{Area} = \frac{ab}{2} = \frac{a}{2} \sqrt{c^2 - a^2} = \frac{a^2 \cot A}{2} = \frac{b^2 \tan A}{2} = \frac{c^2 \sin A \cos A}{2}$$

*Oblique-Angled Triangles*

$$\sin \frac{1}{2} A = \sqrt{\frac{(s-b)(s-c)}{bc}}, \quad \cos \frac{1}{2} A = \sqrt{\frac{s(s-a)}{bc}},$$

$$\text{where } s = \frac{a+b+c}{2}$$

$$\tan \frac{1}{2} A = \sqrt{\frac{(s-b)(s-c)}{s(s-a)}}, \quad \text{similar values for angles } B \text{ and } C.$$

$$\text{Area} = \sqrt{s(s-a)(s-b)(s-c)} = \frac{1}{2} ab \sin C = \frac{a^2 \sin B \sin C}{2 \sin A}$$

$$c = \frac{a \sin C}{\sin A} = \frac{a \sin(A+B)}{\sin A} = \sqrt{a^2 + b^2 - 2ab \cos C}$$

$$\tan A = \frac{a \sin C}{b - a \cos C}, \quad \tan \frac{1}{2}(A-B) = \frac{a-b}{a+b} \cot \frac{1}{2} C$$

$$a^2 = b^2 + c^2 - 2bc \cos A, \quad \text{similar expressions for other sides.}$$

## COMPLEX HYPERBOLIC AND OTHER FUNCTIONS

Properties of "e"

$$e = 1 + 1 + \frac{1}{2!} + \frac{1}{3!} + \dots = 2.71828$$

$$\frac{1}{e} = .3679$$

$$e^x = 1 + x + \frac{x^2}{2!} + \frac{x^3}{3!} + \dots$$

**COMPLEX HYPERBOLIC AND OTHER FUNCTIONS—Continued**

$$\log_{10} e = 0.43429; \log_e 10 = 2.30259$$

$$\log_e N = \log_e 10 \times \log_{10} N; \log_{10} N = \log_{10} e \times \log_e N.$$

$$\sin x = x - \frac{x^3}{3!} + \frac{x^5}{5!} - \frac{x^7}{7!} + \dots$$

$$\cos x = 1 - \frac{x^2}{2!} + \frac{x^4}{4!} - \frac{x^6}{6!} + \dots$$

$$\sinh x = x + \frac{x^3}{3!} + \frac{x^5}{5!} + \frac{x^7}{7!} + \dots$$

$$\cosh x = 1 + \frac{x^2}{2!} + \frac{x^4}{4!} + \frac{x^6}{6!} + \dots$$

$$J_n(x) = \frac{x^n}{2^n n!} \left\{ 1 - \frac{x^2}{2(2n+2)} + \frac{x^4}{2 \cdot 4(2n+2)(2n+4)} - \frac{x^6}{2 \cdot 4 \cdot 6(2n+2)(2n+4)(2n+6)} + \dots \right\}$$

$$\sin x = \frac{e^{jx} - e^{-jx}}{2j}$$

$$\cos x = \frac{e^{jx} + e^{-jx}}{2}$$

$$\sinh x = \frac{e^x - e^{-x}}{2}$$

$$\cosh x = \frac{e^x + e^{-x}}{2}$$

$$e^{jx} = \cos x + j \sin x$$

$$e^{-jx} = \cos x - j \sin x$$

$$j = \sqrt{-1}$$

$$\sinh(-x) = -\sinh x; \cosh(-x) = \cosh x$$

$$\sinh jx = j \sin x; \cosh jx = \cos x$$

$$\cosh^2 x - \sinh^2 x = 1$$

$$\sinh 2x = 2 \sinh x \cosh x$$

$$\cosh 2x = \cosh^2 x + \sinh^2 x$$

$$\sinh(x \pm jy) = \sinh x \cos y \pm j \cosh x \sin y$$

$$\cosh(x \pm jy) = \cosh x \cos y \pm j \sinh x \sin y$$



**GREAT CIRCLE CALCULATIONS—Figures 1, 2 and 3**

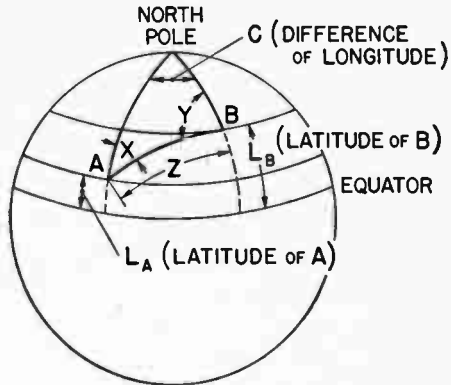

Figure 1

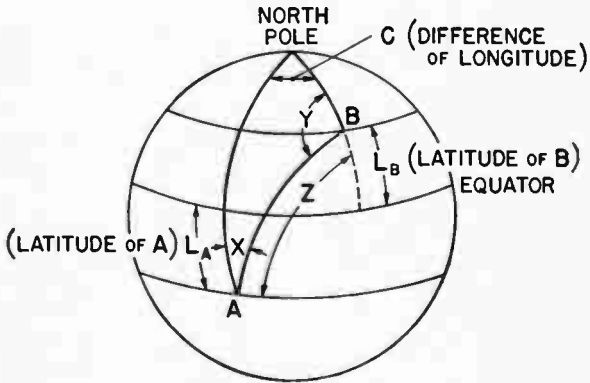

Figure 2

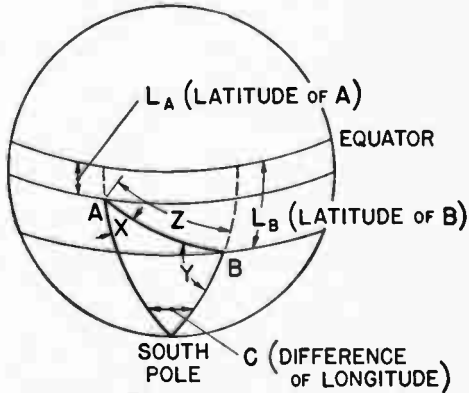

Figure 3

## GREAT CIRCLE CALCULATIONS

Referring to Figs. 1, 2 and 3,  $A$  and  $B$  are two places on the earth's surface the latitudes and longitudes of which are known. The angles  $X$  and  $Y$  at  $A$  and  $B$  of the great circle passing through the two places and the distance  $Z$  between  $A$  and  $B$  along the great circle can be calculated as follows:

$B$  is the place of greater latitude, i.e., nearer the pole

$L_a$  is the latitude of  $A$

$L_b$  is the latitude of  $B$

$C$  is the difference of longitude between  $A$  and  $B$

$$\text{Then } \tan \frac{Y - X}{2} = \cot \frac{C}{2} \frac{\sin \frac{L_b - L_a}{2}}{\cos \frac{L_b + L_a}{2}}$$

$$\text{and } \tan \frac{Y + X}{2} = \cot \frac{C}{2} \frac{\cos \frac{L_b - L_a}{2}}{\sin \frac{L_b + L_a}{2}}$$

$$\text{give the values of } \frac{Y - X}{2} \text{ and } \frac{Y + X}{2}$$

$$\text{from which } \frac{Y + X}{2} + \frac{Y - X}{2} = Y$$

$$\text{and } \frac{Y + X}{2} - \frac{Y - X}{2} = X$$

In the above formulas north latitudes are taken as positive and south latitudes as negative. For example, if  $B$  is latitude  $60^\circ$  N. and  $A$  is latitude  $20^\circ$  S.

$$\frac{L_b + L_a}{2} = \frac{60 + (-20)}{2} = \frac{60 - 20}{2} = \frac{40}{2} = 20^\circ$$

$$\text{and } \frac{L_b - L_a}{2} = \frac{60 - (-20)}{2} = \frac{60 + 20}{2} = \frac{80}{2} = 40^\circ$$

If both places are in the southern hemisphere and  $L_b + L_a$  is negative it is simpler to call the place of greater south latitude  $B$  and to use the above method for calculating bearings from true south and to convert the results afterwards to bearings east of north.

### GREAT CIRCLE CALCULATIONS—Continued

The distance  $Z$  (in degrees) along the great circle between  $A$  and  $B$  is given by the following:

$$\tan \frac{Z}{2} = \tan \frac{L_b - L_a}{2} \frac{\sin \frac{Y + X}{2}}{\sin \frac{Y - X}{2}}$$

The angular distance  $Z$  (in degrees) between  $A$  and  $B$  may be converted to linear distance as follows:

$$Z \text{ (in degrees)} \times 111.136 = \text{kilometers}$$

$$Z \text{ (in degrees)} \times 69.057 = \text{statute miles}$$

$$Z \text{ (in degrees)} \times 60.000 = \text{nautical miles}$$

In multiplying, the minutes and seconds of arc must be expressed in decimals of a degree. For example,  $Z = 37^\circ 45' 36''$  becomes  $37.755^\circ$ .

Example:— Find the great circle bearings at Brentwood, Long Island, Longitude  $73^\circ 15' 10''$  W, Latitude  $30^\circ 48' 40''$  N, and at Rio de Janeiro, Brazil, Longitude  $43^\circ 22' 07''$  W, Latitude  $22^\circ 57' 09''$  S, and the great circle distance in statute miles between the two points.

	LONGITUDE	LATITUDE	
BRENTWOOD	$73^\circ 15' 10''$ W.	$40^\circ 48' 40''$ N.	$L_B$
RIO DE JANEIRO	$43^\circ 22' 07''$ W.	$(-22^\circ 57' 09''$ S.	$L_A$
C	$29^\circ 53' 03''$	$17^\circ 51' 31''$ $63^\circ 45' 49''$	$L_B + L_A$ $L_B - L_A$
$\frac{C}{2} = 14^\circ 56' 31''$ $\frac{L_B + L_A}{2} = 8^\circ 55' 45''$ $\frac{L_B - L_A}{2} = 31^\circ 52' 54''$			
LOG COT $14^\circ 56' 31'' = 10.57371$	LOG COT $14^\circ 56' 31'' = 10.57371$		LOG COT $14^\circ 56' 31'' = 10.57371$
PLUS " COS $31^\circ 52' 54'' = 9.92896$	PLUS " SIN $31^\circ 52' 54'' = 9.72277$		PLUS " SIN $31^\circ 52' 54'' = 9.72277$
MINUS LOG SIN $8^\circ 55' 45'' = 9.19093$	MINUS LOG COS $8^\circ 55' 45'' = 9.99471$		MINUS LOG COS $8^\circ 55' 45'' = 9.99471$
" TAN $\frac{Y+X}{2} = 1.31176$	" TAN $\frac{Y-X}{2} = .30177$		" TAN $\frac{Y-X}{2} = .30177$
$\frac{Y+X}{2} = 87^\circ 12' 26''$	$\frac{Y-X}{2} = 63^\circ 28' 26''$		$\frac{Y-X}{2} = 63^\circ 28' 26''$
$\frac{Y+X}{2} + \frac{Y-X}{2} = Y = 150^\circ 40' 52''$ EAST OF NORTH - BEARING AT BRENTWOOD			
$\frac{Y+X}{2} - \frac{Y-X}{2} = X = 23^\circ 44' 00''$ WEST OF NORTH - BEARING AT RIO DE JANEIRO			
$\frac{L_B - L_A}{2} = 31^\circ 52' 54''$	LOG TAN $31^\circ 52' 54'' = 9.79379$		
$\frac{Y+X}{2} = 87^\circ 12' 26''$	PLUS " SIN $87^\circ 12' 26'' = 9.99948$		
$\frac{Y-X}{2} = 63^\circ 28' 26''$	MINUS LOG SIN $63^\circ 28' 26'' = 9.95170$		
	" TAN $\frac{Z}{2} = 9.84157$		
	$\frac{Z}{2} = 34^\circ 46' 24''$		
	$Z = 69^\circ 32' 48''$		
$69^\circ 32' 48'' = 69.547^\circ$			
LINEAR DISTANCE = $69.547 \times 69.057 = 4802.71$ STATUTE MILES			

## LOGARITHMS OF NUMBERS AND PROPORTIONAL PARTS

	0	1	2	3	4	5	6	7	8	9	Proportional Parts								
											1 2 3			4 5 6			7 8 9		
											1	2	3	4	5	6	7	8	9
10	0000	0043	0086	0128	0170	0212	0253	0294	0334	0374	4 8	12	17	21	25	29	33	37	
11	0414	0453	0492	0531	0569	0607	0645	0682	0719	0755	4 8	11	15	19	23	26	30	34	
12	0792	0828	0864	0899	0934	0969	1004	1038	1072	1106	3 7	10	14	17	21	24	28	31	
13	1139	1173	1206	1239	1271	1303	1335	1367	1399	1430	3 6	10	13	16	19	23	26	29	
14	1461	1492	1523	1553	1584	1614	1644	1673	1703	1732	3 6	9	12	15	18	21	24	27	
15	1761	1790	1818	1847	1875	1903	1931	1959	1987	2014	3 6	8	11	14	17	20	22	25	
16	2041	2068	2095	2122	2148	2175	2201	2227	2253	2279	3 5	8	11	13	16	18	21	24	
17	2304	2330	2355	2380	2405	2430	2455	2480	2504	2529	2 5	7	10	12	15	17	20	22	
18	2553	2577	2601	2625	2648	2672	2695	2718	2742	2765	2 5	7	9	12	14	16	19	21	
19	2788	2810	2833	2856	2878	2900	2923	2945	2967	2989	2 4	7	9	11	13	16	18	20	
20	3010	3032	3054	3075	3096	3118	3139	3160	3181	3201	2 4	6	8	11	13	15	17	19	
21	3222	3243	3263	3284	3304	3324	3345	3365	3385	3404	2 4	6	8	10	12	14	16	18	
22	3424	3444	3464	3483	3502	3522	3541	3560	3579	3598	2 4	6	8	10	12	14	15	17	
23	3617	3636	3655	3674	3692	3711	3729	3747	3766	3784	2 4	6	7	9	11	13	15	17	
24	3802	3820	3838	3856	3874	3892	3909	3927	3945	3962	2 4	5	7	9	11	12	14	16	
25	3979	3997	4014	4031	4048	4065	4082	4099	4116	4133	2 3	5	7	9	10	12	14	15	
26	4150	4166	4183	4200	4216	4232	4249	4265	4281	4298	2 3	5	7	8	10	11	13	15	
27	4314	4330	4346	4362	4378	4393	4409	4425	4440	4456	2 3	5	6	8	9	11	13	14	
28	4472	4487	4502	4518	4533	4548	4564	4579	4594	4609	2 3	5	6	8	9	11	12	14	
29	4624	4639	4654	4669	4683	4698	4713	4728	4742	4757	1 3	4	6	7	9	10	12	13	
30	4771	4786	4800	4814	4829	4843	4857	4871	4886	4900	1 3	4	6	7	9	10	11	13	
31	4914	4928	4942	4955	4969	4983	4997	5011	5024	5038	1 3	4	6	7	8	10	11	12	
32	5051	5065	5079	5092	5105	5119	5132	5145	5159	5172	1 3	4	5	7	8	9	11	12	
33	5185	5198	5211	5224	5237	5250	5263	5276	5289	5302	1 3	4	5	6	8	9	10	12	
34	5315	5328	5340	5353	5366	5378	5391	5403	5416	5428	1 3	4	5	6	8	9	10	11	
35	5441	5453	5465	5478	5490	5502	5514	5527	5539	5551	1 2	4	5	6	7	9	10	11	
36	5563	5575	5587	5599	5611	5623	5635	5647	5658	5670	1 2	4	5	6	7	8	10	11	
37	5682	5694	5705	5717	5729	5740	5752	5763	5775	5786	1 2	3	5	6	7	8	9	10	
38	5798	5809	5821	5832	5843	5855	5866	5877	5888	5899	1 2	3	5	6	7	8	9	10	
39	5911	5922	5933	5944	5955	5966	5977	5988	5999	6010	1 2	3	4	5	7	8	9	10	
40	6021	6031	6042	6053	6064	6075	6085	6096	6107	6117	1 2	3	4	5	6	8	9	10	
41	6128	6138	6149	6160	6170	6180	6191	6201	6212	6222	1 2	3	4	5	6	7	8	9	
42	6232	6243	6253	6263	6274	6284	6294	6304	6314	6325	1 2	3	4	5	6	7	8	9	
43	6335	6345	6355	6365	6375	6385	6395	6405	6415	6425	1 2	3	4	5	6	7	8	9	
44	6435	6444	6454	6464	6474	6484	6493	6503	6513	6522	1 2	3	4	5	6	7	8	9	
45	6532	6542	6551	6561	6571	6580	6590	6599	6609	6618	1 2	3	4	5	6	7	8	9	
46	6628	6637	6646	6656	6665	6675	6684	6693	6702	6712	1 2	3	4	5	6	7	7	8	
47	6721	6730	6739	6749	6758	6767	6776	6785	6794	6803	1 2	3	4	5	5	6	7	8	
48	6812	6821	6830	6839	6848	6857	6866	6875	6884	6893	1 2	3	4	4	5	6	7	8	
49	6902	6911	6920	6928	6937	6946	6955	6964	6972	6981	1 2	3	4	4	5	6	7	8	
50	6990	6998	7007	7016	7024	7033	7042	7050	7059	7067	1 2	3	3	4	5	6	7	8	
51	7076	7084	7093	7101	7110	7118	7126	7135	7143	7152	1 2	3	3	4	5	6	7	8	
52	7160	7168	7177	7185	7193	7202	7210	7218	7226	7235	1 2	2	3	4	5	6	7	7	
53	7243	7251	7259	7267	7275	7284	7292	7300	7308	7316	1 2	2	3	4	5	6	6	7	
54	7324	7332	7340	7348	7356	7364	7372	7380	7388	7396	1 2	2	3	4	5	6	6	7	

## LOGARITHMS OF NUMBERS AND PROPORTIONAL PARTS—Continued

	0	1	2	3	4	5	6	7	8	9	Proportional Parts								
											1	2	3	4	5	6	7	8	9
55	7404	7412	7419	7427	7435	7443	7451	7459	7466	7474	1	2	2	3	4	5	5	6	7
56	7482	7490	7497	7505	7513	7520	7528	7536	7543	7551	1	2	2	3	4	5	5	6	7
57	7559	7566	7574	7582	7589	7597	7604	7612	7619	7627	1	2	2	3	4	5	5	6	7
58	7634	7642	7649	7657	7664	7672	7679	7686	7694	7701	1	1	2	3	4	4	5	6	7
59	7709	7716	7723	7731	7738	7745	7752	7760	7767	7774	1	1	2	3	4	4	5	6	7
60	7782	7789	7796	7803	7810	7818	7825	7832	7839	7846	1	1	2	3	4	4	5	6	6
61	7853	7860	7868	7875	7882	7889	7896	7903	7910	7917	1	1	2	3	4	4	5	6	6
62	7924	7931	7938	7945	7952	7959	7966	7973	7980	7987	1	1	2	3	3	4	5	6	6
63	7993	8000	8007	8014	8021	8028	8035	8041	8048	8055	1	1	2	3	3	4	5	5	6
64	8062	8069	8075	8082	8089	8096	8102	8109	8116	8122	1	1	2	3	3	4	5	5	6
65	8129	8136	8142	8149	8156	8162	8169	8176	8182	8189	1	1	2	3	3	4	5	5	6
66	8195	8202	8209	8215	8222	8228	8235	8241	8248	8254	1	1	2	3	3	4	5	5	6
67	8261	8267	8274	8280	8287	8293	8299	8306	8312	8319	1	1	2	3	3	4	5	5	6
68	8325	8331	8338	8344	8351	8357	8363	8370	8376	8383	1	1	2	3	3	4	4	5	6
69	8388	8395	8401	8407	8414	8420	8426	8432	8439	8445	1	1	2	2	3	4	4	5	6
70	8451	8457	8463	8470	8476	8482	8488	8494	8500	8506	1	1	2	2	3	4	4	5	6
71	8513	8519	8525	8531	8537	8543	8549	8555	8561	8567	1	1	2	2	3	4	4	5	5
72	8573	8579	8585	8591	8597	8603	8609	8615	8621	8627	1	1	2	2	3	4	4	5	5
73	8633	8639	8645	8651	8657	8663	8669	8675	8681	8686	1	1	2	2	3	4	4	5	5
74	8692	8698	8704	8710	8716	8722	8727	8733	8739	8745	1	1	2	2	3	4	4	5	5
75	8751	8756	8762	8768	8774	8779	8785	8791	8797	8802	1	1	2	2	3	3	4	5	5
76	8808	8814	8820	8825	8831	8837	8842	8848	8854	8859	1	1	2	2	3	3	4	5	5
77	8865	8871	8876	8882	8887	8893	8899	8904	8910	8915	1	1	2	2	3	3	4	4	5
78	8921	8927	8932	8938	8943	8949	8954	8960	8965	8971	1	1	2	2	3	3	4	4	5
79	8976	8982	8987	8993	8998	9004	9009	9015	9020	9025	1	1	2	2	3	3	4	4	5
80	9031	9036	9042	9047	9053	9058	9063	9069	9074	9079	1	1	2	2	3	3	4	4	5
81	9085	9090	9096	9101	9106	9112	9117	9122	9128	9133	1	1	2	2	3	3	4	4	5
82	9138	9143	9149	9154	9159	9165	9170	9175	9180	9186	1	1	2	2	3	3	4	4	5
83	9191	9196	9201	9206	9212	9217	9222	9227	9232	9238	1	1	2	2	3	3	4	4	5
84	9243	9248	9253	9258	9263	9269	9274	9279	9284	9289	1	1	2	2	3	3	4	4	5
85	9294	9299	9304	9309	9315	9320	9325	9330	9335	9340	1	1	2	2	3	3	4	4	5
86	9345	9350	9355	9360	9365	9370	9375	9380	9385	9390	1	1	2	2	3	3	4	4	5
87	9395	9400	9405	9410	9415	9420	9425	9430	9435	9440	0	1	1	2	2	3	3	4	4
88	9445	9450	9455	9460	9465	9469	9474	9479	9484	9489	0	1	1	2	2	3	3	4	4
89	9494	9499	9504	9509	9513	9518	9523	9528	9533	9538	0	1	1	2	2	3	3	4	4
90	9542	9547	9552	9557	9562	9566	9571	9576	9581	9586	0	1	1	2	2	3	3	4	4
91	9590	9595	9600	9605	9609	9614	9619	9624	9628	9633	0	1	1	2	2	3	3	4	4
92	9638	9643	9647	9652	9657	9661	9666	9671	9675	9680	0	1	1	2	2	3	3	4	4
93	9685	9689	9694	9699	9703	9708	9713	9717	9722	9727	0	1	1	2	2	3	3	4	4
94	9731	9736	9741	9745	9750	9754	9759	9763	9768	9773	0	1	1	2	2	3	3	4	4
95	9777	9782	9786	9791	9795	9800	9805	9809	9814	9818	0	1	1	2	2	3	3	4	4
96	9823	9827	9832	9836	9841	9845	9850	9854	9859	9863	0	1	1	2	2	3	3	4	4
97	9868	9872	9877	9881	9886	9890	9894	9899	9903	9908	0	1	1	2	2	3	3	4	4
98	9912	9917	9921	9926	9930	9934	9939	9943	9948	9952	0	1	1	2	2	3	3	4	4
99	9956	9961	9965	9969	9974	9978	9983	9987	9991	9996	0	1	1	2	2	3	3	4	4

## NATURAL TRIGONOMETRIC FUNCTIONS FOR DECIMAL FRACTIONS OF A DEGREE

Deg.	Sin	Cos	Tan	Cot	Deg.	Deg.	Sin	Cos	Tan	Cot	Deg.
<b>0.0</b>	0.0000	1.0000	0.0000	$\infty$	<b>90.0</b>	<b>6.0</b>	.10453	0.9945	.10510	9.514	<b>84.0</b>
.1	.00175	1.0000	.00175	573.0	.9	.1	.10626	.9943	.10687	9.357	.9
.2	.00349	1.0000	.00349	286.5	.8	.2	.10800	.9942	.10863	9.205	.8
.3	.00524	1.0000	.00524	191.0	.7	.3	.10973	.9940	.11040	9.058	.7
.4	.00698	1.0000	.00698	143.24	.6	.4	.11147	.9938	.11217	8.915	.6
.5	.00873	1.0000	.00873	114.59	.5	.5	.11320	.9936	.11394	8.777	.5
.6	.01047	.9999	.01047	95.49	.4	.6	.11494	.9934	.11570	8.643	.4
.7	.01222	.9999	.01222	81.85	.3	.7	.11667	.9932	.11747	8.513	.3
.8	.01396	.9999	.01396	71.62	.2	.8	.11840	.9930	.11924	8.386	.2
.9	.01571	.9999	.01571	63.66	.1	.9	.12014	.9928	.12101	8.264	.1
<b>1.0</b>	<b>.01745</b>	<b>.9998</b>	<b>.01746</b>	<b>57.29</b>	<b>89.0</b>	<b>7.0</b>	<b>.12187</b>	<b>0.9925</b>	<b>.12278</b>	<b>8.144</b>	<b>83.0</b>
.1	.01920	.9998	.01920	52.08	.9	.1	.12360	.9923	.12456	8.028	.9
.2	.02094	.9998	.02095	47.74	.8	.2	.12533	.9921	.12633	7.916	.8
.3	.02269	.9997	.02269	44.07	.7	.3	.12706	.9919	.12810	7.806	.7
.4	.02443	.9997	.02444	40.92	.6	.4	.12880	.9917	.12988	7.700	.6
.5	.02618	.9997	.02619	38.19	.5	.5	.13053	.9914	.13165	7.596	.5
.6	.02792	.9996	.02793	35.80	.4	.6	.13226	.9912	.13343	7.495	.4
.7	.02967	.9996	.02968	33.69	.3	.7	.13399	.9910	.13521	7.396	.3
.8	.03141	.9995	.03143	31.82	.2	.8	.13572	.9907	.13698	7.300	.2
.9	.03316	.9995	.03317	30.14	.1	.9	.13744	.9905	.13876	7.207	.1
<b>2.0</b>	<b>.03490</b>	<b>0.9994</b>	<b>.03492</b>	<b>28.64</b>	<b>88.0</b>	<b>8.0</b>	<b>.13917</b>	<b>0.9903</b>	<b>.14054</b>	<b>7.115</b>	<b>82.0</b>
.1	.03664	.9993	.03667	27.27	.9	.1	.14090	.9900	.14232	7.026	.9
.2	.03839	.9993	.03842	26.03	.8	.2	.14263	.9898	.14410	6.940	.8
.3	.04013	.9992	.04016	24.90	.7	.3	.14436	.9895	.14588	6.855	.7
.4	.04188	.9991	.04191	23.86	.6	.4	.14608	.9893	.14767	6.772	.6
.5	.04362	.9990	.04366	22.90	.5	.5	.14781	.9890	.14945	6.691	.5
.6	.04536	.9990	.04541	22.02	.4	.6	.14954	.9888	.15124	6.612	.4
.7	.04711	.9989	.04716	21.20	.3	.7	.15126	.9885	.15302	6.535	.3
.8	.04885	.9988	.04891	20.45	.2	.8	.15299	.9882	.15481	6.460	.2
.9	.05059	.9987	.05066	19.74	.1	.9	.15471	.9880	.15660	6.386	.1
<b>3.0</b>	<b>.05234</b>	<b>0.9986</b>	<b>.05241</b>	<b>19.081</b>	<b>87.0</b>	<b>9.0</b>	<b>.15643</b>	<b>0.9877</b>	<b>.15838</b>	<b>6.314</b>	<b>81.0</b>
.1	.05408	.9985	.05416	18.464	.9	.1	.15816	.9874	.16017	6.243	.9
.2	.05582	.9984	.05591	17.886	.8	.2	.15988	.9871	.16196	6.174	.8
.3	.05756	.9983	.05766	17.343	.7	.3	.16160	.9869	.16376	6.107	.7
.4	.05931	.9982	.05941	16.832	.6	.4	.16333	.9866	.16555	6.041	.6
.5	.06105	.9981	.06116	16.350	.5	.5	.16505	.9863	.16734	5.976	.5
.6	.06279	.9980	.06291	15.895	.4	.6	.16677	.9860	.16914	5.912	.4
.7	.06453	.9979	.06467	15.464	.3	.7	.16849	.9857	.17093	5.850	.3
.8	.06627	.9978	.06642	15.056	.2	.8	.17021	.9854	.17273	5.789	.2
.9	.06802	.9977	.06817	14.669	.1	.9	.17193	.9851	.17453	5.730	.1
<b>4.0</b>	<b>.06976</b>	<b>0.9976</b>	<b>.06993</b>	<b>14.301</b>	<b>86.0</b>	<b>10.0</b>	<b>.1736</b>	<b>0.9848</b>	<b>.1763</b>	<b>5.671</b>	<b>80.0</b>
.1	.07150	.9974	.07168	13.951	.9	.1	.1754	.9845	.1781	5.614	.9
.2	.07324	.9973	.07344	13.617	.8	.2	.1771	.9842	.1799	5.558	.8
.3	.07498	.9972	.07519	13.300	.7	.3	.1788	.9839	.1817	5.503	.7
.4	.07672	.9971	.07695	12.996	.6	.4	.1805	.9836	.1835	5.449	.6
.5	.07846	.9969	.07870	12.706	.5	.5	.1822	.9833	.1853	5.396	.5
.6	.08020	.9968	.08046	12.429	.4	.6	.1840	.9829	.1871	5.343	.4
.7	.08194	.9966	.08221	12.163	.3	.7	.1857	.9826	.1890	5.292	.3
.8	.08368	.9965	.08397	11.909	.2	.8	.1874	.9823	.1908	5.242	.2
.9	.08542	.9963	.08573	11.664	.1	.9	.1891	.9820	.1926	5.193	.1
<b>5.0</b>	<b>.08716</b>	<b>0.9962</b>	<b>.08749</b>	<b>11.430</b>	<b>85.0</b>	<b>11.0</b>	<b>.1908</b>	<b>0.9816</b>	<b>.1944</b>	<b>5.145</b>	<b>79.0</b>
.1	.08889	.9960	.08925	11.205	.9	.1	.1925	.9813	.1962	5.097	.9
.2	.09063	.9959	.09101	10.988	.8	.2	.1942	.9810	.1980	5.050	.8
.3	.09237	.9957	.09277	10.780	.7	.3	.1959	.9806	.1998	5.005	.7
.4	.09411	.9956	.09453	10.579	.6	.4	.1977	.9803	.2016	4.959	.6
.5	.09585	.9954	.09629	10.385	.5	.5	.1994	.9799	.2035	4.915	.5
.6	.09758	.9952	.09805	10.199	.4	.6	.2011	.9796	.2053	4.872	.4
.7	.09932	.9951	.09981	10.019	.3	.7	.2028	.9792	.2071	4.829	.3
.8	.10106	.9949	.10158	9.845	.2	.8	.2045	.9789	.2089	4.787	.2
.9	.10279	.9947	.10334	9.677	.1	.9	.2062	.9785	.2107	4.745	.1
<b>6.0</b>	<b>.10453</b>	<b>0.9945</b>	<b>.10510</b>	<b>9.514</b>	<b>84.0</b>	<b>12.0</b>	<b>.2079</b>	<b>0.9781</b>	<b>.2126</b>	<b>4.705</b>	<b>78.0</b>
Deg.	Cos	Sin	Cot	Tan	Deg.	Deg.	Cos	Sin	Cot	Tan	Deg.

# NATURAL TRIGONOMETRIC FUNCTIONS FOR DECIMAL FRACTIONS OF A DEGREE—Continued

Deg.	Sin	Cos	Tan	Cot	Deg.	Deg.	Sin	Cos	Tan	Cot	Deg.
<b>12.0</b>	0.2079	0.9781	0.2126	4.705	<b>78.0</b>	<b>18.0</b>	0.3090	0.9511	0.3249	3.078	<b>72.0</b>
.1	2096	.9778	.2144	4.665	.9	.1	.3107	.9505	.3269	3.060	.9
.2	2113	.9774	.2162	4.625	.8	.2	.3123	.9500	.3288	3.042	.8
.3	2130	.9770	.2180	4.586	.7	.3	.3140	.9494	.3307	3.024	.7
.4	2147	.9767	.2199	4.548	.6	.4	.3156	.9489	.3327	3.006	.6
.5	2164	.9763	.2217	4.511	.5	.5	.3173	.9483	.3346	2.989	.5
.6	2181	.9759	.2235	4.474	.4	.6	.3190	.9478	.3365	2.971	.4
.7	2198	.9755	.2254	4.437	.3	.7	.3206	.9472	.3385	2.954	.3
.8	2215	.9751	.2272	4.402	.2	.8	.3223	.9466	.3404	2.937	.2
.9	2233	.9748	.2290	4.366	.1	.9	.3239	.9461	.3424	2.921	.1
<b>13.0</b>	0.2250	0.9744	0.2309	4.331	<b>77.0</b>	<b>19.0</b>	0.3256	0.9455	0.3443	2.904	<b>71.0</b>
.1	2267	.9740	.2327	4.297	.9	.1	.3272	.9449	.3463	2.888	.9
.2	2284	.9736	.2345	4.264	.8	.2	.3289	.9444	.3482	2.872	.8
.3	2300	.9732	.2364	4.230	.7	.3	.3305	.9438	.3502	2.856	.7
.4	2317	.9728	.2382	4.198	.6	.4	.3322	.9432	.3522	2.840	.6
.5	2334	.9724	.2401	4.165	.5	.5	.3338	.9426	.3541	2.824	.5
.6	2351	.9720	.2419	4.134	.4	.6	.3355	.9421	.3561	2.808	.4
.7	2368	.9715	.2438	4.102	.3	.7	.3371	.9415	.3581	2.793	.3
.8	2385	.9711	.2456	4.071	.2	.8	.3387	.9409	.3600	2.778	.2
.9	2402	.9707	.2475	4.041	.1	.9	.3404	.9403	.3620	2.762	.1
<b>14.0</b>	0.2419	0.9703	0.2493	4.011	<b>76.0</b>	<b>20.0</b>	0.3420	0.9397	0.3640	2.747	<b>70.0</b>
.1	2436	.9699	.2512	3.981	.9	.1	.3437	.9391	.3659	2.733	.9
.2	2453	.9694	.2530	3.952	.8	.2	.3453	.9385	.3679	2.718	.8
.3	2470	.9690	.2549	3.923	.7	.3	.3469	.9379	.3699	2.703	.7
.4	2487	.9686	.2568	3.895	.6	.4	.3486	.9373	.3719	2.689	.6
.5	2504	.9681	.2586	3.867	.5	.5	.3502	.9367	.3739	2.675	.5
.6	2521	.9677	.2605	3.839	.4	.6	.3518	.9361	.3759	2.660	.4
.7	2538	.9673	.2623	3.812	.3	.7	.3535	.9354	.3779	2.646	.3
.8	2554	.9668	.2642	3.785	.2	.8	.3551	.9348	.3799	2.633	.2
.9	2571	.9664	.2661	3.758	.1	.9	.3567	.9342	.3819	2.619	.1
<b>15.0</b>	0.2588	0.9659	0.2679	3.732	<b>75.0</b>	<b>21.0</b>	0.3584	0.9336	0.3839	2.605	<b>69.0</b>
.1	2605	.9655	.2698	3.706	.9	.1	.3600	.9330	.3859	2.592	.9
.2	2622	.9650	.2717	3.681	.8	.2	.3616	.9323	.3879	2.578	.8
.3	2639	.9646	.2736	3.655	.7	.3	.3633	.9317	.3899	2.565	.7
.4	2656	.9641	.2754	3.630	.6	.4	.3649	.9311	.3919	2.552	.6
.5	2672	.9636	.2773	3.606	.5	.5	.3665	.9304	.3939	2.539	.5
.6	2689	.9632	.2792	3.582	.4	.6	.3681	.9298	.3959	2.526	.4
.7	2706	.9627	.2811	3.558	.3	.7	.3697	.9291	.3979	2.513	.3
.8	2723	.9622	.2830	3.534	.2	.8	.3714	.9285	.4000	2.500	.2
.9	2740	.9617	.2849	3.511	.1	.9	.3730	.9278	.4020	2.488	.1
<b>16.0</b>	0.2756	0.9613	0.2867	3.487	<b>74.0</b>	<b>22.0</b>	0.3746	0.9272	0.4040	2.475	<b>68.0</b>
.1	2773	.9608	.2886	3.465	.9	.1	.3762	.9265	.4061	2.463	.9
.2	2790	.9603	.2905	3.442	.8	.2	.3778	.9259	.4081	2.450	.8
.3	2807	.9598	.2924	3.420	.7	.3	.3795	.9252	.4101	2.438	.7
.4	2823	.9593	.2943	3.398	.6	.4	.3811	.9245	.4122	2.426	.6
.5	2840	.9588	.2962	3.376	.5	.5	.3827	.9239	.4142	2.414	.5
.6	2857	.9583	.2981	3.354	.4	.6	.3843	.9232	.4163	2.402	.4
.7	2874	.9578	.3000	3.333	.3	.7	.3859	.9225	.4183	2.391	.3
.8	2890	.9573	.3019	3.312	.2	.8	.3875	.9219	.4204	2.379	.2
.9	2907	.9568	.3038	3.291	.1	.9	.3891	.9212	.4224	2.367	.1
<b>17.0</b>	0.2924	0.9563	0.3057	3.271	<b>73.0</b>	<b>23.0</b>	0.3907	0.9205	0.4245	2.356	<b>67.0</b>
.1	2940	.9558	.3076	3.251	.9	.1	.3923	.9198	.4265	2.344	.9
.2	2957	.9553	.3096	3.230	.8	.2	.3939	.9191	.4286	2.333	.8
.3	2974	.9548	.3115	3.211	.7	.3	.3955	.9184	.4307	2.322	.7
.4	2990	.9542	.3134	3.191	.6	.4	.3971	.9178	.4327	2.311	.6
.5	3007	.9537	.3153	3.172	.5	.5	.3987	.9171	.4348	2.300	.5
.6	3024	.9532	.3172	3.152	.4	.6	.4003	.9164	.4369	2.289	.4
.7	3040	.9527	.3191	3.133	.3	.7	.4019	.9157	.4390	2.278	.3
.8	3057	.9521	.3211	3.115	.2	.8	.4035	.9150	.4411	2.267	.2
.9	3074	.9516	.3230	3.096	.1	.9	.4051	.9143	.4431	2.257	.1
<b>18.0</b>	0.3090	0.9511	0.3249	3.078	<b>72.0</b>	<b>24.0</b>	0.4067	0.9135	0.4452	2.246	<b>66.0</b>
Deg.	Cos	Sin	Cot	Tan	Deg.	Deg.	Cos	Sin	Cot	Tan	Deg.

## NATURAL TRIGONOMETRIC FUNCTIONS FOR DECIMAL FRACTIONS OF A DEGREE—Continued

Deg.	Sin	Cos	Tan	Cot	Deg.	Deg.	Sin	Cos	Tan	Cot	Deg.
<b>24.0</b>	0.4067	0.9135	0.4452	2.246	<b>66.0</b>	<b>30.0</b>	0.5000	0.8660	0.5774	1.7321	<b>60.0</b>
.1	.4083	.9128	.4473	2.236	.9	.1	.5015	.8652	.5797	1.7251	.9
.2	.4099	.9121	.4494	2.225	.8	.2	.5030	.8643	.5820	1.7182	.8
.3	.4115	.9114	.4515	2.215	.7	.3	.5045	.8634	.5844	1.7113	.7
.4	.4131	.9107	.4536	2.204	.6	.4	.5060	.8625	.5867	1.7045	.6
.5	.4147	.9100	.4557	2.194	.5	.5	.5075	.8616	.5890	1.6977	.5
.6	.4163	.9092	.4578	2.184	.4	.6	.5090	.8607	.5914	1.6909	.4
.7	.4179	.9085	.4599	2.174	.3	.7	.5105	.8599	.5938	1.6842	.3
.8	.4195	.9078	.4621	2.164	.2	.8	.5120	.8590	.5961	1.6775	.2
.9	.4210	.9070	.4642	2.154	.1	.9	.5135	.8581	.5985	1.6709	.1
<b>25.0</b>	0.4226	0.9063	0.4663	2.145	<b>65.0</b>	<b>31.0</b>	0.5150	0.8572	0.6009	1.6643	<b>59.0</b>
.1	.4242	.9056	.4684	2.135	.9	.1	.5165	.8563	.6032	1.6577	.9
.2	.4258	.9048	.4706	2.125	.8	.2	.5180	.8554	.6056	1.6512	.8
.3	.4274	.9041	.4727	2.116	.7	.3	.5195	.8545	.6080	1.6447	.7
.4	.4289	.9033	.4748	2.106	.6	.4	.5210	.8536	.6104	1.6383	.6
.5	.4305	.9026	.4770	2.097	.5	.5	.5225	.8527	.6128	1.6319	.5
.6	.4321	.9018	.4791	2.087	.4	.6	.5240	.8517	.6152	1.6255	.4
.7	.4337	.9011	.4813	2.078	.3	.7	.5255	.8508	.6176	1.6191	.3
.8	.4352	.9003	.4834	2.069	.2	.8	.5270	.8499	.6200	1.6128	.2
.9	.4368	.8996	.4856	2.059	.1	.9	.5284	.8490	.6224	1.6066	.1
<b>26.0</b>	0.4384	0.8988	0.4877	2.050	<b>64.0</b>	<b>32.0</b>	0.5299	0.8480	0.6249	1.6003	<b>58.0</b>
.1	.4399	.8980	.4899	2.041	.9	.1	.5314	.8471	.6273	1.5941	.9
.2	.4415	.8973	.4921	2.032	.8	.2	.5329	.8462	.6297	1.5880	.8
.3	.4431	.8965	.4942	2.023	.7	.3	.5344	.8453	.6322	1.5818	.7
.4	.4446	.8957	.4964	2.014	.6	.4	.5358	.8443	.6346	1.5757	.6
.5	.4462	.8949	.4986	2.006	.5	.5	.5373	.8434	.6371	1.5697	.5
.6	.4478	.8942	.5008	1.997	.4	.6	.5388	.8425	.6395	1.5637	.4
.7	.4493	.8934	.5029	1.988	.3	.7	.5402	.8415	.6420	1.5577	.3
.8	.4509	.8926	.5051	1.980	.2	.8	.5417	.8406	.6445	1.5517	.2
.9	.4524	.8918	.5073	1.971	.1	.9	.5432	.8396	.6469	1.5458	.1
<b>27.0</b>	0.4540	0.8910	0.5095	1.963	<b>63.0</b>	<b>33.0</b>	0.5446	0.8387	0.6494	1.5399	<b>57.0</b>
.1	.4555	.8902	.5117	1.954	.9	.1	.5461	.8377	.6519	1.5340	.9
.2	.4571	.8894	.5139	1.946	.8	.2	.5476	.8368	.6544	1.5282	.8
.3	.4586	.8886	.5161	1.937	.7	.3	.5490	.8358	.6569	1.5224	.7
.4	.4602	.8878	.5184	1.929	.6	.4	.5505	.8348	.6594	1.5166	.6
.5	.4617	.8870	.5206	1.921	.5	.5	.5519	.8339	.6619	1.5108	.5
.6	.4633	.8862	.5228	1.913	.4	.6	.5534	.8329	.6644	1.5051	.4
.7	.4648	.8854	.5250	1.905	.3	.7	.5548	.8320	.6669	1.4994	.3
.8	.4664	.8846	.5272	1.897	.2	.8	.5563	.8310	.6694	1.4938	.2
.9	.4679	.8838	.5295	1.889	.1	.9	.5577	.8300	.6720	1.4882	.1
<b>28.0</b>	0.4695	0.8829	0.5317	1.881	<b>62.0</b>	<b>34.0</b>	0.5592	0.8290	0.6745	1.4826	<b>56.0</b>
.1	.4710	.8821	.5340	1.873	.9	.1	.5606	.8281	.6771	1.4770	.9
.2	.4726	.8813	.5362	1.865	.8	.2	.5621	.8271	.6796	1.4715	.8
.3	.4741	.8805	.5384	1.857	.7	.3	.5635	.8261	.6822	1.4659	.7
.4	.4756	.8796	.5407	1.849	.6	.4	.5650	.8251	.6847	1.4605	.6
.5	.4772	.8788	.5430	1.842	.5	.5	.5664	.8241	.6873	1.4550	.5
.6	.4787	.8780	.5452	1.834	.4	.6	.5678	.8231	.6899	1.4496	.4
.7	.4802	.8771	.5475	1.827	.3	.7	.5693	.8221	.6924	1.4442	.3
.8	.4818	.8763	.5498	1.819	.2	.8	.5707	.8211	.6950	1.4388	.2
.9	.4833	.8755	.5520	1.811	.1	.9	.5721	.8202	.6976	1.4335	.1
<b>29.0</b>	0.4848	0.8746	0.5543	1.804	<b>61.0</b>	<b>35.0</b>	0.5736	0.8192	0.7002	1.4281	<b>55.0</b>
.1	.4863	.8738	.5566	1.797	.9	.1	.5750	.8181	.7028	1.4229	.9
.2	.4879	.8729	.5589	1.789	.8	.2	.5764	.8171	.7054	1.4176	.8
.3	.4894	.8721	.5612	1.782	.7	.3	.5779	.8161	.7080	1.4124	.7
.4	.4909	.8712	.5635	1.775	.6	.4	.5793	.8151	.7107	1.4071	.6
.5	.4924	.8704	.5658	1.767	.5	.5	.5807	.8141	.7133	1.4019	.5
.6	.4939	.8695	.5681	1.760	.4	.6	.5821	.8131	.7159	1.3968	.4
.7	.4955	.8686	.5704	1.753	.3	.7	.5835	.8121	.7186	1.3916	.3
.8	.4970	.8678	.5727	1.746	.2	.8	.5850	.8111	.7212	1.3865	.2
.9	.4985	.8669	.5750	1.739	.1	.9	.5864	.8100	.7239	1.3814	.1
<b>30.0</b>	0.5000	0.8660	0.5774	1.732	<b>60.0</b>	<b>36.0</b>	0.5878	0.8090	0.7265	1.3764	<b>54.0</b>
Deg.	Cos	Sin	Cot	Tan	Deg.	Deg.	Cos	Sin	Cot	Tan	Deg.



## NATURAL TRIGONOMETRIC FUNCTIONS FOR DECIMAL FRACTIONS OF A DEGREE—Continued

Deg.	Sin	Cos	Tan	Cot	Deg.	Deg.	Sin	Cos	Tan	Cot	Deg.
<b>36.0</b>	0.5878	0.8090	0.7265	1.3764	<b>54.0</b>	<b>40.5</b>	0.6494	0.7604	0.8541	1.1708	<b>49.5</b>
.1	.5892	.8080	.7292	1.3713	.9	.6	.6508	.7593	.8571	1.1667	.4
.2	.5906	.8070	.7319	1.3663	.8	.7	.6521	.7581	.8601	1.1626	.3
.3	.5920	.8059	.7346	1.3613	.7	.8	.6534	.7570	.8632	1.1585	.2
.4	.5934	.8049	.7373	1.3564	.6	.9	.6547	.7559	.8662	1.1544	.1
.5	.5948	.8039	.7400	1.3514	.5	<b>41.0</b>	0.6561	0.7547	0.8693	1.1504	<b>49.0</b>
.6	.5962	.8028	.7427	1.3465	.4	.1	.6574	.7536	.8724	1.1463	.9
.7	.5976	.8018	.7454	1.3416	.3	.2	.6587	.7524	.8754	1.1423	.8
.8	.5990	.8007	.7481	1.3367	.2	.3	.6600	.7513	.8785	1.1383	.7
.9	.6004	.7997	.7508	1.3319	.1	.4	.6613	.7501	.8816	1.1343	.6
<b>37.0</b>	0.6018	0.7986	0.7536	1.3270	<b>53.0</b>	.5	.6626	.7490	.8847	1.1303	.5
.1	.6032	.7976	.7563	1.3222	.9	.6	.6639	.7478	.8878	1.1263	.4
.2	.6046	.7965	.7590	1.3175	.8	.7	.6652	.7466	.8910	1.1224	.3
.3	.6060	.7955	.7618	1.3127	.7	.8	.6665	.7455	.8941	1.1184	.2
.4	.6074	.7944	.7646	1.3079	.6	.9	.6678	.7443	.8972	1.1145	.1
.5	.6088	.7934	.7673	1.3032	.5	<b>42.0</b>	0.6691	0.7431	0.9004	1.1106	<b>48.0</b>
.6	.6101	.7923	.7701	1.2985	.4	.1	.6704	.7420	.9036	1.1067	.9
.7	.6115	.7912	.7729	1.2938	.3	.2	.6717	.7408	.9067	1.1028	.8
.8	.6129	.7902	.7757	1.2892	.2	.3	.6730	.7396	.9099	1.0990	.7
.9	.6143	.7891	.7785	1.2846	.1	.4	.6743	.7385	.9131	1.0951	.6
<b>38.0</b>	0.6157	0.7880	0.7813	1.2799	<b>52.0</b>	.5	.6756	.7373	.9163	1.0913	.5
.1	.6170	.7869	.7841	1.2753	.9	.6	.6769	.7361	.9195	1.0875	.4
.2	.6184	.7859	.7869	1.2708	.8	.7	.6782	.7349	.9228	1.0837	.3
.3	.6198	.7848	.7898	1.2662	.7	.8	.6794	.7337	.9260	1.0799	.2
.4	.6211	.7837	.7926	1.2617	.6	.9	.6807	.7325	.9293	1.0761	.1
.5	.6225	.7826	.7954	1.2572	.5	<b>43.0</b>	0.6820	0.7314	0.9325	1.0724	<b>47.0</b>
.6	.6239	.7815	.7983	1.2527	.4	.1	.6833	.7302	.9358	1.0686	.9
.7	.6252	.7804	.8012	1.2482	.3	.2	.6845	.7290	.9391	1.0649	.8
.8	.6266	.7793	.8040	1.2437	.2	.3	.6858	.7278	.9424	1.0612	.7
.9	.6280	.7782	.8069	1.2393	.1	.4	.6871	.7266	.9457	1.0575	.6
<b>39.0</b>	0.6293	0.7771	0.8098	1.2349	<b>51.0</b>	.5	.6884	.7254	.9490	1.0538	.5
.1	.6307	.7760	.8127	1.2305	.9	.6	.6896	.7242	.9523	1.0501	.4
.2	.6320	.7749	.8156	1.2261	.8	.7	.6909	.7230	.9556	1.0464	.3
.3	.6334	.7738	.8185	1.2218	.7	.8	.6921	.7218	.9590	1.0428	.2
.4	.6347	.7727	.8214	1.2174	.6	.9	.6934	.7206	.9623	1.0392	.1
.5	.6361	.7716	.8243	1.2131	.5	<b>44.0</b>	0.6947	0.7193	0.9657	1.0355	<b>46.0</b>
.6	.6374	.7705	.8273	1.2088	.4	.1	.6959	.7181	.9691	1.0319	.9
.7	.6388	.7694	.8302	1.2045	.3	.2	.6972	.7169	.9725	1.0283	.8
.8	.6401	.7683	.8332	1.2002	.2	.3	.6984	.7157	.9759	1.0247	.7
.9	.6414	.7672	.8361	1.1960	.1	.4	.6997	.7145	.9793	1.0212	.6
<b>40.0</b>	0.6428	0.7660	0.8391	1.1918	<b>50.0</b>	.5	.7009	.7133	.9827	1.0176	.5
.1	.6441	.7649	.8421	1.1875	.9	.6	.7022	.7120	.9861	1.0141	.4
.2	.6455	.7638	.8451	1.1833	.8	.7	.7034	.7108	.9896	1.0105	.3
.3	.6468	.7627	.8481	1.1792	.7	.8	.7046	.7096	.9930	1.0070	.2
.4	.6481	.7615	.8511	1.1750	.6	.9	.7059	.7083	.9965	1.0035	.1
<b>40.5</b>	0.6494	0.7604	0.8541	1.1708	<b>49.5</b>	<b>45.0</b>	0.7071	0.7071	1.0000	1.0000	<b>45.0</b>
Deg.	Cos	Sin	Cot	Tan	Deg.	Deg.	Cos	Sin	Cot	Tan	Deg.

# LOGARITHMS OF TRIGONOMETRIC FUNCTIONS FOR DECIMAL FRACTIONS OF A DEGREE

Deg.	L. Sin	L. Cos	L. Tan	L. Cot	Deg.	Deg.	L. Sin	L. Cos	L. Tan	L. Cot	Deg.
<b>0.0</b>	— ∞	0.0000	— ∞	∞	<b>90.0</b>	<b>6.0</b>	9.0192	9.9976	9.0216	0.9784	<b>84.0</b>
.1	7.2419	0.0000	7.2419	2.7581	.9	.1	9.0264	9.9975	9.0289	0.9711	.9
.2	7.5429	0.0000	7.5429	2.4571	.8	.2	9.0334	9.9975	9.0360	0.9640	.8
.3	7.7190	0.0000	7.7190	2.2810	.7	.3	9.0403	9.9974	9.0430	0.9570	.7
.4	7.8439	0.0000	7.8439	2.1561	.6	.4	9.0472	9.9973	9.0499	0.9501	.6
.5	7.9408	0.0000	7.9409	2.0591	.5	.5	9.0539	9.9972	9.0567	0.9433	.5
.6	8.0200	0.0000	8.0200	1.9800	.4	.6	9.0605	9.9971	9.0633	0.9367	.4
.7	8.0870	0.0000	8.0870	1.9130	.3	.7	9.0670	9.9970	9.0699	0.9301	.3
.8	8.1450	0.0000	8.1450	1.8550	.2	.8	9.0734	9.9969	9.0764	0.9236	.2
.9	8.1961	9.9999	8.1962	1.8038	.1	.9	9.0797	9.9968	9.0828	0.9172	.1
<b>1.0</b>	8.2419	9.9999	8.2419	1.7581	<b>89.0</b>	<b>7.0</b>	9.0859	9.9968	9.0891	0.9109	<b>83.0</b>
.1	8.2832	9.9999	8.2833	1.7167	.9	.1	9.0920	9.9967	9.0954	0.9046	.9
.2	8.3210	9.9999	8.3211	1.6789	.8	.2	9.0981	9.9966	9.1015	0.8985	.8
.3	8.3558	9.9999	8.3559	1.6441	.7	.3	9.1040	9.9965	9.1076	0.8924	.7
.4	8.3880	9.9999	8.3881	1.6119	.6	.4	9.1099	9.9964	9.1135	0.8865	.6
.5	8.4179	9.9999	8.4181	1.5819	.5	.5	9.1157	9.9963	9.1194	0.8806	.5
.6	8.4459	9.9998	8.4461	1.5539	.4	.6	9.1214	9.9962	9.1252	0.8748	.4
.7	8.4723	9.9998	8.4725	1.5275	.3	.7	9.1271	9.9961	9.1310	0.8690	.3
.8	8.4971	9.9998	8.4973	1.5027	.2	.8	9.1326	9.9960	9.1367	0.8633	.2
.9	8.5206	9.9998	8.5208	1.4792	.1	.9	9.1381	9.9959	9.1423	0.8577	.1
<b>2.0</b>	8.5428	9.9997	8.5431	1.4569	<b>88.0</b>	<b>8.0</b>	9.1436	9.9958	9.1478	0.8522	<b>82.0</b>
.1	8.5640	9.9997	8.5643	1.4357	.9	.1	9.1489	9.9956	9.1533	0.8467	.9
.2	8.5842	9.9997	8.5845	1.4155	.8	.2	9.1542	9.9955	9.1587	0.8413	.8
.3	8.6035	9.9996	8.6038	1.3962	.7	.3	9.1594	9.9954	9.1640	0.8360	.7
.4	8.6220	9.9996	8.6223	1.3777	.6	.4	9.1646	9.9953	9.1693	0.8307	.6
.5	8.6397	9.9996	8.6401	1.3599	.5	.5	9.1697	9.9952	9.1745	0.8255	.5
.6	8.6567	9.9996	8.6571	1.3429	.4	.6	9.1747	9.9951	9.1797	0.8203	.4
.7	8.6731	9.9995	8.6736	1.3264	.3	.7	9.1797	9.9950	9.1848	0.8152	.3
.8	8.6889	9.9995	8.6894	1.3106	.2	.8	9.1847	9.9949	9.1898	0.8102	.2
.9	8.7041	9.9994	8.7046	1.2954	.1	.9	9.1895	9.9947	9.1948	0.8052	.1
<b>3.0</b>	8.7188	9.9994	8.7194	1.2806	<b>87.0</b>	<b>9.0</b>	9.1943	9.9946	9.1997	0.8003	<b>81.0</b>
.1	8.7330	9.9994	8.7337	1.2663	.9	.1	9.1991	9.9945	9.2046	0.7954	.9
.2	8.7468	9.9993	8.7475	1.2525	.8	.2	9.2038	9.9944	9.2094	0.7906	.8
.3	8.7602	9.9993	8.7609	1.2391	.7	.3	9.2085	9.9943	9.2142	0.7858	.7
.4	8.7731	9.9992	8.7739	1.2261	.6	.4	9.2131	9.9941	9.2189	0.7811	.6
.5	8.7857	9.9992	8.7865	1.2135	.5	.5	9.2176	9.9940	9.2236	0.7764	.5
.6	8.7979	9.9991	8.7988	1.2012	.4	.6	9.2221	9.9939	9.2282	0.7718	.4
.7	8.8098	9.9991	8.8107	1.1893	.3	.7	9.2266	9.9937	9.2328	0.7672	.3
.8	8.8213	9.9990	8.8223	1.1777	.2	.8	9.2310	9.9936	9.2374	0.7626	.2
.9	8.8326	9.9990	8.8336	1.1664	.1	.9	9.2353	9.9935	9.2419	0.7581	.1
<b>4.0</b>	8.8436	9.9989	8.8446	1.1554	<b>86.0</b>	<b>10.0</b>	9.2397	9.9934	9.2463	0.7537	<b>80.0</b>
.1	8.8543	9.9989	8.8554	1.1446	.9	.1	9.2439	9.9932	9.2507	0.7493	.9
.2	8.8647	9.9988	8.8659	1.1341	.8	.2	9.2482	9.9931	9.2551	0.7449	.8
.3	8.8749	9.9988	8.8762	1.1238	.7	.3	9.2524	9.9929	9.2594	0.7406	.7
.4	8.8849	9.9987	8.8862	1.1138	.6	.4	9.2565	9.9928	9.2637	0.7363	.6
.5	8.8946	9.9987	8.8960	1.1040	.5	.5	9.2606	9.9927	9.2680	0.7320	.5
.6	8.9042	9.9986	8.9056	1.0944	.4	.6	9.2647	9.9925	9.2722	0.7276	.4
.7	8.9135	9.9985	8.9150	1.0850	.3	.7	9.2687	9.9924	9.2764	0.7236	.3
.8	8.9226	9.9985	8.9241	1.0759	.2	.8	9.2727	9.9922	9.2805	0.7195	.2
.9	8.9315	9.9984	8.9331	1.0669	.1	.9	9.2767	9.9921	9.2846	0.7154	.1
<b>5.0</b>	8.9403	9.9983	8.9420	1.0580	<b>85.0</b>	<b>11.0</b>	9.2806	9.9919	9.2887	0.7113	<b>79.0</b>
.1	8.9489	9.9983	8.9506	1.0494	.9	.1	9.2845	9.9918	9.2927	0.7073	.9
.2	8.9573	9.9982	8.9591	1.0409	.8	.2	9.2883	9.9916	9.2967	0.7033	.8
.3	8.9655	9.9981	8.9674	1.0326	.7	.3	9.2921	9.9915	9.3006	0.6994	.7
.4	8.9736	9.9981	8.9756	1.0244	.6	.4	9.2959	9.9913	9.3046	0.6954	.6
.5	8.9816	9.9980	8.9836	1.0164	.5	.5	9.2997	9.9912	9.3085	0.6915	.5
.6	8.9894	9.9979	8.9915	1.0085	.4	.6	9.3034	9.9910	9.3123	0.6877	.4
.7	8.9970	9.9978	8.9992	1.0008	.3	.7	9.3070	9.9909	9.3162	0.6838	.3
.8	9.0046	9.9978	9.0068	0.9932	.2	.8	9.3107	9.9907	9.3200	0.6800	.2
.9	9.0120	9.9977	9.0143	0.9857	.1	.9	9.3143	9.9906	9.3237	0.6763	.1
<b>6.0</b>	9.0192	9.9976	9.0216	0.9784	<b>84.0</b>	<b>12.0</b>	9.3179	9.9904	9.3275	0.6725	<b>78.0</b>
Deg.	L. Cos	L. Sin	L. Cot	L. Tan	Deg.	Deg.	L. Cos	L. Sin	L. Cot	L. Tan	Deg.

# LOGARITHMS OF TRIGONOMETRIC FUNCTIONS FOR DECIMAL FRACTIONS OF A DEGREE—Continued

Deg.	L. Sin	L. Cos	L. Tan	L. Cot	Deg.	Deg.	L. Sin	L. Cos	L. Tan	L. Cot	Deg.
<b>12.0</b>	9.3179	9.9904	9.3275	0.6725	<b>78.0</b>	<b>18.0</b>	9.4900	9.9782	9.5118	0.4882	<b>72.0</b>
.1	9.3214	9.9902	9.3312	0.6688	.9	.1	9.4923	9.9780	9.5143	0.4857	.9
.2	9.3250	9.9901	9.3349	0.6651	.8	.2	9.4946	9.9777	9.5169	0.4831	.8
.3	9.3284	9.9899	9.3385	0.6615	.7	.3	9.4969	9.9775	9.5195	0.4805	.7
.4	9.3319	9.9897	9.3422	0.6578	.6	.4	9.4992	9.9772	9.5220	0.4780	.6
.5	9.3353	9.9896	9.3458	0.6542	.5	.5	9.5015	9.9770	9.5245	0.4755	.5
.6	9.3387	9.9894	9.3493	0.6507	.4	.6	9.5037	9.9767	9.5270	0.4730	.4
.7	9.3421	9.9892	9.3529	0.6471	.3	.7	9.5060	9.9764	9.5295	0.4705	.3
.8	9.3455	9.9891	9.3564	0.6436	.2	.8	9.5082	9.9762	9.5320	0.4680	.2
.9	9.3488	9.9889	9.3599	0.6401	.1	.9	9.5104	9.9759	9.5345	0.4655	.1
<b>13.0</b>	9.3521	9.9887	9.3634	0.6366	<b>77.0</b>	<b>19.0</b>	9.5126	9.9757	9.5370	0.4630	<b>71.0</b>
.1	9.3554	9.9885	9.3668	0.6332	.9	.1	9.5148	9.9754	9.5394	0.4606	.9
.2	9.3586	9.9884	9.3702	0.6298	.8	.2	9.5170	9.9751	9.5419	0.4581	.8
.3	9.3618	9.9882	9.3736	0.6264	.7	.3	9.5192	9.9749	9.5443	0.4557	.7
.4	9.3650	9.9880	9.3770	0.6230	.6	.4	9.5213	9.9746	9.5467	0.4533	.6
.5	9.3682	9.9878	9.3804	0.6196	.5	.5	9.5235	9.9743	9.5491	0.4509	.5
.6	9.3713	9.9876	9.3837	0.6163	.4	.6	9.5256	9.9741	9.5516	0.4484	.4
.7	9.3745	9.9875	9.3870	0.6130	.3	.7	9.5278	9.9738	9.5539	0.4461	.3
.8	9.3775	9.9873	9.3903	0.6097	.2	.8	9.5299	9.9735	9.5563	0.4437	.2
.9	9.3806	9.9871	9.3935	0.6065	.1	.9	9.5320	9.9733	9.5587	0.4413	.1
<b>14.0</b>	9.3837	9.9869	9.3968	0.6032	<b>76.0</b>	<b>20.0</b>	9.5341	9.9730	9.5611	0.4389	<b>70.0</b>
.1	9.3867	9.9867	9.4000	0.6000	.9	.1	9.5361	9.9727	9.5634	0.4366	.9
.2	9.3897	9.9865	9.4032	0.5968	.8	.2	9.5382	9.9724	9.5658	0.4342	.8
.3	9.3927	9.9863	9.4064	0.5936	.7	.3	9.5402	9.9722	9.5681	0.4319	.7
.4	9.3957	9.9861	9.4095	0.5905	.6	.4	9.5423	9.9719	9.5704	0.4296	.6
.5	9.3986	9.9859	9.4127	0.5873	.5	.5	9.5443	9.9716	9.5727	0.4273	.5
.6	9.4015	9.9857	9.4158	0.5842	.4	.6	9.5463	9.9713	9.5750	0.4250	.4
.7	9.4044	9.9855	9.4189	0.5811	.3	.7	9.5484	9.9710	9.5773	0.4227	.3
.8	9.4073	9.9853	9.4220	0.5780	.2	.8	9.5504	9.9707	9.5796	0.4204	.2
.9	9.4102	9.9851	9.4250	0.5750	.1	.9	9.5523	9.9704	9.5819	0.4181	.1
<b>15.0</b>	9.4130	9.9849	9.4281	0.5719	<b>75.0</b>	<b>21.0</b>	9.5543	9.9702	9.5842	0.4158	<b>69.0</b>
.1	9.4158	9.9847	9.4311	0.5689	.9	.1	9.5563	9.9699	9.5864	0.4136	.9
.2	9.4186	9.9845	9.4341	0.5659	.8	.2	9.5583	9.9696	9.5887	0.4113	.8
.3	9.4214	9.9843	9.4371	0.5629	.7	.3	9.5602	9.9693	9.5909	0.4091	.7
.4	9.4242	9.9841	9.4400	0.5600	.6	.4	9.5621	9.9690	9.5932	0.4068	.6
.5	9.4269	9.9839	9.4430	0.5570	.5	.5	9.5641	9.9687	9.5954	0.4046	.5
.6	9.4296	9.9837	9.4459	0.5541	.4	.6	9.5660	9.9684	9.5976	0.4024	.4
.7	9.4323	9.9835	9.4488	0.5512	.3	.7	9.5679	9.9681	9.5998	0.4002	.3
.8	9.4350	9.9833	9.4517	0.5483	.2	.8	9.5698	9.9678	9.6020	0.3980	.2
.9	9.4377	9.9831	9.4546	0.5454	.1	.9	9.5717	9.9675	9.6042	0.3958	.1
<b>16.0</b>	9.4403	9.9828	9.4575	0.5425	<b>74.0</b>	<b>22.0</b>	9.5736	9.9672	9.6064	0.3936	<b>68.0</b>
.1	9.4430	9.9826	9.4603	0.5397	.9	.1	9.5754	9.9669	9.6086	0.3914	.9
.2	9.4456	9.9824	9.4632	0.5368	.8	.2	9.5773	9.9666	9.6108	0.3892	.8
.3	9.4482	9.9822	9.4660	0.5340	.7	.3	9.5792	9.9662	9.6129	0.3871	.7
.4	9.4508	9.9820	9.4688	0.5312	.6	.4	9.5810	9.9659	9.6151	0.3849	.6
.5	9.4533	9.9817	9.4716	0.5284	.5	.5	9.5828	9.9656	9.6172	0.3828	.5
.6	9.4559	9.9815	9.4744	0.5256	.4	.6	9.5847	9.9653	9.6194	0.3806	.4
.7	9.4584	9.9813	9.4771	0.5229	.3	.7	9.5865	9.9650	9.6215	0.3785	.3
.8	9.4609	9.9811	9.4799	0.5201	.2	.8	9.5883	9.9647	9.6236	0.3764	.2
.9	9.4634	9.9808	9.4826	0.5174	.1	.9	9.5901	9.9643	9.6257	0.3743	.1
<b>17.0</b>	9.4659	9.9806	9.4853	0.5147	<b>73.0</b>	<b>23.0</b>	9.5919	9.9640	9.6279	0.3721	<b>67.0</b>
.1	9.4684	9.9804	9.4880	0.5120	.9	.1	9.5937	9.9637	9.6300	0.3700	.9
.2	9.4709	9.9801	9.4907	0.5093	.8	.2	9.5954	9.9634	9.6321	0.3679	.8
.3	9.4733	9.9799	9.4934	0.5066	.7	.3	9.5972	9.9631	9.6341	0.3659	.7
.4	9.4757	9.9797	9.4961	0.5039	.6	.4	9.5990	9.9627	9.6362	0.3638	.6
.5	9.4781	9.9794	9.4987	0.5013	.5	.5	9.6007	9.9624	9.6383	0.3617	.5
.6	9.4805	9.9792	9.5014	0.4986	.4	.6	9.6024	9.9621	9.6404	0.3596	.4
.7	9.4829	9.9789	9.5040	0.4960	.3	.7	9.6042	9.9617	9.6424	0.3576	.3
.8	9.4853	9.9787	9.5066	0.4934	.2	.8	9.6059	9.9614	9.6445	0.3555	.2
.9	9.4876	9.9785	9.5092	0.4908	.1	.9	9.6076	9.9611	9.6465	0.3535	.1
<b>18.0</b>	9.4900	9.9782	9.5118	0.4882	<b>72.0</b>	<b>24.0</b>	9.6093	9.9607	9.6486	0.3514	<b>66.0</b>
Deg.	L. Cos	L. Sin	L. Cot	L. Tan	Deg.	Deg.	L. Cos	L. Sin	L. Cot	L. Tan	Deg.

# LOGARITHMS OF TRIGONOMETRIC FUNCTIONS FOR DECIMAL FRACTIONS OF A DEGREE—Continued

Deg.	L. Sin	L. Cos	L. Tan	L. Cot	Deg.	Deg.	L. Sin	L. Cos	L. Tan	L. Cot	Deg.
<b>24.0</b>	9.6093	9.9607	9.6486	0.3514	<b>66.0</b>	<b>30.0</b>	9.6990	9.9375	9.7614	0.2386	<b>60.0</b>
.1	9.6110	9.9604	9.6506	0.3494	.9	.1	9.7003	9.9371	9.7632	0.2368	.9
.2	9.6127	9.9601	9.6527	0.3473	.8	.2	9.7016	9.9367	9.7649	0.2351	.8
.3	9.6144	9.9597	9.6547	0.3453	.7	.3	9.7029	9.9362	9.7667	0.2333	.7
.4	9.6161	9.9594	9.6567	0.3433	.6	.4	9.7042	9.9358	9.7684	0.2316	.6
.5	9.6177	9.9590	9.6587	0.3413	.5	.5	9.7055	9.9353	9.7701	0.2299	.5
.6	9.6194	9.9587	9.6607	0.3393	.4	.6	9.7068	9.9349	9.7719	0.2281	.4
.7	9.6210	9.9583	9.6627	0.3373	.3	.7	9.7080	9.9344	9.7736	0.2264	.3
.8	9.6227	9.9580	9.6647	0.3353	.2	.8	9.7093	9.9340	9.7753	0.2247	.2
.9	9.6243	9.9576	9.6667	0.3333	.1	.9	9.7106	9.9335	9.7771	0.2229	.1
<b>25.0</b>	9.6259	9.9573	9.6687	0.3313	<b>65.0</b>	<b>31.0</b>	9.7118	9.9331	9.7788	0.2212	<b>59.0</b>
.1	9.6276	9.9569	9.6706	0.3294	.9	.1	9.7131	9.9326	9.7805	0.2195	.9
.2	9.6292	9.9566	9.6726	0.3274	.8	.2	9.7144	9.9322	9.7822	0.2178	.8
.3	9.6308	9.9562	9.6746	0.3254	.7	.3	9.7156	9.9317	9.7839	0.2161	.7
.4	9.6324	9.9558	9.6765	0.3235	.6	.4	9.7168	9.9312	9.7856	0.2144	.6
.5	9.6340	9.9555	9.6785	0.3215	.5	.5	9.7181	9.9308	9.7873	0.2127	.5
.6	9.6356	9.9551	9.6804	0.3196	.4	.6	9.7193	9.9303	9.7890	0.2110	.4
.7	9.6371	9.9548	9.6824	0.3176	.3	.7	9.7205	9.9298	9.7907	0.2093	.3
.8	9.6387	9.9544	9.6843	0.3157	.2	.8	9.7218	9.9294	9.7924	0.2076	.2
.9	9.6403	9.9540	9.6863	0.3137	.1	.9	9.7230	9.9289	9.7941	0.2059	.1
<b>26.0</b>	9.6418	9.9537	9.6882	0.3118	<b>64.0</b>	<b>32.0</b>	9.7242	9.9284	9.7958	0.2042	<b>58.0</b>
.1	9.6434	9.9533	9.6901	0.3099	.9	.1	9.7254	9.9279	9.7975	0.2025	.9
.2	9.6449	9.9529	9.6920	0.3080	.8	.2	9.7266	9.9275	9.7992	0.2008	.8
.3	9.6465	9.9525	9.6939	0.3061	.7	.3	9.7278	9.9270	9.8008	0.1992	.7
.4	9.6480	9.9522	9.6958	0.3042	.6	.4	9.7290	9.9265	9.8025	0.1975	.6
.5	9.6495	9.9518	9.6977	0.3023	.5	.5	9.7302	9.9260	9.8042	0.1958	.5
.6	9.6510	9.9514	9.6996	0.3004	.4	.6	9.7314	9.9255	9.8059	0.1941	.4
.7	9.6526	9.9510	9.7015	0.2985	.3	.7	9.7326	9.9251	9.8075	0.1925	.3
.8	9.6541	9.9506	9.7034	0.2966	.2	.8	9.7338	9.9246	9.8092	0.1908	.2
.9	9.6556	9.9503	9.7053	0.2947	.1	.9	9.7349	9.9241	9.8109	0.1891	.1
<b>27.0</b>	9.6570	9.9499	9.7072	0.2928	<b>63.0</b>	<b>33.0</b>	9.7361	9.9236	9.8125	0.1875	<b>57.0</b>
.1	9.6585	9.9495	9.7090	0.2910	.9	.1	9.7373	9.9231	9.8142	0.1858	.9
.2	9.6600	9.9491	9.7109	0.2891	.8	.2	9.7384	9.9226	9.8158	0.1842	.8
.3	9.6615	9.9487	9.7128	0.2872	.7	.3	9.7396	9.9221	9.8175	0.1825	.7
.4	9.6629	9.9483	9.7146	0.2854	.6	.4	9.7407	9.9216	9.8191	0.1809	.6
.5	9.6644	9.9479	9.7165	0.2835	.5	.5	9.7419	9.9211	9.8208	0.1792	.5
.6	9.6659	9.9475	9.7183	0.2817	.4	.6	9.7430	9.9206	9.8224	0.1776	.4
.7	9.6673	9.9471	9.7202	0.2798	.3	.7	9.7442	9.9201	9.8241	0.1759	.3
.8	9.6687	9.9467	9.7220	0.2780	.2	.8	9.7453	9.9196	9.8257	0.1743	.2
.9	9.6702	9.9463	9.7238	0.2762	.1	.9	9.7464	9.9191	9.8274	0.1726	.1
<b>28.0</b>	9.6716	9.9459	9.7257	0.2743	<b>62.0</b>	<b>34.0</b>	9.7476	9.9186	9.8290	0.1710	<b>56.0</b>
.1	9.6730	9.9455	9.7275	0.2725	.9	.1	9.7487	9.9181	9.8306	0.1694	.9
.2	9.6744	9.9451	9.7293	0.2707	.8	.2	9.7498	9.9175	9.8323	0.1677	.8
.3	9.6759	9.9447	9.7311	0.2689	.7	.3	9.7509	9.9170	9.8339	0.1661	.7
.4	9.6773	9.9443	9.7330	0.2670	.6	.4	9.7520	9.9165	9.8355	0.1645	.6
.5	9.6787	9.9439	9.7348	0.2652	.5	.5	9.7531	9.9160	9.8371	0.1629	.5
.6	9.6801	9.9435	9.7366	0.2634	.4	.6	9.7542	9.9155	9.8388	0.1612	.4
.7	9.6814	9.9431	9.7384	0.2616	.3	.7	9.7553	9.9149	9.8404	0.1596	.3
.8	9.6828	9.9427	9.7402	0.2598	.2	.8	9.7564	9.9144	9.8420	0.1580	.2
.9	9.6842	9.9422	9.7420	0.2580	.1	.9	9.7575	9.9139	9.8436	0.1564	.1
<b>29.0</b>	9.6856	9.9418	9.7438	0.2562	<b>61.0</b>	<b>35.0</b>	9.7586	9.9134	9.8452	0.1548	<b>55.0</b>
.1	9.6869	9.9414	9.7455	0.2545	.9	.1	9.7597	9.9128	9.8468	0.1532	.9
.2	9.6883	9.9410	9.7473	0.2527	.8	.2	9.7607	9.9123	9.8484	0.1516	.8
.3	9.6896	9.9406	9.7491	0.2509	.7	.3	9.7618	9.9118	9.8501	0.1499	.7
.4	9.6910	9.9401	9.7509	0.2491	.6	.4	9.7629	9.9112	9.8517	0.1483	.6
.5	9.6923	9.9397	9.7526	0.2474	.5	.5	9.7640	9.9107	9.8533	0.1467	.5
.6	9.6937	9.9393	9.7544	0.2456	.4	.6	9.7650	9.9101	9.8549	0.1451	.4
.7	9.6950	9.9388	9.7562	0.2438	.3	.7	9.7661	9.9096	9.8565	0.1435	.3
.8	9.6963	9.9384	9.7579	0.2421	.2	.8	9.7671	9.9091	9.8581	0.1419	.2
.9	9.6977	9.9380	9.7597	0.2403	.1	.9	9.7682	9.9085	9.8597	0.1403	.1
<b>30.0</b>	9.6990	9.9375	9.7614	0.2386	<b>60.0</b>	<b>36.0</b>	9.7692	9.9080	9.8613	0.1387	<b>54.0</b>
Deg.	L. Cos	L. Sin	L. Cot	L. Tan	Deg.	Deg.	L. Cos	L. Sin	L. Cot	L. Tan	Deg.

# LOGARITHMS OF TRIGONOMETRIC FUNCTIONS FOR DECIMAL FRACTIONS OF A DEGREE—Continued

Deg.	L. Sin	L. Cos	L. Tan	L. Cot	Deg.	Deg.	L. Sin	L. Cos	L. Tan	L. Cot	Deg.
<b>36.0</b>	9.7692	9.9080	9.8613	0.1387	<b>54.0</b>	<b>40.5</b>	9.8125	9.8810	9.9315	0.0685	<b>49.5</b>
.1	9.7703	9.9074	9.8629	0.1371	.9	.6	9.8134	9.8804	9.9330	0.0670	.4
.2	9.7713	9.9069	9.8644	0.1356	.8	.7	9.8143	9.8797	9.9346	0.0654	.3
.3	9.7723	9.9063	9.8660	0.1340	.7	.8	9.8152	9.8791	9.9361	0.0639	.2
.4	9.7734	9.9057	9.8676	0.1324	.6	.9	9.8161	9.8784	9.9376	0.0624	.1
.5	9.7744	9.9052	9.8692	0.1308	.5	<b>41.0</b>	9.8169	9.8778	9.9392	0.0608	<b>49.0</b>
.6	9.7754	9.9046	9.8708	0.1292	.4	.1	9.8178	9.8771	9.9407	0.0593	.9
.7	9.7764	9.9041	9.8724	0.1276	.3	.2	9.8187	9.8765	9.9422	0.0578	.8
.8	9.7774	9.9035	9.8740	0.1260	.2	.3	9.8195	9.8758	9.9438	0.0562	.7
.9	9.7785	9.9029	9.8755	0.1245	.1	.4	9.8204	9.8751	9.9453	0.0547	.6
<b>37.0</b>	9.7795	9.9023	9.8771	0.1229	<b>53.0</b>	.5	9.8213	9.8745	9.9468	0.0532	.5
.1	9.7805	9.9018	9.8787	0.1213	.9	.6	9.8221	9.8738	9.9483	0.0517	.4
.2	9.7815	9.9012	9.8803	0.1197	.8	.7	9.8230	9.8731	9.9499	0.0501	.3
.3	9.7825	9.9006	9.8818	0.1182	.7	.8	9.8238	9.8724	9.9514	0.0486	.2
.4	9.7835	9.9000	9.8834	0.1166	.6	.9	9.8247	9.8718	9.9529	0.0471	.1
.5	9.7844	9.8995	9.8850	0.1150	.5	<b>42.0</b>	9.8255	9.8711	9.9544	0.0456	<b>48.0</b>
.6	9.7854	9.8989	9.8865	0.1135	.4	.1	9.8264	9.8704	9.9560	0.0440	.9
.7	9.7864	9.8983	9.8881	0.1119	.3	.2	9.8272	9.8697	9.9575	0.0425	.8
.8	9.7874	9.8977	9.8897	0.1103	.2	.3	9.8280	9.8690	9.9590	0.0410	.7
.9	9.7884	9.8971	9.8912	0.1088	.1	.4	9.8289	9.8683	9.9605	0.0395	.6
<b>38.0</b>	9.7893	9.8965	9.8928	0.1072	<b>52.0</b>	.5	9.8297	9.8676	9.9621	0.0379	.5
.1	9.7903	9.8959	9.8944	0.1056	.9	.6	9.8305	9.8669	9.9636	0.0364	.4
.2	9.7913	9.8953	9.8959	0.1041	.8	.7	9.8313	9.8662	9.9651	0.0349	.3
.3	9.7922	9.8947	9.8975	0.1025	.7	.8	9.8322	9.8655	9.9666	0.0334	.2
.4	9.7932	9.8941	9.8990	0.1010	.6	.9	9.8330	9.8648	9.9681	0.0319	.1
.5	9.7941	9.8935	9.9006	0.0994	.5	<b>43.0</b>	9.8338	9.8641	9.9697	0.0303	<b>47.0</b>
.6	9.7951	9.8929	9.9022	0.0978	.4	.1	9.8346	9.8634	9.9712	0.0288	.9
.7	9.7960	9.8923	9.9037	0.0963	.3	.2	9.8354	9.8627	9.9727	0.0273	.8
.8	9.7970	9.8917	9.9053	0.0947	.2	.3	9.8362	9.8620	9.9742	0.0258	.7
.9	9.7979	9.8911	9.9068	0.0932	.1	.4	9.8370	9.8613	9.9757	0.0243	.6
<b>39.0</b>	9.7989	9.8905	9.9084	0.0916	<b>51.0</b>	.5	9.8378	9.8606	9.9772	0.0228	.5
.1	9.7998	9.8899	9.9099	0.0901	.9	.6	9.8386	9.8598	9.9788	0.0212	.4
.2	9.8007	9.8893	9.9115	0.0885	.8	.7	9.8394	9.8591	9.9803	0.0197	.3
.3	9.8017	9.8887	9.9130	0.0870	.7	.8	9.8402	9.8584	9.9818	0.0182	.2
.4	9.8026	9.8880	9.9146	0.0854	.6	.9	9.8410	9.8577	9.9833	0.0167	.1
.5	9.8035	9.8874	9.9161	0.0839	.5	<b>44.0</b>	9.8418	9.8569	9.9848	0.0152	<b>46.0</b>
.6	9.8044	9.8868	9.9176	0.0824	.4	.1	9.8426	9.8562	9.9864	0.0136	.9
.7	9.8053	9.8862	9.9192	0.0808	.3	.2	9.8433	9.8555	9.9879	0.0121	.8
.8	9.8063	9.8855	9.9207	0.0793	.2	.3	9.8441	9.8547	9.9894	0.0106	.7
.9	9.8072	9.8849	9.9223	0.0777	.1	.4	9.8449	9.8540	9.9909	0.0091	.6
<b>40.0</b>	9.8081	9.8843	9.9238	0.0762	<b>50.0</b>	.5	9.8457	9.8532	9.9924	0.0076	.5
.1	9.8090	9.8836	9.9254	0.0746	.9	.6	9.8464	9.8525	9.9939	0.0061	.4
.2	9.8099	9.8830	9.9269	0.0731	.8	.7	9.8472	9.8517	9.9955	0.0045	.3
.3	9.8108	9.8823	9.9284	0.0716	.7	.8	9.8480	9.8510	9.9970	0.0030	.2
.4	9.8117	9.8817	9.9300	0.0700	.6	.9	9.8487	9.8502	9.9985	0.0015	.1
<b>40.5</b>	9.8125	9.8810	9.9315	0.0685	<b>49.5</b>	<b>45.0</b>	9.8495	9.8495	0.0000	0.0000	<b>45.0</b>
Deg.	L. Cos	L. Sin	L. Cot	L. Tan	Deg.	Deg.	L. Cos	L. Sin	L. Cot	L. Tan	Deg.

## EXPONENTIALS [ $e^n$ and $e^{-n}$ ]

$n$	$e^n$	Diff.	$n$	$e^n$	Diff.	$n$	$e^n$	$n$	$e^{-n}$	Diff.	$n$	$e^{-n}$	$n$	$e^{-n}$
<b>0.00</b>	1.000		<b>0.50</b>	1.649		<b>1.0</b>	2.718*	<b>0.00</b>	1.000		<b>0.50</b>	.607	<b>1.0</b>	.368*
.01	1.010	10	.51	1.665	16	.1	3.004	.01	0.990	-10	.51	.600	.1	.333
.02	1.020	10	.52	1.682	17	.2	3.320	.02	.980	-10	.52	.595	.2	.301
.03	1.030	11	.53	1.699	17	.3	3.669	.03	.970	-10	.53	.589	.3	.273
.04	1.041	10	.54	1.716	17	.4	4.055	.04	.961	-10	.54	.583	.4	.247
<b>0.05</b>	1.051		<b>0.55</b>	1.733		<b>1.5</b>	4.482	<b>0.05</b>	.951	-9	<b>0.55</b>	.577	<b>1.5</b>	.223
.06	1.062	11	.56	1.751	18	.6	4.953	.06	.942	-10	.56	.571	.6	.202
.07	1.073	10	.57	1.768	18	.7	5.474	.07	.932	-10	.57	.566	.7	.183
.08	1.083	11	.58	1.786	18	.8	6.050	.08	.923	-9	.58	.560	.8	.165
.09	1.094	11	.59	1.804	18	.9	6.686	.09	.914	-9	.59	.554	.9	.150
<b>0.10</b>	1.105		<b>0.60</b>	1.822		<b>2.0</b>	7.389	<b>0.10</b>	.905	-9	<b>0.60</b>	.549	<b>2.0</b>	.135
.11	1.116	11	.61	1.840	19	.1	8.166	.11	.896	-9	.61	.543	.1	.122
.12	1.127	12	.62	1.859	19	.2	9.025	.12	.887	-9	.62	.538	.2	.111
.13	1.139	12	.63	1.878	19	.3	9.974	.13	.878	-9	.63	.533	.3	.100
.14	1.150	12	.64	1.896	20	.4	11.02	.14	.869	-8	.64	.527	.4	.0907
<b>0.15</b>	1.162		<b>0.65</b>	1.916		<b>2.5</b>	12.18	<b>0.15</b>	.861	-9	<b>0.65</b>	.522	<b>2.5</b>	.0821
.16	1.174	12	.66	1.935	19	.6	13.46	.16	.852	-10	.66	.517	.6	.0743
.17	1.185	12	.67	1.954	19	.7	14.88	.17	.844	-8	.67	.512	.7	.0672
.18	1.197	12	.68	1.974	20	.8	16.44	.18	.835	-9	.68	.507	.8	.0608
.19	1.209	12	.69	1.994	20	.9	18.17	.19	.827	-8	.69	.502	.9	.0550
<b>0.20</b>	1.221		<b>0.70</b>	2.014		<b>3.0</b>	20.09	<b>0.20</b>	.819	-8	<b>0.70</b>	.497	<b>3.0</b>	.0498
.21	1.234	13	.71	2.034	20	.1	22.20	.21	.811	-8	.71	.492	.1	.0450
.22	1.246	12	.72	2.054	20	.2	24.53	.22	.803	-8	.72	.487	.2	.0408
.23	1.259	13	.73	2.075	21	.3	27.11	.23	.795	-8	.73	.482	.3	.0369
.24	1.271	12	.74	2.096	21	.4	29.96	.24	.787	-8	.74	.477	.4	.0334
<b>0.25</b>	1.284		<b>0.75</b>	2.117		<b>3.5</b>	33.12	<b>0.25</b>	.779	-8	<b>0.75</b>	.472	<b>3.5</b>	.0302
.26	1.297	13	.76	2.138	22	.6	36.60	.26	.771	-8	.76	.468	.6	.0273
.27	1.310	13	.77	2.160	22	.7	40.45	.27	.763	-8	.77	.463	.7	.0247
.28	1.323	13	.78	2.181	21	.8	44.70	.28	.756	-8	.78	.458	.8	.0224
.29	1.336	14	.79	2.203	23	.9	49.40	.29	.748	-8	.79	.454	.9	.0202
<b>0.30</b>	1.350		<b>0.80</b>	2.226		<b>4.0</b>	54.60	<b>0.30</b>	.741	-8	<b>0.80</b>	.449	<b>4.0</b>	.0183
.31	1.363	13	.81	2.248	22	.1	60.34	.31	.733	-7	.81	.445	.1	.0166
.32	1.377	14	.82	2.270	23	.2	66.69	.32	.726	-7	.82	.440	.2	.0150
.33	1.391	14	.83	2.293	23	.3	73.70	.33	.719	-7	.83	.436	.3	.0136
.34	1.405	14	.84	2.316	24	.4	81.45	.34	.712	-7	.84	.432	.4	.0123
<b>0.35</b>	1.419		<b>0.85</b>	2.340		<b>4.5</b>	90.02	<b>0.35</b>	.705	-7	<b>0.85</b>	.427	<b>4.5</b>	.0111
.36	1.433	14	.86	2.363	24	.6	98.98	.36	.698	-7	.86	.423	.6	.00974
.37	1.448	15	.87	2.387	24	.7	109.7	.37	.691	-7	.87	.419	.7	.00928
.38	1.462	15	.88	2.411	24	.8	122.9	.38	.684	-7	.88	.415	.8	.00891
.39	1.477	15	.89	2.435	25	.9	138.6	.39	.677	-7	.89	.411	.9	.00857
<b>0.40</b>	1.492		<b>0.90</b>	2.460		<b>8.0</b>	2981.	<b>0.40</b>	.670	-6	<b>0.90</b>	.407	<b>8.0</b>	.00835
.41	1.507	15	.91	2.484	25	.9	8103.	.41	.664	-6	.91	.403	.9	.00812
.42	1.522	15	.92	2.509	26	<b>10.0</b>	22026.	.42	.657	-6	.92	.399	<b>10.0</b>	.008045
.43	1.537	16	.93	2.535	25	$\pi/2$	4.810	.43	.651	-6	.93	.395	$\pi/2$	.208
.44	1.553	15	.94	2.560	26	$2\pi/2$	23.14	.44	.644	-6	.94	.391	$2\pi/2$	.0432
<b>0.45</b>	1.568		<b>0.95</b>	2.586		$3\pi/2$	111.3	<b>0.45</b>	.638	-7	<b>0.95</b>	.387	$3\pi/2$	.00898
.46	1.584	16	.96	2.612	26	$4\pi/2$	535.5	.46	.631	-7	.96	.383	$4\pi/2$	.00187
.47	1.600	16	.97	2.638	26	$5\pi/2$	2576.	.47	.625	-6	.97	.379	$5\pi/2$	.000388
.48	1.616	16	.98	2.664	27	$6\pi/2$	12392.	.48	.619	-6	.98	.375	$6\pi/2$	.000081
.49	1.632	17	.99	2.691	27	$7\pi/2$	59610.	.49	.613	-6	.99	.372	$7\pi/2$	.000017
<b>0.50</b>	1.649		<b>1.00</b>	2.718		$8\pi/2$	286751.	<b>0.50</b>	0.607		<b>1.00</b>	.368	$8\pi/2$	.000003

\* Note: Do not interpolate in this column.

$$e = 2.71828 \quad 1/e = 0.367879 \quad \log_{10} e = 0.4343 \quad 1/(0.4343)_e = 2.3026$$

$$\log_{10}(0.4343) = 1.6378 \quad \log_{10}(e^n) = n(0.4343)$$

## NATURAL OR NAPERIAN LOGARITHMS

	0	1	2	3	4	5	6	7	8	9	Mean Differences								
											1	2	3	4	5	6	7	8	9
1-0	0.0000	0099	0198	0296	0392	0488	0583	0677	0770	0862	10	19	29	38	48	57	67	76	86
1-1	0953	1044	1133	1222	1310	1398	1484	1570	1655	1740	9	17	26	35	44	52	61	70	78
1-2	1823	1906	1989	2070	2151	2231	2311	2390	2469	2546	8	16	24	32	40	48	56	64	72
1-3	2624	2700	2776	2852	2927	3001	3075	3148	3221	3293	7	15	22	30	37	44	52	59	67
1-4	3365	3436	3507	3577	3646	3716	3784	3853	3920	3988	6	14	21	28	35	41	48	55	62
1-5	4055	4121	4187	4253	4318	4383	4447	4511	4574	4637	5	13	19	26	32	39	45	52	58
1-6	4700	4762	4824	4886	4947	5008	5068	5128	5188	5247	4	12	18	24	30	36	42	48	55
1-7	5306	5365	5423	5481	5539	5596	5653	5710	5766	5822	3	11	17	24	29	34	40	46	51
1-8	5878	5933	5988	6043	6098	6152	6206	6259	6313	6366	2	11	16	22	27	32	38	43	49
1-9	6419	6471	6523	6575	6627	6678	6729	6780	6831	6881	1	10	15	20	26	31	36	41	46
2-0	6931	6981	7031	7080	7129	7178	7227	7275	7324	7372	5	10	15	20	24	29	34	39	44
2-1	7419	7467	7514	7561	7608	7655	7701	7747	7793	7839	4	9	14	19	23	28	33	37	42
2-2	7885	7930	7975	8020	8065	8109	8154	8198	8242	8286	3	9	13	17	21	26	30	34	38
2-3	8329	8372	8416	8459	8502	8544	8587	8629	8671	8713	2	8	13	17	21	26	30	34	38
2-4	8755	8796	8838	8879	8920	8961	9002	9042	9083	9123	1	8	12	16	20	24	29	33	37
2-5	9163	9203	9243	9282	9322	9361	9400	9439	9478	9517	4	8	12	16	20	24	27	31	35
2-6	9555	9594	9632	9670	9708	9746	9783	9821	9858	9895	3	8	11	15	19	23	26	30	34
2-7	9933	9969	1.0006	0043	0080	0116	0152	0188	0225	0260	2	7	11	15	18	22	25	29	33
2-8	1.0296	0332	0367	0403	0438	0473	0508	0543	0578	0613	1	7	11	14	18	21	25	28	32
2-9	1.0647	0682	0716	0750	0784	0818	0852	0886	0919	0953	3	7	10	14	17	20	24	27	31
3-0	1.0986	1019	1053	1086	1119	1151	1184	1217	1249	1282	3	7	10	13	16	20	23	26	30
3-1	1.1314	1346	1378	1410	1442	1474	1506	1537	1569	1600	2	6	10	13	16	19	22	25	29
3-2	1.1632	1663	1694	1725	1756	1787	1817	1848	1878	1909	1	6	9	12	15	18	22	25	28
3-3	1.1939	1969	2000	2030	2060	2090	2119	2149	2179	2208	3	6	9	12	15	18	21	24	27
3-4	1.2238	2267	2296	2326	2355	2384	2413	2442	2470	2499	2	6	9	12	15	17	20	23	26
3-5	1.2528	2556	2585	2613	2641	2669	2698	2726	2754	2782	1	6	8	11	14	17	20	23	25
3-6	1.2809	2837	2865	2892	2920	2947	2975	3002	3029	3056	3	5	8	11	14	16	19	22	25
3-7	1.3083	3110	3137	3164	3191	3218	3244	3271	3297	3324	2	5	8	11	13	16	19	21	24
3-8	1.3350	3376	3403	3429	3455	3481	3507	3533	3558	3584	1	5	8	10	13	16	18	21	23
3-9	1.3610	3635	3661	3686	3712	3737	3762	3788	3813	3838	3	5	8	10	13	15	18	20	23
4-0	1.3863	3888	3913	3938	3962	3987	4012	4036	4061	4085	2	5	7	10	12	15	17	20	22
4-1	1.4110	4134	4159	4183	4207	4231	4255	4279	4303	4327	1	5	7	10	12	14	17	19	22
4-2	1.4351	4375	4398	4422	4446	4469	4493	4516	4540	4563	2	5	7	9	12	14	16	19	21
4-3	1.4586	4609	4633	4656	4679	4702	4725	4748	4770	4793	1	5	7	9	12	14	16	18	21
4-4	1.4816	4839	4861	4884	4907	4929	4951	4974	4996	5019	2	5	7	9	11	14	16	18	20
4-5	1.5041	5063	5085	5107	5129	5151	5173	5195	5217	5239	1	4	7	9	11	13	15	18	20
4-6	1.5261	5282	5304	5326	5347	5369	5390	5412	5433	5454	2	4	6	9	11	13	15	17	19
4-7	1.5476	5497	5518	5539	5560	5581	5602	5623	5644	5665	1	4	6	8	11	13	15	17	19
4-8	1.5686	5707	5728	5748	5769	5790	5810	5831	5851	5872	2	4	6	8	10	12	14	16	19
4-9	1.5892	5913	5933	5953	5974	5994	6014	6034	6054	6074	1	4	6	8	10	12	14	16	18
5-0	1.6094	6114	6134	6154	6174	6194	6214	6233	6253	6273	2	4	6	8	10	12	14	16	18
5-1	1.6292	6312	6332	6351	6371	6390	6409	6429	6448	6467	1	4	6	8	10	12	14	16	18
5-2	1.6487	6506	6525	6544	6563	6582	6601	6620	6639	6658	2	4	6	8	10	11	13	15	17
5-3	1.6677	6696	6715	6734	6752	6771	6790	6808	6827	6845	1	4	6	7	9	11	13	15	17
5-4	1.6864	6882	6901	6919	6938	6956	6974	6993	7011	7029	2	4	5	7	9	11	13	15	17

## NATURAL OR NAPERIAN LOGARITHMS OF 10<sup>+n</sup>

n	1	2	3	4	5	6	7	8	9
log <sub>e</sub> 10 <sup>n</sup>	2.3026	4.6052	6.9078	9.2103	11.5129	13.8155	16.1181	18.4207	20.7233

## NATURAL OR NAPERIAN LOGARITHMS—Continued

	0	1	2	3	4	5	6	7	8	9	Mean Differences								
											1	2	3	4	5	6	7	8	9
5-5	1-7047	7066	7084	7102	7120	7138	7156	7174	7192	7210	2	4	5	7	9	11	13	14	16
5-6	1-7228	7246	7263	7281	7299	7317	7334	7352	7370	7387	2	4	5	7	9	11	12	14	16
5-7	1-7405	7422	7440	7457	7475	7492	7509	7527	7544	7561	2	3	5	7	9	10	12	14	16
5-8	1-7579	7596	7613	7630	7647	7664	7681	7699	7716	7733	2	3	5	7	9	10	12	14	15
5-9	1-7750	7766	7783	7800	7817	7834	7851	7867	7884	7901	2	3	5	7	8	10	12	13	15
6-0	1-7918	7934	7951	7967	7984	8001	8017	8034	8050	8066	2	3	5	7	8	10	12	13	15
6-1	1-8083	8099	8116	8132	8148	8165	8181	8197	8213	8229	2	3	5	6	8	10	11	13	14
6-2	1-8245	8262	8278	8294	8310	8326	8342	8358	8374	8390	2	3	5	6	8	9	11	13	14
6-3	1-8405	8421	8437	8453	8469	8485	8500	8516	8532	8547	2	3	5	6	8	9	11	13	14
6-4	1-8563	8579	8594	8610	8625	8641	8656	8672	8687	8703	2	3	5	6	8	9	11	12	14
6-5	1-8718	8733	8749	8764	8779	8795	8810	8825	8840	8856	2	3	5	6	8	9	11	12	14
6-6	1-8871	8886	8901	8916	8931	8946	8961	8976	8991	9006	2	3	5	6	8	9	11	12	14
6-7	1-9021	9036	9051	9066	9081	9095	9110	9125	9140	9155	1	3	4	6	7	9	10	12	13
6-8	1-9169	9184	9199	9213	9228	9242	9257	9272	9286	9301	1	3	4	6	7	9	10	12	13
6-9	1-9315	9330	9344	9359	9373	9387	9402	9416	9430	9445	1	3	4	6	7	9	10	12	13
7-0	1-9459	9473	9488	9502	9516	9530	9544	9559	9573	9587	1	3	4	6	7	9	10	11	13
7-1	1-9601	9615	9629	9643	9657	9671	9685	9699	9713	9727	1	3	4	6	7	8	10	11	13
7-2	1-9741	9755	9769	9783	9796	9810	9824	9838	9851	9865	1	3	4	6	7	8	10	11	12
7-3	1-9879	9892	9906	9920	9933	9947	9961	9974	9988	2-0001	1	3	4	5	7	8	10	11	12
7-4	2-0015	0028	0042	0055	0069	0082	0096	0109	0122	0136	1	3	4	5	7	8	9	11	12
7-5	2-0149	0162	0176	0189	0202	0215	0229	0242	0255	0268	1	3	4	5	7	8	9	11	12
7-6	2-0281	0295	0308	0321	0334	0347	0360	0373	0386	0399	1	3	4	5	7	8	9	10	12
7-7	2-0412	0425	0438	0451	0464	0477	0490	0503	0516	0528	1	3	4	5	6	8	9	10	12
7-8	2-0541	0554	0567	0580	0592	0605	0618	0631	0643	0656	1	3	4	5	6	8	9	10	11
7-9	2-0669	0681	0694	0707	0719	0732	0744	0757	0769	0782	1	3	4	5	6	8	9	10	11
8-0	2-0794	0807	0819	0832	0844	0857	0869	0882	0894	0906	1	3	4	5	6	7	9	10	11
8-1	2-0919	0931	0943	0956	0968	0980	0992	1005	1017	1029	1	2	4	5	6	7	9	10	11
8-2	2-1041	1054	1066	1078	1090	1102	1114	1126	1138	1150	1	2	4	5	6	7	9	10	11
8-3	2-1163	1175	1187	1199	1211	1223	1235	1247	1258	1270	1	2	4	5	6	7	8	10	11
8-4	2-1282	1294	1306	1318	1330	1342	1353	1365	1377	1389	1	2	4	5	6	7	8	9	11
8-5	2-1401	1412	1424	1436	1448	1459	1471	1483	1494	1506	1	2	4	5	6	7	8	9	11
8-6	2-1518	1529	1541	1552	1564	1576	1587	1599	1610	1622	1	2	3	5	6	7	8	9	10
8-7	2-1633	1645	1656	1668	1679	1691	1702	1713	1725	1736	1	2	3	5	6	7	8	9	10
8-8	2-1748	1759	1770	1782	1793	1804	1815	1827	1838	1849	1	2	3	5	6	7	8	9	10
8-9	2-1861	1872	1883	1894	1905	1917	1928	1939	1950	1961	1	2	3	4	6	7	8	9	10
9-0	2-1972	1983	1994	2006	2017	2028	2039	2050	2061	2072	1	2	3	4	6	7	8	9	10
9-1	2-2083	2094	2105	2116	2127	2138	2148	2159	2170	2181	1	2	3	4	5	7	8	9	10
9-2	2-2192	2203	2214	2225	2235	2246	2257	2268	2279	2289	1	2	3	4	5	6	8	9	10
9-3	2-2300	2311	2322	2332	2343	2354	2364	2375	2386	2396	1	2	3	4	5	6	7	9	10
9-4	2-2407	2418	2428	2439	2450	2460	2471	2481	2492	2502	1	2	3	4	5	6	7	8	10
9-5	2-2513	2523	2534	2544	2555	2565	2576	2586	2597	2607	1	2	3	4	5	6	7	8	9
9-6	2-2618	2628	2638	2649	2659	2670	2680	2690	2701	2711	1	2	3	4	5	6	7	8	9
9-7	2-2721	2732	2742	2752	2762	2773	2783	2793	2803	2814	1	2	3	4	5	6	7	8	9
9-8	2-2824	2834	2844	2854	2865	2875	2885	2895	2905	2915	1	2	3	4	5	6	7	8	9
9-9	2-2925	2935	2946	2956	2966	2976	2986	2996	3006	3016	1	2	3	4	5	6	7	8	9
10-0	2-3026																		

## NATURAL OR NAPERIAN LOGARITHMS OF 10<sup>-n</sup>

n	1	2	3	4	5	6	7	8	9
log <sub>e</sub> 10 <sup>-n</sup>	5̄-6974	5̄-3948	5̄-0922	5̄-7897	5̄-4871	5̄-1845	5̄-8819	5̄-5793	5̄-2767



## HYPERBOLIC SINES $[\sinh x = \frac{1}{2}(e^x - e^{-x})]$

x	0	1	2	3	4	5	6	7	8	9	Avg. diff.
<b>0.0</b>	.0000	.0100	.0200	.0300	.0400	.0500	.0600	.0701	.0801	.0901	100
1	.1002	.1102	.1203	.1304	.1405	.1506	.1607	.1708	.1810	.1911	101
2	.2013	.2115	.2218	.2320	.2423	.2526	.2629	.2733	.2837	.2941	103
3	.3045	.3150	.3255	.3360	.3466	.3572	.3678	.3785	.3892	.4000	106
4	.4108	.4216	.4325	.4434	.4543	.4653	.4764	.4875	.4986	.5098	110
<b>0.5</b>	.5211	.5324	.5438	.5552	.5666	.5782	.5897	.6014	.6131	.6248	116
6	.6367	.6485	.6605	.6725	.6846	.6967	.7090	.7213	.7336	.7461	122
7	.7586	.7712	.7838	.7966	.8094	.8223	.8353	.8484	.8615	.8748	130
8	.8881	.9015	.9150	.9286	.9423	.9561	.9700	.9840	.9981	1.012	138
9	1.027	1.041	1.055	1.070	1.085	1.099	1.114	1.129	1.145	1.160	15
<b>1.0</b>	1.175	1.191	1.206	1.222	1.238	1.254	1.270	1.286	1.303	1.319	16
1	1.336	1.352	1.369	1.386	1.403	1.421	1.438	1.456	1.474	1.491	17
2	1.509	1.528	1.546	1.564	1.583	1.602	1.621	1.640	1.659	1.679	19
3	1.698	1.718	1.738	1.758	1.779	1.799	1.820	1.841	1.862	1.883	21
4	1.904	1.926	1.948	1.970	1.992	2.014	2.037	2.060	2.083	2.106	22
<b>1.5</b>	2.129	2.153	2.177	2.201	2.225	2.250	2.274	2.299	2.324	2.350	25
6	2.376	2.401	2.428	2.454	2.481	2.507	2.535	2.562	2.590	2.617	27
7	2.646	2.674	2.703	2.732	2.761	2.790	2.820	2.850	2.881	2.911	30
8	2.942	2.973	3.005	3.037	3.069	3.101	3.134	3.167	3.200	3.234	33
9	3.268	3.303	3.337	3.372	3.408	3.443	3.479	3.516	3.552	3.589	36
<b>2.0</b>	3.627	3.665	3.703	3.741	3.780	3.820	3.859	3.899	3.940	3.981	39
1	4.022	4.064	4.106	4.148	4.191	4.234	4.278	4.322	4.367	4.412	44
2	4.457	4.503	4.549	4.596	4.643	4.691	4.739	4.788	4.837	4.887	48
3	4.937	4.988	5.039	5.090	5.142	5.195	5.248	5.302	5.356	5.411	53
4	5.466	5.522	5.578	5.635	5.693	5.751	5.810	5.869	5.929	5.989	58
<b>2.5</b>	6.050	6.112	6.174	6.237	6.300	6.365	6.429	6.495	6.561	6.627	64
6	6.695	6.763	6.831	6.901	6.971	7.042	7.113	7.185	7.258	7.332	71
7	7.406	7.481	7.557	7.634	7.711	7.789	7.868	7.948	8.028	8.110	79
8	8.192	8.275	8.359	8.443	8.529	8.615	8.702	8.790	8.879	8.969	87
9	9.060	9.151	9.244	9.337	9.431	9.527	9.623	9.720	9.819	9.918	96
<b>3.0</b>	10.02	10.12	10.22	10.32	10.43	10.53	10.64	10.75	10.86	10.97	11
1	11.08	11.19	11.30	11.42	11.53	11.65	11.76	11.88	12.00	12.12	12
2	12.25	12.37	12.49	12.62	12.75	12.88	13.01	13.14	13.27	13.40	13
3	13.54	13.67	13.81	13.95	14.09	14.23	14.38	14.52	14.67	14.82	14
4	14.97	15.12	15.27	15.42	15.58	15.73	15.89	16.05	16.21	16.38	16
<b>3.5</b>	16.54	16.71	16.88	17.05	17.22	17.39	17.57	17.74	17.92	18.10	17
6	18.29	18.47	18.66	18.84	19.03	19.22	19.42	19.61	19.81	20.01	19
7	20.21	20.41	20.62	20.83	21.04	21.25	21.46	21.68	21.90	22.12	21
8	22.34	22.56	22.79	23.02	23.25	23.49	23.72	23.96	24.20	24.45	24
9	24.69	24.94	25.19	25.44	25.70	25.96	26.22	26.48	26.75	27.02	26
<b>4.0</b>	27.29	27.56	27.84	28.12	28.40	28.69	28.98	29.27	29.56	29.86	29
1	30.16	30.47	30.77	31.08	31.39	31.71	32.03	32.35	32.68	33.00	32
2	33.34	33.67	34.01	34.35	34.70	35.05	35.40	35.75	36.11	36.48	35
3	36.84	37.21	37.59	37.97	38.35	38.73	39.12	39.52	39.91	40.31	39
4	40.72	41.13	41.54	41.96	42.38	42.81	43.24	43.67	44.11	44.56	43
<b>4.5</b>	45.00	45.46	45.91	46.37	46.84	47.31	47.79	48.27	48.75	49.24	47
6	49.74	50.24	50.74	51.25	51.77	52.29	52.81	53.34	53.88	54.42	52
7	54.97	55.52	56.08	56.64	57.21	57.79	58.37	58.96	59.55	60.15	58
8	60.75	61.36	61.98	62.60	63.23	63.87	64.51	65.16	65.81	66.47	64
9	67.14	67.82	68.50	69.19	69.88	70.58	71.29	72.01	72.73	73.46	71
<b>5.0</b>	74.20										

If  $x > 5$ ,  $\sinh x = \frac{1}{2}(e^x)$  and  $\log_{10} \sinh x = (0.4343)x + 0.6990 - 1$ , correct to four significant figures.

## HYPERBOLIC COSINES [cosh $x = \frac{1}{2}(e^x + e^{-x})$ ]

x	0	1	2	3	4	5	6	7	8	9	Avg. diff.
<b>0.0</b>	1.000	1.000	1.000	1.000	1.001	1.001	1.002	1.002	1.003	1.004	1
1	1.005	1.006	1.007	1.008	1.010	1.011	1.013	1.014	1.016	1.018	2
2	1.020	1.022	1.024	1.027	1.029	1.031	1.034	1.037	1.039	1.042	3
3	1.045	1.048	1.052	1.055	1.058	1.062	1.066	1.069	1.073	1.077	4
4	1.081	1.085	1.090	1.094	1.098	1.103	1.108	1.112	1.117	1.122	5
<b>0.5</b>	1.128	1.133	1.138	1.144	1.149	1.155	1.161	1.167	1.173	1.179	6
6	1.185	1.192	1.198	1.205	1.212	1.219	1.226	1.233	1.240	1.248	7
7	1.255	1.263	1.271	1.278	1.287	1.295	1.303	1.311	1.320	1.329	8
8	1.337	1.346	1.355	1.365	1.374	1.384	1.393	1.403	1.413	1.423	10
9	1.433	1.443	1.454	1.465	1.475	1.486	1.497	1.509	1.520	1.531	11
<b>1.0</b>	1.543	1.555	1.567	1.579	1.591	1.604	1.616	1.629	1.642	1.655	13
1	1.669	1.682	1.696	1.709	1.723	1.737	1.752	1.766	1.781	1.796	14
2	1.811	1.826	1.841	1.857	1.872	1.888	1.905	1.921	1.937	1.954	16
3	1.971	1.988	2.005	2.023	2.040	2.058	2.076	2.095	2.113	2.132	18
4	2.151	2.170	2.189	2.209	2.229	2.249	2.269	2.290	2.310	2.331	20
<b>1.5</b>	2.352	2.374	2.395	2.417	2.439	2.462	2.484	2.507	2.530	2.554	23
6	2.577	2.601	2.625	2.650	2.675	2.700	2.725	2.750	2.776	2.802	25
7	2.828	2.855	2.882	2.909	2.936	2.964	2.992	3.021	3.049	3.078	28
8	3.107	3.137	3.167	3.197	3.228	3.259	3.290	3.321	3.353	3.385	31
9	3.418	3.451	3.484	3.517	3.551	3.585	3.620	3.655	3.690	3.726	34
<b>2.0</b>	3.762	3.799	3.835	3.873	3.910	3.948	3.987	4.026	4.065	4.104	38
1	4.144	4.185	4.226	4.267	4.309	4.351	4.393	4.436	4.480	4.524	42
2	4.568	4.613	4.658	4.704	4.750	4.797	4.844	4.891	4.939	4.988	47
3	5.037	5.087	5.137	5.188	5.239	5.290	5.343	5.395	5.449	5.503	52
4	5.557	5.612	5.667	5.723	5.780	5.837	5.895	5.954	6.013	6.072	58
<b>2.5</b>	6.132	6.193	6.255	6.317	6.379	6.443	6.507	6.571	6.636	6.702	64
6	6.769	6.836	6.904	6.973	7.042	7.112	7.183	7.255	7.327	7.400	70
7	7.473	7.548	7.623	7.699	7.776	7.853	7.932	8.011	8.091	8.171	78
8	8.253	8.335	8.418	8.502	8.587	8.673	8.759	8.847	8.935	9.024	86
9	9.115	9.206	9.298	9.391	9.484	9.579	9.675	9.772	9.869	9.968	95
<b>3.0</b>	10.07	10.17	10.27	10.37	10.48	10.58	10.69	10.79	10.90	11.01	11
1	11.12	11.23	11.35	11.46	11.57	11.69	11.81	11.92	12.04	12.16	12
2	12.29	12.41	12.53	12.66	12.79	12.91	13.04	13.17	13.31	13.44	13
3	13.57	13.71	13.85	13.99	14.13	14.27	14.41	14.56	14.70	14.85	14
4	15.00	15.15	15.30	15.45	15.61	15.77	15.92	16.08	16.25	16.41	16
<b>3.5</b>	16.57	16.74	16.91	17.08	17.25	17.42	17.60	17.77	17.95	18.13	17
6	18.31	18.50	18.68	18.87	19.06	19.25	19.44	19.64	19.84	20.03	19
7	20.24	20.44	20.64	20.85	21.06	21.27	21.49	21.70	21.92	22.14	21
8	22.36	22.59	22.81	23.04	23.27	23.51	23.74	23.98	24.22	24.47	23
9	24.71	24.96	25.21	25.46	25.72	25.98	26.24	26.50	26.77	27.04	26
<b>4.0</b>	27.31	27.58	27.86	28.14	28.42	28.71	29.00	29.29	29.58	29.88	29
1	30.18	30.48	30.79	31.10	31.41	31.72	32.04	32.37	32.69	33.02	32
2	33.35	33.69	34.02	34.37	34.71	35.06	35.41	35.77	36.13	36.49	35
3	36.86	37.23	37.60	37.98	38.36	38.75	39.13	39.53	39.93	40.33	39
4	40.73	41.14	41.55	41.97	42.39	42.82	43.25	43.68	44.12	44.57	43
<b>4.5</b>	45.01	45.47	45.92	46.38	46.85	47.32	47.80	48.28	48.76	49.25	47
6	49.75	50.25	50.75	51.26	51.78	52.30	52.82	53.35	53.89	54.43	52
7	54.98	55.53	56.09	56.65	57.22	57.80	58.38	58.96	59.56	60.15	58
8	60.76	61.37	61.99	62.61	63.24	63.87	64.52	65.16	65.82	66.48	64
9	67.15	67.82	68.50	69.19	69.89	70.59	71.30	72.02	72.74	73.47	71
<b>5.0</b>	74.21										

If  $x > 5$ ,  $\cosh x = \frac{1}{2}(e^x)$  and  $\log_{10} \cosh x = (0.4343)x + 0.6990 - 1$ , correct to four significant figures.

## HYPERBOLIC TANGENTS $[\tanh x = (e^x - e^{-x}) / (e^x + e^{-x}) = \sinh x / \cosh x]$

x	0	1	2	3	4	5	6	7	8	9	Avg. diff.
<b>0.0</b>	.0000	.0100	.0200	.0300	.0400	.0500	.0599	.0699	.0798	.0898	100
1	.0997	.1096	.1194	.1293	.1391	.1489	.1587	.1684	.1781	.1878	98
2	.1974	.2070	.2165	.2260	.2355	.2449	.2543	.2636	.2729	.2821	94
3	.2913	.3004	.3095	.3185	.3275	.3364	.3452	.3540	.3627	.3714	89
4	.3800	.3885	.3969	.4053	.4137	.4219	.4301	.4382	.4462	.4542	82
<b>0.5</b>	.4621	.4700	.4777	.4854	.4930	.5005	.5080	.5154	.5227	.5299	75
6	.5370	.5441	.5511	.5581	.5649	.5717	.5784	.5850	.5915	.5980	67
7	.6044	.6107	.6169	.6231	.6291	.6352	.6411	.6469	.6527	.6584	60
8	.6640	.6696	.6751	.6805	.6858	.6911	.6963	.7014	.7064	.7114	52
9	.7163	.7211	.7259	.7306	.7352	.7398	.7443	.7487	.7531	.7574	45
<b>1.0</b>	.7616	.7658	.7699	.7739	.7779	.7818	.7857	.7895	.7932	.7969	39
1	.8005	.8041	.8076	.8110	.8144	.8178	.8210	.8243	.8275	.8306	33
2	.8337	.8367	.8397	.8426	.8455	.8483	.8511	.8538	.8565	.8591	28
3	.8617	.8643	.8668	.8693	.8717	.8741	.8764	.8787	.8810	.8832	24
4	.8854	.8875	.8896	.8917	.8937	.8957	.8977	.8996	.9015	.9033	20
<b>1.5</b>	.9052	.9069	.9087	.9104	.9121	.9138	.9154	.9170	.9186	.9202	17
6	.9217	.9232	.9246	.9261	.9275	.9289	.9302	.9316	.9329	.9342	14
7	.9354	.9367	.9379	.9391	.9402	.9414	.9425	.9436	.9447	.9458	11
8	.9468	.9478	.9488	.9498	.9508	.9518	.9527	.9536	.9545	.9554	9
9	.9562	.9571	.9579	.9587	.9595	.9603	.9611	.9619	.9626	.9633	8
<b>2.0</b>	.9640	.9647	.9654	.9661	.9668	.9674	.9680	.9687	.9693	.9699	6
1	.9705	.9710	.9716	.9722	.9727	.9732	.9738	.9743	.9748	.9753	5
2	.9757	.9762	.9767	.9771	.9776	.9780	.9785	.9789	.9793	.9797	4
3	.9801	.9805	.9809	.9812	.9816	.9820	.9823	.9827	.9830	.9834	4
4	.9837	.9840	.9843	.9846	.9849	.9852	.9855	.9858	.9861	.9863	3
<b>2.5</b>	.9866	.9869	.9871	.9874	.9876	.9879	.9881	.9884	.9886	.9888	2
6	.9890	.9892	.9895	.9897	.9899	.9901	.9903	.9905	.9906	.9908	2
7	.9910	.9912	.9914	.9915	.9917	.9919	.9920	.9922	.9923	.9925	2
8	.9926	.9928	.9929	.9931	.9932	.9933	.9935	.9936	.9937	.9938	1
2.9	.9940	.9941	.9942	.9943	.9944	.9945	.9946	.9947	.9949	.9950	1
3.	.9951	.9959	.9967	.9973	.9978	.9982	.9985	.9988	.9990	.9992	4
4.	.9993	.9995	.9996	.9996	.9997	.9998	.9998	.9998	.9999	.9999	1
5.	.9999	if x > 5, tanh x = 1.0000 to four decimal places.									

## MULTIPLES OF 0.4343 (0.43429448 = log<sub>10</sub> e)

x	0	1	2	3	4	5	6	7	8	9
0.	0.0000	0.0434	0.0869	0.1303	0.1737	0.2171	0.2606	0.3040	0.3474	0.3909
1.	0.4343	0.4777	0.5212	0.5646	0.6080	0.6514	0.6949	0.7383	0.7817	0.8252
2.	0.8686	0.9120	0.9554	0.9989	1.0423	1.0857	1.1292	1.1726	1.2160	1.2595
3.	1.3029	1.3463	1.3897	1.4332	1.4766	1.5200	1.5635	1.6069	1.6503	1.6937
4.	1.7372	1.7806	1.8240	1.8675	1.9109	1.9543	1.9978	2.0412	2.0846	2.1280
5.	2.1715	2.2149	2.2583	2.3018	2.3452	2.3886	2.4320	2.4755	2.5189	2.5623
6.	2.6058	2.6492	2.6926	2.7361	2.7795	2.8229	2.8663	2.9098	2.9532	2.9966
7.	3.0401	3.0835	3.1269	3.1703	3.2138	3.2572	3.3006	3.3441	3.3875	3.4309
8.	3.4744	3.5178	3.5612	3.6046	3.6481	3.6915	3.7349	3.7784	3.8218	3.8652
9.	3.9087	3.9521	3.9955	4.0389	4.0824	4.1258	4.1692	4.2127	4.2561	4.2995

## MULTIPLES OF 2.3026 (2.3025851 = 1/0.4343)

x	0	1	2	3	4	5	6	7	8	9
0.	0.0000	0.2303	0.4605	0.6908	0.9210	1.1513	1.3816	1.6118	1.8421	2.0723
1.	2.3026	2.5328	2.7631	2.9934	3.2236	3.4539	3.6841	3.9144	4.1447	4.3749
2.	4.6052	4.8354	5.0657	5.2959	5.5262	5.7565	5.9867	6.2170	6.4472	6.6775
3.	6.9078	7.1380	7.3683	7.5985	7.8288	8.0590	8.2893	8.5196	8.7498	8.9801
4.	9.2103	9.4406	9.6709	9.9011	10.1313	10.362	10.592	10.822	11.052	11.283
5.	11.513	11.743	11.973	12.204	12.434	12.664	12.894	13.125	13.355	13.585
6.	13.816	14.046	14.276	14.506	14.737	14.967	15.197	15.427	15.658	15.888
7.	16.118	16.348	16.579	16.809	17.039	17.269	17.500	17.730	17.960	18.190
8.	18.421	18.651	18.881	19.111	19.342	19.572	19.802	20.032	20.263	20.493
9.	20.723	20.954	21.184	21.414	21.644	21.875	22.105	22.335	22.565	22.796

# BESSEL FUNCTIONS

Table I.  
 $J_0(z)$

z	0	0-1	0-2	0-3	0-4	0-5	0-6	0-7	0-8	0-9
0	1-0000	0-9975	0-9900	0-9776	0-9604	0-9385	0-9120	0-8812	0-8463	0-8075
1	0-7652	0-7196	0-6711	0-6201	0-5669	0-5118	0-4554	0-3980	0-3400	0-2818
2	0-2239	0-1666	0-1104	0-0555	0-0025	-0-0484	-0-0968	-0-1424	-0-1850	-0-2243
3	-0-2601	-0-2921	-0-3202	-0-3443	-0-3643	-0-3801	-0-3918	-0-3992	-0-4026	-0-4018
4	-0-3971	-0-3887	-0-3766	-0-3610	-0-3423	-0-3205	-0-2961	-0-2693	-0-2404	-0-2097
5	-0-1776	-0-1443	-0-1103	-0-0758	-0-0412	-0-0068	+0-0270	0-0599	0-0917	0-1220
6	0-1506	0-1773	0-2017	0-2238	0-2433	0-2601	0-2740	0-2851	0-2931	0-2981
7	0-3001	0-2991	0-2951	0-2882	0-2786	0-2663	0-2516	0-2346	0-2154	0-1944
8	0-1717	0-1475	0-1222	0-0960	0-0692	0-0419	0-0146	-0-0125	-0-0392	-0-0653
9	-0-0903	-0-1142	-0-1367	-0-1577	-0-1768	-0-1939	-0-2090	-0-2218	-0-2323	-0-2403
10	-0-2459	-0-2490	-0-2496	-0-2477	-0-2434	-0-2366	-0-2276	-0-2164	-0-2032	-0-1881
11	-0-1712	-0-1528	-0-1330	-0-1121	-0-0902	-0-0677	-0-0446	-0-0213	+0-0020	0-0250
12	0-0477	0-0697	0-0908	0-1108	0-1296	0-1469	0-1626	0-1766	0-1887	0-1988
13	0-2069	0-2129	0-2167	0-2183	0-2177	0-2150	0-2101	0-2032	0-1943	0-1836
14	0-1711	0-1570	0-1414	0-1245	0-1065	0-0875	0-0679	0-0476	0-0271	0-0064
15	-0-0142	-0-0346	-0-0544	-0-0736	-0-0919	-0-1092	-0-1253	-0-1401	-0-1533	-0-1650

## BESSEL FUNCTIONS—Continued

Table 2.  
 $J_1(z)$

z	0	0-1	0-2	0-3	0-4	0-5	0-6	0-7	0-8	0-9
0	0-0000	0-0499	0-0995	0-1483	0-1960	0-2423	0-2867	0-3290	0-3688	0-4059
1	0-4401	0-4709	0-4983	0-5220	0-5419	0-5579	0-5699	0-5778	0-5815	0-5812
2	0-5767	0-5683	0-5560	0-5399	0-5202	0-4971	0-4708	0-4416	0-4097	0-3754
3	0-3391	0-3009	0-2613	0-2207	0-1792	0-1374	0-0955	0-0538	0-0128	— 0-0272
4	— 0-0660	— 0-1033	— 0-1386	— 0-1719	— 0-2028	— 0-2311	— 0-2566	— 0-2791	— 0-2985	— 0-3147
5	— 0-3276	— 0-3371	— 0-3432	— 0-3460	— 0-3453	— 0-3414	— 0-3343	— 0-3241	— 0-3110	— 0-2951
6	— 0-2767	— 0-2559	— 0-2329	— 0-2081	— 0-1816	— 0-1538	— 0-1250	— 0-0953	— 0-0652	— 0-0349
7	— 0-0047	+ 0-0252	0-0543	0-0826	0-1096	0-1352	0-1592	0-1813	0-2014	0-2192
8	0-2346	0-2476	0-2580	0-2657	0-2708	0-2731	0-2728	0-2697	0-2641	0-2559
9	0-2453	0-2324	0-2174	0-2004	0-1816	0-1613	0-1395	0-1166	0-0928	0-0684
10	0-0435	0-0184	— 0-0066	— 0-0313	— 0-0555	— 0-0789	— 0-1012	— 0-1224	— 0-1422	— 0-1603
11	— 0-1768	— 0-1913	— 0-2039	— 0-2143	— 0-2225	— 0-2284	— 0-2320	— 0-2333	— 0-2323	— 0-2290
12	— 0-2234	— 0-2157	— 0-2060	— 0-1943	— 0-1807	— 0-1655	— 0-1487	— 0-1307	— 0-1114	— 0-0912
13	— 0-0703	— 0-0489	— 0-0271	— 0-0052	+ 0-0166	0-0380	0-0590	0-0791	0-0984	0-1165
14	0-1334	0-1488	0-1626	0-1747	0-1850	0-1934	0-1999	0-2043	0-2066	0-2069
15	0-2051	0-2013	0-1955	0-1879	0-1784	0-1672	0-1544	0-1402	0-1247	0-1080

## BESSEL FUNCTIONS—Continued

Table 3.

$J_2(z)$

z	0	0.1	0.2	0.3	0.4	0.5	0.6	0.7	0.8	0.9
0	0.0000	0.0012	0.0050	0.0112	0.0197	0.0306	0.0437	0.0588	0.0758	0.0946
1	0.1149	0.1366	0.1593	0.1830	0.2074	0.2321	0.2570	0.2817	0.3061	0.3299
2	0.3528	0.3746	0.3951	0.4139	0.4310	0.4461	0.4590	0.4696	0.4777	0.4832
3	0.4861	0.4862	0.4835	0.4780	0.4697	0.4586	0.4448	0.4283	0.4093	0.3879
4	0.3641	0.3383	0.3105	0.2811	0.2501	0.2178	0.1846	0.1506	0.1161	0.0813

Table 4.

$J_3(z)$

0	0.0000	0.0000	0.0002	0.0006	0.0013	0.0026	0.0044	0.0069	0.0102	0.0144
1	0.0196	0.0257	0.0329	0.0411	0.0505	0.0610	0.0725	0.0851	0.0988	0.1134
2	0.1289	0.1453	0.1623	0.1800	0.1981	0.2166	0.2353	0.2540	0.2727	0.2911
3	0.3091	0.3264	0.3431	0.3588	0.3734	0.3868	0.3988	0.4092	0.4180	0.4250
4	0.4302	0.4333	0.4344	0.4333	0.4301	0.4247	0.4171	0.4072	0.3952	0.3811

Table 5.

$J_4(z)$

0	0.0000	0.0000	0.0000	0.0000	0.0001	0.0002	0.0003	0.0006	0.0010	0.0016
1	0.0025	0.0036	0.0050	0.0068	0.0091	0.0118	0.0150	0.0188	0.0232	0.0283
2	0.0340	0.0405	0.0476	0.0556	0.0643	0.0738	0.0840	0.0950	0.1067	0.1190
3	0.1320	0.1456	0.1597	0.1743	0.1891	0.2044	0.2198	0.2353	0.2507	0.2661
4	0.2811	0.2958	0.3100	0.3236	0.3365	0.3484	0.3594	0.3693	0.3780	0.3853

# BESSEL FUNCTIONS—Continued

Table 6.

$\rho$	$J_p(1)$	$J_p(2)$	$J_p(3)$	$J_p(4)$	$J_p(5)$	$J_p(6)$	$J_p(7)$	$J_p(8)$	$J_p(9)$	$J_p(10)$	$J_p(11)$	$J_p(12)$	$J_p(13)$	$J_p(14)$
0	+ .7652	+ .2239	— .2401	— .3971	— .1776	+ .1506	+ .3001	+ .1717	— .09033	— .2459	— .1712	+ .04769	+ .2069	+ .1711
0.5	+ .6714	+ .5130	+ .06501	— .3019	— .3422	— .09102	+ .1981	+ .2791	+ .1096	— .1373	— .2406	— .1236	+ .09298	+ .2112
1.0	+ .4401	+ .5767	+ .3391	— .06604	— .3276	— .2767	— .04683	+ .2346	+ .2453	+ .04347	— .1768	— .2234	— .07032	+ .1334
1.5	+ .2403	+ .4913	+ .4777	+ .1853	— .1697	— .3279	— .1991	+ .07593	+ .2545	+ .1980	— .02293	— .2047	— .1937	— .01407
2.0	+ .1149	+ .3528	+ .4861	+ .3641	+ .04657	— .2429	— .3014	— .1130	+ .1448	+ .2546	+ .1390	— .08493	— .2177	— .1520
2.5	+ .04950	+ .2239	+ .4127	+ .4409	+ .2404	— .07295	— .2834	— .2506	— .02477	+ .1967	+ .2343	+ .07242	— .1377	— .2143
3.0	+ .01956	+ .1289	+ .3091	+ .4302	+ .3648	+ .1148	— .1676	— .2911	— .1809	+ .05838	+ .2273	+ .1951	+ .093320	— .1768
3.5	+ .07186	+ .06852	+ .2101	+ .3658	+ .4100	+ .2671	— .03403	— .2326	— .2683	— .09965	+ .1294	+ .2348	+ .1407	— .06245
4.0	+ .02477	+ .03400	+ .1320	+ .2811	+ .3912	+ .3576	+ .1578	— .1054	— .2655	— .2196	— .01504	+ .1825	+ .2193	+ .07624
4.5	+ .0807	+ .01589	+ .07760	+ .1993	+ .3337	+ .3846	+ .2800	+ .04712	— .1839	— .2664	— .1519	+ .06457	+ .2134	+ .1830
5.0	+ .02498	+ .077040	+ .04303	+ .1321	+ .2611	+ .3621	+ .3479	+ .1858	— .05504	— .2341	— .2383	— .07347	+ .1316	+ .2204
5.5	+ .0774	+ .022973	+ .02266	+ .08261	+ .1906	+ .3098	+ .3634	+ .2856	+ .08439	— .1401	— .2538	— .1864	+ .07055	+ .1801
6.0	+ .02094	+ .01202	+ .01139	+ .04909	+ .1310	+ .2458	+ .3392	+ .3376	+ .2043	— .01446	— .2016	— .2437	— .1180	+ .08117
6.5	+ .06	+ .0467	+ .05493	+ .02787	+ .08538	+ .1833	+ .2911	+ .3456	+ .2870	+ .1123	— .1018	— .2354	— .2075	— .04151
7.0	+ .01502	+ .01749	+ .02547	+ .01518	+ .05338	+ .1296	+ .2336	+ .3206	+ .3275	+ .2167	+ .01838	— .1703	— .2406	— .1508
7.5	—	—	—	—	—	+ .08741	+ .1772	+ .2759	+ .3302	+ .2861	+ .1334	— .06865	— .2145	— .2187
8.0	+ .09422	+ .02218	+ .04934	+ .04029	+ .01841	+ .05653	+ .1280	+ .2235	+ .3051	+ .3179	+ .2250	+ .04510	— .1410	— .2320
8.5	—	—	—	—	—	+ .03520	+ .08854	+ .1718	+ .2633	+ .3169	+ .2838	+ .1496	— .04006	— .1928
9.0	+ .05249	+ .02492	+ .08440	+ .09386	+ .05520	+ .02117	+ .05892	+ .1263	+ .2149	+ .2919	+ .3089	+ .2304	+ .06698	— .1143
9.5	—	—	—	—	—	+ .01232	+ .03785	+ .08921	+ .1672	+ .2526	+ .3051	+ .2806	+ .1621	— .01541
10.0	+ .02631	+ .02515	+ .01293	+ .01950	+ .01468	+ .04694	+ .02354	+ .06077	+ .1247	+ .2075	+ .2804	+ .3005	+ .2338	+ .08501

NOTE : 07186 = .007186      0807 = .000807

## NOTES





