

Super

RADIOTRON

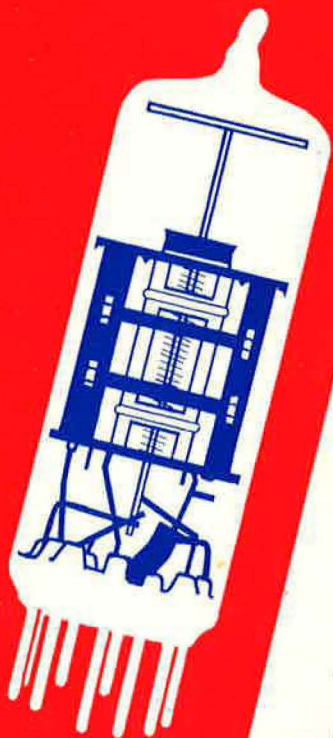
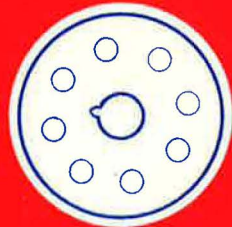
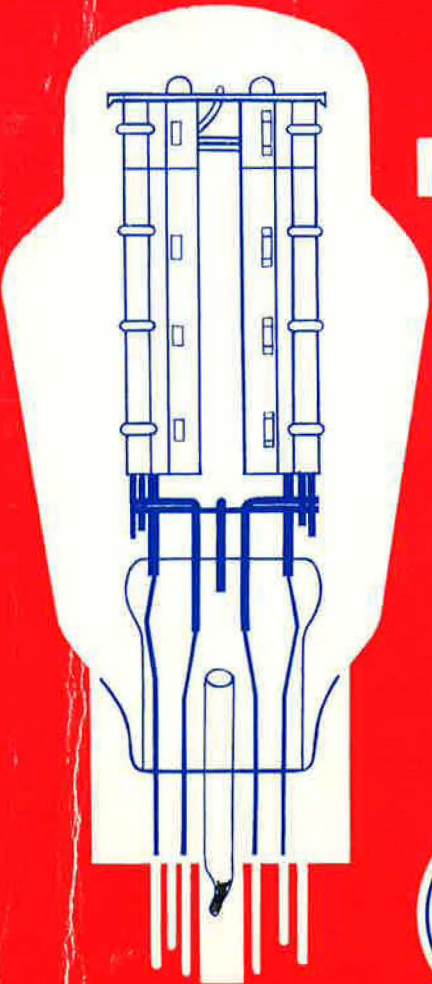

VALVE

MANUAL



PUBL. NO. 17/6d
RVM-4

CONTENTS

RECEIVING VALVES

Technical Data and Base Connections	4
Receiving Valve Equivalents	98

PICTURE TUBES

Picture Tube Data	102
Picture Tube Interchangeability Guide	104

SEMICONDUCTORS

Silicon Rectifier Data	110
Transistor Data	112
Transistor Interchangeability Guide	114

THE SUPER RADIOTRON VALVE MANUAL

First Edition, November, 1961

Second Edition, May, 1962

The information given in this book has been compiled from various sources. Whilst all reasonable efforts have been made to ensure accuracy, no responsibility can be assumed in case of error. Please report all errors to the Technical Editor at the address given below.

Copyright. All Rights Reserved

**AMALGAMATED WIRELESS VALVE CO. PTY. LTD.
47 YORK STREET, SYDNEY**



RECEIVING VALVE DATA

Receiving valves in this manual are classified according to the number of electrodes, as follows:

2 Diode	4B Beam Tetrode
2R Rectifier	5 Pentode
3 Triode	6 Hexode
4 Tetrode	7 Heptode

For valve equivalents, see page 98

TYPE	Class	Use	E_f volts	I_f amps	E_b volts	E_{c2} volts	E_{c1} volts	I_b ma	I_{c2} ma	r_p M Ω	g_m μ mhos	
00A	3	Grid Leak Detector	5.0	0.25	45		0	1.5		0.03	666	$\mu = 20$
01A	3	Class A Amplifier	5.0	0.25	90	—	-4.5	2.5	—	0.011	725	$\mu = 8.0$
					135		-9.0	3.0		0.01	800	$\mu = 8.0$
0A2	2	Voltage Regulator			Starting Voltage = 155 volts Operating Voltage = 150 volts Operating Current = 5.0 to 30 ma							
0A3	2	Voltage Regulator			Starting Voltage = 100 volts Operating Voltage = 75 volts Operating Current = 5.0 to 40.0 ma							
0A4G	3	Relay Tube			Peak Cathode Current = 100 ma Starter Anode Drop = 60 volts DC Cathode Current = 25 ma max.							
0A5	5	Switching			750	Trigger Grid = 90 volts Trigger Grid Res. = 0.25 M Ω Trigger Pulse Voltage = 85 volts						
0B2	2	Voltage Regulator			Starting Voltage = 115 volts Operating Voltage = 108 volts Operating Current = 5.0 to 30 ma							
0B3	2	Voltage Regulator			Starting Voltage = 125 volts Operating Voltage = 90 volts Operating Current = 10.0 to 30 ma							
0C2	2	Voltage Regulator			Starting Voltage = 105 volts Operating Voltage = 75 volts Operating Current = 5.0 to 30 ma							
0C3	2	Voltage Regulator			Starting Voltage = 135 volts Operating Voltage = 105 volts Operating Current = 5.0 to 40 ma							
0D3	2	Voltage Regulator			Starting Voltage = 180 volts Operating Voltage = 150 volts Operating Current = 5.0 to 40 ma							
0G3	2	Voltage Regulator			Starting Voltage = 125 volts Operating Voltage = 85 volts Operating Current = 1.0 to 8.0 ma							
0Y4	2R	Half-wave Rectifier			Max. PIV = 300 volts						Max. Peak I_b = 500 ma	
0Y4G					Max. DC Starting Voltage = 95 volts						Max. DC Output = 75 ma	
					AC Voltage/Plate = 117 volts (rms)							
0Z4	2R, 2R	Full-wave Rectifier			Starting Supply Voltage/Plate = 300 min. peak volts Peak Plate Current = 200 ma max. DC Output Current = 75 ma max. 30 ma min. DC Output Voltage = 300 volts max.							
0Z4A	2R, 2R	Full-wave Rectifier			Starting Supply Volts/Plate = 300 volts (rms) DC Output Current = 110 ma max. 30 ma min.							
0Z4G	2R, 2R	Rectifier			See 0Z4 Characteristics							
1A3	2	Detector Rectifier	1.4	0.15	Max. PIV = 330 volts						Max. DC Output = 0.5 ma	
					Max. Peak Plate Current = 5.0 ma						Max. DC H-K Voltage = 140 v	
1A4P	5	Amplifier	2.0	0.06	See 1D5GP Characteristics							
1A5GT	5	Class A Amplifier	1.4	0.05	85	85	-4.5	3.5	0.7	0.3	800	$R_L = 25K\Omega$ $W_o = 0.10$ watts $R_L = 25 K\Omega$ $W_o = 0.115$ watts
					90	90	-4.5	4.0	0.8	0.3	850	
1A6	7	Converter	2.0	0.06	135	67.5	-3.0	1.2	2.5	0.4	275	$R_{g1} = 50K\Omega$ $I_{c1} = 0.2$ ma
					180	G_{3+5} 67.5	G_4 -3.0	1.3	2.4	0.5	g_c 300	
1A7GT	7	Converter	1.4	0.05	90	G_{3+5} 45	G_4 0		0.7		g_c 250	$E_{c2} = 90$ v, 1.2 ma $R_{g1} = 200 K\Omega$ $I_{c1} = 0.035$ ma

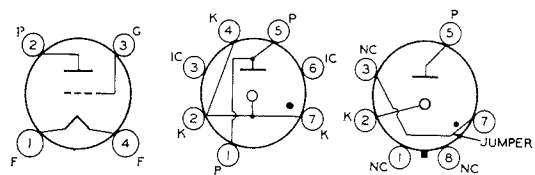

**00-A
01-A**

0A2

0A3

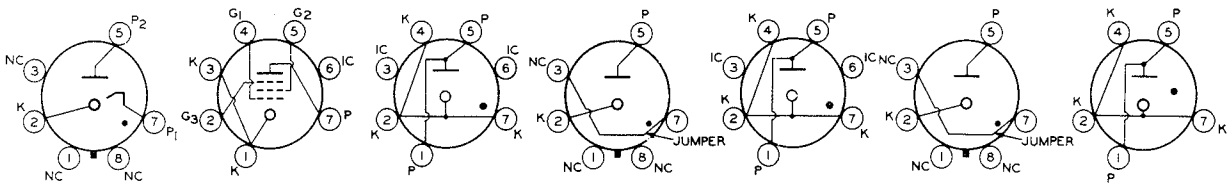

0A4-G

0A5

0B2

0B3

0C2

**0C3
0D3**

0G3

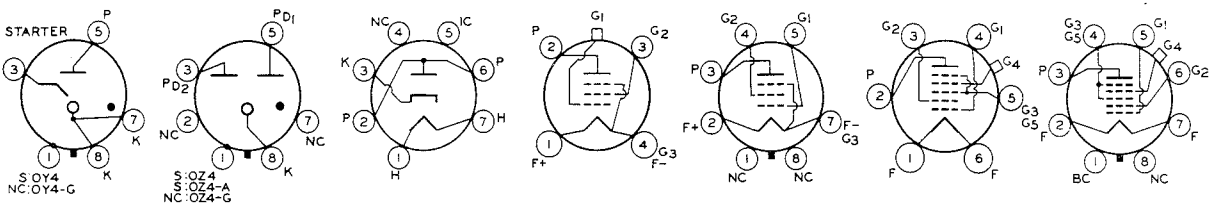

**0Y4
0Y4-G**

**0Z4
0Z4-A
0Z4-G**

1A3

1A4-P

1A5-GT

1A6

1A7-GT

TYPE	Class	Use	E_r volts	I_r amps	E_b volts	E_{c2} volts	E_{c1} volts	I_b ma	I_{c2} ma	r_p M Ω	g_m μ mhos	
1AB5	5	RF Amplifier	1.2	0.13	90 150	90 150	0 -1.5	3.5 6.8	0.8 2.0	0.275 0.125	1100 1350	
1AB6	7	Converter	1.4	0.025	85	G_4 65	G_3 0	0.65	G_4 0.17		g_c 300	$E_{c2} = 35$ v, 1.5 ma $R_{g1} = 27$ K Ω $I_{c1} = 85$ μ a
1AC6	7	Converter	1.4	0.05	85	G_4 60	G_3 0	0.65	0.14	1.0	g_c 325	$E_{c2} = 30$ v, 1.65 ma $R_{g1} = 27$ K Ω $I_{c1} = 0.13$ ma
1AE4	5	RF Amplifier	1.25	0.1	90	90	0	3.5	1.2	0.5	1550	
1AF5	2, 5	Detector Amplifier	1.4	0.025	90	90	0	1.1	0.4	2.0	600	
1AH5	2, 5	Detector Amplifier	1.4	0.025	90	90	0	1.1	0.4	1.6	400	
1AJ4	5	RF Amplifier	1.4	0.025	90	90	0	1.65	0.55	1.0	750	
1AM4	5	RF Amplifier	1.4	0.025	90	67.5	0	2.4	0.9	0.5	350	G_1 voltage for 10 μ mhos = -16 volts
1AQ5	7	Converter	1.4	0.025	90	G_{2+4} 45	G_3 0	0.64	0.8		g_c 250	$R_{g1} = 0.1$ M Ω $I_{c1} = 0.14$ ma
1AR5	2, 5	Amplifier	1.4	0.025	67.5	67.5	0	0.9	0.25	0.8 \ddagger	500	
1AS5	2, 5	Amplifier	1.4	0.025	67.5	67.5	0	0.9	0.25	0.8 \ddagger	500	
1AX2	2R	EHT Rectifier	1.4	0.65	Max. PIV = 25,000 volts				Max. Average Plate Current = 1 ma			
					Max. Peak Plate Current = 11 ma							
1B3GT	2R	EHT Rectifier	1.25	0.2	Max. PIV = 30,000 volts				Max. Average Plate Current = 2 ma			
					Max. Peak Plate Current = 17 ma				Max. Supply Freq. = 300 Kc			
1B4P	5	Amplifier	2.0	0.06	See 1E5GP Characteristics							
1B7GT	7	Converter	1.4	0.10	90	G_4 45	G_3 0	1.5	G_4 1.3	0.35	g_c 350	$E_{c2} = 90$ v, 1.6 ma $R_{g1} = 0.2$ M Ω
1C3	3	Amplifier	1.4	0.05	90	—	0	4.5	—	-0.112 \ddagger	1300	$\mu = 14.5$
					90	—	-3.0	1.4	—	-0.19 \ddagger	760	$\mu = 14.5$
1C4	5	RF Amplifier	2.0	0.12	See 1M5G Characteristics							
1C5GT	7	Class A Amplifier	1.4	0.10	83 90	83 90	-7.0 -7.5	7.0 7.5	1.6 1.6	0.11 0.115	1500 1550	$R_L = 9.0$ K Ω , $W_o = 0.2$ watts, $\mu = 165$ $R_L = 8.0$ K Ω , $W_o = 0.24$ watts, $\mu = 180$
1C6	7	Converter	2.0	0.12	See 1C7G Characteristics							
1C7G	7	Converter	2.0	0.12	135 180	67.5 G_{3+5} 67.5	-3.0 G_4 -3.0	1.3 1.5	2.5 2.0	0.6 0.7	300 g_c 325	$E_{c2} = 180$ v, 4.0 ma $R_{g1} = 50$ K Ω $I_{c1} = 0.2$ ma

\ddagger Approx.

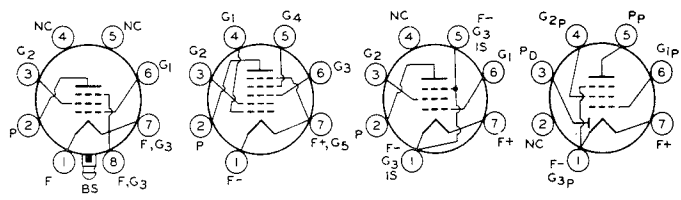

1AB5

1AB6
1AC6

1AE4
1AF4

1AF5
1AH5

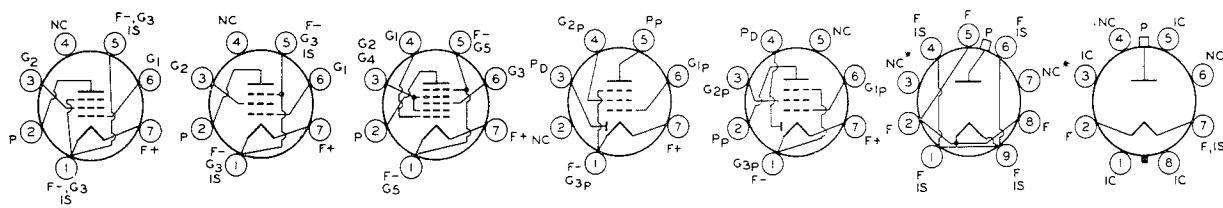

1AJ4

1AM4

1AQ5

1AR5

1AS5

1AX2

1B3-GT

*May be connected to filament, otherwise do not use.

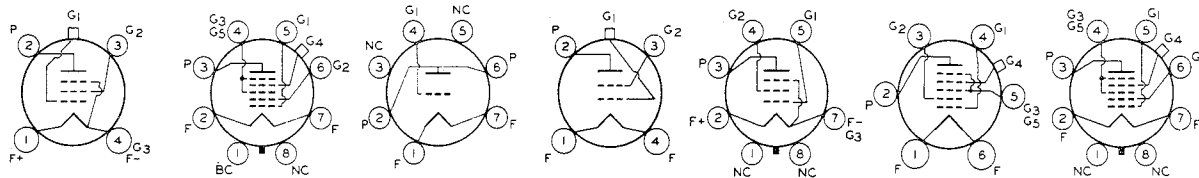

1B4-P

1B7-GT

1C3

1C4

1C5-GT

1C6

1C7-G

TYPE	Class	Use	E_r volts	I_r amps	E_b volts	E_{c2} volts	E_{c1} volts	I_b ma	I_{c2} ma	r_p M Ω	g_m μ mhos	
1D5GP	5	Class A Amplifier	2.0	0.06	90 180	67.5 67.5	$\left. \begin{matrix} -3.0 \\ \text{min.} \end{matrix} \right\}$	2.2 2.3	0.9 0.8	0.6 1.0	720 750	
1D5GT	4	Class A Amplifier	2.0	0.06	180	67.5	-3.0	2.2	0.7	0.6	650	
1D7G	7	Converter	2.0	0.06	See 1A6 Characteristics							
1D8GT	2, 3, 5	Pentode Amplifier	1.4	0.10	90	90	-9.0	5.0	1.0	0.2	925	$R_L = 12.0 \text{ K}\Omega$, $W_o = 0.2 \text{ watts}$
		Triode Amplifier			45	—	0	0.3	—	0.077	325	$\mu = 25$
					90	—	0	1.1	—	0.0435	575	$\mu = 25$
1DN5	2, 5	Class A Amplifier	1.4	0.5	67.5	67.5	0	2.1	0.55	0.6	630	
1E3	3	UHF Amplifier	1.25	0.2	150	—	-3.5	20	—	—	3500	$W_o = 0.45 \text{ watts at } 470 \text{ Mc}$ $\mu = 14$
1E5GP	5	Class A Amplifier	2.0	0.06	90 180	67.5 67.5	-3.0 -3.0	1.6 1.7	0.7 0.6	1.0 1.5	600 650	
1E7GT	5, 5	Class A Amplifier	2.0	0.24	135	135	-7.5	7.0	2.0	—	—	$R_L = 24 \text{ K}\Omega$, $W_o = 0.575 \text{ watts}$
1F4	5	Amplifier	2.0	0.12	See 1F5G Characteristics							
1F5G	5	Class A Amplifier	2.0	0.12	90	90	-3.0	4.0	1.1	0.24	1400	$R_L = 20.0 \text{ K}\Omega$, $W_o = 0.11 \text{ watts}$
					135	135	-4.5	8.0	2.4	0.2	1700	$R_L = 16.0 \text{ K}\Omega$, $W_o = 0.31 \text{ watts}$
1F6	2, 2, 5	Pentode Amplifier	2.0	0.06	See 1F7G Characteristics							
1F7G	2, 2, 5	Pentode RF Amplifier	2.0	0.06	180	67.5	-1.5	2.2	0.7	1.0	650	$R_L = 24.0 \text{ K}\Omega$, $W_o = 0.57 \text{ watts}$
		Pentode AF Amplifier			135	135	-2.0	—	—	—	—	—
1G3GT/ 1B3GT	2R	TV Damper Diode	1.25	0.2	Max. PIV = 26,000 volts (Abs.) Max. Average Plate Current = 0.5 ma Max. Peak Plate Current = 50 ma							
		HV Rect. (RF)			Max. PIV = 33,000 volts (Abs.) Max. Average Plate Current = 1.0 ma Max. Peak Plate Current = 50 ma							
1G4GT	3	Class A Amplifier	1.4	0.05	90	—	-6.0	2.3	—	0.0107	825	$\mu = 8.8$
1G5G	5	Class A Amplifier	2.0	0.12	90	90	-6.0	8.5	2.5	0.133	1500	$R_L = 8.5 \text{ K}\Omega$, $W_o = 0.25 \text{ watts}$
					135	135	-13.5	8.7	2.5	0.16	1550	$R_L = 9.0 \text{ K}\Omega$, $W_o = 0.55 \text{ watts}$
1G6GT	3, 3	Class B Amplifier	1.4	0.10	90	—	0	1.0	—	0.045	675	$R_L = 12,000 \Omega \ddagger$, $\mu = 33$ $W_o = 0.35 \text{ watts}$
1H2	2R	Flyback Half-wave Rectifier	1.4	0.55	Max. PIV = 24,000 volts Max. Peak Plate Current = 50 ma Max. Average Plate Current = 0.5 ma							
1H4G	3	Class A Amplifier	2.0	0.06	90	—	-4.5	2.5	—	0.011	850	$\mu = 9.3$
		Class B Amplifier			180	—	-13.5	3.1	—	0.0103	900	$\mu = 9.3$
					157.5	—	-15.0	1.0	—	$R_L = 8.0 \text{ K}\Omega$, $W_o = 2.1 \text{ watts} \blacktriangledown$		
1H5GT	2, 3	Triode Class A Amplifier	1.4	0.05	90	—	0	0.15	—	0.24	275	$\mu = 65$
1H6G	2, 2, 3	Triode Class A Amplifier	2.0	0.06	135	—	-3.0	0.8	—	0.035	575	$\mu = 20$

▼ Two valves.

⊙ Plate supply voltage.

‡Plate-to-plate.

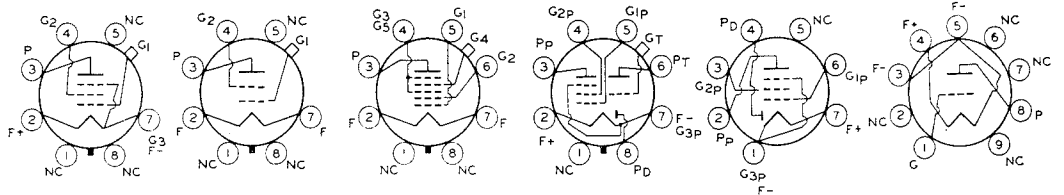

1D5-GP 1D5-GT 1D7-G 1D8-GT 1DN5 1E3

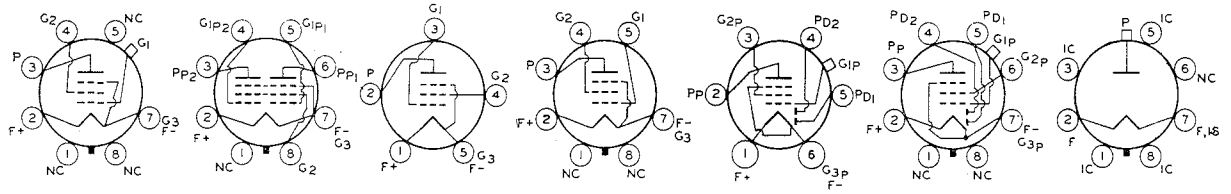

1E5-GP 1E7-GT 1F4 1F5-G 1F6 1F7-G 1G3-GT/1B3-GT

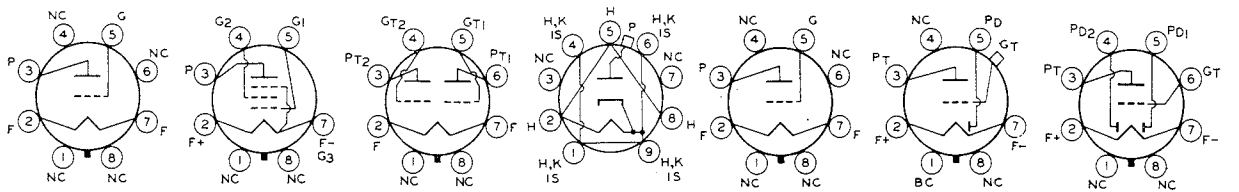

1G4-GT 1G5-G 1G6-GT 1H2 1H4-G 1H5-GT 1H6-G

TYPE	Class	Use	E_f volts	I_f amps	E_b volts	E_{c2} volts	E_{c1} volts	I_b ma	I_{c2} ma	r_p M Ω	g_m μ mhos	
1J3	2R	Flyback Half-wave Rectifier	1.25	0.2	Max. PIV = 26,000 volts Max. Average Plate Current = 0.5 ma Max. Peak Plate Current = 50 ma							
1J5G	5	Class A Amplifier	2.0	0.12	135	135	-16.5	7.0	2.0	0.105	950	$R_L = 13.5 \text{ K}\Omega$, $W_o = 0.45 \text{ watts}$
1J6G 1J6GT	3, 3	Class B Amplifier	2.0	0.24	135 135		0 -3.0	10.0 3.4				$R_L = 10.0 \text{ K}\Omega$, $W_o = 2.1 \text{ watts}$ $R_L = 10.0 \text{ K}\Omega$, $W_o = 1.9 \text{ watts}$
1K3	2R	Flyback Half-wave Rectifier	1.25	0.2	Max. PIV = 26,000 volts Max. Peak Plate Current = 50 ma Max. Average Plate Current = 0.5 ma							
1L4	5	Class A Amplifier	1.4	0.05	90 90	67.5 90	0 0	2.9 4.5	1.2 2.0	0.6 0.35	925 1025	
1L6	7	Converter	1.4	0.05	90	G_{3+5} 45	G_4 0	0.5	0.6	0.65	g_c 300	$E_{c2} = 90 \text{ v}$, 1.2 ma $R_{g1} = 0.2 \text{ M}\Omega$
1LA4	5	Amplifier	1.4	0.05	See 1A5GT Characteristics							
1LA6	7	Converter	1.4	0.05	90	G_{3+5} 45	G_4 0	0.55	0.6	0.75	g_c 250	$E_{c2} = 90 \text{ v}$, 1.2 ma $R_{g1} = 0.2 \text{ M}\Omega$ $I_{c1} = 35 \mu\text{a}$
1LB4	5	Class A Amplifier	1.4	0.05	See 1D8GT Characteristics							
1LC5	5	Class A Amplifier	1.4	0.05	45 90	45 45	0 0	1.10 1.15	0.35 0.30	0.7 1.0	750 775	
1LC6	7	Converter	1.4	0.05	90	G_{3+5} 35	G_4 0	0.75	0.7	0.65	g_c 275	$E_{c2} = 45 \text{ v}$, 1.4 ma $R_{g1} = 0.2 \text{ M}\Omega$ $I_{c1} = 35 \mu\text{a}$
1LD5	2, 5	Pentode Class A Amplifier	1.4	0.05	90	45	0	0.6	0.1	0.75	575	
1LE3	3	Class A Amplifier	1.4	0.05	90 90	— —	0 -3	4.5 1.4	—	0.012 0.019	1300 760	$\mu = 14.5$ $\mu = 14.5$
1LF3	3	Amplifier	1.4	0.05	90		-3	1.4			760	$\mu = 14.5$
1LG5	5	Class A Amplifier	1.4	0.05	90 90	45 90	0 -1.5	1.7 3.7	0.4 0.9	1.0 0.5	800 1150	
1LH4	2, 3	Triode Class A Amplifier	1.4	0.05	See 1H5GT Characteristics							
1LN5	5	Class A Amplifier	1.4	0.05	90	90	0	1.6	0.35	1.1	800	
1N5GT	5	Class A Amplifier	1.4	0.05	90	90	0	1.2	0.3	1.5	750	
1N6G	2, 5	Pentode Class A Amplifier	1.4	0.05	90	90	-4.5	3.4	0.7	0.3	800	$R_L = 25 \text{ K}\Omega$, $W_o = 0.1 \text{ watts}$

† Plate to plate.

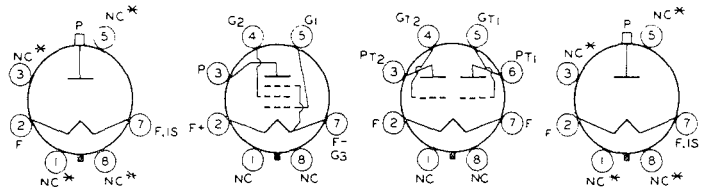

1J3

*May be connected to filament, otherwise do not use.

1J5-G

**1J6-G
1J6-GT**

1K3

*May be connected to filament, otherwise do not use.
Pins 4 and 6 included on some of this type

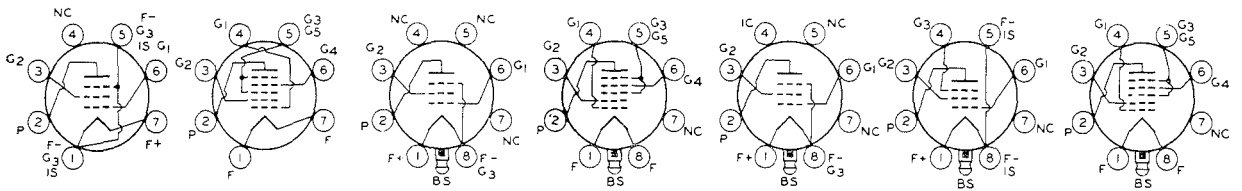

1L4

1L6

1LA4

1LA6

1LB4

1LC5

1LC6

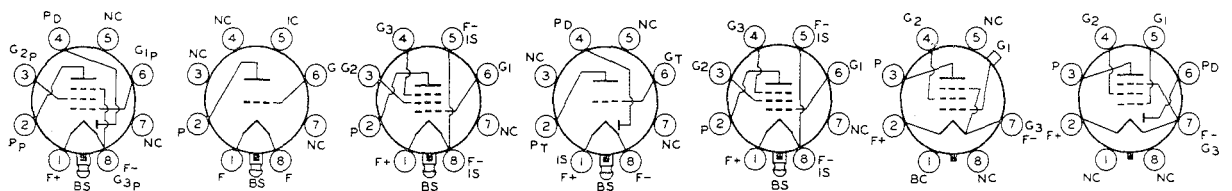

1LD5

**1LE3
1LE3**

1LG5

1LH4

1LN5

1N5-GT

1N6-G

TYPE	Class	Use	E_f volts	I_f amps	E_b volts	E_{c2} volts	E_{c1} volts	I_b ma	I_{c2} ma	r_p M Ω	g_m μ mhos		
1P5GT	5	Class A Amplifier	1.4	0.05	90	90	0	2.3	0.7	0.8	750		
1Q5GT	5	Class A Amplifier	1.4	0.1	90	90	-4.5	9.5	1.3	0.09	2200	$R_L = 8\text{ K}\Omega$, $W_o = 0.27\text{ watts}$	
1R5	7	Converter	1.4	0.05	90 67.5	67.5 G_{2+4} 67.5	0 G_3 0	1.6 1.4	3.2 G_{2+4} 3.2	0.6 0.5	300 g_c 280	$R_{g1} = 100\text{ K}\Omega$ $I_{c1} = 0.25\text{ ma}$	
1S2 1S2A	2R	Pulsed Rectifier	1.4	0.55	Max. PIV = 27,000 volts (Abs.) Average Plate Current = 0.8 ma Peak Plate Current = 40 ma								
1S4	5	Class A Amplifier	1.4	0.1	45 90	45 67.5	-4.5 -7.0	3.8 7.4	0.8 1.4	0.1 0.1	1250 1570	$R_L = 8.0\text{ K}\Omega$, $W_o = 0.065\text{ watts}$ $R_L = 8.0\text{ K}\Omega$, $W_o = 0.27\text{ watts}$	
1S5	2, 5	Pentode Class A Amplifier	1.4	0.05	67.5	67.5		1.6	0.4	0.6	625	$R_{g1} = 10\text{ M}\Omega$ $R_{g2} = 3.1\text{ M}\Omega$	
1T4	5	Class A Amplifier	1.4	0.05	45 90	45 67.5	0 0	1.7 3.5	0.7 1.4	0.35 0.5	700 900		
1T5GT	5	Power Amplifier	1.4	0.05	90	90	-6.0	6.5	0.8	0.25	1150	$R_L = 14\text{ K}\Omega$, $W_o = 0.17\text{ watts}$	
1T6	2, 5	Pentode Class A Amplifier	1.25	0.04	30 45 67.5	30 45 67.5	0 0 0	0.33 0.75 1.6	0.10 0.21 0.4	0.5 0.5 0.4	330 475 600		
1U4	5	Class A Amplifier	1.4	0.05	90	90	0	1.0	0.5	1.0	900		
1U5	2, 5	Pentode Class A Amplifier	1.4	0.05	67.5	67.5	0	1.6	0.4	0.6	625	$R_{g1} = 10\text{ M}\Omega$ $R_{g2} = 3.1\text{ M}\Omega$	
1U6	7	Converter	1.4	0.025	90	G_{3+5} 45	G_4 0	0.55	G_{3+5} 0.55	0.6	g_c 275	$E_{c2} = 90\text{ v}$, 1.1 ma $R_{g1} = 0.2\text{ M}\Omega$ $I_{c1} = 35\text{ }\mu\text{a}$	
1V	2R	Half-wave Rectifier	6.3	0.3	Max. AC Plate Voltage = 325 volts (rms) Max. DC Output Current = 45 ma								
1V2	2R	Half-wave Rectifier	0.625	0.3	Max. PIV = 7500 volts Max. Peak Plate Current = 10 ma Max. Average Plate Current = 0.5 ma								
1W4	5	Power Amplifier	1.4	0.05	90	90	-9.0	5.0	1.0	0.25	925	$R_L = 12.0\text{ K}\Omega$, $W_o = 0.2\text{ watts}$	
1X2	2R	Rectifier	1.25	0.2	Max. PIV = 15,000 volts Max. Average Plate Current = 1 ma								
1X2A	2R	EHT Rectifier	1.25	0.2	Max. PIV = 18,000 volts Max. Peak Plate Current = 10 ma Max. Average Plate Current = 1 ma								
1X2B	2R	EHT Rectifier	1.25	0.2	Max. PIV = 22,000 volts Max. Peak Plate Current = 45 ma Max. Average Plate Current = 0.5 ma								
1Y2	2R	Half-wave Rectifier	1.5	0.29	Max. PIV = 50,000 volts Output Plate Current = 2.0 ma								
1Z2	2R	Half-wave Rectifier	1.5	0.3	Plate Voltage = 7800 volts (rms) DC Output Current = 2.0 ma								
2A3	3	Class A Amplifier	2.5	2.5	250		-45.0	60.0	—	800	5250	$R_L = 2.5\text{ K}\Omega$, $W_o = 3.5\text{ watts}$, $\mu = 4.2$	
		P.P. Class AB1 Amplifier			300 300		* -62 ∇	80.0 ∇ 80.0 ∇		$R_L = 5.0\text{ K}\Omega$, $R_L = 3.0\text{ K}\Omega$, $W_o = 10.0\text{w}\nabla$ $W_o = 15.0\text{w}\nabla$ $R_k = 780\Omega$			

*See quoted value of R_k ∇ Fixed bias ∇ Two valves

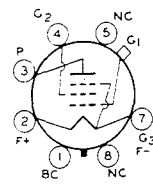

1P5-GT

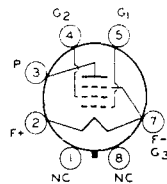

1Q5-GT

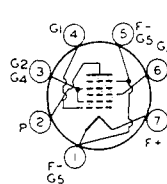

1R5

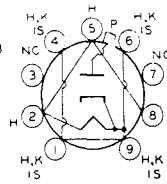

1S2
1S2-A

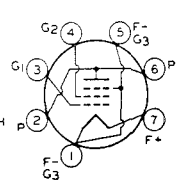

1S4

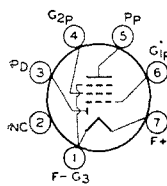

1S5

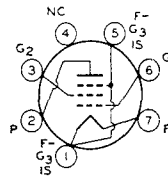

1T4

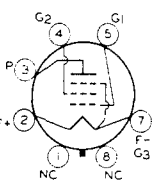

1T5-GT

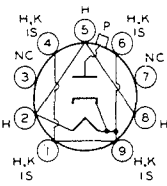

1S2
1S2-A

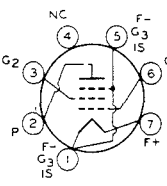

1U4

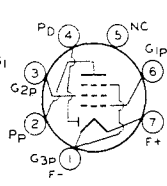

1U5

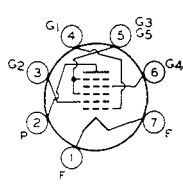

1U6

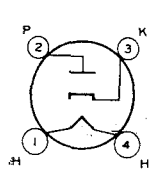

1-v

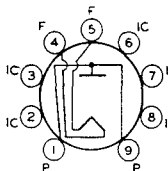

1V2

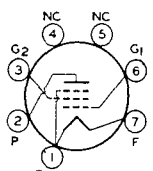

1W4

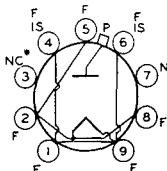

1X2
1X2-A,B

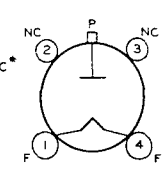

1Y2

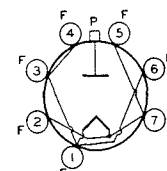

1Z2

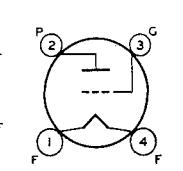

2A3

*May be connected to filament, otherwise do not use.

TYPE	Class	Use	E_f volts	I_f amps	E_b volts	E_{c2} volts	E_{c1} volts	I_b ma	I_{c2} ma	r_p M Ω	g_m μ mhos	
2A4-G	3	Relay Tube	2.5	2.5	Max. PIV = 200 volts Max. Plate Voltage = 200 volts Max. Peak Plate Current = 1.25 amps Max. Average Plate Current = 0.1 amp.							
2A5	5	Amplifier	2.5	1.75	See 6F6G Characteristics							
2A6	2, 2, 3	Triode Amp.	2.5	0.8	See 6SQ7 Characteristics							
2A7	7	Converter	2.5	0.8	See 6A8 Characteristics							
2AF4 2AF4-A 2AF4-B	3	Class A Amp.	2.35	0.6	80		*	16		0.00227	6600	$R_k = 150 \Omega$
		100					20		0.00213	7500		
		UHF Oscillator			100		-4	22	$R_{g1} = 10 \text{ K}\Omega$, $W_o = 160 \text{ mw}$ $I_{c1} = 400 \mu\text{a}$, $R_{g1} = 10 \text{ K}\Omega$			
2B3	2R	Rectifier			Max. PIV = 27,000 volts Max. Output Current = 50 ma							
2B4	3	Relay Tube	2.5	1.4	Tube drop = 19 volts Max. Plate Voltage = 300 volts Max. Peak Plate Current = 300 ma							
2B7	2, 2, 5	Pentode Amplifier	2.5	0.8	See 6B8-G Characteristics							
2BN4	3	VHF Amplifier	2.3	0.6	150		*	9.0		0.0063	6800	$R_k = 220 \Omega$, $\mu = 43$
2BN4A	3	VHF Amplifier	2.35	0.6	See 6BN4-A Characteristics							
2CY5	4	Class A Amplifier	2.4	0.6	125	80	-1.0	10.0	1.5	0.1	8000	
2E5		Tuning Indicator	2.5	0.8	See 6E5 Characteristics							
2EA5	4	VHF Amplifier	2.4	0.6	See 6EA5 Characteristics							
2EN5	2, 2	Phase Comparator	2.1	0.45	Diode current for continual operation = 5.0 ma each plate							
2G5		Tuning Indicator	2.5	0.8	Target Voltage = 250 volts Target Current = 4.0 ma							
2T4	3	UHF Oscillator	2.35	0.6	See 6T4 Characteristics							
2V3-G	2R	Rectifier	2.5	5.0	AC Plate Voltage = 6000 volts (rms) PIV = 16,500 volts DC Output Current = 2.0 ma							
2X2 2X2A	2R	Half-wave Rectifier	2.5	1.75	AC Plate Voltage = 5500 volts (rms) Max. Peak Plate Current = 60 ma DC Output Current = 7.5 ma Max. PIV = 12,500 volts							
2X3G	2R	Rectifier	2.5	2.0	Max. PIV = 1400 volts Max Peak Plate Current = 375 ma							
2Y2	2R	Half-wave Rectifier	2.5	1.75	Max. PIV = 12,000 volts Max. DC Output Current = 5.0 ma							
2Z2	2R	Rectifier	2.5	1.5	Max. AC Plate Voltage = 350 volts (rms) per plate Max. Output Current = 50 ma							
3A2	2R	Half-wave Rectifier	3.15	0.22	Max. PIV = 18,000 volts Max. Peak Plate Current = 80 ma Max. Average Plate Current = 1.5 ma							
3A3	2R	Half-wave Rectifier	3.15	0.22	Max. PIV = 30,000 volts Max. Peak Plate Current = 80 ma Max. Average Plate Current = 1.5 ma							
3A4	5	Power Amplifier	1.4 2.8	0.2 0.1	150	90	-8.4	13.3	2.2	0.1	1900	$R_L = 8.0 \text{ K}\Omega$, $W_o = 0.7 \text{ watts}$
3A5	3, 3	HF Amplifier	1.4 2.8	0.22 0.11	90	—	-2.5	3.7	—	0.0083	1800	At $E_b = 135 \text{ v}$, $I_b = 30 \text{ ma}$, Class C $W_o = 2 \text{ w}$

* See quoted value of R_k .

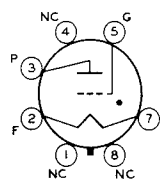

2A4-G

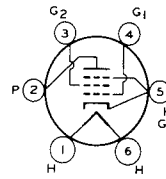

2A5

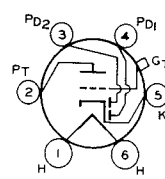

2A6

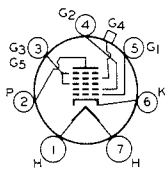

2A7

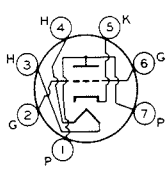

2AF4
2AF4-A
2AF4-B

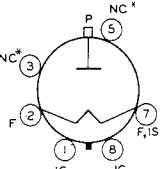

2B3

*May be connected to filament, otherwise do not use.

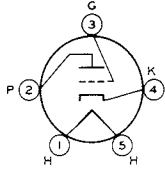

2B4

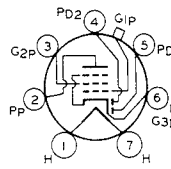

2B7

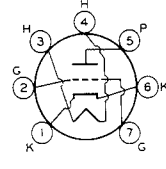

2BN4
2BN4-A

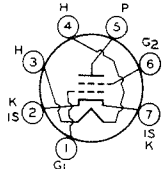

2CY5

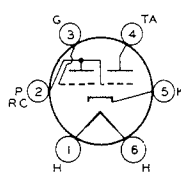

2E5

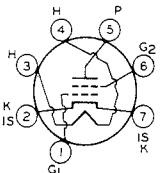

2EA5

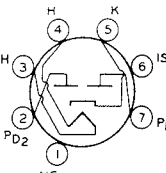

2EN5

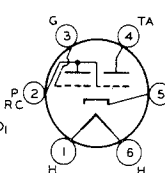

2G5

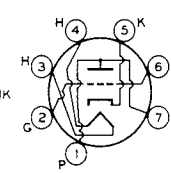

2T4

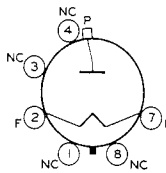

2V3-G

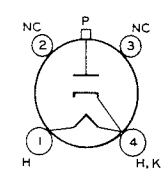

2X2
2X2-A

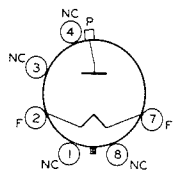

2X3-G

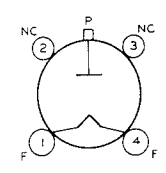

2Y2

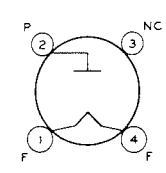

2Z2

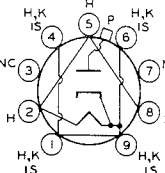

3A2

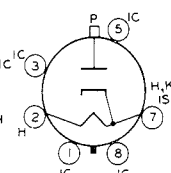

3A3

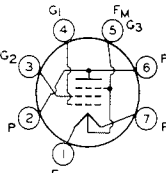

3A4

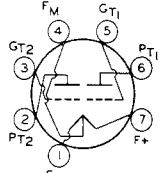

3A5

TYPE	Class	Use	E_r volts	I_r amps	E_b volts	E_{c2} volts	E_{c1} volts	I_b ma	I_{c2} ma	r_p M Ω	g_m μ mhos	
3A8GT	2, 3, 5	Triode Amplifier	1.4	0.1	90	—	0	0.2	—	0.2	325	$\mu = 65$
		Pentode Amplifier	2.8	0.05	90	90	0	1.5	0.5	0.8	750	
3AF4A	3	Amplifier	3.2	0.45	100	—	*	16	—	0.00227	6600	$R_k = 150 \Omega$
		Oscillator			100	—	-4	22	$R_{g1} = 10 \text{ K}\Omega$ $I_{c1} = 400 \mu\text{a}$ Useful $W_o = 160 \text{ mw}$	7500		
3AL5	2, 2	Detector Rectifier	3.15	0.6	Max. PIV = 330 volts Max. DC Output Current/Plate = 9.0 ma Max. Peak H-K = 330 volts Max. Peak Plate Current/Plate = 54 ma							
3AU6	5	Class A Amplifier	3.15	0.6	100	100	*	5.0	2.1	0.5	3900	$R_k = 150 \Omega$
					250	150		10.6	4.3	1.0	5200	$R_k = 68\Omega$
3AV6	2, 2, 3	Triode Amplifier	3.15	0.6	100	—	-1.0	0.5	—	0.08	1250	$\mu = 100$
					250	—	-2.0	1.2	—	0.0625	1600	$\mu = 100$
3B2	2R	EHT Rectifier	3.15	0.22	Max. PIV = 35,000 volts Max. Average Plate Current = 1.1 ma Max. DC Inverse Voltage = 25,000 volts Max. Peak Plate Current = 80 ma							
3B4	5	VHF Power Amp.	2.5	0.165	150	135	-75	—	—	—	1700	$W_o = 1.25 \text{ watts}$
			1.25	0.330								
3B5GT	5	Power Amplifier	1.4	0.10	45	45	-4.5	4.4	0.3	0.1	1400	$R_L = 8.0 \text{ K}\Omega$, $W_o = 0.07 \text{ watts}$ $R_L = 5.0 \text{ K}\Omega$, $W_o = 0.18 \text{ watts}$
			2.8	0.05	67.5	67.5	-7.0	6.7	0.5	0.1	1500	
3BA6	5	RF Amplifier	3.15	0.6	See 6BA6 Characteristics							
3BC5	5	Class A Amplifier	3.15	0.6	250	150	*	7.5	2.1	0.8	5700	$R_k = 180 \Omega$
3BE6	7	Converter	3.15	0.6	See 6BE6 Characteristics							
3BN4	3	VHF Amplifier	3.0	0.45	150	—	*	9.0	—	0.0063	6800	$R_k = 220 \mu = 43$
3BN4A	3	VHF Amplifier	3.0	0.45	See 6BN4A Characteristics							
3BN6	5	Limiter and Discriminator	3.15	0.6	Max. DC Plate Voltage = 300 volts Max. Pos. Peak G_1 Voltage = 55 volts Max. G_2 Voltage = 100 volts Max. Peak H-K Voltage = 90 volts Max. Cathode Current = 11.5 ma							
3BU8	5, 5	Class A Amplifier	3.15	0.6	100	67.5	■	2.2	3.3	—	180	$E_{c3} = 0$
3BY6	7	Sync. Sep. and Sync. Clipper	3.15	0.6	10	25	0	1.4	3.5	—	—	$E_{c3} = 0$
3BZ6	5	Class A Amplifier	6.3	0.3	200	150	*	11	2.6	0.6	6100	$R_k = 180 \Omega$
3C2	2R	Half-wave Rectifier	3.5	0.21	Max. PIV = 33,000 volts Max. Peak Output Current = 80 ma Max. Average Plate Current = 1.1 ma							
3C4	5	Power Amplifier	1.4	0.05	85	85	-5.2	5.0	1.1	0.125	1350	$R_L = 13 \text{ K}\Omega$, $W_o = 0.2 \text{ watts}$
3C5GT	5	Power Amplifier	1.4	0.1	90	90	-9.0	6.0	1.4	—	1550	$R_L = 8.0 \text{ K}\Omega$, $W_o = 0.24 \text{ watts}$ $R_L = 10.0 \text{ K}\Omega$, $W_o = 0.26 \text{ watts}$
			2.8	0.05	90	90	-9.0	6.0	1.4	—	1450	
3CB6	5	Class A Amplifier	3.15	0.6	200	150	—	9.5	2.8	0.6	6200	$R_k = 180 \Omega$
3CE5	5	RF Amplifier	3.15	0.6	See 6CE5 Characteristics							
3CF6	5	Class A Amplifier	3.15	0.6	200	150	-6.5	9.5	2.8	0.6	6200	$R_k = 180 \Omega$

* See quoted value of R_k .■ Adjusted for $I_{g1} = 100 \mu\text{a}$ dc.

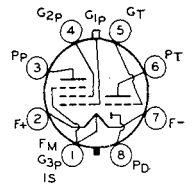

3A8-GT

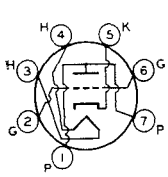

3AF4-A

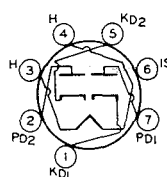

3AL5

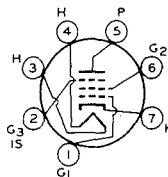

3AU6

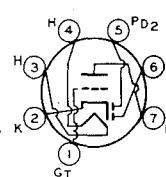

3AV6

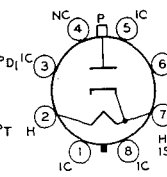

3B2

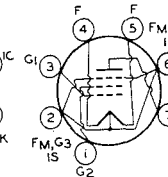

3B4

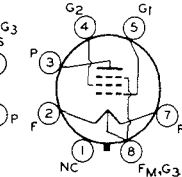

3B5-GT

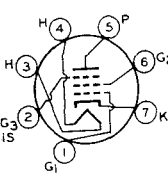

3BA6

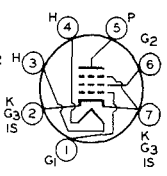

3BC5

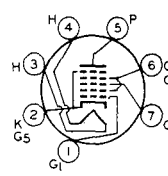

3BE6

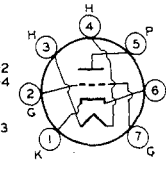

**3BN4
3BN4-A**

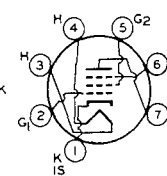

3BN6

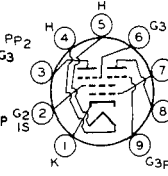

3BU8

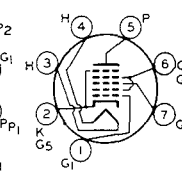

3BY6

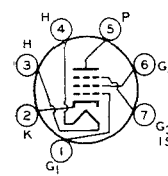

3BZ6

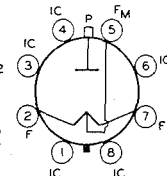

3C2

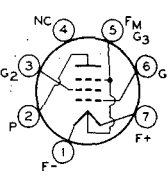

3C4

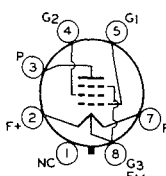

3C5-GT

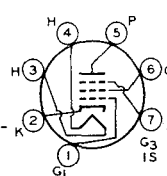

3CB6

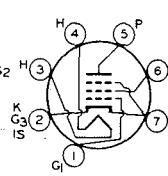

3CE5

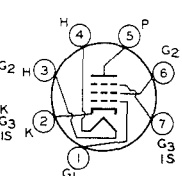

3CF6

TYPE	Class	Use	E_r volts	I_r amps	E_b volts	E_{c2} volts	E_{c1} volts	I_b ma	I_{c2} ma	r_p M Ω	g_m μ mhos	
3CS6	7	Sync. Sep. and Sync. Clipper	3.15	0.6	10	30		2.0	4.5	G_3 Volts = 0 G_1 Volts = 0		
		Class A Amp.			100 100	30 30	-1.0 0	0.8 1.0	5.5 1.3	0.7 1.0	— 1100	
3CY5	4	Class A Amplifier	2.9	0.45	125	80	-1.0	10	1.5	0.1	8000	
3D6	5	Power Amplifier	2.8	0.110	150	90	-4.5	10.2	1.8		2400	$R_L = 14.0$ K Ω ,
			1.4	0.220	150	135	-20.0	23.0	6.0			
3DK6	5	IF Amplifier	3.15	0.6	125	125	*	12.0	3.8		9800	$R_k = 56$ Ω
3DT6	5	Class A Amp.	3.15	0.6	150	100	*	1.1	2.1	0.15	615	$R_k = 560$ Ω
		FM Detector			250	100	*	0.22	5.5	G_3 Volts = -6 $R_L = 270$ K Ω $R_k = 560$ Ω		
3E5	5	Power Amplifier	1.4	0.05	90	90	-8.0	6.0	1.5	0.14	1200	$R_L = 8.0$ K Ω ,
			2.8	0.025	90	90	-8.0	5.5	1.5	0.12	1100	$W_o = 0.2$ watts $R_L = 8.0$ K Ω ,
3E6	5	Voltage Amplifier	1.4	0.1	90	90	0	4.2	1.7	0.25	2000	
			2.8	0.05	90	90	0	2.9	1.2	0.325	1700	
3EA5	4	VHF Amplifier	2.9	0.45	See 6EA5 Characteristics							
3LE4	5	Power Amplifier	2.8	0.05	90	90	-9.0	9.0	1.8	0.11	1600	$R_L = 6.0$ K Ω ,
			1.4	0.10	90	90	-9.0	10.0	2.0	0.10	1750	$W_o = 0.3$ watts $R_L = 6.0$ K Ω ,
3LF4	5	Class A Amplifier	1.4	0.1	See 3Q5GT Characteristics							
			2.8	0.05								
3Q4	5	Class A Amplifier	1.4	0.1	See 3V4 Characteristics							
			2.8	0.05								
3Q5G 3Q5GT	5	Class A Amplifier	1.4	0.1	110	110	-6.6	10.0	1.4	0.1	2200	$R_L = 8.0$ K Ω ,
			2.8	0.05	110	110	-6.6	8.5	1.1	0.11	2000	$W_o = 0.4$ watts $R_L = 8.0$ K Ω ,
3S4	5	Class A Amplifier	1.4	0.1	90	67.5	-7.0	7.4	1.4	0.1	1575	$R_L = 8.0$ K Ω ,
			2.8	0.05	90	67.5	-7.0	6.1	1.1	0.1	1425	$W_o = 0.27$ watts $R_L = 8.0$ K Ω ,
3V4	5	Power Amplifier	1.4	0.1	90	90	-4.5	9.5	2.1	0.1	2150	$R_L = 10$ K Ω ,
			2.8	0.05	90	90	-4.5	7.7	1.7	0.12	2000	$W_o = 0.27$ watts $R_L = 10$ K Ω ,
3W4	5	Power Amplifier	1.4	0.05	85	85	-5.2	6.8	1.4	0.15	1700	$R_L = 11.0$ K Ω ,
			2.8	0.025								$W_o = 0.25$ watts
3Z4	5	Power Amplifier	1.4	0.05	67.5	67.5	-7.0	6.5	1.3	0.1	1450	$R_L = 8.0$ K Ω ,
			2.8	0.025								$W_o = 0.21$ watts
4AU6	5	Class A Amplifier	4.2	0.45	100	100	*	5.0	2.1	0.5	3900	$R_k = 150$ Ω
					250	150		10.6	4.3	1.0	5200	$R_k = 68$ Ω
4BA6	5	RF Amplifier	4.2	0.45	See 6BA6 Characteristics							
4BC5	5	Class A Amplifier	4.2	0.45	100	100	*	4.7	1.4	0.6	4900	$R_k = 180$ Ω
					250	150		7.5	2.1	0.8	5700	
4BC8	3, 3	Class A Amplifier	4.2	0.6	150		*	10.0		—	6200	$R_k = 220$ Ω , μ 35
4BE6	7	Converter	4.2	0.45	See 6BE6 Characteristics							
4BN4	3	VHF Amplifier	4.2	0.3	See 6BN4 Characteristics							

*See quoted value of R_k

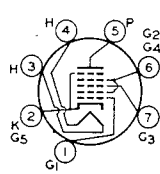

3CS6

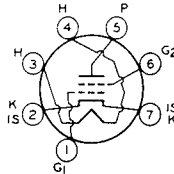

3CY5

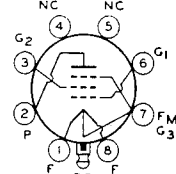

3D6

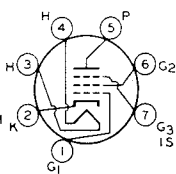

3DK6

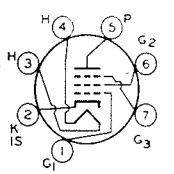

3DT6

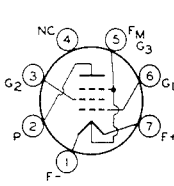

3E5

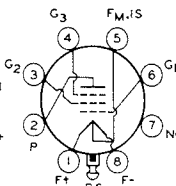

3E6

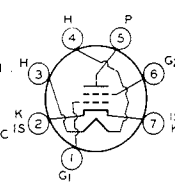

3EA5

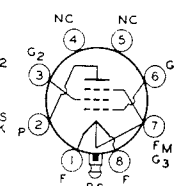

3LE4
3LF4

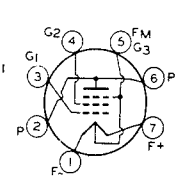

3Q4

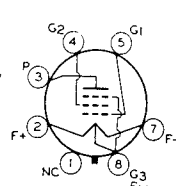

3Q5-G
3Q5-GT

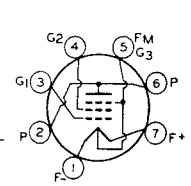

3S4

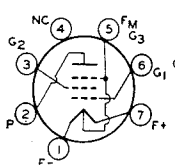

3V4

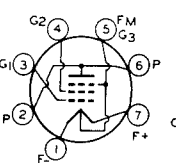

3W4
3Z4

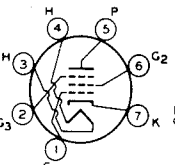

4AU6
4BA6

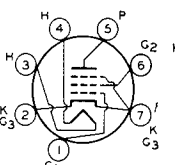

4BC5

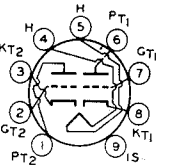

4BC8

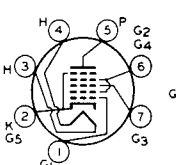

4BE6

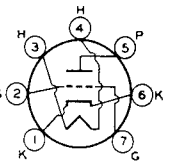

4BN4

TYPE	Class	Use	E_f volts	I_f amps	E_b volts	E_{c2} volts	E_{c1} volts	I_b ma	I_{c2} ma	r_p M Ω	g_m μ mhos	
4BN6	5	Quad. FM Det.	4.2	0.45	See 6BN6 Characteristics							
4BQ7A	3, 3	Class A Amplifier	4.2	0.6	150		*	9.0		6100	6400	$R_k = 220 \Omega$ Cutoff Volts = -10
4BS8	3, 3	Cascode Amp.	4.5	0.6	250	—	-1.0	16		—	10,000	
		Class A Amplifier			150	—	*	10		0.005	7200	$R_k = 220 \Omega$
4BU8	5, 5	Sync. AGC	4.2	0.45	100	67.5	■	2.2	3.3		180	$E_{c3} = 0$
4BX8	3, 3	Cascode Amplifier	4.2	0.6	65		-1.0	9.0			6700	$\mu = 25$
4BZ6	5	RF Amplifier	4.2	0.45	See 6BZ6 Characteristics							
4CB6	5	Class A Amp.	4.2	0.45	200	150	*	9.5	2.8	0.6	6200	$R_k = 180 \Omega$
4CE5	5	RF Amplifier	4.2	0.45	125	125		11.0	2.8	0.3	7600	
4CS6	7	Sync. Sep.	4.2	0.45	See 6CS6 Characteristics							
4CX7	3, 3	Cascode Amp.	4.2	0.6	150		*	9.0			6400	$R_k = 220 \Omega, \mu = 39$
4CY5	4	Class A Amplifier	4.5	0.3	125	80	-1.0	10	1.5	0.1	8000	
4DE6	5	VHF Amplifier	4.2	0.5	See 6DE6 Characteristics							
4DK6	5	VHF Amplifier	4.2	0.45	See 6DK6 Characteristics							
4DT6	5	Class A Amp.	4.2	0.45	150	100	*	1.1	2.1	0.15	515	$R_k = 560 \Omega$
		FM Det.			250	100	*	0.22	5.5			G_3 volts = -6, $R_k = 560 \Omega$ $R_L = 270 K\Omega$
4ES8	3, 3	VHF Amplifier	4.0	0.6	See 6ES8 Characteristics							
5A6	5	Class B Amp.	5.0	0.23	150	139.5	-15	40	7.0			$W_o = 2.8$ watts
		Class C Amp.	2.5	0.46	150	150	-24	40	11.0			$W_o = 3.1$ watts
5AM8	2, 5	Amplifier Detector	4.7	0.6	200	150	*	11.5	2.7		7000	$R_k = 120 \Omega$
					Diode Unit: Max. DC Plate Curr. = 5.0 ma							
5AN8	3, 5	Amplifier	4.7	0.6	See 6AN8 Characteristics							
5AQ5	5	Amplifier	4.7	0.6	See 6AQ5 Characteristics							
5AR4	2R, 2R	Full-wave Rectifier	5.0	1.9	Max. PIV = 1500 volts Peak Plate Current/Plate = 750 ma Max. DC Output Current = 250 ma							
5AS4	2R, 2R	Full-wave Rectifier	5.0	3.0	Max. AC Volts/Plate = 550 volts Max. DC Output = 275 ma							
5AS4A					Max. PIV = 1550 volts Max. Peak lb./Plate = 1.0 amp							
5AS8	2, 5	Amplifier Detector	4.7	0.6	See 6AS8 Characteristics							
5AT8	3, 5	Triode Osc.	4.7	0.6	150			13		$R_{g1} = 2700 \Omega, W_o = 0.5$ watts†		
		Pentode Mixer			150	150	-3.5	6.2	1.8	$g_c = 2100 \mu$ mhos		
5AU4	2R, 2R	Full-wave Rectifier	5.0	4.5	Max. PIV = 1400 volts Peak Plate Current/Plate = 1075 ma DC Output Current = 325 ma							
5AV8	3, 5	Triode Amp.	4.7	0.6	200		-6.0	13	—	0.00575	3300	$\mu = 19$
		Pent. Amplifier			200	150	*	9.5	2.8	0.3	6200	$R_k = 180 \Omega$
5AW4	2R, 2R	Full-wave Rectifier	5.0	4.0	Max. PIV = 1550 volts Peak Plate Current/Plate = 750 ma DC Output Current = 250 ma							
5AZ4	2R, 2R	Full-wave Rectifier	5.0	2.0	See 5Y3GT Characteristics							
5B8	3, 5	Triode Amp.	4.7	0.6	200		-6.0	13		0.0057	3300	$\mu = 19$
		Pent. Amplifier			200	150	*	9.5	2.8	0.3	6200	$R_k = 180 \Omega$

*See quoted value of R_k .

†Approx.

■Adjusted for $I_{g1} = 100 \mu$ a dc.

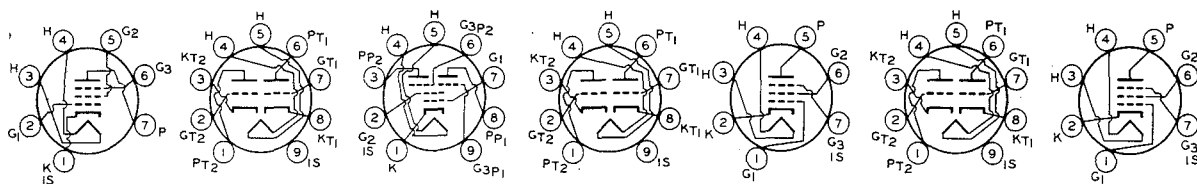

4BN6

**4BQ7-A
4BS8**

4BU8

4BX8

4BZ6

**4BZ7
4BZ8**

4CB6

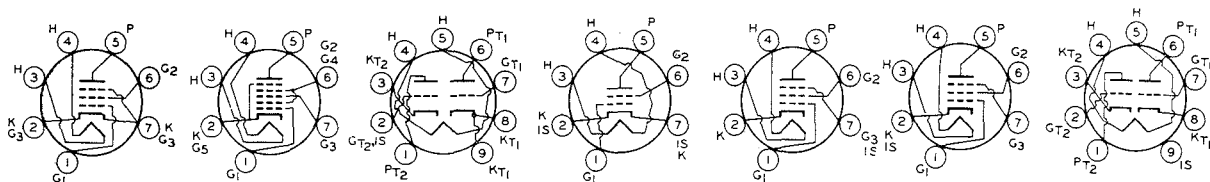

4CE5

4CS6

4CX7

4CY5

**4DE6
4DK6**

4DT6

4ES8

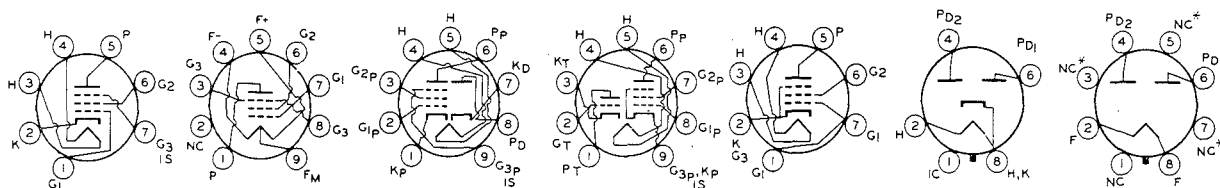

4EW6

5A6

5AM8

5AN8

5AQ5

5AR4

**5AS4
5AS4-A**

*Pin omitted on some of these types.

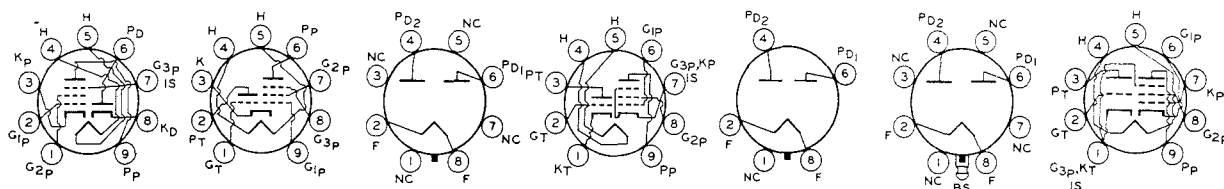

5AS8

5AT8

5AU4

5AV8

**5AW4
5AX4-GT**

5AZ4

5B8

TYPE	Class	Use	E _f volts	I _f amps	E _b volts	E _{c2} volts	E _{c1} volts	I _b ma	I _{c2} ma	Γ _p MΩ	g _m μmhos	
5BE8	3, 5	Triode Osc.	4-7	0-6	150		*	18		0-005	8500	R _k = 56 Ω
		Pent. Amplifier			250	110	*	10	3-5	0-4	5200	R _k = 68 Ω
5BK7A	3, 3	Class A Amplifier	4-7	0-6	150		*	18		0-0046	9300	R _k = 56 Ω, Cutoff Volts = -11
5BQ7A	3, 3	Class A Amplifier	5-6	0-45	150		*	9-0		0-0061	6400	R _k = 220 Ω, μ = 39 Cutoff Volts = -10
5BR8	3, 5	Osc. Mixer	4-7	0-6	See 6BR8 Characteristics							
5BS8	3, 3	Amplifier	5-6	0-45	See 6BS8 Characteristics							
5BT8	2, 2, 5	Amp. Detector	4-7	0-6	See 6BT8 Characteristics							
5BW8	2, 2, 5	RF, IF Amp.	4-7	0-6	See 6BW8 Characteristics							
5BZ7	3, 3	RF Amplifier	5-6	0-45	150		*	10-0		0-0056	6800	R _k = 220 Ω
5CG4	2R, 2R	Full-wave Rectifier	5-0	2-0	Max. PIV = 1400 volts Max. Peak Plate Current/Plate = 400 ma DC Output Current = 125 ma (Max.)							
5CG8	3, 5	Osc. Converter	4-7	0-6	See 6CG8 Characteristics							
5CL8	3, 4	Osc. Converter	4-7	0-6	See 6CL8 Characteristics							
5CL8A	3, 4	VHF Oscillator	4-7	0-6	See 6CL8A Characteristics							
		VHF Amplifier										
5CM6	5	Power Amplifier	4-7	0-6	See 6CM6 Characteristics							
5CM8	3, 5	Class A Amplifier	4-7	0-6	See 6CM8 Characteristics							
5CQ8	3, 4	Tri. Osc. Pent. Amp.	4-7	0-6	See 6CQ8 Characteristics							
5CR8	3, 5	Triode Amplifier Pent. Amplifier	4-7	0-6	See 6CR8 Characteristics							
5CZ5	5	Vert. Defl. Amp.	4-7	0-6	See 6CZ5 Characteristics							
5DH8	3, 5	Triode Vert. Osc.	5-2	0-6	250		*	7-3		0-012	4400	R _k = 390 Ω, μ = 53
		Pent. Vid. Amp.			125	125	*	13-5	3-8	0-15	8600	R _k = 56 Ω
5EA8	3, 5	Triode VHF Amp. Pent. VHF Amp.	4-7	0-6	See 6EA8 Characteristics							
5J6	3, 3	Class A Amp.	4-7	0-6	100		*	8-5	—	0-0071	5300	R _k = 50 Ω
		PP Class C			150		-10	30				W _o = 3-5 watts
5R4G	2R, 2R	Full-wave Rectifier	5-0	2-0	Max. PIV = 2800 volts Max. Peak Plate Current/Plate = 650 ma DC Output Current = 250 ma (max)							
5R4GY 5R4GYA 5R4GYB	2R, 2R	Full-wave Rectifier	5-0	2-0	Max. PIV = 2800 volts Max. Peak Plate Current/Plate = 650 ma DC Output Current = 150 ma (max.)							
5T4	2R, 2R	Full-wave Rectifier	5-0	2-0	Max. PIV = 1500 volts Max. Peak Plate Current/Plate = 675 ma Max. DC Output = 225 ma							
5T8	2, 2, 2, 3	Det. Amplifier	4-7	0-6	100	—	-1-0	0-8	—	0-054	1300	μ = 70
					250	—	-3-0	1-0	—	0-058	1200	μ = 70
5U4G	2R, 2R	Full-wave Rectifier	5-0	3-0	Max. PIV = 1550 volts Max. Peak Plate Current/Plate = 675 ma Max. DC Output = 225 ma							
5U4GB	2R, 2R	Full-wave Rectifier	5-0	3-0	Max. PIV = 1550 volts Max. Peak Plate Current/Plate = 1000 ma Max. DC Output Current = 250 ma							

*See quoted value of R_k

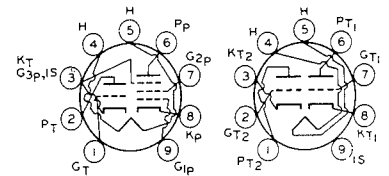

5BE8

**5BK7-A
5BQ7-A**

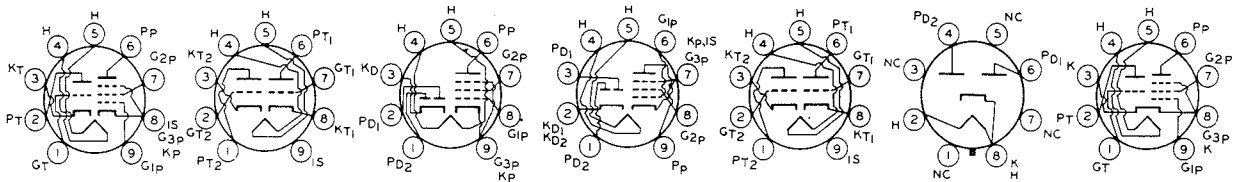

5BR8

5BS8

5BT8

5BW8

5BZ7

5CG4

5CG8

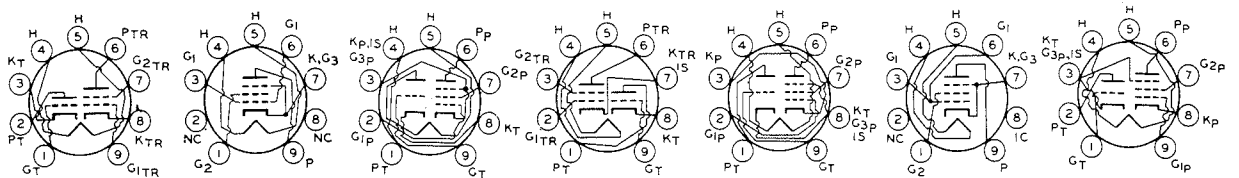

**5CL8
5CL8-A**

5CM6

5CM8

5CQ8

5CR8

5CZ5

5DH8

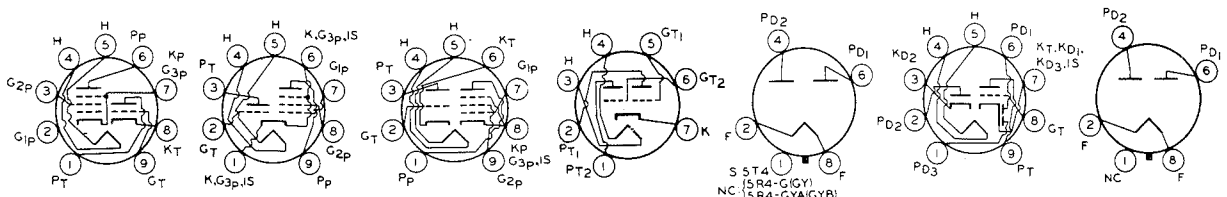

5EA8

5EH8

5EU8

5J6

**5R4-G, GY
5R4-GYA, GYB
5T4**

5T8

**5U4-G
5U4-GA
5U4-GB**

TYPE	Class	Use	E_f volts	I_f amps	E_b volts	E_{c2} volts	E_{c1} volts	I_b ma	I_{c2} ma	r_p M Ω	g_m μ mhos	
5U8	3, 5	Triode Amplifier	4.7	0.6	See 6U8 Characteristics							
		Pent. Amplifier										
5V3	2R, 2R	Full-wave Rectifier	5.0	3.8	Max. AC Voltage/Plate = 500 volts (rms) Max. PIV = 1400 volts Max. Output Current/Plate = 225 ma							
5V4G 5V4GA	2R, 2R	Full-wave Rectifier	5.0	2.0	Max. AC Voltage/Plate = 375 volts (rms) DC Output Current = 175 ma Max. PIV = 1400 volts Max. Peak I_b /Plate = 525 ma							
5V6GT	5	Class A Amplifier	4.7	0.6	250	250	-12.5	45	4.5	0.052	4100	$R_L = 5.0$ K Ω , $W_o = 4.5$ watts
5W4 5W4G 5W4GT	2R, 2R	Full-wave Rectifier	5.0	1.5	Max. AC Voltage/Plate = 350 volts (rms) Max. PIV = 1400 volts Max. DC Output Current = 100 ma Max. Peak Plate Current/Plate = 300 ma							
5X4G	2R, 2R	Full-wave Rectifier	5.0	3.0	See 5U4G Characteristics							
5X4GA	2R, 2R	Full-wave Rectifier	5.0	3.0	Max. PIV = 1550 volts Peak Plate Current/Plate = 900 ma max. DC Output Current = 125 ma max.							
5X8	3, 5	Osc. Converter	4.7	0.6	See 6X8 Characteristics							
5Y3 5Y3G 5Y3GA 5Y3GT	2R, 2R	Full-wave Rectifier	5.0	2.0	Max PIV = 1400 Max. DC Output = 125 ma Max. Peak Plate Current/Plate = 400 ma							
5Y4G 5Y4GA 5Y4GT	2R, 2R	Full-wave Rectifier	5.0	2.0	See 5Y3GT Characteristics							
5Z3	2R, 2R	Full-wave Rectifier	5.0	3.0	See 5U4G Characteristics							
5Z4 5Z4G	2R, 2R	Full-wave Rectifier	5.0	2.0	Max. AC Voltage/Plate = 350 volts (rms) Max. DC Output = 125 ma Max. PIV = 1400 volts Max. Peak I_b /Plate = 375 ma							
6A3	3	Class A Amplifier	6.3	1.0	See 6B4G Characteristics							
6A4/LA	5	Class A Amplifier	6.3	0.3	100 180	100 180	-6.5 -12.0	9.0 22.0	1.6 3.9	0.0833 0.0455	1200 2200	$R_L = 11$ K Ω , $W_o = 0.31$ watts $R_L = 8$ K Ω , $W_o = 1.4$ watts
6A6	3, 3	Class A Amplifier	6.3	0.8	See 6N7GT Characteristics							
6A7 6A7S	7	Converter	6.3	0.3	See 6A8 Characteristics							
6A8 6A8G 6A8GT	7	Converter	6.3	0.3	100 250	G_{3+5} 100	G_4 -3.0	3.5	2.7	0.36	$E_{c2} = 250$ v, 4.0 ma $I_{c1} = 0.4$ ma $R_{g1} = 20$ K Ω , $g_c = 550$ μ mhos	
6AB4	3	Class A Amplifier	6.3	0.15	100	—	*	3.7	—	0.015	4000	$R_k = 270$ Ω , $\mu = 60$
					250	—	*	10.0	—	0.0109	5500	$R_k = 200$ Ω $\mu = 60$
6AB5/ 6N5		Visual Indicator	6.3	0.15	135	Target = 135 volts Grid Bias = -10.0 v for 0° shadow, 0 v for 90° shadow $R_p = 0.25$ M Ω $I_b = 0.5$ ma						Target current = 2.0 ma
6AB7 6AB7/ 1853	5	Class A Amplifier	6.3	0.45	300	200	-3.0	12.5	3.2	0.7	5000	
6AB8	3, 5	Triode Amplifier	6.3	0.3	100	—	-2.0	4	—	—	1350	$R_L = 11$ K Ω ,
		Pent. Amplifier			200	200	-7.7	17.5	3.3	0.15	3400	$W_o = 1.4$ watts
6AC5G 6AC5GT	3	Class B Power Amplifier	6.3	0.4	250	—	+13	32.0	—	0.037	3400	$I_{c1} = 5$ ma
					250	—	0	5.0	—	—	—	$R_L = 10.0$ K Ω , (p-p) $W_o = 8.0$ watts

*See quoted value of R_k

TYPE	Class	Use	E_f volts	I_f amps	E_b volts	E_{c2} volts	E_{c1} volts	I_b ma	I_{c2} ma	r_p M Ω	g_m μ mhos	
6AC7 6AC7A	5	Class A Amplifier	6.3	0.45	300	150	*	10.0	2.5	1.0	9000	$R_k = 160 \Omega$
6AD6G		Tuning Indicator	6.3	0.15	Target Voltage = 150 volts Target Current = 1.2 to 3.0 ma Ray Control Voltage = 75 v for 0° and -50 v for 135°							
6AD7G	3, 5	Triode Amplifier	6.3	0.85	250		-25.0	4.0		0.019	325	$\mu = 6$
		Pent. Amplifier			250	250	-16.5	34.0	6.5	0.08	2500	$R_L = 7.0 \text{ K}\Omega$, $W_o = 3.2 \text{ w}$
6AD8	2, 2, 5	Det. Amp.	6.3	0.3	250	85	*	6.7	2.3	1.0	1100	$R_k = 225 \Omega$
6AE5G 6AE5GT	3	Class A Amplifier	6.3	0.3	95	—	-15.0	7.0	—	0.0035	1200	$\mu = 4.2$
6AE7G 6AE7GT	3, 3	Class A Amplifier	6.3	0.5	250	—	-13.5	5.0	—	0.0093	1500	$\mu = 14$
6AE8	3, 6	Triode Osc.	6.3	0.3	115	—	—	4.5	—	—	$I_{c1} = 300 \text{ ma}$, $R_{g1} = 30 \text{ K}\Omega$	
		Hexode Mixer			250	G_{2+4}	-2	3.5	3.2	1.5	$g_c = 750 \mu\text{mhos}$	
6AF3	2	TV Damper Diode	6.3	1.2	Max. PIV = 4500 volts, Max. PC Plate Current = 185 ma Max. Plate Dissipation = 6.0 watts							
6AF4 6AF4A	3	Class A Amplifier	6.3	0.225	100	—	*	20	—	0.002	7500	$\mu = 16$ $R_k = 150 \Omega$
Osc. at 950 Mc		100			—	-4.0	22	—	$R_{g1} = 10 \text{ K}\Omega$, $I_{c1} = 400 \mu\text{amp}$ $W_o = 160 \text{ mw}$			
6AF6G		Tuning Indicator	6.3	0.15	Target Voltage = 250 volts, Target Current = 2.2 ma Ray Control Voltage = 160 volts for 0° shadow Ray Control Voltage = 0 volts for 95° shadow							
6AG5	5	Pent. Amplifier	6.3	0.3	100	100	*	4.5	1.4	0.6	4500	$R_k = 180 \Omega$
					250	150		6.5	2.0	0.8	5000	$R_k = 180 \Omega$
		Triode Amplifier			180	—	*	7.0	—	0.008	5700	$R_k = 330 \Omega$
					250	—		5.5	—	0.01	3800	$R_k = 820 \Omega$
6AG7	5	Amplifier	6.3	0.65	300	150	-3	30.0	7.0	0.13	11000	$R_L = 10 \text{ K}\Omega$, $W_o = 3.0 \text{ watts}$
6AH4GT	3	Class A Amplifier	6.3	0.75	250	—	-23	30	—	0.002	4500	
6AH5G	4	Class A Amplifier	6.3	0.9	350	250	-18	54	2.5	0.033	5200	
6AH6 6AH6G	5	Class A Amplifier	6.3	0.45	300	150	*	10.0	2.5	0.5	9000	$R_k = 160 \Omega$
6AH7GT	3, 3	Amplifier	6.3	0.3	See 12AH7GT Characteristics							
6AJ8	3, 7	Converter	6.3	0.3	250	103	-2.0	3.25	6.7	1.0	$g_c = 775 \mu\text{mhos}$ Osc. $R_{g1} = 47 \text{ K}\Omega$	
6AK5	5	Class A Amplifier	6.3	0.175	120	120	*	7.5	2.5	0.34	5000	$R_k = 200 \Omega$
					180	120		7.7	2.4	0.69	5100	
6AK6	5	Class A Amplifier	6.3	0.15	180	180	-9.0	15	2.5	0.2	2300	$R_L = 10 \text{ K}\Omega$, $W_o = 1.1 \text{ watts}$

*See quoted value of R_k .

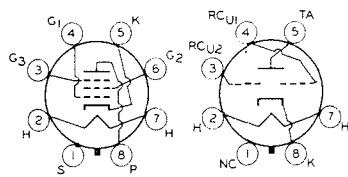

**6AC7
6AC7-A**

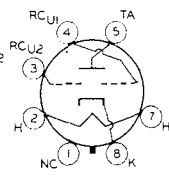

6AD6-G

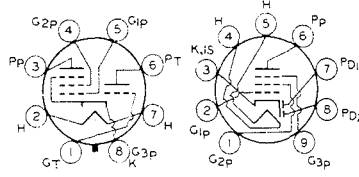

**6AD7-G
6AD8**

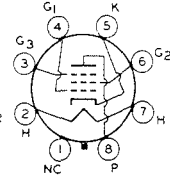

**6AE5-G
6AE5-GT**

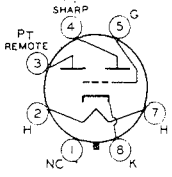

6AE6-G

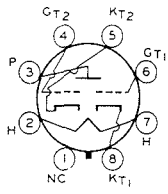

**6AE7-G
6AE7-GT**

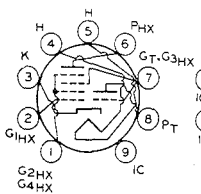

6AE8

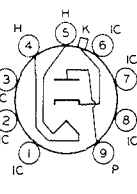

6AF3

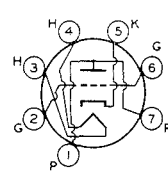

**6AF4
6AF4-A**

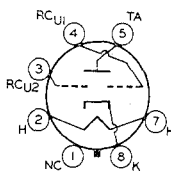

6AF6-G

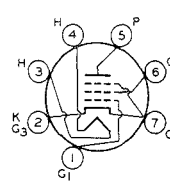

6AG5

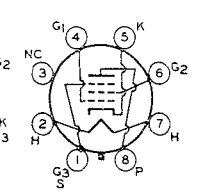

6AG7

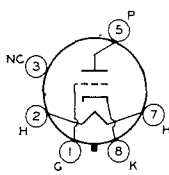

6AH4-GT

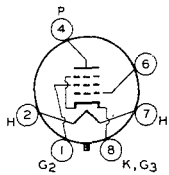

6AH5-G

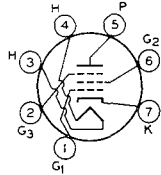

**6AH6
6AH6-G**

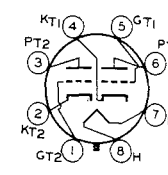

6AH7-GT

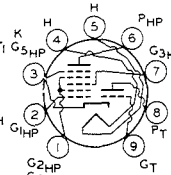

6AJ8

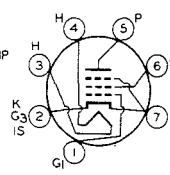

6AK5

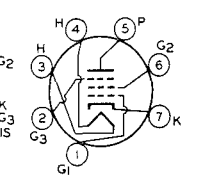

6AK6

TYPE	Class	Use	E_f volts	I_f amps	E_b volts	E_{c2} volts	E_{c1} volts	I_b ma	I_{c2} ma	r_p M Ω	g_m μ mhos	
6AK7	5	Class A Amplifier	6.3	0.65	300	150	-3.0	30.0	7.0	0.13	11000	
6AK8	2, 2, 2, 3	Class A Amplifier	6.3	0.45	100		-1.0	0.8		0.048	1450	$\mu = 70$
					250		-3.0	1.0		0.05	1400	$\mu = 70$
6AL5	2, 2	Detector Rectifier	6.3	0.3	Max. PIV = 330 volts Max. Peak H-K volts = 330 volts Max. Peak Plate Current/Plate = 54 ma			Max. DC Output/Plate = 9 ma				
6AL6G	5	Power Amplifier	6.3	0.9	See 6L6G Characteristics							
6AL7GT		Tuning Indicator	6.3	0.15	Target Voltage = 315 volts, Grid Voltage = 0 v						$R_k = 3.3 K\Omega$	
6AM4	3	Class A Amplifier	6.3	0.225	150	—	*	7.5	—	0.0095	9000	$R_k = 100 \Omega$, $\mu = 85$
6AM5	5	Class A Amplifier	6.3	0.2	250	250	-13.5	16	2.4	0.13	2600	$R_L = 16.0 K\Omega$, $W_o = 1.4$ watts
6AM6	5	RF Amplifier	6.3	0.3	250	250	-2.0	10	2.5	1.0	7500	
6AM8 6AM8A	2, 5	Class A Amplifier	6.3	0.45	200	150	*	11.5	2.7	—	7000	$R_k = 120 \Omega$
6AN4	3	Class A Amplifier	6.3	0.225	200	—	*	13	—	—	10000	$R_k = 100 \Omega$, $\mu = 70$
6AN5	5	Power Amplifier	6.3	0.45	120	120	-6.0	35.0	12.0	0.125	8000	$R_L = 2.5 K\Omega$, $W_o = 1.3$ w
6AN6	2, 2, 2, 2	Rectifier	6.3	0.2	Max. PIV = 210 volts Max. Peak Plate Current/Plate = 45 ma DC Output/Plate = 8 ma			Max. H-K volts = 90 v				
6AN7	3, 6	Triode Osc.	6.3	0.23	250	—	—	5.1	—	—	$R_{g1} = 22.0 K\Omega$	
		Hexode Mixer			250	G_{2+4}	—	G_{2+4}	—	—	$g_c = 750 \mu$ mhos	
6AN8 6AN8A	3, 5	Triode Amplifier Pent. Amplifier	6.3	0.45	200	—	-6.0	13.0	—	0.0057	3300	$R_k = 180 \Omega$
200	150	*			9.5	2.8	0.3	6200				
6AQ4	3	RF Amplifier	6.3	0.3	250	—	-1.5	10	—	—	8500	$\mu = 100$
6AQ5 6AQ5A	5	Class A Amplifier P.P. Amplifier†	6.3	0.45	180	180	-8.5	29.0	3.0	-0.58	3700	$R_L = 5.5 K\Omega$, $W_o = 2.0$ watts
250	250	-12.5			45.0	4.5	-0.52	4100				
6AQ6	2, 2, 3	Triode Amplifier	6.3	0.15	100	—	-1.0	0.8	—	0.061	1150	$\mu = 70$
					250	—	-3.0	1.0	—	0.058	1200	$\mu = 70$
6AQ7GT	2, 2, 3	Triode Amplifier	6.3	0.3	250	—	-2.0	2.3	—	0.044	1600	$\mu = 70$
6AQ8	3, 3	RF Amplifier	6.3	0.435	250	—	-2.0	10.0	—	-0.097	6000	
		Self-Osc. Mixer			250	—	—	5.2	—	-0.22	—	$g_c = 2300$
6AR5	5	Class A Amplifier	6.3	0.4	250	250	-16.5	34.0	5.7	0.065	2400	$R_L = 7.0 K\Omega$, $W_o = 3.2$ w $R_L = 7.6 K\Omega$, $W_o = 3.4$ w
					250	250	-18	32.0	5.5	0.068	2300	
6AR6	4	Tet. Amplifier	6.3	1.2	250	250	-22.5	75	5.0	-0.21	5400	$\mu = 113$
		Triode Amplifier			200	—	-12.5	90	—	-0.01	6000	$\mu = 6$
6AR7GT	2, 2, 5	Det. RF Amp.	6.3	0.3	250	100	-2.0	7.0	1.8	1.0	2500	
6AR8	8	Sync. Detector	6.3	0.3	250	250	*	10	0.4	—	4000	$R_k = 390 \Omega$
6AS5	5	Class A Amplifier	6.3	0.8	150	110	-8.5	35	2.0	—	5600	$R_L = 4.5 K\Omega$, $W_o = 2.2$ watts

*See quoted value of R_k

▼Two valves

†Class AB.

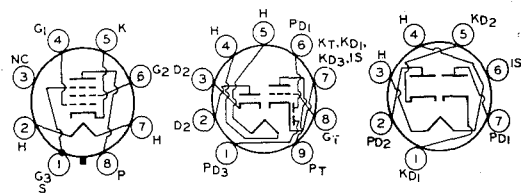

6AK7

6AK8

6AL5

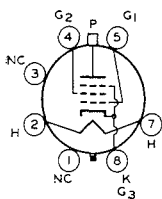

6AL6-G

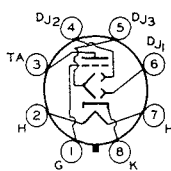

6AL7-GT

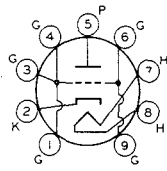

6AM4

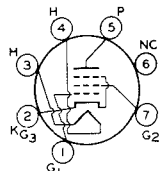

6AM5

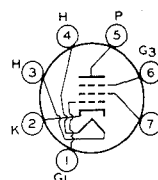

6AM6

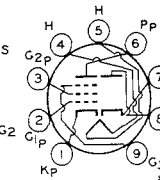

6AM8
6AM8-A

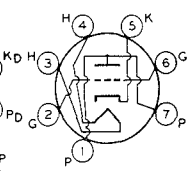

6AN4

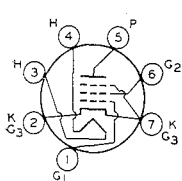

6AN5

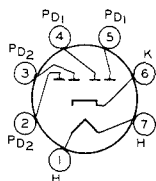

6AN6

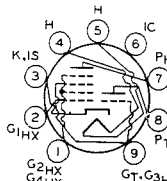

6AN7

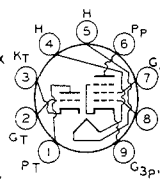

6AN8
6AN8-A

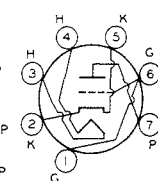

6AQ4

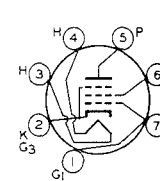

6AQ5
6AQ5-A

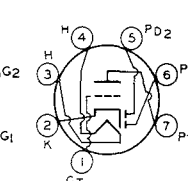

6AQ6

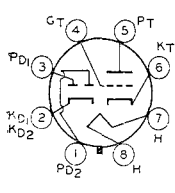

6AQ7-GT

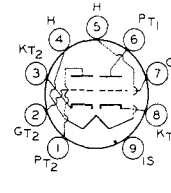

6AQ8

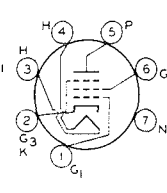

6AR5

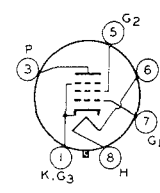

6AR6

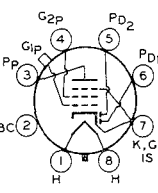

6AR7-GT

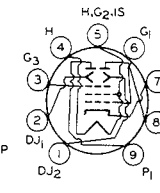

6AR8

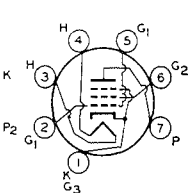

6AS5

TYPE	Class	Use	E_f volts	I_f amps	E_b volts	E_{c2} volts	E_{c1} volts	I_b ma	I_{c2} ma	r_p M Ω	g_m μ mhos		
6AS6	5	Voltage Amplifier	6.3	0.175	120	120	-2.0	5.2	3.5	0.15	3200		
6AS7G 6AS7GA	3, 3	Power Amplifier	6.3	2.5	135	—	*	125	—	280 ohms	7000	$R_k = 250 \Omega$, $\mu = 2.1$	
6AS8	2, 5	Diode Unit	6.3	0.45	Max. PIV = 330 volts Max. Peak Plate Curr. = 50 ma Max. DC Plate Current = 5.0 ma								
		Pent. Amplifier			200	150	*	9.5	3.0	0.3	6200	$R_k = 180 \Omega$	
6AT6	2, 2, 3	Triode Amplifier	6.3	0.3	100 250	—	-1.0 -3.0	0.8 1.0	—	0.054 0.058	1300 1200	$\mu = 70$ $\mu = 70$	
6AT8 6AT8A	3, 5	Triode/Pentode Converter	6.3	0.45	See 6X8 Characteristics								
6AU4GT	2R	TV Damper Diode	6.3	1.8	Max. PIV = 4500 volts (Abs.)			Max. DC Plate Current = 175 ma Max. Peak Plate Curr. = 1050 ma Max. Plate Dissip. = 6.0 w					
6AU4GTA	2R	TV Damper Diode	6.3	1.8	Max. PIV = 4500 volts			Max. Plate Dissip. = 6.5 w Max. Peak Plate Curr. = 1300 ma DC Plate Current = 210 ma					
6AU5GT	5	Horiz. Amplifier	6.3	1.25	Max. Peak Pos. Pulse Plate Voltage = 5500 volts (Abs.) Max. DC Cathode Current = 110 ma Max. DC Screen Voltage = 200 volts Max. Plate Dissipation = 10 watts Max. Screen Dissipation = 2.5 w								
6AU6 6AU6A	5	Class A Amplifier	6.3	0.3	250	150	*	10.6	4.3	1.0	5200	$R_k = 68 \Omega$	
6AU7	3, 3	Class A Amplifier	3.15	0.6	100	—	0	13	—	0.0063	3500	$\mu = 22.0$	
			6.3	0.3	250	—	-8.5	10.5	—	0.008	2200	$\mu = 17.5$	
6AU8 6AU8A	3, 5	Triode Amplifier	6.3	0.6	150	—	*	9.0	—	0.008	4900	$\mu = 40$, $R_k = 150 \Omega$	
Pent. Amplifier		200			125	*	15	3.4	0.15	7000	$R_k = 82 \Omega$		
6AV4	2R, 2R	Full-wave Rectifier	6.3	0.95	Max. PIV = 1250 volts Max. DC Output Current = 90 ma Max. Peak Plate Current/Plate = 250 ma								
6AV5GA 6AV5GT	5	Horizontal Deflection Amplifier	6.3	1.2	Max. DC Voltage = 550 volts Max. Peak Pos. Pulse Voltage = 5500 volts Max. DC Cathode Current = 110 ma Max. Plate Dissipation = 11 watts								
6AV6	2, 2, 3	Class A Amplifier	6.3	0.3	250	—	-2.0	1.2	—	0.06	1600	$\mu = 100$	
6AW7GT	2, 2, 3	Det. Amplifier	6.3	0.3	100	—	0	1.4	—	—	1200	$\mu = 80$	
6AW8	3, 5	Triode Amplifier	6.3	0.6	200	—	-2.0	4.0	—	0.0175	4000	$\mu = 70$	
		Pentode Amp.			200	150	*	13	3.5	0.4	9000	$R_k = 180 \Omega$	
6AW8A	3, 5	Triode Amplifier	6.3	0.6	200	—	-2.0	4.0	—	0.0175	4000	$\mu = 70$	
		Pentode Amplifier			200	150	*	13	3.5	0.4	9000	$R_k = 180 \Omega$	
6AX4GT	2R	TV Damper Diode	6.3	1.2	Max. PIV = 4400 volts (Abs.) Max. Peak Plate Current = 750 ma Max. DC Plate Current = 125 ma								
6AX5GT	2R, 2R	Full-wave Rectifier	6.3	1.2	Max. PIV = 1250 volts Max. DC Output = 80 ma Max. Peak Plate Current/Plate = 375 ma								
6AX7	3, 3	Voltage Amplifier	6.3	0.3	250	—	-2.0	1.2	—	—	1600	$\mu = 100$	
					100	—	-1.0	0.5	—	—	1250		
6AX8	3, 5	Triode Amplifier	6.3	0.45	150	—	*	18	—	0.005	8500	$\mu = 40$, $R_k = 56 \Omega$	
		Pent. Amplifier			250	110	*	10	3.5	0.4	4800	$R_k = 120 \Omega$	

*See quoted value of R_k

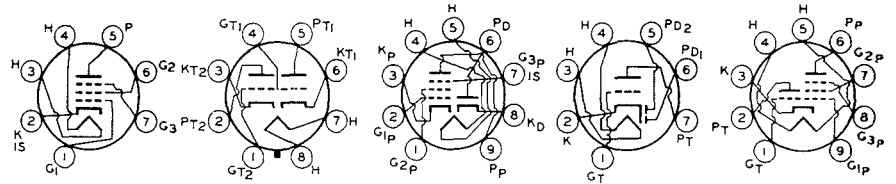

6AS6

**6AS7-G
6AS7-GA**

6AS8

6AT6

**6AT8
6AT8-A**

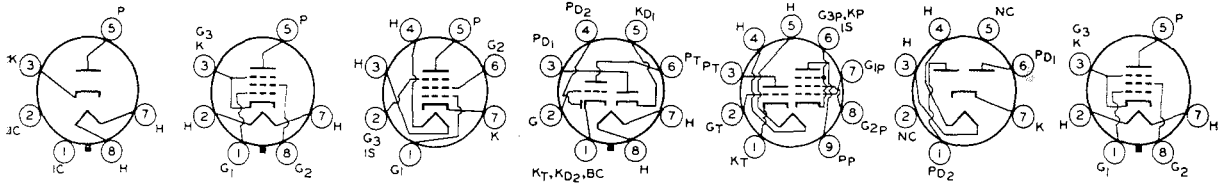

**6AU4-GT
6AU4-GTA**

6AU5-GT

**6AU6
6AU6-A**

6AU7

**6AU8
6AU8-A**

6AV4

**6AV5-GA
6AV5-GT**

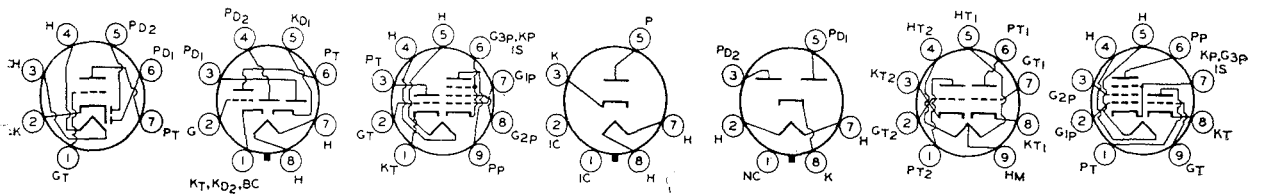

6AV6

6AW7-GT

**6AW8
6AW8-A**

6AX4-GT

6AX5-GT

6AX7

6AX8

TYPE	Class	Use	E_f volts	I_f amps	E_b volts	E_{c2} volts	E_{c1} volts	I_b ma	I_{c2} ma	r_p M Ω	g_m μ mhos	
6AZ8	3, 5	Triode Amplifier	6.3	0.45	200	—	-6.0	13	—	0.006	3300	$\mu = 19$
		Pent. Amplifier			200	150	*	9.5	3.0	0.3	6000	$R_k = 180 \Omega$
6B3	2	TV Damper Diode	6.3	1.2	Max. PIV = 4400 volts Max. DC Plate Current = 150 ma							
6B4G	3	Class A Amplifier	6.3	1.0	250	—	-4.5	60	—	800 ohms	5250	$R_L = 2.5 K\Omega$, $W_o = 3.2 w$ $\mu = 4.2$
		P.P. Amplifier†			325	—	*	80▼	—	—	—	$R_L = 5 K\Omega$, $W_o = 10 w$ ▼, $R_k = 850 \Omega$
6B5	3, 3	Class A Amplifier	6.3	0.8	See 6N6G Characteristics							
6B6G	2, 2, 3	AF Amplifier	6.3	0.3	250	—	-2.0	0.9	—	0.091	1100	$\mu = 100$
6B7	2, 2, 5	RF Amplifier	6.3	0.3	See 6B8G Characteristics							
6B7S	2, 2, 5	RF Amplifier	6.3	0.3	See 6G8G Characteristics							
6B8 6B8G 6B8GT	2, 2, 5	RF Amplifier	6.3	0.3	250	125	-3.0	9.0	2.3	0.6	1125	
6BA6	5	RF Amplifier	6.3	0.3	250	100	*	11.0	4.2	1.0	4400	$R_k = 68 \Omega$
6BA7	7	Converter	6.3	0.3	100	100	-1.0	3.6	10.2	0.5	$R_{g1} = 20 K\Omega$	
					250	100	-1.0	3.8	10.0	1.0	$g_c = 950 \mu$ mhos	
6BA8	3, 5	Triode Amplifier	6.3	0.6	200	—	-8.0	8.0	—	0.0067	2700	$\mu = 18$
6BA8A		Pent. Amplifier			200	150	*	13	3.5	0.4	9000	$R_k = 180 \Omega$
6BC4	3	Class A Amplifier	6.3	0.225	150	—	*	14.5	—	0.0048	10000	$R_k = 100 \Omega$, $\mu = 48$
6BC5	5	Class A Amplifier	6.3	0.3	250	150	*	7.5	2.1	0.8	5700	$R_k = 180 \Omega$
6BC7	2, 2, 2	FM Detector	6.3	0.45	Max. PIV = 330 volts Max. Peak Plate Current = 54 ma Max. DC Output Current = 12 ma							
6BC8	3, 3	Class A Amplifier	6.3	0.4	150	—	*	10	—	—	6200	$\mu = 35$, $R_k = 220 \Omega$
6BD4	3	Voltage Regulator	6.3	0.6	Max. DC Plate Voltage = 20 Kv Max. Unregulated DC Supply Voltage = 40 Kv				Max. DC Plate Current = 1.5 ma Max. Plate Dissip. = 20 watts			
6BD4A	3	Voltage Regulator	6.3	0.6	Max. DC Plate Voltage = 27 Kv Max. Unregulated DC Supply Voltage = 55 Kv				Max. DC Plate Current = 1.5 ma Max. Plate Dissip. = 25 watts			
6BD5GT	5	Horiz. Amplifier	6.3	0.9	Max. Peak Pos. Pulse Plate Voltage = 4000 volts Max. DC Cathode Current = 100 ma Max. Plate Dissipation = 10 watts							
6BD6	5	Class A Amplifier	6.3	0.3	100	100	-1.0	13.0	5.0	0.15	2550	
					250	100	-3.0	9.0	3.0	0.8	2000	
6BD7	2, 2, 3	Det. Amplifier	6.3	0.23	250	—	-3.0	1.0	—	0.058	1200	$\mu = 70$
6BE6	7	Converter	6.3	0.3	250	100	-1.5	2.9	6.8	1.0	$R_{g1} = 20 K\Omega$, $g_c = 475 \mu$ mhos	
6BE7	9	FM Det. and Limiter	6.3	0.2	250‡	20	—	0.69	1.5	5.0	—	Phase Angle $E_{c3} - E_{c5} = 90^\circ$ $R_L = 0.47 M\Omega$
6BE8	3, 5	Triode Amplifier	6.3	0.45	150	—	*	18.0	—	0.005	8500	$\mu = 40$ $R_k = 56 \Omega$
6BE8A		Pent. Amplifier			250	110	*	10.0	3.5	0.4	5200	$R_k = 68 \Omega$
6BF5	5	Vertical Deflection Amplifier	6.3	1.2	Max. DC Plate Voltage = 250 volts Abs. Peak Pos. Pulse Plate Voltage = 900 volts Max. DC Cath. Current = 40 ma Max. Plate Dissip. = 5 watts							

*See quoted value of R_k

▼Two valves

†Class AB

‡Supply Voltage.

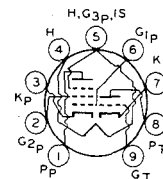

6AZ8

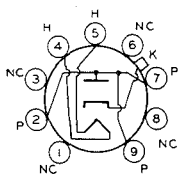

6B3

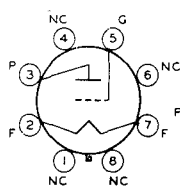

6B4-G

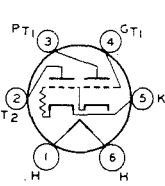

6B5

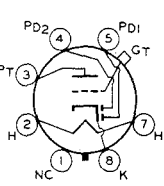

6B6-G

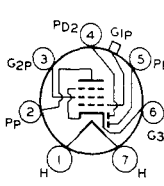

**6B7
6B7-S**

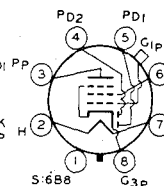

**6B8
6B8-G
6B8-GT**

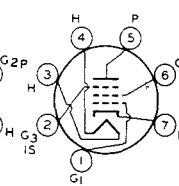

6BA6

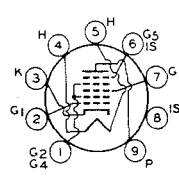

6BA7

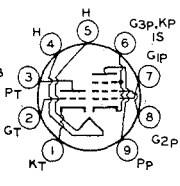

**6BA8
6BA8-A**

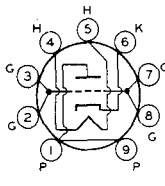

6BC4

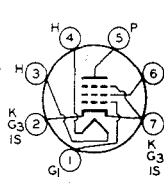

6BC5

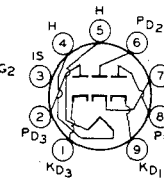

6BC7

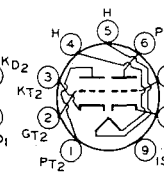

6BC8

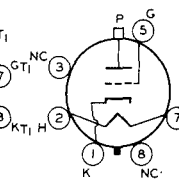

**6BD4
6BD4-A**

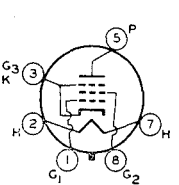

6BD5-GT

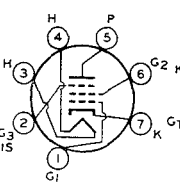

6BD6

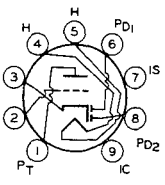

6BD7

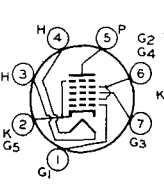

6BE6

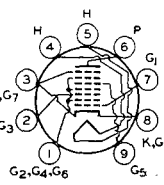

6BE7

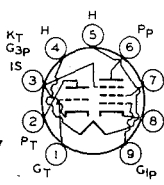

**6BE8
6BE8-A**

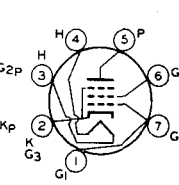

6BF5

TYPE	Class	Use	E_f volts	I_f amps	E_b volts	E_{c2} volts	E_{c1} volts	I_b ma	I_{c2} ma	r_p M Ω	g_m μ mhos	
6BF6	2, 2, 3	Triode Amplifier	6.3	0.3	250	—	-9.0	9.5	—	0.0085	1900	$R_L = 10\text{ K}\Omega$, $W_o = 0.3\text{ watts}$ $\mu = 16$
6BG6G 6BG6GA	5	Horizontal Deflection Amplifier	6.3	0.9	Max. DC Screen Voltage = 350 volts Max. DC Cathode Current = 110 ma Max. Peak Pos. Pulse Plate Voltage = 6600 volts (Abs.) Max. Plate Dissip. = 20 w							
6BH8	3, 5	Triode Amplifier	6.3	0.6	150	—	-5.0	9.5	—	0.005	3300	$\mu = 17$
		Pent. Amplifier			200	125	*	15	3.4	0.15	7000	$R_k = 82\ \Omega$
6BJ5	5	Power Amplifier	6.3	0.64	250	250	-5.0	35	5.5	0.04	10,500	$R_L = 7\text{ K}\Omega$, $W_o = 4\text{ watts}$
6BJ6	5	Class A Amplifier	6.3	0.15	100	100	-1.0	9.0	3.5	0.25	3650	
					250	100	-1.0	9.2	3.3	1.3	3600	
6BJ6A	5	Class A Amplifier	6.3	0.15	Same as 6BJ6 except for controls on formation of interface impedance							
6BJ7	2, 2, 2	DC Restorer	6.3	0.45	Max. PIV = 330 volts Max. Peak Plate Curr./Plate = 10 ma DC Output Current/Plate = 1.0 ma							
6BJ8	2, 2, 3	Class A Amplifier	6.3	0.6	90	—	0	13.5	—	0.047	4700	$\mu = 22$
6BK4	3	Voltage Regulator	6.3	0.2	Max. DC Plate Voltage = 25 Kv Max. DC Plate Current = 1.5 ma Max. Unregulated DC Supply Max. Plate Dissip. = 25 w Voltage = 55 Kv							
6BK5	5	Class A Amplifier	6.3	1.2	250	250	-5.0	35	3.5	0.1	8500	$R_L = 6.5\ \Omega$, $W_o = 3.5\text{ watts}$
6BK6	2, 2, 3	Det. Amplifier	6.3	0.3	100	—	-1.0	0.5	—	0.08	1250	$\mu = 100$
					250	—	-2.0	1.2	—	0.06	1600	$\mu = 100$
6BK7	3, 3	Class A Amplifier	6.3	0.45	100	—	*	9.0	—	0.061	6100	$R_k = 120$, $\mu = 37$
					150	—	*	18	—	0.047	8500	$R_k = 56$, $\mu = 40$
6BK7A 6BK7B	3, 3	Class A Amplifier	6.3	0.45	150	—	*	18	—	0.046	9300	$R_k = 56$, $\mu = 43$
6BK8	5	Low Noise AF Amplifier	6.3	0.2	250‡	140	-2.0	3.0	0.55	2.5	1850	
6BL4	2R	Half-Wave Rect.	6.3	3.0	Max. PIV = 4500 volts (Abs.) Max. Peak Plate Current = 1200 ma Max. DC Plate Current = 200 ma							
6BL7GT	3, 3	Vertical Deflection Amplifier	6.3	1.5	Max. DC Cathode Current = 60 ma Max. Plate Dissip. = 10 w Max. Peak Pos. Pulse Plate Voltage = 1800 volts							
6BL7GTA	3, 3	Vertical Deflection Amplifier	6.3	1.5	Max. Peak Pos. Pulse Plate Voltage = 2000 volts Max. DC Cathode Current = 60 ma Max. Plate Dissipation = 10 w							
6BL8	3, 5	Pent. Amplifier	6.3	0.45	170	170	-2.0	10.0	2.8	0.4	6200	
		Triode Amplifier			100	—	-2.0	14.0	—	0.004	5000	
6BM5	5	Power Amplifier	6.3	0.45	250	250	-6.0	30	3.0	0.06	7000	$R_L = 7\text{ K}\Omega$, $W_o = 3.5\text{ watts}$
6BM8	3, 5	Pent. Amplifier	6.3	0.76	170	170	-11.5	41.0	8.0	0.016	7500	
		Triode Amplifier			100	—	0	3.5	—	0.028	2500	$\mu = 70$
6BN4	3	Class A Amplifier	6.3	0.2	150	—	*	9.0	—	0.006	6800	$R_k = 150\ \Omega$, $\mu = 43$
6BN4A	3	Class A Amplifier	6.3	0.2	150	—	*	9.0	—	0.008	5400	$R_k = 220\ \Omega$, $\mu = 43$
6BN5	5	Class A Power Amplifier	6.3	0.2	225	225	*	26	4.1	0.09	3200	$R_L = 9\text{ K}\Omega$, $R_k = 360\ \Omega$ $W_o = 2.8\text{ watts}$

*See quoted value of R_k .

‡Supply voltage.

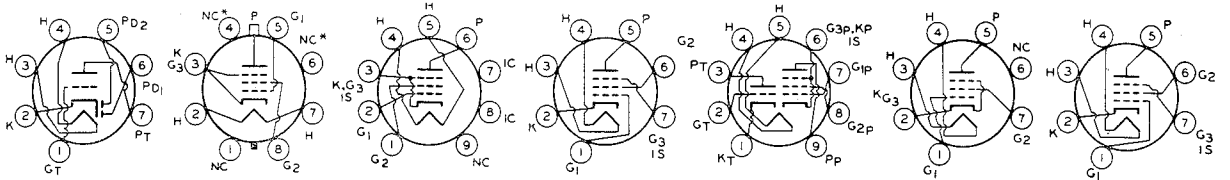

6BF6

**6BG6-G
6BG6-GA**

*Pins omitted on
type 6BG6-G.

6BH5

6BH6

6BH8

6BJ5

**6BJ6
6BJ6-A**

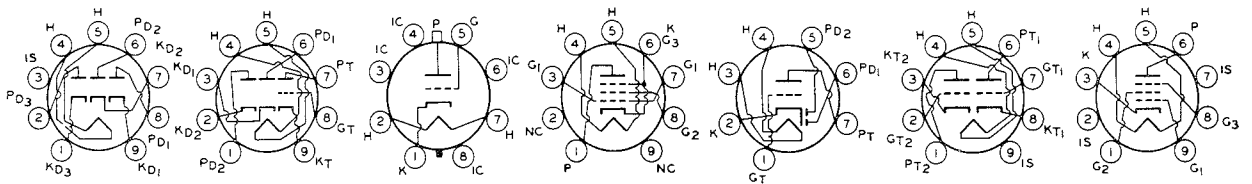

6BJ7

6BJ8

6BK4

6BK5

6BK6

**6BK7
6BK7-A
6BK7-B**

6BK8

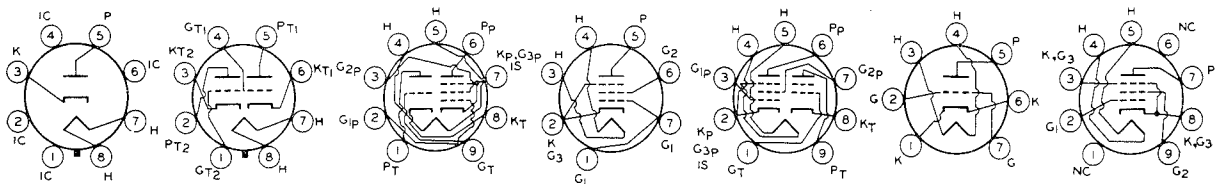

6BL4

**6BL7-GT
6BL7-GTA**

6BL8

6BM5

6BM8

**6BN4
6BN4-A**

6BN5

TYPE	Class	Use	E_f volts	I_f amps	E_b volts	E_{c2} volts	E_{c1} volts	I_b ma	I_{c2} ma	r_p M Ω	g_m μ mhos	
6BN6	5	Limiter Discriminator	6.3	0.3	80	60	*	0.23	5.0	—	—	$R_k = 300 \Omega$
6BN7	3, 3	Oscillator (Unit 1)	6.3	0.75	120	—	-1.0	5.0	—	0.014	2000	$\mu = 28$
		Amplifier (Unit 2)			250	—	-15.0	24	—	0.0022	5500	$\mu = 12$
6BN8	2, 2, 3	Triode Amplifier	6.3	0.6	100	—	-1.0	1.5	—	0.021	3500	
					250	—	-3.0	1.6	—	0.028	2500	
6BQ5	5	Class A Power Amplifier	6.3	0.76	250	250	-7.3	48	5.5	0.038	11,300	$R_L = 5.2 K\Omega$
6BQ6G 6BQ6GA 6BQ6GT 6BQ6GTA	5	Horiz. Deflection Amplifier Class A Amplifier	6.3	1.2	Max. Peak Pos. Plate Voltage = 5500 volts Max. DC Cathode Current = 112.5 ma Max. Plate Dissipation = 11 watts Max. DC Screen Voltage = 200 volts							
					250	-22.5	150	55	2.1	0.02	5500	
6BQ6GTE/ 6CU6	5	Horiz. Deflection Amplifier	6.3	1.2	Max. Plate DC Voltage = 600 volts Max. Peak Pos. Plate Voltage = 6000 v Max. DC Cathode Current = 112.5 ma Max. DC Screen Voltage = 200 volts Max. Plate Dissip. = 11 watts							
6BQ7	3, 3	Class A Amplifier	6.3	0.4	150	—	*	9.0	—	0.0058	6000	$R_k = 220 \Omega \mu = 35$
6BQ7A	3, 3	Class A Amplifier	6.3	0.4	150	—	*	9.0	—	0.006	6400	$R_k = 220 \Omega \mu = 39$
6BR5		Tuning Indicator	6.3	0.3	Target Voltage = 250 volts Target Current = 2.0 ma E_{c1} for shadow angle of $5^\circ = -1$ volt							
6BR7	5	Low Noise AF Amplifier	6.3	0.15	250	100	-3.0	2.1	0.6	2.4	1250	
					100	100	-3.0	2.0	0.7	1.5	1100	
6BR8 6BR8A	3, 5	Triode Amplifier	6.3	0.4	150	—	*	18	—	0.005	8500	$R_k = 56 \Omega$
		Pent. Amplifier			250	110	*	10	3.5	0.4	5200	$R_k = 68 \Omega$
6BS5	5	Vertical Defl. Amplifier	6.3	0.75	250	250	-7.5	50	6	0.017	7000	$R_L = 5 K\Omega$, $W_o = 4.5$ watts $\mu = 120$, $R_k = 140 \Omega$
6BS7	5	Class A Amplifier	6.3	0.15	250	100	-3.0	2.1	0.6	2.4	1250	
6BS8	3, 3	Cascode Amplifier	6.3	0.4	250	—	-1.0	16	—	—	10,000	$R_k = 220 \Omega$
		Class A Amplifier			150	—	*	10	—	0.005	7200	
6BT4	2R, 2R	Full-wave Rectifier	6.3	0.6	Max. Plate Voltage/Plate = 350 volts (rms) Max. DC Output Current = 90 ma							
6BT6	2, 2, 3	Detector Amplifier	6.3	0.3	100	—	-1.0	0.8	—	0.054	1300	$\mu = 70$
					250	—	-3.0	1.0	—	0.058	1200	$\mu = 70$
6BT8	2, 2, 5	Detector Amplifier	6.3	0.45	200	150	*	9.5	2.8	0.3	6200	$R_k = 180$
6BU4	3	Voltage Regulator	6.3	0.45	25,000	—	-8.4	1.0	—	8.2 \ddagger	185	$\mu = 1515$
6BU5	5	Voltage Regulator	6.3	0.15	20,000	70	-2.4	1.0	0.5	—	—	
6BU6	2, 2, 3	Detector Amplifier	6.3	0.3	250	—	-9.0	9.5	—	-0.08	1900	$\mu = 16$
6BU8	5, 5	Class A Amplifier	6.3	0.3	100	67.5	☆	2.2	3.3	$E_{c3} = 0$		
					100	67.5	☆	—	6.5	$E_{c3} = -10$		
6BV7	2, 2, 5	Detector Amplifier	6.3	0.8	180	180	-4.0	20	3.5	0.13	8000	$R_L = 8.0 K\Omega$, $W_o = 2.0$ watts $R_L = 8.0 K\Omega$, $W_o = 4.0$ watts
					250	250	-5.0	38	6.0	0.1	10,000	
6BV8	2, 2, 3	Sync. Detector	6.3	0.6	200	—	*	11	—	-0.059	5600	$R_k = 330 \Omega$
6BW4	2R, 2R	Full-wave Rectifier	6.3	0.9	Max. AC Voltage/Plate = 450 volts (rms) Max. PIV = 1275 volts Max. Peak Plate Current/Plate = 350 ma							

*See quoted value of R_k \ddagger Approx.☆ E_{c1} adjusted for $I_{c1} = 100 \mu$ a

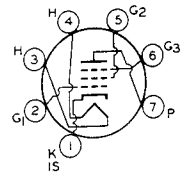

6BN6

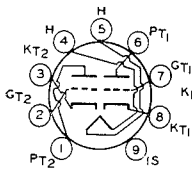

6BN7

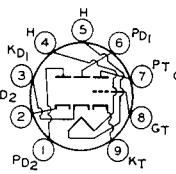

6BN8

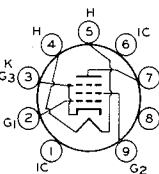

6BQ5

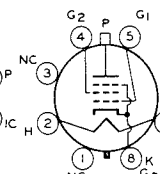

6BQ6-G
6BQ6-GT, -GA
6BQ6-GTA
6BQ6-GTB/6CU6

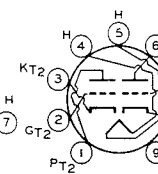

6BQ7
6BQ7-A

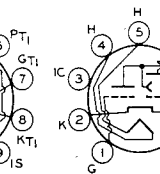

6BR5

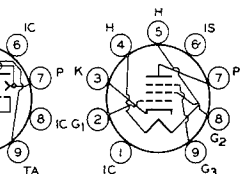

6BR7

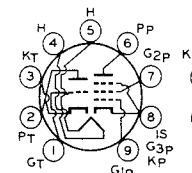

6BR8
6BR8-A

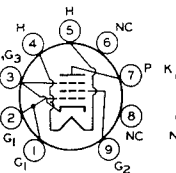

6BS5

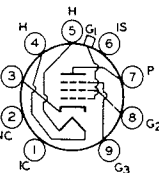

6BS7

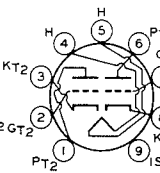

6BS8

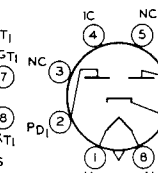

6BT4

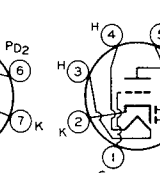

6BT6

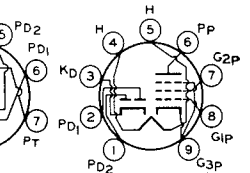

6BT8

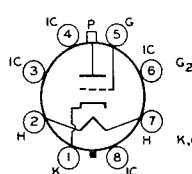

6BU4

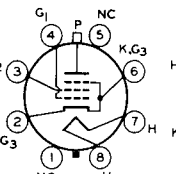

6BU5

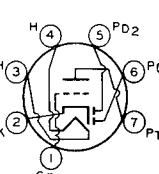

6BU6

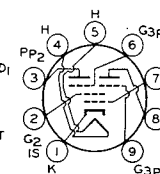

6BU8

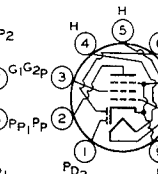

6BV7

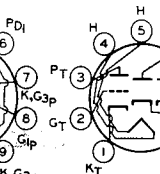

6BV8

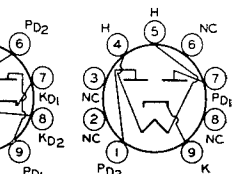

6BW4

TYPE	Class	Use	E_f volts	I_f amps	E_b volts	E_{c2} volts	E_{c1} volts	I_b ma	I_{c2} ma	r_p $M\Omega\mu$	g_m mhos	
6BW6	5	Class A Amplifier	6.3	0.45	180 250	180 250	-8.5 -12.5	29 45	3.0 4.5	0.058 0.052	3700 4100	$R_L = 5.5 K\Omega$, $W_o = 2.0$ watts $R_L = 5.0 K\Omega$, $W_o = 4.5$ watts
6BW7	5	RF Amplifier	6.3	0.3	250	250	*	9.5	3.5	0.75	8500	$R_k = 180 \Omega$
6BW8	2, 2, 5	RF Amplifier	6.3	0.45	250	110	*	10.0	3.5	0.25	5200	$R_k = 68 \Omega$
6BX4	2R, 2R	Full-wave Rectifier	6.3	0.6	Max. PIV = 1350 volts Max. Peak Plate Current = 270 ma Max. DC Output Current = 90 ma							
6BX6	5	RF Amplifier	6.3	0.3	170	170	-2.0	10	2.5	0.4	7200	
6BX7GT	3, 3	Class A Amplifier	6.3	1.5	250	—	*	42	—	0.013	7600	$\mu = 10$, $R_k = 390 \Omega$
6BX8	3, 3	Cascode Amplifier	6.3	0.4	65	—	-1.0	9.0	—	—	6700	$\mu = 25$
6BY5G	2, 2	TV Damper Diode	6.3	1.6	Max. PIV = 3000 volts, Max. DC Output Current = 175 ma Max. Peak Plate Current/Plate = 525 ma							
6BY5GA	2, 2	TV Damper Diode	6.3	1.6	Max. PIV = 3000 volts (Abs.) Max. Peak Plate Current Plate = 525 ma Max. DC Plate Current = 175 ma							
6BY6	7	Sync. Separator and Clipper	6.3	0.3	10	25	0	1.4	3.5	—	—	$E_{c3} = 0$ volts
6BY7	5	RF Amplifier	6.3	0.3	250	100	-2.0	10.0	2.5	0.5	6000	
6BY8	2, 5	Detector Amplifier	6.3	0.6	100 250	100 150	* *	5.0 10.6	2.1 4.3	0.5 1.0	3900 5200	$R_k = 150$ $R_k = 68$
6BZ6	5	IF Amplifier	6.3	0.3	200	150	*	11	2.6	0.6	6100	$R_k = 180 \Omega$
6BZ7	3, 3	Class A Amplifier	6.3	0.4	150	—	*	10	—	0.0056	6800	$R_k = 220 \Omega$, $\mu = 38$ Cutoff volts = -11 volts
6BZ8	3, 3	Cascode Amplifier	6.3	0.4	125	—	*	10	—	0.0056	8000	$R_k = 100 \Omega$
6C4	3	Power Triode	6.3	0.15	250 100	— —	-8.5 0	10.5 11.8	— —	0.0077 0.0082	2200 3100	$\mu = 17$ $\mu = 19.5$
6C5 6C5G 6C5GT	3	Class A Amplifier	6.3	0.3	250	—	-8.0	8.0	—	0.010	2000	$\mu = 20$
6C6	5	AF Amplifier	6.3	0.3	See 6J7G Characteristics							
6C7	2, 2, 3	Triode Amplifier	6.3	0.3	250	—	-9.0	4.5	—	0.016	1250	
6C8G	3, 3	Amplifier	6.3	0.3	250	—	-4.5	3.2	—	0.022	1600	
6CA4	2R, 2R	Full-wave Rectifier	6.3	1.0	Max. Peak Plate Current/Plate = 450 ma Max. DC Output Current = 150 ma Max. PIV = 1000 volts							
6CA5	5	Class A Amplifier	6.3	1.2	110 125	110 125	-4.0 -4.5	32 37	3.5 4.0	0.016 0.015	8100 9200	
6CA7	5	Power Amp.	6.3	1.5	250	150	-14.5	70	10.0	0.018	9000	$W_o = 8.0$ watts
6CB5	5	Class A Amplifier	6.3	2.5	175	175	-30	90	6.0	0.005	8800	
6CB5A		Horiz. Deflection Amplifier			Max. Peak Pos. Plate Voltage = 6800 volts Max. Plate Dissipation = 23 watts Max. DC Screen Voltage = 200 volts Max. DC Cathode Current = 220 ma							
6CB6 6CB6A	5	Class A Amplifier	6.3	0.3	200	150	*	9.5	2.8	0.6	6200	$R_k = 180 \Omega$

*See quoted value of R_k

TYPE	Class	Use	E_f volts	I_f amps	E_b volts	E_{c2} volts	E_{c1} volts	I_b ma	I_{c2} ma	r_p M Ω	g_m μ mhos	
6CD6GA	5	Horizontal Deflection Amplifier	6.3	2.5	Max. DC Screen Voltage = 175 volts Max. Peak Pulse Plate Voltage = 7000 volts Max. DC Cathode Current = 200 ma Max. Plate Dissip. = 20 w							
6CD7		Tuning Indicator	6.3	0.2	Section 1: E_{c1} for shadow angle of $180^\circ = -5$ volts Section 2: E_{c1} for shadow angle of $180^\circ = 0$ volts Target Voltage = 300 volts, Target Current = 2.0 ma							
6CE5	5	Class A Amplifier	6.3	0.3	125	125	-1.0	11.0	2.3	0.3	7600	
6CF6	5	Class A Amplifier	6.3	0.3	200	150	-6.5	9.5	2.8	0.6	6200	$R_k = 180 \Omega$
6CG6	5	RF Amplifier	6.3	0.3	250	150	-8.0	9.0	2.3	0.72	2000	
6CG7	3, 3	Horizontal Deflection Oscillator	6.3	0.6	Max. DC Plate Voltage = 330 volts Max. Peak Negative Pulse Grid Voltage = 660 volts				Max. DC Cathode Curr. = 20 ma Max. Plate Dissip. = 4 w			
		Vertical Deflection Oscillator			Max. DC Plate Voltage = 330 volts Max. Peak Neg. Grid Voltage = 440 volts				Max. DC Cathode Curr. = 20 ma Max. Plate Dissip. = 4 w			
6CG8	3, 5	Triode Oscillator	6.3	0.45	100	—	*	8.5	—	0.0369	5800	$R_k = 100 \Omega, \mu = 40$
6CG8A		Pentode Mixer			250	150	*	7.7	1.6	0.75	4600	$R_k = 200 \Omega$
6CH6	5	RF Amplifier	6.3	0.75	250	250	-4.5	40	6.0	0.05	11,000	
6CH7	3, 3	RF Amplifier	6.3	0.4	150	—	*	10	—	0.0053	6800	$R_k = 220 \Omega, \mu = 36$
6CH8	3, 5	Triode Amplifier	6.3	0.45	200	—	-6.0	13	—	0.0058	3300	$\mu = 19$
		Pent. Amplifier			200	150	*	9.5	2.8	0.3	6200	$R_k = 180 \Omega$
6CJ5	5	RF Amplifier	6.3	0.2	250	250	-2.5	6.0	1.7	1.1	2200	
6CJ6	5	Class A Amplifier	6.3	1.05	250	250	-38.5	32	2.4	0.015	4600	
6CK4	3	Vert. Def. Amplifier	6.3	1.25	Max. PIV = 2000 volts Max. Plate Dissipation = 12 watts				Max. DC Cath. Current = 100 ma			
		Class A Amplifier			250	—	-28	40	—	0.0012	5500	$\mu = 6.6$
6CK5	5	Class A Amplifier	6.3	0.71	250	250	*	36	5.2	0.04	10,000	$R_k = 170 \Omega$
6CK6	5	Class A Amplifier	6.3	0.71	250	250	-5.5	36	5.0	0.13	10,000	
6CL5	5	Amplifier	6.3	2.5	175	175	-40	90	7.0	0.006	6500	
6CL6	5	Class A Amplifier	6.3	0.65	250	150	-3.0	30	7.0	0.15	11,000	$R_L = 7.5 K\Omega,$ $W_o = 2.8$ watts
6CL8	3, 4	Triode Oscillator	6.3	0.45	125	—	0	15	—	0.005	8000	$\mu = 40$
		Tetrode Mixer			125	125	-1.0	12	4.0	0.1	5800	
6CL8A	3, 4	VHF Oscillator	6.3	0.45	125	—	-1.0	14	—	0.005	8000	$\mu = 40$
		VHF Amplifier			125	125	-1.0	12	4.0	0.2	6500	$\mu = 40$
6CM5	5	Horiz. Def. Amplifier	6.3	1.25	Max. Peak Pos. Pulse Voltage = 7000 volts Max. DC Screen Voltage = 550 volts Max. DC Cathode Curr. = 200 ma Max. Plate Dissip. = 10 w Max. Screen Dissip. = 5 w							
		Class A Amplifier			100	100	-7.7	100	7.0	0.005	14,000	
6CM6	5	Class A Amplifier	6.3	0.45	180	180	-8.5	29	3.0	0.05	3700	
					250	250	-12.5	45	4.5	0.05	4100	
6CM7	3, 3	Vertical Deflection Oscillator	6.3	0.6	Unit 1 Max. DC Plate Voltage = 500 volts Max. Peak Neg. Pulse Grid Voltage = 200 volts				Max. Plate Dissip. = 1.25 w Max. DC Cathode Curr. = 15 ma			
		Vertical Deflection Amplifier			Unit 2 Max. DC Plate Voltage = 500 volts Max. Peak Positive Pulse Plate Voltage = 2200 volts				Max. Plate Dissip. = 5.5 w Max. Peak Neg. Pulse Grid Voltage = 200 volts Max. DC Cathode Curr. = 20 ma			
6CM8	3, 5	Triode Amplifier	6.3	0.45	250	-1	-2	1.8	—	0.05	2000	$\mu = 100$
		Pent. Amplifier			200	150	*	9.5	2.8	0.6	6200	$R_k = 180 \Omega$

*See quoted value of R_k

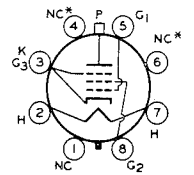

6CD6-G
6CD6-GA

*Pins omitted on type 6CD6-G.

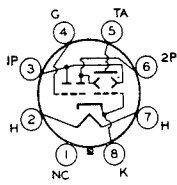

6CD7

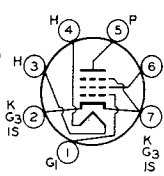

6CE5

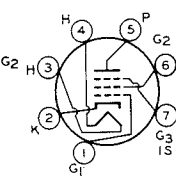

6CF6

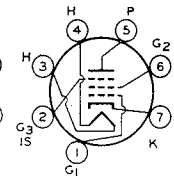

6CG6

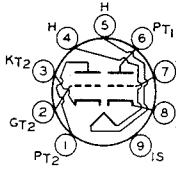

6CG7

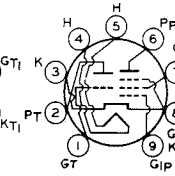

6CG8
6CG8-A

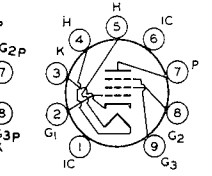

6CH6

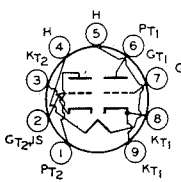

6CH7

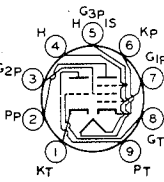

6CH8

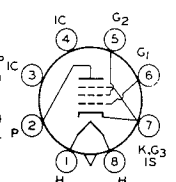

6CJ5

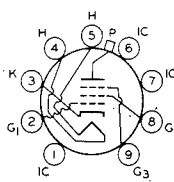

6CJ6

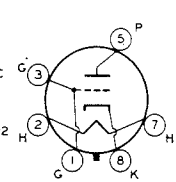

6CK4

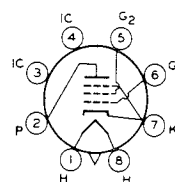

6CK5

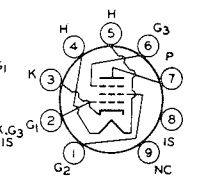

6CK6

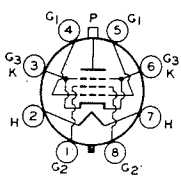

6CL5

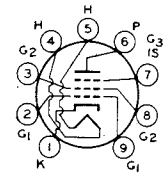

6CL6

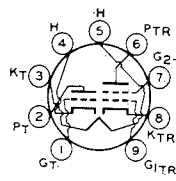

6CL8
6CL8-A

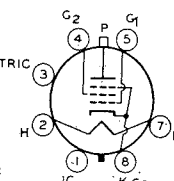

6CM5

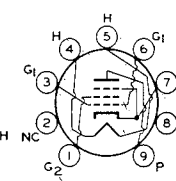

6CM6

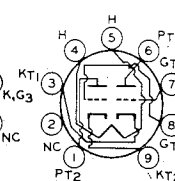

6CM7

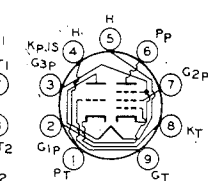

6CM8

TYPE	Class	Use	E_f volts	I_f amps	E_b volts	E_{c2} volts	E_{c1} volts	I_b ma	I_{c2} ma	r_p M Ω	g_m μ mhos		
6CN6	5	Horizontal Defl. Amplifier	6.3	1.4	Max. Screen Supply = 400 volts Max. Peak Pos. Pulse Plate Voltage = 4000 volts Max. DC Cath. Curr. = 200 ma						Max. Screen Dissip. = 8 w Max Plate Dissip. = 25 w		
6CQ6	5	RF Amplifier	6.3	0.2	250	100	-0.5	4.9	1.25		2500		
6CQ8	3, 4	Tetr. Amplifier	6.3	0.45	125	125	-1.0	12	1.2	1.4	5800		
		Triode Amplifier			125		*	15	—	0.005	8000	$R_k = 56 \Omega$	
6CR5	5	Horiz. Defl. Amplifier	6.3	1.2	Max. Peak Pos. Plate Voltage = 5500 volts Max. DC Cathode Current = 112.5 ma Max. Plate Dissipation = 11 watts							Max. DC Screen Voltage = 200 volts	
		Class A Amplifier			250	150	-22.5	65.0	2.1	0.018	6000		
6CR6	2, 5	Det. AF Amplifier	6.3	0.3	250	100	-2.0	9.5	3.0	0.2	1950		
6CR8	3, 5	Triode Amplifier	6.3	0.45	125	—	-2.0	12	—	0.005	4000	$\mu = 22$	
		Tetr. Amplifier			125	125	0	13	3.0	0.3	7700		
6CS5	5	Amplifier	6.3	1.2	110	110	-7.5	49	4.0	0.013	8000	$R_L = 2.0 K\Omega$, $W_o = 2.1$ watts	
6CS6	7	Sync. Separator and Clipper	6.3	0.3	100	30	-1	0.75	1.1	1.0	1100	$E_{c3} = 0$	
6CS7	3, 3	Triode Oscillator	6.3	0.6	250	—	-8.5	10.5	—	0.0077	2200	$\mu = 17$	
		Triode Amplifier			250	—	-10.5	19.0	—	0.0034	4500	$\mu = 15.5$	
6CS8	3, 5	Triode Amplifier	6.3	0.45	125	—	-2.0	12	—	0.005	4000	$\mu = 22$	
		Pent. Amplifier			125	125	*	13	3.0	0.3	7700	$R_k = 56 \Omega$	
6CT7	2, 5	Det. Amplifier	6.3	0.2	250	85	-2.0	5.0	1.5	1.4	2000		
6CU5	5	Class A Amplifier	6.3	1.2	120	110	-8.0	49	4.0	0.01	7500	$R_L = 2.5 K\Omega$, $W_o = 2.3$ watts	
6CU6	5	Horizontal Defl. Amplifier	6.3	1.2	Max. DC Screen Voltage = 175 volts Max. Peak Pos. Pulse Plate Voltage = 6000 volts Max. Plate Dissip. = 11 watts						Max. Screen Dissip. = 2.5 w Max DC Cathode Curr. = 110 ma		
6CU7	3, 6	Triode Amplifier	6.3	0.23	100	—	0	10	—	—	2800	$\mu = 22$	
		Hex. Converter			250	G_{2+4} 85	G_1 -2	3.0	—	1.0	—	$g_c = 750 \mu$ mhos, $R_k = 180 \Omega$	
6CU8	3, 5	Triode Amplifier	6.3	0.45	200	—	-6.0	13	—	0.005	3300	$\mu = 19$	
		Pent. Amplifier			200	150	*	9.5	2.8	0.3	6200	$R_k = 180 \Omega$	
6CV7	2, 2, 3	Det. AF Amplifier	6.3	0.23	250	—	-3.0	1.0	—	0.058	1200	$\mu = 70$	
6CW5	5	Class A Amplifier	6.3	0.76	170	170	-12.5	70	5.0	0.023	10,000		
6CX7	3, 3	Amplifier	6.3	0.4	150	—	*	9.0	—	—	6400	$\mu = 39$, $R_k = 220 \Omega$	
6CX8	3, 5	Pent. Amplifier	6.3	0.75	200	125	*	24	5.2	0.07	10,000	$R_k = 68 \Omega$	
		Triode Amplifier			150	—	*	9.2	—	0.0087	4600	$R_k = 150 \Omega$, $\mu = 40$	
6CY5	4	Class A Amplifier	6.3	0.2	125	80	-1.0	10	1.5	0.1	8000		
6CY7	3, 3	Class A Amplifier	6.3	0.75	250	—	-3.0	1.2	—	0.052	1300	Unit 1	
					150	—	*	30	—	0.001	5400	$R_k = 620 \Omega$ Unit 2	
6CZ5	5	Vert. Defl. Amplifier	6.3	0.45	Max DC Screen Voltage = 285 volts Max. Plate Dissip. = 10 w Max. Peak Positive Pulse Plate Voltage = 2200 volts						Max. Peak Neg. Pulse Grid Voltage = 250 volts Max. DC Cath. Curr. = 40 ma		
6D4	3	Relay Tube	6.3	0.25	125	—	-12	—	—	Max. Peak Cathode Curr. = 100 ma			
					50	—	-6	—	—	Voltage Drop at 25 ma = 16 v			
6D6	5	Class A Amplifier	6.3	0.3	See 6U7G Characteristics								

*See quoted value of R_k

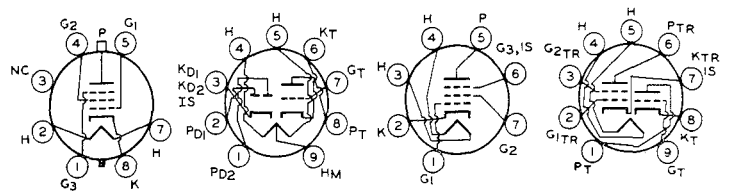

6CN6

6CN7

6CQ6

6CQ8

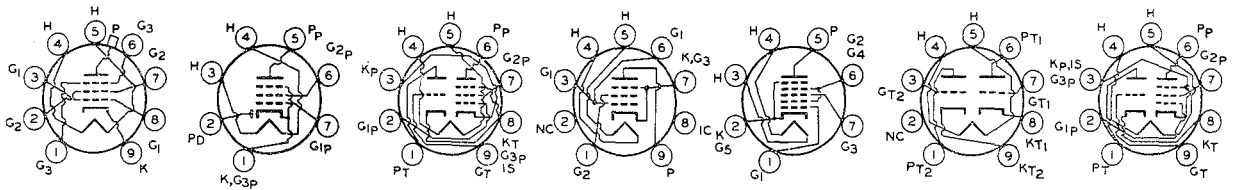

6CR5

6CR6

6CR8

6CS5

6CS6

6CS7

6CS8

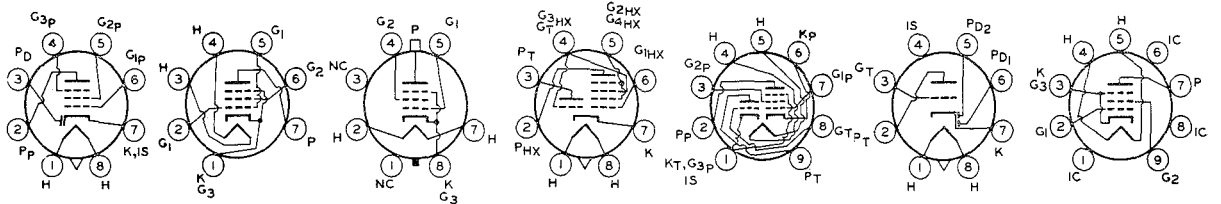

6CT7

6CU5

6CU6

6CU7

6CU8

6CV7

6CW5

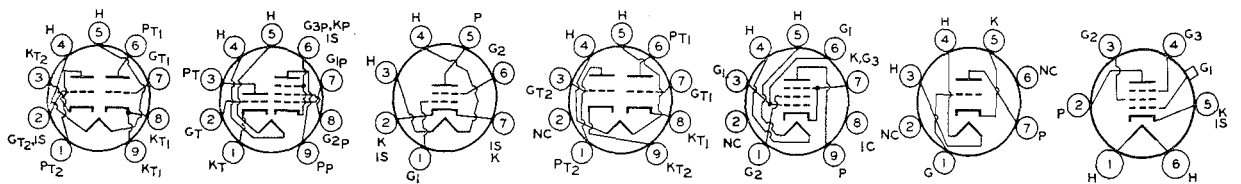

6CX7

6CX8

6CY5

6CY7

6CZ5

6D4

6D6

TYPE	Class	Use	E _f volts	I _f amps	E _b volts	E _{c2} volts	E _{c1} volts	I _b ma	I _{c2} ma	r _p MΩ	g _m μmhos	
6D7	5	Amplifier	6.3	0.3		See 6J7 Characteristics						
6D8G	7	Converter	6.3	0.15	250	G ₃₊₅ 100	G ₄ -3.0	3.5	G ₃₊₅ 2.6	0.4	E _{c2} = 250 volts, 4.3 ma R _{g1} = 50 KΩ R _{g2} = 20 KΩ g _c = 550 μmhos I _{c1} = 0.4 ma	
6DA4	2	TV Damper Diode	6.3	1.2	Max. PIV = 4400 volts Max. Peak Plate Current = 900 ma Max. DC Plate Current = 155 ma							
6DA5		Tuning Indicator	6.3	0.3	Plate Supply Voltage = 250 volts Target Voltage = 250 volts Target Current = 2.0 ma				E _{c1} for 65° shadow angle = -1 volt Plate Current = 0.37 ma			
6DA6	5	Class A Amplifier	6.3	0.2	250	100	0	9	3	1.0	3600	
6DA7	3, 3	Triode Oscillator	6.3	1.0	250	—	-8.0	9.0	—	0.0077	2600	μ = 20
		Triode Amplifier			150	—	-17.5	40	—	0.0011	5700	μ = 6.3
6DB5	5	Class A Amplifier	6.3	1.2	110	110	-7.5	50	10	0.013	8000	
6DB6	5	Colour Demod.	6.3	0.3	150	150	-1.0	5.8	6.6	0.05	2050	E _{c3} = -3 v
6DC6	5	Class A Amplifier	6.3	0.3	200	150	*	9.0	3.0	0.5	5500	R _k = 180 Ω
6DC8	2, 2, 5	RF Amplifier	6.3	0.3	200	100	-1.5	11.0	3.3	0.6	4500	
6DE4	2	TV Damper Diode	6.3	1.6	Max. PIV = 5000 volts. Max. DC Plate Current = 175 ma Max. Peak Plate Current = 1100 ma							
6DE6	5	Class A Amplifier	6.3	0.3	200	150	*	9.5	2.8	0.6	6200	R _k = 180 Ω
6DE7	3, 3	Unit 1 Vert. Defl. Oscillator	6.3	0.9	Max. DC Plate Voltage = 330 volts Peak Neg. Pulse Grid Voltage = 400 volts Max. DC Cathode Curr. = 22 ma Max. Plate Dissip. = 7 w							
		Unit 2 Vert. Defl. Amplifier			Max. Peak Positive Pulse Plate Voltage = 1500 volts Max. Peak Neg. Pulse Grid Voltage = 250 volts Max. DC Cathode Curr. = 50 ma Max. Plate Dissip. = 7 w							
6DG6GT	5	Class A Amplifier	6.3	1.2	110	110	-7.5	49	4.0	0.013	8000	R _L = 2KΩ, W _o = 2.1 watts
					200	125	*	46	2.2	0.028	8000	R _k = 180 Ω, R _k = 4KΩ, W _o = 3.8 w
6DG7	5	RF or IF Amplifier	6.3	0.3	100	100	*	10.8	4.4	0.25	4300	R _k = 68 Ω
					250	100	*	11.0	4.2	1.0	4400	R _k = 68 Ω
6DJ8	3, 3	VHF Amplifier	6.3	0.365	90	—	-1.3	15	—	0.0027	12,500	μ = 33
6DK6	5	IF Amplifier	6.3	0.3	125	125	*	12.0	3.8	—	9800	R _k = 56
6DL7		Tuning Indicator	6.3	0.3	Plate Supply Voltage = 250 volts Plate Voltage = 100 volts Target Voltage = 250 volts				Grid Voltage = 0 volts Target Current = 3.0 ma			
6DN6	5	Power Amplifier	6.3	2.5	125	125	-18	70	6.3	0.004	9000	
6DN7	3, 3	Unit 1 Vert. Defl. Oscillator	6.3	0.9	Max. DC Plate Voltage = 350 volts Max. Plate Dissip. = 1 w Peak Neg. Pulse Grid Voltage = 400 volts							
		Unit 2 Vert. Defl. Amplifier			Peak Positive Pulse Plate Voltage = 2500 volts Max. Plate Dissip. = 10 w Max. DC Cathode Curr. = 50 ma							
6DQ5	5	Horizontal Deflection Amplifier	6.3	2.5	Max. DC Plate Voltage = 900 volts Max. Peak Pos. Pulse Plate Voltage = 7000 volts (Abs.) Max. DC Cathode Current = 285 ma Max. Plate Dissip. = 24 watts							
6DQ6	5	Class A Amplifier	6.3	1.2	250	150	-22.5	75	2.4	0.02	6600	
		Horiz. Defl. Amplifier			Max. Peak Pos. Pulse Voltage = 6000 volts Max. Plate Dissip. = 15 watts Max. DC Cath. Curr. = 120 ma Max. DC Screen Voltage = 200 volts							
6DQ6A	5	Horiz. Defl. Amplifier	6.3	1.2	Max. DC Plate Voltage = 700 volts Max. DC Cathode Curr. = 140 ma Max. Peak Positive Pulse Plate Voltage = 6000 volts Max. Plate Dissipation = 15 w							

*See quoted value of R_k

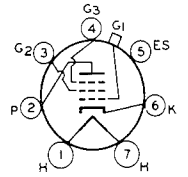

6D7

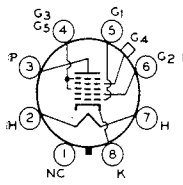

6D8-G

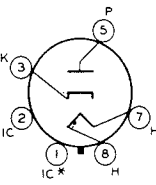

6DA4

*Pins omitted on some of this type.

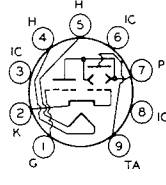

6DA5

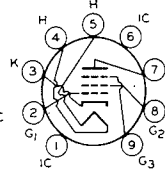

6DA6

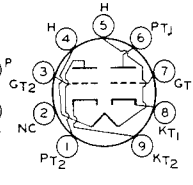

6DA7

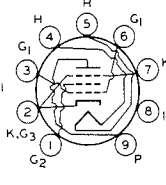

6DB5

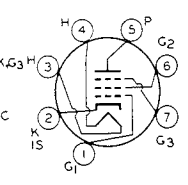

6DB6

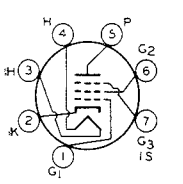

6DC6

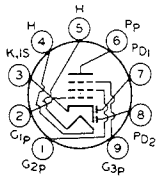

6DC8

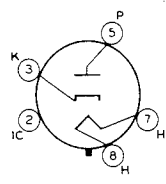

6DE4

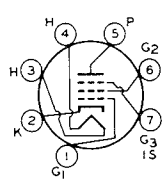

6DE6

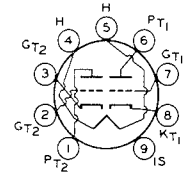

6DE7

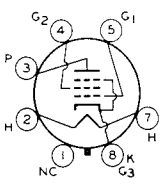

6DG6-GT

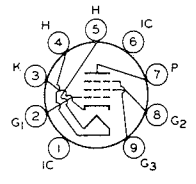

6DG7

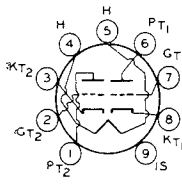

6DJ8

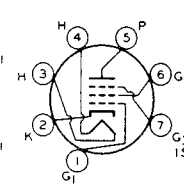

6DK6

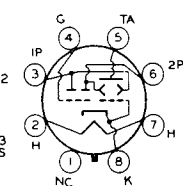

6DL7

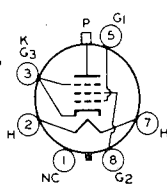

6DN6

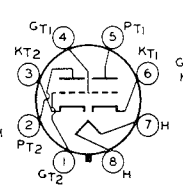

6DN7

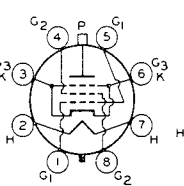

6DQ5

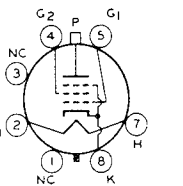

6DQ6
6DQ6-A

TYPE	Class	Use	E_f volts	I_f amps	E_b volts	E_{c2} volts	E_{c1} volts	I_b ma	I_{c2} ma	r_p M Ω	g_m μ mhos	
6DR6	5	Class A Amplifier			See 6CJ6 Characteristics							
6DR7	3, 3	Vert. Defl. Oscillator	6.3	0.9	250	—	-3	1.4	—	0.04	1600	$\mu = 68$
		Vert. Defl. Amplifier			150	—	-17.5	35	—	925 Ω	6500	$\mu = 6$
6DS5	5	Class A Amplifier	6.3	0.8	200	200	-7.5	35	3.0	0.028	6000	$R_L = 6\text{ K}\Omega$, $W_o = 3\text{ watts}$
					250	200	-8.5	29	3.0	0.028	5800	$R_L = 8\text{ K}\Omega$, $W_o = 3.8\text{ watts}$
6DT5	5	Vert. Defl. Amplifier	6.3	1.2	Max. Peak Pos. Plate Voltage = 2200 volts Max. Screen Dissip. = 2 w Max. DC Cathode Current = 55 ma Max. Plate Dissip. = 9 w							
		Class A Amplifier			250	250	-16.5	44	1.5	—	6200	
6DT6	5	Class A Amplifier	6.3	0.3	150	100	*	1.1	2.1	0.15	515	$R_k = 560\ \Omega$
		FM Detector			250	100	*	0.22	5.5	$E_{c3} = -6\text{ volts}$	$R_k = 560\ \Omega$	$R_L = 0.27\text{ M}\Omega$
6DT8	3, 3	Class A Amplifier	6.3	0.3	100	—	*	3.7	—	0.015	4000	$\mu = 60$ $R_k = 270\ \Omega$
					250	—	*	10.0	—	0.01	4500	$\mu = 60$ $R_k = 200\ \Omega$
6DW5	5	Vert. Defl. Amplifier	6.3	1.2	Max. Peak Pos. Pulse Plate Voltage = 2200 volts Max. Screen Dissip. = 2.5 w Max. DC Cathode Current = 65 ma Max. Plate Dissip. = 11 watts							
		Class A Amplifier			200	150	-22.5	55.0	2.0	0.015	5500	
6DY7	5, 5	Class A Amplifier	6.3	1.2	250	250	-12.5	50	3.0	0.028	6000	
		P.P. Amplifier†			400	250	-20	58	1.7	—	—	$R_L = 14\text{ K}\Omega$, $W_o = 20\text{ watts}$
6DZ8	3, 5	Triode Amplifier	6.3	0.9	120	—	*	0.8	—	0.071	1490	$\mu = 100$ $R_k = 1500\ \Omega$
		Pent. Amplifier			145	120	*	45	6	0.0025	7500	$R_L = 2.5\text{ K}\Omega$, $W_o = 2.0\text{ w}$, $R_k = 180\ \Omega$
6E5		Tuning Indicator	6.3	0.3	100 250	E_{c1} for 0° shadow angle = -7.5 volts E_{c1} for 90° shadow angle = 0 volts Target Voltage = 250 volts Target Current = 2.0 ma						
6E6	3, 3	P.P. Class A Amplifier	6.3	0.6	180	—	-20.5	11.5	—	0.0043	1400	$R_L = 15\text{ K}\Omega$, $W_o = 0.75\text{ watts}$
					250	—	-27.5	18.0	—	0.0035	1700	$R_L = 14\text{ K}\Omega$, $W_o = 1.6\text{ watts}$
6E7	5	Class A Amplifier	6.3	0.3	See 6U7G Characteristics							
6EA5	4	Class A Amplifier	6.3	0.2	250	140	-1.0	10	0.95	0.15	8000	
6EA8	3, 5	Triode Amplifier	6.3	0.45	150	—	*	18	—	0.005	8500	$\mu = 40$ $R_k = 56\ \Omega$
		Pent. Amplifier			125	125	-1.0	12	4	0.08	6400	
6EB8	3, 5	Triode Amplifier	6.3	0.75	250	—	-2.0	2.0	—	0.037	2700	$\mu = 130$
		Pent. Amplifier			200	125	*	25	7.0	0.075	12,500	$R_k = 68\ \Omega$
6EF6	5	Vertical Deflection Amplifier	6.3	0.9	Max. Peak Pos.-Pulse Plate Voltage = 2000 volts Max. DC Cathode Current = 60 ma Max. Plate Dissip. = 10 w Max. Screen Dissip. = 2 w							
6EH5	5	Class A Amplifier	6.3	1.2	110	115	*	42	11.5	0.011	14,600	$R_L = 3.0\text{ K}\Omega$, $R_k = 62\ \Omega$, $W_o = 1.4\text{ watts}$
6EHS	3, 5	Triode Amplifier	6.3	.45	125	—	-1.0	13.5	—	—	7500	$\mu = 40$
		Pent. Amplifier			125	125	-1.0	12.0	4.0	0.17	6000	

*See quoted value of R_k

†Class AB

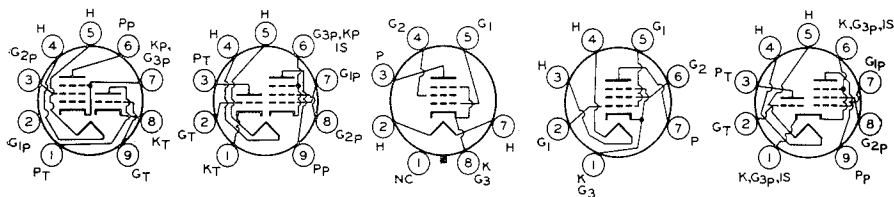
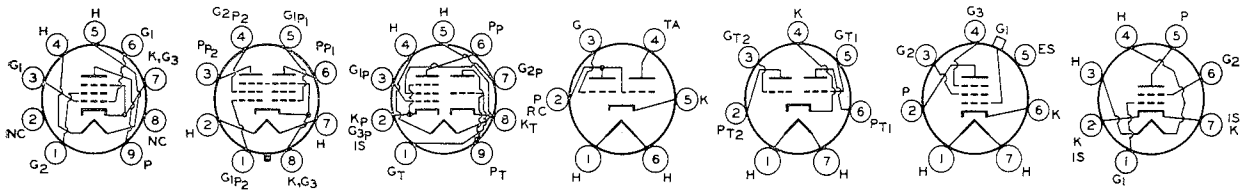
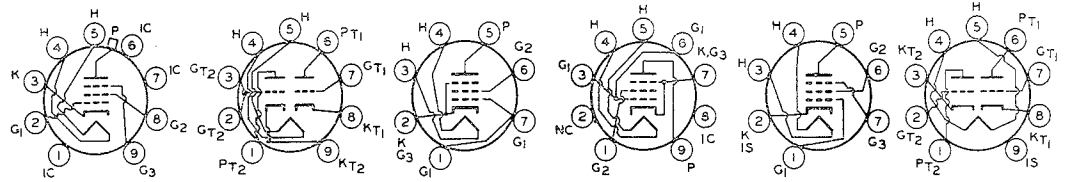

TYPE	Class	Use	E_f volts	I_f amps	E_b volts	E_{c2} volts	E_{c1} volts	I_b ma	I_{c2} ma	r_p M Ω	g_m μ mhos	
6EM5	5	Vert. Defl. Amplifier	6.3	0.8	Max. Peak Pos.-Plate Voltage = 2200 volts Max. DC Cathode Current = 60 ma Max. Plate Dissip. = 10w Max. DC Screen Voltage = 285 volts							
6EM7	3, 3	Triode Oscillator	6.3	0.9	250	—	-3	1.4	—	0.04	1600	
		Triode Amplifier			150	—	-20	50	—	750 Ω	7200	
6ES8	3, 3	Class A Amplifier	6.3	0.365	90	—	-1.2	15	—	—	12,500	
6EU8	3, 5	Triode Oscillator	6.3	0.45	150	—	*	18	—	0.005	8500	$R_k = 56 \Omega$, $\mu = 40$
		Pent. Mixer			125	125	-1	12	4.0	0.08	—	$g_c = 6400 \mu$ mhos
6EV7	3, 3	Class A Amplifier	6.3	0.3	250	—	-2	9.2	—	11,500	5200	$\mu = 60$
6EW6	5	Class A Amplifier	6.3	0.4	125	125	*	11	3.2	0.2	14,000	$R_k = 56 \Omega$
6F4	3	Class A Amplifier	6.3	-225	80	—	*	13.0	—	-0.029	5800	$\mu = 17$, $R_k = 150 \Omega$
6F5 6F5G 6F5GT	3	Class A Amplifier	6.3	0.3	100	-1.0	—	0.4	—	0.085	1150	$\mu = 100$
					250	-2.0	—	0.9	—	0.066	1500	$\mu = 100$
6F6 6F6G	5	Class A Amplifier	6.3	0.7	250	250	-16.5	34.0	6.5	0.08	2500	$R_L = 7.0 K\Omega$, $W_o = 3.2$ watts
					285	285	-20.0	38.0	7.0	0.078	2550	$R_L = 7.0 K\Omega$, $W_o = 4.8$ watts
6F6GT		P.P. Class A Amp.			315	285	-24.0	62.0	12.0	—	—	$R_L = 10 K\Omega \nabla$, $W_o = 11$ watts ∇
		P.P. Amplifier†			375	250	-26.0	34.0	5.0	—	—	$R_L = 10 K\Omega \nabla$, $W_o = 18.5$ watts ∇
6F7	3, 5	Triode Amplifier	6.3	0.3	100	—	-3.0	3.5	—	0.016	500	$\mu = 8$
		Pent. Amplifier			250	100	-3.0	6.5	1.5	0.85	1100	
6F8G	3, 3	Class A Amplifier	6.3	0.6	See 6J5 Characteristics							
6FH5	3	Class A Amplifier	6.3	0.2	135	—	-1	11	—	0.005	9000	$\mu = 50$
6FH6	5	Horiz. Defl. Amplifier	6.3	1.2	250	150	-22.5	75	1.7	0.012	6000	
6FV6	4	Class A Amplifier	6.3	0.2	125	80	-1.0	10	1.5	0.1	8000	
6G5		Tuning Indicator	6.3	0.3	See 6U5/6G5 Characteristics							
6G6G 6G6GT	5	Class A Amplifier	6.3	0.15	180	180	-9.0	15.0	2.5	0.175	2300	$R_L = 10 K\Omega$, $W_o = 1.1$ watts
6G8G	2, 2, 5	RF Amplifier	6.3	0.3	250	125	-3.0	9.5	2.2	0.5	1210	
6GM6	5	Class A Amplifier	6.3	0.4	125	125	*	14	3.4	0.2	13,000	$R_k = 56 \Omega$
6H6 6H6G 6H6GT	2R, 2R	Full-Wave Rectifier	6.3	0.3	Max. PIV = 420 volts Max. DC Output Current/Plate = 8 ma Max. Peak Plate Current/Plate = 48 ma							
6H8G	2, 2, 5	Class A Amplifier	6.3	0.3	100	100	-2.0	5.5	1.9	0.4	2000	$\mu = 800$
					250	125	-2.0	8.5	2.6	0.65	2400	$\mu = 1550$
6J4	3	Class A Amplifier	6.3	0.4	150	—	*	15.0	—	0.005	1200	$\mu = 55$, $R_k = 100 \Omega$
6J5 6J5GT	3	Class A Amplifier	6.3	0.3	250	—	-8.0	9.0	—	0.0077	2600	$\mu = 20$
6J6 6J6A	3, 3	Class A Amplifier	6.3	0.45	100	—	*	8.5	—	0.007	5300	$\mu = 38$ $R_k = 50 \Omega$
6J7 6J7G 6J7GT	5	Class A Amplifier	6.3	0.3	250	100	-3.0	2.0	0.5	1.0	1225	
					100	100	-3.0	2.0	0.5	1.0	1185	

*See quoted value of R_k

▼Two valves

†Class AB.

TYPE	Class	Use	E_f volts	I_f amps	E_b volts	E_{c2} volts	E_{c1} volts	I_b ma	I_{c2} ma	r_p M Ω	g_m μ mhos		
6J8G	3, 6	Converter	6.3	0.3	250	G_{2+4} 100	G_1 -3.0	1.3	G_{2+4} 2.9	4.0	$I_{c1} = 0.4$ ma $R_{g1} = 50$ K Ω , $g_c = 290$ μ mhos		
6J8GA	3, 6	Converter	6.3	0.45	See 6J8G Characteristics								
6K5G	3	Class A Amplifier	6.3	0.3	100	—	-1.5	0.35	—	0.078	900	$\mu = 70$	
6K5GT					250	—	-3.0	1.1	—	0.05	1400	$\mu = 70$	
6K6G	5	Class A Amplifier	6.3	0.4	315	250	-21.0	25.5	4.0	0.11	2100	$R_L = 9.0$ K Ω , $W_o = 4.5$ watts	
6K6GT					250	250	-18.0	32	5.5	0.09	2300	$R_L = 7.6$ K Ω , $W_o = 3.4$ watts	
6K7	5	Class A Amplifier	6.3	0.3	100	100	-1.0	9.5	2.7	0.15	1650		
6K7G					250	125	-3.0	10.5	2.6	0.6	1650		
6K8	3, 6	Converter	6.3	0.3	250	G_{2+4}	G_3	2.5	G_{2+4}	0.6	$I_{c1} = 0.15$ ma $R_{g1} = 50$ K Ω , $g_c = 350$ μ mhos		
6K8G					100	-3.0	6.0						
6K8GT													
6L4	3	Class A Amplifier	6.3	0.225	80	—	*	9.5	—	0.0044	6400	$\mu = 28$, $R_k = 150$ Ω	
6L5G	3	Class A Amplifier	6.3	0.15	135	—	-5.0	3.5	—	0.0113	1500	$\mu = 17$	
					250	—	-9.0	8.0	—	0.009	1900	$\mu = 17$	
6L6	5	Class A Amplifier	6.3	0.9	250	250	-14.0	72.0	5.0	$R_L = 2.5$ K Ω , $W_o = 6.5$ watts			
					250	250	*	75.0	5.4	$R_L = 2.5$ K Ω , $W_o = 6.5$ w., $R_k = 170$ Ω			
		Push Pull Class AB ₁ Amplifier			270	270	-17.5	134 ∇	11.0 ∇	$R_L = 5.0$ K Ω , $W_o = 17.5$ watts ∇			
					270	270	*	134 ∇	11.0 ∇	$R_L = 5.0$ K Ω , $W_o = 18.5$ watts ∇ $R_k = 125$ Ω ∇			
6L6GC	5	P.P. Class AB ₁ Amplifier	6.3	0.9	360	270	-22.5	88	5	$R_L(p-p) = 6.6$ K Ω , $W_o = 26.5$ watts			
					450	400	-37	116	5.6	$R_L(p-p) = 5.6$ K Ω , $W_o = 55$ watts			
6L7	7	Converter	6.3	0.3	250	G_{2+4}	G_1	2.4	7.1	1.0	$E_{c3} = -10$ v, $g_c = 375$ μ mhos		
6L7G		Class A Amplifier			250	100	-3.0	5.3	6.5	0.6	1100		
6M3	2	Damper Diode	6.3	3.0	Max. PIV = 6000 volts Max. Peak Plate Current = 1.1 amp. Max. DC Output Current = 320 ma Max. Plate Dissip. = 8 w								
6M5	5	Class A Amplifier	6.3	0.71	250	250	*	36.0	5.2	0.04	10,000	$R_L = 7.0$ K Ω , $R_k = 170$ Ω $W_o = 3.9$ w.	
6M6	5	Power Amplifier	6.3	1.2	250	250	-6.0	36.0	4.0	0.05	9500	$\mu = 475$	
6M6G												$R_L = 7.0$ K Ω , $W_o = 4.4$ w	
6M7G	5	Remote Cutoff RF Pentode	6.3	0.9	100	100	-2.5	6.2	1.8	0.35	2500	$\mu = 875$	
					250	100	-2.5	6.5	1.7	1.5	2800	$\mu = 4200$	
6M8GT	3, 3, 5	Triode Amplifier	6.3	0.6	100	—	-1.0	0.5	—	0.09	1100	$\mu = 100$	
		Pent. Amplifier			100	100	-3.0	8.5	2.7	0.2	1900		
6N3	2R, 2R	Full-wave Rectifier	6.3	0.9	Max. PIV = 850 volts Max. DC Output Current = 360 ma Max. Peak Plate Current/Plate = 1100 ma								
6N4	3	Class A Amplifier	6.3	0.2	180	—	-3.5	12	—	—	6000	$\mu = 32$	
6N5		Tuning Indicator	6.3	0.15	Target Voltage = 135 volts E_{c1} for 0° shadow angle = -10 volts Target Current = 2.0 ma								
6N6	3, 3	Class A Amplifier	6.3	0.8	300	—	†	9	—	—	—	Input Unit	
6N6G					300	—	†	42	—	0.024	2400	‡	Output Unit $R_L = 7$ K Ω

*See quoted value of R_k

▼Two valves

†Developed internally

‡Input to output

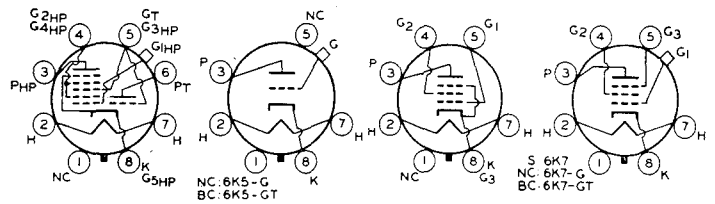

6J8-G

**6K5-G
6K5-GT**

**6K6-G
6K6-GT**

**6K7
6K7-G
6K7-GT**

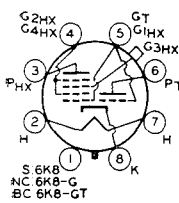

**6K8
6K8-G
6K8-GT**

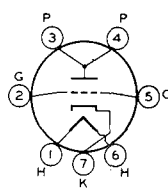

6L4

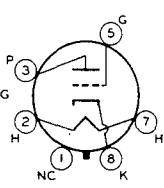

6L5-G

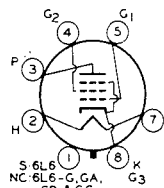

**6L6-G
6L6-GA
6L6-GB, -GC**

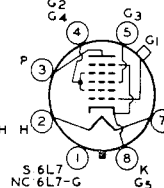

**6L7
6L7-G**

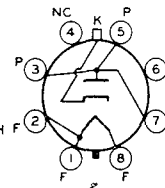

6M3

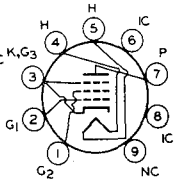

6M5

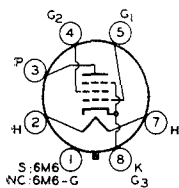

**6M6
6M6-G**

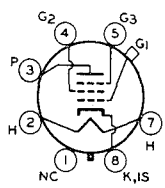

6M7-G

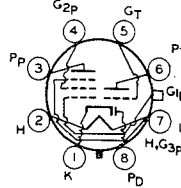

6M8-GT

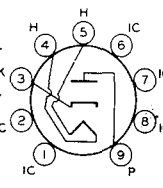

6N3

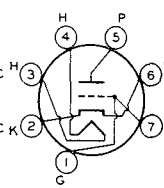

6N4

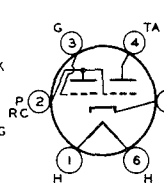

6N5

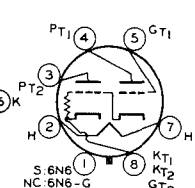

**6N6
6N6-G**

TYPE	Class	Use	E_f volts	I_f amps	E_b volts	E_{c2} volts	E_{c1} volts	I_b ma	I_{c2} ma	I_p M Ω	g_m μ mhos	
6N7	3, 3	Class A Amplifier Driver	6.3	0.8	250	—	-5.0	6.0	—	0.12	3100	$\mu = 35$
6N7G					294	—	-6.0	7.0	—	0.011	3200	
6N7GT		Class B Amplifier			300	—	0	35	—	—	—	—
6N8	2, 2, 5	RF Amplifier	6.3	0.3	250	8.5	-2.0	5.0	1.75	1.6	2200	
6P5G	3	Class A Amplifier	6.3	0.3	250	—	-13.5	5.0	—	0.01	1450	
6P5GT					100	—	-5.0	2.5	—	0.012	1150	
6P7G	3, 5	Triode Amplifier	6.3	0.3	100	—	-3.0	3.5	—	0.016	500	$\mu = 8$
					250	100	-3.0	6.5	0.6	2.0	1100	
6P8G	3, 6	Hexode Conv.	6.3	0.8	250	80	-2.0	1.5	1.4	0.75	$g_c = 650 \mu$ mhos	
		Triode Amplifier			100	—	-2.0	2.2	—	—	$R_{g1} = 50 \text{ K}\Omega$	
6Q4	3	RF Amplifier	6.3	0.48	250	—	-1.5	15	—	—	12,000	$\mu = 80$
6Q5G	3	Thyratron	6.3	0.6	Max. Inst. Plate Voltage = 300 volts Max. Average Anode Current = 1 ma Max. Peak Anode Current = 300 ma $R_{g1} = 10 \text{ K}\Omega$ min.							
6Q7 6Q7G 6Q7GT	2, 2, 3	Triode Class A Amp.	6.3	0.3	100	—	-1.0	0.8	—	-0.58	1200	$\mu = 70$
					250	—	-3.0	1.0	—	-0.58	1200	$\mu = 70$
6R3	2R	Half-wave Rectifier	6.3	0.81	Max. PIV = 5600 volts (Abs.) Max. Peak Plate Current = 450 ma Max. DC Output Current = 150 ma							
6R4	3	Oscillator	6.3	0.2	150	—	-2.0	30	—	—	5500	$\mu = 16$
6S4 6S4A	3	Vertical Deflection Amplifier	6.3	0.6	Max. DC Plate Voltage = 500 volts Max. Peak Pos. Pulse Plate Voltage = 2000 volts Max. DC Cathode Current = 30 ma Max. Plate Dissipation = 7.5 2							
6S5		Tuning Indicator	6.3	0.3	Target Voltage = 250 volts, 2 ma Vane Grid Voltage = 135 volts Control Grid Voltage for Shadow of 60° = 0 volts Control Grid Voltage for Shadow of 360° = -8 volts							
6S7 6S7G	5	Class A Amplifier	6.3	0.15	135	67.5	-3.0	3.7	0.9	1.0	1250	
					250	100	-3.0	8.5	2.0	1.0	1750	
6S8GT	2, 2, 2, 3	Triode Amplifier	6.3	0.3	100	—	-1.0	0.4	—	0.11	900	$\mu = 100$
					250	—	-2.0	0.9	—	0.09	1100	$\mu = 10$
6SA7 6SA7GT	7	Converter	6.3	0.3	250	G_{2+4}	0	3.5	G_{2+4}	1.0	g_c	$R_{g1} = 20 \text{ K}\Omega$
					100	100	8.5	450	$I_{c1} = 0.5 \text{ ma}$			
6SB7Y	7	Converter	6.3	0.3	250	G_{2+4}	G_3	3.8	G_{2+4}	1.0	g_c	$R_{g1} = 20 \text{ K}\Omega$
					100	100	-1.0	10.0	950	$I_{c1} = 0.35 \text{ ma}$		
6SC7 6SC7GT	3, 3	Class A Amplifier	6.3	0.3	250	—	-2.0	2.0	—	0.05	1325	$\mu = 70$
6SD7GT	5	RF Amplifier	6.3	0.3	100	100	-2.0	5.7	2.0	0.25	3350	
					250	100	-2.0	6.0	1.9	1.0	3600	
6SE7GT	5	RF Amplifier	6.3	0.3	250	100	-1.5	4.5	1.5	1.0	3400	
6SF5 6SF5GT	3	Class A Amplifier	6.3	0.3	100	—	-1.0	0.4	—	0.85	1150	$\mu = 100$
					250	—	-2.0	0.9	—	0.66	1500	$\mu = 100$
6SF7	2, 5	Pent. Class A Amplifier	6.3	0.3	100	100	-1.0	12.0	3.4	0.2	1975	
					250	100	-1.0	12.4	3.3	0.7	2050	

TYPE	Class	Use	E_r volts	I_r amps	E_b volts	E_{c2} volts	E_{c1} volts	I_b ma	I_{c2} ma	r_p M Ω	g_m μ mhos								
6SF7	2, 5	Class A Amplifier	6.3	0.3	100 250	100 100	-1.0 -1.0	12.0 12.4	3.4 3.3	0.2 0.7	1975 2050								
6SG7 6SG7GT	5	Class A Amplifier	6.3	0.3	100 250	100 150	-1.0 -2.5	8.2 9.2	3.2 3.4	0.25 1.0+	4100 4000								
6SH7 6SH7GT	5	Class A Amplifier	6.3	0.3	100 250	100 150	-1.0 -1.0	5.3 10.8	2.1 4.1	0.35 0.9	4000 4900								
6SJ7 6SJ7GT	5	Class A Amplifier	6.3	0.3	100 250	100 100	-3.0 -3.0	2.9 3.0	0.9 0.8	0.7 1.0	1575 1650								
6SK7 6SK7GT	5	Class A Amplifier	6.3	0.3	100 250	100 100	-1.0 -3.0	13.0 9.2	4.0 2.6	0.12 0.8	2350 2000								
6SL7GT	3, 3	Class A Amplifier	6.3	0.3	250	—	-2.0	2.3	—	0.044	1600	$\mu = 70$							
6SN7GT 6SN7GTA 6SN7GTB	3, 3	Class A Amplifier Vertical Deflection Amplifier	6.3	0.6	90 250	— —	0 -8.0	10.0 9.0	— —	0.0067 0.0077	3000 2600	$\mu = 20$							
6SQ7 6SQ7GT	2, 2, 3	Class A Amplifier	6.3	0.3	100 250	— —	-1.0 -2.0	0.4 0.9	— —	0.11 0.09	900 1100	$\mu = 100$ $\mu = 100$							
6SR7 6SR7GT	2, 2, 3	Class A Amplifier	6.3	0.3	250	—	-9.0	9.5	—	0.0085	1900	$R_L = 10\text{ K}\Omega$, $W_o = 0.3\text{ watts}$							
6SS7 6SS7GT	5	Class A Amplifier	6.3	0.15	100 250	100 100	-1.0 -3.0	12.2 9.0	3.1 2.0	0.12 1.0	1930 1850								
6ST7	2, 2, 3	Triode Amplifier	6.3	0.15	See 6SR7 Characteristics														
6SU7GTY	3, 3	Class A Amplifier	6.3	0.3	250	—	-2.0	2.3	—	0.044	1600	$\mu = 70$							
6SV7	2, 5	Class A Amplifier	6.3	0.3	250	150	-1.0	7.5	2.8	1.5	3600								
6SZ7	2, 2, 3	Triode Amplifier	6.3	0.15	100 250	— —	-1.0 -3.0	0.8 1.0	— —	0.061 0.058	1150 1200	$\mu = 70$ $\mu = 70$							
6T4	3	UHF Oscillator Class A Amplifier	6.3	0.225	Max. DC Plate Voltage = 200 volts Max. Grid Current = 8 ma Max. DC Cathode Current = 30 ma Max. Plate Dissip. = 3.5 w							80	—	*	18	—	—	7000	$R_k = 150\ \Omega$, $\mu = 13$
6T7G	2, 2, 3	Triode Amplifier	6.3	0.15	135 250	— —	-1.5 -3.0	0.9 1.2	— —	0.065 0.062	1000 1050	$\mu = 65$ $\mu = 65$							
6T8 6T8A	2, 2, 2, 3	Triode Amplifier	6.3	0.45	100 250	— —	-1.0 -3.0	0.8 1.0	— —	0.054 0.058	1300 1200	$\mu = 70$ $\mu = 70$							
6U3	2	Damper Diode	6.3	1.2	Max. PIV = 4000 volts AC volts/plate = 350 volts Max. Peak Plate Current = 400 ma Max. DC Output Current = 180 ma														
6U4GT	2R	Half-wave Rectifier	6.3	1.2	Max. PIV = 3850 volts Max. DC Output Curr. = 138 ma Max. Peak Plate Current = 660 ma														
6U5 6U5G 6U5/6G5		Tuning Indicator	6.3	0.3	Target Voltage = 250 volts Target Current = 4.0 ma Grid Bias = -22 volts for 0° Shadow Angle														

*See quoted value of R_k

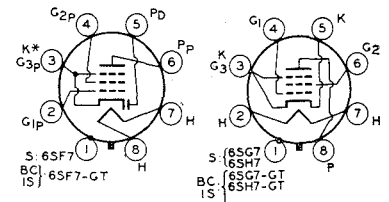

6SF7
6SF7-GT

*6SF7-GT has an
Internal Shield

6SG7, -GT
6SH7, -GT

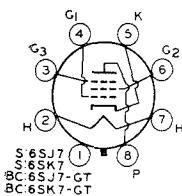

6SJ7, -GT
6SK7, -GT

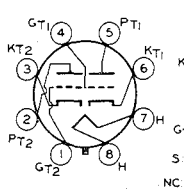

6SL7-GT
6SN7-GT, GTA
6SN7-GTB

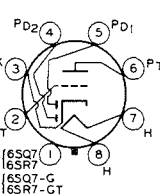

6SQ7, -G
6SQ7-GT
6SR7, -GT

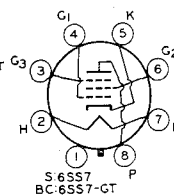

6SS7
6SS7-GT

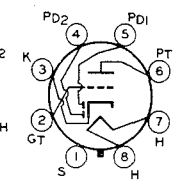

6ST7

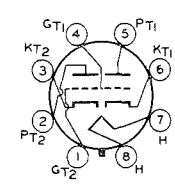

6SU7-GTY

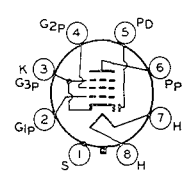

6SV7

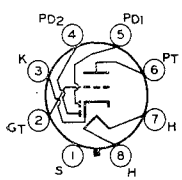

6SZ7

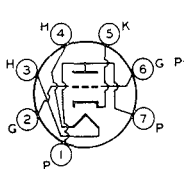

6T4

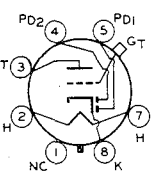

6T7-G

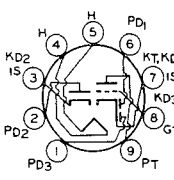

6T8
6T8-A

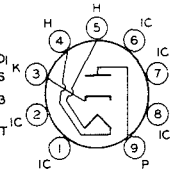

6U3

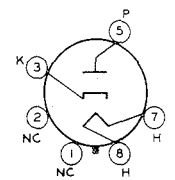

6U4-GT

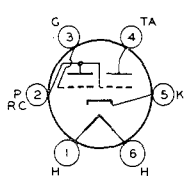

6U5
6U5/6G5

TYPE	Class	Use	E_r volts	I_r amps	E_b volts	E_{c2} volts	E_{c1} volts	I_b ma	I_{c2} ma	r_p M Ω	g_m μ mhos			
6U6GT	5	Power Amplifier	6.3	0.75	200	135	-14	55	3.0	0.02	6200	$R_L = 3.0 \text{ K}\Omega$, $W_o = 5.5 \text{ watts}$		
6U7G	5	Class A Amplifier	6.3	0.3	250	100	-3.0	8.2	2.0	0.8	1600			
6U8	3, 5	Triode Amplifier	6.3	0.45	150	—	*	18	—	0.005	8500	$R_k = 56 \Omega$, $\mu = 40$		
6U8A		Pentode Amplifier			250	110	*	10	3.5	0.4	5200	$R_k = 68 \Omega$		
6V3 6V3A	2R	Damper Diode	6.3	1.75	Max. PIV = 6000 volts (Abs.) Max. Peak Plate Current = 800 ma Max. DC Plate Current = 135 ma						Max. Plate Dissip. = 2.7 w			
6V4	2R, 2R	Full-wave Rectifier	6.3	0.6	Max. AC Volts/Plate = 350 volts (Abs.) DC Output Current = 90 ma						Max. PIV = 980 volts			
6V5GT	5	Power Amp.	6.3	0.45	315	225	-13	35	6.0	0.077	3750	$R_L = 8.5 \text{ K}\Omega$, $W_o = 5.5 \text{ watts}$		
6V6 6V6GT 6V6GTA 6V6GTY	5	Power Amplifier	6.3	0.45	180 250 315	180 250 13.0	-8.5 -12.5 225	29 45 34	3.0 4.5 2.2	0.05 0.05 0.08	3700 4100 3750	$R_L = 5.5 \text{ K}\Omega$, $W_o = 2.0 \text{ watts}$ $R_L = 5.0 \text{ K}\Omega$, $W_o = 4.5 \text{ watts}$ $R_L = 8.5 \text{ K}\Omega$, $W_o = 5.5 \text{ watts}$		
6V7G	2, 2, 3	Triode Amplifier	6.3	0.3	See Type 85 Characteristics									
6V8	2, 2, 2, 3	Det. Amplifier	6.3	0.45	100 250	— —	-1.0 -3.0	0.8 1.0	— —	0.054 0.058	1300 1200	$\mu = 70$ $\mu = 70$		
6W4GT	2R	Half-wave Rectifier	6.3	1.2	Max. DC Output Current = 125 ma Max. PIV = 1250 volts								Max. Peak Plate Current = 600 ma	
6W6GT	5	Vertical Deflection Amplifier	6.3	1.2	Max. DC Cathode Current = 40 ma Max. Plate Dissipation = 7.5 w.				Max. Peak Pos.-Pulse Plate Voltage = 1200 volts Max. Peak Neg.-Pulse Grid Voltage = 250 volts					
6W7G	5	Class A Amplifier	6.3	0.15	250	100	-3.0	2.0	0.5	1.5	1225			
6X2	2R	Half-wave Rectifier	6.3	0.09	Max. PIV = 17,000 volts Max. Peak Plate Current = 80 ma Max. Average Plate Current = 0.35 ma									
6X4	2R, 2R	Rectifier	6.3	0.6	Max. DC Output Current = 70 ma Max. Peak Plate Current/Plate = 210 ma Max. PIV = 1250 volts									
6X5 6X5G 6X5GT	2R, 2R	Full-wave Rectifier	6.3	0.6	Max. PIV = 1250 volts Max. Peak Plate Current/Plate = 210 ma									
6X6G		Tuning Indicator	6.3	0.3	Target Voltage = 250 volts Control Grid Voltage = 50 volts Target Current = 4.0 ma				Target Cathode Voltage = 50 volts					
6X8	3, 5	Triode Amplifier	6.3	0.45	100	—	*	8.5	—	0.0069	5800	$R_k = 100 \Omega$, $\mu = 40$		
6X8A		Pentode Amplifier			250	150	*	7.7	1.6	0.75	4600	$R_k = 200 \Omega$		
6Y3G	2R	Half-wave Rectifier	6.3	0.7	Max. PIV = 14,000 volts Max. Peak Plate Current = 100 ma Max. DC Output Current = 7.5 ma									
6Y5	2R, 2R	Full-wave Rectifier	6.3	0.8	Max. AC Voltage/Plate = 350 (rms) Max. DC Output Current = 50 ma									

*See quoted value of R_k

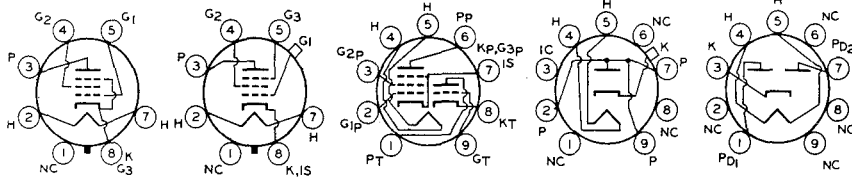

6U6-GT 6U7-G 6U8
6U8-A 6V3
6V3-A 6V4

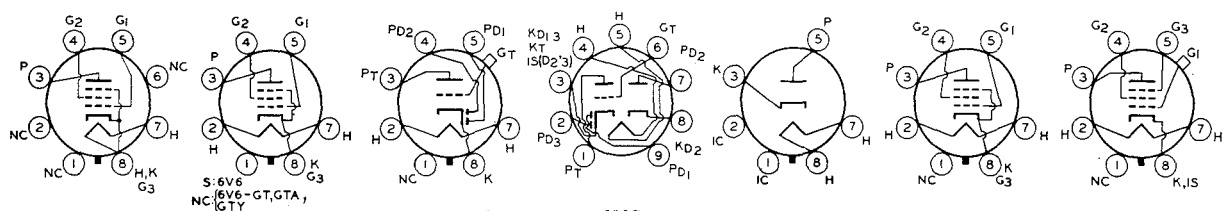

6V5-GT 6V6
6V6-GT
6V6-GTA
6V6-GTY 6V7-G 6V8
6W4-GT 6W6-GT 6W7-G

FLYING LEADS

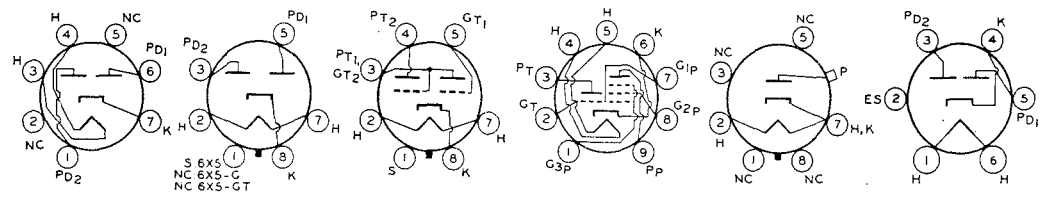

6X2 6X4 6X5
6X5-G
6X5-GT 6X6-G 6X8
6X8-A 6Y3-G 6Y5

TYPE	Class	Use	E _r volts	I _r amps	E _b volts	E _{c2} volts	E _{c1} volts	I _b ma	I _{c2} ma	r _p MΩ	g _m μmhos	
6Y6G 6Y6GA 6Y6GT	5	Class A Amplifier	6.3	1.25	135 200	135 135	-13.5 -14.0	58.0 61.0	3.5 2.2	0.009 0.0183	7000 7100	R _L = 2.0 KΩ, W _o = 3.6 watts R _L = 2.6 KΩ, W _o = 6.0 watts
6Y7G	3, 3	Class B Amp.	6.3	0.6	See Type 79 Characteristics							
6Z4 6Z4/84	2R, 2R	Full-wave Rectifier	6.3	0.5	AC Voltage/Plate = 325 volts				Max. PIV = 1250 volts			
					DC Output Current = 60 ma				Max. Peak Plate Curr. = 180 ma			
6Z5	2R, 2R	Full-wave Rectifier	6.3 12.6	0.8 0.4	Max. AC Voltage/Plate = 230 volts							
					Max. PIV = 1500 volts							
					Max. DC Output = 60 ma							
6Z7G	3, 3	Class B Amplifier	6.3	0.3	135 180	— —	0 0	60 60	— —	— —		R _L † = 9.0 KΩ, W _o = 2.5 watts R _L † = 12.0 KΩ, W _o = 4.2 watts
6ZY5G	2R, 2R	Full-wave Rectifier	6.3	0.3	Max. AC Voltage/Plate = 325 volts (rms)				Max. DC Output = 40 ma			
					Max. PIV = 1250 volts				Max. Peak Plate Curr. = 120 ma			
7A4	3	Class A Amplifier	6.3	0.3	See 6J5 Characteristics							
7A5	5	Class A Amplifier	6.3	0.75	110 125	110 125	-7.5 -9.0	40.0 44.0	3.0 3.3	0.014 0.017	5800 6000	R _L = 2.5 KΩ, W _o = 1.5 watts R _L = 2.7 KΩ, W _o = 2.2 watts
7A6	2, 2	Detector Rectifier	6.3	0.15	Max. AC Voltage/Plate = 150 volts (rms)							
					Max. Peak Plate Current/Plate = 45 ma							
					Max. DC Output Current/Plate = 8.0 ma							
7A7	5	Class A Amplifier	6.3	0.3	See 6SK7 Characteristics							
7A7LM	5	Class A Amplifier	6.3	0.3	250■	100■	-3.0▲	8.6	2.0	0.8	2000	
7A8	8	Converter	6.3	0.15	250	G ₃₊₅ 100	G ₄ -3.0	3.0	G ₃₊₅ 3.2	0.7		I _{c2} = 4.2 ma I _{c1} = 0.4 ma R _{g1} = 50 KΩ, g _c = 550 μmhos
7AB7	5	Class A Amplifier	6.3	0.15	250	100	-2.0	4.0	1.3	0.5	1800	
7AD7	5	Class A Amplifier	6.3	0.6	300	150	*	28.0	7.0	0.3	9500	R _k = 68 Ω
7AF7	3, 3	Class A Amplifier	6.3	0.3	250 100	— —	* *	9.0 10.8	— —	0.007 0.008	2100 1900	R _k = 1100 Ω, μ = 16 R _k = 600 Ω, μ = 16
7AG7	5	Class A Amplifier	6.3	0.15	250	250	*	6.0	2.0	1.0	4200	R _k = 250 Ω
7AH7	5	Class A Amplifier	6.3	0.15	250	250	*	6.8	1.9	1.0	3300	R _k = 250 Ω
7AJ7	5	Class A Amplifier	6.3	0.3	100 250	100 100	-1.0 -3.0	5.7 2.2	1.8 0.7	0.4 1.0	2275 1575	
7AK7	5	Class A Amplifier	6.3	0.8	150 150	90 90	0 0	40 2.0■	21 43	0.0115 —	5500 —	E _{c3} = 0 volts E _{c3} = -9.5 volts
7AU7	3, 3	Class A Amplifier	3.5 7.0	0.6 0.3	100 250	— —	0 -8.5	11.3 10.5	— —	0.006 0.008	3100 2200	μ = 20 μ = 17
7B4	5	Class A Amplifier	6.3	0.3	See 6SF5 Characteristics							
7B5	5	Class A Amplifier	6.3	0.4	See 6K6GT Characteristics							
7B6	2, 2, 3	Triode Amplifier	6.3	0.3	See 6SQ7 Characteristics							
7B6LM	2, 2, 3	Class A Amplifier	6.3	0.3	250		-2.0	0.2	0.9	0.091	1100	μ = 100
7B7	5	Class A Amplifier	6.3	0.15	250	100	-3.0	8.5	1.7	0.75	1750	
7B8	7	Converter	6.3	0.3	See 6A8 Characteristics							

*See quoted value of R_k †Plate to Plate ■ Design Maximum for 117-volt Line ▲ Design Minimum for 117-volt Line

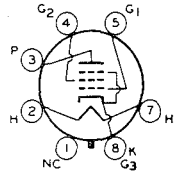

**6Y6-G
6Y6-GA
6Y6-GT**

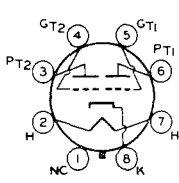

6Y7-G

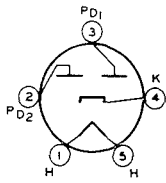

**6Z4
6Z4/84**

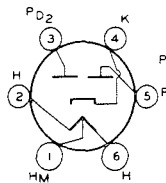

6Z5

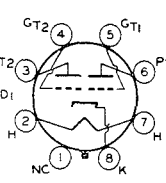

6Z7-G

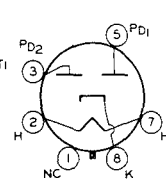

6ZY5-G

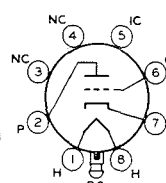

7A4

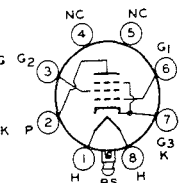

7A5

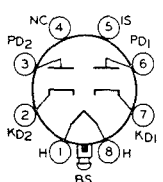

7A6

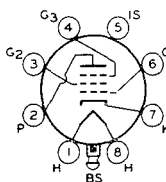

**7A7
7A7-LM**

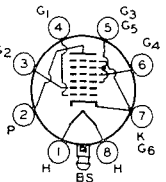

7A8

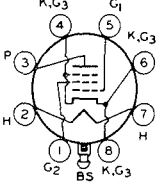

7AB7

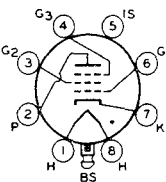

7AD7

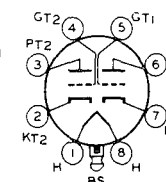

7AF7

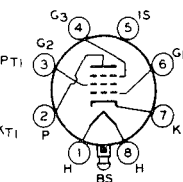

**7AG7
7AH7
7AJ7
7AK7**

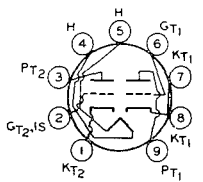

7AN7

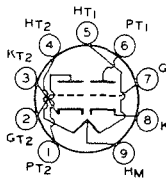

7AU7

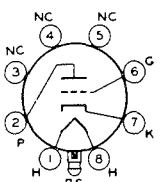

7B4

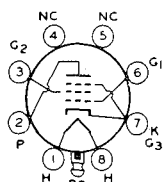

7B5

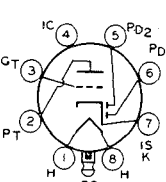

**7B6
7B6-LM**

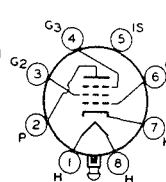

7B7

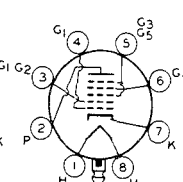

**7B8
7B8-LM**

TYPE	Class	Use	E_f volts	I_f amps	E_b volts	E_{c2} volts	E_{c1} volts	I_b ma	I_{c2} ma	r_p M Ω	g_m μ mhos	
7B8LM	7	Converter	6.33	0.3	100	50	-1.5▲	1.1	1.3	0.6	—	$g_c = 360$
					250	100	-3.0▲	3.5	2.7	0.36	—	$g_c = 550$
7C4	2R	Detector Rectifier	6.3	0.15	Max. Plate Voltage = 117 volts Max. DC Output Current = 5.0 ma							
7C5	5	Class A Amplifier	6.3	0.45	See 6V6GT Characteristics							
7C5LT	5	Class A Amplifier	6.3	0.45	250	250	-12.5	45	4.5	0.052	4100	$R_L = 5.0 \text{ K}\Omega$, $W_o = 4.5 \text{ watts}$ $R_L = 8.5 \text{ K}\Omega$, $W_o = 5.5 \text{ watts}$
					315	225	-13.0	34	2.2	0.077	3750	
7C6	2, 2, 3	Triode Amplifier	6.3	0.15	250	—	-1.0	1.3	—	0.1	1000	$\mu = 100$
7C7	5	Class A Amplifier	6.3	0.15	100	100	-3.0	1.8	0.4	1.2	1225	
					250	100	-3.0	2.0	0.5	2.0	1300	
7D7	3, 6	Hexode Converter	7.0	0.48	250	100	-3.0	1.3	2.8	1.5	—	$g_c = 275 \mu$ mhos
		Triode Oscillator			250	—	-3.0	5.0	—	—	—	$R_{g1} = 50 \text{ K}\Omega$
7E5	3	Class A Amplifier	6.3	0.15	180	—	-3.0	5.5	—	0.012	3000	$\mu = 36$
7E6	2, 2, 3	Triode Amplifier	6.3	0.3	See 6BF6 Characteristics							
7E7	2, 2, 5	Class A Amplifier	6.3	0.3	100	100	*	10.0	2.7	0.15	1600	$R_k = 800\Omega$
					250	100	*	7.5	1.6	0.7	1300	$R_k = 330\Omega$
7EY6	5	Vertical Deflection Amp.	7.2	0.6	Max. Peak Pos. Pulse Plate Voltage = 2500 volts Max. DC Screen Grid Voltage = 300 volts, Max. Screen Dissip. = 2.75 w Max. DC Cathode Curr. = 60 ma. Max. Plate Dissip. = 11 watts							
		Class A Amplifier			250	250	-17.5	44	3.0	0.06	4400	
7F7	3, 3	Class A Amplifier	6.3	0.3	See 6SL7GT Characteristics							
7F8	3, 3	Class A Amplifier	6.3	0.3	250	—	*	6.0	—	0.015	3300	$R_k = 500 \Omega$, $\mu = 48$
7G7	5	Class A Amplifier	6.3	0.45	250	100	-2.0	6.0	2.0	0.8	4500	
7G8	4, 4	Voltage Amplifier	6.3	0.3	250	100	-2.5	4.5	0.8	0.225	2100	
7H7	5	Class A Amplifier	6.3	0.3	100	100	-1.5	7.5	2.6	0.35	4000	$R_k = 180 \Omega$
					250	150	*	10.0	3.2	0.8	4000	
7J7	3, 7	Triode Oscillator	6.3	0.3	250°	—	*	5.0	—	—	1400	$I_{c1} = 0.4 \text{ ma}$ $R_{g1} = 50 \text{ K}\Omega$
		Heptode Mixer			250	100	-3.0	1.4	2.8	1.5		$g_c = 290 \mu$ mhos
7K7	2, 2, 3	Triode Amplifier	6.3	0.3	250	—	-2.0	2.3	—	0.044	1600	$\mu = 70$
7L7	5	Class A Amplifier	6.3	0.3	100	100	-1.0	5.5	2.4	0.1	3000	
					250	100	-1.5	4.5	1.5	1.0	3100	
7N7	3, 3	Amplifier	6.3	0.6	See 6SN7GT Characteristics							
7Q7	7	Converter	6.3	0.3	100	100	-2.0	3.3	8.5	0.5	$R_{g1} = 20 \text{ K}\Omega$	
					250	100	-2.0	3.5	8.5	1.0	$g_c = 550 \mu$ mhos	
7R7	2, 2, 5	Class A Amplifier	6.3	0.3	100	100	-1.0	5.5	2.2	0.35	3000	
					250	100	-1.0	5.7	2.1	1.0	3400	
7S7	3, 7	Triode Converter	6.3	0.3	250●	—	—	5.0	—	—	—	$I_{c1} = 0.4 \text{ ma}$ $R_{g1} = 50 \text{ K}\Omega$
		Heptode Converter			250	100	-2.0	1.8	3.0	1.25	g_c 1650	
7T7	5	Class A Amplifier	6.3	0.3	250	150	-1.0	10.8	4.1	0.9	4900	
					100	100	-1.0	5.3	2.1	0.3	4000	

*See quoted value of R_k

●Supply Voltage

▲Design Value for 117-volt Line

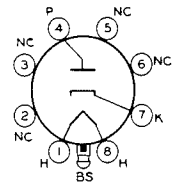

For 7B8LM, see previous page

7C4

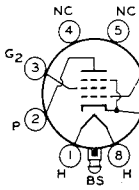

7C5
7C5-LT

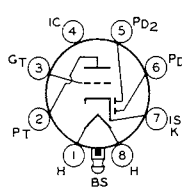

7C6

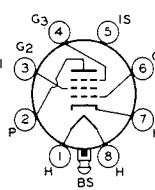

7C7

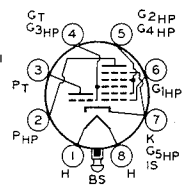

7D7

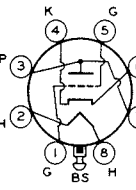

7E5

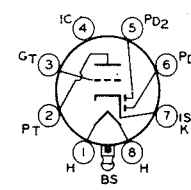

7E6

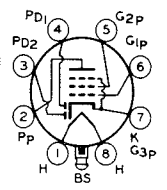

7E7

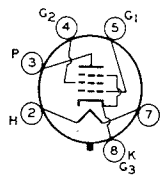

7EY6

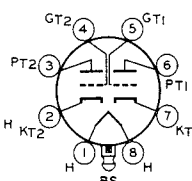

7F7

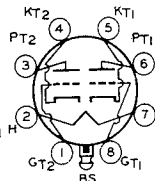

7F8

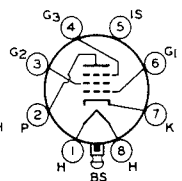

7G7

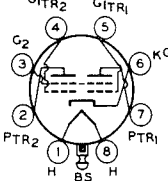

7G8

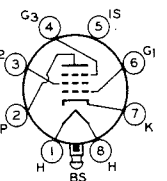

7H7

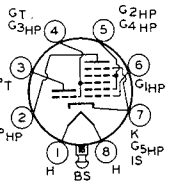

7J7

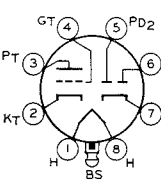

7K7

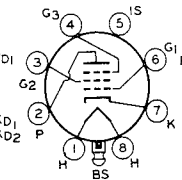

7L7

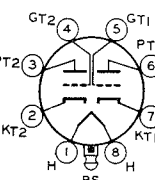

7N7

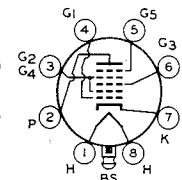

7Q7

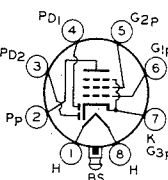

7R7

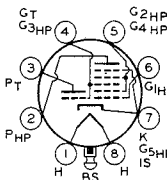

7S7

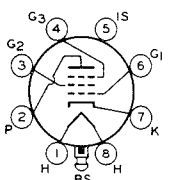

7T7
7V7

TYPE	Class	Use	E_f volts	I_f amps	E_b volts	E_{c2} volts	E_{c1} volts	I_b ma	I_{c2} ma	r_p M Ω	g_m μ mhos	
7V7	5	Class A Amplifier	6.3	0.45	300	150	—	10.0	3.9	0.3	5800	$R_k = 160 \Omega$
7W7	5	Class A Amplifier	6.3	0.45	See 7V7 Characteristics							
7X7	2, 2, 3	Triode Amplifier	6.3	0.3	100	—	0	1.2	—	0.085	1000	$\mu = 85$
					250	—	-1.0	1.9	—	0.067	1500	$\mu = 100$
7Y4	2R, 2R	Full-wave Rectifier	6.3	0.5	Max. DC Output = 70 ma Max. Peak Plate Current/Plate = 180 ma Max. PIV = 1250 volts							
7Z4	2R, 2R	Full-wave Rectifier	6.3	0.9	Max. DC Output Curr. = 100 ma Max. Peak Plate Current/Plate = 300 ma Max. PIV = 1250 volts							
8AU8	3, 5	Pentode Amplifier	8.4	0.45	200	125	*	15.0	3.4	0.15	7000	$R_k = 82 \Omega$
		Triode Amplifier			150	—	*	8.5	—	0.008	4900	$R_k = 150 \Omega$
8AW8A	3, 5	Triode Amplifier	8.4	0.45	See 6AW8A Characteristics							
		Pentode Amplifier										
8BA8A	3, 5	Pentode Amplifier	8.4	0.45	200	150	*	13.0	3.5	0.4	9000	$R_k = 180 \Omega$
		Triode Amplifier			200	—	—	8.0	—	0.007	2700	$\mu = 18$
8BH8	3, 5	Class A Amplifier	8.4	0.45	See 6BH8 Characteristics							
8BN8	2, 2, 3	Class A Amplifier	8.4	0.45	250	—	-3.0	1.6	—	0.028	2500	$\mu = 70$
8BQ5	5	Class A Amplifier	8.0	0.6	See 6BQ5 Characteristics							
8BQ7A	3, 3	Class A Amplifier	8.4	0.3	150	—	*	9.0	—	0.0061	6400	$R_k = 220, \mu = 39$
8CG7	3, 3	Class A Amplifier	8.4	0.45	See 6CG7 Characteristics							
8CM7	3, 3	Class A Amplifier	8.4	0.45	See 6CM7 Characteristics							
8CN7	2, 2, 3	Class A Amplifier	8.4	0.225	100	—	-1.0	0.8	—	0.054	1300	
					250	—	-3.0	1.0	—	0.058	1200	
8CS7	3, 3	Osc. Amplifier	8.4	0.45	See 6CS7 Characteristics							
8CX8	3, 5	Pentode Amplifier	8.0	0.60	See 6CX8 Characteristics							
		Triode Amplifier										
8CY7	3, 3	Class A Amplifier	7.9	0.6	See 6CY7 Characteristics							
8EB8	3, 5	Class A Amplifier	8.0	0.6	See 6EB8 Characteristics							
8EM5	5	Class A Amplifier	8.4	0.6	See 6EM5 Characteristics							
8SN7GTB	3, 3	Class A Amplifier	8.4	0.45	90	—	0	10.0	—	0.0067	3000	$\mu = 20$
					250	—	-8.0	9.0	—	0.0077	2600	$\mu = 20$
9A8	3, 5	Class A Amplifier	9.0	0.3	See 6BL8 Characteristics							
9AK8	2, 2, 2, 3	Detector Amplifier	9.5	0.3	200	—	-2.3	1.0	—	0.05	1400	$\mu = 70$
					100	—	-1.0	0.8	—	0.048	1450	$\mu = 70$
9AQ8	3, 3	Class A Amplifier	9.0	0.3	200	—	-2.1	10.0	—	—	5800	$\mu = 48$
					170	—	-1.5	10.0	—	—	6200	$\mu = 50$
9AU7	3, 3	Class A Amplifier	4.7	.45	See 7AU7 Characteristics							
			9.4	.225								
9BM5	5	Power Amplifier	9.5	0.3	250	250	-6.0	30	3.0	0.06	7000	$R_L = 7.0 K\Omega$, $W_o = 3.5$ watts
9BR7	2, 2, 3	Class A Amplifier	4.7	0.6	250	—	*	10	—	0.0109	4000	$\mu = 60, R_k = 200 \Omega$
			9.4	0.3								

*See quoted value of R_k

For 7V7, see previous page

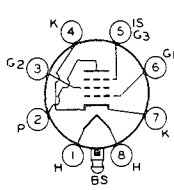

7W7

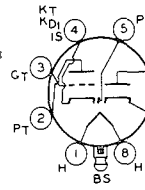

7X7

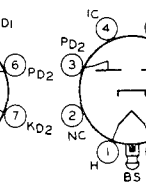

**7Y4
7Z4**

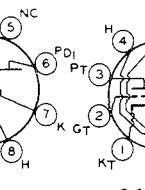

**8AU8, -A
8AW8-A
8BA8-A
8BH8**

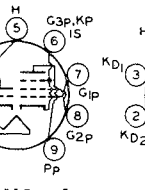

8BN8

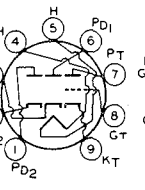

8BQ5

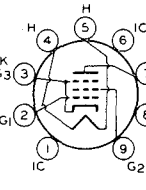

**8BQ7-A
8CG7**

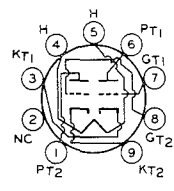

8CM7

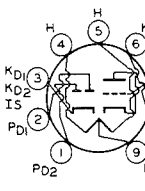

8CN7

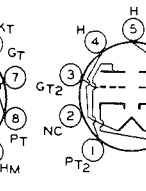

8CS7

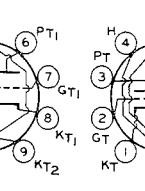

8CX8

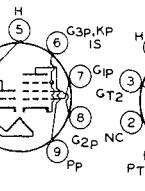

8CY7

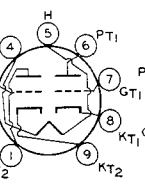

8EB8

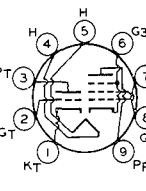

8EM5

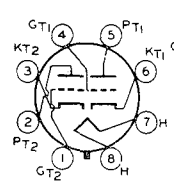

8SN7-GTB

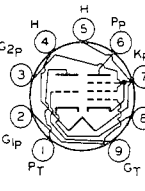

9A8

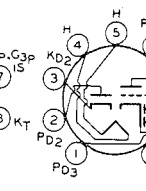

9AK8

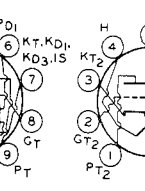

9AQ8

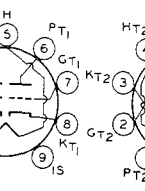

9AU7

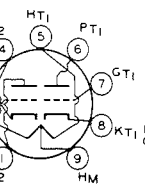

9BM5

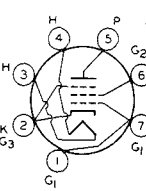

9BR7

TYPE	Class	Use	E_r volts	I_r amps	E_b volts	E_{c2} volts	E_{c1} volts	I_b ma	I_{c2} ma	r_p M Ω	g_m μ mhos	
9BR8	3, 5	VHF Osc.	9.45	0.3	150		*	18		0.005	8500	μ 40, $R_k = 56 \Omega$
		VHF Amp.			250	110	*	10	3.5	.4	5200	$R_k = 68 \Omega$
9BW6	5	Power Amplifier	9.45	0.3	250	250	-12.5	45	4.5	0.05	4100	$R_L = 5 K\Omega$, $W_o = 4.5$ watts
9CL8	3, 4	Class A Amplifier	9.5	0.3	See 6CL8 Characteristics							
9DZ8	3, 5	Class A Amplifier	9.0	0.6	See 6DZ8 Characteristics							
9EF6	5	Vertical Deflection Amplifier	9.4	0.6	See 6EF6 Characteristics							
9U8 9U8A	3, 5	Class A Amplifier	9.45	0.3	See 6U8 Characteristics							
9X8	3, 5	Class A Amplifier	9.5	0.3	See 6X8 Characteristics							
10	3	Class A Amplifier	7.5	1.25	350	—	-32.0	16.0	—	0.0051	1550	$\mu = 8.0$, $R_L = 11 K\Omega$, $W_o = 0.9$ watts,
					425	—	-40.0	18.0	—	0.005	1600	$R_L = 10.2 K\Omega$, $W_o = 1.6$ watts
10C8	3, 5	Triode Amplifier	10.5	0.3	250	—	*	7.3	—	0.012	4400	$\mu = 53$, $R_k = 390 \Omega$
		Pentode Amplifier			135	135	*	11.5	3.2	0.19	8000	$R_k = 100 \Omega$
10DA7	3, 3	Osc. Amplifier	10.5	0.6	250	—	-8.0	9.0	—	0.0077	2600	$\mu = 20$
					150	—	-17.5	40	—	0.0011	5700	$\mu = 6.3$
10DE7	3, 3	Osc. Amp.	10.0	0.6	See 6DE7 Characteristics							
10EB8	3, 5	Amplifier	10.5	0.45	See 6EB8 Characteristics							
11	3	Class A Amplifier	1.1	0.25	90	—	-4.5	2.5	—	0.0155	425	$\mu = 6.6$
					135	—	-10.5	3.0	—	0.015	440	$\mu = 6.6$
11C5	5	Power Amplifier	11.6	0.45	See 35C5 Characteristics							
11CY7	3, 3	Class A Amplifier	11.0	0.45	See 6CY7 Characteristics							
12	3	Class A Amplifier	1.1	0.25	See Type 11 Characteristics							
12A	3	Class A Amplifier	5.0	0.25	180	—	-13.5	7.7	—	0.0047	1800	$R_L = 10.65 K\Omega$, $W_o = 0.285$ watts
					135	—	-9.0	6.2	—	0.0051	1650	$R_L = 9.0 K\Omega$, $W_o = 0.13$ watts
12A4	3	Class A Amplifier	6.3 12.6	0.6 0.3	250	—	-9.0	23	—	.0025	8000	$\mu = 20$
12A5	5	Class A Amplifier	6.3	0.6	100	100	-15.0	17.0	3.0	0.05	1700	$R_L = 4.5 K\Omega$, $W_o = 0.8$ watts
			12.6	0.3	180	180	-25.0	45.0	8.0	0.035	2400	$R_L = 3.3 K\Omega$, $W_o = 3.4$ watts
12A6 12A6GT	5	Power Amplifier	12.6	0.15	250	250	-12.5	30	3.5	0.07	3000	$R_L = 7.5 K\Omega$, $W_o = 3.4$ watts
12A7	2, 5	Pent. Amplifier	12.6	0.3	135	135	-13.5	9.0	2.5	0.102	975	$R_L = 13.5 K\Omega$, $W_o = 0.55$
		Rectifier Unit			Max. AC Volts/Plate = 125 volts rms. Max. DC Output Curr. = 30 ma							
12A8G 12A8GT	7	Converter	12.6	0.15	See 6A8 Characteristics							
12AB5	5	Class A Amplifier	12.6	0.2	250	200	*	33.5	1.6	$R_k = 270 \Omega$, $R_L = 6.0 K\Omega$, $W_o = 3.3$ watts		
		Class AB Amplifier			250	250	-15.0	70.0	5.0	0.06	3750	$R_L = 10 K\Omega$, $W_o = 10.0$ watts

*See quoted value of R_k

▼ Two valves

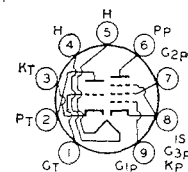

9BR8

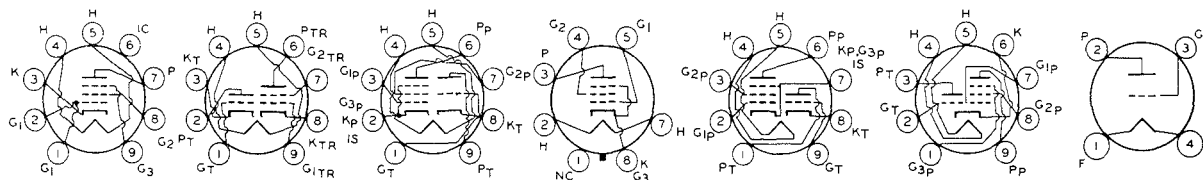

9BW6

9CL8

9DZ8

9EF6

9U8
9U8-A

9X8

10

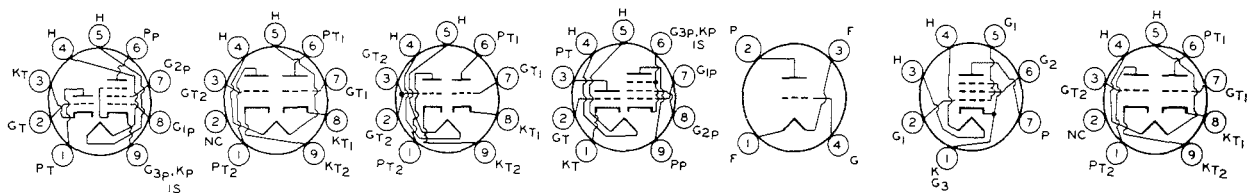

10C8

10DA7

10DE7

10EB8

11

11C5

11CY7

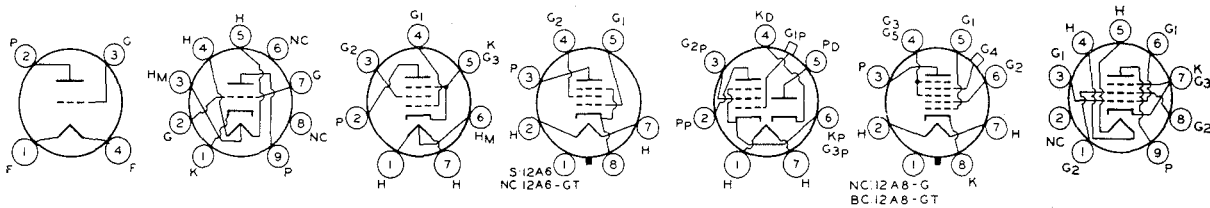

12
12-A

12A4

12A5

12A6
12A6-GT

12A7

12A8-G
12A8-GT

12AB5

TYPE	Class	Use	E_r volts	I_f amps	E_b volts	E_{c2} volts	E_{c1} volts	I_b ma	I_{c2} ma	r_p M Ω	g_m μ mhos	
12AC5	5	RF Amplifier	12.6	0.1	200	200	-3.0	7.2	2.1	1.0	2300	
12AC6	5	Amplifier	12.6	0.15	12.6	12.6	0	5.50	0.2	0.5	730	
12AD5	5	RF Amplifier	12.6	0.1	100	100	-2.5	6.0	1.75	0.6	2200	
12AD6	7	Converter	12.6	0.15	12.6	12.6	1.6 rms	0.45	1.5	1.0	$R_{g1} = 3.3 \text{ K}\Omega, g_c = 260 \mu\text{mhos}$	
12AD7	3, 3	Amplifier	12.6	0.225	250	—	-2.0	1.25	—	0.0625	1600	$\mu = 100$
12AE6	2, 2, 3	Class A Amplifier	12.6	0.15	12.6	—	0	0.75	—	0.015	1000	$\mu = 15$
12AE6A	2, 2, 3	Class A Amplifier	12.6	0.15	12.6	—	*	0.32	—	0.02	715	$\mu = 14.3, R_k = 10 \text{ M}\Omega$
12AE7	3, 3	Driver (1)	12.6	0.45	12.6	—	‡	1.9	—	0.003	4000	$\mu = 13, R_{g1} = 1.5 \text{ M}\Omega$
		(2)			12.6	—	‡	7.5	—	985 ohms	6500	$\mu = 6.4, R_{g1} = 1 \text{ M}\Omega$
12AF3	2	TV Damper Diode	12.6	0.6	See 6AF3 Characteristics							
12AF6	5	Class A Amplifier	12.6	0.15	12.6	12.6	0	0.8	0.3	0.3	1250	
12AG6	7	Converter	12.6	0.15	12.6	12.6	0	0.55	1.4		300	
12AH7GT	3, 3	Class A Amplifier	12.6	0.15	100	—	-3.6	3.7	—	0.01	1550	$\mu = 16$
					180	—	-6.5	7.6	—	0.0084	1900	$\mu = 16$
12AH8	3, 7	Converter	12.6	0.15	250	100	-3.0	2.6	4.4	$g_c = 550 \mu\text{mhos}$		
12AJ6	2, 2, 3	Class A Amplifier	12.6	0.15	12.6	—	0	0.75	—	0.045	1200	$\mu = 55$
12AJ7	3, 7	Hept. Amplifier	12.6	0.15	200	117	-2.3	7.4	4.6	0.5	2400	
		Tri. Amplifier			100	—	0	13.5	—	—	3700	$\mu = 22$
12AL5	2, 2	Det. Rectifier	12.6	0.15	See 6AL5 Characteristics							
12AL8	3, 4	Tri. Amplifier	12.6	0.55	12.6	—	-0.9	0.5	—	0.013	1000	$\mu = 13, R_{g1} = 2.2 \text{ M}\Omega$
		Tetr. Amplifier			12.6	-0.5	+12.6	40	75	480 ohms	15,000	$\mu = 7.2, R_L = 0.8 \text{ K}\Omega$ $W_o = 0.04 \text{ w}$
12AQ5	5	Amplifier	12.6	0.225	See 6V6 Characteristics							
12AT6	2, 2, 3	Class A Amplifier	12.6	0.15	See 6AT6 Characteristics							
12AT7	3, 3	Class A Amplifier	6.3	0.3	100	—	*	3.7	—	0.015	4000	$R_k = 270 \Omega, \mu = 60$
			12.6	0.15	250	—	*	10.0	—	0.01	5500	$R_k = 200 \Omega, \mu = 60$
12AU6	5	Class A Amplifier	12.6	0.15	See 6AU6 Characteristics							
12AU7	3, 3	Class A Amplifier	6.3	0.3	100	—	0	11.8	—	0.0066	3100	$\mu = 20$
12AU7A			12.6	0.15	250	—	-8.5	10.5	—	0.0077	2200	$\mu = 17.5$
12AV5GA	5	Class A Amplifier	12.6	0.6	250	150	-22.5	57	2.1	0.145	5900	
12AV6	2, 2, 3	Class A Amplifier	12.6	0.15	See 6AV6 Characteristics							
12AV7	3, 3	Class A Amplifier	6.3	0.45	150	—	*	18	—	0.048	8500	$\mu = 41, R_k = 56 \Omega$
			12.6	0.225								
12AW6	5	Class A Amplifier	12.6	0.15	See 6AG5 Characteristics							
12AX4GT	2R	TV Damper Diode	12.6	0.6	Max. PIV = 4400 volts Max. Peak Plate Current = 750 ma Max. DC Plate Current = 125 ma							
12AX4GTA												
12AX7	3, 3	Class A Amplifier	12.6	0.15	250	—	-2.0	1.2	—	0.0625	1600	$\mu = 100$
			6.3	0.5								
12AX7A	3, 3	Class A Amplifier			Low Noise, Low Microphony Version of 12AX7							

*See quoted value of R_k ‡Contact potential across specified R_{g1}

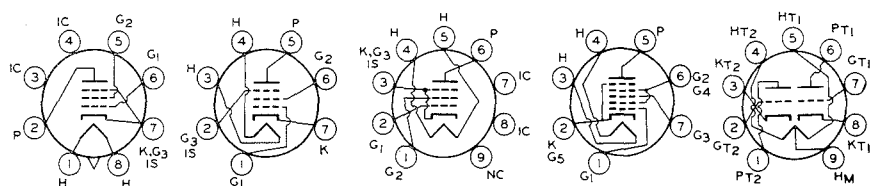

For 12AX7, 12AX7A, see next page

12AC5

12AC6

12AD5

12AD6

12AD7

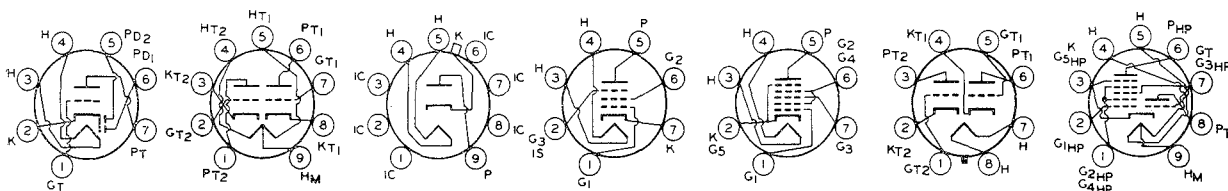

12AE6
12AE6-A

12AE7

12AF3

12AF6

12AG6

12AH7-GT

12AH8

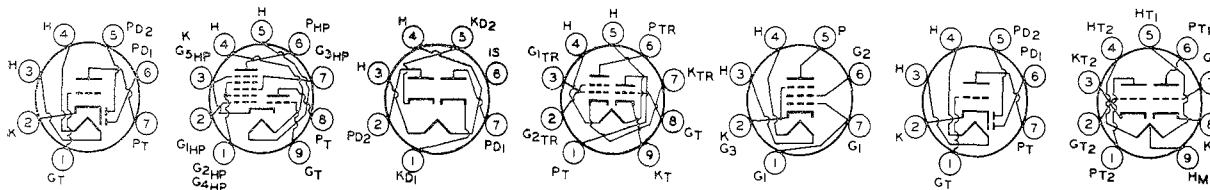

12AJ6

12AJ7

12AL5

12AL8

12AQ5

12AT6

12AT7

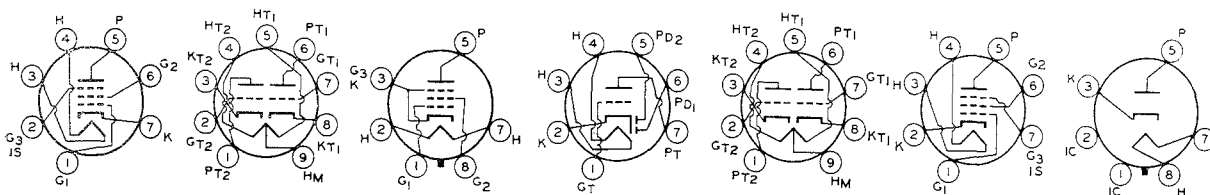

12AU6

12AU7
12AU7-A

12AV5-GA

12AV6

12AV7

12AW6

12AX4-GT
12AX4-GTA

TYPE	Class	Use	E_f volts	I_f amps	E_b volts	E_{c2} volts	E_{c1} volts	I_b ma	I_{c2} ma	r_p M Ω	g_m μ mhos	
12AY7	3, 3	Class A Amplifier	12.6	0.15	250	—	-4	3	—	0.02	1750	$\mu = 40$
12AZ7	3, 3	Class A Amplifier	6.3	0.45	100	—	*	3.7	—	0.015	4000	$R_k = 270 \Omega$, $\mu = 60$
			12.6	0.225	250	—	*	10.0	—	0.0109	5500	$R_k = 200 \Omega$, $\mu = 60$
12B3	2	TV Damper Diode	12.6	0.6	See 6B3 Characteristics							
12B4 12B4A	3	Vertical Deflection Amplifier	6.3	0.6	Max. DC Plate Voltage = 550 volts Max. DC Cathode Curr. = 30 ma Max. Peak Pos.-Pulse Plate Voltage = 1000 volts (Abs.) Max. Plate Dissipation = 5.5 w							
			12.6	0.3								
12B6M	2, 3	Amplifier	12.6	0.15	250	—	-2.0	0.9	—	0.091	1100	$\mu = 100$
12B7	5	Amplifier	12.6	0.15	See 14A7/12B7 Characteristics							
12B8GT	3, 5	Tri. Amplifier	12.6	0.3	90	—	0	2.8	—	0.037	2400	$\mu = 90$
		Pent. Amplifier			90	90	-3.0	7.0	2.0	0.2	1800	
12BA6	5	Class A Amplifier	12.6	0.15	See 6BA6 Characteristics							
12BA7	7	Converter	12.6	0.15	See 6BA7 Characteristics							
12BD6	5	Class A Amplifier	12.6	0.15	See 6BD6 Characteristics							
12BE6	7	Converter	12.6	0.15	See 6BE6 Characteristics							
12BF6	2, 2, 3	Class A Amp.	12.6	0.15	250	—	-9.0	9.5	—	0.0085	1900	$\mu = 16$ $W_o = .3$ watts
12BH7 12BH7A	3, 3	Vertical Deflection Amplifier	12.6	0.3	Max. DC Plate Volts = 450 volts Abs. Max. Peak Positive Pulse Plate Voltage = 1500 volts							
			6.3	0.6	Max. DC Cathode Current = 20 ma Max. Plate Dissipation = 3.5 watts/plate							
12BK5	5	Power Amplifier	12.6	0.6	See 6BK5 Characteristics							
12BK6	2, 2, 3	Det. Amplifier	12.6	0.5	100	—	-1.0	0.5	—	0.08	1250	$\mu = 100$
					250	—	-2.0	1.2	—	0.062	1600	$\mu = 100$
12BL6	5	Class A Amplifier	12.6	0.15	12.6	12.6	0	1.35	0.5	0.5	1350	
12BN6	5	Limiter Discriminator	12.6	0.15	65	60	-1.3	0.23	5.0			
12BQ6GA 12BQ6GT 12BQ6GTA	5	Horizontal Deflection Amplifier	12.6	0.6	See 6BQ6GA Characteristics							
12BQ6-GTB/12CU6	5	Horizontal Deflection Amplifier	12.6	0.6	Max. DC Plate Voltage = 600 volts Max. Plate Dissipation = 11 w Max. DC Cathode Current = 112.5 ma Max. Peak Pos.-Pulse Plate Voltage = 6000 volts (Abs.)							
12BR7 12BR7A	2, 2, 3	Class A Amplifier	12.6	0.225	100	—	*	3.7	—	0.015	4000	$R_k = 270 \Omega$, $\mu = 60$
			6.3	0.45	250	—	*	10	—	0.0109	5500	$R_k = 200 \Omega$, $\mu = 60$
12BT6	2, 2, 3	Detector Amplifier	12.6	0.15	100	—	-1.0	0.8	—	0.054	1300	$\mu = 70$
					250	—	-3.0	1.0	—	0.058	1200	$\mu = 70$
12BU6	2, 2, 3	Detector Amplifier	12.6	0.15	250	—	-3.0	3.9	—	0.011	1500	$R_L = 10 K\Omega$, $W_o = 0.3$ watts
					100	—	-9.0	9.5	—	0.0085	1900	$\mu = 16.5$
12BV7	5	Class A Amplifier	6.3	0.6	250	150	*	27	6.0	0.085	1300	$R_k = 68 \Omega$
			12.6	0.3	250	180	-8.0	0.5 min.	—	—	—	
12BY7 12BY7A	5	Class A Amplifier	12.6	0.3	250	150	*	25	6.0	0.11	12,000	$R_k = 68 \Omega$
			6.3	0.6								

*See quoted value of R_k

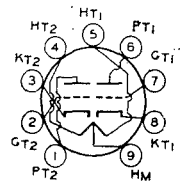

**12AX7
12AX7-A
12AY7
12AZ7**

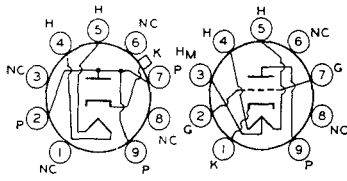

12B3

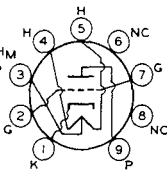

**12B4
12B4-A**

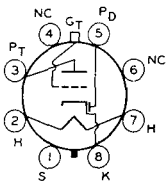

12B6-M

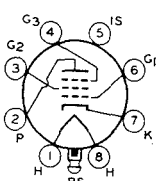

12B7

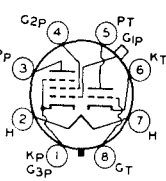

12B8-GT

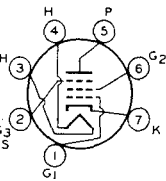

12BA6

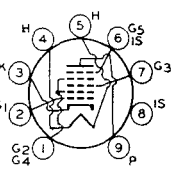

12BA7

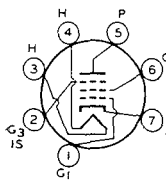

12BD6

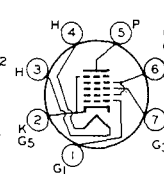

12BE6

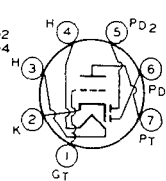

12BF6

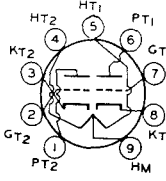

**12BH7
12BH7-A**

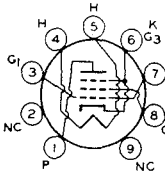

12BK5

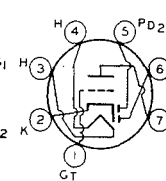

12BK6

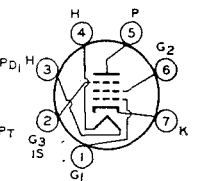

12BL6

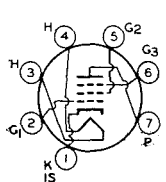

12BN6

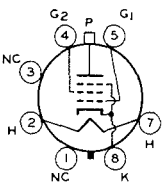

**12BQ6-GA
12BQ6-GT, -GTA
12BQ6-GTB/12CU6**

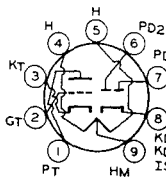

**12BR7
12BR7-A**

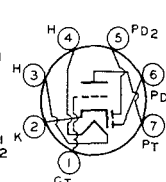

**12BT6
12BU6**

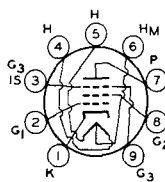

12BV7

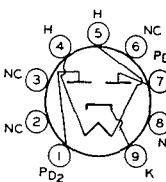

12BW4

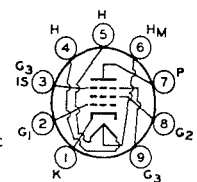

**12BY7
12BY7-A**

TYPE	Class	Use	E_f volts	I_f amps	E_b volts	E_{c2} volts	E_{c1} volts	I_b ma	I_{c2} ma	r_p M Ω	g_m μ mhos	
12BZ7	3, 3	Class A Amplifier	6.3 12.6	0.6 0.3	250	—	-2.0	2.5	—	0.0318	3200	$\mu = 100$
12C5	5	Power Amplifier	12.6	0.6	110	110	-7.5	49	4.0	0.01	7500	$R_L = 2.5 \text{ K}\Omega$, $W_o = 1.9 \text{ watts}$
12C8	2, 2, 5	Class A Amplifier	12.6	0.15	250	125	-3.0	10.0	2.3	0.6	1325	
12CA5	5	Class A Amplifier	12.6	0.6	110	110	-4.0	32	3.5	0.016	8100	$R_L = 3.5 \text{ K}\Omega$, $W_o = 1.1 \text{ watts}$
					125	125	-4.5	37	4.0	0.015	9200	$R_L = 4.5 \text{ K}\Omega$, $W_o = 1.5 \text{ watts}$
12CM6	5	Power Amplifier	12.6	0.225	See 6CM6 Characteristics							
12CN5	5	Class A Amplifier	12.6	0.45	12.6	12.6	0	4.5	0.35	0.04	3800	
12CR5	5	Horiz. Defl. Amplifier	12.6	0.6	See 6CR5 Characteristics							
12CR6	2, 5	Det. Amplifier	12.6	0.15	250	100	-2.0	9.6	2.6	0.8	2200	
12CS5	5	Power Amplifier	12.6	0.6	See 6CS5 Characteristics							
12CS6	7	Sync. Sep.	12.6	0.15	100	30	0	0.8	4.0	0.7	950	$E_{c3} = -1$
					100	30	-1.0	0.75	1.1	1.0	1250	$E_{c3} = 0$
12CT8	3, 5	Triode Amplifier	12.6	0.3	150		*	9.0		0.0082	4900	$R_k = 152 \mu = 40$
		Pentode Amplifier			200	125	*	15.0	3.4	0.15	7000	$R_k = 82$
12CU5	5	Class A Amplifier	12.6	0.6	120	110	-8.0	49	4	0.01	7500	$R_L = 2.5 \text{ K}\Omega$, $W_o = 2.3 \text{ watts}$
12CU5/12C5	5	Class A Amplifier	12.6	0.6	See 6CU5 Characteristics							
12CU6	5	Horiz. Amplifier	12.6	0.6	See 6BQ6G Characteristics							
12CX6	5	Class A Amplifier	12.6	0.15	12.6	12.6		3.0	1.4	0.04	3100	$R_{g1} = 2.2 \text{ M}\Omega$
12CY6	5	Class A Amplifier	12.6	0.2	12.6	12.6		1.6	0.4	0.14	3250	$R_{g1} = 2.2 \text{ M}\Omega$
12D4	2R	Half-wave Rectifier	12.6	0.6	Max. PIV = 4400 volts Plate Dissipation = 5.5 w Peak Plate Current = 900 ma Max. Output Current = 155 ma							
12DB5	5	Power Amplifier	12.6	0.2	110	110	-7.5	49	4.0	0.013	8000	$R_L = 2.0 \text{ K}\Omega$
12DE8	2, 5	Class A Amplifier	12.6	0.2	12.6	12.6	-8.0	1.3	0.5	0.3	1500	
12DF5	2R, 2R	Full-wave Rectifier	12.6	0.45	Max. AC Voltage/Plate = 450 volts (rms) Max. PIV = 1275 volts Max. Peak Plate Curr./Plate = 350 ma Max. Output Current = 60 ma							
			6.3	0.9								
12DF7	3, 3	Class A Amplifier	12.6	0.15	See 12AX7 Characteristics (Special Low Noise)							
			6.3	0.3								
12DK5	5	Class A Amplifier	12.6	0.3	12.6	12.6		2.0	0.65	0.1	3300	$R_{g1} = 2.2 \text{ M}\Omega$
12DK7	2, 2, 4	Det. Amplifier	12.6	0.5	12.6	12.6		6.0	1.0	0.004	5000	$R_{g1} = 2.2 \text{ M}\Omega$
12DL8	2, 2, 4	Det. Amplifier	12.6	0.55	12.6	-2.0	+12.6	8.0	75	480 ohms	15,000	$R_L = 800 \Omega$, $W_o = 0.04 \text{ watts}$
12DM5	5	Power Amplifier	12.6	0.45	110	110	-7.5	49	4.0	0.014	7500	$R_L = 2.5 \text{ K}\Omega$, $W_o = 1.9 \text{ watts}$
12DQ6	5	Horiz. Defl. Amplifier	12.6	0.6	See 6DQ6 Characteristics							

*See quoted value of R_k

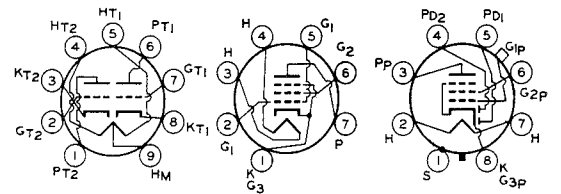

12BZ7

12C5

12C8

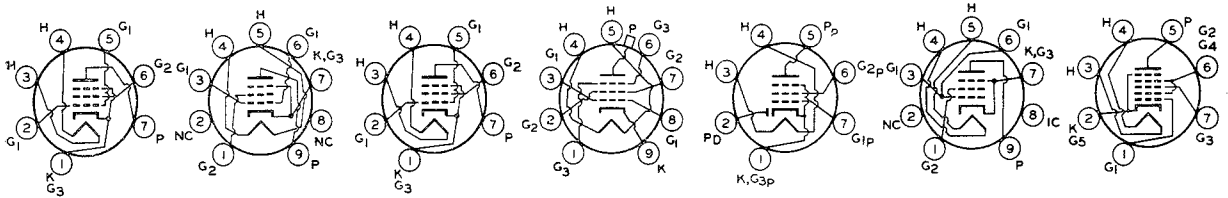

12CA5

12CM6

12CN5

12CR5

12CR6

12CS5

12CS6

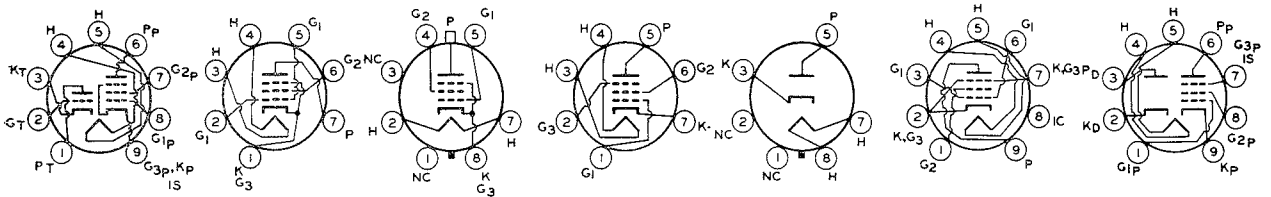

12CT8

12CU5
12CU5/12C5

12CU6

12CX6
12CY6

12D4

12DB5

12DE8

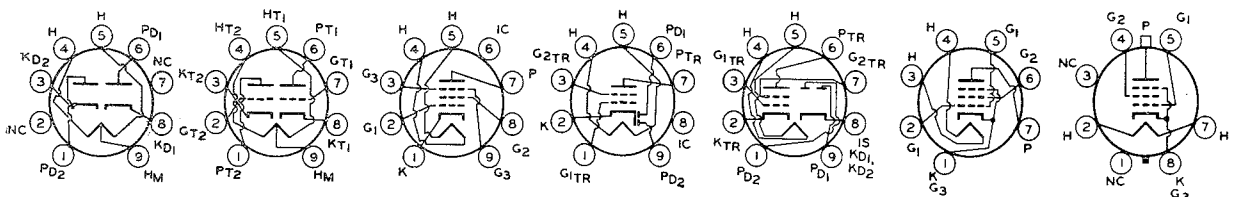

12DF5

12DF7

12DK5

12DK7

12DL8

12DM5

12DQ6
12DQ6-A

TYPE	Class	Use	E _r volts	I _r amps	E _b volts	E _{c2} volts	E _{c1} volts	I _b ma	I _{c2} ma	r _p MΩ	g _m μmhos	
12DQ6A	5	Horiz. Defl. Amplifier	12.6	0.6	See 6DQ6A Characteristics							
12DQ7	5	Video Amplifier	12.6	0.6	200	125	*	26.0	5.6	0.053	10,500	R _k = 68 Ω
12DS7	2, 2, 4	Class A Amplifier	12.6	0.4	12.6	0.5	12.6	40	—	480 Ω	15,000	μ = 7.2, I _{c1} = 75 ma
12DT5	5	Vert. Defl. Amplifier	12.6	0.6	See 6DT5 Characteristics							
12DT7	3, 3	Class A Amplifier	6.3 12.6	0.3 0.15	See 12AX7 Characteristics							
12DT8	3, 3	Class A Amplifier	12.6	0.15	See 6DT8 Characteristics							
12DU7	2, 2, 4	Det. Amplifier	12.6	0.25	12.6	12.6	—	12.0	1.5	0.006	6200	R _L = 2.7 KΩ, R _{g1} = 2.2 MΩ W _o = 0.025 w
12DV7	2, 2, 3	Det. Amplifier	12.6	0.15	12.6	—	—	0.4	—	0.019	750	μ = 14, R _{g1} = 2.2 MΩ
12DV8	2, 2, 4	Det. Amplifier	12.6	0.375	12.6	—	+12.6	6.8	53	900 ohms	8500	R _k = 18 Ω μ = 7.6, R _{g2} = 4.7 MΩ
12DW5	5	Vert. Defl. Amplifier	12.6	0.6	Max. Peak Pos. Plate Voltage = 2200 volts Max. Plate Dissipation = 11 watts Max. DC I _k = 65 ma							
		Class A Amplifier			200	150	-22.5	55	2.0	0.015	5500	
12DW7	3, 3	Unit 1 AF Voltage Amplifier	6.3	0.3	100	—	-1.0	0.5	—	0.08	1250	μ = 100
					250	—	-2.0	1.2	—	0.0625	1600	μ = 100
		Unit 2 AF Phase Inverter	12.6	0.15	100	—	0	11.8	—	0.065	3100	μ = 20
					250	—	-8.5	10.5	—	0.077	2200	μ = 17
12DW8	2, 3, 3	Voltage Amp.	12.6	0.45	12.6	—	0	1.9	—	0.00352	2700	μ = 9.5, R _{g1} = 1.5 MΩ
		Driver			12.6	—	0	7.5	—	970 ohms	6500	μ = 6.4, R _{g1} = 1 MΩ
12DZ6	5	RF Amplifier	12.6	0.19	12.6	12.6		4.5	2.2	0.025	3800	R _{g1} = 10 MΩ
12DZ8	3, 5	Class A Amplifier	12.0	0.45	See 6DZ8 Characteristics							
12E5GT	3	Class A Amplifier	12.6	0.15	100	—	-5.0	2.5	—	0.012	1150	μ = 13.8
					250	—	-13.5	5.0	—	0.0095	1450	μ = 13.8
12EA6	5	Class A Amplifier	12.6	0.19	12.6	12.6	—	3.2	1.4	0.032	3800	R _{g1} = 10 MΩ
12EC8	3, 5	FM Oscillator	12.6	0.225	12.6	—	0	2.4	—	0.006	4700	μ = 25, R _{g1} = 4.7 KΩ
		FM Amplifier			12.6	12.6	0	0.66	0.28	0.75	2000	R _{g1} = 33 KΩ
12ED5	5	Class A Amplifier	12.6	0.45	110	110	-4.0	32	4.0	0.014	8100	R _L = 4.5 KΩ, W _o = 1.1 watts
					125	125	-4.5	37	7.0	0.014	8500	R _L = 4.5 KΩ, W _o = 1.5 watts
12EF6	5	Vertical Defl. Amplifier	12.6	0.45	See 6EF6 Characteristics							
12EG6	7	Mixer Oscillator	12.6	0.15	12.6	12.6		0.04	0.24	0.15	800	R _{g1} = 2.2 mΩ
12EH5	5	Class A Amplifier	12.6	0.6	See 6EH5 Characteristics							
12EK6	5	FM Amplifier	12.6	0.19	12.6	12.6		4.0	1.7	0.05	4200	R _{g1} = 2.2 MΩ
12EL6	2, 2, 3	Det. Amplifier	12.6	0.15	12.6			0.75		0.045	1200	μ = 55, R _{g1} = 1 MΩ

*See quoted value of R_k

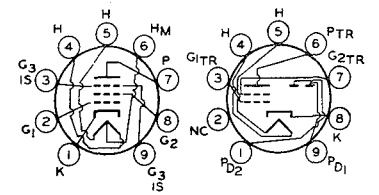

For 12DQ6A, see previous page

12DQ7

12DS7

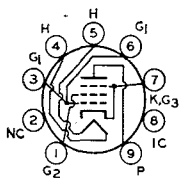

12DT5

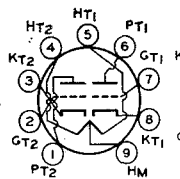

12DT7

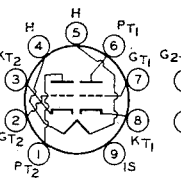

12DT8

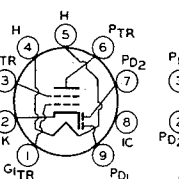

12DU7

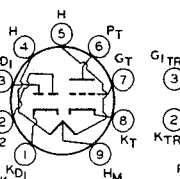

12DV7

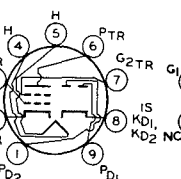

12DV8

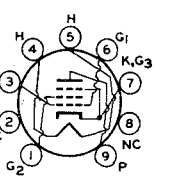

12DW5

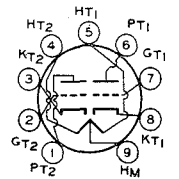

12DW7

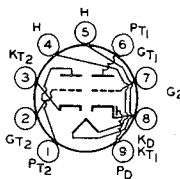

12DW8

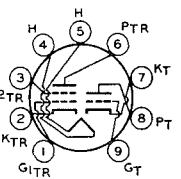

12DY8

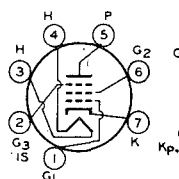

12DZ6

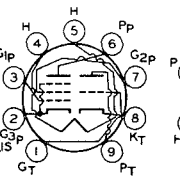

12DZ8

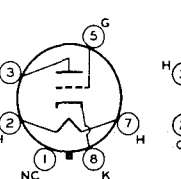

12E5-GT

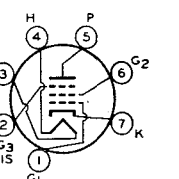

12EA6

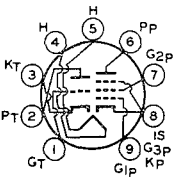

12EC8

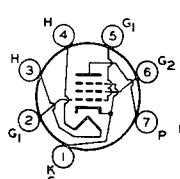

12ED5

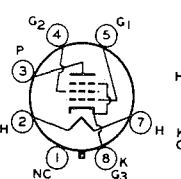

12EF6

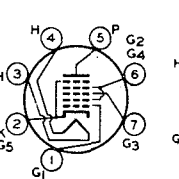

12EG6

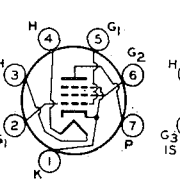

12EH5

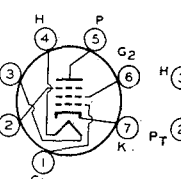

12EK6

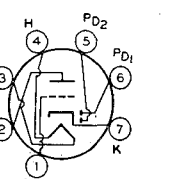

12EL6

TYPE	Class	Use	E_f volts	I_f amps	E_b volts	E_{c2} volts	E_{c1} volts	I_b ma	I_{c2} ma	r_p M Ω	g_m μ mhos	
12EM6	2, 5	Det. Power Amplifier	12.6	0.5	12.6	12.6	—	6.0	1.0	0.004	5000	$R_L = 3.5 \text{ K}\Omega$, $R_{g1} = 15 \text{ M}\Omega$ $W_o = 0.01 \text{ watts}$
12EN6	5	Vert. Defl. Amplifier	12.6	0.6	Max. Peak Pos. Pulse Plate Voltage = 1200 volts Max. Plate Dissipation = 7.0 watts Max. DC $I_k = 50 \text{ ma}$							
		Class A Amplifier			200	110	-9.5	50	2.2	0.028	8000	
12EZ6	5	Class A Amplifier	12.6	0.175	12.6	12.6	-0.7	1.9	0.7	0.4	2700	$R_{g1} = 2.2 \text{ M}\Omega$
12F5GT	3	Class A Amplifier	12.6	0.15	See 6SF5 Characteristics							
12F8	2, 2, 5	Class A Amplifier	12.6	0.15	12.6	12.6	0	1.0	0.38	0.33	1000	
12FA6	7	Converter	12.6	0.15	12.6	12.6	-0.5	0.45	1.0	0.8	$g_c = 320 \mu$ mhos	
12FK6	2, 2, 3	Det. Amplifier	12.6	0.15	12.6	—	—	1.3	—	0.0062	1200	$\mu = 7.4$, $R_{g1} = 2.2 \text{ M}\Omega$
12FM6	2, 2, 3	Det. Amplifier	12.6	0.15	12.6	—	—	1.0	—	0.0077	1300	$\mu = 10$, $R_{g1} = 2.2 \text{ M}\Omega$
12FT6	2, 2, 3	Det. Amplifier	12.6	0.15	12.6	—	—	0.6	—	0.013	1000	$\mu = 14$, $R_{g1} = 2.2 \text{ M}\Omega$
12G4	3	Amplifier	12.6	0.15	See 6SN7GT Characteristics (One Section)							
12G8	3, 3	AF Driver	12.6	0.4	12.6	—	0	7.2	—	0.0085	2600	$R_L = 2.0 \text{ K}\Omega$, $W_o = 0.025 \text{ watts}$ $\mu = 22$
12H4	3	Amplifier	6.3	0.3	90	—	0	10	—	—	0.003	$\mu = 20$
			12.6	0.15	250	—	-8.0	9.0	—	—	0.0026	$\mu = 20$
12H6	2, 2	F.W. Rectifier	12.6	0.15	See 6H6 Characteristics							
12J5	3	Class A Amplifier	12.6	0.15	See 6J5 Characteristics							
12J5GT												
12J6G	5	Det. Amplifier	12.6	0.15	See 6J7 Characteristics							
12J6GT												
12J8	2, 2, 4	Det. Amplifier	12.6	0.25	12.6	12.6		12	1.5	0.006	5500	$R_L = 2.7 \text{ K}\Omega$, $R_{g1} = 2.2 \text{ M}\Omega$ $W_o = 0.02 \text{ watts}$
12K5	4	Class A Amplifier	12.6	0.4	12.6	-2.0	12.6	40	G_1 85	800 ohms	—	$I_{c1} = 75 \text{ ma}$
12K7G	5	Class A Amplifier	12.6	0.15	See 6K7 Characteristics							
12K7GT												
12K8	3, 6	Converter	12.6	0.15	See 6K8 Characteristics							
12K8GT												
12L6GT	5	Class A Amplifier	12.6	0.6	110	110	-7.5	49	4.0	0.013	8000	$R_L = 2.0 \text{ K}\Omega$, $W_o = 2.1 \text{ watts}$
					200	125	*	46	2.2	0.028	8000	$R_L = 4.0 \text{ K}\Omega$, $W_o = 3.8 \text{ watts}$ $R_k = 180 \Omega$
12L8GT	5, 5	Power Amplifier	12.6	0.15	180	180	-9.0	13.0	2.8	0.16	2150	$R_L = 10.0 \text{ K}\Omega$, $W_o = 1.0 \text{ watts}$
12Q7G	2, 2, 3	Det. Amplifier	12.6	0.15	See 6Q7G Characteristics							
12Q7GT	2, 2, 3	Amplifier	12.6	0.15	See 6Q7GT Characteristics							
12R5	5	Vertical Deflection Amplifier	12.6	0.3	Max. DC Plate Voltage = 150 volts Max. DC Cathode Curr. = 155 ma Max. Screen Voltage = 150 volts Max. Plate Dissip. = 4.5 watts Abs. Max. Peak Pos. Pulse Voltage = 1500 volts							
12S7	2, 5	Det. Amplifier	12.6	0.1	200	85	-2.0	5.0	1.5	1.0	2000	

*See quoted value of R_k

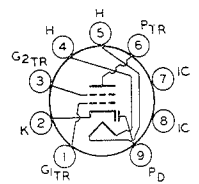

12EM6

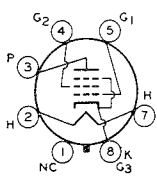

12EN6

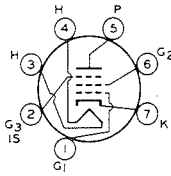

12EZ6

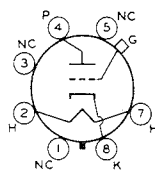

12F5-GT

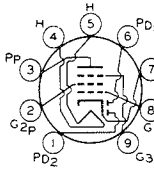

12F8

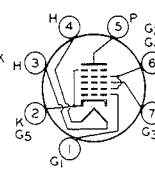

12FA6

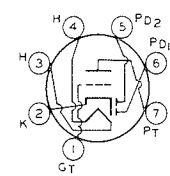

12FK6
12FM6
12FT6

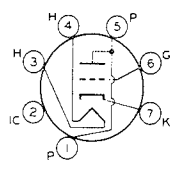

12G4

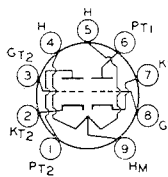

12G8

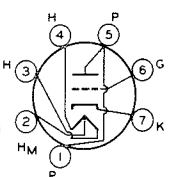

12H4

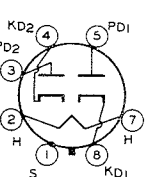

12H6

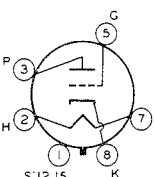

12J5
12J5-GT

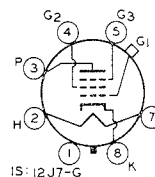

12J7-G
12J7-GT

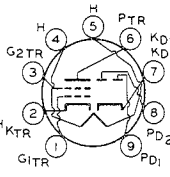

12J8

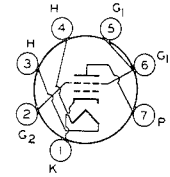

12K5

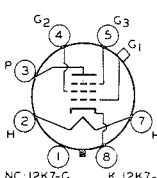

12K7-G
12K7-GT

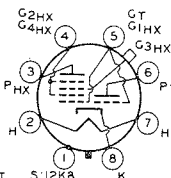

12K8
12K8-GT

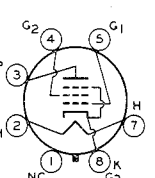

12L6-GT

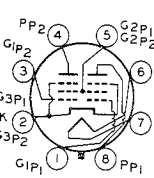

12L8-GT

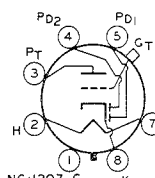

12Q7-G
12Q7-GT

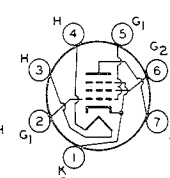

12R5

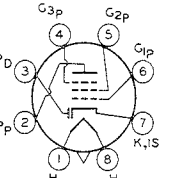

12S7

TYPE	Class	Use	E_r volts	I_r amps	E_b volts	E_{c2} volts	E_{c1} volts	I_b ma	I_{c2} ma	r_p M Ω	g_m μ mhos	
12S8GT	2, 2, 2, 3	Class A Amplifier	12.6	0.15	100 250	— —	-1.0 -2.0	0.4 0.9	— —	0.11 0.91	900 1100	$\mu = 100$ $\mu = 100$
12SA7 12SA7G 12SA7GT	7	Converter	12.6	0.15	See 6SA7 Characteristics							
12SC7	3, 3	Class A Amplifier	12.6	0.15	See 6SC7 Characteristics							
12SF5 12SF5GT	3	Class A Amplifier	12.6	0.15	See 6SF5 Characteristics							
12SG7	5	Class A Amplifier	12.6	0.15	See 6SG7 Characteristics							
12SH7	5	Class A Amplifier	12.6	0.15	See 6SH7 Characteristics							
12SJ7 12SJ7GT	5	Class A Amplifier	12.6	0.15	See 6SJ7 Characteristics							
12SK7 12SK7GT	5	Class A Amplifier	12.6	0.15	See 6SK7 Characteristics							
12SL7GT	3, 3	Class A Amplifier	12.6	0.15	See 6SL7GT Characteristics							
12SN7GT 12SN7GTA	3, 3	Class A Amplifier	12.6	0.3	See 6J5 Characteristics							
12SQ7 12SQ7GT	2, 2, 3	Class A Amplifier	12.6	0.15	See 6SQ7 Characteristics							
12SR7 12SR7GT	2, 2, 3	Class A Amplifier	12.6	0.15	See 6SR7 Characteristics							
12SW7	2, 2, 3	Det. Amplifier	12.6	0.15	250	—	-9.0	9.5	—	0.0085	1900	$\mu = 16$
12SX7GT	3, 3	Class A Amplifier	12.6	0.3	250	—	-8.0	9.0	—	0.0077	2600	$\mu = 20$
					26.5	—	●	1.8	—	0.0115	1800	$\mu = 21$ $R_g = 0.5$ M Ω
12SY7 12SY7GT	7	Converter	12.6	0.15	250	100	-2.0	3.5	8.5	1.0	$g_c = 450$ μ mhos	
12U7	3, 3	Class A Amplifier	12.6	0.15	12.6	—	0	1.0	—	0.0125	1600	$\mu = 20$
12V6GT	5	Class A Amplifier	12.6	0.225	See 6V6 Characteristics							
12W6GT	5	Vert. Defl. Amp.	12.6	0.6	See 6W6GT Characteristics							
12X3	2R	Rectifier	12.6	0.65	Max. PIV = 7000 volts Effective Plate Voltage = 2500 v Max. DC Output Current = 10 ma Max. Peak Plate Current = 200 ma							
12X4	2R, 2R	Full-wave Rectifier	12.6	0.225	See 6X4 Characteristics							
12Z3	2R	Half-wave Rectifier	12.6	0.3	Max. AC Plate Voltage = 235 volts (rms) Max. DC Output = 55 ma							
13DE7	3, 3	Vert. Osc. Vert. Defl. Amp.	13.0	0.45	See 6DE7 Characteristics							
13DR7	3, 3	Vert. Amp. Vert. Osc.	13.0	0.45	See 6DR7 Characteristics							
14A4	3	Class A Amplifier	12.6	0.15	See 6J5 Characteristics							
14A5	5	Class A Amplifier	12.6	0.15	250	250	-12.5	30	3.5	0.07	3000	$R_L = 7.5$ K Ω , $W_o = 2.8$ watts

*See quoted value of R_k

● Self excited

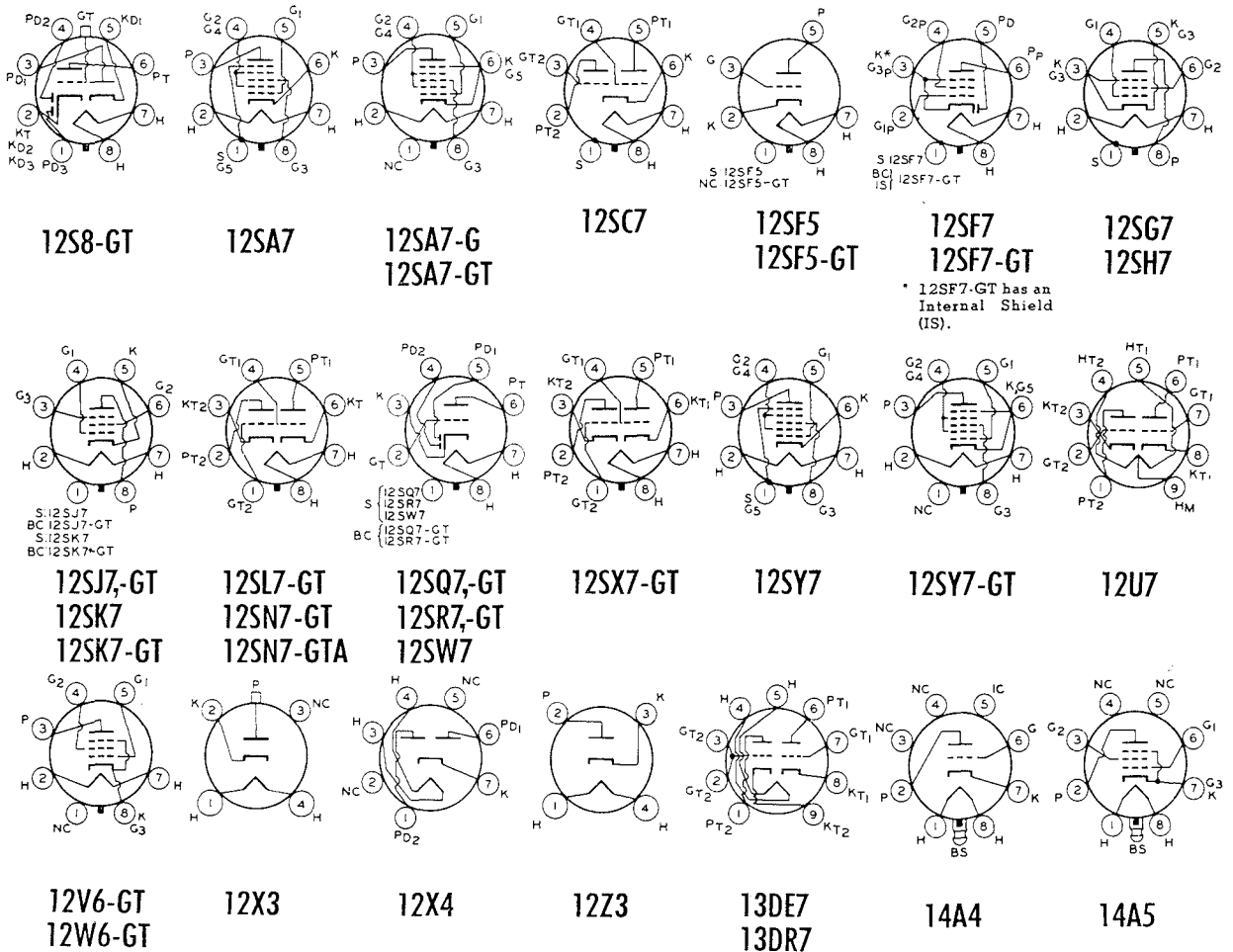

TYPE	Class	Use	E_f volts	I_f amps	E_b volts	E_{c2} volts	E_{c1} volts	I_b ma	I_{c2} ma	r_p M Ω	g_m μ mhos	
14A7	5	Class A Amplifier	12.6	0.15	See 6SK7 Characteristics							
14A7/ 12B7	5	Class A Amplifier	12.6	0.15	250 100	100 100	-3.0 -1.0	9.2 13.0	2.6 4.0	0.8 0.12	2000 2350	
14AF7	3, 3	Class A Amplifier	12.6	0.15	See 7AF7 Characteristics							
14B6	2, 2, 3	Class A Amplifier	12.6	0.15	See 6SQ7 Characteristics							
14B8	7	Converter	12.6	0.15	See 6A8 Characteristics							
14C5	5	Class A Amplifier	12.6	0.225	180 315	180 225	-8.5 -13	29 34	3.0 2.2	0.05 0.077	3700 3750	
14C7	5	Class A Amplifier	12.6	0.15	See 6SJ7 Characteristics							
14E6	2, 2, 3	Class A Amplifier	12.6	0.15	See 6SR7 Characteristics							
14E7	2, 2, 5	Class A Amplifier	12.6	0.15	100 250	100 100	* *	10.0 7.5	2.7 1.6	0.15 0.7	1600 1300	$R_k = 80 \Omega$ $R_k = 330 \Omega$
14F7	3, 3	Class A Amplifier	12.6	0.15	See 6SL7GT Characteristics							
14F8	3, 3	Class A Amplifier	12.6	0.15	250	--	*	6.0	--	--	3300	$\mu = 48, R_k = 500 \Omega$
14G6	2, 2, 3	Det. Amplifier	14.0	0.1	100	--	-1.0	0.8	--	0.05	1400	$\mu = 70$
14H7	5	Class A Amplifier	12.6	0.15	See 7H7 Characteristics							
14J7	3, 7	Converter	12.6	0.15	See 7J7 Characteristics							
14K7	3, 6	Converter	14.0	0.1	200	85	-2.0	3.0	3.0	> 1.0	$g_c = 750 \mu$ mhos	
14L7	2, 2, 3	Det. Amplifier	14.0	0.1	170	--	-1.55	1.5	--	0.042	1650	$\mu = 70$
14N7	3, 3	Class A Amplifier	12.6	0.3	See 6J5 Characteristics							
14Q7	7	Converter	12.6	0.15	See 6SA7 Characteristics							
14R7	2, 2, 5	Class A Amplifier	12.6	0.15	See 7R7 Characteristics							
14S7	3, 7	Mixer Oscillator	12.6	0.15	See 7S7 Characteristics							
14W7	5	Class A Amplifier	12.6	0.225	See 7V7 Characteristics							
14X7	2, 2, 3	Det. Amplifier	12.6	0.15	See 7X7 Characteristics							
14Y4	2R, 2R	Full-wave Rectifier	12.6	0.3	Max. AC Voltage/Plate = 325 volts (rms) Max. Peak Plate Current = 210 ma Output Current = 70 ma							
14Y7	3, 6	Triode Oscillator Hex. Amplifier	14.0	0.1	100 160	-- 43	0 -1.0	10 1.2	-- 1.46	-- 1.0	2800 --	$\mu = 22$ $g_c = 530 \mu$ mhos
14Z3	2R	Rectifier	12.6	0.3	Max. AC Voltage/Plate = 250 volts (rms) Max. Output Current = 60 ma							
15	5	Class A Amplifier	2.0	0.22	67.5 135	67.5 67.5	-1.5 -1.5	1.85 1.85	0.3 0.3	0.63 0.8	710 750	
15A6	5	Video Amplifier	15.0	0.3	180	180	-2.9	36	4.6	0.1	10,000	
17AV5GA	5	Class A Amplifier	16.8	0.45	250	150	-22.5	55	2.1	0.02	5500	
17AX4GT	2R	TV Damper Diode	16.8	0.45	Max. PIV = 4400 volts Max. DC Plate Curr. = 125 ma Max. Peak Plate Curr. = 750 ma							
17BQ6GTB	5	Horiz. Defl. Amplifier	16.8	0.45	Max. DC Screen Voltage = 200 volts Max. DC Cathode Curr. = 112.5 ma				Max. Peak Pos.-Pulse Plate Voltage = 6000 volts (Abs). Max. Plate Dissipation = 11 watts			
17C5	5	Power Amplifier	16.8	0.45	See 12C5 Characteristics							

*See quoted value of R_k

TYPE	Class	Use	E _f volts	I _f amps	E _b volts	E _{c2} volts	E _{c1} volts	I _b ma	I _{c2} ma	r _p MΩ	g _m μmhos		
17C8	2, 2, 5	Det. Amplifier	17.0	0.1	200	200	-2.0	5.0	1.75	1.0	2200		
17CA5	5	AF Amplifier	16.8	0.45	125	125	-4.5	36	4.0	0.015	9200	R _L = 4.5 KΩ	
17CU5	5	Power Amplifier	16.8	0.45	120	110	-8.0	49	4.0	0.01	7500	W _o = 2.3 watts	
17D4	2	TV Damper Diode	16.8	0.45	Max. PIV = 4400 volts Max. DC Plate Current = 155 ma Max. Peak Plate Curr. = 900 ma Max. Plate Dissip. = 5.5 w								
17DE4	2	TV Damper Diode	17.0	0.6	See 6DE4 Characteristics								
17DQ6 17DQ6A	5	Horizontal Deflection Amplifier	16.8	0.45	Max. DC Plate Voltage = 700 volts Max. Peak Pos.-Pulse Plate Voltage = 6000 volts (Abs.) Max. DC Cath. Curr. = 140 ma Max. Plate Dissip. = 15 watts								
17H3	2	Damper Diode	17.5	0.3	Max. PIV = 2000 volts Max. Peak Plate Current = 450 ma Max. Output Current = 75 ma								
17L6GT	5	Class A Amplifier	16.8	0.45	200	125	—	46	2.2	0.03	8000	R _L = 4.0 KΩ, W _o = 3.8 watts	
17R5	5	Power Amplifier	16.8	0.45	110	110	-8.5	40	3.3	0.013	7000		
17Z3	2R	Half-wave Rectifier	17.0	0.3	Max. PIV = 4500 volts Max. DC Output Current = 150 ma								
18A5	5	Power Amplifier	18.5	0.3	200	125	-17.0	40	1.1	0.027	4800		
18DZ8	3, 5	Class A Amplifier	18.0	0.3	See 6DZ8 Characteristics								
18FW6	5	Class A Amplifier	18.0	0.10	100	100	*	11.0	4.4	0.25	4400	R _k = 68 Ω	
18FX6	7	Converter	18.0	0.10	100	100	-1.5	2.3	6.2	0.4	480		
18FY6	2, 2, 3	Class A Amplifier	18.0	0.10	100	—	-1.0	0.6	—	0.077	1300	μ = 100	
19	3, 3	Class A Amplifier	2.0	0.26	See 1J6G Characteristics								
19AQ5	5	Power Amp.	18.9	0.15	See 6AQ5 Characteristics								
19AU4 19AU4GT 19AU4GTA	5	TV Damper Diode	18.9	0.6	See 6AU4GT Characteristics								
19BG6G 19BG6GA	5	Horizontal Deflection Amplifier	18.9	0.3	Max. DC Plate Voltage = 700 volts Max. Peak Pos.-Pulse Plate Voltage = 6600 volts (Abs.) Max. DC Plate Current = 110 ma Max. Plate Dissipation = 20 w								
19C8	2, 2, 2, 3	Det. Amplifier	18.9	0.15	100	—	-1.0	0.5	—	0.08	1250	μ = 100	
19D8	3, 7	Converter	19.0	0.1	200	119	-2.6	3.7	8.1	1.0	g _c = 775, R _k = 150 Ω		
19DE7	3, 3	Tri. VHF Amp. Pent. Amp.	19.4	0.3	See 6DE7 Characteristics								
19J6	3, 3	Class A Amplifier	18.9	0.15	100	—	*	8.5	—	0.007	5300	μ = 38, R _k = 50 Ω	
19T8	2, 2, 2, 3	Class A Amplifier	18.9	0.15	See 6T8 Characteristics								
19V8	2, 2, 2, 3	Det. Amplifier	18.9	0.15	100	—	-1.0	0.8	—	0.054	1300	μ = 70	
					250	—	-3.0	1.0	—	0.058	1200	μ = 70	
19X3	2R	Half-wave Rectifier	19.0	0.3	Max. PIV = 4000 volts Max. DC Output Curr. = 180 ma								
19X8	3, 5	Det. Amplifier	18.9	0.15	See 6X8 Characteristics								
19Y3	2R	Half-wave Rectifier	19.0	0.3	Max. PIV = 700 volts Max. DC Output Current = 180 ma								
20	3	Class A Amplifier	3.3	0.132	90	—	-16.5	3.0	—	0.009	—	μ = 3.5	
					135	—	-22.5	6.5	—	0.006	—		
21A6	5	Class A Amplifier	21.5	0.3	180	180	-23	45	3.0		6500		
21A7	6, 3	Mixer	21.0	0.16	See 7D7 Characteristics								

*See quoted value of R_k

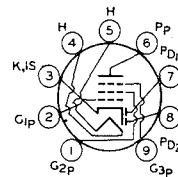

17C8

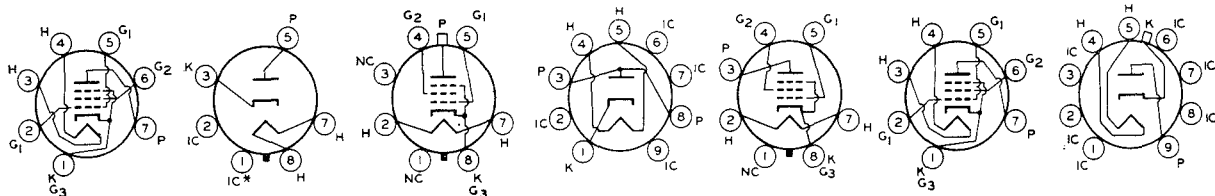

17CA5
17CU5

17D4
17DE4

17DQ6
17DQ6-A

17H3

17L6-GT

17R5

17Z3

*Pin omitted on some of these types.

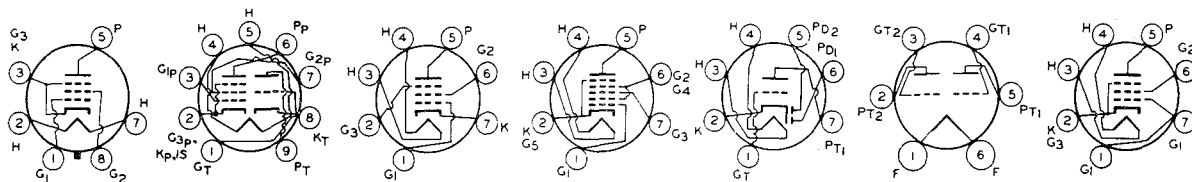

18A5

18DZ8

18FW6

18FX6

18FY6

19

19AQ5

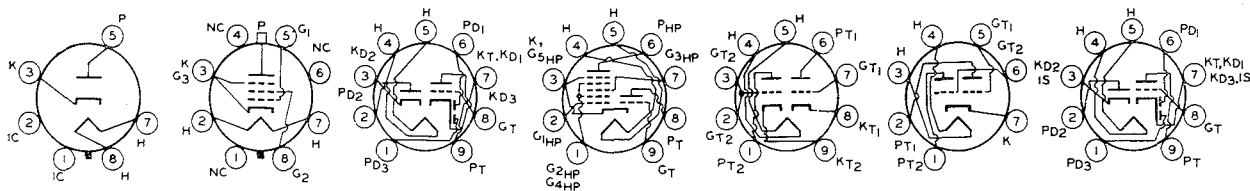

19AU4
19AU4-GT
19AU4-GTA

19BG6-G
19BG6-GA

19C8

19D8

19DE7

19J6

19T8

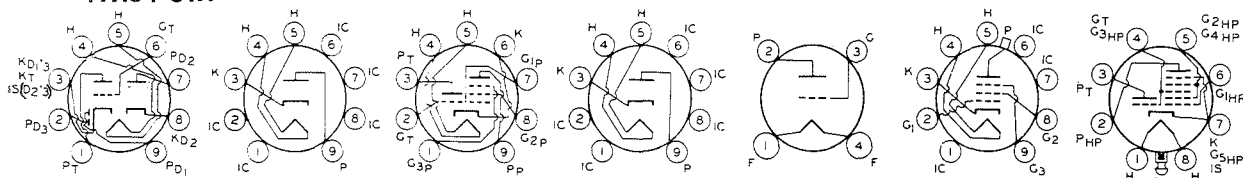

19V8

19X3

19X8

19Y3

20

21A6

21A7

TYPE	Class	Use	E_f volts	I_f amps	E_b volts	E_{c2} volts	E_{c1} volts	I_b ma	I_{c2} ma	r_p MΩ	g_m μmhos	
21B6	5	Class A Amplifier	21.5	0.3	180	180	-23	45	3.0		6500	
22	4	Class A Amplifier	3.3	0.132	135 135	45 67.5	-1.5 -1.5	1.7 3.7	0.6 1.3	0.725 0.325	375 500	
24A	4	Class A Amplifier	2.5	1.75	180 250	90 90	-3.0 -3.0	4.0 4.0	1.7 1.7	0.4 0.6	1000 1050	
25A6 25A6GT	5	Class A Amplifier	25.0	0.3	95 160	95 120	-15.0 -18.0	20 33	4.0 6.5	0.045 0.042	2000 2375	$R_L = 4.5 K\Omega$, $W_o = 0.9$ watts $R_L = 5.0 K\Omega$, $W_o = 2.2$ watts
25A7G 25A7GT	2R, 5	Pent. Amplifier Half-wave Rectifier	25.0	0.3	100	100	-15.0	20.5	4.0	0.05	1800	$R_L = 4.5 K\Omega$, $W_o = 0.77$ watts
					Max. DC Output Current = 75 ma Max. Peak Plate Current = 450 ma Max. PIV = 350 volts							
25AC5G 25AC5GT	3	Class B Amplifier	25.0	0.3	180	—	0	4.0	—	—	—	$R_L = 4.8 K\Omega$, $W_o = 6.0$ watts
25AV5GA 25AV5GT	5	Class A Amplifier Horiz. Defl. Amplifier	25.0	0.3	250	150	-22.5	55	2.1	0.0145	5900	
					Max. Peak Pos. Pulse Plate Voltage = 5,500 volts Max. DC Cathode Current = 110 ma Max. Plate Dissip. = 11 watts							
25AX4GT	2R	TV Damper Diode	25.0	0.3	Max. PIV = 4400 volts Max. Peak Plate Current = 750 ma Max. DC Plate Current = 125 ma							
25B5	3, 3	Class A Amplifier	25.0	0.3	See 25N6G Characteristics							
25B6G	5	Class A Amplifier	25.0	0.3	105 200	105 135	-16.0 -23.0	48 62	2.0 1.8	0.0155 0.018	4800 5000	$R_L = 1.7 K\Omega$, $W_o = 2.4$ watts $R_L = 2.5 K\Omega$, $W_o = 7.1$ watts
25B8GT	5, 3	Tri. Amplifier Pent. Amplifier	25.0	0.15	100 100	— 100	-1.0 -3.0	0.6 7.6	— 2.0	0.075 0.185	1500 2000	$\mu = 12$
25BK5	5	Power Amplifier	25.0	0.3	250	250	-5.0	35	3.5	0.1	8500	$R_L = 6.5 K\Omega$, $W_o = 3.5$ watts
25BQ6GA 25BQ6GT	5	Horiz. Defl. Amplifier	25.0	0.3	See 6BQ6GA Characteristics							
25BQ6- GTB/25CU6	5	Horiz. Defl. Amplifier	25.0	0.3	See 6BQ6GTB/6CU6 Characteristics							
25C5	5	Power Amplifier	25.0	0.3	110	110	-7.5	49	4.0	0.01	7500	$R_L = 2.5 K\Omega$, $W_o = 1.9$ watts
25C6G 25C6GA	5	Class A Amplifier	25.0	0.3	See 6Y6G Characteristics							
25CA5	5	Class A Amplifier	25.0	0.3	See 6CA5 Characteristics							
25CD6G 25CD6GA 25CD6GE	5	Horiz. Defl. Amplifier	25.0	0.3	See 6CD6GA Characteristics							
25CR5	5	Horiz. Defl. Amplifier	25.0	0.3	See 6CR5 Characteristics							

■ Maximum

▼ Two valves

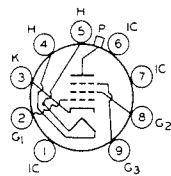

21B6

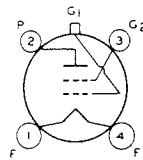

22

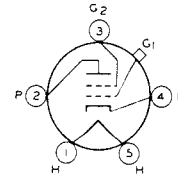

24-A

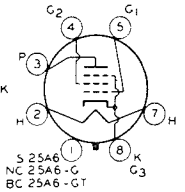

25A6
25A6-G
25A6-GT

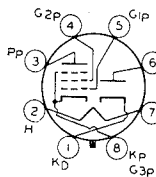

25A7-G
25A7-GT

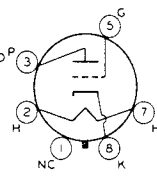

25AC5-G
25AC5-GT

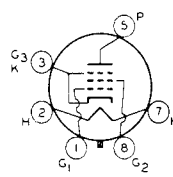

25AU5-GT
25AV5-GA
25AV5-GT

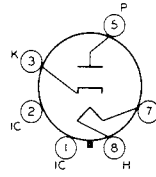

25AX4-GT

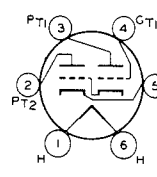

25B5

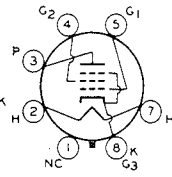

25B6-G

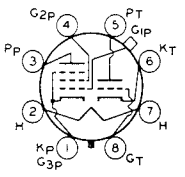

25B8-GT

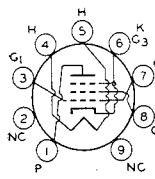

25BK5

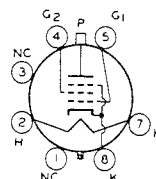

25BQ6-GA
25BQ6-GT
25BQ6-GTB/
25CU6

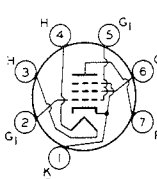

25C5

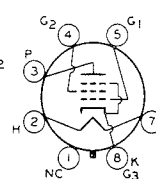

25C6-G
25C6-GA

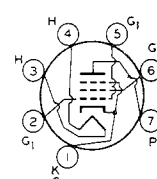

25CA5

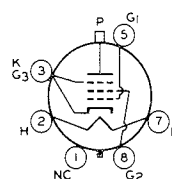

25CD6-G
25CD6-GA
25CD6-GB

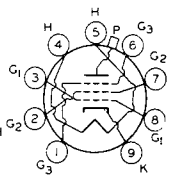

25CR5

TYPE	Class	Use	E_f volts	I_f amps	E_b volts	E_{c2} volts	E_{c1} volts	I_b ma	I_{c2} ma	r_p M Ω	g_m μ mhos	
25CU6	5	Horiz. Defl. Amplifier	25.0	0.3	See 6CU6 Characteristics							
25D4	2	TV Damper Diode	25.0	0.3	See 6DA4 Characteristics							
25DN6	5	Amplifier	25.0	0.6	See 6DN6 Characteristics							
25DQ6	5	Amplifier	25.0	0.3	See 6DQ6 Characteristics							
25DQ6A	5	Amplifier	25.0	0.3	See 6DQ6A Characteristics							
25DT5	5	Amplifier	25.0	0.3	See 6DT5 Characteristics							
25E5	5	Horiz. Defl. Amplifier	25.0	0.3	See 6CM5 Characteristics							
25EC6	5	Class A Amplifier	25.0	0.6	135	135	-22.5	70	4.5	0.0047	7500	
25EH5	5	Class A Amplifier	25.0	0.3	See 6EH5 Characteristics							
25L6 25L6G	5	Amplifier	25.0	0.3	110 200	110 110	-7.5 -8.0	49.0 50.0	4.0 2.0	0.013 0.03	9000 9500	$R_L = 2.0 \text{ K}\Omega$, $W_o = 2.1 \text{ watts}$ $R_L = 3.0 \text{ K}\Omega$, $W_o = 4.3 \text{ watts}$
25L6GT	5	Amplifier	25.0	0.3	See 50L6GT Characteristics							
25N6G	3, 3	Output Triode Tri. Amplifier	25.0	0.3	180 100	— —	— 0	46 5.8	— —	— —	$R_L = 4.0 \text{ K}\Omega$, $W_o = 3.8 \text{ watts}$	Peak AF Signal = 29.7 volts
25U4GT	2	Damper Diode	25.0	0.3	Max. PIV = 3850 volts Max. DC Output Current = 125 ma Max. Peak Current = 660 ma							
25W4GT	2R	Half-wave Rectifier	25.0	0.3	Max. AC Plate Voltage = 350 volts (rms) Max. DC Output = 125 ma Max. PIV = 1250 volts Max. Peak Plate Curr. = 600 ma							
25W6GT	5	Power Amplifier	25.0	0.3	110	110	-7.5	50	4.0	0.013	8000	$R_L = 2.0 \text{ K}\Omega$, $W_o = 2.1 \text{ watts}$
25X6GT	2R, 2R	Half-wave Rectifier Doubler	25.0	0.15	Max. AC Voltage/Plate = 125 volts (rms) DC Output Curr. = 60 ma							
25Y4GT	2R	Half-wave Rectifier	25.0	0.15	Max. AC Voltage = 125 volts (rms) DC Output Curr. = 75 ma							
25Y5	2R, 2R	Half-wave Rectifier Doubler	25.0	0.3	Max. AC Voltage/Plate = 235 volts (rms) Max. DC Output/Plate = 75 ma							
25Z4GT	2R	Half-wave Rectifier	25.0	0.3	Max. AC Plate Voltage = 250 volts (rms) Max. DC Output Current = 100 ma (rms)							
25Z5	2R, 2R	Rectifier Doubler	25.0	0.3	See 25Z6 Characteristics							
25Z6 25Z6G 25Z6GT	2R, 2R	Voltage Doubler Half-wave Rectifier	25.0	0.3	Max. AC Voltage/Plate = 117 volts (rms) Max. DC Output Current = 75 ma Max. Peak Plate Current = 450 ma Max. AC Voltage/Plate = 235 volts (rms) Max. DC Output Current = 75 ma							
26	3	Class A Amplifier	1.5	1.05	90 180	— —	-7.0 -14.5	2.9 6.2	— —	0.0089 0.0073	935 1150	$\mu = 8.3$ $\mu = 8.3$
26A6	5	Class A Amplifier	26.5	0.07	250	250	*	10.5	4.0	1.0	4000	$R_k = 125 \Omega$
26A7GT	5, 5	Power Amplifier	26.5	0.6	26.5	26.5	-4.5	20.0	1.9	0.0015	5700	$R_L = 1.5 \text{ K}\Omega$, $W_o = 0.18 \text{ watts}$

* See quoted value of R_k

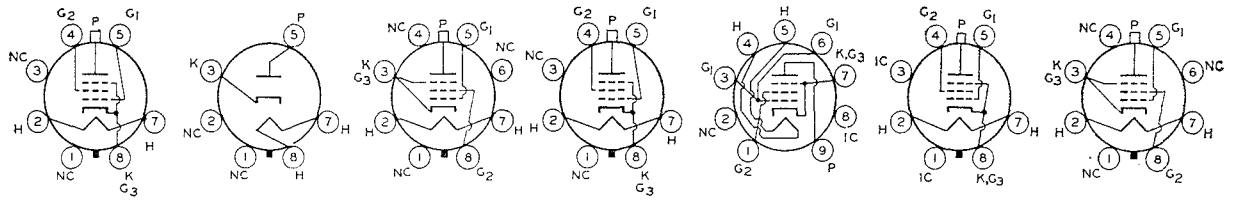

25CU6

25D4

25DN6

25DQ6
25DQ6-A

25DT5

25E5

25EC6

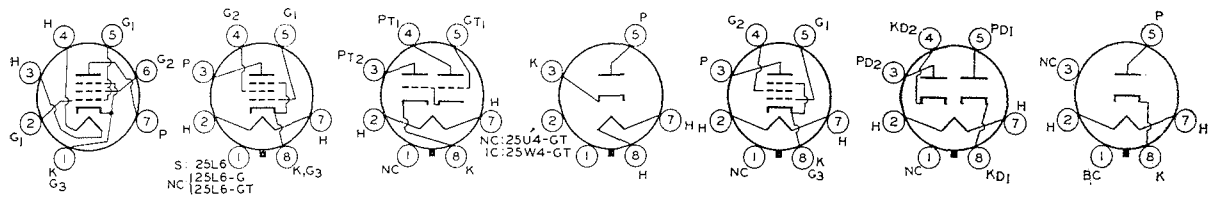

25EH5
25F5

25L6
25L6-G
25L6-GT

25N6-G

25U4-GT
25W4-GT

25W6-GT

25X6-GT

25Y4-GT

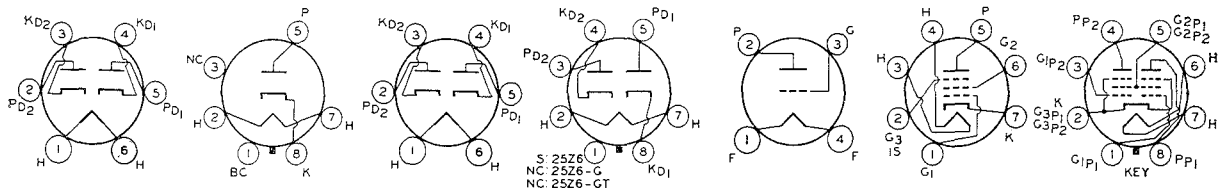

25Y5

25Z4-GT

25Z5

25Z6
25Z6-G
25Z6-GT

26

26A6

26A7-GT

TYPE	Class	Use	E_f volts	I_f amps	E_b volts	E_{c2} volts	E_{c1} volts	I_b ma	I_{c2} ma	r_p M Ω	g_m μ mhos	
26BK6	2, 2, 3	Det. Amplifier	26.5	0.07	100	—	-1.0	0.5	—	0.08	1250	$\mu = 100$
					250	—	-2.0	1.2	—	0.0625	1600	$\mu = 100$
26C6	2, 2, 3	Class A Amplifier	26.5	0.07	26.5	—	—	1.1	—	0.0155	1190	$R_{g1} = 2.0 \text{ M}\Omega$ $\mu = 17$
					250	—	-9.0	9.5	—	0.008	1900	$\mu = 16$
26CG6	5	Class A Amplifier	26.5	0.07	See 6CG6 Characteristics							
26D6	7	Converter Oscillator	26.5	0.07	250	100	-1.5	3.0	7.8	1.0	$g_c = 475 \mu$ mhos	
					100	100	0	27.0	—	—	7200	$\mu = 22.0$
27	3	Class A Amplifier	2.5	1.75	135	—	-9.0	4.5	—	0.009	1000	$\mu = 9.0$
					250	—	-21.0	5.2	—	0.0092	975	$\mu = 9.0$
28D7	5, 5	Class A Amplifier	28.0	0.4	28	28	-3.5	12.5	1.0	0.003	3000	$R_L = 4.0 \text{ K}\Omega$, $W_o = 0.1$ watts
28Z5	2R, 2R	Full-wave Rectifier	28.0	0.24	Max. AC Voltage/Plate = 325 volts (rms) Max. DC Output Current = 100 ma							
30	3	Class A Amplifier	2.0	0.06	See 1H4G Characteristics							
30A5	5	Class A Amplifier	30	0.15	100	100	-6.7	43	3.0	0.022	9200	$R_L = 2.4 \text{ K}\Omega$, $W_o = 1.9$ watts
31	3	Class A Amplifier	2.0	0.13	135	—	-22.5	8.0	—	0.0041	925	$R_L = 7 \text{ K}\Omega$, $W_o = 0.185$ w
					180	—	-30.0	12.3	—	0.0036	1050	$R_L = 5.7 \text{ K}\Omega$, $W_o = 0.375$ watts
31A3	2R	Rectifier	31.0	0.1	Max. Plate Voltage = 250 volts (rms) Max. DC Output Current = 100 ma							
32	4	Class A Amplifier	2.0	0.06	135	67.5	-3.0	1.7	0.4	0.95	640	
					180	67.5	-3.0	1.7	0.4	1.2	650	
32ET5	5	Power Amplifier	32	0.1	110	110	-7.5	30	2.8	0.0215	5500	$R_L = 2.8 \text{ K}\Omega$, $W_o = 1.2$ watts
32L7GT	2R, 5	Class A Amplifier	32.5	0.3	90	90	-5.0	38.0	3.0	0.015	6000	$R_L = 2.6 \text{ K}\Omega$, $W_o = 0.8$ watts
					90	90	-7.0	27.0	2.0	0.017	4800	$R_L = 2.6 \text{ K}\Omega$, $W_o = 1.0$ watts
		Half-wave Rectifier			Max. AC Plate Voltage = 125 volts (rms) Max. DC Output Curr. = 60 ma							
33	5	Class A Amplifier	2.0	0.26	180	180	-18.0	22.0	5.0	0.055	1700	$R_L = 6.0 \text{ K}\Omega$, $W_o = 1.5$ watts
34	5	Class A Amplifier	2.0	0.06	135	67.5	-3.0 (min.)	2.8	1.0	0.6	600	
					180	67.5		2.8	1.0	1.0	620	
35 35/51	4	Class A Amplifier	2.5	1.75	250	90	-3.0	6.5	2.5	0.4	1050	
35A5 35A5LT	5	Class A Amplifier	35.0	0.15	See 35L6GT Characteristics							
35B5	5	Class A Amplifier	35.0	0.15	See 35C5 Characteristics							
35C3	2R	Half-wave Rectifier	35.0	0.15	Max. AC Plate Voltage = 117 volts (rms) Max. DC Output Current = 100 ma							
35C5	5	Class A Amplifier	35.0	0.15	110	110	-7.5	40.0	3.0	0.013	5800	$R_L = 2.5 \text{ K}\Omega$, $W_o = 1.5$ watts

*See quoted value of R_k

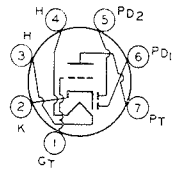

26BK6
26C6

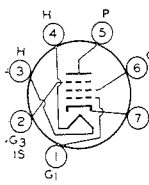

26CG6

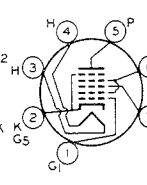

26D6

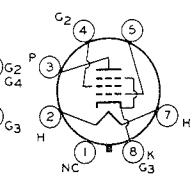

26E6-G

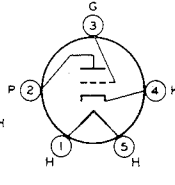

27

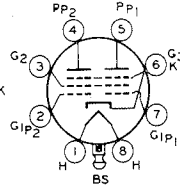

28D7

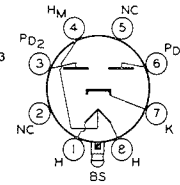

28Z5

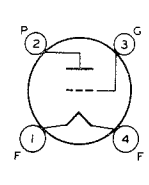

30

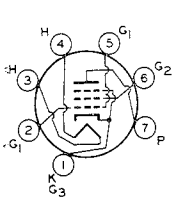

30A5

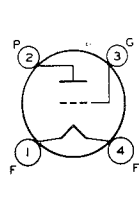

31

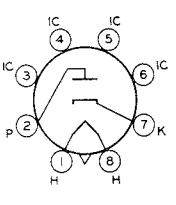

31A3

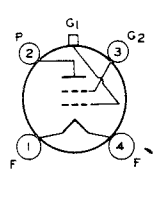

32

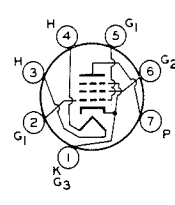

32E5

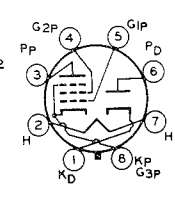

32L7-GT

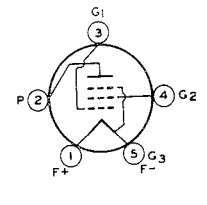

33

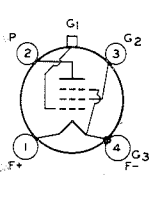

34

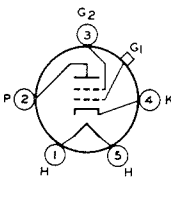

35
35/51

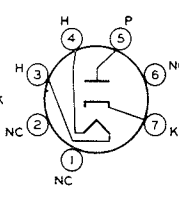

35A3

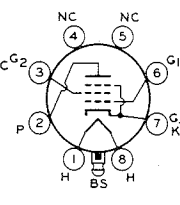

35A5
35A5-LT

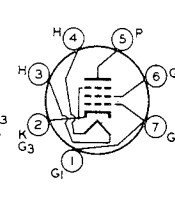

35B5

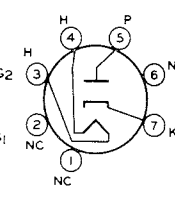

35C3

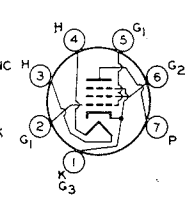

35C5

TYPE	Class	Use	E_f volts	I_f amps	E_b volts	E_{c2} volts	E_{c1} volts	I_b ma	I_{c2} ma	r_p M Ω	g_m μ mhos	
35CD6GA	5	Defl. Amplifier	35.0	0.45	See 6CD6GA Characteristics							
35D5	5	Class A Amplifier	35.0	0.15	110 170	110 170	-6.5 -10.5	34.5 58	2.5 3.0	0.018 0.02	8000 9500	$R_L = 2.5 \text{ K}\Omega$, $W_o = 1.7 \text{ watts}$ $R_L = 2.5 \text{ K}\Omega$, $W_o = 4.8 \text{ watts}$
35DZ8	3, 5	Class A Amplifier	35.0	0.15	See 6DZ8 Characteristics							
35L6G 35L6GT	5	Class A Amplifier	35.0	0.15	110 200	110 125	-7.5 *	40 43	3.0 2.0	0.014 0.034	5800 6100	$R_L = 2.5 \text{ K}\Omega$, $W_o = 1.5 \text{ watts}$ $R_L = 5.0 \text{ K}\Omega$, $W_o = 3.0 \text{ watts}$ $R_k = 180 \Omega$
35W4	2R	Half-wave Rectifier	35.0	0.15	Max. PIV = 330 volts Max. DC Output Curr. = 100 ma Max. Peak Plate Current = 600 ma							
35Y4	2R	Half-wave Rectifier	35.0	0.15	See 35W4 Characteristics							
35Z3 35Z3LT	2R	Half-wave Rectifier	35.0	0.15	See 35Z4GT Characteristics							
35Z4GT	2R	Half-wave Rectifier	35.0	0.15	Max. PIV = 700 volts Max. Peak Plate Curr. = 600 ma Max. DC Output Current = 100 ma							
35Z5G 35Z5GT	2R	Half-wave Rectifier	35.0	0.15	Max. Peak Plate Current = 600 ma Max. DC Output Current = 100 ma Max. PIV = 700 volts							
36 36A	4	Class A Amplifier	6.3	0.3	100 250	55 90	-1.5 -3.0	1.8 3.2	— 1.7 \ddagger	0.55 0.55	850 1080	$\mu = 470$ $\mu = 595$
36AM3	2R	Half-wave Rectifier	36.0	0.1	Max. AC Voltage = 117 volts (rms) Max. Output Current = 75 ma							
37, 37A	3	Class A Amplifier	6.3	0.3	250	—	-18.0	7.5	—	0.0084	1100	$\mu = 9.2$
38	5	Class A Amplifier	6.3	0.3	250	250	-25.0	22.0	3.8	0.10	1200	$R_L = 10 \text{ K}\Omega$, $W_o = 2.5 \text{ watts}$
38A3	2R	Half-wave Rectifier	38	0.1	Max. AC Plate Voltage = 250 volts (rms) Max. Output Current = 110 ma Max. PIV = 700 volts							
39 39/44	5	Class A Amplifier	6.3	0.3	90 250	90 90	$\left. \begin{matrix} -3.0 \\ \text{min.} \end{matrix} \right\}$	5.6 5.8	1.6 1.4	0.4 1.0	1000 1050	
40	3	Class A Amplifier	5.0	0.25	135 180	—	-1.5 -3.0	0.2 0.2	—	0.15 0.15	200 200	$\mu = 30$ $\mu = 30$
40B2		Horiz. Reg.			Avg. Operating Current = 140 ma at 20 volts; 150 ma at 40 volts							
41	5	Class A Amplifier	6.3	0.4	See 6K6GT Characteristics							
42	5	Class A Amplifier	6.3	0.7	See 6F6G Characteristics							
43	5	Class A Amplifier	25.0	0.3	See 25A6 Characteristics							
45	3	Class A Amplifier	2.5	1.5	180 275	— —	-31.5 -56.0	31.0 31.0	— —	0.0016 0.0017	2125 2050	$R_L = 2.7 \text{ K}\Omega$, $W_o = 0.82 \text{ watts}$ $R_L = 4.6 \text{ K}\Omega$, $W_o = 2.0 \text{ watts}$
45A	3	Class A Amplifier	2.5	1.5	325	—	-68	43	—	0.0032		$\mu = 3.5$
45A5	5	Class A Amplifier	45.0	0.1	170 110	170 110	-10.4 -6.4	53 32	10.0 6.0	0.02 0.018		$R_L = 3.0 \text{ K}\Omega$, $W_o = 4.25 \text{ watts}$ $R_L = 3.0 \text{ K}\Omega$, $W_o = 1.7 \text{ watts}$

*See quoted value of R_k \ddagger Maximum

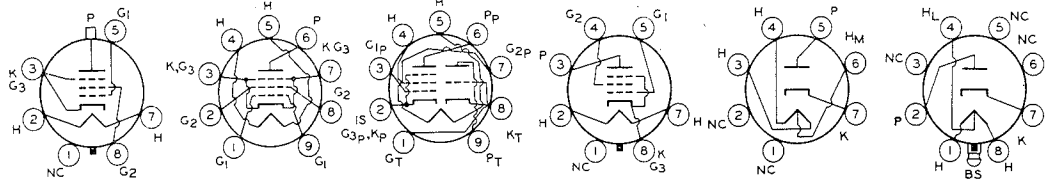

35CD6-GA

35D5

35DZ8

**35L6-G
35L6-GT**

35W4

35Y4

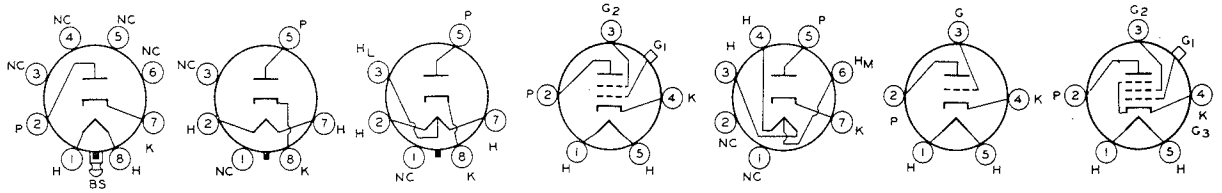

**35Z3
35Z3-LT**

35Z4-GT

**35Z5-G
35Z5-GT**

**36
36-A**

36AM3

**37
37-A**

**38
38-A**

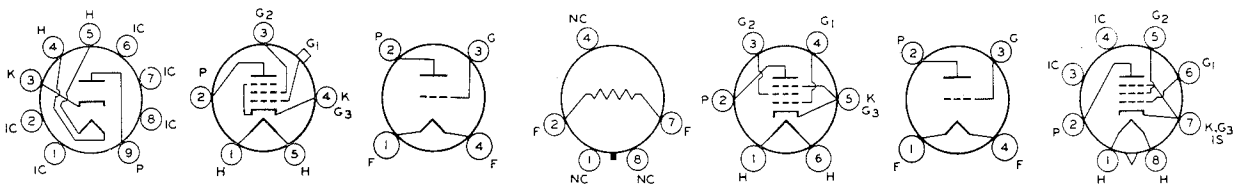

38A3

**39
39/44
39-A**

40

40B2

**41
42
43**

**45
45-A**

45A5

TYPE	Class	Use	E_r volts	I_r amps	E_b volts	E_{c2} volts	E_{c1} volts	I_b ma	I_{c2} ma	r_p M Ω	g_m μ mhos	
45B5	5	Class A Amplifier	45	0.1	170	170	-12.5	70	5.0	0.023	10,000	$R_L = 2.4 K\Omega$, 5.6 w
					100	100	-6.7	43	3.0	0.023	9000	$R_L = 2.4 K\Omega$, 1.9 w
45Z3	2R	Half-wave Rectifier	45.0	0.075	Max. AC Plate Voltage = 117 volts Max. DC Output = 65 ma Max. PIV = 350 volts Max. Peak Plate Current = 390 ma							
45Z5GT	2R	Half-wave Rectifier	45.0	0.15	See 35Z5GT Characteristics							
46	4	Class A Amplifier ■	2.5	1.75	250	—	-33.0	22.0	—	0.0023	2350	$R_L = 6.4 K\Omega$, $W_o = 1.25$ watts
		Class B Amplifier ▽			300 400	—	0 0	8.0 12.0	—	$R_L = 5.2 K\Omega$, $R_L = 5.8 K\Omega$	$W_o = 16.0$ watts $W_o = 20.0$ watts	
47	5	Class A Amplifier	2.5	1.75	250	250	-16.5	31.0	6.0	0.06	2500	$R_L = 7.0 K\Omega$, $W_o = 2.7 K\Omega$
48	4	Tetrode Amplifier	30.0	0.4	96	96	-19.0	52.0	9.0		3800	$R_L = 1.5 K\Omega$, $W_o = 2.0$ watts
					125	100	-20.0	56.0	9.5	3900	$R_L = 1.5 K\Omega$, $W_o = 2.5$ watts	
49	4	Class A Amplifier	2.0	0.12	135	—	-20.0	6.0	—	0.004	1125	$R_L = 11.0 K\Omega$, $\mu = 4.7$ $W_o = 0.17$ watts
50	3	Class A Amplifier	7.5	1.25	300	—	-54	35	—	0.002	1900	$R_L = 4.6 K\Omega$, $W_o = 1.6$ watts $\mu = 3.8$
					450	—	-84	55	—	0.0018	2100	$R_L = 4.35 K\Omega$, $W_o = 4.6$ watts $\mu = 3.8$
50A5	5	Class A Amplifier	50.0	0.15	See 50L6GT Characteristics							
50AX6GT	2R, 2R	Full-wave Rectifier	50.0	0.3	Max. PIV/Plate = 1250 volts Max. Output Current/Plate = 125 ma							
50B5	5	Class A Amplifier	50.0	0.15	See 50C5 Characteristics							
50BK5	5	Power Amplifier	50.0	0.15	250	250	-5.0	35	3.5	0.1	8500	$R_L = 6.5 K\Omega$, $W_o = 3.5$ watts
50BM8	3, 5	Tri. Amplifier	50.0	0.10	100	—	0	3.5	—	0.028	2500	$\mu = 70$
		Pent. Amplifier			200	200	-16.0	35	7.0	0.02	6400	$R_L = 5.6 K\Omega$, $W_o = 3.5$ watts
50C5	5	Power Amplifier	50.0	0.15	110	110	-7.5	49	4.0	0.01	7500	$R_L = 2.5 K\Omega$, $W_o = 1.9$ watts
50C6G	5	Class A Amplifier	50.0	0.15	135	135	-13.5	58.0	3.5	0.0093	7000	$R_L = 2.0 K\Omega$, $W_o = 3.6$ watts
50C6GA					200	135	-14.0	61.0	2.2	0.0183	7100	$R_L = 2.6 K\Omega$, $W_o = 6.0$ watts
50CA5	5	Power Amplifier	50.0	0.15	See 6CA5 Characteristics							
50CD6G	5	Horiz. Amplifier	50.0	0.3	Max. Peak Pos. Pulse Plate = 6000 volts Plate Dissip. = 15 w Max. Screen Voltage = 175 volts Max. Output Current = 200 ma							
50DC4	2R	Half-wave Rectifier	50.0	0.15	Max. AC Voltage/Plate = 117 volts (rms) Max. PIV = 330 volts Max. Peak Plate Current = 720 ma Max. DC Output Current = 110 ma							
50EH5	5	Class A Amplifier	50.0	0.15	See 6EH5 Characteristics							
50L6GT	5	Class A Amplifier	50.0	0.15	100	110	-7.5	49.0	4.0	0.013	8000	$R_L = 2 K\Omega$, 2.1 w
					200	125	*	46.0	2.2	0.028	8000	$R_L = 4 K\Omega$, 3.8 w

*See quoted value of R_k

▽ Two valves

■ G_1 tied to plate▽ G_1 and G_2 tied together

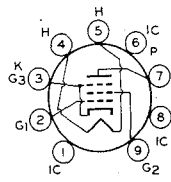

45B5

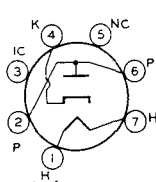

45Z3

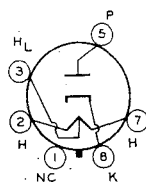

45Z5-GT

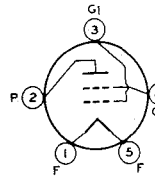

46

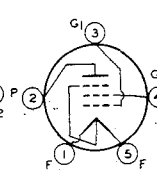

47

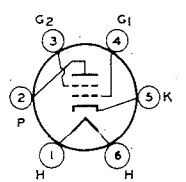

48

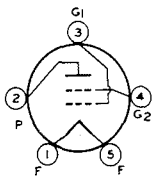

49

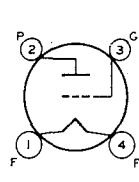

50

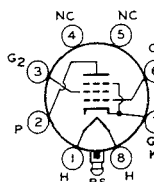

50A5

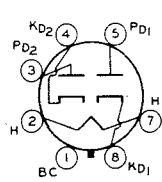

50AX6-G

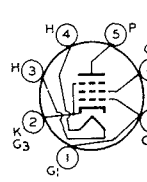

50B5

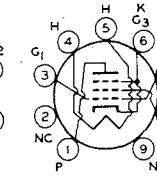

50BK5

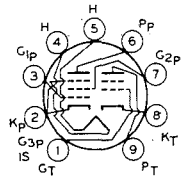

50BM8

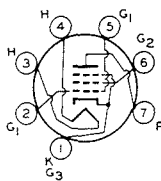

50C5

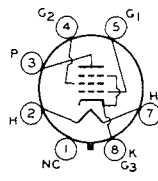

50C6-G
50C6-GA

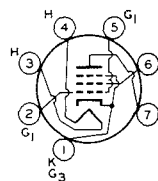

50CA5

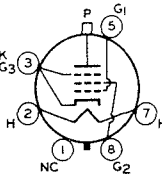

50CD6-G

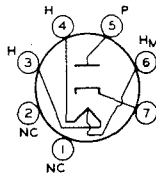

50DC4

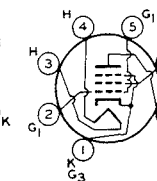

50EH5

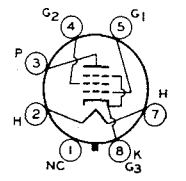

50L6-GT

TYPE	Class	Use	E_f volts	I_f amps	E_b volts	E_{c2} volts	E_{c1} volts	I_b ma	I_{c2} ma	r_p M Ω	g_m μ mhos	
50X6	2R, 2R	Rectifier	50-0	0-15	Max. PIV = 700 volts Max. Peak Plate Current/Plate = 450 ma Max. DC Output Current/Plate = 75 ma							
50Y6GT	2R, 2R	Rect. Doubler	50-0	0-15	See 25Z6 Characteristics							
50Y7GT	2R, 2R	Rectifier	50-0	0-15	Max. PIV = 700 volts Max. Peak Plate Current/Plate = 450 ma Max. DC Output Current/Plate = 75 ma							
50Z6G	2R, 2R	Full-wave Rectifier	50-0	0-3	Max. AC Voltage/Plate = 250 volts (rms) Max. DC Output Current = 250 ma							
50Z7G	2R, 2R	Voltage Doubler	50-0	0-15	Max. AC Voltage/Plate = 117 volts (rms) Max. DC Output Current = 65 ma							
		Half-wave Rectifier			Max. AC Voltage/Plate = 117 volts (rms) Max. DC Output Current = 65 ma							
53	3, 3	Amplifier	2-5	2-0	See 6N7GT Characteristics							
55	2, 2, 3	Amplifier	2-5	1-0	See Type 85 Characteristics							
55N3	2R	Half-wave Rectifier	55-0	0-1	Max. AC Voltage/Plate = 250 volts Max. Output Current = 180 ma							
56	3	Amplifier	2-5	1-0	See Type 76 Characteristics							
57	5	Amplifier Detector	2-5	1-0	See 6J7 Characteristics							
58	5	Amplifier Mixer	2-5	1-0	See 6U7G Characteristics							
59	5	Pent. Amplifier	2-5	2-0	250	250	-18-0	35-0	9-0	0-055	2500	$R_L = 6-0 K\Omega$, $W_o = 3-0$ watts
70L7GT	2, 5	Class A Amplifier	70-0	0-15	110	110	-7-5	40-0	3-0	0-015	7500	$R_L = 2-0 K\Omega$, $W_o = 1-8$ watts
		Half-wave Rectifier			Max. DC Output Curr. = 70 ma Max. Peak Plate Curr. = 420 ma Max. PIV = 350 volts							
71	3	Class A Amplifier	5-0	0-25	180	—	-40-5	20	—	—	1700	$R_L = 4-8 K\Omega$, $W_o = 0-79$ watts
71A	3	Class A Amplifier	5-0	0-25	90	—	-16-5	10-0	—	0-002	1400	$R_L = 3-0 K\Omega$, $W_o = 0-125$ watts
					180	—	-40-5	29-0	—	0-002	1700	$R_L = 4-8 K\Omega$, $W_o = 0-79$
71B	3	Class A Amplifier	5-0	0-125	See 71A Characteristics							
75	2, 2, 3	Class A Amplifier	6-3	0-3	See 6SQ7 Characteristics							
76	3	Class A Amplifier	6-3	0-3	250	—	-13-5	5-0	—	0-0095	1450	$\mu = 13-8$
77	5	Class A Amplifier	6-3	0-3	250	100	-3-0	2-3	0-5	1-0	1250	
78	5	Amplifier Mixer	6-3	0-3	See 6K7 Characteristics							
79	3, 3	Power Amplifier	6-3	0-6	250	—	0	5-3 ϕ	—	—		$R_L = 14-0 K\Omega$, $W_o = 8-0$ watts▼
80	2R, 2R	FW Rectifier	5-0	2-0	See 5Y3GT Characteristics							
81	2R	Half-wave Rectifier	7-5	1-25	Max. AC Plate Voltage = 700 volts (rms) Max. PIV = 2000 volts Max. DC Output Curr. = 85 ma Max. DC Output Current = 85 ma Max. Peak Plate Curr. = 500 ma							

 ϕ Per Plate

▼ Two valves

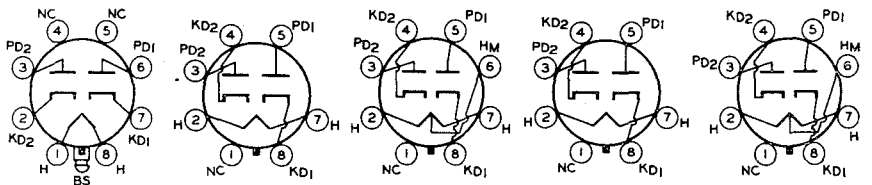

50X6

**50Y6-G
50Y6-GT**

50Y7-GT

50Z6-G

50Z7-G

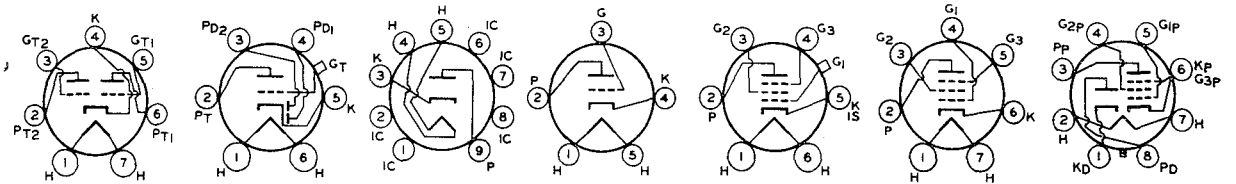

53

55

55N3

56

**57
58**

59

70L7-GT

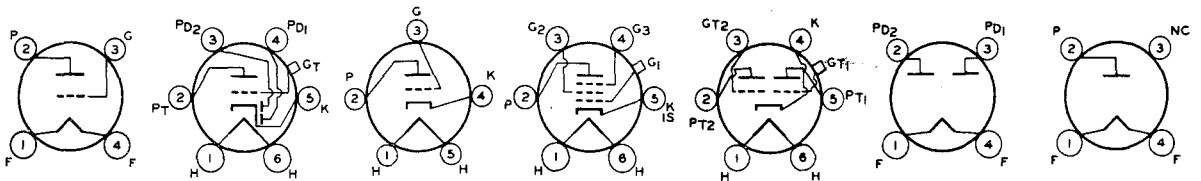

**71
71-A
71-B**

75

76

**77
78**

79

80

81

TYPE	Class	Use	E_f volts	I_f amps	E_b volts	E_{c2} volts	E_{c1} volts	I_b ma	I_{c2} ma	r_p MΩ	g_m μmhos	
82	2R, 2R	Full-wave Rectifier	2.5	3.0	Max. DC Output Current = 115 ma Max. Peak Plate Current/Plate = 600 ma Max. PIV = 1550 volts							
83	2R, 2R	Full-wave Rectifier	5.0	3.0	Max. Peak Plate Current/Plate = 1000 ma Max. PIV = 1550 volts Max. Output Current = 225 ma							
83V	2R, 2R	FW Rectifier	5.0	3.0	See 5V4G Characteristics							
84/6Z4	2R, 2R	Full-wave Rectifier	6.3	0.5	Max. DC Output Current = 60 ma Max. PIV = 1250 volts Max. Peak Plate Curr./Plate = 180 ma							
85	2, 2, 3	Class A Amplifier	6.3	0.3	135	—	-10.5	3.7	—	0.011	750	$R_L = 25\text{ K}\Omega$, $W_o = 0.075\text{ watts}$ $R_L = 20\text{ K}\Omega$, $W_o = 0.35\text{ watts}$
					250	—	-20.0	8.0	—	0.007	1100	
89	5	Class A Amplifier	6.3	0.4	250	250	-25.0	32	5.5	0.07	1800	$R_L = 6.75\text{ K}\Omega$, $W_o = 3.4\text{ watts}$
117L7/ M7GT	2R, 5	Class A Amplifier	117	0.09	105	105	-5.2	43	4.0	0.017	5300	$R_L = 4.0\text{ K}\Omega$, $W_o = 0.85\text{ watts}$
		Half-wave Rectifier			Max. AC Plate Voltage = 117 volts (rms) Max. DC Output Curr. = 75 ma Max. PIV = 350 volts Max. Peak Plate Curr. = 450 ma							
117N7GT	2R, 5	Class A Amplifier	117	0.09	100	100	-6.0	51.0	5.0	0.016	7000	$R_L = 3.0\text{ K}\Omega$, $W_o = 1.2\text{ watts}$
		Half-wave Rectifier			Max. AC Plate Voltage = 117 volts (rms) Max. DC Output Curr. = 75 ma Max. Peak Plate Curr. = 450 ma Max. PIV = 350 volts							
117P7GT	2R, 5	Amplifier, HW Rectifier	117	0.09	See 117L7/M7GT							
117Z3	2R	Half-wave Rectifier	117	0.04	Max. AC Plate Voltage = 117 volts (rms) Max. DC Output Curr. = 90 ma Max. PIV = 330 volts Max. Peak Plate Curr. = 540 ma							
117Z4GT	2R	Half-wave Rectifier	117	0.04	Max. AC Plate Voltage = 117 volts (rms) Max. DC Output Current = 90 ma Max. PIV = 350 volts Max. Peak Plate Current = 540 ma							
117Z6G	2R, 2R	Voltage Doubler	117	0.075	Max. AC Voltage/Plate = 117 volts (rms) Max. DC Output = 60 ma							
117Z6GT		Half-wave Rectifier			Max. AC Voltage/Plate = 235 volts (rms) Max. DC Output Curr./Plate = 60 ma							
5881	5	Power Amplifier	6.3	0.9	See 6L6G Characteristics							
6973	5	Class A Amplifier	6.3	0.45	250	250	-15	46	3.5	0.073	4800	$R_L = 7.5\text{ K}\Omega$, $W_o = 20\text{ watts}$
		P.P. AB ₁ Amp.			350	280	-22	58	3.5	—	—	
7025	2, 3	AF Amplifier	12.6	0.15	See 12AX7 Characteristics							
			6.3	0.3								
7027	5	P.P. AB ₁ Amp.	6.3	0.9	330	330	-24	122	5.6	—	$R_L = 4.5\text{ K}\Omega$, $W_o = 31.5\text{ watts}$	
7199	3, 5	AF Tri. Amp.	6.3	0.45	215	—	-8.5	9.0	—	0.008	2100	$\mu = 17$
		AF Pent. Amp.			100	50	*	1.1	0.35	1.0	1500	$R_k = 1.0\text{ K}\Omega$

*See quoted value of R_k

TYPE	Class	Use	E_f volts	I_f amps	E_b volts	E_{c2} volts	E_{c1} volts	I_b ma	I_{c2} ma	r_p M Ω	g_m μ mhos	
KT61	5	Power Amplifier	6.3	0.95	250	250	-4.4	40	4.3	0.07	9800	$R_L = 6.0 \text{ K}\Omega$, $W_o = 4.3 \text{ watts}$ $R_k = 90 \Omega$
KT66	5	Power Amplifier	6.3	1.27	250	250	-15	85	6.3	0.022	6300	$R_L = 2.2 \text{ K}\Omega$, $W_o = 7.25 \text{ watts}$ $R_k = 160 \Omega$
KT88	5	Class A Amplifier	6.3	1.6	250	250	—	140	—	0.012	11,000	
		Class AB ₂ Amplifier			600	350	-45	100	6.0	—	—	$R_L = 5 \text{ K}\Omega$ $W_o = 100 \text{ watts}$
N78	5	Power Amplifier	6.3	0.64	See 6BJ5 Characteristics							
N709	5	Power Amplifier	6.3	0.76	See 6BQ5 Characteristics							
X79	3, 6	Converter	6.3	0.3	See 6AES Characteristics							
Z729	5	Low-noise AF Amplifier	6.3	0.3	See 6BK8 Characteristics							

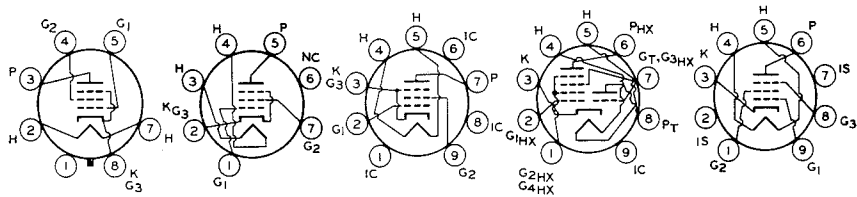

KT61
KT66
KT88

N78

N709

X79

Z729

VALVE EQUIVALENTS

Type	Equivalent	Type	Equivalent	Type	Equivalent
1C1 ✓	1R5	DAF91	1S5	EC94 ✓	6AF4
1C2 ✓	1AC6	DAF92	1U5	EC95	6ER5
1D13 ✓	1A3	DAF96	1AH5	ECC81	12AT7
1F2 ✓	1L4	DC80	1E3	ECC82	12AU7
1F3 ✓	1T4	DCC90	3A5	ECC83	12AX7
1FD1 ✓	1AH5	DF33	1N5GT	ECC85	6AQ8
1FD9 ✓	1S5	DF91	1T4	ECC88	6DJ8
1P1 ✓	3C4	DF92	1L4	ECC91	6J6
1P10 ✓	3S4	DF96	1AJ4	ECC180	6BQ7A
1P11 ✓	3V4	DF904	1U4	ECC189	6ES8
6D2	6AL5	DH63(M)	6Q7/G/GT	ECF80	6BL8
6F12 ✓	6AM6	DH77	6AT6	ECF82	6U8
6L12 ✓	6AQ8	DH149	7C6	ECH80	6AN7
6L34 ✓	6AQ4	DH150	6CV7	ECH81	6AJ8
6LD3	6CV7	DH719	6AK8	ECL80	6AB8
6P9 ✓	6BM5	DH719	6T8A	ECL82	6BM8
6P15 ✓	6BQ5	DK32	1A7GT	ED2	6AL5
7D9 ✓	6AM5	DK91	1R5	EF41	6CJ5
7D10 ✓	6CH6	DK92	1AC6	EF80	6BX6
8D3 ✓	6AM6	DK96	1AB6	EF85	6BY7
8D5 ✓	6BR7	DL29	3D6	EF89	6DA6
8D7 ✓	6BS7	DL33	3Q5GT	EF89F	6DG7
9D6	6CQ6	DL35	1C5GT	EF91	6AM6
9P9	9BM5	DL36	1Q5GT	EF92	6CQ6
13D2	6SN7GT	DL91	1S4	EF93	6BA6
17N8	17C8	DL92	3S4	EF94	6AU6
19U3	19X3	DL93	3A4	EF95	6AK5
62DDT	6CV7	DL94	3V4	EF96	6AG5
62VP	6CJ5	DL95	3Q4	EF183	6EH7
63T1	6AB8	DL96	3C4	EF184	6EJ7
64SPT ✓	6BX6	DL98	3B4	EH90	6CS6
65ME ✓	6BR5	DP61	6AK5	EK90	6BE6
66KU	6BT4	EAA91	6AL5	EL81	6CJ6
67PT ✓	6CK5	EABC80	6T8	EL83	6CK6
141TH ✓	14K7	EABC80	6AK8	EL84	6BQ5
311SU ✓	31A3	EAF42	6CT7	EL85	6BN5
451PT ✓	45A5	EB91	6AL5	EL86	6CW5
B36	12SN7GT	EBC41	6CV7	EL90	6AQ5
B65	6SN7GT	EBC80	6BD7	EL91	6AM5
B152	12AT7	EBC90	6AT6	EL180	12BY7A
B309	12AT7	EBC91	6AV6	EL821	6CH6
B329	12AU7	EBF80	6N8	EQ80	6BE7
B339	12AX7	EBF81	6AD8	EY51	6X2
BF61	6CK5	EBF89	6DC8	EY80	6U3
BPMO4	6AQ5	EC80	6Q4	EY81	6R3
D2M9	6AL5	EC81	6R4	EY82	6N3
D77	6AL5	EC84	6AJ4	EZ35	6X5GT
D152	6AL5	EC90	6C4	EZ40	6BT4
DA90	1A3	EC91	6AQ4	EZ80	6V4
DAC32	1H5GT	EC92	6AB4	EZ81	6CA4

Type	Equivalent	Type	Equivalent	Type	Equivalent
EZ90	6X4	N309	15A6	UF41	12AC5
EZ91	6AV4	N359	21A6	UL41	45A5
GZ30	5Z4	N709	6BQ5	UL84	45B5
GZ32	5V4GA	N727	6AQ5	UY41	31A3
GZ34	5AR4	PABC80	9AK8	UY85	38A3
H63	6F5/GT	PCC85	9AQ8	V2M70	6X4
HAA91	12AL5	PCF80	9A8	V61	6BT4
HABC80	19T8	PCF82	9U8A	VP6	6CQ6
HBC90	12AT6	PL36	25E5	W17	1T4
HBC91	12AV6	PL81	21A6	W149	7B7
HD14	1H5GT	PL83	15A6	W727	6BA6
HD30	3B4	PM04	6BA6	WD142	12S7
HF93	12BA6	PM07	6AM6	WD709	6N8
HF94	12AU6	PY80	19X3	X14	1A7GT
HK90	12BE6	PY81	17Z3	X17	1R5
HL90	19AQ5	PY82	19Y3	X18	1AC6
HL92	50C5	R52	5Z4	X20	1AC6
HL94	30A5	SP6	6AM6	X79	6AE8
HM04	6BE6	U43	6X2	X148	7S7
HY90	35W4	U50	5Y3GT	X719	6AJ8
KT63	6F6G	U52	5U4G	X727	6BE6
L63	6J5/GT	U78	6X4	XCC189	4ES8
L77	6C4	U145	31A3	XL84	8BQ5
LN152	6AB8	U147	6X5GT	Z14	1N5GT
N14	1C5GT	U149	7Y4	Z63	6J7/GT
N16	3Q5GT	U150	6BT4	Z77	6AM6
N17	3S4	U151	6X2	Z152	6BX6
N18	3Q4	U153	17Z3	Z719	6BX6
N19	3V4	U154	19Y3	ZD17	1S5
N78	6BJ5	UAF42	12S7	ZD152	6N8
N142	45A5	UBC41	14L7		
N144	6AM5	UBF80	17C8		
N150	6CK5	UCH42	14K7		
N152	21A6	UCH81	19D8		
N153	15A6	UCL82	50BM8		

PICTURE TUBE DATA

**For picture tube interchangeability
data, see page 104.**

PICTURE TUBE DATA

TYPE	Diagonal Deflection Angle	External Conductive Coating μ i	MAXIMUM RATINGS				TYPICAL GRID-DRIVE SERVICE				Minimum PM Ion-trap Magnet Oersted
			Ultor* volts	Focus Electrode volts	Grid No. 2 volts	Grid No. 1 volts §	Ultor* volts	Grid No. 2 volts	Focus Electrode volts	Grid No. 1 volts	
17AVP4A	90°	1200 to 1500	16,000	+1000 to -500†	500	-125	14,000	300	-55 to +310	-28 to -72	31
							16,000	300	-65 to +350	-28 to -72	33
17BJP4	90°	1200 to 1500	16,000	+1000 to -500†	500	-140	12,000	300	-50 to +265	-28 to -72	—
							14,000	300	-55 to +300	-28 to -72	—
17BZF4	110°	800 to 1500	16,000	+1000 to -500†	500	-140	14,000	300	Zero to +400	-28 to -72	—
							16,000	400	Zero to +400	-36 to -94	—
17CGF4	70°	750 to 1500	16,000	+1000 to -500†	500	-125	1,400	300	-55 to -300	-28 to -72	—
							16,000	300	-65 to +350	-28 to +72	—
17HP4B	70°	750 to 1500	16,000	+1000 to -500†	500	-125	14,000	300	-55 to +300	-28 to -72	31
							16,000	300	-65 to +350	-28 to -72	33
19AKF4	114°	1000 to 1500	20,000	—	550	-154	16,000	300	—	-35 to -72	—
19XP4	114°	1000 to 1500	20,000	+1100 to -550	550	-154	16,000	400	Zero to +400	-36 to -94	—
21ALP4A	90°	500 to 750	18,000	+1000 to -500†	500	-125	16,000	300	-65 to +350	-28 to -72	33
							18,000	400	-75 to +400	-37 to -96	35
21BCP4	90°	2000 to 2500	20,000	+1000 to -500	500	-140	16,000	300	Zero to +450	-28 to -72	—
21CBF4A	90°	2200 to 2900	18,000	+1000 to -500†	500	-140	14,000	300	-55 to +300	-28 to -72	—
							18,000	300	-70 to +396	-28 to -72	—
21CEP4	110°	2000 to 2500	18,000	+1000 to -500†	500	-140	14,000	300	Zero to +400	-28 to -72	—
							16,000	400	Zero to +400	-36 to -94	—
21DAP4	110°	2000 to 2500	18,000	+1000 to -500	500	-154	16,000	400	Zero to +400	-36 to -78	—
23AVF4	110°	2000 to 2500	20,000	+1100 to -550	500	-154	18,000	400	Zero to +400	-42 to -78	—
23CP4/ 23HP4	114°	2000 to 2500	22,000	+1100 to -550	550	-154	18,000	400	Zero to +400	-44 to -94	—
23MP4	114°	1700 to 2000	22,000	+1100 to -550	550	-154	18,000	400	Zero to +400	-36 to -94	—

*The Ultor is the electrode to which is applied the highest dc voltage for accelerating the electrons in the beam prior to its deflection. (G_3 , G_5 , and CL).

†This value has been specified to take care of the condition where an ac voltage is provided for dynamic focusing.

§Positive bias value = 0 volts; peak positive value = 2 volts.

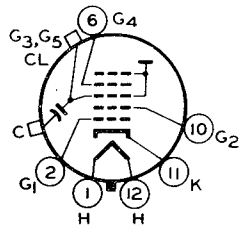

ULTOR = G₃ + G₅ + CL
FOCUSING ELECTRODE = G₄

- 17AVP4A
- 17BJP4
- 17CGP4
- 17HP4B
- 21ALP4A
- 21BCP4
- 21CBP4A

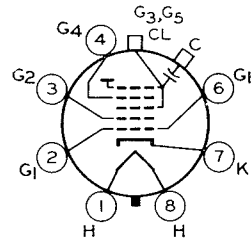

ULTOR = G₃ + G₅ + CL
FOCUSING ELECTRODE = G₄

- 17BZP4
- 19AKP4
- 19XP4
- 21CEP4
- 21DAP4
- 23AVP4
- 23CP4/23HP4
- 23MP4

PICTURE TUBE

TYPE	Replace with	Focus	Heater	Defl. Angle	Ion Trap Magnet (gausses)	MAXIMUM DIMENSIONS—INCHES				
						Overall Length	Envelope Diagonal	Width	Height	Neck Length
5-3T	17HP4B ⁽⁷⁾	ES	8-0V, 0-3A	70°	None	—	—	—	—	—
14ASF4	None	ES	6-3V, 0-6A	110°	None	11-5/8	14	13-5/16	11	6-1/16
14RF4†	None	ES	6-3V, 0-6A	90°	35	13-1/2	14-1/8	13-3/16	10-11/16	5-11/16
14RF4A	None	ES	6-3V, 0-6A	90°	Same as 14RF4 except for Aluminized Screen.					
14WP4	None	ES	6-3V, 0-6A	90°	None	13-9/16	14-1/8	13-3/16	10-11/16	5-11/16
17ATP4/ 17AVF4†	17BJP4 ⁽⁸⁾	ES	6-3V, 0-6A	90°	31-33	16	16-3/4	15-33/64	12-13/32	6-11/16
17ATP4A/ 17AVF4A	17BJP4 ⁽⁸⁾	ES	6-3V, 0-6A	90°	Same as 17ATP4/17AVF4 except for Aluminized Screen.					
17BJF4	17BJP4	ES	6-3V, 0-6A	90°	None	15	16-3/4	15-1/2	12-13/32	5-11/16
17BP4B	17CGP4 ⁽²⁾	M	6-3V, 0-6A	70°	35	19-9/16	16-3/4	15-33/64	12-13/32	7-11/16
17BZP4	17BZP4	ES	6-3V, 0-6A	110°	None	12-13/16	16-11/16	15-3/4	12-7/8	5-9/16
17CGF4	17CGP4	ES	6-3V, 0-6A	70°	None	17-5/8	16-5/8	15-1/2	12-3/8	5-11/16
17HP4†	17CGP4 ⁽⁸⁾	ES	6-3V, 0-6A	70°	31-33	19-5/8	16-5/8	15-1/2	12-3/8	7-1/2
17HP4B	17CGP4 ⁽⁸⁾	ES	6-3V, 0-6A	70°	Same as 17HP4 except for Aluminized Screen.					
17RP4†	17CGP4 ⁽⁸⁾	ES	6-3V, 0-6A	70°	45	19-5/8	16-3/4	15-1/2	12-3/8	7-11/16
19AKP4	19AKP4	ES	6-3V, 0-6A	114°	None	12-5/8	18-3/4	16-17/32	13-1/2	5-1/4
19XF4	19XP4	ES	6-3V, 0-6A	114°	None	11-5/8	18-3/4	16-17/32	13-15/32	4-1/4
21ALP4†	21CBP4A ⁽⁸⁾	ES	6-3V, 0-6A	90°	33-35	20-3/8	21-1/2	20-3/8	16-1/2	7-7/16
21ALP4A/ 21ALF4B	21CBP4A ⁽⁸⁾	ES	6-3V, 0-6A	90°	Same as 21ALP4 except for Aluminized Screen.					
21ATP4	21CBP4A ⁽⁸⁾	ES	6-3V, 0-6A	90°	35	20-3/8	21-9/16	20-7/16	16-9/16	7-11/16
21BCP4	None	ES	6-3V, 0-6A	70°	None	23-13/32	21-11/32	20-3/8	15-11/16	7-11/16
21CBP4A	21CBP4A	ES	6-3V, 0-6A	90°	None	18-3/8	21-1/2	20-3/8	16-1/2	5-7/16
21CEP4	21CEP4	ES	6-3V, 0-6A	110°	None	14-3/4	21-1/2	20-3/8	16-1/2	5-9/16
21DAP4	21DAP4	ES	6-3V, 0-6A	110°	None	15	21-1/2	20-3/8	16-1/2	5-9/16
21ZP4B/300	None	M	6-3V, 0-3A	70°	40	23-13/32	21-11/32	20-3/8	15-11/16	7-11/16
23AVP4*†	23AVP4	ES	6-3V, 0-6A	110°	None	15-9/16	24-51/64	21-7/16	17-7/16	5-1/4
23CP4*	23CP4/23HP4	ES	6-3V, 0-6A	110°	None	15-9/16	24-51/64	21-7/16	17-7/16	5-1/4
23CP4/ 23HP4*	23CP4/23HP4	ES	6-3V, 0-6A	110°	Replacement for 23CP4 and 23HP4.					
23HP4*	23CP4/23HP4	ES	6-3V, 0-6A	110°	None	15-7/8	24-51/64	21-7/16	17-7/16	5-9/16
23MP4	23MP4	ES	6-3V, 0-6A	114°	None	14-11/16	23-31/64	20-9/16	16-5/8	5-1/4
23PQ4*	23CP4/23HP4	ES	6-3V, 0-6A	110°	None	15-9/16	24-51/64	21-7/16	17-7/16	5-1/4
23WP4	23MP4	ES	6-3V, 0-6A	114°	None	14-15/16	23-25/64	20-1/2	16-1/2	5-9/16

*Bonded faceplate.

†Antiglare faceplate.

‡Non-aluminized screen

INTERCHANGEABILITY

	MAXIMUM RATINGS			TYPICAL OPERATION				BASE	TYPE
	Ultor Voltage (volts)	Grid No. 2 Voltage (volts)	H-K Voltage (volts)	Ultor Voltage (volts)	Grid No. 2 Voltage (volts)	Focus Range (volts)	Grid No. 1 Ext. Range		
	17,000	600	200	14,000	450	+800	-33 -77	F	5-3T
	14,000	500	±180	12,000	300	-50 +350	-28 -72	C	14ASP4
	14,000	500	±180	10,000	300	-50 +350	-28 -72	B	14RP4‡
									14RP4A
	14,000	500	±180	12,000	300	-50 +350	-24 -72	B	14WP4
	16,000	500	±180	14,000	300	-65 +350	-28 -72	B	17ATP4/
				16,000	300	-55 +310	-28 -72		17AVP4‡
									17ATP4A/ 17AVP4A
	16,000	500	±180	16,000	300	-55 +360	-28 -72	B	17BJP4
	16,000	410	±150	14,000	300	—	-33 -77	A	17BP4B
	16,000	500	±180	14,000	300	0-400	-28 -72	C	17BZP4
				16,000	400	0-400	-36 -94		
	16,000	500	±180	14,000	300	-50 +350	-28 -72	C	17CGP4
	16,000	500	±180	14,000	300	-55 +310	-28 -72	B	17HP4‡
				16,000	300	-65 +350	-28 -72		
									17HP4B
	16,000	500	±180	14,000	300	-55 +300	-33 -77	B	17RP4‡
	20,000 ⁽¹⁰⁾	550 ⁽¹⁰⁾	±200 ⁽¹⁰⁾	16,000	300	0-400	-35 -72	C	19AKP4
	20,000	550	±200	16,000	400	0-400	-36 -94	C	19XP4
	18,000	500	±180	16,000	300	-65 +350	-28 -72	B	21ALP4‡
				18,000	400	-75 +400	-37 -96		
									21ALP4A/ 21ALP4B
	18,000	500	±180	16,000	300	-64 +350	-28 -72	H	21ATP4
	18,000	500	±180	16,000	300	-50 +350	-28 -72	B	21BCP4
	20,000	500	±180	16,000	300	0-450	-28 -72	B	21CBP4A
	18,000	500	±180	14,000	300	0-400	-28 -72	C	21CEP4
				16,000	400	0-400	-36 -94		
	18,000	500	±180	16,000	400	0-400	-36 -94	C	21DAP4
	18,000	500	±180	16,000	300	—	-33 -77	A	21ZP4B/300
	20,000	500	±180	18,000	400	0-400	-42 -78	C	23AVP4*‡
	20,000	500	±180	18,000	400	0-400	-42 -94	C	23CP4*
									23CP4/ 23HP4*
	20,000	500	±180	16,000	300	0-400	-35 -72	C	23HP4*
	22,000 ⁽¹⁰⁾	550 ⁽¹⁰⁾	±20 ⁽¹⁰⁾	18,000	400	0-400	-36 -94	C	23MP4
	18,000	500	±180	18,000	400	0-400	-44 -94	G	23QP4*
	20,000 ⁽¹⁰⁾	550 ⁽¹⁰⁾	±200 ⁽¹⁰⁾	16,000	300	0-400	-35 -72	C	23WP4

PICTURE TUBE

TYPE	Replace with	Focus	Heater	Defl. Angle	Ion Trap Magnet (gausses)	MAXIMUM DIMENSIONS—INCHES				
						Overall Length	Envelope Diagonal	Width	Height	Neck Length
24AEP4	None	ES	6.3V, 0.6A	90°	None	19-1/2	24-1/8	22-11/16	18-9/16	5-11/16
24AHP4	None	ES	6.3V, 0.6A	110°	None	15-13/16	24-1/8	22-13/16	18-9/16	5-9/16
24APL4	None	ES	6.3V, 0.6A	110°	None	16-3/16	24-1/8	22-13/16	18-5/8	5-5/8
24DP4A	None	ES	6.3V, 0.6A	90°	40	21-1/2	24	22-11/16	18-9/16	7-11/16
27SP4	None	ES	6.3V, 0.6A	90°	40	23-7/16	26-13/16	25-15/16	20-13/32	7-11/16
A43-64	17CGP4 ⁽³⁾	M	6.3V, 0.3A	70°	Same as MW43-64					
AME2350PB*	23CP4	ES	6.3V, 0.6A	110°	None	15-9/16	24-51/64	21-7/16	17-7/16	5-1/4
AW43-20	17CGP4 ⁽⁹⁾	ES	6.3V, 0.3A	70°	None	18-9/16	16-3/4	15-1/2	12-3/8	6-7/16
AW43-80	17BJP4 ^{(8) (9)}	ES	6.3V, 0.3A	90°	50	15-5/8	16-3/4	15-1/2	12-3/8	6-1/2
AW43-88	17BZP4 ⁽⁹⁾	ES	6.3V, 0.3A	110°	None	12-13/16	16-11/16	15-3/4	12-7/8	5-9/16
AW47-30	19AKP4 ⁽⁹⁾	ES	6.3V, 0.3A	114°	None	12-15/16	18-5/8	16-13/32	13-11/32	5-9/16
AW53-80	21CBP4A ⁽⁹⁾	ES	6.3V, 0.3A	90°	50	19-3/8	21-1/2	20-3/8	16-1/2	6-5/16
AW53-88	21DAP4 ⁽⁹⁾	ES	6.3V, 0.3A	110°	None	15	21-1/2	20-3/8	16-1/2	5-7/16
AW59-30	23MP4 ⁽⁹⁾	ES	6.3V, 0.3A	110°	None	15	23-31/64	20-9/16	16-5/8	5-9/16
AW59-90	23MP4 ⁽⁹⁾	ES	6.3V, 0.3A	110°	None	15-1/2	23-35/64	20-5/8	16-5/8	5-9/16
CME2102	21DAP4 ⁽⁹⁾	ES	6.3V, 0.3A	110°	None	15	21-1/2	20-3/8	16-1/2	5-7/16
CRM171	None	M	12.6V, 0.3A	70°	50	19-11/16	16-3/4	15-1/2	12-3/8	7-9/16
CRM172	None	M	12.6V, 0.3A	70°	50	19-3/4	16-3/4	15-1/2	12-3/8	7-9/16
CRM211	None	M	12.6V, 0.3A	70°	50	23-1/2	21-3/8	20-3/8	15-5/8	7-9/16
CRM212	None	M	12.6V, 0.3A	90°	50	20-1/2	21-1/2	20-3/8	16-1/2	7-9/16
MW43-64‡	17CGP4 ^{(3) (9)}	M	6.3V, 0.3A	70°	50	19-1/2	16-3/4	15-1/2	12-3/8	7-3/8
MW43-69	17CGP4 ^{(3) (9)}	M	6.3V, 0.3A	70°	Same as MW43-64 except for Aluminized Screen.					
MW43-80	17BJP4 ⁽⁷⁾	M	6.3V, 0.3A	90°	50	16-7/8	16-3/4	15-1/2	12-3/8	7-3/8
MW53-20	None	M	6.3V, 0.3A	70°	50	23-5/16	21-3/8	20-3/8	15-11/16	7-3/8
MW53-80	21CBP4A ⁽⁷⁾	M	6.3V, 0.3A	90°	50	20-1/4	21-1/2	20-3/8	16-1/2	7-3/8

*Bonded faceplate.

†Antiglare faceplate.

‡Non-aluminized screen

INTERCHANGEABILITY

	MAXIMUM RATINGS			TYPICAL OPERATION				BASE	TYPE
	Ultor Voltage (volts)	Grid No. 2 Voltage (volts)	H-K Voltage (volts)	Ultor Voltage (volts)	Grid No. 2 Voltage (volts)	Focus Range (volts)	Grid No. 1 Ext. Range		
	20,000	500	±180	18,000	300	-50 +350	-28 -72	B	24AEP4
	20,000	500	±180	16,000	300	-50 +350	-28 -72	C	24AHP4
	20,000	500	±180	17,000	300	0-500	-28 -72	C	24ALP4
	20,000	500	±180	18,000	300	-72 +400	-33 -77	B	24DP4A
	20,000	500	±180	18,000	300	-72 +396	-28 -72	B	27SP4
									A43-64
	16,000	400	±180	14,000 16,000	300	+100	-30 -72	C	AME2350PB*
	16,000	460	+180 -125	14,000	300 400	0-400 0-400	-33 -77 -44 -103	B	AW43-20
	18,000	500	+200 -125	14,000 16,000	300 300	-103 +203 -75 +235	-40 -80 -40 -80	D	AW43-80
	16,000	500	+200 -125	14,000 16,000	300 400	0-400 0-400	-30 -72 -38 -94	C	AW43-88
	16,000	500	+200 -125	14,000 16,000	300 400	0-400 0-400	-30 -72 -38 -94	C	AW47-30
	18,000	500	+200 -125	14,000 16,000	300 300	-103 +203 -75 +235	-40 -80 -40 -80	D	AW53-80
	16,000	500	+200 -125	14,000 16,000	300 400	0-400 0-400	-30 -72 -38 -94	C	AW53-88
	16,000	500	+200 -125	16,000 16,000	300 400	0-400 0-400	-30 -72 -38 -94	C	AW59-30
	16,000	500	+200 -125	16,000 16,000	300 400	0-400 0-400	-30 -72 -30 -94	C	AW59-90
	16,000	400	±180	14,000 16,000	300	+100	-30 -72	C	CME2102
	16,000	400	±180	14,000	300	—	-30 -72	A	CRM171
	16,000	400	±180	14,000 16,000	300	—	-30 -72	A	CRM172
	18,000	400	±180	16,000 18,000	300	—	-30 -72	A	CRM211
	20,000	400	±180	16,000 18,000	300	—	-30 -72	A	CRM212
	16,000	410	+200 -125	14,000	300	0-250 ⁽¹⁾	-40 -86	E	MW43-64†
									MW43-69
	18,000	500	+200 -125	14,000 16,000	300	0-300 ⁽¹⁾	-40 -86	E	MW43-80
	18,000	500	+200 -125	14,000 16,000	300 300	0-300 ⁽¹⁾ 0-300 ⁽¹⁾	-40 -80 -40 -80	E	MW53-20
	18,000	500	+200 -125	14,000 16,000	300 300	0-300 ⁽¹⁾ 0-300 ⁽¹⁾	-40 -80 -40 -80	E	MW53-80

NOTES

1. These tubes have a prefocusing electrode connected to pin 7.
2. This tube can be replaced by an electrostatic-focus tube (17CGP4) without ion trap magnet by the addition of a lead to the focus electrode (pin 6) of the 17CGP4 from a suitable voltage for good focus (i.e. from earth to B+). The focus magnet should be discarded.
3. These tubes can be replaced by an electrostatic focus tube (17CGP4) without ion trap magnet, by disconnecting the lead from pin 7 and connecting it to pin 6 and adjusting the voltage for best focus. The focus magnet should be discarded.
4. Can be replaced by 17BJP4 (without ion trap magnet) if the procedure in Note (3) is followed.
5. Can be replaced by 21CBP4A (without ion trap magnet) if the procedure in Note (3) is followed.
6. Can be replaced by 21BCP4 (without ion trap magnet) if procedure in Note (3) is followed.
7. By replacing 7 pin socket with 12 pin and changing heater voltage, a 17HP4B can be used as a substitute.
8. When replacing a tube requiring an ion trap magnet with one which does not, the ion trap should be discarded.
9. These tubes are direct replacements only when used in parallel heater systems. They cannot be used as replacements if the original tube is used in a 300 ma series string circuit.
10. Design maximum ratings.

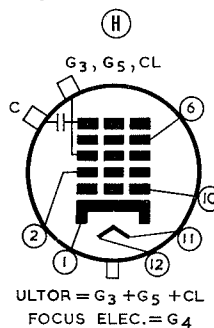
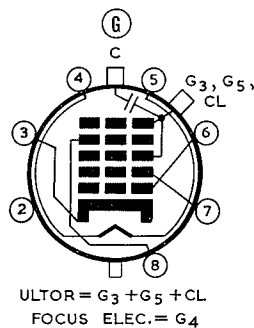
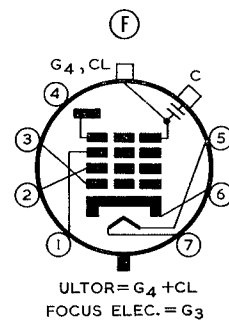
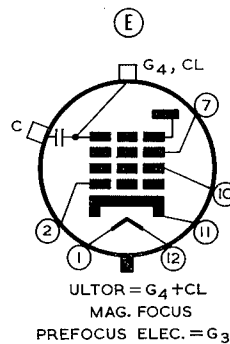
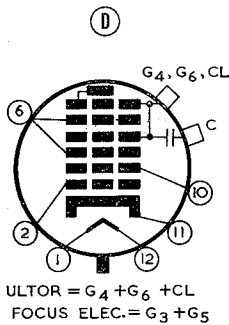
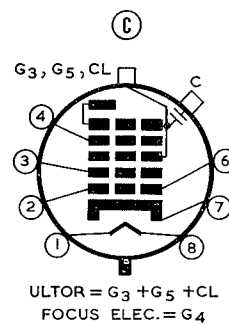
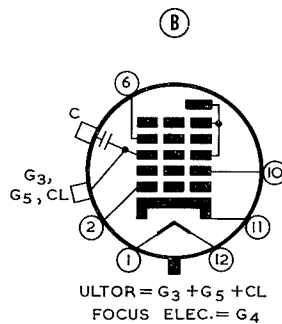
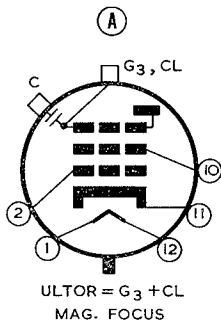

C = EXTERNAL COATING

CL = CONDUCTING LAYER

SEMICONDUCTOR DATA

The types of diodes and transistors tabulated in this data represent only part of the listing available. The inclusion of types in this handbook was restricted to those types most likely to be encountered, particularly in entertainment-type equipment.

**For transistor interchangeability
information, see page 114**

SILICON RECTIFIERS

TYPE	ABSOLUTE—MAXIMUM RATINGS						Max. Rev. Current at Max. PIV μA		OUTLINE
	PIV	RMS Supply Volts*	Forward DC ma		Ambient Temp. °C		25°C	150°C	
			100°C	150°C	Operating	Storage			
1N248C	55	39	—	20,000	175	-65 to +175	—	3,800	A
1N248RC	55	39	—	20,000	175	-65 to +175	—	3,800	A
1N249C	110	77	—	20,000	175	-65 to +175	—	3,600	A
1N249RC	110	77	—	20,000	175	-65 to +175	—	3,600	A
1N250C	220	154	—	20,000	175	-65 to +175	—	3,400	A
1N250RC	220	154	—	20,000	175	-65 to +175	—	3,400	A
1N440B	100	70	500	250	165	-65 to +175	0.3	100	B
1N441B	200	140	500	250	165	-65 to +175	0.75	100	B
1N442B	300	210	500	250	165	-65 to +175	1.0	200	B
1N443B	400	280	500	250	165	-65 to +175	1.5	200	B
1N444B	500	350	425	0	150	-65 to +175	1.75	200	B
1N445B	600	420	400	0	150	-65 to +175	2.0	200	B
1N536	50	35	500	250	165	-65 to +175	5.0	400	B
1N537	100	70	500	250	165	-65 to +175	5.0	400	B
1N538	200	140	500	250	165	-65 to +175	5.0	300	B
1N539	300	210	500	250	165	-65 to +175	5.0	300	B
1N540	400	280	500	250	165	-65 to +175	5.0	300	B
1N547	600	420	500	250	165	-65 to +175	5.0	350	B
1N1095	500	350	500	250	165	-65 to +175	5.0	300	B
1N1195A	300	212	—	20,000	175	-65 to +175	—	3,200	A
1N1195RA	300	212	—	20,000	175	-65 to +175	—	3,200	A
1N1196A	400	284	—	20,000	175	-65 to +175	—	2,500	A
1N1196RA	400	284	—	20,000	175	-65 to +175	—	2,500	A
1N1197A	500	355	—	20,000	175	-65 to +175	—	2,200	A
1N1197RA	500	355	—	20,000	175	-65 to +175	—	2,200	A
1N1198A	600	424	—	20,000	175	-65 to +175	—	1,500	A
1N1198RA	600	424	—	20,000	175	-65 to +175	—	1,500	A
1N1763	400	140†	500‡	—	100	-65 to +150	100	1,000▲	B
1N1764	500	175†	500‡	—	100	-65 to +150	100	1,000▲	B
1N2858	50	35	500	—	125	-65 to +125	—	400▲	B
1N2859	100	70	500	—	125	-65 to +125	—	400▲	B
1N2860	200	140	500	—	125	-65 to +125	—	400▲	B
1N2861	300	210	500	—	125	-65 to +125	—	300▲	B
1N2862	400	280	500	—	125	-65 to +125	—	300▲	B
1N2863	500	350	500	—	125	-65 to +125	—	300▲	B
1N2864	600	420	500	—	125	-65 to +125	—	900▲	B

*Resistive or Inductive Load.

†Capacitor input to filter.

‡At 75°C.

▲At 100°C.

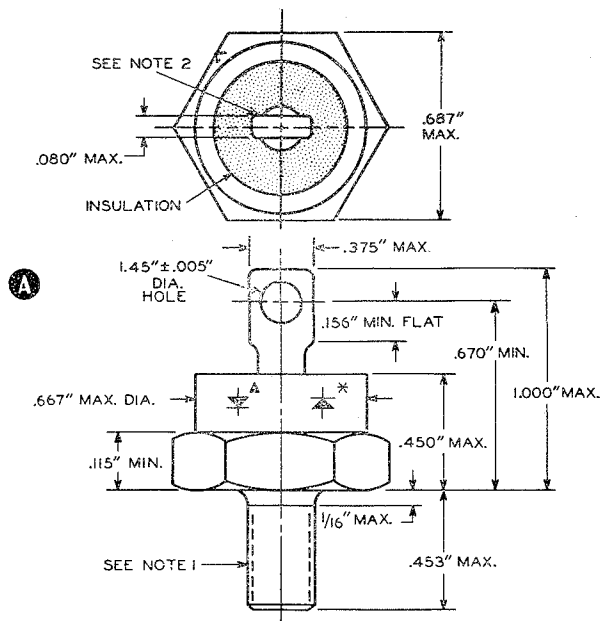

▲ POLARITY SYMBOL FOR TYPES 1N248C, 1N249C, 1N250C, 1N1195A, 1N1196A, 1N1197A AND 1N1198A

* POLARITY SYMBOL FOR TYPES 1N248RC, 1N249RC, 1N250RC, 1N1195RA, 1N1196RA, 1N1197RA AND 1N1198RA

NOTE 1: Must withstand torque of 30 inch-pounds applied to 1/4-28 UNF-2A nut assembled on thread.

NOTE 2: Angular orientation of this terminal undefined.

NOTE 3: Device can be used in any position.

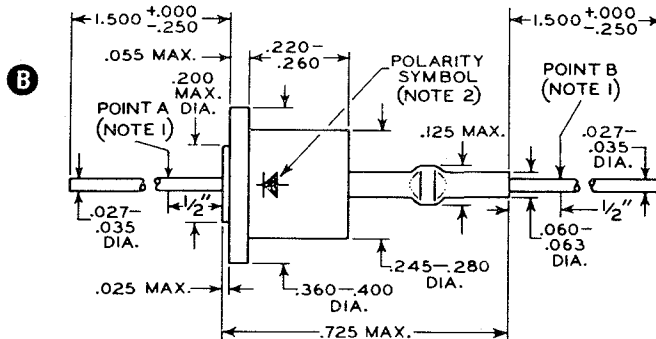

DIMENSIONS IN INCHES

NOTE 1: Do not dip-solder beyond points A and B.

NOTE 2: Arrow indicates direction of forward (easy) current flow as indicated by d c ammeter.

TRANSISTORS

TYPE AND OUTLINE	APPLICATION GUIDE	TYPICAL OPERATION		MAXIMUM RATINGS			CHARACTERISTICS			
		Supply Volts	Collector Current (ma)	Collector - Base Volts	Emitter - Base Volts	Dissipation at 25°C (mW)	h_{fe}	h_{FE}	Max. Power Gain (db)	Alpha Cut-off Frequency (Mc)
2N109 A	Electrically identical with 2N217									
2N139 A	Electrically identical with 2N218									
2N140 A	Electrically identical with 2N219									
2N175 A	Electrically identical with 2N220									
2N176 C	AF Power Amplifier	-14.4	-500	-40	-10	10,000▼	—	63	35.5	—
2N217 D	Large Sig. AF Amp.	-9	-2●	-25	-12	150	—	75	33●	—
2N217S D	Large Sig. AF Amp.	-9	-3●	-25	-12	250†	—	75	33●	—
2N218 D	455Kc IF Amplifier	-9	-1	-16	-12	80	48	—	37	4.7
2N219 D	B/C Band Converter	-9	-0.6	-16	-12	80	48	—	30	7
2N220 D	Low Noise AF Amp.	-4	-0.5	-10	-10	50	65	—	43	0.85
2N247 B	RF Amp. to 10 Mc	-9	-1	-35	-1	80	60	—	45□	30
2N269 D	Computer Switching	—	—	-25	-12	120	—	50	—	13
2N269S D	Computer Switching	—	—	-15	-12	80	140	—	—	20
2N270 B	Large Sig. AF Amp.	-9	-2	-25	-12	250	—	70	32●	—
2N301 C	AF Power Amplifier	-14.4	-900	-40	-10	11,000▼	—	70	33	—
2N301A C	AF Power Amplifier	-14.4	-900	-30	-10	11,000▼	—	70	33	—
2N351 C	AF Power Amplifier	-14.4	-700	-30	-10	10,000▼	—	65	33.5	—
2N370 B	RF Amp. to 20 Mc	-12	-1	-20	-1.5	80	60	—	50.5□	30
2N371 B	RF Osc. to 20 Mc	-12	-1	-20	-0.5	80	60	—	—	30
2N372 B	Mixer to 20 Mc	-12	-1	-20	-0.5	80	60	—	50.5□	30
2N373 B	455Kc IF Amplifier	-12	-1	-25	-0.5	80	60	—	57	30
2N374 B	B/C Band Converter	-12	-0.6	-25	-0.5	80	60	—	40	30
2N376 C	AF Power Amplifier	-14.4	-700	-40	-10	10,000▼	—	78	35	—
2N405 A	Electrically identical with 2N406									
2N406 D	AF Driver Amp.	-6	-1	-20	-2.5	150	35	—	43	0.65
2N407 A	Electrically identical with 2N408									
2N408 D	Large Sig. AF Amp.	-9	-2●	-20	-2.5	150	—	65	33●	—
2N409 A	Electrically identical with 2N410									
2N410 D	455Kc IF Amplifier	-9	-1	-13	-0.5	80	48	—	38	6.8
2N411 A	Electrically identical with 2N412									
2N412 D	B/C Band Converter	-9	-0.6	-13	-0.5	80	75	—	32	10
2N456 C	AF Power Switch/Amp	-28	—	-40	-20	50,000‡	—	52	—	—
2N457 C	AF Power Switch/Amp	-28	—	-60	-20	50,000‡	—	52	—	—
2N544 B	B/C Band RF Amp.	-12	-0.5	-18	-1	80	60	—	47.3□	30
2N591 D	AF Driver Amp.	-14.4	-2	-32	-1	150	70	—	41	0.7
2N640 B	B/C Band RF Amp.*	-12	-1	-34	-1	80	60	—	47.5	42
2N641 B	455Kc IF Amplifier*	-12	-1	-34	-1	80	60	—	60	42
2N642 B	B/C Band Converter*	-12	-0.6	-34	-1	80	50	—	50	42
2N1632 D	B/C Band RF Amp.	-12	-1	-34	-0.5	80	80	—	47.7	45
2N1634 D	455Kc IF Amp.	-12	-1	-24	-0.5	80	75	—	55.7	40
2N1636 D	B/C Band Converter	-12	-0.65	-34	-0.5	80	75	—	36	45
2N1637 D	B/C Band RF Amp.*	-12	-1	-34	-1.5	80	80	—	47.7□	45
2N1638 D	455Kc IF Amp.*	-12	-2	-34	-0.5	80	75	—	61.5	40
2N1639 D	B/C Band Converter*	-12	-0.65	-34	-0.5	80	75	—	37	45

● Two Transistors, Class B

† With Heat Sink

□ At 1.5 Mc

‡ At $T_f = 25^\circ\text{C}$

* For AM Auto Receivers

▼ At $T_f = 80^\circ\text{C}$ h_{fe} = Small Signal Current Gain at 1 Kc h_{FE} = Large Signal DC Current Gain

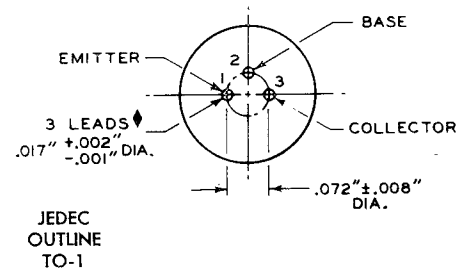
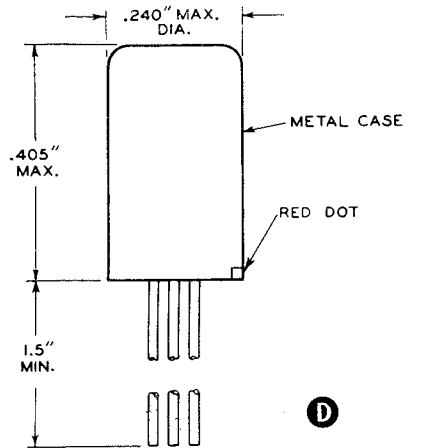
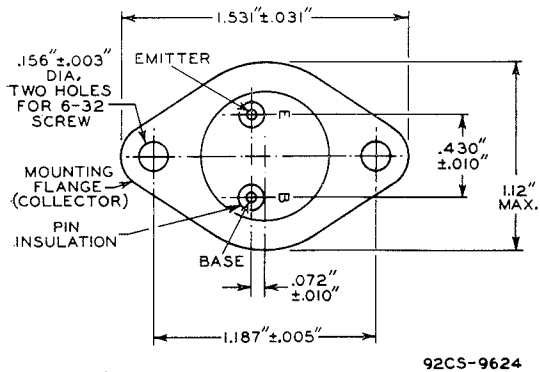
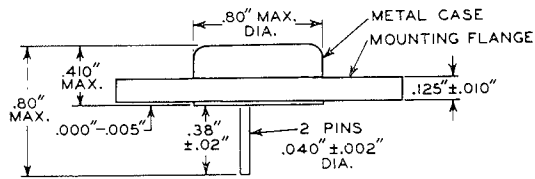
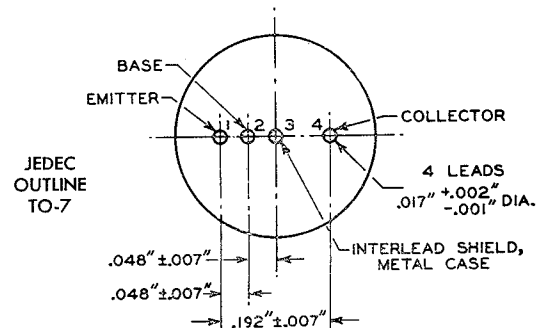
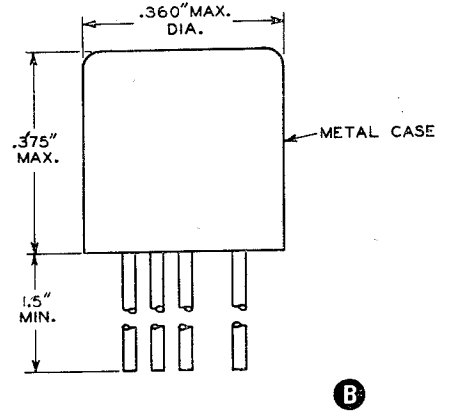
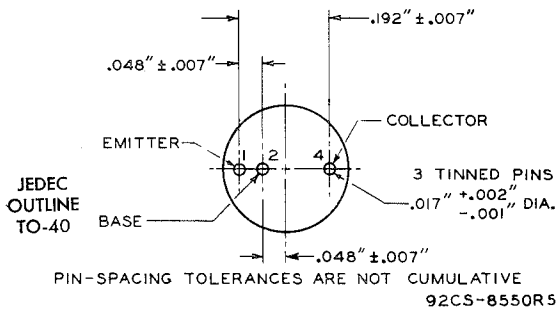
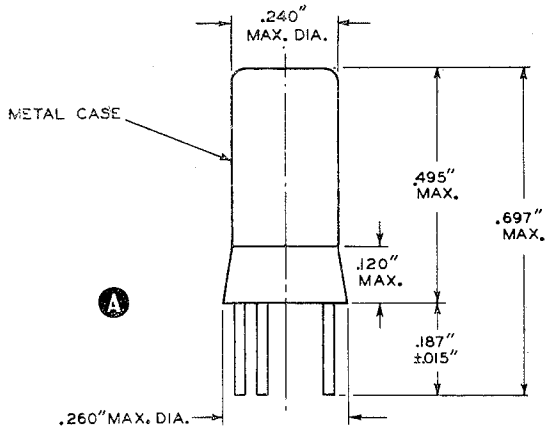

TRANSISTOR INTERCHANGEABILITY GUIDE

This listing is to be used as a guide only. Types shown as replacements are not necessarily electrically and physically identical with the type to be replaced except where marked with an asterisk (*). For more complete information on transistor interchangeability, consult published data on the relevant types.

KEY TO SYMBOLS

* Denotes direct interchangeability.

† Denotes discontinued type.

‡ 2N247 and 2N274 are identical except for case size and interlead capacitances.

• This indicates that the replacement transistor shown is a flying lead type, and must be soldered into the circuit. This can be done in many cases by passing the leads through the appropriate socket holes, and soldering the connections on the underside.

Type	Replacement	Type	Replacement	Type	Replacement
2N34†	2N408•	2N87	2N217•	2N138A	2N406
2N34A†	2N408•	2N88	2N105	2N138B	2N270
2N35†	2N647	2N89	2N105	2N139	2N218•
2N36	2N217	2N90	2N105	2N140	2N219•
2N37	2N408	2N94	2N585	2N155	2N301*
2N38	2N408	2N96†	2N331	2N156	2N301
2N38A	2N408	2N104	2N217•	2N157	2N561
2N39	2N217	2N105	2N105*	2N167	2N1090
2N40	2N217	2N106	2N217•	2N173	2N301
2N41†	2N105	2N107	2N406	2N175	2N220•
2N42	2N217	2N109	2N217•	2N176	2N301
2N43	2N217•	2N111	2N218	2N180	2N217
2N43A	2N331	2N111A	2N218	2N181	2N270
2N44	2N217•	2N112	2N218	2N185	2N270
2N44A	2N217•	2N112A	2N218	2N186	2N217
2N45	2N217•	2N113	2N218•	2N186A	2N270
2N46†	2N105	2N114	2N219•	2N187	2N217•
2N47	2N105	2N115	2N270	2N187A	2N270
2N48	2N105	2N116	2N220•	2N188	2N217•
2N49	2N105	2N123	2N269	2N188A	2N270
2N54	2N217•	2N125	2N585	2N189	2N408
2N55	2N217•	2N126	2N585	2N190	2N408
2N56	2N217•	2N128	2N247‡	2N191	2N270
2N59	2N270	2N129	2N1634	2N192	2N270
2N60	2N270	2N130	2N105	2N195	2N217
2N61	2N270	2N130A	2N105	2N196	2N217
2N62	2N217•	2N131A	2N105	2N197	2N217
2N63	2N217	2N132	2N105	2N198	2N217
2N64	2N217	2N132A	2N105	2N199	2N217•
2N65	2N217	2N133	2N220•	2N200	2N331
2N76	2N217•	2N133A	2N220•	2N204	2N331
2N77†	2N105*	2N135	2N218•	2N205	2N331
2N79†	2N331	2N136	2N218•	2N206†	2N331*
2N85	2N217•	2N137	2N219•	2N207	2N105
2N86	2N217•	2N138	2N406	2N207A	2N105

Type	Replacement	Type	Replacement	Type	Replacement
2N207B	2N105	2N296	2N301A	2N378	2N561
2N215	2N217	2N297A	2N457	2N379	2N561
2N217	2N217*	2N301A	2N301*	2N380	2N561
2N218	2N218*	2N301	2N301A*	2N381	2N270
2N219	2N219*	2N302	2N269	2N382	2N270
2N220	2N220*	2N303	2N269	2N383	2N270
2N223	2N270	2N307	2N301*	2N384	2N384*
2N224	2N270	2N307A	2N301*	2N385	2N1090
2N226	2N270	2N308	2N1634	2N386	2N301A
2N231	2N218	2N309	2N1634	2N388	2N1090
2N232	2N218	2N310	2N1634	2N394	2N269
2N234	2N301*	2N311	2N269	2N395	2N581
2N234A	2N301*	2N312	2N585	2N396	2N269
2N235	2N301*	2N315	2N578	2N397	2N582
2N235A	2N301*	2N316	2N579	2N398	2N398*
2N235B	2N301A	2N317	2N582	2N399	2N456
2N236A	2N301	2N319	2N270	2N400	2N456
2N236B	2N301A	2N320	2N270	2N401	2N456
2N236A	2N301	2N321	2N270	2N402	2N406
2N237	2N220	2N322	2N406	2N403	2N217
2N238	2N217	2N323	2N270	2N404	2N269
2N240	2N582	2N324	2N408•	2N405	2N406•
2N241	2N217	2N325	2N301	2N406	2N406*
2N241A	2N270	2N326	2N301	2N407	2N408•
2N242	2N301A*	2N331	2N331*	2N408	2N408*
2N247	2N247*‡	2N344	2N274‡	2N409	2N410•
2N248	2N247‡	2N345	2N274‡	2N410	2N410*
2N249	2N270	2N346	2N384	2N411	2N412•
2N250	2N301*	2N350	2N301	2N412	2N412*
2N251	2N301A*	2N351	2N301	2N413	2N218
2N252	2N1636	2N351A	2N301	2N413A	2N218
2N255	2N301*	2N352	2N301*	2N414	2N218
2N256	2N301*	2N353	2N301*	2N414A	2N218
2N257	2N301*	2N356†	2N585	2N415	2N1636
2N265	2N408	2N357†	2N1090	2N415A	2N1636
2N267†	2N247‡	2N358†	2N1091	2N416	2N247‡
2N268	2N301A	2N362	2N217	2N417	2N247‡
2N269	2N269*	2N363	2N217S	2N418	2N301
2N270	2N270*	2N367	2N406	2N419	2N561
2N271	2N269	2N368	2N217	2N420	2N561
2N271A	2N269	2N369	2N217	2N421	2N561
2N272	2N217•	2N370	2N370*	2N422	2N215
2N273	2N217•	2N371	2N371*	2N425	2N1319
2N274	2N274*‡	2N372	2N372*	2N426	2N1319
2N279	2N217	2N373	2N1634	2N427	2N579
2N280	2N217	2N374	2N1636	2N428	2N580
2N281	2N217	2N375	2N561	2N438A	2N585
2N283	2N217	2N376	2N301	2N439A	2N1090
2N285	2N301	2N376A	2N301	2N440A	2N1090
2N285A	2N301	2N377	2N1090	2N444	2N585

Type	Replacement	Type	Replacement	Type	Replacement
2N445	2N585	2N598	2N579	2N1016B	2N1488
2N446	2N1090	2N599	2N580	2N1017	2N582
2N447	2N1091	2N602	2N643	2N1021	2N1014
2N456	2N456*	2N603	2N644	2N1022	2N1014
2N457	2N457*	2N604	2N645	2N1023	2N1023*
2N458	2N561	2N605	2N384	2N1031	2N561
2N460	2N331	2N606	2N384	2N1031A	2N561
2N461	2N331	2N607	2N384	2N1038	2N1183
2N464	2N217S	2N608	2N384	2N1039	2N1183A
2N465	2N217S	2N609	2N217	2N1040	2N1183B
2N466	2N217S	2N610	2N217	2N1041	2N1183C
2N481	2N1632	2N611	2N217	2N1043	2N561
2N482	2N1634	2N612	2N217	2N1044	2N561
2N483	2N1634	2N613	2N270	2N1058	2N412
2N484	2N1634	2N614	2N1634	2N1059	2N270
2N485	2N1636	2N615	2N1634	2N1066	2N1066*
2N486	2N1636	2N617	2N1636	2N1067	2N1483
2N499	2N371	2N618	2N561	2N1068	2N1483
2N504	2N1634	2N623	2N645	2N1069	2N1487
2N511	2N456	2N628	2N561	2N1070	2N1489
2N511A	2N457	2N629	2N561	2N1090	2N1090*
2N511B	2N561	2N631	2N408	2N1091	2N1091*
2N518	2N269	2N632	2N408	2N1092	2N1092*
2N519	2N578	2N633	2N408	2N1097	2N217•
2N520	2N578	2N635	2N1091	2N1098	2N217•
2N521	2N579	2N636	2N1091	2N1101	2N647
2N522	2N580	2N637	2N561	2N1102	2N647
2N523	2N643	2N637A	2N561	2N1144	2N217•
2N524	2N586	2N637B	2N561	2N1145	2N217•
2N525	2N586	2N638	2N561	2N1172	2N301A
2N526	2N586	2N638A	2N561	2N1177	2N1177*
2N527	2N586	2N638B	2N561	2N1178	2N1178*
2N536	2N578	2N639	2N561	2N1179	2N1179*
2N544	2N1632	2N639A	2N561	2N1180	2N1180*
2N554	2N301*	2N639B	2N561	2N1183	2N1183*
2N559	2N645	2N640	2N1637	2N1183A	2N1183A*
2N561	2N561*	2N641	2N1638	2N1183B	2N1183B*
2N576	2N585	2N642	2N1639	2N1184	2N1184*
2N576A	2N585	2N643	2N643*	2N1184A	2N1184A*
2N578	2N578*	2N644	2N644*	2N1184B	2N1184B*
2N579	2N579*	2N645	2N645*	2N1193	2N270
2N580	2N580*	2N647	2N647*	2N1202	2N561
2N581	2N581*	2N649	2N649*	2N1224	2N1224*
2N582	2N582*	2N659	2N578	2N1225	2N384
2N583	2N583*	2N660	2N643	2N1226	2N1226*
2N584	2N584*	2N661	2N643	2N1264	2N370
2N585	2N585*	2N662	2N579	2N1265	2N408
2N586	2N586*	2N705	2N1300	2N1291	2N301
2N591	2N591*	2N1010	2N1010*	2N1293	2N301A
2N597	2N578	2N1016A	2N1487	2N1295	2N561

Type	Replacement	Type	Replacement	Type	Replacement
2N1300	2N1300*	2SA15	2N219	1390	2N218•
2N1301	2N1301*	2SA16	2N412	1400	2N218•
2N1395	2N1395*	2SA80	2N1632	1410	2N218•
2N1396	2N1396*	2SA81	2N1632	A2	2N274‡
2N1397	2N1397*	2SA82	2N1634	AO1	2N218
2N1425	2N1425*	2SA83	2N1634	AR10	2N301
2N1426	2N1426*	2SA84	2N1636	AT874	2N591
2N1431	2N270	2SB68	2N398	AT1138	2N301
2N1432	2N274	2SB73	2N220	AT1833	2N301
2N1479	2N1479*	2SB75	2N215	AT1834	2N301
2N1480	2N1480*	2SB76	2N406	CK13	2N247‡
2N1481	2N1481*	2SB77	2N217	CK14	2N247‡
2N1482	2N1482*	2SB78	2N408	CK17	2N247‡
2N1483	2N1483*	2SB83	2N301	CK721	2N217•
2N1484	2N1484*	2SB84	2N301A	CK722	2N217•
2N1485	2N1485*	2SB89	2N270	CK725	2N217•
2N1486	2N1486*	2SC89	2N585	CK727	2N217•
2N1487	2N1487*	2SC90	2N1090	CK751	2N217•
2N1488	2N1488*	2SC91	2N1091	CK759	2N218•
2N1489	2N1489*	2SD75	2N1010	CK760	2N218•
2N1490	2N1490*	2SD77	2N647	CK761	2N218•
2S30	2N412	2T64	2N647	CK762	2N219•
2S31	2N410	2T65	2N647	CK766	2N219•
2S32	2N406	2T66	2N647	CK766A	2N219•
2S33	2N408	2T76	2N218	CK872	2N408•
2S34	2N270	8D	2N218	CK878	2N270
2S35	2N218	8E	2N218	CTP1104	2N301*
2S36	2N218	8F	2N218	CTP1109	2N301*
2S37	2N217	10A	2N270	CTP1132	2N561
2S38	2N270	10B	2N270	CTP1135	2N561
2S39	2N220	10C	2N270	CTP1136	2N561
2S40	2N269	206	2N105	DR126	2N105
2S41	2N301	300	2N217	DR128	2N105
2S42	2N301	301	2N217	GT14	2N217
2S43	2N1632	302	2N217	GT14H	2N105
2S44	2N217	310	2N217	GT20	2N217•
2S45	2N410	350	2N217	GT20H	2N105
2S52	2N412	352	2N217	GT38	2N105
2S56	2N270	353	2N217	GT81	2N217•
2S91	2N270	830	2N219•	GT81H	2N105
2S109	2N1632	1032	2N217•	GT109	2N217•
2S110	2N1636	1033	2N217•	GT122	2N269
2S112	2N372	1034	2N217•	GT222	2N215
2S141	2N370	1035	2N217•	GT759	2N218•
2S142	2N1636	1036	2N217•	GT760	2N218•
2S143	2N1634	1320	2N217•	GT761	2N218•
2S144	2N1636	1330	2N217•	GT762	2N219•
2S145	2N1632	1340	2N217•	HA1	2N105
2SA12	2N218	1350	2N217•	HA2	2N105
2SA13	2N410	1360	2N217•	HA3	2N105

Type	Replacement	Type	Replacement	Type	Replacement
HA8	2N105	OC65	2N105	ST3C	2N408
HA9	2N105	OC66	2N105	ST12	2N408
HA10	2N105	OC70	2N406	ST16A	2N585
HJ15	2N215	OC71	2N408	ST16B	2N585
HJ17	2N217	OC72	2N217•	T34A	2N105
HJ22	2N218	OC73	2N217	T34B	2N105
HJ22D	2N218	OC74	2N270	T34C	2N105
HJ23	2N219	OC75	2N217	T34D	2N217•
HJ23D	2N219	OC76	2N586	T34E	2N217•
HJ32	2N370	OC77	2N398	T34F	2N217•
HJ34	2N270	OC139	2N585	T1040	2N301*
HJ34A	2N270	OC140	2N1090	T1041	2N301*
HJ35	2N301	OC141	2N1091	T1164	2N384
HJ37	2N371	OC170	2N384	T1166	2N384
HJ50	2N217	OC171	2N384	TS1	2N406
HJ51	2N408	SB100	2N247‡	TS2	2N408
HJ70	2N370	SFT107	2N218	TS3	2N217
HJ71	2N371	SFT108	2N219	TS13	2N408
HJ72	2N1636	SFT121	2N217	TS14	2N217
HJ73	2N1634	SFT122	2N217	TS32	2N270
HJ74	2N1636	SFT123	2N217	TS161	2N217•
HJ75	2N1632	SFT127	2N218	TS162	2N217•
HS3	2N269	SFT128	2N218	TS163	2N217•
HS4	2N269	SFT142	2N217S	TS164	2N217•
J1	2N217•	SFT151	2N406	TS165	2N217•
J2	2N217•	SFT152	2N406	TS166	2N220•
J3	2N217•	SFT153	2N406	TS176	2N301*
JP1	2N217•	SFT213	2N301	TS620	2N218•
L5108	2N247‡	SFT214	2N301A	TS621	2N219•
L5121	2N247‡	SFT238	2N456	V6R2	2N412
L5122	2N247‡	SFT239	2N457	V6R4	2N412
MN24	2N301	SFT240	2N561	V6R4M	2N219
MN25	2N301	SFT250	2N561	V15/20P	2N301
MN26	2N301	SFT265	2N277	V25/50B	2N217
OC16	2N301	SFT266	2N301	V30/10P	2N301
OC16G	2N301	SFT267	2N1099	V30/20P	2N301
OC28	2N561	SFT307	2N218	ZJ13	2N217•
OC29	2N301A	SFT308	2N219	ZJ71	2N247‡
OC30	2N301	SFT315	2N1632	ZJ72	2N247‡
OC32	2N217•	SFT317	2N1632	ZJ73	2N247‡
OC33	2N217•	SFT319	2N1634		
OC34	2N217•	SFT320	2N1632		
OC41	2N581	SFT321	2N217		
OC42	2N218	SFT322	2N217		
OC44	2N219	SFT322-1	2N217S		
OC45	2N218	SFT351	2N406		
OC57	2N105	SFT352	2N406		
OC58	2N105	SFT353	2N406		
OC59	2N105	SFT357	2N384		
OC60	2N105	SFT358	2N384		

MEMORANDA

MEMORANDA

Would you like to receive regular supplies of-

- *Interesting technical articles?*
- *Application data?*
- *New release data?*
- *Home constructional articles?*
- *Book reviews?*
- *Authoritative articles and statements?*
- *HiFi circuits and information?*
- *Servicing and maintenance articles?*

You can get all this for the small sum of 10/- per annum, by subscribing to "RADIOTRONICS", a monthly magazine published by AWV as a service to the electronics industry.

The magazine is available only on annual subscription, January to December inclusive, and is used as the exclusive outlet for all types of data, articles and circuits produced by AWV and associated companies.

Send for a free sample copy, or forward your subscription to this address—

**Radiotronics,
Amalgamated Wireless Valve Co. Pty. Ltd.,
Box 2516, G.P.O.,
Sydney, N.S.W.**



**AMALGAMATED WIRELESS VALVE
CO. PTY. LTD.**

SYDNEY MELBOURNE BRISBANE