

# Practical test equipment

G G Dobbs

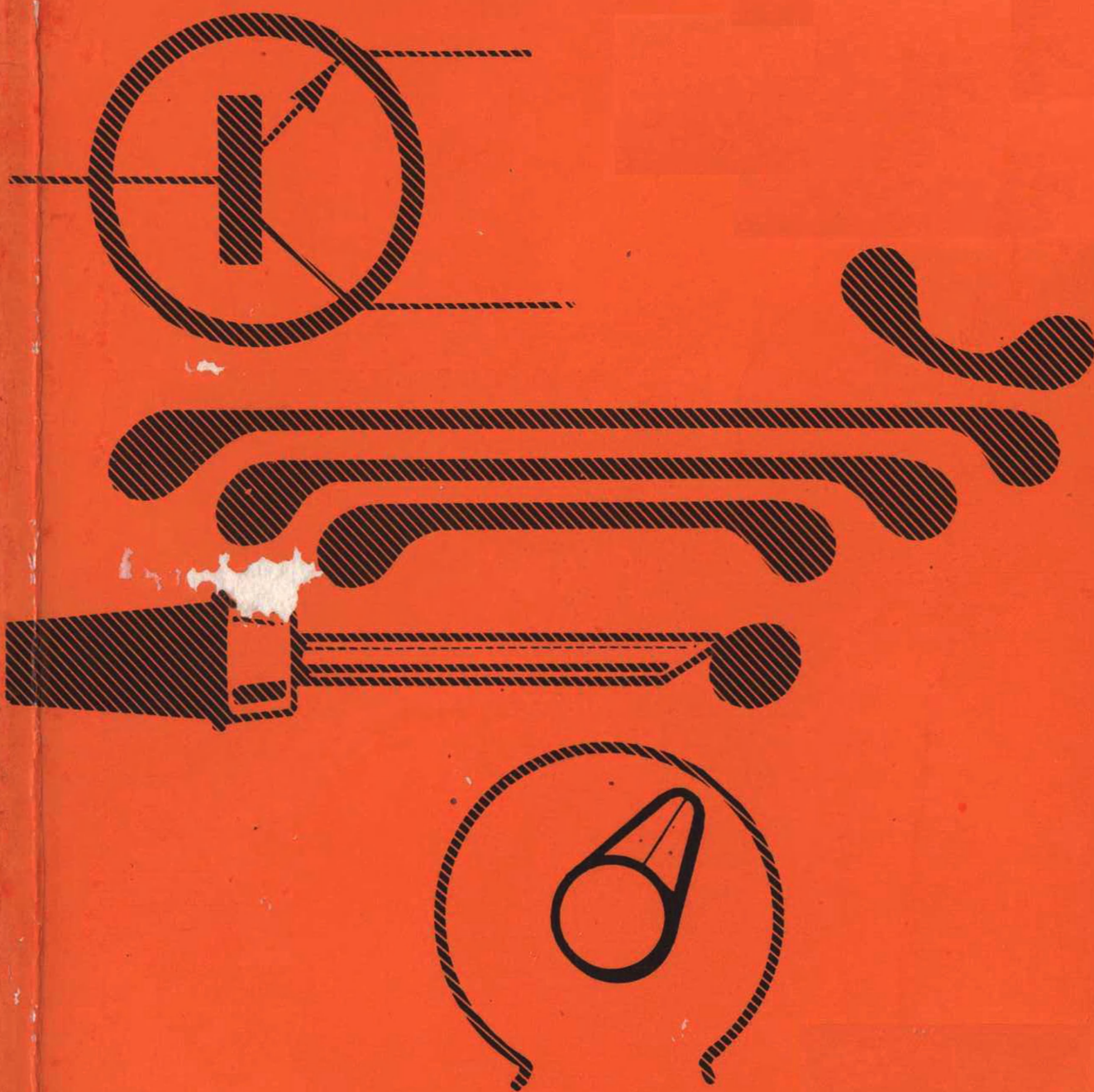

Georgian Press

# **PRACTICAL TEST EQUIPMENT**

by  
**G.C.Dobbs**

**Illustrations by  
Keith Simpson, BSc.**

Georgian Press  
Redgates Court, Calverton, Notts.

© Georgian Press 1976

**ISBN 0 905148 05 3**

All rights reserved. Reproduction or use, without express permission, of editorial or pictorial content, in any manner, is prohibited.

Although every precaution is taken in presenting this material, no liability can be accepted for errors that may occur.

\*

Printed by Ad-Print Services, Alfreton Road, Nottingham..

# CONTENTS

Introduction..... ».....	5
Transistor Tester.....>-----	8
Simple Transistor Checker.....	14
Square Wave Oscillator.....	19
R.F. Signal Generator.....	23
A.C. Bridge.....	32
Multi-Check.,.....	39
Dual Range Ohmmeter.....	48
Test Leads.....	.55
Applications.....	60

**GEORGIAN PRESS ELECTRONIC BOOKS PRESENT  
PRACTICAL CONSTRUCTIONAL PROJECTS  
USING EASILY AVAILABLE COMPONENTS  
CAPABLE OF AMATEUR CONSTRUCTION  
RIGIDLY PROTOTYPE TESTED.**

\*Also by Georgian Press:

Short Wave Receivers For The Beginner, By G.C.Dobbs.

COMPONENTS used in this book are available from most  
local and mail order stockists

PROTOTYPE COMPONENTS from:

J. Birkett, The Strait, Lincoln.

Denco (Clacton) Ltd., Old Road, Clacton-on-Sea, Essex.

## INTRODUCTION

It has been said that in electronics the two main problems are "getting 'em to work" and "keeping 'em working", and that the electronics man is "as good as his test gear". But surprisingly enough, few electronic constructors in the amateur field appear to own much in the way of test equipment. I began without any, and then spent many years with a simple multimeter as the sole item of test equipment. It may be that some amateur electronics fans consider test gear somewhat of a luxury, since some of it often lies idle for long periods waiting for use. Or they may consider it too expensive in terms of its productive use.

This book attempts to overcome both of those objections, in presenting inexpensive, simple test equipment which is practical in application. The equipment is designed for the purely amateur electronics constructor, although the "trade engineer" would find most of the items very useful. All of the circuits have been designed with "go-ability" - that is, they should work first time, and with expense in mind. They have all been constructed by the author, some of them several times, and have all been well tested in their various applications.

There are two basic areas of work for test equipment; to assist in constructional and experimental work, and to test and fault-find the amateur's existing equipment. All of the items in this book serve one or both of these needs.

%

The items of equipment described in the book can be built by constructors of modest experience, as full constructional information is provided in addition to the circuit diagrams. All that is required is a little knowledge of electronics construction, a soldering iron and a few simple handtools. All the prototypes were built under strictly amateur conditions on an old table, using simple handtools.

## MULTIMETERS

Glancing through the contents of the book, the obvious absent friend, from the field of test equipment, is the ever useful Multimeter. This basic instrument used to measure voltage, current and resistance, has a place on every amateur's test bench - so why no place in this book? The simple answer is one of modern production techniques and cost. After trying to design an inexpensive Multimeter, the author found that one could not be built cheaper than those available on the commercial market. There is a vast choice of multimeters from about £4 upwards and one can hardly buy a good basic meter movement for that price. Unless one has access to a very inexpensive good meter movement, and the means of making accurate shunts and series resistances, the multimeter is no longer a viable project for the amateur constructor.

It is, however, possible to offer a few words of advice on the purchase of a commercial multimeter. Obviously choose! an instrument with a clear scale, as large as possible, within the price range. Avoid instruments with odd Full Scale Deflection (F.S.D.) ranges, these often involve having to multiply or divide the actual reading by 2 or 3 to give the! desired result. This sounds simple, but many slips can be made in this way.

Ensure that the instrument has useful ranges. Do not pay] extra for a small instrument with a multitude of ranges - many of which may never be required - if a larger instrument with\* less, but useful, ranges can be bought in the same price\* range. A movement with a mirror scale is also useful as this avoids errors in reading the scale. The mirror overcomes most of the parallax error; false readings through looking at the pointer from various angles.

The most important consideration in choosing a good multimeter is the sensitivity. If a multimeter "loads" a circuit, or offers it a low resistance, some of the readings taken will] be relatively inaccurate. The sensitivity of a multimeter isi usually expressed as OHMS PER VOLT. This represents the.

resistance of the meter to the circuit to be measured depending upon the full scale voltage of the range being used. The higher the ohms per volt reading, the higher the sensitivity of the meter. An inexpensive meter may have a sensitivity as low as 1,000 ohms per volt, the better meters having a sensitivity of 100,000 ohms per volt or more.

## **basic test gear**

Opinions vary as to what constitutes an amateur's basic needs in test equipment. Certainly one requires equipment to generate signals at both audio and radio frequencies and meters to measure the more useful parameters of a circuit. This book provides circuits which do all of these functions. Instruments to give audio and radio frequency outputs and measure voltage, resistance and capacitance. There are also two simple transistor testers. The test gear in the book assumes that the average amateur is working with transistors rather than valves, hence the need to test transistors is obvious. Armed with most or all of the items of test gear in the book, the amateur could attempt most types of circuit construction or faultfinding. When you have built some of the items in this book, you will wonder how you ever managed without them before!



# TRANSISTOR TESTER

This book assumes that most home constructors are working with transistors, rather than valves. Therefore a basic piece of test equipment for the constructor is a simple Transistor Tester. The transistor tester described here will measure the leakage current and small signal gain of most NPN and PNP types. It will also be useful in sorting out unknown types into NPN or PNP and can match up pairs of transistors when required.

## The Circuit

The transistor is tested in the common emitter mode of operation, the most important parameter to be measured is the small signal gain -  $h_{FE}$  or  $H_{fe}$ . S1 is the gain switch. In the position shown this gives a full scale reading on the meter equal to a gain of 100. Switching over gives a full scale reading of 500. S2 is the NPN, PNP change-over switch, shown in the PNP position. Reversing this switch changes the polarity of the battery.

PB1 allows a reading of the gain to be taken. PB2 increases the full scale reading of the meter by 10, this is useful for checking the leakage of germanium type transistors which may read above full scale on the IOOuA meter.

When the transistor is plugged into the socket, SK1, the leakage is automatically shown. This is read directly off the meter in  $\mu A$ , unless the reading is so high that the x10 PB2 has to be used. Pressing PB1 gives a direct reading of the  $h_{FE}$  with 100 being the full scale gain, except when the switch S1 is in the 500 position.

The polarity (NPN or PNP) of a transistor can be found by just plugging it into the socket and switching S2 to find the minimum reading, the switch position indicating NPN or PNP.

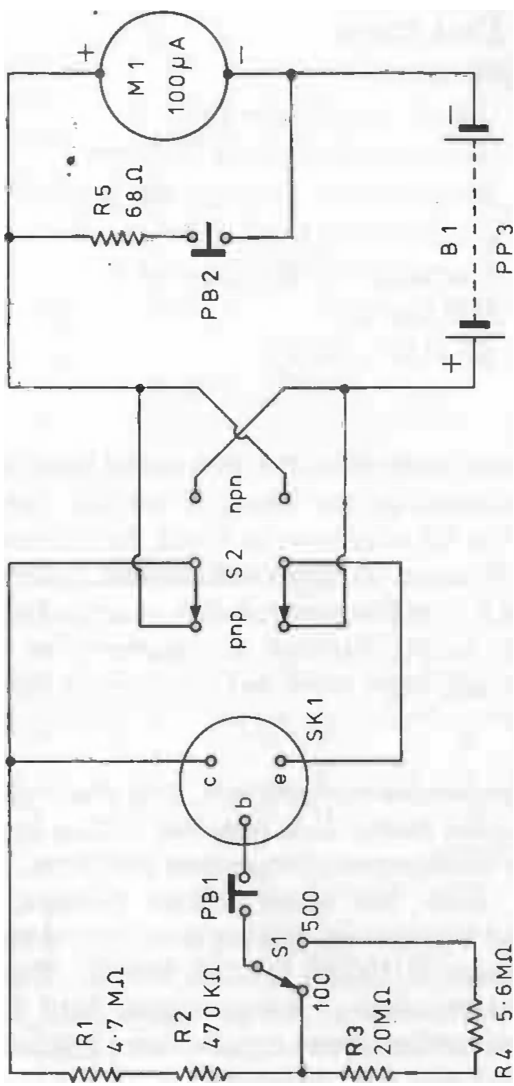

FIG.1. TRANSISTOR TESTER.

CIRCUIT DIAGRAM.

## **Transistor Tester - Components**

R1	4.7M Ohms
R2	470K Ohms
R3	20M Ohms
R4	5.6M Ohms
R6	68 Ohms
MI	100 uA meter (see text)
PB1 and PB2 Miniature Press (on) Buttons.	
51	Single-throw, Single-pole, Switch.
52	Double-pole, Double-throw, Switch.
Ski	Transistor Holder/Socket.
B1	PP3 Battery.
Metal case with lid (4" x 2")	

## **Construction**

The transistor tester is built into a metal box, with all the components mounted on the inside of the lid. The layout of the outside of the lid is shown in Fig.2. No dimensions are given with the drawing, as these will depend upon the actual size of the meter and other components mounted on the front panel. Begin by laying out the components to achieve a balanced layout, and then mark out the various holes prior to cutting the lid.

The most expensive component, and the most difficult to mount will be the meter. It is possible to buy surplus tape recorder meters from some component stockists. These are much cheaper than the usual 100uA meters, and are sometimes called VU meters. Ensure that such a meter has a full scale deflection of 100uA for this circuit. These meters vary in size and mounting. Some mount into convenient rectangular holes, whilst others require more complex circular holes to be drilled and filed to shape.

The slide switches are arranged in rectangular slots, drilled and filed to size. When filing these holes into shape aim for a free movement of the switch slider, for ease of operation.

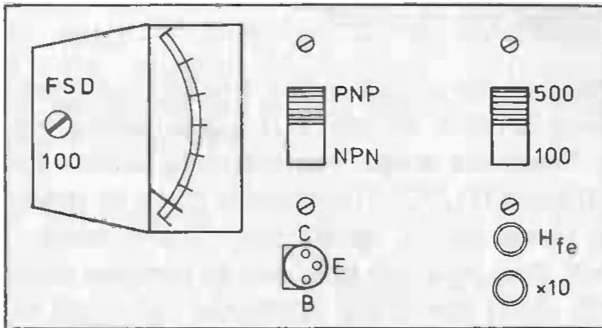

(a) Front Panel

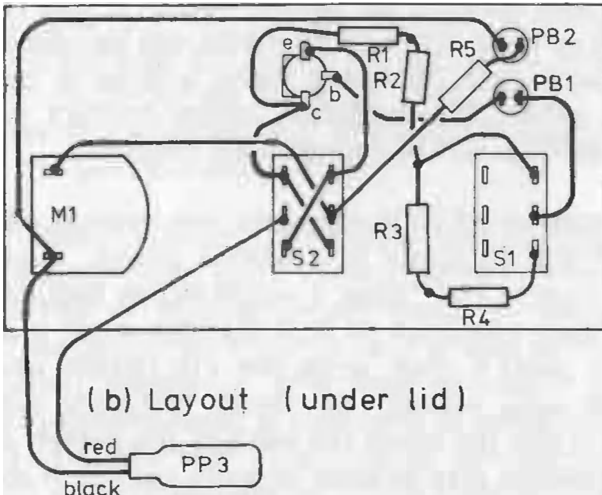

(b) Layout (under lid)

FIG. 2 TRANSISTOR TESTER -

The transistor socket hole is drilled to take the holder as a tight push-fit. The socket can be secured with "Araldite" if it is loose. Adhesive may also be used to secure the meter if no mounting screws are provided.

The wiring of the circuit under the lid is shown in Fig. 2 (b). The wiring is quite simple, but a few points have to be considered. There are three free-standing solder junctions - R3/R4, R2/R3 and R1/R2. These joints must be made firm by twisting the leads before application of the solder and the iron, and then they must be bent out to prevent contact with the metal lid. Also the cross wires on S2 must not make electrical contact, and are best made with PVC covered wire.

### **Operation**

The transistor tester is quite simple in use. The two parameters which it will test are the gain ( $H_{fe}$ ) and the leakage ( $I_{co}$ ) of the transistor. The leakage is simple to test. The transistor is merely plugged into the socket, ensuring that the correct pins go into the correct socket holes. The base connections of most types of transistor can be found in any good transistor data book and many articles in electronic periodicals. When the transistor makes contact with the socket the leakage will be immediately indicated.

In the case of an NPN transistor, the leakage should be very low, if the transistor is a silicon device. Germanium transistors, mostly PNP, have a much higher leakage value. Some may have a leakage so high that the meter reads over full-scale. In such a case, press the  $\times 10$  button which will multiply the scale reading ten times. Naturally even with germanium types, the lower the leakage the better, but high leakage transistors may be used in many circuits, if their gain exceeds the leakage current.

The leakage test is quite useful to determine the type of an unknown transistor. If the transistor is of an unknown type, plug it into the socket according to the usual convention for that type of base. The PNP/NPN switch should be on

NPN. If the meter reads hard over on the stop, try the switch on PNP, if this lowers the reading, with or without the x10 button, the transistor is a PNP type. Naturally if the leakage reads low on the NPN position, it is NPN. If the transistor reads high both ways, it is faulty. So simply plugging in the transistor, the correct way round and operating the PNP/NPN switch for the lowest leakage, can indicate if the transistor is PNP or NPN.

After the leakage has been checked the actual gain of the transistor may be checked. It is best to begin with the range switch (SI) on the 100 range. With the transistor in place, just press the Hfe button and the gain will be indicated. If the reading is above 100, then switch to the 500 range. On this range, the full scale deflection of the meter becomes 500. The actual gain of the tested transistor can either be compared against a known good transistor, or against manufacturers' figures given in a transistor data book.

In the case of germanium types with exceptionally high leakage values requiring the use of the x10 button, the gain can be checked with this button still depressed, to ensure that the gain exceeds the leakage. Depending upon the application for the transistor, it is possible to use high leakage types, if the gain exceeds the  $I_{co}$ .

The above operating procedure may appear complex, but practice by using good known types of transistor, and soon the use of the instrument becomes almost second nature. The tester may then be used to test unknown types and untested transistors. It is easy to obtain some good bargains by buying packs of ungraded or untested transistors and then to grade them according to leakage and gain for future use. Pairs of transistors can be matched for push-pull and parallel operation. It is also possible to test power types by extending the socket with wires and crocodile clips.

# SIMPLE TRANSISTOR CHECKER

The main disadvantage of building several items of test gear is that they require a moving coil meter, which can add several pounds onto the price of the equipment, if a surplus meter cannot be found or used. This simple transistor checker only gives relative checks of the "goodness" of a transistor, but it is very useful. Not only does it cost little to build, it also tests the transistor under actual working conditions, and can test a wide variety of types.

## Circuit

In this circuit, shown in Fig.3. the transistor being tested actually becomes part of an audio oscillator circuit. The circuit is a Hartley type of oscillator using a transistor output transformer and providing an audio tone. When a transistor is in circuit the output from the collector is inductively coupled into the base winding of the transformer, producing audio oscillation. Some adjustment of the feedback, controlled by VR1 helps to test the transistor further by checking if reducing the feedback stops the oscillation.

The switch SW1. provides for both PNP and NPN types to be tested by reversing the battery polarity. The indication is instant when pressing PB1, a small press switch, to give an audio "bleep" in the inexpensive crystal earpiece.

## Simple Transistor Checker - Components

R1	1K Ohms
R2	3.3K Ohms
R3	1K Ohms
VR1	10K Ohms Linear Potentiometer.
T1	LT700 Audio Output Transformer (or similar - see text)
SW1	Double-pole, Double-throw, switch.
Ph.	Crystal earpiece.
PB1	Miniature Press (on) Button.
B1	PP3 battery.

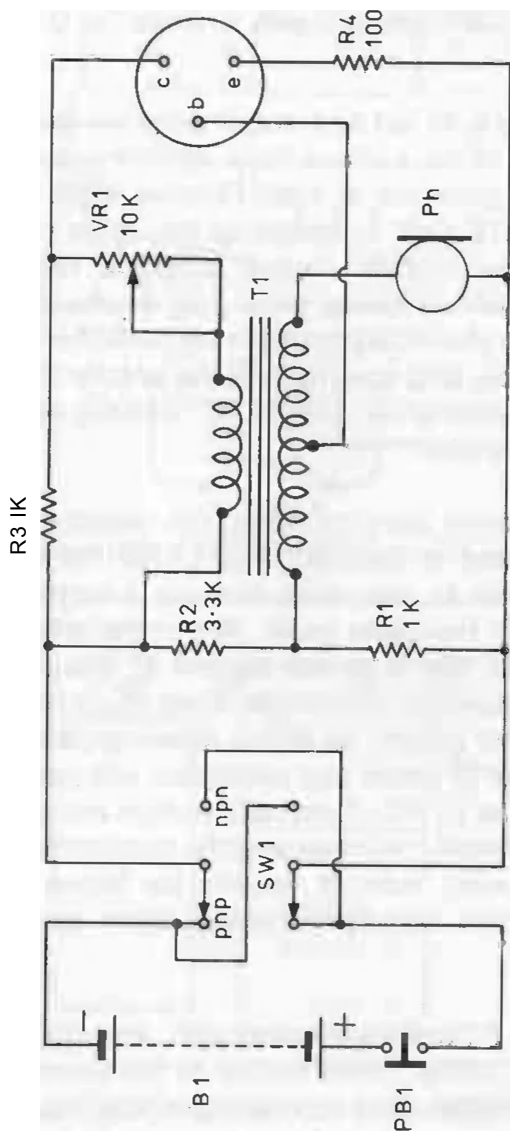

FIG. 3. SIMPLE TRANSISTOR CHECKER: CIRCUIT DIAGRAM.



Case. One ounce rectangular Tobacco Tin.  
Veroboard 0.1" matrix (1.4" x 1.5")

### **Construction**

The circuit is small enough to fit into a 1 oz. Tobacco Tin. This is because it is built up onto a piece of 0.1" matrix veroboard.

The first stage is to cut and prepare the veroboard. This board may be cut with a sharp hack saw or woodworkers knife. Ensure that there are at least 13 holes clear along the copper strips and 12 clear holes along the other plane. The centre holes of the 13 hole copper strip are removed by carefully sawing with a sharp hack saw blade across the copper strips. This should be done slowly with the saw blade square to the copper and sawing until the copper is removed along the line "saw cut break" (Fig.4.(a)) without sawing into the plastic base material.

The first soldering job is to mount the transformer in the exact holes indicated in Fig.4.(a). The LT700 fits exactly as shown. It is possible to save cost and use a surplus output transformer from a transistor radio. Any transformer with a ratio of primary 1K Ohms centre-tapped to about 3 Ohms secondary will perform in this circuit. Care must be taken to wire the transformer exactly as in the drawing otherwise the windings will be out of phase and oscillation will not occur. In types other than the LT700, if oscillation does not occur with known good transistors, try reversing the connections on the secondary (two wire) side. It should be found that the transformer does not require fastening down as the wires hold it into place.

The resistors R1 to R4 are added next, ensuring that they are placed in the correct holes on top of the veroboard, and the under side copper strip connections are made. When soldering veroboard, great care must be taken to avoid excess solder running between adjacent strips and causing a false connection. The leads to VR1, SK1, SW1 and the crystal

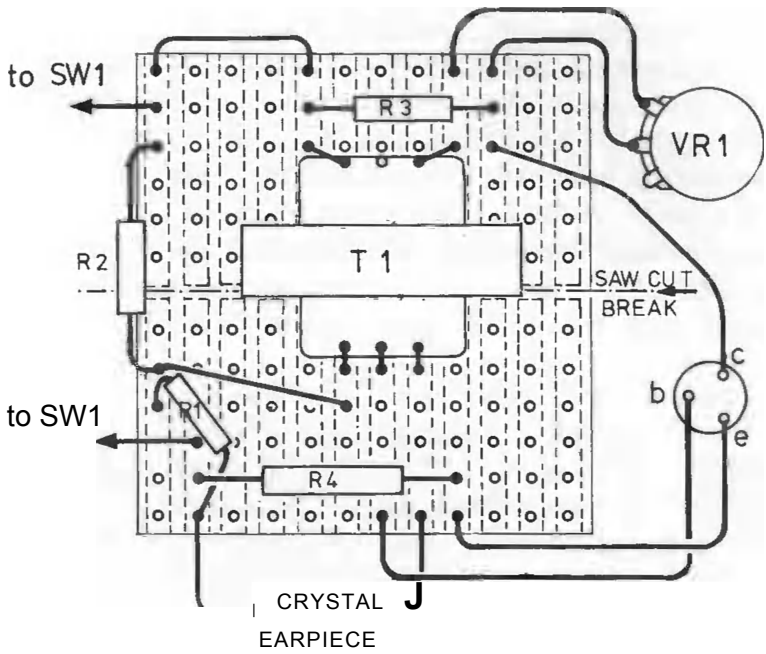

FIG. 4(a): VEROBOARD LAYOUT

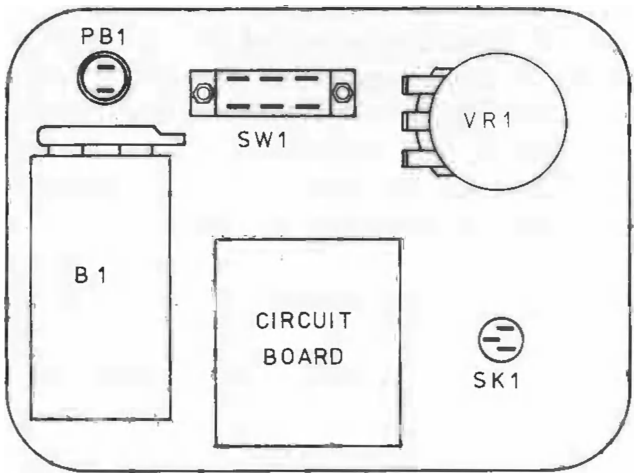

FIG.4(b). GENERAL LAYOUT (UNDER LID)

SIMPLE TRANSISTOR CHECKER

earpiece are soldered into place. The crystal earpiece leads are taken out through a small hole in the side of the tin, so the leads are best pushed through this hole before being soldered to the veroboard. Figure 4.(b). shows the general layout under the lid. This layout can be checked by placing the components onto the lid, before any holes are cut. The veroboard is fastened to the inside of the lid using "Blutack" adhesive. This "putty-like" adhesive not only holds the circuit into place, but a piece about the size of a walnut will also separate and insulate the board from the lid.

## **Operation**

The operation of the checker is very simple. The transistor to be tested is placed in the socket, with the wires plugged into the correct holes. SW1 is used to select PNP or NPN types and VR1 is used to adjust the point at which oscillation begins. If the transistor will oscillate, it is good.

The setting of VR1 determines the amount of feedback required to start oscillation, this is roughly equal to the "in circuit" gain of the transistor. No exact measurements can be made this way, but transistors can be compared with known good types. In some cases the circuit will oscillate on all settings of VR1 - this is fine, indicating a good transistor with high gain. Almost any transistor may be tested with this circuit, including R.F. as well as A.F. and power types. NPN. and PNP types can also be identified.

# SQUARE WAVE OSCILLATOR

A very useful general purpose instrument around any constructor's workshop is a wide range audio oscillator. There are many applications for such a device, especially within the audio and HiFi field. A wide range makes this item of test gear very useful in the testing of audio amplifiers. This circuit is exceptional in that a huge audio range - about 1 Hz (one cycle per second) to about 10,000 Hz can be tuned on a single sweep of the frequency control.

The circuit is shown in Fig.5.(a). The feedback time lapse is controlled by a single large value potentiometer VR1. The output has been found to be constant over the entire range of VR1, and no difficulty should be experienced in obtaining oscillation at any setting. The output impedance is quite low, being taken from the collector of TR2 via C2, and should be suitable for feeding into almost any amplifier.

## Square Wave Oscillator - Components

R1	680 Ohms
R2	330 Ohms
R3	2.2K Ohms
VR1	5M Ohms (10M Ohms for larger sweep - see text)
C1	0.68 uF
C2	0.5 uF
TR1	MOSFET (see text)
TR2	2N706
SW1	Single-pole on/off switch (slide type)
B1	PP3.
Veroboard 0.1" matrix (1 %" x 1 A ")	
Plastic Case (3" x 4J4" x 1)4")	
Phono socket and Plastic pointer knob.	

## Construction

The whole circuit is built up on a piece of veroboard. This veroboard should have at least 12 clear holes in both planes. Care must be taken to follow the layout drawing Fig.5.(b)

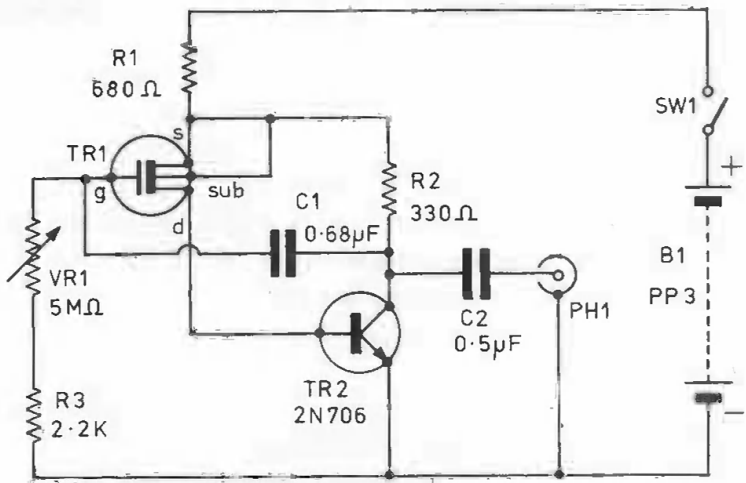
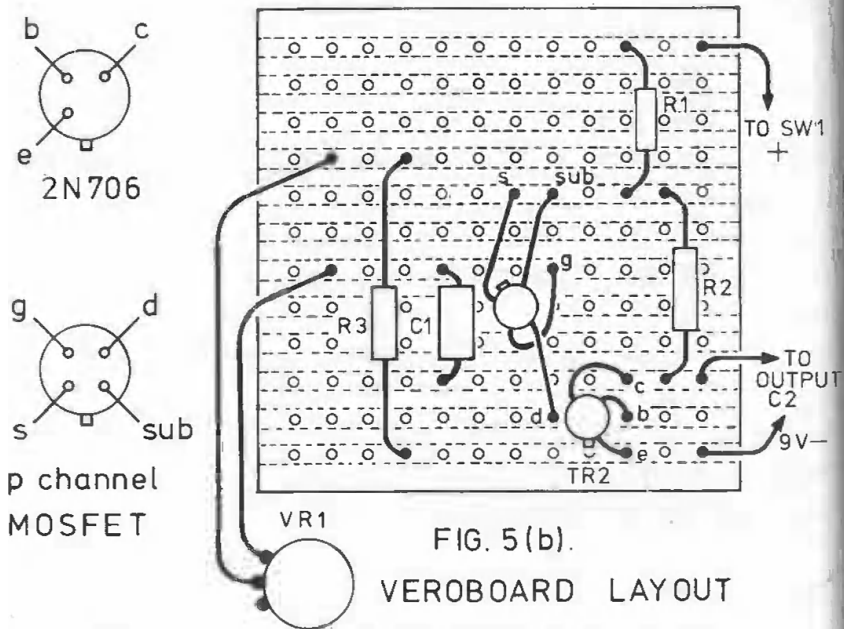

FIG. 5(a). SQUARE WAVE OSCILLATOR.  
CIRCUIT DIAGRAM.



ensuring that all components are mounted in the correct holes.

The best order for mounting the components is to solder in the resistors first, then C1 and C2, then TR2 and TR1, and finally the various leads. Care must be taken to place the correct wires of TR1 into the correct solder holes. Follow the usual careful procedure for the soldering of veroboard. The veroboard is held to the case with a piece of "Blutack", as with the Simple Transistor Checker.

The MOSFET is a surplus device, obtainable cheaply from J. Birkett of Lincoln - see the front of this book for the address. VR1 may be 5M Ohms, but if a really low pulse rate, down to about a cycle about every two seconds, is required, a 10M Ohms control should be used. The position of the components and the circuit board are shown in Figs. 6.(a and b). The output is taken to a phono socket mounted on the lid of the case. The prototype veroboard was held with "Blutack", but in practice the lead of C2 was found to be stiff enough to hold the board in place. The slide switch and Knob for VR1 complete the front panel - Fig.6.(a).

## **Operation**

The unit is very simple to use. It may be tested by using a pair of high impedance headphones or a crystal earpiece, or simply by plugging it into an audio amplifier. The switch SW1. is switched on and the output should be heard. The frequency is controlled by rotating VR1. This unit will test the response - bass to top of any audio amplifier. The output can be monitored on an oscilloscope to check for distortion. The unit can also be used to set up the balance of the two channels in a stereo amplifier. This unit is an inexpensive and useful service tool.

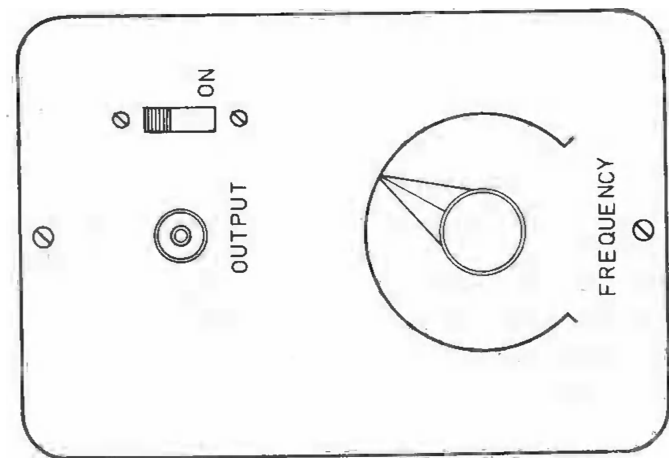

○ B FRO EΛ E

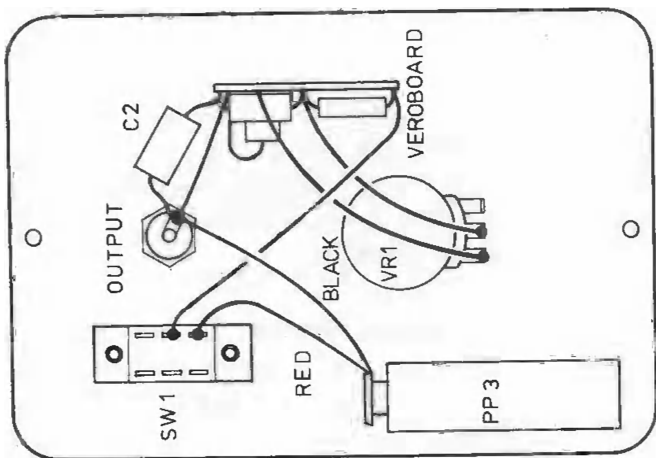

REV  
 $\frac{\Delta V}{\Delta t} = \frac{\Delta V}{\Delta t}$   
 $\Delta V = \Delta V$   
 $\Delta t = \Delta t$

SQUARE WAVE OSCILLATOR

## R.F. SIGNAL GENERATOR

When working with radio receivers it is often vital to have some source of radio frequency signals. Usually it is unwise to rely on radio transmissions, and an external source of R.F. signals is required. This can be a broad band output generator, such a device is described as part of the "Multi-Check" later in this book, giving an output over a wide spectrum. However a tuned and calibrated signal source is more useful, and essential for some tests. This circuit covers from 150 Khz to over 30 MHz in 5 ranges. Each range is tunable and can be calibrated. Higher frequencies can be covered by using the harmonics of the upper ranges. The signal source can be simple R.F. output, or amplitude modulation (A.M.) can be added.

### The Circuit

This circuit makes use of a field effect transistor (f.e.t.). These transistors are high impedance devices, rather like the old triode valves. The circuit is the Hartley type oscillator, so often used in regenerative receivers, but arranged to oscillate over the entire tuned range.

The circuit is shown in Fig.7. VC1 and LI form a tuned<sup>1</sup> circuit at the desired frequency of oscillation. The signal passes through what was called in the "valve days" a leaky grid circuit, to the gate of TR1. The signals appear at the drain of TR1, across L2, which provides the feedback path to LI to maintain oscillations.

TR2 is an audio oscillator to provide an amplitude modulated signal for the R.F. signal. T1 is a tapped transformer primary and part of the signal is fed back via C5 to maintain audio oscillation. The A.F. oscillator and the R.F. oscillator have a common load resistance, R3, which allows the R.F. signal to be modulated by the A.F. signal. Two output sockets are provided. SK1 is a direct audio output source, should this be required. SK2 is the R!F. output and is controlled by an attenuation potentiometer VR1, which limits



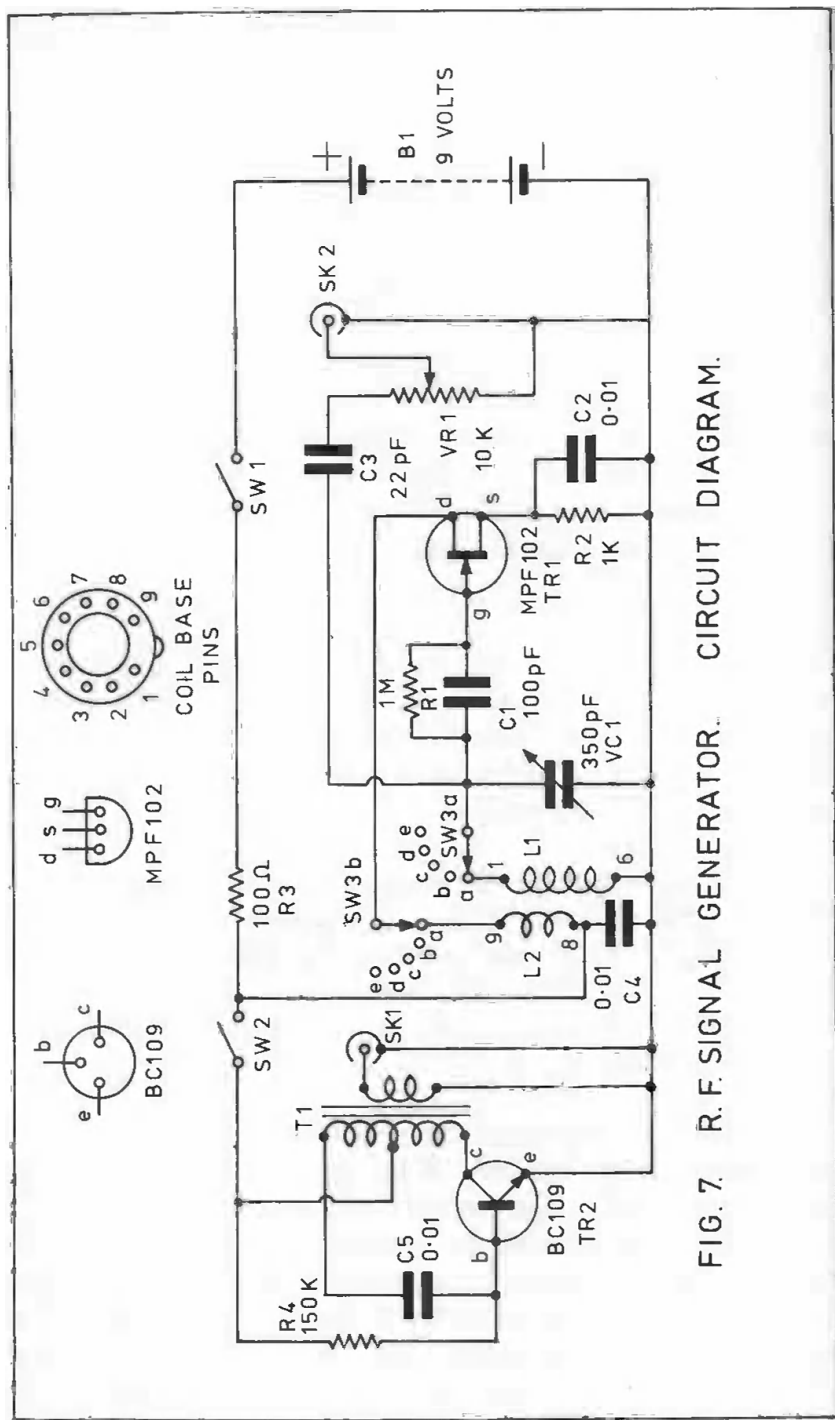

FIG. 7. R. F. SIGNAL GENERATOR. CIRCUIT DIAGRAM.

the output. SW1 is an on/off switch for the whole instrument, and SW2 allows the R.F. signal to be used with or without the modulation.

### **R.F. Signal Generator - Components**

PI            1M Ohms  
P2            1K Ohms  
P3            100 Ohms  
R4            150K Ohms  
C1            100pF (silver mica)  
C2            .01uF (disc)  
C3            22pF (silvermica)  
C4            .01 uF (disc)  
C5            .01 uF (disc)  
VR1          100K linear potentiometer  
VC1          350pF airspaced variable capacitor (see text)  
TR1          MPF 102 f.e.t.  
TR2          BC109  
T1            LT700 transistor output transformer (or similar)  
L1/L2 Windings on Denco VALVE TYPE, YELLOW,  
              plug-in coil.  
SW1          Single pole on/off slider switch  
SW2          AsSW1.  
SW3 2 pole-6 way wafer switch (one position unused)  
SK1 and SK2 phono sockets  
B1            PP3 battery.  
Case Aluminium Box with lid (8" x 6" x 3")  
2 six way tagstrips. 5 B9A Valve Holders  
2 small pointer knobs, 1 large round knob with perspex cursor  
Tin plate or aluminium for coil holder bracket.

### **Construction**

The R.F. Oscillator uses the Denco Range of plug-in coils. This is a readily available range of coils which plug into a B9A valve base. There are several types and ranges. The type required for the signal generator is the MINIATURE DUAL PURPOSE, VALVE TYPE, YELLOW - RANGES 1 to 5. The

following ranges can then be covered:

Range 1 150KHz to 500KHz

Range 2 515KHz to 1.55 MHz

Range 3 1.67MHz to 5.3MHz

Range 4 5.0MHz to 15MHz

Range 5 10.5MHz to 31.5MHz

Harmonics of Range 5 may be used for higher frequencies.

The most complex part of the construction is the mounting of the coils and wiring them to SW3. The coils are mounted on an L shaped bracket, with 90° bent down ends to enable the bracket to be held to the lid/front panel with two 6BA nuts and bolts. This bracket was made of tinplate in the prototype and the 5 holes for B9A valve bases were cut with a chassis punch. If no chassis punch is available, it is probably better to make the bracket with thin gauge aluminium. This will enable the B9A base holes to be made by drilling and filing the softer aluminium. The coils are plugged into the B9A bases after the wiring has been done and the bracket is mounted. Following the diagram in Fig. 9.(b) should make the construction of the bracket quite simple.

The wiring shown in the layout diagram Fig.8. will enable the constructor to wire the coil bases correctly. It is a wise plan to also trace each lead on the circuit diagram Fig.7. as each wire is soldered. This will provide a check on the wiring. Care must be taken to ensure that the correct pins are used and that the earth path to pin 6 and the common lead to C4 are connected.

The tuning capacitor VC1 should be an air-spaced 350pF type. If such a component is not easily available, a 500pF air-spaced type may be used with a 1000pF (silver mica) capacitor in series. If this arrangement is used the 1000pF capacitor should be mounted on the fixed vane side of VC1. The actual position of the capacitor would be between the fixed plates of VC1 and the slider (single tag) of SW3(b). This modification will provide the tuning ranges as given in the table of ranges. The exact frequency covered will also depend

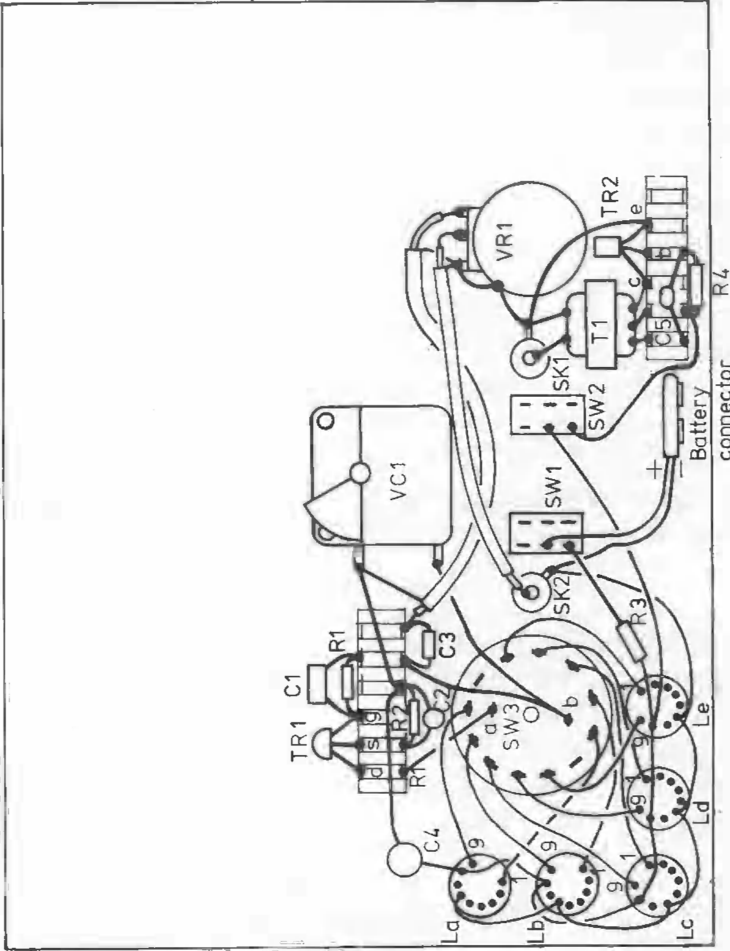

FIG.8. R.F. SIGNAL GENERATOR. LAYOUT 1 (INSIDE LID).

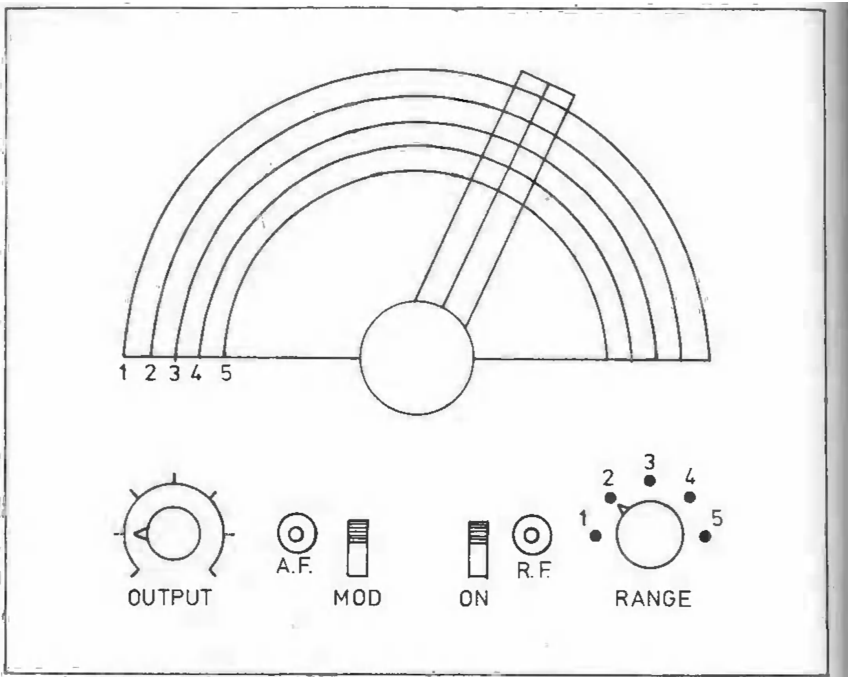

FIG.9(a). R.F. SIGNAL GENERATOR (FRONT PANEL).

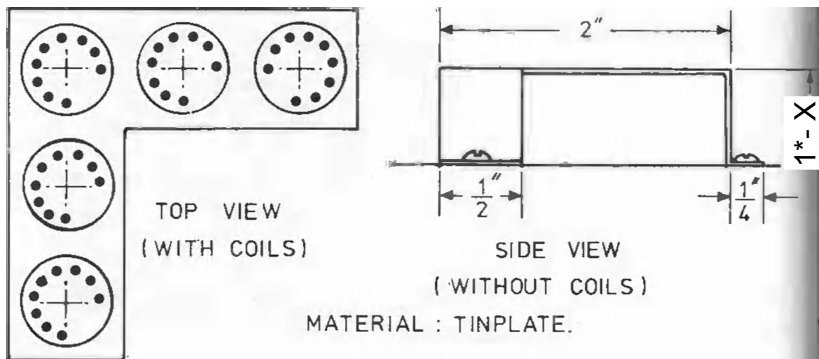

FIG. 9(b). COIL BRACKET.

upon the position of the iron dust core in each coil. In the prototype each coil had its screw about 1/2" out of the former.

The components for the R.F. and A.F. oscillators are mounted on two six-way tagstrips. In the prototype these were soldered first and then attached to the front panel with a piece of "Blutack" putty adhesive. Once again follow the layout diagram, checking the wiring against the circuit in Fig.7. Care must be taken with the leads of the transistors and to avoid adjacent wires touching and shorting the circuits.

The lead from C3 to SK2, via VR1 is a screened lead made from coaxial cable. This helps to reduce stray R.F. output and enhances the action of VR1, as does the earthing of the casing of VR1. T1 is the common LT700 transistor output transformer. A surplus output transformer from a transistor radio would serve as T1. Such a transformer must have a 2,000 Ohm tapped primary and an 8 or 16 Ohm secondary winding. T1 is also held to the front panel by a piece of "Blutack". Slider switches were used for SW1 and SW2 and single hole mounting phono sockets were used for SK1 and SK2.

Because the wiring of this unit is somewhat complex, especially around the coils and SW3, a complete check should be made before the power is switched on. This check can be against both Fig.8. and Fig.7. It is also wise to check that all the earth connections have been made, since these are easily forgotten.

### **Testing and Calibration**

The signal generator can be tested simply with the aid of a radio receiver. An ordinary broadcast radio receiver will quickly show if the instrument is working. Range 1 covers the long wave band and range 2 covers the medium wave band. In order that the signal generator can radiate a signal, a short length of wire (about 2ft long) should be connected to the centre of SK2. This wire is draped over, or close to, the receiver to provide a radiated R.F. signal. Set the receiver on the long wave band, and tune to a quiet spot. Switch on the

signal generator and the A.F. modulation. Slowly tuning across range one should produce a "Bleep" at the frequency to which the receiver is tuned. Holding the signal generator tuning control on that point will give the modulated tone in the receiver's loudspeaker. Check the output at several places on the long wave band. Switch onto range 2 and repeat the same sequence with the receiver tuned on the medium wave band. If a short wave receiver is available, higher frequencies, can be checked.

Calibration is naturally best done with an accurate frequency counter, but few amateur constructors have access to such an instrument. The calibration can be done with an accurate short wave receiver. The ideal receiver for this purpose is a good general coverage short wave receiver, which tunes all the ranges required, and has an accurate dial calibration. If you do not have such a receiver usually one can be found in the "shack" of a local radio amateur. Try the nearest amateur radio club, these are usually friendly places and members are usually very willing to help a home constructor. The radio amateur may also have a calibration unit, usually a 100 KHz crystal calibrator, which will give accurate checks of his receiver's calibration.

The calibration is carried out in much the same way as the testing of the signal generator, with the unit loosely coupled to the receiver. If the receiver has a B.F.O. (beat frequency oscillator for morse transmissions) switch this on and use the signal generator without the A.F. modulation. Set the receiver to convenient points on the required band, these will vary according to the band. On the lowest range, 10 KHz points could be marked, whilst on the highest range, only 1 MHz and 500 KHz points can easily be marked.

The receiver is set as accurately as possible to the required frequencies. A calibration oscillator will be a great aid in obtaining accurate frequency points. It may also be possible to tune exactly onto broadcast stations of a known frequency, the obvious example being Radio 2 on 200 KHz, to

obtain accurate calibration points. The signal generator is then tuned until it is heard on the receiver. If a BFO is being used, the signal generator is tuned to "zero beat", a null point at either side of which the signal can be heard. Without a BFO, tune for the maximum output of the A.F. modulation. This can be done with a tuning meter, or "S meter", if one is fitted to the receiver. Mark the calibration points with a pencil dot, and later draw a short line in black ink and add the calibration frequency. The prototype instrument was fitted with a white paper scale glued to the front panel and marked with 5 concentric circles. The calibration points were marked onto the circle lines and the figures were added with 'Letraset' numbers. To protect the calibration when it was complete, clear sticky-backed plastic was carefully placed over the scale.

Some form of accurate pointer knob is required for the scale. This can be made from a strip of perspex and a normal round plastic knob. A 1" diameter round knob was used as the tuning control and a cursor scale made from perspex was glued to the back of the knob. The cursor is 21/2" long and 1/2" wide and has an indicating line scratched on both sides. The double line enables a more accurate reading to be taken. When the two lines are aligned with the eye, this gives an accurate view of the scale unaffected by parallex errors. When the cursor is attached to the knob, it must not interfere with the hole for the spindle of VC1. A groove can be filed into the base of the knob so that the bottom of the cursor is flush with the bottom of the knob.

### **Operation**

The signal generator will require screened leads for proper operation, - see the later section on test leads. The leads required are either lead A in Fig.19. or lead B in Fig.19. Lead B offers protection to the unit and the receiver by having an isolating capacitor in a screened can, but if used it must also have an earth lead, as with Lead A, connected to the can and terminated with a crocodile clip. The signal generator can be used to align tuned circuits in a receiver, both RF circuits and the I.F. circuits.



## A.C. BRIDGE

How many unknown capacitors have you got in your junk box? Capacitors are usually marked with the value in figures and these markings often wear off, leaving an unknown, hence useless component. It is, therefore, very useful for the home constructor to have some way of measuring the value of capacitors. This instrument not only measures the value of a wide range of capacitors, but also accurately measures the value of unknown resistances.

### The Circuit

The circuit is based upon the Wheatstone Bridge, well known to all students of physics. Such a bridge can be used to measure an unknown value of resistance or capacitance against a known value. The Wheatstone Bridge as used in the physics lab. is usually a D.C. instrument which uses a meter for measurements. This bridge is A.C. operated, with an audio tone, which eliminates the need for an expensive meter.,

The circuit is shown in Fig.10.(a). Look at the actual bridge arrangement - VR1 and the "standard" and "unknown" terminals. If VR1 is placed with the slider in the centre of the potentiometer track, it forms two resistances. The resistance between the slider and the top we can call  $R_a$  and the resistance between the slider and the bottom  $R_b$ . Two resistors can be joined to the two terminal gaps,  $R_s$  across the "standard" and  $R_x$  across the "unknown".

An audio source from the secondary of T1 is applied across the bridge, and a pair of headphones are connected to SK1 - that is between the other two sides of. the bridge. If the standard and the unknown are equal ( $R_s = R_x$ ) and the potentiometer VR1 is in the centre ( $R_a = R_b$ ) then the bridge is balanced and no audio tone is heard in the headphones. This can be represented as:

$R_s$   $R_a$

$R_x$   $R_b$

Since  $R_s = R_x$  and  $R_a = R_b$ , there is no output, this is called the

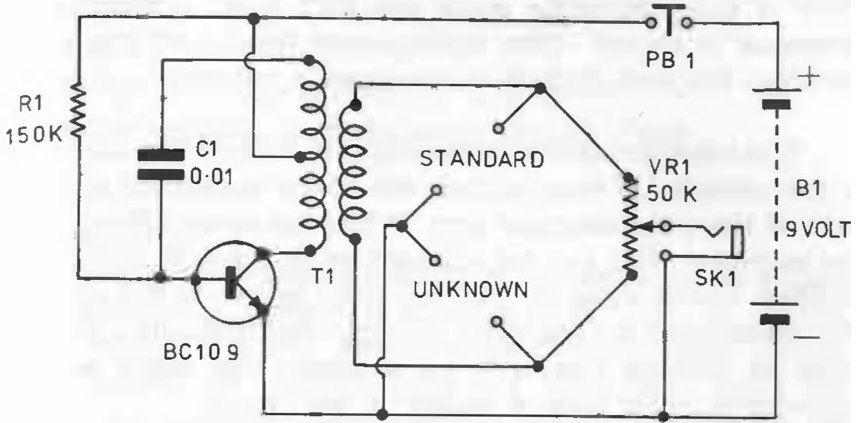

FIG. 10(a). A.C. BRIDGE. ( CIRCUIT DIAGRAM )

SAW CUT

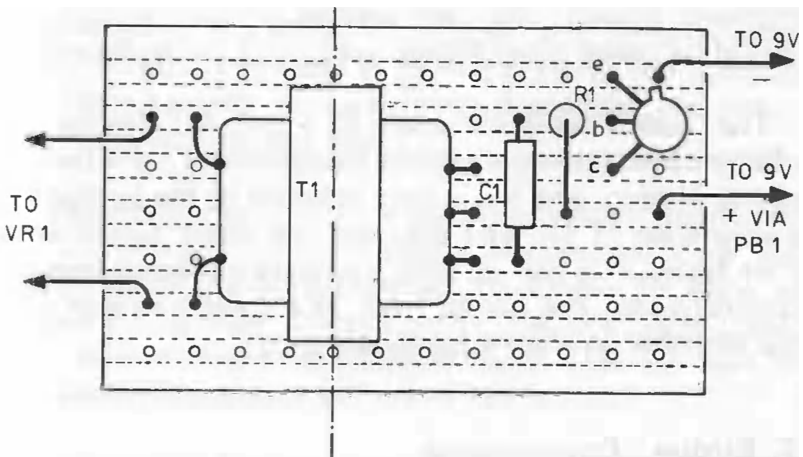

FIG. 10(b). OSCILLATOR VEROBOARD (PLAINSIDE).

null point, and in this circuit will be indicated by no audio tone at SKI. The method of using an audio signal to indicate a null point is quite accurate since the ears have a logarithmic response to sound - that is the lower the sound the more sensitive the ears become to changes in volume.

The equation above shows that the ratio of the unknown to the standard is equal to the ratio of the resistance of each side of the potentiometer arm. If the unknown differs from the standard, VR1 can be adjusted to find a null point. The position of the slider on VR1 will then represent the ratio of the unknown to the standard. VR1 can be fitted with a pointer knob to indicate this ratio on a scale. This scale will be logarithmic either side of nought in the centre.

This action of the A.C. Bridge also applies to capacitors and the ratio of an unknown capacitor to a known value can be found. It is common for A.C. Bridges to have switched values of standard resistance and capacitance which provide various ranges for the instrument. This circuit provides for one's own standard to be used. This not only makes the instrument simpler, but also enables a wide range to be obtained by using good known values for the standards.

The audio oscillator used is a simple Hartley type oscillator based upon the tapped transformer T1. R1 provides the base biasing, and the output is taken to the bridge from the secondary of T1. SKI provides the audio output which can be heard in a pair of high impedance headphones or a crystal earpiece. The output from SKI could be taken to an audio amplifier to drive a loudspeaker.

**A.C. Bridge - Components**

- R1        150K
- Cl        0.1uF
- VR1      50K LinearPotentiometer (large      wire-wound)
- TR1      BC109
- T1        LT700 Transistor output transformer.

pB 1 Miniature press (on) button.

SKI Jack socket

B1 PP3

Veroboard .1" matrix (1 !4" x 1")

Case Aluminium box with lid (4" x 4" x 1 Y<sub>2</sub>")

3 of 4mm Insulated Sockets.Larger pointer Knob.

## Construction

The audio oscillator is built up on veroboard. This should be prepared first. A piece of board with 12 holes by 7 holes should be cut, 1" x 1 1/2" should give plenty of space. There is a cut across the copper strips on the board under the transformer mounting position. This should be made, in the place shown in Fig. 10 (b). by carefully cutting away the copper with a sharp hack saw held flush to the board. After sawing, ensure that none of the tracks have been pushed together, if they have clear the tracks with a knife point.

The transformer is the first component to mount, with the centre in line with the saw cut (underside) solder it to the correct holes on Fig.10.(b). C1 and R1 and then mounted, followed by TR1. The leads to the battery and VR1 complete the veroboard wiring. As usual check that solder has not run across between adjacent tracks.

The potentiometer, VR1, is the critical component in this circuit and should be a good quality wire-wound linear track type. The larger the potentiometer, the longer the track and therefore the greater the accuracy. The prototype used a Colvern wire-wound potentiometer Type CLV/SD, but any good quality component will serve the purpose.

The layout of the components is shown in Fig. 11 .(b). The control VR1 is mounted in the centre of the square front panel, which is the lid of the aluminium box. The veroboard is held in place with "Blutack". Three 4mm sockets (Radiospares type) are used for the STANDARD and UNKNOWN terminals. The centre socket is a common earth

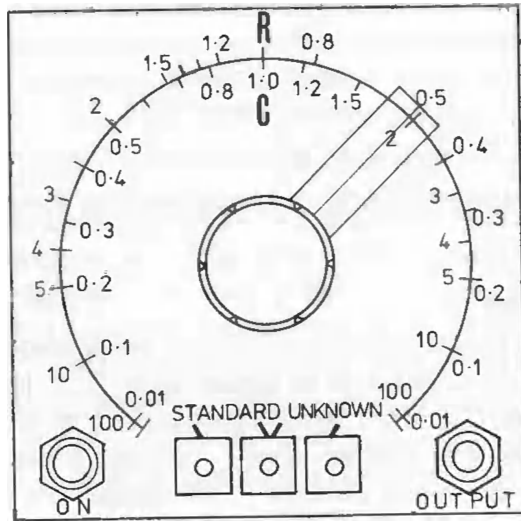

(a). FRONT PANEL.

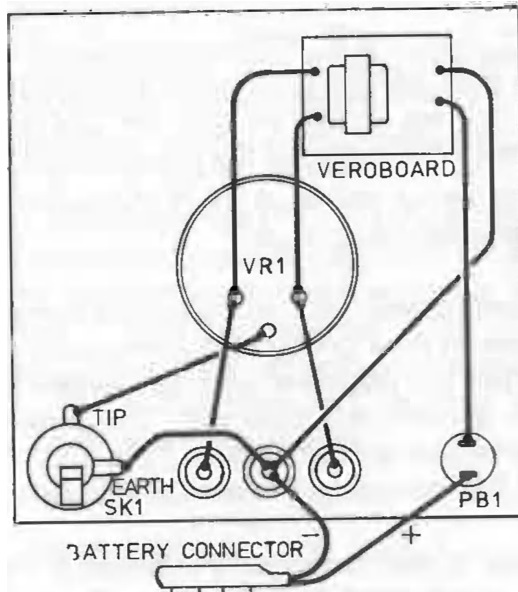

(b). LAYOUT UNDER LID.

FIG.11. A. C. BRIDGE.

point for both the standard and unknown components. A perspex cursor is required for the control knob, (see instructions for making such a cursor in the Signal Generator section of this book). The wiring is quite simple and follows the layout in Fig.11.(b).

An important part of this instrument is the front panel scale. This is a non-linear scale which can be copied from the drawing in Fig.11.(a). The whole front panel is best completely covered with a sheet of white paper. The paper is stuck onto the aluminium lid, marking holes in the correct places after sticking down. The scale can then be drawn onto the paper, or it could be traced onto the paper before sticking it into place. The scale figures and the lettering on the front panel can be made with "Letraset". Finally the whole front panel is covered with a layer of sticky-backed clear plastic film. This protects the front and adds an attractive sheen to the instrument.

As mentioned above, the scale from Fig.11.(a) can be used by tracing it onto the paper. This scale should apply for most potentiometers. There may be a slight variation in the total length of the track, but this variation will be at the ends of the scale which is the least accurate part of the calibration. It is also possible to calibrate the scale using good known value components, to give values either side of the standard. If this is being done close tolerance resistors are probably the best components to use in calibration.

## Operation

Before using the AC. Bridge, it should be set to an accurate zero point. This can be done with two close tolerance resistors of the same value. These are plugged in across the STANDARD and UNKNOWN points. It is not , difficult to connect the wire ends to the 4mm sockets without the use of a 4mm plug. Bend the ends of the wires into a tight U and push into the 4mm sockets. If the wires are separated just wider than the gap between the sockets, the rigidity of the wires will hold them firmly in place. With the two resistors

of the same value in place, plug in a pair of high impedance headphones or a crystal earpiece. Press PB1 and it should be possible to find a null point with no sound in the headphones. This point ought to be exactly on zero on the scale. If it is not on zero adjust the knob on the spindle until the cursor reads zero.

The instrument is simple in use. Close tolerance components make ideal standards, and a supply of suitable standards could be collected to give a wide range of values. The known component is plugged into the STANDARD side and the unknown component into the UNKNOWN side. The press button is operated and VR1 is adjusted to give a null point. If the pointer is over to the left a decimal fraction of the value is given, because the unknown is less than the standard. When the pointer is on the right hand side multiply the value by the positive number on the scale. This applies to CAPACITORS, with RESISTORS the positive values are on the left and the decimal fractions are on the right. The scales are marked R and C as shown in Fig.11.(a).

The output from the headphones or earpiece should be loud enough to obtain quite accurate null points. However it is possible to feed the audio from SKI into an amplifier. A suitable amplifier is included in the circuit of the "Multi-Check", the next instrument in this book. A screened lead can be connected between SKI and the input socket of the Multi-Check.

# MULTI-CHECK

The Multi-Check is a low cost piece of test equipment which will perform a variety of useful tasks for the electronic constructor. When many pieces of equipment are built, some sort of signal source is required with which to test them. Audio sources are easily provided, the Signal Generator described in this book will provide a useful audio output for such tests. However, radio frequency signal sources are often required. An easy way to solve this problem is to build a signal source which produces a basic audio output which is so distorted that radio frequency harmonics are also produced. Such an oscillator makes up half of this instrument.

The other half of the Multi-Check is a small general purpose audio amplifier. Such an amplifier has a variety of uses for an electronics engineer. It can be used as a standby testbench amplifier and for tracing signals through a faulty radio receiver. An R.F. probe can be placed on the front of the amplifier so signals can be traced right from the first stages of a radio receiver.

## The Circuit

The circuit diagram is shown in Fig.12. The left side of the circuit is the oscillator, which is a multivibrator. The multivibrator oscillates because of cross-coupling between the two transistors TR1 and TR2. The collector of TR1 is coupled to the base of TR2 through C1, and the collector of TR2 is coupled to the base of TR1 through C2. These paths provide a feedback route between TR1 and TR2. This type of multivibrator is called an astable multivibrator because of its continuous free-running action.

Two states exist in the circuit, either TR1 is conducting and TR2 non-conducting, or TR2 conducting and TR1 non-conducting. The circuit flips between the two states and for this reason it also has the nick-name of "flip-flop". The time that each stage is in turn on and off depends upon the rate at which C1 charges up through R4, and C2 charges up through R3.



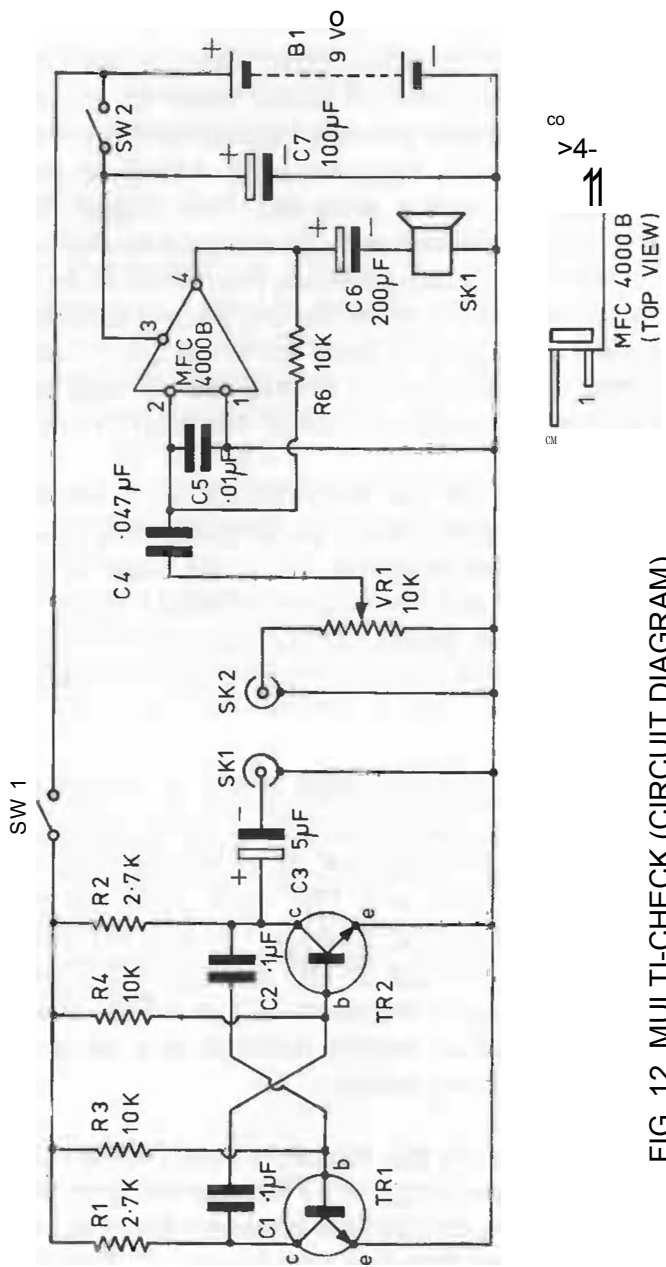

FIG. 12. MULTI-CHECK (CIRCUIT DIAGRAM).

The output is taken from the collector of TR2 via C3. The output is a square wave, the top of the squares being when TR2 conducts and the bottom of the wave being when TR2 is non-conductive. As mentioned the frequency of the on-off action of TR1 and TR2 depends upon the values of C1, R4 and C2, R3, and since these are equal in value the time cycle is the same for both transistors. The frequency at which the oscillation action occurs can be expressed by the formula:

$$f = \frac{1}{1.4C \times R}$$

f = frequency in Hz. R = resistance in Ohms. C = Capacitance in Farads. The value of f is the fundamental frequency of oscillation, but strong harmonics are given out by the circuit to over 10MHz.

The righthand side of the Multi-Check circuit is the audio frequency amplifier. This is a small amplifier based upon an integrated circuit. An integrated circuit, sometimes called an "I.C." is a very small electronic package which performs the task of a large number of conventional components. I.C.'s are now in common use in electronics, so much so that ordinary components are often called "discreet components" to distinguish them from integrated components. The MFC 400B is a complete audio amplifier with about a quarter of a watt of output. It is a tiny block, about 1/2" x 1/2" which with a few discreet components becomes a useful audio amplifier, the MFC 400B has four leads, and an idea of it's appearance can be gained from Fig. 12.

In the complete circuit the input from SK2 goes directly to a potentiometer which acts as a volume control and then is coupled via C4 into the I.C. The MFC 400B then amplifies the signal which appears at pin 4. The amplified signal is coupled through C6 to a small loudspeaker. C5 reduces any high frequency signals which could cause instability and R6 provides a small amount of feedback to stabilize the operation of the amplifier.

## Multi-Check - Components

R1	2.7K Ohms
R2	2.7K Ohms
R3	10K Ohms
R4	10K Ohms
VR1	10K log. Potentiometer
R6	10K Ohms
C1	.1uF (disc)
C2	.1uF (disc)
C3	5uF (electrolytic - 16 volt)
C4	.047 uF
C5	.01 uF (disc)
C6	200uF (electrolytic - 16 volt)
C7	100uF (electrolytic - 16 volt)
TR1	BC109
TR2	BC109
I.C.	MFC 4000B Audio Amplifier
SK1	Phono socket
SK2	Phono socket
SP1	8 or 16 Ohm 2" dia. Loudspeaker
SW1	Single-pole on/off switch (slide type)
SW2	Single-pole on/off switch (slide type)
Veroboard	2 pieces - 1 x 0.7" and 1.2" x 0.6"
Case	Aluminium Box with lid (3" x 4" x 1 1/2")

## Construction

The multivibrator oscillator and the audio amplifier are both built onto veroboard. The multivibrator board requires 11 holes by 4 holes. The layout is shown in Fig. 13.(a). The copper strips require a cut, right across the board at the position of the centre holes. This is shown in the layout drawing and is done with a sharp hacksaw blade sawing flush to the copper side of the board. The cut should make a clear division across the copper strips. If any of the strips have ragged edges which touch adjacent strips these can be cleared with a sharp knife point.

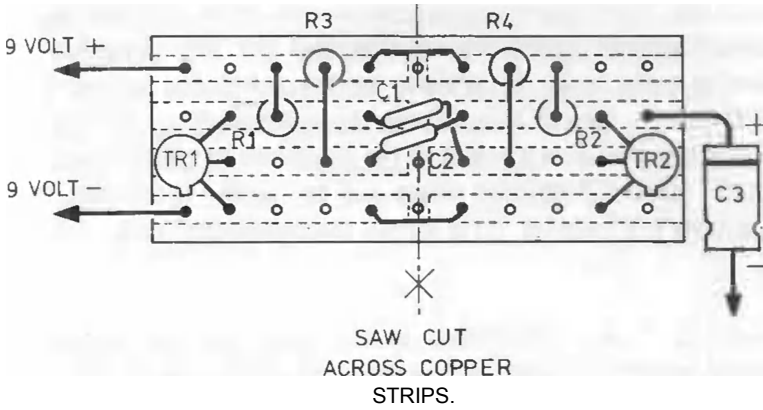

FIG. 13 (a). MULTIVIBRATOR VEROBOARD.

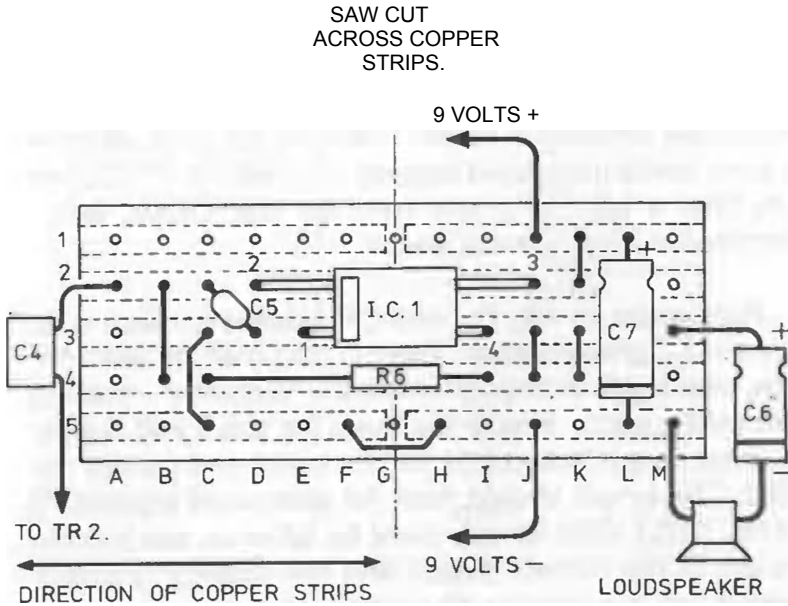

FIG. 13(b). A.F. AMPLIFIER VEROBOARD.

The wiring of the veroboard follows the top-side drawing of Fig.13.(a). The first connections to be made should be the two wires which rejoin the cut strips for the positive and negative supply lines. It is easy to forget these wires if not added first. C1 and C2 can then be soldered to the correct holes. A little trial and error will be required to place the leads so that C1 and C2 do not short out by wires touching, PVC sleeving can be helpful. The other components may then be added.

The I.C. Audio Amplifier is also built up on a piece of veroboard which is cut to allow the use of 5 holes by 13 holes. Again a complete cut has to be made in the copper strips across the board. This cut is made across the centre holes of the strips, in the position marked in Fig.13.(b). The usual precautions for cutting and soldering veroboard should be observed.

Begin the soldering with the link wires which join various parts of the veroboard strips. There are six such wires which are best made from solid copper wire with a PVC covering. Each time a joint is made trim off the excess lead. The components may now be added.

First solder in R6, C5 and C7, leaving enough space to place the I.C. into position. The I.C. can then be soldered into place, treating it as though it were a transistor - making fast clean solder joints. Finally the leads for the 9 volt supply and the capacitors (C4 and C6) for the input and output may be added. The board should then be compared against Fig.12. and Fig.13.(b). Special care must be taken to see that the I.C. pins are in the correct places and the polarity (positive and negative) of the electrolytic capacitors is correct.

The Veroboards and other components are mounted on the lid of the aluminium box. Fig.14.(a) shows the relative positioning of the controls, sockets and speaker and Fig.14.(b) shows the internal arrangement. In practice it was found that the veroboards could be held into place by the

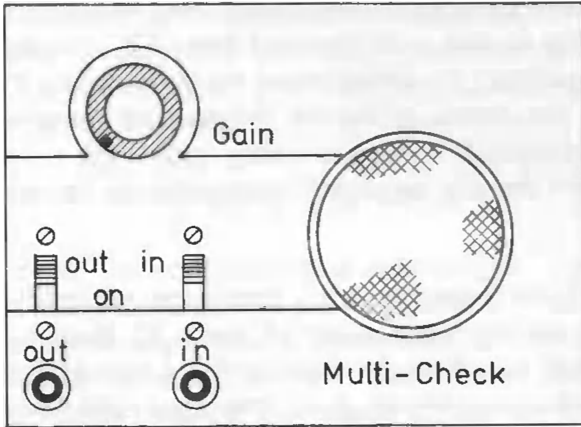

FIG.14 (a). FRONT PANEL.

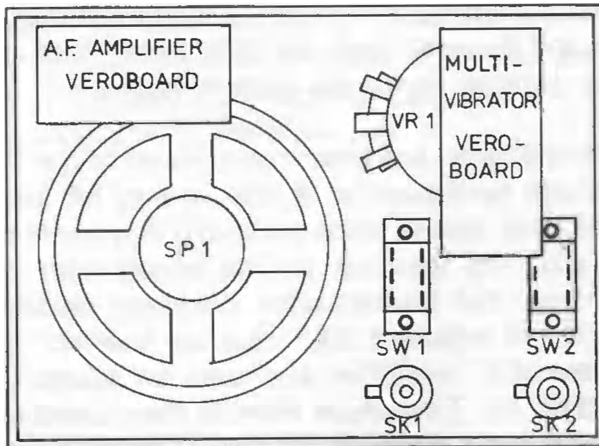

FIG.H(b). POSITION OF COMPONENTS.  
( inside lid 1

MULTI- TEST.

rigidity of the various wires connecting them into the rest of the circuit. The A.F. Amplifier board was held by the leads from C4 and C6. The multivibrator was held in place by the leads to the supply and the lead from C3. The speaker SP1, can be mounted by either using glue or strong PVC tape to hold it to the inside of the lid. When all the connections are made to the controls and sockets, move the veroboards up, away from the lid mounted components to prevent short circuits.

The front panel and it's markings are made up in the same way as the front panel of the A.C. Bridge. A piece of white paper is cut to the size of the front and stuck down onto the aluminium with glue. The large hole for the speaker is cut in the aluminium with either a chassis punch or by drilling and filing - this is best done before the paper is glued to the front. Some form of speaker fret cloth has to be added to the hole to hide and protect the speaker cone. It is possible to buy speaker cloth, but this is expensive. In the prototype a small piece of material from a pair of ladies tights was cut out, stretched and mounted between the paper front and the lid This costs nothing and looks quite effective.

When the paper has been stuck down to the front panel, neat lines can be drawn on it with a thin felt pen to mark around the gain control knob and put a tidy circle around the speaker hole. The lettering can be added with "Letraset". SW1 controls the multivibrator oscillator output, so this switch with its adjacent SK1 can be marked OUT. SW2 controls the A.F. amplifier and can be marked with the adjacent SK2, IN. The whole front is then carefully covered with sticky backed clear plastic film. A sharp pointed model makers knife, or a razor blade can be used to cut out the holes for the controls and the speaker. The speaker hole must be cut with great care to avoid cutting the nylon of the tights material. This was found to be tricky in the prototype and may be best cut before the paper is mounted.

## Operation

Checking the Multi-Check is very simple because it can check itself. A wire is joined from the IN to the OUT sockets. Only one wire is required because the earth path goes through the case. Both SW1 and SW2 are switched on. The audio from the multivibrator will then pass directly into the amplifier and a tone should be heard in the speaker, the volume of which can be adjusted by use of VR1.

Operation of the multi-check is very simple. One simple application is suggested by the test procedure. The unit can be used as a continuity checker by placing items requiring a simple continuity check between the input and output sockets. The main use of the Multi-Check is for signal injection and tracing. The output will provide a signal which can be used to check through the stages of a faulty radio receiver or audio amplifier. The usual procedure is to work from the final stages up to the first stages. The input to the audio amplifier can be used for signal tracing. Working from the first stages of a radio receiver or audio amplifier, the I.C. amplifier can be used to trace the path of the signals. A fuller explanation of the use of the Multi-Check, and the test leads required is given later in the book.



# DUAL RANGE OHMMETER

Most multimeters have a simple ohms range which can be used for checking resistance. Usually the unknown resistance is placed in series with the meter, a battery and a zero setting variable resistance. This gives a reverse reading scale which can be very wide, many reading from 0 to about 40,000 ohms on one non-linear scale. This instrument uses two techniques for measuring resistance and allows two scales to give greater accuracy to the readings. For low resistances the unknown resistor forms a shunt across the meter, and for higher resistances the unknown resistance is placed in series with the meter.

## The Circuit

Figure 15.(a) shows an unknown resistance  $R_x$  placed across the meter as a shunt. Before explaining the action of the resistance measuring principle, one has to understand the function of a meter shunt.

The milliammeter  $M$  has only one full scale deflection (FSD) range. Placing a shunt across the meter will alter the FSD by bypassing a fraction of the current through  $R_x$ . The meter has an internal resistance  $R_m$ , therefore the total current to be measured  $I$ , divides between  $R_m$  and  $R_x$ . The current  $I$  splits up into two parts  $I_m$  and  $I_x$ . This can be expressed as:

$$I = I_m + I_x$$

or 
$$I_x = (I - I_m)$$

The total voltage is the same across the shunt and the meter. If the voltage is expressed as  $V$ , and we use Ohms Law  $V = I.R$

Then:

$$I_x.R_x = I_m.R_m$$

or 
$$I_x = \frac{I_m.R_m}{R_x}$$

But from the above  $I_x = I - I_m$

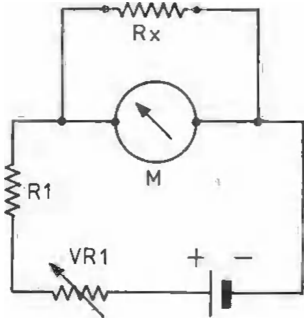

(a)

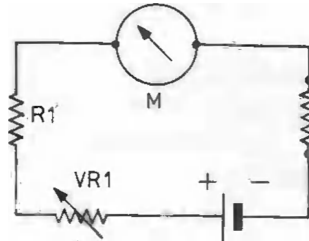

(b)

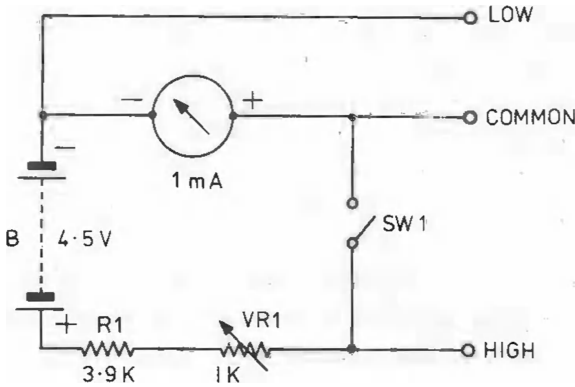

(c)

FIG 15. DUAL RANGE OHMMETER.

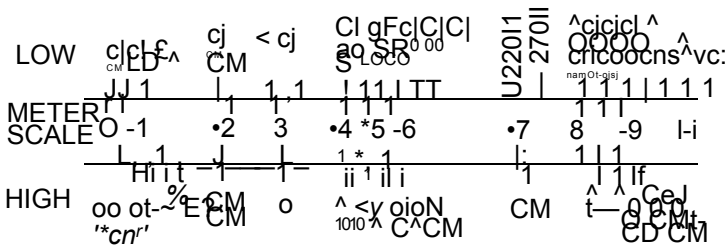

CONVERSION SCALES.

so 
$$\frac{I_m R_m}{I - I_m} = \frac{R_m}{N - 1}$$

The ratio of the total current to the current passed through the meter will be the number of times the FSD has been increased. This can be expressed as  $I/I_m = \text{Number of times FSD is multiplied} = N$ .

Therefore  $R_x = \frac{\text{Ohms}}{N - 1}$

Two things will be noted from this formula - the shunt resistance  $R_x$  needs to only be quite low to increase the FSD of the meter, and as  $R_x$  increases the meter will read higher. These two facts give the basis of a useful instrument. If  $R_x$  is an unknown resistance, and the meter can be calibrated, we have a meter for the forward reading of low resistance values.

In the circuit in Fig.15.(a)  $R_1$  with  $VR_1$  can be arranged to make the meter read FSD without  $R_x$  in the circuit.  $VR_1$  is variable to set the meter and allow for changes in the battery voltage. This arrangement is a simple low resistance measuring instrument.

Figure 15:(b) shows a more conventional ohmmeter circuit. The unknown resistance  $R_x$  is placed in series with  $R_1$  and  $VR_1$  within the meter and battery circuit.  $R_1$  and  $VR_1$  are arranged so that with  $R_x$  shorted out (no resistance) the meter can be adjusted to its FSD. Since  $R_1$ ,  $VR_1$  and  $R_x$  are in series, the total resistance in the circuit, when  $R_x$  is present is  $R_1 + VR_1 + R_x$ . Therefore the higher the resistance of  $R_x$ , the smaller the current flowing in the meter and the lower the reading on the scale. The circuit functions as a reverse reading Ohmmeter - FSD is zero resistance and no reading on the scale indicates an infinitely high resistance. The readings around zero on the meter are so cramped that in practice it is

impossible to read resistances over several hundred thousand ohms. It is possible to work put the calibration of the scale by using Ohms Law, but it is more usual to calibrate the scale using known high tolerance resistances.

The circuit in Fig.15.(c) shows both circuits of Fig.15.(a & b) combined to form one unit. If an unknown resistance is connected between COMMON and LOW and SW1 is closed, the circuit of Fig. 15.(a) is made and the unknown resistor becomes a meter shunt. When an unknown resistance is connected between COMMON and HIGH and SW1 is open, the circuit formed is Fig. 15.(b) and the unknown resistor is in series. The low range reads resistance forwards on the meter scale and the high range reads resistance backwards on the scale.

### **Dual Range Ohmmeter - Components**

- R1        3.9K Ohms
- VR1      1K Ohms Linear potentiometer
- SW1      Single-pole, on/off slide switch
- B        4.5 volt battery (small cycle lamp type)
- Meter 1 mA FSD Japanese type MR-38P (see text)
- Case Aluminium Box with lid (5" x 3" x 1
- 3 of 4mm sockets (Radiospares type) Small plastic knob.

### **Construction**

The circuit is quite simple and therefore easy to build up into the case. All of the components are mounted on the lid. The most difficult task is the cutting of the hole to take the meter. This can be done by marking out the size of the hole, then "chain drilling" a row of holes around the inside of the marked circle. The centre can then be knocked out and the hole filed to exact size with a round, or half-round, file. The meter is mounted right over in one corner of the case next to the sockets and the VR1 zero setting control. This leaves room for the rather large 4.5 volt battery.

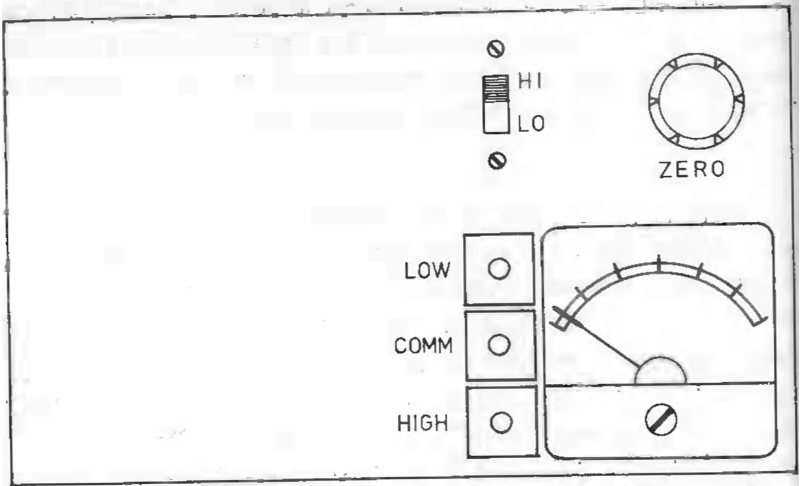

FIG.16(a). DUAL RANGE OHM METER (FRONT PANEL)

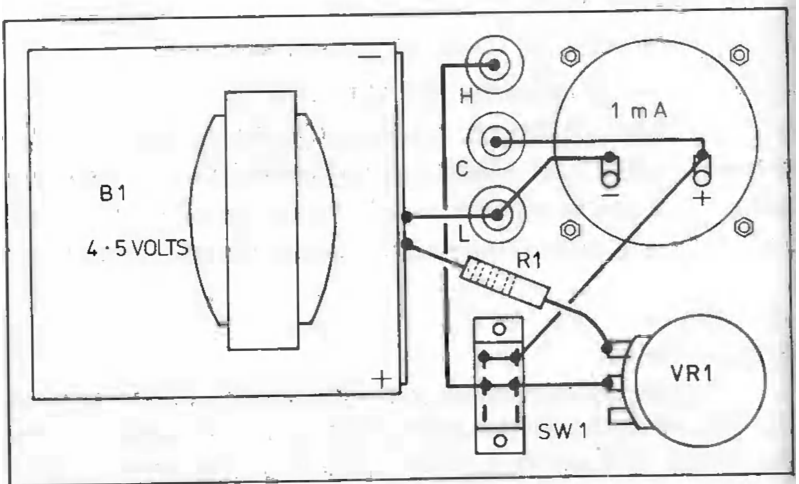

FIG. 16(b). UNDER LID LAYOUT.

The wiring follows the layout in Fig.16. The battery leads are soldered directly onto the two brass contacts. The longer of the two contacts is the negative connection. The front panel is lettered as in Fig.16.(a) with "Letraset", the COMMON socket being the centre of the three sockets. Resistors can be plugged directly into the sockets or a pair of leads with a wander plug on one end and a small crocodile clip on the other may be used to connect the Ohmmeter to the resistor to be measured.

## **Operation**

The operation of the Ohmmeter is quite simple. To read low resistances (about 2 Ohms to 4.7K Ohms) the resistor is connected between LOW and COMMON and the switch is set to LO. Higher resistances (about 100 Ohms to 470K Ohms) are connected between HIGH and COMMON and the switch is set at HI.

Before it is used the meter scale requires calibration for both ranges. The meter used in the prototype was a Japanese type MR-38P which are sold by many electronic stockists. It is difficult to re-mark the scale with resistance values, so a conversion chart or a graph must be used. The conversion scale for the prototype is shown. If a similar meter is used, this scale should apply for any other instrument. But if a different meter is used, the scale will have to be worked out for that meter. However the prototype scale could still apply. A larger meter, type MRA-45, was tried in the prototype and the scale was still found to be accurate, the internal resistance of the meter is the critical factor.

If one wishes to calibrate the individual meter, this is quite a simple task. A selection of high tolerance resistors is required. These are measured with the Ohmmeter, using the appropriate range and the meter reading is noted against the actual value of the resistor. When a range of readings have been taken, a scale can be drawn up for calibration. Some constructors may prefer to draw a graph of the meter

readings against the resistance values. The advantage of a graph is that the continuous line provides a convenient way of reading off values that occur between the calibration points without having to resort to estimation. An important point to remember is to leave the switch in the HI position when the circuit is not in use, otherwise the battery will be in use. It is also worth resetting the zero before each reading.

## TEST LEADS

Not only must a well equipped electronics workshop have a good basic range of test equipment, but a range of leads are required to facilitate the use of the instruments and aid general servicing and testing. Nothing is more annoying than to have a piece of equipment which requires testing and not to have the correct leads to connect the equipment to the test gear. A few basic test leads should form part of the standard equipment available. These are simple and inexpensive to make up and save the hasty making up of hook-up wires which can often prove faulty.

Two basic leads which find many applications in the workshop are the CLIPLEAD and the PLUG-CLIP LEAD. The cliplead is simply about a foot of flexible PVC covered wire with a small crocodile clip at each end. Such leads are invaluable for test connections between circuits, shorting out components, inserting test components and many other simple jobs. The author keeps about a dozen such leads draped over a hook at the side of his bench, and they are in constant use.

The plug-clip lead is another lead of about a foot of PVC covered wire with a crocodile clip at one end and a 4mm socket (or wander socket) at the other end. This lead can be used with some of the pieces of test equipment described in this book. Two such leads, one red and one black, are used to expand the use of both the A.C. Bridge and the Dual Range Ohmmeter. Both of these can test components directly plugged into their sockets, but leads terminated with crocodile clips will aid their ease of use in many cases.

Figure 17. shows a range of leads which are designed for use with the various items of test equipment described in this book. The constructor is advised to make up all, or some, of these leads to facilitate the use of the equipment.

LEAD A in Fig.17 (a 8- b) is a simple probe lead. This is made from an empty ballpoint pen case. The brass "nib" of



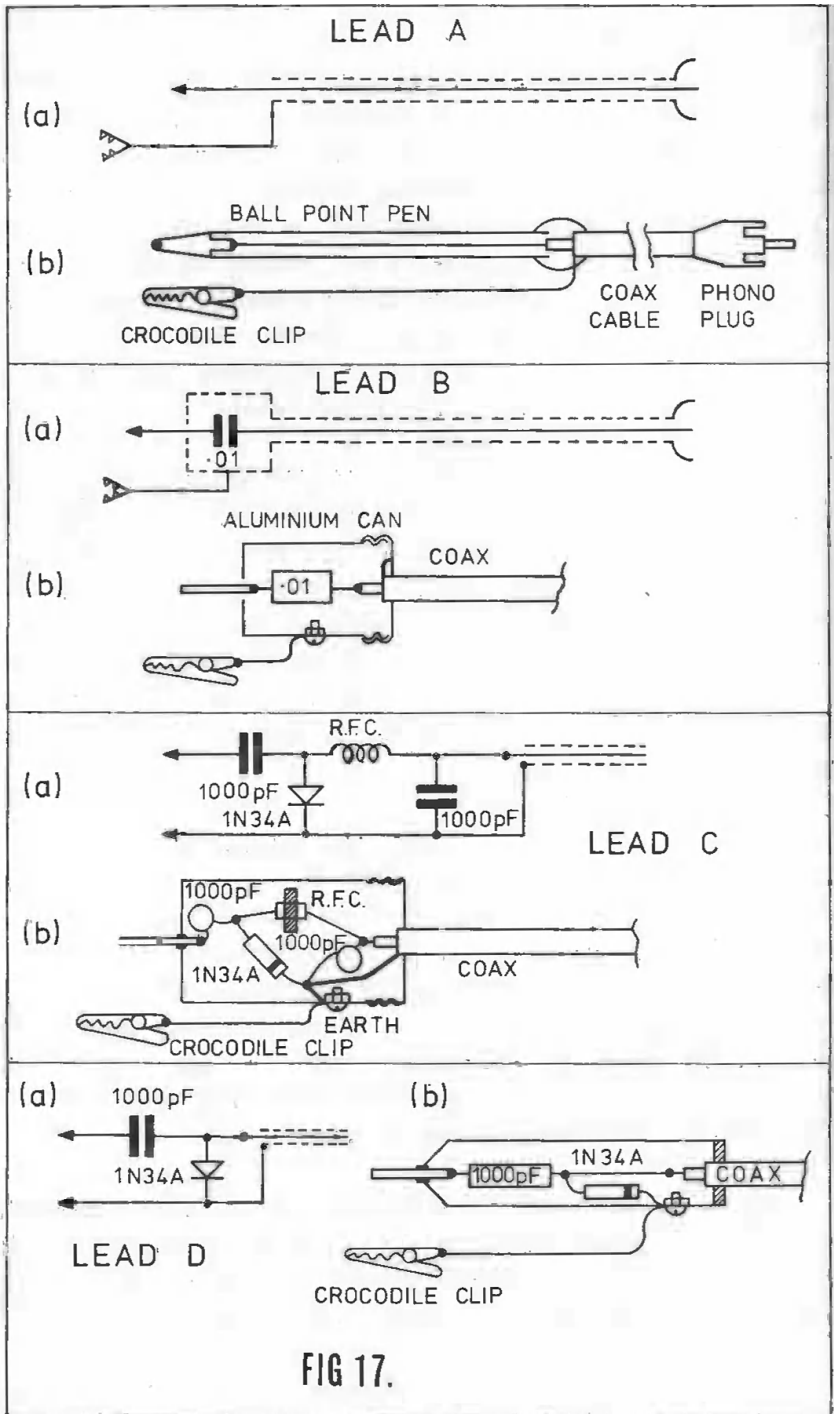

**FIG 17.**

the pen is removed and the plastic tube which contained the ink is pulled off. The "nib" is then washed clean and dried and a lead is soldered to the base of the "nib". This lead goes through the centre of the pen casing and is soldered to the centre conductor of an 18" length of coaxial cable. The outer braiding of the coaxial cable is soldered to a PVCcovered flexible lead terminated with a crocodile clip. The end of the coaxial lead with the two soldered leads is carefully taped onto the end of the pen casing with PVC tape, as shown in Fig. 17. Lead A (b). The other end of the coaxial cable is terminated with a phono plug.

This lead is useful with many of the items of test equipment. It can be used with the Square Wave Generator to provide an output probe, and with the R.F. Signal Generator to give an output lead for both radio frequency and audio frequency outputs. The lead may also be used with the Multi-check to inject the multivibrator output into a circuit or to trace audio signals in a radio receiver or amplifier.

LEAD B performs much the same tasks as Lead A, but with an isolating capacitor between the probe and the circuit. This .01 uF capacitor should be of a high working voltage, certainly over 250 volts. This will isolate the test equipment from the circuit under test, especially when high voltage circuits, for example in valve equipment, are being used. The probe is like Lead A, but an aluminium can replaces the ballpoint pen casing. Suitable cans may be obtained from a variety of sources. It is possible to get such cans from chemists where they are used to hold pills, 35mm film cans are also suitable and it may be possible to get a high voltage capacitor to fit inside the Denco Coil Cans supplied with the coils used for the R.F. Signal Generator.

The actual probe for the lead is made from a short length of stiff copper wire which passes through a hole in the base of the can. The probe is insulated from the can by wrapping PVC tape around the portion which actually passes through the can base. The inner conductor of the coaxial cable is

connected to the probe via the capacitor. It may be wise to insulate these leads with PVC tape to prevent them shorting onto the side of the can. The outer screen lead of the coaxial cable can either be attached to the can lid with a 6 BA nut and bolt, or trapped in the screw threads between the lid and the side of the can. The earthing lead with the crocodile clip is attached to the can with a 6 BA nut and bolt.

Lead B is used for much the same applications as Lead A. It may be used with the Square wave Generator, the R.F. Signal Generator (both outputs) and the Multi-check (multi-vibrator output and audio signals to the input). By ensuring isolation between the probe and the instrument, the test gear can be used on high voltage circuits with Lead B provided THE VOLTAGE OF THE CIRCUIT UNDER TEST IS LESS THAN THE WORKING VOLTAGE OF THE CAPACITOR.

LEAD C is a rather specialised lead for use with the Multi-Check unit. It is an R.F. Probe, which allows the input socket of the Multi-Check to be used to trace radio frequency signals. Once again the probe is built into an aluminium case. The components required are:

2 of 1000 pF Disc Ceramic capacitors  
Radio Frequency Choke 1.5 to 5 mH.  
1N34A Diode (or similar)

The components are built into the aluminium case as shown in Fig.17. Lead C (b). Again care must be taken to insulate the probe and the leads of the components from the sides of the can. One common earth point is used for coaxial cable and components.

Lead C is a test probe which is suitable for use with the input section of the Multi-Check for tracing modulated radio frequency signals in a radio receiver. The components in the screened can form a detector or demodulator circuit. This converts the modulated radio frequency waves, which come before the detector stage in the radio receiver, into audio

signals. These audio signals are passed to the I.C. amplifier of the Multi-Check and are heard in the loudspeaker. The use of this probe is described further in the applications section later in this book.

LEAD D is another radio frequency probe. This is merely a simpler version of Lead C. This probe is smaller and very convenient in use. It is built up inside a metal cigar case. The probe is a stiff piece of copper wire insulated from the case with PVC tape. The leads from the diode and capacitor may also be covered with PVC tape to prevent shorting out in the confined space of the cigar case.

Lead D is used in the same way as Lead C to detect modulated radio frequency signals in the early stages of radio receivers.

# APPLICATIONS

Once test equipment has been built, the constructor has to know how to make full use of it. This has been dealt with in the sections on OPERATION included with each instrument. These short sections have only given a mere indication of what can be done with the equipment. This book is intended as a book of practical projects rather than a textbook on electronic servicing. The author advises readers to obtain some of the many books written on electronic servicing in order to gain expertise in the use of test equipment. However this short section gives some general advice on the use of a couple of the units described in this book.

The factors which govern the sensitivity of a multimeter type voltmeter have already been described, but it is important to know how the sensitivity of a meter can affect its readings and how this can be overcome with a high input impedance meter.

Consider the circuit in Fig.18.(a). The two 220K resistors form a potential divider across the 9 volt supply. Since they are equal in value 4.5 volts should appear at their junction. One may wish to measure this voltage with the 10 volt range on a typical multimeter.

If the sensitivity of the multimeter is 20,000 Ohms per Volt, on the 10 volt range the input resistance of the meter will be 200,000 Ohms. This is roughly equal to the resistance across which the voltage is to be measured. Therefore the resistance of the meter (following Ohms Law) will roughly halve the resistance across which the measurement will be made. This will give a totally misleading reading on the meter.

## Multi-Check

The Multi-Check, despite its simplicity, is a very useful instrument. Some of its uses have been outlined in the Operation section of that chapter. The primary function is that

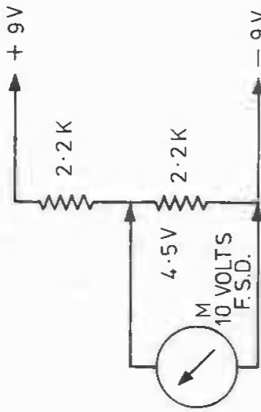

(a)

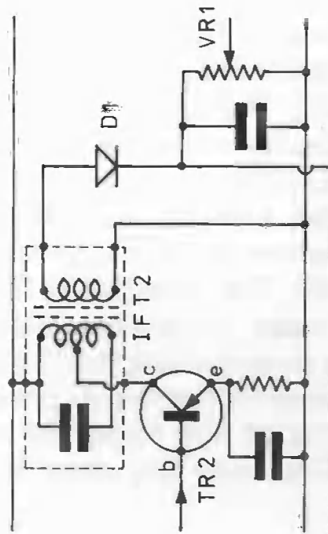

(c) Final I.F. and Detector Stage.

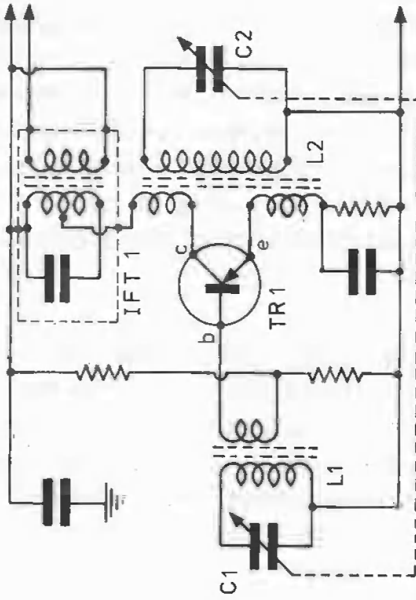

(b) R.F. and Mixer Stage

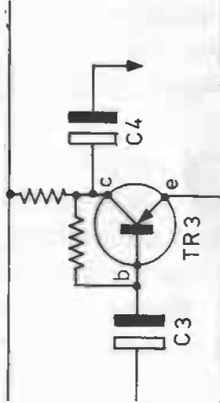

(d) Audio Stage.

FIG 18.

of a signal injection and tracing unit for servicing radio receivers. Checking the voltages and other parameters of a radio receiver being serviced is called static testing, the Multi-Check enables dynamic tests to be made. These are tests made on the actual operation of the receiver whilst it is in the working condition. This can be done by injecting an external signal into the receiver, or tracing an actual received radio signal - the Multi-Check will perform either of these functions.

### **Signal Tracing**

This is the method of attempting to trace the path of the incoming radio signal in the receiver from the first to the final stages. This testing is done with the input socket to the I.C. amplifier. Figure 18.(b to d) shows three typical stages which could be found in a broadcast superhet type receiver. The signal can be checked from the first stage right through the radio.

When testing the R.F. and the I.F. stages of a radio the R.F. probe lead (Lead C or D of Fig.17) is required, this will demodulate the audio signal from the R.F. signal. The simple rule is that before the detector diode of the receiver (D1 of Fig.18) the R.F. probe is required. With this probe in use, the tracing can begin with the first stage. It should be possible to trace loud broadcast stations as early as the first tuned circuit (LI - CI) at the base of TR1, at this point the probe is acting rather like a crystal set. Once a signal has been found the probe can be moved progressively along the further stages of the radio. The collector of TR1 would be another suitable testing point, followed by the output of IFT1. The signal may then be probed along the IF stages, the base and collector of each transistor forming a convenient test point. Failure to find the signal at any stage will narrow down the fault to that stage. The earth clip must be attached to the radio circuit earth.

The R.F. probe may be used as far as the final IF and detector stage (Fig.18.(c)), the final test point being the

output of the final I FT, just before the detector diode D1. After this stage the Multi-Check input may be used with Test Lead B. The first test with this lead can be at the top of the volume control VR1. The Audio Probe now in use will enable all the audio stages to be tested. This is done rather like the IF and RF stages. Figure 18.(d) shows a very simple audio stage. Suitable checking points would be at the base and collector of TR3. It is also possible to probe either side of C3 and C4, or any audio coupling capacitors, to check that they are allowing the signal to pass. The Audio Probe can be used to trace right through the audio stages of a radio, or audio amplifier; once again failure to find a signal being a possible indication of a faulty stage.

The signal injector is used in the reverse manner to the signal tracer. Once again, Lead B will form a suitable probe. This time the signal is injected into each stage beginning at the loudspeaker, where a signal should be heard, and working towards the front end of the radio receiver. The testing points can be much the same as those suggested for the signal tracing method, the failure of a stage to pick up the injected signal indicates a possible fault. This method of servicing requires some practice and it is suggested that the beginner tries his hand with a good working small transistor superhet, injecting and tracing along the radio.



