

1538

# ELECTRONIC DATABOOK

## 3RD EDITION

Packed with vital, up-to-date facts on every aspect  
of electronics practice . . . for hobbyists *and* professionals!

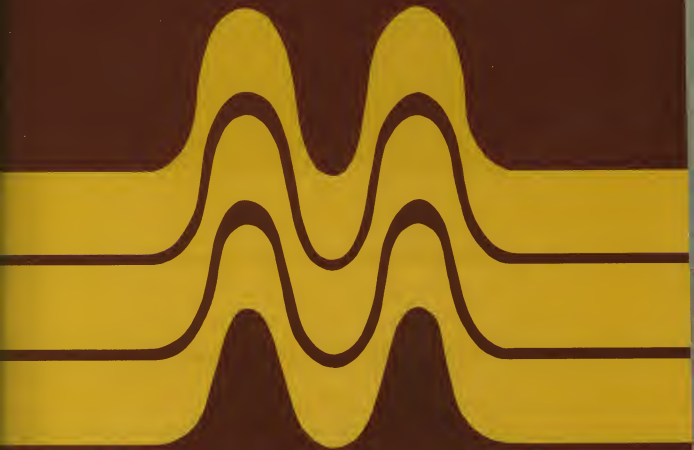

BY RUDOLF F. GRAF

# ELECTRONIC DATABOOK

3RD EDITION

BY RUDOLF F. GRAF

R621.38102  
G757E3

C.1



**TAB BOOKS Inc.**

BLUE RIDGE SUMMIT, PA. 17214

BUSINESS

NOV 6 1985

To My Mother and Father

Material appearing in Definitions of Integrated Circuits, Logic, and Microelectronics Terms is reprinted by permission of *Insulation/Circuits*, May, 1982. Copyright Lake Publishing Corporation, Libertyville, IL 60048

THIRD EDITION

SECOND PRINTING

Copyright © 1983 by Rudolf F. Graf

Printed in the United States of America

Certain portions of this work copyright © 1974 and 1971 under the title *Electronic Design Data Book* by Rudolf F. Graf. Reproduction or publication of the content in any manner, without express permission of the publisher, is prohibited. No liability is assumed with respect to the use of the information herein.

Library of Congress Cataloging in Publication Data

Graf, Rudolf F.  
Electronic databook.

Includes index.

1. Electronics—Tables. 2. Electronics—Graphic methods. I. Title.

TK7825.G68 1983 621.381'021'2 82-19407

ISBN 0-8306-0138-4

ISBN 0-8306-1538-5 (pbk.)

# Contents

<b>PREFACE</b>	<b>v</b>
<b>ACKNOWLEDGMENTS</b>	<b>vii</b>
<b>1. FREQUENCY DATA</b>	<b>2</b>
The entire electromagnetic spectrum is presented. Then portions of this spectrum that are of particular interest to the electrical and electronic engineer are described in greater detail.	
<b>2. COMMUNICATION</b>	<b>18</b>
Information useful in all segments of communication, starting with propagation characteristics, modes, standards, and transmission data is given. Antenna, transmission line, and waveguide characteristics and performance data are presented. Modulation and international telecommunications standards, signals, signal reporting codes, radio amateur data, and emission information are also given, as is information on microphones.	
<b>3. PASSIVE COMPONENTS AND CIRCUITS</b>	<b>70</b>
Resistors, amplifiers, attenuators, filters, inductors, transformers, and capacitors are covered and their characteristics and applications are treated in depth. Computer-calculated tabulations of modern filter designs based on network synthesis are given.	

#### **4. ACTIVE COMPONENTS AND CIRCUITS**

**160**

Vacuum tubes, semiconductors, and integrated circuits are covered. Circuit configurations are given in which these components are employed together with definitions of integrated circuit, logic, and microelectronic terms. A tabulation that shows the characteristics of integrated circuit logic families currently in use is given. Solid-state sensor characteristics and semiconductor memories are covered.

#### **5. MATHEMATICAL DATA, FORMULAS, SYMBOLS**

**220**

This section covers reliability; mathematical signs, symbols, operations, and tables; charts and formulas; prefixes; geometric curves; solids; spherical as well as plane geometry; and trigonometry. Frequency, phase angle, and time relationships for recurrent wave forms are given. Power and voltage level determinations in signals circuits are explained. Letter symbols for all quantities encountered in the electronics, electrical field are defined. This section concludes with a comprehensive selection of conversion factors.

#### **6. PHYSICAL DATA**

**300**

This section covers the most often needed physical data and includes, among other items, laser radiation, motors, radioactivity, optical data, sound, incandescent lamps, cathode ray tubes, crystals, color codes, relay contact code, military nomenclature, atmospheric and space data, chemical data, plastics, temperature and humidity tables, energy conversion factors and equivalents, wire data, hardware, shock and vibration, cooling data, and characteristics of materials.

#### **INDEX**

**400**

# Preface

This revised and expanded edition includes a great deal of new material that has come to light since the second edition was published.

The filter section has been thoroughly updated and now includes computer-generated tabulations of modern filter design based on network synthesis. This major entry was especially prepared for this book by Mr. Ed Wetherhold, whose contribution I most gratefully acknowledge.

I also wish to thank my friends and colleagues Rich Myers and F. Raymond Dewey for giving so unselfishly of their time to review and comment on the previous edition of this work and for generously sharing with me much of their private source material.

The word *knowledge* brings to mind the staggering body of facts and data accumulated by mankind since his descent from the trees. Once, thousands of years ago, it was possible for a man to know all that his kind had discovered. But, time has added so greatly to our reservoir of wisdom, that *knowledge*, today, has assumed another meaning: knowing where to find the information needed.

This book humbly admits to being my attempt at simplifying the task of the busy engineer, technician, amateur, and student in locating the data he needs in the shortest possible time.

Gathered here, in one single volume, is a wealth of information in the form of timely and practical nomograms, tables, charts, and formulas.

Some of the material was available elsewhere, at some time or other, but never has all of it been gathered together under one cover. New and heretofore unpublished charts and nomograms are added because of what seemed to me an obvious need for such material.

The book is arranged in a most readily usable format. It contains only clear-cut, theory-free data and examples that are concise, accurate, and to the point. The user of this book will be looking for answers and he will find them, without having to fight his way through lengthy derivations and proofs.

In order to assist you in finding the data you seek, the book has been divided into six functional sections. That organization, together with a comprehensive index, quickly leads to the specific information needed. The

book maintains uniform terminology and format which assures that data found in one section can be easily and accurately related to those in the rest of the book.

Much new and up-dated material has been added to this current edition of the book. It has been my intention (and certainly my hope) that this new material makes the book still more useful and comprehensive.

The preparation of a reference book such as this is not possible without the cooperation and assistance of numerous industry sources who have so generously made their material available. I gratefully acknowledge, with special thanks, the contributions and critical efforts of Messrs. George J. Whalen, Arthur E. Fury, Rene Colen, and B. William Dudley, Jr.

If this book saves you many hours of tedious computations and search for information, it will indeed have served its intended purpose.

The author and publisher invite your comments and suggestions regarding any such other material as might have been included here, so that it may be considered for any subsequent edition or revision.

# Acknowledgments

Acknowledgment is made to the following organizations and publications who have permitted use of material originally published by them. I appreciate their cooperation during the preparation of this book.

Alpha Metals, Inc.: page 390.

The American Radio Relay League: pages 55-58, 60, 65 (all from *The Radio Amateur's Operating Manual*, © 1969).

Automatic Electric Company: pages 236-237, 238, 267 (all from *Tables and Formslae*).

Centralab Division of Globe-Union, Inc.: page 99.

Clairex Electronics, Inc. (and J. R. Rabinowitz): page 307.

*Computers & Data Processing News*: page 227.

Conrad, Inc.: page 358.

*Design News*: pages 244-245 (Nov. 1963); 248 (March 1967); 250 (Feb. 1959); 286 (March 1958); 361 (Sept. 1959); 385 (June 1967); 401 (Sept. 1975).

*EDN*: pages 27 (Nov. 1968); 47 (Sept. 1963); 51 (June 1964); 49 (Nov. 1968); 69 (Nov. 1968); 80 (Nov. 1968); 91 (May 1967); 101 (Sept. 1966); 108 (Nov. 1965); 109 (Apr. 1959); 115 (Jan. 1962); 150 (Oct. 1966); 157 (Nov. 1961); 159 (Sept. 1966); 181 (Sept. 1962); 225 (Nov. 1963); 234 (July 1959); 254 (May 1968); 256 (Dec. 1966); 263 (March, 1977); 284, 285 (Oct. 1960); 311 (Nov. 1962); 312 (Nov. 1962); 365 (May 1963); 383 (Aug. 1978).

Electric Hotpack Company, Inc.: page 360.

*Electronic Design*: pages 87 (July 1956); 102, 103 (March 1959); 171 (Aug. 1981); 304 (Sept. 1966); 327, 328, 329, 330 (May 1966).

*The Electronic Engineer*: pages 29 (Nov. 1956); 32, 33, 34 (Jan. 1968); 36 (Nov. 1967); 37 (Oct. 1963); 46 (June 1961); 110, 111, 113 (Jan. 1948).

*Electronic Equipment Engineering*: pages 24 (July 1958); 148 (Aug. 1963).

*Electronic Industries*: page 156 (May 1966). Electronic Industries Association: pages 166-170 (from "EIA-NEMA Standards," © 1966 By Electronic Industries Association and the National Electrical Manufacturers Association).



Electronic Products: page 190 (June 1982).  
*Electronics*: page 372, 373 (April 3, 1975).  
Electronic Tube and Instrument Division of General Atronics Corporation: page 331.  
*Electronics World*: pages 42 (June 1965); 98 (Dec. 1964); 100 (Dec. 1964); 211 (1959); 214 (Sept. 1963); 252-253 (1962); 265, 266 (July 1961); 349 (Nov. 1969).  
Franz Company: pages 398-399.  
The Garrett Corporation: pages 340-343.  
General Electric Company: pages 152-155, 162-165.  
General Radio Company: pages 44, 45.  
Hudson Lamp Company: page 319 (from Hudson Lamp Company Catalog).  
Industrial Research, Inc.: pages 149 (March 1959); 228-231 (Apr. 1960) (all from *Electro-Technology*).  
Instrument Systems Corporation: page 377.  
Insulation—Circuits: pages 192-205 (May, 1982).  
Kepco, Inc.: page 366.  
Kim Lighting, Subs. of Kidde Co.: page 346.  
Lenkurt Electric Co., Inc.: page 26 (from Lenkurt Demodulator "Carrier and Microwave Dictionary").  
*Machine Design*: page 326 (July 1970).  
P. R. Mallory & Co., Inc.: pages 83, 318 ("Minimum Detail that the Human Eye Can Resolve") (both from *MYE Technical Manual*, © 1942).  
Martin Marietta Corporation: page 303.  
*Measurements and Data*: page 357.  
*Microwave Journal*: page 219 (Oct. 1964).  
Parker Seal Company: page 249.  
*Popular Electronics*: pages 9, 10 (from *Communications Handbook*, © 1969); page 171.  
PRD Electronics, Inc.: page 48.  
Radio Engineering Laboratories, Inc.: page 21.  
Reynolds Metals Company: pages 246-247, 251 (all from *Facts and Formulas*, © 1961).  
Howard W. Sams & Co., Inc.: page 116 (from *Audio Cyclopeda*, © 1969); pages 173, 190, 369 (from *Referende Data for Radio Engineers*, 5th Edition, © 1968).  
Smithsonian Institution Press: page 317 (from *Smithsonian Physical Tables*).  
Sprague Electric Company: pages 93, 324.  
TAB BOOKS, Inc.: pages 338-339, 389 (from *Master Handbook of Electronic Tables & Formulas* by Martin Clifford, © 1980 BY TAB BOOKS Inc.).  
Testing Machines Inc.: pages 287-299.  
Tilton, Homer B., Visonics Laboratories: page 313.  
TRW, Capacitor Division, page 242.  
Vibrac Corporation: page 379.

# **ELECTRONIC DATABOOK**

**3RD EDITION**

# Section 1

# Frequency Data

- The Electromagnetic Spectrum / 4
- Wavelength Bands and Frequency Used in Radiocommunication / 5
- Broadcasting Frequency Assignments / 5
- TV Channel Frequencies / 6
- Frequencies in Use around the World in the Aeronautical Mobile Bands / 9
- Frequencies Used by Ship and Shore Stations / 10
- International Amplitude-Modulation Broadcasting Frequencies / 10
- Amateur Radio Frequencies / 10
- Citizens Radio (Personal Radio) Frequencies / 10
- Commonly Used Letter-Code Designations for Microwave Frequency Bands / 11
- CTCS (Continuous Tone Coded Squelch) and Remote Control Standard Frequency Table / 12
- Ultrasonic Transducer Materials / 13
- Ultrasonic Frequency Spectrum / 13
- NBS Standard Frequency and Time Broadcast Schedules / 14
- Wavelength-Frequency Conversion Scale / 17

## THE ELECTROMAGNETIC SPECTRUM

This chart presents an overview of the complete electromagnetic radiation spectrum, extending from infrasonics to cosmic rays. The wavelength, the amount of energy required to radiate one photon, a general description, the band designation, and the normal occurrence or use are given. Some specific bands are described in more detail on the following pages.

$$\lambda_m = \frac{300,000}{f_{\text{kHz}}} = \frac{300}{f_{\text{MHz}}} \quad \lambda_{\text{cm}} = \frac{30}{f_{\text{GHz}}}$$

$$\lambda_R = \frac{984,000}{f_{\text{kHz}}} = \frac{984}{f_{\text{MHz}}} \quad \lambda_{\text{in}} = \frac{11.8}{f_{\text{GHz}}}$$

FREQUENCY (hertz)	10	10 <sup>2</sup>	10 <sup>3</sup>	10 <sup>4</sup>	10 <sup>5</sup>	10 <sup>6</sup>	10 <sup>7</sup>	10 <sup>8</sup>	10 <sup>9</sup>	10 <sup>10</sup>	10 <sup>11</sup>	10 <sup>12</sup>	10 <sup>13</sup>	10 <sup>14</sup>	10 <sup>15</sup>	10 <sup>16</sup>	10 <sup>17</sup>	10 <sup>18</sup>	10 <sup>19</sup>	10 <sup>20</sup>	10 <sup>21</sup>	10 <sup>22</sup>	10 <sup>23</sup>		
WAVELENGTH (meters)			10 <sup>8</sup>	10 <sup>7</sup>	10 <sup>6</sup>	10 <sup>5</sup>	10 <sup>4</sup>	10 <sup>3</sup>	10 <sup>2</sup>	10	1	10 <sup>-1</sup>	10 <sup>-2</sup>	10 <sup>-3</sup>	10 <sup>-4</sup>	10 <sup>-5</sup>	10 <sup>-6</sup>	10 <sup>-7</sup>	10 <sup>-8</sup>	10 <sup>-9</sup>	10 <sup>-10</sup>	10 <sup>-11</sup>	10 <sup>-12</sup>	10 <sup>-13</sup>	
(other units)			1km				100m	10m	1cm	1mm			100μ	1μ			1Å				1μev	10 <sup>-13</sup>	10 <sup>-14</sup>	10 <sup>-15</sup>	
QUANTUM OF ENERGY (ev)			10 <sup>-14</sup>	10 <sup>-13</sup>	10 <sup>-12</sup>	10 <sup>-11</sup>	10 <sup>-10</sup>	10 <sup>-9</sup>	10 <sup>-8</sup>	10 <sup>-7</sup>	10 <sup>-6</sup>	10 <sup>-5</sup>	10 <sup>-4</sup>	10 <sup>-3</sup>	10 <sup>-2</sup>	10 <sup>-1</sup>	1	10	10 <sup>2</sup>	10 <sup>3</sup>	10 <sup>4</sup>	10 <sup>5</sup>	10 <sup>6</sup>	10 <sup>7</sup>	10 <sup>8</sup>
(other units)																	1000λ	1000λ	1000λ	1000λ	1000λ	1000λ	1000λ	1000λ	1000λ
GENERAL DESCRIPTION	ELECTRIC WAVES			RADIO WAVES										LIGHT WAVES			X-RAY WAVES			COSMIC RAYS					
BAND DESIGNATION AND NUMBER	ELF	SLF	ULF	VLF	LF	MF	HF	VHF	UHF	EHF		Infrared	Visible	Ultra Violet											
GENERAL OCCURRENCE AND APPLICATION	Infra-sonics Power Transmission	Sonics	Ultra-sonics			AM Radio	TV, FM Broadcasting		Radar	Microwaves			Laser		Optics				Gamma Rays	Cosmic Rays				Particle Accelerators	

## WAVELENGTH BANDS AND FREQUENCY USED IN RADIOCOMMUNICATION

Nomenclature of the frequency and wavelength bands used in radiocommunication in accordance with Article 2, No. 12 of the "Radio Regulations," Geneva, 1959.

<i>Band Number</i>	<i>Frequency Range (lower limit exclusive, upper limit inclusive)</i>	<i>Corresponding Metric Subdivision</i>	<i>Adjectival Band Designation</i>
1	3- 30 c/s (Hz)	Petametric waves	ELF Extremely-Low Frequency
2	30- 300 c/s (Hz)	Terametric waves	SLF Super-Low Frequency
3	300- 3000 c/s (Hz)	Gigametric waves	ULF Ultra-Low Frequency
4	3- 30 kc/s (kHz)	Myriametric waves	VLV Very-Low Frequency
5	30- 300 kc/s (kHz)	Kilometric Waves	LF Low Frequency
6	300- 3000 kc/s (kHz)	Hectometric waves	MF Medium Frequency
7	3- 30 Mc/s (MHz)	Decametric waves	HF High Frequency
8	30- 300 Mc/s (MHz)	Metric waves	VHF Very High Frequency
9	300- 3000 Mc/s (MHz)	Decimetric waves	UHF Ultra-High Frequency
10	3- 30 Gc/s (GHz)	Centimetric waves	SHF Super-High Frequency
11	30- 300 Gc/s (GHz)	Millimetric waves	EHF Extremely-High Frequency
12	300- 3000 Gc/s (GHz) or 3 Tc/s (THz)	Decimillimetric waves	-----

## BROADCASTING FREQUENCY ASSIGNMENTS

This table shows the frequency range, number of available channels, and channel width for AM, FM, and TV service in the United States.

<i>Type of Service</i>	<i>Frequency Range</i>	<i>Number of Available Channels</i>	<i>Width of Each Channel</i>
AM radio	535-1605 kHz	107	10 kHz
FM radio	88- 108 MHz	100	200 kHz
VHF television	54- 72 MHz	12	6 MHz
	76- 88 MHz		
UHF television	174- 216 MHz	70	6 MHz
	470- 890 MHz		

## TV CHANNEL FREQUENCIES

## TV Channels

Channel Number	Frequency Limits (MHz)	Video Carrier (MHz) Sound Carrier (MHz)
2	54	55.25 59.75
3	60	61.25 65.75
4	66	67.25 71.75
5	72	76
		77.25 81.75
6	82	83.25 87.75
	88	
	174	
7		175.25 179.75
	180	
8		181.25 185.75
	186	
9		187.25 191.75
	192	
10		193.25 197.75
	198	
11		199.25 203.75
	204	
12		205.25 209.75
	210	
13		211.25 215.75
	216	
	470	
14		471.25 475.75
	476	
15		477.25 481.75
	482	
16		483.25 487.75
	488	
17		489.25 493.75

Channel Number	Frequency Limits (MHz)	Video Carrier (MHz) Sound Carrier (MHz)
	494	
18		495.25 499.75
	500	
19		501.25 505.75
	506	
20		507.25 511.75
	512	
21		513.25 517.75
	518	
22		519.25 523.75
	524	
23		525.25 529.75
	530	
24		531.25 535.75
	536	
25		537.25 541.75
	542	
26		543.25 547.75
	548	
27		549.25 553.75
	554	
28		555.25 559.75
	560	
29		561.25 565.75
	566	
30		567.25 571.75
	572	
31		573.25 577.75
	578	
32		579.25 583.75
	584	
33		585.25 589.75
	590	
34		591.25 595.75

Channel Number	Frequency Limits (MHz)	Video Carrier (MHz) Sound Carrier (MHz)
35	596	597.25 601.75
36	602	603.25 607.75
37	608	609.25 613.75
38	614	615.25 619.75
39	620	621.25 625.75
40	626	627.25 631.75
41	632	633.25 637.75
42	638	639.25 643.75
43	644	645.25 649.75
44	650	651.25 655.75
45	656	657.25 661.75
46	662	663.25 667.75
47	668	669.25 673.75
48	674	675.25 679.75
49	680	681.25 685.75
50	686	687.25 691.75
51	692	693.25 697.75

Channel Number	Frequency Limits (MHz)	Video Carrier (MHz) Sound Carrier (MHz)
52	698	699.25 703.75
53	704	705.25 709.75
54	710	711.25 715.75
55	716	717.25 721.75
56	722	723.25 727.75
57	728	729.25 733.75
58	734	735.25 739.75
59	740	741.25 745.75
60	746	747.25 751.75
61	752	753.25 757.75
62	758	759.25 763.75
63	764	765.25 769.75
64	770	771.25 775.75
65	776	777.25 781.75
66	782	783.25 787.75
67	788	789.25 793.75
68	794	795.25 799.75



Channel Number	Frequency Limits (MHz)	Video Carrier (MHz) Sound Carrier (MHz)
	-----800-----	
69		801.25 805.75
	-----806-----	
70 (*)		807.25 811.75
	-----812-----	
71		813.25 817.75
	-----818-----	
72		819.25 823.75
	-----824-----	
73		825.25 829.75
	-----830-----	
74		831.25 835.75
	-----836-----	
75		837.25 841.75
	-----842-----	
76		843.25 847.75
	-----848-----	
77		849.25 853.75
	-----854-----	
78		855.25 859.75
	-----860-----	
79		861.25 865.75
	-----866-----	
80		867.25 871.75
	-----872-----	
81		873.25 877.75
	-----878-----	
82		879.25 883.75
	-----884-----	
83		885.25 <b>889.75</b>
	-----890-----	

(\*) Channels 70 to 83 were withdrawn and reassigned to TV translator station until licenses expire. License renewals will be granted only a secondary basis for land mobile radio operation.

FREQUENCIES IN USE AROUND THE WORLD IN THE AERONAUTICAL MOBILE BANDS

WORLD AIR ROUTE AREA	FREQUENCY ALLOCATION (kHz)						
Alaska	2945	3411.5	4668.5	5611.5	6567		11,328
Hawaii		3453.5		5559	6649.5		
West Indies	2861		4689.5				
Central East Pacific		3432.5 3446.5 3467.5 3481.5		5551.5 5604	6612 6679.5	8879.5 8930.5	10,048 10,084 11,299.5 11,318.5
Central West Pacific	2966			5506.5 5536.5		8862.5	13,354.5 17,906.5
North Pacific	2987			5521.5		8939	13,274.5 17,906.5
South Pacific	2945			5641.5		8845.5	13,344.5 17,946.5
North Atlantic	2868 2931 2945 2987			5611.5 5626.5 5641.5 5671.5		8862.5 8888 8913.5 8947.5	13,264.5 13,284.5 13,324.5 13,354.5 17,966.5
Europe	2889 2910	3467.5 3481.5	4654.5 4689.5	5551.5	6552 6582	8871 8930.5	11,299.5 17,906.5
North-South America	2889 2910 2966	3404.5	4696.5	5566.5 5581.5	6567 6664.5	8820 8845.5 8871	11,290 11,337.5 17,916.5
Far East	2868 2987			5611.5 5671.5		8871 8879.5 8930.5	13,284.5 13,324.5 17,966.5
South Atlantic	2875	3432.5			6597 6612 6679.5	8879.5 8939	10,048 13,274.5 17,946.5
Middle East		3404.5 3446.5		5604	6627	8845.5	10,021 13,334.5 17,926.5
North-South Africa	2966	3411.5		5506.5 5521.5		8820 8956	13,304.5 13,334.5 17,926.5 17,946.5
Caribbean	2875 2952 2966			5499 5566.5 5619	6537	8837 8871	10,021 13,294.5 13,344.5 17,936.5
Canada	2973			5499		8871	11,356.5

**FREQUENCIES USED BY SHIP AND SHORE STATIONS**

Band (MHz)	SHIP STATIONS		SHORE STATIONS
	Calling Frequencies (kHz)	Working Frequencies (kHz)	(Approximate Limits)
2	2065 - 2107	Same as calling	2000 - 2065
4	4178 - 4186	4161 - 4176 4188 - 4236	4240 - 4400
6	6267 - 6279	6241 - 6264 6282 - 6355	6362 - 6523
8	8356 - 8372	8322 - 8352 8376 - 8473	8478 - 8742
12	12,534 - 12,558	12,474 - 12,528 12,564 - 12,709	12,714 - 13,128
16	16,712 - 16,744	16,626 - 16,704 16,752 - 16,946	16,950 - 17,285
22	22,225 - 22,265	22,151 - 22,217 22,272 - 22,395	22,400 - 22,670

**INTERNATIONAL AMPLITUDE-MODULATION BROADCASTING FREQUENCIES**

5.950- 6.200 MHz  
 9.500- 9.775  
 11.70 - 11.975  
 15.10 - 15.45  
 17.70 - 17.90  
 21.45 - 21.75  
 25.60 - 26.10

**AMATEUR RADIO FREQUENCIES**

1800 - 2000 kHz	3.300 - 3.500 GHz
3.500 - 4.000 MHz	5.650 - 5.925
7.000 - 7.300	10.00 - 10.50
14.00 - 14.35	24.00 - 24.25
21.00 - 21.45	48.00 - 50.00
28.00 - 29.70	71.00 - 84.00
50.00 - 54.00	152.0 - 170.0
144.0 - 148.0	200.0 - 220.0
220.0 - 225.0	240.0 - 250.0
420.0 - 450.0	Above 275.0
1215 - 1300	
2300 - 2450	

**CITIZENS RADIO (PERSONAL RADIO) FREQUENCIES**

26.96 27.23 MHz  
 462.5375-462.7375  
 467.5375-467.7375

COMMONLY USED LETTER-CODE DESIGNATIONS FOR MICROWAVE FREQUENCY BANDS

<i>Band</i>	<i>Frequency</i>	<i>Wavelength</i>	<i>Typical Use</i>
P	225– 390 MHz	133.3– 76.9 cm	Long range (over 200 miles) to very long range (beyond 1,000 miles) surface-to-air search.
L	390–1550 MHz	76.9– 19.3 cm	Very long through medium range surface-to-air missile and aircraft detection, tracking and air traffic control, IFF transponders, beacon systems.
S	1.55– 5.2 GHz	19.3– 5.77 cm	Medium and long range surface-to-air surveillance, surface-based weather radar, altimetry, missile-borne guidance, airborne bomb-navigation systems.
C	3.9 – 6.2 MHz	7.69– 4.84 cm	Airborne fire control, missile-borne beacons, recon, airborne weather avoidance, aircraft and missile target tracking.
X	5.2–10.9 MHz	5.77– 2.75 cm	Doppler navigation, airborne fire control, airborne and surface-based weather detection, bomb-navigation systems, missile-borne guidance, precision landing approach.
K	10.9– 36 GHz	2.75–0.834 cm	Doppler navigation, automatic landing systems, airborne fire control, radar fuzing, recon, missile-borne guidance.
Q	36– 46 GHz	0.834–0.652 cm	Recon, airport surface detection.
V	46– 56 GHz	0.652–0.536 cm	High-resolution experimental shortrange systems.

**CTCS (CONTINUOUS TONE CODED SQUELCH) AND REMOTE CONTROL STANDARD FREQUENCY TABLE**

The EIA Standard Tone Frequencies for remote (i.e., radio paging) and control applications have been established to allow adequate separation and minimum harmonic relationship for use in multiple frequency systems.

For optimum system performance it is best to choose the widest frequency spacing possible within the recommended range.

<i>Frequency</i> Hz	<i>EIA</i> <i>Code</i>	<i>Frequency</i> Hz	<i>EIA</i> <i>Code</i>	<i>Frequency</i> Hz	<i>EIA</i> <i>Code</i>
67.0	L 1	258.8	136	651.9	153
71.9	L 2	266.0	106	669.9	123
77.0	L 3	273.3	137	688.3	154
82.5	L 4	280.8	107	707.3	124
88.5	L 4A	288.5	138	726.8	155
94.8	L 5	296.5	108	746.8	125
100.0	1	304.7	139	767.4	156
103.5	1A	313.0	109	788.5	126
107.2	1B	321.7	140	810.2	157
110.9	2	330.5	110	832.5	127
114.8	2A	339.6	141	855.2	158
118.8	2B	349.0	111	879.0	128
123.0	3	358.6	142	903.0	159
127.3	3A	368.5	112	928.1	129
131.8	3B	378.6	143	953.7	160
136.5	4	389.0	113	979.9	130
141.3	4A	399.8	144	1006.9	161
146.2	4B	410.8	114	1049.6	131
151.4	5	422.1	145	1084.0	P
156.7	5A	433.7	115	1120.0	S11
162.2	5B	445.7	146	1190.0	S12
167.9	6	457.9	116	1220.0	S2
173.8	6A	470.5	147	1265.0	S14
179.9	6B	483.5	117	1291.4	S3
186.2	7	496.8	148	1320.0	S15
192.8	7A	510.5	118	1355.0	S16
203.5	M1	524.6	149	1400.0	S17
210.7	M2	539.0	119	1430.5	S7
218.1	M3	553.9	150	1450.0	S18
225.7	M4	569.1	120	1500.0	S20
233.6	M5	582.1	H	1520.0	S9
241.8	M6	600.9	121	1550.0	S21
250.3	M7	617.4	152	1600.0	S22
		634.5	122		

## ULTRASONIC TRANSDUCER MATERIALS

The table lists the ultrasonic transducer materials used in instrumentation, sensing and power applications.

Piezoelectric Transducers				
Material	Frequency Range	Maximum Safe Operating Temperature	Typical Applications	
Quartz	100 kHz – 35 + MHz	550°C	Medical and non-destructive testing	
Barium Titanate	100 kHz – 10 MHz	100°C	Most cleaning and processing applications	
Lead Zirconate Lead Titanate	5 kHz – 10 MHz	320°C	Most cleaning and processing applications, (high temperature uses)	
Rochelle Salt	20 Hz – 1 MHz	45°C	Sonar and depth finding	
Magnetostrictive Transducers				
Nickel	10 kHz – 100 kHz	—	Cleaning, drilling, machining, soldering, melt treatment, and applications where transducer has pressure applied	
Vanadium Permendur	10 kHz – 100 kHz	—	Same as nickel	

## ULTRASONIC FREQUENCY SPECTRUM

Ultrasonic Frequency Spectrum

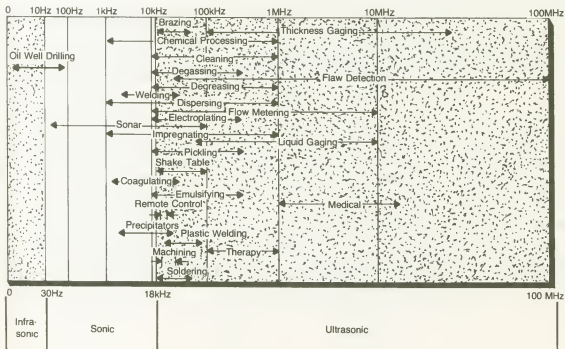

## NBS STANDARD FREQUENCY AND TIME BROADCAST SCHEDULES

The diagrams presented here, with explanatory notes, summarize the technical services provided by the National Bureau of Standards (NBS) radio stations WWV, WWVH, WWVB, and WWVL.

### WWV and WWVH Broadcast Services

**Standard Radio Frequencies.** WWV and WWVH transmit frequencies and time coordinated through the Bureau International de l'Heure (BIH), Paris, France. Transmissions are based upon the International time scale, Universal Coordinated Time (UTC).

WWV broadcasts continuously on radio carrier frequencies of 2.5, 5, 10, 15, 20, and 25 MHz. WWVH broadcasts continuously on radio carrier frequencies of 2.5, 5, 10, 15 and 20 MHz.

The broadcasts of WWV may also be heard via telephone by dialing (303) 499-7111, Boulder, Colorado.

**Standard Audio Frequencies.** Standard audio frequencies of 440 Hz, 500 Hz, and 600 Hz are broadcast on each radio carrier frequency by the two stations. Duration of each transmitted standard tone is approximately 45 seconds. A 600-Hz tone is broadcast during odd minutes by WWV and during even minutes by WWVH. A 500-Hz tone is broadcast during alternate minutes unless voice announcements or silent periods are scheduled. The 440-Hz tone is broadcast beginning one minute after the hour at WWVH and two minutes after the hour at WWV. The 440-Hz tone period is omitted during the first hour of the UTC day.

**Standard Musical Pitch.** The 440-Hz tone is broadcast for approximately 45 seconds beginning 1 minute after the hour at WWVH and 2 minutes after the hour at WWV. The tone is omitted during the zero hour of each UTC day.

**Standard Time Intervals.** Seconds pulses at precise intervals are derived from the same frequency standard that controls the radio carrier frequencies. Every minute, except the first of the hour, begins with a 800-millisecond tone of 1,000 Hz at WWV and 1,200 Hz at WWVH. The first minute of every hour begins with an 800-millisecond tone of 1,500 Hz at both stations.

The 1-second markers are transmitted throughout all programs of WWV and WWVH except that the 29th of the 59th markers of each minute are omitted.

**Time Signals.** The time announcements of WWV and WWVH reference the Coordinated Universal Time Scale maintained by the National Bureau of Standards, UTC(NBS).

The 0 to 24 hour system is used starting with 0000 for midnight at the Greenwich Meridian (longitude zero). The first two figures give the hour, and the last two figures give the number of minutes past the hour when the tone returns.

At WWV a voice announcement of Greenwich Mean Time is given during the 7.5 seconds immediately preceding the minute.

At WWVH a voice announcement of Greenwich Mean Time occurs during the period 15 seconds to 7.5 seconds preceding the minute. The voice announcement for WWVH precedes that of WWV by 7.5 seconds. However, the tone markers referred to in both announcements occur simultaneously.

**Propagation Forecasts.** A forecast of radio propagation conditions is broadcast in voice from WWV at 14 minutes after every hour. The announcements are short-term forecasts and refer to propagation along paths in the North Atlantic area, such as Washington, D.C. to London or New York to Berlin.

The propagation forecast announcements are repeated in synoptic form comprised of a phonetic and a numeral. The phonetic (Whiskey, Uniform, or November) identifies the radio quality at the time the forecast is made. The numeral indicates on a scale of 1 to 9 the radio propagation quality expected during the six-hour period after the forecast is issued. The meaning of the phonetics and numerals are:

<i>Phonetic</i>	<i>Meaning</i>
Whiskey	disturbed
Uniform	unsettled
November	normal

<i>Numeral</i>	<i>Meaning</i>
One	useless
Two	very poor
Three	poor
Four	poor-to-fair
Five	fair
Six	fair-to-good
Seven	good
Eight	very good
Nine	excellent

If, for example, propagation conditions are normal and expected to be good during the next six hours, the coded forecast announcement would be "November Seven."

**Geophysical Alerts.** Current geophysical alerts (Geoalerts) as declared by the World Warning Agency of the International Ursigram and World Days Service (IUWDS) are broadcast in voice from WWV at 18 minutes after each hour and from WWVH at 45 minutes after each hour.

**Weather Information.** Weather information about major storms in the Atlantic and Pacific areas is broadcast from WWV and WWVH respectively.

**Time Code.** The time code is transmitted continuously by both WWV and WWVH on a 100-Hz subcarrier. The code format is a modified IRIG-H time code produced at a 1-pps rate and carried on 100-Hz modulation. The 100-Hz subcarrier is synchronous with the code pulses so that 10-millisecond resolution is readily obtained.

The code contains UTC time-of-year information in minutes, hours, and day of year. Seconds information may be obtained by counting pulses.

The binary coded decimal (BCD) system is used. Each minute contains seven BCD groups in this order: two groups for minutes, two groups for hours, and three groups for day of year. The code digit weighting is 1-2-4-8 for each BCD group multiplied by 1, 10, or 100 as the case may be. A complete time frame is 1 minute. The binary groups follow the 1-minute reference marker.

**Modulation.** At WWV and WWVH, double sideband amplitude modulation is employed with 50 percent modulation on the steady tones, 25 percent for the IRIG-H code, 100 percent for seconds pulses, and 75 percent for voice.

#### **WWVB Broadcast Services**

WWVB transmits a standard radio frequency, standard time signals, time intervals, and UT1 corrections. The station is located near WWV on the same site.

**Program.** WWVB broadcasts a standard radio carrier frequency of 60 kHz with no offset. It also broadcasts a time code consistent with the internationally coordinated time scale UTC(NBS).

#### **WWVL Experimental Broadcasts**

WWVL broadcasts experimental programs, usually involving multiple frequencies. The station is located in the same building with WWVB and on the same site with WWV.

Effective On UTC, 1 July 1972, regularly scheduled transmissions from WWVL were discontinued. Contingent upon need and availability of funds this station broadcasts experimental programs on an intermittent basis only.

WWVL transmits only carrier frequencies with no modulation. The format and frequencies used by WWVL are subject to change to meet the requirements of the particular experiment being conducted.



# WWV Broadcast Format

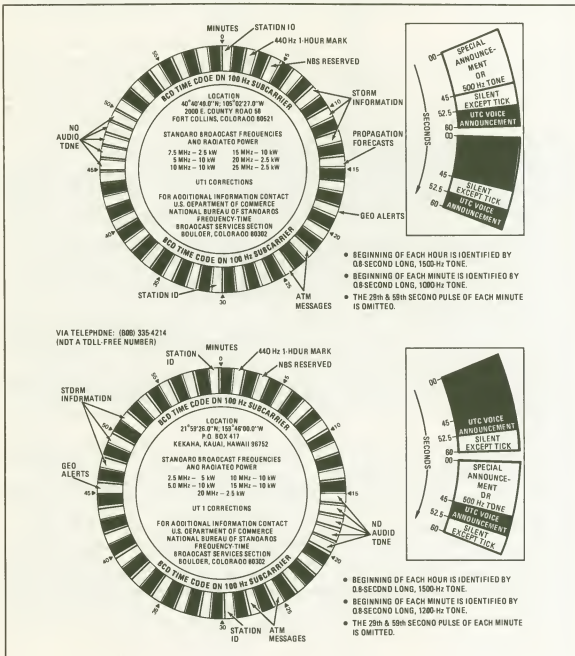

## WAVELENGTH-FREQUENCY CONVERSION SCALE

This scale is based on the formula

$$\lambda_m = \frac{300}{f_{MHz}}$$

It shows the relationship between free space wavelength  $\lambda$  and frequency  $f$  and covers a frequency range extending from 300 Hz to 300 GHz, corresponding to wavelengths of 1000 m (1 km) to 1 mm.

FOR EXAMPLE: A 60-MHz signal has a wavelength of 5 m. A signal whose wavelength is 3 mm has a frequency of 100 GHz.

Frequency    Wavelength  
GHz – millimeter (mm)  
MHz – meter (m)  
kHz – kilometer (km)



## Section 2

# Communication





- Propagation Characteristics of Electromagnetic Waves / 20
- Communication Modes / 21
- International Television Standards / 22
- Free Space Transmission Nomogram / 24
- Signal-Strength Nomogram / 25
- Nomogram Relating Transmitter Output, Transmission Loss, and Receiver Input / 26
- Receiver Bandwidth-Sensitivity-Noise Figure Nomogram / 27
- Line-of-Sight Transmission Range Nomogram Showing the Approximate Transmission Range of Signals in the VHF Band / 28
- Radar Power-Energy Nomogram / 29
- Types of Radar Indicators / 30
- Antenna Reference Chart / 32
- Microwave Antenna Chart / 36
- Antenna Effectiveness Nomogram / 37
- Transmission Line Characteristics / 38
- Characteristic Impedance of Balanced Two-Wire Lines / 39
- Characteristics of Coaxial Cables / 40
- Ultra-High Frequency Half-Wave Shorting-Stub Nomogram / 42
- Transmission Line Nomogram / 43
- Slotted-Line Width-of-Minimum VSWR Nomogram / 44
- Slotted Line Width-of-Minimum Attenuation Calculation Nomogram / 45
- Waveguide Nomogram / 46
- VSWR Nomogram / 47
- VSWR Reduction as a Result of Attenuation / 48
- Doppler to Speed Conversion Nomogram / 49
- Doppler Frequency Nomogram / 50
- Graph for Adding Two In-Phase Signals / 52
- Graph for Separating Signal Power from Noise Power / 53
- Field Power Conversion Chart / 54
- Q Signals (Mnemonic Code) / 55
- Radio Telephone Code / 59
- International Morse Code / 59
- Signal Reporting Codes / 60
- Commercial Radio Operator and Amateur Operator Licenses Requirements / 62
- International Phonetic Alphabet / 65
- ARRL (American Radio Relay League) Word List for Voice Communication / 65
- Transmission Travel Time / 65
- Classification of Emissions / 66
- Microphone Output Nomogram / 68

## PROPAGATION CHARACTERISTICS OF ELECTROMAGNETIC WAVES

Band	Frequency (Wavelength)	Characteristics	Applications
Very-low frequency (VLF)	20-30 kHz (20,000-10,000 m)	Very stable; low attenuation at all times. Influenced by magnetic storms. Ground wave extends over long distances. (No fading out long-time variations occur.)	Continuously operating long-distance station-to-station communication service.
Low frequency (LF)	30-300 kHz (10,000-1,000 m)	Seasonal and daily variations greater than that of VLF; daytime absorption also greater, increasing with frequency. At night similar to VLF although slightly less reliable.	Long-distance station-to-station service (marine, navigational aids).
Medium frequency (MF)	300-3,000 kHz (1,000-100 m)	Less reliable over long distances than lower frequencies. Attenuation: low at night, high in daytime; greater in summer than in winter. Low attenuation at night is due to sky-wave reflection. Ground-wave attenuation is relatively high over land and low over salt water.	Commercial broadcasting police, marine and airplane navigation.
High frequency (HF)	3-30 MHz (100-10 m)	Dependent on ionospheric conditions, leading to considerable variation from day to night and from season to season. Attenuation low under favorable conditions, and high under unfavorable conditions, at medium to very long distances.	Medium and long-distance communication service of all types.
Very-high frequency (VHF)	30-300 MHz (10-1 m)	30-60 MHz sometimes affected by ionosphere. Quasi-optical transmission (similar to light, but subject to diffraction by surface of the earth).	Television, FM commercial broadcasting, radar airplane navigation, short-distance communications.
Ultra-high frequency (UHF)	300-3,000 MHz (100-10 cm)	Substantially same as above; slightly less diffraction. Under abnormal conditions, can be refracted by troposphere similar to sky-wave refraction. This often results temporarily in abnormally long ranges of transmission.	Television, radar, microwave relay, short-distance communications.
Super-high frequency (SHF)	3,000-30,000 MHz (10-1 cm)	Same as above. 1-cm range has broad water-vapor absorption band (slight O <sub>2</sub> absorption).	Radar, microwave relay, short distance communications.

## COMMUNICATION MODES

Principal ground-to-ground communication modes, utilizing the microwave (70 MHz to 20 GHz) region of the spectrum. Characteristically wide-band (100 kHz to 20 MHz) service.

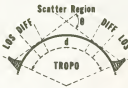
 <p style="text-align: center;"><b>LINE OF SIGHT (LOS)</b></p>	<p>0 to 35 miles, depending on (h).</p>	<p>0.1 to 10W, two to 10-ft antennas</p>	<p>Low-cost, high-performance wide-band system; replaces costly right-of-way mainte- nance of coaxial or multiple cable or overhead wiring.</p>
 <p style="text-align: center;"><b>LOS Space Communications</b></p>	<p>upto 1/2 circum- ference of earth depending on satellite orbit and (<math>\Theta</math>)</p>	<p>1 to 15 kW, 30 to 85-ft antennas</p>	<p>Only practical system of global coverage using three active synchronous satellites (22,000 miles from earth) or a number of orbiting satel- lites (dependent on distance covered and altitude) in con- junction with multiple earth earth stations.</p>
 <p style="text-align: center;"><b>DIFFRACTION (Plane Surface)</b></p>	<p>30 to 70 miles, depending on (h) and (<math>N_B</math>)</p>	<p>0.1 to 100W, six to 28-ft antennas</p>	<p>Diffraction mode is very specialized form of UHF used only rarely where rugged terrain prevents use of direct LOS and permits longer path with obstacle gain.</p> <p>Great attention is being given to refining propagation computation in the diffrac- tion region because of need for utilization in tropo path predictions.</p>
 <p style="text-align: center;"><b>DIFFRACTION (Knife Edge)</b></p>	<p>30 to 120 miles, depending on (h), (<math>N_B</math>) and (<math>G_O</math>)</p>	<p>0.1 to 100W, six to 28-ft antennas</p>	
 <p style="text-align: center;"><b>DIFFRACTION (Rough Surface)</b></p>	<p>30 to 120 miles, depending on (h), (<math>N_B</math>), (<math>G_O</math>), and (<math>A_O</math>)</p>	<p>0.1 to 100W, six to 28-ft antennas</p>	
 <p style="text-align: center;"><b>Scatterer Region</b> <b>LOS DIFF</b> <math>\theta</math> <b>DIFF LOS</b> <b>TROPO</b></p>	<p>70 to 600 miles, depending on many factors</p>	<p>1 to 100 kW, 10 to 120-ft antennas, refined modula- tion and receiver techniques</p>	<p>Only practical wide-band, reliable ground-based method of achieving 70 to 600 mile hop where unsuitable inter- vening territory prevents use of LOS or diffraction modes.</p>

(h) = height of antenna center  
( $N_B$ ) = refractive index  
( $G_O$ ) = obstacle gain

( $A_O$ ) = obstacle absorption  
( $d$ ) = distance between stations  
( $\theta$ ) = scatter angle or angle of elevation

## INTERNATIONAL TELEVISION STANDARDS

This table outlines pertinent characteristics of the current TV standards used throughout the world. The video frequency-channel arrangements are also shown. The systems have been designated by letter and are in use or proposed for use in the countries listed.

Country	Standard Used <sup>c</sup>	Country	Standard Used <sup>c</sup>
Argentina	N	Mexico	M
Australia	B, G	Monaco	E, G
Austria	B, G	Morocco	B
Belgium	C, H	Netherlands	B, G
Brazil	M	Netherlands Antilles	M
Bulgaria	D, K	New Zealand	B
Canada	M	Nigeria	B
Chile	M	Norway	B
China	D	Pakistan	B
Colombia	D, M	Panama	M
Cuba	M	Peru	M
Czechoslovakia	D	Philippines	M
Denmark	B	Poland	D
Egypt	B	Portugal	B, G
Finland	B, G	Rhodesia	B
France	E, L	Romania	K
Germany (East)	B	Saudi Arabia	B
Germany (West)	B, G	Singapore	B
Greece	B, I	South Africa	I
Hong Kong	B, I	Spain	B, G
Hungary	D, K	Sweden	B, G
India	B	Switzerland	B, G
Iran	B	Turkey	B
Ireland	A	United Kingdom	A, I
Israel	B	United States of America	M
Italy	B, G	Union of Soviet Socialist Republics	D
Japan	M	Uruguay	N
Korea	C, L	Yugoslavia	B, G
Luxembourg	F		

<sup>c</sup>Letter designations correspond to those in the following table.

	A	M	N	B	C	G	H	I	D, K	L	F	E
Lines/frame	405	525	625	625	625	625	625	625	625	625	819	819
Fields/sec	50	60	50	50	50	50	50	50	50	50	50	50
Interlace	2/1	2/1	2/1	2/1	2/1	2/1	2/1	2/1	2/1	2/1	2/1	2/1
Frames/sec	25	30	—	25	25	25	25	25	25	25	25	25
Lines/sec	10 125 15 750	—	—	15 625 15 625 15 625	15 625 15 625 15 625	15 625 15 625 15 625	15 625 15 625 15 625	15 625 15 625 15 625	15 625 15 625 15 625	20 475 20 475	20 475	
Aspect ratio <sup>1</sup>	4/3	4/3	—	4/3	4/3	4/3	4/3	4/3	4/3	4/3	4/3	4/3
Video band (MHz)	3	4.2	4.2	5	5	5	5	5.5	6	6	5	10
RF band (MHz)	5	6	6	7	7	8	8	8	8	8	7	14
Visual polarity <sup>2</sup>	+	—	—	—	+	—	—	—	—	+	+	+
Sound modulation	A3	F3	—	F3	A3	F3	F3	F3	F3	F3	A3	A3
Pre-emphasis in microseconds	—	75	—	50	50	50	50	50	50	—	50	—
Deviation (kHz)	—	25	—	50	—	50	50	50	50	—	—	—
Gamma of picture signal	0.45	0.45	—	0.5	0.5	0.5	0.5	0.5	0.5	0.5	0.5	0.6

Notes:

<sup>1</sup> In all systems the scanning sequence is from left to right and top to bottom.

<sup>2</sup> All visual carriers are amplitude modulated. Positive polarity indicates that an increase in light intensity causes an increase in radiated power. Negative polarity (as used in the US—Standard M) means that a decrease in light intensity causes an increase in radiated power.

FREQUENCY RELATIVE TO THE  
VIDEO CARRIER FREQUENCY

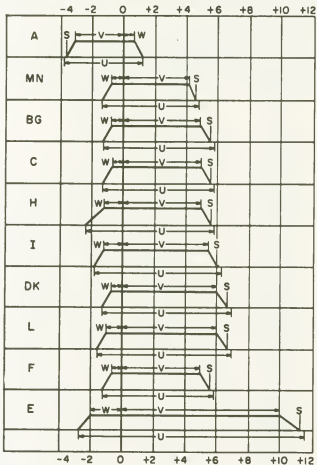

**S** = SOUND CARRIER  
**U** = LIMITS OF RADIO-FREQUENCY CHANNEL  
**V** = NOMINAL WIDTH OF MAIN SIDEBAND  
**W** = NOMINAL WIDTH OF VESTIGIAL SIDEBAND



### FREE SPACE TRANSMISSION NOMOGRAM

This nomogram relates receiver-transmitter distance, wavelength and free space attenuation. It can also be used to convert between nautical and statute miles and between frequency and wavelength.

FOR EXAMPLE: A signal from a 200-MHz transmitter will be attenuated 125 dB before it reaches a receiver located 100 nautical miles away.

At a distance of 200 nautical miles, and a system gain of 130 dB, the highest usable frequency is 180 MHz.

The maximum distance between a transmitter-receiver-antenna system with a total gain of 125 dB operating at 500 MHz is 45 statute miles.

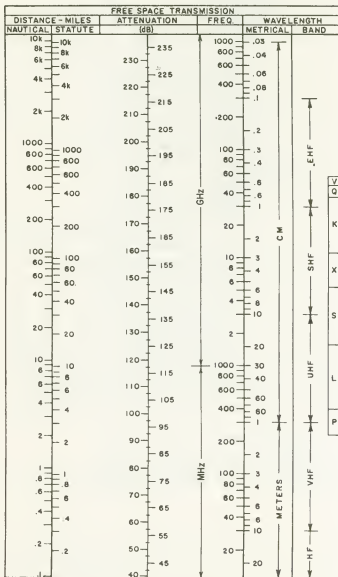

## SIGNAL-STRENGTH NOMOGRAM

This nomogram is used to compute signal-strength input at the receiver based on a formula that converts field intensity at the receiving antenna to receiver input voltage.

If field intensity  $\epsilon$ , in microvolts per meter, of a given signal  $f$ , in MHz, is known, the signal strength  $E_r$ , in microvolts, is determined for an input impedance of 50 ohms ( $E_r$  in  $\mu V$  for  $R = 50$ ) and may be adjusted for any value of input impedance between 30 and 5000 ohms ( $E_r$  in  $\mu V$  for  $30 \leq R \leq 5,000$ ). An isotropic antenna, no-loss transmission line is assumed.

Signal strength for receiving antennas of gain  $> 1$  (0 dB) are solved first by finding from the chart the voltage input for a system with an isotropic antenna and then adjusting the answer using the relation:  $G = 20 \log (E'_r / E_r)$  where  $G$  is the gain of the antenna referred to isotropic;  $E'_r$  is the voltage input to be found; and  $E_r$  is the voltage input.

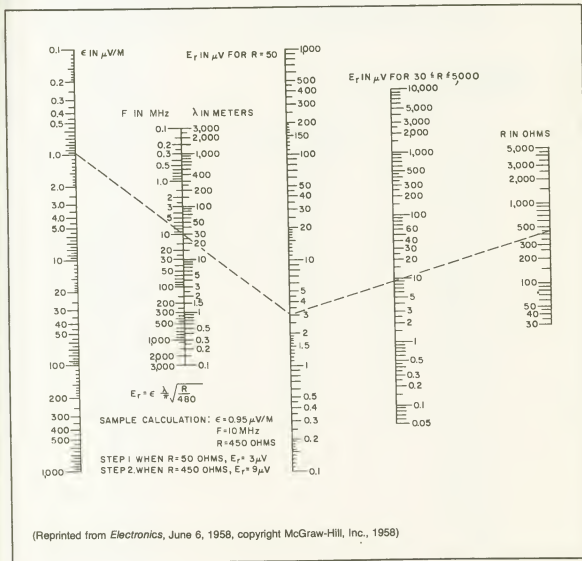

(Reprinted from *Electronics*, June 6, 1958, copyright McGraw-Hill, Inc., 1958)

### NOMOGRAM RELATING TRANSMITTER OUTPUT, TRANSMISSION LOSS, AND RECEIVER INPUT

This nomogram shows the available input voltage (microvolts into 50 ohms), if transmitter output in watts and transmission loss in decibels are known. It can also show the maximum permissible transmission loss if transmitter power and receiver requirements are given, or it can be used to determine the required transmitter output for a given transmission loss and receiver input voltage. Microvolts (into 50 ohms) may be directly converted to dBm on the left scale and watts may be converted to dBm on the center scale.

FOR EXAMPLE: (1) For a transmitter output of 5W and a transmission loss of 90 dB, the receiver input will be 500  $\mu$ V. (2) For a minimum of 50  $\mu$ V at the receiver, and a transmitter output of 5W, the transmission loss may not exceed 110 dB.

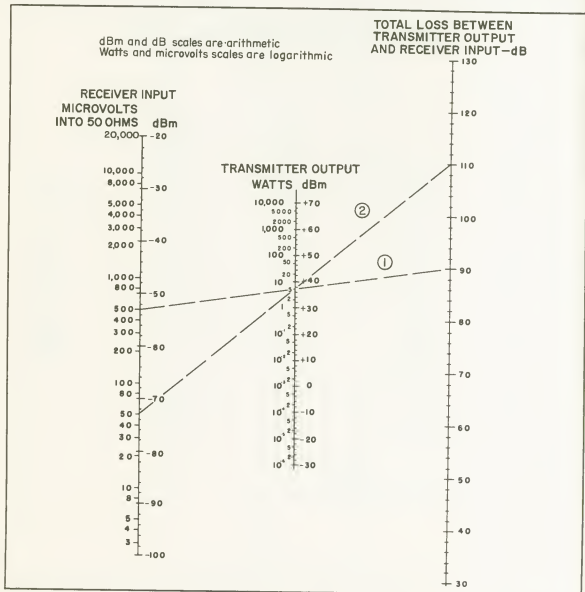

## RECEIVER BANDWIDTH-SENSITIVITY-NOISE FIGURE NOMOGRAM

This nomogram is based on the noise figure of a receiver as given by the equation:

$$NF = \frac{(mE_o \sqrt{P_n/P_s})^2}{2R(4KT\Delta f)}$$

where  $NF$  = noise figure;  $m$  = modulation index;  $P_n$  = noise power;  $P_s$  = signal power;  $K$  = Boltzmann's constant or  $1.38 \times 10^{-23}$  joules/ $^\circ K$ ;  $R$  = antenna resistance;  $T$  = degrees Kelvin;  $\Delta f$  = 6-dB audio bandwidth, and  $E_o$  = signal generator output in  $\mu V$ .

Nominal antenna impedance is 52 ohms and the temperature can be approximated at 300 $^\circ K$ .

To find the noise figure of a receiver, it is only necessary to place a straightedge across the sensitivity and audio bandwidth points, extending it to intersect the noise figure line.

FOR EXAMPLE: Sensitivity of 10  $\mu V$  and bandwidth of 6 kHz gives a noise figure of 100, or 20 dB.

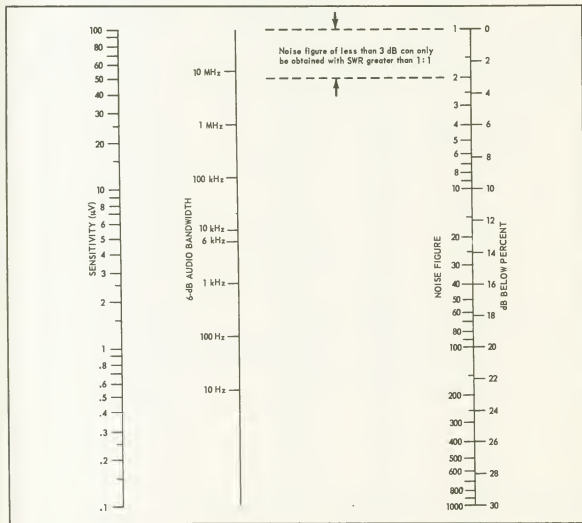

**LINE-OF-SIGHT TRANSMISSION RANGE NOMOGRAM SHOWING  
THE APPROXIMATE TRANSMISSION RANGE OF SIGNALS IN THE VHF BAND**

The theoretical maximum distance that can be covered is equal to the geometrical or "optical" horizon distance of each antenna, and is defined by the formula  $D = 1.23 \sqrt{H_r} + 1.23 \sqrt{H_t}$ , where  $D$  is in miles and  $H_r$  and  $H_t$  are the height in feet, above effective ground level, of the receiving and transmitting antennas. Atmospheric diffraction increases the distance by a factor of  $2 \sqrt{3}$  which defines the "radio" path under normal or standard diffraction, by the formula  $D = 1.41 \sqrt{H_r} + 1.41 \sqrt{H_t}$ .

FOR EXAMPLE: With a receiving antenna height of 30 ft and a transmitting antenna height of 100 ft, the "optical" horizon is 19 miles and the "radio" horizon is 21.5 miles.

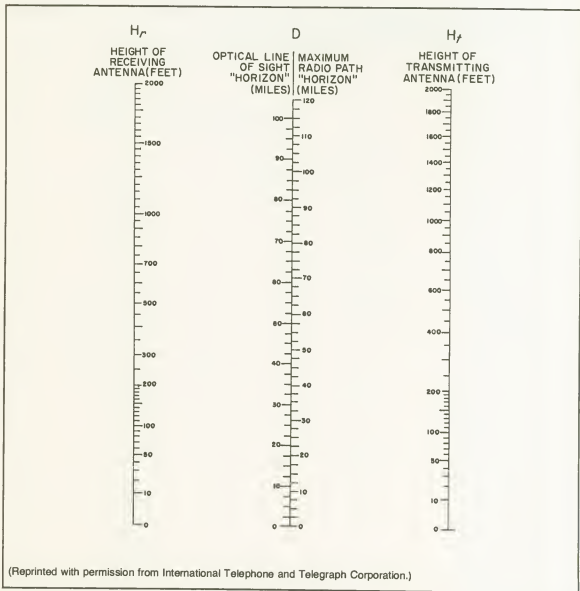

## RADAR POWER-ENERGY NOMOGRAM

The energy available from a radar transmitter is often the limiting factor in determining the maximum free space range. This nomogram relates the four interdependent radar equations involving peak power, average power, energy, duty cycle, pulse width, pulse repetition rate and pulse interval based on the following equations:

$$\frac{P_{AV}}{P_P} = d = \tau f, \text{ and } P_P \tau = E = P_{AV} t$$

- where  $P_P$  = peak power in watts  
 $P_{AV}$  = average power  
 $E$  = energy in joules  
 $d$  = duty cycle  
 $\tau$  = pulse width in microseconds  
 $f$  = pulse repetition rate in pulses /sec  
 $t$  = pulse interval in microseconds

FOR EXAMPLE: A pulse repetition rate of 1,000 pulses /sec with a pulse width of  $5 \mu$  sec will give a duty cycle of 0.005. For a peak power of 100 kW, join this value on the  $P_P$  scale with 0.005 on the duty-cycle scale and read an average power of 500 W. Joining the 100 kW point with the pulse width of  $5 \mu$  sec shows the energy as 0.5 J. (To crosscheck, connect the average power of 500 W with 1,000 pps rep rate, which also yields 0.5 J.)

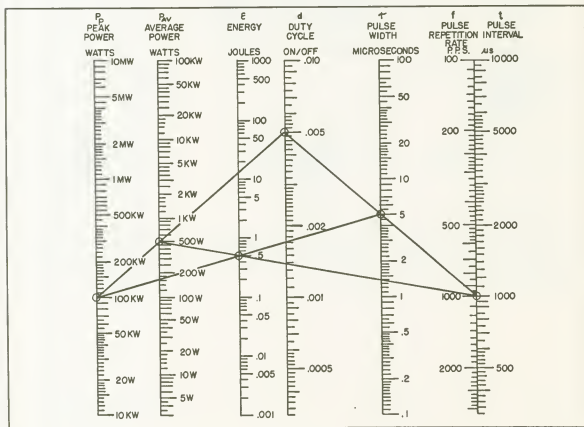

# TYPES OF RADAR INDICATORS

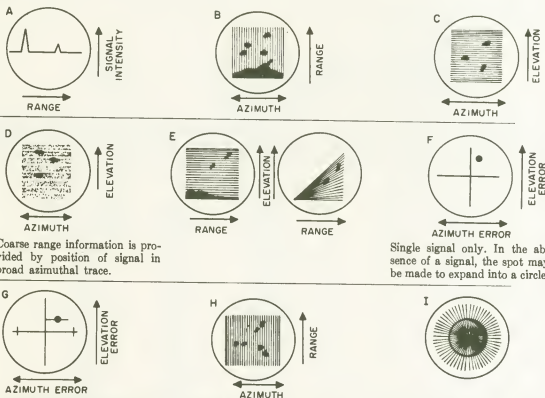

Coarse range information is provided by position of signal in broad azimuthal trace.

Single signal only. In the absence of a signal, the spot may be made to expand into a circle.

Single signal only. Signal appears as "wingspot," position giving azimuth and elevation errors. Length of wings inversely proportional to range.

Signal appears as two dots. Left dot gives range and azimuth of target. Relative position of right dot gives rough indication of elevation.

Antenna scan is conical. Signal is a circle, the radius proportional to range. Brightest part indicates direction from axis of cone to target.



Same as type A, except time base is circular, and signals appear as radial pips.

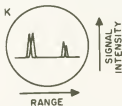

Type A with lobe-switching antenna. Spread voltage splits signals from two lobes. When pips are of equal size, antenna is on target.

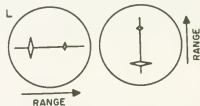

Same as type K, but signals from two lobes are placed back to back.



Type A with range step or range notch. When pip is aligned with step or notch, range can be read from a dial or counter.

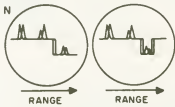

A combination of type K and type M.



Range is measured radially from the center.



## ANTENNA REFERENCE CHART

Antennas may be classified as linear radiators or elements, apertures, and traveling wave types. Basic information on a few types of antennas is tabulated. For each type the following is given: the antenna name, physical size in wavelengths, a line drawing superimposed on coordinate axis, the impedance  $R$  in ohms at the resonant frequency  $f_r$ , the half-power (3 dB) bandwidth in percent, the gain in dB above an isotropic radiator, as well as the conventional half-wavelength dipole, the polarization for the given configuration, and a set of Fraunhofer Zone field strength patterns for each of the three orthogonal planes of the axis system shown.

An isotropic radiator is given, even though such an antenna for electromagnetic waves does not exist. It is a convenient and frequent reference, however, for gain and pattern measurements.

The antennas tabulated may be vertically or horizontally polarized radiators. The configuration shown in the chart is the one most frequently used in practice. The antennas listed may be fed by balanced transmission lines, by coaxial lines and a balun (balanced-to-unbalanced transformer) when necessary, or in some cases by waveguides. Aperture antennas, such as parabolic dishes and horns, are usually fed by waveguides and, for such feed systems, impedance is not too meaningful.

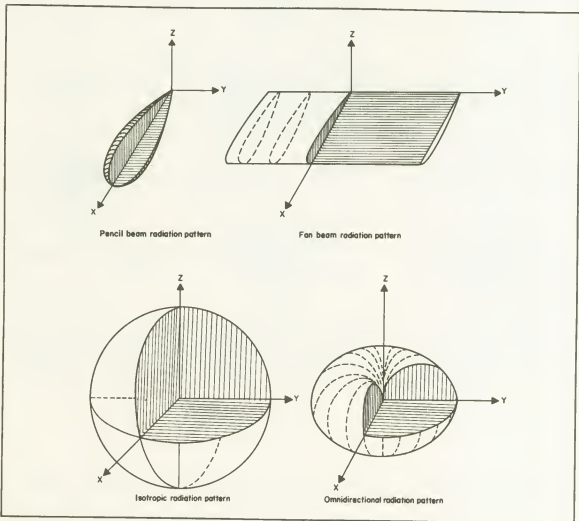

### Broadside Array

$$L = \lambda/2$$

polarization: vertical

Theoretical Gain of Broadside  $\frac{1}{2} \lambda$  elements at different spacings "a".

Spacing in wavelengths "a"	Gain, dB above Dipole
$\frac{1}{2}$	4.8
$\frac{1}{3}$	4.6
$\frac{1}{2}$	4.0
$\frac{2}{3}$	2.4
$\frac{1}{2}$	1.0
$\frac{1}{3}$	0.3

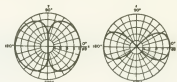

Theoretical Gain of Broadside  $\frac{1}{2} \lambda$  elements for different numbers of elements.

Number of elements	Gain, dB above Dipole
2	4.0
3	5.5
4	7.0
5	8.0
8	9.0

### End Fire Array

$$L = \lambda/2$$

polarization: vertical

Theoretical Gain of Two End Fire  $\frac{1}{2} \lambda$  Elements for Various Spacings "a".

a	Gain, dB above Dipole
$\frac{1}{4}$	1.7
$\frac{1}{2}$	2.2
$\frac{2}{3}$	3.0
$\frac{1}{2}$	3.8
$\frac{1}{20}$	4.1
$\frac{1}{6}$	4.3

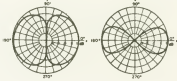

### Parasitic Array

$$L = \lambda/2$$

polarization: horizontal

Number of Elements

Number of Elements	Gain, dB above Dipole	Front to Back Ratio, dB
2	4 to 5.	10 to 15
3	8 to 7	15 to 25
4	7 to 9	20 to 30
5	9	—



### Collinear Array

$$L = \lambda/2$$















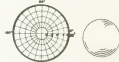



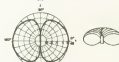

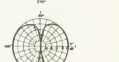

$$b = \lambda/4$$

Spacing "a" between centers of adjacent  $\frac{1}{2} \lambda$  elements

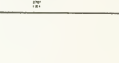
Spacing "a" between centers of adjacent $\frac{1}{2} \lambda$ elements	Number of $\frac{1}{2} \lambda$ elements in array versus gain in dB above a reference Dipole				
	2	3	4	5	8
$a = \frac{1}{2} \lambda$	1.8	3.3	4.5	5.3	8.2
$a = \frac{3}{4} \lambda$	3.2	4.8	8.0	7.0	7.8

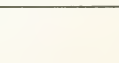

TYPE	CONFIGURATION	IMPEDANCE Resistive at $f_r$ , $R$ , ohms	BANDWIDTH%	GAIN dB above		POLARIZATION	PATTERN #	PATTERN TYPES	
				Isotropic	Dipole				
Isotropic Radiator (theoretical)		—	—	0	-2.14	none	A		
Small Dipole $L < \lambda/2$		very high	very small	1.74	-0.4	H	B	A	
Thin Dipole $L = \lambda/2$ $L/D = 275$		60	34	2.14	0	H	B	B	
Thick Dipole $L = \lambda/2$ $L/D = 51$		49	55	2.14	0	H	B	C	
Cylindrical Dipole $L = \lambda/2$ $L/D = 10$		37	100	2.14	0	H	B	C	
Folded Dipole $L = \lambda/4$ $L/d = 13$		6000	5	1.64	-0.5	H	B	D	
Folded Dipole $L = \lambda/2$ $L/d = 25.5$		300	45	2.14	0	H	B	E	
Cylindrical Dipole $L = \lambda$ $L/D = 9.6$		150	130	3.64	1.5	H	B	E	
Biconical $L = \lambda/2$		72	100	2.14	0	H	B	F	
Biconical $L = \lambda$		350	200	2.14	0	H	B	F	
Turnstile $L = \lambda/2$ $L/d = 25.5$		150	50	-0.86	-3	H	C	G	
Folded Dipole over reflecting sheet $L = \lambda/2$ $L/d = 25.5$ $\lambda/4$ above sheet		150	20	7.14	5	H	D	H	

PATTERN #	POLARIZATION	GAIN db above		3dB BANDWIDTH%	IMPEDANCE Resistive at f, R, ohms	CONFIGURATION	TYPE
		Dipole	Isotrope				
	E V	0	2.14	40	28		Dipole over small ground plane $L = \lambda/4$ $L/D = 53$ $l = 2\lambda$
	E V	0	2.14	45	150		Folded Unipole over small ground plane $L = \lambda/4$ $L/D = 53$ $l = 2\lambda$ $L/d = 13$
	E V	0	2.14	16	50		Coaxial Dipole $L = \lambda/4$ $L/D = 40$
	E V	0	2.14	200	72		Biconical Coaxial Dipole $L = \lambda/2$ $d = \lambda/8$ $D = 3\lambda/8$
	E V	0	2.14	300	50		Disc-Cone or Rod Disc-Cone $L = \lambda/4$ $l = \lambda$
	E V	12	14.14	25	20		Biconical Horn $L = 9\lambda/2$ $D = 14\lambda$
	F H	0	2.14	70	350		Slot in Large Ground Plane $L = \lambda/2$ $l/d = 20$
	B H	1	3.14	13	45		Vertical Full Wave Loop $D = \frac{\lambda}{\pi}$ $D/d = 36$
	G Circ.	8	10.14	200	130		Helical over reflector screen, tube $6\lambda$ long coiled into 6 turns $\lambda/4$ apart
	H H	14.5	16.74	100	600		Rhombic $L = 9\lambda$ $l = 9\lambda/2$
	H H	12.5	14.74	30	300		Parabolic with folded dipole feed ( $\lambda/2$ ) $D 9\lambda/2$
	H H	13	15.14	35	50		Horn, coaxial feed $l = 3\lambda$ $L = 3\lambda$

## MICROWAVE ANTENNA CHART

Shown here is the relationship between circular antenna aperture size, frequency, and gain. Also listed are the antenna performance requirements for various system applications. Practical factors, such as whether the antenna is solid or perforated, the type of aperture illumination, accuracy of construction, and shadowing from the feed system will tend to reduce the gain somewhat.

FOR EXAMPLE: To achieve a gain of 40 dB at 10 GHz requires an antenna with a diameter of 10 m. An antenna with a diameter of 100 m has a gain of 100 dB at 100 GHz.

### Antenna Performance Requirements

APPLICATION	PATTERN	POLARIZATION	GAIN $G_p$ (dB) above isotropic rad.	BEAMWIDTH (H) degree	POINTING ACCURACY, to degree	TYPICAL TYPES
1. SATELLITE Link or Probe	Pencil Beam	any	10 to 40 dB or more	60 to 2 or less	8 to .2 or better	Horn, Phased array, Paraboloid, Cassegrain
2. POINT TO POINT RELAY a. Earth to Earth b. Earth to Satellite c. Satellite to Earth d. Satellite to Satellite	Pencil Beam	any	a. 50 to 120 b. 50 to 120 c. 50 to 160	$5.8 \times 10^{-1}$ to $1.8 \times 10^{-4}$ $5.8 \times 10^{-1}$ to $1.8 \times 10^{-9}$	$5.8 \times 10^{-3}$ to $1.8 \times 10^{-7}$	Horn, Paraboloid, Cassegrain
3. BROADCAST a. Earth Term. b. Sat. Term.	omnidir., wide or fan beam	any	a. 3 to 40 b. 1 to 10	100 to 1.8 160 to 60	10 to .18	a. Vertical radiator b. Cylindrical paraboloid
4. NAVIGATION	omnidir., or fan beam	any	3 to 50	100 to .58	10 to .058	Vertical radiator, Horn, or Paraboloid
5. RADAR a. Search b. Track	cspt Pencil Beam	any	40 to 120	$3.8$ to $1.8 \times 10^{-4}$	$.18$ to $1.8 \times 10^{-5}$	Horn, Paraboloid, Cassegrain, Phased array
6. RADIO ASTRONOMY a. Passive b. Active	Pencil Beam	any	50 to 160 or greater	$.58$ to $1.8 \times 10^{-9}$	$.057$ to $1.8 \times 10^{-7}$	Paraboloid, Cassegrain, Phased array
7. RADIOMETRY Industrial	any	any	unknown	unknown	unknown	Any

### Antenna Gain and Size vs Frequency for Uniformly Illuminated Circular Aperture

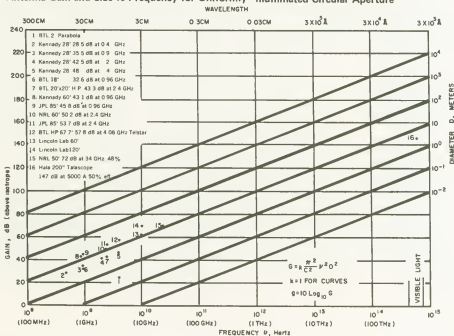

### ANTENNA EFFECTIVENESS NOMOGRAM

Antennas are judged on the basis of radiation efficiency or their VSWR. Radiation efficiency is the ratio of the radiated power to the total power fed into the antenna terminals. Total power is the sum of the radiated power and the power lost in ohmic losses in the form of heat. The power going into the antenna terminals is the power which a transmitter can put out less the power reflected due to antenna mismatch. Antenna effectiveness is the ratio of the radiated power to the power which a transmitter can put into a matched load, i.e., the forward or incident power.

$$\text{Effectiveness} = \frac{4 \text{ VSWR}}{(\text{VSWR} + 1)^2} \times \text{efficiency}$$





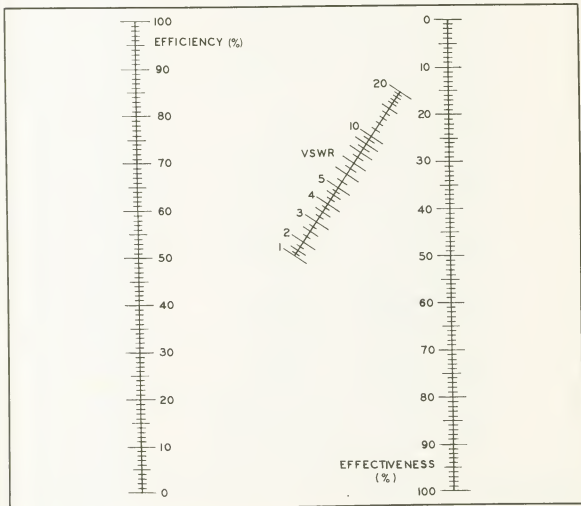





FOR EXAMPLE: A 60% efficient antenna with a 2.5:1 VSWR has an effectiveness of 48% compared to a perfectly matched 100% efficient antenna.

NOTE: In some cases an antenna can be made more effective by lessening its efficiency if this will produce a sufficient reduction in the VSWR.



# TRANSMISSION LINE CHARACTERISTICS

Characteristics of Various Types of Transmission Lines Erected Parallel to a Perfectly Conducting Earth.

LOGARITHMS TO THE BASE 10		$I_1 =$ GENERATOR CURRENT	
LINE CONFIGURATION	CHARACTERISTIC IMPEDANCE	NET GROUND-RETURN CURRENT	
Single wire 	$Z_0 = 138 \text{ Log } \frac{2h}{r}$	$I_{\text{Gnd}} = I_1$	
2-Wire balanced 	$Z_0 = 276 \text{ Log } \frac{s}{r}$	$I_{\text{Gnd}} = 0$	
2-Wire 1 wire grounded 	$Z_0 = 276 \frac{\text{Log } \frac{s}{r} \text{ Log } \left[ \frac{\rho^2}{r^2} \right]}{\text{Log } \left[ \rho^2 \left( \frac{s}{r} \right)^2 \right]}$ $\rho = \frac{2h}{s}$	$I_{\text{Gnd}} = I_1 \frac{\text{Log } \frac{s}{r}}{\text{Log } \frac{s}{2h}}$	
3-Wire 2 wires grounded 	$Z_0 = 69 \left[ \text{Log } \frac{s}{2r} - \frac{(\text{Log } \frac{s}{2r})^2}{\text{Log } \frac{2h}{r}} \right]$	$I_{\text{Gnd}} = I_1 \frac{\text{Log } \frac{s}{r}}{\rho^2 \text{ Log } \frac{r}{2h}}$ $\rho = \frac{2h}{s}$	
4-Wire balanced 	$Z_0 = 138 (\text{Log } \frac{s}{r}) - 21$	$I_{\text{Gnd}} = 0$	
4-Wire 2 wires grounded 	$Z_0 = 138 \frac{\left[ \text{Log } \frac{s}{r} \text{ Log } \left[ \frac{\rho^4}{r^2} \right] \right]}{\left[ \text{Log } \left[ \rho^4 \left( \frac{s}{r} \right)^2 \right] \right]}$ $\rho = \frac{2h}{s}$	$I_{\text{Gnd}} = I_1 \frac{\text{Log } \frac{s}{r}}{\text{Log } \frac{\rho^2 s}{r^2}}$	
5-Wire 4 wires grounded 	$Z_0 = 138 \frac{\left[ \text{Log } \frac{2h}{r} \frac{(\text{Log } 2\rho^2)^2}{\text{Log } \left[ \frac{s^2 h^2}{r^2} \right]} \right]}{\rho \frac{2h}{s}}$	$I_{\text{Gnd}} = I_1 \frac{\text{Log } \frac{s}{r} \sqrt{2}}{\text{Log } \frac{s \rho^4}{r^2}}$	
Concentric (coaxial) 	$Z_0 = 138 \frac{\text{Log } \frac{c}{b}}{\sqrt{1 + \left( \frac{L-1}{s} \right) \omega}}$ $\epsilon =$ Dielectric constant of insulating material		
Double coaxial balanced 	$Z_0 = 276 \frac{\text{Log } \frac{c}{b}}{\sqrt{1 + \left( \frac{L-1}{s} \right) \omega}}$		
Shielded pair balanced 	$Z_0 = \frac{120}{\sqrt{\epsilon}} \left[ 2.303 \text{ Log } \left( 2v \frac{1+\sigma^2}{1-\sigma^2} \right) - \frac{1+4v^2}{16v^4} (1-4\sigma^2) \right]$ $\epsilon =$ Dielectric constant of medium $\epsilon =$ Unity for gaseous medium $v = \frac{h}{b}$ ; $\sigma = \frac{h}{c}$		

(From *Radio Engineers' Handbook* by Frederick E. Terman. Copyright © 1943 by McGraw-Hill Book Company. Used with permission of McGraw-Hill Book Company.)

### CHARACTERISTIC IMPEDANCE OF BALANCED TWO-WIRE LINES

This nomogram determines the theoretical exact impedance of air-dielectric parallel lines in air or in a vacuum, and remote from any conducting plane. It covers conductors having diameters from 0.01 to 5 in., spaced from 0.01 to 100 in. center-to-center.

$$Z_o = 276 \log_{10} \frac{2D}{d}$$

$$D > 2d$$

FOR EXAMPLE: (1) The impedance of a line using #12 wire spaced 1½ in. is 430 ohms. (2) What is the wire diameter for a 300-ohm line spaced 1¼ in.? Answer: 0.20 in.

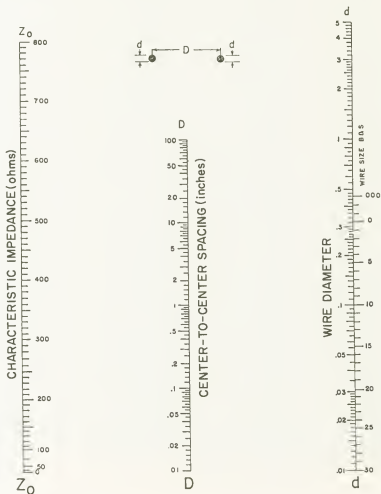

(Reprinted with permission from International Telephone and Telegraph Corporation.)



# CHARACTERISTICS OF COAXIAL CABLES

▼ START HERE TO SELECT BY TYPE NUMBER

RG CABLE TYPE	INNER CONDUCTOR	PE DI- ELECT- RIC		SHIELDS		JACKET		ARMOR (.0126 ALUMINUM WIRE)	OPER. VOLTS RMS	LBS. PER M FT.		
		MAT.	STRAND	O.D.	O.D.	INNER	OUTER				O.D.	MAT.
58/U	3C	1	.051	.185	3C	5C	.260	NCV	.355	—	3000	83
6A/U	CW	1	.0285	.189	3C	C	.264	NCV	.336	—	2700	74
8/U	C	7	.086	.293	C	—	.340	V	.415	—	4000	99
8/AU	C	7	.0285	.293	C	—	.340	NCV	.415	—	4000	99
9A/U	3C	7	.086	.285	3C	5C	.355	NCV	.430	—	4000	126
9B/U	3C	7	.086	.285	3C	5C	.355	NCV	.430	—	4000	126
10A/U	C	7	.086	.293	C	—	.340	NCV	.415	.475	4000	121
11/U	TC	7	.048	.293	C	—	.340	V	.415	—	4000	89
11A/U	TC	7	.048	.292	C	—	.340	NCV	.412	—	4000	89
12A/U	TC	7	.048	.292	C	—	.340	NCV	.412	.475	4000	113
13A/U	TC	7	.048	.290	C	C	.355	NCV	.430	—	4000	114
14A/U	C	1	.102	.383	C	C	.463	NCV	.558	—	5500	201
17A/U	C	1	.188	.695	C	—	.760	NCV	.885	—	11000	446
18A/U	C	1	.188	.695	C	—	.760	NCV	.885	.945	11000	496
19A/U	C	1	.250	.925	C	—	.990	NCV	1.135	—	14000	720
20A/U	C	1	.250	.925	C	—	.990	NCV	1.135	1.195	14000	786
34B/U	C	7	.075	.470	C	—	.535	NCV	.640	—	5200	193
35B/U	C	1	.1045	.690	C	—	.760	NCV	.880	.945	10000	425
55/U	C	1	.032	.121	TC	TC	.176	PE	.206	—	1900	31
55A/U	3C	1	.035	.121	3C	5C	.176	NCV	.216	—	1900	36
55B/U	3C	1	.032	.121	TC	TC	.176	PE	.206	—	1900	32
58/U	C	1	.032	.121	C	—	.150	V	.200	—	1900	24
58A/U	TC	19	.0375	.120	TC	—	.150	V	.199	—	1900	25
58C/U	TC	19	.0375	.120	TC	—	.150	NCV	.199	—	1900	25
59/U	CW	1	.0253	.150	C	—	.191	V	.250	—	2300	36
59B/U	CW	1	.023	.150	C	—	.191	NCV	.246	—	2300	36
62/U	CW	1	.025	.151	C	—	.191	V	.250	—	750	34
62A/U	CW	1	.025	.151	C	—	.191	NCV	.249	—	750	34
63B/U	CW	1	.0253	.293	C	—	.340	NCV	.415	—	1000	78
71/U	CW	1	.025	.151	C	TC	.198	PE	.239	—	750	42
71A/U	CW	1	.025	.151	TC	TC	.198	V	.245	—	750	42
71B/U	CW	1	.025	.151	C	TC	.208	PE	.250	—	750	42
74A/U	C	1	.102	.383	C	C	.564	PE	.558	.615	5500	230
79B/U	CW	1	.025	.293	C	—	.340	NCV	.415	.475	1000	122
164/U	C	1	.1045	.690	C	—	.760	NCV	.890	—	10000	392
174/U	CW	7	.019	.060	TC	—	.069	V	.105	—	—	—
177/U	C	1	.195	.690	3C	5C	.760	NCV	.910	—	14000	463
212/U	3C	1	.056	.189	3C	5C	.265	NCV	.336	—	3000	85
213/U	C	7	.090	.292	C	—	.340	NCV	.412	—	4000	100
214/U	3C	7	.090	.292	3C	5C	.360	NCV	.432	—	4000	129
215/U	C	7	.090	.292	C	—	.340	NCV	.412	—	4000	122
216/U	TC	7	.048	.292	C	C	.360	NCV	.432	—	4000	115
217/U	C	1	.106	.380	C	C	.463	NCV	.555	—	5500	202
218/U	C	1	.195	.690	C	—	.760	NCV	.880	—	11000	457
219/U	C	1	.195	.690	C	—	.760	NCV	.880	.945	11000	507
220/U	C	1	.260	.910	C	—	.990	NCV	1.120	—	14000	725
221/U	C	1	.260	.910	C	—	.990	NCV	1.120	1.195	14000	790
223/U	3C	1	.036	.120	3C	5C	.176	NCV	.216	—	1900	36
224/U	C	1	.108	.380	C	C	.463	NCV	.555	.615	5500	232

3C—silver plated copper, C—bare copper, PE—polyethylene, NCV—non-contaminating vinyl,  
V—polyvinylchloride, TC—tinned copper, CW—copperweld

▼ START HERE TO SELECT BY CHARACTERISTIC IMPEDANCE

	NOMINAL IMPEDANCE OHMS	CAP. PF FT.	ATTENUATION (dB/100 FT.) FREQUENCY IN MEGAHERTZ							VP %	RG CABLE TYPE	
			10	50	100	200	400	600	1000			3000
50	^	29.5	.65	1.6	2.4	3.6	5.2	6.6	8.8	16.7	65.9	58/U
75	□	20	.70	1.8	2.9	4.3	6.5	8.3	11.2	22	65.9	6A/U
52	^	29.5	.56	1.35	2.1	3.1	5.0	6.5	8.8	17.5	65.9	8/U
52	^	29.5	.56	1.35	2.1	3.1	5.0	6.5	8.8	17.5	65.9	8A/U
52	^	29.5	.45	1.26	2.3	3.4	5.2	6.5	9.0	17	65.9	9A/U
50	^	30	.45	1.26	2.3	3.4	5.2	6.5	9.0	17	65.9	9B/U
52	^	29.5	.56	1.35	2.1	3.1	5.0	6.5	8.8	17.5	65.9	10A/U
75	□	20.5	.65	1.5	2.15	3.2	4.7	6.0	8.2	18	65.9	11/U
75	□	20.5	.65	1.5	2.15	3.2	4.7	6.0	8.2	18	65.9	11A/U
75	□	20.5	.65	1.5	2.15	3.2	4.7	6.0	8.2	18	65.9	12A/U
74	□	20.5	.65	1.5	2.15	3.2	4.7	6.0	8.2	18	65.9	13A/U
52	^	29.5	.28	.85	1.5	2.3	3.5	4.4	6.0	11.7	65.9	14A/U
52	^	29.5	.23	.60	.95	1.5	2.4	3.2	4.5	9.5	65.9	17A/U
52	^	29.5	.23	.60	.95	1.5	2.4	3.2	4.5	9.5	65.9	18A/U
52	^	29.5	.14	.42	.69	1.1	1.8	2.45	3.5	7.7	65.9	19A/U
52	^	29.5	.14	.42	.69	1.1	1.8	2.45	3.5	7.7	65.9	20A/U
75	□	20	.29	.85	1.3	2.1	3.3	4.5	6.0	12.5	65.9	34B/U
75	□	20.5	.23	.61	.85	1.25	1.95	2.47	3.5	8.6	65.9	35B/U
53.5	^	28.5	1.3	3.2	4.8	7.0	10.5	13.0	17	32	65.9	55/U
50	^	29.5	1.3	3.2	4.8	7.0	10.5	13.0	17	32	65.9	55A/U
53.5	^	28.5	1.3	3.2	4.8	7.0	10.5	13.0	17	32	65.9	55B/U
53.5	^	28.5	1.4	3.5	5.3	8.3	11.5	17.8	20	40	65.9	58/U
50	^	29.5	1.6	4.1	6.2	9.2	14.0	17.5	23.5	45	65.9	58A/U
50	^	29.5	1.6	4.1	6.2	9.2	14.0	17.5	23.5	45	65.9	58C/U
73	□	21	1.1	2.7	4.0	5.7	8.5	10.8	14.0	26	65.9	59/U
75	□	20.5	1.1	2.7	4.0	5.7	8.5	10.8	14.0	26	65.9	59B/U
93	^	13.5	.82	1.9	2.7	3.9	5.8	7.0	9.0	17	84	62/U
93	^	13.5	.82	1.9	2.7	3.9	5.8	7.0	9.0	17	84	62A/U
125	^	10	.60	1.4	2.0	2.9	4.1	5.1	6.5	11.3	84	65B/U
93	^	13.5	.82	1.9	2.7	3.9	5.8	7.0	9.0	17	84	71/U
93	^	13.5	.82	1.9	2.7	3.9	5.8	7.0	9.0	17	84	71A/U
93	^	13.5	.82	1.9	2.7	3.9	5.8	7.0	9.0	17	84	71B/U
93	^	13.5	.82	1.9	2.7	3.9	5.8	7.0	9.0	17	84	71C/U
52	^	29.5	.28	.85	1.5	2.3	3.5	4.4	6.0	11.7	65.9	74A/U
125	^	10	.60	1.4	2.0	2.9	4.1	5.1	6.5	11.3	84	79B/U
75	□	20.5	.23	.61	.85	1.25	1.95	2.47	3.5	8.6	65.9	164/U
50	^	30	—	—	—	—	2.0	—	—	—	65.9	174/U
50	^	30	.23	.60	.95	1.5	2.4	3.2	4.5	9.5	65.9	177/U
50	^	29.5	.65	1.6	2.4	3.6	5.2	6.6	8.8	16.7	65.9	212/U
50	^	30.5	.56	1.35	2.1	3.1	5.0	6.5	8.8	17.5	65.9	213/U
50	^	30.5	.45	1.26	2.3	3.4	5.2	6.5	9.0	17	65.9	214/U
50	^	30.5	.56	1.35	2.1	3.1	5.0	6.5	8.8	16.7	65.9	215/U
75	□	20.5	.65	1.5	2.15	3.2	4.7	6.0	8.2	18	65.9	216/U
50	^	30	.28	.85	1.5	2.3	3.5	4.4	6.0	11.7	65.9	217/U
50	^	30	.225	.60	.95	1.5	2.4	3.2	4.5	9.5	65.9	218/U
50	^	30	.225	.60	.95	1.5	2.4	3.2	4.5	9.5	65.9	219/U
50	^	29.5	.17	—	.69	1.12	1.85	—	3.6	7.7	—	220/U
50	^	29.5	.17	—	.69	1.12	1.85	—	3.6	7.7	—	221/U
50	^	30	1.3	3.2	4.8	7.0	10.5	13.0	17.0	32	65.9	223/U
50	^	30	.28	.85	1.5	2.3	3.5	4.4	6.0	11.7	65.9	224/U

Ohms Code: ^ Through to 55 □ 56 Through 80 \* 81 Through 100 \* 101 Through 200

(Reprinted from *Special Report on Electronics*, copyright by U.S. Industrial Publications, Inc., 209 Dunn Avenue, Stamford, Connecticut.)

### ULTRA-HIGH FREQUENCY HALF-WAVE SHORTING-STUB NOMOGRAM

This nomogram is used to determine the length in inches of shorting stubs required to eliminate interference in the UHF television range.

FOR EXAMPLE: To eliminate an interfering signal at 575 MHz (channel 31) requires a 8½ in. long half-wave shorting stub, if 300-ohm twin lead is used. If 75-ohm twin lead is used, the stub has to be 7¼ in. for the same frequency.

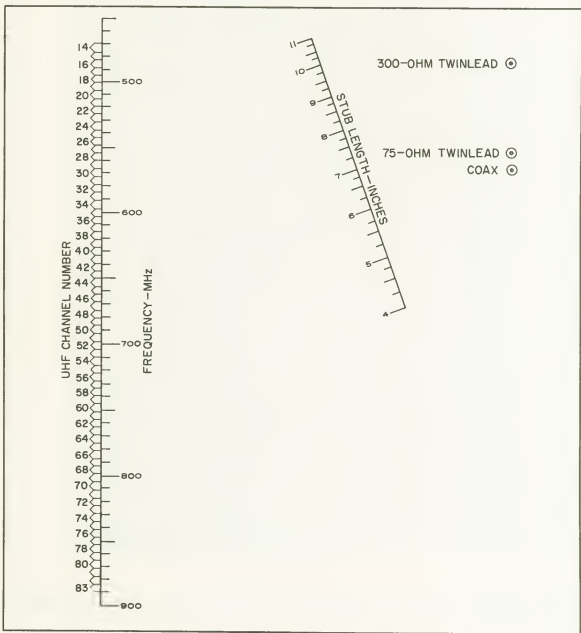

## TRANSMISSION LINE NOMOGRAM

This nomogram gives the actual length of line in centimeters and inches when given the length in electrical degrees and the frequency provided that the velocity of propagation on the transmission line is equal to that in free space. The length is equal to that in free space and is given on the  $L$  scale intersection by a line between  $\lambda$  on  $\lambda^\circ$ .

FOR EXAMPLE:

$$f = 600 \text{ MHz} \quad \lambda^\circ = 30^\circ$$

$$\text{Length } L = 1.64'' \text{ or } 4.2 \text{ cm}$$

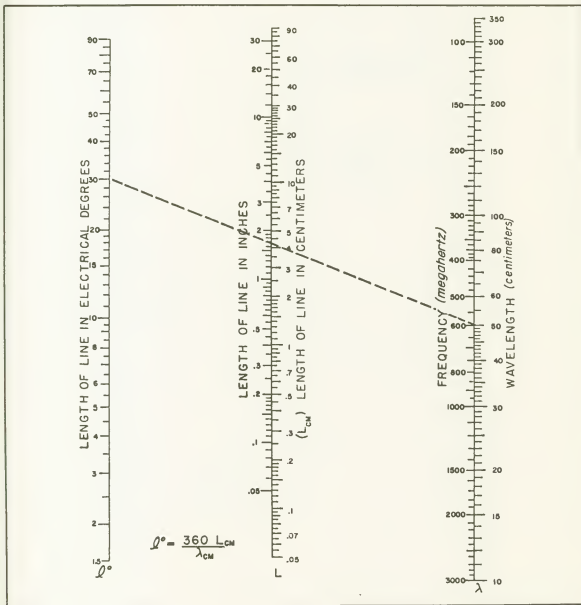

### SLOTTED-LINE WIDTH-OF-MINIMUM VSWR NOMOGRAM

This nomogram is used to determine the VSWR and the magnitude of the reflection coefficient by the use of width-of-minimum measurement technique. This technique relies on the fact that there are two comparatively easy-to-find 3-dB points straddling any minimum, as illustrated.

FOR EXAMPLE: A slotted-line width-of-minimum measurement of 0.18 cm, with a 1-GHz source, indicates a VSWR of 53 or a reflection coefficient magnitude of 0.963.

NOTE: The signal-to-noise ratio at the bottom of the minimum must be at least 10 dB for accurate results.

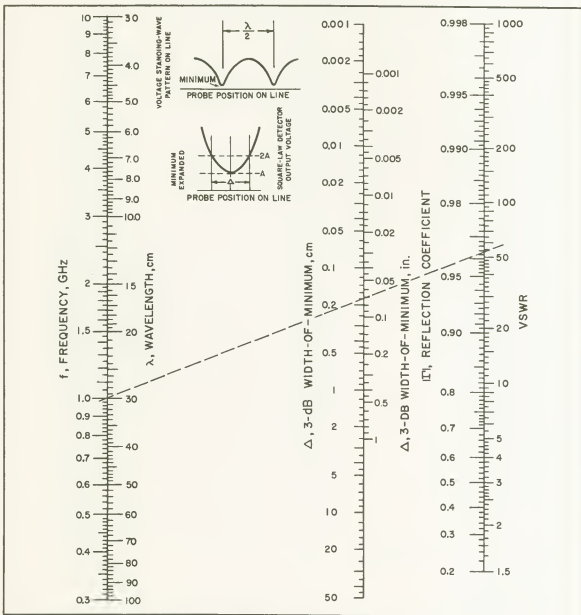

### SLOTTED LINE WIDTH-OF-MINIMUM ATTENUATION CALCULATION NOMOGRAM

This nomogram is used to determine the total attenuation between the probe position and the reference plane based on width-of-minimum measurements.

FOR EXAMPLE: With a short circuit termination at the reference plane, if the width-of-the-minimum measured 30 cm from the reference plane is 0.014 cm at 3.5 GHz, then the attenuation is 0.045 dB.

NOTE: The signal-to-noise ratio at the bottom of the minimum should be at least 10 dB for accurate results.

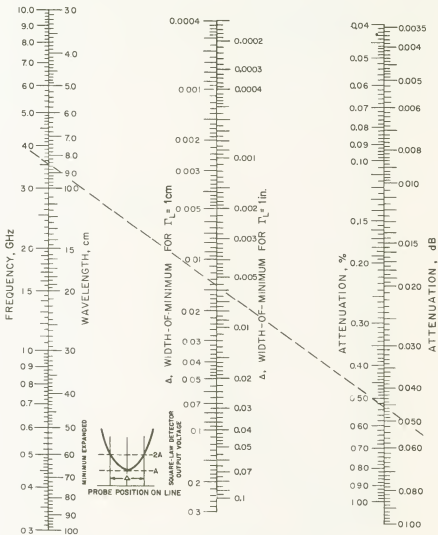

## WAVEGUIDE NOMOGRAM

This nomogram relates three significant waveguide characteristics:

waveguide wavelength ( $\lambda_g$ )  
 free space wavelength ( $\lambda_0$ ) or frequency ( $f$ )  
 cutoff wavelength ( $\lambda_c$ )

The vertical scale gives waveguide wavelength in centimeters. The horizontal scale is for the cutoff wavelength, and the points corresponding to the cutoff wavelength in the TE<sub>10</sub> mode of three common waveguides are indicated. The sloping center scale is calibrated in free space wavelength and frequency.

FOR EXAMPLE: (1) The waveguide wavelength at 6 GHz (5 cm free space wavelength) in an RG-50 waveguide is 7.17 cm. (2) Measurement on an RG-51 waveguide shows the waveguide wavelength to be 6.5 cm. The frequency is 7 GHz, which corresponds to a free space wavelength of 4.27 cm.

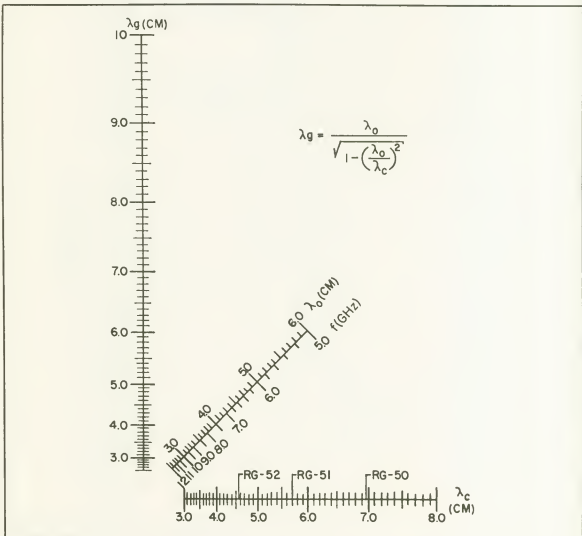

## VSWR NOMOGRAM

If a transmission line is not terminated in its characteristic impedance, then some of the energy sent along the line will be reflected back, and standing waves form on the line. The ratio of the maximum to the minimum voltage of the standing waves is the VSWR (voltage standing wave ratio) and indicates the effectiveness of the match between line and load. For a perfectly matched line, the VSWR is 1. The VSWR can be given in a number of ways:

$$VSWR = \frac{Z_L}{Z_o} = \frac{E_{max}}{E_{min}} = \frac{1 + \sqrt{\frac{\text{Reflected power}}{\text{Forward power}}}}{1 - \sqrt{\frac{\text{Reflected power}}{\text{Forward power}}}}$$

This nomogram is based on the last expression and solves for VSWR from measurements of reflected power and forward power.

FOR EXAMPLE: For a forward power of 180 W and a reflected power of 2.7 W, the VSWR is 1.27.





### VSWR REDUCTION AS A RESULT OF ATTENUATION

This nomogram relates load VSWR, input VSWR, and attenuation. It can be used to find the resultant VSWR with a given amount of attenuation, or to determine the attenuation required for a given VSWR.

FOR EXAMPLE: (1) A 5-dB attenuator will reduce input VSWR to 1.23 if the load VSWR is 2.0. (2) The required attenuation to reduce a load VSWR of 1.8 to an input VSWR of 1.06 is 10.0 dB.

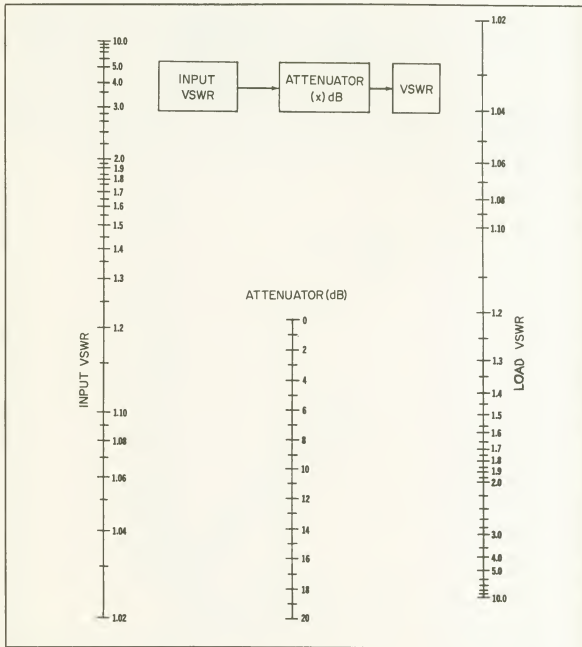

### DOPPLER TO SPEED CONVERSION NOMOGRAM

Radar or sonar frequency may be converted to hundreds of miles per hour or knots per hour by using this chart. The base sonar frequency in kHz is given on the left scale and the base radar frequency in GHz is given on the right. Doppler frequency, in Hz for sonar and hundreds of Hz for radar, is shown at the bottom. The diagonals represent target rate of change of range, which is the velocity speed vector in the source's direction.

The basic formula for Doppler speed is:

$$\text{Doppler frequency} = \frac{\text{base } f. \times \text{target range rate}}{\text{signal velocity in medium.}}$$

The signal velocity in medium is 5,000 ft/sec for sonar and 186,000 mi/sec for radar.

FOR EXAMPLE: (1) The base frequency of a sonar system is 40 kHz and its Doppler frequency is 55 Hz. The speed vector is found by the intersection of these two lines on the chart to be approximately 4.1 knots. (2) The base frequency of a radar system is 11 GHz, and the Doppler frequency is 8,000 Hz. The speed vector of the aircraft in miles per hour is found (from the intersection of these two lines) to be approximately 480 mph.

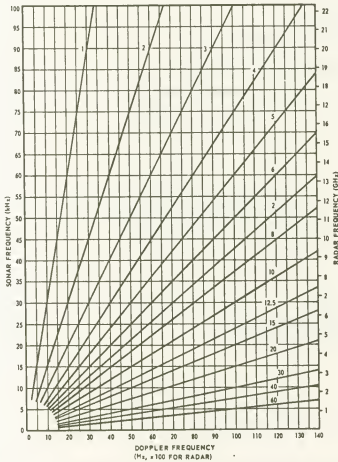

## DOPPLER FREQUENCY NOMOGRAM

This nomogram solves for the Doppler frequency, which is produced as a result of relative motion between a transmitter and its receiver or target. The Doppler frequency is a function of transmitted frequency and velocity of motion. The angle to the velocity vector determines the actual relative velocity. For a navigation system (Fig. A) in an airplane, the earth is the target, and the angle  $A$  is the acute angle between the aircraft heading and the radar beam. In this case the Doppler shift is downward. A forward-looking radar will produce an upward Doppler shift. For surveillance-type radars (Fig. B), the angle  $A$  is the acute angle between the radar beam and target velocity. (Note that the nomogram is based on the Doppler equation for radar and that the Doppler shift for a passive listening device will be half the frequency indicated.)

FOR EXAMPLE: A helicopter navigation system transmits at 10 GHz at an angle of  $70^\circ$ . What is the audio bandwidth required for aircraft velocities of 10 through 200 mph? On the left scales, connect 10 GHz and 10 mph to the turning scale. From that point on, the turning scale connecting through  $70^\circ$  gives 100 Hz as the lowest frequency. Repeating the steps using 200 mph in place of 10 mph shows the highest frequency to be 2 kHz. Thus the required bandwidth is 100 to 2,000 Hz. The nomogram is based on the formula

$$f_d = 89.4 \frac{V}{\lambda}$$

where

$f_d$  = Doppler frequency (Hz)

$V$  = velocity in miles per hour

$\lambda$  = transmitted wavelength in centimeters

Angle-to-velocity vector depends on type of target.

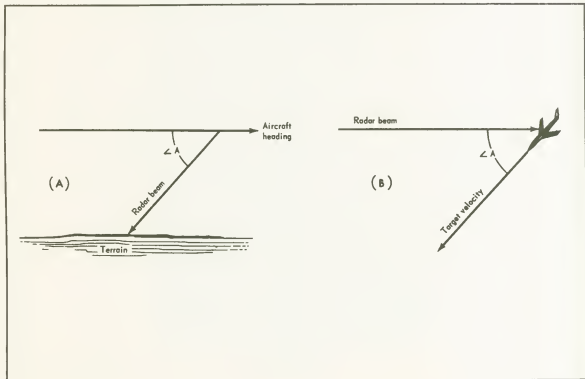

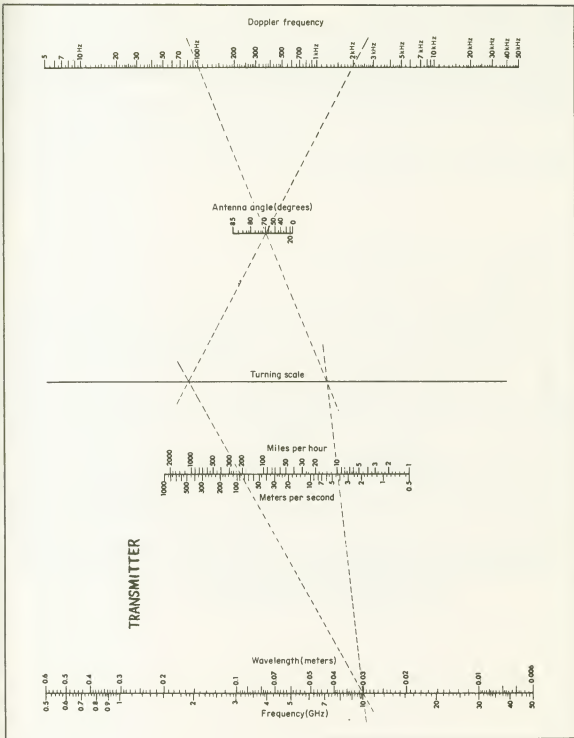

### GRAPH FOR ADDING TWO IN-PHASE SIGNALS

This graph determines the combined signal level and shows the number of dB that must be added to the larger signal.

FOR EXAMPLE: Two in-phase signals are  $-25$  dB and  $-27$  dB respectively. The difference is  $2$  dB and, from the graph,  $2.2$  dB must be added to the larger signal. Thus, the combined signal power level is  $-25$  dB plus  $2.2$  dB or  $-22.8$  dB.

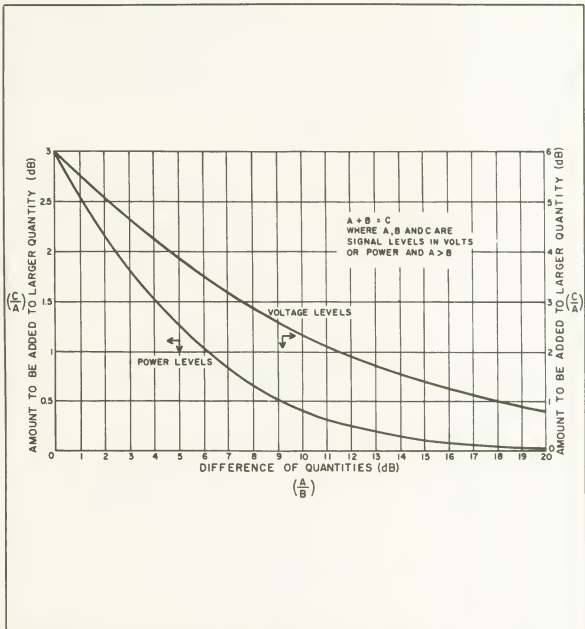

### GRAPH FOR SEPARATING SIGNAL POWER FROM NOISE POWER

When making transmission loss or crosstalk measurements, the presence of noise is a potential source of error. If the total voltage measured across the load resistance when a signal is being transmitted is 15 dB or more greater than the noise voltage alone, the error in the received voltage measurement will be negligible. If, however, the dB difference between the combined signal and noise voltage and the noise voltage alone is less than 15 dB, a correction must be made. To do so, two voltage measurements must be made. Namely, (1) the noise power in dBm, and (2) the combined noise and signal power in dBm. On the horizontal axis locate the point equal to the difference between the two powers and read on the vertical axis the number of dB to be subtracted from the noise plus signal power and obtain the power of the signal alone.

FOR EXAMPLE: The difference between the measurements of combined noise and crosstalk and noise alone is 5 dB. Thus, 1.7 dB must be subtracted from the combined signal and noise level to obtain the level of the signal alone.

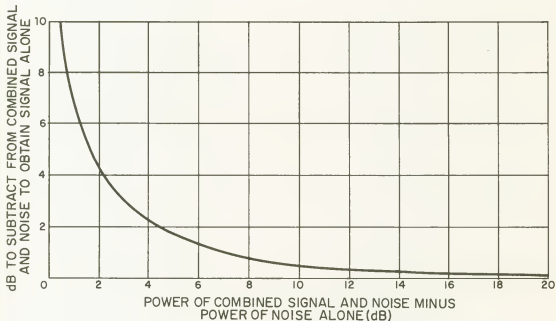

### FIELD POWER CONVERSION CHART

Power density is related to field strength by the equation

$$P = \frac{E^2}{120\pi}$$

where

$P$  = the power density

$E$  = the field strength

$120\pi$  = the resistance of free space

and

This chart converts between field strength and power density.

FOR EXAMPLE: A field strength of 3,000  $\mu\text{V}/\text{m}$  corresponds to a power density of 0.024  $\mu\text{W}/\text{m}^2$  and is 70.5 dB above 1  $\mu\text{V}/\text{m}$ .

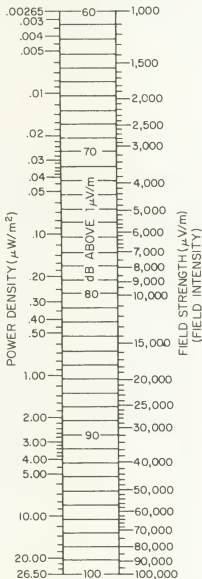

## Q SIGNALS (MNEMONIC CODE)

The Q code was first adopted in 1912 by international treaty agreement to overcome the language barriers faced by ship operators of all nations as they tried to communicate with shore stations all over the world. Many of the original list of 50 signals are still in use with their definitions unchanged. Many more have been added from time to time, and the official meanings of some signals have been changed. In addition, many signals have been informally adopted for use by amateurs in situations not covered by the official lists.

The list below includes virtually every Q signal which could, even remotely, be thought to have an application in amateur radio communication. To simplify the task of finding the definition of an unfamiliar signal, we have combined all the signals into a single alphabetical list, mixing "official" and unofficial signals. The definitions listed are, in most cases, the official ones, taken verbatim from the treaty. In other cases, where definitions are not the official ones, they are as amateurs universally understand them, for purposes of amateur communications. The QN signals, adopted by ARRL for traffic net use, have official definitions which refer to aeronautical situations.

QAM	What is the latest available meteorological observation for (place)? The observation made at (time) was . . .		Transmit (1—test tape, 2—test sentence) by RTTY.
QAP	Shall I listen for you (or for . . .) on . . . kHz? Listen for me (or for . . .) on . . . kHz.	QJI	Shall I transmit continuous (1—mark, 2—space) RTTY signal? Transmit continuous (1—mark, 2—space) signal.
QAR	May I stop listening on the watch frequency for . . . minutes? You may stop listening on the watch frequency for . . . minutes?	QJK	Are you receiving continuous (1—mark, 2—space, 3—mark bias, 4—space bias)? I am receiving continuous (1—mark, 2—space, 3—mark bias, 4—space bias).
QBF	Have we worked before in this contest? We have worked before in this contest.	QKF	May I be relieved at . . . hours? You may expect to be relieved at . . . hours by . . .
QHM	I will tune from the high end of the band toward the middle (Used after a call or CQ.)	QLM	I will tune for answers from the low end of the band toward the middle.
QIF	What frequency is . . . using? He is using . . . kHz.	QMD	I will tune for answers from my frequency down.
QJA	Is my RTTY (1—tape, 2—M/S) reversed? It is reversed.	QMH	I will tune for answers from the middle of the band toward the high end.
QJB	Shall I use (1—TTY, 2—reperf)? (For RTTY use.) Use (1—TTY, 2—reperf)	QML	I will tune for answers from the middle of the band toward the low end.
QJC	Check your RTTY (1—TC, 2—auto head, 3—reperf, 5—Printer, 7—keyboard).	QMU	I will tune for answers from my frequency upward.
QJD	Shall I transmit (1—letters, 2—figs)? (For RTTY) Transmit (1—letters, 2—figs).	QMT	Will you mail the traffic? I will accept the traffic for delivery by mail.
QJE	Shall I send (1—wide, 2—narrow, 3—correct) RTTY shift? Your RTTY shift is (1—wide, 2—narrow, 3—correct).	QNA*	Answer in prearranged order.
QJF	Does my RTTY signal check out OK? Your RTTY signal checks out OK.	QNB*	Act as relay between . . . and . . .
QJH	Shall I transmit (1—test tape, 2—test sentence) by RTTY?	QNC	All net stations copy. I have a message for all net stations.
		QND*	Net is directed (controlled by net control station).
		QNE*	Entire net stand by.
		QNF	Net is free (not controlled).
		QNG	Take over as net control station.
		QNH	Your net frequency is high.
		QNI	Net stations report in.*

\*For use only by Net Control Station



	I am reporting into the net. (Follow with list of traffic or QRU.)		Your exact frequency (or that of . . .) is . . . kHz (or MHz).
QNJ	Can you copy me? Can you copy . . . ?	QRH	Does my frequency vary? Your frequency varies.
QNK*	Transmit messages for . . . to . . .	QRI	How is the tone of my transmission? The tone of your transmission is (1—good, 2—variable, 3—bad.
QNL	Your net frequency is low.	QRJ	Are you receiving me badly? Are my signals weak? I am receiving you badly. Your signals are too weak.
QNM*	You are QRMing the net. Stand by.	QRK	What is the intelligibility of my signals (or those of . . .)? The intelligibility of your signals (or those of . . .) is 1—bad, 2—poor, 3—fair, 4—good, 5—excellent.
QNN	Net control station is . . . * What station has net control?	QRL	Are you busy? I am busy (or I am busy with . . .). Please do not interfere.
QNO	Station is leaving the net.	QRM	Are you being interfered with? I am being interfered with (1—nil, 2—slightly, 3—moderately, 4—severely, 5—extremely).
QNP	Unable to copy you. Unable to copy . . .	QRN	Are you troubled by static? I am troubled by static (1—nil, 2—slightly, 3—moderately, 4—severely, 5—extremely).
QNQ*	QSY to . . . . . and wait for . . . to finish. Then send him traffic for . . .	QRQ	Shall I increase transmitter power? Increase transmitter power.
QNR*	Answer . . . and receive traffic.	QRP	Shall I decrease transmitter power? Decrease transmitter power.
QNS	Following stations are in the net.* (Follow with list.) Request list of stations in the net.	QRQ	Shall I send faster? Send faster (. . . words per minute).
QNT	I request permission to leave the net for . . . minutes.	QRR	Are you ready for automatic operation? I am ready for automatic operation. Send at . . . words per minute.
QNU*	The net has traffic for you. Stand by.	QRRR	Distress call signal for use by amateur c.w. and RTTY stations. To be used only in situations where there is danger to human life or safety.
QNV	Establish contact with . . . on this freq. If successful QSY to . . . and send traffic for . . .	QRS	Shall I send more slowly? Send more slowly.
QNW	How do I route messages for . . . ?	QRT	Shall I stop sending? Stop sending.
QNX	You are excused from the net.* Request to be excused from the net.	QRU	Have you anything for me? I have nothing for you.
QNY*	Shift to another frequency (or to . . . kHz) to clear traffic with . . .	QRV	Are you ready? I am ready.
QNZ*	Zero beat your signal with mine.	QRW	Shall I inform . . . that you are calling him on . . . kHz?
QRA	What is the name of your station? The name of my station is . . .		
QRB	How far approximately are you from my station? The approximate distance between our station is . . . nautical miles (or kilometers).		
QRD	Where are you bound for and where are you from? I am bound for . . . from . . .		
QRE	What is your estimated time of arrival at . . . (or over . . .) (place)? My estimated time of arrival at . . . (or over . . .) (place) is . . . hours.		
QRF	Are you returning to . . . (place)? I am returning to . . . (place). or Return to . . . (place).		
QRG	Will you tell me my exact frequency (or that of . . .)?		

\*For use only by Net Control Station.

	Please inform . . . that I am calling him on . . . kHz.		I can communicate with . . . direct (or by relay through . . .).
QRX	When will you call me again? I will call you again at . . . hours (on . . . kHz).	QSP	Will you relay to . . . free of charge? I will relay to . . . free of charge.
QRY	What is my turn? (Relates to communication) Your turn is Number . . . (or according to any other indication). (Relates to communication)	QSQ	Have you a doctor on board [or is . . . (name of person) on board]? I have a doctor on board [or . . . (name of person) is on board].
QRZ	Who is calling me? You are being called by . . . (on . . . kHz).	QSR	Shall I repeat the call on the calling frequency? Repeat your call on the calling frequency; did not hear you (or have interference).
QSA	What is the strength of my signals (or those of . . .)? The strength of your signals (or those of . . .) is (1—scarcely perceptible, 2—weak, 3—fairly good, 4—good, 5—very good).	QSS	What working frequency will you use? I will use the working frequency . . . kHz.
QSB	Are my signals fading? Your signals are fading.	QST	Calling all radio amateurs.
QSD	Is my keying defective? Your keying is defective.	QSU	Shall I send or reply on this frequency (or on . . . kHz)? Send or reply on this frequency (or on . . . kHz).
QSG	Shall I send . . . messages at a time? Send . . . messages at a time.	QSV	Shall I send a series of V's on this frequency (or . . . kHz)? Send a series of V's on this frequency (or . . . kHz).
QSH	Are you able to home on your D/F equipment? I am able to home on my D/F equipment (on station . . .).	QSW	Will you send on this frequency (or on . . . kHz)? I am going to send on this frequency (or on . . . kHz).
QSI	I have been unable to break in on your transmission. or Will you inform . . . (call sign) that I have been unable to break in on his transmission (on . . . kHz).	QSX	Will you listen to . . . (call sign(s)) on . . . kHz? I am listening to . . . (call sign(s)) on . . . kHz.
QSK	Can you hear me between your signals and if so can I break in on your transmission? I can hear you between my signals; break in on my transmission.	QSY	Shall I change to transmission on another frequency? Change to transmission on another frequency (or on . . . kHz).
QSL	Can you acknowledge receipt? I am acknowledging receipt.	QSZ	Shall I send each word or group more than once? Send each word or group twice (or . . . times).
QSM	Shall I repeat the last telegram which I sent you (or some previous telegram)? Repeat the last telegram which you sent me (or telegram(s) number(s) . . .).	QTA	Shall I cancel message number . . . ? Cancel message number . . .
QSN	Did you hear me [or . . . (call sign)] on . . . kHz? I did hear you [or . . . (call sign)] on . . . kHz.	QTB	Do you agree with my counting of words? I do not agree with your counting of words; I will repeat the first letter or digit of each word or group.
QSO	Can you communicate with . . . direct (or by relay)?	QTC	How many messages have you to send? I have . . . messages for you (or for . . .).
		QTG	Will you send two dashes of ten seconds each followed by your call sign (re-

	peated ... times) (on ... kHz)? or Will you request ... to send two dashes of ten seconds followed by his call sign (repeated ... times) on ... kHz?		
	I am going to send two dashes of ten seconds each followed by my call sign (repeated ... times) (on ... kHz). or I have requested ... to send two dashes of ten seconds followed by his call sign (repeated ... times) on ... kHz.		
QTH	What is your position in latitude and longitude (or according to any other indication)?		
	My position is ... latitude ... longitude (or according to any other indication).		
QTN	At what time did you depart from ... (place)?		
	I departed from ... (place) at ... hours.		
QTO	Have you left dock (or port)? or Are you airborne?		
	I have left dock (or port). or I am airborne.		
QTP	Are you going to enter dock (or port)? or Are you going to alight (or land)?		
	I am going to enter dock (or port). or I am going to alight (or land).		
QTO	Can you communicate with my station by means of the International Code of Signals?		
	I am going to communicate with your station by means of the International Code of Signals.		
QTR	What is the correct time?		
	The correct time is ... hours.		
QTS	Will you send your call sign for tuning purposes or so that your frequency can be measured now (or at ... hours) on ... kHz?		
	I will send my call sign for tuning purposes or so that my frequency may be measured now (or at ... hours) on ... kHz.		
QTV	What are the hours during which your station is open?		
	My station is open from ... to ... hours.		
QTV	Shall I stand guard for you on the frequency of ... kHz (from ... to ... hours)? Stand guard for me on the frequency of ... kHz (from ... to ... hours).		
QTX	Will you keep your station open for further communication with me until further notice (or until ... hours)?		
	I will keep my station open for further communication with you until further notice (or until ... hours).		
QTY	Are you proceeding to the position of incident and if so when do you expect to arrive?		
	I am proceeding to the position of incident and expect to arrive at ... hours on ... (date).		
QTZ	Are you continuing the search?		
	I am continuing the search for ... (aircraft, ship, survival craft, survivors, or wreckage).		
QUA	Have you news of ... (call sign)?		
	Here is news of ... (call sign).		
QUB	Can you give me in the following order information concerning: the direction in degrees TRUE and speed of the surface wind; visibility; present weather; and amount, type, and height of base of cloud above surface elevation at ... (place of observation)?		
	Here is the information requested: ... (The units used for speed and distances should be indicated.)		
QUC	What is the number (or other indication) of the last message you received from me [or from ... (call sign)]?		
	The number (or other indication) of the last message I received from you [or from ... (call sign)] is ...		
QUE	Can you use telephony in ... (language), with interpreter if necessary; if so, on what frequencies?		
	I can use telephony in ... (language) on ... kHz.		
QUF	Have you received the distress signal sent by ... (call sign of station)?		
	I have received the distress signal sent by ... (call sign of station) at ... hours.		
QUH	Will you give me the present barometric pressure at sea level?		
	The present barometric pressure at sea level is ... (units).		
QUK	Can you tell me the condition of the sea observed at ... (place or coordinates)?		
	The sea at ... (place or coordinates) is ...		
QUM	May I resume normal working?		
	Normal working may be resumed.		

## RADIO TELEPHONE CODE

### General Station Operation

- 10-1 Receiving poorly.
- 10-2 Signals good.
- 10-3 Stop transmitting.
- 10-4 Okay—Affirmative—Acknowledged.
- 10-5 Relay this message.
- 10-6 Busy, stand by.
- 10-7 Leaving the air.
- 10-8 Back on the air and standing by.
- 10-9 Repeat message.
- 10-10 Transmission completed, standing by.
- 10-11 Speak slower.
- 10-13 Advise weather and road conditions.
- 10-18 Complete assignment as quickly as possible.
- 10-19 Return to base.
- 10-20 What is your location? My location is . . . .
- 10-21 Call . . . by telephone.
- 10-22 Report in person to . . . .
- 10-23 Stand by.
- 10-24 Have you finished? I have finished.
- 10-25 Do you have contact with . . . ?

### Emergency or Unusual

- 10-30 Does not conform to Rules and Regulations.
- 10-33 Emergency traffic this station.
- 10-35 Confidential information.
- 10-36 Correct time.
- 10-41 Tune to channel . . . for test, operation, or emergency service.
- 10-42 Out of service at home.
- 10-45 Call . . . by phone.
- 10-54 Accident.

- 10-55 Wrecker or tow truck needed.
- 10-56 Ambulance needed.

### Net Message Handling

- 10-60 What is next message number?
- 10-62 Unable to copy, use CW.
- 10-63 Net clear.
- 10-64 Net is clear.
- 10-66 Cancellation.
- 10-68 Repeat dispatch on message.
- 10-69 Have you dispatched message . . . ?
- 10-70 Net message.
- 10-71 Proceed with transmission in sequence.

### Personal

- 10-82 Reserve room for . . . .
- 10-84 What is your telephone number?
- 10-88 Advise present phone number of . . . .

### Technical

- 10-89 Repairman needed.
- 10-90 Repairman will arrive at your station . . .
- 10-92 Poor signal, have transmitter checked.
- 10-93 Frequency check.
- 10-94 Give a test without voice for frequency check.
- 10-95 Test with no modulation.
- 10-99 Unable to receive your signals.

## INTERNATIONAL MORSE CODE

### Alphabetical

A * ---	J * - - - -	S * * * *
B - - - * *	K - - - -	T - - -
C - * - * *	L * - * * *	U * * - -
D - - - *	M - - - -	V * * * -
E * - - -	N - - -	W * - - -
F * * - * *	O - - - -	X * - * - -
G - - - *	P * - * * *	Y - * - - -
H * * * * *	Q - - * - -	Z - - - * *
I * * - -	R - - - *	

### By Groups

Group One	Group Two	Group Three
E * - - -	A * - - -	R * - - -
I * * - -	W * - - -	F * * * -
S * * * *	J * - - -	L * - * * *
H * * * *	N * - - -	U * * - -
T - - - -	D - - - -	V * * * -
M - - - -	B - - * * *	
O - - - -		
Group Four		
K - - - -	Q - - * - -	
X * - * -	G - - - -	
C - * * * *	Z - - * * *	
Y - * - - -	P * - * - -	

### Numerals and Punctuation

1 * - - - - -	6 - * * * *
2 * * - - - -	7 - * * * *
3 * * * - - -	8 - * * * *
4 * * * * -	9 - - - - * *
5 * * * * *	0 - - - - -
Period * - - - -	
Comma - - - - -	
Question mark * - - - * *	
Error * * * * * *	
Double dash - - - - -	
Fraction bar - - - * *	
Wait * - * * *	
Invitation to transmit - - - -	
End of message (AR) * - * * * *	
End of transmission * * * * - -	

### Special Foreign Letters

Ä (German) * - * - -
Å or A (Spanish-Scandinavian) * - - - * -
CH (German-Spanish) - - - - -
E (French) * * - * *
Ñ (Spanish) - - - - -
Ö (German) - - - - *
Ü (German) * * - - -

## SIGNAL REPORTING CODES

---

### RST Code

The standard amateur method of giving signal strength reports. For phone operation only the first two sets of numbers are used with the words "readability" and "strength."

#### Readability (R)

1. Unreadable
2. Barely readable, occasional words distinguishable
3. Readable with considerable difficulty
4. Readable with practically no difficulty
5. Perfectly readable

#### Signal Strength (S)

1. Faint; signal barely perceptible
2. Very weak signal
3. Weak signal
4. Fair signal
5. Fairly good signal
6. Good signal
7. Moderately strong signal
8. Strong signal
9. Extremely strong signal

#### Tone (T)

1. Extremely rough, hissing signal
2. Very rough ac signal
3. Rough, low-pitched ac signal
4. Rather rough ac signal
5. Musically modulated signal
6. Modulated signal, slight whistle
7. Near dc signal, smooth ripple
8. Good dc signal, trace of ripple
9. Purest dc signal

If the signal has the steadiness of crystal control, add "X" after the RST report; add "C" for a chirp; and "K" for a keying click.

A typical report might be: "RST579X," meaning "Your signals are perfectly readable, moderately strong, have a perfectly clear tone, and have the stability of a crystal-controlled transmitter."

This reporting system is used on both CW and voice, leaving out the "Tone" report on voice.

### SINPO Code

A reporting method used in the shortwave field. All the numbers after the letters range from one to five. Q-code equivalents for each characteristic are also shown.

FOR EXAMPLE: A typical report for a station that is coming in loud and clear would read: SINPO 55555.

S Signal Strength (QSA)	I Interference (QRM)	N Atmospheric Noise (QRN)	P Propagation Disturbance (QSB)	O Overall Merit (QRK)
5 Excellent	5 None	5 None	5 None	5 Excellent
4 Good	4 Slight	4 Slight	4 Slight	4 Good
3 Fair	3 Moderate	3 Moderate	3 Moderate	3 Fair
2 Poor	2 Severe	2 Severe	2 Severe	2 Poor
1 Barely audible	1 Extreme	1 Extreme	1 Extreme	1 Unusable

### 555 Code

Another reporting code sometimes used in the shortwave field.

Signal Strength	Interference	Overall Merit
0 Inaudible	0 Total	0 Unusable
1 Poor	1 Very severe	1 Poor
2 Fair	2 Severe	2 Fair
3 Good	3 Moderate	3 Good
4 Very good	4 Slight	4 Very good
5 Excellent	5 None	5 Excellent

### SINPFEMO Code

This eight-figure signal reporting method rates eight characteristics of a signal. (If a characteristic is not rated, the letter "x" is used instead of a numeral.)

Rating Scale	S	I	N	P	F	E	M	O
	Signal Strength	Degrading Effect of			Frequency of Fading	Modulation		Overall Rating
		Interference (QRM)	Noise (QRN)	Propagation Disturbance		Quality	Depth	
5	Excellent	Nil	Nil	Nil	Nil	Excellent	Maximum	Excellent
4	Good	Slight	Slight	Slight	Slow	Good	Good	Good
3	Fair	Moderate	Moderate	Moderate	Moderate	Fair	Fair	Fair
2	Poor	Severe	Severe	Severe	Fast	Poor	Poor or nil	Poor
1	Barely audible	Extreme	Extreme	Extreme	Very fast	Very poor	Continuously overmodulated	Unusable

**COMMERCIAL RADIO OPERATOR AND AMATEUR OPERATOR LICENSES REQUIREMENTS**
**Amateur Operator Licenses**

<i>Class</i>	<i>Prior Experience</i>	<i>Code Test</i>	<i>Written Examination</i>	<i>Privileges</i>	<i>Term</i>
Novice	None	5 w.p.m.	Elementary theory and regulations	All Telegraphy in 3.7-3.75, 7.1-7.15, 21.1-21.2, 28.1-28.2 MHz. 250 watts maximum input.	5 years, renewable
Technician	None	5 w.p.m. (Credit given to Novice Class Licensees)	General theory and regulations	All amateur privileges above 50 MHz. Also novice privileges.	5 years, renewable
General	None	13 w.p.m.	General theory and regulations (Credit given to Technician Class Licensees)	1.8-2, <sup>a</sup> 3.525-3.775, 3.89-4, 7.025-7.15, 7.225-7.3, 14.025-14.2, 14.275-14.35, 21.025-21.25, 21.35-21.45, 28.0-29.7 MHz, and all amateur privileges above 50 MHz.	5 years, renewable
Advanced	None	13 w.p.m. (Credit is given to General Class Licensees)	Intermediate theory and regulations	1.8-2, <sup>a</sup> 3.525-3.775, 3.8-4, 7.025-7.3, 14.025-14.45, 21.025-21.25, and all amateur frequencies above 21.27 MHz.	5 years, renewable
Amateur Extra	None	20 w.p.m.	Advanced theory and regulations	All amateur privileges	5 years, renewable

<sup>a</sup>The 1.8-2 band frequency and power assignments differ from state to state. Check with nearest FCC office.

### Commercial Radio Operator Licenses

<i>Type of License</i>	<i>Age Minimum</i>	<i>Code Requirement</i>	<i>Written Test</i>	<i>Term of License</i>
Restricted Radiotelephone Permit	14 years	None	None; obtained by declaration (FCC Form 753)	Lifetime
Marine Radio Operator Permit	None	None	Elements 1, 2	5 years, renewable
General Radiotelephone License	None	None	Element 3	5 years, renewable
Third Class Radiotelegraph Permit	None	16 code groups 20 plain words per minute	Elements 1, 2, 5	5 years renewable
Second Class Radiotelegraph License	None	16 code groups 20 plain words per minute	Elements 1, 2, 5, 6	5 years, renewable
First Class Radiotelegraph License	21 years; one year experience	20 code groups, 25 plain words per minute	Elements 1, 2, 5, 6	5 years, renewable



## **Commercial Examination Elements**

### **NO. 1, BASIC LAW-**

Provisions of laws, treaties and regulations with which every marine operator should be familiar. (20 Questions, multiple choice type)

### **NO. 2, BASIC OPERATING PRACTICE-**

Operating procedures and practices generally followed or required in communicating by marine radio-telephone stations. (20 Questions, multiple choice type)

### **NO. 3, BASIC RADIOTELEPHONE-**

Technical, legal and other matters including basic operating practices and provisions of laws, treaties and regulations applicable to operating radiotelephone stations other than broadcast. (100 Questions, multiple choice type)

### **NO. 5, RADIOTELEGRAPH OPERATING PRACTICE-**

Radio operating procedures and practices generally followed or required in communicating by radiotelegraph stations primarily other than in the maritime mobile services of public correspondence. (50 Questions, multiple choice type)

### **NO. 6, ADVANCED RADIOTELEGRAPH-**

Technical, legal matters applicable to operating all classes of radiotelegraph stations including maritime mobile services of public correspondence, message traffic routing and accounting, radio navigational aids, etc. (100 Questions)

### **NO. 7, AIRCRAFT RADIOTELEGRAPH-**

Special endorsement on Radiotelegraph First and Second Class Operator Licenses. Theory and practice in operation of radio communication and navigational systems in use on aircraft. (100 Questions, multiple choice type; code test of 20 code groups per minute and 25 WPM plain language.)

### **NO. 8, SHIP RADAR TECHNIQUES-**

Special endorsement on Radiotelegraph or Radiotelephone First or Second Class Operator Licenses. Specialized theory and practice applicable to proper installation, servicing and maintenance of ship radar equipment in use for marine navigational purposes. (50 Questions, multiple choice type)

## INTERNATIONAL PHONETIC ALPHABET

To avoid errors or misunderstanding during voice communication, the new international phonetic alphabet has been adopted.

Letter	Name	Pronunciation	Letter	Name	Pronunciation
A	Alfa	AL-fah	N	November	No-VEM-ber
B	Bravo	BRAH-voh	O	Oscar	OSS-cah
C	Charlie	CHAR-lee (or SHAR-lee)	P	Papa	PAH-PAH
D	Delta	DELL-tah	Q	Quebec	Keh-BECK
E	Echo	ECK-oh	R	Romeo	ROW-me-oh
F	Foxtrot	FOKS-trot	S	Sierra	See-ALR-rah
G	Golf	GOLF	T	Tango	TANG-go
H	Hotel	HOH-tel	U	Uniform	YOU-nee-form (or OO-nee-form)
I	India	IN-dee-ah	V	Victor	VIK-tah
J	Juliett	JEW-lee-ett	W	Whiskey	WISS-key
K	Kilo	KEY-loh	X	X-ray	ECKS-ray
L	Lima	LEE-mah	Y	Yankee	YANG-key
M	Mike	MIKE	Z	Zulu	ZOO-loo

## ARRL (AMERICAN RADIO RELAY LEAGUE) WORD LIST FOR VOICE COMMUNICATION

A—Adam	N—Nancy
B—Baker	O—Otto
C—Charlie	P—Peter
D—David	Q—Queen
E—Edward	R—Robert
F—Frank	S—Susan
G—George	T—Thomas
H—Henry	U—Union
I—Ida	V—Victor
J—John	W—William
K—King	X—X-Ray
L—Lewis	Y—Young
M—Mary	Z—Zebra

Example: W1AW . . . W1  
ADAM WILLIAM . . . W1AW

## TRANSMISSION TRAVEL TIME

The time required for electromagnetic energy to travel interplanetary distances is significant. Shown here are some typical times and distances related to the earth's position.

Moon	(overhead)	=	$23.9 \times 10^4$ n mi	1.27 sec one way
Venus	(nearest)	=	$22.4 \times 10^6$ n mi	139.00 sec one way
	(farthest)	=	$139.0 \times 10^6$ n mi	859.00 sec one way
Mars	(nearest)	=	$42.4 \times 10^6$ n mi	262.00 sec one way
	(farthest)	=	$203.9 \times 10^6$ n mi	1259.00 sec one way
Jupiter	(nearest)	=	$339.8 \times 10^6$ n mi	2099.00 sec one way
	(farthest)	=	$501.2 \times 10^6$ n mi	3096.00 sec one way

## CLASSIFICATION OF EMISSIONS

In accordance with Federal Communications Commission Rules and Regulations 2.201, Subpart C, the following system of designating emission, modulation, and transmission characteristics is employed.

(a) Emissions are designated according to their classification and their necessary bandwidth.

(b) Emissions are classified and symbolized according to the following characteristics.

- (1) Type of modulation of main carrier.
- (2) Type of transmission.
- (3) Supplementary characteristics.

(c) Types of modulation of main carrier:

- |                                | Symbol |
|--------------------------------|--------|
| (1) Amplitude .....            | A      |
| (2) Frequency (or Phase) ..... | F      |
| (3) Pulse .....                | P      |

(d) Types of transmission:

- |   |   |
|---|---|
| (1) Absence of any modulation intended to carry information .....   | 0 |
| (2) Telegraphy without the use of a modulating audio frequency .....  | 1 |
| (3) Telegraphy by the on-off keying of a modulating audio frequency or audio frequencies, or by the on-off keying of the modulated emission (special case: an unkeyed modulated emission) ..... | 2 |

- |  | Symbol |
|--|--------|
| (4) Telephony (including sound broadcasting) .....   | 3      |
| (5) Facsimile (with modulation of main carrier either directly or by a frequency modulated sub-carrier) .. | 4      |
| (6) Television (visual only) .....   | 5      |
| (7) Four-frequency duplex telegraphy .....   | 6      |
| (8) Multichannel voice-frequency telegraphy .....  | 7      |
| (9) Cases not covered by the above .....   | 9      |

(e) Supplementary characteristics:

- |   |        |
|---|--------|
| (1) Double sideband .....                 | (None) |
| (2) Single sideband:                      |        |
| (I) Reduced carrier .....                 | A      |
| (II) Full carrier .....                   | H      |
| (III) Suppressed carrier .....            | J      |
| (3) Two independent sidebands .....       | B      |
| (4) Vestigial sideband .....              | C      |
| (5) Pulse:                                |        |
| (I) Amplitude modulated .....             | D      |
| (II) Width (or duration) modulated .....  | E      |
| (III) Phase (or position) modulated ..... | G      |
| (IV) Code modulated .....                 | F      |

(f) The classification of typical emissions is tabulated as follows:

Type of modulation of main carrier	Type of transmission	Supplementary characteristics	Symbol
Amplitude modulation .....	With no modulation .....		A0
	Telegraphy without the use of a modulating audio frequency (by on-off keying) .....		A1
	Telegraphy by the on-off keying of an amplitude modulating audio frequency or audio frequencies, or by the on-off keying of the modulated emission (special case: an unkeyed emission amplitude modulated) .....		A2
	Telephony .....	Double sideband .....	A3
		Single sideband, reduced carrier .....	ASA
		Single sideband, suppressed carrier .....	ASJ
		Two independent sidebands .....	ASB
			AS4
		Facsimile (with modulation of main carrier either directly or by frequency modulated sub-carrier) ..	ASA
		Television .....	ASG
	Multichannel voice-frequency telegraphy .....	ATA	
	Cases not covered by the above, e.g., a combination of telephony and telegraphy .....	ASB	
Frequency (or Phase) modulation .....	Telegraphy by frequency shift keying without the use of a modulating audio frequency or of two frequencies being emitted at any instant ..		F1
	Telegraphy by the on-off keying of a frequency modulating audio frequency or by the on-off keying of a frequency modulated emission (special case: an unkeyed emission, frequency modulated) .....		F2
	Telephony .....		F3
	Facsimile by direct frequency modulation of the carrier .....		F4
	Television .....		F5
	Four-frequency duplex telegraphy .....		F6
	Cases not covered by the above, in which the main carrier is frequency modulated .....		F9
			F9
Pulse modulation .....	A pulsed carrier without any modulation intended to carry information (e.g., radar) .....		P0
	Telegraphy by the on-off keying of a pulsed carrier without the use of a modulating audio frequency ..		P1D
	Telegraphy by the on-off keying of a modulating audio frequency or audio frequencies, or by the on-off keying of a modulated pulsed carrier (special case: an unkeyed modulated pulsed carrier) .....		P2D
		Audio frequency or audio frequencies modulating the amplitude of the pulses .....	P2E
		Audio frequency or audio frequencies modulating the width (or duration) of the pulses .....	P2F
		Audio frequency or audio frequencies modulating the phase (or position) of the pulses .....	P2G
		Amplitude modulated pulses .....	P2D
		Width (or duration) modulated pulses .....	P2E
		Phase (or position) modulated pulses .....	P2F
		Code modulated pulses (after sampling and quantization) .....	P2G
Cases not covered by the above in which the main carrier is pulse modulated .....		P9	

Class	Name	Code	Action of Modulating Signal
A	Pulse-time modulation	PTM	Varies some characteristic of pulse with respect to time.
	Pulse-position modulation	PPM	Varies position (phase) of pulse on time base.
	Pulse-duration modulation	PDM	Varies width of pulse (also called PWM, or Pulse-Width Modulation).
	Pulse-shape modulation		Varies shape of pulse.
	Pulse-frequency modulation	PFM	Varies pulse recurrence frequency.
B	Pulse-amplitude modulation	PAM	Varies amplitude of pulse—consists of two types: one using unipolar pulses, the other using bipolar pulses.
C	Pulse-code modulation	PCM	Varies the makeup of a series of pulses and spaces. Individual systems are classified as follows: <u>Binary</u> -pulse and spaces, or positive and negative pulses. <u>Ternary</u> -positive pulses, negative pulses, and spaces. <u>N-ary</u> -more complex combinations of pulses and spaces.

## MICROPHONE OUTPUT NOMOGRAM

---

This nomogram determines the output voltages for various microphone ratings and relates this output to actual sound pressure levels.

Two methods of specifying microphone levels are in general use. Acoustic input and electrical output are specified so that the microphone can be considered as a generator, with sound pressure input and voltage or power output.

For low-impedance microphones, output is given in decibels referenced to 1 mW for 10 dynes/cm<sup>2</sup> sound pressure. For high-impedance microphones, output is given in decibels referenced to 1 V for 1 dyne/cm<sup>2</sup> sound pressure. (In both, output is into a resistive load equal to the impedance of the microphone.)

This nomogram is prepared for microphone preamplifiers with low input impedances matched to the microphone impedance. (Open-circuit voltage is 6 dB higher than the nomogram value.) Connecting the microphone impedance and the decibel rating solves for the voltage across a matched load for the standard 10 dynes/cm<sup>2</sup> sound pressure field. By referring to the absolute sound pressure vs decibel scale, any other sound pressure level can be found and the decibel difference (with respect to 10 dynes/cm<sup>2</sup>) can be determined, and adjustments can be made in the output voltage by adding or subtracting decibels.

For high-impedance microphones, the nomogram is used in the same way, except that the impedance is always considered as 40,000 ohms, and the reading will be that for a 10 dynes/cm<sup>2</sup> field. These microphones are usually operated into a very high impedance circuit, hence 6 dB must be added to the output voltage. (Use of this method results in an error of approximately 2 dB.)

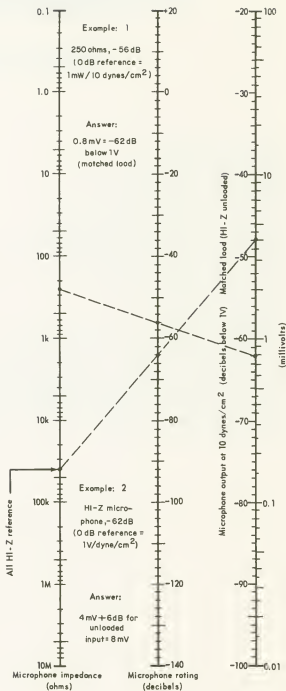
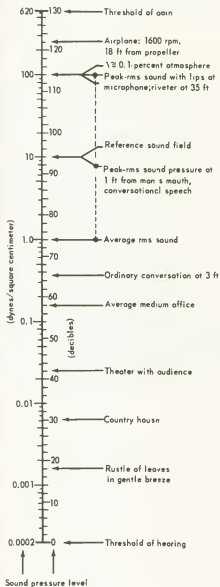

# Section 3

Attenuator Nomograms	/ 72
Twin-T Filter Nomogram	/ 75
Minimum-Loss Matching Pads	/ 78
Preferred Values of Components	/ 79
Thermal Noise Voltage Nomogram (A)	/ 80
Thermal Noise Voltage Nomogram (B)	/ 82
Single-Layer Coil Design Nomogram (A)	/ 83
Single-Layer Coil Design Nomogram (B)	/ 84
Inductance of Straight, Round Wire at High Frequencies	/ 85
Transformer Impedance Nomogram	/ 86
Energy Storage Nomogram	/ 88
Power-Factor Correction	/ 90
Power-Factor Nomogram	/ 91
kVAR-Capacity Nomogram for 60-Hz Systems	/ 92
Self-Resonant Frequency of Parallel Lead Capacitors	/ 93
Reactance Nomograms	/ 94
RF Penetration (Skin Resistance) of Various Materials	/ 98
Impedance of Series-Connected and Parallel-Connected Combinations of $L$ , $C$ and $R$	/ 99
Frequency Characteristics of Resistors, Capacitors, and Inductors	/ 100
Resistance-Voltage-Current=Power Nomogram	/ 101
Voltage Divider Nomogram	/ 102

# Passive Components and Circuits

Nomogram for Capacitively Coupled Circuits	/ 104
R-C Coupling Nomogram	/ 105
Square Wave Response of Amplifiers	/ 106
Low-End Amplifier Response	/ 107
Time-Constant Nomogram (A)	/ 108
Time-Constant Nomogram (B)	/ 109
Frequency Selective Network Nomogram	/ 110
Bandwidth Nomogram	/ 114
Crossover Networks, Design Equations, and Rate of Attenuation Curves	/ 116
Passive LC Filter Design	/ 117
Filter Characteristics and Design Formulas	/ 144
Comb-Filter Design	/ 146
Pulse-Forming Network Nomogram	/ 148
Delay Line Design Nomogram	/ 149
Coaxial Cable Signal Delay Nomogram	/ 150
Voltage Multiplier Circuits	/ 151
Power Transistor and Diode Requirements for Switching Power Supplies	/ 152
Percent Regulation of Power Supplies	/ 156
Power Loss Due to Impedance Mismatch	/ 157
Seven Commonly Used Bridge Circuits and Their Balance Equations	/ 158
Parallel-Resistor/Series-Capacitor Nomogram	/ 159



## ATTENUATOR NOMOGRAMS

These two nomograms solve for the resistor values required for the following: T, Pi, H, O, lattice, bridged T, bridged H, L, and U-type attenuators. The nomograms are based on the equations shown. The keys next to the nomograms show which scales must be used for a particular type of attenuator.

### FOR EXAMPLE:

1.  $Z_o$  is 600 ohms and the required attenuation is 20 dB. Design T, H, and Pi attenuators. From nomogram 1, for a T type,  $R_1$  is 480 ohms and  $R_2$  is 120 ohms. For an H type each of the four series arms would be 240 ohms. For Pi type (middle key)  $R_2$  is 750 ohms and  $R_3$  is 3,000 ohms.

2. A lattice attenuator (key three, nomogram 1) that gives 20 dB of attenuation at 500 ohms requires  $R_1$  to be 410 ohms and  $R_2$  to be 610 ohms.

3. A bridged T attenuator (nomogram 2, first key) with an attenuation of 20 dB and terminal impedances of 450 ohms has  $R_5$  as 4,000 ohms and  $R_6$  as 50 ohms.

4. Design an L-type attenuator (middle key, nomogram) with an attenuation of 14 dB, and an impedance of 50 ohms with the shunt arm at the output end. In this case  $R_5$  is 200 ohms and  $R_6$  is 62.5 ohms.

NOTE: In all cases the input and output impedances are the same.

$$\begin{aligned} R_1 &= Z_o \left( \frac{K-1}{K+1} \right) & R_3 &= Z_o \left( \frac{K^2-1}{2K} \right) & R_5 &= Z_o (K-1) & R_7 &= Z_o \left( \frac{K-1}{K} \right) \\ R_2 &= Z_o \left( \frac{K+1}{K-1} \right) & R_4 &= Z_o \left( \frac{2K}{K^2-1} \right) & R_6 &= Z_o \left( \frac{1}{K-1} \right) & R_8 &= Z_o \left( \frac{K}{K-1} \right) \end{aligned} \quad \text{where } K = \frac{E_{in}}{E_{out}}$$

# NOMOGRAM 1 FOR T, Pi, H, O, AND LATTICE TYPE ATTENUATORS.

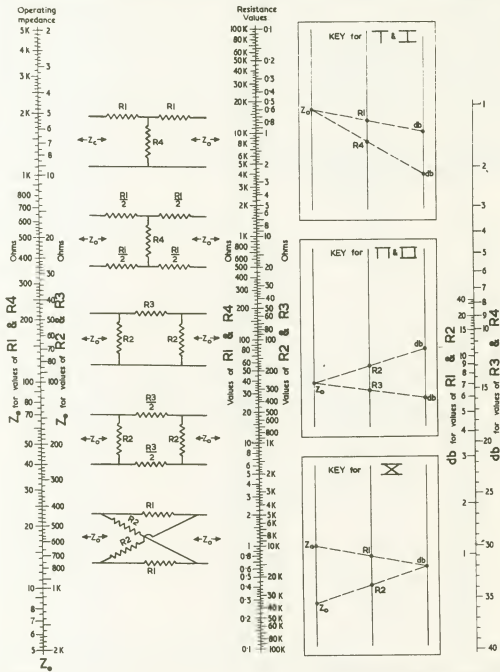

# NOMOGRAM 2 FOR BRIDGED T, H, L, AND U TYPE ATTENUATORS.

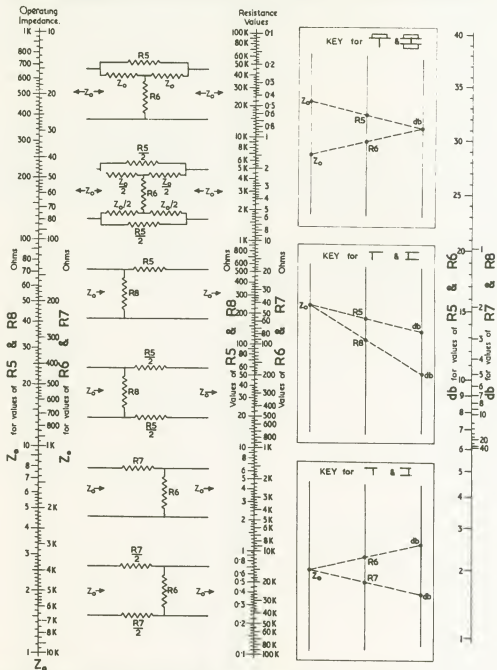

(Reprinted from *Radio-Electronics*, copyright © Gernsback Publications, Inc., December 1953.)

### TWIN-T FILTER NOMOGRAM

Twin-T filters with symmetrical response curves are frequently used to reject specific frequencies, or they may be included in the negative feedback loop of a frequency-selective amplifier as the tuning element. Other component combinations may be used, but the one selected here has the greatest possible selectivity. With this general configuration, any filter exhibits infinite attenuation at the notch frequency ( $f_o$ ) which is specified by the values of  $R_1$  and  $C_1$ . If it is only desired to reject  $f_o$ , then the choice of these values is arbitrary. However, if it is desired to design a filter with a symmetrical response curve so the dc gain is equal to that at high frequencies, that is accomplished when  $R_1 = \sqrt{R_g R_L} / 2$ , and the notch frequency is determined by the expression  $f_o = 1/4\pi C_1 R_1$ . The nomograms are based on these two equations. Usually  $R_g$ ,  $R_L$ , and  $f_o$  are known, and the values of  $R_1$  and  $C_1$  are to be determined. It is also possible to use chart 2 alone and select arbitrary values for  $R_1$  or  $C_1$  if symmetrical response is not essential.

**FOR EXAMPLE:** Design a filter with infinite attenuation at 800 Hz which is to be inserted between a 2,000-ohm source impedance and a load resistance of 100,000 ohms. From nomogram 1 determine that  $R_1$  should be 10,000 ohms, and with that value determine from nomogram 2 that  $C_1$  must be 0.01  $\mu$ F to achieve a symmetrical response curve.

Twin-T notch filter, with component values related as shown, yields maximum selectivity and symmetrical gain-frequency response.

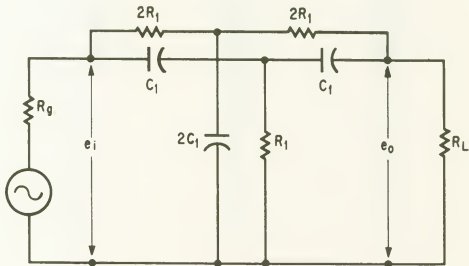

(Reprinted from *Electronics*, April 18, 1966, copyright © McGraw-Hill Inc., 1966.)

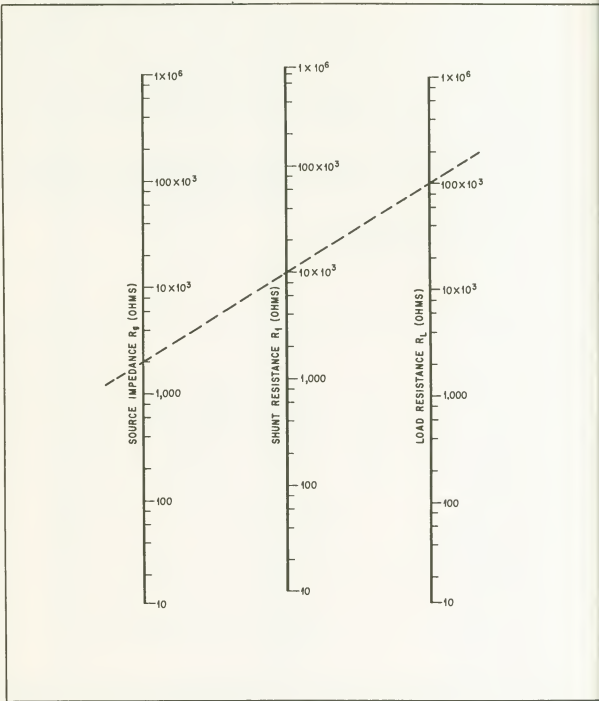

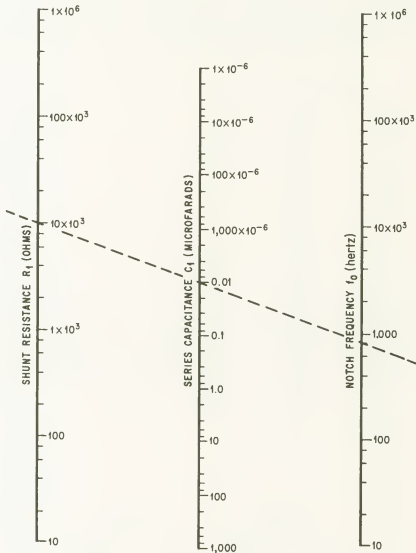

(Reprinted from *Electronics*, April 18, 1966, copyright © McGraw-Hill, Inc., 1966.)

### MINIMUM-LOSS MATCHING PADS

This nomogram solves for the resistance values needed for an impedance matching pad having a minimum of attenuation.  $Z_1$  is the greater and  $Z_2$  is the lesser terminal impedance in ohms. To use the nomogram, calculate the ratio of  $Z_2/Z_1$ , and connect that point on the center scale with  $Z_1$  to find  $R_1$ , and with  $Z_2$  to find  $R_3$ . 890 ohms also read on the center scale.

FOR EXAMPLE: If  $Z_2$  is 400 ohms and  $Z_1$  is 500 ohms, the value of  $R_1$  must be 225 ohms and of  $R_3$  890 ohms for a minimum insertion loss pad that has 4.2 dB of insertion loss.

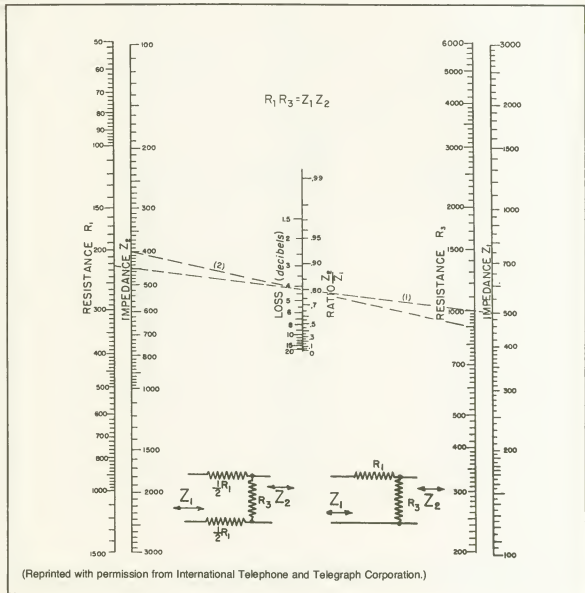

## PREFERRED VALUES OF COMPONENTS

Preferred numbers for nominal values of resistance, capacitance, and inductance have been adopted by the electronics industry. Each value differs from its predecessor by step multiples of  $(10)^{1/16}$ ,  $(10)^{1/12}$ , or  $(10)^{1/24}$  resulting in incremental increase of approximately 40%, 20%, and 10% per step as shown in the table, to yield an orderly progression of component values of  $\pm 20\%$ ,  $\pm 10\%$ , and  $\pm 5\%$ .

Standard values outside of the range listed can be obtained by multiplying by suitable multiples of 10. (For example, 15 can represent 1.5, 150, 15 k, 1.5 M, etc.)

### MIL and EIA Standard for Component Values and Tolerances

$\pm 20\%$	$\pm 10\%$	$\pm 5\%$
10	10	10
		11
	12	12
		13
15	15	15
		16
	18	18
		20
22	22	22
		24
	27	27
		30
33	33	33
		36
	39	39
		43
47	47	47
		51
	56	56
		62
68	68	68
		75
	82	82
		91
100	100	100



### THERMAL NOISE VOLTAGE NOMOGRAM (A)

Given frequency, input  $C$ , and amplifier input  $Z$ , only two operations are required to find the equivalent thermal noise voltage.

When an amplifier is fed from a capacitive source, the spot (one frequency) noise is generated by the real part of the impedance. This nomogram reduces the calculation required to arrive at the noise value. Impedance at the amplifier input is

$$Z = \frac{R - jR^2 \omega C}{R^2 \omega^2 C^2 + 1} \quad (1)$$

Thermal noise is generated by the real part of this expression, which is

$$(REAL Z) = \frac{R}{R^2 \omega^2 C^2 + 1} = \frac{1}{R\omega^2 C^2} \quad (2)$$

The mean square thermal noise voltage associated with the real part of  $Z$  is given by

$$\bar{e}^2 = 4 k T df (REAL Z) \quad (3)$$

For this case

$$df = 1 \text{ (spot frequency)} \\ T = 25^\circ\text{C}$$

Combining (2) and (3)

$$\bar{e}^2 = 4 k T df \frac{1}{R\omega^2 C^2} \quad (4)$$

Equation (4) forms the basis for the nomogram. Nomogram of equivalent spot thermal noise voltage of the parallel combination of a capacitor and an amplifier input resistance.

Using the nomogram:

1. Choose  $f$ ,  $C$ , and  $R$  (in the example  $f = 10$  kHz,  $C = 0.001 \mu\text{F}$ , and  $R = 1$  M ohm).
2. Draw a line between the chosen  $f$  and  $C$ .
3. Mark its intersection on the reference line.
4. Draw a line from the marked point on the reference scale to the chosen  $R$ .
5. The intersection of this line with the  $\bar{e}^2$  scale is the desired equivalent thermal noise voltage in dB re 1 V.

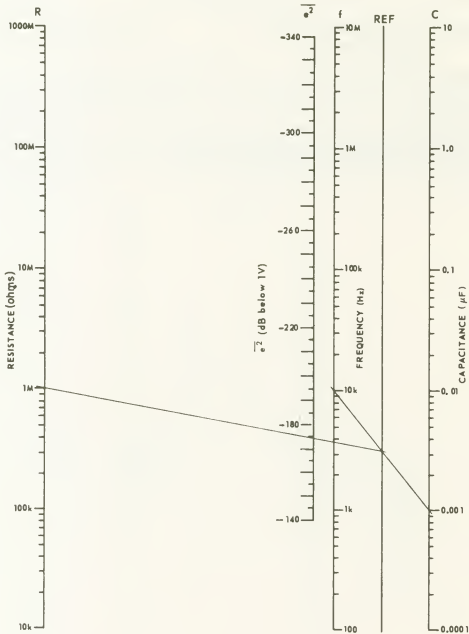

### THERMAL NOISE VOLTAGE NOMOGRAM (B)

Thermally produced noise voltage of any linear conductor is determined by Nyquist's equation

$$E = 2 \sqrt{RkTB}$$

where  $E$  = noise voltage in rms microvolts

$k$  = Boltzmann's constant,  $1.38 \times 10^{-23}$  J/°K

$R$  = resistance

$T$  = absolute temperature (°K)

$B$  = bandwidth in hertz

This nomogram solves the above equation if any three of the four variables are given.

**FOR EXAMPLE:** An amplifier has a voltage gain of 1,000, and input resistance of 470,000 ohms, and a bandwidth of 2 kHz. Find the output noise level due to the input resistance if the amplifier is operated at an ambient temperature of 100°C.

Connect 100°C ( $T$  scale) with 470 K ( $R$  scale) and note intersect point on turning scale. Connect that point with 2 kHz ( $B$  scale) and read noise voltage as 4.4  $\mu$ V on  $E$  scale. The amplifier has a gain of 1,000; thus, the outside noise of the amplifier due to the input resistance is 4.4 mV.

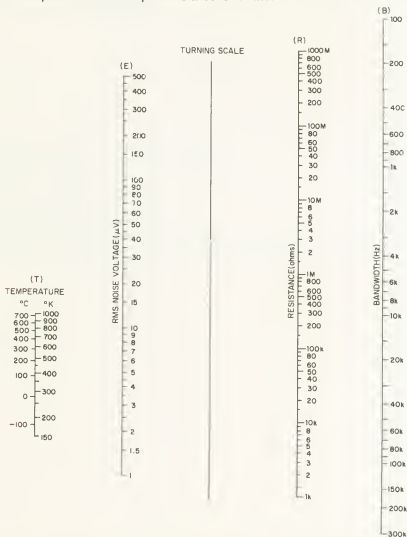

### SINGLE-LAYER COIL DESIGN NOMOGRAM (A)

This nomogram is based on the formula for the inductance of a single-layer coil

$$L = \frac{a^2 N^2}{9a + 10b}$$

where  $L$  = inductance in microhenries  
 $a$  = coil radius in inches  
 $b$  = coil length in inches  
 $N$  = number of turns



FOR EXAMPLE: (1) Find the inductance of a 100-turn coil with a diameter of 2 in. and a winding length of 0.8 in. Find  $K$  (diameter/length)  $2/0.8$  to be 2.5. Connecting 2.5 on the  $K$  scale to 100 on the  $N$  scale intersects the turning axis at 3.8. Now connect 3.8 with 2 on the  $D$  scale, and read the inductance as  $600 \mu\text{H}$ . (2) Determine the number of turns required for a  $290\text{-}\mu\text{H}$  coil 3 in. long with a diameter of 2.5 in.  $K$  is equal to 0.8. Connect 290 on the  $L$  scale with 2.5 on the  $D$  scale, and read 4.6 on the turning axis. Connecting 4.6 and 0.8 on the  $K$  scale gives the answer as 90 turns on the  $N$  scale.

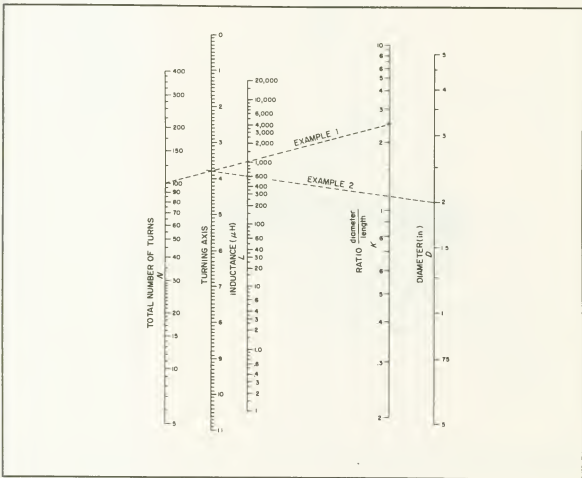

### SINGLE-LAYER COIL DESIGN NOMOGRAM (B)

This nomogram solves for the number of close-wound turns required to achieve inductances in the range of values required for television, fm, and radar if transformers. The nomogram is based on a slight modification of H.A. Wheeler's inductance formula that was used to construct nomogram A. The formula used here (with all dimensions in inches) is

$$L = \frac{a^2 N^2}{8.85a + 10b}$$

FOR EXAMPLE: Ten turns of number 30 AWG enameled wire closewound on a 0.25-inch diameter coil form will produce an inductance of 0.7  $\mu\text{H}$ .

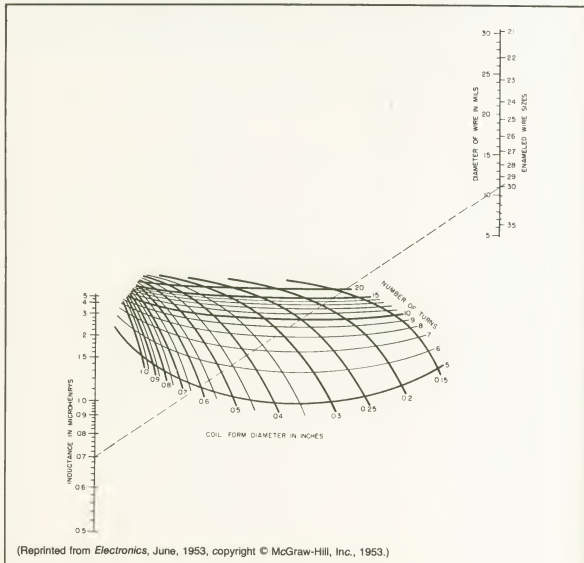

## INDUCTANCE OF STRAIGHT, ROUND WIRE AT HIGH FREQUENCIES

Above several megahertz the inductance of relatively short lengths of wire becomes important because of the effect on circuit performance. The chart shows the relationship between diameter, wire length, and inductance for various diameters. A more precise tabulation is also shown for short lengths of commonly used wire sizes.

FOR EXAMPLE: A straight piece of wire 4 in. long with a diameter of 25 mil has an inductance of 0.2  $\mu$ H. At a frequency of 80 MHz, this represents an inductive reactance of about 100 ohms.

AWG Wire Size	Length (in.)	Approx. Inductance ( $\mu$ H)
20	1/4	0.0031
	1/2	0.0064
	3/4	0.0115
	1	0.019
	1 1/2	0.031
	2	0.04
24	1/4	0.0037
	1/2	0.0082
	3/4	0.014
	1	0.022
	1 1/2	0.036
	2	0.05

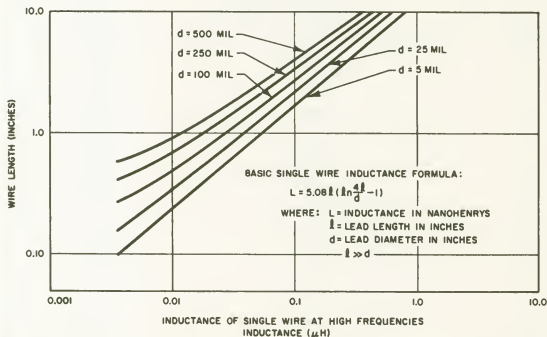

(From *Radio Engineers' Handbook* by Frederick E. Terman. Copyright © 1943 by McGraw-Hill Book Company. Used with permission of McGraw-Hill Book Company.)

### TRANSFORMER IMPEDANCE NOMOGRAM

Tapped transformers provide standard impedances between the various taps and the common terminal. If a nonstandard impedance is required, it can often be found between the taps. This nomogram determines the impedance between terminals *B* and *C* if the impedance from *A* to *B* and *A* to *C* are known, and it is based on the following formula

$$Z_{(B-C)} = \left( \sqrt{Z_{(A-C)}} - \sqrt{Z_{(A-B)}} \right)^2$$

FOR EXAMPLE: If the impedance from *A* to *B* is 15 ohms, and the impedance from *A* to *C* is 250 ohms, then the impedance from *B* to *C* is = 145 ohms.

$$\text{*Derived from } Z_{(B-C)} = Z_{A-B} \left( \sqrt{\frac{Z_{(A-C)}}{Z_{(A-B)}} - 1} \right)^2$$

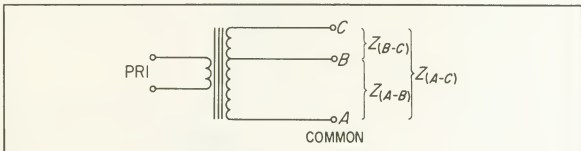

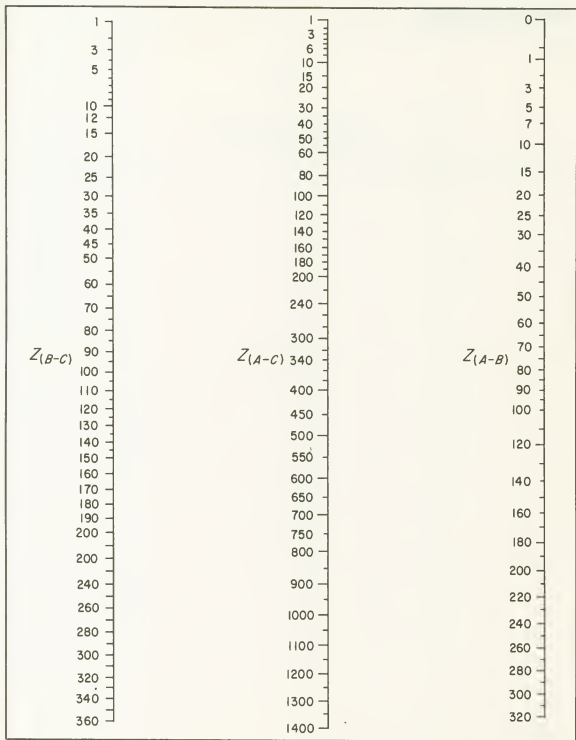



### ENERGY STORAGE NOMOGRAM

---

The nomogram relates capacitance, charging voltage, and stored energy in a capacitor in accordance with the formula

$$J \text{ or } W = \frac{CV^2}{2}$$

where  $J$  or  $W$  = energy in joules or watt-seconds

$C$  = capacitance in microfarad

$V$  = charging voltage

FOR EXAMPLE: The energy stored in a 525- $\mu$ F capacitor charged to 450 V is 53 W-sec or joules.

STORED  
ENERGY  
(W-sec or J)



CHARGING VOLTAGE  
(dc V)



CAPACITANCE  
( $\mu$ F)



## POWER-FACTOR CORRECTION

Power factor is the ratio (usually given in percent) of the actual power used in a circuit to the power apparently drawn from the line.

$$PF = \frac{\text{actual power}}{\text{apparent power}}$$

A low power factor is undesirable, and it can be raised by the addition of power-factor correction capacitors which are rated in kVAR (kilovolt-ampere reactive). To determine the kVAR of the capacitors needed to correct from an existing to a higher power factor, multiply the proper value in the table by the average power consumption on kilowatts, of the load.

FOR EXAMPLE: Find the kVAR of capacitors that is required to raise the power factor of a 500-kW load from 70% to 85%.

From the table select the multiplying factor 0.400 which corresponds to the existing 70% and required 85% power factor. Multiplying 0.400 by 500 shows that 200 kVAR of capacitors are required.

Existing Power Factor %	Corrected Power Factor					
	100%	95%	90%	85%	80%	75%
50	1.732	1.403	1.247	1.112	0.982	0.850
52	1.643	1.314	1.158	1.023	0.893	0.761
54	1.558	1.229	1.073	0.938	0.808	0.676
55	1.518	1.189	1.033	0.898	0.768	0.636
56	1.479	1.150	0.994	0.859	0.729	0.597
58	1.404	1.075	0.919	0.784	0.654	0.522
60	1.333	1.004	0.848	0.713	0.583	0.451
62	1.265	0.936	0.780	0.645	0.515	0.383
64	1.201	0.872	0.716	0.581	0.451	0.319
65	1.168	0.839	0.683	0.548	0.418	0.286
66	1.139	0.810	0.654	0.519	0.389	0.257
68	1.078	0.749	0.593	0.458	0.328	0.196
70	1.020	0.691	0.535	0.400	0.270	0.138
72	0.964	0.635	0.479	0.344	0.214	0.082
74	0.909	0.580	0.424	0.289	0.159	0.027
75	0.882	0.553	0.397	0.262	0.132	
76	0.855	0.526	0.370	0.235	0.105	
78	0.802	0.473	0.317	0.182	0.052	
80	0.750	0.421	0.265	0.130		
82	0.698	0.369	0.213	0.078		
84	0.646	0.317	0.161			
85	0.620	0.291	0.135			
86	0.594	0.265	0.109			
88	0.540	0.211	0.055			
90	0.485	0.156				
92	0.426	0.097				
94	0.363	0.034				
95	0.329					

## POWER-FACTOR NOMOGRAM

The power factor ( $\cos \phi$ ) of a series RL or a parallel RC network is given by the following formulas

$$P.F. \text{ (inductive)} = \frac{R_2}{\sqrt{R_2^2 + (\omega L)^2}}$$

$$P.F. \text{ (capacitive)} = \frac{1}{\sqrt{(R_p \omega C)^2 + 1}}$$

To use the nomogram connect frequency with the desired value of  $L$  or  $C$  and note the intersect point on the turning scale. Using this intersect point, connect to the resistance, and by extending this line, read power factor and phase angle.

### FOR EXAMPLE:

1. A 1-H inductance in series with 100 ohms is connected to a 60-Hz source. In this case  $\phi$  is  $75^\circ$  and  $\cos \phi$  is 0.26.

2. An inverter operating at 2 kHz is used to supply a 100-ohm load which is in parallel with a capacitance of  $0.047 \mu\text{F}$ . In this case  $\phi$  is  $3.5^\circ$  and  $\cos \phi = 0.998$ .

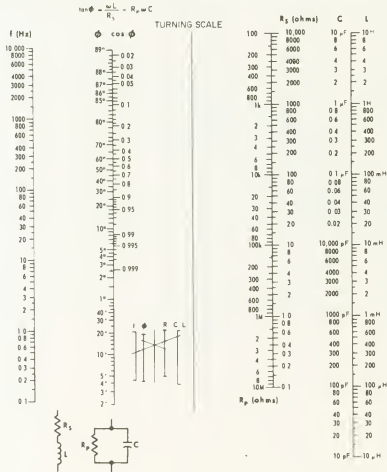

### kVAR-CAPACITY NOMOGRAM FOR 60-Hz SYSTEMS

This nomogram is based on the formula

$$kVAR = \frac{2\pi f CE^2}{10^9}$$

where  $C$  is in microfarad  $E$  in volts, and  $f$  is 60 Hz.

FOR EXAMPLE: To provide 5 kVAR at 460 V requires 62  $\mu F$ .

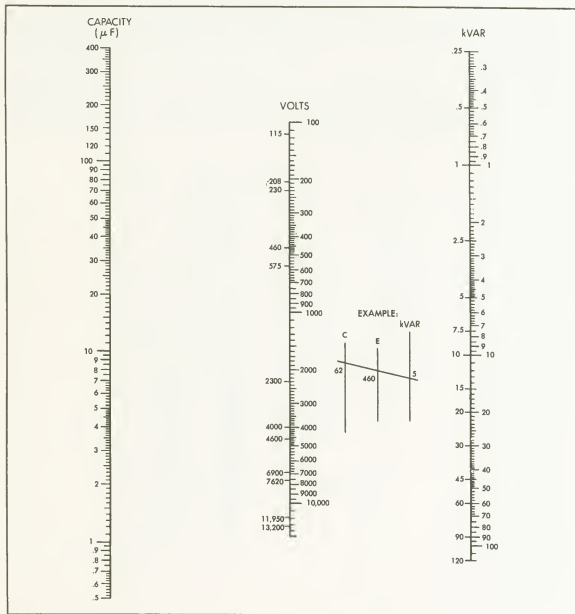

### SELF-RESONANT FREQUENCY OF PARALLEL LEAD CAPACITORS

The curves show the approximate self-resonant frequency of capacitors with various lead lengths. They apply to parallel lead wires of equal length #20 to #24 AWG, spaced no further than 0.375 in. apart.

FOR EXAMPLE: A 1,000-pF capacitor with 2-in. leads resonates at about 18 MHz. The same capacitor with 0.2-in. leads will resonate at 60 MHz.

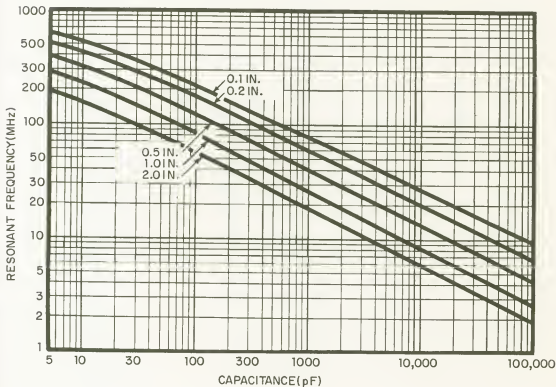

## REACTANCE NOMOGRAMS

---

The set of three nomograms on the following pages covers the frequency range of 1 Hz to 1,000 MHz in three ranges which give direct answers without the need for additional calculations to locate the decimal point. These nomograms may be used to find capacitive reactance, inductive reactance, as well as resonant frequency ( $X_L = X_C$ ) of any combination of inductance and capacitance.

### FOR EXAMPLE:

1. The reactance of a 10-mH inductor at 10-kHz is 630 ohms.
2. The reactance of a 3-pF capacitor at 5 MHz is 10,500 ohms.
3. A 5- $\mu$ F capacitor and a 1.4-H inductance resonante at 60 Hz.

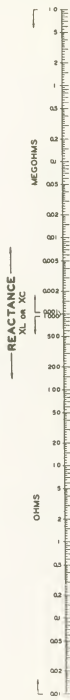



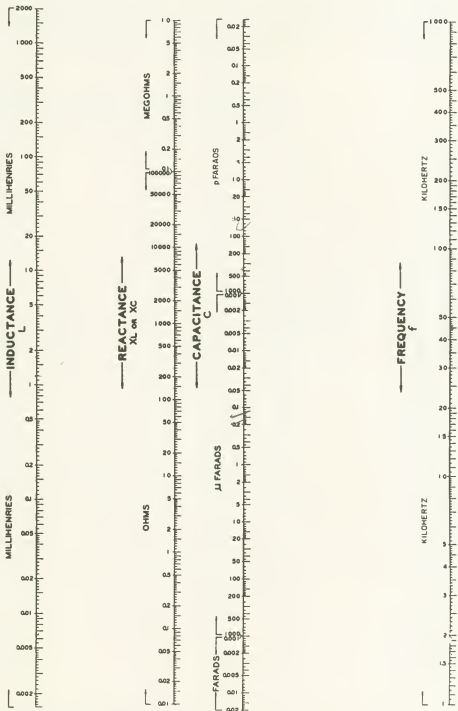

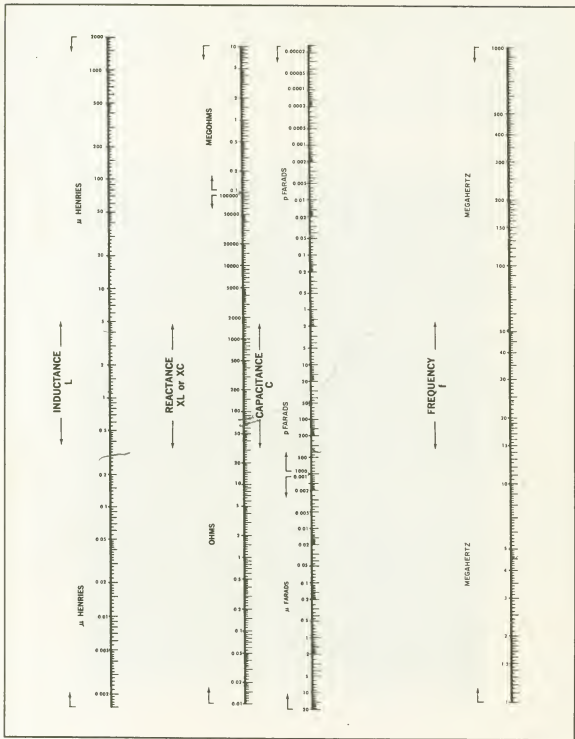

### RF PENETRATION (SKIN RESISTANCE) OF VARIOUS MATERIALS

At very high frequencies current travels close to the outer surface of the conductor and eddy current losses increase beneath the surface. This effect is called "skin resistance" or "rf resistance." This chart shows the minimum required conductor depth related with frequency. The depth varies with the resistivity of the material and is least for silver. Therefore, a silver plating is frequently applied to conductors that are used at high frequencies so as to reduce the skin resistance.

FOR EXAMPLE: At 200 MHz a minimum thickness of 0.81 mils of cadmium is required, whereas only 0.18 mils of silver are needed at the same frequency.

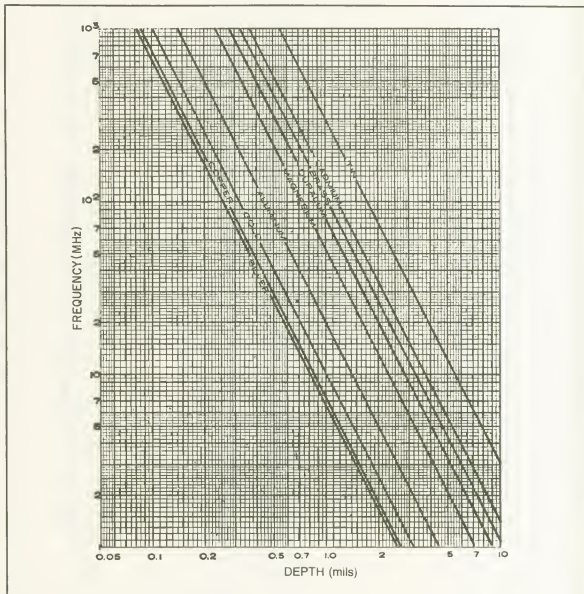

IMPEDANCE OF SERIES-CONNECTED AND PARALLEL-CONNECTED COMBINATIONS OF  $L$ ,  $C$ , AND  $R$ 









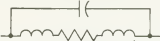

Circuit	Series combination	Impedance $Z = R + jX$	Magnitude of impedance $ Z  = \sqrt{R^2 + X^2}$	Phase angle $\phi = \tan^{-1}(X/R)$	Admittance <sup>0</sup> $Y = 1/Z$
	$R$	ohms $R$	ohms $R$	radians 0	mhos $1/R$
	$L$	$+j\omega L$	$\omega L$	$+\pi/2$	$-j(1/\omega L)$
	$C$	$-j(1/\omega C)$	$1/\omega C$	$-\pi/2$	$j\omega C$
	$R_1 + R_2$	$R_1 + R_2$	$R_1 + R_2$	0	$1/(R_1 + R_2)$
	$L_1(M)L_2$	$+j\omega(L_1 + L_2 \pm 2M)$	$\omega(L_1 + L_2 \pm 2M)$	$+\pi/2$	$-j/\omega(L_1 + L_2 \pm 2M)$
	$C_1 + C_2$	$-j\frac{1}{\omega} \left( \frac{C_1 + C_2}{C_1 C_2} \right)$	$\frac{1}{\omega} \left( \frac{C_1 + C_2}{C_1 C_2} \right)$	$-\frac{\pi}{2}$	$j\omega \left( \frac{C_1 C_2}{C_1 + C_2} \right)$
	$R + L$	$R + j\omega L$	$\sqrt{R^2 + \omega^2 L^2}$	$\tan^{-1} \frac{\omega L}{R}$	$\frac{R - j\omega L}{R^2 + \omega^2 L^2}$
	$R + C$	$R - j \frac{1}{\omega C}$	$\sqrt{\frac{\omega^2 C^2 R^2 + 1}{\omega^2 C^2}}$	$-\tan^{-1} \frac{1}{\omega RC}$	$\frac{\omega^2 C^2 R + j\omega C}{\omega^2 C^2 R^2 + 1}$
	$L + C$	$+j \left( \omega L - \frac{1}{\omega C} \right)$	$\left( \omega L - \frac{1}{\omega C} \right)$	$\pm \frac{\pi}{2}$	$-\frac{j\omega C}{\omega^2 LC - 1}$
	$R + L + C$	$R + j \left( \omega L - \frac{1}{\omega C} \right)$	$\sqrt{R^2 + \left( \omega L - \frac{1}{\omega C} \right)^2}$	$\tan^{-1} \left( \frac{\omega L - 1/\omega C}{R} \right)$	$\frac{R - j(\omega L - 1/\omega C)}{R^2 + (\omega L - 1/\omega C)^2}$

Circuit	Parallel combination	Impedance $Z = R + jX$	Magnitude of impedance $ Z  = \sqrt{R^2 + X^2}$	Phase angle $\phi = \tan^{-1}(X/R)$	Admittance <sup>0</sup> $Y = 1/Z$
	$R_1, R_2$	ohms $\frac{R_1 R_2}{R_1 + R_2}$	ohms $\frac{R_1 R_2}{R_1 + R_2}$	radians 0	mhos $\frac{R_1 + R_2}{R_1 R_2}$
	$C_1, C_2$	$-j \frac{1}{\omega(C_1 + C_2)}$	$\frac{1}{\omega(C_1 + C_2)}$	$-\frac{\pi}{2}$	$+j\omega(C_1 + C_2)$
	$L, R$	$\frac{\omega^2 L^2 R + j\omega L R^2}{\omega^2 L^2 + R^2}$	$\frac{\omega L R}{\sqrt{\omega^2 L^2 + R^2}}$	$\tan^{-1} \frac{R}{\omega L}$	$\frac{1}{R} - \frac{j}{\omega L}$
	$R, C$	$\frac{R - j\omega R^2 C}{1 + \omega^2 R^2 C^2}$	$\frac{R}{\sqrt{1 + \omega^2 R^2 C^2}}$	$\tan^{-1}(-\omega RC)$	$\frac{1}{R} + j\omega C$
	$L, C$	$+j \frac{\omega L}{1 - \omega^2 LC}$	$\frac{\omega L}{1 - \omega^2 LC}$	$\pm \frac{\pi}{2}$	$j \left( \omega C - \frac{1}{\omega L} \right)$
	$L_1(M)L_2$	$+j\omega \frac{L_1 L_2 - M^2}{L_1 + L_2 \mp 2M}$	$\omega \frac{L_1 L_2 - M^2}{L_1 + L_2 \mp 2M}$	$\pm \frac{\pi}{2}$	$-j \frac{1}{\omega} \left( \frac{L_1 + L_2 \mp 2M}{L_1 L_2 - M^2} \right)$
	$L, C, R$	$\frac{\frac{1}{R} - j \left( \omega C - \frac{1}{\omega L} \right)}{\left( \frac{1}{R} \right)^2 + \left( \omega C - \frac{1}{\omega L} \right)^2}$	$\frac{R}{\sqrt{1 + R^2 \left( \omega C - \frac{1}{\omega L} \right)^2}}$	$\tan^{-1} - R \left( \omega C - \frac{1}{\omega L} \right)$	$\frac{1}{R} + j \left( \omega C - \frac{1}{\omega L} \right)$

## FREQUENCY CHARACTERISTICS OF RESISTORS, CAPACITORS, AND INDUCTORS

Tabulated here are the effects when potentials of increasing frequency are applied to resistors, capacitors, and inductors.

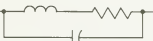
As the frequency increases from dc to above resonance, the effective "look" of the component changes as shown.

DC AND LOW FREQ.	HIGH FREQ. BELOW SELF-RESONANCE	AT SELF-RESONANCE	ABOVE SELF-RESONANCE
 $Z = R$ $X_L = 0$	 $Z = \sqrt{R^2 + X_L^2}$ $X_C \gg X_L$	 $Z = R_{EQUIV.}$ $X_C = X_L$ $R_{EQUIV} = \frac{(\omega L)^2}{R}$	 $Z = X_C$ $X_C \ll X_L$ $R \ll X_L$
 $Z = X_C$ $X_L = 0$ $X_C \gg R$	 $Z = \sqrt{R^2 + X_C^2}$ $X_C \gg X_L$ $X_C = R$	 $Z = \frac{L}{C_0 R}$ $X_C = X_L$ $X_C \ll X_{C0}$	 $Z = \sqrt{R^2 + X_L^2}$ $X_L \gg X_C$
 $Z = R$ $X_L = 0$ $X_C = \infty$	 $Z = X_L$ $X_L \ll X_C$ $R = 0$	 $Z = R_{EQUIV}$ $X_C = X_L$ $R_{EQUIV} = \frac{(\omega L)^2}{R}$	 $X_C \ll X_L$ $Z = X_C$

## RESISTANCE-VOLTAGE-CURRENT-POWER NOMOGRAM

This nomogram is based on Ohm's law, and one straight line will determine two unknown parameters if two others are given. Preferred ( $\pm 20\%$ ) resistance values are marked in addition to the ordinary resistance scale divisions. The power scale is calibrated in watts and dBm with a reference level of  $0 \text{ dBm} = 1 \text{ mW}$  into  $600 \text{ ohms}$ . This, direct conversion between dBm and watts can be made. To cover a wide range of values and yet maintain accuracy, a dual numbering system is used. To avoid confusion, all members should be read from either the regular or the gray-barred scales.

### FOR EXAMPLE:

1. The current through a  $150\text{-k}$  resistor with a potential drop of  $300 \text{ V}$  is  $2 \text{ mA}$ , and the power dissipated is  $600 \text{ mW}$  or  $0.6 \text{ W}$ .
2. When a  $12,000\text{-ohm}$  resistor has a current of  $6 \text{ mA}$  through it, the power dissipated is  $0.43 \text{ W}$  and the voltage across the resistor is  $72 \text{ V}$ .
3. The voltage across a  $4.7 \text{ M ohm}$  resistor with a signal level of  $-30 \text{ dBm}$  is about  $2.15 \text{ V rms}$ .
4. The maximum allowable current through a  $10 \text{ W } 200\text{-ohm}$  resistor is  $0.22 \text{ A}$ . Under these operating conditions there will be  $45 \text{ V}$  across the resistor.

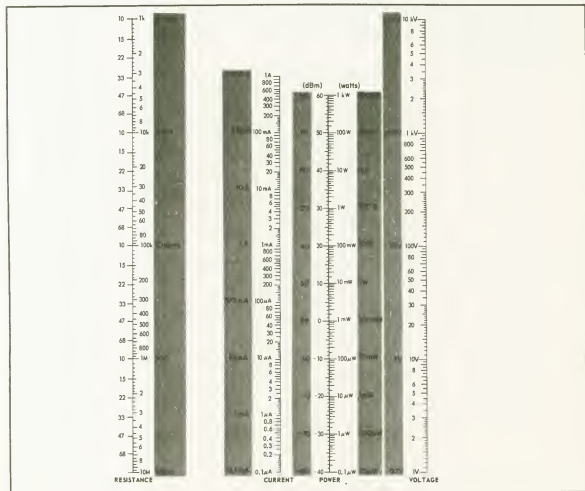

## VOLTAGE DIVIDER NOMOGRAM

This nomogram aids in the rapid selection of component values for the simple resistive and capacitive voltage dividers illustrated, where

$$\frac{e_o}{e_i} = \frac{R_g}{R_g + R_s} \quad \text{or} \quad \frac{e_o}{e_i} = \frac{C_s + C_g}{C_s}$$

Only two decades are covered on the left and right scale to achieve maximum accuracy. The range of the nomogram can be extended by multiplying these two columns by the same power of ten without making any changes in the center column.

### FOR EXAMPLE:

1. A blocking oscillator must be held at cutoff by means of a voltage divider between B- and ground. Cut-off bias is  $-15\text{ V}$ , the negative supply is  $150\text{ V}$ , and the grid-to-ground resistor is  $22,000\text{ ohms}$ . Thus,  $e_o/e_i$  is  $0.1$ . Joining that value with  $2.2$  on the  $R_g$  scale gives  $20$  on the  $R_s$  scale, which makes that resistor equal to  $200,000\text{ ohms}$  since each scale had to be multiplied by  $10^4$ .

2. Design an rf probe with a  $5:1$  attenuator using standard capacitance values. Rotating about the  $0.2$  point on the center scale gives typical values of  $30\text{ pF}$  for  $C_g$  and  $7.5\text{ pF}$  for  $C_s$ .

NOTE: The longer lines outside the left and right columns locate standard  $\pm 10\%$  values and the shorter lines locate standard  $\pm 5\%$  values.

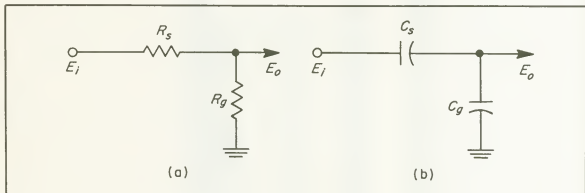

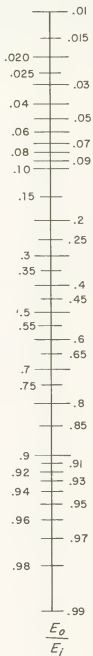



### NOMOGRAM FOR CAPACITIVELY COUPLED CIRCUITS

It is often necessary to know the portion of the input voltage that will appear across the load resistor in a capacitively coupled circuit. This is a function of frequency and a factor of the ratio of  $R$  to  $X_c$ , the required ratio is shown on the center scale. It is interesting to note that any ratio of  $R$  to  $X_c$  greater than 7.4:1 yields over 99% output. The  $X_c$  and  $R$  scales can be multiplied by any common power of ten to extend the range of the nomogram.

FOR EXAMPLE: For  $R = 100 \text{ k}$  and  $X_c = 10 \text{ k}$ ,  $V_2$  will be 99.4% of  $V_1$ .

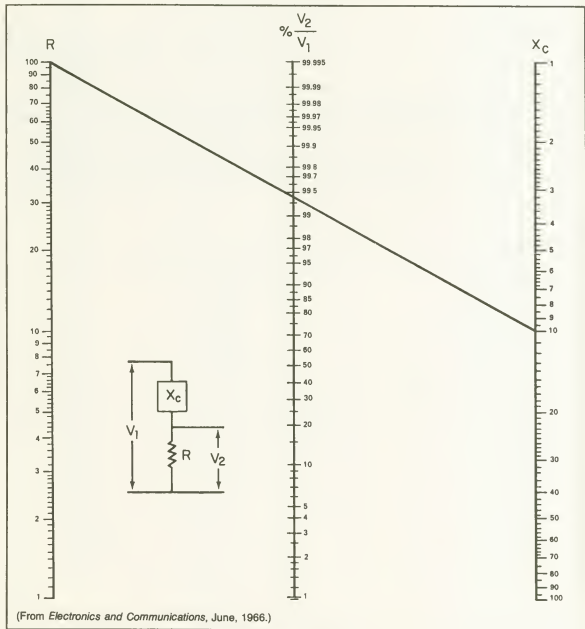

## R-C COUPLING NOMOGRAM





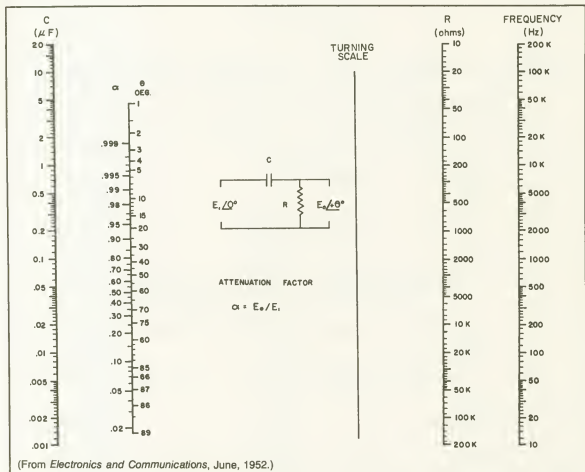







This nomogram is used to calculate phase shift and attenuation in R-C coupling networks. To use, connect capacitance with frequency and note the intersect point on the turning scale. Using this intersect point, connect to the resistance, and by extending this line, read attenuation and phase shift.

FOR EXAMPLE: At 60 Hz, a 0.01- $\mu$ F capacitor and 10,000-ohm resistor will exhibit a phase shift of 72° and an attenuation factor of 0.35.



### SQUARE WAVE RESPONSE OF AMPLIFIERS

This table illustrates how performance characteristics of an amplifier can be determined by observing the waveform of the output, when the input is a square wave.

Output Waveform	Low Frequency		High Frequency		Damping
	Gain	Delay	Gain	Delay	
	Ideal	Ideal	Ideal	Ideal	Ideal
	Inadequate	Good	Excessive	Good	High
	Excessive	Good	Inadequate	Good	High
	Good	Excessive	Good	Inadequate	High
	Good	Inadequate	Good	Excessive	High
	Excessive	Excessive	Inadequate	Inadequate	High
	Excessive	Inadequate	Inadequate	Excessive	High
	Inadequate	Excessive	Excessive	Inadequate	High
	Good	Good	Excessive	Good	Medium
	Good	Good	Excessive	Good	Low
	Good	Good	Excessive	Good	Poor
	Good	Good	Sharp Cutoff or Peaked	Good	Low

## LOW-END AMPLIFIER RESPONSE

In an RC-coupled amplifier, the coupling capacitance ( $C$ ), combines with the output load ( $R$ ), to form a potential divider or filter.

The response curve of this combination usually is specified in terms of the relative gain  $-3$  dB point which can be calculated from the equation:

$$\frac{e_2}{e_1} = \frac{1}{\sqrt{1 + \frac{1}{(2\pi f RC)^2}}} = 0.708$$

where  $T = RC$  and 0.708 is used to calculate the 3 dB point.

The accompanying nomogram relates the parameters  $R$ ,  $C$  or  $f_{-3dB}$ . Given any two, the third term can be determined by a simple straight-line alignment.

**EXAMPLE:** With a load of 10 k, what capacitance will give a low cutoff frequency of 20 Hz?

The alignment shows that a capacitor of  $0.8 \mu\text{F}$  will yield the desired high-pass characteristic.

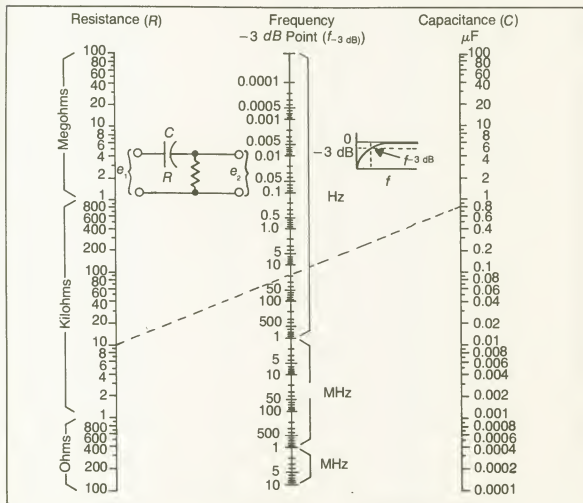

### TIME-CONSTANT NOMOGRAM (A)

This nomogram is based on the formula  $T = RC$  where  $T$  (the time constant) is the time required for the capacitor in an RC series circuit to reach 63.2% of the applied voltage.

FOR EXAMPLE: The time constant of 10 msec can be achieved with a 1-M ohm resistor and a 0.01- $\mu$ F capacitor.

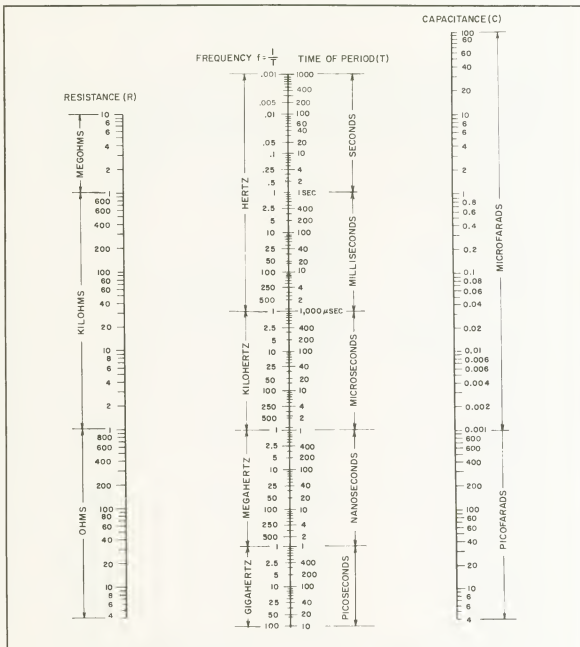

### TIME-CONSTANT NOMOGRAM (B)

This chart is used to determine the time required in an RC series circuit to reach a given fraction of an applied step input, or to determine the percent of the applied input when the time constant is given.

The nomogram is based on the relationship.

$$\frac{E_{out}}{E_{in}} = 1 - e^{-t/RC}$$

FOR EXAMPLE: Determine the time required to charge a 50- $\mu$ F capacitor to 400 V through 1,000 ohms from a 450 V supply. The percent of applied voltage is 88.5% (400 / 450) which requires 2.2 time constants. The time constant is 50 ms (from time-constant nomogram A), so the time required to charge to 400 V is 110 ms.

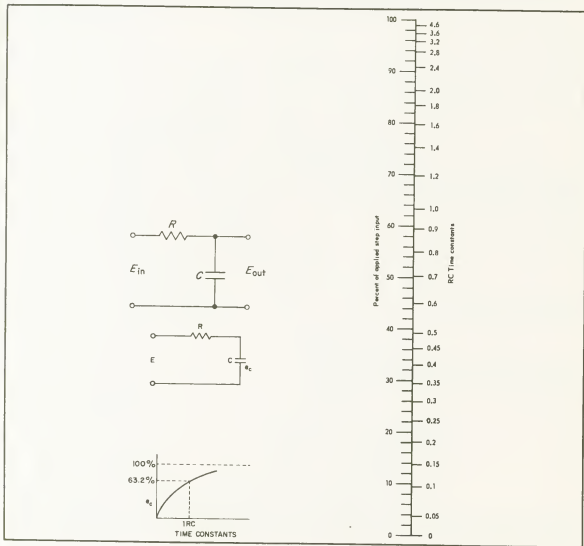

## FREQUENCY SELECTIVE NETWORK NOMOGRAM

The expression  $f = 1/2\pi RC$ , where  $f$  is in hertz,  $C$  and  $R$  in ohms, is the expression for:

1. The 3-dB bandwidth of a single tuned circuit having parameters as shown in Figure 1.
2. The frequency at 3 dB relative attenuation of the parallel RC low-pass network shown in Figure 2.
3. The frequency at 3 dB relative transfer attenuation of the series RC high-pass network of Figure 3.
4. Wien bridge balance.

FOR EXAMPLE:

1. The circuit shown in Figure 1 is used to couple two successive stages of an amplifier. The 3-dB bandwidth of the circuit must be 3.4 MHz and the equivalent shunt capacitance of the circuit is 25 pF. What equivalent resonant resistance will the circuit exhibit? Connect 3.4 MHz and 25 pF and find the equivalent resonant resistance as 1,850 ohms.

2. The low-pass network of Figure 2 uses a 0.05- $\mu$ F capacitor. What value of resistance is required for the output to drop to 0.707 of the input at 5 kHz? Connect 0.05- $\mu$ F with 5 kHz and read answer as 620 ohms.

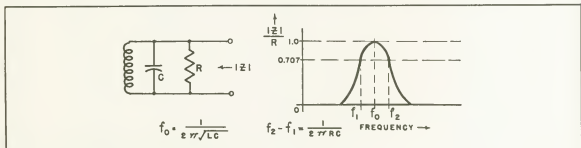

Figure 1. Characteristics of a single tuned circuit.

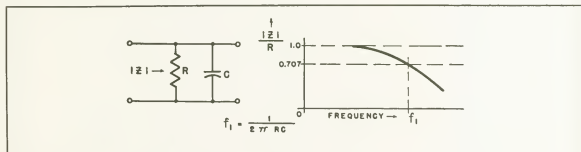

Figure 2. Characteristics of a parallel RC low-pass network.

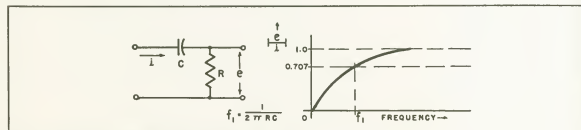

Figure 3. Transfer characteristics of an RC high-pass network.

3. It is required that the RC high-pass network in Figure 3 attenuate rapidly below 300 Hz. What value resistor must be used with a 0.1- $\mu$ F capacitor? Connect 0.1- $\mu$ F with 300 Hz (0.3 kHz) and read answer as 5,250 ohms.

4. Figure 4 shows an RC coupled amplifier and its equivalent circuits. It is assumed that the reactance of the bypass capacitors is negligible throughout the frequency range of the amplifier. If the equivalent circuit resistance has a value of 1,300 ohms and the equivalent capacitance is 25 pF, at what frequency is the amplification 0.707 of the midfrequency range of the amplifier? Connect 25 pF and 1,300 ohms and read frequency of 4.75 MHz at which amplifier gain is down 3 dB.

5. The Wien bridge circuit shown in Figure 5 has  $R_1$  and  $R_2$  equal to 10,000 ohms and  $C_1$  and  $C_2$  equal to 0.1- $\mu$ F. With those values the balance frequency of the circuit is 1.59 kHz.

$$\begin{aligned} R_1 &= R_2 = R \\ C_1 &= C_2 = C \\ \frac{R_3}{R_4} &= 2 \end{aligned}$$

For the measurement of frequency, the unknown frequency is connected across A and B and a null detector, across C and D.

When used with an oscillator, the circuit is connected to a suitable amplifier with regenerative feedback.

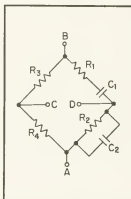
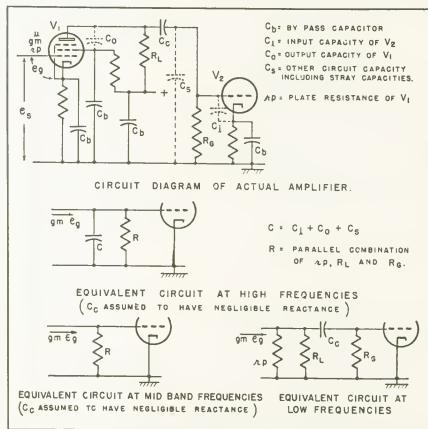

Figure 5. Conventional Wien bridge circuit.

Figure 4. An RC-coupled amplifier and its equivalent circuits.



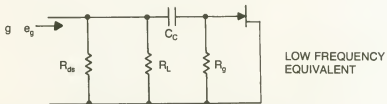
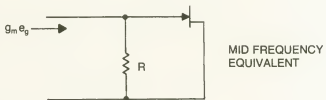
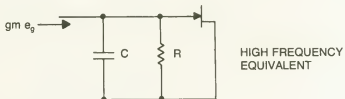
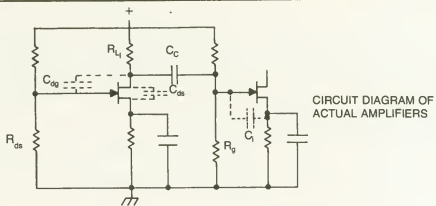
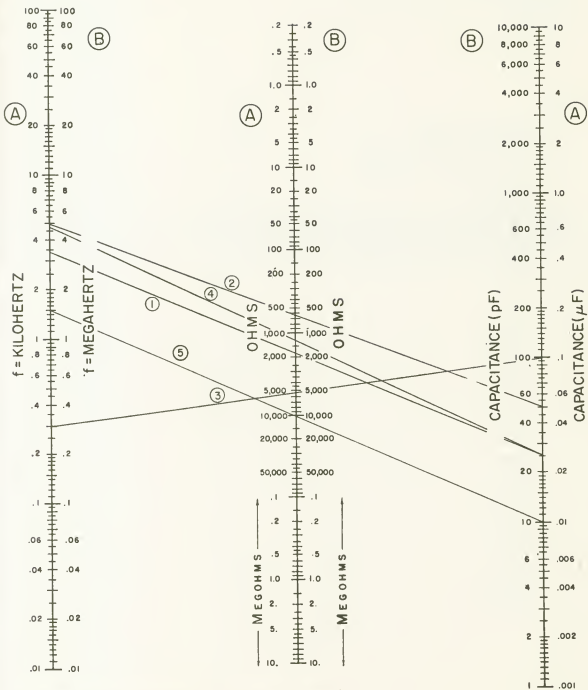

Figure 4. Circuit Diagram of N-Channel JFET Transistor Amplifier. (Continued from page 111.)



Note: Scales with corresponding letters (A or B) are used together.

## BANDWIDTH NOMOGRAM

This nomogram is used to compute the bandwidth of a tuned circuit at 70.7% (-3 dB) of maximum gain. It is based on the equation

$$\Delta f = \frac{f_r}{Q}$$

where

$\Delta f$  = bandwidth in kilohertz

$f_r$  = resonant frequency in megahertz

$Q$  = figure of merit of the inductance

### FOR EXAMPLE:

1. A circuit that has a resonant frequency of 6 MHz, and uses an inductance with a  $Q$  of 140, will have a bandwidth of 43 kHz. NOTE: The range of the nomogram can be extended to cover other frequencies by multiplying or dividing both frequency scales by the same power of 10.
2. To achieve a bandwidth of 2.5 kHz at a resonant frequency of 600 kHz the inductance must have a  $Q$  of 240.

$f_r$   
(MHz)

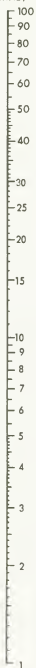

$\Delta f$   
(kHz)

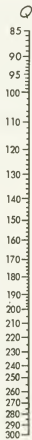
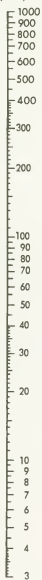

## CROSSOVER NETWORKS, DESIGN EQUATIONS, AND RATE OF ATTENUATION CURVES

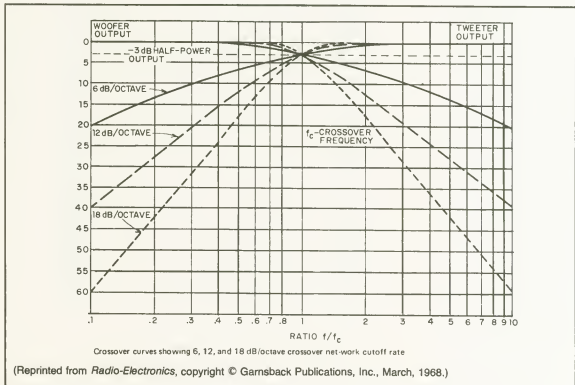
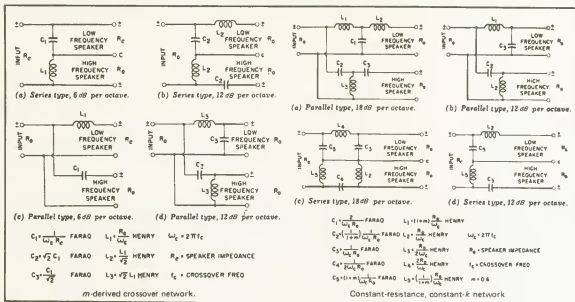

## PASSIVE LC FILTER DESIGN

Previous editions of the *Electronic Databook* used nomograms to determine the component values of image parameter lowpass and highpass filters. This edition provides computer-calculated tabulations of modern filter designs that are based on network synthesis. These modern designs are more versatile, less complicated and easier to build than the old image parameter designs. For example, to simplify construction, the tabulated modern filter designs require fewer components than comparable image parameter designs, and all (or most) of the capacitor values of the modern filter designs are *standard values*.

Most filtering applications do not require a precisely defined cutoff frequency, and as long as the actual cutoff frequency is within about five percent of the desired cutoff frequency, and the passband and stopband attenuation levels are satisfactory, the design will be acceptable. Of almost equal importance is finding a design that has the minimum number of components and that requires standard-value capacitors to simplify the ordering of parts and the assembly of the filter. Standard values for the inductors is less important because the inductors are usually hand-wound or ordered to specification from inductor manufacturers.

Each filter table provides many designs over one frequency decade in which the change in cutoff frequency from one design to the next is sufficiently small so that virtually any cutoff requirement can be satisfied within a few percent. The 50-ohm impedance level for source and load was used for most of the tabulations because this impedance termination is most frequently needed by the electronics engineer. All component values and frequencies versus selected stopband attenuation levels have been computer-calculated for each design for the convenience of the user. Although the tabulated designs are only for the equally terminated condition at the listed impedance level and frequency decade, a simple scaling procedure allows the tables to be scaled to *any equally terminated impedance level and any frequency decade*, while keeping the important advantage of all designs requiring only *standard-value capacitors*. These pre-calculated filter tables are therefore universally applicable because they can be used to select a suitable design having standard-value capacitors for any impedance level or any cutoff frequency.

Only the passive LC filter was considered for tabulation because this filter type is capable of passing rf power, whereas the active filter is not. Also, the passive filter does not require a power supply, and it usually is easier to assemble in small quantities than the active filter.

### Filter Types and Responses

Only the lowpass and highpass filter types having the Chebyshev or elliptic attenuation responses are considered. For design information on other filter types (bandpass, bandstop, etc.), and responses (Butterworth, Bessel, etc.), see References 13-18. Only the 5th- and 7th-degree Chebyshev designs (5 and 7 elements each, respectively) and the 5th-degree elliptic design are included in the tables because these designs are suitable for almost all of the non-stringent filtering requirements encountered by the non-professional filter designer.

The Chebyshev attenuation response is characterized by attenuation ripples in the passband and a constantly (monotonic) increasing attenuation in the stopband. The level of maximum passband ripple ( $A_p$ ) is directly related to the filter reflection coefficient (RC) and VSWR (see Appendix A), and these parameters can be increased or decreased to get a corresponding increase or decrease in the rate of attenuation rise in the filter stopband in the vicinity of the filter cutoff frequency.

The elliptic attenuation response is characterized by attenuation ripple in the passband, attenuation peaks in the stopband, and a specific level of minimum stopband attenuation. The presence of the two resonant circuits in the elliptic filter configuration results in a more abrupt rise in attenuation than is possible with the Chebyshev configuration.

---

The computer programming required for the Chebyshev and elliptic filter design tabulations was prepared by Mike Barge under the direction of Ed Wetherhold. The tables are made available for publication through the courtesy of the Signal Analysis Center of Honeywell Inc., Annapolis, MD.

## Filter Tables

Lowpass and highpass filter designs are listed in ten tables, with eight tables based on a 50 ohm impedance level, and two tables (5B and 8B) based on 600 ohms. The schematic diagram and a typical attenuation response of each tabulated filter appears at the head of each table, except Tables 5B and 8B, where the only difference is the impedance level. The component designations in the schematic diagram and the frequency designations ( $F_{\infty}$ , F3, F20 and F50) in the attenuation response diagram correspond to similar designations in the table column headings.

Although there is passband ripple in all these designs, the amplitude of the ripple is so small that it is usually swamped out by the losses of the filter components. Consequently, when the completed design is measured, the passband response appears to be flat. For this reason, the passband in the response diagrams is shown flat.

The filter reflection coefficient (RC) provides an indication of the flatness of the passband and the VSWR of the filter. For rf filtering applications where low VSWR is desired, designs with low reflection coefficients are preferred. For audio filtering applications, where a faster rise of attenuation is more important than minimizing VSWR, designs having high RC values are preferred.

## Lowpass Filters

**Chebyshev Designs and Applications.** Tables 1 through 4 list 5- and 7-element Chebyshev lowpass designs. Use the 5-element designs when about 30 dB of attenuation is needed at one octave above the cutoff frequency, and the filter component count must be minimized. Use the 7-element designs when about 42 dB of attenuation is needed at one octave above the cutoff frequency. A typical application for these filters is to reduce the harmonic output of transistor amplifiers. Normally, the capacitive input/output configurations shown in Figures 1 and 3 are preferred to the alternative inductive input/output configurations in Figures 2 and 4 to minimize the number of inductors. Inductors are usually more bulky, more expensive and have higher losses than capacitors. Both filter types have identical attenuation responses, but the filter input impedances in the stopbands are markedly different. For the inductive input filter, the input impedance starts increasing between the 3 and 15-dB attenuation level, and continues increasing with increasing stopband frequency. The reverse is true for the capacitive input filter. Under certain conditions, transistor rf amplifiers may become unstable when looking into a decreasing or increasing reactive impedance (see Bibliography, Nos. 8 & 15). Because of this, it is necessary that the rf filter designer be able to design lowpass filters having either capacitive or inductive input elements.

**Elliptic Designs and Applications.** Tables 5A and 5B list 5th-degree elliptic lowpass designs for 50 and 600 ohms, respectively. This type of filter is preferred where a more abrupt rise in attenuation is desired. This type is also useful because the attenuation peaks at F4 and F2 sometimes can be placed at the second and third harmonic frequencies of a constant-frequency rf amplifier to provide more than 60 dB attenuation to the harmonics.

In this filter type, only capacitors C1, C3 and C5 are standard value. The fact that C2 and C4 are not standard values is not important because these capacitors should be tuned to precisely resonate L2 and L4 at F2 and F4. This is necessary if the minimum stopband attenuation level ( $A_s$ ) is to be achieved throughout the entire stopband. A slight variation in the values of C2, L2 and C4, L4 is not important as long as the F2 and F4 frequencies are as close as possible to the tabulated frequencies.

Table 5B is provided for audio filtering applications where this impedance level is very common. This table also serves to provide 600-ohm designs that can be used to confirm the correctness of the impedance scaling procedure to be explained later.

## Highpass Filters

**Chebyshev Designs and Applications.** Tables 6 and 7 list 5- and 7-element Chebyshev highpass filter designs, but unlike the lowpass designs only the capacitive input/output configuration is considered. This is because they are very few applications for the alternate L-input/output configuration. The C-input/output configuration has the important advantage of increasing input impedance with decreasing frequency. This configuration is therefore suitable as an isolation network between a signal source and a detection system being used to examine the harmonics of the signal source fundamental. The highpass filter passes the harmonic frequencies unattenuated,

but provides considerable attenuation to the fundamental signal. Also, the high input impedance of the filter will not cause excessive loading of the generator. This is not true for the alternate inductive input filter.

**Elliptic Designs and Applications.** Tables 8A and 8B list the 5th-degree elliptic highpass designs for 50 and 600 ohms, respectively. This type filter is preferred where a more abrupt increase in attenuation is desired as compared to the Chebyshev filter. The comments concerning the elliptic lowpass design relative to C1, C3 and C5 being standard values and the importance of tuning C2 and C4 to F2 and F4 are equally applicable here. The concluding comments about the elliptic 600-ohm lowpass filter are equally applicable to the highpass filter.

#### How to Use the Precalculated Design Tables

**For 50-Ohm Impedance Levels.** Before selecting a suitable filter design, the reader must know or be able to specify the important parameters of the filter, such as type (highpass or lowpass), cutoff frequency, impedance level, and an approximation of the required stopband attenuation. It is obvious as to which tables to use for lowpass or highpass applications, but it is not so obvious as to which one design of the many possible choices is optimum for the intended application. Generally, the Chebyshev is preferred over the elliptic because the Chebyshev does not require tuning of the inductors; however, if the gradual rise in attenuation of the Chebyshev is not satisfactory, then the elliptic should be considered. For audio frequency filtering, the elliptic designs with high values of RC are preferred because they have a much more abrupt rise in attenuation as compared to the Chebyshev. For rf applications, RC values less than 8% are recommended to minimize VSWR. Low VSWR is also important when cascading high and lowpass designs to achieve a bandpass response of more than two octaves wide. Each filter will operate as expected if it is correctly terminated, but this condition will exist only if both designs have the relatively constant terminal impedance that is associated with low values of RC.

Knowing the filter type and the response needed, the table of designs most appropriate for the application is selected on a trial basis. Find the table and search the cutoff frequency column for a cutoff frequency nearest the desired cutoff frequency. After finding a possible design, examine the stopband attenuation levels to see if they are satisfactory. Then check the RC value to see if it is appropriate for the application. Finally, check the component values to see if they are convenient. Usually, it is easier to obtain capacitors with the ten-percent tolerance than the five-percent value. For example, in the audio frequency range, the capacitor values will probably be in the microfarad range, and capacitors in this size are available only in the ten-percent tolerance group.

Because all the important parameters of each design are listed, it is possible to quickly check many designs so the most suitable design can be selected. After the final choice has been made, interconnect the components in accordance with the schematic diagram above the table headings. Use good engineering practices in assembling the filter components as explained in listing number 12 of the bibliography.

**For Impedance Levels Other Than 50 Ohms.** All tabulated designs are easily scaled to impedance levels other than 50 ohms while maintaining the advantage of standard-value capacitors. If the impedance level differs from fifty ohms by a factor equal to an integral power of ten (such as .01, .1, 10 or 100), the design tables can be scaled by inspection (by shifting the decimal points of the component values). The tabulated frequency,  $A_n$  and RC values remain unchanged. For example, if the 50-ohm impedance level is raised by a factor of ten to 500 ohms, the new capacitance and inductance values are found by multiplying the tabulated inductance values by ten, and by dividing the capacitor values by ten. This means that the decimal points of the inductor values are shifted one place to the right, and the decimal points of the capacitor values are shifted one place to the left. The reverse is true if the impedance level is reduced from 50 to 5 ohms. For example, the impedance level of Design #1, Table 1, can be increased to 500 ohms by shifting the decimal points of L2 and L4 one place to the right (to become 107.3  $\mu$ H), and by shifting the decimal points of the capacitance values one place to the left (to become 300 pF and 560 pF).

To change the tabulated frequency decades to another frequency decade differing by a factor equal to an integral power of ten, multiply all tabulated frequencies by the factor, and divide all capacitance and inductance values by the same factor. For example, the frequency decade of Table 1 can be reduced from 1-10 MHz to 1-10 kHz by multiplying all frequencies by .001 (the frequency units in the column headings become kHz), and by



dividing the capacitance and inductance values by the same factor. (The units of capacitance and inductance become nanofarads and millihenries.)

Filter designs with standard-value capacitors may be found for impedance levels that differ from 50 ohms by a factor equal to a non-integral power of ten (such as 1.2, 12, etc.). To do this, use the following procedure:

1. Calculate the scaled impedance factor,  $R = Z_x/50$  where  $Z_x$  is the desired new impedance level in ohms.
2. Calculate the cutoff frequency of a "trial" 50-ohm filter using the equation:  $F_{50_{\infty}} = R \cdot F_{x_{\infty}}$  where  $F_{x_{\infty}}$  is the desired cutoff frequency of the filter at the new impedance level.
3. From the 50-ohm tables, select a design having its cutoff frequency closest to the calculated  $F_{50_{\infty}}$  value.

The tabulated capacitor values will be used directly, and the frequencies and inductance values will be scaled.

4. Calculate the exact values of  $F_{x_{\infty}} = F'_{50_{\infty}}/R$ , where  $F'_{50_{\infty}}$  is the tabulated cutoff frequency. In a similar manner, calculate all the other frequencies.
5. Calculate the new inductance values for the new filter from  $L_x = R^2 \cdot L_{50}$ , where  $L_{50}$  is the tabulated inductance value of the trial filter design, and  $L_x$  is the inductance value of the scaled filter.

An example follows showing how the 50-ohm design #3 of Table 5A can be replaced with a 60-ohm design having a similar cutoff frequency and other similar characteristics. Using the same previously numbered steps:

1.  $R = 60/50 = 1.2$
2.  $F_{50_{\infty}} = 1.2(1.06 \text{ MHz}) = 1.272 \text{ MHz}$
3. From Table 5A, design #15 has a cutoff frequency closest to the calculated  $F_{50_{\infty}}$  value. The  $A_s$  and RC values are similar to design #3. Design #28 is also suitable as a replacement. The tabulated capacitor values of design #15 are copied directly. Thus, C1, 3, 5, 2 and 4 = 2,200, 3,900, 1,800, 271 and 779 pF, respectively.
4. The exact values of  $F_{x_{\infty}}$ ,  $F_{x_3}$  and  $F_{A_s}$  are calculated, and are equal to:  $1.27 \text{ MHz}/1.2 = 1.058 \text{ MHz}$ ,  $1.45 \text{ MHz}/1.2 = 1.208 \text{ MHz}$  and  $2.17 \text{ MHz}/1.2 = 1.808 \text{ MHz}$ .
5. The L2 and L4 inductance values of the 60 ohm filter are calculated:  $L2_x = (1.2)^2 \cdot 7.85 \mu\text{H} = 11.3 \mu\text{H}$ ,  $L4_x = (1.2)^2 \cdot 6.39 \mu\text{H} = 9.20 \mu\text{H}$ . The validity of the scaling procedure can be confirmed by scaling the new 60-ohm filter to an impedance level of 600 ohms, and scaling the frequency from 1 MHz to 1 kHz, and then comparing the 600-ohm, 1 kHz filter with design #5 of Table 5B. All parameters of the designs will be identical, thus confirming the correctness of the scaling procedure.

The validity of the pre-calculated tables may be confirmed by independently calculating the component values using previously published normalized tables from authoritative sources such as References 8-10 and 13. This is done by finding a tabulated pre-calculated design that has a reflection coefficient nearly identical to that of a published normalized design. For example, design #80, Table 3 is suitable to match a 10% RC Chebyshev design. The pre-calculated impedance level and the cutoff frequency are then used with the normalized values, and the inductance and capacitance component values are calculated in the usual manner. Because the pre-calculated tabulated values agree within less than 1% variation with the independently calculated values, the correctness of the tables is confirmed.

## APPENDIX A

### Equations and Table Relating RC, $A_p$ and VSWR for all Modern Design Filters

$$RC_{(n)} = 100 \cdot \text{SQR} [1 - (0.1 \uparrow x)]$$

where  $100 \cdot \text{SQR} = 100$  times the square root of . . . (1)

$$x = 0.1 (A_p)$$

$\uparrow$  = symbol for exponentiation

\* = symbol for multiplication

$$A_{p(dB)} = -4.3429 \cdot \text{LOG}[1 - (.01 \cdot \text{RC})^2] \quad (2)$$

$$\text{VSWR} = [1 + (.01 \cdot \text{RC})] / [1 - (.01 \cdot \text{RC})] \quad (3)$$

where  $A_p$  = Maximum passband ripple amplitude in dB

RC = Reflection coefficient in percent

VSWR = Voltage standing wave ratio

Equations 1-3 are presented in a format suitable for computer programming. The LOG function in Eq. (2) is based on the natural log.

Table 1. Reflection Coefficient with Corresponding Values of  $A_p$  and VSWR.

REFLECTION COEFFICIENT (%)	MAX. RIPPLE AMPLITUDE (dB)	MAX. VSWR -----	REFLECTION COEFFICIENT (%)	MAX. RIPPLE AMPLITUDE (dB)	MAX. VSWR -----
1.0	0.00434	1.020	12.0	0.0630	1.273
2.0	0.001738	1.041	14.0	0.0860	1.326
3.0	0.003910	1.062	16.0	0.1126	1.381
4.0	0.006954	1.083	18.0	0.1430	1.439
5.0	0.010871	1.105	20.0	0.1773	1.500
6.0	0.015663	1.128	22.0	0.2155	1.564
7.0	0.021333	1.151	24.0	0.2576	1.632
8.0	0.027884	1.174	26.0	0.3040	1.703
9.0	0.035321	1.198	28.0	0.3546	1.778
10.0	0.043648	1.222	30.0	0.4096	1.857

## References

The first four references are recommended as authoritative sources on image parameter passive LC filter design. References 5 through 18 are recommended as authoritative sources on passive LC modern filter design.

1. Skilling, H.H., *Electric Transmission Lines*. New York: McGraw-Hill, 1951. Chapter 10, "Introduction to (Image Parameter) Filters," pp. 224-257.
2. Kerchner, R.M. and Corcoran, G.F. *Alternating-Current Circuits*, 3rd Edition. New York: John Wiley & Sons, 1953. Chapter 13, "Electric Wave (Image Parameter) Filters," pp. 436-487.
3. Van Valkenburg, M.E. *Network Analysis*. Englewood Cliffs, NJ: Prentice-Hall, 1955. Image Parameter theory, pp. 344-353.
4. *Reference Data for Radio Engineers*, Sixth Edition. Howard W. Sams & Co., Inc., a subsidiary of IT&T Corp., 1975. Chapter 7, Filters—Image Parameter Design.
5. Orchard, H.J. "Formulae for Ladder Filters," *Wireless Engineer*. January, 1953.
6. Cohn, S. "Direct Coupled Resonator Filters," *IRE Proceedings*. February, 1957.
7. Zverev, A.I. "Introduction to Filters," *Electro-Technology*. June, 1964, pp. 61-70.
8. Saal, R. and Ulbrich, E. "On the Design of Filters by Synthesis," *IRE Transactions*. CT. 5, 1958, pp. 284-327.
9. Geffe, Philip R. *Simplified Modern Filter Design*. New York: John F. Rider Publisher, Inc., a division of Hayden Publishing Co., Inc. New York, 1963.
10. Saal, R. *The Design of Filters Using the Catalog of Normalized Lowpass Filters*. Backnang, Western Germany: Telefunken GmbH, 1966.

11. Eggen, C.P. and McAllister, A.S. "Modern Lowpass Filter Characteristics," *Electro-Technology*. August, 1966.
12. Zverev, A.I. "The Golden Anniversary of Electric Wave Filters," *IEEE Spectrum*. March 1966, pp. 129-131.
13. Zverev, A.I. *Handbook of Filter Synthesis*. New York: John Wiley & Sons, NY 1967.
14. Geffe, Philip R. "EDN Designers' Guide to Active Filters," *EDN*. February 5, and March 5, 1974. (Parts 1 and 2, Butterworth and Chebyshev Design Fundamentals).
15. Daniels, Richard W. *Approximation Methods for Electronic Filter Design*. New York: McGraw-Hill, 1974.
16. *Reference Data for Radio Engineers*, Sixth Edition. Howard W. Sams & Co., Inc., a subsidiary of IT&T Corp., 1975. Chapter 8, Filters—Modern-Network Theory.
17. Blinchikoff, H. and Zverev, I.A. *Filtering in the Time and Frequency Domains*. New York: John Wiley & Sons, 1976.
18. Williams, A.B. *Electronic Filter Design Handbook*. New York: McGraw-Hill Book Co., 1981.

### Bibliography

1. Wetherhold, E. "Pick a Filter From This Chart," *Electronic Design* 24. Vol. 20, No. 24. November 23, 1972. Rochelle Park, NJ: Hayden Publishing Co., Inc.
2. ———. "Passive LC Filter Design (Part 1), Home Study Course 69/51," *Measurements & Control and Medical Electronics*. Both June 1978. Pittsburgh, PA: Measurements and Data Corp.
3. ———. "Component Selection and Test Procedures for LC Filters (Part 2), Home Study Course 71/53," *Measurements & Control and Medical Electronics*. Both October 1978. Pittsburgh, PA: Measurements and Data Corp.
4. ———. "Lowpass Filters for Amateur Radio Transmitters, *QST*. December 1979.
5. ———. "Practical 75- and 300-ohm High-Pass Filters, *QST*. February, 1982.
6. ———. "Chebyshev Filters Using Standard-Value Capacitors," *R.F. Design*. Vol. 3, No. 2. February, 1980.
7. ———. "Correction to Chebyshev Filters Using Standard-Value Capacitors," *R.F. Design*. Vol. 3, No. 6. June 1980, p. 19.
8. ———. "Lowpass Filters—Table of Precalculated Chebyshev Lowpass Filters With Inductive Input and Output," *R.F. Design*. Part 1, Vol. 4, No. 4. July/August 1981; Part 2, Vol. 4, No. 5. September /October 1981.
9. ———. "Design 7-Element Lowpass Filters Using Standard-Value Capacitors," *EDN*. Vol. 26, No. 1, 7. January 1981.
10. ———. "Elliptic Lowpass Filters for Transistor Amplifiers," *Ham Radio*. January 1981.
11. ———. "7-Element Chebyshev Filters for TEMPEST Testing," *Interference Technology Engineers' Master (ITEM)*. 1981, published annually by R & B Enterprises, Plymouth Meeting, PA.
12. ———. "Filter Construction Techniques," *ITEM*. 1982.
13. ———. "Lowpass Chebyshev Filters use Standard-Value Capacitors," *Engineer's notebook*, p. 160, *Electronics*. June 19, 1980.
14. ———. "Highpass Chebyshev Filters use Standard-Value Capacitors," *Engineer's notebook*, p. 140, *Electronics*. January 27, 1981.
15. ———. "Standard C, L-Input Filters Stabilize Hf Transistor Amplifiers," *Engineer's notebook*, *Electronics*. November 3, 1981.
16. *Electronic Designers' Casebook No. 5*. pp. 94-97, "Low-Pass and High-Pass Filters Use Standard-Value Capacitors, McGraw-Hill, Inc., 1982.
17. J. Barge and E. Wetherhold. "A BASIC Program for Designing Chebyshev Filters," *EMC Technology*. Vol. 1, No. 2, pp. 60-69, April 1982, published quarterly by Don White Consultants, Inc., Gainesville, VA.

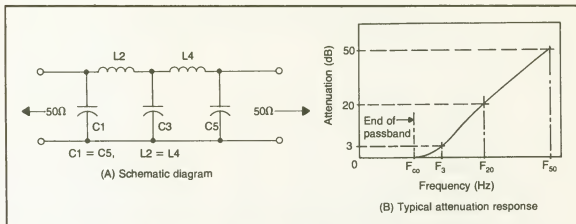

Figure 1. Lowpass filter schematic diagram and attenuation response, capacitive input and output.

Table 1. 50-ohm 5-Element Chebyshev Lowpass Filter Designs Using Standard-Value Capacitors, Capacitive Input and Output. (Continued on page 124.)

Filter No.	Frequency (MHz)				RC (%)	C1, C5 (pf)	L2, L4 ( $\mu$ H)	C3 (pF)
	Cutoff	3-dB	20-dB	50-dB				
1	1.016	1.209	1.652	3.038	9.58	3000	10.73	5600
2	1.101	1.320	1.809	3.334	8.93	2700	9.882	5100
3	1.039	1.371	1.944	3.657	4.06	2200	9.818	4700
4	1.146	1.409	1.951	3.618	7.19	2400	9.373	4700
5	1.127	1.496	2.125	4.002	3.88	2000	9.003	4300
6	1.256	1.541	2.133	3.955	7.27	2200	8.564	4300
7	1.054	1.619	2.379	4.566	1.39	1600	8.351	3900
8	1.232	1.646	2.344	4.420	3.67	1800	8.187	3900
9	1.388	1.701	2.353	4.360	7.38	2000	7.754	3900
10	1.169	1.756	2.570	4.922	1.60	1500	7.703	3600
11	1.275	1.771	2.547	4.830	2.77	1600	7.635	3600
12	1.462	1.825	2.542	4.731	6.30	1800	7.281	3600
13	1.430	1.939	2.773	5.241	3.29	1500	6.960	3300
14	1.541	1.971	2.768	5.179	5.16	1600	6.789	3300
15	1.315	2.101	3.108	5.989	1.07	1200	6.424	3000
16	1.481	2.117	3.065	5.836	2.26	1300	6.393	3000
17	1.754	2.190	3.050	5.677	6.30	1500	6.067	3000
18	1.887	2.252	3.080	5.669	9.33	1600	5.773	3000
19	1.506	2.337	3.440	6.611	1.29	1100	5.782	2700
20	1.700	2.361	3.396	6.441	2.77	1200	5.726	2700
21	1.868	2.403	3.383	6.336	4.93	1300	5.573	2700
22	1.753	2.634	3.854	7.383	1.60	1000	5.135	2400
23	1.985	2.671	3.810	7.193	3.49	1100	5.049	2400
24	2.193	2.737	3.813	7.096	6.30	1200	4.854	2400
25	2.402	2.838	3.865	7.094	10.21	1300	4.549	2400
26	1.892	2.872	4.210	8.073	1.50	910	4.709	2200
27	2.145	2.909	4.159	7.861	3.29	1000	4.640	2200
28	2.392	2.986	4.159	7.741	6.30	1100	4.449	2200
29	2.053	3.157	4.639	8.906	1.38	820	4.283	2000
30	2.362	3.201	4.575	8.646	3.31	910	4.217	2000
31	2.631	3.284	4.575	8.515	6.30	1000	4.045	2000

Table 1. 50-Ohm 5-Element Chebyshev Lowpass Filter designs  
Using Standard-Value Capacitors, Capacitive Input and Output. (Continued from Page 123.)

Filter No.	----- Frequency (MHz) ----- Cutoff	3-dB	20-dB	50-dB	RC (%)	C1, C5	L2, L4 (μH)	C3 (pF)
32	2.338	3.512	5.139	9.843	1.60	750	3.851	1800
33	2.628	3.557	5.083	9.603	3.34	820	3.794	1800
34	2.960	3.664	5.089	9.453	6.76	910	3.614	1800
35	2.705	3.959	5.763	11.01	1.92	680	3.418	1600
36	3.058	4.027	5.710	10.74	4.10	750	3.340	1600
37	3.381	4.145	5.734	10.63	7.35	820	3.182	1600
38	2.772	4.212	6.176	11.84	1.49	620	3.211	1500
39	3.135	4.265	6.101	11.54	3.22	680	3.166	1500
40	3.508	4.379	6.100	11.35	6.30	750	3.033	1500
41	3.391	4.881	7.079	13.49	2.15	560	2.772	1300
42	3.838	4.979	7.026	13.18	4.62	620	2.695	1300
43	4.259	5.147	7.080	13.08	8.32	680	2.545	1300
44	3.607	5.279	7.684	14.67	1.92	510	2.563	1200
45	4.056	5.364	7.614	14.33	3.98	560	2.509	1200
46	4.550	5.545	7.654	14.17	7.72	620	2.372	1200
47	3.963	5.762	8.376	15.98	2.01	470	2.348	1100
48	4.391	5.843	8.309	15.66	3.80	510	2.305	1100
49	4.881	6.012	8.334	15.46	7.05	560	2.198	1100
50	4.398	6.344	9.205	17.55	2.12	430	2.133	1000
51	4.907	6.448	9.135	17.18	4.18	470	2.085	1000
52	5.380	6.618	9.169	17.01	7.13	510	1.996	1000
53	4.811	6.968	10.12	19.30	2.66	390	1.942	910
54	5.426	7.095	10.04	18.96	4.34	430	1.894	910
55	5.997	7.311	10.09	18.68	7.70	470	1.799	910
56	4.862	7.690	11.36	21.86	1.14	330	1.756	820
57	5.511	7.758	11.20	21.28	2.51	360	1.743	820
58	6.066	7.887	11.14	20.90	4.54	390	1.702	820
59	6.771	8.169	11.23	20.73	8.44	430	1.602	820
60	5.262	8.404	12.43	23.95	1.07	300	1.606	750
61	6.042	8.485	12.24	23.25	2.56	330	1.594	750
62	6.702	8.645	12.18	22.82	4.83	360	1.550	750
63	7.332	8.897	12.26	22.66	8.03	390	1.475	750
64	6.687	9.363	13.49	25.62	2.61	300	1.444	680
65	7.484	9.565	13.43	25.13	5.20	330	1.398	680
66	8.254	9.896	13.57	25.00	8.93	360	1.317	680
67	7.213	10.25	14.82	28.20	2.35	270	1.320	620
68	8.181	10.48	14.73	27.57	5.10	300	1.276	620
69	9.109	10.88	14.90	27.43	9.22	330	1.195	620
70	7.818	11.32	16.45	31.37	2.06	240	1.195	560
71	9.021	11.59	16.31	30.54	4.98	270	1.155	560
72	10.16	12.09	16.52	30.38	9.58	300	1.073	560
73	8.659	12.44	18.04	34.38	2.17	220	1.007	510
74	9.636	12.65	17.91	33.67	4.22	240	1.063	510
75	9.224	13.48	19.61	37.45	1.94	200	1.003	470
76	10.39	13.71	19.44	36.57	4.06	220	0.981	470
77	9.851	14.71	21.50	41.14	1.67	180	0.919	430
78	10.54	16.19	23.79	45.66	1.39	160	0.835	390

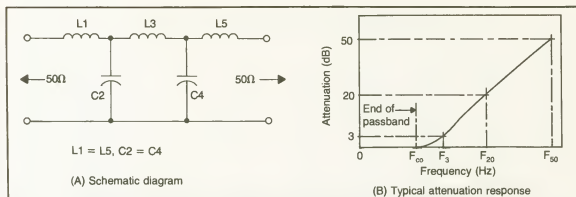

Figure 2. Lowpass filter schematic diagram and attenuation response, inductive input and output.

Table 2. 50-Ohm 5-Element Chebyshev Lowpass Filter Designs Using Standard-Value Capacitors, Inductive Input and Output.  
(Continued on page 126.)

Filter No.	----- Frequency (MHz) ----- Cutoff	3-dB	20-dB	50-dB	RC (%)	L1, L5 (μH)	C2, C4 (pF)	L3 (μH)
1	0.74	1.15	1.69	3.25	1.32	5.6	4700	13.72
2	0.90	1.26	1.81	3.44	2.67	5.6	4300	12.66
3	1.06	1.38	1.94	3.64	4.60	5.6	3900	11.75
4	1.19	1.47	2.05	3.82	6.47	5.6	3600	11.15
5	1.32	1.58	2.17	4.00	8.76	5.6	3300	10.61
6	0.91	1.39	2.03	3.90	1.47	4.7	3900	11.38
7	1.08	1.50	2.16	4.10	2.71	4.7	3600	10.60
8	1.25	1.63	2.30	4.32	4.42	4.7	3300	9.92
9	1.42	1.77	2.46	4.56	6.65	4.7	3000	9.32
10	1.61	1.92	2.63	4.84	9.47	4.7	2700	8.79
11	1.05	1.64	2.41	4.64	1.22	3.9	3300	9.63
12	1.29	1.80	2.60	4.93	2.64	3.9	3000	8.83
13	1.54	1.99	2.80	5.25	4.73	3.9	2700	8.15
14	1.80	2.19	3.03	5.61	7.59	3.9	2400	7.57
15	1.99	2.35	3.21	5.89	10.00	3.9	2200	7.23
16	1.34	2.00	2.93	5.61	1.66	3.3	2700	7.89
17	1.68	2.25	3.20	6.03	3.69	3.3	2400	7.15
18	1.92	2.43	3.40	6.34	5.59	3.3	2200	6.72
19	2.16	2.63	3.62	6.69	7.99	3.3	2000	6.35
20	2.43	2.85	3.87	7.09	10.98	3.3	1800	6.02
21	1.66	2.46	3.59	6.87	1.72	2.7	2200	6.43
22	1.99	2.70	3.86	7.29	3.33	2.7	2000	5.93
23	2.34	2.97	4.15	7.75	5.59	2.7	1800	5.50
24	2.71	3.27	4.49	8.28	8.61	2.7	1600	5.13
25	2.92	3.44	4.68	8.58	10.44	2.7	1500	4.97

Table 2. 50-Ohm 5-Element Chebyshev Lowpass Filter Designs  
Using Standard-Value Capacitors, Capacitive Input and Output. (Continued from Page 125.)

Filter No.	Frequency (MHz)				RC (%)	L1, L5 ( $\mu$ H)	C2, C4 (pF)	L3 ( $\mu$ H)
	Cutoff	3-dB	20-dB	50-dB				
26	2.01	3.01	4.39	8.41	1.66	2.2	1800	5.26
27	2.52	3.37	4.80	9.04	3.69	2.2	1600	4.76
28	2.78	3.57	5.02	9.39	5.07	2.2	1500	4.55
29	3.34	4.02	5.52	10.18	8.68	2.2	1300	4.18
30	3.65	4.28	5.80	10.63	10.98	2.2	1200	4.01
31	2.35	3.61	5.29	10.16	1.41	1.8	1500	4.38
32	3.12	4.14	5.89	11.10	3.83	1.8	1300	3.88
33	3.51	4.45	6.23	11.63	5.59	1.8	1200	3.67
34	3.93	4.78	6.60	12.21	7.77	1.8	1100	3.48
35	4.37	5.16	7.01	12.86	10.44	1.8	1000	3.31
36	3.10	4.51	6.56	12.51	2.00	1.5	1200	3.51
37	3.65	4.90	6.99	13.20	3.52	1.5	1100	3.27
38	4.21	5.34	7.47	13.95	5.59	1.5	1000	3.06
39	4.75	5.77	7.96	14.71	7.97	1.5	910	2.89
40	5.34	6.26	8.50	15.57	10.92	1.5	820	2.74
41	3.53	5.41	7.94	15.24	1.41	1.2	1000	2.92
42	4.30	5.94	8.53	16.17	2.89	1.2	910	2.68
43	5.09	6.53	9.19	17.20	5.02	1.2	820	2.49
44	5.73	7.04	9.75	18.09	7.18	1.2	750	2.35
45	6.42	7.62	10.39	19.09	9.87	1.2	680	2.23
46	4.40	6.60	9.65	18.48	1.63	1.0	820	2.40
47	5.27	7.20	10.32	19.53	3.09	1.0	750	2.22
48	6.15	7.87	11.06	20.70	5.13	1.0	680	2.06
49	6.95	8.51	11.77	21.81	7.39	1.0	620	1.95
50	7.80	9.22	12.56	23.05	10.21	1.0	560	1.85
51	5.23	7.96	11.67	22.38	1.48	0.82	680	1.99
52	6.33	8.72	12.51	23.70	2.95	0.82	620	1.83
53	7.45	9.56	13.45	25.18	5.03	0.82	560	1.70
54	8.44	10.35	14.32	26.55	7.31	0.82	510	1.60
55	9.28	11.05	15.10	27.76	9.54	0.82	470	1.53
56	6.41	9.66	14.15	27.10	1.57	0.68	560	1.64
57	7.75	10.59	15.18	28.73	3.09	0.68	510	1.51
58	8.83	11.41	16.08	30.15	4.76	0.68	470	1.42
59	9.97	12.31	17.08	31.72	6.88	0.68	430	1.34

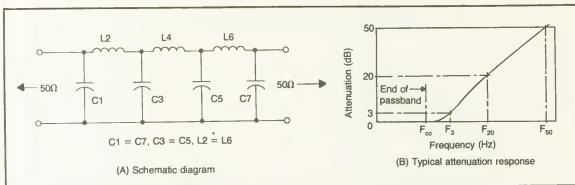

Figure 3. Lowpass filter schematic diagram and attenuation response, capacitive input and output.

Table 3. 50-ohm 7-Element Chebyshev Lowpass Filter Designs Using Standard-Value Capacitors, Capacitive Input and Output.

Filter No.	Cutoff	Frequency (MHz) 3-dB	20-dB	50-dB	RC (%)	C1, C7 (pF)	L2, L6 (μH)	C3, C5 (pF)	L4 (μH)
1	1.037	1.162	1.401	2.050	6.63	2700	18.90	5000	12.57
2	1.047	1.229	1.511	2.260	3.41	2200	18.29	5100	12.29
3	1.118	1.264	1.530	2.258	5.78	2400	10.04	5100	11.66
4	1.033	1.299	1.633	2.486	1.46	1800	9.518	4700	11.88
5	1.124	1.329	1.638	2.455	3.12	2000	9.502	4700	11.40
6	1.308	1.368	1.658	2.450	5.60	2200	9.270	4700	10.78
7	1.294	1.422	1.697	2.474	9.07	2400	8.824	4700	10.01
8	1.101	1.412	1.785	2.731	1.16	1600	8.681	4300	10.97
9	1.214	1.446	1.788	2.687	2.80	1800	8.709	4300	10.51
10	1.314	1.492	1.810	2.677	5.40	2000	8.502	4300	9.910
11	1.417	1.556	1.857	2.705	9.17	2200	8.061	4300	9.138
12	1.250	1.566	1.967	2.894	1.51	1500	7.901	3900	9.846
13	1.318	1.587	1.970	2.968	2.44	1600	7.910	3900	9.617
14	1.440	1.641	1.993	2.951	5.16	1800	7.733	3900	9.035
15	1.565	1.718	2.049	2.984	9.28	2000	7.298	3900	8.268
16	1.445	1.726	2.135	3.210	2.71	1500	7.294	3600	8.919
17	1.517	1.756	2.148	3.197	4.11	1600	7.219	3600	8.537
18	1.660	1.837	2.201	3.218	8.10	1800	6.860	3600	7.826
19	1.507	1.860	2.325	3.526	1.82	1300	6.694	3300	8.265
20	1.682	1.929	2.350	3.487	4.71	1500	6.577	3300	7.721
21	1.767	1.976	2.400	3.497	6.84	1600	6.403	3300	7.370
22	1.556	2.020	2.560	3.925	1.02	1100	6.043	3000	7.682
23	1.679	2.052	2.558	3.879	2.04	1200	6.088	3000	7.472
24	1.786	2.092	2.578	3.841	3.51	1300	6.048	3000	7.213
25	1.993	2.305	2.641	3.862	8.10	1500	5.716	3000	6.522
26	1.746	2.248	2.844	4.354	1.11	1000	5.447	2700	6.894
27	1.893	2.289	2.844	4.291	2.32	1100	5.477	2700	6.677
28	2.032	2.341	3.063	4.203	4.11	1200	5.414	2700	6.403
29	2.148	2.409	3.084	4.272	6.58	1300	5.258	2700	6.064
30	2.006	2.539	3.198	4.877	1.35	910	4.886	2400	6.086
31	2.167	2.588	3.203	4.815	2.71	1000	4.803	2400	5.879
32	2.328	2.669	3.235	4.795	4.95	1100	4.770	2400	5.586
33	2.491	2.756	3.301	4.827	8.10	1200	4.573	2400	5.217
34	2.155	2.762	3.490	5.336	1.17	820	4.442	2200	5.607
35	2.351	2.819	3.499	5.257	2.58	910	4.460	2200	5.406
36	2.574	2.894	3.525	5.230	4.71	1000	4.384	2200	5.147
37	2.717	3.006	3.601	5.246	8.10	1100	4.192	2200	4.782



Table 3. 50-ohm 7-Element Chebyshev Lowpass Filter Designs  
Using Standard-Value Capacitors, Capacitive Input and Output. (Continued from Page 127.)

Filter No.	Frequency (MHz)			RC (%)	C1, C7 (pF)	L2, L6 (μH)	C3, C5 (pF)	L4 (μH)	
	Cutoff	3-dB	20-dB						50-dB
38	2.394	3.041	3.838	5.863	1.24	750	4.041	2000	5.089
39	2.568	3.094	3.840	5.788	2.43	820	4.056	2000	4.933
40	2.778	3.184	3.878	5.753	4.74	910	3.985	2000	4.676
41	2.989	3.307	3.961	5.792	8.10	1000	3.811	2000	4.348
42	2.656	3.383	4.264	6.507	1.31	680	3.640	1800	4.570
43	2.889	3.451	4.271	6.421	2.71	750	3.647	1800	4.489
44	3.090	3.539	4.310	6.393	4.78	820	3.585	1800	4.205
45	3.351	3.695	4.417	6.447	8.60	910	3.404	1800	3.871
46	3.066	3.823	4.795	7.290	1.61	620	3.243	1600	4.029
47	3.300	3.902	4.811	7.211	3.09	680	3.235	1600	3.884
48	3.552	4.022	4.873	7.196	5.65	750	3.154	1600	3.667
49	3.814	4.106	4.992	7.272	9.25	820	2.995	1600	3.394
50	3.166	4.051	5.118	7.824	1.19	560	3.029	1500	3.821
51	3.445	4.133	5.122	7.711	2.57	620	3.041	1500	3.687
52	3.694	4.240	5.168	7.671	4.64	680	2.992	1500	3.515
53	3.985	4.409	5.282	7.723	8.10	750	2.858	1500	3.261
54	3.813	4.717	5.902	8.955	1.76	510	2.636	1300	3.260
55	4.103	4.819	5.927	8.867	3.38	560	2.623	1300	3.135
56	4.429	4.983	6.019	8.865	6.23	620	2.543	1300	2.941
57	4.125	5.108	6.394	9.704	1.74	470	2.433	1200	3.011
58	4.400	5.202	6.414	9.615	3.09	510	2.426	1200	2.913
59	4.719	5.354	6.491	9.593	5.50	560	2.369	1200	2.759
60	5.120	5.606	6.677	9.713	9.66	620	2.232	1200	2.524
61	4.493	5.570	6.975	10.59	1.72	430	2.230	1100	2.762
62	4.819	5.683	7.000	10.48	3.20	470	2.222	1100	2.663
63	5.123	5.827	7.073	10.46	5.30	510	2.177	1100	2.540
64	5.516	6.067	7.245	10.56	8.93	560	2.069	1100	2.349
65	4.933	6.125	7.673	11.65	1.69	390	2.027	1000	2.513
66	5.326	6.262	7.704	11.53	3.34	430	2.018	1000	2.413
67	5.694	6.442	7.801	11.52	5.73	470	1.969	1000	2.287
68	6.077	6.690	7.974	11.62	9.01	510	1.879	1000	2.132
69	5.485	6.749	8.432	12.78	1.88	360	1.846	910	2.275
70	5.838	6.875	8.464	12.67	3.27	390	1.837	910	2.200
71	6.293	7.093	8.581	12.66	5.91	430	1.787	910	2.073
72	6.750	7.391	8.803	12.81	9.64	470	1.693	910	1.914
73	5.682	7.387	9.368	14.37	1.00	300	1.651	820	2.181
74	6.172	7.516	9.361	14.15	2.13	330	1.664	820	2.037
75	6.597	7.681	9.415	14.04	3.81	360	1.649	820	1.958
76	7.007	7.892	9.536	14.05	6.14	390	1.606	820	1.859
77	7.615	8.208	10.23	15.48	2.04	300	1.522	750	1.868
78	7.225	8.403	10.30	15.35	3.86	330	1.507	750	1.788
79	7.716	8.660	10.45	15.37	6.46	360	1.462	750	1.698
80	8.238	9.002	10.71	15.56	9.99	390	1.387	750	1.566
81	7.362	9.039	11.29	17.09	1.93	270	1.379	680	1.698
82	7.985	9.275	11.36	16.93	3.93	300	1.366	680	1.619
83	8.583	9.595	11.55	16.97	6.87	330	1.318	680	1.517
84	7.906	9.865	12.38	18.82	1.59	240	1.256	620	1.562
85	8.673	10.13	12.44	18.58	3.62	270	1.248	620	1.486
86	9.392	10.51	12.66	18.61	6.76	300	1.204	620	1.387
87	8.862	10.95	13.70	20.78	1.70	220	1.135	560	1.403
88	9.407	11.17	13.75	20.59	3.27	240	1.131	560	1.353
89	10.37	11.62	14.01	20.60	6.63	270	1.089	560	1.256
90	9.717	12.02	15.04	22.83	1.76	200	1.034	510	1.279
91	10.47	12.29	15.11	22.60	3.41	220	1.029	510	1.229
92	10.33	12.99	16.33	24.86	1.46	180	0.951	470	1.188

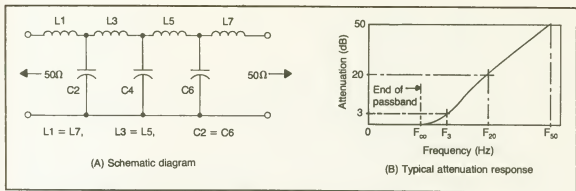

Figure 4. Lowpass filter schematic diagram and attenuation response, inductive input and output.

Table 4. 50-ohm 7-Element Chebyshev Lowpass Filter Designs Using Standard-Value Capacitors, Inductive Input and Output.

Filter No.	Frequency (MHz) Cutoff	3-dB	20-dB	50-dB	RC (%)	L1, L7 ( $\mu$ H)	C2, C6 (pF)	L3, L5 ( $\mu$ H)	C4 (pF)
1	1.014	1.179	1.444	2.152	3.89	5.890	4300	13.37	5100
2	1.087	1.293	1.597	2.398	2.88	5.062	3900	12.04	4700
3	1.197	1.405	1.728	2.584	3.41	4.810	3600	11.15	4300
4	1.328	1.537	1.879	2.797	4.16	4.581	3300	10.29	3900
5	1.425	1.683	2.075	3.110	3.12	3.947	3000	9.274	3600
6	1.528	1.855	2.308	3.486	2.21	3.363	2700	8.316	3300
7	1.634	2.059	2.589	3.945	1.43	2.828	2400	7.408	3000
8	1.859	2.271	2.832	4.284	2.04	2.710	2200	6.775	2700
9	2.137	2.525	3.113	4.665	3.12	2.631	2000	6.182	2400
10	2.291	2.782	3.462	5.228	2.21	2.242	1800	5.544	2200
11	2.452	3.088	3.884	5.918	1.43	1.885	1600	4.939	2000
12	2.849	3.367	4.150	6.219	3.12	1.973	1500	4.637	1800
13	3.126	3.838	4.791	7.256	1.93	1.589	1300	4.004	1600
14	3.269	4.117	5.179	7.890	1.43	1.414	1200	3.704	1500
15	3.475	3.897	4.701	6.915	6.53	2.004	1300	4.169	1500
16	3.985	4.610	5.637	8.390	4.16	1.527	1100	3.429	1300
17	4.274	5.050	6.225	9.329	3.12	1.315	1000	3.091	1200
18	4.633	5.533	6.846	10.29	2.72	1.170	910	2.807	1100
19	5.053	6.115	7.600	11.47	2.30	1.027	820	2.525	1000
20	5.581	6.702	8.309	12.51	2.53	0.953	750	2.311	910
21	6.229	7.412	9.160	13.76	2.85	0.880	680	2.098	820
22	6.791	8.119	10.05	15.11	2.68	0.795	620	1.912	750
23	7.463	8.973	11.13	16.76	2.50	0.710	560	1.725	680
24	8.176	9.847	12.22	18.41	2.44	0.644	510	1.571	620
25	9.207	10.77	13.23	19.76	3.57	0.633	470	1.457	560
26	10.14	11.79	14.44	21.52	3.89	0.589	430	1.337	510
27	10.87	12.93	15.97	23.98	2.88	0.506	390	1.203	470

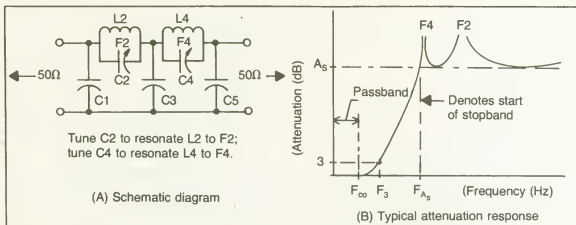

Figure 5. 50-ohm 5th-degree elliptic lowpass filter designs using standard-value capacitors for C1, C3, and C5.

Table 5A. 50-ohm 5th-Degree Elliptic Lowpass Filter Designs Using Standard-Value Capacitors, Capacitive Input and Output.

Filter No.	F-CO (MHz)	F-3dB (MHz)	F-A <sub>s</sub> (MHz)	A <sub>s</sub> (dB)	RC (%)	C1 (pF)	C3 (pF)	C5 (pF)	C2 (pF)	C4 (pF)	L2 (μH)	L4 (μH)	F2 (MHz)	F4 (MHz)
1	0.80	0.99	1.57	47.4	4.40	2700	5600	2200	324	937	12.1	10.1	2.54	1.64
2	0.93	1.09	1.67	46.7	7.16	2700	5100	2200	333	960	10.6	8.74	2.67	1.74
3	1.06	1.20	1.77	46.2	10.5	2700	4700	2200	341	982	9.36	7.56	2.82	1.85
4	1.23	1.35	1.92	45.8	15.3	2700	4300	2200	352	1010	7.93	6.27	3.02	2.00
5	1.47	1.57	2.15	45.4	22.7	2700	3900	2200	364	1045	6.32	4.88	3.32	2.23
6	0.87	1.10	1.83	49.7	3.84	2400	5100	2000	257	735	11.0	9.41	2.99	1.91
7	1.00	1.20	1.93	49.2	6.84	2400	4700	2000	262	748	9.91	8.36	3.12	2.01
8	1.16	1.33	2.06	48.6	9.37	2400	4300	2000	269	765	8.67	7.19	3.30	2.15
9	1.37	1.51	2.25	48.1	14.5	2400	3900	2000	276	785	7.25	5.90	3.55	2.34
10	1.39	1.60	3.10	61.5	10.8	3200	3900	2000	130	355	7.53	6.80	5.09	3.24
11	1.58	1.71	2.45	47.8	30.2	2400	3600	2000	284	805	6.06	4.85	3.84	2.55
12	1.62	1.80	3.37	61.3	16.6	2200	3600	2000	132	359	6.36	5.69	5.49	3.52
13	0.93	1.18	1.91	48.0	3.71	2200	4700	1000	257	743	10.2	8.59	3.11	1.99
14	1.08	1.30	2.02	47.3	6.85	2200	4300	1000	263	759	9.03	7.55	3.25	2.10
15	1.27	1.45	2.17	46.7	9.63	2200	3900	1000	271	779	7.85	6.39	3.45	2.26
16	1.45	1.61	2.32	46.3	13.8	2200	3600	1000	278	798	6.80	5.44	3.66	2.42
17	1.47	1.70	3.20	59.5	9.91	2000	3600	1000	130	357	7.07	6.33	5.24	3.35
18	1.69	1.82	2.54	45.9	19.7	2200	3300	1000	287	821	5.64	4.42	3.96	2.64
19	1.73	1.93	3.49	59.2	15.1	2000	3300	1000	132	362	5.94	5.26	5.67	3.64
20	1.00	1.27	2.00	46.1	3.57	2000	4300	1600	258	752	9.35	7.76	3.24	2.08
21	1.18	1.41	2.12	45.4	6.87	2000	3900	1600	265	771	8.27	6.73	3.40	2.21
22	1.34	1.54	2.24	44.8	8.89	2000	3600	1600	272	790	7.36	5.89	3.56	2.33
23	1.55	1.71	2.41	44.3	13.0	2000	3300	1600	280	812	6.35	4.97	3.78	2.50
24	1.56	1.82	3.32	57.3	8.91	1800	3300	1600	130	360	6.61	5.85	5.42	3.47
25	1.82	1.95	2.65	43.8	19.1	2000	3000	1600	290	841	5.21	3.99	4.09	2.75
26	1.86	2.08	3.62	57.0	14.1	1800	3000	1600	133	366	5.52	4.83	5.88	3.79

Filter No.	F-CO ----- (MHz)	F-3 dB ----- (MHz)	F-A <sub>s</sub> ----- (MHz)	A <sub>s</sub> (dB)	RC (%)	C1	C3	C5	C2	C4	L2	L4	F2	F4
27	1.12	1.44	2.41	49.8	3.42	1800	3900	1500	192	549	8.45	7.25	3.95	2.52
28	1.28	1.56	2.53	49.3	5.41	1800	3600	1500	196	558	7.65	6.47	4.11	2.65
29	1.49	1.73	2.70	48.8	8.40	1800	3300	1500	200	570	6.75	5.62	4.33	2.81
30	1.75	1.95	2.92	48.2	13.0	1800	3000	1500	206	585	5.72	4.68	4.64	3.04
31	2.11	2.27	3.27	47.8	20.2	1800	2700	1500	213	604	4.55	3.64	5.12	3.40
32	1.16	1.54	2.51	47.7	2.70	1600	3600	1300	191	553	7.86	6.65	4.11	2.63
33	1.35	1.68	2.64	47.1	4.53	1600	3300	1300	195	564	7.10	5.92	4.28	2.75
34	1.58	1.86	2.81	46.4	7.41	1600	3000	1300	200	578	6.24	5.11	4.50	2.93
35	1.57	1.93	3.40	53.9	5.51	1500	3000	1300	129	362	6.33	5.54	5.57	3.55
36	1.88	2.11	3.05	45.8	12.0	1600	2700	1300	207	596	5.26	4.21	4.82	3.18
37	1.89	2.19	3.68	53.3	9.50	1500	2700	1300	132	369	5.39	4.65	5.96	3.84
38	2.31	2.48	3.44	45.3	19.5	1600	2400	1300	216	620	4.12	3.21	5.33	3.57
39	2.35	2.58	4.12	52.9	16.3	1500	2400	1300	136	379	4.28	3.62	6.59	4.30
40	1.28	1.66	2.63	46.3	3.11	1500	3300	1200	192	561	7.20	6.00	4.28	2.74
41	1.51	1.83	2.78	45.6	5.33	1500	3000	1200	197	574	6.42	5.25	4.47	2.90
42	1.79	2.06	2.99	44.8	8.89	1500	2700	1200	204	592	5.52	4.42	4.75	3.11
43	2.17	2.38	3.31	44.2	14.7	1500	2400	1200	212	616	4.49	3.49	5.16	3.43
44	2.52	2.70	3.63	43.8	20.8	1500	2200	1200	220	636	3.71	2.82	5.58	3.76
45	1.68	2.10	3.56	51.2	4.41	1300	2700	1100	129	365	5.79	4.99	5.83	3.73
46	2.05	2.40	3.87	50.5	8.22	1300	2400	1100	133	375	4.90	4.15	6.24	4.04
47	2.39	2.68	4.16	50.0	12.3	1300	2200	1100	136	383	4.22	3.52	6.65	4.34
48	2.84	3.08	4.60	49.7	18.6	1300	2000	1100	140	393	3.45	2.82	7.26	4.78
49	1.56	2.08	3.55	50.1	2.69	1200	2700	1000	127	363	5.88	5.07	5.83	3.71
50	1.92	2.35	3.80	49.3	5.41	1200	2400	1000	130	372	5.10	4.32	6.17	3.97
51	2.23	2.59	4.04	48.8	8.40	1200	2200	1000	133	380	4.50	3.75	6.50	4.22
52	2.62	2.92	4.38	48.2	13.0	1200	2000	1000	137	390	3.81	3.12	6.96	4.56
53	3.24	3.60	6.74	61.3	16.0	1100	1800	1000	65.9	180	3.18	2.85	11.10	7.04
54	3.17	3.41	4.90	47.8	20.2	1200	1800	1000	142	402	3.03	2.42	7.68	5.10
55	1.80	2.33	3.87	49.1	3.27	1100	2400	910	121	349	5.21	4.45	6.33	4.04
56	2.09	2.55	4.07	48.6	5.39	1100	2200	910	124	355	4.68	3.94	6.60	4.25
57	2.45	2.84	4.36	48.0	8.69	1100	2000	910	127	364	4.08	3.37	6.99	4.54
58	2.93	3.25	4.77	47.4	13.9	1100	1800	910	131	375	3.38	2.74	7.55	4.97
59	3.64	3.88	5.45	47.0	22.6	1100	1600	910	137	389	2.58	2.04	8.46	5.65
60	1.94	2.52	4.15	48.4	3.11	1000	2200	820	115	331	4.79	4.06	6.78	4.34
61	2.29	2.79	4.39	47.7	5.37	1000	2000	820	118	339	4.26	3.56	7.10	4.58
62	2.73	3.14	4.73	47.0	9.05	1000	1800	820	121	348	3.66	2.99	7.56	4.93
63	3.33	3.65	5.25	46.4	15.2	1000	1600	820	126	361	2.95	2.36	8.25	5.46
64	3.37	3.87	7.23	59.6	11.2	910	1600	820	58.8	161	3.08	2.75	11.8	7.55
65	3.73	4.02	5.63	46.2	19.7	1000	1500	820	129	368	2.56	2.01	8.76	5.85
66	3.82	4.26	7.72	59.5	15.2	910	1500	820	59.6	163	2.70	2.39	12.6	8.07
67	2.14	2.79	4.61	48.8	3.13	910	2000	750	102	294	4.35	3.71	7.55	4.82
68	2.57	3.11	4.92	48.1	5.71	910	1800	750	105	301	3.82	3.19	7.95	5.13
69	3.13	3.56	5.36	47.4	10.1	910	1600	750	108	310	3.20	2.62	8.55	5.59
70	3.49	3.87	5.68	47.1	13.4	910	1500	750	111	316	2.84	2.30	8.97	5.91
71	4.53	4.81	6.67	46.5	24.1	910	1300	750	116	331	2.04	1.60	10.3	6.92

Table 5A. 50-ohm 5th-Degree Elliptic Lowpass Filter Designs  
Using Standard-Value Capacitors, Capacitive Input and Output. (Continued from Page 131.)

Filter No.	F-CO -----(MHz)-----	F-3 dB	F-A <sub>s</sub>	A <sub>s</sub> (dB)	RC (%)	C1	C3	C5	C2	C4	L2	L4	F2	F4
				(dB)	(%)			(pF)			---(μH)---		--(MHz)---	
72	2.39	3.11	5.20	49.4	3.15	820	1800	680	89.3	256	3.91	3.35	8.51	5.44
73	2.93	3.52	5.59	48.6	6.14	820	1600	680	92.0	263	3.37	2.83	9.04	5.83
74	3.26	3.79	5.85	48.2	8.46	820	1500	680	93.6	267	3.07	2.54	9.39	6.10
75	4.17	4.57	6.65	47.5	16.0	820	1300	680	97.7	278	2.36	1.90	10.5	6.92
76	4.23	4.82	9.16	60.8	12.1	750	1300	680	45.8	125	2.46	2.21	15.0	9.58
77	4.83	5.17	7.30	47.2	22.1	820	1200	680	100	286	1.95	1.54	11.4	7.58
78	4.97	5.47	10.0	60.7	17.7	750	1200	680	46.4	127	2.06	1.83	16.3	10.5
79	2.74	3.49	5.73	48.9	3.75	750	1600	620	83.6	240	3.46	2.94	9.36	5.99
80	3.07	3.73	5.97	48.5	5.39	750	1500	620	84.9	243	3.19	2.68	9.67	6.23
81	3.90	4.41	6.63	47.6	10.8	750	1300	620	88.4	252	2.57	2.10	10.6	6.91
82	4.47	4.91	7.15	47.2	15.3	750	1200	620	90.6	258	2.21	1.77	11.3	7.43
83	5.24	5.61	7.89	46.9	21.8	750	1100	620	93.4	266	1.80	1.42	12.3	8.19
84	2.85	3.71	6.15	48.8	3.06	680	1500	560	76.6	220	3.26	2.78	10.1	6.43
85	3.64	4.32	6.72	47.8	6.79	680	1300	560	79.4	228	2.72	2.26	10.8	7.01
86	4.16	4.74	7.14	47.3	9.95	680	1200	560	81.3	233	2.40	1.97	11.4	7.44
87	4.82	5.31	7.72	46.9	14.5	680	1100	560	83.5	239	2.05	1.65	12.2	8.03
88	4.88	5.62	10.6	60.1	10.7	620	1100	560	39.1	107	2.13	1.91	17.4	11.1
89	5.72	6.13	8.58	46.5	21.5	680	1000	560	86.3	246	1.65	1.30	13.3	8.91
90	5.88	6.49	11.8	59.9	16.9	620	1000	560	39.8	109	1.74	1.55	19.1	12.3
91	3.41	4.28	6.93	48.3	4.15	620	1300	510	71.1	204	2.80	2.37	11.3	7.24
92	3.91	4.67	7.29	47.8	6.38	620	1200	510	72.6	208	2.53	2.10	11.8	7.61
93	4.52	5.17	7.78	47.3	9.69	620	1100	510	74.4	213	2.21	1.81	12.4	8.10
94	5.31	5.85	8.47	46.8	14.7	620	1000	510	76.7	219	1.86	1.49	13.3	8.81
95	6.29	6.73	9.40	46.4	21.6	620	910	510	79.3	226	1.50	1.18	14.6	9.76
96	3.67	4.69	7.95	50.5	3.66	560	1200	470	57.6	164	2.59	2.23	13.0	8.31
97	4.27	5.15	8.40	49.9	5.97	560	1100	470	58.8	167	2.32	1.97	13.6	8.77
98	5.02	5.77	9.01	49.4	9.57	560	1000	470	60.3	171	2.01	1.68	14.5	9.40
99	5.91	6.53	9.82	48.9	14.6	560	910	470	62.0	175	1.69	1.38	15.6	10.2
100	7.18	7.68	11.1	48.6	22.5	560	820	470	64.1	181	1.32	1.06	17.3	11.5
101	3.99	5.13	8.00	51.0	3.52	510	1100	430	51.1	145	2.38	2.06	14.4	9.20
102	4.71	5.69	9.34	50.4	6.04	510	1000	430	52.3	148	2.11	1.79	15.2	9.76
103	5.54	6.36	10.0	49.9	9.65	510	910	430	53.5	152	1.82	1.53	16.1	10.5
104	6.64	7.32	11.0	49.4	15.4	510	820	430	55.2	156	1.50	1.23	17.5	11.5
105	7.87	8.42	12.3	49.1	22.3	510	750	430	56.8	160	1.21	0.98	19.2	12.7
106	4.40	5.60	9.24	49.3	3.81	470	1000	390	51.4	147	2.16	1.84	15.1	9.66
107	5.18	6.19	9.82	48.6	6.39	470	910	390	52.6	151	1.91	1.60	15.9	10.2
108	6.17	7.01	10.6	48.0	10.5	470	820	390	54.2	155	1.63	1.34	17.0	11.1
109	7.19	7.90	11.5	47.6	15.5	470	750	390	55.7	159	1.37	1.11	18.2	12.0
110	7.30	8.34	15.9	60.9	11.7	430	750	390	26.1	71.3	1.43	1.28	26.1	16.6
111	8.63	9.20	12.9	47.3	23.2	470	680	390	57.6	164	1.09	0.86	20.1	13.4
112	8.88	9.73	17.7	60.8	18.7	430	680	390	26.6	72.4	1.15	1.02	28.8	18.5

Filter No.	F-CO	F-3 dB	F-A <sub>S</sub>	A <sub>S</sub> (dB)	RC (%)	C1	C3	C5	C2	C4	L2	L4	F2	F4
	----- (MHz) -----					----- (pF) -----				--- (μH) ---		-- (MHz) --		
113	4.88	6.18	10.4	50.1	3.94	430	910	360	45.0	128	1.96	1.68	16.9	10.8
114	5.84	6.93	11.1	49.5	6.94	430	820	360	46.1	131	1.71	1.44	17.9	11.6
115	6.79	7.72	11.9	49.0	10.6	430	750	360	47.3	134	1.48	1.23	19.0	12.4
116	8.06	8.83	13.1	48.5	16.3	430	680	360	48.7	138	1.22	1.00	20.6	13.6
117	9.61	10.2	14.6	48.3	23.9	430	620	360	50.2	142	0.97	0.78	22.8	15.2
118	5.47	6.91	11.8	51.3	4.11	390	820	330	38.5	109	1.76	1.52	19.3	12.3
119	6.39	7.63	12.5	50.7	6.70	390	750	330	39.3	111	1.57	1.33	20.3	13.1
120	7.55	8.59	13.5	50.2	10.8	390	680	330	40.4	114	1.34	1.12	21.7	14.1
121	8.90	9.77	14.8	49.8	16.2	390	620	330	41.4	117	1.11	0.92	23.4	15.4
122	10.9	11.5	16.8	49.5	24.8	390	560	330	42.8	120	0.86	0.70	26.2	17.4
123	9.87	10.7	15.7	48.0	17.4	360	560	300	42.0	119	0.99	0.80	24.7	16.3
124	10.1	11.3	21.6	61.4	13.4	330	560	300	19.7	53.6	1.03	0.93	35.3	22.6
125	8.26	9.33	14.2	48.4	11.2	360	620	300	40.7	116	1.22	1.00	22.6	14.8
126	8.20	9.84	19.6	61.7	8.03	330	620	300	19.3	52.8	1.25	1.14	32.4	20.6
127	7.07	8.34	13.2	48.9	7.26	360	680	300	39.7	113	1.41	1.18	21.3	13.8
128	5.98	7.49	12.3	49.6	4.31	360	750	300	38.7	111	1.61	1.37	20.1	12.9
129	7.69	9.03	13.8	47.1	7.37	330	620	270	40.0	115	1.29	1.06	22.2	14.4
130	6.59	8.17	13.0	47.7	4.57	330	680	270	39.0	112	1.46	1.22	21.1	13.6
131	9.10	10.2	15.0	46.5	11.8	330	560	270	41.2	118	1.09	0.88	23.7	15.6
132	9.15	10.8	20.7	59.6	8.23	300	560	270	19.4	53.3	1.13	1.01	34.0	21.6
133	10.7	11.6	16.4	46.0	17.4	330	510	270	42.6	122	0.91	0.72	25.6	17.0
134	10.9	12.3	22.5	59.3	13.1	300	510	270	19.7	54.1	0.95	0.85	36.7	23.5
135	12.4	13.2	18.1	45.8	24.1	330	470	270	43.9	125	0.74	0.57	27.9	18.8
136	12.8	14.0	24.7	59.2	19.2	300	470	270	20.1	54.9	0.79	0.69	40.1	25.8
137	7.14	8.84	13.6	45.8	4.47	300	620	240	39.1	114	1.34	1.10	22.0	14.2
138	8.44	9.86	14.6	45.1	7.51	300	560	240	40.3	117	1.17	0.94	23.2	15.2
139	9.81	11.0	15.6	44.5	11.4	300	510	240	41.6	121	1.00	0.79	24.6	16.3
140	9.85	11.7	21.6	57.4	7.64	270	510	240	19.5	53.8	1.04	0.93	35.4	22.6
141	11.2	12.2	16.9	44.1	16.0	300	470	240	42.8	124	0.86	0.67	26.2	17.5
142	11.4	13.0	23.1	57.1	11.5	270	470	240	19.8	54.5	0.90	0.79	37.7	24.2
143	13.1	14.0	18.6	43.7	22.7	300	430	240	44.3	128	0.70	0.53	28.6	19.3
144	13.6	14.9	25.4	56.9	17.4	270	430	240	20.2	55.4	0.75	0.65	41.0	26.5

Table 5B. 600-Ohm 5th-Degree Elliptic Lowpass Filter Designs Using Standard-Value Capacitors, Capacitive Input and Output.

Filter No.	F-CO	F-3 dB	F-A <sub>s</sub>	A <sub>s</sub>	RC	C1	C3	C5	C2	C4	L2	L4	F2	F4
	-----	-----	-----	(dB)	(%)	-----	-----	(nF)	-----	-----	---(mH)---	---	---(kHz)---	---
1	0.66	0.82	1.31	47.4	4.40	270	560	220	32.4	93.7	174	145	2.12	1.36
2	0.89	1.00	1.48	46.2	10.5	270	470	220	34.1	98.2	135	109	2.35	1.54
3	1.23	1.31	1.79	45.4	22.7	270	390	220	36.4	105	91.8	70.3	2.76	1.86
4	0.77	0.98	1.59	48.0	3.71	220	470	180	25.7	74.3	147	124	2.59	1.66
5	1.06	1.21	1.80	46.7	9.69	220	390	180	27.1	77.9	113	92.0	2.87	1.88
6	1.41	1.52	2.12	45.9	19.7	220	330	180	28.7	82.1	81.2	63.7	3.30	2.20
7	0.93	1.20	2.01	49.8	3.42	180	390	150	19.2	54.9	122	104	3.29	2.10
8	1.24	1.44	2.25	48.8	8.40	180	330	150	20.0	57.0	97.1	81.0	3.61	2.34
9	1.76	1.90	2.72	47.8	20.2	180	270	150	21.3	60.4	65.5	52.4	4.26	2.83
10	1.07	1.38	2.19	46.3	3.11	150	330	120	19.2	56.1	104	86.4	3.57	2.29
11	1.49	1.71	2.49	44.8	8.89	150	270	120	20.4	59.2	79.5	63.6	3.95	2.59
12	2.10	2.25	3.02	43.8	20.8	150	220	120	22.0	63.6	53.4	40.6	4.65	3.13
13	1.30	1.73	2.95	50.1	2.69	120	270	100	12.7	36.3	84.7	73.0	4.86	3.09
14	1.86	2.16	3.37	48.8	8.40	120	220	100	13.3	38.0	64.8	54.0	5.41	3.51
15	2.64	2.84	4.09	47.8	20.2	120	180	100	14.2	40.2	43.6	34.9	6.40	4.25
16	1.62	2.10	3.46	48.4	3.11	100	220	82	11.5	33.1	68.9	58.5	5.65	3.61
17	2.27	2.62	3.94	47.0	9.05	100	180	82	12.1	34.8	52.6	43.1	6.30	4.11
18	3.11	3.35	4.69	46.2	19.7	100	150	82	12.9	36.8	36.9	29.0	7.30	4.87
19	1.99	2.59	4.33	49.4	3.15	82	180	68	8.93	25.6	56.3	48.2	7.10	4.53
20	2.72	3.16	4.88	48.2	8.46	82	150	68	9.36	26.7	44.2	36.6	7.83	5.09
21	4.03	4.31	6.08	47.2	22.1	82	120	68	10.0	28.6	28.1	22.2	9.47	6.32
22	2.37	3.09	5.12	48.8	3.06	68	150	56	7.66	22.0	47.0	40.0	8.39	5.36
23	3.46	3.95	5.95	47.3	9.95	68	120	56	8.13	23.3	34.6	28.3	9.49	6.20
24	4.77	5.11	7.15	46.5	21.5	68	100	56	8.63	24.6	23.8	18.7	11.1	7.42
25	3.06	3.91	6.62	50.5	3.66	56	120	47	5.76	16.4	37.4	32.1	10.8	6.93
26	4.18	4.80	7.51	49.4	9.57	56	100	47	6.03	17.1	28.9	24.1	12.1	7.83
27	5.98	6.48	9.22	48.6	22.5	56	82	47	6.41	18.1	19.0	15.2	14.4	9.58
28	3.67	4.66	7.70	49.3	3.81	47	100	39	5.14	14.7	31.1	26.5	12.6	8.05
29	5.14	5.84	8.86	48.0	10.5	47	82	39	5.42	15.5	23.4	19.2	14.1	9.23
30	7.19	7.67	10.8	47.3	23.2	47	68	39	5.76	16.4	15.6	12.3	16.8	11.2
31	4.56	5.76	9.83	51.3	4.11	39	82	33	3.85	10.9	25.4	21.9	16.1	10.3
32	6.30	7.16	11.3	50.2	10.8	39	68	33	4.04	11.4	19.3	16.1	18.1	11.7
33	9.05	9.62	14.0	49.5	24.8	39	56	33	4.28	12.0	12.4	10.0	21.8	14.5
34	5.49	6.81	10.8	47.7	4.57	33	68	27	3.90	11.2	21.1	17.6	17.6	11.3
35	7.58	8.51	12.5	46.5	11.8	33	56	27	4.12	11.8	15.7	12.7	19.8	13.0
36	10.4	11.0	15.1	45.8	24.1	33	47	27	4.39	12.5	10.7	8.25	23.3	15.6

•100 nF = .1 μF

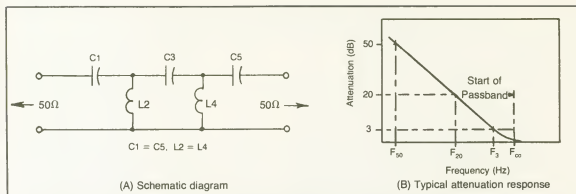

Figure 6. Highpass filter schematic diagram and attenuation response, capacitive input and output.

Table 6. 50-ohm 5-Element Chebyshev Highpass Filter Designs, Using Standard-Value Capacitors, Capacitive Input and Output. (Continued on Page 136.)

Filter No.	----- Frequency (MHz) -----			RC (%)	C1, C5 (pF)	L2, L4 ( $\mu$ H)	C3 (pF)	
	Cutoff	3-dB	20-dB					50 dB
1	1.043	0.726	0.501	0.263	2.17	5100	6.447	2200
2	1.045	0.788	0.554	0.294	3.88	4300	5.969	2000
3	1.169	0.800	0.550	0.288	1.94	4700	5.851	2000
4	1.070	0.857	0.615	0.331	6.30	3600	5.562	1800
5	1.172	0.877	0.616	0.327	3.67	3900	5.358	1800
6	1.329	0.890	0.609	0.318	1.67	4300	5.258	1800
7	1.119	0.938	0.685	0.372	9.33	3000	5.195	1600
8	1.246	0.974	0.693	0.371	5.16	3300	4.860	1600
9	1.380	0.993	0.691	0.364	2.77	3600	4.714	1600
10	1.541	1.003	0.683	0.356	1.39	3900	4.669	1600
11	1.284	1.028	0.738	0.397	6.30	3000	4.635	1500
12	1.432	1.055	0.738	0.391	3.29	3300	4.444	1500
13	1.605	1.068	0.730	0.381	1.60	3600	4.380	1500
14	1.352	1.144	0.840	0.458	10.21	2400	4.286	1300
15	1.545	1.201	0.853	0.456	4.93	2700	3.935	1300
16	1.754	1.227	0.848	0.445	2.26	3000	3.812	1300
17	1.453	1.235	0.900	0.496	10.63	2200	3.985	1200
18	1.604	1.285	0.923	0.496	6.30	2400	3.708	1200
19	1.840	1.325	0.921	0.486	2.77	2700	3.536	1200
20	2.140	1.340	0.906	0.470	1.07	3000	3.501	1200
21	1.569	1.340	0.988	0.540	11.14	2000	3.686	1100
22	1.750	1.402	1.007	0.541	6.30	2200	3.399	1100
23	1.933	1.437	1.007	0.534	3.49	2400	3.267	1100
24	2.265	1.460	0.992	0.516	1.29	2700	3.209	1100
25	1.925	1.542	1.107	0.595	6.30	2000	3.090	1000
26	2.148	1.583	1.107	0.586	3.29	2200	2.963	1000
27	2.408	1.603	1.095	0.572	1.60	2400	2.920	1000
28	2.090	1.688	1.216	0.654	6.76	1800	2.832	910
29	2.357	1.739	1.217	0.644	3.31	2000	2.697	910
30	2.675	1.762	1.202	0.627	1.50	2200	2.656	910
31	2.120	1.805	1.328	0.725	10.76	1500	2.729	820
32	2.284	1.863	1.347	0.727	7.35	1600	2.576	820
33	2.612	1.930	1.351	0.715	3.34	1800	2.431	820
34	3.009	1.957	1.332	0.694	1.38	2000	2.393	820



Table 6. 50-ohm 5-Element Chebyshev Highpass Filter Designs  
Using Standard-Value Capacitors, Capacitive Input and Output. (Continued from Page 135.)

Filter No.	----- Frequency (MHz) -----				RC (%)	C1, C5 (pF)	L2, L4 ( $\mu$ H)	C3 (pF)
	Cutoff	3-dB	20-dB	50 dB				
35	2.567	2.057	1.476	0.793	6.30	1500	2.317	750
36	2.762	2.097	1.479	0.786	4.10	1600	2.245	750
37	3.211	2.137	1.460	0.762	1.60	1800	2.190	750
38	2.691	2.227	1.619	0.877	8.32	1300	2.170	680
39	3.168	2.329	1.628	0.861	3.22	1500	2.013	680
40	3.443	2.352	1.616	0.846	1.92	1600	1.989	680
41	2.993	2.456	1.779	0.961	7.72	1200	1.959	620
42	3.275	2.525	1.789	0.954	4.62	1300	1.869	620
43	3.931	2.587	1.764	0.920	1.49	1500	1.809	620
44	3.370	2.736	1.974	1.064	7.05	1100	1.751	560
45	3.718	2.811	1.980	1.052	3.98	1200	1.673	560
46	4.105	2.852	1.966	1.032	2.15	1300	1.640	560
47	3.693	3.002	2.167	1.168	7.13	1000	1.596	510
48	4.113	3.091	2.174	1.154	3.80	1100	1.520	510
49	4.590	3.136	2.155	1.128	1.92	1200	1.491	510
50	3.950	3.240	2.347	1.268	7.70	910	1.485	470
51	4.393	3.343	2.360	1.255	4.18	1000	1.408	470
52	4.945	3.401	2.340	1.226	2.01	1100	1.375	470
53	4.244	3.517	2.559	1.386	8.44	820	1.375	430
54	4.772	3.650	2.580	1.373	4.34	910	1.291	430
55	5.358	3.714	2.560	1.343	2.12	1000	1.259	430
56	4.724	3.893	2.826	1.528	8.03	750	1.239	390
57	5.223	4.017	2.844	1.516	4.54	820	1.174	390
58	5.934	4.097	2.821	1.479	2.06	910	1.142	390
59	5.014	4.182	3.051	1.655	8.93	680	1.161	360
60	5.599	4.341	3.081	1.645	4.83	750	1.088	360
61	6.228	4.424	3.066	1.613	2.51	820	1.058	360
62	5.437	4.550	3.324	1.806	9.22	620	1.069	330
63	6.033	4.720	3.361	1.797	5.20	680	1.002	330
64	6.775	4.825	3.345	1.761	2.56	750	0.970	330
65	7.702	4.869	3.297	1.713	1.14	820	0.962	330
66	5.936	4.988	3.651	1.985	9.58	560	0.978	300
67	6.658	5.197	3.697	1.976	5.10	620	0.910	300
68	7.427	5.305	3.681	1.938	2.61	680	0.882	300
69	8.558	5.358	3.622	1.880	1.07	750	0.875	300
70	6.686	5.576	4.068	2.207	8.93	510	0.870	270
71	7.428	5.780	4.108	2.194	4.98	560	0.817	270
72	8.392	5.906	4.084	2.146	2.35	620	0.792	270
73	7.836	6.376	4.604	2.482	7.19	470	0.752	240
74	8.591	6.546	4.622	2.459	4.22	510	0.719	240
75	9.643	6.658	4.584	2.404	2.06	560	0.702	240
76	8.529	6.950	5.021	2.708	7.27	430	0.690	220
77	9.430	7.150	5.041	2.679	4.06	470	0.658	220
78	10.43	7.257	5.006	2.627	2.17	510	0.644	220
79	9.358	7.637	5.521	2.979	7.38	390	0.628	200
80	10.45	7.877	5.544	2.944	3.88	430	0.596	200
81	9.686	8.232	6.056	3.304	10.63	330	0.597	180
82	10.70	8.569	6.152	3.305	6.30	360	0.556	180

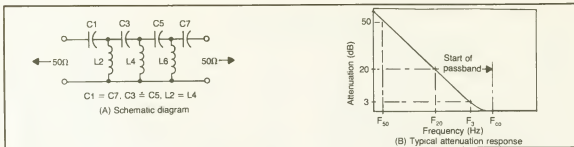

Figure 7. Highpass filter schematic diagram and attenuation response, capacitive input and output.

Table 7. 50-ohm 7-Element Chebyshev Highpass Filter Designs Using Standard-Value Capacitors, Capacitive Input and Output. (Continued on Page 138.)

Filter No.	----- Frequency (MHz) -----				RC (%)	C1, C7 (pF)	L2, L6 (μH)	C3, C5 (pF)	L4 (μH)
	Cutoff	3-dB	20 dB	50-dB					
1	1.022	0.826	0.660	0.435	1.76	5100	6.162	2000	4.982
2	1.002	0.880	0.724	0.489	5.16	3900	5.673	1800	4.855
3	1.079	0.905	0.732	0.487	2.80	4300	5.554	1800	4.601
4	1.159	0.922	0.734	0.482	1.46	4700	5.554	1800	4.449
5	1.086	0.971	0.806	0.549	6.84	3300	5.153	1600	4.477
6	1.160	1.002	0.819	0.550	4.11	3600	4.986	1600	4.216
7	1.232	1.023	0.824	0.547	2.44	3900	4.930	1600	4.055
8	1.338	1.043	0.825	0.539	1.16	4300	4.953	1600	3.921
9	1.130	1.021	0.853	0.583	8.10	3000	4.919	1500	4.312
10	1.217	1.061	0.871	0.587	4.71	3300	4.703	1500	4.006
11	1.299	1.087	0.879	0.584	2.71	3600	4.626	1500	3.826
12	1.386	1.106	0.880	0.578	1.51	3900	4.627	1500	3.713
13	1.344	1.198	0.994	0.676	6.58	2700	4.171	1300	3.617
14	1.455	1.242	1.011	0.676	3.51	3000	4.029	1300	3.379
15	1.567	1.270	1.016	0.670	1.82	3300	4.004	1300	3.244
16	1.413	1.277	1.066	0.729	8.10	2400	3.935	1200	3.449
17	1.546	1.336	1.092	0.734	4.11	2700	3.739	1200	3.162
18	1.677	1.372	1.100	0.727	2.04	3000	3.695	1200	3.011
19	1.541	1.393	1.163	0.795	8.10	2200	3.607	1100	3.162
20	1.649	1.443	1.186	0.800	4.95	2400	3.458	1100	2.953
21	1.802	1.490	1.200	0.795	2.32	2700	3.388	1100	2.779
22	1.973	1.520	1.199	0.782	1.02	3000	3.412	1100	2.684
23	1.695	1.532	1.279	0.875	8.10	2000	3.279	1000	2.874
24	1.825	1.592	1.307	0.881	4.71	2200	3.135	1000	2.671
25	1.948	1.631	1.318	0.877	2.71	2400	3.084	1000	2.551
26	2.150	1.669	1.320	0.862	1.11	2700	3.097	1000	2.447
27	1.846	1.674	1.400	0.959	8.60	1800	3.007	910	2.644
28	2.004	1.748	1.436	0.968	4.74	2000	2.854	910	2.432
29	2.153	1.795	1.449	0.963	2.58	2200	2.805	910	2.314
30	2.312	1.827	1.451	0.951	1.35	2400	2.810	910	2.242
31	2.025	1.845	1.547	1.062	9.25	1600	2.737	820	2.415
32	2.222	1.940	1.593	1.074	4.78	1800	2.573	820	2.193
33	2.406	1.997	1.609	1.067	2.43	2000	2.526	820	2.077
34	2.606	2.034	1.610	1.053	1.17	2200	2.538	820	2.010
35	2.260	2.043	1.705	1.166	8.10	1500	2.459	750	2.156
36	2.377	2.099	1.733	1.173	5.65	1600	2.377	750	2.045
37	2.598	2.175	1.757	1.169	2.71	1800	2.313	750	1.913
38	2.834	2.221	1.760	1.152	1.24	2000	2.319	750	1.842

Table 7. 50-ohm 7-Element Chebyshev Highpass Filter Designs Using Standard-Value Capacitors, Capacitive Input and Output.  
(Continued from Page 137.)

Filter No.	----- Frequency (MHz) -----				RC (%)	(pF) C1, C7	L2, L6 (μH)	C3, C5 (pF)	L4 (μH)
	Cutoff	3-dB	20-dB	50-dB					
39	2.689	2.343	1.922	1.295	4.64	1500	2.130	680	1.813
40	2.822	2.387	1.936	1.291	3.89	1600	2.101	680	1.750
41	3.105	2.447	1.941	1.272	1.31	1800	2.101	680	1.673
42	2.660	2.429	2.040	1.402	9.66	1200	2.882	620	1.842
43	2.838	2.523	2.089	1.418	6.23	1300	1.980	620	1.712
44	3.162	2.636	2.127	1.413	2.57	1500	1.911	620	1.576
45	3.331	2.671	2.130	1.401	1.61	1600	1.911	620	1.538
46	2.982	2.711	2.270	1.557	8.93	1100	1.859	560	1.638
47	3.195	2.816	2.323	1.572	5.50	1200	1.772	560	1.522
48	3.392	2.888	2.348	1.570	3.38	1300	1.734	560	1.451
49	3.810	2.977	2.357	1.542	1.19	1500	1.732	560	1.373
50	3.269	2.974	2.491	1.709	9.01	1000	1.696	510	1.494
51	3.525	3.100	2.553	1.726	5.30	1100	1.610	510	1.380
52	3.763	3.183	2.581	1.722	3.09	1200	1.576	510	1.312
53	4.008	3.240	2.589	1.706	1.76	1300	1.571	510	1.270
54	3.510	3.205	2.691	1.850	9.64	910	1.578	470	1.396
55	3.786	3.347	2.764	1.872	5.73	1000	1.491	470	1.283
56	4.067	3.449	2.800	1.869	3.20	1100	1.453	470	1.213
57	4.355	3.517	2.810	1.851	1.74	1200	1.448	470	1.170
58	4.121	3.651	3.017	2.046	5.91	910	1.367	430	1.179
59	4.424	3.763	3.058	2.044	3.34	1000	1.331	430	1.113
60	4.768	3.846	3.071	2.023	1.72	1100	1.325	430	1.070
61	4.205	3.848	3.235	2.226	9.99	750	1.317	390	1.167
62	4.521	4.015	3.322	2.255	6.14	820	1.244	390	1.074
63	4.890	4.153	3.373	2.253	3.27	910	1.206	390	1.008
64	5.267	4.242	3.386	2.230	1.69	1000	1.202	390	0.969
65	4.864	4.333	3.592	2.441	6.46	750	1.153	360	0.999
66	5.202	4.469	3.646	2.444	3.81	820	1.118	360	0.942
67	5.639	4.582	3.668	2.420	1.88	910	1.108	360	0.899
68	5.260	4.706	3.908	2.660	6.87	680	1.063	330	0.924
69	5.666	4.872	3.976	2.667	3.86	750	1.026	330	0.864
70	6.067	4.981	4.000	2.646	2.13	820	1.016	330	0.829
71	5.800	5.183	4.302	2.927	6.76	620	0.965	300	0.838
72	6.220	5.355	4.372	2.934	3.93	680	0.933	300	0.787
73	6.706	5.487	4.401	2.909	2.04	750	0.923	300	0.752
74	7.249	5.576	4.397	2.867	1.00	820	0.931	300	0.731
75	6.462	5.767	4.784	3.253	6.63	560	0.867	270	0.752
76	6.979	5.972	4.865	3.258	3.62	620	0.837	270	0.703
77	7.496	6.105	4.890	3.229	1.93	680	0.831	270	0.675
78	6.940	6.315	5.292	3.631	9.07	470	0.798	240	0.704
79	7.407	6.551	5.411	3.666	5.78	510	0.762	240	0.656
80	7.946	6.748	5.481	3.661	3.27	560	0.742	240	0.620
81	8.612	6.903	5.502	3.619	1.59	620	0.740	240	0.595
82	7.559	6.883	5.769	3.960	9.17	430	0.733	220	0.646
83	8.113	7.161	5.909	4.000	5.60	470	0.697	220	0.599
84	8.626	7.349	5.976	3.996	3.41	510	0.681	220	0.570
85	9.280	7.509	6.002	3.957	1.78	560	0.677	220	0.548
86	8.298	7.561	6.341	4.353	9.28	390	0.667	200	0.589
87	8.968	7.895	6.508	4.401	5.40	430	0.632	200	0.542
88	9.587	8.113	6.581	4.391	3.12	470	0.618	200	0.515
89	10.22	8.263	6.603	4.351	1.76	510	0.616	200	0.498
90	9.417	8.511	7.105	4.859	8.10	360	0.590	180	0.517
91	10.02	8.796	7.241	4.891	5.16	390	0.567	180	0.485
92	10.79	9.051	7.321	4.873	2.80	430	0.555	180	0.460

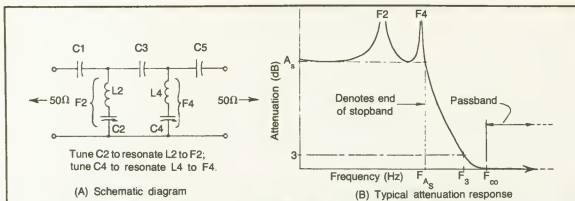

Figure 8. 50-ohm 5th degree elliptic highpass filter designs using standard-value capacitors for C1, C3 and C5.

Table 8A. 50-ohm 5th-Degree Elliptic Highpass Filter Designs Using Standard-Value Capacitors, Capacitive Input and Output. (Continued on Page 140.)

Filter No.	F-CO	F-3dB	F-A <sub>s</sub>	A <sub>s</sub>	RC	C1	C3	C5	C2	C4	L2	L4	F2	F4
	(MHz)	(MHz)	(MHz)	(dB)	(%)	(nF)	(nF)	(nF)	(nF)	(nF)	(μH)	(μH)	(MHz)	(MHz)
1	0.79	0.74	0.50	49.6	20.7	3.3	2.2	3.9	30.5	10.8	8.28	10.2	0.32	0.48
2	0.93	0.84	0.63	41.0	12.9	3.6	2.2	4.7	21.5	7.26	7.09	9.46	0.41	0.61
3	0.92	0.80	0.53	48.1	9.80	3.9	2.2	4.7	34.0	11.9	6.86	8.32	0.33	0.51
4	1.02	0.86	0.60	42.4	5.92	4.0	2.2	5.6	27.7	9.34	6.44	8.18	0.38	0.58
5	1.04	0.82	0.48	50.5	3.73	4.7	2.2	5.6	45.6	16.0	6.36	7.40	0.30	0.46
6	1.15	0.86	0.58	42.3	2.27	5.1	2.2	6.8	32.1	10.7	6.26	7.77	0.36	0.55
7	0.97	0.90	0.69	40.8	18.2	3.0	2.0	3.9	17.6	5.93	7.03	9.58	0.45	0.67
8	0.95	0.85	0.55	49.9	13.8	3.3	2.0	3.9	31.4	11.1	6.67	8.04	0.35	0.53
9	1.08	0.94	0.68	41.6	8.67	3.6	2.0	4.7	22.4	7.53	6.06	7.87	0.43	0.65
10	1.08	0.90	0.57	48.7	6.17	3.9	2.0	4.7	34.9	12.2	5.93	7.07	0.35	0.54
11	1.19	0.94	0.63	43.1	3.57	4.3	2.0	5.6	28.6	9.62	5.73	7.12	0.39	0.61
12	1.28	0.94	0.62	43.0	2.06	4.7	2.0	6.2	30.7	10.3	5.69	7.00	0.38	0.59
13	1.01	0.94	0.67	45.9	19.7	2.7	1.8	3.3	20.7	7.24	6.58	8.40	0.43	0.65
14	0.98	0.88	0.47	61.3	14.7	3.0	1.8	3.3	50.2	18.4	6.22	6.94	0.28	0.45
15	1.14	0.98	0.61	50.4	8.50	3.3	1.8	3.9	32.3	11.4	5.53	6.54	0.38	0.58
16	1.27	1.05	0.73	42.4	5.27	3.6	1.8	4.7	23.2	7.80	5.23	6.62	0.46	0.70
17	1.30	1.01	0.60	49.4	3.42	3.9	1.8	4.7	35.0	12.5	5.19	6.07	0.37	0.58
18	1.33	1.05	0.71	42.9	3.42	3.9	1.8	5.1	25.6	8.60	5.15	6.40	0.44	0.68
19	1.02	0.94	0.57	56.8	22.7	2.4	1.6	2.7	31.7	11.5	6.36	7.38	0.35	0.55
20	1.13	1.01	0.55	59.3	13.6	2.7	1.6	3.0	40.9	15.0	5.41	6.09	0.34	0.53
21	1.24	1.11	0.76	46.5	12.1	2.7	1.6	3.3	21.6	7.52	5.15	6.39	0.48	0.73
22	1.37	1.18	0.83	42.2	7.22	3.0	1.6	3.9	19.2	6.47	4.76	6.09	0.53	0.80
23	1.39	1.12	0.66	51.1	4.59	3.3	1.6	3.9	33.2	11.7	4.67	5.43	0.40	0.63
24	1.54	1.18	0.78	43.3	2.73	3.3	1.6	4.7	24.0	8.08	4.56	5.62	0.48	0.75
25	1.19	1.11	0.81	45.4	21.3	2.2	1.5	2.7	16.4	5.71	5.65	7.28	0.52	0.78
26	1.16	1.06	0.62	56.9	17.0	2.4	1.5	2.7	32.2	11.7	5.37	6.17	0.38	0.59
27	1.38	1.29	0.80	46.8	9.03	2.7	1.5	3.3	22.0	7.66	4.61	5.65	0.50	0.77
28	1.45	1.27	0.94	40.3	8.59	2.7	1.5	3.6	15.6	5.28	4.53	5.99	0.60	0.90
29	1.52	1.26	0.87	42.7	5.28	3.0	1.5	3.9	19.6	6.61	4.36	5.50	0.54	0.83
30	1.56	1.19	0.69	51.6	3.11	3.3	1.5	3.9	33.7	11.9	4.32	4.97	0.42	0.66

Table BA. 50-Ohm 5-th Degree Elliptic Highpass Filter Designs Using Standard-Value Capacitors, Capacitive Input and Output.  
(Continued from Page 139.)

Filter No.	F-CO ----- (MHz)	F-3dB ----- (MHz)	F-A <sub>s</sub> ----- (dB)	A <sub>s</sub> (dB)	RC (%)	C1 ----- (nF)	C3 ----- (nF)	C5 ----- (nF)	C2 ----- (nF)	C4 ----- (nF)	L2 --- (μH)	L4 --- (μH)	F2 -- (MHz)	F4 -- (MHz)
31	1.29	1.23	0.91	45.7	26.9	1.8	1.3	2.2	13.4	4.68	5.43	7.08	0.59	0.87
32	1.25	1.15	0.63	61.3	21.3	2.0	1.3	2.2	33.0	12.1	5.07	5.71	0.39	0.61
33	1.53	1.37	0.94	46.1	11.9	2.2	1.3	2.7	17.2	6.00	4.17	5.19	0.59	0.90
34	1.64	1.41	0.96	45.0	7.91	2.4	1.3	3.0	17.8	6.13	3.92	4.87	0.60	0.92
35	1.75	1.40	0.88	47.8	4.37	2.7	1.3	3.3	22.9	7.95	3.77	4.50	0.54	0.84
36	1.81	1.47	1.03	41.4	4.33	2.7	1.3	3.6	16.4	5.47	3.74	4.76	0.64	0.99
37	1.51	1.40	1.01	45.9	19.7	1.8	1.2	2.2	13.8	4.82	4.39	5.60	0.65	0.97
38	1.47	1.32	0.70	61.3	14.7	2.0	1.2	2.2	33.5	12.3	4.15	4.62	0.43	0.67
39	1.61	1.44	0.96	48.2	13.0	2.0	1.2	2.4	17.5	6.16	3.93	4.81	0.61	0.93
40	1.75	1.51	1.00	46.6	8.27	2.2	1.2	2.7	17.7	6.14	3.65	4.47	0.63	0.96
41	1.87	1.54	1.01	45.6	5.33	2.4	1.2	3.0	18.2	6.27	3.51	4.29	0.63	0.97
42	2.02	1.52	0.92	48.3	2.69	2.7	1.2	3.3	23.4	8.09	3.44	4.04	0.56	0.88
43	1.42	1.33	0.81	56.9	26.0	1.6	1.1	1.8	21.0	7.65	4.66	5.43	0.51	0.78
44	1.65	1.55	1.15	43.7	21.5	1.6	1.1	2.0	10.9	3.76	4.13	5.45	0.75	1.11
45	1.60	1.44	0.80	59.2	15.7	1.8	1.1	2.0	27.1	9.92	3.86	4.36	0.49	0.77
46	1.76	1.59	1.10	46.3	13.8	1.8	1.1	2.2	14.2	4.96	3.64	4.55	0.70	1.06
47	1.87	1.61	1.04	48.7	8.74	2.0	1.1	2.4	17.9	6.30	3.38	4.06	0.65	0.99
48	2.02	1.66	1.06	47.1	5.36	2.2	1.1	2.7	18.1	6.28	3.22	3.88	0.66	1.02
49	1.48	1.38	0.66	69.6	25.8	1.5	1.0	1.6	36.6	13.7	4.42	4.69	0.40	0.63
50	1.78	1.65	1.15	47.8	20.2	1.5	1.0	1.8	12.7	4.47	3.71	4.64	0.73	1.10
51	1.92	1.65	0.88	59.5	9.91	1.8	1.0	2.0	27.6	10.1	3.18	3.55	0.54	0.84
52	2.07	1.80	1.20	46.8	9.03	1.8	1.0	2.2	14.7	5.11	3.07	3.77	0.75	1.15
53	2.18	1.91	1.41	40.3	8.59	1.8	1.0	2.4	10.4	3.47	3.02	3.99	0.90	1.35
54	2.45	1.93	1.34	40.6	3.15	2.2	1.0	3.0	12.7	4.20	2.85	3.63	0.84	1.29
55	1.93	1.81	1.34	45.1	23.5	1.3	0.91	1.6	9.45	3.29	3.56	4.64	0.87	1.29
56	2.11	1.90	1.27	48.2	13.6	1.5	0.91	1.8	13.1	4.60	3.02	3.69	0.80	1.22
57	2.09	1.82	1.02	57.1	11.0	1.6	0.91	1.8	21.9	7.94	2.93	3.33	0.63	0.98
58	2.42	2.00	1.28	47.4	5.69	1.8	0.91	2.2	15.1	5.24	2.68	3.22	0.79	1.23
59	2.51	2.10	1.50	41.0	5.55	1.8	0.91	2.4	10.8	3.59	2.65	3.41	0.94	1.44
60	2.84	2.00	1.18	48.5	1.62	2.2	0.91	2.7	19.0	6.56	2.60	3.03	0.72	1.13
61	2.22	2.08	1.55	43.7	21.0	1.2	0.82	1.5	8.19	2.83	3.05	4.02	1.01	1.49
62	2.33	2.12	1.50	45.5	15.6	1.3	0.82	1.6	9.83	3.42	2.79	3.54	0.96	1.45
63	2.32	2.17	1.39	48.7	8.49	1.5	0.82	1.8	13.5	4.73	2.51	3.01	0.87	1.33
64	2.69	2.25	1.50	45.4	6.05	1.6	0.82	2.0	12.1	4.15	2.42	2.97	0.93	1.43
65	2.89	2.23	1.36	48.2	3.15	1.8	0.82	2.2	15.5	5.37	2.36	2.78	0.83	1.30
66	2.97	2.33	1.59	41.8	3.18	1.8	0.82	2.4	11.1	3.71	2.34	2.94	0.99	1.52
67	2.27	2.12	1.45	49.6	22.7	1.1	0.75	1.3	10.1	3.59	2.93	3.62	0.93	1.40
68	2.60	2.37	1.70	44.2	14.7	1.2	0.75	1.5	8.48	2.92	2.51	3.22	1.09	1.64
69	2.56	2.26	1.37	53.2	11.4	1.3	0.75	1.5	14.6	5.24	2.42	2.82	0.85	1.31
70	2.93	2.40	1.48	49.2	5.35	1.5	0.75	1.8	13.8	4.82	2.20	2.61	0.91	1.42
71	3.12	2.47	1.58	46.0	3.74	1.6	0.75	2.0	12.4	4.25	2.16	2.61	0.97	1.51
72	3.42	2.43	1.43	48.8	1.71	1.8	0.75	2.2	15.8	5.47	2.14	2.50	0.86	1.36
73	2.57	2.40	1.68	47.8	21.9	1.0	0.68	1.2	8.40	2.96	2.60	3.27	1.08	1.62
74	2.49	2.26	1.17	63.2	17.1	1.1	0.68	1.2	20.1	7.40	2.46	2.73	0.72	1.12
75	3.05	2.68	1.85	44.7	9.72	1.2	0.68	1.5	8.77	3.02	1.80	2.64	1.17	1.78
76	3.05	2.56	1.48	53.6	7.02	1.3	0.68	1.5	14.9	5.34	2.05	2.36	0.91	1.42

Filter No.	F-CO	F-3dB (MHz)	F-A <sub>s</sub>	A <sub>s</sub> (dB)	RC (%)	C1	C3	C5	C2	C4	L2	L4	F2	F4
	-----	(MHz)-----		(dB)	(%)	----- (nF)-----			-----		--- (μH) ---		-- (MHz) --	
77	3.48	2.66	1.57	49.9	3.06	1.5	0.68	1.8	14.1	4.94	1.96	2.28	0.96	1.50
78	3.80	2.83	1.93	40.7	2.08	1.6	0.68	2.2	9.25	3.04	1.93	2.44	1.19	1.85
79	2.45	2.29	1.28	61.6	26.5	0.91	0.62	1.0	15.0	5.54	2.67	3.02	0.79	1.23
80	2.76	2.50	1.34	61.3	17.1	1.0	0.62	1.1	16.6	6.11	2.24	2.50	0.82	1.29
81	3.04	2.76	1.87	48.1	14.9	1.0	0.62	1.2	8.66	3.05	2.10	2.58	1.18	1.79
82	3.26	2.97	2.22	41.2	13.8	1.0	0.62	1.3	6.04	2.04	2.03	2.70	1.44	2.14
83	3.54	2.97	1.98	45.3	6.30	1.2	0.62	1.5	9.03	3.11	1.83	2.25	1.24	1.90
84	4.16	2.91	1.65	50.6	1.60	1.5	0.62	1.8	14.4	5.03	1.78	2.04	1.00	1.57
85	3.17	2.96	2.13	46.1	21.7	0.82	0.56	1.0	6.31	2.21	2.13	2.72	1.37	2.05
86	3.66	3.33	2.52	40.2	13.2	0.91	0.56	1.2	5.24	1.76	1.81	2.44	1.64	2.43
87	3.62	3.16	2.05	48.6	9.51	1.0	0.56	1.2	8.93	3.14	1.74	2.10	1.28	1.96
88	3.84	3.17	1.92	50.8	6.00	1.1	0.56	1.3	11.0	3.87	1.66	1.94	1.18	1.84
89	4.19	3.30	2.11	46.1	3.64	1.2	0.56	1.5	9.30	3.19	1.61	1.94	1.30	2.02
90	4.57	3.45	2.38	40.2	2.28	1.3	0.56	1.8	7.35	2.40	1.59	2.02	1.47	2.28
91	3.47	3.24	2.31	46.6	21.5	0.75	0.51	0.91	5.93	2.08	1.93	2.46	1.49	2.23
92	3.75	3.40	2.36	46.4	14.9	0.82	0.51	1.0	6.52	2.28	1.72	2.15	1.50	2.27
93	4.22	3.71	2.72	40.9	8.97	0.91	0.51	1.2	5.44	1.82	1.55	2.03	1.73	2.61
94	4.24	3.52	2.19	49.2	6.00	1.0	0.51	1.2	9.16	3.21	1.51	1.79	1.35	2.10
95	5.03	3.72	2.47	42.4	2.05	1.2	0.51	1.6	7.59	2.52	1.45	1.80	1.52	2.36
96	5.45	3.74	2.49	41.0	1.16	1.3	0.51	1.8	7.56	2.47	1.46	1.81	1.52	2.38
97	3.68	3.45	2.45	47.2	23.2	0.68	0.47	0.82	5.53	1.95	1.84	2.33	1.58	2.36
98	4.02	3.67	2.53	46.9	15.4	0.75	0.47	0.91	6.10	2.14	1.60	2.00	1.61	2.44
99	4.30	3.79	2.55	46.9	10.4	0.82	0.47	1.0	6.69	2.33	1.48	1.82	1.60	2.45
100	4.79	4.05	2.87	41.5	6.18	0.91	0.47	1.2	5.60	1.88	1.38	1.77	1.81	2.76
101	4.89	3.84	2.31	49.7	3.81	1.0	0.47	1.2	9.34	3.27	1.36	1.59	1.41	2.21
102	5.87	3.89	2.31	47.4	1.05	1.2	0.47	1.5	9.71	3.32	1.35	1.58	1.39	2.20
103	4.02	3.78	2.70	46.9	23.4	0.62	0.43	0.75	4.95	1.74	1.69	2.15	1.74	2.60
104	4.34	3.97	2.72	47.5	16.1	0.68	0.43	0.82	5.70	2.00	1.48	1.84	1.73	2.62
105	4.98	4.42	3.30	40.0	9.83	0.75	0.43	1.0	4.28	1.43	1.32	1.76	2.12	3.18
106	4.98	4.21	2.73	47.4	6.86	0.82	0.43	1.0	6.87	2.39	1.28	1.55	1.69	2.61
107	5.51	4.42	3.03	42.2	3.91	0.91	0.43	1.2	5.77	1.93	1.23	1.55	1.89	2.91
108	5.76	4.20	2.42	50.3	2.14	1.0	0.43	1.2	9.53	3.33	1.23	1.42	1.47	2.31
109	4.44	4.17	3.01	46.5	23.6	0.56	0.39	0.68	4.37	1.53	1.54	1.97	1.94	2.90
110	4.82	4.40	3.03	47.2	15.7	0.62	0.39	0.75	5.12	1.80	1.34	1.66	1.92	2.91
111	5.14	4.52	2.99	48.0	10.6	0.68	0.39	0.82	5.88	2.06	1.23	1.50	1.87	2.87
112	5.51	4.63	2.96	47.9	6.60	0.75	0.39	0.91	6.46	2.25	1.16	1.40	1.84	2.84
113	5.88	4.67	2.90	48.0	4.08	0.82	0.39	1.0	7.05	2.45	1.13	1.34	1.78	2.78
114	6.52	4.85	3.19	43.0	2.16	0.91	0.39	1.2	5.94	1.99	1.11	1.37	1.96	3.06
115	4.75	4.48	3.25	46.3	24.8	0.51	0.36	0.62	3.94	1.38	1.45	1.87	2.11	3.14
116	5.16	4.74	3.31	46.7	17.1	0.56	0.36	0.68	4.58	1.58	1.26	1.58	2.11	3.18
117	5.05	4.45	2.30	62.0	12.6	0.62	0.36	0.68	10.8	3.95	1.20	1.33	1.40	2.19
118	5.88	4.98	3.18	48.4	7.24	0.68	0.36	0.82	6.01	2.10	1.08	1.30	1.97	3.05
119	6.54	5.31	3.71	41.4	4.26	0.75	0.36	1.0	4.57	1.52	1.03	1.32	2.32	3.56
120	6.96	5.30	3.59	41.8	2.54	0.82	0.36	1.1	5.04	1.67	1.02	1.28	2.22	3.44
121	5.07	4.77	3.35	48.5	25.2	0.47	0.33	0.56	4.07	1.44	1.35	1.69	2.15	3.22
122	4.92	4.53	2.47	61.7	20.9	0.51	0.33	0.56	8.58	3.16	1.28	1.44	1.52	3.36

Table 8A. 50-Ohm 5-th Degree Elliptic Highpass Filter Designs Using Standard-Value Capacitors, Capacitive Input and Output.  
(Continued from Page 141.)

Filter No.	F-CO	F-3 dB	F-A <sub>S</sub>	A <sub>S</sub> (dB)	RC (%)	C1	C3	C5	C2	C4	L2	L4	F2	F4
	----- (MHz)	----- (MHz)	----- (dB)	(dB)	(%)	----- (nF) -----				----- (μH) -----		----- (MHz) -----		
123	5.99	5.34	3.60	47.1	11.8	0.56	0.33	0.68	4.63	1.62	1.06	1.31	2.27	3.46
124	6.72	5.76	4.15	41.1	7.11	0.62	0.33	0.82	3.74	1.25	0.98	1.27	2.63	3.99
125	6.81	5.48	3.37	49.0	4.58	0.68	0.33	0.82	6.15	2.15	0.96	1.13	2.07	3.22
126	8.07	5.50	3.17	49.3	1.30	0.82	0.33	1.0	7.33	2.54	0.94	1.09	1.91	3.02
127	6.25	5.88	4.61	40.4	21.5	0.43	0.30	0.56	2.45	0.83	1.12	1.55	3.05	4.45
128	5.40	4.95	2.54	64.5	20.2	0.47	0.30	0.51	9.09	3.36	1.15	1.27	1.56	2.43
129	6.10	5.59	3.77	48.8	17.1	0.47	0.30	0.56	4.20	1.48	1.06	1.30	2.39	3.63
130	6.00	5.31	2.77	61.7	13.4	0.51	0.30	0.56	8.73	3.21	1.01	1.13	1.69	2.65
131	7.03	6.00	3.89	47.7	7.64	0.56	0.30	0.68	4.76	1.66	0.91	1.09	2.42	3.73
132	8.08	6.04	3.56	49.7	2.56	0.68	0.30	0.82	6.29	2.19	0.86	1.00	2.16	3.40
133	6.38	5.99	4.26	47.3	23.3	0.39	0.27	0.47	3.18	1.12	1.06	1.34	2.74	4.10
134	6.19	5.63	2.97	62.7	18.4	0.43	0.27	0.47	7.65	2.82	1.00	1.11	1.82	2.84
135	7.34	6.47	4.18	49.2	10.8	0.47	0.27	0.56	4.33	1.53	0.86	1.03	2.61	4.01
136	8.26	7.08	5.13	40.6	6.92	0.51	0.27	0.68	3.00	1.00	0.80	1.04	3.25	4.93
137	8.39	6.73	4.17	48.4	4.41	0.56	0.27	0.68	4.90	1.71	0.78	0.93	2.57	4.00
138	9.30	7.02	4.67	42.7	2.40	0.62	0.27	0.82	3.99	1.33	0.77	0.95	2.87	4.47
139	6.36	5.92	3.08	65.0	24.8	0.36	0.24	0.39	7.06	2.62	1.01	1.12	1.89	2.94
140	8.08	7.52	5.81	40.4	18.1	0.36	0.24	0.47	2.07	0.70	0.84	1.15	3.81	5.61
141	7.94	7.18	4.87	47.7	14.4	0.39	0.24	0.47	3.31	1.16	0.80	0.99	3.08	4.68
142	8.40	7.30	4.62	49.9	3.46	0.43	0.24	0.51	4.10	1.45	0.75	0.89	2.88	4.43
143	8.97	7.44	4.58	49.9	6.06	0.47	0.24	0.56	4.47	1.57	0.71	0.84	2.82	4.38
144	9.94	7.96	5.51	41.6	3.82	0.51	0.24	0.68	3.13	1.04	0.69	0.87	3.43	5.29

Table 88. 600-ohm 5th-Degree Elliptic Highpass-Filter Designs Using Standard-Value Capacitors, Capacitor Input and Output.

Filter No.	F-CO ----- (kHz) ---	F-3 dB	F-A <sub>s</sub> -----	A <sub>s</sub> (dB)	RC (%)	C1	C3	C5 ----- (nF) -----	C2	C4	L2 --- (mH) ---	L4	F2 -- (kHz) --	F4
1	6.50	6.13	4.15	49.6	20.7	33	22	39	305	108	11.9	14.6	2.64	3.99
2	7.57	6.71	4.39	48.1	9.80	39	22	47	348	119	9.88	12.0	2.75	4.21
3	8.70	6.81	4.03	50.5	3.73	47	22	56	456	160	9.17	10.7	2.46	3.85
4	8.40	7.80	5.59	45.9	19.7	27	18	33	207	72.4	9.48	12.1	3.59	5.38
5	9.47	8.13	5.86	50.4	8.50	33	18	39	323	114	7.96	9.42	3.14	4.85
6	10.8	8.39	5.64	49.4	3.42	39	18	47	358	125	7.47	8.74	3.08	4.82
7	11.1	8.76	5.90	42.9	3.42	39	18	51	256	86.0	7.42	9.22	3.65	5.65
8	9.94	9.29	6.75	45.4	21.3	22	15	27	164	57.1	8.13	10.5	4.36	6.50
9	11.5	9.98	6.64	46.8	9.03	27	15	33	220	76.6	6.64	8.13	4.16	6.38
10	12.1	10.6	7.81	40.3	8.59	27	15	36	156	52.0	6.52	8.62	4.99	7.52
11	13.0	9.95	5.71	51.6	3.11	33	15	39	337	119	6.22	7.16	3.47	5.46
12	12.6	11.7	8.38	45.9	19.7	18	12	22	138	48.2	6.32	8.06	5.39	8.07
13	14.6	12.6	8.35	46.6	8.27	22	12	27	177	61.4	5.25	6.43	5.22	8.01
14	16.8	12.7	7.67	48.3	2.69	27	12	33	234	80.9	4.95	5.82	4.68	7.33
15	12.3	11.5	5.48	69.6	25.8	15	10	16	366	137	6.21	6.75	3.34	5.24
16	14.8	13.7	9.57	47.8	20.2	15	10	18	127	44.7	5.35	6.68	6.11	9.21
17	16.0	13.8	7.33	59.5	9.91	18	10	20	276	101	4.58	5.12	4.47	7.01
18	17.2	15.0	9.96	46.8	9.03	18	10	22	147	51.1	4.43	5.42	6.24	9.56
19	18.1	15.9	11.7	40.3	8.59	18	10	24	104	34.7	4.34	5.75	7.49	11.3
20	20.5	16.1	11.2	40.6	3.15	22	10	30	127	42.0	4.10	5.23	6.96	10.7
21	18.5	17.3	12.9	43.7	21.0	12	8.2	15	81.9	28.3	4.39	5.79	8.39	12.4
22	21.0	18.1	11.6	48.7	8.49	15	8.2	18	135	47.3	3.61	4.34	7.21	11.1
23	24.1	18.6	11.4	48.2	3.15	18	8.2	22	155	53.7	3.39	4.00	6.94	10.9
24	24.8	19.4	13.2	41.0	3.18	18	8.2	24	111	37.1	3.37	4.24	8.21	12.7
25	21.4	20.0	14.0	47.8	21.9	10	6.8	12	84.0	29.6	3.75	4.71	8.97	13.5
26	25.4	22.3	15.5	44.7	9.72	12	6.8	15	87.7	30.2	3.03	3.80	9.76	14.8
27	29.0	22.2	13.1	49.9	3.06	15	6.8	18	141	49.4	2.82	3.28	7.98	12.5
28	26.4	24.7	17.8	46.1	21.7	8.2	5.6	10	63.1	22.1	3.06	3.92	11.5	17.1
29	30.2	26.3	17.0	48.6	9.51	10	5.6	12	89.3	31.4	2.51	3.02	10.6	16.4
30	34.9	27.5	17.6	46.1	3.64	12	5.6	15	93.0	31.9	2.32	2.80	10.8	16.8
31	30.6	28.7	20.4	47.2	23.2	6.8	4.7	8.2	55.3	19.5	2.65	3.36	13.2	19.7
32	35.8	31.6	21.2	46.9	10.4	8.2	4.7	10	66.9	23.3	2.13	2.61	13.3	20.4
33	40.7	32.0	19.2	49.7	3.81	10	4.7	12	93.4	32.7	1.96	2.29	11.8	18.4
34	49.0	32.5	19.2	47.4	1.05	12	4.7	15	97.1	33.2	1.94	2.27	11.6	18.3
35	37.0	34.8	25.1	46.5	23.6	5.6	3.9	6.8	43.7	15.3	2.21	2.83	16.2	24.2
36	42.8	37.7	24.9	48.0	10.6	6.8	3.9	8.2	58.8	20.6	1.77	2.16	15.6	23.9
37	49.0	39.0	24.2	48.0	4.08	6.2	3.9	10	70.5	24.5	1.63	1.93	14.9	23.2
38	42.2	39.8	27.9	48.5	25.2	4.7	3.3	5.6	40.7	14.4	1.94	2.43	17.9	26.9
39	49.9	44.5	30.0	47.1	11.8	5.6	3.3	6.8	46.3	16.2	1.53	1.88	18.9	28.8
40	56.7	45.7	28.1	49.0	4.58	6.8	3.3	8.2	61.5	21.5	1.38	1.63	17.3	26.9
41	67.3	45.8	26.4	49.3	1.30	8.2	3.3	10	73.3	25.4	1.36	1.57	15.9	25.2
42	53.2	49.9	35.5	47.3	23.3	3.9	2.7	4.7	31.8	11.2	1.53	1.94	22.0	34.2
43	61.2	53.9	34.8	49.2	10.8	4.7	2.7	5.6	43.3	15.3	1.23	1.48	21.8	33.4
44	69.9	56.1	34.8	48.4	4.41	5.6	2.7	6.8	49.0	17.1	1.13	1.34	21.4	33.3



# FILTER CHARACTERISTICS AND DESIGN FORMULAS

## Band-Pass Sections

### Fundamental Relations

$R$  = load resistance  $f_1$  = lower frequency limit of pass band  $f_2$  = higher frequency limit of pass band

$f_{\infty}$  = a frequency of very high attenuation in low-frequency attenuating band  
 $f_{-\infty}$  = a frequency of very high attenuation in high-frequency attenuating band

$$L_{1k} = \frac{R}{\pi(f_2 - f_1)} \quad L_{2k} = \frac{f_2 - f_1}{4\pi f_1 f_2}$$

$$C_{1k} = \frac{f_2 - f_1}{4\pi f_1 f_2 R} \quad C_{2k} = \frac{1}{\pi(f_2 - f_1)R}$$

### Design of Sections

Type	Attenuation characteristic	A. Filter having T intermediate sections Configuration	Formula	B. Filter having $\pi$ intermediate sections Configuration	Formula	Notation for both T and $\pi$ sections [These formulas apply for both end type I sections]
<p>III</p> <p>(on an approximately 0.0)</p>			$L_1 = mL_{2k}$ $L_2 = mL_{2k}$ $L_3 = mL_{2k}$ $C_1 = \frac{1}{mC_{2k}}$ $C_2 = \frac{1}{mC_{2k}}$ $C_3 = \frac{1}{mC_{2k}}$		$L_1 = \frac{L_{2k}}{m}$ $L_2 = \frac{L_{2k}}{m}$ $L_3 = \frac{L_{2k}}{m}$ $C_1 = mC_{2k}$ $C_2 = mC_{2k}$ $C_3 = mC_{2k}$	$g = \sqrt{\left(1 - \frac{f_1^2}{f_2^2}\right)\left(1 - \frac{f_1^2}{f_{\infty}^2}\right)}$ $h = \sqrt{\left(1 - \frac{f_1^2}{f_2^2}\right)\left(1 - \frac{f_1^2}{f_{-\infty}^2}\right)}$ $m = \frac{f_1/f_2 + h}{f_1/f_2 + g}$ $n = \frac{f_1/f_2}{f_1/f_2 + h}$ $p = \frac{4\pi f_1 f_2 L_{2k}}{R} \left(1 - \frac{f_1^2}{f_2^2}\right) \left(1 - \frac{f_1^2}{f_{\infty}^2}\right)$ $q = \frac{4\pi f_1 f_2 L_{2k}}{R} \left(1 - \frac{f_1^2}{f_2^2}\right) \left(1 - \frac{f_1^2}{f_{-\infty}^2}\right)$ $b = \frac{(1 - m^2)/f_2}{4\pi f_1 f_2 L_{2k}} \left(1 - \frac{f_1^2}{f_2^2}\right)$ $d = \frac{(1 - m^2)/f_2}{4\pi f_1 f_2 L_{2k}} \left(1 - \frac{f_1^2}{f_{-\infty}^2}\right)$ <p>where <math>(m = mn)</math>,  <math>g = h, a = d, b = c, f_{1\infty} = f_1/f_{\infty}, m_1 = m_1, n_1 = 1 - f_1/f_{\infty}</math>                      and  <math>f_{1\infty} = \frac{f_1 + f_2 - 2m^2 f_1}{R(1 - m^2)} + \left[ \frac{(f_1 + f_2 - 2m^2 f_1)^2}{R(1 - m^2)} - 4f_1^2 \right]^{1/4}</math></p>
I			$L_1 = mL_{2k}$ $L_2 = mL_{2k}$ $C_1 = \frac{1}{mC_{2k}}$ $C_2 = \frac{1}{mC_{2k}}$		$L_1 = \frac{L_{2k}}{m}$ $L_2 = \frac{L_{2k}}{m}$ $C_1 = mC_{2k}$ $C_2 = mC_{2k}$	
<p>II</p> <p><math>f_{\infty} = 0</math>  <math>f_{-\infty} = f_2</math></p>			$L_1 = \frac{f_2 R}{(1 + f_1/f_2)}$ $L_2 = \frac{(1 + f_1/f_2)}{4\pi f_1 f_2}$ $C_1 = C_2$		$C_1 = \frac{f_1 + f_2}{4\pi f_1 f_2 R}$ $C_2 = \frac{f_1 + f_2}{4\pi f_1 f_2 R}$ $L_1 = \frac{f_2 R}{f_1 + f_2}$	

III $f_m = 0$ $f_s = 0$ $f_c = 0$			$L_1 = Z_{ab}$ $C_1 = \frac{1}{\omega^2 L_1 Z_{ab}}$ $C_2 = \frac{1}{\omega^2 Z_{ab}}$	$L_1' = \frac{R}{\omega^2}$ $L_2 = \frac{1}{\omega^2} \frac{R}{1 - f_s^2}$ $C_1 = C_2 = C_3 = C_4 = C_5 = C_6 = C_7 = C_8 = C_9 = C_{10}$	$m_1 = \frac{f_s}{f_c} m_2 = \sqrt{\frac{1 - \frac{f_s^2}{f_c^2}}{1 - \frac{f_s^2}{f_c^2}}}$
IV $f_m = 0$ $f_s = 0$ $f_c = 0$			$L_1 = Z_{ab}$ $L_2 = \frac{1}{\omega^2} \frac{Z_{ab}}{1 - f_s^2}$ $C_1 = \frac{1}{\omega^2 Z_{ab}}$ $C_2 = \frac{1}{\omega^2} \frac{Z_{ab}}{1 - f_s^2}$	$L_1 = \frac{4R}{\omega^2}$ $L_2 = \frac{4R}{\omega^2} \frac{1}{1 - f_s^2}$ $C_1 = C_2 = C_3 = C_4 = C_5 = C_6 = C_7 = C_8 = C_9 = C_{10}$	$m_1 = \frac{f_s}{f_c} m_2 = \sqrt{\frac{1 - \frac{f_s^2}{f_c^2}}{1 - \frac{f_s^2}{f_c^2}}}$
V $f_m = 0$ $f_s = 0$ $f_c = 0$			$L_1 = m_1 Z_{ab}$ $L_2 = \frac{1 - m_1^2}{\omega^2} L_{1ab}$ $C_1 = \frac{1}{\omega^2} \frac{Z_{ab}}{m_1}$ $C_2 = \frac{1 - m_1^2}{\omega^2} \frac{Z_{ab}}{m_1}$	$L_1 = \frac{4R}{\omega^2}$ $L_2 = \frac{4R}{\omega^2} \frac{1}{1 - m_1^2}$ $C_1 = \frac{m_1}{\omega^2} \frac{4R}{1 - m_1^2}$ $C_2 = \frac{1 - m_1^2}{\omega^2} \frac{4R}{m_1}$	$m_1 = \frac{f_s}{f_c} m_2 = \sqrt{\frac{1 - \frac{f_s^2}{f_c^2}}{1 - \frac{f_s^2}{f_c^2}}}$
VI $f_m = 0$ $f_s = 0$ $f_c = 0$			$L_1 = m_1 Z_{ab}$ $L_2 = \frac{1 - m_1^2}{\omega^2} L_{1ab}$ $L_3 = \frac{1 - m_1^2}{\omega^2} L_{2ab}$ $C_1 = \frac{1}{\omega^2} \frac{Z_{ab}}{m_1}$ $C_2 = \frac{1 - m_1^2}{\omega^2} \frac{Z_{ab}}{m_1}$ $C_3 = \frac{1 - m_1^2}{\omega^2} \frac{Z_{ab}}{m_1}$	$L_1' = \frac{4R}{\omega^2}$ $L_2 = \frac{4R}{\omega^2} \frac{1}{1 - m_1^2}$ $L_3 = \frac{4R}{\omega^2} \frac{1}{1 - m_1^2}$ $C_1 = \frac{m_1}{\omega^2} \frac{4R}{1 - m_1^2}$ $C_2 = \frac{1 - m_1^2}{\omega^2} \frac{4R}{m_1}$ $C_3 = \frac{1 - m_1^2}{\omega^2} \frac{4R}{m_1}$	$m_1 = \frac{f_s}{f_c} m_2 = \sqrt{\frac{1 - \frac{f_s^2}{f_c^2}}{1 - \frac{f_s^2}{f_c^2}}}$
VII $f_m = 0$ $f_s = 0$ $f_c = 0$			$L_1 = m_1 Z_{ab}$ $L_2 = \frac{1 - m_1^2}{\omega^2} L_{1ab}$ $L_3 = \frac{1 - m_1^2}{\omega^2} L_{2ab}$ $L_4 = \frac{1 - m_1^2}{\omega^2} L_{3ab}$ $C_1 = \frac{1}{\omega^2} \frac{Z_{ab}}{m_1}$ $C_2 = \frac{1 - m_1^2}{\omega^2} \frac{Z_{ab}}{m_1}$ $C_3 = \frac{1 - m_1^2}{\omega^2} \frac{Z_{ab}}{m_1}$	$L_1' = \frac{4R}{\omega^2}$ $L_2 = \frac{4R}{\omega^2} \frac{1}{1 - m_1^2}$ $L_3 = \frac{4R}{\omega^2} \frac{1}{1 - m_1^2}$ $L_4 = \frac{4R}{\omega^2} \frac{1}{1 - m_1^2}$ $C_1 = \frac{m_1}{\omega^2} \frac{4R}{1 - m_1^2}$ $C_2 = \frac{1 - m_1^2}{\omega^2} \frac{4R}{m_1}$ $C_3 = \frac{1 - m_1^2}{\omega^2} \frac{4R}{m_1}$	$m_1 = \frac{f_s}{f_c} m_2 = \sqrt{\frac{1 - \frac{f_s^2}{f_c^2}}{1 - \frac{f_s^2}{f_c^2}}}$
VIII $f_m = 0$ $f_s = 0$ $f_c = 0$			$L_1 = Z_{ab}$ $L_2 = \frac{1}{\omega^2} \frac{Z_{ab}}{1 - f_s^2}$ $C_1 = \frac{1}{\omega^2} \frac{Z_{ab}}{1 - f_s^2}$ $C_2 = \frac{1}{\omega^2} \frac{Z_{ab}}{1 - f_s^2}$	$L_1 = \frac{4R}{\omega^2}$ $L_2 = \frac{4R}{\omega^2} \frac{1}{1 - f_s^2}$ $L_3 = \frac{4R}{\omega^2} \frac{1}{1 - f_s^2}$ $L_4 = \frac{4R}{\omega^2} \frac{1}{1 - f_s^2}$ $C_1 = \frac{m_1}{\omega^2} \frac{4R}{1 - m_1^2}$ $C_2 = \frac{1 - m_1^2}{\omega^2} \frac{4R}{m_1}$ $C_3 = \frac{1 - m_1^2}{\omega^2} \frac{4R}{m_1}$	$m_1 = \frac{f_s}{f_c} m_2 = \sqrt{\frac{1 - \frac{f_s^2}{f_c^2}}{1 - \frac{f_s^2}{f_c^2}}}$

(From *Radio Engineers' Handbook* by F. E. Terman. Copyright © 1943 by McGraw-Hill Book Company, Inc. Used with permission of McGraw-Hill Book Company.)

## COMB-FILTER DESIGN

Comb filters consist of a chain of narrow-band filters which pass spectral lines over the frequency spectrum of the signal. They pass discrete frequency components and discriminate against noise. Such filters are used to separate a composite input signal into a number of channels before data processing in telemetry systems and radar. The spacing between channels may be expressed as a frequency ratio which depends on the number of channels needed to cover one octave, or " $n$ ." Thus  $f/f_c = 2^n$ , where  $f_c$  is the reference,  $f$  is the unknown frequency of the adjacent channel, and  $n$  is any positive or negative real number. For  $n = \pm 1$ ,  $f$  equals  $2f_c$  and  $\frac{1}{2}f_c$ . These values are the center frequencies of channels, one octave away from the reference frequency.

The nomogram solves for positive or negative fractional values of  $n$ . The frequency scales,  $f_c$  and  $f$ , are normalized so that the nomogram can be used for any frequency by shifting the decimal point. The ratio scale,  $n$ , has a decimal range as well as fractional values.

To use the nomogram, place a straight-edge from the octave fraction or decimal on the  $n$  scale to the reference frequency on the  $f_c$  scale. Read the center frequency of the next channel on the  $f$  scale. Hold the  $n$ -scale value as a pivot point and shift the straight-edge to the same frequency on the  $f_c$  scale as the first answer. Read the next bandpass center frequency on the  $f$  scale. Continue the process until all center frequencies are obtained. For negative  $n$  values, divide the reference frequency by two to obtain the lower octave. After this step, proceed as for a positive  $n$  value.

FOR EXAMPLE: Calculate the center frequencies for 1/3 octave filters, starting at 100 Hz (see illustration).

Set the straight-edge from 1/3 or 0.33 on the  $n$  scale to the one (for 100 Hz) on the  $f_c$  scale and read 1.26 on the  $f$  scale; the center frequency of the next channel bandpass filter is 126 Hz. Pivot at 1/3 on the  $n$  scale and shift the straightedge to 126 on the  $f_c$  scale. Read 160 Hz on the  $f$  scale. When 1,260 Hz on the  $f$  scale and 1,000 Hz on  $f_c$  is reached, shift back to the lower portion of the  $f_c$  scale and continue.

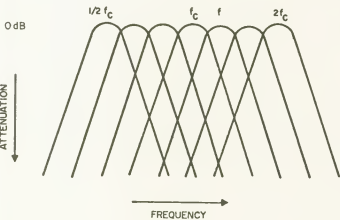
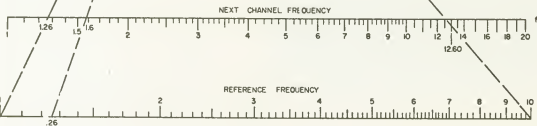
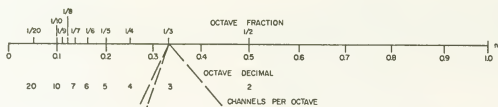

Bandpass filter array shown requires three channels to cover one octave. Therefore  $n = 1/3$ .

## PULSE-FORMING NETWORK NOMOGRAM

Pulse-forming networks supply high-voltage pulses to magnetrons and lasers. This nomogram relates the pulse width and characteristic impedance to the network's inductances and capacitances. It is based on the formulas:

$$Z_0 = \sqrt{\frac{L}{C}}; P_w = 2n \sqrt{LC}$$

$$n = \frac{P_w}{2r}$$

where  $Z_0$  = characteristic impedance  
 $L$  = inductance per section  
 $C$  = capacitance per section  
 $n$  = number of sections  
 $P_w$  = pulse width  
 $r$  = rise time

FOR EXAMPLE: Design a PFN that delivers a 4-kV, 500- $\mu$ sec pulse with a 25- $\mu$ sec rise time into a 1-ohm load: The numbers of sections ( $P_w/2r$ ) is 10. Connecting 1 ohm to 500  $\mu$ sec on the left and right scales yields 250  $\mu$ F and 250  $\mu$ H as total capacitive  $C_N$  and total inductive  $L_N$ . Dividing by 10 gives 25  $\mu$ F and 25  $\mu$ H per section. The two end inductances are 1.15 the value of each section or 2.875  $\mu$ H.

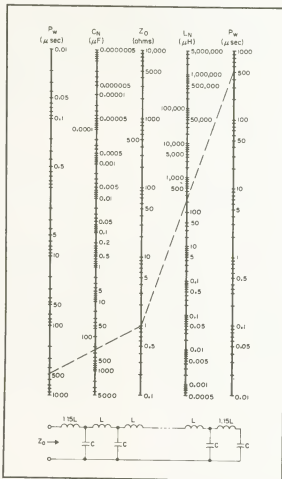

## DELAY LINE DESIGN NOMOGRAM

A pulse applied to the input of a delay line is continuously delayed by a predetermined amount as it travels along the line. The artificial or lumped parameter type of delay line consists of a series of low pass LC filters. The delay for  $n$  sections is given by the formula

$$t = n \sqrt{LC}$$

where  $t$  = time delay in microseconds  
 $n$  = number of sections

$L$  = inductance in microhenries  
 $C$  = capacitance in microfarad

The characteristic impedance  $Z_0$  must be matched to reduce reflections within the delay line and is given by the formula

$$Z_0 = \sqrt{L/C}$$

where  $Z_0$  is in ohms

The cutoff frequency of each section must be higher than the operating frequency  $f_c = \frac{1}{\pi \sqrt{LC}}$

where  $f_c$  is the cutoff frequency in megahertz

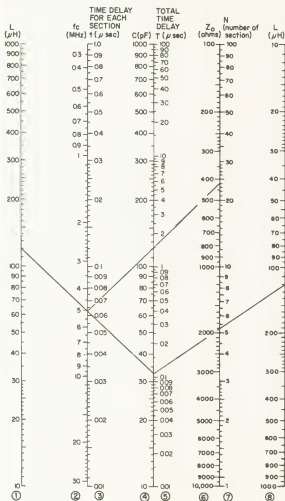

**FOR EXAMPLE:** Determine the parameters for a delay line with a  $1.5\text{-}\mu\text{sec}$  delay and an  $f_0$  of 5 MHz. Pivot around 5 MHz on scale 2 and select standard values of  $L$  and  $C$  on scales 1 and 4. ( $120\ \mu\text{H}$  and  $33\ \text{pF}$ ) The cutoff frequency on scale 2 corresponds to the time delay per section shown on scale 3—in this case  $0.063\ \mu\text{sec/section}$ . The time delay per section aligned with the required total delay ( $1.5\ \mu\text{sec}$ ) on scale 5 shows the total number of sections required as 24 on scale 7. The characteristic impedance of the line is found to be 1,900 ohms as shown on scale 6 by aligning  $C$  ( $33\ \text{pF}$ ) on scale 5, with the previously selected value of  $L$  ( $120\ \mu\text{H}$ ) on scale 8.

SINGLE SECTION

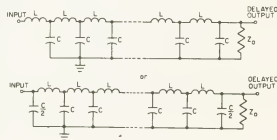
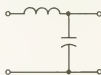

## COAXIAL CABLE SIGNAL DELAY NOMOGRAM

This nomogram solves for the delay per foot as well as the total delay of a coaxial cable when the relative dielectric constant of the insulation is known. The nomogram is based on the relationship

$$T = 1.108 \sqrt{E} \text{ nsec/ft}$$

The relative dielectric constant and delay per foot are plotted on the left-hand index and can be related directly. The chart gives the approximate ranges of dielectric constants of commonly used insulating materials. Some dielectric properties are a function of composition, frequency, and temperature, and the values shown should be used accordingly.

FOR EXAMPLE: A 4-ft cable with a polystyrene dielectric will produce a total delay of about 6.3 to 6.5 nsec.

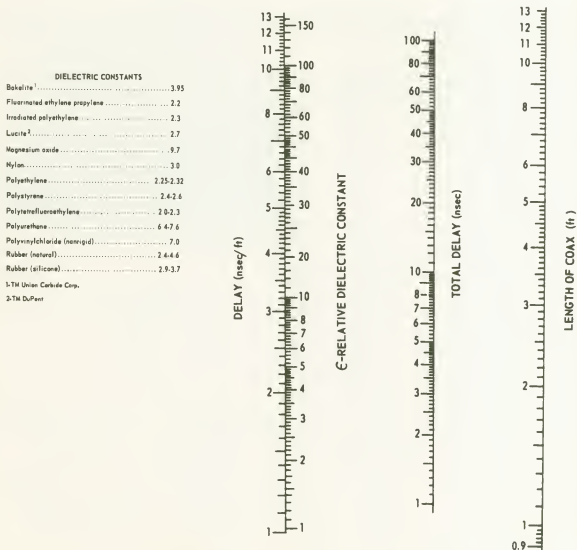

## VOLTAGE MULTIPLIER CIRCUITS

Circuit diagrams are given and the minimum voltage ratings of the capacitors are shown as related to  $V_m$ . The minimum PIV of the diodes is  $2V_m$ .

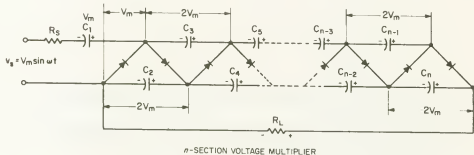
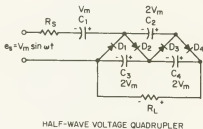
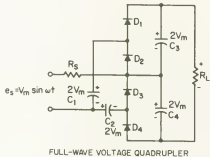
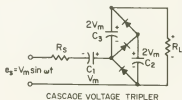
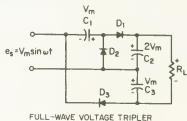
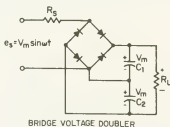
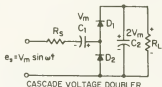
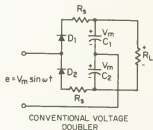



## POWER TRANSISTOR AND DIODE REQUIREMENTS FOR SWITCHING POWER SUPPLIES

This tabulation shows the transfer function, switching transistor currents and voltages, diode currents and voltages as well as voltage and current waveforms for ten different converter circuit configurations used in switching power supplies.

The advantages and disadvantages of each circuit configuration are also given.

CIRCUIT CONFIGURATION			
TYPE OF CONVERTER	(A) BUCK (STEP DOWN)	(B) BOOST (STEP UP)	(C) BUCK-BOOST
IDEAL TRANSFER FUNCTION	$\frac{V_O}{V_{IN}} = \frac{T}{T-\tau} < 1$	$\frac{V_O}{V_{IN}} = \frac{T}{T-\tau} > 1$	$\frac{V_O}{V_{IN}} = \frac{T}{T-\tau} (-1)$
COLLECTOR CURRENT ( $I_C$ )	$I_C \text{ MAX} = I_{RL} + \Delta I_{L1}/2$	$I_C \text{ MAX} = I_{RL} \left( \frac{T}{T-\tau} \right) + \frac{\Delta I_{L1}}{2}$	$I_C \text{ MAX} = I_{RL} \left( \frac{T}{T-\tau} \right) + \frac{\Delta I_{L1}}{2}$
COLLECTOR VOLTAGE RATING	$V_{CEO} = V_{IN}$	$V_{CEO} > V_O + 1$	$V_{CEO} > V_{IN} + V_O$
DIODE CURRENTS	$I_{CR1} = I_{RL} \left( \frac{T-\tau}{T} \right)$	$I_{CR1} = I_{RL}$	$I_{CR1} = I_{RL}$
DIODE VOLTAGES ( $V_{RM}$ )	$V_{RM} = V_{IN}$	$V_{RM} = V_O$	$V_{RM} = V_O + V_{IN}$
VOLTAGE AND CURRENT WAVEFORMS			
ADVANTAGES	HIGH EFFICIENCY, SIMPLE, NO TRANSFORMER, HIGH FREQUENCY OPERATION, EASY TO STABILIZE REGULATOR LOOP	HIGH EFFICIENCY, SIMPLE, NO TRANSFORMER, HIGH FREQUENCY OPERATION	VOLTAGE INVERSION WITHOUT USING A TRANSFORMER, SIMPLE, HIGH FREQUENCY OPERATION
DISADVANTAGES	NO ISOLATION BETWEEN INPUT AND OUTPUT, REQUIRES A CAPACITOR (C), SHORTS C HAS HIGH RIPPLE CURRENT, CURRENT LIMIT DIFFICULT, ONLY ONE OUTPUT IS POSSIBLE	NO ISOLATION BETWEEN INPUT AND OUTPUT, HIGH PEAK COLLECTOR CURRENT, ONLY ONE OUTPUT IS POSSIBLE, POOR TRANSIENT RESPONSE, REGULATOR LOOP HARD TO STABILIZE	Q1 MUST CARRY HIGH PEAK CURRENT, NO ISOLATION BETWEEN INPUT AND OUTPUT, ONLY ONE OUTPUT IS POSSIBLE, POOR TRANSIENT RESPONSE
	* = FOR RELIABLE OPERATION, IT IS SUGGESTED AND RECOMMENDED THAT ALL VOLTAGE		

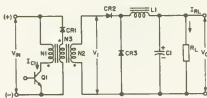
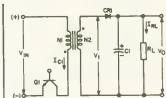

①  
FLYBACK

$$\frac{V_0}{V_{in}} = \frac{N_2}{N_1} \left( \frac{D}{1-D} \right)$$

$$I_{C \text{ MAX}} = I_{RL} \frac{N_2}{N_1} \left( \frac{T}{T-D} \right) + \frac{\Delta I_{L1}}{2}$$

$$V_{CE0} > V_{in} + \left( \frac{N_1}{N_2} \right) V_{OUT}$$

$$I_{CR1} = I_{RL}$$

$$V_{RM} = V_{in} \left( \frac{N_2}{N_1} \right)$$

②  
FORWARD ✓

$$\frac{V_0}{V_{in}} = \frac{N_2}{N_1} \left( \frac{D}{T} \right)$$

$$I_{C \text{ MAX}} = I_{RL} \left( \frac{N_2}{N_1} + \frac{\Delta I_{L1}}{2} \right) + \frac{I_{MAD}}{2}$$

$$V_{CE0} > V_{in} \left( 1 + \frac{N_1}{N_2} \right)$$

$$I_{CR1} = \frac{I_{MAD}}{2} \left( \frac{1}{T} \right)$$

$$I_{CR2} = I_{RL} \left( \frac{T}{T} \right)$$

$$I_{CR3} = I_{RL} \left( \frac{T-D}{T} \right)$$

$$\left. \begin{aligned} V_{CR1} &= V_{in} \left( 1 + \frac{N_1}{N_2} \right) \\ V_{CR2} &= V_{in} \left( \frac{N_2}{N_1} \right) \\ V_{CR3} &= V_{in} \left( \frac{N_2}{N_1} \right) \end{aligned} \right\} V_{RM}$$

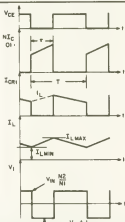

SIMPLE, MULTIPLE OUTPUTS ARE POSSIBLE. COLLECTOR CURRENT REDUCED BY TURNS RATIO OF TRANSFORMER. LOW PARTS COUNT, ISOLATION.

POOR TRANSFORMER UTILIZATION, TRANSFORMER DESIGN CRITICAL, HIGH OUTPUT RIPPLE.

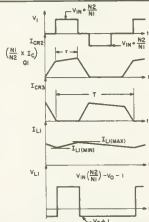

SIMPLE, MULTIPLE OUTPUTS ARE POSSIBLE. COLLECTOR CURRENT REDUCED BY RATIO OF  $\frac{N_2}{N_1}$  LOW OUTPUT RIPPLE.

POOR TRANSFORMER UTILIZATION, POOR TRANSIENT RESPONSE, PARTS COUNT HIGH, TRANSFORMER DESIGN IS CRITICAL.

AND CURRENT RATINGS BE INCREASED TO 125% OF THE REQUIRED MAXIMUM.

## CIRCUIT CONFIGURATION

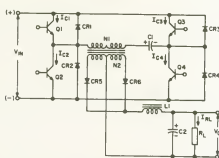
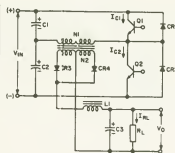

## TYPE OF CONVERTER

⊖  
HALF BRIDGE

⊕  
FULL BRIDGE

## IDEAL TRANSFER FUNCTION

$$\frac{V_o}{V_{in}} = \frac{NZ}{NI} \left( \frac{T}{T'} \right)$$

$$\frac{V_o}{V_{in}} = 2 \frac{NZ}{NI} \left( \frac{T}{T'} \right)$$

COLLECTOR CURRENT ( $I_c$ )

$$I_{c \text{ max}} = \frac{NZ}{NI} \left( I_{RL} + \frac{\Delta I_{L1}}{2} \right) + I_{MAG}$$

$$I_{c \text{ max}} = \frac{NZ}{NI} \left( 2 I_{RL} + \frac{\Delta I_{L1}}{2} \right) + I_{MAG}$$

## COLLECTOR VOLTAGE RATING

$$V_{CE0} = V_{in}$$

$$V_{CE0} = V_{in}$$

## DIODE CURRENTS

$$I_{CR3} = \frac{I_{RL}}{2}$$

$$I_{CR4} = \frac{I_{RL}}{2}$$

$$I_{CR5} = I_{RL}$$

$$I_{CR6} = I_{RL}$$

DIODE VOLTAGES ( $V_{RM}$ )

$$V_{RM} \begin{cases} V_{CR3} = V_{in} \left( \frac{NZ}{NI} \right) \\ V_{CR4} = V_{in} \left( \frac{NZ}{NI} \right) \end{cases}$$

$$V_{RM} \begin{cases} V_{CR5} = 2 V_{in} \left( \frac{NZ}{NI} \right) \\ V_{CR6} = 2 V_{in} \left( \frac{NZ}{NI} \right) \end{cases}$$

## VOLTAGE AND CURRENT WAVEFORMS

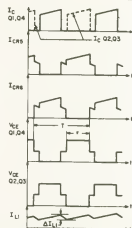
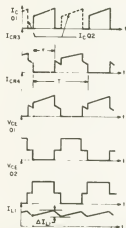

## ADVANTAGES

SIMPLE, GOOD TRANSFORMER UTILIZATION, TRANSISTORS RATED AT  $V_{in}$  ISOLATION, MULTIPLE OUTPUTS,  $I_c$  REDUCED AS A RATIO OF  $\frac{NZ}{NI}$  HIGH POWER OUTPUT

SIMPLE, GOOD TRANSFORMER UTILIZATION, TRANSISTORS RATED AT  $V_{in}$  ISOLATION, MULTIPLE OUTPUTS,  $I_c$  REDUCED AS A RATIO OF  $\frac{NZ}{NI}$  HIGH POWER OUTPUT PREFERRED TO CKT ⊕ WHERE HIGH POWER REQUIRED.

## DISADVANTAGES

POOR TRANSIENT RESPONSE, HIGH PARTS COUNT, C1 AND C2 HAVE HIGH RIPPLE CURRENT, LIMITED DYNAMIC RANGE REQUIRES AUXILIARY POWER SUPPLIES FOR CONTROL CIRCUITS

POOR TRANSIENT RESPONSE, HIGH PARTS COUNT, C1 AND C2 HAVE HIGH RIPPLE CURRENT, LIMITED DYNAMIC RANGE REQUIRES AUXILIARY POWER SUPPLIES FOR CONTROL CIRCUIT

\* - FOR RELIABLE OPERATION, IT IS SUGGESTED AND RECOMMENDED THAT ALL VOLTAGE AND CURRENT RATINGS BE INCREASED TO 125% OF THE REQUIRED MAXIMUM.

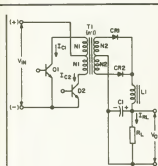

①  
PUSH-PULL

$$\frac{V_o}{V_m} = 2 \frac{N_2}{N_1} \left( \frac{1}{1-D} \right)$$

$$I_{C \text{ MAX}} = \frac{N_2}{N_1} \left( R_L + \frac{\Delta I_L L_1}{2} \right) + \frac{1}{2} I_{\text{MAG}}$$

$$V_{CEO} = 2 V_m$$

$$I_{CR1} = \frac{I_{RL}}{2}$$

$$I_{CR2} = \frac{I_{RL}}{2}$$

$$V_{RM} = \begin{cases} V_{CR1} = 2 V_m \left( \frac{N_2}{N_1} \right) \\ V_{CR2} = 2 V_m \left( \frac{N_2}{N_1} \right) \end{cases}$$

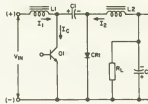

②  
CŪK (BOOST - BUCK INVERTING)

$$\frac{V_o}{V_m} = \left( \frac{L_2}{L_1} \right) (1-D)$$

$$I_{C \text{ MAX}} = I_1 + I_2 = I_1 \left( \frac{1}{1-D} \right)$$

$$V_{CEO} \geq 2 V_m$$

$$I_{CR1} = I_1 + I_2$$

$$I_1 + I_2 = I_1 \left( \frac{1}{1-D} \right)$$

$$V_o = 1$$

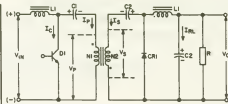

③  
CŪK (WITH TRANSFORMER)

$$\frac{V_o}{V_m} = \frac{N_2}{N_1} \frac{1}{1-D}, 0 < \frac{D}{2}, 0 \leq D \leq 1$$

$$I_{C1} = 1.5 I_{RL} \text{ FOR } D = .33 \ (V_o = .5 V_m)$$

$$I_{C2} = 2 I_{RL} \text{ FOR } D = .50 \ (V_o = V_m)$$

$$I_{C3} = 2.5 I_{RL} \text{ FOR } D = .60 \ (V_o = 1.5 V_m)$$

$$V_{CEO} = \begin{cases} 1.5 V_m & D = .33 \\ 2 V_m & D = .50 \\ 2.5 V_m & D = .60 \end{cases}$$

$$I_{CR1} = 1.5 I_{RL} \text{ FOR } D = .33$$

$$I_{CR2} = 2 I_{RL} \text{ FOR } D = .50$$

$$I_{CR3} = 2.5 I_{RL} \text{ FOR } D = .60$$

$$1.5 V_m \text{ FOR } D = .33$$

$$2 V_m \text{ FOR } D = .50$$

$$2.5 V_m \text{ FOR } D = .60$$

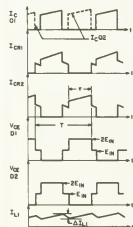

SIMPLE, GOOD TRANSFORMER UTILIZATION. COLLECTOR CURRENT REDUCED AS A FUNCTION OF  $\frac{N_2}{N_1}$ . GOOD AT LOW VALUES OF  $V_m$ .

CROSS CONDUCTION OF Q1 OR POSSIBLE HIGH PARTS COUNT. TRANSFORMER DESIGN CRITICAL. POOR DYNAMIC RANGE. POOR TRANSIENT RESPONSE.

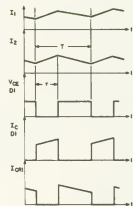

CONTINUOUS INPUT AND OUTPUT CURRENT, HIGHEST EFFICIENCY, LOW RIPPLE, SMALLEST NUMBER OF SWITCHING COMPONENTS, SWITCHING LOSSES CUT IN HALF. DRIVE CURRENT REFERENCED TO GROUND. HIGHEST OPERATING FREQUENCY.

HIGH COLLECTOR CURRENT Q1 HAS HIGH RIPPLE CURRENT REQUIREMENT. HIGH VOLTAGE REQUIRED FOR Q1. POWER OUTPUT LIMITED.

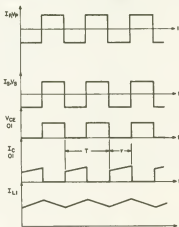

CONTINUOUS INPUT AND OUTPUT CURRENT, HIGHEST EFFICIENCY, VERY LOW RIPPLE, SMALLEST NUMBER OF SWITCHING COMPONENTS, SWITCHING LOSSES LOW. DRIVE CURRENT REFERENCED TO GROUND. HIGHEST OPERATING FREQUENCY.

Q1 AND C2 HAVE HIGH RIPPLE CURRENT REQUIREMENTS. TRANSFORMER DESIGN CRITICAL. POWER OUTPUT IS LIMITED.

(From General Electric Application Note 200.87, "Power Transistor Applications for Switching Regulators and Motor Control," copyrighted © by and reprinted with permission of General Electric Company.)

## PERCENT REGULATION OF POWER SUPPLIES

The percent regulation of a power supply is found by the change in output voltage between *Full Load* and *No Load* voltage as given by the formula:

$$\% \text{ regulation} = \frac{\text{No Load Voltage} - \text{Full Load Voltage}}{\text{Full Load Voltage}} \times 100.$$

FOR EXAMPLE:

1. What is percent regulation if *No Load Voltage* is 500 V and *Full Load Voltage* is 492 V? The difference is 8 V. *Answer:* Connecting 492 and 8 gives a regulation of about 1.6%.

2. For 0.04% regulation what is maximum allowable change in output voltage if required *Full Load Voltage* is 15 V. *Answer:* 0.006 V.

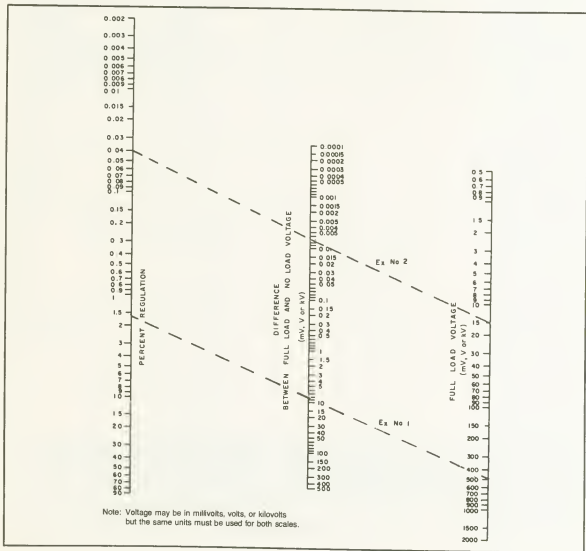

### POWER LOSS DUE TO IMPEDANCE MISMATCH

This chart shows the power loss resulting from inequality in the absolute magnitude of two impedances connected so as to transfer power from one to the other. The figures on the curves are the number of degrees of algebraic phase difference between the two impedances.

FOR EXAMPLE: Find the resulting power loss when a loudspeaker with an impedance of 10 ohms and a phase angle of  $60^\circ$  is fed from a generator with a 100-ohm internal impedance. The impedance mismatch ratio is 10:1, and at the  $60^\circ$  line the loss due to mismatch is read as 5.7 dB.

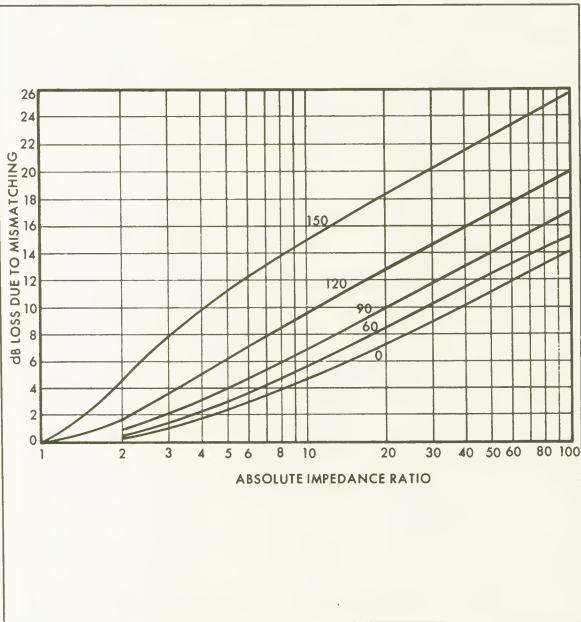

## SEVEN COMMONLY USED BRIDGE CIRCUITS AND THEIR BALANCE EQUATIONS

A bridge consists essentially of four arms connected in series and so arranged, that when an electromotive force is applied across one pair of opposite junctions, the response of a detecting and /or indicating device connected between the other pair of junctions may be zeroed by adjusting one or more of the elements of the arms of the bridge. Seven commonly used bridge circuits and their balance equations are shown.

WHEATSTONE BRIDGE		$R_d = \frac{R_a R_c}{R_b}$	Principally Used to Measure Resistance
WIEN BRIDGE		$\omega^2 = \frac{1}{R_d R_c C_d C_c}$ and $\frac{C_d R_b}{C_c R_a} = \frac{R_c}{R_d}$ or $C_d^2 = \frac{R_b R_d - R_a R_c}{R_d R_d^2 R_c \omega^2}$ and $C_c^2 = \frac{R_a}{(R_b R_d - R_d R_c) R_c \omega^2}$	Capacitance-Frequency
RESONANCE BRIDGE		$\omega L = \frac{1}{\omega C}$ $R_d = \frac{R_a R_c}{R_b}$	Inductance
MAXWELL BRIDGE		$L_d = R_a R_c C_b$ $R_d = \frac{R_a R_c}{R_b}$	Inductance
SCHERING BRIDGE		$C_d = \frac{R_b}{R_a} C_c$ $R_d = \frac{C_b}{C_c} R_a$	Capacitance-Inductance
OWEN BRIDGE		$L_d = R_a R_c C_b$ $R_d = \frac{C_b}{C_d} R_c$	Inductance
HAY BRIDGE		$L = \frac{R_a R_c C_b}{1 + (R_b \omega C_b)^2}$ $R_d = \frac{R_a R_b R_c (\omega C_b)^2}{1 + (R_b \omega C_b)^2}$	Inductance

### PARALLEL-RESISTOR/SERIES-CAPACITOR NOMOGRAM

This nomogram is used to find the effective resistance of resistors connected in parallel or the capacitance of capacitors connected in series. The range of the nomogram may be extended by multiplying the three scales by the same factor  $10^n$ , where  $n$  may be positive or negative.

FOR EXAMPLE: (1) The effective resistance of a 150k and 120k resistor in parallel is 67k. (2) A 6.8  $\mu\text{f}$  and 5.6  $\mu\text{f}$  capacitor connected in series present an effective capacitance of 3  $\mu\text{F}$ .

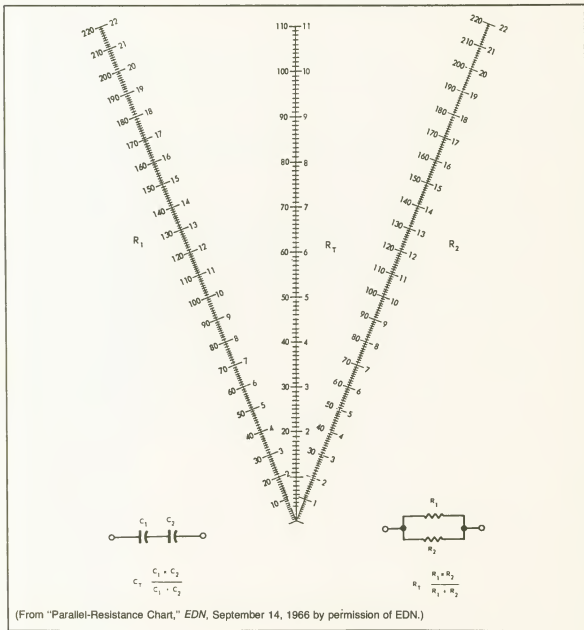

















## Section 4















# Active Components and Circuits

















Major Semiconductor Components	/ 162
Letter Symbols and Abbreviations for Semiconductor Devices	/ 166
Comparative Characteristics of Active Devices	/ 171
Summary of Integrated Circuit Properties	/ 171
Analogy Between the Three Basic Junction Transistor Circuits and Their Equivalent Electron Tube Circuits	/ 172
Definitions of Equivalent Circuit Parameters	/ 173
Equivalent Circuits for Small-Signal Low-Frequency Transistor Stages	/ 174
Transistor Parameter Conversion Tables	/ 176
Multivibrator Design Curves	/ 180
Operational Amplifiers	/ 182
Glossary of Operational Amplifier Terms	/ 188
European Semiconductor Numbering System (Pro Electron Code)	/ 189
Characteristics of Integrated Circuit Logic Families	/ 190
Characteristics of Displays Used in Electronic Equipment	/ 191
Definitions of Integrated Circuits, Logic, and Microelectronic Terms	/ 192
Classification of Amplifiers	/ 206
Risetime of Cascaded Amplifiers	/ 208
Negative Feedback Nomogram	/ 210
Class B Push-Pull Amplifier Nomogram	/ 211
Cathode Follower Nomogram	/ 212
Cathode Feedback Nomogram	/ 213
European Tube Numbering System	/ 215
Solid-State Sensing Technologies	/ 216
Semiconductor Memories	/ 217
Voice Input/Output Family Tree	/ 218
Noise Figure Nomogram for Two Cascaded Stages	/ 219

# MAJOR SEMICONDUCTOR COMPONENTS

NAME OF DEVICE	CIRCUIT SYMBOL	COMMONLY USED JUNCTION SCHEMATIC	ELECTRICAL CHARACTERISTICS	MAJOR APPLICATIONS	ROUGHLY ANALOGOUS TO	
Diode or Rectifier				Conducts easily in one direction, blocks in the other	Rectification Blocking Detecting Steering	Check valve Diode tube Gas diode
Avalanche (Zener) Diode				Constant voltage characteristic in negative quadrant	Regulation Reference Clipping	V-R tube
Integrated Voltage Regulator (IVR)				Programmed to desired $V_{Z1}$ by two resistors	Shunt voltage regulator Reference element Error modifier Level sensing Level shifting	Avalanche Diode
Tunnel Diode				Displays negative resistance when current exceeds peak point current $I_p$	UHF converter Logic circuits Microwave circuits Level sensing	None
Back Diode				Similar characteristics to conventional diode except very low forward voltage drop	Microwave mixers and low power oscillators	None

NAME OF DEVICE	CIRCUIT SYMBOL	COMMONLY USED JUNCTION SCHEMATIC	ELECTRICAL CHARACTERISTICS	MAJOR APPLICATIONS	ROUGHLY ANALOGOUS TO
Diode			 Rapidly increasing current above rated voltage in either direction	Transient voltage suppression and arc suppression	Thyrite Two avalanche diodes in inverse-series connection
n-p-n Transistor			 Constant collector current for given base drive	Amplification Switching Oscillation	Pentode Tube
p-n-p Transistor			 Complement to n-p-n transistor	Amplification Switching Oscillation	None
Photo Transistor			 Incident light acts as base current of the photo transistor	Tape readers Card readers Position sensor Tachometers	None
Unijunction Transistor (UJT)			 Unijunction emitter blocks until its voltage reaches $V_p$ , then conducts	Interval timing Oscillation Level Detector SCR Trigger	None

NAME OF DEVICE	CIRCUIT SYMBOL	COMMONLY USED JUNCTION SCHEMATIC	ELECTRICAL CHARACTERISTICS	MAJOR APPLICATIONS	ROUGHLY ANALOGOUS TO
Complementary Unijunction Transistor (CUJT)				Functional complement to UJT High stability timers Oscillators and level detectors	None
Programmable Unijunction Transistor (PUT)				Programmed by two resistors for $V_P$ , $I_P$ , $I_V$ . Function equivalent to normal UJT. Low cost timers and oscillators Long period timers SCR trigger Level detector	UJT
Silicon Controlled Rectifier (SCR)				With anode voltage (+), SCR can be triggered by $I_G$ remaining in conduction until anode $I$ is reduced to zero Power switching Phase control Inverters Choppers	Gas thyatron or ignitron
Complementary Silicon Controlled Rectifier (CSCR)				Polarity complement to SCR Ring counters Low speed logic Lamp driver	None
Light Activated SCR* (LASCR)				Operates similar to SCR, except can also be triggered into conduction by light falling on junctions Relay Replacement Position controls Photoelectric applications Slave flashes	None

NAME OF DEVICE	CIRCUIT SYMBOL	COMMONLY USED JUNCTION SCHEMATIC	ELECTRICAL CHARACTERISTICS	MAJOR APPLICATIONS	ROUGHLY ANALOGOUS TO
Silicon Controlled Switch* (SCS)				Logic applications Counters Mixie drivers Lamp drivers	Complementary transistor pair 
Silicon Unilateral Switch (SUS)				Switching Circuits Counters SCR Trigger Oscillator	Shockley or 4-layer diode
Silicon Bilateral Switch (SBS)				Switching Circuits Counters TRIAC Phase Control	Two inverse Shockley diodes
Triac				AC switching Phase control Relay replacement	Two SCR's in inverse parallel
Diac Trigger				Triac and SCR trigger Oscillator	Neon lamp

LETTER SYMBOLS AND ABBREVIATIONS FOR SEMICONDUCTOR DEVICES

Table 1: General Semiconductor Symbols

$I, i$	region of a device which is intrinsic and in which neither holes nor electrons predominate
$N, n$	region of a device where electrons are the majority carriers
$NF$	noise figure
$P, p$	region of a device where holes are the majority carriers
$K_{\theta}$	thermal derating factor
$T$	temperature
$T_A$	ambient temperature
$T_C$	case temperature
$T_J$	junction temperature
$T_{STG}$	storage temperature
$\theta$ , or $R_{\theta}$	thermal resistance
$\theta_{J-A}$	thermal resistance, junction to ambient
$\theta_{J-C}$	thermal resistance, junction to case
$\theta(t)$	transient thermal impedance
$\theta_{J-A(t)}$	transient thermal impedance, junction to ambient
$\theta_{J-C(t)}$	transient thermal impedance, junction to case
$t_d$	delay time
$t_f$	fall time
$t_{fr}$	forward recovery time (diodes)
$t_p$	pulse time
$t_r$	rise time
$t_{rr}$	reverse recovery time (diodes)
$t_s$	storage time

Table 2: Signal Diode and Rectifier Diode Symbols

$V_{(BR)}$ or $V_{(BR)R}$	reverse breakdown voltage, dc
$V_{(BR)}$ or $V_{(BR)R}$	reverse breakdown voltage, instantaneous total value
$I_F$	forward current, dc
$I_{F(AV)}$	forward current, average value
$i_F$	forward current, instantaneous total value
$I_f$	forward current, rms value of alternating component
$I_{F(RMS)}$	forward current, rms total value
$I_{FM}$	forward current, maximum (peak) total value
$I_{FM(REP)}$	forward current, repetitive, maximum (peak), total value
$I_{FM(SURGE)}$	forward current, maximum (peak), total value of surge
$I_O$	output current, average rectified
$I_R$	reverse current, dc
$I_R$	reverse current, instantaneous total value
$I_{R(AV)}$	reverse current, average value
$I_{RM}$	reverse current, maximum (peak) total value
$I_r$	reverse current, rms value of alternating component
$I_{R(RMS)}$	reverse current, rms total value
$L_c$	conversion loss (microwave diodes)
$P_F$	forward power dissipation, dc
$P_{F(AV)}$	forward power dissipation, average value
$P_{FM}$	forward power dissipation, maximum (peak) total value
$P_F$	forward power dissipation, instantaneous total value

$P_R$	reverse power dissipation, dc
$P_{R(AV)}$	reverse power dissipation, average value
$P_{RM}$	reverse power dissipation, maximum (peak) total value
$P_R$	reverse power dissipation, instantaneous total value
$V_F$	forward voltage drop, dc
$V_F$	forward voltage drop, instantaneous total value
$V_{F(AV)}$	forward voltage drop, average value
$V_{FM}$	forward voltage drop, maximum (peak) total value
$V_{F(RMS)}$	forward voltage drop, total rms value
$V_f$	forward voltage drop, rms value of alternating component
$V_R$	reverse voltage, dc
$V_R$	reverse voltage, instantaneous total value
$V_{R(AV)}$	reverse voltage, average value
$V_{RM}$	reverse voltage, maximum (peak) total value
$V_{R(wkg)}$	working peak reverse voltage, maximum (peak) total value
$V_{RM(rep)}$	repetitive peak reverse voltage, maximum (peak) total value
$V_{R(nonrep)}$	nonrepetitive peak reverse voltage, maximum (peak) total value
$V_{R(RMS)}$	reverse voltage, total rms value
$V_r$	reverse voltage, rms value of alternating component

**Table 3: Transistor Symbols**

$BV_{CBO}$	obsolete—see $V_{(BR)CBO}$
$BV_{CEO}$	obsolete—see $V_{(BR)CEO}$
$BV_{CER}$	obsolete—see $V_{(BR)CER}$
$BV_{CES}$	obsolete—see $V_{(BR)CES}$
$BV_{CEX}$	obsolete—see $V_{(BR)CEX}$
$BV_{EBO}$	obsolete—see $V_{(BR)EBO}$
$BV_R$	obsolete—see $V_{(BR)R}$
$C_{ibo}$	open-circuit input capacitance, common base
$C_{ibs}$	short-circuit input capacitance, common base
$C_{ieo}$	open-circuit input capacitance, common emitter
$C_{ies}$	short-circuit input capacitance, common emitter
$C_{obo}$	open-circuit output capacitance, common base
$C_{obs}$	short-circuit output capacitance, common base
$C_{o eo}$	open-circuit output capacitance, common emitter
$C_{oes}$	short-circuit output capacitance, common emitter
$f_{htb}$	small-signal short-circuit forward current transfer ratio cutoff frequency (common base)
$f_{htc}$	small-signal short-circuit forward current transfer ratio cutoff frequency (common collector)
$f_{hte}$	small-signal short-circuit forward current transfer ratio cutoff frequency (common emitter)
$f_{max}$	maximum frequency of oscillation
$f_T$	frequency at which small-signal forward current transfer ratio (common emitter) extrapolates to unity
$g_{ME}$	static transconductance (common emitter)
$g_{me}$	small-signal transconductance (common emitter)
$G_{PB}$	large-signal average power gain (common base)
$G_{pb}$	small-signal average power gain (common base)
$G_{PC}$	large-signal average power gain (common collector)
$G_{pc}$	small-signal average power gain (common collector)
$G_{PE}$	large-signal average power gain (common emitter)
$G_{pe}$	small-signal average power gain (common emitter)



$h_{FB}$	static forward current transfer ratio (common base)
$h_{fb}$	small-signal short-circuit forward current transfer ratio (common base)
$h_{FC}$	static forward current transfer ratio (common collector)
$h_{fc}$	small-signal short-circuit forward current transfer ratio (common collector)
$h_{FE}$	static forward current transfer ratio (common emitter)
$h_{fe}$	small-signal short-circuit forward current transfer ratio (common emitter)
$h_{iB}$	static input resistance (common base)
$h_{ib}$	small-signal short-circuit input impedance (common base)
$h_{iC}$	static input resistance (common collector)
$h_{ic}$	small-signal short-circuit input impedance (common collector)
$h_{iE}$	static input resistance (common emitter)
$h_{ie}$	small-signal short-circuit input impedance (common emitter)
$h_{ob}$	small-signal open-circuit output admittance (common base)
$h_{oc}$	small-signal open-circuit output admittance (common collector)
$h_{oe}$	small-signal open-circuit output admittance (common emitter)
$h_{rb}$	small-signal open-circuit reverse voltage transfer ratio (common base)
$h_{rc}$	small-signal open-circuit reverse voltage transfer ratio (common collector)
$h_{re}$	small-signal open-circuit reverse voltage transfer ratio (common emitter)
$I_B$	base current, dc
$I_b$	base current, rms value of alternating component
$i_B$	base current, instantaneous total value
$I_C$	collector current, dc
$I_c$	collector current, rms value of alternating component
$i_C$	collector current, instantaneous total value
$I_{CBO}$	collector cutoff current, dc, emitter open
$I_{CEO}$	collector cutoff current, dc, base open
$I_{CER}$	collector cutoff current, dc, with specified resistance between base and emitter
$I_{CEV}$	collector cutoff current, dc, with specified voltage between base and emitter
$I_{CEX}$	collector current, dc, with specified circuit between base and emitter
$I_{CES}$	collector cutoff current, dc, with base short circuited to emitter
$I_{DSS}$	drain current, dc, with gate shorted to emitter
$I_E$	emitter current, dc
$I_e$	emitter current, rms value of alternating component
$I_{EBO}$	emitter cutoff current (dc), collector open
$P_{BE}$	power input (dc) to the base (common emitter)
$p_{BE}$	power input (instantaneous total) to the base (common emitter)
$P_{CB}$	power input (dc) to the collector (common base)
$p_{CB}$	power input (instantaneous total) to the collector (common base)
$P_{CE}$	power input (dc) to the collector (common emitter)
$p_{CE}$	power input (instantaneous total) to the collector (common emitter)
$P_{EB}$	power input (dc) to the emitter (common base)
$p_{EB}$	power input (instantaneous total) to the emitter (common base)
$P_{iB}$	large-signal input power (common base)
$p_{ib}$	small-signal input power (common base)
$P_{iC}$	large-signal input power (common collector)
$p_{ic}$	small-signal input power (common collector)
$P_{iE}$	large-signal input power (common emitter)
$p_{ie}$	small-signal input power (common emitter)
$P_{OB}$	large-signal output power (common base)
$p_{ob}$	small-signal output power (common base)
$P_{OC}$	large-signal output power (common collector)
$p_{oc}$	small-signal output power (common collector)
$P_{OE}$	large-signal output power (common emitter)

$P_{oe}$	small-signal output power (common emitter)
$P_T$	total nonreactive power input (dc) to all terminals
$\rho_T$	nonreactive power input (instantaneous total) to all terminals
$R_B$	external base resistance
$R_C$	external collector resistance
$r_{CE(sat)}$	collector-to-emitter saturation resistance
$R_E$	external emitter resistance
$Re(h_{ie})$	real part of the small-signal short-circuit input impedance (common emitter)
$V_{(BR)CBO}$	breakdown voltage, collector-to-base, emitter open
$V_{(BR)ICEO}$	breakdown voltage, collector-to-emitter, base open
$V_{(BR)ICER}$	breakdown voltage, collector-to-emitter, with specified resistance between base and emitter
$V_{(BR)ICES}$	breakdown voltage, collector-to-emitter, with base short-circuited to emitter
$V_{(BR)ICEX}$	breakdown voltage, collector-to-emitter, with specified circuit between base and emitter
$V_{(BR)IDGO}$	breakdown voltage, drain-to-gate, source open
$V_{(BR)IEBO}$	breakdown voltage, emitter-to-base, collector open
$V_{(BR)IR}$	breakdown voltage, reverse
$V_{BB}$	base supply voltage
$V_{BC}$	base-to-collector voltage, dc
$V_{bc}$	base-to-collector voltage, rms value of alternating component
$V_{DC}$	base-to-collector voltage, instantaneous value of ac component
$V_{BE}$	base-to-emitter voltage, dc
$V_{be}$	base-to-emitter voltage, rms value of alternating component
$V_{De}$	base-to-emitter voltage, instantaneous value of ac component
$V_{CB}$	collector-to-base voltage, dc
$V_{cb}$	collector-to-base voltage, rms value of alternating component
$V_{cB}$	collector-to-base voltage, instantaneous value of ac component
$V_{CB(If)}$	dc open-circuit voltage (floating potential) between the collector and base, with the emitter biased with respect to the base
$V_{CC}$	collector supply voltage, dc
$V_{CE}$	collector-to-emitter voltage, dc
$V_{ce}$	collector-to-emitter voltage, rms value of alternating component
$V_{cE}$	collector-to-emitter voltage, instantaneous value of ac component
$V_{CE(If)}$	dc open-circuit voltage (floating potential) between the collector and emitter, with the base biased with respect to the emitter
$V_{CEO}$	collector-to-emitter voltage, dc, with base open
$V_{CEO(sat)}$	collector-to-emitter (breakdown) sustaining voltage with base open
$V_{CER}$	collector-to-emitter voltage, dc with specified resistor between base and emitter
$V_{CER(sat)}$	collector-to-emitter (breakdown) sustaining voltage with specified resistor between base and emitter
$V_{CES}$	collector-to-emitter voltage, dc with base short-circuited to emitter
$V_{CES(sat)}$	collector-to-emitter (breakdown) sustaining voltage with base short-circuited to emitter
$V_{CEX}$	collector-to-emitter voltage, dc with specified circuit between base and emitter
$V_{CEX(sat)}$	collector-to-emitter (breakdown) sustaining voltage with specified circuit between base and emitter
$V_{CE(sat)}$	collector-to-emitter saturation voltage, dc
$V_{EB}$	emitter-to-base voltage, dc
$V_{EB(If)}$	dc open-circuit voltage (floating potential) between the emitter and base, with the collector biased with respect to the base
$V_{eb}$	emitter-to-base voltage, rms value of alternating component
$V_{eB}$	emitter-to-base voltage, instantaneous value of ac component
$V_{EC}$	emitter-to-collector voltage, dc

$V_{EC(0)}$	dc open-circuit voltage (floating potential) between the emitter and collector, with the base biased with respect to the collector
$V_{ec}$	emitter-to-collector voltage, rms value of alternating component
$V_{ec}$	emitter-to-collector voltage, instantaneous value of ac component
$V_{EE}$	emitter supply voltage
$V_{RT}$	reach-through voltage

**Table 4: Tunnel Diode Symbols**

$I_I$	inflection point current
$I_P$	peak point current
$I_V$	valley point current
$r_i$	dynamic resistance at inflection point
$V_{PP}$	projected peak point voltage [forward voltage point (greater than the peak voltage), at which the current is equal to the peak current]
$V_I$	inflection point voltage
$V_P$	peak point voltage
$V_V$	valley point voltage

**Typical Characteristics**

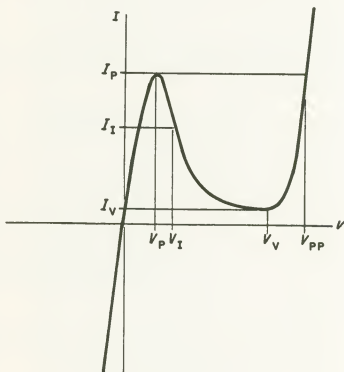

## COMPARATIVE CHARACTERISTICS OF ACTIVE DEVICES

Characteristic	Vacuum Tube	Small-Signal Transistor	High-Power Transistor	Junction Fet	Mosfet
Input impedance	High	<sup>a</sup>	Very low	High	Very high
Output impedance	High	<sup>a</sup>	Low/moderate	High	High
Noise	Low	Low	Moderate	Low	Unpredictable
Warm-up time	Long	Short	Short	Short	Short
Power consumption	Large	Small	Moderate	Very Small	Very small
Aging	Appreciable	Low	Low	Low	Moderate
Reliability	Poor	Excellent	Very good	Excellent	Very good
Overload sensitivity	Excellent	Good	Fair	Good	Poor
Size	Large	Small	Moderate	Small	Small

<sup>a</sup>Impedances depend on circuit arrangement:

For common base  
For common emitter  
For common collector

Input Impedance  
Low (10's of ohms)  
Medium (kilohms)  
High (100's of kilohms)

Output impedance  
High (megohms)  
Medium (10's of kilohms)  
Low (100's of ohms)

## SUMMARY OF INTEGRATED CIRCUIT PROPERTIES

This table compares pertinent characteristics of present day and future ICs.

Properties	Current technologies								Futura (1985-1990)	
	TPL	LSTPL	ECL	IPL	PMOS	NMOS	BULK CMOS	CMOS/SOS	SOS	GaAs
Relative process maturity (1-10)	10 (8)*	9 (4 to 5)*	8 to 9 (3 to 5)	4	10	9	8	4	2	1
Process complexity (No. processing steps)	18 to 22†	18 to 23†	19 to 23†	13 to 17	8 to 14	9 to 15	14 to 17	14 to 20	14 to 20	18
Logic complexity (No. components, 2-input gate)	12	12	8	3 to 4	3	3	4	4	3 to 4	2
Pecking Density (gates/mm <sup>2</sup> )	10 to 20	20 to 40	15 to 20	75 to 150	75 to 150	100 to 200	40 to 90	100 to 500	200 to 500	300 to 1000
Propagation delay, ns (typical value)	8 to 30 (10)	2 to 10 (5)	0.7 to 2 (2)	7 to 50 (20)	30 to 200 (100)	4 to 25 (15)	10 to 35 (20)	4 to 20 (10)	0.2 to 0.4 (0.3)	0.05 to 0.1 (0.07)
Speed-power product (μJ)	30 to 150	10 to 60	15 to 60	0.2 to 2.0	50 to 500	5 to 50	2 to 40	0.5 to 30	0.1 to 0.2	0.01 to 0.1
Typical supply voltages (volts)	+5.0	+5.0	-5.2	+0.8 to +1.0	-15 to +20	+5.0	+10.0	+10.0	+2.0	+1.2
Signal swing (volts)	0.2 to 3.4	0.2 to 3.4	-0.8 to -1.7	0.2 to 0.8	0.0 to -15.0	0.2 to 3.4	0.0 to 10.0	0.0 to 10.0	0.0 to 2.0	0.0 to 0.8
Guaranteed noise margin (volts)	0.3 to 0.4	0.3 to 0.4	0.125	<0.1	1 to 2	0.5 to 20	3.5 to 4.5	3.5 to 4.5	0.2 to 0.8	0.2 to 0.3
Neutron hardness capability (n/cm <sup>2</sup> )	0.2 to 10 <sup>6</sup>	0.2 to 10 <sup>18</sup>	0.5 to 2x10 <sup>18</sup>	1 to 5 x 10 <sup>13</sup>	>10 <sup>18</sup> to 10 <sup>18</sup>	>10 <sup>18</sup> to 10 <sup>18</sup>	>10 <sup>18</sup> to 10 <sup>18</sup>	>10 <sup>18</sup> to 10 <sup>18</sup>	>10 <sup>18</sup> to 10 <sup>18</sup>	>10 <sup>18</sup>
Total dose (%) hardness capability (rads)	10 <sup>6</sup> to 10 <sup>6</sup>	10 <sup>6</sup> to 10 <sup>6</sup>	10 <sup>7</sup> to 10 <sup>6</sup>	10 <sup>6</sup>	10 <sup>6</sup>	1 to 5 x 10 <sup>6</sup>	10 <sup>6</sup> to 10 <sup>6</sup>	10 <sup>6</sup> to 10 <sup>6</sup>	10 <sup>6</sup> to 10 <sup>6</sup>	>10 <sup>6</sup>
Dose rate (%) or photo-current hardness capability (rad/s)	0.5 to 2x 10 <sup>12</sup>	0.2 to 10 <sup>12</sup>	0.2 to 10 <sup>12</sup>	0.1 to 4 x 10 <sup>12</sup>	0.1 to 5 x 10 <sup>6</sup>	0.1 to 5 x 10 <sup>6</sup>	0.5 to 2 x 10 <sup>6</sup>	0.2 to 10 <sup>11</sup>	0.5 to 10 <sup>11</sup>	>10 <sup>11</sup>

(Reprinted with permission from *Electronic Design*, Vol. 29, No. 16; copyright© Hayden Publishing Co., Inc., 1981.)

**ANALOGY BETWEEN THE THREE BASIC JUNCTION  
TRANSISTOR CIRCUITS AND THEIR EQUIVALENT ELECTRON TUBE CIRCUITS**

A transistor can be operated with the input signal applied to the base and the output taken from the collector (common emitter), with the input signal applied to the emitter and the output taken from the collector (common base), or with the input signal applied to the base and the output taken from the emitter (common collector or emitter follower). The performance characteristics of these three connections correspond roughly to the three tube connections shown below, with the exception that the input impedance is generally lower in the transistor circuit. General characteristics of these three connections are given in the table.

Common Emitter	Common Base	Common Collector
Large current gain Large voltage gain Highest power gain Low input resistance High output resistance Analogous to grounded cathode	Approximate unity current gain Large voltage gain Intermediate power gain Very low input resistance Very high output resistance Analogous to grounded grid	Large current gain Approximate unity voltage gain Lowest power gain High input resistance Low output resistance Analogous to cathode follower generally

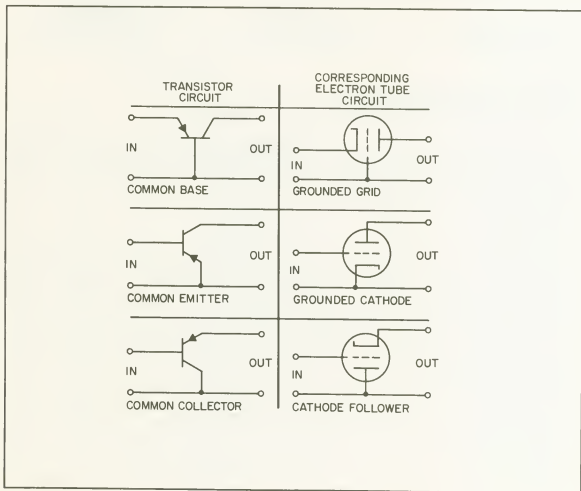

## DEFINITIONS OF EQUIVALENT CIRCUIT PARAMETERS

Parameter	Common Base	Common Emitter	Common Collector	Definition
$z$	$z_{11}, z_{11b}, \text{ or } z_{1b}$	$z_{11e} \text{ or } z_{1e}$	$z_{11c} \text{ or } z_{1c}$	Input impedance with open-circuit output
	$z_{12}, z_{12b}, \text{ or } z_{1b}$	$z_{12e} \text{ or } z_{1e}$	$z_{12c} \text{ or } z_{1c}$	Reverse transfer impedance with open-circuit input
	$z_{21}, z_{21b}, \text{ or } z_{1b}$	$z_{21e} \text{ or } z_{1e}$	$z_{21c} \text{ or } z_{1c}$	Forward transfer impedance with open-circuit output
$y$	$z_{22}, z_{22b}, \text{ or } z_{2b}$	$z_{22e} \text{ or } z_{2e}$	$z_{22c} \text{ or } z_{2c}$	Output impedance with open-circuit input
	$y_{11}, y_{11b}, \text{ or } y_{1b}$	$y_{11e} \text{ or } y_{1e}$	$y_{11c} \text{ or } y_{1c}$	Input admittance with short-circuit output
	$y_{12}, y_{12b}, \text{ or } y_{1b}$	$y_{12e} \text{ or } y_{1e}$	$y_{12c} \text{ or } y_{1c}$	Reverse transfer admittance with short-circuit input
$h$	$y_{21}, y_{21b}, \text{ or } y_{2b}$	$y_{21e} \text{ or } y_{2e}$	$y_{21c} \text{ or } y_{2c}$	Forward transfer admittance with short-circuit output
	$y_{22}, y_{22b}, \text{ or } y_{2b}$	$y_{22e} \text{ or } y_{2e}$	$y_{22c} \text{ or } y_{2c}$	Output admittance with short-circuit input
	$h_{11}, h_{11b}, \text{ or } h_{1b}$	$h_{11e} \text{ or } h_{1e}$	$h_{11c} \text{ or } h_{1c}$	Input impedance with short-circuit output
	$h_{12}, h_{12b}, \text{ or } h_{1b}$	$h_{12e} \text{ or } h_{1e}$	$h_{12c} \text{ or } h_{1c}$	Reverse open-circuit voltage amplification factor
	$h_{21}, h_{21b}, \text{ or } h_{2b}$	$h_{21e} \text{ or } h_{2e}$	$h_{21c} \text{ or } h_{2c}$	Forward short-circuit current amplification factor
	$h_{22}, h_{22b}, \text{ or } h_{2b}$	$h_{22e} \text{ or } h_{2e}$	$h_{22c} \text{ or } h_{2c}$	Output admittance with open-circuit input

Note:  $h_{11} = 1/y_{11}$  and  $h_{22} = 1/z_{22}$ .

### Typical Transistor Parameters

Common Base	Common Emitter	Common Collector
$h_{11} = 39 \text{ ohms}$	$h_{11} = 2,000 \text{ ohms}$	$h_{11} = 2,000 \text{ ohms}$
$h_{12} = 380 \times 10^{-6}$	$h_{12} = -600 \times 10^{-6}$	$h_{12} = 1$
$h_{21} = -0.98$	$h_{21} = 50$	$h_{21} = -51$
$h_{22} = 0.49 \mu\text{mho}$	$h_{22} = 25 \mu\text{mhos}$	$h_{22} = 25 \mu\text{mhos}$

## EQUIVALENT CIRCUITS FOR SMALL-SIGNAL LOW-FREQUENCY TRANSISTOR STAGES

Small-signal, low-frequency, T-equivalent circuits for transistor stages

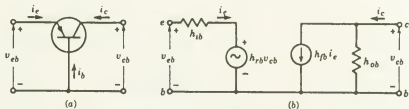

Common-base configuration (a) and hybrid equivalent circuit (b).

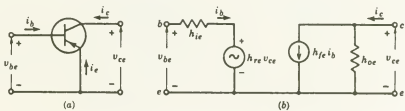

Common-emitter configuration (a) and hybrid equivalent circuit (b).

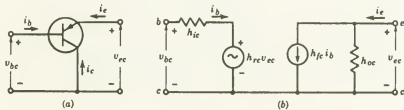

Common-collector configuration (a) and hybrid equivalent circuit (b).

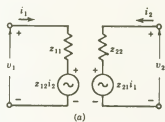

(a)

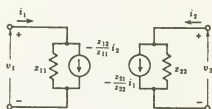

(b)

z-Parameter equivalent circuit.

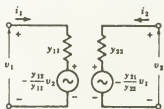

(a)

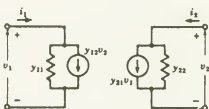

(b)

y-Parameter equivalent circuit.

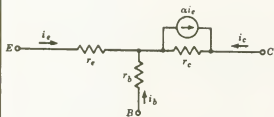

T-equivalent circuit, common base.

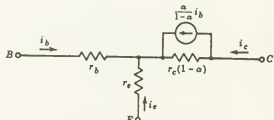

T-equivalent circuit, common emitter.



**TRANSISTOR PARAMETER CONVERSION TABLES**

- (A) Common-base  $h$  parameters in terms of common-emitter, common-collector, and T parameters.  
 (B) Common-collector  $h$  parameters in terms of common-emitter, common-base, and T parameters.  
 (C) Common-emitter  $h$  parameters in terms of common-base, common-collector, and T parameters.  
 (D) T parameters in terms of common-emitter, common-base, and common-collector parameters.

(A)	$h_{ie}$	$\frac{h_{ie}}{(1+h_{ie})(1-h_{ie})+h_{ie}h_{oe}} \approx \frac{h_{ie}}{1+h_{ie}}$	$\frac{h_{ic}}{h_c h_{oc}} \approx \frac{h_c}{h_{ic}}$	$r_e + (1-\alpha)r_b$
	$h_{ob}$	$\frac{h_c h_{oc} h_{ie}(1+h_{ie})}{(1+h_{ie})(1-h_{ie})+h_{ie}h_{oe}} \approx \frac{h_c h_{oc} h_{ie}}{1+h_{ie}}$	$\frac{h_{ic}(1-h_{ic})+h_c h_{oc}}{h_c h_{oc} h_{ic} h_{oc}} \approx h_{ie} - 1$	$\frac{r_b}{r_c + r_b} \approx \frac{r_b}{r_c}$
	$h_{fb}$	$\frac{h_{ie}(1-h_{ie})}{(1+h_{ie})(1-h_{ie})+h_{ie}h_{oe}} \approx \frac{h_{ie}}{1+h_{ie}}$	$\frac{h_{ic}(1+h_{ic})}{h_c h_{oc} - h_{ic} h_{oc}} \approx \frac{1+h_{ic}}{h_{ic}}$	- $\alpha$
	$h_{ob}$	$\frac{h_{oe}}{(1+h_{ie})(1-h_{ie})+h_{ie}h_{oe}} \approx \frac{h_{oe}}{1+h_{ie}}$	$\frac{h_{oc}}{h_c h_{oc} - h_{ic} h_{oc}} \approx \frac{h_{oc}}{h_{ic}}$	$\frac{1}{r_c + r_b} \approx \frac{1}{r_c}$
(B)	$h_{ic}$	$h_{ie}$	$\frac{h_{ob}}{(1+h_{ob})(1-h_{ob})+h_{ob}h_{oc}} \approx \frac{h_{ob}}{1+h_{ob}}$	$r_b + \frac{r_e r_c}{r_e + r_c - \alpha r_c} \approx r_b + \frac{r_e}{1-\alpha}$
	$h_{ic}$	1	$\frac{1+h_{fb}}{(1+h_{ob})(1-h_{ob})+h_{ob}h_{oc}} \approx 1$	$\frac{r_e - \alpha r_c}{r_e + r_c - \alpha r_c} \approx 1 - \frac{r_e}{(1-\alpha)r_c}$
	$h_{ic}$	$(1+h_{ie})$	$\frac{h_{ob}-1}{(1+h_{ob})(1-h_{ob})+h_{ob}h_{oc}} \approx \frac{1}{1+h_{ob}}$	$\frac{r_e}{r_e + r_c - \alpha r_c} \approx \frac{1}{1-\alpha}$
	$h_{oc}$	$h_{oe}$	$\frac{h_{ob}}{(1+h_{ob})(1-h_{ob})+h_{ob}h_{oc}} \approx \frac{h_{ob}}{1+h_{ob}}$	$\frac{1}{r_e + r_c - \alpha r_c} \approx \frac{1}{(1-\alpha)r_c}$
(C)	$h_{ie}$	$\frac{h_{ob}}{(1+h_{ob})(1-h_{ob})+h_{ob}h_{oc}} \approx \frac{h_{ob}}{1+h_{ob}}$	$h_{ic}$	$r_b + \frac{r_e r_c}{r_e + r_c - \alpha r_c} \approx r_b + \frac{r_e}{1-\alpha}$
	$h_{ie}$	$\frac{h_c h_{oc} h_{ob}(1+h_{ob})}{(1+h_{ob})(1-h_{ob})+h_{ob}h_{oc}} \approx \frac{h_c h_{oc} h_{ob}}{1+h_{ob}}$	1	$\frac{r_e}{r_e + r_c - \alpha r_c} \approx \frac{r_e}{(1-\alpha)r_c}$
	$h_{ic}$	$\frac{h_{ob}(1-h_{ob})}{(1+h_{ob})(1-h_{ob})+h_{ob}h_{oc}} \approx \frac{-h_{ob}}{1+h_{ob}}$	$-(1+h_{ic})$	$\frac{\alpha r_c - r_e}{r_e + r_c - \alpha r_c} \approx \frac{\alpha}{1-\alpha}$
	$h_{oe}$	$\frac{h_{oc}}{(1+h_{ob})(1-h_{ob})+h_{ob}h_{oc}} \approx \frac{h_{oc}}{1+h_{ob}}$	$h_{oc}$	$\frac{1}{r_e + r_c - \alpha r_c} \approx \frac{1}{(1-\alpha)r_c}$
(D)	$\alpha$	$\frac{h_{ie}(1-h_{ie})+h_{ie}h_{oe}}{(1+h_{ie})(1-h_{ie})+h_{ie}h_{oe}} \approx \frac{h_{ie}}{1+h_{ie}}$	$h_{fb}$	$\frac{h_c h_{oc} h_{ic}(1+h_{ie})}{h_c h_{oc} h_{ic} h_{ic}} \approx \frac{1+h_{ie}}{h_{ic}}$
	$r_c$	$\frac{h_{ob}+1}{h_{ob}}$	$\frac{1}{h_{ob}}$	$\frac{h_{ic}}{h_{oc}}$
	$r_e$	$\frac{h_{ie}}{h_{oe}}$	$h_{ob}(1+h_{ob}) \frac{h_{ob}}{h_{ob}}$	$\frac{1}{h_{ob}}$
	$r_b$	$\frac{h_{ie}(1+h_{ie})}{h_{oe}}$	$\frac{h_{ob}}{h_{ob}}$	$h_{ic} + \frac{h_{ic}(1-h_{ic})}{h_{oc}}$
	$\beta$	$\frac{h_{ie}+h_{ie}}{1+h_{ie}}$	$\frac{h_{ob}+h_{ob}}{1+h_{ob}}$	$\frac{h_{ic}+h_{ic}}{h_{ic}}$

- (E) Input impedance and output impedance in terms of  $h$  and T parameters.  
 (F) Insertion power gain and transducer power gain in terms of  $h$  parameters.  
 (G) Current gain and voltage gain in terms of  $h$  and T parameters.  
 (H) Available power gain and operating power gain in terms of  $h$  parameters.

	Input impedance	Output impedance	
$h$ parameter	$Z_i = \frac{v_i}{i_i} = h_i - \frac{h_f h_r Z_L}{1 + h_o Z_L}$	$Z_o = \frac{v_o}{i_o} = \frac{1}{h_o - \frac{h_f h_r}{h_i + Z_g}}$	
(E)	Common base T-equivalent circuit	$r_e + r_b \left( \frac{r_c - a r_e + R_L}{r_c + r_b + R_L} \right) \cong r_e + r_b (1 - \alpha)$	$r_c + r_b \left( 1 - \frac{a r_e + r_b}{r_e + r_b + R_g} \right) \cong r_c$
	Common emitter T-equivalent circuit	$r_b + \frac{r_e (r_c + R_L)}{r_c - a r_c + r_e + R_L} \cong r_b + \frac{r_e}{1 - \alpha}$	$r_c - a r_c + r_e \left( 1 + \frac{a r_e - r_e}{r_e + r_b + R_g} \right) \cong \frac{r_c}{1 - \alpha}$
	Common collector T-equivalent circuit	$r_b + \frac{r_c (r_e + R_L)}{r_c - a r_c + r_e + R_L} \cong r_b + \frac{r_e + R_L}{1 - \alpha}$	$r_e + (r_b + R_g) \frac{r_c - a r_c}{r_c + r_b + R_g}$
(F)	Insertion power gain power into load $\left( \frac{\text{power generator would deliver directly}}{\text{power generator would deliver directly}} \right)$	Transducer power gain power into load $\left( \frac{\text{maximum available generator power}}{\text{maximum available generator power}} \right)$	
	$h$ parameter where $Z_g$ and $Z_L$ are pure resistance	$G_i = \frac{h_f^2 (R_g + R_L)^2}{[(h_i + R_g)(1 + h_o R_L) - h_f h_r R_L]^2}$	$G_t = \frac{4 h_f^2 R_g R_L}{[(h_i + R_g)(1 + h_o R_L) - h_f h_r R_L]^2}$
	Current gain	Voltage gain	
$h$ parameter	$A_i = \frac{i_o}{i_i} = \frac{h_f}{1 + h_o Z_L}$	$A_v = \frac{v_o}{v_i} = \frac{1}{h_r - \frac{h_i}{Z_L} \left( \frac{1 + h_o Z_L}{h_f} \right)}$	
(G)	Common base T-equivalent circuit	$\frac{a r_c + r_b}{r_c + r_b + R_L} \cong \alpha$	$\frac{(a r_c + r_b) R_L}{r_e (r_c + r_b + R_L) + r_b (r_c - a r_c + r_e + R_L)} \cong \frac{\alpha R_L}{r_e + r_b (1 - \alpha)}$
	Common emitter T-equivalent circuit	$\frac{- (a r_c - r_e)}{r_c - a r_c + r_e + R_L} \cong \frac{\alpha}{1 - \alpha}$	$\frac{- (a r_c - r_e) R_L}{r_e (r_e + R_L) + r_b (r_c - a r_c + r_e + R_L)} \cong - \frac{\alpha R_L}{r_e + r_b (1 - \alpha)}$
	Common collector T-equivalent circuit	$\frac{r_c}{r_c - a r_c + r_e + R_L} \cong \frac{1}{1 - \alpha}$	$\frac{r_c R_L}{r_c (r_e + R_L) + r_b (r_c - a r_c + r_e + R_L)} \cong \frac{1}{1 + r_e + r_b \frac{1 - \alpha}{R_L}}$
(H)	Available power gain $\left( \frac{\text{maximum available output power}}{\text{maximum available generator power}} \right)$	Operating power gain $\left( \frac{\text{power into load}}{\text{power into transistor}} \right)$	
	$h$ parameter where $Z_g$ and $Z_L$ are pure resistance	$G_a = \frac{h_f^2 R_g}{(h_i + R_g)[h_o(h_i + R_g) - h_f h_r]}$	$G_1 = A_v A_i = \frac{v_o i_o}{v_i i_i} = \left( \frac{h_f}{1 + h_o R_L} \right) h_r \frac{h_i}{R_L} \left( \frac{1 + h_o R_L}{h_f} \right)$

- (I) Z parameters in terms of  $h$  parameters.  
 (J) Y parameters in terms of  $h$  parameters.  
 (K) Common emitter z parameters in terms of common collector and common base z parameters and T parameters.  
 (L) Common emitter y parameters in terms of common collector and common base y parameters and T parameters.

	Common emitter	Common base	Common collector	
(I)	$z_{11b}$	$\frac{\Delta h}{h_{oe}}$	$\frac{\Delta h}{h_{ob}}$	$\frac{1}{h_{oc}}$
	$z_{12b}$	$\frac{\Delta h - h_{re}}{h_{oe}}$	$\frac{h_{rb}}{h_{ob}}$	$\frac{1 + h_{fc}}{h_{oc}}$
	$z_{21b}$	$\frac{\Delta h + h_{fe}}{h_{oe}}$	$\frac{-h_{rb}}{h_{ob}}$	$\frac{1 - h_{rc}}{h_{oc}}$
	$z_{22b}$	$\frac{d}{h_{oe}}$	$\frac{1}{h_{ob}}$	$\frac{d}{h_{oc}}$
(J)	$y_{11b}$	$\frac{d}{h_{ie}}$	$\frac{1}{h_b}$	$\frac{d}{h_c}$
	$y_{12b}$	$\frac{h_{re} + h_{fe}}{h_{ie}}$	$-\frac{h_{rb}}{h_b}$	$-\frac{1 + h_{fe}}{h_c}$
	$y_{21b}$	$-\frac{\Delta h + h_{fe}}{h_{ie}}$	$\frac{h_{rb}}{h_b}$	$\frac{h_{rc} - 1}{h_c}$
	$y_{22b}$	$\frac{\Delta h}{h_{ie}}$	$\frac{\Delta h}{h_b}$	$\frac{1}{h_c}$

$\Delta h = h_i h_o - h_r h_f$   
 $d = (1 + h_f)(1 - h_r) + h_i h_o \cong 1 + h_f$

z parameter	Common collector	Common base	T equivalent-circuit
$z_{11e}$	$z_{11} - z_{12} - z_{21} + z_{22}$	$z_{11}$	$r_e + r_b$
$z_{12e}$	$z_{22} - z_{12}$	$z_{11} - z_{12}$	$r_e$
$z_{21e}$	$z_{22} - z_{21}$	$z_{11} - z_{21}$	$r_e - \alpha r_c$
$z_{22e}$	$z_{22}$	$z_{11} - z_{12} - z_{21} + z_{22}$	$r_e + r_c(1 - \alpha)$

y parameter	Common collector	Common base	T equivalent-circuit
$y_{11e}$	$y_{11}$	$y_{11} + y_{12} + y_{21} + y_{22}$	$\frac{r_e + r_c(1 - \alpha)}{\Delta}$
$y_{12e}$	$-(y_{11} + y_{12})$	$-(y_{12} + y_{22})$	$-\frac{r_e}{\Delta}$
$y_{21e}$	$-(y_{11} + y_{21})$	$-(y_{21} + y_{22})$	$-\frac{r_e - \alpha r_c}{\Delta}$
$y_{22e}$	$y_{11} + y_{12} + y_{21} + y_{22}$	$y_{22}$	$\frac{r_e + r_b}{\Delta}$

$\Delta = r_e r_b + r_c(r_e + r_b(1 - \alpha))$

- (M) Common base  $z$  parameters in terms of common emitter and common collector  $z$  parameters and  $T$  parameters.
- (N) Common base  $y$  parameters in terms of common emitter and common collector  $y$  parameters and  $T$  parameters.
- (O) Common collector  $z$  parameters in terms of common emitter and common base  $z$  parameters and  $T$  parameters.
- (P) Common collector  $y$  parameters in terms of common emitter and common base  $y$  parameters and  $T$  parameters.
- (Q) Input impedance, output impedance, voltage gain, and current gain in terms of  $z$  and  $y$  parameters.

$z$ parameter	Common emitter	Common collector	T-equivalent circuit
$z_{11b}$	$z_{11}$	$z_{11} \quad z_{12} \quad z_{21} + z_{22}$	$r_e + r_b$
$z_{12b}$	$z_{11} \quad z_{12}$	$z_{11} \quad z_{21}$	$r_b$
$z_{21b}$	$z_{11} \quad z_{21}$	$z_{11} \quad z_{12}$	$r_b + \beta r_c$
$z_{22b}$	$z_{11} \quad z_{12} \quad z_{21} + z_{22}$	$z_{11}$	$r_b + r_c$

$y$ parameter	Common emitter	Common collector	T-equivalent circuit
$y_{11b}$	$y_{11} + y_{12} + y_{21} + y_{22}$	$y_{22}$	$\frac{r_b + r_c}{\Delta}$
$y_{12b}$	$(y_{12} + y_{22})$	$(y_{21} + y_{22})$	$\frac{r_b}{\Delta}$
$y_{21b}$	$(y_{21} + y_{22})$	$(y_{12} + y_{22})$	$\frac{r_b + \beta r_c}{\Delta}$
$y_{22b}$	$y_{22}$	$y_{11} + y_{12} + y_{21} + y_{22}$	$\frac{r_c + \beta r_b}{\Delta}$

$\Delta = r_e r_b + r_c [r_e + r_b (1 - \beta)]$

$z$ parameter	Common emitter	Common base	T-equivalent circuit
$z_{11c}$	$z_{11} \quad z_{12} \quad z_{21} + z_{22}$	$z_{22}$	$r_b + r_c$
$z_{12c}$	$z_{22} \quad z_{12}$	$z_{22} \quad z_{21}$	$r_c (1 - \beta)$
$z_{21c}$	$z_{22} \quad z_{21}$	$z_{22} \quad z_{12}$	$r_c$
$z_{22c}$	$z_{22}$	$z_{11} - z_{12} - z_{21} + z_{22}$	$r_b + r_c (1 - \beta)$

$y$ parameter	Common emitter	Common base	T-equivalent circuit
$y_{11c}$	$y_{11}$	$y_{11} + y_{12} + y_{21} + y_{22}$	$\frac{r_e + r_c (1 - \beta)}{\Delta}$
$y_{12c}$	$(y_{11} + y_{12})$	$-(y_{11} + y_{21})$	$-\frac{r_c (1 - \beta)}{\Delta}$
$y_{21c}$	$(y_{11} + y_{21})$	$(y_{11} + y_{12})$	$-\frac{\beta r_c}{\Delta}$
$y_{22c}$	$y_{11} + y_{12} + y_{21} + y_{22}$	$y_{11}$	$\frac{r_b + r_c}{\Delta}$

$\Delta = r_e r_b + r_c [r_e + r_b (1 - \beta)]$

Parameter	Input impedance	Output impedance	Voltage gain	Current gain
$z$	$\frac{\Delta z + z_{11} z_L}{z_{22} + z_L}$	$\frac{\Delta z + z_{22} z_g}{z_{11} + z_g}$	$\frac{z_{21} z_L}{\Delta z + z_{11} z_L}$	$-\frac{z_{21}}{z_{22} + z_L}$
$y$	$\frac{y_{22} + y_L}{\Delta y + y_{11} y_L}$	$\frac{y_{11} + y_g}{\Delta y + y_{22} y_g}$	$\frac{y_{21}}{y_{22} + y_L}$	$\frac{y_{21} y_L}{\Delta y + y_{11} y_L}$

$\Delta z = z_{11} z_{22} - z_{12} z_{21} \quad \Delta y = y_{11} y_{22} - y_{12} y_{21}$

(From "Transistor Circuit Design," Texas Instruments, Inc. Copyright ©1963 by Texas Instruments Incorporated. Used with permission of McGraw-Hill Book Company.)

## MULTIVIBRATOR DESIGN CURVES

The accompanying curves permit an easy and rapid determination of the frequency of oscillation of a symmetrical-astable (free-running) multivibrator, and the pulse duration ( $t_p$ ) of a monostable (one-shot) multivibrator. The pulse duration of the astable multivibrator output also can be read from the curve.

The expressions on which the curves are based are derived readily. The expression for the voltage at the base of the "off" transistor is

$$e_b = E_{cc} (1 - 2e^{-t/RC}) + V_{be}$$

where  $V_{be}$  is the base-to-emitter voltage of an "on" transistor. The above equation assumes that base-to-emitter breakdown is prevented by using transistors whose base-to-emitter breakdown voltage is greater than  $E_{cc}$  volts, or by connecting a diode in either the base or emitter lead.

The "off" transistor turns on when  $e_b = V_{be}$ , or  $e^{-t/RC} = 1/2$  where  $t$  is the "off" time ( $t_p$ ) at the end of which time  $e_b = V_{be}$ . Solving the equation yields  $t_p = 0.69 RC$ . The curves in graph (A) are plots of this equation. For the monostable multivibrator,  $t_p$  is the pulse duration. The period of the symmetrical-astable multivibrator is equal to  $2t_p$ .

Graph (B) is a family of curves of frequency of the symmetrical-astable multivibrator versus capacitance  $C$  for various values of resistance  $R$ . Since the period of the output wave is  $2t_p$ , the equation for frequency is given as  $f = 1/1.38RC$ , from which the curves were plotted.

FOR EXAMPLE: Find the value of  $C$  required to generate a frequency of 500 Hz from a free-running multivibrator, or a 1 msec pulse from a monostable. In both cases the value of  $R$  is limited to 100,000 ohms by the beta of the transistor selected. The curves indicated a value of  $0.0145 \mu F$  for the capacitor.

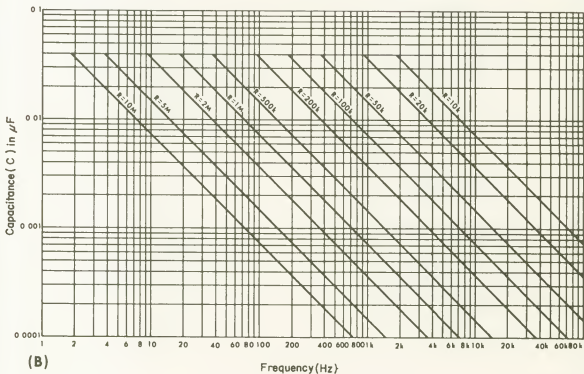
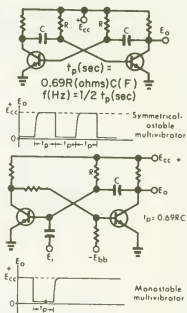
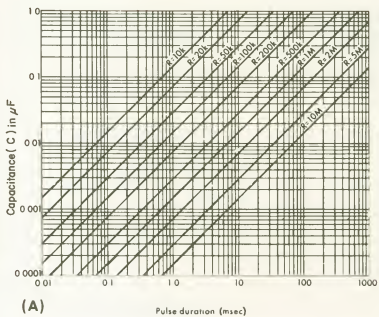

## OPERATIONAL AMPLIFIERS

An operational amplifier is essentially a very high gain dc amplifier whose open-loop gain is generally high enough when compared with the closed-loop gain so that the closed-loop characteristics depend solely on the feedback element. Circuit applications for which operational amplifiers can be used are illustrated below.

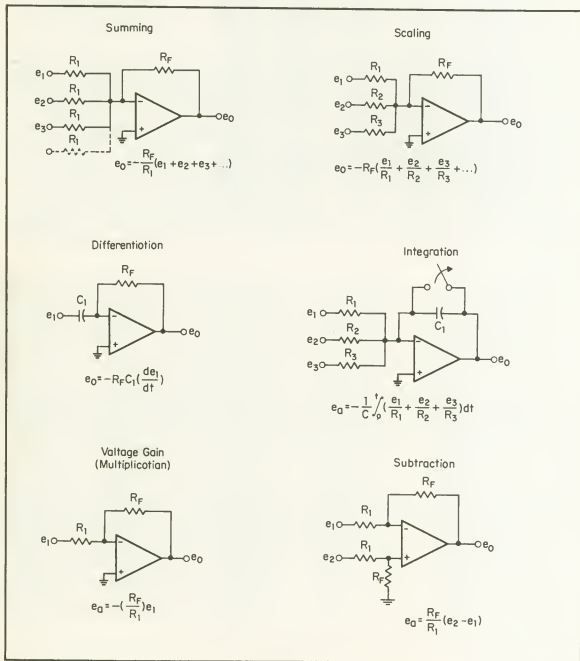

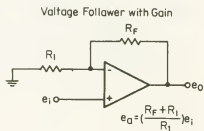
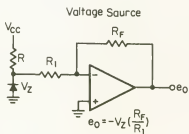
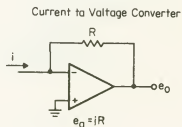
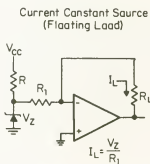
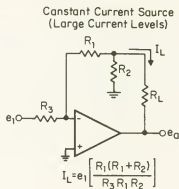
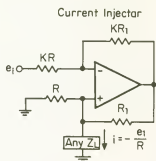



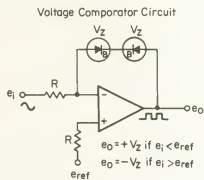
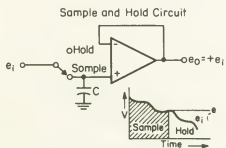
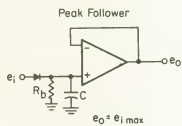
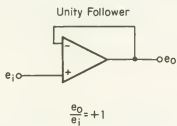

High-impedance Low-voltage Voltmeter

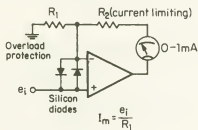

Polarity Separator

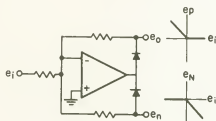

Logarithmic Transconductor

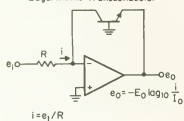

Simple Overvoltage Clamp

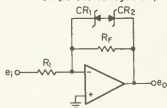

Absolute Value Amplifier

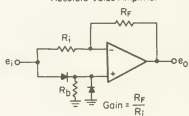

Modulator-Demodulator (Half-Wave)

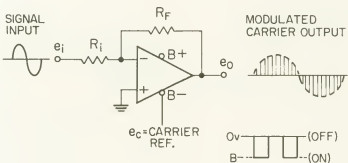

Floating Load

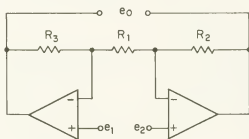

$$e_o = (e_1 - e_2) \left( 1 + \frac{R_2 + R_3}{R_1} \right)$$

### Automatic Gain Control Amplifier

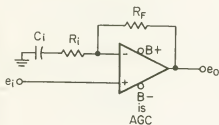

### D/A Converter

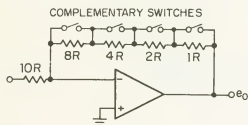

### Second-Order Transfer Function Amplifier

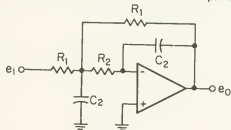

$$\frac{e_o}{e_i} = \frac{1}{(R_1 R_2 C_1 C_2) s^2 + C_1 (2R_2 + R_1) s + 1}$$

### Adjustable Log (0 to $-180^\circ$ ) Amplifier

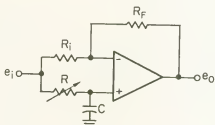

INTERCHANGE R-C FOR LEAD Ckt

#### LAG CIRCUIT

$$R_i = R_F$$

$$\frac{e_o}{e_i} = \frac{1}{\tau s + 1}$$

$$\tau = RC$$

#### LEAD CIRCUIT

$$R_i = R$$

$$\frac{e_o}{e_i} = \frac{\tau s - 1}{\tau s + 1}$$

$$\tau = RC$$

### Second-order Low-pass Active Filter (Two Pole)

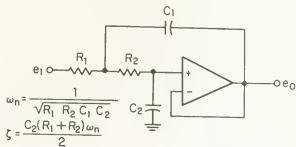

$$\omega_n = \frac{1}{\sqrt{R_1 R_2 C_1 C_2}}$$

$$\zeta = \frac{C_2 (R_1 + R_2) \omega_n}{2}$$

$$\frac{e_o}{e_i} = \frac{1}{R_1 R_2 C_1 C_2 s^2 + C_2 (R_1 + R_2) s + 1}$$

$$= \frac{1}{\left(\frac{s}{\omega_n}\right)^2 + 2\zeta \frac{s}{\omega_n} + 1}$$

### Second-Order High-Pass Active Filter

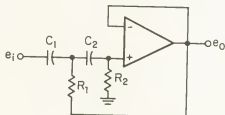

$$\frac{e_o}{e_i} = \frac{\left(\frac{s}{\omega_n}\right)^2}{\left(\frac{s}{\omega_n}\right)^2 + d \left(\frac{s}{\omega_n}\right) + 1}$$

$$\text{WHERE: } d = \frac{\tau_1 + R_1 C_2}{\sqrt{\tau_1 \tau_2}}$$

$$\text{AND: } \omega_n^2 = \frac{1}{\tau_1 \tau_2}$$

$$\tau_1 = R_1 C_1$$

$$\tau_2 = R_2 C_2$$

Fast Recovery  
Overload Circuit

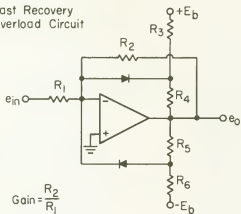

Bandpass Amplifier

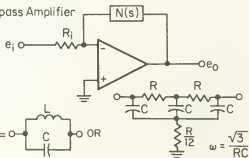

Schmitt Trigger

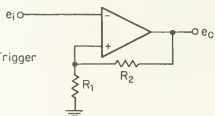

WienBridge Oscillator

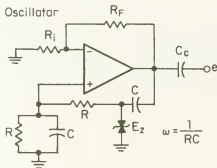

Notch Filter(Active)

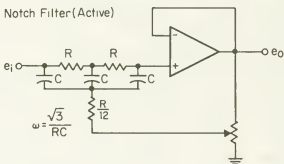

Frequency Divider

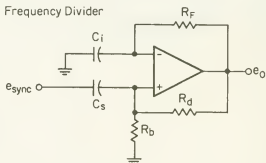

Square-wave Multivibrator

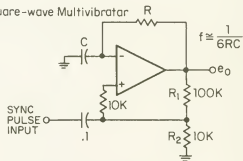

Crystal Oscillator(Square Wave)

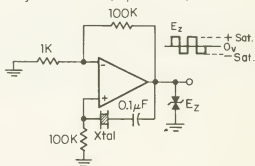

## GLOSSARY OF OPERATIONAL AMPLIFIER TERMS

- Common-mode gain** Ratio of output voltage over input voltage applied to (+) and (-) terminal in parallel.
- Common-mode rejection ratio (CMRR)** Ratio of an op amp's open-loop gain to its common-mode gain.
- Differential-input voltage range** Range of voltages that may be applied between input terminals without forcing the op amp to operate outside its specifications.
- Differential Input Impedance ( $Z_{in\ diff}$ )** Impedance measured between (+) and (-) input terminals.
- Drift, input voltage** Change in output voltage divided by open-loop gain, as a function of temperature or time.
- Input voltage offset** Dc potential required at the differential input to produce an output voltage of zero.
- Input bias current** Input current required by (+) and (-) inputs for normal operation.
- Input offset current** Difference between (+) and (-) input bias currents.
- Offset** Measure of unbalance between halves of a symmetrical circuit.
- Open-loop bandwidth** Without feedback, frequency at which amplifier gain falls 3 dB below its low-frequency value.
- Open-loop voltage gain ( $A_{vol}$ )** Differential gain of an op amp with no external feedback.
- Slew rate** Maximum rate at which output voltage can change with time; usually given in volts per microsecond.









EUROPEAN SEMICONDUCTOR NUMBERING SYSTEM (PRO ELECTRON CODE)

<i>First Letter</i>	<i>Second Letter</i>	<i>Third, Fourth, and Fifth Character</i>
Material	Type	Serial Code
A Germanium B Silicon C Compound materials, such as cadmium sulfide or gallium arsenide used in semiconductor devices. (Energy gap band of 1.3 or more electron-volts) D Materials with an energy gap band of less than 0.6 electron-volts such as indium antimonide R Radiation detectors, photoconductive cells. Hall effect generators, etc.	A Low-power diode, voltage-variable capacitor B Varicap C Small-signal audio transistor D Audio power transistor E Tunnel diode F Small-signal rf transistor G Miscellaneous H Field probe K Hall generator L Rf-power transistor M Hall modulators and multipliers P Photodiode, phototransistor, photoconductive cell (LDR), radiation device R Low-power controlled rectifier S Low-power switching transistor T Breakdown devices, high-power controlled rectifier, Shockley diode, Thyristor, pnpn diodes U High-power switching transistor X Multiplier diode Y High-power rectifier (diode) Z Zener diode	Three figures—serial codes used on devices for domestic and commercial applications  One letter and two figures—serial codes used on devices for use in military, industrial, scientific, and pulse, equipment

The third letter—if there is one—indicates industrial device and is a Y. If there is no third letter, the device is for consumer or entertainment use. The digits that follow the letters for industrial units indicate how many devices of that particular type have been registered. The digits start at 10 and go up to 99. When 99 is reached—i.e., after 89 devices—the last letter changes from a Y to an X and the numbering begins anew, working back towards A. There is no Z. For consumer devices, the numbers that follow the two letters start with 100, allowing registration of 899 similar devices.

FOR EXAMPLE: The designation BLY 80 means the device uses silicon (B) is for high rf power use (L), and is used in industrial applications, (Y); the 80 means that it is the 71st device of its type to be registered with Pro Electron.

# CHARACTERISTICS OF INTEGRATED CIRCUIT LOGIC FAMILIES

	Typical Circuit Diagram	Logic Type	Relative Cost Per Gate	Propagation Time Per Gate (nsec)	Power Dissipation Per Gate (mW)	Typical Noise Margin (V)	Typical Fanin	Typical Fanout	Remarks
RTL Resistor-Coupled Transistor Logic		NOR	Low	15	10	0.2	3	3	Variations in input characteristics result in base-current "hogging" problem. Proper operation not always guaranteed. More susceptible to noise because of low operating and signal voltages.
RCTL Resistor-Capacitor Transistor Logic		NOR	Medium	50	10	0.2	3	4	Very similar to DCTL. Resistors resolve current "hogging" problem and reduce power dissipation. However, operating speed is reduced.
DCTL Direct-Coupled Transistor Logic		NOR	Med-high	30	10	0.2	3	4	Though capacitors can increase speed capability, noise immunity is affected by capacitive coupling of noise signals.
DTL Diode-Transistor Logic		NAND	Medium	25	15	0.7	8	8	Use of pull-up resistor and charge control technique improves speed capabilities. Many variations of this circuit exist, each having specific advantages.
TTL Transistor-Transistor Logic		NAND	Medium	10	20	1	8	12	Very similar to DTL. Has lower parasitic capacity at inputs. With the many existing variations, this logic family is very popular.
CTL Complementary Transistor Logic		OR/NOR	High	5	50	0.4	5	25	Similar to a differential amplifier, the reference voltage sets the threshold voltage. High speed, high fanout operation is possible with associated high power dissipation. Also known as emitter-coupled logic (ECL).
CML Current-Mode Logic (ECL Emmitter Coupled Logic)		AND/OR	High	5	50	0.4	5	25	More difficult manufacturing process results in compromises of active device characteristics and higher cost.
MOSL Metal-Oxide Semiconductor Logic		NOR	Very low	250	<1	2.5	10	5	Limited in switching speed compared to bipolar transistor circuits because the MOS transistor is a high-impedance device and cannot charge the stray circuit capacitance quickly.

## CHARACTERISTICS OF DISPLAYS USED IN ELECTRONIC EQUIPMENT

Display Technology	Average Viewing Angle	Typical Current Requirement	Typical Voltage Requirement	Typical Operating Temperatures	Relative Brightness	Durability	Colors available (basic light source)
Light emitting diodes	Med bright (washout in sunlight)	150° (magnifying lens cuts down angle)	5 to 10 mA	2 to 5V	-40 to 85°C	Rugged, no breakable parts	Red, orange yellow, green
Liquid crystal displays	High contrast, no luminance	90 to 150°	50 to 500 $\mu$ A	3 to 7V	-10 to 65°C	Glass construction	Black on white (or reverse)
Gas discharge	Bright	100°	150mA to 2A	135 to 250V	0 to 70°C	Gas-filled glass construction	Orange
Incandescent	Very bright	150°	10 to 17 mA	3 to 5V	-55 to 100°C	Glass and filaments construction subject to shock	White, filterable to most colors
Vacuum fluorescent	Bright	100°	400 to 650 mA	30 to 50V	-10 to 55°C	Vacuum-tube device, glass construction	Bright-green filterable to many colors

(From *Electronic Products*, June, 1982, courtesy of Electronic Products.)



## DEFINITIONS OF INTEGRATED CIRCUITS, LOGIC, AND MICROELECTRONICS TERMS

**Abrasing equipment** This type of equipment fires a gas propelled stream of finely graded abrasive particles through a precise nozzle against the work surface. When linked to abrading equipment, it can cut intricate patterns in silicon semiconductors.

**Abrasive trimming** Trimming a film resistor to its nominal value by notching the resistor surface with a fine adjusted stream of abrasive material such as aluminum oxide.

**Access time** Time required in a computer to move information from memory to the computing mechanism.

**Activating** A treatment which renders nonconductive material receptive to electroless deposition.

**Active elements** Those components in a circuit which have gain or which direct current flow: diodes, transistors, SCR's, etc.

**Active substrate** A substrate for an integrated component in which parts display transistance. Examples are single crystals of semiconductor materials, within which transistors and diodes are formed.

**A.D. converter** Analog-to-digital converter; a circuit which accepts information in a continuously varying ac or dc current or voltage and whose output is the same information in digital form.

**Adder** Switching circuits which combine binary bits to generate the SUM and CARRY of these bits. Takes the bits from the two binary numbers to be added (ADDEND and AUGEND) plus the CARRY from the preceding less significant bit and generates the SUM and the CARRY.

**Address** Noun: a location, either name or number, where information is stored in a computer. Verb: to select or pick out the location of a stored information set for access.

**Alloy junction** A junction produced by alloying one or more impurity metals to a semiconductor. A small button of impurity metal is placed at each desired location on the semiconductor wafer, heated above its melting point, and cooled. The impurity metal alloys with the semiconductor material to form a *p* or *n* region, depending on the impurity used.

**Alternate print** In screen printing, one squeegee print stroke per substrate in alternate directions.

**Alumina** Aluminum oxide ( $\text{Al}_2\text{O}_3$ ) used as a ceramic substrate material.

**Align** To put into proper relative position, agreement, or coordination when placing parts of a photomask together or placing a photomask over an etched pattern in the oxide on a semiconductor wafer.

**Alignment** The accuracy of coordination or relative position of images on a semiconductor oxide coating and on the photomask, or any other images placed in relation to those.

**"AND"** A boolean logic expression used to identify the logic operation wherein given two or more variables, all must be logical "1" for the result to be logical "1." The AND function is graphically represented by the dot ( $\cdot$ ) symbol.

**Angle of attack** In screen printing, angle at which the squeegee blade attacks the screen surface.

**Anticipated carry adder** A parallel ADDER in which each stage is capable of looking back at all ADDEND and AUGEND bits of less significant stages and deciding whether the less significant bits provide a "0" or a "1" CARRY IN. Having determined the CARRY IN it combines it with its own ADDEND and AUGEND to give the SUM for that bit or stage. Also called FAST ADDER or look ahead CARRY ADDER.

**Arrays** Integrated circuits designed to perform near or actual subsystem operations. They are characterized by high complexity and component density. Each array package replaces a number of conventional I/Cs. Arrays are classified as medium-scale or larger-scale according to function performed. They can be monolithic or fabricated on a silicon wafer with interconnections between circuits.

**Artwork** The original pattern or configuration produced at an enlarged ratio, from which a circuit product is made, using a technique of photographic reduction to achieve microelectronic scale; layouts and photographic films created to produce thick film screens and thin film masks.

**As-fired** Description of properties of ceramic substrates (smoothness) or thick film resistors (values) as they emerge from furnace processing, before any trimming or polishing.

**Asynchronous inputs** Those terminals in a flip-flop which can affect the output state of the flip-flop independent of the clock. Called Set, Preset, Reset or DC Set and Reset, or clear.

**Back bonding** Bonding active chips to the substrate using the back of the chip, leaving the face with its circuitry face up. The opposite is face down bonding.

**Backfill** Filling an evacuated hybrid circuit package with dry inert gas prior to hermetic sealing of the package.

**Bake-out** Elevated temperature process which evaporates unwanted gases and moisture before final sealing of a hybrid circuit package.

**Ball bond** Type of thermocompression bond wherein a ball shaped end interconnect wire is flattened against a metallized pad.

**Basic logic diagram** A logic diagram that depicts logic functions with no reference to physical implementations. It consists primarily of logic symbols and is used to depict all logic relationships as simply and understandably as possible. Nonlogic functions are not normally shown.

**Beam leads** A generic term describing a system in which flat, metallic leads extend beyond the edges of a chip component, much the same as wooden beams extend from a roof overhang. These are used to interconnect the component to film circuitry.

**Beryllia** Beryllium oxide ceramics (BeO) significant in that they have high thermal conductivity characteristics.

**Binders** Substances added to unfired substrates and thick film compounds to add strength.

**Binary coded decimal (BCD)** A binary numbering system for coding decimal numbers in groups of 4 bits. The binary value of these 4-bit groups ranges from 0000 to 1001 and codes the decimal digits "0" through 9. To count to 9 takes 4 bits; to count to 99 takes two groups of 4 bits; to count to 999 takes three groups of 4 bits.

**Binary logic** Digital logic elements which operate with two distinct states. The two states are variously called true and false, high and low, on and off, or "1" and "0." In computers they are represented by two different voltage levels. The level which is more positive (or less negative) than the other is called the high level, the other the low level. If the true ("1") level is the most positive voltage, such logic is referred to as positive true or positive logic.

**Bistable element** Another name for flip-flop. A circuit in which the output has two stable states (output levels "0" or "1") and can be caused to go to either of these states by input signals, but remains in that state permanently after the input signals are removed. This differentiates the bistable element from a gate also having two output states but which requires the retention of the input signals to stay in a given state. The characteristic of two stable states also differentiates it from a monostable element which keeps returning to a specific state, and an astable element which keeps changing from one state to the other.

**Bit** A synonym for binary numeral. Also refers to a single binary numeral in a binary word.

**Bleeding** In photomasking, poor edge definition or acuity caused by spread of image onto adjacent areas.

**Blister** A lump or raised section of a conductor or resistor caused by out-gassing of the binder or vehicle during firing.

**Boat** A container for materials to be evaporated or fired.

**Bond liftoff** The failure mode whereby the bonded lead separates from the surface to which it was bonded.

**Bond-to-bond distance** The distance measured from the bonding site on the die to the bond impression on the post, substrate land, or fingers which must be bridged by a bonding wire or ribbon.

**Bond-to-chip distance** In beam lead bonding, the distance from the heel of the bond to the component.

**Bonding pad** A metallized area at the end of a thin metallic strip or on a semiconductor to which a connection is made. Also called Bonding Island.

**Bonding ribbon and tape** Bonding ribbon and tape are used in the manufacture of high-volume ICs such as memory devices and consumer products. Wire connections between I/O pads on the circuit die and the lead frame are replaced by a piece of tape with finely etched fingers that are patterned to fit exactly onto the pads.

**Bonding wire** Fine gold or aluminum wire for making electrical connections in hybrid circuits between various bonding pads on the semiconductor device substrate and device terminals or substrate lands.

**Boolean algebra** The mathematics of logic which uses alphabetic symbols to represent logical variables and "1" and "0" to represent states. There are three basic logic operations in this algebra: AND, OR, and NOT. (Also see NAND, NOR, Invert which are combinations of the three basic operations.)

**Bubble memories** In general, magnetic bubble memory systems consist of a film deposited on a garnet substrate. Data is stored in magnetic domains (bubbles) which are formed on the film by the application of a perpendicular magnetic field.

**Buffer** A circuit element, which is used to isolate between stages or handle a large fanout or to convert input and output circuits for signal level compatibility.

**Bump chip** A chip that has on its termination pads a bump of solder or other bonding material that is used to bond the chip to external contacts.

**Bump contact** A large area contact used for alloying directly to the substrate of a chip, for mounting or interconnecting purposes.

**Buried layer** A heavily doped (N+) region directly under the N doped epitaxial collector region of transistors in a monolithic integrated circuit used to lower the series collector resistance.

**Burn-in** Operation of electronic components often at elevated temperature, prior to their ultimate application in order to stabilize their characteristics and to identify their early failures.

**Burn-in, dynamic** High temp test with device(s) subject to actual or simulated operating conditions.

**Burn-in, static** High temp test with device(s) subjected to unvarying voltage rather than to operating conditions; either forward or reverse bias.

**Camber** In screen printing, a slight rise or curve in the surface of the substrate.

**Carriage** Mechanism on a screen printer to which the workholder is attached, which conveys the substrate to and from the print position.

**Carriers** Holders for electronic parts and devices which facilitate handling during processing, production, imprinting, or testing operations and protect such parts under transport.

**Ceramic** Non-metallic and inorganic material (e.g., alumina, beryllia, or steatite) used in microelectric substrates and component parts.

**Cermet** A combination of ceramic and metal powders used for thin and thick film resistors.

**Chip** A single substrate on which all the active and passive circuit elements have been fabricated using one or all of the semiconductor techniques of diffusion, passivation, masking, photoresist, and epitaxial growth. A chip is not ready for use until packaged and provided with external connectors. The term is also applied to discrete capacitors and resistors which are small enough to be bonded to substrates by hybrid techniques.

**Chip and wire** A hybrid technology exclusively employing face-up-bonded chip devices interconnected to the substrate conventionally, i.e., by flying wires.

**Chip architecture** The design or structure of an IC chip, incorporating arithmetic logic unit, registers, and control-bus pathway configuration.

- Chip capacitors** Discrete devices which introduce capacitance into an electronic circuit, made in tiny wedge or rectangular shapes to be fired onto hybrid circuits.
- Chip component** An unpackaged circuit element (active or passive) for use in hybrid microelectronics. Besides ICs, the term includes diodes, transistors, resistors, and capacitors.
- Chip-outs** Semiconductor die defects where fragments of silicon on the face have been chipped off in processing, leaving an active junction exposed.
- Circuit** The interconnection of a number of devices in one or more closed paths to perform a desired electrical or electronic function.
- Clean room** A work station or processing area in which steps are taken (e.g., air filtering) to protect incomplete circuits from dust and contamination.
- Clear** An asynchronous input. Also called Reset. To restore a memory element or flip-flop to a "standard" state, forcing the Q terminal to logic "0."
- Clearance** The shortest distance between the outer edges of images applied in sequence.
- Clock** A pulse generator which controls the timing of computer switching circuits and memory stages and regulates the speed at which the computer central processor operates. It serves to synchronize all operations in a digital system.
- Clock input** That terminal on a flip-flop whose condition or change of condition controls the admission of data into a flip-flop through the synchronous inputs and thereby controls the output state of the flip-flop. The clock signal performs two functions: (1) It permits data signals to enter the flip-flop; (2) after entry, it directs the flip-flop to change state accordingly.
- CML (Current Mode Logic)** Logic in which transistors operate in the unsaturated mode as distinguished from most other logic types which operate in the saturation region. This logic has very fast switching speeds and low logic swings. Also called ECL or MECL.
- CMOS** Complementary metal-oxide semiconductor. Device formed by the combination of a PMOS and an NMOS (P-type and N-type channel semiconductors).
- Co-fire** To place circuits onto an unfired ceramic and fire both circuits and ceramic simultaneously.
- Collector junction** The semiconductor junction in a transistor between the collector and base regions.
- Collector** Device used to collect substrates from a screen printer and deposit them, in rows, onto a conveyor/dryer or furnace belt.
- Compliant bond** A bond which uses an elastically and/or plastically deformable member to impart the required energy to the lead.
- Component** A packaged functional unit consisting of one or more circuits made up of devices, which (in turn) may be part of an operating system or subsystem. A part of, or division of, the whole assembly or equipment.
- Component part** A term sometimes used to denote a passive device.
- Component placement equipment** Automatic systems for sorting and placing components onto hybrid circuit substrates: consisting of indexing-conveyor, sorter, placement heads, missing component detector, programmable electro-pneumatic control, and options to handle special requirements.
- Con/dryer** Process equipment designed to receive screen printed substrates and dry the ink on the substrate while conveying them away.
- Contact printing** Print mode in screen printing wherein entire substrate contacts bottom surface of screen during print cycle. Necessary when using metal masks.
- Contaminant** An impurity or foreign substance present in a material that affects one or more properties of the material.
- Cosmetic defect** A variation from the conventional appearance of an item, such as a slight change in color: not necessarily detrimental to performance.
- Corrosion** In semiconductors, a defect in or on the aluminum metallization, usually a white crystalline growth.
- Counter** A device capable of changing states in a specified sequence upon receiving appropriate input signals. The output of the counter indicates the number of pulses which have been applied. (See also Divider.) A counter is made from flip-flops and some gates. The output of all flip-flops are accessible to indicate the exact count at all times.
- Counter, binary** An interconnection of flip-flops having a signal input so arranged to enable binary counting. Each time a pulse appears at the input, the counter changes state and tabulates the number of input pulses for readout in binary form. It has a  $2^n$  possible counts where  $n$  is the number of flip-flops.
- Counter, ring** A special form of counter sometimes called a Johnson or shift counter which has very simple wiring and is fast. It forms a loop or circuits of interconnected flip-flops so arranged that only one is "0" and that as input signals are received, the positioning of the "0" state moved in sequence from one flip-flop to another around the loop until they are all "0," then the first one goes to "1" and this moves in sequence from one flip-flop to another until all are "1." It has  $2 \times n$  possible counts where  $n$  is the number of flip-flops.
- Cover lay, cover coat** Outer layer(s) of insulating material applied over the conductive pattern on the surface of the substrate.
- Crazing** Minute cracks on or near the surface of materials such as ceramic.
- Data** Term used to denote facts, numbers, letters, symbols, binary bits presented as voltage levels in a computer. In a binary system data can only be "0" or "1."
- DCTL (Direct-Coupled Transistor Logic)** Logic employing only transistors as active circuit elements.
- Debug** To remove malfunctions from a system or device.

**Decimal** A system of numerical representation which uses ten numerals 0, 1, 2, 3, ..., 9. Each numeral is called a digit. A number system to the radix 10.

**Defect** Any deviation from the normally accepted characteristics of a product or component.

**Delay** The slowing up of the propagation of a pulse either intentionally, such as to prevent inputs from changing while clock pulses are present, or unintentionally as caused by transistor rise and fall time pulse response effects.

**Detailed logic diagram** A diagram that depicts all logic functions and also shows nonlogic functions, socket locations, pin numbers, test points, and other physical elements necessary to describe the physical and electrical aspects of the logic. The detailed logic diagram is used primarily to facilitate the rapid diagnosis and localization of equipment malfunctions. It also is used to verify the physical consistency of the logic and to prepare fabrication instructions. The symbols are connected by lines that represent signal paths.

**Detritus** Fragments of material produced during resistor trimming which remain in the trimmed area.

**Device** The physical realization of an individual electrical element in a physical independent body which cannot be further reduced or divided without destroying its stated function. This term is commonly applied to active devices. Examples are transistors, pnpn structures, tunnel diodes, resistors, capacitors, and inductors.

**Diamond powders, grits, and compounds** These materials are used mainly as abrasives for processes such as lapping and polishing, abrasives in abrasive trimming, or to create the cutting surface of slicing equipment.

**Die** A tiny piece of semiconductor material, broken from a semiconductor slice, on which one or more active electronic components are formed. (Sometimes called chip).

**Die bonding** Attaching the semiconductor chip to the substrate, with an epoxy, eutectic, or solder alloy.

**Dielectric isolation** The use of silicon dioxide barriers created during silicon IC processing to provide isolation between components on a chip.

**Diffusion** A process, used in the production of semiconductors, which introduces minute amounts of impurities into a substrate material such as silicon or germanium and permits the impurity to spread into the substrate. The process is very dependent on temperature and time.

**Diffusion and oxidation systems** Equipment in which non-conductive materials are made semiconductive by diffusing controlled amounts of selected impurities into the surface and the surface of silicon is oxidized selectively to provide a protective or insulative layer. Diffusion and oxidation are accomplished by exposing the silicon wafer to specific atmospheres in a high temperature furnace.

**Diffusion depth testing** A diffusion depth tester determines to what depth diffused impurities have been implanted into a wafer under ion implantation.

**Digital circuit** A circuit which operates in the manner of a switch, that is, it is either "on" or "off." More correctly should be called a binary circuit.

**Diode** A device permitting current to flow in one direction only. Diodes are used in logic circuits to control the passage or nonpassage of a signal from one element to another.

**Discrete** Having an individual identity. Fabricated prior to installation, and/or separately packaged, not part of an integrated circuit.

**DIP** Dual in-line package.

**Discrete circuits** Electronic circuits built of separate, individually manufactured, tested, and assembled diodes, resistors, transistors, capacitors, and other specific electronic components.

**Discrete component** A circuit component having an individual identity, such as a transistor, capacitor, or resistor.

**Divider (Frequency)** A counter which has a gating structure added which provides an output pulse after receiving a specified number of input pulses. The outputs of all flip-flops are not accessible.

**Dopants** Selected impurities introduced into semiconductor substrates in controlled amounts, the atoms of which form negative (n-type) and positive (p-type) conductive regions. Phosphorus, arsenic, and antimony are n-type dopants for silicon; boron, aluminum, gallium, and indium are p-type dopants for silicon.

**Doping** Addition of controlled impurities to a non-conductive material to achieve the desired semiconductor characteristic, accomplished through thermal diffusion or ion implantation.

**Dot "AND"** Externally connecting separate circuits or functions so that the combination of their outputs results in an "AND" function. The point at which the separate circuits are wired together will be a "1" if all circuits feeding into this point are "1" (also called WIRED "OR").

**Dot "OR"** Externally connecting separate circuits or functions, so that the combination of their outputs results in an "OR" function. The point at which the separate circuits are wired together will be a "1" if any of the circuits feeding into this point are "1."

**Driver** An element which is coupled to the output stage of a circuit in order to increase its power or current handling capability or fanout; for example, a clock driver is used to supply the current necessary for a clock line.

**DTL (Diode-Transistor Logic)** Logic employing diodes with transistors used only as inverting amplifiers.

**Dual-in-line package (DIP)** Carrier in which a semiconductor integrated circuit is assembled and sealed. Package consists of a plastic or ceramic body with two rows of seven vertical leads which are inserted into a circuit board and secured by soldering.

**Durometer** An instrument for measuring the hardness of the squeegee material for screen printing.

**ECL** Emitter-coupled logic; a type of current mode logic in which the circuits are coupled with one another through emitter followers at the input or output of the logic circuit.

**Ejection** Wipe off or removal of the printed part from the workholder, in screen printing.

**Electrical element** The concept in uncombined form of the individual building blocks from which electric circuits are synthesized.

**Electron beam bonding** Process using a stream of electrons to heat and bond two conductors within a vacuum.

**Electron beam lithography** Lithography in which the radiation sensitive film or resist is placed in the vacuum chamber of a scanning beam electron microscope and exposed by an electron beam under digital computer control.

**Electron beam welding** Process in which welder generates a stream of electrons traveling at up to 60% of the speed of light, focuses it to a small, precisely controlled spot in a vacuum, and converts the kinetic energy into extremely high temperature on impact with the workpiece.

**Emitter** The region of transistor from which charge carriers (minority carriers in the base) are injected into the base.

**Enable** To permit an action or the acceptance or recognition of data by applying appropriate signals (generally a logic "1" in a positive logic) to the appropriate input. (See Inhibit.)

**Encapsulate** To embed electronic components or other entities in a protective coating, usually done when the plastic encapsulant is in fluid state so that it will set in solid form as an envelope around the work.

**Entrapment** The damaging admission and trapping of air, flux, and fumes, caused by contamination and plating process defects.

**Epitaxial** Pertaining to a single-crystal layer on a crystalline substrate, and having the same crystalline orientation as the substrate: e.g., silicon atoms condensed from vapor phase onto a silicon-wafer substrate.

**Epitaxial growth** A process of growing layers of material on a selected substrate. Usually silicon is grown in a silicon substrate. Silicon and other semiconductor materials may be grown on a substrate with compatible crystallography, such as sapphire (silicon-on-sapphire).

**Epitaxial layer** A precisely doped, thin layer of silicon grown on a p-doped thick wafer and into which n-type semiconductor junctions are diffused.

**EPROM** Electrically programmable read only memory.

**Etch factor** The ratio of depth of etch to the amount of undercut.

**Exclusive "OR"** A logical function whose output is "1" if either of the two variables is "1" but whose output is "0" if both inputs are "1" or both are "0."

**Exposure** The act of subjecting photosensitive surfaces or matter to radiant energy such as light to produce an image.

**Evaporation and sputtering materials** Metals used for evaporation charges and sputtering targets, including: *chromium* and its alloys, for (1) a thin adhesive layer on IC substrates to allow better deposition of gold or other metal, (2) resistor material, and (3) vacuum deposition in mask production; *aluminum* and certain Al alloys, for first layer deposition in MOS technology; *molybdenum*, as a conductor or adhesive layer for IC fabrication; and *titanium*, as an intermediate adhesive layer for beam-lead interconnection.

**Evaporation sources** Boats and filaments used as heat sources for vacuum evaporation to form thin film layers on substrates. The process is frequently done by resistively heating the evaporant in a ceramic crucible or by self-heating or boats constructed of tungsten, molybdenum, or tantalum.

**Extrinsic properties** Properties introduced into a semiconductor by impurities with a crystal.

**Extrinsic semiconductor** The resulting semiconductor produced when impurities are introduced into an otherwise non-semiconductor crystal. The electrical properties depend upon the impurities.

**Face bonding** Process of bonding semiconductor chip so that its circuitry side faces the substrate. Flipchip and beam lead bonding are two common methods. (Opposite of back bonding.)

**Fall time** A measure of the time required for the output voltage of a circuit to change from a high voltage level to a low voltage level once a level change has started. Current could also be used as the reference, that is, from a high current to a low current level.

**Fanin** The number of inputs available to a specific logic stage of function.

**Fanout** The number of input stages that can be driven by a circuit output.

**Fast ADDER** (See Anticipated CARRY ADDER.)

**FEB (Functional Electronic Block)** Another name for a monolithic integrated circuit of thick-film circuit.

**Feedback** When part of the output of a circuit is channeled back to an input, it is said to have feedback. When part of the output of an amplifier is routed back to augment the input signal, the amplifier has positive feedback or if this rechanneling is employed to diminish the input it is called negative feedback.

**FET** Field effect transistor; semiconductor device in which resistance between source and drain terminals is modulated by a field applied to the third (gate) terminal.

**Film conductor** Electrically conductive material formed by deposition on a substrate.

**Film microcircuit** Thin or thick film network forming an electrical interconnection of numerous devices.

**Film resistor** A device whose resistive material is a film on an insulator substrate; resistance value is determined by trimming.

**Final seal** The hybrid microelectronic packaging step which encloses the circuit so that further internal processing cannot be performed without disassembly.

**Flatpack** Subassembly composed of two or more stages made up of integrated circuits and thin film components mounted

on a ceramic substrate. This semiconductor network is enclosed in a shallow rectangular package with the connecting leads projecting from edges of the package.

**Flip-chip** A generic term describing a semiconductor device having all terminations on one side of the form of bump contacts. After the surface of the chip has been passivated or otherwise treated, it is flipped over for attaching to a matching substrate.

**Flip-flop (storage element)** A circuit having two stable states and the capability of changing from one state to another with the application of a control signal and remaining in that state after removal of signals. (See Bistable element.)

**Flip-flop, "D"** D stands for delay. A flip-flop whose output is a function of the input which appeared one pulse earlier; for example, if a "1" appeared at the input, the output after the next clock pulse will be a "1."

**Flip-flop, "J-K"** A flip-flop having two inputs designated J and K. At the application of a clock pulse, a "1" on the "J" input and a "0" on the "K" input will set the flip-flop to the "1" state; a "1" on the "K" input and a "0" on the "J" input will reset it to the "0" state; and "1"s simultaneously on both inputs will cause it to change state regardless of the previous state. J = 0 and K = 0 will prevent change.

**Flip-flop, "R-S"** A flip-flop consisting of two cross-coupled NAND gates having two inputs designated "R" and "S." A "1" on the "S" input and "0" on the "R" input will reset (clear) the flip-flop to the "0" state, and "1" on the "R" input and "0" on the "S" input will set it to the "1." It is assumed that "0"s will never appear simultaneously at both inputs. If both inputs have "1"s it will stay as it was. "1" is considered nonactivating. A similar circuit can be formed with NOR gates.

**Flip-flop, "R-S-T"** A flip-flop having three inputs, "R," "S," and "T." This unit works as the "R-S" flip-flop except that the "T" input is used to cause the flip-flop to change states.

**Flip-flop, "T"** A flip-flop having only one input. A pulse appearing on the input will cause the flip-flop to change states. Used in ripple counters.

**Floating squeegee** This squeegee, as opposed to a rigid squeegee, has the ability to produce a rocking movement on the horizontal plane in screen printing.

**Flood stroke** Return stroke of squeegee in screen printing which redistributes ink back over the pattern. Provides for proper ink control, and is especially useful for thixotropic inks. (See "Print Stroke".)

**Fluid flow masking** A gold electro-plating technique in which the work to be plated is the cathode and current flows through the fluid stream of plating material, allowing control of deposit at the point of contact between the stream and the workpiece.

**Furnaces, diffusion and firing** Systems designed for enclosed elevated temperature processing of solid state devices and systems, in gaseous atmospheres. Diffusion furnaces are operated at temperatures from 1,000 to 1300°C to achieve doping of semiconductor substrates, by one of a number of processes. Oxidation is a process that puts a protective layer of silicon oxide on the wafer and is used either as an insulator or to mask out certain areas when doping. Deposition systems, of which there are three (liquid, gaseous, solid), are used to deposit impurities on the silicon wafer. Other systems include a drive-in system used to diffuse impurities into the wafer to a specified level, and an alloy system which is used in a final step of the metallization process. Firing furnaces are used for the curing of multilayer ceramics for integrated electronics and for the firing of thick film materials on microcircuits.

**Furnace, screen printing** Process equipment designed to cure substrates after screen printing and drying.

**FULL ADDER** See Adder.

**Gate** 1. A circuit having an output and a multiplicity of inputs designed so that the output is energized only when a certain combination of pulses is present at the inputs. An AND-gate delivers an output pulse only when every input is energized simultaneously in a specified manner. An OR-gate delivers an output pulse when any one or more of the pulses meet the specified conditions. 2. An electrode in a field effect transistor. 3. A circuit that admits and amplifies or passes a signal only when a gating (triggering) pulse is present. 4. A circuit in which one signal serves to switch another signal on and off.

#### Gate definitions below assume positive logic

**Gate, AND** All inputs must have "1" level signals at the input to produce a "1" level output.

**Gate, NAND** All inputs must have "1" level signals at the input to produce a "0" level output.

**Gate, NOR** Any one input or more than one input having a "1" level signal will produce a "0" level output.

**Gate, OR** Any one input or more than one input having a "1" level signal will produce a "1" level output.

**Gates (decision elements)** A circuit having two or more inputs and one output. The output depends upon the combination of logic signals at the input.

**Germanium polycrystalline** A prime raw material for making crystal ingots.

**Glassivation** A deposited layer of glass on top of a metallized wafer or chip; primarily a protective layer.

**Glazed substrate** Ceramic substrate with a glass coating to effect a smooth and nonporous surface.

**Green ceramic** Unfired ceramic material.

**Green substrate** Unfired material in substrate form. Normally substrates are printed after firing. Under special circumstances, however, green (unfired) substrates are printed.

**Half ADDER** A switching circuit which combines binary bits to generate the SUM and the CARRY. It can only take in the two binary bits to be added and generate the SUM and CARRY (see also ADDER).

**Half shift register** Another name for certain types of flip-flops when used in a shift register. It takes two of these to make one stage in a shift register.

**Header** Base of a hybrid circuit package, holding the leads.

**High** See Binary logic.

**High temperature reverse bias** Burn-in type test of diodes and transistors conducted with the junctions reverse biased to effect any failure due to ion migration in bonds of dissimilar metals

**Hole** A mobile vacancy or electron deficiency in the valence structure of a semiconductor. It is equivalent to a positive charge.

**HTRB** High temperature reverse bias.

**Hybrid** A method of manufacturing integrated circuits by using a combination of monolithic, thin-film and thick-film techniques.

**IC** Integrated circuit.

**IC socket** Female contact which provides pluggable electrical engagement on its inner surface for integrated circuit components to achieve interfacing to a PCB.

**Image/pattern** The printed screen or design on the substrate after screen printing.

**Inhibit** To prevent an action, or acceptance of data, by applying an appropriate signal to the appropriate input (generally a logic "0" in positive logic). (See Enable.)

**Ink** In hybrid technology the conductive paste used on thick film materials to form the printed conductor pattern. Usually contains metals, metal oxide, glass frit, and solvent.

**Input/output** Interface circuits or devices offering access between external circuits and the central processing unit or memory.

**Integrated circuit (EIA definition)** (1) "The physical realization of a number of electrical elements inseparably associated on or within a continuous body of semiconductor material to perform the functions of a circuit." (See Slice and Chip.) (2) Electronic circuits or systems consisting of an interconnected array of extremely small active and passive elements, inseparably associated on or within a continuous substrate or body. Other names are *integrated electronic circuit*, *integrated electronic system*, and *integrated microcircuit*.

**Integrated injection logic** Integrated circuit logic which uses bipolar transistor gates. Makes possible large scale integration on silicon for logic arrays and other analog and digital applications.

**Inverter** A circuit whose output is always in the opposite state from the input. This is also called a NOT circuit. (A teeter-totter is a mechanical inverter.)

**I/O** Input/output.

**Ion implantation** Precise and reproducible method of doping semiconductors to achieve a desired characteristic. Ions of the particular dopant are energized and accelerated to the point where they can be driven in a focused beam directly into the silicon wafer. This technique assures uniform, accurately controlled depth of implantation and ionic diffusion in the wafer.

**Ion milling** Ion milling is a VLSI production technique that performs many of the same type of tasks that more traditional wet chemical and plasma etching processes do.

**ISHM** The International Society for Hybrid Microelectronics.

**Isolation diffusion** In MIC technology, the diffusion step which generates back-to-back junctions to isolate active devices from one another.

**Josephson effect** The tunneling of electron pairs through a thin insulating barrier between two superconducting materials.

**Junction** A joining of two different semiconductors or of semiconductor and metal. Alloy, diffused, electrochemical, and grown are the four junction types.

**Kerf** The slit or channel cut in a resistor during trimming by laser beam of abrasive jet.

**Laminar flow** A directed stream of filtered air moved constantly across a clean work station, usually parallel to the workbench surface.

**Land area in imaging** Closed spaces in the screen which result in open spaces on the printed image in screen printing.

**Lapping** Grinding and polishing such products as semiconductor blanks in order to obtain precise thicknesses or extremely smooth, flat, polishing surfaces.

**Large-scale integration (LSI)** Usually denotes arrays of integrated circuits on a single substrate that comprise 100 or more individual active circuit functions or gates.

**Laser bonding** A process which forms a metal-to-metal fastened union, using a laser heat source to join conductors.

**Laser trim** The adjustment (upward) of a film resistor value by applying heat from a focused laser source to remove material.

**Laser welding** Process in which thermal energy released by a laser impinging upon the surface of a metal is conducted into the bulk of the metal work-piece by thermal conduction, bonding component leads to highly conductive materials such as copper printed circuitry.

**Lead frame** The metal part of a solid state device package which achieves electrical connection between the die and other parts of the systems of which the IC is a component. Large scale integrated circuits are welded onto lead frames in such a way that leads are available to facilitate making connections to and from the various solid state devices to the packages.

**Leadless inverted device (LID)** A shaped, metallized ceramic form used as an intermediate carrier for the semiconductor chip devices, especially adapted for attachment to conductor lands of a thick or thin film network by reflow solder bonding.

**Leak detectors** Applied only to hermetic devices, fine leak detectors are used to detect defects in sealing that are too small to be detected by gross-leak methods. Devices are placed in a bomb pressurized with a mixture of gases.

**LID** Leadless inverted device.

**Life aging** Burn-in test which moderates the elevation of temperature and extends the time period in order to test overall device quality as opposed to infant mortality.

**Linear circuit** A circuit whose output is an amplified version of its input, or whose output is a predetermined variation of its input.

**Logic** A mathematical arrangement using symbols to represent relationships and quantities, handled in a microelectronic network of switching circuits or gates, which perform certain functions; also, the type of gate structure used in part of a data processing system.

**Logic diagram** A picture representation for the logical functions of AND, OR, NAND, NOR, NOT.

**Logic function** A combinational, storage, delay, or sequential function expressing a relationship between variable signal input(s) to a system or device and the resultant output(s).

**Logic swing** The voltage difference between the two logic levels "1" and "0."

**Logic symbol** The graphic representation of the aggregate of all the parts implementing a logic function.

**Low** See Binary logic.

**LSI** Large scale integration.

**Magnetic integrated circuit** The physical realization of one or more magnetic elements inseparably associated to perform all, or at least a major portion, of its intended function.

**Masks, microelectronic** Thin metals or other materials with an open pattern designed to mask off or shield selected portions of semiconductors or other surfaces during deposition processes. There also are photomasks or optical masks for contact or projection printing of wafers—these may use an extremely flat glass substrate with iron oxide, chrome, or emulsion coating. There also are thick film screen masks.

**Medium scale integration (MSI)** The physical realization of a microelectronic circuit fabricated from a single semiconductor integrated circuit having circuitry equivalent to more than 10 individual gates or active circuit functions.

**Memory** The semi-permanent storage of numbers, in digital form, in a circuit or system. With reference to computers, the term also describes the storage capability or location and which receives and holds information for later use. Also, the storage arrangement, such as RAM or other type.

**Metalization** The selective deposition of metal film on a substrate to form conductive interconnection between IC elements and points for connections with the outside world.

**Metal-oxide-semiconductor (MOS)** A metal over silicon oxide over silicon arrangement which produces circuit components such as transistors. Electrical characteristics are similar to vacuum tubes.

**MIC** Monolithic integrated circuit.

**Microbond** The realization of a very small fastened joint between conductors or between a conductor and a microelectronic chip device.

**Microcircuit** The physical realization of a hybrid or monolithic interconnected array of very small active and passive electronic elements.

**Microelectronics** The entire spectrum of electronic art dealing with the fabrication of sophisticated, practical systems using miniaturized electronic components. Microelectronics has developed along two basic technologies—monolithic integrated circuits and hybrid integrated circuits.

**Microminiaturization** The process of packaging an assembly of microminiature active and passive electronic elements, replacing an assembly of much larger and different parts.

**Micromodule** A microcircuit constructed of a number of components (e.g., microwafers) and encapsulated to form a block that is still only a fraction of an inch in any dimension.

**Microprobe** An extremely sharp and small exploring tool head attached to a positioning handle, used for testing microelectronic circuits by establishing ohmic contact.

**Microprocessor** An IC package incorporating logic, memory, control, computer, and /or interface circuits, the whole of which is designed to handle certain functions.

**Microwave integrated circuit** The physical realization of an electronic circuit operating at frequencies above one gigahertz and fabricated by microelectronic techniques. Either hybrid or monolithic integrated circuit technology may be utilized.

**Minority carrier** The less-predominant carrier in a semiconductor. Electrons are the minority in p-type; holes are the minority in n-type semiconductors.

**Mobility** The ease with which charge carriers can move through a semiconductor. Generally electrons and holes do not have equal mobility in a given semiconductor. Mobility is higher in germanium than in silicon.

**Module** A packaging unit displaying regularity and separable repetition. It may or may not be separable from other modules after initial assembly. Usually all major dimensions are in accordance with a prescribed set of dimensions.

**Molecular beam epitaxy equipment** This equipment is used for growing epitaxial thin films under UHV conditions by directing beams of atoms or molecules created by thermal or electron beam evaporation onto clean, heated substrates.

**Molecular electronics** Simply, electronics on a molecular scale, dealing with the production of complex circuitry in semiconductor devices with integral elements processed by growing multi-zoned crystals in a furnace for the ultimate performance of electrical functions.

**Monolithic** Refers to the single silicon substrate in which an integrated circuit is constructed. (See Integrated circuit.)

**Monolithic integrated circuit** The physical realization of electronic circuits or sub-systems from a number of extremely small



circuit elements inseparably associated on or within a continuous body or a thin film of semiconductor material.

**Morphology, integrated** The structural characterization of an electronic component in which the identity of the current or signal modifying areas, patterns, or volumes has become lost in the integration of electronic materials, in contrast to an assembly of devices performing the same function.

**Morphology, transitional** The structural characterization of an electronic component in which the areas or patterns of resistive, conductive, dielectric, and active materials in or on the surface of the structure can be identified in a one-to-one correspondence with devices assembled to perform an equivalent function.

**MOS** Metal-oxide-semiconductor. A technology for producing transistors that incorporates metal over oxide over silicon layers. Electrical characteristics are similar to vacuum tubes.

**MSI** Medium scale integration.

**MTNS** Metal thick nitride semiconductor, which is similar to an MTOS device except that a thick silicon nitride or silicon nitride-oxide layer is used instead of just plain oxide.

**MTOS** Metal thick oxide semiconductor, where the oxide outside the desired active gate area is made much thicker in order to reduce problems with unwanted parasitic effects.

**Multichip integrated circuit** Hybrid integrated circuit which includes two or more SIC, MSI, or LSI chips.

**Multilayer dielectric** A compound including glass and ceramic which is applied as an insulating barrier between conductors for multi-layer and crossover work.

**"NAND"** A Boolean logic operation which yields a logic "0" output when all logic input signals are logic "1."

**Negative logic** Logic in which the more negative voltage represents the "1" state; the less negative voltage represents the "0" state. (See Binary logic.)

**Network** A collection of elements, such as resistors, coils, capacitors, and sources of energy, connected together to form several interrelated circuits.

**NMOS** N-channel MOS circuits, using currents made up of negative charges and producing devices at least twice as fast as PMOS.

**Noble metal paste** A soft, moist, smooth compound made up partially of precious metals such as gold, platinum, ruthenium, or others classed as noble metals, providing conductors in film circuitry.

**Noble system** Thick film system using conductors of gold, platinum, and possibly palladium silver, or certain alloys of these precious metals.

**Noise immunity** A measure of the insensitivity of a logic circuit to triggering or reaction to spurious or undesirable electrical signals or noise, largely determined by the signal swing of the logic. Noise can be either of two directions, positive or negative.

**Non-noble system** Thick film system using conductors of copper, tungsten, nickel, molybdenum, and other non-noble metals.

**"NOR"** A Boolean logic operation which yields a logic "0" output with one or more true "1" input signals.

**"NOT"** A Boolean logic operation indicating negation, not "1." Actually an inverter. If inputs is "1" output is NOT "1" but "0." If the input is "0" output is NOT "0" but "1." Graphically represented by a bar over a Boolean symbol such as A. A means "when A is not 1."

**n-Region** The zone in a semiconductor in which electron density is greater than hole density.

**n-type** Semiconductor material whose impurities produce free electrons in the compound, leading to conduction.

**n-type semiconductor** An extrinsic semiconductor in which electron density exceeds hole density. An electron donor type.

**Off-contact printing** Print mode wherein screen printer's squeegee stretches screen to touch the substrate and deposit ink. Usually 0.010" snap-off is used. Allows thicker ink deposition.

**Offset** The change in input voltage required to produce a zero output voltage in a linear amplifier circuit. In digital circuits it is the dc voltage on which a signal is impressed.

**One ("1")** See Binary Logic.

**"OR"** A Boolean logic operation used to identify the logic operation wherein two or more true "1" inputs only add to one true "1" output. Only one input needs to be "true" to produce a "true" output. The graphical symbol for "OR" is a plus sign (+).

**Overglaze** A glass compound in low-melting, vitreous form, used as a coating to passivate thick film resistors and offer mechanical protection.

**Overlap** The contact area between a film resistor and film conductor.

**Packaging** The process of physically locating, connecting, and protecting devices or components.

**Packaging density** The number of devices or equivalent devices per unit volume in a working system or subsystem.

**Pad** In IC technology, the bonding area.

**Parallel gap welding** Type of resistance welding wherein electrodes contact the work from one side only. Mechanism by which bonding occurs is virtually always fusion. Process is well suited to welding component leads to planar surfaces such as IC leads to PC conductors.

**Parallelity** Relationship of screen to work-holder and print head in screen printing. Each should be parallel to one another in order to print accurately.

**Parameter** Any specific characteristic of a device. When considered together, all the parameters of a device describe its operational and physical characteristics.

**Parallel** This refers to the technique for handling a binary data word which has more than one bit. All bits are acted upon simultaneously. It is like the line of a football team. Upon a signal all line men act. (See also Serial.)

**Parallel Adder** A conventional technique for adding where the two multibit numbers are presented and added simultaneously (parallel). A ripple adder is still a parallel adder; the carry is rippled from the least significant to the most significant bit. Another type of parallel adder is the "Look Ahead," or "Anticipated Carry" adder. (See Ripple ADDER and Fast ADDER.)

**Parallel operation** The organization of data manipulation within computer circuitry where all the digits of a word are transmitted simultaneously on separate lines in order to speed up operation, as opposed to serial operation.

**Particle impact noise detection (PIND)** PIND testing equipment detects any loose foreign particles that may be present in a hermetic package. The package is placed on a shaker table where it is in intimate contact with an acoustic transducer that drives an ultrasonic amplifier.

**Parts handling** Devices used to load and unload substrates during screen printing and drying operations.

**Passivation** The growth of an insulating layer on the surface of a semiconductor to provide electrical stability by isolating the transistor surface from electrical and chemical conditions in the environment. It reduces reverse-current leakage, increases breakdown voltages, and improves the power-dissipation rating.

**Passive elements** Resistors, inductors, or capacitors, elements without gain.

**Passive substrate** A substrate for an integrated component which may serve as physical support and thermal link to a thick- or thin-film integrated circuit, but which exhibits no transistance. Examples of passive substrates are glass, ceramic, and similar materials.

**Paste** Synonymous with "composition" and "ink" when relating to screenable, thick film materials.

**Pattern/image** The open area in the screen through which the ink penetrates to become the printed image on the substrate, in screen printing.

**Photomask** A square, flat glass substrate, coated with a photographic emulsion or a very thin layer of metal, on which appear several hundred circuit patterns (each containing thousands of images). The patterns are exposed onto semiconductor wafers.

**Photoresists and processing materials** These are light sensitive materials that are deposited as a uniform film on a wafer or substrate. The exposure of specific pattern is performed through masking operations.

**Pinhole** A minute hole through a layer or pattern.

**Planar process** Fabrication of MICs and semiconductor devices using silicon dioxide as a masking agent and producing components on a single plane.

**Plate** Plate which holds substrate during screen printing.

**Plating** The deposition of a metal layer on a substrate surface by electrolytic or certain chemical means. The materials include gold, copper, solder, etc. The functions of the metal plate vary, including corrosion protection, solderability enhancement, etch resist, bonding for lead frames, and electrical connection, among others.

**PMOS** P-channel MOS; refers to the oldest type of MOS circuit where the electrical current is a flow of positive charges.

**Polishing** A mechanical finishing operation conducted upon solid state substrates to achieve smoothness and desired surface qualities. See *Lapping*.

**Porcelainize** To coat and fire a metal with glass material, forming a hybrid circuit substrate.

**Positive logic** Logic in which the more positive voltage represents the "1" stage. (See Binary logic.)

**Preset** An input like the Set input and which works in parallel with the Set.

**Probing** A term used to describe electrical testing that employs very finely-tipped probes applied sequentially to each of the finished dice of a wafer.

**PROM** Programmable read-only memory; a ROM which requires a programming operation.

**Propagation delay** A measure of the time required for a change in logic level to be transmitted through an element or a chain of elements.

**Propagation time** The time necessary for a unit of binary information (high voltage or low) to be transmitted or passed from one physical point in a system or subsystem to another. For example, from input of a device to output.

**p-type semiconductor** An extrinsic semiconductor in which the hole density exceeds the conduction electron density. An electron acceptor type.

**Print stroke** Stroke of the squeegee in screen printing at which time ink is forced through the pattern on the screen.

**Print-print** Squeegee prints in both directions per substrate in screen printing process.

**Printer** Process unit designed to accept, hold, and screen print a substrate in order that ink may be applied with extremely accurate and repeatable registration.

**Pulse** A signal of very short duration.

**Purple plague** Defect-causing formation of gold-aluminum chemical compounds often produced when gold and aluminum are bonded. Purple in color, brittle, subject to degenerative failure, and sometimes compounded by inclusion of silicon.

**Q output** The reference output of a flip-flop. When this output is "1" the flip-flop is said to be in the "1" state; when it is "0" the output is said to be in the "0" state. (See also State and Set.)

**Q output** The second output of a flip-flop. It is always opposite in logic level to the Q output.

**RAM** Random access memory; a type of memory which offers access to storage locations within it by means of X and Y coordinates.

**RCTL (Resistor-Capacitor-Transistor-Logic)** Same as RTL except that capacitors are used to enhance switching speed.

**Register** A device which can store information, usually that contained in a small subset or word of the total within a digital computer system.

**Registration** The degree of proper alignment of a circuit pattern on the substrate.

**Resist** Material such as ink, paint, or metallic plating, used to protect the desired portions of the printed conductive pattern from the action of the etchant, solder, or plating.

**Reset** Also called clear. Similar to Set except it is the input through which the Q output can be made to go to "0."

**Rigid squeegee** Firm mounting of the screen printer squeegee blade and holder. Squeegee adjustment is more critical.

**Ripple** The transmission of data serially. It is a serial reaction analogous to a bucket brigade or a row of falling dominoes.

**Ripple ADDER** A binary adding system similar to the system most people used to add decimal numbers—that is, add the "units" column, get the carry, add it to the "10's" column, get the carry, add it to the "100's" column, and so on. Again it is necessary to wait for the signal to propagate through all columns even though all columns are present at once (parallel). Note that the carry is rippled.

**Ripple counter** A binary counting system in which flip-flops are connected in series. When the first flip-flop changes it effects the second which effects the third and so on. If there are ten in a row, the signal must go sequentially from the first flip-flop to the tenth.

**Risers** In a multilayer substrate, the conductive paths that vertically connect various levels.

**Rotary (theta) motion** Angular (rotary) adjustment of image to substrate. Allows registration in angularity in addition to "X" and "Y" in screen printing. (Also called Theta motion.)

**Rise time** A measure of the time required for the output voltage of a state to go from a low voltage level ("0") to a high voltage level ("1") once a level change has been started.

**ROM** Read-only memory; a random access storage in which the data pattern is unchangeable after manufacture.

**RTL (Resistor-Transistor-Logic)** Logic is performed by resistors. Transistors are used to produce an inverted output.

**Sapphire substrates** Materials which provide a uniform dielectric constant, controlled orientation, thermal conductivity, and the single crystal surface desired for SOS, hybrid IC, and other microcircuit systems. The material may be grown directly in ribbons, tubes, filaments, and sheets.

**Screen** Tensioned mesh material with an open pattern through which ink penetrates to place an image on the substrate. Screen is above and parallel to the substrate during screen printing.

**Screen printing, thick film** The art of depositing conductive, resistive, and insulating materials on a dielectric base. This deposition is made through selected open areas in screens with inks or pastes forced through the open areas of the screen by squeegee motion onto the substrate base. In some cases, masks instead of conventional mesh screens may be used.

**Scribing** Scratching a tooled line or laser path on a brittle substrate to allow a wafer to be cleft or broken along the line, producing IC chips when all brakes are completed.

**Scribing machines and tools** Equipment used to separate wafers into individual devices, chips, or dice. This has been done by crude techniques similar to glass cutting, but is now accomplished by more efficient methods, using truncated pyramid diamond scribes, automated machines, conical tools, or lasers.

**SEM** Standard electronic module; a subassembly configuration format which meets a particular U.S. Navy set of specifications. This abbreviation is also used for scanning electron microscope.

**Semiconductor** The name applied to materials which exhibit relatively high resistance in a pure state but much lower resistance when minute amounts of impurities are added. The word is commonly used to describe electronic devices made from semiconductor materials.

**Semiconductor devices** Devices in which the characteristic distinguishing electron conduction takes place within a semiconductor, ranging from the single unit transistor to multiple unit devices such as the semiconductor rectifier. Other devices are diodes, photocells, thermistors, and thyristors.

**Semiconductor integrated circuit (SIC)** The physical realization of a number of electric elements inseparably associated on or within a continuous body of semiconductor material to perform the function of a circuit.

**Serial** The technique for handling a binary data word which has more than one bit. The bits are acted upon one at a time. It is like a parade going by a review point.

**Serial operation** The organization of data manipulation within computer circuitry where the digits of a word are transmitted one at a time along a single line. The serial mode of operation is slower than parallel operation, but utilizes less complex circuitry.

**Set** An input on a flip-flop not controlled by the clock (see Asynchronous inputs), and used to effect the Q output. It is this input through which signals can be entered to get the Q output to go to "1." Note it cannot get Q to go to "0."

**Shear tester** Shear testers are used to determine the integrity of a material or to test the adherence between two attached items. It is used for testing eutectic and epoxy die-bond strengths, and for adherence testing a gold-wire ball bonds, gold and solder chip bumps, external lead frames, coined and welded gold electrical contacts, thick film plating, and more.

**Shift** The process of moving data from one place to another. Generally many bits are moving at once. Shifting is done synchronously and by command of the clock. An 8-bit word can be shifted sequentially (serially)—that is, the 1st bit goes out, 2nd bit takes 1st bit's place, 3rd bit takes 2nd bit's place, and so on, in the manner of a bucket brigade. Generally referred to as shifting left or right. It takes 8 clock pulses to shift an 8-bit word or all bits of a word can be shifted simultaneously. This is called parallel load or parallel shift.

**Shift register** An arrangement of circuits, specifically flip-flops, which is used to shift serially or in parallel. Binary words are generally parallel loaded and then held temporarily or serially shifted out.

**SIC** Semiconductor integrated circuit.

**Silicon** A brittle, gray, crystalline chemical element which, in its pure state, serves as a semiconductor substrate in microelectronics. It is naturally found in compounds such as silicon dioxide.

**Silicon gate** A type of MOS in which the gate is made of silicon instead of metal. It is faster and denser than the metal-gate MOS.

**Silicon nitride** A compound of silicon and nitrogen deposited on the surface of silicon monolithic ICs to impart greater stability.

**Silicon oxide** Silicon monoxide or dioxide or a mixture, the latter of which can be deposited on a silicon IC as insulation between metallization layers.

**Single print** One squeegee print stroke and flood return per substrate, in screen printing.

**Skewing** Refers to time delay or offset between any two signals in relation to each other.

**Slewing rate** Rate at which the output can be driven from limit to limit over the dynamic range.

**Slice** A single wafer cut from a silicon ingot forming a thin substrate on which all active and passive elements for multiple integrated circuits have been fabricated utilizing semiconductor epitaxial growth, diffusion, passivation, masking, photo resist, and metallization technologies. A completed slice generally contains hundreds of individual circuits. (see Chip.)

**Small scale integration** A circuit of under 10 gates, generally involving one metallization level implementing one circuit function in monolithic silicon.

**Snap-off** Distance from top of substrate in screen printing to bottom surface of screen. Squeegee must stretch screen this far to meet the substrate and deposit ink. Set by "Z" motion adjustments.

**Snapstrate** Scored large area substrate which, after screen printing, may be snapped or broken apart into smaller sized substrates.

**Snugger** Device for automatically positioning and holding the substrate in proper position during the print cycle, in screen printing.

**Solder systems for bonding and welding** Processors for ceramic hybrid microcircuits, substrates, lead frames, microassemblies, flat packs, wire memory arrays, ceramic headers, and magnet wire, where solder normally has been pretinned on the substrate or individual components, or solder pastes provide solder without the need for pretinning operations. Temperature controlled preheat, reflow, and cooling stages are involved, with reflow being almost instantaneous.

**Solid state** The electronic properties of crystalline materials (usually semiconductor in type). The interaction of light, heat, magnetic fields, and electric currents in these crystalline materials are involved in solid state devices. Less power is required to operate solid state devices and a greater variety of effects can be obtained. (2) Technology utilizing solid semiconductors in place of vacuum tubes for amplification, rectification, and switching.

**SOS** Silicon-on-sapphire transistor device. Silicon is grown on a passive insulating base (sapphire) and then selectively etched away to form a solid state device.

**Sputtering** A method of depositing a thin film of material onto a substrate. The substrate is placed in a large demountable vacuum chamber having a cathode made of the metal or ceramic to be sputtered. The chamber is then operated so as to bombard the cathode with positive ions. As a result, small particles of the material fall uniformly on the substrate.

**Sputtering targets** These are usually in the form of simple circular or rectangular plates, comprised of a variety of materials, and bombarded by gas ions that transfer their momentum to particles of the target, ejecting them into the vacuum chamber that houses the operation. These particles are then deposited in a thin film on strategically located substrates.

**SSI** Small scale integration.

**Squeegee** Hard, flexible blade with a precision edge which, with applied pressure, forces or pushes ink through the screen in screen printing.

**Squeegee pressure** Downward force exerted upon the screen and substrate by the squeegee during screen printing.

**Squeegee speed** Rate of speed at which the squeegee is driven across the screen during screen printing.

**Stability** The specific ability of electronic circuits or other devices to withstand use and environmental stresses without changing. Also continued operation according to specifications despite adverse conditions.

**State** This refers to the condition of an input or output of a circuit as to whether it is a logic "1" or a logic "0." The state of a circuit (gate or flip-flop) refers to its output. The flip-flop is said to be in the "1" state when its Q output is "1." A gate is in the "1" state when its output is "1."

**Static** In burn-in, the quality of a test wherein the device is subject to either forward or reverse bias applied to appropriate terminals; voltages are unvarying throughout test.

**Steatite** Ceramic material composed mainly of a silicate of magnesium, used as a circuit substrate.

**Step** To use the step-and-repeat method.

**Substrate** The physical material upon which an electronic circuit is fabricated. Used primarily for mechanical support but may serve a useful thermal or electrical function. Also, a material on whose surface an adhesive substance is spread for bonding or coating, or any material which provides a supporting surface for other materials.

**Subsystem** A part or division of a system which in itself has the properties of a system.

**Surface diffusion** The high temperature injection of atoms into the surface layer of a semiconductor material to form the junctions. Usually a gaseous diffusion process.

**Synchronous** Operation of a switching network by a clock pulse generator. All circuits in the network switch simultaneously. All actions take place synchronously with the clock.

**Synchronous inputs** Those terminals on a flip-flop through which data can be entered but only upon command of the clock. These inputs do not have direct control of the output such as those of a gate but only when the clock permits and commands. Called JK inputs or ac set and reset inputs.

**System** A group of integrated circuits or other components interconnected to perform a single function or number of related functions. If further interconnected into a large system, the individual elements are referred to as subsystems.

**Taper testers** A taper tester is used to test one aspect of the dimensional integrity of wafers. Taper results when the two faces of the wafer under test are not parallel.

**TCR** Temperature coefficient of resistance.

**Temperature coefficient of resistance** The amount of change in the resistance of a material per degree of temperature rise.

**Thermal compression bonding** Process of diffusion bonding in which two prepared surfaces are brought into intimate contact, and plastic deformation is induced by the combined effects of pressure and temperature, which in turn results in atom movement causing the development of a crystal lattice bridging the gap between facing surfaces and resulting in bonding.

**Thermistor** A semiconductor device, the electrical resistance of which varies with the temperature. Its temperature coefficient of resistance is high, nonlinear, and usually negative.

**Thick film** Conductive, resistive, and/or capacitive passive network deposited on a substrate using a metallic or resistive film which is more than five microns in thickness.

**Thick film hybrid integrated circuits** The physical realization of a hybrid integrated circuit fabrication on a thick film network.

**Thick film resistor, conductor, and dielectric compositions** The principle materials for making thick film circuits, available in paste form and consisting of mixtures of metal, oxide, and glass powders.

**Thin film** Conductive, resistive, and/or capacitive passive network deposited on a substrate using a metallic or resistive film which is less than five microns in thickness.

**Thin film deposition, chemical vapor type** The CVD technique involves a decomposition and reaction between gases on the surface of a heated substrate such that a solid layer is nucleated and grown. Metals are generally derived from the decomposition of the metal halides. Insulators may be formed by reacting metal halides with oxygen (oxides), ammonia (nitrides), diborane (borides), etc.

**Thin film deposition, evaporation type** Popular technique for depositing thin film in vacuum, accomplished by heating the source material in a low pressure chamber so that it vaporizes and then condenses onto all cooler surfaces in line-of-sight from the source.

**Thin film deposition, sputtering type** Evaporation produced by ion bombardment of the source material, known as cathode-sputtering.

**Thin film deposition materials, conductors and resistors** Metals such as aluminum, gold, chromium, nickel, platinum, tungsten, alloys, and cermets deposited as electrical conductors and resistors on silicon or other substrates.

**Thin film deposition materials, inorganic dielectrics** Film compounds produced by various vacuum evaporation processes and deposited on substrates to perform electrical functions. Examples include silicon monoxide, ZnS, CaF, SiO<sub>2</sub>, Al<sub>2</sub>O<sub>3</sub>, Si<sub>3</sub>N<sub>4</sub>, and other chemical compounds.

**Thin film deposition materials, organic dielectrics** Insulating film compounds produced when organic vapors are heated under conditions in which polymerization and deposition occur. Examples are parylene, butadiene, acrolein, and divinyl benzene.

**Thin film deposition materials, semiconductors** Polycrystalline films deposited by vacuum or flash evaporation to produce high purity single crystal silicon or other semiconductor substances.

**Thin film hybrid integrated circuits** The physical realization of a hybrid integrated circuit fabricated on a thin film network.

**Thin film integrated circuit** The physical realization of a number of electric elements entirely in the form of thin films deposited in a patterned relationship on a structural supporting material.

**Toggle** To switch between two states as in a flip-flop.

**Tooling** Vacuum holes, grooves, and locating pins on the tool plate surface dedicated to a certain size substrate in order to position and hold the substrate during the print cycle of screen printing.

**TO package** Can-type IC chip configuration, an outgrowth of the original TO transistor package. Most common are the TO-5, TO-18, and TO-47. The IC chip is mounted within the package, interconnected to terminals on the can, and then hermetically sealed. TO stands for transistor outline.

**Transistance** The characteristic of an electric element which controls voltages or current so as to accomplish gain or switching action in a circuit. Examples of the physical realization of transistance occur in transistors, diodes, saturable reactors, limiters, and relays.

**Transistor** An active semiconductor device having three or more electrodes, and capable of performing almost all the functions of tubes, including rectification and amplification. Germanium and silicon are the main materials used, with impurities introduced to determine the conductivity type (n-type as an excess of free electrons, p-type, a deficiency).

**Transistor testers** Equipment and instruments which detect or measure leakage current, breakdown voltage, gain, or saturation voltage. Some testers are computer operated.

**Trigger** A timing pulse used to initiate the transmission of logic signals through the appropriate circuit signal paths.

**Trimming** Removal of film resistor material in order to increase the resistance to a certain value. Two types of equipment are used for this purpose. The air abrasive jet trimming system (AJT) depends on a precisely controlled stream of abrasive particles to carve away small portions of a thick film resistor. Laser systems are often used for both thick and thin films. With lasers, the material is burned away.

**Truth table** A chart which tabulates and summarizes all the combinations of possible states of the inputs and outputs of a circuit. It tabulates what will happen at the output for a given input combination.

**TTL, T<sup>2</sup>L (Transistor-Transistor-Logic)** A logic system which evolved from DTL wherein the multiple diode cluster is replaced by a multiple-emitter transistor. A circuit which has a multiple emitter input and an active pullup network.

**Turn-on time** The time required for an output to turn on (sink current, to ground output, to go to 0-V). It is the propagation time of an appropriate input signal to cause the output to go to 0 V.

**Turn-off time** Same as Turn-on time except the output stops sinking current, goes off and/or goes to a high voltage level (logic "1").

**Ultrasonic bond** A contact area where two materials are joined by means of ultrasonic energy and pressure.

**Ultrasonic wire bonder** Equipment unit which fastens fine wire onto substrate by use of ultrasonic energy.

**Unit under test (IUT)** Any system, set subsystem, assembly, or subassembly undergoing testing.

**UV curing** Polymerizing, hardening, or cross linking a low molecular weight resinous material in a wet coating or ink, using ultraviolet light as an energy system.

**VLSI** Very large scale integration.

**Vacuum evaporation** The creation of thin films by vaporizing the film substance and allowing its deposition onto a substrate through mask openings.

**Varistor** A two-electrode semiconductor device with a voltage-dependent nonlinear resistance which falls significantly as the voltage is increased.

**Via** A vertical conductor or conductive path forming the interconnection between multi-layer hybrid circuit layers.

**Wafer and die sorters.** Equipment which automates the testing and sorting of semiconductor devices from wafer form.

**Water handling equipment** Equipment used for processing silicon wafers using methods which include batch processing in a common carrier, air bearing single wafer processing, and a combination of batch and single wafer processing.

**Wafers** Slices of semiconductor crystal materials used as substrates for monolithic ICs, diodes, and transistors.

**Wet-process benches** These are benches or stations used for wafer processing. Because of the hazardous materials (acids) that are used, they should be designed with personnel safety and contamination control foremost.

**Wire bond** The fastened union point between a conductor or terminal and the semiconductor die.

**Wire, semiconductor lead** Fine wire used to connect semiconductor chips to substrate patterns, packages, other chips, etc. Usually made from an aluminum alloy or gold.

**Wired "OR"** Externally connected separate circuits or functions arranged so that the combination of their outputs results in an "AND" function. The point at which separate circuits are wired together will be an "O" if any one of the separate outputs is an "O." The same as a dot "AND."

**Word** A group of bits treated as an entity in a computer.

**X axis** The horizontal or left-to-right direction in a two-dimensional system of coordinates.

**X-X** Signifies one direction followed in a step-and-repeat method.

**"X" motion** Registration adjustment left and right of the screen pattern to the substrate, in screen printing.

**Y axis** The vertical direction, perpendicular to the X axis, in a two-dimensional system of coordinates. Y-Y signifies one direction followed in a step-and-repeat method.

**"Y" motion** Registration adjustment front to rear of the screen pattern to the substrate, in screen printing.

**Zener diode** A p-n junction two-terminal, single junction semiconductor device reverse biased into the breakdown region and providing high impedances under less than breakdown voltage but conduction with no impedance above breakdown voltage level.

**Zero ("0")** See Binary logic.

**"Z" motion** Vertical adjustment of screen-substrate distance. Used for setting snap-off and leveling in screen printing.

*(The glossary includes terms from Insulation/Circuits, May, 1982. Copyright Lake Publishing Corporation, Libertyville, IL 60048. Used with permission.)*

## CLASSIFICATION OF AMPLIFIERS

The definitions of class A, B, or C operation apply to vacuum tubes as well as to transistor circuits. Bias voltage on the emitter junction of a transistor determines collector current just as grid voltage determines plate current in a vacuum tube.

Class A allows for 360° operation of a sine wave.

Class B operation is with zero bias (cutoff) and allows 180° conduction.

Class C operation is with bias beyond cutoff which allows less than 180° conduction.

Class AB operation allows small-signal class A operation, and large-signal class B operation.

The above classes of operation are defined and illustrated for transistors and vacuum tubes.

Class	Bias Setting	Input-signal Voltage Swing	Plate or Collector Current Flow	Performance Characteristic
A <sub>1</sub>	Center point of characteristic curve	Confined to linear portion of characteristic curve	Complete cycle	Undistorted output. High gain. Low power conversion efficiency. (25% maximum)
A <sub>2</sub>	Above center point of characteristic curve	Extends into upper (saturation) bend of characteristic curve	Complete cycle	Almost undistorted output. Lower gain but higher efficiency than class A <sub>1</sub> .
AB <sub>1</sub>	Below center point of characteristic curve	Extends into lower (cutoff) bend of characteristic curve	Cuts off for a small portion of negative half-cycle	In push-pull operation output is practically undistorted. Lower gain but higher efficiency than class A <sub>2</sub> .
AB <sub>2</sub>	Center point of characteristic curve	Extends into lower (cutoff) and upper (saturation) bends of characteristic curve	Cuts off for small portion of negative half-cycle	Slight harmonic distortion in push-pull operation. Lower gain but higher efficiency than class AB <sub>1</sub> .
B <sub>1</sub>	Near lower bend of characteristic curve	Extends beyond lower (cutoff) bend of characteristic curve	Cuts off for greater part of negative half-cycle	Little harmonic distortion in push-pull operation. Gain less than class AB <sub>2</sub> . Maximum efficiency 78.5%.
B <sub>2</sub>	Near lower bend of characteristic curve	Extends into lower (cutoff) and upper (saturation) bend of characteristic curve	Cuts off for greater part of negative half-cycle and small portion of positive half-cycle	Some harmonic distortion in push-pull operation. Lower gain but higher efficiency than class B <sub>1</sub> .
C	Beyond lower bend of characteristic curve	Extends well beyond lower (cutoff) and upper (saturation) bends of characteristic curve	Cuts off all of negative and part of positive half-cycles	Considerable harmonic distortion. Low gain. High power conversion efficiency (80% maximum).

Subscript 1 denotes that no grid current flows during any part of the cycle.

Subscript 2 denotes that grid current flows at least for a portion of the cycle.

In class C amplifiers, grid current always flows, and a subscript is therefore unnecessary.

### TRANSISTORS

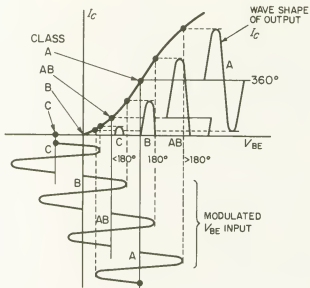

### VACUUM TUBES

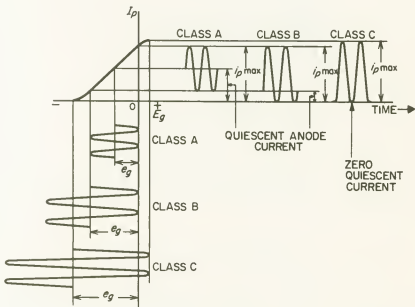



### RISETIME OF CASCADED AMPLIFIERS

Two cascaded amplifying devices will have an overall risetime given by:

$$T_{r_t} = \sqrt{T_{r_1}^2 + T_{r_2}^2}$$

where  $T_{r_1}$ ,  $T_{r_2}$ , and  $T_{r_t}$  are the first stage, second stage, and total risetimes respectively.

The above relation is presented in the accompanying graph.

FOR EXAMPLE: A system incorporating two cascaded amplifiers having risetimes of 100  $\mu$ sec and 25  $\mu$ sec (a ratio of 4:1), would have an overall risetime of 103  $\mu$ sec.

NOTE: The Y-axis is the percentage increase in the risetime above the risetime of the slower of two cascaded devices.

Where  $A_1, A_2 \dots A_n$  are amplifiers with zero output impedance and infinite input impedance

$$e_n = \text{square wave of frequency } F$$

Then for TILTS of 10% or less

$$\% \text{ TILT}_1 = \pi \frac{F_1}{F} \times 100 \quad \text{where } F_1 = \frac{1}{2\pi R_1 C_1}$$

TILTS of 10% magnitude or less are additive. Thus

$$\% \text{ TILT}_2 = \pi \left( \frac{F_1}{F} + \frac{F_2}{F} \right) \times 100$$

where

$$F_2 = \frac{1}{2\pi R_2 C_2}$$

and

$$\% \text{ TILT}_n = \pi \left( \frac{F_1}{F} + \frac{F_2}{F} + \dots + \frac{F_n}{F} \right) \times 100$$

By definition

$$\% \text{ TILT} = \frac{V_1 - V_2}{V/2} \times 100 \approx \pi \frac{F_1}{F} \times 100$$

where

$F$  = Frequency of applied wave  $e_n$

$$F_1 = \frac{1}{2\pi RC} \quad \text{- cutoff of high pass network (3 dB)}$$

C in farads R in ohms

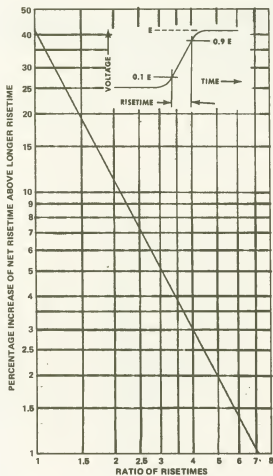

RC coupled Amplifiers % Tilt

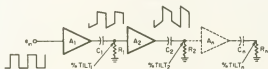

Square Wave Tilt Due To RC Coupling



(From *Electronics and Communications*, December, 1968.)

## NEGATIVE FEEDBACK NOMOGRAM

In negative-feedback amplifier considerations,  $\beta$  (expressed as a percentage) has a negative value. A line across the  $\beta$  and  $\mu$  scales will intersect the center scale to indicate resulting change in gain. It also indicates amount (in decibels) by which input must be increased to maintain original output. Original amplification may be expressed as voltage ratio or in decibels by using appropriate scale at right.

FOR EXAMPLE: For a  $\beta$  of 10% and an amplifier  $\mu$  of 30, the nomogram yields a change in  $\mu$  of 0.25.

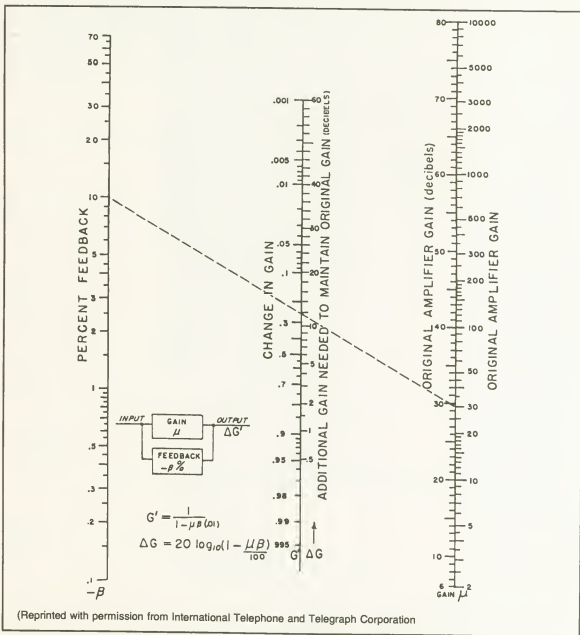

### CLASS B PUSH-PULL AMPLIFIER NOMOGRAM

This nomogram determines the available power from the output of class B vacuum tube or transistor push-pull stage operating under the following conditions: The output is a sine wave, the collector or plate swing is twice the supply voltage, and the available output power is determined by the formula

$$P = \frac{(\sqrt{2} V)^2}{Z}$$

FOR EXAMPLE: A transistor amplifier with a 12-V supply and a collector-to-collector impedance of 400 ohms could produce 720 mW of undistorted output power.

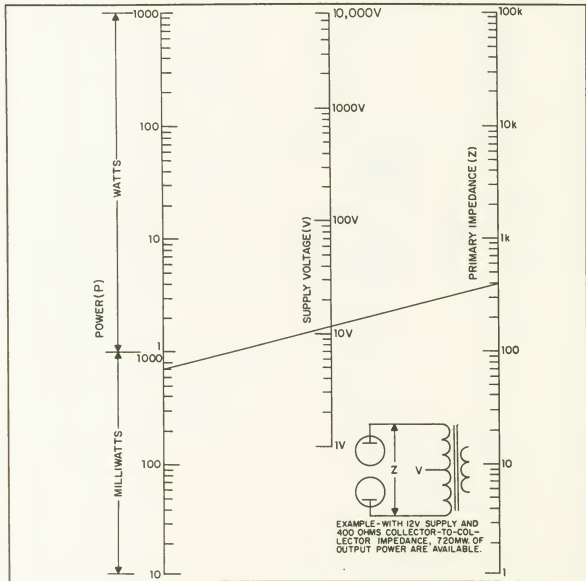

### CATHODE FOLLOWER NOMOGRAM

A cathode follower is useful for properly terminating transmission lines and coaxial cables. It provides high  $Z_{in}$  and low  $Z_{out}$ , good frequency and phase response, ground common to the input and output, reduced input capacitance, power gain and in-phase input and output. To match a transmission line,  $R_o$  should equal the impedance of the line (A). If  $R_o$  is less, add a series resistor (B), if  $R_o$  is greater use a resistor (C) so that  $R = R_o Z_o / (R_o - Z_o)$ .

FOR EXAMPLE: To drive a 52-ohm line using a tube with a  $g_m$  of 5,000 requires an  $R_o$  of 70 ohms. To provide proper cathode bias, determine the required cathode resistance from the tube manual or by calculation, and subtract  $R_o$  to determine  $R_K$ . Assuming that 220 ohms is required for proper bias, the  $R_K$  is 150 ohms and  $R_o$  is 70 ohms. If fixed bias is used,  $R_K$  is not needed.

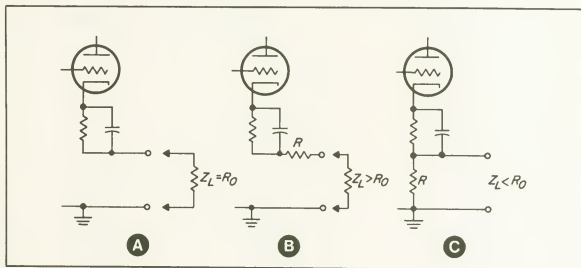

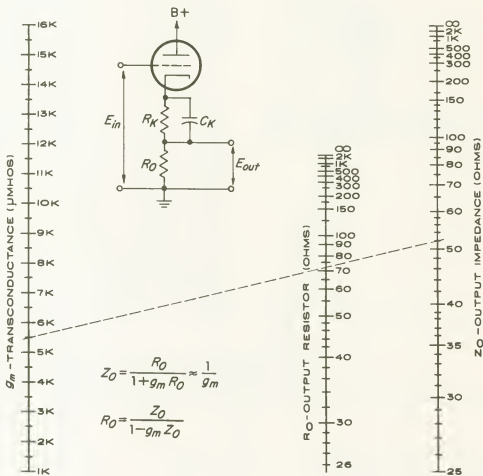

### CATHODE FEEDBACK NOMOGRAM

This nomogram shows the reduction in the gain of an amplifier as a result of negative feedback that is introduced if the cathode resistor is not bypassed.

FOR EXAMPLE: What will be the gain of an amplifier that has an initial stage gain of 20, a cathode resistor of 22 K, and a dynamic plate load resistor of 220 K if the cathode bypass capacitor is removed. The ratio of  $R_L$  to  $R_K$  is 10, thus the resultant "actual" stage gain is 7.

The range of the nomogram can be extended by multiplying all three scales by the same power of 10.

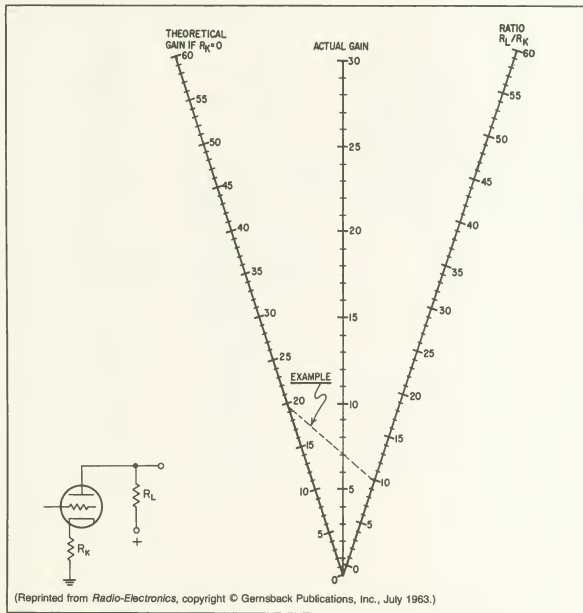

## EUROPEAN TUBE NUMBERING SYSTEM

### Receiving and Amplifying Tubes

First Letter	Second and Subsequent Letter	Numbers
Type of Filament or Heater	Electrode Structure— Class of Tube	Type of Base
A 4 V ac (parallel)	A Single diode	1 Base indicated by second number
C 200 mA heater	B Dual diode	2 Octal
D 0.5-1.5 V dc	C Triode, small-signal	3 Octal
E 6.3 V ac (parallel)	D Triode, large-signal	4 European rim-lock
G 5 V heater	E Tetrode, small-signal	5 Miscellaneous special bases
H 12.6 V 150 mA heater (parallel)	F Pentode, small-signal	6,7 Subminiature tube
K 2 V dc (parallel)	H Hexode or heptode	8 Nine-pin miniature (noval)
M 2.5 V	K Octode, pentagrid converter	9 Seven-pin miniature
O no filament	L Pentode or tetrode, large-signal	Second and third digits differentiate between tubes that have the same general description but different characteristics. If the first number is a 1, then the second number indicates the type of base.
P 300 mA heater (series)	M Electron-beam indicator	
U 100 mA heater (series)	N Thyatron	
Z code cathode	P Secondary emission tube	
	Q Nonode (9 electrodes)	
	T Miscellaneous	
	X Gas-filled full-wave rectifier	
	Y Vacuum half-wave rectifier	
	Z Vacuum full-wave rectifier	
	Two or more of these letters may be combined. Thus ac indicates a diode and a triode in one envelope.	

#### FOR EXAMPLE:

Type ECH81 Triode-heptode oscillator converter, with noval socket and 6.3 V heater

Type EL34 Power pentode with octal base and 6.3-V heater

Type GZ34 Full-wave rectifier with octal base and 5-V heater

NOTE: For special tubes (ruggedized, long-life, etc.), the numbers are placed between the letters. For example: E80F, E90CC, E80CF.

### Transmitting Tubes

First Letter	Second Letter	Third Letter	Numbers
Tube Type	Filament	Cooling Type	Characteristic
D Rectifier	A Tungsten, directly heated	G Mercury filled	No uniform notation used
M Triode	B Thoriated tungsten, directly heated	L Forced air	
P Pentode	C Oxide coated, directly heated	W Water cooled	
Q Tetrode	E Heater/cathode	X Xenon filled	
T Triode			

FOR EXAMPLE: Type QQE-04-20 Dual tetrode with indirectly heated cathode



## SOLID-STATE SENSING TECHNOLOGIES

This table summarizes the characteristics of solid-state sensors of position, temperature, level, pressure, and speed.

<i>Sensing Technique</i>	<i>Actuation</i>	<i>Actuator</i>	<i>Construction</i>	<i>Advantages</i>	<i>Disadvantages</i>
Hall effect	Proximity	Electromagnet or permanent magnet	Integrated circuit only	Not rate sensitive, fast signal conditioning, simple	Requires magnet actuator, cannot achieve fine resolution
Hall effect vane	Interrupted	Ferrous material	IC, permanent magnet	Integral design, not rate sensitive, low cost, signal conditioning	Magnet attraction mode of actuation, cannot achieve fine resolution
Eddy current	Proximity	Ferrous or nonferrous material	Coil, IC and nonferrous material components	All-metal detector, discrete contaminated, high frequency	Cannot achieve fine resolution, discrete unit, not easily
Opt-electronic	Interrupted or reflective	Any opaque material	IC, LED, and components	Defects any opaque material, good resolution	Easily contaminated ambient light sensitive
Piezoelectric	Impact	Any hard material	Crystal	No stand-by power, potentially lowest cost device	Pulse output, requires impact
Piezo-resistance	Pressure or flexing	Gaseous or mechanical	IC	Detection without mechanical linkage	Complex, difficult construction, expensive for accuracy
Variable reluctance (Magnetic) pickup	Proximity	Ferrous	Coil, magnet, IC and discrete components	Fine resolution, integral unit, high speed detection	Cannot sense zero speed, hard signal conditioning, small operate point, complex
Capacitance	Touch or proximity	Any material	IC and sensing capacitor	Detects any low dielectric material	False triggering, moisture and temperature sensitive, complex
Sonic	Audio beam interrupted or reflected	Any material	Transmitter, receiver, IC and discretes	Large sensing gap, detects any material	Triggered by random noise, not precise, non-directional

## SEMICONDUCTOR MEMORIES

This family tree illustrates the interrelationship of the various types of volatile and nonvolatile semiconductor memories.

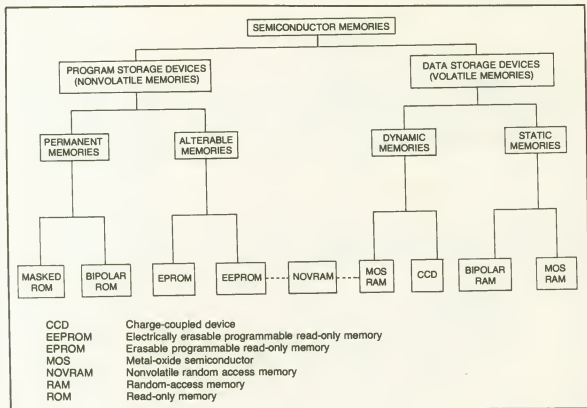

## VOICE INPUT/OUTPUT FAMILY TREE

Electronic voice input/output capability endows machines with the human qualities of hearing (speech recognition) and speaking (speech output). This family tree highlights some of the current applications of voice input/output equipment.

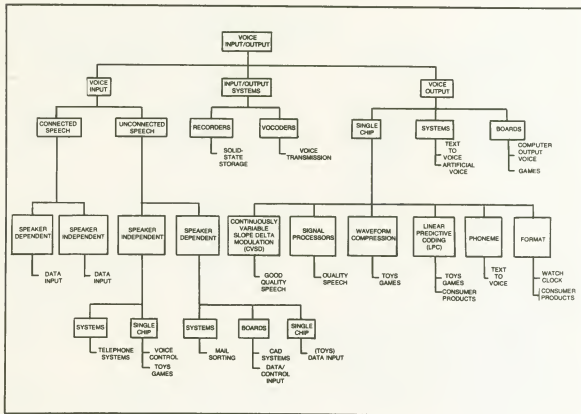

## NOISE FIGURE NOMOGRAM FOR TWO CASCADED STAGES

The cascade noise figure of two noise sources is given by the equation

$$F_T = F_1 + \frac{(F_2 - 1)}{G_1}$$

where  $F_1$ ,  $F_2$ , and  $F_T$  are the first-stage, second-stage, and overall noise figures respectively, and  $G$  is the gain of the first stage—all expressed as power ratios. The nomogram has all scales calibrated in decibels. To use the nomogram connect  $F_2$  and  $G$  and note the intersect point on the turning scale. That point is then connected to  $F_T$  or  $F_1$  depending on which of these figures is given. Two ranges (high and low) are given for all three "F" scales and they must be used together. Only one "G" scale is necessary.

FOR EXAMPLE: A first-stage noise figure of 3 dB, a second-stage noise figure of 7 dB, and a first-stage gain of 8 dB, results in an overall noise figure of 4.2 dB.

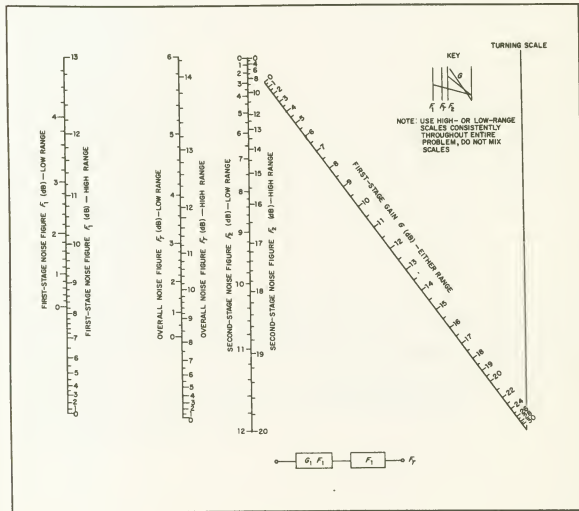

# Section 5

# Mathematical Data, Formulas, Symbols

- Reliability Charts / 222
- Reliability Nomogram / 223
- Reliability—Redundancy Nomogram / 224
- Confidence Level Determinator / 226
- Angular Resolution Table / 227
- The Postulates of Boolean Algebra / 228
- Conversion Chart of Standard Metric Prefixes / 233
- Harmonic Rejection Nomogram / 234
- Powers of Two / 235
- Squares, Cubes, and Roots / 236
- Powers of Numbers  $n^4$  to  $n^8$  / 238
- Mathematical Signs and Symbols / 239
- Factorials / 241
- Rectangular-Polar Conversion Chart / 242
- Geometrical Curves for Reference / 244
- Formulas for Solids / 246
- Areas of a Few Common Shapes / 248
- Triangles / 249
- Values of Functions for Certain Angles / 250
- Trigonometric Functions / 251
- Lissajous Figures / 252
- Pulse Parameter Nomogram / 254
- Pulse Definitions / 255
- Frequency-Period Conversion / 256
- Greek Alphabet / 257
- Roman Numerals / 257
- Phase Angle, Time Interval, and Frequency Nomogram / 258
- Characteristics of Recurrent Waveforms—Relationship Between Peak, Rms, and Average Values / 260
- Fourier Content of Common Periodic Waveforms / 261
- Conversions from dB and dBm to Voltage and Power Ratios, and from dBm to Power and Voltage Levels / 262
- Decibel Nomograms / 264
- Letter Symbols for Quantities Used in Electrical Science and Electrical Engineering / 267
- Letter Symbols for Units Used in Electrical Science and Electrical Engineering / 278
- Conversion of Electromagnetic Units / 284
- Space-Time-Velocity and Acceleration Formulas / 286
- Conversion Factors / 287

## RELIABILITY CHARTS

This chart relates system MTBF (Mean-Time-Between-Failures) with the number of components per system and the component MTBF.

FOR EXAMPLE: A system using 10,000 components with a component MTBF of 30 years will have a system MTBF of 1 day.

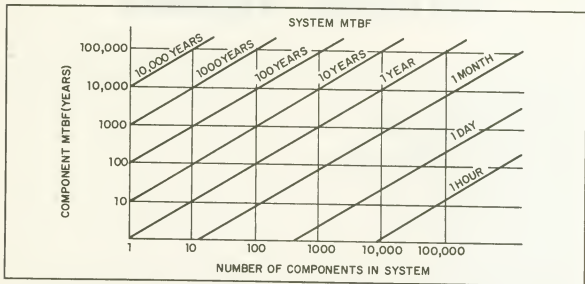

This chart relates system reliability in percent with the number of serial parts, that is, the critical parts that must function in order for the system to perform its function.

FOR EXAMPLE: 10,000 critical parts with a 99.99% parts reliability provide a system reliability of only 37%.

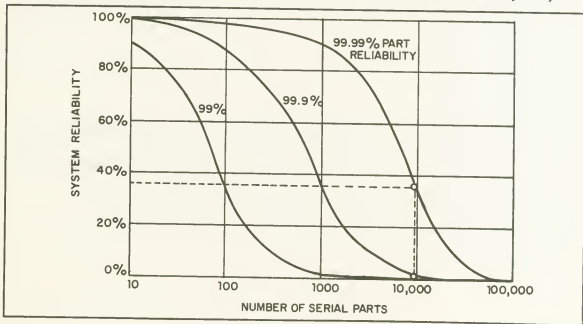

## RELIABILITY NOMOGRAM

Reliability is a dependent function of operating time and failure rate. It is generally given as a percentage or a decimal that states the probability that an equipment will perform its function satisfactorily during a mission. Reliability is based on the formula

$$P_o = e^{-t/T} = e^{-\lambda t}$$

where

$T = 1/\lambda$   $t$  = operating time in hours  
 $P_o$  = probability of success, i.e., reliability  $T$  = mean time between failures  
 $e$  = base of natural logarithm  $\lambda$  = failure rate (% per 1,000 hr)

FOR EXAMPLE: A circuit that has a failure rate of 100%/1,000 hr (an hourly failure rate of 0.001 or an MTBF of 1,000) has a reliability of 99.8% when operated for 2 hr. That means that the circuit will not operate properly an average of 2 times out of 1,000 operations, or out of 1,000 circuits an average of 2 will fail in 2 hr.

NOTE: An equipment or circuit with an MTBF of one hour will have a reliability of only 33.788% (100/e) when operated for one hour.

NOTE: For more detailed treatment of MTBF see the latest edition of *MIL-Handbook-217*.

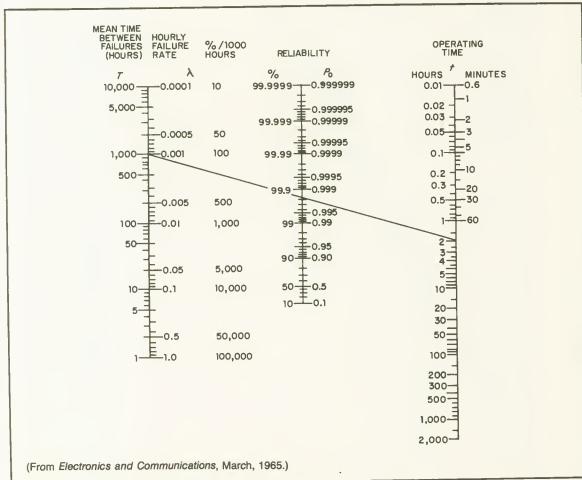

(From *Electronics and Communications*, March, 1965.)



## RELIABILITY—REDUNDANCY NOMOGRAM

For certain critical applications, such as manned space flights, the required reliability is often greater than what can be achieved with a single system. Under these conditions it is necessary to resort to redundancy where two or more identical systems are paralleled. The required redundancy is based on the following equation:

$$P_N = 1 - (1 - P_o)^N$$

where

$P_N$  = probability of success of  $N$  paralleled systems

$P_o$  = probability of success of one system

$N$  = number of paralleled systems

FOR EXAMPLE: A subsystem for a two-week moon exploration flight has a special reliability of 99.99% and a MTBF of 2,000 hr. What is the required redundancy? On reliability nomogram (A) connect 2,000 on the  $T$  scale with 336 (2 weeks) on the  $t$  scale to determine subsystem reliability to be 0.845. On redundancy nomogram connect 0.845 on the  $P_o$  scale with 0.9999 on the  $P_N$  scale to determine that a redundancy of five is required.

$$P_N = 1 - (1 - P_0)^N$$

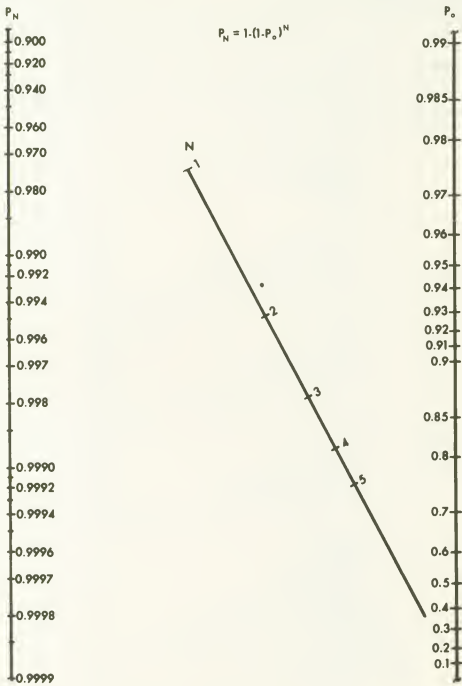

## CONFIDENCE LEVEL DETERMINATOR

This graph is used to determine the *minimum* MTBF for a given confidence level. To use the chart, determine the actual number of Operating Hours, the Observed Failures, and the required Confidence Level. Read across from "Observed Failures" to "Confidence Level" and then down to obtain the "Divisor." Divide the number of Operating Hours by the "Divisor." The result is the *minimum* MTBF for the stated Confidence Level.

FOR EXAMPLE: During 2,000 hours of operation there were 8 failures. What is MTBF stated with a confidence level of 90%? Reading across 8 to the 90% curve shows the divisor to be 13. Dividing 2,000 by 13 yields approximately 154. Thus, it can be said that the MTBF (minimum) is 154 hours with a confidence of 90%. If, in the above example, a confidence level of 70% had been required, then it could be said that the MTBF was 194 hours with a confidence level of 70%.

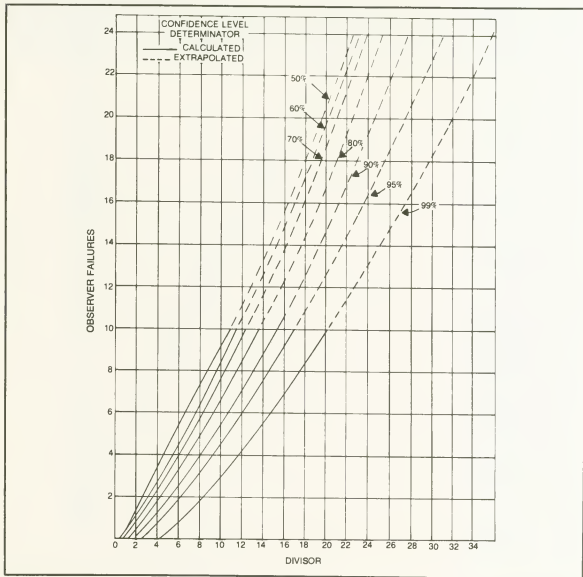





# ANGULAR RESOLUTION TABLE

The shaft angle corresponding to an integral binary fraction is required wherever shaft angle encoders are used. This resolution table aids in determining accurately the angle represented by a specific number of counts or conversely, the precise number of counts which equals a given angle.

n	2 <sup>n</sup>		Angular Resolution Corresponding to Integral-Binary Fraction				2n·2 <sup>n</sup> (rad/mm)	n
	2 <sup>n</sup>	1/2 <sup>n</sup> (0.0007°/count)	31 600/2 <sup>n</sup> (mm/rev)	360/2 <sup>n</sup> (degrees)	360/2 <sup>n</sup> (frequency)	2n·2 <sup>n</sup> (rad/mm)		
0	1	1/1	1 794 000	21 600	360.0	6 263 185.307	179 586.476	0
1	2	1/2	648 000	10 800	180.0	3 141 592.653	89 793.238	1
2	4	1/4	324 000	5 400	90.0	1 570 796.327	44 896.619	2
3	8	1/8	162 000	2 700	45.0	785 398.163	22 448.309	3
4	16	1/16	81 000	1 350	22.5	392 699.081	11 224.154	4
5	32	1/32	40 500	675	11.25	196 349.540	5 612.077	5
6	64	1/64	20 250	337.5	5.625	98 174.770	2 806.039	6
7	128	0.078125	10 125	168.75	2.8125	49 087.385	1 403.020	7
8	256	0.0390625	5 062.5	84.375	1.40625	24 543.692	701.510	8
9	512	0.01953125	2 531.25	42.1875	0.703125	12 271.846	350.755	9
10	1 024	0.009765625	1 265.625	21.09375	0.3515625	6 135.923	175.378	10
11	2 048	0.0048828125	632.8125	10.546875	0.17578125	3 067.961	87.689	11
12	4 096	0.00244140625	316.40625	5.2734375	0.087890625	1 533.980	43.844	12
13	8 192	0.001220703125	158.203125	2.63671875	0.0439453125	766.990	21.922	13
14	16 384	0.0006103515625	79 101.5625	1.318359375	0.02197265625	383.495	10.961	14
15	32 768	0.00030517578125	39 550.78125	659.1796875	0.010986328125	191.747	5.480	15
16	65 536	0.000152587890625	19 775.390625	329.58984375	0.0054931640625	95.874	2.740	16
17	131 072	0.0000762939453125	9 887.6953125	164.794921875	0.00274658203125	47.937	1.370	17
18	262 144	0.00003814697265625	4 943.84765625	82.3974609375	0.00137329101625	23.969	0.685	18
19	524 288	0.000019073486328125	2 471.923828125	41.19873046875	0.000686645508125	11.984	0.342	19
20	1 048 576	0.0000095367431640625	1 235.9619140625	20.599365234375	0.0003433227590625	5.992	0.171	20
21	2 097 152	0.00000476837158203125	617.98095703125	10.2996826171875	0.00017166137953125	2.996	0.085	21
22	4 194 304	0.0000023841860937890625	308.99047851640625	5.149841308890625	0.000085830689765625	1.498	0.042	22
23	8 388 608	0.0000011920930469453125	154.4952392578125	2.5749206544765625	0.0000429153443828125	0.749	0.021	23
24	16 777 216	0.00000059604647392390625	77.24761962390625	1.2874603271484375	0.00002145767219140625	0.374	0.010	24
25	33 554 432	0.000000298023236961953125	38.62380981445125	0.64373016357421875	0.0001072388260593103125	0.187	0.005	25

# THE POSTULATES OF BOOLEAN ALGEBRA

	WORDS (English)	MATHEMATICS (Set Theory)	LOGIC	ENGINEERING	GEOMETRICAL DIAGRAMS
THE LAWS OF COMBINATION	1 THE LAWS OF TAUTOLOGY Repetition--by addition or multiplication--does not alter the truth value of an element	$a \cup a = a$ $a \cap a = a$	$a \vee a = a$ $a \wedge a = a$	$a + a = a$ $a \cdot a = a$	
	2 THE LAWS OF COMMUTATION Disjunction or conjunction is not affected by sequential change. Disjunction--OR: if either input a or input b, or both inputs a and b, are conducting, then the output (a + b) is conducting. Conjunction--AND: if, and only if, both inputs a and b are conducting, then the output (a · b) is conducting.	$a \cup b = b \cup a$ $a \cap b = b \cap a$	$a \vee b = b \vee a$ $a \wedge b = b \wedge a$	$a + b = b + a$ $a \cdot b = b \cdot a$	
	3 THE LAWS OF ASSOCIATION Disjunction or conjunction is unaffected by grouping	$(a \cup b) \cup c = a \cup (b \cup c)$ $(a \cap b) \cap c = a \cap (b \cap c)$	$(a \vee b) \vee c = a \vee (b \vee c)$ $(a \wedge b) \wedge c = a \wedge (b \wedge c)$	$(a + b) + c = a + (b + c)$ $(a \cdot b) \cdot c = a \cdot (b \cdot c)$	
	4 THE LAWS OF DISTRIBUTION An element is added to a product by adding the element to each member of the product. A sum is multiplied by an element by multiplying every member of the sum by the element	$a \cup (b \cap c) = (a \cup b) \cap (a \cup c)$ $a \cap (b \cup c) = (a \cap b) \cup (a \cap c)$	$a \vee (b \wedge c) = (a \vee b) \wedge (a \vee c)$ $a \wedge (b \vee c) = (a \wedge b) \vee (a \wedge c)$	$a + (b \cdot c) = (a + b) \cdot (a + c)$ $a \cdot (b + c) = (a \cdot b) + (a \cdot c)$	
	5 THE LAWS OF ABSORPTION The disjunction of a product by one of its members is equivalent to this member. The conjunction of a sum by one of its members is equivalent to this member	$a \cup (a \cap b) = a$ $a \cap (a \cup b) = a$	$a \vee (a \wedge b) = a$ $a \wedge (a \vee b) = a$	$a + (a \cdot b) = a$ $a \cdot (a + b) = a$	

CIRCUIT  
DIAGRAMS



TRUTH TABLES  
(1 = truth, 0 = falsity)

a	a
1	1
0	0



a	b	a+b	b+a	a·b	b·a
1	1	1	1	1	1
1	0	1	1	0	0
0	1	1	1	0	0
0	0	0	0	0	0

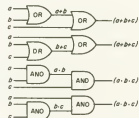













a	b	c	a+b	a+c	b+c	a+b+c	a·b	a·c	b·c	a·b·c
1	1	1	1	1	1	1	1	1	1	1
1	1	0	1	1	1	1	1	0	0	0
1	0	1	1	1	1	1	0	1	0	0
1	0	0	1	1	0	1	0	0	0	0
0	1	1	1	1	1	1	0	0	1	0
0	1	0	1	1	1	1	0	0	0	0
0	0	1	1	1	1	1	0	0	0	0
0	0	0	0	0	0	0	0	0	0	0



a	b	c	a·b	a·c	b·c	a+b	a+c	b+c	a+(b·c)	(a+b)·(a+c)	a·(b+c)	(a·b)+(a·c)
1	1	1	1	1	1	1	1	1	1	1	1	1
1	1	0	1	0	0	1	1	1	1	1	1	1
1	0	1	0	1	0	1	1	1	1	1	1	1
1	0	0	0	0	0	1	1	0	1	1	0	0
0	1	1	0	0	1	1	1	1	1	1	0	0
0	1	0	0	0	0	1	1	0	0	0	0	0
0	0	1	0	0	0	0	1	1	0	0	0	0
0	0	0	0	0	0	0	0	0	0	0	0	0



a	b	a·b	a+(a·b)	a·b	a·(a+b)
1	1	1	1	1	1
1	0	0	1	1	1
0	1	0	0	1	0
0	0	0	0	0	0

	WORDS (English)	MATHEMATICS (Set Theory)	LOGIC	ENGINEERING	GEOMETRICAL DIAGRAMS	
THE LAWS OF THE UNIQUE ELEMENTS	1. THE LAWS OF THE UNIVERSE CLASS The sum consisting of an element and the universe class is equivalent to the universe class. The product consisting of an element and the universe class is equivalent to the element	$a \cup I = I$ $a \cap I = a$	$a \vee I = I$ $a \wedge I = a$	$a + 1 = 1$ $a \cdot 1 = a$	 	
	2. THE LAWS OF THE NULL CLASS The sum consisting of an element and the null class is equivalent to the element. The product consisting of an element and the null class is equivalent to the null class	$a \cup 0 = a$ $a \cap 0 = 0$	$a \vee 0 = a$ $a \wedge 0 = 0$	$a + 0 = a$ $a \cdot 0 = 0$	 	
THE LAWS OF NEGATION (COMPLEMENT)	1. THE LAWS OF COMPLEMENTATION The sum consisting of an element and its complement is equivalent to the universe class. The product consisting of an element and its complement is equivalent to the null class	$a \cup a' = I$ $a \cap a' = 0$	$a \vee \sim a = I$ $a \wedge \sim a = 0$	$a + \bar{a} = 1$ $a \cdot \bar{a} = 0$	 	
	2. THE LAW OF CONTRAPOSITION If an element a is equivalent to the complement of an element b, it is implied that the element b is equivalent to the complement of the element a	$a = \bar{b} \Rightarrow \bar{a} = b$	$a = \sim b \Rightarrow \sim a = b$	$a = \bar{b} \Rightarrow \bar{a} = b$		
	3. THE LAW OF DOUBLE NEGATION The complement of the negation of an element is equivalent to the element	$a = a''$	$a = \sim \sim a$	$a = \bar{\bar{a}}$		
THE LAWS OF EXPANSION	4. THE LAWS OF EXPANSION The disjunction of a product composed of the elements a and b and a product composed of the element a and the complement of element b is equivalent to the element a. The conjunction of a sum composed of the elements a and b and a sum composed of the element a and the complement of element b is equivalent to the element a	$(a \cap b) \cup (a \cap \bar{b}) = a$ $(a \cup b) \cap (a \cup \bar{b}) = a$	$(a \wedge b) \vee (a \wedge \sim b) = a$ $(a \vee b) \wedge (a \vee \sim b) = a$	$(a \cdot b) + (a \cdot \bar{b}) = a$ $(a + b) \cdot (a + \bar{b}) = a$	 	
	5. THE LAWS OF DUALITY The complement of a sum composed of the elements a and b is equivalent to the conjunction of the complement of element a and the complement of element b. The complement of a product composed of the elements a and b is equivalent to the disjunction of the complement of element a and the complement of element b	$(a \cup b)' = a' \cap b'$ $(a \cap b)' = a' \cup b'$	$\sim(a \vee b) = \sim a \wedge \sim b$ $\sim(a \wedge b) = \sim a \vee \sim b$	$(a + b)' = \bar{a} \cdot \bar{b}$ $(a \cdot b)' = \bar{a} + \bar{b}$	 	

CIRCUIT DIAGRAMS	TRUTH TABLES (1 = truth, 0 = falsity)																																													
<p>(always conducting) (always conducting)</p> <p>(always conducting)</p> <p>(never conducting) (never conducting)</p>	<table border="1"> <tr> <td><math>a</math></td> <td>1</td> <td><math>a+1</math></td> <td><math>a \cdot 1</math></td> </tr> <tr> <td>1</td> <td>1</td> <td>1</td> <td>1</td> </tr> <tr> <td>0</td> <td>1</td> <td>1</td> <td>0</td> </tr> </table>	$a$	1	$a+1$	$a \cdot 1$	1	1	1	1	0	1	1	0																																	
$a$	1	$a+1$	$a \cdot 1$																																											
1	1	1	1																																											
0	1	1	0																																											
<p>(never conducting)</p> <p>(never conducting)</p> <p>(never conducting) (never conducting)</p>	<table border="1"> <tr> <td><math>a</math></td> <td>0</td> <td><math>a+0</math></td> <td><math>a \cdot 0</math></td> </tr> <tr> <td>1</td> <td>0</td> <td>1</td> <td>0</td> </tr> <tr> <td>0</td> <td>0</td> <td>0</td> <td>0</td> </tr> </table>	$a$	0	$a+0$	$a \cdot 0$	1	0	1	0	0	0	0	0																																	
$a$	0	$a+0$	$a \cdot 0$																																											
1	0	1	0																																											
0	0	0	0																																											
<p>(always conducting)</p> <p>(never conducting)</p>	<table border="1"> <tr> <td><math>a</math></td> <td><math>\bar{a}</math></td> <td><math>a+\bar{a}</math></td> <td><math>a \cdot \bar{a}</math></td> </tr> <tr> <td>1</td> <td>0</td> <td>1</td> <td>0</td> </tr> <tr> <td>0</td> <td>1</td> <td>1</td> <td>0</td> </tr> </table>	$a$	$\bar{a}$	$a+\bar{a}$	$a \cdot \bar{a}$	1	0	1	0	0	1	1	0																																	
$a$	$\bar{a}$	$a+\bar{a}$	$a \cdot \bar{a}$																																											
1	0	1	0																																											
0	1	1	0																																											
<p>(always conducting)</p> <p>(never conducting)</p>	<table border="1"> <tr> <td><math>a</math></td> <td><math>\bar{a}</math></td> <td><math>b</math></td> <td><math>\bar{b}</math></td> </tr> <tr> <td>1</td> <td>0</td> <td>0</td> <td>1</td> </tr> <tr> <td>0</td> <td>1</td> <td>1</td> <td>0</td> </tr> </table>	$a$	$\bar{a}$	$b$	$\bar{b}$	1	0	0	1	0	1	1	0																																	
$a$	$\bar{a}$	$b$	$\bar{b}$																																											
1	0	0	1																																											
0	1	1	0																																											
<p>(always conducting)</p> <p>(never conducting)</p>	<table border="1"> <tr> <td><math>a</math></td> <td><math>\bar{a}</math></td> <td><math>\bar{\bar{a}}</math></td> </tr> <tr> <td>1</td> <td>0</td> <td>1</td> </tr> <tr> <td>0</td> <td>1</td> <td>0</td> </tr> </table>	$a$	$\bar{a}$	$\bar{\bar{a}}$	1	0	1	0	1	0																																				
$a$	$\bar{a}$	$\bar{\bar{a}}$																																												
1	0	1																																												
0	1	0																																												
<p>(never conducting)</p> <p>(conducting if <math>a</math> is conducting)</p>	<table border="1"> <tr> <td><math>a</math></td> <td><math>b</math></td> <td><math>\bar{b}</math></td> <td><math>a \cdot b</math></td> <td><math>a \cdot \bar{b}</math></td> <td><math>a \cdot b</math></td> <td><math>a \cdot \bar{b}</math></td> <td><math>(a \cdot b) + (a \cdot \bar{b})</math></td> <td><math>(a \cdot b) + (a \cdot \bar{b})</math></td> </tr> <tr> <td>1</td> <td>1</td> <td>0</td> <td>1</td> <td>0</td> <td>1</td> <td>1</td> <td>1</td> <td>1</td> </tr> <tr> <td>1</td> <td>0</td> <td>1</td> <td>0</td> <td>1</td> <td>1</td> <td>1</td> <td>1</td> <td>1</td> </tr> <tr> <td>0</td> <td>1</td> <td>0</td> <td>0</td> <td>0</td> <td>1</td> <td>0</td> <td>0</td> <td>0</td> </tr> <tr> <td>0</td> <td>0</td> <td>1</td> <td>0</td> <td>0</td> <td>0</td> <td>1</td> <td>0</td> <td>0</td> </tr> </table>	$a$	$b$	$\bar{b}$	$a \cdot b$	$a \cdot \bar{b}$	$a \cdot b$	$a \cdot \bar{b}$	$(a \cdot b) + (a \cdot \bar{b})$	$(a \cdot b) + (a \cdot \bar{b})$	1	1	0	1	0	1	1	1	1	1	0	1	0	1	1	1	1	1	0	1	0	0	0	1	0	0	0	0	0	1	0	0	0	1	0	0
$a$	$b$	$\bar{b}$	$a \cdot b$	$a \cdot \bar{b}$	$a \cdot b$	$a \cdot \bar{b}$	$(a \cdot b) + (a \cdot \bar{b})$	$(a \cdot b) + (a \cdot \bar{b})$																																						
1	1	0	1	0	1	1	1	1																																						
1	0	1	0	1	1	1	1	1																																						
0	1	0	0	0	1	0	0	0																																						
0	0	1	0	0	0	1	0	0																																						
<p><math>(a \cdot b)'</math></p> <p><math>\bar{b} \cdot \bar{b}</math></p> <p><math>(a \cdot b)'</math></p> <p><math>\bar{b} + \bar{b}</math></p>	<table border="1"> <tr> <td><math>a</math></td> <td><math>b</math></td> <td><math>a \cdot b</math></td> <td><math>a \cdot b</math></td> <td><math>(a \cdot b)'</math></td> <td><math>\bar{b}</math></td> <td><math>(a \cdot b)'</math></td> <td><math>\bar{b} + \bar{b}</math></td> </tr> <tr> <td>1</td> <td>1</td> <td>1</td> <td>1</td> <td>0</td> <td>X</td> <td>0</td> <td>X</td> </tr> <tr> <td>1</td> <td>0</td> <td>1</td> <td>0</td> <td>0</td> <td>X</td> <td>X</td> <td>X</td> </tr> <tr> <td>0</td> <td>1</td> <td>0</td> <td>0</td> <td>0</td> <td>X</td> <td>X</td> <td>X</td> </tr> <tr> <td>0</td> <td>0</td> <td>0</td> <td>0</td> <td>X</td> <td>0</td> <td>X</td> <td>0</td> </tr> </table>	$a$	$b$	$a \cdot b$	$a \cdot b$	$(a \cdot b)'$	$\bar{b}$	$(a \cdot b)'$	$\bar{b} + \bar{b}$	1	1	1	1	0	X	0	X	1	0	1	0	0	X	X	X	0	1	0	0	0	X	X	X	0	0	0	0	X	0	X	0					
$a$	$b$	$a \cdot b$	$a \cdot b$	$(a \cdot b)'$	$\bar{b}$	$(a \cdot b)'$	$\bar{b} + \bar{b}$																																							
1	1	1	1	0	X	0	X																																							
1	0	1	0	0	X	X	X																																							
0	1	0	0	0	X	X	X																																							
0	0	0	0	X	0	X	0																																							



## Boolean Relationships

Idempoint:

$$a + 0 = a \quad a0 = 0 \quad \text{where}$$

$$a + 1 = 1 \quad a1 = a \quad 0 \equiv \bar{a}$$

$$a + a = a \quad aa = a$$

Commutative:  $a + b = b + a$

$$ab = ba$$

Associative:  $(a + b) + c = a + (b + c)$

$$(ab)c = a(bc)$$

Distributive:  $ab + ac = a(b + c)$

$$a + bc = (a + b)(a + c)$$

Absorption:  $a(a + b) \equiv a + ab \equiv a$

DeMorgan Theorem:  $\overline{\overline{a}} = a$

$$\overline{(ab)} = \bar{a} + \bar{b} \quad \overline{(\overline{ab})} = a + b$$

$$\overline{a + b} = \bar{a}\bar{b} \quad \overline{\overline{a + b}} = a + b$$

Legend:

NOT: The line over a term indicates a false or not true state.

AND: Two terms directly adjacent to each other are called an "AND" function.

OR: Two terms separated by "+" are called an "OR" function.

Examples:  $ab$  reads as "a and not b"







$\bar{a}b$  reads as "Not a and b"

$\overline{ab}$  reads as "Not a and Not b"

$a\bar{b}$  reads as "Not a or Not b"

(See DeMorgan)

## Basic Logic

Logic Function	Symbol	Boolean Equation	Truth Table															
AND		$C = AB$	<table border="1"> <thead> <tr> <th>A</th> <th>B</th> <th>C</th> </tr> </thead> <tbody> <tr><td>0</td><td>0</td><td>0</td></tr> <tr><td>0</td><td>1</td><td>0</td></tr> <tr><td>1</td><td>0</td><td>0</td></tr> <tr><td>1</td><td>1</td><td>1</td></tr> </tbody> </table>	A	B	C	0	0	0	0	1	0	1	0	0	1	1	1
A	B	C																
0	0	0																
0	1	0																
1	0	0																
1	1	1																
NAND		$C = \overline{AB} = \bar{A} + \bar{B}$	<table border="1"> <thead> <tr> <th>A</th> <th>B</th> <th>C</th> </tr> </thead> <tbody> <tr><td>0</td><td>0</td><td>1</td></tr> <tr><td>0</td><td>1</td><td>1</td></tr> <tr><td>1</td><td>0</td><td>1</td></tr> <tr><td>1</td><td>1</td><td>0</td></tr> </tbody> </table>	A	B	C	0	0	1	0	1	1	1	0	1	1	1	0
A	B	C																
0	0	1																
0	1	1																
1	0	1																
1	1	0																
OR		$C = A + B$	<table border="1"> <thead> <tr> <th>A</th> <th>B</th> <th>C</th> </tr> </thead> <tbody> <tr><td>0</td><td>0</td><td>0</td></tr> <tr><td>0</td><td>1</td><td>1</td></tr> <tr><td>1</td><td>0</td><td>1</td></tr> <tr><td>1</td><td>1</td><td>1</td></tr> </tbody> </table>	A	B	C	0	0	0	0	1	1	1	0	1	1	1	1
A	B	C																
0	0	0																
0	1	1																
1	0	1																
1	1	1																
NOR		$C = \overline{A + B}$	<table border="1"> <thead> <tr> <th>A</th> <th>B</th> <th>C</th> </tr> </thead> <tbody> <tr><td>0</td><td>0</td><td>1</td></tr> <tr><td>0</td><td>1</td><td>0</td></tr> <tr><td>1</td><td>0</td><td>0</td></tr> <tr><td>1</td><td>1</td><td>0</td></tr> </tbody> </table>	A	B	C	0	0	1	0	1	0	1	0	0	1	1	0
A	B	C																
0	0	1																
0	1	0																
1	0	0																
1	1	0																
EXCLUSIVE		$C = A\bar{B} + \bar{A}B$	<table border="1"> <thead> <tr> <th>A</th> <th>B</th> <th>C</th> </tr> </thead> <tbody> <tr><td>0</td><td>0</td><td>0</td></tr> <tr><td>0</td><td>1</td><td>1</td></tr> <tr><td>1</td><td>0</td><td>1</td></tr> <tr><td>1</td><td>1</td><td>0</td></tr> </tbody> </table>	A	B	C	0	0	0	0	1	1	1	0	1	1	1	0
A	B	C																
0	0	0																
0	1	1																
1	0	1																
1	1	0																
INVERT		$C = \bar{A}$	<table border="1"> <thead> <tr> <th>A</th> <th>C</th> </tr> </thead> <tbody> <tr><td>1</td><td>0</td></tr> <tr><td>0</td><td>1</td></tr> </tbody> </table>	A	C	1	0	0	1									
A	C																	
1	0																	
0	1																	

## Clocked Logic Elements

	TRUTH TABLE			
	Inputs at Bit Time $t_n$		Outputs at Bit Time $t_{(n+1)}$	
	J	K	Q	$\bar{Q}$
J-K flip-flop	0	0	$Q_n$	$\bar{Q}_n$
	0	1	0	1
	1	0	1	0
	1	1	$\bar{Q}_n$	$Q_n$

	Inputs at Bit Time $t_n$		Outputs at Bit Time $t_{(n+1)}$	
	R	S	Q	$\bar{Q}$
R-S flip-flop	0	0	$Q_n$	$\bar{Q}_n$
	0	1	1	0
	1	0	0	1
	1	1	indeterminats	

## CONVERSION CHART OF STANDARD METRIC PREFIXES

This chart shows, in their relative positions, symbols, multiples ( $10^2$ ), and abbreviations for all the international multiples and submultiples as recommended by the International Committee on Weights and Measures (1962) and adapted by the National Bureau of Standards.

This chart provides a fast and easy method of conversion from any metric notation to any other. "Unity" represents the basic unit of measurement such as volts, ohms, watts, amperes, grams, hertz, etc. The number of steps up or down between the two prefixes which are being compared is equal to the direction *and* the number of places in which the decimal point has to be moved to convert from one to the other.

FOR EXAMPLE: To convert 0.0032 milliampere to nanoampere—move six places down. Answer: 3,200 nA.

To convert 43,280 kilohertz to megahertz—move three places up. Answer: 43.28 MHz.

To convert 10.74 microns to millimeters—move three places up. Answer: 0.01074 mm.

DEFINITION	MULTIPLIER	SYMBOL	NAME	CLASSIFICATION
	$10^{18}$	e	exa	MULTIPLES
	$10^{15}$	p	peta	
million millions (British billion) or trillion	$10^{12}$	T	tera	
thousand millions (American billion)	$10^9$	G	giga	
millions	$10^6$	M	mega	UNITY
thousands	$10^3$	k	kilo	
hundreds	$10^2$	h	hecto	
tens	10	da	deca	
tenths	$10^{-1}$	d	deci	SUBMULTIPLES
hundredths	$10^{-2}$	c	centi	
thousandths	$10^{-3}$	m	milli	
millionths	$10^{-6}$	μ	micro	SUBMULTIPLES
thousandths of a million (or millimicro) or billionth nano	$10^{-9}$	n	nano	
millionth of a million (or micromicro) or trillionth	$10^{-12}$	p	pico	
thousandths of a millionth of a million (or millimicromicro) or quadrillionth	$10^{-15}$	f	femto	
millionths of a millionth of a 10 <sup>-16</sup> millionth (or quintillionth)	$10^{-18}$	a	atto	

### HARMONIC REJECTION NOMOGRAM

This scale relates the magnitude of harmonic distortion, expressed as a rejection ratio in decibels, to percentage of distortion.

FOR EXAMPLE: (1.) A design specifies that a given audio sine-wave oscillator should have its closest harmonic at least 28 dB below the fundamental. The chart indicates that the closest harmonic must be less than 3.9% of the magnitude of the fundamental.

(2.) Find the harmonic content of a signal made up of the following:

Fundamental frequency	100 V rms
Second harmonic	5 V rms
Third harmonic	2 V rms

Adding harmonics vectorially gives

$$\sqrt{5^2 + 2^2} = 5.39$$

$$\% \text{ distortion} = \frac{\text{harmonic voltage}}{\text{fundamental voltage}} \times 100 = \frac{5.39}{100} \times 100$$

Thus the distortion is 5.39%, which means that the harmonic content of the signal is 25.2 dB below the fundamental.

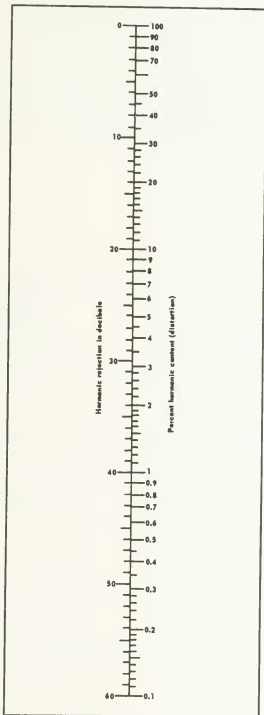

POWERS OF TWO

$2^n$	$n$	$2^{-n}$
1	0	1.0
2	1	0.5
4	2	0.25
8	3	0.125
16	4	0.062 5
32	5	0.031 25
64	6	0.015 625
128	7	0.007 812 5
256	8	0.003 906 25
512	9	0.001 953 125
1 024	10	0.000 976 562 5
2 048	11	0.000 488 281 25
4 096	12	0.000 244 140 625
8 192	13	0.000 122 070 312 5
16 384	14	0.000 061 035 156 25
32 768	15	0.000 030 517 578 125
65 536	16	0.000 015 258 789 062 5
131 072	17	0.000 007 629 394 531 25
262 144	18	0.000 003 814 697 265 625
524 288	19	0.000 001 907 348 632 812 5
1 048 576	20	0.000 000 953 674 316 406 25
2 097 152	21	0.000 000 476 837 158 203 125
4 194 304	22	0.000 000 238 418 579 101 562 5
8 388 608	23	0.000 000 119 209 289 550 781 25
16 777 216	24	0.000 000 059 604 644 775 390 625
33 554 432	25	0.000 000 029 802 322 387 695 312 5
67 108 864	26	0.000 000 014 901 161 193 847 656 25
134 217 728	27	0.000 000 007 450 580 596 928 828 125
268 435 456	28	0.000 000 003 725 290 298 461 914 062 5
536 870 912	29	0.000 000 001 862 646 149 230 957 031 25
1 073 741 824	30	0.000 000 000 931 322 574 615 478 515 625
2 147 483 648	31	0.000 000 000 465 661 287 307 739 257 812 5
4 294 967 296	32	0.000 000 000 232 830 643 853 869 628 906 25
8 589 934 592	33	0.000 000 000 116 415 321 826 934 814 453 125
17 179 869 184	34	0.000 000 000 058 207 660 913 467 407 226 562 5
34 359 738 368	35	0.000 000 000 029 103 830 456 733 703 613 281 25
68 719 476 736	36	0.000 000 000 014 551 915 228 366 851 806 640 625
137 438 953 472	37	0.000 000 000 007 275 957 614 183 425 903 320 312 5
274 877 906 944	38	0.000 000 000 003 637 978 807 091 712 951 660 156 25
549 755 813 888	39	0.000 000 000 001 818 989 403 184 869 689 941 406 25
1 099 511 627 776	40	0.000 000 000 000 909 494 701 772 928 237 915 039 062 5
2 199 023 255 552	41	0.000 000 000 000 454 747 350 888 464 118 957 519 531 25
4 398 046 511 104	42	0.000 000 000 000 227 373 678 443 232 059 478 759 765 625
8 796 093 022 208	43	0.000 000 000 000 113 686 837 721 616 029 739 379 882 812 5
17 592 186 044 416	44	0.000 000 000 000 056 843 818 860 808 014 869 689 941 406 25
35 184 372 088 832	45	0.000 000 000 000 028 421 709 430 404 007 434 844 970 703 125
70 368 744 177 664	46	0.000 000 000 000 014 210 854 715 902 003 717 422 485 351 862 5
140 737 488 355 328	47	0.000 000 000 000 007 105 427 357 601 001 858 711 242 675 781 25
281 474 976 710 656	48	0.000 000 000 000 003 552 713 678 800 500 929 355 621 337 890 625
562 949 953 421 312	49	0.000 000 000 000 001 776 356 839 400 290 464 677 810 668 945 312 5
1 125 899 906 842 624	50	0.000 000 000 000 000 888 178 419 700 125 328 905 334 472 656 25
2 251 799 813 685 248	51	0.000 000 000 000 000 444 089 209 850 062 616 169 452 667 236 328 125
4 503 599 627 370 496	52	0.000 000 000 000 000 222 044 604 925 031 308 084 726 333 618 184 062 5
9 007 199 254 740 992	53	0.000 000 000 000 000 111 022 302 462 515 654 042 263 186 809 802 031 25
18 014 398 509 481 984	54	0.000 000 000 000 000 055 511 151 231 257 827 021 181 583 404 541 015 625
36 028 797 018 963 968	55	0.000 000 000 000 000 027 755 575 615 628 913 510 990 791 702 270 507 812 5
72 057 594 037 927 936	56	0.000 000 000 000 000 013 877 787 807 814 456 755 295 399 851 135 253 906 25
144 115 188 075 855 872	57	0.000 000 000 000 000 006 938 893 903 907 228 377 647 697 925 567 826 953 125
288 230 376 511 711 744	58	0.000 000 000 000 000 003 469 446 951 953 614 188 823 648 962 783 815 476 562 5
576 460 752 303 423 488	59	0.000 000 000 000 000 001 734 232 478 976 807 092 411 924 481 391 906 738 281 25
1 152 921 504 606 846 976	60	0.000 000 000 000 000 000 867 361 737 988 403 547 205 962 365 993 369 140 625
2 305 843 009 213 693 952	61	0.000 000 000 000 000 000 433 680 668 994 201 773 602 981 120 347 976 684 570 312 5
4 611 686 018 427 387 904	62	0.000 000 000 000 000 000 216 840 434 497 100 898 801 490 560 172 988 342 285 156 25
9 223 372 036 854 775 808	63	0.000 000 000 000 000 000 108 420 217 248 550 443 400 745 280 086 994 171 142 578 125
18 446 744 073 709 551 616	64	0.000 000 000 000 000 000 054 210 108 624 275 221 371 610 850 382 040 043 087 085 571 289 062 5
36 893 488 147 419 103 232	65	0.000 000 000 000 000 000 027 105 054 312 137 610 850 186 320 021 748 545 785 644 531 25
73 786 976 294 838 206 464	66	0.000 000 000 000 000 000 013 552 527 156 068 805 425 093 180 010 874 271 392 822 285 625
147 573 952 589 676 412 928	67	0.000 000 000 000 000 000 006 726 263 578 034 402 712 546 580 095 437 135 696 411 132 812 5
295 147 905 179 352 825 856	68	0.000 000 000 000 000 000 003 388 131 789 017 201 356 120 092 718 567 848 205 566 406 25
590 295 810 358 705 651 712	69	0.000 000 000 000 000 000 001 694 065 894 508 600 678 136 845 001 359 283 924 102 783 203 125
1 180 591 620 717 411 303 424	70	0.000 000 000 000 000 000 000 847 032 947 254 300 339 068 322 500 679 641 962 091 391 601 962 5
2 361 183 241 434 822 606 848	71	0.000 000 000 000 000 000 000 423 516 473 627 152 169 534 161 250 339 820 811 025 495 800 781 25
4 722 366 482 869 645 213 696	72	0.000 000 000 000 000 000 000 211 758 238 813 575 084 767 880 625 129 619 910 490 512 847 900 390 648

$n$	$2^n$
73	94447 32955 73929 04273 92
74	18889 65933 14785 80854 784
75	37778 93186 29571 81709 568
76	75557 86372 59143 23419 136
77	15111 57274 51828 64683 8272
78	30223 14549 03857 29387 6544
79	60446 29098 07314 58735 3068
80	12089 25819 61462 91747 06176
81	24178 51639 22925 83494 12352
82	48357 03216 45851 86988 24704
83	96714 06556 91703 33978 49408
84	19342 81311 38340 86795 29881 8
85	38685 62822 76681 33590 59763 2
86	77371 25245 53362 87181 19626 4
87	15474 25049 10672 53438 23905 28
88	30948 50096 21345 08872 47810 56
89	61897 00196 42690 13744 95621 12
90	12379 40039 28536 02748 99124 224
91	24758 80078 57078 05407 96248 448
92	49517 60157 14152 10996 96496 896
93	99035 20314 28304 21991 92993 792
94	19807 04062 85600 84398 38596 7584
95	39614 08125 71321 68798 77197 5168
96	79228 16251 42643 37593 54395 0336
97	15845 63250 85288 87516 70819 00072
98	31691 26500 57057 35037 41758 01344
99	63382 53001 14114 70074 83518 02688
100	12678 50060 22822 94014 96703 20537 8

SQUARES, CUBES, AND ROOTS

$n$	$n^2$	$\sqrt{n}$	$\sqrt{10n}$	$n^3$	$n$	$\sqrt[3]{n}$	$\sqrt[3]{10n}$	$\sqrt[3]{100n}$
1	1	1.000000	3.162278	1	1	1.000000	2.154435	4.641589
2	4	1.414214	4.472136	8	2	1.259921	2.714418	5.848035
3	9	1.732051	5.477226	27	3	1.442250	3.107233	6.694330
4	16	2.000000	6.324555	64	4	1.587401	3.419952	7.368063
5	25	2.236068	7.071068	125	5	1.709976	3.684031	7.937005
6	36	2.449490	7.745967	216	6	1.817121	3.914868	8.434327
7	49	2.645751	8.366600	343	7	1.912931	4.121285	8.879040
8	64	2.828427	8.944272	512	8	2.000000	4.308869	9.283178
9	81	3.000000	9.486833	729	9	2.080084	4.481405	9.654894
10	100	3.162278	10.000000	1,000	10	2.154435	4.641589	10.00000
11	121	3.316625	10.48809	1,331	11	2.223980	4.791420	10.32280
12	144	3.464102	10.95445	1,728	12	2.289428	4.932424	10.62659
13	169	3.605551	11.40175	2,197	13	2.351335	5.065797	10.91393
14	196	3.741657	11.83216	2,744	14	2.410142	5.192494	11.18689
15	225	3.872983	12.24745	3,375	15	2.466212	5.313293	11.44714
16	256	4.000000	12.64911	4,096	16	2.519842	5.428835	11.69607
17	289	4.123106	13.03840	4,913	17	2.571282	5.539658	11.93483
18	324	4.242641	13.41641	5,832	18	2.620741	5.646216	12.16440
19	361	4.358899	13.78405	6,859	19	2.668402	5.748897	12.38562
20	400	4.472136	14.14214	8,000	20	2.714418	5.848035	12.59921
21	441	4.582576	14.49138	9,261	21	2.758924	5.943922	12.80579
22	484	4.690416	14.83240	10,648	22	2.802039	6.036811	13.00591
23	529	4.795832	15.16575	12,167	23	2.843867	6.126926	13.20006
24	576	4.898979	15.49193	13,824	24	2.884499	6.214465	13.38866
25	625	5.000000	15.81139	15,625	25	2.924018	6.299605	13.57209
26	676	5.099020	16.12452	17,576	26	2.962496	6.382504	13.75069
27	729	5.196152	16.43168	19,683	27	3.000000	6.463304	13.92477
28	784	5.291503	16.73320	21,952	28	3.036589	6.542133	14.09460
29	841	5.385165	17.02839	24,389	29	3.072317	6.619106	14.26043
30	900	5.477226	17.32051	27,000	30	3.107233	6.694330	14.42250
31	961	5.567764	17.60682	29,791	31	3.141381	6.767899	14.58100
32	1,024	5.656854	17.88854	32,768	32	3.174902	6.839904	14.73613
33	1,089	5.744563	18.16590	35,937	33	3.207534	6.910423	14.88806
34	1,156	5.830952	18.43909	39,304	34	3.239612	6.979532	15.03895
35	1,225	5.916080	18.70829	42,875	35	3.271066	7.047299	15.18294
36	1,296	6.000000	18.97367	46,656	36	3.301927	7.113787	15.32619
37	1,369	6.082763	19.23538	50,653	37	3.332222	7.179054	15.46680
38	1,444	6.164414	19.49359	54,872	38	3.361975	7.243156	15.60491
39	1,521	6.244998	19.74842	59,319	39	3.391211	7.306144	15.74061
40	1,600	6.324555	20.00000	64,000	40	3.419952	7.368063	15.87401
41	1,681	6.403124	20.24846	68,921	41	3.448217	7.428959	16.00521
42	1,764	6.480741	20.49390	74,088	42	3.476027	7.488872	16.13429
43	1,849	6.557439	20.73644	79,503	43	3.503398	7.547842	16.26133
44	1,936	6.633250	20.97618	85,184	44	3.530348	7.605905	16.38643
45	2,025	6.708204	21.21320	91,125	45	3.556893	7.663094	16.50964
46	2,116	6.782330	21.44761	97,336	46	3.583048	7.719443	16.63103
47	2,209	6.855655	21.67948	103,823	47	3.608826	7.774980	16.75069
48	2,304	6.928203	21.90890	110,592	48	3.634241	7.829735	16.86865
49	2,401	7.000000	22.13594	117,649	49	3.659306	7.883735	16.98499
50	2,500	7.071068	22.36068	125,000	50	3.684031	7.937005	17.09976

$n$	$n^2$	$\sqrt{n}$	$\sqrt{10n}$	$n^3$	$n$	$\sqrt[3]{n}$	$\sqrt[3]{10n}$	$\sqrt[3]{100n}$
50	2,500	7.071068	22.36068	125,000	50	3.684031	7.937005	17.09976
51	2,601	7.141428	22.58318	132,651	51	3.708430	7.989570	17.21301
52	2,704	7.211103	22.80351	140,608	52	3.732511	8.041452	17.32478
53	2,809	7.280110	23.02173	148,877	53	3.756286	8.092672	17.43513
54	2,916	7.348469	23.23790	157,464	54	3.779763	8.143253	17.54411
55	3,025	7.416198	23.45208	166,375	55	3.802952	8.193213	17.65174
56	3,136	7.483315	23.66432	175,616	56	3.825862	8.242571	17.75808
57	3,249	7.549834	23.87467	185,193	57	3.848501	8.291344	17.86316
58	3,364	7.615773	24.08319	195,112	58	3.870877	8.339551	17.96702
59	3,481	7.681146	24.28992	205,379	59	3.892996	8.387207	18.06969
60	3,600	7.745967	24.49490	216,000	60	3.914868	8.434327	18.17121
61	3,721	7.810250	24.69818	226,981	61	3.936497	8.480926	18.27160
62	3,844	7.874008	24.89980	238,328	62	3.957892	8.527019	18.37091
63	3,969	7.937254	25.09980	250,047	63	3.979057	8.572619	18.46915
64	4,096	8.000000	25.29822	262,144	64	4.000000	8.617739	18.56636
65	4,225	8.062258	25.49510	274,625	65	4.020726	8.662391	18.66256
66	4,356	8.124038	25.69047	287,496	66	4.041240	8.706588	18.75777
67	4,489	8.185353	25.88436	300,763	67	4.061548	8.750340	18.85204
68	4,624	8.246211	26.07681	314,432	68	4.081655	8.793659	18.94536
69	4,761	8.306624	26.26785	328,509	69	4.101566	8.836556	19.03778
70	4,900	8.366600	26.45751	343,000	70	4.121285	8.879040	19.12931
71	5,041	8.426150	26.64583	357,911	71	4.140818	8.921121	19.21997
72	5,184	8.485281	26.83282	373,248	72	4.160168	8.962809	19.30979
73	5,329	8.544004	27.01851	389,017	73	4.179339	9.004113	19.39877
74	5,476	8.602325	27.20294	405,224	74	4.198336	9.045042	19.48695
75	5,625	8.660254	27.38613	421,875	75	4.217163	9.085603	19.57434
76	5,776	8.717798	27.56810	438,976	76	4.235824	9.125805	19.66095
77	5,929	8.774964	27.74887	456,533	77	4.254321	9.165656	19.74681
78	6,084	8.831761	27.92848	474,552	78	4.272659	9.205164	19.83192
79	6,241	8.888194	28.10694	493,039	79	4.290840	9.244335	19.91632
80	6,400	8.944272	28.28427	512,000	80	4.308869	9.283178	20.00000
81	6,561	9.000000	28.46050	531,441	81	4.326749	9.321698	20.08299
82	6,724	9.055385	28.63564	551,368	82	4.344481	9.359902	20.16530
83	6,889	9.110434	28.80972	571,787	83	4.362071	9.397796	20.24694
84	7,056	9.165151	28.98275	592,704	84	4.379519	9.435388	20.32793
85	7,225	9.219544	29.15476	614,125	85	4.396830	9.472682	20.40828
86	7,396	9.273618	29.32576	636,056	86	4.414005	9.509685	20.48800
87	7,569	9.327379	29.49576	658,503	87	4.431048	9.546403	20.56710
88	7,744	9.380832	29.66479	681,472	88	4.447960	9.582840	20.64560
89	7,921	9.433981	29.83287	704,969	89	4.464745	9.619002	20.72351
90	8,100	9.486833	30.00000	729,000	90	4.481405	9.654894	20.80084
91	8,281	9.539392	30.16621	753,571	91	4.497941	9.690521	20.87759
92	8,464	9.591663	30.33150	778,688	92	4.514357	9.725888	20.95379
93	8,649	9.643651	30.49590	804,357	93	4.530655	9.761000	21.02944
94	8,836	9.695360	30.65942	830,584	94	4.546836	9.795861	21.10454
95	9,025	9.746794	30.82207	857,375	95	4.562903	9.830476	21.17912
96	9,216	9.797959	30.98387	884,736	96	4.578857	9.864848	21.25317
97	9,409	9.848858	31.14482	912,673	97	4.594701	9.898983	21.32671
98	9,604	9.899495	31.30495	941,192	98	4.610436	9.932884	21.39975
99	9,801	9.949874	31.46427	970,299	99	4.626065	9.966555	21.47229
100	10,000	10.00000	31.62278	1,000,000	100	4.641589	10.00000	21.54435

POWERS OF NUMBERS  $n^4$  to  $n^8$

$n$	$n^2$	$n^3$	$n^4$	$n^5$	$n^6$	$n^7$	$n^8$
1	1	1	1	1	1	1	1
2	16	32	64	128	256	512	1024
3	61	243	729	2187	6561	19683	59049
4	256	1024	4096	16384	65536	262144	1048576
5	625	3125	15625	78125	390625	1953125	9765625
6	1296	9776	46656	279936	1679616	10077696	60466176
7	2401	18007	117649	823543	5784001	40353607	282475249
8	4096	32768	262144	2097152	16777216	134218752	1073743872
9	8561	59049	531441	4782969	43046721	389418511	3513757369
10	10000	100000	1000000	10000000	100000000	1000000000	10000000000
11	14641	181061	2383261	31817101	430483701	5734363301	75951685001
12	20736	248832	2985984	35831808	42996176	520083840	6291620096
13	28681	371293	4826809	62748517	81537307	106489500	139010321
14	38416	537824	7529536	105413504	14575891	20618176	28242956
15	50625	759375	11390625	170893375	25626960	3814716	561848
16	65536	1048576	16777216	268335456	42349673	6574774	1024000
17	83521	1418857	2412369	41038673	6976774	1172716	1960000
18	104976	1869656	34012224	612220032	101199606	15000000	22000000
19	130321	2478099	47045881	893871739	169835630	25000000	37000000
20	160000	3200000	64000000	1280000	2560000	5120000	10240000
21	194481	408431	8576121	1801069	3782296	7940000	16384000
22	234256	513632	113379904	2494358	5487587	11840000	25600000
23	278461	6436343	14803589	3404825	7831099	10961000	20000000
24	331776	7962924	191102976	4586471	11007531	1513423	21000000
25	390625	975625	244140625	6103816	15256799	20000000	25000000
26	456976	11861376	308951736	8031810	20882706	28000000	37000000
27	531441	14348807	387420489	10460353	28242954	38000000	51000000
28	614856	17210368	461890304	13492929	37780200	50000000	67000000
29	707281	20511149	594823321	17249676	50024641	66000000	88000000
30	610000	24300000	7290000	2167000	6510000	1960000	5900000
31	923251	28629151	8875037	2751261	6526910	20000000	61000000
32	1048576	33554532	10737418	3435974	10995116	42000000	136000000
33	1185921	39135393	123914680	4261844	14064088	50000000	163000000
34	1336336	45434924	15448044	5292533	17857939	60000000	196000000
35	1500625	52521875	18382656	6433930	22518754	70000000	236000000
36	1679616	60466176	21767823	7838416	28211099	85000000	284000000
37	1674161	69343957	254857264	9438188	35124795	100000000	340000000
38	2085136	79235196	30109364	11441558	4347921	120000000	160000000
39	2313441	90224199	35187438	13723101	53520093	140000000	196000000
40	2560000	102400000	4096000	16384000	65536000	260000000	1040000000
41	2825761	115856201	4750104	19475427	7984925	310000000	1260000000
42	3111696	130691232	5498032	23358333	9589552	360000000	1510000000
43	3418801	147008443	6321363	27181861	11688200	420000000	1780000000
44	3748096	164916224	7265314	31927781	14048224	490000000	2080000000
45	4100625	184528125	8303786	37366945	18181525	570000000	2420000000
46	4477456	205962976	8474297	43581766	20047612	660000000	2800000000
47	4878661	229345007	10779215	50862312	23811287	760000000	3200000000
48	5308416	254803966	12230590	58706634	28179280	880000000	3700000000
49	5764801	282475249	13841287	6722307	33232931	1000000000	4300000000
50	6250000	312500000	15825000	78125000	39062500	1000000000	10000000000
51	6250000	312500000	15825000	78125000	39062500	1000000000	10000000000
52	7311616	380204032	19770610	9438188	43046721	1100000000	12100000000
53	7804881	418195493	22164361	101199606	134218752	1300000000	15100000000
54	8503056	459185224	24789411	11390625	150000000	1520000000	17300000000
55	9150625	50283475	27680641	12668500	1679616	1760000000	19900000000
56	9834496	550731776	30840979	139010321	18484776	2000000000	22600000000
57	10556001	60192657	3429647	15256799	20000000	2200000000	24800000000
58	11318496	65635678	3806863	16777216	22079842	2400000000	27000000000
59	12117361	714924299	42180534	18484776	24000000	2600000000	29400000000
60	12960000	7778000	4665600	2790000	3700000	5100000	10000000
61	13845841	8445963	512037	3427428	4500000	6100000	11000000
62	14776336	9161328	5680024	3521848	4600000	6200000	11000000
63	15752961	924385	525203	3839960	4800000	6400000	11000000
64	16777216	10737416	671489	4398045	5100000	6800000	11000000
65	17850625	11602906	8541889	4902279	5500000	7300000	11000000
66	18974736	12523236	8265395	5455167	6000000	7800000	11000000
67	2015121	13501251	935338	6000716	6600000	8400000	11000000
68	21381376	14539336	8888748	6720988	7200000	9000000	11000000
69	22667121	15640313	10791616	7446333	7900000	9700000	11000000
70	24010000	16807000	11784000	8235430	9000000	10600000	11000000
71	25411681	18042294	12810028	9061120	9300000	10600000	11000000
72	26873856	19349176	13931407	10036013	7220241	6646000	9000000
73	28399624	20730716	1513423	1104399	6064001	5000000	4000000
74	29985776	22190016	16420649	12151280	6991947	6000000	5000000
75	31640625	23730469	1778762	13345389	81011292	8000000	10000000
76	33362176	25352554	19266993	14645195	11000000	11000000	13000000
77	35153041	27067842	20642328	16048523	12537363	13000000	15000000
78	37015056	28874144	22519960	17585569	13701444	15000000	18000000
79	38950081	30770564	24308746	19203909	15171088	17000000	21000000
80	40960000	32768000	26214400	20971500	16772160	18772160	22000000
81	43046721	34867844	28242956	2282954	18484776	20000000	23000000
82	45212176	37039884	30000000	24800000	20000000	22000000	25000000
83	47458321	39390406	32694037	27136051	22522922	24000000	27000000
84	49787136	41821194	35129803	29500003	24787589	26000000	29000000
85	52200625	44370531	37714952	32057709	27249053	28000000	31000000
86	54700616	47042702	40456724	34792782	29821793	30000000	33000000
87	57289781	49842092	43382850	37725479	32821618	32000000	35000000
88	59969536	52773192	46440409	40867580	35963542	34000000	37000000
89	62742241	55840594	49698129	44231335	39365888	36000000	39000000
90	85610000	5904900	5314410	4782969	5167610	672969	104672
91	86574961	6240321	578993	6167693	5167610	4702525	632189
92	71632956	590815	606550	6389898	6017009	5598818	6056818
93	74805201	695886	689868	6484776	6056818	632189	6056818
94	78074896	8040000	689868	6484776	6056818	632189	6056818
95	81450625	7373099	7350919	693373	632189	632189	632189
96	81943656	8153727	827578	7514475	7323896	7323896	7323896
97	88529281	8587340	8329720	7873744	8079826	7873744	8079826
98	92238616	9038998	8358424	8361255	8507630	8507630	8507630
99	98059601	9509900	9414801	9320653	9227447	9227447	9227447

## MATHEMATICAL SIGNS AND SYMBOLS

•	Radix (base) point
•	Logic multiplication symbol
∞	Infinity
+	Plus, positive, logic OR function
-	Minus, negative
±	Plus or minus, positive or negative
∓	Minus or plus, negative or positive
×	Times, logic AND function
÷	Divided by
/	Divided by (expressive of a ratio)
=	Equal to
≡	Identical to, is defined by
≈	Approximately equal to, congruent to
≈	Approximately equal to
≠	Not equal to
~	Similar to
<	Less than
≥	Not less than
≪	Much less than
≫	Greater than
≯	Not greater than
≫	Much greater than
≤	Equal to or less than
≥	Equal to or greater than
∝	Proportional to, varies directly as
→	Approaches
:	Is to, proportional to
••	Therefore
#	Number
%	Percent
@ or @	At the rate of; at cost of
ε or e	The natural number = 2.71828 ~
π	Pi = 3.14159... ~
()	Parentheses. Used to enclose a common group of terms.
[]	Brackets. Used to enclose a common group of terms which includes one or more groups in parentheses.
{ }	Braces. Used to enclose a common group of terms which includes one of more groups in brackets.
∠	Angle
°	Degrees (arc or temperature)
'	Minutes, prime
''	Seconds, double prime
	Parallel to
⊥	Perpendicular to
...	And beyond, ellipsis



$x + y$	$x$ added to $y$ , $x$ OR $y$
$x - y$	$y$ subtracted from $x$
$x \cdot y$ , $x \times y$ , or $xy$	$x$ multiplied by $y$ , $x$ AND $y$
$x \div y$	$x$ divided by $y$
$x/y$ or $\frac{x}{y}$	$x$ divided by $y$
$1/x$	Reciprocal of $x$
$x^n$	$x$ raised to the indicated power of $n$
$\sqrt{x}$	Indicated root ( $\sqrt{\quad}$ ) of $x$
$x : y$	$x$ is to $y$
$ x $	Absolute value of $x$ , magnitude of $x$
$\vec{X}$ , $\hat{X}$ , or $\mathbf{X}$	Vector $X$
$\bar{x}$	Average value of $x$
$f(x)$ or $F(x)$	Function of $x$
$i$	$\sqrt{-1}$
$j$	Operator, equal to $\sqrt{-1}$
$\Delta x$	Increment of $x$
$dx$	Differential of $x$
$\partial x$	Partial differential of $x$
$\frac{\Delta x}{\Delta y}$	Change in $x$ with respect to $y$
$\frac{dx}{dy}$	Derivative of $x$ with respect to $y$
$\frac{d}{dy}(x)$	Derivative of $x$ with respect to $y$
$D_x x$	Derivative of $x$ with respect to $y$
$\frac{\partial x}{\partial y}$	Partial derivative of $x$ with respect to $y$
$\Sigma$	Summation
$\Sigma_a^b$	Summation between limits (from $a$ to $b$ )
$\Pi$	Product
$\prod_a^b$	Product between limits (from $a$ to $b$ )
$\int$	Integral
$\int_a^b$	Integral between limits (from $a$ to $b$ )
$\int x dy$	Integral of $x$ with respect to $y$
$ _a$	Evaluated at $a$
$ _a^b$	Evaluated between limits (from $a$ to $b$ )

# FACTORIALS

## Numerical

$n$	$\frac{1}{n!}$					$n!$	$n$
1	1.					1	1
2	0.5					2	2
3	.16666	66666	66666	66666	66667	6	3
4	.04166	66666	66666	66666	66666	24	4
5	.00833	33333	33333	33333	33333	120	5
6	0.00138	88888	88888	88888	88889	720	6
7	.00019	84126	98412	69841	26984	5040	7
8	.00002	48015	87301	58730	15873	40320	8
9	.00000	27557	31922	39858	90653	362880	9
10	.00000	02755	73192	23985	89065	3628800	10
11	0.00000	00250	52108	38544	17188	39916800	11
12	.00000	00020	87675	69878	68099	479001600	12
13	.00000	00001	60590	43836	82161	6227020800	13
14	.00000	00000	11470	74559	77297	87178291200	14
15	.00000	00000	00764	71637	31820	1307674368000	15
16	0.00000	00000	00047	79477	33239	20922789888000	16
17	.00000	00000	00002	81145	72543	355687428096000	17
18	.00000	00000	00000	15619	20697	6402373705728000	18
19	.00000	00000	00000	00822	06352	12164510408832000	19
20	.00000	00000	00000	00041	10318	243290208176640000	20

$n! = 1 \times 2 \times 3 \times 4 \times 5 \dots n$

FOR EXAMPLE: For  $n = 7$ ,  $n! = 5040$ .

$1/n! = 0.001984126984126984126984$ ,

$\log(n!) = 3.702431$ .

## Logarithmic

Logarithms of the products $1 \times 2 \times 3 \dots n$ , $n$ from 1 to 100.							
$n$	$\log(n!)$	$n$	$\log(n!)$	$n$	$\log(n!)$	$n$	$\log(n!)$
1	0.000000	26	26.605619	51	66.190645	76	111.275425
2	0.301030	27	28.036983	52	67.906648	77	113.161916
3	0.778151	28	29.484141	53	69.630924	78	115.054011
4	1.380211	29	30.946539	54	71.363318	79	116.951638
5	2.079181	30	32.423660	55	73.103681	80	118.854728
6	2.857332	31	33.915022	56	74.851869	81	120.763213
7	3.702431	32	35.420172	57	76.607744	82	122.677027
8	4.605521	33	36.938686	58	78.371172	83	124.596105
9	5.559763	34	38.470165	59	80.142024	84	126.520384
10	6.559763	35	40.014233	60	81.920175	85	128.449803
11	7.601156	36	41.570535	61	83.705505	86	130.384301
12	8.680337	37	43.138737	62	85.497896	87	132.323821
13	9.794280	38	44.718520	63	87.297237	88	134.268303
14	10.940408	39	46.309585	64	89.103417	89	136.217693
15	12.116500	40	47.911645	65	90.916330	90	138.171936
16	13.320620	41	49.524429	66	92.735874	91	140.130977
17	14.551069	42	51.147678	67	94.561949	92	142.094765
18	15.806341	43	52.781147	68	96.394458	93	144.063248
19	17.085095	44	54.424599	69	98.233307	94	146.036376
20	18.386125	45	56.077812	70	100.078405	95	148.014099
21	19.708344	46	57.740570	71	101.929663	96	149.996371
22	21.050767	47	59.412668	72	103.786996	97	151.983142
23	22.412494	48	61.093909	73	105.650319	98	153.974368
24	23.792706	49	62.784105	74	107.519550	99	155.970004
25	25.190646	50	64.483075	75	109.394612	100	157.970004

### RECTANGULAR-POLAR CONVERSION CHART

---

This chart quickly converts between cartesian (rectangular) and polar forms of notation. The horizontal (real) and the vertical (imaginary) coordinates are used for rectangular notations, and the angular (magnitude) and circular (angle) coordinates are used for polar notation. The same units of measurement are used for both systems. This makes conversion from one system to the other readily possible. The range of the chart can be extended by multiplying the horizontal and vertical axes by the same power of ten.

FOR EXAMPLE:

1.  $2 + j3$  is equivalent to  $3.6/\underline{56^\circ}$
2.  $70/\underline{55^\circ}$  is equivalent to  $40 + j57$
3.  $6 - j3$  is equivalent to  $6.7/\underline{333^\circ}$



## GEOMETRICAL CURVES FOR REFERENCE

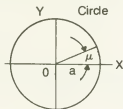

$$X^2 + Y^2 = a^2$$

$$X = a \cos \mu, Y = a \sin \mu$$

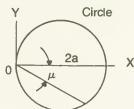

$$r = 2a \cos \mu$$

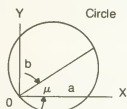

$$r = a \cos \mu + b \sin \mu$$

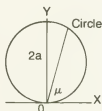

$$r = 2a \sin \mu$$



$$X = a \cos \mu, Y = b \sin \mu$$

$$\frac{X^2}{a^2} + \frac{Y^2}{b^2} = 1$$

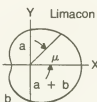

$$r = a + b \cos \mu$$

$$a > b > 0$$

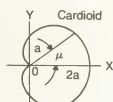

$$r = a(1 + \cos \mu)$$

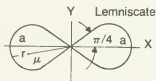

$$r^2 = a^2 \cos 2 \mu$$

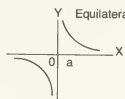

$$XY = a^2$$



$$\frac{X^2}{a^2} - \frac{Y^2}{b^2} = 1$$

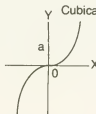

$$a^2 Y = X^3$$

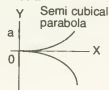

$$aY^2 = X^3, a > 0$$



$$\frac{Y^2}{b^2} = \frac{X}{a}$$

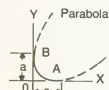

$$X^3 + Y^3 = a^3$$

Witch of Agnesi

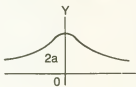

$$Y(X^2 + 4a^2) = 8a^3$$

Three-leaved roses

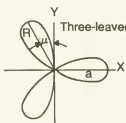

$$r = a \cos 3\mu$$



$$r = a \sin 3\mu$$

Four-leaved roses

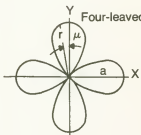

$$r = a \cos 2\mu$$

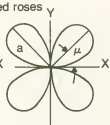

$$r = a \sin 2\mu$$

Cissoid of Diocles

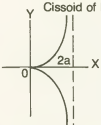

$$Y^2(2a - X) = X^3$$

Strophoid

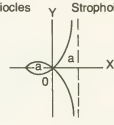

$$Y^2 = X^2 \frac{a + X}{a - X}$$

Exponential curve

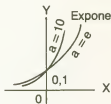

$$Y = a^x$$

Logarithmic Curve

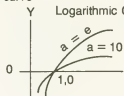

$$Y = \log_a X$$

Probability curve

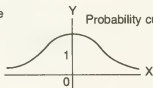

$$Y = e^{-x^2}$$

Cycloid

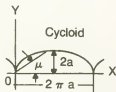

$$\begin{aligned} X &= a(\mu - \sin \mu) \\ Y &= a(1 - \cos \mu) \end{aligned}$$

Hypercycloid

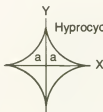

$$X^{2n} + Y^{2n} = a^{2n}$$

Catenary



$$Y = a(\cos H \frac{X}{a} - 1)$$

Tractrix

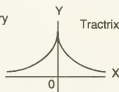

$$X = \pm (a \operatorname{sech}^{-1} \frac{Y}{a} \sqrt{a^2 - Y^2})$$

# FORMULAS FOR SOLIDS

Cube

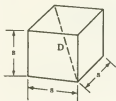

Surface Area  
 $A = 6s^2$   
 Volume  
 $V = s^3$   
 Diagonal  
 $D = 1.7321s$

Right Regular Pyramid

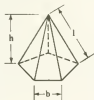

Surface Area  
 $A = \frac{1}{2}bnl + An$  (area of base)  
 Volume  
 $V = \frac{1}{3}Anh$

Parallelepiped

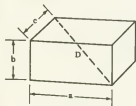

Surface Area  
 $A = 2(ab + bc + ac)$   
 Volume  
 $V = abc$   
 Diagonal  
 $D = \sqrt{a^2 + b^2 + c^2}$

Right Regular Cone

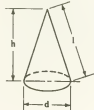

Surface Area  
 $A = 1.5708d(.5d + l)$   
 Volume  
 $V = .2618d^2h$

Right Circular Cylinder

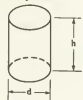

Surface Area  
 $A = 1.5708 d (2h + d)$   
 Volume  
 $V = .7854d^2h$

Frustrum of Right Regular Pyramid

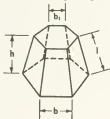

Surface Area  
 $A = \frac{1}{2}l(n(b + b_1) + Ab + Ab_1)$   
 Volume  
 $V = \frac{1}{5}h (An + At + \sqrt{ABAT})$

Frustrum of Right Circular Cylinder

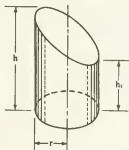

Lateral Area  
 $A = 3.1416 r (h + h_1)$   
 Area of Top Section  
 $A = 3.1416r \sqrt{r^2 + \left(\frac{h_1 - h}{2}\right)^2}$   
 Area of Base  
 $A = 3.1416r^2$   
 Volume  
 $V = 1.5708r^2(h + h_1)$

Frustrum of Right Regular Cone

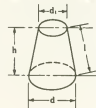

Surface Area  
 $A = .3927(d_1^2 + d^2) + 4l(d + d_1)$   
 Volume  
 $V = .2618h (d^2 + dd_1 + d_1^2)$

Sphere



Surface Area  
 $A = 3.1416d^2$

Volume  
 $V = .3236d^3$

Sector of Sphere



Surface Area  
 $A = 1.5708 r (4h + c)$

Volume  
 $V = 2.0944r^2h$

Segment of Sphere



Surface Area of Top Section  
 $A = 6.2832rh$  or  
 $A = .7854 (4h^2 + c^2)$

Total Surface Area  
 $A = 1.5708 (2h^2 + c^2)$

Volume  
 $V = 1.0472h^3 (3r - h)$  or  
 $V = .1318h (3c^2 + 4h^2)$

Zone of Sphere

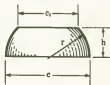

Area of Spherical Surface  
 $A = 6.2832rh$

Total Surface Area  
 $A = .7854 (8rh + c^2 + c^2)$

Volume  
 $V = .1318h (3c^2 + 3c^2 + 4h^2)$

Torus

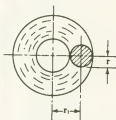

Surface Area  
 $A = 39.478rr_1$

Volume  
 $V = 19.739r^2r_1$

Ellipsoid



Volume  
 $V = .5236abc$

Paraboloid



Volume  
 $V = .3927ab^2$



AREAS OF A FEW COMMON SHAPES

SQUARES

AREA =  $a^2$



HALF ROUNDS

AREA =  $\frac{0.7854d^2}{2}$



ROUNDS

AREA =  $0.7854d^2$



HALF OVALS

AREA =  $0.7854 ab$

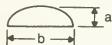

OVALS

AREA =  $0.7954 ab$



OCTAGONS

AREA =  $3.314r^2$



HEXAGONS

AREA =  $3.464r^2$



RIGHT-ANGLED TRIANGLE

AREA =  $\frac{ab}{2}$



RECTANGLES

AREA =  $ab$

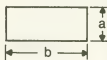

SEGMENT OF ROUNDS

AREA =  $\frac{rl - c(r-h)}{2}$



EQUILATERAL TRIANGLES

AREA =  $0.433013b^2$



KEYSTONES

AREA =  $\frac{a(b+c)}{2}$

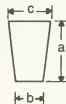



## RIGHT-ANGLED

Known	Find	FORMULAS
a, c	A, B, b	$\sin A = \frac{a}{c}, \cos B = \frac{a}{c}, b = \sqrt{c^2 - a^2}$
	Area	$\frac{a}{2} \sqrt{c^2 - a^2}$
a, b	A, B, c	$\tan A = \frac{a}{b}, \tan B = \frac{b}{a}, c = \sqrt{a^2 + b^2}$
	Area	$\frac{ab}{2}$
A, a	B, b, c	$B = 90^\circ - A, b = a \cot A, c = \frac{a}{\sin A}$
	Area	$\frac{a^2 \cot A}{2}$
B, a, c	B, a, c	$B = 90^\circ - A, a = b \tan A, c = \frac{b}{\cos A}$
	Area	$\frac{b^2 \tan A}{2}$
A, c	B, a, b	$B = 90^\circ - A, a = c \sin A, b = c \cos A$
	Area	$\frac{c^2 \sin A \cos A}{2} = \frac{c^2 \sin 2A}{4}$

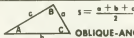

## OBLIQUE-ANGLED

Known	Find	FORMULAS
a, b, c	A	$\sin \frac{1}{2} A = \sqrt{\frac{(b-c)(b+c)}{bc}}, \cos \frac{1}{2} A = \sqrt{\frac{s(s-a)}{bc}}, \tan \frac{1}{2} A = \sqrt{\frac{(b-c)(b+c)}{s(s-a)}}$
	B	$\sin \frac{1}{2} B = \sqrt{\frac{(a-c)(a+c)}{ac}}, \cos \frac{1}{2} B = \sqrt{\frac{s(s-b)}{ac}}, \tan \frac{1}{2} B = \sqrt{\frac{(a-c)(a+c)}{s(s-b)}}$
	C	$\sin \frac{1}{2} C = \sqrt{\frac{(a-b)(a+b)}{ab}}, \cos \frac{1}{2} C = \sqrt{\frac{s(s-c)}{ab}}, \tan \frac{1}{2} C = \sqrt{\frac{(a-b)(a+b)}{s(s-c)}}$
	Area	$\sqrt{s(s-a)(s-b)(s-c)}$
a, A, B	b, c	$b = \frac{a \sin B}{\sin A}, c = \frac{a \sin C}{\sin A}, \frac{a \sin(A+B)}{\sin A}$
	C	$C = 180^\circ - (A+B)$
	Area	$\frac{1}{2} a b \sin C = \frac{a^2 \sin B \sin C}{2 \sin A}$
a, b, A	B	$\sin B = \frac{b \sin A}{a}$
	C	$C = 180^\circ - (A+B)$
	c	$c = \frac{a \sin C}{\sin A} = \frac{b \sin C}{\sin B} = \sqrt{a^2 + b^2 - 2ab \cos C}$
	Area	$\frac{1}{2} a b \sin C = \frac{1}{2} a c \sin B = \frac{1}{2} b c \sin A$
a, b, C	A	$\tan A = \frac{a \sin c}{b - a \cos c}$
	B	$B = 180^\circ - (A+C), \tan \frac{1}{2}(A-B) = \frac{a-b}{a+b} \cot \frac{1}{2} C$
	C	$c = \frac{a \sin c}{\sin A} = \sqrt{a^2 + b^2 - 2ab \cos C}$
	Area	$\frac{1}{2} a b \sin C$

$$a^2 = b^2 + c^2 - 2bc \cos A, b^2 = a^2 + c^2 - 2ac \cos B,$$

$$c^2 = a^2 + b^2 - 2ab \cos C$$

$$\frac{a}{\sin A} = \frac{b}{\sin B} = \frac{c}{\sin C}$$

## VALUES OF FUNCTIONS FOR CERTAIN ANGLES

Angle deg.	Arc	Sin	Cos	Tan	Cot	Sec	Csc	Chord.
0	0	0	+1	0	$\infty$	+1	$\infty$	0
30	$1/6 \pi$	1/2	$1/2\sqrt{3}$	$1/3\sqrt{3}$	$\sqrt{3}$	$2/3\sqrt{3}$	2	$\sqrt{2-\sqrt{3}}$
45	$1/4 \pi$	$1/2\sqrt{2}$	$1/2\sqrt{2}$	+1	+1	$\sqrt{2}$	$\sqrt{2}$	$\sqrt{2-\sqrt{2}}$
60	$1/3 \pi$	$1/2\sqrt{3}$	1/2	$\sqrt{3}$	$1/3\sqrt{3}$	2	$2/3\sqrt{3}$	1
90	$1/2 \pi$	+1	0	$\infty$	0	$\infty$	+1	$\sqrt{2}$
120	$2/3 \pi$	$1/2\sqrt{3}$	-1/2	$-\sqrt{3}$	$-1/3\sqrt{3}$	-2	$2/3\sqrt{3}$	$\sqrt{3}$
135	$3/4 \pi$	$1/2\sqrt{2}$	$-1/2\sqrt{2}$	-1	-1	$-\sqrt{2}$	$\sqrt{2}$	$\sqrt{2+\sqrt{2}}$
150	$5/6 \pi$	1/2	$-1/2\sqrt{3}$	$-1/3\sqrt{3}$	$-\sqrt{3}$	$-2/3\sqrt{3}$	2	$\sqrt{2+\sqrt{3}}$
180	$\pi$	0	-1	0	$\infty$	-1	$\infty$	2
210	$7/6 \pi$	-1/2	$-1/2\sqrt{3}$	$1/3\sqrt{3}$	$\sqrt{3}$	$-2/3\sqrt{3}$	-2	$\sqrt{2+\sqrt{3}}$
225	$5/4 \pi$	$-1/2\sqrt{2}$	$-1/2\sqrt{2}$	+1	+1	$-\sqrt{2}$	$-\sqrt{2}$	$\sqrt{2+\sqrt{2}}$
240	$4/3 \pi$	$-1/2\sqrt{3}$	-1/2	$\sqrt{3}$	$1/3\sqrt{3}$	-2	$-2/3\sqrt{3}$	$\sqrt{3}$
270	$3/2 \pi$	-1	0	$\infty$	0	$\infty$	-1	$\sqrt{2}$
300	$5/3 \pi$	$-1/2\sqrt{3}$	1/2	$-\sqrt{3}$	$-1/3\sqrt{3}$	2	$-2/3\sqrt{3}$	1
315	$7/4 \pi$	$-1/2\sqrt{2}$	$1/2\sqrt{2}$	-1	-1	$\sqrt{2}$	$-\sqrt{2}$	$\sqrt{2-\sqrt{2}}$
330	$11/6 \pi$	-1/2	$1/2\sqrt{3}$	$-1/3\sqrt{3}$	$-\sqrt{3}$	$2/3\sqrt{3}$	-2	$\sqrt{2-\sqrt{3}}$
360	$2\pi$	0	+1	0	$\infty$	+1	$\infty$	0

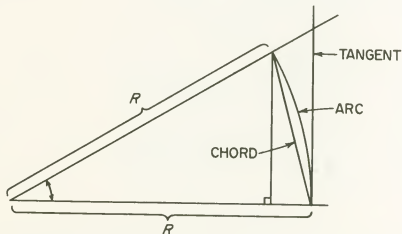

# TRIGONOMETRIC FUNCTIONS

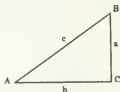

## Fundamental Trigonometric Functions

$$\begin{aligned} \sin A &= \frac{a}{c} & \csc A &= \frac{c}{a} \\ \cos A &= \frac{b}{c} & \sec A &= \frac{c}{b} \\ \tan A &= \frac{a}{b} & \cot A &= \frac{b}{a} \end{aligned}$$

## Functions of one angle

$$\begin{aligned} \sin^2 A + \cos^2 A &= 1 \\ \sec^2 A - \tan^2 A &= 1 \\ \csc^2 A - \cot^2 A &= 1 \end{aligned}$$

## Functions of the sum of two angles

$$\begin{aligned} \sin(A+B) &= \sin A \cos B + \cos A \sin B \\ \cos(A+B) &= \cos A \cos B - \sin A \sin B \\ \tan(A+B) &= \frac{\tan A + \tan B}{1 - \tan A \tan B} \\ \cot(A+B) &= \frac{\cot A \cot B - 1}{\cot B + \cot A} \end{aligned}$$

## Functions of the difference of two angles

$$\begin{aligned} \sin(A-B) &= \sin A \cos B - \cos A \sin B \\ \cos(A-B) &= \cos A \cos B + \sin A \sin B \\ \tan(A-B) &= \frac{\tan A - \tan B}{1 + \tan A \tan B} \\ \cot(A-B) &= \frac{\cot A \cot B + 1}{\cot B - \cot A} \end{aligned}$$

## Functions of one-half an angle

$$\begin{aligned} \sin \frac{1}{2} A &= \frac{\sin A}{2 \cos \frac{1}{2} A} = \pm \sqrt{\frac{1 - \cos A}{2}} \\ \cos \frac{1}{2} A &= \frac{\sin A}{2 \sin \frac{1}{2} A} = \pm \sqrt{\frac{1 + \cos A}{2}} \\ \tan \frac{1}{2} A &= \frac{1 - \cos A}{\sin A} = \pm \sqrt{\frac{1 - \cos A}{1 + \cos A}} \\ \cot \frac{1}{2} A &= \pm \sqrt{\frac{1 + \cos A}{1 - \cos A}} \end{aligned}$$

## Functions of twice an angle

$$\begin{aligned} \sin 2A &= 2 \sin A \cos A = \frac{2 \tan A}{1 + \tan^2 A} \\ \cos 2A &= \cos^2 A - \sin^2 A = \frac{1 - \tan^2 A}{1 + \tan^2 A} \\ &= 2 \cos^2 A - 1 = \frac{1 - \tan^2 A}{1 + \tan^2 A} \\ \tan 2A &= \frac{2 \tan A}{1 - \tan^2 A} = \frac{\sin 2A - \sin A}{\cos 2A + \cos A} \\ \cot 2A &= \frac{\cot^2 A - 1}{2 \cot A} \end{aligned}$$

## Functions of three times an angle

$$\begin{aligned} \sin 3A &= 3 \sin A - 4 \sin^3 A \\ \cos 3A &= 4 \cos^3 A - 3 \cos A \\ \tan 3A &= \frac{3 \tan A - \tan^3 A}{1 - 3 \tan^2 A} \\ \cot 3A &= \frac{\cot^3 A - 3 \cot A}{3 \cot^2 A - 1} \end{aligned}$$

## Functions of angles squared

$$\begin{aligned} \sin^2 A &= \frac{1 - \cos 2A}{2} \\ \cos^2 A &= \frac{1 + \cos 2A}{2} \\ \tan^2 A &= \frac{1 - \cos 2A}{1 + \cos 2A} \\ \cot^2 A &= \frac{1 + \cos 2A}{1 - \cos 2A} \\ \sin^2 A - \sin^2 B &= \sin(A+B) \sin(A-B) \\ \cos^2 A - \sin^2 B &= \cos(A+B) \cos(A-B) \end{aligned}$$

## Functions—Relationships

$$\begin{aligned} \sin A &= \frac{\cos A}{\cot A} = \frac{1}{\csc A} = \cos A \tan A = \sqrt{1 - \cos^2 A} \\ \cos A &= \frac{\sin A}{\tan A} = \frac{1}{\sec A} = \sin A \cot A = \sqrt{1 - \sin^2 A} \\ \tan A &= \frac{\sin A}{\cos A} = \frac{1}{\cot A} = \sin A \sec A \\ \cot A &= \frac{\cos A}{\sin A} = \frac{1}{\tan A} = \cos A \csc A \\ \sec A &= \frac{\tan A}{\sin A} = \frac{1}{\cos A} \\ \csc A &= \frac{1}{\sin A} = \frac{\cot A}{\cos A} \\ \sin A + \sin B &= 2 \sin \frac{1}{2}(A+B) \cos \frac{1}{2}(A-B) \\ \sin A - \sin B &= 2 \cos \frac{1}{2}(A+B) \sin \frac{1}{2}(A-B) \\ \cos A + \cos B &= 2 \cos \frac{1}{2}(A+B) \cos \frac{1}{2}(A-B) \\ \cos A - \cos B &= -2 \sin \frac{1}{2}(A+B) \sin \frac{1}{2}(A-B) \\ \tan A + \tan B &= \frac{\sin(A+B)}{\cos A \cos B} \\ \tan A - \tan B &= \frac{\sin(A-B)}{\cos A \cos B} \\ \cot A + \cot B &= \frac{\sin(A+B)}{\sin A \sin B} \\ \cot A - \cot B &= \frac{\sin(B-A)}{\sin A \sin B} \end{aligned}$$

## LISSAJOUS FIGURES

For two signals having the same frequency, the phase can be determined by measuring the major and minor axes of the ellipse. The phase angle is equal to twice the angle whose tangent is the ratio of the major axis to the minor axis. The absolute accuracy of this method is dependent upon the phase in the horizontal and vertical amplifiers of the oscilloscope being equal and the care that is taken to make the horizontal and vertical amplitudes equal.

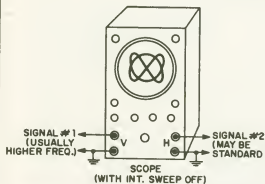

① ② ③  
 NO. LOOPS TANGENT TO HORIZ. LINE DEPENDS ON VERT. FREQ. (IN THIS CASE, 3)

①  
 NO. LOOPS TANGENT TO VERT. LINE DEPENDS ON HORIZ. FREQ. (IN THIS CASE, 2)

FREQUENCY RATIO = VERT. FREQ. : HORIZ. FREQ. :: 3 : 2  
 (FOR EXAMPLE, IF HORIZ. FREQ. IS 600Hz THEN VERT. FREQ. IS 900Hz)

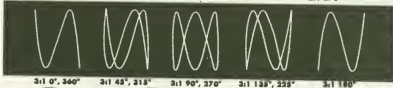
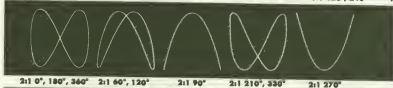
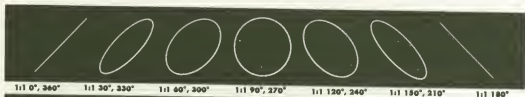



8:4



6:1

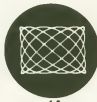

6:5



7:1



7:2



7:3

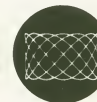

7:4

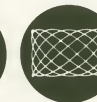

7:5

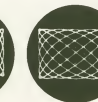

7:6



8:1

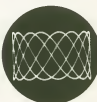

8:3

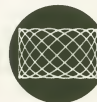

8:5

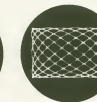

8:7

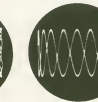

9:1



9:2

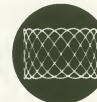

9:4

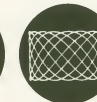

9:5

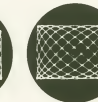

9:7

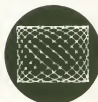

9:8

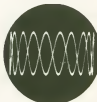

10:1

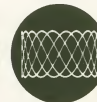

10:3

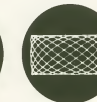

10:7

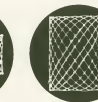

10:9

### PULSE PARAMETER NOMOGRAM

This normalized nomogram relates pulse rise time, repetition frequency, and pulse width to data channel bandwidth. To use the nomogram, connect a horizontal line through the selected bandwidth. The intersection with the other columns gives maximum pulse repetition frequency, minimum pulse width, and minimum risetime. For a given bandwidth, any combination of factors below the line can be used.

FOR EXAMPLE: For a bandwidth of 10 MHz ( $10 \times 10^6$  Hz) the fastest risetime is  $0.035 \times 10^{-8}$  sec, the maximum pulse repetition frequency is  $3.34 \times 10^6$  pulses per second, and the minimum pulse width is  $0.15 \times 10^{-8}$  sec.

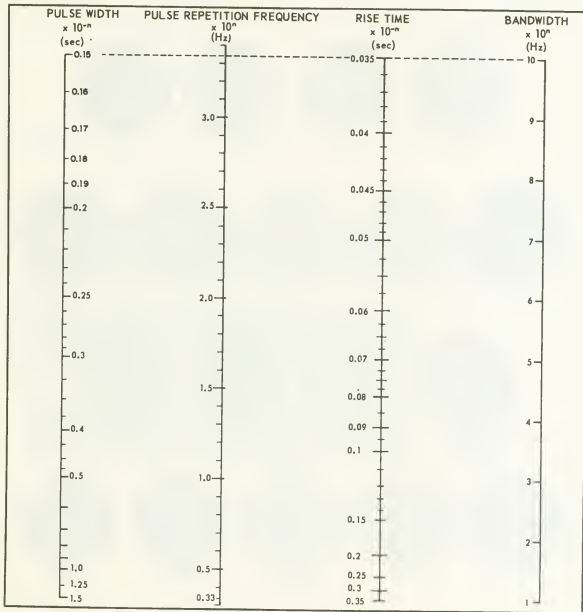

## PULSE DEFINITIONS

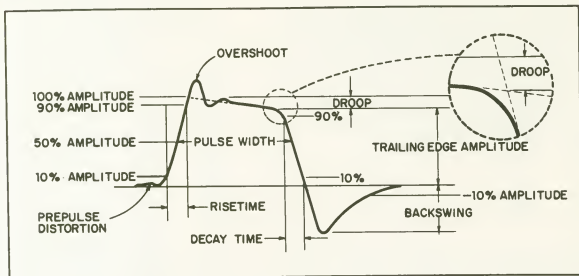



## FREQUENCY-PERIOD CONVERSION

This scale is based on the formula  $f=1/T$ . It converts between the frequency ( $f$ ) and the period ( $T$ ) of any recurrent waveform between 1 Hz and 10,00 GHz. It is useful where a large number of conversions are required as in the case when an oscilloscope with a time-calibrated sweep is used for frequency measurements.

FOR EXAMPLE: (1) The period of a 40-MHz signal is 25 nsec. (2) The frequency of a signal with a period of 12.5  $\mu$ sec is 80 kHz.

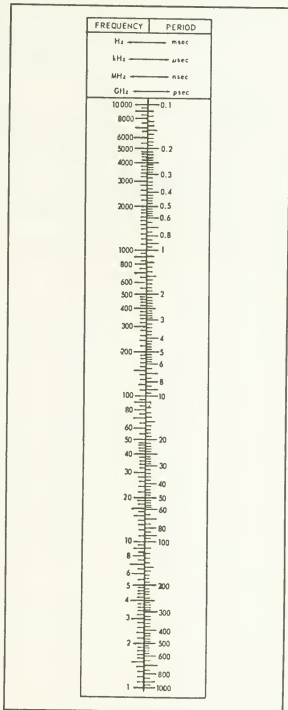

## GREEK ALPHABET

Letter		Name	Letter		Name
Small	Capital		Small	Capital	
α	Α	Alpha	ν	Ν	Nu
β	Β	Beta	ξ	Ξ	Xi
γ	Γ	Gamma	ο	Ο	Omicron
δ	Δ	Delta	π	Π	Pi
ε	Ε	Epsilon	ρ	Ρ	Rho
ζ	Ζ	Zeta	σ	Σ	Sigma
η	Η	Eta	τ	Τ	Tau
θ	Θ	Theta	υ	Υ	Upsilon
ι	Ι	Iota	φ	Φ	Phi
κ	Κ	Kappa	χ	Χ	Chi
λ	Λ	Lambda	ψ	Ψ	Psi
μ	Μ	Mu	ω	Ω	Omega

## ROMAN NUMERALS

The chief symbols are I = 1; V = 5; X = 10; L = 50; C = 100; D = 500; and M = 1,000. Note that IV = 4, means 1 short of 5; IX = 9, means 1 short of ten; XL = 40, means 10 short of 50; and XC = 90, means 10 short of 100. Any symbol following one of equal or greater value adds its value—II = 2. Any symbol preceding one of greater value subtracts its value—IV = 4. When a symbol stands between two of greater value its value is subtracted from the second and the remainder is added to the first—XIV = 14; LIX = 59. Of two equivalent ways of representing a number, that in which the symbol of larger denomination preceded is preferred—XIV instead of VIX for 14.

1	I	8	VIII
2	II	9	IX
3	III	10	X
4	IV	50	L
5	V	100	C
6	VI	500	D
7	VII	1,000	M

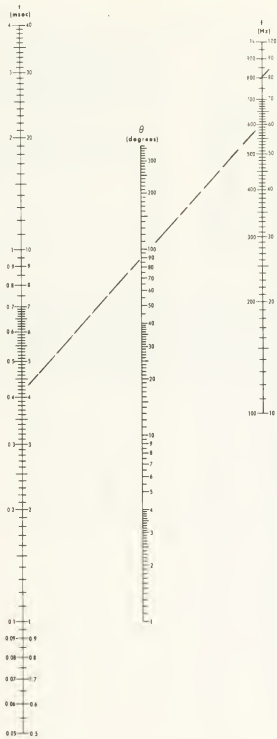

### PHASE ANGLE, TIME INTERVAL, AND FREQUENCY NOMOGRAM

---

Time delay, phase angle, and frequency are related by the following formula:

$$t = \frac{10^2\theta}{36f}$$

where

$t$  is in milliseconds

$\theta$  is in degrees

$f$  is in hertz

FOR EXAMPLE: A phase angle of  $90^\circ$  between two 60-Hz wave shapes has a time interval of 4.16 msec.





NOTE: Corresponding right-hand frequency and time scales are used together as are left-hand frequency and time scales. The range of the nomogram can be extended by multiplying the frequency scale by any power of 10 and dividing the time scale by the same power of 10.

## CHARACTERISTICS OF RECURRENT WAVEFORMS—RELATIONSHIP BETWEEN PEAK, RMS, AND AVERAGE VALUES

Description	Waveform	$E_{rms}$	$E_{ave}$
Alternating sine wave		$\frac{E_{peak}}{\sqrt{2}}$	$\frac{2E_{peak}}{\pi}$
Sawtooth wave		$\frac{E_{peak}}{\sqrt{3}}$	$\frac{E_{peak}}{2}$
Clipped sawtooth wave		$E_{peak} \sqrt{\frac{T_0}{3T}}$	$\frac{E_{peak} T_0}{2T}$
Square wave		$E_{peak} \sqrt{\frac{1}{2}}$	$\frac{E_{peak}}{2}$
Rectified sine wave		$\frac{E_{peak}}{\sqrt{2}}$	$\frac{2E_{peak}}{\pi}$
Clipped sine wave		$E_{peak} \sqrt{\frac{T_0}{2T}}$ if $T = T_0$ or $\frac{E_{peak}}{2}$	$\frac{E_{peak}}{\pi}$
Alternating square wave		$E_{peak}$	$E_{peak}$
Rectangular wave		$E_{peak} \sqrt{\frac{T_0}{T}}$	$\frac{E_{peak} T_0}{T}$
Triangular wave		$\frac{E_{peak}}{\sqrt{3}}$	$\frac{E_{peak}}{2}$

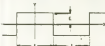
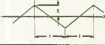
## FOURIER CONTENT OF COMMON PERIODIC WAVEFORMS

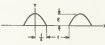
The Fourier content of five common periodic waveforms, out to the seventh harmonic, is given in this table. Magnitudes only are tabulated—not phase relationships. The magnitudes are those of the voltage waveform, followed by the corresponding percentage values in parentheses. If energy content is desired, these values must be squared. Note that there are no even harmonics present in any of the symmetrical waveforms.

Waveform	Name	Harmonic Composition (magnitude)						
		Fund.	2nd	3rd	4th	5th	6th	7th
	Square Wave	$\frac{4}{\pi} E$ (12.7%)	0	$\frac{4}{3\pi} E$ (42.5%)	0	$\frac{4}{5\pi} E$ (25.5%)	0	$\frac{4}{7\pi} E$ (18.2%)
	Triangular Wave	$\frac{8}{\pi^2} E$ (81%)	0	$\frac{8}{9\pi^2} E$ (9%)	0	$\frac{8}{25\pi^2} E$ (3.2%)	0	$\frac{8}{49\pi^2} E$ (1.6%)
	Sawtooth Wave	$\frac{2}{\pi} E$ (63.6%)	$\frac{1}{\pi} E$ (31.8%)	$\frac{2}{3\pi} E$ (21.2%)	$\frac{1}{2\pi} E$ (15.9%)	$\frac{2}{5\pi} E$ (12.7%)	$\frac{1}{3\pi} E$ (10.6%)	$\frac{2}{7\pi} E$ (9.1%)
	Half-Wave Rectifier Output	$\frac{1}{\pi} E$ (31.8%)	$\frac{2}{3\pi} E$ (21.2%)	0	$\frac{2}{15\pi} E$ (4.2%)	0	$\frac{2}{35\pi} E$ (1.8%)	0
	Full-Wave Rectifier Output	$\frac{2}{\pi} E$ (63.6%)	$\frac{4}{3\pi} E$ (42.3%)	0	$\frac{4}{15\pi} E$ (8.5%)	0	$\frac{4}{35\pi} E$ (3.6%)	0

SYNTHESIS OF A SQUARE WAVE

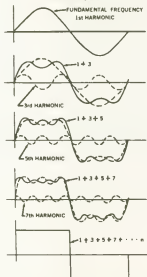

$$\left( \sin x + \frac{1}{3} \sin 3x + \frac{1}{5} \sin 5x + \frac{1}{7} \sin 7x + \dots + \frac{1}{n} \sin nx \right) \sin \pi x$$

SYNTHESIS OF A TRIANGULAR WAVE

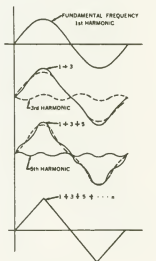

$$\sin x - \frac{1}{9} \sin 3x + \frac{1}{25} \sin 5x - \frac{1}{49} \sin 7x + \dots + \frac{1}{n^2} \sin nx$$

(From May, 1968 *Electronic Instrument Digest*, copyright © Milton S. Kiver Publications, Inc.)

# CONVERSIONS FROM DB AND DBM TO VOLTAGE AND POWER RATIOS, AND FROM DBM TO POWER AND VOLTAGE LEVELS

Ratio in db or dBm	Relationships for Either dB or dBm				Relationships for dBm Only			
	Voltage Ratio (per unit)	Power Ratio (per unit)	Voltage Ratio (per cent)	Power Ratio (per cent)	Power (Referred to 1 mW)	Voltage Across 50 ohms	Voltage Across 70 ohms	Voltage Across 600 ohms
+120.0	10 <sup>6</sup>	10 <sup>12</sup>	—	—	10 GW	224 kV	265 kV	775 kV
+80.0	10 <sup>4</sup>	10 <sup>8</sup>	—	—	100 kW	2.24 kV	2.65 kV	7.75 kV
+60.0	10 <sup>3</sup>	10 <sup>6</sup>	—	—	1 kW	224 V	265 V	775 V
+50.0	316	10 <sup>5</sup>	—	—	100 W	70.7 V	83.7 V	245 V
+40.0	100	10 <sup>4</sup>	—	—	10.0 W	22.4 V	26.5 V	77.5 V
+30.0	31.6	10 <sup>3</sup>	3160	—	1.00 W	7.07 V	8.37 V	24.5 V
+20.0	10.00	100.0	1000	—	100 mW	2.24 V	2.65 V	7.75 V
+17.0	7.08	30.1	708	5010	50 mW	1.59 V	1.88 V	5.49 V
+13.98	5.00	25.0	500	2500	25 mW	1.12 V	1.325 V	3.875 V
+12.04	4.00	16.0	400	1600	16 mW	895 mV	1.060 V	3.100 V
+9.54	3.00	9.00	300	900	9 mW	672 mV	795 mV	2.325 V
+6.02	2.00	4.00	200	400	4 mW	448 mV	530 mV	1.550 V
+3.01	1.41	2.00	141	200	2 mW	316 mV	374 mV	1.092 V
+2.00	1.26	1.58	126	158	1.26 mW	282 mV	334 mV	976 mV
+1.00	1.12	1.26	112	126	1.12 mW	251 mV	297 mV	868 mV
0.00	1.00	1.000	100	100	1.00 mW	224 mV	265 mV	775 mV
-1.00	0.893	0.793	89.3	79.3	790 μW	201 mV	237 mV	693 mV
-2.00	0.793	0.633	79.3	63.3	630 μW	178 mV	215 mV	615 mV
-3.01	0.707	0.500	70.7	50.0	500 μW	158 mV	187 mV	548 mV
-6.02	0.500	0.250	50.0	25.0	250 μW	114 mV	133 mV	388 mV
-9.54	0.333	0.111	33.3	11.1	110 μW	74.5 mV	88.3 mV	258 mV
-12.04	0.250	0.063	25.0	6.3	62.5 μW	56.0 mV	66.2 mV	194 mV
-13.98	0.200	0.040	20.0	4.0	40.0 μW	44.8 mV	53.0 mV	155 mV
-17.0	0.141	0.020	14.1	2.0	20.0 μW	31.6 mV	37.4 mV	109 mV
-20.0	0.100	0.010	10.0	1.0	10.0 μW	22.4 mV	26.5 mV	77.5 mV
-30.0	0.032	0.001	3.16	0.1	1.0 μW	7.07 mV	8.37 mV	24.5 mV
-40.0	0.010	10 <sup>-4</sup>	1.000	0.01	100 mW	2.24 mV	2.65 mV	7.75 mV
-50.0	0.0032	10 <sup>-5</sup>	0.316	0.001	10 mW	707 μV	837 μV	2.45 mV
-60.0	0.001	10 <sup>-6</sup>	0.100	10 <sup>-4</sup>	1 mW	224 μV	265 μV	775 μV
-80.0	10 <sup>-4</sup>	10 <sup>-8</sup>	0.010	10 <sup>-6</sup>	10 μW	22.4 μV	26.5 μV	77.5 μV
-120.0	10 <sup>-8</sup>	10 <sup>-12</sup>	—	—	1 nW	224 nV	265 nV	775 nV

(From May, 1968 *Electronic Instrument Digest*,  
copyright © Milton S. Kiver Publications, Inc.)

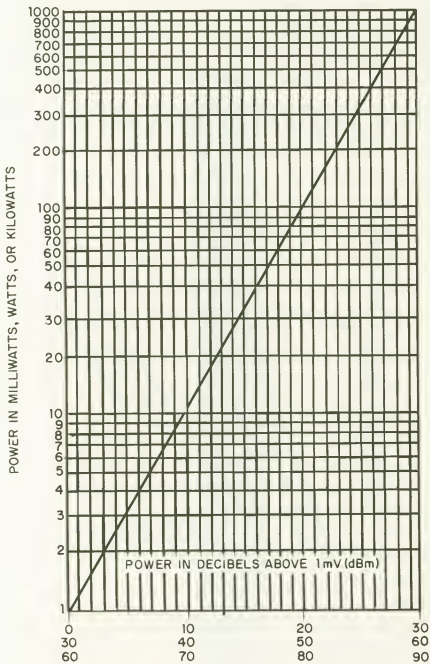

(From May, 1968 *Electronic Instrument Digest*, copyright © Milton S. Kiver Publications, Inc.)



## DECIBEL NOMOGRAMS

The nomogram below is based on the equation shown and makes possible rapid addition or subtraction of two or more dB levels.

For off-scale levels 1, 2, 5, 10, 20, 30, etc., can be added or subtracted, simultaneously, to all nomograph scale values. For more than two levels, add any two, and to the first sum add the third, etc.

FOR EXAMPLE: (1) What is the combined sound power level of 70, 76 and 80.5 dB? Align  $(dB)_a = 76$  with  $(dB)_b = 70$  and read  $(dB)_c = 77.0$ ; align  $(dB)_a = 77.0$  with  $(dB)_b = 80.5$  and read the answer as  $(dB)_c = 82.1$  dB.

(2) When a fan is on, the sound pressure level equals 68 dB and 64 dB with the fan off. What is the sound pressure level of the fan? To extend the range of the nomogram, subtract 10 from all scale values; align  $(dB)_c = 68 = 78 - 10$  with  $(dB)_a = 64 = 74 - 10$ , and read  $(dB)_b = 75.8 - 10 = 65.8$  dB = fan sound pressure level.

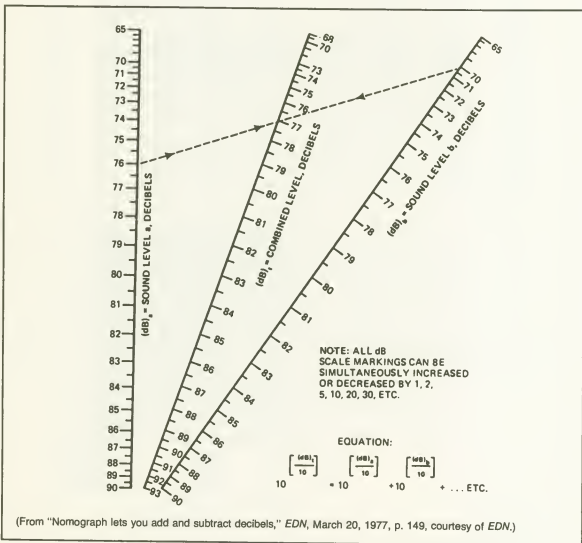

## DECIBEL NOMOGRAPHS

With the nomograph below and the one on the next page dB gain or loss of any equipment can be determined (even if input and output impedances differ) if input and output voltages and resistances can be measured. The nomograms cover a power range of 10,000 to 1, a voltage range of 100 to 1, and a decibel range from +40 to -40 dB. Voltage and resistance scales of nomogram 1 bearing the same suffix are used together.

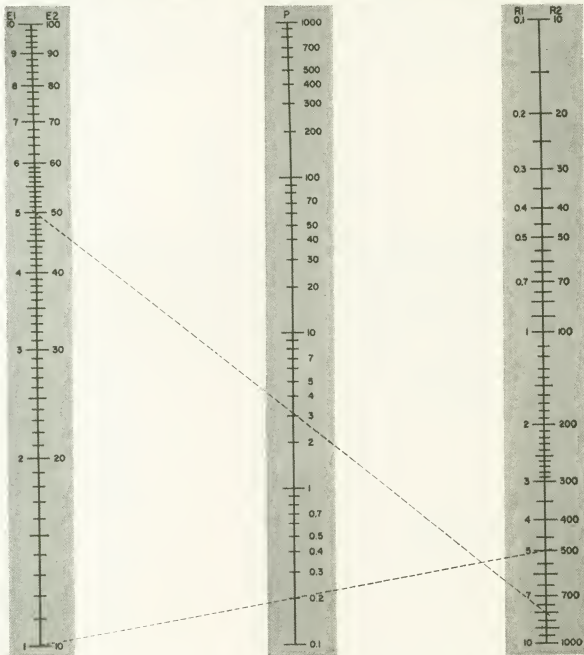

FOR EXAMPLE: Determine the gain of an amplifier that produces an output of 5 V across 8 ohms with a 10-V signal applied to its 500-ohm input. From nomogram 1, the input power is 0.2 W and the output power is 3.1 W. Connecting input and output power on nomogram 11 shows the amplifier gain to be slightly less than 12 dB.

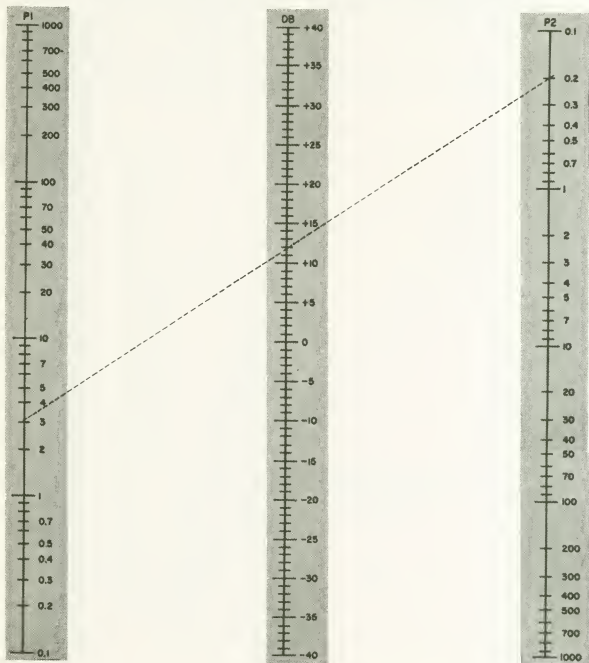

## LETTER SYMBOLS FOR QUANTITIES USED IN ELECTRICAL SCIENCE AND ELECTRICAL ENGINEERING

### Extracted from IEEE Standard No. 280

The tables that follow list quantities grouped in several categories, and give quantity symbols, units based on the International System,\* and unit symbols.

Those quantity symbols that are separated by a comma are alternatives on equal standing. Where two symbols for a quantity are separated by three dots (...), the second is a reserve symbol, which is to be used only where there is specific need to avoid a conflict. As a rule the tables do not indicate the vectorial or tensorial character that some of the quantities may have.

The International System of Units (Système International d'Unités) is the coherent system of units based on the following units and quantities:

Unit	Quantity
meter	length
kilogram	mass
second	time
ampere	electric current
kelvin	temperature
candela	luminous intensity
radian	plane angle
steradian	solid angle

This system was named (and given the international designation SI) in 1960 by the Conférence Générale des Poids et Mesures (CGPM). The SI units include as subsystems the MKS system of units, which covers mechanics, and the MKSA or Giorgi system, which covers mechanics, electricity, and magnetism.

\*The name of the unit is given as a further guide to the definition of the symbol. A quantity shall be represented by the standard letter symbol appearing in the table regardless of the system of units in which the quantity is expressed.

Item	Quantity	Quantity Symbol <sup>a</sup>	Unit Based on International System	Unit Symbol	Remarks
1. Space and Time					
	angle, plane	$\alpha, \beta, \gamma, \theta, \Phi, \psi$	radian	rad	Other Greek letters are permitted where no conflict results.
	angle, solid	$\Omega \dots \omega$	steradian	sr	
	length	$l$	meter	m	
	breadth, width	$b$	meter	m	
	height	$h$	meter	m	
	thickness	$d, \delta$	meter	m	
	radius	$r$	meter	m	
	diameter	$d$	meter	m	
	length of path	$s$	meter	m	
	line segment				
	wavelength	$\lambda$	meter	m	
	wave number	$\sigma \dots \tilde{\nu}$	reciprocal meter	m <sup>-1</sup>	$\sigma = 1/\lambda$ The symbol $\tilde{\nu}$ is used in spectroscopy.
	circular wave number	$k$	radian per meter	rad/m	$k = 2\pi/\lambda$
	angular wave number				
	area	$A \dots S$	square meter	m <sup>2</sup>	
	volume	$V, v$	cubic meter	m <sup>3</sup>	
	time	$t$	second	s	
	period	$T$	second	s	
	time of one cycle				

Item	Quantity	Quantity Symbol <sup>a</sup>	Unit Based on International System	Unit Symbol	Remarks
	time constant	$\tau \dots T$	second	s	The name <i>cycle per second</i> is also used for this unit. The symbol for the unit <i>cycle per second</i> is <i>c/s</i> ; the use of <i>cps</i> as a symbol is deprecated.
		$f \dots \nu$	hertz	Hz	
	speed of rotation	$n$	revolution per second	r/s	The symbol $f$ is used in circuit theory, sound, and mechanics; $\nu$ is used in optics and quantum theory.
	rotational frequency				
	angular frequency	$\omega$	radian per second	rad/s	$\omega = 2\pi f$
	angular velocity		radian per second	rad/s	$p = -\delta + j\omega$
	complex (angular) frequency oscillation constant	$p \dots s$	reciprocal second	$s^{-1}$	
	angular acceleration	$\alpha$	radian per second squared	rad/s <sup>2</sup>	
	velocity	$v$	meter per second	m/s	In vacuum, $c_0$ ; see 8.1.
	speed of propagation of electromagnetic waves	$c$	meter per second	m/s	
	acceleration (linear)	$a$	meter per second squared	m/s <sup>2</sup>	
	acceleration of free fall gravitational acceleration	$g$	meter per second squared	m/s <sup>2</sup>	Standard value, $g_N$ ; see 8.10.
	damping coefficient	$\delta$	neper per second	Np/s	If $F$ is a function of time given by $F = Ae^{-\delta t} \sin(2\pi t/T)$ ,

<sup>a</sup>Commas separate symbols on equal standing. Where two symbols are separated by three dots the second is a reserve symbol and is to be used only when there is specific need to avoid a conflict. See Introduction to the Tables.

logarithmic decrement	$\Lambda$	(numeric)			then $\delta$ is the damping coefficient. $\Lambda = T\delta$ , where $T$ and $\delta$ are as given in the equation of 1.28.
attenuation coefficient	$\alpha$	neper per meter		Np/m	
phase coefficient	$\beta$	radian per meter		rad/m	
propagation coefficient	$\gamma$	reciprocal meter		m <sup>-1</sup>	$\gamma = \alpha + j\beta$ .
2. Mechanics <sup>b</sup>					
mass	$m$	kilogram		kg	Mass divided by volume.
(mass) density	$\rho$	kilogram per cubic meter		kg/m <sup>3</sup>	
momentum	$p$	kilogram meter per second		kg · m/s	
moment of inertia	$I, J$	kilogram meter squared		kg · m <sup>2</sup>	
second (axial) moment of area	$I, I_a$	meter to the fourth power		m <sup>4</sup>	Quantities 2.4a and 2.4b should be distinguished from 2.4.

Item	Quantity	Quantity Symbol <sup>a</sup>	Unit Based on International System	Unit Symbol	Remarks
	second (polar) moment of area	$J, I_p$	meter to the fourth power	$m^4$	They have often been given the name "moment of inertia."
	force	$F$	newton	N	
	weight	$W$	newton	N	Varies with acceleration of free fall.
	weight density	$\gamma$	newton per cubic meter	$N/m^3$	Weight divided by volume.
	moment of force	$M$	newton meter	$N \cdot m$	
	torque	$T \dots M$	newton meter	$N \cdot m$	
	pressure	$p$	newton per square meter	$N/m^2$	The name <i>pascal</i> has been suggested for this unit.
	normal stress	$\sigma$	newton per square meter	$N/m^2$	
	shear stress	$\tau$	newton per square meter	$N/m^2$	
	stress tensor	$\sigma$	newton per square meter	$N/m^2$	
	linear strain	$\epsilon$	(numeric)		
	shear strain	$\gamma$	(numeric)		
	strain tensor	$\epsilon$	(numeric)		
	volume strain	$\theta$	(numeric)		
	Poisson's ratio	$\mu, \nu$	(numeric)		Lateral contraction divided by elongation.
	Young's modulus	$E$	newton per square meter	$N/m^2$	$E = \sigma/\epsilon$
	modulus of elasticity	$G$	newton per square meter	$N/m^2$	$G = \tau/\gamma$
	shear modulus	$G$	newton per square meter	$N/m^2$	
	modulus of rigidity	$K$	newton per square meter	$N/m^2$	$K = -p/\theta$
	bulk modulus	$K$	newton per square meter	$N/m^2$	
	work	$W$	joule	J	
	energy	$E, W$	joule	J	$U$ is recommended in thermodynamics for internal energy and for blackbody radiation.

<sup>a</sup>The units and corresponding unit symbols are included for use in electrical science and electrical engineering. In mechanics and mechanical engineering other units and corresponding unit symbols are also used. (USAS Y10.3 now being revised.)

	energy (volume) density	$w$	joule per cubic meter	$J/m^3$	
	power	$P$	watt	W	Rate of energy transfer. $W = J/s$
	efficiency	$\eta$	(numeric)		
3. Heat <sup>c</sup>	absolute temperature	$T \dots \Theta$	kelvin	K	In 1967 the CGPM voted to give the name <i>kelvin</i> to the SI unit of temperature, which was formerly called <i>degree Kelvin</i> , and to assign it the symbol K (without the symbol $^{\circ}$ ).
	thermodynamic temperature				

Item	Quantity	Quantity Symbol <sup>a</sup>	Unit Based on International System	Unit Symbol	Remarks
temperature customary temperature		$t \dots \theta$	degree Celsius	$^{\circ}\text{C}$	The symbol $^{\circ}\text{C}$ is printed without space between $^{\circ}$ and the letter that follows. The word <i>centigrade</i> has been abandoned as the name of a temperature scale. The units of temperature interval or difference are identical on the Kelvin and Celsius scales. The name kelvin and symbol K were adopted by the CGPM. The name <i>degree</i> and the symbol <i>deg</i> are also used. When it is necessary to distinguish between the Fahrenheit degree and the Celsius degree, the symbols deg F and deg C may be used.
heat		$Q$	joule	J	Heat crossing a surface divided by time.
internal energy		$U$	joule	J	
heat flow rate		$\Phi \dots q$	watt	W	
temperature coefficient		$\alpha$	reciprocal kelvin	$\text{K}^{-1}$	A temperature coefficient is not completely defined unless the quantity that changes is specified (e.g., resistance, length, pressure). The pressure (temperature) coefficient is designated by $\beta$ ; the cubic expansion (temperature) coefficient, by $\alpha$ , $\beta$ , or $\gamma$ .
thermal diffusivity		$a$	square meter per second	$\text{m}^2/\text{s}$	
thermal conductivity		$\lambda \dots k$	watt per meter kelvin	$\text{W}/(\text{m} \cdot \text{K})$	
thermal conductance		$G_{\theta}$	watt per kelvin	$\text{W}/\text{K}$	
thermal resistivity		$\rho_{\theta}$	meter kelvin per watt	$\text{m} \cdot \text{K}/\text{W}$	
thermal resistance		$R_{\theta}$	kelvin per watt	$\text{K}/\text{W}$	
thermal capacitance		$C_{\theta}$	joule per kelvin	$\text{J}/\text{K}$	
heat capacity					
thermal impedance		$Z_{\theta}$	kelvin per watt	$\text{K}/\text{W}$	
specific heat capacity		$c$	joule per kelvin kilogram	$\text{J}/(\text{K} \cdot \text{kg})$	Heat capacity divided by mass.

<sup>a</sup>The units and corresponding unit symbols are included for use in electrical science and engineering. In mechanical engineering other units and corresponding unit symbols are also used. (CF. USAS Y10.4.)

Item	Quantity	Quantity Symbol <sup>a</sup>	Unit Based on International System	Unit Symbol	Remarks
	entropy	$S$	joule per kelvin	J/K	
	specific entropy	$s$	joule per kelvin kilogram	J/(K · kg)	Entropy divided by mass.
	enthalpy	$H$	joule	J	
4. Radiation and Light	radiant intensity	$I \dots I_e$	watt per steradian	W/sr	
	radiant power	$P, \Phi \dots \Phi_e$	watt	W	
	radiant flux	$W, Q \dots Q_e$	joule	J	The symbol $U$ is used for the special case of blackbody radiant energy.
	radiant energy				
	radiance	$L \dots L_e$	watt per steradian square meter	W/(sr · m <sup>2</sup> )	
	radiant exitance	$M \dots M_e$	watt per square meter	W/m <sup>2</sup>	
	irradiance	$E \dots E_e$	watt per square meter	W/m <sup>2</sup>	
	luminous intensity	$I \dots I_v$	candela	lm	
	luminous flux	$\Phi \dots \Phi_v$	lumen	lm · s	
	quantity of light	$Q \dots Q_v$	lumen second	lm · s	
	luminance	$L \dots L_v$	candela per square meter	cd/m <sup>2</sup>	The name $n/l$ is sometimes used for this unit.
	luminous exitance	$M \dots M_v$	lumen per square meter	lm/m <sup>2</sup>	
	illuminance	$E \dots E_v$	lux	lx	lx = lm/m <sup>2</sup>
	illumination				
	luminous efficacy	$K(\lambda)$	lumen per watt	lm/W	( $\lambda$ ) is not part of the basic symbol but indicates that luminous efficacy is a function of wavelength. $K = \Phi/P$
	total luminous efficacy	$K, K_t$	lumen per watt	lm/W	
	refractive index	$n$	(numeric)		
	index of refraction				
	emissivity	$\epsilon(\lambda)$	(numeric)		( $\lambda$ ) is not part of the basic symbol but indicates that emissivity is a function of wavelength.
	total emissivity	$\epsilon, \epsilon_t$	(numeric)		
	absorbance	$a(\lambda)$	(numeric)		( $\lambda$ ) is not part of the basic symbol but indicates that the absorbance is a function of wavelength.
	transmittance	$\tau(\lambda)$	(numeric)		( $\lambda$ ) is not part of the basic symbol but indicates that the transmittance is a function of wavelength.
	reflectance	$\rho(\lambda)$	(numeric)		( $\lambda$ ) is not part of the basic symbol but indicates that the reflectance is a function of wavelength.
5. Fields and Circuits	electric charge	$Q$	coulomb	C	
	quantity of electricity				



Item	Quantity	Quantity Symbol <sup>d</sup>	Unit Based on International System	Unit Symbol	Remarks
	linear density of charge	$\lambda$	coulomb per meter	C/m	
	surface density of charge	$\sigma$	coulomb per square meter	C/m <sup>2</sup>	
	volume density of charge	$\rho$	coulomb per cubic meter	C/m <sup>3</sup>	
	electric field strength	$E \dots K$	volt per meter	V/m	
	electrostatic potential	$V \dots \phi$	volt	V	
	retarded scalar potential	$V_r$	volt	V	
	voltage electromotive force	$V, E \dots U$	volt	V	
	electric flux	$\Psi$	coulomb	C	
	electric flux density (electric displacement)	$D$	coulomb per square meter	C/m <sup>2</sup>	
	capacitance permittivity absolute permittivity	$\epsilon$	farad per meter	F/m	Of vacuum, $\epsilon_0$ .
	relative permittivity	$\epsilon_r, \kappa$	(numeric)		
	complex relative permittivity	$\epsilon_r^*, \kappa^*$	(numeric)		$\epsilon_r^* = \epsilon_r' - j\epsilon_r''$
	complex dielectric constant				$\epsilon_r''$ is positive for lossy materials. The complex absolute permittivity $\epsilon^*$ is defined in analogous fashion.
	electric susceptibility	$\chi_e \dots \epsilon_1$	(numeric)		$\chi_e = \epsilon_r - 1$
	electric polarization	$E_1 \dots K_1$	volt per meter	V/m	$E_1 = (D/\epsilon_0) - E$
	electric dipole moment	$P$	coulomb per square meter	C/m <sup>2</sup>	$P = D - \epsilon_0 E$
	(electric) current	$I$	coulomb meter	C · m	
	current density	$J \dots S$	ampere per square meter	A/m <sup>2</sup>	
	linear current density	$A \dots a$	ampere per meter	A/m	Current divided by the breadth of the conducting sheet.
	magnetic field strength	$H$	ampere per meter	A/m	
	magnetic (scalar) potential	$U, U_m$	ampere	A	
	magnetic potential difference	$F, F_m \dots \mathcal{F}$	ampere	A	
	magnetic flux	$\Phi$	weber	Wb	
	magnetic flux density	$B$	tesla	T	T = Wb/m <sup>2</sup>

Item	Quantity	Quantity Symbol <sup>1</sup>	Unit Based on International System	Unit Symbol	Remarks
magnetic induction					
magnetic flux linkage	$\Lambda$		weber	Wb	
(magnetic) vector potential	$A$		weber per meter	Wb/m	
retarded (magnetic) vector potential	$A_r$		weber per meter	Wb/m	
(magnetic) permeability	$\mu$		henry per meter	H/m	Of vacuum, $\mu_v$ .
absolute permeability					
relative (magnetic) permeability	$\mu_r$		(numeric)		
initial (relative) permeability	$\mu_0$		(numeric)		
complex relative permeability	$\mu^*$		(numeric)		$\mu_r^* = \mu_r' - j\mu_r''$ $\mu_r'$ is positive for lossy materials. The complex absolute permeability $\mu^*$ is defined in anelegant fashion.
magnetic susceptibility	$\chi_m \dots \mu_i$		(numeric)		$\chi_m = \mu_r - 1$
reluctivity	$\nu$		meter per henry	m/H	$\nu = 1/\mu$
magnetization	$H_i, M$		ampere per meter	A/m	$H_i = (B/\mu_0) - H$
magnetic polarization	$J, B_i$		tesla	T	$J = B - \mu_0 M$
intrinsic magnetic flux density					
magnetic (free) moment	$m$		ampere meter squared	A · m <sup>2</sup>	The vector product $m \times B$ is equal to the torque.
capacitance	$C$		farad	F	
elastance	$S$		reciprocal farad	F <sup>-1</sup>	$S = 1/C$
(self) inductance	$L$		henry	H	
reciprocal inductance	$l'$		reciprocal henry	H <sup>-1</sup>	
mutual inductance	$L_{ij}, M_{ij}$		henry	H	If only a single mutual inductance is involved, $M$ may be used without subscripts.
coupling coefficient	$k \dots \kappa$		(numeric)		$k = L_{ij}/(L_i L_j)^{1/2}$
leakage coefficient	$\sigma$		(numeric)		$\sigma = 1 - k^2$
number of turns (in a winding)	$N, n$		(numeric)		
number of phases	$m$		(numeric)		
turns ratio	$n \dots n_s$		(numeric)		
transformer ratio	$a$		(numeric)		Square root of the ratio of secondary to primary self inductance. The coefficient of coupling is high, $a = n_s$ .
resistance	$R$		ohm	$\Omega$	
resistivity	$\rho$		ohm meter	$\Omega \cdot m$	
volume resistivity					
conductance	$G$		mho	mho	$G = \text{Re } Y$ The IEC has adopted

Item	Quantity	Quantity Symbol <sup>d</sup>	Unit Based on International System	Unit Symbol	Remarks
					the name <i>siemens</i> (S) for this unit. The CGPM has not yet adopted a name.
	conductivity	$\gamma, \sigma$	mho per meter	mho/m	$\gamma = 1/\rho$ The symbol $\sigma$ is used in field theory, as $\gamma$ is there used for the propagation coefficient. See remark for 5.50.
	reluctance	$R, R_m \dots \mathcal{R}$	reciprocal henry	H <sup>-1</sup>	Magnetic potential difference divided by magnetic flux.
	permeance	$P, P_m \dots \mathcal{P}$	henry	H	$P_m = 1/R_m$
	impedance	$Z$	ohm	$\Omega$	$Z = R + jX$
	reactance	$X$	ohm	$\Omega$	
	capacitive reactance	$X_C$	ohm	$\Omega$	For a pure capacitance, $X_C = -1/\omega C$
	inductive reactance	$X_L$	ohm	$\Omega$	For a pure inductance, $X_L = \omega L$
	quality factor	$Q$	(numeric)		$Q = \frac{2\pi \text{ (peak energy stored)}}{\text{(energy dissipated per cycle)}}$ For a simple reactor, $Q =  X /R$
	admittance	$Y$	mho	mho	$Y = 1/Z = G + jB$
	susceptance	$B$	mho	mho	See remark for 5.50. $B = \text{Im } Y$
	loss angle	$\delta$	radian	radian	See remark for conductance.
	active power	$P$	watt	W	$\delta = \arctan (R/ X )$
	reactive power	$Q \dots P_q$	var	var	
	apparent power	$S \dots P_s$	voltampere	VA	
	power factor	$\cos \phi \dots F_p$	(numeric)		
	reactive factor	$\sin \phi \dots F_q$	(numeric)		
	input power	$P_i$	watt	W	
	output power	$P_o$	watt	W	
	Poynting vector	$S$	watt per square meter	W/m <sup>2</sup>	
	characteristic impedance	$Z_0$	ohm	$\Omega$	
	surge impedance				
	intrinsic impedance of a medium	$\eta$	ohm	$\Omega$	
	voltage standing-wave ratio	$S$	(numeric)		
	resonance frequency	$f_r$	hertz	Hz	The name <i>cycle per second</i> (c/s) is also used for this unit.
	critical frequency	$f_c$	hertz	Hz	
	cutoff frequency				
	resonance angular frequency	$\omega_r$	radian per second	rad/s	
	critical angular frequency	$\omega_c$	radian per second	rad/s	
	cutoff angular frequency				
	resonance wavelength	$\lambda_r$	meter	m	
	critical wavelength	$\lambda_c$	meter	m	
	cutoff wavelength				
	wavelength in a guide	$\lambda_g$	meter	m	

Item	Quantity	Quantity Symbol <sup>d</sup>	Unit Based on International System	Unit Symbol	Remarks
	hysteresis coefficient	$k_h$	(numeric)		
	eddy-current coefficient	$k_e$	(numeric)		
	phase angle	$\phi, \theta$	radian	rad	
6. Electronics and	phase difference				
Telecommunica-	carrier frequency	$f_c$	hertz	Hz	The name <i>cycle per second (c/s)</i> is also used for this unit.
instantaneous frequency	$f, f_i$	hertz	Hz		
intermediate frequency	$f_i, f_{if}$	hertz	Hz		
modulation frequency	$f_m$	hertz	Hz		
pulse repetition frequency	$f_p$	hertz	Hz		
frequency deviation	$f_d$	hertz	Hz		
Doppler frequency shift	$f_D$	hertz	Hz		
pulse duration	$t_p$	second	s		
rise time (of a pulse)	$t_r$	second	s		
fall time (of a pulse)	$t_f$	second	s		
decay time (of a pulse)					
duty factor	$D$	(numeric)		$D = t_p f_p$	
pulse duty factor					
phase propagation time	$t_\phi$	second	s		
group propagation time	$t_g$	second	s		
duration of a signal element	$\tau$	second	s		
signaling speed	$1/\tau$	baud	Bd		
cathode-heating time	$t_k$	second	s		
deionization time	$t_d$	second	s		
ionization time	$t_i$	second	s		
form factor	$k_f$	(numeric)			
peak factor	$k_{pk}$	(numeric)			
distortion factor	$d$	(numeric)			
modulation factor (AM)	$m$	(numeric)			
modulation index (FM)	$\eta$	(numeric)			
signal power	$P_s, S$	watt	W		
noise power	$P_n, N$	watt	W		
noise-power density	$N_o$	watt per hertz	W/Hz		
energy of a signal element	$E$	joule	J		
signal-to-noise power, ratio <sup>o</sup>	$R, S/N$	(numeric)		$R = P_s/P_n$	
elementary signal-to-noise ratio <sup>o</sup>	$R, R_e$	(numeric)		$R_e = E/N_o$	
gain (power) <sup>o</sup>	$G$	(numeric)			
amplification (current or voltage) <sup>o</sup>	$A$	(numeric)			
noise factor <sup>o</sup>	$F$	(numeric)			
noise figure					

Item	Quantity	Quantity Symbol <sup>a</sup>	Unit Based on International System	Unit Symbol	Remarks
bandwidth		$\beta$	hertz	Hz	See remark for carrier frequency.
feedback transfer ratio		$\beta$	(numeric)		
critical frequency of an ionized layer		$f_c$	hertz	Hz	See remark for carrier frequency.
plasma frequency		$f_p$	hertz	Hz	See remark for carrier frequency.
ion (number density)		$n^+, n^-$	ion per cubic meter	$m^{-3}$	
mobility (of a charge carrier in a medium)		$\mu$	square meter per volt second	$m^2/(V \cdot s)$	
rate of production of electrons per unit volume		$q$	electron per cubic meter second	$m^{-3} s^{-1}$	
recombination coefficient		$\epsilon$	cubic meter per second	$m^3/s$	
effective attachment coefficient		$\beta$	reciprocal second	$s^{-1}$	
$\mu$ -factor		$\mu_{ij}$	(numeric)		$\mu_{ij} = \left  \frac{\partial v_j}{\partial v_i} \right $ where $v_j$ and $v_i$ are the voltages of the $i$ th and $j$ th electrodes, and the current to the $i$ th electrode and all electrode voltages other than $v_j$ and $v_i$ are held constant.
amplification factor		$\mu$	(numeric)		The amplification factor is the $\mu$ -factor for the anode and control-grid electrodes.
interelectrode transmittance		$\gamma_{ij}$	mho	mho	See remark for conductance.
interelectrode transconductance		$g_{ij}$	mho	mho	The real part of the interelectrode transmittance. See conductance.
mutual conductance transconductance		$g_m, g_{eg}$	mho	mho	The mutual conductance is the control-grid-to-anode transconductance. See conductance.
conversion transconductance		$g_c$	mho	mho	Transconductance defined for a heterodyne conversion transducer. See conductance.
plate resistance		$r_a$	ohm	$\Omega$	
anode resistance		$r_a$	ohm	$\Omega$	
anode dissipation power		$P_a$	watt	W	
grid dissipation power		$P_g$	watt	W	
saturation current of a cathode		$I_s$	ampere	A	

Item	Quantity	Quantity Symbol <sup>d</sup>	Unit Based on International System	Unit Symbol	Remarks
secondary-emission ratio	$\delta$		(numeric)		
temperature of mercury condensate	$T_{\text{Hg}}$		kelvin	K	
radiant sensitivity of a phototube, dynamic	$s$		ampere per watt	A/W	
radiant sensitivity of a phototube, static	$S$		ampere per watt	A/W	
luminous sensitivity of a phototube, dynamic	$s_v$		ampere per lumen	A/lm	
luminous sensitivity of a phototube, static	$S_v$		ampere per lumen	A/lm	
Subscripts, electronic tubes					
anode			a		
cathode			k		
grid			g		
heater			h		
filament (emitting)			f		
fluorescent screen or target			t		
external conducting coating			M		
internal conducting coating			m		
deflector electrode			x or y		
internal shield			s		
wave-retardation electrode			wr		
beam-forming plate			bp		
switch, moving contact			cm		
switch, fixed contact			cf		
Subscripts, semiconductor devices					
emitter terminal			E, e		
base terminal			B, b		
collector terminal			C, c		
anode			A, a		
cathode			K, k		
control terminal (gate)			G, g		
junction (general)			J, j		
7. Machines and Power Engineering					
synchronous speed (of rotation)	$n_1$		revolution per second	r/s	
synchronous angular frequency	$\omega_1$		radian per second	rad/s	
slip	$s$		(numeric)		
number of poles	$p, 2p$		(numeric)		
pole strength	$p \dots m$		weber	Wb	The IEC gives $p$ for the number of pairs of poles, although $p$ has been widely used in the U.S. for the number of poles. Where ambiguity may occur, the intended meaning should be indicated.

## LETTER SYMBOLS FOR UNITS USED IN ELECTRICAL SCIENCE AND ELECTRICAL ENGINEERING

Extracted from IEEE Standard No. 260

The use of unit symbols, instead of the spelled-out names of the units, is frequently desirable where space is restricted. Their use presupposes that the reader will find them intelligible. If there is any doubt that the reader will understand a symbol, the name of the unit should be written in full. When an unfamiliar unit symbol is first used in text, it should be followed by its name in parentheses; only the symbol need be used thereafter. Explanatory notes or keys should be included where appropriate on drawings and in tabular matter.

The use of unit symbols is never mandatory, but when unit symbols are employed they must conform to those given in the Standard.

### List of Symbols

Symbols for units are listed alphabetically by name of unit below. The list is intended to be reasonably complete, but could not possibly include all units that might conceivably be used in modern electrical technology. Many compound symbols and many illustrations of the use of the metric prefixes are included. Other combined forms may easily be constructed.

Every effort should be made to maintain the distinction between upper- and lowercase letters shown in the list, wherever the symbols for units are used, even if the surrounding text uses uppercase style.

In the notes accompanying the symbols, some units are identified as SI units. These units belong to the International System of Units (Système International d'Unités), which is the name given in 1960 by the Conférence Générale des Poids et Mesures to the coherent system of units based on the following basic units and quantities:

Unit	Quantity	Unit	Quantity
meter	length	ampere	electric current
kilogram	mass	kelvin	temperature
second	time	candela	luminous intensity

The SI units include as subsystems the MKS system of units, which covers mechanics, and the MKSA or Giorgi system, which covers mechanics, electricity, and magnetism.

Unit	Symbol	Remarks
ampere	A	
ampere-hour	Ah	
ampere-turn	At	
angstrom	Å	
atmosphere		
normal atmosphere	atm	1 atm = 101 325 N/m <sup>2</sup>
technical atmosphere	at	1 at = 1 kgf/cm <sup>2</sup>
atomic mass unit (unified)	u	The (unified) atomic mass unit is defined as one-twelfth of the mass of an atom of the <sup>12</sup> C nuclide. Use of the old atomic mass unit (amu), defined by reference to oxygen, is deprecated.
bar	bar	1 bar = 100 000 N/m <sup>2</sup>
barn	b	1 b = 10 <sup>-28</sup> m <sup>2</sup>
bel	B	
billion electronvolts	GeV	The name <i>billion electronvolts</i> is deprecated; see <i>giga</i> electronvolt.
British thermal unit	Btu	

## LETTER SYMBOLS FOR UNITS USED IN ELECTRICAL SCIENCE AND ELECTRICAL ENGINEERING

<i>Unit</i>	<i>Symbol</i>	<i>Remarks</i>
calorie (International Table calorie)	cal <sub>IT</sub>	1 cal <sub>IT</sub> = 4.1868 J The 9th Conférence Générale des Poids et Mesures has adopted the joule as the unit of heat, avoiding the use of the calorie as far as possible
calorie (thermochemical calorie)	cal <sub>th</sub>	1 cal <sub>th</sub> = 4.1840 J (See note for International Table calorie.)
candela	cd	
candela per square foot	cd/ft <sup>2</sup>	
candela per square meter	cd/m <sup>2</sup>	The name <i>nit</i> is sometimes used for this unit.
candle	cd	The unit of luminous intensity has been given the name <i>candela</i> ; use of the name <i>candle</i> for this unit is deprecated.
centimeter	cm	
circular mil	cmil	1 cmil = (π/4) · 10 <sup>-6</sup> in <sup>2</sup>
coulomb	C	
cubic centimeter	cm <sup>3</sup>	
cubic foot	ft <sup>3</sup>	
cubic foot per minute	ft <sup>3</sup> /min	
cubic foot per second	ft <sup>3</sup> /s	
cubic inch	in <sup>3</sup>	
cubic meter	m <sup>3</sup>	
cubic meter per second	m <sup>3</sup> /s	
cubic yard	yd <sup>3</sup>	
curie	Ci	Unit of activity in the field of radiation dosimetry
cycle per second	c/s	The name <i>hertz</i> (Hz) is internationally accepted for this unit.
decibel	dB	
decibel referred to one milliwatt	dBm	
degree (plane angle)	...°	
degree (temperature)		
degree Celsius	°C	Note that there is no space between the symbol ° and the letter. The use of the word <i>centigrade</i> for the Celsius temperature scale was abandoned by the Conférence Générale des Poids et Mesures in 1948. In 1967 the CGPM gave the name <i>kelvin</i> to the SI unit of temperature, which was formerly called <i>degree Kelvin</i> , and assigned it the symbol K (without the symbol °).
degree Fahrenheit	°F	
kelvin	K	
dyne	dyn	
electronvolt	eV	
erg	erg	
farad	F	
foot	ft	
footcandle	fc	The name <i>lumen per square foot</i> (lm/ft <sup>2</sup> ) is preferred for this unit.



<i>Unit</i>	<i>Symbol</i>	<i>Remarks</i>
footlambert	fL	If luminance is to be measured in English units, the candela per square foot (cd/ft <sup>2</sup> ) is preferred.
foot per minute	ft/min	
foot per second	ft/s	
foot per second squared	ft/s <sup>2</sup>	
foot poundal	ft · pdl	
foot pound-force	ft · lbf	
gal	Gal	1 Gal = 1 cm/s <sup>2</sup>
gallon	gal	The gallon, quart, and pint differ in the U.S. and the U.K. and their use is deprecated.
gallon per minute	gal/min	
gauss	G	The gauss is the electromagnetic CGS unit of magnetic flux density. Use of SI unit, the tesla, is preferred. See note for cycle per second.
gigacycle per second	Gc/s	
gigaelectronvolt	GeV	
gigahertz	GHz	
gilbert	Gb	The gilbert is the electromagnetic CGS unit of magnetomotive force. Use of the SI unit, the ampere (or ampere turn), is preferred.
gram	g	
henry	H	
hertz	Hz	
horsepower	hp	
hour	h	Time may be designated as in the following example: 9 <sup>h</sup> 46 <sup>m</sup> 30 <sup>s</sup> .
inch	in	
inch per second	in/s	
joule	J	
joule per kelvin	J/K	
kelvin	K	In 1967 the CGPM gave the name <i>kelvin</i> to the SI unit of temperature which had formerly been called <i>degree Kelvin</i> and assigned it the symbol K (without the symbol °).
kilocycle per second	kc/s	See note for cycle per second.
kiloelectronvolt	keV	
kilogauss	kG	
kilogram	kg	
kilogram-force	kgf	In some countries the name <i>kilopond</i> (kp) has been adopted for this unit.
kilohertz	kHz	
kilojoule	kJ	
kilohm	kΩ	
kilometer	km	
kilometer per hour	km/h	
kilovar	kvar	

<i>Unit</i>	<i>Symbol</i>	<i>Remarks</i>
kilovolt	kV	
kilovoltampere	kVA	
kilowatt	kW	
kilowatthour	kWh	
knot	knot	
lambert	L	The lambert is the CGS unit of luminance. Use of the SI unit, the candela per square meter, is preferred.
liter	l	
liter per second	l/s	
lumen	lm	
lumen per square foot	lm/ft <sup>2</sup>	
lumen per square meter	lm/m <sup>2</sup>	
lumen per watt	lm/W	
lumen second	lm · s	
lux	lx	1 lx = 1 lm/m <sup>2</sup>
maxwell	Mx	The maxwell is the electromagnetic CGS unit of magnetic flux. Use of the SI unit, the weber, is preferred.
megacycle per second	Mc/s	See note for cycle per second.
megaelectronvolt	MeV	
megahertz	MHz	
megavolt	MV	
megawatt	MW	
megohm	MΩ	
meter	m	
mho	mho	The IEC has adopted the name <i>siemens</i> (S) for this unit.
microampere	μA	
microbar	μbar	
microfarad	μF	
microgram	μg	
microhenry	μH	
micrometer	μm	
micromho	μmho	See note for mho.
micron	μm	The name <i>micrometer</i> is preferred.
microsecond	μs	
microsiemens	μS	
microwatt	μW	
mil	mil	1 mil = 0.001 in
mile (statute)	mi	
nautical mile	nmi	
mile per hour	mi/h	
milliampere	mA	
millibar	mbar	
millibarn	mb	
milligal	mGal	
milligram	mg	
millihenry	mH	

<i>Unit</i>	<i>Symbol</i>	<i>Remarks</i>
milliliter	ml	
millimeter	mm	
conventional millimeter of mercury	mmHg	1 mmHg = 133.322 N/m <sup>2</sup>
micrometer	μm	The name <i>nanometer</i> is preferred.
millisecond	ms	
millisiemens	mS	
millivolt	mV	
milliwatt	mW	
minute (plane angle)	...	
minute (time)	min	Time may be designated as in the following example: 9 <sup>h</sup> 46 <sup>m</sup> 30 <sup>s</sup>
nanoampere	nA	
nanofarad	nF	
nanometer	nm	
nanosecond	ns	
nanowatt	nW	
nautical mile	nmi	
neper	Np	
newton	N	
newton meter	N · m	
newton per square meter	N/m <sup>2</sup>	
oersted	Oe	The oersted is the electromagnetic CGS unit of magnetic field strength. Use of the SI unit, the ampere per meter, is preferred.
ohm	Ω	
ounce (avoirdupois)	oz	
picoampere	pA	
picofarad	pF	
picosecond	ps	
picowatt	pW	
pint	pt	The gallon, quart, and pint differ in the U.S. and the U.K., and their use is deprecated.
pound	lb	
poundal	pd	
pound-force	lbf	
pound-force foot	lbf · ft	
pound-force per square inch	lbf/in <sup>2</sup>	Although use of the abbreviation psi is common, it is not recommended. See pound-force per square inch.
pound per square inch		
quart	qt	The gallon, quart, and pint differ in the U.S. and the U.K., and their use is deprecated.
rad	rd	Unit of absorbed dose in the field of radiation dosimetry.
radian	rad	
rem	rem	Unit of dose equivalent in the field of radiation dosimetry.

<i>Unit</i>	<i>Symbol</i>	<i>Remarks</i>
revolution per minute	r/min	Although use of the abbreviation rpm is common, it is not recommended.
revolution per second	r/s	
roentgen	R	Unit of exposure in the field of radiation dosimetry.
second (plane angle)	...''	
second (time)	s	Time may be designated as in the following example: $9^h 46^m 30^s$ .
siemens	S	$1 \text{ S} = 1 \Omega^{-1}$
square foot	ft <sup>2</sup>	
square inch	in <sup>2</sup>	
square meter	m <sup>2</sup>	
square yard	yd <sup>2</sup>	
steradian	sr	
tesla	T	$1 \text{ T} = 1 \text{ Wb/m}^2$
tonne	t	$1 \text{ t} = 1000 \text{ kg}$
(unified) atomic mass unit	u	The (unified) atomic mass unit is defined as one-twelfth of the mass of an atom of the <sup>12</sup> C nuclide. Use of the old atomic mass unit (amu), defined by reference to oxygen, is deprecated.
var	var	Unit of reactive power
volt	V	
voltampere	VA	Unit of apparent power
watt	W	
watthour	Wh	
watt per steradian	W/sr	
watt per steradian square meter	W/(sr · m <sup>2</sup> )	
weber	Wb	$1 \text{ Wb} = 1 \text{ V} \cdot \text{s}$
yard	yd	

## CONVERSION OF ELECTROMAGNETIC UNITS

Three common systems of electromagnetic units are in universal employ. They are:

1. The absolute system of CGS electromagnetic system.
2. The practical CGS electromagnetic system.
3. The MKS system (Gaussian or Giorgi depending upon the choice of constants).

The chart allows rapid conversion from one system to another. In any one row, any quantity divided by any other quantity produces unity.

### These Quantities Are Those Effected by Rationalization

Quantity	Rationalized			Unrationalized		
	MKS	CGS EM	CGS ES	MKS	CGS EM	CGS ES
Dielectric displacement	1	$10^{-5}$	$3 \times 10^5$	$4\pi$	$4\pi \times 10^{-5}$	$12\pi \times 10^5$
	$10^5$	1	$3 \times 10^{10}$	$4\pi \times 10^5$	$4\pi$	$12\pi \times 10^{10}$
	$1/3 \times 10^{-5}$	$1/3 \times 10^{-10}$	1	$4\pi/3 \times 10^{-5}$	$4\pi/3 \times 10^{-10}$	$4\pi$
	$1/4\pi$	$1/4\pi \times 10^{-5}$	$3/4\pi \times 10^5$	1	$10^{-5}$	$3 \times 10^{-5}$
	$1/4\pi \times 10^5$	$1/4\pi$	$3/4\pi \times 10^{10}$	$10^5$	1	$3 \times 10^{10}$
	$1/12\pi \times 10^{-5}$	$1/12\pi \times 10^{-10}$	$1/4\pi$	$1/3 \times 10^{-5}$	$1/3 \times 10^{-10}$	1
Units	Coulomb/m <sup>2</sup>	Abcoulomb/m <sup>2</sup>	Statcoulomb/cm <sup>2</sup>	Coulomb/m <sup>2</sup>	Abcoulomb/cm <sup>2</sup>	Statcoulomb/cm <sup>2</sup>
Magnetic field intensity	1	$10^{-3}$	$3 \times 10^7$	$4\pi$	$4\pi \times 10^{-3}$	$12\pi \times 10^7$
	$10^3$	1	$3 \times 10^{10}$	$4\pi \times 10^3$	$4\pi$	$12\pi \times 10^{10}$
	$1/3 \times 10^{-7}$	$1/3 \times 10^{-10}$	1	$4\pi/3 \times 10^{-7}$	$4\pi/3 \times 10^{-10}$	$4\pi$
	$1/4\pi$	$1/4\pi \times 10^{-3}$	$3/4\pi \times 10^7$	1	$10^{-3}$	$3 \times 10^7$
	$1/4\pi \times 10^3$	$1/4\pi$	$3/4\pi \times 10^{10}$	$10^3$	1	$3 \times 10^{10}$
	$1/12\pi \times 10^{-7}$	$1/12\pi \times 10^{-10}$	$1/4\pi$	$1/3 \times 10^{-7}$	$1/3 \times 10^{-10}$	1
Units	Amp-turn/m	Oersted	ESU	Amp-turn/m	Oersted	ESU
Magnetomotive force	1	$10^{-1}$	$3 \times 10^9$	$4\pi$	$4\pi \times 10^{-1}$	$12\pi \times 10^9$
	10	1	$3 \times 10^{10}$	$40\pi$	$4\pi$	$12\pi \times 10^{10}$
	$1/3 \times 10^{-9}$	$1/3 \times 10^{-10}$	1	$4\pi/3 \times 10^{-9}$	$4\pi/3 \times 10^{-10}$	$4\pi$
	$1/4\pi$	$1/4\pi \times 10^{-1}$	$3/4\pi \times 10^9$	1	$10^{-1}$	$3 \times 10^9$
	$10/4\pi$	$1/4\pi$	$3/4\pi \times 10^{10}$	10	1	$3 \times 10^{10}$
	$1/12\pi \times 10^{-9}$	$1/12\pi \times 10^{-10}$	$1/4\pi$	$1/3 \times 10^{-9}$	$1/3 \times 10^{-10}$	1
Units	Amp-turn	Gilbert	ESU	Amp-turn	Gilbert	ESU

Quantity	Practical Unit	Electromagnetic Unit	Electrostatic Unit
	MKS	CGS EM	CGS ES
1. Capacitance	1 Farad	$10^{-9}$ Abfarad	$9 \times 10^{11}$ Statfarad
	$10^9$ Farad	1 Abfarad	$9 \times 10^{20}$ Statfarad
	$1/9 \times 10^{-11}$ Farad	$1/9 \times 10^{-20}$ Abfarad	1 Statfarad
2. Charge	1 Coulomb	$10^{-1}$ Abcoulomb	$3 \times 10^9$ Statcoulomb
	10 Coulomb	1 Abcoulomb	$3 \times 10^{10}$ Statcoulomb
	$1/3 \times 10^{-9}$ Coulomb	$1/3 \times 10^{-10}$ Abcoulomb	1 Statcoulomb
3. Charge density	1 Coulomb/m <sup>2</sup>	$10^{-7}$ Abcoulomb/cm <sup>2</sup>	$3 \times 10^2$ Statcoulomb/cm <sup>2</sup>
	$10^7$ Coulomb/m <sup>2</sup>	1 Abcoulomb/cm <sup>2</sup>	$3 \times 10^{10}$ Statcoulomb/cm <sup>2</sup>
	$1/3 \times 10^{-3}$ Coulomb/m <sup>2</sup>	$1/3 \times 10^{-10}$ Abcoulomb/cm <sup>2</sup>	1 Statcoulomb/cm <sup>2</sup>
4. Conductivity	1 Mho/m	$10^{-11}$ Abmho/cm	$9 \times 10^9$ Statmho/cm
	$10^{11}$ Mho/m	1 Abmho/cm	$9 \times 10^{20}$ Statmho/cm
	$1/9 \times 10^{-9}$ Mho/m	$1/9 \times 10^{-20}$ Abmho/cm	1 Statmho/cm
5. Current	1 Ampere	$10^{-1}$ Abampere	$3 \times 10^9$ Statampere
	10 Ampere	1 Abampere	$3 \times 10^{10}$ Statampere
	$1/3 \times 10^{-9}$ Ampere	$1/3 \times 10^{-10}$ Abampere	1 Statampere
6. Current density	1 Ampere/m <sup>2</sup>	$10^{-5}$ Abampere/cm <sup>2</sup>	$3 \times 10^5$ Statampere/cm <sup>2</sup>
	$10^5$ Ampere/m <sup>2</sup>	1 Abampere/cm <sup>2</sup>	$3 \times 10^{10}$ Statampere/cm <sup>2</sup>
	$1/3 \times 10^{-5}$ Ampere/m <sup>2</sup>	$1/3 \times 10^{-10}$ Abampere/cm <sup>2</sup>	1 Statampere/cm <sup>2</sup>
7. Electric field intensity	1 Volt/meter	$10^6$ Abvolt/cm	$1/3 \times 10^{-4}$ Statvolt/cm
	$10^{-6}$ Volt/meter	1 Abvolt/cm	$1/3 \times 10^{-10}$ Statvolt/cm
	$3 \times 10^9$ Volt/meter	$3 \times 10^{10}$ Abvolt/cm	1 Statvolt/cm
8. Electric potential	1 Volt	$10^8$ Abvolts	$1/3 \times 10^{-2}$ Statvolts
	$10^{-8}$ Volt	1 Abvolt	$1/3 \times 10^{-10}$ Statvolts
	$3 \times 10^2$ Volt	$3 \times 10^{10}$ Abvolts	1 Statvolt
9. Electric dipole moment	1 Coulomb-meter	10 Abcoulomb-cm	$3 \times 10^{11}$ Statcoulomb-cm
	$10^{-1}$ Coulomb-meter	1 Abcoulomb-cm	$3 \times 10^{10}$ Statcoulomb-cm
	$1/3 \times 10^{-11}$ Coulomb-meter	$1/3 \times 10^{-10}$ Abcoulomb-cm	1 Statcoulomb-cm
10. Energy	1 Joule	$10^7$ Erg	$10^7$ Erg
	$10^{-7}$ Joule	1 Erg	1 Erg
	$10^{-7}$ Joule	1 Erg	1 Erg
11. Force	1 Newton	$10^5$ Dyne	$10^5$ Dyne
	$10^{-5}$ Newton	1 Dyne	1 Dyne
	$10^{-5}$ Newton	1 Dyne	1 Dyne
12. Flux density	1 Weber/m <sup>2</sup>	$10^4$ Gauss	$1/3 \times 10^{-6}$ esu
	$10^{-4}$ Weber/m <sup>2</sup>	1 Gauss	$1/3 \times 10^{-10}$ esu
	$3 \times 10^6$ Weber/m <sup>2</sup>	$3 \times 10^{10}$ Gauss	1 esu
13. Inductance	1 Henry	$10^9$ Abhenry	$1/9 \times 10^{-11}$ Stathenry
	$10^{-9}$ Henry	1 Abhenry	$1/9 \times 10^{-20}$ Stathenry
	$9 \times 10^{11}$ Henry	$9 \times 10^{20}$ Abhenry	1 Stathenry
14. Inductive capacity	1 Farad/meter	$10^{-11}$ Abfarad/cm	$9 \times 10^9$ Statfarad/cm
	$10^{11}$ Farad/meter	1 Abfarad/cm	$9 \times 10^{20}$ Statfarad/cm
	$1/9 \times 10^{-9}$ Farad/meter	$1/9 \times 10^{-20}$ Abfarad/cm	1 Statfarad/cm
15. Magnetic flux	1 Weber	$10^8$ Maxwell	$1/2 \times 10^{-2}$ esu
	$10^{-8}$ Weber	1 Maxwell	$1/2 \times 10^{-10}$ esu
	$3 \times 10^2$ Weber	$3 \times 10^{10}$ Maxwell	1 esu
16. Magnetic dipole moment	1 Ampere-meter <sup>2</sup>	$10^3$ Abamp-cm <sup>2</sup>	$3 \times 10^{13}$ Statamp-cm <sup>2</sup>
	$10^{-3}$ Ampere-meter <sup>2</sup>	1 Abamp-cm <sup>2</sup>	$3 \times 10^{10}$ Statamp-cm <sup>2</sup>
	$1/3 \times 10^{-12}$ Ampere-meter <sup>2</sup>	$1/3 \times 10^{-10}$ Abamp-cm <sup>2</sup>	1 Statamp-cm <sup>2</sup>
17. Permeability	1 Henry meter	$10^7$ Abhenry cm	$1/9 \times 10^{-13}$ Stathenry cm
	$10^{-7}$ Henry meter	1 Abhenry cm	$1/9 \times 10^{-20}$ Stathenry cm
	$9 \times 10^{13}$ Henry meter	$9 \times 10^{20}$ Abhenry cm	1 Stathenry cm
18. Power	1 Watt	$10^7$ erg/sec	$10^7$ erg/sec
	$10^{-7}$ Watt	1 erg/sec	1 erg/sec
	$10^{-7}$ Watt	1 erg/sec	1 erg/sec
19. Resistance	1 Ohm	$10^9$ Abohm	$1/9 \times 10^{-11}$ Statohm
	$10^{-9}$ Ohm	1 Abohm	$1/9 \times 10^{-20}$ Statohm
	$9 \times 10^{11}$ Ohm	$9 \times 10^{20}$ Abohm	1 Statohm

### SPACE-TIME-VELOCITY AND ACCELERATION FORMULAS

This tabulation presents all basic linear motion formulas with all their variations. Terms are defined and units of measurement are specified.

- A = Acceleration or deceleration—ft/sec/sec (32.2 for gravity)  
 D = Distance—ft (may be used in lieu of "H" in vertical free fall)  
 E = Energy—ft—lbs  
 F = Force—lbs  
 H = Height—ft (may be used in lieu of "D" with A—32.2)

$$M = \text{Mass} \quad \frac{W}{32.2} = \frac{\text{lb—sec}^2}{\text{ft}}$$

T = Time—sec

$V_a$  = Average velocity—ft/sec

$V_f$  = Final velocity—ft/sec

$V_i$  = Initial velocity—ft/sec

W = Weight—lbs

To Find	Formulae					
A	$\frac{V_f - V_i}{T}$	$\left(\text{When } V_i = 0\right) \frac{V_f}{T}$	$\left(\text{When } V_i = 0\right) \frac{V_f^2}{2D}$	$\frac{2D}{T^2}$	$\frac{WV_a}{FT}$	$\frac{F}{M}$
D	$V_a T$	$\frac{T(V_i + V_f)}{2}$	$\left(\text{When } V_i = 0\right) \frac{V_f T}{2}$	$\frac{V_a^2}{2A}$	$\frac{AT^2}{2}$	$\frac{E}{F}$
E	FD	WH				
F	MA	$\frac{M(V_f - V_i)}{T}$	$\frac{E}{D}$	$\frac{WV_a}{AT}$		
H	$\frac{E}{W}$	$16.1 T^2$				
M	$\frac{W}{32.2}$	$\frac{F}{A}$	$\frac{FT}{V_f - V_i}$			
T	$\frac{D}{V_a}$	$\frac{2D}{V_f + V_i}$	$\frac{V_f - V_i}{A}$	$\left(\text{When } V_i = 0\right) \frac{V_f}{A}$	$\left(\text{When } V = 0\right) \frac{2D}{V_f}$	
	$\sqrt{\frac{2D}{A}}$	$\sqrt{\frac{H}{4}}$	$\frac{WV_a}{FA}$	$\frac{M(V_f - V_i)}{F}$		
$V_f$	$2V_a - V_i$	$\left(\text{When } V_i = 0\right) 2V_a$	$\frac{2D}{T} - V_i$	$\left(\text{When } V_i = 0\right) \frac{2D}{T}$	$AT + V_i$	$\left(\text{When } V_i = 0\right) AT$
$V_i$	$2V_a - V_f$	$\frac{2D}{T} - V_f$	$V_f - AT$	$V_f - \frac{FT}{M}$		
W	$\frac{AFT}{V_a}$	$32.2 M$	$\frac{E}{H}$			

CONVERSION FACTORS

To Convert	Into	Multiply By	To Convert	Into	Multiply By
A					
Abcoulomb	Statcoulombs	$2.998 \times 10^{10}$	ares	sq. meters	100.0
Acre	Sq. chain (Gunters)	10	Astrometrical Unit	Kilometers	$1.495 \times 10^8$
Acre	Rods	160	Atmospheres	Ton/sq. inch	.007348
Acre	Square links (Gunters)	$1 \times 10^5$	atmospheres	cms of mercury	76.0
Acre	Hectare or sq. hectometer	.4047	atmospheres	ft. of water (at 4°C)	33.90
acres	sq feet	43,560.0	atmospheres	in. of mercury (at 0°C)	29.92
acres	sq meters	4,047.	atmospheres	kg/sq cm	1.0333
acres	sq miles	$1.562 \times 10^{-3}$	atmospheres	kgs/sq meter	10,332.
acres	sq yards	4,840.	atmospheres	pounds/sq.in.	14.70
acre-feet	cu feet	43,560.0	atmospheres	tons/sq ft	1.058
acre-feet	gallons	$3.259 \times 10^5$	B		
amperes/sq cm	amps/sq in.	6.452	Berrels (U.S., dry)	cu. inches	7056.
amperes/sq cm	amps/sq meter	$10^4$	Berrels (U.S., dry)	quarts (dry)	105.0
amperes/sq in.	amps/sq cm	0.1550	Berrels (U.S., liquid)	gallons	31.5
amperes/sq meter	amps/sq meter	$1,550.0$	berrels (oil)	gallons (oil)	42.0
amperes/sq meter	amps/sq cm	$10^{-4}$	bers	atmospheres	0.9869
ampere-hours	coulombs	$3,600.0$	bars	dynes/sq cm	$10^6$
ampere-hours	faradays	0.03731	bars	kg/sq meter	$1,020 \times 10^4$
ampere-turns	gilberts	1.257	bars	pounds/sq ft	2,089.
ampere-turns/cm	amp-turns/in.	2.540	bars	pounds/sq in.	14.50
ampere-turns/cm	amp-turns/meter	100.0	Berry (US Cloth)	Dyne/sq. cm.	1.000
ampere-turns/cm	gilberts/cm	1.257	BTU	Meters	36.576
ampere-turns/in.	amp-turns/cm	0.3937	Btu	Liter-Atmosphere	10.409
ampere-turns/in.	amp-turns/meter	39.37	Btu	ergs	$1.0550 \times 10^{10}$
ampere-turns/in.	gilberts/cm	0.4950	Btu	foot-lbs	778.3
ampere-turns/meter	amp-turns/in.	0.01	Btu	gram-calories	252.0
ampere-turns/meter	amp-turns/m.	0.0254	Btu	horsepower-hrs	$3.931 \times 10^{-4}$
ampere-turns/meter	gilberts/cm	0.01257	Btu	joules	1,054.8
ampere-turns/meter	inch	$3937 \times 10^{-9}$	Btu	kilogram-calories	0.2520
Angstrom unit	Meter	$1 \times 10^{-10}$	Btu	kilogram-meters	107.5
Angstrom unit	Micron or (Mu)	$1 \times 10^{-4}$	Btu/hr	kilowatt-hrs	$2.928 \times 10^{-4}$
Are	Acre (US)	.02471	Btu/hr	foot-pound/sec	0.2162
Are	sq. yards	119.60	Btu/hr	gram-cal/sec	0.0700
ares	acres	0.02471	Btu/hr	horsepower-hrs	$3.929 \times 10^{-4}$
			Btu/hr	watts	0.2931



To Convert	Into	Multiply By	To Convert	Into	Multiply By
8tu/min	foot-lbs/sec	12.96	cubic centimeters	gallons (U.S. liq.)	$2.642 \times 10^{-4}$
8tu/min	horsepower	0.02356	cubic centimeters	liters	0.001
8tu/min	kilowatts	0.01757	cubic centimeters	pints (U.S. liq.)	$2.113 \times 10^{-3}$
8tu/min	watts	17.57	cubic centimeters	quarts (U.S. liq.)	$1.057 \times 10^{-3}$
8tu/sq ft/min	watts/sq in.	0.1221	cubic foot	bushels (dry)	0.8036
Bucket (8r. dry)	Cubic Cm.	$1.818 \times 10^4$	cubic feet	cu cms	28,320.0
bushels	cu ft	1.2445	cubic feet	cu inches	1,728.0
bushels	cu in.	2,150.4	cubic feet	cu meters	0.02832
bushels	cu meters	0.03524	cubic feet	cu yards	0.03704
bushels	liters	35.24	cubic feet	gallons (U.S. liq.)	7.48052
bushels	pecks	4.0	cubic feet	liters	28.32
bushels	pints (dry)	64.0	cubic feet	pints (U.S. liq.)	59.84
bushels	quarts (dry)	32.0	cubic feet	quarts (U.S. liq.)	29.92
			cubic feet/min	cu cms/sec	472.0
			cubic feet/min	gallons/sec	0.1247
			cubic feet/min	liters/sec	0.4720
Calories, gram (mean)	B.T.U. (mean)	$3.9685 \times 10^{-3}$	cubic feet/min	pounds of water/min	62.43
centares (centiares)	sq meters	1.0	cubic feet/min	million gals/day	0.646317
Centigrade (Celsius)	Fahrenheit	$(C^\circ \times 9/5) + 32$	cubic feet/sec	gallons/min	448.631
Centigrams	grams	0.01	cubic inches	cu cms	16.39
Centiliter	Ounce fluid (US)	.3382	cubic inches	cu feet	$5.787 \times 10^{-4}$
Centiliter	Cubic inch	.6103	cubic inches	cu meters	$1.639 \times 10^{-5}$
Centiliter	drams	2.705	cubic inches	cu yards	$2.143 \times 10^{-3}$
centiliters	liters	0.01	cubic inches	gallons (U.S. liquid)	$4.329 \times 10^{-3}$
centimeters	feet	$3.281 \times 10^{-2}$	cubic inches	liters	0.01639
centimeters	inches	0.3937	cubic inches	mil-feet	$1.061 \times 10^5$
centimeters	kilometers	$10^{-5}$	cubic inches	pints (U.S. liq.)	0.03463
centimeters	meters	0.01	cubic inches	quarts (U.S. liq.)	0.01732
centimeters	miles	$6.214 \times 10^{-6}$	cubic meters	bushels (dry)	28.36
centimeters	millimeters	10.0	cubic meters	cu cms	$10^6$
centimeters	mils	393.7	cubic meters	cu feet	35.31
centimeters	yards	$1.094 \times 10^{-2}$	cubic meters	cu inches	61,023.0
centimeter-dynes	cm-grams	$1.020 \times 10^{-3}$	cubic meters	cu yards	1.308
centimeter-dynes	meter-kgs.	$1.020 \times 10^{-8}$	cubic meters	gallons (U.S. liq.)	264.2
centimeter-dynes	pound-feet	$7.376 \times 10^{-8}$	cubic meters	liters	1,000.0
centimeter-grams	cm-dynes	980.7	cubic meters	pints (U.S. liq.)	2,113.0
centimeter-grams	meter-kgs	$10^{-5}$			

## C

centimeter-grams	7.233 × 10 <sup>-5</sup>	cubic meters	1.057.
centimeters of mercury	0.01316	cubic yards	7.646 × 10 <sup>5</sup>
centimeters of mercury	0.4461	cu cms	27.0
centimeters of mercury	136.0	cu feet	46,656.0
centimeters of mercury	27.85	cu inches	0.7646
centimeters of mercury	0.1934	cu meters	202.0
centimeters/sec	1.9685	gallons (U.S. liq.)	764.6
centimeters/sec	0.03281	liters	1,615.9
centimeters/sec	0.036	pints (U.S. liq.)	807.9
centimeters/sec	0.1943	quarts (U.S. liq.)	0.45
centimeters/sec	0.6	cubic ft/sec	3.367
centimeters/sec	0.02237	gallons/sec	12.74
centimeters/sec	3.728 × 10 <sup>-4</sup>		
centimeters/sec	0.03281	<b>D</b>	
centimeters/sec	0.036	Gram	1.650 × 10 <sup>-24</sup>
centimeters/sec	0.01	seconds	86,400.0
centimeters/sec	0.02237	grams	0.1
Chain	792.00	liters	0.1
Chain	20.12	meters	0.1
Chains (surveyors' or Gunter's)	22.00	quadrants	0.01111
circular mills	5.067 × 10 <sup>-6</sup>	radians	0.01745
circular mills	0.7854	seconds	3,600.0
Circumference	6.283	radians/sec	0.01745
circular mills	7.854 × 10 <sup>-7</sup>	revolutions/min	0.1667
Cords	8	revolutions/sec	2.778 × 10 <sup>-3</sup>
Cord feet	16	grams	10.0
Coulomb	2.958 × 10 <sup>9</sup>	dekagrams	10.0
Coulombs	1.036 × 10 <sup>-5</sup>	dekaliters	10.0
faradays	64.52	dekameters	10.0
coulombs/sq in.	10 <sup>4</sup>	Drams (apothecaries' or Troy)	0.1371429
coulombs/sq meter	0.1550	Drams (apothecaries' or Troy)	0.125
coulombs/sq cm	1,550.10 <sup>-4</sup>	Drams (U.S., fluid or apoth.)	3.6967
coulombs/sq meter	6.452 × 10 <sup>-4</sup>	drams	1.7718
coulombs/sq in.	3.531 × 10 <sup>-5</sup>	drams	27.3437
cu feet	0.06102	drams	0.0625
cu inches	10 <sup>-6</sup>	Dyne/cm	.01
cu meters	1.308 × 10 <sup>-6</sup>	Erg/sq. millimeter	9.868 × 10 <sup>-7</sup>
cu yards		Atmospheres	









To Convert	Into	Multiply By	To Convert	Into	Multiply By
kilowatts	kg-calories/min	14.34	meters/sec	miles/hr	2.237
kilowatt-hrs	watts	1,000.0	meters/sec	miles/min	0.03728
kilowatt-hrs	Btu	3,413.	meters/sec/sec	cms/sec/sec	100.0
kilowatt-hrs	ergs	$3.600 \times 10^{13}$	meters/sec/sec	ft/sec/sec	3.281
kilowatt-hrs	foot-lbs	$2.655 \times 10^6$	meters/hr/sec	kms/hr/sec	3.6
kilowatt-hrs	gram-calories	859,850.	meters/sec/sec	miles/hr/sec	2.237
kilowatt-hrs	horsepower-hrs	1.341	meter-kilograms	cm-dynes	$9.807 \times 10^7$
kilowatt-hrs	joules	$3.6 \times 10^6$	microfarad	farads	$10^{-6}$
kilowatt-hrs	kg-calories	859.85	micrograms	grams	$10^{-6}$
kilowatt-hrs	kg-meters	$3.671 \times 10^5$	microhms	megohms	$10^{-12}$
kilowatt-hrs	pounds of water evaporated from and at 212° F.	3.53	microhms	ohms	$10^{-6}$
kilowatt-hrs	pounds of water raised from 62° to 212° F.	22.75	microliters	liters	$1 \times 10^{-6}$
knots	feet/hr	6,080.	miles (naut.)	feet	6,080.27
knots	kilometers/hr	1.8532	miles (naut.)	kilometers	1.853
knots	nautical miles/hr	1.0	miles (naut.)	meters	1,853.
knots	statute miles/hr	1.151	miles (statute)	miles (statute)	1.1516
knots	yards/hr	2,027.	miles (statute)	yards	2,027.
knots	feet/sec	1,689	miles (statute)	centimeters	$1.609 \times 10^5$
league	miles (approx.)	3.0	miles (statute)	feet	5,280.
Light year	Miles	$5.9 \times 10^{12}$	miles (statute)	inches	$6.336 \times 10^4$
lines/sq cm	Kilometers	$9.46091 \times 10^{12}$	miles (statute)	kilometers	1,609.
lines/sq in.	gausses	1.0	miles (statute)	meters	1,609.
lines/sq in.	gausses	0.1550	miles (statute)	miles (naut.)	0.8684
lines/sq in.	webers/sq cm	$1.550 \times 10^{-9}$	miles (statute)	yards	1,760.
lines/sq in.	webers/sq in.	$10^{-6}$	miles (statute)	cms/sec	44.70
lines/sq in.	webers/sq meter	$1.550 \times 10^{-5}$	miles (statute)	feet/min	88.
links (engineer's)	inches	12.0	miles/hr	feet/sec	1.467
links (surveyor's)	inches	7.92	miles/hr	kms/hr	1,609
liters	bushels (U.S. dry)	0.02838	miles/hr	kms/min	0.02682
liters	cu cm	1,000.0	miles/hr	knots	0.8684
liters	cu feet	0.03531	miles/hr	meters/min	26.82
liters	cu inches	61.02	miles/hr/sec	miles/min	0.1667
			miles/hr/sec	cms/sec/sec	44.70
			miles/hr/sec	feet/sec/sec	1.467

liters	cu meters	0.001	miles/hr/sec	1.609
liters	cu yards	1.308 × 10 <sup>-3</sup>	meters/sec/sec	0.4470
liters	gallons (U.S. liq.)	0.2642	cms/sec	2.682.
liters	pints (U.S. liq.)	2.113	feet/sec	88.
liters	quarts (U.S. liq.)	1.057	kms/min	1.609
liters/min	cu ft/sec	5.886 × 10 <sup>-4</sup>	knots/min	0.8684
liters/min	gals/sec	4.403 × 10 <sup>-3</sup>	miles/hr	60.0
lumens/sq ft	foot-candles	1.0	cu inches	9.425 × 10 <sup>-6</sup>
Lumen	Spherical candle power	.07958	kilograms	1,000.
Lumen	Watt	.001496	meters	1 × 10 <sup>-9</sup>
Lumen/sq. ft.	Lumen/sq. meter	10.76	grains	0.01543236
lux	foot-candles	0.0929	grams	0.001
			parts/million	1.0
			hanries	0.001
			liters	0.001
			centimeters	0.1
maxwells	kilolines	0.001	feet	3.281 × 10 <sup>-3</sup>
maxwells	webers	10 <sup>-8</sup>	inches	0.03937
megalines	maxwells	10 <sup>6</sup>	kilometers	10 <sup>-6</sup>
megohms	microhms	10 <sup>12</sup>	meters	0.001
megohms	ohms	10 <sup>6</sup>	miles	6.214 × 10 <sup>-7</sup>
meters	centimeters	100.0	milli-	39.37
meters	feet	3.281	millimeters	1.094 × 10 <sup>-3</sup>
meters	inches	36.37	micrometers	1.54723
meters	kilometers	0.001	yards	2.540 × 10 <sup>-3</sup>
meters	miles (naut.)	5.396 × 10 <sup>-4</sup>	cu ft/sec	8.333 × 10 <sup>-5</sup>
meters	miles (stat.)	6.214 × 10 <sup>-4</sup>	centimeters	0.001
meters	millimeters	1,000.0	feet	2.778 × 10 <sup>-5</sup>
meters	yards	1.094	inches	1.5
meters	varas	1.179	kilometers	0.059192
meters/min	cms/sec	1.667	yards	0.061612
meters/min	feet/min	3.281	miner's inches	0.01667
meters/min	feet/sec	0.05468	Minims (British)	1.852 × 10 <sup>-4</sup>
meters/min	kms/hr	0.06	Minims (U.S., fluid)	2.909 × 10 <sup>-4</sup>
meters/min	knots	0.03238	Minutes (angles)	60.0
meters/min	miles/hr	0.03728	minutes (angles)	10.0
meters/sec	feet/min	196.8	minutes (angles)	10.0
meters/sec	feet/sec	3.281	myriagrams	10.0
meters/sec	kilometers/hr	3.6	kilometers	10.0
meters/sec	kilometers/min	0.06	kilowatts	10.0

### M







To Convert	Into	Multiply By	To Convert	Into	Multiply By
rods	feet	16.5	temperatura (°C) +273	Y	1.0
Scruples	grams	20	temperatura (°C) + 17.78	temperatura (°F)	1.8
seconds (angle)	degrees	$2.778 \times 10^{-4}$	temperatura (°F) +460	absolute temperatura (°F)	1.0
seconds (length)	minutes	0.01667	temperatura (°F) -32	temperatura (°C)	5/9
seconds (length)	quadrants	$3.087 \times 10^{-6}$	tons (long)	kilograms	1,016.
seconds (angle)	readians	$4.848 \times 10^{-6}$	tons (long)	pounds	2,240.
Slug	Kilogram	14.59	tons (short)	tons (short)	1.120
Slug	Pounds	32.17	tons (metric)	kilograms	1,000.
Sphere	Stadians	12.57	tons (metric)	pounds	2,205.
square centimeters	circular mils	$1.973 \times 10^5$	tons (short)	kilograms	907,1848
square centimeters	sq ft	$1.076 \times 10^{-3}$	tons (short)	ounces	32,000.
square centimeters	sq inches	0.1550	tons (short)	ounces (troy)	29,166.66
square centimeters	sq meters	0.0001	tons (short)	pounds	2,000.
square centimeters	sq mils	$3.861 \times 10^{-11}$	tons (short)	tons (long)	2,430.56
square centimeters	sq millimeters	100.0	tons (short)	tons (metric)	0.9078
square centimeters	sq yards	$1.196 \times 10^{-4}$	tons (short)	kg/sq meter	9,765.
square feet	acres	$2.296 \times 10^{-4}$	tons (short)/sq ft	pounds/sq in.	2,000.
square feet	circular mils	$1.833 \times 10^8$	tons of water/24 hrs	gallons/min	83,333
square feet	sq cms	929.0	tons of water/24 hrs	cu ft/hr	1,3489
square feet	sq inches	144.0	Volts/inch	V	
square feet	sq meters	0.09290	Volts/cm.	Volts/cm.	.38370
square feet	sq mils	$3.587 \times 10^{-8}$	Volts (absolute)	Statvolts	.0033336
square feet	sq millimeters	$9.290 \times 10^4$	watts	Btu/hr	3,4129
square feet	sq yards	0.1111	watts	Btu/min	0.05688
square inches	circular mils	$1.273 \times 10^6$	watts	ergs/sec	$10^7$
square inches	sq cms	6.452	tons of water/24 hrs	foot-lbs/min	44.27
square inches	sq feet	$6.944 \times 10^{-3}$			
square inches	sq millimeters	645.2			
square inches	sq mils	$10^6$			
square inches	sq yards	$7.716 \times 10^{-4}$			

square kilometers	247.1	watts	foot-lbs/sec	0.7378
square kilometers	$10^{10}$	watts	horsepower	$1.341 \times 10^{-3}$
square kilometers	$10.76 \times 10^6$	watts	horsepower (metric)	$1.360 \times 10^{-3}$
square kilometers	$1.550 \times 10^9$	watts	kg-calories/min	0.01433
square kilometers	$10^6$	watts	kilowatts	0.001
square kilometers	0.3861	Watts (Abs.)	B.T.U. (mean)/min.	0.066884
square kilometers	$1.196 \times 10^6$	watt-hours	joules/sec.	1
square kilometers	$2.471 \times 10^{-4}$	watt-hours	Btu	3.413
square meters	10.76	watt-hours	erg	$3.60 \times 10^{10}$
square meters	1,550.	watt-hours	foot-pounds	2.656.
square meters	$3.861 \times 10^{-7}$	watt-hours	gram-calories	859.85
square meters	$10^6$	watt-hours	horsepower-hrs	$1.341 \times 10^{-3}$
square meters	1.196	watt-hours	kilogram-calories	0.86005
square miles	640.0	watt-hours	kilogram-meters	367.2
square miles	$27.88 \times 10^6$	Watt (International)	kilowatt-hrs	0.001
square miles	2,590	webers	Watt (absolute)	1.0002
square miles	$2.590 \times 10^6$	webers	maxwells	$10^8$
square miles	$3.098 \times 10^6$	webers/sq in.	kilolines	$10^5$
square miles	1,973.	webers/sq in.	gausses	$1.550 \times 10^7$
square millimeters	0.01	webers/sq in.	lines/sq in.	$10^8$
square millimeters	$1.076 \times 10^{-5}$	webers/sq meter	webers/sq cm	0.1550
square millimeters	$1.550 \times 10^{-3}$	webers/sq meter	webers/sq meter	1,550.
square millimeters	1.273	webers/sq meter	gausses	$10^4$
square millimeters	$6.452 \times 10^{-6}$	webers/sq meter	lines/sq in.	$6.452 \times 10^4$
square millimeters	$10^{-6}$	webers/sq meter	webers/sq cm	$10^{-4}$
square millimeters	$2.066 \times 10^{-4}$	webers/sq meter	webers/sq in.	$6.452 \times 10^{-4}$
square millimeters	8,361.	Y		
square millimeters	9.0	centimeters	centimeters	91.44
square millimeters	1,296.	yards	kilometers	$9.144 \times 10^{-4}$
square millimeters	0.8361	yards	meters	0.9144
square millimeters	$3.228 \times 10^{-7}$	yards	miles (naut.)	$4.934 \times 10^{-4}$
square millimeters	$8.361 \times 10^5$	yards	miles (stat.)	$5.682 \times 10^{-4}$
		yards	millimeters	91.44

# Section 6

- Energy Conversion Chart / 302
- Laser (Eye Hazard) Nomogram / 303
- Laser Radiation Nomogram / 304
- Spectral Characteristics of Photoreceptors and Light Sources / 305
- Photometry Nomogram / 306
- Minimum Detail That the Human Eye Can Resolve / 308
- Suggested Values of Illuminance / 308
- Illumination Units Conversion Nomogram / 309
- Units Used in Photometry and Radiometry / 310
- Illumination Power Conversion Nomogram / 312
- Luminance Spectrum / 313
- Tabulation of Sound Intensity Levels / 314
- Equal Loudness Curves of the Average Human Ear / 316
- Reverberation Time / 317
- Physiological Effects of Electric Current on the Human Body / 318
- Characteristics of Miniature Incandescent Lamps / 319
- Color Codes for Electronic Components / 320
- EIA and Military Designations of Temperature Characteristics and Tolerances for Ceramic Dielectric Capacitors / 324
- Generalized Radioactivity Decay Curve / 326
- Cathode-Ray Tube Phosphor Characteristics / 327
- Guide to Crystal Selection / 328
- Military Nomenclature System / 332
- Magnetic Field Strength Nomogram / 334
- International Time Map / 336
- High Altitude Chart / 337
- Atmosphere Chart / 338
- PPM/ $^{\circ}$ C Vs % Change Conversion Chart / 339
- Atmospheric Layers / 340
- Wind Designations / 340
- Lightning and Thunderstorm Activity for Various Sections of the U.S. / 341
- Windchill Chart / 342
- Wind Map of the U.S. / 343
- Ground Conductivity / 344
- The Triboelectric (or Electrostatic) Series / 345
- Corrosion / 346
- Thermoplastics for Electrical Applications / 347
- Thermosetting Plastics for Electrical Applications / 349
- Significance of Properties of Electrical Insulating Materials / 349
- Temperature Conversion Tables and Formulas / 351

# Physical Data

- Relative Humidity Tables / 355
- Temperature-Humidity Index / 358
- Color Scale of Temperature / 359
- Thermal Spectrum / 359
- Standard Annealed Copper Wire Table / 360
- Properties of Common Wire and Cable Insulations / 361
- Wire Stranding Chart / 361
- Temperature Classification of Insulating Materials / 362
- Voltage-Current-Wire Size Nomogram / 363
- Fusing Currents of Wires / 364
- Suggested Ampacities for Appliance Wiring Material—All Types of Insulation / 364
- Audio Line Table / 365
- Spark-Gap Breakdown Voltages / 366
- Printers / 367
- ASCII Code / 368
- Baudot Code / 369
- Graphic Symbols for Electronic Diagrams / 370
- Conversion Table for Basic Physical Units / 374
- Terminal and Control Markings on Foreign Equipment / 375
- Torque-Power-Speed Nomogram / 376
- Approximate Full-Load Current for Continuous-Duty Motors / 377
- Characteristics of Selected Motor Types / 378
- Family Tree of Electric Motors / 380
- Power Consumption of Electrical Equipment / 381
- Nomogram Relating Amplitude, Frequency, and Acceleration of a Body with Simple Harmonic Motion / 382
- Shock Deceleration Nomogram / 383
- Air-Cooling Nomogram / 385
- Metallic Elements / 386
- Densities of Solids and Liquids in Cubic Centimeters and Cubic Feet / 386
- Solder Alloys / 387
- Track Width of Printed Wiring Boards / 388
- Defined Values and Physical Constants / 389
- Approximate Capacitance of Conductors (pf/inch) / 392
- Approximate Resistance of Conductors (ohms/inch) / 392
- Velocity of Sound in Solids, Gases, and Liquids / 392
- Relay Contact Code / 393
- Heat-Sink Thermal Resistance Chart / 395
- Foreign Voltage Guide / 396
- Typical Hardware Used in Electronic Equipment / 398
- Coordinates for Equally Spaced Holes / 399

# ENERGY CONVERSION CHART

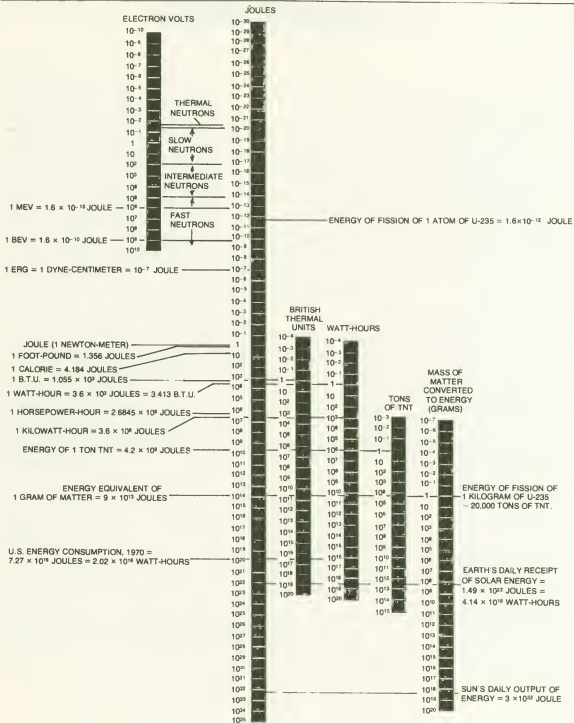

## LASER (EYE HAZARD) NOMOGRAM

This nomogram is used to estimate the safe range at which an object may be illuminated directly. It incorporates a scale for the introduction of loss factors including losses in the eye, optical surfaces external to the laser mirror, and optical losses.

FOR EXAMPLE: Assume system losses of 50%, a pupil diameter of 4 mm, a laser output of 0.05 J, and a laser beamwidth of 1 mrad. Connect loss factor and pupil size to turning scale (1), from that point to laser output of 0.05 J to turning scale (2), then through safety threshold point to turning scale (3), and finally through laser beamwidth (4) to distance line. In this case the safe range is approximately 4.0 km or 2.6 statute miles.

NOTE: "Safe" threshold levels are a subject of some controversy and the figures specified in the nomogram should be interpreted in the light of most recent information.

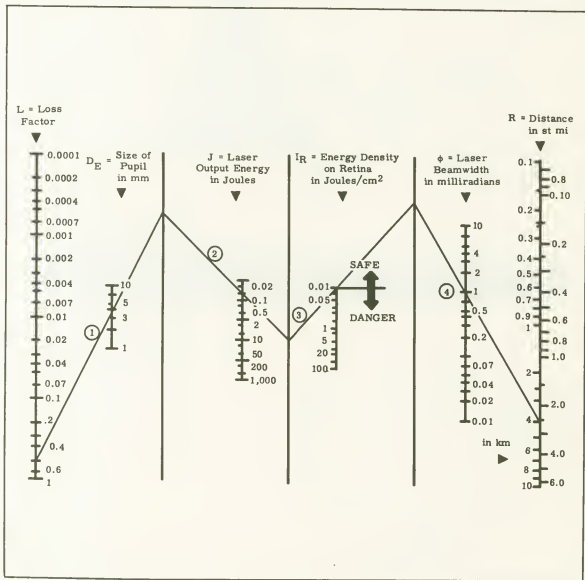



## LASER RADIATION NOMOGRAM

This nomogram relates laser radiation terms, which may be given as photon energy, wave number, frequency, or wavelength. Any of these terms can be converted to the others by a horizontal line across the nomogram.

FOR EXAMPLE: 1. Light at a wavelength of  $0.5 \mu$  can also be described as having (1) A wavelength of 5000 Å, (2) a frequency of 600 THz or  $6 \times 10^{14}$  Hz, (3) a wavenumber of 20,000  $\text{cm}^{-1}$ , and (4) a photon energy of 2.48 eV.

- Electrons when falling through 4 V will radiate at 3100 Å.
- Light at 200 THz will produce conduction in semiconductors with band-gaps up to 0.83 V.

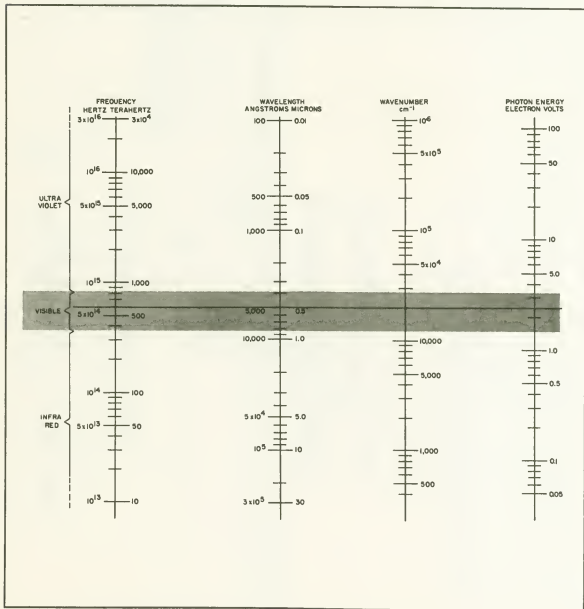

## SPECTRAL CHARACTERISTICS OF PHOTORECEPTORS AND LIGHT SOURCES

This figure shows spectral sensitivity of various photoreceptors. Response of cadmium sulfide cells is similar to that of the human eye, but other commonly used receptors perform best at wavelengths invisible to the eye.

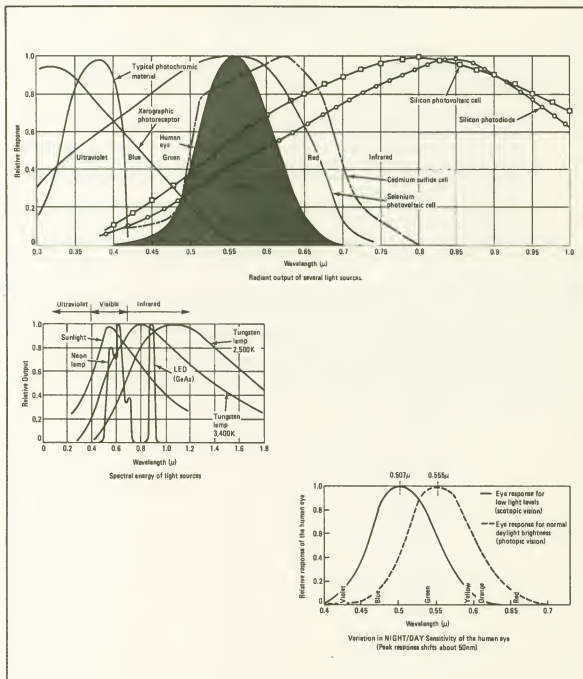

## PHOTOMETRY NOMOGRAM

This nomogram solves the light intensity equation:

$$\text{foot-candles} = \frac{\text{candlepower}}{(\text{distance in feet})^2}$$

which assumes a point source (distance greater than five times maximum lamp dimension).

Most lamps are classified according to wattage, and the following approximate relations apply:

1. The shorter the rated life of the lamp, the higher the efficiency (op/watt) and the higher the color temperature of the light.
2. For standard 120-V inside-frosted incandescent lamps rated for 1,000 hr, the following hold true:
  - a. Efficiency increases with increasing wattage.
  - b. A 25-W lamp is approximately 19 cp, a 60-W lamp about 60 cp, and a 150-W lamp is near 200 cp.
  - c. Color temperature increases with increasing wattage (150-W lamp is near 2,900 K).
  - d. When lamps are operated at constant voltage, light output falls with time, rapidly during the first 50 hrs and more slowly thereafter.
  - e. When lamps are operated at constant current, light output rises with time, slowly at first, then accelerating to catastrophic failure.

FOR EXAMPLE: A 6-cp lamp will produce a light intensity of 100 fc, at a distance of 2.94 in. (0.245 ft) from the lamp filament. The same lamp will provide 1 fc at 29.4 in. and 0.01 fc at 294 in.

### Several Useful Definitions

A *foot-candle* is the illumination produced when the light from one candle falls normally on a surface at a distance of one foot.

A *lux* (commonly used in Europe) is the illumination produced when the light from one candle falls normally on a surface at a distance of one meter.

A point source emitting light uniformly in all directions radiates  $4\pi$  lumens/candle.

A *lambert* is the brightness of a perfectly diffusing surface emitting or reflecting one lumen per square centimeter.

A *foot lambert*  $1/\pi$  candles/ft<sup>2</sup>.

(Read correspondingly headed columns, i.e., A, A', A'', etc.)

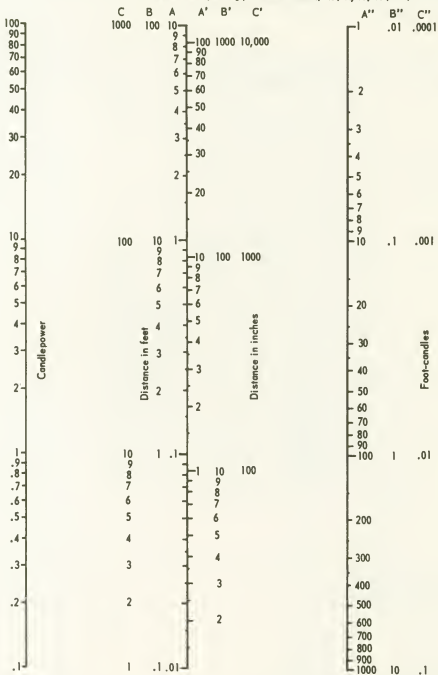

## MINIMUM DETAIL THAT THE HUMAN EYE CAN RESOLVE

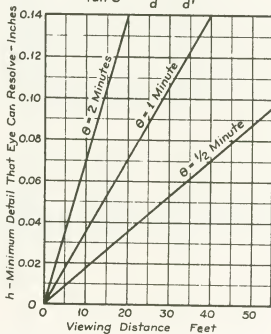
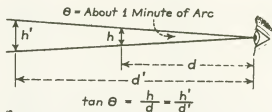

## SUGGESTED VALUES OF ILLUMINANCE

Auditorium	10 fc
Lecture room—library	30 fc
Classroom	30 fc
Drafting room	30 fc
Low-contrast work inspection	250 fc
Hospital operating room	500-1,000 fc

## ILLUMINATION UNITS CONVERSION NOMOGRAM

This nomogram relates candles/square foot, footcandles, lumens/square foot, lamberts, foot-lamberts, lumens/square centimeter, candles/square centimeter, candles/square inch, end lux, and it is based on the following relationships:

foot-lamberts = lumens/square foot = foot-candles = 10.764 lux

lamberts = lumens/square centimeter = 295.72 candles/square foot = 929.03 lumens/square foot

lux = lumens/square centimeter and candles/square centimeter = 3.14159 lambert

A line from any known value through the index point intersects all other scales at corresponding values.

FOR EXAMPLE:

$$4 \text{ L} = 8.2 \text{ cd/in.}^2 = 3,715 \text{ lm/ft}^2 \\ = 4,400 \text{ fc} = 1,183 \text{ cd/ft}^2$$

NOTE: the ranges can be extended by multiplying all scales by the same power of 10.

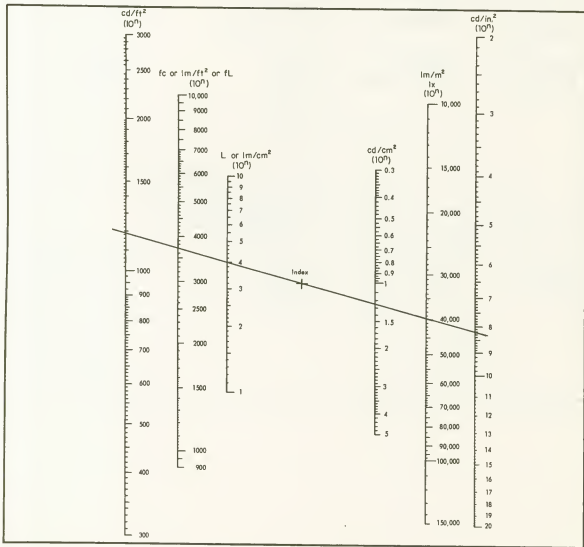

UNITS USED IN PHOTOMETRY AND RADIOMETRY .

Measurements of Sources (as Seen by Observer)  
(Examples: Lamps, Stars, T.V., Lighthouse)

<i>Measurement</i>	<i>Radiometric (Wide Band Receiver)</i>	<i>Photometric (Eye will be the Receiver)</i>	<i>Where Used</i>
Total emission	Power: watts	: Lumens	Lamps light standards
Emissions into a solid angle from a point source	Intensity: watts/steradian	Luminous Intensity Candela = $\frac{\text{Lumen}}{\text{Steradian}}$	Stars
Emissions into a solid angle from a large source	Radiance watts/m <sup>2</sup> /steradian	Luminance (Brightness) : $\frac{\text{Candle}}{\text{ft}^2} = \pi$ foot lamberts : $\frac{\text{Candle}}{\text{m}^2} = 1$ nit : $\frac{\text{Candle}}{\text{cm}^2} = 1$ stilb = $\pi$ lamberts also: 1 foot lambert = .0010764 lamberts = 3.426 nits	Lamps T.V. Screen L.E.D.
Emission into all angles point source	Emittance watts/m <sup>2</sup>	Luminous Emittance : Lumen/ft <sup>2</sup> : Lumen/m <sup>2</sup> : Lumen/cm <sup>2</sup>	Flourescent lamps

Measurements of Sources (as Seen by Observer)  
(Examples: Lamps, Stars, T.V., Lighthouse)

Measurement	Radiometric (Wide Band Receiver)	Photometric (Eye will be the Receiver)	Where Used
Total emissions received	Power: watts	: Lumens	Detectors
Emissions per unit area	Irradiance $W/m^2$	Illuminance : $\frac{\text{Lumen}}{ft^2} = \text{foot candle}$ : $\frac{\text{Lumen}}{m^2} = \text{lux} = \text{meter candle}$ : $\frac{\text{Lumen}}{cm^2} = \text{phot}$ also: 1 foot candle = 10.764 lux	

Typical Measurements and Values

Source	Total Emissions		Luminance	Illuminance	
	Photometric Lumens	Radiometric Watts	Photometric Foot Lamberts	Photometric Lumens/m <sup>2</sup>	Radiometric W/m <sup>2</sup>
Sun (noon)			$4.7 \times 10^8$	$10^5$	.1
Lightning Flash			$2 \times 10^{10}$		
100W Lamp	1630	30	$2.6 \times 10^6$		
40W Fluorescent Lamp	2560	16	2000		
Moon			730	.27	
Twilight				10	
Starlight (Total)				.001	
(zero magnitude)				$2.6 \times 10^{-6}$	
(6th magnitude)				$10^{-8}$	



### ILLUMINATION POWER CONVERSION NOMOGRAM

This nomogram relates international lumens, watts, and candlepower. Select the known value. A line from that point through the index point intersects other scales at corresponding values.

FOR EXAMPLE:

$$5 \text{ lm} = 0.0074 \text{ W}$$

$$50 \text{ lm} = 3.98 \text{ cp}$$

NOTE: the ranges can be extended by multiplying all scales by the same power of 10.  
The nomogram is based on the following:

$$1 \text{ cp} = 12.566 \text{ lm}$$

$$1 \text{ lm} = 0.001496 \text{ W}$$

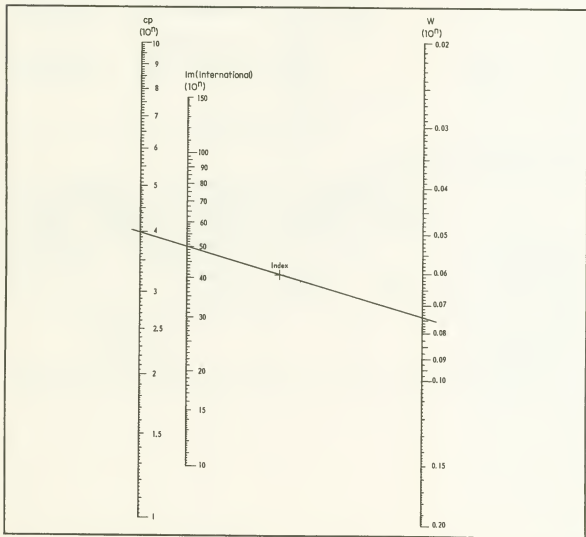

# LUMINANCE SPECTRUM

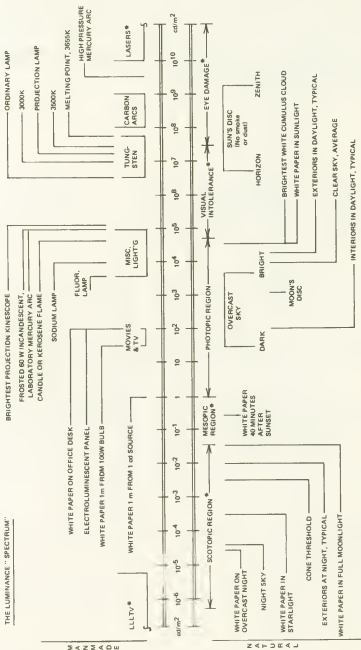

\* Actual ranges depend on spectral makeup of radiation.

Courtesy, Homer B. Tilton, Tucson, Arizona 85710.

## TABULATION OF SOUND INTENSITY LEVELS

This tabulation extends from the barely audible to the unbearable and/or damaging sound intensity levels. The various levels are given in terms of sound pressure in dynes per square centimeter, sound intensity (at the eardrum) in watts per square centimeter, and intensity level in decibels above  $10^{-16}$  W/cm<sup>2</sup> and related to familiar sound situations.

FOR EXAMPLE: A faint to moderate sound such as can be found in an average residence is equal to a sound pressure of 0.024 dyn/cm<sup>2</sup>, which produces a sound intensity at the eardrum of  $10^{-12}$  W/cm<sup>2</sup> (1 pW/cm<sup>2</sup>) and is equal to an intensity level of 40 dB above  $10^{-16}$  W/cm<sup>2</sup>.

Description or Effect	Sound Pressure (dyn/cm <sup>2</sup> )	Sound Intensity at Eardrum (W/cm <sup>2</sup> )	Intensity Level (dB above $10^{-16}$ W/cm <sup>2</sup> )	Familiar Sources of Sound (number in parentheses shows distance from source)
Impairs hearing		$10^{-1}$	150	
Pain	2040	$10^{-2}$	140	jet engine largest air raid siren (100 ft)
Threshold of pain		$10^{-1}$	130	level of painful sound
Threshold of discomfort	204	$10^{-4}$	120	pneumatic hammer (5 ft) airplane 1600 rpm (18 ft from propeller) automobile horn
Deafening		$10^{-5}$	110	engine room of submarine (at full speed) bass drum (maximum)
Discomfort begins	20.4	$10^{-6}$	100	boiler factory loud bus horn thunder clap subway (express passing a local station) can manufacturing plant very loud musical peaks noisiest spot at Niagara Falls

Description or Effect	Sound Pressure (dyn/cm <sup>2</sup> )	Sound Intensity at Eardrum (W/cm <sup>2</sup> )	Intensity Level (dB above 10 <sup>-16</sup> W/cm <sup>2</sup> )	Familiar Sources of Sound (number in parentheses shows distance from source)
Very loud	2.04	10 <sup>-7</sup>	90	loudest orchestral music noisy factory heavy street traffic
		10 <sup>-8</sup>	80	loud speech police whistle very loud radio average factory average orchestral volume
Loud	0.204	10 <sup>-9</sup>	70	busy street noisy restaurant average conversation (3 ft)
		10 <sup>-10</sup>	60	quiet typewriter average (quiet) office hotel lobby quiet residential street
Moderate	0.0204	10 <sup>-11</sup>	50	soft violin solo church quiet automobile
		10 <sup>-12</sup>	40	average residence lowest orchestral volume quiet suburban garden
Faint	0.00204	10 <sup>-13</sup>	30	average whisper very quiet residence
		10 <sup>-14</sup>	20	faint whisper (5 ft) ordinary breathing (1 ft) outdoor minimum (rustle of leaves)
Very faint		10 <sup>-15</sup>	10	anechoic room normal threshold of hearing
Threshold of hearing	0.000204	10 <sup>-16</sup>	0	reference level

## EQUAL LOUDNESS CURVES OF THE AVERAGE HUMAN EAR

The curves show that the frequency response characteristic of the human ear varies with the loudness of the sound. At low sound levels the ear is relatively insensitive to the lower frequencies, which must be at least 60 dB to be heard. Higher sound levels are heard nearly equally well at the high and low frequencies. Therefore, for listening at low volume levels, the low frequencies must be boosted considerably to produce the effect of equal loudness and to avoid an apparent lack of low frequency tones. The ear is most sensitive to sounds in the 2,000 to 4,000 Hz range.

(20- to 29-year old subjects)

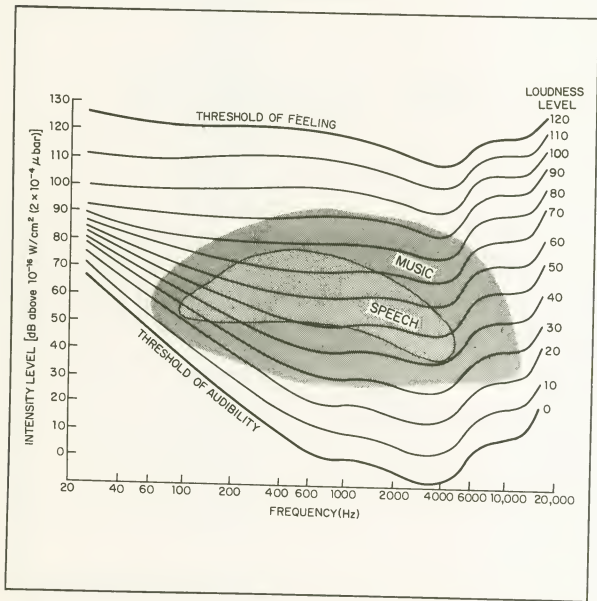

## REVERBERATION TIME

These graphs determine the optimum recommended reverberation time as a function of room volume and usage. The optimum times for speech rooms, motion picture theaters, and school auditoriums are given by a single line, whereas the optimum time for music is a broad band. Furthermore, the optimum reverberation time is not the same for all kinds of music. For example, slow organ and choral music require more reverberation than does a brilliant allegro composition played on woodwinds or a harpischord.

The first chart is used to find the optimum reverberation time for frequencies above 512 Hz. For lower frequencies that value must be multiplied by the appropriate factor in the second graph. For small rooms the lower part of the shaded portion (closer to 1.0 should be used.)

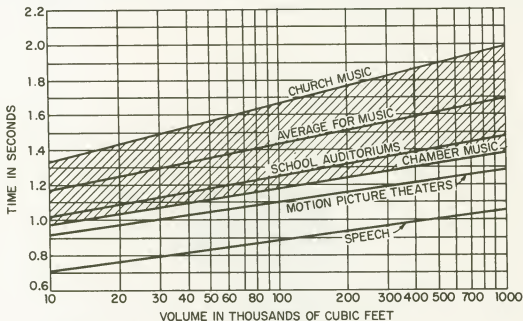

Optimum reverberation time as a function of volume of rooms for various types of sound for a frequency of about 512 Hz.

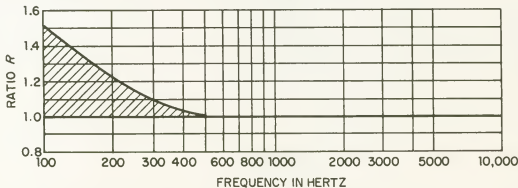

Ratio of the reverberation time for various frequencies as a function of the reverberation for 512 Hz.

## PHYSIOLOGICAL EFFECTS OF ELECTRIC CURRENT ON THE HUMAN BODY

The chart shows the physiological effect of various current densities on the human body. Voltage is not the prime consideration, though it takes voltage to produce the current flow. The amount of shock current depends on the body resistance between the points of contact and the skin condition, (that is, moist or dry). For example, the internal resistance between the ears is only 100 ohms (less the skin resistance), while from hand to foot it is close to 500 ohms. Skin resistance may vary from about 1,000 ohms for wet skin to over  $\frac{1}{2}$  Mohm for dry skin, and is even lower for ac.

The chart shows that shock becomes more severe as current rises. At values as low as 20 mA breathing becomes labored, and as the current approaches 100 mA, ventricular fibrillation of the heart occurs. Above 200 mA, the muscular contractions are so severe that the heart is forcibly clamped during the shock. This clamping protects the heart from going into ventricular fibrillation and the victim's chances for survival are good if the victim is given immediate attention. Resuscitation, consisting of artificial respiration, will usually revive the victim.

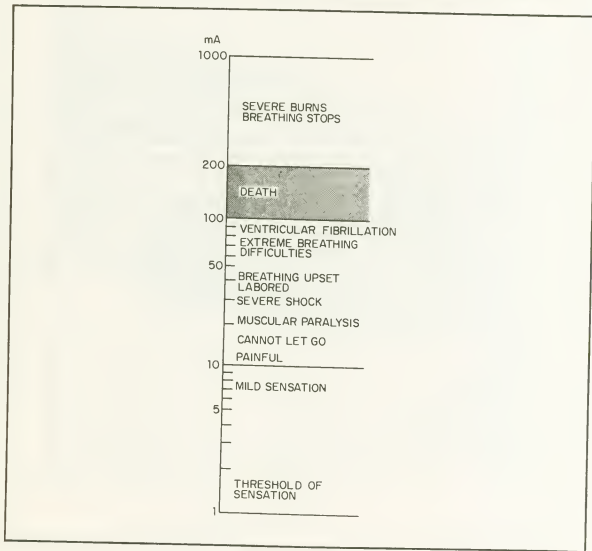

## CHARACTERISTICS OF MINIATURE INCANDESCENT LAMPS

This graph relates light output, current, and life of incandescent lamps with rated (design) voltage. The curves show that the light output varies directly as the applied voltage raised to the 3.4th power, while life is inversely proportional to applied voltage raised to the 12th power.

FOR EXAMPLE: At 110% of rated voltage, the current will increase by 5%, light output increases by 40%, and life will be reduced to nearly 35% of that at design voltage.

At 80% of rated voltage, current decreases by 10%, light output drops by more than 50%, but lamp life is increased to 18 times normal.

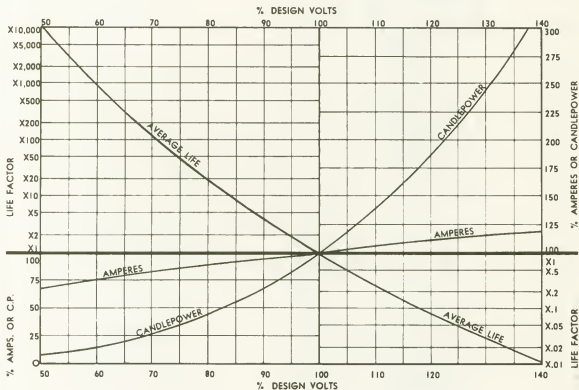



COLOR CODES FOR ELECTRONIC COMPONENTS

STANDARD COLORS	NUMERICAL VALUES <sup>1</sup>				FILM RESISTORS			CERAMIC CAPACITORS				CHASSIS WIRING	TWT WIRED LEADS		
	Num. of Figs.	Decadal Multiplier	Value (%)	Sig. Figs.	Tol. ±%	Sig. Figs.	Mult.	Over 10 or 100 (±%)	Tol. 10 or 100 (±%)	Temp. Coeff. (ppm/°C)	Extended Temp. Range Multiplier			Trace	TWT Element
BLACK	0	10 <sup>0</sup>	±20	0	10 <sup>0</sup>	—	0	1	20	2	0	0.0	—1	none	Grounds, heaters, filament filaments
BROWN	1	10 <sup>1</sup>	±1	1	10 <sup>1</sup>	1	1	10	1	0.1	—30	—10	none	Heaters or fil. of grid.	
RED	2	10 <sup>2</sup>	±2	2	10 <sup>2</sup>	2	2	100	2	—75	1.0	—100	none	Heaters or filaments, off-grid.	
ORANGE	3	10 <sup>3</sup>	±3	3	10 <sup>3</sup>	—	3	1,000	2.5	—150	1.5	—1,000	Screen grids	none Helix 1 green Helix 2 blue Helix 3 gray Helix 4	
YELLOW	4	10 <sup>4</sup>	GMV <sup>2</sup>	4	10 <sup>4</sup>	—	4	10,000	—	—220	2.2	—10,000	Cathodes	none also heater if common	
GREEN	5	10 <sup>5</sup>	±5 (optimal)	5	10 <sup>5</sup>	0.5	5	5	0.5	—330	3.3	+1	Control grids	none black Grid 1 Grid 5	
BLUE	6	10 <sup>6</sup>	±6	6	10 <sup>6</sup>	0.25	6	—	—	—470	4.7	+10	Plates	none black Grid 2 Grid 6	
VIOLET	7	10 <sup>7</sup>	±12½	7	10 <sup>7</sup>	0.10	7	—	—	—750	7.5	+100	Not used	—	

GRAY	8	$10^{-2}$ (alternate)	$\pm 30$	8	0.05	8	0.01	$\pm 30$	+1,000	ac pow. lines	none black Grid 3 Grid 7
WHITE	9	$10^{-1}$ (alternate)	$\pm 10$ (optional coating)	9	—	9	0.1	10	1	above ac before any resistor, AVC, etc.	none black Grid 8 Grid 8
SILVER	—	$10^{-2}$ (preferred)	$\pm 10$	—	0.01	10	—	—	—	—	—
GOLD	—	$10^{-1}$ (preferred)	$\pm 5$	—	0.1	5	—	—	—	—	—
NO COLOR	—	—	$\pm 20$	—	—	—	—	—	—	—	—
ILLUS.	A, B	C		D							

<sup>1</sup> For components such as resistors, capacitors, and wires. Also, for identification of components.

<sup>2</sup>  $\pm 100\%$  tolerance or Guaranteed Minimum Value.

<sup>3</sup> If heater-cathode elements are internally connected, but

for external connection and the tracer is still internally connected.

<sup>4</sup> COMPOSITION RESISTORS

STANDARD—6-DOT

Fig. Identifier (Violet)

First significant fig. (Violet)

Second significant fig. (Violet)

Third significant fig. (Violet)

Multiplier (Silver)

Tolerance (Silver)

Characteristic (Silver)

(470  $\Omega$   $\pm$  10%)

(22 M  $\Omega$   $\pm$  10%)

RED

RED

RED

RED

RED

RED

RED

RED

RED

RED

RED

RED

RED

RED

RED

RED

RED

RED

RED

RED

RED

RED

RED

RED

RED

RED

RED

RED

RED

RED

RED

RED

RED

RED

RED

RED

RED

<sup>1</sup> Orange body identifies elements used principally for modulation purposes or beam

control.

<sup>2</sup> Elements used to control beam current, beam noise, etc.

<sup>3</sup> Elements are numbered according to their relative position from cathode—lowest

to highest.

<sup>4</sup> Elements are numbered according to their relative position from cathode—lowest

to highest.

<sup>5</sup> Elements are numbered according to their relative position from cathode—lowest

to highest.

<sup>6</sup> Elements are numbered according to their relative position from cathode—lowest

to highest.

<sup>7</sup> Elements are numbered according to their relative position from cathode—lowest

to highest.

<sup>8</sup> Elements are numbered according to their relative position from cathode—lowest

to highest.

<sup>9</sup> Elements are numbered according to their relative position from cathode—lowest

to highest.

<sup>10</sup> Elements are numbered according to their relative position from cathode—lowest

to highest.

<sup>11</sup> Elements are numbered according to their relative position from cathode—lowest

to highest.

<sup>12</sup> Elements are numbered according to their relative position from cathode—lowest

to highest.

<sup>13</sup> Elements are numbered according to their relative position from cathode—lowest

to highest.

<sup>14</sup> Elements are numbered according to their relative position from cathode—lowest

to highest.

<sup>15</sup> Elements are numbered according to their relative position from cathode—lowest

to highest.

<sup>16</sup> Elements are numbered according to their relative position from cathode—lowest

to highest.

<sup>17</sup> Elements are numbered according to their relative position from cathode—lowest

to highest.

<sup>18</sup> Elements are numbered according to their relative position from cathode—lowest

to highest.

<sup>19</sup> Elements are numbered according to their relative position from cathode—lowest

to highest.

<sup>20</sup> Elements are numbered according to their relative position from cathode—lowest

to highest.

<sup>21</sup> Elements are numbered according to their relative position from cathode—lowest

to highest.

<sup>22</sup> Elements are numbered according to their relative position from cathode—lowest

to highest.

<sup>23</sup> Elements are numbered according to their relative position from cathode—lowest

to highest.

<sup>24</sup> Elements are numbered according to their relative position from cathode—lowest

to highest.

<sup>25</sup> Elements are numbered according to their relative position from cathode—lowest

to highest.

<sup>26</sup> Elements are numbered according to their relative position from cathode—lowest

to highest.

<sup>27</sup> Elements are numbered according to their relative position from cathode—lowest

to highest.

(a) PLUM RESISTORS

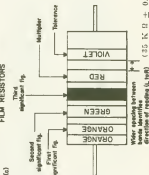

(b) PLUM RESISTORS

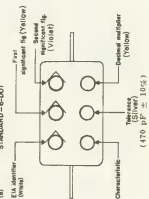

KLYSTRON WIRED LEADS		CROSSED FIELD DEVICES			STEREO PICK-UP LEADS			SEMI-CON-DUCTOR DEVICES <sup>1</sup>		TRANSFORMERS				STAND-COLORS
Tracer	Tube Element	Heater type— Body or other grounded elements	VTR <sup>2</sup>	W/P (all types)	2 Wire	3 Wire	4 Wire	5 Wire	(Diodes & Rectifiers)	A-F	I-P	Power	Center-Tap	STAND-COLORS
none	Body or other grounded elements	Body or other grounded elements	VTM	W/P (all types)	Return grid	Return grid	Return grid	Return grid	Not Appl. cable	Grid (return, tapping, plate or center-tapped)	Grid (diode) return	Primary leads if tapped—black and yellow stripe, black and red stripe	Primary leads if tapped—black and yellow stripe, black and red stripe	BLACK
none <sup>3</sup>	Heater	Heaters or filament off-grid.							0	Plate (start) lead on center-tapped primaries. (Plate may use filament)		Filament winding #2	Black and yellow stripe.	BROWN
none	Collector (if isolated)	Anode	Anode	Delay Line	Right high	Right high	Right high	Right high	1	1 A	1 B	H-V plate winding	Black and yellow stripe.	RED
none <sup>1</sup>	Reflector, phase inductor or electrostatic element #21	—	—	SOLE	—	—	—	—	2	2 B	3 C			ORANGE
green	element #22								3	3 C				
blue	element #23													
gray	element #24													
white	element #25													
none <sup>1</sup>	Control cathode lead if common	Cathode or common heater—cathode							4	4 D		Rectifier filament	Yellow and blue stripe.	YELLOW
none <sup>1</sup> black	Grid 1 Grid 3	—	Injector	Grid	Right low	Right low	Right low	Right low	5	5 E		Filament winding #1	Green and blue stripe.	GREEN
none black	Grid 2 Grid 6	—	—	Accelerator	Left low	Left low	Left low	Left low	6	6 F	Plate lead of primary			BLUE



**EIA AND MILITARY DESIGNATIONS OF TEMPERATURE CHARACTERISTICS AND TOLERANCES FOR CERAMIC DIELECTRIC CAPACITORS**

**General Application and High-K Capacitors**

EIA

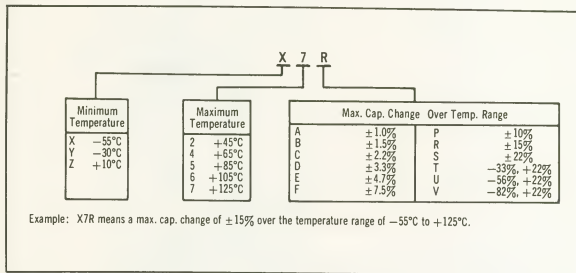

**Military**

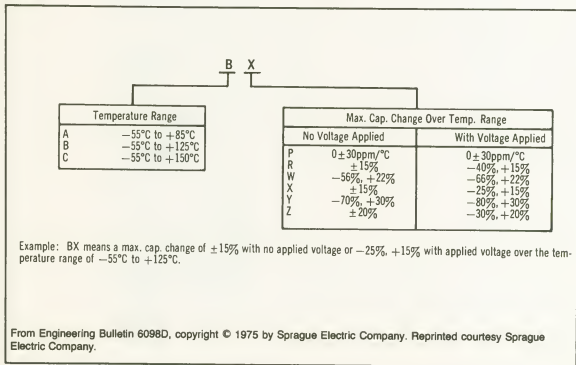

From Engineering Bulletin 6098D, copyright © 1975 by Sprague Electric Company. Reprinted courtesy Sprague Electric Company.



### GENERALIZED RADIOACTIVITY DECAY CURVE

Knowing the isotope half-life, its original activity at some particular time, it is an easy matter, using the chart, to determine the residual activity at some subsequent time.

FOR EXAMPLE: A sample of radioactive iodine—131 has an activity of  $10\ \mu\text{C}$ , find the remaining strength 20 days later.

ANSWER: From an appropriate source determine the half-life of the isotope. For radioactive iodine—131, the half-life is 8.1 days.

Calculate how many "half-lives" there are corresponding to the time interval in question, that is, divide the time interval by the half-life: in this case  $20/8.1 = 2.47$ .

Enter this value on the horizontal axis of the chart and read the "fraction remaining" on the vertical axis as shown by the broken lines. In the case under consideration the value is 0.177.

Multiply this value by the original activity thus giving a final value of  $1.77\ \mu\text{C}$ .

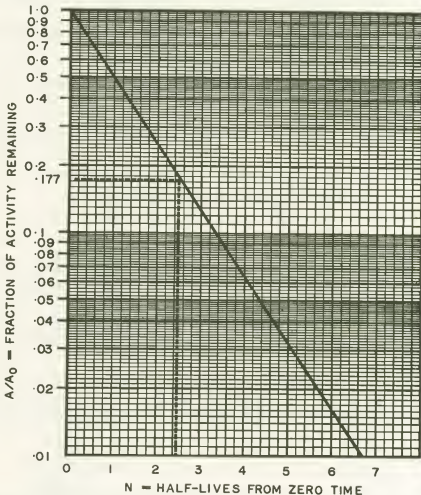

(From *Electronics and Communications*, August, 1962.)

**CATHODE-RAY TUBE PHOSPHOR CHARACTERISTICS**

Type	Color		Spectral Range A°	Persistence	Application
	Fluorescence	Phosphorescence			
P1	Yellow-Green	Yellow-Green	4900-5800	Medium	Oscillography
P2	Yellow-Green	Yellow-Green	4400-6100	Medium	Oscillography
P3	Yellow-Orange	Yellow-Orange	5040-7000	Medium	No longer in general use
P4	White	White	4100-6900	Medium short	Television
P5	Blue	Blue	3500-5600	Medium short	Photographic
P6	White	White	4160-6950	Short	No longer in general use
P7	White	Yellow-Green	3900-6500	One, medium short; One, long	Radar and oscillography
P10	Dark trace: color depends upon absorption characteristics and type of illumination		4000-5500	Very long	Radar
P11	Blue	Blue	4000-5500	Medium short	Oscillographic recording
P12	Orange	Orange	5450-6800	Long	Radar
P13	Red-Orange	Red-Orange		Medium	No longer in general use
P14	Purple-Blue	Yellow-Orange	3900-7100	One, medium short, One, medium	Radar
P15	Green	Green	3700-6050	Visible, short; Ultraviolet, very short	Flying spot scanning systems; photographic
P16	Blue-Purple and near UV	Blue-Purple and near UV	3450-4450	Very short	Flying spot scanning systems; photographic
P17	Yellow-White to Blue-White	Yellow	3800-6400	One, short; One, long	Radar
P18	White	White	3260-7040	Medium to medium short	Television
P19	Orange	Orange	5450-6750	Long	Radar
P20	Yellow-Green	Yellow-Green	4850-6700	Medium to medium short	Radar
P21	Red-Orange	Red-Orange	5540-6500	Medium	Radar
P22	Tri-color		4000-7200	Medium short	Color Television
P23	White	White	4100-7200	Medium to medium short	Television
P24	Green	Green	4300-6300	Short	Flying spot scanning systems
P25	Orange	Orange	5300-7100	Medium	Radar
P26	Orange	Orange	5450-6650	Very long	Radar
P27	Red-Orange	Red-Orange	5820-7200	Medium	Color television monitor service
P28	Yellow-Green	Yellow-Green	4650-6350	Long	Radar
P29	Two-color phosphor screen composed of a linear array of alternate strips of P2 and P25 phosphors				Radar
P31	Green	Green	4150-6000	Medium short	Oscillography
P32	Purple-Blue	Yellow-Green	3800-6550	Long	Radar
P33	Orange	Orange	5450-6850	Very long	Radar
P34	Blue-Green	Yellow-Green	3900-6800	Very long	Radar and oscillography
P35	Blue-White	Blue-White	4350-6480	Medium short	Photographic



## GUIDE TO CRYSTAL SELECTION

Important operating parameters are listed for various crystal cuts. The impedance of a crystal is close to zero at the resonant frequency ( $f_s$ ) and rises to a peak at the antiresonant frequency ( $f_p$ ). The practical parallel resonant operating frequency ranges between  $f_s$  and  $f_p$  and may include these two limiting values. The operating frequency is expressed as

$$f_p = f_s \sqrt{1 + \frac{C_1}{C_0}}$$

The steep slope of the curve and the corresponding large differential between the impedances at  $f_s$  and  $f_p$  indicate that the  $Q$  of the crystal is high. Also, the frequency separation between  $f_s$  and  $f_p$  is determined by the capacitance ratio  $C_0/C_1$ . For example, the 45° cut is a favorite choice in crystal filters because of its low  $C_0/C_1$  ratio. Thus a larger filter bandwidth is achieved with fewer crystals.

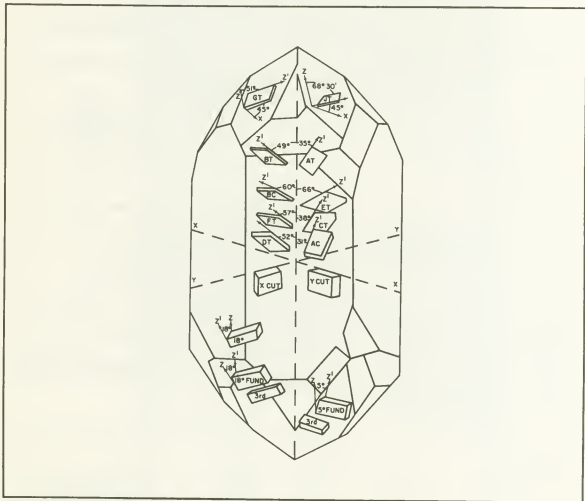

The orientation of the better known crystal cuts shows the difference among the types.

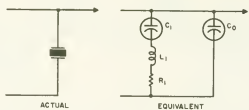

Equivalent circuit of a crystal includes the capacitances contributed by the wire leads and the holder in  $C_0$ . ratio of  $C_0$  and  $C_1$  indicates the frequency separation between the resonant and antiresonant frequencies of the crystal.

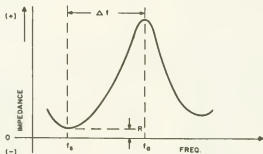

The impedance of a crystal is near zero at the series resonant frequency,  $f_s$  and reaches its peak at the antiresonant frequency,  $F_A$ . Steep slope between these two frequencies indicates a high Q.

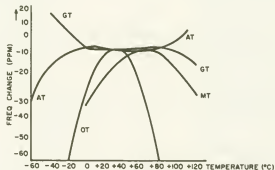

Temperature characteristics of four popular crystal cuts show the extremely stable behavior of the GT cut. Its frequency change is about 1 part per million over a 100°C range.

Cut	Designation	Mode of vibration	Frequency range in kHz	$C_0/C_1$	Max. drive level	Remarks
Duplex 5°X	J	Length	0.800-10	190-250	0.20	Used in frequency and oscillator applications. Zero-temperature coefficient occurs at approximately room temperature; therefore the crystal is limited to oven operation and to rigid temperature-control conditions.
XY	Custom-made	Length, width	3-50	600-900	0.1	Suited for oven-control applications, especially in its optimum frequency range.
NT	N	Length	4-150	800-1500	0.1	Preferred in low-frequency oscillators and filters. It operates over large temperature ranges. Stability of $\pm 5$ ppm can be obtained over $\pm 5^\circ\text{C}$ , if oven-controlled in the frequency range. Rugged, if properly mounted. Can obtain frequency stability within $\pm 0.0025\%$ over the normal room-temperature range, without temperature control.
+5°X	H	Flexure	5-140	225	0.1	A relatively large frequency deviation over temperature range restricts filter applications to controlled environments. Low temperature coefficient and large ratio of stored mechanical energy to electrical energy are the characteristic features. Used in wideband filters, below the range of practical size E plates, and in transistor oscillators, where LC circuits are not stable enough, or where there is a space problem. Disadvantages: Fabrication difficulties. The crystal must be made in the form of a long, thin bar to fit in a special holder, to avoid jumping between modes.
BT	B	Thickness	1-75	-	-	Thicker crystal possible at higher frequencies. Disadvantages: Too thick for low frequency. Also, difficult to fabricate and has zero-temperature coefficient over only a very small temperature range. Not as active as the AT.
-18-1/2°X	F	Extensional	50-250	200	-	Used principally in filters where low temperature coefficient is sacrificed for freedom from certain spurious responses. Suitable for multi-electrodes.
+5°X	E	Extensional	50-250	130-160	2.0	Mostly applicable in low-frequency filters, because of low $C_0/C_1$ and good temperature coefficient.
DT	D	Face shear	80-500	450	2.0	Suitable for oven and non-oven applications. Its low capacity ratio permits many useful filter applications. Used as calibrator crystal and time base for frequency counters. Also used in FM and TV transmitters. Disadvantage: Does not perform well over 500 kHz.

Cut	Designation	Mode of vibration	Frequency range in kHz	$C_p/C_1$	Max. drive level	Remarks
MT	M	Extensional	50-250	250	2.0	Its low temperature coefficient makes it useful for oscillator control and for filters where low $C_p/C_1$ ratio is required along with low inductance and good temperature coefficient. However, this crystal is seldom used, because more compact units have replaced it.
GT	G	Extensional	85-400	375	0.1	Has the greatest stability yet attained within a cut. Does not vary more than 1 part per million over a range of 100°C. Offers a low temperature coefficient over a wide frequency range, by coupling any desired mode with another of nearly equal amplitude at a frequency equal to 0.86 times its natural frequency. Used in frequency standards and when stability without temperature control or low impedance is essential. Disadvantages: Most expensive of all types, because of painstaking labor required to obtain exact orientation in dimension.
CT	C	Face shear	300-1100	350-400	2.0	Provides a zero temperature coefficient in the shear mode for low frequencies. Widely used in low-frequency oscillators and filters and does not require constant temperature control over normal operating conditions. Useful in filters because of low $C_p/C_1$ ratio. Popular in oscillators because of its low series resistance, especially above 400 kHz. Disadvantages: Large face dimensions make it difficult to fabricate for the very low frequencies.
X	Custom-made	Extensional	350-20,000	-	-	Mechanically stable and an economic type of cut. Disadvantages: Large temperature coefficient, with the tendency to jump from one mode to another.
SL	Custom-made	Face shear, coupled to flexure	300-800	450	-	Electrical characteristics similar to DT, but it is larger, has better Q and uniformity of characteristics above 300 kHz. Its various characteristics make it desirable for some filter applications.
Y	Y	Thickness, shear	500-20,000	-	-	Most active. Ratio of stored mechanical to electrical energy is large. Is strong mechanically. Disadvantages: Large temperature coefficient and poor frequency spectrum.
AT	A	Thickness	550-20,000 fundamental 10,000-60,000 (3rd overtone) 100,000 (5th overtone)	10-100,000	1.0-8.0	Excellent temperature and frequency characteristics. Its overtones are used in cases where the frequency should not change with oscillator reactance variations. Designs provide suitable capabilities for satisfying 70-80% of all crystal requirements. Preferred for high-frequency oscillator-control wherever wide variation of temperature is encountered. Because of small size, it can be readily mounted to meet stringent vibration specifications. Disadvantage: Difficult to fabricate for optimum operation without coupling between modes.

## MILITARY NOMENCLATURE SYSTEM

The AN nomenclature designation is assigned to:

1. Complete sets of equipment and major components of military design.
2. Groups of articles of commercial or military design which are grouped for a military purpose.
3. Major articles of military design which are not part of, or used with, a set.
4. Commercial articles where nomenclature facilitates identification and/or procedures.

As applied to complete sets, the nomenclature consists of the two letters AN followed by a slash and three indicator letters which indicate installation, type of equipment, and purpose. The number that may follow the letters indicates model number, and a subsequent letter refers to modification.

FOR EXAMPLE: AN/APN—10B      airborne-radar-navigational aid 10th model-second modification

As applied to components, the AN nomenclature consists of one or two designator letters substituted for AN.

FOR EXAMPLE: An indicator model 42 for use with APQ-13 is designated as ID-42/APQ-13. Modifications are indicated by letters, for example, ID-42B/APQ-13

### Component Indicator Letters

AB—Support, antenna	HC—Crystal holder	RL—Reel assembly
AM—Amplifier	HD—Air conditioning apparatus	RP—Rope and twine
AS—Antenna assembly	ID—Indicating device	RR—Reflector
AT—Antenna	IL—Insulator	RT—Receiver and transmitter
BA—Battery, primary type	IM—Intensity measuring device	S—Shelter
BB—Battery, secondary type	IP—Indicator, cathode-ray tube	SA—Switching device
BZ—Signal device, audible	J—Junction device	SB—Switchboard
C—Control article	KY—Keying device	SG—Generator, signal
CA—Commutator assembly, sonar	LC—Tool, line construction	SM—Simulator
CB—Capacitor bank	LS—Loudspeaker	SN—Synchronizer
CG—Cable and transmission line, r f	M—Microphone	ST—Strap
CK—Crystal kit	MD—Modulator	T—Radio and radar transmitter
CM—Comparator	ME—Meter, portable	TA—Telephone apparatus
CN—Compensator	MK—Maintenance kit or equipment	TD—Timing device
CP—Computer	ML—Meterological device	TF—Transformer
CR—Crystal	MT—Mounting	TG—Positioning device
CU—Coupling device	MX—Miscellaneous	TH—Telegraph apparatus
CV—Converter (electronic)	O—Oscillator	TK—Tool kit or equipment
CW—Cover	OA—Operating assembly	TL—Tool
CX—Cord	OS—Oscilloscope, test	TN—Tuning unit
CY—Case	PD—Prime driver	TS—Test equipment
DA—Antenna, dummy	PF—Fitting, pole	TT—Teletypewriter and facsimile apparatus
DT—Detecting head	PG—Pigeon article	TV—Tester, tube
DY—Dynamotor	PH—Photographic article	U—Connector, audio and power
E—Hoist assembly	PP—Power supply	UG—Connector, r. f.
F—Filter	PT—Plotting equipment	V—Vehicle
FN—Furniture	PU—Power equipment	VS—Signaling equipment, visual
FR—Frequency measuring device	R—Radio and radar receiver	WD—Cable, two-conductor
G—Generator	RD—Recorder and reproducer	WF—Cable, two-conductor
GO—Goniometer	RE—Relay assembly	WM—Cable, multiple-conductor
GP—Ground rod	RF—Radio frequency component	WS—Cable, single conductor
H—Head, hand, and chest set	RG—Cable and transmission line, bulk r. f.	WT—Cable, three-conductor
		ZM—Impedance measuring device

## Set or Equipment Indicator Letters

<i>1st letter Designed Installation Classes</i>	<i>2d letter Type of Equipment</i>	<i>3d letter Purpose</i>	<i>Model No.</i>	<i>Modifi- cation letter</i>	<i>Miscellaneous Identification</i>
A Airborne (installed and operated in aircraft).	A Invisible light, heat radiation.	A Auxiliary assemblies (not complete operating sets used with, or part of, two or more sets or sets series).	1 2 3 4 etc.	A B C D T etc.	X } Changes in voltage, phase, Y } or frequency. Z } T Training. (V) Variable grouping.
B Underwater mobile, submarine.	B Pigeon.	B Bombing.			
C Air transportable (inactivated, do not use).	C Carrier.	C Communications (receiving and transmitting).			
D Pilotless Carrier.	D Radiac.	D Direction finder, reconnaissance, end/or surveillance.			
F Fixed.	E Nupec.	E Ejection and/or release.			
G Ground, general ground use (include two or more ground-type installations).	F Photographic.	G Fire-control or searchlight directing.			
	G Telegraph or teletype.	H Recording end/or reproducing (graphic meteorological end sound).			
	I Interphona and public address.				
	J Electromechanical or inertial wire covered.				
K Amphibious.	K Telemetering.	K Computing.			
	L Countermasures.	L Searchlight control (Inactivated, use G).			
M Ground, mobile (installed as operating unit in a vehicle which has no function other than transporting the equipment).	M Meteorological.	M Maintenance and test assemblies (including tools).			
	N Sound in air.	N Navigational aids (including altimeters, beacons, compasses, radars, depth soundings, approach and landing).			
P Pack or portable (animal or men).	P Rader.	P Reproducing (inactivated, do not use).			
	Q Sonar and underwater sound.	Q Special, or combination of purposes.			
S Water surface craft.	R Radio.	R Receiving, passive detecting.			
T Ground, transportable.	S Special types, magnetic, etc., or combinations of types.	S Detecting end/or range and bearing, search.			
U General utility (includes two or more general installation classes, airborne, shipboard, end ground).	T Telephona (wira).	T Transmitting.			
V Ground, vehicular (installed in vehicle designed for functions other than carrying electronic equipment, etc., such as tanks).	V Visual and visible light.				
W Water surface and underwater.	W Armament (peculiar to armament, not otherwise covered).	W Automatic flight or remote control.			
	X Facsimile or television.	X Identification and recognition.			
	Y Data processing.				

## MAGNETIC FIELD STRENGTH NOMOGRAM

This nomogram solves for the magnetic field strength, surrounding a power line, as a function of current in the line and the distance from it. Electronic equipment is susceptible to magnetic field interference, and this nomogram helps in determining the magnitude of the problem. For convenience the distance scale is calibrated in inches and centimeters.

FOR EXAMPLE: The magnetic field strength at a point 5 cm from a line that carries 100 A is 4.2 gauss.

### Derivation of the Field-Strength Equation

The field at point  $P$  resulting from the current in segment  $dl$  is given by

$$dB = \mu_0 \frac{I}{r^2} \cos \alpha dl$$

If  $dl$  is small, then

$$\begin{aligned} dl \cos \alpha &= r d\alpha \\ r &= R/\cos \alpha \end{aligned}$$

and

$$\therefore dB = \mu_0 \frac{I}{R} \cos \alpha d\alpha$$

If the line is very long with respect to  $R$ ,

$$B = \int_{-\pi/2}^{\pi/2} \mu_0 \frac{I}{R} \cos \alpha d\alpha = \mu_0 \frac{2I}{R}$$

If  $B$  is in gauss,  $I$  in amperes, and  $R$  in centimeters,  $\mu_0$  is equal to 0.1.

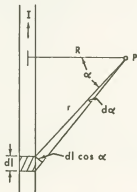

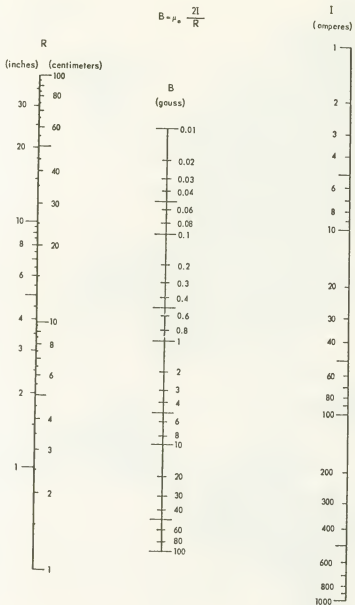



## INTERNATIONAL TIME MAP

This map shows the number of hours to add or subtract from Eastern Standard Time to determine the time anywhere on earth.

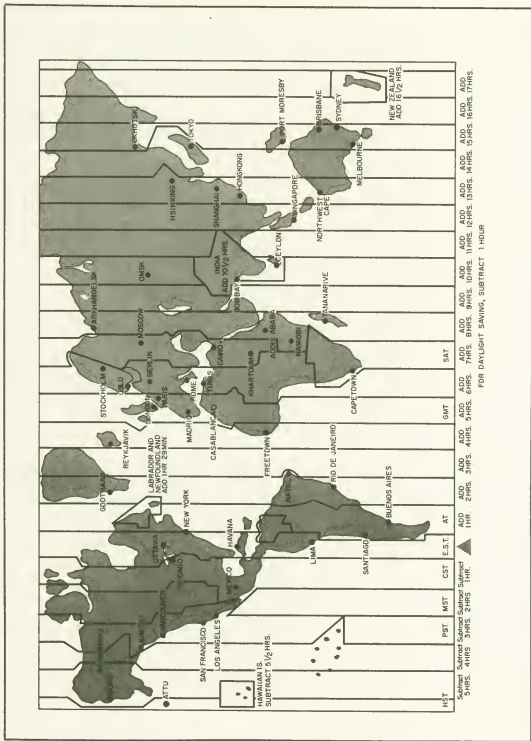

# HIGH ALTITUDE CHART

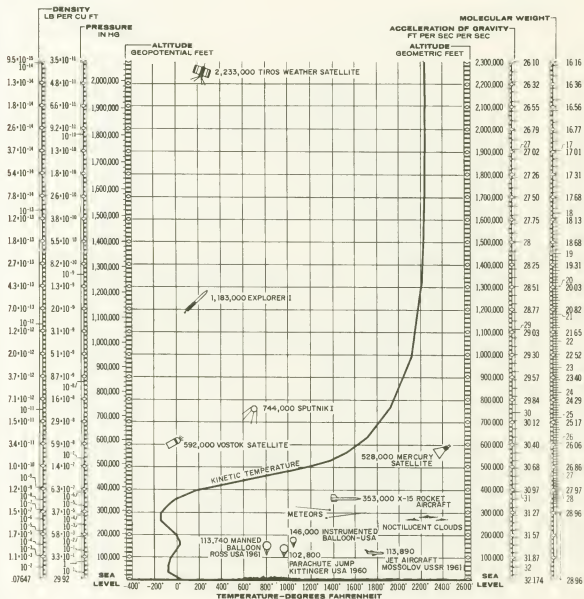

# ATMOSPHERE CHART

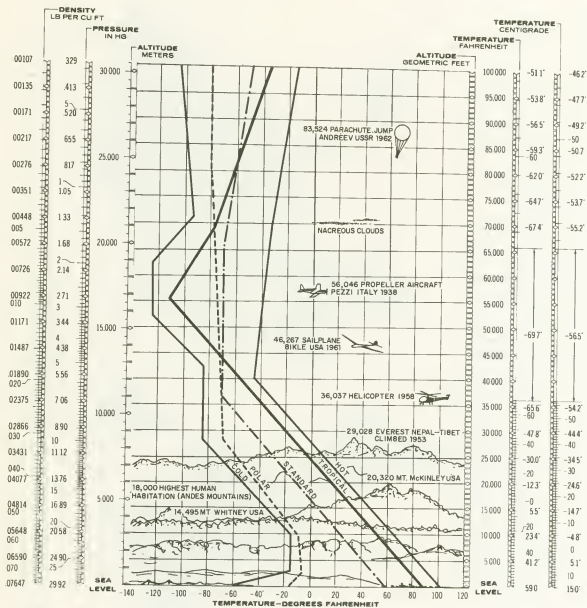

### PPM/°C VS % CHANGE CONVERSION CHART

This chart is used to determine the % change over a certain temperature range when the ppm/°C characteristic is known or to determine the desired ppm/°C for a maximum change over a given temperature range.

FOR EXAMPLE: 1. What will be the change in capacitance of a capacitor with a TC of 750 ppm when used over a 60° temperature range? *Answer: 4.5%*

2. What is the required stability in ppm/°C of an oscillator that should not change in frequency by more than 1% when used between 10 to 90°C (i.e., temp. change = 80°C)? *Answer: 125 ppm/°C*

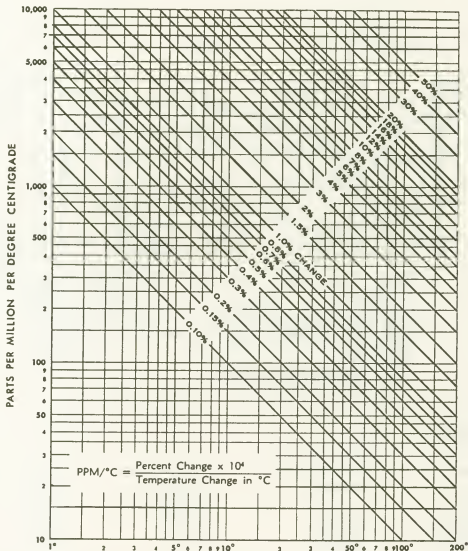

(Reprinted courtesy TRW Capacitor Division, Ogallala, Nebraska.)

## ATMOSPHERIC LAYERS

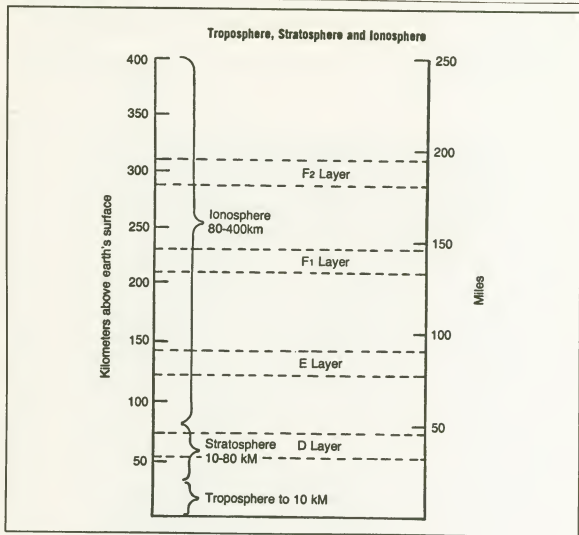

## WIND DESIGNATIONS

<i>Designation</i>	<i>Wind Speed (mph)</i>	<i>Designation</i>	<i>Wind Speed (mph)</i>
Calm	Less than 1	Moderate gale	32 to 38
Light air	1 to 3	Fresh gale	39 to 46
Light breeze	4 to 7	Strong gale	47 to 54
Gentle breeze	8 to 12	Whole gale	55 to 63
Moderate breeze	13 to 18	Storm	64 to 72
Fresh breeze	19 to 24	Hurricane	Above 72
Strong breeze	25 to 31		

### LIGHTNING AND THUNDERSTORM ACTIVITY FOR VARIOUS SECTIONS OF THE U.S.

Based on U.S. Weather Bureau data, this map shows the number of lightning storms occurring over a 20-year period.

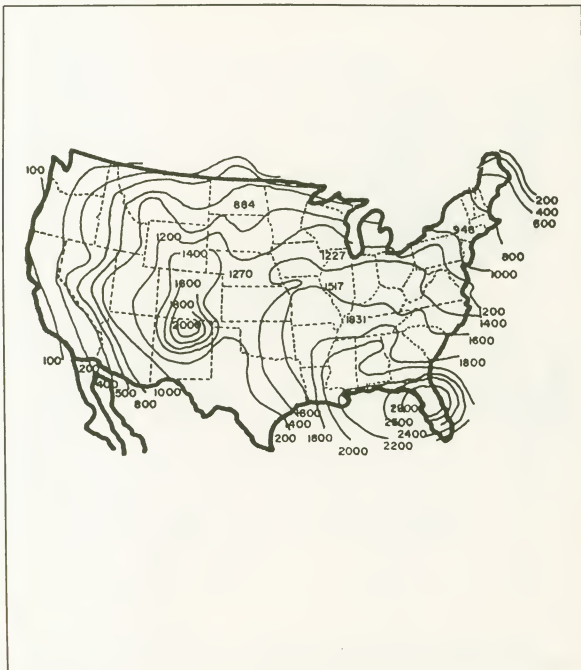

# WINDCHILL CHART

This chart shows the "windchill" and state of comfort under varying conditions of temperature and wind velocity.

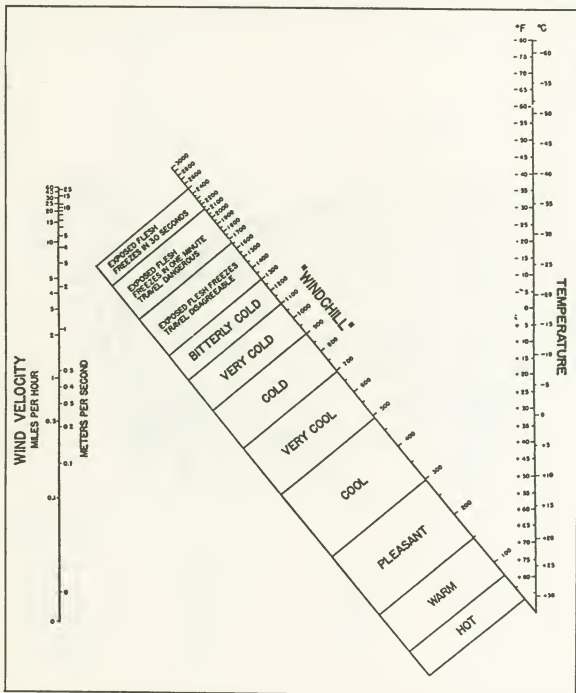

## WIND MAP OF THE U.S.

This map shows the annual wind extremes in miles/hour, 30 feet above ground, 50 year mean recurrence interval.

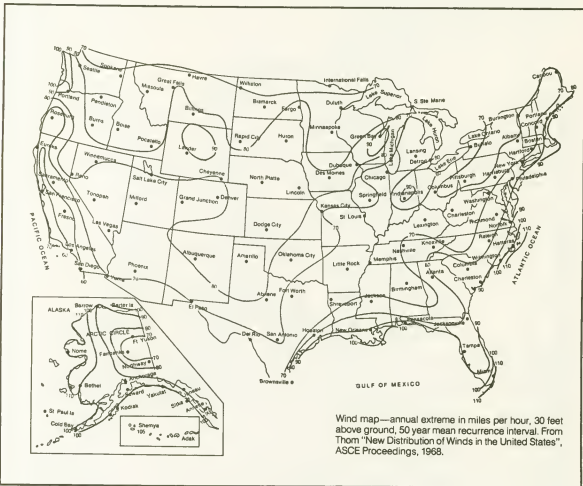

**Steady Wind - miles/hour**  
(as shown on map)

60  
70  
80  
85  
90  
100  
110  
120

**Gusting Wind - equivalent miles/hour**  
(using standard 1.3 gust factor)

78  
91  
104  
110  
117  
130  
143  
156

(Reprinted from "SBC Square Beam Cutoff," Kim Lighting publication A5, page A5-10, courtesy Kim Lighting.)



## GROUND CONDUCTIVITY

This map shows the effective ground conductivity in the United States in millimhos /meter. The conductivity of seawater (not shown) is assumed to be 5,000 millimhos /meter.

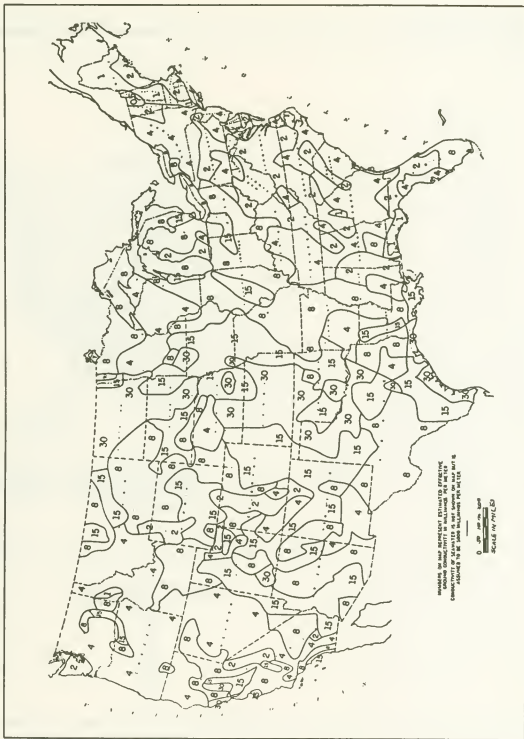

### THE TRIBOELECTRIC (OR ELECTROSTATIC) SERIES

The table below is so arranged that any material becomes positively charged (that is, it gives up electrons) when rubbed with any material lower on the list. The farther apart the materials are on the list, the higher the charge will be. Surface conditions and variations in characteristics of some materials may alter some positions slightly.

Positive polarity (+)

Asbestos  
Rabbit's fur  
Glass  
Mica  
Nylon  
Wool  
Cat's fur  
Silk  
Paper  
Cotton  
Wood  
Lucite  
Sealing wax  
Amber  
Polystyrene  
Polyethylene  
Rubber balloon  
Sulphur  
Celluloid  
Hard rubber  
Vinylite  
Saran wrap

Negative polarity (-)

FOR EXAMPLE: A rubber balloon rubbed with nylon will produce a negative charge on the balloon and leave the nylon positively charged.

## CORROSION

Galvanic corrosion occurs when two dissimilar metals are in contact, in a liquid capable of carrying an electric current. Under these conditions the least noble metal (the anode) corrodes, while the more noble metal (the cathode) is not attacked.

In general, galvanic corrosion may be avoided by uniformity in the types of metals used. If uniformity is not practical, then metals should be used that are as close as possible to each other in the galvanic table, which lists metals in order of increasing nobility.

Stainless steel is "active" when chemicals present do not allow the formation of an oxide film on the surface of the metal. The treatment of stainless steel in a passivating solution accelerates the formation of the oxide film, thus making it "passive" and thereby increasing its resistance to galvanic corrosion.

Table 1. Listings of base-to-noble metal sequence, activity series, and galvanic series. Base metals at the top of the list function as the anode when used with metals lower in the series (more noble), and are subject to corrosion. The activity series, with hydrogen gas as the arbitrary reference, indicate the relative inertness of reactivity of metals. The reactive elements are above hydrogen while the inert elements are below. The galvanic series, the most used series in considering the electronics of corrosion, indicate voltage readings recorded between the indicated metal and a silver/silver-chloride reference electrode while immersed in a relatively unpolluted sea-water electrolyte.

BASE-NOBLE METAL SEQUENCE	ACTIVITY SERIES	GALVANIC SERIES	
		Material	Voltage
BASE ↓	Magnesium ↓	Magnesium	1.5
Magnesium	Aluminum	Zinc	1.03
Zinc	Zinc	Aluminum	0.75*
Aluminum	Chromium	Cast iron & carbon steel *	0.61
Cadmium	Iron	Stainless steel	0.55*
Steel or Iron	Cadmium	Bronze	0.4
Chromium-iron (active)	Nickel	Yellow brass	0.36
Lead-tin solders	Tin	Copper	0.36
Lead	Lead	Red brass	0.33
Nickel (active)	Hydrogen	Admiralty brass	0.29
Brasses	Copper	Copper-nickel	0.27*
Copper	Silver	Nickel	0.2
Bronzes	Palladium	Monel	0.075
Copper-nickel alloys	Platinum		
Nickel-copper alloys	↓		
Silver solder	Gold		
Nickel (passive)			
Chromium-iron (passive)			
Silver			
Graphite			
Gold			
Platinum			
↓ NOBLE			

\*Represents an "average" reading taken of varying alloys of each of the respective metals

## THERMOPLASTICS FOR ELECTRICAL APPLICATIONS

<i>Material and Major Application Considerations</i>	<i>Common Available Forms</i>	<i>Representative Tradenames and Suppliers</i>
<p><b>Acetals</b> Good electrical properties at most frequencies, which are little changed in humid environments to 125° C. Outstanding mechanical strength, stiffness, toughness, and dimensional stability.</p>	Extrusions, injection moldings, stock shapes.	Dalrin (DuPont); Calcon (Celanese Corp.)
<p><b>Acrylics</b> Excellent resistance to arcing and electrical tracking. Excellent clarity and resistance to outdoor weathering.</p>	Castings, extrusions, injection moldings, thermoformed parts, stock shapes, film, fiber.	Lucite (DuPont); Plexiglas (Rohm and Haas Co.)
<p><b>Cellulose</b> Good electrical properties and toughness. Used more for general-purpose applications than for ultimate in any electrical requirement. Several types available.</p>	Blow moldings, extrusions, injection moldings, thermoformed parts, film, fiber, stock shapes.	Tanite (Eastman Chemical Co.); Ethocal-EC (Dow Chemical Co.); Fortical-CAP (Celanese Corp.)
<p><b>Chlorinated Polyethers</b> Good electrically, but most outstanding properties are corrosion resistance and physical and thermal stability.</p>	Extrusions, injection moldings, stock shapes, film.	Panton (Hercules Powder Co.)
<p><b>Fluorocarbons</b> TFE Electrically one of the most outstanding thermoplastic materials. Very low electrical losses; very high electrical resistivity. Useful from -200° to over 500°F. Excellent high frequency dielectric. Has excellent combination of mechanical and electrical properties but is relatively weak in cold-flow properties. Nearly inert chemically, as are most fluorocarbons. Very low coefficient of friction. Nonflammable. FEP: Similar to TFE, except useful temperature limited to about 400°F. Easier to mold than TFE. CTFE: Excellent electrical properties and relatively good mechanical properties. Stiffer than TFE and FEP, but does have some cold flow. Useful to about 400°F. PVF<sub>2</sub>: One of the easiest of the fluorocarbons to process. Stiffer and more resistant to cold flow than TFE. Good electrically. Useful to about 300°F. Major electrical application is wire jacketing.</p>	Compression moldings, stock shapes, film.	Teflon TFE (DuPont); Halon TFE (Allied Chemical Corp.)
	Extrusions, injection moldings, laminates, film.	Teflon FEP (DuPont)
	Extrusions, isostatic moldings, injection moldings, film, stock shapes.	Kel-F (3M Co.); Plaskon CTFE (Allied Chemical Corp.)
	Extrusions, injection moldings, laminates, film.	Kynar (Pennsalt Chemicals Corp.)
<p><b>Nylons</b> Conventional: Good general-purpose electrical properties. Easily processed. Good mechanical strength and abrasion resistance and low coefficient of friction. Commonly used types of nylon are nylon 6, nylon 6/6 and nylon 6/10. Some have limited use in electrical applications because of moisture-absorption properties. Nylon 6/10 is best here. High-Temperature: Has excellent combination of thermal endurance (to 200°C) and electrical properties. Exhibits relatively low dielectric constant, high volume resistivity, and good dielectric strength. Has high tensile strength and wear resistance.</p>	Extrusions, injection moldings, laminates, rotational moldings, stock shapes, film, fiber.	Zytel (DuPont); Plaskon (Allied Chemical Co.); Bakelite (Union Carbide Corp.)
	Fiber, sheet, tape, paper, fabric.	Nomex (DuPont)
<p><b>Polysulfones</b> Good combination of thermal endurance (to over 300°F) and dielectric properties. Relatively low dielectric constant and dissipation factor, and high volume resistivity. Electrical properties are maintained at 90% of initial values after one year at 300°F. Good dimensional stability and high creep resistance. Flame resistant, and good chemical resistance.</p>	Extrusions, injection moldings, thermoformed parts, stock shapes, film, sheet.	Polysulfone (Union Carbide Corp.)

<i>Material and Major Application Considerations</i>	<i>Common Available Forms</i>	<i>Representative Tradenames and Suppliers</i>
<p><b>Parylenes</b></p> <p>Excellent low-loss dielectric properties and good dimensional stability. Low permeability to gases and moisture. Produced as a film on a substrate, from a vapor phase. Used primarily as thin films in capacitors and dielectric coatings.</p>	Film coatings.	Parylene (Union Carbide Corp.)
<p><b>Polycarbonates</b></p> <p>Relatively low electrical losses and high volume resistivity. Loss properties are stable to about 150°C. Excellent dimensional stability, low water absorption, low creep, and outstanding impact resistance.</p>	Extrusions, injection moldings, thermoformed parts, stock shapes, film.	Lexen (G. E. Co.); Merlon (Mobby Chemical Co.)
<p><b>Polylesters</b></p> <p>Outstanding dielectric strength and tear strength. Widely used for machine-applied tape insulation. Has high volume resistivity and low moisture absorption.</p>	Films and tapes.	Mylar (DuPont); Scotchper (3M Co.); Celanar (Celanese Corp.)
<p><b>Polyethylenes, Polypropylenes, Polyallomers</b></p> <p>Excellent electrical properties, especially low electrical losses. Tough and chemically resistant, but weak to varying degrees in creep and thermal resistance. Thermal stability generally increases with density classes of polyethylene. Polypropylenes are generally similar to polyethylenes, but offer about 50°F higher heat resistance. Polyallomers are electrically similar to polyethylene and polypropylene but have better stress-crack resistance and surface hardness. Crosslinked polyethylenes provide improved thermal endurance.</p>	Blow moldings, extrusions, injection molding, thermoformed parts, stock shapes, film, fiber, foam.	Alathen Polyethylene (DuPont); Petrothene Polyethylene (USI Chemical Co.); Grex H. O. Polyethylene (Allied Chemical Corp.); Hi-Fax H. D. Polyethylene, Pro-Fax Polypropylene (Hercules Powder Co.); Tenite Polyethylene, Polypropylene, and Polyallomer (Eastman Chemical Co.)
<p><b>Polyimides and Polyamide-imides</b></p> <p>Among the highest-temperature thermoplastics available, having useful operating temperatures to about 700°F or higher. Excellent electrical properties, good rigidity, and excellent thermal stability.</p>	Films, coatings, molded and machined parts, resin solutions.	Vespal parts and shapes, Kapton film, and Pyre-M.L. resin (DuPont); AI (Amoco); Skybond (Monsanto Co.)
<p><b>Polyphenylene Oxides (PPO)</b></p> <p>Excellent electrical properties, especially loss properties to above 350°F, and over a wide frequency range. Good mechanical strength and toughness. A lower-cost grade, Noryl, has similar properties to PPO, but with a 75° to 100°F reduction in heat resistance.</p>	Extrusions, injection moldings, thermoformed parts, stock shapes, film.	PPO and Noryl (G. E. Co.)
<p><b>Polystyrenes</b></p> <p><b>General-Purpose:</b> Excellent electrical properties, especially loss properties. Conventional polystyrene is temperature-limited, but high-temperature modifications such as Rexolite or Polypenco crosslinked polystyrene are widely used, especially for high-frequency applications.</p> <p><b>ABS:</b> Good general electrical properties but not outstanding for any specific electric application. Extremely tough, with high impact resistance. Can be formulated over a wide range of hardness and toughness properties. Special grades available for plated surfaces.</p>	Blow moldings, extrusions, injection moldings, rotational moldings, thermoformed parts, foam.	Styron (Dow Chemical Co.); Lustrax (Monsanto Co.); Rexolite (American Enka Corp.); Polypenco O-200.5 (Polymer Corp.)
	Extrusions, injection moldings, thermoformed parts, laminates, stock shapes, foam.	Marbon Cycolec (Borg-Warner Corp.); Lustran (Monsanto Co.); Abson (Goodrich Chemical Co.)
<p><b>Vinyls</b></p> <p>Good low-cost, general-purpose thermoplastic materials, but electrical properties are not outstanding. Properties are greatly influenced by plasticizers. Many variations available, including flexible and rigid types. Flexible vinyls, especially PVC, are widely used for wire insulation.</p>	Blow moldings, extrusions, injection moldings, rotational moldings, film, sheet.	Diamond PVC (Diamond Alkali Co.); Plivoc (Goodyear Chemical Co.); Seran (Oow Chemical Co.)

## THERMOSETTING PLASTICS FOR ELECTRICAL APPLICATIONS

<i>Material and Major Application Considerations</i>	<i>Common Available Forms</i>	<i>Representative Tradenames and Suppliers</i>
<p><b>Alkyds</b> Excellent dielectric strength, arc resistance, and dry insulation resistance. Low dielectric constant and dissipation factor. Good dimensional stability. Easily molded.</p>	Compression and transfer moldings.	Plaskon (Allied Chemical Corp.); Glaskyd (American Cyanamid Co.)
<p><b>Aminos (Melamina and Ureas)</b> Good general electrical properties, but not outstanding except for glass-filled melaminas whose hardness and arc resistance make them useful for molded connectors.</p>	Compression and transfer moldings, extrusions, laminates.	Plaskon (Allied Chemical Corp.); Resinina (Monsanto Co.); Cymel melamina, Beetle uras (American Cyanamid Co.)
<p><b>Diallyl Phthalates (Allylics)</b> Unsurpassed among thermosets in retention of electrical properties in high-humidity environments. Also, they have among the highest volume and surface resistivities in thermosets. Low dissipation factor and heat resistance to 400°F or higher. Excellent dimensional stability. Easily molded.</p>	Compression, injection, and transfer moldings; extrusions; laminates.	Dapon (FMC Corp.); Diall (Allied Chemical Corp.)
<p><b>Epoxies</b> Good electrical properties, low shrinkage, excellent dimensional stability, and good to excellent adhesion. Easy to compound, using nonpressure processes, for a variety of and properties. Useful over a wide range of environments.</p>	Castings; compression, injection, and transfer moldings; extrusions; laminates; matched-die moldings; filament windings; foam.	Epon (Shell Chemical Co.); Epi-Res (Jones-Dabney Co.); D.E.R. (Dow Chemical Co.); Araldite (Ciba Products Co.); ERL (Union Carbide Corp.); Scotchcast (3M Co.)
<p><b>Phenolics</b> Good general electrical properties, leading to wide use for general-purpose molded parts. Not outstanding in any specific electric property, but some formulations have excellent thermal stability above 300°F.</p>	Castings; compression, injection, and transfer moldings; extrusions; laminates; matched-die moldings; stock shapes; foam.	Bakelita (Union Carbide Corp.); Durez (Hooker Chemical Corp.)
<p><b>Polyesters</b> Very low dissipation factor. Low-cost and extremely easy to compound using nonpressure processes. Like epoxies, they can be formulated for either room temperature or elevated temperature use. Not equivalent to epoxies in environmental resistance.</p>	Compression, injection, and transfer moldings; extrusions; laminates; matched-die moldings; filament windings; stock shapes.	Selactron (Pittsburgh Plate Glass Co.); Laminac (American Cyanamid Co.); Paraplex (Rohm & Haas Co.)
<p><b>Silicones (rigid)</b> Excellent electrical properties, especially low dielectric constant and dissipation factor, which change little to 400°F.</p>	Castings, compression and transfer moldings, laminates.	DC Resins (Dow Corning Corp.)

## SIGNIFICANCE OF PROPERTIES OF ELECTRICAL INSULATING MATERIALS

<i>Property and Definition</i>	<i>Significance of Values</i>
<p><b>Dielectric Strength</b> All insulating materials fail at some level of applied voltage for a given set of operating conditions. The dielectric strength is the voltage an insulating material can withstand before dielectric breakdown occurs. Dielectric strength is normally expressed in voltage gradient terms, such as volts per mil. In testing for dielectric strength, two methods of applying the voltage (gradual or by steps) are used. Type of voltage, temperature, and any preconditioning of the test part must be noted. Also, thickness of the piece being tested must be recorded because the voltage per mil at which breakdown occurs varies with thickness of test piece. Normally, breakdown occurs at a much higher volt-per-mil value in very thin test pieces (a few mils thick) than in thicker sections (½ in. thick, for example).</p>	<p>The higher the value, the better the insulator. Dielectric strength of a material (per mil of thickness) usually increases considerably with decrease in insulation thickness. Materials suppliers can provide curves of dielectric strength vs thickness for their insulating materials.</p>

#### Resistance and Resistivity

Resistance of an insulating material, like that of a conductor, is the resistance offered by the conducting path to passage of electrical current. Resistance is expressed in ohms. Insulating materials are very poor conductors, offering high resistance. For insulating materials, the term *volume resistivity* is more commonly applied. Volume resistivity is the electrical resistance between opposite faces of a unit cube for a given material and at a given temperature. The relationship between resistance and resistivity is expressed by the equation  $\rho = RA/l$  where  $\rho$  = volume resistivity in ohm-cm,  $R$  = resistance in ohms between faces;  $A$  = area of the faces, and  $l$  = distance between faces of the piece on which measurement is made. This is not resistance per unit volume, which would be ohm/cm<sup>3</sup>—although this term is sometimes erroneously used. Other terms are sometimes used to describe a specific application or condition. One such term is *surface resistivity*, which is the resistance between two opposite edges of a surface film 1 cm square. Since the length and width of the path are the same, the centimeter terms cancel. Thus, units of surface resistivity are actually ohms. However, to avoid confusion with usual resistance values, surface resistivity is normally given in ohms/sq. Another broadly used term is *insulation resistance*, which, again, is a measurement of ohmic resistance for a given condition, rather than a standardized resistivity test. For both surface resistivity and insulation resistance, standardized comparative tests are normally used. Such tests can provide data such as effects of humidity on a given insulating material configuration.

#### Dielectric Constant

The dielectric constant of an insulating material is the ratio of the capacitance of a capacitor containing that particular material to the capacitance of the same electrode system with air replacing the insulation as the dielectric medium. The dielectric constant is also sometimes defined as the property of an insulation which determines the electrostatic energy stored within the solid material. The dielectric constant of most commercial insulating materials varies from about 2 to 10, air having the value 1.

#### Power Factor and Dissipation Factor

Power factor is the ratio of the power dissipated (watts) in an insulating material to the product of the effective voltage and current (volt-ampere input) and is a measure of the relative dielectric loss in the insulation when the system acts as a capacitor. Power factor is nondimensional and is a commonly used measure of insulation quality. It is of particular interest at high levels of frequency and power in such applications as microwave equipment, transformers, and other inductive devices.

Dissipation factor is the tangent of the dielectric loss angle. Hence, the term *tan delta* (tangent of the angle) is also sometimes used. For the low values ordinarily encountered in insulation, dissipation factor is practically the equivalent of power factor, and the terms are used interchangeably.

#### Arc Resistance

Arc resistance is a measure of an electrical breakdown condition along an insulating surface, caused by the formation of a conductive path on the surface. It is a common ASTM measurement, especially used with plastic materials because of the variations among plastics in the extent to which a surface breakdown occurs. Arc resistance is measured as the time, in seconds, required for breakdown along the surface of the material being measured. Surface breakdown (arcing or electrical tracking along the surface) is also affected by surface cleanliness and dryness.

The higher the value, the better for a good insulating material. The resistance value for a given material depends upon a number of factors. It varies inversely with temperature, and is affected by humidity, moisture content of the test part, level of the applied voltage, and time during which the voltage is applied. When tests are made on a piece that has been subjected to moist or humid conditions, it is important that measurements be made at controlled time intervals during or after the test condition has been applied, since dry-out and resistance increase occur rapidly. Comparing or interpreting data is difficult unless the test period is controlled and defined.

Low values are best for high-frequency or power applications, to minimize electrical power losses. Higher values are best for capacitance applications. For most insulating materials, dielectric constant increases with temperature, especially above a critical temperature region which is unique for each material. Dielectric constant values are also affected (usually to a lesser degree) by frequency. This variation is also unique for each material.

Low values are favorable, indicating a more efficient system, with lower power losses.

The higher the value, the better. Higher values indicate greater resistance to breakdown along the surface due to arcing or tracking conditions.

## TEMPERATURE CONVERSION TABLES AND FORMULAS

To convert from Fahrenheit to Celsius—locate temperature (°F) in center column and read °C in left column.

To convert from Celsius\* to Fahrenheit—locate temperature (°C) in center column and read °F in right column.

-452.4	T <sub>0</sub>	-70	-60	T <sub>0</sub>	0	T	59	70	T <sub>0</sub>	139	140	T <sub>0</sub>	290	300	T <sub>0</sub>	1000	
C		F	C	F	C	F	C	F	C	F	C	F	C	F	C	F	
-273	-459.4		-56.1	-69	-92.2	-17.2	1	33.8	21.1	70	168.0	60.0	140	284.0	149	300	572
-268	-450		-55.5	-65	-90.1	-16.7	11	159.9	21.1	71	159.9	60.8	141	285.8	154	310	580
-262	-440		-55.0	-67	-88.6	-18.1	3	37.4	22.2	72	161.6	61.1	142	287.6	160	320	608
-257	-430		-54.4	-68	-86.8	-15.6	4	39.2	22.8	73	163.4	61.7	143	289.4	166	330	626
-251	-420		-53.9	-65	-85.0	-15.0	9	41.0	23.3	74	165.2	62.2	144	291.2	171	340	644
-246	-410		-53.3	-64	-83.2	-14.4	6	42.8	23.9	75	167.0	62.8	145	293.0	177	350	662
-240	-400		-52.8	-63	-81.4	-13.9	7	44.6	24.4	76	168.8	63.3	146	294.8	182	360	680
			-62.2	-62	-79.6	-13.3	8	46.4	25.0	77	170.6	63.9	147	296.6	188	370	698
			-51.7	-61	-77.8	-12.8	9	48.2	25.6	78	172.4	64.4	148	298.4	193	380	716
			-61.1	-60	-76.0				26.1	79	174.2	65.0	149	300.2	199	390	734
-234	-390		-50.6	-59	-74.2	-12.2	10	80.0	26.7	80	176.0	65.6	150	302.0	204	400	752
-229	-380		-50.0	-58	-72.4	-11.7	11	81.8	27.2	81	177.8	66.1	151	303.8	210	410	770
-223	-370		-49.5	-57	-70.6	-11.1	12	53.6	27.8	82	179.6	66.7	152	305.6	216	420	788
-218	-360		-48.9	-56	-68.8	-10.6	13	55.4	28.3	83	181.4	67.2	153	307.4	221	430	806
-212	-350		-48.4	-55	-67.0	-10.0	14	57.2	28.9	84	183.2	67.8	154	309.2	227	440	824
-207	-340		-47.8	-54	-65.2	-9.44	15	59.0	29.4	85	185.0	68.3	155	311.0	232	450	842
-201	-330		-47.3	-53	-63.4	-8.89	16	60.8	30.0	86	186.8	68.9	156	312.9	238	460	860
-196	-320		-46.7	-52	-61.6	-8.33	17	62.6	30.6	87	188.6	69.4	157	314.6	243	470	878
-190	-310		-46.2	-51	-59.8	-7.78	18	64.4	31.1	88	190.4	70.0	158	316.4	249	480	896
-184	-300		-45.6	-50	-58.0	-7.22	19	66.2	31.7	89	192.2	70.5	159	318.2	254	490	914
-179	-290		-45.0	-49	-56.2	-6.67	20	68.0	32.2	90	194.0	71.1	160	320.0	260	500	932
-173	-280		-44.4	-48	-54.4	-6.11	21	69.8	32.8	91	195.8	71.7	161	321.8	266	510	950
-169	-279	-459.4	-43.9	-47	-52.6	-5.56	22	71.6	33.3	92	197.6	72.2	162	323.6	271	520	968
-168	-270	-454	-43.3	-46	-50.8	-5.00	23	73.4	33.9	93	199.4	72.8	163	325.4	277	530	986
-162	-260	-435	-42.8	-45	-49.0	-4.44	24	75.2	34.4	94	201.2	73.3	164	327.2	282	540	1004
-157	-250	-418	-42.2	-44	-47.2	-3.89	25	77.0	35.0	95	203.0	73.9	165	329.0	288	550	1022
-151	-240	-400	-41.7	-43	-45.4	-3.33	26	78.8	35.6	96	204.8	74.4	166	330.8	293	560	1040
-146	-230	-382	-41.1	-42	-43.6	-2.78	27	80.6	36.1	97	206.6	75.0	167	332.6	299	570	1058
-140	-220	-364	-40.6	-41	-41.8	-2.22	28	82.4	36.7	98	208.4	75.6	168	334.4	304	580	1076
-134	-210	-346	-40.0	-40	-40.0	-1.67	29	84.2	37.2	99	210.2	76.1	169	336.2	310	590	1094
-129	-200	-328															
-123	-190	-310	-39.4	-39	-38.2	-1.11	30	86.0	37.8	100	212.0	76.7	170	338.0	316	600	1112
-118	-180	-292	-38.8	-38	-36.4	-0.56	31	87.8	38.3	101	213.8	77.2	171	339.8	321	610	1130
-112	-170	-274	-38.3	-37	-34.6	0	32	89.6	38.9	102	215.6	77.8	172	341.6	327	620	1148
-107	-160	-256	-37.8	-36	-32.8	0.56	33	91.4	39.4	103	217.4	78.3	173	343.4	332	630	1166
-101	-150	-238	-37.2	-35	-31.0	1.11	34	93.2	40.0	104	219.2	78.9	174	345.2	338	640	1184
-95.6	-140	-220	-36.6	-34	-29.2	1.67	35	95.0	40.6	105	221.0	79.4	175	347.0	343	650	1202
-90	-130	-202	-36.1	-33	-27.4	2.22	36	96.8	41.1	106	222.8	80.0	176	348.8	349	660	1220
-84.4	-120	-184	-35.5	-32	-25.6	2.78	37	98.6	41.7	107	224.6	80.6	177	350.6	354	670	1238
-78.9	-110	-166	-35.0	-31	-23.8	3.33	38	100.4	42.2	108	226.4	81.1	178	352.4	360	680	1256
-73.3	-100	-148	-34.4	-30	-22.0	3.89	39	102.2	42.8	109	228.2	81.7	179	354.2	366	690	1274
-72.6	-99	-146.2	-33.9	-29	-20.2	4.44	40	104.0	43.3	110	230.0	82.2	180	356.0	371	700	1292
-72.2	-98	-144.4	-33.3	-28	-18.4	5.00	41	105.8	43.9	111	231.8	82.8	181	357.8	377	710	1310
-71.7	-97	-142.6	-32.8	-27	-16.6	5.56	42	107.6	44.4	112	233.6	83.3	182	359.6	382	720	1328
-71.1	-96	-140.8	-32.2	-26	-14.8	6.11	43	109.4	45.0	113	235.4	83.8	183	361.4	388	730	1346
-70.6	-95	-139.0	-31.7	-25	-13.0	6.67	44	111.2	45.6	114	237.2	84.4	184	363.2	393	740	1364
-70.0	-94	-137.2	-31.1	-24	-11.2	7.22	45	113.0	46.1	115	239.0	85.0	185	365.0	399	750	1382
-69.5	-93	-135.4	-30.6	-23	-9.4	7.78	46	114.8	46.7	116	240.8	85.6	186	366.8	404	760	1400
-68.9	-92	-133.6	-30.0	-22	-7.6	8.33	47	116.6	47.2	117	242.6	86.1	187	368.6	410	770	1418
-68.4	-91	-131.8	-29.5	-21	-5.8	8.89	48	118.4	47.8	118	244.4	86.7	188	370.4	416	780	1436
-67.8	-90	-130.0	-28.9	-20	-4.0	9.44	49	120.2	48.3	119	246.2	87.2	189	372.2	421	790	1454
-67.2	-89	-128.2	-28.3	-19	-2.2	10.00	50	122.0	48.9	120	248.0	87.8	190	374.0	427	800	1472
-66.6	-88	-126.4	-27.7	-18	-0.4	10.56	51	123.8	49.4	121	249.8	88.3	191	375.8	432	810	1490
-66.1	-87	-124.6	-27.2	-17	1.4	11.11	52	125.6	50.0	122	251.6	88.9	192	377.6	438	820	1508
-65.5	-86	-122.8	-26.6	-16	3.2	11.7	53	127.4	50.6	123	253.4	89.4	193	379.4	443	830	1526
-65.0	-85	-121.0	-26.1	-15	5.0	12.2	54	129.2	51.1	124	255.2	90.0	194	381.2	449	840	1544
-64.4	-84	-119.2	-25.5	-14	6.8	12.8	55	131.0	51.7	125	257.0	90.6	195	383.0	454	850	1562
-63.9	-83	-117.4	-25.0	-13	8.6	13.3	56	132.8	52.2	126	258.8	91.1	196	384.8	460	860	1580
-63.3	-82	-115.6	-24.4	-12	10.4	13.9	57	134.6	52.8	127	260.6	91.7	197	386.6	466	870	1598
-62.8	-81	-113.8	-23.9	-11	12.2	14.4	58	136.4	53.3	128	262.4	92.2	198	388.4	471	880	1616
-62.2	-80	-112.0	-23.3	-10	14.0	15.0	59	138.2	53.9	129	264.2	92.8	199	390.2	477	890	1634
-61.7	-79	-110.2	-22.8	-9	15.8	15.6	60	140.0	54.4	130	266.0	93.3	200	392.0	482	900	1652
-61.1	-78	-108.4	-22.2	-8	17.6	16.1	61	141.8	55.0	131	267.8	93.9	201	393.8	488	910	1670
-60.6	-77	-106.6	-21.7	-7	19.4	16.7	62	143.6	55.6	132	269.6	94.5	202	395.6	493	920	1688
-60.0	-76	-104.8	-21.1	-6	21.2	17.2	63	145.4	56.1	133	271.4	95.0	203	397.4	499	930	1706
-59.5	-75	-103.0	-20.6	-5	23.0	17.8	64	147.2	56.7	134	273.2	95.6	204	399.2	504	940	1724
-58.9	-74	-101.2	-20.0	-4	24.8	18.3	65	149.0	57.2	135	275.0	96.1	205	401.0	510	950	1742
-58.4	-73	-99.4	-19.5	-3	26.6	18.9	66	150.8	57.8	136	276.8	96.7	206	402.8	516	960	1760
-57.8	-72	-97.6	-18.9	-2	28.4	19.4	67	152.6	58.3	137	278.6	97.2	207	404.6	521	970	1778
-57.3	-71	-95.8	-18.4	-1	30.2	20.0	68	154.4	58.9	138	280.4	97.8	208	406.4	527	980	1796
-56.7	-70	-94.0	-17.8	0	32.0	20.6	69	156.2	59.4	139	282.2	98.3	209	408.2	532	990	1814
												143	290	564			



1000 to 1490			1500 to 1990			2000 to 2490			2500 to 3000		
C	F		C	F		C	F		C	F	
538	1000	1832	816	1500	2732	1093	2000	3632	1371	2500	4532
543	1010	1850	821	1510	2750	1099	2010	3650	1377	2510	4550
549	1020	1868	827	1520	2768	1104	2020	3668	1382	2520	4568
554	1030	1886	832	1530	2786	1110	2030	3686	1388	2530	4586
560	1040	1904	838	1540	2804	1116	2040	3704	1393	2540	4604
566	1050	1922	843	1550	2822	1121	2050	3722	1399	2550	4622
571	1060	1940	849	1560	2840	1127	2060	3740	1404	2560	4640
577	1070	1958	854	1570	2858	1132	2070	3758	1410	2570	4658
582	1080	1976	860	1580	2876	1138	2080	3776	1416	2580	4676
588	1090	1994	866	1590	2894	1143	2090	3794	1421	2590	4694
593	1100	2012	871	1600	2912	1149	2100	3812	1427	2600	4712
599	1110	2030	877	1610	2930	1154	2110	3830	1432	2610	4730
604	1120	2048	882	1620	2948	1160	2120	3848	1438	2620	4748
610	1130	2066	888	1630	2966	1166	2130	3866	1443	2630	4765
616	1140	2084	893	1640	2984	1171	2140	3884	1449	2640	4784
621	1150	2102	899	1650	3002	1177	2150	3902	1454	2650	4802
627	1160	2120	904	1660	3020	1182	2160	3920	1460	2660	4820
632	1170	2138	910	1670	3038	1188	2170	3938	1466	2670	4838
638	1180	2156	916	1680	3056	1193	2180	3956	1471	2680	4856
643	1190	2174	921	1690	3074	1199	2190	3974	1477	2690	4874
649	1200	2192	927	1700	3092	1204	2200	3992	1482	2700	4892
654	1210	2210	932	1710	3110	1210	2210	4010	1488	2710	4910
660	1220	2228	938	1720	3128	1216	2220	4028	1493	2720	4928
666	1230	2246	943	1730	3146	1221	2230	4046	1499	2730	4945
671	1240	2264	949	1740	3164	1227	2240	4064	1504	2740	4964
677	1250	2282	954	1750	3182	1232	2250	4082	1510	2750	4982
682	1260	2300	960	1760	3200	1238	2260	4100	1516	2760	5000
688	1270	2318	966	1770	3218	1243	2270	4118	1521	2770	5018
693	1280	2336	971	1780	3236	1249	2280	4136	1527	2780	5036
699	1290	2354	977	1790	3254	1254	2290	4154	1532	2790	5054
704	1300	2372	982	1800	3272	1260	2300	4172	1538	2800	5072
710	1310	2390	988	1810	3290	1266	2310	4190	1543	2810	5090
716	1320	2408	993	1820	3308	1271	2320	4208	1549	2820	5108
721	1330	2426	999	1830	3326	1277	2330	4226	1554	2830	5126
727	1340	2444	1004	1840	3344	1282	2340	4244	1560	2840	5144
732	1350	2462	1010	1850	3362	1288	2350	4262	1566	2850	5162
738	1360	2480	1016	1860	3380	1293	2360	4280	1571	2860	5180
743	1370	2498	1021	1870	3398	1299	2370	4298	1577	2870	5198
749	1380	2516	1027	1880	3416	1304	2380	4316	1582	2880	5216
754	1390	2534	1032	1890	3434	1310	2390	4334	1588	2890	5234
760	1400	2552	1038	1900	3452	1316	2400	4352	1593	2900	5252
766	1410	2570	1043	1910	3470	1321	2410	4370	1599	2910	5270
771	1420	2588	1049	1920	3488	1327	2420	4388	1604	2920	5288
777	1430	2606	1054	1930	3506	1332	2430	4406	1610	2930	5306
782	1440	2624	1060	1940	3524	1338	2440	4424	1616	2940	5324
788	1450	2642	1066	1950	3542	1343	2450	4442	1621	2950	5342
793	1460	2660	1071	1960	3560	1349	2460	4460	1627	2960	5360
799	1470	2678	1077	1970	3578	1354	2470	4478	1632	2970	5378
804	1480	2696	1082	1980	3596	1360	2480	4496	1638	2980	5396
810	1490	2714	1088	1990	3614	1366	2490	4514	1643	2990	5414
									1649	3000	5432

Interpolation Factors			Interpolation Factors		
C	F		C	F	
0.56	1	1.8	3.33	6	10.8
1.11	2	3.6	3.89	7	12.6
1.67	3	5.4	4.44	8	14.4
2.22	4	7.2	5.00	9	16.2
2.78	5	9.0	5.56	10	18.0

\*The term Centigrade was officially changed to Celsius by international agreement in 1948. The Celsius scale uses the triple phase point of water, at 0° Centigrade, in place of the ice point as a reference, but for all practical purposes the two terms are interchangeable.

Given	Temperature Conversion				
	Celsius	Fahrenheit	Kelvin	Reaumur	Rankine
Cels.	—	$\left(\frac{9}{5}C\right) + 32$	$C + 273.16$	$\frac{4}{5}C$	$1.8(C + 273.16)$
Fahr.	$\frac{5}{9}(F - 32)$	—	$\left[\frac{5}{9}(F - 32)\right] + 273.16$	$\frac{4}{9}(F - 32)$	$F + 459.7$
Kelvin	$K - 273.16$	$\left[\frac{9}{5}(K - 273.16)\right] + 32$	—	$\frac{4}{5}(K - 273.16)$	$K \times 1.8$
Reau.	$Re \times \frac{5}{4}$	$\left(\frac{9}{4}Re\right) + 32$	$\left(\frac{5}{4}Re\right) + 273.16$	—	$\left(\frac{9}{4}Re\right) + 491.7$
Rank.	$\frac{Ra}{1.8} - 273.16$	$Ra - 459.7$	$\frac{Ra}{1.8}$	$\frac{4}{9}(Ra - 491.7)$	—

Five major temperature scales are in use at present. They are: Fahrenheit, Celsius, Kelvin (Absolute), Rankine, and Reaumur. The interrelationship among the scales is shown here.

# Comparative Temperature Scales

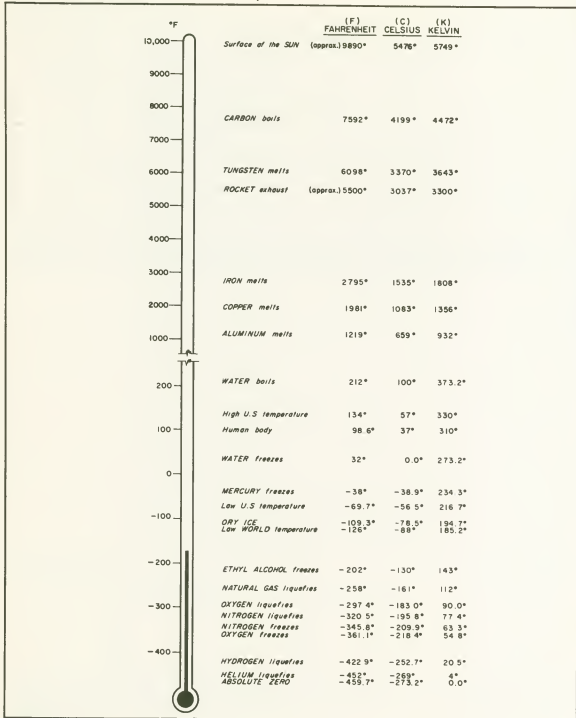



RELATIVE HUMIDITY TABLES

DIFFERENCE BETWEEN WET AND DRY BULB READINGS DEGREES CELSIUS: 7.60 mm Hg

WET BULB TEMP., °C	1	2	3	4	5	6	7	8	9	10	11	12	13	14	15	16	17	18	19	20	21	22	23	24	25	26	27	28	29	30	31	32	33	34	35	36	37	38	39	40	41	42	43	44	45																																																																																																																																																																																																																																																																																																																																																																																																																																																																																																																																																																																																																																																																																																																																																																																																																																																																																																																																																																																																																																																																																																																																																																																																																																																																																																																																																																																
0	81	82	84	86	87	89	91	93	95	97	99	101	103	105	107	109	111	113	115	117	119	121	123	125	127	129	131	133	135	137	139	141	143	145	147	149	151	153	155	157	159	161	163	165	167	169	171	173	175	177	179	181	183	185	187	189	191	193	195	197	199	201	203	205	207	209	211	213	215	217	219	221	223	225	227	229	231	233	235	237	239	241	243	245	247	249	251	253	255	257	259	261	263	265	267	269	271	273	275	277	279	281	283	285	287	289	291	293	295	297	299	301	303	305	307	309	311	313	315	317	319	321	323	325	327	329	331	333	335	337	339	341	343	345	347	349	351	353	355	357	359	361	363	365	367	369	371	373	375	377	379	381	383	385	387	389	391	393	395	397	399	401	403	405	407	409	411	413	415	417	419	421	423	425	427	429	431	433	435	437	439	441	443	445	447	449	451	453	455	457	459	461	463	465	467	469	471	473	475	477	479	481	483	485	487	489	491	493	495	497	499	501	503	505	507	509	511	513	515	517	519	521	523	525	527	529	531	533	535	537	539	541	543	545	547	549	551	553	555	557	559	561	563	565	567	569	571	573	575	577	579	581	583	585	587	589	591	593	595	597	599	601	603	605	607	609	611	613	615	617	619	621	623	625	627	629	631	633	635	637	639	641	643	645	647	649	651	653	655	657	659	661	663	665	667	669	671	673	675	677	679	681	683	685	687	689	691	693	695	697	699	701	703	705	707	709	711	713	715	717	719	721	723	725	727	729	731	733	735	737	739	741	743	745	747	749	751	753	755	757	759	761	763	765	767	769	771	773	775	777	779	781	783	785	787	789	791	793	795	797	799	801	803	805	807	809	811	813	815	817	819	821	823	825	827	829	831	833	835	837	839	841	843	845	847	849	851	853	855	857	859	861	863	865	867	869	871	873	875	877	879	881	883	885	887	889	891	893	895	897	899	901	903	905	907	909	911	913	915	917	919	921	923	925	927	929	931	933	935	937	939	941	943	945	947	949	951	953	955	957	959	961	963	965	967	969	971	973	975	977	979	981	983	985	987	989	991	993	995	997	999	1001	1003	1005	1007	1009	1011	1013	1015	1017	1019	1021	1023	1025	1027	1029	1031	1033	1035	1037	1039	1041	1043	1045	1047	1049	1051	1053	1055	1057	1059	1061	1063	1065	1067	1069	1071	1073	1075	1077	1079	1081	1083	1085	1087	1089	1091	1093	1095	1097	1099	1101	1103	1105	1107	1109	1111	1113	1115	1117	1119	1121	1123	1125	1127	1129	1131	1133	1135	1137	1139	1141	1143	1145	1147	1149	1151	1153	1155	1157	1159	1161	1163	1165	1167	1169	1171	1173	1175	1177	1179	1181	1183	1185	1187	1189	1191	1193	1195	1197	1199	1201	1203	1205	1207	1209	1211	1213	1215	1217	1219	1221	1223	1225	1227	1229	1231	1233	1235	1237	1239	1241	1243	1245	1247	1249	1251	1253	1255	1257	1259	1261	1263	1265	1267	1269	1271	1273	1275	1277	1279	1281	1283	1285	1287	1289	1291	1293	1295	1297	1299	1301	1303	1305	1307	1309	1311	1313	1315	1317	1319	1321	1323	1325	1327	1329	1331	1333	1335	1337	1339	1341	1343	1345	1347	1349	1351	1353	1355	1357	1359	1361	1363	1365	1367	1369	1371	1373	1375	1377	1379	1381	1383	1385	1387	1389	1391	1393	1395	1397	1399	1401	1403	1405	1407	1409	1411	1413	1415	1417	1419	1421	1423	1425	1427	1429	1431	1433	1435	1437	1439	1441	1443	1445	1447	1449	1451	1453	1455	1457	1459	1461	1463	1465	1467	1469	1471	1473	1475	1477	1479	1481	1483	1485	1487	1489	1491	1493	1495	1497	1499	1501	1503	1505	1507	1509	1511	1513	1515	1517	1519	1521	1523	1525	1527	1529	1531	1533	1535	1537	1539	1541	1543	1545	1547	1549	1551	1553	1555	1557	1559	1561	1563	1565	1567	1569	1571	1573	1575	1577	1579	1581	1583	1585	1587	1589	1591	1593	1595	1597	1599	1601	1603	1605	1607	1609	1611	1613	1615	1617	1619	1621	1623	1625	1627	1629	1631	1633	1635	1637	1639	1641	1643	1645	1647	1649	1651	1653	1655	1657	1659	1661	1663	1665	1667	1669	1671	1673	1675	1677	1679	1681	1683	1685	1687	1689	1691	1693	1695	1697	1699	1701	1703	1705	1707	1709	1711	1713	1715	1717	1719	1721	1723	1725	1727	1729	1731	1733	1735	1737	1739	1741	1743	1745	1747	1749	1751	1753	1755	1757	1759	1761	1763	1765	1767	1769	1771	1773	1775	1777	1779	1781	1783	1785	1787	1789	1791	1793	1795	1797	1799	1801	1803	1805	1807	1809	1811	1813	1815	1817	1819	1821	1823	1825	1827	1829	1831	1833	1835	1837	1839	1841	1843	1845	1847	1849	1851	1853	1855	1857	1859	1861	1863	1865	1867	1869	1871	1873	1875	1877	1879	1881	1883	1885	1887	1889	1891	1893	1895	1897	1899	1901	1903	1905	1907	1909	1911	1913	1915	1917	1919	1921	1923	1925	1927	1929	1931	1933	1935	1937	1939	1941	1943	1945	1947	1949	1951	1953	1955	1957	1959	1961	1963	1965	1967	1969	1971	1973	1975	1977	1979	1981	1983	1985	1987	1989	1991	1993	1995	1997	1999	2001	2003	2005	2007	2009	2011	2013	2015	2017	2019	2021	2023	2025	2027	2029	2031	2033	2035	2037	2039	2041	2043	2045	2047	2049	2051	2053	2055	2057	2059	2061	2063	2065	2067	2069	2071	2073	2075	2077	2079	2081	2083	2085	2087	2089	2091	2093	2095	2097	2099	2101	2103	2105	2107	2109	2111	2113	2115	2117	2119	2121	2123	2125	2127	2129	2131	2133	2135	2137	2139	2141	2143	2145	2147	2149	2151	2153	2155	2157	2159	2161	2163	2165	2167	2169	2171	2173	2175	2177	2179	2181	2183	2185	2187	2189	2191	2193	2195	2197	2199	2201	2203	2205	2207	2209	2211	2213	2215	2217	2219	2221	2223	2225	2227	2229	2231	2233	2235	2237	2239	2241	2243	2245	2247	2249	2251	2253	2255	2257	2259	2261	2263	2265	2267	2269	2271	2273	2275	2277	2279	2281	2283	2285	2287	2289	2291	2293	2295	2297	2299	2301	2303	2305	2307	2309	2311	2313	2315	2317	2319	2321	2323	2325	2327	2329	2331	2333	2335	2337	2339	2341	2343	2345	2347	2349	2351	2353	2355	2357	2359	2361	2363	2365	2367	2369	2371	2373	2375	2377	2379	2381	2383	2385	2387	2389	2391	2393	2395	2397	2399	2401	2403	2405	2407	2409	2411	2413	2415	2417	2419	2421	2423	2425	2427	2429	2431	2433	2435	2437	2439	2441	2443	2445	2447	2449	2451	2453	2455	2457	2459	2461	2463	2465	2467	2469	2471	2473	2475	2477	2479	2481	2483	2485	2487	2489	2491	2493	2495	2497	2499	2501	2503	2505	2507	2509	2511	2513	2515	2517	2519	2521	2523	2525	2527	2529	2531	2533	2535	2537	2539	2541	2543	2545	2547	2549	2551	2553	2555	2557	2559	2561	2563	2565	2567	2569	2571	2573	2575	2577	2579	2581	2583	2585	2587	2589	2591	2593	2595	2597	2599	2601	2603	2605	2607	2609	2611	2613	2615	2617	2619	2621	2623	2625	2627	2629	2631	2633	2635	2637	2639	2641	2643	2645	2647	2649	2651	2653	2655	2657	2659	2661	2663	2665	2667	2669	2671	2673	2675	2677	2679	2681	2683	2685	2687	2689	2691	2693	2695	2697	2699	2701	2703	2705	2707	2709	2711	2713	2715	2717	2719	2721	2723	2725	2727	2729	2731	2733	2735	2737	2739	2741	2743	2745	2747	2749	2751	2753	2755	2757	2759	2761	2763	2765	2767	2769	2771	2773	2775	2777	2779	2781	2783	2785	2787	2789	2791	2793	2795	2797	2799	2801	2803	2805	2807	2809	2811	2813	2815	2817	2819	2821	2823



## TEMPERATURE-HUMIDITY INDEX

The United States Weather Bureau developed the formula for temperature—humidity index. It is based on temperature and relative humidity.

$$THI = 15 + 0.4(T_{\text{dry bulb}} + T_{\text{wet bulb}})$$

where temperatures are in degrees Fahrenheit. It has been determined that when the THI reaches 72, some people are uncomfortable; when it reaches 76 most everyone is uncomfortable.

Actually it is the combination of both high temperature and high humidity which causes discomfort. Lowering either one will increase comfort. On the other hand, lower temperature plus low humidity can cause discomfort on the cool side. Thus, in the wintertime, when the humidity in heated buildings is low, a higher temperature is needed for comfort than is required during other seasons when the humidity is higher.

FOR EXAMPLE: At a dry-bulb temperature of 75°F and a relative humidity of 60%, the THI is 71.

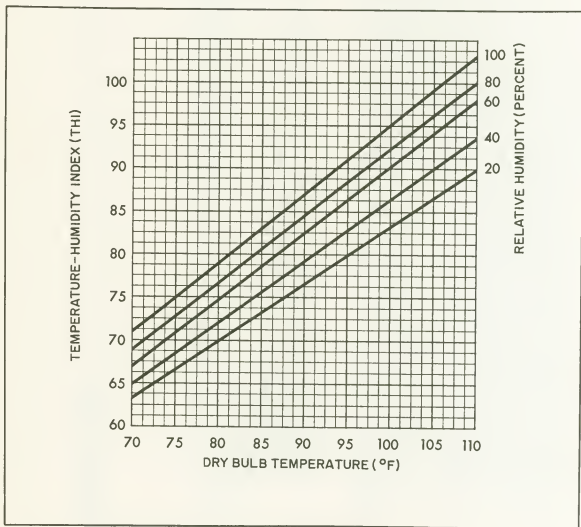

## COLOR SCALE OF TEMPERATURE

Commonly used terms to describe the color of heat are related to the approximate range of temperature.

Incipient red heat	500- 550	Yellow heat	1050-1150
Dark red heat	650- 750	Incipient white heat	1250-1350
Bright red heat	800- 900	White heat	Above 1450
Orange-red heat	900-1000		

## THERMAL SPECTRUM

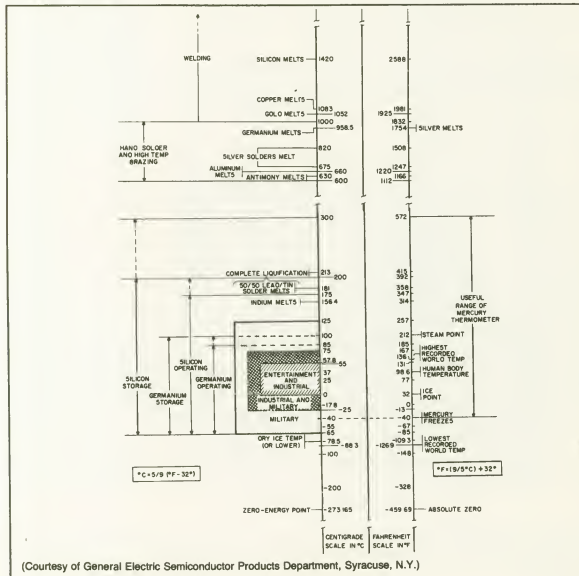

(Courtesy of General Electric Semiconductor Products Department, Syracuse, N.Y.)



### STANDARD ANNEALED COPPER WIRE TABLE

AWG B & S Gauge	Diam- eter in Mils	Cross Section		Ohms/ 1000 Ft at 20°C (68°F)	Lb/ 1000 Ft	Ft./Lb	Ft./Ohm at 20°C (68°F)	Ohms/Lb at 20°C (68°F)	Lb./Ohm at 20°C (68°F)
		Circular Mils	Square Inches						
0000	460.0	211,600	0.1662	0.04901	640.5	1.561	20,400	0.00007652	13,070
000	409.6	167,800	0.1318	0.06180	507.9	1.968	16,180	0.0001217	8,219
00	364.8	133,100	0.1045	0.07793	402.8	2.482	12,830	0.0001935	5,169
0	324.9	105,500	0.08289	0.09827	319.5	3.130	10,180	0.0003076	3,251
1	289.3	83,690	0.06573	0.1239	253.3	3.947	8,070	0.0004891	2,044
2	257.6	66,370	0.05213	0.1563	200.9	4.977	6,400	0.0007778	1,286
3	229.4	52,640	0.04134	0.1970	159.3	6.276	5,075	0.001237	808.6
4	204.3	41,740	0.03278	0.2485	126.4	7.914	4,025	0.001966	508.5
5	181.9	33,100	0.02600	0.3133	100.2	9.980	3,192	0.003127	319.8
6	162.0	26,250	0.02062	0.3951	79.46	12.58	2,531	0.004972	201.1
7	144.3	20,820	0.01635	0.4982	63.02	15.87	2,007	0.007905	126.5
8	128.5	16,510	0.01297	0.6282	49.98	20.01	1,592	0.01257	79.55
9	114.4	13,090	0.01028	0.7921	39.63	25.23	1,262	0.01999	50.03
10	101.9	10,380	0.008155	0.9989	31.43	31.82	1,001	0.03178	31.47
11	90.74	8,234	0.006467	1.260	24.92	40.12	794	0.05053	19.79
12	80.81	6,530	0.005129	1.588	19.77	50.59	629	0.08035	12.45
13	71.96	5,178	0.004067	2.003	15.68	63.80	499.3	0.1278	7.827
14	64.08	4,107	0.003225	2.525	12.43	80.44	396.0	0.2032	4.922
15	57.07	3,257	0.002558	3.184	9.858	101.4	314.0	0.3230	3.096
16	50.82	2,583	0.002028	4.016	7.818	127.9	249.0	0.5136	1.947
17	45.26	2,048	0.001609	5.064	6.200	161.3	197.5	0.8167	1.224
18	40.30	1,624	0.001276	6.385	4.917	203.4	156.6	1.299	0.7700
19	35.89	1,288	0.001012	8.051	3.899	256.5	124.2	2.065	0.4843
20	31.96	1,022	0.0008023	10.15	3.092	323.4	98.50	3.283	0.3046
21	28.46	810.1	0.0006363	12.80	2.452	407.8	78.11	5.221	0.1915
22	25.35	642.4	0.0005046	16.14	1.945	514.2	61.95	8.301	0.1205
23	22.57	509.5	0.0004002	20.36	1.542	648.4	49.13	13.20	0.07576
24	20.10	404.0	0.0003173	25.67	1.223	817.7	38.96	20.99	0.04765
25	17.90	320.4	0.0002517	32.37	0.9699	1,031.0	30.90	33.37	0.02997
26	15.94	254.1	0.0001996	40.81	0.7692	1,300	24.50	53.06	0.01885
27	14.20	201.5	0.0001583	51.47	0.6100	1,639	19.43	84.37	0.01185
28	12.64	159.8	0.0001255	64.90	0.4837	2,067	15.41	134.2	0.007454
29	11.26	126.7	0.00009953	81.83	0.3836	2,607	12.22	213.3	0.004688
30	10.03	100.5	0.00007894	103.2	0.3042	3,287	9.691	339.2	0.002948
31	8.928	79.70	0.00006260	130.1	0.2413	4,145	7.685	539.3	0.001854
32	7.950	63.21	0.00004964	164.1	0.1913	5,227	6.095	857.6	0.001166
33	7.080	50.13	0.00003937	206.9	0.1517	6,591	4.833	1,364	0.0007333
34	6.305	39.75	0.00003122	260.9	0.1203	8,310	3.833	2,168	0.0004612
35	5.615	31.52	0.00002476	329.0	0.09542	10,480	3.040	3,448	0.0002901
36	5.000	25.00	0.00001964	414.8	0.07568	13,210	2.411	5,482	0.0001824
37	4.453	19.83	0.00001557	523.1	0.06001	16,660	1.912	8,717	0.0001147
38	3.965	15.72	0.00001235	659.6	0.04759	21,010	1.516	13,860	0.00007215
39	3.531	12.47	0.000009793	831.8	0.03774	26,500	1.202	22,040	0.00004538
40	3.145	9.888	0.000007766	1049.0	0.02993	33,410	0.9534	35,040	0.00002854

Temperature coefficient of resistance: The resistance of a conductor at temperature  $t$  in degrees Celsius is given by

$$R_t = R_{20} [1 + a_{20} (t - 20)]$$

where  $R_{20}$  is the resistance at 20°C and  $a_{20}$  is the temperature coefficient of resistance at 20°C. For copper,  $a_{20} = 0.00393$ . That is, the resistance of a copper conductor increases approximately 0.4% per degree Celsius rise in temperature.

## PROPERTIES OF COMMON WIRE AND CABLE INSULATIONS

Insulation Material	Breakdown Voltage	R. F. Losses	Operating Temp. (°C)	Weather Resistance	Flexibility	Suggested Use
Standard PVC	High	Medium	-20 to +80	Good	Fair	General purpose
Premium PVC	High	Medium	-55 to +105	Good	Fair	General purpose
Polyethylene	High	Low	-60 to +80	Good	Good	R. f. cables
Natural rubber	High	High	-40 to +70	Poor	Good	Light duty
Neoprene	Low	High	-30 to +90	Good	Good	Rough service
Waxed cotton	Low	High		Poor	Good	Experimenting
Teflon	High	Low	-70 to +260	Good	Fair	High temperature

## WIRE STRANDING CHART

A stranded conductor is made up of a number of smaller wire strands. This chart shows the size of each strand, when the number of strands in the finished wire size is known. Also, the number of strands for each given strand size may be determined for a finished wire gauge size.

Locate the conductor's desired AWG size on the chart and trace it vertically. The number and size of strands needed to make the stranded conductor will be indicated by the horizontal line (strand number) and diagonal line (strand size), respectively.

For example:

A #22 AWG stranded conductor can be made with 4 strands of #28 AWG wire or 10 strands of #32 AWG wire, etc.

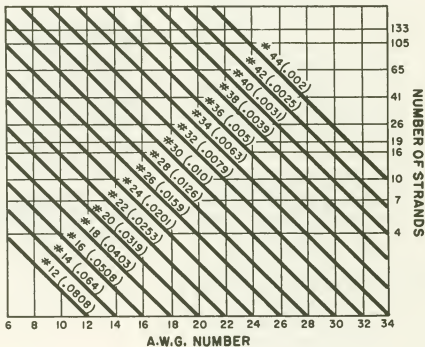

## TEMPERATURE CLASSIFICATION OF INSULATING MATERIALS

### Temperature Classifications

#### Definitions of Insulating Materials (IEEE)

Class	Definition	
0	Materials or combinations of materials such as cotton, silk, and paper without impregnation. Other materials or combinations of materials may be included in this class if by experience or accepted tests they can be shown to be capable of operation at	90C
A	Materials or combinations of materials such as cotton, silk, and paper when suitably impregnated or coated or when immersed in a dielectric liquid such as oil. Other materials or combinations of materials may be included in this class if by experience or accepted tests they can be shown to be capable of operation at	105C
B	Materials or combinations of materials such as mica, glass fiber, asbestos, etc., with suitable bonding substances. Other materials or combinations of materials, not necessarily inorganic, may be included in this class if by experience or accepted tests they can be shown to be capable of operation at	130C
F	Materials or combinations of materials such as mica, glass fiber, asbestos, etc., with suitable bonding substances. Other materials or combinations of materials, not necessarily inorganic, may be included in this class if by experience or accepted tests they can be shown to be capable of operation at	155C
H	Materials or combinations of materials such as silicone elastomer, mica, glass fiber, asbestos, etc., with suitable bonding substances such as appropriate silicone resins. Other materials or combinations of materials may be included in this class if by experience or accepted tests they can be shown to be capable of operation at	180C
220C	Materials or combinations of materials which by experience or accepted tests can be shown to be capable of operation at	220C
Over 220C (class C)	Insulation that consists entirely of mica, porcelain, glass, quartz, and similar inorganic materials. Other materials or combinations of materials may be included in this class if by experience or accepted tests they can be shown to be capable of operation at temperatures over	220C

#### NOTES:

1. Insulation is considered to be "impregnated" when a suitable substance provides a bond between components of the structure and also a degree of filling and surface coverage sufficient to give adequate performance under the extremes of temperature, surface contamination (moisture, dirt, etc.), and mechanical stress expected in service. The impregnant must not flow or deteriorate enough at operating temperature so as to seriously affect performance in service.
2. The electrical and mechanical properties of the insulation must not be impaired by the prolonged application of the limiting insulation temperature permitted for the specific insulation class. The word "impaired" is here used in the sense of causing any change which could disqualify the insulating material for continuously performing its intended function whether creepage spacing, mechanical support, or dielectric barrier action.
3. In the above definitions the words "accepted tests" are intended to refer to recognized Test Procedures established for the thermal evaluation of materials by themselves or in simple combinations. Experience or test data, used in classifying insulating materials are distinct from the experience or test data derived for the use of materials in complete insulation systems. The thermal endurance of complete systems may be determined by Test Procedures specified by the responsible Technical Committees. A material that is classified as suitable for a given temperature may be found suitable for a different temperature, either higher or lower, by an insulation system Test Procedure. For example, it has been found that some materials suitable for operation at one temperature in air may be suitable for a higher temperature when used in a system operated in an inert gas atmosphere.
4. It is important to recognize that other characteristics, in addition to thermal endurance, such as mechanical strength, moisture resistance and corona endurance, are required in varying degrees in different applications for the successful use of insulating materials.

## VOLTAGE-CURRENT-WIRE SIZE NOMOGRAM

This nomogram can be used to determine:

1. The minimum wire size for any given load current and voltage drop;
2. the mV drop/foot for any given wire size and load current;
3. the maximum recommended\* current for any given size wire.

FOR EXAMPLE: 1. With a permissible voltage drop of 5 mV/ft, the minimum wire size in a 3-A circuit is #12 AWG.

2. At 300 mA the voltage drop across #22 AWG wire is 4.5 mV/ft.

3. The maximum recommended current for #18 AWG wire is 3.5 A. (This is found by connecting point A on the IR drop scale with the wire gauge scale, and reading the intersect point on the Current scale).

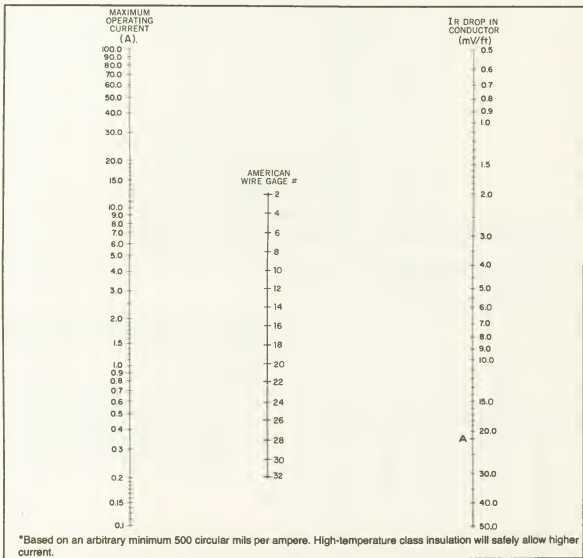

## FUSING CURRENTS OF WIRES

This table gives the fusing currents in amperes for five commonly used types of wires. The current  $I$  in amperes at which a wire will melt can be calculated from  $I = Kd^{3/2}$  where  $d$  is the wire diameter in inches and  $K$  is a constant that depends on the metal concerned. A wide variety of factors influence the rate of heat loss, and these figures must be considered approximations.

AWG & S Gauge	$d$ (in.)	Copper $K = 10,244$	Alu- minum $K = 7565$	German Silver $K = 5230$	Iron $K = 3148$	Tin $K = 1642$
40	0.0031	1.77	1.31	0.90	0.54	0.28
38	0.0039	2.50	1.85	1.27	0.77	0.40
36	0.0050	3.62	2.68	1.85	1.11	0.58
34	0.0063	5.12	3.79	2.61	1.57	0.82
32	0.0079	7.19	5.32	3.67	2.21	1.15
30	0.0100	10.2	7.58	5.23	3.15	1.64
28	0.0126	14.4	10.7	7.39	4.45	2.32
26	0.0159	20.5	15.2	10.5	6.31	3.29
24	0.0201	29.2	21.6	14.9	8.97	4.68
22	0.0253	41.2	30.5	21.0	12.7	6.61
20	0.0319	58.4	43.2	29.8	17.9	9.36
19	0.0359	68.7	51.6	35.5	21.4	11.2
18	0.0403	82.9	61.4	42.3	25.5	13.3
17	0.0452	98.4	72.9	50.2	30.2	15.8
16	0.0508	117	86.8	59.9	36.0	18.8
15	0.0571	140	103	71.4	43.0	22.4
14	0.0641	166	123	84.9	51.1	26.6
13	0.0719	197	146	101	60.7	31.7
12	0.0808	235	174	120	72.3	37.7
11	0.0907	280	207	143	86.0	44.9
10	0.1019	333	247	170	102	53.4
9	0.1144	396	293	202	122	63.5
8	0.1285	472	349	241	145	75.6
7	0.1443	561	416	287	173	90.0
6	0.1620	668	495	341	205	107

## SUGGESTED AMPACITIES FOR APPLIANCE WIRING MATERIAL—ALL TYPES OF INSULATION

Size AWG	Copper Temperature						
	90C	105C	125C	200C	250C		
Amperes per Conductor							
30	3	3	3	4	4	CURRENT RATING FOR DIFFERENT CONDUCTOR MATERIALS MAY BE CALCULATED BY MULTIPLYING THE APPROPRIATE COPPER CONDUCTOR RATING BY THE FOLLOWING FACTORS: Nickel - clad copper 0.87 Nickel 0.43 Note: The ultimate temperature an appliance wire reaches is influenced more by its proximity to heat sources (resistors, motors, etc.), within the appliance than by the current flowing in the wire itself. The ratings, therefore, should only be used as a guide. In no case should the wire be used in a manner that will cause it to exceed its maximum temperature rating.	
28	4	4	5	6	6		
26	5	5	6	7	8		
24	7	7	8	10	11		
22	9	10	11	13	14		
20	12	13	14	17	19		
18	25	20	22	26	29		
16	27	28	30	36	38		
Correction Factors For Various Air Temperatures							
30C	1.00	1.00	1.00	1.00	1.00		
40	0.91	0.93	0.95	0.97	0.98		
50	0.82	0.85	0.89	0.94	0.95		
60	0.71	0.77	0.83	0.91	0.93		
70	0.58	0.68	0.76	0.87	0.91		
80	0.41	0.57	0.69	0.84	0.87		
90	...	0.44	0.61	0.80	0.83		
100	...	0.25	0.51	0.77	0.80		
125	...	...	...	0.66	0.69		
150	...	...	...	0.54	0.56		
200	...	...	...	...	0.43		

## AUDIO LINE TABLE

This chart shows the maximum length of line that can be used between an amplifier and speaker(s) that would assure that the power loss does not exceed 15% in low-impedance circuits, and 5% in high-impedance circuits.

When several speaker lines are brought separately to an amplifier, calculations must be made for each line independently.

FOR EXAMPLE: Four 16-ohm speakers are connected in parallel to the 4-ohm tap for perfect impedance match. Line losses are calculated for each line on the basis of the 16-ohm impedance rather than the combined 4-ohm impedance.

### Maximum Length of Line for 15% Power Loss—Low Impedance Lines

Wire Size (B and S)	Load Impedance		
	4 ohms	8 ohms	16 ohms
14	125 ft	250 ft	450 ft
16	75 ft	150 ft	300 ft
18	50 ft	100 ft	200 ft
20	25 ft	50 ft	100 ft

### Maximum Length of Line for 5% Power Loss—High Impedance Lines

Wire Size (B and S)	Load Impedance		
	100 ohms	250 ohms	500 ohms
14	1000 ft	2500 ft	5000 ft
16	750 ft	1500 ft	3000 ft
18	400 ft	1000 ft	2000 ft
20	250 ft	750 ft	1500 ft

## SPARK-GAP BREAKDOWN VOLTAGES

The curves are for a voltage that is continuous or at a frequency low enough to permit complete deionization between cycles, between needle points, or clean, smooth, spherical surfaces (electrodes ungrounded) in dust-free clean air. Temperature is 25°C and pressure is 760 mm (29.9 in.) of mercury. Peak kilovolts shown in the graph should be multiplied by the factors given in the table for other atmospheric conditions.

An approximate rule for uniform fields at all frequencies up to at least 300 MHz is that the voltage breakdown gradient of air is 30 peak kV/cm or 75 peak kV/in. at sea level (760 mm of mercury) and normal temperature (25°C). The breakdown voltage is approximately equal to pressure and inversely proportional to absolute (° Kelvin) temperature.

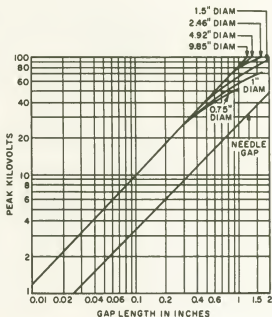

Spark-gap breakdown voltages.

Table of Multiplying Factors

Pressure		Temperature (°C)					
(in. Hg)	(mm Hg)	-40	-20	0	20	40	60
5	127	0.26	0.24	0.23	0.21	0.20	0.19
10	254	0.47	0.44	0.42	0.39	0.37	0.34
15	381	0.68	0.64	0.60	0.56	0.53	0.50
20	508	0.87	0.82	0.77	0.72	0.68	0.64
25	635	1.07	0.99	0.93	0.87	0.82	0.77
30	762	1.25	1.17	1.10	1.03	0.97	0.91
35	889	1.43	1.34	1.26	1.19	1.12	1.05
40	1016	1.61	1.51	1.42	1.33	1.25	1.17
45	1143	1.79	1.68	1.58	1.49	1.40	1.31
50	1270	1.96	1.84	1.73	1.63	1.53	1.44
55	1397	2.13	2.01	1.89	1.78	1.67	1.57
60	1524	2.30	2.17	2.04	1.92	1.80	1.69

## PRINTERS

The family trees show the various types of serial and parallel printers and how they relate.

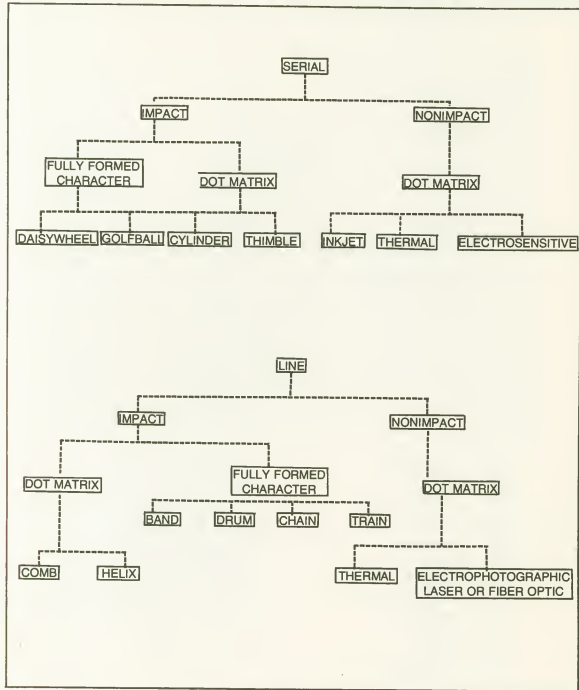



## ASCII CODE

The American Standard Code for Information Interchange (ASCII code) is used extensively in computer data transmission. The ASCII Code produced by most computer keyboards is shown here.

BIT NUMBERS					0 <sub>0</sub> 0	0 <sub>0</sub> 1	0 <sub>1</sub> 0	0 <sub>1</sub> 1	1 <sub>0</sub> 0	1 <sub>0</sub> 1	1 <sub>1</sub> 0	1 <sub>1</sub> 1			
b <sub>7</sub>	b <sub>6</sub>	b <sub>5</sub>	b <sub>4</sub>	b <sub>3</sub>	b <sub>2</sub>	b <sub>1</sub>	COLUMN		ROW						
							0	1	2	3	4	5	6	7	
			0	0	0	0	0	NUL	DLE	SP	0	@	P	\	p
			0	0	0	1	1	SOH	DC1		1	A	Q	o	q
			0	0	1	0	2	STX	DC2	"	2	B	R	b	r
			0	0	1	1	3	ETX	DC3	#	3	C	S	c	s
			0	1	0	0	4	EOT	DC4	\$	4	D	T	d	t
			0	1	0	1	5	ENQ	NAK	%	5	E	U	e	u
			0	1	1	0	6	ACK	SYN	8	6	F	V	f	v
			0	1	1	1	7	BEL	ETB	^	7	G	W	g	w
			1	0	0	0	8	BS	CAN	(	8	H	X	h	x
			1	0	0	1	9	HT	EM	)	9	I	Y	i	y
			1	0	1	0	10	LF	SUB	*	:	J	Z	j	z
			1	0	1	1	11	VT	ESC	+	;	K	[	k	{
			1	1	0	0	12	FF	FS	,	<	L	\	l	
			1	1	0	1	13	CR	GS	-	=	M	]	m	}
			1	1	1	0	14	SO	RS	.	>	N	^	n	~
			1	1	1	1	15	SI	US	/	?	O	_	o	DEL

NUL Null, or all zeros  
 SOH Start of heading  
 STX Start of text  
 ETX End of text  
 EOT End of transmission  
 ENQ Enquiry  
 ACK Acknowledge  
 BEL Bell, or alarm  
 BS Backspace  
 HT Horizontal tabulation  
 LF Line feed  
 VT Vertical tabulation  
 FF Form feed  
 CR Carriage return  
 SO Shift out  
 SI Shift in  
 DLE Data link escape

DC1 Device control 1  
 DC2 Device control 2  
 DC3 Device control 3  
 DC4 Device control 4  
 NAK Negative acknowledge  
 SYN Synchronous idle  
 ETB End of transmission block  
 CAN Cancel  
 EM End of medium  
 SUB Substitute  
 ESC Escape  
 FS File separator  
 GS Group separator  
 RS Record separator  
 US Unit separator  
 SP Space  
 DEL Delete

## BAUDOT CODE

The Baudot Code is a 5-bit code suitable for punched paper tape and standard teletypewriter operation. In addition to the five bits per character, each character is preceded by a start bit, which is a space, followed by a stop bit, which is a mark, approximately 1½ times longer than the regular data mark.

CHARACTER		IMPULSE POSITION				
LOWER CASE	UPPER CASE	1	2	3	4	5
A	-	●	●			
B	?	●			●	●
C	:		●	●	●	
D	\$	●			●	
E	3	●				
F	!	●		●	●	
G	@	●			●	●
H	#			●		●
I	8		●	●		
J	,	●	●		●	
K	(	●	●	●	●	
L	)		●			●
M	.			●	●	●
N	,			●	●	
O	9			●		●
P	0		●	●	●	
Q	1	●	●	●	●	
R	4	●		●		●
S	Bell	●		●		
T	5					●
U	7	●	●	●		
V	;		●	●	●	●
W	2	●	●			●
X	/	●	●	●	●	
Y	6	●		●	●	●
Z	"	●				●
LETTERS	Lower Case	●	●	●	●	●
FIGURES	Upper Case	●	●	●	●	●
SPACE				●		
CARRIAGE RETURN					●	
LINE FEED		●				
BLANK						

NOTE: PRESENCE OF ● INDICATES MARKING IMPULSE

ABSENCE OF ● INDICATES SPACING IMPULSE

# GRAPHIC SYMBOLS FOR ELECTRONIC DIAGRAMS

## Semiconductors

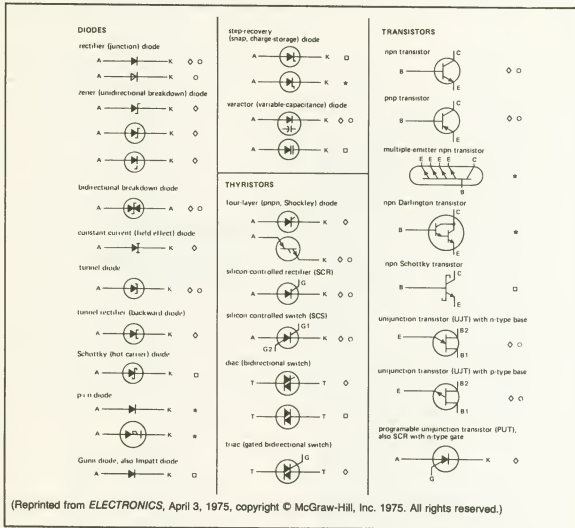

## Optoelectronic Devices

### FIELD-EFFECT TRANSISTORS (FETs)

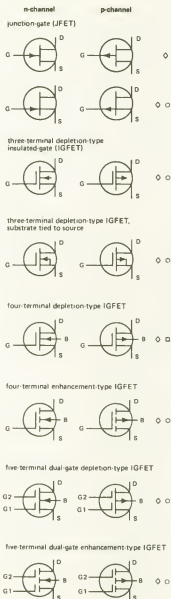

### DIODES

light emitting diode (LED)



photodiode



npn bidirectional photodiode (photo-duo-diode)



ppn bidirectional photodiode (photo-duo-diode)

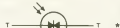

ppn two-segment photodiode, with common cathode



ppn four-quadrant photodiode, with common cathode



### TRANSISTORS

npn phototransistor, no base connection

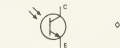

npn phototransistor, with base connection



### OPTICALLY COUPLED ISOLATORS

with photodiode output

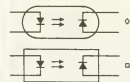

with phototransistor output, no base connection

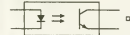

with phototransistor output, and base connection

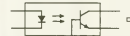
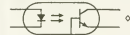

with photo-Darlington output, no base

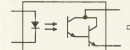

with photo-Darlington output, and base

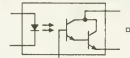

with photodiode and amplifier-transistor output

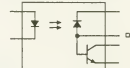

with NAND-gate-photodetector output

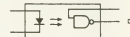

◊ = IEEE/ANSI approval
○ = IEC approval
\* = Proposed IEEE revision
□ = Popular industry usage
✓ = NARM approval

## Two-State Logic Devices

### GATES

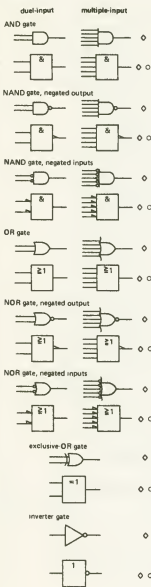

### FLIP-FLOPS

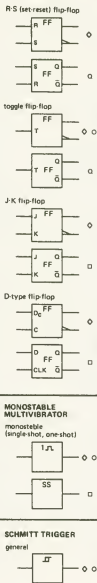

## Fundamental Circuit Components

### RESISTORS

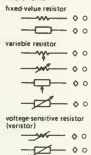

### CAPACITORS



### INDUCTORS



### TRANSFORMERS

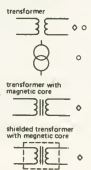

### CRYSTALS



### BATTERIES



### SOURCES



### LAMPS

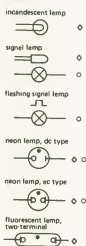

### CIRCUIT PROTECTORS



### AUDIO DEVICES



### AMPLIFIERS

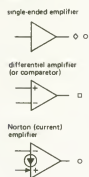

## Contacts, Switches, and Relays

### CONTACTS



### closed contact



### open contact



### make before-break contact assembly



### break before-make contact assembly



### SWITCHES

single pole  
single-throw (spst)



single pole  
double-throw (spdt)



double pole  
double-throw (dpdt)



push-button switch,  
normally open



push button switch,  
normally closed



multiposition switch



RELAY CONTACT  
ARRANGEMENTS

(relay arrow indicates  
direction of operation)

Form A, spst  
normally open  
(make)



Form B, spst  
normally closed  
(break)



Form C, spdt  
(break, make)



Form D, spdt  
(make, break)



## Transmission Path

### CABLE

two-conductor cable  
with grounded shield



coaxial cable with  
grounded shield



### twisted pair



### WAVEGUIDE

circular waveguide



rectangular waveguide



### flexible waveguide



### twisted waveguide



### STRIPLINE

unbalanced stripline



### balanced stripline



### GROUND

earth ground



chassis or frame  
connection



## Microwave Circuits

### COUPLING

coupling by loop to space



coupling by loop to  
guided transmission  
path



coupling by loop from  
coaxial to circular  
waveguide, with dc  
grounds connected



### DIRECTIONAL COUPLERS

dual directional coupler



### HYBRID JUNCTIONS

waveguide hybrid  
junction



### stripline hybrid junction



### CIRCULATORS

fixed-direction  
circulator



reversible-direction  
circulator



### MODE SUPPRESSORS

for both coaxial and  
waveguide transmission



### FILTERS

mode filter



bandpass filter



low pass filter



high-pass filter



band-reject filter



### PHASE SHIFTERS

matched phase shifter



CONVERSION TABLE FOR BASIC PHYSICAL UNITS

	CGS-ESU	Multiply by to get CGS-EMU		Multiply by to get Rationalized MKS	
1. Length	Centimeter	1	Centimeter	10 <sup>-2</sup>	Meter
2. Mass	Gram	1	Gram	10 <sup>-3</sup>	Kilogram
3. Force	Dyne	1	Dyne	10 <sup>-5</sup>	Newton, Dyne-five
4. Energy, Work	Erg	1	Erg	10 <sup>-7</sup>	Joule
5. Power	Erg/second	1	Erg/second	10 <sup>-7</sup>	Watt
6. Electric Charge	Statcoulomb	3.335 x 10 <sup>-11</sup>	Abcoulomb	10	Coulomb
7. Linear Charge Density	Statcoulomb/cm.	3.335 x 10 <sup>-11</sup>	Abcoulomb/cm.	10 <sup>3</sup>	Coulomb/m.
8. Surface Charge Density	Statcoulomb/cm. <sup>2</sup>	3.335 x 10 <sup>-11</sup>	Abcoulomb/cm. <sup>2</sup>	10 <sup>5</sup>	Coulomb/m. <sup>2</sup>
9. Volume Charge Density	Statcoulomb/cm. <sup>3</sup>	3.335 x 10 <sup>-11</sup>	Abcoulomb/cm. <sup>3</sup>	10 <sup>7</sup>	Coulomb/m. <sup>3</sup>
10. Electric Flux	Statcoulomb	3.335 x 10 <sup>-11</sup>	Abcoulomb	10	Coulomb
11. Displacement, Electric Flux Density	Statcoulomb/cm. <sup>2</sup>	3.335 x 10 <sup>-11</sup>	Abcoulomb/cm. <sup>2</sup>	10 <sup>5</sup>	Coulomb/m. <sup>2</sup>
12. Polarization	Statcoulomb/cm. <sup>2</sup>	3.335 x 10 <sup>-11</sup>	Abcoulomb/cm. <sup>2</sup>	10 <sup>5</sup>	Coulomb/m. <sup>2</sup>
13. Electric Dipole Moment	Statcoulomb-cm.	3.335 x 10 <sup>-11</sup>	Abcoulomb-cm.	10 <sup>-1</sup>	Coulomb-m.
14. Potential	Statvolt	2.998 x 10 <sup>10</sup>	Abvolt	10 <sup>-8</sup>	Volt
15. Electric Field Intensity	Statvolt/cm.	2.998 x 10 <sup>10</sup>	Abvolt/cm.	10 <sup>-6</sup>	Volt/m.
16. Current	Statampere	3.335 x 10 <sup>-11</sup>	Abampere	10	Ampere
17. Surface Current Density	Statampere/cm.	3.335 x 10 <sup>-11</sup>	Abampere/cm.	10 <sup>2</sup>	Ampere/m.
18. Volume Current Density	Statampere/cm. <sup>2</sup>	3.335 x 10 <sup>-11</sup>	Abampere/cm. <sup>2</sup>	10 <sup>5</sup>	Ampere/m. <sup>2</sup>
19. Resistance	Statohm	8.988 x 10 <sup>20</sup>	Abohm	10 <sup>-9</sup>	Ohm
20. Resistivity	Statohm-cm.	8.988 x 10 <sup>20</sup>	Abohm-cm.	10 <sup>-11</sup>	Ohm-m.
21. Conductance	Statmho	1.113 x 10 <sup>-21</sup>	Abmho	10 <sup>9</sup>	Mho
22. Conductivity	Statmho/cm.	1.113 x 10 <sup>-21</sup>	Abmho/cm.	10 <sup>11</sup>	Mho/m.
23. Capacity	Statfarad, Cm.	1.113 x 10 <sup>-21</sup>	Abfarad	10 <sup>9</sup>	Farad
24. Elastance	Statdaraf	8.988 x 10 <sup>20</sup>	Abdaraf	10 <sup>-9</sup>	Daraf
25. Dielectric Constant, Permittivity	—	1.113 x 10 <sup>-21</sup>	—	.7958 x 10 <sup>10</sup>	Farad/m.
26. Inductance	Stathenry	8.988 x 10 <sup>20</sup>	Abhenry (Centimeter)	10 <sup>-9</sup>	Henry
27. Permeability	—	8.988 x 10 <sup>20</sup>	Gauss/Oersted	1.257 x 10 <sup>-6</sup>	Henry/m.
28. Reluctivity	—	1.113 x 10 <sup>-21</sup>	Oersted/Gauss	10 <sup>7</sup>	—
29. Magnetic Charge	—	2.998 x 10 <sup>10</sup>	Unit Pole	1.257 x 10 <sup>-7</sup>	Weber
30. Magnetic Flux	—	2.998 x 10 <sup>10</sup>	Maxwell (Line)	10 <sup>-8</sup>	Weber
31. Magnetic Flux Density, Magnetic Induction	—	2.998 x 10 <sup>10</sup>	Gauss, Lines/cm. <sup>2</sup>	10 <sup>-4</sup>	Weber/m. <sup>2</sup>
32. Magnetization	—	2.998 x 10 <sup>10</sup>	Pole/cm. <sup>2</sup>	1.257 x 10 <sup>-2</sup>	Weber/m. <sup>2</sup>
33. Magnetic Dipole Moment	—	2.998 x 10 <sup>10</sup>	Pole-cm.	1.257 x 10 <sup>-9</sup>	Weber-m.
34. Magnetic Field Intensity, Magnetizing Force	—	3.335 x 10 <sup>-11</sup>	Oersted (Gilbert/cm.) (Gauss)	10 <sup>2</sup> .7958 x 10 <sup>2</sup>	Praoersted Ampere-turn/m.
35. Magnetomotive Force	—	3.335 x 10 <sup>-11</sup>	Gilbert	10 .7958	Pragilbert Ampere-turn
36. Reluctance	—	1.113 x 10 <sup>-21</sup>	Gilbert/Maxwell (Oersted)	10 <sup>9</sup> .7958 x 10 <sup>9</sup>	Pragilbert/Weber Ampere-turn/Weber
37. Permeance	—	8.988 x 10 <sup>20</sup>	Maxwell/Gilbert	10 <sup>-9</sup> 1.257 x 10 <sup>-8</sup>	— Weber/Ampere-turn

Practical System: Incomplete system similar to MKS, but using centimeters and grams.

For all Systems: Temperature is in °C. Time is in seconds.

For MKS System: Space Permittivity  $8.854 \times 10^{-12}$  F/m. Space permeability  $1.257 \times 10^{-6}$  H/m.

Older or obsolete names are shown in parentheses.

To convert CGS-ESU to Rationalized MKS, multiply by both factors.

## TERMINAL AND CONTROL MARKINGS ON FOREIGN EQUIPMENT

### Radio-Phono

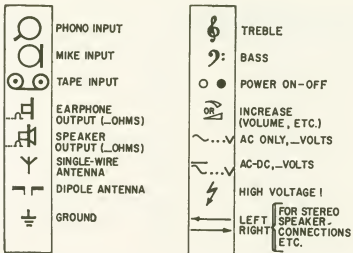

### Television

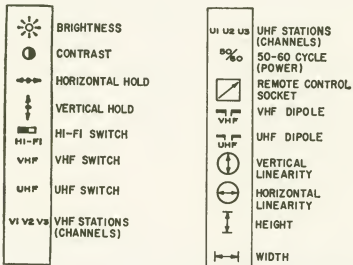

(Reprinted from *Radio Electronics*, copyright © Gernsback Publications, Inc., September, 1964.)



### TORQUE-POWER-SPEED NOMOGRAM

This nomogram relates power, torque, and speed.

FOR EXAMPLE: 200 oz-in. at 500 rpm is 0.1 hp, which equals approximately 75 W. The nomogram is based on the formula:

$$\text{Horsepower} = 9.92 \times \text{torque} \times \text{speed} \times 10^{-7}$$

where torque is in ounce-inches and speed in revolutions per minute.

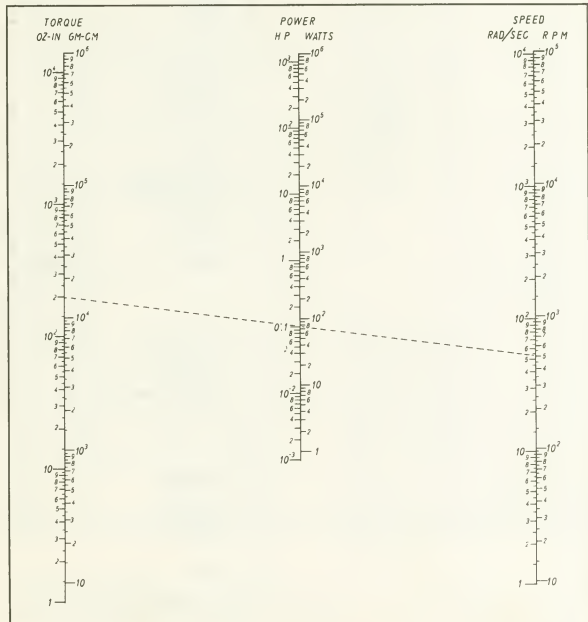

APPROXIMATE FULL-LOAD CURRENT FOR CONTINUOUS-DUTY MOTORS

Direct-Current Motors<sup>a</sup>  
(Amperes at Full Load)

HP	115 V	230 V	550 V
1/2	4.6	2.3	
3/4	6.6	3.3	1.4
1	8.6	4.3	1.8
1 1/2	12.6	6.3	2.6
2	16.4	8.2	3.4
3	24	12	5.0
5	40	20	8.3
7 1/2	58	29	12.0
10	76	38	16.0
15	112	56	23.0
20	148	74	31
25	184	92	38
30	220	110	46
40	292	146	61
50	360	180	75
60	430	215	90
75	536	268	111
100		355	148
125		443	184
150		534	220
200		712	295

Single-Phase, Alternating-Current Motors<sup>b</sup>  
(Amperes at Full Load)

HP	115 V	230 V	440 V
1/6	3.2	1.6	
1/4	4.6	2.3	
1/2	7.4	3.7	
3/4	10.2	5.1	
1	13	6.5	
1 1/2	18.4	9.2	
2	24	12	
3	34	17	
5	56	28	
7 1/2	80	40	21
10	100	50	26

For full-load currents of 208- and 200-V motors, increase corresponding 230-V motor full-load current by 10% and 15%, respectively.

<sup>a</sup>These values for full-load current are average for all speeds.

<sup>b</sup>These values of full-load current are for motors running at speeds usual for belted motors and motors with normal torque characteristics. Motors built for especially low speeds or high torques may require more running current, in which case the name plate current rating should be used.

# CHARACTERISTICS OF SELECTED MOTOR TYPES

Motor Type	Basic Characteristics	Performance Ranges	Application Areas
CONVENTIONAL PERMANENT-MAGNET*	A simple alternative to wound-field short, PM field plus wound armature. Linear torque-speed relationships in small units Life limited by brushes in high-speed or severe applications Readily controlled by transistors or SCR's	Output from 1W to a fraction of a horsepower Time constants to 62.6% of no-load speed) to <10 msec Efficiencies from 60 to 70% in 1/2HP sizes With new magnet materials, can deliver high peak powers (horsepower range)	For full range of responsive, good-performance drive and control applications With appropriate environmental precautions, suitable for military/aerospace use Preferred as a high performance, general-purpose servomotor
LIMITER-ROTATOR DC TORQUE	No commutator wear or friction Unlimited life Infinite resolution Smooth, cog-free rotation No EM generation Available as motor elements or fully housed	Travel range typically to 120° Torque from a low oz-in to >40 lb-ft Mechanical time constants from 10 to 50 msec	Very high-accuracy positioning or velocity control over a limited angle
CONTINUOUS-ROTATOR DC TORQUE	Slow speed, high torque Relatively low power output Available as pole-pair-shaped components Wide dynamic range Large number of coils give smooth operation	From 10's of oz-in to 100's of ft-lb Moderate mechanical time constants Control to seconds of sec. Relatively expensive	For direct coupling to load For very precise control Alternative to geared types
MOVING-COIL/PRINTED-ARMATURE (ROTORLESS MOTOR)	Similar to permanent-magnet dc axils Linear torque-speed characteristics Smooth, noncogging rotation Handles very high, short-duration peak loads Fast response (<10 msec)	Outputs from <1W to fractional horsepower High efficiencies Very low mechanical and electrical time constants	Computer peripherals where smooth control and fast response are needed Control applications needing high response bandwidth, fast starting and stopping
VARIABLE-RELUCTANCE STEPPER	Roughness and rugged High stepping rates dependent on driver circuitry No locking torque at zero energization Four inherent damping Low power efficiency Can exhibit resonance Operates open loop Wide dynamic range Easily controlled Very reliable and low in cost in popular frame sizes	Several hundred to thousands of gps Power output up to a few hundred watts.	Alternative to synchronous motor Used in control applications where fast response rather than high power is the principal requirement Interface well to digital computers
SMALL SHAFT PERMANENT-MAGNET STEPPER	Uses similar principle to give very small stepping angles High stepping rates High cogging torques with zero input power Efficiency usually very low	Stepping rate from <100 gps to many 1000's. Dependent on driver electronics Power up to a few hundred watts Single step takes a few milliseconds	Useful in numerical control and actuator application where control is digital Provides fast starting and high-resolution tracking
INVERTER-DRIVEN AC	Operates from dc line using a switching inverter Somewhat less efficient than ac induction motors, otherwise similar in performance Single-phase (capacitor) or 2-phase versions most common	Outputs from <1W to fractional horsepower Efficiencies from 20 to 80% in larger models Speeds up to 30,000 RPM and higher	Use where dc is only power available For general applications where ac supplies vary widely, as in furnace applications Use where brushes might not be sufficiently reliable, as in very high speeds or in severe environments Variable-frequency versions used in accelerating high inertial loads
BRUSHLESS DC	PM units using electronic commutation of stator "armature" (Imitates conventional dc motor characteristics, but torque modulation with rotation is higher) Lack of brushes gives reliability in difficult applications	From <1W to 1-2 hp Relatively high time constants Speeds to 30,000 RPM Efficiencies to 80% Voltages to 100's of Vdc	For brushless, long-life applications requiring superior efficiency and control May be operated at very high altitudes or totally submerged
AC CONTROL	Brushless 2-phase Low inertia Scrambled cage Linear torque-speed curves in small units Increasing curvatures for units >20W Clamping falls off at low control voltages Efficiency very low (10-30%) Poor overload capability	Primarily used in low-power-output applications (<1W to 500W) Available in 60 and 400 Hz versions Time constants in the 10's of milliseconds	Recommended for ac motor systems requiring very low output power Very small sizes (0.5 in. dia) available Used in many military systems because of high motor reliability
HYSTERESIS	Synchronous Low-to-moderate efficiency Moderate starting torque Synchronization independent of load inertia Smooth, cog-free torque Low heating	Power output up to about 100W Speeds up to 30,000 RPM Efficiencies can exceed 50%	Use where synchronous operation required Suitable in constant speed computer peripheral applications
NOTES	*Versions of these motors using newly developed, very high energy rare-earth magnets can now be made in compact, integral horsepower sizes with very high peak overload capability		

Specific Applications	Comparisons with Other Motors	Selection and Application Factors
Preferred for actuators where high peak and steady power (100's of watts) and fast response (10 to 20 msec) required Basic drive in aircraft control systems	Higher efficiency, damping, lower electrical time constants than comparable ac control motors, except in very low-power applications Far more efficient than stepper drives More easily controlled than other motor types	Set for safe operation with acceptable temperature rises Check operating conditions for abrupt starts or reversals which can demagnetize PM leads Check for altitude or environmental effects on brushes, especially over 10,000 RPM High stall currents are drawn in efficient ac high-power motors Low-output-impedance electronic control required to utilize inherent motor damping
Frequently used in equipment incorporating gyro Flexible shape a significant asset in gyro gimbal Gives smooth, frictionless control	Much simpler than continuous rotation servos with or without commutators	Suitable for direct-drive, unshaded, high-accuracy mechanical control Similar wide-angle brushless tachometers available Requires high-power driving amps
Highest precision military and aerospace applications Automatic positioning and tracking to within seconds of arc Used in with super accurate multiple resolvers Wide response band useful in high-accuracy steering platforms Used with cross-rate tables	Supplies most precise control, smooth, and accurate tracking for continuous-rotation applications Requires higher power/amp compared with geared units	Shift direct coupling to load preferred PWM amps preferred for high control power
Small, inexpensive units find use in computer peripherals like tape drives and card readers Ideal for control and automatic applications.	Faster response than iron-rotor motors Excellent brush life Lower starting voltage, limited only by brush friction Much more efficient than stepper drives	Recommended for low cogging, low starting voltage, fast response applications Risks built up quickly Thermal transients and heat removal can be important factors Larger, high-performance units can be expensive Low armature reactance permits commutation of very high current surges.
Used as computer-peripheral drivers (floppy discs, card readers) where motor detourments, response limits Gearing provided by driving electronics Simple, low-cost alternative to laser positioners in positioning floppy-disc heads Can be used in closed-loop applications	Power output and efficiency generally very low compared with dc control motors	Care required in application Performance dependent on electronic driver circuitry Heat dissipation a possible problem At certain pulse rates resonance can occur which reduce load-handling capability Load inertia reduces performance Friction can improve damping Damping, gearing and mechanical couplings require special attention.
Provides very low cost open-loop control in actuator areas Cogging torque reflected through gear train might abrade brake Where feedback is required, can be used with optical incremental encoder discs	Efficiency of shaft power generation is low More flexible than comparable means Simple and inexpensive alternative to synchronous or wide-speed-range drives Handles higher load inertia than variable-reluctance stepper and has better damping	Choose where special control characteristics are preferred over efficiency Check for resonances at all pulse rates Gearing can require safety margins because of impacts inherent in stepper operation. Coupling compliances can help in accelerating load inertia, but additional resonances can be introduced. Driver-circuit design is critical Standard drivers available.
Useful in fan applications for high-reliability computer equipment For high altitude, severe environment applications where brushes fail	Less efficient than true brushless motors using electronic commutation More complex, expensive and noisier than brush-type dc motors Less suitable for control than other dc types Very long life with properly designed inverter	Inverter can be separate or packaged with motor High-line-critical spines EMI generation, with heavy filter capacitors required for suppression SCR inverters preferred in higher power uses, but transistor inverters are easier to troubleshoot and more reliable Power-supply capacitors can be required and must withstand supply transients
Ideal for high-altitude fans Suitable for pumps where fluid in the airgap does not significantly degrade operation Used in very high-speed machine tools	More efficient, easier to control, generate less EMI than inverter type motors Commutating transistors can be used for speed control, reversing current and torque limiting without a separate controller, unlike other types Delivers highest sustained output in a given package size	Electronics can be packaged externally or within motor housing High peak line currents Rely on filter required if EMI is a problem Power-supply capacitors could be required With properly designed electronics, life is limited only by bearings. Transistors can fail under some commutation scenarios
Instrument servos for military applications 400 Hz carrier leads to higher shaft power, motor efficiency and smaller size Drives dials, feedback transducers and mechanical devices Frequently simpler than all-electronic systems in applications requiring only output displays	Efficiency, power output and overvoltage capability are poor compared with dc devices Suitable for very low-power applications because there is no brush contact and less cogging	Older design, good proven units generally available For critical applications, use tachometer damping because inherent damping is unreliable and network damping difficult to apply Required 90° phase shift is best supplied by the control amp Main field-capacitor phase shift only movement in very small motors Main field power keeps units hot even when idling
Useful in driving memory discs, which require uniform, cog-free torque very close tolerances, freedom from bearing play and maximum speed modulation Used in precision gyro drives	Somewhat less efficient than salient-pole synchronous machines of either record-type or PM construction Less hunting than other types of synchronous motors Simpler than phase-locked drives	High efficiencies important for computer applications Low power factors lead to high input currents Higher power factors available in single-phase capacitor versions Sensitive to input harmonics Can accelerate high-inertia loads Does not have a preferred synchronization angle

\*These types have low rotor thermal capacities to gauge the heat rise it takes about 200W to raise the temperature of a 1-lb armature by 1°C in 1 sec. Other values can be suitably proportioned

(Reprinted from "Motor Comparison Chart," EDN, August 5, 1978, pages 97-99, courtesy EDN.)

FAMILY TREE OF ELECTRIC MOTORS

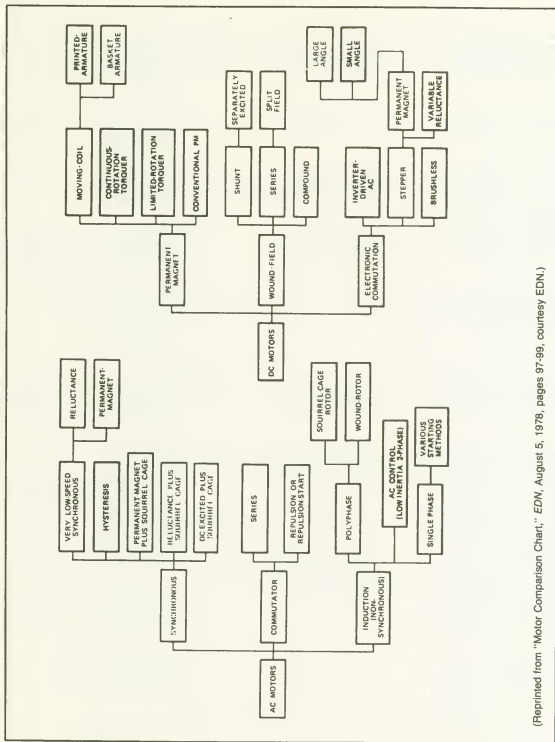

(Reprinted from "Motor Comparison Chart," EDN, August 5, 1978, pages 97-99, courtesy EDN.)

**POWER CONSUMPTION OF ELECTRICAL EQUIPMENT**

Device	Average Rating (Watts)
Air Cleaner	50
Air Conditioner (room)	1,500
Blender	390
Broiler	1,450
Carving Knife	100
Clock	2
Clothes Dryer	4,850
Coffee Maker	900
Deep Fryer	1,450
Dehumidifier	250
Dishwasher	1,200
Electric Blanket	175
Fan:	
attic	370
furnace	290
window	200
Floor Polisher	300
Freezer:	
(14 cu. ft.)	340
(frostless - 15 cu. ft.)	440
Frying Pan	1,200
Heater (portable)	1,320
Heating Pad	65
Hot Plate	1,250
Humidifier	175
Iron (Hand)	1,000
Microwave Oven	1,450
Mixer	125
Oil Burner (stoker)	265
Radio	70
Radio /Record Player	100
Range with oven	12,200
Refrigerator:	
(12 cu. ft.)	300
(frostless, 12 cu. ft.)	390
Refrigerator /Freezer:	
(14 cu. ft.)	352
(frostless, 14 cu. ft.)	600
Roaster	1,300
Sandwich Grill	1,150
Sewing Machine	75
Television:	
black and white:	
tube type	160
solid state	55
color TV:	
tube type	300
solid state	200
Toaster	1,150
Trash Compactor	400
Vacuum Cleaner	630
Waffle Iron	1,100
Washing Machine:	
automatic	500
nonautomatic	280
Waste Disposer	440
Water Heater:	
standard	2,475
quick recovery	4,475
Water Pump	460

### NOMOGRAM RELATING AMPLITUDE, FREQUENCY, AND ACCELERATION OF A BODY WITH SIMPLE HARMONIC MOTION

This nomogram is based on the formula

$$g = 0.10225 (d) (f)^2$$

where

$g$  = acceleration in g-units

$f$  = frequency of vibration in cps

$d$  = amplitude of vibration (peak displacement each side of resting point) in inches

FOR EXAMPLE: A vibrating body with a displacement of 0.01 in. each side of center at 200 Hz, has an acceleration of 40 g's.

NOTE: To find the acceleration in a rotating body resulting from centrifugal force, substitute radius of rotation for amplitude ( $d$ ), and revolutions per second for vibrations per second ( $f$ ).  $g = 32$  ft/sec /sec in the MKS system of units.

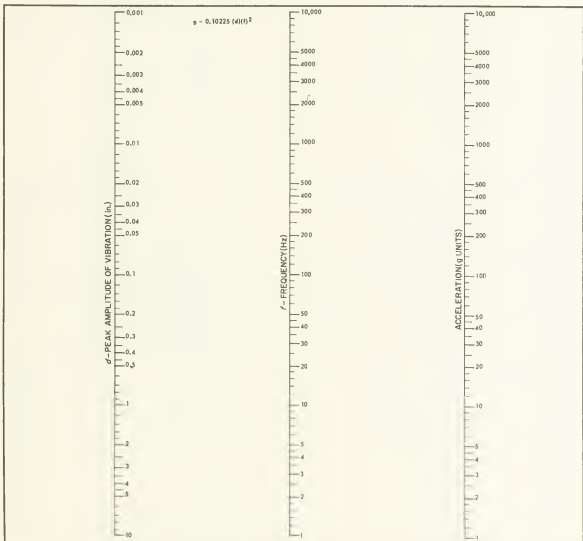

## SHOCK DECELERATION NOMOGRAM

This nomogram relates deceleration (G load), stopping distance, and drop height as an aid to designers and engineers who must deal with problems of shock caused by violent or sudden deceleration.

The equation used to plot the nomograph is  $\log G = \log g + \log H - \log D$ . Relating deceleration (G load), stopping distance, and drop height, it is based on the following relationships:

$$\begin{aligned}H &= gt^2 / 2 \\D &= Gt'^2 / 2 \\V &= gt \\V_i &= Gt'\end{aligned}$$

where:

$H$  = free-fall distance  
 $g$  = acceleration due to free fall  
 $t$  = free-fall time  
 $D$  = stopping or deflection distance  
 $G$  = G load due to impact shock  
 $t'$  = deceleration time  
 $V$  = terminal velocity due to free fall at instant of impact  
 $V_i$  = initial deceleration velocity at instant of impact

Since at the moment of impact the terminal velocity ( $V_t$ ) caused by acceleration is equal to the initial velocity ( $V_i$ ), it follows that:

$$gt = Gt'$$

Combining the equations:

$$H/D = \frac{gt^2 / 2}{Gt'^2 / 2} = gt(t)/Gt'(t')$$

Since  $gt = Gt' H/D = t/t'$ . Also, since  $G/g = t/t'$ ,  $H/D = G/g$ . Transposing,  $G = g(H/D)$  or  $\log G = \log g + \log H - \log D$ . This equation is based on a constant or uniformly decelerating force. For linear deceleration the equation for load distance relationship is:  $G = 2gH/D$ .

Neither formula includes the stopping distance as part of the distance traveled because its effect is negligible for small values of stopping distance (D).

FOR EXAMPLE: 1. Find the G load on a shock-mounted case that endures a 30-in. drop height with a maximum mount deflection of 0.4 in. Assume a rigid case and uniform deceleration in the mount.

ANSWER: Intersect impact shock (G) scale with a line connecting the 30-in. drop height with 0.4 in. on the absorber deflection scale. Read answer off impact shock scale. In this example, it is 73G.

2. Find the impact shock on a piece of equipment that is dropped 20 in. on expanded rubber foam gasket. The foam is compressed a total of 0.1 in. and is assumed to have a linear deceleration characteristic.

ANSWER: Intersect the impact shock (G) scale with a line connecting the 20-in. drop height with 0.1 in. on the absorber deflection scale. Since peak impact shock (G) load due to linear deceleration is approximately twice as severe as that due to uniform deceleration, the value of 200G obtained is multiplied by 2 for linear deflection. Answer is 400G.



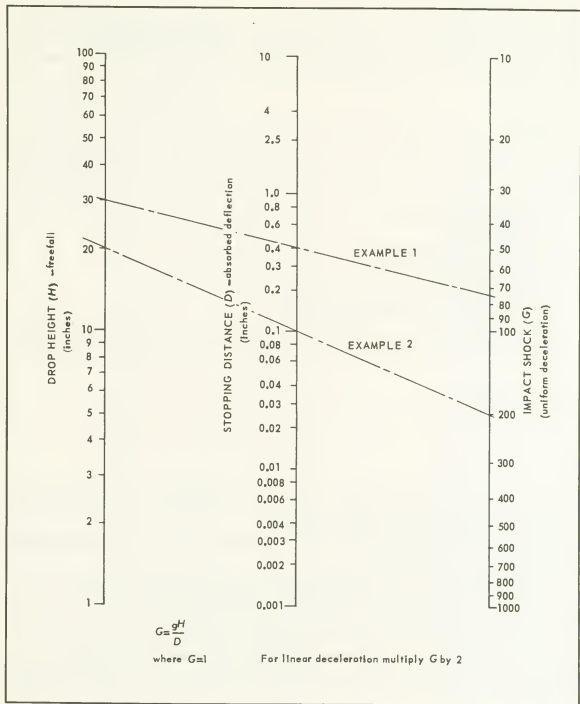

## AIR-COOLING NOMOGRAM

For a given power dissipation and air density, this nomogram solves for the air flow (cubic feet per minute) that is required to keep the temperature rise of an equipment at a specified value. At sea level (760 mm Hg), 0°C, and an air density of 0.079 lb/ft<sup>3</sup>, the temperature rise is approximately equal to 3,000 P/Q, where P is power dissipation in kilowatts and Q is the air flow in cubic feet per minute.

To use the nomogram first determine the ambient temperature and altitude at which the equipment must operate and note from the graph the applicable air density for these conditions. On the nomogram align the permissible temperature rise with the equipment's power dissipation and note the intersect point on the turning scale. Align this point with the applicable air density and read required air flow in cubic feet per minute on scale B.

FOR EXAMPLE: To operate an equipment with a power consumption of 500 W at sea level, an ambient temperature of 20°C, and a permissible heat rise of 15°C, requires an air flow of 50 ft<sup>3</sup>/min.

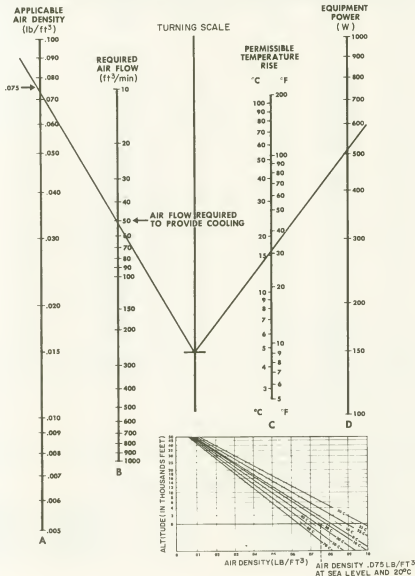

# METALLIC ELEMENTS

Name and Symbol	Color	Atomic Weight	Specific Gravity or Density	Specific Heat	Melting-point (°Celsius)	Coefficient of Linear Expansion
Aluminum Al	Silver-white	27.1	2.70	0.2140	933	0.000231
Antimony Sb	Bluish-white	120.2	6.71-6.86	0.0508	630	0.000105
Arsenic As	Steel-gray	75.0	5.72	0.081	450	0.000055
Bismuth Bi	Pinkish-gray	127.4	3.8	0.048	271	—
Barium Ba	Silver-white	91.3	1.8	0.5620	—	—
Boron B	Pinkish-white	208.0	8.823	0.2005	2081	0.00014
Bromine Br	—	79.8	—	—	—	—
Cadmium Cd	Tin-white	112.4	8.546-8.667	0.0548	322	0.000267
Cesium Cs	Silver-white	132.9	1.9	0.048	27	—
Calcium Ca	Yellow	40.1	1.578	0.1700	850	0.000286
Carbon C	Gray	14.0	7.64	0.0448	823	—
Chromium Cr	Gray	52.0	6.81-7.3	0.1200	1700	—
Coalt Co	Grayish-white	59.0	8.5-8.7	0.1070	1490	0.000123
Columbium (see Niobium) Cb	—	—	—	—	—	—
Copper Cu	Red	63.6	8.92-8.95	0.0952	1,100	0.000187
Erbium Er	—	167.0	—	—	—	—
Gadolinium Gd	—	157.0	—	—	—	—
Gallium Ga	Bluish-white	69.6	5.9	0.079	30	—
Germanium Ge	Bluish-white	72.5	5.5	0.074	800	—
Gold Au	Yellow	197.2	19.265	0.0324	1,063	0.000187
Indium In	White	114.8	7.42	0.0308	178	0.000136
Iridium Ir	Steel-white	193.1	22.38	0.0308	2,250	0.000025
Iron Fe	Silver-white	55.8	7.84	0.1140	1,530	0.000116
Lanthanum La	Gray	138.9	8.183	0.0449	626	—
Lead Pb	Bluish-white	207.2	11.234-11.38	0.0314	328	0.00027
Lithium Li	Silver-white	7.02	0.569-0.598	0.9410	180	—
Magnesium Mg	Silver-white	24.3	1.75	0.2500	632	0.000269
Manganese Mn	Reddish-gray	55.0	8.0	0.1200	810	—
Mercury Hg	Bluish-white	200.5	13.596	0.0319	-40	0.000010
Molybdenum Mo	Silver-white	96.0	8.8	0.0722	2,450	—
Neodymium Nd	—	142.0	7.0	—	840	—
Niobe (see Niobium) Nb	—	92.9	8.8	0.1080	1,450	0.000127
Niobium Nb	Steel-gray	92.9	12.1	0.071	1,950	—
Osmium Os	Bluish-white	196.8	22.5	0.0311	2,500	0.000085
Palladium Pd	Tin-white	106.7	11.4	0.0593	1,548	0.000117
Platinum Pt	—	195.2	21.5	0.0244	1,780	0.000099
Potassium K	Silver-white	39.10	0.8735	0.1660	80	0.000841
Praseodymium Pr	—	140.5	6.5	—	960	—
Radium Ra	—	226.0	—	—	—	—
Rhodium Rh	Tin-white	102.8	12.1	0.0860	2,000	—
Rubidium Rb	Silver-white	85.5	1.52	0.077	38.5	0.000085
Ruthenium Ru	—	101.1	12.261	0.0611	2,400	0.000096
Samarium Sm	—	150.3	7.7	—	1,350	—
Scandium Sc	—	44.1	—	—	—	—
Silver Ag	White	107.9	10.4-10.57	0.0560	962	0.000192
Sodium Na	Silver-white	23.0	0.98	0.293	98	0.000271
Strontium Sr	Yellow	87.6	2.5	—	800	—
Tantalum Ta	Black	181.8	16.8	0.0385	2,910	0.000079
Tellurium Te	—	127.5	8.25	0.049	452	0.000187
Tenness T	—	168	—	—	—	—
Thallium Tl	Bluish-white	204.0	11.8	0.0335	303	0.000302
Thorium Th	Gray	232.0	11.2	0.0278	1,690	—
Thulium Tm	—	171	—	—	—	—
Tin Sn	White	118.0	7.260	0.0559	232	0.000203
Titanium Ti	Dark gray	48.1	4.5	0.13	1,800	—
Tungsten W	Light gray	184.0	19.259	0.0284	3,300	—
Uranium U	Grayish-white	238.5	18.33	0.0277	1,500	—
Vanadium V	Whitish-gray	51.1	5.8	0.125	1,880	—
Vanadium Vb	—	173.0	—	—	—	—
Vanadium Vc	—	89.0	3.80	—	—	—
Zinc Zn	Bluish-white	65.4	7.1	0.0935	418	0.000274
Zirconium Zr	Gray	90.8	4.15	0.062	1,300	—

(Reprinted from *Master Handbook of Electronic Tables & Formulas* by Martin Clifford, courtesy TAB BOOKS, Inc.)

## DENSITIES OF SOLIDS AND LIQUIDS IN CUBIC CENTIMETERS AND CUBIC FEET

Aluminum	2.56 g. per cub. cm.	1.611 lb. per cub. ft.	Platinum	21.50 g. per cub. cm.	1,342.2 lb. per cub. ft.
Copper	8.9 g. per cub. cm.	555.4 lb. per cub. ft.	Sea Water	1.025 g. per cub. cm.	64.0 lb. per cub. ft.
Gold	19.3 g. per cub. cm.	1,205.0 lb. per cub. ft.	Silver	10.5 g. per cub. cm.	655.5 lb. per cub. ft.
Ice	0.9167 g. per cub. cm.	57.2 lb. per cub. ft.	Tin	7.28 g. per cub. cm.	448. lb. per cub. ft.
Iron	7.87 g. per cub. cm.	491.3 lb. per cub. ft.	Tungsten	18.6 g. per cub. cm.	1,161.2 lb. per cub. ft.
Lead	11.0 g. per cub. cm.	686.7 lb. per cub. ft.	Uranium	18.7 g. per cub. cm.	1,167.4 lb. per cub. ft.
Mercury	13.596 g. per cub. cm.	846.7 lb. per cub. ft.	Water	1.000 g. per cub. cm.	62.4 lb. per cub. ft.
Nickel	8.80 g. per cub. cm.	549.4 lb. per cub. ft.	Zinc	7.19 g. per cub. cm.	448.8 lb. per cub. ft.

## SOLDER ALLOYS

The term solder alloys covers a broad range of materials with greatest emphasis placed on compositions of tin and lead. The tin lead system of alloys has a general solidus temperature of 361°F. The eutectic composition, the alloy with a single sharp melting point and no plastic range, is 63% tin, 37% lead. This alloy is in widest use in the electronic industry.

The specific tin lead alloy selected is determined by the nature of the joining operation and the degree to which a plastic or "mushy" solder state can be tolerated or is desirable. Tin lead alloys with a tin content from 20% up through and including 97.5% have the same 361°F solidus line. Alloys containing lower percentages of tin have an increased solidus temperature. This is also true of tin antimony, tin silver, and lead silver alloys. The higher solidus line permits operation of the soldered part in higher ambient temperatures. It also permits sequential or piggy-back soldering. Where two soldering connections are to be made in areas very close to each other, the first joint can be made with one of the high-temperature alloys. When the second joint is made with an alloy in the normal tin lead system, the first joint will not be disturbed.

Solder Alloy Chart

Percent Tin	Percent Lead	Percent Silver	Percent Antimony	Temperature at which Solder Becomes Plastic		Temperature at which Solder Becomes Liquid	
				°C	°F	°C	°F
0	100			300	572	327	621
5	95			267.5	514	300	572
15	85			223	433	290	554
20	80			183	361	280	536
25	75			183	361	287	513
30	70			183	361	266	491
35	65			183	361	245	473
40	60			183	361	235	456
45	55			183	361	223	433
50	50			183	361	212	414
55	45			183	361	200	392
60	40			183	361	189	372
63	37			eutectic alloy <sup>a</sup>		183	361
65	35			183	361	186	367
70	30			183	361	191	376
75	25			183	361	195	383
80	20			183	361	201	394
85	15			183	361	207	404
90	10			183	361	214	417
95	5			183	361	222	432
97.5	2.5			183	361	227	441
100	0					232	460
26	63		2	187	369	237	459
20	78.7	1.3		181	358	276	529
27	70	3		178	352	263	487
	95	5		306	581	300	680

<sup>a</sup>A eutectic alloy is that composition of two or more metals that has one sharp melting point and no plastic range.

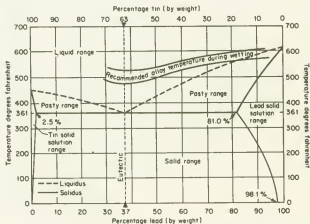

### TRACK WIDTH OF PRINTED WIRING BOARDS

The two graphs are used to determine the current-carrying capacity and sizes of etched copper conductors (tracks) for various temperature rises above ambient. To use the charts, enter the top chart from the left at the current value which is anticipated, to the point where it interrupts the applicable copper temperature-rise curve. Then, proceed vertically down to the second chart to the appropriate weight (the weight of one square foot of copper of a given thickness) slanted line, and proceed left to determine the minimum track width.

FOR EXAMPLE: To carry 10 amperes and not exceed a 20°C rise above ambient requires a 0.100-inch wide conduct of 2-ounce copper track.

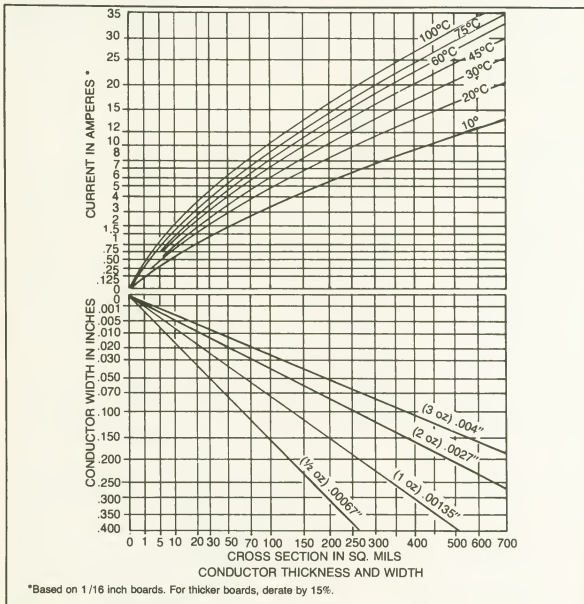

## DEFINED VALUES AND PHYSICAL CONSTANTS

A consistent set of physical values has been adapted by the National Bureau of Standards. The values presented below are at least as accurate as any others available, and have the advantage of being self-consistent, thus preventing the necessity of having to make a choice between different answers derived in different ways.

### Fundamental Constants

Compiled by E. R. Cohen and B. N. Taylor under the auspices of the CODATA Task Group on Fundamental Constants. This set has been officially adopted by CODATA and is taken from J. Phys. Chem. Ref. Data, Vol. 2, No. 4, p. 663 (1973) and CODATA Bulletin No. 11 (December 1973).

Quantity	Symbol	Numerical Value *	Uncert. (ppm)	SI †	← Units →	cgs ‡
Speed of light in vacuum	$c$	299792458(1.2)	0.004	$m \cdot s^{-1}$		$10^8 \text{ cm} \cdot s^{-1}$
Permeability of vacuum	$\mu_0$	$4\pi$ =12.5663706144		$10^{-7} \text{ H} \cdot m^{-1}$ $10^{-7} \text{ H} \cdot m^{-1}$		
Permittivity of vacuum, $1/\mu_0 c^2$	$\epsilon_0$	8.854187818(71)	0.008	$10^{-12} \text{ F} \cdot m^{-1}$		
Fine-structure constant, $[\mu_0 c^2/4\pi](e^2/\hbar c)$	$\alpha$ $\alpha^{-1}$	7.2973506(60) 137.03604(11)	0.82 0.82	$10^{-3}$		$10^{-3}$
Elementary charge	$e$	1.6021892(46) 4.803242(14)	2.9 2.9	$10^{-19} \text{ C}$		$10^{-18} \text{ emu}$ $10^{-18} \text{ esu}$
Planck constant	$h$ $\hbar = h/2\pi$	6.626176(36) 1.0545887(57)	5.4 5.4	$10^{-34} \text{ J} \cdot s$ $10^{-34} \text{ J} \cdot s$		$10^{-33} \text{ erg} \cdot s$ $10^{-33} \text{ erg} \cdot s$
Avogadro constant	$N_A$	6.022045(31)	5.1	$10^{23} \text{ mol}^{-1}$		$10^{23} \text{ mol}^{-1}$
Atomic mass unit, $10^{-3} \text{ kg} \cdot \text{mol}^{-1} N_A^{-1}$	$u$	1.6605655(86)	5.1	$10^{-27} \text{ kg}$		$10^{-26} \text{ g}$
Electron rest mass	$m_e$	9.109534(47) 5.4858026(21)	5.1 0.38	$10^{-31} \text{ kg}$ $10^{-4} \text{ u}$		$10^{-30} \text{ g}$ $10^{-4} \text{ u}$
Proton rest mass	$m_p$	1.6726485(86) 1.007276470(11)	5.1	$10^{-27} \text{ kg}$ $u$		$10^{-26} \text{ g}$ $u$
Ratio of proton mass to electron mass	$m_p/m_e$	1836.15152(70)	0.38			
Neutron rest mass	$m_n$	1.6749543(86) 1.008665012(37)	5.1 0.037	$10^{-27} \text{ kg}$ $u$		$10^{-26} \text{ g}$ $u$
Electron charge to mass ratio	$e/m_e$	1.7588047(49) 5.272764(15)	2.8 2.8	$10^{11} \text{ C} \cdot \text{kg}^{-1}$		$10^7 \text{ emu} \cdot g^{-1}$ $10^{17} \text{ esu} \cdot g^{-1}$
Magnetic flux quantum, $[c]^{-1}(\hbar c/2e)$	$\Phi_0$ $h/e$	2.0678506(54) 4.135701(11) 1.3795215(36)	2.6 2.6 2.6	$10^{-15} \text{ Wb}$ $10^{-15} \text{ J} \cdot s \cdot C^{-1}$		$10^{-7} \text{ G} \cdot \text{cm}^2$ $10^{-7} \text{ erg} \cdot s \cdot \text{emu}^{-1}$ $10^{-17} \text{ erg} \cdot s \cdot \text{esu}^{-1}$
Josephson frequency- voltage ratio	$2e/h$	4.835939(13)	2.6	$10^{14} \text{ Hz} \cdot V^{-1}$		
Quantum of circulation	$h/2m_e$ $h/m_e$	3.6369455(60) 7.273891(12)	1.6	$10^{-4} \text{ J} \cdot s \cdot \text{kg}^{-1}$ $10^{-4} \text{ J} \cdot s \cdot \text{kg}^{-1}$		$\text{erg} \cdot s \cdot g^{-1}$ $\text{erg} \cdot s \cdot g^{-1}$
Faraday constant, $N_A e$	$F$	9.648456(27) 2.8925342(82)	2.8 2.8	$10^4 \text{ C} \cdot \text{mol}^{-1}$		$10^5 \text{ emu} \cdot \text{mol}^{-1}$ $10^{14} \text{ esu} \cdot \text{mol}^{-1}$
Rydberg constant, $[\mu_0 c^2/4\pi]^2(m_e e^4/4\pi\hbar^2 c)$	$R_\infty$	1.097373177(83)	0.075	$10^7 \text{ m}^{-1}$		$10^5 \text{ cm}^{-1}$
Bohr radius, $[\mu_0 c^2/4\pi]^{-1}(\hbar^2/m_e e^2) = a_0/4\pi R_\infty$	$a_0$	5.2917706(44)	0.82	$10^{-10} \text{ m}$		$10^{-8} \text{ cm}$
Classical electron radius, $[\mu_0 c^2/4\pi](e^2/m_e c^2) = a_0/4\pi R_\infty$	$r_e = a_0 \alpha^2$	2.8179380(70)	2.5	$10^{-15} \text{ m}$		$10^{-13} \text{ cm}$
Thomson cross section, $(8/3)\pi r_e^2$	$\sigma_T$	0.6652448(33)	4.9	$10^{-28} \text{ m}^2$		$10^{-24} \text{ cm}^2$
Free electron g-factor, or electron magnetic moment in Bohr magnetons	$g_e/2 = \mu_B/\mu_{BH}$	1.0011596567(35)	0.0035			

Quantity	Symbol	Numerical Value *	Uncert. (ppm)	SI †	← Units →	CGS ‡
Free muon g-factor, or muon magnetic moment in units of $[c](e\hbar/2m_\mu c)$	$g_\mu/2$	1.00116616(31)	0.31			
Bohr magneton, $[c](e\hbar/2m_e c)$	$\mu_B$	9.274078(36)	3.9	$10^{-24}$ J-T <sup>-1</sup>		$10^{-21}$ erg-G <sup>-1</sup>
Electron magnetic moment	$\mu_e$	9.284832(36)	3.9	$10^{-24}$ J-T <sup>-1</sup>		$10^{-21}$ erg-G <sup>-1</sup>
Gyromagnetic ratio of protons in H <sub>2</sub> O	$\gamma'_p$	2.6751301(75)	2.8	$10^8$ s <sup>-1</sup> -T <sup>-1</sup>		$10^4$ s <sup>-1</sup> -G <sup>-1</sup>
$\gamma'_p$ corrected for diamagnetism of H <sub>2</sub> O	$\gamma_p$	4.257602(12)	2.8	$10^7$ Hz-T <sup>-1</sup>		$10^4$ Hz-G <sup>-1</sup>
Magnetic moment of protons in H <sub>2</sub> O in Bohr magnetons	$\mu'_p/\mu_B$	1.52099322(10)	0.066	$10^{-1}$		$10^{-1}$
Proton magnetic moment in Bohr magnetons	$\mu_p/\mu_B$	1.521032209(16)	0.011	$0^{-1}$		$10^{-1}$
Ratio of electron and proton magnetic moments	$\mu_e/\mu_p$	658.2106880(66)	0.010			
Proton magnetic moment in nuclear magnetons	$\mu_p$	1.4106171(55)	3.9	$10^{-23}$ J-T <sup>-1</sup>		$10^{-20}$ erg-G <sup>-1</sup>
Magnetic moment of protons in H <sub>2</sub> O in nuclear magnetons	$\mu'_p/\mu_N$	2.7927740(11)	0.38			
$\mu'_p/\mu_N$ corrected for diamagnetism of H <sub>2</sub> O	$\mu_p/\mu_N$	2.7928456(11)	0.38			
Nuclear magneton, $[c](e\hbar/2m_p c)$	$\mu_N$	5.050824(20)	3.9	$10^{-21}$ J-T <sup>-1</sup>		$10^{-18}$ erg-G <sup>-1</sup>
Ratio of muon and proton magnetic moments	$\mu_\mu/\mu_p$	3.1833402(72)	2.3			
Muon magnetic moment	$\mu_\mu$	4.490474(18)	3.9	$10^{-23}$ J-T <sup>-1</sup>		$10^{-20}$ erg-G <sup>-1</sup>
Ratio of muon mass to electron mass	$m_\mu/m_e$	206.76865(47)	2.3			
Muon rest mass	$m_\mu$	1.883566(11)	5.6	$10^{-23}$ kg		$10^{-25}$ g
		0.11342920(26)	2.3	u		u
Compton wavelength of the electron, $h/m_e c = a^2/2R_\infty$	$\lambda_C$	2.4263089(40)	1.6	$10^{-12}$ m		$10^{-12}$ cm
	$\lambda_C = \lambda_C/2\pi = a^2/4\pi R_\infty$	3.8615905(64)	1.6	$10^{-13}$ m		$10^{-11}$ cm
Compton wavelength of the proton, $h/m_p c$	$\lambda_{C,p}$	1.3214099(22)	1.7	$10^{-16}$ m		$10^{-13}$ cm
	$\lambda_{C,p} = \lambda_{C,p}/2\pi$	2.1030892(36)	1.7	$10^{-17}$ m		$10^{-14}$ cm
Compton wavelength of the neutron, $h/m_n c$	$\lambda_{C,n}$	1.3195909(22)	1.7	$10^{-16}$ m		$10^{-13}$ cm
	$\lambda_{C,n} = \lambda_{C,n}/2\pi$	2.1001941(35)	1.7	$10^{-17}$ m		$10^{-14}$ cm
Molar volume of ideal gas at s.t.p.	$V_m$	22.41383(70)	31	$10^{-3}$ m <sup>3</sup> -mol <sup>-1</sup>		$10^4$ cm <sup>3</sup> -mol <sup>-1</sup>
Molar gas constant, $V_m p_0/T_0$ ( $T_0 = 273.15$ K; $p_0 = 101325$ Pa = 1 atm)	$R$	8.31441(26)	31	J-mol <sup>-1</sup> -K <sup>-1</sup>		$10^7$ erg-mol <sup>-1</sup> -K <sup>-1</sup>
		8.20568(26)	31	$10^{-3}$ m <sup>3</sup> -atm-mol <sup>-1</sup> -K <sup>-1</sup>		$10$ cm <sup>3</sup> -atm-mol <sup>-1</sup> -K <sup>-1</sup>
Boltzmann constant, $R/N_A$	$k$	1.380662(44)	32	$10^{-23}$ J-K <sup>-1</sup>		$10^{-13}$ erg-K <sup>-1</sup>
Stefan-Boltzmann constant, $\pi^2 k^4/60N_A^3 c^2$	$\sigma$	5.67032(71)	125	$10^{-8}$ W-m <sup>-2</sup> -K <sup>-4</sup>		$10^{-8}$ erg-s <sup>-1</sup> -cm <sup>-2</sup> -K <sup>-4</sup>
First radiation constant, $2\pi hc^2$	$c_1$	3.741832(20)	5.4	$10^{-18}$ W-m <sup>2</sup>		$10^{-8}$ erg-cm <sup>2</sup> -s <sup>-1</sup>
Second radiation constant, $hc/k$	$c_2$	1.438786(45)	31	$10^{-3}$ m-K		cm-K
Gravitational constant	$G$	6.6720(41)	615	$10^{-11}$ m <sup>3</sup> -s <sup>-2</sup> -kg <sup>-1</sup>		$10^{-8}$ cm <sup>3</sup> -s <sup>-2</sup> -g <sup>-1</sup>
Ratio, kx-unit to ångström, $\lambda = \lambda(\text{Å})/\lambda(\text{kxu})$ ; $\lambda(\text{CuK}\alpha_1) = 1.537400$ kxu	$\Lambda$	1.0020772(54)	5.3			
Ratio, Å* to ångström, $\lambda^* = \lambda(\text{Å})/\lambda(\text{Å}^*)$ ; $\lambda(\text{WK}\alpha_1) = 0.2090100$ Å*	$\Lambda^*$	1.0000205(56)	5.6			

ENERGY CONVERSION FACTORS AND EQUIVALENTS

Quantity	Symbol	Numerical Value *	Units	Uncert. (ppm)
1 kilogram (kg·c <sup>2</sup> )		8.987551786(72)	10 <sup>16</sup> J	0.008
		5.609545(16)	10 <sup>23</sup> MeV	2.9
1 Atomic mass unit (u·c <sup>2</sup> )		1.4924418(77)	10 <sup>10</sup> J	5.1
		931.5016(26)	MeV	2.8
1 Electron mass (m <sub>e</sub> ·c <sup>2</sup> )		8.187241(42)	10 <sup>11</sup> J	5.1
		0.5110034(14)	MeV	2.8
1 Muon mass (m <sub>μ</sub> ·c <sup>2</sup> )		1.6928648(96)	10 <sup>11</sup> J	5.6
		105.65948(35)	MeV	3.3
1 Proton mass (m <sub>p</sub> ·c <sup>2</sup> )		1.5033015(77)	10 <sup>10</sup> J	5.1
		938.2796(27)	MeV	2.8
1 Neutron mass (m <sub>n</sub> ·c <sup>2</sup> )		1.5053738(78)	10 <sup>10</sup> J	5.1
		939.5731(27)	MeV	2.8
1 Electron volt		1.6021892(46)	10 <sup>-18</sup> J	2.9
			10 <sup>-18</sup> erg	2.9
	1 eV/h	2.4179696(63)	10 <sup>14</sup> Hz	2.6
	1 eV/hc	8.065479(21)	10 <sup>8</sup> m <sup>-1</sup>	2.6
			10 <sup>3</sup> cm <sup>-1</sup>	2.6
Voltage wavelength conversion, hc	1 eV/k	1.160450(36)	10 <sup>4</sup> K	31
		1.986478(11)	10 <sup>-25</sup> J·m	5.4
		1.2398520(32)	10 <sup>-6</sup> eV·m	2.6
			10 <sup>-4</sup> eV·cm	2.6
Rydberg constant	R <sub>∞</sub> hc	2.179907(12)	10 <sup>-18</sup> J	5.4
			10 <sup>-11</sup> erg	5.4
		13.605804(36)	eV	2.6
Bohr magneton	R <sub>∞</sub> c	3.28984200(25)	10 <sup>15</sup> Hz	0.075
	R <sub>∞</sub> hc/k	1.578885(49)	10 <sup>8</sup> K	31
	μ <sub>B</sub>	9.274078(36)	10 <sup>-24</sup> J·T <sup>-1</sup>	3.9
		5.7883785(95)	10 <sup>-5</sup> eV·T <sup>-1</sup>	1.6
	μ <sub>B</sub> /h	1.3996123(39)	10 <sup>15</sup> Hz·T <sup>-1</sup>	2.8
	μ <sub>B</sub> /hc	46.68604(13)	m <sup>-1</sup> ·T <sup>-1</sup>	2.8
Nuclear magneton			10 <sup>-3</sup> cm <sup>-1</sup> ·T <sup>-1</sup>	2.8
	μ <sub>N</sub> /k	0.671712(21)	K·T <sup>-1</sup>	31
	μ <sub>N</sub>	5.05824(20)	10 <sup>-27</sup> J·T <sup>-1</sup>	3.9
		3.1524515(53)	10 <sup>-8</sup> eV·T <sup>-1</sup>	1.7
	μ <sub>N</sub> /h	7.622532(22)	10 <sup>8</sup> Hz·T <sup>-1</sup>	2.8
	μ <sub>N</sub> /hc	2.5426030(72)	10 <sup>-3</sup> m <sup>-1</sup> ·T <sup>-1</sup>	2.8
		10 <sup>-4</sup> cm <sup>-1</sup> ·T <sup>-1</sup>	2.8	
	μ <sub>N</sub> /k	3.65826(12)	10 <sup>-4</sup> K·T <sup>-1</sup>	31

\* Note that the numbers in parentheses are the one standard-deviation uncertainties in the last digits of the quoted value computed on the basis of internal consistency, that the unified atomic mass scale <sup>12</sup>C=12 has been used throughout, that u=atomic mass unit, C=coulomb, F=farad, G=gauss, H=henry, Hz=hertz=cycle/s, J=joule, K=kelvin (degree Kelvin), Pa=pascal=N·m<sup>-2</sup>, T=tesla (10<sup>8</sup> G), V=volt, W=watt, Wb=weber= T·m<sup>2</sup>, and W=watt. In cases where formulas for constants are given (e.g., R<sub>∞</sub>), the relations are written as the product of two factors. The second factor, in parentheses, is the expression to be used when all quantities are expressed in cgs units, with the electron charge in electrostatic units. The first factor, in brackets, is to be included only if all quantities are expressed in SI units. We remind the reader that with the exception of the auxiliary constants which have been taken to be exact, the uncertainties of these constants are correlated, and therefore the general law of error propagation must be used in calculating additional quantities requiring two or more of these constants.

† Quantities given in u and atm are for the convenience of the reader; these units are not part of the International System of Units (SI).

‡ In order to avoid separate columns for "electromagnetic" and "electrostatic" units, both are given under the single heading "cgs Units." When using these units, the elementary charge *e* in the second column should be understood to be replaced by *e<sub>m</sub>* or *e<sub>s</sub>*, respectively.



### APPROXIMATE CAPACITANCE OF CONDUCTORS (pt/inch)

Spacing (in.)	XXXXP	Material Melamine	Teflon
1/32	1.05	1.25	0.33
1/16	0.85	1.10	0.26
1/8	0.72	0.90	0.22

### APPROXIMATE RESISTANCE OF CONDUCTORS (ohms/inch)

Based on 100% conductivity of copper at 20°C

$$R = \frac{0.000503}{w} \text{ for 1 ounce copper}$$

$$R = \frac{0.000226}{w} \text{ for 2 ounce copper}$$

$$R = \frac{0.000135}{w} \text{ for 3 ounce copper}$$

w = conductor width in inches

### VELOCITY OF SOUND IN SOLIDS, GASES, AND LIQUIDS

Velocity of Sounds in Solids			
Medium	Velocity (ft./sec)	Medium	Velocity (ft./sec)
Aluminum	17,192	Magnesium	16,079
Brass	11,221	Nickel	15,615
Cadmium	7,874	Quartz Glass	17,618
Copper	11,745	Silver	8,661
Cork	1,640	Steel	16,569
Iron	16,962	Tin	8,957

Velocity of Sound in Gases at 0°C			
Medium	Symbol	Velocity (ft./sec)	
Air		1,087	
Ammonia	NH <sub>3</sub>	1,361	
Argon	A	1,046	
Carbon Monoxide	CO	1,106	
Carbon Dioxide	CO <sub>2</sub>	881 (above 100 Hz)	
Chlorine	CL	674	
Ethylene	C <sub>2</sub> H <sub>4</sub>	1,040	
Helium	He	3,182	
Hydrogen	H <sub>2</sub>	4,165	
Methane	CH <sub>4</sub>	1,417	
Neon	Ne	1,427	
Nitric Oxide	NO	1,066	
Nitrous Oxide	N <sub>2</sub> O	859	
Nitrogen	N <sub>2</sub>	1,096	
Oxygen	O <sub>2</sub>	1,041	







  

Velocity of Sounds in Liquids		
Medium	Temperature (°C)	Velocity (ft./sec)
Water (fresh)	17	4,691
Water (sea)	15	4,937
Alcohol (ethyl)	20	3,838
Benzene	20	4,330
Ether (ethyl)	20	3,313
Glycerin	20	6,299
Mercury	20	4,757

## RELAY CONTACT CODE

This is the letter code adapted by the American Standards Association and by the National Association of Relay Manufacturers to describe relay contacts.



















### Other standard contact symbols

Form	IEC, JIC and NMTBA symbol	Other IEC symbols
A		
B		
C		
D		

#### \*LETTER ABBREVIATIONS

B: BREAK  
C: CLOSED  
D: DOUBLE  
M: MAKE  
N: NORMALLY  
O: OPEN  
P: POLE  
S: SINGLE  
T: THROW

EXAMPLE: SP ST NC OB is read as Single Pole, Single Throw, Normally Closed, Double Break

FORM	TERM	CONTACT CONFIGURATION	FORM	TERM	CONTACT CONFIGURATION
A	MAKE	 SP ST NO'	J	MAKE MAKE BREAK	
B	BREAK	 SP ST NC'	K	SP DT CENTER OFF	
C	BREAK MAKE (transfer)	 SP DT'	L	BREAK MAKE MAKE	
D	MAKE-BEFORE BREAK (continuity transfer)		U	DOUBLE MAKE CONTACT ON ARMATURE	
E	BREAK MAKE-BEFORE BREAK		V	DOUBLE BREAK CONTACT ON ARMATURE	
F	MAKE MAKE		W	DOUBLE BREAK DOUBLE MAKE CONTACT ON ARMATURE	
G	BREAK BREAK		X	DOUBLE MAKE	 SP ST NO DM'
H	BREAK BREAK MAKE		Y	DOUBLE BREAK	 SP ST NC DB'
I	MAKE BREAK MAKE		Z	DOUBLE BREAK DOUBLE MAKE	 SP ST DB'

## HEAT-SINK THERMAL RESISTANCE CHART

Heat-sink thermal resistance can be determined with the accompanying chart. Values determined graphically are not as accurate as those found from thermal equations but are precise enough for most applications. To find thermal resistance, draw a vertical line from the scale for surface area to the scales for materials and read the corresponding thermal resistance. For example, a 3/16-in.-thick piece of horizontally mounted copper with a surface area of 15 in.<sup>2</sup> has a thermal resistance of approximately 4.1°C/W. And a 3/32-in.-thick piece of vertically mounted copper with a surface area of 25 in.<sup>2</sup> has a thermal resistance of approximately 3.1°C/W. Note that vertical heatsinks have lower thermal resistances than horizontal sinks because convection provides increased heat dissipation.

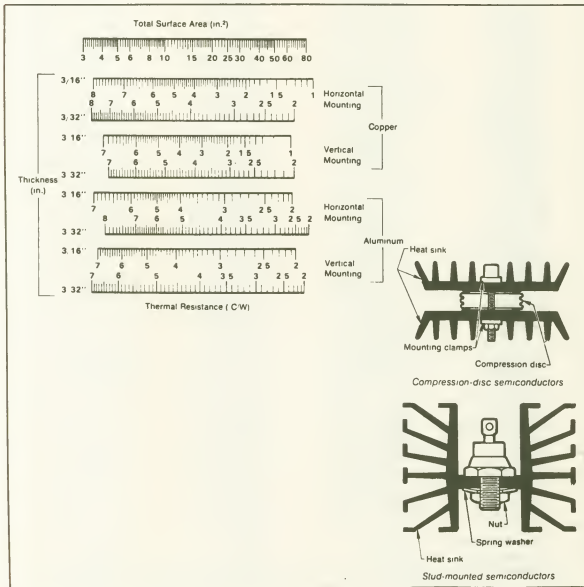

## FOREIGN VOLTAGE GUIDE

Following is an up-to-date guide to predominant electric voltages in foreign countries. In general, all references to 110 V apply to the range from 110 V to 160 V. References to 220 V apply to the range from 200 V to 260 V. Where 110/220 V is indicated, voltage varies within the country, depending on location.

Aden	220V	Dominica	220V
Afghanistan	220V	Dominican Rep.	110/220V
Algeria	110/220V	Ecuador	110/220V
Angola	220V	Egypt	110/220V
Anguilla	220V	El Salvador	110V
* Antigua	110/220V	Ethiopia	110/220V
† Argentina	220V	† Fiji	220V
Aruba	110V	Finland	220V
†† Australia	220V	France	110/220V
* Austria	220V	French Guiana	110/220V
Azores	110/220V	Gabon	220V
Bahamas	110/220V	Gambia	220V
Bahrain	220V	*† Germany	110/220V
Bangladesh	220V	Ghana	220V
Barbados	110/220V	Gibraltar	220V
Belgium	110/220V	* Great Britain	220V
Bermuda	110/220V	† Greece	110/220V
Bhutan	220V	Greenland	220V
Bolivia	110/220V	* Grenada	220V
Bonaire	110/220V	Grenadines	220V
* Botswana	220V	* Guadeloupe	110/220V
† Brazil	110/220V	Guatemala	110/220V
Brit. Honduras	110/220V	Guinea	220V
Brit. Virgin I.	110/220V	Guyana	110/220V
Bulgaria	110/220V	Haiti	110/220V
Burma	220V	Honduras	110/220V
Burundi	220V	* Hong Kong	220V
Cambodia	110/220V	Hungary	220V
Cameroon	110/220V	Iceland	220V
Canada	110V	† India	220V
Canal Zone	110/220V	Indonesia	110/220V
Canary I.	110/220V	Iran	220V
Cayman I.	110V	Iraq	220V
Cen. African Rep.	220V	* Ireland	220V
Chad	220V	Isle of Man	220V
* Channel I. (Brit)	220V	Israel	220V
† Chile	220V	Italy	110/220V
†† China	220V	Ivory Coast	220V
Colombia	110V	* Jamaica	110/220V
Costa Rica	110/220V	Japan	110V
Cuba	110V	Jordan	220V
Curacao	110V	* Kenya	220V
* Cyprus	220V	Korea	110V
Czechoslovakia	110/220V	Kuwait	220V
Dahomey	220V	Laos	110/220V
Denmark	220V	Lebanon	110/220V

Lesotho	220V	Samoa	110/220V
Liberia	110/220	St. Barthelemy	220V
Libya	110/220V	St. Eustatius	110/220V
*Liechtenstein	220V	* St. Kitts	220V
Luxembourg	110/220V	* St. Lucia	220V
Macao	110/220V	St. Maarten	110/220V
† Madeira	220V	St. Vincent	220V
Majorca	110V	Saudi Arabia	110/220V
Malagasy Rep.	220V	* Scotland	220V
* Malawi	220V	Senegal	110V
* Malaysia	220V	Seychelles	220V
Mali	110/220V	Sierra Leone	220V
Malta	220V	* Singapore	110/220V
Martinique	110/220V	Somalia	110/220V
Mauritania	220V	* South Africa	220V
Mexico	110/220V	* Spain	110/220V
Monaco	110/220V	Sri Lanka (Ceylon)	220V
Montserrat	220V	Sudan	220V
Morocco	110/220V	Surinam	110/220V
Mozambique	220V	Swaziland	220V
Nepal	220V	† Sweden	110/220V
* Netherlands	110/220V	* Switzerland	110/220V
Neth. Antilles	110/220V	Syria	110/220V
* Nevis	220V	Tahiti	110V
New Caledonia	220V	Taiwan	110/220V
New Hebrides	220V	Tanzania	220V
‡ New Zealand	220V	Thailand	220V
Nicaragua	110V	Tobago	110/220V
Niger	220V	Togo	110/220V
* Nigeria	220V	Tonga	220V
* Northern Ireland	220V	Trinidad	110/220V
Norway	220V	Tunisia	110/220V
Okinawa	110V	Turkey	110/220V
Oman	220V	Turks & Caicos I.	110V
Pakistan	220V	Uganda	220V
Panama	110V	United Arab Emirates	220V
Papua New Guinea	220V	Upper Volta	220V
† Paraguay	220V	Uruguay	220V
Peru	220V	USA	110V
Philippines	110/220V	USSR	110/220V
Poland	220V	U.S. Virgin I.	110V
Portugal	110/220V	Venezuela	110V
Puerto Rico	110V	Vietnam	110/220V
Qatar	220V	* Wales	220V
* Rhodesia	220V	Yemen	220V
Romania	110/220V	* Yugoslavia	220V
Rwanda	220V	Zaire	220V
Saba	110/220V	Zambia	220V

\*Denotes countries in which plugs with 3 square pins are used (in whole or part) ‡Requires plug with angled blades

†Countries using dc in certain areas

\*Countries with recessed outlets

(Reprinted from "Foreign Electricity Is No Deep Dark Secret," courtesy of Franzus Company Inc.)

# TYPICAL HARDWARE USED IN ELECTRONIC EQUIPMENT



## COORDINATES FOR EQUALLY SPACED HOLES

It is sometimes necessary to determine the  $x$  and  $y$  coordinates of a circle divided into an equal number of parts. The following table can be used directly, or it can serve as a crosscheck against answers obtained by normal trigonometric methods.

FOR EXAMPLE: A circle that has a radius of 5.0 cm and contains 4 holes spaced at  $90^\circ$ . Determine the distance between their centers.  $A = 1.4142R = 1.4142 (5.0) = 7.07$  cm.

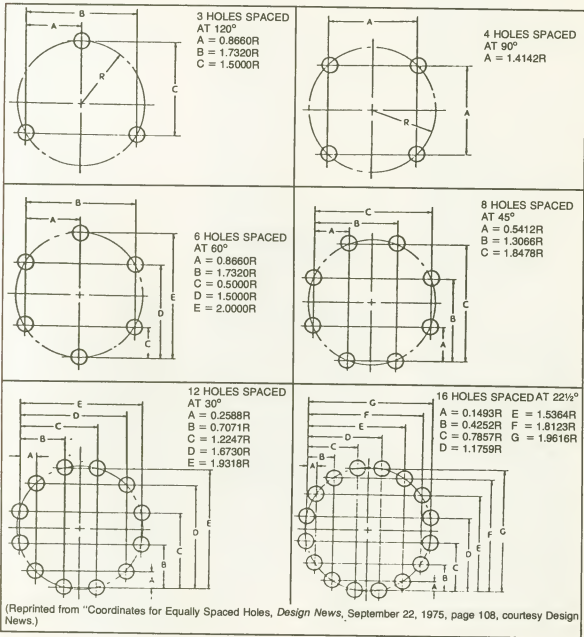

(Reprinted from "Coordinates for Equally Spaced Holes, *Design News*, September 22, 1975, page 108, courtesy Design News.)



# Index

- A**
- Abbreviations, semiconductor, 166-170
  - Absolute value amplifier, 185
  - Acceleration, 266, 299
    - gravity, 337
  - Acetates, 347
  - Acrylics, 347
  - Active devices, characteristics, 171
  - Active filter circuit, 186
  - Active notch filter, 186
  - Actual power/apparent power, 90
  - Advanced license, 62
  - Aeronautical frequencies, 9
    - mobile band, 9
  - Air cooling, 385
  - Air density, 337-339
  - Air flow, 385
  - Air traffic control frequencies, 11
  - Airspace transmission line, 38, 39
  - Alkyds, 349
  - Alphabet, international phonetic, 65
  - Alternating sine wave, 260
  - Alternating square wave, 260
  - Altitude, 337-339
  - Altitude chart, 337
  - AM, 66, 67
  - AM radio broadcast frequencies, 5
  - Amateur extra license, 62
  - Amateur operator license, 62
    - requirements, 62
  - Aminos, 349
  - Amplifier
    - JFET transistor, 112
      - low-end, 107
      - negative feedback, 210
      - operational, 182
      - performance characteristics, 106
      - push-pull, 211
      - RC-coupled, 107, 110, 111, 113
      - square wave, 106
    - Amplifier gain, 212
    - Amplifier noise, 80-82
    - Amplifiers, classification, 206
    - Amplifying tubes, European, 215
    - Amplitude modulation, 66-67
    - AN nomenclature, 320-323
    - Angles, 250
    - Angular resolution, 227
  - Antenna
    - biconical, 33
    - biconical horn, 33
    - coaxial dipole, 33
    - dipole, 33
    - folded dipole, 33
    - helical, 33
    - horn, 33
    - microwave, 36
    - parabolic, 33
    - rhombic, 33
    - turnstile, 33
    - vertical full wave loop, 33
  - Antenna aperture, 36
  - Antenna bandwidth, 32-35
  - Antenna effectiveness, 37
  - Antenna efficiency, 37
  - Antenna gain, 36
  - Antenna impedance, 32-35
  - Antenna pattern, 32-35
  - Antenna reference charts, 32-35
  - Antenna polarization, 32-35
  - Antenna reference charts, 32-35
  - Apparent power, 90
  - Appliance wiring, 364
  - Appliances, power consumption, 381
  - Arc resistance, 350
  - Areas, 248
  - ARRL word list, 65
  - ASCII code, 371
  - Aspect ratio, 22
  - Astable multivibrator, 180, 181
  - Atmosphere, properties, 337-340
  - Atmospheric layers, 340
  - Attenuation
    - crossover network, 116
    - VSWR reduction, 48
  - Attenuation factor, 105
  - Attenuation response, 117

- Attenuators, 72-74
    - bridged-T, 72-74
    - H, 72-74
    - lattice, 72-74
    - O, 72-74
    - pi, 72-74
    - resistive, 72-74
    - U, 72-74
  - Atto, 233
  - Audibility threshold, 316
  - Audio line table, 365
  - Automatic gain control amplifier, 186
  - Automatic landing systems, 11
  - Avalanche diode, 162
  - Average velocity, 286
  - AWG, 360
  - Azimuth, 30
  - Azimuth error, 25, 30
- B**
- B & S gauge, 360
  - Back diode, 162
  - Backswing, 255
  - Balanced two-wire lines, 39
  - Bandpass amplifier, 185
  - Bandpass filter, 144
  - Bands, 5
  - Bandwidth, tuned circuit, 114-115
  - Baudot code, 369
  - Beacon frequencies, 11
  - Biconical antenna, 33
  - Biconical horn, 33
  - Body resistance, 318
  - Breakdown, spark gap, 366
  - Bridge
    - Hay, 158
    - Maxwell, 158
    - Owen, 158
    - Shering, 158
    - Wheatstone, 158
    - Wien, 111, 158
  - Bridge circuits, 158
  - Bridge voltage doubler, 151
  - Bridged H attenuator, 72-74
  - Bridged T attenuator, 72-74
  - Broadcast antenna, 36
  - Broadcast array, 34-35
  - Broadcast frequencies, 5
- C**
- Cable insulation, 361
  - Calcium, 326
  - Candlepower, 306, 309, 319
  - Candles/square centimeter, 309
  - Candles/square foot, 309
  - Candles/square inch, 309
  - Capacitance, 285
    - effective capacitance of, 159
    - reactive, 94-97
  - Capacitance bridge, 158
  - Capacitive coupling, 104
  - Capacitive reactance, 94-97
  - Capacitors
    - ceramic dielectric, 324-325
    - color codes, 321
    - energy storage, 88, 89
    - frequency characteristic, 100
    - self-resonant frequency, 93
    - values, 79
  - Capacity, 374
    - KVAR, 92
  - Cardioid, 244
  - Cascade voltage doubler, 151
  - Cascade voltage tripler, 151
  - Cascaded amplifier, 219
    - risetime, 209
  - Cascaded stages, noise figure, 219
  - Catenary, 245
  - Cathode feedback, 213
  - Cathode follower, 212, 214
    - circuit, 172
  - Cathode ray tube phosphors, 331
  - Cellulose, 347
  - Celsius, 351, 354
  - Centi, 233
  - Centigrade, 351-354
  - Centimetric waves, 5
  - Cesium, 326
  - Characteristics of active devices, 171
  - Charge, 285
  - Charge density, 285
  - Chassis wiring, color codes, 320
  - Chebyshev attenuation response, 117
  - Chlorinated polyethers, 347
  - Circle, 244, 399
  - Circuit components, 372
  - Cissoid of Diocles, 245
  - Citizen's radio frequencies, 10
  - Class A amplifier, 206-207
  - Class A insulation, 362
  - Class AB amplifier, 206-207
  - Class B amplifier, 206-207
    - push-pull, 211
  - Class B insulation, 362
  - Class C amplifier, 206-207
  - Class C insulation, 362
  - Class F insulation, 362
  - Class H insulation, 362
  - Class O insulation, 362
  - Class 220 C insulation, 362
  - Classification of emissions, 66
  - Clipped sawtooth wave, 260
  - Clipped sine wave, 260
  - Clystron wire leads, 320-321
  - CML, 190
  - Coaxial antenna, 33
  - Coaxial cables
    - attenuation, 40
    - characteristics, 40
    - signal delay, 150
  - Cobalt, 326
  - Code
    - 555, 60
  - International Morse, 59
    - mnemonic, 55-58
    - Q, 55-58
    - radio telephone, 59
    - signal reporting, 60
    - SINPO, 60
  - Coil design, 83
    - single layer, 83-84
  - Colinear array, 35
  - Color codes, 260-261
  - Color scale, temperatures, 359
  - Comb filter, 146-147
  - Commercial radio operator license, 63-64
    - requirements, 62
  - Common base circuit, 172, 173, 175, 179
  - Common collector circuit, 172-173, 175-179
  - Common emitter circuit, 172-173, 175-179
  - Communication modes, 21
  - Complementary silicon controlled rectifier, 164-165
  - Complementary transistor logic, 190
  - Complementary unijunction transistor, 164-165
  - Component color codes, 320-323
  - Component MTBF, 222
  - Component tolerances, 79
  - Component values, preferred, 79
  - Concentric transmission line, 38
  - Conditional license, 62-64
  - Conductance, 374
  - Conductivity, 374
  - Conductors
    - capacitance of, 392
    - resistance of, 392
  - Cone, 246
  - Confidence level, 226
  - Constant current source, 183
  - Constant K network, 144
  - Constant-resistance network, 116
  - Constants, 389
  - Contacts, 373, 393
  - Control marking, foreign equipment, 375
  - Conversion factors, 287-299
  - Cooling, 385
  - Copper conductors, 388
  - Copper wire tables, 360
  - Corrosion, 346
  - Cosmic rays, 4
  - Crossed field devices, color codes, 322
  - Crossover network, 116
  - Crystal cuts, 329-330
  - Crystal displays, 191
  - Crystal oscillator, 185
  - Crystals, 327-331
  - CSCR, 164-165

CTCS, 12  
CTL, 190  
Cube roots, 236-237  
Cubes, 236-277  
Cubical parabola, 244  
CUJT, 164  
Current, 285, 374  
    density, 285  
    motors, 377  
Current injector circuit, 182  
Current mode logic, 190  
Current-to-voltage inverter, 183-185  
Cutoff, waveguide, 46  
Cut-off wavelength, 46

## D

da, 233  
D/A converter, 186  
dB, 262-263  
dBm, 262-263  
DCTL, 190  
Deca, 233  
Decametric waves, 5  
Decay time, 255  
Deceleration, 286, 386  
Deci, 233  
Decibel conversion, 262-263  
Decibel nomogram, 264-266  
Decimetric waves, 5  
Decimillimetric waves, 5  
Definitions, 192-205  
Delay line, 149  
Density, air, 337-339  
Deviation, 22  
Diac, 164-165  
Dial symbols, electronic, 370  
Diallyl phthalates, 349  
Dielectric constant, 150, 350, 374  
Dielectric displacement, 284  
Dielectric strength, 350  
Differentiation, 182  
Diffraction  
    knife edge, 21  
    plain surface, 21  
    rough surface, 21  
Diode, 163  
Diode power requirements for switch-  
    ing power supplies, 152  
Diode transistor logic, 190  
Dipole antenna, 33  
Direct-coupled transistor logic, 190  
Discomfort index, 358  
Displacement, electric flux density,  
    374  
Dissipation factor, 350  
Doppler frequency, 50  
Doppler navigation, 11  
Doppler to speed conversion, 49  
Doubler, voltage, 151  
Dry bulb thermometer, 355-358  
DTL, 190

## E

ECL, 190  
EIA Designations, 324-325  
EIA Standard Tone Frequencies, 12  
Effective impedance, 99  
Effectiveness, antenna, 37  
EHF, 4-5  
EIR nomogram, 101  
Elastance, 374  
Electric current, effect on the human  
    body, 318  
Electric dipole moment, 285, 374  
Electric field density, 285, 374  
Electric flux, 374  
Electric potential, 285  
Electric waves, 4  
Electrical charge, 374  
Electrical equipment power consump-  
    tion, 381  
Electromagnetic spectrum, 4  
Electromagnetic units, 284, 285  
Electromagnetic waves, propagation  
    characteristic, 20  
Electron volts, 304  
Electronic symbols, 370  
Electronics and telecommunication,  
    372-374  
Electrostatic series, 345  
Elements, metallic, 386  
Elevation, 30-31  
Elevation error, 30-31  
ELF, 4  
Ellipse, 244  
Ellipsoid, 247  
Elliptical attenuation response, 117  
Emission classification, 66-67  
Emitter-coupled logic, 190  
Encoders, 227  
End fire array, 35  
Energy, 285, 286  
    conversion, 302  
    conversion factors, 391  
    work, 374  
Energy storage capacitor 88-89  
Epoxy, 349  
Equal loudness curves, 316  
Equilateral hyperbola, 244  
Equivalent resistance, 91  
European semiconductor numbering  
    system, 189  
European tube numbering system,  
    215  
Eutectic temperature, 387  
Exponential curve, 245  
Eye, 326  
Eye hazard, laser, 303  
Eye spectrosensitivity, 326

Factorials, 241  
Fahrenheit, 351-354  
Failure rate, 223

## F

Feedback, cathode, 213  
Femto, 233  
Field density, 54  
Field intensity, 50  
    receiving antenna, 25  
Field power conversion, 54  
Field strength, 54  
Fields and circuits, 272-275  
Fields/second, 23  
Figure of merit, 114  
Filter  
    comb, 146, 147  
    design, 117-143  
    high pass, 117  
    low pass, 117  
    twin-T, 75-77  
Final velocity, 286  
Fire control frequencies, 11  
First class radio telegraph license,  
    63-64  
First class radio telephone license,  
    63-64  
555 code, 61  
Floating load circuit, 185  
Fluorescent display, vacuum, 191  
Fluorocarbons, 276, 347  
Flux density, 285  
FM radio frequencies, 5  
Folded dipole antenna, 33  
Foot-candles, 306-307, 309-310  
Foot-lamberts, 310  
Force, 285, 286, 374  
Foreign equipment terminal and con-  
    trol markings, 377  
Foreign voltage guide, 396  
Forward power, transmission line, 47  
Fourier content, 261  
Four-leaved roses, 245  
Frames, 23  
Free fall, 383  
Free space, cutoff, waveguide, 46  
Free space frequency, 46  
Free space transmission, 24  
Free space wavelength, 46  
Frequencies  
    aeronautical mobile bands, 8-9  
    broadcasting, 5, 10  
    Citizen's radio, 10  
    remote control, 12  
    ship station, 10  
    shore station, 10  
    TV channels, 6-8  
Frequency bands, 5  
    microwave, 11  
Frequency bridge, 158  
Frequency characteristics  
    capacitors, 100  
    inductors, 100  
    resistors, 100  
    RL and C, 100  
Frequency divider, 185  
Frequency modulation, 66, 67

Frequency nomograph, 258  
Frequency-period conversion, 256  
Frequency selective networks, 110-113  
Frequency-wavelength conversion, 17  
Full load current, motors, 377  
Full wave, 261  
Full wave voltage doubler, 151  
Full wave voltage quadrupler, 151  
Functions of angles, 250  
Fusing current, 364

## G

Galvanic series, 346  
Gamma of picture signal, 23  
Gamma rays, 4  
Gas discharge, 191  
Gases, 392  
Gate definitions, 197  
General license, 62  
Geoalerts, 16  
Geometric curves, 244-245  
Geometrical horizons, 28  
Giga, 233  
Gold, 305  
Graphic symbols, 370  
Greek alphabet, 257  
Ground to ground communication, 21 modes, 21  
Grounded cathode circuit, 172  
Grounded grid circuit, 172

## H

H parameter, 176, 177  
H type attenuator, 72-74  
Half life, 305  
Half wave, 261  
Half wave voltage quadrupler, 151  
Hardware, 400  
Harmonic distortion, 234  
Harmonic rejection, 234  
Harmonics, 234  
Hay bridge, 158  
Heat, 270-271  
Heat-sink thermal resistance, 395  
Hecto, 233  
Hectometric waves, 5  
Height, 286  
Helical antenna, 33  
HF, 4-5  
    propagation, 20  
High altitude chart, 337  
High frequency current, 98  
High frequency inductance, 85  
High frequency inductance wire, 85  
High-pass active filter, second order, 186  
High-pass network RC, 110  
Holes, equally spaced, 399  
Horn antenna, 33

Human ear, 186  
Human eye spectrosensitivity, 326  
Humidity, relative, 356-357  
Hyperbola, 244  
Hypocycloid, 245

## I

IC logic families, 190  
IER nomogram, 101  
Illuminance, 308  
Illumination units, 309  
Impedance  
    parallel connected RL and C, 99  
    series connected RL and C, 99  
    two-wire lines, 39  
Impedance match power loss, 157  
Impedance mismatch power loss, 157  
Impedance ratio, transformer, 88-89  
Impedance transformer, 86  
Incandescent display, 191  
Incandescent lamps, 314  
Indicators, radar, 30-31  
Indium, 305  
Inductance, 285  
Inductance bridge, 158  
Inductive capacity, 285  
Inductive reactance, 94-97  
Inductor values, preferred, 79  
Inductors, frequency characteristics, 100  
Infrared, 4  
Infrasonics, 4  
Initial velocity, 286  
Insulating materials, temperature classification, 362  
Input VSWR, 48  
Integrated circuit logic families, 190  
Integrated circuit definitions, 192  
Integrated circuit properties, 171  
Integrated voltage regulator, 162-163  
Integration, 182  
Interface, 23  
International Morse code, 59  
International phonetic alphabet, 65  
International television standards, 22  
International time map, 336  
Interplanetary transmission time, 65  
Iodine, 305  
Iron, 305  
Isotope, 32-35, 246  
IVAR, 162-163

## J

JEDEC, 331  
Jupiter, 65

## K

Kelvin, 353-354  
Kilo, 233  
Kilometric waves 5  
KVAR, 90, 92  
KVAR-capacity, 92

## L

L type attenuator, 72-74  
Lambert, 311  
Lamp life, 319  
LASCR, 164-165  
Laser, 4, 303  
    beam width, 303  
    eye hazard, 303  
    output energy, 303  
    radiation, 304  
Lattice type attenuator, 72-74  
LED, 304  
Lemniscate, 244  
Length, 374  
Letter code, microwave frequencies, 11  
Letter symbols, 166-170, 267-277, 278-283  
LF, 4-5  
LF propagation, 20  
License requirements  
    amateur operator, 62  
    commercial operator, 63-64  
Light, 271, 272  
Light activated SCR, 165  
Light emitting diode, 190  
Light sources, 245, 304  
Light waves, 4  
Lighting activity, 341  
Limaçon, 244  
Line of sight, 21  
Line-of-sight transmission range, 28  
Linear charge density, 374  
Lines/frame, 23  
Lines/second, 23  
Liquid crystal, 191  
Liquids, 392  
Liquids, densities of, 386  
Lissajous figures, 252-253  
Load VSWR, 48  
Logarithm, factorials, 241  
Logarithmic curves, 245  
Logarithmic transistor circuit, 185  
Logic definitions, 197  
Logic devices, 372  
Loudness level, 316  
Loudspeaker crossover networks, 116  
Low-end amplifier response, 107  
Low-pass active filter, second order, 183  
Low-pass network, RC, 110  
Lumen, 311  
Lumens/square centimeter, 311  
Lumens/square foot, 311  
Lumens/square meter, 311  
Luminance spectrum, 313  
Lux, 311

**M**

*m*-derived network, 116

Machines, 277  
Magnetic charge, 374  
Magnetic dipole moment, 285, 374  
Magnetic field intensity, 284, 374  
Magnetic field strength, 334  
Magnetic flux, 285, 374  
Magnetic flux density, 374  
Magnetic force, 374  
Magnetic induction, 374  
Magnetization, 374  
Magnetomotive force, 285, 374  
Mars, 65  
Mass, 286  
Matching pad, minimum loss, 78  
Mathematical operations, 240  
Mathematical signs and symbols, 239  
Maxwell bridge, 158  
Mean time between failures, 222-225  
Mechanics, 269-270  
Mega, 233  
Memories, semiconductor, 217  
Metal oxide semiconductor logic, 190  
Metallic elements, 386  
Metric prefixes, 233  
Metric waves, 5  
MF, 4-5  
MF propagation, 20  
Micro ( $\mu$ ), 233  
Microelectronics terms definitions, 192-205  
Microphone output, 68-69  
Microwave antenna, 36  
Microwave circuits, 373  
Microwave frequency band, 11  
Military designations, 324-325  
Military nomenclature, 332-333  
Milli, 233  
Millimetric waves, 5  
Minimum attenuation, slotted line, 45  
Minimum loss, matching pad, 78  
Mnemonic code, 56-58  
Modulator-demodulator, 185  
Molecular weight, 337  
Moon, 65  
Monostable multivibrator, 180-181  
Morse code, 59  
MOSL, 190  
Motor characteristics, 378  
Motors, full load current, 377  
MTBF, 222-224, 226  
Multipliers, voltage, 151  
Multivibrator  
  astable, 180-181  
  monostable, 180-181  
  symmetrical, 180-181  
Multivibrator design, 180-181  
Myriometric waves, 5

## N

Nano, 233  
National Bureau of Standards, 14-16  
Natural rubber insulation, 361

Navigation antenna, 36  
Negative feedback, 210  
Neon lamp, 304  
Neoprene insulation, 361  
Network, pulse forming, 148  
Noble metal, 346  
Noise figure, 27, 219  
  receiver, 27  
Noise power/signal power separation, 53  
Noise-signal separation, 53  
Noise voltage, thermal, 80-82  
Notch filter, 186  
Novice license, 62  
npn transistor, 162-163  
Nylons, 347

## O

O type attenuator, 72-74  
Ohm's law, 101  
  nomogram, 101  
Operational amplifier, 182-187  
  terms, 187  
Optical horizon, 28  
Optics, 4  
Optimum reverberation time, 317  
Optoelectronic devices, 371  
Oscillator  
  crystal, 186  
  Wien bridge, 186  
Overtone clamp circuit, 185  
Owen bridge, 158

## P

PAM, 67  
Parabolic antenna, 33  
Paraboloid, 247  
Parallel circuit, 99  
Parasitic array, 34  
Parylenes, 348  
Passive LC filter design, 117-143  
PCM, 67  
PDM, 67  
Peak follower circuit, 184  
Period-frequency conversion, 256  
Permeability, 285, 374  
Permeance, 374  
PFM, 67  
Phase angle, 258  
Phase modulation, 66, 67  
Phase shift, 105  
  RC network, 105  
Phenolics, 349  
Phonetic alphabet, 65  
  international, 65  
Phosphor characteristics, CRT, 331  
Photometry, 306-307  
Photon energy, 304  
Photoreceptors, 304  
Photo transistor, 164-165  
Physical constants, 389  
Physical units conversion, 374

Pi type attenuator, 72-74  
Pico, 233  
Plastics, 347-350  
PM, 67  
pnp transistor, 164-165  
Polar-rectangular conversion, 242-243  
Polarity separator circuit, 184  
Polarization, 374  
Polarization, antenna, 32-34  
Polyallomers, 348  
Polyamide-imides, 348  
Polycarbonates, 348  
Polyesters, 348, 349  
Polyethylenes, 348  
Polyimides, 348  
Polyphenylene oxides, 348  
Polypropylenes, 348  
Polystyrenes, 348  
Polysulfones, 347  
Potential, 374  
Power, 374  
  rotation, 376  
  units, 285  
Power consumption of electrical equipment, 381  
Power density, 53  
Power engineering, 277  
Power factor, 91, 350  
  RC network, 91  
  RL network, 91  
Power factor correction, 90  
Power loss, impedance mismatch, 157  
Power supply regulation, 156  
Power supply switching, 152  
Powers of numbers, 235  
Powers of two, 238  
PPI, 30-31  
PPM, 67  
PPM/ $^{\circ}$ C, 339  
Predistortion, 255  
Pre-emphasis, 23  
Pressure, 337-339  
PRF, 91  
Printed wiring boards, 388  
Printers, 367  
Probability curve, 245  
Probability of success, 225  
Programmable unijunction transistor, 164-165  
Propagation, 20  
Propagation characteristic, electro-magnetic waves, 20  
Propagation forecast, WWV, 14-16  
Propagation velocity, 41  
PTM, 67  
Pulse-amplitude modulation, 67  
Pulse-code modulation, 67  
Pulse definitions, 255  
Pulse-duration modulation, 67  
Pulse-forming network, 148

Pulse-frequency modulation, 67  
Pulse interval, 30-31  
Pulse modulation, 66-67  
Pulse parameters, 254  
Pulse-position modulation, 67  
Pulse repetition frequency, 254  
Pulse risetime, 254  
Pulse-shape modulation, 67  
Pulse-time modulation, 67  
Pulse width, 148  
Push-pull amplifier, 211  
PUT, 164-165  
PVC, 361  
Pyramid, 246

## Q

Q, 114-115  
Q signal, 55-58  
Quadrupler, voltage, 156  
Quartz crystals, 327-330

## R

Racan, 11  
Radar  
  antenna, 36  
  frequencies, 11  
  indicators, 30-31  
  power, 29  
  power-energy, 29  
Radiation, 305  
  and height, 271-272  
  spectrum, 4  
Radioactivity decay curve, 326  
Radio astronomy, 36  
Radio operator license, 62-64  
Radio telephone code, 59  
Radio waves, 4  
Radiometry, 36  
Range, on radar indicators, 30-31  
Rankine, 353  
RC coupled amplifier, 111  
R-C coupling, 105  
R-C filters, 75-77  
R-C high-pass network, 110-111  
R-C low-pass network, 110-111  
R-C time constant, 108-109  
RCTL, 190  
Reactance  
  capacitive, 94-97  
  inductive, 94-97  
  nomogram, 94-97  
Reaumur, 353  
Receiver bandwidth sensitivity-noise  
  figure, 27  
Receiving tubes, European, 215  
Rectangular polar conversion, 242-  
  243  
Rectangular wave, 260  
Rectified sine wave, 260  
Rectifier, 162-165  
Rectifier diode symbols, 166-167  
Redundancy, 225

Reflected power, transmission line, 47  
Reflection coefficient, slotted line, 44  
Regulation, power supply, 156  
REI nomogram, 101  
Relative humidity, 355-357  
Relay contact code, 393  
Reliability, 222-224  
Reluctivity, 374  
Remote control frequencies, 12  
Repetition rate, 29  
Resistance, 350, 374  
  units, 285  
Resistance bridge, 158  
Resistance-capacitance coupling,  
  105  
Resistive attenuators, 72-74  
Resistivity, 350, 374  
Resistor capacitor transistor logic, 190  
Resistor-coupled transistor logic, 190  
Resistor frequency characteristic, 100  
Resistor values, preferred, 79  
Resistors, color code, 321  
Resistors, effective resistance of, 159  
Resolution, human eye, 308  
Resonance bridge, 158  
Resonant frequency, capacitors, 93  
Restricted radio telephone permit,  
  63-64  
Reverberation, 317  
RF band, 23  
RF penetration, 98  
RG cable, 40-41  
Rhombic antenna, 33  
Risetime, 148, 255  
  cascaded amplifier, 208-209  
Roman numerals, 257  
RST code, 60  
RTL, 190

## S

Sample and hold circuit, 184  
Satellite antenna, 36  
Sawtooth wave, 260-261  
SBS, 164-165  
Scaling, 182  
Schmitt trigger, 186  
SCR, 164-165  
SCS, 164-165  
Second class radio telephone license,  
  63-64  
Second-order high-pass active filter,  
  186  
Second-order low-pass active filter,  
  186  
Second-order transfer function am-  
  plifier, 186  
Self-resonant frequency, capacitors,  
  93  
Semiconductor devices, color code,  
  322-323  
Semiconductor memories, 217

Semiconductor numbering system,  
  European, 189  
Semiconductor symbols, 166  
Semicubical parabola, 244  
Sensing Technologies, solid-state,  
  216  
Series circuit, 99  
Shaft angle, 227  
Shering bridge, 158  
SHF, 4-5  
  propagation, 20  
Shielded pair transmission line, 38  
Ship and shore station frequencies, 10  
Ship station frequencies, 10  
Shock, 318, 383  
Shorting stubs, 42  
Signal Analysis Center, 117  
Signal delay, coaxial cable, 150  
Signal diode symbols, 166  
Signal level, additions, 52  
Signal level, in phase, 52  
Signal power/noise power separation  
  nomogram, 53  
Signal reporting codes, 60-62  
Signal strength nomogram, 25  
Signs, mathematical, 239  
Silicon bilateral switch, 164-165  
Silicon controlled rectifier, 164-165  
Silicon controlled switch, 164-165  
Silicon unilateral switch, 164-165  
Silicones, 350  
Sine wave, 260  
Single-layer coil design, 83, 84  
SINPFEMO code, 61  
SINPO code, 61  
Skin resistance, 98  
SLF, 4  
Slotted line  
  minimum attenuation, 44-45  
  nomogram, 44  
  reflection coefficient, 44  
  width of minimum attenuation, 45  
  VSWR, 44  
Solder, 387  
Solids, 246, 386, 392  
Sonics, 4  
Sound  
  intensity, 314-315  
  intensity level, 314-315  
  modulation, 23  
  pressure, 314-315  
  velocity of, 392  
Space and time, 268-269  
Spark-gap breakdown, 366  
Speaker crossover network, 116  
Speaker line length, 365  
Spectral sensitivity  
  human eye, 326  
  photoreceptors, 326  
Spectrum, electromagnetic, 4  
Speech recognition, 218  
Speed, 376

Sphere, 247  
Square wave, 106, 260-261  
  multivibrator, 186  
Squares, 236  
Standard frequency broadcast, 14-16  
  schedule, 14-16  
Standard time broadcast schedule,  
  14-16  
Stereo pickup leads, color code, 322,  
  323  
Subtraction circuit, 182  
Summing amplifier, 182  
Surface charge density, 374  
Surface current density, 374  
SUS, 164, 165  
Switches, 373  
Symbols, mathematical, 239  
Symmetrical multivibrator, 180-181  
System MTBF, 222

## T

T-equivalent circuit, 177, 179  
T parameter, 176-177  
T-type attenuators, 72-74  
Target tracking frequencies, 11  
Technician license, 62  
Teflon insulation, 361  
Telecommunication, 275-277  
Television frequencies, 5, 6-8  
Television standards, international, 22  
Temperature, color scale, 359  
Temperature conversion, 253-254,  
  339  
Temperature-humidity index, 358  
Ten code, 59  
Tera, 233  
Terminal marking, foreign equipment,  
  375  
Thermal noise voltage, 80-82  
Thermal resistance chart, 402  
Thermoplastics, 347-348  
Thermosetting plastics, 349-350  
THI, 358  
Third class radio telegraph permit, 63,  
  64  
Third class radio telephone permit,  
  63,64  
Three-leaved roses, 245  
Threshold of audibility, 316  
Thunderstorm activity, 341  
Thyrector, 162, 163  
Time, 268-269, 286  
Time constant, 108-109  
  R-C, 108-109  
Time delay, 257  
Time map, international, 336  
Time signal, 14-16  
Torque, 376  
Torus, 247  
Tracking frequencies, 11  
Trailing edge, 255  
Transformer, 88-89

color code, 320-321  
  impedance, 86  
  nomogram, 86-87  
  turns ratio, 88-89  
Transistor amplifier, 206-207  
Transistor circuit  
  available power gain, 177  
  current gain, 177  
  input impedance, 177, 179  
  insertion power gain, 177  
  operating power gain, 177  
  output impedance, 177, 179  
  power gain, 177  
  power requirements for switching  
  power supplies, 152  
  voltage gain, 177  
Transistor symbols, 167-170  
Transistor-transistor logic, 190  
Transmission line, 38  
  attenuation, 40, 41  
  characteristics, 38  
  electrical degrees, 43  
  electrical length, 43  
Transmission loss, 26  
Transmission output/receiver input,  
  26  
Transmission path, 373  
Transmission travel time, 65  
Travel time-transmission, 65  
Traveling wave tube, wired leads,  
  320-321  
Triac, 164-165  
Triangles, 249  
Triangular wave, 260-261  
Triboelectric series, 345  
Trigonometric functions, 251  
Tripler, voltage, 151  
TTL, 190  
Tuned circuit, 110  
  bandwidth, 110, 114-115  
Tungsten lamp, 305  
Tunnel diode, 162-163, 170  
Turns ratio, 88-89  
Turnstile antenna, 33  
Twin-T filter, 75-77  
Two-wire line, 38, 39  
TWT wired leads, 320  
Types of radar indicators, 30-31

## U

U type attenuator, 72-74  
UHF, 4  
  half-wave shorting stub, 42  
  propagation, 20  
  shorting stub, 42  
  television frequencies, 5  
UJT, 164-165  
ULF, 4  
Ultrasonic, 4  
Unijunction transistor, 164-165  
Unity follower circuit, 184

U.S. standard atmosphere properties,  
  337-339

## V

Vacuum fluorescent display, 191  
Vacuum tube amplifier, 206-207  
Velocity of propagation, 40, 41  
Venus, 65  
Vertical full-wave loop antenna, 33  
VHF, 4-5  
  propagation, 20  
  television frequencies, 5  
Vibration, 385  
Video band, 23  
Vinyls, 348  
Visual polarity, 23  
VLF, 4-5  
  propagation, 20  
Voice family tree, electronic, 218  
Voltage comparator circuit, 184-185  
Voltage divider  
  capacitive, 102-103  
  resistive, 102-103  
  resistive-capacitive, 104  
Voltage doubler, 151  
Voltage drop nomogram, 363  
Voltage follower with gain, 183-185  
Voltage guide, foreign, 396  
Voltage multiplication, 182  
Voltage multiplier, 151  
Voltage quadrupler, 151  
Voltage source, 183-185  
Voltage tripler, 151  
Volume charge density, 374  
Volume current density, 374  
VSWR, 37, 47  
  reduction, attenuation, 48  
  slotted line, 44

## W

Watt, 310  
Waveforms, 260  
Waveguide, 46  
  cutoff, 46  
  free space wavelength, 46  
  wavelength, 46  
Wavelength bands, 5  
Wavelength-frequency conversion, 17  
Waxed cotton insulation, 361  
Weight, 286  
Wet bulb thermometer, 355-357  
Wheatstone bridge, 158  
Width of minimum, 44, 45  
Wien bridge, 111, 158  
Wien bridge oscillator, 186  
Wind designations, 341  
Wind map, 343  
Windchill chart, 342  
Wire fusing, 364  
Wire inductance at high frequencies,  
  85

Wire insulation, 361  
Wire tables, 360  
Wires, fusing current, 364  
Wiring ampacities, 364  
Wiring boards, 388  
Witch of Agnesi, 245  
Work, 374

WWV, 11  
WWVB, 14-16  
WWVH, 11  
WWVL, 14-16

**X**

X-ray waves, 4

**Y**

Y-parameter equivalent, 178, 179  
circuit, 175, 178

**Z**

Z parameter, 178  
Zener diode, 162, 163







## Electronic Databook—3rd Edition

by Rudolf F. Graf



Any electronic job will be easier *and* less time consuming when you have instant access to exactly the nomogram, table, chart, or formula you need, *when you need it!* All this and *much more* is included in this completely revised and updated version of one of the most respected information sources in the electronics field!

Here's a *single data source* that provides a rich fund of reliable, easy-to-use facts . . . data needed by hobbyists and experimenters as well as vital information for professionals, including data never before published in handbook form. Generously illustrated and thoroughly indexed, this handbook is divided into six convenient sections: Frequency Data; Communication; Passive Components; Active Components; Mathematical Data, Formulas, and Symbols; and Physical Data.

If you're involved in *any* area of electronics—from novice experimenter to graduate engineer—you'll find this an indispensable information source!

Rudolf Graf has been an electronics professional for more than 30 years and is a graduate in communications engineering from Polytechnic Institute of Brooklyn. A senior member of IEEE, he has written numerous books and articles on electronics, mechanics, and automotive engineering topics.

**TAB TAB BOOKS Inc.**

Blue Ridge Summit, Pa. 17214

FPT > \$17.50

ISBN 0-8306-1538-5

PRICES HIGHER IN CANADA

1695-0583













