

TROUBLESHOOTING with the OSCILLOSCOPE

By
Robert G. Middleton

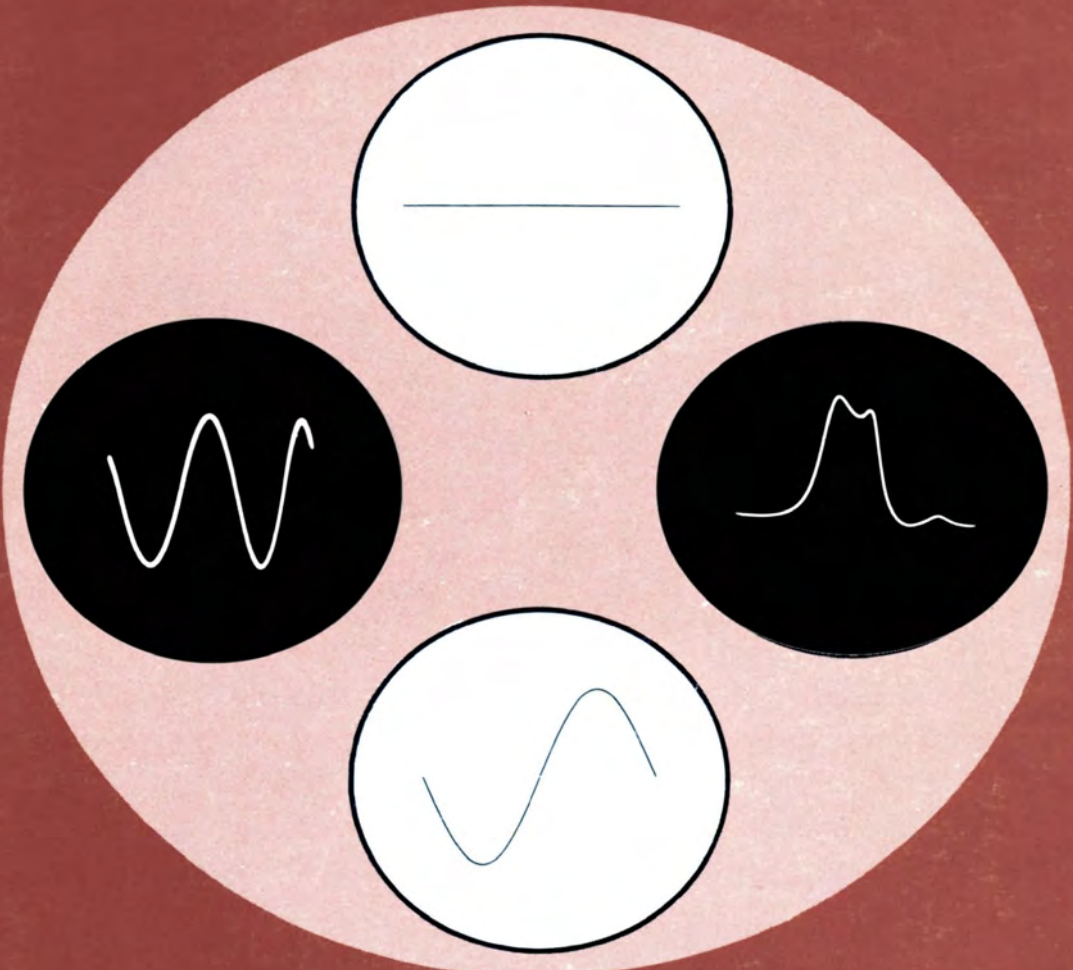

TROUBLESHOOTING
with the
OSCILLOSCOPE

by **ROBERT G. MIDDLETON**

Howard W. Sams & Co., Inc.
4300 WEST 62ND ST. INDIANAPOLIS, INDIANA 46268 USA

**Copyright ©1962, 1967, 1967, and 1975 by
Howard W. Sams & Co., Inc.,
Indianapolis Indiana 46268**

**THIRD EDITION
FOURTH PRINTING—1979**

**All rights reserved. Reproduction or use, without
express permission, of editorial or pictorial content,
in any manner, is prohibited. No patent liability is
assumed with respect to the use of the information
contained herein. While every precaution has been
taken in the preparation of this book, the publisher
assumes no responsibility for errors or omissions.
Neither in any liability assumed for damages resulting
from the use of the information contained herein.**

**International Standard Book Number : 0-672-21103-3
Library of Congress Catalog Card Number : 74-15456**

Printed in the United States of America

Preface

Troubleshooting with an oscilloscope is widely accepted today as the most reliable method for analyzing modern electronic circuitry. Service technicians who fully understand the workings of a scope rate it among their most valuable instruments. The purpose of this book is to help you obtain the maximum benefits from a scope, even if you have never used the instrument before. The book was planned and written with a full appreciation of the type of practical instruction technicians need.

To begin with, you will learn the fundamentals of waveform analysis as well as the purpose and function of every operating control, regardless of whether your oscilloscope is simple or elaborate. Later on, the selection and use of different types of probes are explained. This consideration is very important in obtaining proper waveform displays.

The major portion of the book concentrates on troubleshooting television and radio receiver circuits. Audio amplifiers have also been included. You will learn how to use a scope for localizing troubles to specific circuits and, in some cases, to the defective component itself.

Since the first edition of this book was published, television and radio servicing has become more sophisticated. For example, fm stereo multiplex reception has become very popular, and receiver sales are high. Accordingly, the essentials of multiplex testing have been included in this new edition. Many circuits are now being designed around transistors instead of tubes; consequently, the book now has a basic coverage of solid-state devices. Owners of many television service shops have added triggered-sweep scopes to their complement

of test equipment. Inasmuch as these scopes are somewhat more difficult to operate than standard scopes are, a basic discussion of them has been included.

Electronics technology is becoming increasingly more advanced. We must keep up with these advances if we are to remain competitive. Unless the full capabilities of oscilloscope use are clearly understood, it will become extremely more difficult in the future for you to properly service modern circuitry.

In preparing this edition of *Troubleshooting With the Oscilloscope*, I have recognized the current need, and have made a dedicated effort to meet it. In order for you to obtain maximum value from the contents, I strongly suggest that you actually work with your equipment as the various procedures are described. This “reinforced learning,” gained at the workbench, will prove to be much more valuable to you than the knowledge you can acquire from just reading the book.

ROBERT G. MIDDLETON

Contents

CHAPTER 1

INTRODUCTION	7
------------------------	---

CHAPTER 2

HOW TO OPERATE AN OSCILLOSCOPE	19
--	----

Intensity-Control Adjustment—Centering-Control Adjustment—Focus-Control Adjustment—Application of a 60-Hertz AC Test Voltage—Pattern Size versus Intensity-Control Setting—Gain Controls—Frequency Control—Retrace Blanking—Horizontal Nonlinearity—Calibration and Peak-To-Peak Voltage Measurements—Complex Waveforms—Step Attenuators—DC versus Peak-To-Peak Volts—Sync Function—Action of Triggered-Sweep Controls—Lissajous Patterns—Display of Narrow Pulses—Display of Square Waves—Fluctuating Line Voltage

CHAPTER 3

USING OSCILLOSCOPE PROBE	57
------------------------------------	----

Low-Capacitance Probe—Demodulator Probes—Resistive Isolating Probe—High-Voltage Capacitance-Divider Probe—Stray Fields—Inconsistent Low-C Probe Response—Ground Lead of Scope Probe

CHAPTER 4

SIGNAL TRACING IN RF, I-F, AND VIDEO AMPLIFIERS	75
---	----

Troubleshooting RF Amplifier—Signal Tracing in the I-F Section—Signal Tracing in the Video Amplifier

CHAPTER 5

SIGNAL TRACING IN THE SYNC SECTION	97
--	----

The BU8 Circuit—Readjustment of Vertical-Centering Control—Sweep Frequency for Waveforms with Alternate Symmetry—Sync Separator with Phase-Inverter Stage—Transistorized Sync Amplifier and AFC-Circuitry Variations

CHAPTER 6

TROUBLESHOOTING THE AFC AND HORIZONTAL OSCILLATOR SECTION	109
Oscillator or Afc Trouble?—Signal-Tracing the Horizontal-Oscillator Section—Synchroguide Ringing-Coil Check—Ringing-Coil and Multivibrator Configuration—Circuit Variations	

CHAPTER 7

WAVEFORM TESTS IN THE HORIZONTAL-SWEEP SECTION . . .	121
Sweep-Circuit Troubleshooting—Low Drive—Narrow Picture—High-Voltage Power Supply—Boost-Voltage Filtering—Keystoning—Solid-State Horizontal-Output System	

CHAPTER 8

TROUBLESHOOTING THE VERTICAL-SWEEP SECTION	133
Vertical Synchronization—Coupling-Capacitor Checks—Feedback Waveforms—Vertical- Output Transformer—Cathode Circuit—Vertical-Blanking Network—Solid-State Vertical Sweep System	

CHAPTER 9

SIGNAL-TRACING THE SOUND I-F AND AUDIO SECTION	145
Test Signal for the Intercarrier Section—Minimizing Circuit Loading—Limiter Characteristics	

CHAPTER 10

TROUBLESHOOTING POWER SUPPLIES	153
Stacked B+ Configuration—Input Waveform to Filter—Incidental Bypassing Function—Current Waveforms—"Above-Ground" Test Methods	

CHAPTER 11

RADIO-RECEIVER TROUBLESHOOTING	161
Scope Requirements—Gain Measurements—Type of Test Signal—Oscillator Defects—I-F Stage Troubles—Audio Stage Tests—Hum Tracing—FM Stereo Multiplex Tests and Troubleshooting	

CHAPTER 12

TESTING AUDIO AMPLIFIERS	177
Linearity Checks—Phase Shift—Linear Time-Base Displays—Square-Wave Tests—Overshoot—Square-Wave Test of Stereo-Multiplex Adapter	

INDEX	187
------------------------	------------

Introduction

All servicing with the oscilloscope is based on waveform analysis and interpretation. Therefore, an introductory explanation of waveforms is required. The most basic waveform is the sine wave, illustrated in Fig. 1-1A. We describe a sine wave in terms of degrees and volts. Its peak voltage is measured from the reference (zero) line to the 90° point on either the positive or the negative half-cycle. Peak-to-peak voltage is measured from the 90° limit to the 270° limit. Its rms voltage is 0.707 of peak voltage. We also describe a sine wave in terms of time. Thus, if 360° are completed in one microsecond, the wave is said to have a frequency of one million hertz,* or one megahertz (1 MHz). The basic distinction between amplitude and frequency is shown in Fig. 1-1B.

However, sine waves as such are in the minority in the vast array of waveforms encountered at the service bench. For example, we will observe pulse and sawtooth waveforms frequently, as illustrated in Fig. 1-2. Horizontal sync pulses and sweep-deflection waveforms are prime examples. Nevertheless, the sine wave remains the basic element in a complex waveform. For many practical situations, we regard a square wave as being built up from sine waves, as illustrated in Fig. 1-3. Similarly, we may consider that a sawtooth wave is built up from sine waves, as shown in Fig. 1-4. A positive pulse followed by a negative pulse is built up as seen in Fig. 1-5.

More sophisticated analyses of square waves and pulses require the measurement of rise time. This measurement is made with a triggered-

*hertz (Hz)=cycles per second

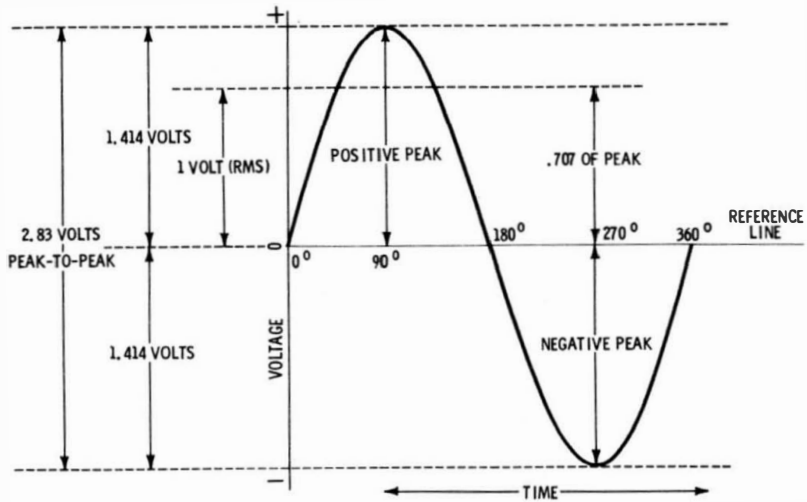

(A) The fundamental sine wave.

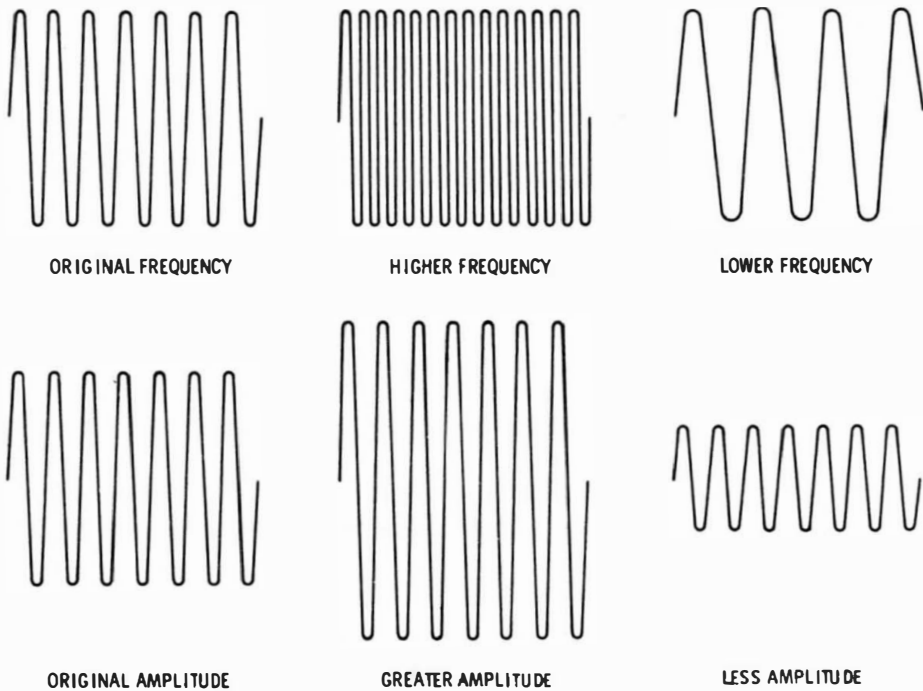

(B) Distinction between amplitude and frequency.

Fig. 1-1. Basic waveforms.

sweep scope that has a calibrated time base. Fig. 1-6 illustrates how a pulse is expanded by speeding up the sweep until the rise time of the waveform is easily measurable on the scope screen. When we state



Fig. 1-2. Typical pulse and sawtooth waveforms.

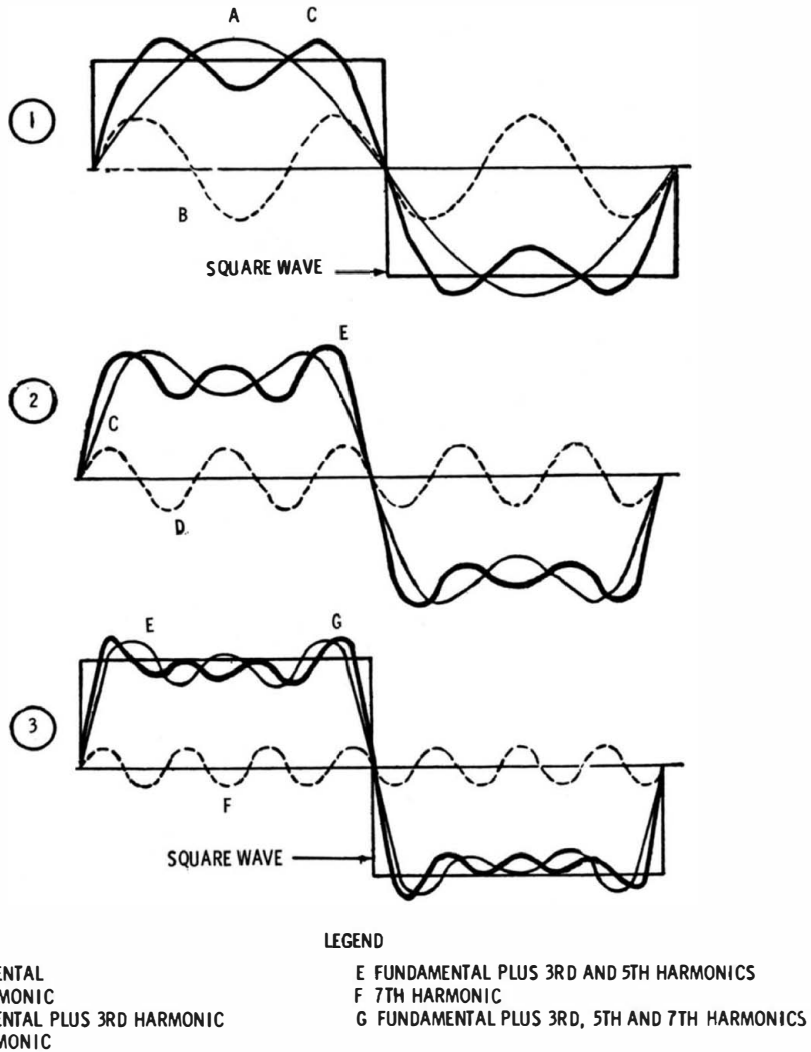

Fig. 1-3. Build-up of a square wave from sine waves.

that we are observing a 20-microsecond pulse, we refer to the *pulse width*. In other words, the pulse has a duration of 20 microseconds. This is evident from the first photo in Fig. 1-6; the sweep speed is 0.02 milliseconds (20 microseconds) per centimeter, and the pulse duration extends over one centimeter, or one major division on the scope screen.

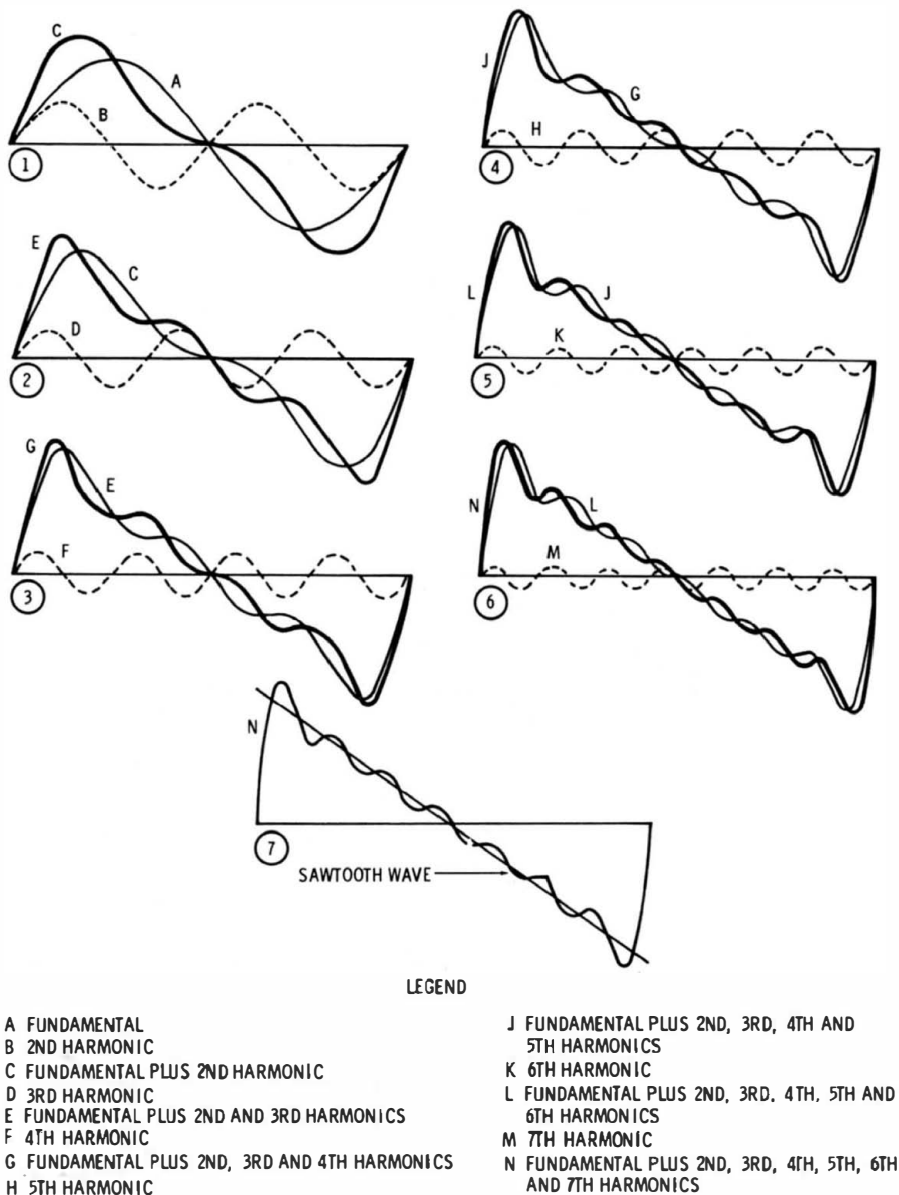

Fig. 1-4. Build-up of a sawtooth wave from sine waves.

Apprentice technicians are sometimes puzzled by the fact that the leading edge of a square wave may be invisible if the rise time is comparatively fast. This is a result of the swift travel of the electron beam during the rise interval. Next, if the sweep speed is increased, the leading edge becomes more clearly visible because the intensity control can then be advanced considerably without burning the screen. For example, observe the difference in leading-edge displays

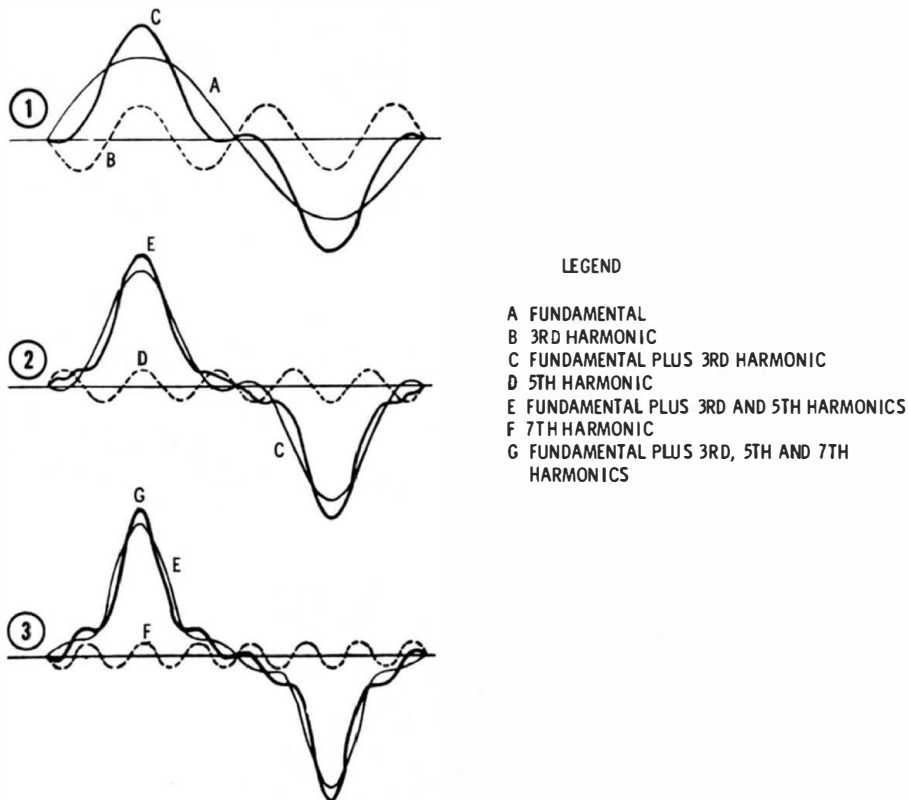

Fig. 1-5. Build-up of a positive pulse followed by a negative pulse.

in Fig. 1-6, from sweep speeds of 0.02 ms/cm to 0.04 μ s/cm.

Rise time is defined as the elapsed time from the 10-percent to the 90-percent amplitude points on the leading edge of the pulse, as shown in Fig. 1-7. This measurement is also made on waveforms other than square waves and pulses. When a square wave is passed through an RC differentiating circuit, it is changed into positive and negative exponential pulses. Fig. 1-8 shows a universal RC time-constant chart that details the output waveforms for both differentiating and integrating circuits. The RC time constant is equal to ohms multiplied by farads, and the product is in seconds. Note in Fig. 1-8 that the output from an integrating circuit rises from 10 percent to 90 percent of maximum amplitude in approximately two time constants. Similarly, the output from a differentiating circuit falls from 90 percent to 10 percent of maximum amplitude in approximately two time constants. Both waveforms pass through their 50 percent of maximum amplitude points at the end of 0.707 time constant. At the end of five time constants, both waveforms have attained practically their steady-state, or resting, values.

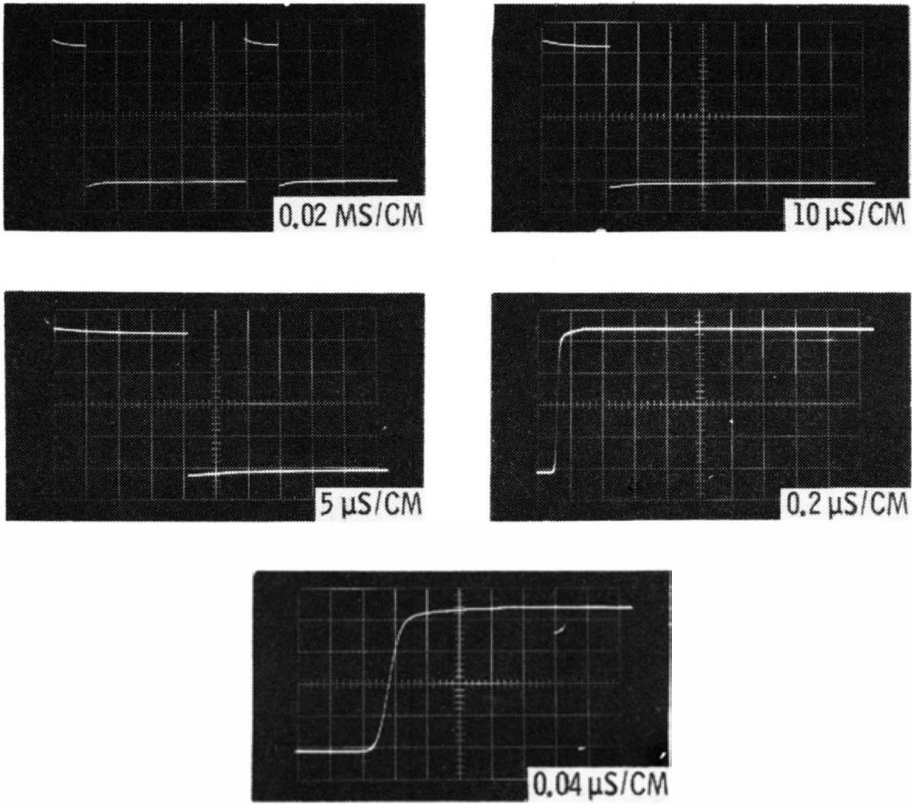
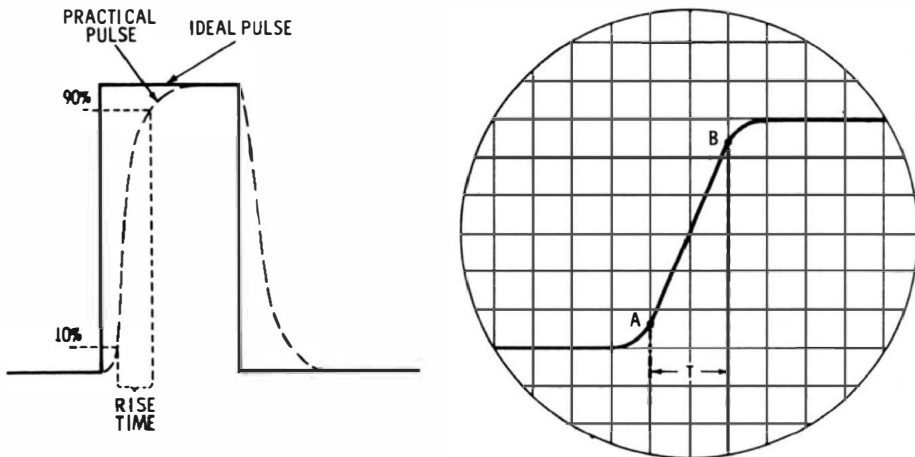

Fig. 1-6. Expansion of a 20-microsecond pulse as the sweep speed is progressively increased.



(A) Rise time is measured from the 10 percent point to the 90 percent point on the leading edge of the pulse.

(B) A fast pulse must be expanded on the oscilloscope screen in order to measure rise time T .

Fig. 1-7. Graphical definition of the rise time of a pulse.

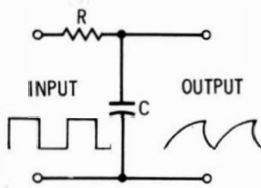
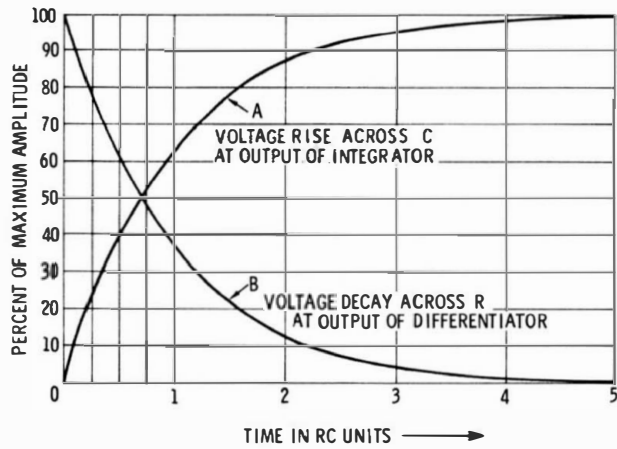

(A) Integrating circuit.

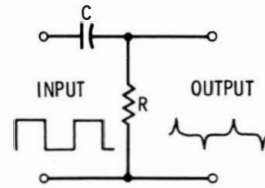

(B) Differentiating circuit.

Fig. 1-8. Universal RC time-constant chart showing the effects of integrating and differentiating circuits on a square-wave input.

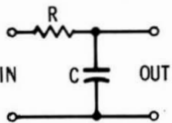
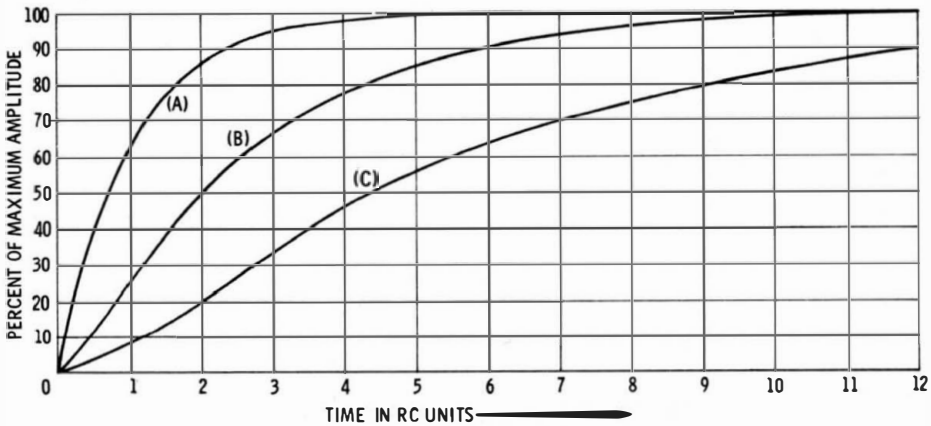

(A) One-section integrator.

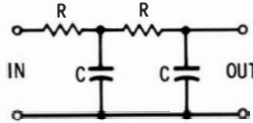

(B) Two-section integrator.

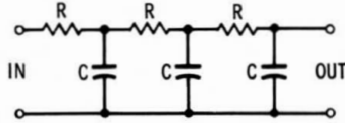

(C) Three-section integrator.

Fig. 1-9. Universal time-constant chart for one-section, two-section, and three-section integrator circuits.

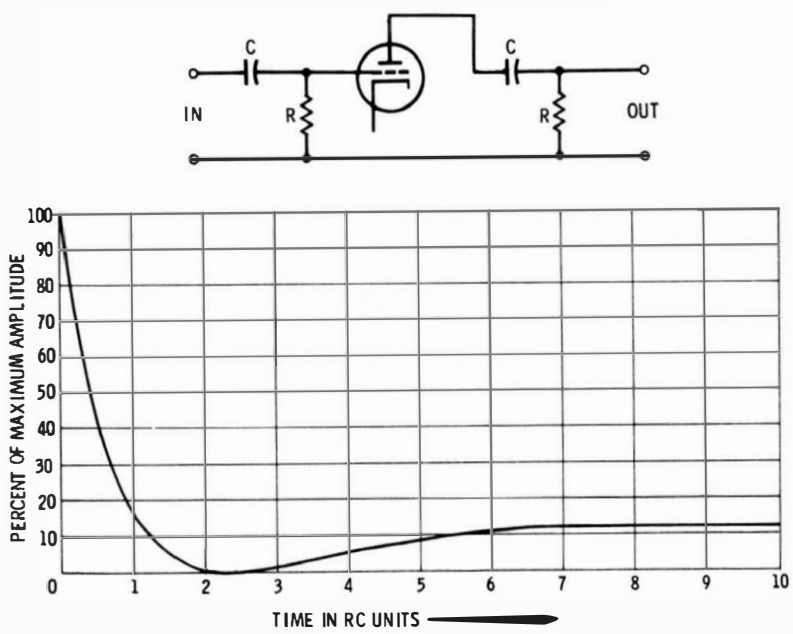
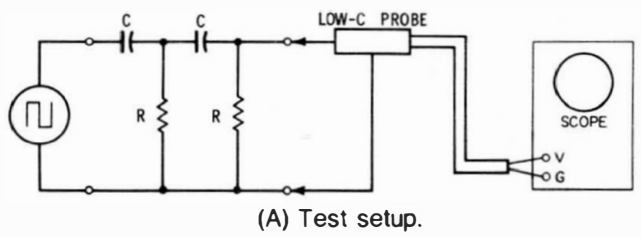
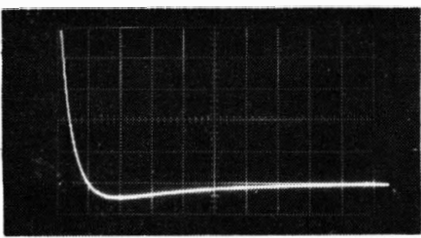

Fig. 1-10. Universal time constant chart for RC-coupled amplifier with two RC sections.

Of course, electronic circuitry generally employs more complex circuits than simple RC differentiators and integrators. For example, a two-section or three-section integrator might be “packaged” in an encapsulated unit. Fig. 1-9 shows a universal time-constant chart for such integrators. Observe that the rise time increases progressively as more RC sections are connected in cascade. Furthermore, the



(A) Test setup.



(B) Output waveform.

Fig. 1-11. Square wave response of a two-section symmetrical differentiating circuit.

waveform changes shape; the output waveform from two-section and three-section integrators is not a simple, but a complex, exponential waveform.

Another very practical example of RC sections in cascade is provided by an ordinary RC-coupled amplifier, as shown in Fig. 1-10. This is a universal RC time-constant chart for the low-frequency square-wave response of the illustrated circuit. Note that the tube provides isolation between the two RC sections; therefore, the second section does not load the first section. In turn, the output waveform is somewhat different from a situation in which the tube is not present. This fact is evident in Fig. 1-11.

The great utility of universal RC time-constant charts is that they show the normal shape of the waveform and its development in time, regardless of the time constant itself. In other words, the progressive amplitudes of the waveforms are related to time in RC units. However, there is a limitation in the Fig. 1-10 chart, and in the B and C waveforms shown in the Fig. 1-9 chart; in either case, the R and C values in the second section (or in the third section) are the same as in the first section. In other words, these are normal waveforms for symmetrical RC networks.

Suppose that a two-section RC integrator is unsymmetrical, as shown in Fig. 1-12. The RC values in the second section are doubled. Now, the output waveform rises more slowly than for a symmetrical

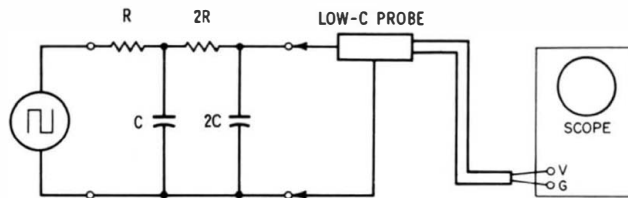

(A) Test setup.

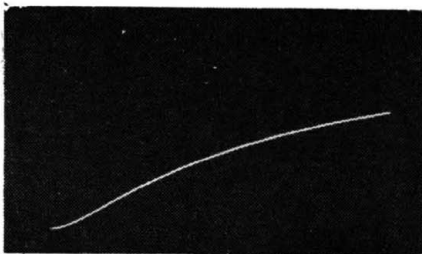

(B) Output waveform.

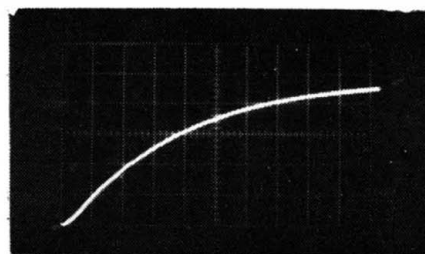

(C) Output waveform; sweep speed reduced one-half.

Fig. 1-12. Square-wave response of a 1-2 unsymmetrical two-section integrator.

network. In the first photo of Fig. 1-12, the sweep speed is one centimeter per RC unit; in the second photo, the sweep speed is one-half centimeter per RC unit. Note that the waveform in Fig. 1-12 rises to 50 percent of maximum amplitude in approximately five time constants. On the other hand, curve B in Fig. 1-9 rises to 50 percent of maximum amplitude in two time constants.

The network in Fig. 1-12 is called a 1-2 configuration because the RC values in the second section are twice as great as in the first section. Now, suppose we reverse the input and output terminals of the network; then we have the 2-1 configuration shown in Fig. 1-13. Note that reversal of this network does not change its square-wave

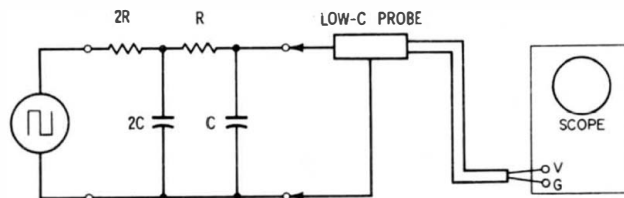

(A) Test setup.

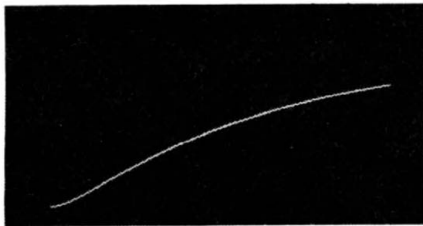

(B) Output waveform.

Fig. 1-13. Square wave response of a 2-1 unsymmetrical two-section integrator.

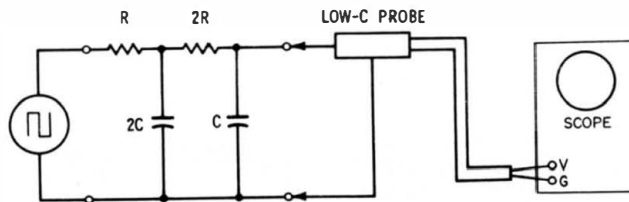

(A) Test setup.

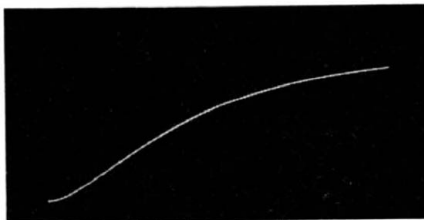

(B) Output waveform.

Fig. 1-14. Square wave response of a 1-2/2-1 unsymmetrical two-section integrator.

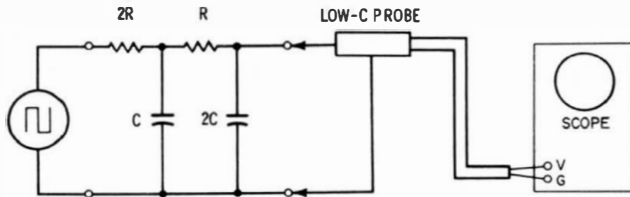

(A) Test setup.

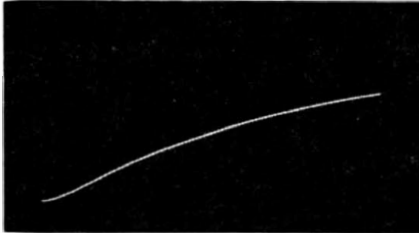

(B) Output waveform.

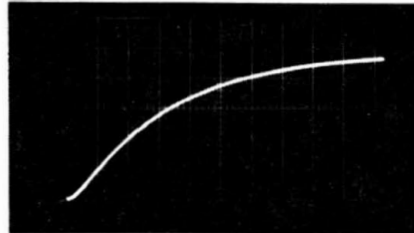

(C) Output waveform; sweep speed reduced one-half.

Fig. 1-15. Square wave response of a 2-1/1-2 unsymmetrical two-section integrator.

response—the output waveform is the same in both Figs. 1-12 and 1-13. It must not be supposed, however, that this fact is true of all RC networks—in general, the output waveform will be changed by reversing the input and output terminals.

Observe the network shown in Fig. 1-14; it may be called a 1-2/2-1 integrator. If its input and output terminals are reversed, we obtain

Fig. 1-16. Voltage components of a pulse waveform.

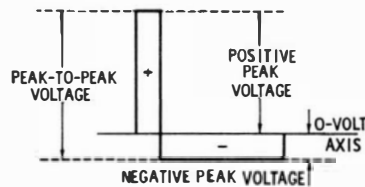

the 2-1/1-2 integrator shown in Fig. 1-15. The output waveform for the reversed network is quite different. Therefore, it cannot be generally assumed that a reversed RC network will develop the same output waveform.

To return briefly to the topic of waveform voltages, we must realize that the positive peak voltage of a complex waveform is usually different from its negative peak voltage. For example, Fig 1-16 shows the peak voltages for a pulse waveform. Although they are widely different, their sum is nevertheless equal to the peak-to-peak voltage of the pulse waveform.

All troubleshooting with the oscilloscope can be classified under one or more of the following basic tests:

1. *Signal Tracing.* This test consists of checking for the presence or absence of a signal voltage at successive points through a signal channel. An audio-frequency, radio-frequency, intermediate-frequency, or video-frequency signal may be involved.
2. *Waveform Checks.* This test comprises amplitude (peak-to-peak voltage) measurement and waveshape observation. These waveform characteristics, in turn, are compared with those specified in the receiver service data.
3. *Frequency Response.* A frequency-response test displays a curve or pattern on the oscilloscope screen which shows the relative output voltages at all frequencies within the passband of an rf i-f, or vf amplifier. This response curve, in turn, is compared with the curve specified in the receiver service data.
4. *Phase Checks.* A phase test displays a pattern on the scope screen which shows the phase difference between a given signal and a reference signal. Specialized test signals may be employed, particularly in color-tv test procedures, as specified in the receiver service data.
5. *Frequency Measurement.* Frequency tests are made to best advantage with a triggered-sweep scope that has a calibrated time base. For example, the accuracy of a square-wave generator or an audio oscillator can be easily checked in this manner.
6. *Time Measurement.* Time measurement must be made with a triggered-sweep scope that has a calibrated time base. For example, the width of pulses in solid-state horizontal-sweep circuits, or the periods of pulses in tv digital circuitry can be easily checked in this manner.

With this brief introduction to the subject of waveform analysis, we turn to the scope itself and consider the operation of controls in free-running and triggered-sweep scopes. Certain additional considerations of waveform principles will be noted incidentally in our discussion of troubleshooting techniques. If it is inconvenient for you to make frequent reference to charts and other basic data in this book, it may be advisable to have photostatic enlargements made that can be tacked on the wall over your service bench. This procedure can minimize the time required to analyze a basic waveform. Nonbasic waveforms must be checked by consulting the service data for the receiver under test.

How To Operate an Oscilloscope

Oscilloscopes are not difficult to operate, although they do have a large number of controls. Even the simplest scopes (Fig. 2-1A) have about a dozen knobs and switches. Note that oscilloscope controls are generally grouped as shown in Fig. 2-1B. Of course, even the names of the groups or control zones may be puzzling to the apprentice technician. However, if the action of each control or switch is taken step by step, the instrument soon loses its mystery. Most service scopes are ac operated and hence have a power cord which must be plugged into a 117-volt, 60-Hz outlet.

To turn the scope on, set the power switch to its “on” position. This switch may be an individual control, or it may be combined with an operating control—usually the intensity control. In this case, the control is turned from its “off” position to the right, just as a radio or television receiver is turned on. When power is applied to the scope circuits, a pilot lamp glows or, in some cases, an edge-lighted graticule is illuminated (Fig. 2-2).

INTENSITY-CONTROL ADJUSTMENT

After a brief warm-up period, a spot or line may appear on the screen. If not, turn up the intensity control. Do not advance it more than is necessary, however, because the screen of the cathode-ray tube can be burned, particularly if the electron beam is forming a small spot on the screen.

If a spot or a line does not appear when the intensity control is turned up, either the horizontal- or vertical-centering control may be

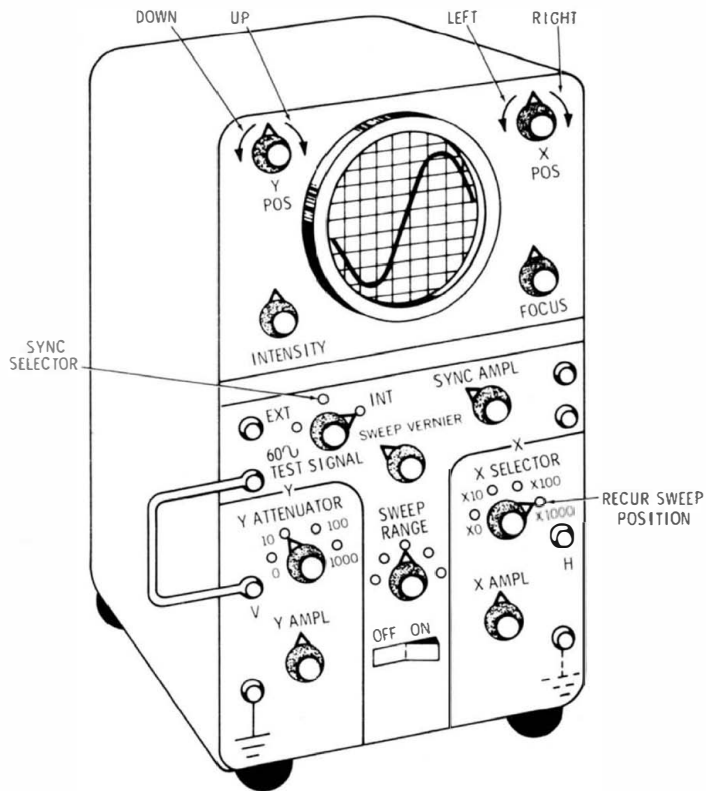

(A) Typical panel layout.

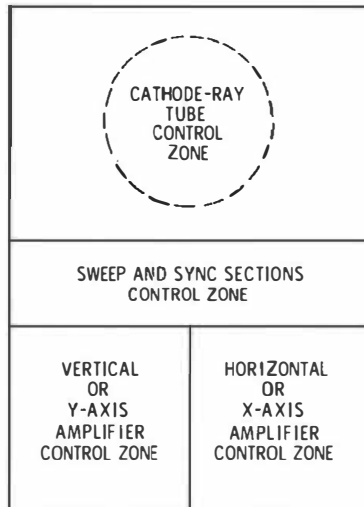

Courtesy Radio Shack

(B) Typical grouping of operating controls.

Fig. 2-1. A simple oscilloscope.

Fig. 2-2. Some scopes have illuminated graticules; most have simple pilot lamps.

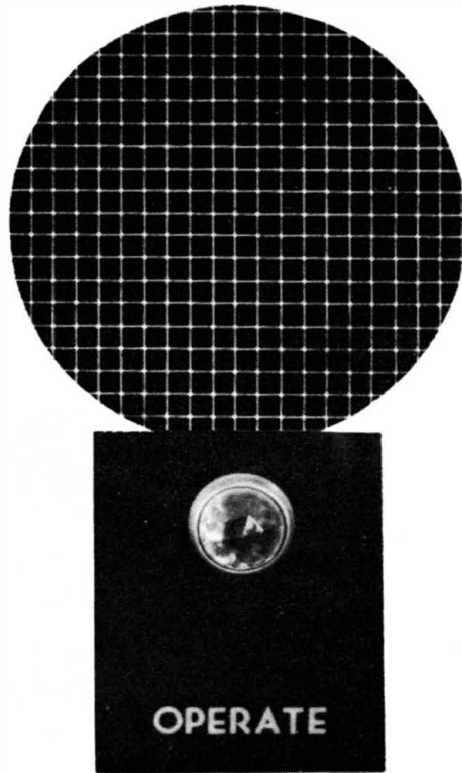

at the extreme end of its range. This can throw the spot or line off-screen. Therefore, begin the operating procedure by adjusting each centering control to its midrange.

CENTERING-CONTROL ADJUSTMENT

The action of the centering controls is seen in Fig. 2-3. The spot moves up and down as the vertical-centering control is rotated back and forth. Similarly, the spot moves left and right as the horizontal-centering control is rotated back and forth. In theory, any desired pattern could be traced out on the screen by turning the centering controls. This is a simple manual analogy to the pattern development which takes place automatically when the electronic circuits of a scope are energized.

In practice, of course, patterns are not traced out in this manner. The centering controls are set to position the beam on the screen, and are not readjusted unless particular test conditions make this desirable. Some types of patterns may not appear centered on the screen unless the centering controls are readjusted, for reasons that will be explained later.

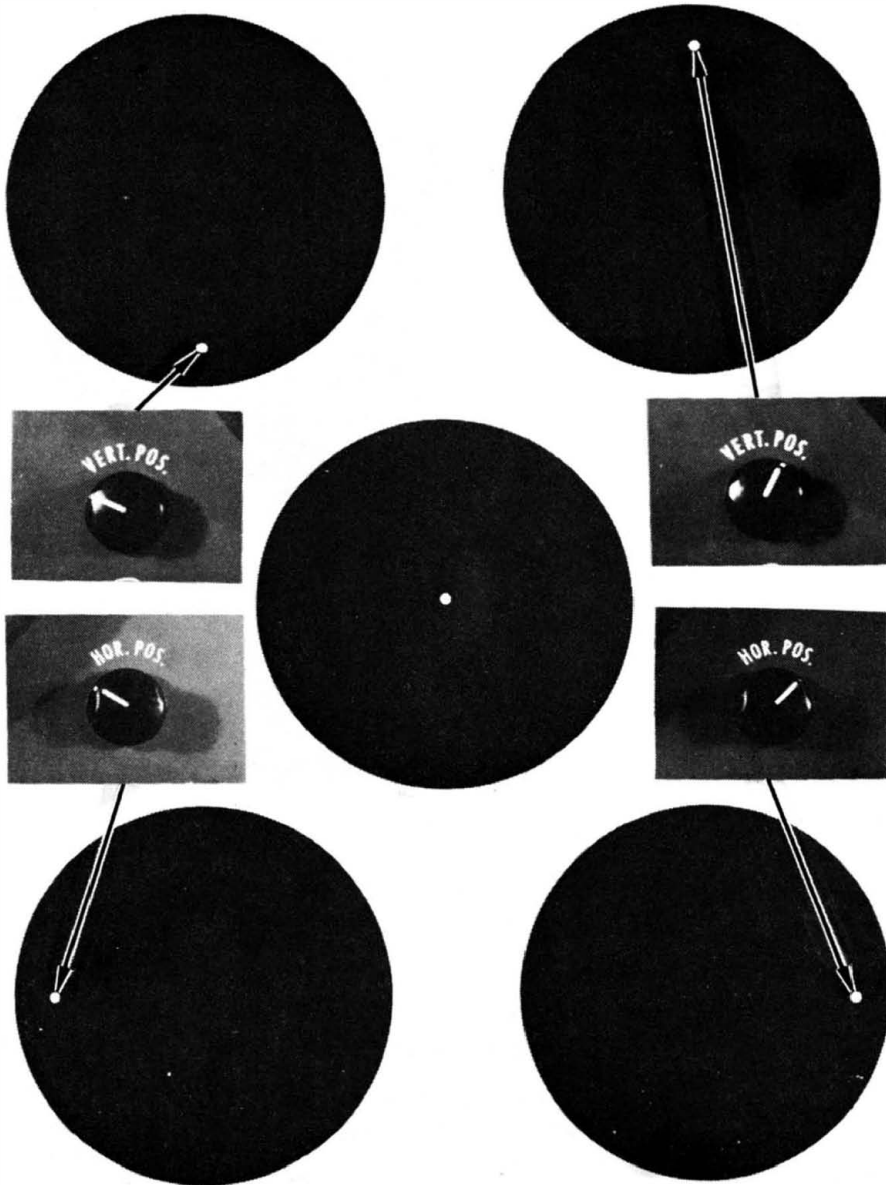

Fig. 2-3. Action of positioning (centering) controls.

FOCUS-CONTROL ADJUSTMENT

Fig. 2-4 shows how the appearance of a spot changes on the scope screen as the focus control is turned. The focus control is adjusted for the smallest spot possible. In most scopes, the intensity and focus controls interact. Therefore, the focus control may need to be readjusted if the intensity-control setting is changed.

With this brief general introduction, it is helpful to observe the control functions and terminal facilities for a high-performance service-type oscilloscope, such as the one illustrated in Fig. 2-5. Fourteen controls are provided, three of which are concentric. Each control is identified in Table 2-1, and its function is briefly explained. If you are unfamiliar with some of the technical terms, their meaning will become clear further along in this chapter.



Fig. 2-4. Action of focus control.



Courtesy RCA Corp.

Fig. 2-5. A high-performance service-type oscilloscope.

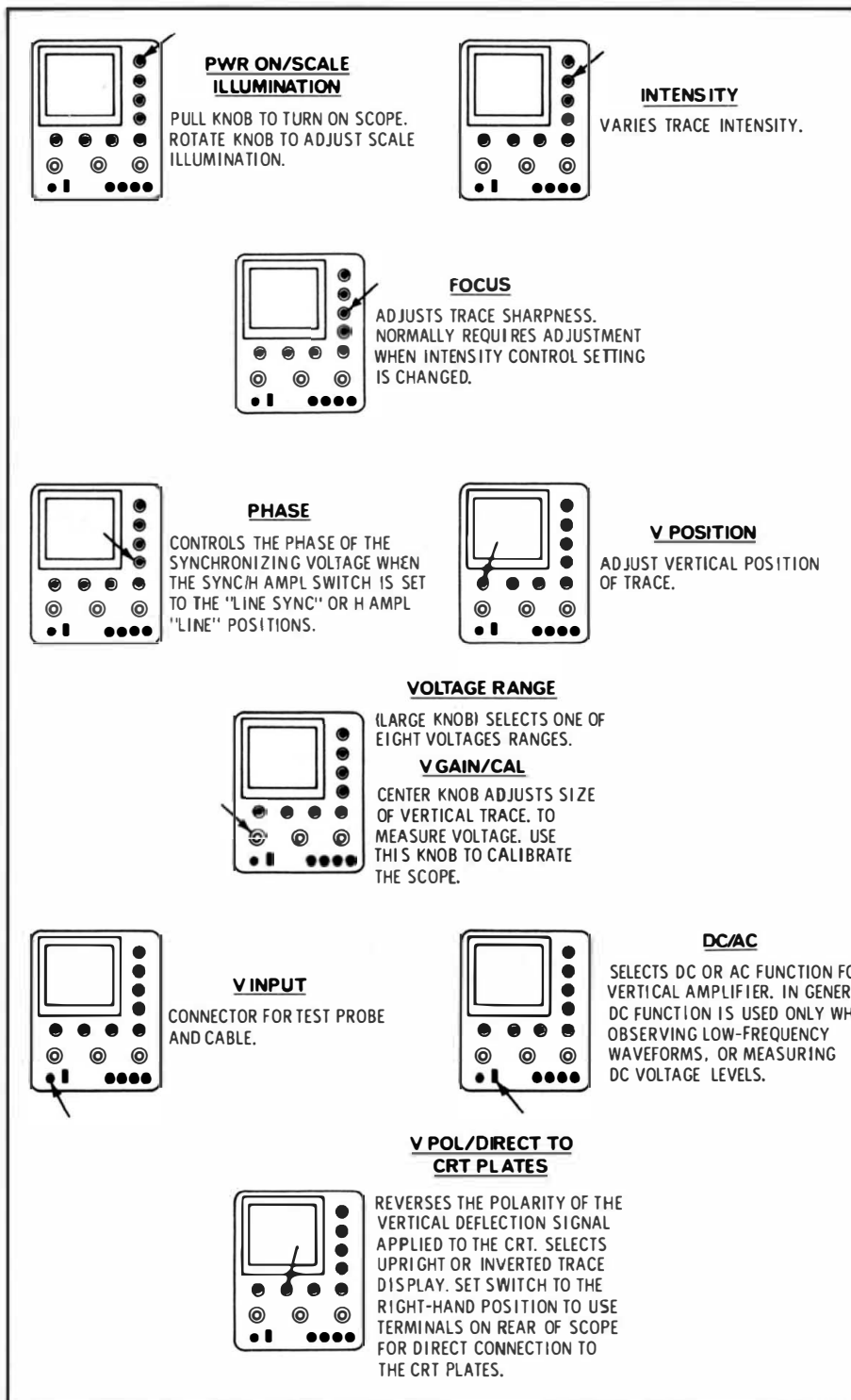
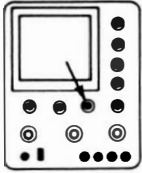
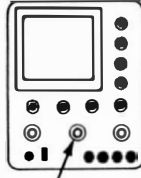

Table 2-1. Control Functions



H POSITION

ADJUSTS HORIZONTAL POSITION OF TRACE.



SYNC/H AMPL

(LARGE KNOB)
SYNC FUNCTION

EXT—CONNECTS SIGNAL APPLIED TO SYNC TERMINAL TO THE SWEEP OSCILLATOR.

LINE—APPLIES AN AC SIGNAL FROM THE POWER SUPPLY TO THE SWEEP OSCILLATOR. SYNCs OSCILLATOR AT THE POWER-LINE FREQUENCY.

INT "+" AND "-" — SELECTS PHASE OF THE INTERNAL SYNC SIGNAL.

H AMPL FUNCTION

LINE—APPLIES AN AC SIGNAL FROM THE POWER SUPPLY TO THE HORIZONTAL AMPLIFIER TO PROVIDE A SINUSOIDAL HORIZONTAL SWEEP AT THE POWER-LINE FREQUENCY.

EXT—CONNECTS EXTERNAL SIGNAL APPLIED AT H INPUT TERMINAL TO THE HORIZONTAL AMPLIFIER.

H GAIN

(CENTER KNOB)

ADJUSTS THE GAIN OF THE HORIZONTAL AMPLIFIER AND VARIES THE WIDTH OF THE HORIZONTAL TRACE.

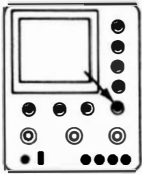

SYNC

CONTROLS THE AMPLITUDE OF THE SYNCHRONIZING VOLTAGE APPLIED TO THE SWEEP OSCILLATOR. ADJUST FULLY COUNTERCLOCKWISE THEN CLOCKWISE ONLY AS FAR AS NECESSARY TO LOCK PATTERN IN STATIONARY POSITION.

SWEEP RANGE

(LARGE KNOB)

VERNIER

(CENTER KNOB)

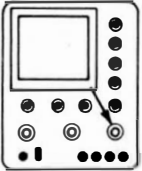

SWEEP RANGE—SELECTS THE FREQUENCY RANGE OF THE SWEEP OSCILLATOR. USE IN CONJUNCTION WITH THE INNER VERNIER KNOB. PROVIDES CONTINUOUS CONTROL OF THE OSCILLATOR SWEEP FREQUENCY. THE TV V AND H POSITIONS ARE PRESET AT 30 Hz AND 7875 Hz TO PROVIDE AUTOMATIC LOCK-IN OF VERTICAL AND HORIZONTAL SYNC PULSES.

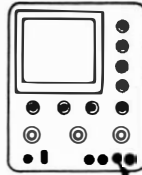

CAL TERMINAL

PROVIDES 5 V P-P 60 Hz SQUARE-WAVE SIGNAL FOR CALIBRATING VERTICAL AMPLIFIER.

H INPUT/SYNC TERMINAL

H INPUT—FOR CONNECTING EXTERNAL SIGNAL TO HORIZONTAL AMPLIFIER. SET SYNC/H AMPL SWITCH TO EXT "H AMPL". CONNECT GROUND OF EXTERNAL SIGNAL TO GND TERMINAL.

SYNC—FOR CONNECTION OF EXTERNAL SYNC SIGNAL. SET SYNC/H AMPL SWITCH TO SYNC "EXT". CONNECT GROUND OF EXTERNAL SIGNAL TO GND TERMINAL.

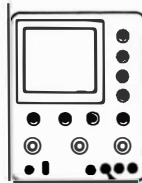
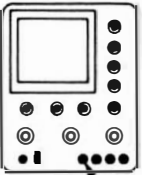

GND TERMINAL

CONNECTED TO OSCILLOSCOPE CASE AND CHASSIS.

and Terminal Facilities

Courtesy RCA Corp.

APPLICATION OF A 60-HERTZ AC TEST VOLTAGE

All scopes have some provision for the application of a vertical-input signal. If a 60-Hz test voltage is applied to the vertical-input terminals, a sine-wave pattern can be displayed on the scope screen (See Fig. 2-1A.) A suitable test voltage can be obtained by connecting the vertical-input terminals between the heater line and ground in a radio or tv receiver. Many scopes have a 60-Hz test-voltage terminal on the front panel, as in Fig. 2-1A. A lead can be connected from the vertical-input terminal to the test-voltage terminal.

A sine-wave pattern may or may not appear when the test voltage is applied. This depends on the setting of certain operating controls. For example, if the horizontal-deflection rate is incorrect, only a blur may be displayed, as in Fig. 2-6. Practically all scopes have a coarse and a fine (vernier) sawtooth frequency control. The coarse control is a rotary step switch; the vernier control is a potentiometer. The two are also called the sweep-range or horizontal control and the frequency-vernier control (Fig. 2-7).

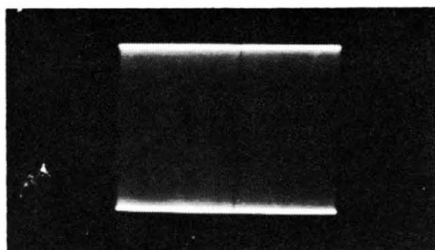

Fig. 2-6. Waveform appears as a blur on the screen when horizontal-sweep rate is too high.

Set the step control to a position which includes 60 Hz (in Fig. 2-7 this is the 10-100 position). Adjustment of the continuous control "fills in" the step and permits the sawtooth oscillator to operate at 60 Hz. Rotate the control to see whether a single-cycle display appears on the screen. Possibly no other adjustments will be required, and a pattern as detailed in Fig. 2-8 may appear. Note that the displayed cycle is not quite complete. A small portion is "lost" on retrace because the sawtooth deflection voltage does not drop to zero instantly during retrace time. The lost portion of the display is often seen as a visible retrace line in the pattern (Fig. 2-8).

At this point, the required adjustment of the vernier sawtooth control may be quite critical. Perhaps the single-cycle display can be stopped only for an instant. Then it "breaks sync," and a blurred pattern reappears. On the other hand, the pattern may lock tightly, but appear broken into fragments. The first difficulty is due to the sync control being set too low. The second difficulty is caused by the sync control being set too high (Fig. 2-9). In either case, the pattern

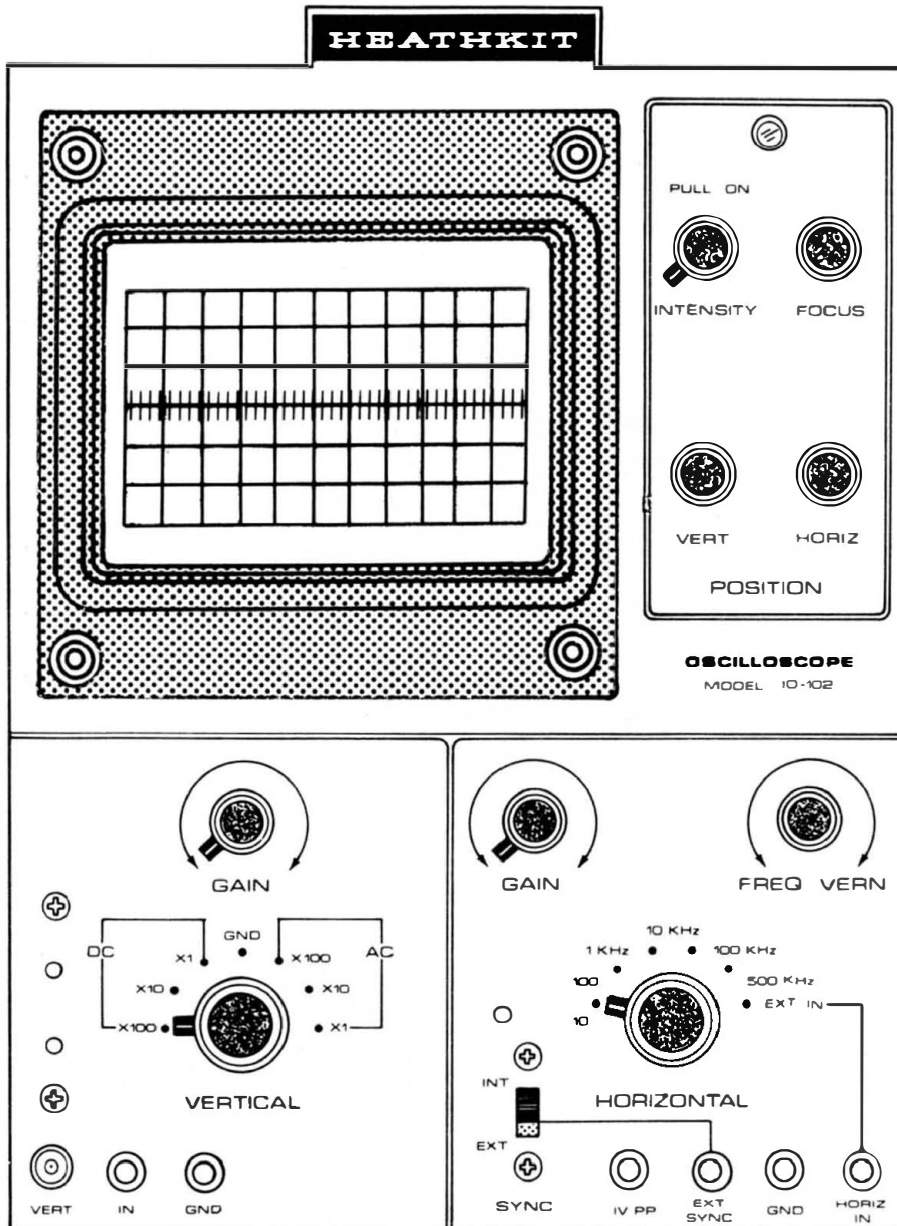

Fig. 2-7. Operating controls.

Courtesy Heath Co.

is locked improperly by the sync control. The proper method for adjusting the sync control is to advance the control sufficiently to lock the pattern, but not so far that operation of the sawtooth oscillator is disturbed. Note that scopes such as depicted in Fig. 2-7 provide automatic sync action.

A pattern like the one illustrated in Fig. 2-10 is sometimes confusing. Such a pattern is displayed when the sweep frequency is set to

twice the signal frequency. For example, if the signal frequency is 60 Hz, the pattern shown in Fig. 2-10 is obtained when the sweep frequency is set to 120 Hz. On the other hand, when the sweep frequency is set to one-half of the signal frequency, two cycles of the signal will be displayed, minus a small portion of the waveform that is lost on retrace. (See Fig. 2-11.)

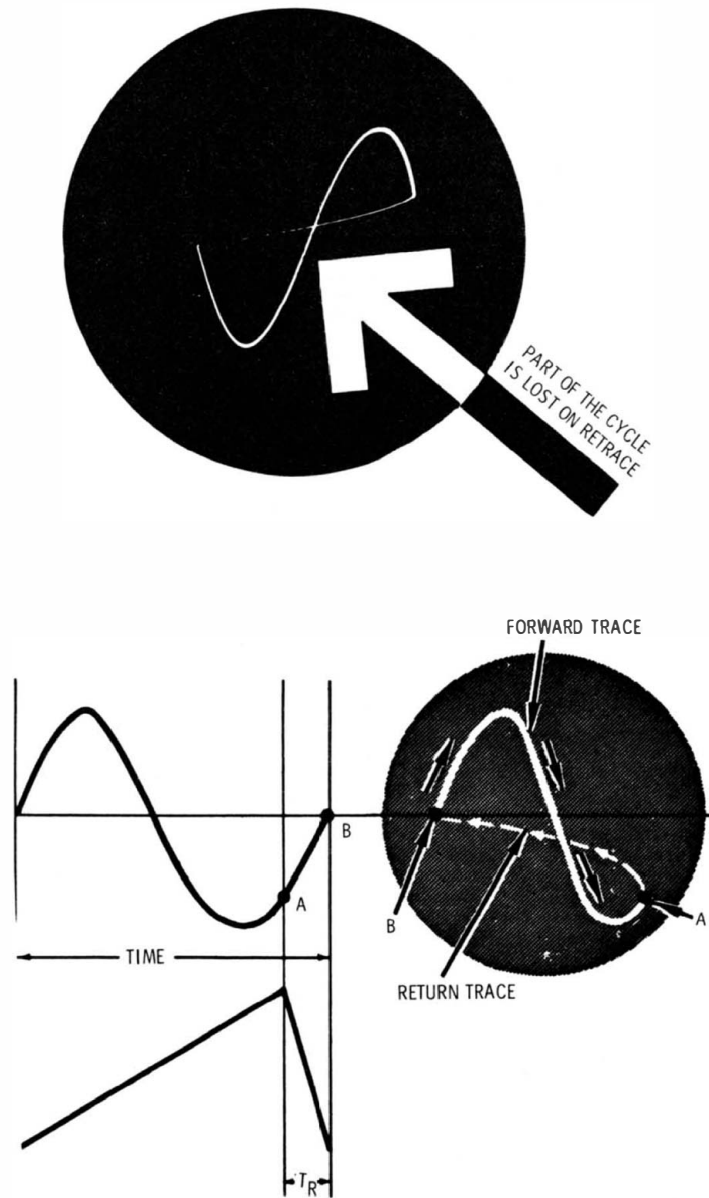

Fig. 2-8. Detail of a single-cycle display.

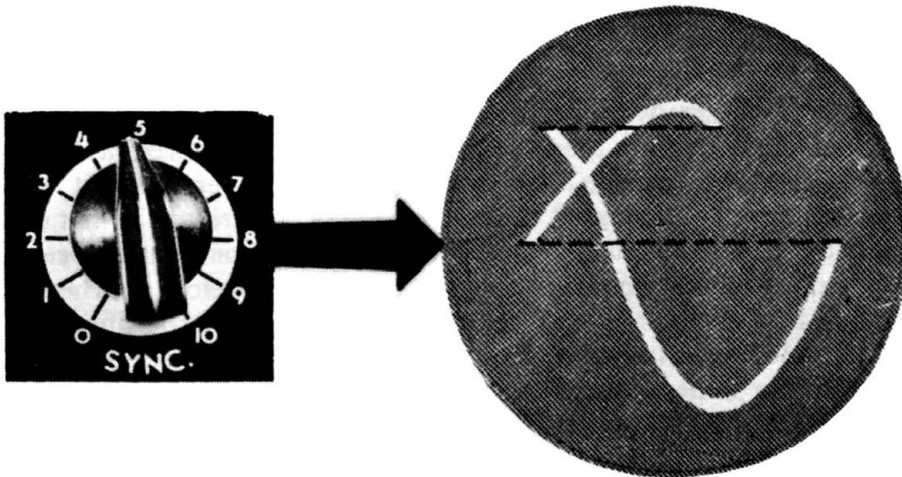

Fig. 2-9. Sync control is advanced too far.

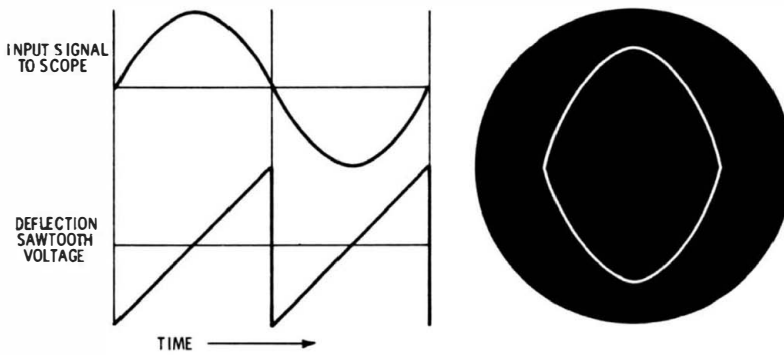

Fig. 2-10. Display of sine wave when the sweep frequency is double the signal frequency.

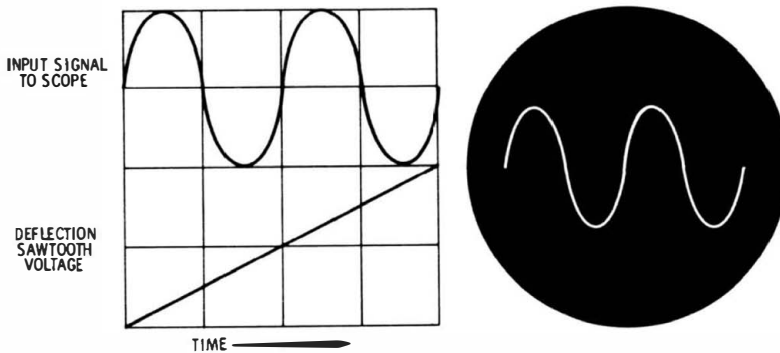

Fig. 2-11. Display of sine wave when the sweep frequency is one-half the signal frequency.

PATTERN SIZE VERSUS INTENSITY- CONTROL SETTING

Now that a sine-wave pattern is displayed on the screen, the trace appears much dimmer than the former small spot or horizontal line. If the sine-wave pattern fills most of the screen vertically, it will appear quite dim compared with a simple spot. The reason is that the electron beam has a much longer path to trace out; consequently, each point along the trace receives much less energy. Therefore, it is necessary to turn up the intensity control in order to make the sine-wave pattern more clearly visible. However, this usually changes the focus also, and in some scopes, the pattern tends to "bloom." This is the same reaction that occurs in many tv pictures when the brightness control is turned too high.

If the brightness of the pattern is not satisfactory, check the ambient light in the shop. High-level illumination from a window may be "washing out" the display. Move the scope, or place a light hood around the scope screen.

Some scopes have brighter patterns (in good focus) than other scopes do. Pattern brightness depends on the amount of voltage applied to the accelerating anode. For example, if the accelerating voltage is increased from 1 kV to 2 kV the available pattern brightness will be greatly increased. However, increasing the accelerating voltage also increases the energy content of the electron beam. Thus, more energy is required in the scope's vertical- and horizontal-deflection systems in order to move the beam a given distance on the face of the crt. The net result of increasing the accelerating voltage, then, is increased pattern brightness along with an apparent reduction in the scope's vertical and horizontal gain (sensitivity). In most service scopes, therefore, a compromise has to be made between pattern brightness, deflection sensitivity, and cost.

A sine-wave pattern (or any other pattern) can be shifted vertically and horizontally on the screen by adjusting the centering controls, as was discussed previously in the cases of the spot and the line. As the scope warms up, the sine-wave pattern may drift vertically, horizontally, or both. In that case, readjust the centering controls as required.

GAIN CONTROLS

Vertical

Another difficulty may arise at this point. Perhaps the pattern locks satisfactorily, but vertical deflection is insufficient or excessive (Fig. 2-12). The vertical-gain control no doubt is set incorrectly. It is adjusted normally for a pattern height of approximately three-fourths of full screen.

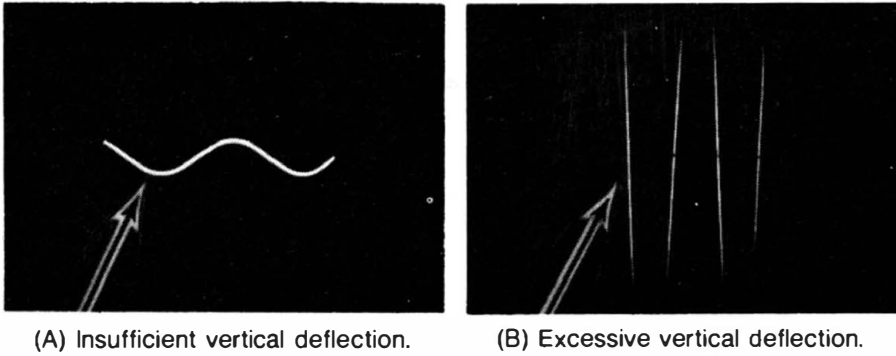

(A) Insufficient vertical deflection.

(B) Excessive vertical deflection.

Fig. 2-12. Vertical-gain control effect.

Although the simplest scopes have a single vertical-gain control, most scopes have both step and vernier controls. The step control shown in Fig. 2-7 has three positions. If the input voltage is comparatively high, the step control is set to a lower position, and vice versa. Other step gain controls may have four or more positions. They permit application of a wide range of input voltages, without overloading the vertical amplifier in the scope.

All oscilloscopes have vertical amplifiers. An amplifier is necessary because a cathode-ray tube is comparatively insensitive, and requires approximately 300 volts for adequate deflection. Because it is often necessary to investigate signal voltages as low as .02 volt, a high-gain vertical amplifier is required in practical work.

In the simplest scopes, the vertical-gain control is a potentiometer. This type of control is satisfactory only for low-frequency operation. A simple potentiometer control distorts a high-frequency waveform because of its stray capacitances. These are indicated in Fig. 2-13. Stray capacitance C1 is not of practical concern here, for high-frequency response is limited by stray capacitances C2, C3, C4, and C5. These act as small bypass capacitors within and around the gain control, and have more or less of a shunting action on high-frequency input signals.

This difficulty could be avoided if a low-resistance potentiometer (such as 1000 ohms) could be used. This is not practical, however,

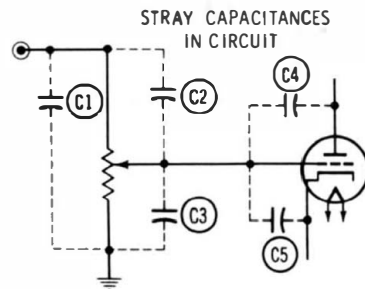

Fig. 2-13. Potentiometer gain control.

because an input resistance of 1000 ohms would cause serious loading in most electronic circuits under test. Ohm's law applies to ac voltages just as it does to dc voltages. If the input resistance is low, the scope connection will draw a heavy current from the circuit under test, resulting in disturbed circuit action and, in turn, distorted waveforms.

For these reasons, the input resistance of a scope must be high. A typical value is 1 megohm. Suppose, however, that a simple potentiometer gain control (as in Fig. 2-13) had a resistance of 1 megohm. In that case, stray capacitances C2, C3, C4, and C5 would have excessive bypassing action at high frequencies. Undistorted waveforms would be passed only if the gain control were set to maximum. At a reduced setting, more or less bypassing action would take place and cause progressive distortion of the waveform. Therefore, a more elaborate gain-control configuration is required for controlling signal voltages at frequencies other than the power frequency.

Step Gain

An interesting principle of circuit action makes possible a gain-control configuration having both high input resistance and distortionless attenuation. At low frequencies, these requirements are met by a resistive voltage divider, and at high frequencies, by a capacitive voltage divider (Fig. 2-14). The resistive divider distorts high frequencies, and the capacitive divider distorts low frequencies. However, when the two configurations are combined, as in Fig. 2-15, all frequencies are passed without distortion. Trimmer capacitors C2 and C3 are used to balance the high- and low-frequency response. These capacitors are maintenance adjustments, and are located inside the scope case.

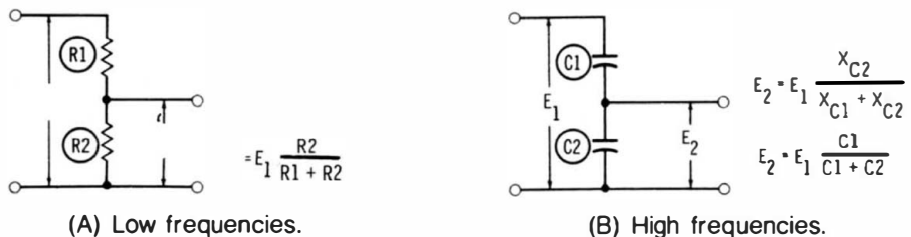

Fig. 2-14. Voltage dividers for low and high frequencies.

The step attenuator in Fig. 2-15 has three positions. The input signal is applied across series resistors R1, R2, and R3 (Fig. 2-15). The input resistance is 1.5 megohms for any of the three steps. When the step attenuator is set to a tap on the divider network, the output signal is reduced. Thus, cathode follower V1 is not overloaded, even though the input signal may be quite high. The step attenuator is merely set to a lower position.

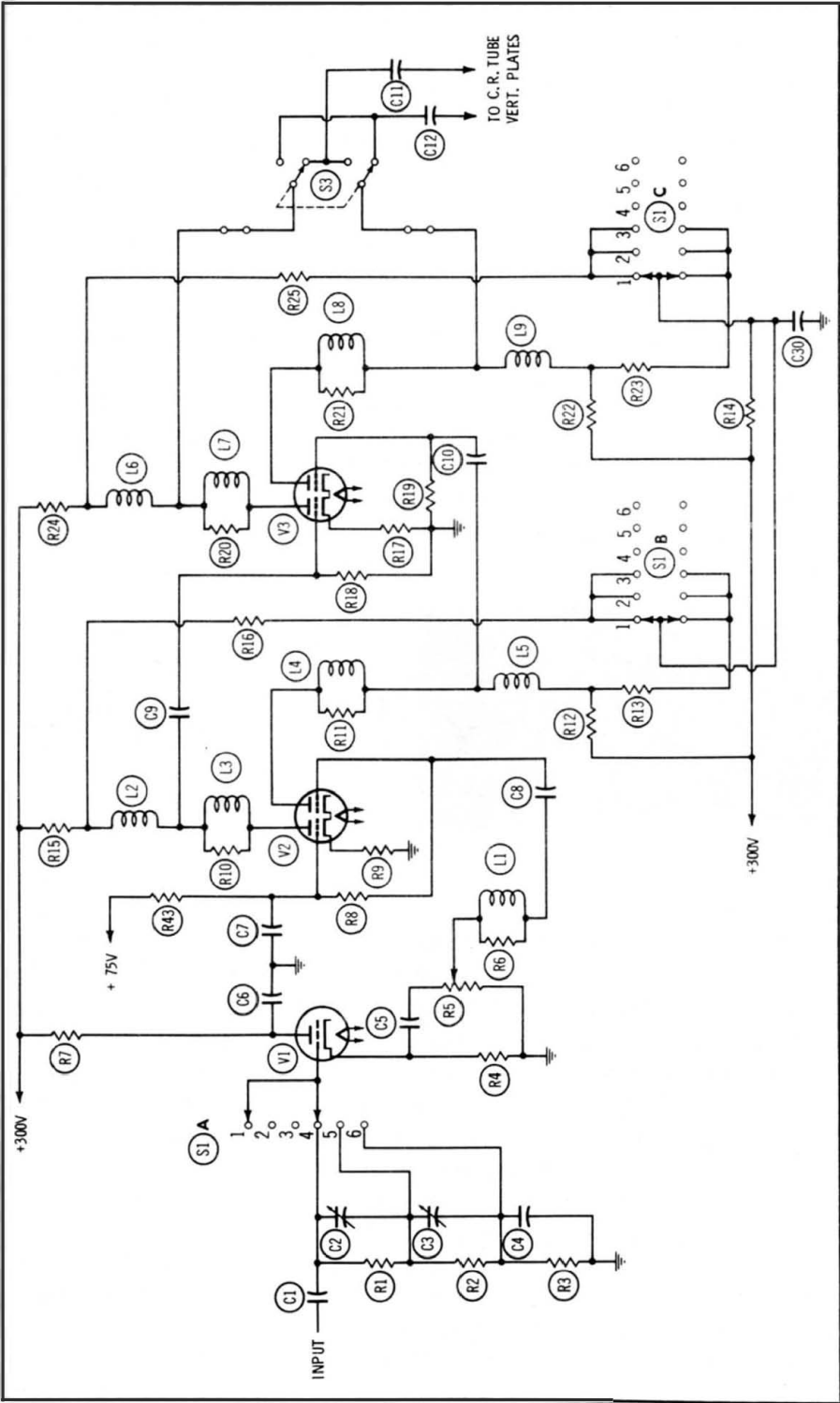

Fig. 2-15. Typical vertical-amplifier circuit.

The continuous (vernier) vertical-gain control (R5) is in the cathode circuit of V1. Because of its comparatively low resistance, good high-frequency response is obtained for all positions of the control. Furthermore, a cathode follower is an electronic impedance transformer. It matches a high input impedance to a low output impedance. To summarize, the overall action of the input system provides high input resistance, accommodates a wide range of input signals, and permits the pattern to be adjusted to any desired height on the scope screen.

The vertical amplifier, V2 and V3, is a push-pull configuration. Here, the proper settings of step- and vernier-gain controls are of prime importance. In many scopes which have both of these controls, incorrect gain settings will overload the cathode follower and cause the waveform to be clipped (Fig. 2-16). This means that the step attenuator has been set too high, and the vernier attenuator too low. Distortion is corrected by lowering the setting of the step control, and advancing the setting of the vernier control. Clipping is a distortion which can be quite confusing if it is not understood.

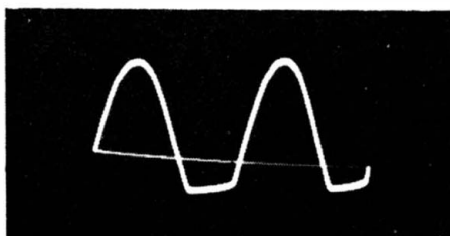
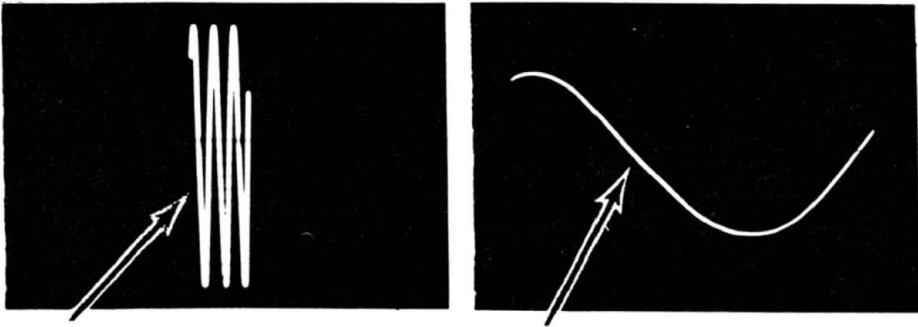

Fig. 2-16. Sine wave clipped by overloading.

Horizontal

Although vertical deflection is satisfactory, the pattern may be excessively compressed or expanded horizontally (Fig. 2-17). The horizontal-gain control must be adjusted. Less elaborate scopes have a simple potentiometer-type horizontal-gain control only; others have both step- and continuous-gain controls. In most cases, the horizontal-step control is merely a resistive divider network. However, a few service scopes have the same type of compensated step control used in the vertical section. These scopes are somewhat more expensive.

For most test work, good high-frequency response in the horizontal section is not needed. Therefore, the horizontal amplifier circuit is often simpler than the vertical. A typical horizontal-input and -amplifier circuit is shown in Fig. 2-18. The horizontal-input step attenuator has two positions. A vernier horizontal-gain control is in the cathode circuit of the cathode follower. The output of the cathode follower is coupled to a paraphase amplifier, which changes a single-ended input into a double-ended output.



(A) Insufficient horizontal deflection. (B) Excessive horizontal deflection.

Fig. 2-17. Horizontal-gain control effect.

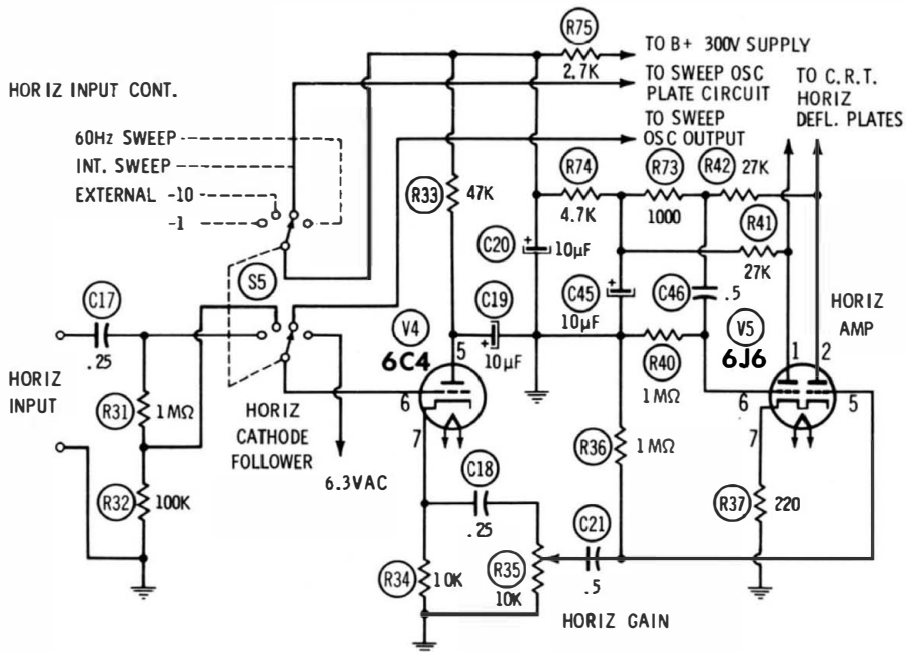

Fig. 2-18. Typical horizontal-amplifier circuit.

FREQUENCY CONTROL

When using the oscilloscope, it is customary to display two cycles of the signal on the cathode-ray tube screen. This is done by adjustment of the sawtooth-frequency control. Consider, for example, a 60-Hz signal. When the sawtooth-frequency control is adjusted to 30 Hz, the signal goes through two excursions during one trace interval, and two cycles of the signal are displayed. Similarly, when the sawtooth frequency is adjusted to 20 Hz, three cycles of the signal are displayed.

A typical sawtooth oscillator is shown in Fig. 2-19. This is a free-running oscillator which feeds a sawtooth voltage to the horizontal amplifier. The step frequency control is used to select a pair of capacitors ranging in value from 80 pF to 0.25 μ F. Higher values of capacitance provide a lower sawtooth frequency. The vernier frequency control is a pair of ganged potentiometers. Higher values of resistance provide a lower sawtooth frequency. The vernier control is used to "fill in" between the various positions of the step control. The sawtooth frequency can be adjusted from 10 Hz to 100 kHz.

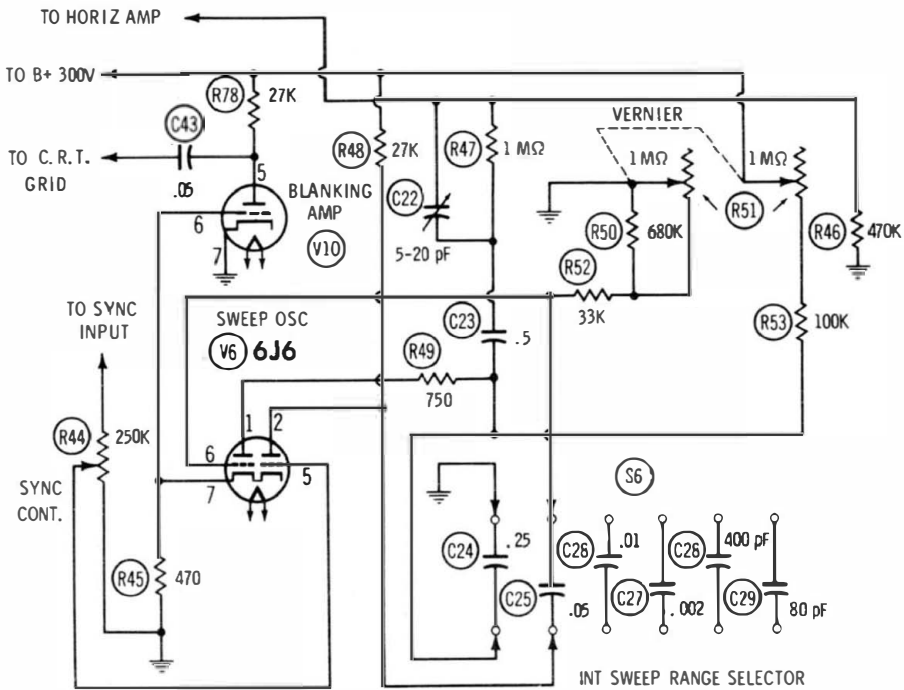

Fig. 2-19. Typical sawtooth-sweep oscillator and blanking amplifier.

RETRACE BLANKING

Blanking amplifier V10 in Fig. 2-19 eliminates the retrace line in pattern displays. During retrace time, a positive pulse voltage is generated across resistor R45. This pulse voltage is fed to the grid of the blanking-amplifier tube, amplified, and reversed in polarity. This negative impulse is applied to the grid of the cathode-ray tube, cutting the tube off during the retrace interval. For example, the pattern shown in Fig. 2-16 has a visible retrace, while the pattern in Fig. 2-12 does not.

HORIZONTAL NONLINEARITY

Sometimes horizontal deflection is nonlinear. The pattern appears cramped at one end and expanded at the other end (Fig. 2-20A). This trouble can be caused by a weak tube in the horizontal-amplifier or the sawtooth-oscillator section, by low plate-supply voltage to either section, or by defective capacitors, particularly coupling capacitors. In Fig. 2-19, C22 is a maintenance control which is set for best horizontal linearity.

Amplifier linearity can be checked by applying a 60-Hz voltage to both the horizontal- and vertical-input terminals of the scope. The horizontal-function switch is then set to a horizontal-input position—either “low” or “high” as required to accommodate the input voltage level. The vertical- and horizontal-gain controls are then adjusted to obtain about three-fourths of full-screen deflection. In the ideal situation, a perfectly straight diagonal line appears on the screen. However, nonlinearity in either the vertical or horizontal amplifier, or both, results in a curved diagonal trace. (Fig. 2-20B).



(A) Severe horizontal nonlinearity. (B) Nonlinear amplification present.

Fig. 2-20. Horizontal nonlinearity.

CALIBRATION AND PEAK-TO-PEAK VOLTAGE MEASUREMENTS

An oscilloscope is a voltmeter which displays instantaneous, peak, and peak-to-peak voltages. It also displays the rms values of some waveforms. The meaning of instantaneous values is evident in Fig. 2-21. Each dot in the sine-wave pattern represents a particular instantaneous voltage. This is, in practice, a form of time calibration, which will be explained in more detail later. It is pertinent to note here, however, that certain instantaneous voltages have the specific designations of positive peak voltage, negative peak voltage, and peak-to-peak voltage. (Fig. 2-22).

Peak-to-peak voltages are specified in receiver service data. They are usually measured on the scope screen, although a peak-to-peak vtvm can be used if the impedance of the circuit under test is not too

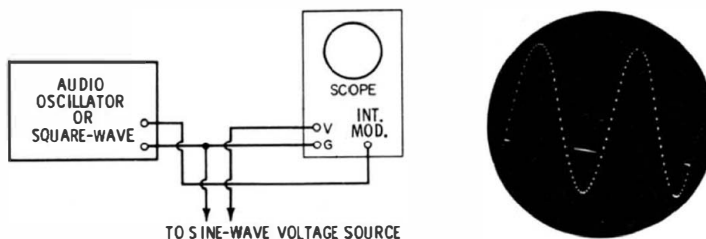

Fig. 2-21. Instantaneous voltages "marked" and timed by intensity modulation of the scope.

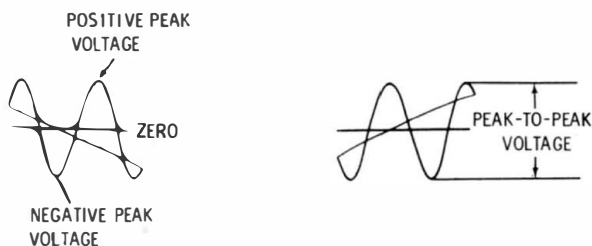

Fig. 2-22. Meaning of positive-peak, negative-peak, and peak-to-peak voltages.

high. (A vtvm loads a circuit more than a scope does.) To calibrate a scope for peak-to-peak voltage measurements, its sensitivity for the chosen setting of the vertical-gain controls is determined. A known peak-to-peak voltage is applied to the vertical-input terminals of the scope, and the resulting number of divisions is noted for deflection along the vertical axis. Thus, if a 1-volt peak-to-peak signal is applied to the scope and 10 divisions of vertical deflection are observed, the vertical-gain controls are set for a sensitivity of 0.1 volt peak to peak per division.

Many scopes have provision for applying a known peak-to-peak voltage to the vertical amplifier. Three examples were illustrated in Fig. 2-1A, Table 2-1, and Fig. 2-7. In Fig. 2-1A, a binding post provides a 1-volt peak-to-peak source. In Table 2-1, the last entry depicts a calibration terminal which provides a 5-volt p-p square wave for calibrating the vertical amplifier. In Fig. 2-7, a calibration terminal is provided which supplies a 1-volt p-p sine wave. There is no basic distinction between a square-wave and a sine-wave p-p calibrating voltage. It may be noted that the more elaborate scopes generally provide a square-wave calibrating voltage.

Consider the voltage from an ordinary heater string. It has an rms value of 6.3 volts. Because it is a sine-wave voltage, its peak-to-peak value is found by multiplying 6.3 by 2.83. Therefore, 6.3 volts rms has an amplitude of 17.8 volts peak to peak, which is usually rounded off to 18 volts peak to peak in practical work. Thus, if the vertical

input of the scope is connected to a heater line, an 18-volt peak-to-peak voltage is being applied to the vertical amplifier.

Consider an arbitrary calibration voltage, such as 12 volts peak to peak, being applied to the vertical-input terminals. If the vertical-gain controls are adjusted to make the voltage waveform extend over 12 divisions vertically (Fig. 2-23), the scope will be calibrated for 1 volt peak to peak per division. In turn, each major division on the graticule marks off 5 volts peak to peak. In this manner, a scope is calibrated easily for any convenient source of peak-to-peak voltage. Note carefully, however, that a service-type vom reads the rms voltage of sine waves. The peak-to-peak voltage of a sine wave is 2.83 times the rms reading.

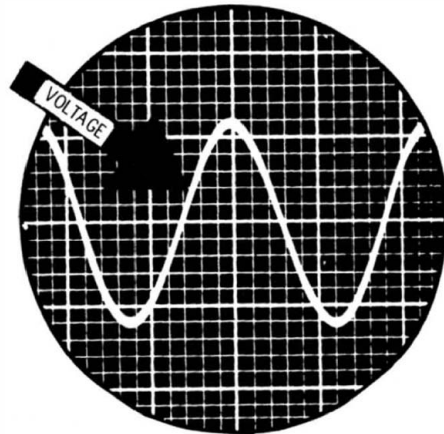

Fig. 2-23. A vertical excursion of 12 divisions.

COMPLEX WAVEFORMS

Although a sine wave is symmetrical, most waveforms encountered in electronic test work are unsymmetrical. A pulse waveform, such as the one shown in Fig. 2-24 is unsymmetrical and, in turn, has a positive peak voltage which is not the same as its negative peak voltage. Nevertheless, once a scope has been calibrated with a sine wave, peak-to-peak voltages of complex waveforms can also be measured on the screen.

A square waveform is a complex symmetrical waveform, and its voltage is measured in peak-to-peak values. Fig. 2-25 shows a square wave which has the same peak-to-peak voltage as the sine wave illus-

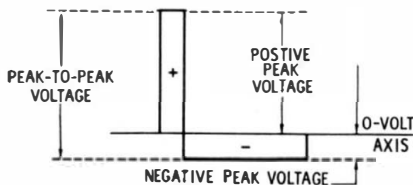

Fig. 2-24. Pulse-waveform voltages.

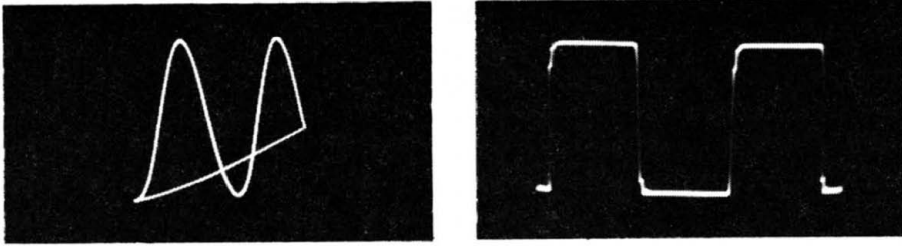

Fig. 2-25. These waveforms have the same peak-to-peak voltages, but their rms values are different.

trated; however, the rms voltage of the square wave is different from that of the sine wave. Note carefully that service-type vom's respond differently to these two waveforms, even though they have the same peak-to-peak voltage. A vom indicates the true rms voltage of the sine wave, but does not indicate correctly when a square wave is measured. A peak-to-peak reading vtvm indicates, of course, the true peak-to-peak voltage of any type of waveform.

Once the sensitivity of a scope is adjusted for a certain number of volts per division, peak voltages can be measured as easily as peak-to-peak voltages. An example is seen in Fig. 2-26. With no input signal, the scope displays only a horizontal trace. This is the beam-resting, or zero-volt, level. When a complex waveform is displayed, it appears partly above the zero-volt level and partly below. The number of divisions from the zero-volt level to the positive peak of the waveform indicates its positive peak voltage. Likewise, the number of divisions from the zero-volt level to the negative peak indicates its negative peak voltage. Peak voltages are measured in the same units as peak-to-peak voltages.

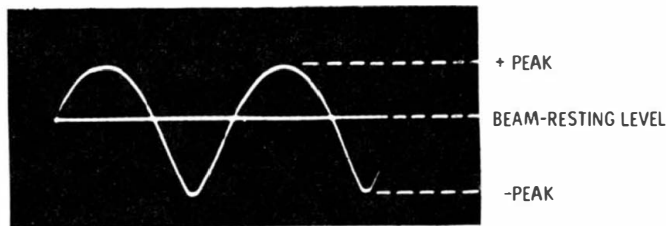

Fig. 2-26. The beam-resting level of a scope shows the positive and negative portions of a waveform.

STEP ATTENUATORS

Step attenuators are usually decade devices. They attenuate a signal voltage by 0.1, 0.01, or 0.001. Conventional step markings are X1, X10, X100, and X1000. Decade attenuation facilitates measurement of peak-to-peak voltages. For example, suppose that the vertical step

attenuator is set to the X10 position and the vernier attenuator is adjusted to provide a sensitivity of 1 volt peak to peak per division. If a waveform voltage is applied to the vertical-input terminals and the pattern is off-screen at top and bottom, it is a simple matter to turn the step attenuator to the X100 position. This brings the pattern within screen limits, and changes the sensitivity to 10 volts peak to peak per division.

If the applied waveform voltage does not produce sufficient vertical deflection, the step attenuator can be turned to the X1 position. This increases the pattern height ten times, and changes the sensitivity to 0.1 volt peak to peak per division. In summary, adjustment of the vertical step attenuator does not change the basic calibration of the scope. However, such adjustment makes possible quick measurement of peak-to-peak voltages over a wide range from a single calibration.

A triggered-sweep oscilloscope generally has an inherently calibrated vertical amplifier with a vertical step attenuator which indicates peak-to-peak voltages per division. Fig. 2-27 shows a typical vertical step attenuator for this kind of scope. Thirteen steps are provided in this example, with peak-to-peak voltage range from 0.05 to 500 volts per division. Note that these values usually apply to waveforms obtained with a direct probe. On the other hand, some scopes indicate peak-to-peak voltages of waveforms obtained with a low-capacitance probe. If a scope is calibrated for use with a direct probe, the indicated values must be multiplied by 10 when the scope is used with a standard low-capacitance probe (with a 10-to-1 attenuation factor). Low-capacitance probes are explained in greater detail in Chapter 3.

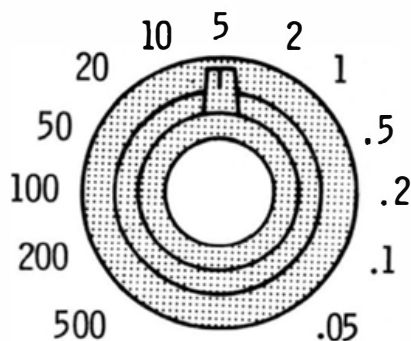

Fig. 2-27. Example of a step attenuator that indicates peak-to-peak voltages.

DC VERSUS PEAK-TO-PEAK VOLTS

Many technicians use dc scopes. A dc scope has a low-frequency response down to zero frequency, or dc. On the other hand, an ac scope has some definite low-frequency limit, such as 20 Hz. The typical response of a dc scope is illustrated in Fig. 2-28. If a 10-volt

battery, for example, is connected to the vertical-input terminals, a positive polarity deflects the beam upward, and it remains deflected until the dc voltage is removed. Similarly, when the terminal polarity is reversed, the beam is deflected downward from its resting position by the same amount it was deflected upward.

What is the relationship between dc deflection and peak-to-peak ac deflection? The two deflections are the same. In other words, if the beam deflects by the amount shown in Fig. 2-28 for an input of + 10 volts dc, it will deflect by the same amount for a 10-volt peak-to-peak ac input. Hence, a dc scope can be calibrated either with a dc or an ac voltage source.

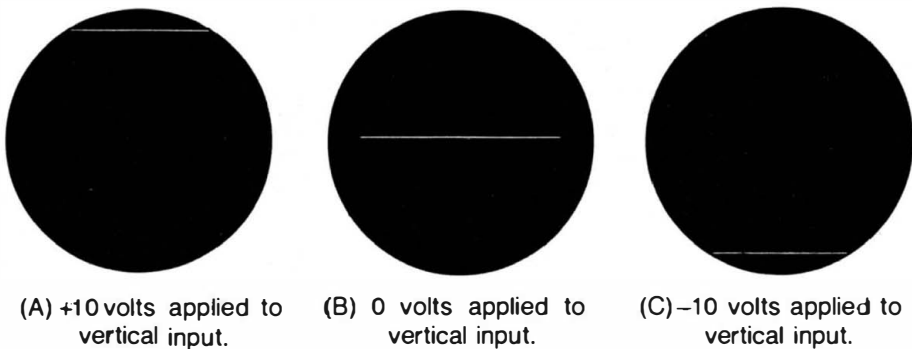

Fig. 2-28. Response of a dc scope.

Many waveforms in electronic circuits consist of an ac voltage with a dc voltage component. The output from a video detector, the signal across a cathode resistor, and the signal at the collector of a transistor are examples. When such voltages are applied to a dc scope, the response takes place as shown in Fig. 2-29. The beam level rises (or falls) from its resting position in correspondence with the dc component. *The ac waveform is displayed on the dc level.*

All dc scopes have switching facilities for changing from dc to ac response. Thus, in Fig. 2-29, if the scope is switched to ac response, the ac waveform is unchanged, but it drops and is centered on the zero-volt level. In other words, the dc component is removed during ac operation. Changeover from dc to ac response is accomplished by switching a series blocking capacitor into the vertical-input circuit.

SYNC FUNCTION

External

Most scope tests are made with the pattern locked by internal sync. That is, the synchronizing voltage is obtained internally from the input signal voltage. For some tests, a sync voltage separate from the

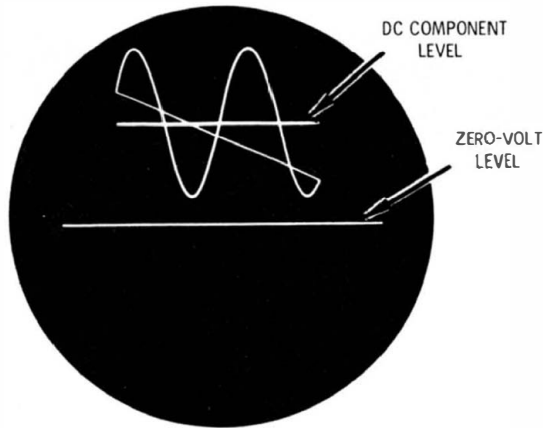

Fig. 2-29. Response of a dc scope to ac voltage with a dc component.

signal voltage is required. The signal voltage characteristics may be unsuitable for locking the pattern, or circuit phases may be of interest. For example, when the composite video signal is displayed on 60- or 30-Hz deflection, it is often found difficult (and sometimes impossible) to lock the pattern on internal sync. This occurs because the horizontal sync pulses are as large as the vertical sync pulses, and the scope's sync circuits are not able to separate the vertical from the horizontal pulses.

In this situation, the pattern can be locked tightly by setting the selector switch to the "Ext. Sync" position and connecting a lead from the external sync terminal to a 60-Hz source, such as the vertical blocking-oscillator circuit. Another often satisfactory solution is to set the selector switch to the "Line Sync" position. This locks the sync circuits to the 60-Hz power-line frequency.

An example of phase investigation is illustrated in Fig. 2-30. Here, the signal progression is being checked along an artificial delay line, such as is found in pattern generators. Each section of the delay line changes the signal phase by a specified time interval, as required for normal generator operation. In order to test these time intervals with a scope, the function control is set to the "Ext. Sync." position. A test lead is run from the "Ext. Sync" terminal to the input (or output) end of the delay line. Then, as the vertical-input lead is moved progressively from one line section to the next, the exact phase delay in each case is displayed on the scope screen.

Phase investigations are occasionally of great concern when checking audio amplifiers which have feedback networks. Incorrect phase shift can cause distortion or unstable operation, sometimes with violent oscillation. A conventional amplifier stage steps up the signal voltage and reverses its phase. Any sync function can be used when measuring stage gain, merely by comparing the heights of the input

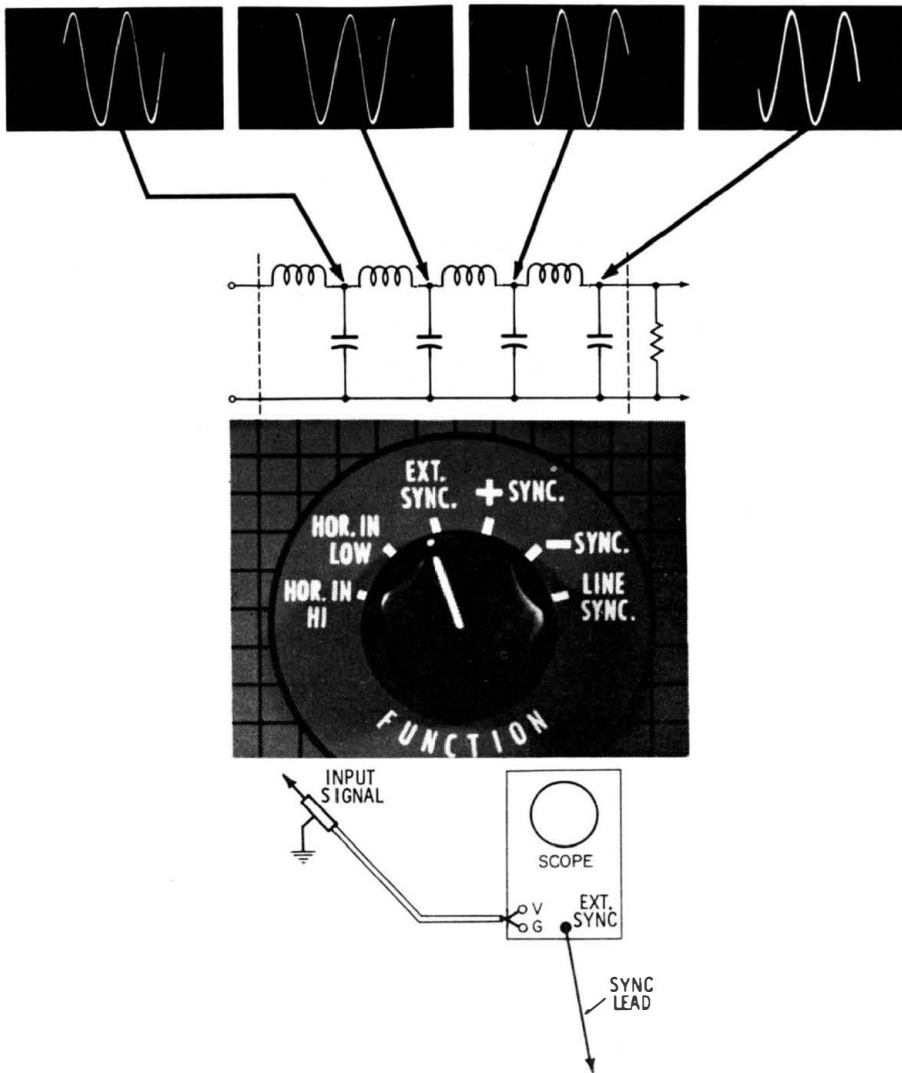
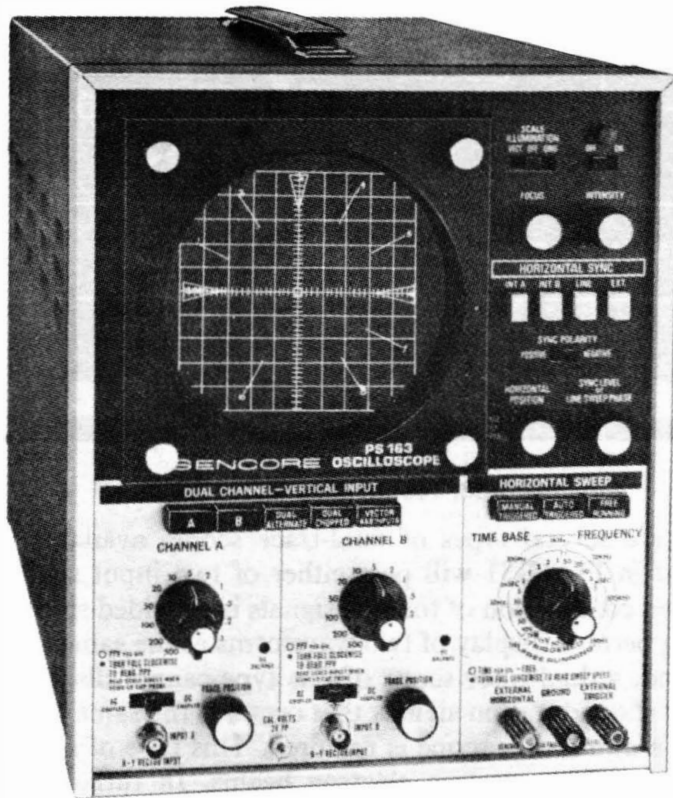

Fig. 2-30. External sync is used when checking out a generator delay line.

and output patterns of the amplifier. The phase shift from input to output, however, can be checked only by utilizing the external sync function of the scope.

Another method of making phase-shift tests is to utilize a dual-trace scope, such as that illustrated in Fig. 2-31. This type of scope contains a built-in electronic switch, so that two vertical channels (Channel A and Channel B) are provided. In turn, two vertical-input signals can be applied to the scope, and the corresponding waveforms are displayed on the crt screen as shown in Fig. 2-32. Note that the phase difference between the two waveforms is directly shown on the screen. Another example of a dual-trace test is seen in Fig. 2-33. Here, the

timing of the burst keying pulse with respect to the color burst is displayed. Note that timing tests of complex waveforms are essentially the same as phase-shift tests of sine waves.



Courtesy Sencore

Fig. 2-31. A dual-channel dual-trace triggered sweep oscilloscope.

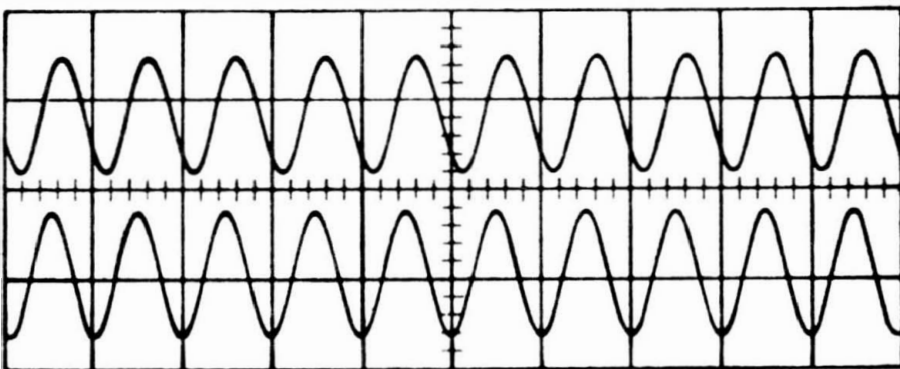
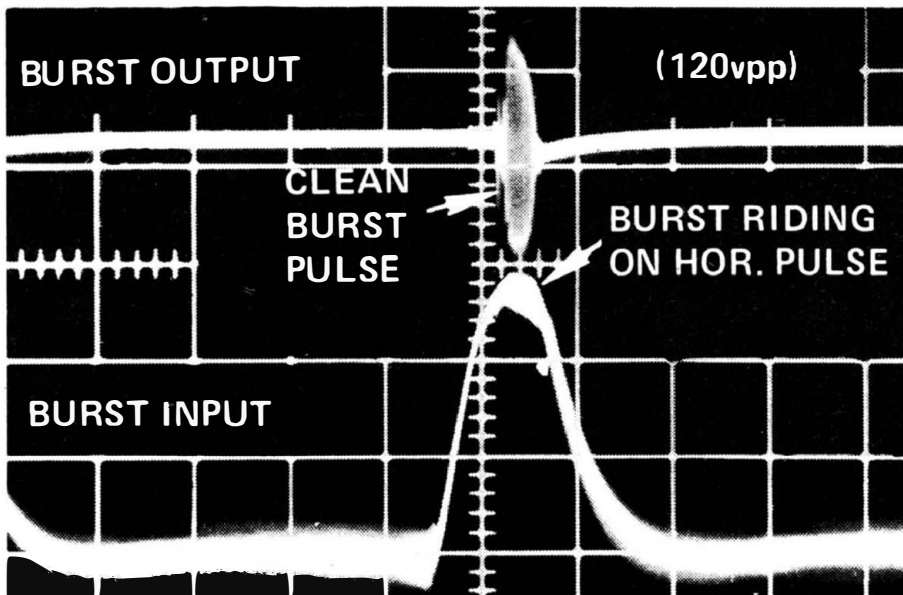

Fig. 2-32. Phase measurement with a dual-trace scope.



Courtesy Sencore

Fig. 2-33. Test of color-burst timing.

There are several types of dual-trace scopes available. The type illustrated in Fig. 2-31 will pass either of two input signals, one at a time, and comparison of the two signals is provided since electronic switching permits display of two waveforms at the same time. On the other hand, a dual-trace scope of this type cannot display two non-recurrent short-duration signals that occur at the same time. For this purpose, a *dual-beam* scope is required. This type of scope employs a special crt that has two electron beams. In turn, two different waveforms can be traced on the screen at the same time. Also, an elaborate dual-beam scope can display the upper waveform on one time base and can display the lower waveform on another time base.

Electronic switches used in dual-trace scopes may be capable of switching in either of two modes. In the first mode, the two signals are alternately sampled in rapid succession during the sweeps so that the waveforms are displayed as a series of closely spaced dots instead of a continuous line. This is called the chopped mode. Next, in the second mode, recurring signals are displayed synchronously with the sweep repetition rate and are traced out alternately on the screen. The switching occurs during the sawtooth retrace interval. This is called the alternate mode, and it is the preferred method when using high-speed sweeps.

Triggered Time Bases

The oscilloscope illustrated in Fig. 2-31 provides a choice of free-running and triggered time bases. A time base is a sawtooth horizon-

tal-deflection (sweep) system. A free-running time base is self-oscillatory and generates a sawtooth output whether or not a signal is applied to the vertical amplifier. On the other hand, a triggered time base is not self-oscillatory; it generates a sawtooth output only when a signal is applied to the vertical amplifier. A single sawtooth waveform is generated at the instant that the vertical-input signal passes through a certain voltage level with a chosen polarity. An oscilloscope that provides a choice of free-running (recurrent) sweep and triggered sweep is called a *dual-mode* oscilloscope.

As noted previously, the chief advantage of a triggered-sweep scope is that a small portion of a waveform can be selected and greatly expanded horizontally. Most triggered time bases are also calibrated, and the sweep speed is indicated by the setting of the time-base control. As an illustration, the time-base control shown in Fig. 2-34 has a triggered-sweep range from 0.1 microsecond per division to 100 milliseconds per division. This facility permits the operator to measure frequency, pulse widths, rise time, and various other waveform characteristics that involve time. A concentric time-base control is shown in Fig. 2-34. The inner control knob is a vernier adjustment of sweep speed and is uncalibrated. Therefore, when reading sweep-speed values from the scale, it is necessary to turn the vernier control off (fully clockwise in this example). Additional controls are associated with a calibrated triggered-sweep time base, as explained in the next topic.

Fig. 2-34. A calibrated time-base control for a triggered-sweep oscilloscope.

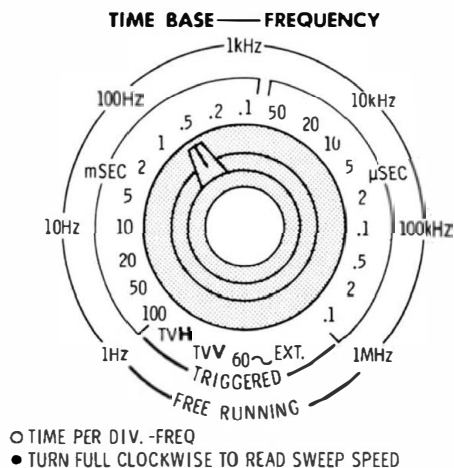

ACTION OF TRIGGERED-SWEEP CONTROLS

The time-base controls for a typical triggered-sweep scope are illustrated in Fig. 2-35. In usual operation, the "Horizontal-Display" switch is set to its "Int." (internal) position; the horizontal amplifier

is then driven by the sawtooth time base. Note that the “Time-Base” control is calibrated in microsecond, millisecond, and 1-second steps. A “Var.” (variable) setting is also provided—the sweep is uncalibrated when operating in the “Var.” position. In general, we operate the time base on one of its calibrated settings so that we can measure rise time, delay time, elapsed time, etc.

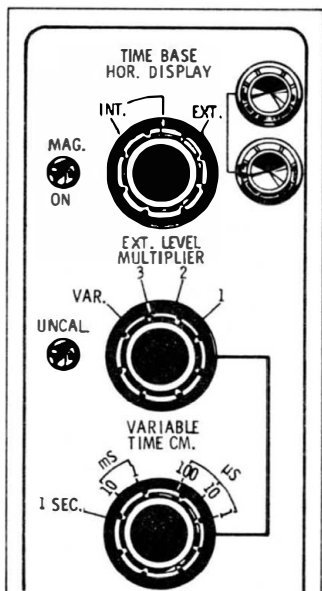

Fig. 2-35. Time-base controls of a triggered-sweep scope.

Let us observe how a waveform can be expanded for analysis of detail by operating the time base at high speed. In Fig. 2-36A, a combination sawtooth and staircase waveform is shown as it appears when displayed at slow sweep speed. The steps in the waveform are invisible. However, when the vertical gain is advanced 500 times and the sweep speed is likewise increased 500 times, the waveform detail appears clearly, as illustrated in Fig. 2-36. Similarly, a pulse, square-wave, or video signal can be expanded for analysis of detail.

The trigger controls of a triggered-sweep scope are shown in Fig. 2-37. Switches permit triggering to occur on either the positive or negative portion of a waveform. Most waveforms are displayed in the ac trigger position. To the beginner, the dc trigger position might be misleading—actually, the term “dc” in this case denotes that only the low frequencies of the signal are permitted to pass into the trigger section. This is a useful function for proving stable display and expansion of the color burst, for example. In the “Auto.” (automatic) position, triggering occurs in a manner similar to the operation of a free-running scope. However, there is a basic difference in that synchronization is essentially automatic and no sync-amplitude control is utilized.

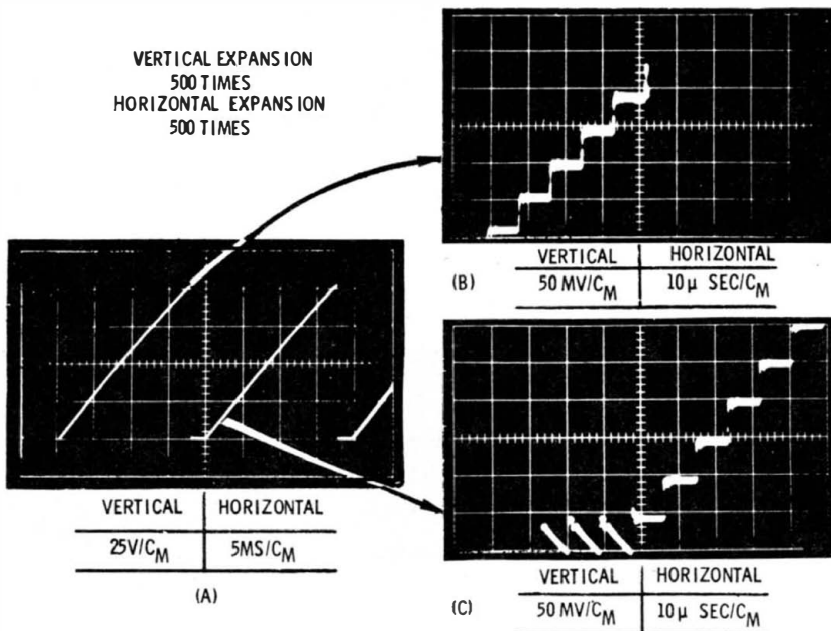
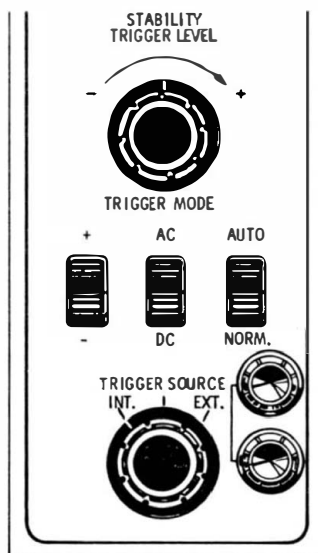

Fig. 2-36. "Stair step" voltage waveform expanded 500 times.

Fig. 2-37. Trigger controls of a triggered-sweep scope.



When the trigger section is set to its "Norm." (normal) position, the "Stability" and "Trigger-Level" controls are operative. The "Stability" control must be operated over the correct part of its range, as illustrated in Fig. 2-38. At one extreme end of its range, we obtain only a horizontal trace on the scope screen (Fig. 2-38A). Over the correct portion of its range, the desired pattern is displayed (Fig.

2-38B). At the other extreme end of its range, the screen becomes blank (Fig. 2-38C). Suppose that positive triggering is in use; the displayed waveform starts on its rising interval as shown in Fig. 2-39. On the other hand, suppose that negative triggering is in use; the waveform starts on its falling interval, as illustrated in Fig. 2-40.

By adjusting the "Trigger-Level" control, we can progressively shift the trigger point from the zero level to the peak, and start the waveform at any intermediate point. This is a useful feature that permits the operator to select a small interval anywhere along a

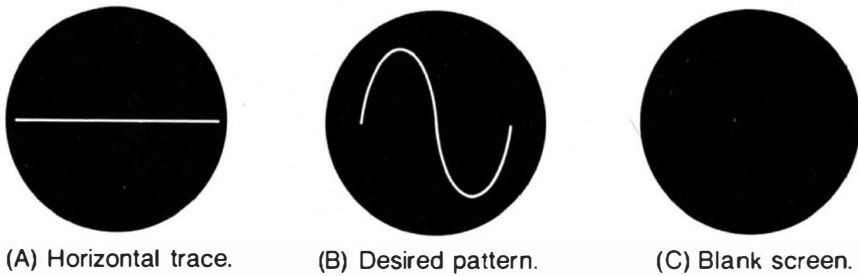

Fig. 2-38. Stability-control action.

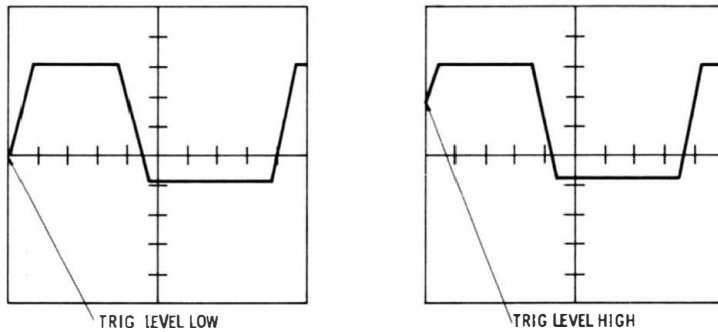

Fig. 2-39. This waveform is being triggered along its positive slope (rising interval).

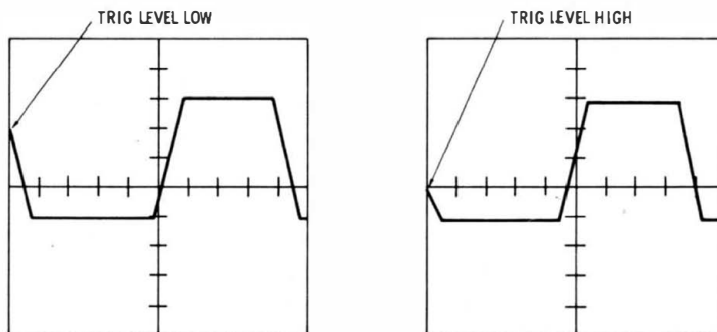

Fig. 2-40. This waveform is being triggered along its negative slope (falling interval).

waveform, and expand this small interval to occupy the entire screen. The beginner is advised to become familiar with a triggered-sweep scope utilizing the "Auto." function. Although a small interval cannot be selected along a waveform when the "Auto." function is used, operation is comparatively simple—the "Stability" and "Trigger-Level" controls are inoperative. After familiarity is gained with the time-base controls, the beginner may proceed to operate the scope in its "Norm." trigger mode.

LISSAJOUS PATTERNS

Lissajous patterns are displayed by feeding sine-wave voltages to both the vertical and horizontal amplifiers. Because many scopes have a 60-Hz sweep position on the function switch, such tests can be made readily by utilizing this function. When any 60-Hz sine-wave voltage is applied to the vertical-input terminals, a Lissajous pattern then appears on the scope screen.

The pattern shows the phase of the vertical signal with respect to the horizontal signal. Progressive phases are illustrated in Fig. 2-41. Scopes which have internal 60-Hz sine-wave deflection often have a "Sweep-Phasing" control. As it is turned, the Lissajous pattern goes through the various shapes shown in Fig. 2-41. A circular pattern provides a good check for sine-wave purity. Furthermore, if there are harmonics in the 60-Hz voltage to the vertical or horizontal amplifier, or both, a perfect circle cannot be obtained. Irregularities are seen instead.

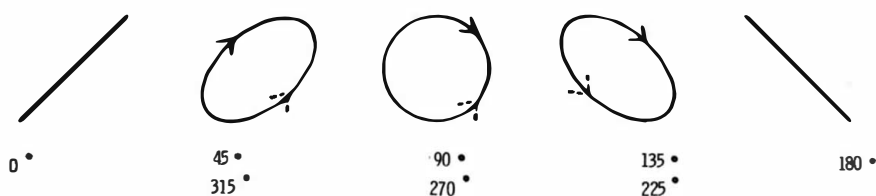

Fig. 2-41. Lissajous patterns show phase difference between two sine waves.

Lissajous patterns can be obtained, of course, at any frequency within the response range of the scope. The principle of pattern development is the same, regardless of frequency. Fig. 2-42 illustrates how in-phase deflection voltages on the vertical and horizontal crt plates produce a straight line. Similarly, Fig. 2-43 shows how a 90° phase difference produces a circular pattern. When one of the frequencies is double, triple, or quadruple the other frequency, crossover patterns result. If the two frequencies are not integrally related, the pattern is not fixed, but moves through successive phase sequences.

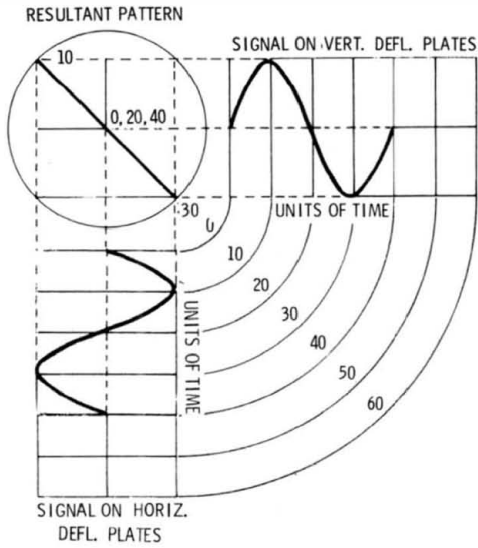

Fig. 2-42. In-phase sine waves form a straight-line Lissajous pattern.

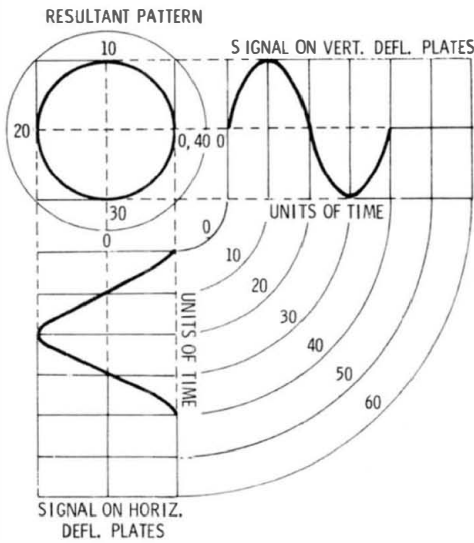

Fig. 2-43. Sine waves 90 degrees out of phase form a circular Lissajous pattern.

DISPLAY OF NARROW PULSES

As seen in Fig. 2-30, function switches provide a choice of positive or negative internal sync. When a sine wave or square wave is being displayed, the pattern locks equally well on either positive or negative sync. If a narrow pulse is being displayed, however, sync lock will be much tighter when the appropriate sync polarity is used. Positive pulses lock best on positive sync, and negative pulses lock best on negative sync. The reason for this is that a very narrow positive pulse

has a very small negative peak voltage (and vice versa). Hence, if negative sync is used when a narrow positive pulse is displayed, there is very little voltage available for locking.

Any complex waveform distributes itself above and below the zero-volt level to make the positive area equal the negative area. This is a direct consequence of the fact that the average value of an ac waveform is zero, or there is just as much current in the positive direction as in the negative direction. Thus, the area of the positive half-cycle is equal to the area of the negative half-cycle, although the peak voltages are different. A scope displays voltage along the vertical axis, and time along the horizontal axis (when sawtooth deflection is used). Voltage multiplied by time gives electrical quantity, and the product is an area. Therefore, positive and negative areas of the waveform are necessarily equal.

DISPLAY OF SQUARE WAVES

The square wave is one of the basic complex waveforms. For the purpose of circuit testing, there are two ways to analyze a square wave. One way is to consider that the waveform is a rapid change of voltage followed, after a certain interval, by a similar but opposite voltage change. The other way is to consider the waveform as the algebraic sum of a large number of sine waves that have different frequencies and amplitudes. The fundamental sine-wave component has a frequency equal to the repetition rate of the square wave. The other sine-wave components are odd harmonics of the fundamental. (In theory, an infinite number of odd harmonics is required to obtain a perfect square wave.)

Square waves are quite useful in circuit testing because a single test suffices to show how a circuit responds to a wide range of frequencies, with regard to both voltage and phase. Some examples of reproduced square waves are shown in Fig. 2-44.

All square waves, when carefully inspected, are found to depart more or less from an ideal square wave having perfectly square corners with zero rise and fall times. It is impossible to generate a perfect square wave, because the higher harmonics are weakened. However, a good generator provides a square-wave output which can be considered as ideal for most applications.

Differentiation and integration occur in RC circuits, as shown in Fig. 2-45. It is a basic law that if differentiation takes place in one part of a circuit, integration must take place in another part. This is the case because the sum of the waveforms around the circuit must add up to cancel the applied square-wave voltage. This is called Kirchhoff's law, which is almost as fundamental as Ohm's law in analysis of circuit action.

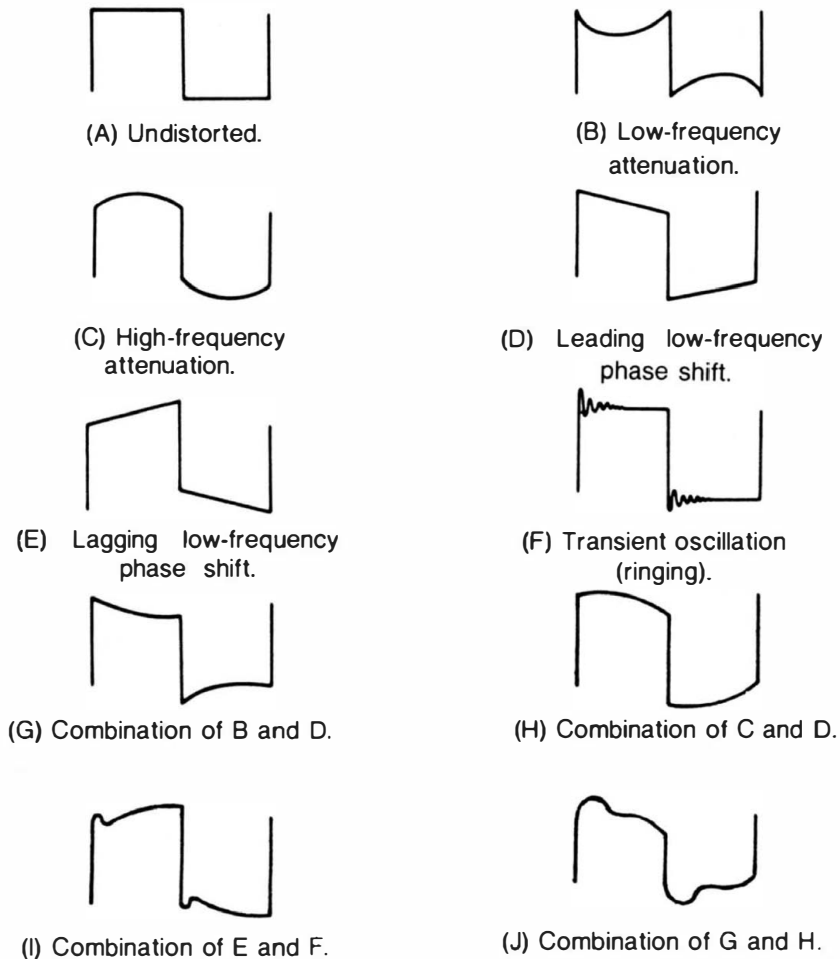
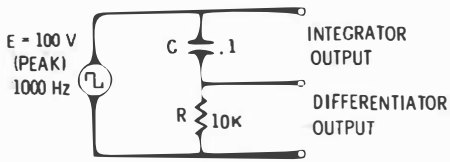

Fig. 2-44. Key square-wave reproductions.

The result of a typical square-wave test is seen in Fig. 2-46. Here the input and output voltages of the unit under test are shown superimposed. There is a substantial loss in square-wave voltage through the unit under test. Integration is prominent, with a slight differentiation evidenced by the small downhill tilt of the top in the reproduced square wave. When both integration and differentiation occur, they do so in successive circuit sections. It is possible for the integration in one section to cancel the differentiation in a following section in order to obtain an undistorted output. Vertical-sweep circuits in tv receivers afford a practical example of this circuit action.

FLUCTUATING LINE VOLTAGE

Line-voltage fluctuation can be a problem in heavily industrialized or remote rural areas. Appreciable variation in line voltage can cause



(A) Circuit.

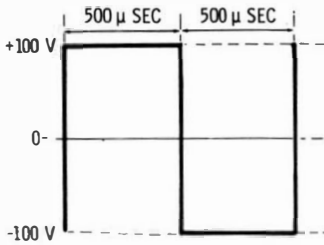

(B) Voltage across generator output terminals.

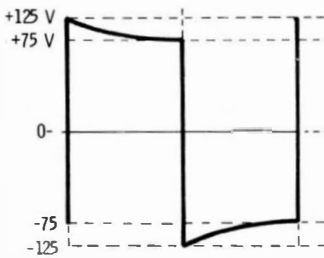

(C) Voltage across resistor terminals.

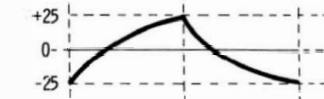

(D) Voltage across capacitor terminals.

Fig. 2-45. RC differentiating and integrating action on a square wave.

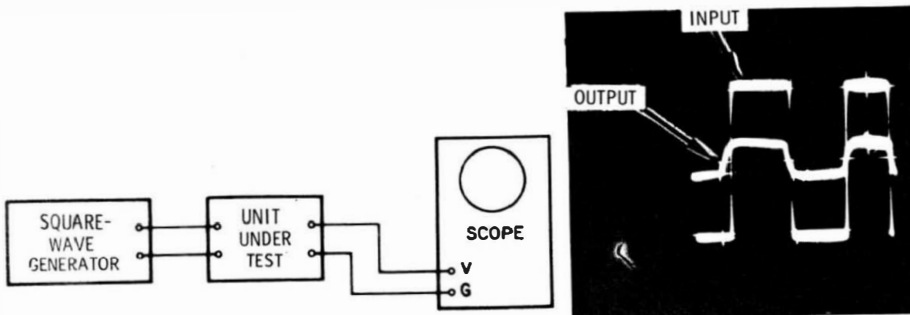
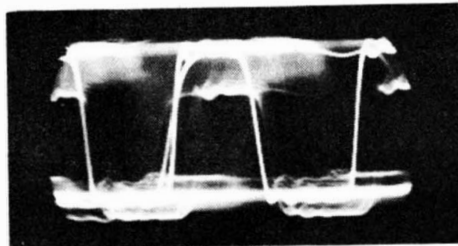

Fig. 2-46. Result of a typical square-wave test.

Fig. 2-47. Pattern jumping caused by fluctuating line voltage.



pattern jumping, as in Fig. 2-47. If that is the case, the voltage must be stabilized. The best method is to use an automatic line-voltage regulating transformer to power the scope and the equipment under test. Although such transformers do not completely smooth out rapid fluctuations, pattern stability is greatly improved.

In service scopes having regulated power supplies, the automatic line-voltage regulating transformer is required only to power the equipment under test.

Using Oscilloscope Probes

A scope has appreciable input capacitance, which is about 20 or 30 pF at the vertical-input terminal. Test leads or a coaxial cable must be connected to the input terminal for actual test work (Fig. 3-1). Unshielded test leads may not be suitable for testing in tv signal circuits, such as the grid of a video amplifier or sync separator. The unshielded leads often pick up excessive hum voltage and flyback-pulse interference. It is standard practice, therefore, to make all scope tests with a coaxial input cable to the vertical-amplifier terminals.

When a coaxial input cable is used, the total input capacitance to the scope becomes about 100 pF. This capacitance does not cause

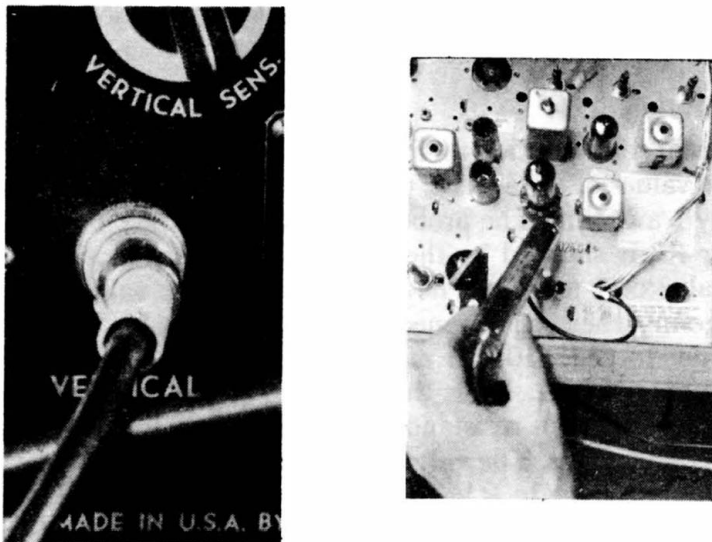
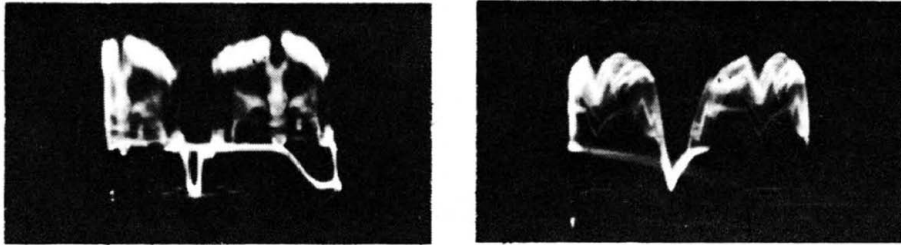

Fig. 3-1. Coaxial cable prevents pickup of stray fields.

objectionable circuit loading when testing across a cathode resistor, for example, but it will disturb many video and sync circuits seriously. Fig. 3-2 shows how a sync pulse can be distorted objectionably by shunting excessive capacitance across the circuit under test. The total input capacitance to the scope is imposed when a direct probe (straight-through connection) is used.



(A) Display of a normal video signal.

(B) Signal distorted by integration.

Fig. 3-2. Typical result of circuit loading.

LOW-CAPACITANCE PROBE

It is standard practice to use a low-capacitance probe instead of a direct probe, in order to avoid waveform distortion caused by circuit loading. The most common type of low-capacitance probe is a compensated attenuating device. This type of probe reduces the signal voltage and, in turn, the input capacitance to the scope. Most probes are adjusted to attenuate the signal voltage to 0.1 of its source value, and to reduce the scope input capacitance to 0.1 of the value imposed by a direct probe. The input impedance to the scope is thus effectively increased ten times.

Configuration

A typical configuration for a low-capacitance probe is shown in Fig. 3-3. The values of R1 and R2 depend on the scope's input resistance, typically 1 megohm. The probe does not stand alone in actual operation, for R2 is shunted by the scope's input resistance. Thus, if R2 has a value of 1 megohm, its effective resistance value will become 0.5 megohm when it is connected to the input cable of the scope.

In order to get a 10-to-1 attenuation, R1 is made nine times the effective value of R2. R1 is therefore 4.5 megohms for the example cited. The total input resistance to the probe (when connected to the cable) is 5 megohms. The voltage drop across R2 equals $0.5/5$, or 0.1 of the input voltage to R1. Thus, a 10-to-1 attenuation occurs. This attenuation is observed only at low frequencies, such as 60 Hz, because the input capacitances of the cable and scope have a greater by-passing effect on higher frequencies.

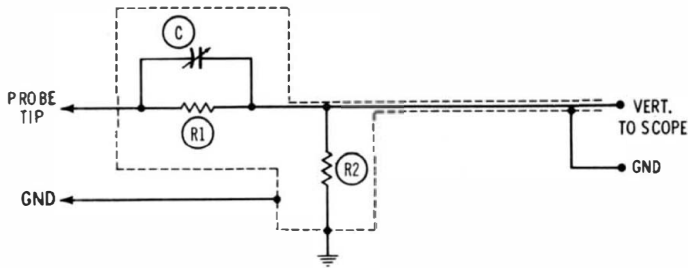

Fig. 3-3. Low-capacitance probe.

The probe must be compensated in order to obtain proper attenuation and distortionless signal passage. This is the function of trimmer capacitor C. The probe will have a 10-to-1 attenuation at high frequencies when C is adjusted correctly. The time constant of C and R1 must be equal to the time constant of the effective input resistance and capacitance to the scope. As a practical example, assume that the input capacitance at the cable is 100 pF. The time constant to the scope is then 0.5×10^6 multiplied by 100×10^{-12} , or 50×10^{-6} second. Thus the time constant is 50 microseconds. Hence, the time constant of R1 and C must also be adjusted to 50 microseconds. Inasmuch as R1 has a resistance of 4.5 megohms, C must have a value of about 11 pF. A trimmer capacitor is used so that an exact adjustment can be made.

Adjustment

There are two principal methods of adjusting a low-capacitance probe. The first makes use of square waves. If a 15-kHz square wave is fed from a square-wave generator to the low-C probe, the reproduced square wave will change shape on the scope screen as C is adjusted. When the capacitance is too high, the square wave appears differentiated. When it is too low, the square wave appears integrated. Correct adjustment of C provides distortionless reproduction of the square wave.

Not all square-wave generators provide a perfect output. It is advisable first to check the generator waveform by connecting the direct probe of the scope to the generator output terminals. Observe the waveform and then duplicate this waveform with the low-C probe connected to the scope input cable. The probe can be adjusted properly regardless of generator distortion. It is necessary only to reproduce the same waveform applied by the generator.

The second method of probe adjustment is a two-frequency test. For example, a 60-Hz sine-wave voltage is applied to the probe, and the resulting vertical deflection noted. Next, a 15-kHz sine-wave voltage is applied to the probe from an audio oscillator. The audio oscillator is set for the same output voltage as in the 60-Hz test. Also,

capacitor C is adjusted to give the same vertical deflection on the scope screen as before. Output voltages at 60 Hz and at 15 kHz can be checked with the scope, using a direct probe.

Most service scopes are suitable for operation with low-C probes, but there are a few exceptions. A scope must have a step attenuator which provides a fixed value of input resistance and capacitance on each step in order to operate properly with a low-C probe. However, a low-C probe cannot be matched to a scope which has merely a potentiometer for the vertical-gain control. While the probe can be adjusted for proper response at one gain setting, another gain setting may not match the probe and therefore distortion results.

Low-capacitance probes are useful over the frequency response range of the scope. If the scope has a flat response from 20 Hz to 2 MHz with a direct probe, it will have the same frequency response when a low-C probe is used. The probe does not change the existing frequency response of a scope, but merely steps up the input impedance. For these reasons, a low-C probe is used to test sync, video-amplifier, horizontal-oscillator and afc, and sweep circuits. The frequencies in these circuits range from 60 Hz to 15 kHz, plus harmonic frequencies up to 1 or 2 MHz.

The permissible voltage which may be applied to a low-C probe is the same as for a direct probe. Because conventional scopes have blocking capacitors rated at 600 volts, this is the maximum input voltage permissible with a direct probe. Similarly, the components used in commercial low-C probes are not rated for more than about 600 volts. When higher peak-to-peak voltages are to be tested, another type of probe should be used to avoid possible damage to both scope and probe. High-voltage probes are explained later in this chapter.

Why are low-C probes generally designed with a 10-to-1 attenuation factor? This factor ties in with the decade step attenuators on modern scopes. Recall that once a scope has been calibrated with a known peak-to-peak voltage, recalibration is not required when the step attenuator is turned to another position; the decimal point in the calibration factor is merely shifted to the left or right, as the case may be. If the scope is calibrated using a direct probe, it is likewise not necessary to recalibrate if a 10-to-1 low-C probe is to be utilized next. The decimal point in the calibration factor is shifted one place to the right.

Use a Lab-Type Probe With a Lab-Type Scope

Lab-type low-capacitance probes utilize concentric construction, as shown in Fig. 3-4. In other words, the probe construction follows the basic plan of a coaxial cable. This construction permits display of fast-rise waveforms with very little distortion. For example, a square

Fig. 3-4. Lab-type low-capacitance probe.

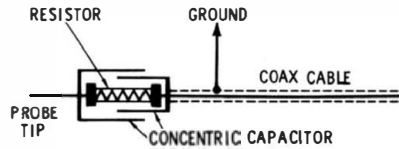

wave or pulse with a rise time of 0.02 microsecond passes through a lab-type probe with practically no overshoot or ringing.

On the other hand, a service-type low-capacitance probe is constructed with ordinary components and has no coaxial configuration. In turn, fast-rise waveforms are distorted by the residual inductance of the components and connecting wires. When a typical service-type low-C probe is used with a lab-type scope, a 1-MHz square wave with a rise time of 0.02 microsecond is displayed. The result is a large amount of overshoot and ringing, as illustrated in Fig. 3-5. Therefore, good practice requires that a lab-type probe be used with a lab-type scope.

(A) *Test setup.*

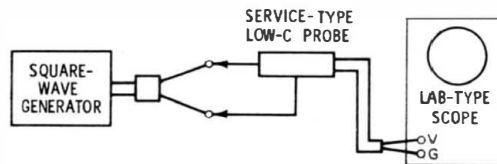

(B) Overshoot and ringing of 1-MHz square wave.

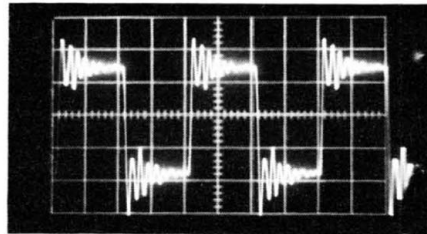

Fig. 3-5. Square-wave test showing the effect of using a service-type low-capacitance probe with a lab-type scope.

Note that the vertical attenuators in lab-type scopes are calibrated in peak-to-peak volts. Since the vertical amplifier is very stable, reliance can be placed on the indicated calibration values over long periods of time. A low-C probe, when used with the scope, customarily reduces the input voltage to the vertical amplifier by a factor of 10. Fig. 3-6 depicts calculation of the peak-to-peak voltage; we note the peak-to-peak voltage reading of the vertical attenuator, multiply it by the number of centimeters of vertical deflection, and finally multiply this value by the attenuation factor of the probe (usually 0.1).

Sometimes the instantaneous voltage of a waveform is of interest. In other words, we wish to measure the peak-to-peak voltage at a particular point along a waveform. Fig. 3-7 shows an example of a staircase waveform in which we wish to measure the peak-to-peak

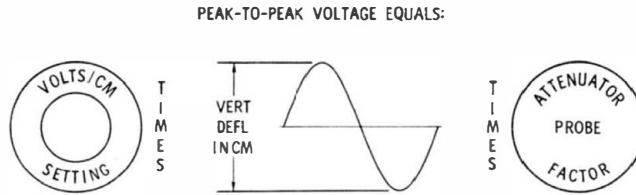

Fig. 3-6. Reading peak-to-peak voltage from vertical-gain setting.

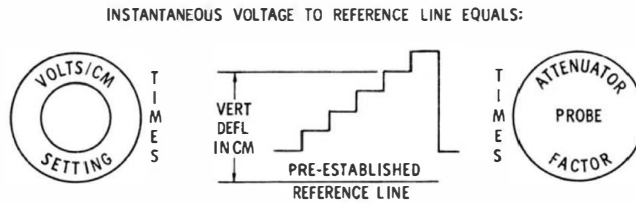

Fig. 3-7. Read the instantaneous voltage at a point along the waveform.

voltage of the fourth step. We proceed to note the peak-to-peak voltage reading of the vertical attenuator, and multiply this reading by the number of centimeters from the base line of the waveform to the fourth step. Finally, we multiply this value by the attenuation factor of the probe (usually 0.1).

Demodulator Probes

Technicians commonly make tests in circuits operating at 20 MHz, 40 MHz, or even higher frequencies even though service scopes have a top frequency limit of 1 or 2 MHz, or occasionally 4 or 5 MHz. In order to display waveforms in high-frequency circuits, a demodulator probe is used (Fig. 3-8). It is a special form of detector probe that operates on the same principle as a detector in a tv receiver. The rectifier and its associated circuitry recover the modulation envelope from the high-frequency carrier. This envelope contains video frequencies to which a scope can respond. The response of an ordinary demodulator probe is not as good as that of a video detector in a tv receiver. The reason is that a probe must have a fairly high input impedance to avoid undue circuit loading. A demodulator-probe circuit, therefore, is like that in Fig. 3-8, instead of like a video-detector circuit. If a demodulator probe were constructed with the circuit principles of a video detector, it would have very good frequency response. However, the input impedance would be very low, and most i-f circuits would be “killed” when the probe is applied to the circuit.

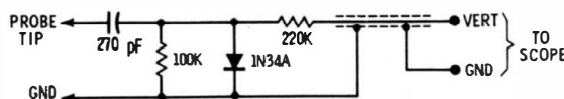

Fig. 3-8. Typical demodulator probe.

A visualization of demodulator-probe action is shown in Fig. 3-9. This is an idealized presentation. In practice, the corners of the output waveform are rounded, and the rise and fall intervals of the waveform are slowed down. Thus, after a horizontal sync-pulse signal passes through a conventional demodulator probe, it becomes substantially distorted, or "feathered."

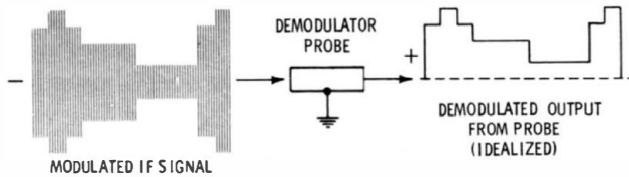

Fig. 3-9. Visualization of demodulator-probe action.

While it is possible to devise wideband demodulator probes that do not distort horizontal sync pulses, these probes require a cathode-follower tube as an electronic impedance transformer. This makes a wideband probe somewhat complicated and expensive. Therefore such probes are usually not used outside of laboratories. In service work, the probes are simple and comparatively inexpensive. These provide usable information even though video signals are substantially distorted.

A compromise between circuit loading and waveform distortion is sometimes made by the use of a demodulator probe such as the one shown in Fig. 3-10. This configuration imposes somewhat greater circuit loading than the probe in Fig. 3-8, but does not distort the horizontal sync pulses so much. The technician must not expect, however, to obtain perfect reproduction of video signals with a simple demodulator probe.

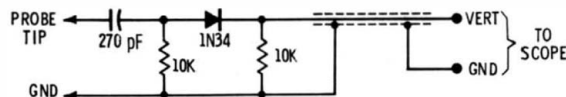

Fig. 3-10. A compromise type of demodulator probe.

A demodulator probe is sometimes called a *traveling detector*, because it can be used to trace a signal stage by stage through an i-f-amplifier section. The probe is essentially an indicating rather than a measuring device. It would be an error to attempt to measure i-f stage gain with a demodulator probe. Circuit loading and detuning often change the stage response greatly, so that amplitude comparisons can be very misleading.

The maximum input voltage which can be applied to a demodulator probe is limited chiefly by the rating of the crystal diode. As a rule,

no more than 50 volts peak to peak should be applied. This is not a severe limitation because demodulator probes are used customarily in low-level circuit testing, in which the signal voltage is seldom greater than 5 volts. However, should an i-f stage break into oscillation, it is possible for the oscillating voltage to exceed the probe rating and damage the crystal diode in the probe. Caution is therefore advisable.

Again do not make the mistake of using a demodulator probe when a low-C probe should be used. Fig. 3-11A shows a normal waveform in a video amplifier obtained with a low-C probe. Shown in Fig. 3-11B is the seriously distorted waveform displayed when by mistake a demodulator probe is used instead. Here are the rules:

1. *When the signal frequency falls within the response range of the scope, always use a low-C probe.*
2. *When the signal frequency is higher than the response range, always use a demodulator probe.*

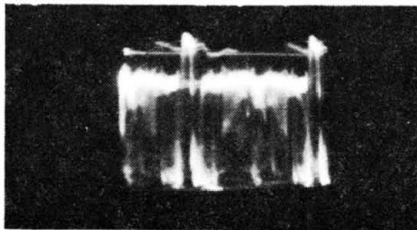

(A) Normal waveform, using low-C probe.

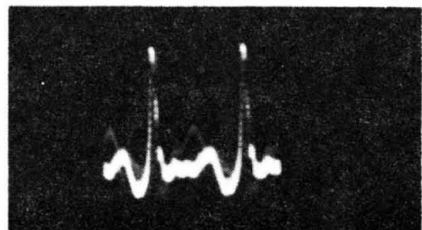

(B) Distorted waveform, using demodulator probe.

Fig. 3-11. Do NOT use a demodulator probe in video-amplifier circuits.

Do not be confused by the observation that a distorted waveform can sometimes be seen when a low-C probe is applied at an i-f amplifier grid or plate. In theory as applied here, nothing should be seen because the i-f frequency is much higher than the response range of the scope. What actually happens is that the i-f amplifier is being overdriven by the i-f signal. As a result, the tube is driven into grid current. The amplifier tube operates as a partial detector under this abnormal condition of operation.

RESISTIVE ISOLATING PROBE

A resistive isolating probe is a simple device consisting of a resistor connected in series with the coaxial cable to the scope (Fig. 3-12). This probe is used only in sweep-alignment procedures. It is basically a low-pass filter consisting of a series resistance feeding into a shunt capacitance (cable capacitance). The probe is a simple integrating circuit.

Fig. 3-12. A resistive isolating probe.

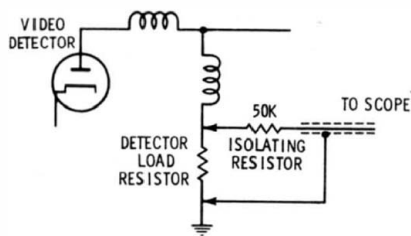

This probe sharpens the marker indications on a response curve, and helps to remove noise interference when making low-level sweep tests. The probe must have a suitable time constant for satisfactory operation. When the time constant is too long, the response curve is distorted and the marker position (if the marker is on the steep side of a curve) is displaced. On the other extreme, broad markers result when the time constant is too short. In general, a 50K resistor with a conventional coaxial cable gives a good response in sweep-alignment work.

It is sometimes thought that a resistive isolating probe could be used in place of a low-capacitance probe in testing sync circuits, video-amplifier circuits, etc. However, this is a misconception. The low-pass filter action of the resistive isolating probe weakens or wipes out the high frequencies in such waveforms, imposes phase shifts, and greatly distorts the sync or video waveforms. This probe is also unsuitable for i-f amplifier tests. If applied to i-f circuits, nothing is displayed on the scope screen, because the i-f signal is "killed" by the probe before it gets to the scope.

HIGH-VOLTAGE CAPACITANCE-DIVIDER PROBE

High peak-to-peak voltages occur in the horizontal-sweep section of a tv receiver. These voltages will arc through a low-C probe, damaging both probe and scope. A special probe therefore is required to test these high ac voltages. A typical circuit is shown in Fig. 3-13. This is a capacitance-divider arrangement. When two capacitors are connected in series, an applied ac voltage drops across the capacitors in inverse proportion to their capacitance values. Thus, if one capacitor has 99 times the capacitance of the other, 0.01 of the applied voltage is dropped across the larger capacitor. In turn, the smaller capacitor requires a high voltage rating.

Fig. 3-13. Typical high-voltage capacitor-divider probe.

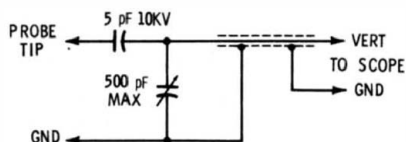

The attenuation factor of the probe is 100-to-1, and is set by a trimmer capacitor. This is a maintenance adjustment. A 100-to-1 factor is used to tie the probe attenuation in with the decade step attenuator of the scope. The probe attenuates horizontal sweep-circuit signals to 0.01 of their source value, thus protecting the scope against damage. If the scope has been calibrated with a direct probe, it is not necessary to recalibrate when a high-voltage probe is to be used. The decimal point in the calibration factor is shifted two places to the right.

The high-voltage probe is useful in any horizontal-frequency circuit test. However, it attenuates the usual sync-circuit and horizontal-oscillator voltages too much for convenient observation. Its use is therefore generally restricted to the horizontal-sweep circuit. Beginners sometimes erroneously use a high-voltage capacitance-divider probe in 60-Hz circuits, such as the vertical-sweep circuit. Vertical-frequency waveforms are distorted by the probe, as shown in Fig. 3-14.

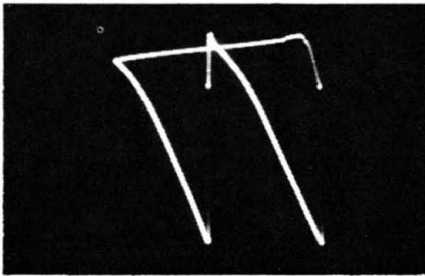

(A) Correct waveform, obtained with a low-capacitance probe.

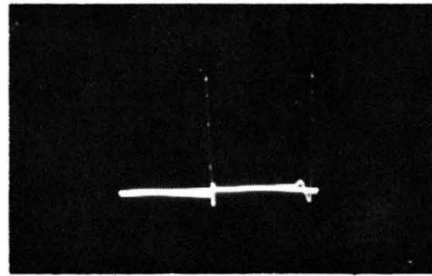

(B) Distorted waveform displayed by high-voltage capacitance-divider probe.

Fig. 3-14. Distortion of 60-Hz waveform by high-voltage capacitance-divider probe.

The reason for this distortion is seen from Fig. 3-15. The probe does not stand alone, but works into the vertical-input impedance (R_{in} and C_{in}) of the scope. The shunt resistance can be neglected at horizontal frequencies, because it is very high compared with the low reactance of the input capacitance. But, at vertical frequencies, the shunt resistance has a value on the same order as the reactance of the input capacitance. The probe thus acts as a differentiator at vertical frequencies, and vertical-frequency waveforms are badly distorted.

When a low-C probe or a high-voltage capacitance-divider probe is used, the waveform aspect is the same as with a direct probe. In most scopes, the beam is deflected when a positive voltage is applied to the vertical-input terminal, and vice versa. When a demodulator probe is used, the waveform aspect is determined by the polarity of

the crystal diode in the probe. If the diode is reversed, a positive-going sync display will be changed to a negative-going display, as shown in Fig. 3-16.

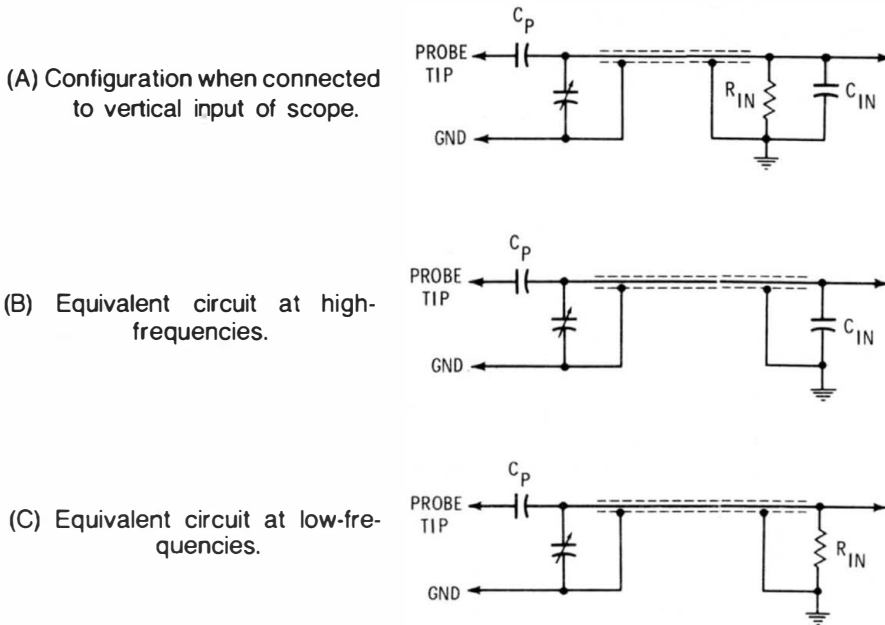
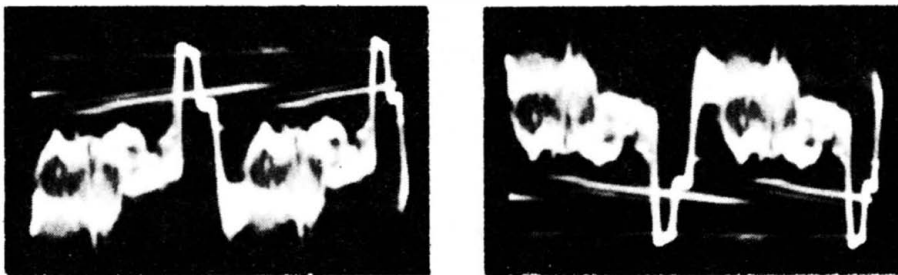

Fig. 3-15. High-voltage capacitance-divider probe and its load circuit.



(A) Positive.

(B) Negative.

Fig. 3-16. Positive- and negative-going video signals.

A few scopes have a polarity-reversing switch, making it possible for the user to invert the pattern. If a negative-going pulse is displayed when a demodulator probe is used and the operator prefers to invert the display, it is then necessary only to turn the polarity-reversing switch. Its chief use is in sweep-alignment displays (Fig. 3-17). Some technicians prefer to work with positive-going curves, and a polarity-reversing switch makes the curve aspect independent of detector polarity.

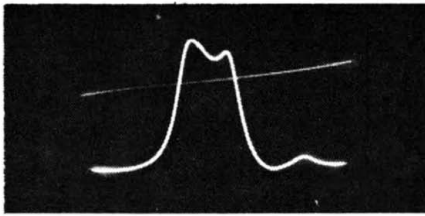

(A) Positive-going curve.

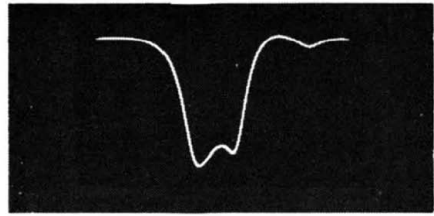

(B) Negative-going curve.

Fig. 3-17. Sweep-alignment curves.

STRAY FIELDS

Exposed binding-post connections, even though a shielded input cable is used to the scope, can be a source of hum or horizontal-pulse pickup when a low-capacitance or demodulator probe is used. The reason for this is that the vertical-input terminal becomes a high-impedance point regardless of the circuit impedance under test. Coaxial connectors therefore are preferred to binding posts. A coax connector provides a completely shielded connection which is immune to stray fields.

Do not be confused by the stray-field pattern which appears when a direct or low-capacitance probe (or unshielded test leads) are left unconnected on the bench (Fig. 3-18). The stray-field pattern disappears if the probe or leads are connected across a resistor, capacitor, or inductor. Appearance of the stray-field pattern on open circuit is due to the high input impedance and high sensitivity of the scope. Stray fields are a source of very high impedance voltages. When the input impedance to the scope is reduced by connecting the input leads or probe across a component, stray fields induce a negligible voltage into the leads.

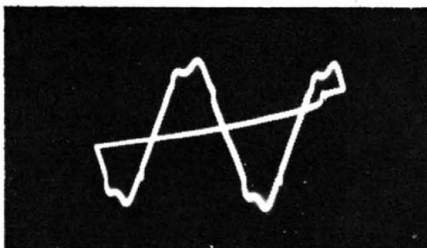

Fig. 3-18. Stray-field pattern, displayed when test leads of scope are left open.

If a low-C probe is connected to a very high impedance circuit, however, and stray fields are fairly strong, the probe tip will sometimes pick up enough stray-field interference to be troublesome. This situation is infrequent, but when it does occur, the stray-field interference can be minimized by removing the alligator clip from the end of the probe, so that a minimum pick-up surface is exposed. A clip

can be used without difficulty in most tests. This is convenient because the probe does not have to be held in contact with the circuit point under test.

Most stray-field problems are external to the scope itself, but sometimes distortion of waveforms results from internal difficulties. An example is false deflection of the base line at the left-hand end when the scope is operated at high gain. This results from cross talk between the blanking and the vertical step-attenuator circuits in most cases. Scopes susceptible to this type of distortion sometimes operate normally when the blanking function is not used. The difficulty can be corrected by enclosing the vertical step attenuator in a grounded shield can.

Base-line distortion may be observed even when the blanking function is not used. This results from cross talk between the horizontal-deflection and vertical step-attenuator circuits. The only remedy is to enclose the step-attenuator components in a shield box, as mentioned.

Sometimes an unstable vertical amplifier in a scope will simulate stray-field interference. For example, if the scope does not have input cathode followers, parasitic oscillation may occur in the pattern when testing across a coil with the scope operating at high gain. Most service scopes have input cathode followers. Those service scopes without cathode followers may need to be operated with caution when testing resonant circuits which can form a tuned-plate tuned-grid oscillator in combination with the peaking coils in the first vertical-amplifier stage. This applies principally in signal-tracing sound i-f circuits, which resonate at 4.5 MHz.

INCONSISTENT LOW-C PROBE RESPONSE

Sometimes when a low-C probe is adjusted for proper response on one setting of the step attenuator, its response is poor on another setting. This generally results from improper adjustment of the compensating trimmers in the step attenuator. (Refer to Fig. 2-15.) In case C2 or C3, or both, are misadjusted, probe response will be inconsistent on different attenuator steps. Both incorrect attenuation factor and waveform distortion can result.

To check the adjustments of the compensating trimmers in a step attenuator, it is most convenient to use a square-wave signal with an approximate 15-kHz repetition rate. The trimmers are set so that good square-wave reproduction is obtained on each step.

Basis of Bandwidth Requirement

Audio amplifiers step up voice and musical frequencies. The range of these frequencies can be simply demonstrated by connecting a

speaker to the vertical-input terminals of a scope. The waveform of any sound entering the speaker will be seen on the scope screen. If the speaker output transformer is used, connect the primary terminals to the scope input terminals. Much weaker sounds are then reproduced. Analysis of various speech and musical tones will show that a top frequency of about 10 kHz and a lower limit of about 20 Hz is necessary for full reproduction of sound. This is the bandwidth requirement of an audio amplifier.

Video i-f amplifiers step up modulated i-f signals. The basis of the bandwidth requirement is illustrated in Fig. 3-19. A modulated sine wave has sideband frequencies. They can be separated individually from the modulated wave by narrow bandpass filters, such as those in amateur radio gear. The “spread” of the sideband frequencies

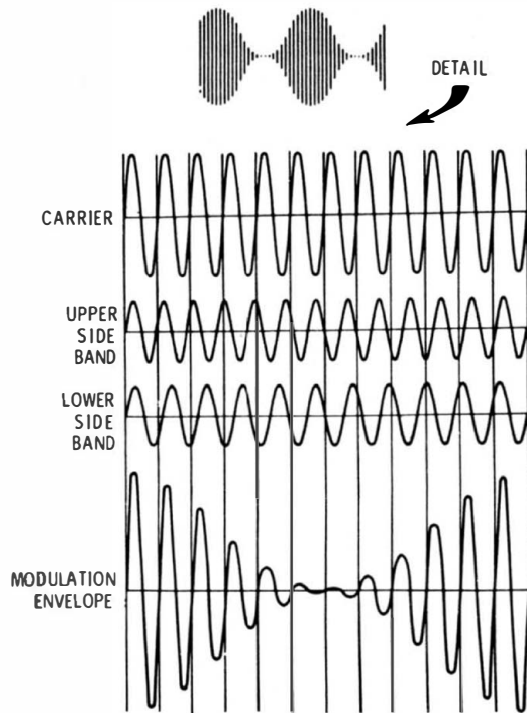

Fig. 3-19. Build-up of a modulated sine wave.

determines the bandwidth requirement of an i-f amplifier. For example, consider a 40-MHz carrier wave modulated by a 4-MHz video signal. The modulated wave consists of the 40-MHz carrier, a 44-MHz sideband, and a 36-MHz sideband. A form of single-sideband transmission and reception is used in tv transmission, so that the i-f amplifier need have a bandwidth of only 4 MHz, instead of 8 MHz. For the example cited, the i-f amplifier would pass the 40-MHz carrier and the 44-MHz sideband.

GROUND LEAD OF SCOPE PROBE

Do not overlook the necessity for a suitable ground return when making oscilloscope tests. Consider the simplest situation (Fig. 3-20) in which an unshielded test lead is connected from the vertical-input terminal of the scope to the circuit under test. Excessive hum voltage appears in the pattern, as shown, because no ground lead is connected between the scope case and the chassis of the receiver under test. The hum voltage appears because the ground-return path is forced to route itself through the power supplies of the receiver and scope via the 117-volt line. The hum interference disappears when a ground lead is connected from the scope case to the receiver chassis.

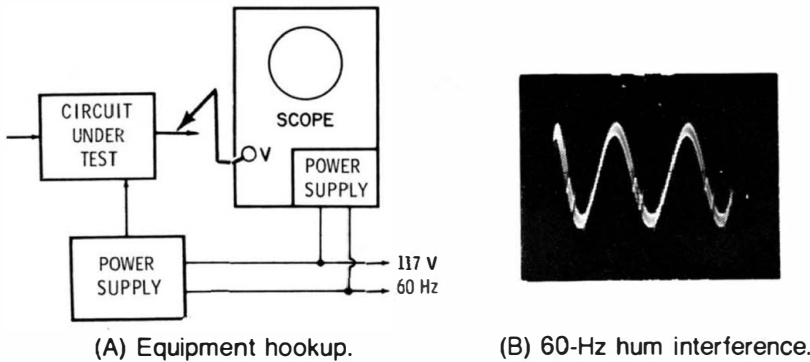
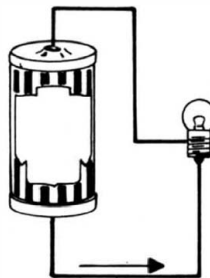

Fig. 3-20. Effect of omitting ground-return lead.

The need for a complete circuit is plainly evident in the case of direct current, as in Fig. 3-21. If one of the leads is omitted, the lamp does not light. However, capacitance can complete a ground-return circuit in an ac configuration (Fig. 3-22). The reactance of capacitor C at 60 Hz permits alternating current to flow through the neon bulb. The bulb glows, although there is not a complete metallic path around the circuit. (Note that one side of the power line is always grounded, as a protection against lightning.) The higher the capacitance of C , the brighter the lamp glows.

Both the receiver and the scope shown in Fig. 3-23 have power-supply transformers. There is stray capacitance between the primary

Fig. 3-21. If one of the leads is omitted, the lamp does not light.



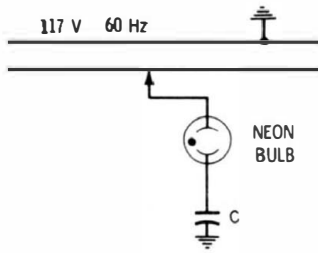

Fig. 3-22. Capacitor provides return path.

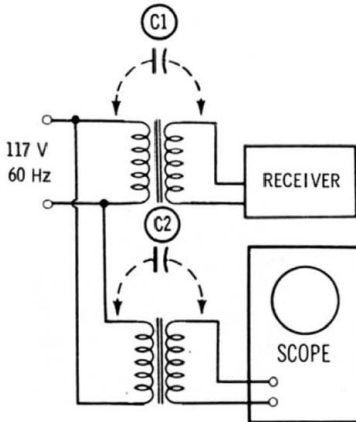

Fig. 3-23. Stray capacitances C1 and C2 form a high-impedance "connection" between the receiver chassis and scope case.

and secondary of each transformer. Although there is no ground lead connecting the receiver chassis and the scope case, a high-impedance "connection" nevertheless exists between them, because of stray capacitances C1 and C2. There is a small capacitive transfer of 60-Hz current from primary to secondary via C1 and C2. It is so small that it is generally regarded as being of no importance. Nevertheless, if a ground-return lead from the scope to the receiver chassis is mistakenly omitted, forcing a ground-return path through C1 and C2, the small 60-Hz voltage drop across each of stray capacitances C1 and C2 will appear in the pattern.

In the case of a demodulator probe, it is essential to use the short ground lead which is connected to the probe housing. Technicians sometimes suppose that if an open ground lead is run from the scope to the receiver chassis, there is no need to bother with the short high-frequency ground lead of the probe. This is a serious error for the following reason. Unless the high-frequency ground lead is kept quite short, its series inductance and stray capacitance will act as a filter and seriously disturb the high-frequency signal. At 40 MHz, for example, the signal may be killed completely. If a long ground lead permits some i-f signal to pass, the waveform is likely to be highly distorted.

The need for using the short ground lead provided with a low-capacitance probe is less important. But, when testing video wave-

forms (which have frequency components up to 4 MHz), waveform distortion can occur unless a reasonably short ground-return lead to the probe is used.

Fig. 3-24 is a simplified block diagram of a typical black-and-white tv receiver. It shows the various stages and test points for application of the scope probe. The letters at each test point indicate the correct type of probe to use, and also indicate the approximate setting of the scope sweep frequency. For clarity, all amplifier stages are included within one block in the diagram of Fig. 3-24. However, tests may be

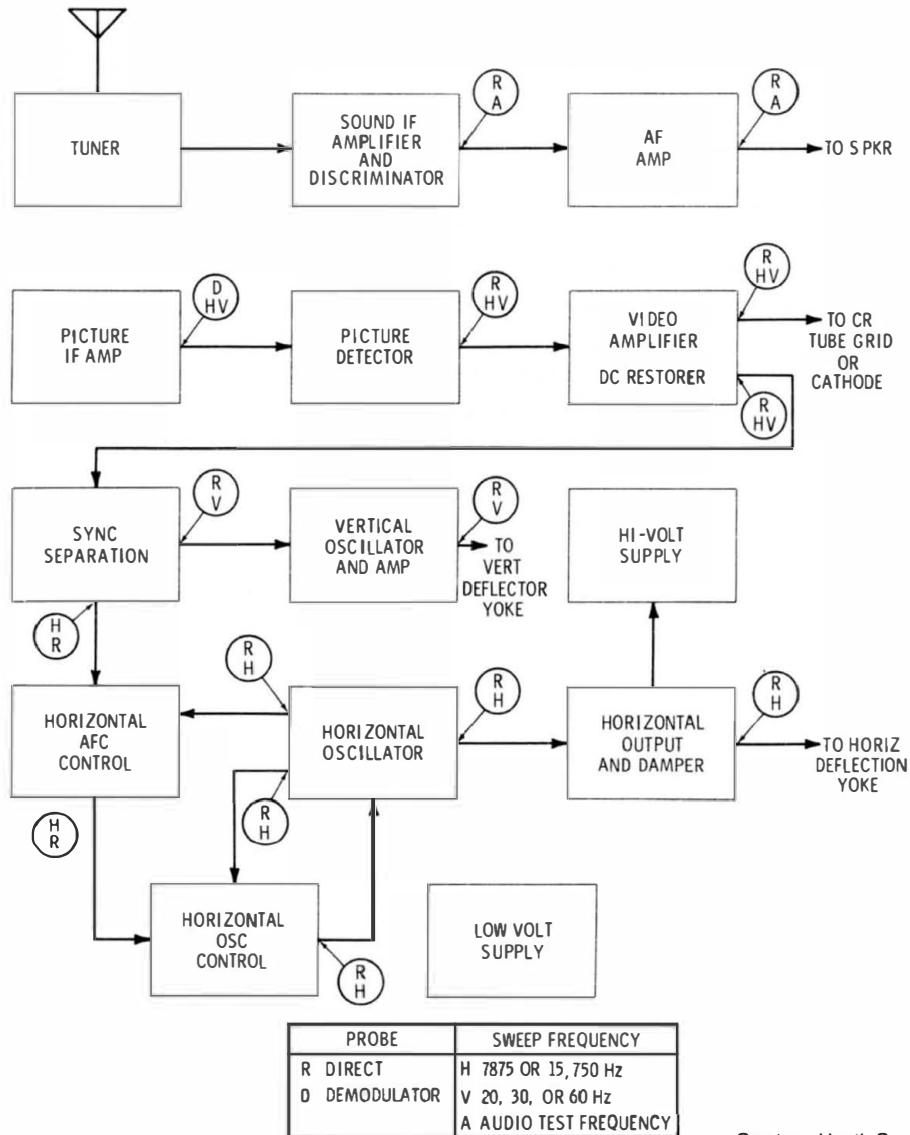

Courtesy Heath Co.

Fig. 3-24. Simplified block diagram for a tv receiver, showing test points.

made at input terminals or output terminals of individual amplifier stages, by using the indicated probe and sweep-frequency setting. Note that at any point up to the video detector, the signal voltages will be quite small and considerable vertical gain will be required. On the other hand, within the sync and deflection circuits, signal voltages are comparatively high and much less vertical gain is required. Of course, under trouble conditions, the normal signal amplitude may be greatly weakened, or no signal voltage may be found at the test point.

When making tv receiver tests, remember that two basic frequencies are involved in the video signal. The vertical or field frequency is 60 Hz. In turn, any test of circuit action (except that within the horizontal oscillator and its differentiator network, or in the horizontal-amplifier stages) can generally be made with a sweep frequency of 20 or 30 Hz, thus displaying two or three complete fields of the signal. To test horizontal pulse shapes or horizontal-deflection circuit action, the sweep frequency should be set at 15,750 or 7875 Hz. This sweep rate will display one or two complete cycles of the waveform. As a general preliminary test, the point-to-point method of signal checking is most helpful because receiver malfunction is often caused by loss of all or a significant portion of the picture information and pulses at some stage along the signal channel.

Signal Tracing in RF, I-F, and Video Amplifiers

Signal tracing is the procedure by which the progress of an applied signal voltage is checked, stage by stage, through the signal channels of a television receiver. The signal channels consist of an rf amplifier, mixer, video-i-f amplifier, video amplifier, sound i-f amplifier, and audio amplifier.

TROUBLESHOOTING RF AMPLIFIER

When the symptom is “no picture and no sound,” signal tracing starts logically at the tuner—after tubes have been checked, of course. A typical tuner configuration using tubes is shown in Fig. 4-1. A transistor-type tuner is shown in Fig. 4-2. The same functions are performed by both the tubes and the transistors. However, the dc voltages in a transistor tuner are comparatively low. Note also that the grid of an rf amplifier tube, for example, draws practically no current, whereas the base of an rf amplifier transistor draws appreciable current.

The *test point* (often called the *looker point*) is a convenient terminal from which to make a preliminary signal-tracing test. A low-capacitance probe and scope are connected to it, and the tuner input terminals are energized from a tv antenna or from a pattern or signal generator. If the scope has good sensitivity, about an inch of vertical deflection will normally be obtained from a fairly strong input signal. When a pattern generator is used, the video waveform in Fig. 4-3 will normally be observed.

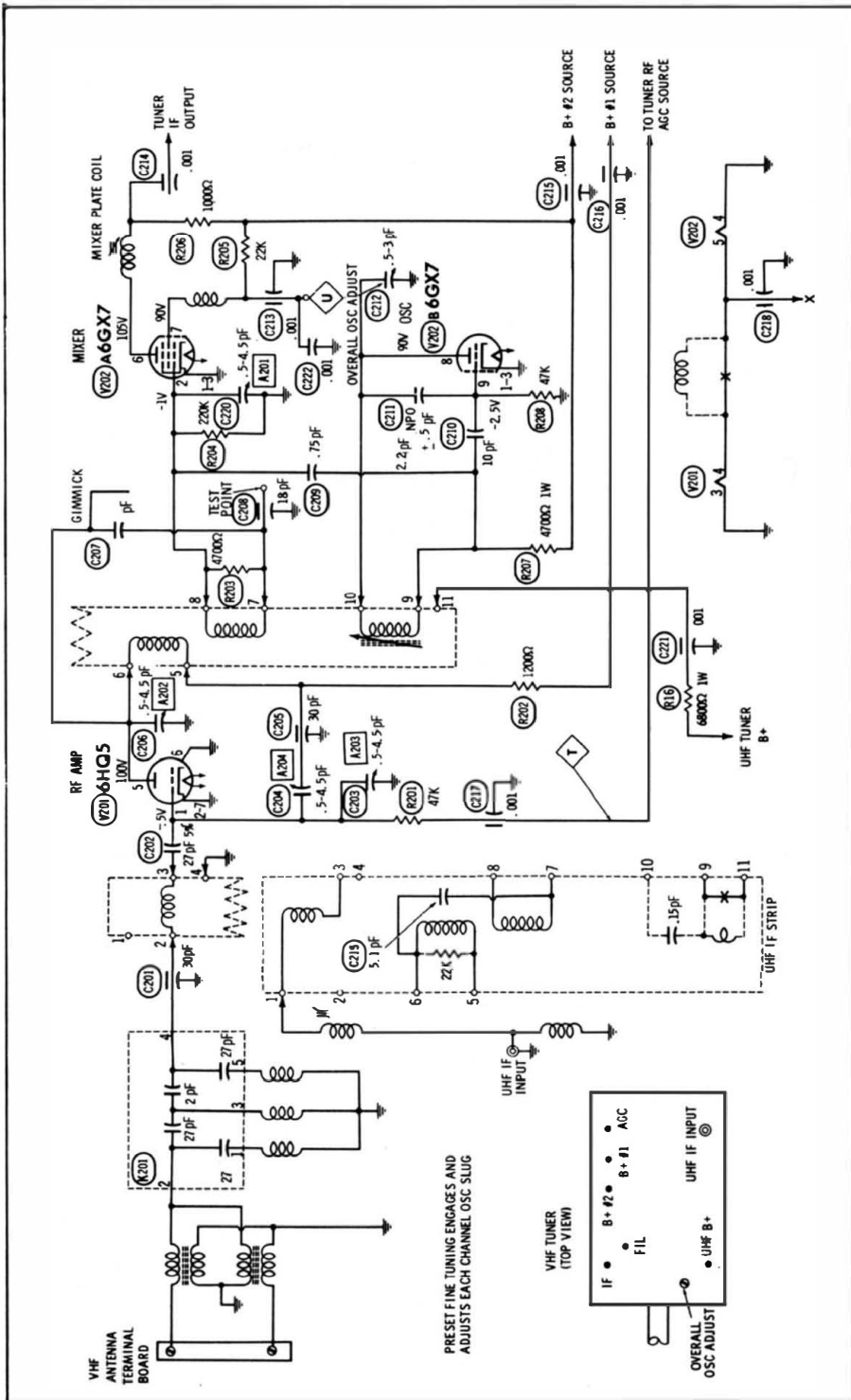

Fig. 4-1. Typical tuner configuration using tubes.

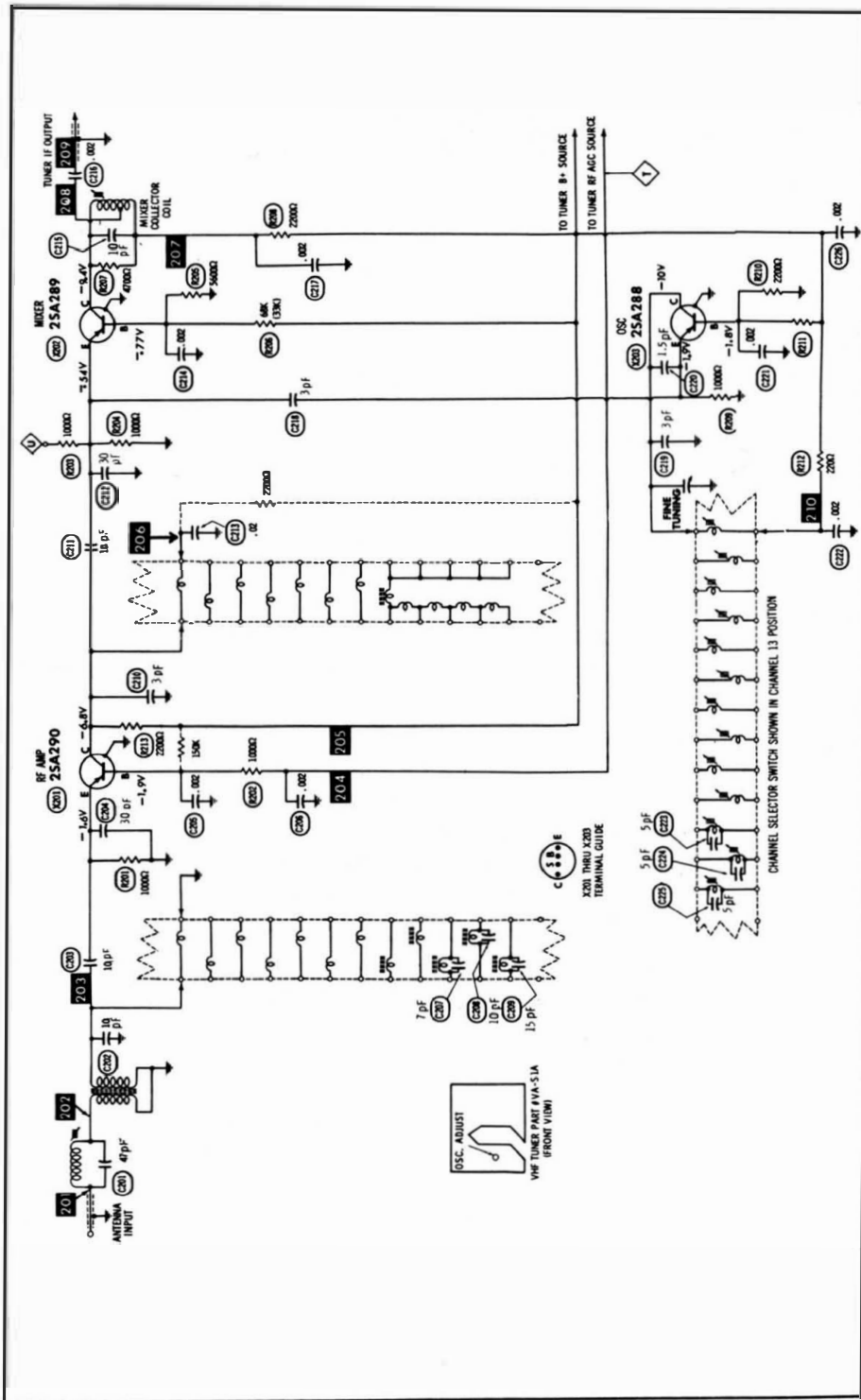

Fig. 4-2. Typical transistor-type tuner.

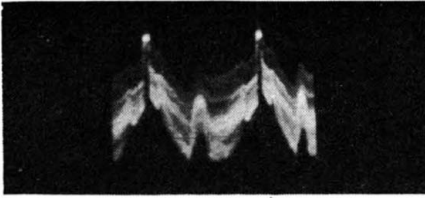

Fig. 4-3. Video waveform present at the looker point.

If the scope sensitivity is low, a direct probe can be applied to the looker point—although the increased circuit loading will add to the waveform distortion. Even with a low-C probe, the reproduced video waveform has appreciable distortion because the looker point is a tap on the mixer grid-leak. Thus, between the mixer grid and the probe there is series resistance, which acts as a low-pass filter. The horizontal-sync pulses are attenuated considerably, and the high-frequency components of video information are lost. Nevertheless, the significant consideration is the presence or absence of the signal. If the signal is absent, the tuner components must be checked. Voltages can be measured with a vom or vtvm, and resistors with an ohmmeter. Capacitors must be removed from the circuit and checked on a tester (or by substitution). When components are inconveniently “buried” in a tuner, many technicians prefer to send it to a specialty shop for repair.

There is a reason for using a low-C or direct probe instead of a demodulator probe at the looker point. The mixer is a heterodyne configuration in which the grid circuit operates basically as a rectifier and not as an amplifier. (There is a small gain through the mixer stage, but this is not its primary function.) The grid normally operates at zero bias (or contact potential). Should a dc bias voltage be fed to the grid, the tube would be biased to the midpoint of its characteristic and operate as an amplifier instead of detector. No i-f signal would appear at the plate and, for all practical purposes, the mixer would be dead.

A substantial negative bias will appear on the mixer grid during normal operation. It is generated by grid current during positive peaks of the oscillator signal, which is injected into the mixer grid circuit. This signal-developed bias provides a good check of oscillator operation. If a vom or vtvm measures zero volts or only the contact potential (about -0.5 volt), the oscillator stage is dead.

When no signal is found during a scope check at the looker point, do not forget to measure the agc voltage to the rf amplifier. Trouble in the agc line can bias off (cut off) the rf amplifier tube, and thereby give a false appearance of tuner trouble. The agc voltage should measure nearly zero volts with no signal input to the tuner. With an applied signal, several volts of negative bias will be measured when the signal level is turned up.

If a tv station signal is used, a changing video waveform will normally be displayed at the looker point. The signal has the basic appearance shown in Fig. 4-3. If an a-m signal generator is used to drive the tuner, a sine-wave signal will normally be observed at the looker point (Fig. 4-4). The waveform may or may not appear distorted, depending on the signal generator being used. Some a-m generators have a good sine-wave modulation, while others have a highly distorted waveform. Distorted modulation is not of concern; only the presence or absence of a signal is checked for at the looker point.

Fig. 4-4. An a-m generator displays a sine-wave signal.

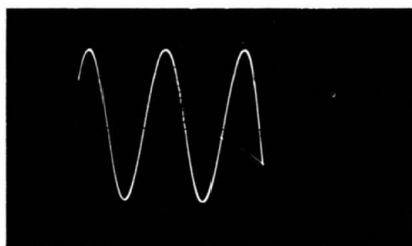

The detector action of a mixer tube is indicated in Fig. 4-5. Partial rectification is illustrated. The modulated rf input signal has an average value of zero, because the positive and negative half-cycles have equal excursions. The output signal, however, does not have an average value of zero. It has a dc component on which the modulating frequency component is superimposed. The modulating frequency is comparatively low, and falls within the response range of the scope. Hence, the modulating frequency waveform is seen on the scope screen.

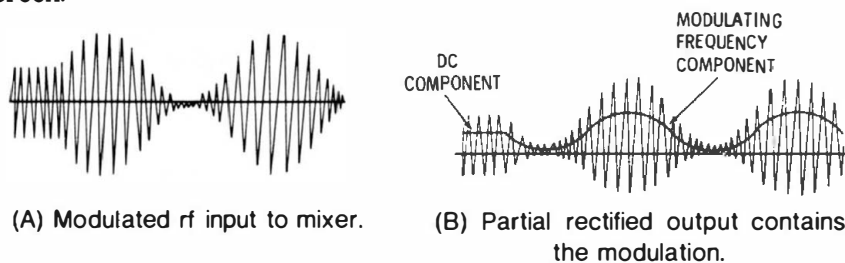

Fig. 4-5. Detection process in mixer tube.

SIGNAL TRACING IN THE I-F SECTION

A demodulator probe is used to signal-trace the video i-f section. Fig. 4-6 shows a simplified video i-f circuit, with successive test points lettered. The lowest signal level occurs at point A, and the highest at point H. The normal signal level at point E will be greater than the normal level at point D, because of the stage gain. However, when making demodulator probe tests, the reverse may seem to be the fact. Input capacitance of the probe causes circuit detuning.

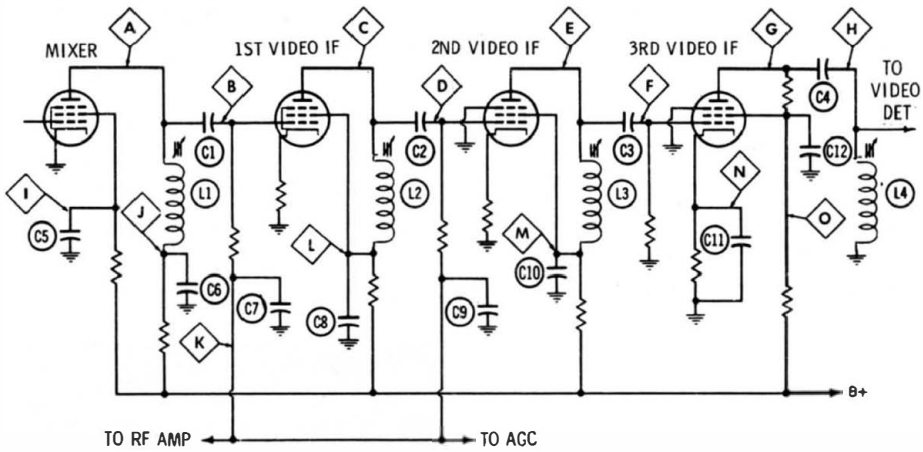

Fig. 4-6. A three-stage video i-f amplifier.

It is helpful to make signal-tracing tests with a signal generator instead of a tv broadcast signal, because you can adjust the level of the generator signal as required. Unless you use a very high-gain scope, a fairly high-level signal is required to check the first i-f stage with an ordinary demodulator probe. If you use an a-m signal generator, the signal-tracing pattern appears as illustrated in Fig. 4-7A.

A sweep-generator signal is also useful, and the signal-tracing pattern appears as shown in Fig. 4-7B. A test-pattern generator can also be used in lieu of a tv broadcast signal.



(A) Pattern using a-m generator. (B) Pattern using sweep generator.

Fig. 4-7. Typical signal-tracing patterns.

Most i-f amplifiers are stagger-tuned. In case L3 is tuned to a lower frequency than L2, application of the probe at point E temporarily makes the resonant frequency of L3 still lower. The impedance of the L3 plate-load circuit becomes abnormally low. The stage may appear to have a loss instead of a gain. Hence, do not consider apparent gain indications as meaningful, and look merely for the presence of a signal. A typical pattern is shown in Fig. 4-8. The scope is deflected at a 30-Hz rate. The pattern is distorted because of limited probe bandwidth, and the vertical sync pulse is the most prominent element in the pattern.

Fig. 4-8. Typical pattern obtained in an i-f signal-tracing test.

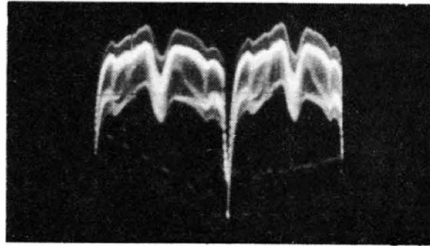

In the example cited, wherein L2 is tuned to a higher frequency than L3 (Fig. 4-6), applying the probe at point D may cause the i-f stage to break into oscillation. This occurs when the probe's input capacitance lowers the resonant frequency of L2 to about the same value as L3. The stage then operates as a tuned-plate tuned-grid oscillator. No pattern appears on the scope screen, because the stage is blocked by the high signal-developed bias resulting from oscillation. Thus, the stage may seem to be dead when tested at point D, but the false conclusion is avoided by observing that a signal is found at point E.

If a signal is found at point C but not at point D, this indicates that coupling capacitor C2 is open. Little or no signal is normally found at decoupling points, such as I, J, K, etc. Do not be misled by the presence of a small signal at decoupling points. It is difficult to get a perfect ac ground at 40 MHz because of the series inductance of connecting leads. Thus, unless the leads of the decoupling capacitor are very short, bypass action is somewhat incomplete. When a stage does not check out satisfactorily in the signal-tracing test, individual components in the stage are tested next. Voltages and resistances are measured and compared with values specified in the receiver service data. Capacitors are tested on a capacitor checker, or by substitution.

Poor Picture Quality

Trouble in the i-f amplifier can cause a poor picture-quality symptom, as illustrated in Fig. 4-9. If a laboratory-type (wideband) demodulator probe is available, the defective stage can be located directly by a signal-tracing procedure. The video signal is inspected for distortion as the probe is moved progressively through the i-f amplifier section. If a service-type demodulator probe is used, the video signal will be so severely distorted that the needed indication is masked. Therefore, an indirect troubleshooting method must be used.

A sweep generator is used instead of a pattern or signal generator. Good picture quality depends on adequate bandwidth and a reasonably flat-topped frequency response. Fig. 4-10 shows how bandwidth is measured between the 6-dB (half-voltage) points. A bandwidth of

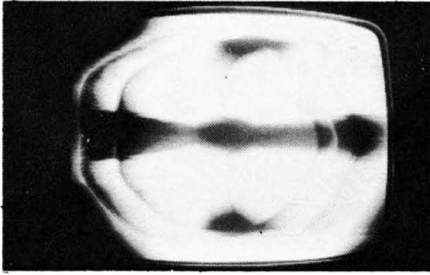

Fig. 4-9. A poor picture-quality symptom.

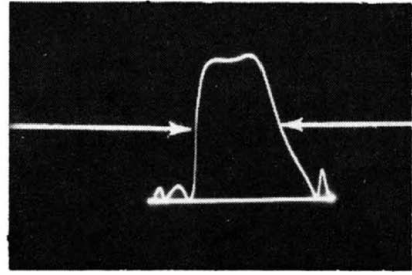

Fig. 4-10. Bandwidth is measured between the 6-dB points.

at least 3 MHz is required for acceptable picture quality. If the top is not reasonably flat, but is sharply peaked as in Fig. 4-11, picture quality will be poor even when bandwidth is adequate. A sharp peak causes ringing in the picture (circuit ghosts).

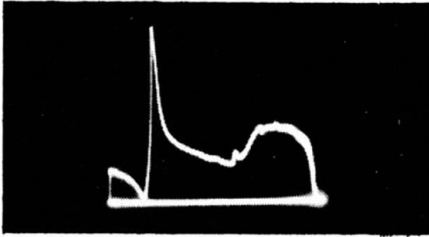

Fig. 4-11. A sharp peak on a response curve causes ringing.

Ringing appears as illustrated in Fig. 4-12. As you turn the fine-tuning control, the pattern changes rapidly. This occurs because the picture i-f carrier is being moved up or down on the i-f response curve. If you bring your hand near the i-f tube(s) which are in the regenerative circuit, the pattern will again change rapidly. Because the i-f response curve is so sharply peaked (Fig. 4-11), a small change in stray capacitance shifts the ringing frequency considerably. Regeneration is also responsive to signal-level (agc bias) changes. The reason for this dependency is that the sharpness of the peak depends greatly on the amount of i-f signal being fed back. When the i-f gain is reduced,

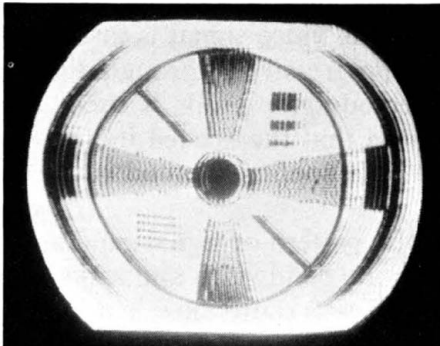

Fig. 4-12. Distortion caused by i-f regeneration.

less i-f voltage is fed back. This reduces the amplitude of the peak and increases the bandwidth.

When the distorting stage is localized, the dc voltages and resistances in the circuit are measured, capacitors are checked, and the stage alignment is investigated. Alignment of the tuned circuits is usually checked last, because poor picture quality is most likely to be caused by a defective component. There is usually only one defective component to be localized. If a screen bypass capacitor is shorted, however, it sometimes damages the screen resistor also, because of excessive current drain. (The undistorted video signal is shown in Fig. 4-13.)

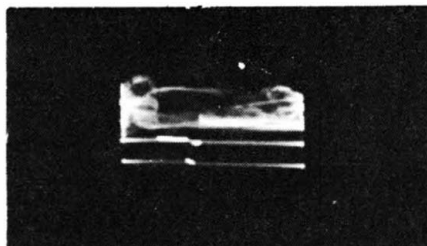

Fig. 4-13. Undistorted video signal.

Picture Pulling, or Loss of Sync

When an i-f tube is overloaded, the sync pulses are always compressed or clipped, as seen in Fig. 4-14. Overloading is usually caused by the grid or cathode bias being too low. Thus, if C11 or C9 becomes shorted (Fig. 4-6), sync compression can be expected. Of course, it is assumed that i-f amplifier tubes are good. Vertical sync punching is often observed when bias on an i-f tube is too low. The vertical sync pulse is depressed below the level of the horizontal pulses. Sync punching causes unstable vertical sync, or complete loss of vertical lock.



Fig. 4-14. Sync pulses compressed.

Severe overloading in an i-f stage can cause a negative picture when the grid-leak resistance is comparatively high. When a picture is completely negative, all the tones are reversed. When it is partially negative, the deep grays and blacks are reversed in tone, while medium and light grays are reproduced normally. Negative picture reproduction is caused by modulation reversal, whereby positive

modulation is converted to negative modulation. Excessive grid current, with suitable circuit constants, results in this conversion.

Hum in the I-F Signal

Two types of hum voltage can enter the video signal. Power-supply hum may be either 60-Hz or 120-Hz frequency, depending on the type of power supply. Heater hum has a 60-Hz frequency. A scope is a sensitive indicator of hum, showing clearly the presence of hum voltage at levels below the point at which hum bars appear in the picture. When the hum level is high, the video signal appears typically as shown in Fig. 4-15, and the picture contains hum bars as in Fig. 4-16. Sync stability is often affected when the hum level is high.

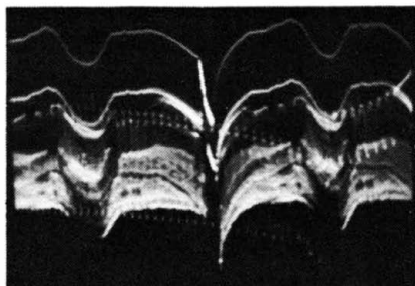

Fig. 4-15. Hum in the video i-f signal.

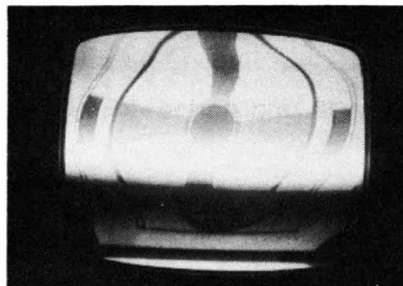

Fig. 4-16. Strong hum bar in picture.

Basically, 60-Hz hum produces one cycle of sine-wave curvature in the video signal, while 120-Hz hum produces two cycles. The pattern is not always simple; agc action tends to smooth out the hum, and amplification becomes non-linear when the hum level is high, distorting the hum waveform. Only heater hum has a sine-wave shape; power-supply hum usually has a distorted sawtooth waveshape.

To trace hum voltage to its source in an i-f amplifier, it is usually necessary to clamp the agc line with a bias box or battery. Doing so eliminates the confusion of agc reaction, and the video signal will be normal until the stage injecting the heater hum voltage is reached. Thus, heater hum is easily and definitely localized in a signal-tracing test.

Power-supply hum, however, is a generalized source which feeds into all the i-f stages. The hum component increases from stage to stage, and has its lowest amplitude at the first i-f grid. When power-supply hum is suspected, use a low-C probe with the scope, and check for hum on the B+ supply line. There is always some hum voltage present, but it should not be greater than the value specified in the receiver service data.

If normal reception resumes when the agc line is clamped, the hum voltage is entering the i-f amplifier via the agc line. The trouble then

will be found in the agc section, and not in the i-f section. Do not confuse hum voltage on the agc line with 60-Hz variations stemming from sync-section trouble. For example, if a fault in the afc circuit causes the picture to pull considerably at the top, a loss of phase will occur between grid and plate pulses in a keyed-agc tube, and a 60-Hz voltage simulating hum will appear on the agc line.

Low Contrast Versus Stage Gain

Low contrast in the picture (Fig. 4-17) is due to low gain. It is sometimes necessary to localize a low-gain i-f stage, to clear up a symptom of low contrast. Localization is uncertain with a demodulator-probe test because of the erratic nature of circuit loading imposed by ordinary probes. However, by using the picture detector as the demodulator, and by using an i-f signal-injection technique, a low-gain stage can be quickly localized.

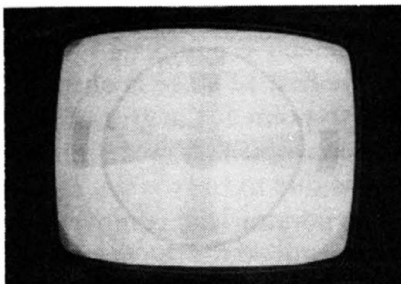

Fig. 4-17. Picture has low contrast.

The test setup illustrated in Fig. 4-18 can be used. Connect a scope and low-capacitance probe to the picture-detector output to serve as an indicator. Use an a-m generator as a signal source, and connect a 270-pF blocking capacitor in series with the “hot” lead, to avoid drain-off of dc bias. Clamp the agc line with -1.5 or -3 volts dc from a bias box or battery, and apply the generator signal first at point 1 to drive the input of the picture detector. Operate the generator on

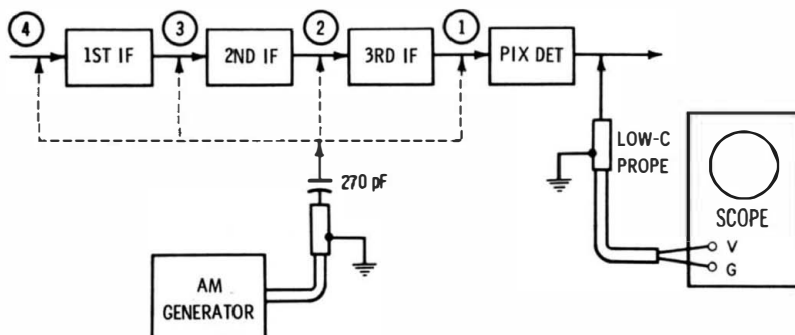

Fig. 4-18. Stage-gain test setup.

its modulated-output function, tune to the mid-frequency of the i-f band, and advance the generator output to produce about a half inch of vertical deflection on the scope screen. (This is a sine-wave pattern.)

Next, transfer the “hot” lead from the generator to point 2, the grid of the third i-f tube. In case the third i-f stage is operating normally, the sine-wave pattern on the scope screen will increase in height considerably. With -1.5 volts of bias, a gain of 5 is typical; however, the exact stage gain differs depending on the tube type and circuitry details. If the third i-f stage is faulty, the pattern will increase only slightly in height, or may even decrease. In such case, check out the components in the third i-f stage.

The next test is made by connecting the “hot” generator lead to point 3, the grid of the second i-f amplifier. If the pattern is off-screen vertically, go back to point 2 and reduce the generator output for a suitable pattern height, such as .5 inch. Then transfer the generator lead to point 3, and observe how many times the pattern height increases. Again, a substantial gain should be found. Otherwise, there is a defective component in the second i-f stage.

The first i-f stage is checked for gain by transferring the generator lead to point 1, the grid of the first i-f amplifier. This progressive test procedure will show definitely whether a low-contrast picture symptom is due to i-f trouble, and, if so, which stage is at fault. Each time the generator lead is moved back one stage, the true gain of the stage is determined for the particular grid-bias voltage to which the agc line is clamped.

This procedure gives a true gain figure, because the a-m generator has low output impedance (the output cable is terminated usually in either 50 or 75 ohms). When the generator signal is applied to the grid of an i-f tube, the low impedance of the source “swamps out” the resonant response of this grid circuit, and the following i-f circuitry operates normally.

Ground-Circuit Difficulties

Although ordinary low-impedance demodulator probes are not susceptible to stray-field interference, extended ground loops can cause application problems in low-level circuits such as the first video i-f stage. In Fig. 4-19, for example, when the signal is checked at point A, a different pattern may be observed if the probe is grounded at point 2 instead of at point 1. The reason is that the separated ground points have appreciable reactance between them at 40 MHz. If the probe is grounded at point 2, the voltage difference between points 1 and 2 is added to the grid waveform. Obviously, if the demodulator probe is connected between grounds 1 and 2, the probe input will not be short-circuited. Instead, a waveform will be seen on the screen

when the scope is operated at high gain. The farther a pair of 40-MHz grounds is separated, the greater the ground-circuit interference.

Some i-f amplifiers have a common ground point for all components within a given stage. In such case, the possibility of ground-circuit pickup is not present. However, this is not true of all i-f strips, as ground points for grid and plate circuits may be several inches apart in some chassis. The most troublesome ground-circuit interference occurs when the probe is moved from one stage to the next without transferring the probe ground lead. That is, the signal is being checked in the first i-f stage, for example, but the probe ground is connected to the chassis at the output of the second stage. This is poor practice, because the ground-circuit drop may introduce more signal voltage than is present at the first i-f grid.

Signal-Injection Precautions in Transistor I-F Strips

A typical transistor i-f strip is shown in Fig. 4-20. Although the dc voltages are much lower than in a tube-type i-f amplifier, the signal levels are not greatly different in normal operation. Hence, signal tracing is essentially the same in both types of amplifiers.

When a signal is injected into a transistor i-f strip, damage to transistors must be avoided. An a-m signal generator may have a substantial 60-Hz output voltage unless the ground lead is connected to the receiver chassis. Therefore, connect the ground lead first, and remove it last. Another precaution is to use a blocking capacitor in series with the "hot" lead of the generator; otherwise, drain-off of base bias can damage the transistor in some i-f configurations. The same precautions apply when a test-pattern signal is injected from a tv analyzer.

SIGNAL TRACING IN THE VIDEO AMPLIFIER

A low-C probe is used when signal-tracing in the video-amplifier section. Fig. 4-21 shows a typical circuit for the video-amplifier sec-

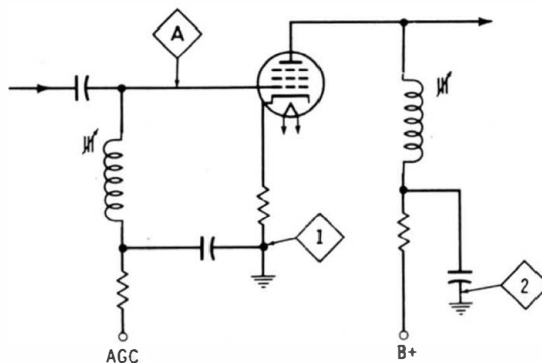

Fig. 4-19. Grounds (1) and (2) are at different 40-Hz potential.

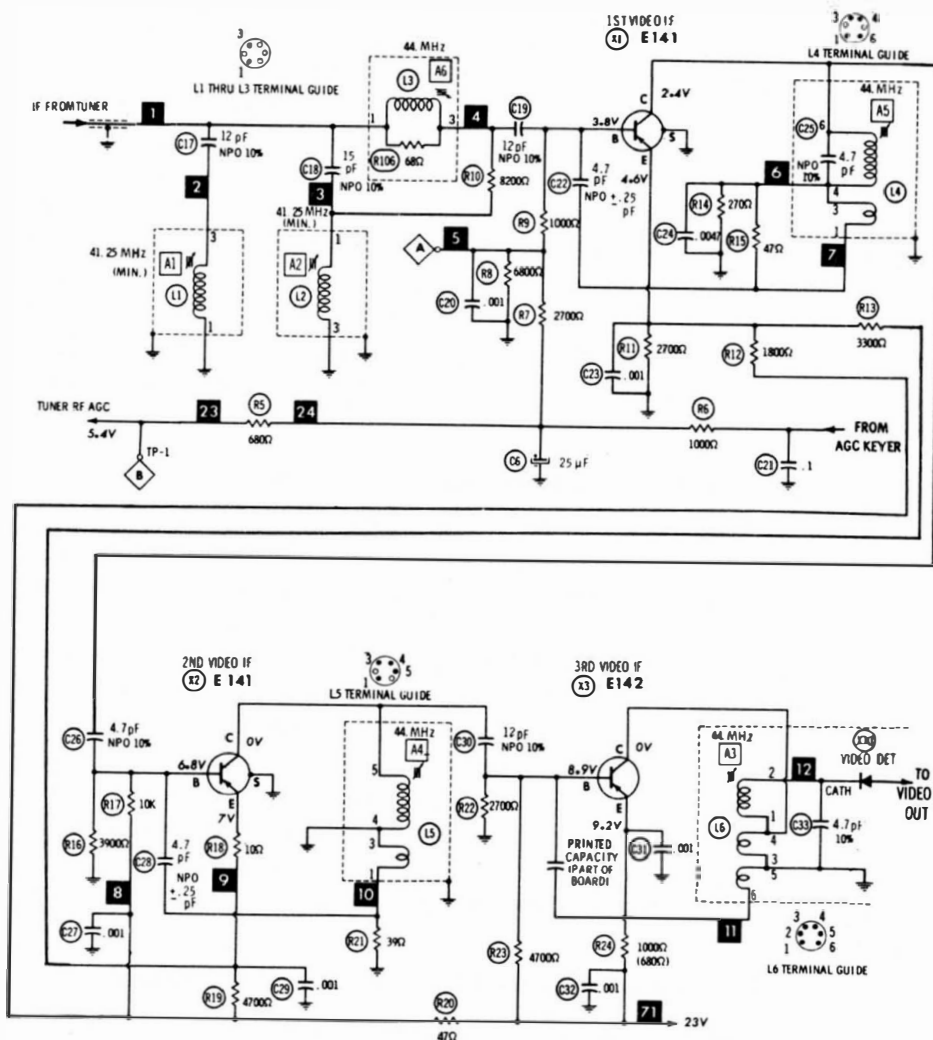

Fig. 4-20. Typical transistor i-f amplifier.

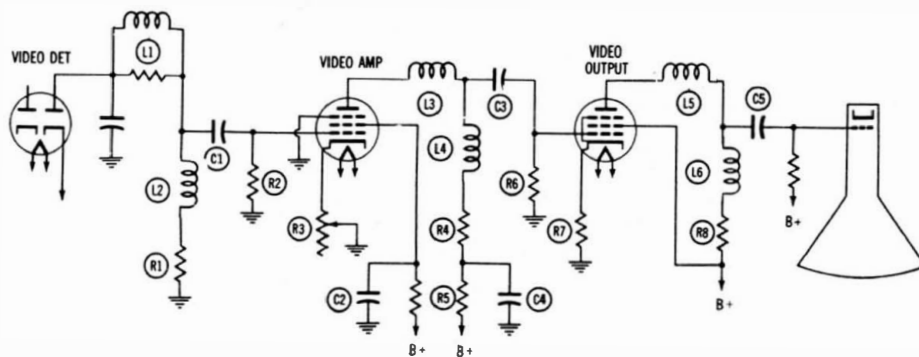

Fig. 4-21. Typical video amplifier.

tion. This is an ac coupled amplifier. Some video amplifiers are dc coupled, and many utilize only one stage. The coupling capacitors in ac coupled amplifiers are checked easily in the signal-tracing procedure. Fig. 4-22 shows how a low-C probe is shifted from input to output of a coupling capacitor in this test. Practically the same undistorted video signal is found normally at either end of the capacitor.

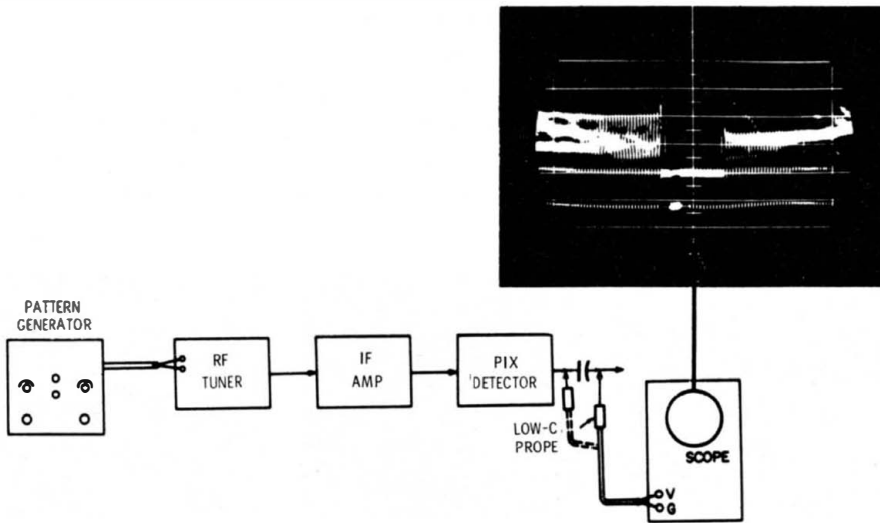

Fig. 4-22. Signal tracing across a coupling capacitor.

If the capacitor is open or nearly open, the video signal will be normal at the input end, but differentiated at the output, as shown in Fig. 4-23. If a good capacitor is bridged across the open unit, the output waveform will be restored to normal. Thus, the scope and low-C probe serve as an efficient in-circuit capacitor checker.

In case an integrated video signal is observed, as shown in Fig. 4-23B, decoupling capacitor C4 (Fig. 4-21) will be the suspect. The suspicion is confirmed by checking across C4 with the probe. If a video signal is present, the capacitor is open. An open decoupling

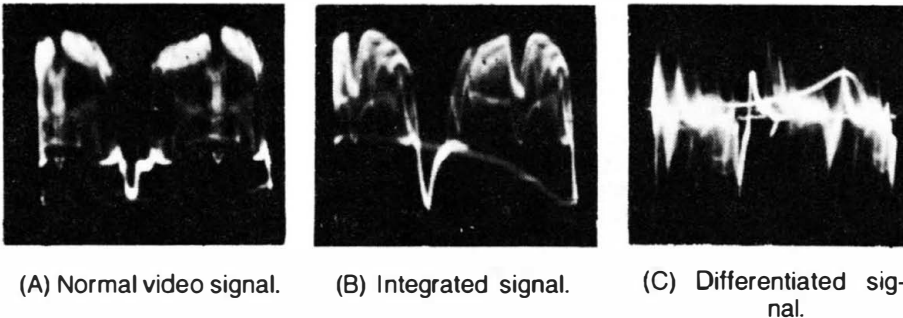

Fig. 4-23. Normal and abnormal video waveforms in Fig. 4-21.

capacitor causes integration of the video signal because the plate-load resistance is thereby abnormally increased. In turn, high video frequencies are attenuated and shifted in phase. Phase shifts in the video signal cause picture smear.

In order to see clearly the nature of frequency distortion and phase shift in a video signal, it is helpful to observe a simplified waveform consisting of a hybrid sine and square wave, as seen in Fig. 4-24. This waveform normally consists of a section of sine wave followed by a section of square wave. When differentiated, the flat top becomes curved downward, showing the loss of low frequencies. Also, the sine-wave section is shifted in phase and leads the normal wave. The flat top becomes curved upward when integrated, showing the loss of high frequencies. The sine wave section is shifted in phase and lags the normal wave.

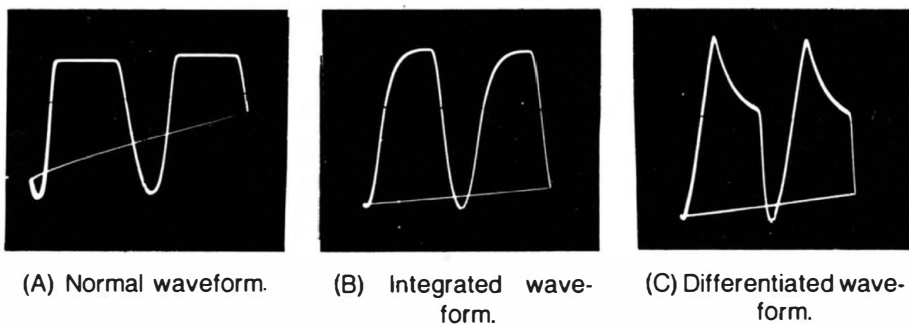

Fig. 4-24. Hybrid sine and square waves.

White Compression

When incorrect operating voltages cause a video-amplifier tube to compress or clip the video signal in the white region (Fig. 4-25), the picture appears muddy and filled up. On the other hand, compression or clipping of the sync tips causes impaired sync lock. Although sync clipping can occur in either the video amplifier or the i-f amplifier, white compression occurs only in the video amplifier.

If white compression is localized to a stage, check the dc voltages at the video-amplifier tube(s). Incorrect grid or cathode bias is the most common cause, although off-value plate and screen voltages are

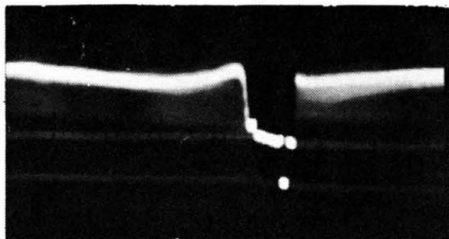

Fig. 4-25. Video signal with white portions compressed.

sometimes responsible. A leaky coupling capacitor or a shorted cathode-bypass capacitor changes the grid and cathode bias voltages, respectively. Off-value plate or screen voltages are usually caused by resistors increasing in value (although a resistor occasionally decreases in value). A leaky screen bypass capacitor reduces the screen voltage, and a leaky plate-decoupling capacitor reduces the plate voltage. An open screen bypass capacitor causes a greatly reduced gain figure, and the picture has low contrast.

Gain is checked quickly by comparing vertical deflections at the input and output of the video amplifier. Since normal gain figures vary considerably from one chassis to another, check the receiver service data. Peak-to-peak voltages at the video-amplifier output and input are specified. If the gain is normal but the peak-to-peak voltages are low, the trouble is in a stage ahead of the video amplifier.

Poor Definition

If poor picture definition occurs in the video amplifier, a signal-tracing test with square-wave input will disclose the faulty circuit. The output from a square-wave generator is applied at the video-detector output terminal, and a low-C probe is connected to the video-amplifier output terminal. Poor-definition picture, sweep-frequency response, and 100-kHz square-wave symptoms are shown in Fig. 4-26. The attenuated high-frequency response in the sweep-frequency pattern and the rounded corners in the 100-kHz square-wave pattern correspond to the "wiped out" vertical wedges in the test pattern.

The symptoms shown in Fig. 4-26 throw suspicion on the load resistors or peaking coils in a branch of the video amplifier. Remember that the video-detector output circuit is also the video-amplifier input circuit. Therefore, if the video-detector load resistor increases in value considerably, the symptoms seen in Fig. 4-26 appear. The square-wave signal-tracing procedure is useful because the distorted response is first found at the defective circuit branch.

A peaking coil is sometimes shunted by a damping resistor, as indicated in Fig. 4-21. If the peaking coil opens, the circuit will still be operative through the damping resistor. However, high-frequency distortion will be severe, square-wave corner rounding will be evident, and the picture will be badly smeared. If a damping resistor opens or increases greatly in value, the usual symptom is square-wave overshoot (Fig. 4-27). A small amount of overshoot is not objectionable, and has the effect of sharpening the edges of objects in the picture, particularly when old movie films are being televised. However, excessive overshoot causes an objectionable "outlining" of sharp edges in an image.

When the chassis has a one-stage video amplifier, the tube must be driven to maximum output to obtain normal picture contrast.

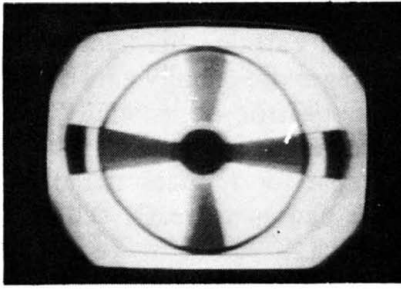

(A) Picture.

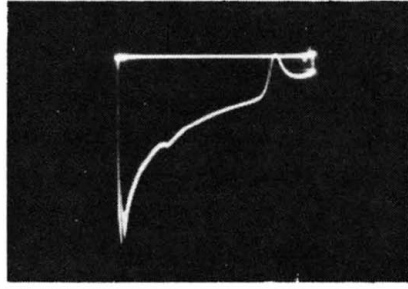

(B) Sweep-frequency response.

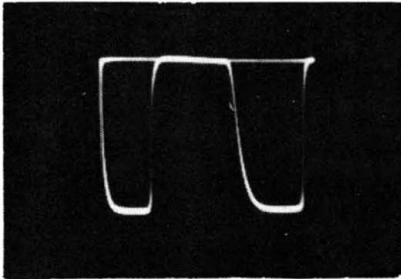

(C) Square-wave response.

Fig. 4-26. Picture, sweep-frequency, and 100-kHz square-wave symptoms.

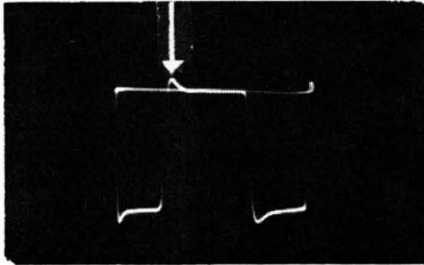

Fig. 4-27. Square wave with overshoot.

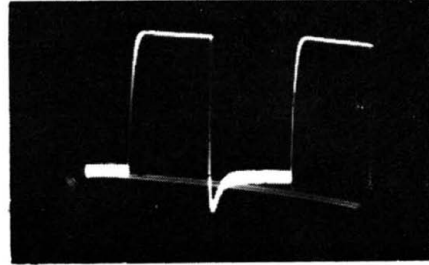

Fig. 4-28. Square wave that has an unsymmetrical overshoot.

Unless adequate screen and plate voltages are supplied to the tube, full contrast may require driving the grid into grid current on positive peaks. In that case, any overshoot arising in the grid-circuit branch will appear as an unsymmetrical overshoot (Fig. 4-28). On positive peaks of drive signal, the low grid-circuit impedance damps the peaking-coil response excessively, and the leading corner of the square wave is rounded. On the other hand, during negative peaks of drive signal, the grid-circuit impedance is high and the peaking-coil response is undamped by the tube.

Ringings and Circuit Ghosts

In case the plate-load resistor of a video-amplifier tube decreases in value considerably, the high-frequency response will rise excessive-

ly. In turn, a square-wave signal displays both overshoot and ringing, as in Fig. 4-29. Here, the ringing is more prominent on the trailing edge, due to grid-current generated by the leading edge. Ringing produces “repeats,” or circuit ghosts, in the picture.

Excessive high-frequency response implies subnormal low-frequency response. This results in more or less tilt in the top of the square wave. The picture symptom is smearing or lack of a solid tone in large objects in a scene. Severe tilt is apparent in Fig. 4-29, along with the overshoot and ringing.

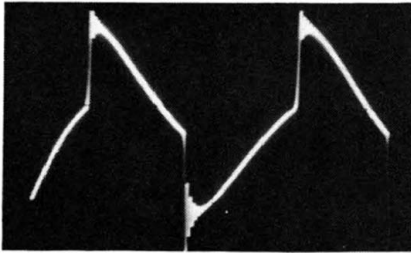

Fig. 4-29. Differentiation, ringing, and overshoot in a reproduced square wave.

A valid check for ringing cannot be made unless the square-wave generator has a sufficiently fast rise time. The rise time of the generator should be at least as fast as that of the video amplifier. According to a rough rule of thumb, the rise time of an amplifier is given by one-third of the period corresponding to the frequency 3 dB down at the high end of the amplifier's response. In other words, if a video amplifier has a 4-MHz bandwidth, the corresponding period will be 0.25 microsecond, and the rise time will be about 0.08 microsecond. Hence, the square-wave generator should have a rise time of 0.08 microsecond or less for a useful ringing test.

Square-wave tests are also useful for evaluating the performance of a transistor video amplifier. Fig. 4-30 shows the configuration of a typical transistor video amplifier. The test setup is made as shown in Fig. 4-31. Although it is not essential to disconnect the video-detector diode, doing so will reduce the loading on the square-wave generator and help to obtain a better input waveform. Be careful to avoid overdrive in the case of a transistor video amplifier, because transistors are much more easily damaged than tubes. The output from the square-wave generator should be not more than 1 volt peak to peak.

In theory, a video amplifier should reproduce a perfect square wave. However, in practice, distortion is always present; the less the distortion, the better the performance of the amplifier. Fig. 4-32 illustrates the 100-kHz square-wave response of a high-performance video amplifier. This type of response is normally observed in color tv and in deluxe black-and-white video amplifiers. The leading edge of the

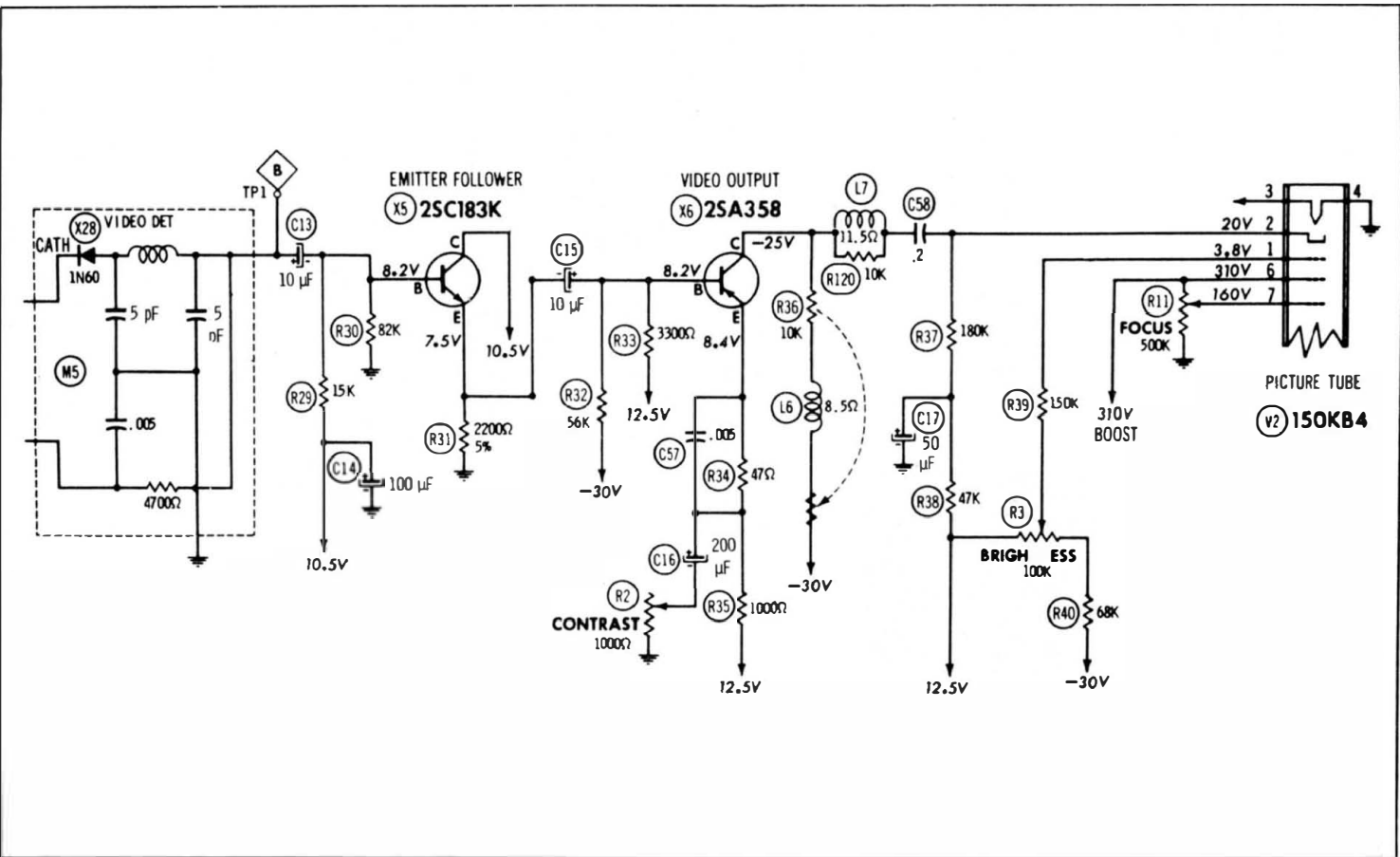

Fig. 4-30. Typical transistor video amplifier.

reproduced square wave may be expanded if a triggered-sweep scope is used (Fig. 4-33), and the rise time measured by means of the calibrated sweeps. Rise time is related to bandwidth by the formula $BW = 0.35/T$, where BW is the bandwidth in Hz, and T is the rise time in seconds (actually, a small fraction of a second).

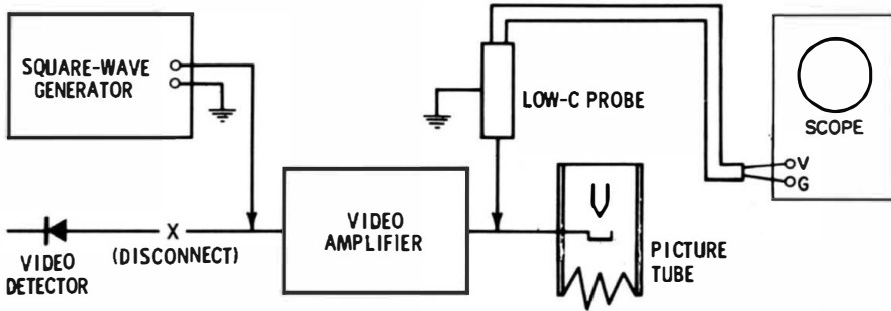

Fig. 4-31. Test setup.

Fig. 4-32. Normal 100-kHz square-wave response of a high-performance video amplifier.

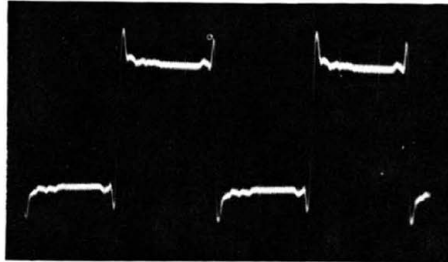

Fig. 4-33. Expanded leading edge.

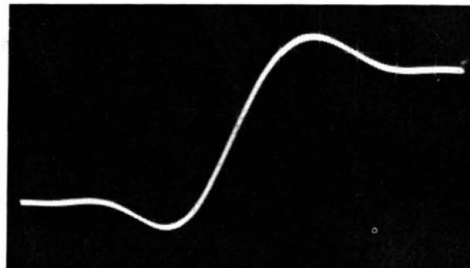
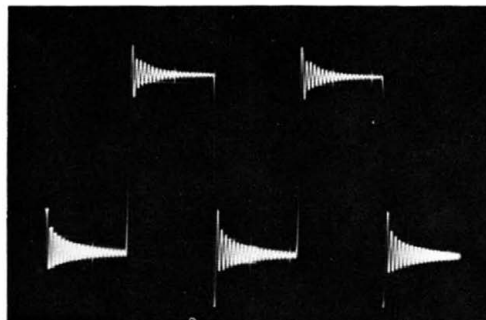

Fig. 4-34. Typical 100 kHz square-wave response of an economy-type video amplifier.



Economy-type video amplifiers normally exhibit appreciable ringing, as illustrated in Fig. 4-34. This ringing (along with overshoot) is accepted in order to obtain a reasonably fast rise time. In general, overshoot should not exceed 10 percent. The rise time should be on the order of 0.08 microsecond. If overshoot is excessive, or if the rise time is appreciably slower than normal, check the peaking coils, load-resistor values, bypass capacitors, and decoupling capacitors. It is advisable to check peaking coils by substitution.

Signal Tracing in the Sync Section

The sync separator is a branch of the signal channel. Its purpose is to clip the sync tips from the composite video signal. The separated sync signal is then used to synchronize the horizontal and vertical oscillators.

THE BU8 CIRCUIT

A typical sync-separator circuit used in modern receivers is shown in Fig. 5-1. Sync separation (and noise limiting) occurs in the left-hand section of the tube. The other section is the agc keyer.

The normal input signal to the sync separator is shown in Fig. 5-2. It is checked at point A with a low-capacitance probe. (Unless an input signal is applied to the receiver from a pattern generator or tv antenna, only a random noise pattern appears.) Its normal amplitude is about 30 volts peak to peak. Although sync lock is maintained at lower amplitudes, substantial attenuation results in unstable sync or complete loss of synchronization. If the amplitude of the signal at point A is low, check the signal at points B and C. An open capacitor in the grid circuit causes excessive attenuation and waveform distortion. If the .005- μ F coupling capacitor is leaky, the dc grid bias on the tube will be changed and the tube and circuit characteristics will be shifted. As a result, the waveform at point A will become blurry and attenuated (Fig. 5-3).

If the signal is normal at point A, the next check is made at point D, the plate of the sync separator. The normal waveform at this point consists of cleanly separated sync pulses (Fig. 5-4), with only a slight

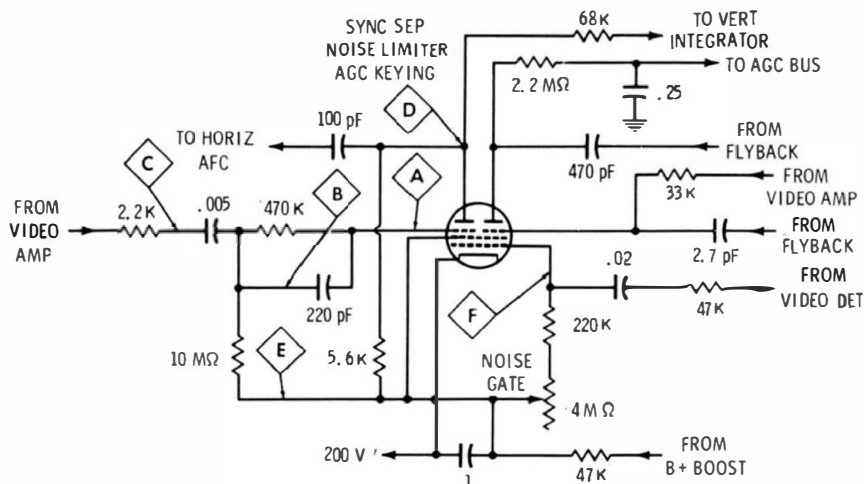

Fig. 5-1. Typical sync-separator configuration.

trace of residual video signal along the top. If the waveform is normal at point D, horizontal locking trouble is logically sought in the afc or horizontal-oscillator section. Likewise, vertical locking trouble will be due to a defect in the vertical integrator or vertical oscillator. But in the event that the waveform at point D is not normal and has appreciable residual video signal (Fig. 5-5), there is probably a defective component in the plate circuit. The 100-pF coupling capacitor may be leaky, for example.

Faulty sync separation can also be caused by a defect in the cathode circuit. In order to trace this signal, check the waveform at point E. A low-amplitude video signal (about 5 volts peak to peak) normally appears. Little or no signal at this point commonly is caused by leakage in the 0.1- μ F cathode bypass capacitor. However, if this capacitor is open, sync separation is not so seriously disturbed.

The first grid in the tube (Fig. 5-1) is common to both sections. It operates in the noise-gate circuit. A low-amplitude negative-going signal (about 0.2 volt peak to peak) from the video detector is applied to point F, and appears as shown in Fig. 5-6. The signal amplitude

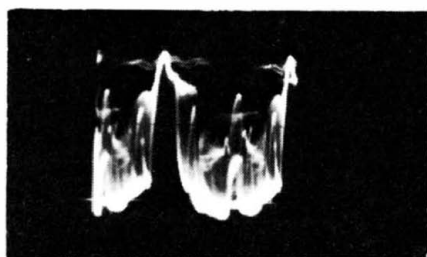

Fig. 5-2. Normal input to sync separator.

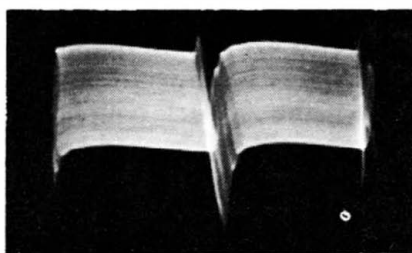

Fig. 5-3. Coupling capacitor leaky.

is normally too low to affect sync separation unless a high-level noise pulse arrives. The high negative peak voltage of the noise pulse cuts the tube off for the duration of the pulse. Thus, a "hole" is punched in the separator output signal, and sync stability is far better than if the noise-gate circuit were not used.

In case the .02- μ F coupling capacitor to the noise-gate grid is open, the negative-going video signal obviously does not feed into the grid circuit, and the noise gate becomes inoperative. This is of no consequence during strong-signal reception. Horizontal sync becomes less stable, however, on weak and noisy channels, because high-level noise pulses then feed through to the afc circuit. However, if the .02- μ F coupling capacitor is leaky, the picture disappears and no video signal is found at point F. What happens here is that dc voltage bleeds through to the video detector and "kills" the video signal, unless the noise-gate control is set to a high resistance.

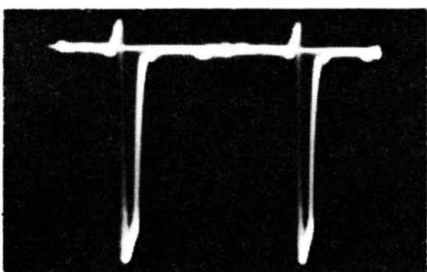

Fig. 5-4. Normal separated sync signal.

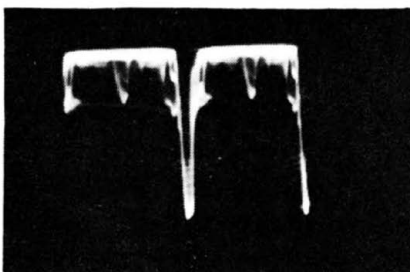

Fig. 5-5. Unsatisfactory sync separation.

The foregoing explanation of sync separation is typical. Although numerous variations in circuitry occur, particularly in older types of chassis, the general principles are the same. The sync separator always operates to strip the sync tips from the composite video signal, permitting the passage of little or no residual video. If a noise-gate circuit is used, its action is to punch a "hole" in the separated sync signal for the duration of high-level noise pulses. The technician should consult the receiver service data in each case, to determine the normal waveforms and peak-to-peak voltages.

One note of caution—the normal waveforms are sometimes distorted because of reflected trouble from the horizontal-afc or -oscillator circuit. Receivers having keyed agc may generate spurious ac voltages on the agc line when the picture is out of horizontal sync. This spurious ac can "chop up" the video-signal input to the sync separator, as shown in Fig. 5-7. To avoid being misled in this situation, clamp the agc line with a bias box or a battery before checking waveforms in the sync section.



Fig. 5-6. Negative-going noise-gate.

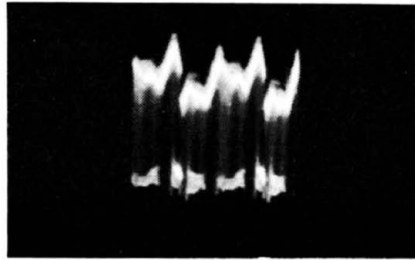

Fig. 5-7. Distortion of video signal, caused by loss of horizontal sync.

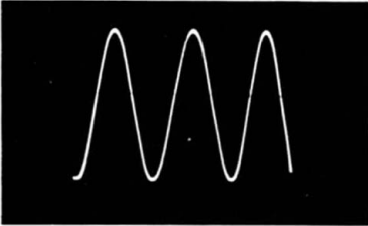
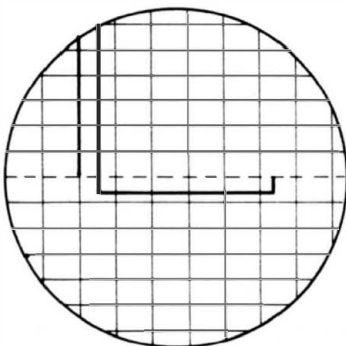

Fig. 5-8. Centered sine-wave pattern.

READJUSTMENT OF VERTICAL-CENTERING CONTROL

In signal-tracing procedures, the scope pattern may not be centered on the screen. This depends on the waveform. Readjustment of the vertical-centering control is sometimes required to prevent the top or bottom of the waveform from extending off-screen. Fig. 5-8 shows a sine-wave pattern centered on the screen. If the beam-resting level is centered, the sine-wave pattern will also be centered, in consequence of the waveform symmetry.

Next consider the display of a positive or negative pulse voltage, as in Fig. 5-9. With the beam-resting level centered on the screen, the pulse waveforms are decentered upward or downward, depending on



(A) Positive pulse.

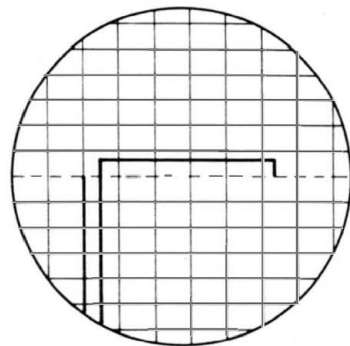

(B) Negative pulse.

Fig. 5-9. Display of positive and negative pulses.

the pulse polarity. The vertical-centering control must be readjusted to center the pulse waveform. Service scopes do not have automatic centering circuits. Therefore, whenever the waveform is poorly centered, the operator must readjust the vertical-centering control.

Some specialized scopes do have automatic centering circuits. This is accomplished by use of a dc restorer diode, as shown in Fig. 5-10. The beam-resting level is adjusted to a suitable point, such as one inch from the bottom of the screen. Then, when a waveform voltage is being displayed, the restorer automatically generates a dc bias which clamps the bottom of the waveform to the preset level. Either a positive or a negative pulse appears with the lower peak of the waveform clamped to this level. Thus, with the vertical-gain control adjusted for normal pattern height, all waveforms are automatically centered on the screen, regardless of their shape.

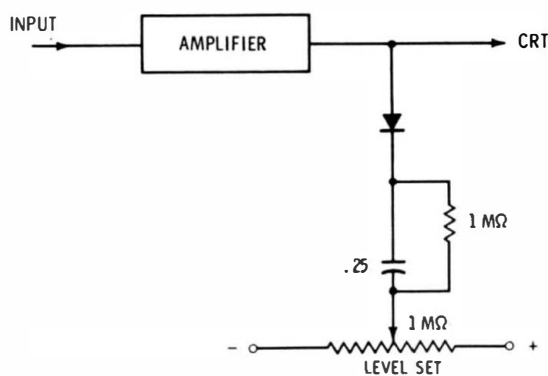

Fig. 5-10. Circuit for automatic centering.

SWEEP FREQUENCY FOR WAVEFORMS WITH ALTERNATE SYMMETRY

Sometimes waveforms have alternate symmetry, as seen in Fig. 5-11. Adjacent peaks have different voltages, but alternate peaks have the same voltage. These waveforms must be displayed with an even number of peaks in the pattern, i.e., two, four, etc. If you attempt to display a pattern with one peak or three peaks, for example, the result will be an unsatisfactory blur. The reason for this is that the sweep oscillator locks in first on a low peak, and then on a high peak, when an odd number of peaks is displayed. Thus high and low peaks overlap, or the waveform “jumps one step” on each forward trace. This makes a blurred display. On the other hand, with an even number of peaks in the pattern, the sweep oscillator locks each time on the same type of peak. The result is a clear pattern.

An even number of peaks is displayed in the pattern when the fine-frequency control is adjusted to a suitable point. If the pattern

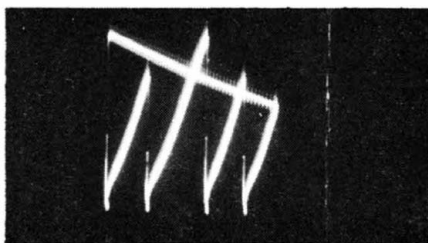

Fig. 5-11. Waveform with alternate symmetry.

locks in a blurred aspect at first, merely turn the fine-frequency control higher or lower. As the next locking frequency is approached, an unblurred pattern will suddenly fall into lock. This is not a difficult point in scope operation, but it may be confusing to the beginner. Receiver service data generally recommend the display of two complete cycles in reference patterns. If this rule is followed, blurred and overlapping displays will not occur.

Waveforms with alternate symmetry are commonly found when checking the B + supply voltage to a sync-separator or sync-amplifier tube, for example. There may be excessive ripple voltage on the supply line, because of defective decoupling capacitors or failing filter capacitors in the power supply. Excessive ripple modulates the sync signal and can cause picture pulling and rolling, or complete loss of sync.

Typical causes of alternate symmetry are as follows. The vertical-output stage usually has a heavy current demand at 60-Hz intervals. The power-supply ripple frequency in many receivers, however, is 120 Hz. With marginal filter capacitors or faulty decoupling circuits, these two ripple waveforms beat, and the resultant ripple waveform has alternate symmetry.

The 120-Hz ripple from a full-wave power supply displays more or less alternate symmetry unless the secondary of the power transformer is center-tapped exactly (equal voltages applied to each rectifier), and unless each rectifier has the same plate resistance (or front-to-back ratio in contact rectifiers). Also, one side of the center-tapped secondary may be loaded by an auxiliary half-wave power supply in some receivers.

SYNC SEPARATOR WITH PHASE-INVERTER STAGE

Many tv receivers have a sync-separator triode followed by a phase-inverter stage, as shown in Fig. 5-12. The separator operates as discussed previously, with composite video signal at points A through D. The signal amplitude is about 30 percent lower at point D than at point A. The 10K resistor prevents the separator input from loading the video amplifier objectionably. Between points B and D, the RC network serves to attenuate noise impulses to some extent. In

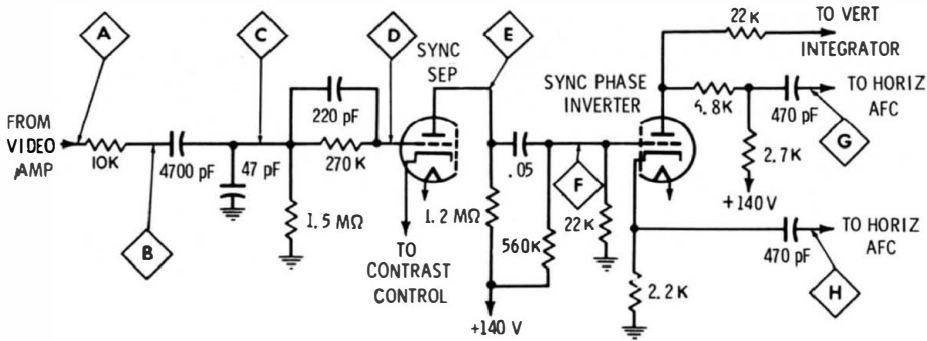

Fig. 5-12. Sync-separator and phase-inverter configuration.

turn, the horizontal sync pulse at point D normally appears rounded, compared with its shape at point A.

If the output signal at point E is weak or absent, check with a low-capacitance probe from point A through point D. Normal output from the sync separator is shown in Fig. 5-13. If an open, leaky, or shorted capacitor or an off-value resistor is attenuating or distorting the grid-input signal, the separator output will be affected accordingly.

The waveform amplitude from point E to point F does not change appreciably in normal operation. However, there is somewhat less residual video signal at point F because of the filtering action of the RC coupling network. Normal amplitude at point F is about 15 volts peak to peak. If substantially less, check the .05- μ F coupling capacitor. If the capacitor is open, horizontal-sync lock becomes quite unstable, vertical-sync lock is lost completely, and the picture rolls. The vertical-sync pulse is completely unable to couple into the phase-inverter grid via stray capacitance, while a residue of horizontal sync does transfer.

Phase-Inverter Action

The sync phase inverter provides stripped sync pulses in opposite polarities to the afc section. Outputs are taken from both the plate and the cathode of the inverter triode. These waveforms are of the opposite polarity, as shown in Fig. 5-14. Note how sawtooth components are added to the waveforms at points G and H. These are comparison waveforms from the sweep section which are fed back

Fig. 5-13. Normal sync-separator output signal.



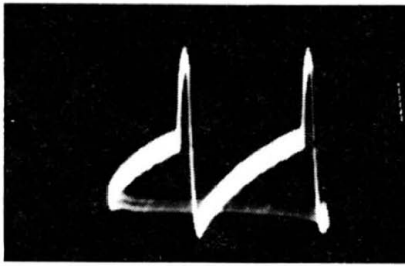

(A) At point G.

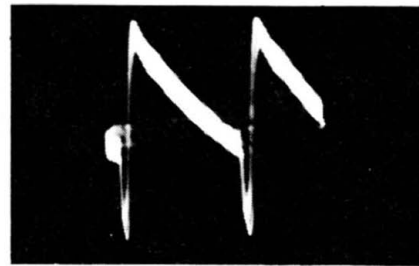

(B) At point H.

Fig. 5-14. Phase-inverter outputs.

into the afc circuit. Thus, waveforms at the inverter output are a combination of signal and self-generated voltages.

How does the inverter stage work? Recall that the output from a triode amplifier (plate output) has a 180° phase shift with respect to the grid-input signal. That is, the plate output for a complex waveform is “turned upside down” with respect to the grid waveform. Also, the output from a cathode follower has 0° phase shift with respect to the grid-input signal, that is, the cathode output is a replica of the grid input. The phase-inverter stage combines these two circuit actions.

Suppose one of the 470-pF coupling capacitors is open. Only the sawtooth component will be displayed in the Fig. 5-14 waveform. If there were a defect in the sawtooth feedback circuit in the afc section, only the sync-pulse component would be displayed in the Fig. 5-14 waveform.

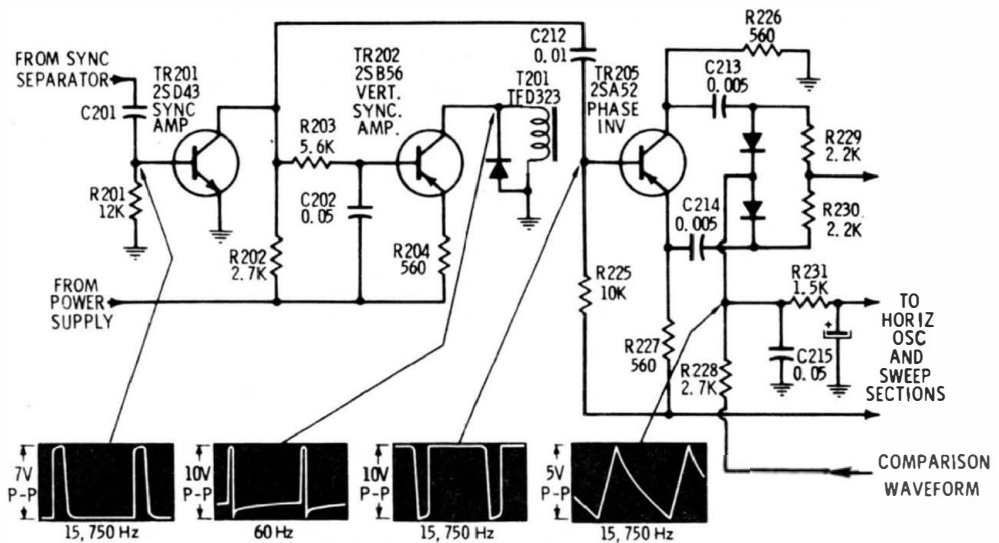

Fig. 5-15. A typical transistor sync amplifier and afc section, with separate vertical-sync amplifier.

Under normal conditions, the sync-pulse amplitudes are approximately equal at points G and H in Fig. 5-12. If you find a substantial difference in amplitudes, check the resistors in the inverter output circuit. A change in load impedance causes a corresponding change in waveform amplitude. The waveform detail at points G and H is not identical because the inverter plate feeds the vertical integrator as well as the afc circuit. The plate-load impedance has a somewhat different reactance from the cathode-load impedance in the inverter stage.

The waveforms in Fig. 5-14 represent the display for a picture in horizontal sync. If the picture is tearing or out of sync, the relationship of the pulse to the sawtooth changes. Try then to adjust the horizontal-hold control so that the picture is in horizontal sync. If it is impossible to hold the picture in lock, the sync pulses will "ride" the sawtooth component. Although the pattern is more difficult to evaluate under this condition, its essential features can be noted.

TRANSISTORIZED SYNC AMPLIFIER AND AFC

As seen in Fig. 5-15, a transistor sync amplifier and afc section is similar in most respects to its tube-type counterpart. However, the integrator may be followed by a separate vertical-sync amplifier, as shown in the diagram. This provides better separation of the vertical-sync pulses from horizontal-sync pulses by partial isolation of the vertical-sync section. Although dc supply voltages are lower in transistor circuits, we observe that the normal peak-to-peak voltages of the waveforms are in the same general range as for tube-type configurations.

When attenuated and/or distorted waveforms are observed, the components in the associated section should be checked. Leaky or open capacitors are the most common troublemakers. If excessive voltage has been applied to a transistor, the transistor is very likely to be damaged. Leakage from collector to base is the usual result, or the collector junction may be burned out completely. In any event, the terminal voltages of the transistor will be incorrect. Whenever a defective transistor is localized, be sure to check the circuit components before replacing the transistor. This is practical insurance against quick damage to a replacement transistor.

CIRCUITRY VARIATIONS

There are numerous variations in sync-separator circuitry. The basic principle is the same in all, however. The foregoing illustrations put the technician in a good position to tackle trouble in any sync circuit. The important considerations are to keep in mind how the

sync section works, how to make progressive waveform tests correctly, and not to take anything for granted. When in doubt, consult the receiver service data.

It is a highly dubious procedure to attempt troubleshooting in the sync section without referring to specified waveforms for the particular chassis because these can vary widely and unexpectedly. This point is illustrated in Fig. 5-16, which shows sync-separator outputs for two different receivers. The first waveform displays no visible residual video in the stripped sync, while the second contains appreciable residual video. Each of these waveforms is normal for the particular chassis. The afc sections have more or less relaxed requirements for the individual receivers in this regard.

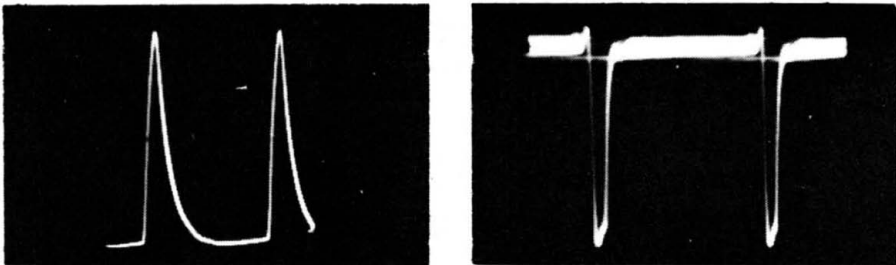

Fig. 5-16. Sync-separator output from two different receivers.

In the second example, trouble in the sync section results in excess residual video, as seen in Fig. 5-17, and horizontal sync is impaired. Thus, in these circumstances the only reliable guide is the service data for the particular receiver. Finally, it is well to remember that all waveforms have a reasonably normal tolerance; however, do not confuse tolerance with trouble symptoms. This is an essential part of waveform analysis. Waveform amplitudes may vary ± 20 percent and still be within normal tolerance, unless closer tolerances are specified.

There are normal tolerances on waveshapes, although these are more difficult to set forth in a cut-and-dried format. Beginners sometimes suppose that a sync pulse should have distinct and squared corners, as in Fig. 5-18. Such well-defined sync pulses may not even be found normally at the picture-detector output, and are never found at the sync-separator output (see Fig. 5-16). In fact, the amplitude of the sync pulses is much more important than their shape, from the standpoint of sync-section operation. There is, of course, no drawback to maintenance of well-defined pulses in the receiver circuitry. The essential point is that the squareness or roundness of the pulse has no practical effect on the end result of circuit action.

Quite the contrary consideration is encountered in other receiver sections. For example, a blanking pulse that is not sufficiently flat-topped or is too narrow will leave some of the retrace lines unblanked

or, if too wide, will blank out part of the desired picture. Obviously, proper evaluation of tolerance on waveshapes comes with experience and understanding.

As you proceed with the following chapters, these points will become clearer. Proper evaluation in each situation hinges on the basic features of circuit action. The purpose of the network must first be understood. Then the means by which this purpose is accomplished must be mastered. In due time, it becomes almost second nature for you to separate automatically the normal tolerances from the trouble symptoms.

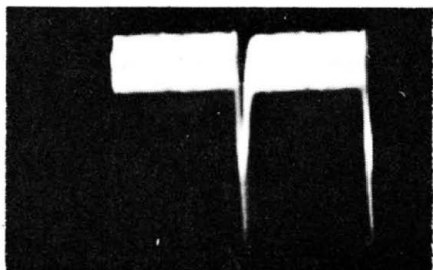

Fig. 5-17. Excessive video in the stripped-sync waveform.

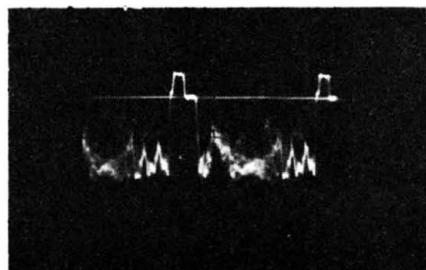

Fig. 5-18. Sync pulses that have distinct corners.

Troubleshooting the AFC and Horizontal-Oscillator Section

The afc section has two signal inputs, one from the sync separator and the other from the horizontal oscillator. Signal tracing in this section is accomplished with a low-C probe. The receiver should be driven by a pattern generator or from a tv antenna. A typical horizontal-oscillator and -afc configuration is illustrated in Fig. 6-1. Signal tracing starts with a check of the input signal from the sync separator at point A.

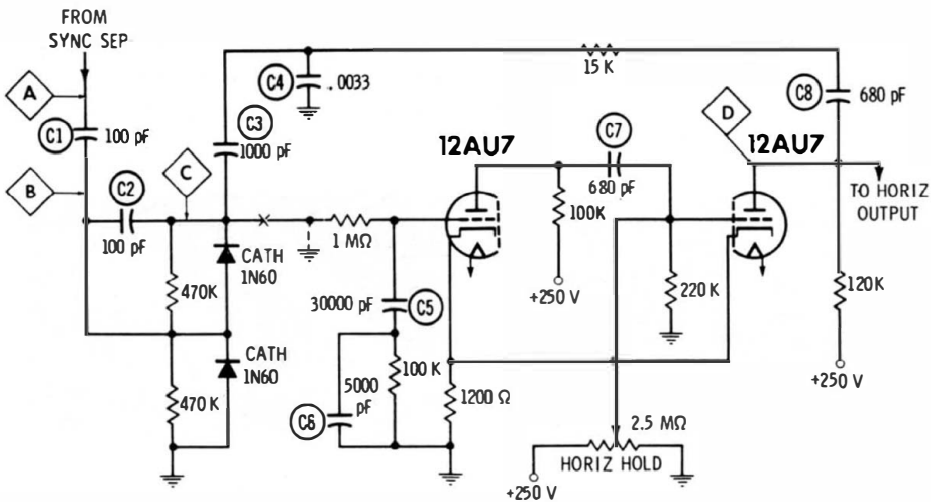

Fig. 6-1. Typical horizontal-oscillator and -afc configuration.

Normally, a waveform is found at point A, as shown in Fig. 6-2. If the waveform at point A is absent or seriously distorted, the trouble is due to a defect in the sync separator, and not in the afc circuit. But if the sync separator is supplying a normal signal, check next at point B. It might be expected that the same waveform would be found here as at point A, but this is not the case. The reactance of the 100-pF coupling capacitor causes the waveshape to be different because it becomes mixed to some extent, with a sawtooth component from the horizontal oscillator (Fig. 6-3). The same waveform appears at points B and A only when the oscillator is inoperative.

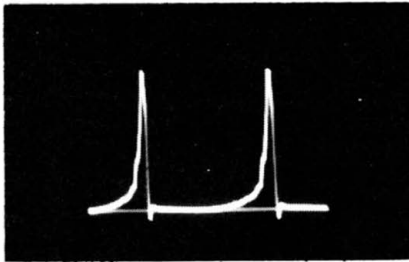

Fig. 6-2. Normal input waveform obtained from the sync separator.

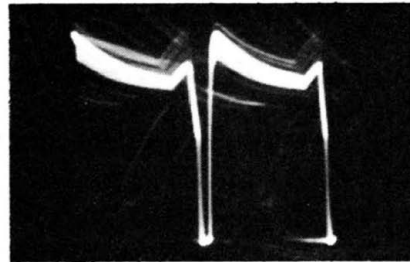

Fig. 6-3. Normal waveform at the output end of the coupling capacitor.

The sawtooth waveform from the horizontal oscillator (Fig. 6-4) enters the afc circuit at point C in Fig. 6-1. But suppose that capacitor C2 becomes leaky. The waveform then does not change in amplitude appreciably, but it becomes distorted as seen in Fig. 6-5. Horizontal locking is unstable under this condition. When waveform tests throw suspicion on a circuit, measure the dc voltages and resistances. Test the capacitors on a capacitor checker, or by substitution. Note in Fig. 6-1 that the 1N60 afc diodes may become defective and cause waveform changes. The diodes can be checked for front-to-back ratio with an ohmmeter or by substitution.

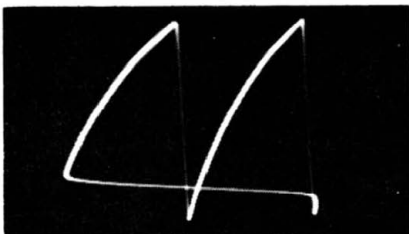

Fig. 6-4. Normal sawtooth waveform from horizontal-oscillator circuit.



Fig. 6-5. Waveform from horizontal-oscillator circuit when coupling capacitor is leaky.

The afc circuit is basically a waveform comparison configuration. The incoming sync pulses are mixed with a sawtooth wave from the oscillator. The mixed waveform is fed to the afc diodes and rectified. This rectified dc voltage is fed to the grid of the first tube in the multivibrator (oscillator) circuit. When this dc bias voltage is positive, the oscillator speeds up; when it is negative, the oscillator slows down.

The polarity of the dc output voltage from the afc diodes depends on the phase of the sawtooth wave with respect to the sync pulses. When the pulses ride on top of the sawtooth wave, the mixed waveform has a high peak-to-peak voltage. When they ride part way down on the sawtooth wave, the mixed waveform has a lower peak-to-peak voltage. If a change in oscillator frequency (pulling) causes the sync pulses to ride lower on the sawtooth in one diode circuit, the opposite will occur for the other diode circuit. The dc output from the afc diodes will swing positive or negative, depending on which way the oscillator is pulling—that is, on whether it is trying to run too fast or too slow.

Next, consider the solid-state horizontal afc, oscillator, and driver arrangement shown in Fig. 6-6. This is an example of a balanced type of afc circuit which is driven in push-pull from a sync phase inverter. A comparison waveform from the collector of the driver transistor is fed through L17 and C39 to the center of the balanced-diode afc circuit. Note that C96, C38, R123, R124, C97, and C98 form a coupling, filtering, and antihunt network. An antihunt network provides a system input-output phase relation which prevents self-oscillation. The most informative test in case of picture trouble symptoms is to check the peak-to-peak voltages and shapes of the afc and oscillator waveforms. In case the oscillator is off-frequency and the horizontal-hold control is out of range, it is helpful to note whether the oscillator is running too fast or too slow. This observation serves to eliminate particular components from suspicion.

OSCILLATOR OR AFC TROUBLE?

Sometimes the receiver acts as if the oscillator were running so far off-frequency that the afc circuit cannot pull it into sync. A simple test can be made to determine whether the trouble is in the afc section or in the oscillator section. Disconnect the 1-M Ω isolating resistor as indicated at X in Fig. 6-1, and ground the disconnected end of the resistor as indicated by the dotted-line connection. If the trouble is in the afc circuit, it will be possible to free-wheel the picture into horizontal sync (at least momentarily) by critical adjustment of the horizontal-hold control. If the picture cannot be framed, the trouble is in the oscillator circuit.

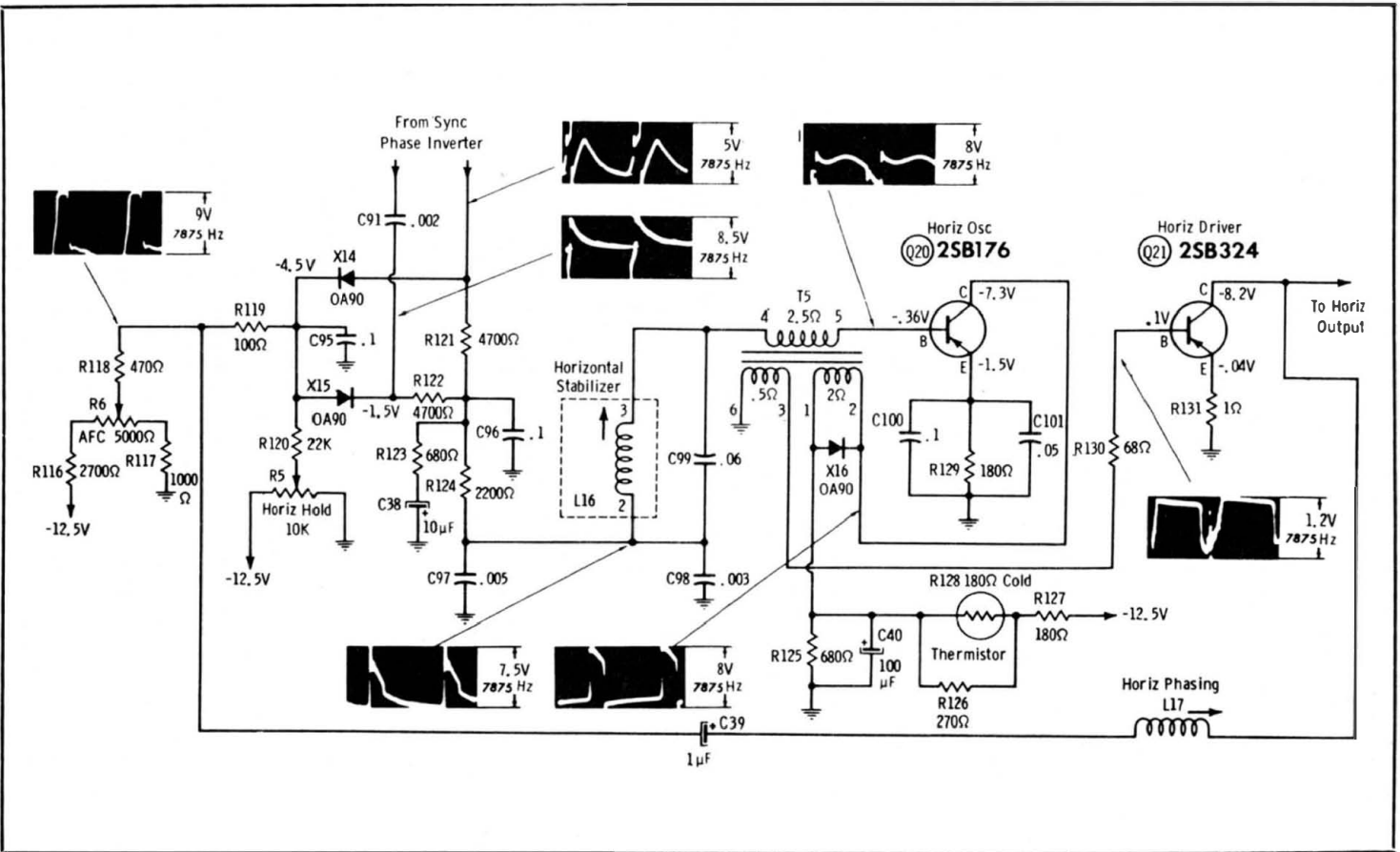

Fig. 6-6. A solid-state horizontal-afc, oscillator, and driver configuration.

This test is based on the principle that a normal oscillator operates at about 15,750 Hz when the afc control voltage is zero. Hence, the control voltage is set to zero by this test connection in order to see whether the oscillator is capable of normal operation.

Although the circuit may look complex, it is merely an assembly of basically simple components. Therefore, the attack on a defective circuit is first of all a check of the individual components. Note here, too, that Ohm's law applies to reactance and to impedance in the same general manner as to resistance.

In case C1 is open, horizontal sync lock becomes extremely touchy. The waveform at point B in Fig. 6-1 does not exhibit a prominent sync-pulse component, but becomes a distorted sawtooth (Fig. 6-7). The sawtooth amplitude is less than that of the normal waveform, because the pulse component is missing.

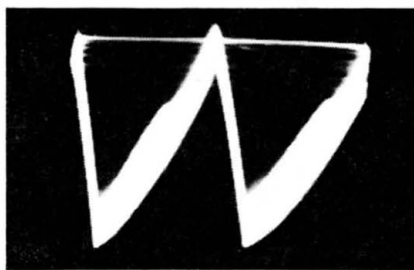

Fig. 6-7. Waveform at point B when C1 is open.

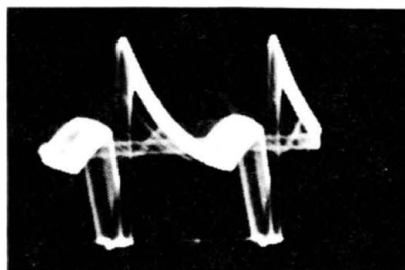

Fig. 6-8. Waveform at point B when C2 is open.

When C2 is open, the waveform at point B becomes distorted as in Fig. 6-8. Although it might be expected that an open capacitor would decrease the waveform amplitude, that is not here. The diode response changes when the capacitor is open, and the waveform amplitude doubles (approximately). Stability of sync lock is not greatly affected on strong channels, but becomes unstable on weak-channel reception. Note that the waveform in Fig. 6-8, as in the case of previously illustrated waveforms, is taken with the picture framed in horizontal sync. This is important because the afc waveforms often become considerably changed and blurry if the picture is out of horizontal sync. When checking the waveforms, look at the picture occasionally to see whether or not it is still in sync. If not, adjust the horizontal-hold control as required, even if the adjustment is critical.

If C3 is open, the distorted waveform in Fig. 6-9 will appear at point B. The waveform has about double the normal amplitude, because of the increase in circuit impedance when C3 has no leading action. The comparison waveform (oscillator sawtooth) is absent, and therefore the picture cannot be framed horizontally unless the 1-M Ω resistor is disconnected and grounded as shown by the dotted lines in Fig.

6-1. Then the picture can be free-wheeled into frame by careful adjustment of the horizontal-hold control.

Again, if C4 is open, a distinctive distortion occurs in the waveform at point B, as shown in Fig. 6-10. This distorted waveform has an amplitude several times higher than normal. When C4 is open, its normal attenuating or bypassing action is removed, and the sawtooth comparison wave increases substantially in amplitude.



Fig. 6-9. Waveform at point B when C3 is open.

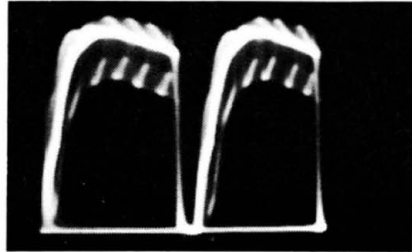

Fig. 6-10. Waveform at point B when C4 is open.

SIGNAL-TRACING THE HORIZONTAL-OSCILLATOR SECTION

When the horizontal oscillator is inoperative, the screen is dark because there is no drive to the horizontal-output tube, and therefore no high voltage to the picture tube. Faults other than oscillation failure also cause a dark screen. For example, when C5 is open (Fig. 6-1), the oscillator continues to function, but at an incorrect frequency. When the drive to the horizontal-output tube is considerably off-frequency, the high-voltage output falls so low that the screen becomes dark. Also, when C5 is open, the grid-circuit impedance of the multivibrator input tube becomes very high, and spurious feedback occurs through the afc section into other receiver sections. This spurious feedback oscillation is audible and is called "squegging." Squegging may also generate excessive spurious voltages which can break down some components.

All waveforms throughout the afc and oscillator section become highly distorted when the receiver is squegging. For example, Fig. 6-11 shows the distorted waveform at point B in Fig. 6-1. Its amplitude is considerably higher than that of the normal waveform. A similar trouble symptom occurs when C6 is open, but the squegging frequency is higher, and the screen does not go dark. The picture will not lock horizontally, of course. All waveforms in the horizontal section are distorted, and the waveform at point B appears as in Fig. 6-12. Its amplitude is considerably higher than normal.

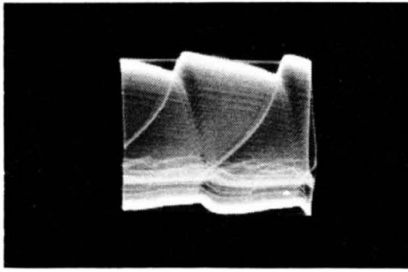

Fig. 6-11. Waveform at point B when C5 is open.

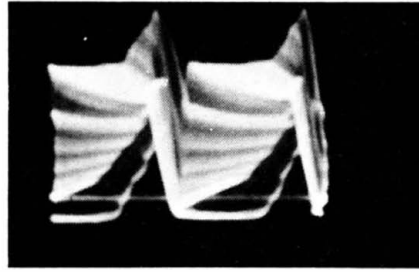
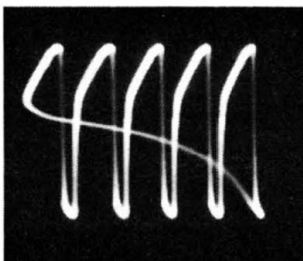
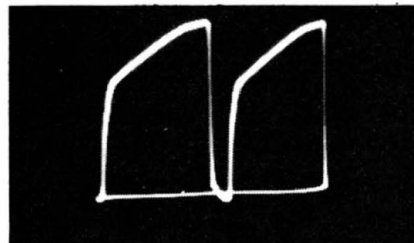

Fig. 6-12. Waveform at point B when C6 is open.

The normal output waveform from the horizontal oscillator is seen in Fig. 6-13. It is a peaked sawtooth waveform which drives the horizontal-output tube, and is checked at point D in Fig. 6-1. Normal amplitude is 130 volts peak to peak. Reduced amplitude can be caused by either leakage or loss of capacitance in C7. If C7 is completely open, the oscillator will stop and the screen will be dark. The symptoms of leakage and low capacitance are shown in Fig. 6-14. Fig. 6-14A shows the distorted waveform which appears when C7 is quite leaky, and Fig. 6-14B shows the effect of capacitance loss. Both waveforms appear at point D and both have more cycles than usual in the pattern when the scope deflection rate is set for 7875 Hz. More cycles appear than usual, because defects in C7 speed up the oscillator. Although the horizontal-hold control is turned to the end of its range, the picture may be broken up into diagonal strips.

Fig. 6-13. Normal output waveform from horizontal oscillator.



(A) Leaky capacitor.

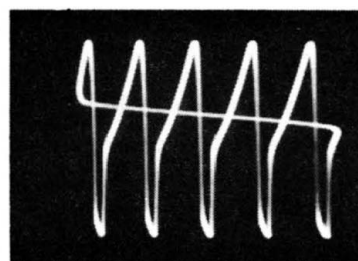

(B) Low capacitance.

Fig. 6-14. Waveform symptoms of defects in C7 of Fig. 6-1.

When C8 in Fig. 6-1 is open, the picture-tube screen is dark. If C8 is leaky, the picture is present but horizontal sync is unstable. Waveform symptoms of these defects in C8 are shown in Fig. 6-15. With C8 open (Fig. 6-15A), the waveform at point D in Fig. 6-1 is greatly reduced from its normal amplitude. Also, the oscillator runs too slowly, causing fewer cycles than usual to appear in the pattern. Low drive and low-frequency output combine to darken the picture-tube screen. If C8 is leaky, the oscillator can usually be adjusted to operate temporarily at 15,750 Hz, but continual drift necessitates frequent resetting of the horizontal-hold control. The waveform at point D (Fig. 6-15B) is considerably distorted, but is almost normal in amplitude.

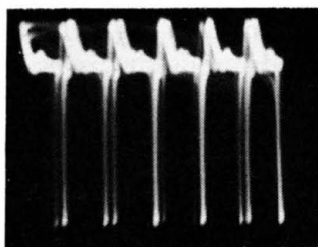

(A) Open capacitor.

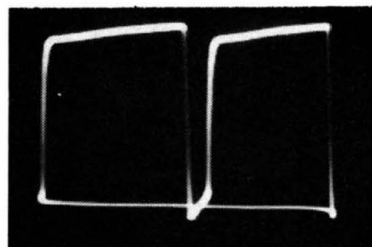

(B) Leaky capacitor.

Fig. 6-15. Waveform symptoms of defects in C8 of Fig. 6-1.

In addition to defective capacitors, off-value resistors or incorrect B+ supply voltage can cause trouble in horizontal-oscillator operation. Incorrect resistance values are easy to localize; therefore, the resulting waveform distortions are not shown here.

The foregoing discussion is concerned with a particular circuit configuration, but the general principles developed apply to other configurations. The essential procedure here is to check the observed waveshapes and amplitudes against the service data for the particular receiver, and, when deviations are noted, to analyze the pattern for the information which it contains.

SYNCHROGUIDE RINGING-COIL CHECK

Some horizontal-oscillator circuits, such as the Synchroguide configuration shown in Fig. 6-16, have a ringing coil for stabilization of the oscillating frequency. The ringing coil is shown at L_a. To check the slug adjustment, connect a low-C probe as indicated, and observe the peaks of the waveform displayed on the scope screen. The pattern comprises a combination pulse and sine wave in which the positive peaks normally have the same horizontal level, as illustrated. If the pulse peaks are higher or lower than the sine-wave peaks, adjust the slug in the ringing coil as required.

Fig. 6-16. Signal of Synchroguide ringing-coil adjustment.

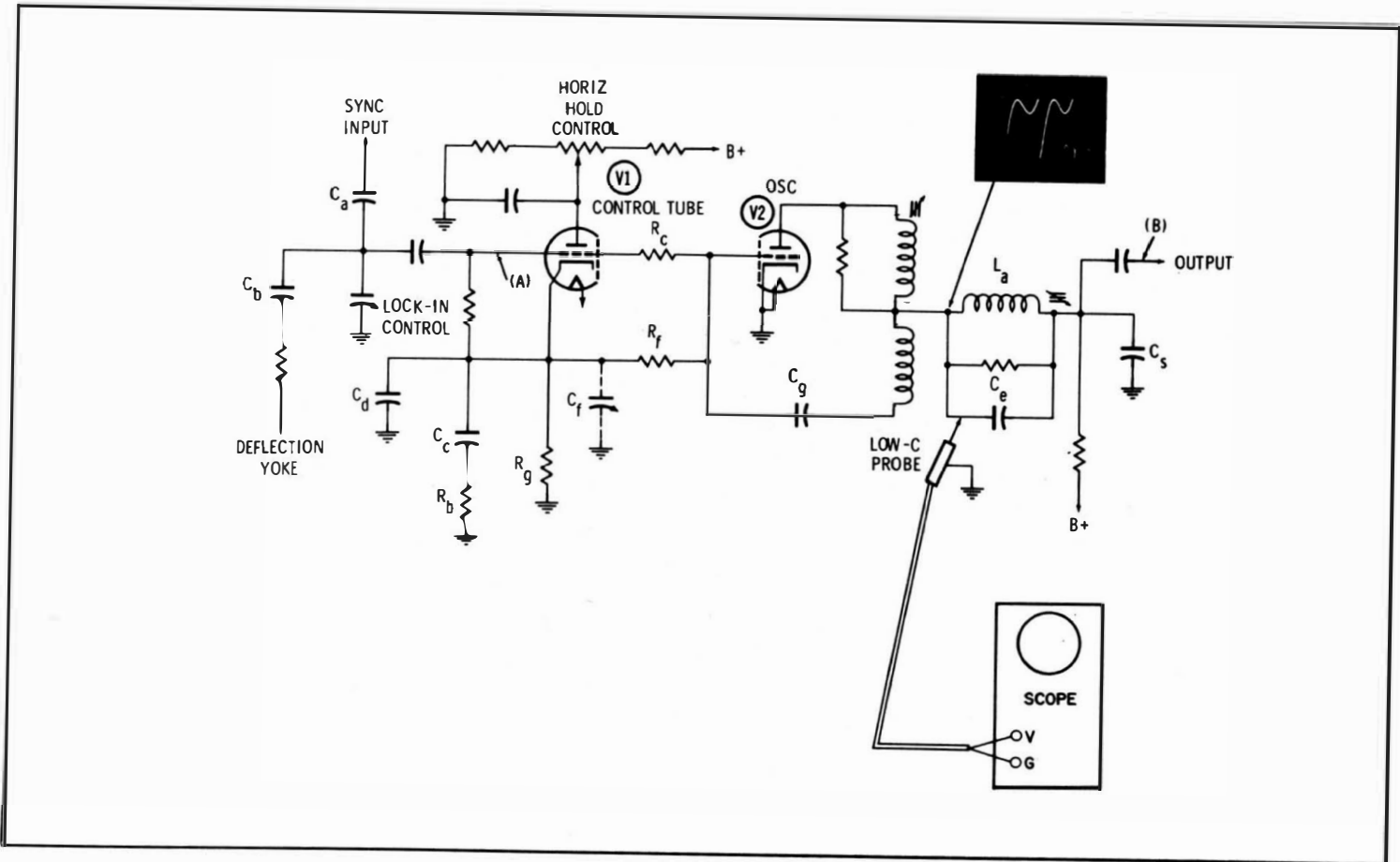

A circuit defect is present when the peaks cannot be brought to the same height. The Synchroguide circuit uses a pulse-width method of generating control bias to the horizontal blocking oscillator. The control tube in Fig. 6-16 is biased beyond cutoff. In other words, the grid is held highly negative with respect to the cathode (-14 volts is typical). A sawtooth voltage (Fig. 6-17A) is fed back from the blocking oscillator and combined with the sync pulse at the grid of the control tube. This waveform is seen at point A in Fig. 6-16.

The positive peak of this combination waveform reduces the dc grid bias so that the control tube can conduct. Tube conduction generates a positive voltage in the cathode circuit (across R_g in Fig. 6-16). This voltage reduces the negative grid bias at the oscillator, causing the oscillator to speed up. The value of the positive voltage which is thus generated depends on the phase relation between the sawtooth voltage and the pulse. Note in Fig. 6-17A how part of the pulse rides on top of the sawtooth, but also how part falls down on the steep portion of the sawtooth and does not contribute to the conduction interval.

If the pulse moves slightly to the left on the sawtooth, more of the pulse will appear on top, thus making the conduction interval longer. In turn, more positive bias is generated and the oscillator speeds up. The sawtooth then pulls to the right, part of the pulse is lost, and, effectively, the pulse width decreases. Equilibrium occurs at the width which keeps the sawtooth frequency exactly in step with the sync pulse.

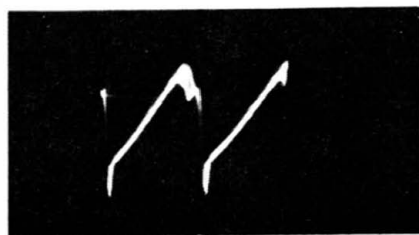

(A) At point A.

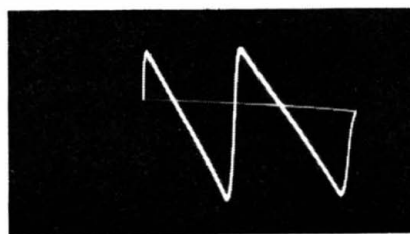

(B) At point B.

Fig. 6-17. Normal Synchroguide waveforms.

Component defects in either the control stage or the oscillator stage can cause the oscillator to pull excessively. The pulse width is narrower or wider than normal, causing inability to bring the peaks of the waveform in Fig. 6-16 to the same level. Leaky capacitors are a common cause of this difficulty. The leakage changes the normal dc voltage distribution in the system, forcing the control bias from its normal range. Off-value resistors are less likely to cause pulling, but they should be checked in case the capacitors are good. The transformer is checked last, because it is an infrequent cause of operating trouble.

RINGING-COIL AND MULTIVIBRATOR CONFIGURATION

In older receivers you will often find the afc tube controlling a multivibrator sawtooth generator which includes a ringing coil, as shown in Fig. 6-18. A comparison sawtooth from the sweep circuit (Fig. 6-19) is fed into the afc diodes, where it is mixed with stripped sync from the phase inverter. The sawtooth has a normal amplitude of 15 volts peak to peak. If the sawtooth is weak or absent, the multivibrator frequency will be uncontrolled. Leakage or shorts in the $.01\text{-}\mu\text{F}$ capacitor are likely to be the cause.

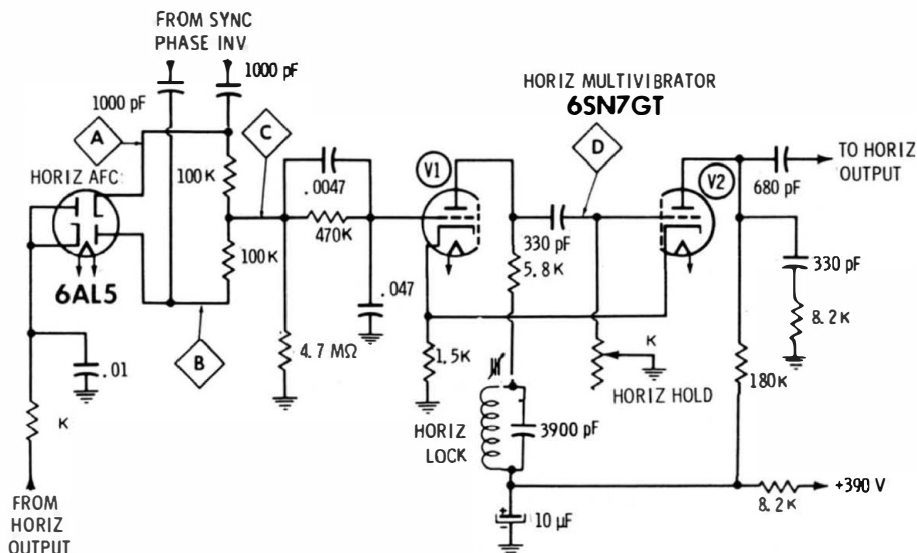

Fig. 6-18. Multivibrator with ringing coil.

Positive sync pulses are coupled to the plate of one afc diode, and negative sync pulses are coupled to the cathode of the other diode. Thus, both diodes are normally conducting simultaneously. At point A in Fig. 6-18 a mixed pulse and sawtooth wave is seen, as in Fig. 6-20. The applied sawtooth voltage alternates above and below a zero level. Therefore, the mixed waveforms in the afc tube will make the two diodes conduct equally.

If the multivibrator tries to drift to a higher or lower frequency than the pulses, the feedback sawtooth will fall more or less out of step with the pulses. In turn, the afc diodes will develop a positive or negative dc voltage at point C, and the multivibrator will speed up or slow down. Hence, the dc voltage at point C rises and falls, or may change polarity when the oscillator attempts to drift either in a low- or high-frequency direction.

At point D in Fig. 6-18 another key troubleshooting waveform is observed. This is a combination pulse and sine-wave pattern, as in Fig.

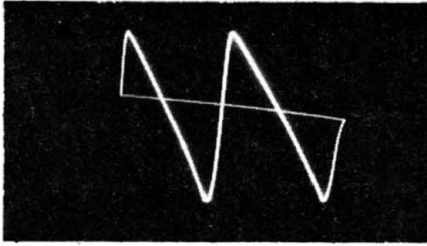

Fig. 6-19. Comparison sawtooth from the sweep circuit.

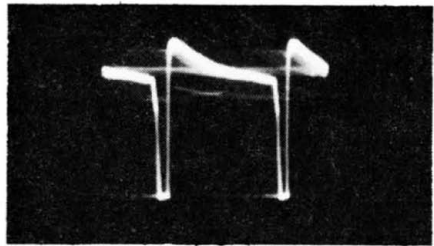

Fig. 6-20. Mixed pulse and sawtooth waveform.

6-21. The pulse is generated by multivibrator action during the horizontal-retrace interval. The sine wave is generated by shock excitation of the horizontal-locking (ringing) coil. If the pulse does not ride on top of the sine wave, adjust the slug in the ringing coil as required. This is a stabilization adjustment. The sine wave causes multivibrator tube V2 to come out of cutoff rapidly instead of gradually. The noise immunity of the circuit is thus improved.

The RC network in the grid of V1 is a filtering and holding configuration. It provides a smooth dc control voltage to the grid, and it also delays passage of sudden input changes. As a result, noise pulses tend to average out and the oscillator is less likely to tear the picture when the noise level is high. Look for open capacitors if appreciable ac is found at the grid of V1.

CIRCUIT VARIATIONS

Although the end result is always the same in any afc-oscillator configuration, different manufacturers employ wide variations in circuitry. Do not attempt, therefore, to evaluate waveforms without reference to the service data for the particular chassis. It is practically impossible for even experienced technicians to inspect a new circuit and deduce the correct waveforms and peak-to-peak voltages. Commercial circuits are too complex for such deductions to be drawn with any reasonable accuracy.

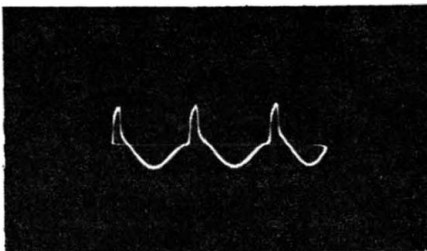

Fig. 6-21. Pulse and sine waveform.

Waveform Tests in the Horizontal-Sweep Section

The horizontal-sweep section has a reputation of being the “toughest” section in a tv receiver. While it is somewhat more complex than some of the other sections, logical waveform checks greatly simplify what can be a time-wasting trial-and-error procedure. Always check the drive waveform first, as shown in Fig. 7-1. This immediately sectionalizes a horizontal-sweep symptom. If the drive is absent or weak, the trouble is in the horizontal oscillator. Normal drive, however, indicates trouble in the sweep section.

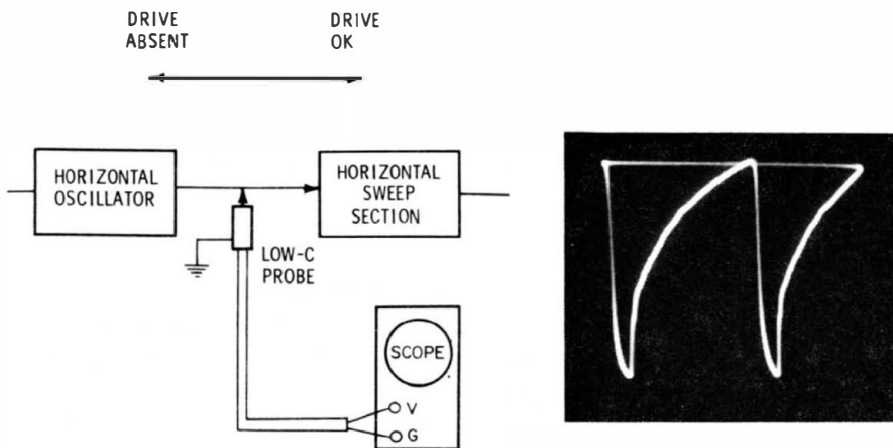

Fig. 7-1. Check drive first.

There is one exception to this general rule: if the horizontal oscillator should obtain plate-supply voltage from the B+ boost circuit, weak drive can result from sweep circuit defects which reduce the boost voltage. In that case, confirm the possibility by measuring the boost voltage. If the boost voltage is low, you can connect a bench power supply to the oscillator B+ line to restore normal drive.

SWEEP-CIRCUIT TROUBLESHOOTING

The illustrated arrangement in Fig. 7-2 uses the popular autotransformer circuit. This is the flyback transformer which matches the plate resistance of the 6DN6 output tube to the deflection-coil impedance for maximum power transfer. It also steps up the flyback pulse voltage for the high-voltage power supply.

The center-tapped yoke has a 4700-ohm damping resistor to minimize ringing. Voltage and current waveforms in the deflection circuit have different shapes, because the circuit is reactive (inductive). A complex voltage drives the same current waveform through a resistive circuit. But this complex voltage drives a different current waveshape through a reactance or impedance, as depicted in Fig. 7-3. Both voltage and current waveforms are used in signal-tracing horizontal-sweep circuits.

The drive waveform to the grid of the horizontal-output tube is a voltage waveform. It is checked at point A in Fig. 7-2, and normally appears as in Fig. 7-1. C1 has a value of 4000 pF and, therefore, has appreciable reactance to the scanning frequency. While the horizontal oscillator supplies 90 volts peak to peak to the coupling capacitor, only 75 volts peak to peak are applied to the grid of the output tube. This is normal. If less than 75 volts peak to peak were found at the grid, the coupling capacitor would fall under suspicion unless the horizontal oscillator was not supplying normal output. When the capacitance of C1 is reduced, the drive waveform not only has reduced amplitude, but also becomes distorted from severe clipping of the positive peak. If C1 is completely open, no drive voltage reaches the grid of the output tube, and the picture-tube screen is dark.

LOW DRIVE

Low drive voltage reduces the deflection current through the yoke and causes a narrow picture. Low drive also reduces the high-voltage output, dimming the picture. Although reduced high voltage causes picture blooming, the amount of blooming is less than that of the narrowing action when drive voltage is low. The normal cathode-current waveform is seen in Fig. 7-4A. The distorted current waveform which occurs when C1 is leaky is shown in Fig. 7-4B. The

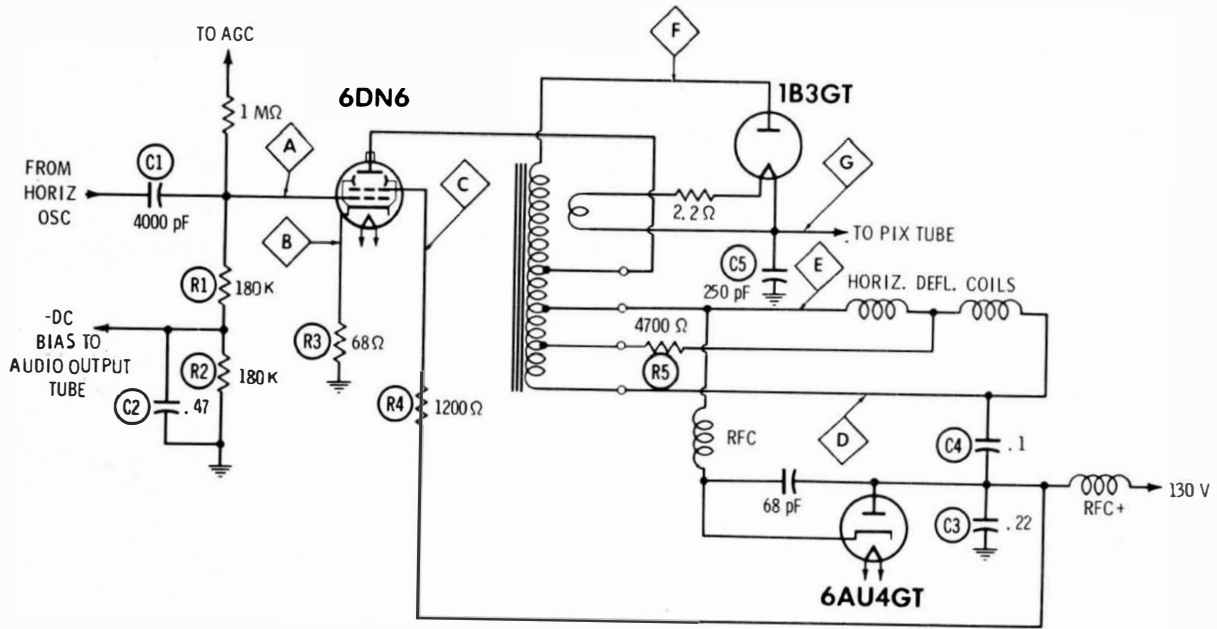

Fig. 7-2. Typical horizontal sweep configuration.

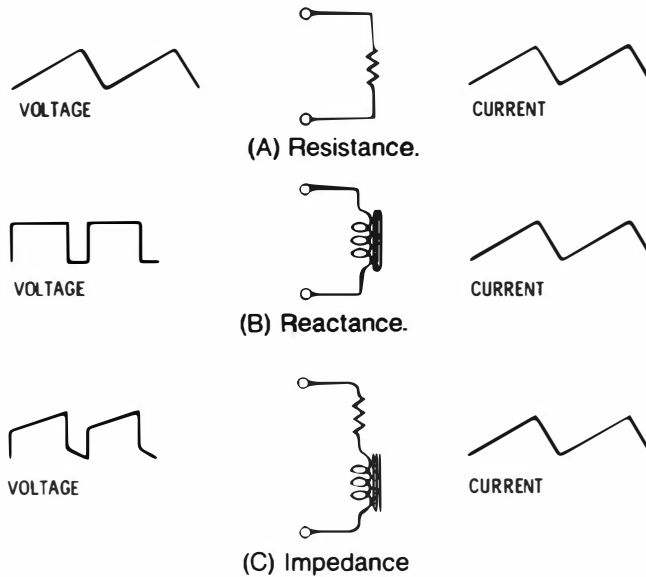
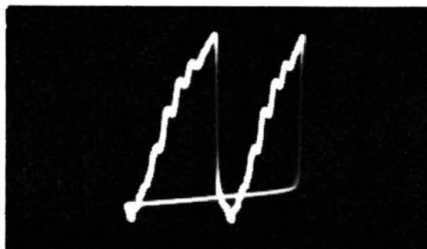

Fig. 7-3. Voltage waveforms needed for a sawtooth current.

cathode-current waveform reflects various system faults because it is the sum of plate, screen, and grid current in the output tube. Leakage in C1 results in a narrow picture. This is due to reduction of grid bias at the output tube and consequent clipping of the drive waveform.

The normal waveform at the screen is shown in Fig. 7-5A, and the distorted waveform which appears when the screen resistor increases in value is shown in Fig. 7-5B. When the resistance of R4 (Fig. 7-2) is too high, the picture becomes narrow. There are two reasons for this symptom: first, too high screen resistance reduces the dc voltage to the screen grid, which limits the power from the tube; and second, the screen resistor is unbypassed in this configuration. When the screen resistor increases in value, the signal amplitude at the screen grid increases, although the dc voltage decreases. The screen-grid circuit operates as a triode plate-load circuit. When the load resistance



(A) Normal current waveform at point B.

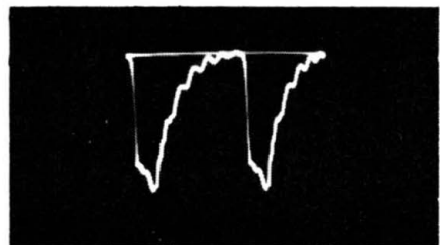

(B) Distorted waveform when C1 is leaky.

Fig. 7-4. Normal and abnormal waveforms at point B of Fig. 7-2.

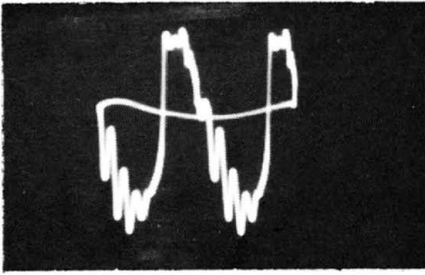

(A) Normal waveform at point C.

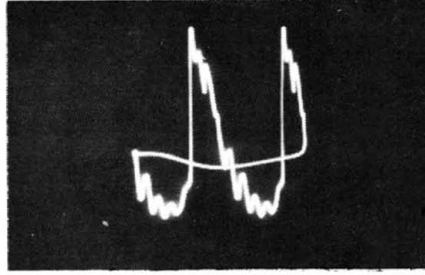

(B) Distorted waveform caused by increase in value of R4.

Fig. 7-5. Normal and abnormal waveforms at point C of Fig. 7-2.

is increased, the output signal voltage increases. In a beam-power tube, however, the useful power is not supplied by the screen grid, but by the plate. The screen-grid signal is 180° out of phase with the control-grid signal.

The screen grid has an amplification factor which is less than the control-grid factor. For this reason, an increase in screen-signal amplitude reduces the output from the plate. In other words, the un-bypassed screen grid has a degenerative action. Compare this action with the signal at the cathode (point B in Fig. 7-2). Here the signal is in phase with the control-grid signal. The cathode signal is nevertheless degenerative because a positive-going signal at the grid increases the plate current.

NARROW PICTURE

The normal waveform at point D is shown in Fig. 7-6. A very narrow picture can be caused by an open in C4, in which case the waveform at point D becomes highly distorted, as seen in Fig. 7-7. If C4 is leaky, the change in waveshape is not marked but its amplitude becomes less. Again, the picture symptom is a reduction in width. These examples show how useful the scope can be in trouble-

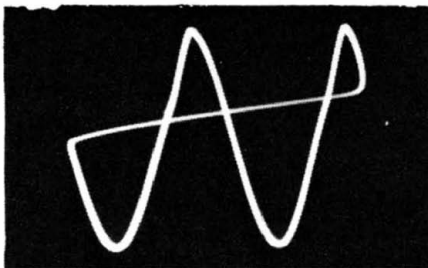

Fig. 7-6. Normal waveform at point D of Fig. 7-2.

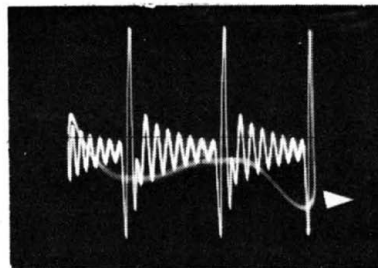

Fig. 7-7. Distorted waveform at point D when C4 is open.

shooting the horizontal-sweep section. Various component defects which cause the same picture symptom are distinguished by the different changes imposed on circuit waveforms. A narrow-picture symptom, for example, need never be tackled on a guesswork trial-and-error basis. Logical application of the scope usually will permit the technician to close in rapidly and certainly on the defective component.

A 2500-volt peak-to-peak pulse (Fig. 7-8) is normally found at point E in Fig. 7-2. This high voltage cannot be tested with a low-capacitance probe, and a high-voltage capacitance-divider probe is used to display the waveform. If the value of R5 is incorrect, the ringing along the bottom of the waveform (Fig. 7-9) becomes more prominent. Ringing becomes most severe when R5 is completely open. This is a useful quick test to determine whether ringing bars in the raster are being caused by a sweep-circuit defect or by a spurious modulation of the video signal. Ringing bars which originate in the sweep section will show up invariably in the waveform at point E in Fig. 7-2. However, if there is little or no ringing in the waveform at point E, the source of the ringing bars is other than in the sweep section.

A confirming test is made by connecting a 0.25- μ F capacitor from the output lead of the video amplifier to ground. If the "ringing bars" disappear, the spurious voltages are coming from the video section. The cause may be a missing high-voltage cage or poor grounding of a cage which, therefore, permits ripple from the high-voltage section to be picked up by the video input lead to the picture tube. Picture-tube extension cables are particularly likely to pick up stray fields from the high-voltage section and cause mysterious "ringing bars" in the raster.

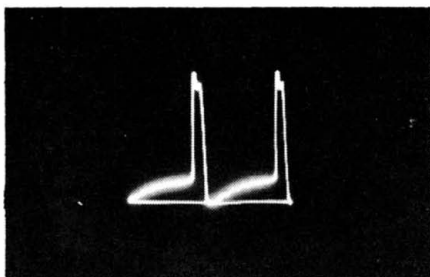

Fig. 7-8. Normal waveform at point E of Fig. 7-2.

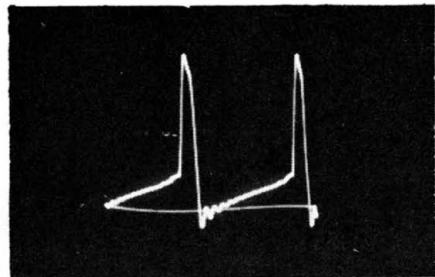

Fig. 7-9. Waveform at point E when R5 has increased in value.

HIGH-VOLTAGE POWER SUPPLY

The high-voltage power-supply circuitry is comparatively simple, as seen in Fig. 7-2. In order to measure the amplitude and inspect the waveshape, a special high-voltage capacitance-divider probe is

required. Note that it is not completely informative merely to clip a probe on the insulation to the 1B3 plate lead. Even though the true waveform is displayed, variations in thickness of insulation and effective capacitance cause a change in scope calibration from one chassis to another.

A professional-type test is made with the special high-voltage capacitance-divider probe illustrated in Fig. 7-10. An inch or two of coax from which the braid has been stripped is taped against the stripped end of a coax input cable to the scope. This arrangement forms a capacitance-divider probe, which can be calibrated for an exact 100-to-1 voltage division. This calibration is accomplished either by proper selection of the open-section length, or by connecting a suitable value of capacitor (a trimmer capacitor can be used) across the output end of the scope-input cable.

The easiest way to calibrate the probe is first to select a waveform—in the horizontal section—which can be displayed with a direct probe, such as the waveform across a booster capacitor or at the screen grid of the output tube. Then, check the same waveform with the high-voltage capacitance-divider probe, advancing the scope's decade step attenuator two positions (this makes the scope 100 times more sensitive). The waveform then appears at the same amplitude on the scope screen if the probe is correctly adjusted.

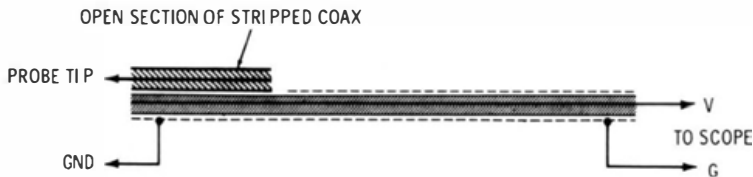
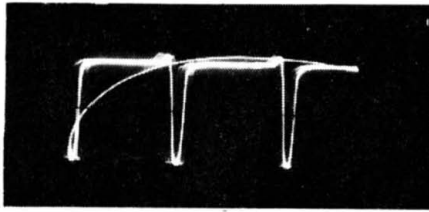

Fig. 7-10. Special high-voltage capacitance-divider probe.

If there is any tendency of the exposed end of the coax section to form corona when the probe is applied at the plate of the 1B3, then use anticorona dope to coat and seal the end of the coax section. Note particularly that this probe, like the high-voltage capacitance-divider probe previously discussed, provides correct waveshapes only when testing horizontal-frequency waveforms. Vertical-frequency waveforms will be distorted to a greater or lesser degree.

Typical test results are illustrated in Fig. 7-11. Although the peak-to-peak voltage is normally on the order of 15 KV at point F, it is also normally very low at point G unless filter capacitor C5 is open. In some receivers, C5 is omitted and filtering is accomplished by the input capacitance to the high-voltage terminal of the picture tube. But there is appreciable ripple amplitude at point G in these receivers.

Even though the waveform amplitude is normally low at point G, do not make the error of checking ripple voltage with a low-C probe.



(A) Input too high; rectifier tube all right.

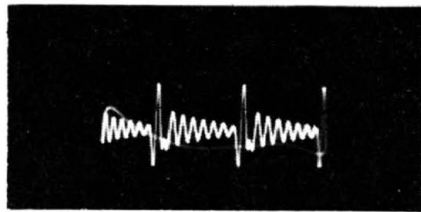

(B) Breakdown in high-voltage winding.

Fig. 7-11. Typical test results.

The dc voltage here is very high and will arc through a low-C probe immediately. Ripple voltage should be checked only with the special high-voltage capacitance-divider probe, advancing the scope sensitivity to maximum, if necessary, in order to obtain adequate deflection.

The waveform at the plate of the horizontal-output tube is normally quite similar to the waveform at the high-voltage rectifier plate, although it is considerably lower in amplitude. More prominent ringing will be observed in many receivers along the base line of the pulse at point F. The reason for this is that the high-voltage winding of the transformer introduces additional uncoupled (stray) reactance into the high-voltage rectifier circuit.

Fig. 7-2 illustrates the basic principles which are common to all flyback systems, although circuitry details vary considerably from one chassis to another. The end result of all configurations is the same: a peaked sawtooth (or simple sawtooth) drive voltage to the horizontal-output tube generates a linear sawtooth current through the horizontal-deflection coils and a reasonably smooth dc output from the high-voltage power supply. It is invariably advisable to consult the receiver service data for correct waveshapes and peak-to-peak amplitudes.

BOOST-VOLTAGE FILTERING

The unfiltered output from a boost-B+ circuit has a high 15, 750-Hz ripple. Boost voltage in some receivers is applied to the crt focusing electrode or first anode, through a filter, with a small electrolytic capacitor. If vertical bars or shaded strips appear in the raster, check with the scope to see if the boost line has a high ac ripple. This is sometimes a baffling problem. The dc voltage measures correctly, and the fact that the electrolytic capacitor might be low in value, thus permitting high-level ripple voltage to modulate the raster, might be overlooked.

Few tv receivers are completely free from raster shading. Owners of receivers are usually tolerant of this condition, unless it becomes quite prominent, as seen in Fig. 7-12. The raster has reasonably

Fig. 7-12. Shaded pincushioned raster.

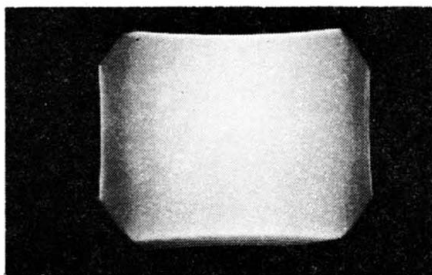

uniform illumination from top to bottom, but is very noticeably shaded from left to right. The trouble stems, therefore, from the horizontal section in the receiver. Waveform checks at each picture-tube electrode will indicate quickly the point at which the spurious ac voltage is entering. Do not forget the high-voltage power supply. An open high-voltage filter capacitor can introduce sufficient ripple into the second-anode supply voltage to shade the raster.

Pincushioning, evident in Fig. 7-12, is not a waveform-based symptom. It merely indicates that the antipincushion magnets are not properly adjusted, or that a replacement yoke does not match the picture tube (or vice versa). Consult the receiver service data for correct replacement parts and tubes. If a replacement yoke does not match the horizontal-output transformer (or vice versa), the trouble condition does show up as waveform distortions and/or incorrect amplitudes. Again, refer to the receiver service data for recommended replacement parts.

KEYSTONING

Keystoning as seen in Fig. 7-13 is usually caused by defective vertical-deflection coils in the yoke (see Chapter 8), but this is not always the case. In some receivers, reliance is placed on a single, large electrolytic capacitor in the horizontal section to decouple the horizontal and vertical circuits. When the capacitor is low in value, the heavy sawtooth-current in the horizontal circuits modulates the dc supply to the vertical-sweep circuit, causing a keystone raster.

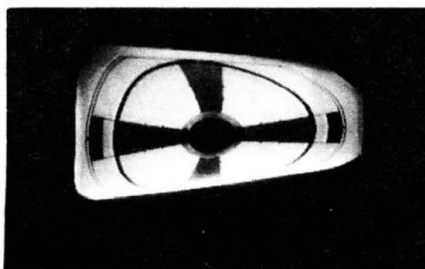
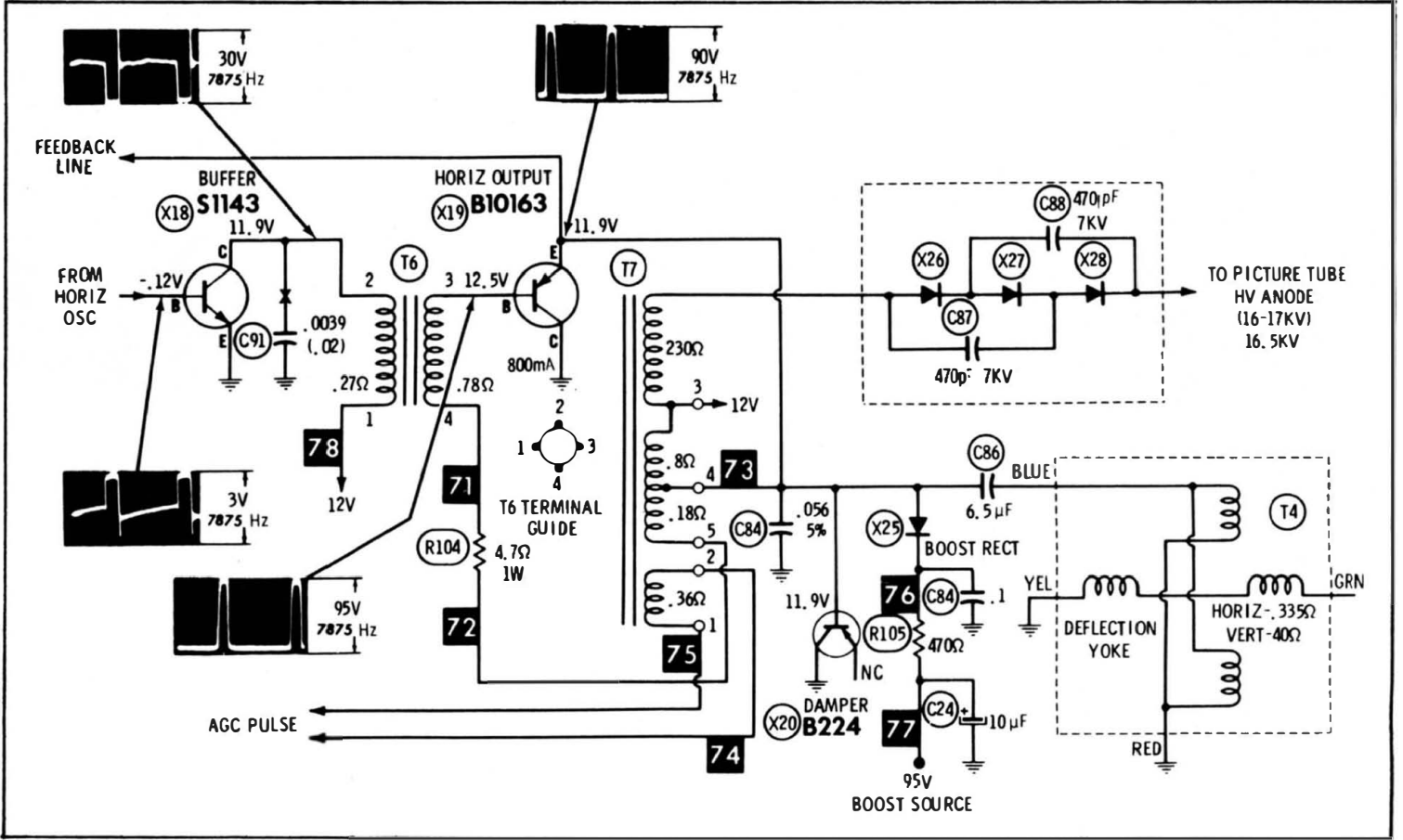

Fig. 7-13. Keystoneing is not always caused by yoke trouble.

Fig. 7-14. Typical solid-state horizontal-output system



In that case, a scope check of the common supply line to the horizontal and vertical sections will show a high-amplitude horizontal sawtooth to be present. Again, faulty decoupling can also cause horizontal keystoneing by permitting 60-Hz sawtooth ripple to feed into the horizontal system. This is usually less prominent than the vertical keystoneing.

SOLID-STATE HORIZONTAL-OUTPUT SYSTEM

The same general principles that apply to electron-tube horizontal-sweep systems are found in a solid-state system such as the one shown in Fig. 7-14. The chief distinction is that a solid-state arrangement has lower internal impedances. This means that voltages are comparatively low and that currents are comparatively high. Transistors are normally very long-lived, and if they fail, they tend to do so catastrophically. However, a buffer or output transistor will occasionally develop an abnormal amount of leakage current. Picture symptoms are reduced width and compression on the right-hand side of the screen. A scope test will show reduced amplitudes of the buffer and output waveforms. An audible power-supply hum may also develop, caused by the abnormal current drain.

To summarize, do not make conclusions in troubleshooting the horizontal-sweep section until the key waveforms have been checked. This procedure can often save time as well as needless expense in replacement of normal components.

Troubleshooting the Vertical-Sweep Section

The vertical-sweep section is straightforward, particularly in older-model receivers which utilize separate oscillator and output stages. The trend in newer receivers is toward simplified circuitry in which the two functions are combined, as shown in Fig. 8-1. Interaction of oscillator and output functions results in some added complexities of trouble analysis. If the scope is properly applied, however, operating troubles can be localized with reasonable effort.

VERTICAL SYNCHRONIZATION

The vertical oscillator cannot lock in sync unless the sync separator supplies a suitable pulse to the integrator. Normal output from the separator is shown in Fig. 8-2A. The prominent pulse in the pattern consists of both the stripped vertical-sync pulse and a larger "kickback" pulse from the 6EM7. The two pulses can be separated by adjusting the vertical-hold control for a split picture. The vertical-sync pulse then appears like the smaller pulses in Fig. 8-2B. If the picture is rolling because of a defect in the vertical section, the sync pulse will ride through the pattern and the scope will lock on the larger pulse.

If a normal vertical-sync pulse is not present, turn your attention to the sync separator. But if the input is normal, proceed to check at the input and output terminals of the integrator. The integrator has substantial input capacitance. Therefore, signal passage from

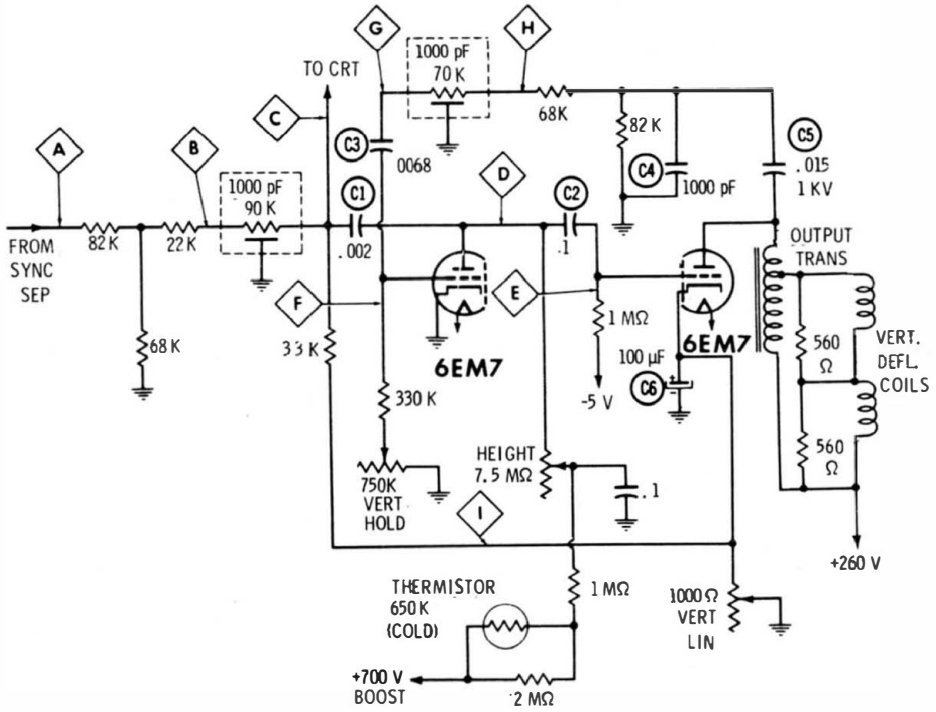
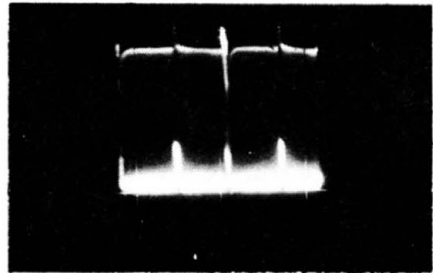
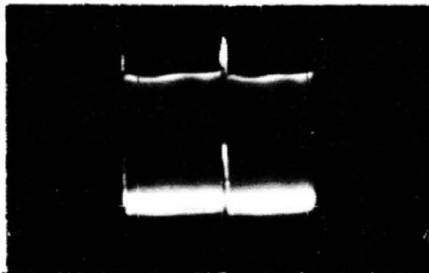

Fig. 8-1. Typical vertical-sweep configuration.

point A to point B through the resistive network results in elimination of most of the horizontal sync pulses which were evident in Fig. 8-2. Normal waveforms at the input and output of the integrator unit are shown in Fig. 8-3.

Integration largely eliminates the horizontal pulses, and the vertical pulses are somewhat attenuated also. Because the output of the integrator is coupled to the plate of the first 6EM7 section, the "kickback" pulse is comparatively increased in the waveform. Thus, if the waveform at point C is observed when the picture is split, the vertical sync



(A) Input waveform at point A of Fig. 8-1.

(B) Change in waveform when picture is split.

Fig. 8-2. Integrator input waveforms.

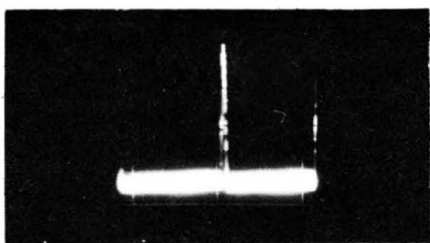

(A) Waveform at point B.

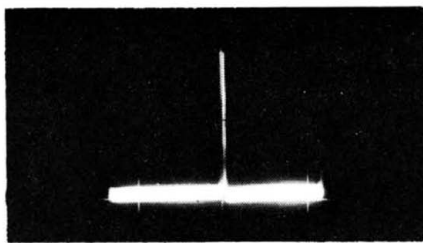

(B) Waveform at point C.

Fig. 8-3. Normal waveforms at input and output of integrator.

pulses have a relatively low amplitude, as shown in Fig. 8-4. Because relative pulse amplitudes differ considerably from one circuit configuration to another, always check the receiver service data for the particular chassis. No visible "kickback" pulse is found at the output of the integrator in some receivers.

The chief consideration at this point is the presence of a normal vertical sync pulse and the virtual elimination of horizontal pulses. Otherwise, vertical lock is unstable or absent. If integrator defects permit feedthrough of horizontal pulses, interlacing will be poor and the picture will lack full definition. Note that defects in the oscillatory circuit will reduce the amplitude of the "kickback" pulse, or it may be absent altogether. But this does not affect the amplitude of the vertical sync pulse. If the sync pulse is not present at point C, look for a shorted capacitor in the integrator assembly. Note also that point C is connected to the vertical blanking network. A shorted capacitor in this network can greatly reduce or even "kill" the sync pulse.

COUPLING-CAPACITOR CHECKS

Even though ample sync is being supplied, defective vertical operation can be caused by defective coupling capacitors. This is a more common cause of off-frequency operation or unstable lock than are defective resistors. C1 and C2 are immediately suspected if a normal waveform (Fig. 8-5) is not observed at point D in Fig. 8-1. The coupling capacitors should be tested first for leakage on a capacitor checker, at rated working voltage. If the leakage resistance is very

Fig. 8-4. Waveform at point C when the picture is split.

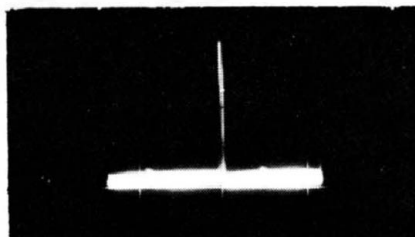



Fig. 8-5. Normal waveform at point D of Fig. 8-1.



Fig. 8-6. Waveform at point D when C1 is low in value.

high (note that the capacitors must operate in a high-resistance circuit), check next to see whether either of the capacitors is open or has lost substantial capacitance. If a capacitor checker is not available, make a substitution test.

If C1 is low in value, the picture becomes nonlinear vertically. Also, the waveform at point D becomes distorted as seen in Fig. 8-6. The waveform amplitude increases because the integrator network loads the oscillator to a lesser extent. Similarly, if C2 is low in value, the normal waveform at point E becomes distorted, as shown in Fig. 8-7. If the coupling capacitors are all right, do not leave this branch of the circuit until the height control is checked out. It can become worn, with resulting change in resistance value and stability of adjustment. In particular, if the oscillator operates normally for a length of time, following which the oscillator “pulls” excessively and breaks vertical lock, an unstable height control should be suspected.

A defective height control can be simulated falsely in some cases by a defective thermistor (650K cold resistance shown in Fig. 8-1). Thermistors tend to increase in value after an extended service period. The function of the thermistor is to maintain constant vertical sweep with usual variations of supply voltage due to line-voltage fluctuation. But if this branch of the circuitry checks out satisfactorily, turn your attention to the feedback branch of the oscillator.

FEEDBACK WAVEFORMS

The normal waveform for this circuit at point F is shown in Fig. 8-8. If distorted or low in amplitude, check the waveform also at point



(A) Normal waveform.

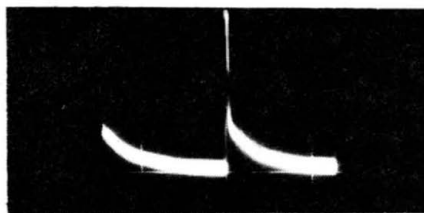

(B) C2 low in value.

Fig. 8-7. Normal and abnormal waveforms at point E.

Fig. 8-8. Normal waveform at point F.

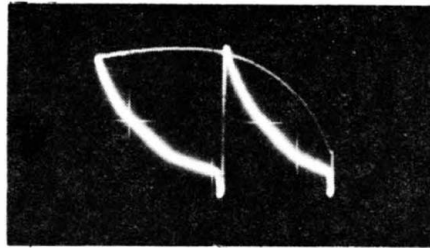

G. The normal waveform is shown in Fig. 8-9A. A typical distorted waveform which results when C3 is low in value is shown in Fig. 8-9B. The vertical oscillator speeds up, and the picture cannot be locked. The increased oscillator frequency causes additional cycles to appear in the pattern when the scope is deflected at a 30-Hz rate. Leakage in C3 has much the same effect as capacitance loss because the negative dc grid bias is bled to ground.

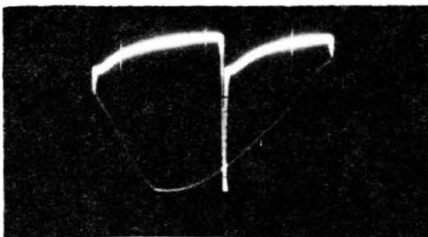

(A) Normal waveform.



(B) C3 low in value.

Fig. 8-9. Normal and abnormal waveforms at point G.

A defect in the vertical-hold control can simulate leakage in C3, but is a less common cause of trouble. An ohmmeter check should indicate rated resistance value, without any rough spots as the control is turned through its range. When the foregoing components are cleared from suspicion, make a waveform check at point H. The waveform appears normally as in Fig. 8-10. Incorrect shape and/or amplitude indicates a faulty component in the coupling unit or in the components between point H and the output transformer. Each should be checked out in turn.

It is generally undesirable to check waveforms at the plate of the output-tube section or in its near vicinity. The amplitudes are com-

Fig. 8-10. Normal waveform at point H.

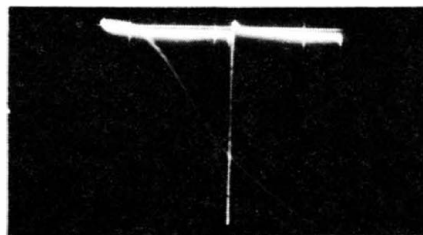

paratively high, and a low-C probe can be damaged. Note that C5 is a 1-kV capacitor. It cannot be checked properly on an ordinary capacitor tester; a substitution test is advised. C4 is a conventional capacitor. If it is open, however, the pulse voltage across the 82K resistor will rise excessively because of the loss of capacitor-divider action.

VERTICAL-OUTPUT TRANSFORMER

Troubles in the vertical-output transformer may or may not be readily apparent. If there is a breakdown between windings or from winding to core, arcing will occur which is often audible. Such arcing causes the picture to fluctuate erratically in height. A direct short between turns or leakage between layers produces a steady trouble symptom of insufficient height. Note carefully the difference in symptoms between shorts in the transformer and in the yoke; the former reduces picture height, while the latter causes keystoneing. Thus, yoke faults are more easily localized.

A good confirming test for shorted turns in the output transformer can be made with a square-wave generator. The receiver is turned off, and a square-wave generator is connected as shown in Fig. 8-11. No circuit disconnections are required. The inductance of the output circuit normally distorts a 10-kHz square wave as seen in Fig. 8-12. The long curved portion of the waveform is an indicator of the circuit inductance with respect to the circuit resistance. Shorted turns absorb energy and not only reduce the inductance, but also introduce an effective ac resistance. Hence, shorted turns cause a marked change in the square-wave response, as illustrated in Fig. 8-12.

To summarize, the square-wave test is made after it has been determined that reduced picture height is not due to faulty capacitors or resistors, and after you are certain that the vertical sweep does not

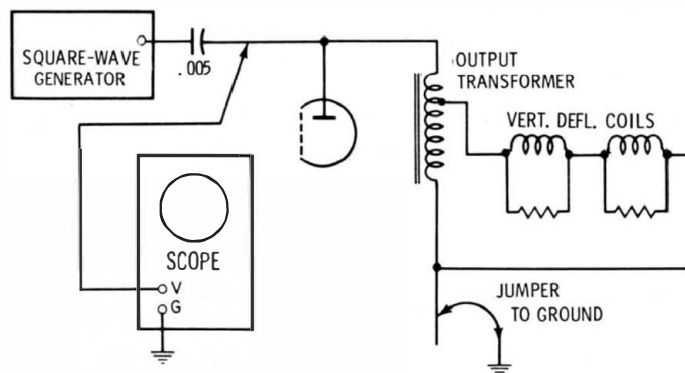
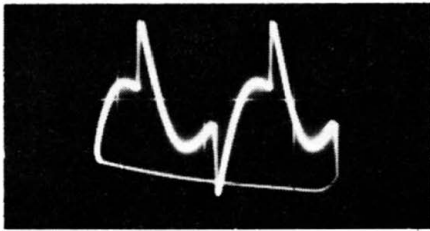
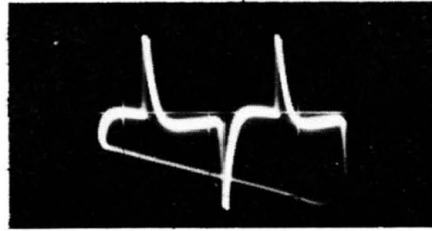

Fig. 8-11. Test setup for shorted turns.

fluctuate and that audible arcing is not occurring. If audible arcing is occurring, however, the output transformer should be replaced without making any further tests in the circuit.



(A) Normal 10-kHz square-wave response.



(B) Shorted turns in output transformer.

Fig. 8-12. Results of shorted-turns test.

CATHODE CIRCUIT

The normal cathode-circuit waveform is checked at point I and appears as illustrated in Fig. 8-13. The usual troublemaker here is 100- μ F electrolytic capacitor C6. As the capacitor ages, it tends to lose capacitance. Also, the picture becomes so nonlinear that the vertical-linearity control must be turned to the end of its range. A waveform check then quickly shows the deficiency, as in Fig. 8-13. It might be supposed that the fine structure of the waveform would become more prominent when C6 loses capacitance, but the opposite is true. The reason for this is that the 60-Hz component increases rapidly in amplitude compared with the horizontal cross talk which is picked up.

If C6 has merely lost capacitance, a bridging test with a good electrolytic unit will restore normal operation. However if the trouble is due primarily to leakage, a bridging test may be inconclusive. In that case, C6 should be checked at its working voltage on a capacitor tester, or a substitution test should be made.

VERTICAL-BLANKING NETWORK

Most present-day receivers have vertical-blanking networks to cut off the picture tube during vertical-retrace time. In theory, blanking should not be required, but it is desirable in practice because viewers sometimes operate the picture tube at higher brilliance than normal. This makes the blanking pedestals in the video signal inadequate to their task. Also, not all receivers have dc coupled video amplifiers. This situation intensifies the problems of retrace visibility. When an ac coupled video amplifier is used, the operating point of the picture tube shifts with changing background brightness in the televised

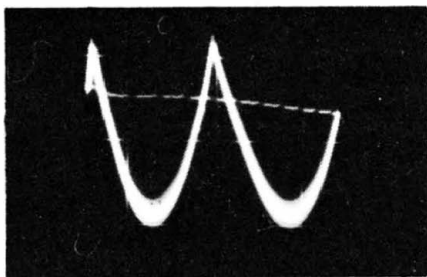

(A) Normal waveform.

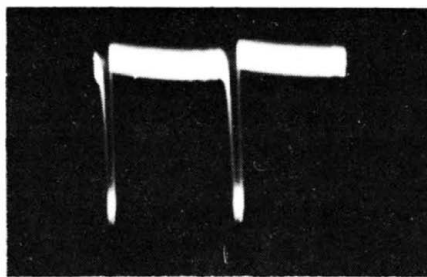

(B) C6 low in value.

Fig. 8-13. Normal and abnormal waveforms at point I.

scene. As a result, retrace lines will become visible in certain scenes, depending on the background brightness level.

Again, as a picture tube weakens, the viewer automatically turns up the brightness control to compensate for lower screen output. This shifts the picture-tube operating point abnormally, and brings up the visibility of vertical-retrace lines. These considerations weigh in favor of vertical-blanking networks, as shown in Fig. 8-14. A scope provides an easy method of closing in on circuit faults. Check first the output at point A. The blanking-pulse amplitude should be sufficient to cut off the picture tube, and this peak-to-peak voltage is usually specified in the receiver service data. If coupling capacitor C1 is open or low in value, the waveform amplitude will be subnormal, as illustrated in Fig. 8-15. In case C1 is open, the normal waveform will be found, of course, at the input end of C1, at point C.

The normal waveform at point B is shown in Fig. 8-16. If the vertical-sweep section is operating normally otherwise, absence or distortion of this waveform is the result only of a poor connection to the input blanking network. With a normal waveform at point B, check next at point C, to determine whether C2 is open. Note that leakage in C2 makes it impossible to lock the picture vertically.

R1 and C3 serve two functions. In combination with C2, this is a waveshaping network which changes the peaked sawtooth input into

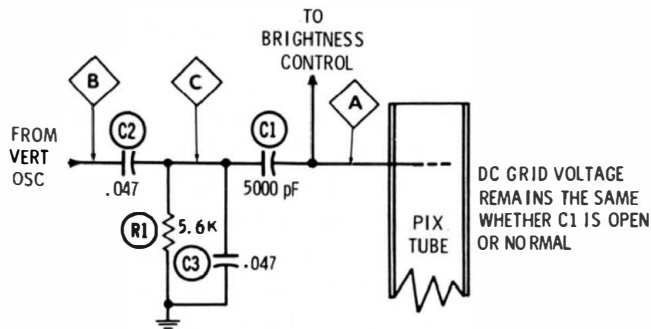
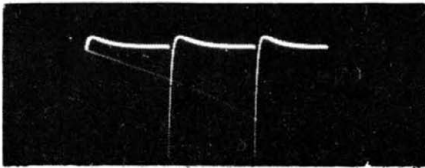
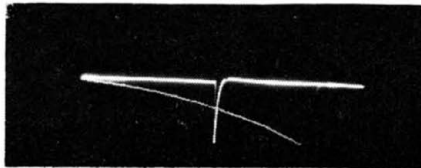

Fig. 8-14. Vertical-retrace blanking circuit.



(A) Waveform when C1 is normal.



(B) Waveform when C1 is low in value.

(C) Waveform when C1 is open.



Fig. 8-15. Waveforms at point A of Fig. 8-14.

a pulse output for proper blanking action. Thus, if C3 is open, a distorted peaked-sawtooth wave is applied to the grid of the picture tube, and proper blanking action does not occur. The blanking action, however, is very uneven and part of the picture is dimmed or blanked out completely. The blanking network also has a voltage-divider action which prevents excessive peak voltage from being applied to the picture-tube grid. Although capacitor trouble is first to be suspected, be sure to check R1 if necessary.

SOLID-STATE VERTICAL-SWEEP SYSTEM

A solid-state vertical-sweep system is shown in Fig. 8-17. It is very similar to its electron-tube counterpart. However, the solid-state circuits have low internal impedances (comparatively low voltages and high currents). Note that diode X8 is a protective device; it prevents excessive drive to the base of Q14, which could result in transistor damage. When picture trouble symptoms of vertical nonlinearity or subnormal picture height occur, scope tests are very helpful in localizing the defective circuit. As an illustration, if C22 becomes open, a sawtooth waveform will be found at the left-hand terminal but not at the right-hand terminal. Again, in case C24 loses a substantial portion of its capacitance, the driving waveform to Q16 will have less than 0.9-V p-p amplitude. Or, in case C21 becomes open, the driving waveform to Q15 will have excessive amplitude and will be distorted.

Fig. 8-16. Input waveform to the vertical-blanking network.

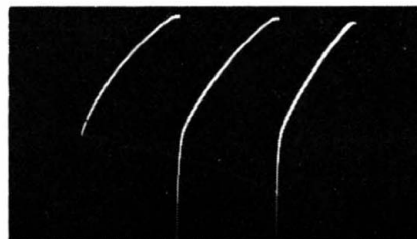
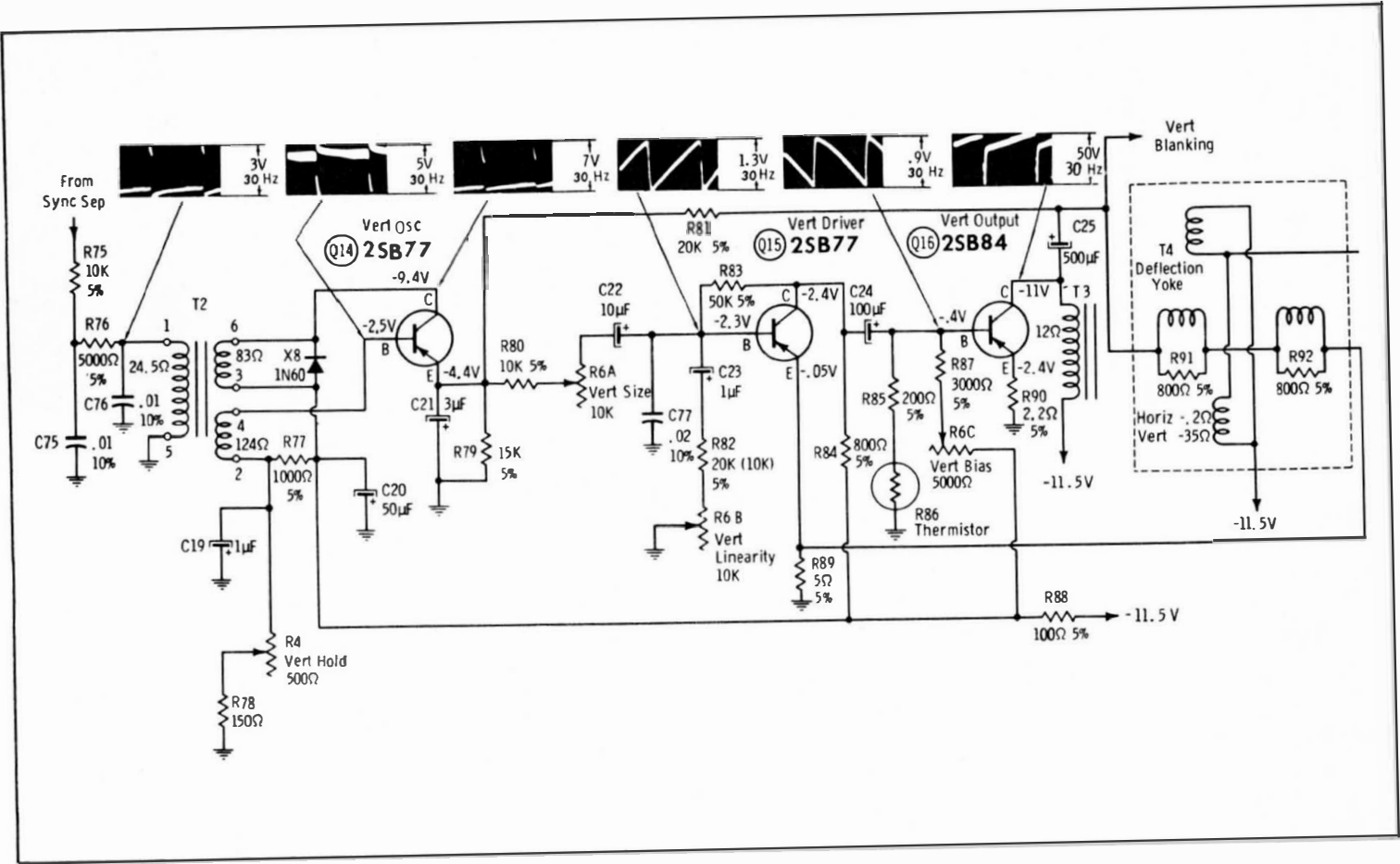

Fig. 8-17. A solid-state vertical-sweep system.



There is considerable interaction between the driver and the output circuits in Fig. 8-17 because of the feedback loop via R81. As a result of this interaction, it is sometimes difficult to decide whether a fault that appears to be in the driver section might actually be in the output section. In other words, it is not necessarily true that distortion of the drive waveform to Q15 indicates trouble in the base circuit section of Q15, because a fault in the output network will be reflected back to the driver input circuit through the feedback loop. Therefore, scope tests must often be supplemented by dc voltage and resistance measurements to isolate a defective component. Note that tests in solid-state circuitry are often facilitated by the use of a high-low type of ohmmeter. In other words, an ohmmeter that applies less than 0.08 volt to the test points will not “turn on” semiconductor devices. Therefore, all normal semiconductors “look like” open circuits to this type of ohmmeter.

The principles established in the foregoing discussion apply to all of the numerous variations encountered in vertical-section circuitry. Keep in mind the basic circuit action, and always refer to the receiver service data when making waveform analyses.

Signal-Tracing the Sound I-F and Audio Section

A simple intercarrier sound system is diagrammed in Fig. 9-1. Some tv receivers have more stages, including a 4.5-MHz i-f amplifier preceding the limiter, and an audio driver following the sound detector. A ratio detector, or sometimes a discriminator, is used instead of a gated-beam detector. The basic signal processing occurs in all cases in this order: 4.5-MHz amplification, partial or full limiting, fm detection, and audio amplification.

The sound take-off coil (or transformer) may be connected at the video-amplifier or the picture-detector output. Sometimes the sound take-off transformer does double duty as a 4.5-MHz trap in the video amplifier. You may find an occasional receiver in which the output from the last i-f stage branches into a limiter. The 4.5-MHz signal is generated by heterodyning in the limiter instead of the picture detector. Again, you may rarely find a slope detector following the limiter. In some receivers, the audio-output stage does double duty as a B+ voltage divider.

TEST SIGNAL FOR THE INTERCARRIER SECTION

If a modulated 4.5-MHz sound signal from an a-m generator is applied through a small blocking capacitor to the sound take-off point, you can usually signal-trace the entire sound section. Offhand, this might seem to be impossible, because the limiter stage normally

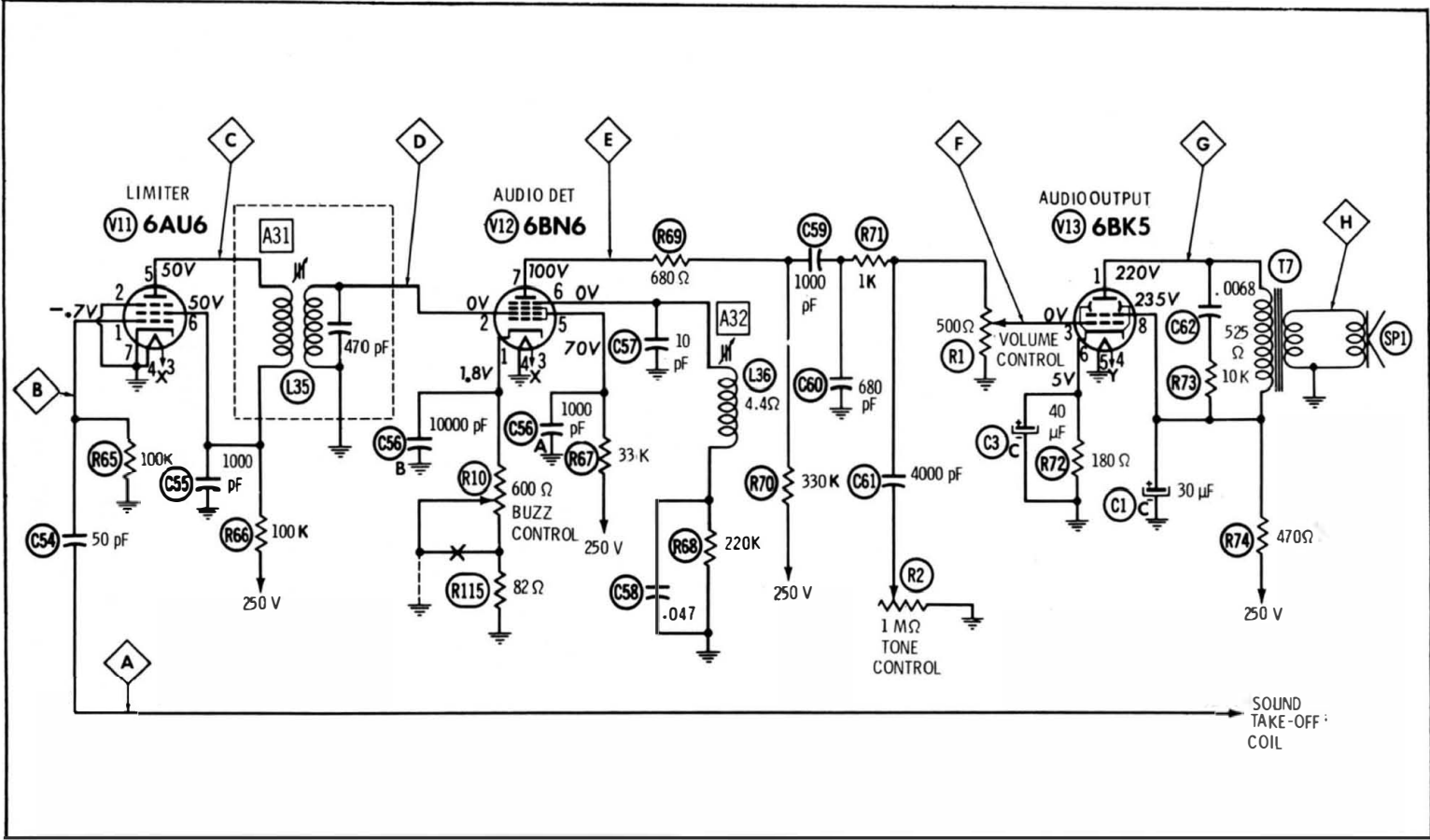

Fig. 9-1. Typical intercarrier sound system.

rejects amplitude modulation. On the other hand, most a-m generators have appreciable incidental fm, particularly when set for high-percentage modulation as illustrated in the following pages. Incidental fm makes it possible for the generator to do double duty in testing the sound section.

Signal-tracing in the sound section should be done with a wide-band scope and a low-capacitance probe. There are two reasons: There is no a-m component in the output of a normally operating limiter (or at least negligible a-m signal), and hence a demodulator probe gives no indication when used with an ac scope. The other reason is that a demodulator probe has comparatively low input impedance, and disturbs the narrow-band fm circuits excessively. Comparatively, a low-C probe imposes less loading and detunes the circuits less.

The scope should have good response at 4.5-MHz. Otherwise, the signal under test will be attenuated accordingly in the scope amplifier. If the a-m signal is found at points A and B in Fig. 9-1, the sound-takeoff circuit up to the grid of the limiter is working. At point C the signal may have less apparent amplitude modulation. If the limiting action is complete, you will see a modulation envelope corresponding only to the incidental fm in the test signal (Fig. 9-2). In general, the modulation depth will be less than that of the combined a-m and fm seen at the limiter grid. If the a-m generator has no incidental fm, the output from a saturated limiter will have no modulation envelope. (Fig. 9-3).

Fig. 9-4 depicts a configuration using a sound i-f amplifier operating in class A to drive the limiter. Amplitude modulation is repro-

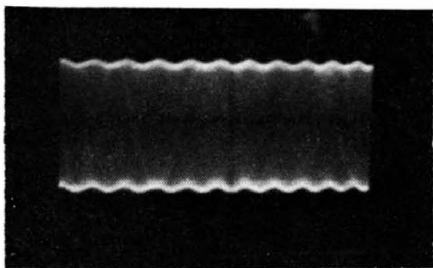

Fig. 9-2. Apparent a-m limiter output, due to incidental fm.

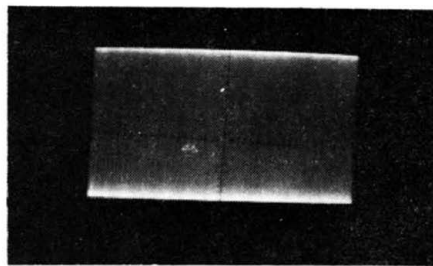

Fig. 9-3. Saturated limiter output, no incidental fm.

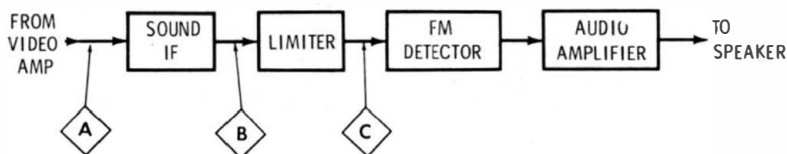
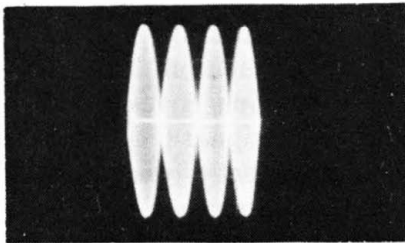

Fig. 9-4. Normally tuned i-f circuits may change the waveform.

duced at points A and B, but not at point C, if the limiter is saturated. However, the waveform can appear quite different at point B than at point C when there is incidental fm in the a-m test signal. The fm component “sweeps” the sound i-f tuned circuits and adds a partial “response curve” to the a-m envelope.

This situation is illustrated in Fig. 9-5, which shows a display of the output from a fully modulated a-m generator, compared with the display after passing through a tuned class-A amplifier. The input waveform has considerable incidental fm because of 100 percent modulation. That is, the output consists of a mixture of amplitude modulation and an fm “sweep” signal. Various parts of the a-m envelope can be increased or cancelled, depending on the shape of the fm envelope. The latter varies as the generator is tuned slightly higher or lower in frequency. In Fig. 9-5, there is a cancellation as the troughs are entered, making the amplifier output appear as if the test signal were overmodulated.



(A) Output waveform from a-m output generator.

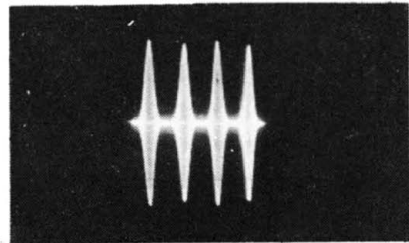

(B) Output waveform from i-f amplifier.

Fig. 9-5. Incidental fm from modulated oscillator is maximum at 100-percent modulation.

Another typical condition of incidental fm distortion is seen in Fig. 9-6. Here, a-m modulation is nearly 100 percent, and there is considerable incidental fm in the output. The amplifier output appears with a “flat-topped” envelope at one setting of the generator tuning dial. The envelope changes shape as the generator is tuned through the i-f passband, but the amplifier output never matches the generator output.

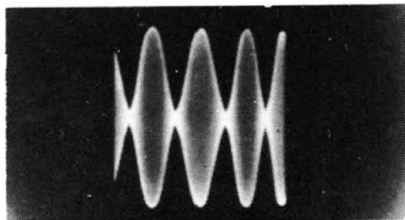

(A) Generator output.

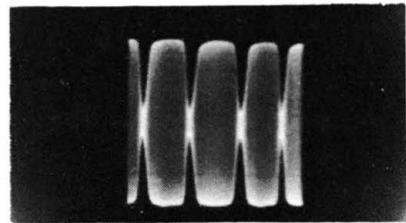

(B) Amplifier output.

Fig. 9-6. Another example of incidental fm distortion.

Incidental fm is reduced when the a-m generator is set for a comparatively low percentage modulation. This is evidenced by less change in envelope shape as the generator is tuned through the sound i-f passband. A few service-type a-m generators have negligible incidental fm, and practically no change in envelope is observed as the generator is tuned through the i-f band. The generator output has the same waveform as the output from the driven class-A amplifier. The waveform of the generator output is not necessarily a sine wave. A scope test may show that a sine waveform is approached at some frequencies, or bands, but departs widely from a sine shape on other bands or at different points on the same band. The illustrations in Fig. 9-7 are typical of one service-type generator.

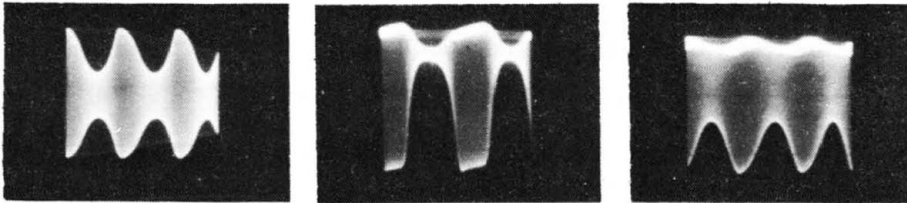

Fig. 9-7. Distorted outputs from an a-m generator.

It is not necessary that an a-m generator have a good waveform. Signal-tracing can be accomplished and stage-gain measurements can be made regardless of waveform. It is only necessary to distinguish between distortion present in the generator output, and distortion which may be introduced by the sound circuits. When test work is started, it is advisable to connect the generator output cable directly to the scope's vertical-input terminals, to determine the waveform to be used at the given frequency. At this time, check also the percentage modulation. About 30-percent modulation is suitable for sound-section tests. Most a-m generators have adjustable modulation depth.

The general modulating frequency is usually about 400 Hz. Thus, if the scope is deflected horizontally at a 100-Hz rate, four modulation peaks will appear in the pattern, as seen in Fig. 9-8. If the deflection rate is increased to about 300 kHz, the carrier peaks become the prominent feature in the pattern. For the types of tests described in this chapter, the 100-Hz deflection rate is preferred.



(A) Low deflection rate.

(B) High deflection rate.

Fig. 9-8. Effect of scope deflection rate on waveform aspect.

Signal-tracing the audio section will quickly show where the signal is stopped or substantially attenuated. The scope is the most useful instrument to find where a signal is being distorted. The most common cause of distorted sound is clipping, illustrated in Fig. 9-10. Clipping can result from low plate or screen supply voltages, or incorrect grid (or cathode) bias. The latter commonly results from a shorted cathode bypass capacitor, or from a leaky grid-coupling capacitor. Leaky screen or decoupling capacitors can reduce the screen or plate supply voltage. Less commonly, resistors in the audio circuit increase in value and cause clipping distortion.

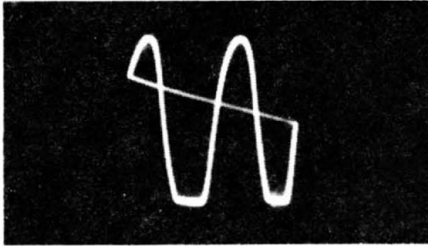

Fig. 9-10. Negative peak clipping of the audio signal.

supply voltages to the limiter tube, and on good capacitors and resistors in the circuitry.

The same signal which is found at point C in Fig. 9-1 should also appear at point D. Otherwise, the sound i-f transformer is defective or misaligned. An audio-frequency signal is normally present at points E through H. If not, check the dc voltages and resistances in the associated circuit. Also, if necessary to close in on the defective component, check capacitors on a capacitor tester or by substitution. Resistance checks can be made on coils, although this shows little aside from continuity. If a coil does not tune satisfactorily, a substitution test is preferred.

Electrolytic capacitors, if present, must be checked. Leakage or loss of capacitance can cause weak or distorted output, or both. Although numerous variations of sound-section circuitry are used in different chassis, the general principles are the same in all. It is necessary in each case to consult the receiver service data for specified voltages, resistances, and component values.

Inability of the limiter to eliminate amplitude modulation is one of the causes of sync buzz. Buzz modulation is generated in the i-f amplifier, video amplifier, or both. If the modulation depth is excessive, audible buzz will be present, regardless of limiter efficiency. It is assumed here, however, that the i-f and video amplifiers are operating properly and that only a normal amount of buzz modulation is to be contended with by the limiter.

The most severe demand is placed on the limiter stage when it is followed by a discriminator, because a discriminator has no inherent rejection of amplitude modulation. Hence, if you should be servicing a buzz complaint on a receiver of this type (they are in the minority, however), make a careful check of the limiter action. Up to 50-percent amplitude modulation should be completely "wiped off" both top and bottom of the test signal. This does require an a-m generator with very little incidental fm, because an adequate limiter stage will otherwise appear to be defective.

Less severe requirements are imposed on the limiter by a ratio detector, because this configuration inherently can reject up to 30-percent amplitude modulation if operating normally. Ratio detectors should be preceded, however, with at least partial limiting because misadjustment of the fine-tuning control or too high setting of the contrast control can otherwise lead to audible buzz and cause customer dissatisfaction. Again, if the ratio-detector alignment should drift slightly, partial limiting will assist in suppressing sync buzz. A limiter becomes more effective as the plate and screen voltages are reduced (tube saturates earlier), but the peak-to-peak voltage output is reduced accordingly. A compromise between output level and limiting action is commonly made by the manufacturer.

Troubleshooting Power Supplies

Power supplies and their associated circuitry are the source of various obscure trouble symptoms that can cause excessive waste of time in random hit-or-miss approaches. Poor sync action, raster shadowing, loss of interlacing, and audio interference in the picture are typical of these trouble symptoms. Voltage measurements seldom provide useful clues, because the basic difficulty is ac contamination of the dc supply voltages. Hence, a scope can be a valuable timesaver in localizing power-supply troubles.

STACKED B+ CONFIGURATION

Many modern receivers use a stacked B+ section in the power-supply system, as shown in Fig. 10-1. The audio-output tube doubles as a B+ voltage divider, in order to reduce manufacturing costs. The normal ripple waveform at the audio-output cathode is shown in Fig. 10-2A. Obscure symptoms can arise if the 200- μ F filter capacitor becomes low in value (Fig. 10-2B). The dc supply voltages remain about the same, but sound modulation appears in the picture, and sync action becomes unstable. A scope check at the output of the 240-volt power supply may show a ripple voltage below the maximum amplitude specified in the receiver service data. However, a check across the 200- μ F filter capacitor immediately reveals the trouble.

When an audio-output tube is used as a voltage divider, the B+ voltage must be filtered once again in the circuit following the cathode of the tube. The reason is that the dc supply voltage becomes contaminated with audio signal through the output tube. This initial

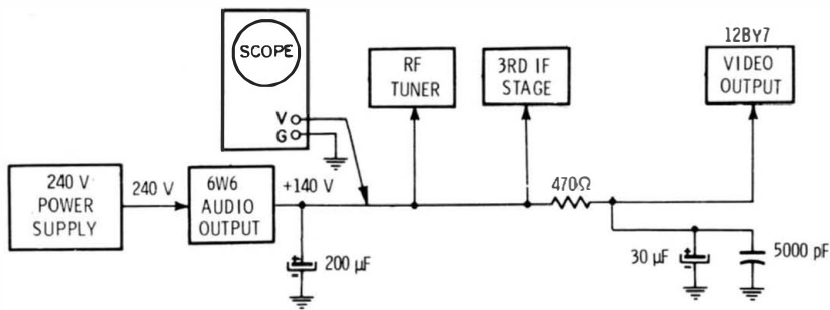

Fig. 10-1. Audio-output tube is also used as a B+ voltage divider.

filtering is done, in Fig. 10-1, by the 200- μ F capacitor, and is followed by a second filter section which supplies the video-output tube. The latter section not only provides a smooth dc supply to the video section, but also serves to decouple the video amplifier from the i-f and rf sections. Note that the 30- μ F capacitor is shunted by a 5000-pF capacitor. The purpose of the small capacitor is to provide a low-impedance bypass to ground for high-frequency ac voltages. Large electrolytic capacitors often have appreciable inductance, which lessens their effectiveness in high-frequency circuits.



(A) Normal ripple.

(B) Abnormal ripple.

Fig. 10-2. Ripple wave at cathode of audio-output tube when 200- μ F bypass capacitor is defective.

INPUT WAVEFORM TO FILTER

A typical transformer power-supply circuit is shown in Fig. 10-3. The input waveform to the filter is checked at point A. It might be supposed that this waveform would be the same in all receivers, but this is not the case. Depending on the number of sections in the filter, use of inductors or resistors between sections, and current drain from the different sections, this input waveform varies. Two common examples are illustrated in Fig. 10-4.

The input waveform approximates a sawtooth when the input impedance of the filter is essentially capacitive, because of appreciable resistive isolation between sections. The sawtooth waveform is generated because the rectifier conducts in pulses (it is back-biased by the B+ voltage), and the input filter capacitor is suddenly charged by

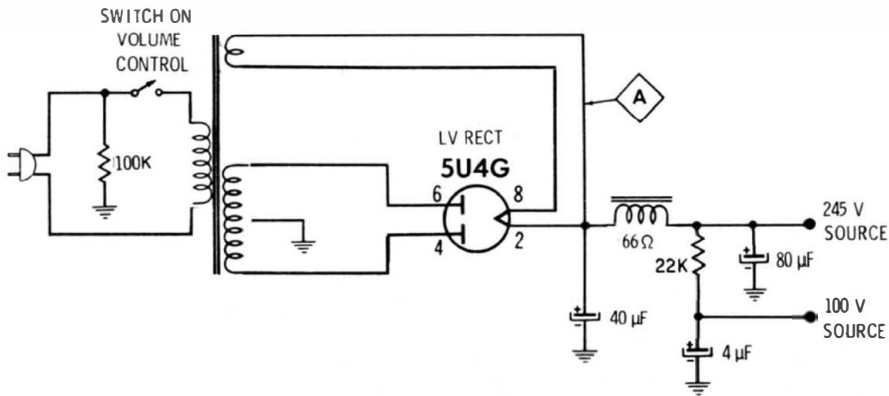

Fig. 10-3. A transformer-type power supply.

each pulse. The capacitor discharges exponentially between pulses and supplies dc current to the filter sections following. The nature of this pulse-charging sequence is seen in Fig. 10-5. This is the current in a transformerless-type receiver. The waveform shows both the heater and filter current in the line. The heater current is a sine wave and is superimposed on the pulse current drawn by the rectifiers. A pulse current waveform by itself is shown in Fig. 10-6.



Fig. 10-4. Typical waveforms at filter input.

In the Fig. 10-3 configuration, a filter choke is connected between the sections. A choke normally has appreciable inductance and comparatively low resistance. The inductive reactance modifies in the input voltage wave, as seen in the right-hand photo of Fig. 10-4.

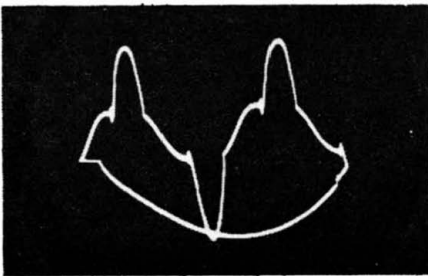

Fig. 10-5. Filter draws pulses of current from the rectifier.

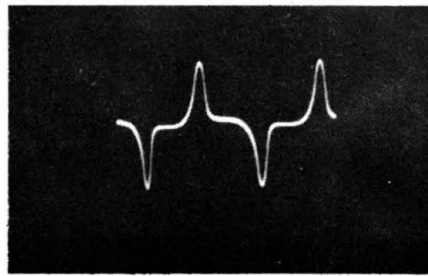

Fig. 10-6. Pulse current without a sine-wave component.

Depending on inductance and capacitance values and current drain, the waveform may also be unsymmetrical (tilted), as seen in Fig. 10-7. In any event, the essential point is that the power supply has normal operating waveforms (and amplitudes) which are characteristic of its configuration and demand. These characteristics can be checked in the receiver service data, or by comparison with the waveforms in a similar chassis. If a component is defective or if a branch current is not normal, waveshapes and amplitudes change to a greater or lesser extent, depending on the severity of the trouble condition.

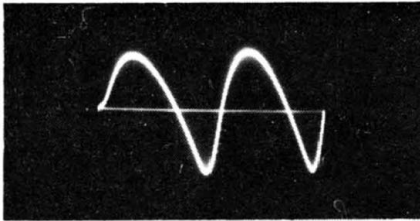

Fig. 10-7. Unsymmetrical waveform at filter input.

INCIDENTAL BYPASSING FUNCTION

Power-supply waveforms generally contain details which reflect circuit action in various receiver sections (Fig. 10-7). In older receivers or elaborate modern receivers, extensive filtering is provided, which results in “clean” input waveforms. Waveforms across output filter capacitors, on the other hand, are generally contaminated with residues from the sweep circuits in particular, and sometimes from other circuits as well. Economy-type receivers display appreciable contamination of the input waveform also, because of simplified power-supply circuitry.

Both horizontal and vertical sweep residues are prominent in the Fig. 10-8 waveform. The residues appear because the sweep circuits are not decoupled individually from the power supply, in which the filter capacitors are also serving a decoupling function. Because their bypassing action is somewhat incomplete, the sweep residues appear in the power-supply waveform. The horizontal-sweep residue is seen as a “picket-fence” interference in the main waveform. The vertical-sweep residue appears as different heights of alternate peaks.

The vertical-output stage has a comparatively heavy current demand and operated at 60 Hz. The full-wave rectifier, however, gener-



Fig. 10-8. Alternate peaks of the signal have different heights.

ates a 120-Hz ripple. Therefore, the vertical sweep-current demand is imposed on every other peak of the ripple waveform. A power supply, like any voltage source, has a certain source impedance; and when current demand rises, the voltage output drops. The lower the source impedance, the better the regulation and the less the amplitude variation on alternate ripple peaks. The essential point here is that the ratio of peak amplitudes is an indicator of the power-supply regulation, and this is duly noted by the experienced technician. Poor regulation can result from loss of filter capacitance, poor power factor, high forward resistance in contact rectifiers, or defective filter chokes.

In a voltage-doubler on half-wave power supply, the ripple frequency is 60 Hz and the vertical sweep-current demand occurs on each peak of the ripple waveform. Thus, if the receiver is tuned to a local tv station, the vertical-sweep residue will be effectively masked by the ripple waveform. Again, if the receiver is tuned to a distant station or if a conventional pattern generator is used, the vertical-sweep residue "snakes" through the ripple waveform, and its amplitude is plainly evident. The reason for this is that power companies in remote areas do not have exactly the same frequency as the local power company, and ordinary pattern generators do not have the vertical-sweep oscillator locked to the power-line frequency. Again, if the receiver is tuned to a local station, the vertical-sweep residue will "snake" through the ripple waveform if the vertical-hold control is misadjusted to make the picture roll.

CURRENT WAVEFORMS

A dc meter can be connected in series with any branch of the power-supply circuit, but it shows only the value of the dc current component. This information can be useful on occasion, however. The ac current, which is of primary concern in troubleshooting procedures, can be checked properly only with a scope. Note that an ac meter reads inaccurately because of the waveform error (power-supply waveforms are not sine waves), unless a peak-to-peak meter is used. The latter will show the true amplitude of the ac waveform. In the final analysis, a scope is the most satisfactory indicator of current waveforms.

Service checks of current waveforms are commonly hampered by the necessity for inserting a small resistance in series with the circuit under test, and connecting the scope across the resistor. There are exceptions, of course. For example, if a scope is connected across the 470-ohm resistor in Fig. 10-1 (which is already in the circuit), the current in this supply line will be displayed. If a filter resistor is between two filter capacitors, the scope can be connected across the

filter resistor to display the current in this part of the circuit. Some receivers have a fuse resistor which makes a convenient current-waveform test point.

Inasmuch as current waveforms are generally unspecified, technicians make use of comparison tests in similar chassis. Comparison tests can localize a defective component quickly. Remember that ordinary scopes operate with a “hot” case when such tests are made; therefore, use caution to avoid a shock! Incidentally, it is interesting to note here that ac probes are now available for scopes, but they are expensive. Such ac probes are quite convenient, because no connection is required to the circuit under test. The probe is merely clamped around the lead, and the current waveform appears on the scope screen. Current probes are calibrated so that peak-to-peak currents can be read from the scope pattern. A current probe, of course, leaves the scope case “cold.” It permits a quick and accurate test of the ac being drawn by each circuit branch. If used with dc scope, it also shows the value of dc being drawn by each branch.

The characteristics of current indication by a dc scope are shown in Fig. 10-9. The ac waveform rises above the beam-resting level by an amount which shows the value of dc present. The amplitudes of the ac and dc waveforms are measured in peak-to-peak volts. That is, dc and peak-to-peak volts have equal units on a calibrated scope.

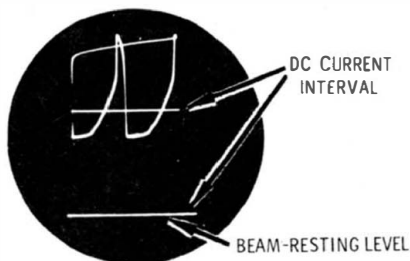

Fig. 10-9. Ac and dc current indication.

“ABOVE-GROUND” TEST METHODS

Just as current waveforms can be checked effortlessly in any circuit branch when a current probe is used, modern methods are available for checking voltage waveforms in any circuit without difficulty. As a simple example, consider again the test illustrated in Fig. 10-10. The scope displays the voltage waveform across the resistor. The waveform is, of course, identical with the current in the lead from the first to the second filter capacitor. The “hot” scope case is a possible source of shock to the operator, and is the outstanding difficulty here.

Several service-type scopes are designed to eliminate this difficulty by providing a balanced input to the vertical amplifier in the scope. (Balanced input is also called push-pull input, double-ended input, or differential input.) Fig. 10-11 shows how this type of scope has two

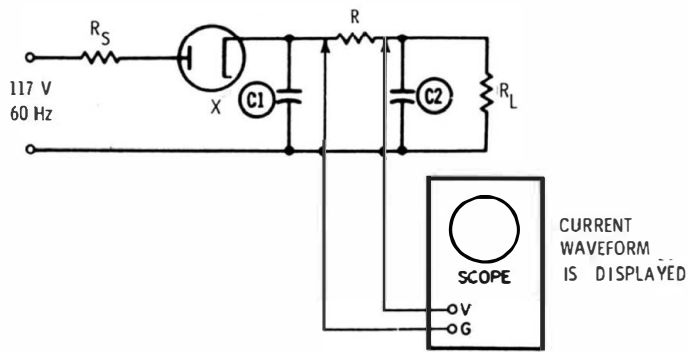
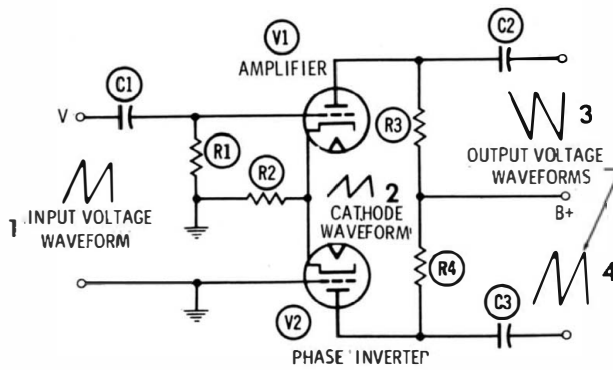
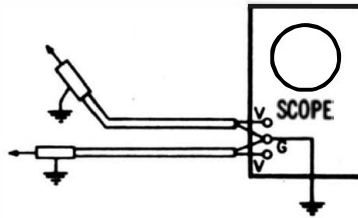
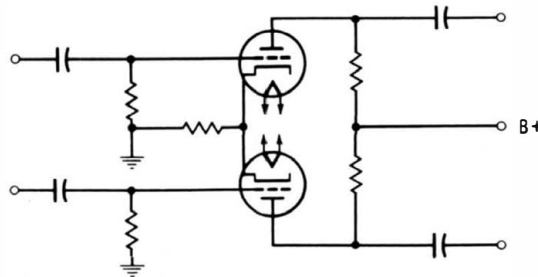

Fig. 10-10. Scope case is "hot" in this above-ground test.

Fig. 10-11. Balanced vertical input.



(A) Ordinary input.



(B) Balanced input.

Fig. 10-12. Input circuits.

vertical-input terminals and a ground terminal. The ground terminal is usually connected to the chassis of the receiver under test, or it may be left unconnected if the scope is well designed. The two vertical-input leads are used in exactly the same manner as the single vertical lead and ground lead of an ordinary scope. The chief advantage of this method is that the two vertical-input leads can be connected across any power-supply component without making the scope case "hot." The case is always at ground potential.

Balanced input is obtained by simple circuitry, as shown in Fig. 10-12. Nearly all present-day scopes use paraphase vertical amplifiers. These are push-pull amplifiers with a common cathode resistor. In an ordinary scope, the grid of one tube is grounded, as shown in Fig. 10-12A. However, the grids of both tubes are driven in a scope with balanced input, as seen in Fig. 10-12B. Either input A or B can be used as a "hot" lead and the other as a ground lead, or both inputs A and B can be used as "hot" leads in above-ground tests. This latter use is quite important. Thus, if a scope has balanced input, all the tests which are possible with an ordinary scope can be made, plus above-ground tests which are difficult with ordinary scopes.

Radio-Receiver Troubleshooting

Signal-tracing is one of the principal troubleshooting methods used in radio-receiver servicing. Although ordinary signal tracers are quite useful, they fall short of the oscilloscope's information capability. A scope is the best radio signal tracer, because it gives both distortion data and exact amplitude measurements. Scope patterns show where distortion originates, and indicate the type of distortion present, which in turn helps to pinpoint the defective component. Accurate gain measurements can also be made, and these measurements cannot be approximated by an ordinary signal tracer.

Only a-m receiver troubleshooting is covered in this chapter. Techniques applying to fm receivers are basically the same as those discussed in the chapter on sound sections of tv receivers. Test signals for a-m radio troubleshooting should be supplied by an a-m generator. Broadcast signals are difficult to work with because of their transient characteristics. Even a grid-dip meter is a more satisfactory signal source than a broadcast antenna.

SCOPE REQUIREMENTS

Conventional a-m chassis can be serviced with any scope which is adequate for black-and-white tv work. The highest signal frequency of interest is 1.5 MHz. A simple high-frequency probe must be used with the scope in order to avoid objectionable circuit loading and detuning. The configuration shown in Fig. 11-1 meets these requirements.

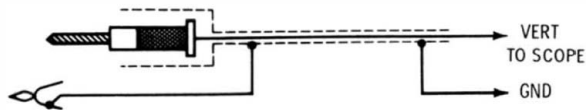

Fig. 11-1. Tubular-ceramic trimmer capacitor serves as a high-frequency probe.

A tubular ceramic trimmer capacitor is convenient in making up a shop-constructed probe. The head is clipped from the adjusting screw, which is ground to a probe point. The unit is then placed in a small housing as shown, and connected to the coax input cable to the scope. Be sure to include the housing to shield the exposed surface of the trimmer. Otherwise, pickup of stray fields will be excessive, and tests in low-level circuits will be impractical. The adjusting screw should be turned out as far as possible, while permitting adequate deflection on the scope screen. This ensures that the circuit under test will not be loaded too much. In low-level circuits, the trimmer must be adjusted for a higher capacitance value.

Calibration is not often required, but is easily made when the occasion arises. The probe should be calibrated at the frequency of interest, such as 455 kHz, or other test value. To calibrate, use a signal generator or another receiver which is operating normally. A peak-to-peak reading vtm is used to measure the voltage of the signal source. If a radio receiver is used, connections are made for 455-kHz calibration, as shown in Fig. 11-2.

The detector input circuit is heavily loaded, and the peak-to-peak vtm indicates considerably less than the true signal voltage. However, this is not a matter for concern. It is necessary to work only from a known signal voltage. The vertical-gain control of the scope is adjusted for a convenient number of deflection intervals on the screen, and the reading of the peak-to-peak vtm is noted. Signal amplitudes, in turn, can be measured on the scope screen until the probe adjustment is to be changed.

GAIN MEASUREMENTS

An uncalibrated scope can be used for gain measurements, because the gain figure is merely a ratio. Connect the output from an a-m signal generator to the antenna input terminals of the receiver, or couple the output via a small coil into the loop antenna. When the high-frequency probe of the scope is transferred from the grid to the plate terminal of an i-f stage, for example, the comparative heights of the two displays give a measure of stage gain, as seen in Fig. 11-3.

This is a basic display, but it is difficult to work with because the first waveform has a comparatively low amplitude. The decade attenuator of the scope is utilized accordingly. A simple example is this:

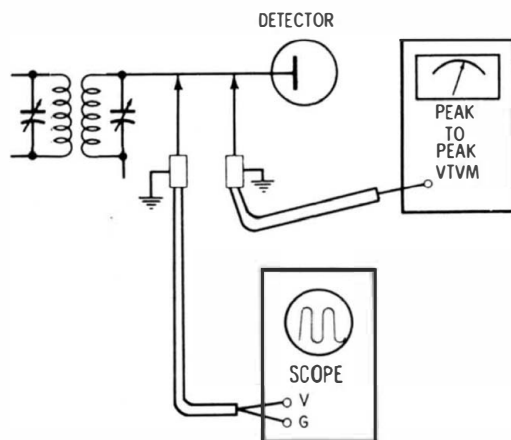

Fig. 11-2. Calibrating the probe and the scope.

if the first waveform has the same amplitude as the second waveform when the decade control is advanced one step for the first test, the stage gain is 10. The gain of a stage in normal operation depends on the avc bias voltage, and this in turn depends on the signal level. The receiver is therefore stabilized, preferably with a standard avc clamp voltage such as -1.5 volts.



(A) Input.

(B) Output.

Fig. 11-3. Basic gain displays.

It is important to be accurate in making gain measurements, and not to use the probe with an excessively high capacitance adjustment. This detunes an i-f transformer objectionably, and also makes the gain figure incorrect. Also, do not overload the receiver with a high input signal from the generator. The signal will be clipped, and a false gain figure will be obtained. The normal gain for an i-f stage cannot be calculated easily, and reference should be made to the receiver service data or to a comparative check in a normally operating receiver.

The difficulty in making gain calculations is seen from an inspection of the circuit diagram in Fig. 11-4. Although the tube type is known, its mutual conductance depends on the avc clamp voltage. This information can sometimes be obtained from a tube manual, but the plate-load impedance into which the tube works can be determined only with lab-type equipment. Reliance must be placed, there-

Fig. 11-4. Typical a-m radio-receiver configuration.

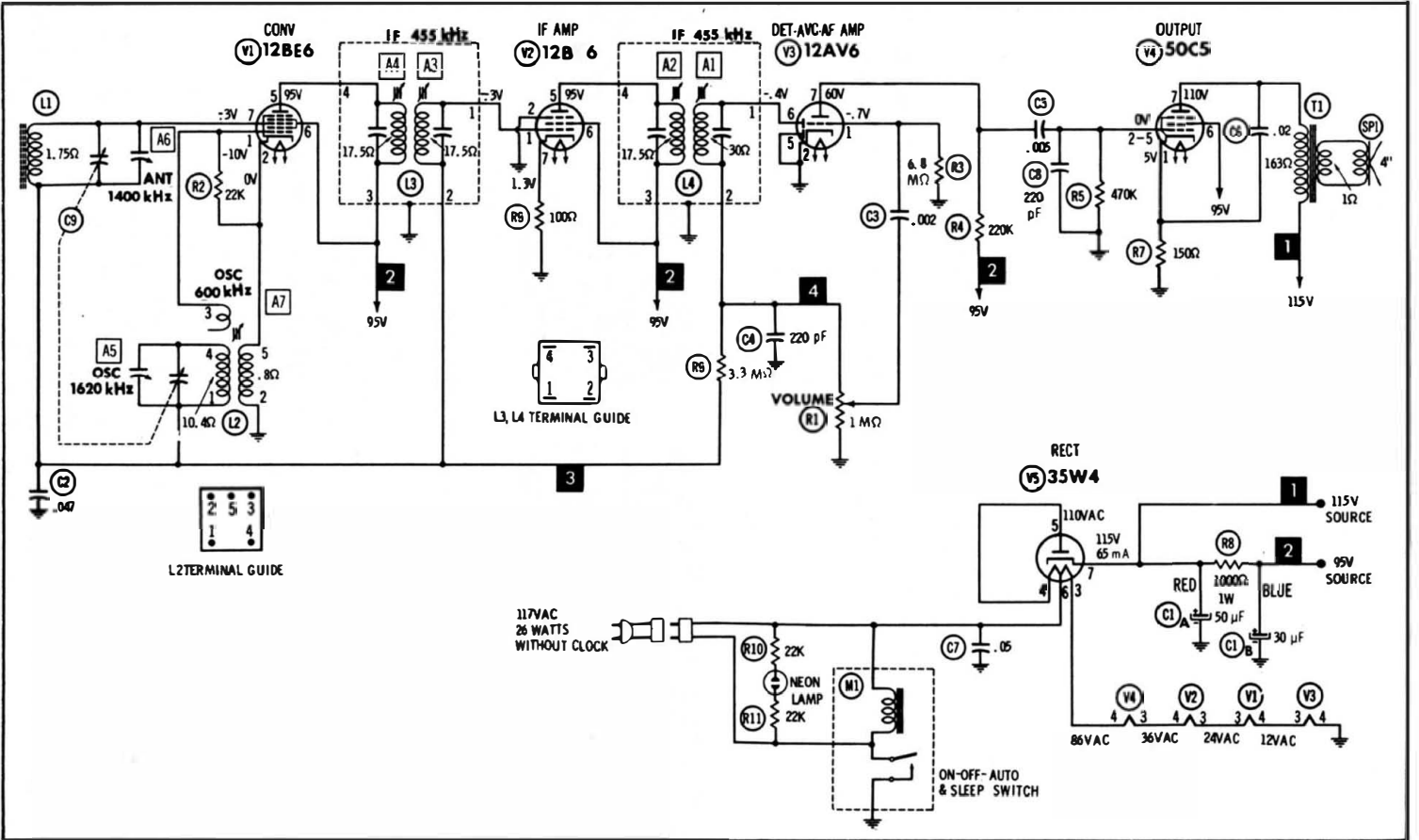

fore, on service data for the particular receiver configuration, or on comparative data obtained from a similar receiver which is operating normally.

TYPE OF TEST SIGNAL

An amplitude-modulated test signal is illustrated in Fig. 11-3. Modulation is necessary when using an ordinary signal tracer, but an unmodulated (cw) signal can be used when checking through the rf and i-f circuits with a scope. Patterns appear in such a case as in Fig. 11-5. This photo shows individual i-f cycles because the horizontal-deflection rate is used when displaying patterns such as are shown in Fig. 11-3. Internal sync is used to lock the pattern, in either case.

A cw signal is, of course, not suitable for checking the circuit past the detector, even if a dc scope is used. Although the detector generates a dc output voltage in response to a cw signal, this output is blocked by the audio coupling capacitor. Therefore, an amplitude-modulated signal must be used in these tests. A modulation depth of 30 percent is standard, but is not necessary.

The shape of the modulation envelope may change greatly as the generator is tuned through the receiver passband (see Fig. 11-6). This is the result of incidental fm in the output of the a-m generator. The photos were made using a poor-quality generator having excessive incidental fm. The situation is aggravated by using a high percentage of modulation. As shown in Fig. 11-7, less change in envelope shape results with tuning when the modulation percentage is reduced, because the incidental fm is then less.

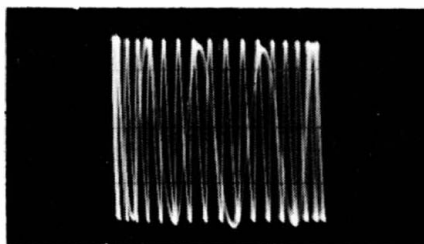

Fig. 11-5. The unmodulated output from the signal generator.

OSCILLATOR DEFECTS

The applied test signal is of no concern when checking the oscillator because it is a self-generating circuit. If the oscillator is not dead, a pattern such as in Fig. 11-5 is observed, regardless of whether or not an input signal is present. The normal amplitude of the oscillator output may be given in the receiver service data, or a comparative test can be made in another receiver with the same tube lineup as the receiver under test.



Fig. 11-6. Envelope changes with receiver tuning due to incidental fm.

A defective oscillator circuit occasionally has an output signal of normal amplitude, but runs off-frequency, making the receiver appear to be dead. This is a particularly difficult trouble condition when appreciable preselection is used in the receiver. It is a simple matter, however, to measure the oscillator frequency with a scope. Observe the number of peaks in the oscillator waveform. Then, apply the signal-generator output directly to the scope, and tune the generator for the same number of peaks. The reading on the generator dial is then the same as the oscillator frequency. In normal operation, the oscillator frequency will differ from the rf input frequency by 455 kHz. Even though the receiver dial may not be highly accurate, this procedure serves as a rough guide in evaluating oscillator operation.



Fig. 11-7. Envelope variation at lower-percentage modulation.

For a more accurate determination, apply an rf signal from the generator to the receiver, and connect the scope probe to the preamplifier output. Then tune the generator for maximum scope deflection. If the circuit is operating properly, the reading of the generator dial will differ 455 kHz from the oscillator frequency.

If the oscillator frequency measures incorrectly (usually too high), look for an open capacitor in the circuit. A defective oscillator coil is a less frequent trouble cause, but is a possibility. To summarize, a preliminary scope test of the oscillator in case of a "dead receiver" complaint can often save considerable time.

I-F STAGE TROUBLES

Trouble symptoms in i-f circuits range from weak and/or distorted output to regeneration and spurious oscillation. Weak output is easily pinpointed by stage-gain checks. When a weak stage is located check the dc voltages at the associated tube. A leaky screen bypass capacitor or an increase in value of a dropping resistor can reduce the screen

voltage and cause a weak output. An open screen bypass capacitor does not change the dc screen voltage appreciably, but it does reduce stage gain because of negative feedback.

Excessive control-grid bias reduces gain, and can occur when an avc decoupling resistor is broken or otherwise open. The associated grid then “floats” and develops a high negative dc voltage from rectification of stray-field voltage. An open grid-return circuit has an extremely high impedance, and couples strongly into stray fields. Check also the i-f transformer at the low-gain point, if advisable or necessary. Corrosion or mechanical defects can cause excessive signal loss. Such defects usually make it impossible to peak the transformer, although this is not always the case.

Low gain occurs in many receivers when a plate decoupling capacitor is open. This forces the plate signal to return to ground through the power supply, which can have an objectionably high impedance at 455 kHz. Circuits in which a plate decoupling capacitor does double duty can also develop low gain because of out-of-phase feedback from another circuit. Leakage in the decoupling capacitor results in low dc plate voltage. This does not reduce gain greatly at low signal levels, but compresses and distorts the signal at normal operating levels.

Receivers like the one shown in Fig. 11-4 have a multiple-duty screen bypass capacitor. If the capacitor is low in value, regeneration can develop. This causes the receiver to tune very sharply and distort a broadcast signal. The bandwidth of an i-f stage is reduced greatly when regeneration occurs. Use the scope to check for signal voltage across the bypass capacitor. If appreciable signal is present, replace the capacitor.

Again, if a multiple-duty screen bypass capacitor opens completely, the receiver can break into violent oscillation. Symptoms vary from a motorboating sound to a “dead” receiver. In the latter case, a dc voltage measurement at the detector output will show a very high value (the detector rectifies the high-level oscillation voltage). The scope shows a high-level i-f signal, with no rf signal applied to the receiver input.

If the receiver oscillates with the avc clamp voltage removed, but stabilizes when the clamp voltage is connected, look for an open bypass capacitor on the avc line. A leaky avc bypass causes overload distortion until the clamp voltage is applied, after which the receiver operates satisfactorily on normal signal levels.

AUDIO STAGE TESTS

If signal-tracing shows that the circuits up to the detector are operating normally, exchange the high-frequency probe for a low-capacitance probe, and then proceed to check the waveforms past the

detector. If there is weak or no output from the detector, the charging capacitor is first suspected. The capacitor may be leaky, shorted, or open. A cathode resistor which is open or greatly increased in value will cause weak or no output. An open detector decoupling resistor, or one which has increased in value, is a less common cause of weak or no detector output.

Audio stage-gain tests are made in the manner described previously. A typical pair of patterns is shown in Fig. 11-8. In this example, the input waveform is not a true sine wave because of the generator characteristic. However, the output waveform is considerably different in shape from the input waveform, because the stage is distorting. In economy-type receivers, such distortion is unavoidable and does not cause customer dissatisfaction. On the other hand, in an expensive receiver, an investigation would be made to determine the cause.

In case the gain is low and/or distortion excessive, check the dc voltages and circuit resistances first. Follow up with tests for open capacitors in the faulty stage. In the case of an open coupling capacitor, the scope will show normal signal at the input end of the capacitor, but little or no signal at the output end. In tracking down a distorted audio signal, do not be confused by inversion of the signal from grid to plate. A conventional amplifier shifts the phase of the input signal 180°. Thus, a waveform which is clipped at the top in a grid circuit will be clipped at bottom in the plate circuit.

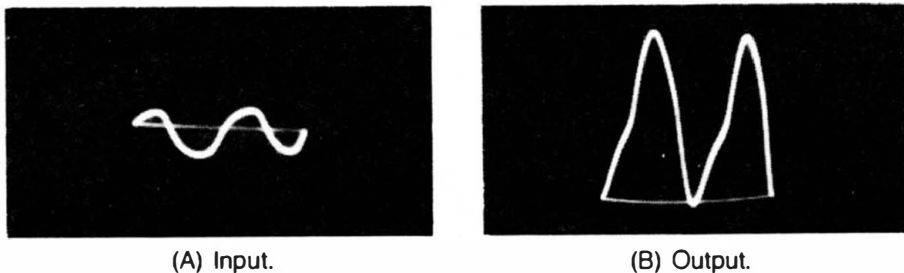

Fig. 11-8. Gain check of an audio-output stage.

HUM TRACING

When there is objectionable hum in the speaker output, check the power-supply ripple first. A filter capacitor may have marginal value, or a filter choke may be defective. If the ripple is not abnormally high, the hum voltage is probably entering at some point in the signal circuits. Trace back from the speaker with the scope to find where the hum first appears. A shielded lead in the audio-input stage, for example, may be poorly grounded. Or a defective socket can inject hum voltage from the heater into a cathode circuit which operates above ground. Socket leakage between heater and grid terminals also causes audible hum.

FM STEREO MULTIPLEX TESTS AND TROUBLESHOOTING

Although fm stereo multiplex servicing is somewhat more complicated than standard am or fm radio servicing, it can be performed quite easily with the proper test equipment. The basic test consists of a separation check, as illustrated in Fig. 11-9. A multiplex receiver has two outputs, called the left (L) and the right (R) channel. It is advisable to disconnect the two speakers, and load the output terminals with resistors of rated value. A scope is connected across each load resistor in turn, and the channel response is checked with a signal from an fm multiplex generator; the output from the generator is connected to the antenna input terminals of the receiver.

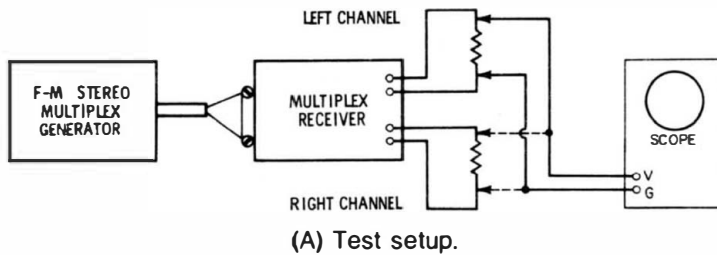

(B) Left-channel output.

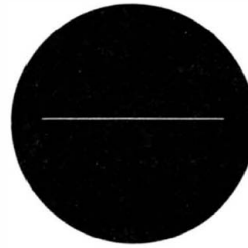

(C) Right-channel output.

Fig. 11-9. Basic fm stereo separation check.

The generator usually has a fixed-frequency output, such as 100 MHz. Hence, the multiplex receiver must be tuned to this frequency. First, set the generator controls for L-channel output, with the scope connected across the left-channel load resistor. Adjust the separation control on the receiver to obtain maximum pattern height, as shown in Fig. 11-9B. Then, set the generator for R-channel output; if complete separation is obtained, only a horizontal line will be displayed on the scope screen, as shown in Fig. 11-9C. However, a small pattern will usually be observed; therefore, adjust the separation control slightly to minimize the amplitude of the pattern.

Separation is rated in dB by the receiver manufacturer. Observe the relative amplitudes of the L- and R-channel responses. The ratio of

these amplitudes is the voltage ratio, which corresponds to dB values. After the dB separation is measured for the left channel, repeat the test for the right-channel load resistor. If the dB separation is less than the manufacturer's rating, there is probably a defect in the multiplex receiver. Look for a faulty tube first; transistors and semiconductor diodes are less likely to cause trouble than tubes. However, if a tube is not the cause, capacitors should be checked.

Capacitors are more common troublemakers than resistors or coils. It is also possible that poor separation is due to misalignment; however, we check alignment last. Some fm multiplex generators have a built-in rf sweep generator, so that alignment can be checked with the same equipment that is used to check separation. The service data for the receiver should be consulted to determine the proper connection points for the scope when a sweep-alignment test is made. Note that an external marker generator may be required if the fm multiplex generator does not have built-in marker facilities.

After prolonged service, the generator may require touch-up of its maintenance controls. To check the generator, the composite audio signal is fed to the vertical-input terminals of a scope, as shown in Fig. 11-10. Normal waveforms with and without the 19-kHz pilot signal are illustrated in Fig. 11-10B and C. If the waveforms are distorted, the generator maintenance controls should be readjusted as explained in the instruction manual for the generator. Of course, any defective tubes in the generator must be replaced before correct waveforms can be obtained.

The normal composite audio signal has the waveshape illustrated in Fig. 11-10. This waveform is built up as follows: Suppose that the generator is set for L-channel output; the L-channel signal will be a

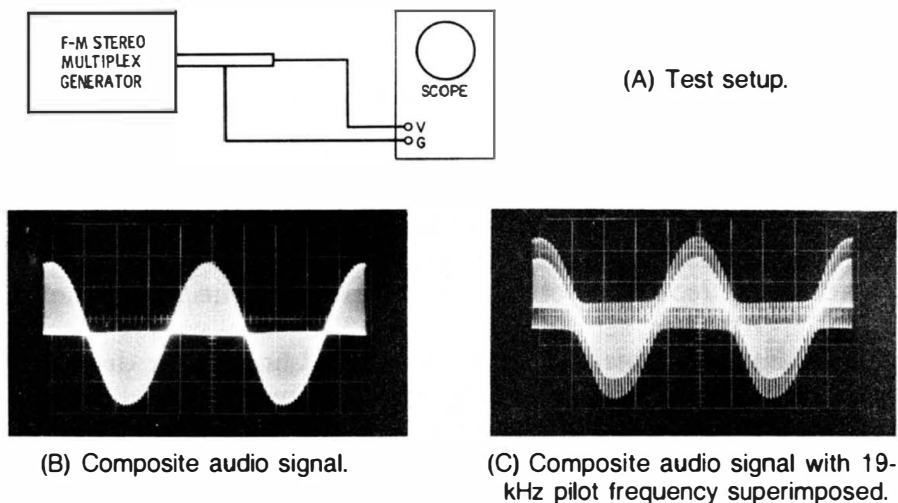

Fig. 11-10. Multiplex generator output check.

sine wave, as shown in Fig. 11-11A, and the R-channel signal will be zero, as shown in Fig. 11-11B. To form the composite audio signal, the L and R signals are first added together to obtain an $L + R$ signal. It follows from Fig. 11-11 that the $L + R$ signal is the same as the L-channel signal, because $1 \text{ kHz} + 0 = 1 \text{ kHz}$.

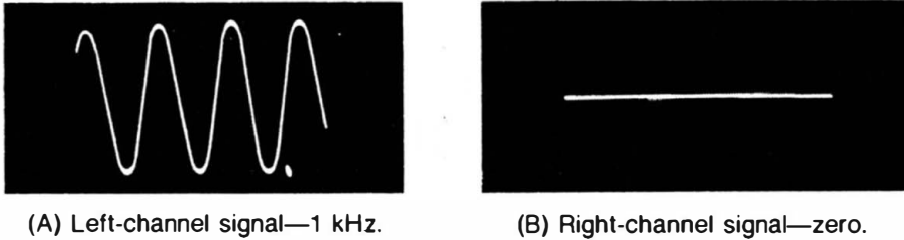

Fig. 11-11. Left- and right-channel signals when generator is set for L-channel output.

Next, the R-channel signal is subtracted from the L-channel signal to form the $L - R$ signal. Again, the $L - R$ signal will be the same as the L signal in this case, because $1 \text{ kHz} - 0 = 1 \text{ kHz}$. Now, let us follow the processing of the $L + R$ and $L - R$ signals in the generator. The $L + R$ signal is used, without any change, in formation of the composite audio signal. On the other hand, the $L - R$ signal is amplitude-modulated on a 38-kHz subcarrier. The amplitude-modulated waveform is shown in Fig. 11-12. However, the 38-kHz subcarrier is suppressed from the modulated waveform. Refer to Fig. 11-13.

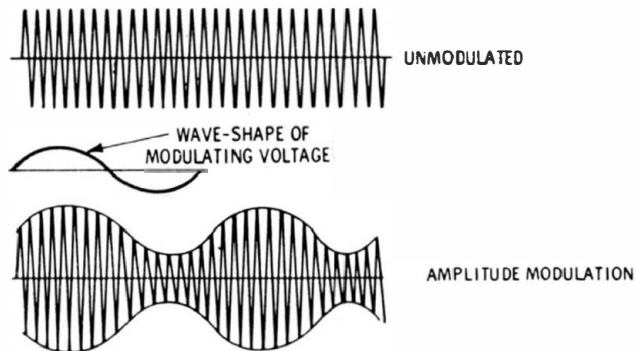

Fig. 11-12. The L-R signal is amplitude-modulated on a 38-kHz subcarrier.

When a carrier (or a subcarrier) is amplitude-modulated by a sine wave, a pair of sideband frequencies is generated, as illustrated in Fig. 11-13. The carrier is suppressed by means of a balanced modulator. This leaves the upper and lower sidebands. These sum and difference frequencies beat together to form a double-frequency modulation envelope, as shown in Fig. 11-14. Note that when the carrier (or subcarrier

er) is removed from an amplitude-modulated waveform, the envelope frequency doubles.

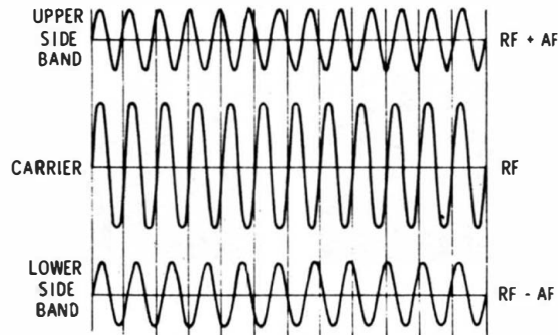

Fig. 11-13. Two sideband frequencies are generated by amplitude modulation.

Finally, the composite audio signal is formed by combining the L + R signal (which is a 1-kHz sine wave) with the waveform “sidebands without carrier” illustrated in Fig. 11-14. The addition of these two waveforms will alternately “raise” and “lower” the modulated waveform, producing the composite audio signal shown in Fig. 11-10B. When the 19-kHz pilot frequency is switched on, we see the pilot signal riding on the composite audio signal, as illustrated in Fig. 11-10C.

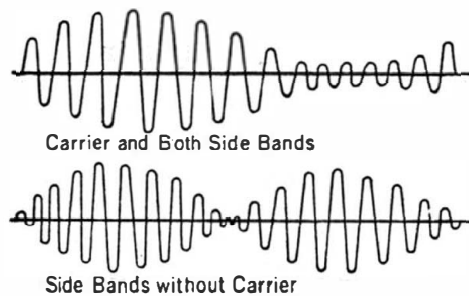
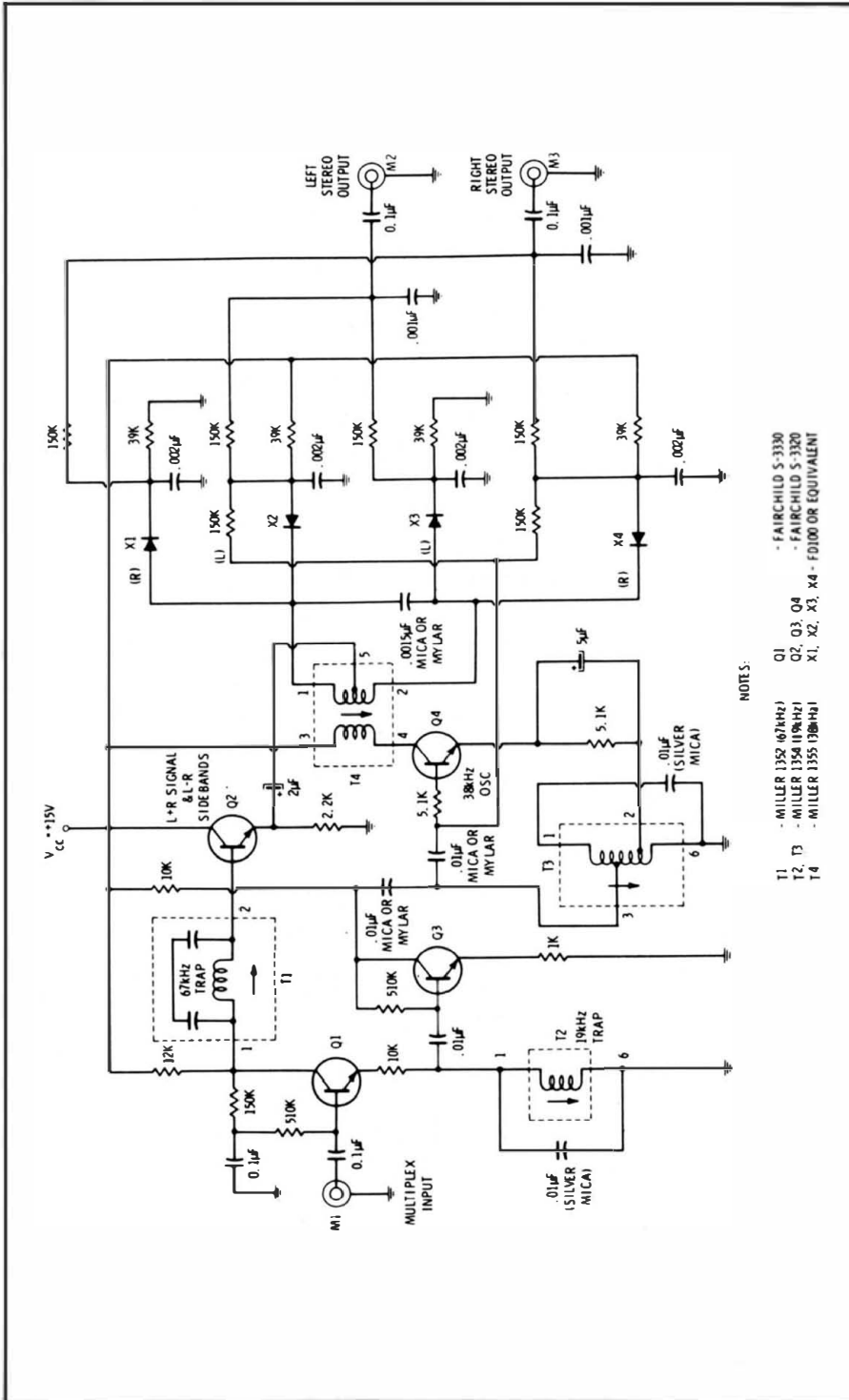

Fig. 11-14. Suppression of the carrier results in a double-frequency modulation envelope.

It is helpful to observe the configuration for a switching-bridge type of multiplex decoder, shown in Fig. 11-15. This is the most widely used decoder design. Its circuit action can be easily understood by reference to Fig. 11-16, which shows the basic multiplex waveforms processed by the decoder. The input to the switching bridge consists of the L and R waveforms with suppressed subcarrier, as seen in Fig. 11-16A; another input to the bridge consists of the 38-MHz subcarrier. This subcarrier is reinserted by the bridge, and the result is the



NOTE 5:
 T1 - MILLER 1352 (67KHz) Q1 - FAIRCHILD S-3330
 T2, T3 - MILLER 1354 (19KHz) Q2, Q3, Q4 - FAIRCHILD S-3320
 T4 - MILLER 1355 (38KHz) X1, X2, X3, X4 - FD100 OR EQUIVALENT

Fig. 11-15. A switching-bridge type of multiplex decoder.

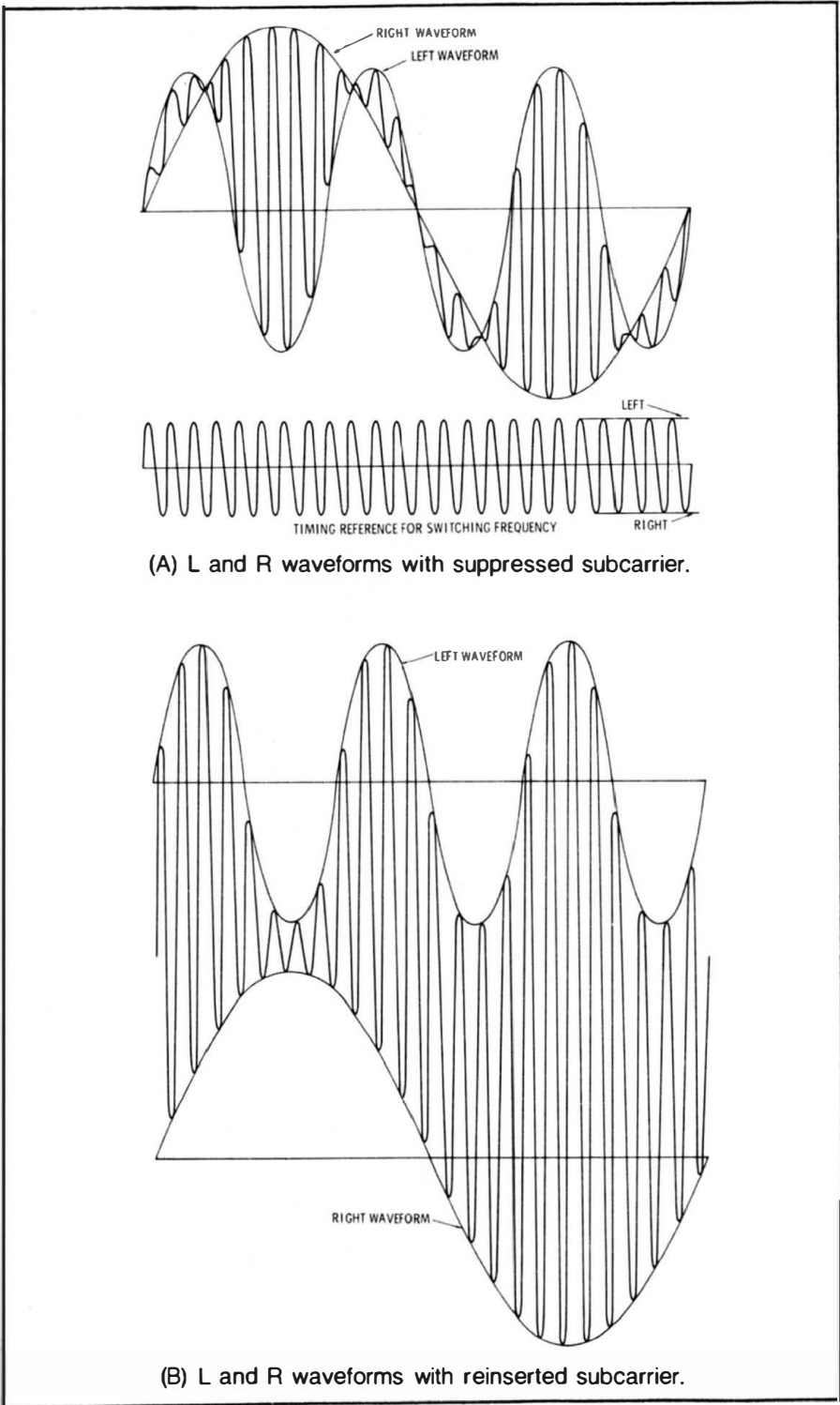

Fig. 11-16. Stereo multiplex waveforms.

waveform shown in Fig. 11-16B. Note that the L information now appears at the top of the waveform and that the R information appears at the bottom of the waveform. The L and R audio signals are then separated.

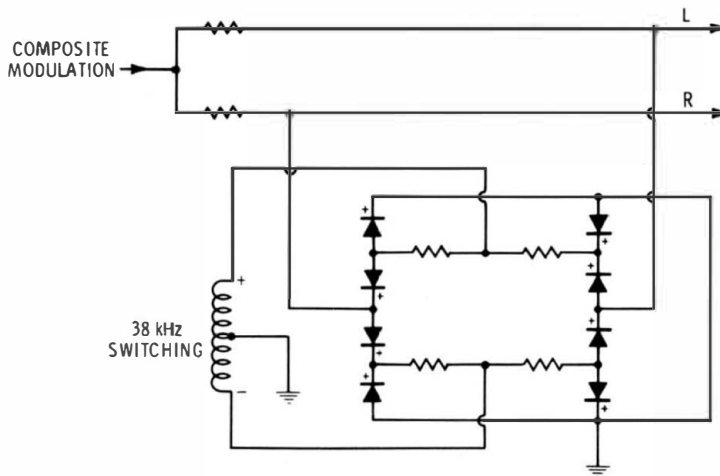

Fig. 11-17. Switching-bridge circuit action: The four left-hand diodes conduct when the 38-kHz voltage has the polarity shown; the four right-hand diodes conduct when the polarity is reversed.

With reference to Fig. 11-17, the left-hand and right-hand sides of the bridge conduct alternately, depending on the polarity of the 38-kHz switching signal. In other words, a sampling action takes place whereby the right-hand side of the bridge supplies samples of the L signal, and the left-hand side of the bridge supplies samples of the R signal. This is basically a detector action, except that two different signals are being detected alternately. Outputs from the switching bridge are applied to low-pass filters in order to remove the 38-kHz component and pass the audio information. With reference to Fig. 11-15, this filtering action is provided by 0.001- μ F capacitors and 150-K resistors connected to the L and R output leads.

Testing Audio Amplifiers

A wide variety of useful tests can be made in audio equipment with a scope. Such equipment ranges from the simple audio amplifiers used in table-model radios, through commercial-sound installations, to high-fidelity amplifiers. The vertical and horizontal amplifiers in service-type scopes are seldom capable of hi-fi response. It might therefore be supposed that accurate checks of distortion could not be made. It is a general rule that test equipment must have performance characteristics equal to or better than the device under test. There are, however, certain exceptions which are made possible by suitable test techniques.

LINEARITY CHECKS

Amplitude nonlinearity is a basic cause of distortion in audio amplifiers. In order to make a linearity test with a scope, first determine the linearity of the scope itself. This provides a reference pattern for use in evaluating the linearity of an audio amplifier. Connect the output from an audio oscillator to both the vertical- and horizontal-input terminals of the scope, as shown in Fig. 12-1. (The waveform of the audio oscillator is of no concern here.) Now set the audio oscillator frequency to approximately 400 Hz. A diagonal-line display appears on the scope screen.

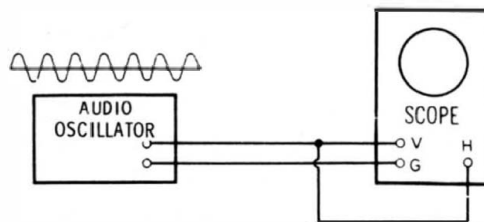

Fig. 12-1. Check of scope linearity.

If the scope amplifiers are linear, a perfectly straight line will be displayed. If the amplifiers are not linear, the line may have some curvature, as in Fig. 12-2. For an accurate evaluation, place a straight-edge along the pattern. This is the reference pattern used in the following test. Connect the equipment as shown in Fig. 12-3. Load resistor R must have an adequate wattage rating, and its resistance should equal the recommended load impedance for the amplifier. The amplifier should be driven to its maximum rated power output. Power output is determined by measuring the ac voltage across R. The voltage is measured in rms units with an ordinary vom. The power in watts is equal to E^2/R .

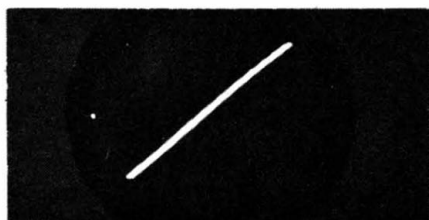

Fig. 12-2. Reference linearity pattern.

Now, observe the pattern on the scope screen. If it is exactly the same as the reference pattern, the amplifier under test is linear. On the other hand, more or less nonlinearity is indicated by more or less departure from the reference pattern. If the amplifier under test has good performance characteristics, there may be some doubt whether or not the scope pattern really shows any departure from reference. In fact, very small amounts of nonlinearity are difficult to evaluate with certainty.

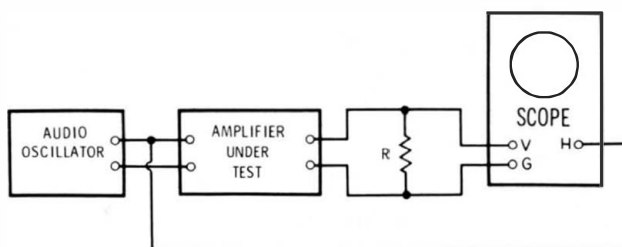

Fig. 12-3. Amplifier linearity check.

An amplifier which has substantial nonlinearity at high power output usually shows less nonlinearity when the power output is reduced. Any amplifier develops increasing nonlinearity as the power output is increased. Objectionable nonlinearity at rated power output can be caused by incorrect grid bias, low plate or screen supply voltages defective transformers, off-value resistors, or open bypass capacitors. Leaky coupling capacitors change the normal grid bias on

a tube. Leaky or shorted cathode bypass capacitors change the normal cathode bias. If a coupling capacitor is low in value, the preceding stage must be overdriven to obtain rated power output, with resulting nonlinearity. An open capacitor in a feedback network causes amplitude nonlinearity.

PHASE SHIFT

Unless the amplifier is defective, it is highly unlikely that you will observe any phase shift in the pattern at 400 Hz. Phase shift in the amplifier under test causes the line pattern to open into an ellipse. The proportions of the ellipse indicate the amount of phase shift. Some key patterns are illustrated in Fig. 12-4. Amplifier defects resulting in phase shift include low-value coupling, decoupling, and bypass capacitors; defective transformers; or a defect in the feedback circuit.

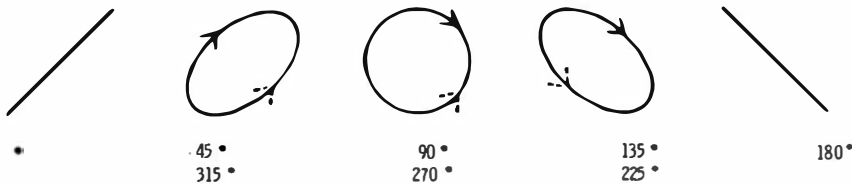

Fig. 12-4. Typical phase shift patterns.

Any amplifier, including the scope amplifiers, will exhibit phase shift at some limiting upper frequency. Here, stray circuit capacitances begin to become significant. The stray capacitances have a partial bypassing effect around plate load resistors in particular, causing the load to become noticeably reactive at the high test frequency. Phase shift is always the result of reactance. Unless amplifiers are dc coupled, they also exhibit phase shift at some limiting low frequency. This occurs because the values of coupling, decoupling, and bypass capacitors are insufficient to maintain negligible reactance at the low test frequency.

In case of simultaneous amplitude nonlinearity and phase shift, a distorted ellipse is displayed. The ellipse appears more or less flattened, skewed, or egg-shaped, with one end more "open" than the other. In hi-fi amplifiers, nonlinearity is more objectionable than phase shift, because listeners detect nonlinear distortion more readily than phase shift in the audible output. The better hi-fi amplifiers are designed, however, to minimize phase shift.

LINEAR TIME-BASE DISPLAYS

The cyclogram test depicted in Fig. 12-3 is preferred to a display on a linear time base (sawtooth deflection) because small amounts of

distortion are much more difficult to observe on a linear time base. If substantial distortion is present, as in Fig. 12-5, it is immediately evident, but on the other hand, it is practically impossible to observe small amounts of distortion. If a linear time base is used, adopt the same precautions in establishing a reference pattern, as previously described. Connect the audio-oscillator output directly to the scope's vertical-input terminals, and observe this reference pattern. It shows the combined effect of observable distortion in the generator waveform, plus possible additional distortion from the scope's vertical amplifier.

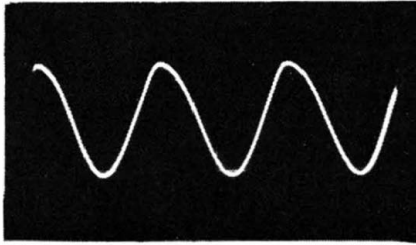

Fig. 12-5. Distorted sine wave.

Where the technician is concerned only with the signal amplitude, as in gain measurements, a linear time base serves satisfactorily. It is also appropriate for checking bypass capacitors, as seen in Fig. 12-6.

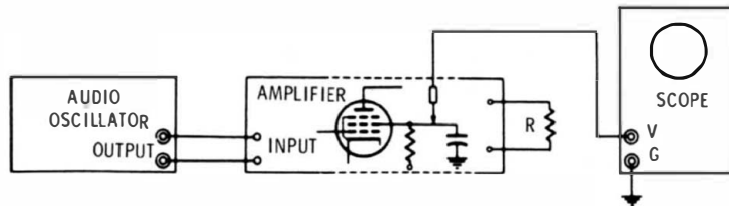

Fig. 12-6. Checking a screen bypass capacitor.

If the bypass capacitor is satisfactory at the test frequency, little or no ac voltage is present. An open capacitor, however, causes a large deflection on the scope screen. A linear time base is also used when a scope supplements a harmonic-distortion meter, as shown in Fig. 12-7. The harmonic-distortion meter filters out the fundamental in the test frequency, and passes the harmonics. The meter indicates only the percentage of harmonic distortion, but the scope will show whether second, third, or higher harmonics are present.

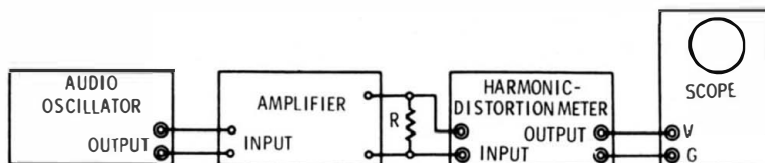

Fig. 12-7. Scope identifies the nature of distortion.

When the positive peaks of a sine wave are clipped or compressed (Fig. 12-8), even harmonics are generated. The waveform is unsymmetrical. If both positive and negative peaks are clipped equally, the resulting waveform is symmetrical, and odd harmonics are generated. Again, if positive and negative peaks are clipped unequally, both odd and even harmonics are developed. Any change in the shape of a sine wave, no matter how gradual, and regardless of the portion of the wave affected, generates harmonics.

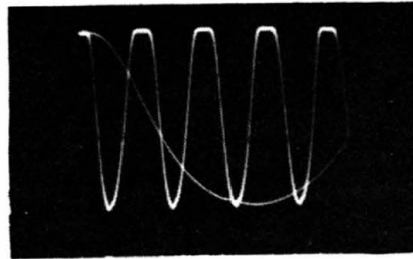

Fig. 12-8. Severe even-harmonic distortion of a sine wave.

Parasitic oscillation is identified easily in scope tests. It causes a “bulge” on the waveform, usually at the peak. (See Fig. 12-9.) The bulging or ballooning interval consists of a high-frequency oscillation, generally occurring on the peak of drive to a tube which is being driven into grid current. When the grid is being driven positive, the grid input resistance falls to a comparatively low value. Stray reactances in leads and transformer windings can then “see” a high Q which permits a brief interval of high-frequency oscillation. Parasitic oscillation is commonly controlled by connecting small resistors in series with the grid and plate leads at the socket terminals.

Notch distortion, if appreciable, can also be seen in a scope pattern. This difficulty occurs principally in push-pull amplifiers which are incorrectly biased. This distortion is exhibited as irregularities in the shape of the sine wave in passing through the zero axis. Notch distortion is aggravated by high-level drive. Any push-pull amplifier develops this type of distortion when driven too hard. If the distortion occurs at rated power output, check the bias voltages at the push-pull tubes. If the bias is correct, check for low plate or screen voltages.

SQUARE-WAVE TESTS

High-fidelity amplifiers are often rated for a square-wave response. A different class of information is provided by square-wave tests, which supplements the data from steady-state tests with an audio oscillator. The leading and trailing edges of a square wave are very steep, and therefore the rise and fall times of an amplifier become apparent. This is sometimes referred to as the attack time of the

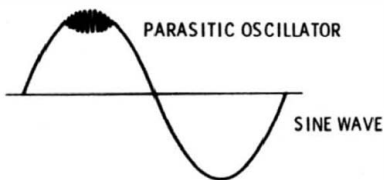

Fig. 12-9. Appearance of parasitic oscillation on a sine wave.

amplifier. It is a transient response, as contrasted to a steady-state response. In theory, it is possible to deduce the transient characteristics from a study of the frequency and phase response over the pass-band of the amplifier. Practically, however, this becomes almost prohibitively difficult, particularly when several audio stages are cascaded.

Most oscilloscopes have vertical amplifiers which exceed the capabilities of a hi-fi amplifier in square-wave tests, but this is not true at all. It is advisable, therefore, first to check the transient response of the scope, as illustrated in Fig. 12-10. Any distortion over the

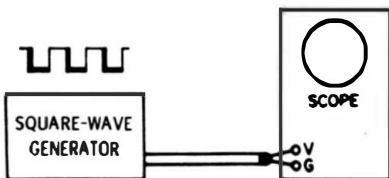

Fig. 12-10. Checking the transient response of a scope.

contemplated range of square-wave test frequencies must be taken into account, so that it is not improperly charged to deficiencies in the audio amplifier. It is common to find tilt in the top of a 60-Hz square wave, as seen in Fig. 12-11. In an ac scope, the coupling, decoupling, and bypass capacitors in the vertical amplifier may be too small in value to reproduce a 60-Hz square wave without tilt. Or the square-wave generator itself may not be free from tilt at low frequencies.

When a 60-Hz square wave is passed through the audio amplifier, any tilt contributed by the amplifier will be added to the reference waveform. It is much less common to find uphill tilt, as shown in Fig. 12-12. This response is caused by overcompensation of low frequen-

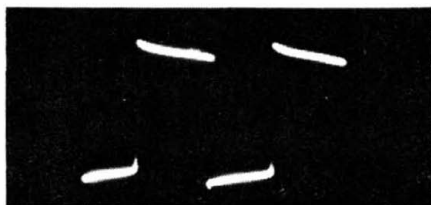

Fig. 12-11. Tilt in top of square wave is caused by low-frequency attenuation and phase shift.

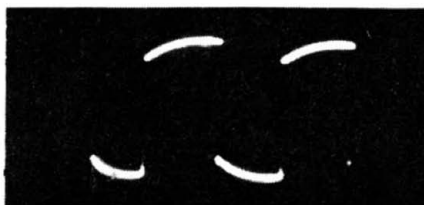

Fig. 12-12. Low-frequency overcompensation causes top of square wave to slope uphill.

cies. In audio amplifiers, the cause is usually traced to a defect in the feedback network. An open capacitor in some feedback circuits can result in more negative feedback at low than at high frequencies.

Theoretically, a 60-Hz square-wave test gives all the information about transient response which can be obtained. There is no reason why tests are required at higher square-wave frequencies. A practical difficulty arises, however, in evaluating the extremely high harmonic responses from a 60-Hz test. High harmonics have less amplitude, and their effect on the reproduced waveform tends to be masked by low-frequency harmonics. Moreover, fine detail of corner reproduction is so highly compressed at low test frequencies that the display is not readily evaluated. Finally, attack time becomes plainly visible only at high test frequencies, when ordinary sawtooth deflection is used.

The meaning of attack time is seen in Fig. 12-13. It is the time required for the square wave to rise from 10 percent to 90 percent of its final amplitude. In order to measure attack time, advance the square-wave test frequency until the attack interval occupies a usable horizontal interval. Compare the attack interval with the total interval for one complete square-wave cycle. Knowing the frequency of the square-wave signal, its period (time of a complete cycle) is given by the reciprocal of the frequency. The attack time is given, in turn, by the fraction of the total interval occupied by the attack interval.

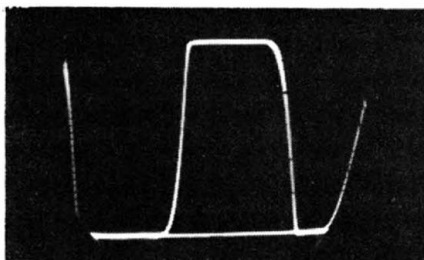

Fig. 12-13. Slow rise and fall time.

OVERSHOOT

Overshoot is a characteristic often associated with attack time (Fig. 12-14). An amplifier which has a very short attack time may, in turn, display objectionable overshoot. High-fidelity amplifiers are occasionally rated for overshoot at a specified square-wave frequency. This rating is given as a percentage. To measure percentage overshoot, compare the amplitude of the overshoot pulse with the total amplitude of the square wave between its flat-topped portions.

Causes of overshoot are a rising high-frequency response in the amplifier circuits (sometimes due to a defective feedback network), or to uncoupled inductance in transformers. Make certain that the amplifier under test is working into the rated load. Some amplifiers

are more load sensitive than others. Overshoot may be accompanied by ringing, as shown by the severe situation in Fig. 12-15. When ringing is encountered, first check the feedback network. Defective transformers can also be responsible for this symptom.

Most audio transformers ring and otherwise distort a square wave if the test frequency is too high. Hence, a meaningful test is obtained only within the square-wave limits specified by the manufacturer. An improperly loaded transformer may also ring within its rated range. Normal loading damps the windings and suppresses the response of uncoupled inductance and distributed capacitance. Therefore, in event of difficulty, check for circuit defects which may reduce normal loading, for even a high-resistance connection can be responsible.

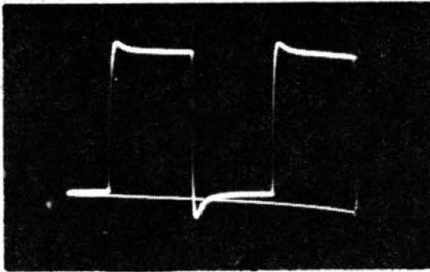

Fig. 12-14. Overshoot occurring in a square-wave pattern.

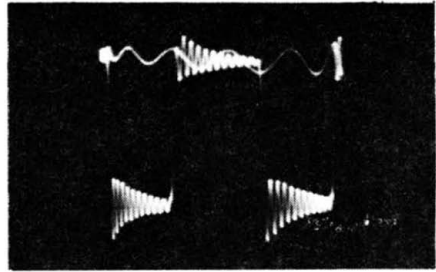

Fig. 12-15. Severe ringing occurring in square-wave test.

Parasitic oscillation occasionally occurs in square-wave tests (Fig. 12-16) just as in sine-wave tests. If the output from the square-wave generator is reduced, the spurious oscillation will usually disappear. It is eliminated in most cases by connecting 50-ohm resistors at the plate and grid terminals of the offending tube. If, due to a defective feedback network, suppression resistors will not help, the defective component must be located and replaced.

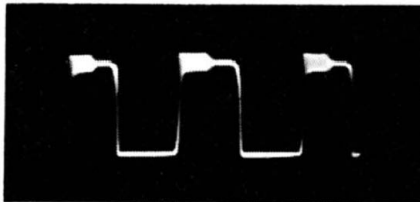

Fig. 12-16. Parasitic oscillation occurring in square-wave test.

SQUARE-WAVE TEST OF STEREO-MULTIPLEX ADAPTER

Because a multiplex adapter for fm stereo normally responds to an $L + R$ and an $L - R$ signal it cannot be directly energized by a square-wave signal for meaningful tests. Therefore, we must first use

an fm multiplex generator to process the square-wave signal as shown in Fig. 12-17. The output from the square-wave generator is fed to the external-modulation terminals of the multiplex generator. In turn, the multiplex generator supplies a composite audio signal for testing the square-wave response and separation of the multiplex adapter.

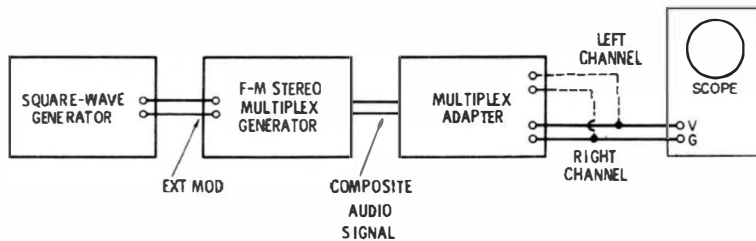

Fig. 12-17. Test setup for square-wave check of multiplex adapter.

The composite audio signal appears as illustrated in Fig. 12-18; we see this waveform if the scope is connected directly to the output of the multiplex generator. Note that the waveform appears superficially the same whether the generator is switched to L-channel or R-channel output. The superficial similarity results from the fact that only a phase difference distinguishes one signal from the other.

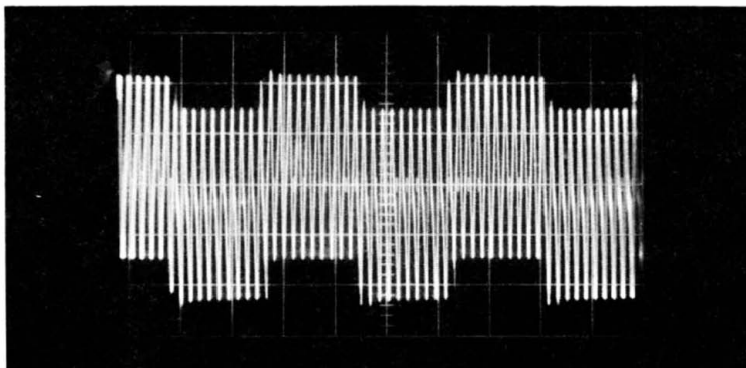
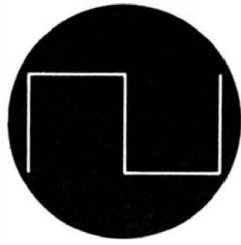
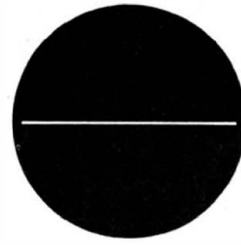

Fig. 12-18. Modulation of composite audio signal with 1-kHz square wave.

When the composite audio signal is passed through the multiplex adapter, as illustrated in Fig. 12-17, the signal is processed by the adapter to develop the L-channel and R-channel signals. When the separation control on the adapter is adjusted correctly, maximum square-wave output is normally observed from the R channel, and practically zero signal from the L channel. Fig. 12-19 illustrates the ideal outputs from the L and R channels. In practice, we expect to see a small and distorted square-wave output from the left channel, instead of a straight horizontal trace. The separation control is adjusted for best separation.



(A) Right-channel response.



(B) Left-channel response.

Fig. 12-19. Ideal response of multiplex adapter to square-wave test.

It is customary to make a 2-kHz square-wave test. Of course, other square-wave repetition rates can also be used. At 60 Hz, we usually see a noticeable tilt in the square-wave reproduction. At high frequencies, we expect to observe some integration of the reproduced square wave. A 2-kHz square wave is normally reproduced with little noticeable distortion. Excessive distortion and/or poor separation points to a defective component in the multiplex adapter. Check the tubes first. If they are not defective, a faulty capacitor is the most likely cause. Semiconductor diodes may not be well matched, which could cause poor separation. Resistors seldom become defective, but this possibility should not be overlooked. In transistorized adapters, a defective transistor could be causing trouble.

Index

A

Above-ground test methods, power supplies, 158-160
Ac ripple, high, 128
Action of triggered-sweep controls, 47-51
Adjustment, ringing coil, tv receiver, 116
Afc, transistorized, 105
Afc-oscillator circuit variations, 120
Afc, section, troubleshooting, 109-114
Alternate symmetry waveforms, 101-102
Amplifier
 audio, 67-70
 bandwidth requirement, 81-82
 i-f, signal tracing, 79-87
 rf, troubleshooting, 75-79
 sync, transistorized, 105
 video
 economy-type, 95-96
 i-f, 70
 rise time of, 93
 signal tracing, 87-96
Anticorona dope, 127
Antihunt network, 111
Antipincushion magnets, 129
Application of a 60-hertz ac test voltage, 26-29
Attenuators
 step, 32, 40-41, 69
 trimmer adjust, 32, 69
 10-to-1, 60
 100-to-1, 66
 vertical, 61
Audio-amplifier testing, 177-187
 linearity checks, 177-179
 linear time-base displays, 179-181
 multiplex adapter, square wave test, 184-186
 phase shift, 179
 square-wave tests, 181-183

Audio amplifiers, 69-70
Audio stage tests, radio receiver, 167-168

B

Bandwidth measurement, 81-82
Blanking, retrace, 36
Blocking capacitor, 85, 86, 87
Blocking capacitor, probe, 60
Blooming, picture, 122
Boost-voltage filtering, 128-129
Buzz modulation, 151

C

Calibration and peak-to-peak voltage measurements, 37-39
Capacitor, probe blocking, 60
Centering-control adjustment, 21, 24-25
Circuit testing, square waves, with, 53
Coaxial input cable, 57-58
Compensated attenuating device, 58
Compensated probe, 59
Complex waveforms, 7, 39-40
Compression, white, 90
Control functions, oscilloscope, 23-25
Coupling capacitor
 checks, vertical-sweep section, 135-136
Current waveforms, 157-158

D

Dc trigger position, 48
Dc versus peak-to-peak volts, 41-42
Definition, poor, 91-92
Demodulator probe, 79, 81, 86
Differentiating and integrating circuits, 11, 13-17, 53, 55
Display
 narrow pulses, 52, 53
 square waves, 53-54

- E**
- Exponential pulses, 11
 - External pulses, 43-44
- F**
- Filtering, boost-voltage, 128-129
 - Fluctuating line voltage, 54-56
 - Flyback transformer, 122
 - Fm distortion, incidental, 148-149
 - Fm stereo multiplex tests, 169-175
 - Focus-control adjustment, 22-23, 24
 - Free-wheel, 111, 115
 - Frequency
 - control, 35-36
 - measurement test, 18
 - response test, 18
- G**
- Gain controls, 30
 - horizontal, 34-35
 - step gain, 32-34
 - vertical, 30-32
 - Gain measurements, radio receivers, 162-165
 - Ghosts, circuit, 93
 - Ground-circuit difficulties, 86-87
 - Ground lead of scope probe, 71-73
- H**
- Harmonics, waveform, 9-10
 - Hertz (Hz), 7
 - High-voltage power supply, 126-128
 - Horizontal nonlinearity, 37
 - Horizontal-oscillator section,
 - signal-tracing, 114-116
 - Horizontal-output system, solid-state, 131
 - Horizontal-sweep section, waveform tests, 121-131
 - Hum tracing, radio receivers, 168
 - Hum voltage, 71
 - Hybrid sine and square wave, 90
- I**
- I-f amplifier, signal tracing, 79-87
 - I-f stage troubles, radio receiver, 166-167
 - Incidental bypassing function, power supplies, 156-157
 - Input waveform to filter, power supplies, 154-156
 - Instantaneous
 - voltages, 37
 - reading, 61-62
 - Intensity control
 - adjustment, 19-21
 - pattern size, 30
 - Intercarrier section, test signal, 145-149
 - Inverter stage, 104
- K**
- Keystoning, 129-131
 - Kirchhoff's Law, 53
- L**
- Limiter characteristics, sound i-f, 150-152
 - Linear time-base displays, audio amplifiers, 179-181
 - Linearity checks, audio amplifier, 177-179
 - Lissajous patterns, 51-52
 - Looker point, 75
 - Low-capacitance probe
 - adjustment, 59-60
 - configuration, 58-59
 - demodulator, 62-64
 - lab-type, 60-61
 - Low contrast versus stage gain, 85-86
 - Low drive voltage, 122-125
- M**
- Modulated sine wave, 70
 - Modulation, reversed, 83-84
 - Multiplex adapter, square wave test,
 - audio amplifiers, 184-186
 - Multiplex decoder, 172
 - Multivibrator with ringing coil, 119-120
- N**
- Narrow picture, 122, 125-126
 - Narrow pulses, display of, 52, 53
 - Nonlinearity
 - audio amplifiers, 178-179
 - horizontal deflection, 37
 - Notch distortion, 181
- O**
- Oscillator defects, radio receiver, 165-166
 - Oscillator or afc trouble?, 111-114
 - Oscillator, sawtooth, 36
 - Oscilloscope, operation of, 19-56

ac scopes, 41-42
 adjustment
 centering-control, 21, 24-25
 focus-control, 22-23, 24
 frequency, 35-36
 horizontal, 34, 35
 intensity-control, 19-21, 24
 vertical-gain control, 30-32
 automatic centering, 101
 control functions, 23-25
 dual-mode, 47
 narrow pulses, display, 52, 53
 peak-to-peak voltage measurements, 37-39
 square wave, display, 53-54
 stability, 49-51
 sweep-phasing, 51
 sync function
 automatic, 48-51
 external, 42-46
 trigger level, 48, 49-51
 triggered sweep, 7-8, 18, 47
 Oscilloscope probe, 57-74
 ground lead, 71-74
 high-voltage capacitance-divider, 65-67
 low-capacitance, 58-64
 resistance isolating, 64-65
 response, inconsistent low-C, 69-70
 stray fields, 68-69
 "Outlining," 91

P

Parasitic oscillation, audio amplifiers, 181
 Pattern size versus intensity-control setting, 30
 Peak-to-peak voltage
 calibration and measurements, 37-39
 reading, 61-62
 sine wave, 7
 Peak voltage, 7
 Phase-inverter action, 103
 Phase checks test, 18
 Phase shift
 audio amplifiers, 43, 179
 video amplifiers, 90
 Picture blooming, 122
 Picture pulling or loss of sync, 83-84
 Pincushioning, 129

Polarity-reversing switch, 67
 Poor definition, 91-92
 Poor picture quality, 81-84
 Probe, 57-74
 attenuation, 58-59, 60, 61, 65, 66
 blocking capacitor, 60
 ground lead, 71-74
 high-voltage capacitance-divider, 65-67
 lab-type, 60-61
 low-capacitance, 58-64
 resistance isolating, 64-65
 response, inconsistent low-C, 67-70
 service-type, 61
 special, 65
 stray fields, 68-69
 Pulse
 narrow, display of, 52-53
 rise time, 11, 12
 width, 8-9
 Pulse and sine-wave, combination, 119-120

R

Radio receiver troubleshooting, 161-175
 audio stage tests, 167-168
 fm stereo multiplex tests, 169-175
 gain measurements, 162-165
 hum tracing, 168
 i-f stage troubles, 166-167
 oscillator defects, 165-166
 scope requirements, 161-162
 test signal, type of, 165
 Raster shading, 128-129
 RC time constant, 11, 13
 Readjustment of vertical-centering control, 100-101
 Regulation, power supply, 157
 "Repeats," 93
 Resistive isolating probe, 64-65
 Response, probe frequency, 69-70
 Retrace blanking, 36
 Reversed picture, 83-84
 Ringing, 82-83
 bars in raster, 126
 circuit ghosts, 82, 92-96
 -coil and multivibrator, 119-120
 minimizing, 122
 Ripple
 high-voltage, 126, 127, 128

- 120-Hz, 157
- Rise time
 - amplifier, video, 93
 - definition of, 11, 12
- S**
- Saw-tooth
 - deflection, 26
 - frequency control, 35-36
 - wave, 7, 10
- Scope requirements, radio receivers, 161-162
- Signal channels, tv receiver, 75
- Signal-injection precautions in transistor i-f strips, 87
- Signal-injection technique, 85-86
- Signal tracing, 18
 - afc and horizontal-oscillator section, 114-116
 - amplifiers, 75-96
 - ground loop difficulties, 86-87
 - i-f, 79-87
 - transistor strips, precautions in, 105
 - rf, 75-79
 - video, 87-96
 - audio section, 151, 152
 - sound i-f and audio section, 145-152
 - limiter characteristics, 150-152
 - minimizing circuit loading, 150
 - test signal, 145-149
 - sync section, 97-107
 - circuit, BU8, 97-99
 - circuitry variations, 105-107
 - sync separator with phase-inverter stage, 102-105
 - transistorized, 105
- Sine wave, 7
- Solid-state
 - system
 - horizontal-output, 131
 - vertical-sweep, 141-143
- Sound i-f and audio section, 145-152
- Square wave, 7
 - audio-amplifier tests, 181-183
 - differentiated, 53-54, 55, 59
 - display of, 53-54
 - integrated, 53-54, 55, 59
 - multiplex-adaptor, test, 184-186
 - probe adjustment with, 59
 - response, video amplifier, 91-96
 - vertical output-transformer test, 138-139
- "Squegging," 114
- Stability control, 49-51
- Stacked B+ configuration, power supplies, 153-154
- Stagger-tuned, 80
- Step attenuators, 40-41
- Stray fields, 68-69
- Sweep-circuit troubleshooting, 122
- Sweep frequency for waveforms with alternate symmetry, 101-102
- Switch, polarity-reversing, 67
- Symmetry, alternate, 101-102
- Sync buzz, sound i-f, 151
- Sync
 - amplifier, transistorized, 105
 - control, 26-27
 - external, 42-46
 - function, 42-47
 - loss, 83-84
 - triggered time bases, 46-47
 - Sync-separator circuit, 97-99
 - phase-inverter, with, 102-105
- Synchroguide ringing-coil check, 116-118
- T**
- Testing audio amplifiers, 177-186
- Test point, tv receiver, 73-74, 75
- Test signal, intercarrier section, 145-149
- Test signal, type of, radio receiver, 165
- Test voltage, application of 60-hertz, 26-29
- Thermistor, defective, 136
- Time
 - base
 - free-running, 46-47
 - triggered, 46-51
 - constant
 - charts, 13
 - RC, 11, 13
 - measurement test, 18
- Tolerance, waveform amplitudes, 107
- Transformer
 - flyback, 122
 - vertical-output, 138-139
- Transistorized sync amplifier and afc, 105
- Traveling detector, 63

- Trigger-level control, 49-51
 - Triggered-sweep scope, 7-8, 47-51
 - Troubleshooting
 - afc and horizontal-oscillator section, 120
 - amplifier, rf, 75
 - classification of, 18
 - fm stereo, 169-175
 - horizontal-sweep circuit, 121-131
 - power supplies, 153-160
 - above-ground test methods, 158-160
 - incidental bypassing function, 156-157
 - input waveform to filter, 154-156
 - stacked B+ configuration, 153-154
 - radio receivers, 161-175
 - tests, basic, 18
 - vertical-sweep section, 133-143
 - coupling capacitor checks, 135-136
 - feedback waveforms, 136-138
 - vertical-blanking network, 139-141
 - vertical-output transformer, 138-139
 - vertical synchronization, 133-135
 - Trouble symptoms
 - afc and horizontal-oscillator section, 109-120
 - horizontal-sweep circuit, 121-131
 - keystoning, 129-131
 - low drive, 122-125
 - narrow picture, 125-126
 - pincushioning, 129
 - ringing bars in raster, 126
 - shaded raster, 128
 - i-f amplifier
 - heater hum, 84-85
 - low contrast, 85-86
 - negative picture, 83-84
 - picture pulling, 83-84
 - poor picture quality, 81-83
 - power-supply hum, 84-85
 - ringing, 82
 - sync loss, 83-84
 - radio receivers,
 - audio stage, 167-168
 - i-f stage, 166-167
 - oscillator, 165-166
 - sync circuit, 105-107
 - vertical-sweep
 - synchronization
 - rolling picture, 133
 - unstable lock, 135
 - video amplifier
 - picture smear, 91
 - poor picture definition, 91-92
 - ringing, 92-96
 - white compression, 90-91
 - Tuner, 75-78
 - transistor-type, 77
 - tube-type, 76
- U**
- Unstable sync, 97-99
- V**
- Vertical-blanking network, 139-141
 - Vertical-centering control, adjustment, 21, 100-101
 - Vertical-gain control, adjustment, 30-32
 - Vertical-output transformer, 138-139
 - Vertical synchronization, 133-135
 - coupling capacitor checks, 135-136
 - feedback waveforms, 136-138
 - "kickback" pulse, 133-135
 - Video i-f amplifiers, 70, 87-96
 - Voltage
 - instantaneous, 37
 - measurements, 37-39
 - peak, 37
 - peak-to-peak, 37
 - sine wave, 7
 - waveform, "stair step," 48-49
- W**
- Waveform, 7-10
 - amplitude, 8
 - analysis, 7-18
 - basic, 7-8
 - checks, 18
 - complex, 7, 39-40
 - fundamental, 8-10
 - hybrid, 90
 - symmetrical, 39
 - tests, horizontal-sweep section, 121-131
 - tolerance, 107
 - unsymmetrical, 39-40
 - with alternate symmetry, 101-102
 - White compression, 90-91

TROUBLESHOOTING WITH THE OSCILLOSCOPE

THIRD EDITION

Malfunctioning electronic equipment, whether manufactured or home-built, is costly in time and money. With today's economy, rapid and economical repair becomes almost a necessity!

One of the quickest and least costly means of troubleshooting most electronic equipment is to use an oscilloscope—properly. The author not only provides correct step by step procedures on use of the oscilloscope, but combines this with specific facts of television receiver troubleshooting.

The introductory chapter has a concise review of a fundamental sine wave and other waveforms, a clear discussion of RC time constants, plus a capsule description of the six basic tests of oscilloscope troubleshooting.

The 14 controls, and function of each, of a service-type oscilloscope are listed in a convenient table in Chapter 2. New material in this chapter focuses on dual-trace, dual-beam, and triggered time bases.

Chapters 3 through 10 describe the use of the oscilloscope in troubleshooting a television receiver. Photographs of normal and abnormal waveforms illustrate the signal waveforms, stage by stage, at test points of the signal path in a television receiver.

Troubleshooting a-m and fm receivers (Chapter 11) and audio amplifiers (Chapter 12) complete this informative and practical "course" on troubleshooting with the oscilloscope.



Bob Middleton is one of the few full-time professional free-lance technical writers in the electronics field. His many books and magazine articles have proved invaluable to students, technicians, and engineers, because they are based on his own practical experience. His home workshop is filled with a wide variety of test instruments, receivers, and other equipment which he uses to prepare his many books.

Mr. Middleton is the author of several SAMS books including Hi-Fi Stereo Servicing Guide, Tape Recorder Servicing Guide, TV Tube Systems and Troubles, Color-TV Waveform Analysis, 101 Ways to Use Your Oscilloscope, Digital Equipment Servicing Guide, Scanner-Monitor Servicing Guide, and Record Changer Servicing Guide.

SamsSM
PUBLICATION
