



A *Howard W. Sams* PHOTOFACT PUBLICATION • APG-1

# ABC's of Electronic Test Probes



by **Rudolf F. Graf**

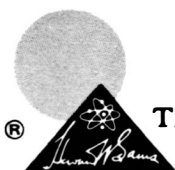


**Fundamental information on the design, function, and use of the many types of probes needed in testing electronic equipment.**



**abc's of**  
**ELECTRONIC TEST**  
**PROBES**

by  
**Rudolf F. Graf**



HOWARD W. SAMS & CO., INC.  
THE BOBBS-MERRILL COMPANY, INC.

*Indianapolis • New York*

SECOND EDITION  
FIRST PRINTING — JULY, 1966

Copyright © 1966 by Howard W. Sams & Co., Inc., Indianapolis, Indiana. Printed in the United States of America.

All rights reserved. Reproduction or use, without express permission, of editorial or pictorial content, in any manner, is prohibited. No patent liability is assumed with respect to the use of the information contained herein.

Library of Congress Catalog Card Number: 66-25344

# Preface

The science of measurement has come of age in an era of increasing need for accurate data taking. To obtain this degree of accuracy we must have some understanding of the instruments and their pickup devices used to take measurements.

The probes described in this book have been designed to go beyond the limitations of the instruments with which they are used or, in some cases, to extend their usefulness. Together the proper probe and instrument can explore, test, observe, and measure many phenomena; however, the most costly measuring instrument is but a worthless pile of metal and glass if the probe fails.

This is an introductory book intended to provide a basic background to modern electronic probes and their uses. It explains what they are, how they operate, and what they can be expected to do, in simple, easy-to-understand language. My aim has been to introduce some of the many facts concerning probes and to provide a guide for the technician and serviceman to this complex subject.

My appreciation and indebtedness are due those who graciously supplied much of the illustrative material in this book. Also, a word of appreciation to my wife, Bettina, who unselfishly gave much of her time and sacrificed many days of companionship to help make this book possible. Finally, this book is dedicated to my son and daughter, Jeffery and Debbie.

RUDOLF F. GRAF



# Contents

## CHAPTER 1

DIRECT AND ISOLATION PROBES . . . . .	7
Test Leads—Direct Probes—Isolation Probes	

## CHAPTER 2

HIGH-VOLTAGE PROBES . . . . .	18
Resistive High-Voltage Probes — Capacitive-Divider High-Voltage Probes—Safety First	

## CHAPTER 3

LOW-CAPACITANCE PROBES . . . . .	39
Cathode-Follower Probes	

## CHAPTER 4

RECTIFIER PROBES . . . . .	58
Vacuum-Tube and Semiconductor Diodes — Peak-Reading, Shunt-Type Rectifiers Using Vacuum Tubes — Peak-Reading, Shunt-Type Rectifiers Using Semiconductor Diodes — Peak-Reading, Series-Type Rectifiers	

**CHAPTER 5**

DEMODULATOR PROBES . . . . . 85  
Shunt-Type Demodulator Probes—Series Demodulator Probes—Bal-  
anced Demodulator Probes—Peak-To-Peak or Voltage-Doubler De-  
modulator Probes—Demodulator Probe Selection and Use

**CHAPTER 6**

SPECIAL-PURPOSE PROBES . . . . . 107  
Signal-Tracer Probes — Hum-Field Tracing Probes — Signal-Injector  
Probes—Clamp-on and Clip-on Probes

APPENDIX . . . . . 126

INDEX . . . . . 127



# Direct and Isolation Probes

If we wish to measure or observe a signal, we must be concerned with not only the frequency of the signal, but also its voltage and impedance levels. The voltages encountered may vary considerably. For example, in television receivers, only a few microvolts may appear at the input of the tuner, but up to 20,000 volts may be applied to the picture tube.

Voltages can be a-c, d-c, or a combination of both. Alternating voltages may consist of simple sine waves of various frequencies, or a complex wave combining harmonically related sine waves. Alternating-current signals may also have a d-c potential. This d-c may be essentially “clean,” or it may have a certain amount of ripple. There are also pulsating d-c voltages, like the ones which are found at the output of a rectifier.

When the voltage is measured or observed at some point in a circuit—whether with a meter, an oscilloscope, or a tracer—the impedance at that point is important. This fact is often overlooked by even the more experienced technicians.

Resistive circuit loading becomes a problem when the test equipment has a low input impedance. However, such loading can be minimized by the use of high-impedance measuring instruments. An-

other point that should be considered is the effect of stray fields on scope and meter indications. The instruments themselves cannot differentiate between desired and undesired signals. They must therefore be shielded from extraneous electromagnetic and electrostatic fields which could introduce noise, hum, or other interference. Enclosing test equipment in a metal case helps shield against such stray fields. For maximum shielding, however, the leads from the test equipment must also be shielded.

In sensitive circuits, unshielded test leads sometimes produce rather puzzling effects. They may also act as antennas and radiate signals from one part of the circuit to the other. In this way, cross coupling or feedback occurs between sections normally isolated from each other. Oscillations may then occur, which may result in giving erroneous readings.

Shielding the test leads does indeed exclude interference. Unfortunately, it adds something else—shunt capacitance. At the higher frequencies, shunt capacitance lowers the input impedance of the instrument, thereby adding to the loading of the circuit under test. Thus, although gaining the desired shielding, we do so at the expense of undesirable shunt capacitance.

## TEST LEADS

The simplest probe (if it can be called a probe) is the test leads in Fig. 1-1. Essentially, such leads are an extension of the input circuits in the test instrument. Rarely are test leads alone fully satisfactory,

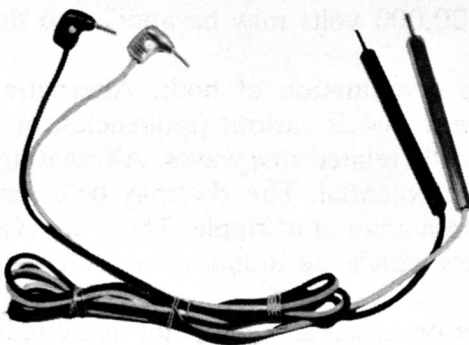


Fig. 1-1. Test leads.

Courtesy General Cement Mfg. Co.

except for low-impedance, high-level measurements in relatively low-frequency circuits. They are quite good for such simple measurements as d-c resistance. In r-f, i-f, video, or high-fidelity audio tests, however, test leads can introduce erroneous indications.

## DIRECT PROBES

The *shielded direct probe* (sometimes called a *straight-through probe*) is simply a shielded cable terminated in a test prod. Fig. 1-2 shows its internal construction. It is generally used with signal tracers, vacuum-tube voltmeters, and oscilloscopes, adding an overall capacitance of approximately 100 pf to their input circuits. The frequency range over which a direct probe can be used depends on (1) the complexity of the signal to be observed and (2) the impedance of the circuit to be measured. Actually, the maximum frequency range of a direct

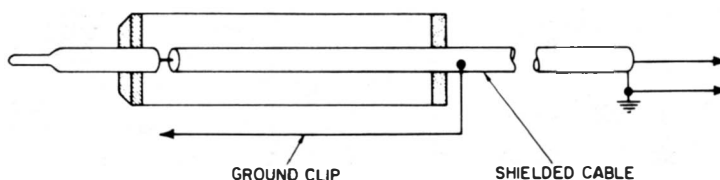


Fig. 1-2. Internal construction of a shielded direct probe.

probe depends on the impedance of the circuit being tested. If circuit impedance is low, all low-frequency voltages (even those with complex waveforms) can be measured. However, as circuit impedance increases, the shunting effect of the probe becomes more pronounced. Hence, the direct probe is not suitable for frequencies above several hundred cycles in some cases; in other cases, it is satisfactory for frequencies of several thousand cycles.

The direct probe is not absolutely accurate for measuring and observing complex waveforms, particularly those containing high-frequency pulses. Loading by the cable capacitance modifies the wave-shape too much.



(A) Waveform obtained when unshielded test leads are used. (B) Waveform obtained when shielded direct probe is used.

Fig. 1-3. The effect of a shielded direct probe on a waveform.

However, there are places where this probe is most useful—for example, to check ripple in power supplies and plate-supply circuits, and to signal-trace and observe audio, transistor, and other low-impedance circuits. The additional shunt capacitance placed across the circuit under test is usually between 50 and 150 pf, depending on the length of the cable and its capacitance per foot.

When a direct shielded probe is used, maximum sensitivity from the test instrument can be obtained because the probe contains no attenuating elements. To help prevent pickup of unwanted signals when a direct connection is required, a shielded probe, rather than unshielded test leads, should be used.

The importance of choosing a fully shielded direct probe is illustrated in Fig. 1-3. The waveform in Fig. 1-3A was obtained by using ordinary test leads; in Fig. 1-3B, a shielded direct probe was used.

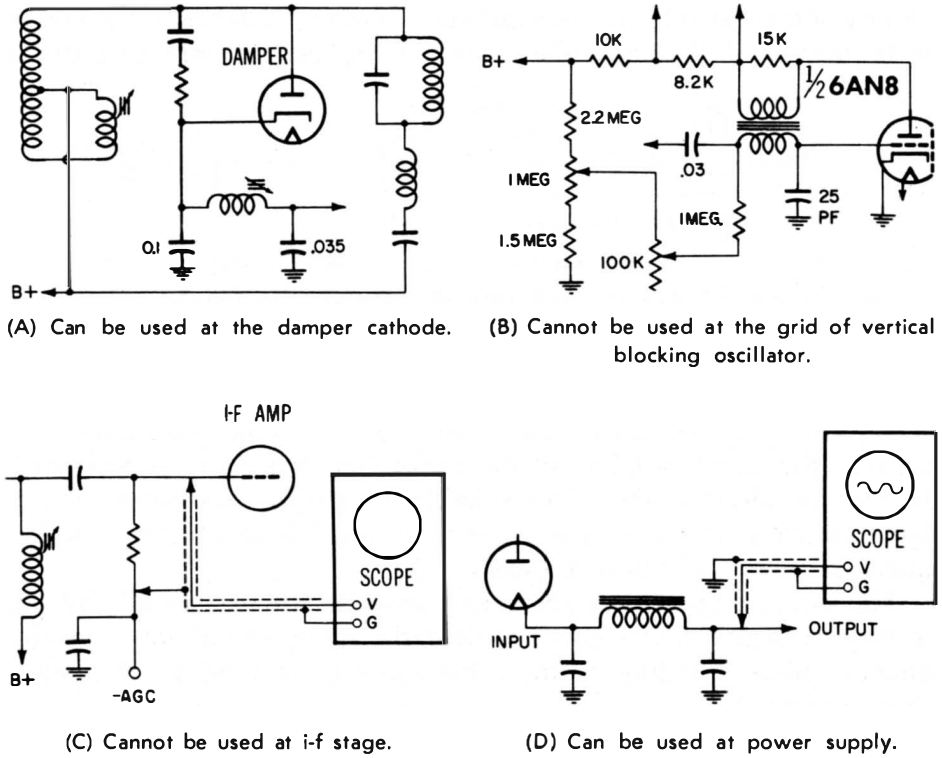


Fig. 1-4. Examples of circuits where a direct probe can or cannot be used.

The signal displayed is the same, except that the waveform in Fig. 1-3A is very jittery because of hum picked up by the open leads.

In order not to excessively load or otherwise disturb the circuit under test, the probe should have an input impedance at least ten times higher than the source impedance. Some examples of where and where not to use a direct probe are shown in Fig. 1-4.

The impedance of the circuit under test must not be so sensitive that it would be detuned or otherwise disturbed by a shunt capacitance of 100 pf or so from the probe. Fig. 1-4A shows a horizontal-damper circuit. A direct probe *can* be readily used at the damper-tube cathode, where the capacitance is at least 0.1 mfd. On the other hand, suppose

that we applied a direct probe at, say, the grid of the vertical blocking oscillator in Fig. 1-4B. Because of the lower capacitance to ground (only 25 pf), the added 100 pf from the probe would drastically alter the circuit performance, or even disable the circuit. When we are trying to decide whether or not to use a direct probe, it is not so much the operating frequency that is important; rather, it is the capacitance and impedance levels. To further explain this statement, let's use the illustrations just discussed as examples. The frequency of the voltage at the damper cathode in Fig. 1-4A was 15,750 cps, yet it was only 60 cps at the grid of the vertical blocking oscillator in Fig. 1-4B. The direct probe could not be used at the blocking oscillator grid, simply because of the high circuit impedance. The mere fact that a direct probe could measure a signal with a frequency of 15,750 cps at the damper cathode would indicate that impedance—not frequency—was the determining factor here.

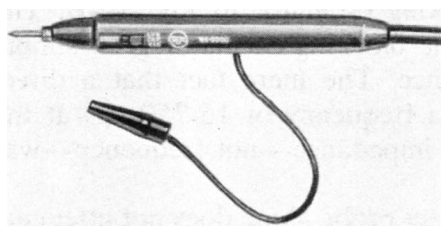
Aside from its loading effect, a direct probe alone does not attenuate the voltages applied to it. In other words, the same amount of voltage applied at the tip of the probe will be applied to the input terminal of the test instrument. For this reason, a direct probe used with an oscilloscope must never contact any points exceeding the maximum voltage that can be safely applied to the scope input. Therefore, to measure voltages beyond the capability of the measuring instrument, we must use a low-capacitance or high-voltage probe (both types will be discussed later), or a simple divider of two or more resistors.

Because of its severe capacitance shunting effect, a direct probe should not be applied directly to the output circuit of a video detector. Doing so will not only seriously reduce the apparent bandwidth of the circuit, but may also cause parasitic oscillation. Only a low-capacitance probe is suitable here. Use of an isolation probe or simply an isolation resistor is sometimes suggested at the video-detector output. However, such a resistive-type isolation probe exhibits a low-pass filtering action, which will be discussed later in this chapter.

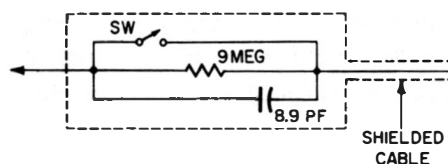
A direct probe used with an oscilloscope is not suitable for checking the television i-f amplifier because the frequencies encountered are beyond the capable response of the oscilloscope. A demodulator probe would be required here. However, if you do use a direct probe at the grid of an i-f amplifier (as shown in Fig. 1-4C), you will probably get a weak or greatly disturbed response because of regeneration at some frequency within the receiver i-f band. This regeneration will overload the i-f stage causing the i-f tube to be overdriven. The resulting waveshape will be distorted and not at all indicative of the true circuit performance.

A direct probe is suitable for observing and tracing hum or ripple in a power supply. (See Fig. 1-4D.) The small shunt capacitance of

the probe does not affect the extremely high shunt capacitance in the power-supply circuit. The biggest advantage of the direct probe is that it lets us use the full sensitivity of the oscilloscope to measure the rather low ripple voltages in most well-filtered power-supply circuits. (Remember that 600 volts d-c is the maximum that can be applied to the vertical-input terminals of most oscilloscopes. Never exceed this level!) On the other hand, trying to measure ripple voltage of a television high-voltage supply with a direct probe would be disastrous.



(A) The probe.



(B) Probe circuit.

Courtesy Radio Corporation of America

**Fig. 1-5. A combination direct-low-capacitance probe.**

Even though the ripple may be relatively low, the high d-c potential (in the thousands of volts) is far beyond the capabilities of the oscilloscope (unless the proper attenuating probe is used).

An interesting combination is the direct-low-capacitance probe, in Fig. 1-5, using a resistor and a capacitor in parallel. This combination, together with the compensating capacitance in the oscilloscope, forms a low-capacitance probe. Also note that the isolation resistor has a value of 9 megohms. This higher-than-usual value gives a 10-to-1 attenuation when the probe is used with any of the oscilloscopes for which it is designed. Consequently, when the combination is used as a low-capacitance probe, the input signal must be sufficient to compensate for this loss. When the switch is closed, this probe becomes simply a direct shielded probe.

It is sometimes desirable to observe current waveforms in deflection circuits. This can be done by connecting a 1-ohm resistor in series with the circuit. When a direct probe is placed across this resistor, the oscilloscope will indicate the exact waveshape of the current. The shunting of the direct probe on this 1-ohm resistor is negligible.

## ISOLATION PROBES

There are two types of isolation probes—one for oscilloscopes and another for vacuum-tube voltmeters. Both probes have the same cir-

cuit, except that the vtvm probe uses an isolation resistor with a value of 1 megohm or higher, whereas the oscilloscope probe uses one between 10K and 50K ohms. For this reason, the probes are not interchangeable. The time constant of the isolation resistor and distributed capacitance is very important.

Fig. 1-6 shows an isolating probe for a d-c vacuum-tube voltmeter. These probes usually contain a 1-megohm resistor near the tip. The term *isolation* describes the function of the resistor—to isolate the test instrument so it will not interact with the circuit under test. The isolation resistor also reduces the effects of hand capacitance and shielded-lead capacitance. Otherwise, loading due to the shunting ca-

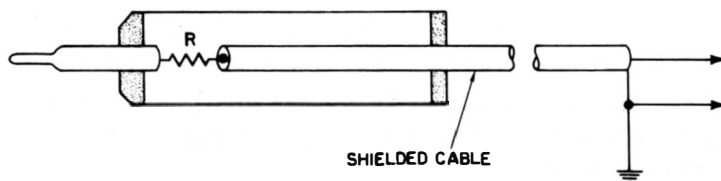


Fig. 1-6. Internal construction of an isolation probe for a d-c vtvm.

pacitance of the shielded lead, plus the input capacitance of the vtvm, would produce erroneous readings in sensitive circuits.

The isolation resistor and the distributed capacitance across it not only isolates the vtvm from the circuit under test, but also keeps out the high-frequency a-c component. This resistor is usually part of the voltage-divider network in the vtvm input circuit; as such, its value is extremely important to the accuracy and calibration of the meter.

When a vtvm d-c probe contains an isolation resistor, the effective input capacitance of the d-c probe is usually reduced to approximately 1 pf. The isolation resistor also prevents the shielded cable from acting as a resonant stub and thus causing erroneous readings at frequencies where the cable length is an integral or fractional part of a wavelength. If there were no isolation resistor, the input capacitance would be around 100 pf. Direct-current voltages in r-f and i-f-amplifier circuits, as well as in local oscillators, would be most difficult, and frequently impossible, to measure.

Sometimes it is desirable to change the resistor in the probe to one of a higher value, or to add an isolation resistor in order to improve the isolation and lower the shunting impedance. We do this by adding another resistor externally. By making this resistor equal to the total input resistance of the vtvm (the resistance of the voltage divider plus the original isolation resistor), we will double the input impedance. Meanwhile, we will also cut the full-scale sensitivity in half. For example, if the voltage-divider resistance in the vtvm is 10 megohms and the isolation resistor in the probe is 1 megohm, and we add an addi-

tional 11-megohm resistor in series, we will now have a 22-megohm input impedance—double that of the original value. However, all readings must now be multiplied by 2. For example, what used to be a 10-volt full-scale reading is now 20 volts. Thus, if we read 8 volts with the range-selector switch at the 10-volt position, we actually have 16 volts at the test point.

We can go one step further; we can triple (or even quadruple) the input impedance of a vtvm if we wish to measure voltages in extremely sensitive circuits (in very low-current, high-impedance, high-voltage circuits, for example). If we quadruple the input impedance, we must multiply by 4 any voltage readings obtained. Thus, in the previous example where the meter had an 11-megohm input impedance, we can put 33 megohms in series with the probe, giving a total input impedance of 44 megohms. However, if we again read 8 volts on the 10-volt scale, we would actually be measuring 32 volts. If the readings are too low, we switch to the next lower voltage range.

Vacuum-tube voltmeters have for many years required separate probes for d-c and for a-c voltage and resistance measurements. This is necessary because of the isolation resistor in a d-c probe. Some manufacturers have overcome the disadvantage of separate probes by placing the resistor in a housing which can be attached to the probe tip for d-c voltage measurements, or by installing a switch in the probe handle. This switch inserts the isolation resistor in the circuit for d-c measurements, but takes it out for other readings. Such a switch should be relatively simple to operate. Yet, it must be compact, so the probe can be handled easily.

An isolation resistor used in conjunction with the oscilloscope will help facilitate waveform observance at the video-detector load. In this way the i-f response curve can be seen when a sweep signal is being applied. The isolation resistor serves a dual purpose: (1) As an r-f filter, it prevents any i-f signal which might have passed through the detector circuit from reaching the oscilloscope and being radiated back into the receiver. (2) Together with the capacitance of the cable and oscilloscope input, the isolation resistor forms an integrating network which bypasses and greatly attenuates any signal above several kilocycles. This results in a sharper marker pip on the i-f response curve. Since this curve consists of relatively low-frequency components, its shape will not be altered by the use of this probe. Any 15,750-cps interference will be greatly reduced, or even eliminated, by the filtering action which occurs with the probe above several kilocycles (unless the interfering signal is excessively strong).

Sometimes an unshielded isolation probe is used with an oscilloscope. However, such a probe tends to pick up horizontal sync-pulse radiation and power-supply hum when not connected to the circuit



under test. These extraneous signals will disappear, however, when the probe is connected to the circuit. Any undesired signals observed during the test are therefore usually from the circuit itself. Although an unshielded isolation probe can be used with a scope for testing in some circuits, a good, shielded isolation probe is still hard to beat.

If direct-connection test leads or probes are used at critical circuit points (at the converter grid of a television front-end, for example), a feed-back loop may tend to be established between the receiver, oscilloscope amplifier, and power line. This loop may produce un-



Fig. 1-7. The effect of a resistive isolation probe on the sharpness of the marker pip.

desired oscillation. An isolation resistor inserted into the circuit, however, will suppress this tendency by isolating the test circuit from the oscilloscope. Fig. 1-7 shows the effect of such a resistive isolating probe on the marker pip. Fig. 1-7A shows the marker indication when the probe is not used; Fig. 1-7B, when it is. The time constant (formed by the isolating resistor and the capacitance of the shielded cable and oscilloscope) of this filter must be such that marker displacement is not introduced on even the steepest portion of the response curve. Such displacement could be caused by an excessively large time delay in the filter. Thus, the values of the isolation resistor and filter capacitor (if a separate unit is added) should be chosen to give a relatively short time-constant.

Careful observation of the beat-frequency marker signal on a response curve will show that the high-frequency components are at either end of the marker. At zero beat and nearby, the frequencies are very low. Therefore, a simple RC filter will more or less suppress the

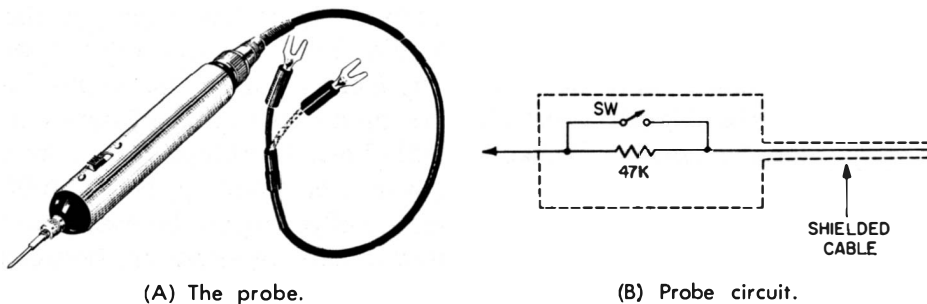


Fig. 1-8. A combination direct-isolation probe for use with an oscilloscope.

Courtesy Scala Radio Company

higher frequencies (depending on the value of the resistor and capacitor) without affecting the low-frequency component or zero beat.

A combination direct and isolation probe to be used with an oscilloscope is shown in Fig. 1-8. This probe is designed to minimize circuit loading and pickup from stray fields near the chassis. Careful shielding tends to prevent false indications caused by stray voltages. The input cable is designed to add the least possible capacitance to the oscilloscope input circuit in order to reduce the shunting effect of the probe. When the switch is closed, we have a direct probe; when open, we have an isolation probe with a 47,000-ohm resistor between the oscilloscope input and the circuit under test.

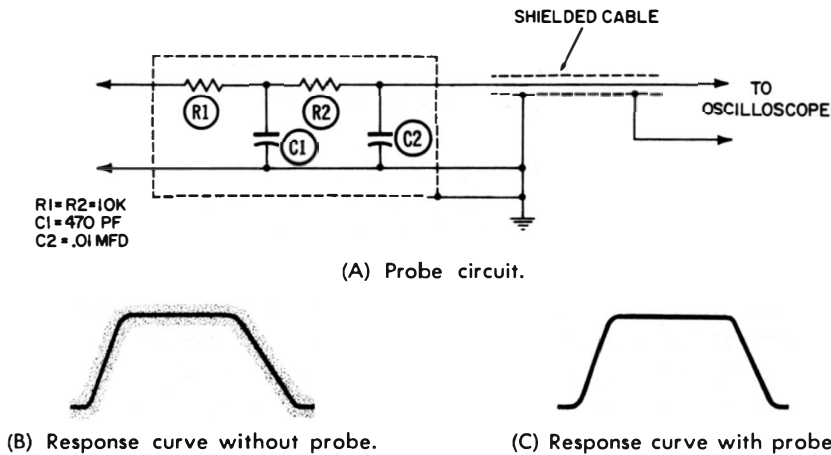


Fig. 1-9. Isolation-filter probe circuit and its effect on response-curve indications.

If we connect an oscilloscope directly across the load resistor of a video-detector output circuit, the scope may operate as a resonant stub unless resistive isolation is used. Stub action is reflected—via the inter-electrode capacitance of the video detector—into the last i-f stage. Such a disturbance will not only detune the last i-f transformer, but may also result in uncontrollable oscillation of the i-f amplifier.

Besides providing a low-pass filter action, the isolation resistor also raises the input impedance of an oscilloscope. For example, if we have a total capacitance of 150 pf (by total we mean the shunt capacitance of the shielded cable plus the input capacitance of the oscilloscope) the reactance at 500 kc is 2000 ohms. Therefore, if we take a measurement in a 500-kc circuit, we would be shunting it with 2000 ohms. At higher frequencies, this shunting effect would be even more pronounced. Now, if we use an isolation resistor of anywhere between 10K and 50K ohms, we have automatically minimized the shunting effect to at least the value of the isolation resistance. This reduction in the shunting effect is sometimes of the utmost importance—for ex-

ample, when excessively high-frequency signals are causing a fuzzy alignment curve. If the isolation resistor alone is not a good enough filter, we can build a low-pass filter which acts like the isolation resistor and the distributed cable capacitance, only more so. Sometimes a 0.001-mfd up to a 0.01-mfd capacitor across the vertical-input terminals of the scope will do the job. However, a more elaborate isolation filter like the one in Fig. 1-9 is often preferred. Fig. 1-9A illustrates its circuit; Fig. 1-9B, the response curve when the filter is not used; and Fig. 1-9C, the response curve when the filter is used. With a sweep frequency of only 60 to 120 cycles, a good scope response up to only 10 kc or so is sufficient for proper response or reproduction of the sweep-generated response curve of a tuned circuit or amplifier.

The complete isolation-filter network in Fig. 1-9A should be made into a probe and connected to the oscilloscope through a shielded cable. Resistor R1 is the isolation resistor; and C1, C2 and R2 form a pi-type, low-pass filter.

For ease in making measurements with a vtvm or vom, a polarity-reversing probe is unique. Transistors, for example, usually require a front-to-back resistance ratio check. A polarity-reversing probe used with an ohmmeter will greatly speed up this type of check by eliminating the need to reverse the test leads. Instead, the switch on the probe automatically reverses the polarity of the test leads.

## High-Voltage Probes

Broadly speaking, there are two types of high-voltage probes. One of these, used with d-c vtvm's or vom's, is of the resistive type: a multiplier resistor in the probe and the input resistance of the instrument form a voltage divider. The other one, used with an oscilloscope or a-c vtvm, is the capacitive type: a small capacitor with a very high voltage rating is used within the probe, while the input capacitance of the instrument and the cable capacitance form another capacitor. The voltage division which occurs is inversely proportional to these two capacitances. We will discuss the resistive type of high-voltage probe first.

### RESISTIVE HIGH-VOLTAGE PROBES

The highest voltage range of most vtvm's and multimeters is usually too low for measuring the very high d-c potentials in some sections of television receivers and other electronic equipment.

Direct-current voltage ranges usually are no higher than 1000 volts in vtvm's, and around 1200 to 1300 volts in multimeters. However, many multimeters have built into them an input series resistor, making possible d-c measurements of around 5000 volts. Nevertheless, the voltage range of these instruments must be extended

even further before high-voltage circuits can be measured. Fortunately, this can be done with a high-voltage probe.

A multiplier resistor, built into the insulated handle of the probe, is connected in series with the internal resistance of the meter. The resistor thus acts as one leg of a voltage divider. Its value is determined by the highest voltage to be measured.

A typical high-voltage multiplier resistor is about  $\frac{3}{16}$  inch in diameter and  $5\frac{1}{2}$  inches long, will withstand up to approximately 30,000 volts, and is rated at five watts. Longer or thicker units have somewhat higher ratings. For higher than 30,000 volts, resistors can be connected in series within the probe. The resistors are unusually

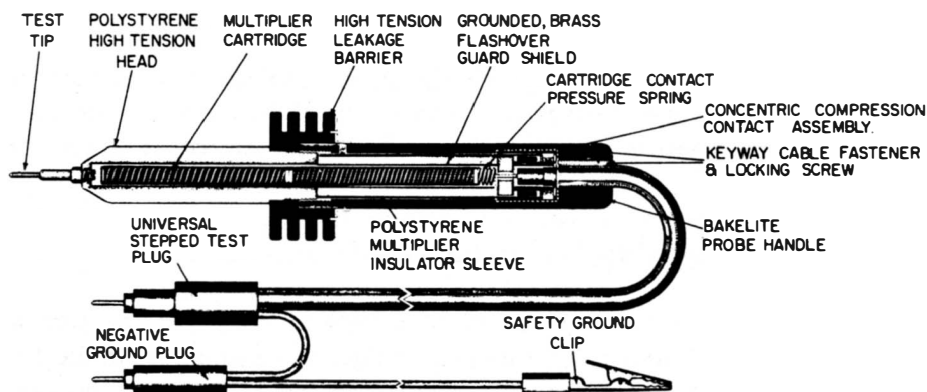


Fig. 2-1. Internal construction of a high-voltage probe.

long to minimize the chance of voltage breakdown between the ends. The resistance itself consists of a high-stability carbon coating applied on a strong moisture-resistant steatite rod. Hence, the detrimental effects of temperature and high humidity on the resistance characteristics are held to a minimum. The coating is wound spirally around the rod. Thus, a very long *effective* resistor is provided in a small space. This method also permits use of a relatively low specific resistance coating, producing stable resistors with extremely high resistances (up to one million megohms). The relatively low voltage gradient between turns makes a breakdown unlikely, unless the voltage rating is greatly exceeded. The internal construction of a high-voltage probe is shown in Fig. 2-1.

Shielding the multiplier resistor against stray pickup is not practical because this would materially reduce the safety factor gained by using a long resistor and a probe.

Permanent connection to the ends of the resistance element or elements is made by means of a silver contact coating. Another coating of special electrical varnish protects the outside of the resistor. This protective coating must not be punctured because the resistance

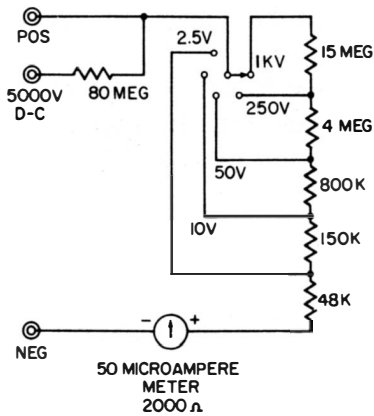


Fig. 2-2. Simplified d-c input circuit of a typical vom.

coating underneath could also be damaged. No solder connections are required between the resistor and external elements, since connection to the resistor is generally made by means of compression springs.

Multiplier resistors are usually chosen to extend the range of a meter by some easily applied multiplying factor—such as 5, 10, 25, 30, or 100.

Let us refer to the input circuit of a typical vom like the one in Fig. 2-2. As we switch from range to range, the input resistance between the positive and the negative terminal varies in direct proportion to the full-scale voltage range at which the meter is set. On the 2.5-volt range, for example, we have 50,000 ohms between the positive and negative terminals (the 48K resistor plus the 2000-ohm meter resistance); on the 10-volt range, we have 200,000 ohms; on the 50-volt range, 1,000,000 ohms; on the 250-volt range, 5 megohms; and on the 5000-volt range, 100 megohms.

On the other hand, the input resistance of the vtvm in Fig. 2-3 remains constant, no matter where the voltage-range selector switch is set. This input resistance is the five megohms in the isolation probe

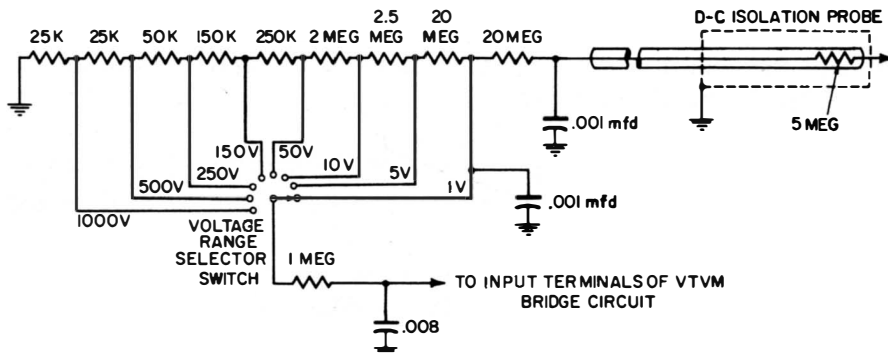


Fig. 2-3. Input circuit of a typical vtvm.

plus 20 megohms, or 25 megohms, plus the sum of all the voltage-divider resistors, which adds up to another 25 megohms. Thus, we have a total input resistance of 50 megohms.

How, if at all, does this difference in the meter input circuit affect the selection of a high-voltage probe? Let us first consider the multimeter. We said before that the high-voltage multiplier resistor in the probe is part of the voltage divider. In order for it to act as such, we must also know the sensitivity of the meter in ohms per volt (20,000 for the multimeter in Fig. 2-2). The ohms-per-volt rating of any multimeter is determined by the current required for full-scale deflection. Here, we use a meter with a full-scale sensitivity of 50 microamperes.

By using Ohm's law, we can easily determine the current-limiting resistance required per volt for full-scale reading. Let us say we want to measure 1 volt:

$$\begin{aligned} R &= \frac{E}{I} \\ &= \frac{1}{0.00005} \\ &= \frac{100,000}{5} \\ &= 20,000 \text{ ohms} \end{aligned}$$

This 20,000 ohms is the constant resistance required for each volt to be measured. For 5 volts we need  $5 \times 20,000$ , or 100,000 ohms; for 100 volts,  $100 \times 20,000$ , or 2 megohms; for 1000 volts, 20 megohms; and for 5000 volts, 100 megohms.

To increase the voltage range to 25,000 volts full scale by means of a high-voltage probe, we use the 5000-volt range of the meter, and employ the multiplier resistance of the high-voltage probe to drop the other 20,000 volts. Let us figure what resistance we need. Since we must drop 20,000 volts across the multiplier resistor in the probe, and we need a resistance of 20,000 ohms for each volt we want to measure, we simply multiply 20,000 (volts) by 20,000 (ohms/volt) to come up with 400 million ohms (400 megohms).

Setting up a formula for calculating the value of the multiplier resistor for a particular h-v full-scale range is no problem. All we have to know is the resistance at the meter terminals on the voltage range we want to use. Since the multiplier resistor is in series with the meter resistance, the voltage drops will be proportional to the respective resistances. This gives us the following formula:

$$\frac{E_{\text{ext}}}{R_{\text{ext}}} = \frac{E_{\text{int}}}{R_{\text{int}}}$$

or,

$$\frac{R_{int}}{R_{int}} = \frac{E_{int}}{E_{ext}}$$

where,

$E_{ext}$  is the voltage drop across the multiplier resistor,

$E_{int}$  is the full-scale voltage reading of the meter,

$R_{ext}$  is the resistance of the high-voltage multiplier resistor,

$R_{int}$  is the resistance between the meter terminals for “ $E_{int}$ ” full-scale voltage readings.

The new full-scale reading is  $E_{ext} + E_{int}$ .

The h-v probe now extends the meter range to 25,000 volts. To read the meter properly, we use the 5000 volt d-c scale and multiply the reading by 5. For example, if the meter reads 4000 volts, we are actually measuring 20,000 volts.

A particular value of multiplier resistor is suitable for only one range of the vom. Notice that the internal resistance between the

**Table 2-1. Resistors required for extending the voltage range of nonelectronic voltmeters (20,000 ohms/volt)**

Manufacturer	Model No.	Vom Range Setting(s) (D-C Volts)	Range(s) Vom extended to (D-C Volts)	Scale Factor	Multiplier Resistor Megohms
EICO	555, 565	5000	25,000	5	400
		1000	25,000	25	480
		1000	30,000	30	580
		500	25,000	50	490
EMC	104	3000	30,000	10	540
Hickok	450	5000	25,000	5	400
		1000	25,000	25	480
		1000	30,000	30	580
Precision	85, 858-P, 654-P, 10-54-P, 120	6000	30,000	5	480
RCA	WV-38A	250	25,000	100	495
Simpson	221, 260	5000	25,000	5	400
		1000	25,000	25	480
		1000	30,000	30	580
		500	25,000	50	490
		262	4000	20,000	5
Triplet	625 NA	500	50,000	100	991
	630, 630A	6000	30,000	5	480
Weston	785	1000	25,000	25	480
		1000	30,000	30	580
		500	25,000	50	490



positive and negative terminals of the multimeter in Fig. 2-2 changes with each voltage-range setting. Therefore, a different value of multiplier resistance must be computed for other voltage ranges, using the formula just discussed.

Table 2-1 shows the values of multiplier resistors needed to extend the voltage range of multimeters with sensitivities of 20,000 ohms per volt. Normally it is impractical to extend the high-voltage range of vom's with lower sensitivities, because the power dissipated in the multiplier resistor would be far beyond what could be tolerated. A simple calculation will show what happens when we extend the range of a 20,000 ohms-per-volt vom to 25,000 volts, using the 5000-volt range as before—and then if we try to do the same for a vom with a sensitivity of only 1000 ohms per volt.

We previously calculated that we need a 400-megohm resistor for our 20,000 ohms-per-volt vom. From Ohm's law,  $W = E^2 \div R$ , we find the following:

$$\begin{aligned} W &= \frac{(20,000)^2}{400,000,000} \\ &= \frac{400,000,000}{400,000,000} \\ &= 1 \text{ watt} \end{aligned}$$

At a full-scale reading of 25,000 volts, the multiplier resistor dissipates 1 watt. This value makes it quite practical for us to use the 5-watt, spiral-deposited, high-voltage multiplier resistor available for the purpose.

Now let us see what happens if we try to extend the 5000-volt range of a 1000-ohms-per-volt meter to 25,000 volts. Again using the formula, we find that the multiplier resistor is 20 megohms, and that the power it dissipates for a full-scale reading of 25,000 volts is 20 watts. Such a power value becomes very impractical, of course, not only from a heat dissipation point of view, but also for another important reason. There are few electronic high-voltage circuits from which so much power can be drawn without either causing the circuit to become inoperative, or else to be so loaded down that any readings would be meaningless.

High-voltage probes are used most frequently for measuring the voltages in high-voltage power supplies of television receivers. The voltage regulation of these circuits, however, is inherently poor. That is, if more current is drawn from the supply than it is designed to deliver, the voltage will drop sharply. Moreover, in such a circuit the loading effect of the probe becomes more pronounced with lower-

sensitivity meters. This fact must be considered when voltage measurements are made in television high-voltage circuits.

Present-day picture tubes draw a beam current of approximately 75 to 100 microamperes when the set is adjusted for *normal* brightness. Suppose we use the 20,000-ohms-per-volt meter to measure voltages of, say, 15,000 volts in the high-voltage supply of a television receiver. If we use the probe we designed for a 25,000 volt range, we will apply across this voltage under test a total resistance of 500 megohms. The current drawn by 500 megohms from a 15,000-volt source is:

$$\begin{aligned} I &= \frac{E}{R} \\ &= \frac{15,000}{500,000,000} \\ &= \frac{15}{500,000} \\ &= 0.00003 \text{ amperes, or} \\ &\quad 30 \text{ microamperes.} \end{aligned}$$

Television high-voltage power supplies are generally designed to deliver only a limited amount of current at a particular value of high voltage. This current may be very close to the maximum beam current needed when the set is adjusted for maximum brightness. Any further load upon the supply will cause a drop in voltage. An average picture tube, for example, will draw around 300 microamperes of beam current at the *maximum* brightness setting. If the brightness control is adjusted for maximum and the high-voltage power supply is designed to deliver only 300 microamperes maximum, placing our 20,000 ohms-per-volt meter across the supply would add 30 microamperes, giving a total load of 330. This additional load can cause the high voltage to drop, giving a reading that would seem below normal. On the other hand, had we used a 1000-ohms-per-volt meter and designed a high-voltage probe for it, we would have overloaded the high-voltage supply so much that the resultant reading would have been meaningless. This situation can be remedied by reducing the load on the high-voltage supply when the voltage is measured. If the brightness is reduced from maximum to normal, the required beam current will likewise be reduced (from approximately 300 to 100 microamperes).

Now the additional 30-microampere load placed on the high-voltage supply by the 20,000 ohms-per-volt meter is negligible, allowing an accurate voltage measurement. The load on the high-voltage supply can be even further reduced by disconnecting the high-voltage lead

from the picture-tube anode. Fig. 2-4 shows the output capabilities of a typical television high-voltage power supply.

In a properly operating set, the loading effect of a meter can be observed by noting the brightness with and without the probe, and observing any appreciable difference. If the brightness changes, then the loading from the probe varied the output of the high-voltage supply noticeably.

It is possible to use the same h-v probe on several voltage ranges of the vtvm, because the internal resistance of the instrument remains

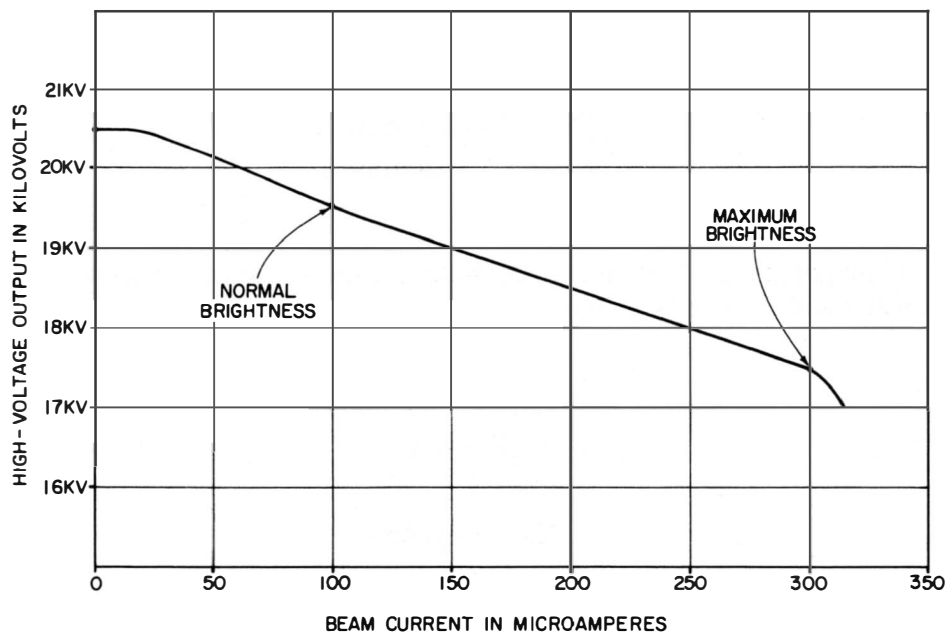


Fig. 2-4. Output voltage versus load current of a typical television high-voltage supply.

constant on all ranges. When figuring the value of a high-voltage multiplier resistor for a vtvm, however, do not forget that an isolation resistor of anywhere from 1 to 20 megohms is usually placed within the d-c probe. (This resistor is removed in changing from the isolation to the high-voltage probe.) Therefore, the d-c input resistance of the vtvm (normally in megohms) is reduced by the amount of resistance in the isolation probe.

The value of the multiplier resistor is determined, as before, by the required new full-scale range and the input resistance of the meter. Here, however, the formula must also take into account the isolation resistor. Thus, we get

$$R_p = R_{in} (M - 1) + R_{iso}$$

where,

$R_p$  is the value of the high-voltage multiplier resistor,

$R_{in}$  is the input resistance of the vtvm (the value given in the manufacturer's specifications, including the isolation resistor),

$R_{iso}$  is the value of the isolation resistor in the d-c probe supplied with the meter,

$M$  is the desired multiplying factor for h-v measurements (any easily applied factor, such as 5, 10, 25, 30, or 100).

Let us now use this formula to find the proper value of multiplier resistor required to extend the range of the vtvm in Fig. 2-3 to 25,000 volts. The 1000-volt scale would give us a multiplying factor of 25. Thus,

$$R_{in} = 50 \text{ megohms,}$$

$$R_{iso} = 5 \text{ megohms,}$$

$$M = 25.$$

If megohms are used for all resistances, the value of the multiplier resistor will also be in megohms. Therefore,

$$\begin{aligned} R_p &= R_{in} (M - 1) + R_{iso} \\ &= 50 (25 - 1) + 5 \\ &= 50 (24) + 5 \\ &= 1200 + 5 \\ &= 1205 \text{ megohms.} \end{aligned}$$

If you want to calculate the multiplying factor for a probe with a resistor, the formula becomes

$$M = \frac{R_p + R_{in} - R_{iso}}{R_{in}}$$

Thus, if we had a meter with an input resistance of 11 megohms (with a 1-megohm isolation resistor), and a probe with a multiplier resistor of 1090 megohms, the multiplying factor would be

$$\begin{aligned} M &= \frac{1090 + 11 - 1}{11} \\ &= \frac{1100}{11} \\ &= 100. \end{aligned}$$

The multiplying factor of a probe applies to *every range* of a vtvm because the input resistance always remains constant and no current

is drawn from the voltage-divider network to actuate the meter movement.

Table 2-2 shows the values of multiplier resistors required for some of the commercial vtvm's. Many manufacturers produce different models of vtvm's which, as the table shows, sometimes require different probe resistances. The value depends on the total resistance of the multiplier string, so always check to be sure.

**Table 2-2. Resistors required for extending the voltage range of vacuum-tube voltmeters**

Manufacturer	Model No.	Vtvm Range Setting(s) (D-C Volts)	Range(s) Vtvm extended to (D-C Volts)	Factor Scale	Multiplier Resistor Megohms
EICO	214, 221	1000	30,000	30	740
	232, 249	500 & 150	50,000 & 15,000	100	1090
EMC	106	1000	30,000	30	480
Hickok	215	300	30,000	100	1046
Jackson	709	1000	30,000	30	320
		1000 & 100	100,000 & 10,000	100	1090
Precision	EV-10	6000	30,000	100	1320
	EV-20	1200	30,000	100	1320
RCA	WV-77A	300 & 60	30,000 & 6,000	100	1090
	WV-87A, 97A	500 & 150	50,000 & 15,000	100	1090
Simpson	303	300	30,000	100	991
Sylvania	221 Z	1000	30,000	30	494
Triplett	650	500 & 100	50,000 & 10,000	100	1090

We sometimes must use a high-voltage probe with a vtvm to measure in other than very high-voltage circuits. With a high-voltage probe, we can realize extremely high input impedances. That is, the circuit loading by the vtvm will be very low. For example, if we use the vtvm in Fig. 2-3, we will have an input impedance of 50 megohms. For a measurement on the 100-volt range, we have a sensitivity of 50 megohms divided by 100, or 500,000 ohms per volt—which is quite high. However, we may at some time need a meter with a much higher input impedance, in order to measure, say, 100 volts or so. If our high-voltage probe has a 455-megohm multiplier resistor, a multiplying factor of 10 will be introduced in every reading. Therefore, we can now get a full-scale reading of 100 volts on the 10-volt range. Note, however, that the meter now presents to the circuit under test, not 50 megohms as before, but an input resistance of 500 megohms.

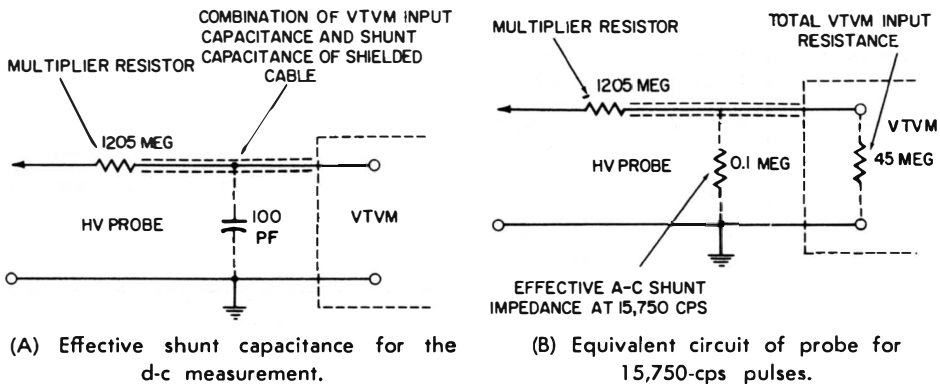
This technique of increasing the input impedance of a vtvm will prove very helpful when the voltage in the grid circuit of a television

vertical blocking-oscillator circuit is measured. Grid resistors here may range from 10 megohms up and d-c voltage levels are below 100 volts.

It is sometimes necessary to measure d-c voltage of a few hundred volts in circuits where very large, high-voltage pulses are present (for example, at the plate cap of the horizontal-output tube in a television receiver). Many service manuals have a note reading "Do not measure" at that point. Here is why:

At the plate cap we find both alternating current and direct current. The d-c is the normal B+ voltage of about 350 volts, but the a-c component consists of 15,750-cps pulses with a peak value of around 6000 volts. Because their frequency is high and their duration short, the meter needle cannot follow these pulses. Hence, they are not read on the meter. They do, however, cause a current to flow in the meter multiplier resistors. As a result, the resistors will overheat, and are likely to open or permanently change in value.

In spite of this problem, we can still measure the d-c plate voltage of the horizontal-output tube, provided we use a resistive h-v type of probe. Here, the probe and the input capacitance of the meter (plus



**Fig. 2-5. Effect on the shunt capacitance of an h-v probe when a d-c voltage containing a-c pulses at 15,750 cps is measured.**

the capacitance of the shielded cable, if used) act as a low-pass filter. To explain this, let us use the vtvm input circuit in Fig. 2-3 and the 1205-megohm h-v multiplier probe.

This probe gives us a multiplying factor of 25. We would use the 50-volt range, giving us 1250 volts full scale. However, too much mental calculation would be required. On the other hand, the 10-volt range is too low, giving us a full-scale reading of only 250 volts. We would therefore set our meter to the 100-volt range, since we expect to read in the neighborhood of 300 volts. This gives us a full-scale reading of 2500 volts. Now we can read our B+. But what about the effect of the pulses?

The vtvm has a certain input capacitance—normally around 15 to 25 pf. If the h-v probe uses a shielded cable, it, too, will have a shunt capacitance of anywhere from 50 to 100 pf. Adding these capacitances, we get about 100 pf of total shunt capacitance, as shown in Fig. 2-5A. At 15,750 cps, the reactance of 100 p-f is about 100,000 ohms, or 0.1 megohm. This makes the circuit effectively like that of Fig. 2-5B at this frequency. This 0.1-megohm reactance is in parallel with the total meter input resistance of 45 megohms. However, the effective a-c shunt impedance will still be 0.1 megohm because the effect of the 45 megohms in parallel will be of no consequence.

This impedance, together with the probe multiplier resistor, forms a voltage divider for the high-frequency pulses. The attenuation ratio is therefore 1205:0.1, or approximately 12,000:1. If the pulses have a peak amplitude of 6000 volts, only  $6000 \div 12,000$ , or about half a volt, will appear at the meter. This, of course, will not harm it.

Even if the h-v lead is not shielded, we can still use the h-v probe for this measurement. If we take an average vtvm input capacitance of 20 pf, the shunt impedance will be about 0.5 megohm. This will give a pulse attenuation of 1200:0.5, or 2400:1. With  $6000 \div 2400$ , or only 2.5 volts at the meter—still a safe value.

The high-voltage probes are usually terminated by a phone jack, an *Amphenol* connector, or pin jacks. Since the wire from the probe to the instrument is usually not shielded, only one connection to the meter is required. The common connection from the meter is generally made directly by one of the test leads supplied with the instrument.

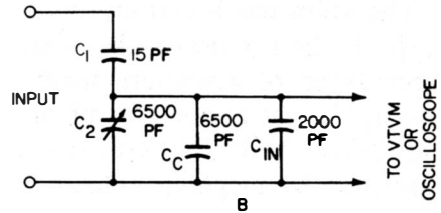
## **CAPACITIVE-DIVIDER HIGH-VOLTAGE PROBES**

So far, we have talked about measuring d-c high voltages only. There are times, however, when we will want to measure or observe high-voltage pulses, such as those in the horizontal-sweep system of a television receiver. These high-voltage pulses, you will remember, were purposely bypassed when the resistive high-voltage probe in the previous application was used. They can be measured or observed, however, with a capacitive-divider type of high-voltage probe.

Capacitive-divider high-voltage probes are employed with oscilloscopes to check waveforms, and with vtvm's to measure high a-c voltages. These probes are not frequency compensated. Their attenuation factor is determined by the ratio of the oscilloscope or vtvm input impedance plus cable capacitance to the high-voltage capacitor in the probe. Since there is no resistive element within the probe, its operation at low frequencies is not too satisfactory. It does, however, operate most efficiently at the higher frequencies found in television



(A) Physical appearance.



$C_1$  = INTERELECTRODE CAPACITY OF HV TUBE  
 $C_2$  = CALIBRATING CAPACITOR  
 $C_C$  = COAXIAL CABLE CAPACITANCE  
 $C_{IN}$  = INPUT CAPACITANCE OF VTVM OR OSCILLOSCOPE

(B) Basic probe circuit.

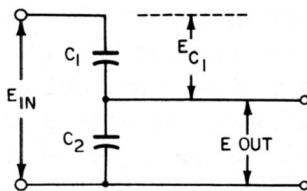
Courtesy Hewlett-Packard Company

**Fig. 2-6. A capacitive-divider high-voltage probe.**

horizontal-sweep circuits. The lower-frequency pulses in the vertical-sweep section are generally handled more effectively by the 10:1 low-capacitance probe, since the amplitude of these signals is not high enough that a h-v probe is required.

Fig. 2-6A shows a capacitive-divider probe which safely measures as high as 25,000 volts. The frequency range extends from 25 cycles to 20 megacycles. As the frequency increases, the voltage rating of the probe is reduced in order to limit the amount of r-f current flowing through the high-voltage capacitor. A fixed safety gap prevents damage to the probe, should we accidentally apply a voltage higher than the probe is rated for. Breakdown will occur if the applied voltage exceeds about 28,000 volts. Fig. 2-6B shows the basic circuit for this type of capacitive-divider, high-voltage probe.

The probe in Fig. 2-6 is intended primarily for laboratory application, but is included here to show its construction. It has a voltage-division ratio of 1000:1. The maximum voltage rating at 60 cycles is 25,000 volts; at 100 kilocycles, 22,000 volts; at 1 megacycle, 20,000 volts; at 10 megacycles, 15,000 volts; and at 20 megacycles, only 7,000 volts. Fig. 2-6A shows a 15-pf high-voltage vacuum capacitor, which is encased in a glass envelope. One terminal of this capacitor,



$$E_{IN} = E_{C_1} + E_{OUT}$$

$$\text{ALSO } C_1 E_{C_1} = C_2 E_{OUT}$$

$$\text{SO THAT } \frac{E_{C_1}}{E_{OUT}} = \frac{C_2}{C_1} = M$$

$$\text{THEREFORE } C_2 = M C_1$$

$M$  = ATTENUATION FACTOR

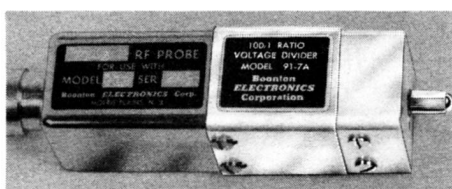
**Fig. 2-7. Basic capacitive-divider h-v probe circuit, showing how voltage division is accomplished.**



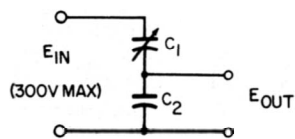
C1 in Fig. 2-6B, is connected to the high-voltage point and the other to the meter oscilloscope input.

The operation of this type of probe is based on the fact that a voltage applied to capacitors in series will divide between them in inverse proportion to their respective capacitances. If the capacitance of C2 in Fig. 2-7 is 99 times that of C1,  $\frac{1}{100}$  of the applied voltage will appear across C2 and  $\frac{99}{100}$  across C1. This is true because the reactance of C2 is 99 times lower than that of C1. Most of the voltage will appear across the high reactance, of course.

As with the resistive high-voltage probe, the element in the probe has the most high-frequency voltage developed across it; only a relatively small amount is developed across the input circuit of the instru-



(A) The probe.



(B) Probe circuit.

Courtesy Boonton Electronics Corp.

**Fig. 2-8. A capacitive-divider h-v probe used with a high-impedance probe.**

ment. If we measure 10,000 volts with a 100:1 probe, we find 9900 volts across the high-voltage capacitor of the probe, and only 100 volts across the input circuit of the oscilloscope.

The ideal probe would have an infinite resistance and an infinitesimal shunt capacitance. In this way, the probe would not affect the circuit under test at all. (The total capacitance of capacitors in series is less than the smallest capacitance.) In order to realize a very small shunt capacitance, we must make C1 in Fig. 2-7 as small as possible and still maintain a 99:1 ratio between C1 and the sum of the cable, input, and calibrating capacitances.

Fig. 2-8 shows a capacitive-divider probe for use with a high-impedance probe over a range extending from 500 kc to 600 mc. An exact 100-to-1 division ratio can be obtained by adjusting variable capacitor C1. A very sophisticated solution has been found to the problem of obtaining a low-capacitance and high-voltage "capacitor." This is to use a high-voltage rectifier tube—but as a capacitor, not as a rectifier. These tubes have a very high voltage rating. However, the capacitance between the filament and the plate cap is very small—usually around 1 pf.

Fig. 2-9A shows the details for constructing a capacitive-divider high-voltage probe. The equivalent circuit is shown in Fig. 2-9B.

The high-voltage input capacitor of this probe consists of the plate-to-filament interelectrode capacitance of a 1X2A high-voltage rectifier tube rated at 18,000 volts maximum. This tube is used as a rather inexpensive high-voltage capacitor with a value of approximately 1 pf. The interelectrode capacitance of the tube is connected in series with the sum of the input capacitance of the oscilloscope, the capacitance of the cable, and the calibrating trimmer capacitor. By proper adjustment of trimmer C2, accurate 100-to-1 attenuation can be obtained.

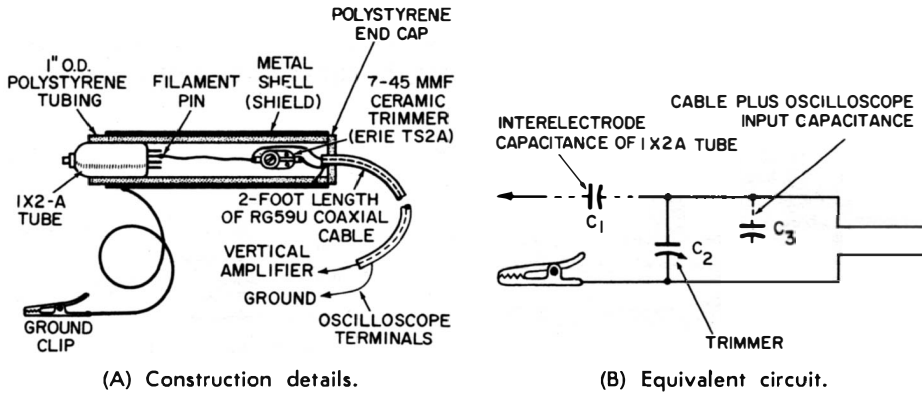


Fig. 2-9. Assembling a capacitive-divider h-v probe.

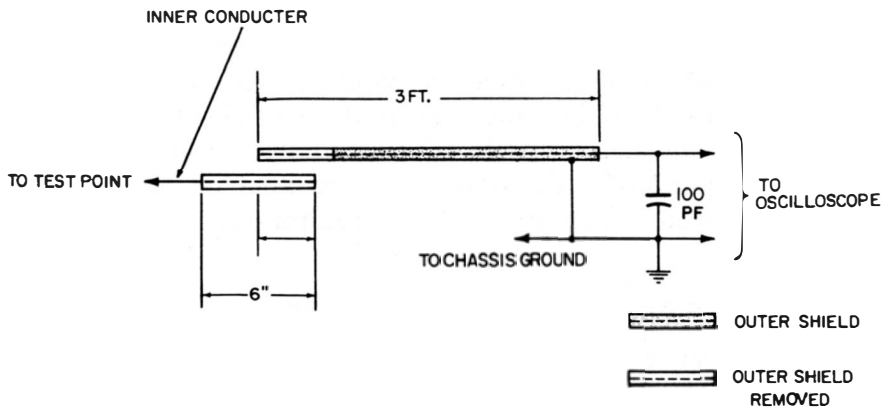
The tube is cemented into the end of a length of polystyrene tubing, and its plate top cap used as the high-voltage test prod. A lead is connected from one of the filament pins to C2 (7-45 pf ceramic trimmer). This capacitor is mounted inside the polystyrene tube. A hole is provided in the wall of the tube so a trimmer-adjusting screwdriver can be inserted.

This trimmer permits the total output capacitance (the sum of the trimmer, cable, and oscilloscope input capacitances) to be adjusted to 99 pf. The voltage-reduction ratio through the probe will then be 100:1 (assuming the interelectrode tube capacitance is 1 pf). If the tube capacitance is a little more or less than 1 pf, the trimmer can be adjusted to compensate for this accordingly. The calibrating trimmer need not be a h-v type, since only  $\frac{1}{100}$  of the test voltage will be dropped across it. At 15 kilovolts, for example, this will be only 150 volts.

The input impedance of such a probe is approximately 10 megohms, with a plate-to-filament capacitance of 1 pf. At 15,750 cps, the impedance is reduced to about .1 megohm, which normally is still much higher than the impedance of the circuit under test. If we use the high-voltage probe with an oscilloscope calibrated for a sensitivity of 10 volts peak-to-peak per square, the probe now converts the oscillo-

scope sensitivity to 1000 volts peak-to-peak per square. Thus, a peak-to-peak waveform of 5000 volts will cover five squares.

Most present-day oscilloscopes have a maximum vertical-deflection sensitivity of 0.02 volts rms/inch. This corresponds to  $0.02 \times 2 \times 1.414 = 0.05656$  volt peak-to-peak. Thus, to get a 1-inch deflection on the scope with a 100:1 probe, we must have a peak-to-peak input signal of  $100 \times 0.05656$ , or 5.656 volts. This is about the practical low-voltage limit for a 100:1 probe. A 50:1 probe is satisfactory where the shunt capacitance of a 10:1 probe is too high and a 100:1 probe does not deliver sufficient signal.



**Fig. 2-10. A simple capacitive-divider high-voltage probe made from two lengths of coaxial cable.**

A relatively simple high-voltage divider can also be made from two lengths of RG59/U coaxial cable, as shown in Fig. 2-10. Remove all the outer braid from the shorter coax, and approximately 3½ inches from the longer one. Then overlap the two pieces of coax three inches, and tape them together with plastic electrical tape. Connect a 100-pf, 500-volt capacitor between the inner and outer conductors of the longer coax in order to obtain the proper attenuation ratio. This capacitance-divider probe gives a stepdown ratio of approximately 100:1. If you want a more accurate attenuation ratio, use a fixed capacitor of about 80 pf shunted by a small trimmer.

### **How to Calibrate Capacitive-Divider H-V Probes**

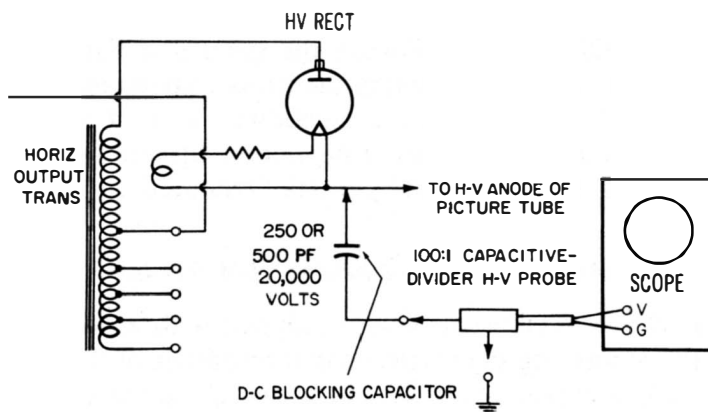
Most of today's oscilloscopes are equipped with a decimal step attenuator. By connecting the vertical-input terminals of the oscilloscope *directly* to a low-impedance pulse source (such as the cathode of the horizontal driver tube, the bottom of the primary winding of the horizontal-output transformer, or the cathode of the damper tube) you

can check the calibration factor of the probe. First, turn the coarse attenuator of the oscilloscope to the X100 position, and observe the amount of vertical deflection on the oscilloscope screen. Adjust the vertical attenuator of the scope to any convenient position. Now, connect the 100:1 capacitance voltage-divider probe and advance the coarse attenuator to the X1 position. This will make the oscilloscope 100 times more sensitive. Apply exactly the same signal source as before and do *not* move the fine attenuator. Adjust the trimmer capacitor to obtain the same amount of vertical deflection as before. The probe is now properly calibrated, and is adjusted to exactly 100:1 attenuation.

After the probe has been calibrated, it is easy to compute the exact value of the peak-to-peak voltage under test, by simply multiplying the oscilloscope calibration factor by 100 (adding two zeros). Such actual measurements can be made only if the probe is used with oscilloscopes that have step attenuators, preferably calibrated in multiples of 10. The cable supplied with the probe must be kept in use. If another cable is substituted, the probe must be recalibrated.

### **Uses for the Capacitive-Divider H-V Probe**

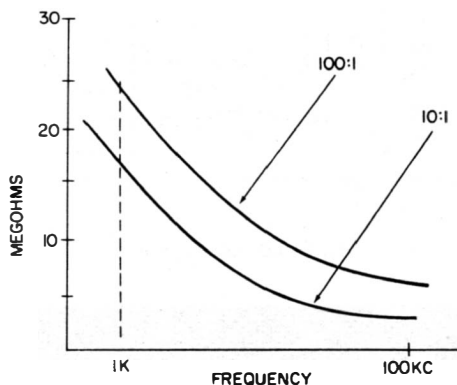
Some of the less expensive oscilloscopes do not have a compensated input system. The input capacitance of such oscilloscopes will thus vary as the vertical-attenuator setting is varied. Therefore, the calibration factor of the probe at various attenuator settings will also be changed somewhat, and waveform distortion is likely to be encountered at lower settings because of frequency discrimination and phase shift within the attenuator itself. These factors must be considered when this probe is used with an oscilloscope having an uncompensated vertical-input circuit.



**Fig. 2-11. Connections for checking the waveform and peak-to-peak voltage in a television high-voltage supply when a capacitive-divider h-v probe is used.**

The capacitive-divider h-v probe can also be used for measuring the peak-to-peak ripple voltage in the output circuits of a television high-voltage supply, provided a suitably rated high-voltage filter capacitor is connected in series with the probe to block the d-c voltage component. (See Fig. 2-11.)

Oscilloscopes are generally designed for input voltages up to 600 volts. Distortion will take place if this maximum voltage is exceeded by even a small amount. Moreover, if exceeded greatly, it will damage the oscilloscope input circuit *unless* a suitable attenuating probe is used. For example, when a 6000-volt peak signal is applied to the



**Fig. 2-12. Shunting impedance of a typical 100:1 capacitive-divider h-v probe and a 10:1 low-capacitance probe.**

100:1 capacitive-divider h-v probe, the oscilloscope receives only  $\frac{1}{1,000}$  of this voltage, or 60 volts. This is certainly well within the capabilities of the oscilloscope input circuit.

The capacitive-divider h-v probe is suitable not only for quantity, but also for quality measurements. The probe enables the waveshapes of the signal at various test points in the television receiver to be compared with those in the service data.

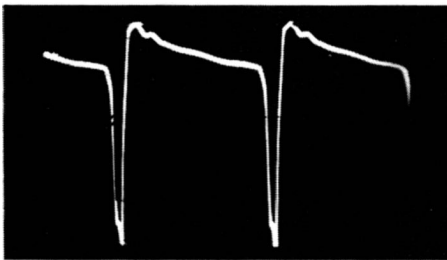
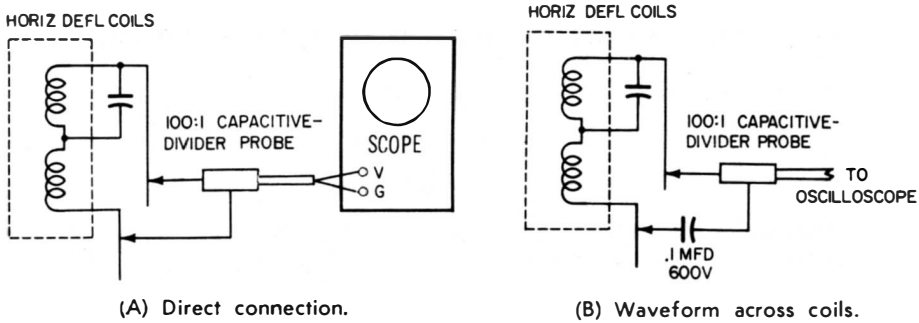
Because considerable capacitance is shunted across the scope terminals, the resistive components of the scope input impedance can be neglected at high frequencies. Therefore, such a probe does not require compensation at the frequencies encountered in the average horizontal, oscillator-driven television power supplies.

We must realize, however, that since the probe is not frequency compensated, it is not suitable for low-frequency circuits (such as 60-cycle vertical-sweep circuits) because the reactance of the oscilloscope input capacitance at 60 cps would greatly exceed the resistive component of the oscilloscope input impedance. This, however, need not be of concern because the 10:1 low-capacitance probe will adequately accommodate the operating voltages encountered in vertical-sweep circuits.

The 100:1 capacitive-divider probe not only loads the circuits less than the 10:1 low-capacitance probe does, but also delivers only one-

tenth as much signal. The shunt capacitance is approximately 2 pf for the capacitance-divider probe, and 8 pf for the low-capacitance probe. Fig. 2-12 shows their shunting effect.

Peak-to-peak voltage readings in television receivers should fall within approximately 20 percent of the reading given in the service manual for the particular set under test. For example, a 5000-volt peak-to-peak signal should measure between 4000 to 6000 volts peak-to-peak in order to be within the normal tolerances expected in com-



(C) Capacitor in series with grounded lead.

**Fig. 2-13.** Checking the waveform across the horizontal-deflection coils with a 100:1 capacitive-divider probe.

mercial television receivers. Remember that the voltage readings in service manuals are generally based on a line voltage of 117 volts. Any variation must be taken into account because it will affect the high voltages in the horizontal-deflection circuits.

Fig. 2-13A shows a 100:1 capacitance-divider probe applied across the horizontal-deflection coils. The resultant waveform, shown in Fig. 2-13C, is almost always indicative of the actual waveform across the horizontal-deflection coils. Sometimes, however, there is sufficient impedance between the "low" side of the deflection coils and ground to produce a distorted waveform. If so, the actual waveform across the coils can be obtained by placing a 0.1-mfd capacitor in series with the ground lead of the probe, as shown in Fig. 2-13B. The capacitance (0.1 mfd here) must be high enough that the a-c impedance is negligible. It is not recommended, for safety's sake, that the scope ground

be connected to the “low” end of the deflection coil because the scope case will then be at B+ potential, and any contact between it and the receiver chassis will result in a nasty jolt.

## **SAFETY FIRST**

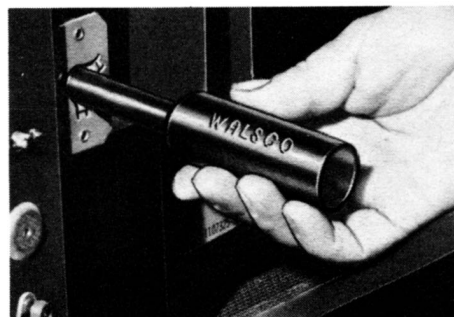
It is interesting to note that sometimes as much as 95 percent of the high voltage under test is dropped within the probe. For example, when 20,000 volts are measured, 19,000 volts may be dropped by the multiplier resistor in the probe, and only 1000 volts within the vtvm. Therefore, the probe must be constructed of a good insulating material, in order to provide maximum protection for its user.

Most present-day high-voltage probes are equipped with a safety flange (sometimes referred to as a flash guard or barrier) consisting of one or more discs about two-thirds of the way up the probe. These discs prevent the operator’s fingers from slipping too close to the high-voltage source. They also greatly reduce the possibility of corona or arcing.

### **Some Safety Precautions**

The high-voltage power supplies of television receivers can be dangerous. For this reason, television receivers are equipped with an a-c interlock that disconnects the power line from the set when the rear cover is removed. It is possible, however, for a charge to remain in the receiver even after the power line has been disconnected. Most color television receivers have a safety device which automatically grounds the high-voltage supply when the back is removed. Fig. 2-14 shows a color television interlock “cheater” that enables the set to be operated even with the back removed. In addition to preventing the high-voltage supply from being disabled, the “cheater” also accommodates a high-voltage probe so voltage measurements can be made.

**Fig. 2-14. A color television interlock “cheater” permits h-v measurements with the back removed.**



Courtesy Walsco Electronics Mfg. Company

Be extremely cautious when checking equipment that does not use pulse-operated or r-f power supplies (such as the high current, high-voltage supplies in industrial equipment). For absolutely safe high-voltage measurements, the following sequence is suggested.

1. Turn off the equipment to make sure there will be no high voltage at the measurement point.
2. Connect the high-voltage probe to the meter to be used and set the meter to the required scale.
3. Connect a ground lead between the equipment under test and the meter.
4. Attach the probe to the high-voltage point *while the equipment is still turned off*.
5. Turn the equipment on and read the meter; then turn the equipment off.
6. Be sure the high voltage has been dissipated before removing the probe.
7. Before checking a transformerless television receiver with an a-c powered vtvm, be sure the meter case or negative terminal is at the same potential as the television receiver B-. The meter ground, if connected to the television receiver, could be the "other side" of the power line. If so, a short circuit will take place. For this reason, it is advisable to use an isolation transformer with the vtvm when this type of receiver is checked.

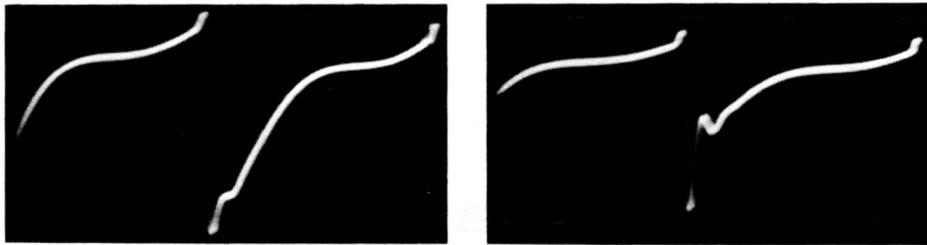


## Low-Capacitance Probes

Most oscilloscopes, vtvm's, signal tracers, distortion analyzers, and frequency meters or counters have a comparatively high input resistance. They also have a certain amount of shunt capacitance, which will not be detrimental when used for measuring in low-impedance circuits. However, severe distortion may occur in high-impedance, high-frequency circuits, such as sync and video-amplifier circuits. Even a slight degree of loading may produce erroneous indications. With a low-capacitance probe (also known as a high-impedance or attenuation probe), the sync pulses can be followed from the take-off point to the horizontal and vertical oscillators without disturbing the synchronization of the receiver. This probe is also useful for signal-tracing and checking the signal levels through various stages of video amplifiers, because it does not contribute excessive shunt capacitance across the peaking coils to disturb the operation of the circuit. Signal levels can be observed at both the grid and the plate circuits without upsetting the circuit operation.

The low-capacitance (low-C) probe is also useful for checking the waveforms in horizontal-afc circuits. Proper waveshapes at the various test points are usually given on television schematics and in service manuals. Since a low-C probe will not load the circuit, the scope indication will be a truer representation of conditions within the circuit. The signal observed may now be compared with the one shown in the service literature.

The grid-leak resistor in the vertical-blocking oscillator may have a value as high as 10 megohms, and the waveform at the grid will be sharply spiked. Therefore, any high-frequency content in this waveform could easily be lost if a direct scope connection were made at the grid. However, if a 10:1 low-C probe were used, the capacitance across the circuit under test would be reduced to about one-tenth the value it would be if a direct connection were made. The resultant waveform displayed on the scope will therefore be more accurate,



(A) Waveform without the probe.

(B) Waveform with the probe.

**Fig. 3-1. Effect of a low-capacitance probe on waveform indications.**

since the circuit loading is greatly reduced. Waveform distortion may occur at the grid of *some* vertical oscillators, even with a 10:1 probe. If so, a 100:1 low-C probe must be used. Fig. 3-1 shows the effect of a low-C probe on a waveform indication.

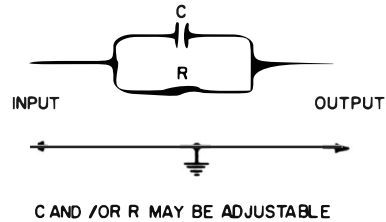
The shunt capacitance in the vertical-input circuit of an average oscilloscope is approximately 30 to 50 pf. To this we can add, on the average, another 25 to 50 pf arising from the use of the test leads. Thus, when we place our test prod at some point within a circuit in order to observe the waveform, we are automatically shunting this point with a capacitance of 55 to 100 pf. This will have no noticeable effect in some circuits, but in others—particularly where the waveforms under observation contain relatively high frequencies, such as square sync pulses—the additional capacitance will alter the shape of the waveform appreciably. Not only will the waveshape become distorted, but the peak amplitude of the signal will also be reduced. Furthermore, the additional capacitance of the connecting leads, or an instrument having relatively high input capacitance, will detune resonant or tuned high-frequency circuits like the ones in television i-f stages.

The input resistance of test instruments is usually high. It may consist of the grid resistance of a tube, or the sum total resistance of a vtvm input-circuit voltage divider, plus the resistance of the isolation resistor. This resistor, as its name implies, isolates the instrument from the circuit under test. That is all well and good if we need just

resistive isolation and if the signals are essentially sinusoidal. If we want to observe signals on an oscilloscope, we may use a small capacitor for isolation, instead of a resistor. That, too, will reduce the input capacitance of the instrument; however, we do not have a known attenuation factor. Let's see what happens if a resistor or capacitor is used alone. We will soon realize that neither will do the job that both can accomplish together.

If, when checking waveforms with a scope, we use an isolation resistor alone in the probe, it and the distributed and input capacitance of the oscilloscope will form a low-pass filter, thereby causing integration to take place. This, of course, results in a rather large attenua-

Fig. 3-2. Low-capacitance probe circuit.



tion of *higher* frequencies and, therefore, subsequent rounding off of all sharp waveforms. On the other hand, a series capacitor alone, used to reduce the input capacitance and loading effect, would have to be a small one. The impedance of this capacitor will be quite high, however, compared with the input resistance of the oscilloscope. Therefore, this combination—the series capacitor and input resistance—will form a differentiating network (high-pass filter), resulting in attenuation of the *lower* frequencies. If we now combine a series resistor and a capacitor of the proper value to get not only low shunt capacitance, but also frequency compensation *and* a known attenuation ratio, we will have accomplished what we set out to do. Fig. 3-2 illustrates the basic circuit for such a probe in which a low-value, semivariable capacitor and a shunt resistor are encased in a special housing. The reduction in shunt capacitance takes place because the added capacitor (approximately 5-15 pf) is actually placed in series with the 80 to 100 pf from the connecting cable and the vertical-amplifier input

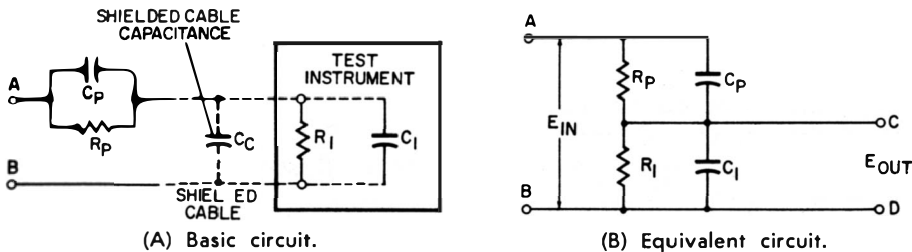


Fig. 3-3. Operation of the low-capacitance probe.

circuit. This added capacitance reduces the effective input capacitance to a little less than the 5- to 15-pf—certainly a marked improvement over the 80 pf or so present before the probe was added. There is, however, one disadvantage to this arrangement: the voltage actually reaching the vertical amplifier of the scope is reduced in the same proportion as the input capacitance. Thus, if the total input capacitance is decreased to one-tenth, so is the signal voltage reaching the scope. In television service work, the low-C probe is usually used for observing waveforms in circuits which have sufficient voltage to offset this loss, such as the video-amplifier, sweep, and sync stages.

Let us look at a simplified diagram (Fig. 3-3) in order to understand the operation of a low-capacitance probe. Since the probe is always used with a shielded lead, the capacitance of the shielded cable ( $C_C$  in Fig. 3-3A) and the input capacitance of the instrument are added together. This total capacitance (which we will call  $C_I$ ) is shunted by the input resistance ( $R_I$ ) of the instrument. The resistor in the probe is denoted  $R_P$ , and the probe capacitance  $C_P$ .

The signal under test is applied between terminals A and B. The equivalent circuit in Fig. 3-3B shows we now have a voltage divider consisting of two resistors shunted by two capacitors.

Low frequencies divide across  $R_P$  and  $R_I$  in *direct proportion* to their resistance and the high frequencies divide across  $C_P$  and  $C_I$  in *inverse proportion* to their capacitance, or in *direct proportion* to their capacitive reactance. The voltage division is constant from direct current up into the r-f range. The attenuation factor is very easily calculated, as we will soon see. Essentially, the probe increases the input impedance of the test instrument and, at the same time, attenuates the input signal. The attenuation factor can generally be compensated for by simply adjusting the vertical-gain control of an oscilloscope for greater deflection, provided the signal under test is of sufficient amplitude. We have, however, gained the advantage of reducing or eliminating waveshape distortion, which would normally occur if there were no low-C probe.

In order for the probe to be properly compensated for at all frequencies, the following relationship must hold true:

$$C_P R_P = C_I R_I$$

where,

$C_P$  is the probe capacitance,

$R_P$  is the probe resistance,

$C_I$  is the input capacitance (cable plus oscilloscope),

$R_I$  is the input resistance of the oscilloscope.

The amount of attenuation experienced from using the low-C probe is given by the following formula:

$$A = \frac{R_P + R_I}{R_I}$$

$$A = \frac{X_{C_P} + X_{C_I}}{X_{C_I}} = \frac{C_I + C_P}{C_P}$$

Now suppose we have an oscilloscope with an input resistance of 500,000 ohms and an input capacitance of 25 pf. Using a two-foot coaxial cable with a capacitance of 10 pf per foot between the probe and the oscilloscope will add 20 more pf. Therefore, the effective input capacitance of the scope will now be 45 pf. Let us see what the values of  $R_P$  and  $C_P$  would have to be to provide an attenuation factor of 10:1.

$$R_I = 500K$$

$$C_I = 45 \text{ pf}$$

Since

$$A = \frac{R_P + R_I}{R_I},$$

$$R_P = R_I (A - 1)$$

Therefore,

$$R_P = 500,000 (10 - 1)$$

$$= 500,000 \times 9$$

$$= 4.5 \text{ megohms}$$

We need a probe resistor of 4.5 megohms for an attenuation factor of 10:1. Now, what will  $C_P$  have to be?

Since

$$A = \frac{C_I + C_P}{C_P},$$

$$C_P = \frac{C_I}{(A - 1)}$$

Therefore,

$$C = \frac{45 \text{ pf}}{(10 - 1)}$$

$$= \frac{45 \text{ pf}}{9}$$

$$= 5 \text{ pf}$$

Thus, we need 5 pf for the probe capacitor. What must we do to make this probe practical to construct? A 4.5-megohm resistor is

quite easy to obtain. However, as far as the capacitor is concerned, there are several problems. First of all, the input capacitance of the oscilloscope may vary by 20 percent or more from the manufacturer's specifications. Moreover, the cable capacitance may also vary by the same percentage. We also have to take into account a little distributed capacitance here and there. So, from a practical point of view, a small adjustable ceramic or mica trimmer capacitor between 3 to 30 pf can be used. Its exact value is not important since it will be adjusted anyway. However, its lowest value must always be lower than the calculated probe capacitance; and its adjustment range is expected to compensate for other distributed capacitances in the circuit.

Not only does the low-C probe raise the input capacitance and reduce the input signal by the same attenuation factor, but it also attenuates any d-c component in the circuit under test. In doing so, it reduces the d-c voltage stress across the series blocking capacitor in the input circuit of a-c oscilloscopes (some of which have either a-c or d-c inputs). In a d-c scope or at the d-c input setting on an a-c/d-c oscilloscope, this blocking capacitor is not in the circuit, of course.

Frequency compensation of a low-C probe is best accomplished with a square-wave generator. The trimmer in the probe is adjusted for best square-wave reproduction at 20 and 20,000 cps. Several adjustments should be made by alternately switching back and forth between 20 and 20,000 cps. Usually, a satisfactory compromise adjustment can be made after a few tries. If a square-wave generator is not available, an audio sine-wave generator will do. Adjust the probe trimmer for a sine wave of equal amplitude (or a compromise) at 20 and 20,000 cps. Repeat the adjustment several times as before.

A *properly* operating television receiver can also be used in adjusting the low-C probe. Apply the probe at the grid or cathode of the picture tube (depending on which elements are fed from the video-

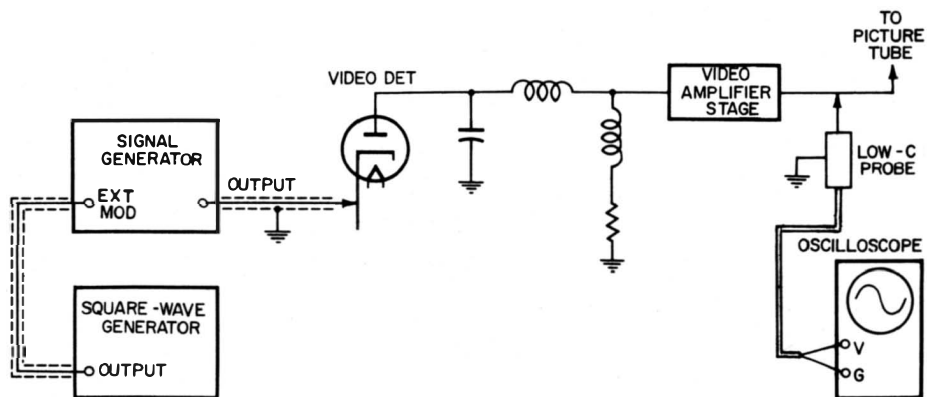
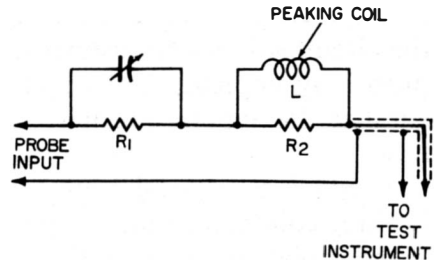


Fig. 3-4. Test setup for checking the response of a video amplifier with a low-C probe.

**Fig. 3-5. A low-C probe with peaking coil added to help compensate for insufficient vertical amplifier bandwidth in some oscilloscopes.**

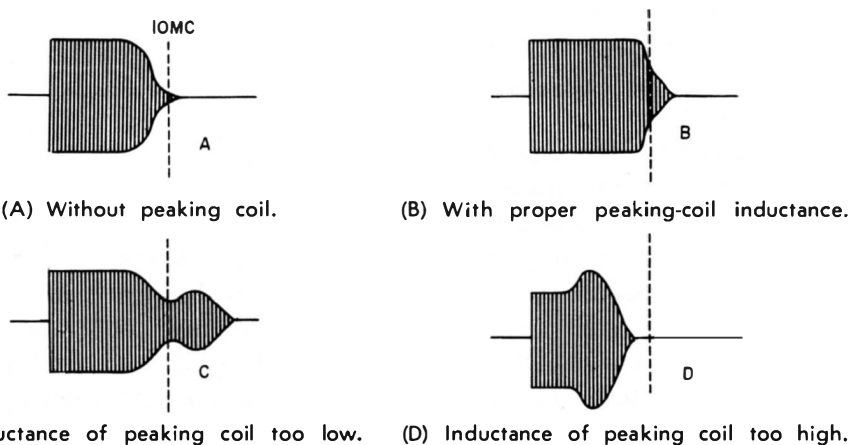


output stages) and observe the composite video signal on the oscilloscope. Then adjust the capacitor in the probe until the equalizing and vertical-sync pulses have the same peak amplitude and observe the horizontal pulses for proper shape (set the oscilloscope sweep rate at 15,750 cps). The trimmer capacitor in the probe can again be slightly adjusted, if necessary, so the horizontal-sync pulses will have the least rounding and tilt.

In many instances the frequency response of a particular oscilloscope is so narrow that the higher frequencies are attenuated. Thus, when a composite video signal is viewed (the higher frequencies in this instance), the horizontal-sync (15,750 cps) and equalizing pulses (31,500 cps) are not amplified as greatly as the low-frequency vertical pulses (60 cps). Never forget that the frequency characteristic of the scope presentation can be only as good as the response of the scope before the probe was added.

A low-C probe should not be used when the full sensitivity rather than the wide-band response of an oscilloscope is required—for example, in tracing and locating hum. Instead, a direct probe made of ordinary shielded cable is preferred.

Fig. 3-4 shows the proper way to check the response of a video amplifier with a low-C probe. If we want to observe the video signal



**Fig. 3-6. Effect of peaking coil inductance on the response curve.**

at the picture tube, it is advisable to disconnect the picture tube so the circuit will not be disturbed by the slight capacitance added by the probe. By unplugging the picture-tube socket, we have actually substituted the input capacitance of the probe for that of the picture tube.

Insufficient vertical-amplifier bandwidth in oscilloscopes with no peaking coils can be improved by adding a small, damped peaking coil in the probe, as shown in Fig. 3-5. The value of the coil will fall somewhere between 150 and 300 microhenrys—depending on the distributed capacitance in the probe, cable, and scope. Several values of inductance should be on hand; the proper one is determined experimentally. Damping resistor  $R_2$  in Fig. 3-5 reduces the  $Q$  of the coil to provide a broader peak and thus an essentially flat overall frequency response. Its exact value can be anywhere from 5000 to 10,000 ohms.

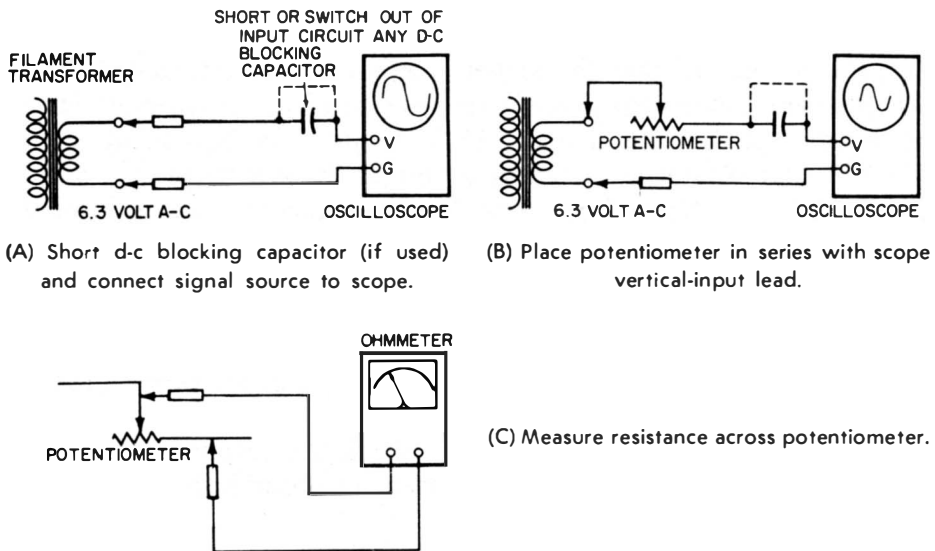


Fig. 3-7. Measuring the input resistance of an oscilloscope.

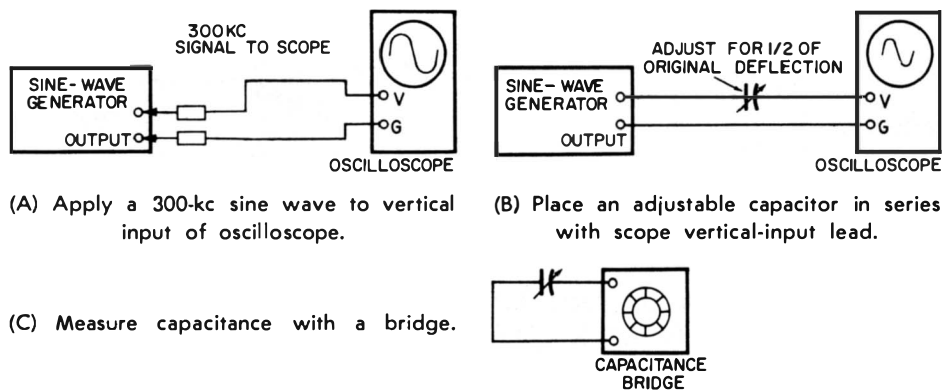
In order to determine the best value for  $L$ , apply the output from a video sweep generator to the probe, and observe the undemodulated response curve on the oscilloscope. Fig. 3-6 shows the effect of the peaking coil on the response curve. Try several values of  $L$  for best response, and adjust the trimmer capacitor in the probe for the flattest output. Use the smallest possible inductance consistent with a good response curve. Of course, the output of the video sweep generator must be flat. (This can be quickly checked with a demodulator probe.) It is therefore desirable to use a cable with the lowest possible shunt capacitance, because the cable itself adds a substantial amount.



The lower the instrument and cable capacitances, the smaller the compensating capacitor can be, with a consequent reduction in the shunting capacitance of the probe.

A set of five low-capacitance probes is made by Tektronix, Inc. The attenuation ratios which are now available are 5:1, 10:1, 20:1, 50:1, and 100:1.

The input resistance of an oscilloscope can be easily measured in the following manner. First be sure any d-c blocking capacitor in the input circuit (Fig. 3-7A) is either shorted or switched out of the circuit. Then connect a low-voltage a-c signal (such as the 6.3 volts from a filament transformer) to the vertical-input terminals of the oscilloscope, and adjust the vertical-gain control to obtain nearly full-screen deflection or an even number of divisions. Now disconnect one

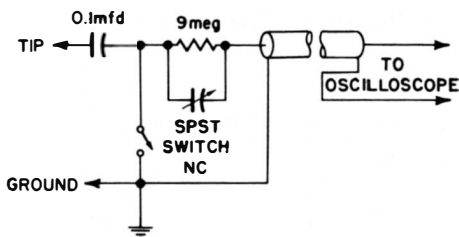


**Fig. 3-8. Measuring the input capacitance of an oscilloscope.**

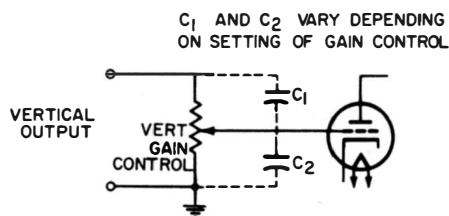
lead and insert a 3- to 5-meg potentiometer in series with the lead, as shown in Fig. 3-7B. Without disturbing the scope setting, adjust the pot until the signal deflects exactly half the number of divisions it did originally. Remove the pot and measure with an ohmmeter that portion of the resistance that was inserted in the circuit (Fig. 3-7C). The value measured will equal the input resistance of the scope.

In order to measure the input capacitance of the oscilloscope, we proceed as follows: First, set the scope vertical attenuation to the position at which we wish to measure the capacitance. Apply a 300-kc a-c signal (Fig. 3-8A) and note the deflection. Now disconnect one scope lead and add a small adjustable capacitor (around 100 pf or so) in series with the lead, as shown in Fig. 3-8B. Try various values, or a trimmer in parallel with a fixed capacitor. The value giving exactly one-half the deflection, when the signal was directly connected to the input circuit, is equal to the input capacitance of the scope. Determine the amount of capacitance with a capacitance bridge (Fig. 3-8C). Be sure the level of the signal stays constant during this test.

Probe attenuation can be checked by applying a 1000-cps sine wave to the vertical-input terminals and adjusting the scope deflection to a convenient number of divisions as close to full-scale deflection as possible. Now connect the probe to the scope terminals and apply the same 1000-cps signal voltage to the probe. This time the deflection will cover a much smaller number of divisions. Divide this number into the one previously obtained. The result is the probe attenuation factor. For example, if there were 40 divisions of vertical deflection without the probe and now, with the probe, only four divisions, the probe attenuates 40 divided by 4, or a factor of 10. Frequency compensation must be made, of course, as outlined before.



**Fig. 3-9.** Low-capacitance probe with micro-switch added to reduce signal bounce.



**Fig. 3-10.** High-impedance, uncompensated gain-control used in some oscilloscopes.

When a direct or low-capacitance probe is connected to an oscilloscope, but the probe tip is not connected to anything, a stray field signal will appear on the screen if the gain of the oscilloscope is turned up high. This is called *pickup* and appears because the probe tip presents a very high impedance. This type of interference will disappear as soon as the probe is connected to the circuit under observation.

When a low-capacitance probe is applied at the plate or screen of a tube or at any other point where a d-c voltage is present in addition to the a-c signal under observation, a bounce trace will be seen. When the probe tip is connected to the test point, the input blocking capacitor of the oscilloscope charges to the d-c voltage present. This charging action takes place through the probe and the vertical input of the scope attenuator circuit. Oscilloscopes designed to have good low-frequency response usually have a large value blocking capacitor; this may be as much as 1 mfd. Charging such a large capacitor through a high resistance produces a long charging surge, which, in turn, could produce a long and disturbing bounce in the signal.

A slight modification of the low-capacitance probe can avoid this problem. Fig. 3-9 shows a normally closed switch added to the probe so that the input blocking capacitor, which is now in the probe, be-

comes charged immediately when a d-c potential such as the plate of a vacuum tube is applied across it. The switch (a small microswitch inserted in the tip of the probe) can now be opened, and the signal will appear without a bounce. With a little ingenuity the microswitch can be installed in the probe so that any pressure which is produced when the probe tip is connected to the test point will open the switch automatically, eliminating the necessity for performing this function manually.

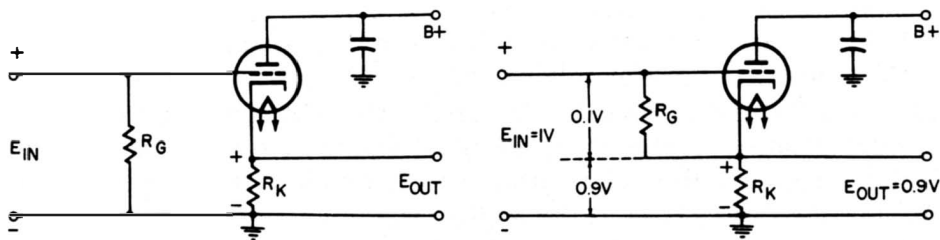
Shorting the blocking capacitor to ground eliminates bounce, but it also connects a very large capacitor in shunt with the circuit under observation. This could have a serious detuning effect and might even cause some circuits such as blocking oscillator circuits to cease functioning. However, when the switch is opened, the circuit will resume normal operation, which could result in the change of some d-c levels at the test point. This will produce some bounce which, in this case, cannot be avoided.

To review briefly, there are three distinct advantages of a low-capacitance probe.

1. The input impedance is kept high.
2. The input impedance is known and can therefore be reckoned with because it does not depend on the leads or their proximity to ground.
3. Pickup of extraneous signal is reduced to a minimum because a shielded lead is used.

### CATHODE-FOLLOWER PROBES

Cathode-follower probes provide another means of offsetting the loading effect of an instrument on high-impedance circuits. A cathode follower is a high-impedance input/low-impedance output device which exhibits excellent frequency response.



(A) Grid resistor connected to ground. (B) Grid resistor connected to cathode.

Fig. 3-11. Basic cathode-follower circuit.

In order for high-frequency waveforms in high-impedance circuits to be measured or observed with any degree of success, the input impedance of that measuring device must be considerably higher than that of the circuit point being measured.

All measuring instruments affect, even if only to a small degree, the circuit to which they are connected. This disturbance becomes more noticeable in high-impedance circuits. The ideal measuring device would require absolutely no energy from the circuit under test. In order to approach this ideal condition, we endeavor to make the input impedance of the instrument as high as possible—which, of course, would require the shunting resistance to be high and the shunt capacitance quite low.

One of the problems in measuring voltages with a high-impedance voltmeter or oscilloscope in high-impedance audio and video circuits is the effect of test-lead capacitance. Shielded test leads are usually necessary to prevent hum pickup, but their shunt capacitance may seriously load the circuit under test—even as high as 100 pf or more. At 15 kc this represents a reactive loading of about 100,000 ohms—a very appreciable amount, even across a one-half megohm circuit.

An average oscilloscope, together with its shielded cable, offers a circuit load of about 2 megohms shunted by around 125 pf. However, for proper compensation we must take into account the position of the vertical-gain control.

Some of the more inexpensive oscilloscopes have uncompensated vertical-input circuits like the one in Fig. 3-10, in which the input capacitance varies with each setting of the vertical-gain control. Thus, it is not practical to use a low-C probe at any but the one setting for which it has been calibrated. On the other hand, a cathode-follower type low-C probe overcomes this problem and, in addition to its other advantages, is the only practical probe that can be used with an oscilloscope having an uncompensated vertical-gain control.

A cathode follower resembles an RC-coupled amplifier, except that the output is taken from the cathode instead of the plate circuit. The basic circuit of a cathode follower is shown in Fig. 3-11A. Notice that the grid resistor ( $R_g$ ) goes directly to ground.

When a signal is applied, the plate current changes in step with the control-grid to cathode voltage. Since the plate and cathode currents are the same, the cathode current also changes when the plate current changes, reproducing the input signal across the unbypassed cathode resistor ( $R_k$ ). The output signal, which is taken from across  $R_k$ , has the same phase as the applied signal.

Since the cathode return is also part of the grid-cathode circuit, the output voltage across the unbypassed resistor ( $R_k$ ) is opposed by part of the input voltage. As a result, negative feedback and degeneration

are introduced. The voltage developed across  $R_k$  can never be equal to (or greater than) the applied voltage. Thus, the cathode follower has a gain of less than unity. We have a high input impedance at the input of the circuit, but a low impedance at the output. No voltage gain is derived, therefore, although the circuit does have a large power gain.

Fig. 3-11B shows a slight modification of the cathode-follower circuit. The input resistor ( $R_g$ ) is now returned to the cathode. This connection makes it possible for a higher value of cathode resistor to be used and, consequently, a signal of greater amplitude to be applied.

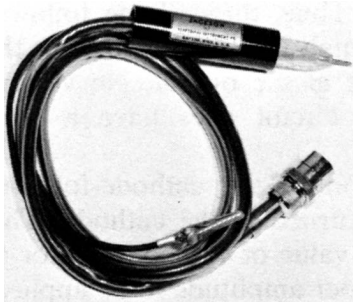
To understand how a cathode follower works, assume we have an input signal of one volt applied between the grid and ground (the input terminals of the probe). The output voltage is taken across cathode resistor  $R_k$ . Because grid resistor  $R_g$  is connected to the cathode and not to ground, it is in series with the cathode resistor. Consequently, we have a current amplifier with a voltage gain of somewhat less than 1. For ease of understanding and for the sake of illustration, let us assume the voltage gain is 0.9. Therefore, with an input signal of 1 volt, we will get an output signal of 0.9 volt.

If we apply a 1-volt signal of such polarity that the grid is positive, the cathode current through  $R_k$  will immediately increase, making the cathode more positive with respect to ground. Thus, as the grid goes positive, so does the cathode. The cathode voltage changes in phase with the input voltage. The voltage across cathode resistor  $R_k$  will approach the input voltage. As we said before, for ease of understanding we shall assume a gain of 0.9 for the circuit. Thus, only 0.1 volt remains across the grid resistor, which therefore looks 10 times as large as it actually is. For example, with a 10-megohm grid resistor, the input resistance of the probe will be 10 times as much, or 100 megohms.

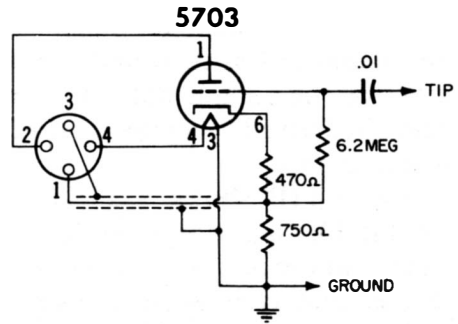
The input resistance of circuit B is equal to  $R_g \div 1 - A$ , where  $A$  is the gain of the circuit. If the gain is 0.95 and  $R_g$  is still 10 megohms,  $R_{in}$  will be 200 megohms.

With good design, the gain of a cathode follower can be made as high as 0.98—which, of course, would greatly increase the input resistance. Theoretically, if the gain could be made exactly 1—in other words, if the output signal (the one across  $R_k$ ) would be exactly equal to the input signal—the input resistance would be infinite.

In the circuit in Fig. 3-11A, the input resistance is equal to the value of the grid resistor. Because of the large amount of inverse feedback, the output impedance is only a few hundred ohms. So, we can feed our output signal to an oscilloscope or vtvm through a shielded lead, without running into pickup problems or undue attenuation of high-frequency signals.



(A) The probe.



(B) Probe circuit.

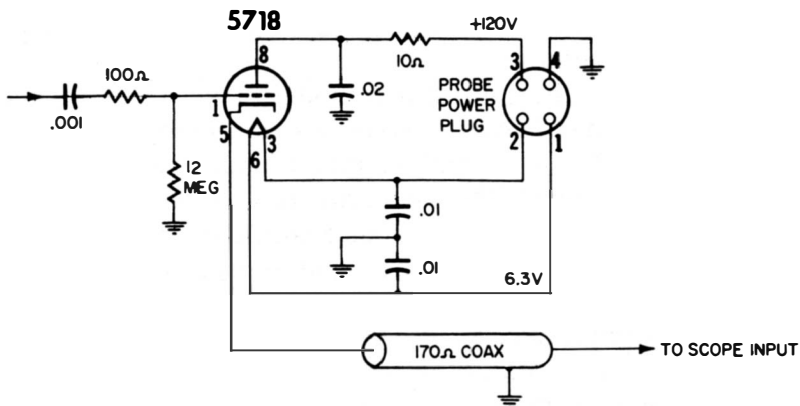
Courtesy Jackson Electrical Instrument Co.

**Fig. 3-12. Jackson LC-2-1P cathode-follower probe.**

A cathode-follower probe is also suitable for use with an a-c vtvm. However, the gain of the probe, being somewhat less than 1, must be taken into account when voltage readings are made.

Another very favorable advantage of a cathode follower is that the capacitance between the grid and cathode circuits is also decreased by a factor of  $1 - A$ . Thus, for a gain of 0.9 we are left with only one-tenth the grid-to-cathode capacitance. The only other capacitance left is grid-to-plate, which accounts for about half the total input capacitance.

Sometimes it is advisable to use a cathode-follower probe ahead of a demodulator probe if circuit impedances are so high that the demodulator probe alone would present greater loading than can be tolerated. The cathode-follower probe can thus "pick-off" the signal and convert it to a low-impedance level without too much loss—at which time the demodulator probe takes over.



**Fig. 3-13. Schematic of the Tektronix P170-CF cathode-follower probe.**

Now, for some practical circuits. Some oscilloscope and vtvm manufacturers have provided for a cathode-follower type of low-C probe, in which the required supply voltages are furnished by the test equipment being used. The Jackson Model LC 2-1P probe in Fig. 3-12, is designed for an oscilloscope equipped with a connector to provide the necessary filament and plate voltages. This connector also carries the cathode-follower output signal to the vertical-input circuit of the oscilloscope.

A 0.01-mfd blocking capacitor in the grid circuit allows a-c measurements to be made in circuits where both alternating current and direct current are present. The maximum signal voltage that can be

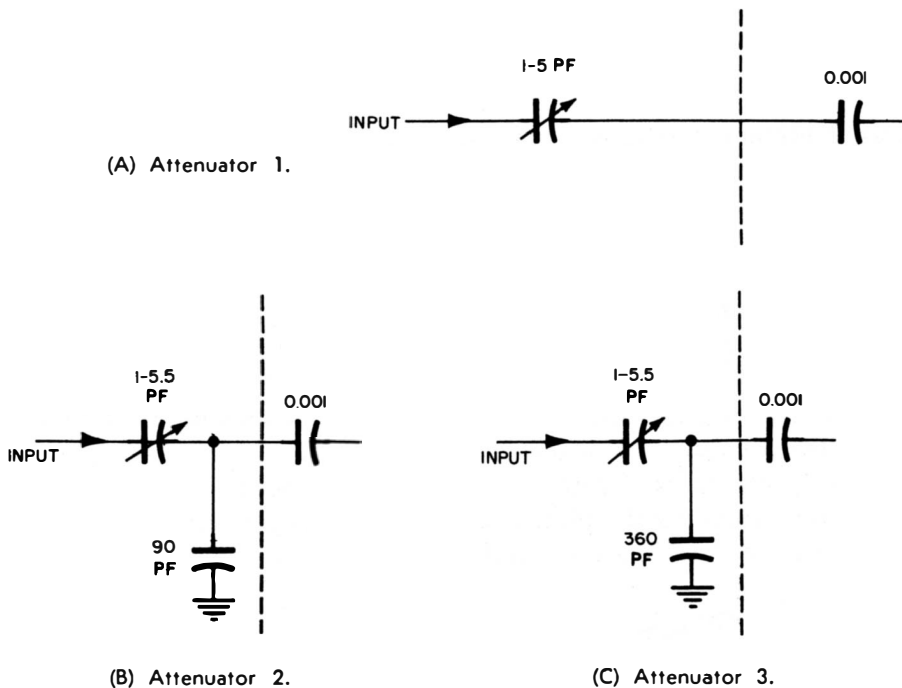
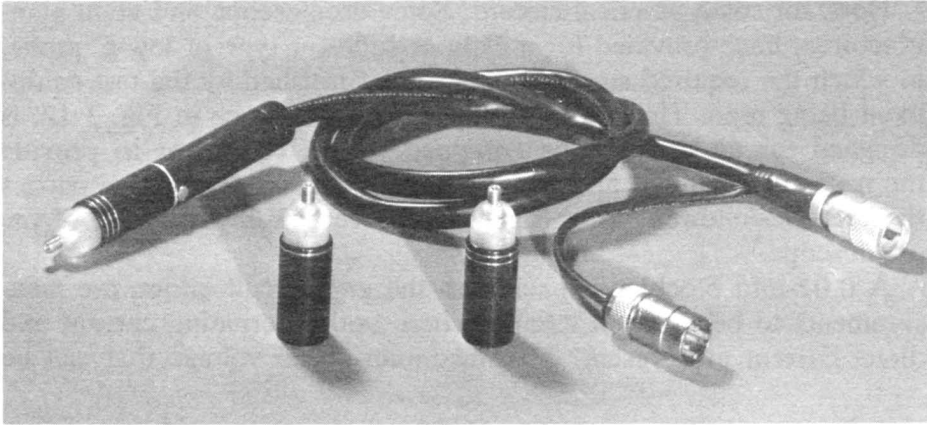


Fig. 3-14. Attenuations used with the cathode-follower probe in Fig. 3-13.

applied to this probe is 25 volts peak-to-peak, and the maximum d-c level at which measurements can be made is 500 volts. The input impedance of the probe is 6.2 megohms, shunted by 8 pf. A 5703 subminiature tube is used in the cathode-follower circuit, and the probe has an attenuation ratio of 2 to 1—lower than the ratios of the r-c type low-C probes discussed previously.

Another cathode-follower probe is the Tektronix P170-CF shown schematically in Fig. 3-13. The three attenuator circuits used with it are shown in Fig. 3-14. This probe, when used without attenuators, also has an attenuation factor of 2-to-1. It is designed for a maximum



Courtesy Tektronix, Inc.

**Fig. 3-15. The P170-CF cathode-follower probe and the various attenuators.**

signal input of no more than  $\pm 2$  volts peak for undistorted output. Available are variable attenuator heads that screw onto the head of the probe (Fig. 3-15) and are adjustable by means of a screwdriver adjustment in the nose.

A maximum signal of  $\pm 6$  volts may be applied at a minimum setting of the first attenuator (Fig. 3-14A). For an attenuation ratio of 20 or over, the input signal may be increased to  $\pm 20$  volts with the second attenuators (Fig. 3-14B). If we use the third attenuator (Fig. 3-14C), which gives a minimum attenuation of 200, a maximum input signal of  $\pm 200$  volts may be applied.

This probe is used with a Type 517 oscilloscope, which has provisions for supplying the plate and filament voltages required for proper operation of the 5718 tube in the probe.



**Fig. 3-16. A probe power supply.**

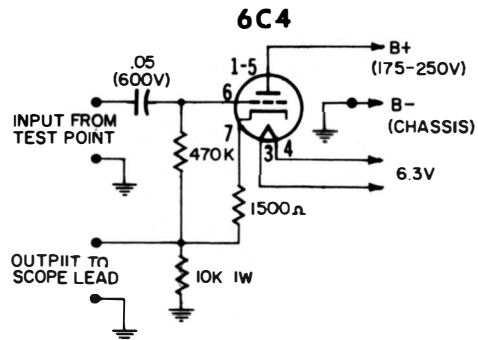
Courtesy Tektronix, Inc.



Note that there is no cathode resistor in the probe. The cathode follower depends on the termination of the coaxial cable to complete its cathode circuit to ground. When the probe is used with the Type 517 oscilloscope, the cathode resistor of the tube is the 170-ohm input termination of the preamplifier grid line in the scope. With any other oscilloscope, however, a suitable 170-ohm termination resistor must be connected across the vertical-input terminals of the scope. For proper matching, the output signal from the cathode follower is fed through the coaxial cable, the characteristic impedance of which is also 170 ohms. If the instrument has no plate and filament voltages, a source of low-ripple 120-volt B+ and 6.3-volt filament voltage (150 milliampere; preferably direct current) must be made available. A power supply suitable for operating two of these probes is shown in Fig. 3-16.

A mathematical analysis would show that a cathode follower with a capacitive load in a cathode circuit exhibits a negative-resistance component (conductance) at certain frequencies. For example, the probe circuit in Fig. 3-13 exhibits conductance between approximately 2.5 to 12 megacycles, its greatest value being somewhere between 7 and 8 megacycles. Therefore, in an inductive or tuned circuit that resonates between 2.5 and 12 megacycles, we may experience an ap-

Fig. 3-17. An easily constructed cathode-follower probe.



parent increase in the  $Q$  of the circuit. If the circuit losses are sufficiently low, the application of the probe may cause oscillations, similar to the way a Colpitts oscillator operates. Such difficulties can generally be overcome by inserting an isolation resistor of several thousand ohms at the probe tip.

Always remember, when using a cathode-follower probe, that the output-signal level will contain a d-c component of several volts. Therefore, if there is no d-c blocking capacitor, one must be inserted in the input circuit of the oscilloscope. When an a-c/d-c scope is employed, the switch should be in the a-c position.

If no cathode-follower probe is at hand, one can be very easily constructed for checking equipment when a filament and plate voltage

source is readily available. This might happen while we are servicing a television receiver and want to make observations on an oscilloscope, but have neither a low-C nor a cathode-follower probe handy. Fig. 3-17 shows the circuit of a cathode-follower probe that can be easily assembled because it contains only a few parts.

The filament and plate voltages for this probe are taken from the receiver with which it is used. Signals up to 75 volts peak-to-peak can be applied to this cathode follower. Higher ones should be attenuated

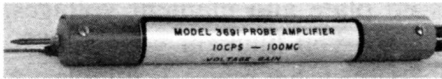


Fig. 3-18. Nuvistor-transistor high-impedance probe.

Courtesy C-Cor Electronics, Inc.

before they are applied to the probe, or else they can be directly applied to the vertical-input terminals of the oscilloscope.

Fig. 3-18 shows a photograph of a unity-gain, low-capacitance probe which combines the advantages of the high input impedance of a nuvistor vacuum tube with the low output impedance of the transistor emitter-follower circuit. The probe has a nominal gain of unity at 50 megacycles and a minimum input impedance of one megohm shunted by approximately 50 picofarads. It has an output of one-half volt peak-to-peak into a 50-ohm load at frequencies up to 100 megacycles. When operating from a 50-ohm source, the frequency range extends from 10 cps to 200 megacycles. The equivalent input

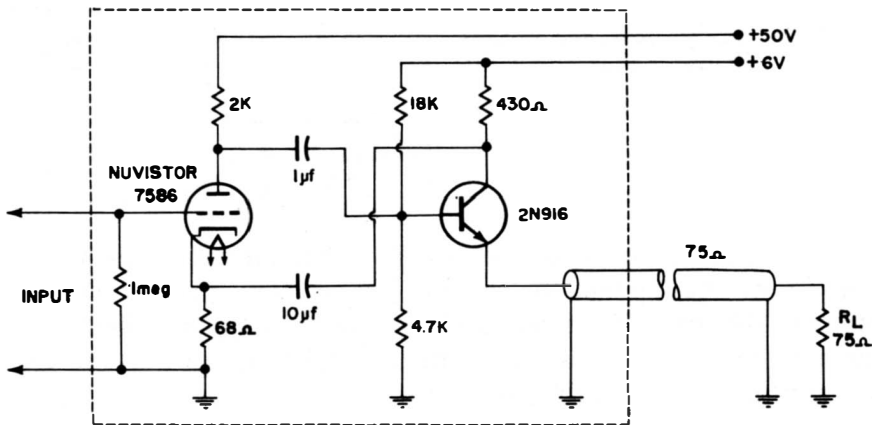


Fig. 3-19. Schematic of unity-gain, nuvistor-transistor high-impedance probe.

noise is less than 40 microvolts at a 50-megacycle bandwidth with a 10-kilohm input terminator and is typically 130 microvolts at full bandwidth. This particular probe requires a power source of 25 volts d-c at 30 ma and 6.3 volts a-c at 0.15 amp.

A representative circuit of a nuvistor-transistor probe is shown in Fig. 3-19. Input is to the grid of the nuvistor whose plate is coupled through a 1-mfd capacitor to the transistor base. To achieve low output impedance the transistor is connected in an emitter-follower configuration. To maintain high-gain stability, negative feedback is obtained by adding the 10-mfd capacitor from the collector of the transistor to the cathode of the nuvistor, resulting in overall unity gain. The maximum input level is about 0.2 volts.

## Rectifier Probes

Rectifier probes are added to the voltmeters to enable the measurement of r-f, i-f, and video frequencies. Normally they increase the input resistance and decrease the input capacitance of the meter.

Vtvm's are essentially d-c indicating devices. The most common is the two-tube bridge type (shown schematically in Fig. 4-1), in which a potential unbalance due to application of a voltage to one of the grids causes a difference of potential between the two cathodes. This, in turn, sends a current through the meter.

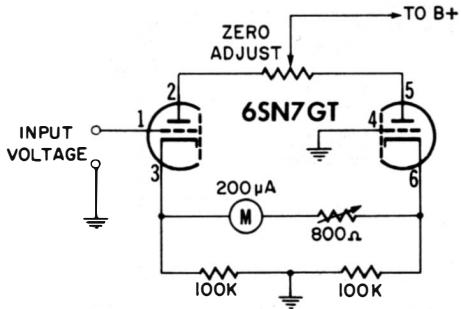
The d-c scales of the meter are linear, but a linear a-c scale would also be desirable. Therefore, a linear rectifier is needed, the d-c output of which is directly proportional to the applied a-c voltage.

A vacuum-tube or semiconductor diode in the probe furnishes this rectification. Although both types of diodes serve the same purpose, each has its advantages and drawbacks. The waveform, frequency, and amplitude of the voltage being measured determine the selection.

If we are interested in measuring the peak value of a signal, the vtvm must have a half-wave peak-indicating rectifier preceding its voltage-divider input circuit. The scale of the vtvm is then calibrated to read peak a-c voltage.

The rectifier circuit itself may be built into the vtvm, or contained within the probe . . . the operating principle is the same. If the circuit is in the meter, the frequency response is limited to no more than a

Fig. 4-1. Basic circuit of a vacuum-tube voltmeter.



few megacycles at best. Beyond that, accuracy will drop sharply because of the shunt capacitance from the cable connected to the meter. The most common rectifier circuit, the shunt type in Fig. 4-2, uses either a vacuum-tube (Fig. 4-2A) or semiconductor (Fig. 4-2B) diode.

Some vtm's contain rectifier circuits which indicate peak-to-peak voltages of all waveforms—including sine waves as well as complex waves and pulses. Peak-to-peak reading vtm's are particularly useful in the servicing of television receivers because, in addition to the correct waveshape, the service manuals indicate the peak-to-peak voltage values throughout the receiver. Peak-to-peak indicating vtm's usually have an additional scale showing the rms values of sine-wave signals.

Peak-to-peak indications are obtained by means of voltage-doubler rectifier circuit which, like the half-wave rectifier, is built into the instrument or probe. Here again we may use semiconductor rectifiers or a twin-diode vacuum tube—usually a small high-frequency diode designed for reasonably high voltages, with low plate-to-cathode capacitance.

Some instruments of their probes permit either peak or peak-to-peak indications to be selected by simply flipping a switch.

Fig. 4-3 shows a diode with only heater voltage applied. If a meter is inserted in the plate circuit, a small current will flow from cathode to plate, even though no plate voltage is applied.

This current occurs when some of the electrons which leave the heated cathode manage to reach the plate, even though no positive voltage is present there to attract them. Admittedly, the current is in-

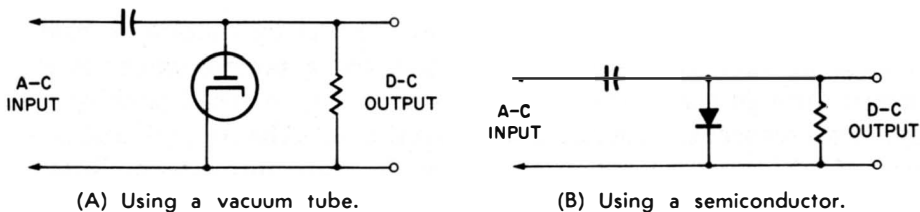


Fig. 4-2. A shunt-type diode rectifier circuit.

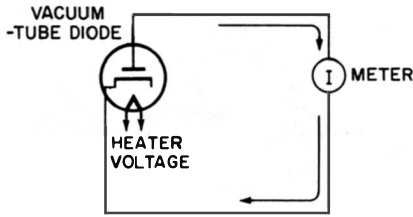


Fig. 4-3. Current will exist in a diode circuit with only heater voltage applied.

deed small. Nonetheless, if there were a resistor in the plate-to-cathode circuit, a voltage drop would be developed across it.

Even if the current is only 25 microamperes, a 20,000-ohm resistor in the plate circuit will produce a voltage drop of one-half of a volt. This means the plate will now be one-half volt negative with respect to the cathode. Therefore, we would first have to apply one-half volt to the probe—in order to overcome this opposing voltage—before we could get any output indication from the signal under test. Of course, the sensitivity of the probe will then be reduced, particularly at low voltages. We will also get a one-half volt indication on our vtvm, even though there is no applied voltage. This voltage (called *contact potential*) can be nullified, however, by a bucking (canceling) voltage equal in magnitude but opposite in polarity.

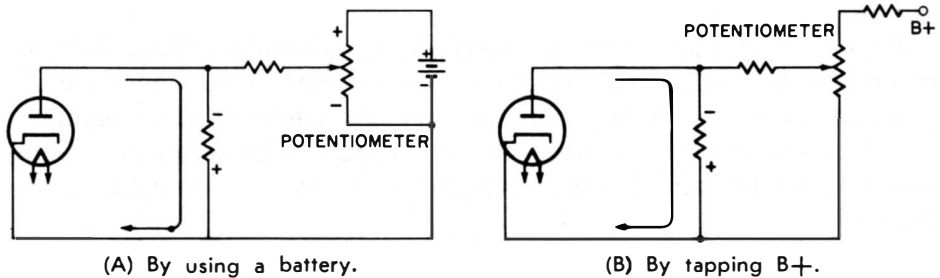


Fig. 4-4. Two ways of obtaining a bucking potential.

The contact potential of a vacuum-tube diode can be nullified in several ways. The one usually employed in a vacuum-tube voltmeter is to connect one or more dry cells and a potentiometer to the tube in such a manner that we can adjust the pot to deliver a voltage of equal size but opposite polarity to the one developed by the diode. This is shown in Fig. 4-4A. If we want to get away from the problem of replacing dry cells, we can get the same results by tapping a bleeder resistor in the power supply. In Fig. 4-4B, a potentiometer is connected through a voltage-divider resistor to B+. A small positive voltage (with respect to ground) is developed across the potentiometer, the arm of which is connected to the diode plate through an isolation resistor. By proper adjustment of the potentiometer, we can apply a bucking potential which opposes the contact potential developed by

the tube. As long as the diode is operating properly, the potentiometer should need no further adjustment.

A third way of neutralizing the contact potential of the diode is to add another diode—either the second half of a twin diode, or a separate tube within the instrument—and use the contact potential of this diode to counteract that of the first. This is explained later in the chapter.

## VACUUM-TUBE AND SEMICONDUCTOR DIODES

Although it does have the advantage of being able to handle higher voltages than the semiconductor diode, the vacuum-tube diode requires a filament voltage and a means of compensating for the contact potential it develops. On the other hand, the semiconductor diode not only requires no filament voltage, but also is smaller. Its voltage-handling capabilities are usually limited, but its output may be fed directly to the d-c voltmeter—no balancing (bucking) potential is needed.

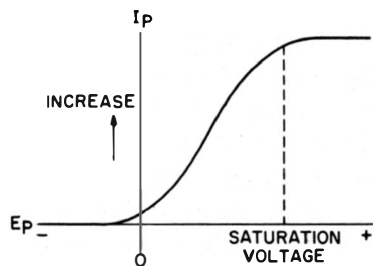
The plate-voltage—plate-current characteristics of a typical diode tube are shown in Fig. 4-5. Except at the two extremes of the curve, the plate current varies proportionally with the plate voltage. At the top of the curve, the characteristic of a diode is such that any further increase in plate voltage will not proportionally increase the plate current. This point is the *saturation voltage* of the tube.

It is most desirable for the plate current of the vacuum tube to vary in step with the plate voltage. In this way, when a vacuum tube is used as a rectifier, its output over most of the characteristic curve will be directly proportional to the applied a-c signal.

We can avoid the saturation region by limiting the maximum voltage applied to the tube. However, linear output still cannot be obtained at the lower end of the curve when small input voltages are introduced. For this reason, the 1-, 3-, and sometimes the 5-volt ranges are nonlinear on a vtvm containing a vacuum-tube rectifier.

The vacuum-tube diode in a probe should have the lowest possible plate-to-cathode capacitance and the highest possible input resistance,

Fig. 4-5. Typical plate-voltage and -current characteristics of a vacuum-tube diode.



in order to offer a high input impedance to the circuit under test. Special diodes are available which have all the desirable characteristics for use in high-frequency probes. The chart in Table 4-1 compares the characteristics of vacuum-tube and semiconductor diodes.

**Table 4-1. Comparison of vacuum-tube and germanium diode characteristics**

Vacuum-Tube Diodes	Germanium Crystal Diodes
<p>Develops contact potential which must be compensated for.</p> <p>Emission affected by line voltage.</p> <p>High-frequency response limited by transit time.</p> <p>Maximum input voltage is usually 200 to 500 volts.</p> <p>Momentary overload usually doesn't cause permanent damage.</p> <p>Is stable over wide temperature range.</p> <p>Tubes can be easily replaced. Usually no selection, only changing required.</p> <p>Response becomes very nonlinear below one volt due to curvature of characteristic curve.</p>	<p>Develops no contact potential.</p> <p>No such problem.</p> <p>High-frequency response better than for tube.</p> <p>Maximum input voltage of most crystal probes is 28 volts peak.</p> <p>Voltage overload usually destructive.</p> <p>Affected by changes in temperature.</p> <p>Diodes may have to match meter scale and instrument calibration.</p> <p>More linear response than tube at low voltage levels.</p>

Semiconductor diodes are very small compared to vacuum tubes. For this reason, the elements do not have much capacitance and series inductance. So, we gain the advantage of a very good frequency response. There are a few commercial probes which, by using the frequency-response characteristic to the utmost, permit measurements in the gigacycle range.

Fig. 4-6 shows some vacuum-tube and semiconductor diode symbols and how to identify their polarities.

When an a-c voltage is applied across a semiconductor diode, current will flow during one half of each cycle. During the other half the semiconductor diode will present a much higher resistance. This is its *inverse resistance*. The ratio between these two resistances should be at least 1000:1. In most vacuum tubes, the inverse resistance of around two to ten megohms is so high, compared to the shunt resistance across the circuit, that we can ignore it. In a semiconductor diode, however, it may drop as low as several thousand ohms. Since the inverse resistance and the input circuit of the probe are essentially in parallel, the input impedance of the probe may be seriously reduced at low frequencies. (Keep this fact in mind when measuring low-frequency signals with a probe containing a semiconductor diode!)



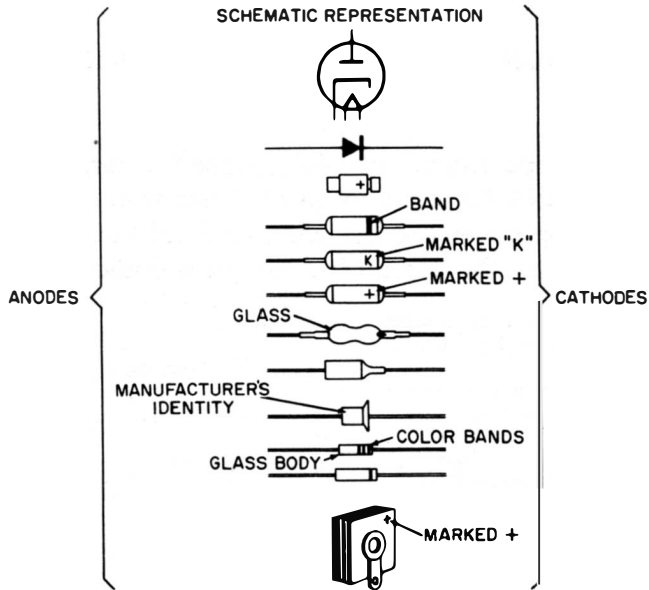
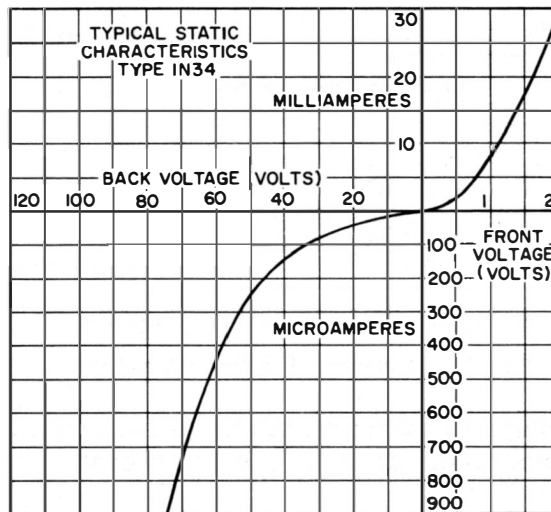


Fig. 4-6. Representations of a vacuum-tube, germanium, silicon, and selenium diodes.

The characteristic curve of a 1N34 diode (Fig. 4-7) is similar to that of a vacuum tube at the lower portion, becoming essentially a square-law curve below one volt. Unlike the vacuum tube, however, the semiconductor diode has zero current at zero volts. The reason is that we do not have the contact-potential problem we had with the vacuum tube, since there are no electrons being propelled by thermionic emission.

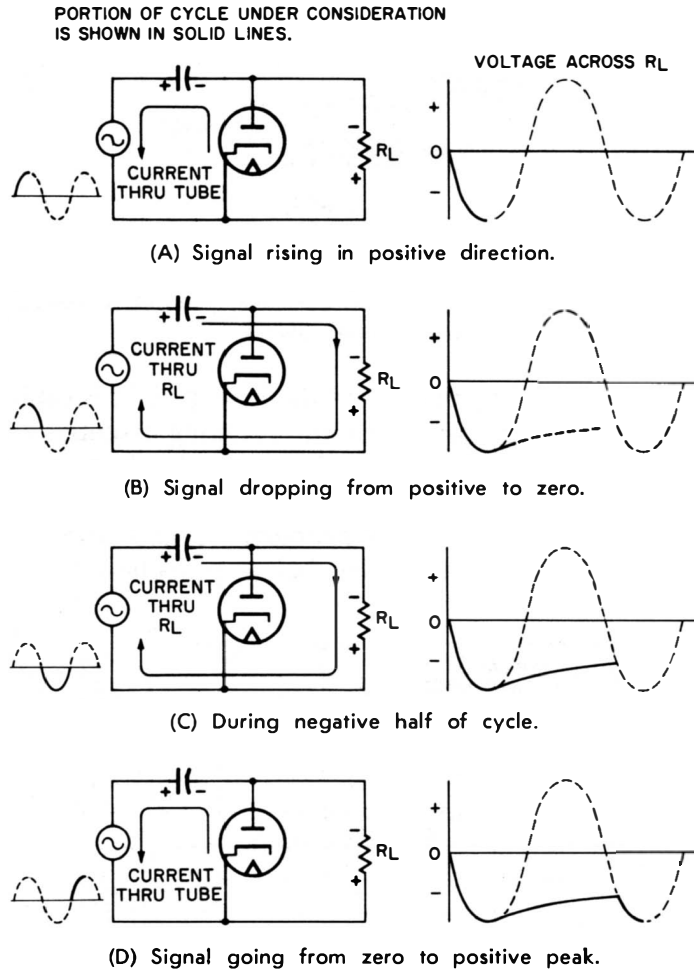


Courtesy Sylvania Electric Products, Inc.

Fig. 4-7. Static characteristics of the 1N34 germanium diode.

## PEAK-READING, SHUNT-TYPE RECTIFIERS USING VACUUM TUBES

A rectifying probe raises the high-frequency range of the meter being used. The probe functions as an r-f detector to provide a rectified output voltage proportional to the peak value of the voltage detected. First, let us discuss the circuit of the peak-indicating, shunt-type



**Fig. 4-8. Operation of a shunt-type rectifier.**

rectifier employing a vacuum-tube diode. Its d-c output is equal to the peak value of either (but not both) half cycles of the applied a-c input voltage.

Fig. 4-8 shows the simple circuit for a shunt diode rectifier. It has an a-c input voltage (which, for simplicity, we will assume to be a sine

wave) and a load resistor,  $R_L$ , across which we get our output voltage.  $R_L$  may be split up into two resistors and the output taken across only one of them. For ease of explanation, we will use only one resistor now.

When the input voltage first swings in a positive direction (Fig. 4-8A), the plate of the diode also becomes positive with respect to the cathode. The tube then conducts and thereby acts as a low resistance in parallel with  $R_L$ . During the first half of the positive cycle, the increasing positive plate voltage attracts electrons through the tube, to the side of the capacitor connected to the plate. The capacitor is thus charged to the peak value of the applied voltage; the polarity of this voltage is such that the side connected to the plate is negative with respect to the side connected to the input signal. As the voltage drops from its peak value during the second portion of the positive cycle (Fig. 4-8B), the tube does not conduct because its plate is negative with respect to its cathode. Now the tube acts as a high resistance across the circuit, so the capacitor begins to discharge through  $R_L$ .

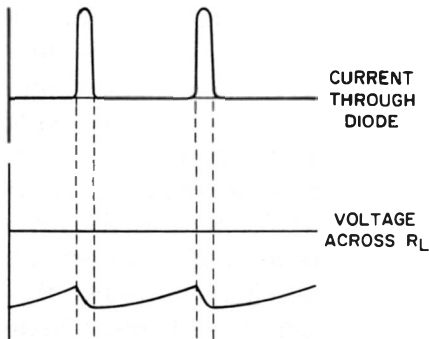
The resistance of  $R_L$ , although relatively high, is still lower than that of the tube when not conducting. So the discharge will take place rather slowly and will follow the shape of the standard discharge curve of a capacitor. The time constant of this circuit is made so long that, even at low frequencies (and here, the lower frequency limit is determined partly by the size of the capacitor), very little of the capacitor charge will leak off through the resistor before the current flows through the tube, again recharging the capacitor.

As the input signal passes through zero and into the negative half-cycle (Fig. 4-8C), the capacitor will continue to discharge through the resistor. There can be no further conduction through the diode because its plate is still negative with respect to its cathode. The input signal again goes through zero and in the positive direction (Fig. 4-8D). When the input voltage exceeds the level to which the capacitor has discharged through the load resistor, the plate becomes more positive than the cathode and the tube conducts, again charging the capacitor to the peak value.

After the first cycle, the circuit will assume a steady-state condition. The only current will consist of pulses—each lasting only a tiny fraction of a cycle—through the diode during positive peaks of the input signal, as shown in Fig. 4-9. The plate resistance is infinite while the tube is not conducting. This infinite resistance, plus the fact that the load resistor is usually many megohms, is the reason for the extremely high input impedance of the circuit. Any or all of the capacitor charge that leaks off through the load resistor while the tube is not conducting is applied to the vtvm. The voltage drop across  $R_L$  is directly proportional to the charge on the capacitor. Therefore, the

d-c voltage output is a direct indication of the peak value of one-half cycle of the applied a-c voltage.

In addition to functioning as a charging capacitor for the rectifier circuit, the input capacitor also blocks any direct current, to prevent it from reaching the diode. Therefore, measurements can be made at the plates and grids of vacuum tubes, where a d-c voltage also accompanies the a-c signal.



**Fig. 4-9.** Current pulses through diode after several cycles of input signal have passed.

Because of the way the diode is connected in Fig. 4-8, the meter indication will be proportional to the positive peak voltage of any signal applied. The diode will conduct during the positive half-cycle only; there will be no conduction during the negative half-cycle, regardless of any excursion in that direction. If we ground the plate and connect the cathode to the capacitor, we will get an indication during the negative peak value of the input voltage only. The tube operates exactly as before, except now it conducts during only the negative peak of the input signal. Of course, the plate is still made positive (with respect to the cathode) before the tube conducts.

When the rectifier is in a separate probe connected to the vtvm with a shielded cable, the shield or ground will be positive with respect to the vtvm input terminal if this tube is connected as shown in Fig. 4-8. If we reverse the tube—that is, ground the plate and connect the cathode to the capacitor—the shield will be negative with respect to the input terminal. In a zero-center vtvm, the needle will swing to the left or right, depending on the polarity of the probe output voltage. On most vtvm's, however, the zero is on the left side of the dial. By setting the polarity switch on the front panel, we can make the needle read upward, regardless of whether a positive or negative voltage is applied.

From Fig. 4-9, we can see that the capacitor charges through the tube during only a very short portion of the input-voltage cycle. During the remainder of the cycle (which is many times longer), the capacitor discharges through the resistor. The rather low average cur-

rent through the vacuum tube results in a very high input impedance for the probe. By maintaining a low shunt capacitance and limiting the current through the tube to a small portion of the cycle, we present a high impedance to the circuit under test. This, of course, means less loading than if there were a large distributed capacitance and a more continuous current through the diode.

During each cycle of the input voltage, the capacitor is quickly charged, but only partially discharged. Therefore, the time constant of the input capacitor and the load resistor must be made as long as practical, so the capacitor will discharge as little as possible between peaks of the input voltage. In this way, the d-c level can be maintained equal to the peak input voltage.

In Fig. 4-10 we see that with a given time constant, the output voltage depends on the frequency of the input signal. The time constant must therefore be chosen so the shunt capacitance is kept low for the higher frequencies. Yet the time constant must be long enough that low-frequency voltages can also be measured satisfactorily. It is obvious that the value chosen for the capacitor must be a compromise. Usually it is such that the time constant of the RC network is approximately 100 times the reciprocal of the lowest frequency we wish to measure. This is given by the following equations:

$$T = \frac{1}{f}$$

where,

T is the time for one cycle of the input signal,

f is the frequency of the signal in cycles per second.

The time constant of an RC circuit equals R times C (where R is the resistance in megohms and C is the capacitance in microfarads); RC must equal 100T. Therefore, by substitution,

$$RC = 100 \times \frac{1}{f}$$

$$fRC = 100$$

$$C = \frac{100}{fR}$$

If the value of the capacitor is too small, or if the frequency to be measured is lower than the one chosen for our capacitor value, the meter indication will be low because the capacitor will lose too much charge between peaks of the input voltage. Therefore, the average voltage across  $R_L$  will be lower than the peak input voltage.

Let us consider the relationship between time constant RC and the charge remaining in a capacitor at various times during discharge.

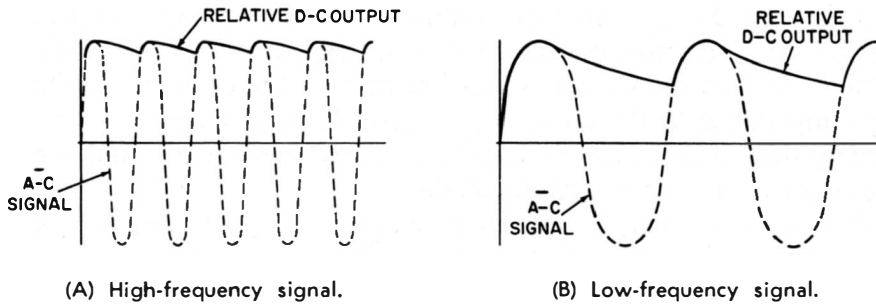


Fig. 4-10 Effect of the input-signal frequency on the rectifier output.

This relationship is shown by Fig. 4-11, where the charge is plotted vertically and time ( $t$ ) horizontally. Notice that the  $X$  axis is divided into  $RC$  units, not seconds—that is,  $0.1RC$ ,  $0.2RC$ ,  $1RC$ , and so on. Although the co-ordinate for any value of  $t$  can be found by formula, we will not give it here, but may quote values obtained by its use.

The formula enables us to find the charge remaining on the capacitor after one cycle of discharge. This can be done for *any*  $RC$  product or *any* signal frequency. For example, suppose we choose a specific signal frequency and design a probe to meet the requirement of  $RC = 100T$ . How closely will the output voltage match the input voltage? Rearranging the formula, we get  $T = RC \div 100$ . The corresponding value for  $t$  in Fig. 4-11 would be  $RC \div 100$ , or  $0.01RC$ , except for one fact:  $t$  in Fig. 4-11 represents the discharge time en-

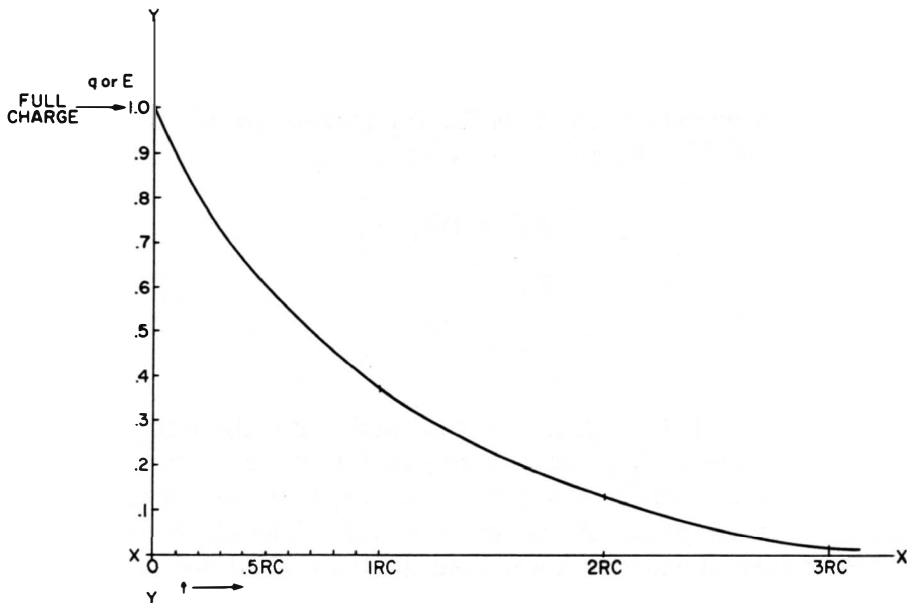


Fig. 4-11. Discharge curve for an  $RC$  circuit.

tirely;  $T$ , the duration time of one complete input cycle, is therefore half charge and half discharge time. For this reason, we must use the formula,  $t = 0.005RC$ . This value is too small to be read on the curve of Fig. 4-11, but, if substituted in our absentee formula, yields 0.9952—the charge remaining at the end of the cycle. In other words, the charge on the capacitor has dropped less than one-half of one percent. Thus, the formula  $RC = 100T$  gives us a negligible loss. In fact, a figure of  $RC = 10T$  might sometimes be acceptable. The latter would give a loss of not quite five percent.

Let us see what value of  $RC$  would be necessary for a probe designed to pass 60 cps—first for  $RC = 100T$ , and then for  $RC = 10T$ .

(1) At 60 cps,  $T = 1 \div 60$  and  $RC = 100 \div 60$ .

If we choose 10 megohms for  $R$ , then  $C$  must be approximately 0.17 mfd. If  $R$  is 20 megohms, then  $C$  can be half as large, or 0.085 mfd.

(2)  $RC = 10T$  and  $T = 1 \div 60$ ; therefore,  $RC = 10 \div 60$ .

If  $R$  is 10 megohms,  $C$  will be .016 mfd; and if  $R$  is 20 megohms,  $C$  will be 0.0085 mfd.

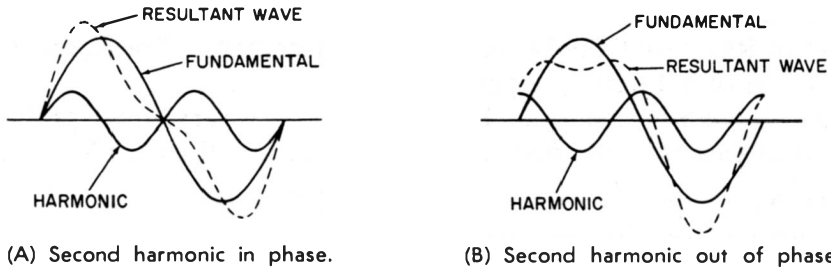
Frequencies lower than 60 cps would result in a greater loss, which becomes smaller at higher frequencies. Therefore, the probe is good for all frequencies above 60 cps (up to the point where distributed circuit capacitance begins to take effect). For lower frequencies, however, we must accept more loss.

Besides the characteristics of a probe at higher frequencies, we must be concerned with those of the material in the probe, plus skin effect and the transit time of the tube. To keep the dielectric losses as low as possible, those portions of a tube carrying r-f energy are usually protected by polystyrene or other good r-f insulation. Skin effect (where the higher-frequency currents travel close to the surface of a conductor instead of through it) can be greatly reduced by making the r-f-carrying circuit—in other words, the probe tip and the capacitor leading to the diode—as short as possible. Transit-time difficulties can be lessened, up to several hundred megacycles, by using the tiny ultra-high-frequency diode tubes designed for this purpose.

One of the more important requirements for a high-frequency probe is that it exhibit the lowest possible shunt capacitance. Why this is true can be understood from the fact that at 100 megacycles, for example, the reactance of a 10-pf capacitance is only 160 ohms. The probe itself not only must have a low input capacitance, but also must not introduce additional stray capacitance when connected to the equipment under test.

So far we have dealt with sine waves only. But if the input voltage contains harmonics, our meter indication may differ (sometimes even

greatly) from the rms value. The amount will depend on the percentage of harmonics and their phase relationship to the fundamental frequency. Fig. 4-12A shows the resultant waveform when an in-phase second harmonic is combined with the fundamental; Fig. 4-12B, when the second harmonic is out of phase. Table 4-2 is an example of the



**Fig. 4-12. Effect of the second-harmonic phase on the fundamental waveform.**

erroneous readings obtained when voltages containing harmonics are applied to an rms-calibrated vtvm. These errors will crop up, regardless of whether the meter is calibrated for peak or for rms voltages.

A peak-reading voltmeter will also give erroneous readings if used to measure an unsymmetrical waveform. Moreover, if a 180-degree phase shift exists (such as at the grid and plate of a tube), two different peaks will be measured—the positive or negative one at the grid, and a peak of the opposite polarity at the plate. One way of circumventing this problem is to measure peaks of the same polarity at both the grid and plate. This we do by using the polarity-reversal switch on the voltmeter as we check from grid to plate. However, we must also take the electrical characteristics of the signal source into account, so we can be sure such a reversal will not be detrimental.

### **Transit Time**

The frequency of the voltage under test increases until the time (transit time) the electrons take to travel from the filament or cathode to the plate of the diode becomes a noticeable—and often an appreciable—portion of a cycle of the applied input voltage. From here on, the tube characteristics change radically: The electron flow between elements is no longer instantaneous; nor does it follow exactly the changes in plate-to-cathode voltage. Because the tube is unable to respond faithfully to the changes in amplitude of the input signal, an error is introduced in the output voltage. This error becomes larger as the frequency of the applied signal increases. The plate resistance and the plate-to-cathode capacitance of the tube also change. This is



**Table 4-2. Measurement errors from harmonic or other spurious voltages**

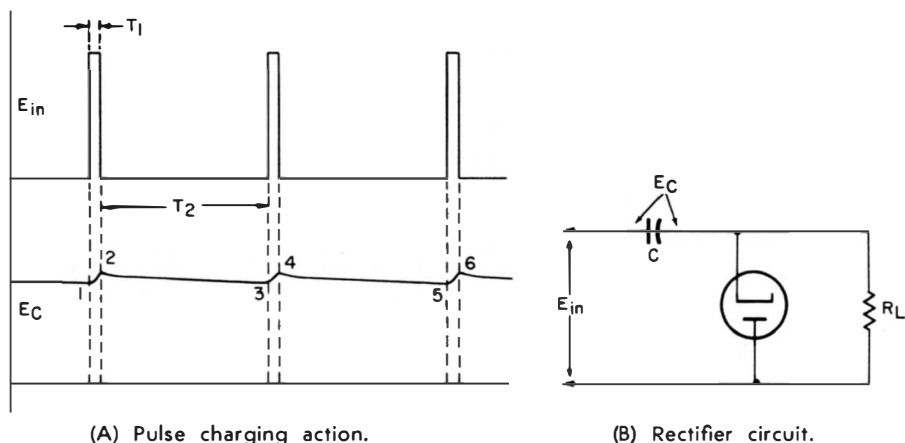
% Harmonic	True Rms Value	Peak Meter Indication
0	100	100
10% 2nd.	100.5	90 to 110
20% 2nd.	102	80 to 120
50% 2nd.	112	75 to 150
10% 3rd.	100.5	90 to 110
20% 3rd.	102	88 to 120
50% 3rd.	112	108 to 150

the reason tubes with a short transit time, high self-resonant frequency, and the lowest possible cathode-to-plate interelement capacitance have been designed.

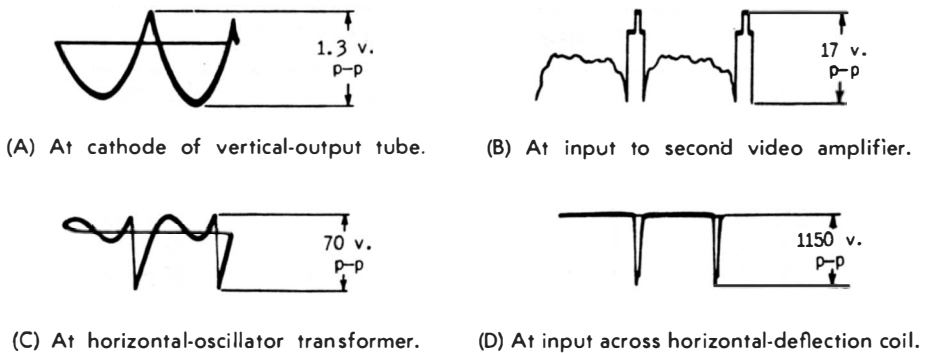
In the input diode of the vtvm, the amount of error due to the transit-time effect depends on the magnitude and frequency of the applied voltage and on the characteristics of the tube—the latter involving the shape, size, and spacing of the electrodes.

### Pulse Response

Let's examine the pulse in Fig. 4-13A. Its width,  $T_1$ , is small compared with the repetition rate,  $T_2$ . The tube, which conducts only when pulses are present, will thus charge the capacitor connected across the load resistor. Our meter will read the voltage developed across  $R_L$  in Fig. 4-13B. The voltage across the capacitor (Fig. 4-13A) has a chance to build up between the very short time interval 1 and 2 only, but has a relatively long time to discharge. The slope of the curve between 2 and 3 will be determined by the time constant of the

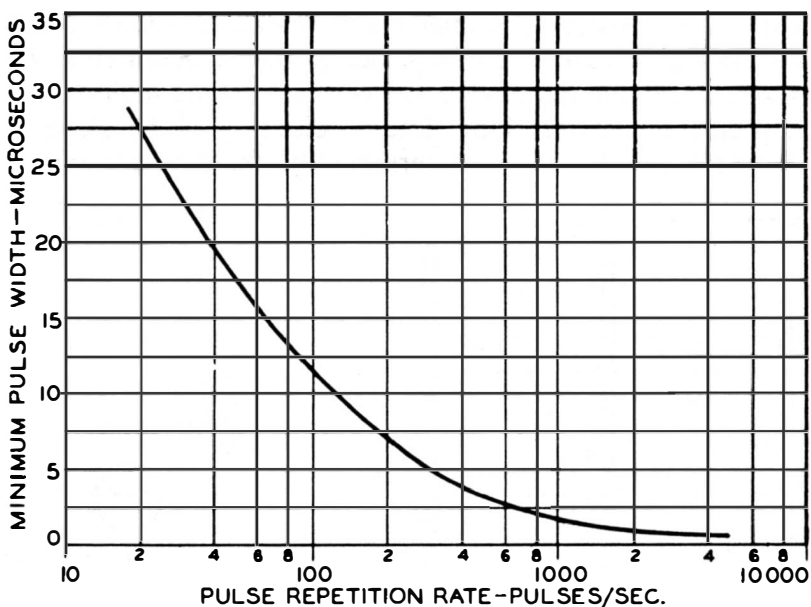


**Fig. 4-13. Output-voltage and pulse-width repetition-rate relationship of the rectifier.**



**Fig. 4-14. Typical nonsymmetrical voltages encountered in television receivers.**

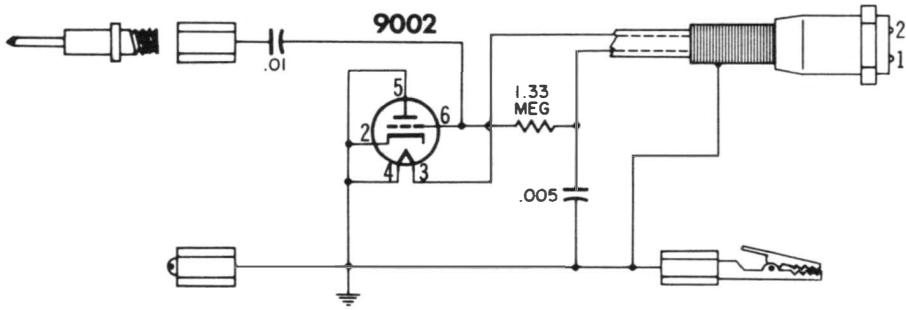
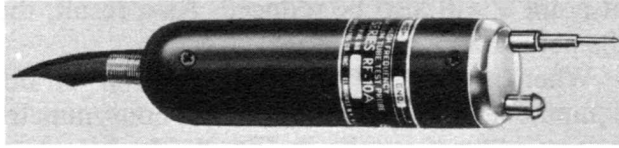
capacitor and load resistor. If the ratio between time intervals  $T_2$  and  $T_1$  is small, the capacitor will then have no difficulty charging to the peak value of the applied voltage. On the other hand, if the ratio is high, we will run into a problem. Assume that  $T_2$  is 999 microseconds and  $T_1$  is 1 microsecond. During this 1 microsecond, the tube must therefore pass the total current drawn by the load during the entire 1000 microseconds from pulse to pulse. So the instantaneous current drawn from the source is 1000 times the current required by the measuring circuit. Moreover, because of transit-time difficulties, the slope from point 1 to 2 may not be steep enough to fully charge the capacitor to the peak applied voltage. Therefore, the capacitor charge



Courtesy Radio Corporation of America

**Fig. 4-15. Pulse-response of a typical vtvm.**

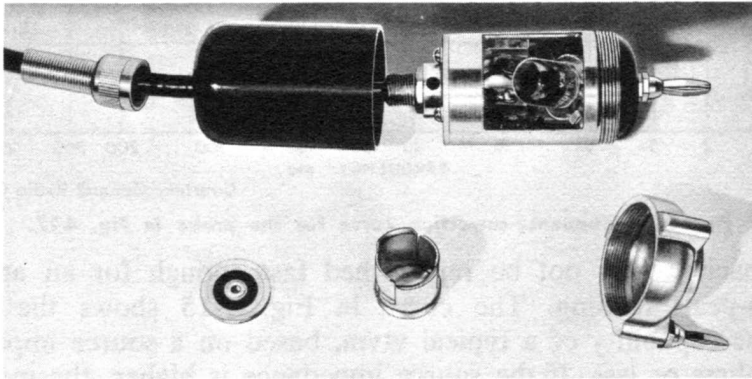
(A) Probe.



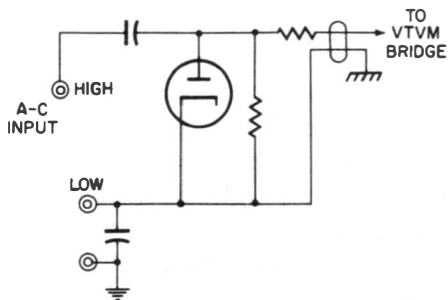
(B) Probe circuit.

Courtesy Precision Apparatus Co., Inc.

**Fig. 4-16. Model RF-10A peak-indicating probe.**



(A) Construction.



(B) Circuit.

Courtesy General Radio Company

**Fig. 4-17. A commercial high-frequency peak-indicating probe.**

at point 3 will also be reduced. As a result, the reading will be below the actual peak value.

When servicing a television receiver or other complex electronic equipment, we encounter many nonsymmetrical and nonsinusoidal voltages like the ones in Fig. 4-14. As you can see, the pulses are narrow and widely spaced—in other words, they have a low repetition rate. Before we can obtain an accurate indication of their peak or peak-to-peak values, we must remember that a relatively constant charge must be maintained on the capacitor between input-voltage peaks. If these peaks are short and very widely spaced, the charge on

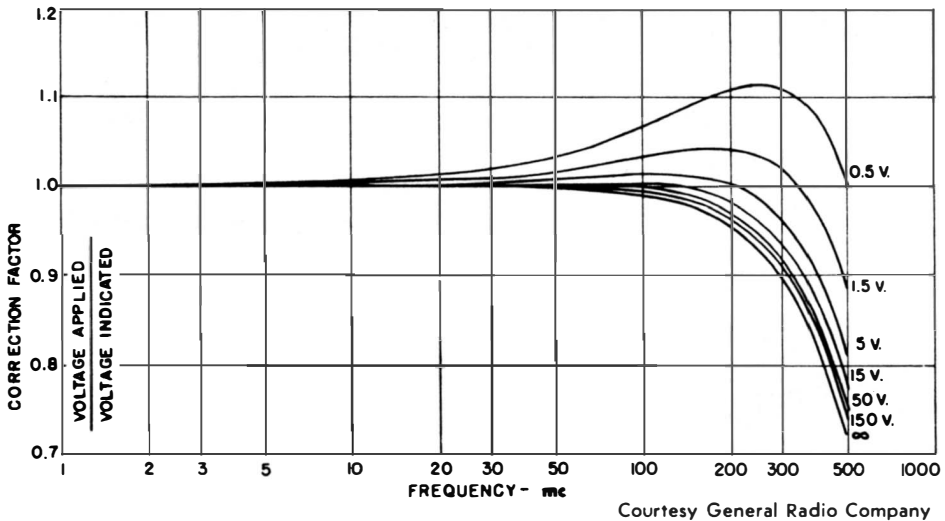


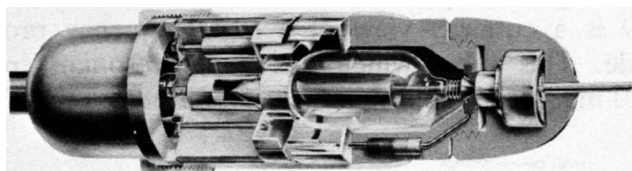
Fig. 4-18. Frequency-correction curve for the probe in Fig. 4-17.

the capacitor may not be replenished fast enough for an accurate peak-to-peak reading. The curve in Fig. 4-15 shows the pulse-response capability of a typical vtvm, based on a source impedance of 50 ohms or less. If the source impedance is higher, the measurement error will increase proportionally.

The pulse-response capability of a peak or peak-to-peak measuring circuit is determined by the time constant of a resistor and capacitor. Therefore, we can measure pulses with a low repetition rate and a narrow pulse width by increasing the value of either the capacitor or the load resistor. The load resistor used to develop the output across the grid circuit of the bridge-type vtvm should be as large as possible without causing grid current to flow. The capacitor should also be as large as possible—up to a certain point. Beyond this point the shunt capacitance will be unbearable.

Because of the difficulties encountered when a vtvm is used to measure the peak-to-peak value of a complex wave, an oscilloscope is often preferred for more accurate measurements.

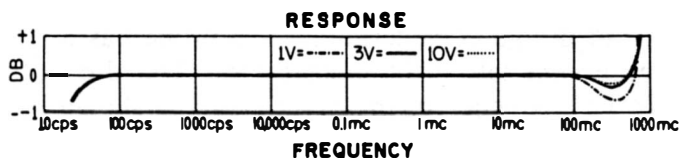
Fig. 4-16A shows the Precision Apparatus RF-10A peak-indicating probe. It employs a diode-connected subminiature triode, as shown by the schematic in Fig. 4-16B. Meter readings become inaccurate below three volts, and even more so below one volt. Below 200 cycles, a low-frequency correction factor must also be applied. The probe indication is proportional to the positive peak value of the applied a-c voltage.



Courtesy Hewlett-Packard Co.

**Fig. 4-19. Internal view of the Hewlett-Packard high-frequency probe used with Model 410-B vtvm.**

Another interesting probe is shown disassembled in Fig. 4-17A, and schematically in Fig. 4-17B. The instrument to which the probe is attached operates as a peak voltmeter calibrated to read rms values of sine waves. At high frequencies, the meter normally reads high because of resonance in the input circuit. However, the transit-time effect of the acorn diode rectifier tube in the probe causes the meter to read



Courtesy Hewlett-Packard Co.

**Fig. 4-20. Frequency response of the probe in Fig. 4-19.**

low. At low voltages, the transit time and resonance effects tend to cancel each other. At higher voltages, however, the measuring errors are due almost entirely to resonance.

The curve in Fig. 4-18 shows the frequency correction required for various ranges. At low frequencies, the equivalent input-circuit impedance of the probe is 25 megohms; but losses due to a shunt capacitance of about 3.1 pf (with the probe cap and plug removed; 4.3 pf if they are included) reduce the 25 megohms at high frequencies.

When the rotating metal cover of the probe in Fig. 4-17A is closed, the probe is completely shielded except for the small insulated area. A metal cap permits various fittings and screws to be attached to the end of the probe. A phenolic cover, held by a nut fastened to a cable

strain release, insulates the probe body behind the cap. For high-frequency measurements, where the minimum inductance is desirable, a cap can be fastened to a flat ground plate and an axial hole provided for the center terminal.

At low frequencies, the response of this probe drops off because of the increasing reactance of the input circuit (but not more than 2 percent at 20 cycles).

A high-frequency multiplier attachment is available which increases the voltage rating of this probe 10 times.

Fig. 4-19 is a cutaway view of a high-frequency probe using a special diode. This tube, which has a self-resonant frequency of around 1250 mc, places approximately 1.5 pf across the circuit under

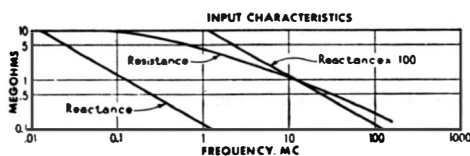


Fig. 4-21. Input characteristics of the probe in Fig. 4-19.

Courtesy Hewlett-Packard Co.

test. At low frequencies the probe has an input impedance of 10 megohms shunted by 1.5 pf. Its frequency response is flat within  $\pm 1$  db from 20 cycles to 700 megacycles. The lower part of this probe is completely enclosed within a grounding shell to aid in establishing a reliable high-frequency ground connection. The Hewlett-Packard probe in Fig. 4-19 is used with the Model 410B vtvm.

As a result of design considerations, the probe has a resonant frequency of approximately 1500 megacycles. The d-c output of the probe *versus* the frequency of the input signal is shown in Fig. 4-20. Note that there are three characteristic curves at the high-frequency end—one each for the 1-, 3-, and 10-volt ranges. At these high frequencies, the response of the probe is affected by (1) the transit time, which depends not only on the frequency, but also on the magnitude of the applied voltage; and (2) the self-resonant frequency of the probe, which is independent from the voltage under test. The effect of the transit time is shown by a dip in the 1-volt curve in the vicinity of 500 mc. The rise beyond 500 mc can be attributed to the fact that the probe becomes resonant and thereby overshadows the transit-time effect. The input resistance and shunt capacitive reactance of the probe in Fig. 4-19 is shown in Fig. 4-21. At frequencies up to 100 mc, the input resistance is greater than 10 meg-ohms, decreasing at higher frequencies because of dielectric and tube losses and the high-frequency effect of the resistor. The shunt-capacitance component is approximately 1.5 pf and, therefore, the reactance curve varies accordingly.

In a voltmeter probe using a vacuum-tube diode, one of the problems in achieving good stability is the effect of changes in line voltage on the characteristics of the tube. When no plate voltage is applied to the tube, we will still get some contact potential. This contact potential, which transfers a small amount of energy to the anode, is directly related to the filament voltage. Hence, changes in the filament voltage will vary the amount of contact potential. Even though relatively small, this change may nonetheless prove to be annoying when measurements are made at low-voltage levels. If the contact potential of another diode is used to counterbalance that of the active tube (as explained previously), the line-voltage changes will affect both tubes at the same time and in the same direction. Therefore, the change in contact potential will not be so detrimental to the accuracy of the measurement.

A ballast element, sometimes used in the more expensive instruments, regulates the filament voltage supplied to the rectifying diode. In this way, a more constant voltage can be maintained over a rather wide variation in line voltages.

### PEAK-READING SHUNT-TYPE RECTIFIERS USING SEMICONDUCTOR DIODES

The circuit of a semiconductor diode probe (Fig. 4-22) is similar to the one employing a vacuum tube mentioned before, in which the peak value of the input voltage is developed across the input capacitor. The same time-constant relationship also holds true for the semiconductor diode—except for one slight difference. When we calculate our time constant, we must remember that the back resistance of a semiconductor diode is not infinite. For this reason, and because the diode is in parallel with the load resistor, some of the capacitor charge leaks off through the diode. We would therefore need a somewhat larger capacitor in order to minimize errors at low frequencies.

When the diode is connected as shown in Fig. 4-22A, the output of the probe is negative; so the vtvm must be set for negative d-c volts. If we reverse the diode (as shown in Fig. 4-22B), the output will be positive, and now the meter must be set for positive d-c volts.

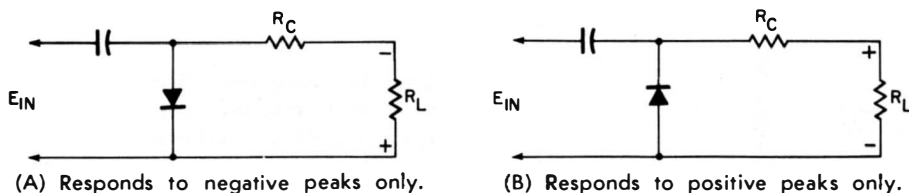
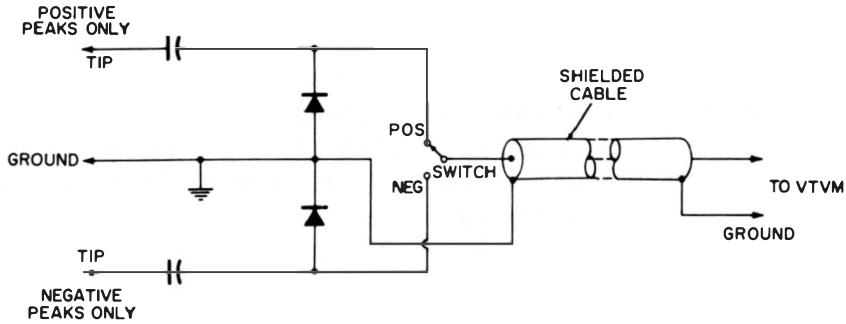


Fig. 4-22. Shunt-type peak-reading rectifier probes using germanium diodes.

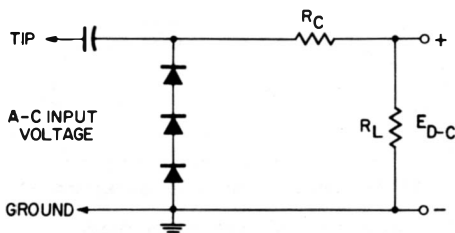


**4-23. A peak-indicating probe which will read either the positive or the negative peak, depending on the switch setting.**

The two probes in Fig. 4-22 can be combined, giving one which, by means of an spst switch, can measure either the positive or negative peak of a signal. Its circuit is shown in Fig. 4-23. In order to be completely symmetrical, this probe should be made with two individual tips and identical circuitry, except that the cathode of one diode and the anode of the other are grounded. This gives a choice of positive or negative peak indication, allowing us to measure the positive or negative half-cycle of an unsymmetrical signal.

The signal-handling capability of a probe can be increased by connecting two or more rectifiers in series, as shown in Fig. 4-24. Not only is the voltage-handling capability of the probe increased, but also the input impedance, because the back resistances and shunt capacitances of the diodes are now in series. With two diodes, the voltage-handling capability and shunt resistance are doubled, and the shunt capacitance is one-half. With three diodes . . . tripled and one-third—and so on for each additional diode.

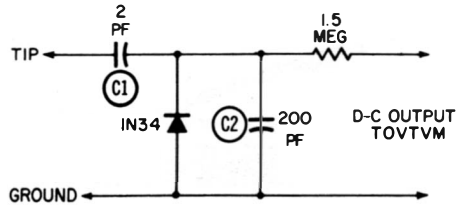
The applied a-c voltage must never exceed the voltage rating of the semiconductor diode; nor should the d-c component exceed the voltage rating of the blocking capacitor. The highest operating frequency of a probe is determined not only by its self-resonant frequency, but also by the spacing of its components and leads. The input impedance of a well-designed shunt-type peak-indicating probe is usually over 250,000 ohms, up to 1 megacycle; and over 5000 ohms, up to 250 megacycles.



**Fig. 4-24. Using more than one diode in series to increase the input impedance and voltage-handling capability of a probe.**



Fig. 4-25. Capacitive-divider method of increasing the voltage capability of a probe.

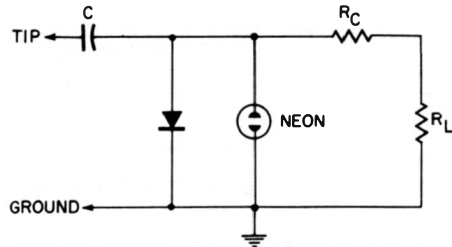


It is possible to increase its r-f voltage-handling capabilities by shunting the probe with a capacitor to form a capacitive divider with the input charging capacitor. The circuit (Fig. 4-25) has a 100:1 voltage division. This is suitable for measuring up to 2500 volts, because the voltage across the semiconductor will not exceed 25 volts—still a safe value for our diode.

To prevent a voltage overload from burning out the diode, it can be shunted with a neon bulb, as shown in Fig. 4-26. The bulb will light during an overload and thereby keep the voltage down to a safe level until the overload has been removed. The ionization level of the bulb must be lower than the maximum rated voltage of the diode.

Fig. 4-27 shows the schematic of a high-frequency probe designed for a vtm having an input resistance of 10 megohms. The frequency

Fig. 4-26. Using a neon bulb to protect the diode against damage from overloads.



response of this shunt-type peak-indicating probe is flat within  $\pm 10$  percent, from 20 kc to 100 mc; and the indication is proportional to the *positive* peak of the applied voltage.

The crystal diode-detector probe in Fig. 4-28 is slipped over the regular d-c isolation probe of the RCA Model WV-98A vtm, for which it was designed. Obviously, no additional lead is required to the meter. The probe extends the frequency range of the vtm to 250 megacycles. It can be used in circuits where the d-c voltages do not

Fig. 4-27. A high-frequency peak-indicating probe for use with a vtm having a 10-megohm input resistance.

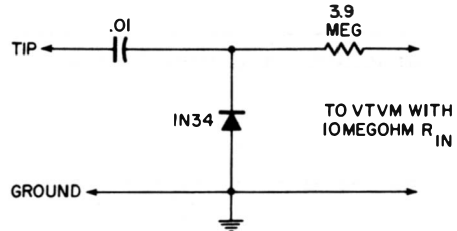


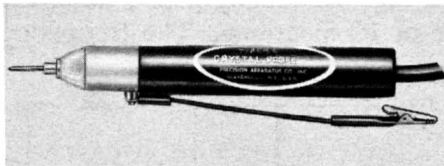


Fig. 4-28. This crystal diode-detector probe is slipped over the regular d-c isolation probe for which it was designed.

Courtesy Radio Corporation of America

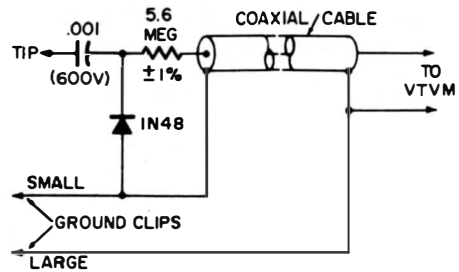
exceed 250 volts and the a-c voltages are not more than 20 volts rms or 28 volts peak.

Fig. 4-29 shows another interesting probe. The 5.6-megohm series resistor is chosen to give rms indications on the vtvm for a sinusoidal input voltage. Designed for a frequency range of 50 kc to 250 mc, the probe is accurate within  $\pm 10$  percent. On the 3-volt range, a cor-



Courtesy Precision Apparatus Co., Inc.

(A) The probe.



(B) Probe circuit.

Fig. 4-29. A typical commercial peak-indicating probe.

rection must be applied. The probe has a shunt capacitance of approximately 3 pf when the small ground clip is attached. A second ground clip, from the connector can be used for measuring frequencies below 200 kc. The equivalent shunt resistance is approximately 200,000 ohms at 50 kc, decreasing as the frequency increases. A compensated X10 multiplier (Fig. 4-30) can be used to extend the usable a-c voltage range to 300 volts rms. The probe tip must be unscrewed, replaced with the multiplier head, and the tip screwed into the other end of the multiplier. Do not forget that all scale readings taken with the X10 multiplier head must be multiplied by 10 before the actual voltages can be read. The X10 multiplier head also lowers the input shunt capacitance and raises the equivalent shunt resistance.

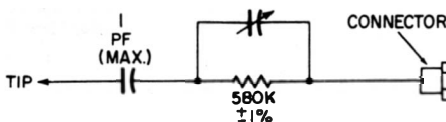


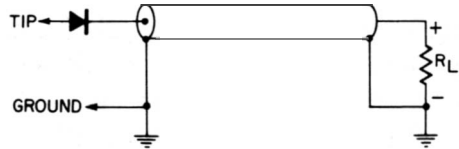
Fig. 4-30. A X10 multiplier for the probe in Fig. 4-29.

## PEAK-READING, SERIES-TYPE RECTIFIERS

Fig. 4-31 shows about the simplest version of a peak indicating probe—a semiconductor diode connected in series with the center conductor of a shielded cable. The capacitance of the cable, acting as the charging capacitor, charges to the positive or negative peak value of the applied voltage (depending on the way the diode is connected).

Even though very simple to make, this probe has its faults. At certain frequencies, the shielded cable may act as a resonant stub. The way to circumvent this difficulty is to insert a charging capacitor and a resistor, and then let the cable capacitance act as an additional ca-

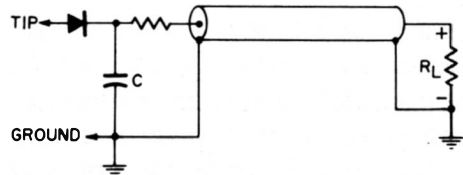
Fig. 4-31. Basic circuit of a peak-reading series-type rectifier probe.



pacitor to smooth out the peaks. (This is shown in Fig. 4-32.) The resistor can also act as a calibrating resistor so that either peak or rms readings can be obtained with the vtvm. If the diode is connected as shown in Figs. 4-31 and 4-32, the output voltage will be positive and there will be a positive voltage on the center conductor of the cable going to the vtvm. If the diode is reversed, the center conductor will of course have a negative d-c voltage.

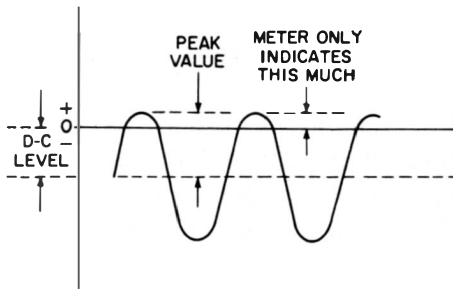
No blocking capacitor is shown because these probes are suitable only for low-level a-c measurements where no (or a very low) d-c component is present. If there is a d-c component and its direction and magnitude are such that it cuts off the diode or overrides the signal, we may get no indication at all. Moreover, if the signal is larger

Fig. 4-32. Adding a charging capacitor and a resistor to the base circuit will improve its performance.



than the reverse bias voltage, our indication will be considerably lower than the actual a-c voltage. The reason is that the d-c voltage biases the semiconductor diode into the nonconducting region, so this bias voltage is exceeded only during the extreme peaks of the a-c signal. (See Fig. 4-33.)

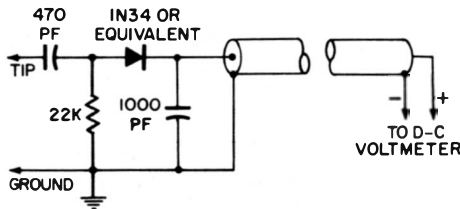
There is, however, an advantage to this arrangement—we have about the least shunt capacitance we could possibly hope for with a rectifying probe. Here is why. The approximately 1-pf shunt capacitance of the semiconductor diode is in series with the considerably



**Fig. 4-33.** Measuring error introduced when alternating current is measured in a circuit that also contains direct current and no d-c blocking capacitor is used.

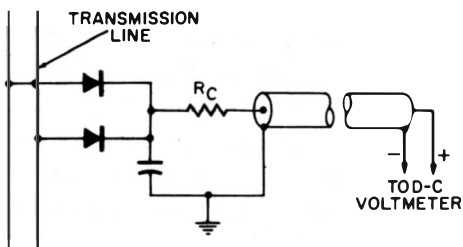
greater shunt capacitance of the cable (or charging capacitor, if used). Since the sum of any two capacitors in series is always less than the smaller of the two, the equivalent capacitance is less than 1 pf. To that, however, must be added the distributed capacitances from the operator's hand, the shielded cable, and the proximity of the probe to the ground or return of the circuit being measured. Nevertheless, the shunt capacitance is lower than with most any other rectifier probe.

A semiconductor-diode probe can also be used with a vom to extend the a-c frequency response of the meter beyond that of the built-in rectifier. Such a probe circuit is shown in Fig. 4-34. The meter should have a sensitivity of at least 5000 ohms per volt—and preferably



**Fig. 4-34.** A rectifier probe suitable for a vom with a sensitivity of 5000 ohms per volt or higher.

higher. The output terminals of the probe are connected to the d-c voltage terminals of the voltmeter. Since the input resistance of the meter is rather low (only 15,000 ohms on the 3-volt range of a 5000 ohms-per-volt meter), the rather high load the probe places on the circuit will tend to alter the r-f voltage being measured (unless we are measuring voltages in low-impedance circuits). For this reason, any indication—although theoretically that of the peak voltage under test—will be only of voltage present, rather than actual measure. This is due to the circuit loading effect of the probe. With low-impedance



**Fig. 4-35.** A probe suitable for measuring a balanced circuit.

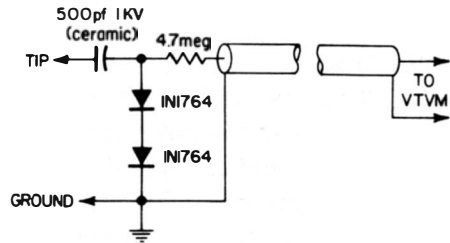
circuits, however, we can actually calibrate the probe with a known voltage and thereby get meaningful measurements.

If we want to measure in a balanced-to-ground circuit (in a twin-lead transmission line, for example), we can add another diode, as shown in Fig. 4-35. We now have a double-ended probe we can apply directly across the transmission line to measure, with the least shunt capacitance, the voltages on the line. The diodes are connected in the same direction because, at any point across the line, the polarity of the voltage alternates at the operating frequency. As a result, first one diode will conduct, and then the other. The charging capacitor thus receives two pulses—one each time a diode conducts. As before, resistor  $R_c$  isolates the probe from the circuit, it can also be used as a calibrating resistor.

### Rectifier Probe Selection and Use

Two important considerations in the selection of a probe are the range of frequencies to be measured and the type of voltage to be applied. Even though more suitable than vacuum-tube types at higher

Fig. 4-36. A 500-volt r-f probe.



frequencies (there are some exceptions, however!), semiconductor probes have a more limited voltage-measuring range. Fig. 4-36 shows a 500-volt probe useful for obtaining the resonant point of transmitter tank circuits, grid circuits, or other high-voltage r-f circuits. The probe shown responds to negative peaks; reversing both diodes will result in an output based on positive peaks.

The 1N1764 silicon rectifiers have a peak inverse voltage of 500 volts each; thus two of them connected in series permit the probe to be safely used in circuits where the peak voltages are less than 500 volts. The voltage rating of the probe can be raised by adding more diodes. (The peak-voltage rating can be increased by 250 volts for each additional diode.) Since the d-c output is proportional to the peak value of the voltage under test, best accuracy will be obtained when the input voltage is sinusoidal. The series resistor is selected for an rms indication for sine-wave input. Fig. 4-37 shows that for frequencies from 5 kc to 50 mc the greatest accuracy with this probe is obtained at voltages greater than four volts.

Before taking any measurements, we must of course have an idea of what kind of signal we have and what indication we want. If we have a sine wave, a peak-indicating meter can give us peak or rms readings. On the other hand, if we have a nonsinusoidal wave, only peak-to-peak readings would indicate what we have. The voltage level being measured must never be higher than the maximum rating of the semiconductor diode, or several hundred volts for a vacuum-tube

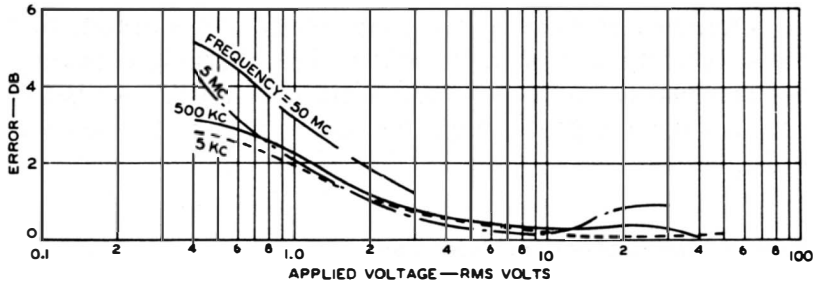


Fig. 4-37. Output accuracy of the probe shown in Fig. 4-36 as related to frequency and level of the input voltage.

diode (except high-voltage rectifiers). In addition, the probe must have facilities for making a good ground connection close to the circuit under test.

Voltmeters with built-in rectifiers have a limited high-frequency range, because the large shunt capacitance of the shielded lead through which the signal is applied greatly attenuates the high frequencies. This is one advantage of having the probe at the end of the cable, rather than in the meter. The meter also loads the circuit under test because of shunting by the cable. Locating the rectifier in the probe rather than in the instrument not only lessens the attenuation of the signal as it enters the meter or scope, but also lessens the loading effect of the meter on the circuit.

The success of a rectifier probe depends on its construction and on the components used. If low-inductance capacitors, good quality resistors, a good insulating material for mounting the components, and shortest possible wiring and leads are used, and if designed to have minimum stray capacitance, the probe will be quite practical for very high frequencies. Many such well-designed probes are available, either as accessories or supplied with the instrument.

## **Demodulator Probes**

The usefulness of the present-day oscilloscope is undisputed. Its value as a research tool and service instrument is further enhanced by several types of demodulator probes which permit the oscilloscope to be used at frequencies it would otherwise not be suitable for—such as those in television i-f, r-f, and video stages, which are too high to be observed directly on an oscilloscope.

Television stations transmit a composite television video signal consisting of an amplitude-modulated r-f carrier, together with blanking and sync pulses. These carrier frequencies are close to 900 megacycles if we go as far as Channel 83 in the ultrahigh-frequency band. Although the vertical-amplifier sensitivity of oscilloscopes is quite high, their limited frequency response causes us difficulty. Direct observation of signals above several megacycles becomes unreliable, and often impossible, with a general-purpose oscilloscope. Wide-band oscilloscopes, with a frequency response extending to perhaps five megacycles or more, are not only more expensive, but their deflection sensitivity also is usually less than that of a high-gain, relatively narrow-band oscilloscope. The latter somewhat limits their suitability for observation in low-level circuits.

When we talk about the sensitivity and frequency response of an oscilloscope, we will concern ourselves with the vertical amplifier only. With many oscilloscopes, the signal we wish to observe can be con-

nected directly to the vertical-deflection plates. Thus, we circumvent the frequency-limiting characteristics of the vertical amplifier; but, in doing so, we sacrifice the deflection sensitivity gained by using the amplifier. Therefore, this method of operating is suitable only for signals whose amplitudes are such that we get satisfactory deflection directly, without the need for additional amplification.

Because the vertical-amplifier circuits of oscilloscopes do not respond to the high frequencies in the i-f and r-f circuits of radio and television receivers, and since we are interested in the modulation envelope only, we can use a demodulator probe to demodulate our signal and thus get the desired indication on the oscilloscope.

The performance requirements for a demodulator probe are more stringent than for a rectifier probe. The main difference between a demodulator and a rectifier probe is that the former rectifies and removes the carrier frequency before passing the modulation envelope of the r-f signal on to the vertical amplifier of the oscilloscope. The rectifier probe, on the other hand, rectifies and filters both the carrier and the modulation component, giving an output proportional to the peak value of the carrier signal (whether modulated or not). Accordingly, the filter characteristics of an oscilloscope demodulator probe are determined by the service applications it is designed to meet.

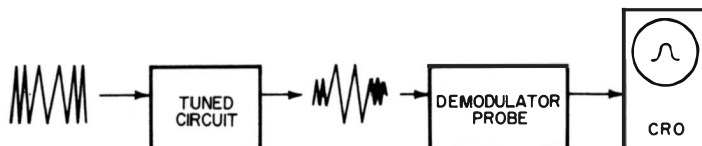
The peak value of our modulated signal varies at the modulation rate. We must therefore design our probe so its output voltage will rise and fall with the envelope of the r-f signal. In other words, in video circuits our probe must completely rectify and filter video frequencies from 100 kc to 4.5 mc, and must also pass a 60-cps square wave undistorted. For i-f signal tracing, the probe should have a relatively high input impedance from 25 up to 45 megacycles. The demodulator probe thus gives a low-frequency vertical-deflection voltage proportional to the instantaneous amplitude of the r-f signal. Since the voltage levels at which such signals exist are not too low, we do not need a very sensitive probe. So, we can direct our efforts toward designing a wide-band probe. The gain of the oscilloscope is also on our side. It usually does not take much input signal to get a substantial deflection on a relatively sensitive oscilloscope. Fortunately, the input to the oscilloscope is the demodulated signal; so, we can concentrate on the probe for fidelity and on the oscilloscope for sensitivity.

The input characteristics of the probe also are important. Must the impedance always be high? Or should it sometimes be low? Does the frequency response always have to be wide? Or is a relatively narrow frequency response sometimes sufficient? Such questions enter into the choice of a probe. Any characteristic can be made predominant by proper design. The highest possible fidelity of reproduction is usually achieved at the expense of input impedance. Therefore, a probe



which faithfully reproduces signals over a wide frequency range usually has a low input impedance. Conversely, a high-input impedance probe usually has rather poor frequency characteristics. Demodulator probes are rather good compromise.

Some of the more desirable characteristics of a typical demodulator probe include the highest practical input impedance, the greatest possible sensitivity, high fidelity of output, good mechanical construction, and 60-cps hum rejection. Of course, these qualities cannot all be successfully combined in a practical probe—but at least this is our design goal.



**Fig. 5-1. Tuned circuit changes f-m signal to a-m signal; demodulator probe extracts information from a-m signal; oscilloscope displays signal.**

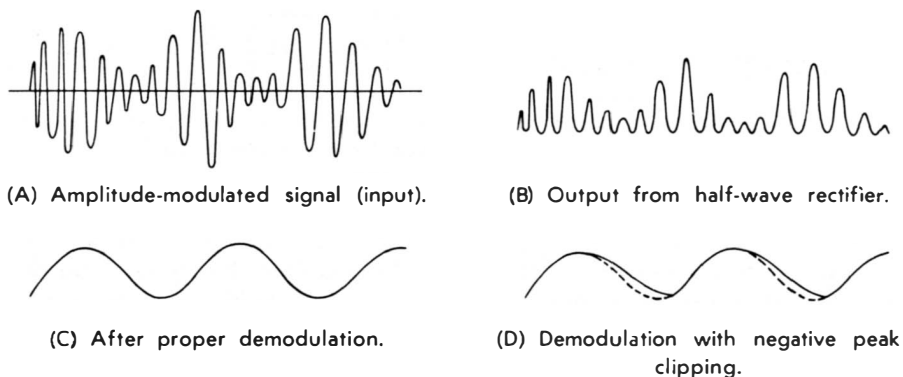
The r-f signal we observe will be either frequency- or amplitude-modulated. Nevertheless, we must first demodulate the signal, and then apply the demodulated signal to the vertical amplifier of our oscilloscope. Let us first consider a frequency-modulated signal, which we can use to test the frequency response of an i-f amplifier. Fig. 5-1 shows such a signal applied to a tuned circuit. The output signal from the tuned circuit varies in amplitude, in conformance with the frequency response of the tuned circuit.

A frequency-modulated test signal has a center frequency from which it deviates, usually at a 60- or 120-cps rate. For example, if the signal has a center frequency of 44 megacycles and a deviation of  $\pm 4$  megacycles, it will contain all frequencies from 40 to 48 megacycles. The tuned circuit will pass only those frequencies within its passband, and the magnitude of each frequency at its output will be directly proportional to the characteristics of the tuned circuit. The signals here are of such high frequencies that they cannot be displayed directly on an oscilloscope, but must first be demodulated. This is accomplished either with a demodulator probe, or by the demodulator in the equipment under test. If we wish to observe the characteristics of successive tuned stages as we progress toward the earlier stages of a receiver, we apply the output of a demodulator probe to our oscilloscope.

We start out by applying a constant-amplitude, frequency-modulated signal to our circuit under test. Then we take the output signal, which now has amplitude characteristics corresponding to the frequency response of the circuit under test, and demodulate it. (This is shown in Fig. 5-1.) We thus come up with a modulation envelope

representing the characteristics of the tuned circuit. Now we have a means of observing the characteristics of a circuit that operates at frequencies far beyond the capabilities of an oscilloscope.

At first glance, a demodulator probe looks much like the rectifier probe discussed previously. That is true—the probe circuits *do* look alike. However, the values of the components in the two probes differ. With the rectifier probe, we charge a capacitor to the peak value of the applied signal, and keep it charged to that value. Then we measure this charge with a d-c measuring device. A different situation prevails with the demodulator probe. Here, we are interested not so much in the exact amplitude of the signal, but in its shape. The probe must



**Fig. 5-2. Successive steps involved in demodulating an amplitude-modulated signal.**

therefore faithfully demodulate an amplitude-modulated signal and present on the oscilloscope an exact reproduction of the modulation envelope. We are now faced with a time-constant problem. Whereas before we wanted a long time constant, now we want a relatively short one, compared with that of the signal under test. Fig. 5-2 shows the action of a half-wave demodulator probe. When a signal is demodulated, either the positive or the negative half of the modulated signal is rectified to provide either the positive- or the negative modulation envelope. Therefore, from the probe is obtained a unidirectional output signal which changes in step with the modulated signal. If the time constant of the probe is too long, a sharp drop (fall time) cannot be followed because the charge on the capacitor will not have a chance to leak off. This will cause negative-peak clipping. On the other hand, if the time constant is too short, our signal will be ragged or fuzzy, and it will tend to follow the carrier frequency rather than the modulation.

The magnitude of the signal is generally such that semiconductor diodes can be used in place of vacuum tubes. This is an advantage, for semiconductor diodes require no heater voltage; nor is there the hum problem associated with a-c filament voltage, to cause trouble-

some hum modulation on an oscilloscope. In addition, the semiconductor diode makes possible a much smaller (and thus more easily handled) probe than does a vacuum tube.

The front-to-back resistance ratio of the diodes should be as high as possible. In a balanced probe, this ratio (as well as the values of both the front and back resistances) should be matched for both diodes.

The characteristic curve of a germanium diode becomes nonlinear below about 0.5 volt. This causes difficulties at signal levels of 0.5 volt or lower. The curvature, which distorts and magnifies changes in signal voltage, becomes troublesome when we measure voltage ratios. For example, a 5-to-1 change in actual signal level from 0.5 to 0.1 volt may show up as a change of perhaps 6- or 8-to-1 because of the nonlinear characteristics of the diode. Another time this characteristic may become bothersome is in observing the response curve of a tuned circuit. At the extremes of the curve, where there is very little signal, the probe may show that the curve falls off more rapidly than it actually does. This is an important point to consider when measurements are made at low levels.

The response of a probe to complex signals is determined by the relationship of the resistors and capacitors following the rectifier. The r-f high-frequency limits are influenced by the circuit preceding the rectifier probe. A high-impedance diode and a short lead will greatly improve the high-frequency characteristics of a demodulator probe and proper shielding is most important. Available are series- and shunt-type demodulator probes which use series resistors to isolate the oscilloscope and cable shunt capacitances from the probe.

As the frequency increases, the impedance of our demodulator probe becomes very low. Therefore, we must be sure to measure from a low-impedance point if possible, so the low impedance our probe presents at frequencies above 100 megacycles does not disturb the circuit response. At 1 mc the equivalent input resistance of a typical semiconductor demodulator probe is approximately 25,000 ohms. It drops to about 5000 ohms at 100 mc, continuing to drop as the frequency rises. The input capacitance of a demodulator probe should be kept as low as possible; the average is somewhere between 3 and 10 pf.

### **SHUNT-TYPE DEMODULATOR PROBES**

The performance characteristics of the shunt-type demodulator probe are similar to those of the equivalent shunt-type rectifier probe in Chapter 4. The schematics of both probes are similar, except the capacitance and resistance of the shunt-type demodulator probe are

smaller in order to provide a shorter time constant. In some demodulator probes, the semiconductors are inserted in a direction which will give a positive-going output voltage. Therefore, the anode of the diode is at ground potential, and the cathode is connected to the input signal whose positive modulation envelope we will then display. If this output is applied to an oscilloscope designed to give an upward deflection when a *positive-going* voltage is applied to its vertical-input circuit (most oscilloscopes are designed this way), maximum output from the probe will result in maximum upward excursion on the response curve. The response curve will then be of a polarity usually considered normal or upright. If the oscilloscope gave an upward deflection for a *negative-going* voltage, the response curve would be inverted.

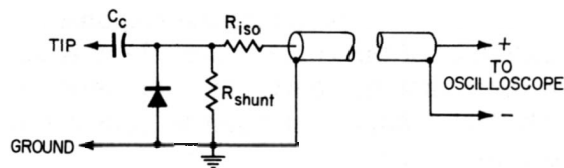


Fig. 5-3. Basic schematic of shunt-type demodulator probe.

Although not necessarily incorrect, inverted response curves may be misleading (or inconvenient) if they are to be compared with certain illustrated examples. A reversal of the diode would reinvert the curve, bringing it back to the accepted, normal position. For convenience, both types of probes could be kept on hand—one giving a positive and the other a negative output. The desired polarity of the response curve could then be obtained by using the proper probe.

Fig. 5-3 shows the schematic of a shunt-type demodulator probe. Like the rectifier probe, it has a capacitor which charges to the instantaneous peak value of the modulation envelope. This is a most important requirement; so we try to achieve it as closely as we can. The series resistor here is not used for calibration, but rather to isolate the cable capacitance from the input circuit. Unlike the rectifier probe (which develops a constant d-c voltage), this one develops a varying d-c voltage. If the r-f filtering is not sufficient, the r-f pulses may become troublesome if permitted to travel the length of the cable.

A demodulator probe for video-amplifier display must be designed to demodulate a 60-cps, square-wave-modulated r-f signal without introducing noticeable distortion. The ability of the probe to do this depends on the resistance and capacitance values within the probe, as well as on the prevailing distributed capacitances. We want these components to be small—yet, if they are too small, they will not do their job. For instance, too small a series resistor will not isolate sufficiently, and too small a shunt resistance (if used) will short out

the signal voltage applied to the probe. We must therefore arrive at a compromise. The time constant of the probe is made up of the cable and input capacitances of the probe, as well as any additional shunt filter capacitance, plus the combined resistance of the shunt and series resistors. The probe is less susceptible to hum because fortunately we now want a small value of charging capacitor (usually not more than a few hundred pf).

We can improve high-frequency characteristics of our demodulator probe by inserting a small inductance in the cable. The situation here, however, is somewhat more delicate because we have to be concerned with the waveshape of the output signal. Therefore, if we have a high-frequency square wave modulating a high-frequency signal, and want to display the demodulated square wave on our oscilloscope, we can insert a small peaking coil to reduce the rounding of the leading edge. However, we must make sure that our inductance does not cause ringing. The coil must therefore be selected very carefully. It may even have to be damped by a shunting resistor. To further reduce the loading effect of a demodulator probe, we can also use an isolation resistor of a few thousand ohms ahead of our blocking capacitor.

Probes are often used to display a-c waveforms in the presence of relatively high d-c voltages. If so, suitably rated blocking capacitors must be used. The semiconductor diodes must not only have a high front-to-back ratio, but must also accommodate reasonably high a-c signal voltages without loss of sensitivity or burn-out.

At the video-amplifier output we may find a rather large signal—in fact, one greater than the voltage-handling capability of our diodes. If so, we can put two or more semiconductor diodes in series to increase our signal voltage-handling capabilities, as we did for the rectifier probe. In low-level circuits, however, the output of our probe may not be sufficiently great to provide a usable deflection on our oscilloscope. So we may have to use additional amplification. This must be a high-quality amplifier which introduces very little, if any, hum at all on its own; its frequency response should be essentially flat from about 20 to at least 500,000 cycles. A resistance-coupled amplifier must therefore have a gain of at least 20—and if possible, higher.

### **SERIES DEMODULATOR PROBES**

Here again we have a circuit like the one discussed at great length in the chapter on rectifier probes. This is still about the simplest probe we can make—which we do by placing a semiconductor diode in series with our shielded cable, as shown in Fig. 5-4. Between successive peaks of the modulated r-f signal, the capacitor is discharged some-

what, and then is of course, charged again by the following r-f pulse. If the cable acts as the capacitor, it will carry a series of pulses at the carrier frequency rate. These pulses may have serious consequences at those frequencies where the cable is a multiple of a quarter wavelength. Depending on the frequency, a condition of resonance or anti-resonance may exist which greatly changes the sensitivity of the probe. Furthermore, since this cable capacitance is quite large, we would experience the negative-peak clipping mentioned previously—horizontal-sync pulses would be greatly attenuated and severely distorted.

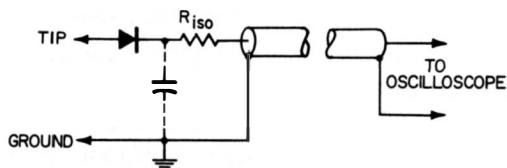


Fig. 5-4. Basic schematic of a series demodulator probe.

In order to avoid these difficulties, we must remove the cable capacitance from the circuit. We can do this with the rectifier probe by inserting an isolation resistor between the cable input and the demodulator output. The value of this resistor must not be too large. Otherwise, it will seriously distort the waveshape of the demodulated signal, as well as shift the marker position on the steep side of the response curve. The isolation resistor reduces the sensitivity of the probe somewhat. It is therefore best to make the resistor small (or even leave it out if we can) and compensate by other means—such as using a capacitor as a charging capacitor in lieu of the cable capacitance.

We can rapidly discharge the cable capacitance by shunting it with a resistor, so our oscilloscope can follow the modulation envelope of high frequencies and steep pulses. The back resistance of the semiconductor diode determines the performance of the probe. This is a variable value; in fact, if the diode has a low back resistance, the shunting resistor may not even be needed because the cable capacitance can discharge through the diode.

Also to be considered is the effect of measuring an a-c voltage when a d-c biasing voltage is present. This bias voltage may even exceed our signal voltage; if it does, we will get no indication at all. If the signal peaks exceed the biasing voltage, we will get an indication only while the diode receives a signal in the conducting direction. This difficulty can occur in a series demodulator probe if a good blocking capacitor is not used and d-c is present. (It can also be caused by a leaky oscilloscope input capacitor, even though a good blocking capacitor is used.) Ideally, the blocking capacitor is an open circuit. However, it does have some leakage resistance which, although high, is in series with our

rectifier and input circuit. As such, it forms part of a voltage divider across any d-c circuit we apply our probe to. It takes only a minute leakage, resulting in a small biasing voltage, to disable our probe. Therefore, if a probe is not working properly, the blocking capacitor should be one of the first items checked.

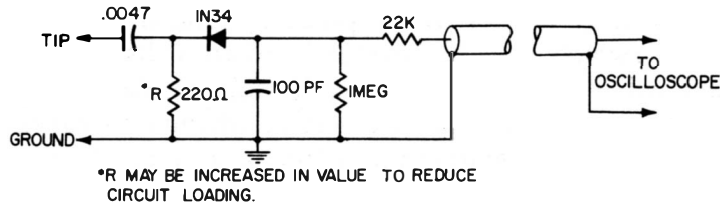
The d-c blocking capacitor in the oscilloscope also becomes important when we use a series demodulator probe. Its leakage resistance is in series with the vertical attenuator. Thus, we do have a d-c resistance path (it may be a great many megohms) between the vertical-input terminals. It and the back resistance of the semiconductor diode now form a voltage divider. If the probe is applied to the plate of a vacuum tube (which may be several hundred volts above ground), d-c current will flow through the semiconductor diode, the leakage resistance of the capacitor, and the vertical attenuator, causing a certain amount of d-c voltage to appear across our diode. This is undesirable because (1) the current, if sufficiently high, will damage the diode, and (2) the voltage drop across the diode may bias the diode into an operating region where its full sensitivity will not be realized.

Because these circuits are powered from a rectifier, hum voltages may be present. Although not noticeable on the picture tube of a television receiver, these hum voltages would be displayed, along with the signal under test, on our oscilloscopes. This is so because up to now we have had no means of 60- or 120-cps rejection. We can correct this by adding a small capacitor in series with our semiconductor diode. That is the first job of this capacitor. The second one is based on the fact that, being small (usually mica or ceramic), its insulation resistance is almost infinite. We therefore will not have the d-c current and diode biasing problems we would have without this capacitor. Of course, the problem is aggravated if our oscilloscope has no blocking capacitor. We could add a resistance, of a few megohms at most, from the input terminals to ground. However, large—and probably destructive—currents would develop through the diodes if we measured at the plate of vacuum tubes without using any d-c blocking capacitors.

The input capacitance of the probe may be sufficiently high to detune the circuit under test. This effect not only is detrimental in some circuits, but may also cause regeneration (oscillation which may damage the diode in the probe). This difficulty is overcome by connecting a probe with a low input impedance across the stage *following* the one we are observing. The intervening stage, which acts as a sort of buffer, may also be tuned, but the low impedance of the probe will effectively swamp the tuned response of the circuit and thus prevent regeneration. Because it is now a low-impedance probe, its output is much lower than if it were a high-impedance one. We can usually

take care of that by advancing the gain control on the oscilloscope. Although some output is lost, we have prevented our circuit from breaking into oscillation, which would make any observation impossible.

The probe in Fig. 5-5 is of conventional design, with a blocking capacitor, a series rectifier, and a network to filter out any r-f impulses. The blocking capacitor should be as close to the rectifier as possible; its other end, designated the *tip*, should be short so it can be brought out directly to the point under measurement. The blocking and charg-



**Fig. 5-5. Series demodulator probe (low impedance).**

ing capacitors, if of a good quality, should allay our worries that the leakage resistance of the oscilloscope input capacitor will harm our rectifier. (This type of low-impedance probe is often shown in the service manuals for television receivers.) If a low-impedance probe is not available, we can still use a high-impedance demodulator probe for measuring in a tuned circuit. This we do by adding a swamping network consisting of a d-c blocking capacitor, plus a resistor of several hundred ohms, in series across our tuned circuit. The leads between the probe tip and the ground lead must be very short for both components.

It is of prime importance that the detuning effect of the probe be reduced. One way is to apply the output from a cathode-follower probe to the demodulator probe. Being a low-capacitance device, the cathode-follower probe is designed to do nothing more than pick off a signal with the least disturbance to the circuit. Its output can then be directly connected to the demodulator probe and, in turn, fed to the oscilloscope through a shielded cable. With signals of up to several megacycles, a demodulator probe is often unnecessary if the vertical-amplifier response of the oscilloscope is wide enough to accommodate them. We simply pick off our modulated signal with the cathode-follower probe, applying its output directly to the vertical-input circuit of the oscilloscope. This is a good arrangement for us to keep in mind when observing video-amplifier or sync circuits.

The series-demodulator probe in Fig. 5-5 is used most frequently for television receiver servicing, where it is moved from stage to stage during alignment or signal tracing. Since it is a demodulator (detector)



probe and travels from stage to stage, it is often referred to as a "traveling detector." Fig. 5-6 shows the circuit and construction information of another simple probe suitable for alignment of video-i-f stages. This probe is designed to provide the proper loading for correct adjustment of over-coupled i-f stages.

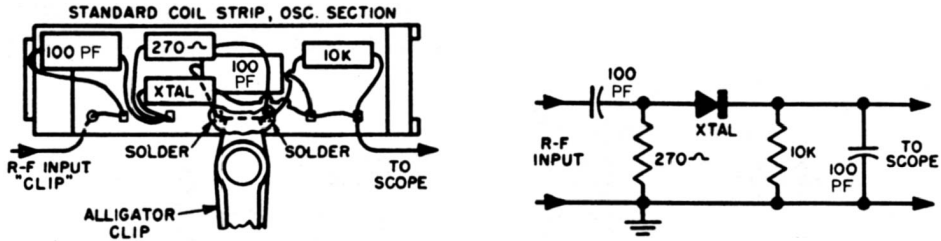


Fig. 5-6. Series demodulator probe suitable for alignment of overcoupled video i-f stages.

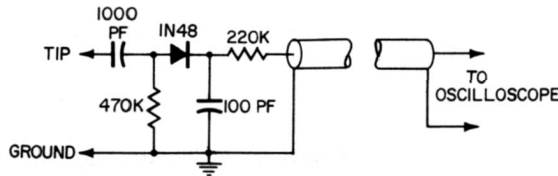


Fig. 5-7. Series demodulator probe in kit form (EICO Model PSD).

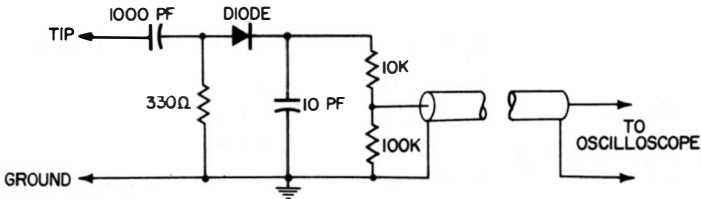


Fig. 5-8. Probe recommended for television receiver alignment.

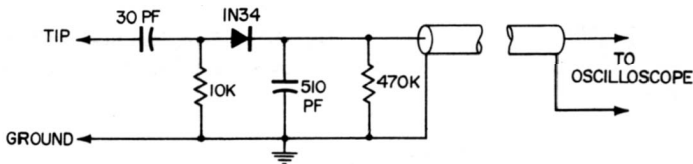


Fig. 5-9. High-impedance series demodulator probe.

Fig. 5-7 shows the circuit of a series demodulator probe available in kit form; Fig. 5-8, a semiconductor-diode detector probe recommended by a television manufacturer for aligning his television receiver. A high-impedance demodulator probe is shown in Fig. 5-9.

## BALANCED DEMODULATOR PROBES

A balanced demodulator probe will often be useful, just as the rectifier probe has been, for observations in such balanced circuits as a twin-lead transmission line or the input of television receivers, boosters, or converters. The probe in Fig. 5-10 has a balanced 300-ohm input and a single-ended, or unbalanced, output. Two rectifiers, con-

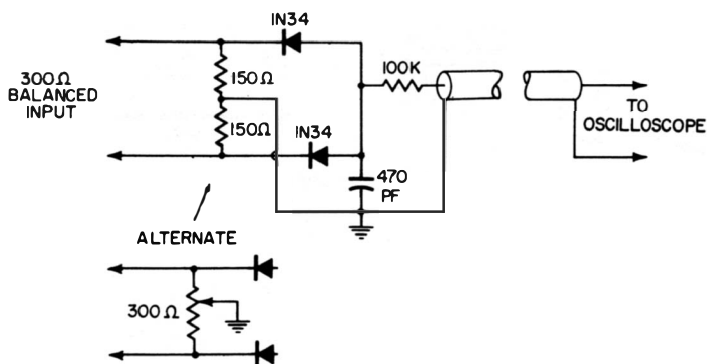


Fig. 5-10. Balanced demodulator probe having 300-ohm input.

nected in the same direction, are employed. This arrangement is satisfactory without a d-c blocking capacitor because there is usually no d-c voltage where balanced measurements are made. The charging capacitor receives alternate pulses from either diode. When one diode is conducting at its maximum, the other has a signal in the opposite direction, also of maximum magnitude. These polarities alternate at the frequency of the signal under measurement. The output signal from the probe is the modulation envelope of the amplitude-modulated

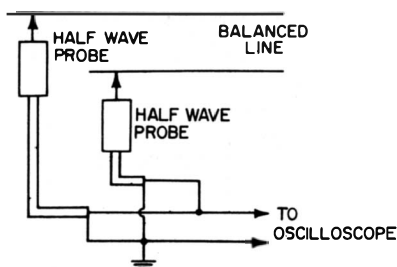


Fig. 5-11. Two identical half-wave probes used to measure a balanced line.

signal under test. The ground lead from our probe should be kept as short as possible and connected to the nearest ground. If a balanced demodulator probe is not available and measurements under balanced conditions are desirable, we can use two identical demodulator probes in parallel, and also connect their outputs in parallel to our oscillo-

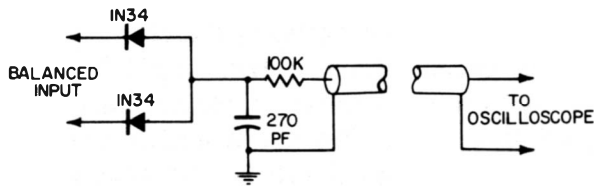


Fig. 5-12. Balanced high-impedance probe.

scope. This method is shown in Fig. 5-11. Be sure the diodes in both probes are connected in the same direction. A balanced high-impedance probe is diagrammed in Fig. 5-12.

If we use only one unbalanced probe to measure on a balanced line, we will upset the balance and thus get an erroneous indication. It is therefore advisable, when making measurements in a balanced circuit, to construct a balanced probe, or else use two probes as outlined in the previous paragraph. Fig. 5-13 shows the schematic of

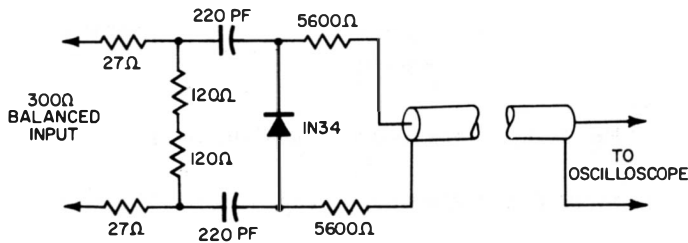


Fig. 5-13. A 300-ohm balanced demodulator probe using only one semiconductor diode.

another balanced probe which uses only one diode, but still offers a balanced input of 300 ohms and an unbalanced output to our oscilloscope. This probe can be constructed on terminal strips. It does not have to be shielded because the low-value resistors make it relatively insensitive to extraneous pickup.

### PEAK-TO-PEAK OR VOLTAGE-DOUBLER DEMODULATOR PROBES

We can get a more sensitive probe by making a voltage-doubler or peak-to-peak reading probe. The probe is referred to as one or the other, depending on the type of signal measured. With a symmetrical wave, we will have a voltage-doubler action; but with an unsymmetrical wave, the output voltage will equal the peak-to-peak value of that waveform. A typical voltage-doubler demodulator probe is shown in Fig. 5-14. With a symmetrical signal, a voltage-doubler probe will produce, on our oscilloscope, twice the deflection a half-wave probe

would. Such a voltage-doubler probe is therefore useful at low signal levels. However, because it has a lower input impedance than the half-wave probe, it is suitable only for measurements where impedance levels are relatively low. This characteristic may turn out to be the limiting factor in some applications. The frequency response of the voltage-doubler demodulator probe is, therefore, not nearly as good as that of a half-wave probe.

The input capacitor and output charging capacitors are again made rather small in order to make the probe relatively insensitive to 60- or 120-cps hum. The signal-handling capabilities of our probe are once more limited by the voltage rating of the diode. The d-c level at which measurements are made should not exceed the voltage rating of the

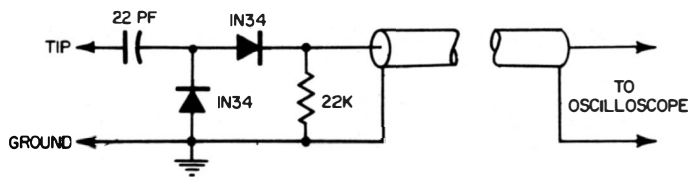


Fig. 5-14. A voltage-doubler demodulator probe.

probe input capacitor. Alternating voltages in excess of 50 volts peak will tend to produce pattern distortion, whereas inputs in excess of 60 volts peak can impair the sensitivity of the semiconductor diodes, or even burn them out completely. Because of the 60-cps rejection capabilities of our probe, we can make tests for r-f signals in filament, automatic gain control, and B+ circuits, and thus check to see whether or not the filtering, bypass, and decoupling capacitors are doing their jobs.

The peak-to-peak probe may provide more or less than twice the output of a half-wave probe. The reason is that the signals may not always be symmetrical in their positive and negative excursions. Hence, if we measure the larger excursion with our half-wave probe, the peak-to-peak probe will give us less than twice the output of the half-wave probe. Conversely, if we measure the smaller excursion of the modulated signal, the voltage-doubler probe will then give us more than twice the reading than that of the half-wave probe.

In order to check the half-wave and voltage-doubler probes against each other, obtain a symmetrical signal, preferably one you can control (from a signal generator, for example). First, observe this signal on an oscilloscope, to see whether both halves of the modulation envelope are equal. Then take measurements with both probes to see whether the voltage-doubler probe gives exactly twice the output of the half-wave probe.

A peak-to-peak indicating circuit can be modified to give only peak voltage readings. This is done by means of a switch, which eliminates one diode and capacitor from the circuit. An example of this type of circuit is shown in Fig. 5-15. When the switch is in the "peak" position, only one diode is in use. In the "peak-to-peak" position, both diodes are active.

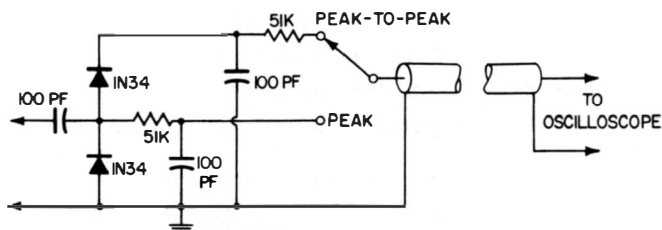


Fig. 5-15. Combination peak and peak-to-peak reading demodulator probe.

## DEMODULATOR PROBE SELECTION AND USE

The r-f and i-f frequencies in television receivers are too high to be displayed directly on an oscilloscope. Before these signals can be observed, they must be demodulated so a modulation envelope can be obtained. In other words, a demodulator probe extracts the signal from the r-f carrier. This signal will have a d-c component and, on a d-c oscilloscope, will be displayed vertically by an amount equal to the d-c component. On an a-c oscilloscope, the signal will be centered about the zero axis.

The demodulator probe adds a certain amount of capacitance. This we must take into account when measuring the stage gain and characteristic of tuned circuits, because the output voltage of our probe may not be the same as the actual voltage at the point of measurement (depending on which direction our probe detunes the circuit). Sometimes the probe may supply the necessary additional capacitance to properly tune our circuit; then we would get a better indication than without the probe. On the other hand, if our probe detunes the circuit, the indication would be lower than normal. The circuit may also break into oscillation when the probe is applied, in which event any indication would be completely meaningless.

Demodulator probes should be shielded so they will not pick up voltages, other than those at the point under observation. If a probe is simply held near a field-producing element (such as the horizontal-output transformer of a television receiver), there will of course be an indication, which should disappear as soon as the probe is connected

to the point under test. To check the shielding of our probe connect a small resistor of perhaps 10,000 ohms between the tip and ground. With the resistor connected in this manner, move the probe around the television chassis. If the probe is properly shielded, there will be no indication on the oscilloscope.

Briefly comparing the characteristics of series, shunt, and voltage-doubler probes, we find that the series-demodulator probe is somewhat more sensitive, but does not attenuate hum as much as the shunt-type demodulator probe does. Furthermore, the series-type probe, although more sensitive, causes more distortion—which becomes objectionable if faithful reproduction of the modulation envelope is

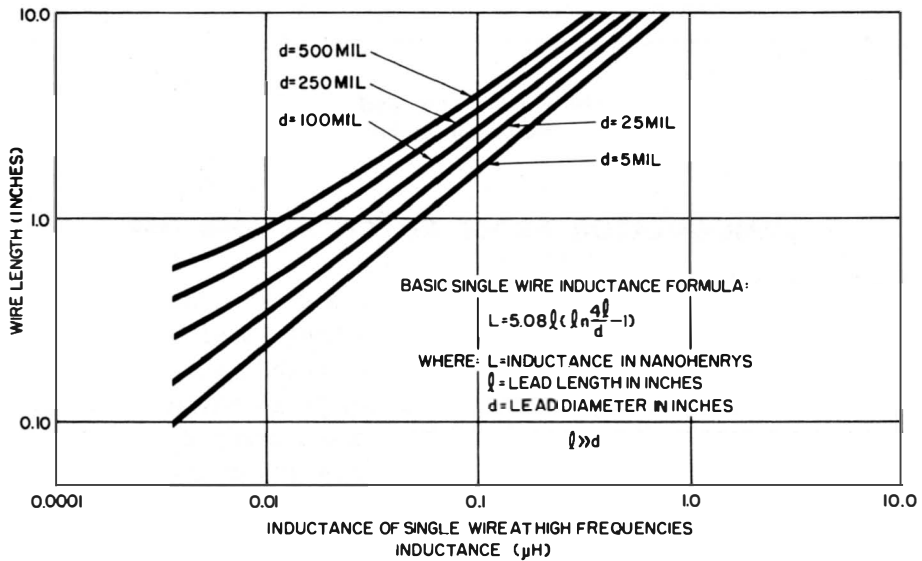


Fig. 5-16. Inductance of single wire at high frequencies.

important. The shunt-type demodulator probe is less sensitive, but provides a somewhat greater rejection of hum and higher fidelity of demodulation. The voltage-doubler probe has a higher sensitivity, but its frequency response is more limited.

The ambitious person who wants to build his own probe will do well to pay close attention to the following. The probe should be carefully shielded. If a balanced probe, it must be balanced both mechanically and electrically. Connections within the probe should be short, and components must be suitable for high frequencies. The resistors should be small, noninductive carbon or carbon-film; and capacitors must be disc ceramic or small mica. Furthermore, two or more diodes used together, especially in a balanced arrangement, should have matching forward and back resistances. Keep signal and ground leads short to minimize the inductive effect. (See Fig. 5-16.)

A tuned circuit can be used with a demodulator probe—either a coil with a capacitor across it, or one resonating with its own distributed capacitance. The tuned circuit is connected between the tip and the ground connection of the probe, and is then placed near the circuit whose waveform we wish to observe. The resonant circuit of the probe should be tuned to the same frequency as the circuit under test. The advantage of such an arrangement is that the coupling to the tuned circuit can be made quite loose. Thus, the circuit under test will not be loaded and thus disturbed as much as it would if a direct connection were made with a demodulator probe. For this purpose, we can use an i-f coil if we wish to make observations in the i-f circuit, or a video-peaking coil in a video circuit. Minimum additional capacitance is almost always desirable because the distributed capacitance of a probe will add enough to assure resonance at the desired frequency.

Sometimes we may wish to pick up a signal by placing a floating shield over the tube and connecting our demodulator probe to it. We will indeed pick up a signal—plus extraneous signals which may be picked up from the horizontal- and vertical-sweep circuits. In many instances, the interfering signals will override the one which is under test. To overcome this difficulty, therefore, it is best to disable the sweep circuits.

In r-f measurements, keep the ground lead very short, and make the ground connection as close as possible to the ground return of the point where the signal is taken off. This fact cannot be over emphasized. More often than not, beginners mistakenly use just any point as a ground, and then simply move the probe clip around. More than anything else, the ground connection may, at frequencies above 100 megacycles, determine the correctness of our response curve.

The length and position of the ground lead are also important. The ground return lead is part of the r-f carrying circuit and, as such, the demodulator circuit. In a probe used for measurements up to the video range, the position of the ground clip may not be overly critical. On the other hand, with television carrier frequencies, it must be short and direct. If the ground return is too far from the probe, deceiving displays will be obtained because of ground-current loops in the chassis. A simple d-c ground connection made to arbitrary point somewhere on the chassis, is not always satisfactory.

Because of its loading effect, the demodulator probe should always be applied to low-impedance points. If we have no such point and do not want to swamp the circuit, we can insert a resistor of several ohms in the cathode circuit of a tube. The resistor will often develop across the tube sufficient signal to give a usable display on our oscilloscope, and yet not load the circuit if picked up by the demodulator probe.

The blocking capacitor, of course, will eliminate any d-c voltage developed from this connection.

A detailed treatise on the use of demodulator probes in servicing television receivers is beyond the scope of this book. We will therefore touch only on some of the highlights, to whet the reader's interest.

The response of a video amplifier can be checked in two ways. Both require that a swept video signal be applied at the video-amplifier input. The output signal can be applied directly to the vertical-input circuit of a wide-band oscilloscope, or it can be demodulated with a demodulator probe and its output displayed on an oscilloscope.

A much simpler way to display the video-amplifier characteristics on our oscilloscope is to use a demodulator probe. What we do is apply the video-amplifier output to the demodulator probe, and then observe the modulation envelope on our oscilloscope. However, the oscilloscope must definitely be able to display a 60-cps square wave with no distortion, because the sweep generator usually operates at a 60-cps sweep rate. If the video-amplifier characteristics were ideal, amplification would be equal for frequencies up to 4.5 megacycles. As a result, the response curve would increase sharply at the low-frequency end, stay flat all the way up to the highest frequency, and then drop off sharply. This, of course, is a square wave; and since each sweep is completed in  $\frac{1}{60}$  of a second, a 60-cps square wave is thus displayed. When a demodulator probe is used, the picture-tube socket should be removed from the picture tube and the probe inserted at the point where the video signal is obtained, because video circuits are critical as far as shunt capacitance is concerned. What we have done is remove the effective capacitance of the picture tube and substitute an equal amount of capacitance presented by our demodulator probe. The swept signal, if used directly, should be connected to the oscilloscope through a low-capacitance probe. We apply this signal to the video-amplifier input, and apply the output from our demodulator probe to the vertical-input circuit of the oscilloscope. A marker signal should also be applied so the frequency characteristics of the video amplifier can be determined. The value of the series filter resistor in the demodulator probe now becomes of great importance. The time constant of the resistor and the filter capacitance of the probe must be long enough to give the probe a good response for a signal as low as 60-cps square wave. In this way, the display near zero frequency will be correct, not fuzzy, because of the inability of the probe to respond to those low frequencies.

Video amplifiers can also be tested with square waves at several frequencies. The demodulator probe is not used. Instead, we apply the output from our video amplifier through a low-capacitance probe, to the vertical-input circuit of a wide-band oscilloscope.



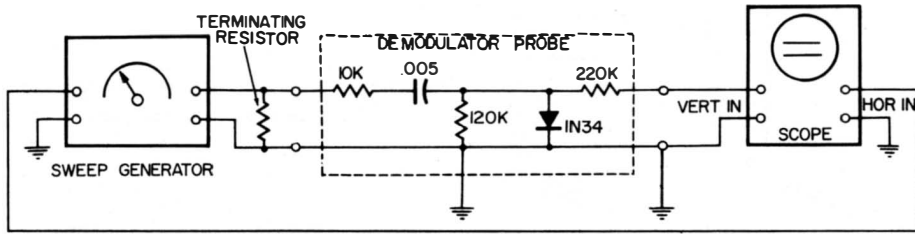


Fig. 5-17. Equipment setup for testing flatness and linearity of sweep-generator output.

We can test our probe by using the output from a 60-cycle square-wave generator to modulate an r-f signal and then apply the modulated r-f signal to our demodulator. The output of the probe should again be a 60-cps square wave, and the fidelity of the square wave will be a direct indication of the demodulation capabilities of our probe.

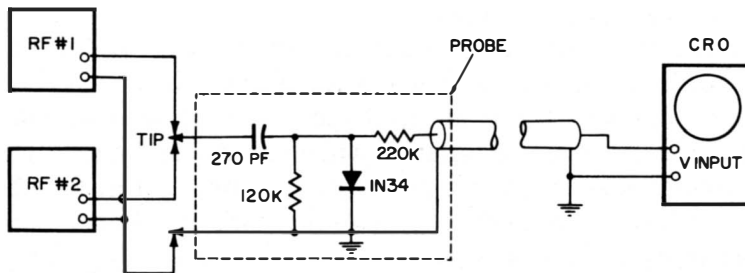


Fig. 5-18. How to compare the frequency of one r-f signal with that of another.

Demodulator-probe characteristics at low frequencies (in the audio-frequency range) are of interest. With most probes, if we apply the signals of various frequencies—starting from perhaps 20 to 30 cycles or so and going up to several hundred thousand cycles—we will experience feed-through over a certain broad frequency range. This will manifest itself as an output voltage equal to the input voltage, without being modified in any way. This feedthrough characteristic

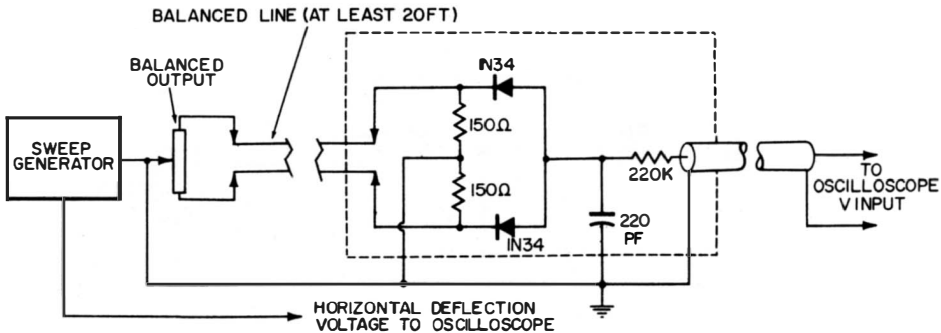


Fig. 5-19. How to check the characteristic impedance of a balanced line.

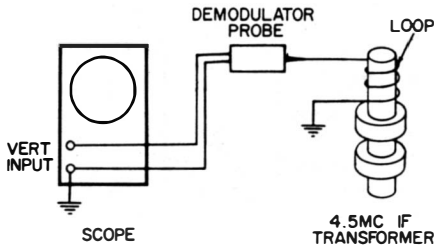


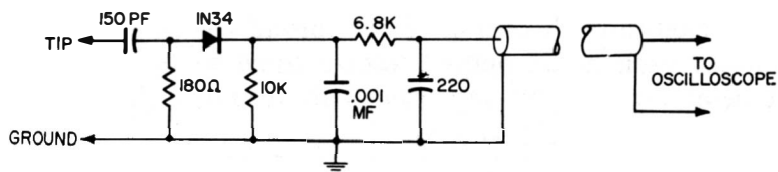
Fig. 5-20. How to check the 60-cps sync-buzz voltage in a receiver.

will drop off at high and at low frequencies for two reasons. (1) At the high-frequency end, the filter characteristics of our r-f network will attenuate; and (2) at the low-frequency end, the reactance of the input capacitor will become very high. This behavior, which is normal for demodulator probes, should be remembered.

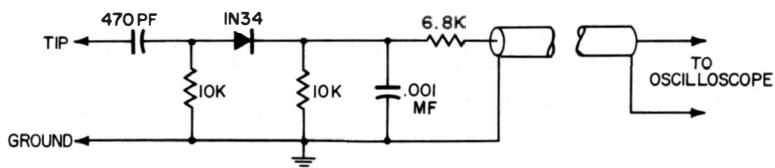
Be extremely careful not to overload the probe and thus damage the semiconductor diode. Never apply the probe to the horizontal- or vertical-deflection circuits, because even a momentary contact will immediately burn out the diode.

Semiconductor diodes are rather sensitive to heat. So, if one must be replaced, hold the lead with a pair of pliers, which will serve as a heat sink to conduct the heat from the soldering iron or gun away from the diode. Also, it is advisable, when using a probe in a television receiver, not to lean it against hot vacuum tubes or resistors because enough heat may be conducted through it to ruin the diode.

The accuracy and linearity of the output from a sweep generator can be tested with a demodulator probe and oscilloscope, as shown in Fig. 5-17. Connect the demodulator probe to the properly terminated output from the sweep-generator cable, and the output from the demodulator probe to the vertical-input terminals of the oscilloscope. Couple in a marker signal through a small coupling capacitor. (One or more markers can be used.)



(A) Low impedance.



(B) High impedance.

Fig. 5-21. Demodulator circuits.

A demodulator probe can also be used to check the frequency of one r-f signal against another, as shown in Fig. 5-18. The r-f signals from the two sources are fed to the input circuit (one end of the 270-pf capacitor), and the output signal from the demodulator is fed to the vertical-input terminals of the oscilloscope. Then the frequency of one of the signals is varied. As we approach and go through the same frequency as the other signal, we will observe a zero-beat pattern on the oscilloscope screen.

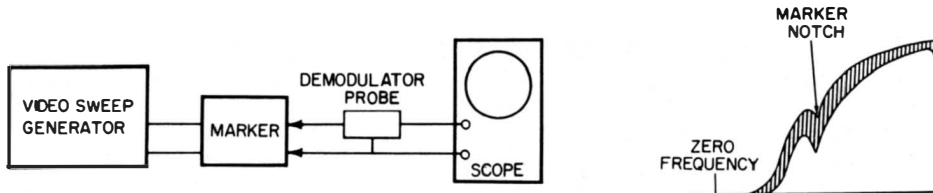


Fig. 5-22. How to check the frequency-demodulation limit of a probe.

In order to check the characteristic impedance of a line, we connect one end to a sweep generator with the appropriate center frequency. At the other end we connect a balanced probe, as shown in Fig. 5-19. The load resistor should be equal to the characteristic impedance of the probe; so, we use two 150-ohm resistors in series to give us the required 300 ohms. The center connection between the cable and resistors is grounded to provide a d-c return for the probe.

If the characteristic impedance of the line is equal to 300 ohms, the display on our oscilloscope will be a straight line. If other than 300 ohms, the display will be curved, the amount being directly proportional to the degree of mismatch. At least twenty feet of transmission line must be used in order for a satisfactory indication to be displayed on the oscilloscope. If the line is shorter, the standing waves may not be strong enough to develop a satisfactory indication.

We can apply a voltage-doubler probe directly to the 4.5-megacycle sound circuit in order to measure the percentage of downward modulation due to 60-cps buzz voltage. For this measurement, we will require a d-c oscilloscope. A pickup loop like the one in Fig. 5-20 can be used to check for sync buzz in intermediate frequency and video amplifiers.

Voltage-doubler probes can also be used for making tests in the chroma bandpass amplifier and other video-frequency circuits of color television receivers. The probe should be applied across a low-impedance point, such as the color-intensity control, in order that the probe shunt capacitance will disturb the circuit as little as possible. It should not be connected across the filter coils because shunt capacitance will change the bypass characteristics of the circuit.

In order not to present a noticeable load to the circuit under test, the probe should have an impedance at least ten times as high as the impedance at the circuit point under consideration. For certain alignment procedures, the oscilloscope must be connected to the output of the video-i-f stages—preferably through a low-impedance detector like the one in Fig. 5-21A. On the other hand, a high-impedance detector is more desirable for aligning chroma and sound-i-f stages. One such detector is shown in Fig. 5-21B.

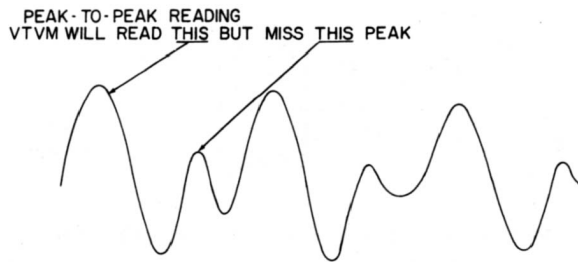


Fig. 5-23. Waveshape having two different values of peak voltage.

The low-frequency limit of the demodulating capability of a demodulator probe can be checked as shown in Fig. 5-22. The output from a video-frequency sweep generator is fed through a marker box to the demodulator probe, the output of which is connected to the input terminals of an oscilloscope. An absorption-type marker is preferred because it does not give confusing beats. As the lower frequency limit of the probe is approached, the probe output falls off and shows evidence of incomplete rectification and filtering. The lower frequency limit can be determined by adjusting the marker to this point.

The peak-to-peak reading with a vtvm rectifier probe will give an indication of the peak-to-peak value of the signal, but will ignore anything between the peaks. Let us look for the moment at the waveshape in Fig. 5-23. The smaller signal between the peaks might just as well not be there, as far as the vacuum-tube voltmeter is concerned. Its presence or absence will not be indicated on the meter. On the oscilloscope, however, it is clearly shown.

A demodulator probe can be converted to a peak-to-peak or peak reading rectifying probe by adding a relatively large capacitor (0.01 mfd) across its output circuit. The capacitor can be added externally and the voltage across it applied to the input terminal of the vacuum-tube voltmeter. The d-c voltage indication will then be proportional to the peak value of the voltage under test.

## **Special-Purpose Probes**

Signal tracing and substitution offer two valuable methods for servicing electronic equipment. They are often quicker than voltage and resistance measurements or parts substitution, although not always more advantageous. The method to use depends on the complexity of the circuit and the degree of difficulty we experience. Signal tracing or injection are normally employed when the circuit, although not completely inoperative, is malfunctioning to such a degree that the difficulty cannot easily be found with the classic measuring methods.

Even though voltages and resistances may be of the correct value, or within the limits specified in the applicable service literature, the circuit still may exhibit the wrong waveshape, or its frequency may not be correct. Some circuits may develop difficulties only when a signal is applied to them. A signal-injector probe duplicates this condition by substituting a signal.

### **SIGNAL-TRACER PROBES**

A signal tracer is one of the simplest yet most effective instruments for rapid and accurate troubleshooting of electronic circuits. Its biggest advantage is that it permits the circuit to be checked under dynamic operating conditions. The technique of signal tracing is relatively easy and straightforward. A test signal, or one from a transmitting station,

is applied to the circuit. Then the signal tracer is moved progressively *from the input to the output* of the equipment under test. At the same time, the test signal is checked to see if it is present, and if so, whether it has been amplified or reduced (or perhaps distorted). An inoperative or maladjusted stage can thus be quickly localized and then other static measurements made, to further localize within that stage the defective component or components. The most popular tracer is the easy-to-operate untuned type, which has no controls except perhaps one for volume.

The probe required for a particular signal-tracing job depends on the type of signal, which in turn depends on the circuit under observation and whether the equipment under test can supply its own signal. (Before we can trace a signal, we must obviously have one to begin with!) The frequency and nature of the signal to be measured are also important. What kind of signal is it—audio frequency, low or high radio frequency, modulated, pulse, or what?

A television station signal is usually traced with a semiconductor demodulator probe. The probe output is applied to the vertical-input circuit of an oscilloscope. If the television signal is weak, the display on the oscilloscope may be too small to be of any value. The thing to do here is substitute another signal for the one from the television station, or else use a probe which amplifies the signal before applying it to the oscilloscope.

A signal-tracer probe (as well as its output cable) must be shielded so it will not pick up extraneous signals or hash from stray fields and thus mask out our signal.

Our choice of a demodulator probe is also governed by the output desired. Do we want maximum output? Or will we be satisfied with a good match and the least loading? In a demodulator probe, sensitivity must be sacrificed for fidelity. For signal-tracing purposes, however, we are ordinarily more than willing to do the opposite—particularly in low-level stages like those in the r-f, mixer, and first i-f stages of a television receiver. For this reason, semiconductor probes intended for signal tracing usually compromise between providing the highest possible output while maintaining reasonable fidelity, so they will be suitable for observing video-amplifier output signals and the waveshapes in television sweep and sync circuits.

The classic approach to signal tracing involves simply moving the probe from stage to stage, starting at the front and moving toward the output of higher-gain stages, while noting the increase in signal at each successive stage. Initially, it is advisable to go from plate to plate, rather than from grid to plate or plate to grid, because the impedances are usually lower in the plate than in the grid circuits. Thus, the test probe does not affect the plate circuits as severely as it does the grid

circuits. The ratio between the signal at the output of a stage to the one at the output of the preceding stage is the gain of the stage being measured.

A sweep signal can also be traced through the i-f-amplifier stages. However, the resultant pattern does not usually represent the true response of the stage or stages under test. The reason is that the loading effect of the probe alters the response characteristics of the circuit. This loading effect can be reduced considerably by using a low-capacitance or cathode-follower probe ahead of the signal-tracer probe, or by making the plate load of the last tube nonresonant. The latter is done by shunting (swamping) the load with a resistor of a few hundred ohms.

Some signal-tracer probes are so sensitive that, when held close to a tube pin or on top of an insulated wire carrying a signal, they pick up enough signal by capacitive coupling to give a suitable indication. This type of signal pickup gives considerably less circuit loading than some others.

The main purpose in signal tracing is not to show the exact waveform or faithfully reproduce the signals at a particular point of a circuit. Rather, it is to show the presence or absence, or the strength or weakness, of a signal at that point.

Signal tracing from stage to stage by means of an oscilloscope affords a rapid and convenient method of locating a defective circuit. Many circuits (such as sweep circuits) generate their own waveforms; therefore, no external signal is needed. On the other hand, audio and video amplifiers and sync circuits do require an external signal, from either a broadcasting station or an audio generator or oscillator.

Aside from showing the approximate gain in each stage, a signal tracer will also meet the challenge of a dead receiver in which all voltages seem normal. Starting at the antenna, we work from plate to grid to plate, etc., until we reach the point where we completely lose the signal. The trouble is between this point and the one where the signal was last encountered.

A signal-tracer probe will help us locate an intermittent. As we trace the signal, we tap the chassis or tube gently (preferably with the eraser end of a pencil) until we find the intermittent. A signal tracer will also tell us whether or not there is a signal.

As we go toward the output of an audio amplifier, we will notice a substantial increase in the signal. However, going from the primary to the secondary of the output transformer, we will observe just the opposite. Because we are moving from a high-impedance, high-voltage primary to a low-impedance, high-power secondary, we will obviously get a reduction in voltage. After all, a signal tracer indicates only voltage—not audio power.

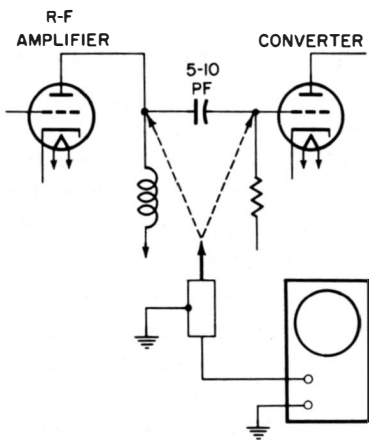


Fig. 6-1. Signal tracing an r-f converter.

A demodulator probe and an oscilloscope can be used to trace a modulated r-f signal—from the antenna, all the way through the detector stages—at frequencies of up to several hundred megacycles. Tune the receiver to some frequency within its range and feed a fixed signal (from a signal generator) into the antenna terminals. (The signal from a transmitting station may be used, but one from a signal generator is preferred because it is steady and can be kept under control at all times.)

An attempt to evaluate gain may sometimes lead to confusion because the capacitive loading effect of the probe may detune the circuit. For example, in Fig. 6-1 the tracer probe (connected to an oscilloscope) is shown checking either side of the coupling capacitor, between the r-f amplifier and converter stages. (This capacitor usually has a value of between 5 and 10 pf.) At the plate of the r-f amplifier we may get a deflection of, say, ten units on our oscilloscope. However, at the grid of the converter stage, we may get a deflection of only six or seven units. This is rather confusing, to say the least.

There is nothing wrong with the circuit—it is just the additional capacitance of the signal-tracer probe that is giving us trouble. The probe input capacitance is somewhere around 10 pf. When applied at the grid of the converter tube, this additional capacitance forms a volt-

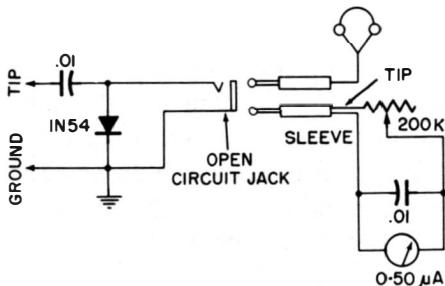
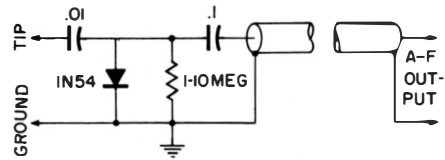


Fig. 6-2. An a-f/r-f signal tracer probe giving both visual and aural indication.



Fig. 6-3. An a-f/r-f signal tracer for use with headphones or a-f amplifier. The r-f signals must be modulated.



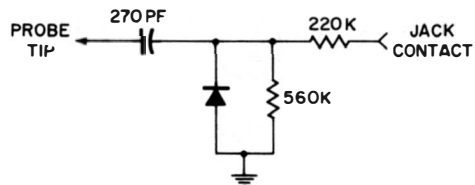
age divider with the coupling capacitor. The full voltage at the plate of the converter is now divided between the input capacitance of the detector probe. We read on the scope only the voltage across the detector probe. Therefore, this voltage will be lower than the one that would normally reach the grid of the converter tube if there were no additional shunt capacitance from the signal-tracer probe.

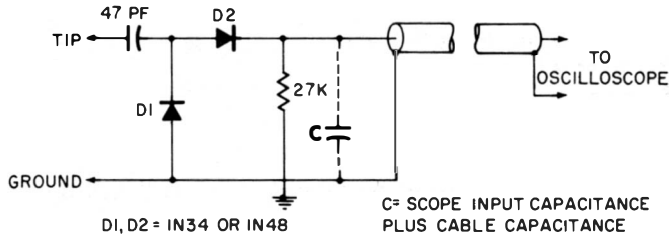
Fig. 6-2 shows a semiconductor-diode signal tracer which requires no external power supply and provides audio output as well as a meter indication. This instrument can be used for troubleshooting the r-f, detector, oscillator, i-f, and audio stages of the receiver, as well as in audio amplifiers. A 1N54 high-efficiency germanium crystal diode improves the performance. The 0.01-mfd r-f bypass capacitor at the input protects the diode, headphones, and meter from any d-c voltage in the circuit under test, but passes audio and r-f signals. The 200,000-ohm gain control in the meter circuit allows the meter movement to be adjusted for a suitable deflection. The stronger the signal, the more the resistance inserted into the circuit, and vice versa. Either the meter or the earphones can be plugged into the jack, depending on whether a visible or aural indication is desired. Note that the signal must be a modulated r-f or an audio one before an aural indication can be obtained. However, an indication will be obtained whether the r-f signal is modulated or not, because the meter responds to the d-c level of the rectified signal.

Another simple signal-tracing probe is shown in Fig. 6-3. It also is an r-f/a-f type of probe, except that the d-c component of the r-f signal is blocked by the 0.1-mfd capacitor. The audio component can then be applied to headphones or to an amplifier or scope. The probe should be shielded to prevent pickup of extraneous signals. When used with headphones, this setup is known as a *radio stethoscope*.

An interesting r-f/i-f (video-frequency) signal-tracer probe is the RCA Type WG-302A. Its schematic is shown in Fig. 6-4. This is a

Fig. 6-4. Schematic of RCA WG-302A signal-tracing probe.



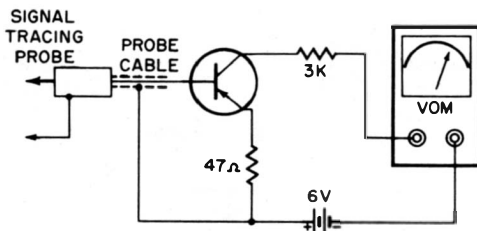


**Fig. 6-5. Diagram of a high-frequency signal-tracer probe—voltage-doubler type.**

slip-on probe used with the WG-300B direct-low-capacitance probe. The circuit of the WG-300B was shown in Fig. 1-5. The signal-tracer probe in Fig. 6-4 contains a semiconductor diode and an r-f filter housed in a plastic case. When using it with the WG-300B, set the switch on the latter to the Direct position. The time constant of the rectifier circuit is such that when the slip-on probe is used in high-frequency circuits, the low-frequency modulation is separated from the amplitude-modulated r-f carrier and fed to the oscilloscope input through the direct probe. The waveform is centered vertically on the zero axis of the screen when an a-c RC-coupled oscilloscope is used. On a direct-coupled oscilloscope, the waveform is displayed vertically, the distance being proportional to the d-c voltage resulting from rectification of the r-f carrier.

When this signal-tracing probe is used with an oscilloscope, and a sweep generator is employed to sweep the picture or sound-i-f amplifier of a television receiver, it is possible to observe the response curves of tuners and of picture and sound i-f and video amplifiers, plus the overall response curves in all high-frequency sections of the television receiver, without upsetting the performance of the high-frequency stages.

The low (3-pf) input capacitance permits the probe to be used in such critical circuits without seriously detuning the amplifiers. Because its capacitance is lower than that of the kinescope grid circuit, the probe can also be connected to the video-amplifier output without affecting the circuit.



**Fig. 6-6. Transistor amplifier for signal-tracing probe.**

The probe extends the range of an oscilloscope to 50 mc—enough to cover the i-f and video-frequency sections of television receivers. A three-inch ground lead, connected between the probe and the low side of the circuit under test, will extend the usable range to 250 mc for signal tracing in tuners. To add the ground lead, remove the nylon screw in the body of the case; then install the ground lead here, except use a metal screw and insulate the screw head.

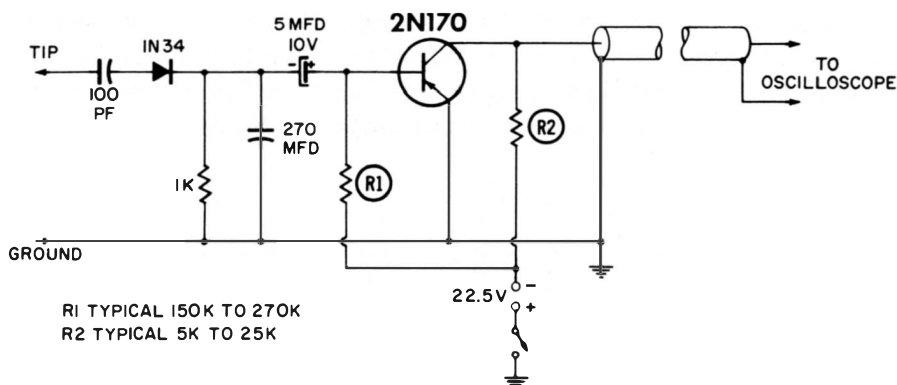


Fig. 6-7. Single-transistor demodulator signal-tracer probe.

The WG-302A r-f/i-f/v-f signal-tracing probe is an indicating device rather than a voltage-measuring instrument. For voltage measurements, the probe and oscilloscope should be calibrated against a known voltage.

The high-frequency voltage-doubler probe in Fig. 6-5 is designed for signal tracing in television, video and i-f circuits. The semiconductor diodes are so connected that positive-going sync pulses are provided to the input circuit of the oscilloscope.

The low internal capacitance of the series diode (D2), being effectively in series with the cable and scope capacitances, isolates the latter from the input circuit. Hence, the input capacitance is kept low, without the need for a series isolating resistor.

The input signal capacitor of only 10 pf further reduces the input capacitance to an absolute minimum. For this reason, the probe has excellent 60- and 120-cps rejection, and can therefore be used to trace r-f interference in B+ and filament circuits. A signal here would constitute an undesirable voltage, which could be cross-coupled between circuits and thereby cause the receiver to operate improperly. The amplitude of the output signal is about twice that of a single diode probe.

Sometimes a signal-tracer probe does not deliver sufficient signal for a readable deflection on a vtvm or oscilloscope. If not, a single-transistor amplifier stage inside the probe will add sufficient gain to permit

r-f measurements directly at the television tuner. Figs. 6-6 and 6-7 show these circuits. There may be a slight deflection in the meter circuit even with no signal applied, due to leakage within the transistor. Select the transistor that gives the least initial meter deflection. The one in this circuit is a pnp. If an npn transistor is used, the battery voltage and probe cable terminals must be reversed.

Fig. 6-7 shows the demodulator-tracer-amplifier all in one. The unit, together with its battery, should be encased in a plastic tube and connected to the oscilloscope through a shielded cable. The output may also be connected to a pair of headphones. The biggest advantage of the battery-operated signal tracer is that no transformer and no isolation from the line are required. Both amplifiers have a gain of 10.

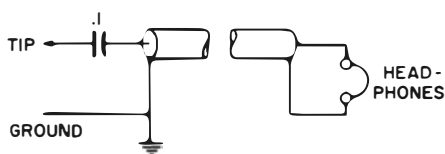
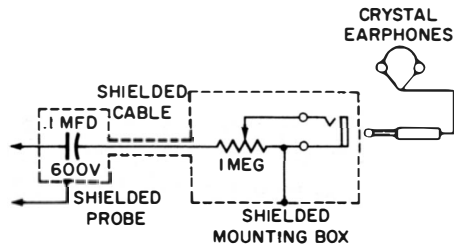


Fig. 6-8. An a-f signal-tracer probe.

Just about the simplest signal tracer imaginable is an r-f signal tracer consisting of a pair of high-impedance earphones connected to a blocking capacitor encased in a probe. The capacitor prevents the d-c points from short-circuiting through the earphones. We simply listen to the audio signal at various test points in the amplifier, and then judge its quality and volume by ear. Such a probe (Fig. 6-8) consists simply of a 0.1-mfd blocking capacitor mounted near the tip of a probe. Probe housings are available, making it a simple matter to insert the capacitor into a probe and solder it to the tip. If the probe is plastic, it should be shielded to isolate the circuit under test from hum pickup and body capacitance. This is done by lining the inside of the probe with metal foil. The shield must be connected to the braid of the flexible coaxial cable coming from the headphones.

This elementary signal tracer is used frequently for making rapid analyses in audio circuits. However, it also has some disadvantages. It tends to load the circuit because of the relatively low impedance (2000 ohms) of the earphones and the negligible reactance of the capacitor at audio frequencies. Furthermore, the human ear is insensitive to any small changes in volume, or even to relatively large amounts of distortion. Nor is there any provision for adjusting the volume. So, as we approach the high-level output stages of an amplifier, the signal grows louder and louder in the earphones, until it becomes quite uncomfortable to the listener. Crystal earphones, the impedance of which is close to 100,000 ohms in the audio range, will not load the circuits under test as much as the high-resistance magnetic earphones.

Fig. 6-9. An a-f signal-tracer probe with volume control.

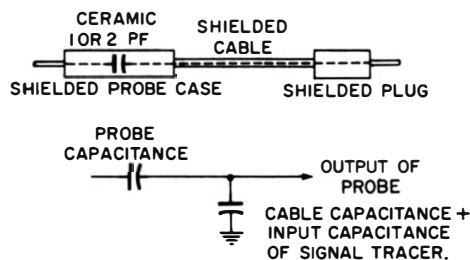


The somewhat advanced version in Fig. 6-9 has a volume control and earphone jack, usually mounted in a small metal box. Crystal earphones are used to minimize circuit loading. If desired, the output signal can be fed to an oscilloscope or a-c vtvm, or to an amplifier that has its output connected to a speaker or meter.

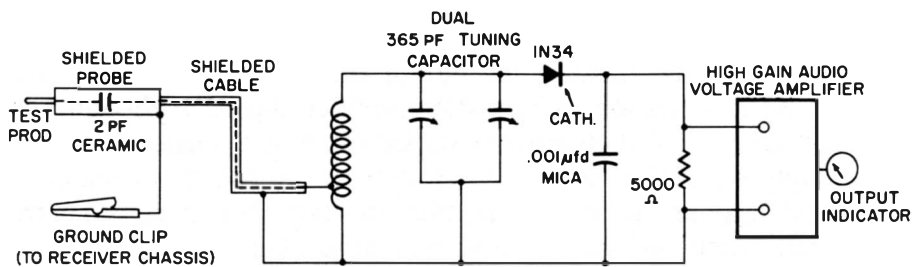
For the sake of operating simplicity, most signal tracers have no tuned input circuits. Instead, the output from a simple demodulator probe is fed into one or more audio-amplifier stages. Although adequate for most work, such a tracer sometimes is not sensitive or selective enough. Amplifiers can be used after the probe, but because of broadband response of the probe, plus the fact that there is no frequency selectivity, the amount of gain is rather limited. A tuned signal tracer overcomes some of these disadvantages. It is many times more sensitive (and somewhat more complex) than an untuned tracer. With it we can narrow our response down to the frequency or band of frequencies we are interested in, and thus exclude all other signals. Such a tracer must be resonated at the frequencies being measured. The tuned circuit need not be in the probe. (For this reason the probe, which sometimes contains a vacuum tube, can be made rather compact.) The output from the probe is fed into the instrument, which contains several tuned circuits. Here, it is demodulated and then fed into a conventional audio amplifier.

A tunable signal tracer is appropriately called a *channel analyzer*. It can be distinguished from the simpler tracers discussed so far by the fact that it is tuned to the frequency (intermediate frequency or radio frequency) at which the measurements are made. Any possibility of a spurious indication from signals, other than those we are interested in,

Fig. 6-10. Capacitance-type signal-tracer probe and equivalent circuit.



is thus eliminated. Because this signal is often taken across tuned circuits, the capacitive loading effect of the probe must be small enough not to detune the circuit under test. Such a probe, together with its equivalent circuit, is shown in Fig. 6-10. The input or coupling capacitor is a 1- or 2-pf miniature ceramic mounted as close as possible to the tip and inside a shielded test probe. This arrangement is much like the one discussed in the chapter on capacitance-divider type high-voltage probes, except the input capacitor is not a high-voltage type because the probe is not designed for high-voltage circuits. However, the shunt capacitance from the input circuit of the signal tracer, as well as the capacitance of the shielded cable used with the probe, must once again be taken into account.



Courtesy Sylvania Electric Products, Inc.

Fig. 6-11. Tuned signal-tracer.

Fig. 6-11 shows a simple but quite useful tuned signal tracer. Plug-in coils of different values can be constructed to make this tracer tunable from 400 kilocycles to 30 megacycles in four ranges. The input stage consists of a single tuned circuit and a 1N34 germanium diode detector. This is essentially a crystal receiver. A 2-pf capacitor, encased in a shielded probe and connected through a shielded cable, connects the probe to the tuned circuit under test. This one is like the shielded test probe discussed before. Proper impedance match is obtained by connecting the probe to a tap on the coil. The detector output is fed to a high-gain audio amplifier terminated by an output meter or other indicator—or if required, by a speaker. If ultimate sensitivity is not required, a pair of earphones can be substituted for the 5000-ohm resistor and high-gain audio amplifier. Because of the fact that the signal tracer is tuned, its sensitivity will be greater than if it were not tuned to the circuit.

Tuning is accomplished by two parallel-connected 365-pf variable capacitors. The tuning range includes all the i-f, r-f, and oscillator frequencies ordinarily encountered in broadcast and short-wave receivers. The coil can be a simply-wound plug-in type to simplify range changing. If desired, a rotary selector switch can be added for greater convenience in changing from band to band. A dial and knob should

be connected to the tuning capacitor, and a calibrated dial constructed. The dial can be graduated in kilocycles and megacycles by feeding a modulated signal at integral frequencies from a signal generator to the tracer. In addition to acting as a tunable signal tracer, the instrument can also be used for checking r-f oscillators and signal generators, transmitters, and carrier-controlled equipment.

We know that tuned signal-tracing probes select only the signal desired and exclude all undesired ones. Thus, before we can trace a buzz pulse through a video- or video-i-f amplifier, we must exclude the video signal.

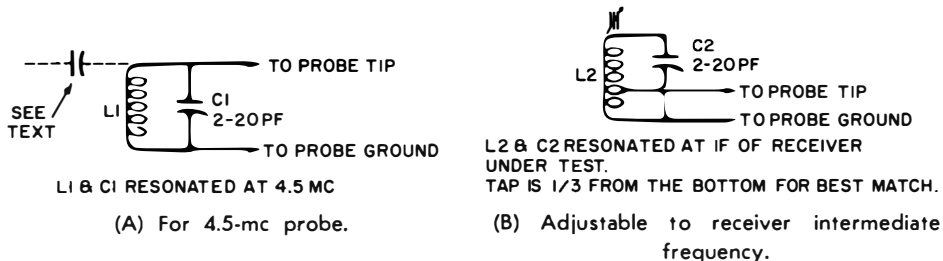


Fig. 6-12. Tuned heads for signal-tracer probes.

Any of the untuned signal-tracer probes discussed can be equipped with a tuned head to make the probe suitable for tracing buzz pulses in intercarrier television receivers. Fig. 6-12 gives specifications for two probe heads. One is tuned to 4.5 megacycles; the other can be tuned to the i-f amplifier frequency of television receivers. The inductance in Fig. 6-12A is one of the video-peaking coils in the television receiver.

The coil (L1), together with a small trimmer capacitor, should be made to resonate at 4.5 megacycles so it will respond to the 4.5-mc audio i-f signal, but not to the video signal. The probe coil is held near the peaking coils in the video amplifier. Energy is thus picked up by inductive coupling. The demodulated output signal from the probe can be observed on an oscilloscope or listened to through headphones or an audio amplifier.

The circuit in Fig. 6-12B shows a coil and capacitor resonated to the i-f amplifier frequency. They are also coupled inductively to the i-f coil of the receiver, and the output observed in the same way. Both coils pick up the desired signal, but eliminate all video information (which would completely mask the buzz waveform).

Sometimes it is impractical to use inductive coupling because the coils are shielded or the receiver is so crowded the probe cannot be brought close enough to pick up sufficient signal. Instead, capacitive coupling (through a 1- or 2-pf capacitor) can be used between the probe and the "hot" end of the coil being tested.

Fig. 6-13 shows a very sensitive r-f signal-tracing probe. This grid-leak detector probe not only detects a very weak signal but—unlike semiconductor or other vacuum-tube types—amplifies it, too. The resistor and capacitor in the grid circuit form the grid leak and thus provide demodulation. Such a probe is useful for signal tracing in the front ends of radio and television receivers, where the r-f signal voltage is usually in the microvolt range. The probe is so sensitive it can pick up a signal at the antenna of a receiver. In fact, it will give an indication when held in the hand or applied to a short wire! The grid-leak

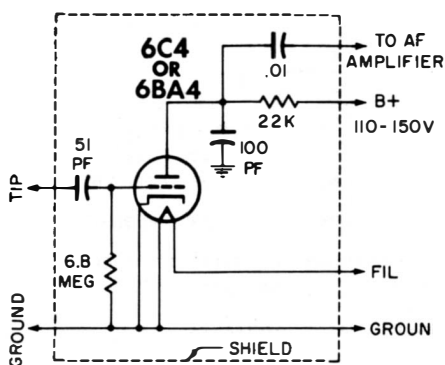


Fig. 6-13. Signal-tracing probe using grid-leak detection.

detector operates as a combination diode-detector triode-amplifier. In effect, the grid and cathode of the tube act as the plate and cathode of the diode detector. The grid, plate, and cathode then operate as a high-gain triode amplifier.

The values are typical: the input capacitor is usually between 10 and 100 pf, and the grid-leak resistor, anywhere from 5 to 25 megohms. The capacitor in the plate circuit bypasses any r-f signal that may have passed through the tube. If too large, this capacitor will also bypass the audio signals we are interested in. It should be no more than 100 pf or so. The plate resistor is the load, across which is developed the output signal representing the demodulation envelope of any amplitude-modulated signal. This output is then applied to an audio amplifier. Both demodulation and amplification are supplied. The probe is so sensitive it is easily overloaded. Therefore, it is suitable for relatively low signals only. High fidelity also is not one of its advantages. Filament and plate voltages are required; they are usually supplied by the amplifier.

Because of this sensitivity, the grid-leak detector is ideal for tracking down the source of hum, which is sometimes rather difficult to do. We can locate hum by tracing the signal at each grid and plate, moving toward the output stage until we reach the point where the hum increases markedly. Here is the villain! It may be emanating from a defective tube, an open bypass capacitor, or any other hum-producing element.



The probe can also be used for checking screen and cathode bypass capacitors. If we find a signal at a screen or bypassed cathode, we know immediately that the bypass capacitor is either open or too low in value.

An unusually small and effective signal tracer is the fountain-pen size Stethotracer shown in Figure 6-14. The instrument is transistorized and completely self-contained. It operates from a single AAA size, 1.5 volt cell and is completely insulated from the a-c power line, thereby eliminating such hum problems as might exist with line-operated tracers. The Stethotracer has an audio gain of approximately 1000 (60 db) at 1 kc and is supplied with attenuator probes for operation in higher-level circuits. An interchangeable RF crystal detector head for use in the r-f and i-f regions extends the useful frequency

Fig. 6-14. Stethotracer with earphones and three interchangeable attenuator probes.



Courtesy Don Bosco Electronics

## HUM-FIELD TRACING PROBE

The probe in Fig. 6-15 is useful for exploring hum fields and checking hum currents in audio, radio, and television equipment. It is connected directly, or through an a-c voltage calibrator, to the vertical-

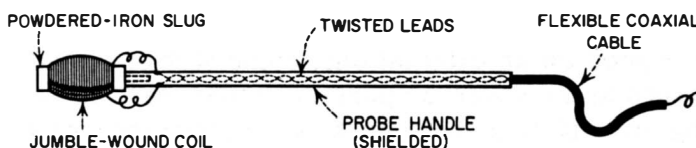


Fig. 6-15. Hum-field tracing probe.

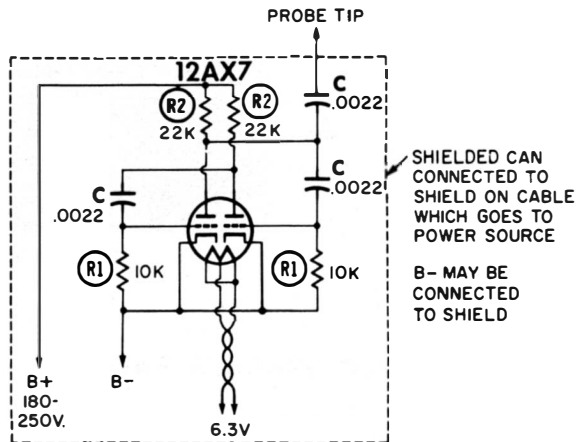
amplifier input terminals of an oscilloscope. The oscilloscope gain must be reduced so no or negligible residual hum( due to stray pickup in the room) will be displayed on the screen. When the probe is placed in a hum field, the increase in vertical amplitude will then be proportional to the field strength.

The hum probe can be used for determining the best orientation of transformers, chokes, and leads carrying alternating current. It can also be used to check hum currents in chassis, by pressing its nose to the chassis and observing the amplitude of the hum pattern on the oscilloscope screen.

range to 200 Mc. The instrument will provide a maximum output voltage of 0.5 volts peak-to-peak and can be used with an oscilloscope or a vtvm as a preamplifier to extend their sensitivity.

## SIGNAL-INJECTOR PROBES

Unlike the signal tracer, the signal-injector probe works from the output to the input. For example, in a superheterodyne receiver we inject a signal at the output stage; then we work toward the power amplifier, the first amplifier, the second detector, the i-f amplifier, the mixer, and the r-f amplifier, until we reach the antenna.



Courtesy Don Bosco Electronics

Fig. 6-16. Schematic of a signal-injector probe using a 12AX7 tube.

A signal-injector probe furnishes its own signal; thus, it does not have to depend on an external one. Some sort of output indicator is needed, such as a speaker, amplifier, or radio. As long as the circuit is operating, we will hear the output as we move the probe toward the front. But the moment we pass the dead stage, the output will be lost completely (or will drop if the stage is defective but not dead).

Most signal-injector probes are considered to be noise generators. They are usually vacuum-tube or transistor multivibrators, or blocking oscillators, operating at a fundamental frequency of around two to ten kilocycles. The output signal is a rather rough square wave which is rich in harmonics. Thus, it can be applied to both audio and r-f circuits of up to several megacycles. Adjustments or a change of probes is not needed. The very broad-band signal is, therefore, suitable for all types of circuits.

Fig. 6-16 shows the schematic of an easily constructed injector probe. A miniature 12AX7 dual-triode is used in the multivibrator cir-

cuit, which operates at approximately 10,000 cps. The available signal is coupled to the probe tip through a 0.0022-mfd capacitor. A four-conductor cable (it does not have to be shielded) should be used to connect the power source to the probe.

Fig. 6-17 shows a signal-injector probe using two transistors, also in a multivibrator circuit. This probe and the one just discussed can be put together very easily. The vacuum-tube probe requires an outside voltage source and must therefore be connected to a filament and plate supply. The transistor probe can be made completely self-contained.

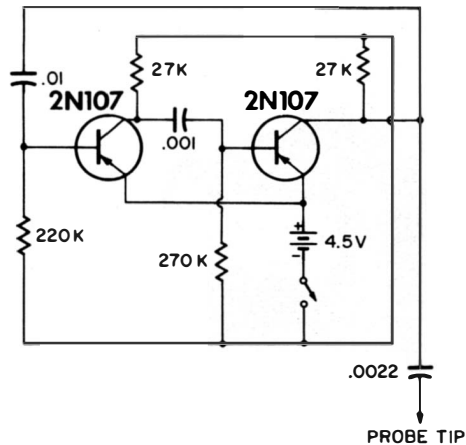


Fig. 6-17. Diagram of a transistorized signal-injector probe.

Courtesy Hewlett-Packard Co.

For this reason, it has the tremendous advantage of being portable—it can be applied anywhere and at any time, because no interconnecting wires are needed.

An interesting signal-injector probe—called the “Mosquito” because the signal sounds like a mosquito in flight—is shown in Fig. 6-18. Fully transistorized and powered by a single penlight cell, it houses a transistor oscillator operating at about two kilocycles. Its waveform is square with a sharp spike—very rich in harmonics extending to the i-f and r-f ranges. This probe is turned on by simply



Courtesy Hewlett-Packard Co.

Fig. 6-18. The “Mosquito” transistorized signal-injector probe.

sliding the pocket clip forward. The signal can be heard in the speaker or observed on an oscilloscope.

Signal-injector probes can be inductively coupled to all magnetic-sensitive circuits and pickups. No direct connection is needed.

## CLAMP-ON AND CLIP-ON PROBES

Usually when we want to measure current, we must break into the circuit and insert the meter connection. Not only is this inconvenient, but in some circuits, particularly those containing transistors, the resistance of the moving-coil instrument is often so high (compared with the resistance in the circuit) that it can become intolerable. An ideal current-measuring instrument would have zero series impedance and would therefore present no reactive loading to the circuit under test.



Fig. 6-19. Clip-on probe used for direct-current measurements.

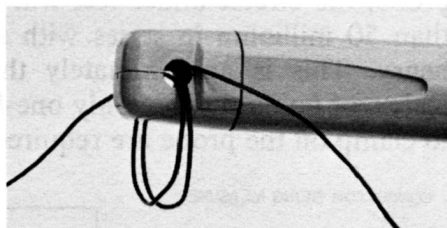
Courtesy Hewlett-Packard Co.

The clip-on d-c milliammeter probe in Fig. 6-19, together with the instrument for which it is designed, makes the measurement of direct current in low- and high-impedance circuits very simple and convenient. The d-c current range covered extends from about 0.3 milliampere to 1 ampere. The fact that the probe introduces no d-c loading is a particularly valuable property when currents are measured in low-impedance transistor circuits, because this can be done without disturbing any operating conditions. The jaws of the probe open for clipping around the conductor, and only a half-inch conductor is necessary for a correct current reading.

The probe senses the strength of the magnetic field produced by the current under observation. This sensing requires no energy from the field; therefore, the probe introduces no resistance into the circuit being measured—a most desirable situation. Since it is a direct-current

probe, the direction of the current can be determined because the probe is marked with an arrow which shows the current direction for an upscale reading. The probe itself contains a magnetic amplifier which provides an a-c output signal proportional to the magnetizing force produced by the direct current being measured. This a-c output signal is somewhere around 0.01 volt peak at a frequency of 40 kilocycles. It is amplified in the meter and then applied to a phase-sensitive detector, the output of which feeds the indicating meter.

**Fig. 6-20. Clip-on probe showing method of increasing pickup sensitivity.**



Courtesy Hewlett-Packard Co.

Fig. 6-20 shows the probe with a conductor looped through it several times. This is done to increase the effective magnetizing force of the current and thus to make the instrument more sensitive. The readings obtained under these conditions must be divided by the number of loops in the conductor.

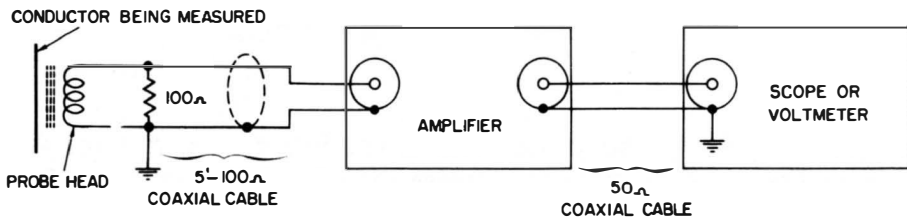
Fig. 6-21 shows a similar-looking clip-on probe designed for use with an oscilloscope, together with an appropriate amplifier. It will display current over an amplitude ranging from 1 milliamperes to 15 amperes peak-to-peak and covering a frequency range from below 50 cps to 8 megacycles. This probe consists of a wide-range current transformer with a split core which is again clamped over the wire carrying the current which we want to observe. The basic schematic of this probe is shown in Fig. 6-22. We see that the current-carrying



Courtesy Stoddart Aircraft Radio Co., Inc.

**Fig. 6-21. Clip-on probe and amplifier for use with an oscilloscope.**

conductor is, in effect, a single-turn primary for the transformer. The probe output is fed to the amplifier, the output of which is connected to the oscilloscope. The amplifier converts a sample of the current which is induced in the probe to a proportionate voltage with a current-to-voltage conversion factor of one millivolt per milliampere. This results in a convenient one-to-one relationship so that a one-volt output from the amplifier indicates that one ampere of current is flowing in the circuit under test. The frequency response of the amplifier is  $\pm 3$  db from 25 cps to over 20 mc. As a result of applying the probe, the circuit under test will see an additional impedance of less than 50 milliohm in series with an inductance of about 0.05 microhenry. This is approximately the inductance of one and one-half inches of hookup wire. Only one-half inch of wire and sufficient room to clamp on the probe are required for a measurement.



Courtesy Pyramid Instrument Corp.

Fig. 6-22. Circuit representation of probe and amplifier in typical setup.

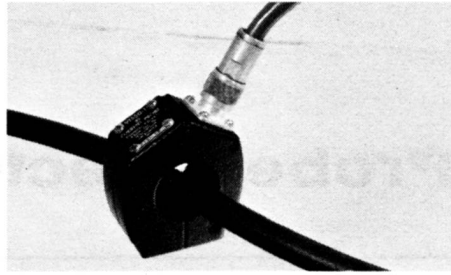
The ferrite core used in the probe has magnetic properties which make it suitable over such a wide frequency range. Magnetic (as well as electrostatic) shielding is incorporated to minimize response of the probe to fields other than those of the current being measured.

Direct current up to a half-ampere or higher will not have any noticeable effect on any measurement. The sensitivity of this probe can also be increased, as we did with the d-c probe, by increasing the number of turns which act as the primary. The increase in sensitivity will be directly proportional to the number of turns.

This probe can be modified somewhat to act as a magnetic search probe and indicate the direction and magnitude of a-c magnetic fields. This is done by placing the probe around a single shorted-turn coil. The magnetic fields will induce, in the coil, eddy currents which will in turn be indicated by the probe and displayed on an oscilloscope. We can thus observe the direction and strength of the a-c field.

The clamp-on current-measuring probe affords the maximum in flexibility and ease of operation. Fig. 6-23 shows a clamp-on r-f current probe. It is used for measuring radio interference in order that the intensity of the r-f current in an electrical conductor or group of conductors can be accurately determined. Here, again, the conductor

Fig. 6-23. Clamp-on r-f current probe.



under test acts as a one-turn primary winding. The unique mechanical design of the probe permits it to be used around any insulated cable up to  $1\frac{1}{4}$  inches in diameter. This probe is suitable for use over a frequency range extending from 14 kc to 100 mc and is capable of measurements in circuits where the r-f current may be as high as 1 ampere. Essentially, this probe is a radio-frequency toroidal transformer designed to deliver voltage through a 50-ohm coaxial cable to any receiver having an input impedance of 50 ohms and covering the frequency range at which we are making our measurements.

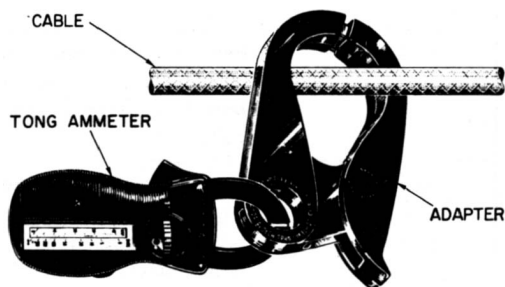


Fig. 6-24. Snap-on high-current probe (tong ammeter) and adapter for extending current range.

A snap-on high-current measuring probe (also called a *tong ammeter*) for appliance and electrical testing is shown in Fig. 6-24. It, too, operates on the transformer principle, where the wire carrying the current acts as one turn on the primary of a current transformer. An accessory, available for use with this probe, extends the current range by a factor of ten. This adapter, called a *Deca-Tran*, is shown together with the probe. Here, again, the sensitivity of the probe can be increased by wrapping two or more turns around the clamp.

# Probe Selection Chart

Probe type	Used with	Purpose
Direct	oscilloscope	Use in low-impedance, low-frequency circuits (such as B+) where added capacitance of shielded cable is of no consequence.
Isolation	oscilloscope vtvm	Isolates measuring instrument from circuit under test. Series resistance and cable capacitance act as low-pass filter to sharpen pips on response curves.
High voltage (resistive)	vtvm vom	Extends high-voltage range of vtvm and vom to allow measurements of voltages to 50kv.
High voltage (capacitive)	oscilloscope	Permits oscilloscope observation of high-voltage pulses and waveshapes in tv horizontal sweep and high-voltage circuits.
Low capacitance	oscilloscope	For testing in high-impedance, wide-band, high-frequency (to several Mc) circuits, such as video, sync and sweep circuits, with minimum amount of circuit loading.
Rectifier	vtvm	Rectifies and filters r-f signals (to several 100 Mc) and provides a d-c output proportional to the peak or peak-to-peak value.
Demodulator	oscilloscope	For visual signal tracing in r-f, video, and sound i-f stage and for displaying i-f and video amplifier response curves.
Signal tracer	signal tracer	To reduce circuit loading and detuning effect during signal tracing.
Hum-field tracing	signal tracer	Used to explore interfering hum fields.
Signal injector	equipment under test	Permits rapid checking of a-f, i-f and r-f circuits by injecting a broad-band signal.
Clip-on	oscilloscope vtvm	Probe is clipped around current-carrying conductor which permits current measurement without breaking into the circuit.



# Index

## A

Ammeter, tong, 125-126  
Amplitude-modulated signal, 87-88  
Attenuation formula, 42-43

## B

Basic circuit, vacuum-tube voltmeter,  
59  
Bucking potential, 60-61

## C

Cable  
capacitance, 9  
length, 9  
Characteristics  
vacuum-tube and germanium diode,  
62  
Contact potential, 60

## D

Deca-Tran, 125-126  
Detector, 94

## E

Electrostatic shielding, 125

## F

Frequency response, 75-77

## G

Gain control circuit, 48-49

## H

Hum, 10

## I

Impedance  
input, 10  
source, 10  
Inductance  
peaking coil, 45-47  
single wire at high frequencies, 100-  
101  
Inverse resistance, 62

## L

Load, 10

## M

Magnetic shielding, 125  
Marker box, 106

Measuring oscilloscope input  
  capacitance, 47-49  
  resistance, 46-47  
Microswitch to reduce signal bounce,  
  48-49

## O

Oscillation, parasitic, 11

## P

Parasitic oscillation, 11  
Peaking coil inductance, 45-47  
Pick-off, 52  
Pickup, 48  
Potential  
  bucking, 60-61  
  contact, 60  
Probes  
  cathode-follower, 49-57  
    attenuations used with, 53-54  
    basic circuit for, 49-51  
    Jackson LC-2-1P, 52-53  
  demodulator, 85-106  
    balanced, 96-97  
    circuits, 104  
    peak-to-peak or voltage-doubler,  
      97-98  
    selection and use, 99  
    series-type, 91-96  
      basic schematic, 92  
    shunt-type, 89-91  
      basic schematic, 90  
    direct, 9-12  
      shielded, 9  
    direct-isolation, 15  
    high-impedance, 56-57  
      nuvistor-transistor, 56  
    high voltage, 18-38  
      capacitive-divider, 29-37  
      resistive, 18-29  
    indirect, 12-17  
    isolation-filter, 16  
    low-capacitance, 12, 39-57  
      basic circuit for, 41  
      effect on waveform of, 40-41  
      operation of, 41-49  
  peak-indicating, 73-77  
    commercial high-frequency, 73  
    Hewlett-Packard high-frequency,  
      75  
    frequency response, 75  
    input characteristics of, 76-77  
    Model RF-10A, 73  
  peak-reading, 77-84  
  series-type, 81-84

Probes—cont'd  
  *peak-reading*  
    shunt-type, 77, 80  
    rectifier, 64-77  
    power supply, 54  
    rectifier, 58-84  
    selection and use of, 83-84  
    semiconductor diode, 61-63  
    vacuum-tube, 61-63  
  resistive isolation, 13-15  
  special-purpose, 107-126  
    clamp-on, 122-126  
    clip-on, 122-126  
      r-f current, 124-125  
    signal-injector, 120  
      schematic of, 120  
    transistorized Mosquito, 121-  
      122  
  signal-tracer, 107-120  
    a-f/r-f, 110-111  
    high-frequency, 112  
    hum-field, 119-120  
    RCA WG-302A, 112-113  
    transistor amplifier for, 112-  
      114  
    snap-on high-current, 125-126  
    straight-through, 9-10  
Pulse response, 71-75

## R

RC network  
  discharge curve for, 68-69  
  formula for, 67-68

## S

Safety, 37-38  
Saturation voltage, 61  
Sensitivity, 10  
Shielding  
  electrostatic, 125  
  magnetic, 125  
Signal bounce, 48-49  
Sync buzz voltage, 104-105

## T

Test leads, 8  
Time constant, 13  
Tip, 94  
Tong ammeter, 125-126  
Transit time, 70-71  
Traveling detector, 95  
Trimmer, 44, 47  
Tuned circuit, 101



# ABC's of ELECTRONIC TEST PROBES

## by Rudolf F. Graf

Many people think of an electronic test probe as just a handy termination on the end of a cable connected to test equipment and used for poking around inside a chassis. Though the circuitry involved in the design of a probe is usually quite simple, the signals which are seen by the probe may be complex. From necessity it becomes very important to understand which probe to use for each type of signal to be observed.

Electronic test probes are the link between the test equipment and the circuit or signal being checked. It should be a strong link, because without the proper probe you cannot hope to obtain accurate measurements on which to base an answer to the problem.

This book is written to provide information about the circuitry, construction, basic functions, and applications of the most common types of electronic test probes found in the field today. Thus, it will extend and improve your knowledge and ability in any testing or servicing application. *ABC's of Electronic Test Probes* is an important and needed addition to everyone's electronics library.



## ABOUT THE AUTHOR

Rudolf Graf has spent over 20 years in the electronics industry—holding positions ranging from instructor, consultant, and design and development engineer, to sales engineer and director of engineering. He is holder of a first-class radiotelephone operator's license. For three years Mr. Graf held the position of eastern editor of *Radio-TV Maintenance*. He is also the author of *Modern Dictionary of Electronics*, a popular SAMS book.



**HOWARD W. SAMS & CO., INC.**  
**THE BOBBS-MERRILL COMPANY, INC.**

APG-1

\$2.25 (In Canada \$2.85)