

\$4.25

CONDUCTANCE CURVE DESIGN MANUAL

KEATS A. PULLEN, Jr., Eng., D.



JOHN F. RIDER PUBLISHER, INC., NEW YORK

COPYRIGHT 2008 FOR PHYLLIS K. PULLEN, M.D.
by Robert J. Legg

COPYRIGHT 1958 BY JOHN F. RIDER PUBLISHER, INC.

All rights reserved. This book or any parts thereof may not be reproduced in any form or any language without permission of the publisher.

LIBRARY OF CONGRESS CATALOG CARD NUMBER 58-8591

Printed in the United States of America

INTRODUCTION

The *Conductance Curve Design Manual* has been prepared to make available to engineers, scientists, and technicians, a group of data organized to help the user design circuits which function in the manner desired, with a minimum of readjustment. It is divided into three principal sections:

- (1) a brief explanation of the special curves and their application in typical R-C amplifier designs.
- (2) a set of tables useful in making tube substitutions, and tables to simplify the selection of tubes for given applications.
- (3) a special set of curves organized to facilitate tube circuit design.

Chapter 1 describes briefly the forms of curves, and gives examples of the use of the additional data. As the principal purpose of this *Manual* is to provide data on the tubes, organized in a form which simplifies design, a brief discussion of the different sets of curves is included here.

Chapter 2 of the *Manual* develops, from the general plate current equation for tubes, some of the more commonly used equations for both triode and pentode amplifiers. This discussion is intentionally limited to several typical R-C amplifier problems as most of the design principles are displayed in the examples. The use of the techniques on more complex circuits can be readily deduced, or obtained from the appropriate reference articles in the bibliography.

Chapter 3 provides some typical design examples for both triodes and pentodes, showing the calculation of amplification and distortion and the selection of bias. In addition, the problem of selecting both the screen and cathode bypass capacitors is solved.

The first of the two tables in the cross-reference data shows the *Manual* equivalents for several hundred common tubes, and includes structure and basing data. The second table lists tubes for which curves are included, and all their equivalents as provided in Table 1.

The two power-handling tables, one for triodes and one for pentodes, may be used to improve operational reliability. These tables list the tubes in ascending order of plate conductance or screen-to-plate trans-conductance.

Tube curves themselves represent the characteristics of 71 tubes. Low-

power and high-power tubes, triodes and pentodes, and several mixer tubes are included.

Because of the great familiarity of the term RETMA in the engineering field, we have retained this term rather than use the newer abbreviation resulting from the Association's recent name change: EIA ~ Electronic Industries Association.

New York, N. Y.
March 1958

John F. Rider Publisher, Inc.

PREFACE

Electron tube information supplied by manufacturers generally consists of static characteristic curves, maximum ratings, and typical operating conditions. Although these data are useful, they are inadequate for design work, as component values that are selected based on them, usually have to be altered in the actual circuit to achieve the desired performance. Extensive use of cut-and-try methods by circuit designers clearly indicates the need for additional electrical information on these tubes, and for modification of the mathematical methods for handling this information. The triode curves given in this *Manual* consist of standard plate characteristic curves with contours of constant grid-to-plate transconductance (g_m), and contours of constant plate conductance (g_p), superimposed on them.

Curves provided here for tetrode and pentode tubes have been designed to present the rapidly varying relations in full, and reduce the more slowly varying relations to correction curves. For this reason, the contours of constant grid bias are plotted as a function of screen voltage and plate current, rather than as standard plate characteristics.

In addition, contours of constant grid-to-plate transconductance (G_{m1}) are superimposed on the static screen characteristics. The pentode curves also include correction curves for X_p and X_{c2} as a function of e_b/E_{c2} to allow adjustment of the design for any ratio of plate-to-screen voltage. This permits the determination of both plate and screen current at any value of plate and screen voltage. Tube data presented in these forms are called "G-Curves." G-Curves permit design over a wide range of operating conditions and help in the design of circuits which, when actually built, conform closely to the predictions of the calculated design.

G-Curves contain the dynamic as well as the static characteristics of a tube in a single convenient graph. One of the important advantages of the G-Curve technique is that the designer can meet specific requirements by making, on paper, point-by-point determinations of dynamic operating conditions anywhere within a tube's ratings. It is therefore possible to optimize a design so that a given performance can be obtained with minimum tube element dissipation. Tube life and circuit

reliability are enhanced and the experimental readjustment often required in electronic circuit design is minimized.

In brief, the circuit design technique presented here is based on the fundamental equations of vacuum tube circuits. The small-signal parameters such as g_m and g_p , which appear in these equations are obtained directly from the G-Curves included in this *Manual*. Quantities of interest, such as output voltage, gain, distortion, etc., may be obtained explicitly for use with the fundamental equations because of the additional data available with the G-Curve technique. In most treatments of vacuum tube fundamentals, the circuit equations are developed and the concept of small-signal parameters, although well explained, are not used as a basis for circuit design.

The use of these curves and the equations listed in Chapter 2 enable the designer to understand more dearly in what manner circuit performance changes whenever any circuit parameters are varied. Also, it becomes evident that when a required performance cannot be obtained without operating the tube at or near its peak rating, another tube type with greater power-handling capability should be chosen.

The selection of a different tube type is relatively simple in terms of the tables of power-handling ability included in this *Manual*. First, amplifier distortion and tube dissipation are calculated. If the distortion is larger than desired and/or the dissipation is high, a tube having a larger nominal value of g_p or G_{m2} should be selected. If on the other hand the distortion is lower and/or the dissipation is much less than permissible, then a tube having a lower g_p or G_{m2} may be selected.

Tube reliability is one of the major problems confronting designers of specialized equipment. It may be attained by the design of conservatively rated circuits where the selection of tubes and operating conditions is such that circuit performance is accomplished with the lowest possible element dissipation. The G-Curve technique is well suited to the design of conservatively rated circuits since it provides the design information required.

The author wishes to thank Mr. W. E. Babcock of RCA for his technical review and comments on this *Manual*. He wishes also to note the assistance of H. G. McGuire and T. Turner in the preparation of some of the material.

Kingsville, Md.
March 1958

Keats A. Pullen, Jr., Eng.D.

Acknowledgment

The author wishes to express his appreciation to General Electric Company for their courtesy in supplying data used in the preparation of the following curves:

6AM4	5840	
6BY4	5844	
12AU7	5899	
12AX7	5902	
5654	5965	
5670	6005	
5686	6021	
5691	6072	
5692	6111	
5693	6112	
5718	6134	6386
5719	6136	6414
5749	6137	6661
5751	6201	6679
5814A	6265	6829

About the author of *The Conductance Curve Design Manual* :

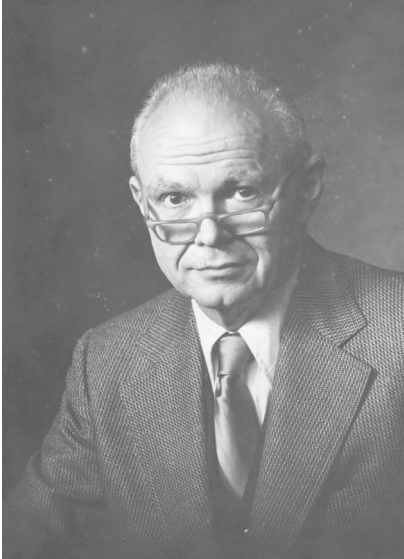

Keats A. Pullen, Jr. ED, PE

was born in Onawa, IA, in November 1916. He attended schools in Los Gatos, CA, then earned a B.S. in physics from the California Institute of Technology, Pasadena, CA, in 1939. He received his Doctorate in Engineering from Johns Hopkins University in 1946 and became a licensed professional engineer in Maryland in 1948.

In June 1946, Dr. Pullen started working at the Ballistics Research Laboratory (BRL), Aberdeen Proving Ground, MD, where he remained until 1978. He transferred from BRL to the U.S. Army Material Systems Analysis Activity (AMSAA) in 1978, where he remained until his retirement from the Army in 1990.

While working at BRL and AMSAA, Dr. Pullen designed and evaluated designs for a wide range of electronic systems for military use, such as DOVAP, DORAN, EMA, a drone program, satellite systems, Havename, and other systems. During his years working at Aberdeen Proving Grounds, he was also on the faculty of several universities where he taught college courses in engineering. These included the Pratt Institute of Technology in Brooklyn, New York, the University of Delaware, and Drexel University.

Dr. Pullen was a Life Fellow of the Institute of Electrical and Electronics Engineers, President of the Aberdeen Chapter of the Armed Forces Communications and Electronics Association, a member of ADPA, AUSA, the Association of Old Crows, and Sigma Xi. In 1982, he received the Marconi Memorial Medal from the Veteran Wireless Operators Association.

During his lifetime, Dr. Pullen published nine books, more than 25 reports, and many more papers and letters. He also was the holder of six patents. He was active in developing improved communication systems for the Special Operations Forces, Airland Battle 2000, and in developing grounding improvements for the Army, to protect the increasingly delicate systems that support the U.S. Military.

Dr. Pullen died in December 2000, at age 84, as the result of a fall. He was survived by his wife, Dr. Phyllis K. Pullen, four sons, Peter, Paul, Keats III, Andrew, his daughter Victoria Leonard, and seven grandchildren.

General Symbols

C_k	cathode bypass capacitance for stabilizing bias voltage
C_s	shunt capacitance for stabilizing screen voltage
D	second-harmonic distortion (percent)
E_b	static plate voltage, no signal
E_{bb}	d-c plate supply voltage
E_{bn}	plate voltage at negative limit of bias
E_{bp}	plate voltage at positive limit of bias
E_{bz}	intersection of dynamic load line with $i_b = 0$ axis
E_c or E_{c1}	grid bias voltage with no applied signal
E_{c2}	static screen grid voltage
E_{cc}	grid bias supply voltage
E_k	static voltage between cathode and cathode return (usually ground)
e_b	total instantaneous plate-to-cathode voltage
e_c	total instantaneous grid-to-cathode voltage for triodes
e_{c1}	total instantaneous grid-to-cathode voltage for pentodes
e_{c2}	total instantaneous screen-grid-to-cathode voltage
e_{c3}	bias on grid three (used with mixer tubes)
e_g	a-c component of e_c
e_{g1}	a-c component of e_{c1}
e_{g2}	a-c component of e_{c2}
e_k	a-c component of cathode voltage
e_L	instantaneous voltage across load resistance R_L
e_p	a-c component of e_b
e_s	input signal voltage, instantaneous value
G_{m1}	nominal transconductance of pentode for $e_b/e_{c2} = 2$ (first grid)
G_{m2}	nominal screen-to-plate transconductance for $e_b/e_{c2} = 2$
G_{m3}	nominal transconductance from grid three to plate (used with mixer tubes)
g_m	triode transconductance
g_{m1}	transconductance, for pentode first grid (corrected)
g_{m2}	screen-to-plate transconductance for pentode (corrected)
g_{m12}	control-to-screen transconductance
g_{m22}	screen self-conductance

g_p	plate conductance (= $1/r_p$)
I_b	static plate current with no signal
I_{bm}	plate current at maximum power dissipation
I_{bn}	plate current at negative limit of bias
I_{bp}	plate current at positive limit of bias
I_{c2}	screen current
I_p	nominal plate current in pentode for $e_b/e_{c2} = 2$
I_{pp}	nominal plate current at condition of positive limit bias
i_b	total instantaneous plate current
i_{c2}	total instantaneous screen grid current
i_{g2}	a-c component of i_b
i_k	total alternating cathode current ($i_p + i_{g2}$)
i_p	a-c component of i_b
K	gain
K_n	gain at most negative excursion of e_c
K_p	gain at most positive excursion of e_c
K_s	gain at static bias, E_c
P_{c2}	power dissipated in screen grid
P_p	power dissipated in plate
P_{pm}	maximum instantaneous plate dissipation
R_i	input resistance
R_{k1}	unbypassed portion of cathode bias resistance
R_{k2}	bypassed portion of cathode bias resistance
R_L	static load resistance
R_{LD}	dynamic load resistance
R_o	output resistance
r_p	plate resistance ($\Delta e_b / \Delta i_b$ with E_{c1} and E_{c2} constant $\sim 1 / g_p$)
R_s	series resistance for limiting screen voltage and current
X_{c2}	screen correction factor ($X_{c2} \sim i_{c2}/I_p \sim g_{m1}/G_{m1}$)
X_p	plate correction factor ($X_p \sim i_b/I_p \sim g_{m1}/G_{m1}$)

CONTENTS

General Symbols	xi
Chapter 1: THE CURVES	1
Triode Data	1
Special Noise Contours	2
Logarithmic Data	2
Pentode Data	2
Screen-to-Plate Transconductance in Pentodes	3
Logarithmic Data	4
Mixer Data Sheets	4
Measurement of Tube Data	4
G-Curve Preparation	4
Chapter 2: THE EQUATIONS	6
The Basic Equation	6
Resistance-Coupled Amplifier Equations	6
Cathode Degenerative Amplifier Equations	8
Cathode Follower Equations	8
Chapter 3: AMPLIFICATION TECHNIQUES	10
Triode R-C Amplifier	10
Load Lines	10
Amplification	12
Distortion	12
Power Dissipation in the Triode Tube	13
Pentode R-C Amplifier	14
Initial Selections	16
Small-Signal Amplifications	17
Distortion	17
Power Dissipation in the Pentode	17
Calculation of the Series Screen Resistance	18
Screen Bypass Capacitor	18
Dynamic Load Lines	19
Triode Degenerative Amplifier	20
Distortion	20
Pentode Degenerative Amplifier	20
Triode Cathode Follower	21
Pentode Cathode Follower	22
Calculating the Cathode Bypass Capacitor	22

Bibliography	23
Cross-Reference Data	25
Table I: Tubes with Electrical Characteristics	
Similar to <i>Manual</i> Tubes	27
RETMA Bases	31
Table II: Tubes for which Curves are listed	
in this <i>Manual</i>	33
Tables of Power-Handling Ability	36
Table III: Triodes	37
Table IV: Pentodes	38
Tube Curves	39
Index	114
Index of Tube Curves	115

THE CURVES

TRIODE DATA

Triode G-Curves are prepared from large scale sets of standard plate characteristic curves. This is done by adding contours which define the positions of contours for several values of the transconductance and plate conductance parameters. The method chosen for distinguishing the various contours is to use solid lines for the bias contour curves, dashed lines for the transconductance contours, and dotted lines for the plate conductance contours. The designation of the specific values of the parameters applying to any contour is indicated by a number placed beside the contour. The grid bias values are expressed in volts, and the small-signal parameter values are expressed in micromhos.

A value of plate conductance is also tabulated along with the corresponding transconductance, in the Table of Triode Power-Handling Abilities. These values are determined along the zero-bias contour at a point corresponding, with most tubes, to 75% of rated dissipation. As a result, the selection of a tube for a modified design is accomplished by finding one having either twice the nominal g_p , or half, depending on whether the design was overloaded or overly conservative initially. Usually two or three trials will lead to a satisfactory tube.

Example 1. Find the transconductance and the plate conductance for the 6J5 tube with $e_b = 100$ volts and $e_c = -2$ volts.

On the G-Curve for the 6J5 tube, examination of the area around $e_b = 100$ volts and $e_c = -2$ volts shows the following:

e_c	g_m	i_b	e_c	g_p	i_b
-	3500	8 ma	-	175	9.7 ma
-2	-	6.8 ma	-2	-	6.8 ma
-	3000	5.8 ma	-	150	6.3 ma

Interpolating with these data gives an approximate g_m of 3200 micromhos and a g_p of 153 micromhos.

The accuracy required of the interpolation is fortunately very low. Because of normal manufacturing variations, the positions of the contours may vary from tube to tube by as much as 20%. As a result, a linear approximation actually gives results that are as close as can be justified by both the data and the devices themselves.

SPECIAL NOISE CONTOURS

The curves of the 6AM4 tube include a contour of minimum noise figure. This has been obtained from the manufacturer's data which indicate the correct bias for use with the tube (with a low-impedance grid circuit) in a grounded-grid connection. This contour, which indicates the bias required for obtaining the highest signal-to-noise ratio, is found to lie near the negative edge of the contact potential area (where the grid will bias itself with an infinite grid impedance) for the tube. Operation of the tube on the minimum noise contour should be attempted only in a grounded-grid connection.

LOGARITHMIC DATA

The triode characteristic curves as normally presented do not give enough data in the low current range for the design of such circuits as multi-vibrators, flip-flops, and relaxation oscillators. Therefore characteristic curves of tubes for switching applications are plotted on the basis of a linear plate voltage scale and a logarithmic plate current scale. The small-signal data are also plotted on a logarithmic scale. As an example, the curves for the 5965 tube are plotted on the ordinary basis and the logarithmic basis in this set.

PENTODE DATA

The G-Curves provided on pentode tubes are curves of constant bias as a function of screen-grid voltage E_{c2} , and nominal plate current I_p . The small-signal data included are in the form of contours of constant value of nominal transconductance G_{m1} . Data on plate conductance are not included since they rarely require consideration with pentode tubes. One of the few examples where the plate conductance data are useful is in connection with series-pass tubes in regulated power supplies.

An examination of the relations of the various voltages and currents for pentode tubes shows that the voltages having the greatest effect on plate current are grid-to-cathode voltage e_{c1} , and screen-to-cathode voltage E_{c2} with plate voltage e_b , having a rather small effect. Consequently the plotting of grid voltage as a function of plate voltage and plate current, as is done on standard data sheets on pentodes, does not give the most significant data on the pentode. However, plotting the characteristics of pentodes on the basis of their screen voltage shows directly the importance of the rate of change of plate current with screen voltage. It also shows the importance of the dependence.

The screen characteristic curves are plotted for a ratio of plate-to-screen voltage (e_b/E_{c2}) equal to two. Values of i_b , and g_{m1} for ratios of plate-to-screen voltage other than two may be obtained by the X_p correction curve included in the upper left-hand corner of each data sheet*.

*note - The correction curves are obtained by plotting the curves $X_p = i_b/I_p$ and $X_{c2} = i_{c2}/I_p$ as a function of e_b/e_{c2} , where I_p is the value of i_b , where $e_b/e_{c2} = 2$. A series of these

An uncorrected value of I_p or G_{m1} is read from the G-Curve at the desired grid bias and screen voltage. It is then corrected by use of the value X_p for the voltage ratio applying by the equations:

$$\begin{aligned} i_b &= X_p I_p \\ g_{m1} &= X_p G_{m1} \end{aligned} \quad (1)$$

Values of i_{c2} and g_{m12} may also be obtained with the help of the X_{c2} curve also located in the upper left-hand corner of the data sheet. This X_{c2} factor is read from the X_{c2} curve at the plate-to-screen voltage ratio in question. The values of i_{c2} and g_{m12} are:

$$\begin{aligned} i_{c2} &= X_{c2} I_p \\ g_{m12} &= X_{c2} G_{m1} \end{aligned} \quad (2)$$

Example 2. Find the plate current, screen current, and the transconductance from control grid to screen and plate for the 6AH6 tube with a bias of -1 volt and a screen and plate voltage of 100 volts.

TABLE OF SOLUTIONS .

Data Given	Read from Curve	Equations	Solution .
Tube 6AH6	$X_p = 0.97$	$i_b = X_p I_p$	$i_b = 8.4 \text{ ma}$
$e_b = 100 \text{ volts}$	$X_{c2} = 0.23$	$i_{c2} = X_{c2} I_p$	$i_{c2} = 2.0 \text{ ma}$
$E_{c2} = 100 \text{ volts}$	$I_p = 8.7 \text{ ma}$	$g_{m1} = X_p G_{m1}$	$g_{m1} = 9200 .$
$e_{c1} = -1 \text{ volt}$	$G_{m1} = 9500$	$g_{m12} = X_{c2} G_{m1}$	$g_{m12} = 2200 .$

SCREEN-TO-PLATE TRANSCONDUCTANCE IN PENTODES

The screen-to-plate transconductance (g_{m2}) of pentode tubes is normally only needed in the selection of the correct tube for a given application; occasionally, however, it is needed in design. Its value may be obtained from the G-Curve by finding the slope of the bias contour at the required points. The nominal value is adjusted by the use of X_p and X_{c2} to correct for the space-current distribution.

The nominal values of G_{m2} given in the Table of Power-Handling Ability for Pentodes may be used to guide the selection of a pentode, as the values given in the table correspond to zero-bias conditions with the plate and screen voltages equal. As a result, a higher value of G_{m2} means that the same current can be obtained at lower plate and screen voltages, or more output power may be obtained for a given tube dissipation.

correction curves may be prepared and averaged, with possibly a little extra weight being given to the contours obtained for bias voltages near zero. The resulting relations show the variations of X_p above $e_b/e_{c2} = 0.5$ to within 3 - 5 % of the true value, or much closer than can be expected from the tube itself. The values of X_{c2} take the same form from tube to tube, but may differ in overall magnitude by from 5 - 25 % with average tubes.

LOGARITHMIC DATA

The design of variable-gain radio-frequency and intermediate-frequency amplifiers requires data in the low current region and therefore makes desirable a special logarithmic set of curves. The special sheet for this application presents the characteristics for the remote-cutoff type of pentodes on a logarithmic plate current scale, and a linear screen voltage scale. Transconductance contours arranged in a logarithmic order are presented on this plot. An example of a G-Curve of this type for a remote-cutoff pentode may be seen on the 6BJ6 G-Curve.

MIXER DATA SHEETS

Special data sheets are required for the multi-control-grid type of mixer tubes such as the 6CS6, 6BE6, etc. For mixer design it is necessary to have data showing the effect each control grid has on the plate current, as well as the data on the small-signal interaction.

Static design of the mixer tube circuit requires a standard screen characteristic sheet for the preliminary phase of the design. The final conversion design is accomplished with the special sheets, called converter sheets (see the 6BE6 sheets). The converter G-Curve information is presented in two sections, one of which shows G_{m1} and e_{c3} contours, the other G_{m3} and e_{c1} contours, as a function of the screen voltage and the plate current. Use of these curves is described elsewhere*.

MEASUREMENT OF TUBE DATA

The current-voltage relationships for the G-Curves measured for this *Manual* were recorded with an X-Y recorder and special variable-voltage supplies. The small-signal parameters were measured with a General Radio type 561D Vacuum Tube Bridge. Each G-Curve so obtained represents the average of the measurements of a number of tubes, and has been correlated with other data sources as well. Although the curves thus obtained consist strictly of small sample lots, the data appear to be adequate for all but the most stringent design problems.

Some of the data sheets have been transcribed from extended data provided by the manufacturer. (See sheets carrying the statement "Data courtesy of General Electric Co." for examples. In these cases, special large-size copies were made available.) Such transcription of data can frequently be accomplished because of the trend toward improved data which has resulted from the introduction of G-Curves. The data have been replotted because of the greater flexibility of use possible with G-Curves.

*ref - Pullen, K. A., "Design of Mixers Using Conductance Curves," *Electronic Design*, June 1, 1957.

G-CURVE PREPARATION

The transcription from extended data to G-Curves can be made by the user. With triodes, the values of bias or plate current for a given plate voltage corresponding to given values of transconductance or plate conductance (reciprocal of plate resistance), may be marked directly on the plate characteristic curves. The contours may then be smoothed through the corresponding points.

Transcription of the extended data on pentodes to screen characteristic curves is based principally on the contours of constant screen voltage as a function of bias and plate current, and the contours of constant screen voltage as a function of bias and transconductance. If the X_p correction is assumed to be unity, the positions of the successive bias contours as a function of screen voltage and plate current, may be read directly from the screen voltage contours. The position of the transconductance contours may be read similarly.

Resulting data may be plotted as a function of screen voltage and plate current, giving the screen characteristic curves approximately. The plate (X_p) and screen (X_{c2}) correction curves are obtained from the standard plate characteristic curves by reading the plate current for a plate voltage twice the screen voltage, and determining the ratio of the values of plate and screen currents to this current for different ratios of e_b/e_{c2} .

Although considerable effort has been made to be certain of the average correctness of the curves provided herein, neither the author nor the publishers can guarantee satisfactory results because of the wide variations from tube to tube, and from manufacturer to manufacturer. A wide practical experience in the use of all the included curves indicates, however, that satisfactory results can be obtained if the techniques are applied as described. The wide variations result from minor differences in brand design, and changes in design during production. Curves prepared directly from published characteristics given by one manufacturer, will often not apply to another brand, particularly in uncontrolled areas — very low plate and screen voltages, near zero grid bias, and near plate-current cutoff in particular.

THE EQUATIONS

THE BASIC EQUATION

Although the equations describing the operation of the vacuum tube are derived in many text books, the derivation is repeated here so that a form more suitable for use with G-Curves can be shown. With these equations and the G-Curves, the performance of a vacuum tube in its circuit may be calculated at any point within the operating area.

The total instantaneous value of the plate current in a tube is a function of the tube parameters and can be expressed as:

$$i_b = f (e_b, e_{c1}, e_{c2}, \dots)$$

The unspecified parameters are functions of such things as filament voltage, tube geometry, temperature, and many other factors. Holding the unspecified parameters constant, a series expansion of the above equation in terms of partial derivatives of 'f' can be written. These partial derivatives are the commonly used conductance parameters in the following equation:

$$i_p = g_{m1} e_{g1} + g_{m2} e_{g2} + \dots + g_p e_p \quad (3)$$

where the g's are the values of the partial derivatives. This is the basic equation from which equations for use with the G-Curve technique are derived. For triodes, it reduces to:

$$i_p = g_m e_g + g_p e_p \quad (4)$$

RESISTANCE-COUPLED AMPLIFIER EQUATIONS

The triode R-C amplifier circuit is shown in Fig. 2-1. For the present analysis R_{k1} may be assumed equal to zero, or a short circuit. Because supply voltage E_{bb} is constant, plate voltage change e_p is equal but opposite in polarity to the output voltage change, i.e. :

$$e_p = -e_L = -i_p R_L$$

Using this to eliminate i_p from Equation 4 gives:

$$e_p = -g_m R_L e_g / (1 + g_p R_L)$$

and the equation for amplification follows immediately:

$$K = e_p / e_g = -g_m R_L / (1 + g_p R_L) \quad (5)$$

Fig 2-1. Voltage relations of triode and pentode amplifiers.

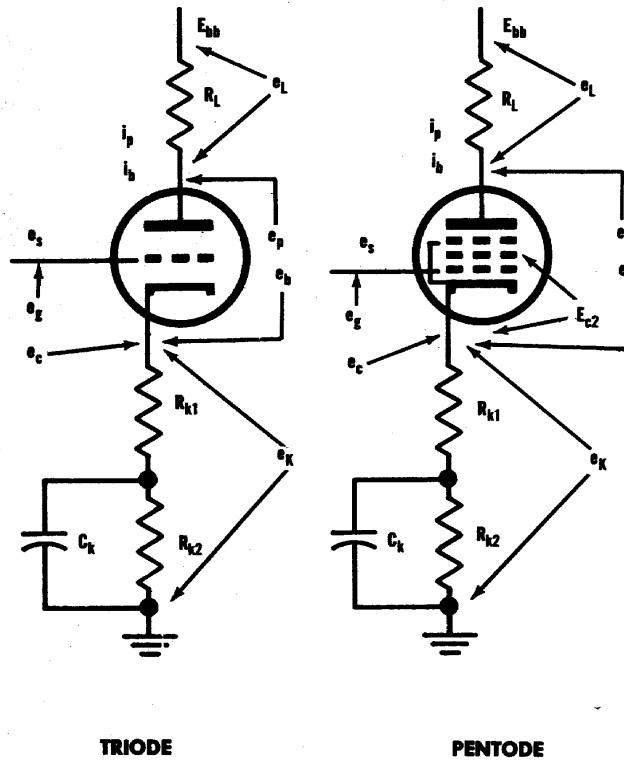

Small signal components	e_p	i_p	e_g
Instantaneous components	e_b	i_b	e_c

See General Symbols: page xi

In the case of pentodes the plate conductance is normally negligible — that is, plate resistance r_p is very large provided plate voltage e_b is more than half the screen voltage, E_{c2} . The pentode amplification equation for constant screen voltage follows from Equation 5 by setting g_p equal to zero, and by replacing g_m with g_{m1} . The resulting equation is:

$$K = e_p/e_{g1} = -g_{m1} R_L \quad (6)$$

As the transconductance is dependent on both G_{m1} and X_p (see equation 1), equation 6 reduces to:

$$K = -G_{m1} X_p R_L \quad (7)$$

CATHODE DEGENERATIVE AMPLIFIER EQUATIONS

The triode cathode degenerative amplifier is an R-C amplifier in which a portion of the cathode resistor R_{k1} is left unbypassed (Fig. 2-1). Thus the instantaneous signal voltage between grid and cathode is:

$$e_g = e_s - e_k = e_s - i_p R_{k1}$$

and the plate-to-cathode voltage is:

$$e_p = -e_k - e_L = -i_p (R_{k1} + R_L)$$

Substitution of these relations into the basic equation (4) gives the amplification equation:

$$K = -e_L / e_s = -g_m R_L / [1 + (g_m + g_p) R_{k1} + g_p R_L] \quad (8)$$

This equation resembles that for the triode R-C amplifier (Equation 5) but has an added term in the denominator, the term introduced by the cathode degeneration, $(g_m + g_p) R_{k1}$.

For the pentode degenerative amplifier, the equations for signal voltages are slightly different:

$$e_{g1} = e_s - i_k R_{k1} = e_s - (i_p + i_{g2}) R_{k1}$$

and

$$e_p = -i_k R_{k1} - i_p R_L = - (i_p + i_{g2}) R_{k1} - i_p R_L$$

Now, if the screen grid is adequately bypassed to the cathode, the instantaneous value of the varying component of the screen current i_{g2} may be neglected. Likewise, for properly designed pentode amplifiers, the plate conductance term may be neglected. Under these conditions, the equation for amplification becomes:

$$K = -e_L / e_s = -g_m R_L / (1 + g_{m1} R_{k1}) \quad (9)$$

which, in terms of pentode parameters, becomes:

$$K = -G_{m1} X_p R_L / (1 + G_{m1} X_p R_{k1}) \quad (10)$$

CATHODE FOLLOWER EQUATIONS

The cathode follower is an amplifier (with an amplification less than unity) that has its output signal taken between cathode and ground. To obtain a cathode follower from Fig. 2-1, the resistance of R_L is set equal to zero and the bypass capacitor across R_{k2} is removed. The circuit equations then are, for the voltages:

$$e_g = e_s - e_k = e_s - i_p R_k$$

and

$$e_p = -e_k$$

where R_k is the sum of R_{k1} and R_{k2} . Substitution in Equation 4 gives the amplification equation:

$$K = e_k/e_s = g_m R_k / [1 + (g_m + g_p) R_k] \quad (11)$$

The equation for the amplification of a pentode cathode follower is derived in a similar manner; using the same assumptions as made on page 8, it is:

$$K = g_{m1} R_k / (1 + g_{m1} R_k) \quad (12)$$

and substituting for the pentode parameters:

$$K = G_{m1} X_p R_k / (1 + G_{m1} X_p R_k) \quad (13)$$

AMPLIFICATION TECHNIQUES

The resistance-coupled amplifier, although one of the simplest to design, demonstrates many of the important techniques used with G-Curves. Separate consideration of the design of triode and pentode amplifiers is required as the design techniques differ appreciably. Design features which are not directly dependent on the G-Curve technique, such as bandwidth, cutoff frequency limits, etc., are not discussed here as they can be established adequately by standard techniques.

THE TRIODE R-C AMPLIFIER

As the important specifications on an amplifier are the input and output voltages, the impedance levels, the amplification and the distortion, the purpose of the design procedure is to provide a circuit that conforms with the specifications. The following basic steps may be used with G-Curves to provide the required design:

- 1 - Select a trial tube.
- 2 - Select a tentative supply voltage E_{bb} and load resistance R_L , and draw a load line.
- 3 - Read the small-signal parameters, g_m and g_p , at several points along the load line.
- 4 - Calculate the small-signal amplifications.
- 5 - Calculate the distortion.
- 6 - Calculate the dissipations.

The selection of a trial tube initially is an educated guess. If an amplifier for handling small voltages is required, a tube may be selected from among the top third (low g_p or G_{m2}) of the appropriate Table of Power-Handling Ability. For moderate voltages select from the middle third, and so forth. After a tube has been selected the design may be prepared as described, and if desired, a re-design made with a tube having a lower or higher nominal g_p or G_{m2} rating, as indicated by the results from the initial design.

Fig 3-1. Basic design of a triode amplifier.

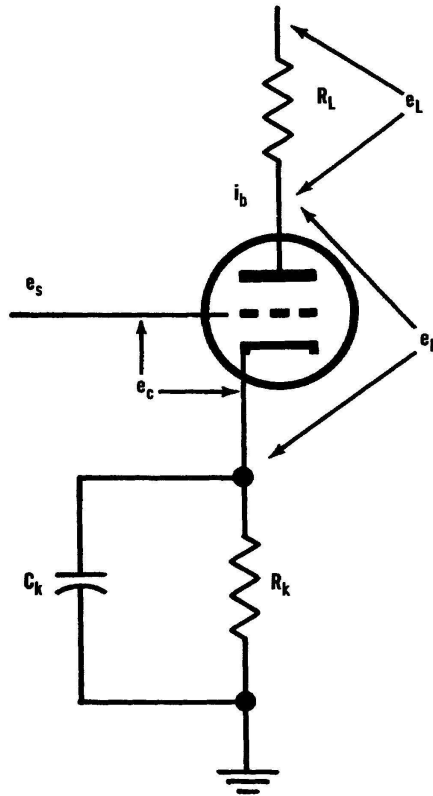

LOAD LINES

The triode R-C amplifier circuit is shown in Fig. 3-1. Based on this circuit, the equation for the load line is:

$$e_b = E_{bb} - i_b R_L \quad (14)$$

This is the equation for a straight line which, when plotted on the plate characteristic curve, shows how the voltage across the tube varies with the current through the tube. It is most easily plotted from two limit points such as the following:

$$\begin{aligned} i_b &= \text{zero when } e_b = E_{bb} \\ e_b &= \text{zero when } i_b = E_{bb}/R_L \end{aligned}$$

The load line may be drawn through these points.

Example 3. Find the limit points for a 6J5 tube used with a supply voltage of 250 volts and a load resistance of 25,000 ohms; repeat with a load of 50,000 ohms.

Case I	Point I	Point 2
$R_L = 25,000$ ohms $E_{bb} = 250$ volts	$e_b = 250$ volts $i_b = 0$ ma	$e_b = 0$ $i_b = 10$ ma
Case II	Point I	Point 2
$R_L = 50,000$ ohms $E_{bb} = 250$ volts	$e_b = 250$ volts $i_b = 0$ ma	$e_b = 0$ $i_b = 5$ ma

These lines may be drawn on the 6J5 G-Curve.

AMPLIFICATION

Read the small-signal parameters g_m and g_p at several desired points along the load line and tabulate for calculation of the amplification using Equation 5. These values of K are true small-signal amplifications and not average amplifications as are normally obtained.

Example 4. Read and tabulate the small-signal parameter values at several bias values for Cases I and II, and calculate the values of K .

Case 1: 6J5 tube $E_{bb} = 250$ volts and $R_L = 25,000$ ohms						
e_c	0	-2	-4	-6	-8	volts
g_m	3800	3150	2500	1950	1350	umhos
g_p	165	150	130	110	80	umhos
K	-18.5	-16.6	-14.7	-13.0	-11.3	
Case II: 6J5 tube $E_{bb} = 250$ volts and $R_L = 50,000$ ohms						
e_c	0	-2	-4	-6	-8	volts
g_m	3200	2400	1850	1350	900	umhos
g_p	140	120	105	80	60	umhos
K	-20.0	-17.1	-14.8	-13.5	-11.3	

DISTORTION

The second-harmonic distortion of an input signal as generated in the amplifier may be determined by using the small-signal amplifications in the following equation:

$$D = 25 (K_p - K_n) / (K_p + K_n) \quad (15)$$

The values of the amplification K_p and K_n correspond to the amplifications at the most positive and most negative values of e_c , respectively. Equation 15 is valid as long as K is approximately a linear function of e_c . Higher-order components of harmonic distortion are present when a plot of K vs e_c gives a curved line. The amplitudes of these components may be calculated with the help of Fourier analysis techniques and the small-signal amplifications at several points.

Example 5. If the input voltage e_s is 8 volts peak to peak and the tube is biased at $E_c = -4$ volts, then from Case I Example 4, the distortion is approximately 6%. For a peak-to-peak signal of 4 volts, the distortion is 3%, showing that the distortion decreases as the input signal is decreased.

POWER DISSIPATION IN THE TRIODE TUBE

Maximum plate power dissipation in an R-C amplifier occurs when the plate voltage is one-half the voltage at which the load line intersects the line of zero plate current. In Fig.3-2 maximum plate dissipation

Fig. 3-2. Load lines for power dissipation.

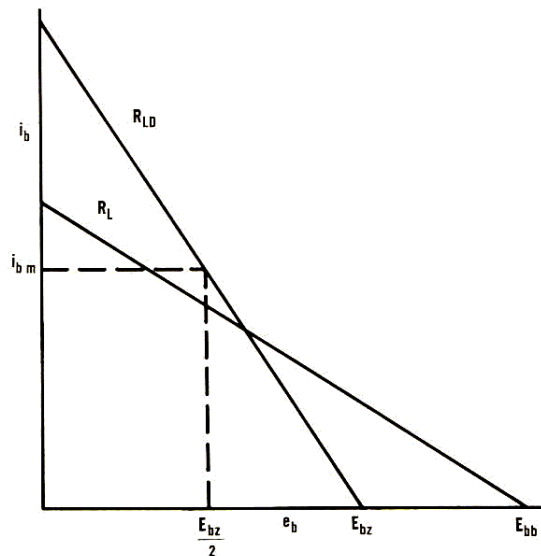

NOTE. if R_L and R_{LD} coincide, $E_{bb} = E_{bz}$.

occurs when plate voltage e_b is one-half supply voltage E_{bb} for the amplifier, with negligible coupled loading; or, half the voltage at which the dynamic load line cuts the line of zero plate current when the coupled loading reduces the dynamic load impedance to R_{LD} . The maximum plate power dissipation can be calculated from the equation:

$$P_{pm} = 0.5 E_{bz} I_{bm} \quad (16)$$

where E_{bz} is the plate voltage at the intersection of the dynamic load

line and the zero plate current line, and I_{bm} is the plate current at maximum power dissipation (when plate voltage $e_b = E_{bz}/2$). The dissipation at any point is:

$$P_p = e_b I_b$$

As the life and reliability of a tube depend on how conservatively it is operated, a compromise may be required between life and dissipation. In general, for a-c amplifiers, the plate dissipation calculated at the static bias condition should not exceed the desired fraction (e.g., 1/2 to 2/3) of the rated dissipation of the tube. For d-c amplifiers it is the maximum plate dissipation which should not exceed the desired fraction of the tube rating.

Example 6. Calculate the maximum plate dissipations for Cases I and II for Example 3.

Case I: RL = 25,000 ohms	E _{bb} = E _{bz} = 250 volts	P _{pm} = 0.625 watt
Case II: RL = 50,000 ohms	E _{bb} = E _{bz} = 250 volts	P _{pm} = 0.313 watt

As the plate dissipation rating for the 6J5 is 2.5 watts, the tube is operating well within the limits of its rating.

DYNAMIC LOAD LINES

A dynamic rather than a static load line may be required for calculating characteristics in the design of an amplifier if appreciable loading is coupled onto the amplifier. If the external load is R_g , then the dynamic load impedance (Fig. 3-3) is given by the equation:

$$R_{LD} = R_L R_g / (R_L + R_g)$$

The static load line may be plotted through E_{bb} in the usual fashion, a static operating point A chosen along it, and the dynamic load line then passed through the point A at a slope corresponding to the value of R_{LD} . The values of the small-signal parameters are then read from R_{LD} and amplifications calculated in the normal way.

THE PENTODE R-C AMPLIFIER

The following are the steps normally used in the design of pentode R-C amplifiers using G-Curves:

- 1 - Select a trial tube (see page 10).
- 2 - Select the bias and screen voltage and determine plate voltage, supply voltage, and load resistance.
- 3 - Calculate small-signal amplifications at several values of bias.
- 4 - Calculate output voltage and distortion.
- 5 - Calculate plate and screen dissipations.

If the design provides insufficient output within the limits of dissipation and distortion, or the output is much greater than is required, the wrong tube type probably has been selected and a redesign should be made using a different tube.

Fig.3-3 Load lines for static and dynamic design.

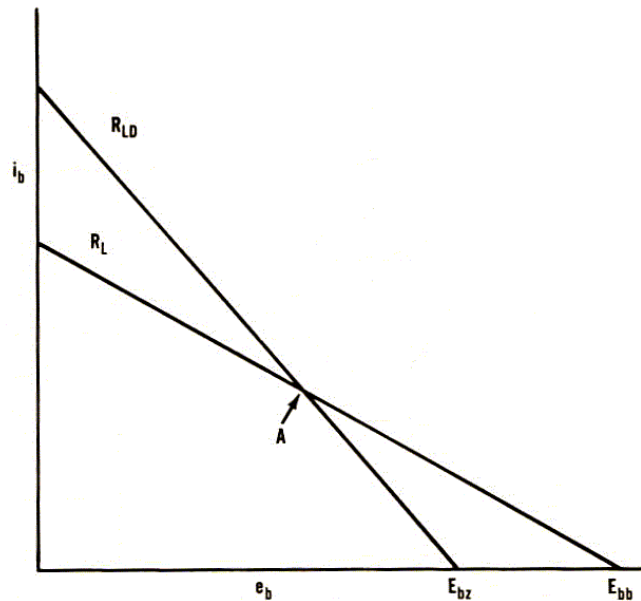

The element voltages used with the tube should be as small as possible, consistent with the following restrictions:

- (1) The screen voltage should be larger than 20 to 50 volts to keep operation out of the area where tube behavior may be erratic.
- (2) The minimum plate voltage, at zero control grid bias, should be greater than one-half the screen voltage for class-B amplifiers, and three-quarters the screen voltage for voltage amplifiers, to keep the plate current relatively independent of plate voltage.
- (3) The screen voltage should be high enough to ensure that the static bias is not in the contact bias area. (A static bias more negative than -1 volt is normally required.)*

As the screen voltage is usually constant, it is designated as E_{c2} , and is represented on the pentode G-Curve by a vertical line at the appropriate voltage. Data may be read along this load line in exactly the same manner as with the more conventional triode load line.

* **Note** - The bias should be sufficiently large that grid current will not flow during the static or signal conditions. This will make certain that the bias is not altered by grid current flow — a flow causes increased distortion.

THE INITIAL SELECTIONS

The pentode R-C amplifier circuit is shown in Fig.3-4. Based on this circuit, a tube may be selected, and then its screen voltage selected. Then the values of plate current may be determined and the load resistance selected.

Fig.3-4 Basic design of a pentode amplifier.

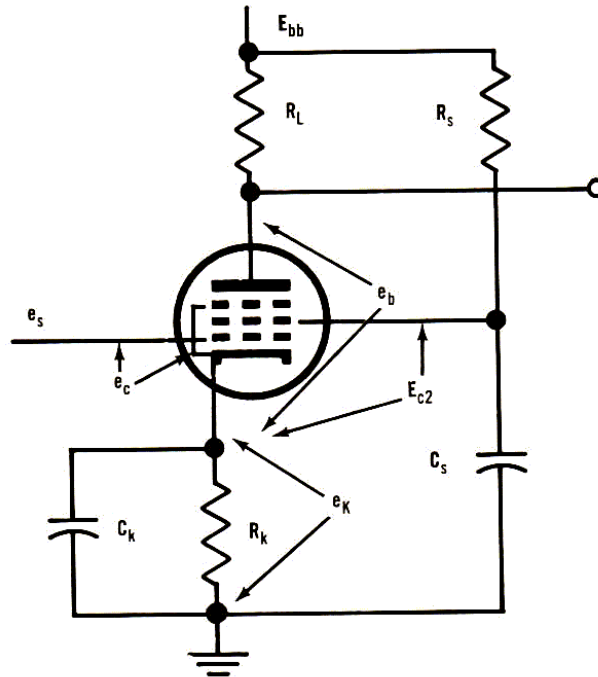

Example 7. A 6BH6 pentode has been chosen for use with Fig.3-4. Assuming a 200-volt supply and choosing $E_{c2} = 100$ volts, the minimum plate voltage is 75 volts, giving the voltage (maximum) across the load resistor R_L as 125 volts. To minimize the grid current, assume that the positive limit grid bias is -0.5 volts. From the G-Curve the nominal plate current $I_p = 7.0$ ma at the minimum bias. Since $e_b/E_{c2} = 0.75$, the value of X_p is 0.95 and the corrected plate current is 6.65 ma (see page 2). Therefore, the load resistance is 19,000 ohms – actually an 18,000-ohm resistor probably would be used.

If a bias excursion to zero bias can be permitted, then $I_p = 9.3$ ma and, with $e_b/E_{c2} = 0.75$, $X_p = 0.95$. Then $i_b = 8.83$ ma, giving R_L as 14,150 ohms. A standard 15,000-ohm resistor would be used.

SMALL-SIGNAL AMPLIFICATIONS

The small-signal amplifications are calculated for several bias points using the equation:

$$K = -G_{m1} X_p R_L \quad (7)$$

The values of G_{m1} , X_p , e_L , and e_b may be tabulated and the amplifications calculated as indicated in the following example:

Example 8. Calculate the amplification of the amplifier of Example 7 at bias values of -0.5, -1.0, -1.5, -2.0, and -2.5 volts. Assume $R_L = 19,000$ ohms.

e_{c1}	-0.5	-1.0	-1.5	-2.0	-2.5	volts
I_p	7.0	4.6	2.8	1.7	0.8	ma
e_L	133	87.5	53.2	32.3	15.2	volts
e_b	67	112.5	146.8	167.7	184.8	volts
e_b/E_{c2}	0.67	1.1	1.5	1.7	1.8	
X_p	0.96	0.97	0.98	0.99	0.99	
G_{m1}	5300	4200	3000	2000	1000	umhos
K	-96.7	-77.3	-55.9	-37.6	-18.8	

The above data is based on an R_L of 19,000 ohms.

DISTORTION

If the distortion is primarily second harmonic, it can be calculated using Equation 15. If the tube in Example 8 is biased at -1.5 volts, and the grid swing is 1 volt peak to peak, the distortion is 8.6% and the peak-to-peak output is 55.2 volts. With 2 volts, however, D is 16.9% and the output voltage is 118 volts.

POWER DISSIPATIONS IN THE PENTODE

Both the plate dissipation and the screen dissipation must be considered in the pentode amplifier. As in the triode (see page 13), the maximum plate dissipation is:

$$P_{pm} = 0.5 E_{bz} I_{bm} \quad (17)$$

The maximum screen dissipation, on the other hand, occurs at maximum screen current because of the constant screen voltage. The screen current at any value of plate current may be found from the nominal plate current by using the screen correction factor, X_{c2} applying at the conditions in question. The screen dissipation is:

$$P_{c2} = E_{c2} I_p X_{c2} \quad (18)$$

The value of e_b at maximum plate current may be checked in the process of design, to verify the correctness of X_{c2} . The equation for this calculation is:

$$e_b = E_{bb} - I_p X_p R_L \quad (19)$$

Example 9. Determine the maximum plate and screen dissipations for the amplifier of Example 7.

Plate Dissipation	Screen Dissipation
$e_b = E_{bz}/2 = 100$ volts	$I_{pp} = 7.0$ ma
$I_{bm} = 5.26$ ma	$e_b = E_{bb} - I_p X_p R_L = 74$ volts
$P_{pm} = 0.53$ watt	$X_{c2} = 0.42$
	$I_{c2} = 2.94$ ma
	$P_{c2}(\text{max}) = 0.294$ watt

These dissipations are well within the prescribed ratings.

CALCULATIONS OF THE SERIES SCREEN RESISTANCE

A series resistance (R_s in Fig.3-4) must be used between the screen of the tube and the voltage source to limit the screen voltage and current. The screen voltage is held constant by a bypass capacitor (C_s in Fig.3-4) of sufficient capacitance to keep the effect of screen voltage variation negligible. The value of resistance R_s required may be calculated from the equation:

$$R_s = (E_{bb} - E_{c2}) / I_p X_{c2} \quad (20)$$

where the I_p and the X_{c2} are the values at the static bias.

Example 10. What series screen resistance is required for Example 9?

Data Given	Read from Curves	Equation	Solution
$E_{bb} = 200$ volts	$I_p = 2.8$ ma	Equation(20)	
$E_{c2} = 100$ volts	$X_{c2} = 0.39$		
$E_{c1} = -1.5$ volts			$R_s = 90,000$ ohms
$e_b \sim 150$ volts			

THE SCREEN BYPASS CAPACITOR

The screen bypass capacitor may be found by the use of the equation:

$$C_s = 5 G_{m2} X_{c2} / (2 \pi f) = 5 g_{m22} / (2 \pi f) \quad (21)$$

where g_{m22} is the screen conductance of the tube, or by the equation:

$$C_s = \Delta I_{c2} / (2 \pi f \Delta E_{c2}) = \Delta I_{c2} / (2 \pi f \Delta E_s) \quad (22)$$

where the deltas (Δ) indicate the total changes in I_{c2} , E_{c2} , and E_s , respectively. Equation 21 should be used if size and weight are critical, as it gives the minimum acceptable value, but requires a more detailed calculation; otherwise Equation 22 may be used.

These equations are based on the assumption that variations in screen voltage resulting from screen current changes should be small compared with the output signal; less than, or equal at most to the input signal. The first equation makes certain that the screen degeneration is sufficiently small that the stage amplification will not be deteriorated by the reactance in the screen circuit. In the second equation, the capacitance is made large enough to ensure that the change in charge cannot make the screen voltage vary by more than the magnitude of the input signal. (it is generally used in the absence of screen conductance data.)

Example 11. What value of capacitance C_s is required if $(2 \pi f) = 600$ radians ? (f_1 is approximately 100 cycles.) Take $G_{m2} = 100$ umhos, and $X_{c2} = 0.40$.

By 21, $C_s = 0.3$ uf

By 22, $C_s = 2$ uf

DYNAMIC LOAD LINES

The design of pentode amplifiers, where the dynamic load impedance is different than the static load impedance, is similar to that outlined for triodes (see page 14). The static operating point is determined using the static load impedance after which the design is continued using the dynamic load impedance.

Example 12. Assume that the dynamic load impedance for Example 7 is 10,000 ohms. Calculate the amplifications at the same bias points.

e_{c1}	-0.5	-1.0	-1.5	-2.0	-2.5	volts
I_p	7.0	4.6	2.8	1.7	0.8	ma
Δe_L	42	18	0	-11	-20	volts
e_b	105	129	147	158	167	volts
e_b/E_{c2}	1.05	1.3	1.5	1.6	1.7	
X_p	0.97	0.98	0.98	0.99	0.99	
G_{m1}	5300	4200	3000	2000	1000	umhos
$G_{m1} X_p$	5140	4120	2940	1980	990	umhos
K	-51.4	-41.2	-29.4	-19.8	-9.9	

In Example 7, the value of e_b for $e_{c1} = -1.5$ volts is the static voltage, E_b . For that reason, the change in output voltage, Δe_L , is calculated with respect to $E_b = 147$ volts by:

$$\Delta e_L = (i_b - I_b) R_{LD}$$

The total plate voltage, e_b , is the sum of E_b and $-\Delta e_L$.

TRIODE DEGENERATIVE AMPLIFIERS

The equation for the gain of this amplifier was derived in Chapter 2, and is:

$$K = -g_m R_L / [1 + (g_m + g_p) R_{k1} + g_p R_L] \quad (8)$$

where R_k , is the portion of the cathode bias resistor which is not bypassed. The equation for the load line for this amplifier is slightly modified from that of the ordinary triode amplifier:

$$e_b = E_{bb} - i_b (R_{k1} + R_L) \quad (23)$$

In other respects, the design technique is unchanged.

Example 13. To illustrate the effect of degeneration clearly, the design of Example 4, Case 1, may be modified by assuming $R_{k1} = 400$ ohms. Find the change of amplification and distortion.

As R_{k1} , is negligible compared to R_L , the same data may be used, giving:

e_c	0	-2	-4	-6	-8	volts
K	-14.1	-13.0	-11.8	-10.7	-9.4	

DISTORTION

The distortion generated by the degenerative amplifier may be calculated using either Equation 15 or the Fourier technique. Using Equation 15 with a peak-to-peak signal voltage e_s of 8 volts, the amplifier of Example 13 will have a distortion of 5%. In a similar manner, a peak signal of 4 volts yields a distortion of 2.4% ($E_{c1} = -4$ volts). As can be seen from page 13, the distortions without degeneration are 6.0 and 3.0%, respectively.

THE PENTODE DEGENERATIVE AMPLIFIER

The amplification equation for the pentode degenerative amplifier has been derived on page 8; it is:

$$K = -G_{m1} X_p R_L / (1 + G_{m1} X_p R_{k1})$$

The plate-to-cathode voltage, and the voltage to ground are given by the, equations:

$$e_b = E_{bb} - I_p [X_p (R_{k1} + R_L) + X_{c2} R_{k1}]$$

$$E_K = I_p (X_p + X_{c22}) R_k$$

$$e_k = I_p X_p R_{k1}$$

The second of this group is used to calculate the bias, and the third the degenerative signal voltage.

THE TRIODE CATHODE FOLLOWER

The equations for the cathode follower are given on page 8. They show that it can handle a much larger input voltage than can an ordinary amplifier because most of the input signal is offset by the signal voltage developed in the cathode circuit. This leaves only a small grid-to-cathode voltage. The load line for it is usually dependent on the value of the cathode resistance alone since normally no plate load resistor is used with it. As with ordinary amplifiers, a static and a dynamic load line should be used if the coupled loading has sufficient magnitude. The equation for amplification is:

$$K = g_m R_k [1 + (g_m + g_p) R_k]$$

The dynamic output impedance (not to be confused with the dynamic load impedance, which should be large compared to R_k) is given by the equation:

$$R_o = 1 / (g_m + g_p) \quad (24)$$

The input impedance, with the grid returned to ground, is:

$$R_i = R_g \quad (25)$$

It may, however, be made much higher by returning grid resistor R_g to a tap on the cathode resistor (between R_k , and R_{k2}). Usually sufficient resistance R_{k1} is placed between the cathode and the tap point to provide the necessary bias. In this case the input resistance is:

$$R_i = R_g / (1 - K) \quad (26)$$

The output impedance is also higher in this arrangement.

Example 14. A cathode follower is required using a 6J5, $E_{bb} = 250$ volts, and $R_k = 25,000$ ohms. What are its characteristics?

The small-signal data may be tabulated in the usual manner:

	0	-2	-4	-6	-8	volts
g_m	3800	3150	2500	1950	1350	umhos
g_p	165	150	130	110	80	umhos
K	0.95D	0.942	0.936	0.926	0.918	
R_o	252	303	380	485	700	ohms

If the static bias point is -4 volts and the grid swing is 8 volts peak to peak, the distortion is 0.43%, the output voltage is 115 volts, and the input signal 123 volts peak to peak. The output resistances are very easily obtained at each bias point by the G-Curve technique. When matching is critical, therefore, the additional information can be invaluable. The example shows that the output resistance varies rather widely, with the result that the selection of the proper values of R_k , and the static bias point E_c can easily provide the required matching.

THE PENTODE CATHODE FOLLOWER

Pentode-type tubes are used for cathode followers when a very low output resistance, a very high input resistance, and a very small input capacitance are required. The equation for amplification is:

$$K = G_{m1} X_p R_k / (1 + G_{m1} X_p R_k)$$

The pentode G-Curves may be used with this equation to determine the small-signal parameters and the gain, output and input resistances are found just as with triodes. (This procedure must be modified if the screen is bypassed to ground instead of to the cathode.)

CALCULATING THE CATHODE BYPASS CAPACITOR

When cathode degeneration is not desired, cathode resistor R_k may be bypassed with a capacitor of sufficient size to ensure that the alternating voltage between the cathode and ground is negligible over the passband of the amplifier. The amount of cathode degeneration is given by the term $(g_m + g_p) R_k$ in Equation 8. If a bypass capacitor C_k is connected in parallel with R_k this degeneration term becomes $(g_m + g_p) Z_k$, where Z_k is given by $R_k / (1 + j \omega C_k R_k)$. Sufficient bypassing is obtained when the degeneration term is small compared to the balance of the denominator of Equation 8. The approximate conditions required for a triode are given by:

$$C_k = 5 (g_m + g_p) / [2 \pi f_1 (1 + g_p R_L)] \quad (27)$$

For pentode tubes, this equation may be written:

$$C_k = 5 G_{m1} X_p / (2 \pi f_1) \quad (28)$$

These equations may be obtained in the same way as Equations 21 and 22. The actual derivations however, are published elsewhere (see bibliography.)

The fact that the designs considered here seem only to apply to R-C amplifiers, should not mislead the reader into thinking that other types of amplifiers cannot be designed in similar manner. As a matter of fact, any amplifier in effect develops its output in some kind of a load resistance or impedance. For example, the transformer-coupled amplifier may be solved by drawing a static load line corresponding to the primary resistance of the transformer, followed by a dynamic load line at the effective impedance of the load as seen at the input to the transformer. Tuned amplifiers are handled similarly, since the dynamic load line is established by determining the effective impedance of the circuit, and then plotting the corresponding line. In fact, the method is completely general and can be used, with minor modifications, with almost every circuit confronting the electronics man.

BIBLIOGRAPHY

- Radiotron Designer's Handbook, 4th Ed., pp. 23, 554-555, published by Amalgamated Wireless Valve Co., Pty., Ltd., Sydney, Aust.
- Pullen, K. A., "Instrument Design Using G-Curves," *The Instrument Maker*, January-February 1949.
- "Amplifier Design Using G-Curves," (Abstract), Proc. I.R.E., February 1949.
 - "Using G-Curves in Tube Circuit Design," (Part I), *Tele-Tech and Electronic Industries*, July 1949.
 - "Using G-Curves in Tube Circuit Design," (Part II), *Tele-Tech and Electronic Industries*, August 1949.
 - "Tube Circuit Design Using the G-Curve Technique," Ballistic Research Laboratories Memorandum Report 489, 1949.
- Hodge, A. H. and Pullen, K. A., "The Use of Conductance Curves for Pentode Circuit Design," Ballistic Research Laboratories Memorandum Report 499, 1949.
- Pullen, K. A., "The Use of Conductance Curves for Pentode Circuit Design," *Tele-Tech and Electronic Industries*, November 1950.
- "Using Conductance Curves in Electronic Circuit Design," Proc. National Electronics Conference, Vol. 6, 1950.
 - "Notes on U-H-F Oscillator Design," *Tele-Tech and Electronic Industries*, February 1953.
 - "Conductance Curves Speed Triode R-C Amplifier Design," *Tele-Tech and Electronic Industries*, May 1953.
 - "Conductance Curves Speed Pentode R-C Amplifier Design," *Tele-Tech and Electronic Industries*, July 1953.
 - "G-Curves and Impedance Amplifiers," *Tele-Tech and Electronic Industries*, September 1953.
 - "The Use of Screen-to-Plate Transconductance in Multigrid Tube Circuit Design," *Electrical Engineering*, October 1954.
 - "The Use of Screen-to-Plate Transconductance in Multigrid Tube Circuit Design," Ballistic Research Laboratories Memorandum Report 817, August 1954.
 - "Improved Techniques for Tube Circuit Design," *Radio and Television News*, (Engineering Edition), July 1951.
 - "Conductance Techniques as Applied to the Vacuum Tube Reliability Program," Proc. Conference on Reliability and Maintenance of Electronic Equipment, October 1955.
 - "Conductance Curve Design of Relaxation Circuits," Transactions of the Professional Group on Circuit Theory, National I.R.E. Meeting, 1953.
 - "Conductance Curve Design of Relaxation Circuits," *Electronic Design*, September 1955.

- "Use of Screen-to-Plate Transconductance in Multigrid Tube Circuit Design," *Communication and Electronics*: (Publication of AIEE), November 1955.
- "Designing Cathode Coupled Amplifier Using Conductance Curves," *Electronic Design*, January 1956.
- "Designing Cascade Amplifiers Using G-Curves," *Electronic Design*, May 1, 1956.
- "G-Curves and Degenerative Amplifiers," *Tele-Tech and Electronic Industries*, April 1954.
- "Design Techniques Using Conductance Curves (Pentode Degenerative Amplifiers)," *Electronic Design*, October 1, 1956.
- "Guides to Tube Selection," *Electronic Design*, November 1, 1956.
- "R-F and I-F Amplifier Design With Conductance Curves," *Electronic Design*, February 1, 1957.
- "Oscillator Design Techniques Using Conductance Curves," *Electronic Design*, May 15, 1957.
- "Design of Mixers Using Conductance Curves," *Electronic Design*, June 1, 1957.
- "Achievement of Reliability by Design and Redesign," *Electronic Equipment*, May 1957.
- "Conductance Design Curves for Electron Tubes," Ballistic Research Laboratories Memorandum Report 1073, May 1957.
- "Design of Oscillators," (Part I), *Electronic Design*, July 1, 1957.
- "Design of Oscillators," (Part II), *Electronic Design*, July 15, 1957.
- Design of Active Circuits, New York: John F. Rider Publisher, Inc., (in preparation)

CROSS-REFERENCE DATA

The following tube characteristic cross-reference and equivalence charts are included to help guide the user in selecting substitutes for tubes listed in this *Manual*. They also enable the designer to use tubes that are not included, but have identical characteristics.

Where several similar tubes differing only in filament voltage are available, standard practice in these lists has been to make the principal listing in the 6- or the 7- tube series. Tubes bearing codes starting with the numbers 3, 4, 5, 9, 12, 19, 25, etc., should be checked under the corresponding 6- series. The 14- series should be checked under the 7 -series.

Tube classification techniques have always been a problem. The setting up of a simple standard means of identifying the characteristics of a tube by a number and letter combination has been tried several times in this country. In every case the standardizing nomenclature has fallen into disuse. The best identifying system so far found by the writer appears to be one used by several European organizations, typically Mullard, Telefunken, and others. For that reason, a slightly modified version of the Continental system has been prepared for use in tube classification in this *Manual*. The defining table, with additions made to improve its utility with the present application, follows.

The nomenclature used consists of a series of identifying letters followed by two or more numbers. The first letter of the series is used to indicate the filament or heater voltage or current. (Additions to the standard table are followed by the symbol π .) For the first letter:

A	4.0-volt filament	H	150-ma heater
C	200-ma heater	J	26-volt heater
D	0.5- to 1.5-volt filament	K	2.0-volt filament
E	6.3-volt heater	P	300-ma heater
	(also used with 6.3-/12.6-volt tubes)		
G	5.0-volt heater	U	100-ma heater

The series of letters following the first letter are used to identify the types of structures, i.e., diodes, triodes, etc., that comprise the active elements of the tube. The revised list as used in this *Manual* is as follows:

A	single diode	M	electron-beam indicator
B	double diode	N	thyatron
C	triode	P	secondary-emission tube (used only as third letter)
D	output triode	Q	nonode
E	tetrode	S	dual-control pentode (π)
F	voltage-amplifier pentode	X	full-wave gas rectifier
FR	remote-cutoff pentode (π)	Y	half-wave rectifier
H	hexode	Z	full-wave rectifier
K	heptode or octode		
L	output pentode		

Several of the above letters may have to be used with a tube to describe completely the tube structure. For example, the twin-triode 6SN7

carries the type designation ECC, and the 6SQ7 carries designation EBC.

In addition to the above group of letters, the following numbers convey additional information on the tube. The first number identifies the type of tube socket required. The designations are as follows:

2	loctal base	6	subminiature in-line
3	octal base	7	subminiature circle eight
4	B8A base (not used in the USA)	8	nine-pin miniature base
5	B9G base	9	seven-pin miniature base

Other bases are identified by *Sp* followed by the number of pins available with the socket.

The numbers following these numbers on the type indicate the specific engineering design number. As a consequence, they are of little interest and are not used herein.

In addition to the above data, the RETMA base pattern number is included for those tubes on which it is known.

Two tables of classification are included in the next few pages. The first includes a fairly complete listing of tubes that have electrical characteristics reasonably similar to those for which curves are included. This table includes classification data indicating the type of tube, and the tube base type. In addition, a column listing the RETMA base diagram is included. The final column lists the *Manual* equivalent on which curves are available.

Tubes whose curves are included are italicized in the tube type column. Electrical equivalents that are mechanically interchangeable are type I; electrical equivalents differing mechanically are type II. Differences in filament voltage or current are indicated by a capital F, and premium tube types by capital P.

For example, the code (I-F) means that the tubes are electrically equivalent except for the heater voltage or current, which are different.

The second table lists the tubes whose curves are included in the *Manual* along with a tabulation of the various equivalent types with which the curves may be used.

**TABLE I: TUBES WITH ELECTRICAL CHARACTERISTICS
SIMILAR TO *MANUAL* CURVES**

<i>Tube Type</i>	<i>Classification</i>	<i>RETMA 'Base</i>	<i>"Manual" Equivalent</i>
2C51	ECC8	8CJ	5670 (I-P)
6AB4	EC9	5CE	6201 (II-P)
6AC7/1852	EF3	8N	6134 (I-P)
6AG7	EL3	8Y	6AG7
6AH4GT	ED3	8EL	6AH4GT
6AH6	EF9	7BK	6AH6
6AJ7	EF3	8N	6134 (I-P)
6AK5	EF9	7BD	6AK5
6AK7	EL3	8Y	6AG7 (I)
6AL6	EL3	6AM	6L6 (II)
6AM4	EC8	9BX	6AM4
6AM8/5AM8	EAF8	9CY	6AM8
6AQ5/19AQ5	EL9	7BZ	6005 (I-P)
6AR6	EL3	6BQ	6AR6
6AS7G	EDD3	8BD	6AS7G
6AU6	EF9	7BK	6136 (-P)
6AV5GT	EL3	6CK	6BQ6 (II)
6BA6/12BA6	EFR9	7BK	5749 (I-P)
6BD6/12BD6	EFR9	7BK	6137 (II-P)
6BE6/3BE6/12BE6	EK9	7CH	6BE6
6BH6	EF9	7CM	6BH6
6BJ6	EFR9	7CM	6B J6
6BQ6GT/25BQ6GT	EL3	6AM	6BQ6
6BQ7A/6BQ7	ECC8	9AJ	6BQ7A
6BY4	EC- <i>Sp</i>	6BY4	6BY4
6BZ7	ECC8	9AJ	6BQ7A (I)
6C4	EC9	6BG	6135 (I-F-P)
6CB6/3CB6	EF9	7CM	6CB6
6CD6GA	EL3	5BT	6CD6GA
6CL6	EL8	9BV	6CL6
6CM6/12CM6	EL8	9CK	6CM6
6CS6	EH9	7CH	6CS6
6CU6	EL3	6AM	6BQ6GT (I)
6DQ5	EL3	8JC	6DQ5
6DQ6-A	EL3	6AM	6DQ6-A
6F8G	ECC3	8G	6J5 (II)
6J5/12J5	EC3	6Q	6J5
6J6/9J6/19J6	ECC9	7BF	6J6
6K7	EFR3	7R	6137 (II-P)
6L6	EL3	7AC	6L6
6SD7	EFR3	8N	6B J6 (II)
6SJ7	EF3	8N	5693 (I-P)
6SK7/12SK7	EFR3	8N	6137 (I-P)

**TABLE I: TUBES WITH ELECTRICAL CHARACTERISTICS
SIMILAR TO *MANUAL* CURVES (Contd.)**

<i>Tube Type</i>	<i>Classification</i>	<i>RETMA 'Base</i>	<i>"Manual" Equivalent</i>
6SL7/12SL7	ECC3	8BD	6SL7
6SN7/12SN7/25SN7	ECC3	8BD	5692 (I-P)
6SS7	EFR3	8N	6137 (II-P)
65U7	ECC3	8BD	6SL7 (I)
6T	EL3		6V6 (II)
6TP	EL3		6L6 (II)
6V6/12V6	EL3	7AC	6V6
6Y6G	EL3	7AC	6Y6
7A4/14A4	EC2	5AC	6J5 (II)
7A7/14A7	EFR2	8V	6137 (II -P)
7C5/14C5	EL2	6AA	6V6 (II)
7F7/14F7	ECC2	8AC	6SL7 (II)
7N7/14N7	ECC2	8AC	6J5 (II)
10F3	EF		6134 (II -P)
12AT7	ECC8	9A	6201 (I-P)
12AU7	ECC8	9A	5814A (I-P)
12AV7	ECC8	9A	5965 (I-P)
12AX7	ECC8	9A	12AX7
12AY7	ECC8	9A	12AY7
12AZ7	ECC8	9A	6201 (I-P)
12BH7	ECC8	9A	12BH7
12BY7	EL8	9BF	12BY7
12BZ7	ECC8	9A	12BZ7
12K7	EFR3	7R	6137 (I-P)
125X7	ECC3	8BD	6J5 (II)
26D6	JK9	7CH	6BE6 (I-F)
396A	ECC8	8CJ	5670 (I-P)
403A, 403B	EF9	7BD	5654 (I-P)
417A	EC8	9V	5842/417A
731A	EF9	7BD	6AK5 (I)
829	ELL-7Sp	7BP	5894A
1132	EF5		6AK5 (II)
1381HQ	EF9	7BD	6AK5 (I)
1491	ECC8	8CJ	5670 (I-P)
1614	EL3	7AC	6L6 (II)
1622	EL3	7AC	6L6 (I)
1631	EL3	7AC	6L6 (I)
1642	ECC8	8CJ	5670 (I-P)
1649	EF3	8N	6134 (I-P)
1851	EF3	7R	6134 (II-P)
5591	EF9	7BD	6AK5 (I)
5637	EC	8DK	5719 (II)

**TABLE : TUBES WITH ELECTRICAL CHARACTERISTICS
SIMILAR TO *MANUAL* CURVES (Contd.)**

<i>Tube Type</i>	<i>Classification</i>	<i>RETMA Base</i>	<i>"Manual" Equivalent</i>
5654	EF9	7BD	5654
5670	ECC8	8CJ	5670
5686	EL8	9G	5686
5687	EDD8	9H	5687
5691	ECC3	8BD	5691
5692	ECC3	8BD	5692
5693	EF3	8N	5693
5702WA	EF-sp	5702 (R117)	6AK5 (II)
5718	EC7	8DK	5718
5719	EC7	8DK	5719
5749	EFR9	7BK	5749
5750	EK9	7CH	6BE6 (I)
5751	ECC8	9A	5751
5763	EL8	9K	5763
5814A/6135	ECC8	9A	6135/5814A
5840	EFR7	8DL	5840
5842	EC8	9V	5842/417A
5844	ECC9	7BF	5844
5871	EL3	7AC	6V6 (I)
5881	EL3	7AC	6V6 (1)
5894A	ELL-7Sp	5894A-7BP	5894A
5899	EFR7	8DL	5899
5900	EFR7	8DL	5899 (I)
5901	EF7	8DL	5840 (I)
5902	EL7	8DL	5902
5906	EF7	8DL	5840 (I)
5932	EL3	7AC	6L6 (I)
5965	ECC8	9A	5965
5992	EL3	7AC	6V6 (I)
6005	EL9	7BZ	6005
6021	ECC8	8DG	6021
6028	EF9	7BD	6AK5 (I)
6061	EL8	9AM	6V6 (II)
6062	EL8	9K	5763 (I)
6067	ECC8	9A	5814A (I)
6080	EDD3	8BD	6AS7 (I)
6082	EDD3	8BD	6AS7 (I-F)
6090	EF9	7BD	5654 (I)
6096	EF9	7BD	6AK5 (I)
6098	EL3	6BQ	6AR6 (I)
6099	ECC9	7BF	6J6 (I)
6101	ECC9	7BF	6J6 (I)
6111	ECC7	8DG	6111

**TABLE I: TUBES WITH ELECTRICAL CHARACTERISTICS
SIMILAR TO *MANUAL* CURVES (Contd.)**

<i>Tube Type</i>	<i>Classification</i>	<i>RETMA 'Base</i>	<i>"Manual" Equivalent</i>
6112	ECC7	8DG	6112
6113	ECC3	8BD	6SL7 (I)
6134	EF3	8N	6134
6135/5814A	EC9	6BG	6135
6136	EF9	7BK	6136
6137	EFR3	8N	6137
6180	ECC3	8BD	6J5 (II)
6185	ECC8	8CJ	5670 (I)
6189	ECC8	9A	5814 (I)
6197	EL8	9BV	6CL6 (I)
6201	ECC8	9A	6201
6216	EL8	9CE	6216
6265	EF9	7CM	6265
6336	EDD3	8BD	6336
6386	ECC8	8CJ	6386
6394	EDD3	8BD	6336 (I-F)
6414	ECC8	9A	6414
6485	EF9	7BK	6AH6 (I)
6661	EF9	7CM	6661
6662	EFR9	7CM	6B J6 (I)
6669	EL9	7BZ	6005 (I)
6677	EL8	9BV	6CL6 (I)
6679	ECC8	9A	6679
6680	ECC8	9A	5814A (I)
6760	EL8	9CE	6216 (I-F)
6761	EL8	9CE	6216 (I)
6829	ECC8	9A	6829
6927	ECC9	7BF	6J6 (I)
6928	EL9	7BZ	6005 (I)
7756	EL3	6BQ	6AR6 (I)
B36	ECC3	8BD	6J5 (II)
B65	ECC3	8BD	6J5 (II)
BPM04	EL9	7BZ	6V6 (II)
CK605CX	EF6	5702(R117)	5654 (II)
EC90	EC9	6BG	6135 (I-P)
ECC35	ECC3	8BD	6SL7 (I-F)
ECC81	ECC8	9A	6201(I-P)
ECC82	ECC8	9A	5814A (I-P)
ECC91	ECC9	7BF	6J6 (I)
EF93, HF93	EF9	7BK	5749 (I-P)
EF95	EF9	7BD	6AK5 (I)
EH90	EH9	7CH	6CS6 (I)

**TABLE I: TUBES WITH ELECTRICAL CHARACTERISTICS
SIMILAR TO *MANUAL* CURVES (Contd.)**

<i>Tube Type</i>	<i>Classification</i>	<i>RETMA 'Base</i>	<i>"Manual" Equivalent</i>
EK90, HK90	EK9	7CH	6BE6 (I)
EL90, HL90	EL9	7BZ	6005 (I-F-P)
HM04	HK9	7CH	6BE6 (I)
L63	EC3	6Q	6J5 (I)
NR77	EL3	7AC	6L6 (I)
A4073F	EF3	8N	6134 (I-P)
A4273F	ECC3		6J5 (11)
A4434	ECC9	7BF	6J6 (I)
A4450	EL9	7BZ	6005 (I-P)
A4475	ECC3	8BD	6AS7G (I)
A4524A	EF9	7CM	6BH6 (I)
A4541A	EL8	9K	5763 (I)
PM04	EFR8	7BK	5749 (I-P)
PM05	EF9	7BD	6AK5 (I)
QM328	EL8	9G	5686 (I)
T2M05	ECC9	7BF	6J6 (I)
TS229	ECC8	9H	5687 (I)
X107	BK9	7CH	6BE6 (I-F)
Z2096	BC9	6BG	5814A (I-P)
Z2101	ECC8	9A	12AY7 (I-P)

RETMA BASES

5AC-2	1-H	2-P			6-G	7-K	8-H	
5BT-3		2-H	3-KG ₃		5-G ₁	7-H	8-G ₂	Cap-P
5CE-9	1-P	2-IS	3-H	4-H	6-G	7-K		
6AA-2	1-H	2-P	3-G ₂		6-G ₁	7-KG ₃	8-H	
6AM-3		2-H		4-G ₂	5-G ₁	7-H	8-KG ₃	Cap-P
6BG-9	1-P	2-IC	3-H	4-H	5-P	6-G	7-K	
6BQ-3	1-KBFP		3-P		5-G ₂	6-H	7-G ₁	8-H
6CK-3	1-G ₁	2-H	3-KG ₃		5-P		7-H	8-G ₂
6Q-3	1-S	2-H	3-P		5-G		7-H	8-K
7AC-3		2-H	3-P	4-G ₂	5-G ₁		7-H	8-KG ₃
7BD-9	1-G ₁	2-K	3-H	4-H	5-P	6-G ₂	7-KG ₃ S	
7BF-9	1-PT ₂	2-PT ₁	3-H	4-H	5-GT ₁	6-GT ₂	7-K	
7BK-9	1-G ₁	2-G ₃	3-H	4-H	5-P	6-G ₂	7-K	
7BP-Sp	1-H	2-G ₁ T ₂	3-G ₂	4-KG ₃	5-HCT	6-G ₁ T ₁	7-H	
			Cap ₁ -PT ₂	Cap ₂ -PT ₁				
7BZ-9	1-G ₁	2-KBFP	3-H	4-H	5-P	6-G ₂	7-G ₁	

RETMA BASES (Contd.)

7CH-9	1-G1	2-KG5	3-H	4-H	5-P	6-G2G4	7-G3		
7CM-9	1-G1	2-K	3-H	4-H	5-P	6-G2	7-G3IS		
7R-3	1-S	2-H	3-P	4-G2	5-G3	7-H	8-K	Cap-G1	
8AC-2	1-H	2-KT2	3-PT2		4-GT2	5-GT1	6-PT1	7-KT1	8-H
8BD-3	1-GT2	2-PT2	3-KT2	4-GT1	5-PT1	6-KT1	7-H	8-H	
8CJ-8	1-H	2-KT1	3-GT1	4-PT1	5-IS	6-PT2	7-GT2	8-KT2	9-H
8DG-7	1-PT1	2-GT1	3-H	4-KT1	5-KT2	6-H	7-GT2	8-PT2	
8DK-7	1-G		3-H		5-K	6-H		8-P	
8DL-7	1-G1	2-KG3	3-H	4-KG3	5-P	6-H	7-G2	8-KG3	
8EL-3	1-G	2-H			5-P		7-H	8-K	
8G-3	2-H	3-PT2	4-KT2	5-GT1	6-PT1	7-H	8-KT1	Cap-GT2	
8JC-4	1-G1	2-H	3-KG3	4-G2	5-G1	6-KG3	7-H	Cap-P	
8N-3	1-S	2-H	3-G3	4-G1	5-K	6-G3	7-H	8-P	
8V-2	1-H	2-P	3-G2	4-G3	5-S	6-G1	7-H	8-H	
8Y-3	1-G3S	2-H	3-IS	4-G1	5-K	6-G2	7-H	8-P	
9AJ-8	1-PT2	2-GT2	3-KT2	4-H	5-H	6-PT1	7-GT1	8-KT1	9-IS
9A-8	1-PT2	2-GT2	3-KT2	4-H	5-H	6-PT1	7-GT1	8-KT1	9-HCT
9AM-8	1-G1	2-G1	3-K	4-H	5-H	7-P	8-G2	9-G3	
9BF-8	1-K	2-G1	3-G3	4-H	5-H	6-HCT	7-P	8-G2	9-G3
9BV-8	1-K	2-G1	3-G2	4-H	5-H	6-P	7-G3	8-G2	9-G1
9BX-8	1-G	2-K	3-G	4-G	5-P	6-G	7-H	8-H	9-G
9CE-8	1-P	2-G1	3-KG3	4-H	5-H	6-P	7-G2	8-K	
9CK-8	1-G2		3-G1	4-H	5-H	6-G1	7-KG3		9-P
9CY-8	1-K	2-G1	3-G2	4-H	5-H	6-P	7-K	8-P	9-G3
9G-8	1-K	2-G1	3-KG3	4-H	5-H	6-G2	7-P	8-K	9-G2
9-H-8	1-PT1	2-GT1	3-KT1	4-H	5-H	6-KT2	7-GT2	8-HCT	9-PT2
9K-8	1-P		3-G3	4-H	5-H	6-G2	7-K	8-G1	9-G1
9V-8	1-P		3-H	4-G	5-G	6-K	7-G	8-G	9-H
5637-Sp	1-P	2-G	3-H	4-H	5-K				
5702(R117)		1-P	2-G2	3-H	4-H	5-G3	6-K	7-G1	

(clockwise from red dot)

**TABLE II: TUBES FOR WHICH CURVES ARE LISTED
IN THIS MANUAL**

Tube Type	Classification	Equivalents	
		Class I	Class II
6AG7	EL3	6AK7	None
6AH4	ED3	None	None
6AH6	EF9	6485	6AC7 1851 1852 6134 6AJ7
6AK5	EF9	5591 403B EF95 403A PMO5 73 IA 5608 6028 1381HQ 6096 5654	5702WA 1132 CK605CX
6AM4	EC8	None	None
6AM8	EAF8	None	None
6AR6	EL3	6098 7756	None
6AS7G	EDD3	6080 6082	
6BE6	EK9	3BE6 12BE6 5750 HK90 EK90 X107 HM04 26D6	
6BH6	EF9	6265 6661	
6BJ6	EFR9	6662	6SD7
6BQ6GT	EL3	25BQ6GT 6CU6	6AVSGT
6BQ7A	ECC8	6BZ7 4BQ7	
6BY4	EC-Sp	None	None
6C4	EC9	6135 EC90 Z2096	None
<i>(See 12AU7 curves)</i>			
6CB6	EF9	3CB6	
6CD6GA	EL3	None	None
6CL6	EL8	6197 6677	
6CM6	EL8	12CM6	6AQ5 6005
6CS6	EH9	EH90	
6DQ5	EL3	None	None
6DQ6-A	EL3	None	None
6J5	EC3	12J5 L63	6F8G 12SN7 7A4 12SX7 6SN7 14N7 7N7 25SN7 B65 B36 6180 5692

**TABLE II: TUBES FOR WHICH CURVES ARE LISTED
IN THIS MANUAL (Contd.)**

<i>Tube Type</i>	<i>Classification</i>	<i>Equivalents</i>			
		<i>Class I</i>		<i>Class II</i>	
6J6	ECC9	9J6	6099	6021	
		19J6	6101		
		ECC91	6927		
		T2MO5			
6L6	EL3	5881	5932	6AL6	6TP
		1631	1614		
6SL7	ECC3	5691	ECC35	7F7	
		12SL7	6113	14F7	
		6SU7			
6V6	EL3	12V6	5871	6AQ5	6005
		6061	5992	6T	BPM04
				7C5	EL90
				14C5	HL90
				19AQ5	6CM6
6Y6	EL3			6BQ6	6AV5
12AU7	ECC8	5814A	ECC82	None	
		6067			
12AX7	ECC8		ECC83	None	
12AY7	ECC8	6072	Z2101	None	
12BH7	ECC8		None	None	
12BY7	EL8		None	None	
12BZ7	ECC8		None	None	
417A	EC8		None	None	
5654	EF9	6090	6AK5	1132	CK605CX
		5608	403B		
5670	ECC8	2C51	1491	None	
		396A	6185		
5686	EL8	QM328		None	
5687	EDD8	TS229		None	
5691	ECC3	6SL7	12SL7	7F7	
		6SU7	ECC35	14F7	
5692	ECC3	6SN7	25SN7	6F8G	6J5
		12SN7	B65	7A4	14N7
		12SX7		7N7	B36
5693	EF3	6SJ7		None	
5718	EC7	None		None	
5719	EC7	None		None	
5749	EFR9	6BA6	HF93		
		12BA6	PM04		
		EF93			

**TABLE II: TUBES FOR WHICH CURVES ARE LISTED
IN THIS MANUAL (Contd.)**

<i>Tube Type</i>	<i>Classification</i>	<i>Equivalents</i>			
		<i>Class I</i>		<i>Class II</i>	
5751	ECC8	None		None	
5763	EL8	6062		None	
5814A	ECC8	12AU7	ECC82	None	
		6067	6680		
		6189			
5840	EF7	5901	5906	1132	
5842	EC8	417A		None	
5844	ECC9	None		None	
5894A	ELL-Sp	None		None	
5899	EFR7	5900		None	
5902	EL7	None		None	
5965	ECC8	12AV7	6829	None	
6005	EL9	6AQ5	EL90	6T	12V6
		19AQ5	HL90	6V6	14C5
		BPM04	A4450	7C5	5871
		6669	6928		
6021	ECC7	None		6J6	
6072	ECC8	12AY7	Z2101	None	
6111	ECC7	None		None	
6112	ECC7	None		None	
6134	EF3	6AC7	6A J7	6AH6	
		1852	1622	10F3	
		1649	A4073F	1851	
6135	EC9	6C4	Z2096	12AU7	5814A
		EC90			
6136	EF9	6AU6		6BH6	
6137	EFR9	6SK7	12SK7	7A7	14A7
		12K7	6K7	6BD6	12BD6
				6SS7	
6201	ECC8	12AT7	ECC81	6AB4	
		12AZ7	6679		
6216	EL8	6760	6761	None	
6265	EF9	6BH6	6661	None	
6336	EDD3	6394		None	
6386	ECC8	None		None	
6414	ECC8	None		None	
6661	EF9	6BH6	6265	None	
6679	ECC8	12AT7	ECC81	6AB4	
		12AZ7	6201		
6829	ECC8	12AV7	5965	None	

TABLES OF POWER-HANDLING ABILITY

The following tables list tubes based on power conductance, in their order of power-handling ability. The triode table lists the tubes in ascending order of plate conductance; the Pentode table (including tetrodes) lists the tubes in ascending order of screen-to-plate transconductance. The conductance values measure the approximate amount of current which may be passed by the tube for a given value of screen or plate voltage, indicating the amount of power which can be developed for a given dissipation.

Since good design is obtained by plotting the load contour roughly parallel to the constant-dissipation contour in the neighborhood of zero bias, it has been found convenient to list the approximate values of conductance on the zero-bias contour at the specified dissipation. In addition to these data, the approximate values of transconductance at the same point are included, as are the nominal power dissipations for the significant electrodes - plate, or screen and plate, as required. These latter data are convenient in that they give the user an idea of the types of applications for which the tube may be used, for example, audio or video amplifiers, etc.

The data may be accumulated at any set of conditions which will give an indication of the behavior of the tube in its area of high dissipation, as in any case an adjustment factor is required for numerical design.* For this reason, the zero bias condition at three-quarters peak dissipation has been chosen for triodes; a correction factor or gamma of two* is convenient in adjusting the dissipation levels. With pentodes, the zero bias condition with the plate dissipation one-half the peak has been chosen to allow an additional margin for the variation of screen and plate dissipations. The value of the gamma factor again is near two.

* Pullen, K. A., "Guides to Tube Selection," *Electronic Design*, Nov. 1, 1956.

TABLE III: POWER-HANDLING ABILITY OF TRIODES

*Values of transconductance and plate conductance at approximately
¾ rated dissipation, unless noted*

<i>Tube</i>	<i>g_m (approx.)</i>	<i>g_p (approx.)</i>	<i>Rated Dissipation (W)</i>
12AX7	2,600	25	1.0
5751	2,000	27	1.0
6SL7GT	2,000	30	1.0
6112	2,500	39	0.55
5719	2,500	40	0.55
12AY7	2,500	58	1.5
6072	2,800	58	1.5
12BZ7	7,500	60	1.5
6BY4	6,500	65	1.1
6679	8,500	105	2.8
6201	6,500	125	2.5
6AU8	6,500	141	2.5
6AM4	11,000	142	2.0
6BF7	5,300	150	1.0
6414	10,000	150	2.0
6135/5814A	3,500	177	2.75
6C4 - 12AU7	3,500	177	2.75
5670	6,200	184	1.5
6J6	6,200	184	1.5
5965	9,500	184	2.75
5492	3,000	185	1.75
5844	6,000	190	1.0
6021	6,500	192	0.7
6BQ7	8,500	200	2.0
6U8	8,500	203	2.7
6J5	4,500	220	2.5
6829	10,500	230	2.2
6BZ7	8,500	250	2.0
6BC8	8,500	250	2.0
5718	8,000	261	3.3
6111	6,000	266	1.1
6AZ8	5,500	280	2.5
6BH8	6,000	280	2.5
6386	6,000	300	2.5
12BH7	8,000	340	3.5
6463	6,000	350	4.0/7.0
5842	28,000 (half)	568 (half)	4.2
5687	12,500	613	4.2/7.5
6AH4	8,500	1,000	7.5
5998	10,000	4,000	13
6AS7G	12,000 (half)	5,500 (half)	13
6336	22,000	3,000	30

TABLE IV: POWER-HANDLING ABILITY OF PENTODES

*Values of transconductance and screen-to-plate transconductance
at half the rated plate dissipation*

<i>Tube</i>	<i>G_{m1} (approx.)</i>	<i>G_{m2} (approx.)</i>	<i>Rated P_p</i>	<i>Rated P_{c2}</i>
6661	6,000	102	3.0	0.5
6265	5,000	104	2.0	0.5
5693	2,400	108	2.0	0.3
6BH6	5,000	110	3.0	0.5
6BE6	2,500	118	1.0	1.0
6136	6,000	138	3.0	0.65
6CS6	2,000	160	1.0	1.0
6AM8	8,000	160	2.8	0.5
6CB6	8,000	172	2.0	0.5
5915A	3,000	175	1.0	1.0
6137	3,000	195	3.3	0.4
5749	5,000	200	3.0	0.6
5840	6,080	202	1.1	0.55
5899	4,900	204	1.1	0.55
6AK5	7,000	220	1.7	0.5
5654	6,000	220	1.7	0.5
6BJ6	5,000	230	3.0	0.6
6AH6	13,300	268	3.2	0.4
6AZ8	6,000	300	2.0	0.5
6134	14,000	312	3.0	0.38
E-180-F	22,000	380	3.0	0.9
5686	3,750	420	7.5	3.0
12BY7	15,000	431	6.0	1.1
6V6	5,000	468	12.0	2.0
6CM6	5,000	480	12.0	2.0
6AG7	11,000	486	9.0	1.5
6005	5,000	500	12.0	2.0
6CL6	12,500	504	7.5	1.7
5763	12,000	552	12.0	2.0
6L6	8,000	780	19	2.5
807	9,800	880	25	3.5
5902	6,000	900	3.7	0.4
6AR6	9,000	1,120	19.0	3.2
5894A	10,500	1,200	20	7.0
6216	14,000	1,620	10	1.0
6BQ6GT	11,000	1,980	11	2.5
6Y6G	12,000	2,150	12.5	1.75
6CD6GA	20,000	3,000	15	3.0
6DQ6A	9,000	3,470	15	3.0
6DQ5	16,000	5,400	2.4	3.2

THE TUBE CURVES

The curves in the following section represent a compilation of tube data organized to facilitate circuit design. They have been obtained in several ways, among them:

- 1) Replotting of manufacturers' data
- 2) Measurement, followed by coordination with published data
- 3) A combination of 1 and 2

At the same time that they have been prepared, an effort has been made to evaluate the importance of the various parameters in practical design and to prepare the curves in a way which takes best advantage of the important factors. In this way the curves themselves tend to help the user become an experienced designer - they rapidly show him the range of characteristics available in a tube as well as showing him a great deal about the relative linearity of the device.

Interestingly enough, the data which prove to be most critical are the small-signal, or conductance data. The static contours can vary in position over an appreciable range without introducing serious accuracy problems, whereas considerable difficulty may be encountered if the conductance contours are incorrectly positioned. As a result, the included curves, because of the conductance information, both speed up the design process and make it more accurate.

Because of the ways in which the curves have been obtained, the reader may find that some variations exist between manufacturers' data and the curves. These differences are most pronounced in the static contours, and usually indicate either poor control of g_p or G_{m2} on the tubes themselves, particularly from producer to producer, or indicate that possibly the tube is being used outside the normally controlled area. For these reasons, and because new tubes are being issued at frequent intervals, it is planned to reissue this *Manual* as need arises so that the user can be kept up to date.

As the dissipation of a tube is such an important factor, the plotting of contours corresponding to critical values of dissipation on the G-Curves can be useful. For this reason, contours marking the positions of the half-rated and full-rated plate dissipations are marked by red curves, a broken curve indicating half-of-rated, and a solid curve representing full-rated dissipation. This method of marking the power contours is used to prevent confusion with the bias and conductance contours. Note that where two power ratings are carried on one sheet (6C4 - 12AU7, for example) the lower one is plotted.

A convenient technique in using the power contours is to locate the point corresponding to either 1/2 or 3/4 of rated dissipation on the zero-bias contour, calling the coordinates of this point (E_{bp} , I_{bp}). Then, for a single-tube amplifier, the static operating point may be defined by the equations:

$$E_{bp} = 0.6 E_b \quad Z_L = E_b / I_{bp} = 5 E_{bp} / 3 I_{bp}$$

$$I_b = 0.6 I_{bp}$$

The static supply voltage is 5/3 of the zero-bias voltage, and the plate voltage for current cutoff is 8/3 E_{bp} . For a push-pull amplifier, the plate-supply voltage is raised and the grid bias made more negative. These voltages are changed sufficiently to reduce the static amplification of the single tube at E_b to approximately one-half that at E_{bp} .

The pentode dissipation contours indicate the conditions for half and full-rated power input with the plate and screen voltages equal. If the plate voltage at zero bias E_{bp} is taken to be 3/4 of screen voltage E_{c2} , the maximum plate dissipation occurs with $e_b = E_{c2}$. The equations applying to the pentode otherwise are the same as those for the triode:

$$E_{bp} = 0.6 E_b; \quad I_b = 0.6 I_{bp}; \quad Z_L = 5 E_{bp} / 3 I_{bp}$$

CURVE 6AG7

SCREEN CHARACTERISTICS

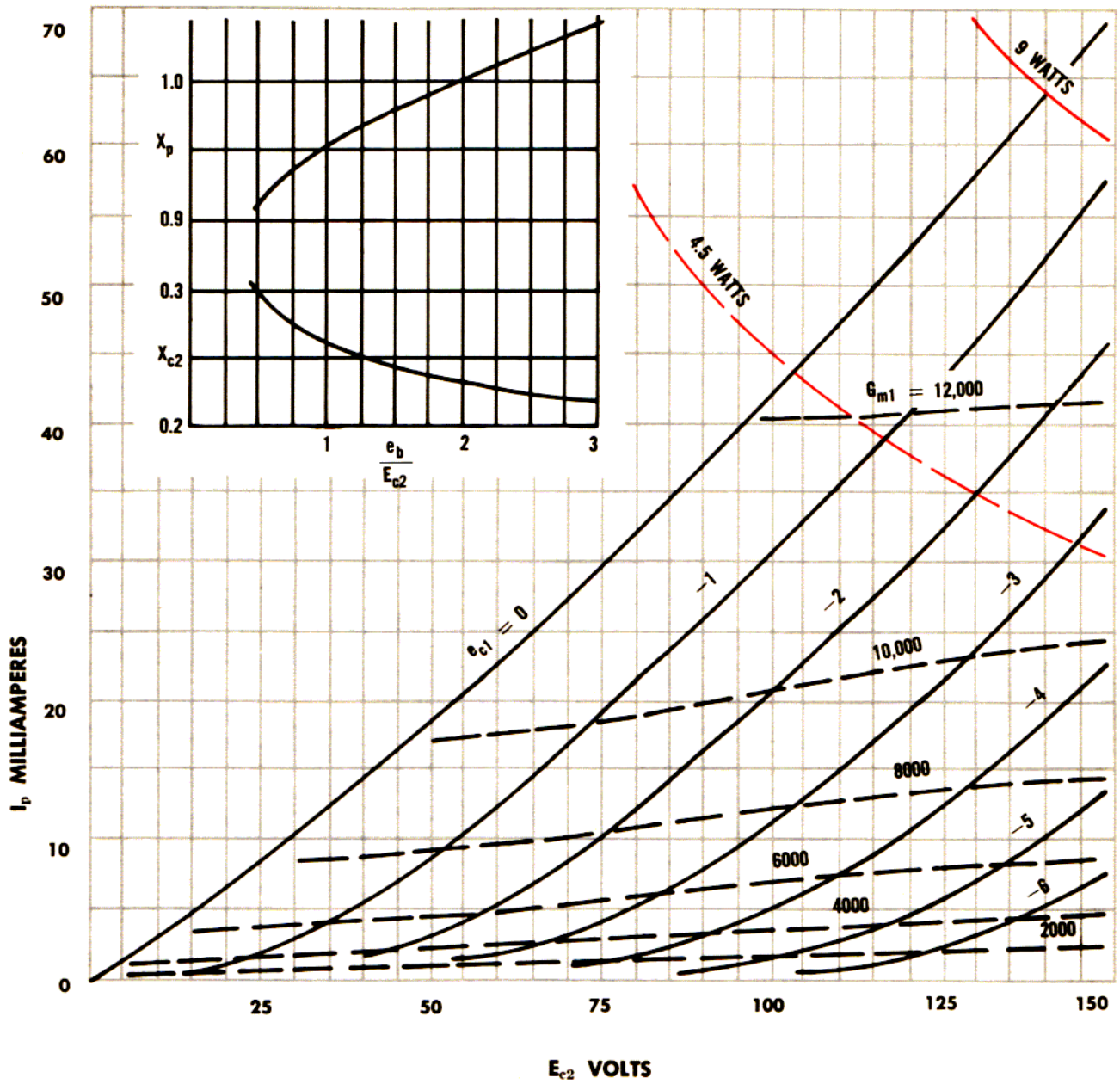

P_p 9.0 WATTS: P_{c2} 1.5 WATTS

BASE: 1-G₃ 2-7-F 3-SH 4-G₁ 5-K 6-G₂ 8-P

CURVE 6AH4

PLATE CHARACTERISTICS

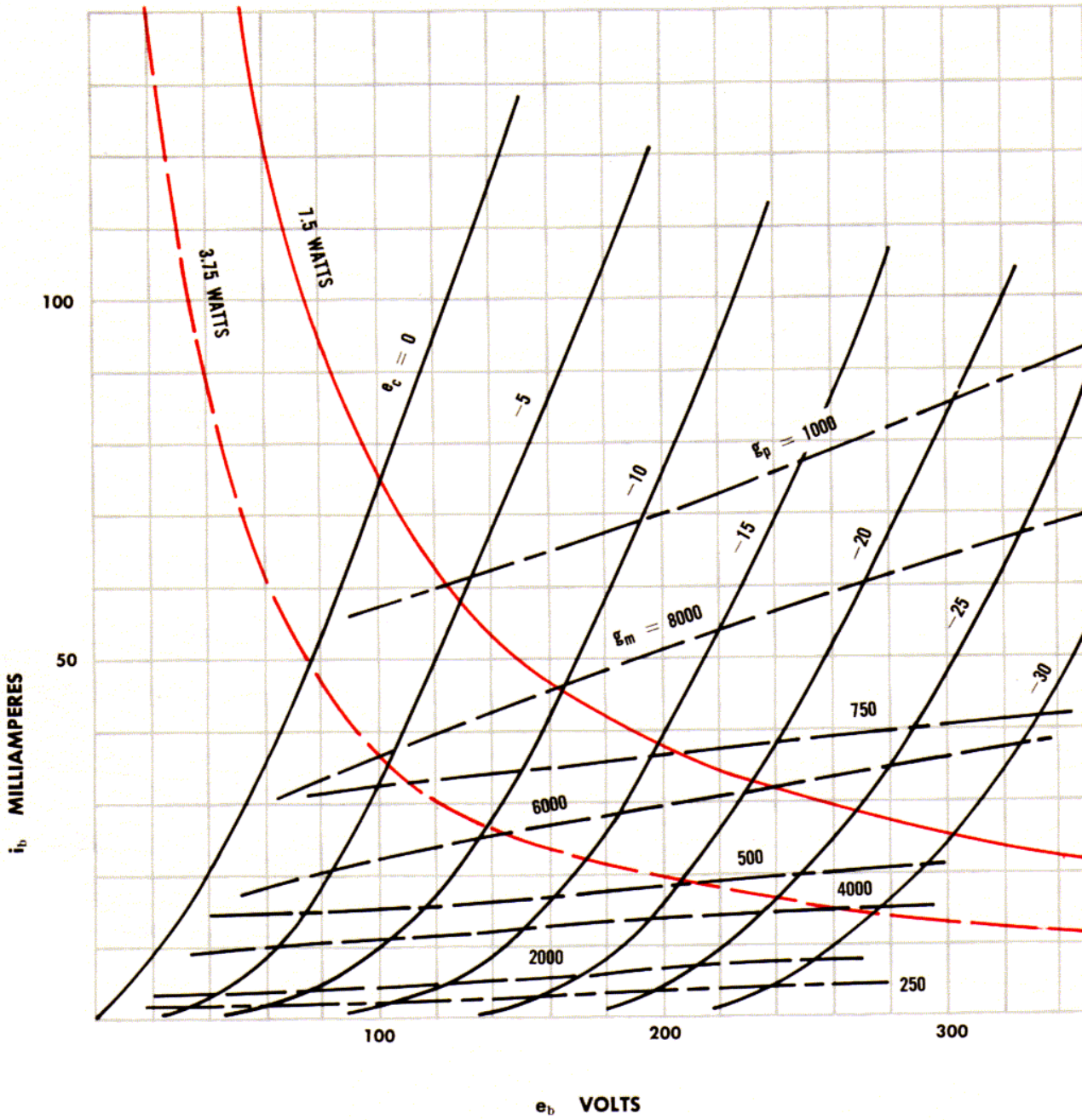

P_p 7.5 WATTS

BASE: 1-G 2-H 5-P 7-H 8-K

CURVE 6AH6

SCREEN CHARACTERISTICS

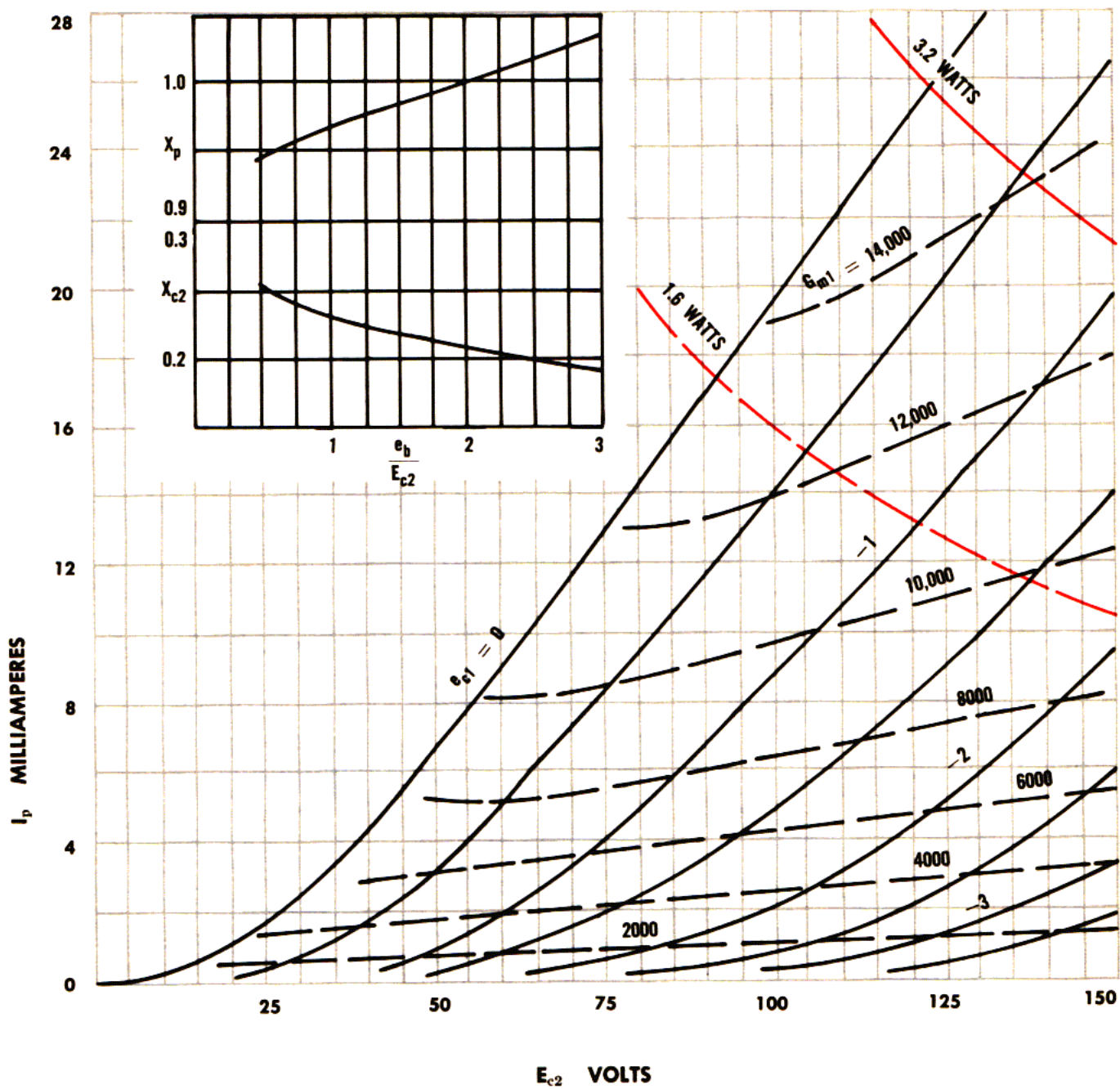

P_p 3.2 WATTS: P_{c2} 0.4 WATT

BASE: 1-G₁ 2-G₃ 3 4-F 5-P 6-G₂ 7-K

CURVE 6AK5

SCREEN CHARACTERISTICS

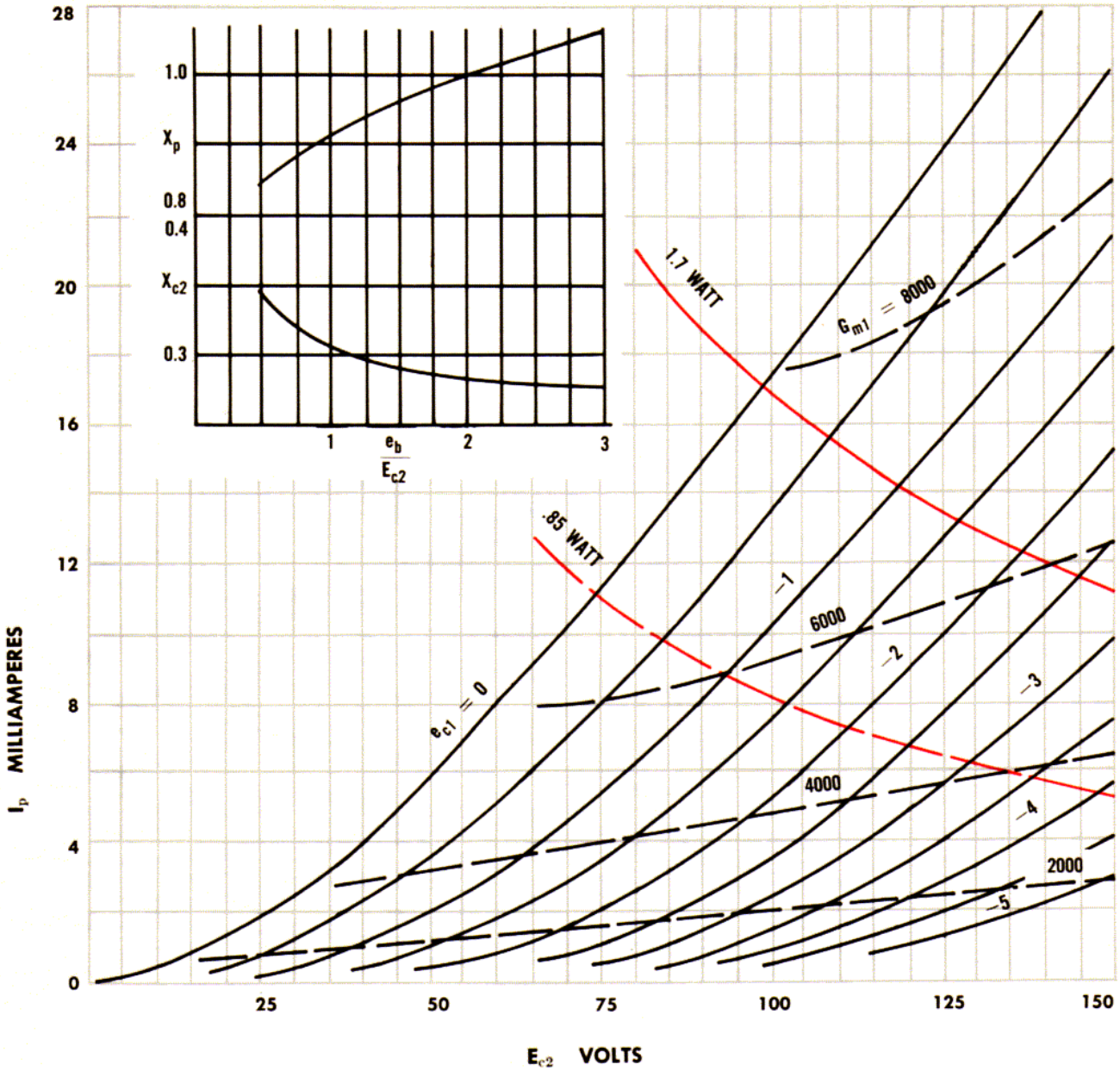

P_p 1.7 WATT: P_{c2} 0.5 WATT

BASE: 1-G₁ 2-K 3 4-F 5-P 6-G₂ 7-K-G₃

CURVE 6AM4

PLATE CHARACTERISTICS

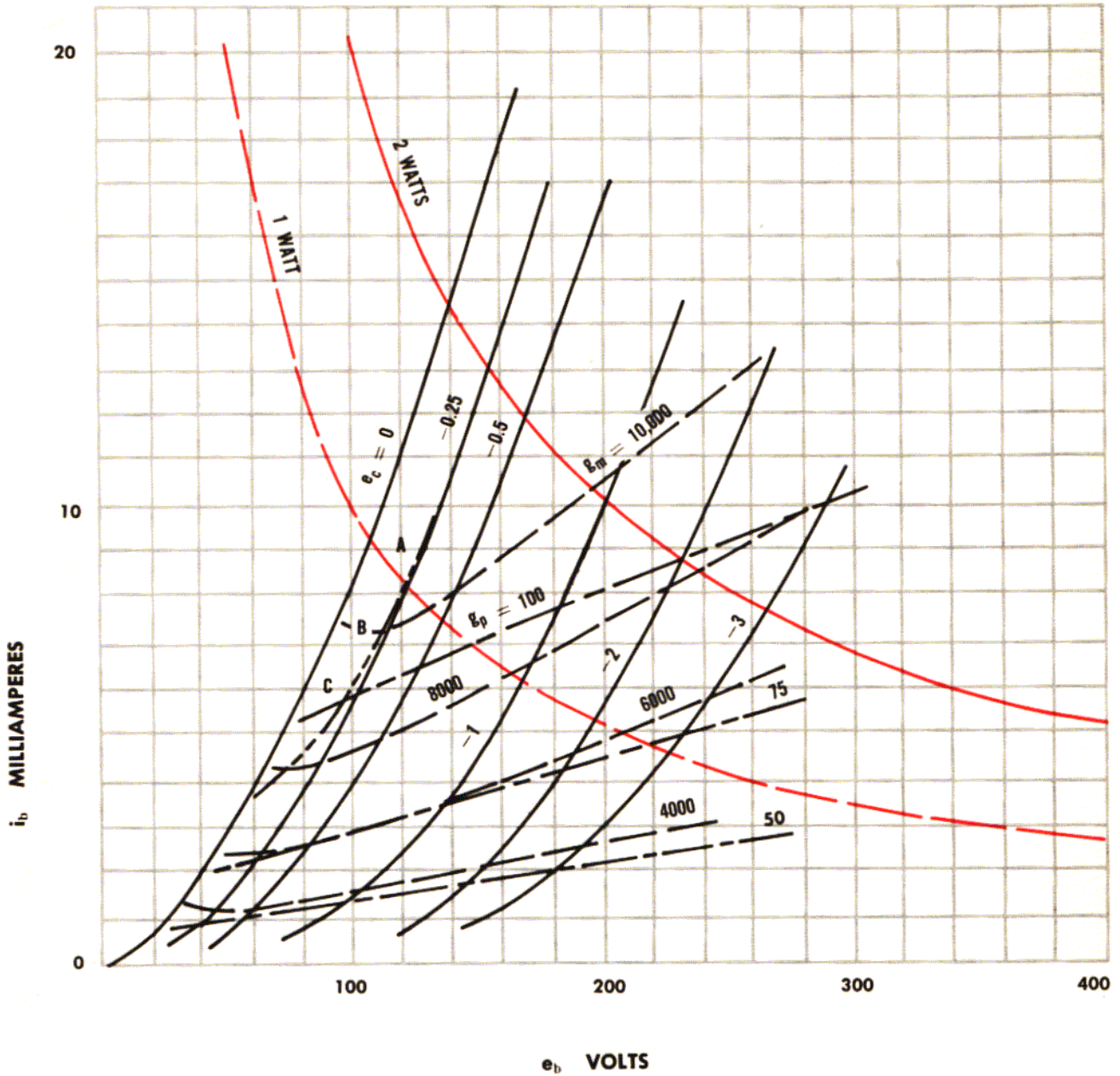

P_p 2 WATTS

BASE: 1 3 4-G_{in} 2-K 5-P 6 9-G_{out} 7 8-H

NOISE FIGURES AT 900 MC: A 14 db: B 14.5 db: C 15 db

CONTOUR OF NOISE FIGURE MINIMA: — — — — —

CURVE 6AM8

SCREEN CHARACTERISTICS

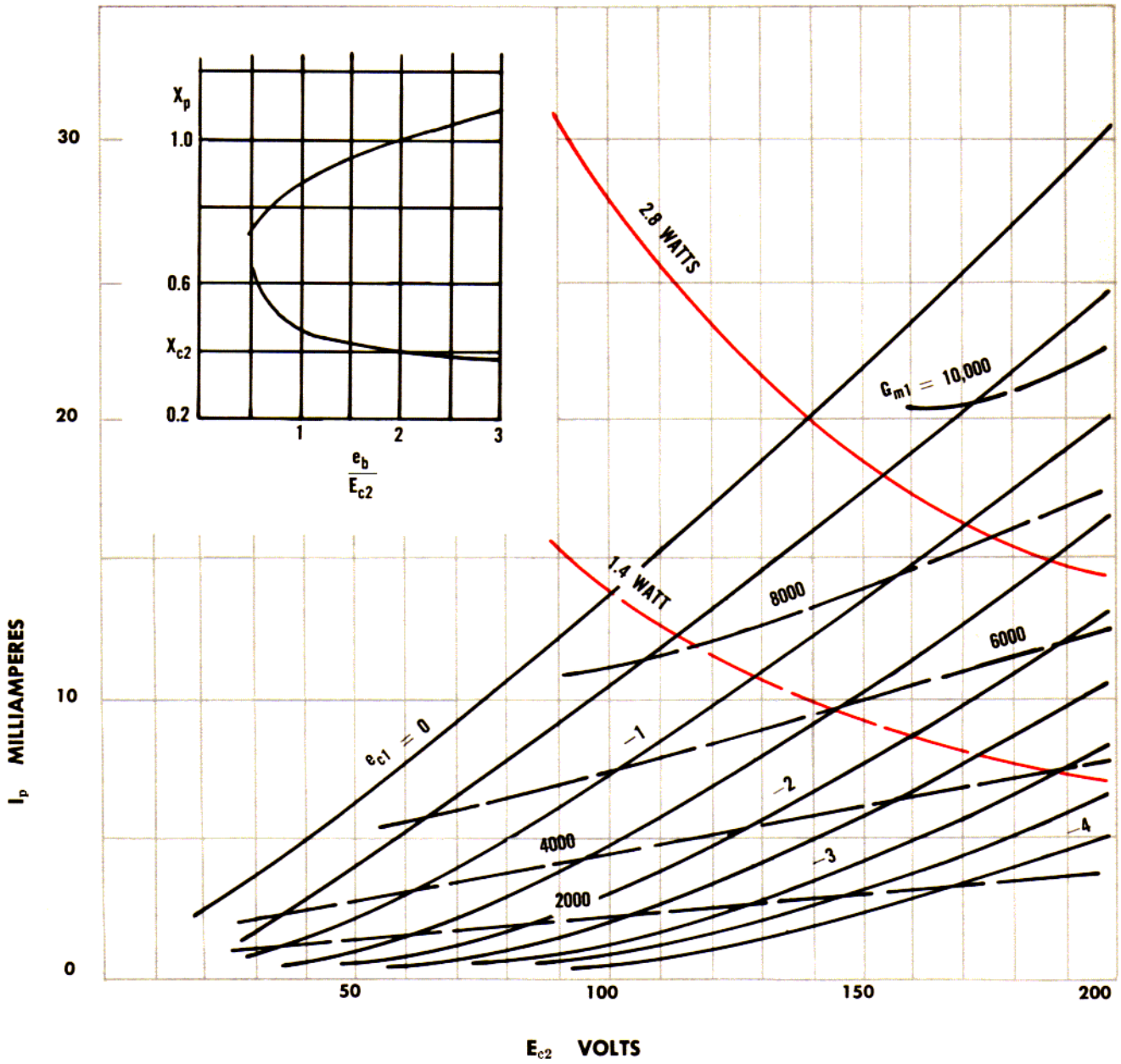

P_p 2.8 WATTS: P_{c2} 0.5 WATT

BASE: 1-K_p 2-G₁ 3-G₂ 4 5-H 6-P_p 7-K_D 9-G₃

CURVE 6AR6

SCREEN CHARACTERISTICS

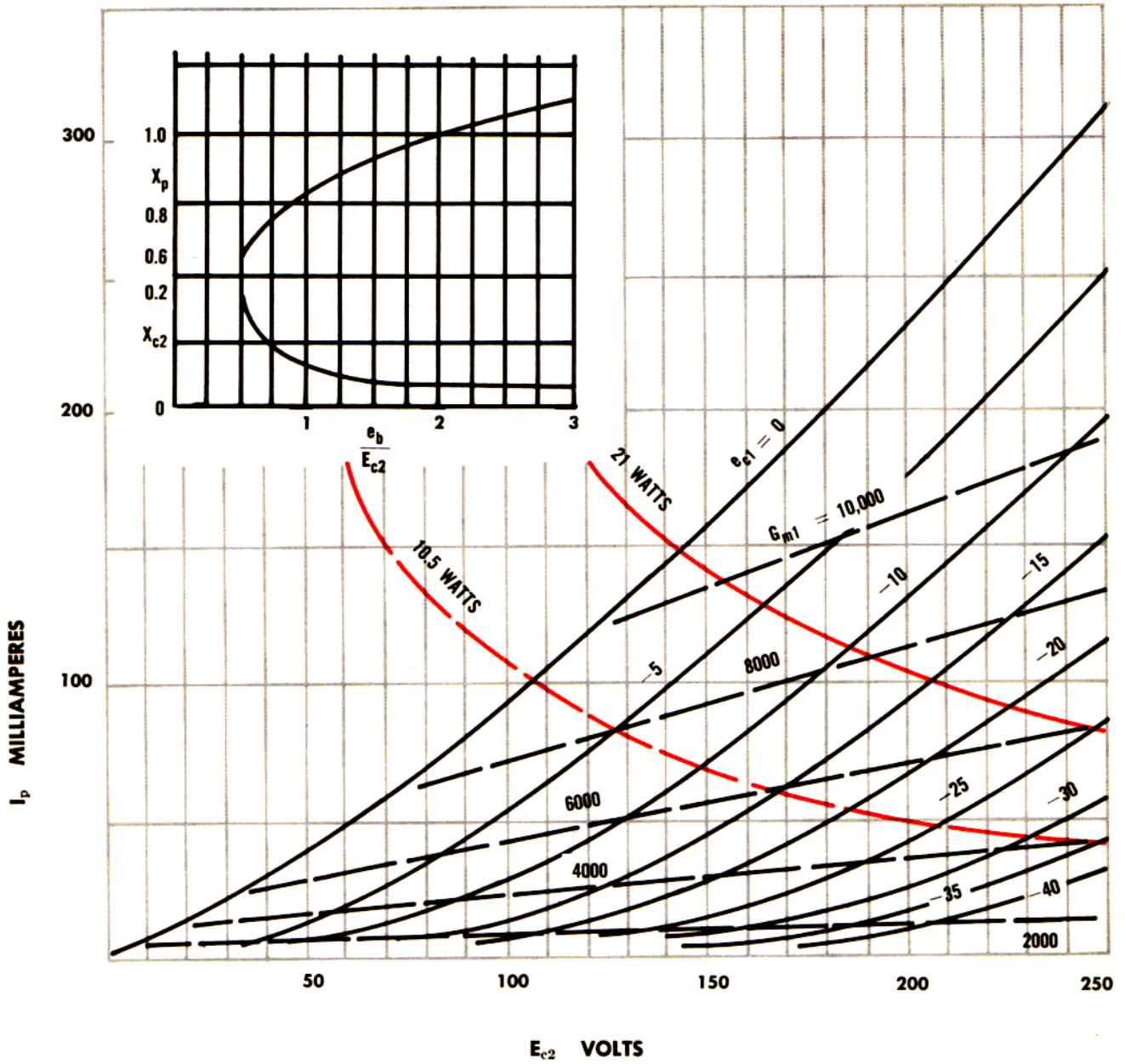

P_p 21 WATTS: P_{c2} 3.5 WATTS

BASE: 1-K 2 4-NC 3-P 5-G₂ 6 8-H 7-G₁

CURVE 6AS7G

PLATE CHARACTERISTICS

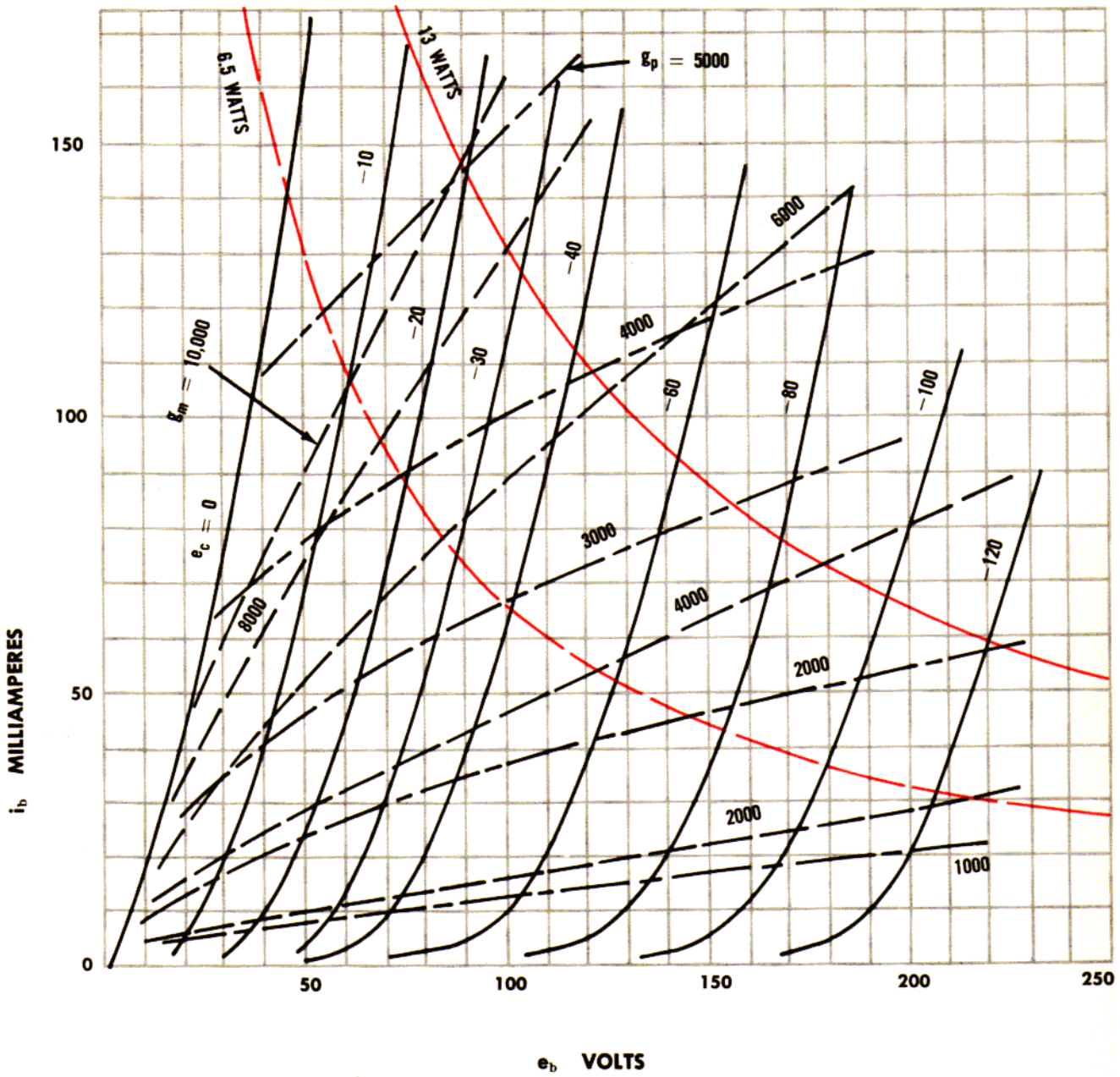

P_p 13 WATTS

BASE: 1-G₂ 2-P₂ 3-K₂ 4-G₁ 5-P₁ 6-K₁ 7 8-F

CURVE 6BE6 (1)

SCREEN CHARACTERISTICS

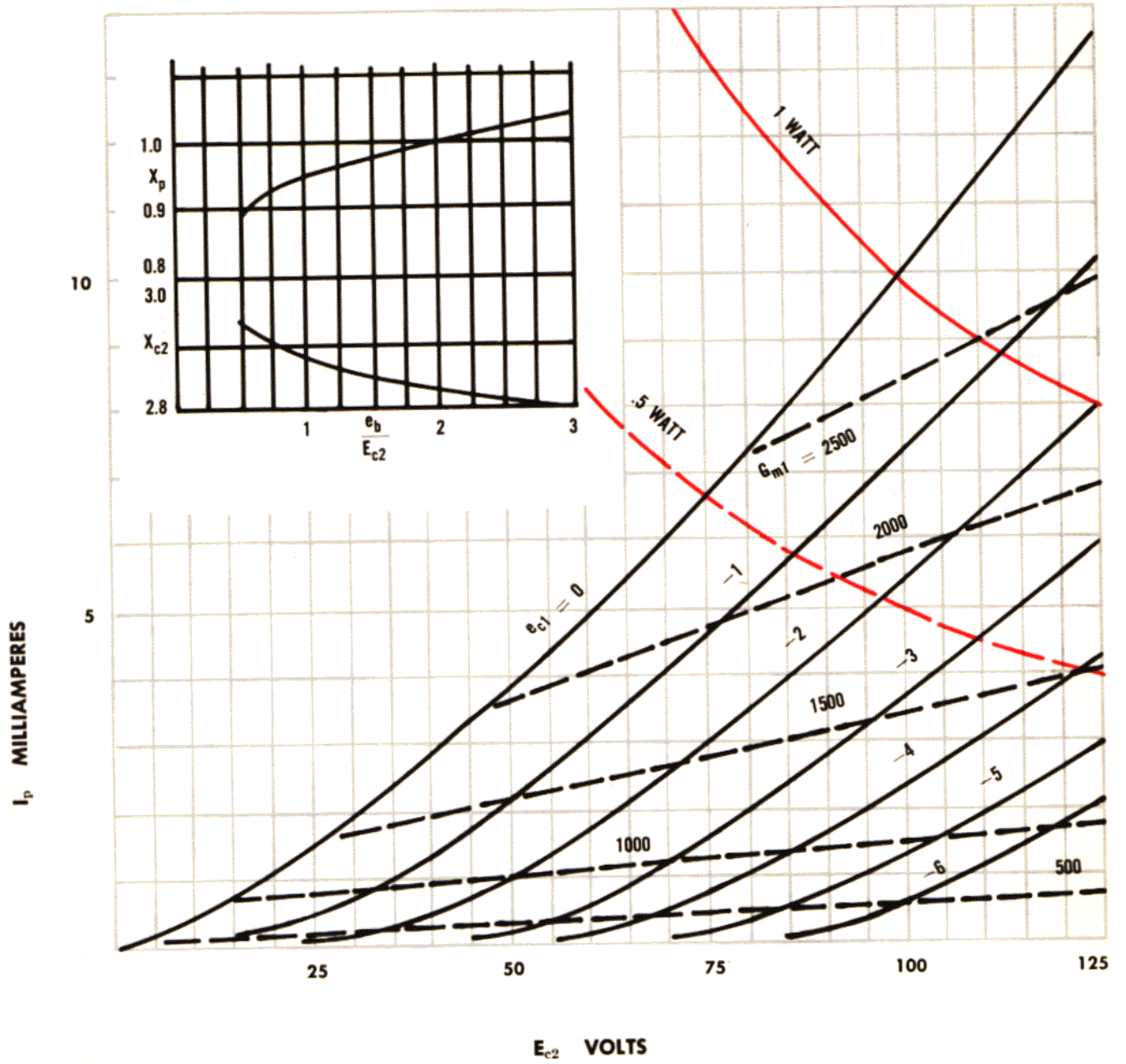

P_{p1} 1 WATT: P_{c2} 1 WATT

BASE: 1- G_1 2-K 3 4-H 5-P 6- G_2 G_4 7- G_3

CURVE 6BE6 (2)

SCREEN CHARACTERISTICS

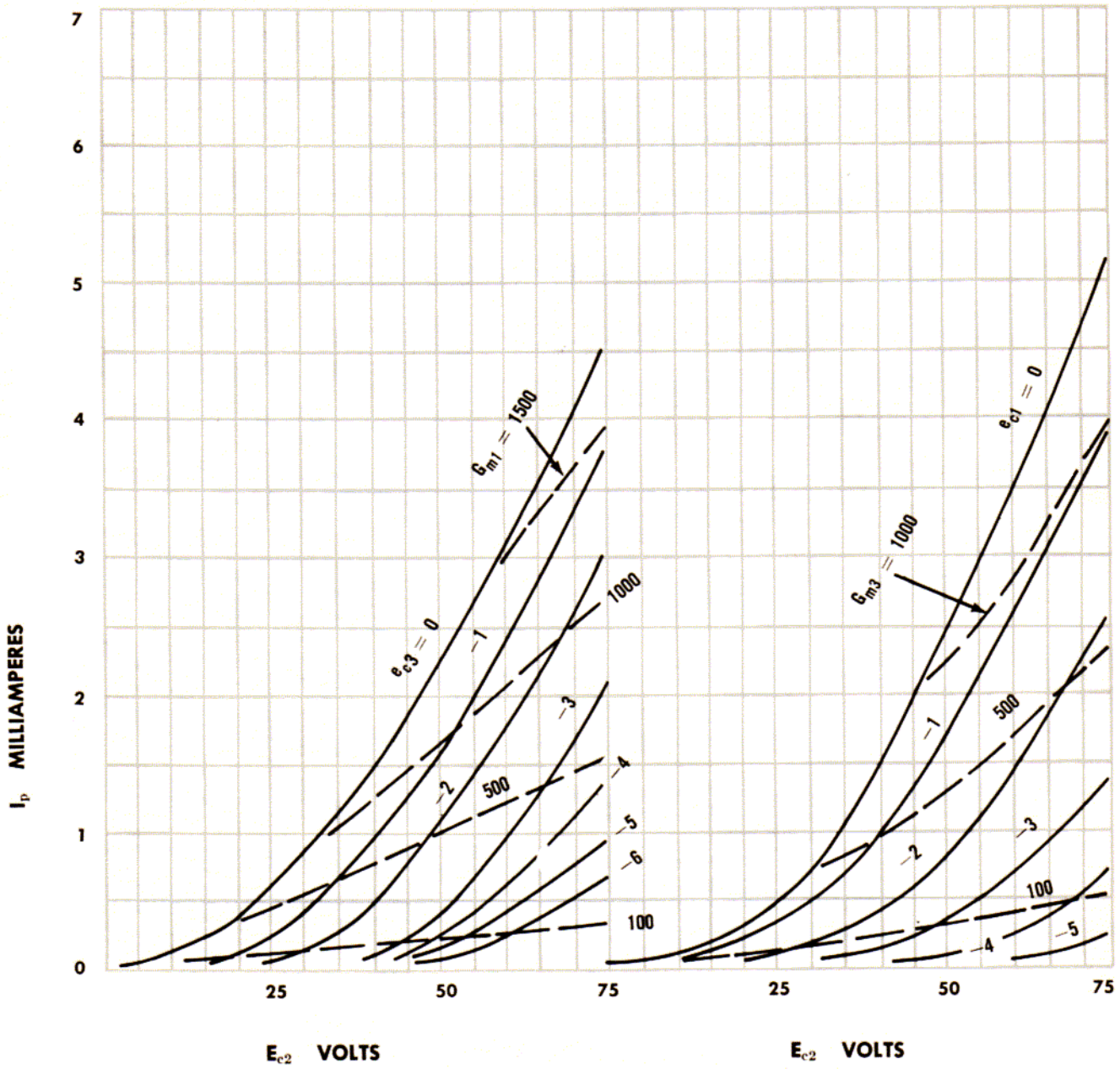

NO. 1: SIGNAL GRID BIAS—1 VOLT

NO. 3: SIGNAL GRID BIAS—1 VOLT

BASE: 1-G₁ 2-K 3 4-H 5-P G-G₂ G₄ 7-G₃

CURVE 6BH6

SCREEN CHARACTERISTICS

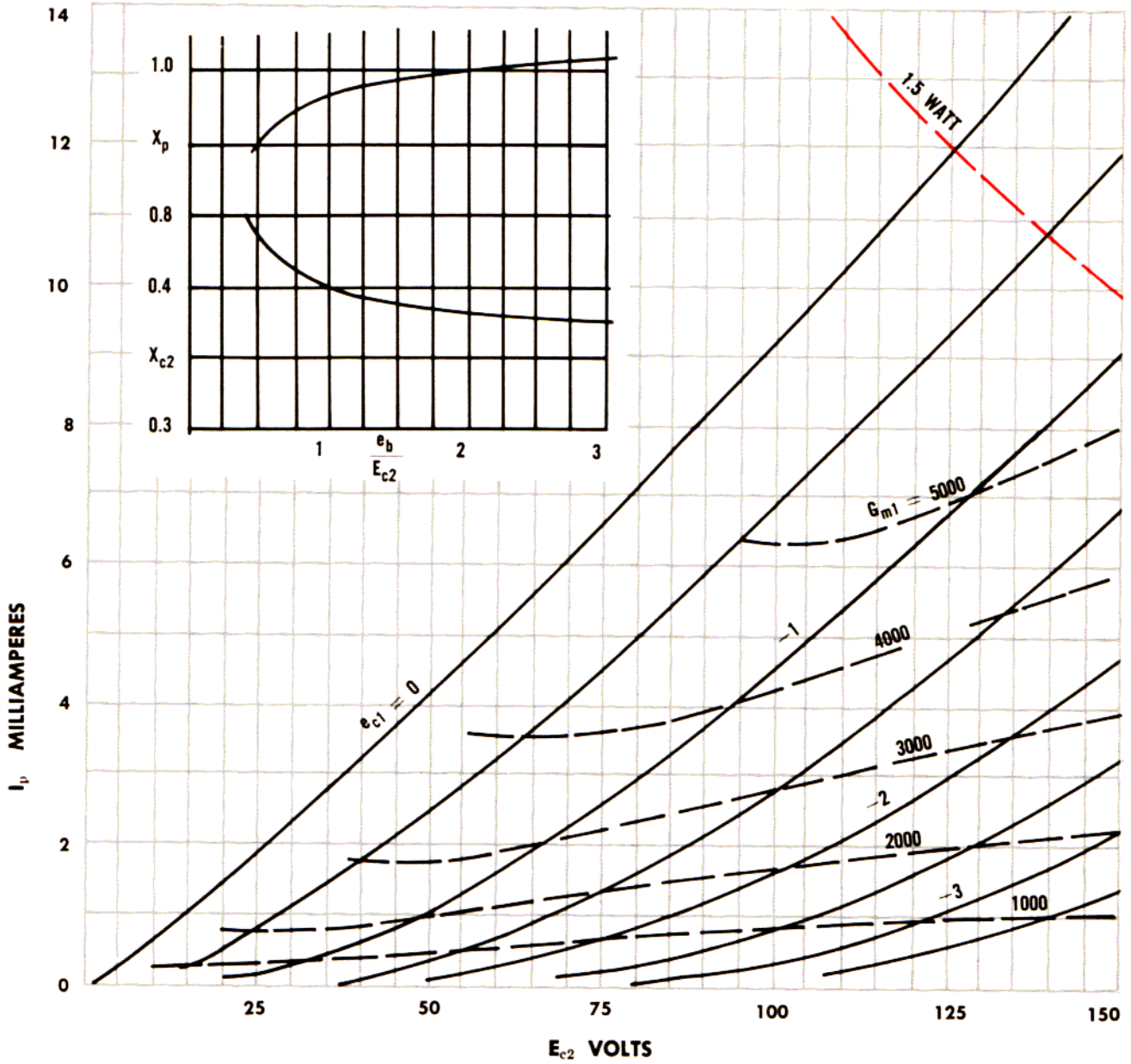

P_p 3.0 WATTS: P_{c2} 0.5 WATT

BASE: 1-G₁ 2-K 3 4-F 5-P 6-G₂ 7-G₃

CURVE 6BJ6

SCREEN CHARACTERISTICS

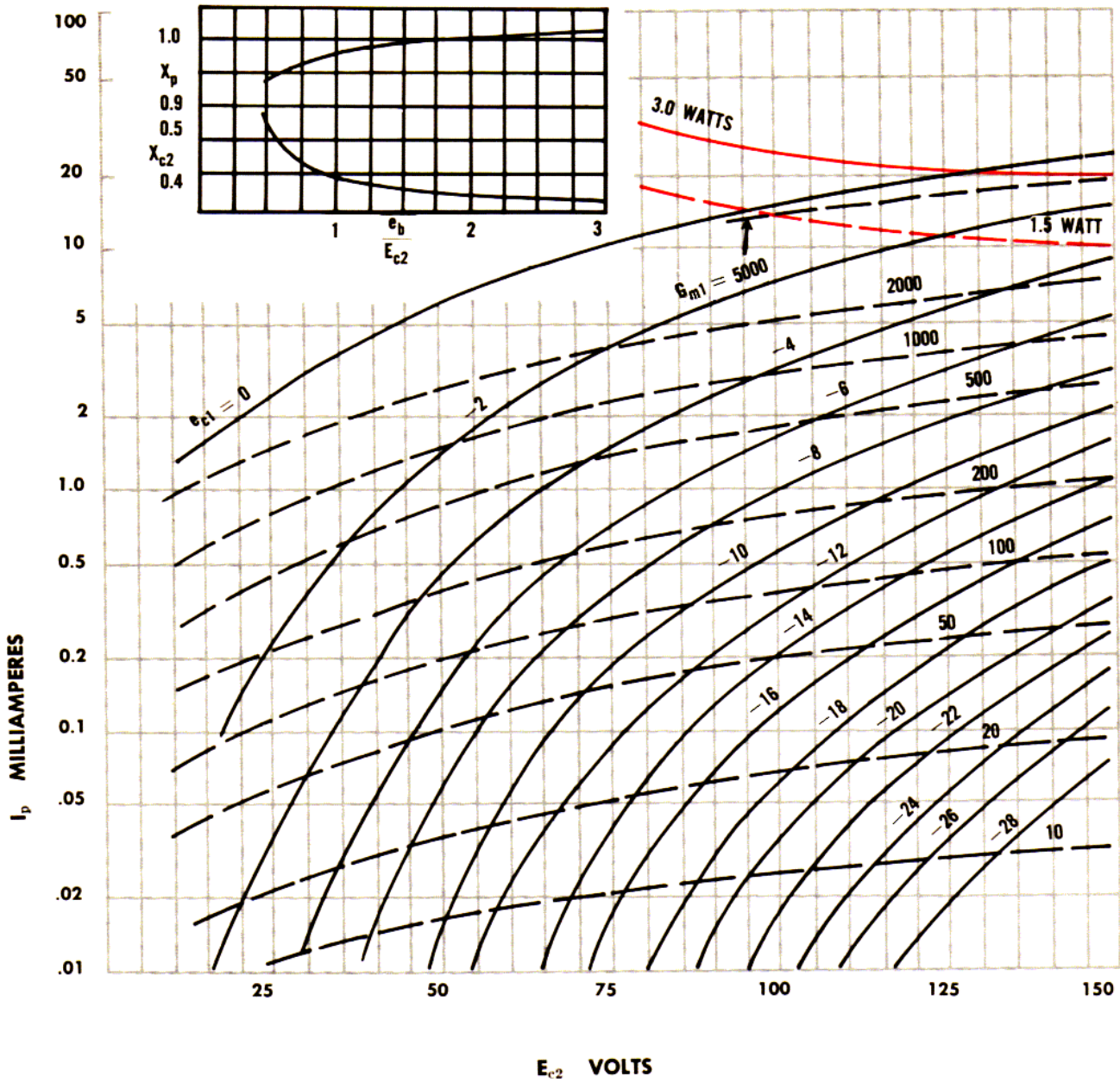

P_p 3.0 WATTS: P_{c2} 0.6 WATT

BASE: 1-G₁ 2-K 3 4-F 5-P 6-G₂ 7-G₃

CURVE 6BQ6GT

SCREEN CHARACTERISTICS

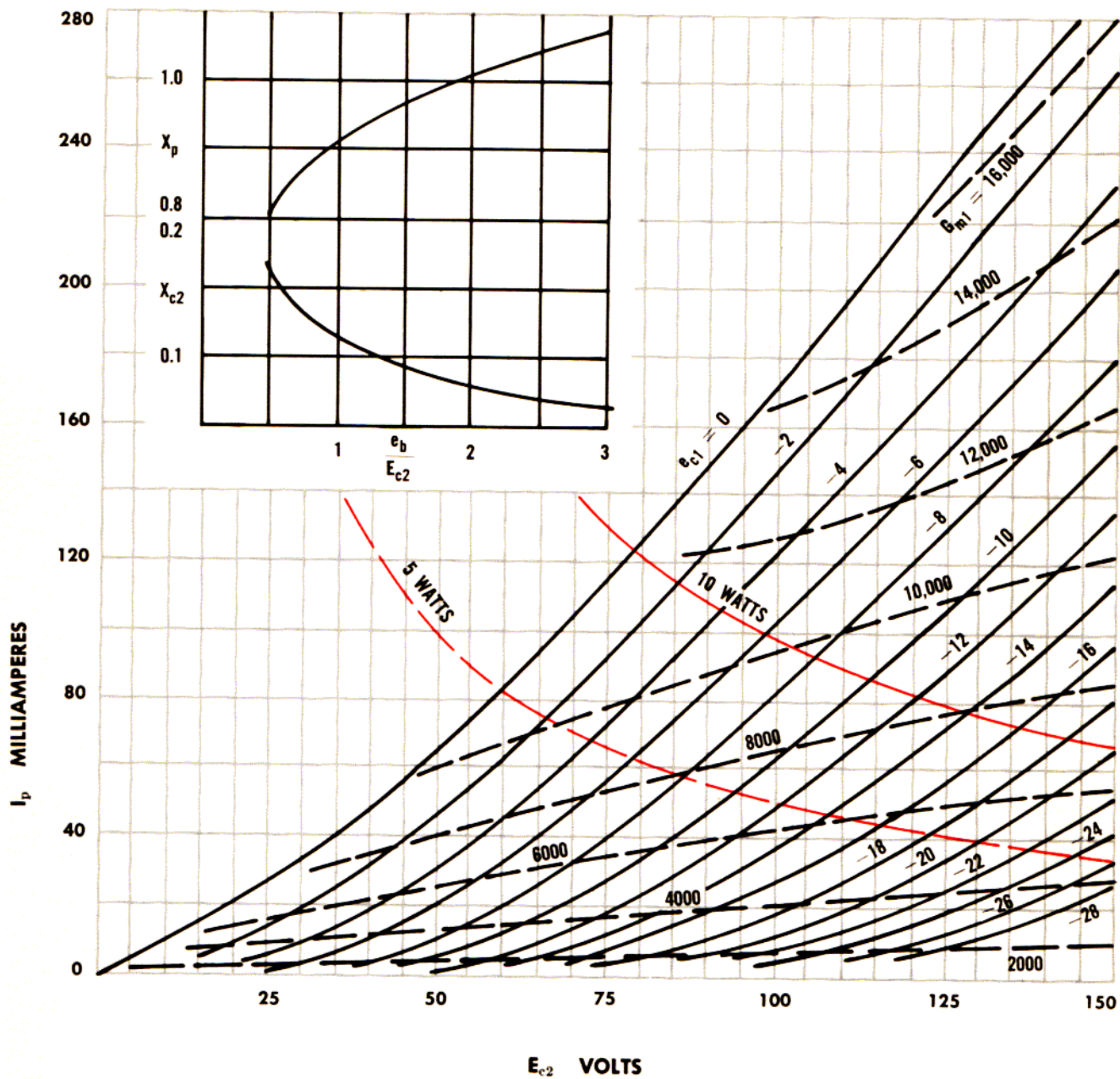

P_p 10 WATTS: P_{c2} 2.5 WATTS

BASE: 2-F 4-G₂ 5-G 7-F 8-K Cap-P

CURVE 6BQ7A

PLATE CHARACTERISTICS

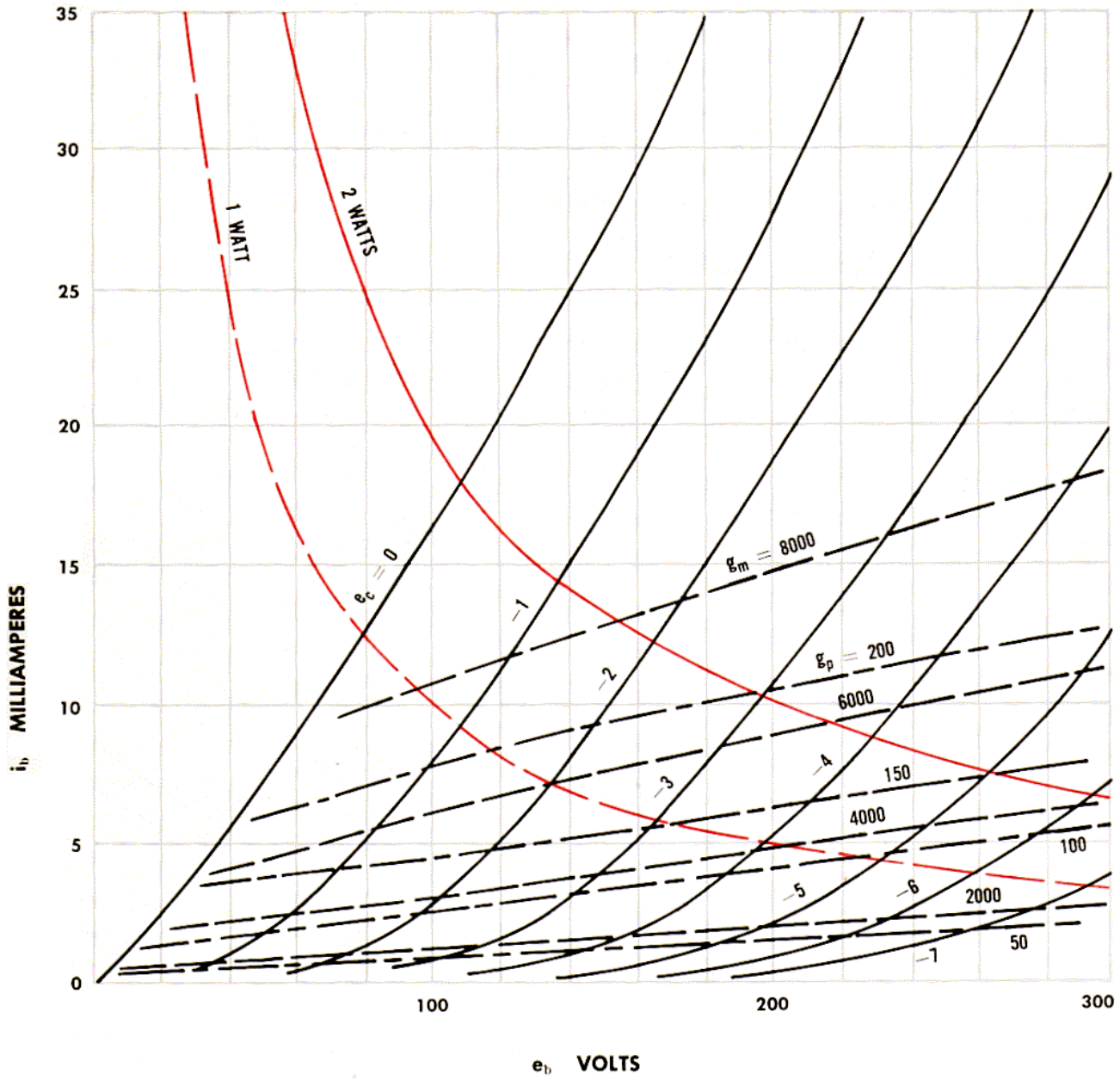

P_p 2 WATTS

BASE: 1-P₂ 2-G₂ 3-K₂ 4 5-H 6-P₁ 7-G₁ 8-K₁ 9-SH

CURVE 6BY4

PLATE CHARACTERISTICS

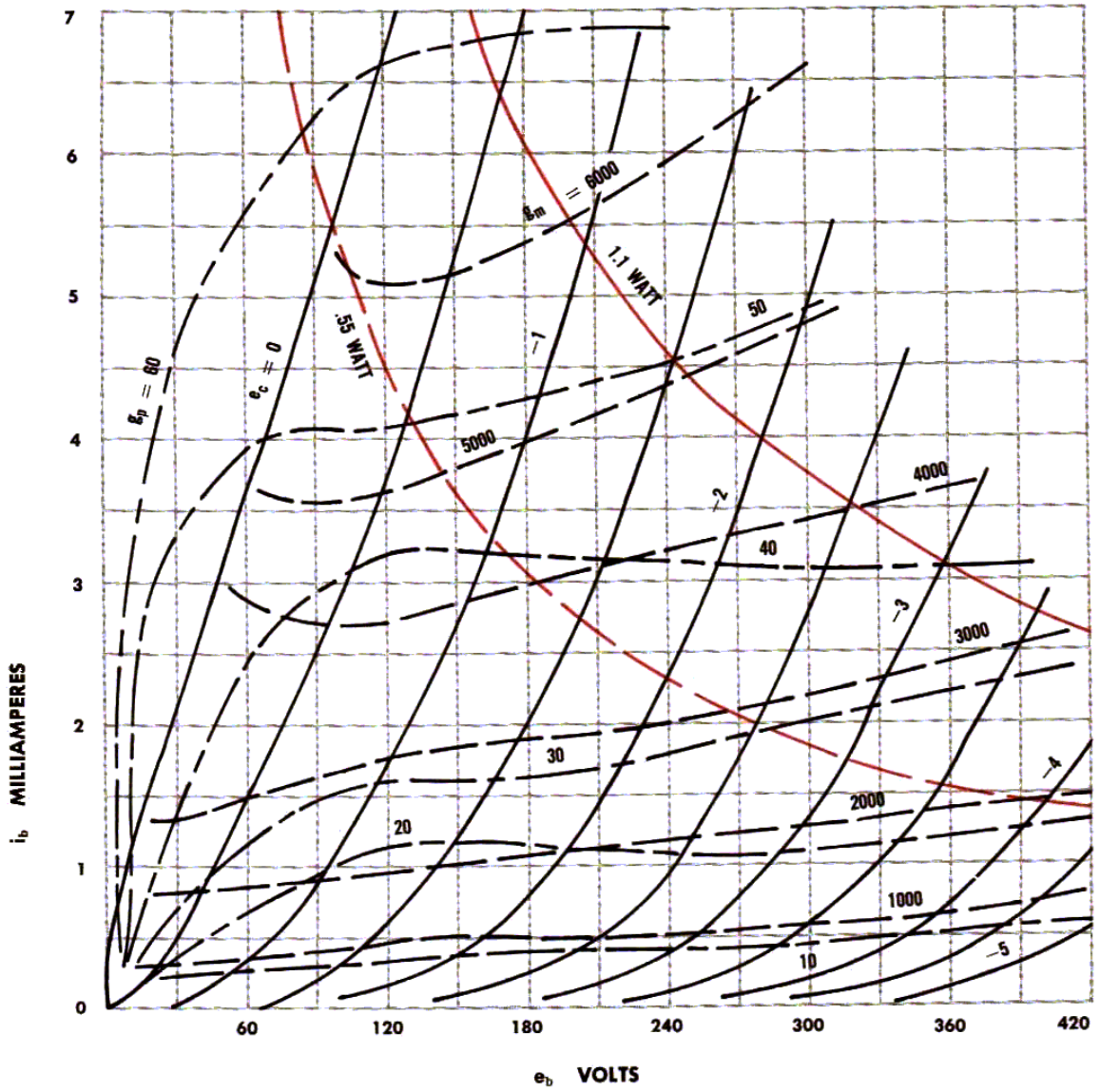

P_p 1.1 WATT

Special socket:

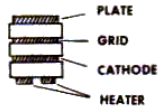

CURVE 6CB6

SCREEN CHARACTERISTICS

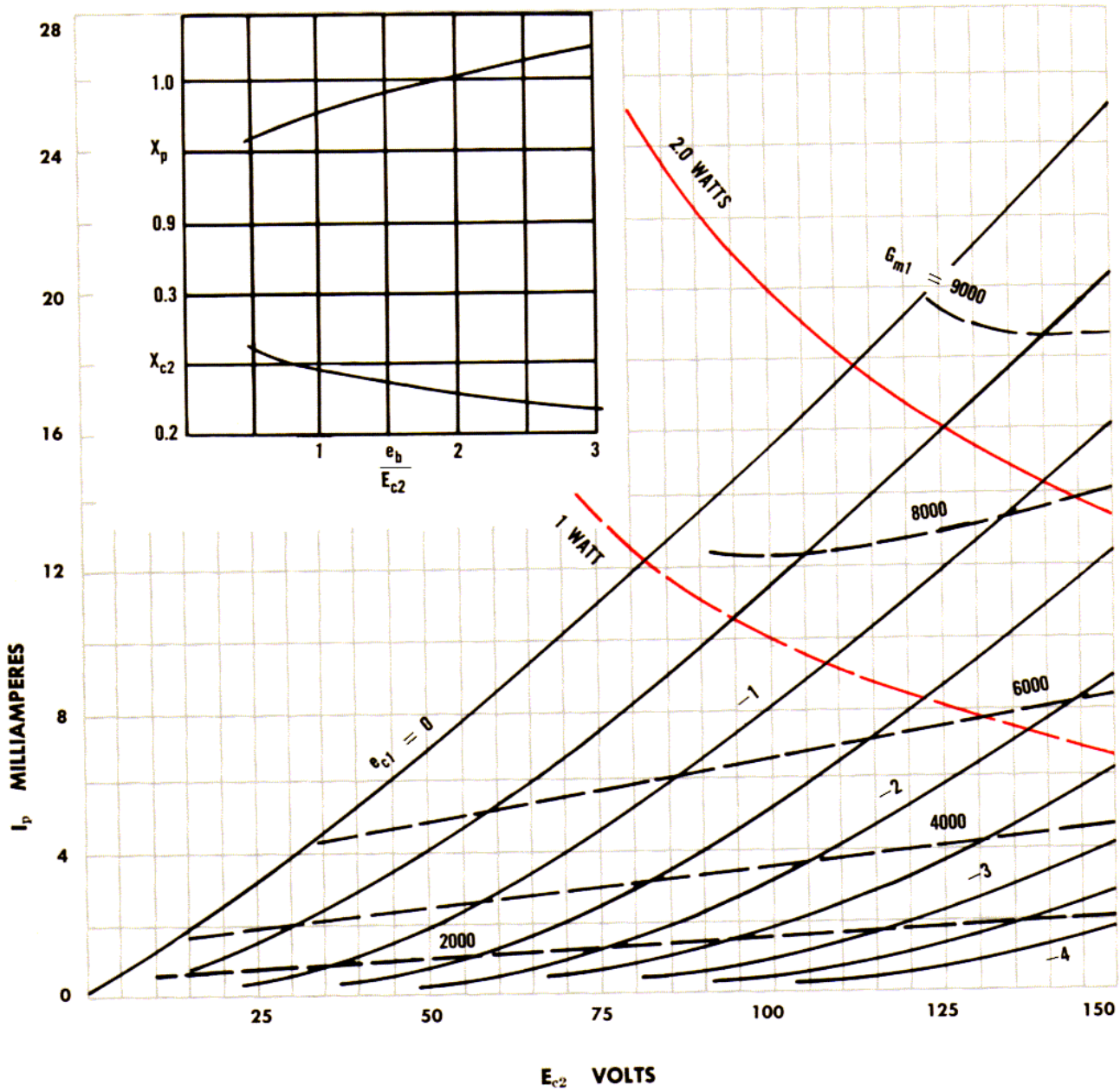

P_p 2.0 WATTS: P_{c2} 0.5 WATT

BASE: 1-G₁ 2-K 3 4-F 5-P 6-G₂ 7-G₃

CURVE 6CD6GA

SCREEN CHARACTERISTICS

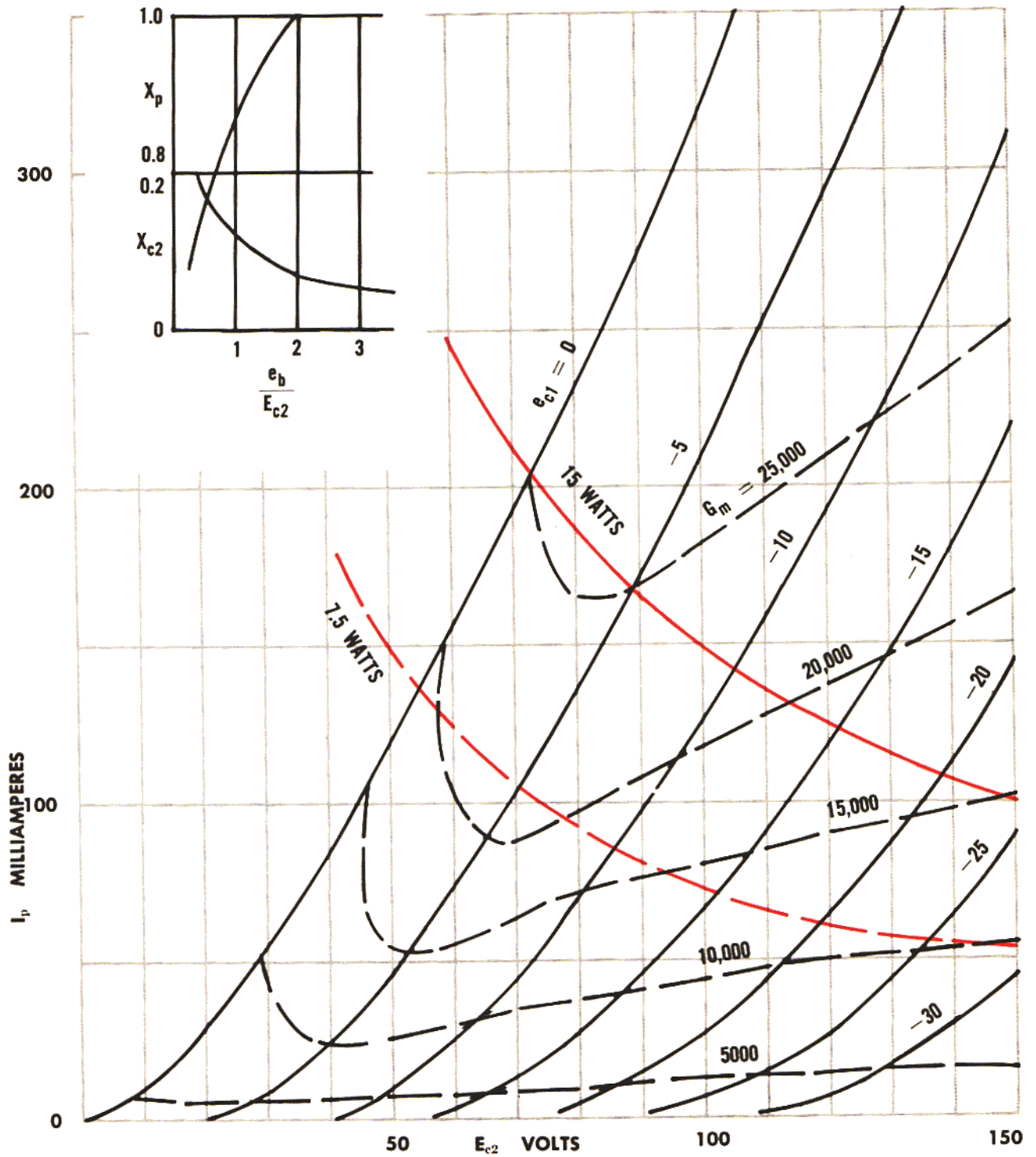

P_p 15 WATTS: P_{c2} 3 WATTS

BASE: 2-H 3-K 5-G₁ 7-H 8-G₂ Cap-P

CURVE 6CL6

SCREEN CHARACTERISTICS

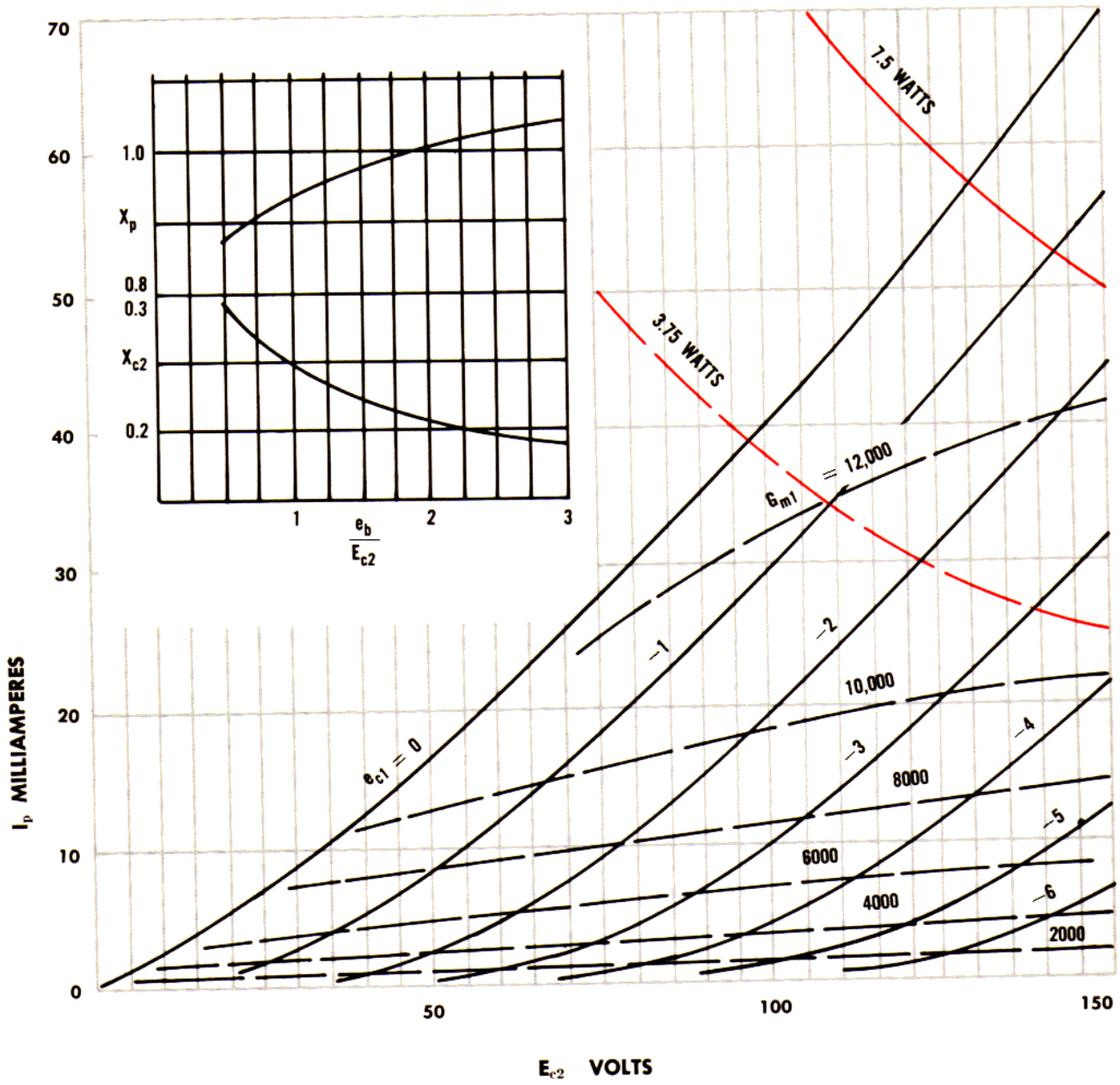

P_p 7.5 WATTS: P_{c2} 1.7 WATT

BASE: 1-K 2 8-G₁ 3 8-G₂ 4 5-H 6-P 7-G₃IS

CURVE 6CM6

SCREEN CHARACTERISTICS

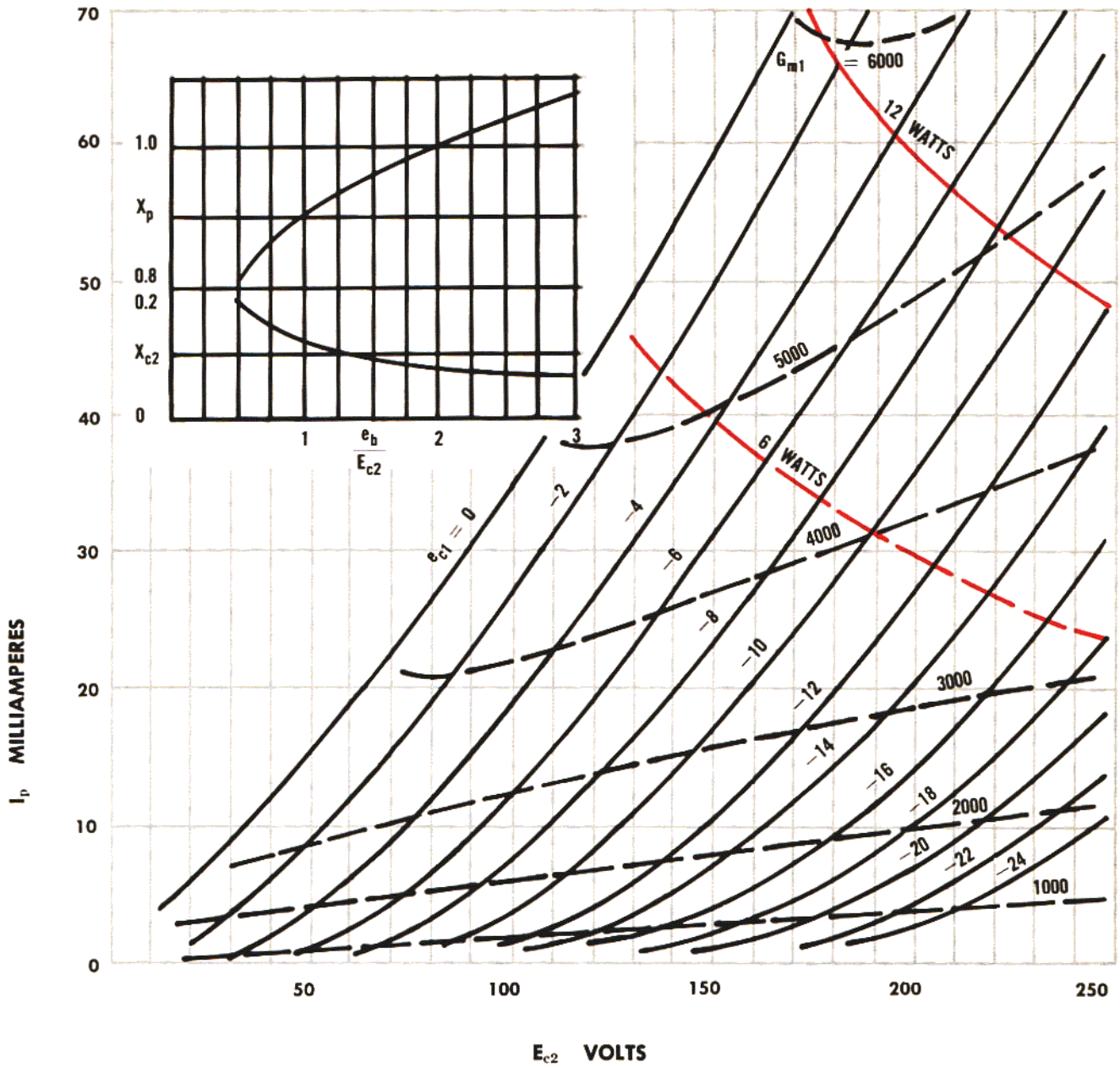

P_p 12 WATTS: P_{c2} 2 WATTS

BASE: 1-G₂ 2-NC 3-G₁ 4 5-H 6-G₁ 7-K-G₃ 8-NC 9-P

CURVE 6CS6 (1)

SCREEN CHARACTERISTICS

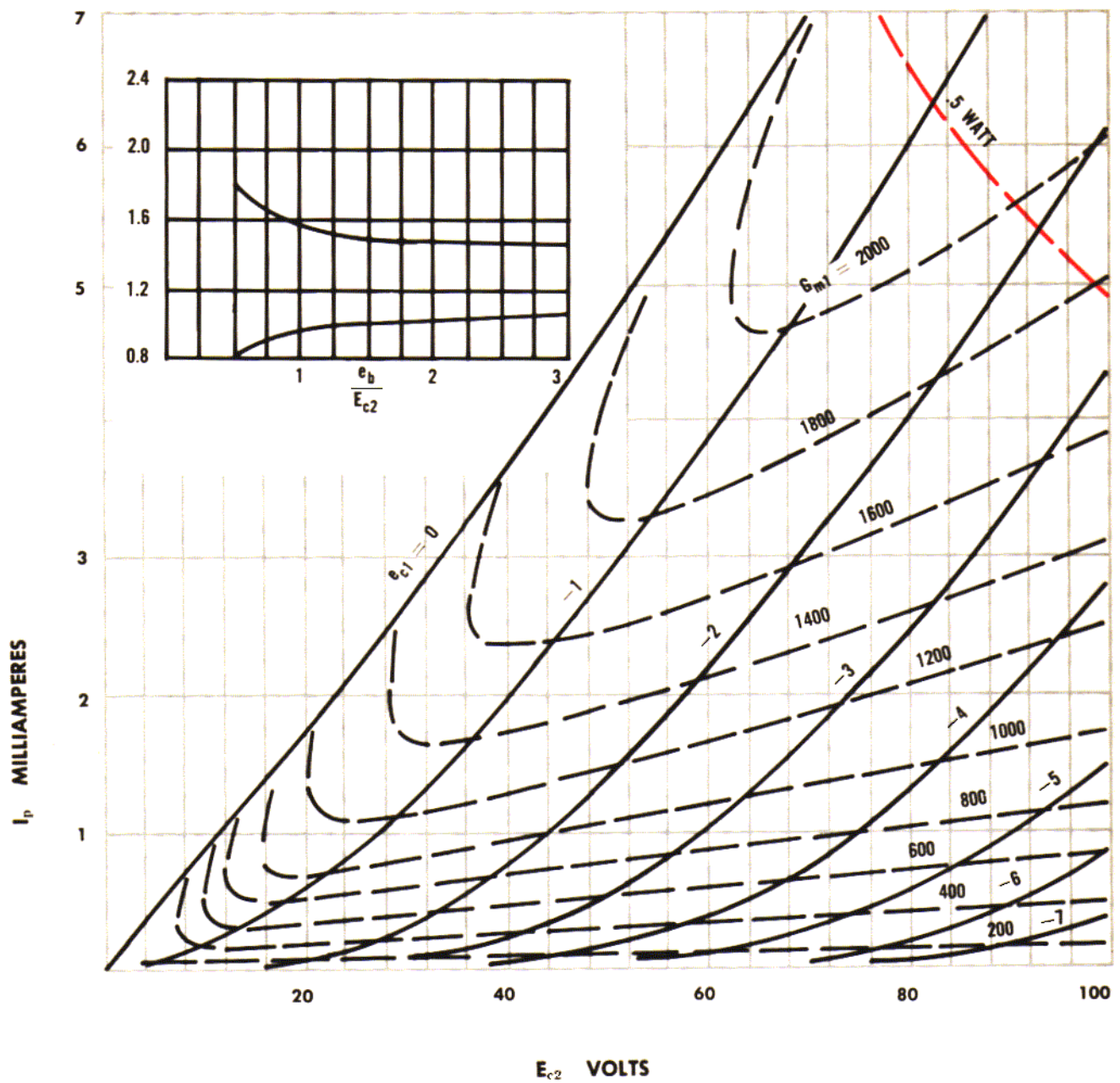

P_p 1 WATT: P_{c2} 1 WATT

BASE: 1-G₁ 2-K G₅ 3 4-H 5-P 6-G₂ G₄ 7-G₃

CURVE 6CS6 (2)

SCREEN CONVERTER

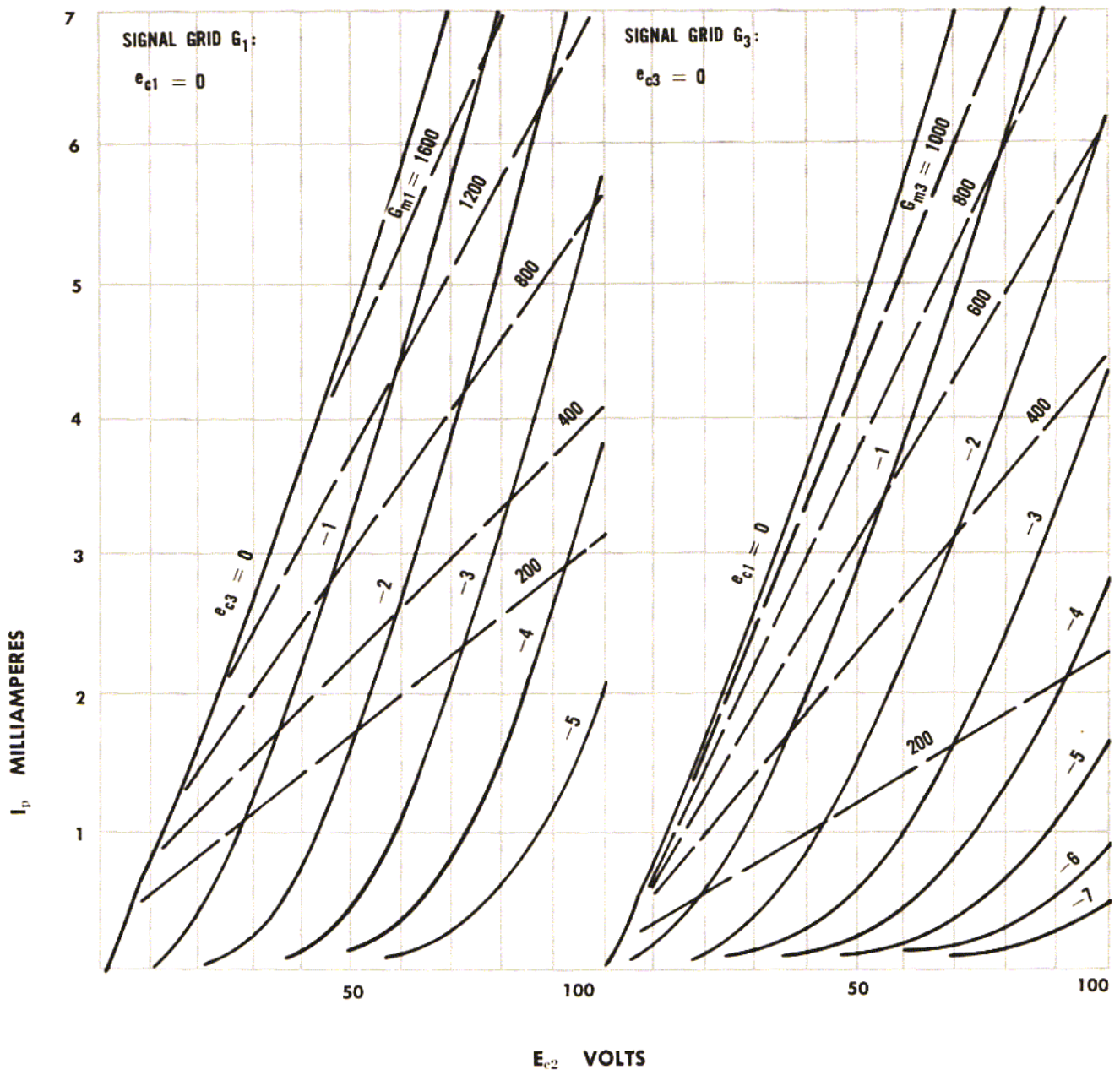

P_p 1 WATT: P_{c2} 1 WATT

BASE: 1- G_1 2-K G_5 3 4-H 5-P 6- G_2 G_4 7- G_3

CURVE 6DQ5

SCREEN CHARACTERISTICS

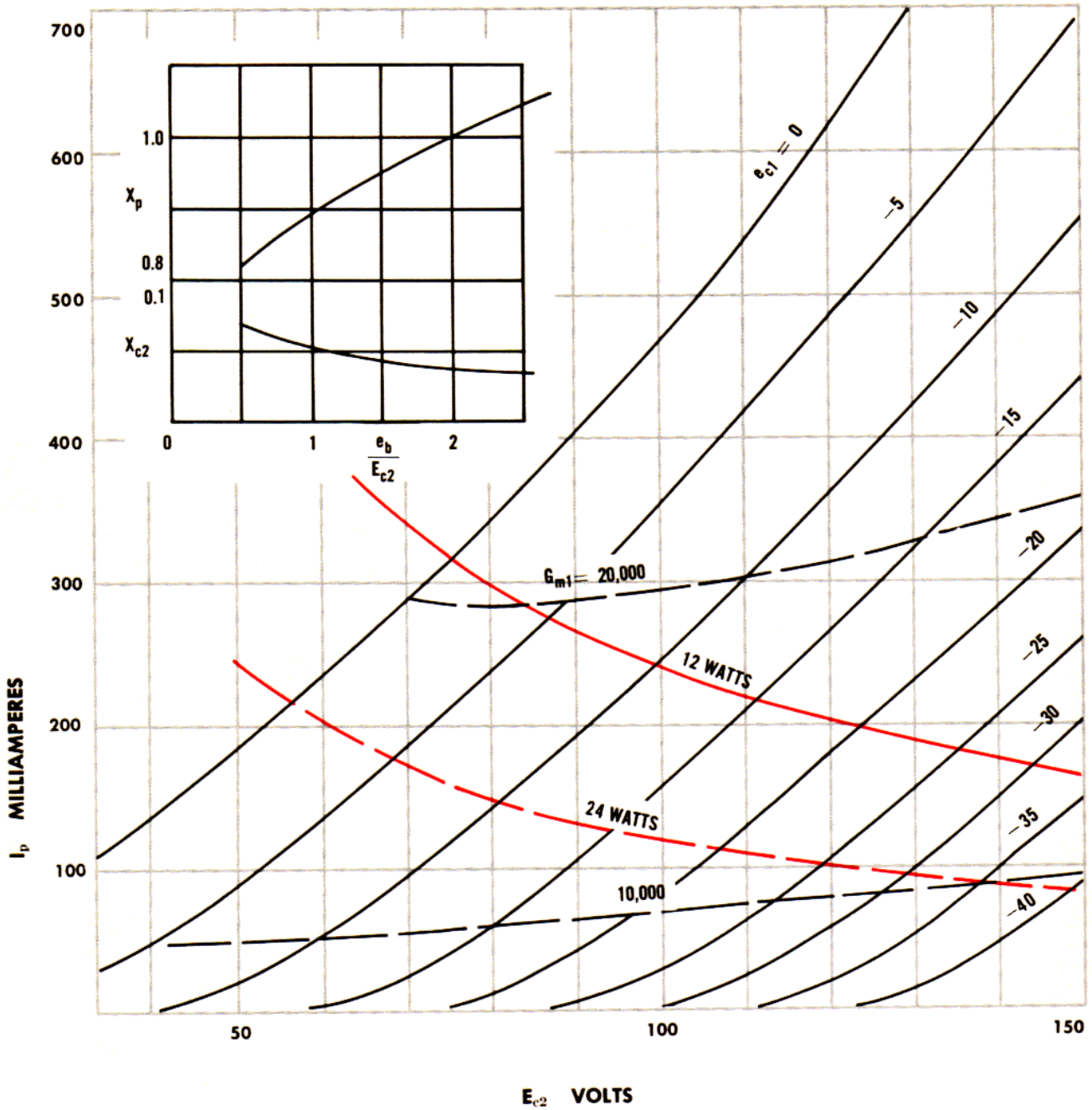

P_p 24 WATTS: P_{c2} 3.2 WATTS

BASE: 1-G 2-H 3-K-G₃ 4-G₂ 5-G₁ 6-K-G₃ 7-H Cap-P

CURVE 6DQ6-A

SCREEN CHARACTERISTICS

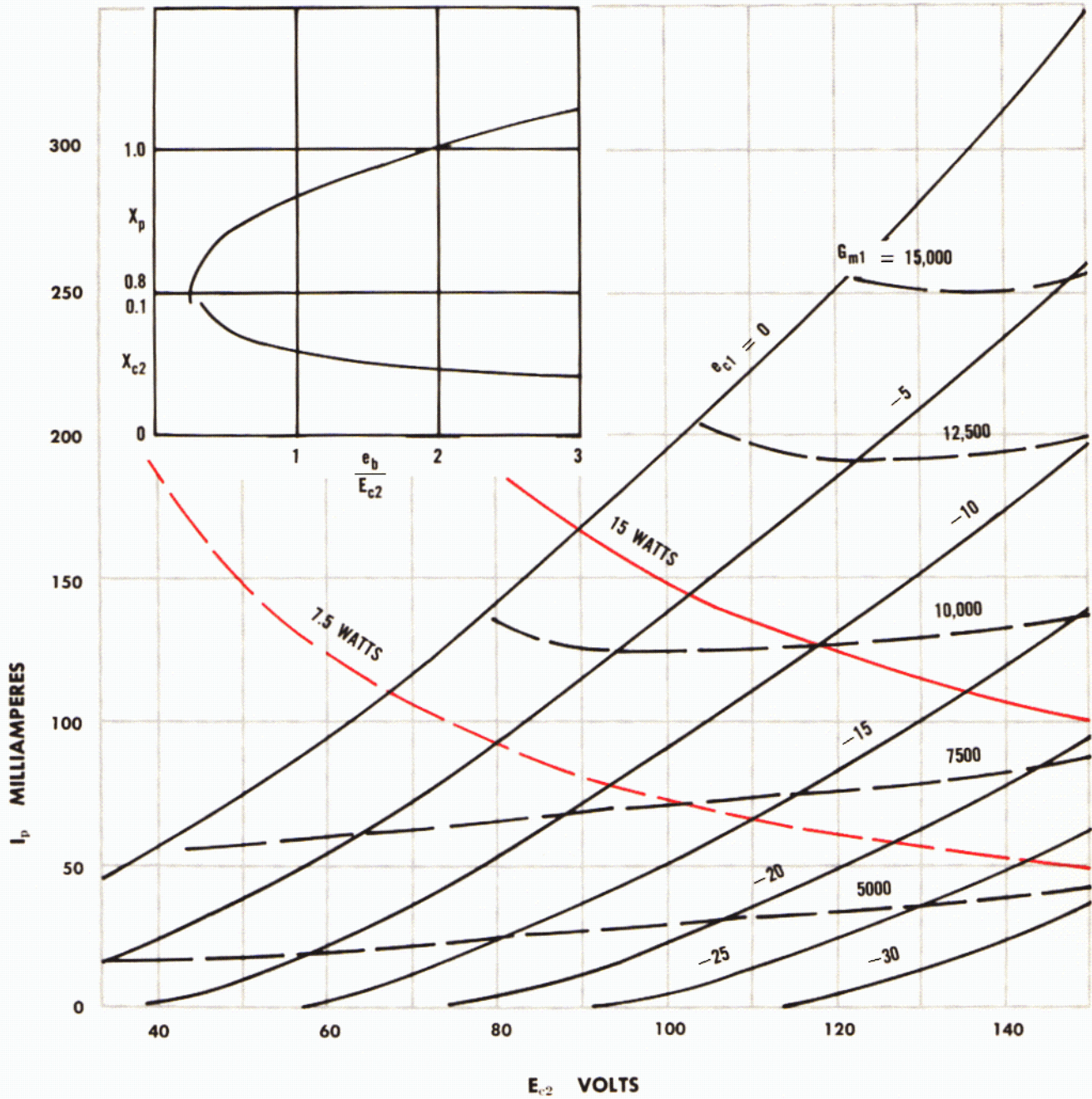

P_p 15 WATTS: P_{c2} 3 WATTS

BASE: 2-H 4-G₂ 5-G₁ 7-H 8-K-G₃ Cap-P

CURVE 6J5

PLATE CHARACTERISTICS

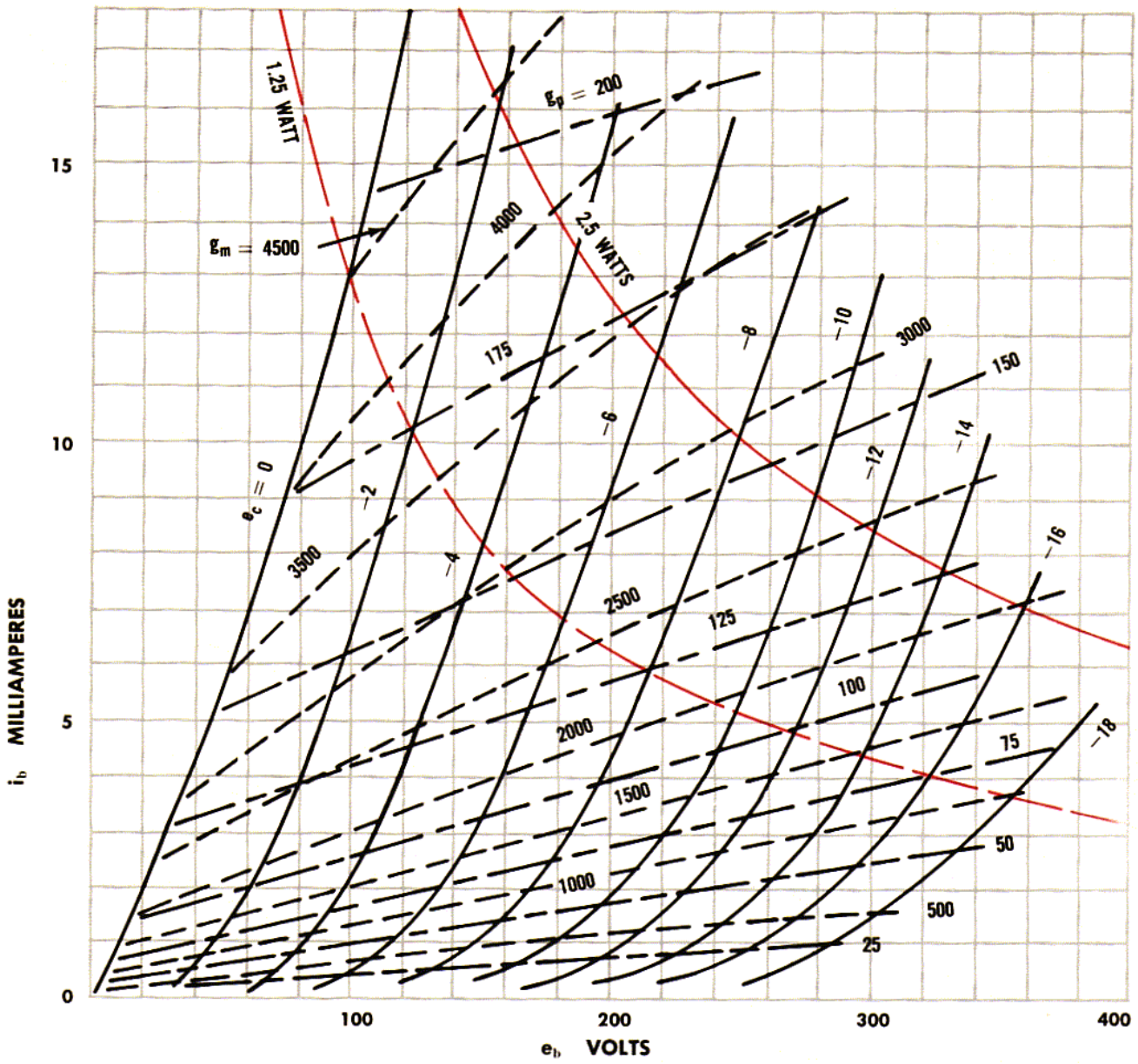

P_p 2.5 WATTS

BASE: 2-F 3-P 5-G 7-F 8-K

CURVE 6J6

PLATE CHARACTERISTICS

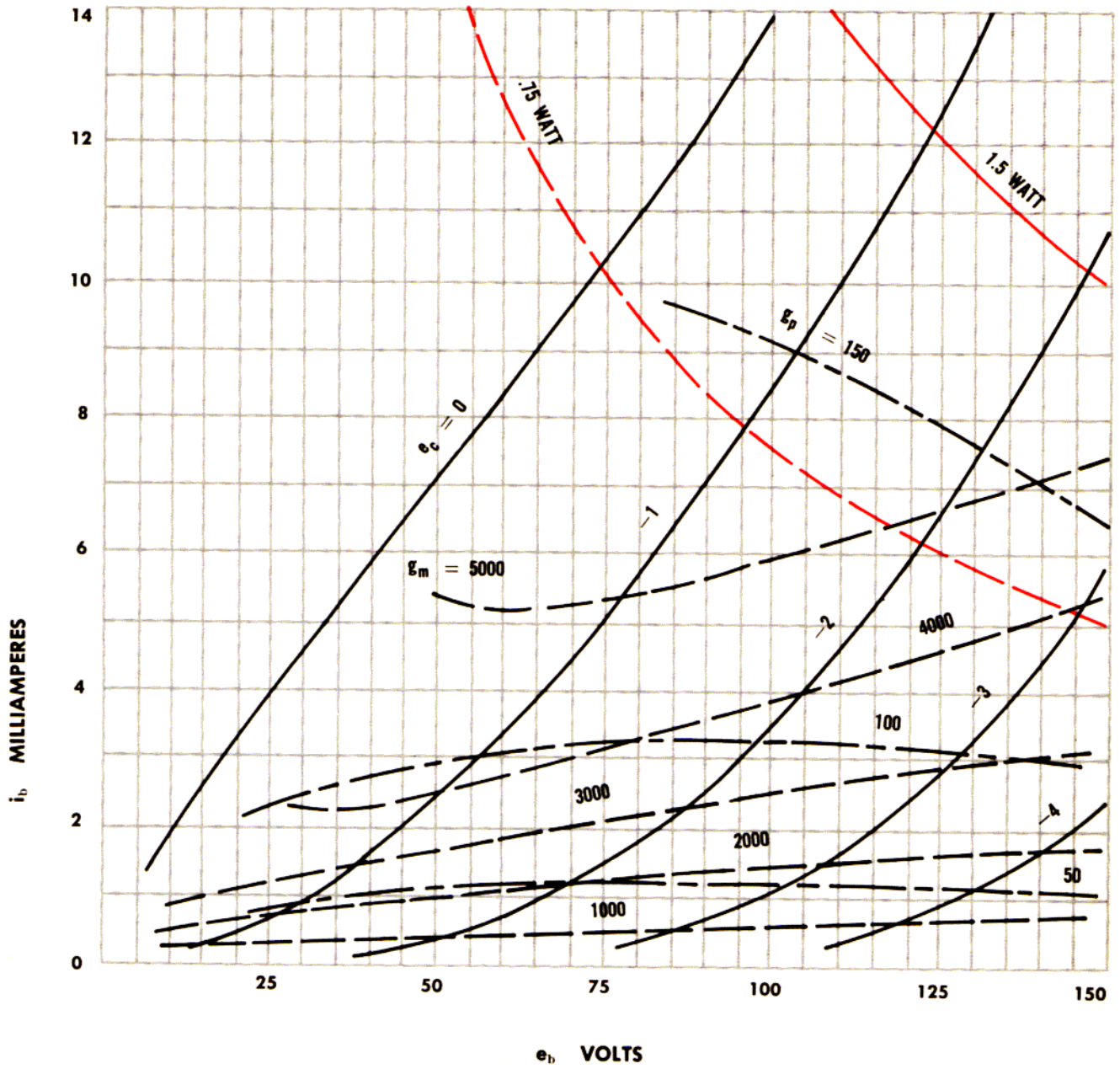

P_p 1.5 WATT

BASE: 1-P₂ 2-P₁ 3 4-F 5-G₁ 6-G₂ 7-K

CURVE 6L6

SCREEN CHARACTERISTICS

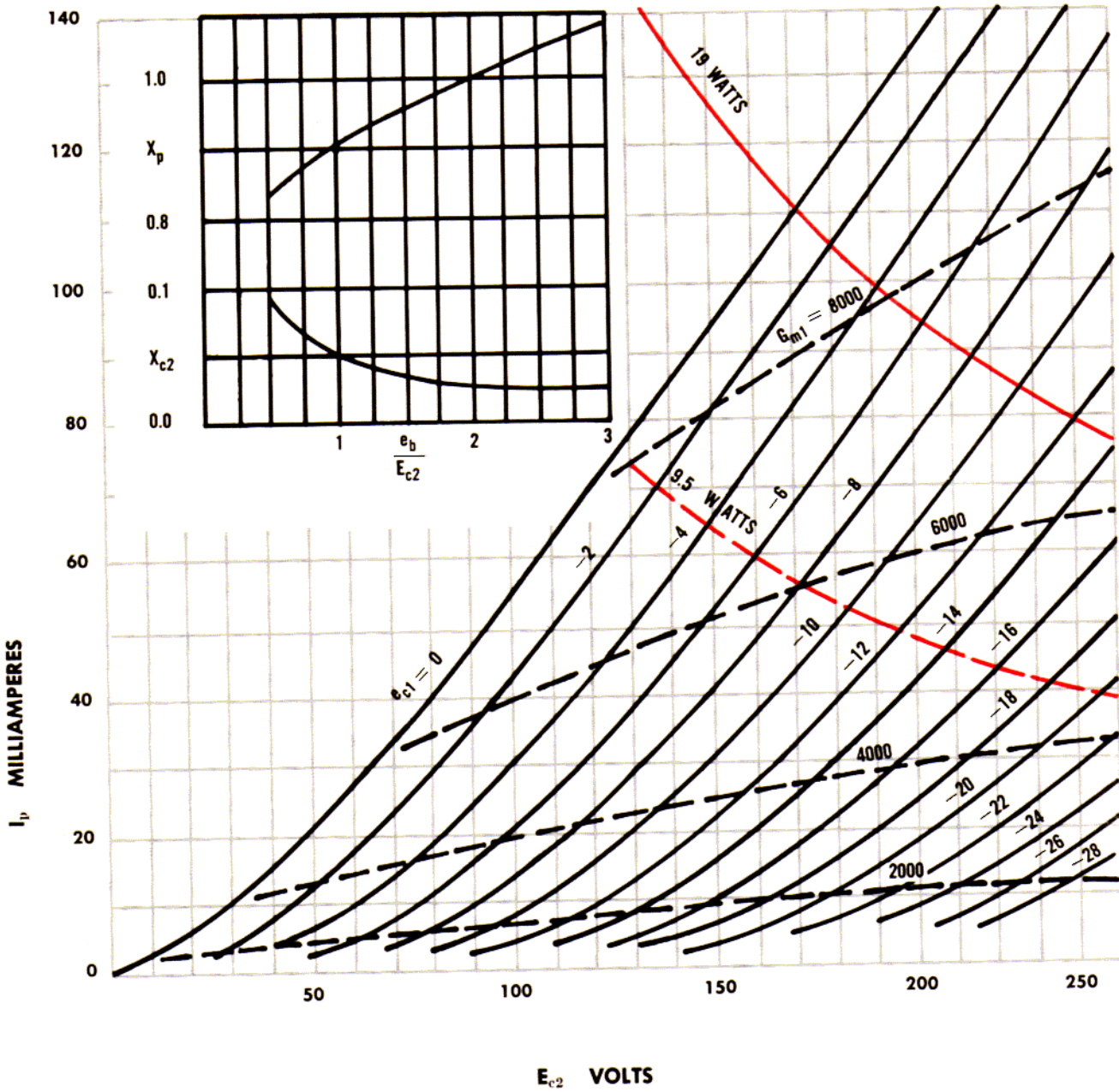

P_p 19 WATTS: P_{c2} 2.5 WATTS

BASE: 1-SH 2-7-F 3-P 4- G_2 5- G_1 8-K

CURVE 6SL7

PLATE CHARACTERISTICS

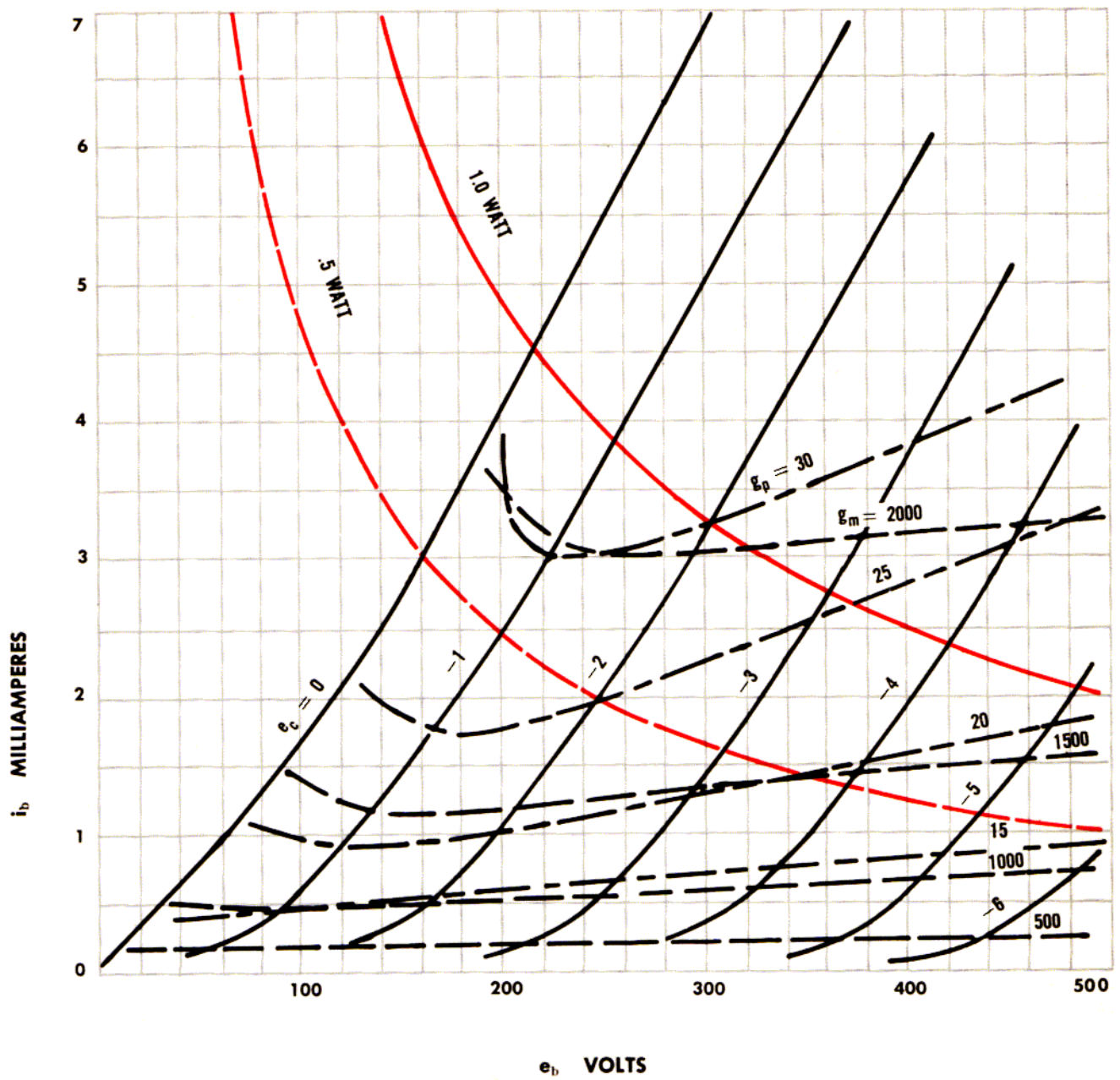

P_p 1.0 WATT

BASE: 1-G₂ 2-P₂ 3-K₂ 4-G₁ 5-P₁ 6-K₁ 7 8-H

CURVE 6V6

SCREEN CHARACTERISTICS

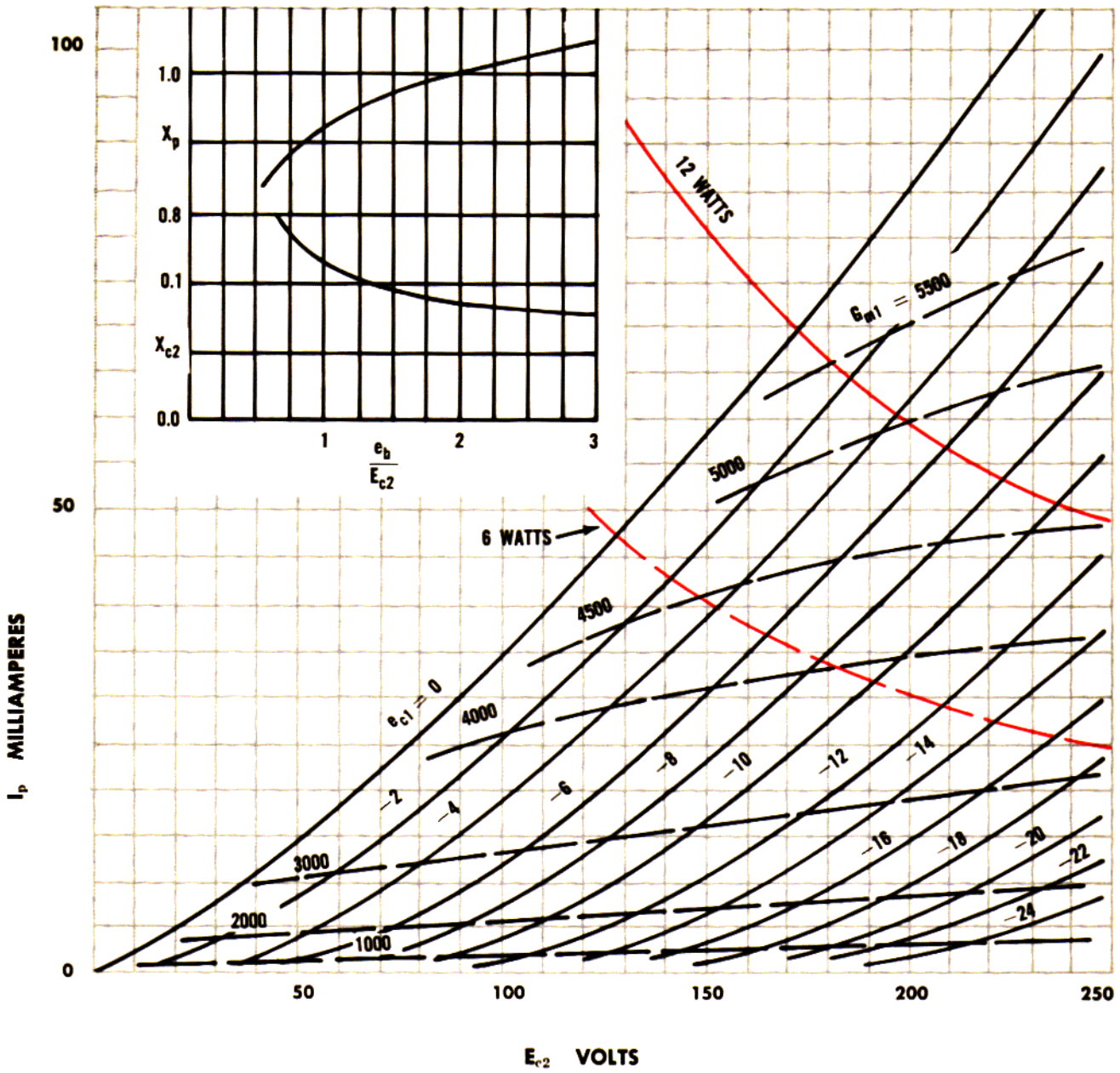

P_p 12 WATTS: P_{c2} 2 WATTS

BASE: 1-SH 2-7-F 3-P 4- G_2 5- G_1 8-K

CURVE 6Y6

SCREEN CHARACTERISTICS

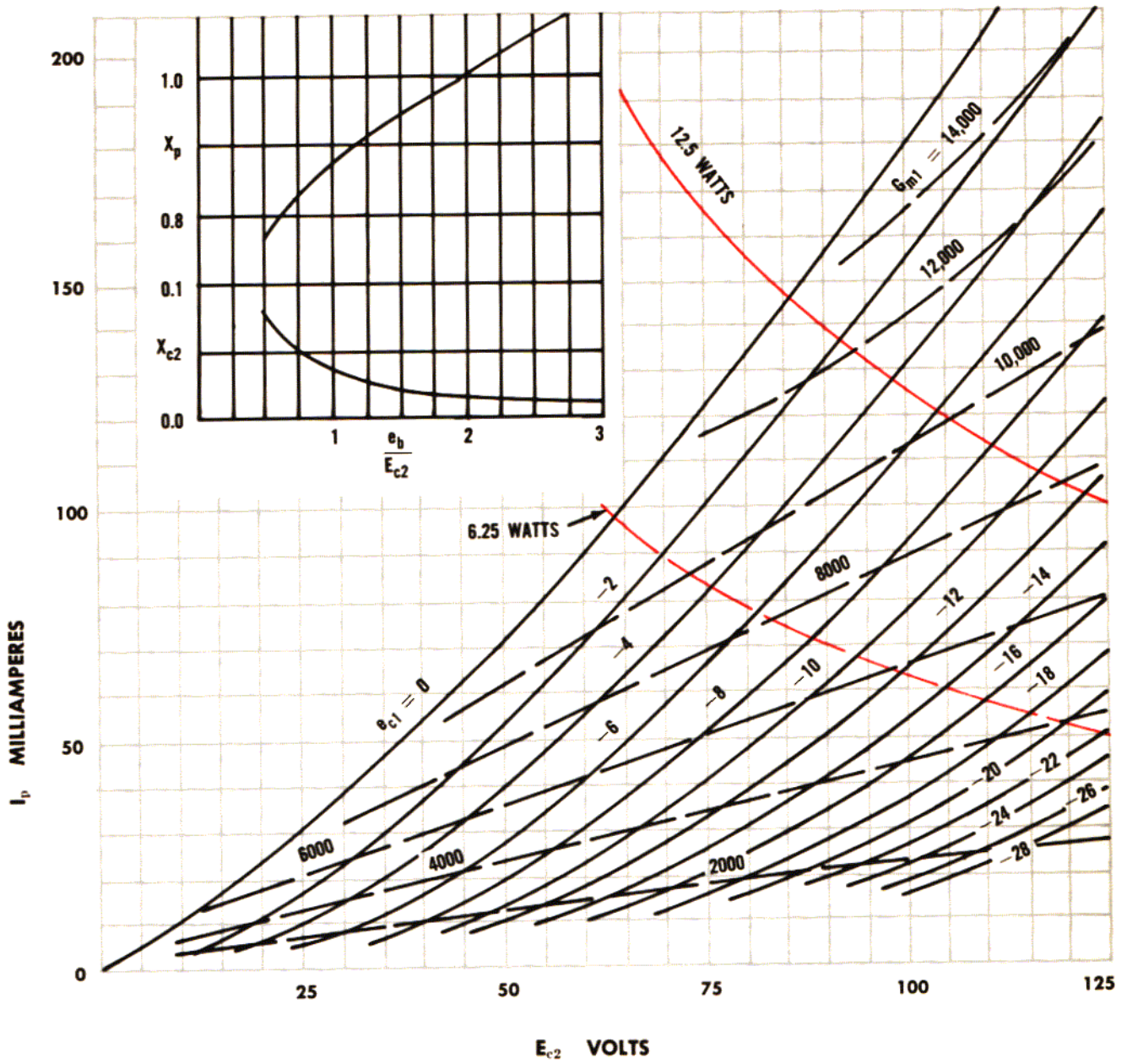

P_p 12.5 WATTS: P_{c2} 1.75 WATTS

BASE: 2 7-F 3-P 4-G₂ 5-G₁ 8-K

CURVE 12AU7-6C4

PLATE CHARACTERISTICS

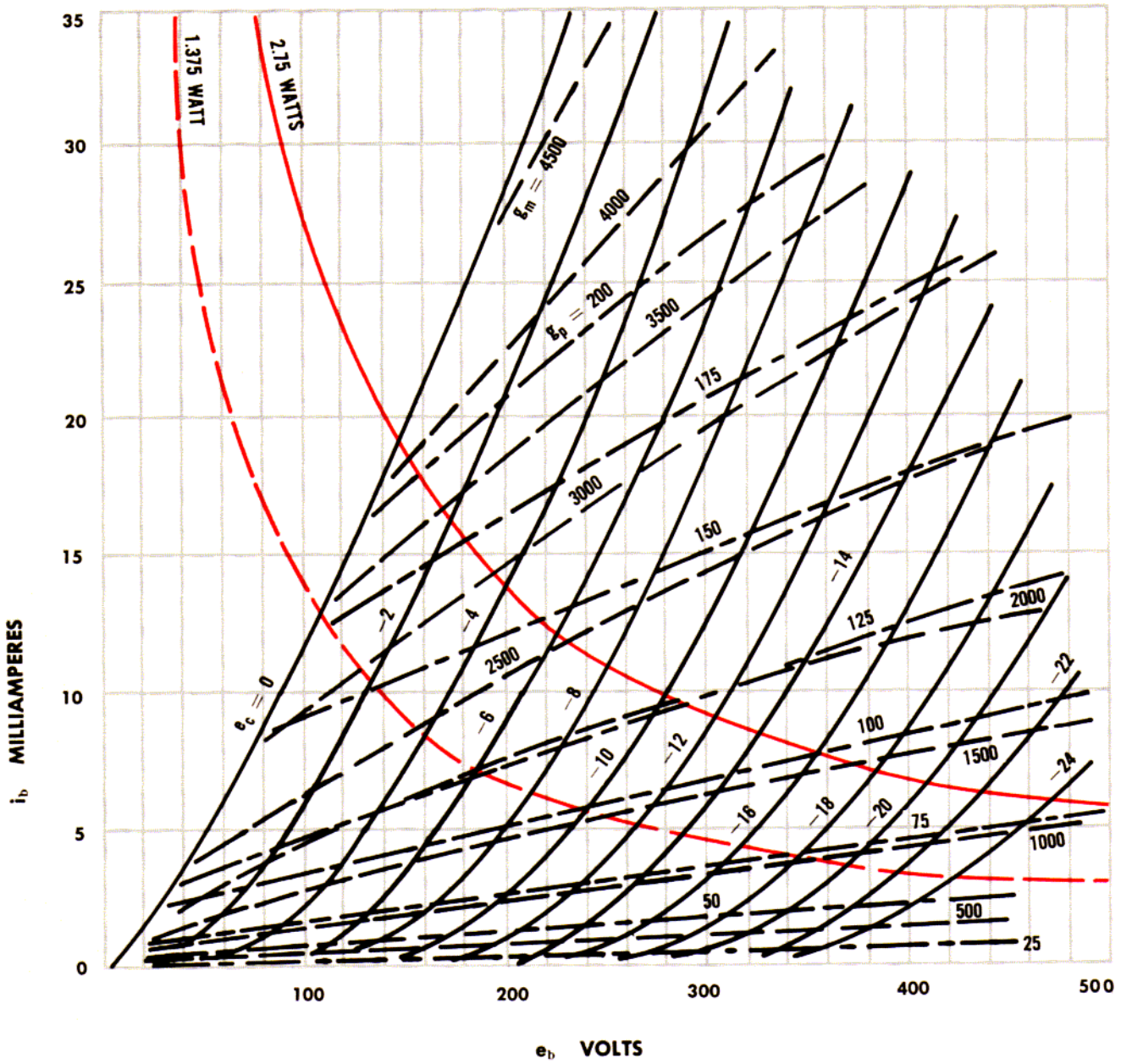

12AU7: P_p 2.75 WATTS

BASE: 1-P₂ 2-G₂ 3-K₂ 4 5-H 6-P₁ 7-G₁ 8-K₁ 9-HCT

6C4: P_p 3.5 WATTS

BASE: 1 5-P 2-1C 3 4-H 6-G 7-K

CURVE 12AX7

PLATE CHARACTERISTICS

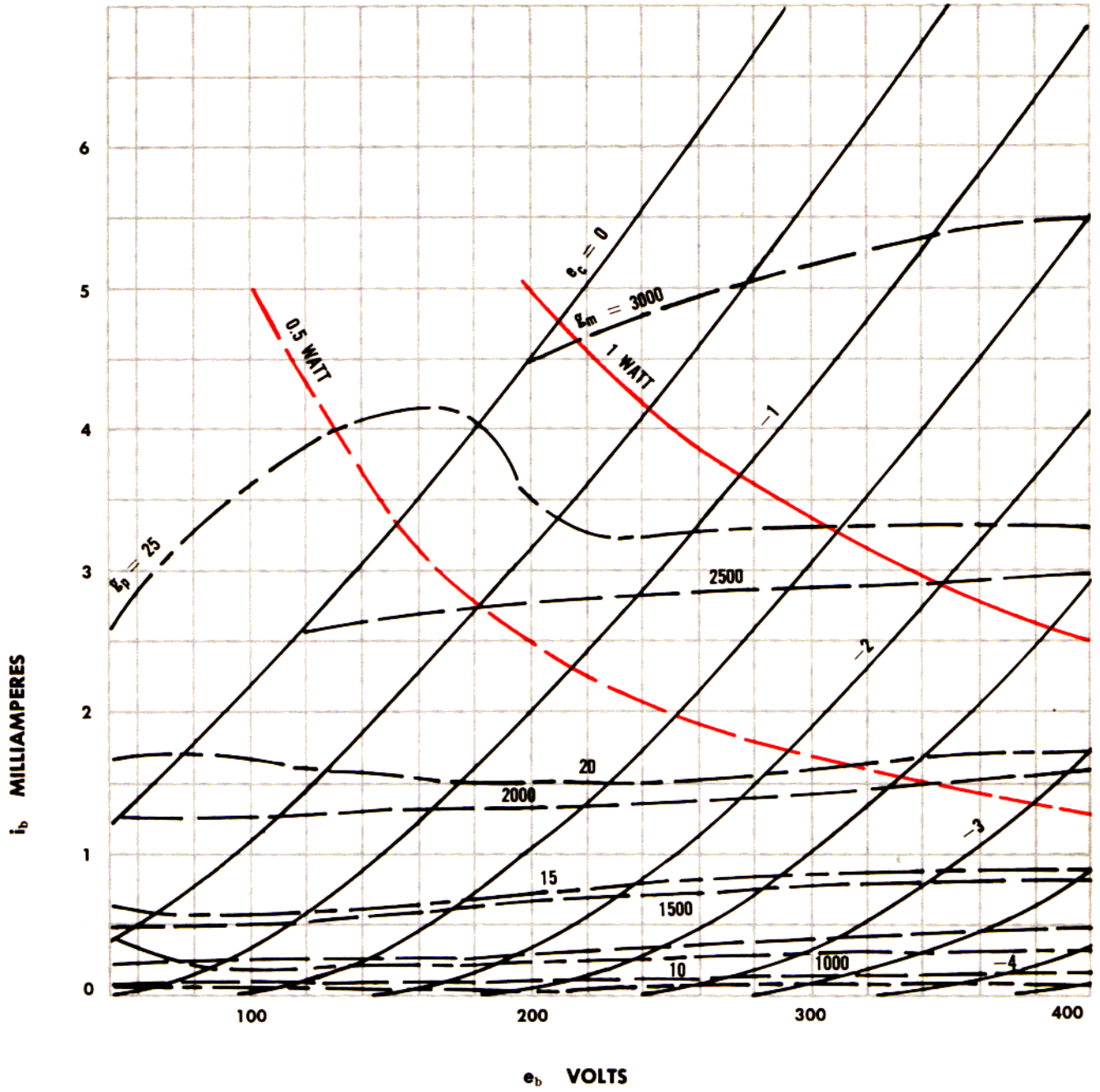

P_p 1 WATT

BASE: 1-P₂ 2-G₂ 3-K₂ 4 5-H 6-P₁ 7-G₁ 8-K₁ 9-HCT

CURVE 12AY7

PLATE CHARACTERISTICS

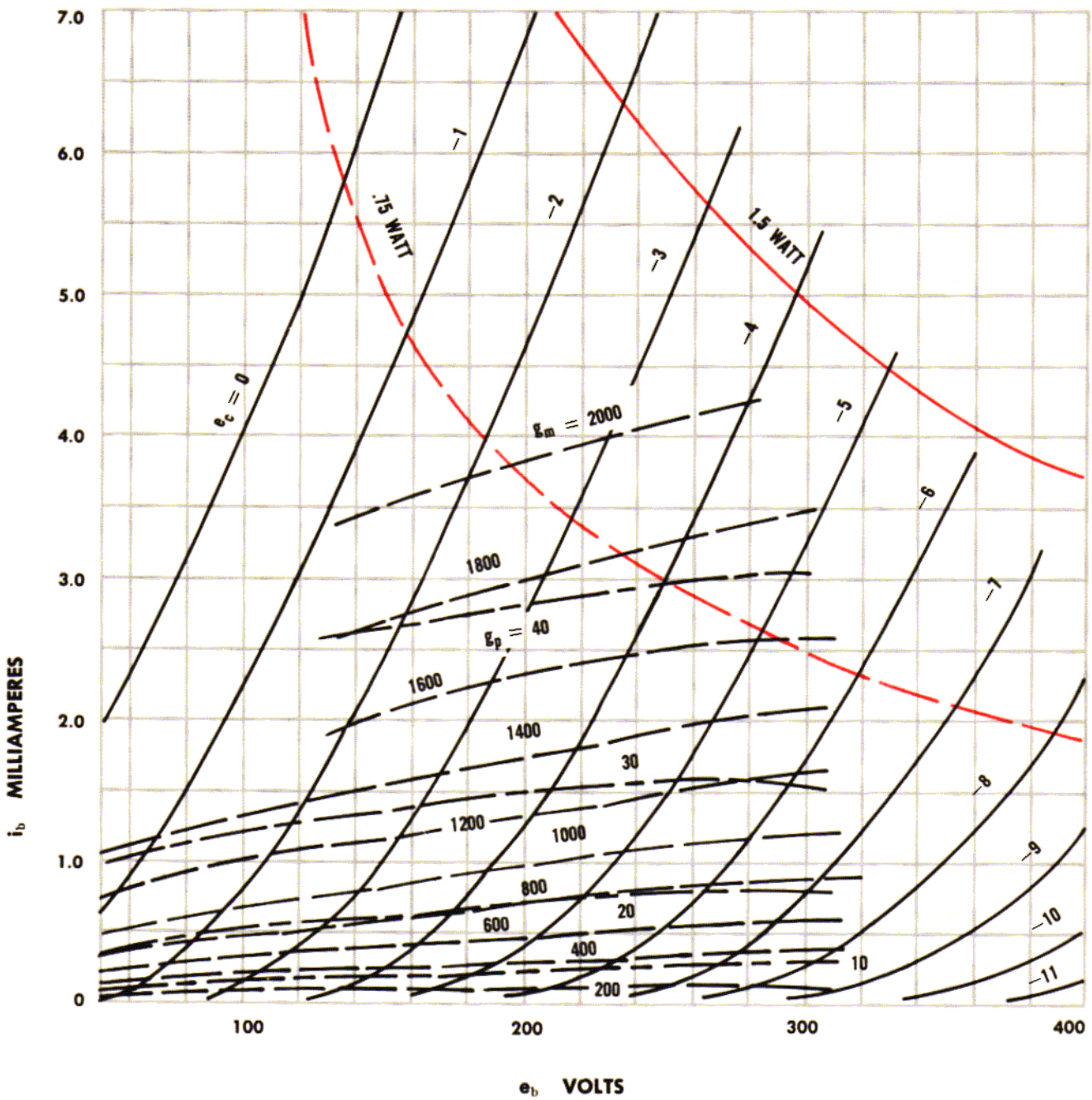

P_p 1.5 WATT

BASE: 1-P₂ 2-G₂ 3-K₂ 4 5-H 6-P₁ 7-G₁ 8-K₁ 9-HCT

CURVE 12BH7

PLATE CHARACTERISTICS

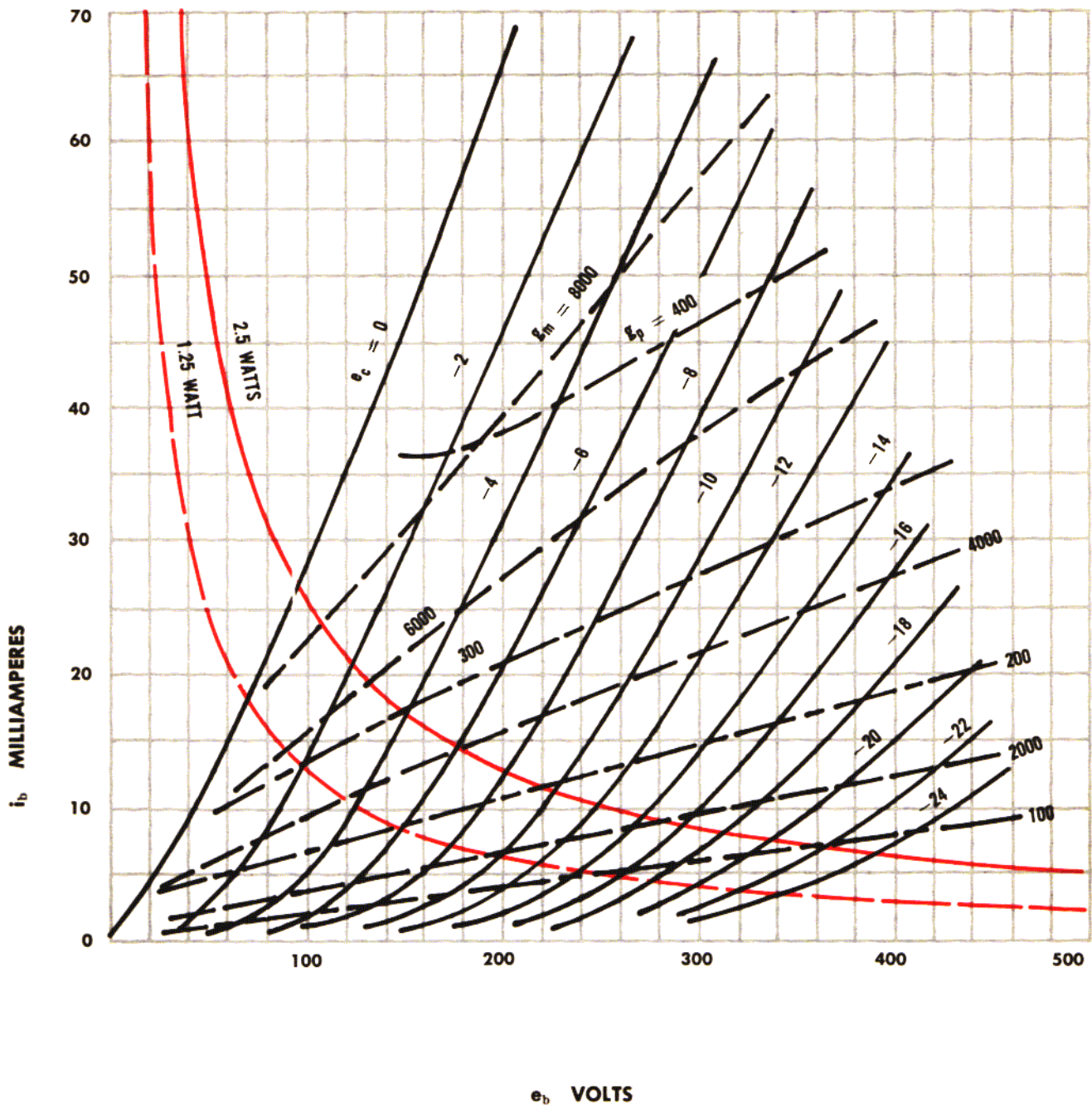

P_p 2.5 WATTS

BASE: 1-P₂ 2-G₂ 3-K₂ 4 5-F 6-P₁ 7-G₁ 8-K₁ 9-FCT

CURVE 12BY7

SCREEN CHARACTERISTICS

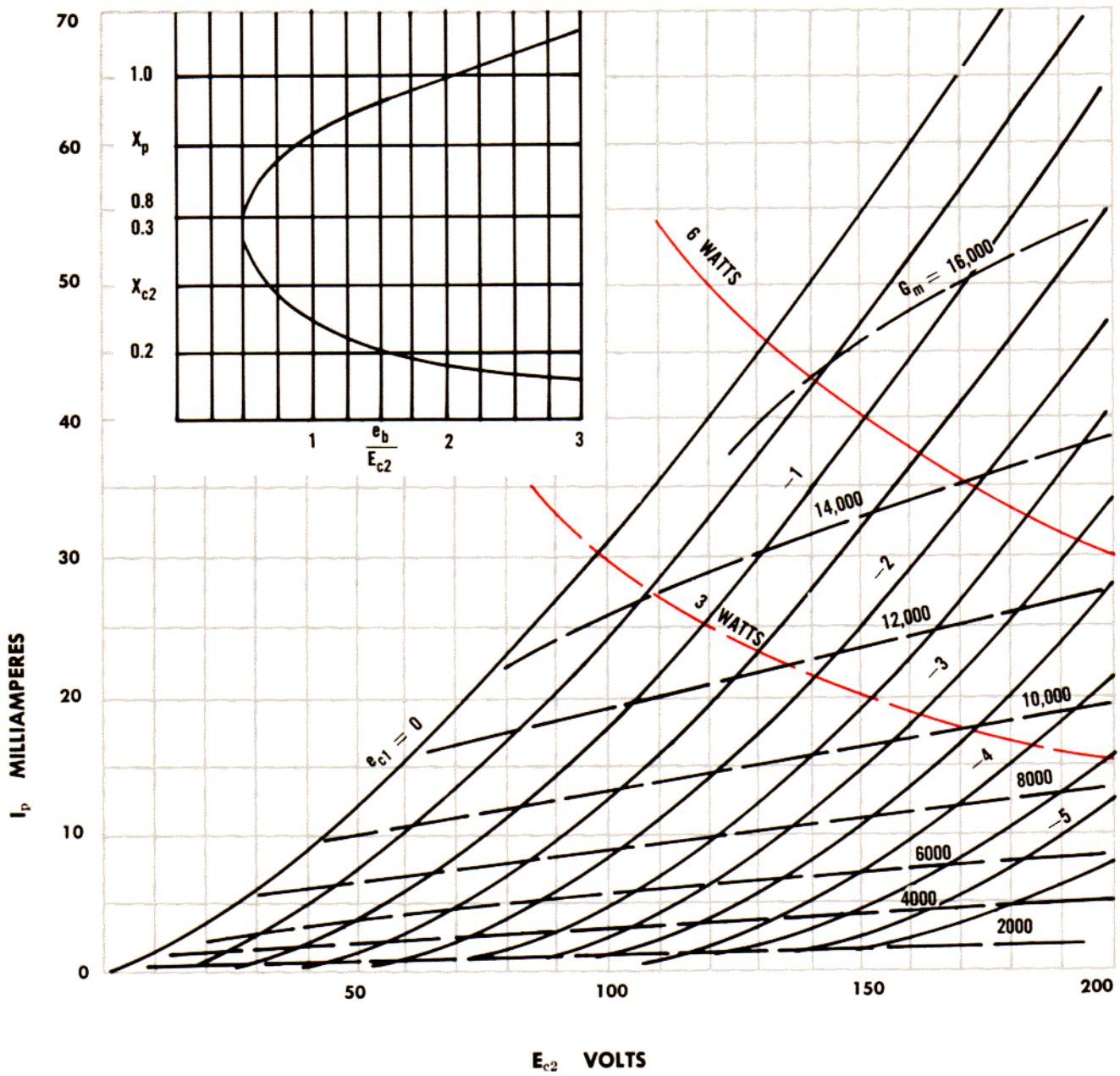

P_p 6.0 WATTS: P_{c2} 1.1 WATT

BASE: 1-K 2-G₁ 3 9-G₃ SH 4 5-F 6-FCT 7-P 8-G₂

CURVE 12BZ7

PLATE CHARACTERISTICS

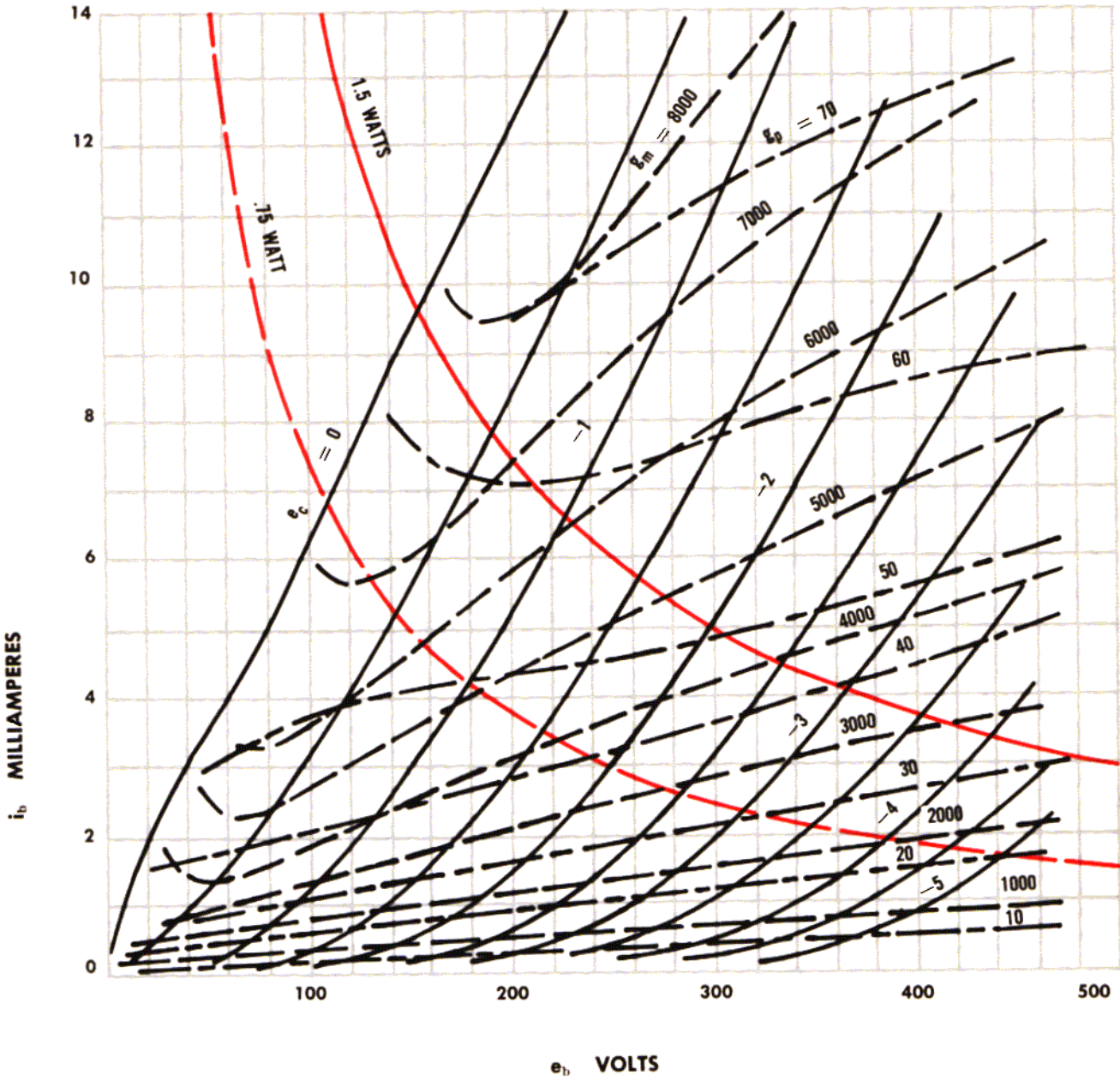

P_p 1.5 WATT

BASE: 1-P₂ 2-G₂ 3-K₂ 4 5-F 6-P₁ 7-G₁ 8-K₁ 9-FCT

CURVE 417A (5842)

PLATE CHARACTERISTICS

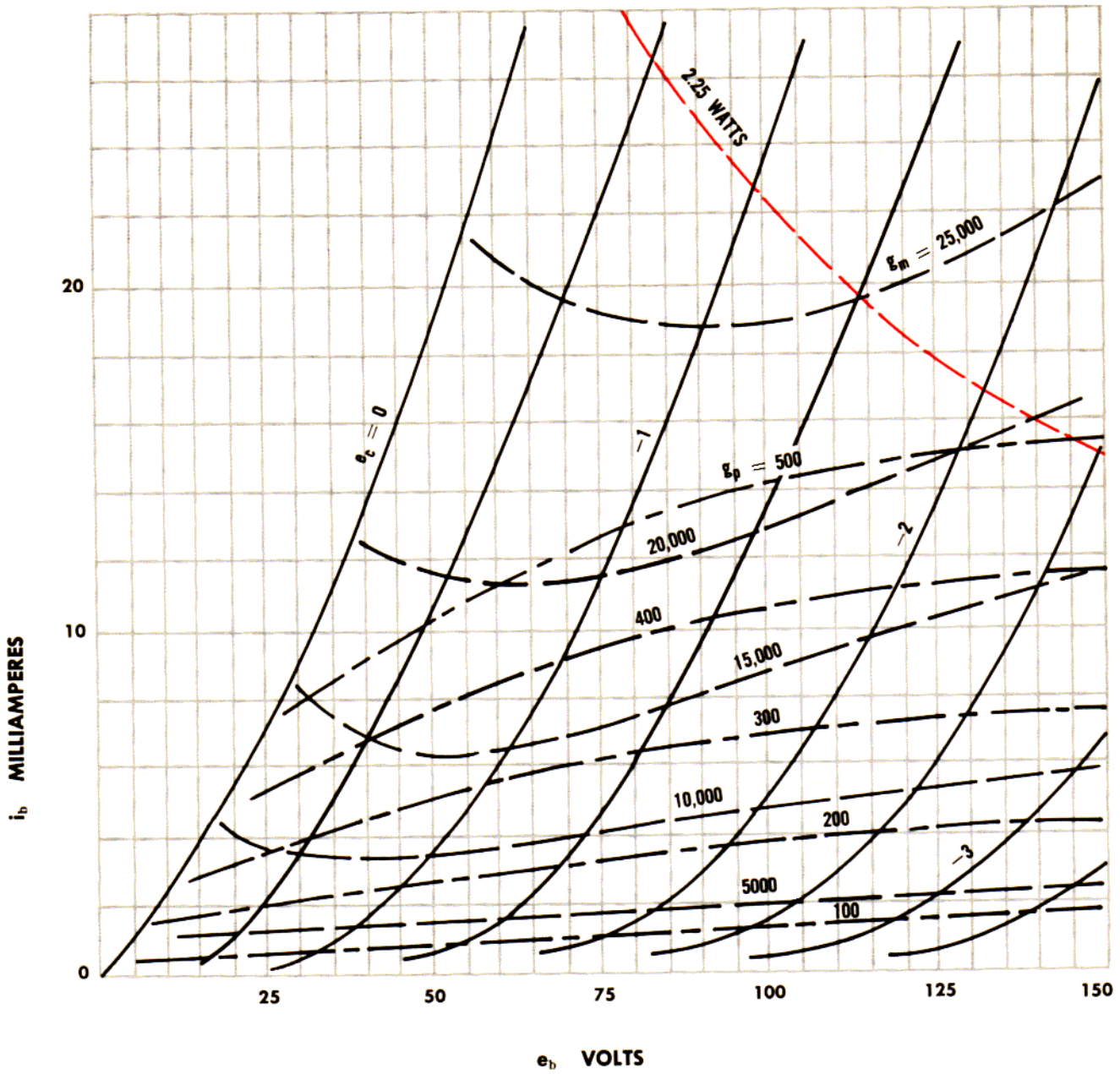

P_p 4.5 WATTS

BASE: 1-P 2-NC 3 9-H 4 5 7 8-G 6-K

CURVE 5654

SCREEN CHARACTERISTICS

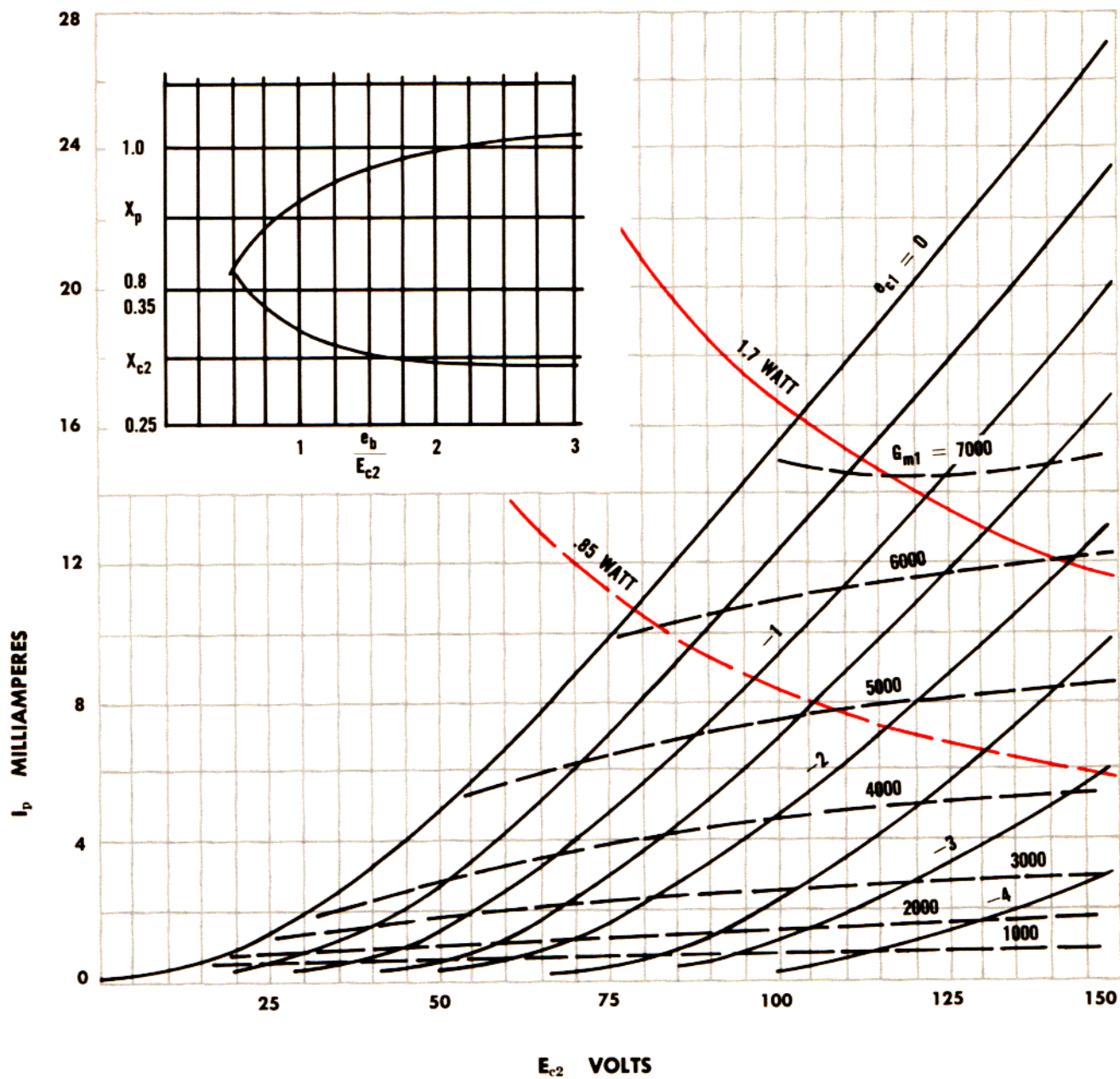

P_p 1.7 WATT: P_{c2} 0.5 WATT

BASE: 1-G₁ 2-K 3 4-H 5-P 6-G₂ 7-K-G₃

CURVE 5670

PLATE CHARACTERISTICS

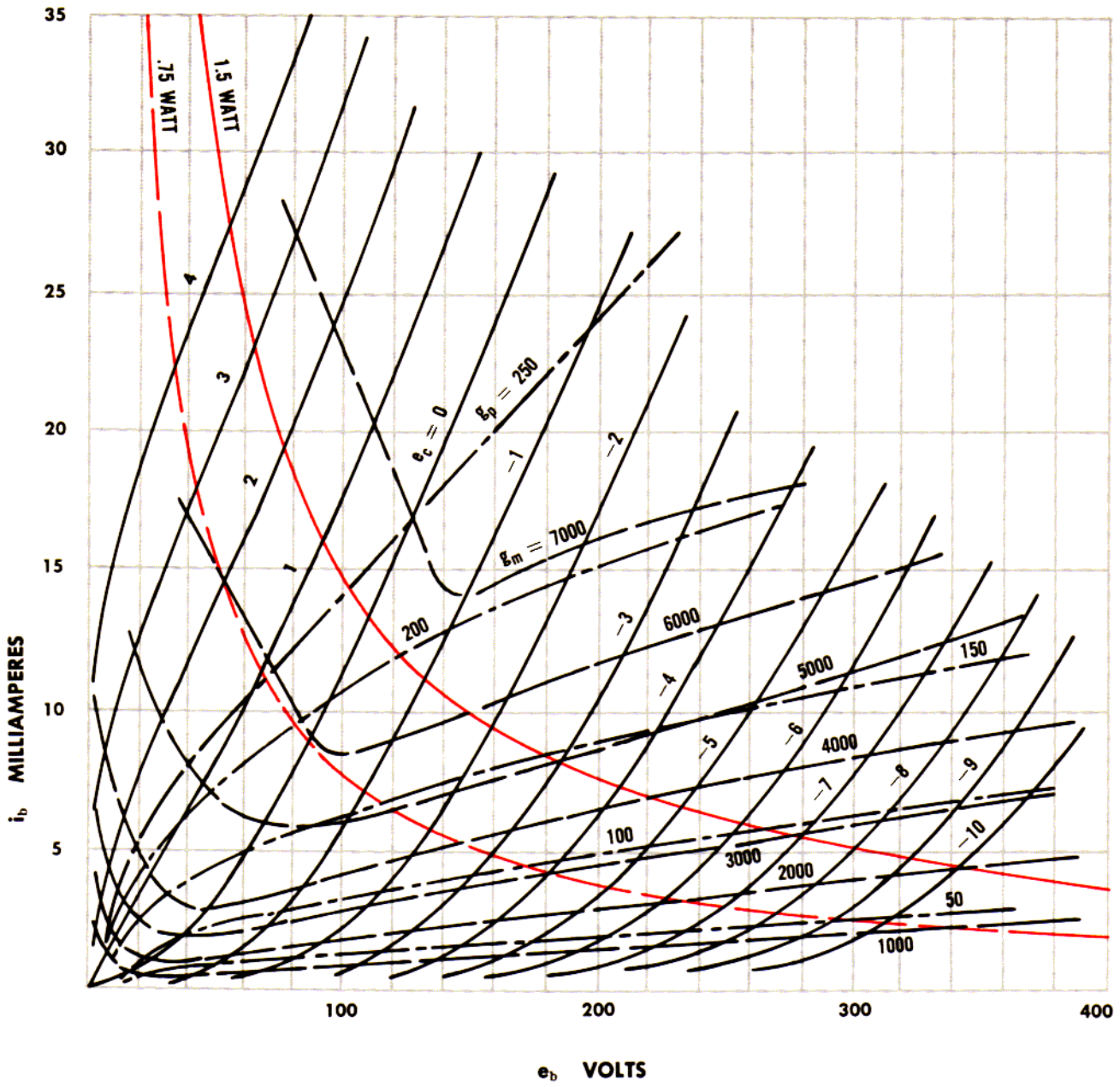

P_p 1.5 WATT

BASE: 1 9-H 2-K₂ 3-G₂ 4-P₂ 5-IS 6-P₁ 7-G₁ 8-K₁

CURVE 5686

SCREEN CHARACTERISTICS

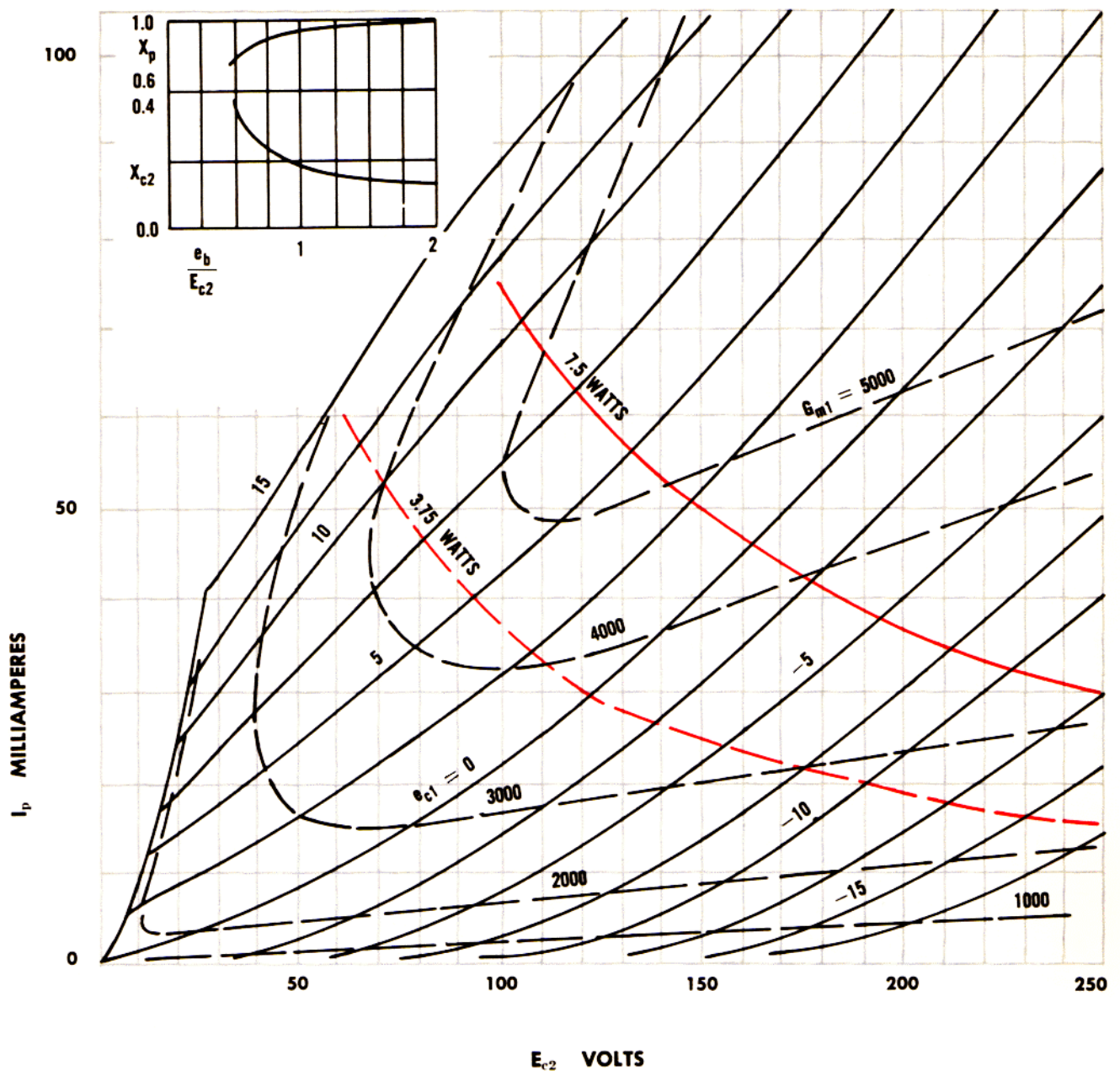

P_p 7.5 WATTS: P_{c2} 3.0 WATTS

BASE: 1 8-K-G₃ 2-G₁ 3-K-G₃ 4 5-H 6 9-G₂ 7-P

CURVE 5687

PLATE CHARACTERISTICS

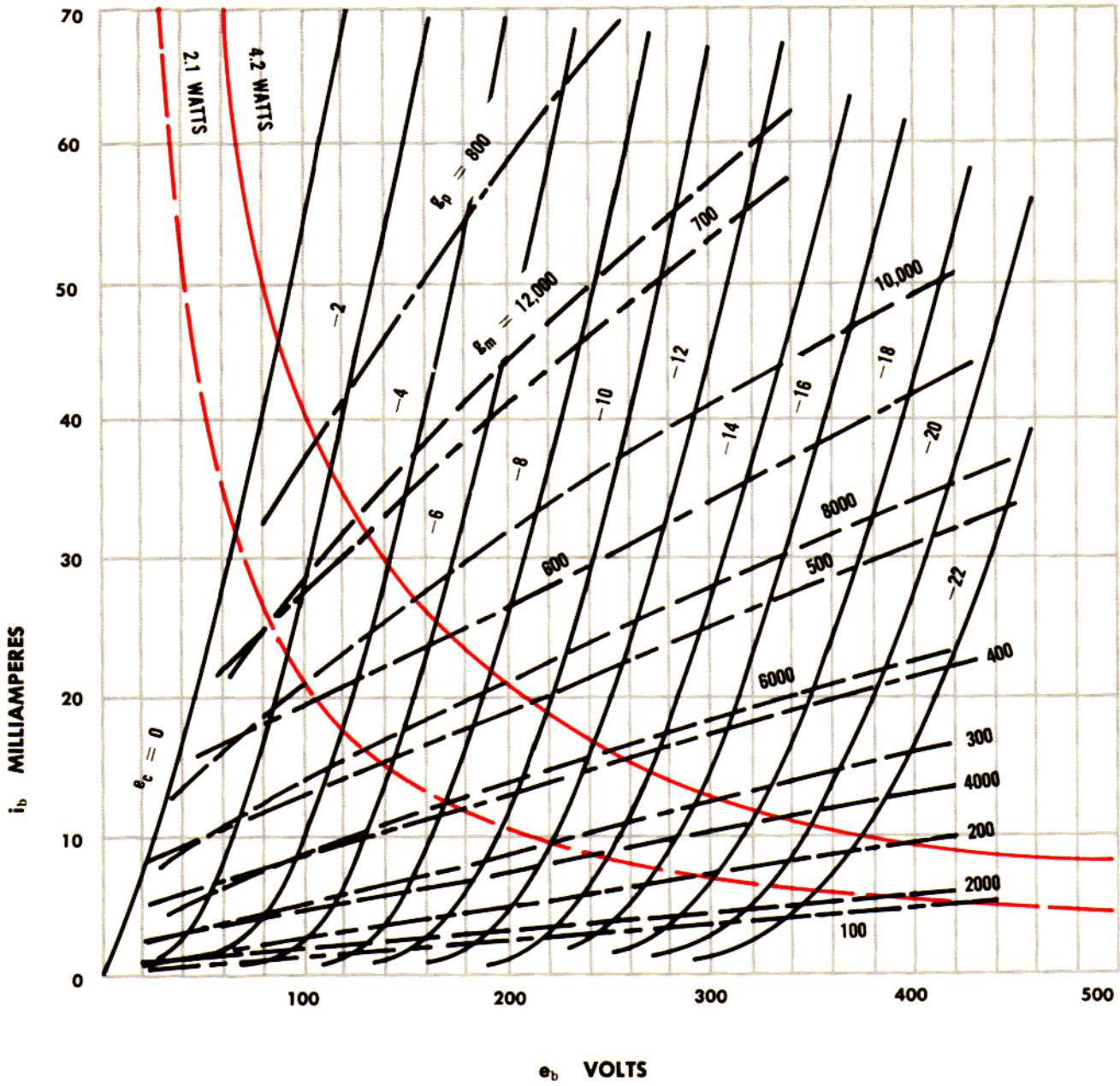

P_p 4.2 WATTS

BASE: 1-P₁ 2-G₁ 3-K₁ 4 5-H 6-K₂ 7-G₂ 8-HCT 9-P₂

MAXIMUM TOTAL PLATE DISSIPATION - BOTH SECTIONS: 7.5 WATTS

CURVE (6SL7) 5691

PLATE CHARACTERISTICS

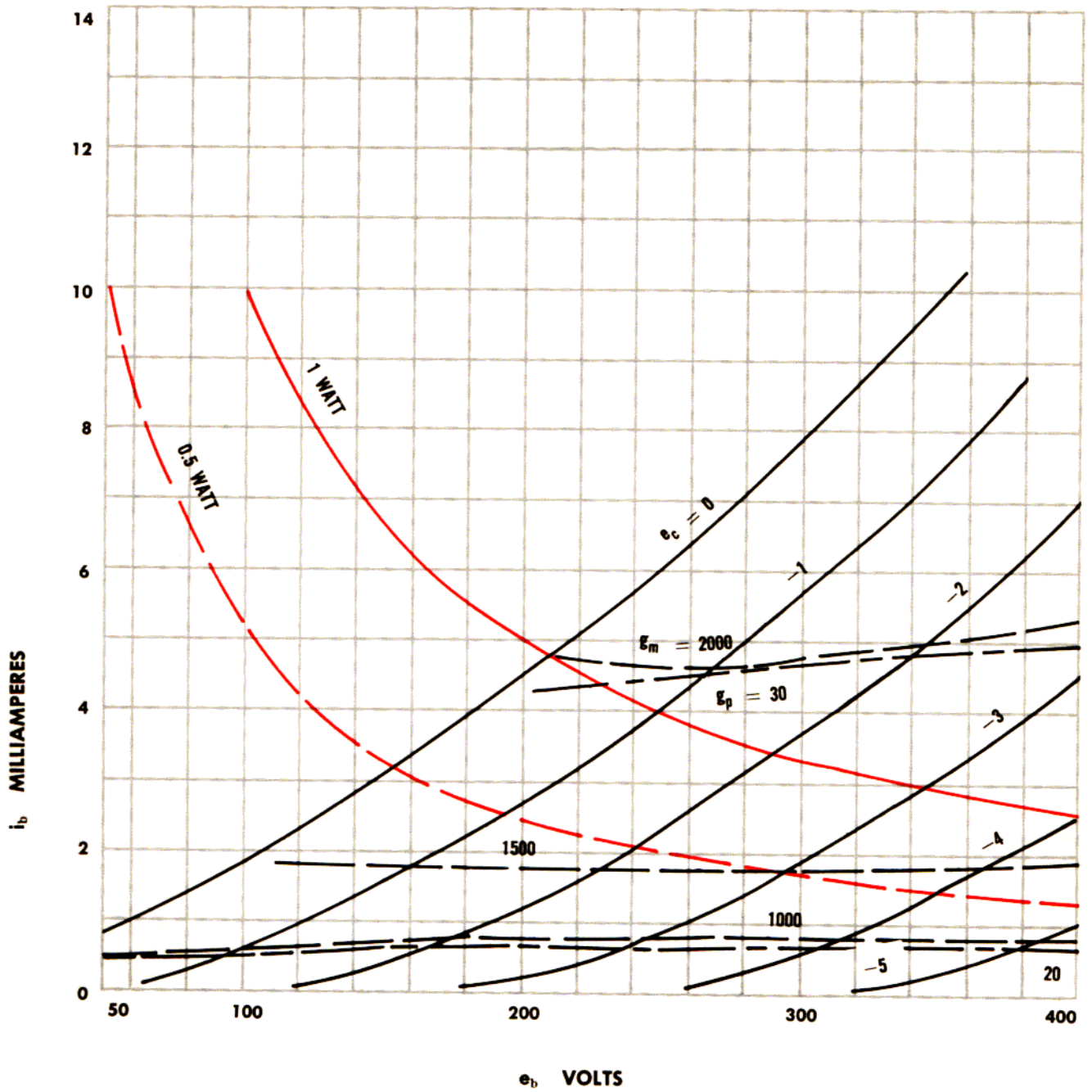

P_p 1.0 WATT

BASE: 1-GT₂ 2-PT₂ 3-KT₂ 4-GT₁ 5-PT₁ 6-KT₁ 7 8-H

CURVE 5692 (6SN7)

PLATE CHARACTERISTICS

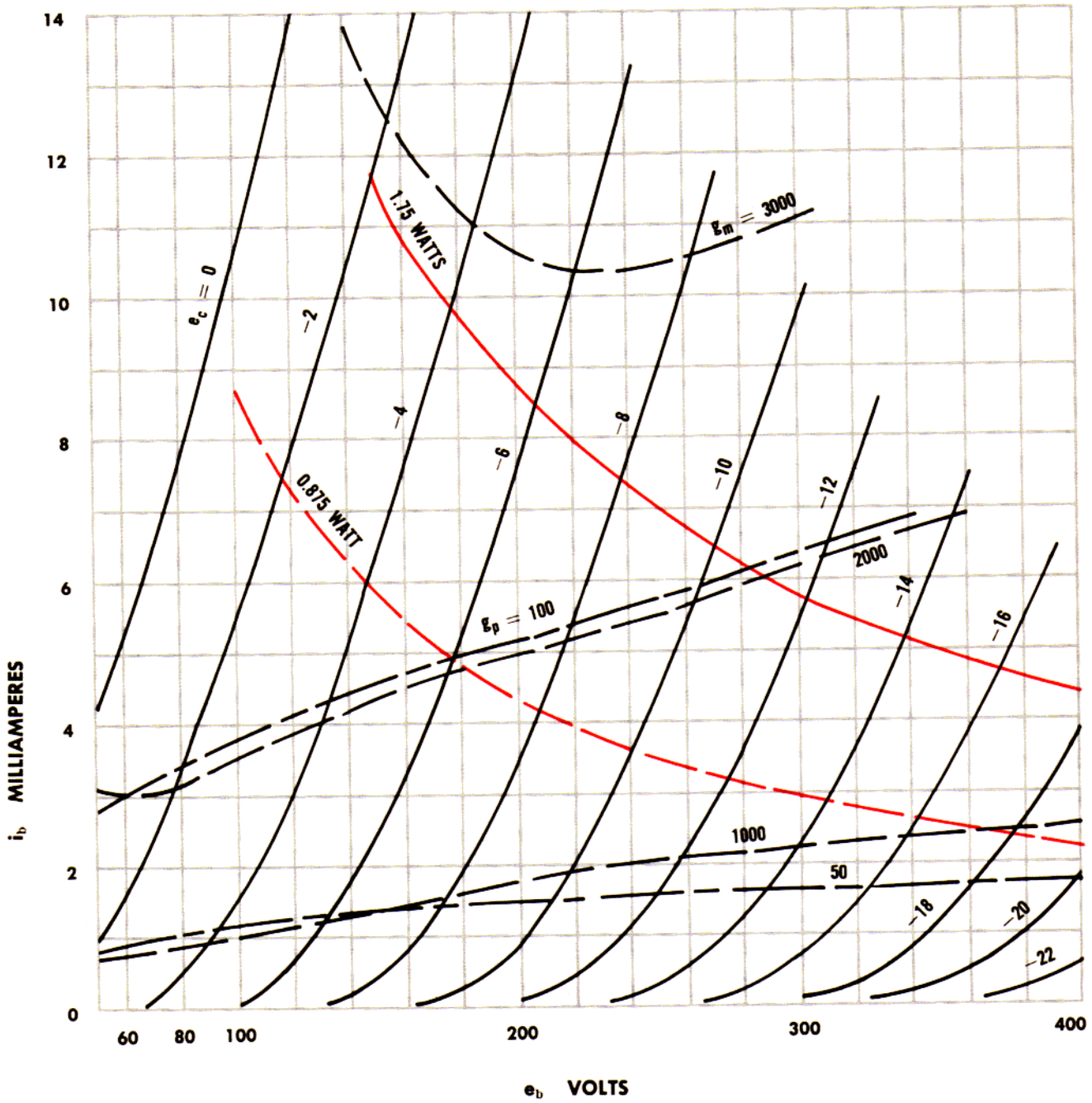

P_p 1.75 WATT

BASE: 1-G₂ 2-P₂ 3-K₂ 4-G₁ 5-P₁ 6-K₁ 7 8-H

CURVE (6SJ7) 5693

SCREEN CHARACTERISTICS

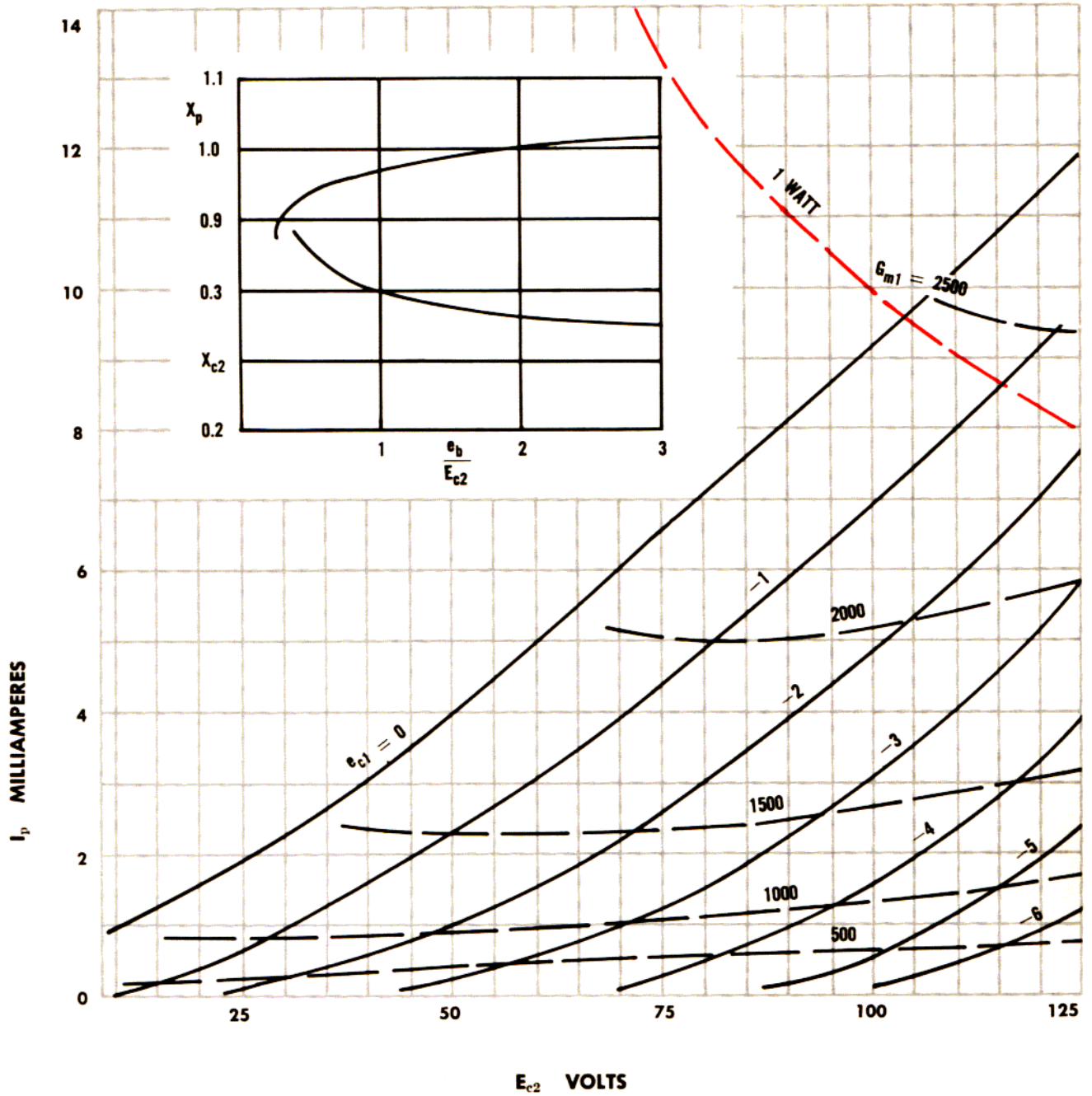

P_p 2.0 WATTS: P_{c2} 0.3 WATT

BASE: 2-H 3-G₃ 4-G₁ 5-K 6-G₂ 7-H 8-P

CURVE 5718

PLATE CHARACTERISTICS

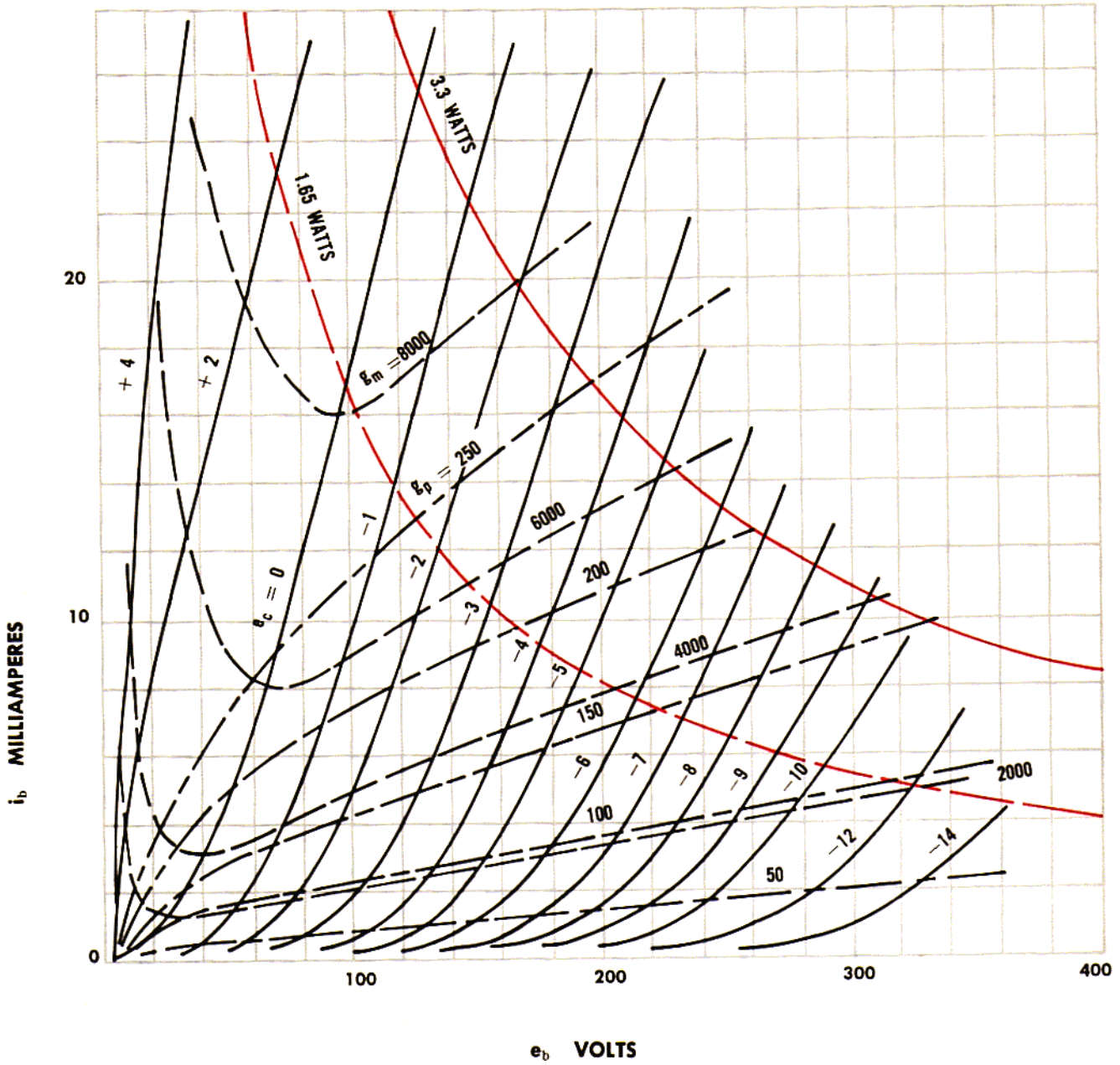

P_p 3.3 WATTS

BASE (SUB-MIN.): 1-G 2-NC 3-H 4-NC 5-K 6-H 7-NC 8-P

CURVE 5719

PLATE CHARACTERISTICS

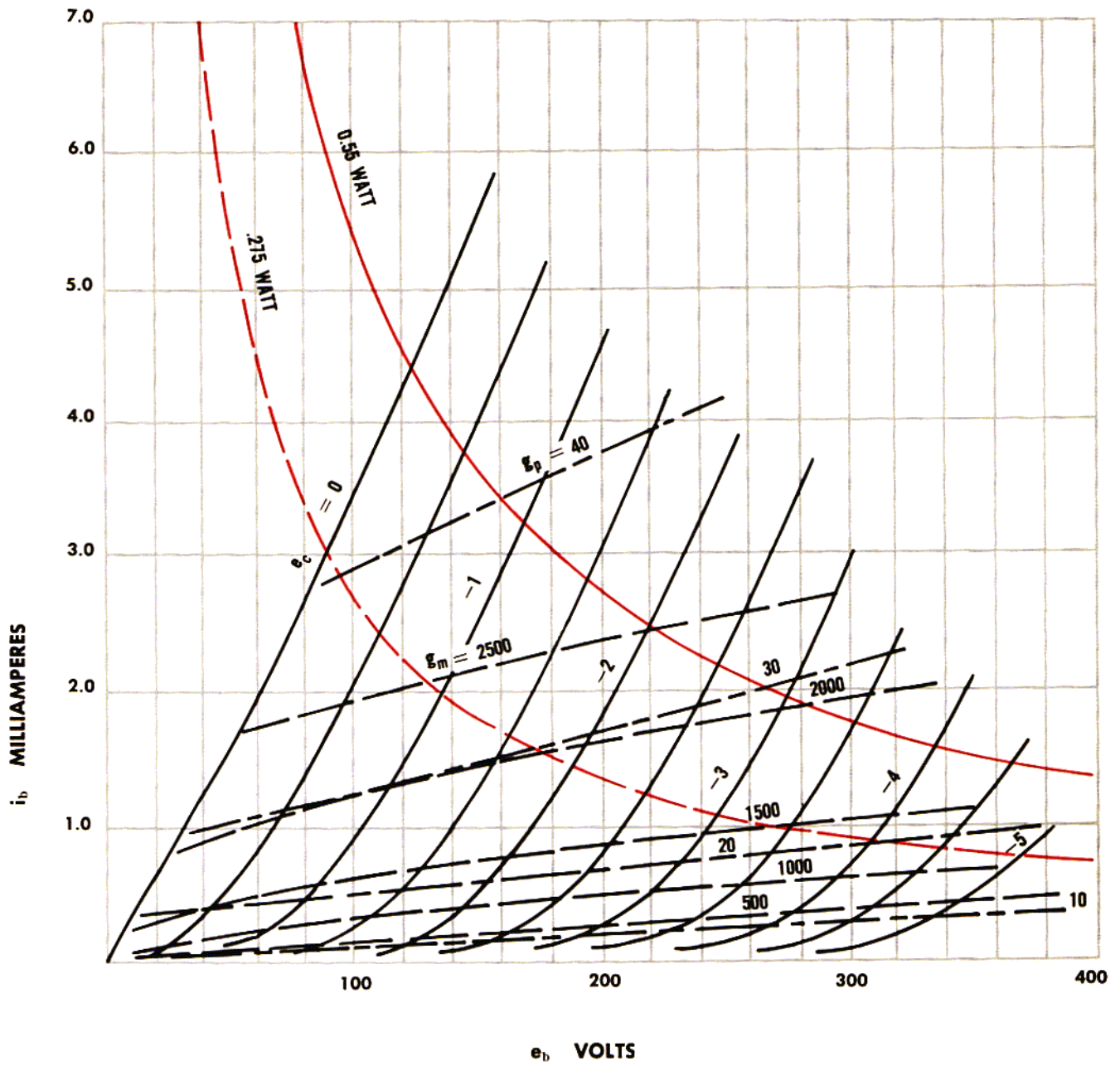

P_p 0.55 WATT

BASE: 1-G 2 4 7-NC 3 6-H 5-K 8-P

CURVE 5749 - 6BA6

SCREEN CHARACTERISTICS

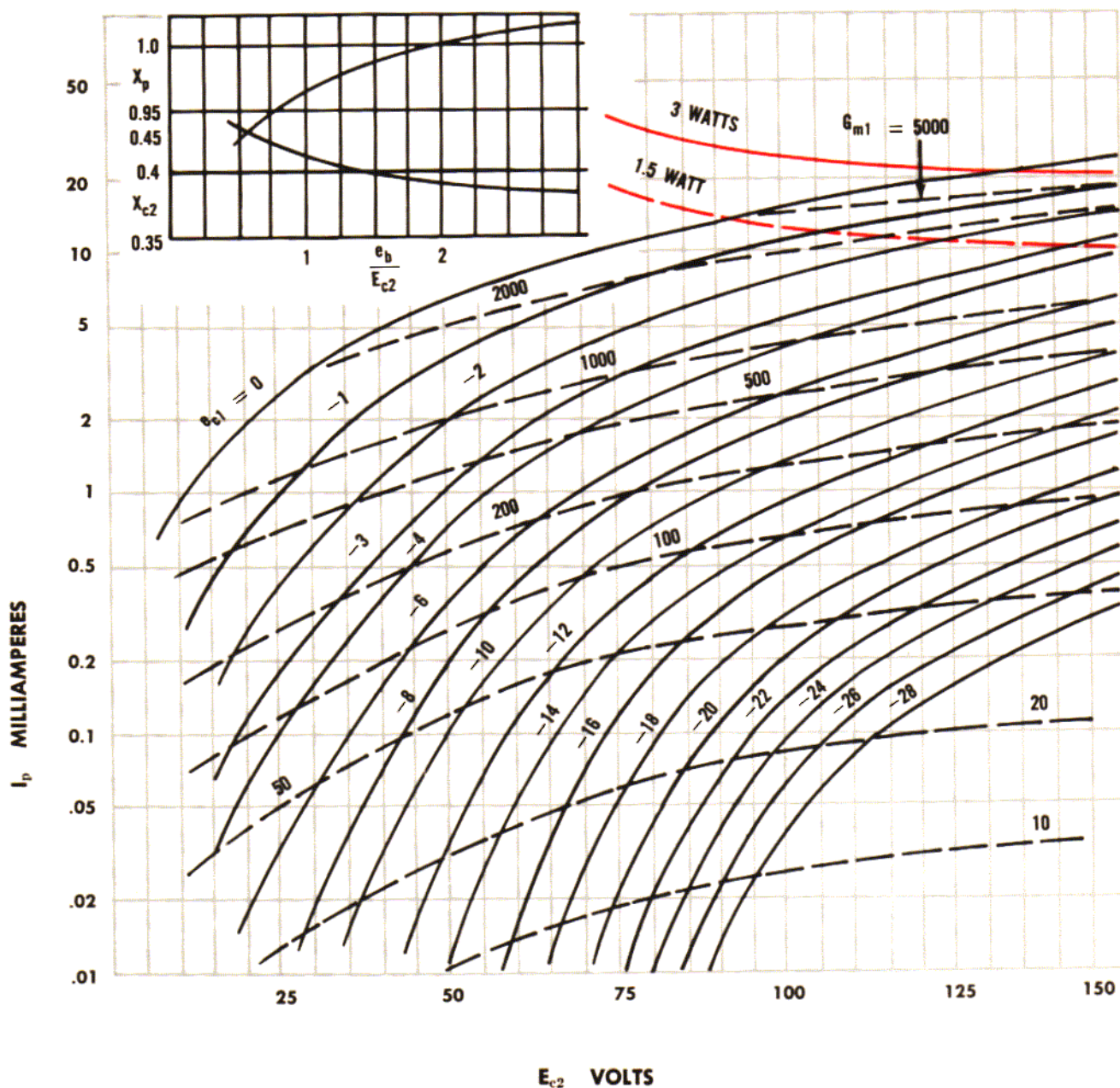

P_p 3.0 WATTS: P_{c2} 0.6 WATT

BASE: 1-G₁ 2-G₃ 3 4-H 5-P 6-G₂ 7-K

CURVE 5751

PLATE CHARACTERISTICS

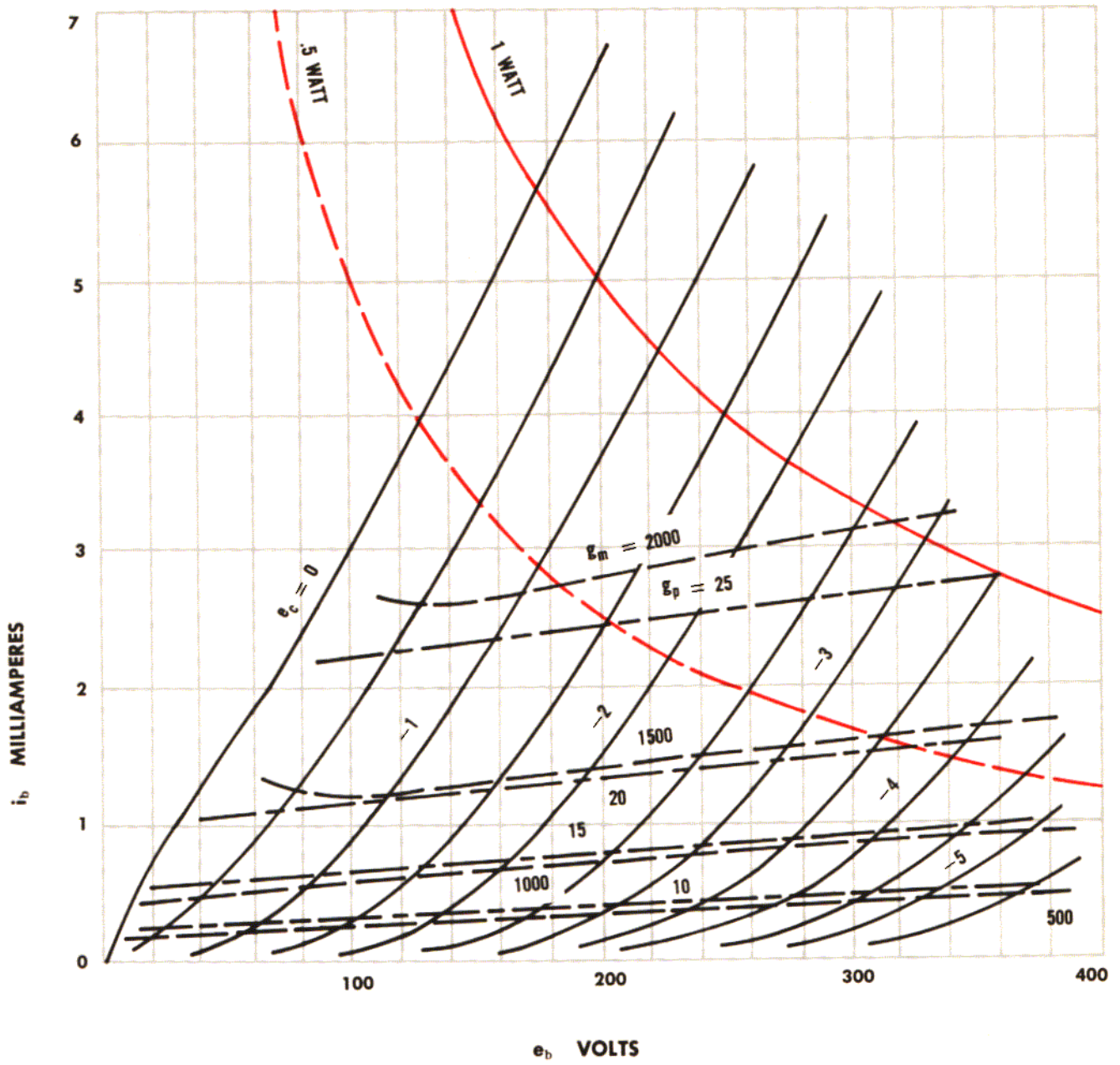

P_p 1 WATT

BASE: 1-P₂ 2-G₂ 3-K₂ 4 5-H 6-P₁ 7-G₁ 8-K₁ 9-HCT

CURVE 5763

SCREEN CHARACTERISTICS

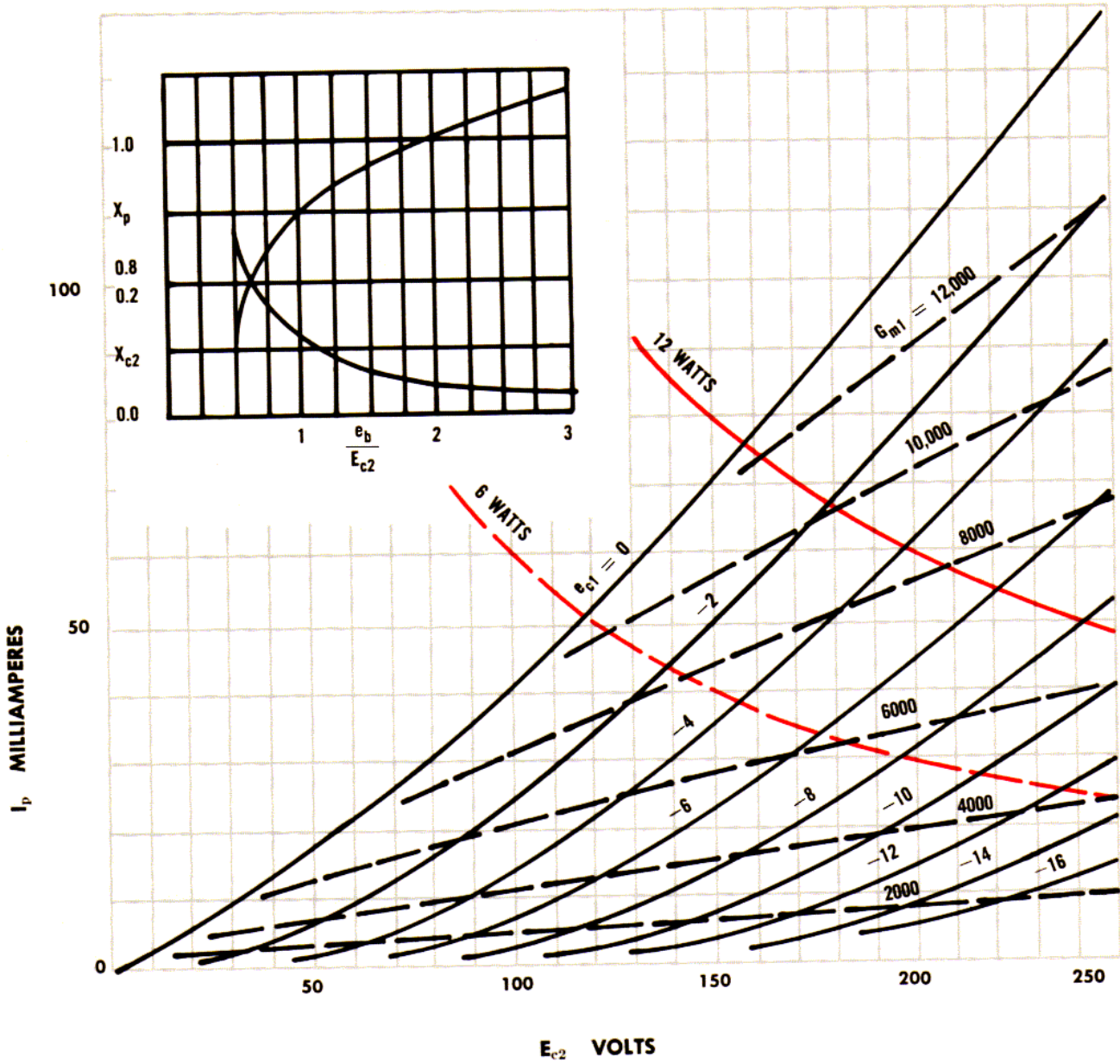

P_p 12 WATTS: P_{c2} 2 WATTS

BASE: 1-P 3-G₃ 4 5-H 6-G₂ 7-K 8 9-G₁

CURVE 5814A-6135

PLATE CHARACTERISTICS

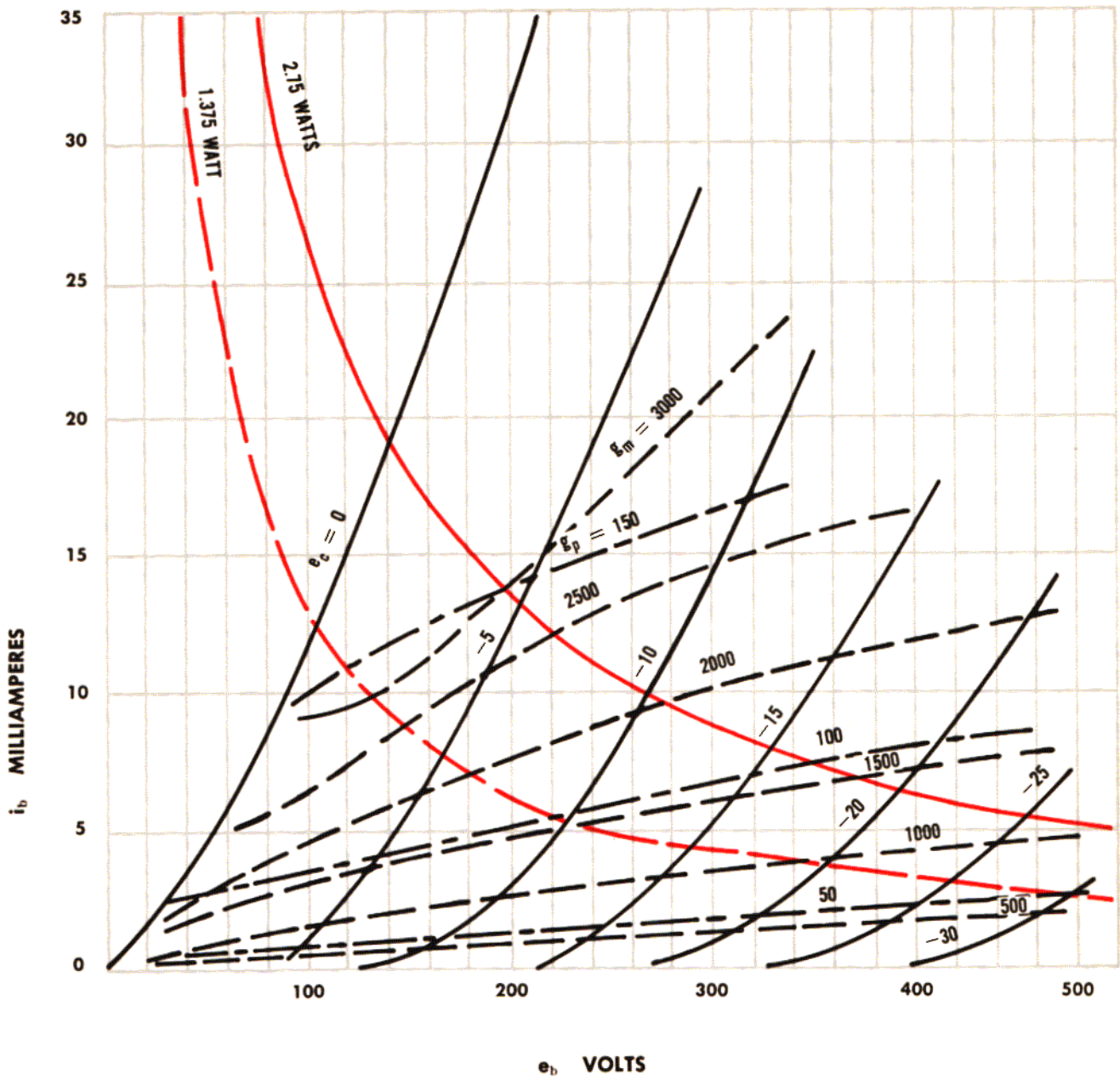

6135: P_p 3.5 WATTS

BASE: 1 5-P 2-1C 3 4-H 6-G 7-K

5814A: P_p 2.75 WATTS

BASE: 1-P₂ 2-G₂ 3-K₂ 4 5-H 6-P₁ 7-G₁ 8-K₁ 9-HCT

CURVE 5840

SCREEN CHARACTERISTICS

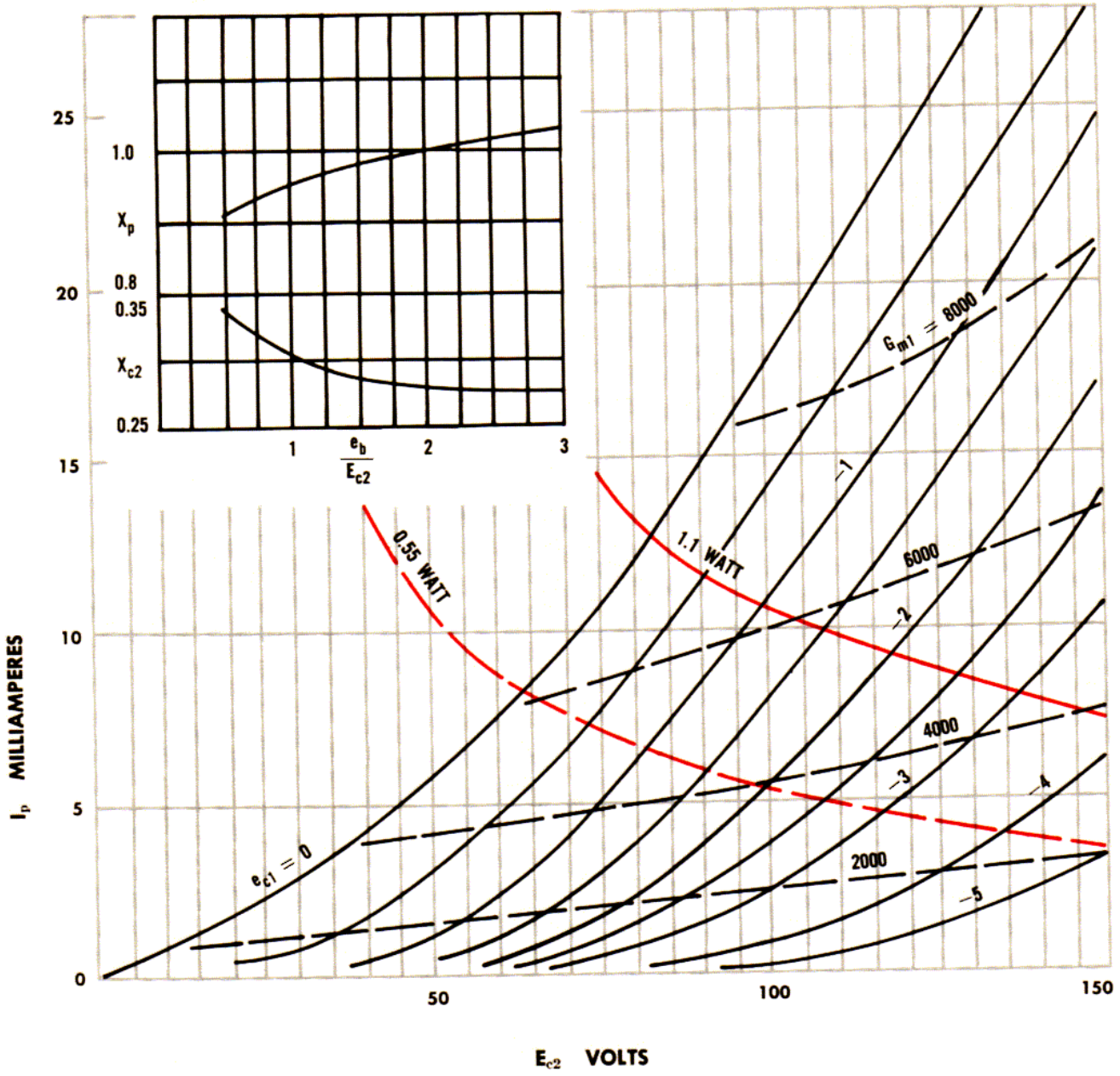

P_p 1.1 WATT: P_{c2} 0.55 WATT

BASE: 1-G₁ 2 4 8-K G₃ 3 6-H 5-P 7-G₂

CURVE 5844GL

PLATE CHARACTERISTICS

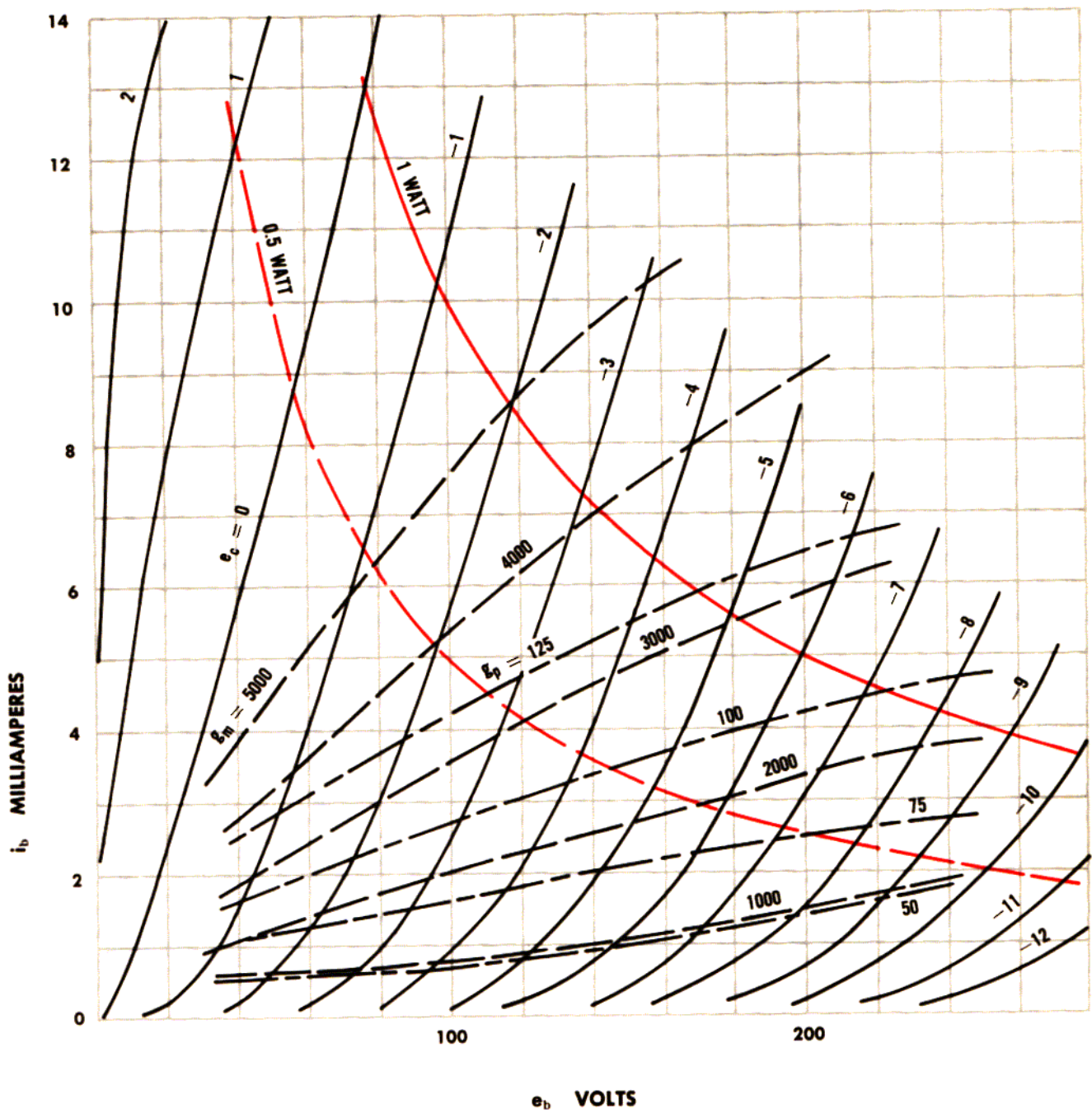

P_p 1 WATT

BASE: 1-P 2-P₂ 3 4-H 5-G₂ 6-G₁ 7-K

CURVE 5894A

SCREEN CHARACTERISTICS

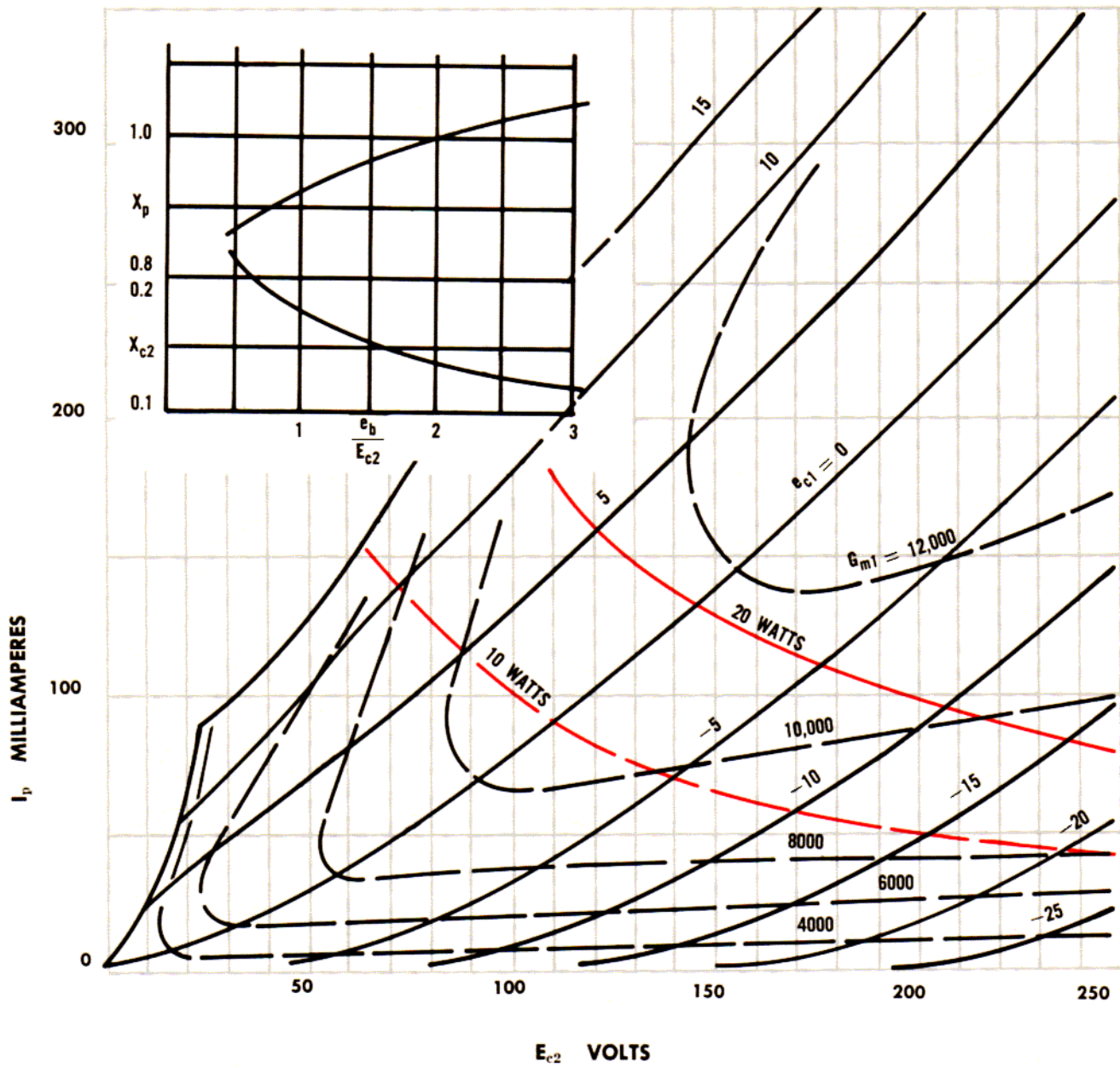

P_p 20 WATTS: P_{c2} 7 WATTS TOTAL

BASE: 1-7-H 2-G₁₂ 3-G₂₂ G₂₁ 4-K-15 5-HCT 6-G₁₁ Caps-P₂ P₁

CURVE 5899

SCREEN CHARACTERISTICS

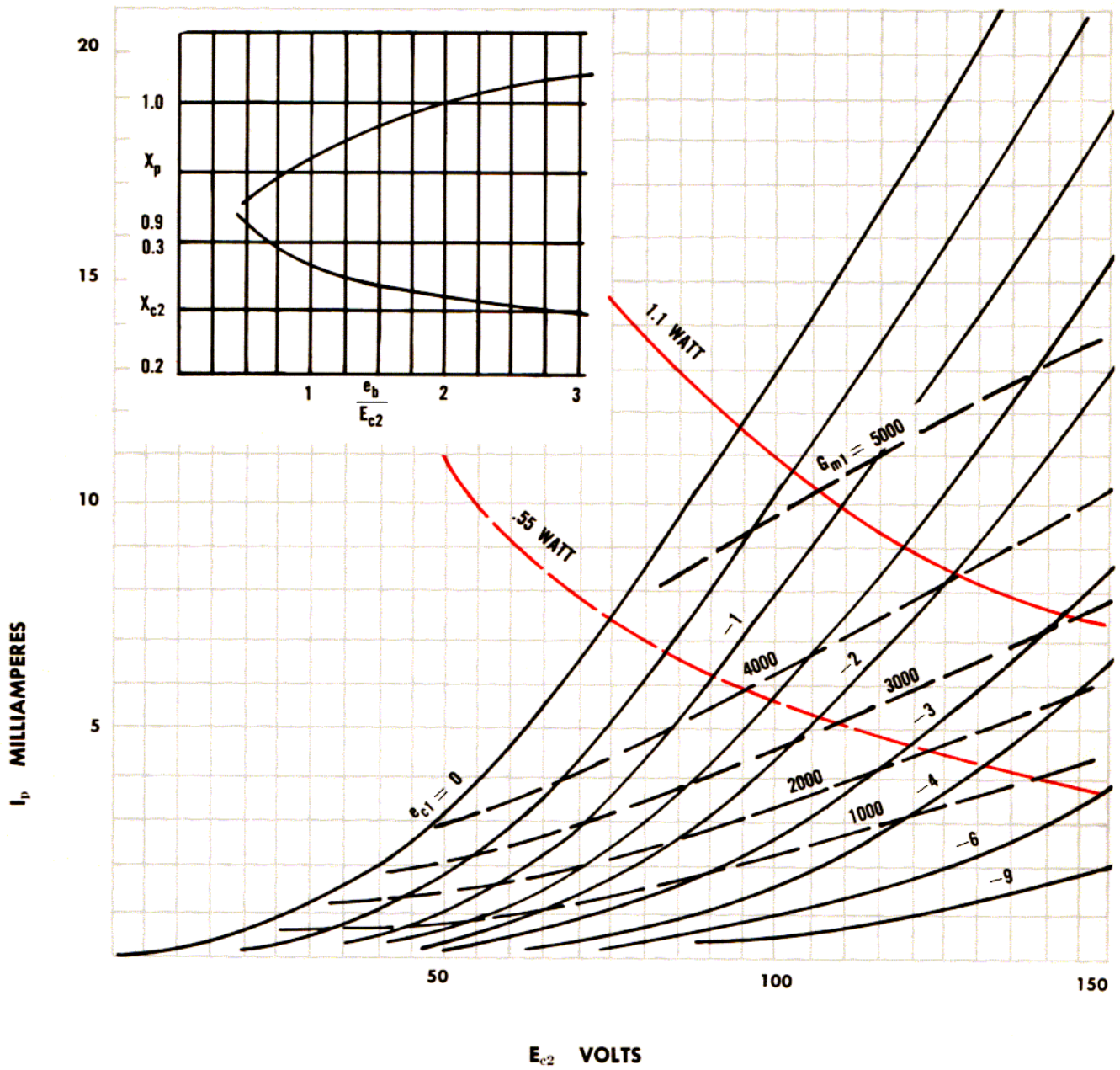

P_p 1.1 WATT: P_{c2} 0.55 WATT

BASE: 1-G₁ 2 8-K-G₃ 3 6-H 4-K-G₃ 5-P 7-G₂

CURVE 5902

SCREEN CHARACTERISTICS

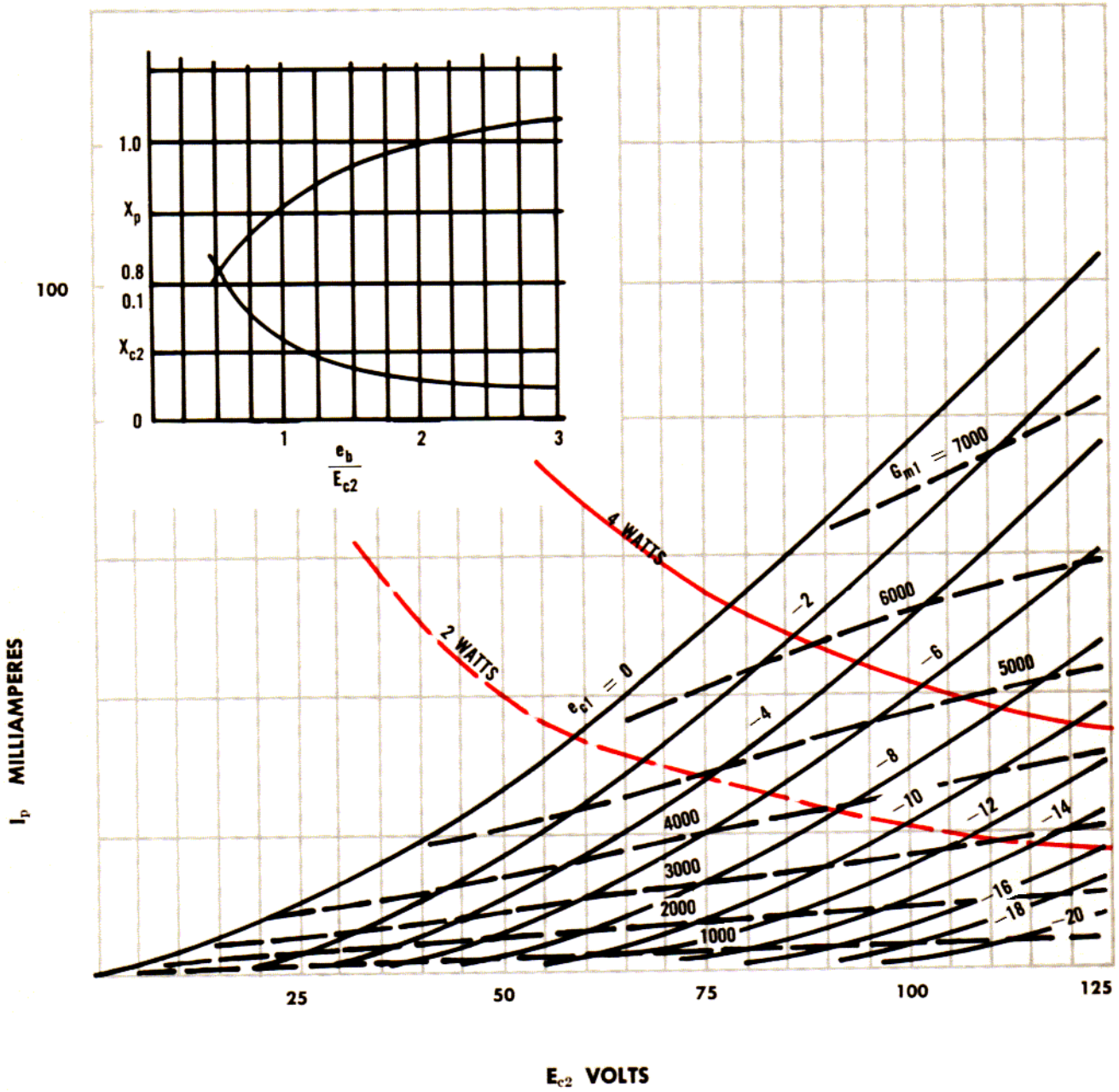

P_p 4 WATTS: P_{c2} 1 WATT

BASE: 1-G₁ 2 4 8-K-G₃ 3 6-H 5-P 7-G₂

CURVE 5965 (1)

PLATE CHARACTERISTICS

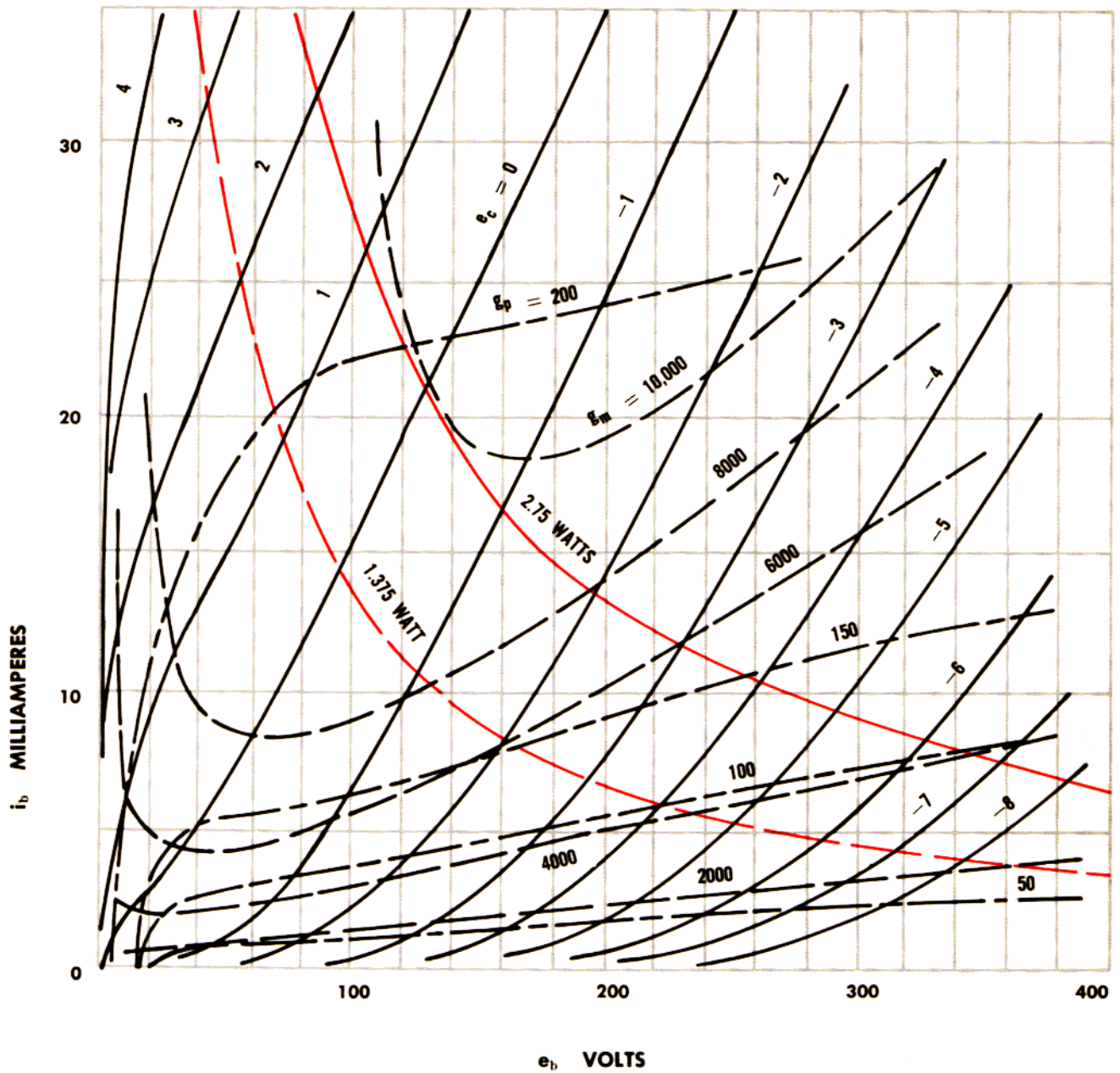

P_D 2.75 WATTS

BASE: 1-P₂ 2-G₂ 3-K₂ 4 5-H 6-P₁ 7-G₁ 8-K₁ 9-HCT

CURVE 5965 (2)

PLATE LOGARITHMICS

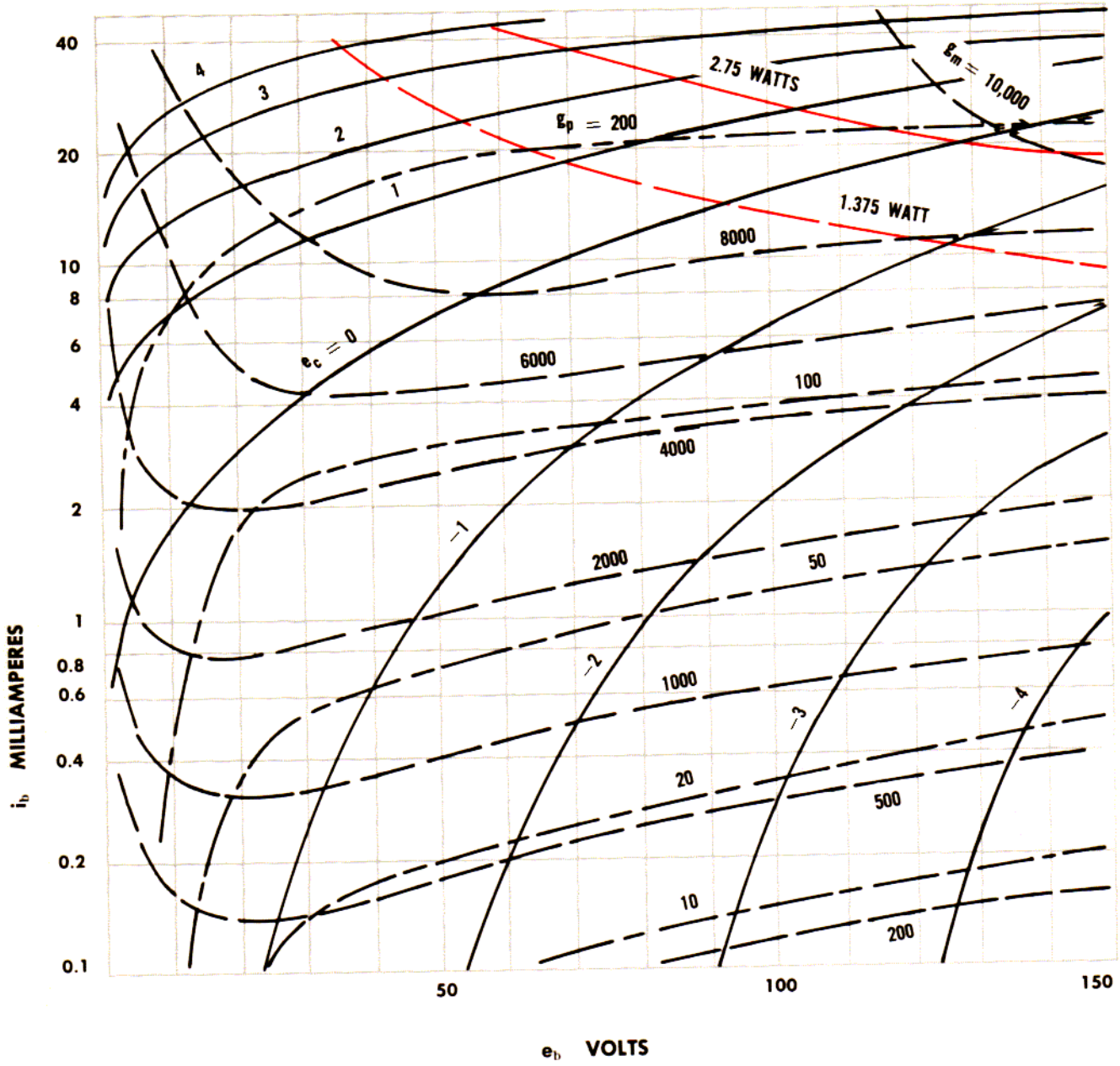

P_p 2.75 WATTS

BASE: 1-P₂ 2-G₂ 3-K₂ 4 5-H 6-P₁ 7-G₁ 8-K₁ 9-HCT

CURVE 6005

SCREEN CHARACTERISTICS

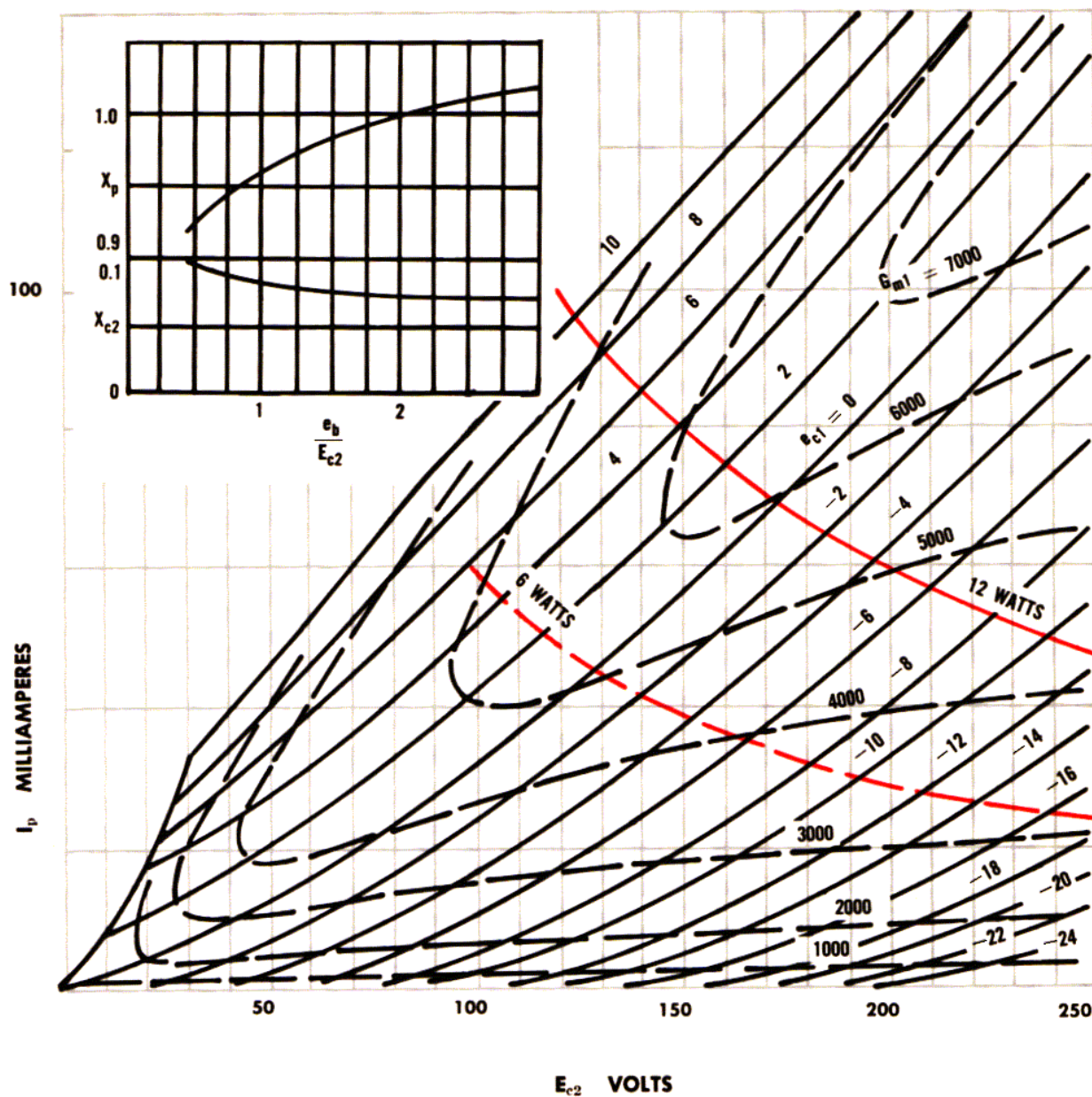

P_p 12 WATTS: P_{c2} 2 WATTS
 BASE: 1 7-G₁ 2-K G₃ 3 4-H 5-P 6-G₂

CURVE 6021

PLATE CHARACTERISTICS

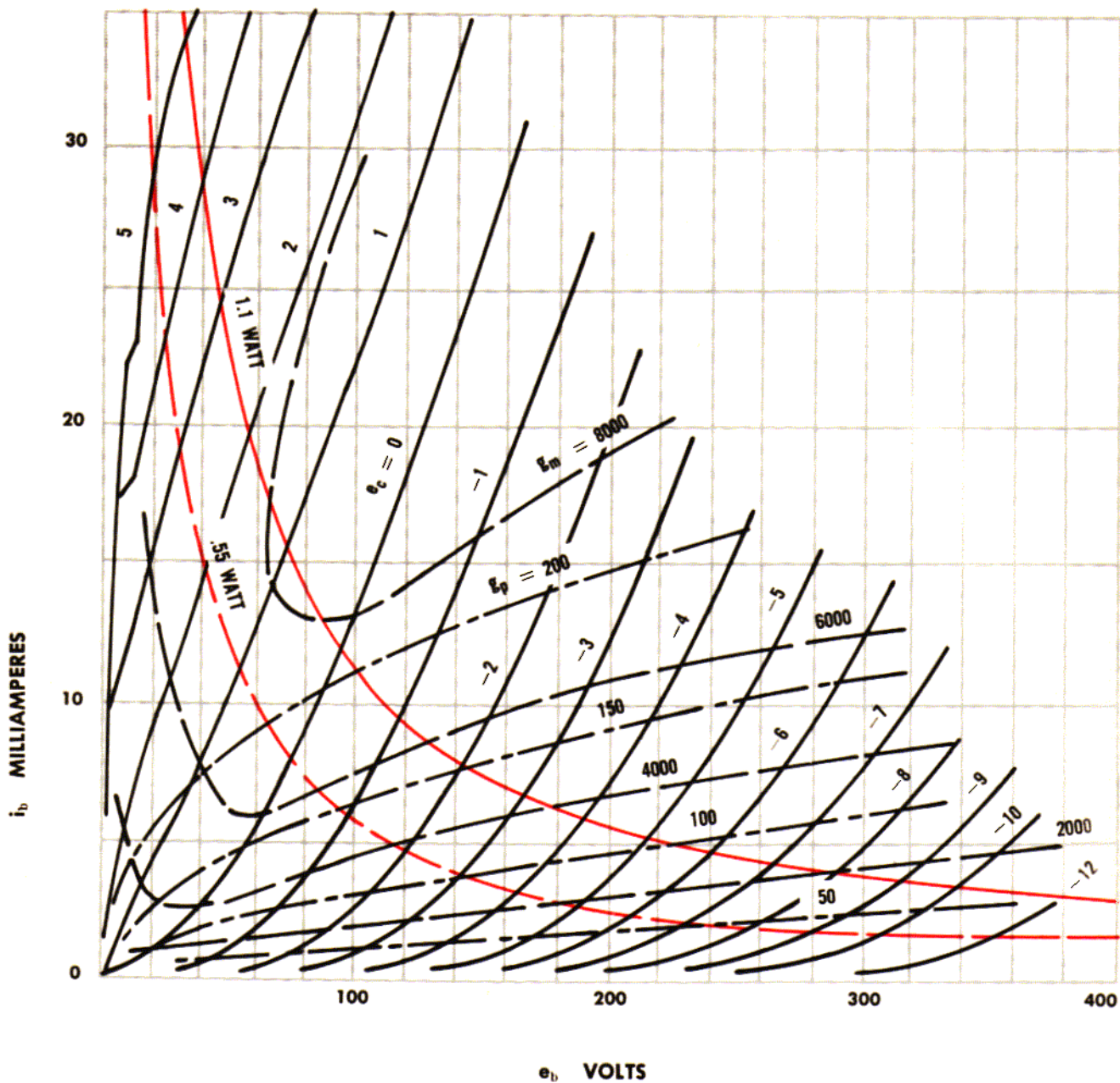

P_p 1.1 WATT

BASE: 1-P₂ 2-G₂ 3 6-H 4-K₂ 5-K₁ 7-G₁ 8-P₁

CURVE 6072

PLATE CHARACTERISTICS

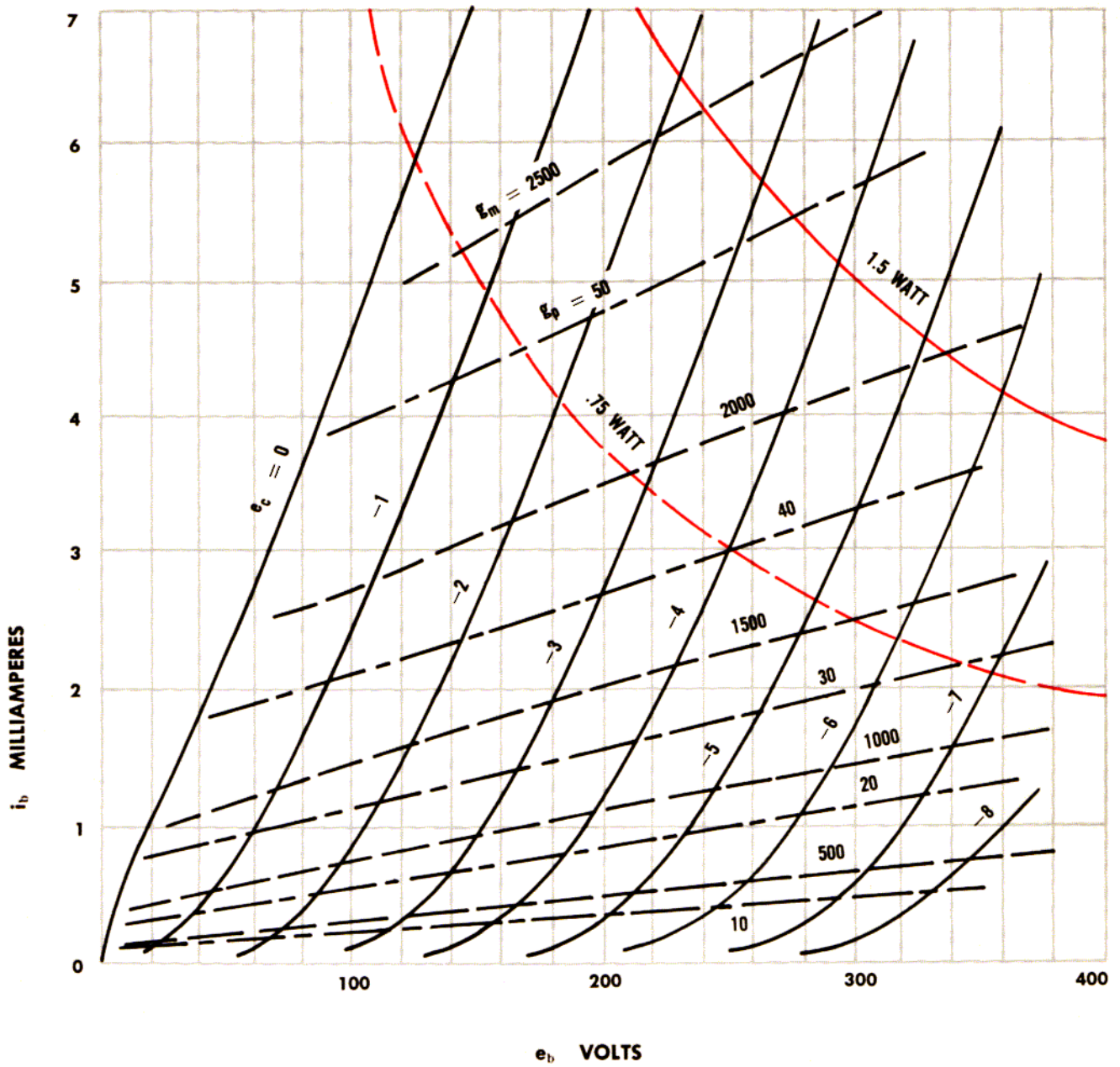

P_p 1.5 WATT

BASE: 1-P₂ 2-G₂ 3-K₂ 4 5-H 6-P₁ 7-G₁ 8-K₁ 9-HCT

CURVE 6111

PLATE CHARACTERISTICS

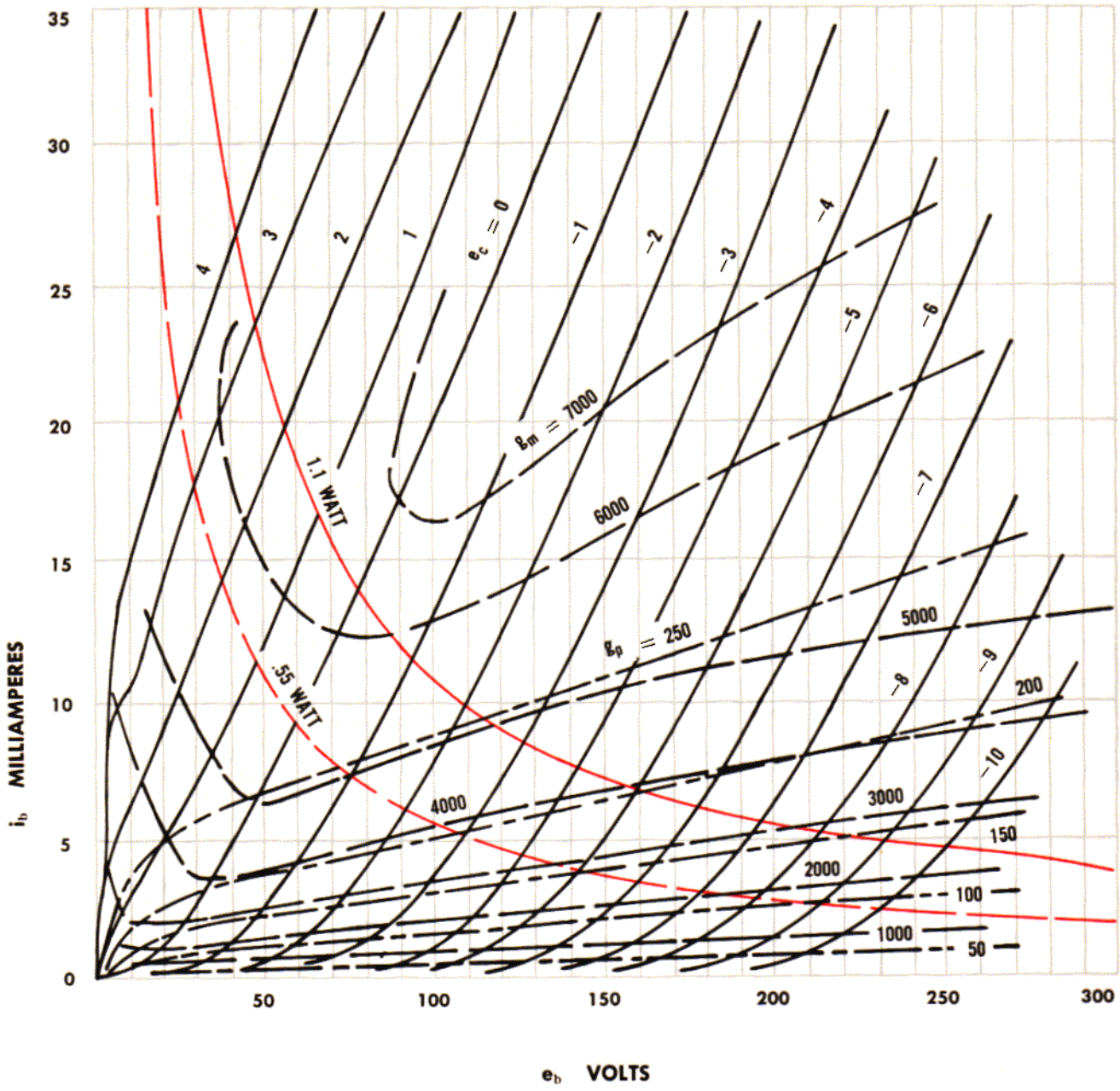

P_p 1.1 WATT

BASE: 1-P₂ 2-G₂ 3-6-H 4-K₂ 5-K₁ 7-G₁ 8-P₁

CURVE 6112

PLATE CHARACTERISTICS

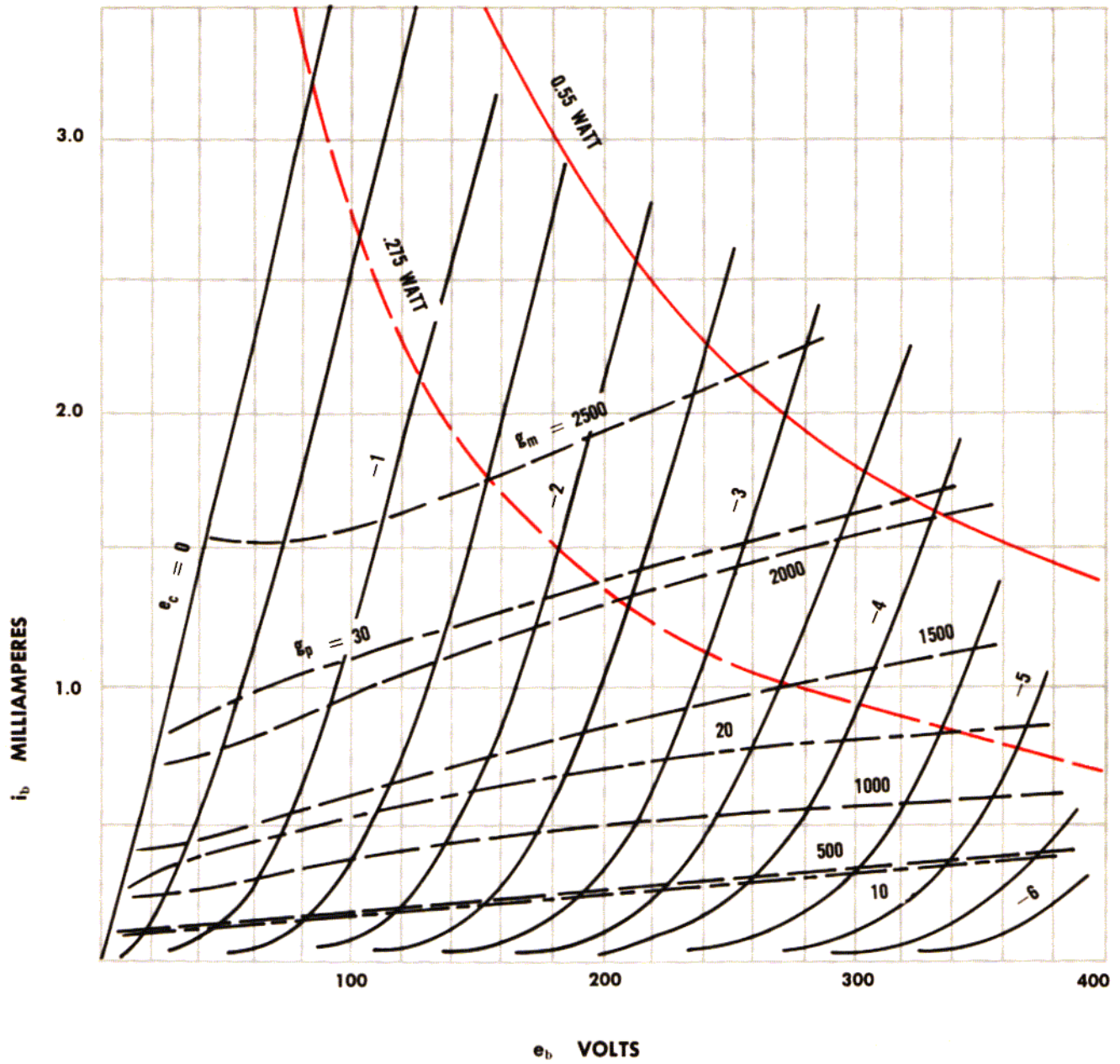

P_p 0.55 WATT

BASE: 1-P₂ 2-G₂ 3-6-H 4-K₂ 5-K₁ 7-G₁ 8-P₁

CURVE 6134

SCREEN CHARACTERISTICS

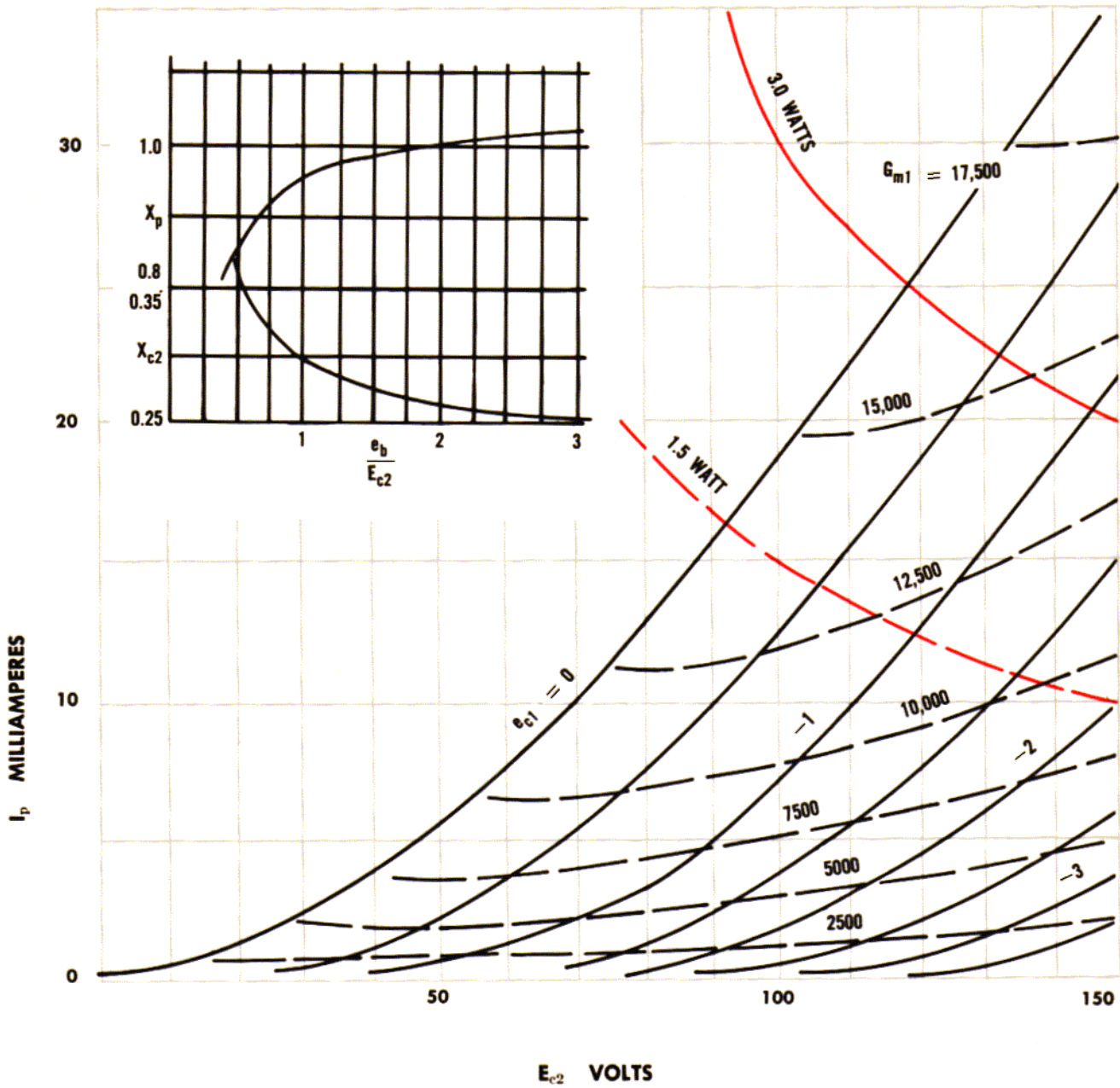

P_p 3.0 WATTS: P_{c2} 0.38 WATT

BASE: 1-SH 2 7-H 3-G₃ 4-G₁ 5-K 6-G₂ 8-P

CURVE 6136

SCREEN CHARACTERISTICS

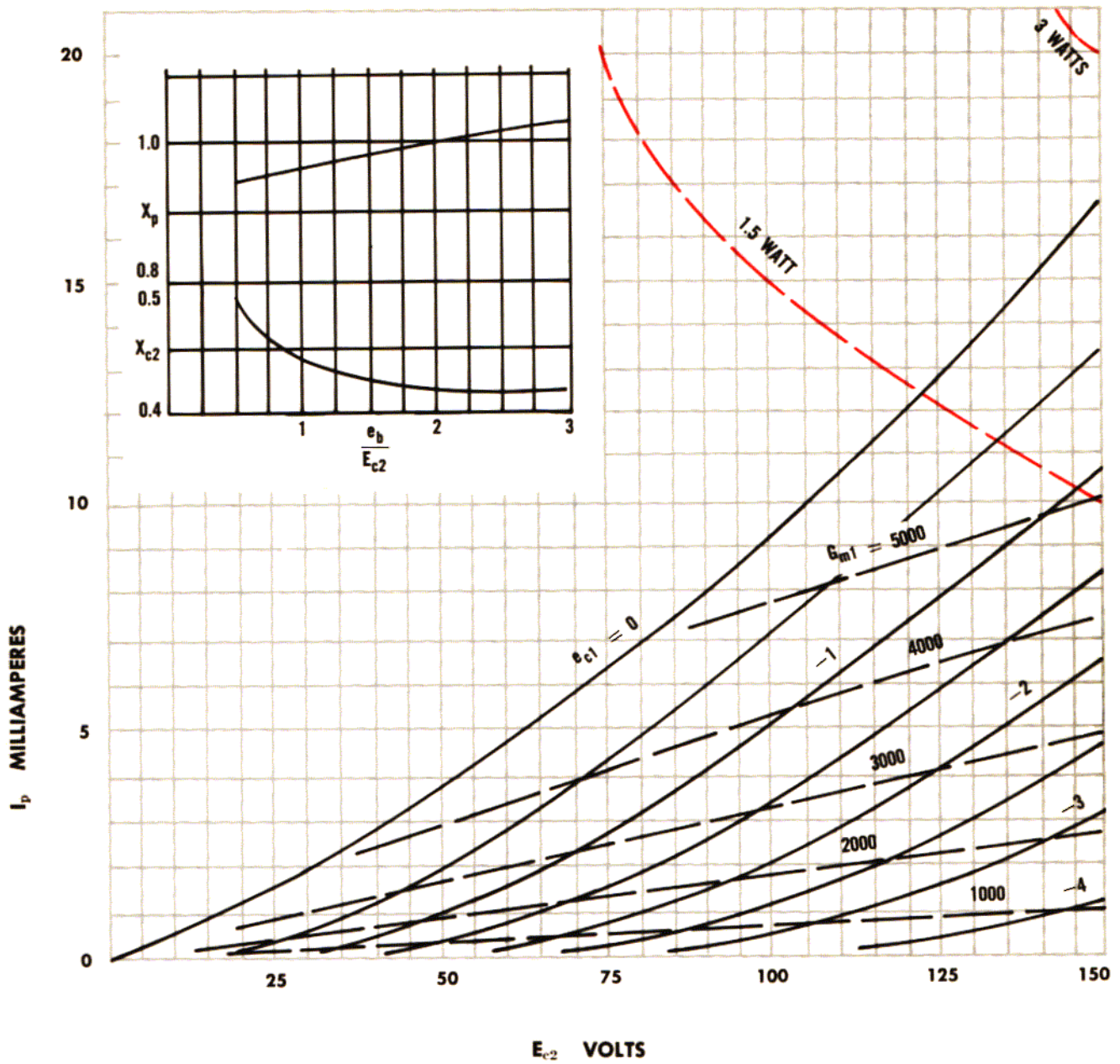

P_p 3.0 WATTS: P_{c2} 0.65 WATT

BASE: 1-G₁ 2-G₃ 3 4-H 5-P 6-G₂ 7-K

CURVE 6137

SCREEN CHARACTERISTICS

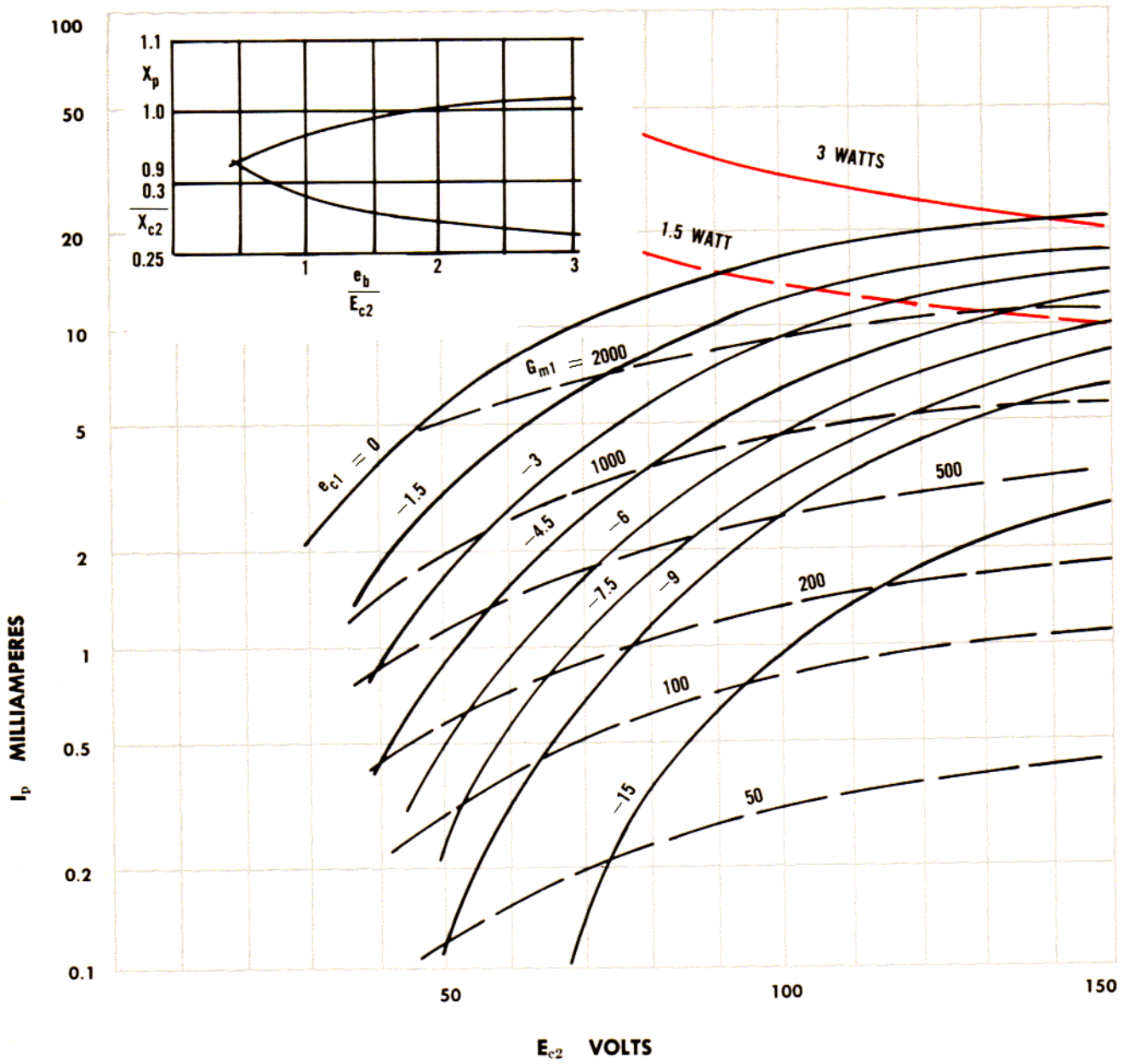

P_p 3.0 WATTS: P_{c2} 0.4 WATT

BASE: 1-SH 2 7-H 3-G₃ 4-G₁ 5-K 6-G₂ 8-P

CURVE 6201

PLATE CHARACTERISTICS

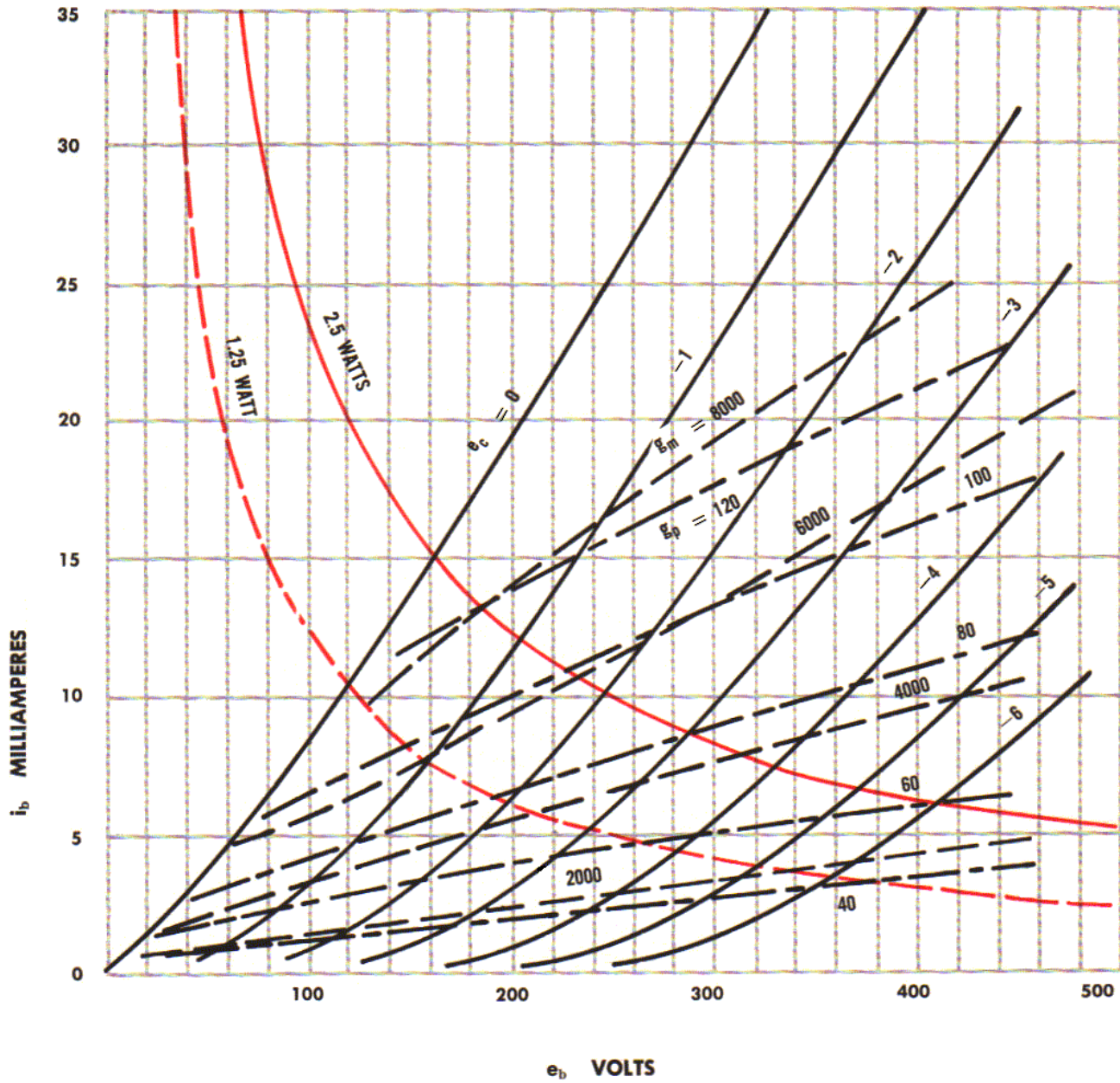

P_p 2.5 WATTS

BASE: 1-P₂ 2-G₂ 3-K₂ 4 5-H 6-P₁ 7-G₁ 8-K₁ 9-HCT

CURVE 6216

SCREEN CHARACTERISTICS

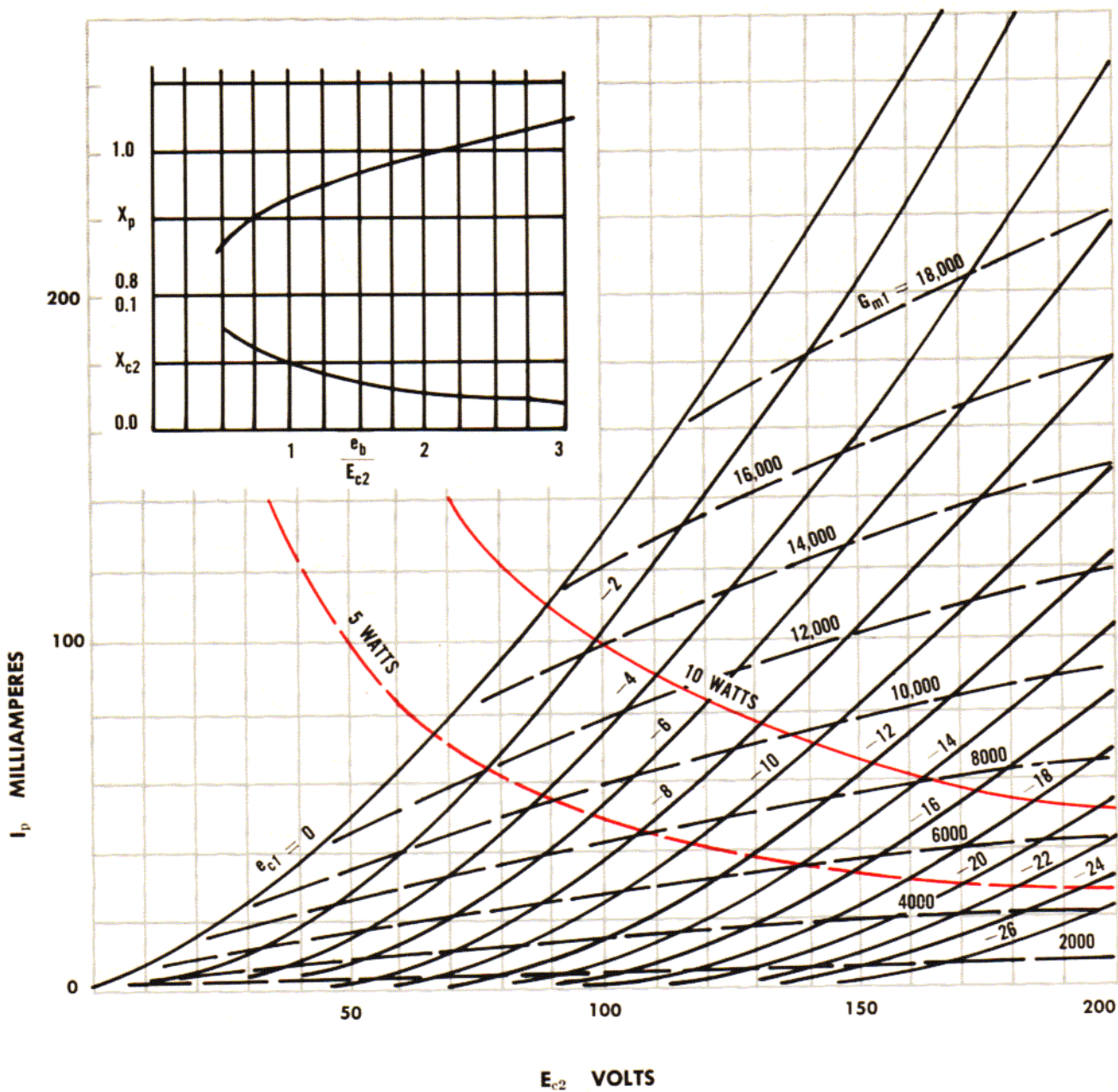

P_p 10 WATTS: P_{c2} 1.0 WATT

BASE: 1-P 2- G_1 3-K- G_3 4 5-H 6-P 7- G_2 8-K 9-NC

CURVE 6265

SCREEN CHARACTERISTICS

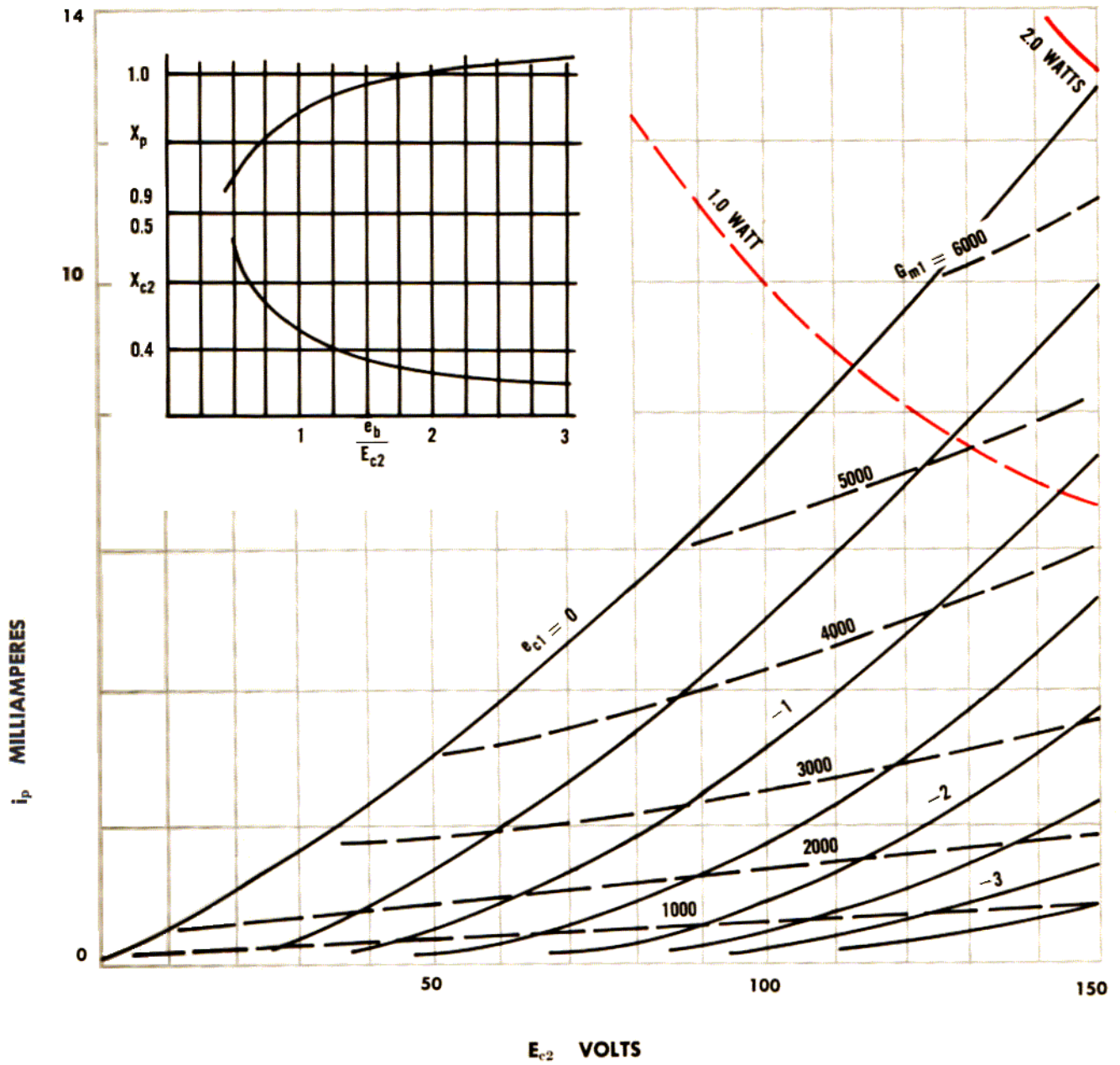

P_p 2.0 WATTS: P_{c2} 0.5 WATT

BASE: 1-G₁ 2-K 3 4-H 5-P 6-G₂ 7-G₃

CURVE 6336

PLATE CHARACTERISTICS

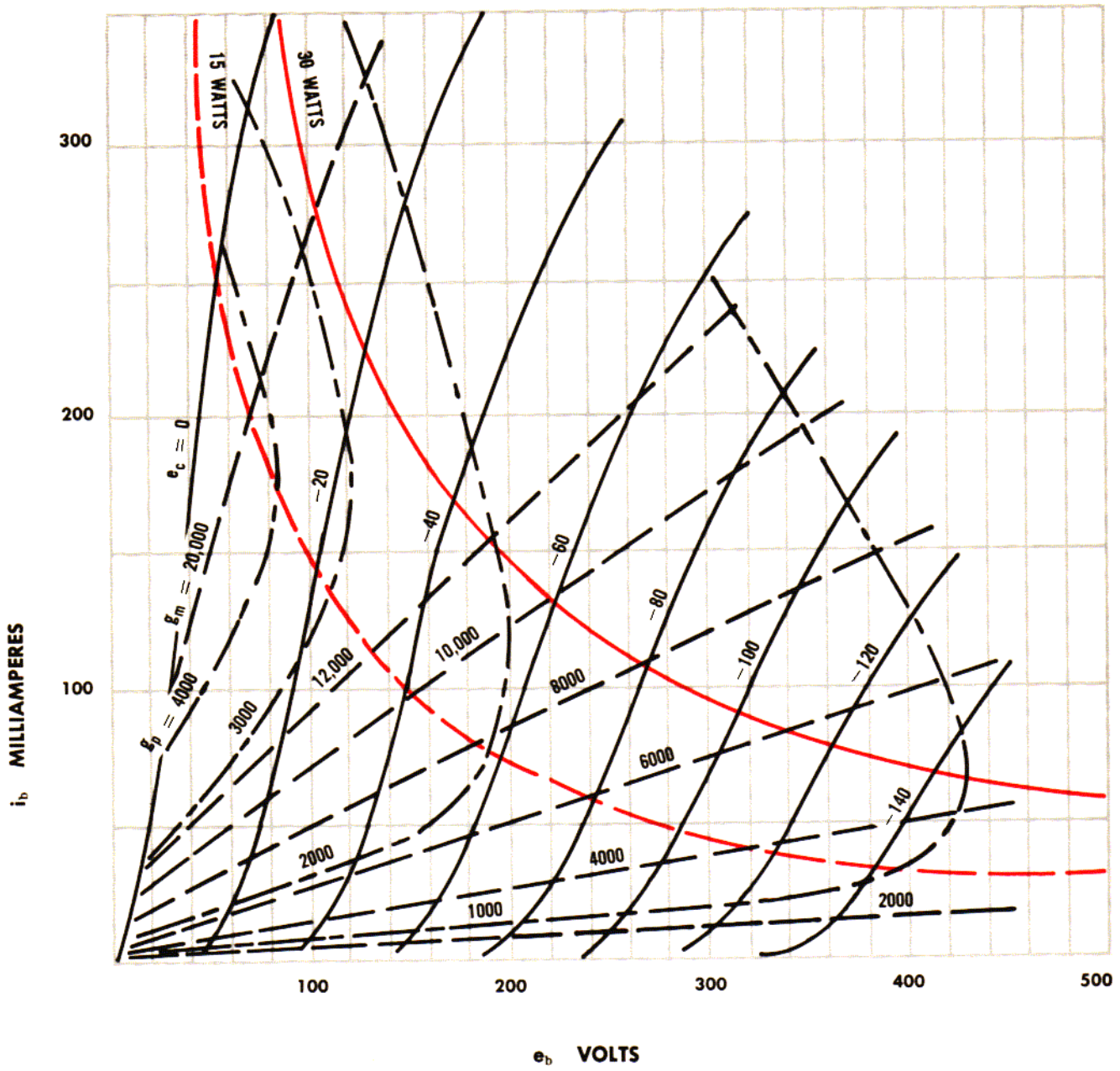

P_p 30 WATTS

BASE: 1-G₂ 2-P₂ 3-K₂ 4-G₁ 5-P₁ 6-K₁ 7 8-H

CURVE 6386

PLATE CHARACTERISTICS

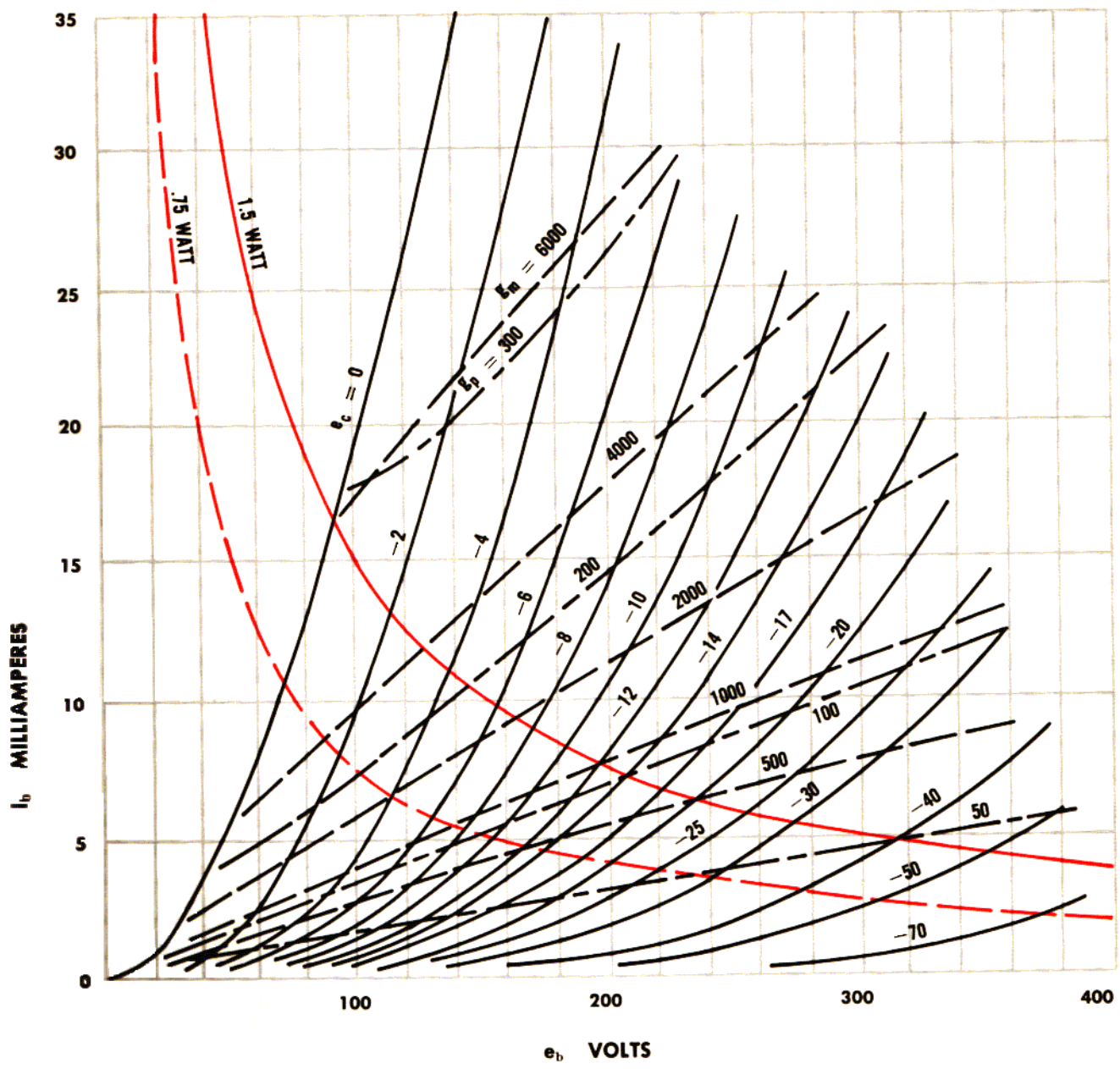

P_p 1.5 WATT

BASE: 1 9-H 2-K₂ 3-G₂ 4-P₂ 5-IS 6-P₁ 7-G₁ 8-K₁

CURVE 6414

PLATE CHARACTERISTICS

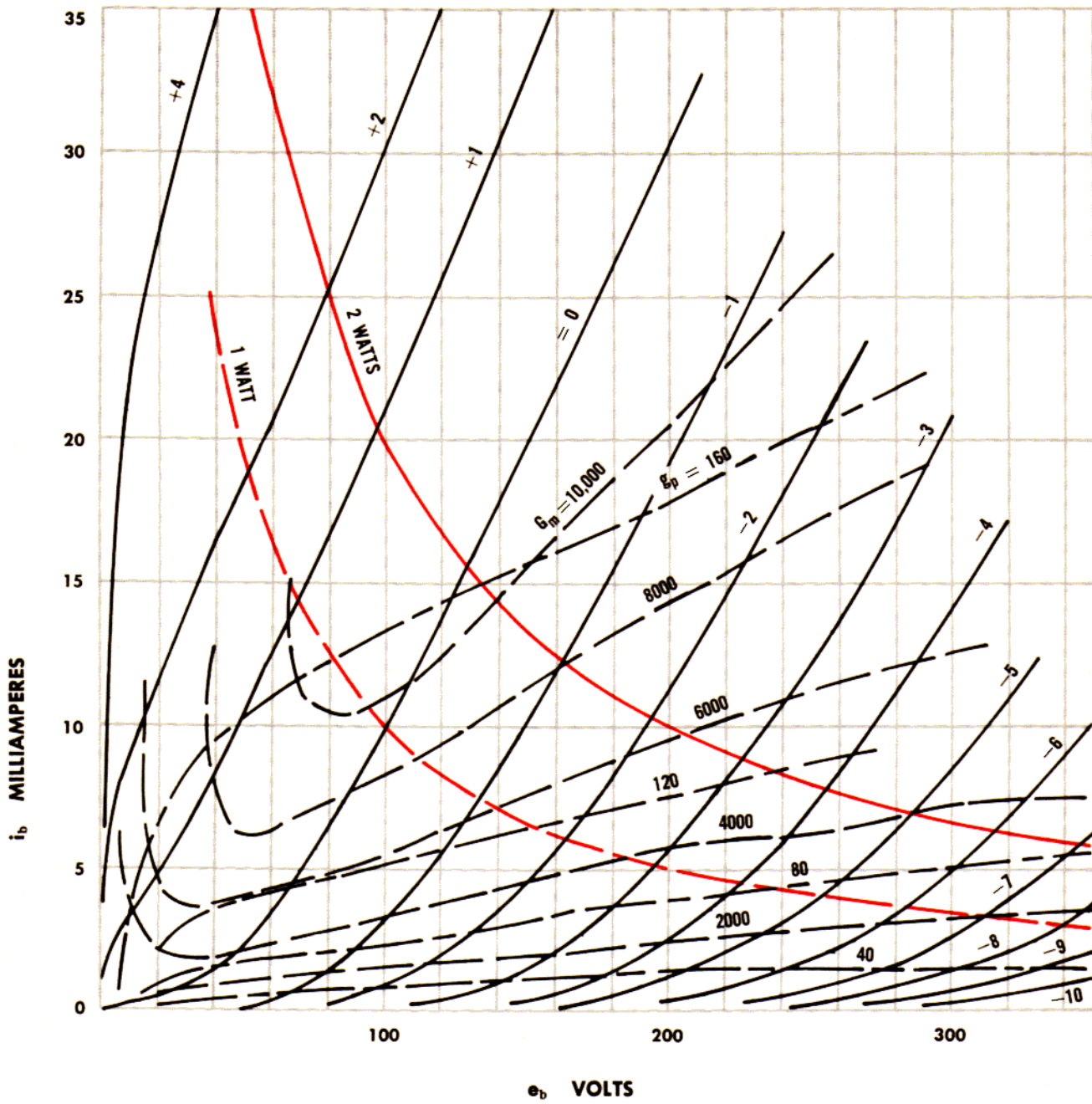

P_p 2 WATTS

BASE: 1-P₂ 2-G₂ 3-K₂ 4 5-H 6-P 7-G 8-K₁ 9-HCT

CURVE 6661

SCREEN CHARACTERISTICS

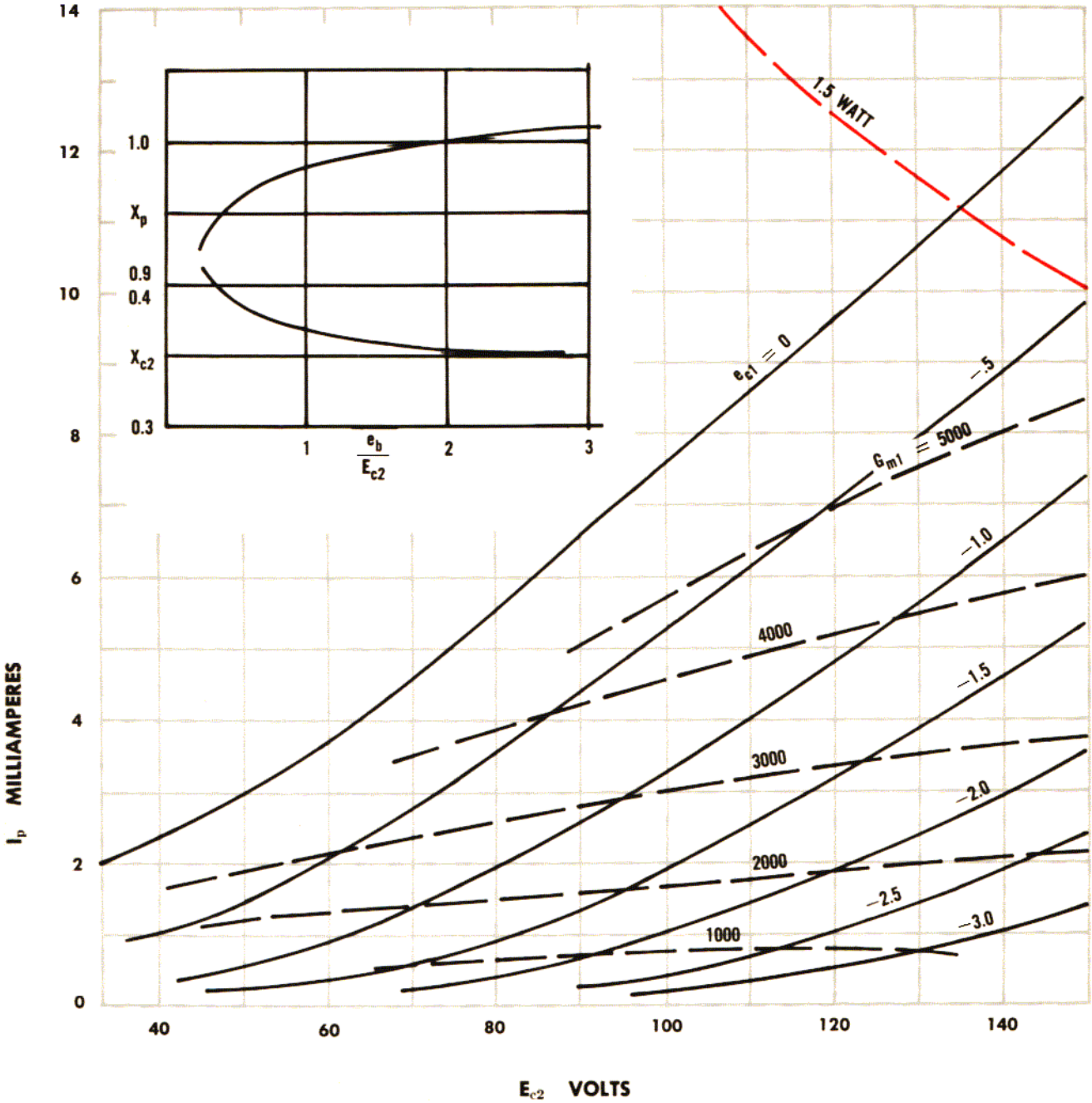

P_p 3.0 WATTS: P_{c2} 0.5 WATT

BASE: 1-G₁ 2-K 3 4-H 5-P 6-G₂ 7-G₃

CURVE 6679

PLATE CHARACTERISTICS

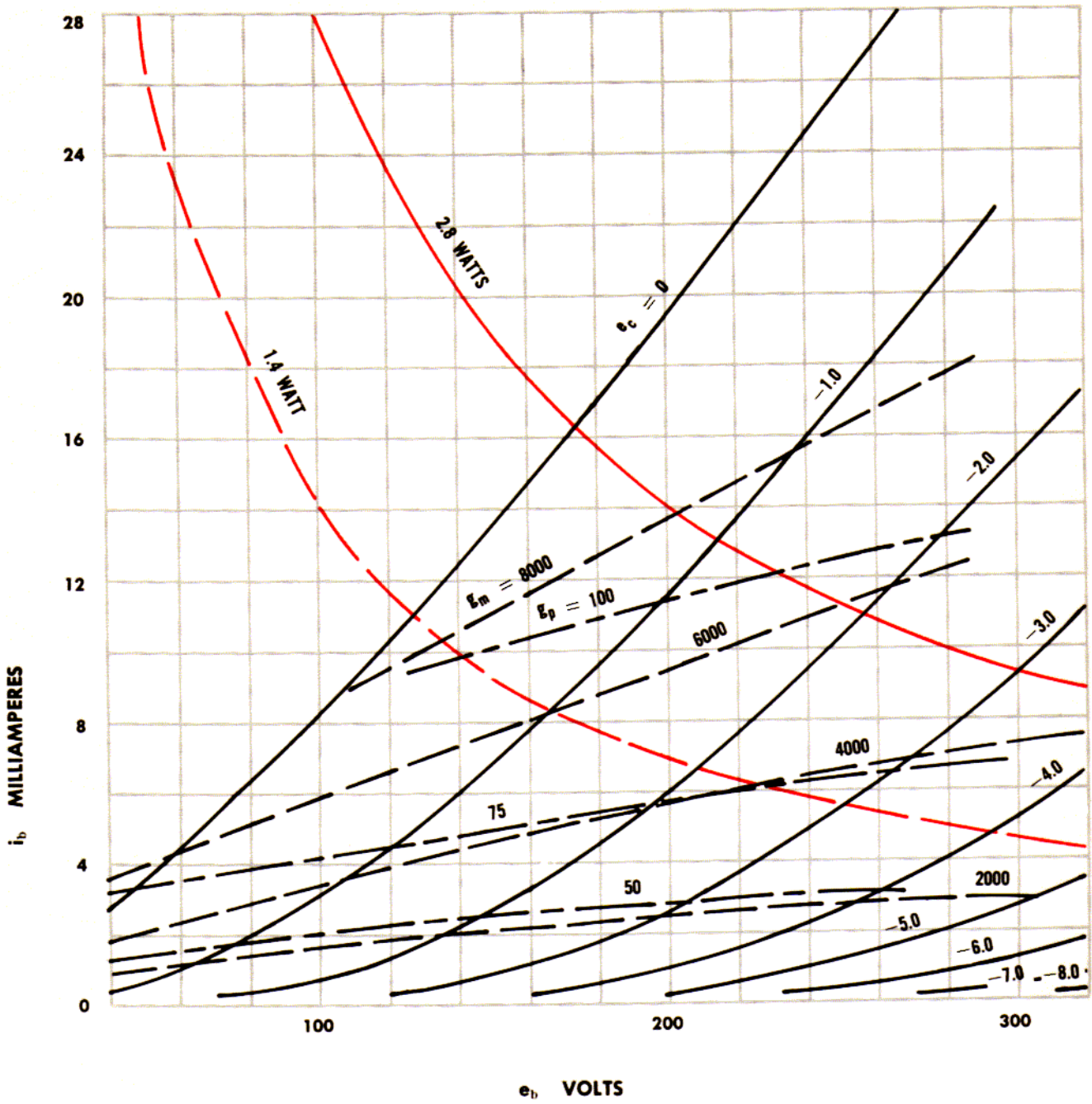

P_p 2.8 WATTS

BASE: 1-P₂ 2-G₂ 3-K₂ 4 5-H 6-P₁ 7-G₁ 8-K₁ 9-HCT

PLATE CHARACTERISTICS

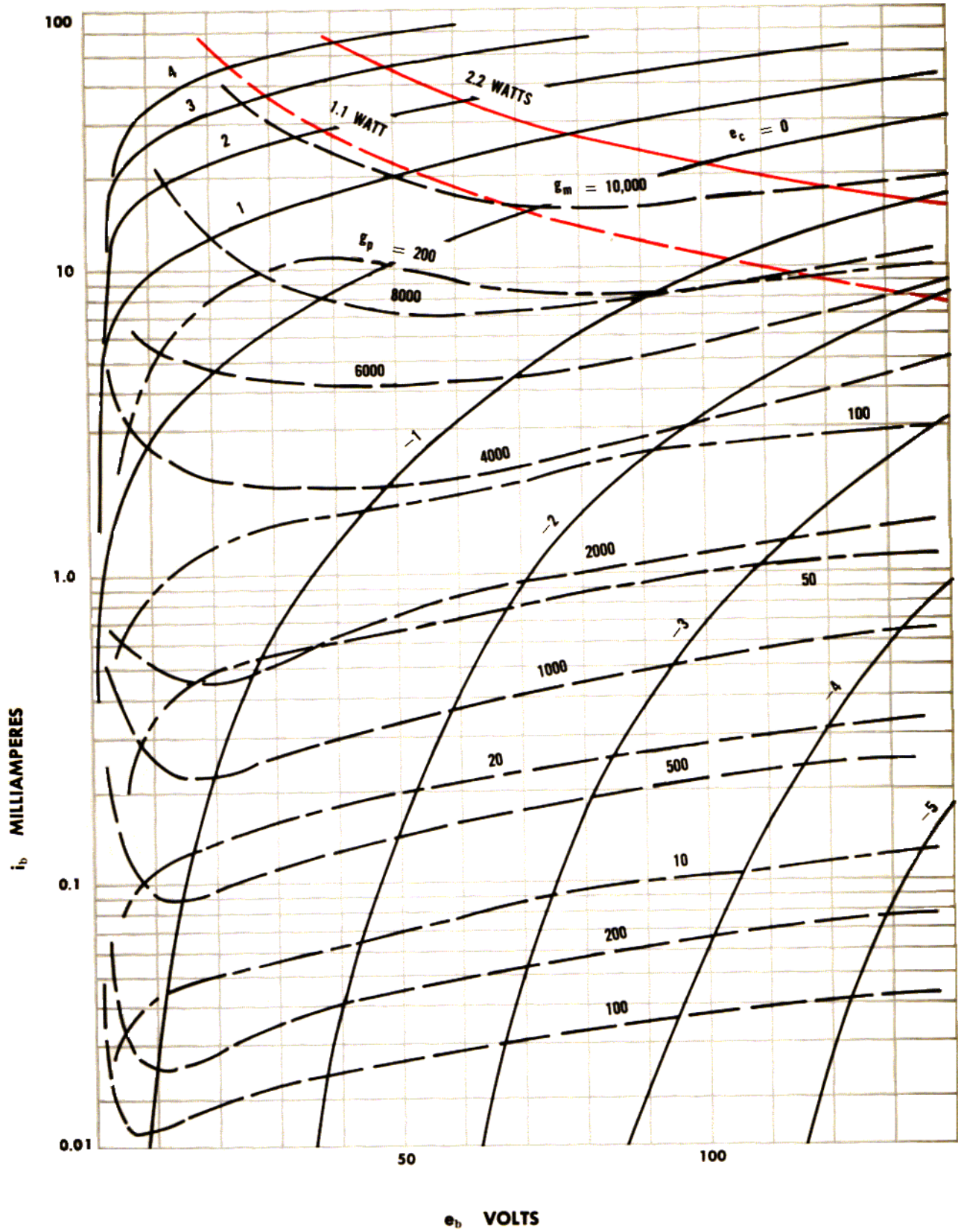

P_p 2.2 WATTS

BASE: 1- P_2 2- G_2 3- K_2 4 5-H 6- P_1 7- G_1 8- K_1 9-HCT

INDEX

- Amplification techniques, 10
- Amplifier, 10
 - cathode follower 8, 20, 22
 - degenerative, 8
 - pentode cathode, 8, 20
 - triode cathode, 8, 20
 - grounded grid, 2
 - pentode R-C, 7, 14
 - triode R-C, 6, 10
- Capacitor, screen bypass (C_s), 18
 - cathode bypass (C_k), 22
- Conductance, 6
 - plate, 1
 - screen, 18
- Contact potential, 2
- Contents, table of, xiii - xiv
- Contour, bias, 1
 - noise, 2
 - plate conductance, 1
 - transconductance, 1
- Converter curves, 4
- Corrected currents, 3
 - transconductance, 3
- Correction curves, 2
- Cross-reference data, 25
 - tables, 27, 28, 29, 30
- Data transcription, 4
 - sources, ix,
- Derivatives, partial, 6
- Dissipation, power (P), 10, 13, 17
 - plate, 14, 17
 - screen, 17
- Distortion (D), 10,
 - triode, 12
 - pentode, 17
 - triode degenerative, 20
- EIA (RETMA) bases, 31, 32
- Equations, 6
- Equivalence tables,
 - 2C51 - 6SK7 27
 - 6SL7 - 5637 28
 - 5654 - 6111 29
 - 6112 - EH90 30
 - EK90 - Z2101 31
- Flip-flops, 2
- G-Curve, vii, 1, 2, 39
 - preparation of, 5
 - index of, 115
- G-Curves, for tubes listed in Table II, 41-112
- Grid Bias (E_c), 1
- Grounded grid amplifier, 2
- Impedance, dynamic load (R_{LD}), 13
- Load Line, 10
 - dynamic, 14, 19
- Logarithmic data, 2, 4
- Measurement of tube data, 4
- Mixer data sheets, 4
- Multivibrator, 2
- Noise, 2
 - contours, 2
- Oscillator, 2
- Parameter, 1
- Partial derivative, 6
- Pentodes, 2
 - power handling ability of, 38
 - screen-to-plate transconductance, 3
 - logarithmic data, 4
- Plate characteristic curves, 1, 2
 - conductance, 1, 5
 - current equation, 6
- Power handling ability, 3, 10, 36, 37, 38
- Relaxation, 2
- Resistance, cathode, 6, 8, 9
 - load, 6, 10
 - plate (r_p), 5, 7
 - series screen, 18
- Resistance-Coupled (R-C) amplifier, 6, 7, 14
- RETMA (EIA) bases, 31
- Screen characteristic curves, 2
 - converter curves, 4
- Screen grid, 2
- Screen-to-plate transconductance, 2
- Signal-to-noise ratio, 2
- Symbols, table of, xi
- Transconductance (G), vii, 1, 2, 3
 - tables, 37, 38
- Triodes, 1
 - power handling ability of, 37
- Tube curves, 39-112
 - list, 115
 - equivalent types, 27, 28, 29, 30, 31
- Tubes,
 - for which G-Curves are given,
 - Table of, 33
 - with electrical characteristics similar to *Manual* curves,
 - Table of, 27
 - Index of, 115
- Uncorrected currents, 3
 - transconductance, 3
- Zero bias, 1, 3, 4, 36

TUBE CONDUCTANCE CURVE LIST

6AG7.....	41	5751.....	87
6AH4.....	42	5763.....	88
6AH6.....	43	5814A.....	89
6AK5.....	44	5840.....	90
6AM4.....	45	5844.....	91
6AM8.....	46	5894A.....	92
6AR6.....	47	5899.....	93
6AS7.....	48	5902.....	94
6BE6.....	49, 50	5965.....	95, 96
6BH6.....	51	6005.....	97
6BJ6.....	52	6021.....	98
6BQ6GT.....	53	6072.....	99
6BQ7A.....	54	6111.....	100
6BY4.....	55	6112.....	101
6CB6.....	56	6134.....	102
6CD6GA.....	57	6136.....	103
6CL6.....	58	6137.....	104
6CM6.....	59	6201.....	105
6CS6.....	60, 61	6216.....	106
6DQ5.....	62	6265.....	107
6DQ6A.....	63	6336.....	108
6J5.....	64	6386.....	109
6J6.....	65	6414.....	110
6L6.....	66	6661.....	111
6SL7.....	67	6679.....	112
6V6.....	68	6829.....	113
6Y6.....	69		
12AU7.....	70		
12AX7.....	71		
12AY7.....	72		
12BH7.....	73		
12BY7.....	74		
12BZ7.....	75		
417A.....	76		
5654.....	77		
5670.....	78		
5686.....	79		
5687.....	80		
5691.....	81		
5692.....	82		
5693.....	83		
5718.....	84		
5719.....	85		
5749.....	86		