

RADIO RECEIVER SERVICING

by JOHN T. FRYE

COMPLETELY REVISED AND ENLARGED

Includes brand new chapter describing the most
efficient, fully-tested servicing methods for

Transistor Radios and Printed Circuits



A *McGraw-Hill*
PHOTOFAC T PUBLICATION

\$ 2.95

RADIO RECEIVER SERVICING

by

JOHN T. FRYE



SECOND EDITION

(Revised and Enlarged)

HOWARD W. SAMS & CO., INC.
THE BOBBS-MERRILL COMPANY, INC.

Indianapolis • New York

FIRST EDITION

First Printing — January, 1955
Second Printing — October, 1956
Third Printing — August, 1958

SECOND EDITION

First Printing — November, 1959

RADIO RECEIVER SERVICING

Catalog Number: RS-2

Copyright © 1959 by Howard W. Sams & Co., Inc. Copyright 1955 by Howard W. Sams & Co., Inc., Indianapolis 6, Indiana. Printed in the United States of America.

Reproduction or use, without express permission, of editorial or pictorial content, in any manner, is prohibited. No patent liability is assumed with respect to the use of the information contained herein.

Library of Congress Catalog Card Number: 59-15240

PREFACE TO SECOND EDITION

Five years is a long time in the rapidly expanding field of electronics, and that is how long it has been since the first edition of Radio Receiver Servicing was written. During those five years, solid-state rectifiers have pretty well taken over in radio power supplies, twelve-volt auto sets have become standard, and the transistor has come into its own.

These advances, coupled with the warm reception given the first book, seemed to warrant a completely revised edition -- and that is what this is. Every word of the original book has been carefully studied, weighed, changed, discarded, or allowed to stand in the light of how accurately and helpfully it describes the radio service picture today. In addition, many thousands of new words, accompanied by new pictures and diagrams, have been added. What the writer has learned about servicing in those five years -- and a good technician learns every hour he stands at the bench -- has been interwoven as an added bonus.

When it was found that several schools were using the original edition as a textbook -- although such use had not been anticipated -- it was decided to add review questions at the end of each chapter. These questions are carefully framed to underscore the most important points in the chapter.

The writer hopes and believes the result is an honestly written, up-to-date book on radio receiver servicing that will be equally helpful to the practicing technician at his bench, or to the student in the classroom.

September, 1959

JOHN T. FRYE

TABLE OF CONTENTS

	Page
INTRODUCTION	7
SECTION I -- NO RECEPTION	
Chapter 1 -- The Dead Set	17
Chapter 2 -- Tubes Light But No Sound	29
Chapter 3 -- Only Slight Hum Is Heard	40
Chapter 4 -- Only Noise Can Be Heard	51
Chapter 5 -- Excessive Current Indication	60
SECTION II -- UNSATISFACTORY RECEPTION	
Forward	74
Chapter 6 -- Sets With Excessive Hum	75
Chapter 7 -- Set Does Not Separate Stations	87
Chapter 8 -- Sets That Whistle, Motorboat, Etc.	100
Chapter 9 -- Noisy Sets	112
Chapter 10 -- Sets With Distortion	122
Chapter 11 -- Weak Sets	132
SECTION III -- INTERMITTENTS AND MISCELLANEOUS SERVICE PROBLEMS	
Forward	146
Chapter 12 -- Intermittent Loss of Reception	147
Chapter 13 -- Intermittent Faulty Reception	159
Chapter 14 -- Transistor Receivers and Printed Circuits	169
Chapter 15 -- Auto Radios and Storage-Battery Portables	184
Chapter 16 -- All-Wave and FM Sets	197
Conclusion	213
Answers to Review Questions	214

INTRODUCTION

This is not another volume of radio theory; neither is it an oversimplified introduction to radio repairing. Instead, it is a down-to-earth book on how to repair radios and is written directly for the man who is ready to make his living, or at least part of it, doing radio service.

Such a man, it is felt, will already have acquired certain mental and physical equipment necessary for the work to be done. In preparing this book for him, therefore, it has been assumed that he has the following:

1. Basic Knowledge of Radio Theory.

This may have been obtained from a radio school, from electronic instruction in the armed forces, or from extensive reading. Many books on radio theory are available, but the one with which the writer is most familiar is his own BASIC RADIO COURSE; so it will be taken for granted that the reader's understanding of how radio works is at least equal to the theory explained in that book.

2. A Complete Set of Service Literature Covering All Sets Upon Which Work Will Be Attempted.

The wiring diagrams, alignment information, voltage readings, and part values contained in a good set of service manuals are considered indispensable by veteran service technicians; and such material is doubly important to the beginner with no general fund of experience on which to rely. If the reader intends to do general radio servicing, his service sheets should describe all sets produced since the end of World War II. Since practically no home receivers were built during the war, the only sets not covered in these manuals will be those brought out prior to 1942. Such sets are rapidly being "junked"; but if there does come into the shop an occasional one for which service information is needed, that particular data can be quickly obtained from the publisher of the service manual for a nominal sum.

3. A Good Vacuum-Tube Voltmeter.

The VTVM has rightly been termed the workhorse of the service bench. In measuring low voltages of poor regulation, such as AVC voltage or the voltage developed at the grid of an oscillator, it is without peer. Its high resistance and the isolation provided by the

probe resistor allow it to be used on tuned circuits with a minimum detuning effect. At the same time, its virtual freedom from overload damage is highly desirable in doing random probing of circuits containing unknown voltages.

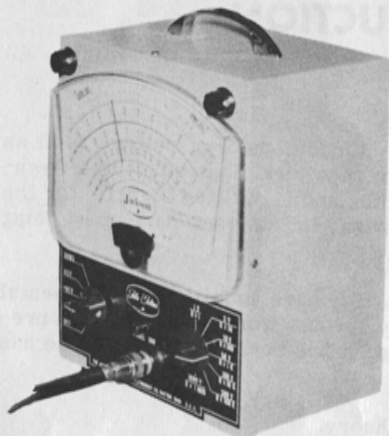

Jackson Model 590 VTVM.



Triplet Model 631 VOM & VTVM.

Typical vacuum-tube voltmeters.

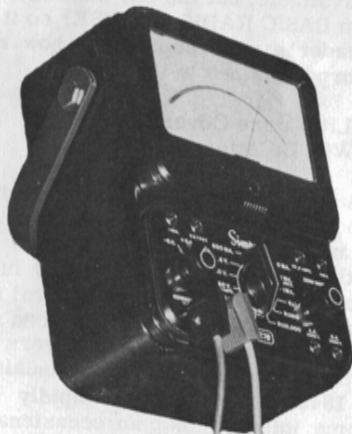

Simpson Model 270 VOM.



Hickok Model 457 VOM.

Typical volt-ohmmeters.

4. A Volt-Ohmmeter Having a Sensitivity of 20,000 Ohms Per Volt.

Just as the VTVM is an ideal bench instrument, so is the VOM the ideal portable instrument. It is rugged, it requires no external power source or warm-up period, and its accuracy is not dependent on line-voltage stability nor affected by aging vacuum tubes. It is just as suitable for taking most voltage readings in a receiver as the

VTVM. In fact, the majority of voltage values given in service literature are statedly taken with a 20,000-ohm-per-volt VOM. The fact that the VTVM and the VOM can be used interchangeably for many jobs is no reason for not having both. The particular uses each has are essential ones; furthermore, when both are at hand, failure of one of them will not bring service work to a grinding halt. Finally, both are frequently needed to check voltage at two different points simultaneously.

5. A Signal Tracer.

No servicing aid is easier to use or provides quicker and easier covering of trouble than the signal tracer. The fact that some of the old-timers do not use signal tracing in no way discredits the instrument. Rather this is a sad reminder of how easy it is to slip into the habit of thinking that a harder way of doing a thing is the best



EICO Model 147 Multi-Signal Tracer.



PACO Model Z-80 Audio-RF Signal Tracer.

Signal tracers.

way simply because that is the way it has always been done. The signal tracer need not be an elaborate one with tuned circuits and the like. In fact, the writer prefers the untuned type that uses a crystal probe in conjunction with a high-gain audio amplifier. This type of tracer is low in cost and requires a minimum of manipulation, but it will perform all of the signal-tracing functions described in this book.

6. A Signal Generator.

A reliable signal generator is an absolute necessity for aligning the many variable and semivariable tuned circuits found in AM and FM receivers; furthermore, it is needed for the "signal-injection" method of trouble shooting often used. A good signal generator is one that delivers a wide range of fundamental frequencies in several spread-out bands. Frequencies from 100 kilocycles to at least 50 megacycles should be covered in this manner, and if higher frequencies are provided so much the better. The original accuracy of the instrument must be good, and the generator should be ruggedly built to hold calibration over a long period of time. The dial should be large enough and tuning movement slow enough that any desired

frequency may be easily set with accuracy. High output should be available; yet the shielding and attenuator should permit this output to be reduced smoothly and gradually to a very low minimum. Internal audio modulation of the output should be provided.



Precision Model E-200-C Signal-Marking Generator.

RCA Model WR-49B RF Signal Generator.

Signal generators.

7. A Tube Tester.

A service technician might get by without this instrument, if he had sufficient stock of tubes and the time to substitute new ones one at a time in each socket of every set and note if improvement resulted; but that certainly would be a time-wasting procedure. A tube checker is much faster and will spot marginal cases never revealed by such a crude method. Furthermore, it will be found that

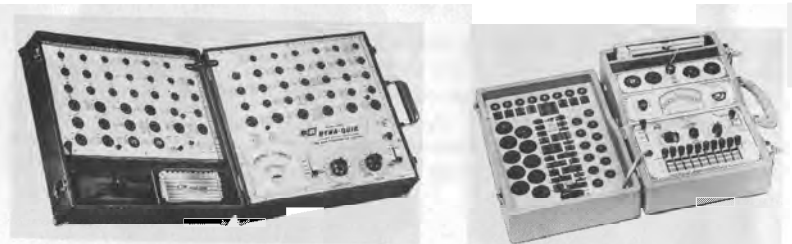

B & K Model 650 Tube and Transistor Tester.

Seco Model 107 Tube Tester.

Typical tube testers.

customers who may doubt a service technician's opinion about the condition of a tube will accept without question the verdict of a tube tester. Since tube sales represent a sizable portion of Service income, any device that aids those sales quickly pays for itself. One note of warning, though: the service technicians should not be infected with the customer's childlike faith in the infallibility of tube testers, even the best of them. On rare occasions a tube will show up and check all right in the tester but will not work in the set. Keeping this possibility in mind will often save a lot of time and trouble.

8. An Isolation Transformer.

A voltage-adjusting isolation transformer is not merely a safety device; it is actually a service instrument. The fact that it protects the service technician from a possible fatal shock when he is working on hot-chassis receivers certainly makes it a must for the service shop. It will be found that when such a receiver is isolated from the line, the signal-generator and meter connections can be made to the set without observing the special precautions and hum-reducing measures which are necessary when the transformer is not used. If by adjusting the line voltage applied to the set one is able to simulate a wide range of conditions that may be found in the home, one can uncover troubles that cannot be found in any other way.

9. An Adequate Stock of Replacement Parts.

Of course, after you have found a defective part in a set you will need a new part to replace it; but it may surprise you to know how often you will need new parts to locate a defective unit. It has already been pointed out that occasionally a tube tester will fail to reveal a defective tube, but substituting a new tube will immediately spotlight the trouble. In the same way doubtful capacitors are often quickly checked by bridging them with new capacitors, IF transformers are



Adjust-A-Volt variable transformer.

tacked into a circuit in place of a suspected unit, and noisy resistors are unmasked by clipping new resistors in their place. Many times part substitution is the quickest and most practical way to locate

trouble, but to use this method a good stock of standard replacement items must be on hand.

10. A Good Set of Hand Tools.

Sometimes a new service technician becomes so impressed with the fact that he is an electronic technician that he spends all of his equipment money on electronic instruments and tries to limp along with a single broken-bladed screwdriver, a pair of automobile pliers, and a tinner's soldering iron as hand tools. This is foolish. Time is money to a service technician; and good hand tools, since they are in constant use, are just as important timesavers as are good trouble-shooting instruments. Best quality diagonal cutters, sharp-nosed and duck-billed pliers, conventional and Phillips screwdrivers in assorted sizes, complete sets of miniature end and Spintite wrenches, various shapes of files, complete array of aligning tools, speaker shims, wire strippers, hacksaw, sturdy vise, electric drill, solder gun — these are the minimum furnishings of a service technician's tool rack.



A set of hand tools.

The service technician possessing this mental and physical equipment needs only one more essential to transform him into an efficient, self-confident radio repairman: experience. No matter how thoroughly he knows his theory nor how well-equipped his bench is, only experience can give him the complete confidence he needs to wade unafraid into the most complicated receiver or — considerably more important — give him the shrewd insight that will allow him to move directly and without lost motion toward the cause of the trouble.

It is regrettably true that while he must have the confidence and knowledge gained from doing; yet experience alone is a slow and inefficient instructor, possibly because it gives the test first and

the lesson afterward. Not until the student has committed many blunders and false moves does he finally hit upon the right solution and thus learn from experience how the thing should have been done. What is needed is some way by which the fruits of experience can be plucked while the thorny wastes are avoided. To provide such a way is, in a nutshell, the ambitious aim of this book.

The method of accomplishing this is simple and direct. One by one all imaginable receiver faults are presented in groups of symptoms, just as they **would be** presented to the service technician through a customer's complaints. Then the following steps are described: (1) how to ponder the symptoms and arrive at suitable theories concerning the cause of the trouble; (2) what instruments to select and exactly how to use them to check these theories; and (3) the proper method of correcting the trouble, when it is uncovered.

In short, the reader is helped in quickly obtaining experience of the right sort by being permitted to lean upon the experience the writer has stored up in working on radios for more than a quarter of a century. It is just **like learning** to ride a bicycle. If a boy and his bicycle are both durable enough, eventually he can ride it by himself; but he can learn much quicker and **easier, with** far less damage to his person and to the bicycle, if an older and experienced rider will walk beside him for a short time to hold him up and explain what to do.

Consider a single example of how the writer's experience is transferred to the reader. For any particular group of receiver symptoms, there are many possible causes; but experience shows that some of these troubles develop much more often than do others. In this book, the service technician is directed to look first for the most probable cause of trouble, then for the second most probable, and so on. The only time this procedure is not followed is when a more remote possibility can be easily checked without taking the chassis out of the cabinet, since the difficulty suspected as **the** most probable could only be examined by removing the set.

In this volume, the reader will search in vain for any favored system of trouble hunting. Instead he will find that each system is used when, and only when, it is the easiest and most logical to employ. Signal injection, signal tracing, circuit disturbance, voltage measurement, resistance measurement — each will be applied just as **a** screwdriver of the right bit and size is automatically selected for loosening a particular screw. In this way, the reader will not only learn how to use **all the** common methods of locating trouble; but, as is equally important, he will acquire a knowledge of when **to use** each of them.

Two important mechanical features of the book should be noted. First, receiver problems start with those easiest to solve and then progress steadily to ones that are increasingly difficult to unravel. Secondly, symptoms are discussed with regard to the three general types of receivers most commonly encountered in service work: (1) the power-transformer set, (2) the AC-DC series-filament type, and (3) the three-way portable type. Special cases such as FM re-

ceivers, all-wave sets, transistor receivers, auto radios, and storage-battery portables are taken up in separate chapters at the back of the book. This arrangement makes easy reading, a minimum of repetition, and a concentration of help where it will do the most good.

The volume is intended to be read, first, from cover to cover. A great deal of practical general information has been sprinkled throughout the chapters dealing with specific kinds of receiver failures. The bonus bits of information have been inserted at points where their introduction seems the most logical and natural, and they will be absorbed effortlessly by one who goes through the book from the beginning.

After the book has been read, it is not intended to be placed on a shelf to collect dust. Instead it is a reference work designed to be consulted whenever a service technician runs into a problem he cannot readily solve by himself. Between its covers is a sort of electronic Rogues' gallery containing symptomatic pictures of about every kind of receiver failure imaginable. When the service technician finds himself baffled, he has merely to match up the symptoms in the book and then follow the step-by-step procedure for ferreting out the trouble.

As time goes by he will need to consult the book less and less often, for its teachings will become part of his growing fund of knowledge. Never forget that all the important part of service work is done as Hercule Poirot puts it, "In the little gray cells of the mind." As soon as the student can be taught to think like a service technician, he is a service technician — and not before! Any form of instruction that merely tells what to do but fails to teach how to think will only produce an automaton that cannot function without constant direction.

Finally, this book has not been written in a sober and dignified style. Will Durant says, "Wisdom is not wise if it scares away merriment," and to this the writer breathes a hearty "Amen!" He has had fun writing the book, and he devoutly hopes the reader will have fun reading it.

QUESTIONS

1. Give two sources of basic knowledge of radio theory.
2. Describe service literature needed by the beginning radio technician.
3. Name four essential test instruments.
4. What two important functions are provided by a voltage-adjusting isolation transformer?
5. List several important tools for doing good service work.
6. Explain why an adequate supply of replacement parts is needed in locating radio trouble.



SECTION I

No Reception



CHAPTER 1

The Dead Set

Service technicians are fond of comparing their work with that performed by members of the medical profession, and there is a strong resemblance between the diagnostic techniques required in the two fields. Radio servicing and doctoring, however, are poles apart in this basic respect: the patient that even the best doctor will admit he cannot help is the dead one; while for the service technician, the deader a set the easier it ordinarily is to repair. That is why we shall start with a set that is completely devoid of life; one that emits no sound from the speaker, no light from the dial lamps or glass tubes, no warmth from the metal tubes — in short, a receiver that is "stone cold dead in the market."

The first thing to do is to look at the circuit diagram. The significant symptom is lack of filament current; so notice if the set is a transformer type, an AC-DC receiver, or a so-called three-way portable. In each of these cases, the filaments are supplied in a different manner.

THE TRANSFORMER SET

Fig. 1-1 shows a typical AC-input circuit for a transformer type of receiver. Notice the tube filaments are heated from two separate secondary windings on the power transformer. **L3** supplies the filament of the rectifier; **L4** provides current for all other filaments, including those of the pilot lamps. Sometimes a rectifier with an indirectly heated cathode, such as a 6X5, is used; and then **L3** is omitted and the rectifier filament is fed from the same secondary that supplies the other tube filaments.

The fuse is shown in dotted outline to indicate it may or may not be present. Unless the set is large and expensive, the chances are a fuse will not be found. At any rate, check the diagram rather

No Reception

than rely on being able to see a fuse-holder along the rear of the chassis. Occasionally fuses are tucked away in unsuspected places.

With the VOM set to a middle range of the ohmmeter, turn on the receiver and touch the test leads to the two prongs of the power plug of the receiver. If you get a reading of only a few ohms you can be sure that the plug, the line cord, the switch, the primary of the power transformer, and the fuse if any are not defective. If the ohmmeter shows infinite resistance, which is much more likely, you will know there is an open circuit in one of these items or in the connections between them.

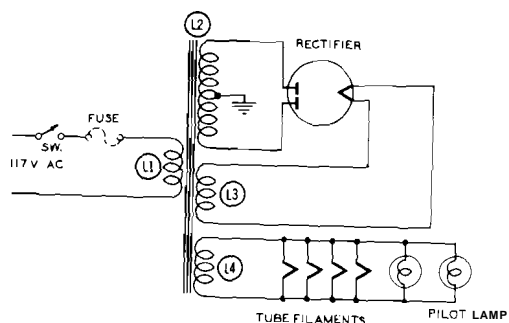

Fig. 1-1. AC input circuit for a transformer type receiver.

In the latter event, use the ohmmeter to check the continuity of the fuse if one is present. If it is open, replace it with a good unit of the specified value. If that blows out shortly after the set is turned on, the set is drawing excessive current. The reason for this can be determined by following the instructions given in Chapter 5 which deals with that symptom.

If the fuse is good or is not present and no continuity is obtained from one plug prong to the other, use insulation-piercing test prods (the writer prefers the type with small chucks that use replaceable phono-needle tips) and the ohmmeter to test the continuity of each conductor of the line cord between the plug prong to which it is connected and the point where the cord enters the chassis. If a break is indicated in one or both conductors, employ the sharp-pointed prods to make connection with each conductor about three inches away from the plug. Continuity through the primary winding of the transformer from these points indicates a break in the line cord at the most commonly worn part, which is next to the plug where the cord is subjected to maximum flexing. In that event, the end of the cord should be cut off about three or four inches back of the plug and a new plug installed; or, if the cord shows any signs of deterioration, the whole thing should be renewed.

The Dead Set

If no continuity can be observed, even though the prods pierce the line-cord insulation right next to the chassis; then the trouble must lie inside the set, and the chassis will have to be removed. If it is not immediately obvious how the receiver comes out, look at the service notes for instructions on chassis removal. Doing so will often save time and prevent damage to the set or cabinet.

Once the set is out, use the ohmmeter to check for continuity across the tie-point ends of the line cord, making sure that the set switch is still turned on and that the line cord is not plugged in. If an open circuit is still indicated, the switch should be suspected. Check across its terminals with the ohmmeter. If a dead short is not indicated, the switch is bad and must be replaced. If it is mounted on the rear of a volume or tone control, it is a good practice to replace both the switch and the control with the proper replacement items given in the service data. Since such a control represents one of the few moving and consequently wearing parts in a receiver, it will probably be ready for replacement anyway.

If checking the switch indicates that it is good, then the only remaining possibility is that the transformer primary is open. Because of the relatively heavy wire used in this winding, open circuits in it are seldom found — but they can happen! On two occasions the writer found leads of the primary broken just at the point where they entered the shell of the transformer. These probably broke because of excessive flexing in manufacture, shipping, or installation. If a break in the winding cannot be found at a point where it can be readily repaired, the whole transformer must be replaced.

Let us go back and suppose that on our first test we found a proper resistance indicated from one plug prong to the other. That means that the primary circuit of the transformer must be in order and that there must be something wrong in the secondary circuits feeding the tube filaments or with the tubes themselves. For all of the tubes to be burned out at once is placing a terrific strain on coincidence; but it has been known to happen when the set was struck by lightning, when it was accidentally plugged into a 220-volt outlet, or when the owner did a little experimental tube "swapping" on his own before bringing in the set for repair. Check a couple of tubes in the tube tester. The rectifier and output tubes are two good choices. If the rectifier is of the direct-heating type, this will provide one tube fed by each filament secondary winding. Incidentally, look at the service data or the tube-position chart to make sure these tubes are in their proper sockets. Failure to notice that tubes have been switched in their sockets has put many a gray hair in the service technician's thatch.

If the tubes light in the tube checker but not in their proper sockets in the set, the chassis must come out. Remove the rectifier tube, and lay it aside so that high DC voltages will not be present in

No Reception

the set. Plug in the receiver and **turn it on**. Use your VOM set to the ten-volt AC range in order to check whether **or** not a filament voltage is present across the proper filament terminals of all the sockets in the set except the rectifier socket. If no **filament** voltage is found at any of these sockets, locate the ends **or** the filament winding coming out of the power transformer, and measure the voltage right where these leads are soldered to tie-points. If voltage is found (and it should be), use the AC voltmeter to trace along the leads from that point until you locate the place where either a broken wire or a poor connection is preventing the current from reaching the tube filaments; then repair that break.

If a very low filament voltage is found at the tube sockets, turn off the set at once and check the diagram to see if a thermal switch (Surgistor) is not shown in series with one of the power leads. Such a switch consists of a high-wattage resistor and a pair of bi-metal contacts as pictured in Fig. 1-2. A typical value for the resistor is 100 ohms. When the set is turned on, the contacts are open and all current to the set flows through this resistor, heating it and, by conduction, convection, and radiation, the nearby bi-metal contact arm. Within a few seconds this heat causes the contacts to close and short **out** the resistor. Current then passing through the contact arm generates enough heat to keep the contacts closed, but the resistance of the unit drops from 100 ohms to only a fraction of an ohm.



Fig. 1-2. A Surgistor thermal switch.

The purpose of the unit is to protect the tube filaments from the large surge of current that goes through them when full voltage is applied to them in their cold, low-resistance state. The series resistance in the power lead allows the tubes to warm up at reduced voltage; then full power is automatically applied. If the resistor opens, the effect will be the same as an open fuse. If the contacts fail to close, usually the applied voltages will be too low for the set to operate. In the latter event, keep in mind one thing: a certain minimum amount of current through the Surgistor is necessary to cause the contacts to close. If the set does not draw its rated load, say because the filament circuit is open, the Surgistor contacts will not close although **the unit** itself may be perfectly all right. If shorting out the thermal switch restores the set to normal operation, replacing the Surgistor is necessary.

If no thermal switch is present, the low filament voltage indicates a short circuit is pulling the transformer output voltages down.

The Dead Set

Leaving the set turned on **will** be certain to cause damage. In this **event**, the receiver will be drawing an excessive current; the proper servicing procedure is outlined in the chapter dealing with that contingency (Chapter 5).

THE AC-DC SET

The chief characteristic of the filament circuit of the AC-DC receiver is that the tube filaments are connected in series. Most sets of recent vintage simply connect the filament string across the 117-volt line, **as shown** in Fig. 1-3. Older sets, especially those employing tubes drawing .3 ampere of filament current, usually employ a resistor in series with the tube string. In some sets, this series resistor is built into the line cord, as shown in Fig. 1-4. In others, it is in the form of a "ballast tube" inside the set, as shown in Fig. 1-5.

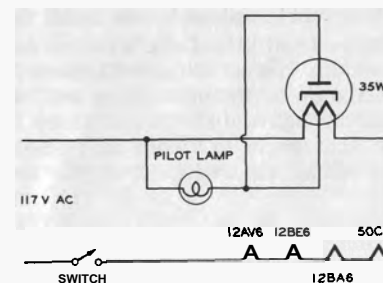

Fig. 1-3. Filament circuit of an AC-DC receiver.

Obviously when one tube in the string or when the series resistor fails, the receiver will be completely dead. Tube failures are **so** common in the circuit of Fig. 1-3 that checking the tubes of a dead set using it is the first test to make. Provision for reaching the tubes by removal of a cardboard back that often **carries** the loop antenna is made **in** these little sets. Actually, it is usually better to slip the chassis out of the cabinet to get at the tubes. Then they can be removed easily and safely without danger of their slipping from cramped fingers or without likelihood of breaking off the leads of the dangling loop antenna. On top of that, this deprives you of an excuse for not cleaning the dial glass in the cabinet, a small service that rates very high with your lady customers!

The quickest way to check a tube filament is to measure the continuity from one filament prong to the other with the VOM set to its lowest-resistance range. Good filaments will **show** resistances between ten and a hundred ohms; a burned-out tube, of course, will show infinite resistance. It is a good practice to check the **output-tube filament first then the rectifier filament, and finally the remain-**ing tubes in whatever order you please. Output tubes and rectifiers fail more often than do tubes having lower-voltage filaments.

No Reception

If the rectifier is out, check the pilot lamp that is usually connected across a portion of the rectifier filament shown in Fig. 1-3. Since the plate current of the rectifier flows through this part of the

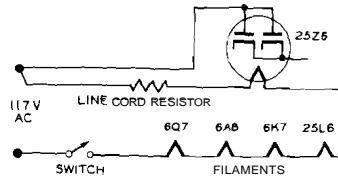

Fig. 1-4. This receiver employs a series resistor built into the line cord.

filament, it is the part that usually burns out; then, all of the current tries to go through the pilot lamp and burns it out. Before turning on the set, replace a burned-out pilot lamp with the new rectifier in the socket. Not only does this protect the new filament from overloading, but exceptional brilliancy of the pilot lamp will warn of excessive current being drawn through the rectifier. Many a time the writer has watched a pilot light begin to bloom alarmingly as the rectifier cathode warmed up, and he has switched off the set in time to save the new rectifier.

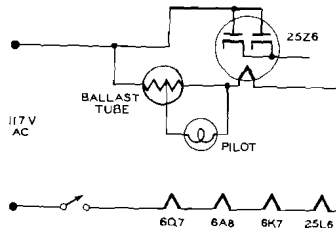

Fig. 1-5. The series resistor in this circuit is in the form of a ballast tube.

If the tube filaments check all right, then it will be necessary to check the plug, line cord, switch, and socket-to-socket filament wiring with the ohmmeter as was done with the transformer set. Line-cord and switch failures are fairly common; wiring failures are very rare, except in the case of new sets where a solder connection may have been overlooked in production and inspection.

Receivers that use line-cord resistors are very susceptible to resistor failure due to kinking and twisting. Quite often the break occurs right at the plug where it can be detected with nothing more complicated than a sharp eye. In that case, an extra inch or so of resistor may be unraveled from its asbestos core and connected to the proper plug prong. These resistor cords cannot be shortened any

The Dead Set

substantial amount without increasing the current through the tubes beyond their rating; so if a break in the resistor is not right next to the plug, the whole cord must be replaced. In checking dead receivers that use line-cord resistors, first examine the plug to see if both conductors and the resistor make good connections with the prongs. Then check the tube filaments. If no open ones are found, remove the chassis from the cabinet and use your ohmmeter to check the continuity of the whole length of the line-cord resistor and also of the line-cord conductors. If all is in order so far, test the switch and finally the socket-to-socket wiring. Somewhere along this methodical course, very likely in the early stages, you will find the open circuit that is keeping the tubes from lighting.

Sets that use a ballast resistor shown in Fig. 1-5 should be checked in the same manner as the sets illustrated in Fig. 1-3, except that if all the tube filaments are found to be good the ballast tube should be the next item checked. Some tube testers have provision for testing ballast tubes; but if yours does not, you can use your ohmmeter to check this tube—that's-not-a-tube. All you need is a diagram of the base connections. This diagram will show how the resistors are connected and the resistance values to be expected. This you can get from your service manuals. Be sure to check for over-all resistance and also for proper resistance between all taps. If the ballast tube proves to be all right, proceed to test the other elements of the filament circuit described for the other series-filament sets. In replacing either ballast tubes or resistor cords, it is imperative to substitute only the items specified in the service data.

THE THREE-WAY PORTABLE RECEIVER

The filament circuit of a three-way portable receiver is more complicated and subject to more variations than are found in the other two basic types. Consider a typical circuit of Fig. 1-6. You will notice that the miniature-tube filaments are connected in series. On battery, they are fed from a nine-volt battery source. On AC, the line voltage is rectified by a 117Z3, this output is filtered, and then a portion of it is fed through a dropping resistor to the series filament string. Sometimes a 35Z5 is used instead of the 117Z3, and then a resistor line cord is employed to drop the line voltage for the 35Z5 filament, as sketched in Fig. 1-7. Much more common is the practice of using a selenium or silicon rectifier to provide both filament current and B-plus voltage, as shown in Fig. 1-8.

If the miniature tubes do not light on AC (and you have to examine them in a dim light to tell if they are lighting), there are a multitude of possible causes: AC plug, line cord, line-cord resistor, change-over switch, On-Off switch, rectifier, shorted filter capacitors, open filament-dropping resistor, open circuit in the filament wiring, or a burned-out tube. The array looks rather frightening, doesn't it? Fortunately, there are several helpful short cuts in pin-pointing the trouble.

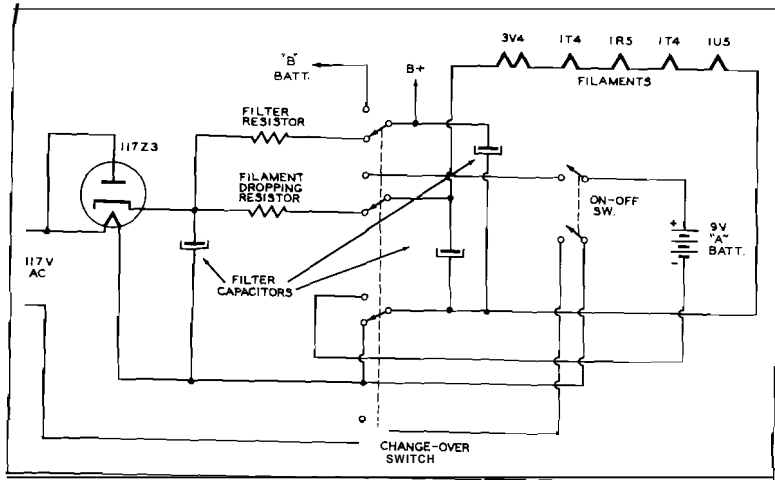

Fig. 1-6. Typical filament circuit of a three-way portable.

The first move to make in any case is to see if the filaments will light on battery when a good battery is used. If they do but fail to light on AC, you know that the trouble lies outside of the miniature-tube filament circuit proper. If they fail to light on battery, then you can concentrate on the loop represented by the A battery, the change-over switch, the On-Off switch, and the tube filaments.

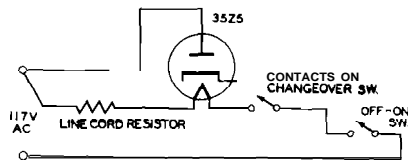

Fig. 1-7. Circuit of a portable receiver using a 35Z5 rectifier tube.

If the tubes do not light on the battery, the most probable cause is an open filament in one of the tubes. Since the tubes are of the instant-heating type, no time is saved by using the ohmmeter. Far more important is the fact that a low-current filament can be burned out by the voltage present across the test prods of many ohmmeters, especially when they are set to the low-ohm scale. By the same token, it is an excellent practice never to use a VOM or VTVM on the lowest range of the ohmmeter scale when probing inside a set using 50-milliampere filament tubes.

If the tubes are all right, use an appropriate DC-voltmeter scale of the VOM to trace the battery voltage from the battery plug through the plug leads, through the On-Off switch, through the battery-AC

changeover switch, and then on through the filament wiring until you find a break. The battery-plug connections and the switch contacts are the most likely places to find trouble.

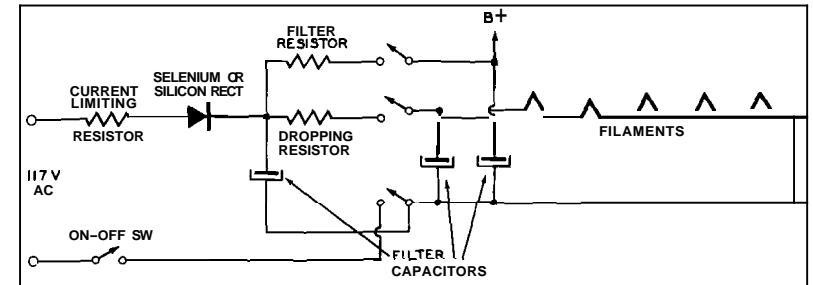

Fig. 1-8. Filament circuit of a portable receiver employing a selenium or silicon rectifier.

If the tubes light on the battery but not on AC and if a rectifier tube is used, see if it is lighting. If not, find out why by employing the methods described for running down dead-filament trouble in AC-DC sets. While you will have only one filament instead of several, you will have two switches instead of one to consider. Tube, plug, line-cord resistor, line cord, On-Off switch, changeover switch, and wiring should be investigated in that order by using the VOM set to a middle-resistance range to check continuity. In the vast majority of instances, the trouble will be located among the first few items.

When the rectifier tube lights but the others do not, check the rectifier for emission in the tube tester. Provided it is good, use the ohmmeter to check the series filament dropping resistor and the current-limiting resistor for proper resistance. If either is off more than ten per cent from the rated value, replace it, being careful to use a resistor of both proper resistance and wattage. The filament dropping resistor has to be husky enough to dissipate considerable wattage. On the other hand, a surge-limiting resistor is deliberately made low in wattage so that it may double in brass as a fuse. If a Short circuit occurs beyond the rectifier, a half-watt resistor is much cheaper to replace than a rectifier; so in replacing such a resistor, remember this is one place where "bigger" is not "better."

If the resistor is all right, make another resistance check between the cathode connection of the rectifier and a B-minus point. Compare the resistance measured with the resistance which the service data says should exist between these two points. If it is considerably lower than it should be, one of the filter capacitors probably has a high DC leakage. Unsolder the positive leads of the capacitors, and measure the resistance from each such lead to the opposite negative connection with the ohmmeter set to a high range. Be sure to observe proper polarity with the test prods. A good capacitor will

No Reception

show a heavy "kick" of the ohmmeter when the test leads are first connected, and then the pointer will gradually settle back to a reading of several thousand ohms or even megohms. Lack of this charging "kick" indicates an open-circuit capacitor. A final reading of only a few dozen ohms signifies a leaky capacitor. Capacitors showing either symptom should be replaced, for leaky capacitors will partially short-circuit the output of the rectifier. An open-circuit input capacitor, the one directly across the rectifier output, will cause the output voltage to be about thirty per cent lower than it should be. A quick check of a suspected open-circuit input filter capacitor can be made by bridging it with a known good capacitor while observing the voltage output of the rectifier. If this brings up the voltage substantially, the capacitor is open.

The bad capacitor usually will be one of two or more units housed in a single can or cardboard container. The best policy is to replace the whole filter-capacitor assembly. In the first place, there is often no room to install an outboard capacitor beneath the crowded chassis of a portable set; secondly, since one unit has yielded up the ghost, the life expectancy of the others which are of the same age is not good. Once more the service manuals should be consulted for a replacement that will fit both mechanically and electrically.

In dealing with a set using a selenium rectifier in which the tubes do not light, the one different item is the rectifier itself. Selenium rectifiers are subject to two kinds of failure: shorting and decreased output. When a rectifier shorts, all you need to detect the condition is a nose — a not-too-sensitive nose at that. A shorted rectifier will overheat, the paint will peel, and it will throw off a strong odor of rotten eggs!

Low-output rectifiers simply do not deliver their proper direct current, but this condition is harder to detect. What is worse, it is very common. If everything else is found to be satisfactory but the voltage present between the cathode of the selenium rectifier and B-minus is ten per cent or more lower than it should be, you have good reason to suspect the rectifier. One way to check on this is to substitute a good rectifier for the one in the set, as illustrated in Fig. 1-9.

Unsolder all leads going to the cathode of the rectifier, but leave them connected to each other. Attach two flexible leads of any convenient length to a good 100-milliampere 130-volt selenium rectifier, and fasten small alligator clips to the ends of the leads. Clip the lead from the cathode of this rectifier to the wires that were removed from the rectifier in the set. Clip the other lead to the terminal of the selenium rectifier that is still soldered into the circuit. Then turn on the receiver (it should be plugged into the isolation transformer), and measure the DC voltage present from the cathode connection of the rectifier to B-minus of the set. If this voltage is up to where it should be, usually between 120 and 130 volts, a selenium-rectifier replacement is indicated.

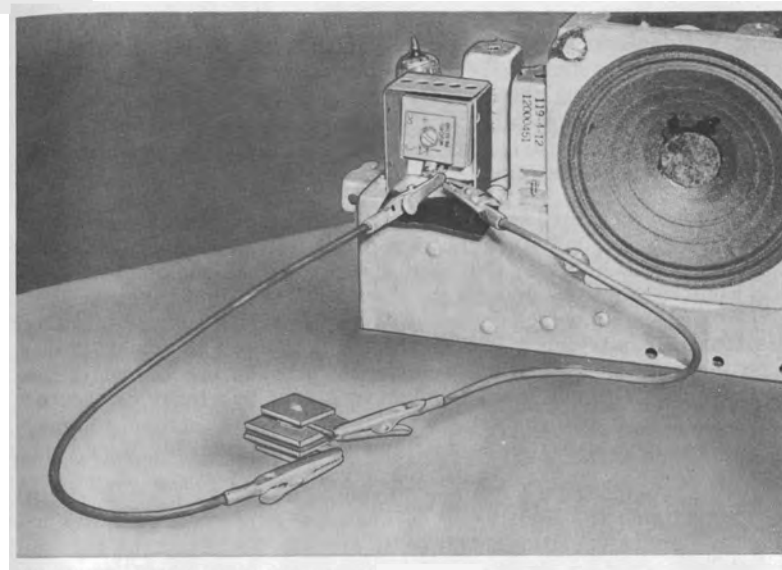

Fig. 1-9. Checking a selenium rectifier by substitution.

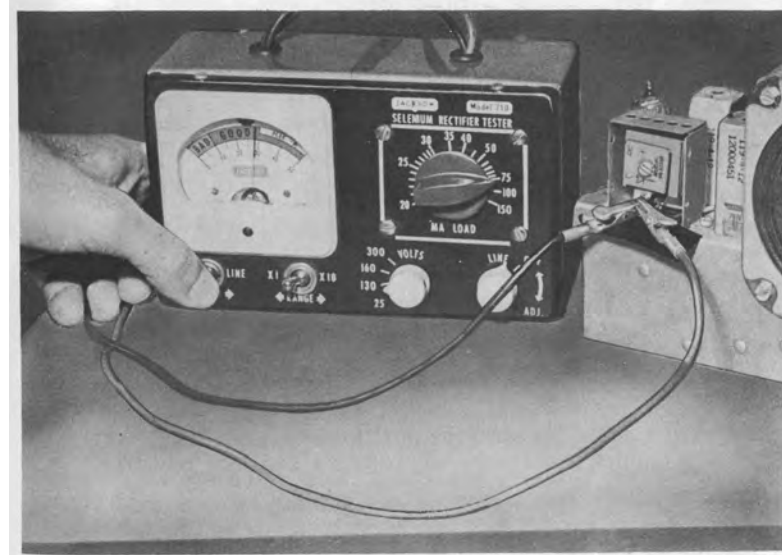

Fig. 1-10. Checking a selenium rectifier using a selenium rectifier tester.

No Reception

The condition of the selenium rectifier can also be checked by using a **selenium-rectifier** tester. Disconnect the leads from one terminal of the selenium rectifier and connect the test leads of the tester. After setting the controls on the tester, a direct reading is obtained which is indicative of the condition of the rectifier. Fig. 1-10 illustrates this particular test. If the unit tests weak or bad, obviously it should be replaced.

Silicon rectifiers usually do not give visual or olfactory evidence when they go bad; but since they are ordinarily held in a clip or detachable pigtail holders, the easiest way to check one of them is to slip a unit known to be good in its place and see if this restores normal voltage and filament current. Always inspect the current-limiting resistor before trying a new rectifier. If it looks as though it has been too hot, check for low resistance between the output of the rectifier and B-minus, such as might be caused by a leaky or shorted filter capacitor, before trying a new rectifier. Otherwise you may have the painful experience of seeing your new rectifier blow, too.

This completes the chapter on sets in which the filaments will not light. Using the techniques outlined and expanding them to embrace any minor variations of the basic circuits discussed, the service technician should be able to impart quickly the fundamental spark of life to any set he may encounter.

QUESTIONS

1. What is the significant symptom of a "dead" set?
2. What instrument is used to check the continuity through fuses, switches, and line cords?
3. Describe the operation and purpose of a "Surgistor."
4. What is the important difference between the way tube filaments are connected in a transformer set and the way they are connected in an AC-DC receiver?
5. **When** a burned-out rectifier is replaced in an AC-DC set, why should a burned-out pilot lamp also be replaced before the set is turned on?
6. Why is it inadvisable to use the ohmmeter to check the filaments of tubes used in three-way portable receivers?
7. How can an ohmmeter be used to make a rough check of the condition of a filter capacitor?
8. Name two possible causes of low voltage being measured at the output of a selenium rectifier in a three-way portable.
9. **What** is a quick and simple way to check a silicon rectifier?

CHAPTER 2

Tubes Light But No Sound

A customer's description of receiver symptoms can rarely be taken literally. He may call a **hum** a whistle, a whistle a howl, and a howl a kind of vibration. Moreover, he may tell you his set is "dead as a doornail," when a glance through the rear of the cabinet will show that all the tubes and dial lamps glow with lively brilliance as soon as the set is turned on.

The morbid description probably arises from the fact that he has used his ear instead of his eye for diagnosis; for no sound, not even normal low hum, can be heard from the speaker though the ear may be pressed against the grille cloth. With such a set, a little reflection will tell you that the trouble must lie in the speaker, the output transformer, the output stage, or the power supply for that stage. In a normal set, the small amount of 60- or 120-cycle ripple present in the DC plate current of the output tube will always produce a perceptible amount of hum in the speaker. In a set with a **well**-filtered power supply, this hum may be low enough to be more felt than heard; but it will be there unless something is wrong with the aforementioned output-circuit components.

THE TRANSFORMER SET

The transformer set is usually housed in a console cabinet. In such cases the speaker and often the output transformer mounted on the speaker in the lower cabinet are easily accessible for testing without removing the chassis. So are the output and rectifier tubes, and they should receive your first attention. Make sure these tubes, located by consulting the tube-position chart in the cabinet or your service literature, are lit.

If they are glass, you can tell by just looking at them; but while you are looking, notice a couple of other things. See if the screen grid of the output tube is glowing with a red or white heat. If it is, the set may have an output transformer with an open primary winding that has removed the voltage from the plate of the tube and is allowing the screen to absorb the entire electron output of the cathode, thus causing it to overheat. Note, too, if the rectifier seems to be filled with a blue or pink glowing gas. Such a gassy rectifier will often **light up** but **will put** out no current at all. If the plates of the rectifier start glowing a **cherry red**, the set should be switched off at **once**, for this indicates a short circuit somewhere in the receiver. A gassy tube should be replaced with a good one. The procedure for locating

No Reception

and correcting a power-supply short circuit is outlined in a later chapter.

In the case of tubes with metal envelopes, these envelopes will become noticeably warm to the touch after the set has been turned on for a minute or so if the filaments are lighting. (Yes, you use every sense you have in radio servicing and could use a couple more!) If the output or rectifier tube does not light, you are in luck; for replacing the dead tube with a good one will probably clear up the trouble. If they do light, next turn your attention to the speaker and output transformer.

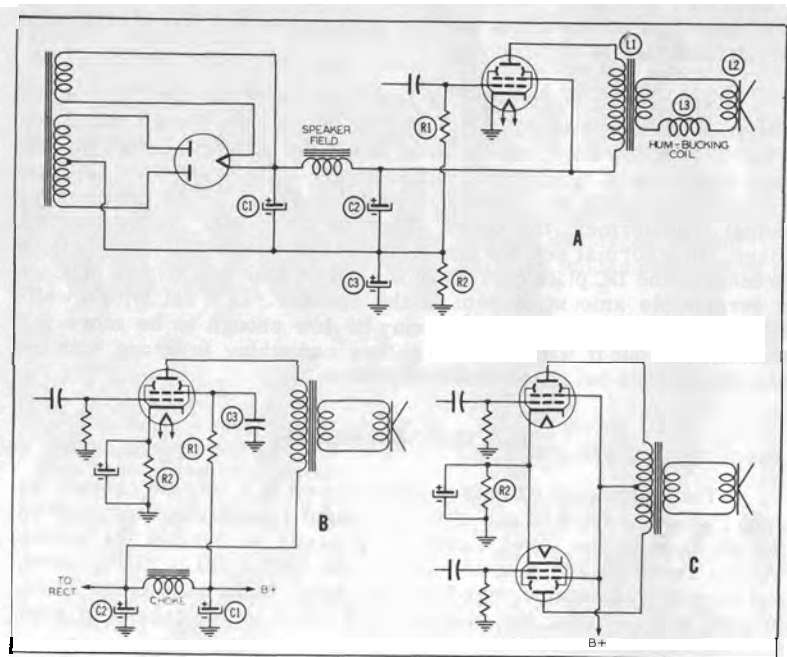

Fig. 2-1. Basic output circuits commonly used.

Fig. 2-1 shows basic output circuits commonly used. At Fig. 2-1A is shown a circuit typical of older sets. Notice that it employs a dynamic speaker with the field coil being used as a filter choke. A hum-bucking coil L3 is connected in series with the secondary of the output transformer L1 and the voice coil L2. The center tap of the high-voltage winding of the power transformer goes through R2 to ground, and the voltage drop across this resistor supplies negative bias for the grid of the output tube.

If the output transformer is mounted on the speaker frame, turn on the set, hold the back of your solder gun as close as possible to

Tubes Light But No Sound

the frame of this transformer (as shown in Fig. 2-21, and pull the trigger of the gun. If this produces a loud hum in the speaker, you can be sure the transformer secondary, the hum-bucking coil, the voice coil, and the connections between these three units are all right. Magnetic coupling between the solder-gun transformer and the output transformer has produced in the secondary of the output transformer a 60-cycle voltage that drives the voice coil.



Fig. 2-2. Using a solder gun to check the output transformer and speaker.

When the output transformer is mounted on the chassis and is therefore less accessible, it is easier to check the speaker with the ohmmeter of the VOM. Turn off the set, remove the leads to the speaker connections, and switch the VOM to a low range of the ohmmeter. Touch the test leads to the voice-coil connections on the speaker frame. If the voice coil and the flexible leads to it are all right, the ohmmeter will indicate somewhere between two and twenty ohms (usually around three to five ohms); and at the instant the connection is made to the leads, you will hear a click from the speaker. In the case of a PM type of speaker, the click will be quite loud; but even a dynamic speaker will retain enough residual magnetism in the pole piece without the field coil being energized to produce an easily noticed click.

If no click is heard and if the ohmmeter shows infinite resistance, you have either an open voice coil or much more likely a

break in one of the flexible leads going from the speaker connections to the voice coil. A quick way to check the latter possibility is to turn on the receiver, set the volume reasonably high, and then move the flexible leads around one at a time with an alignment tool. If, during the movement of one of the leads, the set comes alive, that lead is defective. Then you are faced with the necessity of (1) replacing the lead, (2) replacing the speaker cone, or (3) replacing the whole speaker. Since the second and third items would entail considerable expense and might result in some delay in obtaining the new parts, it is reasonable to begin with the first item.

The flexible lead and the end of the voice coil usually make connection in an eyelet or clamp affixed to the paper cone of the speaker. If you try to unsolder the defective lead from the eyelet and then to solder a new one in place, you are certain to char and burn a large hole in the cone around the eyelet. The thing to do is to cut closely around the eyelet with the corner of a sharp razor blade or knife point, taking care: (1) not to cut off the voice-coil wire cemented to the face of the cone; (2) to soften this cement with a drop or so of acetone; (3) to unsolder the end of the flexible lead fastened to the speaker connection; and then (4) to work the eyelet away from the face of the cone carefully until the defective lead can be unsoldered from it and a new length of the flexible material soldered in place without scorching the paper cone. Then the eyelet can be returned to its original position and fastened in place with a drop of speaker cement, while another drop of cement fastens the disturbed voice-coil wire back to the cone face. When this cement has hardened, the free end of the flexible lead can be soldered to the speaker connection; and the repair is complete.

If moving the flexible leads produces no sound from the speaker, the voice coil itself is probably open. The needle probes can be used with the ohmmeter to check continuity from one eyelet on the cone to the other. Infinite resistance between these points indicates an open voice coil; and unless the break can be found right next to an eyelet, the only thing to do is replace either the cone or the speaker. In the case of speakers of small diameter, new cones are often not available; and in any case, it is often just as economical and more satisfactory to replace the whole speaker. When the speaker is eight inches or larger in diameter, reconing the speaker might be considered. If you are well equipped to do this type of work or if it can be done elsewhere at a reasonable cost, such an operation might be recommended. On the other hand, if considerable delay is involved, the customer might prefer to pay the additional cost of the new speaker to avoid waiting for the reconing job.

When either the ohmmeter check or the test with the solder gun reveals the speaker voice coil to be all right, you can use the ohmmeter and the needle probes to check the resistance of the field coil, if one is present, and to check the resistance of the primary of the

output transformer if the transformer is mounted on the speaker. In both cases, the quickest method is to thrust the sharp probe points through the insulation of the leads where they enter the winding.

Before you actually make this test, the danger to the ohmmeter in such a situation should be discussed. Naturally, you should not use an ohmmeter on a set that is not turned off or unplugged from the line; because the meter is almost certain to be damaged if the test prods are touched to points having different potentials. Possibly you did not realize, though, that a set which is completely disconnected from the line can still bend an ohmmeter pointer or burn out the meter movement.

Consider the circuit of Fig. 2-1A, and suppose the field coil is open. Assume the set has only recently been turned off and unplugged. During the time it was on, filter capacitor C1 will have charged to the peak voltage supplied by the rectifier, often 400 volts or more. After the plug is removed from the wall socket, there is no path by which this charge can escape other than the high-leakage resistance of the capacitor; so, several minutes will normally be required for the potential to disappear. During this time, if the ohmmeter test leads are placed across the terminals of the open-circuited field coil, C1 will discharge directly through the meter; and damage is almost certain to result.

To avoid such a revolting development whenever you are working on a set that had just been on, always check first with a high-range voltmeter across the points where you intend to place your ohmmeter test prods. Never use the ohmmeter as long as any voltage is indicated across these points.

Using these precautions, verify the resistance of the field coil with the proper resistance given in the service manual. Usually it will fall between 400 and 3,000 ohms. If the coil is open, it will be worth while to peel back the paper covering and examine the points where the coil wire is soldered to the heavy leads. Often a break occurs right at these points and can easily be repaired. If the open circuit is down inside the winding, a new field coil is the only practical repair. Some speakers have their pole pieces welded in place so that field-coil replacement is impossible, but many have provision for replacing the coil. An exact duplicate coil should be obtained from the manufacturer of the set or of the speaker and installed. When performing this job, remember that "easy does it," for there is always danger of bending the voice-coil thimble hopelessly out of shape or of injuring the voice coil itself when you are intent on driving out a stubborn pole piece.

The DC resistance of the primary of an output transformer usually will be found to be between 200 and 1,000 ohms, and a complete transformer replacement is the only solution for an open primary.

No Reception

Refer to the service manual for the replacement parts available. If a universal type of output transformer is used, complete instructions for selecting the proper taps to match the particular voice coil to the output tubes are packed with these transformers.

Before you are forced to admit that the chassis must be removed, do not forget to check the plug by which the speaker and output transformer are often connected to the receiver proper. A poor connection in it or improper matching of the male and female portions of the plug can easily cause your trouble. If all is shipshape you may as well give up, take the chassis and speaker out of the cabinet, and put them on your bench.

Once they are connected together and the set turned on, you can use the voltmeter or your VOM to trace the cause of the trouble quickly. You should look for anything that will prevent the plate of the output tube from drawing normal plate current through the primary of the output transformer; so, start by checking the plate voltage. If it is zero but the voltage present at the other end of the primary winding is normal or higher than normal, the trouble is perhaps caused by an open primary and can be verified with the ohmmeter.

When the plate voltage is normal, the next check is that of the screen voltage. As is shown in Fig. 2-1A, the screen voltage is usually supplied from the same point as the primary winding of the output transformer; but this is not always the case. Sometimes the screen is fed through a separate resistor such as that shown in Fig. 2-1B. Loss of screen voltage could be caused by the opening of R1 or the shorting of C3. Again the ohmmeter can be used to determine which.

When no voltage is found at either the plate or screen, the power supply must be suspected. Check the voltage at the filament or cathode of the rectifier which serves as the high-voltage output point. If this voltage is normal or higher than normal, the speaker field, filter choke, or filter resistor — whichever is used to do the job — is probably open. Leave the voltmeter connected to the output of the rectifier, and switch off the set. If the voltage drops to zero very slowly, you can be sure something of this nature is wrong. On the other hand, if the voltage at the rectifier is lower than it should be and if it goes to zero abruptly when the set is switched off, the trouble is probably a shorted capacitor somewhere between the rectifier filament and the point to which the output transformer and screen of the output tube are connected. Checking with the ohmmeter across each capacitor which is in a position to produce such a short will quickly reveal the faulty part.

When plate and screen voltages are both near normal, next check the cathode and control-grid voltages. An exceptionally high bias caused by high voltage at either point will greatly reduce or even

Tubes Light But No Sound

completely cut off the plate current. In Fig. 2-1A, a very high negative voltage on the grid of the output tube would probably be caused by the opening of R2. In Fig. 2-1B, an exceptionally high positive voltage at the cathode would perhaps be caused by the opening of the cathode resistor R2. If either of such voltages should be found, the set should be turned off and the trusty ohmmeter used to find the cause. Then the defective part can be replaced.

Fig. 2-1C shows a push-pull output stage. It is not uncommon to find both sides of the primary open in such a circuit. What actually has happened is that one side of the primary has opened up some time before without the owner's noticing it, although a marked impairment of tone quality may be produced. At the same time a heavy strain is put upon the remaining half of the primary because of lowered bias on the still-active tube which eventually goes out and causes the set to be completely dead. Even the most unobserving customer will usually notice something wrong then!

Do not think that the output circuits shown in Fig. 2-1 exhaust the possibilities of such circuits. That is far from the truth. They are just typical examples used to illustrate likely points of trouble, and they are subject to wide variations. For example, the speaker field or choke may be in the negative high-voltage lead, or bias for the final tube may be obtained in a manner radically different from those shown. In general, though, it will still hold true that the cause of no sound from the speaker will be found somewhere in the speaker, the output transformer, the output tube, or the voltages applied to the output tube.

THE AC-DC SET

The first check to be made in these sets is of the output and rectifier tubes. If they are good, it is usually necessary to remove the chassis from the cabinet in order to reach the speaker; and once that is done, you may as well start directly with the measurement of the voltages at the output-tube socket. In taking the voltage readings, be sure the negative test lead of the voltmeter is on the B-minus point. Ordinarily, the terminals on the rear of the line switch can be assumed to be B-minus and are easily reached. The negative lead or solder connection of the filter capacitor is another B-minus point that is easy to identify. If the voltages read do not check with what you think they should be, consult the diagram of the set in the service manual; for occasionally, in these AC-DC sets, you will encounter a voltage-doubling rectifier circuit in which neither the voltages nor the B-minus point of the circuit will be what you would expect.

If plate voltage is present and there is nothing wrong with the output transformer and speaker, you will notice a click in the speaker when the voltmeter lead is touched to the plate prong of the output

No Reception

tube. If no such click is heard, the trouble is perhaps in the speaker voice coil or its leads, and you should proceed as in the case of similar trouble in a transformer set. If the click is heard, the trouble must lie in an improper screen, cathode, or control-grid voltage. When one of these voltages deviates from that indicated in the service data, study the diagram and try to imagine a part failure that could produce the improper reading. Suspect capacitors first, resistors second, and other parts third. Use your ohmmeter to determine whether or not you have guessed right. If not, continue investigation until the trouble is located by considering the causes in order from the most logical to the least. Since you will be dealing only with the small portion of the circuit immediately connected with the output tube, this should not take long.

Speaker failures are common in these small sets; output-transformer failures are less so. Many times a capacitor will short-circuit and destroy a rectifier; so, if a rectifier tube lights but delivers no output, it is a good idea to check the resistance between the rectifier cathode and B-minus before turning on the receiver with a new tube in the socket. If this resistance is abnormally low, locate the shorted component with the ohmmeter and replace it. Outside of these special considerations, proceed just as you would in dealing with a transformer set.

THE THREE-WAY PORTABLE RECEIVER

It is difficult to be sure whether the tubes are lighting and whether there is sound from the speaker in these sets; because the tube filaments are not easily seen, the normal hum from the speaker when the set is operating on AC is not great, and there is no hum when it is operating on battery. Some sound, though, can usually be heard, even if it is only the crackling of a warming-up filament. If the tubes have been tested and are lighting and if no sound can be heard on either AC or battery, the set will undoubtedly have to be removed from the cabinet for further checking.

Check the speaker with either the solder-gun technique described previously or with the ohmmeter. If you depend upon the click from the speaker when the ohmmeter leads are touched to the voice-coil terminals rather than upon the actual ohmmeter reading, it will not be necessary to unsolder the leads from the output transformer. This leaves the secondary of the transformer in parallel with the voice coil, and you will get a low-resistance reading through the secondary even though the voice coil is open; but you will not hear the click unless the voice coil is operating satisfactorily.

Providing the speaker is all right, you will next have to make voltage checks on the output tube; and in the majority of these miniature sets, this is a ticklish job. The socket connections are hard to reach and usually are concealed by other parts; there is scarcely

Tubes Light But No Sound

room in the crowded chassis to insert even a sharp look, let alone a test lead. Yet you are constantly aware that if the B-plus voltage is shorted to the filament circuit, several tubes can be burned out in a second. These facts account for a certain lack of enthusiasm on the part of service technicians for these "cute" little sets, but they also dictate the necessity for taking certain precautions.

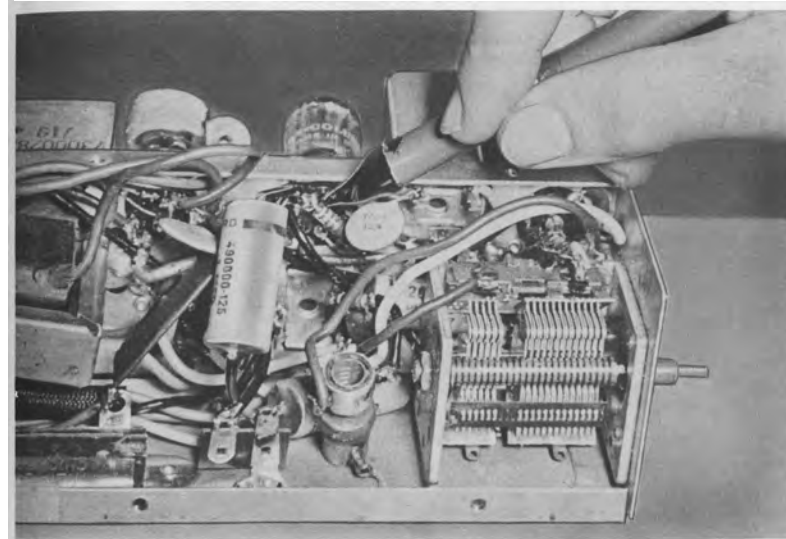

Fig. 2-3. Test probes with the ends taped for use in a crowded chassis.

First, disconnect the batteries and do the checking with the set on AC. Second, employ your smallest probes, and tape the ends of them so that only the very tips are exposed, as illustrated in Fig. 2-3. Third, avoid pushing parts around recklessly to get at the socket connections; and when moving parts, always be on the alert for the danger of shoving two bare wires together. You cannot rely on the chassis being B-minus in these sets, and it is better to use the negative connection of the filter capacitor for this purpose.

When a plate, screen, filament, or control-grid voltage is found to deviate materially from the requirements in the service-data voltage chart, once more study the diagram for possible causes of the difficulty and check with the ohmmeter. Remember not to use the lowest range unless you are sure this will not burn out tube filaments, as was mentioned in Chapter 1. Resistors and capacitors used in these sets are usually of minimum wattage and voltage rating in order to conserve space; so, failure of these components is not unusual. Moreover, these sets are subjected to a great deal of handling and

No Reception

often receive thumps and jars that produce short circuits, broken connections, or similar difficulties in the crowded wiring. Tube prongs that do not make good connections with their sockets are also common, and many of these sets can be brought to life simply by wiggling one of the miniature tubes in its socket. Replacing a defective socket is a major, last-resort task; but often a sharp-pointed scratch awl can be used to manipulate loose and bent prong

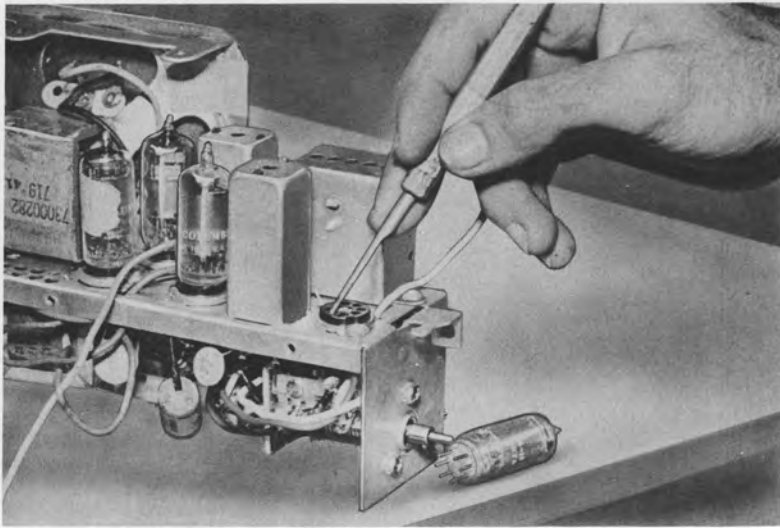

Fig. 2-4. A scratch awl being used to straighten bent prong holders on a miniature tube socket.

holders into proper shape and position for making good contact with the pins. See Fig. 2-4.

If you will follow the procedures outlined, you should have no difficulty in quickly locating the trouble in a set that has light without sound.

QUESTIONS

1. When the tubes light but not the slightest sound is heard from the speaker, where do you expect to find the trouble?
2. What does a red-hot screen of an output tube usually indicate in a dead set?
3. Describe how a solder gun can be used to make a quick check of speaker voice coil, output transformer secondary, and connections between them.

Tubes Light But No Sound

4. How can a receiver not even plugged in still present a threat to an ohmmeter?
5. When replacing a rectifier tube in an AC-DC receiver that lights but delivers no output, what precautions should first be taken?
6. Describe precautions to be used in working on three-way portables to avoid burning out tubes by accidentally short-circuiting wires.
7. How can loose tube socket prong holders often be repaired?

CHAPTER 3

Only Slight Hum Is Heard

A set that emits only a low hum from the speaker does not provide very definite clues to the cause of trouble. The hum shows the voice coil is not open; and if the set uses a PM speaker, it also indicates current is passing through the primary of the output transformer. With a dynamic speaker, normal AC ripple in the field coil current will often produce noticeable hum from the cone, even though the primary of the output transformer is open.

Actually what is not heard from the speaker is more helpful than the lone sound emitted. Lack of station reception establishes that the signal is being lost somewhere ahead of the speaker. Lack of characteristic oscillator hiss indicates that either the oscillator is not working or the trouble lies in the mixer or some stage following the mixer. On the other hand, even with the oscillator not working, we should still be able to hear static and other random noise passing directly through a mixer that is functioning normally; so we are reasonably safe in ruling out the oscillator and in concluding that the trouble must lie in the mixer, IF, detector, audio, or output stages.

That still leaves most of the circuits of the set open to suspicion. In such a case, where the observed symptoms do not localize the probable cause of the trouble sufficiently, we must employ a troubleshooting technique that will supply this specific information.

THE TRANSFORMER SET

Nothing irks the writer quite so much as to spend considerable time and effort removing a chassis that is difficult to remove from a console cabinet only to find that the trouble was a shorted tube or some other minor trouble that could have been corrected without taking out the chassis at all. That is why he firmly believes in making all possible tests to discover the cause of trouble before the chassis is pulled.

Make sure that the set is switched to **RADIO** rather than **PHONO** and that the **bandswitch**, if any, is set to the broadcast band. Turn the volume control wide open. Before leaving the set on for any length of time, notice if the rectifier plates are turning red or if there is an odor of hot metal or charring resistors that would indicate something is overheating. If so, the set will have to be switched off and the serious short circuit located by means of the ohmmeter, as described

later. If nothing of this nature is observed, the set can safely be left on while you proceed with your circuit disturbance testing.

In this type of test, the static operating conditions of a tube circuit are abruptly changed. One way of doing this is to drop the plate current suddenly to zero by pulling the tube from its socket. Another way is to produce a sudden change in grid potential by touching the grid connection with a finger or a screwdriver bit. Such an act will always produce a momentary change in grid potential at the instant of contact. Furthermore, the body absorbs a certain amount of AC 60-cycle current from the atmosphere. When a finger is touched to a grid lead with a high impedance between it and ground, this absorbed AC is sufficient to produce a peak-to-peak grid swing of two or three volts.

The first of the two ways of disturbing the circuit will produce a signal that will be carried through the normally operating stages which follow the point of disturbance on to the loudspeaker where it will emerge as a sharp click. In the second way of disturbing the circuit by touching the grid lead of an audio amplifying stage with the finger, the AC thus introduced to the grid will cause a 60-cycle hum to come from the speaker. Now let us apply this knowledge to an actual set.

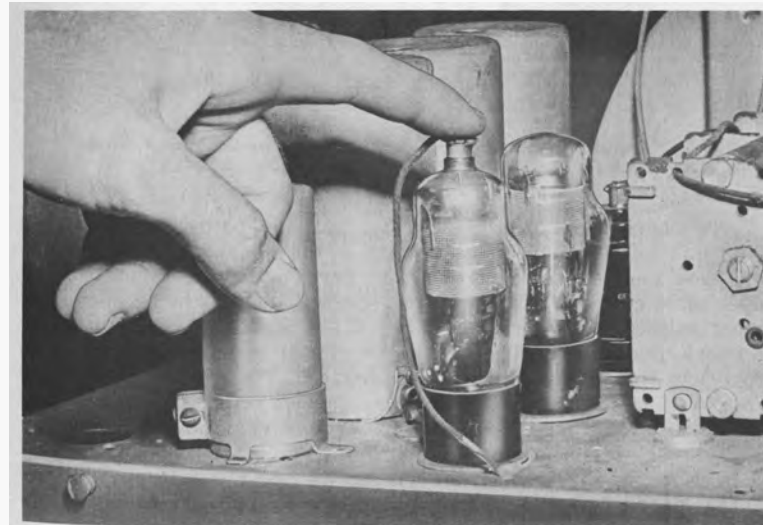

Fig. 3-1. Method of injecting hum.

If the set being checked uses a grid-cap tube as an audio amplifier (such as a 6F5, 75, or 6Q7), touch the grid cap with a finger tip, as shown in Fig. 3-1. If this stage and the one following it are both

No Reception

operating properly, a **loud hum will be** heard from the speaker. When the audio amplifier is a single-ended type, such as a 6SF5, or 6SQ7, pull it from its socket and listen for a click in the speaker. Absence of such a click indicates that either the tube itself is not drawing plate current or else there is something wrong in the output stage following it.

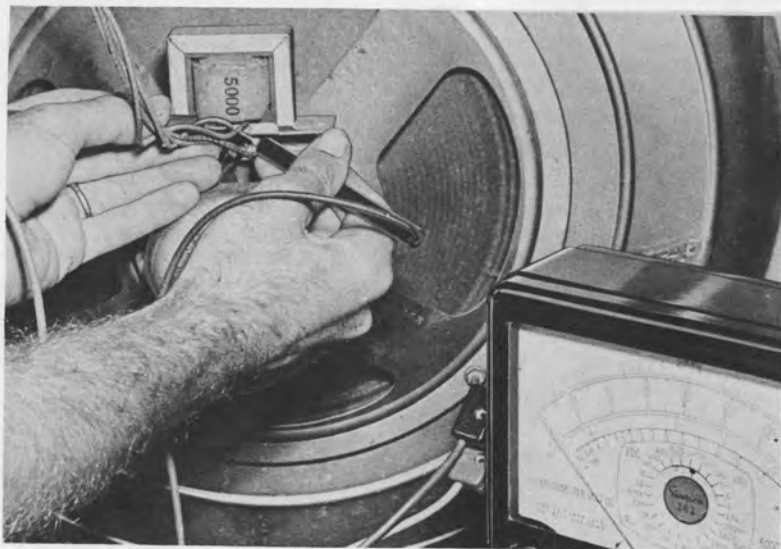

Fig. 3-2. Checking the primary winding of an audio output transformer.

To check the latter possibility, pull the output tube from the socket and see if this causes a click in the speaker. If no click is heard, you can be confident that that particular tube is not drawing proper plate current. The only two causes that could be corrected without pulling the chassis would be: (1) a defective tube — and you can check this with your tube tester — or (2) an open primary of an output transformer mounted on the speaker. The receiver should be turned off and the insulation-piercing probes of the ohmmeter used to check the transformer primary for proper resistance by measuring across the leads going into that primary. An illustration of this test is shown in Fig. 3-2. If the winding is found to be open, only the speaker needs to be removed from the cabinet to install a new transformer.

Suppose, though, that your circuit disturbance check of the audio-amplifier stage reveals everything to be all right at this point. Then you should skip the detector stage, if a separate tube such as

Only Slight Hum Is Heard

a 6H6 is used for a detector, and touch the grid cap of the IF amplifier tube or pull it from its socket. Keep in mind that touching the grid cap of such a tube with a metallic object will produce a click in the speaker if the tube itself and the stages following it are all right. On the other hand, pulling a tube from the socket will produce a click under some circumstances even though the tube has shorted or open elements. Pulling a preceding tube, however, will reveal whether or not the tube that follows it will pass the signal.

If the IF tube successfully passes the circuit disturbance test, apply the same check to the mixer tube. Whenever pulling a tube fails to produce a click in the speaker, check both the tube removed and the one immediately following it, preferably by substituting tubes known to be good. Mixer and IF amplifier tubes are notorious for developing faults that prevent their functioning but which cannot be detected in a casual check with a tube tester.

It is not possible to describe precisely how loud the click should be when making each circuit disturbance test. The best way to learn what to expect is to do a bit of experimenting on normal receivers. Sometimes a faint click will be heard when pulling a tube at the front end of a receiver, even though a detector or audio-amplifier stage is dead. This is due to the fact that removing part of the load from the common filament circuit causes a slight circuit disturbance in the output stage. This click is far weaker than the one heard when the intervening stages are working as they should, and it will never be mistaken for a normal click by a service technician who has done a little tube-pulling homework in a receiver that operates normally.

After a defective stage has been located by the circuit-disturbing method, it would be possible to pin-point the trouble still more closely by making voltage and resistance checks down through the socket holes; but this would benefit nothing, inasmuch as it still would be necessary to remove the chassis to repair the trouble when found. For that reason, as soon as the technician is sure the trouble is not a defective tube, output transformer, or some other item that can be reached and repaired without taking out the chassis, he may as well start pulling knobs and unscrewing chassis bolts.

At the risk of appearing lazy, the writer wishes again to point out ways to avoid unnecessary work at this juncture. The trick is to remove only those items absolutely necessary. For example, a receiver will not play normally on the bench unless its matching antenna is removed from the cabinet and used with it; but it is not necessary to remove the antenna when working on a receiver that is as dead as this one. Once the trouble is removed, strong local stations can be picked up after a fashion even without an antenna; and they are all we need to receive to tell us the trouble is cleared.

If the speaker is a PM type with the output transformer mounted on the chassis, any size of PM speaker can be used as a substitute

No Reception

while the chassis is on the bench. Of course, if a dynamic speaker is employed, it must be connected to the chassis when the set is turned on.

Many times, as is shown in Fig. 3-3, it will be found that without having to disconnect the speaker leads or even the leads to the loop antenna the chassis can be slid out and turned with the bottom side up on a low stool or bench placed directly behind the cabinet. Necessary trouble shooting with the VOM or VTVM can be performed

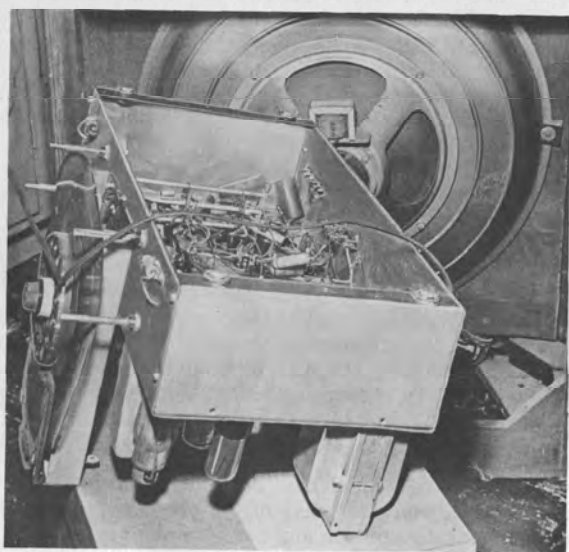

Fig. 3-3. Chassis removed from cabinet without disconnecting antenna and speaker leads.

and repairs made with the chassis in this position almost as easily as if it were on the bench. Time saved in not having to remove and replace the speaker and loop antenna; to disconnect wires running to phono pickup, motor, and remote pilot lamps; or to restaple wires that have been torn loose from their proper position in the cabinet can be applied to repairing another set. You must never forget that to a service technician time is money.

With a speaker connected and the volume turned to maximum, the first move is to check the plate voltage of the tube that failed to respond to your circuit disturbance testing as you progressed from the speaker toward the front of the set, circuitwise. If plate voltage is present but you fail to hear a click as you connect the voltmeter, the trouble lies in the following stage; and you should transfer your

Only Slight Hum Is Heard

attention to it. If voltage is present at the plate and a click is heard, then the trouble must lie within the stage itself; and you should proceed with further tests of screen, cathode, and grid potentials. When no voltage is present, there will be no click; then you may know that you have hit upon the trouble right away. All that remains to be done is to find out why no plate voltage is present.

The circuit diagram of the particular set being tested should be constantly before you as you make voltage checks; but for the purpose of our discussion, let us assume that the typical voltage-distribution circuit of a transformer set shown in Fig. 3-4 applies in the case at hand. Suppose, too, that you heard no click when an output tube was

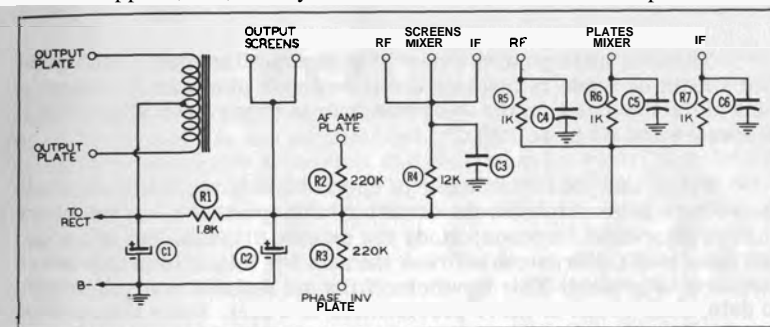

Fig. 3-4. Typical voltage distribution circuit commonly used in a transformer set.

'pulled from its socket and that no plate voltage could be measured at the socket connection. Lack of plate voltage could result either from an open primary winding on the output transformer or from a shorted input capacitor C1. The quickest way to discover which is the case is to check the voltage present at the output of the rectifier. If normal or higher voltage is found at this output, the transformer winding must be open. The set can be switched off and the ohmmeter used between the rectifier output and the plate of the output tube to double-check this. In this particular case, you have a push-pull output stage, and further resistance checks should be made to determine if both halves of the primary are open. As mentioned before, this can happen.

If no voltage is present at the output of the rectifier, turn off the set at once and check with the ohmmeter from the Output of the rectifier to ground. If a low resistance of only a few ohms is read, C1 is probably shorted. Cut it loose from the circuit and check it with the ohmmeter before replacing it. If C1 were actually shorted, you doubtless would have noticed before this that the rectifier and power transformer were becoming excessively hot; for a short circuit in this capacitor would throw a heavy load on both these parts.

No Reception

A screen-grid tube draws little or no plate current without screen voltage; so if you find the plate voltage normal, you should next check the screen voltage of the output tube. Lack of voltage at this point could be due to an open circuit in resistor R1 or to a short circuit in output filter capacitor C2. Again switch off the set and check the resistance from the screen of the output tube to ground. If it is very low, cut C2 loose and see if the screen voltage does not rise to normal when the set is turned back on. If it does, replace C2. You should note that a short circuit in C2 would cause excessive current to pass through R1; so this resistor should be examined for evidence of overheating and should be checked with the ohmmeter for proper resistance value. If there is any indication whatever of damage, replace R1.

There is little point in describing in repetitive detail each move that should be made in tracking down the cause of a lack of voltage at each different point in the receiver, but in every case this general procedure should be followed:

First, use your voltmeter to check back from the point where the voltage is dead toward the rectifier until you reach a place where voltage is present. Second, study the circuit diagram and ask yourself what part failures could break the path for this voltage or short-circuit it to ground. Third, switch off the set and use your ohmmeter to determine which of these possibilities is a fact. Since this method of trouble shooting is used so extensively in service work, perhaps one more example of its use would not be amiss.

Suppose pulling the IF amplifier tube from the socket produced no click. Use of the VOM shows that no plate voltage is present. Voltage is found though at the junction of R1 and C2, although none can be discovered at the junction of C6 and R7. Looking at the circuit diagram, we note that plate voltage is fed from the junction of R1 and C2 through R7 and thence through the primary of an IF transformer to the plate connection of the tube socket. Plate voltage could be lost if the IF transformer primary were open, if R7 were open, or if C6 were shorted. We reason that if the transformer primary were defective, we should still have voltage showing at the junction of C6 and R7; so we conclude one of these must be defective. An ohmmeter reading from their junction to ground shows practically zero resistance. C6 is cut loose and measured with the ohmmeter, and it indicates dead short. Looking at the circuit, we notice that the shorting of C6 would cause a heavy current to pass through R7; so we examine it and find what a more experienced technician would have spotted long before: that it is burned and charred to a gray ash color and is broken in the middle. Both R7 and C6 are replaced with new units, and the radio comes to life.

If all voltages are found to be correct in a stage but no signal can be passed from it to a following stage, then the unit coupling the

Only Slight Hum Is Heard

stages together must be suspected. IF transformers perform this chore between mixer and IF stage and between IF stage and detector. In the audio section, the signal is usually transferred from the plate circuit of one tube to the grid circuit of the next either by a coupling capacitor or by an audio transformer. IF transformer trimmers have been known to short-circuit a transformer winding and so prevent signal transfer without noticeably changing plate or grid potentials. Checking the DC resistance of the winding, as measured with an ohmmeter, against the proper resistance given in service data will show up such a condition. Bridging a capacitor that is suspected of being open with a good unit will restore the set to operation if this is the cause of the trouble. Audio-transformer windings can be checked for proper resistance with the ohmmeter of the VOM.

These last possibilities are rarely found in a set that is completely dead except for hum. Even when a coupling capacitor is open, some signal will leak through from a strong station. In a lifetime of servicing, the writer has not encountered more than a half-dozen cases of faulty IF-transformer trimmers that shorted out a signal completely. The examples are given simply to remind the reader that he must always be alert to the possibility that an unusual circumstance can be causing the trouble. Actually the chances are at least a hundred to one that the cause of the trouble will be found in a defective tube, shorted capacitor, open resistor, or some combination of these part failures.

THE AC-DC SET

These little sets are usually so easy to remove from their housings that little time is saved by making any tests even on tubes with the chassis still in the cramped quarters of the cabinet. Put the chassis upside down in front of you with the set turned on and the volume wide open. First, check the voltage at the plate of the output tube. If none is present, move the positive probe of the VOM to the screen connection of the tube socket. If voltage is found, examine the circuit to see if there is not a capacitor, like C1 in the diagram of Fig. 3-5, connected between the plate of the output tube and B-minus or the cathode of the tube. Usually one will be found, and the

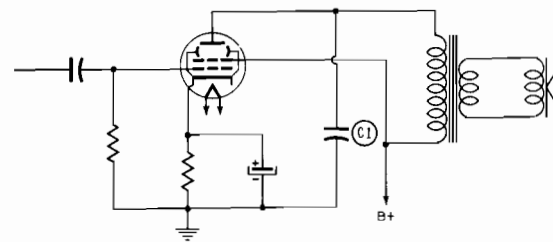

Fig. 3-5. Typical output circuit of AC-DC receiver.

No Reception

chances are excellent it will be shorted. Such a capacitor is subjected not only to the DC plate voltage but also to the superimposed audio peak voltages developed across the output-transformer primary. If a check with the ohmmeter shows that it is shorted, replace it with a new unit of not less than a 600-volt rating or better still one with a 1,000-volt rating.

Sometimes this capacitor is connected from plate to screen of the output tube in order to keep the DC plate voltage from appearing across it. If it shorts out in this position, it does not upset the voltages on the tube; but it does short-circuit the primary of the transformer and prevent any signal voltage from reaching the speaker.

If the output-tube voltages are all right, next check the plate voltage of the audio amplifier feeding it, noticing if a click is heard when the voltmeter is connected. If everything is OK here, move on to the IF tube and then to the mixer, comparing the plate voltages with what the service data indicates they should be and always listening for the clicks that tell you the signal produced by touching the plate lead with the voltmeter probe is feeding through to the speaker. If the telltale clicks disappear at one point, substitute a new tube for that following the one whose plate-voltage measurement produces no sound. Tubes 12SA7, 12SK7, 12SQ7, 12BA6, 12BE6, and 12AT6 often develop internal failures that cause them to be completely dead except for a lighting filament.

When you find a dead stage and are sure that the tube is all right, start checking all the tube potentials. If voltage is lacking at a particular point, employ exactly the same methods as were used with the transformer set to discover where the voltage is lost. Because of the comparatively simple voltage-distribution networks ordinarily employed in these sets, this is easily and quickly done.

The main troubles found in AC-DC sets that only produce a slight hum will be shorted tubes, shorted capacitors, and open resistors — in that order. Occasionally, an open primary in either an IF or output transformer will be found. Still more rarely an open filter choke or speaker field coil serving as a filter choke will open up and prevent current from reaching the various tube elements. These faults can be discovered in exactly the same manner used in locating an open resistor.

THE THREE-WAY PORTABLE RECEIVER

The first thing to do with these sets is what you did with them in the previous chapter; i.e., see if they sound equally dead on AC and battery. If they do, you are safe in assuming the trouble is not in the power supplies.

It is not a good idea to pull tubes from their sockets in this type of set with the receiver turned on; however, it will not hurt to

Only Slight Hum Is Heard

wiggle each tube gently in its socket to make sure a poor connection between a tube pin and the socket is not the cause of the trouble. If this does no good, you may as well run all the tubes through the tube tester. Be sure and test them for both emission and shorts. Replace any doubtful ones. If the set is still dead after this is done, the only thing left is to perform a methodical measurement of tube potentials, starting with the output-tube socket and progressing toward the front of the receiver.

Ordinarily, it is better to disconnect the batteries and operate the receiver on AC while making these voltage checks. This reduces the danger of accidentally burning out the tubes. In addition, observe all the precautions mentioned in the previous chapter. These tubes are fragile and expensive, and one slip of a test prod can take out the whole string.

Clicks heard when plate leads are contacted with the voltmeter are not so loud in these little sets, but they are just as meaningful. Remember the majority of the sets use pentode audio amplifiers; so you must check the screen voltage as well as the plate voltage on this stage. Both screen and plate voltages are ordinarily fed through quarter-watt resistors that often fail. It is essential to check individual filament voltages, too. In most circuits there are capacitors connected from points on the filament string to ground, and a partial short circuit of one of these can rob one or more tubes of proper filament voltage. Since you are accustomed to taking filament voltages in transformer and AC-DC sets pretty well for granted, this is easily overlooked.

Once you find something amiss in your voltage measuring, the cause is run down with the same circuit-studying and logical-thinking techniques used with other receivers. Bypass capacitors are of the low-voltage type to conserve space, and they become leaky or shorted with little provocation. Compact wiring plus rough handling often produce wire-to-wire short circuits that would be unusual in other types of receivers. Because of the low signal level passing through these small sets, a defect that would still allow some signal to pass in a more powerful set will render the little set dead; so do not overlook the possibility that an open coupling capacitor could be the trouble.

QUESTIONS

1. Describe two ways of using "circuit disturbance" testing.
2. When pulling a particular tube does not produce a click in the speaker, what two possibilities does this indicate?
3. What is the best way to learn how loud a click should be expected when pulling a tube from a normally-operating set?

No Reception

4. Explain why it is not always necessary to remove built-in antennas and speakers when working on a chassis on the bench.
5. What device normally transfers the signal from the mixer to an IF stage? What is the effect of an open winding or a shorted trimmer in this device?
6. Why should at least a 600-volt capacitor be used to replace the capacitor going from the plate of the output tube to ground?
7. After you locate a dead stage by circuit-disturbing testing, what is the next step?
8. Is the plate voltage of the audio amplifier of a three-way portable the only important voltage to be measured? Why?

CHAPTER 4

Only Noise Can Be Heard

This set is the most alive-sounding we have met so far. While no station can be picked up at any setting of the tuning dial, a normal amount of noise (such as usually appears between stations) can be heard. Static crashes and the noise from an electric drill come through clearly; turning on and off a bench lamp will produce a sharp click in the speaker; so will touching the external antenna terminal or lead with a screwdriver.

What unusual condition, we ask ourselves, permits noise to ride straight on through the mixer and IF channel while the signal from a station cannot pass? The chief difference between noise and a station signal is that the first usually blankets a broad band of frequencies while the latter is confined to a single narrow channel. We know that IF stages will only pass a signal having the frequency to which they are tuned, usually approximately 456 kilocycles.

In the case of noise, some of it is bound to be present at this IF frequency; and so it rides straight on through the mixer and the IF amplifiers. Signals from stations operating in the broadcast band of 540 to 1600 kilocycles cannot pass through the IF channel, however, until they have first been converted to the IF frequency by being mixed with a signal from the local oscillator in the set.

The set symptoms, plus these facts, point straight at the oscillator as being at fault; and, English jurisprudence to the contrary, it should be considered guilty until it can be proved innocent.

THE TRANSFORMER SET

The first move to make is to locate the tube that performs the oscillator function. Consult your service data to be certain which tube this is. In most sets it will be a pentagrid converter, such as a 6A8, 6SA7, or 6BE6; but this is not always the case. Often a straight mixer, such as a 6L7, or even a pentagrid converter employed as a mixer will be used with a separate oscillator tube. When you are certain as to which tube acts as an oscillator, remove it and substitute another you know to be good. If a separate mixer is used, do the same with it, on the chance that the tube element into which the oscillator voltage is injected may be shorted or open. Do not bother to test in a tube checker the tubes you remove. Oscillator and converter tubes are a tricky lot for showing up good in a tube tester but failing to work in a set.

No Reception

If substituting good tubes does not bring the set to life, you may as well remove the chassis to the bench for further testing. Since the receiver must be in operating condition while you are making your tests, it will probably be necessary to remove the speaker, too, if it is of the dynamic type; otherwise a bench PM speaker can be used.

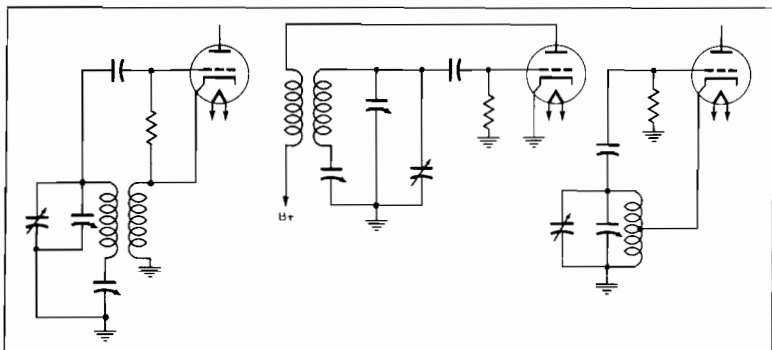

Fig. 4-1. Various types of oscillator circuits.

Various types of oscillator circuits found in broadcast receivers are diagrammed in Fig. 4-1. Remember, that while these are shown as separate triode oscillator tubes, the same basic circuits apply to the oscillator section of a converter tube. In either case, the grid portion of the circuit in which we are interested will be the same. While other portions of the circuits vary considerably, all have this in common: the RF is conducted to the grid by a blocking capacitor. A resistor forms a DC return path to ground, cathode, or B-minus. In every case, the process of oscillation produces a negative voltage on the grid; and with other factors remaining the same, the amount of voltage developed indicates the relative strength of oscillation.

This provides us with a sure test for determining if the oscillator is working. Warm up the VTVM for the chore. Set it for a range of from fifteen to thirty volts; switch it so the DC probe reads negative volts; attach the ground lead to the chassis. With the set turned on, touch the probe of the VTVM to the socket connection going to the grid of the oscillator tube or of the oscillator section of the converter. If oscillation is occurring, you will get a reading on the grid of from five to fifteen volts negative. Varying the tuning dial will cause some change in the reading, a lower value usually being indicated at the low-frequency end of the dial. Touching the grid connection with the finger will usually load the oscillator so heavily that it will cease oscillating, and then the grid voltage will fall to zero. Touching the grid lug with the ordinary test lead of a VOM would do the same thing. That is why it is necessary to use the VTVM that contains an isolating resistor, usually about one megohm, in the probe tip.

Only Noise Can Be Heard

This is a good time to note that when the oscillator is killed by touching a hot portion of the grid circuit with a finger tip, a soft "plop" will be heard in the speaker. That supplies a "quick-and-dirty" method of checking for oscillator functioning without removing the chassis. Simply touch the finger to the stator of the oscillator section of the tuning capacitor, and note whether or not this distinctive "plop" is heard. Be warned, though, that usually some sound will be heard even if the oscillator is not working; so until such time as you have learned to recognize this brief swan song of a dying oscillator, you had better stick to measuring oscillator grid voltage.

If the oscillator is not working, the first thing to do is to check the various voltages present at the tube socket and compare them with the voltages shown in the service manual. There is one word of caution here: an oscillator tube draws less plate current when it is oscillating than it does when dead; so if the oscillator plate or the particular grid used as an oscillator plate shows less voltage than the service data indicates, take this into consideration. If the plate is fed through a series dropping resistor, it would be in no way unusual to find the voltage down twenty or thirty per cent while the oscillator is dead.

Either lack of voltage or exceptionally low voltage will provide a clue that must be investigated. Exactly the same method should be used as described in the previous chapter for locating the cause of insufficient or missing voltage. First study the diagram to see how voltage is fed from the output of the rectifier to the particular socket terminal showing an improper voltage. Then, with the set turned on, use the voltmeter of the VOM to make voltage-to-ground measurements at various points along this path, moving progressively step by step from the tube socket toward the output of the rectifier. When a point of near-normal voltage is reached, switch off the set and use the ohmmeter of the VOM to go back along the voltage path toward the tube socket, measuring resistance to ground at each convenient point.

Abnormally low readings point toward a short circuit, and the lower the reading the nearer you are to the shorted circuit element. Capacitors are far and away the most common cause of this kind of trouble. Paper capacitors are very obliging and ordinarily develop almost complete short circuits of only an ohm or so, making them easy to locate. Electrolytic capacitors, on the other hand, seldom achieve dead shorts but usually will read a few dozen ohms. When they want to be still more difficult and mislead the service technician, they will display readings of several hundred or even several thousand ohms when no voltage is applied to them; but when the set voltage is on, their resistance will fall to a much lower value. Since the ohmmeter cannot be used with the set voltage on, this makes such capacitors very hard to spot. Mica capacitors do not fail as often as

No Reception

either paper or electrolytic capacitors, but they can develop DC resistances of any value from zero to several hundred thousand ohms.

If the resistance-to-ground readings obtained between the normal voltage point and the tube-socket terminal are in agreement with the values quoted in the service data or are even higher, the trouble is probably an open circuit somewhere between these two points. The ohmmeter is then used to measure the resistance of various elements connecting the points, such as resistors, coils, and transformer windings. By using the circuit diagram, the voltmeter, the ohmmeter, and your intelligence — not necessarily in that order, however — you cannot fail to discover quickly any short circuit or open circuit that is causing the missing or low voltage.

Sometimes every potential on the oscillator or converter tube will be very close to specified values; yet the oscillator will be as dead as a burnt match. In such an event, check the capacitor — it is usually mica — that connects the grid to the oscillator coil. Unsolder one end of this capacitor and check it with the highest range of your ohmmeter. It should show infinite resistance. If it shows less than this, replace it with a new capacitor. Even if it does show infinite resistance, "tack" another capacitor of the same value in its place. (By "tack" I mean solder the ends of the uncut leads of the capacitor in place, using only drops of solder to hold them.) If this restores the oscillator to life, the original capacitor was open. Discard the old capacitor and install the new one permanently by cutting the leads to proper length and making them mechanically secure before soldering.

If the grid-coupling capacitor is all right (as would be indicated by its replacement making no difference in the operation), the next part to suspect is the grid resistor, not because it often gives trouble but because it is easier to check than some remaining oscillator parts. If the value of this resistor, as indicated by your ohmmeter, varies more than ten per cent from its rated resistance, replace it.

If this fails to help, all that is left to check is the oscillator coil circuits. Study the diagram to determine the minimum number of leads that must be disconnected, so that you can check the resistance of each winding and of each portion of tapped windings without your readings being falsified by other circuit elements that are connected in parallel with the coils. Then unsolder those leads, and check each winding and partial winding with the lowest resistance range of your ohmmeter.

In addition to the actual resistance value indicated, notice if there is any tendency of the ohmmeter needle to waver back and forth. Be sure, of course, that your test probes are making good contact with the coil terminals. Such a refusal of the ohmmeter pointer to

Only Noise Can Be Heard

stand still indicates the winding itself or its connections to the terminals contain a variable resistance. If a winding resistance reads ten per cent or more higher than it should, or if this restless-pointer condition is evident, try heating the terminals with the soldering iron until the solder flows freely. After the solder has cooled, check the resistance again. If it is normal, the trouble was a poor winding-to-terminal connection; and your trouble is probably over. If not, you will have to replace the coil.

While you have the leads disconnected, be sure to check the oscillator tuning capacitor; the parallel trimmer; and the series padder, if one is used, for possible short circuits. All should show resistance values well up in the megohms. Sometimes a sheet of mica dielectric in the compression type of trimmer will become broken or misaligned and allow the plates to short together. In the same way the plates of the tuning capacitor may become bent so that they rub against one another. If this is the case, the plates can be carefully straightened so that this does not happen. Defective trimmers are best replaced. When the trimmer is an integral part of the tuning capacitor, often a new mica sheet can be fashioned from blank stock with a razor blade.

If the windings of the coil check close to their rated resistances and if separate grid and plate windings are used, be sure to employ a high resistance range of the ohmmeter to test for the possibility of a partial short circuit between windings. If any appreciable reading at all is obtained, the coil should be replaced. In fact, even if you cannot find anything wrong with the coil in your resistance measurements, and if you have checked all the other possibilities mentioned before, your final move is to replace the oscillator coil. Sometimes a short circuit will develop inside a winding that will short out only a few turns of the winding. This may not be enough to make a measurable difference in the DC resistance, but it will alter the Q of the coil to the point where it will not sustain oscillation.

For the past several paragraphs, we have assumed that you discovered the oscillator to be dead. Now, suppose you found it was working. Suppose, too, the set employed separate oscillator and mixer tubes. About the only logical conclusion would be that something was preventing the oscillator voltage from being injected into the mixer.

Fig 4-2 shows diagrams of three different methods by which this injection is accomplished. In Fig. 4-2A, the oscillator voltage is taken from a tap on the grid winding and is injected into the cathode of the mixer through a coupling capacitor. To prevent this RF voltage from being grounded, an RF choke is used in the cathode lead to ground. Obviously, a failure of the coupling capacitor could

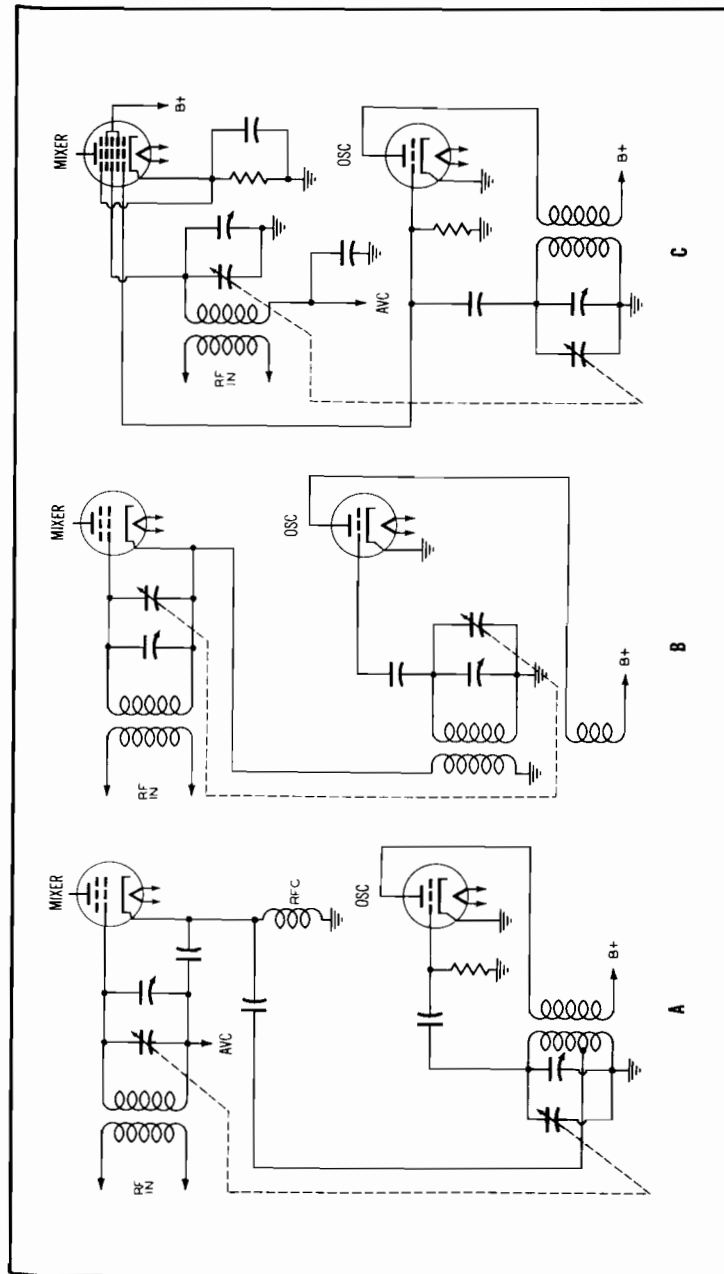

Fig. 4-2. Various methods of injecting the oscillator voltage into the mixer.

prevent the oscillator voltage from reaching the mixer. Likewise, shorting of the RF choke could ground this voltage and prevent mixing. In Fig. 4-2B, a coil in the cathode lead of the mixer is inductively coupled to the oscillator coils. Failure of this cathode coil could keep the oscillator voltage from the mixer. In Fig. 4-2C, a lead goes directly from the grid of the oscillator tube to an injection grid of the 6L7. In this case, only a failure of the grid lead of the 6L7 itself could prevent the oscillator voltage from mixing with the RF input of the mixer. In each case, the thing to do is to study the diagram and try to imagine part failures that could cause the trouble. Then check these parts with your instruments or by substitution of parts. When a doubtful one is located, replace it.

This may sound too simple and logical, but remember that good servicing is simple and logical.

THE AC-DC SET

An AC-DC set that receives only noise points at oscillator trouble just as it did with the transformer type of receiver and the same general reasons for oscillator failure hold good. However, because of the simple circuitry used in these sets, there are some time-saving short cuts to be used in isolating the difficulty.

Swing the tuning capacitor through its full arc. If no sudden crackling sound is heard at any point, you can be sure the plates of the oscillator tuning capacitor are not shorting together. Try touching the stator of the oscillator tuning capacitor with your finger and listen for a "plop" sound. If none is heard, you can be fairly certain the oscillator is not working. Replace the converter tube with a new one. You will seldom find separate mixer and oscillator tubes used in these sets. If this does not help, pull the chassis from the cabinet.

Unscrew the trimmer of the oscillator section as far as it will go, noting how many revolutions of the screwdriver were made in doing this. If the oscillator does not start, you can be sure the trimmer is not shorting out, especially if the top leaf of the trimmer raises well away from the bottom leaf. Turn the trimmer screw back to where it was and up end the chassis so you can get at the tube socket connections.

Connect the ground lead of the VTVM to B-minus, and check for a negative voltage at the oscillator grid of the converter. If none is found, you know for certain that the tube is not oscillating. Next, use the VTVM (since you already have it turned on and connected to B-minus) to check all other voltages on the converter tube. If you find any that depart greatly from those given in the service data, run down the reasons, using the methods described in the first part of this chapter and in the previous chapter.

No Reception

Unsolder one end of the grid-coupling capacitor, and check it with the ohmmeter for leakage. If none is found, "tack" a good capacitor in its place. Do not try to hold this substitute capacitor in your fingers; merely touch the leads to the proper points as you would in bridging a suspected paper or electrolytic capacitor. You can kill a normally functioning oscillator by pinching the mica grid capacitor between the thumb and forefinger. If the new capacitor does not help, test the grid resistor for correct value.

If the resistor is all right, measure the resistance of the coil windings and test for any leakage between those windings. Resistance readings that are high or an ohmmeter pointer that refuses to remain steady during these measurements call for a hot soldering-iron treatment of all the coil terminals. If this does not help, the coil should be replaced. Even though the resistance readings seem normal, it is a good idea to try a new coil.

A replacement coil may be substituted temporarily for a coil suspected of being bad. Do not dismount the original coil from the chassis. Simply transfer the leads going to it over to the proper terminals of the universal coil, and piece them out a bit if this is necessary to make them reach. If this restores the oscillator to operation, you know for sure that a new coil is needed; then, you can install the replacement coil permanently.

THE THREE-WAY PORTABLE RECEIVER

The same symptom, of receiving only noise, points toward a dead oscillator in these little sets, too; but the reason for oscillator failure may be quite different. The first test to make is to plug the set into the isolation voltage-regulating transformer and raise the applied line voltage to 125 or 130 volts. If this causes the set to start playing, drop the voltage back to a normal 117 volts and turn off the set. Replace the converter tube with a new one, and turn on the set again. If it begins to play, drop the line voltage back to 95 volts and see if the oscillator quits. If it does not, your service job is finished — all but the pleasant part of making out the bill! The trouble was simply a converter tube with low emission.

If the oscillator refuses to work unless the line voltage is above 95 volts, however, there is more to do. The trouble is probably a weak line-voltage rectifier that supplies both plate and filament voltage for the rest of the tubes. If this rectifier is a vacuum tube, replace it with a good one. If it is a selenium rectifier, temporarily substitute a new unit as described in Chapter 1. With the new rectifier in place, check to see if the oscillator will work down to 95 line volts. If it does, install the new rectifier permanently.

Next try the old converter tube, and see if it will or will not work with 95 line volts. If it does, do not replace it. The original

Only Noise Can Be Heard

trouble was low converter filament current caused by the weak rectifier. In such a case, a brand new tube will temporarily work at a somewhat lower line voltage; but this advantage is soon lost. With the real trouble corrected, a new tube is not needed.

If neither elevating the line voltage nor changing the converter tube brings the set to life, the next thing to do is remove the chassis and make careful checks of all the converter tube voltages. Lack of negative grid voltage is again a sure indication of a dead oscillator when taken with a VTVM. It is especially important that the converter tube have the required filament voltage when the line voltage is set at 117 volts. If it does not have, find out why. Filament bypass capacitors that are leaky, filament-dropping resistors that are too high in value, loss of capacity in input filter capacitors, and rectifier current-limiting resistors that have increased in value are likely suspects. Lack or loss of voltage at other tube terminals is tracked down in the same way as in the other sets, except that extra precautions are taken against burning out the fragile filaments while making the measurements.

If the voltages are all satisfactory, except for the negative grid voltage, start checking the grid-coupling capacitor, the grid resistor, and the oscillator coil in exactly the same way prescribed for the transformer and AC-DC sets. Do not overlook the possibility of a defective tube socket or a short in the crowded wiring. Moving the tube gently about will usually cause the oscillator to start and cut out again if the socket is bad. If it is, it can usually be repaired as discussed in Chapter 2.

Coil, grid-capacitor, and grid leak failures are not entirely unknown in these small sets; but the most common causes of oscillator failure are bad tubes and weak rectifiers. Never waste time on other possibilities until you have made sure the trouble is in neither of these units.

QUESTIONS

1. When a set will receive noise but no station, what is the most likely cause of trouble?
2. Why is tube substitution better than testing in a tube checker for a doubtful oscillator or converter tube?
3. Describe a sure check for determining if an oscillator is working.
4. What is a "quick and dirty" method of checking oscillator action?
5. How is a part "tacked" into a circuit in place of a doubtful unit?
6. When making an ohmmeter check of a coil winding, what does a wavering needle indicate?
7. Can an oscillator coil that shows normal resistance in windings and no short circuit between windings still be bad? How?
8. What is a very common cause of oscillator failure peculiar to the three-way portable?
9. What is the other most common cause of oscillator failure in these sets?

CHAPTER 5

Excessive Current Indication

It might be thought a multiplicity of symptoms would only confuse the radio technician in his search for the cause of trouble. Ordinarily, this is not the case at all. Such symptoms are really clues to where the difficulty lies, and the more of them the technician observes the easier it is for him to pinpoint the circuit defect.

Take the case of the set which will not play and which also gives an indication of excessive current flowing through some parts of its circuit. This indication may take the form of set or house fuses that blow when the set is either plugged in or turned on, of rectifier plates that glow red hot, of a growling power transformer accompanied by a blinking of the lights when the switch is snapped on, or of a complaint that the set smoked just before or after it quit playing. It is a thousand to one the cause of the excessive current is also the reason behind the set's not playing; and when this cause is found and removed, the set will be restored to normal operation.

THE TRANSFORMER SET

In Chapter 1 there was a partial discussion of likely causes of a set's blowing its own fuse repeatedly. This fuse is usually about one- or two-ampere capacity and is intended to melt if a short circuit appears in either the primary or secondary circuits of the power transformer. The first thing to do when encountering such a condition is to remove the rectifier tube from its socket and see if this clears the fuse-blowing trouble. If it does, you can be sure the fault lies in the high-voltage DC circuit fed by the rectifier or in the rectifier tube itself. Checking the tube in a tube tester will quickly establish whether it is bad or not.

The important check in this case is for gas or shorted elements and not for emission. Gas would probably have already revealed itself in a glass tube in the form of a flashing purple or blue light around the plates just before the fuse gave up. A gassy rectifier puts on a pyrotechnic display that only a very inexperienced technician could confuse with the shifting pale fluorescent glow that is often seen on the glass envelope of a normally operating tube. While the tube is being tested for shorts, be sure and thump it with your forefinger or with a small rubber hammer on the chance the short-circuiting condition might be caused by loose tube elements that jar in and out of contact. Cathode type rectifiers, such as the 6X5 and 5Z4, are particularly subject to internal short circuits and should always be viewed with suspicion.

If the tube passes its test successfully, turn your attention to the filter and distribution circuits for DC voltage. Fig. 5-1 reveals the portion of a typical circuit in which we shall be interested. Keep in mind that a considerable amount of excess current is needed to

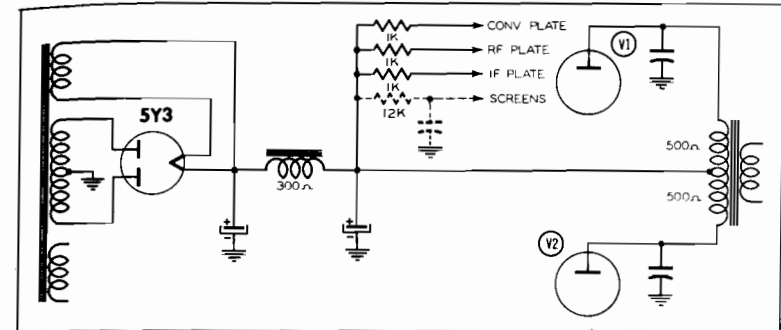

Fig. 5-1. Typical filter and voltage distribution circuit of transformer set with representative resistance values.

blow the fuse; so you may safely assume that the short circuit will lie, resistance wise, very close to the rectifier output. For example, if the screen bypass shown in dotted outline were to short, this would still leave the resistance of the filter choke in series with the 12K screen-dropping resistor between the rectifier output and ground. The added current through the rectifier would be approximately 20 milliamperes, probably not enough to cause the fuse to open. Instead, almost the full voltage of the power supply would appear across the screen-dropping resistor and cause it to overheat and char. This overheating would probably cause a discoloration of the resistor similar to that shown in Fig. 5-2, and an ohmmeter check should be made to determine whether or not the resistor has changed in value.

On the other hand, the failure of any of the capacitors drawn in solid lines would place a resistance of two thousand ohms or less across the rectifier output and might produce an increase in current of 100 milliamperes or more, which certainly would cause the fuse to fail. If either filter capacitor or a bypass of an output-tube plate shorted, this sharp increase in current would certainly result; however, in the case of the plate-lead bypasses to the RF, converter, and IF stages, a little qualification is necessary. The failure of one of these capacitors would certainly lower the resistance sufficiently to produce heavy current, but this current would have to flow through the 1K-ohm decoupling resistor, which ordinarily has a rating of a half or quarter watt. These little resistors will often overheat and burn in two before the fuse melts. Sometimes, though — just often enough to make it easy to overlook — a carbon resistor that is overheated will suffer a sudden lowering of its resistance that reduces

No Reception

the voltage drop across it and so stops the overheating before it is destroyed. Keeping such a possibility in mind may save considerable time when checking for a low-resistance short circuit.

Your trusty ohmmeter is again the weapon to use in tracking down the cause of the fuse-blowing. What you are looking for is any part failure that will lower the resistance "seen" by the rectifier from a normal value of twenty-five to fifty thousand ohms or more to an abnormal value of only a few thousand ohms or less. Start by measuring the resistance from the rectifier output to ground, observing proper polarity with your test prods. This will doubtless be much lower than the value given in the service data. Next measure the resistance from the filter output to ground. If this is lower than your first reading, you are getting warmer. Next, check the resistance from the plate of an output tube to ground. If this is more than the second reading, the trail is going colder; so double back to the lowest reading so far obtained and take another fork of the circuit that branches off from that point, such as possibly the plate of another tube in a push-pull output stage or the plate lead of an RF or IF stage.

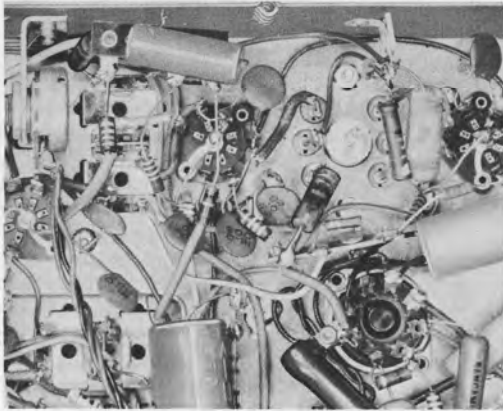

Fig. 5-2. The appearance of an overheated resistor.

Possibly an example of this procedure will help clarify it. Suppose, in checking a receiver with the circuit of Fig. 5-1, the reading obtained from the rectifier output to ground was 800 ohms. The resistance obtained across the output filter capacitor was 500 ohms. The resistance measured from the plate of V1 to ground was 1,000 ohms. Resistances shown from the plate leads of the RF, IF, and converter stages were all about 1,500 ohms. Finally, a measurement made from the plate of V2 to ground showed a resistance of only two or three ohms. When the bypass capacitor at this point was disconnected and measured, it showed a dead short. Replacing it with a good unit restored the receiver to normal operation.

Excessive Current Indication

This all sounds very simple and easy, doesn't it? Basically it is, too; but in all honesty, I must admit it is not quite so easy as it sounds. First, not all voltage distribution circuits are as straightforward as the one shown. For example, filter chokes are often placed in the B-minus instead of the B-plus lead, as shown in Fig. 5-3; and then a resistance reading taken from the rectifier output to ground gives you the resistance across the output filter capacitor. To measure the resistance of the input capacitor, the negative test lead must be shifted to the center tap of the high-voltage winding. Points like these, however, can be easily noted if you will study the service diagram before making each measurement.

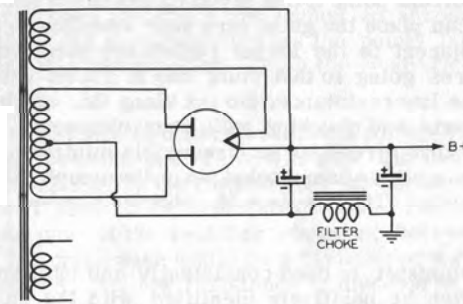

Fig. 5-3. Circuit similar to one shown in Fig. 5-1 but with filter choke placed in the B-minus lead.

Secondly, there is quite a difference between following a circuit shown clearly in a neat diagram and identifying these circuit components in the tangled jumble of wires seen in the bottom of most receivers. The thing to do is to trace the circuit in the diagram and then identify suspected parts you wish to check by referring to pictures of the chassis in which each circuit component is labelled with its proper call-out. Do not waste time trying to trace the wiring in the set proper.

Finally, there are several helpful tricks that will speed up this Process. If the receiver has a dynamic speaker with the output transformer mounted on the speaker frame, several circuit components can be isolated for resistance checking free of the influence of the remainder of the circuit simply by removing the speaker plug from its chassis socket. Remember that some circuit components are not always in plain view. Resistors and bypass capacitors are often enclosed in IF shield cans, and the latter are sometimes fabricated as an integral part of a trimmer capacitor. Note carefully whether or not a circuit element is shown inside or out of the shield-can symbol, for this will tell you where you can expect to find it.

Do not become obsessed with the idea that only capacitors can produce short circuits. In the majority of cases, capacitors will be

No Reception

at fault; but filter choke, field coil, and output-transformer primary windings have been known to short-circuit to their cores. Moreover, if you forget that it can happen, a tube screen or plate that is lying over against a grounded suppressor can produce a mighty mystifying state of affairs. Twice in his experience, the writer has discovered a rectifier tube socket that had arced over and carbonized a low-resistance path from a filament prong to a grounded rivet. Twice in twenty-five years is not often, but the trouble this caused — chiefly because I stubbornly ignored what the ohmmeter was trying to tell me — made a lasting impression.

The important point is that if you cannot find a shorted capacitor on which you can place the guilt, turn your attention to other parts of the circuit adjacent to the lowest resistance point you have found. Disconnect wires going to that point one at a time until you find the one bearing the low resistance. Go out along this single lead, cutting loose other parts and checking with your ohmmeter until you have localized the short circuit to an irreducible minimum portion of the circuit, such as a single tube-socket pin or the completely disconnected winding of a choke. Then replace the shorted element.

If the ohmmeter is used consistently and intelligently, a short circuit can often be positively identified with the unsoldering of a single connection; but there will be other times when several connections will have to be broken to be sure that the short circuit is cornered. Often it will be better to cut leads loose with the diagonal cutters and then resolder them than to try to unsolder the connection in the first place. This is especially true when the connection is made to tube-socket prongs, small IF transformer connections, or those terminals that will not stand too much heat or movement. If the leads are long enough, cutting them loose and resoldering them will actually result in a better-looking joint. In addition to that, it is faster.

The information given should permit you to locate any short circuit in the high-voltage distribution system; but let us go way back and suppose that when you pulled the rectifier tube from its socket, the set still blew a fuse every time it was switched on. This leaves us with these possibilities; (1) a short circuit in the leads to the primary, (2) a short circuit across the leads from the high-voltage secondary, (3) a short circuit across one of the filament-winding secondaries, or (4) an internal short circuit in the windings of the transformer.

First, make a resistance check across the primary leads of the transformer. Do not expect much DC resistance. It is the inductance of this winding that keeps down the current. A resistance of two to ten ohms would be normal. If the resistance is zero, of course, a short is indicated. If the short cannot be spotted where the leads enter the

Excessive Current Indication

transformer shell, it is undoubtedly inside the winding and the transformer will have to be replaced. On the other hand, if a normal resistance is found across the primary, next turn your attention to the secondary windings.

In the long run, probably the quickest way of checking these is to cut them entirely loose from the receiver circuits. Then measure the resistance between each winding and the core of the transformer. These values should be extremely high. With the rectifier out of the socket, measure the resistance from one plate terminal to the other and from each plate terminal to ground. All of these readings should be in the megohms. Remove all tubes and dial lamps and check to be sure no center-tapped resistors are connected across the filament leads. Then check the resistance across the points from which each filament winding was disconnected. Again the readings should be very high.

If a low resistance is encountered, find out why. In the case of a low resistance between one of the windings and the core, you will know that the insulation of the transformer has broken down and the transformer will have to be replaced. If a low resistance is found across the plate pins of the rectifier socket or between one pin and ground, about the only cause would be a carbonized socket that would have to be replaced. If a low resistance is discovered across a filament circuit, look for a short circuit along the filament leads themselves. Leads to pilot lamps and pilot-lamp sockets are good hunting grounds for short circuits. Leaving the ohmmeter leads clipped in position across a filament circuit and then moving the filament wiring about will often permit you to spot the location of a short circuit quickly; for whenever the short is cleared, however briefly, the kick of the needle will reveal the fact.

If no low resistances are discovered in any of these tests, you may as well face the lucrative fact; your customer probably needs a new power transformer! However, like any good dentist, you want to be sure the tooth is really bad before you "yank" it; so you need one final double check. Unfortunately, resistance measurements of the windings are almost useless in determining whether or not turns are shorted. A few shorted turns will change the over-all resistance of a winding little; yet they will load the transformer so heavily that it will quickly destroy itself.

There is your clue as to how to make your final check. Leave all the secondary windings disconnected, place a ten-ampere fuse in the fuse holder, and turn on the receiver. If the lights blink a bit and the transformer emits a kind of hollow groan when you throw the switch, you will not have long to wait. Soon you will hear a frying, sizzling sound inside the transformer; and you may even see a wisp of smoke curling out of it. When that happens, you can prescribe a new transformer with a clear conscience; for if the old one overheats when running free and unloaded, it certainly is bad.

Let us now take the case of the set without a fuse of its own that blows house fuses whenever it is plugged in or turned on. If this happens as soon as the plug is inserted, even before the set is switched on, the trouble probably lies in the connections to the plug, the cord, or the anchor points of the cord inside the chassis. The plug itself is a likely suspect, especially if it has ever been replaced. Home-talent electrical work can be pretty weird. Look closely to see if the ends of the wire have not fuzzed out and are shorting right at the plug. If nothing is wrong there and if the cord itself looks good, especially where it enters the chassis, take a look at the tie-points of the cord. If strain relief has not been properly provided, a severe pull on the cord may have bent the tie-points together or pulled them

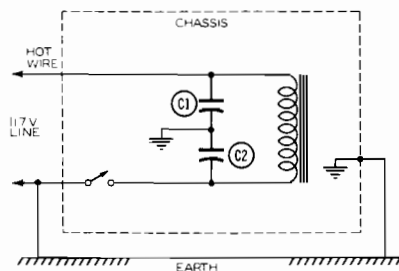

Fig. 5-4. Input circuit of transformer receiver showing how shorted line-bypass capacitors can cause fuses to melt and other strange symptoms.

over against the chassis. Notice, too, if capacitors go from either or both sides of the line to ground. If they are present, be sure and check them for short circuits. Fig. 5-4 shows the reason that this is essential. One side of the 117-volt line is always grounded, and quite often the chassis is grounded, too. Consider what will then happen when a surge breaks down the insulation of a capacitor such as C1 going from the hot side of the line to the chassis. Current comes in on the hot wire, goes through C1 to the chassis, and thence goes through the ground lead back to ground — a direct short circuit! Such a set, if it has a good ground connection, will burn out fuses as fast as you can screw them in.

Suppose that, during a thunderstorm some summer night, a nearby lightning stroke sends a surge along the line and it causes the insulation of C2 to fail. Now the current must pass through the transformer primary on its way to ground, and so the set will suddenly turn itself on and refuse to be turned off! The writer has seen this happen several times.

On the other hand, if C2 were shorted and the plug was turned around so that the switch was in the hot lead, the fuse would not go out until the receiver switch was turned on. This would also be the

case if the primary leads of the transformer were short-circuited together. Again this complaint might indicate that the switch itself was defective and was causing the line it carried to be short-circuited to the chassis in certain positions. In all of these cases, though, you should have little trouble in finding the reason why the set causes the house fuses to go out. All you need to do is to employ the resistance-measuring, wire-clipping, circuit-isolating technique you have already learned to use in tracing short circuits. You may be confident the trouble will be found in the comparatively simple primary circuit, because a small transformer cannot do a good enough job of reflecting a secondary short circuit to melt a twenty-ampere fuse. The transformer itself will go first.

If the rectifier plates start to glow red hot in a fuseless set, you know the trouble must lie in the DC circuit; so, for that circuit you simply use the same trouble-shooting technique described in the early part of this chapter. If the lights blink and the transformer growls when the set is switched on, this simply means that the set fuse would be melting if it had a fuse; so you again take the same steps as were outlined under the fuse-blowing symptom.

If the owner complains that the set smoked before or after it quit playing, you call into use a very delicate service instrument — your nose! Properly trained, your nose is all you need to tell you if the smoke came from an expensive transformer or an inexpensive charring resistor. The odors produced by the two are entirely different, but it is almost impossible to describe them so that they may be recognized. The odor of a burning resistor could be experienced, of course, by simply hooking a half-watt unit of a few dozen ohms across the AC line and sniffing the ensuing aroma. The same thing could be done with a transformer by hooking it to the line and shorting out a secondary, but that would be carrying the pursuit of empirical knowledge a little far. At any rate, you will not be in the service game long before you run across the odor of an over heated transformer; and, like the odor of a skunk, once experienced, it will never be forgotten nor mistaken for anything else.

If the transformer has been smoking, the first thing to determine is whether or not it was overheated because of having one of its secondary windings overloaded with a short circuit or if its troubles are internal. Methods of determining this have already been described in detail. If a short circuit is found and corrected, you still must establish whether or not the transformer was ruined by being overheated. A good transformer can take a lot of punishment, and the fact that one got hot enough to smell or even smoke a little does not necessarily mean that it must be discarded. A good check is to keep the receiver in continuous operation for several hours. If the transformer does not overheat during this test, you may safely leave it in the set; but just to protect yourself, mention on the bill that the transformer was subjected to a severe strain by the other trouble

No Reception

found in the receiver but apparently was not hurt. Then, if it fails in a few weeks, you are in the clear. If it does not, the customer will be grateful to you for thinking of his interest.

If the transformer has an internal short circuit or if it has been ruined by being overloaded, it must be replaced; and the service data should be consulted for a correct replacement. Before installing the new unit, be sure to clean all of the gummy mess that usually runs out of an overheated transformer from the chassis and the cabinet. If you fail to do this, the pungent odor of the ruined transformer will cling to the set for weeks to come; and the warmer the set becomes, the stronger this odor will grow. Housewives take a dim view of this condition.

THE AC-DC SET

Excessive current indications in these receivers take the form of melting house fuses, burning resistors, and dial lamps or rectifier filaments that are destroyed by excessive current.

If the set blows the house fuses when it is plugged in or switched on, the trouble will ordinarily be found in the plug, line cord, switch and associated wiring, or a bypass capacitor that is often connected directly across the 117-volt line. Simple visual inspection of the plug, cord, and wiring to the switch will many times reveal the reason the house fuses go out. The ohmmeter can be used to check the capacitor. Since the chassis is not grounded to the earth in these receivers, you can forget the complications brought on by such a condition.

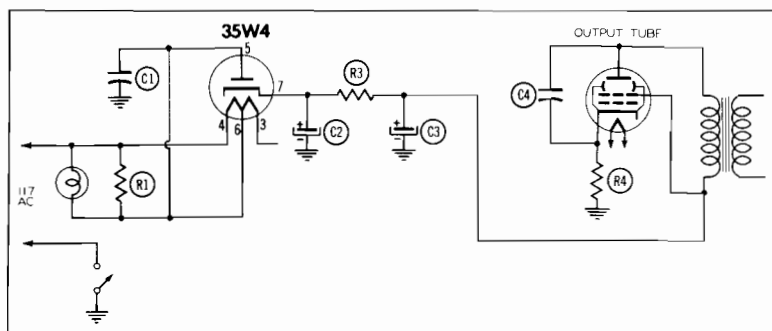

Fig. 5-5. AC-DC voltage distribution circuit showing weak points discussed in text.

Fig. 5-5 shows likely spots in which to look for charring resistors. First, note that instead of the bypass capacitor being connected directly across the line, one side of it in this case goes to the plate of the rectifier tube. If it shorts in this position, three things immediately happen: the pilot lamp will flare up like a flash bulb, R1

Excessive Current Indication

goes up in a puff of smoke, and the portion of the rectifier filament between pins 4 and 6 disintegrates. All this is caused by the line voltage taking a short cut through short-circuited C1. If you mistakenly jump to the conclusion that all the set needs is a new rectifier and pilot lamp and install these, you'll be sorry! As soon as the set is turned on, they will suffer the same fate. Any time a customer tells you a set smoked, make discovering what smoked and why it smoked your first order of business.

Observe that rectifier plate current divides among three paths: the pilot lamp, R1, and the portion of the 35W4 filament between pins 4 and 6. Any increase in rectifier-output current will increase the current through all three paths; if one path opens, an increased load is imposed on the remaining two. Suppose C2 short-circuits. This will increase the plate current tremendously and will probably cause all three of these circuit elements to burn in two, one after the other. If C3 shorts, the resistance of filter resistor R3 might hold down the current so that the parts would not be destroyed immediately; but the pilot lamp would certainly give a warning by its greatly increased brilliance. Remember then, that a too-bright pilot lamp usually indicates that too much current is flowing through the rectifier.

In some cases, a resistor of low wattage and less than 50 ohms resistance is connected in series with the rectifier plate lead for protection. It is intended to burn in two and save the rectifier if a short circuit occurs in the DC distribution circuit. If the short circuit is not directly across the rectifier output, the filter resistor will sometimes fail before the rectifier is damaged. It is interesting to see that in a circuit like the one shown in Fig. 5-5, the failure of the cathode-bias resistor of the output stage R4 would not necessarily indicate excessively heavy current through this tube. Instead, it might well indicate that C4 had shorted and that the full DC plate voltage was flowing to ground through the resistor.

Exactly the same procedure is used in AC-DC receivers to locate shorted elements as was employed with transformer receivers. The only difference is that in making the resistance checks the negative test lead is usually connected to B-minus instead of the chassis. A diagram, an ohmmeter, and clear logical thinking are the same basic instruments employed.

THE THREE-WAY PORTABLE RECEIVER

This type of receiver presents few indications of excessive current not already discussed. Many of these sets have AC inputs very similar to those of AC-DC sets, and the rectifier-tube circuit will react the same way to a shorted filter capacitor and the like. When the rectifier is a selenium type, a current-limiting resistor of low ohmage is invariably employed; and a heavy current through the rectifier will cause this resistor to overheat. Again, heavy rectifier current or a defect in the rectifier itself will occasionally make

No Reception

the rectifier become too hot. In this case, **your** sense of smell will again tell you what has happened; and an educated nose is not needed. An overheated selenium rectifier throws off an effluvium that smells exactly like rotten eggs or a strong artesian-water odor raised to about the tenth power! Before replacing such a rectifier with a new one, make careful resistance checks to be sure a short circuit in the DC voltage distribution circuit has not brought on this condition.

When a silicon rectifier fails, it almost invariably short circuits. It quits acting like a self-respecting rectifier and behaves more like a piece of copper wire. This places raw AC on the polarized electrolytic filter capacitors, and the reverse voltage damages them quickly if the surge-limiting resistor does not give up first. The electronic Tinkers-to-Evers-to-Chance goes something like this: the silicon rectifier short circuits; the reverse voltage pushes a high damaging current through the electrolytic capacitors, causing them to heat and puncture; the heavy current burns the surge-limiting resistor in two. Always check the filter capacitors carefully before replacing a charred surge-limiting resistor and a silicon rectifier. Many technicians automatically replace the filter capacitors under these conditions, and the practice is easy to defend.

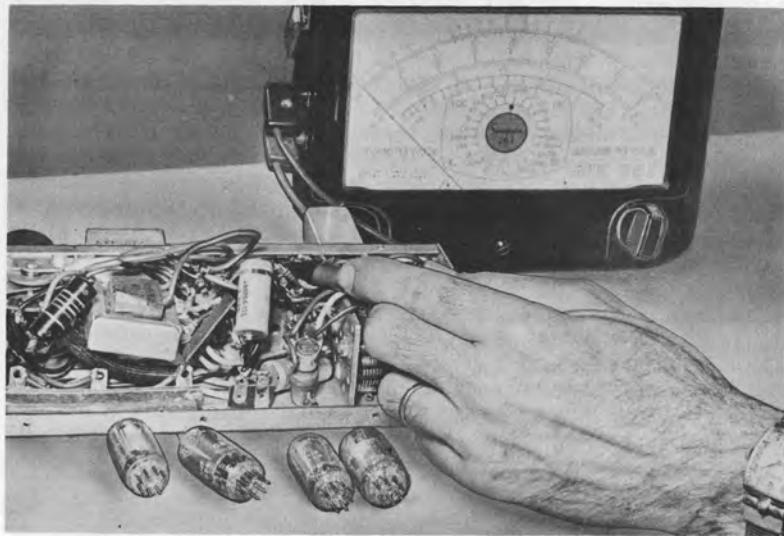

Fig. 5-6. Measuring resistance in a three-way portable.

Before you start looking for a short circuit in one of these receivers, remember that it is very easy to **burn out** one of the delicate tube filaments with the current put out by some ohmmeters. It is good insurance to remove all tubes while making resistance measurements as illustrated in Fig. 5-6. Because the A and B voltages are

Excessive Current Indication

both furnished from the same supply on AC operation, as discussed in Chapter 1, an excessive-current indication in these receivers is likely to be a burned-out filament. Most of these filaments are designed to carry only fifty milliamperes, and they will give up much quicker than a rectifier or resistor subjected to the same overload. So, if you replace a burned-out tube with a new one and that one promptly goes out, do not charge this off blithely to coincidence and put in another new tube. Start studying the diagram for a possible part failure that could cause too much current to pass through that filament, and then reach for your ohmmeter to check this possibility.

If you will maintain an unshakable faith in the immutability of Ohm's law — compared to which the famed Death and Taxes are changeable, uncertain things — you will soon learn to welcome an excessive current indication in a dead receiver. You will realize that such an indication throws a sharp spotlight on a small portion of the total receiver circuit and that a few checks with your ohmmeter within the area thus spotlighted are all that will be needed to uncover the exact cause of the trouble.

QUESTIONS

1. Give several indications of excessive current being drawn by a receiver.
2. How does gas inside a rectifier usually reveal its presence?
3. To what kind of tube failure are close-spaced cathode-type rectifiers such as the 6X5, 5Z4, and 5V4G especially subject? What special treatment is advisable in checking tubes of this type?
4. Explain why a shorted IF screen bypass capacitor is unlikely to be the cause of a blown fuse in a transformer receiver. Under what circumstances might it do so?
5. Describe how to use an ohmmeter to pinpoint the location of a short circuit in the DC voltage distribution system of a receiver.
6. With proper service literature available, is it necessary to trace every wire to locate suspected units? Why?
7. Where are capacitors and resistors often concealed from view in a receiver?
8. Tell where short circuits can occur other than inside capacitors.
9. How can you be absolutely certain a power transformer has shorted turns?
10. Describe how a thunderstorm can turn a receiver on and make it impossible to be turned off with the switch.

SECTION II

Unsatisfactory Reception

FOREWORD

This section of the book takes up receivers that play but do not play well. Each chapter concerns itself primarily with a single cause of unsatisfactory reception, although related symptoms may or may not be present. As before, first the symptoms are presented and described, then these are discussed as possible clues to the cause of the trouble, and finally steps necessary to isolate the difficulty are outlined and corrective measures indicated.

One difference, however, will be noticed in the presentation. In this section of the book it is assumed the service technician has gained sufficient experience so that he no longer needs or wants minute direction of his every move. For example, it is taken for granted that if he is told to check the plate voltage of the output tube with a VOM, he will know that the set must be plugged in and turned on before making this check; he will carefully adjust the VOM to a DC voltage range adequate for the voltage expected; and he will connect the positive and negative probes of the instrument to the proper circuit points to secure the wanted measurement. By the same token, it is also assumed that without further warning he will never be guilty of using his ohmmeter on a live set.

In short, from this point on the writer intends to talk to the reader as he would to another service technician who has already graduated — although quite recently — from the "grass-green" ranks.

CHAPTER 6

Sets With Excessive Hum

You will soon find that people vary widely in their tolerance of hum in receivers. One person will bring in a set that hums like a B-29 but ask you to repair something else, such as a broken dial cord. When asked if the excessive hum is not annoying, he will be surprised that you consider it so. The hum level has risen so gradually that he has become accustomed to hearing it, and it does not bother him. On the other hand, you are bound to meet the perfectionist who will almost shove your head through the speaker cone in his attempt to make you hear the barely perceptible hum about which he is complaining.

You must rely on your own judgment as to whether or not a receiver has too much hum. When checking for this condition, here are some points to watch: (1) The speaker must be in the cabinet when you do your listening. The baffle provided by the cabinet is necessary to reproduce the 60- or 120-cycle notes representing hum. (2) The volume should be set for quiet room-listening level, and the program should be voice rather than music. Even a loud hum can be covered up with a high-level musical selection. (3) Stand directly in front of the speaker when making the test. You can usually walk around a badly humming receiver and find a spot or so at the sides where the low-frequency sound waves from the front and back of the speaker cancel each other and the hum seems to disappear. (4) Be sure and check for hum on strong as well as weak stations. A certain type of hum will only show up when a strong signal is being received.

THE TRANSFORMER SET

These chassis are ordinarily used in console cabinets that form baffles for the large-cone speakers employed. Such a combination has good low-frequency response that accents any hum present in the output circuit. On the other hand, transformer sets employ full-wave rectification producing 120-cycle output that is easier to filter than

Unsatisfactory Reception

is the 60-cycle output of a half-wave rectifier. The net result is that you get just about as many hum complaints from transformer sets as from any other.

As a first check, see **if the** volume-control setting influences the amount of hum. This will tell you if the hum is originating ahead of the control or behind it. Let's first assume that the hum stays about the same, no matter where the volume control is set, and that it is constant whether a signal is being received or not. These clues point at weak or open filter capacitors, but we want to be sure before we pull the chassis. It could be a case of a filament-to-cathode short in either an output tube or an audio amplifier. If the output stage is push-pull, there is a further possibility that only one-half of this stage is functioning.

To check this possibility, turn down the volume completely and remove one of the output tubes. If this tube has been working, the hum should increase. Replace the tube and pull its twin from the other socket of the push-pull stage. Again an increase in hum indicates the tube has been working. If the hum remains the same when one of the tubes is removed, **you** can be reasonably sure that the tube is not **functioning**; so try a new one in its place. **If this does** not help there is a possibility that the output transformer is defective. To check it, leave the tube out of the socket and use your VOM to check for the presence of plate voltage at the plate pin on the socket. If none is present, it is likely one-half of the primary of the output transformer is open; and you can test for this possibility with your ohmmeter, as described in Chapter 2 of Section I. If plate voltage is present, the trouble must lie with some other part of the circuit of the tube in which case it would be necessary to remove the chassis.

If both output tubes are found to be functioning, try new tubes in any audio-amplifier or phase-inverter stages between the volume control and the output stage. If this does not cure the hum, you may as well remove the chassis for further tests.

Open or weak filter capacitors are by far the most common cause of hum, and they should be suspected right from the beginning. Several different types of electrolytic capacitors are shown in Fig. 6-1. The only reason for not checking them first is that doing so usually requires removing the chassis from the cabinet. An expert technician can often determine, just by listening, whether an input or output filter capacitor is open. **Ordinarily the hum** is more severe when the input capacitor fails, and voice or music being received will be chopped up by the strong 120-cycle hum present. An accompanying clue is the reduced DC voltage at all points.

When the output filter capacitor fails, the DC voltage is not affected and the hum is usually not so loud, although it is sufficiently loud to be objectionable. This same output filter capacitor, however,

Sets with Excessive Hum

frequently doubles as both an RF and audio bypass; so when it fails **there** is, in addition to the increase in hum, a tendency of the set to motorboat or oscillate. There may also be a sharp reduction in the ability of the set to reproduce low notes.

The quickest way to check for an open or weak filter capacitor **is to** bridge the suspected unit with another of like or greater voltage rating and of substantially the same capacity. As it is with everything else, there is a right and wrong way of doing this. The **wrong way** is to hold a cartridge type of electrolytic in the fingers and gingerly try to make the stiff wire leads contact the **two** points to which the capacitor under suspicion is connected. In trying to perform this

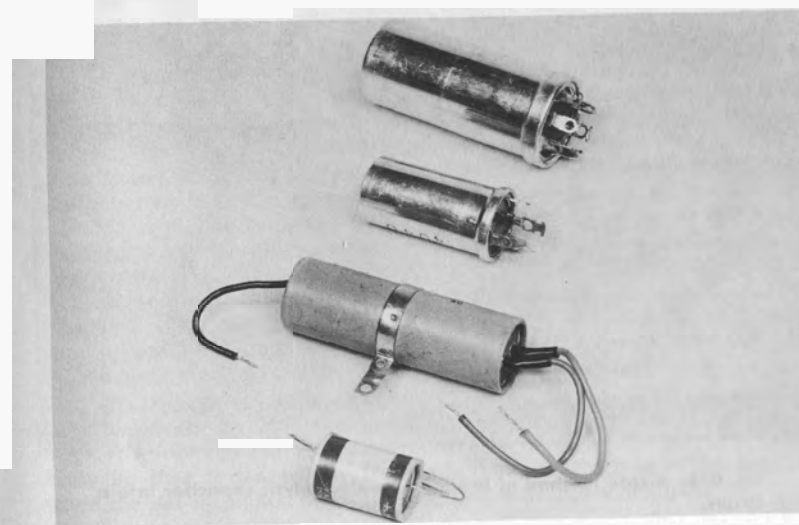

Fig. 6-1. Various types of electrolytic capacitors.

feat it is very easy to short-circuit something you shouldn't with the hard-to-manage wire leads and so damage the receiver, to injure the bridging capacitor by accidentally applying reversed polarity voltage to it, or to get a nasty shock from touching one of the bare wire leads in contact with a high-voltage point. A better and safer method is to use a pair of wedged Fahnstock and battery clips as shown in Fig. 6-2, in order to connect a pair of test leads to the bridging unit, making sure the red lead connects to the positive terminal of the capacitor. Then these leads can be used to connect the bridging capacitor across any two points with ease and safety.

Several points should be watched in employing this technique. For one thing, it is normal for the hum to lessen slightly when filter capacitors not at fault are bridged. When the capacitor really causing

Unsatisfactory Reception

the trouble is paralleled with a good unit, the hum will almost entirely disappear, and corollary symptoms will clear up at the same time. Do not overlook the possibility that both input and output filter capacitors may be open or weak. They could have failed in rapid succession; or, if they are of the type having a common negative or common positive, a break may have occurred along this common element. In such an event, bridging either unit will reduce the hum somewhat; but it will not disappear until both capacitors are bridged simultaneously with good replacements.

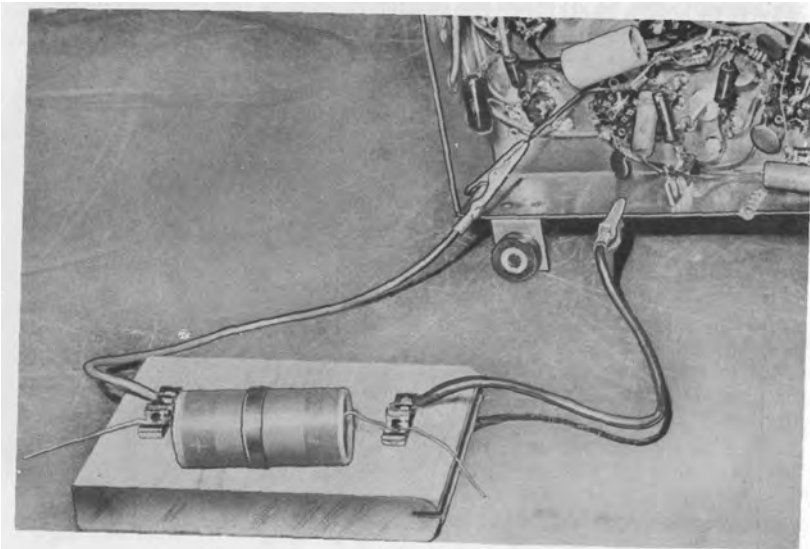

Fig. 6-2. A safe method of bridging an electrolytic capacitor into a circuit.

If simple bridging of filter capacitors does not eliminate the hum, it is a good idea before actually cutting any wires to try to establish definitely whether or not the trouble is insufficient filtering. To do this, measure the DC voltage across the output filter capacitor with your VTVM. Then measure the AC voltage present across these points with the same instrument. If the DC voltage is less than forty of fifty times greater than the AC voltage measured, filtering is insufficient; then you should proceed to explore some of the more unusual types of filter failures.

It could be that the filter choke or other unit used in place of the choke is defective. Check this element for proper resistance as given in the service data. Another nasty, rare, but not unheard-of thing with multicell capacitors is a short circuit from one cell to another. Such an occurrence effectively shorts out the filter choke or

Sets with Excessive Hum

substitute, and you can bridge filter capacitors in a set containing this fault until you grow a long gray beard without curing the hum. The proper check for such a condition is to cut the dual, triple, or quadruple capacitor entirely loose from the circuit and then to use separate good capacitors in the place of each disconnected cell.

Once you have located a defective filter section, you must then make up your mind whether or not to replace all filter capacitors or just the bad unit. Common sense should dictate your decision. If the set has some years on it and if this is the first filter failure, it is best to replace all filter units, because there is the possibility that other aging capacitors will soon break down. On the other hand, if the set is comparatively new or if the filter capacitors have apparently been recently replaced, the chances are that the bad capacitor was defective from the start; so the other capacitors can be left in the circuit.

In replacing filter capacitors, keep the following points in mind. Follow service data specifications as to suitable replacements, if at all possible. When this cannot be done, be sure the replacements you select have voltage ratings at least equal to those of the original units and that they do not vary more than 20 per cent from the rated capacities. Do not connect a new capacitor across an old one left in the circuit; when possible, completely remove the old capacitor. Obviously you cannot do this when you are replacing only one cell of a dual or triple unit, but you can and should cut loose the lead of the defective unit that is not common to the good unit or units still to be used. Do not hesitate to replace a can type electrolytic with a cartridge unit of equal voltage rating and capacity, if this is more convenient. Always try to keep any electrolytic capacitor as far away as possible from any heat-producing resistor or tube. Make sure that any capacitor you install is mechanically secure. Installing a capacitor so that it dangles by its leads from the bottom of the chassis when the set is picked up is the mark of a sloppy workman.

Suppose your checks with the VTVM reveal that the filtering of the power supply is satisfactory. Then the hum must be originating somewhere between the volume control which has no effect on the hum and the speaker which is loudly telling the world that hum is present. The question now becomes, "How can you trace this hum to its source?"

One way is to use the signal tracer shown in Fig. 6-3. You want all the sound to come from the speaker of the signal tracer; therefore, kill the set speaker by clipping a short piece of wire across the Voice-coil terminals. Fasten the ground lead of the audio probe of the signal tracer to the chassis, and touch the probe tip to the plate of the output tube. You will doubtless hear the hum distinctly. Move the probe to the grid of the output stage and see if the hum is still present. If it is, move the probe to the grid of the preceding audio stage and listen for hum again.

Unsatisfactory Reception

You undoubtedly have grasped the purpose of all this. By starting at the output of the set and moving toward the volume control in short steps with the signal-tracer probe while listening for the presence of hum, you are certain to find, when you take one of these steps, that you lose the hum. When that happens, you know that the hum is originating somewhere between the last point at which you heard it and the final check position at which it is not heard. Usually, this will confine the origin to a single stage.



Fig. 6-3. Signal tracer in use.

Another way of doing the same thing can be accomplished with only a large bypass capacitor, say a 1-mfd paper unit. Allow the set speaker to operate, and bypass the grid of the output stage to ground with the bypass capacitor. If this kills the hum, move ahead to the grid of the preceding audio stage. Keep going until you find a point where bypassing a grid or plate to ground does not affect the hum. Then you will have bracketed the hum source as lying between this point and the last point at which using the capacitor did make the hum disappear.

Once the trouble is pinned down to a single stage, here are some likely causes of trouble that should be investigated; a metal shell not properly grounded to the chassis, a short circuit between a filament wire and another socket connection, or an open grid. Remember, the possibility of internal tube trouble has already been eliminated by tube substitution.

Sets with Excessive Hum

To check whether or not the metal shield is properly grounded, wedge a screwdriver bit between the bottom rim of the shell and the chassis. If this kills the hum, carefully inspect the socket to see why the shell is not being grounded through the proper pin and the socket connection. When you find out why, fix it!

If the shell is grounded, carefully check over the socket to see if a filament wire may be shorting to an improper socket lug. A carelessly wired socket, bent socket lugs, a filament lead pulled so tightly around one of the socket connections that the insulation of the lead is cut through, a big blob of excess or loose solder — these are some of the things you should look for. If you can see nothing wrong, wiggle the socket lugs and move the wires about with an orange stick or insulated service tool. This will often show up a short circuit or loose connection that cannot be seen with the eye in a crowded chassis. When such a fault is found, the remedy will be obvious.

If an extremely high resistance appears between a grid and ground, the grid is said to be left "floating," and the tube then becomes very sensitive to the 60-cycle field always present in the air around a receiver. To a trained ear, the hum from an open grid sounds different than the hum that results when a direct connection is made between a tube element and a 60-cycle source. The floating-grid hum seems to have less body. This is because it has a much higher harmonic content than does the nearly harmonic-free, sine-wave source.

Even if you do not have a trained ear, you can easily check for an open grid by simply waving your hands around! When a hand is brought within a few inches of an open grid, more AC will be induced on the grid and the hum from the speaker will increase. If holding your finger within an inch of a grid lead causes a noticeable increase in hum, that grid is probably floating.

Any break in the path from grid to ground can produce this condition. That means that open grid resistors, including open volume controls that are often used as grid returns for first audio stages, are likely suspects. Check them with a high range of your ohmmeter, comparing your readings with those given in the service data. If the audio stages are transformer coupled, a secondary grid winding may be open. Some receivers provide bias for an audio stage by means of a bias cell, which is really a miniature battery. When these cells fail, they develop an infinitely high resistance that leaves the grids they are supposed to bias virtually floating. Never try to check the Voltage of these cells with your VOM, because damage to the unit will result. Use your VTVM. If the cell is weak or dead, replace it with a fresh cell, and your hum will probably disappear.

If everything seems to be in order from the volume control to the Loudspeaker and yet you feel that the hum is louder than it should

Unsatisfactory Reception

be, there remains one final possibility on sets employing field-coil dynamic speakers: the hum-bucking coil may be reversed. Swapping the leads of this coil is worth trying, especially if there is any indication they may have been removed previously.

Let us now go back and suppose you found that turning down the volume control reduced the hum. That means the trouble must lie ahead of the control. Check all tubes appearing between the antenna and the detector with the tube checker, watching particularly for elements shorted to a filament. Possibly a quicker and better test would be to substitute tubes known to be good, one at a time, for those in the set. Leave the receiver turned on while doing this, and be careful to note if the hum increases as your hand nears any particular tube. If this happens, inspect that tube for an open grid, a floating tube shield or shell. If the tube is the first in the set — RF stage or mixer — the trouble may well be a loose connection or broken lead between the loop antenna and chassis. Such a defect can usually be spotted visually or by moving the leads, but you can always make sure of proper continuity with your ohmmeter. Reduced sensitivity normally accompanies an open antenna lead, but in a metropolitan area where only strong stations are being received, the chief thing noticed will be the hum.

If you can find nothing wrong above the chassis — or at least nothing you can repair topside — you will have to remove the set for further checking underneath. The RF probe of the signal tracer can be used to check for the origin of hum in this portion of the circuit just as the audio probe was employed before. Start with the detector and proceed toward the front of the set, going from plate to grid, to preceding plate, and so on. When you have found the stage where the hum starts, the job will be half done. If you have never before used a signal tracer, be warned that when the RF probe is touched to the plate of the mixer tube the oscillator will be picked up with a sound that might easily be mistaken for hum. You will soon learn to recognize this characteristic sound heard whenever the RF probe is brought near the oscillator section of the receiver.

If a floating grid is indicated, the trouble will probably be an open winding in an RF or IF transformer. The ohmmeter can quickly establish whether or not this is so. Short circuits to the filament wiring can be detected just as they were in the audio stages. In addition, though, an open AVC or screen bypass capacitor can sometimes produce hum in these stages; so, check by bridging them with good capacitors of like characteristics.

Actually, hum seldom originates in the front-end of a receiver except that caused by the disconnected or open loop lead already mentioned. There is, however, the special case of "tunable" hum. This hum is heard only when certain stations are tuned in, usually

Sets with Excessive Hum

strong nearby stations. Occasionally, it can be made to disappear or move to another station by reversing the plug in the wall socket or changing the radio to another part of the house. The hum is loudest, apparently, when the station carrier is not being modulated; so, for test purposes, you can often radiate an unmodulated signal from your signal generator by attaching the output to a short antenna. This will provide you with a carrier whose strength and frequency can be varied until you obtain the loudest tunable hum upon which to work.

Adjust the receiver to a station producing the hum or to the signal from your signal generator which shows up the hum nicely, and then try bridging with new capacitors of the same values any capacitors found between one side of the 117-volt line and the chassis. Nine times out of ten this will make the hum disappear, indicating the capacitor being bridged is open.

Once you have made sure nothing is wrong with the line bypass capacitors, try bridging the AVC bypasses with new units. Do the same with screen and cathode bypass capacitors. If the filter capacitors have ever been changed, check to make sure that plate voltage for tubes in the RF and IF section is supplied from the output rather than from the input filter. A careless technician could easily have transferred this supply lead to the wrong point while changing filters.

THE AC-DC SET

Chief causes of hum in AC-DC receivers are the same as in transformer sets: open or weak filter capacitors, tubes with shorted elements, and short circuits between other circuits and the filament circuit which in this case is the 117-volt AC line.

Since these sets are easy to remove from the cabinet and since filter capacitor failures are the most common cause of hum, the first check should be to bridge all filter capacitors with good units. It is important to study the service diagram before doing this rather than to assume you know how it is arranged. Many different filter circuits are used in these sets, and you may think you are bridging a certain capacitor when actually you are not. The same basic techniques should be used in checking the filter circuits as were outlined for the transformer receivers.

If nothing can be found wrong in the filter circuit, try new tubes in the set. Breakdowns of the insulation between filaments and cathodes are quite common with AC-DC receivers because of the comparatively high potentials between these elements. Output tubes are particularly apt to develop faults that will raise the hum level.

If this does not help, replace the original tubes and start looking in the sockets or wiring for a possible short circuit that could

Unsatisfactory Reception

place the AC voltage on a tube element where it does not belong, just as you did with the transformer sets. In addition, though, remember that B-minus is not often connected to the chassis in these receivers; and whereas a short to the chassis in a transformer receiver would cause the set to go dead, a short to the chassis in an AC-DC receiver will merely produce a loud hum.

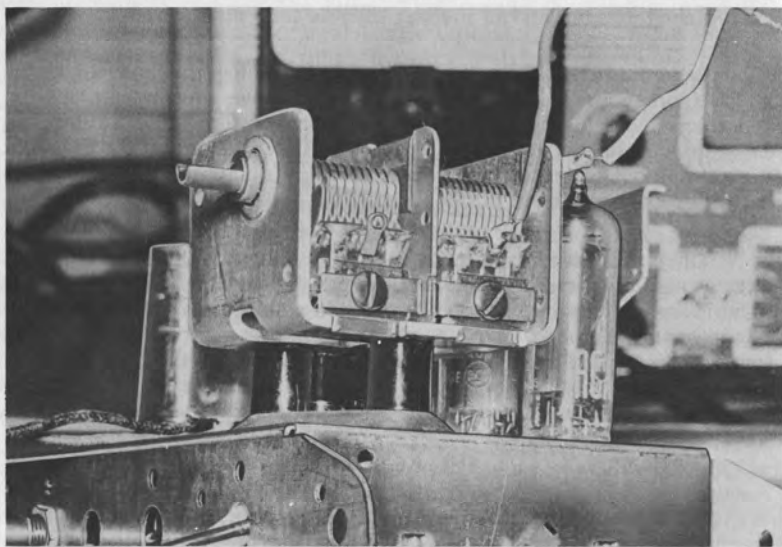

Fig. 6-4. Tuning capacitor insulated from chassis.

A good example of a hum-producing short circuit will be found in the case of a tuning capacitor that is insulated from the chassis by rubber grommets or plastic insulators around the mounting screws as shown in Fig. 6-4. If one of these grommets cuts through — as it often does from the constant strain imposed by a spring-loaded dial cord — the result will often be a loud hum that can be made to come and go by shifting the tuning-capacitor frame. One case of intermittent hum was traced by the writer to a metal dial pointer that occasionally touched the metallic foil dial face fastened to the chassis and effectively shorted the tuning-capacitor frame to the chassis. Sometimes a dial lamp is mounted on the tuning-capacitor frame and will produce a loud hum when a short circuit develops between one of the conductors and the metal shell of the socket.

These receivers suffer open grid returns, including broken antenna leads, just as do transformer sets; and they are tracked down in the same way. They are just as subject to tunable hum when a line bypass capacitor opens up or is blown apart by a lightning surge that comes in on the power line and jumps the switch.

Sets with Excessive Hum

THE THREE-WAY PORTABLE RECEIVER

Usually hum has to be rather bad in these sets to elicit a complaint. Their small cabinets, and speakers do not encourage hum, and the owner ordinarily is not so critical of performance. When hum does become a problem, filter capacitors are again the chief offender.

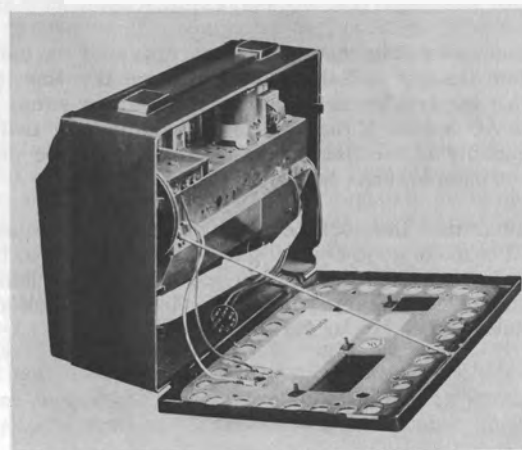

Fig. 6-5. Portable receiver with loop antenna mounted in a hinged cover.

Do not bridge capacitors in one of these sets with the receiver turned on. To do so is quite likely to result in blown tubes. It is much safer to turn off the set, connect the bridging capacitor to the proper points, and then turn on the set again. Be sure to discharge the bridging capacitor each time after removing it. Trying to reconnect it in a charged condition can easily blow every tube filament in the radio. Again you should consult the wiring diagram to be certain you are properly bridging the desired capacitors. Do not overlook the low-voltage, high-capacity filter capacitors ordinarily found across the filament supply circuits.

If a filter unit is found to be bad, you will usually have no choice between replacing just that unit or the whole capacitor of which it is just a part. There simply is not room in the crowded small chassis for any outboard replacements. Follow instructions in the service data for selecting the replacement.

Try new tubes. Tubes in these sets do not often develop faults producing true hum, but often a tube will produce a microphonic howl that a customer will describe as a hum.

Unsatisfactory Reception

An open loop antenna lead is very common in these sets because the loop is often mounted in a hinged cover, as shown in Fig. 6-5, and connections are made to it through hinges or flexible leads. Since each set presents a different mechanical problem in this respect, specific advice cannot be given; but hinge contacts can be improved with an application of one of the prepared contact cleaners. Do not try to use ordinary wire to replace flexible loop leads in these sets. They are made of special materials and should be obtained from the manufacturer. When one lead breaks, replace both.

If the receiver does not hum when operated on batteries but does hum when the set is being powered from the line, you can be fairly sure that the trouble is in the filter circuit or some short circuit along the AC leads. If the hum is present in both instances, the trouble is probably of the floating grid nature, and you should start checking for broken antenna leads, or the like.

Remember that the sockets used with the little tubes in these sets often fail to make good contact with the tube pins; so try moving each tube gently in its socket to see if you can stop the hum. If such proves to be true, use a sharp-pointed ice pick or scratch awl to bend the pin-contacting jaws closer together.

QUESTIONS

1. Name four points to watch in checking a receiver for possible hum.
2. What is the most common cause of hum?
3. Explain the difference in symptoms between an open input filter capacitor and an open output filter capacitor.
4. What is the safe and proper way to bridge a suspected filter capacitor?
5. How can a large paper bypass capacitor be used to locate the source of hum?
6. What is meant by a "floating" grid?
7. Give the most common cause of "tunable" hum.
8. What is the effect of a short circuit between the insulated tuning capacitor and the chassis of an AC-DC receiver?
9. What special types of filter capacitors must not be overlooked in checking a three-way portable for hum?

CHAPTER 7

Set Does Not Separate Stations

When a customer complains that stations run together on his receiver, make sure his complaint is justified. The first step is to ask him: Do you have this trouble only at night or in daytime as well? What particular stations do you have trouble in separating?

A listing of broadcasting stations reveals as many as 160 assigned to a single one of the higher frequencies. The power of stations so assigned is not great, being approximately 250 watts; and their daylight ground-wave range is quite limited so that they seldom interfere with one another. At night, however, when sky-wave transmission plays a strong part, a station a thousand miles away can and often does put in a better signal than another station on the same frequency only twenty miles away. Since each separate station on the same frequency varies in signal strength so that first one and then another is heard, the customer may mistakenly conclude that stations on adjacent frequencies are interfering with one another. This is very likely to be the case if he admits the trouble shows up only at night.

When he tells you what stations interfere with each other, you can quickly decide whether or not this is normal for your area -- assuming, of course, that you are as familiar as you should be with receiving conditions where you live. For example, if he complains that his four-tube receiver won on a punchboard will not pull a weak out-of-town station from under a strong local station only ten kilocycles away, you had best not make any rash promises about rectifying the condition. On the other hand, if he says he cannot separate two stations which you know from experience should be easy to separate with a receiver that is operating normally, you can take on the job with confidence that you can give satisfaction.

With the receiver on the bench, a listening test will usually tell you where to start looking for trouble. If adjacent-channel stations are hard to separate all over the dial, probably the IF transformers are out of alignment. If you only have difficulty separating stations on the high-frequency end of the dial, probably the RF stage is not tracking there and should be brought into line with the tuning-capacitor trimmer. Poor station separation on the low-frequency end of the dial would indicate that tracking is off there, and low-frequency padding capacitors should be inspected for proper adjustment as well as for tuning-capacitor plate alignment. If a strong local station is

heard all over the dial, the trouble is not one of alignment at all but is caused by rectification in a stage, such as an audio amplifier, that is not supposed to be rectifying.

THE TRANSFORMER SET

Suppose you decide the IF transformers are out of alignment. This means the set must be completely realigned. First, consult your service data to learn the IF frequency, where to connect the signal generator for each step, where to connect the output meter, the

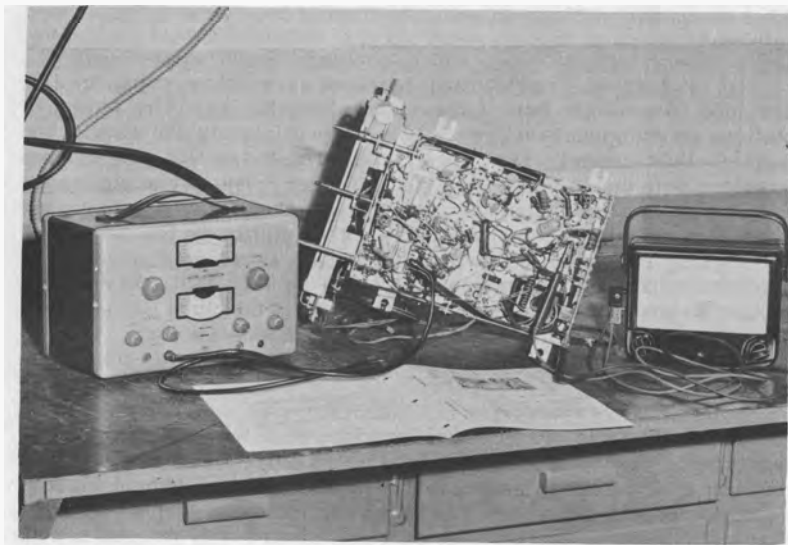

Fig. 7-1. Typical alignment set-up.

location of all trimmers, and the order in which they should be adjusted. A typical alignment set up is illustrated in Fig. 7-1. When such alignment data is available, follow it to the letter. There will be times, however, when you will have to align a receiver for which you do not have this information. In that case, the following general instructions may be used as a guide.

Be sure there is always a blocking capacitor in the hot lead of the signal generator to protect the instrument from damage in the event the cable leads are clipped to points carrying a different potential. If no such capacitor is provided inside the instrument or the cable furnished with it, make up one from a .006-mfd mica capacitor by attaching a small alligator clip to one lead and arranging the other lead so that the center conductor of the output cable of the signal generator may be easily attached to it.

Connect the outside ground lead of the cable to the receiver chassis. The inner hot lead ordinarily goes through a blocking capacitor to the signal grid of the mixer tube. In a modern compact chassis using miniature tubes, it is often difficult to reach the grid lug of the mixer tube socket with the cable connection of your generator without shorting out something; however, this same grid is invariably connected to one of the stator sections of the tuning capacitor which is normally accessible from the top of the chassis. Attach your hot lead to that stator section which you can see is connected to the mixer-signal grid.

With the receiver turned on and the volume control wide open, set the tuning dial to the extreme low-frequency end of the broadcast band. Turn on the signal generator, switch on the AM modulation, and adjust the attenuators to maximum output. If you know the IF frequency — it is sometimes printed on top of the IF shield can or is given on a label pasted on the cabinet — set the signal generator to that frequency. If not, slowly swing the generator frequency from 450 to 470 kilocycles. If the receiver is an ordinary broadcast type manufactured within the past ten years, the chances are better than fifty to one the IF frequency is supposed to lie within these limits, with 455 and 456 being by far the most commonly used frequencies. However, if you do not hear the modulation from the speaker, slowly lower the frequency of the signal generator until you do hear the AM signal.

As soon as it is heard, start cutting down on the generator output as you continue to tune the generator. Keep the generator output just great enough so that the signal may be clearly heard. Finally, you will reach a point in the generator tuning where moving its frequency in either direction causes the signal heard in the speaker to decrease in volume. Leave the generator settings alone and try tuning the receiver. If moving the tuning capacitor of the receiver has practically no effect on the signal heard from the speaker, you can be sure the generator is set to the frequency to which the IF transformers are tuned. On the other hand, if tuning the receiver causes the signal from the generator to fade out and disappear, the generator frequency or one of its harmonics is being heterodyned to the IF frequency, and you must continue your search for the actual intermediate frequency. When it is really found, tuning the receiver will have no effect on the signal heard from the generator.

Having satisfied yourself that the generator is operating on the frequency to which the IF transformers are tuned, swing the generator frequency back and forth through several kilocycles and note carefully the effect on the strength of the audio tone coming from the speaker. When the transformers are perfectly aligned, the signal will fall off quickly as the generator frequency is shifted either way from the point of maximum response. When they are out of alignment, you will be able to tune through several kilocycles without much change in

Unsatisfactory Reception

volume; or, as is often the case, you will find two frequencies at which the signal peaks up and has a valley of low response between peaks.

While doing this, be sure to keep the output of the signal generator as low as will permit you to hear the AM modulation, and keep the volume control turned to maximum. Failure to observe these important points will allow the receiver AVC circuit to "get into the act" and give misleading information regarding the response characteristics of the IF system. Always reduce the generator output with the step attenuator first and then with the fine attenuator. The step attenuator should be set so that the fine attenuator yields at its maximum position just slightly more signal strength than needed. It is not good practice to leave the step attenuator set to a high signal-strength level and then try to reduce this level by turning the fine control to a minimum.

With a little practice, you will be able to tell instantly whether or not the receiver is performing normally from the mixer grid to the speaker by noticing how much signal from the generator is needed to produce a clearly audible tone from the speaker. The less signal, the greater the sensitivity. By working with receivers, you will soon learn which setting of the attenuators will produce a signal that will normally suffice to make the tone audible. When the IF transformers are out of alignment, the sensitivity suffers; therefore, this is a corollary symptom that may occur.

Note the frequency at which the signal generator is set. If you have no reason to suspect the alignment trimmers have been tampered with, this frequency should be reasonably close to the original IF frequency. For example, if the generator is set at 450 kilocycles the original frequency was very likely 456 kilocycles; so move the generator frequency to that point. If the signal can no longer be heard, increase the generator output until you can hear it. You are then ready to realign the IF transformers.

It is extremely important to have and use the proper alignment tool for which the transformers were designed. Fig. 7-2 shows an assortment of such alignment tools. All are made of nonmetallic material; but some are screwdrivers of various-sized bits, others are socket wrenches, and still others are keys shaped to fit sockets moulded in the ends of the slugs of permeability-tuned transformers.

Using an ordinary screwdriver or the wrong alignment tool can bring about several undesirable results: (1) a metallic screwdriver can short from a hot trimmer screw to the shield can and cause damage; (2) the large amount of metal in the screwdriver can cause an IF transformer circuit to be detuned when the screwdriver is touched to a trimmer adjustment; (3) when some trimmers are touched with a metallic screwdriver a loud hum is produced that

Set Does Not Separate Stations

masks the signal from the generator; (4) slugs can be broken or reamed out by trying to turn them with a tool that does not fit until they can no longer be moved at all; and (5) by no means the least desirable result is that the technician may receive a shock while trying to adjust a trimmer screw carrying a high voltage.

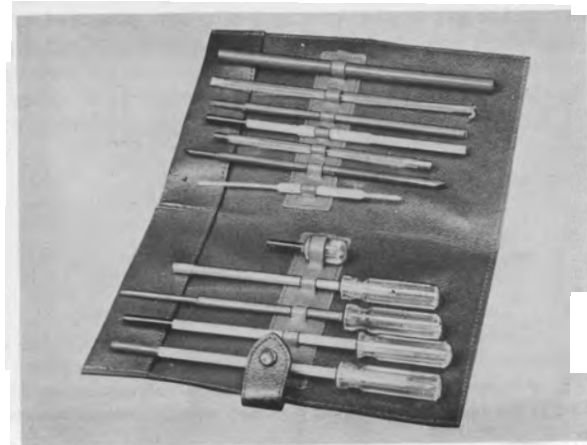

Fig. 7-2. Common alignment tools now being used.

Rough alignment can be performed without the use of an output meter. Start with the trimmer that tunes the output of the last IF transformer, and adjust it for maximum sound from the speaker. Then reduce the signal-generator output until the tone is again just clearly audible, and adjust the input trimmer of the transformer in like fashion. Repeat the process with the preceding stage, and so on until all IF trimmers have been adjusted.

As each trimmer is adjusted, make sure you are able to pass entirely through a peak in output as the trimmer is turned. If this cannot be done — that is, if turning the trimmer has no effect on output or if maximum output is secured when the trimmer is turned in or out completely — something is wrong and should be corrected before continuing the alignment process. Possible causes of such a condition are: a defective trimmer, a defective IF transformer winding, an open plate- or grid-bypass capacitor. Such capacitors would be C1 and C2, respectively, in Fig. 7-3. Temporarily bridge with a good capacitor the capacitor associated with the tuned circuit that will not peak and try to peak this circuit again. If success is not obtained, the trouble is probably inside the IF transformer or trimmers. Naturally, if the use of the good capacitor corrects the condition, the defective unit should be permanently replaced.

Unsatisfactory Reception

The quickest way to check for trouble inside an IF transformer is to replace temporarily the transformer in the circuit with a known good unit. It is not necessary to remove the transformer itself to do this. Simply cut loose its plate and grid leads. Then tack the uncut leads of a similar IF transformer to the proper points of plate, grid, B-plus, and AVC circuits. The fact that one end of each winding of the transformer in the set is still connected to low-potential points will

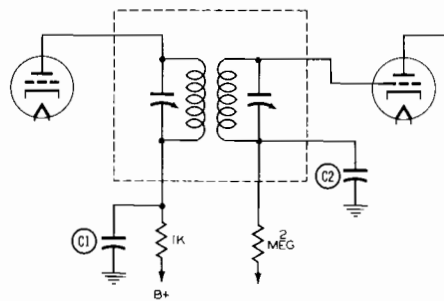

Fig. 7-3. IF transformer circuit showing location of bypass capacitors C1 and C2. Failure of these capacitors may affect tuning of the transformer.

not interfere with the working of the substitute transformer. Clip a lead between the shield can of the substitute transformer and the chassis. Now try peaking the trimmers of this substitute transformer. If you meet with success — if the trimmers of both primary and secondary permit passing through a peak of response — replace the transformer in the set with the substitute without wasting time trying to find whether a winding or a trimmer was causing the trouble. Even if you did pinpoint the trouble, it is highly doubtful if you could make a repair; so you would end up replacing the transformer anyway.

When you have peaked all transformers by ear, the job should be finished with an output meter. Set your VOM to read output volts, and connect the black test lead to the chassis and the red lead to the plate of an output tube. Most books on radio say to hook the output meter across the voice coil, but the writer knows from experience that the usual output meter, with a low range of around 2.5 volts, will not produce a useful amount of deflection with a signal input safely below the point where AVC action starts. When connected as directed, the meter will be found very sensitive to slight changes in volume, even though the signal from the speaker is maintained at a level just clearly audible.

Now go over the IF trimmers again, in the same order as before, adjusting each one for maximum deflection of the meter pointer. Only a very slight readjustment should be necessary in each case, but the total gain in meter reading will convince you that using an

Set Does Not Separate Stations

output meter is worth while. Turn each trimmer in and out to be sure of what the peak reading should be, but always make the final turning of the trimmer screw in a clockwise direction. With compression type trimmers, this is good insurance against a trimmer plate's hanging on a thread of the adjusting screw and later slipping off to upset the alignment.

With the IF circuits properly aligned, you are ready to tackle the adjustment of the oscillator, mixer, and any RF trimmers that may be used. It is a good idea to switch the output meter to a high range while making preliminary adjustments.

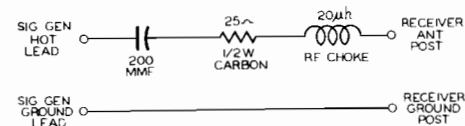

Fig. 7-4. Circuit of dummy antenna that may be used between signal generator and input connections of AM receiver while aligning front-end circuits.

First, make sure the dial pointer of the set is where it should be. If you do not have specific data on setting the pointer, entirely close the tuning capacitor and move the pointer to the last dial mark on the low-frequency end of the dial. Moving the pointer on the tuning capacitor or dial cable is a simple mechanical task that differs with each set; so you figure out how to do it by yourself. After all, you are a big boy now!

To align the remaining trimmers, it is necessary to introduce a signal from the generator into the antenna circuit of the receiver. If the receiver is designed for use with an external antenna, you can use the dummy antenna made up of a capacitor, resistor, and RF choke (as shown in Fig. 7-4) between the signal generator and the input connections of the receiver. When the set has a loop antenna, the hot lead of the generator cable may be connected to a short length of wire placed anywhere near the loop and the signal will be radiated from this wire to the loop. Do not move either the wire or the loop while adjusting the receiver front-end alignment.

Provision having been made for getting the signal from the generator into the set, adjust the receiver dial pointer to the highest frequency indicated on the dial and set the signal generator to this same frequency. Now turn the oscillator trimmer, normally found on top of the oscillator section of the tuning capacitor, until the generator signal is heard in the speaker. Attenuate the output of the generator, and adjust this trimmer for maximum response just as you did with the IF trimmers. In making this adjustment and all

Unsatisfactory Reception

subsequent adjustments, the output of the generator should be kept as low as will enable the modulation to be heard clearly with the volume control set at maximum.

Next, set the dial pointer to 1,400 kilocycles, and adjust the generator frequency for maximum response as indicated by the output meter. Then, leaving both generator and receiver tuned to this 1,400-kilocycle frequency, adjust the trimmer of the mixer stage to maximum. This trimmer is normally found on the end of the stator

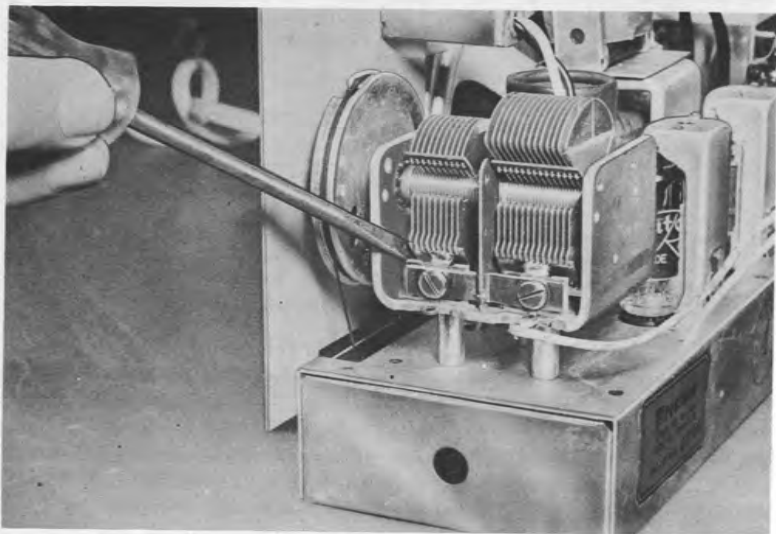

Fig. 7-5. Stator section of tuning cap being pried into place.

of the mixer tuning section of the tuning capacitor. If the set has an RF stage, do the same with the trimmer there.

Move the generator frequency to 600 kilocycles and tune the receiver for maximum response near that frequency. If the set has a low-frequency padder, adjust it while rocking the receiver tuning control back and forth until the signal strength as indicated by the output meter is maximum. Note if the dial pointer is resting on or very near 600 kilocycles. If it is, set the pointer and generator both back at 1,400 kilocycles, and again adjust the oscillator trimmer for maximum output. This is necessary because any adjustment of the low-frequency padder will affect slightly the oscillator setting at the high-frequency end of the dial, just as any adjustment of the high-frequency trimmer will change slightly the tracking of the oscillator at the low-frequency end. If either of these trimmers is changed

Set Does Not Separate Stations

considerably, the other should be reset so that dial-pointer readings correspond with generator frequencies of 1,400 and 600 kilocycles.

If the point of maximum response at the low-frequency end of the dial is considerably removed from 600 kilocycles, this indicates the mixer and possibly an RF stage are not tracking with the oscillator. Take a careful look at the tuning capacitor. Note carefully if the rotor plates are equally spaced between the stator plates in all sections. If not, is the poor spacing such that it can be corrected by moving the entire rotor endways in one direction or the other? When such is the case, some tuning capacitors have an adjustable thrust bearing on the end of the rotor shaft to allow the rotor to be shifted slightly. If only one section of the tuning capacitor shows improper spacing or if the poor spacing is such that moving the rotor to improve the condition in one section will aggravate it in another, try correcting this by prying gently against the end supports of the stator plates in order to move the stator sections in the proper directions. See Fig. 7-5.

Ordinarily, once you have proper spacing in all sections of the tuning capacitor, your tracking troubles will disappear. If they persist, look for improper connections to the loop, shorted turns in the loop, defective RF or mixer coils, defective fixed or variable padder capacitors. Some of these matters can be checked visually or by experiment; others will require substitution of known good parts. Just remember this: if the oscillator can be made to track perfectly with the dial, the trouble is not there, and you must seek the difficulty in the stage that will not track with the oscillator. On the other hand, if the dial pointer cannot be made to follow the signal-generator frequency settings up and down the dial, the oscillator circuit is at fault.

Many sets do not have low-frequency padders on the oscillator and depend upon the shape and size of the plates in the oscillator tuning section to provide tracking. The only adjustment is usually notched outside rotor plates (illustrated in Fig. 7-6) that may be bent to vary the amount of capacity present at various settings of this unit. Bending these plates should be a last resort and not a form of first aid!

In a few receivers, one final trimmer may be found that will need adjustment; this is the IF wave trap. Such a trap is sometimes included in the antenna input circuit of receivers without loop antennas to trap out any signal on the IF frequency. To adjust the trap, leave the signal-generator connections the same as those that were used for front-end alignment, but move the generator frequency to that used for aligning the IF transformers, and increase the signal output until a substantial indication can be seen on the output meter. What you are doing is forcing the IF frequency through the input circuit to the mixer grid. Adjust the wave-trap trimmer for minimum

Unsatisfactory Reception

deflection of the output meter. This completes the alignment, and the receiver should do a reasonably good job of separating stations.

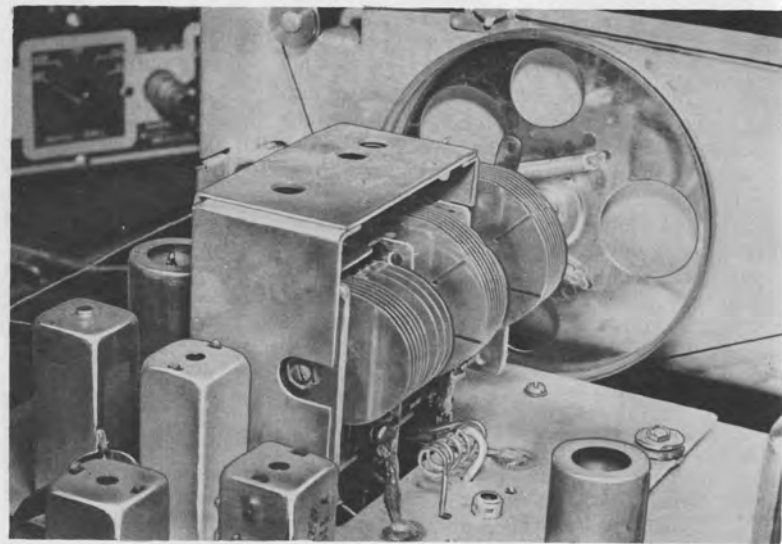

Fig. 7-6. Tuning capacitor slotted plates.

THE AC-DC SET

These receivers can be treated basically the same as transformer sets when the complaint is poor station separation; however, a few important differences should be pointed out.

Always use an isolation transformer when aligning an AC-DC receiver. In addition to providing safety, this normally permits the ground lead of the generator to be connected to the chassis for IF alignment without introducing a bad hum. Without the transformer, this hum can only be avoided by attaching the ground lead to the lethal B-minus which is one side of the line!

These sets will normally require realignment more often than transformer sets for several reasons: the IF transformers are subjected to higher temperatures because of the crowded chassis and smaller cabinets; lower-cost transformers are often used; the little sets are carried about and knocked around more. Since alignment of the little sets is usually a simple process, many technicians make it a standard practice to go over the alignment every time such a set is put on the bench for any reason.

A few of these receivers will simply not stay in alignment because the IF transformer coils are impregnated with a wax that

Set Does Not Separate Stations

softens and changes coil characteristics under high temperatures. Some relief can be afforded by wrapping the transformer shield can with asbestos paper, but the best solution is to replace a transformer that drifts out of alignment in a few days with a new unit that is properly designed.

Not many technicians bother to use an output meter when aligning these receivers. Instead they depend upon their ears to indicate maximum and minimum output. While a small improvement could doubtless be had by using an output meter, the difference is so slight that the technicians do not consider it worth while, especially when they feel these low-cost sets will not hold precise alignment for any great length of time anyway.

Loop antennas in these sets are often subjected to severe manhandling; so it is not uncommon to trace the cause of poor tracking to shorted loop turns. Usually the way to make a repair is obvious. Speaker cement can be employed to hold loose turns firmly in place. A loop antenna should always be in the same position, with respect to the chassis, that it occupies normally while the loop trimmer is being adjusted. This presents no difficulty when the loop is fastened to the chassis, but it does pose a problem when the loop is cemented to the cabinet. About the best you can do then is to use a sawed-off alignment tool to make this one adjustment after the set is returned to the cabinet.

Increasingly popular ferrite core antennas, such as the one pictured in Fig. 7-7, seldom develop shorted turns, but now and then the ferrite core is fractured by rough usage. This makes tracking the antenna tuning impossible, and replacing the antenna is the proper cure. It is also very important that these antennas are maintained in their proper positions in the receiver. Allowing such an antenna

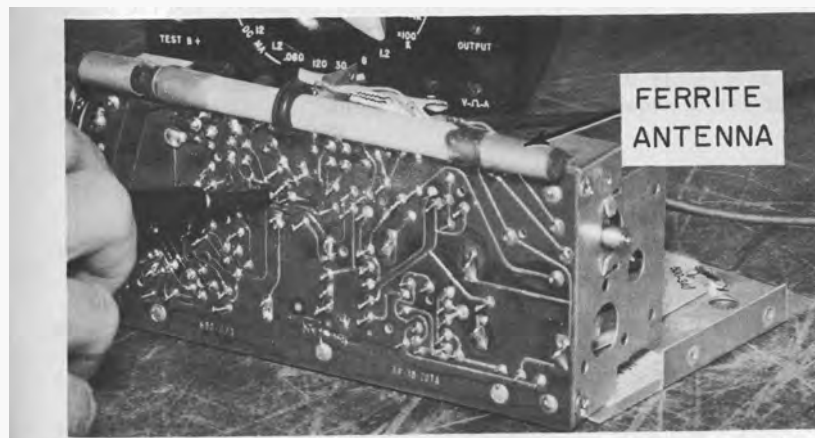

Fig. 7-7. Typical ferrite antenna.

Unsatisfactory Reception

to rest against a metal chassis will seriously impair its Q and change its inductance. See that a ferrite antenna is positioned where the picture in your service literature tells you it should be.

Always find out if the customer knows that turning these receivers about has a marked influence upon reception. You will find many people who do not understand the directional characteristics of a loop antenna and that interference may result from the position of the set so that it favors the interfering station and discriminates against the one they are trying to receive.

THE THREE-WAY PORTABLE RECEIVER

Almost all that has been said about the need and method of re-aligning transformer and AC-DC sets applies to these receivers. They, too, should always be plugged into an isolation transformer while being aligned; and it is best to align them on AC rather than batteries.

Loop antennas in these receivers are found in some weird places, and many of the newer models employ high-Q ferrite core antennas. The antenna, whatever type, should be in its normal physical relation to the chassis when the antenna trimmer is adjusted. This often means the set must be in the cabinet with the back closed. In most cases, however, there is an opening in the cabinet for inserting an alignment tool to make the trimmer adjustment. This hole is usually closed with a removable ornamental hole plug.

The effect of the batteries on antenna tuning presents another problem. The presence or absence of these batteries in the field of the antenna obviously changes its inductance and, therefore, the setting of its trimmer. If the customer intends to use batteries in the set at all, it should be aligned with them in place; and the owner should be told to keep fresh batteries in the set at all times. A few people will be found who are not interested in battery operation. In that case, since it is never a good idea to leave exhausted batteries in the set, it should be aligned without them.

QUESTIONS

1. Under what common conditions is it impossible for any receiver to separate stations?
2. What causes a strong local signal to be heard all over the dial?
3. Why is it necessary to keep the signal generator output as low as possible when performing alignment?
4. Give five good reasons for not using an ordinary screwdriver to adjust alignment screws.
5. List some possible reasons for an IF trimmer adjustment not peaking.

6. How is the signal from a generator injected into a loop antenna?
7. Why is an isolation transformer advisable when using the signal generator to align an AC-DC set?
8. When an IF transformer will not stay in alignment, what is the cause and what should be done?
9. Should the batteries of a three-way portable be in place when adjusting the antenna trimmer? Why?

CHAPTER 8

Sets That Whistle, Motorboat, Etc.

The words "whistling" and "motorboating" have a happy holiday ring to them; but believe me, they signify no picnic to the service technician who must work on sets displaying these symptoms. They normally indicate an unwanted oscillation in an amplifier circuit of the receiver, and stopping such an oscillation can sometimes give even an experienced technician quite a struggle.

The man who first dubbed the characteristic low-frequency oscillation "motorboating" had both a good ear and a way with words, for the sound issuing from the speaker often does strongly resemble the "plop-plop-plop-plop" of an idling one-cylinder outboard motor. As the frequency of this oscillation increases, the "plops" merge together into a musical note which has a pitch that may be anywhere in the audible range and which the set owner is likely to describe loosely as a hum, growl, buzz, whistle, screech, rumble, or "what-have-you." It was to embrace this variable, hard-to-describe range of oscillation that the "etc." was included in the chapter heading.

Quite often oscillation in an amplifier circuit is of a frequency far above the audible range and manifests itself audibly only when its frequency is heterodyned by another signal and the beat note between the two is detected and passed into the audio amplifier. These beat-note sounds are usually most apparent when they have a pitch that the ordinary person likens to a whistle; so normally a set with a whistle complaint is one with oscillation in either an IF or RF amplifier stage. Always remember that different people call the same sound by different names.

Motorboating is probably the easiest oscillation to cure, because it quite often is caused by a defect in the comparatively simple audio or filter circuits; so let us discuss that one first.

THE TRANSFORMER SET

First, vary the volume up and down. If the setting of the volume control has no effect on either the volume or the frequency of the motorboating sound, you can be pretty sure the oscillation is confined to the final audio stages. If the frequency changes but not the volume, the first audio stage is probably involved. If the volume of the oscillation can be cut off with the control, the oscillation must be taking place ahead of the volume control. The most common condition is that in which the control has no effect on the oscillation.

Before removing the chassis, check to see if all tube shields are making firm connection to the chassis. See if possibly the speaker leads are not sagging close to an audio-stage grid lead. If they are, move them. Be sure to note whether or not original metal-shell tubes may have been replaced with glass equivalents in the audio or output stages. While such substitutions can normally be made in these stages without causing trouble, the writer has seen a few cases where replacing a metal tube with a glass one will produce motorboating. Try substituting new tubes for those in the audio portion of the set. Gassy tubes often produce motorboating.

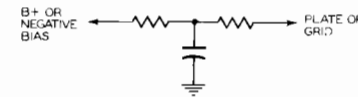

Fig. 8-1. A plate or grid may be fed through this combination of two resistors and a bypass capacitor.

If no wiggling of shields, moving of wires, or swapping of tubes will stop the putt-putt sound, you may as well remove the chassis and check the number one cause of this trouble: open or weak output-filter capacitors.

While tracking down an oscillation, always keep in front of you the conditions under which oscillation can occur. There must be amplification, and some of the output voltage of the amplifier must be fed back in the proper phase to the input of the amplifying circuit. That circuit may be a single stage, or it may embrace several stages. Such feedback is normally prevented by careful shielding, mechanical isolation of input and output circuits, and bypassing all return circuits to ground. For oscillation to start, there must be a failure in one of these preventive departments. Capacitor bypass failure is the most common.

The output-filter capacitor doubles as a plate-return bypass for most of the circuits in the set, and in many sets it is the sole output stage screen bypass. Under some circumstances, it can still do a fair job of filtering but will fall down badly on its other assignment of conducting audio-frequency signals to ground. These on-the-loose signals can then wander about from one circuit to another almost at will, and oscillation is very likely to happen. When the output stage is involved in the oscillation loop — and it usually is — the large inductance of the primary of the output transformer in the plate circuit of the output stage usually tunes the frequency of the oscillation to the low motorboating sound.

Try bridging the output-filter capacitor just as you did when looking for hum. If this cures the motorboating, replace the capacitor. If it does not, try bridging any other plate, screen, or cathode bypass capacitors found in the audio circuits. Do not overlook the possibility

Unsatisfactory Reception

that the screen of the output stage may be fed through a voltage-dropping resistor and have a separate bypass. Again an audio plate or an audio grid is often fed through a combination of two resistors in series with a bypass capacitor to ground from their junction, as is shown in Fig. 8-1. Be sure to bridge any such capacitors with good units of like value.

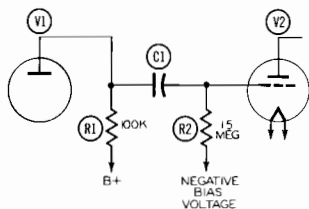

Fig. 8-2. If C1 became leaky, the positive voltage from the plate of V1 would override the negative voltage applied to the grid of V2.

If you can locate no open or weak bypass or filter capacitors the next logical move is to make a thorough voltage check of the entire audio system. Compare each plate, screen, cathode, and signal-grid-voltage reading with that which the service data says should appear at that point. If the set uses a push-pull amplifier, be sure to check for proper balance between voltages on similar elements of each tube. Check voltages carefully in any signal-inverter stages. A condition of unbalance in a push-pull circuit can lead to motorboating. The VTVM is the best instrument to use in making these checks because it can easily accommodate the changing polarity of the voltages being tested and because it will faithfully read bias voltages fed to grids through high values of resistance.

Remember a low plate- or screen-voltage reading does not necessarily mean that the real cause of trouble lies in a plate or screen circuit. More likely, the lower voltages are produced by excessive current which, in turn, is caused by too-low bias. For example, in the circuit of Fig. 8-2, it is very common for capacitor C1 to develop DC leakage which allows the positive voltage on the plate of V1 to override the negative voltage fed to the grid of V2 through R2. Depending on how low the DC resistance of C1 is, the grid of V2 may become merely less negative, or it may actually go positive if the leakage of the capacitor is bad enough. Never jump to the conclusion that an abnormal reading on one tube element indicates something wrong with the circuit feeding that particular element. Check all voltages on the tube first and then try to evolve a theory that will embrace all abnormalities noted. Doing so will mark you as a technician rather than a "test prodder."

Coupling capacitors, such as C1 in Fig. 8-2, are rather critical as to value. In certain bypass uses, it is often said — not always

Sets That Whistle, Motorboat, Etc.

with reason, however — "They'll work OK as long as they're big enough." In this case, replacing a coupling capacitor with one of greater capacity is simply asking for motorboating trouble. Stick to the value originally specified in your own replacements, and restore that value if some previous technician has strayed from it.

If nothing wrong has been found to this point, investigate the possibility that a grid resistor of an audio stage is either open or has increased tremendously in value. When either condition is present, that stage will sometimes perform as a blocking oscillator and produce typical motorboating sounds from the speaker. Check with the ohmmeter all resistors appearing between audio grids and ground. Do not overlook the fact that the volume control itself serves as a grid resistor in many sets. Replace any resistors that have increased twenty per cent or more in value. If any bias cells are employed in grid circuits, test them with your VTVM for proper voltage. Replace any that are dead or low in voltage.

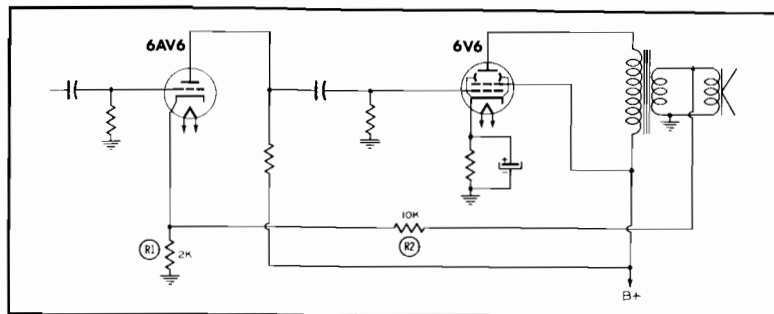

Fig. 8-3. Typical audio-output circuit employing negative feedback.

One other possible cause of motorboating must be kept in mind in dealing with modern receivers. Something may be wrong in a negative feedback circuit. Fig. 8-3 is typical of such circuits, although practical methods of producing negative feedback are almost infinite. As can be seen, the output voltage developed across the voice coil is fed back through R2 to the cathode of the 6AV6. The phase of this feedback voltage is determined by which side of the voice coil is grounded and which side is connected to the feedback lead. The amount of feedback introduced into the cathode of the 6AV6 is determined by the resistance ratio of R1 to R2. If anything happens to cause the phase of the voltage fed back to be positive or in phase with the voltage produced by the signal on the grid of the 6AV6, the feedback loop greatly encourages oscillation. A puzzling case of motorboating was traced by the writer to reversed ground and feedback connections to the voice-coil leads of a replacement output transformer. The technician who replaced the transformer had apparently become accustomed to thinking that it ordinarily makes no difference where the

Unsatisfactory Reception

voice-coil leads were connected; consequently, he could not grasp that in this one instance it made a tremendous difference.

Negative feedback, properly applied, exerts a stabilizing influence on an amplifier. In some instances, an amplifier is so designed it will oscillate if this stabilizing influence is removed. In Fig. 8-3, the failure of R2 would remove the feedback, and any change in the values of R1 or R2 would affect the amount of feedback. The thing to do is to study the feedback circuit carefully to determine what component failures could either reverse or decrease the feedback. Then check such components by measurement or replacement. Pay particular attention to any parts that have been replaced in the feedback circuit.

Now let us take up the case of the receiver with a motorboating sound that can be reduced to zero with the volume control, indicating trouble lurking in the RF, converter, IF, or detector circuits. It is

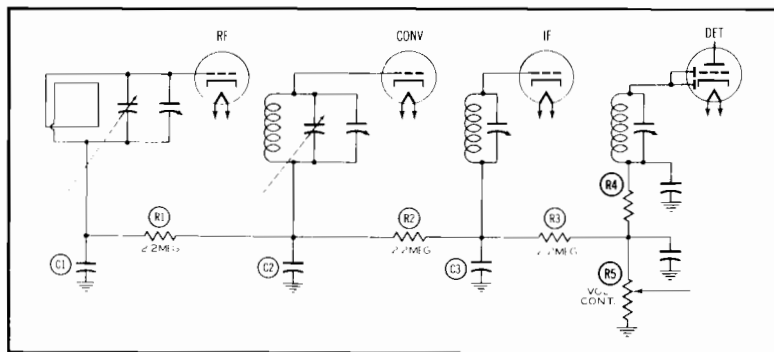

Fig. 8-4. Typical AVC circuit.

a good practice first to replace, one at a time, all tubes used in these circuits on the chance that a tube with gas or an open element is causing the trouble. Nothing saddens a service technician quite so much as to spend hours trying to run down a cause of difficulty through circuit checking only to discover finally it was a tube all the time! It is interesting to note that the second detector tube can be involved whether the trouble is shown to be ahead or behind the volume control. Its diode section ordinarily works in front of the control, and the triode or pentode section works behind it.

After the tubes have been cleared of suspicion, start checking capacitors. A very frequent cause of front-end motorboating is an open bypass capacitor along the AVC line. In the skeleton diagram of Fig. 8-4 such capacitors are C1, C2, and C3. Bridge these capacitors, one at a time, with a good unit. If at any point this causes the motorboating to stop, replace the capacitor being bridged. While you are

Sets That Whistle, Motorboat, Etc.

checking these particular bypass units, it is not much more trouble to do the same with all plate, screen, and cathode bypass capacitors in this same portion of the receiver; so subject them to the bridging test, too. Under some circumstances, they can cause motorboating.

In the AVC circuit, resistors such as R1, R2, R3, R4, and R5 of Fig. 8-3 can suddenly develop several dozen megohms of resistance and start a set to motorboating. Use your ohmmeter to determine if this has happened to the set on which you are working. Replace any resistors that deviate substantially from original values. If nothing is wrong with them, use your ohmmeter to check between each grid and the AVC line. As can be seen from Fig. 8-3, this will mean checking the loop, the RF transformer secondary, and two IF transformer secondaries for continuity. If any are found open or have an exceptionally high resistance, the transformers will have to be replaced or the break in the loop leads will have to be repaired.

Next, let us turn to sets that whistle. First, determine precisely how and where they whistle. Is the whistle heard on every station? Does it change in pitch while tuning across each station? Is it heard on stations occupying only one end of the band? Is it heard on only one or two stations? If so, what is the frequency of those stations?

If the whistle is heard on all stations across the entire band or across a large portion of the band, the trouble may be oscillation in the IF amplifier. The first thing to do is substitute tubes known to be good for any used in this portion of the set. In a surprising number of cases, the simple act of changing an IF amplifier tube will cure the whistling. If it does not, try new tubes in the RF and converter sockets; make sure all tube shields are making good chassis contact; double check all leads going to the loop to be sure they are not only connected but are properly connected. Incorrect loop connections can often produce oscillation.

If nothing wrong can be found, check the alignment of the IF stages. If you need to do so, refresh your memory by rereading alignment instructions given in Chapter 7. Let this be added: in a few instances, difficulty will be experienced in aligning a set with the signal generator connected to the converter grid while all IF trimmers are adjusted. The trouble will appear in the form of the set's breaking into oscillation every time one or more trimmer adjustments approach a peak in response. If this happens, do not leave the trimmers detuned. In a properly operating IF amplifier, every trimmer can be adjusted to a maximum response without oscillation occurring.

Instead, try connecting the signal generator to the grid of the last IF amplifier tube while the primary and secondary circuits of the output IF transformer are adjusted. Then advance the signal

Unsatisfactory Reception

generator to the grid of the preceding tube — it may be another IF amplifier or it may be a converter — adjust the trimmers of the transformer primary which appears in the plate circuit of this tube. Keep on advancing the signal-generator connection, one stage at a time, until all trimmers have been adjusted. Sometimes an IF amplifier can be aligned in this manner so that it will perform perfectly without oscillation when the same thing cannot be done with the signal generator left connected to the converter grid.

If the IF amplifier cannot be properly aligned without oscillation by any method, then the next thing to look for is an open bypass capacitor. Start by bridging the output filter capacitor. Then bridge all screen, plate return, cathode, and AVC bypass capacitors connected with RF, converter, or IF amplifier tubes. Look carefully to make sure grid and plate leads coming out of IF transformers do not run close to each other. These leads should always be kept as far apart as possible. Make sure IF transformer shields are anchored firmly to the chassis.

Sometimes it helps to know which tube or tubes are involved in the oscillation. This can usually be determined by touching the grid connection of each tube with a finger tip or with the bit of a fair-sized screwdriver. If the tube is not involved in the oscillation loop, touching the grid will have no effect; on the other hand, if it is involved, the oscillation will stop while the grid lead is being contacted. While the information thus obtained can be helpful, do not let it mislead you into confining your search for trouble to too small an area of the circuit. Quite often oscillation is caused by the failure of a part that seems to be quite remote from the tube oscillating. The fact that a change in value of the filter circuit can produce oscillation in an IF amplifier tube is a good example.

If nothing else can be found wrong, it is easily possible that the trouble may lie in an IF transformer. Sometimes heat loosens the windings on their mountings and allows one coil to slide closer to the other. This upsets the critical coupling that should exist between the primary and secondary windings and will often result in an amplifier that cannot be aligned properly. Try tacking in a new transformer as shown in Fig. 8-5 and described in Chapter 7. Usually inter-stage or input transformers are more likely to develop defects that result in oscillation than are output IF transformers; so, substitute for them first. A transformer that must be widely detuned to stop oscillation is the best place to start your substitution. If substituting a new IF transformer for one in the set stops the oscillation and permits all trimmers to be adjusted on the nose, the new transformer should be permanently installed.

Another common type of whistle is one heard only on a station with a frequency twice or three times that of the IF frequency. For example, if the IF frequency is 455 kc, this whistle will only be heard

Sets That Whistle, Motorboat, Etc.

on a station at 910 kc or one in the vicinity of 1365 kilocycles. This whistle is produced by the second or third harmonic of the IF frequency getting back into the input of the receiver and heterodyning with a transmitted signal being received. In the example given, trouble would be much more likely at 910 kilocycles than at 1365 kilocycles for two reasons: (1) the second harmonic would normally be stronger than the third; (2) since stations are assigned every ten kilocycles, there would be no station at 1365 kilocycles against which

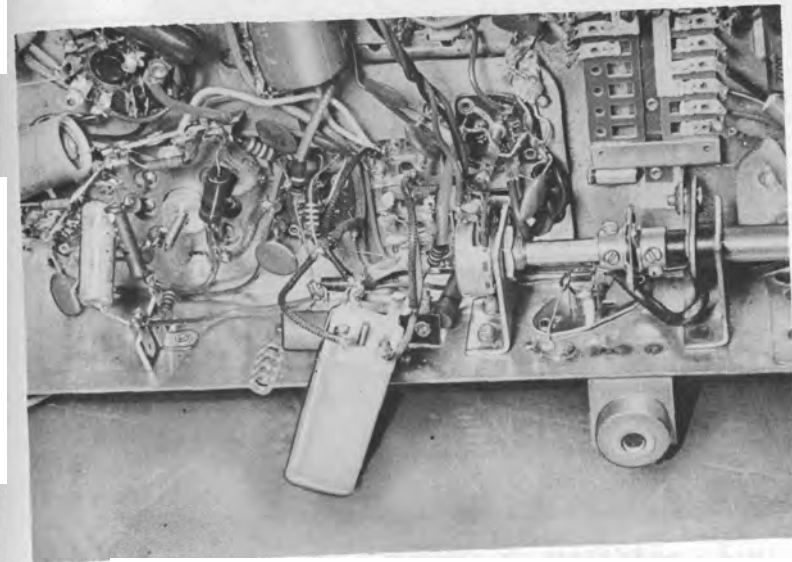

Fig. 8-5. An IF transformer tacked into the circuit.

signal the third harmonic could beat. Of course, if the IF alignment were not precise — a condition quite common — the third harmonic could easily fall on 1360 or 1370 kilocycles.

Look at the skeleton diagram of Fig. 8-6, which shows the detector and audio amplifier section of a typical receiver. Capacitors C1 and C2 are intended to filter out any IF component or harmonics from the AVC and audio circuits. If these mica capacitors open up, the job is not accomplished, and then harmonics of the IF frequency can easily be radiated to the nearby loop antenna.

With the set whistling on the station, try bridging both of these units with new capacitors of proper value and see if the sound stops. If it does, replace the capacitor shown to be open. While you are at it, try bridging C3, the plate bypass of the output stage, because the writer has seen cases where the opening of this capacitor will produce the symptom being discussed. More often, though, the opening

Unsatisfactory Reception

of C3 produces a condition where a howl or bubbling sound originates in the audio system whenever the volume control is advanced. Turning down the volume will usually cause this sound to change pitch and finally stop at a low-volume setting.

If there is nothing wrong with the capacitors, look for some other method by which the output of the IF amplifier can be coupled into the input circuit of the receiver. Loop leads that come close to

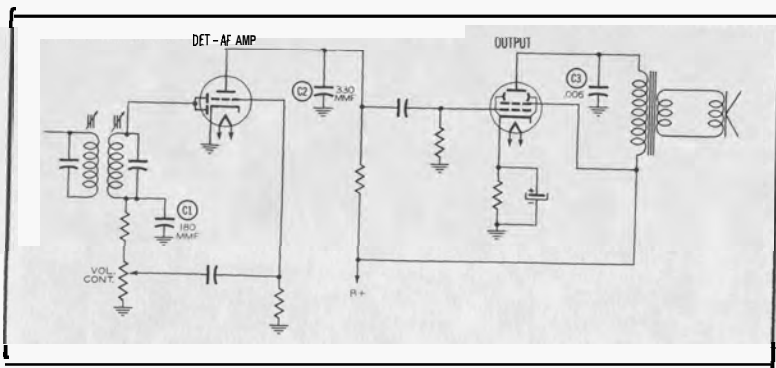

Fig. 8-6. Partial schematic diagram of the detector and audio amplifier section of a typical receiver.

the detector tube or the IF output transformer secondary leads is a case in point. The writer remembers an example of this trouble that was traced to a phono jack which a technician had thoughtlessly mounted on the loop-antenna form. Since the phono input went directly to the output of the detector, this coupled the detector output and the receiver input quite closely together. Moving the phono jack away from the loop winding cured the difficulty. Always keep loop leads well away from the detector circuit, and be certain the loop is positioned where it should be. Under some circumstances, speaker leads and loop leads too close together can produce the whistling symptom. Try separating them.

There is one more sound that may as well be discussed, and that is the microphonic howl. In this case, the feedback is mechanical rather than electronic. The trouble is caused by some circuit element acting as a microphone and picking up vibrations from the speaker and feeding them back into the receiver circuit. When the amount of energy fed back in this manner is great enough, oscillation starts and the set produces an audio howl from the speaker.

Tubes very often become microphonic, especially in high-gain audio stages. While the set is howling, touch each tube firmly with the finger tips, as illustrated in Fig. 8-7, or a rubber hammer. Doing

Sets That Whistle, Motorboat, Etc.

this damps the mechanical vibration and impairs the ability of the tube to perform as a microphone. When the tube causing the trouble is touched, the howl will stop only to start again when the touch is removed. The only practical cure for a microphonic tube is a replacement.

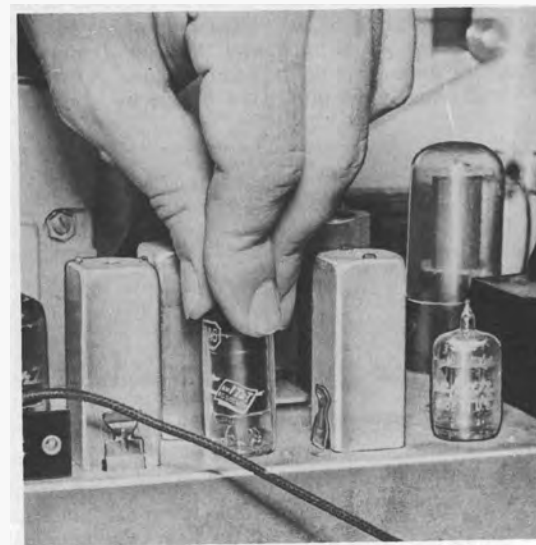

Fig. 8-7. Method of damping a microphonic tube.

On rare occasions, other circuit elements can become microphonic, especially components of the oscillator circuit. Employing a fiber rod instead of your finger, use the same damping test on tuning capacitor plates (both stator and rotor); on the oscillator coil and its mounting; on leads from the coil to the tuning capacitor; and on the mica coupling capacitor in the oscillator grid circuit. If touching any of these components with the fiber rod stops the howl, try to anchor the part more firmly in place, or change the mechanical tension on it by bending wires, or secure loose coil turns with speaker cement. In only a few rare instances will it be necessary actually to replace the microphonic part.

THE AC-DC SET

You can apply to AC-DC receivers just about everything that has been said in this chapter on locating trouble in a transformer set. The little sets do not ordinarily have as many individual decoupling circuits and rely more heavily on the output filter capacitor for both RF and audio bypassing; therefore, motorboating and whistling will

Unsatisfactory Reception

more often be traced to a failure of this component in AC-DC sets. Defective tubes and open bypass capacitors occur about as often in one type of set as in any other.

While checking capacitors, do not overlook the one ordinarily found between B-minus and the chassis. If this opens up, it can produce motorboating and whistling. Also be on the alert for a special type of bypass capacitor often found in the IF circuits of modern sets. This capacitor is designed to be self-resonant at the IF frequency and does a much better job of bypassing this one frequency than does an ordinary tubular capacitor of the same value. A special capacitor of this nature will usually be identified either by special marking on

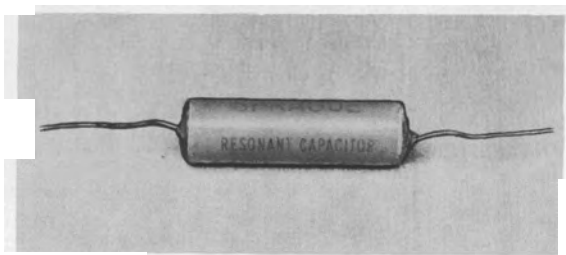

Fig. 8-8. Self-resonant capacitor used in modern sets.

the unit similar to that shown in Fig. 8-8, or by a description in the service data. Make sure some other technician has not replaced such a capacitor with an ordinary type. If he has, this may make it impossible to keep the IF amplifier from oscillating. Always follow service data recommendations exactly in replacing such capacitors.

THE THREE-WAY PORTABLE RECEIVER

Again the instructions given for transformer type sets should be carefully reviewed and followed in dealing with motorboating and whistling in these receivers. They will be found to be much more susceptible to microphonic-tube trouble than are the other two types of receivers. In fact, it may be necessary to try two or three new tubes in some sets before one will be found that is free of this trouble. Do not return the other new tubes as defective, however, until you have tried them in another receiver. In a second set they may give no trouble whatever.

Open loop leads will be found quite often in these receivers and may lead to motorboating or whistling. Always check this possibility carefully. Broken connections and short circuits are quite common in these receivers as a result of the rough handling they often receive. Such defects can lead to oscillation of various types. Quite often, as has been mentioned before, miniature-tube-socket connections fail to

Sets That Whistle, Motorboat, Etc.

make good connection to tube pins. If such a poor connection occurs on a shield-grounding pin, oscillation may well result. Moving tubes gently in their socket will ordinarily spotlight the trouble by causing the oscillation to start and stop as the tube in the offending socket is shifted. If a bad socket is found, it can ordinarily be repaired by restoring the pin-gripping jaws to their proper position with a sharp-pointed tool.

In a few instances, one of these sets will oscillate when operating on batteries if the B-battery is old or partially exhausted. Replacing the battery with a fresh unit will clear up the difficulty.

QUESTIONS

1. Motorboating is usually caused by a defect in what circuits?
2. What conditions are necessary to produce oscillation?
3. How can a weakening output filter capacitor produce motorboating?
4. Are capacity values of audio coupling capacitors critical? Explain.
5. What can happen in a negative feedback circuit to produce oscillation?
6. Does the second detector tube work ahead of or behind the volume control?
7. When an IF amplifier oscillates, what is the first thing to do?
8. Explain how a defective IF transformer can cause oscillation.
9. What causes a whistle on a station whose frequency is twice or three times that of the IF frequency?
10. What precautions are necessary in replacing a self-resonance capacitor?
11. When a three-way portable oscillates on batteries but not on AC, what is a possible cause?

CHAPTER 9

Noisy Sets

"This set is noisy," is a common complaint heard by the service technician. Ordinarily, the customer refers to a noise that cannot accurately be described as a hum, whistle, howl, or motor-boating. Instead, the sound coming from the speaker along with the program is more in the nature of a scratching, crackling, popping, rustling, static-like noise. These are only a few of the adjectives you will hear applied to it!

There is always the possibility that the noise is not in the set at all but originates in some electrical device in the customer's neighborhood. More times than not, however, the customer will already have checked on this by comparing reception on the noisy set with that of other receivers in his home or the homes of his neighbors. Even if he has failed to do so, you are naturally familiar with receiving conditions at your shop and can tell by listening to the set for a few minutes if it is unusually noisy. When that proves to be the case, you **should set** about finding the cause in a methodical manner.

THE TRANSFORMER SET

Start by shaking the line cord vigorously while you notice if this has any effect upon the noise. If it does, remove the cord plug from the wall socket and examine it closely for any indication of a loose connection between a cord wire and a **plug** electrode. A poor connection here often causes an intermittent frying, sizzling sound in the speaker. If such a condition is found, correct it by tightening the wire-holding screws or replacing the entire plug.

If the cord passes the shake test, try tapping the cabinet and chassis of the set sharply with the knuckles. If each blow triggers a burst of noise, a loose connection is indicated. See that all tube shields are firmly in place. Check for possible loose connections in the receptacles for loop leads, speaker leads, and phonograph player leads. Make sure that the pilot-lamp bracket is firmly anchored. Momentarily remove the pilot lamp and see if the noise disappears. Sometimes these lamps, especially those designed for 117 volts, become defective and cause a rasping sound to issue from the speaker when they are jarred.

If the loop antenna is of the type that is stamped from a copper sheet and cemented to a Bakelite plate all in one operation, look closely for any turns that may be loose and are intermittently touching

other turns. If only a single turn is uncemented, you can usually make a satisfactory repair by a generous application of speaker cement; but if the whole loop is losing its bond with the Bakelite, replacing the entire assembly is indicated. If nothing can be found loose above the chassis, your search will have to be continued underneath.

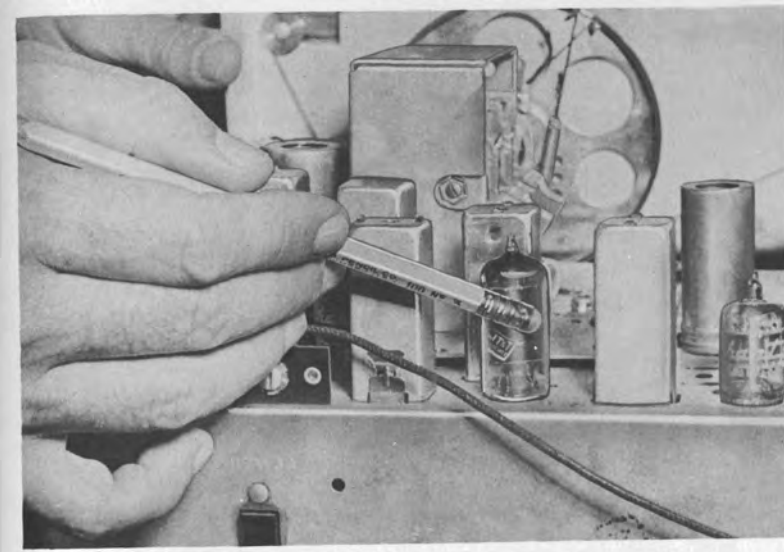

Fig. 9-1. A noisy tube may be located by tapping with pencil.

Jarring the chassis may have no effect upon the noise. In that case, try rapping each tube sharply with a lead pencil, as illustrated in Fig. 9-1. There is a proper technique to this tube tapping. Grid-cap tubes **should be** struck first directly on **top** of the cap. Very often a poor connection develops between the cap and its conductor, and jarring the cap will make the noise come and go as the successive strokes of the pencil fall upon it. Other tubes should be struck on top first and then from various angles on the side. The loose connection within may be positioned so that only a blow at the right spot will disturb it sufficiently to affect the noise. As to how hard you should strike the tubes, let us say you should not strike them any harder with the pencil than you would want someone to rap you across the bridge of the nose with the same instrument. A little experimenting will reveal precisely how hard that is!

If you find a tube that seems to be noisy, double check by substituting a **good tube** for it and **then tap** the new tube. If the noise still persists, you have simply been jarring some other loose connection when you were striking the tube and the vibration is being conducted

through the chassis. Some noisy tubes have to reach a certain temperature before the noise shows up. Once past this temperature, they will not make a noise until they have cooled down again. Quizzing the customer about the peculiarities of the noise may save you a lot of trouble in looking for it.



Fig. 9-2. Checking for an off-center voice coil.

In a few instances, the noise will only show up when a signal is being received; yet no thumping on the chassis or tubes will produce it while the set is tuned in. That should make you suspicious of the speaker. Sometimes tiny metal filings will get into the gap between the voice coil and the speaker frame and cause an intermittent short as the voice coil moves back and forth. The same result is had when the voice coil is off center and the winding itself rubs on the frame. To test for this condition, slowly move the cone back and forth with your fingers, as shown in Fig. 9-2, while the receiver is turned on and notice if the scratching sound is heard at any one position of the cone. If it is, you have tracked down the varmint! To dispatch it, try first to recenter the cone with speaker shims in the conventional manner. If there are metal particles in the gap, they can often be blown out with compressed air or removed by the delicate manipulation of a thin, flexible-metal, speaker shim.

When you have checked all these things but have not located the source of the noise, try substituting new tubes one at a time in all the sockets of the set. If that does not help, you may as well pull the chassis and start looking beneath it. If jarring affected the noise,

tap the various circuit components lightly with an insulated alignment tool. Pay particular attention to socket connections, capacitors suspended by their leads, resistors, line-switch terminals, and band-changing switch contacts. When the source of the trouble is found — and a simple loose connection cannot elude big smart you for very long — the solution will be obvious.

When the noise is not affected by jarring, waste no time; break out your signal tracer at once. Start with the plate of the output stage and advance a stage at a time toward the front of the set. As you contact each plate connection with the probe, listen to see if the noise is still present. When you find a plate at which it cannot be heard, the noise obviously originates in the stage following. Each stage in a receiver has its own most likely sources of noise; so let's take them up one at a time.

When you can only hear the noise at the output-tube plate, cut loose any capacitors that may appear between that plate and ground or cathode. If that does not stop the noise, the trouble is probably a partially open primary in the output transformer. Such a defect results in noise at any setting of the volume control, and it is usually worse when the set is first turned on. The crackling, frying disturbance is often accompanied by a squeaking sound. You can be sure by turning off the set, removing the output tube, clipping a 10-watt, 10,000-ohm resistor between the plate connection of the output-tube socket and ground, and turning the set on again. This will allow about the proper amount of current to flow through the primary of the transformer. If you still hear the noise, you may be almost certain the primary is at fault; however, tacking a new transformer into the circuit in its place will settle the matter beyond all doubt.

If no noise can be heard when the output tube is out of its socket, the noise must be coming from some other circuit of the output stage. Check all resistors and capacitors connected with that stage by cutting the units out of the circuit one at a time and substituting known good parts for them.

Next suppose the noise is found originating at the plate of the audio amplifier stage. The conventional audio stage has a mica capacitor going from the plate connection to ground. Many times this capacitor develops a partially shorted condition that will result in a very noisy set. Cut one end of the capacitor loose and see if the noise stops. If it does, replace the capacitor. If the noise continues, perhaps the plate resistor is noisy. Tack another in its place and see. When the audio stage is a pentode type, do the same with the screen-dropping resistor and its bypass capacitor. In a few cases, you will find a coupling audio transformer between the audio amplifier and the output stage. The primary of this transformer can give the same trouble as the primary of the output transformer, and it can be checked in the same way. However, the resistor used to load down the primary while the audio amplifier tube is out of its socket should be approximately 30,000 ohms.

Unsatisfactory Reception

When the noise is cornered in an IF stage, the first suspect should be the primary of the IF transformer in the plate circuit. This winding becomes partially open and produces noise just as transformers do in the audio section. Sometimes you can check the resistance of this winding with the low range of your ohmmeter and spot the trouble. It will be indicated by a reading that is greater than specified in the service data. Or, an ohmmeter needle that keeps wavering about may indicate variable continuity through the winding. To be sure, though, the quickest check is simply to tack a new IF transformer in place as described previously. If that puts an end to the noise, you know a new transformer is indicated.

Miniature slug-tuned IF transformers whose windings are tuned with fixed capacitors molded into the insulating material at the base of the transformer are notorious for developing intermittent leakage between these capacitors. The result of the positive high voltage on the primary leaking across to the secondary that usually connects to a negative grid or diode is an intermittent crackling noise of varying intensity, ordinarily accompanied by weak and distorted reception. To check for this condition, cut the secondary of the suspected transformer entirely loose from the circuit and use the VTVM to see if any positive voltage is present on the secondary with respect to B-minus when the set is turned on. If there is, leakage is present and the transformer must be replaced.

If you can't pin a thing on the IF transformer, turn your suspicions to noisy plate, screen, and cathode resistors and to any bypass capacitors associated with them. Often touching the probe of the signal tracer to each of these tube-element connections will indicate in which circuit the noise is arising, and then you can substitute new parts in that circuit to pinpoint the cause of the difficulty. You cannot bridge noisy resistors and capacitors with good units when hunting noise. The suspected part must be removed from the circuit by unsoldering one lead and the new part must be tacked or clipped in place.

The signal tracer is not too much help in checking noise in a mixer stage because the oscillator sound drowns out the noise; however, you can start by checking the primary of the IF transformer in the plate circuit. It is guilty just as often as is the winding in the plate circuit of an IF stage, and it is checked in the same manner. Check also for leakage between primary and secondary windings as mentioned above. There are lots of other places to find noise in a mixer stage, however. Among the more notorious are: the mica coupling capacitor between the oscillator coil and the oscillator grid connection; the windings of the oscillator coil; resistors used to drop the voltage for the screen and oscillator anode; and the mica coupling capacitor that sometimes couples the signal grid to the plate of an RF stage, if one is used. Resistors and capacitors suspected of being noisy are best checked by direct substitution. Coil windings may be roughly tested with an ohmmeter, but the final test is again substitution.

RF stage noise can come from a defective primary winding in an RF transformer or from a defective choke or resistor used in place of that winding. Pulling the RF tube out of the socket will stop the current flow through the winding or resistor and so stop the noise, but it would also stop it if the noise were originating in a noisy screen dropping resistor. The best method of checking, therefore, is still to substitute new parts for those suspected. The signal tracer and the ohmmeter may be used to sort out the most likely causes of trouble, but you cannot be sure until the replacing of a part has banished the annoying sound.

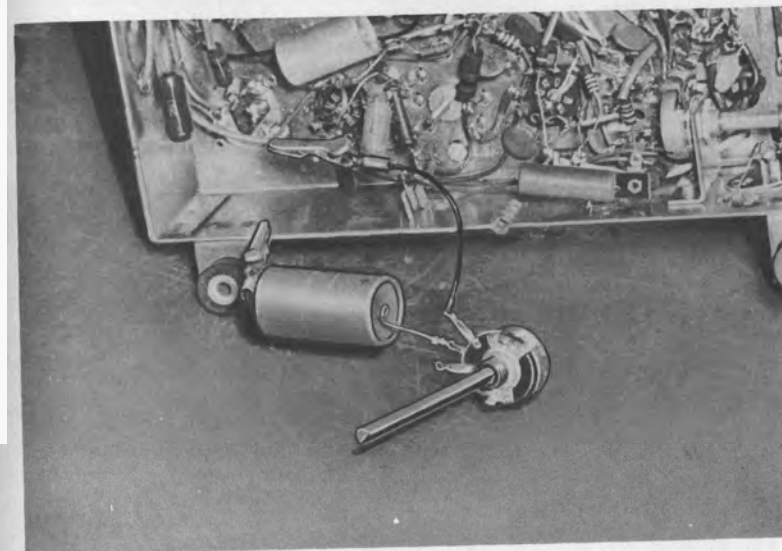

Fig. 9-3. Variable resistor and capacitor to ease a bridging capacitor into a circuit.

You may trace the noise right up to the plate of the RF stage and find every part in that stage is perfectly all right; yet there will be many times when the noise will still persist. Do not give up; there are still several interesting possibilities. One of these is a filter-capacitor defect that does not interfere with its filtering action but turns it into a "jim-dandy" noise generator that will not only produce noise in the set in which it is used but will perform a like service for other receivers nearby. This irregular scratching sound is probably caused by sparking at a poor connection between the capacitor lead and the foil, and it is picked up by the antenna and amplified just the same as is a signal. In fact, this sound behaves so much like the noise created by some outside electrical device that it is often dismissed as "natural" by inexperienced technicians.

Unsatisfactory Reception

You cannot use the bridging technique to check a capacitor suspected of this defect. More times than not, the bridging will send a surge through the circuit at the moment of contact, and will temporarily stop the noise. The trouble is that the same surge could also stop noise originating in some other circuit. Some technicians ease the bridging capacitor in and out of the circuit by connecting it in series with a variable resistance of a quarter megohm or so. Then the resistor-capacitor combination is connected across the unit to be bridged, as shown in Fig. 9-3, and the resistance of the variable resistor is slowly reduced from maximum to zero.

Personally, I prefer to disconnect one lead of a suspected capacitor and clip a good unit in its place. If the noise is gone when the set is turned on, I double check by turning off the set and reconnecting the old capacitor. If that brings back the noise, the capacitor obviously needs replacing.

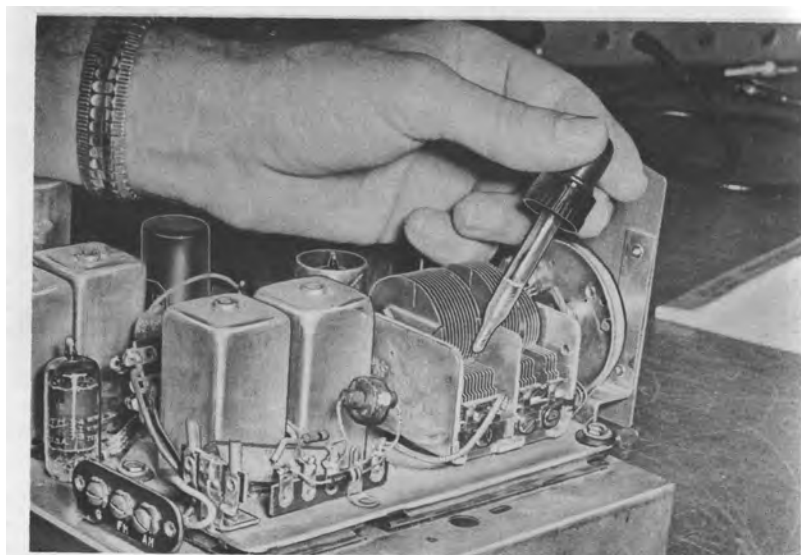

Fig. 9-4. Eyedropper being used to squirt carbon-tet between plates of tuning capacitor.

Sooner or later you are bound to encounter a set upon which some inexperienced service technician has perpetrated the service technician's unpardonable sin — used acid-core solder. Noise sources in such receivers can be almost anywhere. The acid fumes produced by contact with a hot soldering iron seep into the most unlikely places and either eat a conductor partially in two or set up a fluctuating chemical short circuit that is a prolific noise producer.

Noisy Sets

A perfect example comes to mind in which the noise was coming from a shielded audio grid lead with insulation that had become damp with acid inside the metal shield. It was finally tracked down by cutting loose both ends of the wire and checking resistance between the inner conductor and shield with the high range of the ohmmeter.

You find many sets that produce a scratching noise when they are tuned. This usually indicates rubbing tuning-capacitor plates or metallic particles between those plates. The former are corrected by carefully positioning the rotor with the end-thrust adjusting screw or by straightening bent rotor plates so they do not contact the stator plates. Metal particles can usually be blown out with compressed air or washed out with carbon tetrachloride, as shown in Fig. 9-4. Some technicians disconnect the tuning capacitor from the circuit and connect the high-voltage secondary of an old neon transformer putting out around 5,000 volts across the capacitor. Then the primary of the transformer is connected to the line, and the tuning capacitor is opened and closed a few times by means of an insulated extension tuning shaft while the high voltage is arcing across the plates. This arc burns out all dust and other particles that may have been shorting the plates. Although the neon transformer is capable of putting out only a few milliamperes of current, that 5,000 volts should always be treated with healthy respect.

At this point, where its use is first mentioned, I want to talk seriously about carbon tetrachloride. This chemical is an excellent oil and grease solvent and cleaner and in the past has been used extensively in the service shop for cleaning volume controls, switches, crystals, etc. It was mistakenly considered harmless; now we know better. Carbon tetrachloride, carelessly used, can kill you! Many deaths have been traced directly to it. The armed forces have practically discontinued its use altogether.

The potentially lethal nature of "carbon tet" would have been discovered long ago except for one fact: quite often a span of two or three weeks separates exposure to the chemical and the onset of illness caused by it. This lapse of time prevented doctors from seeing the connection between the puzzling illness and its true cause.

When carbon tet is sprayed on an open flame it is converted into deadly phosgene gas such as was used in the First World War; but this conversion does not have to take place for it to kill. Carbon tetrachloride can enter the body by being accidentally swallowed, by breathing its fumes, or through skin breaks. Once inside, it attacks the liver and produces degeneration. People vary widely in their tolerance to it. In general, overweight people, people with pulmonary diseases, and alcoholics—I am sure we have none of these among our readers! --are particularly susceptible to carbon tetrachloride poisoning.

Unsatisfactory Reception

If you do use it, observe the following precautions: (1) Never breath the fumes. Use it only with adequate ventilation. Since the fumes are heavier than air, the exhaust system should have one intake at floor level. (2) Make sure it does not splash into your eyes. (3) Never permit it to touch an open cut or abrasion of the skin. (4) Never expose it to the flame of a blowtorch or throw it on a hot surface. (5) Use it only when a safer chemical will not do the job.

THE AC-DC SET

These sets are very prone to develop noisy filter capacitors, loose loop turns, and noisy tubes. Rectifier tubes such as the 35Z5, 35Y4, and 35W4 very often develop an internal fault that causes them to radiate a scratchy-sounding signal into the nearby loop whenever they are jarred ever so slightly. Even walking across the floor or vibrations from the speaker will produce the sound. Proximity of the rectifier and loop antenna in these sets aggravates the condition. Shielding the rectifier tube will stop the noise, but since this interferes with necessary heat radiation from the rectifier, tube replacement is the only practical solution.

Mixer tubes and second detector tubes are very likely to develop noisy conditions in these sets; so replacing them is always a good way to start. Be sure and look for any noisy 117-volt filament pilot lamps often used in these small receivers. Sometimes you will find a poor connection between portions of metallic grillwork or other metallic trim that makes a noise as it is jarred. If this is the cause, the noise will disappear when the chassis is removed from the cabinet.

Other than these few instances, the search for a noisy condition in an AC-DC receiver proceeds along exactly the same lines outlined for hunting the trouble in a transformer set.

THE THREE-WAY PORTABLE RECEIVER

My experience has been that noise in these sets is usually found in the tubes; so replace them, one at a time, the very first thing. If that does not help, be sure and examine connections between the loop antenna and the set. Since such connections are ordinarily made through flexing leads or sliding contacts, they are frequent sources of noise.

If batteries have ever been allowed to remain in the set long after they are dead, corrosive fumes and acids from these batteries will often have the same effect on chassis and wiring as the use of acid-core solder. Clean all battery contacts that show signs of corrosion with a soda-water solution.

Batteries that are partially run down, and even on very rare occasions a defective brand-new battery, can produce noisy reception on battery operation. The quickest check, of course, is to replace the batteries and see if the noise stops.

Noisy Sets

When you get noise on either battery operation or line operation but not when the set is being used on the other type of power, your noise-cornering is half done for you. Quite obviously, it must be arising in the portion of the set peculiar to the type of operation in use when the noise is heard. For example, a noisy rectifier will only cause trouble when the set is being used on the line; and a poor battery connection will only be heard when the set is on batteries.

This may sound like an over-simplified, horse-sense observation; but it is amazing how easy it is to overlook a simple, logical deduction such as this when you become enmeshed in the intricacies of trouble shooting. That is why it is a good practice every now and then to lay aside your complicated test equipment and say to yourself, "Now just what the heck am I trying to find out?" Believe me it helps!

If you can find no special-case cause for noise in one of these little receivers, subject the set to the same methodical search for noise that was prescribed for the transformer set. Parts that do the same job in each receiver can produce noise in the same way; and your signal tracer, ohmmeter, and store of replacement parts are just as useful in tracing the noise to its source.

QUESTIONS

1. How can a "printed" loop antenna produce noise?
2. What is the thought behind tapping tubes in a noisy set?
3. How can a speaker cause noise?
4. How can an IF transformer whose windings are OK still produce noise?
5. Explain how filter capacitors can produce a crackling, scratching noise?
6. What precautions are mandatory in using carbon tetrachloride?
7. When jarring causes noise in an AC-DC set, what tube should first be suspected of causing it?
8. What is the most common cause of noise in three-way portables?

CHAPTER 10

Sets With Distortion

Very likely you will never have a customer bring in a receiver and say simply, "This set distorts." Instead he will probably remark, "People in this set sound like they're talking with amouth full of mush"; or, "This speaker is hoarse as a **bullfrog**"; or, "Everything sounds kinda muffled in this job." As mentioned before, a good service technician starts by being a good interpreter!

To tell the truth, though, audio distortion can take so many intricate forms that an accurate description is very nearly impossible. Fortunately, the trouble is usually easier to correct than it is to describe.

THE TRANSFORMER SET

If distortion is bad, it will be readily apparent on either voice or music; but slight distortion will ordinarily be more noticeable with music. The thing to do with a distorting set is to listen to it first at very low volume, then at high volume, and finally on both weak and strong stations. To a trained ear, this listening test can tell a lot.

If the distortion is only heard at low volume but disappears when the volume is advanced, the trouble is perhaps a voice coil rubbing on the pole piece of the speaker. At low volume, the weak impulses are not strong enough to move the voice coil back and forth because of the friction; but at high volume levels, the voice coil is jerked back and forth so vigorously that the slight drag has noticeable effect on it. To test this possibility, remove the speaker; and while the set is playing, run your finger around the edge of the cone face, applying a slight pressure that pushes the edge of the cone backward. If the distortion clears up when pressure is applied to one portion of the cone circumference but grows worse when that pressure is diametrically opposite, you have found the trouble. The voice coil is rubbing on the pole piece on the side opposite of the point at which pressure cleared the condition.

The cure is to re-center the voice coil. On speakers that have an adjustable spider or one cemented to a movable plate, this is no problem at all. First, soften with acetone the cement holding the dust cover over the hole in the center of the cone and remove the cover. Then, loosen the screws that hold the voice-coil spider adjustment in place. Next, insert equally spaced speaker shims of the

proper size between the voice coil and the pole piece and tighten the spider-holding screws as shown in Fig. 10-1, and remove the shims. Once in a great while the trouble will be caused by a piece of paper off the voice-coil thimble or by a particle of dirt that is wedged between the voice coil and the pole piece. Usually, the foreign object

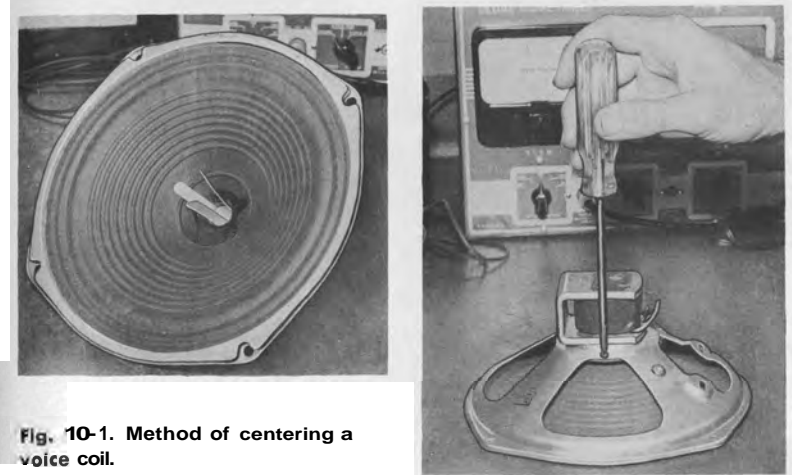

Fig. 10-1. Method of centering a voice coil.

can be worked out of the space by careful and gentle manipulation with a lone speaker shim.

Many low-cost speakers have no provision for moving the voice-coil spider. Instead, the spider is of a concentric bellows type of construction and is firmly cemented to a fixed metal plate. In this case, insert your speaker shims as before, and then very carefully apply three or four drops of acetone to the outer rim of the spider. Be careful not to get any acetone on the voice coil itself. A long-snouted eyedropper is very useful in placing the drops exactly where you want them, as illustrated in Fig. 10-2. This acetone will soften the spider and then, as the solvent rapidly evaporates, allow the spider to take a new set that will hold the voice coil properly centered. It is a good idea to leave the shims in place ten or fifteen minutes after the acetone has been applied; then, when you remove them, the voice coil should stay properly positioned.

Sometimes the distortion takes the form of a rattling, buzzing sound heard only on certain notes at high volume. This indicates a cracked or unglued cone or one with a loose voice-coil winding. If the edge of the cone has come loose from the frame, glue it back with Speaker cement. It is usually a good idea to have speaker shims in place while performing this operation to be certain you do not upset the voice-coil centering. Cracks in the cone can be repaired by a very sparing application of speaker cement worked down between the

Unsatisfactory Reception

edges of the break with a knife blade, as shown in Fig. 10-3. Never use any more cement than is absolutely necessary when repairing a break in the cone proper, because this will weight and stiffen the cone at that point.

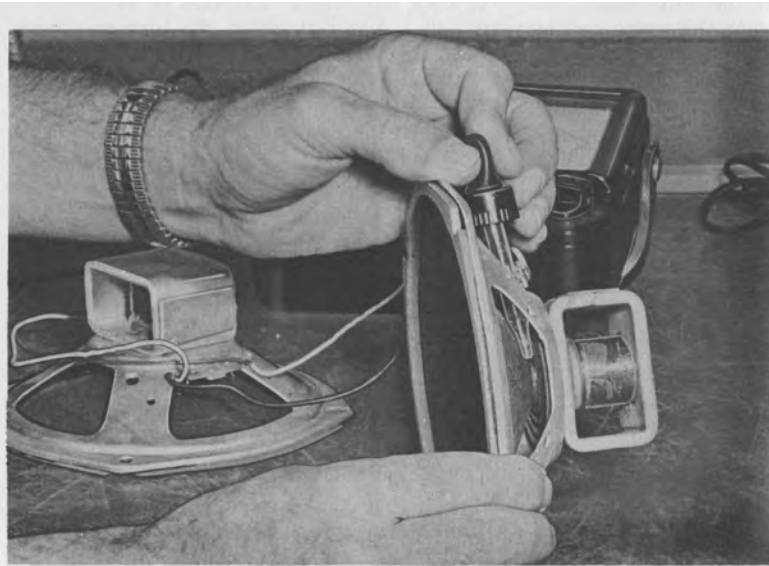

Fig. 10-2. Applying acetone to loosen spider of a speaker.

If the cracks are very long, and especially if they are radial cracks extending from the center to the rim of the cone, the cone had best be replaced. The same should be done if the trouble is found to be a voice-coil winding loose on its thimble. Because of the very limited space in which the voice coil must move and the importance of its being critically positioned, a repair of this defect is seldom practical. Be sure, though, that the trouble really is a loose voice-coil winding and not a voice-coil lead or other wire touching the back side of the cone or possibly a foreign object wedged down between the bottom rear edge of the cone and the speaker frame. These things produce sounds very similar to a loose voice coil.

In a very short time, the novice technician will learn to recognize by ear almost every defect that originates in a speaker. While these sounds are hard to describe so they may be recognized, they are utterly unlike forms of distortion originating in other parts of the receiver.

Defective tubes often produce distortion, and this possibility should be checked before removing any one form, the

Sets with Distortion

receiver acts as though something were trying to choke off the signal on its way through the set. Only strong signals are heard normally. The rest sound rather strangled, with only loud passages being able to force their way through. Noise and static are not heard between

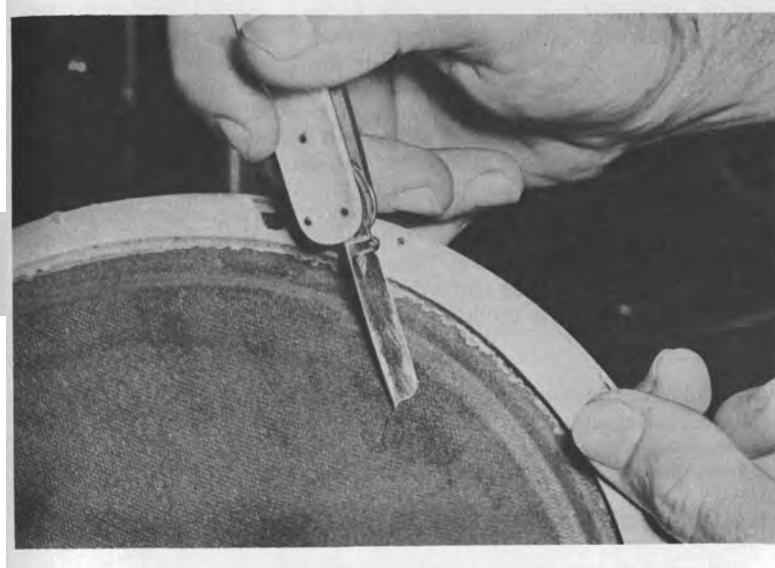

Fig. 10-3. Repairing a break in the speaker cone.

stations. When you get such a set, try substituting new tubes for those used in the RF, mixer, IF, and detector stages. The IF amplifier tubes are particularly likely to become gassy and cause this form of distortion. It can also be produced by other causes, but new tubes are the first thing to try.

Sometimes audio tubes, especially those used in output stages, develop secondary grid emission. When this happens, the grid potential of the tube gradually moves in a positive direction as the tube remains in use. The loss of negative bias produces distortion that grows progressively worse. As the customer usually describes it, "The set is all right when I first turn it on, but the longer it plays the worse it sounds." When encountering a set that does this, replace all audio tubes one at a time and see if changing any one clears up the trouble. Remember to let the set run long enough each time for the distortion to start, if time plays a part in it. If this does not help, you may as well remove the chassis. About all the remaining causes of distortion are produced by under-the-chassis components.

Almost the same symptoms as those of an output tube with secondary grid emission may be caused by a leaky coupling capacitor

between the grid of the output tube and the plate of an audio amplifier. The DC plate voltage leaks through the capacitor and overrides the grid bias, causing the output tube to draw excessive current and badly distort the signal passing through it. In both the case of the leaky coupling capacitor and the tube with secondary grid emission, the grid will either be positive or less negative than it should be when tested with a voltmeter. However, if the grid end of the coupling capacitor is cut loose, the grid will return to a normal potential if the capacitor is at fault; furthermore, a reading taken from the disconnected end of the capacitor to ground will usually show the full positive potential applied to the other end of the capacitor, especially if the measurement is done with a VTVM. After the first kick of the pointer as the meter is connected, a good coupling capacitor should show no positive potential at all. If the capacitor is all right and the grid of the tube to which it was connected remains positive after the capacitor is cut loose, you almost certainly have a bad tube. Replace it with a good one, and the grid potential will very likely return to normal.

Bad coupling capacitors probably account for fifty per cent of all distortion complaints. Remember that push-pull stages will usually have a coupling capacitor driving the grid of each output tube, and there may be other coupling capacitors connecting previous audio stages. Check them all as soon as you have the chassis out of the cabinet. Any one, if leaky, can cause distortion.

A set that sounds normal when receiving weak stations but that distorts badly on strong local signals probably has something wrong with its AVC system. Sufficient bias is not developed on strong signals to prevent overloading of one or more stages. Once again leaky capacitors—those that bypass various points on the AVC line to ground—are usually the cause of the difficulty. Since the AVC voltage is fed to the tube grid circuits through resistances of very high value, even a slight leakage in one of these capacitors is sufficient to short-circuit a large proportion of the developed AVC voltage to ground. To check for this condition, tune the set to a strong local station and use your VTVM to measure the developed AVC voltage at various points along its distribution system. A strong local signal should develop from ten to fifteen volts across the load resistor, and this voltage should diminish very little—not more than a volt or so—right out to the grids of the controlled tubes. If the developed voltage is low and if it practically disappears at some point along the line, it is extremely probable that a leaky capacitor is shorting it out.

Switch off the set and resort to your ohmmeter to locate the faulty capacitor. Exactly the same methods are used to locate a leaky capacitor in this circuit as you used to run down a similar fault in the B-plus system in Chapter 5. The only difference is that now a proper reading will usually be in the megohms, and anything along-

the AVC bus below hundred thousand ohms or so indicates a virtual short circuit. You still measure the resistance to ground from each end of a resistor through which voltage is fed, and the lower reading indicates in which direction the leaky capacitor lies. When you have found the point of lowest resistance to ground along the AVC distribution system, examine the circuit to see which capacitor could be the guilty one; then disconnect this and check it with your ohmmeter on a high range. Good .05- to .1-mfd capacitors usually found in an AVC circuit should read better than one hundred megohms of resistance. If any read less than that, replace them with good quality new capacitors.

I do not want to leave the impression that leaky capacitors are the only troubles found in AVC systems. Isolating resistors can suddenly open up; diode AVC rectifiers may fail; IF transformer secondaries through which AVC voltage is fed can short to ground or become open. These things, though, happen very, very rarely; but shorting capacitors are as common as ants at a picnic. That is why you should be sure there are none of these before you start looking for something else.

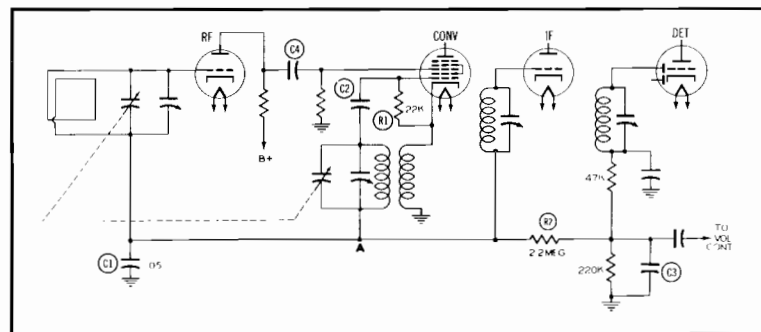

Fig. 10-4. Partial schematic of AVC circuit of a typical receiver.

To illustrate the point, consider the case of the set for which the AVC system is diagrammed in skeleton form in Fig. 10-4. This set had rather peculiar symptoms. On strong stations it distorted badly, but all other stations were received quite weakly. When the VTVM was connected to the AVC lead, it was found that a minimum negative potential of about seven volts existed on the grid of the IF and RF stages; yet this increased only about a volt or so when a strong local station was tuned in. Resistance from tie-point A to ground measured only one hundred thousand ohms; still, when C1 was disconnected and measured, it showed nearly one thousand megohms of resistance. By disconnecting various leads taking off from point A and using the ohmmeter, it was established that the partial

Unsatisfactory Reception

short circuit was in the oscillator section. With that clue to point the way, only a couple of more measurements with the ohmmeter were needed to reveal that C2 has a leakage resistance of around eighty thousand ohms.

This is what was happening: the negative voltage developed on the oscillator grid was being connected to the AVC system through the leaky capacitor C2. That accounted for the high negative bias that caused weak reception on most stations. On the other hand, when a strong station was tuned in, the control bias it developed and tried to feed to the grids through the 2.2-megohm resistor R2 was mostly shortcircuited to ground through the two windings of the oscillator coil R1 and the leaky C2. This produced the overloading on strong signals.

Another time, a bad cause of overloading on strong signals was traced to a loss of AVC voltage produced by leakage between the two windings of the oscillator coil. This leakage was not sufficient to stop oscillation--it probably occurred at the "cold" ends of the two windings--but it effectively grounded the AVC bus.

Usually about the time you sell yourself on the idea that you are a hot-shot technician and that, after all, fixing radios is a lead-pipe cinch, a set such as this comes along to deflate your ego—and add to your store of useful experience.

There are border-line cases in which it is hard to determine by merely listening just where distortion is arising. That is when you fall back on your signal tracer to determine in precisely which stage the trouble begins. Use the audio probe and start with the output tube and work forward, a stage at a time, until you reach the volume control. Listen at the plate and grid of each tube to determine if the distortion is present at both points. Naturally, if the signal is clear at the input but distorted at the plate, something in that stage is causing the trouble. When such a stage is found, the first thing to do is to check carefully every voltage on the tube and compare your readings with the service data. The cause of any deviation from normal should be tracked down by methods already described and corrected.

Incorrect bias voltage is the most common cause of distortion. Remember that bias voltage is the difference in potential existing between the control grid and the cathode; so, anything that changes the voltage between cathode and ground also changes the grid bias. Leaky cathode-bypass capacitors are not at all unusual. They can be checked by disconnecting them and measuring their DC resistance with an ohmmeter. Be sure to observe proper polarity with electrolytic capacitors. Even an electrolytic capacitor should display an ohmage of several hundred times the resistance it is bypassing. Incidentally, while you have the bypass capacitor disconnected, measure the resistance of the cathode resistor. It may have changed value and upset the bias on the tube.

Sets with Distortion

It must be mentioned that an open cathode-bypass capacitor in the audio section can also produce distortion which often goes unnoticed. This distortion takes the form of discrimination against low frequencies. High frequencies are passed through a stage with an open cathode resistor with little attenuation, but bass notes are cut way down or lost entirely. Bridging a suspected cathode-bypass capacitor with a good unit will quickly reveal this fault by a marked improvement in low-frequency response.

Sometimes a coupling capacitor will develop a high resistance between a lead and the foil to which it connects. Strong signals will break down this poor connection and come through, but weak ones will not. The result is a partially strangled kind of reception described previously. At the same time, high frequencies will come through better than low ones. Bridging such a capacitor with a good unit will restore normal reception and spotlight the fault.

If reception is normal from the volume control to the speaker, switch to the RF probe on your signal tracer and advance from the detector stage toward the front of the set. Once more look for the stage in which the distortion starts. When that is found, make a critical study of all voltages on the tube. Pay particular attention to grid, cathode, and screen voltages. Measure with the VTVM the AVC voltage developed at the grid-return point of each controlled tube as you tune through a strong local station. Note if this voltage rises sharply to keep the strong signal from causing overloading. When anything abnormal is found, study the diagram for clues as to what could be causing this, and then employ your ohmmeter to prove or disprove your calculated guesses.

Other than the AVC troubles previously described, distortion seldom arises in the front end of a receiver; but it can happen. For example, if the mica coupling capacitor C4 in Fig. 10-4 became leaky, it would put a positive bias on the converter tube that might easily lead to distortion. The careful technician would spot this trouble, of course, when he found a positive voltage on the grid of this tube instead of the zero voltage he would have expected. Under some conditions, excessively high or low screen voltage on an IF amplifier can produce distortion. Low screen voltage is usually the result of a leaky screen-bypass capacitor or of a voltage-dropping resistor that has increased in value. High screen voltage is caused by a voltage-dropping resistor that has decreased in value; or, in the case of a voltage-divider arrangement for feeding the screens, it is caused by the opening of the low-potential end of the divider.

On older sets that employ a field-coil winding, it is sometimes possible for this winding to open up without changing anything else in the receiver. In this case, the speaker field loses its excitation, and the speaker becomes a very inefficient reproducer. An excessive amount of signal must be fed to the voice coil to produce adequate volume. Under such circumstances, the output tube is usually over-

Unsatisfactory Reception

loaded and begins to distort before adequate volume is achieved. In this case, of course, the distortion should be a secondary symptom. Lack of volume should be the first thing noticed; however, in some instances, especially when working on a set with which you are not familiar, it is easy to mistake a related trouble for the main difficulty.

THE AC-DC SET

These little receivers often develop such distortion troubles as rubbing voice coils, leaky audio coupling capacitors, output tubes with secondary emission, defective IF amplifier tubes, and shorted AVC bypass capacitors. All such difficulties are located in AC-DC receivers in exactly the same way they are found in transformer sets.

Because their small speakers and inadequate baffles usually do not reproduce a sixty-cycle note well, a novice technician occasionally mistakes the modulation of a signal with hum caused by an open filter capacitor in one of these sets for true distortion. The chopping up of the signal is much more noticeable than the low-pitched hum doing the chopping. He quickly finds, though, that when he locates and replaces the open filter capacitor the distortion goes away; and the next time, he wastes no time looking for some odd and baffling cause of distortion!

THE THREE-WAY PORTABLE RECEIVER

Everything that can cause distortion in a transformer set can perform the same office in one of these portables, and you use the same instruments and techniques in running down troubles. In addition, though, one of these receivers can come up with a few interesting causes of distortion peculiar only to them.

For example, the tiny filaments in the tubes used in these sets often suffer a serious loss of emission. When this happens, especially to an output tube, it cannot respond to the demand of a signal for positive current peaks; and the flattening of these peaks produces distortion along with reduced output. Since you ordinarily do not expect too much output from these sets anyway, the distortion is often more noticeable than the reduced volume. - Sometimes capacitors become leaky or resistors change value along the series-filament supply circuit with the result that one tube filament may be "starved" while others are oversupplied. The starved filament will act exactly like a tube with inadequate filament emission, and distortion will again result. That is why it is particularly important to check all filament voltages in one of these sets. Since you ordinarily do not measure filament voltage in the other two types of receivers, this is easy to overlook.

In the same way on battery operation, weak batteries can cause distortion in addition to weak reception. Very often a distortion trouble can be partially isolated by noticing that it is present when one type of power is being used but disappears when you switch to the

Sets with Distortion

other. Never fail to take advantage of this helpful characteristic when working on one of these receivers.

QUESTIONS

1. What is a likely cause of distortion heard only at low volume level?
2. Describe how to center a voice coil with no provision for moving the spider.
3. What should be done with a speaker having long radial cracks from center to rim of the cone?
4. Describe the symptoms of an output tube with secondary emission.
5. What other faulty condition will cause symptoms similar to those in Question 4?
6. Where do you look for the cause of distortion occurring only on loud signals?
7. What is the effect of an open cathode bypass capacitor in an audio stage?
8. Give two possible causes of choked, strangled-sounding reception.
9. How does low filament emission of a tube in a three-way portable cause distortion?

CHAPTER 11

Weak Sets.

Unless you have had experience with a simple, crystal-detector receiver, you can scarcely appreciate the weak level of the radio signal that strikes a receiving antenna even if the signal is from a local station. Observing how tremendously the signal must be amplified before it is ready to drive a speaker may make this point easier to grasp. In the chart of Fig. 11-1 are listed various receiver components through which a signal passes, together with typical voltage amplifications provided by each component. This information is given both for a transformer set with an RF stage and for an AC-DC receiver.

When you notice that even a five-tube AC-DC receiver should be capable of amplifying a received signal more than ten million

	Transformer Set	AC-DC Set
Antenna Coil	7.5	20
RF Stage	25	--
Mixer Stage	35	15
1st IF Transformer	.6	1.8
IF Tube	150	100
2nd IF Transformer	.6	.65
Audio Amplifier	34	30
Output Tube	11	10
Approximate total possible amplification: product of individual gains	132,500,000	10,500,000

Fig. 11-1. Typical amplification figures provided by various receiver components.

times, it underscores the point that amplification is one of the most important functions performed by a radio receiver. By the same token, anything that lessens this ability of a set to amplify is bound to produce a noticeable impairment in its operation. Such impairment usually leads the owner to complain that the set is weak.

THE TRANSFORMER SET

Be sure and quiz the customer as to why he thinks his set is weak. Ask him if the volume is down on all stations or on just some particular one. If only on one, find out which one. He may be slandering his poor receiver because it cannot achieve the impossible — such as pulling in a noontime program on which a relative is to be interviewed over a 250-watt station a thousand miles away! Believe me, this happens.

If the complaint sounds justified, listen to the receiver yourself — and listen with all your powers of observation alert! Notice if stations tune broadly or sharply. If the tuning is exceptionally broad, the IF transformers are probably out of alignment. Tune in several stations of different signal strength. Run the volume control up and down. When the lack of amplification is in the audio portion of the receiver, all of the stations will be received with approximately the same volume; but the volume will be inadequate even with the volume control wide open. On the other hand, if the lack of amplification is in the RF or IF portions, local stations will be heard with normal volume; fairly strong signals will sound weak; and average signals will probably not be heard at all. In some cases, such as when a weak rectifier causes all voltages to be low, a receiver will display both sets of symptoms.

If these observations lead to nothing conclusive, begin a methodical check of things you can test without removing the chassis. Start by wiggling all tubes in their sockets. In many cases, a poor contact in the socket will cause a tube to fail in its job of amplifying. Ironically, this is particularly common with those lock-in type of sockets that were especially designed to overcome this trouble. Corrosion on the steel-tube pins or sprung jaws on the socket often cause one tube element to be partially or completely disconnected from the circuit. In such a case, shifting the tube a bit will ordinarily cause the volume to hop up and down as the connection is made or broken. Squirt contact cleaner down into the tube-pin sockets with an eyedropper, and then replace the tube and work it about a bit. If the volume stays at a high level no matter how the tube is wiggled, a repair may be considered effected. If not, the socket will have to be repaired by bending the jaws closer together with a sharp-pointed tool, or the socket will have to be replaced. Incidentally, use common sense in the matter of wiggling the tube. Do not force it so far to one side or the other that damage is done to the socket or tube pins.

If there are any grid-cap tubes, strike them sharply on top of their caps with a small screwdriver handle or similar tool. If this causes a change in volume either way, replace the tube and repeat this test. Such tubes often develop a poor connection between the cap and the grid lead. When it is established that a tube has such a fault, it can often be repaired by melting the solder from the cap; scraping the exposed wire lead until it is bright; and then resoldering.

Unsatisfactory Reception

Run all tubes through the tube tester; or better still, replace all tubes one at a time with new ones and see if this restores the volume. While a tube tester is more reliable in spotting tubes that are weak than tubes with some other defects, it still is not infallible. Tube replacement constitutes a test that is more dependable and one that is very often quicker. If the changing of any tube restores the receiver volume and sensitivity to normal, the service job is solved then and there. Keep in mind, though, that more than one tube may be weak; so while you change the tubes one at a time and listen after inserting each new tube, leave the new tubes in until you have replaced all tubes. Then you can return the old tubes to the sockets in which new tubes produced no improvement.

Whether you use the tube tester or depend upon tube replacement, pay particular attention to IF and audio amplifier tubes. They are especially important because they are responsible for a high percentage of the total amplification of the receiver. Also remember this: in a set that uses a separate duo-diode detector tube such as a 6H6, the filament of this tube can be entirely open and yet the set will operate, although at considerable reduced volume. Partial detection takes place in one of the previous stages, and the signal passes right through the dead detector to the audio amplifier. When these tubes were in their heyday, this happened so often that the first test with a weak set using one of them was to reach in and feel that sawed-off little tube to see if it was warm! Be sure and check the rectifier tube carefully, too; for if it fails to put out sufficient current, all the voltages in the set will be low.

After you have convinced yourself nothing is wrong with the tubes, try holding your hand near the stator portions of the variable tuning capacitor as illustrated in Fig. 11-2. If bringing your hand near one particular section causes an increase in volume, study your circuit data to see what circuit that section tunes. A receiver with provision for an external antenna will very often have a burned-out or open antenna coil. In such a case, holding the hand near the section of the tuning capacitor that tunes the grid circuit of the first tube (be that an RF stage or mixer) will cause the volume to rise sharply, because the signal picked up by your body is transferred to the tuned circuit. At other times, the primary of the RF transformer in the plate lead of the RF stage opens up. In this case, holding the hand near the mixer-tuning section of the tuning capacitor will permit the signal from the transmitter to bypass the dead RF stage.

Note that in either of these cases, the increase in volume will be considerable when the hand is brought very near but does not touch the stator. A slight change in volume would merely indicate that the tuned circuit approached was not in perfect alignment with the station being received. If these tests show something amiss, the coil in question can be checked with the ohmmeter. Replacement is usually the only practical repair, although occasionally you will be lucky

Weak Sets

enough to find a break right at the point where a winding connects to a solder terminal.

Where the set uses a loop antenna, be sure and check loop leads to see if they are properly connected. It is not at all unusual for a housewife to pull off these leads while dusting inside the cabinet and then to put them back in any old fashion. Feminine logic being what it is, she may never see any possible connection between this act and the fact that the radio lost its voice shortly thereafter — especially if her husband warned her not to try and dust inside the cabinet! If the leads are connected to the proper points, check them carefully for possible breaks, especially when the loop can be easily turned from the front of the set. Those leads were designed to last a lifetime with normal use, but the design engineer did not consider the

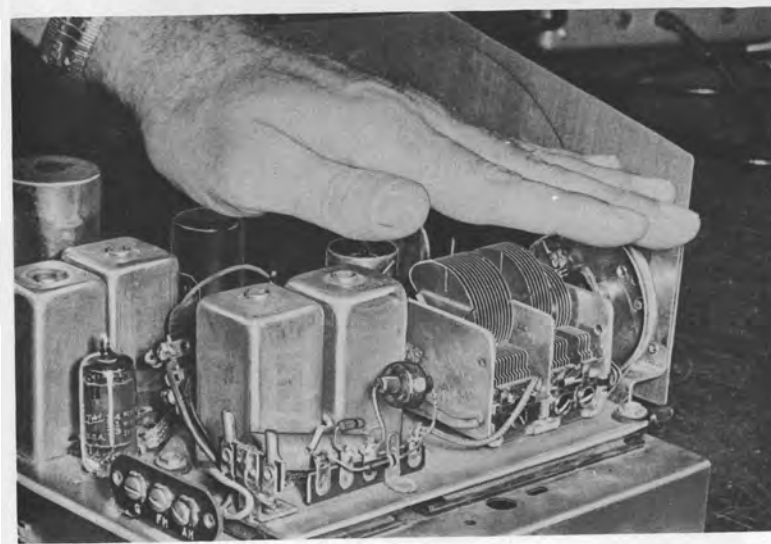

Fig. 11-2. Checking for an open antenna coil.

possibility that Little Leroy might sit and twist the loop-turning knob back and forth by the hour.

Do not overlook the possibility the IF's may be badly out of alignment, especially if preliminary tests mentioned point in that direction. While IF transformers seldom detune themselves, they quite often have help from set owners who cannot resist meddling with something about which they know nothing. While most of these owners would be drawn and quartered before confessing their tinkering, circumstantial evidence often betrays their guilt; and, as Henry David Thoreau remarked, about finding a trout in the milk, "Some

Unsatisfactory Reception

circumstantial evidence is very strong!" Finding all the IF transformer adjustment screws turned down tight is just such evidence.

Usually a signal generator can be connected across the mixer input while the chassis is still in the cabinet of a console as shown in Fig. 11-3. Then, by tuning the signal generator back and forth, you can quickly determine if the IF amplifier is peaked on the proper frequency. Even though it is, try touching up the alignment of individual transformers. While the over-all response of the amplifier may be on the right frequency, individual tuned circuits may be off in opposite directions. If misalignment proves to be the cause of weak reception, refreshing your memory with the instructions given

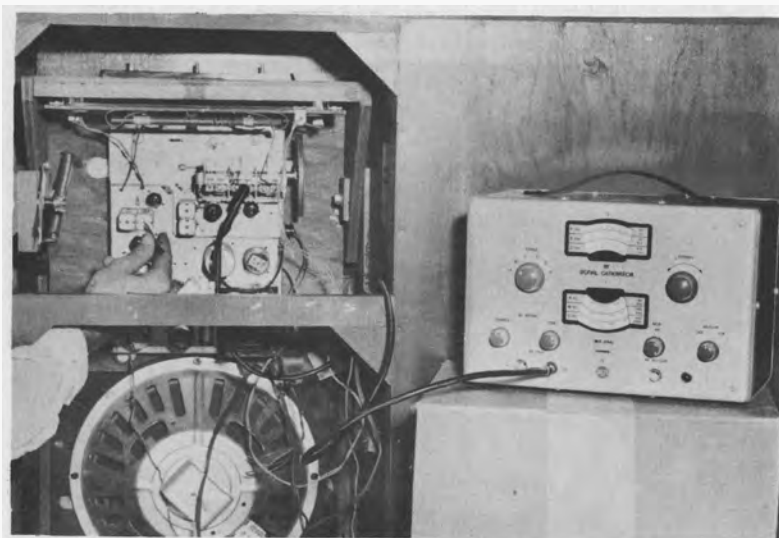

Fig. 11-3. Touching up the IF transformer while receiver is in cabinet.

in Chapter 7 might be a good idea. Incidentally, if you are familiar with how much signal is needed from the signal generator to produce an audible sound in the speaker when a set is normal, you can establish whether or not the set is all right from the mixer grid to the speaker at the same time that you are checking the alignment. If only a high output from the generator will force a signal through, you can be sure something is wrong somewhere between these two points.

Finally, before you pull the chassis, take a peek at the speaker. If it is of the field-coil dynamic type, it is remotely possible the field coil may not be energized. I say "remotely" because the field coil is usually employed in the filter circuit of the receiver in such a way

Weak Sets

that if it opens up the receiver would be completely dead. Its leads could short, though, or a capacitor connected across it could develop a short circuit that would bypass current around the winding.



Fig. 11-4. Testing continuity of speaker field.

Turn off the receiver and use needle-pointed test probes to pierce the insulation of leads going to the field coil as shown in Fig. 11-4. An ohmmeter across the other ends of these leads will establish if the field coil has continuity and proper resistance. Next switch the VOM from the ohmmeter to a high range of the DC voltmeter and turn on the receiver. See if the voltage drop across the field winding agrees with what the service data says it should be. If it does, the field coil is being energized. If it does not, use your ohmmeter, your diagram, and your brains to find out why! Of course, you could determine if the field is energized by removing the speaker, uncementing the dust cover in the center of the cone, and observing if the pole piece would strongly attract a screwdriver bit or similar magnetic metal object; but the other method is usually quicker, easier, and just as positive.

After you remove the chassis, turn on the set and touch a finger to the grid connection of the first audio amplifier. If the set is normal from this point to the speaker, you should hear a loud growl. A normal audio amplifier reacts to having its input grid stroked about the same way a healthy lion does to having his tail twisted. If a sufficiently loud growl is heard, you know your trouble lies ahead of this point; if the growl is feeble, you will look for trouble between the input grid and the speaker.

Unsatisfactory Reception

In either case, your VTVM is the first instrument to use. Methodically check every tube voltage in the portion of the receiver where you have decided the trouble lies, and compare every measurement with that specified in the service data. You should be especially on the lookout for the following: low plate and screen voltages; exceptionally high negative-grid or positive-cathode voltage; high minimum AVC voltage. When any of these are found, if you have paid attention to what you read in previous chapters, you should know exactly how to employ your voltmeter and ohmmeter to spot the cause. Remember that a defect causing one tube voltage to change will usually produce a shift in all other tube potentials; so try to decide which key discrepancy is producing the others, and concentrate on the reason behind that wrong voltage. When found, it will be the same shorted or leaky bypass capacitor, open or increased value of resistor, short circuit in the wiring, or open coil winding, any of which you have learned to expect where improper voltages are involved.

If all voltages are low but the B-plus to ground resistance is normal, the input filter capacitor may be open. Normally, this also results in bad hum; but in some sets having two-section filters, the increase in hum is not so noticeable. If the minimum AVC voltage is too high, remember the case described in Chapter 10 where the oscillator grid voltage leaked through a defective capacitor to the AVC bus and kept the negative voltage on this line at a high value.

When all voltages in the set are within ten per cent of those specified in the service data, the cause of weak reception is a little more unusual; so trot out the Old Reliable instrument for unusual cases—the signal tracer. Right here let's make an important point about this piece of equipment. Its value to the user is directly proportional to the amount of time he spends experimenting with it on properly functioning sets. Just as a medical student applies his stethoscope to a great many healthy hearts before he is ready to listen to those that are diseased, a service technician must be thoroughly familiar with what constitutes a normal indication on a signal tracer applied to all the circuits of every different type of receiver before he can recognize abnormal performance.

When you have this knowledge, you can use your signal tracer to locate quickly the circuit component in which the signal is not being adequately boosted or in which it may even be attenuated. If previous testing leads you to believe the trouble must lie in a particular portion of the circuit, apply the proper probe of the tracer directly to that portion of the set. If you have received no such message from your observations, you may as well start at the plate of an output tube and work toward the front of the set. In either case, the procedure is the same; you compare the signal heard at the input of a tube, transformer, or coupling capacitor with that heard when the tracer probe is shifted to the output of the device. Any difference in signal levels is evaluated in view of what is supposed to happen. For example,

Weak Sets

RF or output tubes should show moderate gain; IF transformers may show either a slight gain or a slight loss; or coupling capacitors should transmit the signal without appreciable gain or loss.

When you locate a component that is not doing right by our signal, you may be able to use your ohmmeter to pinpoint further the real trouble; but in many cases, it will be best to replace the whole component without wasting any more time. IF transformers develop shorted turns, high-resistance windings, and shorted trimmer capacitors that greatly impair their ability to transfer a signal from one circuit to another. The same thing happens when coupling capacitors become open. RF transformers are subject to the same failures as IF transformers. An audio amplifier or output tube with an open cathode-bypass capacitor will have its ability to amplify signals greatly reduced. Incidentally, you can easily spot such an open capacitor with your signal tracer by noting the improper presence of the signal on the unbypassed cathode.

One final cause of weak signals is insufficient oscillator voltage applied to the mixer stage. Anything wrong with the oscillator itself would be revealed in low developed voltage on the grid, and this should have been spotted when taking voltage measurements. However, in sets using separate oscillator and mixer tubes, the RF voltage developed by the oscillator must be transferred to the mixer. This is accomplished in an endless variety of ways; but in every case the transformer, coupling capacitor, or whatever is used to transfer the oscillator signal may develop a fault that prevents sufficient voltage being injected into the mixer; and then weak, noisy reception results.

If this kind of reception is obtained and if nothing wrong can be found elsewhere in the receiver, look for trouble in the transfer circuit. Thorough checks with the ohmmeter and the substitution of new parts for those suspected will reveal the fault, if one is present.

THE AC-DC SET

As can be seen from examination of Fig. 11-1, an AC-DC set does not have as much amplification as a typical transformer set. Part of this is due to the fact that a transformer set often has more stages, and the rest is the result of the higher voltages applied to the tubes of the larger receiver, with the consequent increase in amplification this affords. As a result of this difference in amplification, the AC-DC set needs a much greater percentage of its total possible amplification. It lacks the reserve power of the transformer receiver. It follows, then, that more complaints of weak reception are made about the little receivers.

Replacing the tubes with known good ones is a first step with these sets. They are harder on tubes than transformer receivers. Rectifiers very often lose emission and cause weak reception because

Unsatisfactory Reception

of lowered voltage. It is worth mentioning that quite often the presence or absence of a dial lamp in an AC-DC receiver will have a marked effect on the emission from the rectifier; so, be sure a dial lamp is in its socket and burning while you are doing your checking. IF tubes that are only a little weak can seriously affect the sensitivity. Output tubes that are low in emission will limit the maximum volume on all stations.

When new tubes make no difference, check the alignment by the use of the signal generator. It will very often be found incorrect. IF transformers that are hemmed in by heat-radiating rectifiers and output tubes are quite common on the crowded chassis of these receivers; and, as mentioned previously, excessive heat can cause IF transformers to drift out of alignment and even impair them permanently. The signal tracer is the best instrument to use in determining whether or not an IF transformer is causing a signal loss.

Since it is usually necessary to remove the antenna of these little receivers to reach the tubes, antenna leads often break loose. Ability to receive only local stations and a loud hum present with such reception are symptoms that often accompany broken loop leads.

Failure of the input filter capacitor has a more marked effect on the B-plus voltage supplied by the half-wave rectifiers usually found in AC-DC receivers than it has when the same part goes bad in a transformer set. This statement is doubly true when a voltage-doubler rectifier is employed in the little set; so whenever you find over-all low voltage, be sure and subject all filter capacitors to the bridging test.

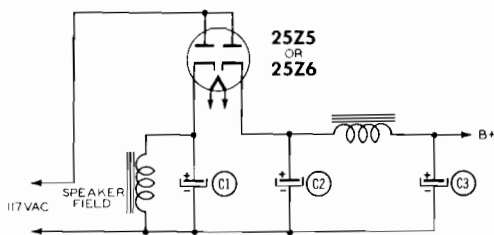

Fig. 11-5. Rectifier circuit formerly popular in AC-DC receivers.

Older AC-DC sets quite often employed 25Z5 or 25Z6 rectifiers and a field-coil speaker connected as shown in Fig. 11-5. One half of the rectifier supplies the speaker field with an energizing current that is filtered by C1. The other half supplies B-plus voltage that is filtered in the usual manner by two capacitors and a choke. Note that in such a set the speaker field can open or C1 can lose its capacity without any effect whatever on the B-plus voltage delivered to the set.

Weak Sets

In such an event, however, the speaker field would lose all or part of its energizing current, and reception would be very weak. About the time you decide all AC-DC circuits are alike, some one will drag in something like this to remind you that you should always study the diagram!

THE THREE-WAY PORTABLE RECEIVER

Weak tubes are very often the cause of weak reception in transformer and AC-DC sets, but they are most often behind this trouble in portable receivers. Because of the series-filament arrangement used and the critical value of filament voltage needed for proper operation, a change in the filament structure of one of the tubes quite often affects the operation of other tubes that are normal. That is why it is especially important to substitute new tubes in all sockets of a weak receiver of this kind. If this restores the sensitivity of the set, then the old tubes can be replaced one at a time to see which ones should be permanently replaced.

While you are changing the tubes, be on the lookout for a poor socket connection. Those miniature sockets give considerable trouble and are easily damaged by wrestling a tube in and out of a socket too vigorously.

When you start checking voltages, pay particular attention to the voltage delivered by the rectifier. If this voltage is down only five or ten volts, it is a good idea to try a new rectifier, selenium or vacuum tube as the case may be. While the difference in plate and screen voltages would not be sufficient to cause the set to be weak, remember that the rectifier also supplies filament current for the tubes; and when you check these filament voltages carefully, you may find them low by as much as twenty or twenty-five per cent. That is too low for proper emission. Many a weak set will show a surprising improvement in sensitivity and volume when a new rectifier is installed.

Plate and screen voltages for the pentode audio amplifier tubes often used in these sets are fed through high-value resistors of very low wattage. These resistors often develop a large increase in resistance for no apparent reason, and the result is a serious loss of audio amplification. When possible, it is a good idea to replace the original quarter-watt resistors with half-watt units.

Do not overlook the very common trouble with these little sets: the broken leads going to the loop antenna. If it happens that the lead going to the cold end of the loop is the one broken, you may get sufficiently good reception to mislead you. Checking across the loop-lead terminals while the loop antenna, if it is lid mounted, is moved back and forth will reveal if trouble exists in this department.

Unsatisfactory Reception

It hardly seems necessary to point out that weak batteries can cause poor reception when batteries are being used. Check the battery voltages in such a case, even though the batteries are brand new. When checking the battery voltages, the batteries should be connected to the circuit with the receiver turned on. This method is illustrated in Fig. 11-6. Improper storage conditions can cause batteries to run down rapidly; and once in a great while, you will encounter a defective battery. A good service technician suspects every part in the set until its innocence is proved by the evidence of his test instruments.

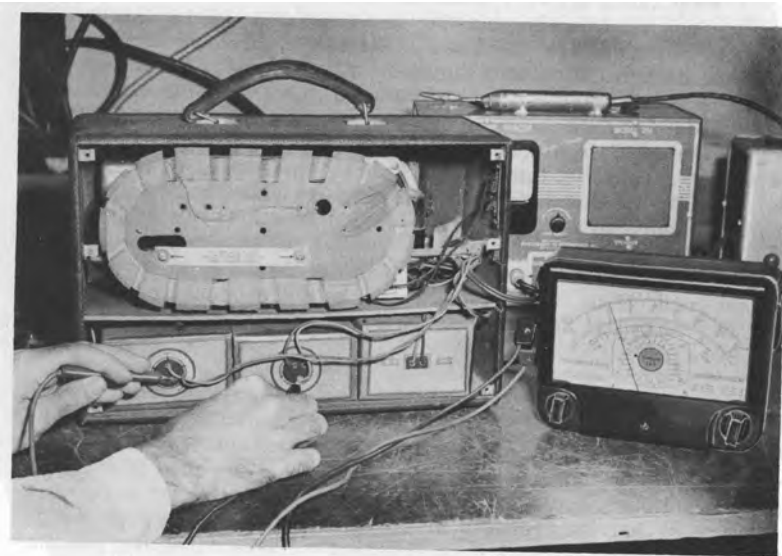

Fig. 11-6. Checking the battery voltage of a portable receiver.

If you have trouble in pinning down the cause of weak reception, fall back on your signal tracer again. It can be used just as effectively with transformer sets, AC-DC sets, or three-way portable receivers. Once the tracer has pointed out the place in the circuit where the signal strength falters in its normal rapid increase, the voltmeter and the ohmmeter can take it from there and quickly lay bare the real trouble. Any time you find you are making no progress with one test instrument, do not hesitate to turn to another for help. Not only is it possible that the new instrument may do a better job of locating the trouble, but there is also the important fact that using it will force your mind out of the rut into which it has been working and will let you approach the difficulty from a new angle. That is always a good idea!

Weak Sets

QUESTIONS

1. Roughly, how many times is a received signal amplified in an AC-DC set?
2. When practically all stations are received with the same insufficient volume, what does this indicate?
3. When only strong stations have sufficient volume, where do you look for the trouble?
4. Which tubes contribute the most to total receiver amplification?
5. When holding the hand near the tuning capacitor improves reception greatly, what does this indicate?
6. What can you learn about the likely location of the cause of weak reception by touching the grid of the first audio tube?
7. Why should the signal tracer be used on normally-operating sets as well as on defective ones?
8. Why are IF transformers of an AC-DC set found out of alignment more often than those of a transformer type receiver?
9. Explain why replacing an output tube in a three-way portable can improve the operation of the IF amplifier or the converter tube.



SECTION III

**Intermittents and
Miscellaneous
Service Problems**



FOREWORD

Horses have horseflies, picnics have ants, and service technicians have intermittent receivers. In the cynically true words of the philosopher, "There is always a fly in the ointment."

The disagreeable subject of intermittent receivers has been deliberately postponed as long as possible for two reasons: first, talking about them to a fledgling service technician would be like mentioning to a bridegroom such things as pin curlers, stockings hung in the bathroom, and the high cost of baby food. There is no point in frightening a man away before he is fairly started! Secondly, the intermittent sets are those that separate the men from the boys in the service game. Solving some of these troubles takes every bit of experience, technical skill, and straight thinking the technician possesses. They constitute the Final Examination. It is fitting, therefore, that he should tackle these tough customers only after he has bolstered his self-confidence and experience by considerable wrestling with other easier-to-lick sets.

"Intermittent" is the name — or epithet! — applied to a receiver that plays all right part of the time but intermittently displays serious faults in operation. These faults may take the form of the set's going completely dead, of abrupt changes in volume, or of a hum that comes and goes. The trouble may appear and disappear in a rhythmic cycle, or it may be entirely unpredictable, sometimes showing up a dozen times in a half-hour and again being absent for whole days. A particularly exasperating feature of many intermittent sets is that the trouble will appear and remain present until the instant a test lead is applied to any part of the circuit, and then the trouble is gone in a flash — possibly to stay away for hours. Working on such a set is as frustrating to a technician as it would be for a surgeon to try to operate on a patient who came out of the anaesthetic every time he was touched with a scalpel!

Because of the complexity of the subject, intermittent operation will be covered in two chapters; first will be discussed the sets in which the signal disappears completely; then will be taken up receivers in which reception is not entirely lost but only intermittently impaired by volume changes, distortion, hum, noise, and so on.

Finally, the remainder of the book is concerned with specialized service problems the radio service technician is certain to encounter. Some of these are comparatively recent developments. For example, one chapter treats of transistor radios and printed circuits. While it is true that printed circuits are found in many tube-type radios of recent vintage, they are used almost without exception in transistor receivers; so it seems logical to lump the two together. What is said about printed circuit servicing applies equally, of course, to transistor or tube sets.

Other chapters deal with such specialized receivers as all-wave and communications sets, automobile receivers and storage-battery portables, and FM receivers. Certainly no claim is made that the treatment of such sets is exhaustive, because whole books have been written on servicing some of these types; but an honest attempt is made to touch on the peculiar service problems each brings up, problems unlike those met in working on ordinary broadcast receivers of the three basic types we have been discussing.

CHAPTER 12

Intermittent Loss of Reception

In past chapters, we have mentioned the importance of obtaining as much information as possible about the symptoms of a receiver from the owner, but this is doubly true when the set is operating intermittently. In such a case, you should be as uninhibited as Dr. Kinsey about asking questions! Remember the set may refuse to "intermit" except under certain conditions; and unless you are prepared to waste whole hours waiting for the set to cut out, it is essential that you know these conditions and be able to reproduce them in your shop. Here are some questions you should ask:

Exactly how does the set misbehave? How often does it do this? How long has it been doing it? When was the last time it did so? How long does this usually happen after the set has been turned on? Is it more likely to happen at any particular time of the day? When this happens, can you restore normal operation by banging on the cabinet? Stamping on the floor? Switching the set off and back on? Changing bands? Turning on a light in the house? Swearing?

Almost as important as the things you should do to an intermittent set are the things you should not do. Above all, do nothing that will upset any delicately balanced condition that may be producing the intermittent operation until you have had a chance to hear that performance for yourself at least once. Hearing a set cut out will often tell you exactly where to look for the trouble. On the other hand, if you start shaking and banging the set around, pulling out tubes to check them, moving wires or the like, you are likely to banish the trouble just long enough so it will never reveal itself in the shop but will start all over again as soon as the set is in the customer's home. Treat an intermittent with all the gentle, calculating cajolery that a parent uses in trying to coax his "small fry" to unfasten a locked bathroom door. Force and temper have no part in either performance.

To solve these troubles, you must understand that most of their intermittent behavior (or misbehavior!) patterns are triggered by temperature changes. Tiny thermally caused expansions and contractions within a defective part serve to make and break an essential connection. With this clue to aid you, it is often possible to decide what type of part is at fault by noticing how long it takes for the set to cut out after it is first turned on. From a cold start, the tubes are the first parts to reach operating temperature. Normally — and mind you there are exceptions to this — tube trouble will show itself within the first five or ten minutes of operation. Coil windings and resistors carrying current are the next to become thoroughly warm. If they are going to cause trouble, you can usually expect it to show up in the first quarter of an hour. Coupling and bypass capacitors mounted beneath the chassis often require a full half-hour to become thoroughly warm; so you may look at them with suspicion if the set begins cycling after that period of time. Finally, the chassis itself takes considerable time to reach a maximum temperature; and if your trouble is caused by poor chassis-soldered connections, bad shield contacts, or anything else affected by expansion of the chassis, it may take an hour or so for this to appear.

Keep in mind that these are very rough approximations subject to many qualifications. As a single example: if a coupling capacitor lies very close to a high-wattage filter resistor, that capacitor will reach a high temperature much quicker than it would otherwise. Still the time it takes for a set to cut out is often the key to the trouble; so it should never be disregarded.

THE TRANSFORMER SET

The complete disappearance of reception is the most significant characteristic of this form of intermittent. That means the signal path through the set must be completely severed and not merely impeded by the intermittent difficulty. Generally speaking, this rules out failure of antenna circuit components, defects in an RF stage, opening of bypass or coupling capacitors, or the breakdown of any other parts that would normally result in lowered volume or the set's going into oscillation; but it would not preclude reception of some sort.

Schopenhauer wrote that a man shows what he is by the way in which he dies, and the way in which an intermittent receiver dies is just as significant. If the set begins to lose volume, gradually grows weaker and weaker, and finally fades out completely, the trouble is more than likely to be a tube filament that opens up when it reaches a certain critical temperature and permits the cathode to cool down until emission ceases.

At some point the broken ends of the cooling, contracting filament will touch together; and then the filament will again warm the cathode and reception will slowly return. In some instances, the

heating-cooling cycle will be of such short duration that the volume will never entirely disappear but will come and go in waves with peaks and valleys that are usually marked by faint clicks produced by the touching and separating of the broken ends of the filament. At other times, a cycle may cover a period of many minutes, and the ON and OFF portions may have almost any conceivable ratio to each other.

Unfortunately, being reasonably certain the trouble lies in a tube filament still leaves you in much the same quandry as the young Eastern prince who was presented with a brand-new harem but was slow to avail himself of this gift. When questioned about it, he explained, "It is not that I do not understand what is expected of me, but I simply do not know where to begin." At first blush it might seem that any of the tubes could be selected for suspicion; but there are ways, however, of eliminating some of them.

You can tell if the filaments of glass-envelope tubes are opening just by watching them. If the light in one of these dims out at the same time the sound from the speaker disappears, you need not be a Sherlock Holmes to deduce which tube is defective. If the OFF portion of the cycle is sufficiently long, you can sort out bad metal tubes by feeling the envelopes after the set has been cut out for three or four minutes. A cold envelope indicates an open filament, of course. If after the set has cut out you can still hear a normal slight hum from the speaker, you can be sure the rectifier and output-tube filaments are all right. Try running the volume control up and down. If this has a noticeable effect on the background hum heard while there is no reception, you can be confident the opening filament is not between the volume control and the speaker. If the receiver has a phono jack, you can double check on this by switching the set to Phono and touching the hot jack connection with a metal object. If the set is all right from that point on, a loud hum will be heard.

When the set has cut out, tubes in the IF and RF stages can be checked if they are the grid-cap type by touching the caps with a screwdriver bit. As long as the tube itself is functioning and all the tubes behind it are, a click will be heard in the speaker. A similar test can be conducted with single-ended types by pulling them from the socket and listening for clicks. In short, if the set will cut out for a few minutes, you can run down the trouble exactly as you did in Section I when you were searching for the cause of a dead set.

Life gets tedious, though, when a temperamental filament refuses to open up or to stay open long enough for you to apply any of the aforementioned tests. Then you must try to make the set cut out. If the customer says the set usually cuts out during the late evening hours, it may indicate that the high line voltage present during these light-load hours has a part in it. Plug the set into your adjustable-voltage isolation transformer, and place about 120 line volts on it for

Intermittents and Miscellaneous Service Problems

a few minutes. If the set gave most trouble during the early evening hours, low line voltage may be needed to touch off the intermittent condition; so try running it **on about** 105 volts. I have often had good luck in starting an intermittent condition by running a receiver at 120 volts for about ten minutes and then dropping the line voltage to around 100 volts. This seems to be more effective than keeping the set continuously on either high or low voltage.

When the owner reports the set usually misbehaves during the first few minutes of operation and then settles down and operates normally until it is shut off and allowed to cool down, you know the set must be cool for the intermittent condition to show itself. When the weather is cold, it often helps to leave such a set outside for an hour or so before starting to check it; or you can chill tubes thoroughly **in the** freezing compartment of a refrigerator **to make** one of them reveal its intermittent filament. On the other hand, covering up the whole **set with** a canvas or using a cardboard to block off the ventilation louvres will sometimes raise the temperature of a receiver sufficiently to trigger an intermittent condition.

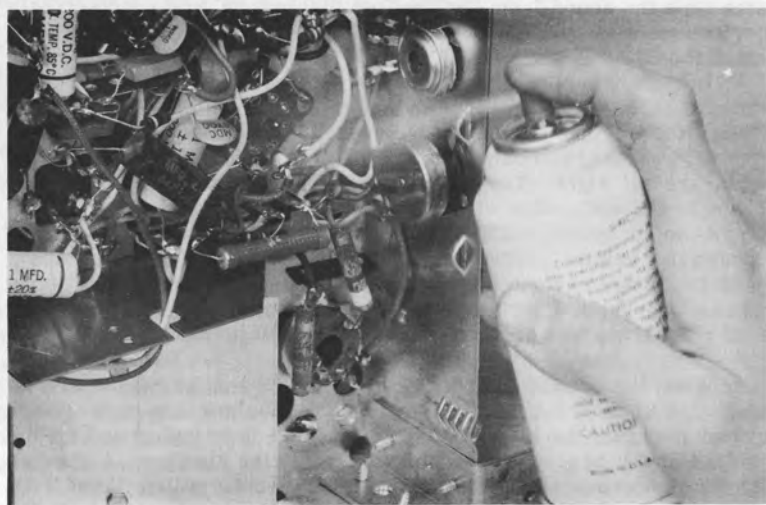

Fig. 12-1. Cooling a component to check for intermittent trouble.

A wonderful aid to triggering intermittents is General Cement's Spr-Koat Circuit Cooler shown in use in Fig. 12-1. This is simply a pressurized can of comparatively harmless freon gas such as is used in refrigerators. When the **finger-operated** valve is depressed, **a narrow** spray of the gas can be directed on any suspected component. The temperature of that component drops rapidly. The stream of **gas** is **so cold** it will actually freeze the flesh if allowed to play on it at

Intermittent Loss of Reception

close range; so be careful. Don't spray it on your hand to see how cold it is, and don't spray it on a hot glass tube envelope. With this gas you can lower the temperature of a single capacitor, resistor, coil, or connection to room temperature and far below in a matter of seconds while the rest of the set stays warm. If the component chilled is one that operates normally when warm but cuts out when cool, this spray technique will expose the culprit in nothing flat.

When the owner says the set dies abruptly, you can mark off any possibility of filament failure; but that does not mean there **is no** tube trouble. Internal short circuits that develop when the tube reaches a certain temperature very frequently cause a sudden loss of **reception**. In this case, a very gentle tapping of a defective tube may restore normal operation when the set has cut off or cause the set to quit playing when it is operating normally. Tapping of tubes **when** searching for an intermittent condition should be done much **more** gently than when looking for noisy tubes.

If the cutting out happens with any dependable frequency, it is a good idea to replace all the tubes one at a time to see if you can find one socket in which a new tube causes the condition to stop. If you do, be sure and double-check by replacing the old tube and observing if the intermittent condition returns. The trouble could have been a defective socket connection that was temporarily "cured" by the disturbance caused by pulling the tube from the socket. If you put in all new tubes and the trouble is still present, at least you have eliminated as many possibilities as the set has tubes.

When no sound at all can be heard from the speaker after the set cuts out, the speaker voice coil may be open. A quick check of this **can be** made by connecting the VOM set to read "Output" across the voice-coil terminals. If the pointer of the meter still continues **to** move up and down after the set stops playing, you can be sure the trouble lies either in the voice coil or the flexible leads to it, and a repair or replacement can be made as explained in Chapter 2.

If none of the tests mentioned up to now have turned up the cause behind the intermittent behavior, it is time to remove the chassis and give it the blitzkreig or all-out treatment. Place the chassis on an unused end of the bench and connect your test equipment as shown in Fig. 12-2. Connect your VOM output meter from the plate of the output tube to ground. Fasten the RF probe of the signal tracer to the plate of the first IF stage. Connect the VTVM set to read negative volts from the AVC bus to ground. Now tune in a station and make a note of the levels of the various indicators attached to the circuit. Then go about your business of repairing other sets.

The instant the set cuts out, rush over to it and rapidly note the readings on the two meters and note if the sound coming from the signal-tracer speaker is as loud as it was. The evidence **con-**

Intermittents and Miscellaneous Service Problems

tained in these three observations can go a long way toward pinpointing the location of the trouble. For example, if all three indicators maintain their same level, the trouble will almost have to be in the secondary of the output transformer, for we already have established that the speaker voice coil was all right.



Fig. 12-2. Test equipment connected to an intermittent chassis.

If the VOM reading falls to zero while the other two indicators remain up, this means the trouble must lie in the audio amplifier or output stage. The VTVM set to read AC volts can be connected to the plate of the audio amplifier; the signal-tracer audio probe can be connected to the grid of the output stage; and the VOM can be switched to read DC plate voltage on the output tube. The next time the set cuts out, the three indicators will show whether the trouble is an opening primary winding of the output transformer; whether it originates within the output stage; or whether it occurs in the audio amplifier. With the possibilities narrowed down in this fashion, a few checks with the voltmeter and ohmmeter or the substitution of parts should quickly clear up the difficulty.

Assume the indicators are back to their original connections and that the AVC voltage falls off while the signal from the tracer speaker goes up a bit. This means the signal is disappearing between the plate of the first IF tube and the AVC rectifier. Shifting the signal tracer to other key points in this circumscribed area will usually

Intermittent Loss of Reception

nail down the trouble to a single part, such as a defective IF transformer.

As a final illustration, suppose all three indicators fall to zero when the set cuts out. This clearly shows that the trouble is arising ahead of the plate of the first IF tube. Move the signal tracer probe to the grid of the IF amplifier and connect the VTVM probe to the oscillator grid. The next time the set cuts out, you will be able to tell if the trouble lies in the oscillator circuit or if it is happening in the first IF tube. If the VTVM reading stays normal but the signal tracer signal falls out, the signal tracer probe can be moved to the grid of the mixer stage to determine whether the difficulty lies in this stage or ahead of it.



Fig. 12-3. An RF probe for use with a VTVM.

It might be mentioned here that an auxiliary RF probe, such as the one shown in Fig. 12-3, when used with the VTVM, will enable this instrument to follow and measure the signal passing through the RF-IF parts of the receiver as easily as the ordinary AC probe does this in the audio portion. Having such a probe is a great help in cornering intermittent troubles.

Tubes will be found to be the most common cause of sets that go dead and come back to life. On rare occasions you will run across a transformer winding, a filter choke, or a speaker field coil winding that will open and close; but usually when one of these opens up, it stays open. Voice-coil troubles are fairly common in these cases. Sometimes it helps to make speaker troubles appear if you move the cone back and forth by hand beyond its normal excursions. IF transformers will be found guilty of causing this trouble now and then. Defective trimmers are often at fault. Oscillators that quit inter-

Intermittents and Miscellaneous Service Problems

tained in these three observations can go a long way toward pinpointing the location of the trouble. For example, if all three indicators maintain their same level, the trouble will almost have to be in the secondary of the output transformer, for we already have established that the speaker voice coil was all right.



Fig. 12-2. Test equipment connected to an intermittent chassis.

If the VOM reading falls to zero while the other two indicators remain up, this means the trouble must lie in the audio amplifier or output stage. The VTVM set to read AC volts can be connected to the plate of the audio amplifier; the signal-tracer audio probe can be connected to the grid of the output stage; and the VOM can be switched to read DC plate voltage on the output tube. The next time the set cuts out, the three indicators will show whether the trouble is an opening primary winding of the output transformer; whether it originates within the output stage; or whether it occurs in the audio amplifier. With the possibilities narrowed down in this fashion, a few checks with the voltmeter and ohmmeter or the substitution of parts should quickly clear up the difficulty.

Assume the indicators are back to their original connections and that the AVC voltage falls off while the signal from the tracer speaker goes up a bit. This means the signal is disappearing between the plate of the first IF tube and the AVC rectifier. Shifting the signal tracer to other key points in this circumscribed area will usually

Intermittent Loss of Reception

nail down the trouble to a single part, such as a defective IF transformer.

As a final illustration, suppose all three indicators fall to zero when the set cuts out. This clearly shows that the trouble is arising ahead of the plate of the first IF tube. Move the signal tracer probe to the grid of the IF amplifier and connect the VTVM probe to the oscillator grid. The next time the set cuts out, you will be able to tell if the trouble lies in the oscillator circuit or if it is happening in the first IF tube. If the VTVM reading stays normal but the signal tracer signal falls out, the signal tracer probe can be moved to the grid of the mixer stage to determine whether the difficulty lies in this stage or ahead of it.



Fig. 12-3. An RF probe for use with a VTVM.

It might be mentioned here that an auxiliary RF probe, such as the one shown in Fig. 12-3, when used with the VTVM, will enable this instrument to follow and measure the signal passing through the RF-IF parts of the receiver as easily as the ordinary AC probe does this in the audio portion. Having such a probe is a great help in cornering intermittent troubles.

Tubes will be found to be the most common cause of sets that go dead and come back to life. On rare occasions you will run across a transformer winding, a filter choke, or a speaker field coil winding that will open and close; but usually when one of these opens up, it stays open. Voice-coil troubles are fairly common in these cases. Sometimes it helps to make speaker troubles appear if you move the cone back and forth by hand beyond its normal excursions. IF transformers will be found guilty of causing this trouble now and then. Defective trimmers are often at fault. Oscillators that quit inter-

Intermittents and Miscellaneous Service Problems

mittently are not unknown either. They are usually caused by a high resistance in one of the oscillator-coil windings or a defective coupling capacitor in the grid or tuning circuit. Replacing suspected parts is the best thing to do in such a case. Poor connections are always a possibility, especially on socket lugs and other solder terminals. These are the things you look for if banging the set, stamping on the floor, and so on cause the difficulty to come and go. They are found by carefully shifting wires and tapping parts while the set is playing.

THE AC-DC SET

These receivers are very subject to **intermittent filament** troubles, but fortunately an open filament is easier to locate in them than it is in a transformer set. Since all the filaments are connected in series and the pilot lamp is ordinarily across a section of the rectifier filament, the behavior of this lamp is a good indication of what is going on in the filament circuit. If a set comes in with the lamp burned out, it is quite possible the section of the rectifier filament bridged by it has opened up and sent the full filament current through the lamp, causing it to fail. Replace the lamp anyway. If the rectifier filament opens again and burns it out, the cost of a pilot lamp is a cheap price to pay to locate an intermittent condition quickly. When the lamp flickers on and off, this is almost positive evidence that one of the other tube filaments, or the unbridged part of the rectifier filament, is opening up. In that case, remove the chassis from the cabinet at once and trace the filament circuit wiring.

Connect the ground connection of your VTVM set to read AC volts of something more than 117 volts to one side of the AC line. Turn on the set and wait until the dimming dial lamp tells you the filament circuit has opened. Then quickly touch the probe to each filament prong of every tube, starting with the one to which the ground lead of the VTVM is connected and progressing a tube at a time until you reach the one to which the other side of the line is connected through the line switch. When you find a tube filament that shows no voltage on one side and the full line voltage on the other during the time the set is cut out, you have located your defective tube. While the filament circuit is intact, of course, a difference in the AC potentials measured at the two filament prongs of the tube will be closely equal to the rated filament voltage of the tube. If it takes the set a long time to cut out, you may want to clip the VTVM across each filament in turn and note if the reading jumps up to the line voltage when this finally happens. It will only do so when across a tube filament that opens up. When across a good filament, the voltage will fall to zero at the moment of filament failure.

For some reason, tubes with high-voltage filaments become intermittent more often than **lower-voltage** types. Such tubes as 50L6, 3525, 35L6, 50A5, 50B5, 35W4, and 50C5 are very often at

Intermittent Loss of Reception

fault. If the OFF part of the cycle is observed to be fairly long, you can often locate a bad **filament** with the lowest range of the ohmmeter portion of your VOM. Wait until the set cuts out and then quickly remove a tube and measure the resistance of the filament with the ohmmeter as shown in Fig. 12-4. An open filament will show infinite resistance, of **course**. Start with the higher filament-voltage tubes and then move down to lower-voltage types, being sure to wait each time until the set cuts out before removing a tube for testing. This method only **works** when the set will remain dead for at least a minute or so at a time. If the cycle is shorter than that, you can waste a lot of time using it, because the break in the filament may close before you can get the tube out of the socket and connect your test leads. This can easily trick you into believing a guilty tube is all right. That is why the first method suggested is usually quicker, even though it does entail removing the chassis from the cabinet.

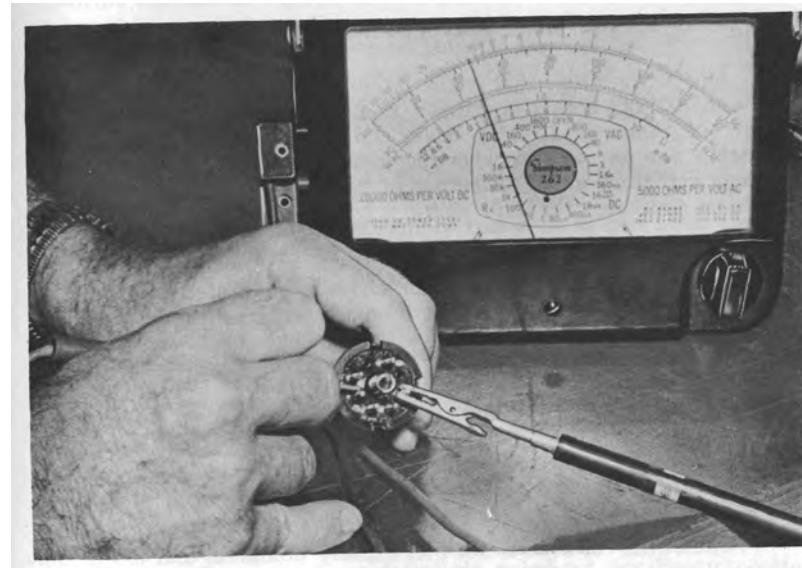

Fig. 12-4. Measuring the resistance of a tube filament with an ohmmeter.

AC-DC intermittent conditions differ from transformer intermittent conditions chiefly in regard to the filament circuit. Other causes of this condition are common to both types and are found by the same methods. Probably intermittently shorting tubes are found more frequently in the small sets because of the higher filament voltages and the greater potential present between cathode and filament. Converter, IF amplifier, and second detector tubes are especially susceptible to this fault; but such faults can usually be unmasked by the tapping technique described previously.

Intermittents and Miscellaneous Service Problems

When an AC-DC set coyly refuses to cut out on the service bench, it should be subjected to the same raising and lowering of the line voltage, chilling and heating of chassis and tubes, and careful probing for poor connections that were followed with the transformer sets.

Do not overlook the possibility of a break in the line cord or a defective line switch in these receivers. When a connection is barely made in one of these components, the slightest movement or vibration may serve to open it. The effect will seem very much like that produced by an intermittent filament. With the set turned on, moving the line cord about vigorously will show up a fault in this part; tapping the line switch while the chassis is held in various positions will reveal a poor connection there. When such a defect is found, replacement is in order.

THE THREE-WAY PORTABLE RECEIVER

Any of the things that cause intermittent operation in transformer and AC-DC sets can happen in these portable receivers, but some of them practically never do. For example, intermittent filaments are as rare as whooping cranes because of the different filament structure used. Once one of these tiny filaments is broken, it seldom goes back together again.

Heat-caused intermittent conditions are much less likely in these sets, too; because not so much heat is generated by them. On the other hand, loose-connection intermittent conditions are more common because of the comparatively rough handling given the portable sets.

Oscillator drop-out is the most common immediate cause of intermittent reception. This, in turn, is usually brought on by decreased filament emission which may or may not be produced by a filament current that is too low.

The owner of such a set will usually complain that it will play along all right for a while and then suddenly cut out for a few seconds. If he is unusually alert for a customer, he may have noticed that this drop-out coincided with the starting of a refrigerator or furnace blower. He may even have noticed that the trouble showed up at only certain times of the day when cooking or other heavy loads might be expected to lower the line voltage.

What is happening, of course, is that the emission from the filament of the converter tube is just barely sufficient to sustain oscillation at a certain line voltage. Whenever the line voltage dips below this point for any reason, the filament current supplied the converter decreases and the oscillator quits. Whenever the line voltage rises again to the critical minimum, the oscillator starts.

Intermittent Loss of Reception

The first thing to do with such a set is plug it into the adjustable-voltage isolation transformer and lower the line voltage applied to it until the set goes dead. If this happens at any voltage higher than 100 volts, try a new converter tube and see if the set will then operate down to 100 volts or less. If not, you can be suspicious that the rectifier is not supplying sufficient current. When the rectifier is a tube type, substituting a new tube will quickly establish whether or not the old one is low on emission. If the rectifier is a selenium type, as is more often the case with modern sets, it should be temporarily replaced with a good unit such as that described in Chapter 1.

If the set still will not operate at low line voltage, try replacing the other tubes with new ones one at a time. Sometimes the filament structure of one of these tubes changes so as to increase its resistance materially. Since the tube filaments are in series, this cuts down the current through all of them. The converter tube reacts more dramatically to reduced filament current than some of the others; so the main symptom of the reduced current may be that the oscillator quits as the line voltage goes down. Many times replacing a 3V4 output tube will show there is actually nothing wrong with the 1R5 converter-oscillator that has been cutting out.

If the set still will not operate down to 100 line volts, your trouble is probably a weak input filter capacitor or leaky capacitors along the B-plus or filament supply line that is depriving the converter tube of proper filament current. The former is checked by bridging it with a good capacitor at the time when the line voltage is just below the point where the oscillator quits and by noticing if this restores reception. Cutting suspected filter capacitors loose along the B-plus and filament lines will also start the radio playing if their leakage is causing the trouble. If these measures do not help, check the resistance of the filament-dropping resistors to see if they have possibly increased in value.

Only after you are absolutely sure that oscillator failure is not causing the set to go dead should you start looking for other things such as opening voice coils, defective resistors, bad IF transformers, or the like. Once you have definitely ruled out oscillator trouble, however, your search for the cause of the set's intermittently going dead can proceed along the same lines that were followed in hunting this trouble in the transformer set.

Never put off using the signal tracer, VTVM, and other helpful instruments too long in the vain hope you will sooner or later stumble onto the trouble by haphazard methods. Neither must you form the bad habit of postponing working on intermittent sets as long as possible. The thing to do is to attack them vigorously, enthusiastically, and imaginatively with every instrument and technique at your disposal.

Intermittents and Miscellaneous Service Problems

Above all, never, never, never let an intermittent condition whip you, even though you must devote whole days to solving it. Every one you repair will give you new confidence and experience with which to tackle the next, and eventually you may even learn to like working on these sets. Solving a tough intermittent condition gives a good technician the same sort of grim pleasure that a farmer feels when he chops out a Canadian thistle!

QUESTIONS

1. What questions should be asked the owner of a set that cuts out?
2. What is a likely cause of a slow dying and return of reception?
3. Describe some methods of triggering thermal intermittents.
4. What kind of tube trouble do you suspect when the set quits abruptly and comes back on again the same way?
5. Tell how the VOM, VTVM, and signal tracer can all three be connected simultaneously to an intermittent receiver to isolate the trouble.
6. Give two ways to locate an intermittent filament in an AC-DC receiver.
7. Are intermittent filaments common in three-way portables?
8. What is the most common cause of intermittent reception in three-way portables?

CHAPTER 13

Intermittent Faulty Reception

In the very beginning of this book, it was mentioned that a completely dead set is easier to repair than one that performs poorly. It is just as true that a set which intermittently dies completely is usually easier to diagnose than one which has occasional lapses into some state of unsatisfactory reception. Only the failure of a comparatively few basic parts can entirely cut off reception; whereas, the number of things that can lower the volume, cause distortion, or introduce hum and noise embrace almost every part in the receiver.

If you are a really acute reader — and of course you are! — you doubtless noticed the parts regarded with suspicion while we were hunting the cause of a set's intermittently dying were the self-same parts revealed in Section I to be the cause of dead sets, the only difference being that in one case the part failure was permanent whereas in the other it was an off-again-on-again sort of affair. This might encourage you to make the further clever deduction that a good place to look for clues to the cause of a set's intermittently developing reception faults would be in Section II where various permanent reception faults are discussed. If you think that, you are so right! Any part whose complete, honest, permanent failure can lower the volume of a receiver or cause reception to be distorted and noisy can produce these same conditions as intermittent symptoms when the part failure is a capricious, vacillating thing. Keeping this fact constantly in the back of your mind is a great help in locating trouble in these sets.

THE TRANSFORMER SET

If the volume fades and returns slowly, the trouble is doubtless an intermittently opening and closing filament with a short time cycle. Sometimes, changing the line voltage on the set with your voltage regulating transformer will lengthen the off part of the cycle until you can employ some of the methods outlined in Chapter 12 to spot the tube with the bad filament. In one case, raising the line voltage may accomplish this; in another, lowering the voltage will do it; in still other cases, neither one will help.

If the cycle has a rapid dependable frequency the bad tube can be found by simply replacing each tube with a new one until one of these exchanges cures the trouble. When the on part of the cycle is lengthy and unpredictable, matters are considerably complicated. A voltmeter across a suspected filament will not give reliable indication of its opening because the opening of any of the parallel filaments

will produce a slight increase in the filament voltage measured at any of the sockets. What you need is an AC ammeter to place in series with the filament circuit of a suspected tube. Then, if the filament

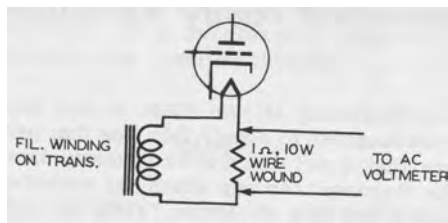

Fig. 13-1. Measuring filament current by use of voltage drop.

opened, the ammeter would drop to zero. You can convert the AC voltmeter of either your VOM or VTVM into an AC ammeter by the simple method diagrammed in Fig. 13-1. One of the filament leads of a tube you wish to check is unsoldered from the socket and R1, a

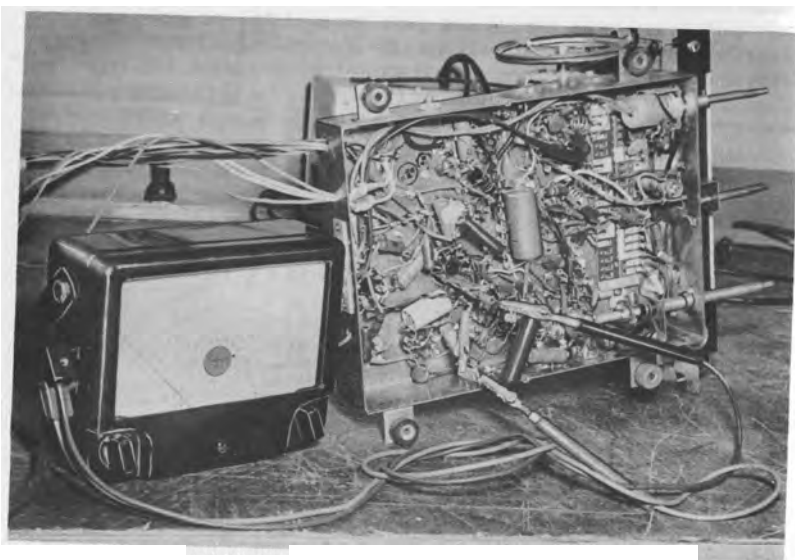

Fig. 13-2. Resistor equipped with alligator clips to insert into filament circuit.

one-ohm wire-wound resistor, equipped with alligator clips as shown in Fig. 13-2, is clipped between the end of the lead and the lug from which it was removed. Then the test leads of the VOM or VTVM, set to its lowest AC volts scale, are attached to the ends of this resistor.

As long as current flows through the filament, a slight voltage drop across R1 will indicate on your meter. The voltage shown will reflect the amount of current drawn by the tube. For example, a 150-ma filament will produce a .15-volt reading on the meter; a 300-ma tube will read .3 volts, and so on.

More important for our purposes, is the fact that when the filament opens up, the AC voltage reading will fall to zero. This arrangement can be inserted in the filament circuit of each tube in turn and left there until the volume fades. When this happens, a glance at the meter will tell you if your search is ended or if you must try another tube. In the meantime, you can be doing your other work.

Ordinarily sets that change volume do so abruptly, and this eliminates the possibility of an intermittent filament. It does not mean, however, that there can be nothing else wrong with a tube. Quite often tubes develop short circuits, poor internal connections, or bad socket contacts that make the volume hop up and down. Troubles of this nature, unlike broken filaments, can almost always be made to reveal themselves if you wiggle the tubes in their sockets or tap them while the radio is playing. When you locate a single tube that reacts thus to a light going over, you are "getting warm." Always be sure, though, that the jarring of the tube itself is causing the volume to change and not the vibration transmitted to some other defective part or connection nearby. Grid-cap tubes are happy hunting grounds for this sort of trouble because of an oxidized condition that often develops between the grid lead and the cap. Tapping the cap of such a tube sharply will usually cause the volume to shift with each blow. Unsoldering the cap, scraping the lead clean, and resoldering will often cure the difficulty; but a new tube is a sure cure.

When talking about sets that go completely dead, we ruled out as suspects such things as defective coupling and bypass capacitors, antenna-circuit troubles, or other items whose failure does not ordinarily result in a completely silent receiver. Now that we are working on receivers that only half die, these things can be ruled right back in. Not only may they be the cause of the trouble; they usually are.

If asked to name the most common cause of sets that suffer abrupt intermittent loss of volume, the writer would unhesitatingly say, "Coupling and bypass capacitors — in that order." These capacitors develop a faulty connection between a lead and its associated foil. When cold, the bad connection is often held tightly together by contraction, and the receiver plays normally. As the capacitor warms up and expands, the lead and foil separate a millionth of an inch or so, the capacitor no longer does a good job of transferring or by-passing a signal, and the volume drops. At this point, a refrigerator may cut on or off or somewhere in the house someone may snap a light switch that produces a small surge in the line voltage. Or,

perhaps a sharp pulse of RF current enters the antenna circuit. Either of these or their combination may produce across the poor connection inside the capacitor a surge of voltage that will arc over the infinitesimal gap and temporarily restore the connection and the lost volume. Further expansion will again interrupt the connection, ad infinitum, "ad nauseam."

One thing that makes these sets with intermittent capacitors so difficult is that quite often they will not cut out when the chassis is removed from the cabinet. Several factors enter into this: the chassis may be held in a position in the cabinet totally different from that which it occupies on the bench. This places a different gravitational stress on suspending capacitor leads. Heating of parts may be different on the bench because of the better over-all ventilation afforded and the fact that convection currents of warm air take altogether different routes. Finally, bolting the set into the cabinet may rack the chassis just enough to produce on a capacitor lead a strain that encourages the intermittent condition. When the chassis is unbolted, this strain disappears along with the trouble you are trying to find.

In extreme cases, it may be necessary to duplicate the in-cabinet conditions as closely as possible with the chassis on the bench. It can be propped up so it occupies exactly the same position, a canvas may be thrown over it to keep in the generated heat, and the chassis may be twisted with the hands to simulate what possibly happens when the chassis bolts are tightened down. Fortunately, these measures are necessary only in extreme cases. Usually a defective capacitor can be located by quicker, more easily applied methods.

First, try tapping a suspected capacitor very lightly with a lead pencil. The idea is to strike the capacitor just hard enough to set it vibrating on its suspended leads. This will show up a bad lead-to-foil connection much quicker than twisting or pulling on the leads proper. If tapping does no good, try applying heat. Heat application, to be effective as a pinpointing service tool, should be applied to a very small area at a time. Using an infrared lamp with a reflector type of bulb such as can be bought at any electrical store, allows you to do this handily. At close range, the circle of greatest heating by the infrared rays measures only a few inches in diameter; and a single capacitor can be treated to a rapid temperature rise without greatly affecting adjacent parts. Very often such individual treatment of capacitors will flush a bad one from hiding in a matter of minutes. In fact, the heat from the lamp warms a capacitor in its beam so rapidly that you must be careful not to overdo it and melt the wax from the ends of the capacitor. Try repeating the tapping technique described previously while the capacitor is warm. If this fails, reverse your field and try spraying the capacitors with a refrigerant spray (Fig. 12-1). Cold will often succeed in flushing out the villain where heat has failed.

It might seem a good idea to bridge a suspected capacitor with a good unit while the volume of the set has cut down and note if this restores the sound level, but actually such a move can lead to ambiguous and time-wasting results. When the capacitor is connected, it causes a surge to go through the bridged capacitor. This surge often "cures" the poor connection inside the suspected capacitor for several hours or days of operation. The same surge travels through the amplifier circuits of the set and may well arc a bad connection in a totally different capacitor and lead you to believe the one you are bridging is guilty. If the bridging technique is to be used at all, the set should be turned off and the bridging capacitor discharged before it is connected. The set should again be turned off before the bridging capacitor is removed. If the intermittent condition disappears while the outboard capacitor is in place but shows up again every time it is removed, this would be conclusive evidence that the bridged capacitor was bad.

If a bad coupling capacitor cannot be found by these methods, subject the various cathode, screen, plate-return, and AVC bypass units to the same treatment. You may think an open bypass capacitor always results in oscillation or motorboating, but this is not true. An open cathode bypass, for example, introduces negative feedback; and the most noticeable result is a loss in amplification. In some cases, the opening of a plate return or AVC bypass capacitor serves to detune a circuit utilizing that capacitor. The input circuit diagrammed in Fig. 13-3 illustrates this. The AVC bypass unit C1 also serves to complete the path through a common ground connection by which C2 tunes L1. If C1 opens up, the ability of the variable capacitor to tune the coil is lost. These two illustrations should impress upon your mind the importance of checking all bypass units in a receiver with intermittent changes in volume.

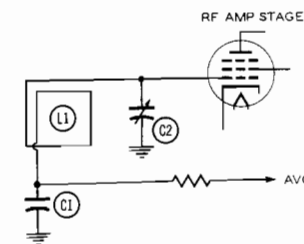

Fig. 13-3. Partial schematic of the input circuit of a receiver.

Bad capacitors are the most common cause of intermittent changes in volume, and they should always be the first under-the-chassis items checked; but they are by no means the only components that can produce this symptom. Coils with oxidized connections or partially open windings can do the same thing. Almost invariably, however, a bad coil will display noise along with changes in volume.

Intermittents and Miscellaneous Service Problems

This is your cue to apply the same tests suggested in Chapter 9 for dealing with noisy IF-transformer, output-transformer, and speaker-field coils. Doing so will usually enable you to cure both noise and volume changing at one lick.

The opening of an input filter capacitor can lower the volume because of the accompanying voltage drop in the B-plus circuits. An open output filter capacitor can do the same thing because of the fact that it often constitutes a plate return and screen bypass for the output tube. In either of these cases, however, the complaint would probably be intermittent hum rather than intermittent changes in volume. It is well to maintain an open mind as to all possible causes, though. The rare causes are the ones that give you trouble. The obvious is easily seen.

And finally, we come to one of the few classic causes where the customer may, and often does, correctly diagnose his own trouble. This is when he taps the volume-control knob and says, "I think something's wrong with this gadget." Worn carbon elements or corroded sliding contacts within a control often produce within the rotation of the control one or more spots at which smooth and stable adjustment of the volume cannot be had. With the control set to one of these spots — and they usually appear at the most-used positions — the volume will hop up and down erratically of its own volition. Such a control will be noisy and scratchy when adjusted, and the change in volume will be stepped rather than smoothly continuous. At certain settings of the control, the receiver may squeal.

In true hardship cases wherein the customer must have his set repaired as cheaply as possible — and you are bound to have some of these — a noisy control can often be quieted for a considerable time by the use of one of the various liquid preparations made for this purpose. The fluid is simply squirted into the control by means of an eyedropper, hypodermic needle, or similar instrument as shown in Fig. 13-4; and then the control is rotated vigorously. It often helps to pull out on the control shaft during this rotation. If sliding contacts have been causing the trouble, this procedure will quiet the control and stop the intermittent changing of volume for various lengths of time. In some instances, I have known this treatment to last for a year or more. Ordinarily, though, I prefer to replace the worn control with a new one.

Sets having a noise that comes and goes are probably second on the list of intermittent problems. Intermittently noisy tubes, especially the grid-cap types, are quite common. Coil windings carrying current often produce noise fitfully on their way to developing a complete open circuit. Filter capacitors with poor internal connections breed staticlike noise that starts and stops with seemingly no provocation, although they may temporarily cease their racket if the set is switched off and turned back on immediately — a practice

Intermittent Faulty Receptia

no thinking service technician condones but which many set owners cheerfully practice. Methods of establishing whether or not each of these items is producing noise, as well as corrective measures, have been fully covered in Chapter 9 dealing with noisy sets.

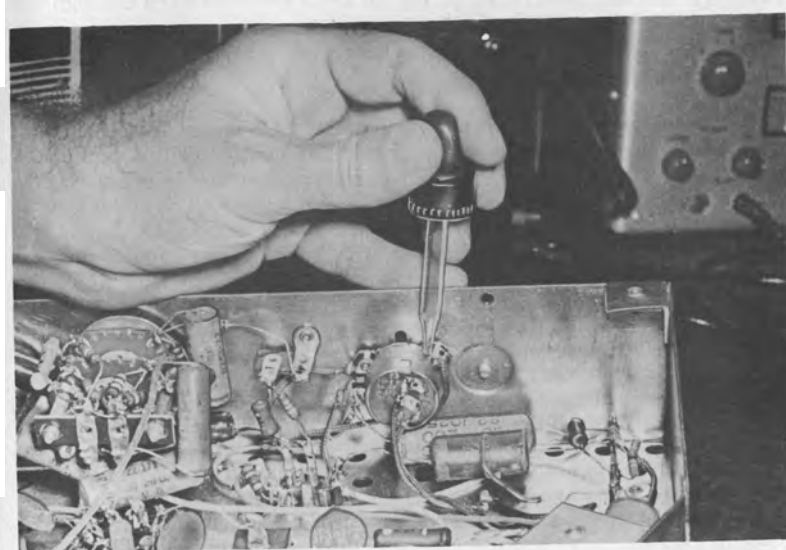

Fig. 13-4. Contact cleaner being squirted into the volume control.

Finally, intermittent noise can be produced by any loose connection in the wiring, tube sockets, shielding, or hardware disturbed by externally produced vibration such as that caused by bumping the cabinet or walking across the floor, or by vibrations from the speaker itself. Occasionally, a noise will be present only when the speaker reproduces certain notes to which the cabinet is resonant. Noise of this sort is the easiest to find because it can invariably be located by a judicious thumping of the chassis, tapping of parts, and shifting of wires while you keep a careful ear cocked to sounds issuing from the speaker. When found, the cause of the noise can be corrected by measures just as obvious and simple.

Intermittent hum is a fairly common complaint. Quite often it is caused by heat-actuated short circuits between the cathode and filament of a tube. A hum that is present with or without a station tuned in is probably caused by such a short in an audio stage; whereas, one that is only noticed on a station carrier will usually be found in a tube ahead of the second detector. A short-indicating tube tester will spot the trouble if it happens consistently. When it only appears at rare intervals, the signal tracer can be left connected to the plate of

Intermittents and Miscellaneous Service Problems

a suspected tube, and then you can notice if the hum appears in the signal-tracer speaker when it is heard in the set. If it does, move the tracer probe to the plate of a preceding tube and see if the hum is present there. If not, the trouble is likely in the first tube. At any rate, by moving the tracer probe forward and backward through the circuit, you will finally be able to bracket the source of hum in a single tube. A new tube will clear up the trouble if the trouble is within the tube itself.

Sometimes a bad socket connection will cause hum. Shifting the tube about in the socket will transfer the control of this hum from "automatic" to "manual" if a poor socket connection is producing it. A combination of "horse sense" and a sharp-pointed tool such as a scratch awl, will enable you to repair most socket troubles. An intermittent capacitor across the AC line or from one side of the line to the chassis is a versatile performer. It can produce a drop in volume, a vibration-triggered noise, an intermittent hum on strong carriers, or any combination of these symptoms! Never overlook this tricky trouble maker when checking for any intermittent condition.

Every now and then, you will receive a complaint of tone quality changing intermittently, with the high frequencies predominating one time and the bass notes the other. In other cases, you will discover that changes in tone are being mistaken for changes in volume. These changes are often caused by intermittent capacitors in the tone-control circuit proper; intermittent cathode bypass capacitors in the audio circuits; intermittent capacitors used in negative-feedback circuits; or intermittent capacitors connected from the plates of output tubes to ground, cathode, or screen lugs. These capacitors are checked for intermittent condition by the same tapping, bridging, heating and cooling techniques applied to similar units in other parts of the set. Intermittent resistors, especially "spotty" variable tone controls, often are at the bottom of these changes in tone quality. Treat a variable tone control just as you would a volume control. It may respond to cleaning, but replacement constitutes a more workmanlike repair. On rare occasions you may run across a coupling capacitor that does not entirely open up but merely suffers from sharp changes in capacity. When the capacity drops, low notes will be lost but high audio frequencies will come through as before. Listening to the signal tracer with its probe touched first to one end of the coupling capacitor and then to the other will show if intermittent changes inside this unit are causing the lows to drop out from time to time.

THE AC-DC SET

Remember the story of the funeral of the meanest man in town when the minister asked if someone could not say something good about the deceased before the casket was lowered? Finally, one man stepped forward hesitatingly and mumbled, "Well, Jim always dug a good posthole." In the same tenor, let it be said that intermittent

Intermittent Faulty Reception

tube filaments in the much maligned little AC-DC receivers are easier to locate than the same trouble in a transformer set. An AC voltmeter is clipped across each filament in turn until the volume fades. If the filament to which the test leads are connected is opening, the meter reading will jump from the tube's rated filament voltage up to the full line voltage when this occurs.

In all other particulars, you go about running down the cause of intermittent faulty reception in an AC-DC set precisely the same way you hunt this trouble in a transformer receiver. Tubes, coupling capacitors, bypass capacitors, controls, and connections will be found guilty roughly in that order. Because of their small cabinets, high-voltage filaments, and lack of slow-heating transformers, these little receivers reach a maximum temperature quicker than do most console sets; therefore you usually do not have to wait so long for an intermittent condition to show up after the set is turned on as you do with a transformer radio. That is to the good!

THE THREE-WAY PORTABLE RECEIVER

As mentioned previously, intermittent filaments are seldom a problem in these receivers, but a low-emission filament can easily produce fading when the supply voltage varies. This problem was discussed with regard to converter tubes in the previous chapter. In that case, low emission in the converter filament caused the oscillator to drop out and the set to go completely dead at times. When filaments of tubes other than the converter are low in emission, a comparatively small change in filament voltage can produce a large change in the ability of the tube to amplify; and this is reflected in a very noticeable variation in volume.

Replacing the tubes one at a time with new tubes and lowering the line voltage to 100 volts after each new tube is inserted will quickly tell you if one of them has a low-emission filament. When all new tubes are in place and the receiver still loses all or nearly all its volume at the low line voltage, try a new rectifier. If this does not help, make an individual filament-voltage check of each tube and see if possibly a change in a resistor or a filament-supply filter capacitor is not robbing one or more tubes of their normal share of the filament voltage. If such a case is found, correct it by replacing the defective parts.

These sets do not get very hot during operation; so intermittent conditions are more likely to be mechanically rather than thermally inspired. Loose connections, capacitors with poor bonds between leads and foil, and bad sockets will account for a high percentage of the complaints. Bad connections in the leads going to the loop antenna may cause complaints of intermittent changes of volume, noise, or hum. Correcting such poor connections is a different problem with almost each set, but it normally will entail using contact cleaner on contact-establishing hinges or replacement of flexible leads.

Intermittents and Miscellaneous Service Problems

Defective or weak batteries will often cause changes in volume when the set is being powered by them. Any time one of these receivers misbehaves on battery power only, try fresh batteries before doing anything else. If the trouble still persists, it is almost certain to be in the battery-plug connections or the contacts of the switches that transfer the receiver from AC to battery operation. A good application of contact cleaner to these contacts will ordinarily clear up the trouble in a jiffy.

And so, gentle reader, we sadly bid farewell to the wonderful and terrifying "Land of the Intermittent Sets"; but do not be too downcast. You will meet them again, and again, and again!

QUESTIONS

1. How can you often lengthen the cycle of an intermittent action in a set?
2. How can an AC voltmeter be used to measure AC filament current?
3. Name the most common cause of abrupt, intermittent loss of volume.
4. Explain what happens inside an intermittent capacitor when it cuts out.
5. Why isn't it a good idea to bridge capacitors suspected of being intermittent?
6. What are the symptoms of a worn or dirty volume control?
7. List the symptoms that can be produced by an intermittent capacitor from one side of the line to the chassis or B-minus point.
8. Why are mechanical intermittent conditions more common than thermal ones in three-way portables?

CHAPTER 14

Transistor Receivers and Printed Circuits

Transistor-set servicing is just enough like tube-set servicing to be confusing. If the two were wholly different, you would not be tempted to apply your tube-servicing techniques to transistors; but many of the components used in both types look exactly the same, and some of the same troubleshooting and repair techniques can be used on both.

Techniques that won't work or that may actually cause damage in transistor servicing are of primary importance; so let's review these first and consider new equipment needed. After that we shall be ready to take up transistor-set troubles according to symptoms, just as we did with tube receivers.

When working on transistor receivers, keep these points clearly in mind:

1. Transistors are easily damaged by heat, even that from a small soldering iron. When soldering to a transistor lead, clamp sharp-nose pliers (the writer prefers self-locking surgical clamps) to the lead as a heat sink between the soldering iron and the transistor. Remove transistors from sockets before soldering to these sockets.

2. Never remove transistors from sockets, or replace them, with the power turned on. Accompanying surges can destroy the transistor.

3. When signal tracing, never short a transistor electrode to ground to see if this produces a click. Such a practice may ruin the transistor.

4. Your ohmmeter in transistor servicing is like a shotgun at a wedding: only called in as a last resort. Voltage across and current through the ohmmeter probes can ruin a transistor or damage low-voltage electrolytic capacitors.

5. The AVC circuit, called the Automatic Gain Control (AGC) circuit in transistor sets, may develop either a negative- or positive-going voltage with signal according to the types of transistors controlled.

6. Power transistors may be damaged if operated without a load.

Intermittents and Miscellaneous Service Problems

7. With tube receivers, tubes are the first thing you suspect of being defective. Transistors are the last things you suspect.

The signal generator and signal tracer work just as well on transistor sets as tube types. The VTVM is used for voltage measurement because of its very light loading of circuits tested and because it is likely to have a low-range scale, such as 1 or 1.5 volts. Voltages are measured to much closer tolerances in transistor work. In some cases, the difference of 1/10 volt means the difference between proper and improper operation. The VOM is used for current measuring if the VTVM is not equipped with current ranges.

Some new special equipment is needed. A small, low-wattage soldering iron of the "pencil" type as shown in Fig. 14-1 is almost a necessity for working in the tight corners and avoiding damage to the printed circuit board caused by too much heat. Probes must be tiny to get into crowded spaces, well insulated to prevent accidental short circuiting, and sharp to penetrate the coating sprayed over printed wiring. The writer likes the kind that has a chuck which grips a needle. Plastic tape is wrapped around the chuck so that only the point of the needle is exposed. You will also need a good transistor tester. A pressurized can of clear lacquer or plastic spray should be on hand for recoating parts of the printed circuit that have been repaired.

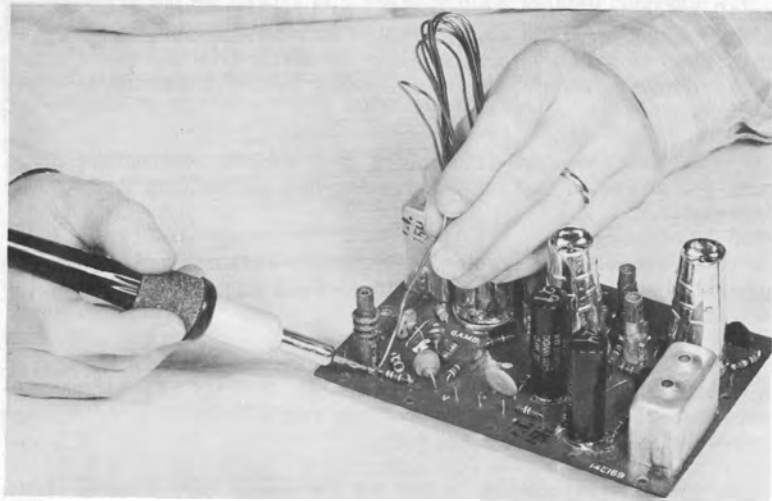

Fig. 14-1. Small, low-wattage soldering iron prevents the application of excessive and damaging heat.

Finally, unless you want to keep on hand dozens of expensive test batteries of different sizes, shapes, and voltages, you will need

Transistor Receivers and Printed Circuits

a battery substitute. One like that shown in Fig. 14-2 is ideal because it can double as a supply for automobile radios. In fact, it is an auto-radio battery substitute with extra filtering added to reduce the ripple. Such a supply usually puts out a continuously-variable voltage range of 0-16 volts at 5 amperes. For short periods, 10 amperes is available for powering older auto receivers. More important for our immediate purpose, the extra filtering reduces the ripple voltage to a fraction of 1% at the current needed by transistor receivers. Such a supply provides you with the equivalent of a completely fresh battery for any transistor set using a single-voltage power supply. In addition, you can lower the voltage to simulate weakening batteries, or you can let an intermittent "cook" on this supply for hours on end without depleting the customer's battery.



Fig. 14-2. Using an auto-radio battery substitute that has the extra filtering required for hybrid and transistor receivers. (Courtesy of Electro Products Laboratories.)

You need just one more item before tackling a transistor receiver: complete service data for the receiver on your bench. Perhaps, after you've spent a few years working on transistor receivers and after their design has become more uniform, you will be able to fall back on your experience and general knowledge to puzzle out an unfamiliar set--but not now! Here, in the beginning, you need all the help you can get. There is no better help than service literature that shows by diagrams and pictures the location and characteristics of every part, gives normal voltages at every transistor electrode, gives normal current drawn from the battery, outlines a step-by-step alignment procedure, and even solves the Chinese puzzle of getting the thing out of the case! Let's assume that you have such literature for the representative set diagrammed in Fig. 14-3 and that this set has come in for service.

Intermittents and Miscellaneous Service Problems

through transistors will lead to erroneous readings. If C14 is shorted, disconnecting one end will restore normal reception.

An open voice coil usually means installing a new, exact-duplicate speaker. In fact, a high percentage of transistor receiver parts are "special" and must be obtained from the manufacturer. Coils and transformers are especially likely to be tailored to just one circuit, and trying to substitute for them will get you into trouble. **When a choice is available**, this information will probably be given in your service data.

If the current is less than normal, use the VTVM to check the potentials on the output transistor or transistors. Low current is often due to an open primary of the output transformer, and a consequent loss of voltage on the collector or collectors. Such a condition is found more often in a completely dead transistor set with a single-ended output than in one with a push-pull stage, but it can happen to the latter.

This is about as far as you should go in trying to find a short cut to the root of the trouble. From here on in, no matter what the complaint, good service procedure requires the use of signal injection and signal tracing to isolate the stage in which trouble is located. These two methods are used far more often in transistor service than in tube service.

Connect the 400-cycle output of the signal generator through a 0.1-mfd coupling capacitor to the hot end of the volume control. If the signal is heard normally from the speaker, you know trouble lies in the front end of the receiver; if not, it must lie between the volume control and the speaker. In the latter event, move down through the audio amplifier with the signal, connecting it first to the input and then to the output of each stage, until you hear the signal. Then you will know the trouble must lie just ahead of this point.

In a radio that will not play at all, excluding possibilities already discussed, about the only remaining causes of trouble in the output stage are: (1) defective T1, (2) improper potentials on transistor, or (3) defective transistor. You already know how to check out a transformer. Improper potentials on base, emitter, or collector will probably indicate changes in the values of R18, R19, or R20, or a defective transistor. Replace any resistor not within 10% of rated value, or less than that if a closer tolerance is indicated.

Defective transistors usually reveal their condition by deviation from normal voltages specified for their terminals; but even if these voltages are correct and you know other circuit components are all right, the transistor must be bad if it fails to do its assigned job of amplifying, oscillating, detecting, etc. A signal generator to inject a signal, a signal tracer to pick it off, and your intelligence to eval-

Transistor Receivers and Printed Circuits

uate the result can be combined to make the receiver circuit itself serve as an indicator of open or shorted transistors.

As for transistors with insufficient gain, you can locate these by substituting good transistors for them or by checking them in a transistor tester such as is shown in Fig. 14-4. Such an instrument is well worth its cost for resolving doubtful cases and for comparing and matching transistors.

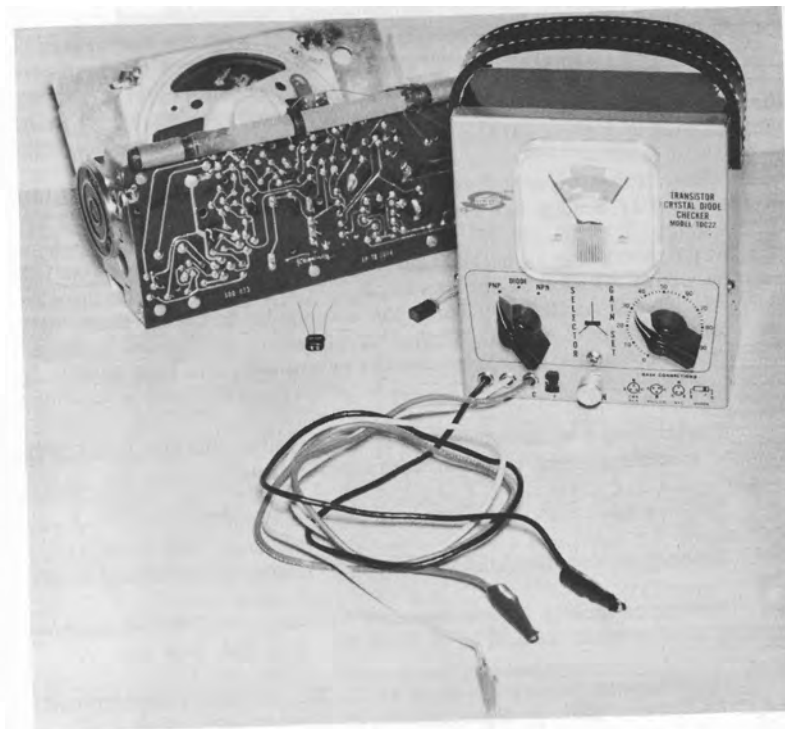

Fig. 14-4. Sencore Model TDC22 transistor and crystal diode tester.

If signal injection or tracing shows the signal disappearing in the driver stage, measure the transistor terminal voltages. collector voltage means C13 is shorted or T1 has an open primary. The shorted capacitor would draw excessive current from the battery through the primary and possibly burn it out; so both conditions might be present. Your milliammeter in the battery circuit will tell you what to expect. If wrong voltages are present, make sure R15, R16, and R17 are close to rated value. Be certain C3 and C4 are not shorted. If C3 is open, no signal will be transferred from the volume control. If everything checks all right but a signal injected into the

Intermittents and Miscellaneous Service Problems

base still does not come out the collector, the transistor must be bad. Check it.

What if we lose the signal in the detector circuit; that is, the signal tracer can pick off a signal across the secondary of L5, but it is not found at the slider of the volume control? Suspect the diode first and check it by cutting one end loose and substituting a good diode. Check C12 for a short circuit. Is the volume control open? Is the slider making good contact with the resistance element? While you are at it, observe the voltage developed between the volume control side of the diode and ground, with and without the secondary of L5 shorted out. If short circuiting the secondary causes any appreciable change in the voltage when the receiver is not tuned to a station, the IF amplifier is probably oscillating and producing a high AGC voltage that is cutting off the controlled IF amplifier.

This brings us to a defective IF stage. Incidentally, about 90% of transistor IF stages are tuned to 455 kc. The other are on 262 kc. If the stage is dead, an IF primary or secondary may be open, a trimmer capacitor may be shorted out, a resistor such as R8 or R12 may be open, or one of the sections of C9 or C11 may be open or shorted. Check capacitors for open circuit by bridging them with good units of like capacity. If you have reason to suspect a transformer of having shorted windings or trimmers, the best test is to tack in a new transformer.

Oscillating and motorboating IF's are quite common, and here are some of the causes together with their cures:

Battery with high impedance — try a new one.

Antenna or speaker leads too close to IF stage — redress leads.

Tuning capacitor frame, speaker bracket, or IF shield cans not making good contact with printed circuit — see that they do.

Open bypass capacitors such as C1, C2, or either section of C9 and C11 — bridge with good capacitors of similar capacity.

Neutralizing capacitors, C8 and C10, open — substitute new ones of exactly the same value.

R8, R12, R13, or R14 have changed in value — check resistance.

A resistor frequently found across an IF transformer winding, to load it, may have opened or changed value — replace with proper resistor.

Oh yes, one more thing: before long you are almost certain to run across an IF amplifier labelled "2nd IF Amp-AF Amp." This stage, as its label implies, serves as both an IF and audio amplifier;

Transistor Receivers and Printed Circuits

and it is called a "reflex" circuit. If reflex amplifiers are old stuff to you, your age is showing! They were quite popular in the early days of tube radios when tubes were so expensive you had to get everything out of each one that you could.

The transistorized version shown in Fig. 14-5 works like this: On its first pass through the transistor at IF frequency, the signal is amplified and appears across the tuned transformer primary, is induced into the secondary, and is detected by the diode in ordinary fashion. But then this audio signal is fed back to the base through R3, is amplified again by the transistor, and appears across the volume control. There is no interaction between the two signals because the transformer primary looks like just a piece of wire to the low audio frequency, and the high IF frequency is bypassed around the volume control by C4.

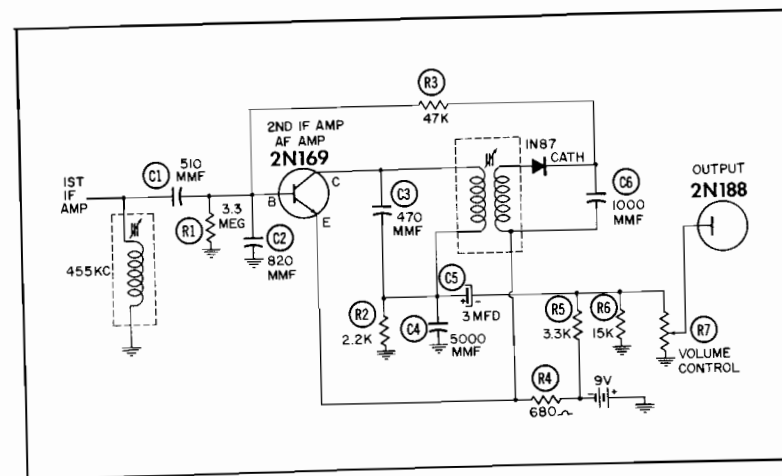

Fig. 14-5. Reflex transistor amplifier.

To check a reflex amplifier, treat it just as though it were two separate amplifiers. Feed an IF signal into the base and look for it at the detector diode; feed an audio signal into the base and pick it off across the volume control. You can see things may happen that will permit the stage to do one of its two jobs well but make it fall down on the other. For example, a shorted IF transformer primary would kill it as an IF amplifier; a shorted C4 would mean no audio would be found at the volume control.

Finally we come to the converter stage that is actually a combination of mixing amplifier and local oscillator. As an amplifier, it can be treated just as if it were an IF amplifier. The same tests will apply except that the frequency handled will be the station frequency. Any deviation from rated voltage values should be investigated and

Intermittents and Miscellaneous Service Problems

corrected. Most of the troubles in this stage, though, appear in the oscillator portion; and a dead oscillator does not change the voltages too much. In fact, it is a little tricky to tell if the oscillator is alive or dead, since you don't have a convenient tell-tale oscillator grid-leak voltage as you do with a tube.

However, both collector and emitter current go down when the oscillator is working, and this is all the clue a smart boy like you needs! Put your VTVM across a resistor feeding either the emitter or collector and watch the voltage closely as you short out either winding of the oscillator coil. If the oscillator is working, the voltage will jump up smartly and then go back down when the short circuit is removed. Defective coil, open coupling capacitor C6, shorted tuning capacitor, open IF primary winding, shorted turns in loop antenna, transistor with insufficient gain--these are some of the likely causes of oscillator failure. The best test for an oscillator coil that may have shorted turns is to try a new coil, and the same is true for a loop antenna. Methods of checking other suspicious units have already been discussed.

WEAK RECEPTION

Weak reception is a common complaint with transistor sets. Check the battery first. Look for loose connections. Flex the loop to see if there are any cracks in it. Check audio coupling capacitors. These are low-voltage, high capacity electrolytics; and in the first transistor sets such capacitors failed very frequently. Much improvement has been made in them, but they are still well up on the list of transistor receiver troubles. Check such capacitors as C2, C4, C9, and C11 in the circuit of Fig. 14-3. Check alignment. Try another diode. Use signal injection and signal tracing to find which stage is not delivering the signal it should; then employ voltage checking and unit checking in that circuit to see what is wrong.

If reception is weak on the low end of the band, insufficient oscillator injection voltage may be the cause, especially if the converter transistor has been changed. Loosen the wax seal that holds the feedback winding of the oscillator coil and slide the winding back and forth until you get the best reception; then fasten it there.

NOISE AND DISTORTION

Noisy reception is usually traced to weak batteries, poor connections, defective audio or IF transformers, bad oscillator coil, or defective transistors. The signal tracer is invaluable in revealing in which stage, or even in which component, the noise arises.

When distortion is the complaint, note if it is worse as the volume is turned up but seems about the same on all stations or if it is worse on strong stations and seems to be independent of the volume control setting. The former case indicates something wrong in the

Transistor Receivers and Printed Circuits

audio section. Incorrect bias brought on by leaky or shorted coupling or bypass capacitors is a very common cause. A resistor that has changed value is another. Resistor or capacitor failures in negative feedback circuits are still another. Careful checks of the audio amplifier and output stages will turn up the cause of the trouble.

When distortion occurs only on strong signals, the trouble must lie in the front end of the receiver. Defective bias on one of the RF or IF stages could be the cause, but defective AGC is more likely. Check such components as C2, C12, R13, R14 and M2 in the circuit of Fig. 14-3.

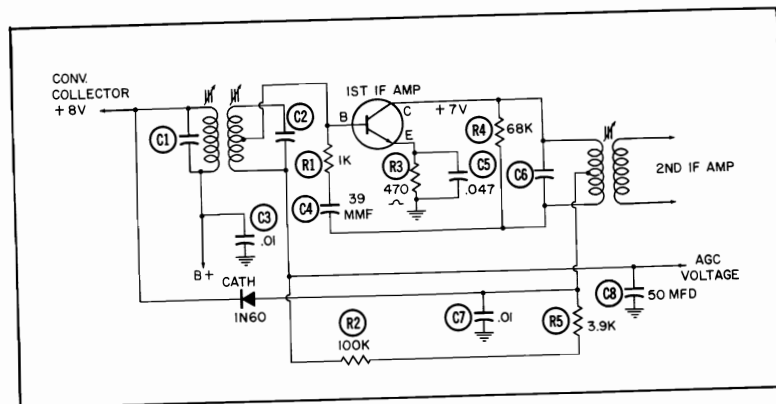

Fig. 14-6. AGC system using diode to improve action.

You will find an extra diode in many modern sets connected as shown in Fig. 14-6. DC-wise, this diode is connected between the collector voltage of the converter and the collector voltage of the AGC-controlled 1st IF amplifier. Signal-wise, it is connected across the primary of the first IF transformer. With weak signals, the diode has one volt of reverse bias and does not conduct and has no effect on the signal. As the received signal increases and AGC voltage is developed, current through the IF transistor goes down and collector voltage goes up to eight volts and higher. This converts the diode to an increasingly conducting state and makes it act like a decreasing resistance shorted across the IF transformer winding, cutting down on its efficiency and consequently on the signal passed. Since much of the AGC action depends on the throttling operation of this diode, do not overlook the possibility it may be open when searching for the cause of overloading stages ahead of the detector.

An intermittent in a printed-circuit transistor set might sound like a tribulation for a modern-day job, but actually it is usually not too bad. Since practically no heat is generated in a transistor receiver, there are few thermal intermittents. Mechanical intermittents--bad solder joints, broken printed circuits, loose connections,

Intermittents and Miscellaneous Service Problems

short circuits--are ordinarily not too difficult to find by methods already outlined. There are exceptions!

In conclusion, let me say this: do not consider the transistor service methods described as an inflexible procedure. Transistor receivers are comparatively new. New transistors and new circuits for them are coming out daily, and new circuits offer an opportunity to develop new service techniques. Constantly strive to find better, simpler, quicker ways to isolate trouble, to test components, and to make repairs. Become thoroughly familiar with what constitutes normal operation so that you may perceive abnormal behavior more quickly. For example, with a correctly operating receiver in front of you, touch the hot lead of the volume control and notice how loud a buzz this produces in the speaker. Touch, in turn, the input connections of the converter, IF's, and detector transistors or diodes with a metal screwdriver bit and observe how loud a click is heard in the speaker in each instance. Store this information away and use it as a rapid form of signal injection on the next weak or dead set.

Several points of printed circuit servicing have been mentioned as we discussed transistor receivers. Now, let's face up to a hard fact:

Manufacturers like printed circuits because they lend themselves to automation. They wish technicians would love them, too, and to that end they are beginning to make sincere efforts to manufacture printed circuits that are not only better but are easier to service than some have been in the past.

The best help to date, though, has come from a publisher of service literature. Fig. 14-7A shows the circuit and Fig. 14-7B, a picture of a printed board as displayed by the "CircuitTrace" method in a Howard W. Sams Photofact. Note that each important part of the circuit bears a number that is matched with a similar number in the picture, indicating that point on the actual printed board. With this in front of you, you can immediately locate any circuit point you wish to check.

One of the most exasperating troubles that occur in printed circuits is a tiny fracture of a printed lead, usually brought on by flexing of the board. The crack across the lead is so tiny it is extremely hard to see, even when "touch-type servicing" has revealed the general area in which it must lie. A magnifying glass is a great help in spotting such a break. The writer prefers a 5" 2X jeweler's loupe screwed into his eye. Not only does this leave both hands free for delicately flexing the board, but it also gives one such a professional look!

The less unsoldering and soldering you do on a printed circuit the better. For that reason it is often advisable to cut the leads off a defective component above the board and solder the new component

Transistor Receivers and Printed Circuits

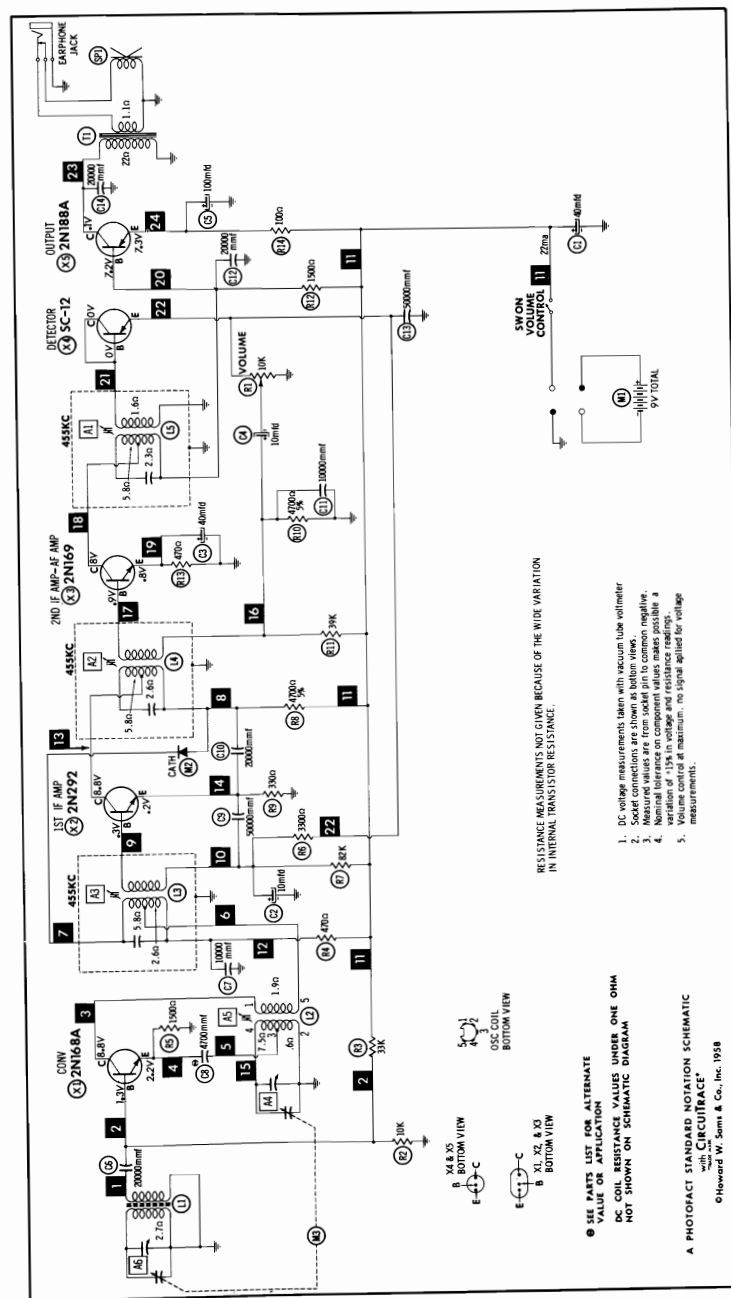

Fig. 14-7A. Schematic diagram of Trav-Ler Model TR-280 illustrating "CircuitTrace."

Intermittents and Miscellaneous Service Problems

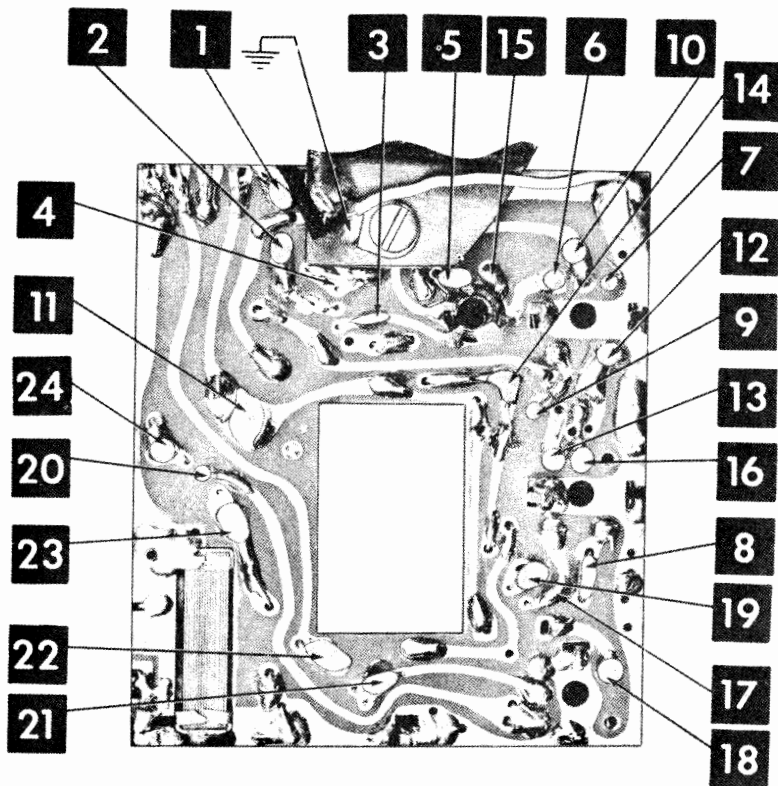

Fig. 14-7B. Circuit-board picture of Trav-Ler Model TR-280 illustrating "CircuiTrace."

to these leads. Resistor leads are sometimes not long enough for this, but they will be if you crush the resistor with a pair of pliers so the whole leads can be used.

One of the nastiest things to get loose from a printed board is a capacitor of the fabricated plate type in which the connections and the metal lugs on the side of the can have all been thrust through holes in the board, bent over, and soldered. Probably the best way is first to use a solder gun to heat each lug or connection, one at a time, and bend it straight. Then heat the connections on one side in quick rotation while a firm sideways pressure is exerted on the same side of the can, causing the heated lugs to pull up out of their holes a bit. Push the can the other way and heat the other connections. Repeating this maneuver, you can gradually work the capacitor up loose from the board.

If you don't have a particular single-ended capacitor for a printed circuit repair but do have the capacitor in ordinary double-

Transistor Receivers and Printed Circuits

ended form, you can bend over one lead and tape it close along the capacitor body to make an acceptable substitute.

Once found, breaks in printed circuit leads are easy to repair. Simply solder a short length of bare wire across the break and spray the cooled repair with clear lacquer or plastic spray. But be careful with your soldering. It is very easy to short across the closely-spaced leads. A sloppy solder-slinger is about as much out of place in transistor servicing as the proverbial bull in a china shop.

The main thing is this: don't let printed circuits "get your goat" or make you lose your temper. Work gently and deliberately and daintily — and charge by the hour!

QUESTIONS

1. List some precautions to be observed in transistor set servicing.
2. What new equipment is needed?
3. Where do you look first for the cause of a dead set?
4. What is meant by "touch-type servicing"?
5. What two methods of locating trouble are used a great deal in transistor servicing?
6. How do you determine if a transistor is defective?
7. How does an oscillating IF amplifier reveal itself?
8. Give five possible causes of motorboating or oscillation in an IF amplifier.
9. How is a reflex amplifier checked?
10. How do you determine if an oscillator is working?
11. Give a common cause for weak reception on the low end of the band and the cure for this condition.
12. Describe how a diode is used to improve AGC action in some transistor receivers.
13. What is meant by "CircuiTrace"?
14. How do you remove a fabricated plate capacitor from a printed circuit board?
15. List some precautions to be used in working on printed circuits.

CHAPTER 15

Auto Radios And Storage-Battery Portables

Art and morality, someone has said, have this much in common: in both, the important thing is to draw the line somewhere. A line must be drawn somewhere in deciding what to include in a book on radio servicing, too; because the entire field is so broad and ramified that a single volume cannot hope to cover all of it.

Nonetheless, it was decided the auto-radio branch of servicing was too important to omit entirely; so in the following pages will be found a discussion of the peculiar problems of this branch of servicing, with especial emphasis placed on the aspects that differ from household-radio servicing. At the same time, no attempt will be made to go into the subject of noise suppression in auto-receiver installations. That broad subject will be left to the several books devoted to it. All we hope to do here is to introduce the reader to the auto receiver so that he will not feel he is meeting a total stranger if an occasional set of this type wanders into his shop.

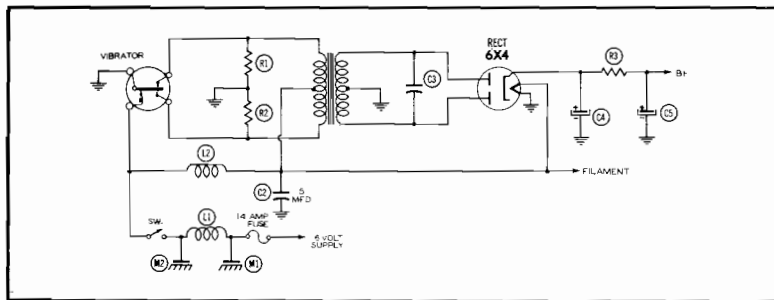

Fig. 15-1. Typical power supply circuit used in older auto radios.

The most striking difference between an auto receiver and a household set lies in their respective power supplies. In Fig. 15-1 is diagrammed a typical power supply found in many older auto receivers. One side of the car battery is fed to the receiver chassis through the car frame which serves as a common ground. The ungrounded side of the battery enters the set through a fuse, an On-Off switch, a filter composed of special capacitors M1 and M2 together with RF choke L1, the primary windings of the power transformer, and finally the contacts of the nonsynchronous vibrator. You know -- or should -- how this vibrator acts to convert the six or twelve volts DC battery voltage into alternating current in the primary of the

transformer and how this current is stepped up in the secondary to the potential needed to produce the proper rectified and filtered B-plus voltage used by the set. The 6X4 rectifier converts this alternating current into DC just as it does in a household receiver; and the output of the rectifier is filtered by C4, R3, and C5 in the same way. The filaments are fed directly from the battery through another decoupling RF choke L2. Fig. 15-2 shows a variation of part of this diagram often found in older receivers. The difference is that a synchronous vibrator is used instead of a vacuum tube to rectify the output voltage of the transformer.

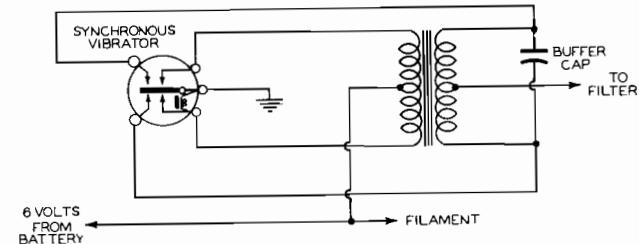

Fig. 15-2. Schematic of a power supply using a synchronous vibrator.

The technician who has worked only on house radios will encounter several new items in this portion of an auto set. First, he will note that the fuse is rated at fifteen amperes of current instead of the two or three amperes he has been used to finding in console receivers. Secondly, he may think it unusual to find RF chokes in the power-supply leads, especially chokes such as L1 and L2 of Fig. 15-1. These ordinarily consist of ten to twenty self-supporting turns of heavy wire wound in a single-layer coil a half-inch or so in diameter and often encased in a paper tube. One of these chokes is shown in Fig. 15-3. M1 and M2 are capacitors fabricated by riveting metal plates, called "spark plates," to the chassis with insulated rivets and with a layer of fishpaper sandwiched in between to serve as a dielectric. An example of this type of capacitor is shown in the photograph in Fig. 15-3. The vibrators, several types of which are shown in Fig. 15-4, are essentially automatic switches cycling at a usual frequency of around 115 cps. The power transformers differ from those the technician has known in that their primary windings are center tapped and have a much lower impedance than those designed for 117 volts AC. C3 in Fig. 15-1 is called a "buffer capacitor" and is connected across the secondary of the transformer so that its "reflected" influence will eliminate or reduce harmful sparking at the contacts of the vibrator. It is a very important item, as will be proved later. Finally, a conventional hot-cathode rectifier may not be present at all. The rectifying may be done mechanically by a synchronous vibrator; or a gaseous rectifier, such as an OZ4, may be used in place of a 6X5.

Other essential differences in engineering and construction will be noticed. For example, the auto set is much better shielded than the average household receiver. It must have a higher sensitivity to permit it to do a good job with the very limited antenna facilities provided on a car. It is much better protected against heat, moisture,

SPARK PLATE

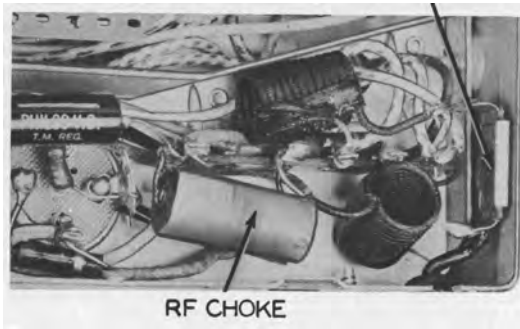

Fig. 15-3. Physical appearance of RF choke and spark plate in a receiver.

and vibration. In fact, when you consider that an auto set is frequently subjected to temperature ranges of better than one hundred degrees, that it must take whatever humidity conditions the outdoors has to offer, and that it is under constant vibration and jarring while the car is in use, you might conclude these receivers are better built than their stay-at-home counterparts — and you would be right!

A few different servicing techniques are necessary. The vibration to which the set is subjected must always be kept in mind. The practice of supporting capacitors by their wire leads is not good in auto-radio replacements. The body of the capacitor should be anchored by a clamp or by taping so that all strain is taken off the leads. This also goes for large resistors, IF cans, transformers, and similar components should be bolted down solidly. Tube sockets must be good. More than ever, it is important that every solder joint be made mechanically solid before the solder flows over it.

It is also essential to remember that the elaborate shielding found in an auto set is put there because it is needed. It often has a double duty to perform. Not only must it isolate various stages from each other, but it must also keep strong ignition noise generated by the car out of the receiver circuits. That is why it is so essential to replace every single one of those self-tapping screws found holding the lids on the set. They are not used so freely to insure that the covers do not fly off; instead, they are intended to form an unbroken

cordon of guards against the infiltration of unwanted interference. Put 'em all back, and replace any which some previous sloppy technician has left out.

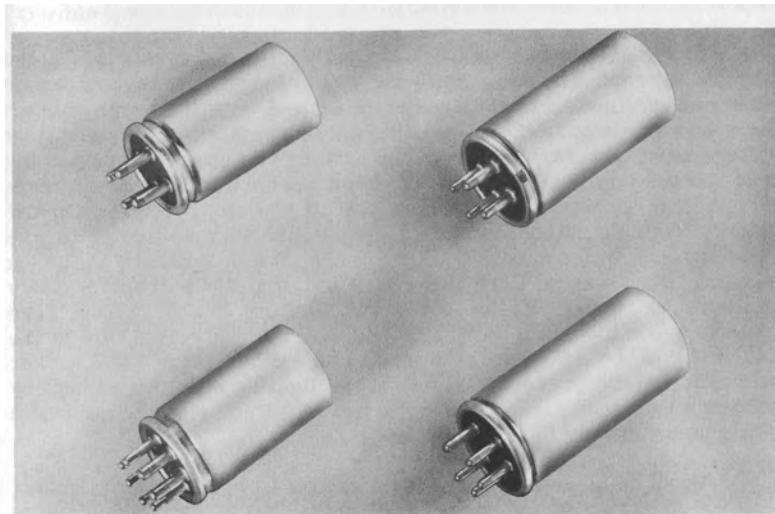

Fig. 15-4. Several types of vibrators.

In previous chapters, the importance of not removing a chassis without reason has been stressed. When working on an automobile radio, it is doubly important that you do not remove the set unnecessarily. In the first place, some of them are harder to get out than the first olive from a bottle. It is not at all unusual that the glove compartment must be entirely removed and the receiver snaked out through the glove-compartment opening. In other cases, it will be required that you pretty well dismantle the heating and defrosting system of the car before you can pluck the receiver from the automobile's innards. On top of all that, it will very often be found that the trouble with the receiver is connected with its installation in the car; and the set may perform perfectly on the service bench, only to return to its former bad habits as soon as it is replaced in the car. Removing the set should be a last resort and not a form of first aid.

Suppose the set will not light up at all and that no cheerful humming is heard from the vibrator. First, examine the fuse. If it looks all right, double-check it for continuity with the ohmmeter of your VOM. Then switch to the voltmeter and see if the car battery voltage is present between the fuse holder and the frame of the car. If it is, make a critical examination of the fuse holder. Remember, this circuit usually carries eight or nine amperes of current, and a fairly low resistance connection that would be of no consequence to a smaller current may be serious here. Clean any corroded contacts, resolder

any suspicious-looking joints, and stretch the contact spring so that it applies more pressure to the fuse. If this does not restore normal operation, try a new fuse even though the old one seems good. An ohmmeter check is not too reliable in this instance.

Make sure the case of the set is making a good connection to the body of the car. Checking from the case of the set to the car frame with your voltmeter while the set is turned on will reveal whether there is a good contact. If any voltage reading at all is obtained, that voltage must be subtracted from the battery voltage to determine the true voltage applied to the set. Tighten anchoring bolts to maintain this voltage as near zero as possible. If you can reach the On-Off switch terminals without removing the set, use your voltmeter to see if the battery current passes through the switch contacts in the On position. Somewhere along this check list, you are extremely likely to find the cause of the set's not lighting up. In a few rare instances, the trouble might be traced to a broken connection at the end of one of the RF choke coils or at some other point. The broken connection would prevent the tubes from lighting even though battery voltage was traced right through the switch. Removing the set would likely be necessary in such an event.

Blown fuses commonly cause a set not to light up. This raises another question: What caused the fuse to fail? One occasionally goes out for no obvious reason. The fuse may be defective; a slow-acting voltage regulator may have permitted a surge of current from the generator to reach the set; or vibrator points may have stuck momentarily. In such a case, putting in a new fuse will take care of the trouble. On the other hand, the vibrator points may be permanently frozen or there may be a serious short circuit along the hot battery lead, in the transformer secondary circuit, or in the B-plus circuit that caused the fuse to melt.

You could put in a new fuse and turn on the set. If the radio started and kept playing for a few minutes, you could then pronounce it all right. This, however, would not be a very scientific procedure. It is much better to buy from your distributor a small center-zero ammeter that will read up to twenty-five or thirty amperes of current. Equip this with heavy flexible leads and clips or connectors so that it may be inserted in the hot lead in place of the fuse. Such a meter need not be expensive, polarity can be ignored when using, and it will stand a lot of abuse. It does not have to be too accurate as long as it "lies" the same way every time. Using it on a few normally operating receivers will tell you where you can expect to find the pointer when the receiver is drawing the usual seven to nine amperes of current.

Always insert this meter in the place of a blown fuse and turn on the set. If the current drawn is normal, even after a few minutes of operation, you can then put in a new fuse with some confidence

that it is all that is needed. On the other hand, if the current is excessive, you will not blow a new fuse unnecessarily; but what is more important, you will not let a job get out of your shop with an uncured trouble that will cause another fuse to fail or some other part to be damaged within a short time. In some cases, especially when the abnormally low resistance is in the B-plus circuit, the set will draw more current than it should; but the excess will not be quite enough to melt a fuse until a small extra surge comes along. The use of the ammeter will spot these sets, while simply replacing the fuse would let them get away.

If the current indication is abnormally high, try removing the vibrator. When this drops the current to a mere ampere or so — the total filament current of the tubes — try a new vibrator. If this produces a normal current through the ammeter, if the vibrator sounds steady and free-running, and if the radio plays satisfactorily in every way, you may reasonably conclude that a new vibrator is all that is needed.

If the ammeter current remains higher than normal; if the vibrator sounds labored and erratic; or if noise, low volume, or fading is noticed; something wrong in the set probably caused the original vibrator points to stick and will do the same with the replacement if the set is left running for any length of time.

When removing the vibrator does not cause the current shown by the ammeter to drop to a low value, the short circuit obviously must lie along the hot battery lead. Short-circuited spark plates are a possibility; so are shorted primary windings in the power transformer. A short circuit could exist along the filament circuit. Remove the set and put it on the bench. Then employ exactly the same techniques you used in Chapter 5 to locate the cause of excessive current. Your ohmmeter will work just as well on an auto set as it will on a house radio!

When a laboring vibrator indicates that the short circuit is probably on the secondary side of the transformer, you again use the techniques learned in Chapter 5. One new and prime suspect, however, is the buffer capacitor. This capacitor is subjected to very high transient voltages, and it often fails. Any change in either its leakage resistance or actual capacity will have a marked effect — invariably bad — on the operation of the vibrator. So important is this capacitor that most vibrator manufacturers recommend replacement of it whenever a new vibrator is installed.

Use an exact replacement buffer capacitor whenever possible. If one cannot be obtained, be sure that the replacement you do use is of at least 1,600 volts rating; that it is moisture and heat resistant, such as the solid molded-plastic case type; and that it has the exact capacity originally specified. (Note that I say "originally specified"

Intermittents and Miscellaneous Service Problems

rather than "formerly used." A previous technician may have substituted a wrong value. Check the service data to be sure.)

If the buffer capacitor is all right, the trouble must lie in the rectifier tube, if one is used, or in the B-plus circuits. You know how to handle these cases. Just "sick" your faithful ohmmeter on to them, and it will come up with a leaky bypass or filter capacitor gripped between its test leads in no time.

Do not get the idea the only thing that happens to a vibrator is stuck points which can fail in an open condition as well as in a shorted condition. In either case, the set will light up, but the vibrator will not start. A new vibrator will start right off unless something is wrong in the connections to the transformer primary, in the primary windings themselves, or in the connections at the vibrator socket. In general, do not try to repair a vibrator. Sometimes dressing the points will restore one to operating condition for a while, but there is more to proper vibrator operation than merely having the reed flutter back and forth. Really accurate and proper adjustment can seldom be accomplished in the service shop.

Intermittent conditions are common in auto receivers, and there are a couple of new causes to meet. First, there is always the possibility a poor connection or a broken lead exists in the antenna lead-in. Shaking the antenna and the shielded lead from it to the receiver with reasonable vigor while the set is playing will usually show up trouble of this nature. Alternatively, the shielded cable may be removed from the place where it plugs into the set, and an ohmmeter may be used to measure continuity from the antenna to the end of the plug and to detect any shorted condition between the inner conductor and the shield. Incidentally, it is very important that both ends of the shield of the antenna cable be properly grounded to prevent ignition noise from getting into the receiver.

A bad vibrator may produce a fluctuating output voltage that will cause intermittent operation. Poor grounding of the receiver or a high-resistance connection in the hot lead from the battery will do the same thing. If the receiver operates only when the generator is charging, the trouble may be a weak battery or a poor connection at either end of one of the battery cables. Remote speaker leads sometimes short-circuit or break. Never remove an auto set before you have first made a thorough check of all tubes.

Once you decide the set should be removed — and do not try to make major circuit repairs in the cramped quarters of the car — it can be treated on the bench about as you would treat any set. You will need a source of power, of course. A fully charged battery can be used, but a power supply operating from the 117-volt line current and specially designed for powering auto sets (such as shown in Fig. 14-2) offers distinct advantages. For one thing, it does for a car

Auto-Radios and Storage-Battery Portables

radio what your adjustable isolation transformer does for house sets; it permits you to vary the input voltage to simulate abnormal conditions. Weak reception, noise, oscillation, distortion, intermittent fading, and similar conditions will be traced to the same causes and will respond to the same cures that you have come to know well in your work on house radios. One final word of caution, however: you will encounter a much wider range of IF frequencies in auto sets than you are accustomed to meet in home sets. Here are some of the most common IF frequencies used: 175, 260, 262, 370, 455, 456, 460, 465, and 470 kilocycles. Always refer to the service data to be sure of the correct IF frequency before attempting alignment.

Mechanical troubles will be encountered much more often in auto sets. Some of the automatic tuning systems used are truly ingenious but can develop some of the most exasperating difficulties when they do not work. Gummy deposits are the chief enemy of these devices, and many of them can be set back in operation by merely a good cleaning with carbon tetrachloride plus a modest amount of the right sort of oil or grease. Finding what is wrong with any mechanism falls into three steps: (1) Figure out what is supposed to happen in what order. (2) Locate where this ideal chain of events breaks down and determine why. (3) Remove the difficulty. This may sound like an attempt to "reduce to an absurdity," but the fact remains that it is the proper procedure to use if you are attempting to repair a broken-down diesel locomotive or a stubborn Rube Goldberg automatic tuning system.

HYBRID AND ALL-TRANSISTOR AUTO RADIOS

If you have been working only on older auto sets, one of these days you are going to put a new set on the bench and be in for several surprises when you start testing it. There will be no vibrator, no rectifier, no power transformer. You will find 12 volts on the filaments of the tubes and the same voltage on the plates and screens. There will be no output tube. One or two king-size transistors will be bolted right to the chassis or even to the outside of the case. The output transformer will have only one winding and will be used as an autotransformer.

When you get out the service data, you will find a diagram something like that shown in Fig. 15-5. This "hybrid" set is the direct result of car manufacturers going to twelve-volt ignition systems. When they did this, tube manufacturers began coming out with a whole series of new tubes intended to work on 12 volts of plate and screen potential. These tubes can be made to perform well such functions as amplification, oscillation, mixing, and detection. The only thing they can't do well is handle large amounts of power output; but right there is where the power transistors shine. The result is the electronic -- pardon the expression -- jackass you see in Fig. 15-5. Its mamma was a tube and its papa was a transistor!

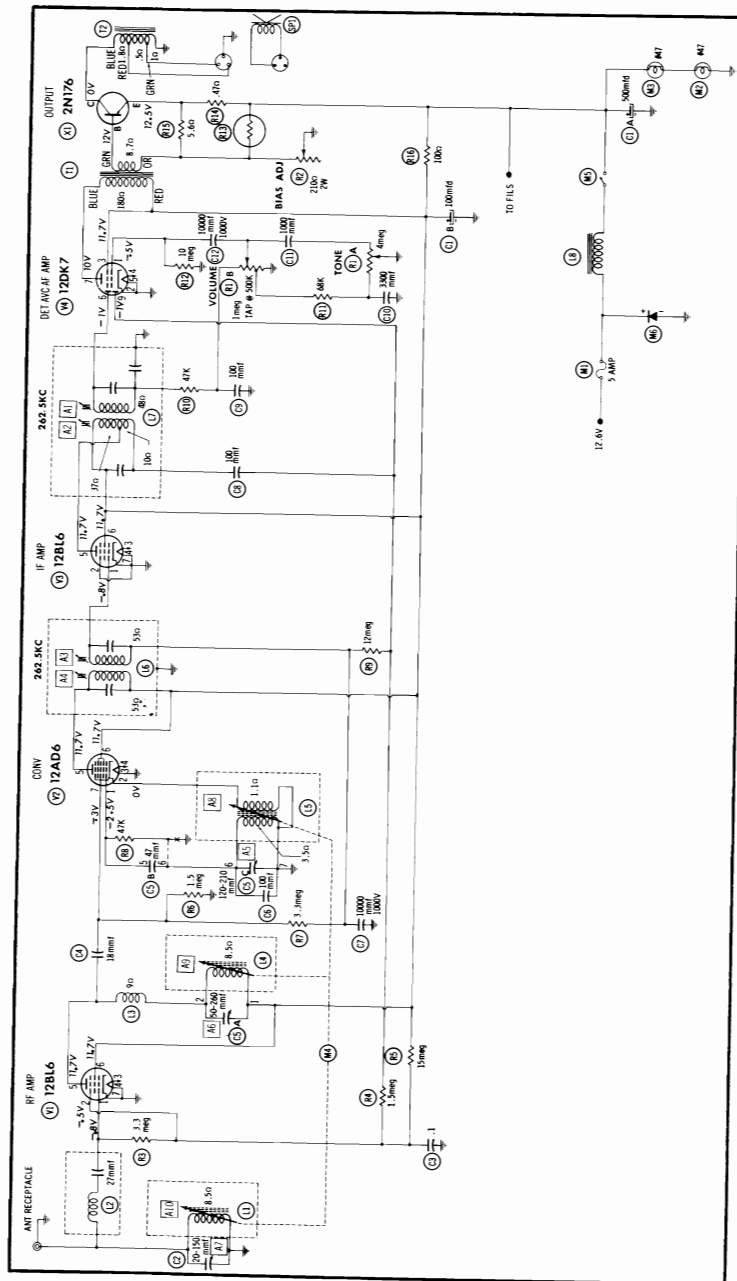

Fig. 15-5. American Motors Model 8990494 auto radio.

Actually these new sets do not introduce many new service problems, and they do away with several old ones. Getting rid of vibrator troubles, power transformer troubles, and rectifier troubles at one fell swoop is quite an accomplishment. Lower potentials mean less strain on filter and bypass capacitors. Current requirements are cut to a couple of amperes or so. A five-ampere fuse is ordinarily used in these sets.

There are, though, some points to watch: (1) Be sure and observe proper polarity when connecting a set of this kind to your bench battery or battery substitute. Reversed polarity could ruin the transistors and the filter capacitors. (2) Don't operate the set without the speaker connected. Power transistors are rugged, but they can't take that kind of abuse. (3) When checking electrolytic capacitors, don't exceed their voltage rating. Most of them have 16 volts DC working voltage rating. (4) Be careful not to short the case of the output transistor. This case and the mounting stud are connected internally to the collector and carry the collector voltage. The case is insulated from the chassis by a thin mica or anodized aluminum washer. Be sure this washer is in good condition and in place when replacing a power transistor. (5) The power transistor must have a good heat sink to carry off heat generated. That means it must make a good mechanical bond to the chassis. Special silicone grease is often recommended to furnish a good heat path from the transistor case to the chassis. (6) The low-voltage tubes have very close spacing between elements. Trying to improvise tests for them in old tube testers may result in damage to them from applying more voltage than they can take. Test them only in tube checkers designed for them.

Outside of these points, you can treat the receivers just as you would any other tube-type receiver. Because of the very close spacing of the tube elements, you can expect more internal shorts in the tubes. The bias adjustment on output transistors is critical and should be set exactly in accordance with service instructions.

And then there are the all-transistor auto receivers. Some of these are dillies. For example, some of them permit you to pull out everything but the RF stage and the power output stage in one chunk and use it as a portable receiver with its own speaker and its own dry-cell battery. You can imagine the switching contacts and circuitry involved. But all in all, transistor auto sets seldom present problems you have not already encountered in portable and house transistor sets and hybrid auto sets. They use, in general, the same circuitry and are subject to the same troubles.

STORAGE-BATTERY PORTABLE

You will not be in the service game long before you encounter an electronic hybrid known as the "storage-battery portable." This receiver is a sort of cross between a three-way portable and an automobile receiver. While it employs 1.4-volt tubes and can be used

Intermittents and Miscellaneous Service Problems

this happens, carefully clean the contacts by which the battery is connected to the set. In many cases, these contacts are in the form of banana plugs that slip into sockets moulded right into the battery case. When a poor contact is had, the pulsing-current requirements of the vibrator cause the filament voltage of the set to be modulated at the vibrator frequency; and hum is produced. In other cases, the poor connection to the battery allows the pulsating DC output of the battery charger to do the same thing. At any rate, improving the connections will banish the trouble.

By treating the power supply as you would an auto receiver and the remainder of the circuit as you would a three-way portable, these sets should present no further serious problems. You will note, however, that the filaments are connected in parallel arrangements with resistances (or choke windings) being used to reduce the two-volt battery voltage to the proper 1.4-volt requirements of the tubes.

The chief trouble with these sets is to persuade the owners to give them the small but essential amount of care they need. Keeping the battery filled with distilled water and keeping the battery charged, even when the radio is not being used, is essential; yet many owners will tuck one of these sets away in a closet at the end of the summer and never look at it again until the following summer. Sometimes reminding such people of the stiff price of a new two-volt battery helps considerably!

QUESTIONS

1. What is the greatest difference between the power supply of a conventional car radio and that of a household set?
2. What is the purpose of the buffer capacitor?
3. In auto radio servicing, what precautions are made necessary by vibration?
4. What is the double purpose of shielding in auto receivers?
5. When should you replace a buffer capacitor, and what precautions are necessary in this replacement?
6. What is a "hybrid" auto receiver?
7. List some points to watch in working on hybrid receivers.
8. What care must be observed in testing low-voltage tubes?
9. In a storage-battery portable, what is the effect of poor connections to the battery?

CHAPTER 16

All-Wave And FM Sets

A few years ago a receiver that did not cover all frequencies between 550 kc and 15,000 kc was considered as inadequate as would be a TV set today with provision for receiving only channels 2 through 6. Later, these short-wave bands were largely replaced by such things as push buttons, tuning eyes, bass and treble controls, and timer clocks; but there are still a great many of these all-wave sets lurking around. The writer joins many other technicians in firmly believing that quality construction of radio sets reached a high tide during the period these multiband sets were being produced; and many of them have proved themselves to be as durable as Ford's Model A. What's more, the owner is quite likely to be just as proud of his "vintage" receiver as a Model A owner is of his car. Finally, the best quality of receivers built today, the communications sets, are essentially refined all-wave radios.

It is necessary, therefore, that you be familiar with the special problems connected with servicing these receivers. First, let us take up the comparatively simple all-wave receiver designed for use by the average person and leave consideration of receivers for specialized communications until later.

ALL-WAVE RECEIVERS

An all-wave receiver is essentially the same as any other broadcast receiver from the converter plate through the speaker. The difference lies in the oscillator, converter, RF amplifier, and antenna circuits. Fig. 16-1 shows a typical circuit of a comparatively simple all-wave receiver. Band No. 1 on this receiver tunes from 540 to 1700 kc, band No. 2 from 1.7 to 5.5 mc, band No. 3 from 5.5 to 17 mc, and band No. 4 from 16 to 46 mc. Each band, you will note, requires a separate oscillator coil and antenna transformer to cover its tuning range. If the set had an RF stage, an RF transformer similar in construction to the multicoil antenna transformer would be used to couple the plate of the RF stage to the grid of the mixer tube on all bands.

In some sets, a complete separate transformer or oscillator coil that is individually shielded is used for each band; in many others, each set of transformers consists of several windings on a single coil form. The set diagrammed in Fig. 16-1 is of this latter type. Notice that the lower-frequency coils not in use are automatically shorted out to prevent their acting as self-resonant traps and

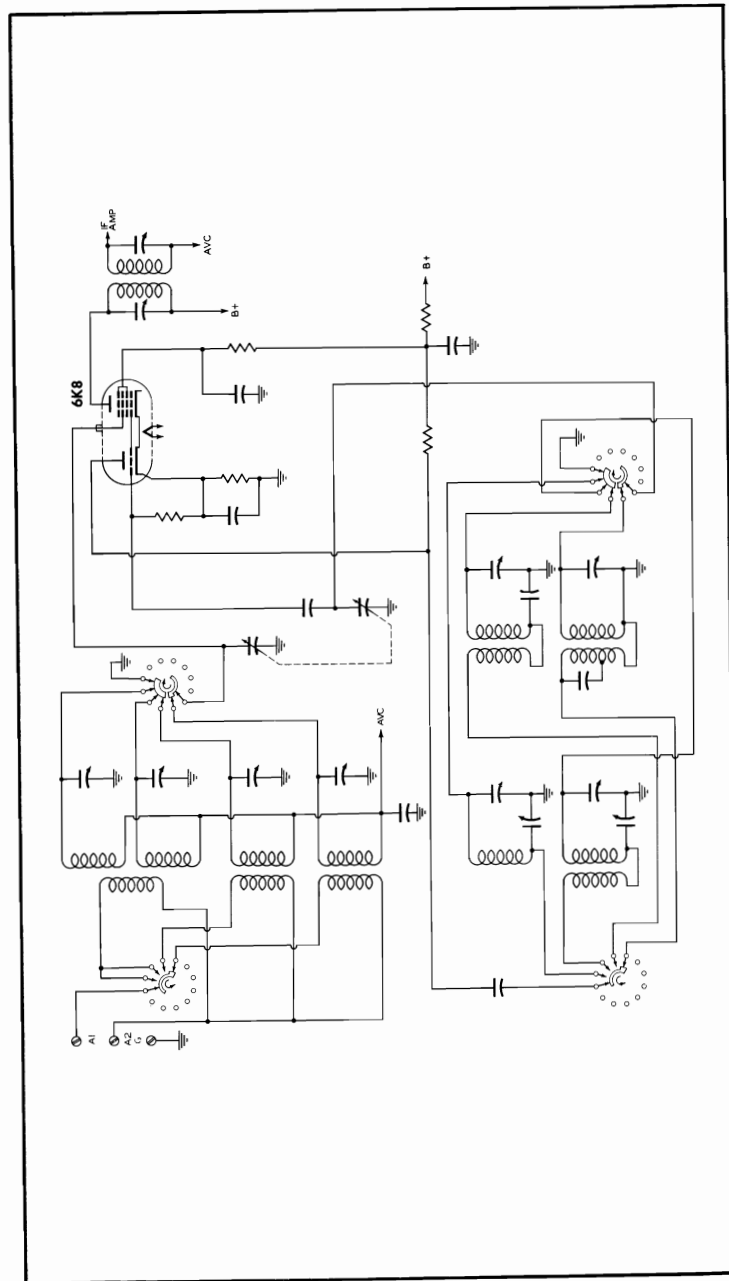

Fig. 16-1. Oscillator and mixer circuit of an all-wave receiver.

causing "suck-out" spots to appear in the tuning range of the coil in use.

It does not take much imagination to see that complicating the front end of a set in this manner increases the opportunity for trouble. Twelve transformers present more room for something to happen than three; and when you remember that both primary and secondary windings of these transformers must be switched in and out of the circuit with a multicontact several-position switch, you can picture the sinister possibilities.

Fortunately, many of the troubles that happen are almost self-diagnosing. For example, if the receiver is dead on only one band while normal reception is had on the others, you need waste no time seeking the difficulty in circuit components in use on all bands. The search is immediately narrowed down to the various coils, transformers, and associated parts switched into the circuit when the dead band is in use — and incidentally, never overlook the switch itself. Dirty, corroded, and bent contacts on the band-change switch very often result in a receiver that will not play on a particular band. When this condition is discovered, a liberal application of a good contact cleaner to the switch contacts while the switch is worked a few times will usually take care of dirt and corrosion. Bent contacts may often — but not always — be restored to their original position and tension by careful manipulation with tweezers, medical forceps, and other small tools. In some instances, it may be necessary to replace the whole switch. If you do not make a very careful diagram of the many wires going to this switch and show such things as color and position, so that you may reconnect them without hesitation to the proper points on the new switch, you will regret it! This is one place where even a good memory simply cannot be trusted.

Coils fail as often in all-wave sets as in any others, but sometimes such a failure presents a much worse problem. For example, suppose the antenna coil in Fig. 16-1 is burned and charred by lightning. In a simple broadcast set, this would require either replacing just the antenna coil or at most the two-coil transformer. In our all-wave job, however, the broadcast-band antenna coil is wound on a form containing all the other antenna coils as well as the secondaries of these transformers. Lugs and mounting brackets on the ends of the coil normally make it impossible to use a slipover primary. Quite often there is no space to mount an entirely separate antenna transformer to cover the band that is out, even if an antenna transformer that would work satisfactorily could be obtained. In the long run, the best repair is to replace the entire antenna transformer assembly, even though this entails breaking and resoldering many connections and complete realignment of the front end of the set.

This subject of alignment brings up one of the most important differences in all-wave receivers. Circuits operate somewhat differently in the megacycle region than they do down in the broadcast

band. In the first place, when a circuit is working at several megacycles, its resonant frequency can be drastically shifted by minor mechanical changes that would have no appreciable effect at broadcast frequencies. In short, you can't go wrestling wires, capacitors, and resistors about in the oscillator, RF, and mixer circuits of these receivers without seriously upsetting the alignment. Moving a wire a half-inch is sufficient to change an oscillator frequency five hundred kilocycles at thirty megacycles!



Fig. 16-2. Cabinet view of a communications receiver.

Do not try to depend upon general service procedures in aligning an all-wave set, but follow your service-data instructions religiously. The order in which trimmers are adjusted can sometimes make the difference between a set that aligns easily and one that cannot be properly aligned at all. You will find that it is often necessary to rock the tuning capacitor even when aligning high-frequency trimmers on the short-wave bands. In the past, such rocking was usually practiced only on the low-frequency end of the band. It now becomes necessary because a high-frequency oscillator tends to have its frequency influenced by the tuning of other circuits near its frequency, even though those circuits are comparatively loosely coupled to it. The rocking adjustment of mixer and RF trimmers helps overcome this tendency of the oscillator to "pull."

Another tricky business you must watch lies in the fact that there are usually two points to which a short-wave circuit can be aligned to produce a response on the output meter. One is the proper point, the other is called an "image." If a high-frequency trimmer

is incorrectly adjusted to an image, the receiver will not track on that band. Careful reading and following of alignment instructions will avoid this happening. General instructions cannot be given because the position of the image depends upon whether the oscillator is intended to track higher or lower in frequency than the signal; and sometimes the oscillator works on the high side and again on the low, even occasionally changing position on different bands in the same set.

Carefully follow instructions concerning the methods recommended for connecting the signal generator to the set during various phases of alignment. The various values of resistors and capacitors suggested are selected for good reasons. All tube shields should be securely in place before alignment is attempted.

COMMUNICATIONS RECEIVERS

And now we come to the communications receivers. One of the less complicated communications receiver is pictured in Fig. 16-2. A partial schematic diagram of the RF and IF circuits are shown in Fig. 16-3. Let me say right here that a good technician has the same healthy respect for one of these sets that a garage mechanic has for the mechanism of a Rolls-Royce automobile. In neither case is there any room for a tinkerer. That does not mean that even a comparatively inexperienced service technician should be afraid to touch one of these sets. Bad tubes, shorted bypass capacitors, open resistors, and poor connections are located in a communications receiver just about as easily as they are in a broadcast radio. When replacing parts, however, it is very essential that you adhere strictly to original replacements or service-data recommendations. Many of these parts are quite critical as to value, and an incorrect replacement will seriously affect the performance of the receiver. A single example is the temperature-compensating capacitors usually found in the oscillator circuit to overcome temperature-produced changes in oscillator frequency. If one of these is replaced with an ordinary mica unit, even though it is of the same capacity and voltage rating, the performance of the oscillator will be degraded.

Another point is that you should use extreme care in removing old parts and replacing new ones. A bottom view of a more complicated communications receiver is shown in Fig. 16-4. Tiptoe around through the circuits with all the care and caution of a cat burglar working in the home of an insomniac. Never move apart or wire unless it is absolutely necessary, and then make sure you replace it exactly as it was.

Suppose the owner wants the set realigned. Do not take on this job without due deliberation. First find out why he wants this done. The tuned circuits in these sets are carefully engineered to hold their alignment over a long period of time against all ordinary hazards except one: the tinkerer and his busy little screwdriver! If the owner has turned the trimmers, the receiver undoubtedly does need alignment; but otherwise alignment is probably being unjustly blamed while something else is causing the trouble.

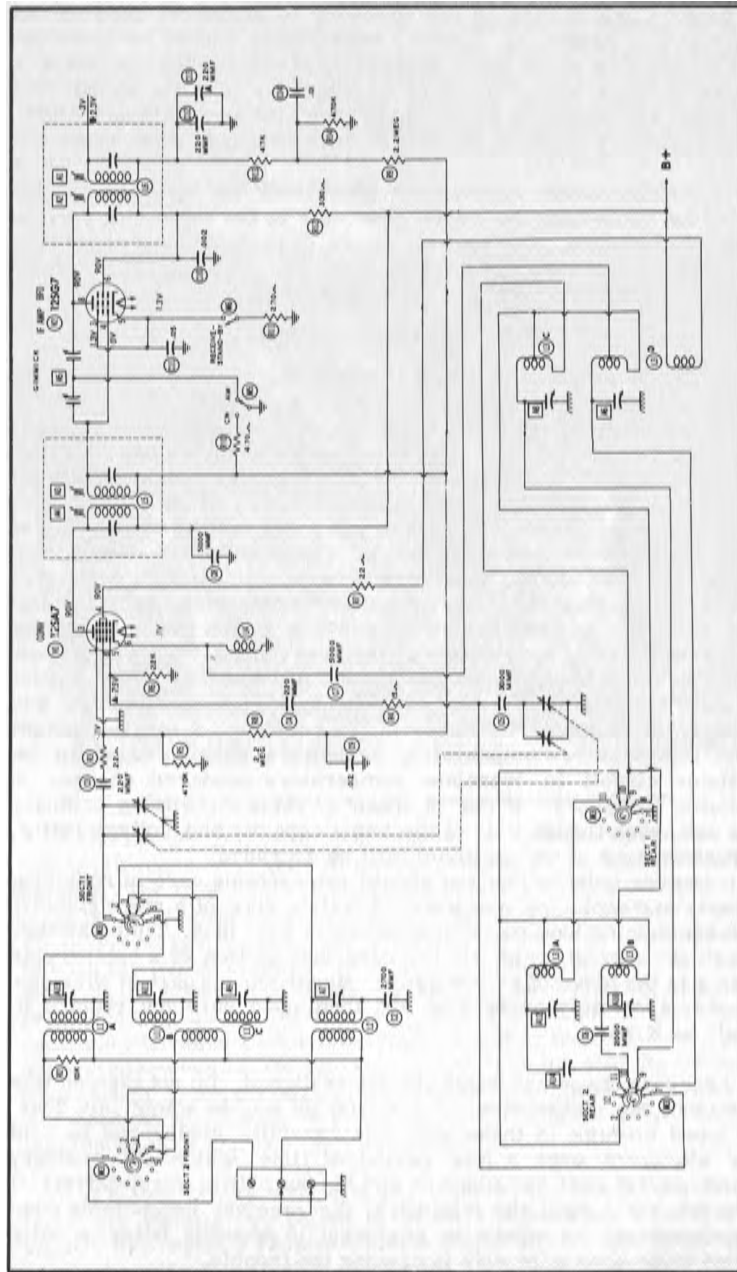

Fig. 16-3. Partial diagram of the RF and IF circuits of the receiver shown in Fig. 16-2.

Even when you are convinced alignment is needed, I hesitate to recommend that you undertake the job unless (1) you have a very accurate and dependable signal generator, (2) you have complete and detailed alignment information on that particular receiver, and (3) you have had at least some operational experience with communications receivers so that you will know when one is operating as it should. Unless such terms as double-conversion, crystal phasing, single-signal selectivity, RF gain control, S-meter, and band spread have clear and concrete meanings for you, it is much better to suggest that the owner return the set to the manufacturer for alignment. The famed fury of a woman scorned is a tempest in a teapot compared to the monumental anger of a radio ham whose pet receiver has been fouled up by an improperly executed alignment job.

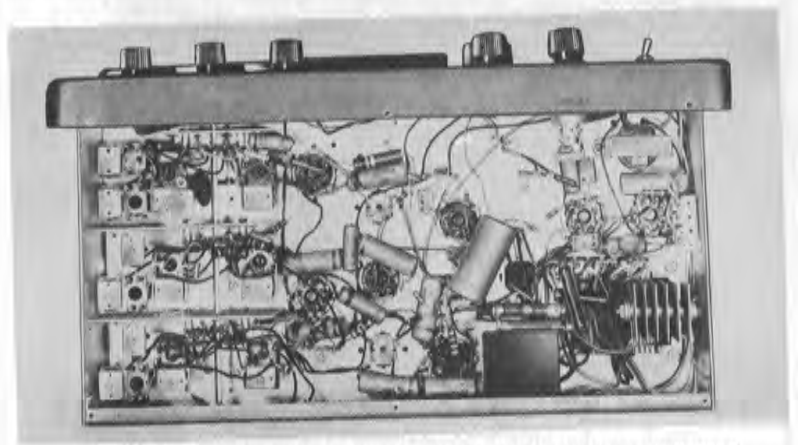

Fig. 16-4. Bottom view of chassis of one of the more complicated communications receivers.

Lest it seem I am advising you not to go near the water until you learn to swim, I hasten to add that I strongly recommend the purchase of a good used communications receiver by the novice technician. Such a receiver will provide a standard of reception against which to check all other receivers that cross the bench. The ability of such a set to pick up the many transmissions of the National Bureau of Standards station WWV will furnish primary standards of frequency to be used in calibrating signal generators and other service shop equipment. Finally, by operating, aligning, and maintaining this receiver, the technician can thoroughly acquaint himself with the specialized problems and procedures connected with using and servicing these sets. Once he has done that, no other receiver service problem will cause him many fears. The cost of a good used communications receiver is a cheap price to pay for that kind of self-confidence.

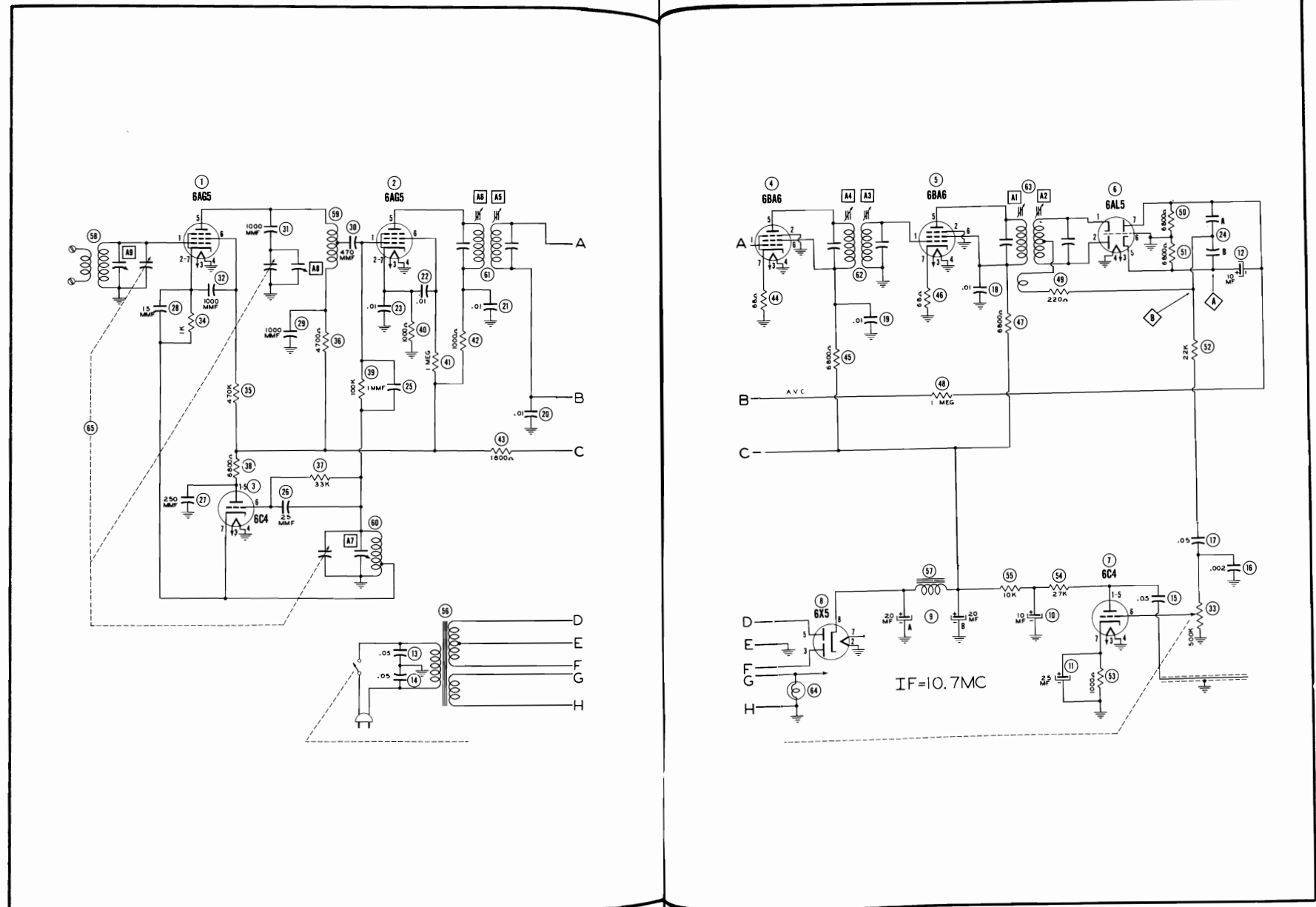

Fig. 16-5. Schematic

diagram of an FM receiver.

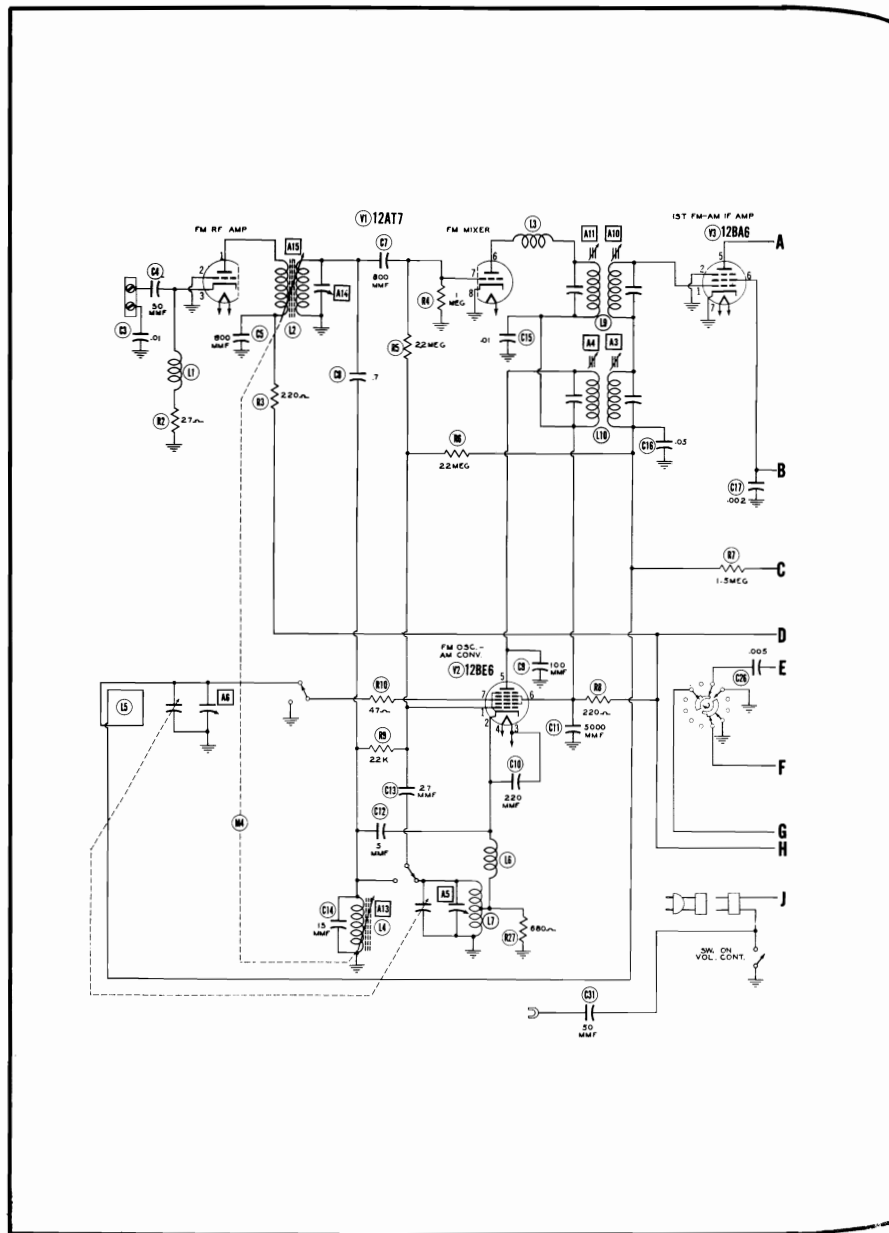
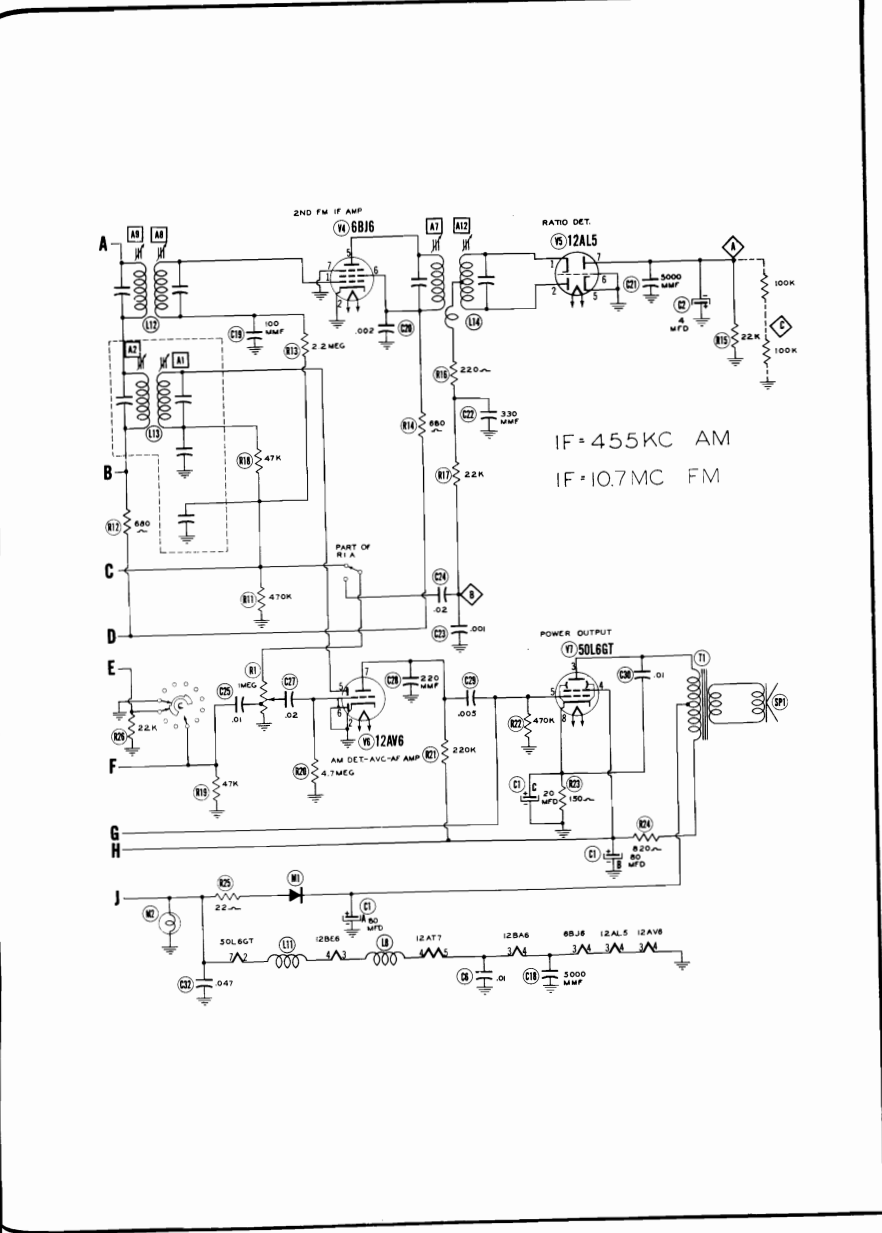

Fig. 16-6. Schematic diagram



of an AM-FM receiver.

FM AND AM-FM RECEIVERS

It has always seemed to the writer that an FM set such as the one diagrammed in Fig. 16-5 is much more nearly a blood relative of a television receiver than of a broadcast radio. The band it tunes, 88 to 108 megacycles, is right in the middle of the TV VHF band; the FM type of transmission received is the same as that used for the audio portion of the television signal in the United States; and a TV type of antenna must be used for good reception. Still, you find many combination AM-FM receivers on the market today, even in the form of AC-DC sets such as the one diagrammed in Fig. 16-6; and the owner of one of these is usually blissfully unaware that he has two basically different receivers housed in a single cabinet. The service technician, however, is acutely aware of the difference.

At one hundred megacycles, coils, capacitors, tubes, and even tuning arrangements are often radically different from these same items at lower frequencies. For example, a tuned circuit may be a long line that looks suspiciously like — and probably is — a length of twin-lead. Instead of a conventional tuning capacitor, the technician is likely to find a miniature mechanism that bears the grisly but apt name of "guillotine tuner." A tuner of this type is shown in Fig. 16-7. A bypass capacitor may strongly resemble either a fat wood tick with a pair of wires sticking out of one side or a quarter-watt resistor. This is no place to be guessing what things are. Work hand in glove with your service data.

I hate to continue harping on this single string, but once more let me remind you that extreme caution must be used in moving the wires and parts of an FM receiver. Even the IF frequency is usually around 10.7 megacycles where just a little change in stray capacity is sufficient to detune a circuit. The leads of all replacement capacitors and resistors should be clipped as closely as possible to the length employed in the original parts. In the front end of the set, things are even more critical. Changing oscillator tubes will frequently necessitate realignment because of the slight difference in the internal capacities of the new and old tubes.

It may seem odd to you, but this writer is not going to sound off with any general instructions for aligning FM receivers. He has tried to make it plain all along that he is a great believer in specific rather than general service information. He strongly feels it is especially important for the novice technician to develop the habit of turning to his service data whenever there is the least doubt in his mind as how to proceed; and considering the many varieties of circuits found in FM sets, that will probably happen quite often in working on these receivers. There are at least three different types of FM detectors in common use, each of which requires a different alignment technique. FM front ends display almost as much variety as women's hats. Even the IF circuits of combination AM-FM receivers have several different versions. In view of all this, any

capsule type of FM alignment information is about as valuable as a single lesson on how to play the piano.

Good service data on FM receivers lists two methods of alignment. One uses an AM generator and a VTVM; the other employs a sweep generator and a cathode-ray oscilloscope. There is no reason for the novice technician to feel he cannot do as good a job with the first method as can be obtained with the second. As an actual test, the writer has on several occasions aligned FM receivers with the AM generator and VTVM and then inspected the results with a sweep generator and scope. In every case where the alignment instructions were conscientiously followed, the results obtained could not be appreciably bettered with the more complicated and expensive instruments. While the alignment can admittedly be done faster by the latter method, it cannot normally be done better — and that is what counts when you are learning the business.

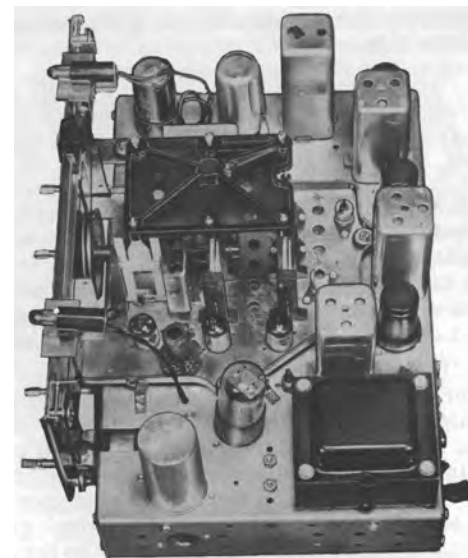

Fig. 16-7. Top view of an AM-FM receiver using a guillotine tuner.

It is well to remember that the IF amplifier of an FM receiver is deliberately broadened to pass a bandwidth of roughly 150 kilocycles. A little drift in this circuit is not going to have much effect. The detector circuit, on the other hand, must be precisely aligned for good operation, and even a slight detuning of the circuits directly associated with the detector tube will seriously affect reception. Knowing this will often enable you to touch up the detector-circuit

tuning, using only a transmitted signal when you are in a customer's home without your alignment equipment. Doing so will often produce a tremendous improvement in reception; in fact, a complete alignment might add little to the effect produced by this single precise adjustment.

To make the adjustment properly you must have a clear idea of how the FM signal sounds when the detector is tuned "right on the nose" and how it sounds when tuned either side of that point. The best way to gain this knowledge is to experiment with a receiver on your bench. Tune across a station with a receiver that you have just placed in perfect alignment. Notice how, as you approach the station, you first hear the signal with increasing loudness but with some distortion. Then you pass through a null point where the signal disappears. Next, there is a comparatively broad area of reception with one point right in the middle of this area where the signal is loud, noise free, and without distortion. This is where the set is normally tuned. Finally, as you keep on turning the dial, another null point is passed through; the signal is heard again with some distortion; and at last it fades away and is lost.

When the detector is properly adjusted, the null points and the areas of slight distortion just beyond these points are symmetrically positioned with regard to the optimum tuning point of the receiver. When the signal falls off abruptly on one side of the best reception area but continues to be heard for some distance on the other side, the secondary trimmer of the output IF transformer needs adjustment. It is rather difficult to describe exactly how this sounds, but a little intelligent listening and moving of this trimmer while tuning back and forth through a station will soon enable you to tell instantly whether or not an FM detector is properly adjusted. That knowledge is just as much a service tool as your screwdriver.

Do not get the mistaken idea you cannot use your AM generator and signal tracer for signal tracing through the circuits of an FM set. The AM signal will go through to the limiter stage just as readily as it will through an AM receiver, and it will continue right on through the limiter and detector stages with some attenuation but with still quite usable strength. In fact, you depend upon its doing so when you align the IF section with your AM signal generator and VTVM. If the signal generator is set precisely to the IF frequency for which the detector is adjusted, the signal heard in the speaker of the set will be cut down considerably; but if the generator frequency is moved just slightly to either side of this point, fair volume will result. Since the generator signal is amplitude modulated, it can be picked off with the crystal probe of the signal tracer at any point.

Bypass capacitors, resistors, tubes, and coils are subject to the same failures in these receivers as in AM sets. In general, exact replacement values are more important than they would be in similar positions in an AM receiver because of the higher frequencies involved. You will normally find more ceramic capacitors used in

the FM receivers. Do not replace them with paper types. They are not used just to save space. Quite often the shorter leads possible with these capacitors result in a better job of bypassing at the frequencies used.

You will find some special-purpose tubes used in FM receivers. Two such tubes employed in many AM-FM combinations are the 6T8 and its alter ego, the 19T8, which are triple-diode, high-mu-triode tubes. One diode serves an AM detector; the other two are used as the FM detector; and the triode serves as a high-gain audio stage in either service. These tubes have a habit of shorting internally, probably in rebellion against having so many elements stuffed into one tiny envelope; so watch out for them. The shorts test of your tube checker will reveal the trouble.

In AM-FM combinations, there is considerable difference from set to set as to how much of the circuit is common to both types of reception and how much is switched in and out of use. Consider this illuminating example. In a few sets, entirely separate IF strips are used; but in most of the receivers, the AM and FM intermediate-frequency transformers have their corresponding windings connected in series. Because of the wide separation in the intermediate frequencies used, the transformer winding not in use has such a low reactance that the operation of the active transformer is unimpaired. In this setup, the opening of a coil in either transformer will disable the set for both types of operation. This is not true where separate IF transformers are switched in and out of the circuit.

Whenever one of these combination sets operates satisfactory with one type of reception but is either dead or has some defect when trying to receive the other type, a careful study of the diagram to find out exactly what circuit components are common and which ones are specialized will often save considerable wasted effort. It is best not to take it for granted that you know which are which. Design engineers are a very tricky and original group of fellows who delight in crossing you up — or so it seems.

In conclusion, then, let me assure you that you will not have any great trouble with FM receivers if you do the following: (1) familiarize yourself thoroughly with the diagram before attempting any work on the set; (2) follow alignment instructions to the letter; (3) disturb the wiring and other circuit components just as little as possible while testing and making repairs; (4) try to replace parts so neatly, with close attention paid to lead length, placement, and exact values, that it is difficult to tell a new part was put in; (5) do not hesitate to switch back and forth freely among your service instruments and your trouble-shooting techniques while trying to pin down an obscure trouble; and, above all, (6) keep your finest servicing instrument, your keenly observing, always questioning, logically reasoning mind at work at all times.

Come to think of it, if you do this, you will not have much trouble with any set!

Intermittents and Miscellaneous Service Problems

QUESTIONS

1. What circuits in an all-wave receiver are different from those in a broadcast receiver?
2. If only one band of an all-wave receiver fails to function, where do you look for trouble?
3. What extra precautions are necessary in aligning an all-wave receiver?
4. What is an "image"?
5. On whose communications receiver should the technician practice?
6. Why is general information not given for aligning FM receivers?
7. What is the bandwidth of the IF amplifier of a broadcast FM receiver?
8. Can an AM signal generator and signal tracer be used for signal tracing in an FM receiver? Explain.
9. In high frequency circuits, do you replace ceramic capacitors with paper types?
10. What is your test servicing instrument?

CONCLUSION

At the end of a book such as this, the writer wonders how nearly he has achieved the aim with which he started. That aim, boldly stated in the Introduction, was to transfer to the mind of the reader as much as possible of the usable experience gained by the writer in working on radios for more than a quarter of a century.

If this mind-grafting operation has been in any way successful, the theoretical knowledge you had before you started the book should now be brought into a sharper, more understandable focus. You ought to feel much more at home with the instruments on your bench and be able to select the proper one for tracking down the cause of a particular symptom almost automatically. Articles read in technical radio publications should be more readily grasped because of your unconscious absorption of a great deal of the technician's jargon in these pages. Finally, most important of all, you should now be able to tackle an ailing radio with a great deal more easy confidence in your ultimate ability to make a repair than you ever felt before.

Any omissions that are found — and there are bound to be a few in so vast and complicated a subject — are not deliberate. There has been no attempt or intention to withhold "trade secrets." When you try to describe in minute detail any operation with which you are so familiar you perform it automatically, it is very, very easy to glide unconsciously over a detail that seems perfectly obvious to you but is something entirely different to your listener. If you have ever tried to teach a woman how to drive, you will know exactly what is meant.

In conclusion, the writer cannot resist giving one final bit of nontechnical advice: Never allow your service work to become routine drudgery. There is nothing in the work itself to make it so. The endless variety of circuits, symptoms, receiver faults, and new developments that parade across your bench should be a perpetual and stimulating challenge and should keep you constantly studying and thinking about your work. This natural process can only be stopped when you decide — always prematurely! — that you know all that's worth knowing about radio service and close the doors of your mind. When that occurs, your development and growth as a technician halts abruptly; but what is still more serious, the magic slips away and doing your job turns from fun to work. Never be so foolish as to let that happen!

ANSWERS TO REVIEW QUESTIONS

Introduction

1. Radio school, armed forces training, extensive reading.
2. Literature should include wiring diagrams, alignment information, voltage readings, and parts values of all sets likely to be encountered.
3. VTVM, VOM, Signal Tracer, Signal Generator.
4. Protects technician from danger of working on a "hot" chassis; permits him to duplicate wide range of line-voltage conditions found in homes.
5. Solder gun, electric drill, good vise, sharp-nosed and duck-billed pliers, diagonal cutters, conventional and Phillips screwdrivers in assorted sizes, complete set of Spintite wrenches, hacksaw, files, complete set of alignment tools, speaker shims, wire strippers.
6. It is often necessary to try a known good part in place of a suspected one to see if this restores normal operation.

Chapter 1

1. Tubes do not light.
2. Ohmmeter.
3. Inserts appreciable resistance in series with line for several seconds after set is turned on, and then shorts this resistance out. Purpose is to protect tube filaments from high initial surge currents.
4. Connected in parallel in transformer set; in series in AC-DC receiver.
5. Pilot lamp shunts portion of filament carrying both plate and filament currents. When it is out, this portion of filament is subjected to additional strain. Blooming pilot lamp as set warms up can often warn of short circuit in time to cut off set and prevent loss of rectifier.
6. The current through the probes is sufficient to burn out the filaments with some types of ohmmeters.
7. Leakage is revealed by low resistance. Presence of capacity is indicated by the kick of the pointer with charging current as the ohmmeter is connected.
8. Open input filter capacitor, weak selenium rectifier.
9. Substitute a new one.

Chapter 2

1. The speaker, the output transformer, the output stage, or the power supply for that stage.
2. An open primary in the output transformer.
3. It is held close to the transformer so as to induce a hum into the speaker if the voice-coil and transformer-secondary circuits are intact.
4. A charge on a filter capacitor that has not been bled off can ruin the ohmmeter.
5. Check for a possible short circuit in the B+ circuit that may have ruined rectifier and will ruin new one if not removed.
6. Disconnect batteries while checking; employ small, taped probes; move wires and parts carefully.
7. The contact jaws can be bent back into place with a sharp-pointed scratch awl.

Chapter 3

1. Pull tube from socket or touch grid connection and listen for click in speaker. In some stages, a finger on the grid will produce a hum.
2. The tube is not drawing plate current, or something is wrong in the stages following it.
3. Keep experimenting on normal receivers until you know.
4. A substitute can be used for a PM speaker. The antenna is not needed to determine when a dead set has been restored to life.
5. An IF transformer. An open winding or shorted trimmer kills the signal at this point, or at least greatly reduces it.
6. Because the DC voltage and the AC signal voltage are often both impressed across this capacitor.
7. Start checking all voltages and components in that stage.
8. No, because most of these sets use pentode audio amplifier tubes, and the screen voltage is almost as important as the plate voltage.

Chapter 4

1. The oscillator is probably not working.
2. Quite often such tubes will check "Good" in a tube tester but still not work.
3. Check for the presence of negative grid voltage on the oscillator tube. Its presence indicates oscillation, and the amount of the voltage is a rough check of the vigor of the oscillation.
4. Touch the stator of the oscillator tuning capacitor and listen for a "plop" as the oscillator goes out of oscillation. No "plop," no oscillation.

5. The uncut leads of the new part are temporarily connected into the circuit with drops of solder.
6. A defective winding.
7. Yes, it can have shorted turns in a winding.
8. A converter tube with weak filament emission.
9. A weak rectifier that supplies insufficient filament current to the converter.

Chapter 5

1. Set or house fuses that blow, red-hot rectifier plates, a growling power transformer, lights dim when set is turned on, smoking set.
2. Flashing purple, pink, or blue light around plates of rectifier when set is turned on.
3. Internal short circuits. Tubes should be tapped smartly while being tested.
4. Usually a resistor of several hundred ohms appears between the output of the filter and the screen of the tube, and this resistance would not allow enough current to flow through the shorted bypass capacitor to blow a fuse. Occasionally overheating reduces the resistance of such a resistor until it no longer affords that protection.
5. The ohmmeter is used to locate the point in the B+ voltage distribution system with the least resistance to ground. Then parts that could produce such a low resistance are cut loose one at a time until the condition is cleared.
6. No, the suspected part number of the diagram is matched with the same number on the picture of the set. This is much faster than locating the part by tracing the wiring.
7. Inside IF transformer shield cans.
8. Filter chokes, field coils, and output transformer primary windings short-circuit to cores; tube elements short internally; sockets carbonize and produce short circuits.
9. Remove all loads and apply power to the transformer. If it overheats, it has shorted turns.
10. Lightning can strike the line or induce a surge in it that will short-circuit the capacitor from one side of the line to chassis. Then power can flow from the hot power lead through the transformer primary and through this capacitor to the chassis, down through the chassis-grounding lead to the earth, and back through the earth to the grounded side of the pole transformer secondary. This bypasses the switch in the ground lead from the transformer.

Chapter 6

1. (1) Speaker should be baffled. (2) Volume should be low and a voice transmission should be tuned in. (3) Stand directly in front of speaker. (4) Listen for hum on strong as well as weak stations.
2. Open or weak filter capacitors.
3. Input filter capacitor failure produces more severe hum that chops up voice or music; DC voltage is low. Output filter capacitor failure does not affect voltage and usually produces somewhat less hum; but there may be accompanying motor-boating or oscillation and loss of low frequencies.
4. Use test leads connected to the bridging capacitor.
5. Use it to bypass grids and plates to ground while noting effect on hum. This will enable you to "bracket" the stage in which the hum is arising.
6. A grid that has an extremely high resistance between it and ground.
7. An open bypass capacitor between one side of the line and ground.
8. It produces hum.
9. The low-voltage high-capacity filter capacitors ordinarily found across the filament supply circuits.

Chapter 7

1. When the stations are on the same frequency.
2. Overloading and rectification in an amplifier stage.
3. To keep the AVC action from providing misleading results.
4. (1) Can cause short-circuit and damage. (2) Metal detunes transformer. (3) Causes hum that masks signal from generator. (4) Tuning slugs may be damaged. (5) Technician may receive shock.
5. Defective trimmer, defective transformer winding, open plate-return or grid-return bypass capacitor.
6. Connect hot lead of generator to short length of wire placed near loop.
7. Prevents possibility of shock and avoids annoying hum when the generator is connected to the chassis.
8. The transformer is defective; possibly the windings are affected by heat. Replace the transformer.
9. Yes, their presence in the field of the loop affects its tuning.

Chapter 8

1. Audio or filter circuits.
2. There must be amplification, and some of the output voltage of the amplifier must be fed back in the proper phase to the input.

3. This capacitor serves as a "decoupling" capacitor that ties audio signals down to ground. When it opens, it permits output signals to feed back to other stages.
4. Yes, too large a capacitor can produce motorboating; too small a capacitor can result in impaired low-frequency response.
5. Something can happen to remove the stabilizing influence of the feedback or actually to reverse the phase and make the feedback positive.
6. The detector section works ahead of the volume control. The other section in the tube works as an audio amplifier behind the volume control.
7. Change tubes.
8. Heat may cause the windings to slide together and upset critical coupling necessary for proper operation.
9. The second or third harmonic of the IF is getting back into the input of the receiver and is heterodyning with the signal being received.
10. Use only a similar capacitor.
11. A partially exhausted battery may be presenting a high impedance to audio signals, thus failing to provide a low-resistance path to ground.

Chapter 9

1. Turns may lose their bond with the circuit board and short together.
2. This helps to reveal noise-producing loose elements inside the tubes.
3. Metal filings may be shorting the voice coil to the pole piece, or loose turns in the voice coil may be shorting out; the cone may be cracked or uncemented from the frame of the speaker.
4. There may be leakage from one winding to another through the material in which the fixed capacitors are imbedded.
5. Poor connections between the leads and the foil can produce this noise.
6. (1) Do not breathe fumes. (2) Do not get it into your eyes. (3) Do not permit it to touch an open cut or skin abrasion. (4) Never expose it to the flame of a blowtorch or throw it on a hot surface.
7. The rectifier.
8. Tubes.

Chapter 10

1. Speaker voice coil rubbing on pole piece.
2. Put shims in place; soften spider with acetone; let set; remove shims.
3. Replace cone or entire speaker.

4. After set is on for a while, it begins to distort and grid bias is gradually lost.
5. A leaky coupling capacitor.
6. In the AVC circuit.
7. A marked loss of low frequencies.
8. A defective tube or a partially-open coupling capacitor.
9. The filament cannot supply enough electrons for signal-peaks, and "flat-topping" of the signal being amplified results.

Chapter 11

1. Ten and a half million times.
2. Lack of amplification in the audio section.
3. Something wrong in the circuits between the antenna and the volume control.
4. The IF and audio amplifier tubes.
5. Probably the antenna coil is open.
6. If a loud growl is heard, the trouble probably lies ahead of the volume control; if not, the trouble is likely in the audio stages.
7. To learn the normal strength of signal at each point in the receiver.
8. Because they are subjected to more heat.
9. The tube filaments are all in series, so an increase in the resistance of one filament cuts down the current through all the filaments. The reduced current produced by an increase in the resistance of an output tube could show up as impaired operation of IF-amplifier or converter tubes, since these tubes are more sensitive to changes in filament current.

Chapter 12

1. How does the set misbehave? How often? For how long has this been going on? When was the last time it did it? How long does the set have to be on before it happens? Does it happen at a particular time of day? How can you restore normal operation?
2. A tube with an intermittent filament.
3. Run line voltage up and down; heat portions of set; cool portions of set; tap components.
4. Shorting elements.
5. The VOM is connected across the output transformer primary; the signal tracer is connected to the plate of the first IF amplifier; the VTVM reads AVC voltage. The evidence of these indicators will reveal in what general portion of the receiver the signal is being lost. Then the meters and signal tracer can be reconnected to pinpoint the defect even closer when the signal cuts out.

6. A voltmeter across the filament will go up if the filament opens, down when any other filament of the set opens. The tubes can be removed from the set when the signal disappears and quickly checked with an ohmmeter connected to the filament prongs.
7. No.
8. Oscillator drop-out.

Chapter 13

1. By changing the applied line voltage with the voltage-adjusting isolation transformer.
2. A one-ohm resistor can be inserted in the filament lead and the AC voltage across this resistor measured. The potential in volts will equal the current in amperes.
3. Coupling capacitors that open.
4. The connection between lead and foil is broken.
5. The bridging may temporarily "cure" the difficulty, but it will show up again later.
6. Volume hops up and down of own volition. Control is noisy when moved. Control of volume is erratic. Set may squeal at certain settings of control.
7. A drop in volume, a vibration-triggered noise, an intermittent hum on strong carriers, or any combination of these symptoms.
8. Because less heat is generated in the three-way portable.

Chapter 14

1. Keep heat from transistors; use "heat-sinks" on leads when soldering. Never take resistors from sockets or replace them with the power turned on. Never short a transistor electrode to ground to see if this produces a click. Use your ohmmeter very carefully in transistor servicing. Do not operate power transistors without a load. Transistors are the last thing you suspect of giving trouble.
2. A low-wattage soldering iron; small, insulated, sharp probes; a transistor tester; pressurized can of plastic spray; a battery substitute; adequate transistor-set service data.
3. At the battery.
4. Moving components gently to see if operation cannot be temporarily restored and so expose a loose connection, short circuit, etc.
5. Signal tracing and signal injection.
6. Check its operation in the circuit; substitute a new transistor; or check it in the transistor tester.
7. By AGC voltage being developed when no signal is being received.

8. (1) High battery impedance. (2) Antenna or speaker leads too close to IF amplifier. (3) Tuning capacitor frame, speaker bracket, or IF shield not making good contact with printed circuit. (4) Open bypass capacitors. (5) Open neutralizing capacitor. (6) IF transformer loading resistor increased in value.
9. Check its ability to perform as an IF or RF amplifier first; then see if it performs correctly as an audio amplifier.
10. See if the collector or emitter current increases when the oscillator coil is shorted out. This can be done by checking the voltage drop across a resistor feeding one of these electrodes. The collector and emitter current goes down when a transistor is oscillating.
11. Insufficient injection voltage. Increase it by tightening the coupling between the two windings of the oscillator coil.
12. The diode is made to act as a variable resistance across an IF transformer winding. Through action of the AGC circuit, the resistance represented by the diode goes down as the AGC voltage goes up. This decreases the transformer efficiency and reduces the signal passing through the transformer.
13. "CircuitTrace" is a patented method of indicating important circuit check points and is used in Howard W. Sams PHOTOFACTS. The circuit check points are numbered, and these numbers are duplicated in a picture of the actual printed circuit board; thus, any important point of the circuit can be instantly located on the board.
14. By alternately melting the soldered connections on one side and then the other and by rocking the capacitor so as to pull the unsoldered terminals a bit at a time.
15. Heat the printed circuit as little as possible. Avoid flexing the board any more than necessary. Be very neat about soldering. Cut the leads off a defective component above the board and solder the new component to these leads. Recoat repaired portions of circuit with plastic spray.

Chapter 15

1. The car power supply uses a vibrator to convert the car-battery DC into AC to be stepped up with a transformer.
2. To reduce sparking at the vibrator points.
3. All replacement parts should be firmly anchored in place.
4. To isolate one circuit from the other and to prevent ignition noise from getting into the circuits of the receiver.
5. Usually it should be replaced whenever the vibrator is replaced. The exact specified value of capacitance should be used, and the voltage rating should be at least as high as that specified.
6. One that uses both tubes and transistors.

7. Observe correct battery polarity. Don't operate set without speaker connected. When checking electrolytic capacitors, don't exceed their voltage rating. Do not short the case of an output transistor. Make sure power transistors make proper contact with their heat sinks and are not shorted. Check low-voltage tubes only in tester designed for them.
8. Older tube testers may apply voltages too great for the close spacing of these tubes.
9. Hum is produced.

Chapter 16

1. Antenna, RF, converter, and oscillator circuits.
2. In the circuits that are switched into service when that band is in use.
3. Follow specific alignment instructions; check for images; use "rocking" technique where specified; do not move wires about in front-end.
4. A frequency which can be confused with the proper frequency during alignment.
5. His own.
6. Because the circuits vary so much that only specific alignment instruction is of any real value.
7. 150 kilocycles.
8. Yes. If the receiver of the generator is slightly detuned, "slope detection" of the AM signal will enable the signal to be heard in the speaker.
9. No, because the ceramic types often provide very essential short leads and other desirable high-frequency characteristics.
10. Your keenly observing, always questioning, logically reasoning mind.



ABOUT THE AUTHOR

A mechanic is born; a writer is made; but a technical writer must be a good bit of both. John T. Frye was born in Waldenburg, Arkansas, in 1910. As far back as the family can be traced, his male ancestors on both sides were garage mechanics, saw-mill owners, steam engineers, grist-mill operators, blacksmiths, and carpenters.

Becoming interested in radio in the early 1920's, he obtained an amateur license, and began servicing radios during the latter half of that decade. At the same time he developed a growing interest in self-expression, and the first half of the 1930's was spent securing writing training from Indiana, Columbia, and Chicago Universities.

Since then Mr. Frye has been dividing his time equally between doing radio and TV service work and writing technical articles. His "Mac's Service Shop" and his fictional feature, "Carl and Jerry," are well known to many thousands of readers. All in all, he has published over 500 articles, some of which have been translated into Spanish, Portuguese, Japanese, and Hindustani.



HOWARD W. SAMS & CO., INC.
THE BOBBS-MERRILL COMPANY, INC.