



# RCA

# phototubes and photocells

TECHNICAL MANUAL PT-60

---

Vacuum and gas photodiodes

Multiplier phototubes

Solid-state photocells

---



RADIO CORPORATION OF AMERICA

Electronic Components and Devices • Lancaster, Pa.

# CONTENTS

<b>THEORY AND MEASUREMENTS</b> .....	<b>3</b>
Photoelectric Theory, Photoemission, Semiconductor Photocells, Photoconductivity, Photovoltaic Effect, Photoelectric Measurements, Light, Photometric Units, Illumination From Uniformly Diffusing Surfaces, Luminous and Absolute Rating Systems, Radiant Energy.	
<b>VACUUM PHOTOTUBES</b> .....	<b>22</b>
Construction and Principles of Operation, Spectral Response, Current-Voltage Characteristics, Linearity, Frequency Response, Noise, Environmental Factors, Application Considerations.	
<b>GAS-FILLED PHOTOTUBES</b> .....	<b>33</b>
Construction and Principles of Operation, Current-Voltage Characteristics, Variation of Current with Light Flux, Time- Or Frequency-Response Characteristics, Noise, Environmental Factors, Application Considerations.	
<b>MULTIPLIER PHOTOTUBES</b> .....	<b>38</b>
Construction and Principles of Operation, Dynode Properties, Dynode Configurations, Coupling Dynode System to Cathode, Design for Minimum Transit-Time Spread, Gain Characteristics, Spectral Response, Dark Current, Noise, Transit-Time Effects, Linearity of Output Current, Temperature Effects, Effect of Magnetic Fields, Fatigue and Life Characteristics.	
<b>PHOTOCELLS</b> .....	<b>71</b>
Cadmium-Sulfide Photoconductive Cells, Junction Photocells, Germanium P-N Junction Photocells, Silicon Photovoltaic Cells, Data-Processing Cells, Germanium and Germanium/Silicon Infrared Detectors	
<b>GENERAL APPLICATION CONSIDERATIONS</b> .....	<b>80</b>
Level of Light or Radiation, Spectral Energy Distribution, Frequency Response, Typical Applications.	
<b>INTERPRETATION OF DATA</b> .....	<b>85</b>
<b>SELECTION CHART</b> .....	<b>90</b>
<b>TECHNICAL DATA</b> .....	<b>91</b>
<b>SOCKET AND SHIELD INFORMATION</b> .....	<b>182</b>
<b>RCA PHOTOCELL CHART</b> .....	<b>186</b>
<b>INDEX</b> .....	<b>190</b>

Copyright 1963 by Radio Corporation of America  
(All Rights Reserved)



Trade Mark(s) Registered  
Marca(s) Registrada(s)

10 - 63  
Printed in USA

# RCA

## phototubes and photocells

THIS book has been prepared to assist equipment designers in their use of vacuum, gas, and multiplier phototubes, solid-state photocells, and associated circuits. It covers theory, characteristics, and applications of the four classes of devices, as well as information on selecting the right type of device for a specific application. The section on Technical Data contains detailed information on phototubes and photocells presently in the RCA line.

ACKNOWLEDGMENT is given to Dr. Ralph W. Engstrom for supplying the text material on Theory and Measurements, Vacuum Phototubes, Gas-Filled Phototubes, Multiplier Phototubes, and General Application Considerations, as well as for technical guidance and review of other text material in this manual.

RADIO CORPORATION OF AMERICA

Electronic Components and Devices

LANCASTER, PA.

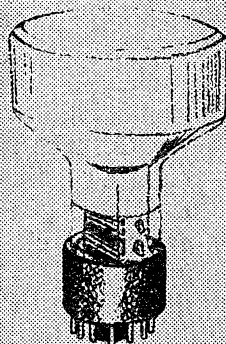
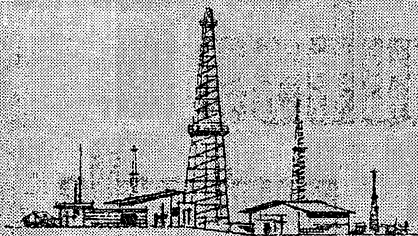
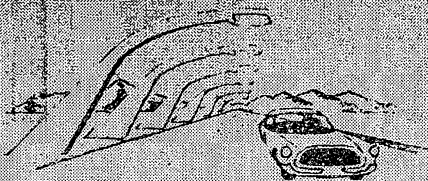

For a broad spectrum of applications  
for space, research, medicine, and  
industry.

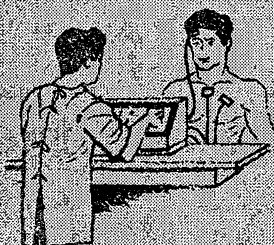
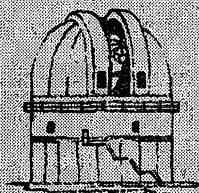
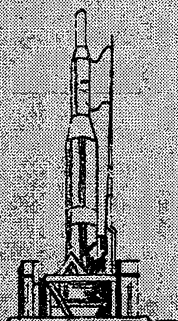

**RCA  
PHOTOTUBES  
AND  
PHOTOCELLS**

# Theory and Measurements

**T**HE photosensitive devices described in this manual are extremely versatile tools for extending man's sense of sight. The variety of types developed during the past few decades make it possible to equal and surpass many, if not all, of the human eye's remarkable capabilities for detection and observation. These devices exceed the sensitivity of the eye to all the colors of the spectrum, and even penetrate beyond the visible region into the ultraviolet and infrared. They can observe a bullet in flight or track a cosmic-ray particle. They can accompany a rocket into outer space or explore a hole drilled deep into the crust of the earth.

The availability of these devices has led to a wide range of practical applications. **Vacuum-type phototubes** are used primarily for radiation measurement. **Gas-type phototubes** made possible the addition of sound to motion pictures by converting sound patterns traced on film into electrical signals. **Multiplier phototubes**, which have tremendous amplification capability, are used extensively in photoelectric measurement and control devices, and in the large and growing field of scintillation counting. **Photocells** are most widely used in the field of industrial photoelectric control because of their simplicity, low cost, and high sensitivity.

## Photoelectric Theory

The earliest observation of a photoelectric effect was made by Becquerel in 1839. He found that when one of a pair of electrodes in an electrolyte was illuminated, a voltage or current resulted. During

the latter part of the 19th century, the observation of a photovoltaic effect in selenium led to the development of selenium and cuprous oxide photovoltaic cells.

The emission of electrons resulting from the action of light on a photoemissive surface was a later development. Hertz discovered the photoemission phenomenon in 1887, and in 1888 Hallwachs measured the photocurrent from a zinc plate subjected to ultraviolet radiation. In 1890, Elater and Geitel produced a forerunner of the vacuum phototube which consisted of an evacuated glass bulb containing an alkali metal and an auxiliary electrode used to collect the negative electrical carriers (photoelectrons) emitted by the action of light on the alkali metal.

The development of the transistor and related devices has been closely paralleled by the development of solid-state photosensitive devices, such as photoconductive cells, p-n photojunction cells, phototransistors, and silicon photovoltaic cells used as solar-energy converters.

## Photoemission

The modern concept of photoelectricity stems from Einstein's pioneer work for which he received the Nobel Prize. The essence of Einstein's work is the following equation for determining the maximum kinetic energy  $E$  of an emitted photoelectron:

$$E = \frac{mv^2}{2} = h\nu - \phi \quad (1)$$

Eq. (1) shows that the maximum energy of the emitted photoelectron  $mv^2/2$  is proportional to the energy

of the light quanta  $h\nu$  less the energy  $\phi$  (the work function) which must be given to an electron to allow it to escape the surface of the photocathode. For each metal, the photoelectric effect is characterized by a value of  $\phi$ , which is usually expressed in electron-volts.

In the energy diagram for a metal shown in Fig. 1, the work function represents the energy which must be given to an electron at the top of the energy distribution to raise it to the level of the potential barrier at the metal-vacuum interface.

According to the quantum theory, only one electron can occupy a particular quantum state of an atom. In a single atom, these states are separated in distinct "shells"; normally only the lower energy states are filled. In an agglomeration of atoms, these states are modified by interaction with neighboring atoms, particularly for the outermost electrons of the atom. As a result, the outer energy levels tend to overlap and produce a continuous band of possible energy levels, as shown in Fig. 1.

The diagram shown in Fig. 1 is

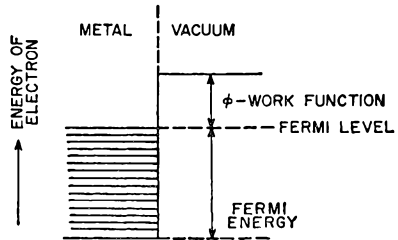

Fig. 1. Energy model for a metal showing the relationship of the work function and the Fermi level.

for a temperature of absolute zero; all lower energy levels are filled. As the temperature is increased, some of the electrons absorb thermal energy which permits them to occupy scattered states above the maximum level for absolute zero. The energy distribution of electrons in a particular metal is shown in Fig. 2 for several different temperatures. At absolute zero, all the lower states are occupied up to the Fermi level. At higher temperatures, there is some excitation to upper levels. The electron density at a particular temperature is described by the Fermi-Dirac

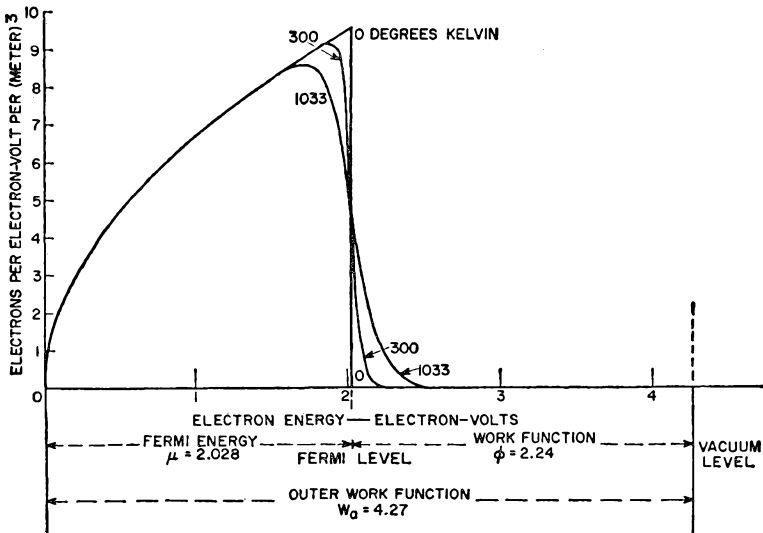

Fig. 2. Energy distribution of conduction electrons in potassium at temperatures of 0, 300, and 1033 degrees Kelvin based on elementary Sommerfeld theory. (ref. 17)

energy-distribution function, which indicates the probability of occupation  $f$  for a quantum state having energy  $E$ :

$$f = \frac{1}{1 + \exp. [(E - E_r)/kT]} \quad (2)$$

When  $E$  is equal to  $E_r$ , the value of  $f$  is  $\frac{1}{2}$ . It is customary to refer to the energy of level  $E_r$ , for which there is a 50-per-cent probability of occupancy, as the Fermi level. At absolute zero, the Fermi level corresponds to the top of the filled energy distribution. Although the Fermi level is nearly the same at higher temperatures, as at absolute zero, as shown in Fig. 2, it is actually slightly lower. This reduction of the Fermi level occurs because the number of possible energy states increases in a conductor as the square root of  $E$ , whereas the probability of occupancy function is symmetrical around a value of  $E = E_r$ .

If the energy derived from the radiant energy is just sufficient to eject an electron at the Fermi level, the following relation exists:

$$h\nu_0 = \phi \quad (3)$$

$\nu_0$ , the threshold frequency of the exciting radiation, is related to the long-wavelength limit  $\lambda_0$  and the velocity of light  $c$  as follows:

$$\lambda_0 = c/\nu_0 \quad (4)$$

The relationship may be rewritten to relate the long-wavelength limit to the work function, as follows:

$$\lambda_0 = \frac{12395}{\phi} \text{ angstroms} \quad (5)$$

Because some of the electrons occupy states slightly higher than the Fermi level, as shown in Fig. 2, excitation of these electrons produces an extended response at the red threshold of the spectral-response characteristic. As a result, there is no abrupt red threshold at normal temperatures, and the true work function cannot be obtained in a simple manner from the spectral-response measurement. However, a universal function devised by Fowler

can be used to predict the shape of the spectral-response curve near the threshold; the work function can then be calculated from these data.

Although many attempts have been made to calculate entire spectral-response characteristics for metals, only order-of-magnitude agreement with experiment has been obtained. It was formerly assumed that surface electrons existing in an image-type force field accounted for the threshold emission spectrum. Early work by Tamm and Schubin<sup>1</sup> postulated that a threshold for a "volume photoeffect" occurs at about twice the frequency of that for the surface threshold. More recent work by Mayer and his associates<sup>2</sup> indicates that in fact the threshold for the volume effect and surface effect may be the same. Because electrons in the volume of the metal have been described as "free", there has been a dilemma in the explanation of conservation of momentum in the absorption of photons. This dilemma has been resolved by taking into account the interaction of the free electrons with the periodic field of the crystal lattice of the metal.

The yield of photoelectrons per incident photon must be low because metals contain large numbers of these free electrons. On the one hand, these electrons result in high optical reflectivity in the visible and near-ultraviolet regions. On the other hand, the free electrons scatter the excited electrons within the metal, reducing the energy available for escape. Consequently, excited electrons originating at a depth of more than 10 angstroms have only a slight chance of escaping. These predictions have been confirmed by measurements of the photoelectric yield in metals, which indicate a quantum efficiency of less than  $10^{-3}$  electron per incident photon.

Measurement of the work function and spectral response for clean metal surfaces has been of considerable importance in the development of photoelectric theory. Table I shows a number of the results obtained. Fig. 3 shows spectral-response curves

TABLE I

Photoelectric work functions and long-wavelength threshold values for pure metals.<sup>17, 18</sup>

Element	Work Function (volts)	Threshold (angstroms)	Element	Work Function (volts)	Threshold (angstroms)
Ag	4.73	2610	Na	2.46	5040*
Al	2.5 — 3.6	3652	Ni	4.86*	2650
Au	4.82	2650	Pb	3.5 — 4.1	2980—3550
Ba	2.51 — 2.52	4920—4940*	Pd	6.30	1962
Bi	4.32*	2870	Pt	6.20*	2000
C	(4.7)	2565—2615	Rb	2.16 — 2.19	5660—5740*
Ca	2.706	4580*	Rh	4.57	2500
Cd	4.24*	2920	Se	5.63* — 4.64*	2200—2670
Ce	2.88*	4300	Sn (B)	4.5	2740
Co	4.25, 4.12	2900, 3000	Sn (Y)	4.38	2820
Cr	4.36*	2840	Sn Liquid	4.21	2925
Cs	1.87 — 1.96	6320—6630*	Sr	2.07*	6000
Cu	4.1 — 4.5	2750—3000	Ta	4.12*	3010
Fe	4.63*	2680	Th	3.40*	3650
Ge	(4.3)	2880	Ti	3.93*	3150
Hg	4.53	2735	U	3.65*	3800
K	2.24	5530*	W	4.59*	2700
Li	2.28	5430*	Zn	3.32	3720
Mg	3.61	3430*	Zn Single Crystals	3.57	3460
Mo	4.35*	2850	Zr	3.76*	3300

\* Calculated from  $12395/\lambda$  (angstroms) =  $\phi$  (volts)

for the alkali metals.<sup>8</sup> The curves indicate a regular progression of the wavelength for maximum response with atomic number. The most red-sensitive of these metals is cesium, which is widely used in the activation of most commercial phototubes.

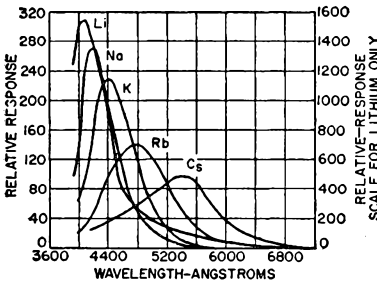

Fig. 3. Spectral-response characteristics for the alkali metals showing regular progression in the order of the periodic table. (ref. 17)

The energy distribution of emitted photoelectrons has been measured for a number of metals and photosurfaces. Typical results are shown in Fig. 4 for a potassium film of 20 molecular layers on a base of silver.<sup>4</sup> The maximum emission energy corresponds to that predicted by the Einstein photoelectric equation.

Because a quantum of radiation is necessary to release an electron, the photoelectric current is proportional to the intensity of the radiation. This first law of photoelectricity has been verified experimentally over a wide range of light intensities. For most materials, the quantum efficiency is very low; on the best sensitized commercial photosurfaces, the maximum yield reported is as high as one electron for three light quanta.

Research on commercially useful photoemitters has been directed pri-

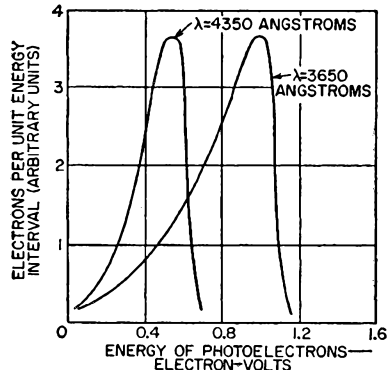

Fig. 4. Energy distribution of photoelectrons from a potassium film. (ref. 4)



marily toward developing devices sensitive to visible radiation. The first important commercial photo-surface was silver-oxygen-cesium. This surface, which provides a spectral response designated S-1, is sensitive throughout the entire visible spectrum and into the infrared. Although it has rather low sensitivity and high dark emission, the good response in the red and near-infrared regions provides a spectral response which is a good match to the emission of a tungsten lamp. One of the most important early uses of this photoemitter was in the sound head for motion-picture projectors.

Although other emitters using rubidium and potassium as the principal element were developed, none was of great commercial value until the development of the cesium-antimony photoemitter,<sup>5</sup> which provides an S-4 or S-11 spectral response. The spectral response of the cesium-antimony photocathode includes most of the visible region; maximum response is in the blue and the ultraviolet regions. A recently developed photoemitter,<sup>6</sup> described as multi-alkali (Sb-K-Na-Cs), provides an S-20 spectral response and is remarkable for its high quantum efficiency and its extended red response. Spectral-response curves for these designations are shown in the TECHNICAL DATA section.

Because emitters such as the cesium-antimony and the multi-alkali cathode are semiconductors, the theory developed for metals does not apply in all respects. In a semiconductor, the highest filled energy band for electrons is called the valence band. Immediately above the valence band, there is an energy gap for which no electron-energy states exist. This gap is referred to as the forbidden gap. In a metal, this gap does not exist and the continuum of energy states directly above the filled energy levels permits conduction. Above the forbidden gap in a semiconductor, there is a band of permitted energy states referred to as the conduction band, which at ordinary temperatures contains very few electrons. Fig. 5

shows an energy model for a semiconductor photoemitter. The band-gap energy corresponding to the forbidden gap between the valence and conduction bands is represented by  $E_g$  and is expressed in electron-volts. The potential barrier from the bottom of the conduction band to the vacuum outside the semiconductor surface is represented by  $E_a$ , the electron affinity.

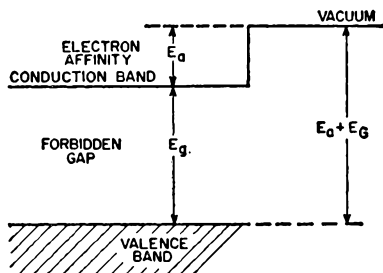

Fig. 5. Energy model of a semiconductor photoemitter.

When radiation of sufficient energy  $h\nu$  excites an electron in the valence band causing it to move to the conduction band, photoconductivity may result; however, photoemission does not take place until the electron escapes the barrier to the vacuum. Therefore, the minimum photon energy necessary to produce threshold emission is  $E_g$  plus  $E_a$ .

For the cesium-antimony photocathode, the value of  $E_g$  plus  $E_a$  is 2.05 electron-volts; the value of  $E_a$  is 0.45 electron-volts. Corresponding values for the multi-alkali photocathode are 1.55 and 0.55 electron-volts.<sup>7</sup> Although both of these emitters are believed to have impurity (p-type) levels in the band-gap region which account for minor effects, the photoemission is primarily intrinsic (that is, originating from the valence band).

An important advantage of using semiconductors as photoemitters is that their quantum efficiency in the visible spectrum is much higher than that of metals (up to 30 per cent

instead of up to 0.1 per cent). In a semiconductor, a photo-excited electron is less likely to lose its energy by electron-electron collision than in a metal. The principal mechanism of energy loss is through the process of impact ionization and pair production, i.e., the creation of a "hole" and electron across the band gap. Usually the threshold energy for such pair production is several times larger than the band-gap energy. In semiconductors in which the electron affinity is small compared with the threshold energy required for pair production, the depth from which an electron can escape may be expected to be large; consequently, the quantum yield should be large, as is actually the case with materials which are practical photoemitters.

### Semiconductor Photocells

A photocell is defined as a photosensitive device in which the movement of electrons is in a solid (in contrast to a phototube in which the movement takes place in a vacuum or gas). For photocells, therefore, the electron affinity and emission outside the solid material need not be considered.

The behavior of semiconductor photocells is most easily explained by reference to energy-state models. Energy models for several types of semiconductors and for an insulator are shown in Fig. 6. The distinction between semiconductor and insulator is arbitrary; materials with band gaps smaller than two electron-volts are usually called semiconductors; those with larger band gaps are called insulators. In an insulator (A), essentially no thermal excitation of electrons from the valence band to the conduction band takes place at normal temperatures. In an intrinsic semiconductor (B), the forbidden gap is sufficiently small to permit some thermal excitation; the amount of excitation increases exponentially with temperature. The thermally excited electrons contribute to a conduction current. The removal of

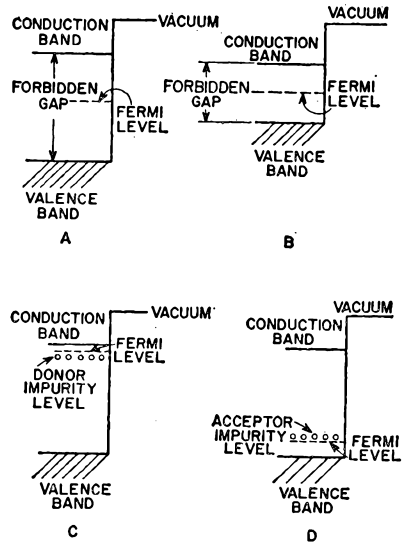

Fig. 6. Energy models for intrinsic and impurity-type semiconductors and for an insulator. (A) an insulator, which has a large forbidden gap. (B) an intrinsic semiconductor, which has a smaller forbidden gap. (C) an n-type impurity semiconductor. (D) a p-type impurity semiconductor.

electrons from the filled-band level leaves vacant levels in the energy structure, which are referred to as holes. Electrons of the filled band may then move under the influence of the applied field to fill these holes. As a result, the holes may also contribute to the conductivity as they travel across the semiconductor in the opposite direction from the electrons.

Conduction is also possible in substances which are insulators in the pure state because of the presence of certain impurities or imperfections. Two types of impurity semiconductors are possible; n-type (donor, C) and p-type (acceptor, D). For an n-type semiconductor, the highest filled quantum level of the impurity lies just below the conduction band of the original or parent lattice (Fig. 6). Conduction becomes

possible when electrons from the donor impurity are thermally or otherwise excited to the conduction band.

In the p-type semiconductor, the unfilled level of the impurity lies just above the filled band of the parent lattice. Excitation of an electron from this filled band to the acceptor impurity is then possible and conduction takes place by means of holes in the valence band.

The Fermi levels of these various types of materials are also indicated in Fig. 6. For the insulators and intrinsic semiconductors, the Fermi level lies approximately halfway between the valence and conduction bands; for an impurity-type semiconductor, the Fermi level usually lies in the forbidden band near the impurity level—close to the conduction band in the case of a donor-type impurity, and close to the valence band in the case of an acceptor-type impurity.

### Photoconductivity

In photoconductors, currents flow when light excites electrons from the filled band to the conduction band. Conduction may also be produced by the excitation of electrons from an impurity level to the conduction band in an n-type semiconductor or by the excitation of electrons from the filled band to an acceptor level in a p-type semiconductor (in the latter case conduction is by means of holes).

Although excited electrons or holes may travel freely through the photoconductor to the electrodes, they may also be captured by various types of imperfection centers in the photoconductor<sup>8</sup>. If such a capture site provides only temporary retention of the carrier and there is good probability of thermal re-excitation, it is called a trapping center. However, if the capture results in good probability of recombination with a carrier of the opposite polarity, the center is referred to as a recombination center.

Fig. 7 shows the various modes of electron transition in a n-type

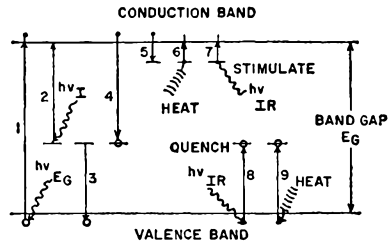

Fig. 7. Basic electronic processes in an n-type photoconductor such as CdS.

photoconductor such as CdS. Arrow 1 illustrates the case in which the host crystal is excited by an absorption of light having energy equal to or greater than the band gap. In this case, one electron-hole pair is formed for each photon absorbed. Arrow 2 represents the excitation of a bound electron at an imperfection level. These imperfections may be either impurities or crystal defects such as vacancies. Arrow 3 is the capture of a photo-excited hole by an imperfection center. Arrow 4 is the capture of a photo-excited electron by a center which has previously captured a photo-excited hole, thereby resulting in a recombination of the carriers. Arrow 5 is the capture of a photo-excited electron by an electron-trapping center. Arrow 6 is the thermal freeing of a trapped electron. The optical freeing of a trapped electron and a captured hole is shown by arrows 7 and 8, respectively. Arrow 9 is the thermal freeing of a trapped electron.

Transitions 1 and 2 determine spectral response; 3 and 4 determine free-electron lifetime and, hence, photoconductivity; 5 and 6 frequently determine speed of response; 7 causes stimulation of conductivity; 8 and 9 correspond to optical and thermal quenching of photoconductivity when the centers involved are those having small cross-section for free electrons. Transitions 3 and 4 may be either radiative, that is, give rise to luminescence emission, or nonradiative.

Because of the relatively low mobility of carriers in semiconductors, space charge usually limits the currents to low values. The effect of the charge is greatly increased by the presence of trapping centers. In some cases, the space-charge fields of trapped holes result in the ejection of electrons from the negative terminal (or those of trapped electrons in the ejection of holes from the positive terminal) giving rise to a secondary current. As a result of such secondary processes, it is possible to have a quantum efficiency greater than one; that is, one photon results in the movement through the semiconductor of more than one electron. Time delays are observed in the photocurrent which are associated with the time spent by current carriers in traps or recombination centers.<sup>9</sup>

Fig. 8 shows some of these processes for an n-type photoconductor. At condition (1), the absorption of a photon forms a free electron-hole pair; (2) under the applied electric field, the photo-excited electron moves toward the anode; (3) similarly, the photon-excited hole moves toward the cathode; (4) the hole is captured at an imperfection center; (5) after the initial electron has left the photoconductor at the anode, the residual positive space charge due to the excess captured hole leads to the entrance of an electron into the photoconductor from the cathode. Photocurrent continues until a free electron recombines with the captured hole.

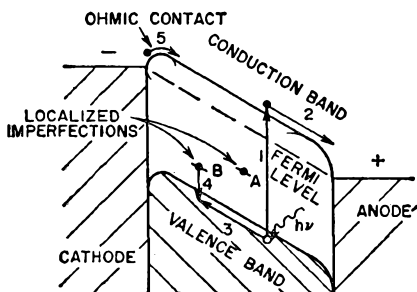

Fig. 8. An n-type photoconductor in operation. Two ohmic metallic contacts to the photoconductor are assumed.

## Photovoltaic Effect

The same type of energy-state model that applies to photoconductors also applies to photovoltaic cells. In a photovoltaic cell, however, a junction of two different materials produces a contact potential. The two materials may be a semiconductor and a metal, or they may be an n- and a p-type semiconductor. The silicon solar cell is this latter type of photovoltaic cell. An n-type silicon wafer is formed with a p-type layer on one surface. The operation of such a cell is illustrated in Fig. 9. The p-type material is shown at the left and the n-type material at the right.

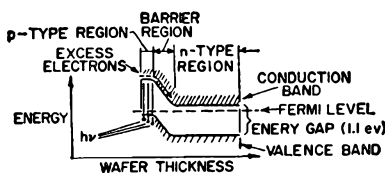

Fig. 9. Energy model of a silicon solar cell.

For the p-type, the Fermi level lies near the bottom of the forbidden gap; for the n-type, it is near the top. When the two types of silicon are in intimate contact, a potential adjustment takes place across the boundary. Electrons flow from the n-type material to the lower vacant levels of the p-type material, and holes flow across the boundary in the opposite direction. When the Fermi levels are at the same height, the current ceases to flow, as shown in the potential-energy model. A contact potential equal to the original difference in Fermi levels exists; the p-type material is negative. When the area in the neighborhood of the junction is illuminated, hole-electron pairs are created. The minority carriers created (holes in the n-type silicon and electrons in the p-type silicon) then flow across the junction and constitute the current developed by the photovoltaic cell.

## Photoelectric Measurements

## Light

Historically, photoelectric measurements and specifications have been related to the measurement of illumination. It is appropriate, therefore, to consider the characteristics of the eye and related photometric units. Although characteristics of the human eye vary from person to person, standard luminosity coefficients for the eye were defined by the Commission Internationale de Eclairage (International Commission on Illumination) in 1931. These standard C.I.E. luminosity coefficients are listed in Table II. They represent the relative luminous equivalents of an equal-energy spectrum for each wavelength in the visible range, assuming foveal vision. An absolute "sensitivity" figure established for the standard eye relates photometric units and radiant power units. At 5550 angstroms, the wavelength of maximum sensitivity of the eye, one watt of radiant power corresponds to 680 lumens.

The sensitivity of the eye outside the wavelength limits shown in Table II is very low, but not actually zero. Studies with intense infrared sources

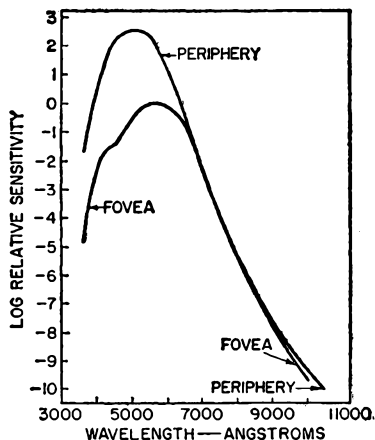

Fig. 10. Relative spectral sensitivity of the dark-adapted fovea and peripheral retina. (ref. 10)

have shown that the eye is sensitive to radiation of wavelength at least as long as 10500 angstroms. Fig. 10 shows a composite curve given by Griffin, Hubbard, and Wald<sup>10</sup> for the sensitivity of the eye for both foveal and peripheral vision from 3600 to 10500 angstroms. According to Goodeve<sup>11</sup> the ultraviolet sensitivity of the eye extends to between 3125 and 3023 angstroms. Below this level, the absorption of radiation by the

TABLE II

Standard (C.I.E.) spectral luminous-efficiency values (relative to unity at 555 millimicrons wavelength). These values represent the relative capacity of radiant energy of various wavelengths to produce visual sensations.<sup>12</sup>

Wavelength (angstroms)	C.I.E. Value	Wavelength (angstroms)	C.I.E. Value	Wavelength (angstroms)	C.I.E. Value
3800	0.00004	5100	0.503	6400	0.175
3900	0.00012	5200	0.710	6500	0.107
4000	0.0004	5300	0.862	6600	0.061
4100	0.0012	5400	0.954	6700	0.032
4200	0.0040	5500	0.995	6800	0.017
4300	0.0116	5600	0.995	6900	0.0082
4400	0.023	5700	0.952	7000	0.0041
4500	0.038	5800	0.870	7100	0.0021
4600	0.060	5900	0.757	7200	0.00105
4700	0.091	6000	0.631	7300	0.00052
4800	0.139	6100	0.503	7400	0.00025
4900	0.208	6200	0.381	7500	0.00012
5000	0.323	6300	0.265	7600	0.00006

proteins of the eye lens apparently limits further extension of vision into the ultraviolet. Light having a wavelength of 3023 angstroms is detected by its fluorescent effect in the front part of the eye.

### Photometric Units

Photometry deals with the measurement of light in reference to the effect produced on the theoretical standard C.I.E. observer. Measurements are made by visual comparison or by some equivalent photoelectric method. Units, standards, and systems of measurement have been developed to correspond to the effect as observed by the eye.

**Luminous intensity (or candle-power)** is a measure of a light source which describes its luminous flux per unit solid angle in a particular direction. For many years the standard measure of luminous intensity was the international candle established by a group of carbon-filament lamps at the Bureau of Standards. In 1948 the International Commission on Illumination agreed on the introduction of a new standard of luminous intensity and recommended the adoption of the name *candela* to distinguish it from the international candle. The term *candela* is now widely used abroad and is coming into general use in the United States; the older term *candle* is sometimes still used, but refers to the new candle or *candela*.

The *candela* is defined by the radiation from a black body at the temperature of solidification of platinum. A *candela* is one-sixtieth of the luminous intensity of one square centimeter of such a radiator. The major advantage of the new standard is that it may be reproduced in any laboratory. The effective change in the value of the candle as a result of the 1948 agreement is of the order of tenths of one per cent and, therefore, is negligible in practical measurements.

A suitable substandard for practical photoelectric measurements is the developmental-type calibrated lamp, RCA Dev. No. C70048, which operates at a current of about 4.5 amperes and a voltage of 7 to 10 volts. A typical lamp calibrated at a color temperature of 2870 degrees Kelvin provides a luminous intensity of 55 candelas. The luminous intensity of a tungsten lamp measured in candelas is usually numerically somewhat greater than the power delivered to the lamp in watts.

**Luminous flux** is the time rate of flow of light energy—that characteristic of radiant energy which produces visual sensation. The unit of luminous flux is the lumen, which is the flux emitted in unit solid angle by a uniform point source of one candela. Such a source produces a total luminous flux of  $4\pi$  lumens.

A radiant source may be evaluated in terms of luminous flux if the radiant-energy distribution of the source is known. If  $W(\lambda)$  is the total radiant power in watts per unit wavelength, total radiant power over

all wavelengths is  $\int_0^{\infty} W(\lambda) d\lambda$ ,

and the total luminous flux  $L$  in lumens can be expressed as follows:

$$L = \int_0^{\infty} [680 W(\lambda)] [y(\lambda)] d\lambda \quad (6)$$

where  $y(\lambda)$  represents the luminosity coefficient (Table II) as a function of wavelength.

The lumen is the most widely used unit in the rating of photoemissive devices. For diode phototubes, typical test levels of luminous flux range from 0.01 to 0.1 lumen; for multiplier phototubes, the range is from  $10^{-7}$  to  $10^{-6}$  lumen (0.1 to 10 microlumens).

Stars of various magnitudes are frequently measured photoelectrically. The flux in lumens  $L$  from a star of magnitude  $m$  which is received by a telescope having a diameter of  $d$  inches can be expressed as follows:

$$2.5 \log_{10} (L) = 7.57 - 30 + 5 \log_{10} (d) - m \quad (7)$$

An increase of one magnitude indicates a decrease of  $\sqrt[5]{100}$  in illumination.

Illumination is the density of luminous flux incident on a surface. A common unit of illumination is the footcandle, which is the illumination produced by one lumen uniformly distributed over an area of one square foot. It follows that a source of one candela produces an illumination of one footcandle at a distance of one foot.

Table III lists some common values of illumination encountered in photoelectric applications. Further information concerning natural radiation is shown in Fig. 11, which indicates the change in natural illumination at ground level during, before, and after sunset for a condition of clear sky and no moon.<sup>12</sup>

Photometric luminance (or brightness) is a measure of the luminous flux per unit solid angle leaving a surface at a given point in a given direction, per unit of projected area. The term photometric luminance is used to distinguish a physically measured luminance from a subjective luminance. The latter varies with illumination because of the shift in spectral response of the eye toward the blue region at lower

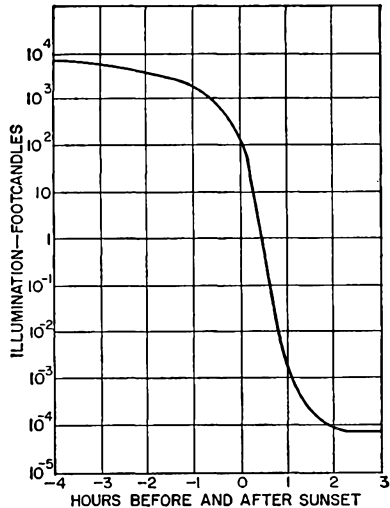

Fig. 11. Natural illumination on the earth for the hours immediately before and after sunset with a clear sky and no moon.

levels of illumination. The term luminance describes the light emission from a surface, whether the surface is self-luminous or receives its light from some external luminous body.

For a surface which is uniformly diffusing, luminance is the same regardless of the angle from which the surface is viewed. This condition results from the fact that a uniformly diffusing surface obeys Lam-

TABLE III

Typical values of illumination for various conditions.

Condition	Illumination (Footcandles)
Average solar illumination, 42° N latitude noon, June 21, measured in a plane perpendicular to the sun's rays. ....	8800
Recommended for reading. ....	30 to 70
Moonlight. ....	0.02
Natural night illumination, clear, no moon.* ....	9 x 10 <sup>-5</sup>
Natural night illumination, heavily cloudy, no moon. ....	2 x 10 <sup>-5</sup>

\* Although published data are in some disagreement, it appears that starlight itself is a substantial but not a major component of the quoted figure. Note also that zodiacal radiation in the near-infrared is many orders of magnitude higher than in the visible region.

bert's law, or the cosine law of emission. Thus, both the emission per unit solid angle and the projected area are proportional to the cosine of the angle between the direction of observation and the surface normal.

A logical unit of luminance based on the definition given above is a candela per unit area. When the unit of area is the square meter, this unit is called a nit; when the unit of area is a square centimeter, the unit is a stilb. It is also possible to refer to a candela per square foot. However, none of these units is as commonly used in photoelectric measurement as the footlambert, which is a unit of photometric luminance equal to  $1/\pi$  candela per square foot. The advantage of using the footlambert for a uniform diffuser is that it is equivalent to a total emission of one lumen per square foot from one side of the surface. This relationship can be demonstrated by the following conditions as shown in Fig. 12: an elementary portion of a

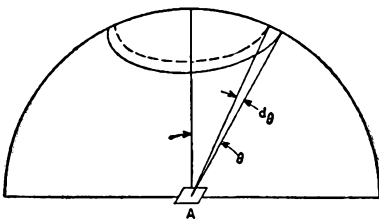

Fig. 12. Diagram illustrating Lambert's law and the calculation of total luminous flux from a diffuse radiator.

diffusing surface, having an area of  $A$  square feet has a luminance of one footlambert, or  $1/\pi$  candela per square foot. Consider the light flux which is emitted into an elementary solid angle,  $2\pi \sin \theta d\theta$ . At an angle of  $\theta$ , the projection of the elementary area is equal to  $A \cos \theta$ . Because the luminous flux in a particular direction is equal to the product of the source strength in candelas and the solid angle, the total luminous flux

$L$  in lumens from the area  $a$  may be obtained by integration over the hemisphere as follows:

$$L = \int_0^{\pi/2} \frac{1}{\pi} (A \cos \theta) (2\pi \sin \theta) d\theta = A \quad (8)$$

In other words, the total flux from a uniform diffuser having a luminance of one footlambert is one lumen per square foot.

### Illumination From Uniformly Diffusing Surfaces

An advantage of the above relationship is that the illumination at a surface in front of and parallel to an extended and uniformly diffusing surface having a luminance of one footlambert is equal to one lumen per square foot or one footcandle. As a result, an instrument reading illumination in footcandles indicates photometric luminance or brightness in footlamberts if the instrument is illuminated essentially from the entire hemisphere. (This statement neglects the possible perturbation caused by the measuring instrument.)

In a typical application, a uniformly diffusing radiating surface may be of such small size that it can be considered practically a point source. However, if the radiator is assumed to be a flat surface radiating according to Lambert's law, the distribution of flux about the point is not the same as for an ordinary point source. In this case, if the surface luminance is one footlambert and the area is  $A$  square feet, the flux per steradian in a direction normal to the surface would be  $A(1/\pi)$  lumens, or at an angle  $\theta$  with respect to the normal line the flux would be  $A(1/\pi) (\cos \theta)$  lumens per steradian.

Table IV provides a reference of luminance values for a number of common sources.

All photometric data in this manual are presented in units of candelas, lumens, footcandles, and



TABLE IV

Typical values of luminance (photometric brightness) for various sources.<sup>19</sup>

Source	Luminance (Footlamberts)
Sun, as observed from Earth's surface at meridian. ....	$4.7 \times 10^8$
Moon, bright spot, as observed from Earth's surface. ....	730
Clear blue sky. ....	2300
Lightning flash. ....	$2 \times 10^{10}$
Atomic fission bomb, 0.1 millisecond after firing, 90-foot diameter ball. ....	$6 \times 10^{11}$
Tungsten filament lamp, gas-filled, 16 lumen/watt. ....	$2.6 \times 10^6$
Plain carbon arc, positive crater. ....	$4.7 \times 10^8$
Fluorescent lamp, T-12 bulb, cool white, 430 ma, medium loading. ....	2000

footlamberts; Table V permits conversion to other units if such conversion is required.

### Luminous and Absolute Rating Systems

Although the practice of using luminous ratings for photosensitive devices is almost universal in the photoelectric industry, there are situations in which an absolute rating system, or system based on radiant power units instead of photometric units, is more appropriate.

All photodetectors do not have the spectral-sensitivity range of the eye; most do not even closely approximate its spectral response. In

the case of an infrared detector, luminous sensitivity is practically meaningless although luminous sensitivity is sometimes arbitrarily defined as the response of the device to the whole radiation of the test source (usually a tungsten lamp) and the radiant flux from the lamp is defined by its luminous flux. Sometimes, in order to convey this particular meaning, the term hololumen is used in place of lumen. At other times, the device may be rated directly in terms of radiant power—for example, by use of the power in watts projected on the device from a black-body source of prescribed temperature.

TABLE V

Conversion table for various photometric units.

1 footcandle (lumen/ft <sup>2</sup> )	= 10.764 lux (meter candle) (lumen/meter <sup>2</sup> )
	= 0.001076 phot (lumen/cm <sup>2</sup> )
1 footlambert (1/π candle/ft <sup>2</sup> )	= 0.0010764 lambert (1/π candle/cm <sup>2</sup> )
	= 1.0764 millilamberts
	= 3.426 nits (candle/meter <sup>2</sup> )
	= 0.0003426 stilbs (candle/cm <sup>2</sup> )
	= 0.3183 candle/ft <sup>2</sup>
	= 10.764 apostilbs (1/π candle/meter <sup>2</sup> )

In general, the specification of the luminous sensitivity of a device is not sufficiently definitive; the distribution of radiant energy from the source as well as the spectral response of the device and the spectral sensitivity of the eye must be known. However, because many photoelectric devices are fabricated to approximate the visual range, the rating of these devices in luminous terms is convenient, although not entirely unambiguous.

A practical advantage of using luminous standards for testing photoelectric devices is that the test standard usually is a tungsten lamp calibrated for color temperature and luminous intensity. Secondary standards can readily be prepared by photometric comparison.

Because the spectral emission of the tungsten lamp is known, the radiant sensitivity of a photodevice can be calculated by rather simple procedures if the relative spectral-response characteristic of the device is known.<sup>13</sup> Therefore, the luminous rating is not just an isolated value.

For devices sensitive primarily in the ultraviolet region, the tungsten lamp is a poor standard because of the very small amount of ultraviolet radiation it provides. Such devices are sometimes rated in terms of watts of monochromatic power. Similarly, in the infrared region luminous reference is of doubtful meaning. For this reason, and because infrared-sensitive devices are frequently used as detectors of thermal radiation, such devices are often rated in terms of the radiation of a black body at a temperature that can provide a spectrum rich in the energy of the spectral region characteristic of the device.

## Radiant Energy

**Black-body radiation.**<sup>14</sup> As a body is raised in temperature, it first emits radiation primarily in the invisible infrared region; then, as the temperature is increased, the radiation shifts to the shorter wavelength

in the visible spectrum. If the radiating body is one which may be described technically as "black", its behavior may be accurately described by the laws of radiation. Because the black-body radiation is used as a standard for the infrared region and because other sources may be described in terms of the black body, a brief review of black-body radiation laws and standards is given below.

A black body is one which absorbs all incident radiation; none is transmitted and none is reflected. Because, in thermal equilibrium, thermal radiation balances absorption, it follows that a black body is the most efficient thermal radiator possible. A black body radiates more total power and more power at a particular wavelength than any other thermally radiating source at the same temperature. There are two general theoretical laws which describe the radiation from a black body.

The Stefan-Boltzmann law describes the total radiant flux  $W$  per unit area from a black body as a function of temperature, as follows:

$$W = \sigma T^4 \quad (9)$$

where  $\sigma$  is equal to  $5.6819 \times 10^{-12}$  watt per square centimeter per degree<sup>4</sup>, and  $T$  is the temperature of the radiator in degrees Kelvin.

Planck's radiation law describes the spectral distribution of black-body radiation as follows:

$$J_\lambda = C_1 \lambda^{-5} \left( e^{\frac{C_2}{\lambda T}} - 1 \right)^{-1} \quad (10)$$

where  $J_\lambda$  is the power in watts in the complete solid angle of  $2\pi$  steradians on one side of the black-body plane (Lambert's cosine law applying) per unit area for an increment of wavelength of one centimeter;  $C_1$  is equal to  $3.7413 \times 10^{-12}$  square centimeter-watts (the first radiation constant);  $\lambda$  is the wavelength in centimeters; and  $C_2$  is equal to 1.4380 centimeter-degree (the second radiation constant). Fig. 13 illustrates the dis-

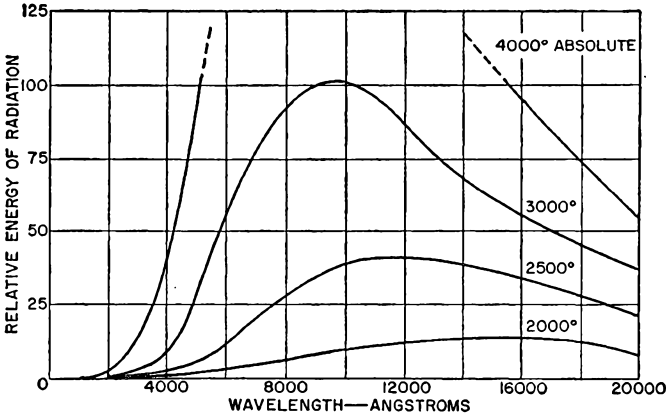

Fig. 13. Distribution of black-body radiant energy as a function of wavelength at various temperatures.

tribution of black-body radiant energy as a function of wavelength for a number of different temperatures as calculated from Eq. (10).

Although no material is ideally black, the equivalent of a theoretical black body can be achieved in the laboratory by providing a hollow radiator with a small exit hole. The radiation from the hole approaches that from a theoretical black radiator if the area of the cavity is large compared with the area of the exit hole. The characteristic of 100-percent absorption is achieved because any radiation entering the hole is reflected many times inside the cavity. For many years experimental physicists had to build their own black-body radiators; however, well-designed commercial radiators are now available.

For a radiation source which is not black, the radiation may be calculated from black-body radiation laws provided the emissivity as a function of wavelength is known. Spectral emissivity  $e_\lambda$  is defined as the ratio of the output of a radiator at a specific wavelength to that of a black body at the same temperature. Tungsten sources, for which tables of emissivity data are available,<sup>25</sup> are widely used as practical standards, particularly for the visible range. Tungsten radiation stand-

ards for the visible range are frequently given in terms of color temperature, instead of true temperature. The color temperature of a selective radiator is determined by comparison with the true temperature of a black body; when the output of the selective radiator is the closest possible approximation of a perfect color match in the range of the visual sensitivity, the color temperature is numerically the same as the black-body temperature. For a tungsten source, the relative distribution of radiant energy in the visible spectral range is very close to that of a black body although the absolute temperatures differ. However, the match of energy distribution becomes progressively worse in the ultraviolet and infrared spectral regions.

**Radiation sources and characteristics.** Relative spectral-emission characteristics for a number of important radiation sources are shown in Fig. 14. Each of these sources is described briefly below.

Tungsten lamps are probably the most important type of radiation source for photoelectric applications because of their availability, reliability, and constancy of operating characteristics. Commercial phototube design has been considerably

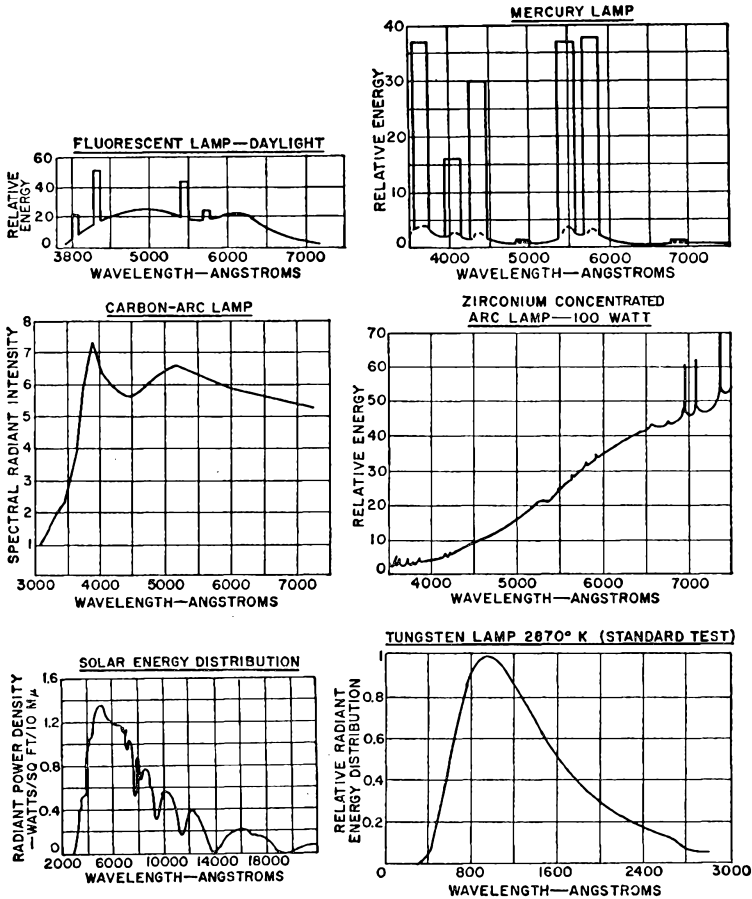

Fig. 14. Relative spectral-emission characteristics for several representative radiation sources.

influenced by the characteristics of the tungsten lamp.

The common fluorescent lamp, which is a very efficient light source, consists of an argon-mercury glow discharge in a bulb internally coated with a phosphor that converts ultraviolet radiation from the discharge into useful light output. There are numerous types of fluorescent lamps having different output spectral distribution depending upon the phosphor and gas-filling. The spectral response shown in Fig. 14 is a typi-

cal curve for a fluorescent lamp of the "daylight" type.

A very useful point source<sup>10</sup> is the zirconium concentrated-arc lamp. Concentrated-arc lamps are available having ratings from 2 to 300 watts, and in "point" diameters from 0.003 to 0.116 inch. Operation of these lamps requires one special circuit to provide a high starting voltage and another well-filtered and ballasted circuit for operation.

Although many types of electrical discharge have been used as

radiation sources, probably the most important are the mercury arc and the carbon arc. The character of the light emitted from the mercury arc varies with pressure and operating conditions. At increasing pressures, the spectral-energy distribution from the arc changes from the typical mercury-line spectra characteristic to an almost continuous spectrum of high intensity in the near-infrared, visible, and ultraviolet regions. Fig. 14 includes the spectral-energy distribution from a water-cooled mercury arc at a pressure of 130 atmospheres. The carbon arc is a source of great intensity and high color temperature. A typical energy-distribution spectrum of a dc high-intensity arc is shown in Fig. 14.

#### Matching sources and receiver.

In applications involving a photodetector and a radiation source, it is frequently necessary to estimate or calculate the expected response from the combination. For a tungsten-lamp source operating at normal brightness, the response is the product of the luminous flux from the lamp and the sensitivity of the photodevice specified in terms of response per lumen for a tungsten source (a standard color temperature of 2870 degrees Kelvin is usually specified). For other combinations of source (or source temperature) and receiver, the same simplification does not follow, unless the spectral distribution of the source in the range of the receiver corresponds closely to that of the tungsten lamp with which the receiver has been calibrated.

In general, the calculation of the expected response of a particular photodetector and a radiation source involves a consideration of the point-by-point match of the spectral emission and the spectral response. Specifically, the response may be calculated as follows:

If  $W(\lambda)$  is the radiant power from the source in watts per unit wavelength, the total power from the source is given by

$$W_{\text{Total}} = \int_0^{\infty} W(\lambda) d\lambda \quad (11)$$

If the total power of the source is known (as it usually is) and the relative distribution of the radiant flux is known from data such as Fig. 14, an absolute value of  $W(\lambda)$  may be obtained by performing the integration indicated in Eq. (11) with the known relative values  $W_{\text{rel}}(\lambda)$  and solving for the calibration constant  $\frac{W(\lambda)}{W_{\text{rel}}(\lambda)}$ .

If the receiver has an acceptance area  $A$  normal to the line from the source to the receiver, and the distance from the source to the receiver is  $d$ , the total power intercepted by the device (assuming a uniform spatial distribution of radiant flux) can be expressed as follows:

$$\frac{W_{\text{Total}} A}{4\pi d^2} = \frac{A}{4\pi d^2} \int_0^{\infty} W(\lambda) d\lambda \quad (12)$$

Let  $R(\lambda)$  represent the spectral-response characteristic function for the receiver in amperes per watt. Because the response of the device at any wavelength is the product of the power intercepted at that wavelength and the sensitivity at that wavelength, the total response  $I$  in amperes of the device to the source for all wavelengths is given by

$$I = \frac{A}{4\pi d^2} \int_0^{\infty} W(\lambda) R(\lambda) d\lambda \quad (13)$$

A linear relationship between response and radiation is assumed.

Given only the relative spectral response of the photosensitive device  $r(\lambda)$ , normalized to unity at the wavelength of maximum response, and the luminous sensitivity of the device  $s$  in amperes per lumen from a tungsten lamp at a specified color temperature, the absolute sensitivity of the device,  $R(\lambda)$ , may be calculated<sup>13</sup> as follows:

If  $\sigma$  is the absolute sensitivity of the device at the wavelength of peak

sensitivity in amperes per watt, the sensitivity  $R(\lambda)$  is given by

$$R(\lambda) = \sigma r(\lambda) \quad (14)$$

The term  $w(\lambda)$  is used to represent the energy distribution of the radiation from the tungsten lamp falling on the active area of the photosensitive device.

The light flux in lumens on the device is then given by

$$L = 680 \int_0^{\infty} y(\lambda) w(\lambda) d\lambda \quad (15)$$

(See Eq. 6.) As in Eq. (13), the total current  $I$  developed is given by

$$I = \int_0^{\infty} w(\lambda) \sigma r(\lambda) d\lambda \quad (16)$$

Because the sensitivity  $s$  is specified in amperes per lumen, the equation for  $s$  can be written as follows:

$$s = I/L = \frac{\int_0^{\infty} w(\lambda) \sigma r(\lambda) d\lambda}{680 \int_0^{\infty} y(\lambda) w(\lambda) d\lambda} \quad (17)$$

Finally, the absolute sensitivity of the device in amperes per watt at the wavelength of peak sensitivity can be obtained by solving for  $\sigma$ .

$$\sigma = \frac{680s \int_0^{\infty} y(\lambda) w(\lambda) d\lambda}{\int_0^{\infty} w(\lambda) r(\lambda) d\lambda} \quad (18)$$

Because  $w(\lambda)$  appears in both the numerator and the denominator, it is not necessary that this value be any more than a relative function showing the distribution of energy from the tungsten lamp.

**Spectral-response designation.** To facilitate the designation of the spectral response of photodetectors, the manufacturers of such devices

through their representation in the Electronic Industries Association (EIA) have set up a series of registered S-numbers which indicate the relative spectral response of the device, i.e., a combination of the transmission characteristic of the envelope or window as well as the basic photosensitivity of the detector element. These numbers are often misused to indicate the photosensitive material or the basic photosensitivity of the detector element alone; it is important to note the distinction. Table VI lists the correct meaning of particular S-numbers.

## References

- 1 Tamm and Schubin, "Theory of the Photoeffect of Metals", *Z. Physik*, 68 (1931)
- 2 Mayer, H. and Thomas, H., "External Photoeffect of Alkali Metals", *Z. Physik*, 147 (1957)
- 3 Seiler, E. F., "Color Sensitiveness of Photosensitiveness of Photoelectric Cells", *Astrophys. J.*, 52 (1920)
- 4 Brady, J. J., "Energy Distribution of Photoelectrons as a Function of the Thickness of a Potassium Film", *Phys. Rev.*, 46, (1934)
- 5 Goerlich, P., *Z. Phys.*, 101, (1936)
- 6 Sommer, A. H., "New Photoemissive Cathodes of High Sensitivity", *Rev. Sci. Instr.*, 26, No. 7, (1955)
- 7 Spicer, W. E., "Photoemissive, Photoconductive, and Optical Absorption Studies of Alkali-Antimony Compounds", *Phys. Rev.*, 112, No. 1, (1958)
- 8 Bube, R. H., *Photoconductivity of Solids*, John Wiley & Sons, New York, (1960)
- 9 Rose, Albert, "An Outline of Some Photoconductive Processes", *RCA Review*, 12, (1951)
- 10 Griffin, D. R., Hubbard, R. and Wald, G., "The Sensitivity of the Human Eye to Infrared Radiation", *JOSA*, 37, No. 7, (1947)
- 11 Goodeve, C. F., "Vision in the Ultraviolet", *Nature*, (1934)
- 12 I.E.S. *Lighting Handbook*, Illuminating Engineering Society, New York, N.Y., (1959)

TABLE VI

Typical combinations of photosensitive surfaces and window materials which can provide the basic spectral-response designations standardized by E.I.A.

Spectral Response Number	Type of Photodetector	Photosensitive Material	Envelope
S-1	Photocathode	Ag-O-Cs	Lime-glass
S-2*			
S-3	Photocathode	Ag-O-Rb	Lime-glass
S-4	Photocathode	Cs-Sb	Lime-glass
S-5	Photocathode	Cs-Sb	UV-transmitting glass
S-6	Photocathode	Na	Unspecified
S-7	Photocathode	Cs-Rb-O-Ag	Pyrex
S-8	Photocathode	Cs-Bi	Lime-glass
S-9	Photocathode	Cs-Sb (semitransparent)	Lime-glass
S-10	Photocathode	Ag-Bi-O-Cs (semitransparent)	Lime-glass
S-11	Photocathode	Cs-Sb (semitransparent)	Lime-glass
S-12	Photoconductor	CdS (crystal with plastic coating)	Lime-glass
S-13	Photocathode	Cs-Sb (semitransparent)	Fused silica
S-14	Photojunction (Photocell)	Ge	Lime-glass
S-15	Photoconductor (Photocell)	CdS (sintered)	Lime-glass
S-16	Photoconductor (Photocell)	CdSe	Lime-glass
S-17	Photocathode	Cs-Sb (reflecting substrate)	Lime-glass
S-18	Photoconductor (Vidicon)	Sb <sub>2</sub> S <sub>3</sub>	Lime
S-19	Photocathode	Cs-Sb	Fused silica
S-20	Photocathode	Sb-K-Na-Cs (semitransparent)	Lime-glass
S-21	Photocathode	Cs-Sb (semitransparent)	UV-transmitting glass
S-22	Presently unspecified		
S-23	Photocathode	Rb-Te	Fused silica
S-24	Photocathode	Na <sub>2</sub> KSb	Lime-glass

\* Now obsolete. Formerly a variation similar to S-1, discarded by EIA action to reduce confusion.

## References cont'd

- <sup>15</sup> Engstrom, R. W., "Absolute Spectral-Response Characteristics of Photosensitive Devices", *RCA Review*, 21, (1960)
- <sup>16</sup> Forsythe, W. E., *Measurement of Radiant Energy*, McGraw-Hill Book Co., N.Y. (1937)
- <sup>17</sup> DeVos, J. C., *Physica*, 20, (1954)
- <sup>18</sup> Zworykin, V. K. and Ramberg, E. G., *Photoelectricity and its Application* John Wiley and Sons, Inc., New York, (1949)
- <sup>19</sup> Buckingham, W. D. and Deibert, C. R., "Characteristics and Applications of Concentrated-Arc Lamps", *J. Soc. Motion Picture Eng.*, 47, (1946)
- <sup>20</sup> Hughes, A. L. and DuBridge, *Photoelectric Phenomena*, McGraw-Hill Book Co., Inc., New York (1932)
- <sup>21</sup> Walsh, J. W., *Photometry*, Constable and Co. Ltd., London, (1953)

# Vacuum Phototubes

## Construction and Principles of Operation

IN a vacuum phototube, one of the simplest of photodetectors, the essential elements are a photocathode, an anode, an envelope, and a suitable termination or base. The shape of the photocathode is determined by the particular optical requirements of the application and the general electron-optical requirement that electrons emitted from the cathode must be collected by the anode. The most common cathode shape is semi-cylindrical; one side is open to admit light and an anode rod is located approximately at the center line of the cylinder. An ideal geometrical layout for omnidirectional response without interference from the anode is provided by evaporating cathode material on the inside of the envelope window to form a semitransparent cathode and locating the anode in the center of the bulb. Cup-shaped cathodes have been used with ring-shaped anodes.

The anode of a vacuum phototube is usually made small to minimize obstruction of the light falling on the photocathode. As a result, the anode may not collect all the electrons emitted from the cathode. This situation arises because of the tangential component of the electron-emission velocity which causes some of the electrons to miss the anode and strike the glass window. When the energy of the electrons striking the glass wall is sufficient, secondary electrons are emitted from the glass and may be collected by the anode. If the secondary-emission ratio is substantially greater than unity, the glass window becomes charged to a

positive potential, approaching that of the anode. If the applied voltage is too low to provide an effective secondary-emission ratio\* greater than unity, the glass becomes charged negatively to approximately cathode potential.

Fig. 15 shows a perfectly cylindrical electric field in which the electron-emission energy is  $E$  electron-volts and the emission velocity is tangent to the surface of the cathode and in a plane normal to the axis of the tube. When the electron path is

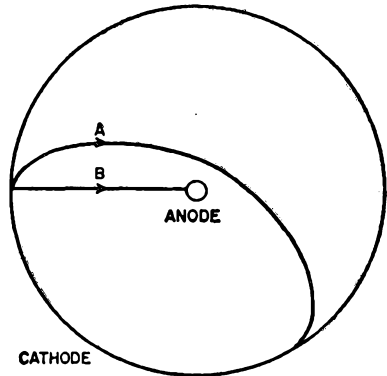

Fig. 15. Paths of electrons in a tube having cylindrical geometry. Directions of emission velocities are (a) tangential and (b) radial.

just tangent to the anode, or when the electron path impinges on the anode, a consideration of conservation of angular momentum and energy leads to the following relation:

\* Effective secondary-emission ratio is defined as the ratio of collected secondary-electron current (total secondary-emission current less return current) to primary current.



$$\frac{b^2}{a^2} \cong \frac{V + E}{E} \quad (19)$$

where  $b$  is the cathode radius,  $a$  is the anode radius, and  $V$  is the potential difference between anode and cathode. For an electron energy of one volt and an applied potential of 100 volts, the anode radius must be greater than one-tenth the radius of the cathode in order to collect the emitted electrons. In a typical construction, the radius of the cathode cylinder is approximately 8 millimeters and the anode radius is 0.5 millimeter. In this case, the number of electrons which strike the glass depends upon the wavelength of the exciting radiation.

Fig. 16 shows the sort of erratic behavior that occurs when the anode radius is too small (in this case the ratio of the cathode radius to the anode radius is about 30:1). Data

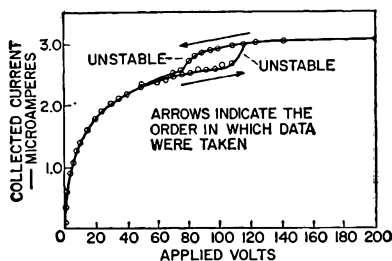

Fig. 16. Erratic current-voltage characteristic in a vacuum phototube caused by bulb charges which result when the anode is too small to collect all emitted photoelectrons.

shown are for a nonstandard 935 vacuum phototube having an anode-wire diameter of 0.020 inch (one-half the normal dimension). The outside of the envelope was wrapped in a metal foil except for the window; the foil was at cathode potential. The phenomenon was also observed when the foil was at anode potential and when no foil was used.

On the lower branch of the "hysteresis" loop, as the voltage is increased, the glass becomes negatively charged. At the unstable point on the right, the secondary-emission ratio reaches unity; the result is an

increase in the collected current. The top of the loop represents the condition in which the glass is positively charged. Although the case of Fig. 16 is an exaggerated one because of the small anode size, some instability of the output current is occasionally observed in conventional tubes. An anode voltage of about 250 volts eliminates the condition entirely.

The construction of the phototube stem and envelope follows the standard practices of the electron-tube industry. A typical construction is shown in Fig. 17. Choice of metals and glasses for specific sealing conditions is governed principally by their rates of thermal expansion. Table VII lists expansion coefficients for the more common glasses and metals used in the manufacture of phototubes.<sup>1</sup>

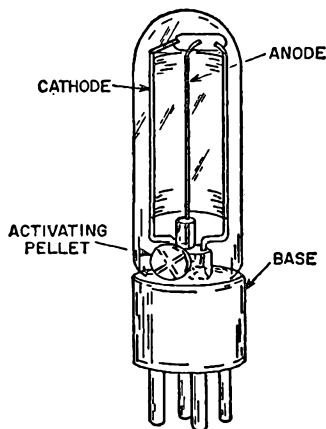

Fig. 17. Typical construction of a vacuum phototube.

An essential process in the manufacture of most phototubes is the introduction of cesium. Although in some special phototubes cesium is introduced from a side tube, the most common method of introducing this activating material is by means of an activating pellet, as shown in Fig. 17. A mixture of cesium chromate and silicon is

TABLE VII

## Expansion Coefficients for Common Glasses and Materials Used in the Manufacture of Phototubes

	Coefficient of Expansion $\times 10^{-7}$ (per $^{\circ}\text{C}$ )	
<b>Soft Glasses</b>		
0080		92
0120		89
7285*		95
*Radioactivity less than 10 cpm/kilogram		
<b>Hard Glasses</b>		
7040		47
7052		46
7720 (Nonex)		86
7740 (Pyrex)		32
7750		41
9741		39
<b>Quartz</b>		
7912 (Vycor)		8
Lithium Fluoride		400
<b>Sapphire</b>		
	Temperature - $^{\circ}\text{C}$	
Parallel to C-axis	50	666
	500	833
	1000	903
Perpendicular to C-axis	50	50
	500	77
	1000	831
<b>Metals</b>		
	Temperature Range - $^{\circ}\text{C}$	
Tungsten	0 — 500	46
Molybdenum	25 — 500	55
Nickel-Iron	20 — 400	53
(42 alloy) 42 per cent Ni		
Nickel-Iron	30 — 310	95
(52 Alloy) 50 per cent Ni		
Kovar	25 — 300	60
Platinum	25 — 100	91
Chrome Iron	25 — 500	108
Dumet		92 radial 65 axial

formed into a pill and held between the two sides of a metal container. During processing the activator container is heated to a dull-red color by the use of radio-frequency heating. An exothermic reaction takes place in which silicon chromate is formed and metallic cesium is released.

Although microphonic problems are not common in phototubes, it is sometimes important to prevent the introduction of a modulated current caused by relative movement of the elements of the phototube. Special beads and "snubbers" are sometimes introduced for this purpose and metal parts are usually spot-welded together.

## Properties of Vacuum Phototubes

### Spectral Response

The spectral response of a vacuum phototube depends upon the photocathode material and the spectral transmission of the bulb window. Although pure metals have photoemissive properties, their response is usually rather poor and predominantly in the ultraviolet region; for most practical purposes, therefore, pure metallic photocathodes are of little value. Useable sensitivity has been obtained only with surfaces involving alkali

metals. One of the first photoelectric surfaces to be used commercially was potassium sensitized with hydrogen. This type of surface is produced by the evaporation of a thin layer of potassium in vacuum. The surface is sensitized by exposing it to a glow discharge in a hydrogen atmosphere to form a surface layer of potassium hydride, which is presumed to be covered with a potassium film. The resultant surface may be symbolically represented as  $(K) - KH - K$ .<sup>2</sup> This sensitization process greatly increases the photoelectric yield, but produces little change in either the threshold or the wavelength of maximum response. The sensitivity at the wavelength of maximum response, 4400 angstroms, has been reported as high as 0.023 ampere per watt (about 7-per-cent quantum efficiency). However, as shown in Fig. 18, the spectral response is so limited (especially for applications involving tungsten lamps) that the surface is not generally used for commercial applications.

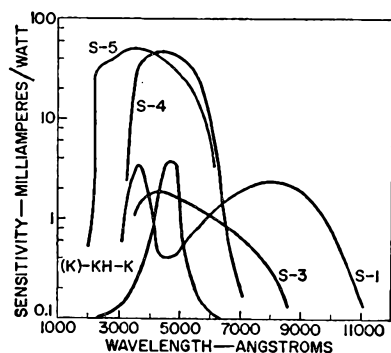

Fig. 18. Spectral response characteristics of vacuum phototubes:  $(K) - KH - K$ ; S-1; S-3; S-4; S-5.

The silver-oxygen-cesium photocathode (used in tubes having S-1 response) is more important commercially because it is more sensitive to long wavelengths than the potassium-hydride photocathode. Commercial photocathodes of this type

are prepared by oxidizing a porous silver base in an oxygen glow discharge to a degree determined by the appearance of interference colors at the surface. Cesium is then introduced and the surface is baked at about 250 degrees centigrade until a characteristic straw color results. Maximum sensitivity at the 8000-angstrom peak corresponds to only about 0.8-per-cent quantum efficiency, but the spectral range is wide. In addition, this type of photocathode can tolerate a somewhat higher ambient temperature (100 degrees centigrade maximum) than most photocathodes.

A closely related photocathode in which rubidium replaces cesium is used in tubes having a spectral-response characteristic identified as S-3. Although the sensitivity of this surface is not high, it has proved useful in color-matching applications.

The most important photocathode currently used in vacuum phototubes is the cesium-antimony "alloy" surface developed by Goerlich.<sup>3</sup> In the formation of this photocathode, an evaporated layer of antimony is treated with cesium vapor at 170 degrees centigrade. The resulting photocathode, which is believed to be a semiconductor  $Cs_3Sb$ ,<sup>4</sup> is characterized by high sensitivity in the visible spectrum. The spectral response for the cesium-antimony surface deposited on a solid backing mounted in a lime-glass bulb is shown in Fig. 18; it is identified as S-4. Quantum efficiency is occasionally as high as 31 per cent at 4000 angstroms, the wavelength of peak response.

The envelopes of most phototubes are made of Corning 0080 lime glass, which cuts off transmitted radiation in the ultraviolet region at about 3000 angstroms. Envelopes have also been made of ultraviolet-transmitting Corning 9741 glass. A cesium-antimony cathode having the latter type of window provides the spectral response identified as S-5 in Fig. 18. Some special phototubes have fused-silica windows, which further extend the spectral response in the ultraviolet region.

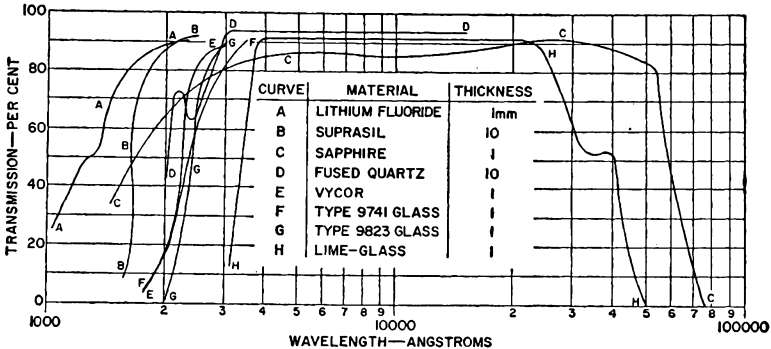

Fig. 19. Transmission characteristics of various glasses used in phototube manufacture.

Transmission curves of several glasses used in phototube manufacture are shown in Fig. 19. These curves are for a typical thickness of 1 millimeter, except as noted; ultraviolet cutoff is critically dependent on the thickness of the glass. The transmittance  $T$  of glass at a particular wavelength is described by the following relationship:

$$T = K10^{-\beta t} \quad (20)$$

where  $K$  is a factor (approximately 0.9) dependent upon the surface reflectivity,  $\beta$  is the coefficient of absorption, and  $t$  is the thickness. Near the cutoff wavelength it is important to use as thin a glass as practicable. Some experimental phototubes have windows made of a thin inverted bubble of glass.

### Current-Voltage Characteristics

A typical current-voltage characteristic for a vacuum phototube is shown in Fig. 20. At the foot of the curve (region A), the energy of the photoelectrons is sufficient to permit some collection by the anode, even against an opposing field. As the voltage is increased in the positive direction (region B), more of the emitted electrons are collected. However, because of the finite size of the anode, some of the electrons which escape and strike the bulb are lost to

the output circuit. In the normal operating range (region C), the increase in current (approximately 5 per cent) is caused by a number of factors. Some of the increase is the result of improved collection efficiency at higher voltage. Photoemission is also slightly increased as a result of the applied electric field at the cathode, which aids

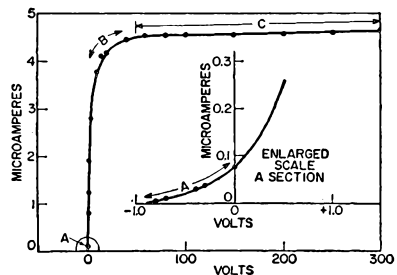

Fig. 20. Current-voltage characteristic for a typical vacuum phototube showing the various regions of interest.

in the emission by reducing the voltage barrier at the surface associated with the photoelectric work function. The increase in emission from this field effect is primarily observed in the neighborhood of the long-wavelength cutoff of the spectral characteristic. Therefore, a phototube operated at a higher voltage is slightly more red-sensitive. In some phototubes, the vacuum may

not be sufficiently low to prevent all ionization; this condition usually results in an increased slope of the current-voltage characteristic in the C range.

### Linearity

Vacuum phototubes are characterized by a photocurrent response which is linear with incident light level over a wide range—so much so that these tubes are frequently used as standards in light-comparison measurements. Fig. 21 shows the linear current-light relationship characteristic of a vacuum phototube. If a tube is to be relied upon as a standard because of its linearity characteristic, the voltage used should be sufficient to prevent instability of the type shown in Fig. 16.

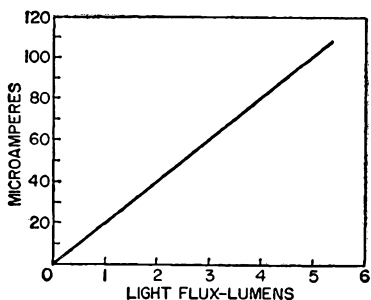

Fig. 21. The linearity of current as a function of light for a vacuum phototube.

Because the photosensitivity of the photocathode may vary across the surface, the same area on the photocathode should be used throughout the measurement. Caution should also be taken to avoid the effects of shadowing by the anode. The anode should either always occupy the same relative area in the light beam, or the shadow effects should be avoided by placing the light beam to one side.

Two effects may limit the linear operation of the phototube at high light levels, fatigue and space

charge. At high current levels (recommended absolute-maximum current ratings are listed in the Phototube Data section) the tube may suffer both temporary and permanent fatigue, resulting from a change in surface composition. Because such fatigue is usually a function of both current and time, phototubes can often be used safely at very high light levels if the exposure is brief. The use of pulsed light makes it possible to develop large photocurrents (up to the point where the space charge limits the output current) without excessive fatigue effects.

The problem of currents limited by space charge between coaxial cylinders has been worked out by Langmuir and Blodgett.<sup>5</sup> In practical units, the expression for the current  $I$  in amperes per unit length  $l$  of axis is given by

$$\frac{I}{l} = \frac{14.66 \times 10^{-6} V^{3/2}}{r\beta^2} \quad (21)$$

where  $l$  is the length of the cylinder,  $r$  is the radius of the anode cylinder,  $V$  is the applied voltage between cathode and anode, and  $\beta$  is a non-dimensional function of the ratio of the cathode and anode radii. Fig. 22 shows an experimental current-voltage curve for a 1P39 vacuum phototube; the current is plotted on a 2/3-power scale to show the limitation resulting from space charge. The theoretical line is for an assumed cathode radius of 0.8 centimeter, an anode radius of 0.051 centimeter, and a cathode length of 2.22 centimeters. Because the cylinder is only half closed, there are large end effects. Although Eq. (21) does not take into account the initial velocity of the electrons, it is adequate for general order-of-magnitude evaluations. Space charge is usually not a limitation in vacuum phototubes because steady currents of the magnitude necessary to produce space-charge limitation would usually first produce severe fatigue limitation.

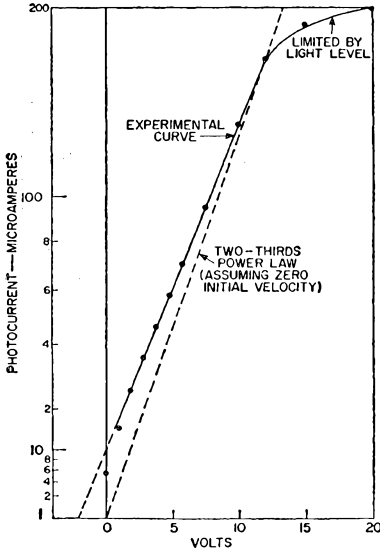

Fig. 22. Experimental current-voltage curve for a 1P39 taken at high values of current to show the space-charge limitation. Note that the current scale is drawn on a two-thirds power scale so that the space-charge law becomes a straight line.

### Frequency Response

The inherent response time of a vacuum phototube is exceedingly short. No time delay between the incidence of light and the emission of electrons has been measured.<sup>6</sup> For a vacuum phototube such as the 1P39 (anode radius of 0.051 centimeter, cathode radius of 0.8 centimeter) with an applied potential of 100 volts, the transit time for an electron having an initial velocity of zero has been calculated to be  $3.9 \times 10^{-9}$  seconds (3.9 nanoseconds). The transit time itself does not limit frequency response; rather it is limited by the spread in transit time resulting from differences in initial electron velocities. For an electron energy of 1 volt and emission velocity directed toward the anode, the transit time for an applied potential of 100 volts is 3.3 nanoseconds. Thus, a total spread in transit time of approximately 0.6 nanosecond may be expected.

Although the calculation indicates that vacuum phototubes may theoretically be used at light-modulation frequencies approaching  $10^9$  cycles per second (one gigacycle) practical difficulties preclude the realization of such performance. For example, the 1P39 has an interelectrode capacitance of 2.6 picofarads and its associated circuit further adds to this value; the total capacitance is approximately a minimum of 10 picofarads. In order that the circuit time constant not limit the response, the equivalent resistance-capacitance time constant of the circuit should be less than 0.6 nanosecond. For a capacitance of 10 picofarads, the load impedance would have to be less than 60 ohms. Unless the light level were high, such operation would not be possible. Nevertheless, for light pulses of high magnitude and short duration, the vacuum phototube is capable of very short response time when coupled with a minimum load resistance.

### Noise

As the light level and the photocurrent become less, it becomes difficult to distinguish the photocurrent from the dark current (current resulting from sources other than radiant flux on the photocathode). One limit of detection is in the fluctuation of the dark current, or dark noise.

Dark currents in vacuum phototubes arise from various sources. When both the anode and cathode are terminated in a base attached to one end of the tube, the leakage across the base may be a major source of dark current. Such leakage is particularly troublesome in an atmosphere having high humidity, especially if the base of the tube is dirty. In a vacuum phototube, internal electrical leakage usually results from excess photocathode activating material. Tubes having anode and cathode terminations at opposite ends of the tube, especially when the separation is also maintained inside the

envelope, have a minimum of electrical leakage.

In such phototubes, the main source of dark current may be dark emission of electrons from the photocathode. Dark noise in the vacuum phototube is shot noise caused by such random dark emission. The rms fluctuation current in such cases is given by the following shot-noise relationship:

$$\overline{I^2 \Delta f}^{1/2} = [ 2e i_d \Delta f ]^{1/2} \quad (22)$$

where  $i_d$  is the dark emission current,  $e$  is the electron charge ( $1.6 \times 10^{-19}$  coulombs), and  $\Delta f$  is the bandpass of the measuring circuit. When the signal current is just equal to this rms fluctuation current, the condition is that of minimum signal detection.

This minimum signal detection is rarely realized in vacuum phototubes. The noise associated with the dark emission is usually very small compared with the circuit noise. For example, for a load resistor of value  $R$ , the rms-thermal-noise voltage

(Johnson noise) associated with the resistor is given as follows:

$$\overline{V^2 \Delta f}^{1/2} = [ 4 kTR \Delta f ]^{1/2} \quad (23)$$

where  $k$  is Boltzmann's constant ( $1.38 \times 10^{-23}$  Joule per degree),  $T$  is the absolute temperature, and  $\Delta f$  is the bandpass.

The Johnson noise may be compared with the voltage across the load resistance resulting from the fluctuating shot-noise current:  $R(2e i_d \Delta f)^{1/2}$ . The signal voltage and the shot-noise voltage across  $R$  both increase directly as  $R$ , whereas the Johnson noise voltage increases only as the square root of  $R$ .

Consequently, if the load resistance is made sufficiently high, the signal-to-noise ratio from the circuit improves until the limitation resulting from shot noise alone is reached (see Fig. 23). The resistance  $R$  for which the two noise sources are equal may be determined as follows:

$$R(2e i_d \Delta f)^{1/2} = (4kTR \Delta f)^{1/2}$$

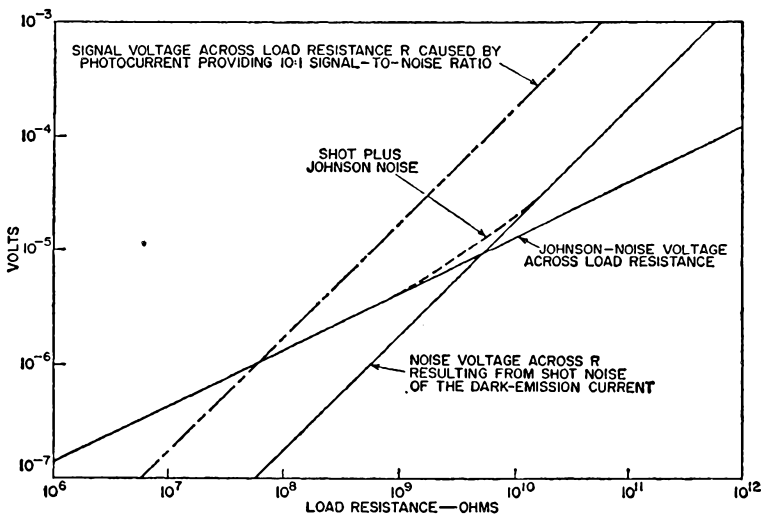

Fig. 23. Variation of signal voltage, Johnson-noise voltage, and shot-noise voltage developed across the load resistor by the dark emission—all as a function of the load resistor. Data are for a vacuum phototube having S-1 response, dark emission of 10 picoamperes, and temperature of 300° K, and for a bandwidth of 1 cycle.

or

$$R = \frac{2 kT}{e i_a} \quad (24)$$

For example, for a vacuum phototube having S-1 response and total dark emission of  $10^{-11}$  ampere (10 picoamperes) at room temperature, the value of R from Eq. (24) is 5000 megohms. For tubes having lower dark emission, such as those with S-4 response, the value of load resistance which must be exceeded to override Johnson noise becomes orders of magnitude above practicability. Even with a 5000-megohm load resistance, the time constant of the circuit limits the response to only a few cycles per second. For applications requiring detection of very low light levels with high-frequency response, it is advisable to use a multiplier phototube.

### Environmental Factors

As a rule, the sensitivity of a vacuum phototube is only slightly affected by the ambient temperature. However, a small reversible effect may be observed in the spectral range near the long-wavelength cutoff where increasing the temperature tends to increase the wavelength for cutoff. Permanent changes may result from redistribution of the sensitizing metals at elevated temperatures.

Most phototubes are rated to a maximum temperature in the range of 75 to 100 degrees centigrade. Above the maximum rated temperature, the phototube usually suffers permanent loss of sensitivity depending upon the length of exposure time. As the temperature approaches the temperature to which the tube is subjected during processing sensitization (in the range from 150 to 250 degrees centigrade), serious loss of sensitivity occurs in less than an hour. As the temperature is increased, the dark emission also increases exponentially; a typical increase is 2:1 for every 10 degrees centigrade.

Most vacuum tubes are not de-

signed for environments of extreme shock or vibration. In a nonruggedized tube, the cathode would probably be distorted in its position relative to the anode by such environments, even to the extent of causing a short. Even if no permanent damage is done to the phototube, difficulty may arise from modulation of the photocurrent resulting from vibration of the photocathode in the beam of light because different areas of the photocathodes may have different sensitivities. A typical variation in cathode sensitivity (sometimes resulting from the heat used to seal the bulb to the stem) is from low sensitivity near the stem to high sensitivity at the upper end of the cathode.

Under normal operating conditions, the vacuum phototube is one of the most stable photosensitive devices available. When stored in the dark at normal temperatures and operated at low photocurrents, vacuum phototubes can be used as a reasonably good laboratory standard. They usually show a loss in sensitivity during continuous operation, depending upon the magnitude of the current. Fig. 24 shows typical life characteristics of vacuum phototubes having S-4 and S-1 spectral responses for continuous operation under the test condition.

Most vacuum phototubes are rated to several hundred volts; normally there is no need for higher voltages. Spacings of the leads in the stem and base are not designed for very high voltages which would cause arc-overs, usually across the base. For best operation, high temperatures, high humidity, high voltage, dirty or greasy environments, and excessive vibration or shock should be avoided.

### Application Considerations

Vacuum phototubes are used to best advantage in applications which exploit their stability, good frequency response, flat current-voltage characteristic, and linearity of photocurrent with radiant flux.



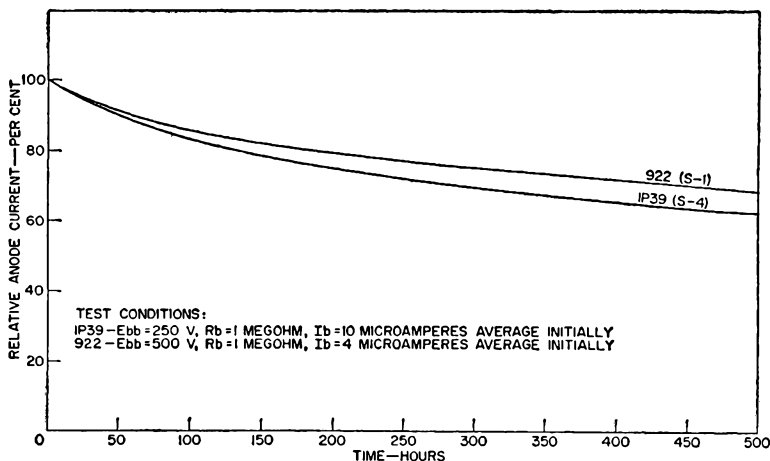

Fig. 24. Typical life characteristics for two types of phototubes having S-4 and S-1 spectral-response characteristics.

In applications requiring the observation of light pulses of short duration, or light modulated at relatively high frequencies, the vacuum phototube performs better than gas-filled phototubes or most solid-state photocells. Because vacuum phototubes are relatively stable over long periods, they may be used as standards of reference or in applications requiring long periods of operation without recalibration. The vacuum phototube, because of its linear characteristic, may be used in many applications as an instrument for measuring light flux.

The maximum ratings provided in the data for vacuum phototubes should be carefully adhered to, especially in commercial applications in which many tubes are used in identical circuits. In laboratory applications, however, it is possible to exceed published ratings if the experimenter takes into consideration the behavior of the device and the reasons for the stated limitations. The minimum dc load resistance value shown in the data for each type is recommended to prevent damage to associated circuit components in the event of a short circuit in the phototube, which normally serves as a high series resistance.

The voltage supply for a vacuum

phototube is not critical because of the flat current-voltage characteristic. A minimum of approximately 20 volts is usually recommended for most phototubes to provide an adequate collection field, although more than 100 volts may be desirable to prevent bulb charging caused by initial electron velocities. Voltages higher than the maximum rating (usually around 250 volts) should not be used because they may result in electrical breakdown between external elements of the tube.

Usually, the life of a vacuum phototube (for a given decrease in sensitivity) is related approximately inversely to the current drawn through the tube. More stable and reliable performance results if small areas of concentrated illumination on the cathode surface are avoided.

Phototubes should not be stored in light when not in use. Blue and ultraviolet light especially can cause photochemical changes in the cathode which result in changes in sensitivity. It is especially important to avoid exposure to intense illumination such as sunlight even when no voltage is applied to the tube. Permanent damage may result if the tube is exposed to light so intense that it causes excessive heating of the cathode. Tubes should not be stored

for long periods at temperatures near the maximum rating of the tube; high temperatures almost always result in loss of sensitivity of the tube.

A vacuum phototube may be operated with either dc or ac applied voltage. Usually a dc supply is preferred, especially for measurements involving very small currents. However, in some applications an ac supply can be used to advantage because of the time relationship provided; the ac supply may also be less expensive in some applications. Because the vacuum phototube acts as a rectifier, the use of steady illumination and an ac applied voltage results in approximately square waves of unidirectional current flow. In this case, a dc current meter would indicate an average current approximately half that indicated when a dc power supply is used.

Whenever a small ac signal from the phototube is to be observed and the amplifier gain is high or the load resistance is large, it is recommended that shielding be provided for the phototube and the signal output leads. It is advisable to make the signal lead as short as possible to avoid pickup and stray capacitance. This precaution is important if frequency response is a consideration. Because a phototube is a high-resistance device, it is important that insulation of associated circuit parts and wiring be adequate. In very critical applications it may be desirable to use a phototube in which the signal lead (either anode or cathode depending upon polarity of signal desired) is terminated through an insulated bulb-top cap. The power supply should be connected between ground and the phototube element not used for signal output to avoid unnecessary pickup of extraneous signals.

For maximum sensitivity of phototube circuits, leakage resistance of circuit parts and wiring insulation should be high. Leakage across moisture films on the surface of the glass can be prevented by coating the glass with pure white ceresine wax,

silicones, or other non-hygroscopic insulators. For example, in the case of a tube having a top-cap connection, a continuous band of wax approximately a half-inch wide around the top cap or around the bulb is sufficient to interrupt all external leakage paths.

Some phototubes have special nonhygroscopic bases which provide a substantial advantage in critical applications; special sockets can also be obtained which minimize leakage in humid conditions. Teflon is one of the best materials for such sockets.

In many applications, it is advantageous to modulate the light flux which is to be detected by the phototube. Modulation can be achieved in a variety of ways: the most common method is the use of a rotating disk or "chopper" which has a number of holes that modulate the light beam; other methods use a vibrating reed or diaphragm, rotating mirrors, or a Kerr cell.

Undesirable modulation may occur if vibration of the phototube causes a shift in the position of the light spot on the photocathode because the photosurface may not be uniformly sensitive or because the anode may interrupt more or less of the light. In general, it is desirable to use a large spot of light on the photocathode to minimize microphonic effects and cathode current density.

## References

- <sup>1</sup> Kohl, W. H., *Material and Techniques for Electron Tubes*, Reinhold Publishing Corp., New York (1960)
- <sup>2</sup> Lukirsky, P. I. and Rijanoff, S., "Dependence of Photoemission of Potassium on Arrangement of Atomic Hydrogen and Potassium Layers on Its Surface", *A. Physik*, 75, (1932)
- <sup>3</sup> Goerlich, P., "On Composite Transparent Photocathodes", *Z. Physik*, 101, (1936)
- <sup>4</sup> Sommer, A., "Photoelectric Alloys of Alkali Metals", *Proc. Phys. Soc. (London)*, 55, (1943)
- <sup>5</sup> Langmuir, I., and Blodgett, K. B., "Currents Limited by Space Charge between Coaxial Cylinders", *Phys. Rev.*, 22, (1923)
- <sup>6</sup> Lawrence, E. O. and Beams, J. W., "Instantaneity of the Photo-Electric Effect", (abstract), *Phys. Rev.*, 29, (1927)

# Gas-Filled Phototubes

## Construction and Principles of Operation

**M**OST gas-filled phototubes have the same general construction as vacuum phototubes except that an inert gas such as argon at a pressure of approximately 0.1 millimeter of mercury is introduced before the final sealing of the tube. Ionization of the molecules of the inert gas results in amplification of the primary photoemission. This amplification provides an important advantage over the vacuum phototube for applications in which the primary photocurrents are small and it is necessary to minimize external amplification. With gas-filled tubes, amplification factors of from 5 to 10 become quite practical; even higher amplification can be used under carefully controlled conditions.

When electrons are emitted from the cathode by photoelectric action, they are accelerated through the gas by the applied voltage. If the energy of the electrons exceeds the ionization potential of the gas (15.7 volts in the case of argon), collision of an electron and a gas molecule can result in ionization, that is, the creation of a positive ion and a second electron. The probability of an ionizing collision in a gas depends upon the energy of the electron and the density of the gas. The mean free path of an electron also depends upon the electron energy. In argon the mean free path is of the order of 1.4 to 3 millimeters at a gas pressure of 0.1 millimeter of mercury. (For a general discussion of electrons in a gas and related phenomena, see references 1 and 2.) Not every collision

results in an ionization. As the voltage on the phototube anode is increased above the ionization potential, the amplification of the photocurrent increases. At 90 volts, an electron averages 3 ionizing collisions while traversing the gap between cathode and anode. This degree of ionization results in an eight-fold amplification ( $2^3$ ) of the photocurrent.

However, in practice, the actual amplification is greater than that which results from ionization because secondary effects become more important as the voltage on the tube is increased. The most important of these effects is the release of secondary electrons when positive ions strike the photocathode. Other effects of minor importance are the release of secondary electrons by metastable atoms produced by electron excitation in the gas, ionization by positive ions, and electron emission from photons created in the gas.

The combination of these effects produces an amplified current  $i$  described by the following equation:

$$i = i_0 \frac{e^{ad}}{1 - \gamma(e^{ad} - 1)} \quad (25)$$

where  $i_0$  is the initiating photoelectric current,  $a$  is the number of ions formed per electron per unit length across the tube from cathode to anode, and  $\gamma$  is a lumped constant (nominally the number of secondary electrons emitted from the cathode per impacting positive ion, but actually including the other minor and secondary sources of regenerative current in the tube).

Eq. (25) shows that, as the voltage is increased on the tube and both  $a$  and  $\gamma$  increase, a point is ultimately

reached at which the denominator approaches zero as a result of the combined effect of the primary and secondary mechanisms. At this point, a state of uncontrolled current is reached, and the current increases to the limit of the circuit or until a glow discharge sets in, which may result in permanent damage to the photocathode.

## Properties of Gas-Filled Phototubes

### Current-Voltage Characteristics

Fig. 25 shows the increase in anode current of a gas-filled phototube as the voltage is increased. Most commercial gas-filled phototubes are designed to operate with a 90-volt supply. The intersection of the load line and the anode-current characteristic defines the operating point. The ratio of this current to the current at 25 volts (with the same load) for a specified light flux (usually 0.1 lumen) and a specified load (usually

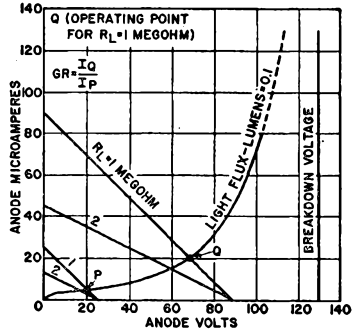

Fig. 25. Current-voltage characteristic for a gas-filled phototube illustrating gas-ratio (GR), load lines, operating point, and breakdown voltage.

1 megohm) is referred to as the gas-ratio or GR. The breakdown voltage is that voltage at which, with no light on the tube, an uncontrolled discharge occurs. This voltage is well above the 90-volt maximum operating voltage to provide for stable performance.

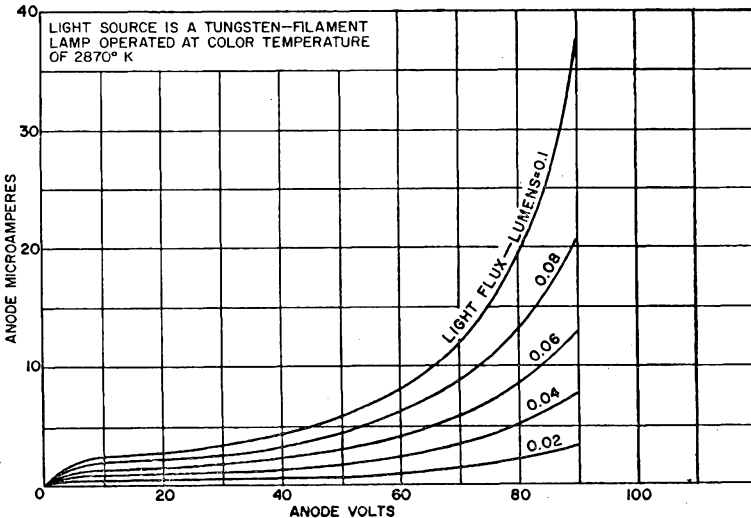

Fig. 26. Current-voltage characteristics for various light levels for a type 918 gas-filled phototube. Some nonlinearity with light is observed at maximum currents.

### Variation of Current With Light Flux

A series of current-voltage curves for various values of light flux is shown in Fig. 26 for type 918. As the level of light increases, the current increases more than linearly. This relationship is illustrated more specifically in Fig. 27, which shows the current developed as a function of light flux for a gas-filled phototube. The nonlinear behavior is caused by positive-ion space charge. The field strength near the cathode is low because of the cylindrical construction. The mobility of positive ions is much less than the mobility of the electrons; at a current of approximately 20 microamperes, the accumulation of positive-ion space charge is sufficient to distort the cylindrical field and increase the electrical gradient near the photocathode. This increased gradient provides a more efficient field distribution for the production of multiple ionization than when the bulk of the voltage drop is concentrated near the anode, as in the case of the undistorted cylindrical field. For applications in

which linear response is required over a wide range of light levels, it is best to use a vacuum phototube.

### Time- Or Frequency-Response Characteristics

The time of response of a gas-filled phototube, unlike that of a vacuum tube, is limited by the secondary effects associated with gas amplification. Fig. 28 shows the frequency-response characteristics of gas-filled phototubes having cesium-antimony photocathodes and silver-oxygen-cesium photocathodes. Because response becomes increasingly poor above 10,000 cycles per second, applications are limited to the audio range. Gas-filled phototubes are widely used in pickups for sound reproduction, both in theaters and in 16-millimeter sound systems. The frequency-response characteristic shown in Fig. 26 was obtained by passing light through a toothed wheel driven by a variable-speed motor and then through a fixed aperture and onto the photocathode. The teeth were so shaped that in

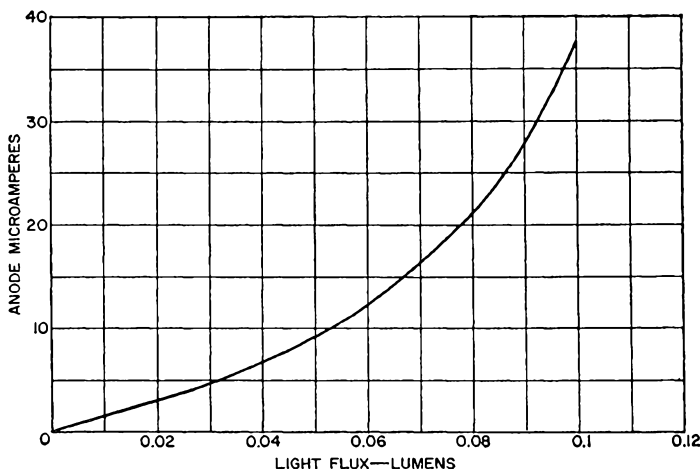

Fig. 27. Anode current (at 90 volts, zero series resistance) in a gas-filled phototube as a function of light flux showing the increasing nonlinearity at high levels of light flux.

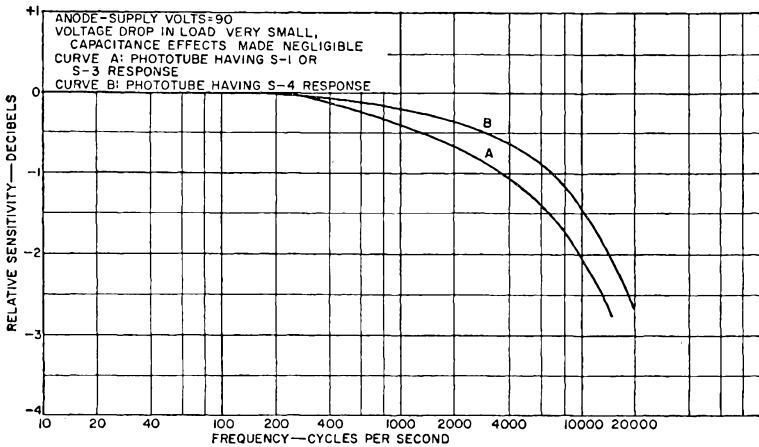

Fig. 28. Frequency response of gas-filled phototubes:  
 (a) Response of a tube having S-1 spectral response (Ag-O-Cs photocathode)  
 (b) Response of a tube having S-4 spectral response (Cs-Sb).

combination with the aperture they produced a sinusoidal variation of the light flux.

The loss in high-frequency response is chiefly the result of the transit time of the positive ions involved in the gas-amplification process. The loss of frequency response becomes more severe as the gas amplification is increased. On the other hand, when an argon-filled phototube is operated at a voltage below the ionization point for argon, it behaves very much like a vacuum phototube with no gas amplification and little loss in frequency response.

At normal operating voltage for a gas-filled phototube, the transit time of the positive ions is less than 10 microseconds. Cumulative effects of the regenerative process cause slightly longer delay times for part of the current. However, a small component of the current is delayed by too great a factor to be the result of positive-ion transit-time effects. Ordinarily, only a small percentage of the total current shows this effect. The slight falling off of the frequency-response curves (Fig. 28) near 1000 cycles per second and less which results from this effect increases as the gas amplification is increased.

Fig. 29 shows this component of the delayed current for a special gas-filled phototube designed for use in studying the mechanism of delay in gas amplification.<sup>3</sup> The very slow component of the gas-amplified photocurrent results from secondary-electron emission by metastable atoms. The transit time of metastable atoms (of the order of  $10^{-4}$  second) is governed by diffusion time and is not affected by the electric field.

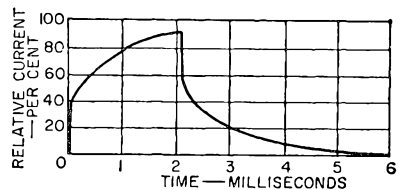

Fig. 29. Time response to a square wave flight for a special gas-filled phototube designed to emphasize the lag resulting from secondary effects of metastable argon atoms (Ref. 3).

## Noise

The gas-amplification process is not entirely noise-free because the gas ratio for an individual photoelectron is a statistically variable quantity. However, additional noise

resulting from the gas-amplification statistics is only a fraction of that which results from the random emission of electrons from the photocathode. The Equivalent Noise Input for a gas-filled phototube is nearly the same as for a vacuum phototube having equal photocathode sensitivity provided the vacuum type is followed by a noiseless amplifier having a gain equal to the gas ratio of the gas tube and a bandpass limited by the frequency-response characteristic of the gas-filled phototube. The principal advantage of the gas amplification in realizing low equivalent-noise input is to reduce the value of the load resistance for which the resistor noise is equal to the thermionic shot noise of the tube.

### Environmental Factors

The previous discussion of the effects of temperature on vacuum phototubes applies also to gas-filled phototubes. Because the number of gas molecules does not change with temperature (even though the pressure does), the gas amplification does not vary appreciably with temperature.

In other respects (shock, vibration, humidity) the behavior of the gas tube is similar to that of the vacuum phototube. However, because the positive ions bombard the photocathode during operation, the life and the stability of a gas-filled phototube are not as good as the life and stability of vacuum phototubes operated at the same current.

### Application Considerations

Gas-filled phototubes are used to best advantage in applications which exploit the simplicity of the circuit associated with the tube and the low cost with which the additional sensitivity is achieved. Because linearity and frequency response are reasonably good, gas-filled tubes may be used for a wide variety of practical applications, particularly when the more precise characteristics of the vacuum phototube are not needed. The most im-

portant use of these tubes is in motion-picture sound-on-film sensor systems for theater and home projection equipment.

It is especially important not to exceed the absolute maximum voltage and current ratings of gas-filled phototubes; excessive voltages can cause damage from ionization effects, and excessive currents can result in loss of sensitivity.

Because the gas-filled phototube does not have the flat current-voltage characteristic of the vacuum phototube, it is usually not feasible to use large load resistances without great loss in linearity of response, as shown by the current-voltage characteristic and load lines in Fig. 25. However, in special applications it is possible to use a large load resistance provided the light level is low so that the drop in voltage across the load is negligible. In fact, the maximum recommended operating point can be exceeded to advantage in such cases; the large load resistance protects the tube and circuit elements from damage in case the glow potential should be exceeded. Under very carefully controlled conditions, gas-filled phototubes can be operated at very high gas ratios (of the order of 100); however, because of the inherent instability of the tube under these conditions, such operation is normally not recommended.

In some gas-filled phototubes, there is a slight tinting of the glass envelope opposite the photocathode. This tinting, which does not materially affect tube operation, is caused by sputtering of cathode material as a result of ion bombardment during the processing and aging of the tube. Further tinting may occur during long and especially severe operation of the phototube.

### References

- <sup>1</sup> Cobine, J. D., *Gaseous Conductors*, McGraw-Hill Book Co., New York (1941)
- <sup>2</sup> Loeb, L. B., *Basic Process of Gaseous Electronics*, Univ. of Calif. Press (1955)
- <sup>3</sup> Engstrom, R. W. and Huxford, W. S., "Time Lag Analysis of the Townsend Discharge in Argon with Activated Cesium Electrodes", *Phys. Rev.*, 58 (1940)

# Multiplier Phototubes

## Construction and Principles of Operation

**A**LTHOUGH photoelectric emission is a relatively efficient process on a per-quantum basis, the primary photocurrent for low light levels is so small that special amplification techniques are required for most applications. The multiplier phototube, which uses secondary electron emission to provide current amplification in excess of  $10^6$ , is a very useful detector for low light levels.

In a multiplier phototube, the photoelectrons emitted by the photocathode are, in general, electrostatically directed to a secondary emitting surface called a dynode. When normal operating voltages are applied to the dynode, 3 to 6 secondary electrons are emitted per primary electron. These secondaries are focused to a second dynode, where the process is repeated. In addition to 6 to 14 dynodes, a multiplier phototube may contain other electrodes for focusing the electron stream, reducing space-charge effects, or accelerating the electrons to reduce transit-time effects. The last dynode is followed by an anode which collects the electrons and serves as the signal-output electrode in most applications.

### Dynode Properties

Secondary emission<sup>1-3</sup> in many respects is similar to photoelectric emission. The impact of primary electrons rather than incident photons causes the emission of electrons. One primary electron excites several low-energy secondary elec-

trons near the surface of the emitter; some reach the surface and overcome the work function (in the case of metals) or the electron affinity (for semiconductors) and escape into the vacuum. In general, the number of secondaries created increases as the primary electron energy is increased. However, the depth from which the electrons must escape also increase as the primary energy increases because of the greater primary penetration; this factor tends to reduce the number of secondaries at higher dynode voltages.

Fig. 30<sup>4</sup> shows the number of emitted secondary electrons  $\delta$  per primary electron (secondary emission coefficient) as a function of the energy of the primary electrons for a number of practical dynode materials. The same general pattern is observed for metals, but the yield is insufficient for use in multiplier phototubes.

An important property of the secondary electrons is the energy distribution of the emitted secondaries. A typical distribution curve is shown in Fig. 31. The peak at the extreme right corresponds to the energy of the primary electrons, and probably represents elastically scattered primary electrons. The true secondaries are represented by the peak at the left. Although the spread of secondary-electron velocities of good secondary emitters is generally much less than that shown in Fig. 31, it is nevertheless large in comparison with that of the photoelectron velocities. This velocity spread dictates to some extent the type of electron optics needed for efficient utilization of the secondary electrons.



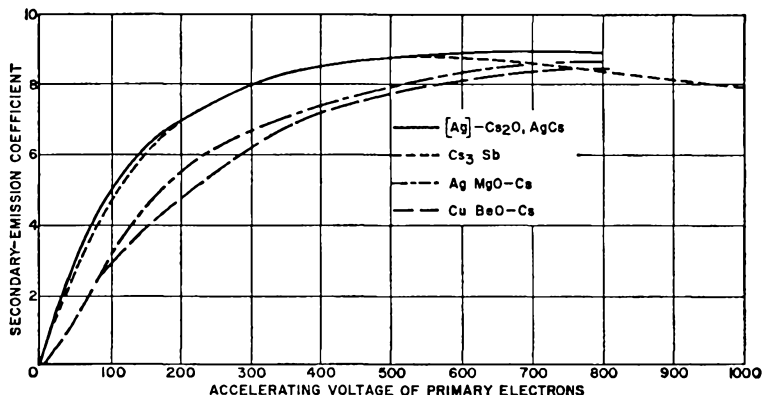

Fig. 30. Secondary emission coefficient for a number of dynode materials.

The materials silver-oxygen-cesium ( $Ag-O-Cs$ ) and cesium-antimony ( $Cs_3Sb$ ) used in the photocathodes of phototubes having spectral responses of S-1 and S-4 are also useful as secondary emitters. They are practical from a manufacturing standpoint because the activation process is nearly identical to that used in the production of the corresponding photocathode. However, it is very difficult to produce both the cesium-antimony and the silver-oxygen-cesium emitters in the same envelope. Furthermore, because of the generally high dark

emission and instability of the  $Ag-O-Cs$  surface, it is no longer used commercially.

The  $Cs_3Sb$  emitter has the highest secondary emission of the materials in the practical working range near 100 volts. This material, however, has certain limitations: it cannot tolerate exposure to air, it is damaged by temperatures in excess of 75 degrees centigrade, and it does not have stable characteristics when subjected to current densities in excess of approximately 100 microamperes per square centimeter. During manufacture, the cesium-

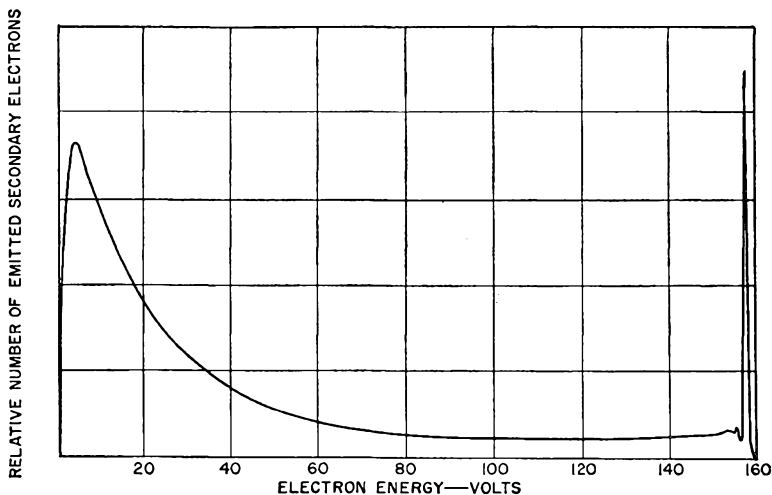

Fig. 31. Typical secondary-electron energy distribution<sup>4</sup> for a silver target: primary electron energy is approximately 150 volts.

antimony dynode requires a slightly different technique to achieve optimum secondary emission and stability than does the cesium-antimony photocathode. Although this difference is not of major consequence, the result is that on the average the photocathode sensitivity in tubes having cesium-antimony dynodes is slightly less than that achieved with certain other combinations.

A very practical secondary emitter can be made from an oxidized silver-magnesium alloy containing approximately 2 per cent of magnesium. Oxidation by means of low-pressure water vapor or carbon dioxide produces a concentration of MgO on the surface which does not occur when the alloy is heated in oxygen directly (probably because the large H<sub>2</sub>O or CO<sub>2</sub> molecules do not diffuse as far into the surface, and therefore Mg migrates to the surface before oxidation). When cesium vapor is present during the processing of multiplier photocathodes, it has the further benefit of increasing the secondary-emission ratio.<sup>6-7</sup> Although Ag-Mg-O dynodes do not have as high a secondary-emission ratio as Cs<sub>3</sub>Sb dynodes, the material is easily processed and is more stable at relatively high currents. In addition, it can tolerate higher temperatures, and can be out-gassed at higher temperatures during exhaust. This surface has a low thermionic background emission, which is important in applications requiring detection of low-level light. Without the cesium activation, the oxygen-activated silver-magnesium layer is used in demountable systems for detecting ions and other particles.

A material with characteristics similar to those of Ag-Mg-O can be formed from an oxidized layer of copper-beryllium alloy<sup>8</sup> in which the beryllium component is about 2 per cent of the alloy. Oxidation of the beryllium is accomplished in a manner similar to that used to oxidize the magnesium in the Ag-Mg emitter; secondary emission is enhanced by the bake-out in cesium vapor.

Secondary emission and stability are similar to those of the Ag-Mg-O dynode, although copper-beryllium has some advantages in ease of handling and dynode manufacture.

### Dynode Configurations

One of the primary problems of design in a multiplier phototube is the shaping and positioning of the dynodes (usually in a recurrent geometrical pattern) so that all stages are properly utilized and no electrons are lost to support structures in the tube or deflected in other ways. Although it is not necessary that the electrons come to a sharp focus on each succeeding stage, the shape of the fields should be such that electrons tend to return to a center location on the next dynode, even though the emission point is not at the optimum location of the preceding dynode. If this requirement is not met, the electrons increasingly diverge from the center of the dynode in each successive dynode stage. This effect in turn leads to skipping of stages and loss of gain. Magnetic fields may be combined with electrostatic fields to provide the required electron optics, although today most multiplier phototubes are electrostatically focused.

A number of different dynode configurations (See Figs. 32 and 33) are used in multiplier phototubes. The circular arrangement of dynodes of the 931A and similar types permits a compact layout, but allows little flexibility in adding dynodes beyond the circle; however, fewer than the full circle of nine dynodes can be used. The collection between stages and the transit-time dispersion is remarkably good for the circular cage which was one of the earliest systems developed.<sup>9</sup>

The Rajchman linear-dynode structure<sup>10</sup> (as in type 6810A) provides a good recurrent-field system, although the dynode shapes are rather complex. This design is further complicated by a curvature not

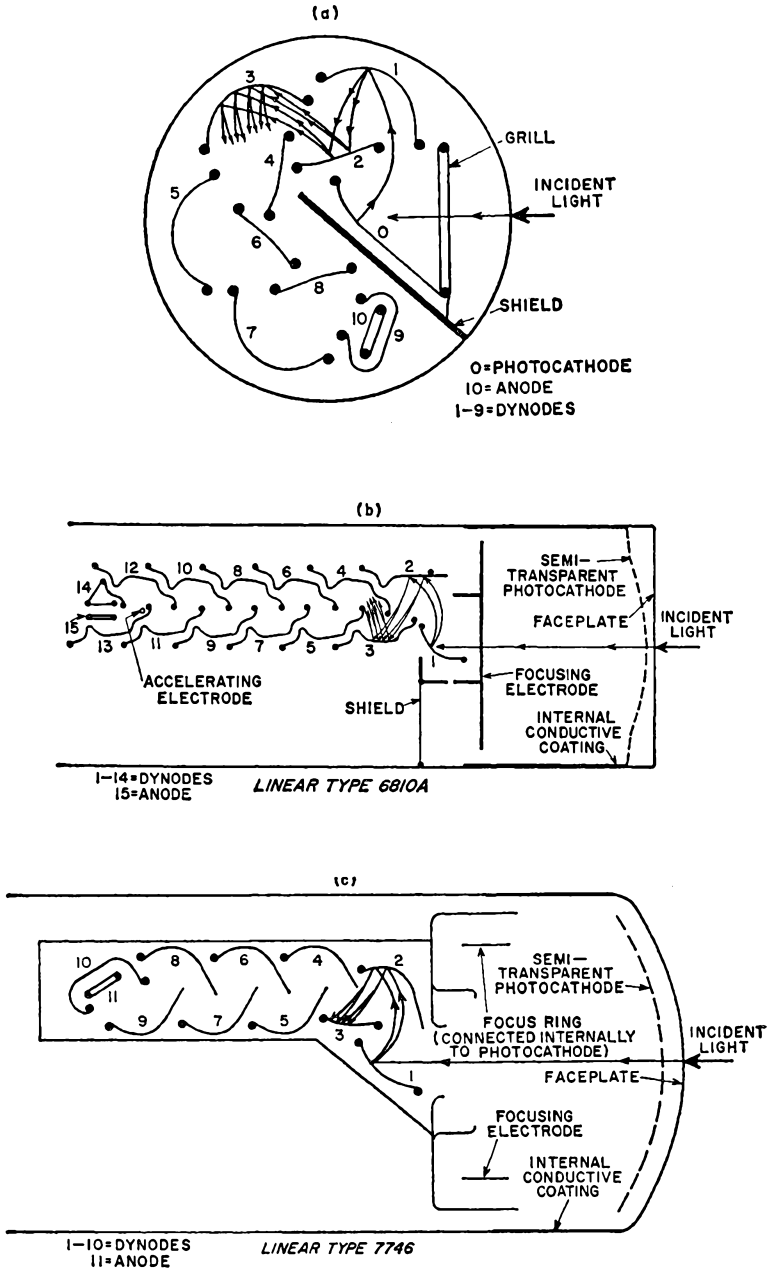

Fig. 32. Various dynode configurations in general use: (A) circular-cage type. (B) and (C) linear types.

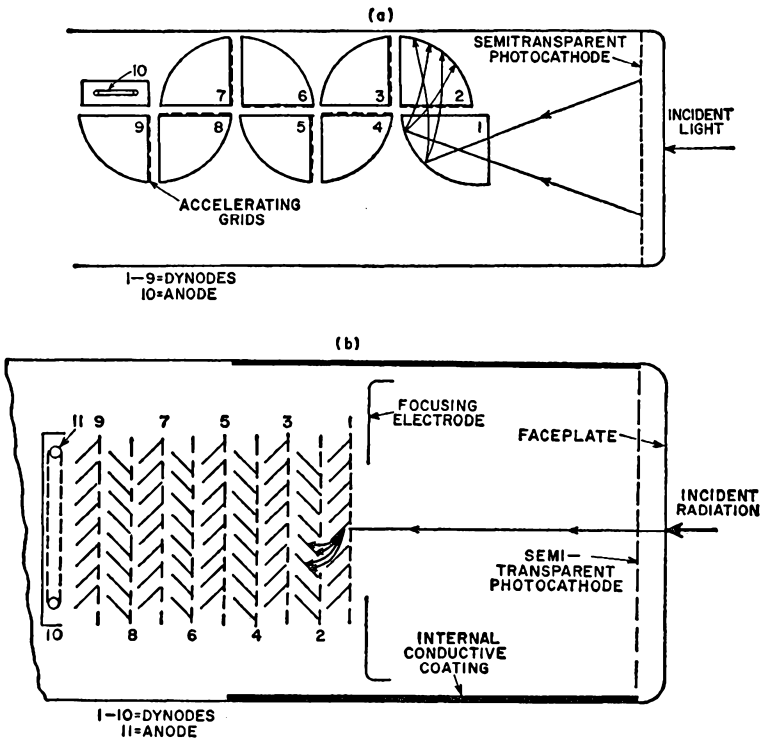

Fig. 33. Various dynode configurations in general use: (A) box type. (B) venetian-blind type.

only as shown in the drawing, but also at right angles to the plane of the drawing. This curvature provides a focusing field which maintains the electron stream near the middle of the dynode structure and prevents bombardment of the supporting spacers at the edges of the dynodes. For this reason, a larger number of dynodes can be used successfully without problems caused by lateral spreading of the electron stream. In general, linear-style dynode systems have good transit-time characteristics because of the focusing properties and the good withdrawal fields at the dynode surface.

Although focused-dynode arrays have a minimum of stray electrons between stages, the acceptance area of the first stage is generally small. If the first stage is used as a cath-

ode, as in the 931A, the cathode area is too small for many applications.

Box-type dynodes provide very efficient collection of electrons between boxes, except for losses to the grid wire. However, because of the lack of specific focusing properties and the wide variation in withdrawal fields, the dynodes do not provide a good transit-time dispersion characteristic.

The venetian-blind type of dynode (as in type 8053) can be coupled simply and in a relatively small space. More dynodes can easily be added to the chain if the system is opaque to feedback either by light or by ions. A disadvantage of this type of focusing is the rather low value of electric field at the emitting surfaces, which results in relatively large transit-time dispersion. Some

electrons are lost from one dynode to the next because of the low withdrawal field, and some electrons are lost to the wire grid used to prevent field interaction between dynodes.

At the present time, the transmission type of dynode is only used experimentally in multiplier phototubes. The dynode is a thin membrane on which primary electrons impinge from one side and secondary electrons are emitted from the other. Dynodes are mounted in closely spaced parallel planes. For this reason, the transit time and transit-time spread can be made very small. Transmission secondary-emission dynodes are not practical for ordinary applications because of the difficulty and expense of construction and because present dynodes have very poor life at ordinary current levels.

### Coupling Dynode System To Cathode

One of the design problems of a dynode system is the coupling of the recurrent dynode chain to the photocathode. In the circular-cage type, the first stage of the circle serves as cathode (type 931A); however, for many applications this limited-area cathode is too small. In scintillation counting, it is desirable to have relatively large flat photocathodes at the end of the tube for efficient coupling of the tube to the scintillation crystal. When the first stage of the circular cage is used as a dynode, as it is in the 6342A, the effective size of the first dynode is critically small for collecting all the electrons from the photocathode.

In the linear-cage type (type 6810A), the problem is increased by the requirement of housing the whole assembly in an axial configuration. In this case the first dynode is at an angle which presents almost a minimum of projected area to the photocathode.

The venetian-blind type of dynode is well suited to the design of

a multiplier phototube for scintillation counting because it can be mounted parallel to the photocathode and has a relatively large acceptance area. This arrangement permits the design of tubes having larger photocathodes (8054) and good collection efficiency at the first dynode.

### Design For Minimum Transit-Time Spread

When a tube is required for scintillation-counting applications in which a minimum transit-time spread is desired, the venetian blind dynode is not suitable. Matheson<sup>11</sup> has designed a special focused cage structure designed to solve both the problem of high speed and the problem of good collection. In this design (type 7746), the front end of the cage deviates from a strictly linear construction to present a large effective area for the collection of photoelectrons on the first dynode.

The ideal arrangement should also provide for equal transit time for all photoelectrons to the first dynode. Fig. 34 also shows the Matheson<sup>12</sup> solution to this problem: a curved cathode and annular rings just above the first dynode to correct and shape the potential field between the cathode and first dynode.

A multiplier phototube devised by G. A. Morton, R. M. Matheson, and M. H. Greenblatt<sup>11</sup> provides minimum interdynode transit-time spread; accelerator electrodes placed between dynodes, as shown in Fig. 35, are connected to a highly positive potential. The proximity of the high voltage provides a large withdrawal field for the electrons, and although they are slowed down after passing the accelerator electrode, the transit time and transit-time spread are very short.

The output sections of some multiplier phototubes have special terminals for very high-speed pulse counting and analysis. The construction may be specially designed to

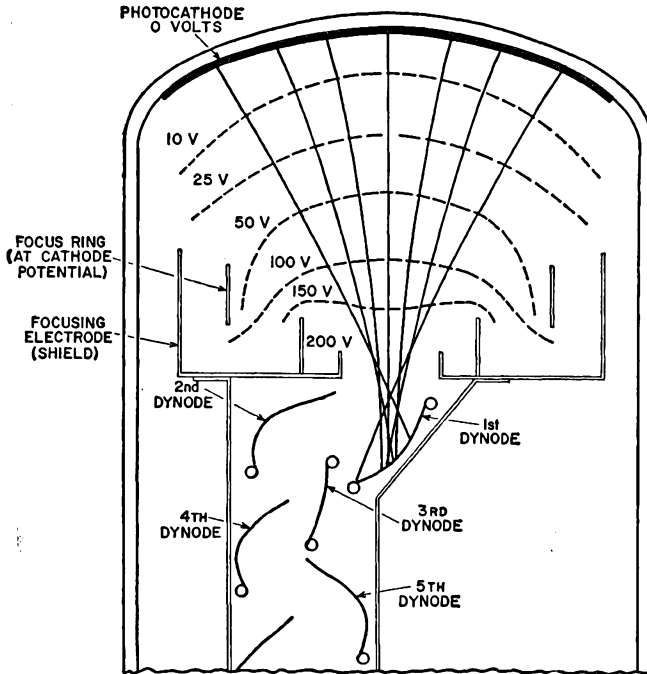

Fig. 34. Matheson-type front-end configuration showing equipotential lines and electron trajectories feeding into a modified linear-type dynode cage which exposes more of the first dynode area to the photoelectron stream.

provide a maximum pulse current before space-charge limits the response of the tube.

## Properties of Multiplier Phototubes

### Gain Characteristics

When several secondary-emission stages are coupled together, so that the secondary electrons from one become the primary electrons of the next, the total gain  $\mu$  of the multiplier phototubes is given by

$$\mu = \delta^n \quad (26)$$

where  $\delta$  is the secondary emission per stage (assumed to be equal for each stage) and  $n$  is the number of stages. It is also assumed in this expression that all the secondary electrons are collected at the next stage.

In practice, some of the electrons may skip stages, or become lost to the amplification process by impinging upon nonproductive secondary-emission areas.

It is customary to describe the gain of the multiplier phototube as a function of the applied voltage. Fig. 36 shows two such curves on a semilog scale. These curves illustrate the wide range of amplification in a multiplier phototube. They also indicate the necessity of providing a well regulated voltage supply for the dynode stages.

It is possible to operate a multiplier phototube so that each stage is at the voltage required for maximum secondary emission, as shown in Fig. 31. In such cases, the gain could be made practically independent of voltage over a small range. However, such a condition would require approximately 500 volts per stage; thus the total volt-

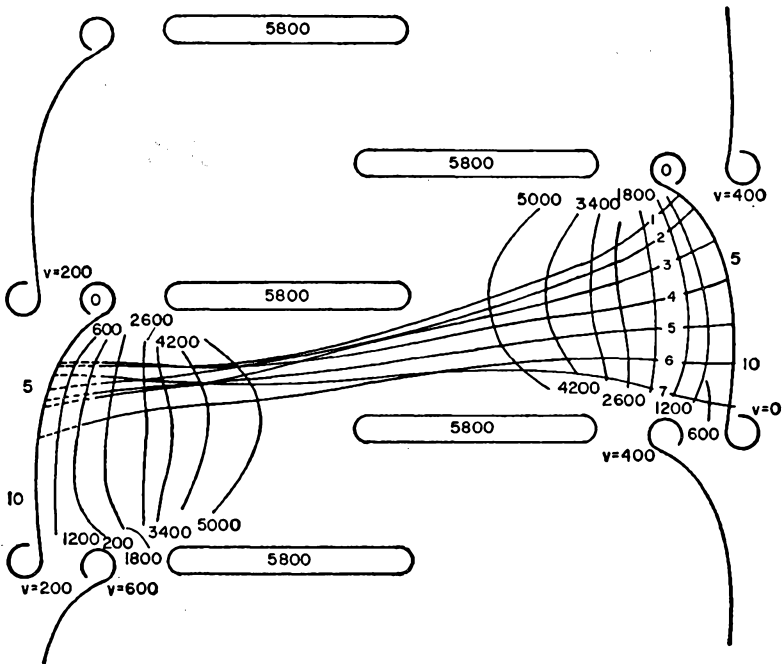

Fig. 35. Interdynode accelerator-electrode system designed by G. A. Morton to provide minimum transit-time spread.

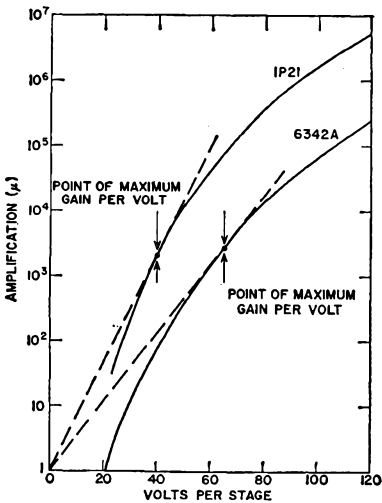

Fig. 36. Log of gain as a function of volts per stage for a tube (IP21) with Cs-Sb dynodes and for a tube (6342A) with Cu-Be dynodes.

age required would be very high for the amount of gain achieved.

In the design or operation of a multiplier phototube having a fixed supply voltage, the number of stages can be chosen so that the gain of the tube is maximum. For this purpose, the optimum voltage per stage is that value at which a line through the origin (unity gain on the log-gain scale) is tangent to the curve, as shown in Fig. 36. This point is identified on the graph as the point of maximum gain per volt. (Note that this argument neglects the voltage used between the last dynode and the anode and any discrepancy resulting from nonuniform distribution of voltage per stage.) In most applications of multiplier phototubes, the tubes are operated above the point of maximum gain per volt. It is customary to present tube data with both the gain and the voltage on a logarithmic scale; over the normal range of operation the resultant

curve is then closely approximated by a straight line.

### Spectral Response

Photocathodes developed for diode phototubes are also used in multiplier phototubes. Photoelectrons emitted from the photocathode are directed to the first dynode of the tube instead of to the anode as in a photodiode. However, several special photocathodes which are rarely used in photodiodes have been used in multiplier phototubes.

Cathodes of the transmission type are often used in multiplier phototubes, in contrast with the opaque type used in most photodiodes. A transmission-type photocathode is one in which a semi-transparent layer is applied to the inside surface of the envelope window. Light impinges on the outer (glass) side of the photocathode, and electrons are emitted on the inner or vacuum side. The vacuum-evaporation and processing of a transmission-type cathode require careful control to achieve uniformity and high sensitivity. The most common transmission-type photocathode is made of antimony and cesium, the same elements used for the opaque photocathode in tubes having an S-4 spectral response. During the processing of the tube, antimony is vacuum-evaporated onto the inner surface of the window. A metallic substrate is often put on the window first to improve the conductivity of the photocathode or to facilitate the activation process. The antimony is usually evaporated from a heated filament pre-beaded with antimony; the beads are positioned to provide a uniform layer of antimony. The thickness of the evaporated layer is usually monitored photoelectrically by measurement of the transmission of light through the layer during the evaporation procedure. After the antimony is evaporated, cesium vapor is allowed to react with the antimony. The resultant photocathode has a chemical composition of approximately  $Cs_3Sb$ .

The first transmission-type cesium antimony cathodes were used in tubes having a spectral response designated as S-9. Later, when tubes began to be used in scintillation-counting applications, the processing was modified to increase the blue sensitivity of the cathode because scintillators typically have a blue emission. This modified response was designated S-11; both response characteristics are shown in Fig. 37.

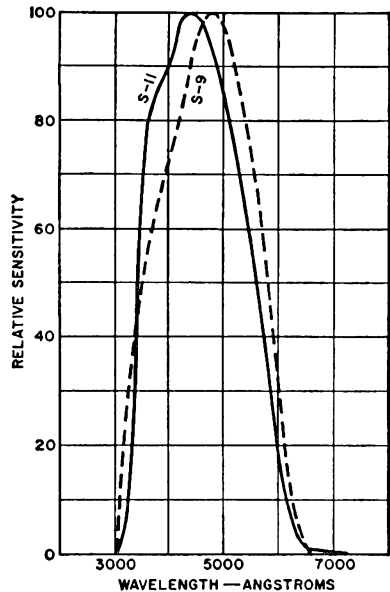

Fig. 37. Comparison of the S-9 and S-11 spectral response characteristics. Both curves are for transmission-type cesium-antimony photocathodes. The S-11 response was evolved to provide maximum blue response for scintillation counting.

The principal difference in processing which results in the S-11 response is the use of a thinner layer of antimony. A photocathode layer of  $Cs_3Sb$  tends to absorb blue light and transmit red, as shown in Fig. 38. Two effects combine to explain the dependence of the spectral characteristic on the thickness of the photocathode. (1) As the thickness



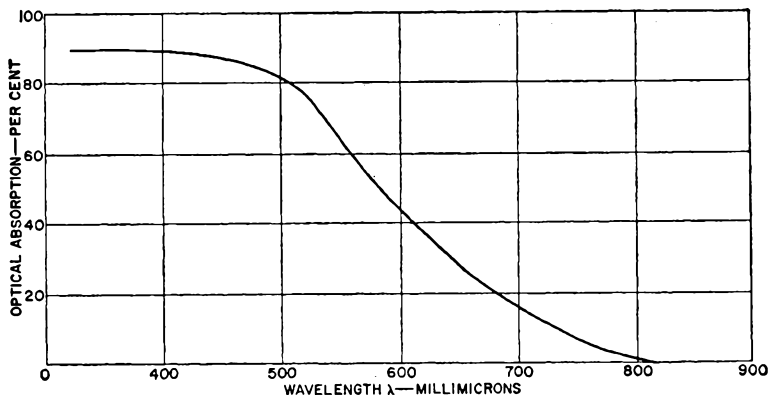

Fig. 38. Optical absorption of  $Cs_3Sb$  layer having a typical S-11 spectral response.

of the cathode is increased, more light is absorbed; this increased absorption tends to increase the sensitivity in direct proportion. (2) As the thickness is increased, the photoelectrons must emerge from a greater depth to escape into the vacuum; this effect tends to reduce photoemission because of the absorption of photoelectrons. The spectral-response characteristic S-9 was evolved for use with a typical tungsten light source. The resulting rather thick surface provided better response at the red end of the spectrum. A compromise to a thinner cathode improved the blue response (S-11) with the loss of some red response.

Two transmission-type photocathodes of importance, particularly in the red region of the spectrum, are the bismuth-silver-oxygen-cesium (Bi-Ag-O-Cs) cathode used in tubes having S-10 spectral response, and the multialkali  $[(Cs)Na_2KSb]$  cathode, used in tubes having S-20 spectral response. These spectral-response characteristics are shown in Fig. 39.

The semitransparent Bi-Ag-O-Cs cathode is prepared by first evaporating a thin layer of bismuth and then a thin layer of silver. The silver is then oxidized, and cesium vapor is allowed to react with the layer.

The multialkali photocathode<sup>18</sup> is very difficult to process to uniformly high sensitivity. The process is complicated and involves alternate treatment with evaporated antimony and alkali vapors. The resultant photocathode is the most sensitive known for the region from the ultraviolet to the red end of the spectrum. However, compared with the cesium-antimony photocathode, the multi-alkali photocathode has only a slight advantage in the blue region.

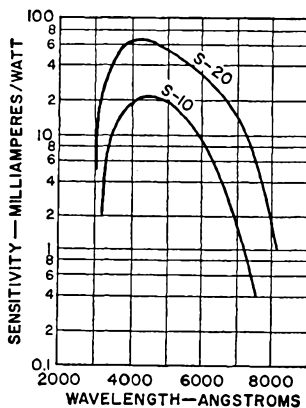

Fig. 39. Spectral response characteristics for S-10 (Bi-Ag-O-Cs photocathode) and S-20  $[(Cs)Na_2KSb]$  photocathode.

The **bialkali photocathode** ( $\text{Na}_2\text{KSb}$ ) also deserves mention although at the present time its use is only experimental. The  $\text{Na}_2\text{KSb}$  cathode has a spectral response (tentatively identified as S-24) similar to the S-11 (See Fig. 40), but has the advantage of a lower thermionic emission at room temperature of the order of  $10^{-16}$  amperes per square centimeter. In fact, some data have indicated values as low as  $10^{-19}$  amperes per square centimeter. Another advantage of the  $\text{Na}_2\text{KSb}$  cathode is its ability to withstand somewhat higher temperatures than other cathodes; it can be used to about 100 degrees centigrade. The bialkali cathode promises to be useful as a cathode for low-energy scintillation counting because of its good blue sensitivity and very low dark current.

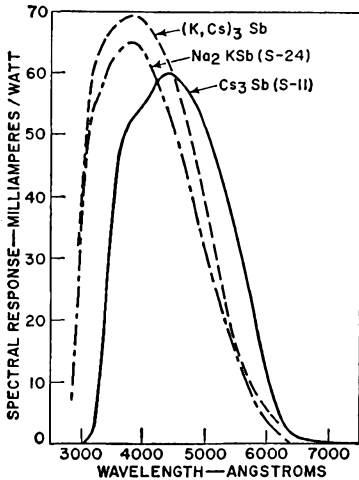

Fig. 40. Comparison of the absolute spectral sensitivities of three antimony alkali photocathodes:  $\text{Cs}_3\text{Sb}$ ,  $\text{Na}_2\text{KSb}$ , and  $(\text{K,Cs})_3\text{Sb}$ . The S-11 curve shown is representative of the cathode on type 8053; the S-24 and  $(\text{K,Cs})_3\text{Sb}$  curves are tentative.

Another two-alkali antimony cathode has recently been announced by A. H. Sommer,  $(\text{K,Cs})_3\text{Sb}$ . Although its properties have not been thoroughly explored, it is apparent that it has high blue sensitivity and

low dark current. Its tentative spectral response is also given in Fig 40. At the present time, it seems that the most promising application is in scintillation counting, perhaps for low energy work, although the dark current and temperature characteristics may not be quite as promising as the  $\text{Na}_2\text{KSb}$  cathode.

As in vacuum photodiodes, the spectral response of multiplier phototubes is generally limited in the ultraviolet region by the type of window used in the device, as shown in Fig. 19. Fig. 41 compares the spectral responses of multiplier phototubes having several photocathode-window combinations.

In recent years, considerable developmental effort has been expended on cathodes made of the following materials:  $\text{Cs}_2\text{Te}$ ,  $\text{Rb}_2\text{Te}$ , and  $\text{CsI}$  and  $\text{CuI}$ . All of these cathode materials are useful in the ultraviolet region, particularly because of their lack of sensitivity in the longer wavelength region. They are generally combined with a window made of a material such as  $\text{LiF}$  or sapphire.

The only photocathode useful in the infrared region is the silver-oxygen-cesium ( $\text{Ag-O-Cs}$ ) cathode used in tubes having S-1 response, as shown in Fig. 18. For wavelengths longer than 8000 angstroms to its limit of response, about 11000 angstroms, it is the most sensitive photocathode.

Some multiplier phototubes have photosensitive dynodes— $\text{Cs-Sb}$ , for example. When the transmission-type cathode is quite thin, as in the case of  $\text{Cs-Sb}$  photocathodes used in tubes having S-11 response, transmitted light may strike the first dynode and cause the emission of photoelectrons. This effect is of second order because photoelectrons emitted from the first dynode do not have the benefit of multiplication by the secondary emission from the first dynode; nevertheless, the effect is observable. The increase in sensitivity occurs primarily at the red end of the spectrum, where the transmission of the photocathode is

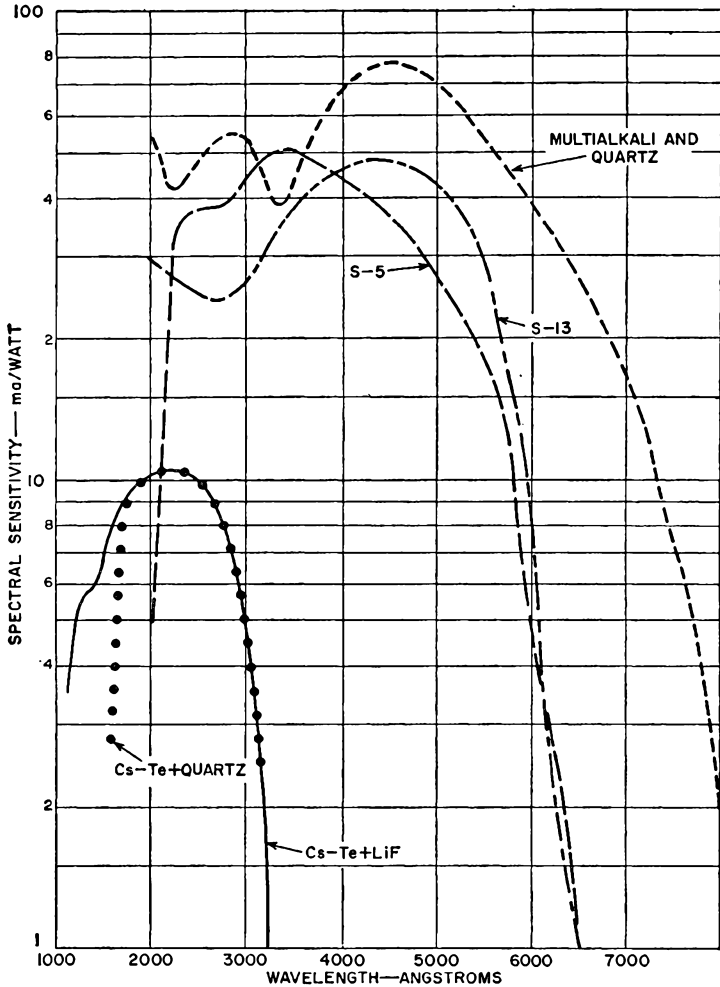

Fig. 41. Spectral response characteristics of various photocathode-window combinations useful for the ultraviolet: S-5 (Cs-Sb with 9741 glass); S-13 (transmission type Cs-Sb with quartz); Cs-Te with quartz; Cs-Te with LiF window; multialkali with quartz.

greatest. In the blue region, which is most important in scintillation counting, the maximum effect is of the order of 2.5 per cent (assuming 10 per cent transmission, identical cathode and first-dynode sensitivity, and a secondary-emission ratio at the first dynode of 4:1). The effect would be negligible for dynodes made of silver-magnesium or copper-beryllium.

The spectral response of a phototube is somewhat sensitive to

the angle of incidence of light on the cathode. The effect is complicated, but to a first approximation it is possible to explain the increased red sensitivity with angle of incidence in tubes having S-11 response (shown in Fig. 42) by the increased absorption of red light with greater angle of incidence.

The effect of temperature on spectral response is minor and occurs primarily in the red region of the spectrum,<sup>4</sup> as shown in Fig. 43.

At higher temperatures, the distribution of electrons in the semiconductor photocathode is shifted to higher energy levels and, consequently, more electrons are emitted by the near-threshold energy radiation.

### Dark Current

Even though a multiplier phototube is in complete darkness, electron currents may be observed to flow from dynode to dynode. These currents increase in magnitude toward the anode end of the tube since any electron component of the dark

current is amplified in the same way as the photo-originated electrons. Usually, only the dark current in the anode circuit of the tube is of importance to the observer. This anode dark current is described in this section as the "dark current" of the multiplier phototube.

The dark current and the resulting noise of the multiplier phototube is of particular concern because it is usually the critical factor in limiting the lower level of light detection. It is important to understand the variation of dark current in the multiplier phototube as a function of various parameters, in

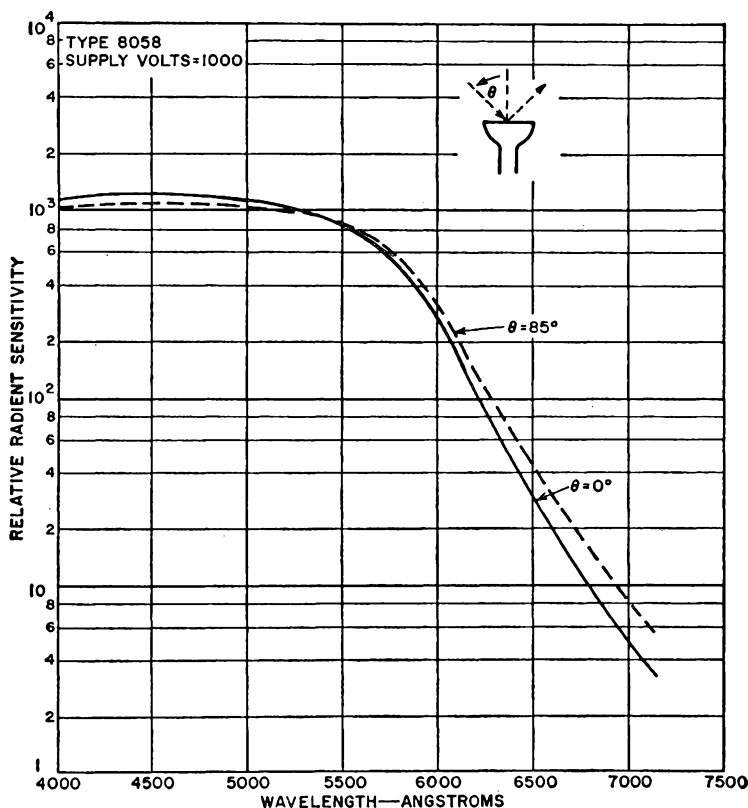

Fig. 42. Spectral-response characteristics for a Cs-Sb transmission-type photocathode (S-11) for two different incident angles of radiation. The increased red response for the large angle of incidence may be explained in part by the increase in absorption due to the longer path; compare the absorption characteristic shown in Fig. 38.

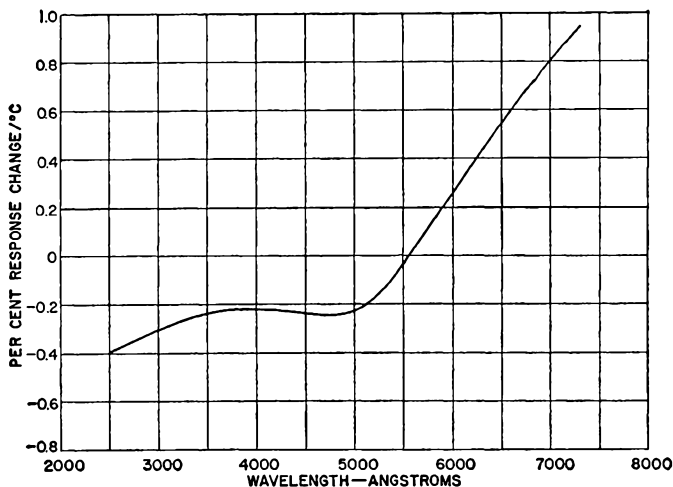

Fig. 43. Temperature coefficient of Cs-Sb cathodes as a function of wavelength; data taken at 20 degrees centigrade. Note the large positive effect near the threshold.

order to realize the ultimate in low-light-level detection. Although all of the peculiarities of dark-current production in the multiplier phototube are not well understood, the possible sources of dark current are described below:

Dark current in a multiplier phototube may be categorized by origin into three types: ohmic leakage, dark or "thermionic" emission of electrons from the cathode and other elements of the tube, and regenerative effects.

Ohmic leakage, which results from the imperfect insulating properties of the glass stem, the supporting members, or the plastic base, is always present. This type of leakage is usually negligible, but in some tubes it may become excessive because of the presence of residual metals used in the processing of the photocathode or the dynodes. Condensation of water vapor, dirt, or grease on the outside of the tube may increase ohmic leakage beyond reasonable limits. Simple precautions are usually sufficient to eliminate this sort of leakage. In unfavorable environmental conditions, however, it may be necessary to coat the base of the tube with moisture-resisting materials, which

may also prevent external arc-overs resulting from high voltage.

Ohmic leakage is the predominant source of dark current at low-voltage operating condition. It can be identified by its proportionality with applied voltage. At higher voltages, ohmic leakage is obscured by other sources of dark current.

Fig. 44 shows the typical variation of dark current of a multiplier phototube as a function of applied voltage. Note that in the mid-range of voltage, the dark current follows the gain characteristic of the tube. The source of the gain-proportional dark current is the dark or thermionic emission of electrons from the photocathode and the first-dynode stage. Because each electron emitted from the photocathode is multiplied by the secondary-emission gain of the tube, the result is a unipotential output pulse having a magnitude equal to the charge of one electron multiplied by the gain of the tube. (There are statistical amplitude variations which will be discussed later.) Because the emission of thermionic electrons is random in time, the output dark current consists of random unidirectional pulses. The time average of these pulses, which may be measured on a dc

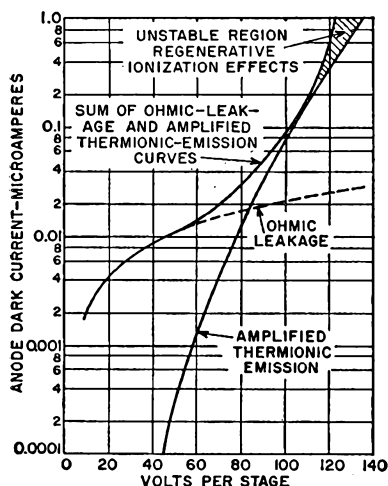

Fig. 44. Typical variation of dark current with voltage for a multiplier phototube.

meter, is usually the principal dc component of the dark current at normal operating voltages. The limitation to the measurement of very low light levels is the variable character of the thermionic dark-current component. It is not possible to balance out this wide-band noise component of the multiplier phototube, as it might be to balance out a steady ohmic-leakage current. Nevertheless, it is usually advantageous

to operate the multiplier phototube in the range where the thermionic component is dominant. In this range, the relationship between sensitivity and noise is fairly constant as the voltage is increased because both the photoelectric emission and the thermionic emission are amplified by the same amount.

At higher dynode voltages, a regenerative type of dark current develops, as shown in Fig. 44. The dark current becomes very erratic, and may at times increase to the practical limitations of the circuit. Continued flow of large dark currents may cause damage to the sensitized surfaces. Some possible causes of the regenerative behavior will be discussed in more detail later. All multiplier phototubes eventually become unstable as the gain is increased.

The best operating range can generally be predicted from a consideration of the ratio of the dark current to the output sensitivity of the tube. This ratio, known as the equivalent anode-dark-current input (EADCI), is shown as a function of luminous sensitivity in Fig. 45. The EADCI is equivalent to the light flux on the photocathode which would result in an output-current change equal to the dark current observed. If thermionic emission

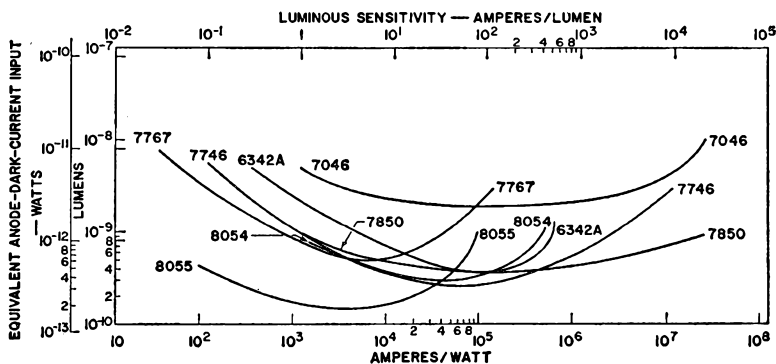

Fig. 45. "Equivalent anode dark current input" as a function of the luminous sensitivity for various multiplier phototubes. The Equivalent Anode Dark Current Input represents the light flux which would result in an output current change just equal to the dark current. Optimum operating range is usually where this function is near a minimum.

were the sole source of dark current, the EADCI would be a horizontal line on the graph. In some tubes a regenerative condition sets in before the really flat operating region has been attained.

As may be expected, the thermionic component of the dark current is very much a function of the temperature. Fig. 46 shows the temperature variation of the equivalent of the dark current at the photocathode (anode dark current divided by gain) per unit cathode area. The data for this figure were obtained from a number of tubes having well defined (flat) minima of the EADCI curves. In some cases, the photocathode equivalent of the output dark current was derived from noise measurements because of the difficulty of separating the leakage from the electronic component of dark current at low temperatures. (The relation between thermionic emission and noise is discussed later.) The data shown in Fig. 46 represent the actual dark emission per unit area associated with particular photocathode types rather than with particular tubes. Because of the manner in which the data

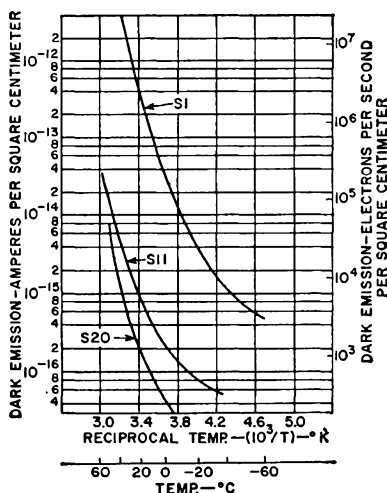

Fig. 46. Temperature variation of dark current for multiplier phototubes in the manner of a Richardson plot.

were compiled, the thermionic emission shown is probably representative of the best achievable at the present state of the art.

The variation of dark current or noise with temperature is most important for ultimate low-light-level sensitivity. Various cryostats have been designed to take advantage of the reduced noise at low temperature.<sup>15</sup> An important practical consideration at low temperatures is the prevention of condensation of moisture on the window. In a Dewar-type arrangement, condensation is not a problem; in simpler set-ups moisture condensation may be prevented by a controlled low-humidity atmosphere at the external window.

In most multiplier phototubes, the electrostatic potential of the walls surrounding the photocathode and dynode-cage region is important particularly with respect to the onset of the regenerative dark-current component. The bulb wall can be maintained near photocathode potential if the bulb is wrapped or painted with a metallic coating maintained at cathode potential; the connection of the metallic coating to the cathode is usually made through a high impedance to avoid shock hazard. A positive potential on the bulb wall can cause noisy operation. Even though the bulb is not connected to a positive potential, the proximity of a shield or container at positive potential may lead to the development of a positive charge. Fig. 47 shows the effect of various bulb-shield potentials on the dark noise. This effect may not be observed for all tubes and all types, but should be recognized as a possible source of increased noise.

Excess noise or dark current is often accompanied by fluorescent effects on the inner surface of the bulb. When the potential of the bulb is positive, stray electrons attracted to the bulb cause the emission of light on impact, depending on the nature of the glass surface and the presence of contamination. Secondary electrons resulting from the impact of the stray electrons on the

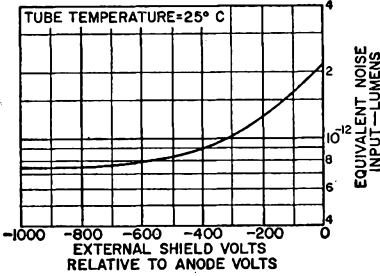

Fig. 47. Effect of external-shield potential on the noise of a 1P21 multiplier phototube. Note the desirability of maintaining a negative bulb potential.

glass surface are collected by the most positive elements in the tube and help maintain the positive potential of the inner surface of the glass. Under these circumstances, it is possible to observe the formation of glowing spots on the inside of the glass bulb, provided the eye is dark-adapted and the applied voltage is sufficiently high. Some of this emitted light may reflect back to the cathode and cause regenerative dark current.

Other surfaces within the multiplier phototube are also important in the control of regenerative dark current. In the 6342A, for example, the focus-shield potential shows a point of distinct noise minimum,<sup>16</sup> as shown in Fig. 48. The mechanism of this behavior is not understood at present.

Another phenomenon which deserves mention in connection with dark current is the effect of previous exposure to light. If a photocathode is exposed to strong light, with or without an applied voltage, a measurement made immediately afterward shows a higher-than-normal dark current which decreases rapidly with time. The effect is more marked when the exposure is richer in short-wavelength radiation. Very long periods are required to attain the low dark current associated with equilibrium, as shown in Fig. 49.

An analysis of the rate of decay of the dark emission suggests the following reciprocal relationship:

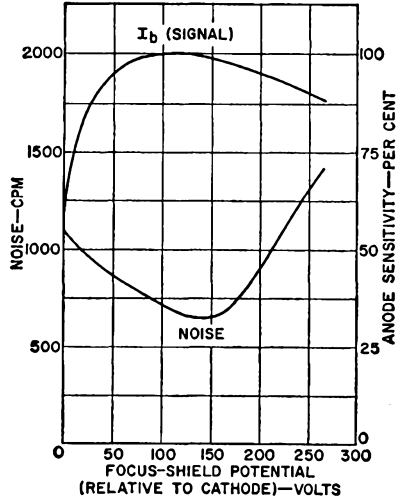

Fig. 48. Typical variation of noise output of a 6342A multiplier phototube as a function of focus-shield potential. Also indicated is the output signal current showing how only a minimum loss in signal sensitivity results from a choice of shield potential which minimizes noise.

$$i_d = \frac{a}{1 + bt} + i_0 \quad (27)$$

where  $i_d$  is dark emission as a function of time,  $a$  and  $b$  are constants,  $t$  is time, and  $i_0$  is the constant level of dark emission. However, the significance of this relationship is not apparent at present. It is possible that the heavy initial exposure to

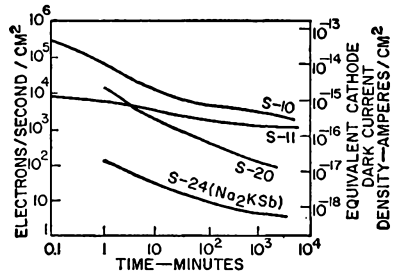

Fig. 49. Variation of dark current following exposure of cathode to cool-white fluorescent-lamp radiation. The various cathodes are identified by their spectral-response symbols.



light alters the Fermi level of the photocathode as a result of the introduction of excited states and that the photocathode then decays to its initial state. For best operation and low noise, therefore, it is recommended that the photocathode be kept dark at all times, or at least for many hours before making low-level measurements.

**Origins of Dark Current.** In a metal, the electrons which escape as thermionic emission are generally from the top of the conduction band (see Fig. 1). Thus, the work function for photoemission and thermionic emission is the same. Thermionic emission as a function of work function  $\phi$  in volts and temperature  $T$  in degrees Kelvin is given by the familiar Richardson equation:

$$j = \frac{4\pi emk^2 T^2}{h^3} e^{-\phi e/kT} \quad (28)$$

where  $j$  is the thermionic current density;  $e$ , the electron charge;  $m$ , the electron mass;  $k$ , Boltzman's constant; and  $h$ , Planck's constant. In MKS units, the equation becomes

$$j = 1.2 \times 10^6 T^2 e^{-\phi e/kT} \quad (29)$$

For semiconductor photocathodes, the work functions of photoemission and thermionic emission may be quite different. The work function for photoemission (see Fig. 5) is the potential height from the top of the valence band to the vacuum level, or  $E_a$  (the electron affinity) plus  $E_g$  (the forbidden gap, i.e., the separation of valence and conduction bands). For an intrinsic semiconductor, thermionic emission originates from the valence band, as does photoemission but the "work function" is not the same as for photoemission. In the case of an intrinsic semiconductor, thermionic-emission density can be expressed as

$$j = \frac{4\pi emk^2 T^2}{h^3} e^{-\left(E_a + \frac{E_g}{2}\right) e/kT} \quad (30)$$

For an excess impurity semiconductor where thermionic emission originates from the impurity centers, the equation for thermionic emission is written as follows:

$$j = \frac{4\pi emk^2 T^2}{h^3} n_0^{1/2} \frac{h^{3/2}}{(2\pi mkT)^{3/4}} e^{-\frac{(E_a + R/2) e}{kT}} \quad (31)$$

where  $n_0$  is the impurity concentration and  $R$  is the depth below the conduction band to the impurity level.<sup>17</sup> Photoemission still originates primarily from the valence band.

In Fig. 46, the slope of the curve of cathode dark current as a function of reciprocal temperature has approximately the magnitude predicted, but it is difficult to explain the change in slope. Perhaps there are "islands" of different impurity level or concentration, or it may be that the impurity concentration is a function of temperature. Exposure to temperatures above the normal operating range sometimes results in permanent reduction in dark current.

Another source of dark emission from the photocathode results from radioactive elements in the tube or surroundings which cause scintillations in the glass envelope of the tube. For example, it is very difficult to obtain glass that does not contain potassium, which has a natural component of radioactive  $K^{40}$ . Some glasses, such as fused silica, have comparatively low background radiation.

## Noise

The amplification of a multiplier phototube is usually high enough so that the noise in the dark current completely dominates coupling-resistor noise except for very small resistances. Under normal operating conditions, the noise which limits detectability results from amplified thermionic emission. Thermionic emission may originate from both the photocathode and the dynode surfaces. The latter emission is usually negligible as a result of the

difference in gain through the tube. If the multiplication of the secondary emission is assumed to be noise-free, the expression for the rms noise current is similar to that for a vacuum phototube, Eq. (22), as follows:

$$\frac{I_B}{I^2 \Delta f} = \mu [2 e i_a \Delta f]^{1/2} \quad (32)$$

where  $\mu$  is the amplification factor of the multiplier phototube and the other symbols are as defined previously. As in the case of vacuum phototubes, it is possible to calculate the minimum value of coupling resistance  $R$  which may be used. If it is assumed that the tube-generated noise is just equal to the coupling Johnson noise, as in Eq. (24), the minimum value of  $R$  is given by

$$R = \frac{2kT}{\mu^2 e i_a} \quad (33)$$

For example, if the equivalent cathode dark current  $i_a$  is  $10^{-16}$  ampere and the gain of the tube is  $10^6$ , the value of  $R$  for which the two noise sources are equivalent is 50 ohms. Thus, the multiplier phototube is far superior to the vacuum phototube for the amplification of very small light signals. The possibility of very low values of coupling resistance permits the observation of high-speed phenomena not possible with vacuum phototubes having large coupling resistances.

The above discussion does not consider the increase in noise resulting from the secondary-emission amplification mechanism. If this source is included, a more refined expression may be written:<sup>18</sup>

$$\frac{I_B}{I^2 \Delta f} = \mu \left[ 2 e i_a \left( 1 + \frac{B}{m-1} \right) \Delta f \right]^{1/2} \quad (34)$$

where  $m$  is the secondary-emission ratio per stage (usually of the order of 4) and  $B$  is a statistical factor (found by measurement on a 5819 to be 1.54.<sup>19</sup>).

An important consideration in

the operation of multiplier phototubes is the ratio of the signal to the noise. The output signal current  $I_B$  may be expressed as follows:

$$I_B = \mu F R \quad (35)$$

where  $F$  is the flux in lumens on the photocathode and  $R$  is the sensitivity in amperes per lumen. ( $F$  and  $R$  can also be expressed in terms of watts instead of lumens.) The following simplified expression may be written for the ratio of the dc signal current to the rms noise current in a bandwidth  $\Delta f$ :

$$\frac{I_B}{\left( \frac{I_B}{I^2 \Delta f} \right)^{1/2}} = \frac{F R}{[2 e i_a \Delta f]^{1/2}} \quad (36)$$

In the detection of low light levels, it is often advantageous to modulate the light by means of a "chopper" and to couple the multiplier phototube to an amplifier having a narrow bandpass at the chopping frequency. In this way the dc component of the dark current is eliminated, and the inherent signal-to-noise ratio of the multiplier phototube is more readily realized.

For example, when the modulation of the light is sinusoidal, a modulation factor  $M$  can be defined as the peak-to-peak cathode photocurrent amplitude divided by the average cathode photocurrent. The rms output-signal current can be expressed as

$$\frac{i_k M \mu}{2\sqrt{2}}$$

where  $i_k$  is the average photocathode current. If the average cathode current is small compared with the equivalent cathode dark emission  $i_a$ , the following expression may be written for the signal-to-noise ratio  $S/N$ :

$$\begin{aligned} S/N &= \frac{\text{rms modulated signal current}}{\text{rms noise current}} \\ &= \frac{M i_k}{4 \left[ e i_a \left( 1 + \frac{B}{m-1} \right) \Delta f \right]^{1/2}} \end{aligned} \quad (37)$$

It is frequently advantageous to rate a multiplier phototube by its equivalent noise input or ENI. This figure is the amount of light in lumens (or other radiation units) which produces an rms signal current just equal to the noise current in a bandwidth of one cycle. For example, if a square-wave modulation is assumed for which the peak-to-peak amplitude is just equal to the unmodulated current with on time equal to off time, a modulation factor  $M$  of  $8/\pi$  can be assumed in Eq. (37). If  $F$  is the unmodulated flux, the average cathode current  $i_c$ , is then given by

$$i_c = FR/2 \quad (38)$$

For the case where  $S/N$  is equal to unity, ENI is equal to the unmodulated light flux  $F$ . The value of ENI is then determined as follows:

$$\frac{S}{N} = 1 = \frac{(ENI)R}{\pi \left[ e i_d \left( 1 + \frac{B}{m-1} \right) \right]^{1/2}} \quad (39)$$

or

$$ENI = \frac{\pi \left[ e i_d \left( 1 + \frac{B}{m-1} \right) \right]^{1/2}}{R} \quad (40)$$

Note that this equation may be used to determine the equivalent photocathode dark current. For example, when  $B$  equals 1.54 and  $m$  equals 4, the value of  $i_d$  is given by

$$i_d \cong 0.4 \times 10^{18} R^2 (ENI)^2 \quad (41)$$

When the dark current is observed on a wide-bandpass oscilloscope, it consists of unidirectional pulses of variable amplitude. It is presumed that these pulses represent thermionic electrons from the cathode amplified by secondary emission. The distribution of the heights of these pulses is quite closely exponential<sup>20</sup> with a trend to a double-slope characteristic.<sup>21</sup>

The cause of this distribution is

not clearly understood. In the case of tubes such as the 931A and 6655A, which have CsSb dynodes, thermionic emission may originate from the dynodes as well as from the cathode. This explanation could well account for the many small pulses. On the other hand, it has been speculated that the distribution of secondary emission itself may be exponential. This point of view is proposed by J. A. Baicker<sup>21</sup> who also suggests that the two-slope characteristic shown in Fig. 50 is the result of single and multiple emission of electrons from the cathode. The multiple emission may be the result of impact by positive ions. However, the evidence for this assumption is not as yet clearly established. The statistics of secondary emission are discussed further below.

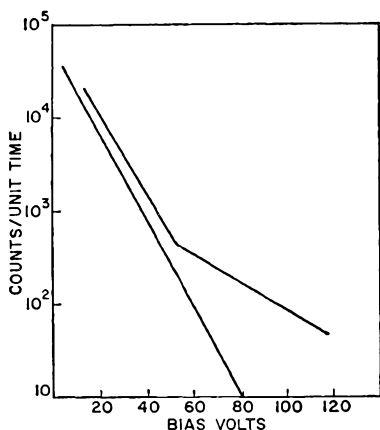

Fig. 50. Pulse-height distribution of dark-current pulses in two 7264 multiplier phototubes. The data were obtained by integral-bias counting.

**Noise in the Signal.** When the photocurrent is well in excess of the thermionic emission, measurement precision is limited by the randomness of photoemission and secondary emission. This type of limitation is most prevalent in applications such as the detection of a star against the background of the sky, where the modulated signal is produced by scanning back and forth across the

star and in the detection of small marks on scanned paper. The expression for the rms noise current output is identical to Eq. (32) or to Eq. (34) (when secondary-emission statistics are included), except that the average cathode photocurrent  $i_k$  is substituted for  $i_a$ . When the modulation of the light is sinusoidal and the magnitude of the modulation is small compared with the background, the expression for the rms noise current in the signal,  $N_s$ , may be determined by a development parallel to that of Eq. (37), as follows:

$$S/N_s = \frac{\text{rms modulated signal current}}{\text{rms noise current in signal}}$$

$$= \frac{M}{4} \left[ \frac{i_k}{e \left( 1 + \frac{B}{m-1} \right) \Delta f} \right]^{1/2} \quad (42)$$

In an application of this type, which requires maximum sensitivity in the presence of a light background, the multiplier phototube used should have high cathode sensitivity. Gain is unimportant except at the first stage, where high dynode-No. 1-to-cathode voltage is required to minimize noise from the statistical variation of secondary emission (through the factor  $m$ ).

In most practical multiplier phototubes, some of the photoelectrons fail to enter the secondary-emission section of the tube as a result of imperfect design or misalignment of tube components. The collection efficiency for the photoelectrons is usually near unity, but in some tubes may be of the order of 0.5 or less. If this consideration is included in Eq. (42), the cathode current must be the collected current rather than the emitted current. The collected current may be defined as follows:

$$i_k (\text{collected}) = i_k (\text{emitted}) \times \epsilon \quad (43)$$

where  $\epsilon$  is the collection efficiency. Eq. (42) then becomes

$$S/N_s = \frac{M}{4} \left[ \frac{i_k \epsilon}{e \left( 1 + \frac{B}{m-1} \right) \Delta f} \right]^{1/2} \quad (44)$$

This equation may be used to provide an approximate measure of the collection efficiency, or at least a relative comparison between tubes.<sup>29</sup>

The noise in the signal is similar to the dark noise in that it also consists of random pulses of variable amplitude. The random spacing of the pulses corresponds to the basic randomness of the emission of photoelectrons. In this case pulses originating from the dynodes are negligible. The distribution of anode pulse heights has been measured at the Lawrence Radiation Laboratory<sup>22</sup> for single-photoelectron inputs; data obtained are shown in Fig. 51. The curve passes through a maximum for small pulses instead of increasing indefinitely near zero pulse height, as the dark-current distribution apparently does. The distribution is approximately that calculated from Poisson statistics.

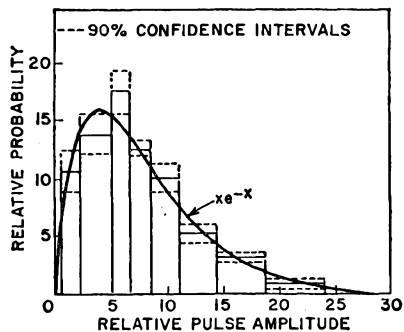

Fig. 51. Measured amplitude distribution of anode pulses due to single photo-electron inputs for a 2-inch diameter, 14-stage multiplier phototube having  $C_{83}Sb$  dynodes. Gain per stage is approximately 3.

Scintillation Counting.<sup>28-28</sup> Another type of application in which

the statistics of operation of the multiplier phototube are important in scintillation counting. In a typical application, nuclear disintegrations produce gamma rays which cause scintillations in a crystal such as NaI(Tl). A multiplier phototube coupled closely to the face of the crystal converts the scintillations to electrical output pulses. Because the energy of a light flash is closely proportional to the gamma-ray energy and because multiplier phototubes are linear in operation, the electrical pulse height can be used as a direct measure of the gamma-ray energy. However, the number of photoelectrons per scintillation is relatively small (of the order of several hundred). The output pulses vary in height because of the statistics of the small numbers and because the scintillations themselves vary. An important requirement in nuclear spectrometry is the ability to discriminate between pulses of various heights; hence, the importance of Pulse-Height Resolution.

Measurement of the pulse-height resolution of a multiplier phototube has not been standardized; however, a NaI(Tl) crystal and a  $\text{Cs}^{137}$  source of gamma rays are generally used as a reference combination. A typical pulse-height distribution curve is shown in Fig. 52.

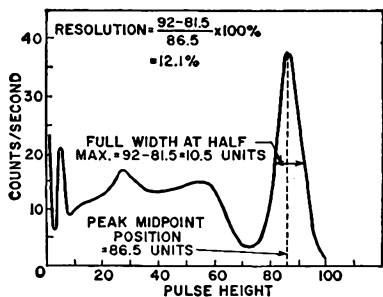

Fig. 52. Distribution of pulse heights observed in a scintillation counting experiment using gamma rays from  $\text{Cs}^{137}$  to excite a NaI (Tl) crystal.

The main peak of the curve at the right is associated with monoenergetic gamma rays which lose their entire energy by photoelectric conversion in the crystal. Pulse-height resolution is measured as the width of this distribution peak at its half height divided by the pulse height at maximum.

Pulse-height resolutions measured in this manner vary from 6 to 20 per cent. Multiplier phototubes vary considerably in their ability to resolve scintillation pulses of different heights. Good optical coupling is required to use all the light from the scintillation effectively. This requirement makes it necessary to provide the tube with a semitransparent photocathode on the window-faceplate and a scintillating crystal coupled directly to the faceplate. High and uniform photocathode sensitivity is essential, especially in the spectral region corresponding to the blue emission from the crystal. Fig. 53 compares the distribution of light from the NaI(Tl) source and the S-11 spectral response commonly used in the coupling multiplier. It

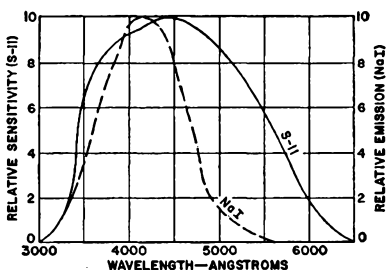

Fig. 53. Distribution of light from a scintillating NaI(Tl) crystal compared with the typical (S-11) spectral response of multiplier phototubes most commonly used in scintillation counting.

is also important that electrons emitted from the cathode be efficiently used by the first dynode.

Pulse-height-resolution measurements are a reliable guide to efficient operation in scintillation counting. It should be noted, however, that

pulse-height resolution is not solely determined by the characteristics of the multiplier phototube; the properties of the scintillating crystal, its housing, and the coupling to the phototube and the location of the gamma-ray source are also important.

Another characteristic used to describe the effectiveness of multiplier phototubes for scintillation counting is the so-called Plateau Characteristic. Although the term is widely used, there is no accepted definition for plateau; adoption of this concept may be traced to the parallel use of scintillation counters and Geiger counters. Pulse-height resolution is a preferred measure of scintillation counting efficiency; however, because of the interest in plateau characteristics for certain applications, a brief description of the general implication of the term is given below.

The plateau characteristic is obtained in the same manner as pulse-height-resolution data, except that the pulses are recorded by integral-bias rather than differential-bias. The number of pulses larger than a particular value is plotted as a function of the voltage applied to the multiplier phototube. The plateau which develops (Fig. 54) corresponds not to the valley to the left of the photopeak in Fig. 52, as might be expected, but to the region of the curve at the extreme left in Fig. 52 just before the sharp upturn.<sup>29</sup> Operation on the plateau corresponds to the counting of scintillation pulses originating from Compton-scattering, as well as from

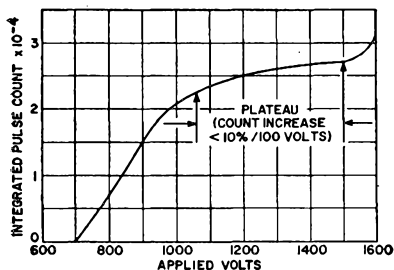

Fig. 54. Typical plateau characteristic.

photoelectric conversion.

It is generally desirable to have a relatively flat plateau which extends for several hundred volts. A good plateau characteristic is partially determined by such properties as low dark current and high photocathode sensitivity; it is also determined by the particular amplification-voltage characteristic. Thus, a rapid variation of gain with voltage results in a short and steep plateau; this effect is not inherently undesirable, but merely corresponds to a scale change. Plateau characteristic should not be used for indiscriminate comparison of different types of multiplier phototubes. Pulse-height-resolution data are a more fundamental guide to the choice of multiplier phototubes than plateau characteristics. Similarly, a pulse-height distribution provides greater insight to the source of the scintillations than the integral-bias-type plateau curve.

When a multiplier phototube is used to observe very short light flashes, such as those which occur in scintillation counting, After-Pulses<sup>30</sup> (i.e., minor secondary pulses following the main anode-current pulse) are sometimes observed. Two general classes of after-pulses are characterized by the time between the main pulse and the after-pulse: (1) delays of the order of nanoseconds; (2) delays of the order of microseconds. The former have been shown to be the result of feedback of light to the photocathode. The fact that light is generated in the output stages of the tube has been verified by many observers, especially in tubes in which the construction is open enough to permit observation of the dynode areas. The light output follows the current level in the tube; at reasonably high levels of current, the dynodes at the end of the tube seem to be covered by a blue-green light.

Light generated by luminescent effects associated with the high-density pulse current in the output stages of the tube is reflected and transmitted back to the photocathode.

Delay time is a combination of the transit time of the secondary and primary electrons through the multiplier phototube and the transit time of the light itself. This type of feedback has been minimized by baffles designed into the structure of the tube. After-pulses in the nanosecond range are usually observed only under conditions of very-high-gain operation, of the order of  $10^6$ .

The second type of after-pulse, of microsecond delay, has been observed in many different types of tube. No consistent explanation of their cause has been proposed, although they are clearly some type of regenerative effect. Fig. 55 shows some exaggerated after-pulses from an experimental tube. When the gain and voltage are sufficiently high, even "after-after" pulses may be observed.

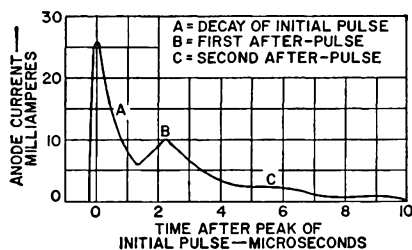

Fig. 55. Multiple after-pulses observed in an experimental multiplier phototube following a high current primary pulse. The initial pulse is generated by the light from a pulsed CRT; time constant of the phosphor and circuit combined is approximately 0.8 microsecond.

Studies of the microsecond after-pulses under various conditions indicate that they are of several different origins. In one class, the amplitude of the after-pulse increases at least as rapidly as the square of the amplification factor; this relationship suggests a regeneration effect dependent on feedback from the anode end of the tube.

Feedback effects which have time delays of the order of microseconds can be circumvented in special applications by pulsing the voltage so that high gain is achieved before the regenerative pulse de-

velops. Post<sup>21</sup> was able in this manner to operate 931A tubes at voltages of 4 to 5 kilovolts with very high gains, output-current peaks to 0.7 ampere, and pulse rise times of the order of  $0.8 \times 10^{-6}$  second.

### Transit-Time Effects

One of the principal advantages of multiplier phototubes compared with simple photodiodes is the high amplification achieved without appreciable loss in frequency response. Calculated power spectrum of the noise for type 931 is shown in Fig. 56.<sup>22</sup> (The 931 was an earlier form of the present 931A multiplier phototube. The electrode structures are identical; the principal differences are in the supporting members and test specifications, particularly for dark current and sensitivity.) The figure shows the power spectrum of the noise pulses arising from the amplification of single electrons from the photocathode. The loss of frequency response above 100 megacycles results partly from the shaping of the output-current pulse by the passage of the amplified electron cloud from the next-to-the-last dynode through the anode structure to the last dynode. The electron cloud is then further amplified at the last dynode and passes again to the anode, even oscillating in the anode space before final collection.

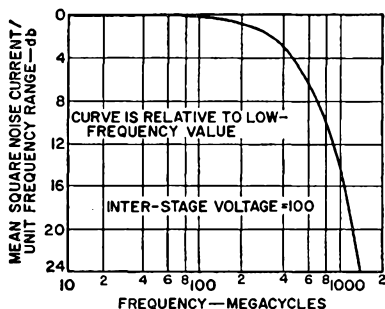

Fig. 56. Power spectrum of the noise from the RCA 931 multiplier phototube operated at 100 volts per stage, as calculated by R. D. Sard.

The electron cloud is also spread out by variations in transit time through the multiplier section. These transit-time variations arise from the different energies and directions of secondary electrons. This calculated frequency response has been supported by pulse measurements which show that a type 931A multiplier phototube has a rise time (10 to 90 per cent) less than  $10^{-9}$  second.<sup>31</sup>

The actual delay time between the arrival of a photon and the recording of an electrical pulse in the anode circuit of the multiplier phototube may be much longer than the pulse rise time. The pulse delay time is the result of the accumulated transit times for the several stages of the tube. For a 931A, the transit-delay time is approximately  $16.7 \times 10^{-9}$  second when the tube is operated at 100 volts per stage.

In tubes having large photocathodes suitable for scintillation counting, one of the principal transit-time effects occurs in the space between the cathode and the first dynode. The large photocathode necessitates a fairly long path to the first dynode to provide good photoelectron collection from the entire photocathode. In addition, for some tubes, all areas on the photocathode are not equally distant in transit time of the photoelectrons to the first dynode. In tubes designed for short-time resolution, the photocathode areas are curved and the first few dynodes are oriented to minimize transit-time spread.<sup>32</sup>

In a new type of multiplier phototube presently under development, transit times are further reduced by the use of accelerator grids between dynodes (See Fig. 35)<sup>33</sup> Secondary electrons are thus subjected to a higher accelerating field near the emitting surface and to a decelerating field near the collector. The effect is almost an order-of-magnitude improvement over tubes having comparable cathode areas. In some high-speed tubes, the last-dynode and anode leads are constructed to form a twin-lead transmission line to the elements themselves.

Because of the very short time response of the multiplier phototubes, it has been difficult to find a test light source which has a sufficiently short time of flash. A spark source,<sup>33</sup> which produces a good delta-function light impulse having a main pulse width less than  $10^{-9}$  second, is suitable for the measurement of the time delay in multiplier phototubes. Fig. 57 shows the transit-time delay for an 8053 as a function of supply voltages; the curve closely approximates

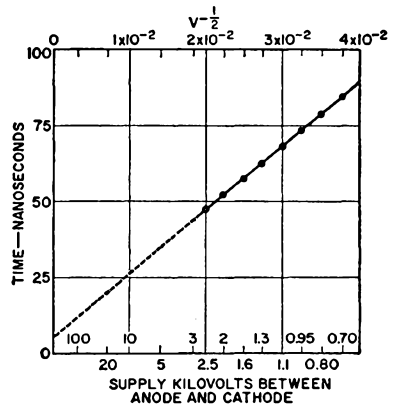

Fig. 57. Transit time as a function of the square root of reciprocal applied voltage for a type 8053 multiplier phototube.

the inverse half power of the applied voltage. This effect is to be expected, provided the effects of initial velocities and secondary-emission delay are negligible. The intercept of the line on the time axis is at  $5.2 \times 10^{-9}$  second. This effect has been previously observed;<sup>34</sup> it is probably due to the delay induced by the circuit within the tube. Fig. 58 shows the time delays for a number of multiplier phototubes over a range of operating voltages.

In most applications, the delay time of a multiplier phototube is not as important as the pulse rise time or the pulse width for a delta-function input. Fig. 59 shows the output pulse width at half maximum amplitude for an 8053 as a function of the reciprocal square root of the voltage. The light source used was



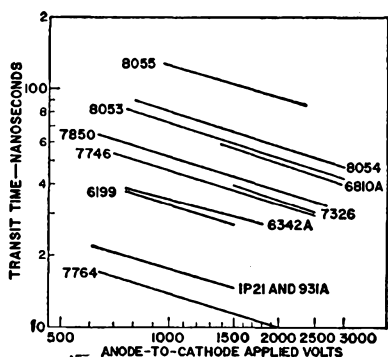

Fig. 58. Transit time as a function of supply voltage (log scale) for a number of multiplier phototubes.

the spark light source described above. The pulse width observed is spread by the width of the light pulse itself, approximately  $0.7 \times 10^{-9}$  second. The output pulse width also follows the inverse half power of the applied voltage, as does the transit-time delay. This relationship indicates that the transit-time spread is determined more by the tube structure (e.g. unequal path lengths) than by initial velocities. These data also suggest a finite intercept on the time axis of  $4 \times 10^{-9}$  second.

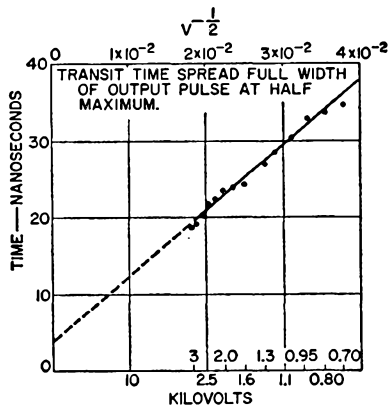

Fig. 59. Transit time spread of an 8053 as measured by the full width of the output pulse at half maximum as a function of the inverse half power of the applied voltage.

Rise Time. For the same delta-function input mentioned above, the

rise time, which is closely related to the pulse width, has been measured for a number of multiplier phototubes as the time required for the pulse to rise from 10 to 90 per cent of the maximum value. These values are plotted for a range of typical operating voltages in Fig. 60. No correction has been made for the finite rise time of the light pulse itself, which is estimated to be in the order of  $0.6 \times 10^{-9}$  second.

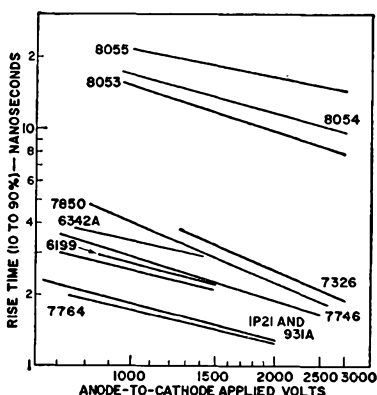

Fig. 60. Rise time (10 to 90 percent) as a function of voltage for a number of multiplier phototubes.

If the inherently wide passband of the multiplier phototube is to be fully used, it is important not to limit the response in the anode output circuit. In a 931A tube, for example, the capacitance of the anode to all other electrodes is 6.5 picofarads. If the capacitances of the leads and the input of a first-stage amplifier tube are included, the total shunt capacitance can be 20 picofarads. If it is desirable to maintain a time constant of  $10^{-9}$  second, the coupling resistor must be less than 500 ohms. At the very shortest times, the tube elements become part of a transmission line and "ringing" (transient oscillation) occurs if the tube and circuit are improperly designed and matched.

## Linearity Of Output Current

The output current of a multiplier phototube has been shown to be proportional to the light input over a wide range of values.<sup>20</sup> The limit to linearity occurs when space charge begins to form. The first limitation of space charge is not necessarily in the space between the last dynode and anode, but more frequently in the space between the last two dynodes. The voltage gradient between anode and last dynode is usually much higher than for other dynodes, and therefore results in the limitation at the previous stage, even though the current is less. The maximum current, at the onset of space charge, is proportional to the  $3/2$  power of the voltage gradient in the critical dynode region. By use of an unbalanced dynode voltage distribution and increasing the interstage voltages near the end of the tube, it is possible to increase the output current in a given tube. In the case of the limiting currents, it is necessary to restrict the operation to pulsed light to avoid damage to the tube. Fig. 61 shows the range of linear current which can be obtained from the 931A, and the region in which the space charge limits the linearity. Table VIII shows the maximum current which can be drawn from various multiplier phototubes.

It should be pointed out that a linear behavior is not always obtained from multiplier phototubes. For example, if the test light spot on a 931A is not directed close to the center of the active area of the photocathode, disturbing effects may arise from the proximity of the ceramic end plates. Near the end plates, the fields are not uniform and are affected by charge patterns on the insulator spacers, which change with the current level. An exterior negative shield placed around the bulb wall can also improve tube linearity. Aging effects resulting from the passage of excessive current may change the sen-

sitivity of the tube and cause an apparent non-linearity.

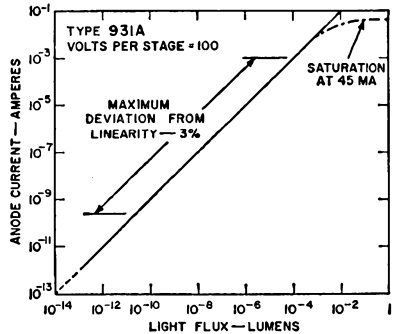

Fig. 61. Range of linearity, current as a function of light flux, for a type 931A multiplier phototube.

## Temperature Effects

The gain of a multiplier phototube is fairly independent of temperature over the normal operating ranges. Careful measurement with low current (to avoid fatigue effects) usually indicates a positive variation of gain with temperature. For a 1P21 (having  $Cs_3Sb$  dynodes) Engstrom<sup>20</sup> has reported an increase in gain of approximately 0.3 per cent per degree centigrade rise in temperature.

Photocathodes usually show a slight increase in sensitivity with increasing temperature at the long-wavelength threshold of the spectral response. Otherwise, however, they are quite stable with temperature except for permanent changes, which probably result from redistribution of cesium at higher temperatures.

A most important characteristic of multiplier phototubes is the rapid increase of dark current with temperature, especially as a result of thermionic emission, as discussed previously. Similarly, background noise increases rapidly with temperature because it is dependent on the dark-current origins. Fig. 62 shows the noise background for a 1P21 as a function of temperature.

TABLE VIII

Maximum (Space-Charge-Limited) Output Current for Various Multiplier Phototubes

Tube Type	Max. Saturated Current (Amperes)	Over-all Voltage	Voltage Distribution**
931A, 1P21, 1P22, 1P23, 6328, 6472	0.045	1000	1, 1, 1, 1, 1, 1, 1, 1, 1, 1
2059	1.75*	2648	1, 1.46, 0.83, 1, 1.2, 3.3
5819, 6217, 6342A, 6655A, 6903	0.045** 0.37	1200 2500	2, 1, 1, 1, 1, 1, 1, 1, 1, 1 2, 1, 1, 1, 1, 1, 1.9, 2.7, 4, 1.5
6810A, 7264, 7265	0.23*** 1.2†	2500 3800	2, 1, 1, 1, 1, 1, 1, 1, 1, 1, 1.25, 1.75, 2.0 2, 1, 1, 1, 1, 1, 1.3, 1.5, 1.9, 2.3 2.8, 3.8, 4.4, 5, 6
7046	0.23††	2750	4, 1, 1, 1, 1, 1, 1, 1, 1, 1, 1.25, 1.75, 2.0
7850 4459	0.30	2500	2, 1.4, 1, 1, 1, 1, 1, 1, 1.25, 1.5, 1.75, 2.0
7746	0.30	2200	2, 1.4, 1, 1, 1, 1, 1, 1.25, 1.5, 1.75, 2.0
8053	0.70 0.23	2500 1950	2, 1, 1, 1, 1, 1, 1, 4, 3.5, 4, 4.8 2, 1, 1, 1, 1, 1, 1, 1, 1, 1

\*Note that types with identical geometry have been grouped together; it has been assumed that all would have the same space-charge characteristic, although in most cases the "satellite" types were not separately tested.

\*\*The numbers represent the relative divider stage voltages: cathode-to-first dynode, first-dynode-to-second-dynode, etc. In most cases the stage voltages have been increased toward the output end of the tube to increase the space-charge-limited output current.

\*Data from D. L. Lasher and D. L. Redhead, RSI, 34, 115 (1963); the 2059 is essentially a five-stage 931A.

\*\*Based on data for 931A which has identical geometry after the first stage.

\*\*\*Lawrence Radiation Laboratory Counting Handbook, UCRL-3307, December 2, 1958.

†W. Widmaier, R. W. Engstrom, R. G. Stoudenheimer, "IRE Transactions on Nuclear Science," NS-3, November 1956.

††Based on 6810A data because of identical dynode and anode design.

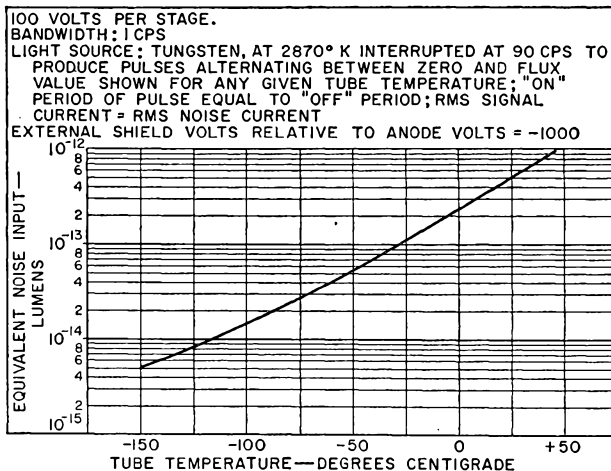

Fig. 62. Background noise variation in multiplier phototubes as a function temperature.

Considerable advantage in low-light-level operation may be achieved by cooling of the tubes. However, not all multiplier phototubes can be cooled without compensating for the temperature variation of the resistivity of the photocathode layer. For tubes such as the 1P21, in which the photocathode is overlaid on a solid conductor, there is no problem. However, in the semitransparent type of photocathode, since the photocathode is a semiconductor, the conductivity at low temperatures may become so poor that the emission of photoelectrons from the center results in a positive charge pattern which effectively blocks the normal operation of the tube. No fixed lower-temperature limit can be given for proper operation because the minimum temperature depends upon the photocurrent and the dark-emission current, as well as on the particular photocathode. Fig. 63 shows the resistivity per square for semitransparent photocathodes as a function of temperature.

### Effect Of Magnetic Fields

To some degree, all multiplier phototubes are sensitive to the presence of magnetic fields. Typical loss of sensitivity in the presence of a magnetic field is shown in Fig. 64. The loss of gain results from the

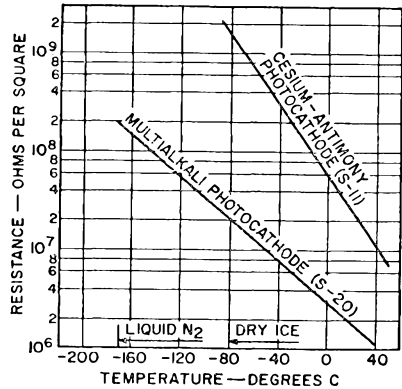

Fig. 63. Resistance per square as a function of temperature for the Cs-Sb and the multialkali semitransparent photocathodes. These data were obtained with special tubes having connections to parallel conducting lines on the photocathode.

deflection of electrons from their normal path between stages. Tubes for scintillation counting are generally quite sensitive to magnetic fields because of the relatively long path from the cathode to the first dynode.

If multiplier phototubes are to be used in the presence of magnetic fields, as is often the case, it is essential to provide magnetic shielding around the tube. High-mu-material shields are generally available

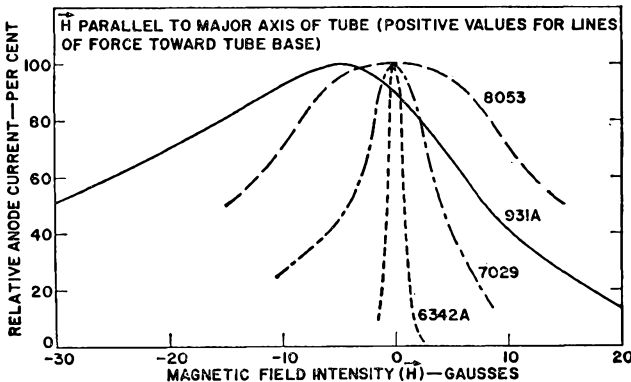

Fig. 64. Variation of output current of several multiplier phototubes as a function of magnetic field strength.

commercially. In some experiments, even the earth's magnetic field may be critical, especially if the tube is moved about.

It is possible to take advantage of magnetic fields to modulate the output current of the multiplier phototube. Under the application of normal fields, no permanent damage results. However, it is possible to cause a slight magnetic polarization of some of the internal structure of the tube. If this condition should occur, the performance of the tube may be somewhat degraded by loss in collection efficiency; however, it is a simple matter to "degauss" (demagnetize) the tube by placing it in an alternating magnetic field and then gradually withdrawing it. A maximum field of 100 gauss at the center of a coil operated on a 60-cycle alternating current is usually sufficient to degauss a tube.

### Fatigue And Life Characteristics

It is difficult to predict the precise changes in sensitivity of a multiplier phototube which may occur during the course of operation. The fatigue characteristic is a function of output current, previous history, and type of dynode material. Because fatigue is quite variable from tube to tube, only typical patterns can be described.

Generally, sensitivity changes become more rapid as the output current increases. In fact, for an individual tube, the sensitivity change is approximately a function of the product of time and output current, especially for rather large currents. It may be that changes in dynode characteristics result from an alteration of the surface caused by the impact of the primary electrons. One possibility is that cesium is released from the surface and then recombines elsewhere in the tube. The release of cesium may be expected to be more or less proportional to total charge impact, as indicated above.

When sensitivity of the tube is lost as a result of the passage of a

heavy current, it frequently is recovered when the tube is removed from operation. This recovery is accelerated by an increase in temperature within the permitted range. (Too high a temperature may cause permanent loss in sensitivity.) Recovery is probably the result of cesium returning to the dynode surfaces.

Because recovery occurs even during operation, sensitivity loss is not determined by the product of current and time at very low currents. Fig. 65 shows the short-time fatigue and recovery characteristic of a typical 1P21 having an initial anode current of 100 microamperes; the recovery is considerably slower than the fatigue. At currents of 10 microamperes or less, this situation may be reversed. For a tube with Cs-Sb dynodes, therefore, little improvement in stability is achieved by use of an anode current smaller than 10 microamperes.

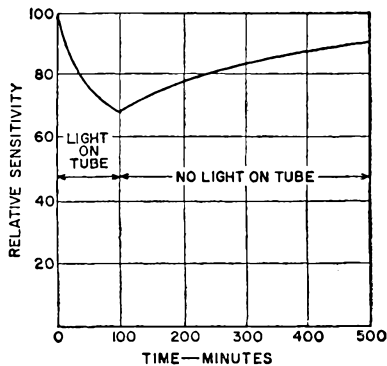

Fig. 65. Short-time fatigue and recovery characteristics of a typical 1P21 operating at 100 volts per stage and with a light source adjusted to give 100 microampere initial anode current. At the end of 100 minutes the light is turned off and the tube allowed to recover sensitivity. Tubes recover approximately as shown, whether the voltage is on or off.

Over a longer period, the rate of sensitivity change decreases, as shown in Fig. 66, but the change tends to become more permanent and recovery is only partial.

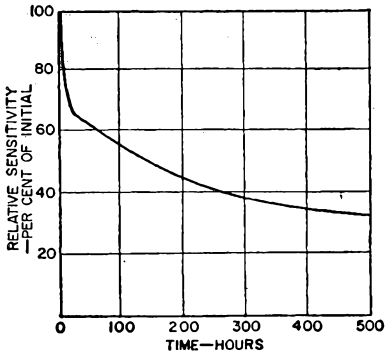

Fig. 66. Typical sensitivity loss for a 1P21 operating at 100 volts per stage for a period of 500 hours. Initial anode current is 100 microamperes and is readjusted to this operating value at 48, 168, and 360 hours.

Multiplier phototubes having silver-magnesium or copper-beryllium dynodes are much more stable at high operating currents than those having cesium-antimony dynodes. There is no significant difference in stability between silver-magnesium or copper-beryllium dynodes. A typical characteristic of sensitivity change on life is shown in Fig. 67 for a type 6342A multiplier phototube (silver-magnesium dynodes). The sensitivity tends to increase at first, then levels off and decreases very slowly. The operating current in this case is 2 milliamperes, as compared to the 100-microampere current used for the Cs-Sb dynodes typified by the characteristic shown in Fig. 66.

In addition to the life characteristics, which are probably the result of changes in the dynode layer itself, other changes of a temporary nature also occur. Not all these changes are well understood; some are charging of insulators in the tube.

Fig. 68 illustrates one of the peculiar instabilities which are sometimes observed in multiplier phototubes. When the light is first turned on, the current apparently overshoots and then decays to a steady value.

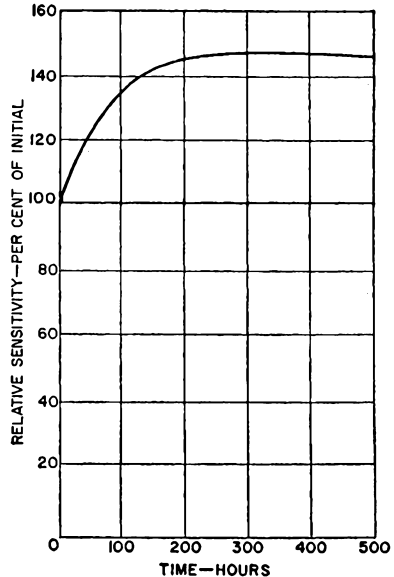

Fig. 67. Typical sensitivity variation on life for a 6342A multiplier phototube (silver magnesium dynodes) operating with 1250-volt anode supply voltage for a period of 500 hours. Initial anode current is 2 milliamperes and is readjusted to this operating value at 48, 168 and 360 hours.

This particular phenomenon, observed in a developmental type, was probably the result of the charging of the supporting insulator for the dynodes. The effect was observed to

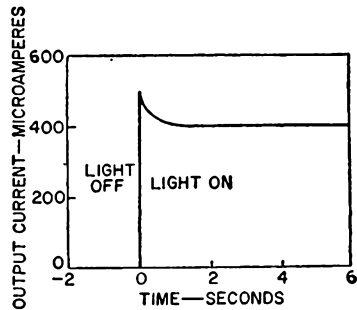

Fig. 68. Sudden shift in anode current probably as the result of insulator spacer charging. Observation was made using an experimental multiplier phototube in which the effect was unusually large.

occur more rapidly at higher currents, presumably because of the greater charging current. Observation of the phenomenon at different stages in the tube showed that it originated between the first and second stages. Electrons striking the insulator probably resulted in secondary emission and a resultant positive charge. The change is potential affected the electron optics in the space between dynodes. The effect was observed as an increase in some tubes and as a decrease in others. This particular development tube type was modified to minimize the effect by use of a metal shield to cover part of the spacer at each end of the first dynode space.

A related phenomenon is the variation of pulse height with pulse-count rate in scintillation-counting applications. Thus, when a radioactive source is brought closer to a scintillating crystal a greater rate of scintillations should be produced, all having the same magnitude. In a particular multiplier phototube a few per cent change in amplitude may result and cause problems in measurement. Fig. 69 shows the typically minor variation of pulse height with pulse-count rate for a type 6342A multiplier phototube.<sup>85</sup>

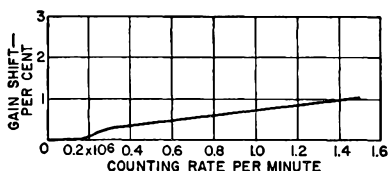

Fig. 69. Typical variation of pulse height with pulse-count rate for a 6342A. (Cs<sup>137</sup> source with a NaI (Tl) source).

In order to investigate the phenomena of pulse-height variation with pulse-count rate, a purposely exaggerated experiment was devised. Instead of a scintillating crystal, a

pulsed cathode-ray tube was used as a light source. Two pulse rates were studied: 100 and 10,000 pulses per second. Pulse duration was one microsecond; decay time to 0.1 maximum was 0.1 microsecond. The experiment was devised to study the rate at which the multiplier-phototube output response changed when the pulse rate was suddenly switched between the two rates. Tubes such as the 6342A, and especially the 8053 and 8054, showed practically no effect (of the order of one per cent or less). Fig. 70 shows the pulses during the switching procedure for a competitor's multiplier phototube. The adjustment

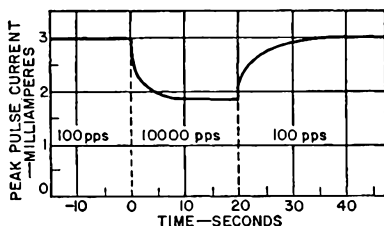

Fig. 70. Variation of output pulse height as the rate of pulsing is changed in a poorly designed experimental tube. Light pulses were provided from a cathode-ray tube. At the left of the graph, which shows the pulse-amplitude envelope with time for the output of the multiplier phototube, the pulses are at 100 per second. The pulse rate is increased suddenly to 10,000 per second and again reduced as indicated. Changes in amplitude are probably the result of insulator charging.

decay curves are approximately exponential. The phenomena were completely reversible and were observed on many different tube types (to a lesser extent). The time-decay period of several seconds suggests the changing of an insulator spacer to a new potential as the result of the increased charge flow and the subsequent modification of interdynode potential fields.

## References

- McKay, K. G., "Secondary Electron Emission", *Advances in Electronics*, 1, (1948).
- Bruning, N., *Physics and Application of Secondary Electron Emission*, McGraw-Hill Book Co., New York (1954).
- Kollath, R., *Hanbuch der Physik*, 21, 232 (1956).
- Massey, H. S. W. and Burhop, E. H. S., *Electronic and Ionic Impact Phenomena*, Oxford Univ. Press, New York (1952).
- Zworykin, V. K., Ruedy, J. E. and Pike, E. W., "Silver Magnesium Alloy as a Secondary Electron Emitting Material", *J. Appl. Phys.*, 12 (1941).
- Rappaport, P., "Methods of Processing Silver-Magnesium Secondary Emitters for Electron Tubes", *J. Appl. Phys.*, 25 (1954).
- Wargo, P., Haxby, B. V., and Sheperd, W. G., "Preparation and Properties of Thin-Film MgO Secondary Emitters", *J. Appl. Phys.*, 27 (1956).
- Allen, J. S., "An Improved Electron Multiplier Particle Counter", *Rev. Sci. Instr.*, 18 (1947).
- Rajchman, J. and Snyder, R. L., "An Electrostatically Focused Multiplier", *Electronics*, 13, Dec. (1940).
- Rajchman, J., "Les Courants Residuels dans Les Multiplicateurs d'Electrons Electrostatiques", (Thesis), Kundig, Geneva (1938).
- Morton, G. A., Matheson, R. W. and Greenblatt, M. H., "Design of Photomultipliers for the Sub-Millisecond Region", *IRE Transactions on Nuclear Science*, NS-5 Dec. (1958).
- Engstrom, R. W. and Matheson, R. W., "Multiplier Phototube Development Program at RCA Lancaster", *IRE Transactions on Nuclear Science*, NS-7, June-Sept. (1960).
- Sommer, A. H., "Use of Lithium in Photoemissive Cathodes", *Rev. Sci. Instr.* 26 (1955), 28 (1957).
- Lontie-Bailliez, M. and Messen, A., *L'Influence de la Temperature sur les Photomultiplicateurs*, Centre de Physique Nucleaire, Universite de Louvain.
- Wiggins, S. C. and Earley, K., "Photomultiplier Refrigerator", *Rev. Sci. Instr.* 23, No. 10, Oct. (1962).
- Pagano, R., Damerell, C. J. S., Cherry, R. D., "Effect of Photocathode-to-First-Dynode Voltage on Photomultiplier Noise Pulses", *Rev. Sci. Instr.* 33, No. 9, Sept. (1962).
- Wright, D. A., *Semi-Conductors*, Methuen and Co., New York (1955).
- Engstrom, R. W., Stoudenheimer, R. G., and Glover, A. M., "Production Testing of Multiplier Phototubes", *Nucleonics*, 10, No. 4, Apr. (1952).
- Morton, G. A. and Mitchell, J. A., "Performance of a 931-A Type Multiplier as a Scintillation Counter", *Nucleonics*, 4, No. 1, (1949).
- Engstrom, R. W., "Multiplier Phototube Characteristics; Application to Low Light Levels", *J. Opt. Soc. Am.*, 37, (1947).
- Baicker, J. A., "Dark Current Photomultiplier" *IRE Transactions on Nuclear Science*, NS-7, (1960).
- Trusting, R. F., Kerns, W. A. and Knudsen, H. K., "Photomultiplier Single-Electron Statistics", *IRE Transactions on Nuclear Science*, NS-9, (1962).
- Birks, J. B., *Scintillation Counters*, McGraw-Hill Book Co., New York (1953).
- Morton, G. A., "Photomultipliers for Scintillation Counting," *RCA Review*, 10, (1949).
- Crauthamel, C. E., *Applied Gamma-Ray Spectrometry*, Pergamon Press, New York (1960).
- Bell, P. R., "Beta- and Gamma-Ray Spectrometry", *Interscience*, New York (1955).
- Wall, N. S., and Alburger, D. E., *Nuclear Spectroscopy* (Fay Ajzenberg-Solove, Ed.) Academic Press, New York (1960).
- Proc. Fifth, Sixth, Seventh, and Eighth Scintillation Counter Symposia; *IRE Transactions on Nuclear Science*; NS-3, No. 4 (1956); NS-5, No. 3 (1958); NS-7, Nos. 2, 3 (1960); and NS-9, No. 3 (1962).
- Engstrom, R. W. and Weaver, J. L., "Are Plateaus Significant in Scintillation Counting?", *Nucleonics*, 10 (1959).
- Mueller, D. W., Best, G., Jackson, J. and Singletary, J., "After-Pulsing In Photomultipliers", *Nucleonics*, 10, No. 6 (1952)
- Post, R. F., "Performance of Pulsed Photomultipliers", *Nucleonics*, 10, No. 5 (1952)
- Sard, R. D., "Calculated Frequency Spectrum of the Shot Noise from a Photomultiplier Tube", *J. Appl. Phys.*, 17, (1946).
- Kerns, Q. A., "Improved Time Response in Scintillation Counting", *IRE Transactions on Nuclear Science*, NS-3, (1956).
- Smith, R. V., "Photomultiplier Transit-Time Measurements", *IRE Transactions on Nuclear Science*, NS-3, (1956).
- Covell, D. F. and Euler, B. A., "Gain Shift Versus Counting Rate in Certain Multiplier Phototubes", *USNRDL-TR-521*, U.S. Naval Radiological Defense Laboratory, San Francisco (1961).



# Photocells

**P**HOTOSENSITIVE devices in which electron flow occurs in a solid photoconductive material are called **photocells**. In a photoconductive material, electrical conductivity is a function of the intensity of incident electromagnetic radiation. Although many materials are photoconductive to some degree, this section is limited to the three types which are most useful commercially: cadmium sulfide, germanium, and silicon.

## Cadmium-Sulfide Photoconductive Cells

The basic elements of a cadmium-sulfide photoconductive cell include a ceramic substrate, a layer of photoconductive cadmium sulfide, metallic electrodes, and a protective enclosure. The photoconductive layer is prepared from cadmium sulfide which has been treated with various activating materials (such as a chloride and copper). The electrodes are formed by evaporation through a mask of a metal such as tin, indium, or gold. The finished cell is protected from moisture by a glass or glass-metal envelope of the type shown in Fig. 71.

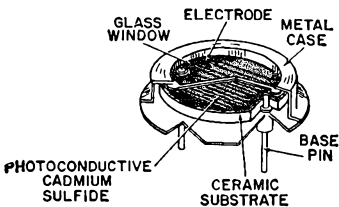

Fig. 71. Typical RCA cadmium-sulfide photocell.

In a circuit, a cadmium sulfide cell having ohmic contacts acts as an ohmic impedance. One of the important parameters of such a cell is its conductance as a function of illumination. Fig. 72 shows a characteristic of this type in which the

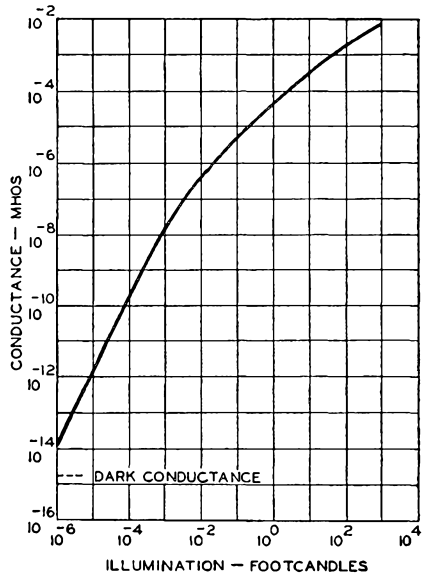

Fig. 72. Conductance as a function of illumination for a cadmium-sulfide photocell.

slope of the curve is nearly constant around a given operating point. The conductance  $G$  may be expressed as follows:

$$G = G_1 L^\gamma \quad (45)$$

where  $G_1$  is the conductance for unit illumination,  $L$  is the illumination, and  $\gamma$  is the slope of the character-

istic. The performance of the cell at a given operating point is described by specifying  $G_1$  (expressed in terms of the current drawn through the cell at a given applied voltage) and  $\gamma$ . For a typical cell, the 7163,  $G_1$  and  $\gamma$  are 53 micro-ohms and 1, respectively; the photocurrent measured at 1 foot-candle and 50 volts (ac) is approximately 2 milliamperes.

The capacitance of these cells does not respond instantaneously to changes in incident illumination because of the presence of electron traps within the forbidden gap of the cadmium sulfide. Although the build-up and decay of conductance on the application or removal of illumination is only approximately exponential and depends on the magnitude of the illumination, the term time constant is frequently used to describe the time required for the conductance to rise to 63.2 per cent of the maximum value or to fall from the peak to 36.8 per cent of the maximum value. For example, if a cell has been in the dark for a long time and is then illuminated with 10 footcandles, the time constant is approximately 70 milliseconds. In general, the cell responds

more quickly at high light levels and the rise time is usually longer than the decay time. Typical photocurrent rise curves are shown in Figs. 73 and 74.

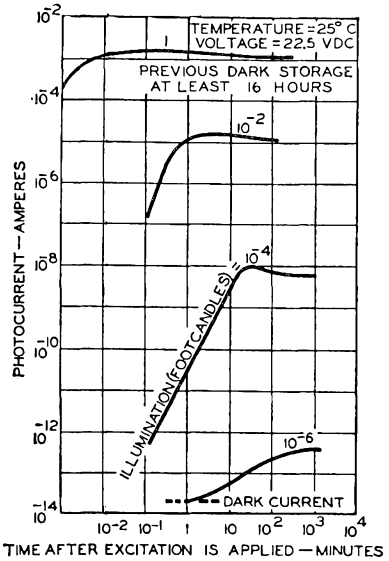

Fig. 73. Photocurrent rise characteristics for a cell selected for low dark current.

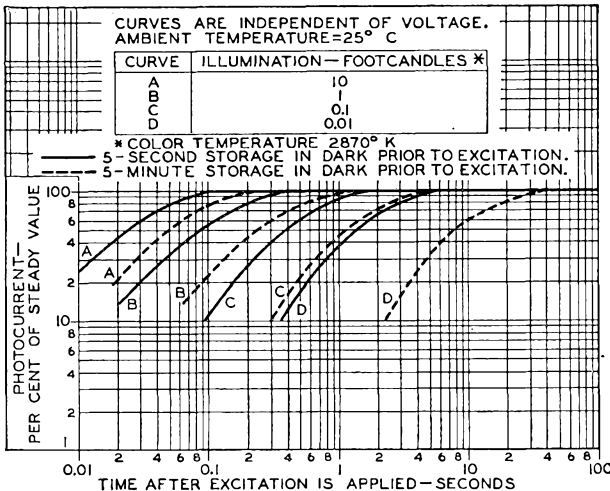

Fig. 74. Typical rise characteristics of a cadmium-sulfide cell.

In addition to the short-term effects just described, other phenomena resulting from previous light exposure proceed more slowly. In general, long exposure to high levels of light makes the cell slightly less sensitive and somewhat faster in response. These changes are reversible; the cell reverts to its former condition during storage in the dark. Because of the long-term time effects, cells should be preconditioned to light before measurement of sensitivity. A commonly used production-testing preconditioning schedule provides for exposure of the cells to a 500-footcandle fluorescent light for 16 to 24 hours. Voltage is not applied to the cell during the preconditioning schedule.

Certain time effects are also related to the application of voltage, and as a result cells are often slightly less sensitive under ac than under dc operating conditions.

For most applications, the conductance of the photocell must be substantially lower in the dark than when the cell is illuminated. Cell performance under unilluminated condi-

tions is described in terms of dark current and decay current. Dark current, the current passed under specified conditions of voltage and temperature when the cell has been in the dark a long time, is usually extremely low. Because of time effects it is more convenient to specify the decay current, which is observed at a given interval after removal of the light used for a sensitivity determination. For a typical photocell such as type 7163, the decay current is below 40 microamperes at a voltage of 50 volts, 10 seconds after removal of 1-footcandle illumination. Typical photocurrent decay curves are shown in Figs. 75 and 76.

In the typical curve of photocurrent as a function of applied voltage at various levels of illumination shown in Fig. 77, linearity extends over six orders of magnitude of voltage. Peak-to-valley response as a function of frequency of square-wave light input is shown in Fig. 78. The curve shows that the frequency response improves as the level of illumination increases.

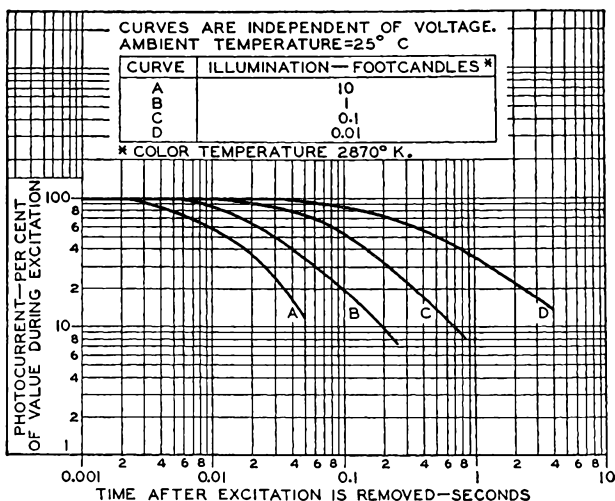

Fig. 75. Typical decay characteristics of a cadmium-sulfide cell.

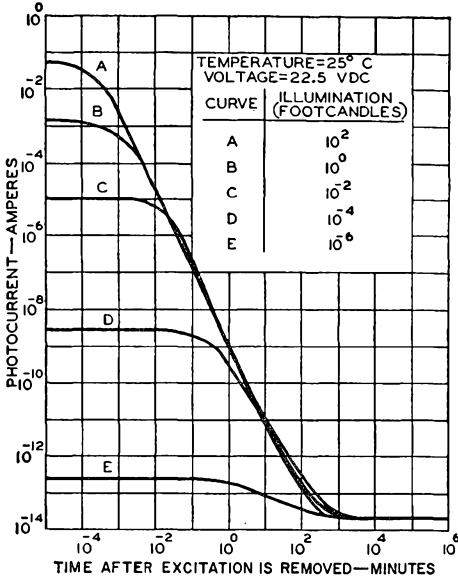

Fig. 76. Photocurrent decay characteristics for a cell selected for low dark currents.

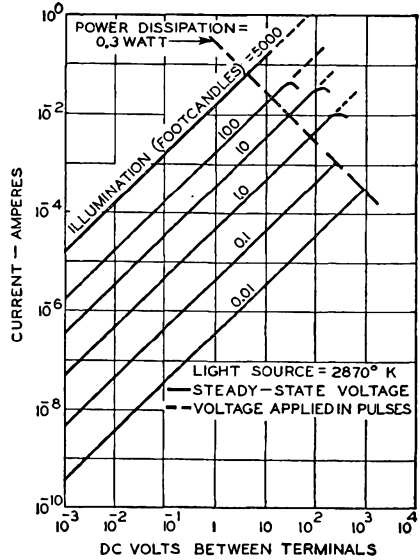

Fig. 77. Curve showing photocurrent as a function of applied voltage at various levels of illumination.

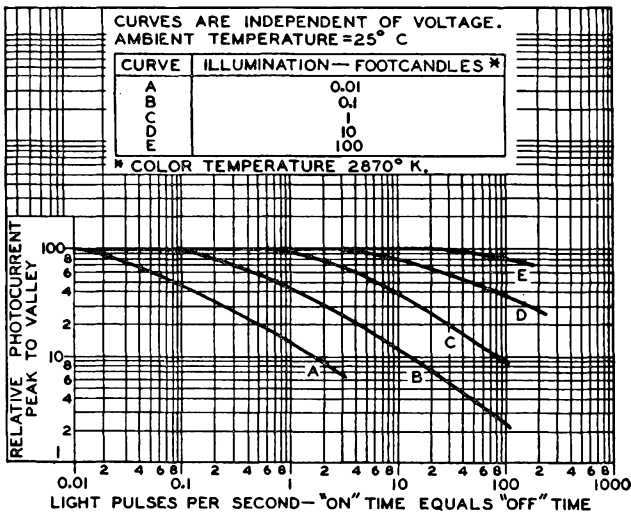

Fig. 78. Peak-to-valley response as a function of frequency of square-wave light input.

The sensitivity of a cadmium-sulfide cell tends to decrease as the ambient temperature rises. The typical curves shown in Fig. 79 indicate that the effect is marked at the lower level of illumination, but becomes negligible at 10 footcandles and higher.

The sensitivity of cadmium-sulfide photocells varies as a function of the wavelength of incident illumination, as shown in Fig. 80. The response curve is centered within the visible range, and has a peak of sensitivity near 5800 angstroms. Because the spectral response of cadmium sulfide closely matches that of the human eye, cadmium-sulfide cells

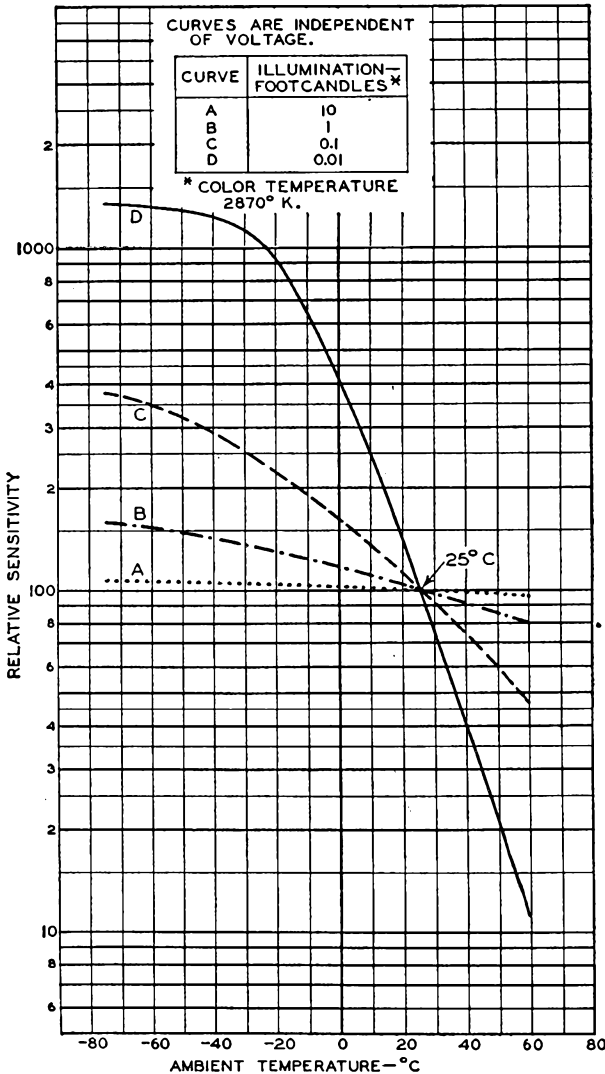

Fig. 79. Sensitivity as a function of temperature for a cadmium-sulfide cell.

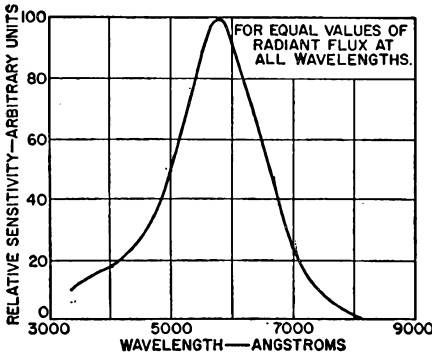

Fig. 80. Spectral response of a cadmium-sulfide cell as a function of the wavelength of incident illumination.

can be used for control applications in which human vision is a factor, such as street-light control and automatic iris control for cameras.

## Junction Photocells

In some applications, photoconductive materials such as germanium and silicon are used in junction devices; a p-n junction formed of such material has a nonohmic characteristic, as shown in Fig. 81. The solid curve applies when the device is in the dark; when light is applied to the cell, the curve shifts downward as shown. The junction photocell is

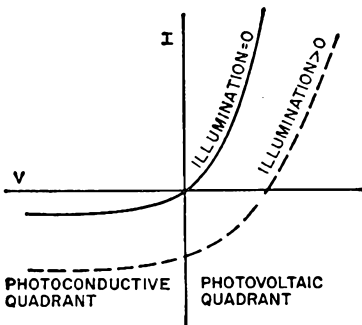

Fig. 81. Current-voltage characteristic for a photojunction device.

usually used as either a photoconductive or photovoltaic device. In photoconductive applications, the cell is biased in the reverse direction, and the output voltage is developed across a series load resistor. In photovoltaic applications, the cell is used to convert radiant power directly into electrical power.

A photojunction device operated in the photoconductive mode has a characteristic similar to that of Fig. 81, but rotated 180 degrees, as shown in Fig. 82. The circuit analyzed by Fig. 82 is shown in Fig. 83; as the illumination on the cell is increased, a change in voltage is developed across the resistor.

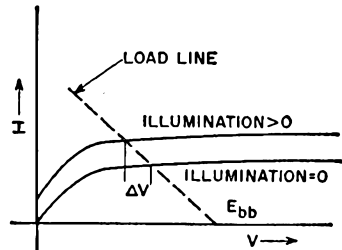

Fig. 82. Analysis of a photojunction device in the photoconductive mode of operation.

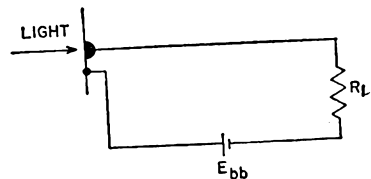

Fig. 83. Photojunction device connected in the photoconductive mode.

## Germanium P-N Junction Photocells

A germanium photocell, such as the 4420, which has a quantum efficiency of approximately 0.45, is intermediate in sensitivity between a phototube and a typical cadmium-sulfide photoconductive cell. The 4420 has a dark current of less than 35 microamperes, and the current

through the cell increases by about 0.7 microampere for each increase in illumination of 1 footcandle. The increase in photocurrent is linear with the increase of illumination.

The response of germanium junction photocells to sudden changes in illumination is fairly rapid. The 4420, for example, has a time constant (photocurrent-decay characteristic) of approximately 7 microseconds. Because of this relatively fast response, the germanium cell is useful for optical excitation frequencies well above the audio range.

The germanium junction devices contribute relatively little noise to a circuit. The noise is  $1/f$  in character; a typical value of the equivalent noise input at 1000 cycles per second (1-cycle-per-second bandwidth) is 60 microfootcandles.

### Silicon Photovoltaic Cells

Silicon solar cells, such as the SL2205 and the SL2206 are junction devices used to convert the radiant power of the sun to electrical power for space applications. The cell consists of a thin slice of single-crystal p-type silicon up to two centimeters square into which a layer (about 0.5 micron) of n-type material is diffused. The bottom contact of the cell is usually a continuous layer of solder, and the top contact consists of a series of grid lines (electrodes). A non-reflective coating of silicon monoxide is usually applied to the top surface to minimize reflection of usable radiant energy from the silicon surface.

N-on-p type cells are formed by diffusing phosphorous into a p-type base. The advantage of the n-on-p cell over the p-on-n cell is that it is far more resistant to degradation from the high-energy particles (protons and electrons) encountered in space applications.

When the electrical performance of a silicon solar cell is analyzed, the characteristic curve of Fig. 81 is inverted and appears as shown in Fig. 84. The analysis consists of drawing

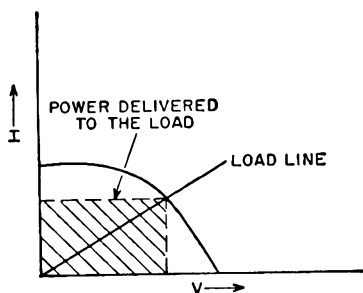

Fig. 84. Current-voltage characteristic of a photojunction device connected in the photovoltaic mode.

the load line consistent with the load resistor used in series with the cell. The power delivered to the load is determined by the area of the rectangle constructed as shown in Fig. 84. The value of the load resistor may be adjusted to provide maximum power from the cell for a specific condition of input radiation.

The performance of a silicon solar cell is frequently described in terms of conversion efficiency, which is defined as the ratio of the electrical output power to the incident radiant power, when the load resistance is adjusted to provide an output voltage of 0.46 volt, which is near the maximum-transfer point. The spectral content and the intensity of the illumination used must also be specified. Several typical illumination-source specifications are listed below.

Tungsten efficiency radiation from a bank of tungsten-filament lamps operated at a color temperature of 2800 degrees Kelvin is passed through a filter of 3 centimeters of water, which absorbs unwanted infrared radiation. The intensity is adjusted to provide a calibrated photovoltaic cell with a short-circuit current equal to the current measured when the calibrated cell is illuminated by the sun at air-mass one at an intensity of 100 milliwatts per square centimeter (extrapolated). The load resistor is adjusted to provide 0.46 volt.

**Table Mountain.** The source is the natural sunlight on a clear day on Table Mountain in California. (Table Mountain is the former site of the Smithsonian Astrophysical Observatory.)

**Air Mass Zero.** The source is natural sunlight at a distance sufficiently above the surface of the earth to eliminate atmospheric effects.

**Air Mass One.** The source is natural sunlight on a clear day at the surface of the earth (sea level) when the sun is directly overhead.

**Solar simulators.** The source is a combination of xenon and tungsten lamps adjusted to approximate the sunlight above the earth's atmosphere.

As a result of the spectral response of the silicon cell and the spectral distribution of the light sources, it is usually found that the air-mass-zero efficiency is less than the tungsten efficiency. The Table Mountain efficiency, on the other hand, is higher than the air-mass-zero efficiency.

The spectral response of a silicon solar cell has its peak in the near-infrared region. The radiation from sunlight, however, shows a peak of intensity near 4750 angstroms, as shown in Fig 85. For maximum con-

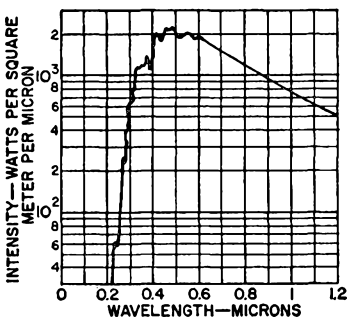

Fig. 85. Radiation from the sun (outside the earth's atmosphere); Johnson solar spectral irradiance curve—*Journal of Meteorology*, 11, 431 (1954).

version efficiency, the solar cell should respond to more blue radiation than is characteristic of the band-gap of silicon. Therefore, cells

are processed so that the peak of response is shifted toward the shorter wavelengths. The shift is obtained by making the n-layer (n-on-p cells) thinner and taking advantage of effects resulting from the absorption of light in silicon. A typical response curve for an n-on-p cell is shown in Fig. 86.

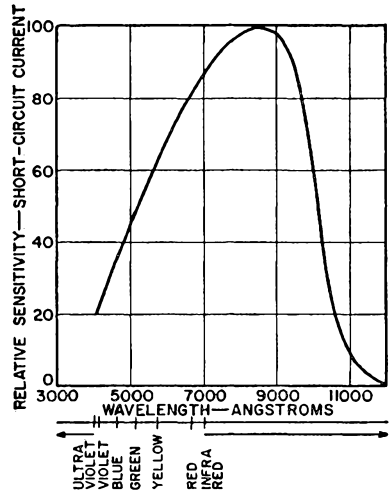

Fig. 86. Spectral response characteristic for a silicon solar cell.

Other materials now in the developmental stage also show promise in the field of solar-energy power conversion. Gallium arsenide, for example, has a narrower band-gap than silicon. Consequently, because its peak spectral response is farther in the blue region of the spectrum, the potential conversion efficiency of the material exceeds that of silicon.

## Data-Processing Cells

Data-processing (read-out) cells are multiple-unit silicon photovoltaic devices used for sensing light in such applications as reading punched cards, and in axial position indicators. A typical cell consists of a thin piece of silicon on which several n-on-p photovoltaic elements have been formed. Although these types



have been designed for specific applications in data processing, the technique for preparing such devices is very flexible and permits wide variations in the location, size, and number of the sensing elements. Individual mechanical packages, of several cells per package, can be placed in various spatial arrays to form sensing strips over large areas.

### Germanium And Germanium/Silicon Infrared Detectors

The atmosphere is not uniformly transparent to electromagnetic radiation. It contains various "atmospheric windows" through which radiation of specific wavelengths can readily pass. As shown in Fig. 87, the p-type gold-doped germanium cell and the zinc- or gold-doped germanium-silicon alloy cells have response ranges which take advantage of such windows.

The sensitive material of the p-type gold-doped germanium cell is germanium activated with gold and compensated with arsenic or antimony. Incident radiation excites electrons from the filled band to a low-lying impurity level contributed by the gold. The spectral response ex-

tends to about 9 microns. Because the active gold level is relatively near the filled band, the cell must be cooled to suppress noise resulting from thermal excitation and recombination. Furthermore, because the radiation results in a relatively small change in the resistance of the germanium element, the input signal should be chopped, and the output amplified by a low-noise amplifier. A typical cell consists of the germanium element within an integrating chamber, a Dewar envelope containing liquid nitrogen for cooling, and a germanium window treated with an antireflection coating. The electrical circuit consists of the cell, a load resistor, a voltage source, and a low-noise amplifier.

Germanium-silicon alloy cells are similar to the p-type gold-doped germanium device. The alloy, however, makes it possible to use an activator level which is closer to the valence band. The spectral sensitivity of the alloy cell extends to 14 microns. As a result of this extended response, the device must be cooled to a lower temperature. Pumped liquid nitrogen at a reduced pressure (50 degrees Kelvin) is used as a coolant; liquid neon and liquid hydrogen are also sometimes useful.

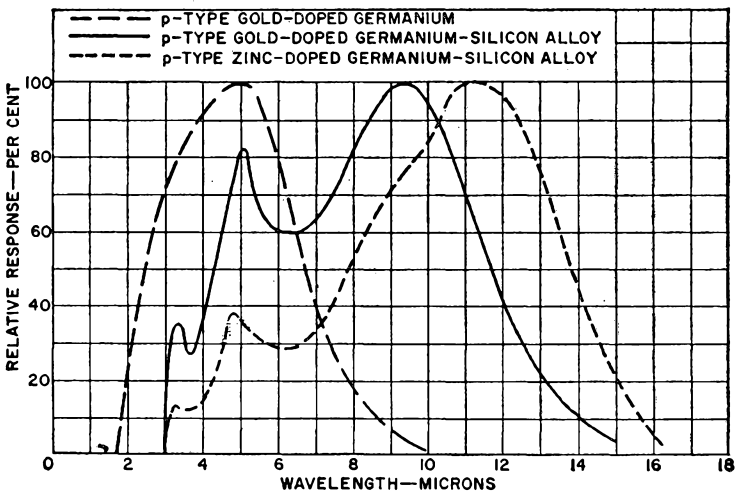

Fig. 87. Spectral response of infrared-sensitive detectors.

# General Application Considerations

**M**ANY criteria must be considered before choosing a photosensitive device for a particular application. Some application requirements can be filled by only one type of device; however, for many applications, any one of several possible devices may be suitable. This section provides a general guide to the selection of photosensitive devices for most typical applications.

## Level of Light or Radiation

All the devices described in this manual can be used over wide ranges of light or radiational level. Of course optical, environmental, or circuit adjustment may be necessary to accommodate the particular device. Fig. 88 shows the approximate useful

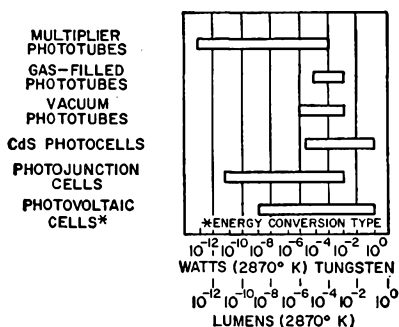

Fig. 88. The range of power or luminous flux for which the various detector types are useful. The indicated ranges are only for guidance, and may at times be exceeded. The overlapping scales of luminous and power fluxes are scaled in reference to a tungsten lamp operating at 2870 degrees Kelvin color temperature. For a different reference source, the luminous equivalent of the power flux would be different.

range of each class of photosensitive device. Multiplier phototubes are indicated for the lowest levels of radiation because of their inherent advantage of secondary-emission gain. Higher levels of radiation should be avoided in the case of multiplier phototubes because of fatigue, saturation, and life problems. However, the range can be increased upward for a multiplier phototube by decreasing the applied voltage.

Because the gain of a gas-filled phototube is much less than that of a multiplier phototube, it cannot be used at as low a level of light; however, such tubes can operate satisfactorily at higher ranges. Vacuum phototubes can be used at higher levels of radiation than either gas-filled phototubes or multiplier phototubes. Cadmium sulfide photocells are usually most useful in the higher ranges of light intensity. At the lower ranges, they are somewhat limited by response-time problems. Solar cells (photovoltaic cells, energy-conversion typed) are of use only at the upper range of radiation levels. At low levels, the power developed is too small to be of value for most applications.

The far-infrared detectors are generally useful only for the very low levels of radiation. If a large amount of infrared radiation is available, the complication of special cooling can be avoided by other simpler devices such as the bolometer or thermocouple.

## Spectral Energy Distribution

Although many of the different detectors of radiation have a broad spectral sensitivity range, there are

times when the spectral energy distribution of the source is of special importance in selecting the proper device. For the far-infrared region, only the solid-state photoconductors are suitable. Similarly, in the ultraviolet region, only photoemissive devices are practical; however, in the visible range, many devices can be used. The spectral response characteristics of the various types of devices are included in the pertinent sections of this manual.

Some applications require a device having a specific spectral sensitivity to match a particular response. However, for many applications, no such detector exists. For example, measurement of light levels requires that the receiver have the same spectral sensitivity as the eye. Although the devices described in this manual have spectral response covering the range of visible radiation, none of the responses exactly matches that

of the eye. In this case, the spectral response may be modified by means of special color filters to provide a combination detector and filter which does match the eye response. The filter characteristic required may be obtained by dividing the spectral sensitivity characteristic of the eye by the spectral response of the device to be corrected. Fig. 89 shows the close approximations which can be obtained by using commercial color filters.

Fig. 90 shows the transmission characteristics of a number of other useful filters and radiation transmitting substances. Color filters are frequently used to isolate various regions of the spectrum to improve detection or matching characteristics of photodetectors. The transmission of various glasses and the atmosphere are also provided because these factors have an important influence on practical optical systems.

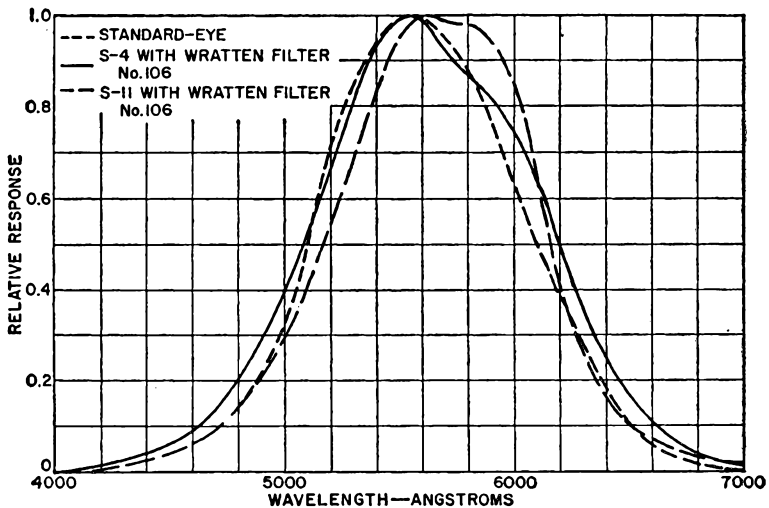

Fig. 89. Spectral responses S-4 and S-11 modified by the Wratten filter 106 closely match spectral sensitivity characteristic of the eye.

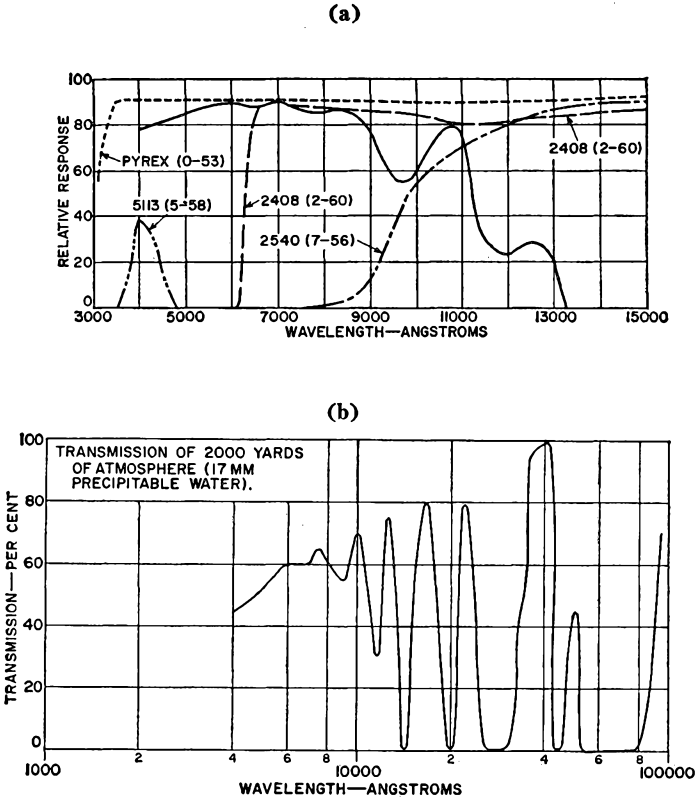

Fig. 90. Transmission characteristics of various useful color filters, glasses, and the atmosphere. ( A ) 2540, 5113, 2408, Pyrex ( B ) 2000 yds of air.)

### Frequency Response

The approximate useful range of frequency response for the various types of photosensitive devices is shown in Fig. 91. All the detectors are useful from dc operation to a specific cutoff frequency. However, for photocells of the germanium type, in which the dark current is quite substantial, the detection of unmodulated signals is not practical. A modulated signal can be automatically discriminated from the dark-current component. A comparison of ranges in Fig. 91 shows that the multiplier phototube is especially useful in detecting very-high-frequency modulations.

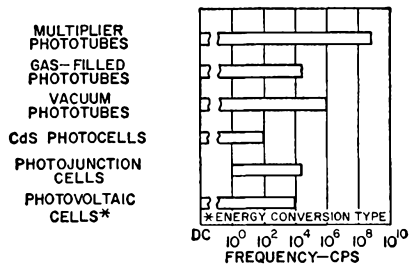

Fig. 91. Range of frequency response of various photodetectors. Recommendation of operation for dc (unmodulated light) sources is indicated by the symbol dc at the left end of the frequency range.

In some cases the light to be detected is modulated by the nature of the application, or is in the form of light pulses. For cases in which the light is unmodulated, it is often desirable to provide discrimination between signal current and dark current by one of several means, such as a light-chopper wheel.

The light chopper wheel is usually about 8 inches in diameter and made of a material such as 0.030-inch Duralumin. Holes or alternate segments are so placed that when the wheel is rotated in the beam of light, a modulated beam falls on the light detector. If a 1800 rpm synchronous motor is used to drive the disk, and three equally spaced 60-degree cutouts are made in the disk, the resultant modulation (as the cutouts pass over a radial slit) ap-

is moved across a slit, a sine wave modulation can be achieved (see Fig. 92a). A circle passing over a square at 45 degrees (Fig. 92b) and having a diameter equal to the diagonal produces an approximate sine wave with about 10-per-cent first-harmonic distortion (Uniform illumination of the apertures is assumed.)

### Typical Applications

As discussed in the previous sections, photosensitive devices are extremely versatile devices which are being used in an ever-increasing variety of applications. Shown below is a brief listing of several typical applications for each category of photosensitive devices. Choice of a particular type for a specific application should be based on the

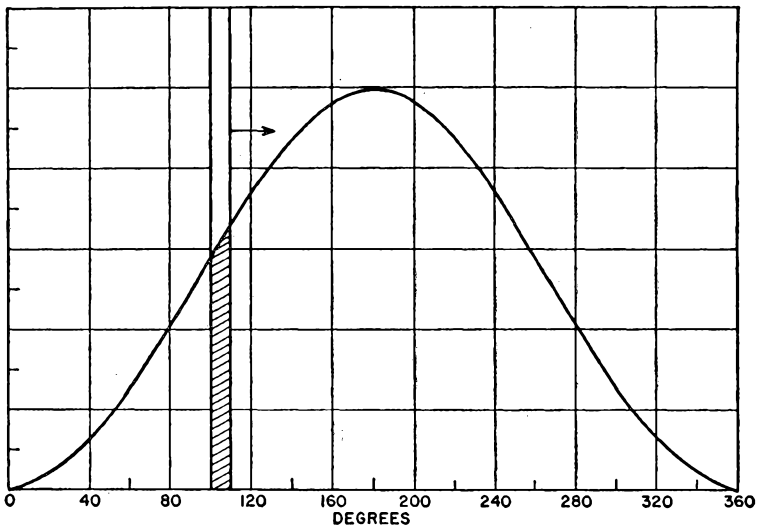

Fig. 92a. Illustration of a slit passing over a sine-wave type aperture to produce sine-wave modulation.

proximates a 90-cycle square wave, which is a convenient frequency because it is not a multiple or sub-multiple of the 60-cycle current. Almost any type of modulation can be accomplished with properly shaped apertures. For example, if the moving aperture is shaped like the area under a sine curve and it

ratings and characteristics shown in the Technical Data Section.

#### Vacuum Phototubes

- Photometry
- Spectrophotometry
- Industrial controls
- Facsimile
- Colorimetry

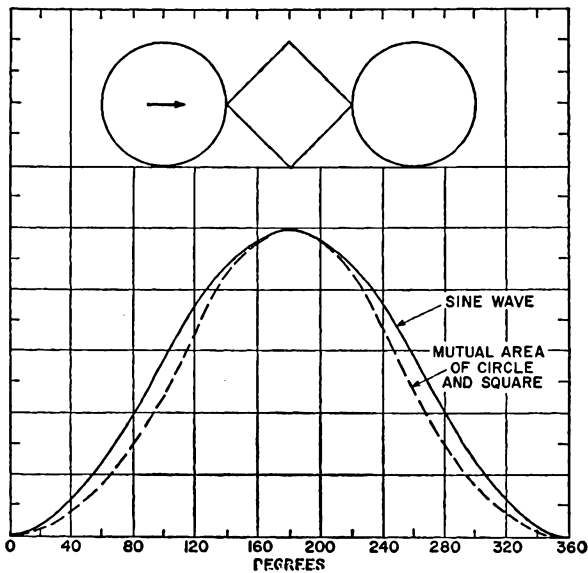

Fig. 92b. Production of sine-wave approximation by use of circular holes and a square aperture of 45 degrees.

### Typical Applications (con't)

#### Gas Phototubes

- Industrial controls
- Sound reproduction

#### Multiplier Phototubes

- Scintillation counting
- Photometry
- Spectrophotometry
- Flying-spot generator
- Star tracking
- Cerenkov radiation measurement
- Laser detection
- Industrial controls
- Colorimetry
- Timing measurement

#### Photoconductive Cells

- Industrial controls
- Camera iris control
- Street light control

#### Photojunction Cells

- Sound reproduction
- Data processing

#### Photovoltaic Cells

- Solar power conversions
- Industrial controls
- Photometry

# Interpretation of Data

**T**HE data given in the TECHNICAL DATA SECTION include ratings, characteristics, minimum circuit values, and characteristic curves for RCA vacuum and gas photodiodes and multiplier phototubes. Data for photoconductive cells and photojunction cells are also included. This section discusses the parameters given in the data and indicates briefly the method of measurement used for the more important parameters.

## Maximum Ratings

Ratings are established on phototube and photocell types to help equipment designers utilize the performance and service capability of each device to best advantage. These ratings are based on careful study and extensive testing by the tube manufacturer, and indicate limits within which the operating conditions must be maintained to ensure satisfactory performance. The maximum ratings given for the photosensitive devices included in this manual are based on the Absolute Maximum System. This system has been defined by the Joint Electron Device Engineering Council (JEDEC) and standardized by the National Electrical Manufacturers Association (NEMA) and the Electronic Industries Association (EIA).

Absolute-maximum ratings are limiting values of operating and environmental conditions which should not be exceeded by any device of a specified type under any condition of operation. Effective use of these ratings requires close control of supply-voltage variations, component variations, equipment-control adjust-

ment, load variations and environmental conditions.

For the most part, electrode voltage and current ratings for phototubes are self-explanatory and require little discussion. However, it should be noted that the maximum average cathode current (for gas and vacuum phototubes) and the maximum average anode current (for multiplier phototubes) are averaged over an interval no longer than 30 seconds.

## Characteristics

The characteristics given in the TECHNICAL DATA SECTION are typical values which indicate the performance of the device under certain operating conditions. Characteristic curves represent the characteristics of an average tube; however, individual tubes (like any manufactured product) may have characteristics that range above or below the values given in the characteristic curves. The more important of these characteristics for phototubes are discussed below.

The spectral-sensitivity characteristic represents a response curve which is typical of the spectral response obtained with a given phototube. Such a curve also indicates the range of maximum response. The short-wavelength cutoff of the spectral response is fairly well fixed by the ultraviolet absorption properties of the tube envelope. The long-wavelength cutoff is determined by such factors as the thickness of the photocathode layer and the particular activation of the photosurface.

In some critical applications, an exact knowledge of the spectral re-

sponse of a phototube may be required. A simplified system for the measurement of spectral response as a function of wavelength is shown in Fig. 93. For this measurement, one or more monochromators are used to select narrow bands of radiation from a given source of radiant energy. The output radiant flux in the narrow bands is then directed to a calibrated radiation thermocouple and measured in watts. This same output flux is also directed to the photocathode and measured in amperes by a current-reading device.

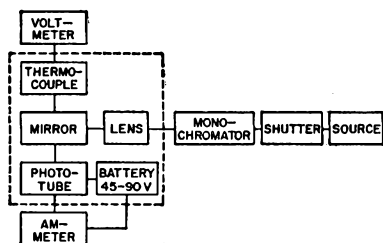

Fig. 93. Typical system for determining spectral-sensitivity characteristics of phototubes.

Luminous sensitivity is defined as the output current divided by the incident luminous flux at constant electrode voltages. This parameter is expressed in terms of amperes per lumen (a/lm). Fig. 94 shows a typical

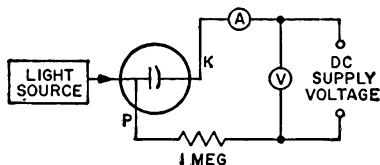

Fig. 94. Typical circuit for measuring sensitivity of photodiodes.

cal circuit for the measurement of luminous sensitivity of photodiodes; Fig. 95 shows a similar circuit used for multiplier phototubes. For these measurements, the phototube is placed in a light-tight shielded enclosure to prevent extraneous radiation from affecting test results. The light source normally used is an aged 50-candlepower tungsten-filament lamp operated at a color temperature of 2870°K and having a lime-glass envelope. The lamp is calibrated for color temperature and candlepower against a secondary standard lamp supplied by the U.S. National Bureau of Standards.

For the measurement of luminous sensitivity of vacuum phototubes, a voltage in the order of 250 volts is generally applied; for gas photodiodes, 90 volts is used. As shown in Fig. 94, a microammeter is inserted in series with the photodiode. A one-megohm resistor is also

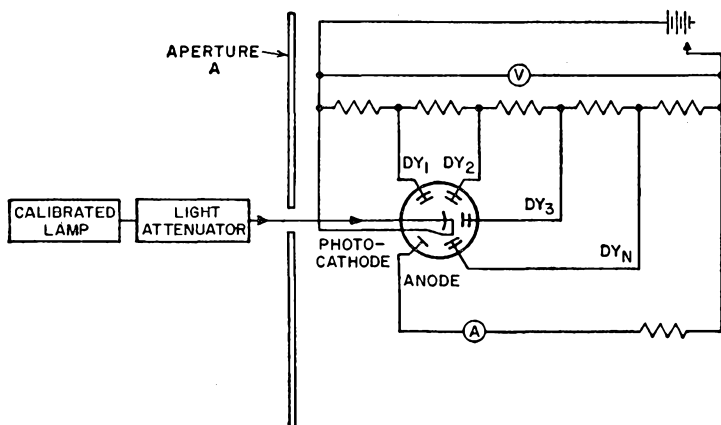

Fig. 95. Typical circuit for measuring sensitivity of multiplier phototubes.



used in series with the phototube because it represents a typical load and, in addition, provides a measure of safety for the meter in case of a short circuit. With multiplier phototubes, the tube is connected across a voltage divider, as shown in Fig. 95, which provides voltages as specified for the individual type. The current passing through the divider should have a value at least ten times that of the maximum anode current to be measured. A luminous flux in the range of  $10^{-8}$  to  $10^{-5}$  lumen (0.01 to 10 microlumens) is directed to the photocathode.

(As shown in the data for some multiplier phototubes, the luminous sensitivity can also be given with the last dynode stage used as the output electrode. With this arrangement, an output current of opposite polarity to that obtained at the anode is provided. Under this condition, the load is connected in the last dynode circuit and the anode serves only as the collector.)

Cathode luminous sensitivity is the photocurrent emitted per lumen of incident light flux at constant electrode voltage and is expressed in terms of microamperes ( $\mu\text{a}$  or  $10^{-6}$  ampere) per lumen. For photodiodes, this characteristic is measured by means of the circuit shown in Fig. 94 with a light flux of approximately 0.1 lumen applied. From a practical standpoint, there is no distinction made between the measurement of anode and cathode luminous sensitivity for photodiodes. In the case of multiplier phototubes, a measuring circuit similar to that shown in Fig. 95 is used with a dc voltage of 100 to 250 volts (specific value given in data for individual type) applied between the cathode and all other electrodes connected as anode. Light-limiting apertures are used and a light flux in the order of 0.01 lumen is generally applied. The measured photocurrent (minus the dark current) is then divided by the specified light level to determine cathode luminous sensitivity.

Radiant sensitivity is the output current divided by the incident radiant power of a given wavelength

at constant electrode voltages. Cathode radiant sensitivity is the amount of current leaving the photocathode divided by the incident radiant power of a given wavelength. These parameters are generally expressed in terms of amperes per watt (a/w). Although these characteristics can be measured by use of the circuits described above with the addition of a calibrated radiation thermocouple, they can be more readily computed from the measured cathode and anode luminous sensitivity values. This calculation<sup>1,2</sup> uses the conversion factors shown in Table IX, and is dependent on established typical spectral-response characteristics. For this reason, the result may differ somewhat from the value directly measured.

A suitable light source for use in this type of measurement is a spark discharge in a mercury switch capsule<sup>3</sup>. Although this source does not provide an ideal delta-function pulse, the resulting rise time of approximately 0.4 nanosecond is useful for many purposes.

Current amplification for multiplier phototubes is the ratio of the anode luminous sensitivity to the photocathode luminous sensitivity at constant electrode voltages, and is a computed parameter. (This characteristic can also be given as a ratio of radiant sensitivity.) Because of its magnitude, the amplification factor for multiplier phototubes is generally expressed in terms of millions, and is plotted logarithmically.

For a gas photodiode, the amplification factor is a ratio of photocurrents at two different anode voltages: the operating voltage (usually 90 volts) and 25 volts.

Equivalent anode-dark-current input is the anode dark current of a phototube divided by the radiant or luminous sensitivity. This parameter serves as a useful figure of merit for the comparison of dark current in multiplier phototubes, and can be expressed in picowatts (pw or  $10^{-12}$  watt) or nanolumens (nlm or  $10^{-9}$  lumen). The measurement method for this characteristic is similar to that for luminous sensitivity except

TABLE IX  
Spectral Responses for Devices with Related Photocathode  
Characteristic Values

Device S-Number	Conversion Factor (k) (lm/w)	Typical Luminous Sensitivity ( $S_{\tau_{70}}$ ) (2780°K) ( $\mu\text{a/lumen}$ )	Max Luminous Sensitivity <sup>1</sup> ( $\mu\text{a/lumen}$ ) $S_{\text{max}}$	$\lambda_{\text{max}}$ (angstroms)	Typical Radiant Sensitivity ( $\sigma_{\tau_{70}}$ ) (ma/w)	Typical Quantum Efficiency <sup>2</sup> (per cent)	Typical Photocathode Dark Emission <sup>3</sup> at 25°C (amperes/cm <sup>2</sup> ) $\times 10^{-15}$
S-1	93.9	25	60	8000	2.35	0.36	900
S-3	286	6.5	20	4200	1.86	0.55	
S-4	977	40	110	4000	39.1	12	0.2
S-5†	1252	40	80	3400	50.1†	18†	0.3
S-8	755	3	20	3650	2.26	0.77	0.13
S-9	683	30	110	4800	20.5	5.3	
S-10	508	40	100	4500	20.3	5.6	70
S-11	804	60	110	4400	48.2	14	3
S-13	795	60	80	4400	47.7	13	4
S-17	664	125	160	4900	83	21	1.2
S-19	*	40	70	*	22*	11*	0.3
S-20	428	150	250	4200	64.2	18	0.3
S-21	779	30	60	4400	23.4	6.6	

<sup>1</sup> Care must be used in converting  $s_{\text{max}}$  to a  $\sigma_{\text{max}}$  figure. Photocathodes having maximum lumen sensitivity frequently have more red sensitivity than normal, and the formula cannot be applied without re-evaluation of the spectral response for the particular maximum sensitivity device.

<sup>2</sup> 100 per cent quantum efficiency implies one photoelectron per incident quantum, or  $e/h\nu = \lambda/12,395$ , where  $\lambda$  is expressed in angstrom units. Quantum efficiency at  $\lambda_{\text{max}}$  is computed by comparing the radiant sensitivity at  $\lambda_{\text{max}}$  with the 100 per cent quantum efficiency expression above.

<sup>3</sup> Most of these data are obtained from multiplier phototube characteristics. For tubes capable of operating at very high gain factors, the dark emission at the photocathode is taken as the output dark current divided by the gain (or the equivalent minimum anode dark current input multiplied by cathode sensitivity). On tubes where other dc dark-current sources are predominant, the dark noise figure may be used. In this case, if all the noise originates from the photocathode emission, it may be shown that the photocathode dark emission in amperes is approximately  $0.4 \times 10^{18} \times$  (equivalent noise input in lumens times cathode sensitivity in amperes per lumen)<sup>2</sup>. The data shown are all given per unit area of the photocathode.

\* No value for k or  $\lambda_{\text{max}}$  is given because the spectral response data are in question. The values quoted for  $\sigma$  and typical quantum efficiency are only typical of measurements made at the specific wavelength 2537 angstroms and not at the wavelength of peak sensitivity as for the other data.

† The S-5 spectral response is suspected to be in error. The data tabulated conform to the published curve, which is maximum at 3400 angstroms. Present indications are that the peak value should agree with that of the S-4 curve (4000 angstroms). Typical radiant sensitivity and quantum efficiency would then agree with those for S-4 response.

that the applied voltage is adjusted until a specified anode luminous sensitivity is obtained. The light flux is then removed and the anode dark current is measured. If the measurement is made in terms of radiant flux, the wavelength of radiant energy is also specified and the applied voltage is adjusted to a specified anode current.

Equivalent noise input is that value of incident luminous flux which, when modulated in a stated manner, produces an rms output current equal to the rms noise current within a specified bandwidth. This charac-

teristic can be expressed in terms of picolumens (plm or  $10^{-12}$  lumens). The test conditions for this measurement are similar to those used for luminous sensitivity measurements except that the incident radiation is modulated by a mechanical "light-chopper" which produces a square-wave signal at the phototube anode.

Transit time of multiplier phototubes is defined as the time interval between the arrival of a delta-function light pulse (a pulse having finite integrated light flux and infinitesimal width) at the entrance window of the tube and the time at which

the output pulse at the anode terminal reaches peak amplitude. Fig. 96 shows a typical circuit for the measurement of transit time. As shown, a small pulsed light spot of specified diameter is directed on a central area of the photocathode. Because transit time is dependent upon the magnitude of the applied voltage, the voltages are specified for each type.

For this measurement, the length of the delay cable is adjusted until the time difference ( $T_0$ ) between the phototube output pulses and the marker pulses from the light source can be observed on a sampling oscilloscope. Transit time ( $T_t$ ) is then equal to

$$T_t = T_0 + T_d - T_a - T_c$$

where  $T_d$  is the electrical transit time of the delay cable;  $T_a$  is equal to the time it takes the light pulse to travel the distance between the mercury-switch light-pulse generator and the photocathode;  $T_c$  is equal to the electrical transit time of cable "A".

Anode-pulse rise time indicates the time required for the instantaneous amplitude of the output pulse at the anode terminal to go from 10 per cent to 90 per cent of the peak value. This parameter is normally expressed in nanoseconds (nsec or  $10^{-9}$  second). The circuit shown in Fig. 96 can also be used to

measure rise time. For this measurement, the incident light usually illuminates the entire photocathode. The rise times of the light source and the oscilloscope (or other display devices used), however, must be considered.

Transit-time spread is the time interval between the half-amplitude points of the output pulse at the anode terminal, which results from a delta function of light incident on the entrance window of the tube. This parameter is seldom measured directly because it is difficult to differentiate between the decay of the light source and the decay of the phototube. Transit-time variations between anode pulses as a function of light-spot position on the photocathode serve as a satisfactory indication of transit-time spread. As given in the data section, this parameter is expressed as greatest delay between anode pulses. For measurement of this parameter, a small-diameter light spot is initially centered on the photocathode; the transit time of the phototube is then determined and used as a reference point. The same light spot is then directed to another specified point on the cathode and this transit time is determined. The difference between these transit times indicates the transit-time spread.

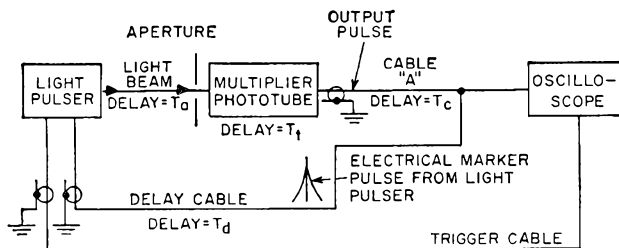

Fig. 96. Typical circuit for determining time response of phototubes.

## References

1. Engstrom, R. W., "Calculation of Radiant Photoelectric Sensitivity from Luminous Sensitivity", *RCA Review*, 16, No. 1, March 1955.
2. Engstrom, R. W., "Absolute Spectral Response Characteristics of Photosensitive Devices", *RCA Review*, 21, No. 2, June 1960.
3. Kerns, Q. A., Kirsten, F. A., and Cox, G. C., "Generator of Nanosecond Light Pulse for Phototube Testing", *Rev. Sci. Instr.*, 30, pp. 31-36, Jan. 1959.

# QUICK SELECTION GUIDE

## FOR RCA MULTIPLIER PHOTOTUBES

Spectral Response	Number of Stages	RCA type	Luminous Sensitivity (a/lm)	Anode Supply (volts)	Maximum Diameter (in.)	Maximum Length (in.)	Wavelength of Maximum Response (angstroms)
S-1	10	7102	4.5	1250	1.56	4.57	8000
S-4	9	1P21	80	1000	1.31	3.69	4000
S-4	9	931A	24	1000	1.31	3.69	4000
S-4	9	6472	35	1000	1.19	2.75	4000
S-4	9	6328	35	1000	1.31	3.12	4000
S-4	9	7117	35	1000	1.31	3.12	4000
S-5	9	1P28	50	1000	1.31	3.69	3400
S-8	9	1P22	1.0	1000	1.31	3.69	3650
S-10	10	6217	24	1000	2.31	5.81	4500
S-11	10	2020	6	1250	2.31	5.81	4400
S-11	10	2067	15	1000	1.56	2.80	4400
S-11	10	4438	27	1000	1.56	3.91	4400
S-11	10	4439	27	1000	1.56	3.91	4400
S-11	10	4440	27	1000	1.56	4.12	4400
S-11	10	4441	27	1000	1.56	3.18	4400
S-11	10	5819	25	1000	2.31	5.81	4400
S-11	10	6199	27	1000	1.56	4.57	4400
S-11	10	6342A	18	1250	2.31	5.81	4400
S-11	10	6655A	50	1000	2.31	5.81	4400
S-11	14	6810A	3050	2000	2.38	7.5	4400
S-11*	14	7046	180	2800	5.25	11.12	4200
S-11	14	7264	875	2000	2.38	7.5	4400
S-11	10	7746	1200	2000	2.31	6.12	4400
S-11	6	7764	0.3	1200	0.78	2.75	4400
S-11	10	7767	16	1250	0.78	4	4400
S-11	12	7850	6000	2300	2.06	6.31	4400
S-11	10	8053	19	1500	2.31	5.81	4400
S-11	10	8054	19	1500	3.65	6.31	4400
S-11	10	8055	19	1500	5.31	7.69	4400
S-13	10	6903	24	1000	2.31	6.56	4400
S-17	10	7029	40	1000	1.56	3.75	4900
S-19	9	7200	40	1000	1.31	5.69	3300
S-20	14	7265	3000	2400	2.38	7.5	4200
S-20	10	7326	22.5	1800	2.38	6.78	4200

\*Extended S-11 response; response from approximately 2500 to 6500 angstroms.

# Technical Data

THIS section contains maximum ratings, characteristics, and curves for RCA gas, vacuum, and multiplier phototubes. Also included is a chart describing RCA's line of photocells. All ratings given in this section are based on the Absolute Maximum System.

Tube types are listed according to the numerical-alphabetical-numerical sequence of their type designations. For socket and shield data for all phototubes, see page 182. For Key to Terminal-Connection Diagrams, see inside back cover.

A number of abbreviations have been used to simplify the tabulation of parameters. Some of the less familiar are shown below.

a/lm	— ampere per lumen
a/w	— ampere per watt
nlm	— nanolumen or $10^{-9}$ lumen
nsec	— nanosecond or $10^{-9}$ second
pf	— picofarad or $10^{-12}$ farad
plm	— picolumen or $10^{-12}$ lumen
pw	— picowatt or $10^{-12}$ watt
$\mu$ a	— microampere or $10^{-6}$ ampere

NINE-STAGE, side-on type having S-4 response. Wavelength of maximum spectral response is  $4000 \pm 500$  angstroms. This type makes use of cesium-antimony dynodes and a cesium-antimony, opaque photocathode. Window material is Corning No. 0080 lime glass or equivalent. Tube weighs approximately 1.6 ounces and has a non-hygroscopic base.

## 1P21 MULTIPLIER PHOTOTUBE

### DIRECT INTERELECTRODE CAPACITANCES (Approx.):

Anode to Dynode No. 9	4.4	pf
Anode to All Other Electrodes	6	pf

### MAXIMUM RATINGS (Absolute-Maximum Values):

Supply Voltage (DC or Peak AC):		
Between anode and cathode*	1250 max	volts
Between anode and dynode No. 9	250 max	volts
Between consecutive dynodes	250 max	volts
Between dynode No. 1 and cathode	250 max	volts
Average Anode Current	0.1 max	ma
Ambient Temperature	76 max	$^{\circ}$ C

### TYPICAL CHARACTERISTICS:

DC Supply Voltage**	1000	750	volts
Radiant Sensitivity (at 4000 angstroms)	78000	12000	a/w
Cathode Radiant Sensitivity (at 4000 angstroms)	0.04	0.04	a/w
Luminous Sensitivity*	80	12	a/lm

Cathode Luminous Sensitivity**	40	40	$\mu\text{a/lm}$
Current Amplification (in millions)	2	0.3	
Equivalent Anode-Dark-Current Input at 25°C at a luminous sensitivity of 20 a/lm	0.5 max	—	nIm
Equivalent Noise Input†	0.5	—	pIm

\*Operation with a supply voltage of less than 500 volts dc is not recommended; if used, illumination must be limited so that cathode photocurrent does not exceed approximately 0.01 microampere.

\*\*DC supply voltage (E) is connected across a voltage divider which provides 1/10 of E between cathode and dynode No. 1, 1/10 of E for each succeeding dynode stage, and 1/10 of E between dynode No. 9 and anode.

†With light input of 10 microlumens from a tungsten-filament lamp operated at a color temperature of 2870° K. Range of luminous sensitivity is 40 to 800 a/lm at 1000 volts; 5.4 to 100 a/lm at 750 volts.

\*\*With light input of 0.01 lumen from a tungsten-filament lamp operated at a color temperature of 2870° K; 100 volts applied between photocathode and all other electrodes connected as anode.

†At tube temperature of 25°C and with external shield connected to cathode; bandwidth is equal to 1 cycle per second. A tungsten-filament light source at a color temperature of 2870°K is interrupted at a low audio frequency to produce incident radiation pulses alternating between zero and the value stated. The "on" period of the pulse is equal to the "off" period.

**SENSITIVITY AND CURRENT AMPLIFICATION CHARACTERISTICS**

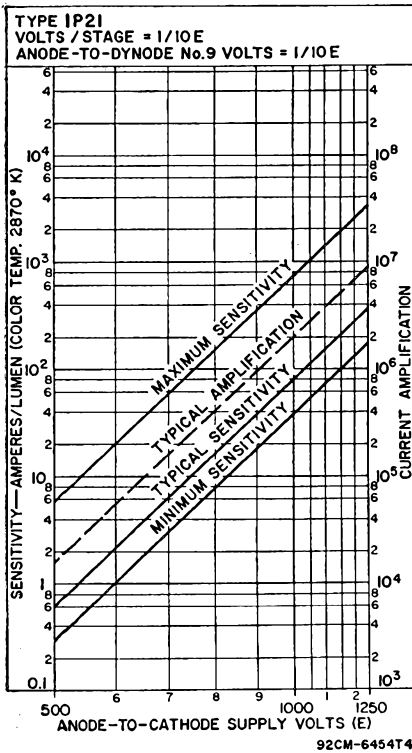

**TYPICAL EFFECT OF MAGNETIC FIELD ON ANODE CURRENT**

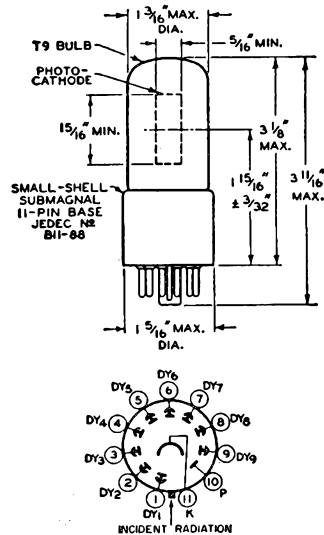
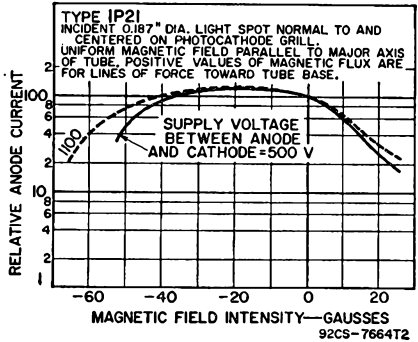

TYPICAL ANODE CHARACTERISTICS

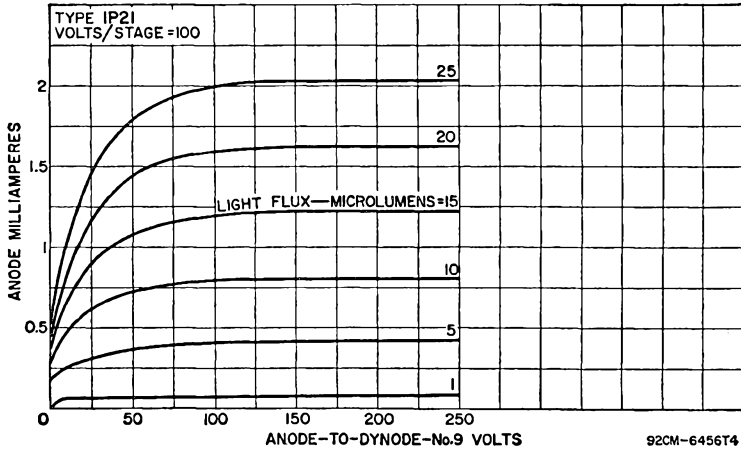

NINE-STAGE, side-on type having S-8 response. Wave-length of maximum response is  $3650 \pm 500$  angstroms. This type makes use of cesium-antimony dynodes and a cesium-bismuth, opaque photocathode. Window material is Corning No. 0080 lime glass or equivalent. Tube weighs approximately 1.6 ounces and has a non-hygroscopic base. For outline and terminal-connection diagram, refer to type 1P21.

**1P22  
MULTIPLIER  
PHOTOTUBE**

**DIRECT INTERELECTRODE CAPACITANCES (Approx.):**

Anode to Dynode No. 9 .....	4.4	pf
Anode to All Other Electrodes .....	6	pf

**MAXIMUM RATINGS (Absolute-Maximum Values):**

Supply Voltage (DC or Peak AC):		
Between anode and cathode .....	1250 max	volts
Between anode and dynode No. 9 .....	250 max	volts
Between consecutive dynodes .....	250 max	volts
Between dynode No. 1 and cathode .....	250 max	volts
Average Anode Current .....	1 max	ma
Ambient Temperature .....	50 max	°C

**TYPICAL CHARACTERISTICS:**

DC Supply Voltage*	1000	750	volts
Radiant Sensitivity (at 3650 angstroms)	750	110	a/w
Cathode Radiant Sensitivity (at 3650 angstroms)	0.0023	0.0023	a/w
Luminous Sensitivity**	1.0	0.145	a/lm
Cathode Luminous Sensitivity*	3	3	µa/lm
Current Amplification	330,000	48000	
Equivalent Anode-Dark-Current Input at 25°C at a luminous sensitivity of 0.4 a/lm	0.375 max	—	nlm
Equivalent Noise Input**	7.5	—	plm

\*DC supply voltage (E) is connected across a voltage divider which provides 1/10 of E between cathode and dynode No. 1, 1/10 of E for each succeeding dynode stage, and 1/10 of E between dynode No. 9 and anode.

\*\*With light input of 10 microlumens from a tungsten-filament lamp operated at a color temperature of 2870°K. Range of luminous sensitivity is 0.115 to 16 a/lm at 1000 volts; 0.016 at 1.85 a/lm at 750 volts.

\*With light input of 0.01 lumen from a tungsten-filament lamp operated at a color temperature of 2870°K; 100 volts applied between photocathode and all other electrodes connected as anode.

\*\*At tube temperature of 25°C and with external shield connected to cathode; bandwidth is equal to 1 cycle per second. A tungsten-filament light source at a color temperature of 2870°K is interrupted at a low audio frequency to produce incident radiation pulses alternating between zero and the value stated. The "on" period of the pulse is equal to the "off" period.

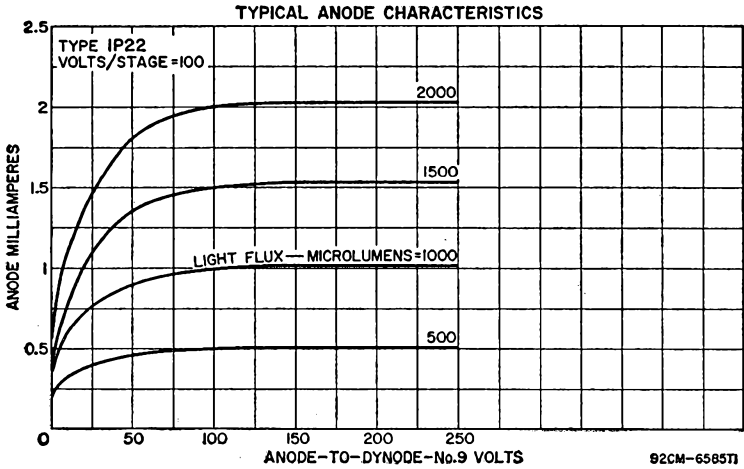

### SENSITIVITY AND CURRENT AMPLIFICATION CHARACTERISTICS

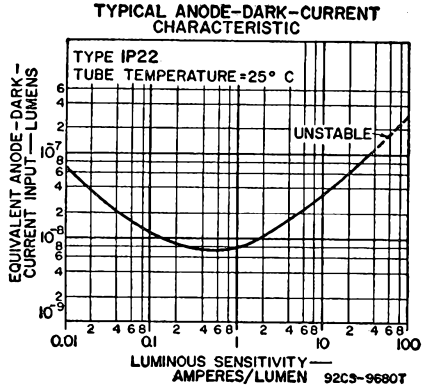
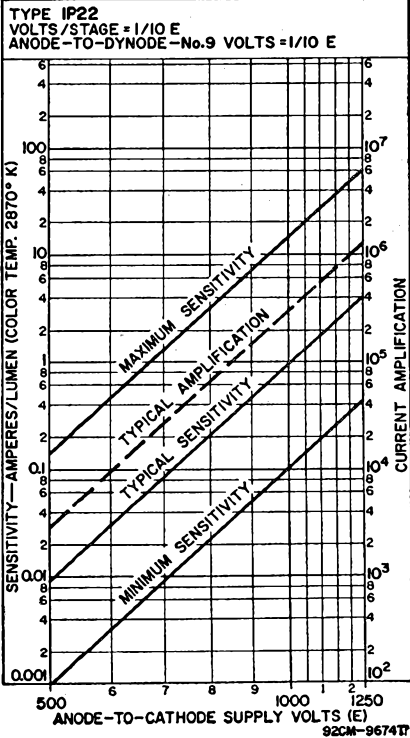



NINE-STAGE, side-on type having S-5 response. Wavelength of maximum response is  $3400 \pm 500$  angstroms. This type makes use of cesium-antimony dynodes and a cesium-bismuth, opaque photocathode. Window material is Corning No. 9741 ultraviolet-transmitting glass or equivalent. Tube weighs approximately 1.6 ounces and has a non-hygroscopic base. For outline and terminal-connection diagram, refer to type 1P21.

# 1P28 MULTIPLIER PHOTOTUBE

**DIRECT INTERELECTRODE CAPACITANCES (Approx.):**

Anode to Dynode No. 9 .....	4.4	pf
Anode to All Other Electrodes .....	6	pf

**MAXIMUM RATINGS (Absolute-Maximum Values):**

Supply Voltage (DC or Peak AC):		
Between anode and cathode .....	1250 max	volts
Between anode and dynode No. 9 .....	250 max	volts
Between consecutive dynodes .....	250 max	volts
Between dynode No. 1 and cathode .....	250 max	volts
Average Anode Current .....	0.5 max	ma
Ambient Temperature .....	75 max	°C

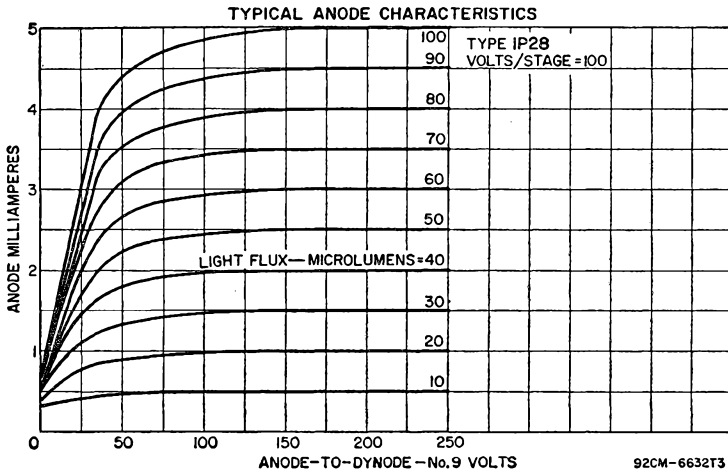

**TYPICAL CHARACTERISTICS:**

DC Supply Voltage*	1000	750	volts
Radiant Sensitivity (at 3400 angstroms)	61800	7900	a/w
Cathode Radiant Sensitivity (at 3400 angstroms)	0.05	0.05	a/w
Luminous Sensitivity			
At 0 cps**	50	6.4	a/lm
With dynode No. 9 as output electrode	30	—	a/lm
Cathode Luminous Sensitivity*	40	40	µa/lm
Current Amplification (in millions)	1.25	0.16	
Equivalent Anode-Dark-Current Input at 25°C			
at a luminous sensitivity of 20 a/lm:			
With anode as output electrode	1.25 max	—	nIm
With dynode No. 9 as output electrode	2 max	—	nIm
Equivalent Noise Input:			
Luminous**	0.75	—	plm
Ultraviolet†	0.00085	—	pw

\*DC supply voltage (E) is connected across a voltage divider which provides 1/10 of E between cathode and dynode No. 1, 1/10 of E for each succeeding dynode stage, and 1/10 of E between dynode No. 9 and anode.

\*\*With light input of 10 microlumens from a tungsten-filament lamp operated at color temperature of 2870°K. Range of luminous sensitivity is 17.5 to 300 a/lm at 1000 volts.

\*With light input of 0.01 lumen from a tungsten-filament lamp operated at a color temperature of 2870°K; 100 volts applied between photocathode and all other electrodes connected as anode.

\*\*At tube temperature of 25°C and with external shield connected to cathode; bandwidth is equal to 1 cycle per second. A tungsten-filament light source at a color temperature of 2870°K is interrupted at a low audio frequency to produce incident radiation pulses alternating between zero and the value stated. The "on" period of the pulse is equal to the "off" period.

†Under the same conditions as (\*\*) except that a monochromatic source radiating at 2537 angstroms is used.

EQUIVALENT-NOISE-INPUT CHARACTERISTICS

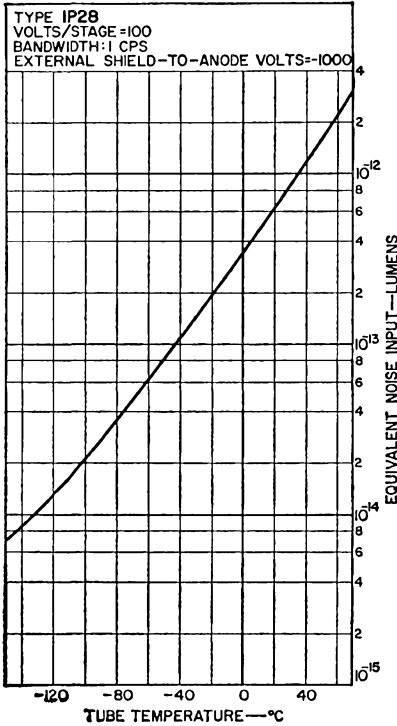

SENSITIVITY AND CURRENT AMPLIFICATION CHARACTERISTICS

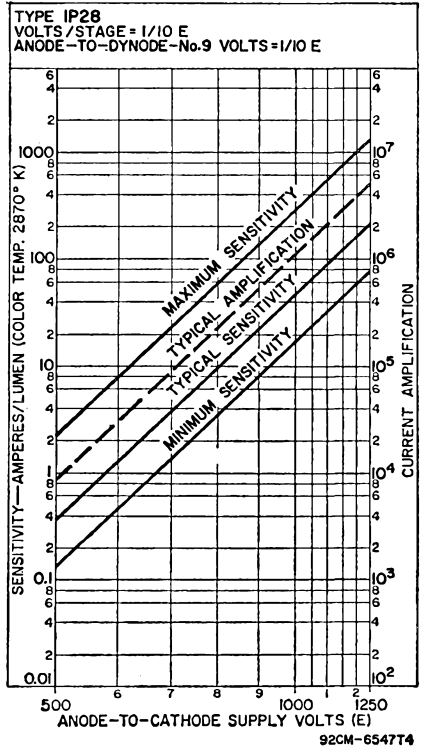

# 1P29

## GAS PHOTODIODE

SIDE-ON type having S-3 response. Wavelength of maximum spectral response is 4200 ± 1000 angstroms. This type makes use of a semicylindrical photocathode, and has a direct interelectrode capacitance of 3 picofarads. It weighs approximately 1.1 ounces.

**MAXIMUM RATINGS (Absolute-Maximum Values):**

	Rating 1	Rating 2	
Anode-Supply Voltage (DC or Peak AC)	80 max	100 max	volts
Average Cathode-Current Density	50 max	25 max	µa/sq in
Average Cathode Current	10 max	5 max	µa
Ambient Temperature	100 max	100 max	°C

**TYPICAL CHARACTERISTICS:**

Anode-Supply Voltage .....	90	volts
Radiant Sensitivity (at 4200 angstroms) .....	0.011	a/w
Luminous Sensitivity* .....	40	$\mu\text{a}/\text{lm}$
Gas Amplification Factor** .....	9 max	
Anode Dark Current (at 25°C) .....	0.10 max	$\mu\text{a}$

**MINIMUM CIRCUIT VALUES:**

Anode-Supply Voltage .....	80 or less	100 min	volts
DC Load Resistance:			
For average currents above 5 $\mu\text{a}$ .....	0.1 min	—	megohms
For average currents below 5 $\mu\text{a}$ .....	0 min	—	megohms
For average currents above 3 $\mu\text{a}$ .....	—	2.5 min	megohms
For average currents below 3 $\mu\text{a}$ .....	—	0.1 min	megohms

\*With light input of 0.1 lumen from a tungsten-filament lamp operated at a color temperature of 2870°K. Range of luminous sensitivity is 20 to 70  $\mu\text{a}/\text{lm}$ .  
 \*\*Ratio of luminous sensitivities at 90 and 25 volts.

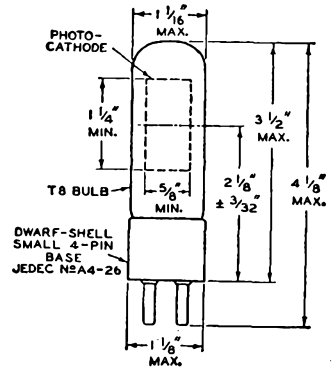
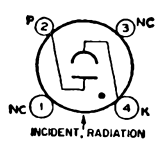
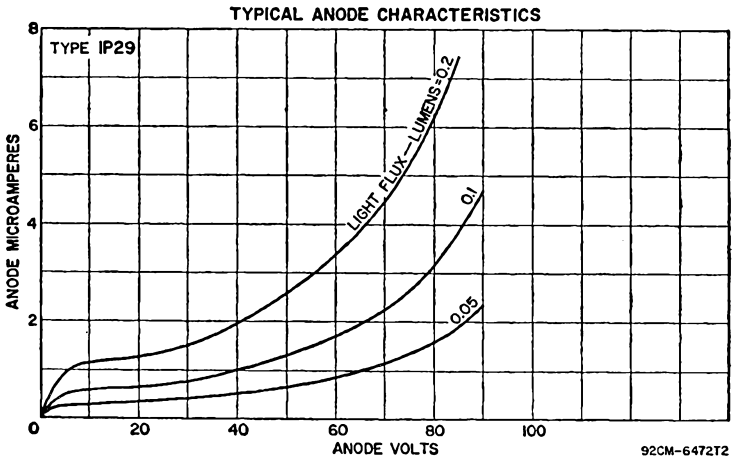

# 1P37 GAS PHOTODIODE

SIDE-ON type having S-4 response. Wavelength of maximum spectral response is  $4000 \pm 500$  angstroms. This type makes use of a semicylindrical photocathode, and has a direct interelectrode capacitance of 3 picofarads. It weighs approximately 1.1 ounces. For curves of typical anode characteristics, refer to type 5581. For outline and terminal connection diagram, refer to type 1P29.

**MAXIMUM RATINGS (Absolute-Maximum Values):**

	Rating 1	Rating 2	
Anode-Supply Voltage (DC or Peak AC)	80 max	100 max	volts
Average Cathode-Current Density	50 max	25 max	$\mu\text{a}/\text{sq}$ in
Average Cathode Current	10 max	5 max	$\mu\text{a}$
Ambient Temperature	75 max	75 max	$^{\circ}\text{C}$

**TYPICAL CHARACTERISTICS:**

Anode-Supply Voltage	90	volts
Radiant Sensitivity (at 4000 angstroms)	0.13	$\text{a}/\text{w}$
Luminous Sensitivity*	135	$\mu\text{a}/\text{lm}$
Gas Amplification Factor**	5.5 max	
Anode Dark Current (at $25^{\circ}\text{C}$ )	0.05 max	$\mu\text{a}$

**MINIMUM CIRCUIT VALUES:**

Anode-Supply Voltage	80 or less	100	volts
DC Load Resistance:			
For average currents above $5 \mu\text{a}$	0.1 min	—	megohms
For average currents below $5 \mu\text{a}$	0 min	—	megohms
For average currents above $3 \mu\text{a}$	—	2.5 min	megohms
For average currents below $3 \mu\text{a}$	—	0.1 min	megohms

\*With light input of 0.1 lumen from a tungsten-filament lamp operated at a color temperature of  $2870^{\circ}\text{K}$ . Range of luminous sensitivity is 75 to 205  $\mu\text{a}/\text{lm}$ .

\*\*Ratio of luminous sensitivities at 90 and 25 volts.

# 1P39 VACUUM PHOTODIODE

SIDE-ON type having S-4 response. This type is similar to type 929, but has a maximum anode dark current at  $25^{\circ}\text{C}$  of 0.005 microampere at 250 volts, and makes use of a non-hygroscopic base for increased resistance between anode and photocathode pins under adverse conditions of high humidity.

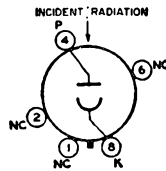
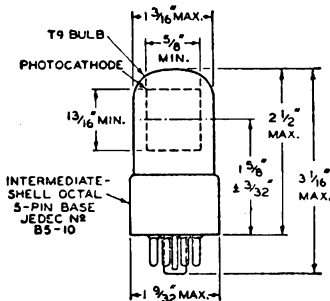

# 1P40 GAS PHOTODIODE

SIDE-ON type having S-1 response. This type is similar to type 930, but has a maximum anode dark current at  $25^{\circ}\text{C}$  of 0.005 microampere at 90 volts, and makes use of a non-hygroscopic base for increased resistance between anode and photocathode pins under adverse conditions of high humidity.

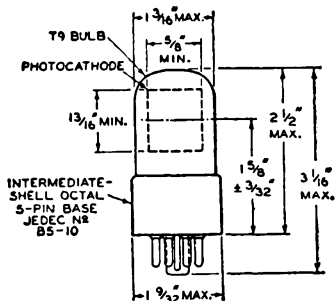
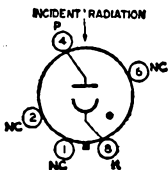

# 1P41 GAS PHOTODIODE

**MAXIMUM RATINGS (Absolute-Maximum Values):**

	Rating 1	Rating 2	
Anode-Supply Voltage (DC or Peak AC)	70 max	90 max	volts
Average Cathode-Current Density	40 max	20 max	$\mu\text{a}/\text{sq in}$
Average Cathode Current	8 max	1.5 max	$\mu\text{a}$
Ambient Temperature	100 max	100 max	$^{\circ}\text{C}$

**TYPICAL CHARACTERISTICS:**

Anode-Supply Voltage	90	volts
Radiant Sensitivity (at 8000 angstroms)	0.0084	$\text{a/w}$
Luminous Sensitivity*	90	$\mu\text{a}/\text{lm}$
Gas Amplification Factor	8.5 max	
Anode Dark Current (at 25 $^{\circ}\text{C}$ )	0.1 max	$\mu\text{a}$

**MINIMUM CIRCUIT VALUES:**

Anode-Supply Voltage	70 or less	90	volts
DC Load Resistance:			
For average currents above 1.5 $\mu\text{a}$	0.1 min	—	megohms
For average currents below 1.5 $\mu\text{a}$	0 min	—	megohms
For average currents above 1 $\mu\text{a}$	—	2.5 min	megohms
For average currents below 1 $\mu\text{a}$	—	0.1 min	megohms

\*With light input of 0.06 lumen from a tungsten-filament lamp operated at a color temperature of 2870 $^{\circ}\text{K}$ . Range of luminous sensitivity is 50 to 145  $\mu\text{a}/\text{lm}$ .

**TYPICAL ANODE CHARACTERISTICS**

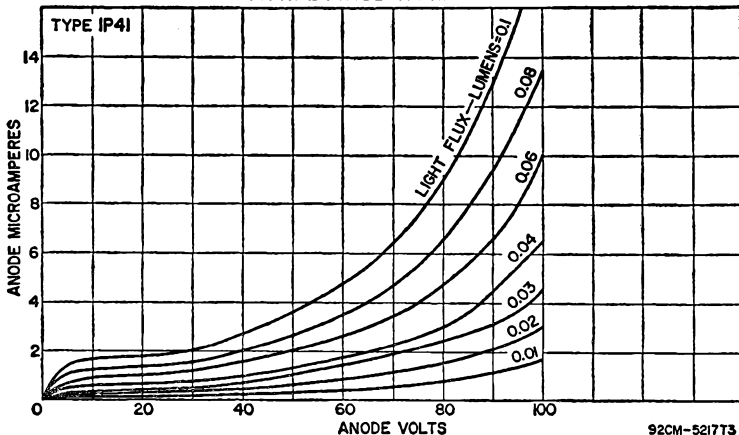

92CM-5217T3

NOTE: Incident radiation is into end of bulb.

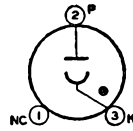
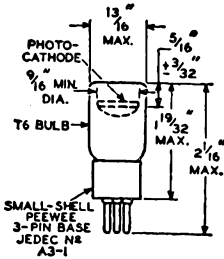

# 1P42 VACUUM PHOTODIODE

SMALL head-on type having S-9 response. Wave-length of maximum spectral response is  $4800 \pm 500$  angstroms. This type makes use of a flat circular photocathode, and has a direct interelectrode capacitance of 0.9 picofarad. It weighs approximately 0.1 ounce.

**MAXIMUM RATINGS (Absolute-Maximum Values):**

Anode-Supply Voltage (DC or Peak AC) .....	180 max	volts
Average Cathode-Current Density .....	25 max	$\mu\text{a}/\text{sq in}$
Average Cathode Current .....	0.4	$\mu\text{a}$
Ambient Temperature .....	75 max	$^{\circ}\text{C}$

**TYPICAL CHARACTERISTICS:**

Anode-Supply Voltage .....	180	volts
Radiant Sensitivity (at 4800 angstroms) .....	0.025	a/w
Luminous Sensitivity* .....	37	$\mu\text{a}/\text{lm}$
Anode Dark Current (at 25 $^{\circ}\text{C}$ ) .....	0.005 max	$\mu\text{a}$

\*With light input of 0.015 lumen from a tungsten-filament lamp operated at a color temperature of 2870 $^{\circ}\text{K}$ . Range of luminous sensitivity is 20 to 70  $\mu\text{a}/\text{lm}$ .

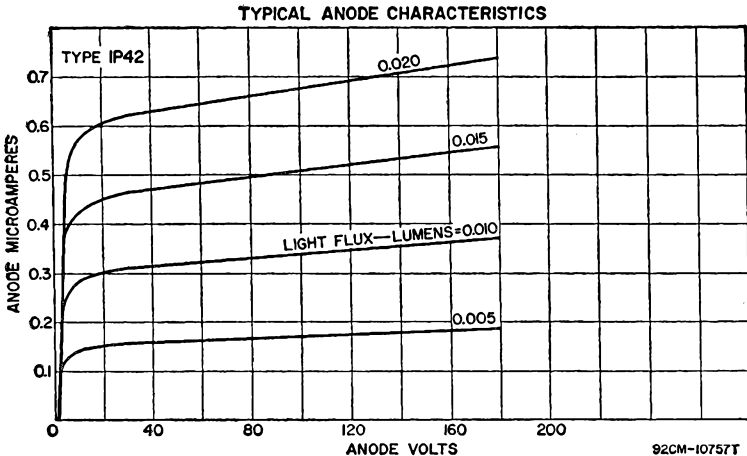

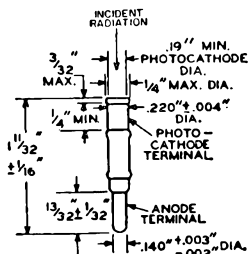
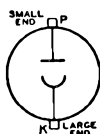

## 868 GAS PHOTODIODE

SIDE-ON type having S-1 response. Wavelength of maximum spectral response is  $8000 \pm 1000$  angstroms. This type makes use of a semicylindrical photocathode, and has a direct interelectrode capacitance of 3 picofarads. It weighs approximately 1.1 ounces. For curves of typical anode characteristics, refer to type 1P41. For outline and terminal-connection diagram, refer to type 1P29.

**MAXIMUM RATINGS (Absolute-Maximum Values):**

	Rating 1	Rating 2	
Anode-Supply Voltage (DC or Peak AC) .....	80 max	100 max	volts
Average Cathode-Current Density .....	50 max	25 max	$\mu\text{A}/\text{sq in}$
Average Cathode Current .....	10 max	5 max	$\mu\text{A}$
Ambient Temperature .....	100 max	100 max	$^{\circ}\text{C}$

**TYPICAL CHARACTERISTICS:**

Anode-Supply Voltage .....	90	volts
Radiant Sensitivity (at 8000 angstroms) .....	0.0084	a/w
Luminous Sensitivity* .....	90	$\mu\text{A}/\text{lm}$
Gas Amplification Factor** .....	8 max	
Anode Dark Current (at $25^{\circ}\text{C}$ ) .....	0.1 max	$\mu\text{A}$

**MINIMUM CIRCUIT VALUES:**

Anode-Supply Voltage .....	80 or less	100	volts
DC Load Resistance:			
For average currents above $5 \mu\text{A}$ .....	0.1 min	—	megohms
For average currents below $5 \mu\text{A}$ .....	0 min	—	megohms
For average currents above $3 \mu\text{A}$ .....	—	2.5 min	megohms
For average currents below $3 \mu\text{A}$ .....	—	0.1 min	megohms

\*With light input of 0.1 lumen from a tungsten-filament lamp operated at a color temperature of  $2870^{\circ}\text{K}$ . Range of luminous sensitivity is 50 to  $145 \mu\text{A}/\text{lm}$ .  
 \*\*Ratio of luminous sensitivities at 90 and 25 volts.

LOW-LEAKAGE, side-on type having S-1 response. Wavelength of maximum spectral response is  $8900 \pm 1000$  angstroms. This type makes use of a semicylindrical photocathode, and has a direct interelectrode capacitance of 2.2 picofarads. It weighs approximately 1.1 ounces.

## 917 VACUUM PHOTODIODE

**MAXIMUM RATINGS (Absolute-Maximum Values):**

Anode-Supply Voltage (DC or Peak AC) .....	500 max	volts
Average Cathode-Current Density .....	30 max	$\mu\text{A}/\text{sq in}$
Average Cathode Current .....	10 max	$\mu\text{A}$
Ambient Temperature .....	100 max	$^{\circ}\text{C}$

**TYPICAL CHARACTERISTICS:**

Anode-Supply Voltage .....	250	volts
Radiant Sensitivity (at 8000 angstroms) .....	0.0019	a/w

Luminous Sensitivity\* ..... 20  $\mu\text{A}/\text{lm}$   
 Anode Dark Current (at 25°C) ..... 0.005 max  $\mu\text{A}$

\*With light input of 0.1 lumen from a tungsten-filament lamp operated at a color temperature of 2870°K. Range of luminous sensitivity is 12 to 40  $\mu\text{A}/\text{lm}$ .

TYPICAL ANODE CHARACTERISTICS

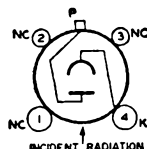
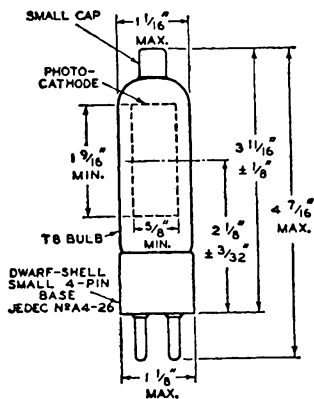
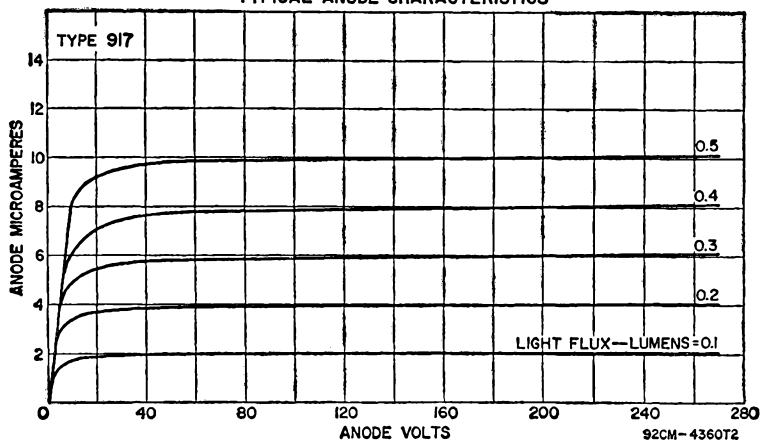

## 918 GAS PHOTODIODE

SIDE-ON type having S-1 response. Wavelength of maximum spectral response is  $8000 \pm 1000$  angstroms. This type makes use of a semicylindrical photocathode, and has a direct interelectrode capacitance of 3 picofarads. It weighs approximately 1.1 ounces. For outline and terminal-connection diagram, refer to type 1P29.

### MAXIMUM RATINGS (Absolute-Maximum Values):

	Rating 1	Rating 2	
Anode-Supply Voltage (DC or Peak AC) .....	70 max	90 max	volts
Average Cathode-Current Density .....	50 max	25 max	$\mu\text{A}/\text{sq in}$
Average Cathode Current .....	10 max	5 max	$\mu\text{A}$
Ambient Temperature .....	100 max	100 max	$^{\circ}\text{C}$



**TYPICAL CHARACTERISTICS:**

Anode-Supply Voltage .....	90	volts
Radiant Sensitivity (at 8000 angstroms) .....	0.014	a/w
Luminous Sensitivity* .....	150	$\mu\text{a}/\text{lm}$
Gas Amplification Factor** .....	10.5 max	
Anode Dark Current (at 25°C) .....	0.1 max	$\mu\text{a}$

**MINIMUM CIRCUIT VALUES:**

Anode-Supply Voltage .....	70 or less	90	volts
DC Load Resistance:			
For average currents above 5 $\mu\text{a}$ .....	0.1 min	—	megohms
For average currents below 5 $\mu\text{a}$ .....	0 min	—	megohms
For average currents above 3 $\mu\text{a}$ .....	—	2.5 min	megohms
For average currents below 3 $\mu\text{a}$ .....	—	0.1 min	megohms

\*With light input of 0.1 lumen from a tungsten-flament lamp operated at a color temperature of 2870°K. Range of luminous sensitivity is 120 to 220  $\mu\text{a}/\text{lm}$ .

\*\*Ratio of luminous sensitivities at 90 and 25 volts.

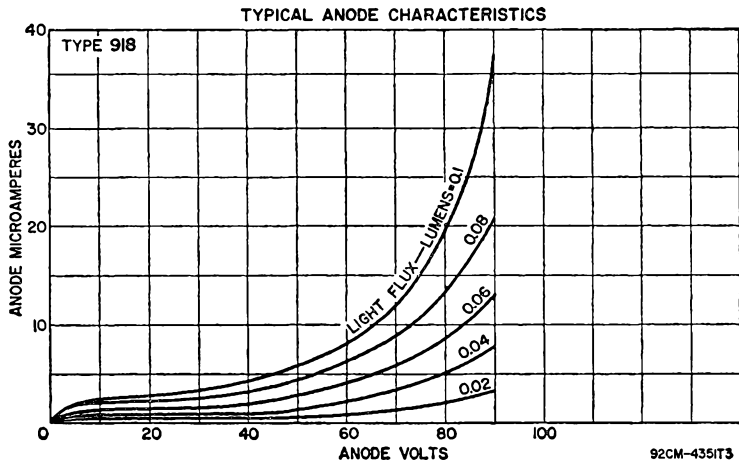

LOW-LEAKAGE, side-on type having S-1 response. This type is similar to type 917, but has the photocathode rather than the anode connected to the top cap.

**919  
VACUUM  
PHOTODIODE**

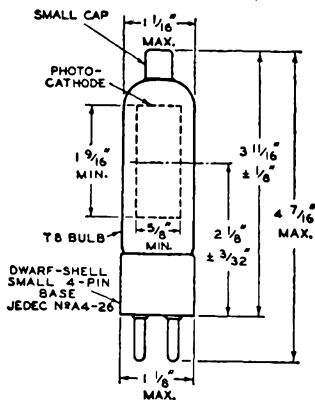
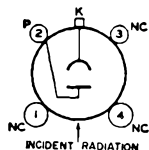

# 920 GAS PHOTODIODE

SIDE-ON, TWIN-UNIT type having S-1 response. Wavelength of maximum spectral response is  $8000 \pm 1000$  angstroms. This type makes use of a quarter-cylindrical photocathode. It weighs approximately 1.1 ounces.

**DIRECT INTERELECTRODE CAPACITANCES (Approx.):**

Cathode to Cathode .....	1.8	pf
Cathode to Anode (each unit) .....	1.6	pf
Anode to Anode .....	0.4	pf

**MAXIMUM RATINGS (Each Unit, Absolute-Maximum Values):**

	Rating 1	Rating 2	
Anode-Supply Voltage (DC or Peak AC) .....	70 max	90 max	volts
Average Cathode-Current Density .....	30 max	15 max	$\mu\text{a}/\text{sq in}$
Average Cathode Current .....	4 max	2 max	$\mu\text{a}$
Ambient Temperature .....	100 max	100 max	$^{\circ}\text{C}$

**TYPICAL CHARACTERISTICS (Each Unit):**

Anode-Supply Voltage .....	90	volts
Radiant Sensitivity (at 8000 angstroms) .....	0.0094	a/w
Luminous Sensitivity* .....	100	$\mu\text{a}/\text{lm}$
Ratio of Luminous Sensitivities (Unit No. 1 to Unit No. 2) .....	2 max	
Gas Amplification Factor** .....	9 max	
Anode Dark Current (at 25 $^{\circ}\text{C}$ ) .....	0.1 max	$\mu\text{a}$

**MINIMUM CIRCUIT VALUES (Each Unit):**

Anode-Supply Voltage .....	70 or less	90	volts
DC Load Resistance:			
For average currents above 2 $\mu\text{a}$ .....	0.1 min	—	megohms
For average currents below 2 $\mu\text{a}$ .....	0 min	—	megohms
For average currents above 1 $\mu\text{a}$ .....	—	2.5 min	megohms
For average currents below 1 $\mu\text{a}$ .....	—	0.1 min	megohms

\*With light input of 0.04 lumen from a tungsten-filament lamp operated at a color temperature of 2870 $^{\circ}\text{K}$ . Ratio of luminous sensitivity is 50 to 175  $\mu\text{a}/\text{lm}$ .

\*\*Ratio of luminous sensitivities at 90 and 25 volts.

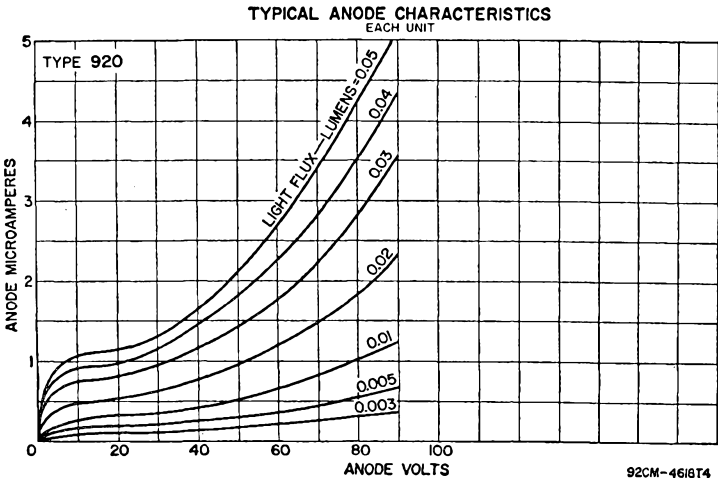

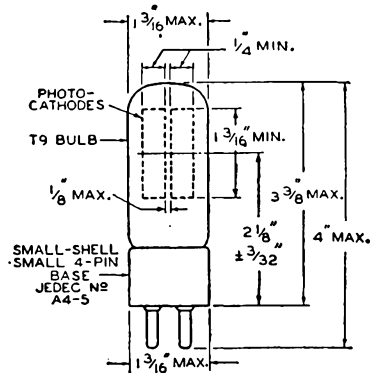
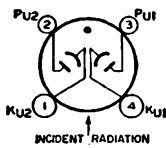

# 921 GAS PHOTODIODE

CARTRIDGE type having S-1 response. Wavelength of maximum spectral response is  $8000 \pm 1000$  angstroms. This type makes use of a semicylindrical photocathode, and has a direct interelectrode capacitance of 1 picofarad. It weighs approximately 0.4 ounce. For curves of typical anode characteristics, refer to type 930.

**MAXIMUM RATINGS (Absolute-Maximum Values):**

Anode-Supply Voltage (DC or Peak AC) .....	90 max	volts
Average Cathode-Current Density .....	30 max	$\mu\text{a}/\text{sq in}$
Average Cathode Current .....	3 max	$\mu\text{a}$
Ambient Temperature .....	100 max	$^{\circ}\text{C}$

**TYPICAL CHARACTERISTICS:**

Anode-Supply Voltage .....	90	volts
Radiant Sensitivity (at 8000 angstroms) .....	0.013	a/w
Luminous Sensitivity* .....	135	$\mu\text{a}/\text{lm}$
Gas Amplification Factor .....	10 max	
Anode Dark Current (at 25 $^{\circ}\text{C}$ ) .....	0.01 max	$\mu\text{a}$

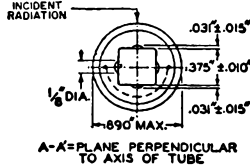
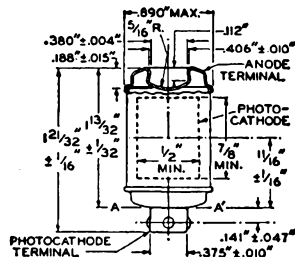
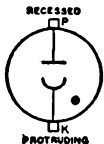



SIDE-ON type having S-1 response. This type is electrically similar to type 930, but has a direct interelectrode capacitance of 2 picofarads. This type is used principally for renewal purposes.

## 923 GAS PHOTODIODE

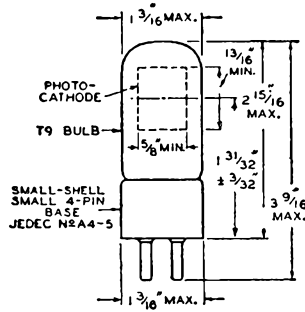
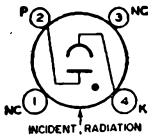

SIDE-ON, short-bulb type having S-1 response. Wavelength of maximum spectral response is  $8000 \pm 1000$  angstroms. This type makes use of a semicylindrical photocathode, and has a direct interelectrode capacitance of 1.6 picofarads. It weighs approximately 0.8 ounce.

## 925 VACUUM PHOTODIODE

### MAXIMUM RATINGS (Absolute-Maximum Values):

Anode-Supply Voltage (DC or Peak AC)	250 max	volts
Average Cathode-Current Density	30 max	$\mu\text{A}/\text{sq in}$
Average Cathode Current	5 max	$\mu\text{A}$
Ambient Temperature	100 max	$^{\circ}\text{C}$

### TYPICAL CHARACTERISTICS:

Anode-Supply Voltage	250	volts
Radiant Sensitivity (at 8000 angstroms)	0.0019	$\text{A}/\text{W}$
Luminous Sensitivity*	20	$\mu\text{A}/\text{lm}$
Anode Dark Current (at $25^{\circ}\text{C}$ )	0.0125 max	$\mu\text{A}$

\*With light input of 0.1 lumen from a tungsten-filament lamp operated at a color temperature of  $2870^{\circ}\text{K}$ . Range of luminous sensitivity is 12 to  $40 \mu\text{A}/\text{lm}$ .

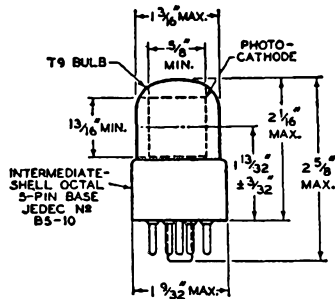
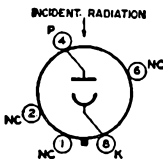

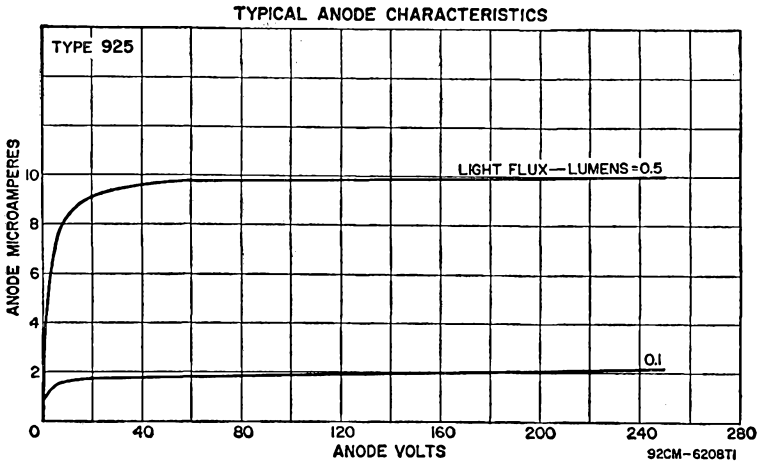

# 926

## VACUUM PHOTODIODE

CARTRIDGE type having S-3 response. Wavelength of maximum spectral response is  $4200 \pm 1000$  angstroms. This type makes use of a semicylindrical photocathode, and has a direct interelectrode capacitance of 1 picofarad. It weighs approximately 0.4 ounce.

**MAXIMUM RATINGS (Absolute-Maximum Values):**

Anode-Supply Voltage (DC or Peak AC) .....	500 max	volts
Average Cathode-Current Density .....	30 max	$\mu\text{a}/\text{sq in}$
Average Cathode Current .....	5 max	$\mu\text{a}$
Ambient Temperature .....	100 max	$^{\circ}\text{C}$

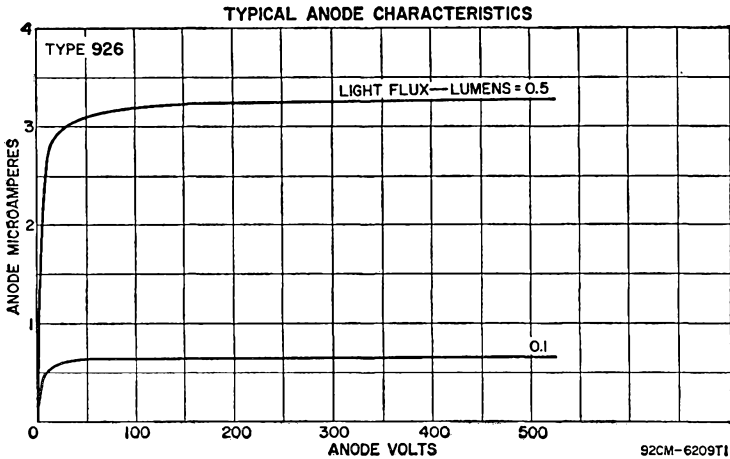

**TYPICAL CHARACTERISTICS:**

Anode-Supply Voltage .....	250	volts
Radiant Sensitivity (at 4200 angstroms) .....	0.0019	a/w
Luminous Sensitivity* .....	6.5	$\mu\text{a}/\text{lm}$
Anode Dark Current (at 25°C) .....	0.005 max	$\mu\text{a}$

\*With light input of 0.1 lumen from a tungsten-filament lamp operated at a color temperature of 2870°K. Range of luminous sensitivity is 4 to 15  $\mu\text{a}/\text{lm}$ .

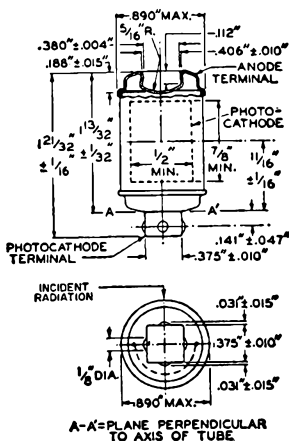
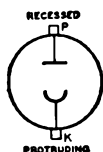

SIDE-ON type having S-1 response. Wavelength of maximum spectral response is  $8000 \pm 1000$  angstroms. This type makes use of a semicylindrical photocathode, and has a direct interelectrode capacitance of 2 picofarads. It weighs approximately 0.3 ounce.

**927  
GAS  
PHOTODIODE**

**MAXIMUM RATINGS (Absolute-Maximum Values):**

	Rating 1	Rating 2	
Anode-Supply Voltage (DC or Peak AC) .....	70 max	90 max	volts
Average Cathode-Current Density .....	60 max	30 max	$\mu\text{a}/\text{sq in}$
Average Cathode Current .....	4 max	2 max	$\mu\text{a}$
Ambient Temperature .....	100 max	100 max	°C

**TYPICAL CHARACTERISTICS:**

Anode-Supply Voltage .....	90	volts
Radiant Sensitivity (at 8000 angstroms) .....	0.012	a/w
Luminous Sensitivity* .....	125	$\mu\text{a}/\text{lm}$
Gas Amplification Factor** .....	10 max	
Anode Dark Current (at 25°C) .....	0.1 max	$\mu\text{a}$

**MINIMUM CIRCUIT VALUES:**

Anode-Supply Voltage .....	70 or less	90	volts
DC Load Resistance .....			
For average currents above 2 $\mu\text{a}$ .....	0.1 min	—	megohms
For average currents below 2 $\mu\text{a}$ .....	0 min	—	megohms
For average currents above 1 $\mu\text{a}$ .....	—	2.5 min	megohms
For average currents below 1 $\mu\text{a}$ .....	—	0.1 min	megohms

\*With light input of 0.1 lumen from a tungsten-filament lamp operated at a color temperature of 2870°K. Range of luminous sensitivity is 75 to 185  $\mu\text{a}/\text{lm}$ .

\*\*Ratio of luminous sensitivities at 90 and 25 volts.

TYPICAL ANODE CHARACTERISTICS

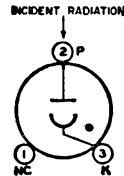
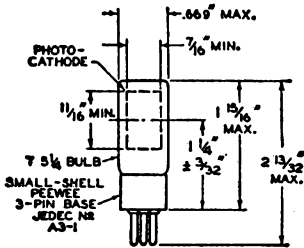
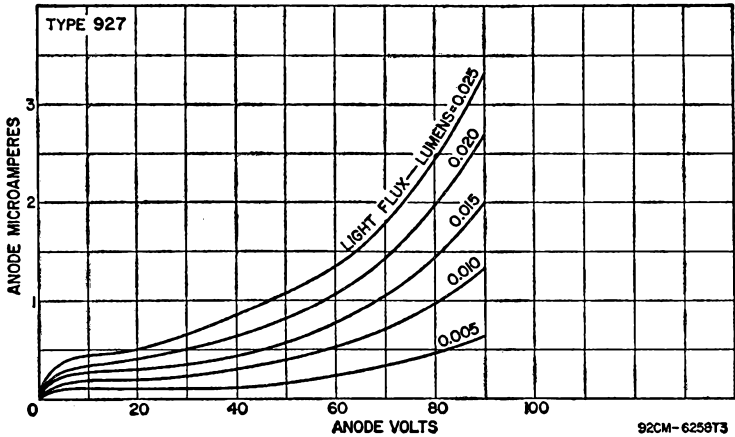

# 928 GAS PHOTODIODE

NON-DIRECTIONAL type having S-1 response. Wave-length of maximum spectral response is  $8000 \pm 1000$  angstroms. This type makes use of a cylindrical-mesh photocathode, and has a direct interelectrode capacitance of 3 picofarads. It weighs approximately 1 ounce.

**MAXIMUM RATINGS (Absolute-Maximum Values):**

	Rating 1	Rating 2	
Anode-Supply Voltage (DC or Peak AC)	70 max	90 max	volts
Average Cathode-Current Density	60 max	30 max	$\mu\text{a}/\text{sq in}$
Average Cathode Current	6 max	3 max	$\mu\text{a}$
Ambient Temperature	100 max	100 max	$^{\circ}\text{C}$

**TYPICAL CHARACTERISTICS:**

Anode-Supply Voltage	90	volts
Radiant Sensitivity (at 8000 angstroms)	0.0061	$\text{a}/\text{w}$
Luminous Sensitivity*	65	$\mu\text{a}/\text{lm}$
Gas Amplification Factor**	10 max	
Anode Dark Current (at $25^{\circ}\text{C}$ )	0.1 max	$\mu\text{a}$

**MINIMUM CIRCUIT VALUES:**

Anode-Supply Voltage	70 or less	90	volts
----------------------	------------	----	-------



DC Load Resistance:

For average currents above 3 $\mu$ A .....	0.1 min	—	megohms
For average currents below 3 $\mu$ A .....	0 min	—	megohms
For average currents above 2 $\mu$ A .....	—	2.5 min	megohms
For average currents below 2 $\mu$ A .....	—	0.1 min	megohms

\*With light input of 0.1 lumen from a tungsten-filament lamp operated at a color temperature of 2870°K. Range of luminous sensitivity is 40 to 100  $\mu$ A/lm.

\*\*Ratio of luminous sensitivities at 90 and 25 volts.

TYPICAL ANODE CHARACTERISTICS

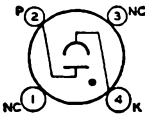
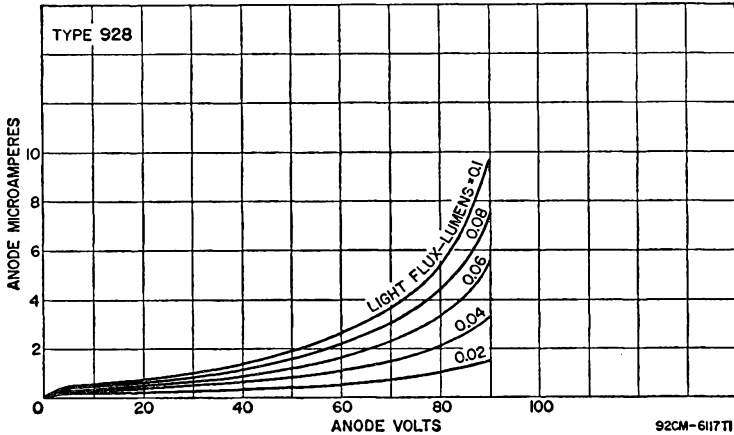

NOTE: Incident radiation is perpendicular to axis of photocathode.

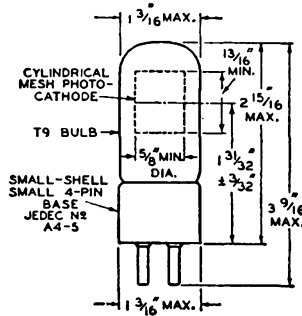

SIDE-ON type having S-4 response. Wavelength of maximum spectral response is  $4000 \pm 500$  angstroms. This type makes use of a semicylindrical photocathode, and has a direct interelectrode capacitance of 2.6 picofarads. It weighs approximately 0.9 ounce. For outline and terminal-connection diagram, refer to type 1P39.

**929**  
**VACUUM**  
**PHOTODIODE**

MAXIMUM RATINGS (Absolute-Maximum Values):

Anode-Supply Voltage (DC or Peak AC) .....	250 max	volts
Average Cathode-Current Density .....	25 max	$\mu$ A/sq in
Average Cathode Current .....	5 max	$\mu$ A
Ambient Temperature .....	75 max	°C

**TYPICAL CHARACTERISTICS:**

Anode-Supply Voltage .....	250	volts
Radiant Sensitivity (at 4000 angstroms) .....	0.044	a/w
Luminous Sensitivity* .....	45	$\mu\text{a}/\text{lm}$
Anode Dark Current (at 25°C) .....	0.0125 max	$\mu\text{a}$

\*With light input of 0.1 lumen from a tungsten-filament lamp operated at a color temperature of 2870°K. Range of luminous sensitivity is 25 to 70  $\mu\text{a}/\text{lm}$ .

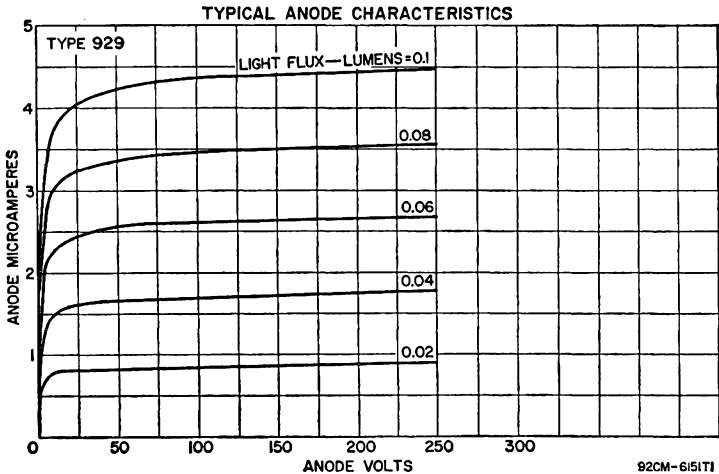

**930  
GAS  
PHOTODIODE**

SIDE-ON type having S-1 response. Wavelength of maximum spectral response is  $8000 \pm 1000$  angstroms. This type makes use of a semicylindrical photocathode, and has a direct interelectrode capacitance of 2.4 picofarads. It weighs approximately 0.9 ounce. For outline and terminal-connection diagram, refer to type 1P40.

**MAXIMUM RATINGS (Absolute-Maximum Values):**

	Rating 1	Rating 2	
Anode-Supply Voltage (DC or Peak AC) .....	70 max	90 max	volts
Average Cathode-Current Density .....	60 max	30 max	$\mu\text{a}/\text{sq in}$
Average Cathode Current .....	6 max	3 max	$\mu\text{a}$
Ambient Temperature .....	100 max	100 max	$^{\circ}\text{C}$

**TYPICAL CHARACTERISTICS:**

Anode-Supply Voltage .....	90	volts
Radiant Sensitivity (at 8000 angstroms) .....	0.013	a/w
Luminous Sensitivity* .....	135	$\mu\text{a}/\text{lm}$
Gas Amplification Factor** .....	10 max	
Anode Dark Current (at 25°C) .....	0.1 max	$\mu\text{a}$

**MINIMUM CIRCUIT VALUES:**

Anode-Supply Voltage .....	70 or less	90	volts
DC Load Resistance:			
For average currents above 3 $\mu\text{a}$ .....	0.1 min	—	megohms
For average currents below 3 $\mu\text{a}$ .....	0 min	—	megohms
For average currents above 2 $\mu\text{a}$ .....	—	2.5 min	megohms
For average currents below 2 $\mu\text{a}$ .....	—	0.1 min	megohms

\*With light input of 0.1 lumen from a tungsten-filament lamp operated at a color temperature of 2870°K. Range of luminous sensitivity is 90 to 205  $\mu\text{a}/\text{lm}$ .

\*\*Ratio of luminous sensitivities at 90 and 25 volts.

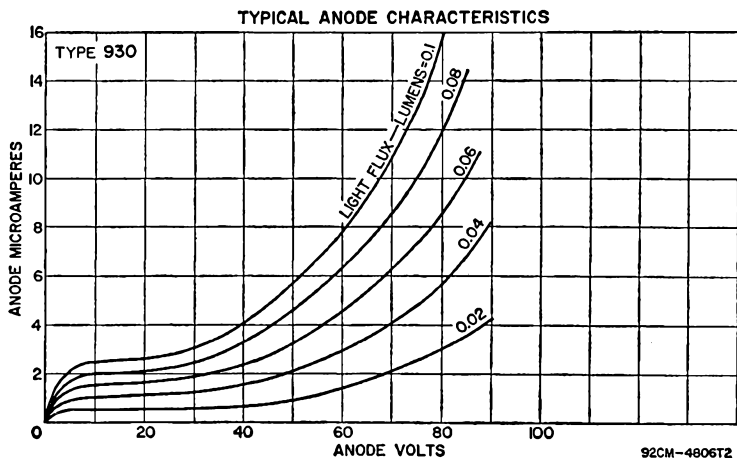

NINE-STAGE, side-on type having S-4 response. Wavelength of maximum response is  $4000 \pm 500$  angstroms. This type makes use of cesium-antimony dynodes and a cesium-antimony, opaque photocathode. Window material is Corning No. 0080 lime glass or equivalent. Tube weighs approximately 1.6 ounces and has a non-hygroscopic base. For outline and terminal-connection diagram, refer to type 1P21.

## 931A MULTIPLIER PHOTOTUBE

**DIRECT INTERELECTRODE CAPACITANCES (Approx.):**

Anode to Dynode No. 9 .....	4.4	pf
Anode to All Other Electrodes .....	6	pf

**MAXIMUM RATINGS (Absolute-Maximum Values):**

<b>Supply Voltage (DC or Peak AC):</b>		
Between anode and cathode .....	1250 max	volts
Between anode and dynode No. 9 .....	250 max	volts
Between consecutive dynodes .....	250 max	volts
Between dynode No. 1 and cathode .....	250 max	volts
Average Anode Current .....	1 max	ma
Ambient Temperature .....	75 max	°C

**TYPICAL CHARACTERISTICS:**

DC Supply Voltage* .....	1000	750	volts
Radiant Sensitivity (at 4000 angstroms) .....	24000	3300	a/w
Cathode Radiant Sensitivity (at 4000 angstroms) .....	0.03	0.03	a/w
Luminous Sensitivity** .....	24	3.3	a/lm
Cathode Luminous Sensitivity* .....	30	30	µa/lm
Current Amplification .....	800,000	110,000	
Equivalent Anode-Dark-Current Input at 25°C			
at a luminous sensitivity of 20 a/lm .....	2.5 max	—	nlm
Equivalent Noise Input** .....	0.95	—	plm

\*DC supply voltage (E) is connected across a voltage divider which provides 1/10 of E between cathode and dynode No. 1, 1/10 of E for each succeeding dynode stage, and 1/10 of E between dynode No. 9 and anode.

\*\*With light input of 10 microlumens from a tungsten-filament lamp operated at a color temperature of 2870°K. Range of luminous sensitivity is 4.5 to 300 a/lm at 1000 volts.

\*With light input of 0.01 lumen from a tungsten-filament lamp operated at a color temperature of 2870°K; 100 volts applied between photocathode and all other electrodes connected as anode.

\*\*At tube temperature of 25°C and with external shield connected to cathode; bandwidth is equal to 1 cycle per second. A tungsten-filament light source at a color temperature of 2870°K is interrupted at a low audio frequency to produce incident radiation pulses alternating between zero and the value stated. The "on" period of the pulse is equal to the "off" period.

TYPICAL ANODE CHARACTERISTICS

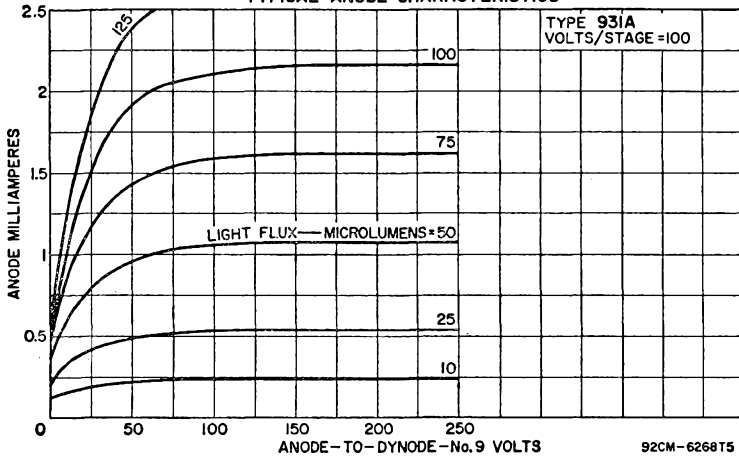

SENSITIVITY AND CURRENT AMPLIFICATION CHARACTERISTICS

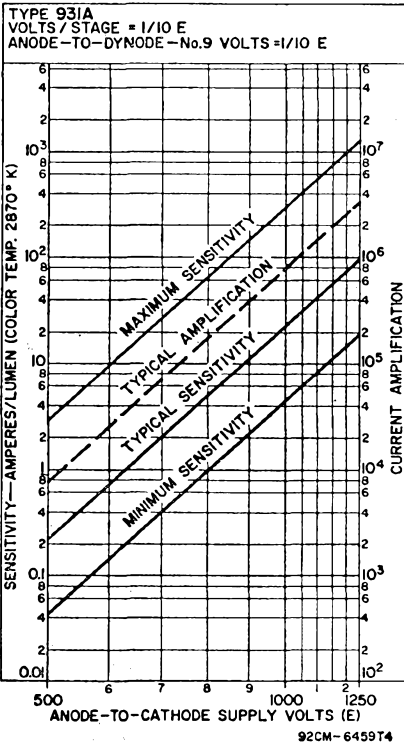

EQUIVALENT-NOISE-INPUT CHARACTERISTIC

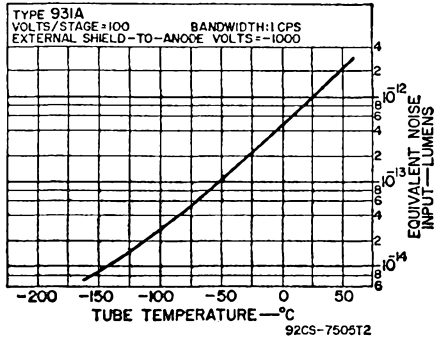

TYPICAL EFFECT OF MAGNETIC FIELD ON ANODE CURRENT

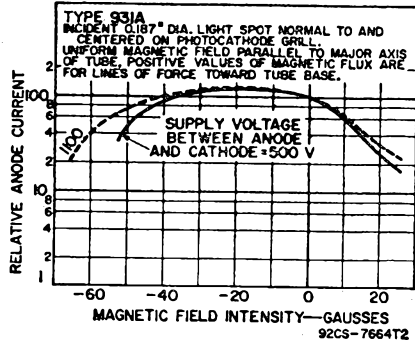

VARIATION IN SENSITIVITY OF PHOTOCATHODE ACROSS ITS PROJECTED WIDTH IN PLANE OF GRILL

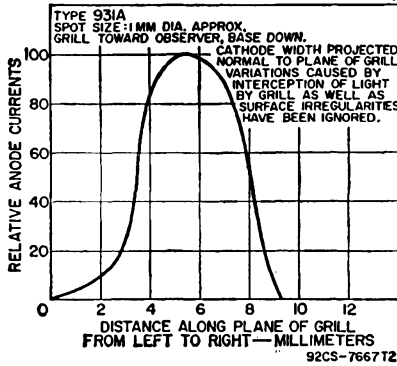

SIDE-ON type having S-4 response. Wavelength of maximum spectral response is  $4000 \pm 500$  angstroms. This type makes use of a semicylindrical photocathode, and has a direct interelectrode capacitance of 1.5 picofarads. It weighs approximately 0.4 ounce.

**934**  
**VACUUM**  
**PHOTODIODE**

**MAXIMUM RATINGS (Absolute-Maximum Values):**

Anode-Supply Voltage (DC or Peak AC) .....	250 max	volts
Average Cathode-Current Density .....	80 max	$\mu\text{a}/\text{sq in}$
Average Cathode Current .....	4 max	$\mu\text{a}$
Ambient Temperature .....	75 max	$^{\circ}\text{C}$

**TYPICAL CHARACTERISTICS:**

Anode-Supply Voltage .....	250	volts
Radiant Sensitivity (at 4000 angstroms) .....	0.029	$\frac{\text{a}}{\text{w}}$
Luminous Sensitivity* .....	80	$\mu\text{a}/\text{lm}$
Anode Dark Current (at 25 $^{\circ}\text{C}$ ) .....	0.005 max	$\mu\text{a}$

\*With light input of 0.1 lumen from a tungsten-filament lamp operated at a color temperature of 2870 $^{\circ}\text{K}$ . Range of luminous sensitivity is 19 to 75  $\mu\text{a}/\text{lm}$ .

**TYPICAL ANODE CHARACTERISTICS**

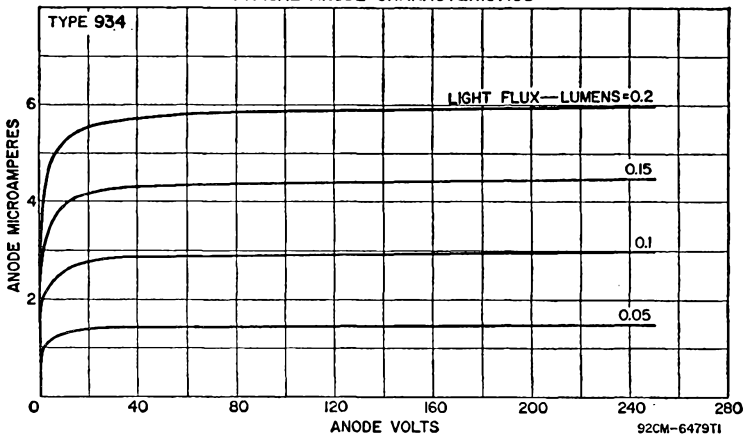

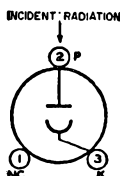
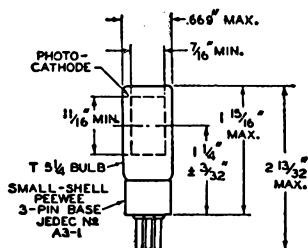

## 935 VACUUM PHOTODIODE

SIDE-ON type having S-5 response. Wavelength of maximum spectral response is  $3400 \pm 500$  angstroms. This type features a very low anode dark current. It makes use of a semicylindrical photocathode, and has a direct interelectrode capacitance of 0.6 picofarad. It weighs approximately 1 ounce.

### MAXIMUM RATINGS (Absolute-Maximum Values):

Anode-Supply Voltage (DC or Peak AC) .....	250 max	volts
Average Cathode-Current Density .....	30 max	$\mu\text{A}/\text{sq in}$
Average Cathode Current .....	10 max	$\mu\text{A}$
Ambient Temperature .....	75 max	$^{\circ}\text{C}$

### TYPICAL CHARACTERISTICS:

Anode-Supply Voltage .....	250	volts
Radiant Sensitivity (at 3400 angstroms) .....	0.043	$\text{a}/\text{w}$
Luminous Sensitivity* .....	35	$\mu\text{A}/\text{lm}$
Anode Dark Current (at $25^{\circ}\text{C}$ ) .....	0.0005 max	$\mu\text{A}$

\*With light input of 0.1 lumen from a tungsten-filament lamp operated at a color temperature of  $2870^{\circ}\text{K}$ . Range of luminous sensitivity is 18 to  $70 \mu\text{A}/\text{lm}$ .

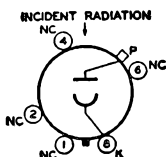
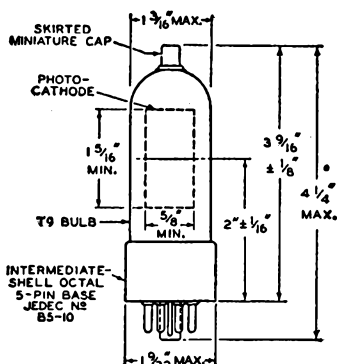

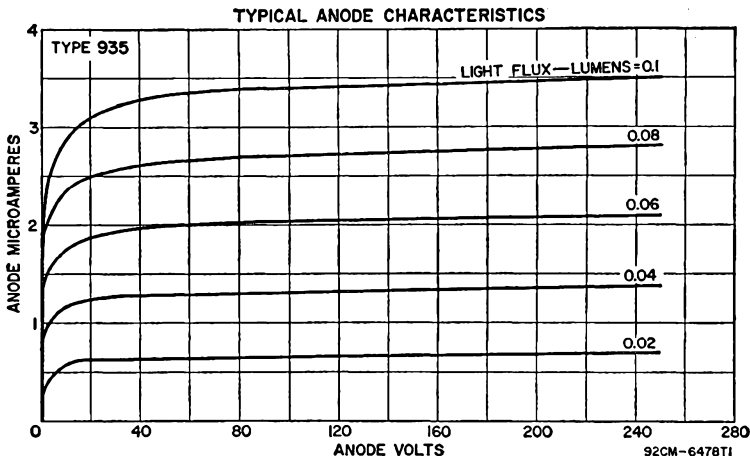

**2020  
MULTIPLIER  
PHOTOTUBE**

TEN-STAGE, head-on, flat-faceplate type having S-11 response. Wavelength of maximum response is  $4400 \pm 500$  angstroms. This type makes use of copper-beryllium dynodes and a cesium-antimony, semi-transparent photocathode having a high-conductivity grating. Window material is Corning No. 0080 lime glass or equivalent. Tube weighs approximately 5.2 ounces and has a non-hygroscopic base.

**DIRECT INTERELECTRODE CAPACITANCES (Approx.):**

Anode to Dynode No. 10 .....	4.4	pf
Anode to All Other Electrodes .....	7	pf

**MAXIMUM RATINGS (Absolute-Maximum Values):**

Supply Voltage (DC or Peak AC):		
Between anode and cathode .....	1500 max	volts
Between anode and dynode No. 10 .....	250 max	volts
Between dynode No. 1 and cathode .....	400 max	volts
Between focusing electrode and cathode .....	400 max	volts
Average Anode Current .....	2 max	ma
Cathode Irradiation† .....	0.1 max	lm
Ambient Temperature .....	75 max	°C

**TYPICAL CHARACTERISTICS:**

DC Supply Voltage* .....	1250	volts
Radiant Sensitivity (at 4400 angstroms) .....	4800	a/w
Cathode Radiant Sensitivity (at 4400 angstroms) .....	0.04	a/w
Luminous Sensitivity:		
At 0 cps** .....	6.0	a/lm
With dynode No. 10 as output electrode .....	3.6	a/lm
Cathode Luminous Sensitivity:		
With tungsten light source* .....	50	µa/lm
With blue light source** .....	0.03 min	µa
Current Amplification .....	120,000	
Equivalent Anode-Dark-Current Input at 25°C		
at a luminous sensitivity of 20 a/lm .....	2.25 max	nlm
Equivalent Noise Input†† .....	7	plm

†Above this value of cathode irradiation, serious loss in linearity between light input and anode current will be caused by the resistivity of the cathode.

\*DC supply voltage (E) is connected across a voltage divider which provides 1/6 of E between cathode and dynode No. 1, 1/12 of E for each succeeding dynode stage, and 1/12 of E between dynode No. 10 and anode. Focusing-electrode voltage is adjusted to that value between 10 and 60 per cent of dynode No. 1 potential (referred to cathode) which provides maximum anode current.

\*\*With light input of 10 microlumens from a tungsten-filament lamp operated at a color temperature of 2870°K. Range of luminous sensitivity is 2.5 to 75 a/lm at 1250 volts.

\*With light input of 0.01 lumen from a tungsten-filament lamp operated at a color temperature of 2870°K; 200 volts applied between photocathode and all other electrodes connected as anode.

\*\*Same conditions as (+), but a blue filter is used (Corning C.S. No. 5-58, glass code No. 5118, polished to 1/2 stock thickness).

††At tube temperature of 25°C and with external shield connected to cathode; bandwidth is equal to 1 cycle per second. A tungsten-filament light source at a color temperature of 2870°K is interrupted at a low audio frequency to produce incident radiation pulses alternating between zero and the value stated. The "on" period of the pulse is equal to the "off" period.

Typical Anode Characteristics

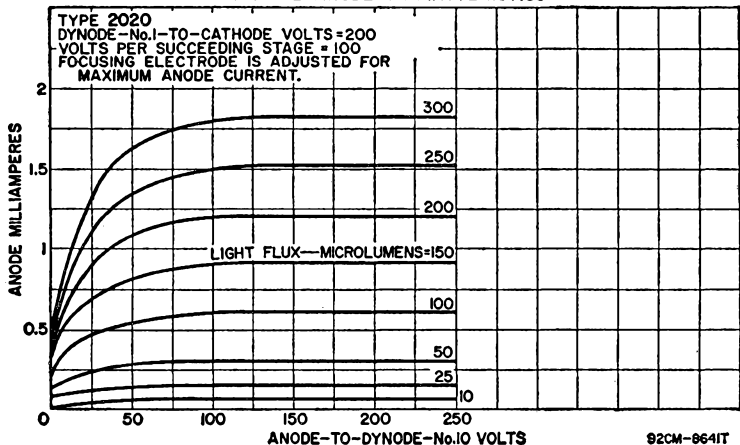

Sensitivity and Current Amplification Characteristics

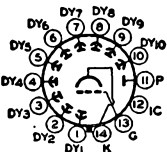
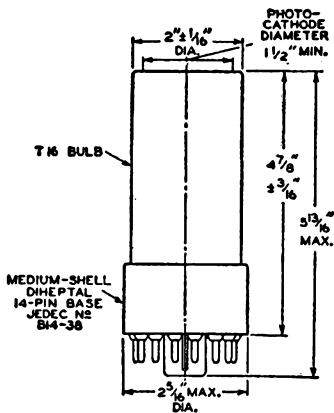
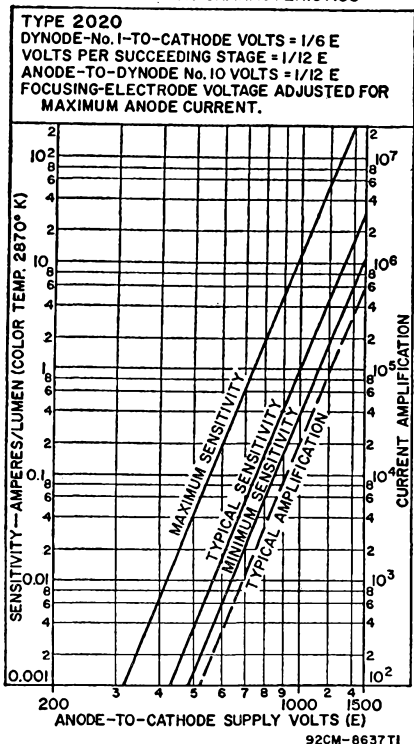

NOTE: Incident radiation is into end of bulb.



**EFFECT OF MAGNETIC FIELD ON ANODE CURRENT**

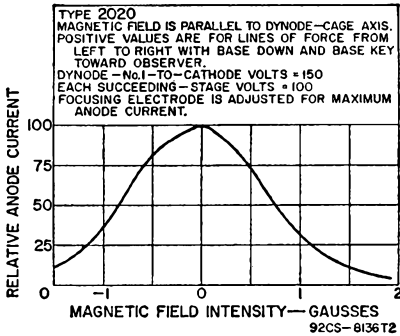

**TYPICAL ANODE-DARK-CURRENT CHARACTERISTIC**

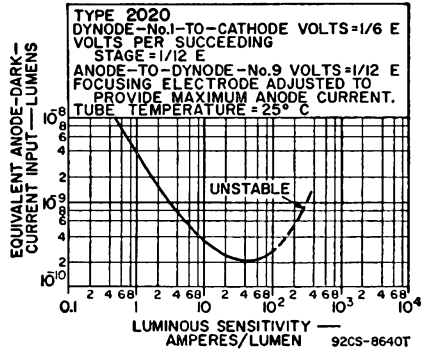

TEN-STAGE, ruggedized, head-on type having S-11 response. Wavelength of maximum response is  $4400 \pm 500$  angstroms. This type makes use of cesium-antimony dynodes and a cesium-antimony, semitransparent photocathode having a circular hemispherical shape. Window material is Corning No. 0080 lime glass or equivalent. Tube weighs approximately 1.8 ounces without base.

**2067  
MULTIPLIER  
PHOTOTUBE**

**DIRECT INTERELECTRODE CAPACITANCES (Approx.):**

Anode to Dynode No. 10 .....	4	pf
Anode to All Other Electrodes .....	7	pf

**MAXIMUM RATINGS (Absolute-Maximum Values):**

<b>DC Supply Voltage:</b>		
Between anode and cathode .....	1250 max	volts
Between anode and dynode No. 10 .....	250 max	volts
Between consecutive dynodes .....	200 max	volts
Between dynode No. 1 and cathode .....	300 max	volts
Average Anode Current .....	0.75 max	ma
Ambient Temperature .....	75 max	°C

**TYPICAL CHARACTERISTICS:**

DC Supply Voltage*	1000	volts
Radiant Sensitivity (at 4400 angstroms)	12000	a/w
Cathode Radiant Sensitivity (at 4400 angstroms)	0.036	a/w
Luminous Sensitivity**	15	a/lm
<b>Cathode Luminous Sensitivity:</b>		
With tungsten light source*	45	µa/lm
With blue light source**	0.03 min	µa/lm
Current Amplification	330,000	
<b>Equivalent Anode-Dark-Current Input at 25°C</b>		
at a luminous sensitivity of 20 a/lm	3 max	nIm
Equivalent Noise Input†	6.6	pIm

\*DC supply voltage (E) is connected across a voltage divider which provides 1/6 of E between cathode and dynode No. 1, 1/12 of E for each succeeding dynode stage, and 1/12 of E between dynode No. 10 and anode.

\*\*With light input of 1 microlumen from a tungsten-filament lamp operated at a color temperature of 2870°K. Range of luminous sensitivity is 3.3 to 100 a/lm at 1000 volts.

\*With light input of 0.01 lumen from a tungsten-filament lamp operated at a color temperature of 2870°K; 200 volts applied between cathode and all other electrodes connected as anode.

\*\*Same conditions as (\*), but a blue filter is used (Corning C.S. No. 5-58, glass code No. 5113, polished to 1/2 stock thickness).

†At tube temperature of 25°C and with external shield connected to cathode; bandwidth is equal to 1 cycle per second. A tungsten-filament light source at a color temperature of 2870°K is interrupted at a low audio frequency to produce incident radiation pulses alternating between zero and the value stated. The "on" period of the pulse is equal to the "off" period.

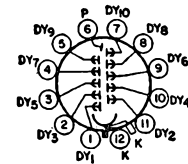
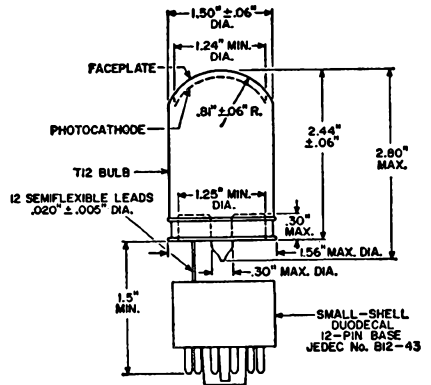
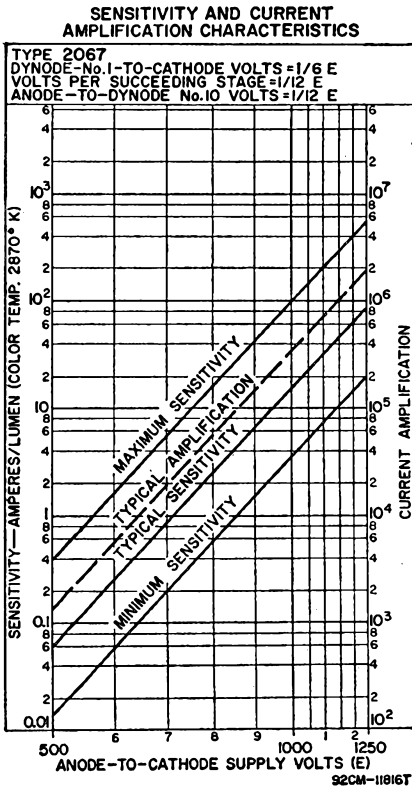
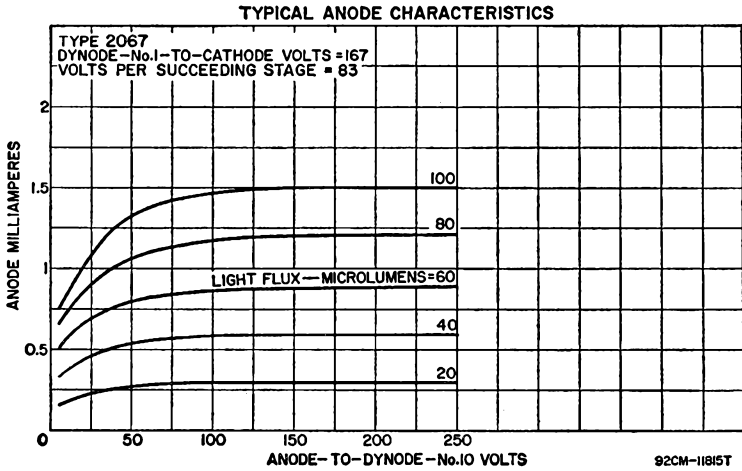

NOTE: Incident radiation is into end of bulb.

SIDE-ON type having unobstructed photocathode area and S-4 response. Wavelength of maximum spectral response is  $4000 \pm 500$  angstroms. This type makes use of a semicylindrical photocathode, and has a direct interelectrode capacitance of 2.4 picofarads. It weighs approximately 0.9 ounce. For outline and terminal-connection diagram, refer to type 1P40.

# 4409 GAS PHOTODIODE

**MAXIMUM RATINGS (Absolute-Maximum Values):**

	Rating 1	Rating 2	
Anode-Supply Voltage (DC or Peak AC)	80 max	100 max	volts
Average Cathode-Current Density	60 max	30 max	$\mu\text{a}/\text{sq in}$
Average Cathode Current	6 max	3 max	$\mu\text{a}$
Ambient Temperature	75 max	75 max	$^{\circ}\text{C}$

**TYPICAL CHARACTERISTICS:**

Anode-Supply Voltage	90	volts
Radiant Sensitivity (at 4000 angstroms)	0.13	a/w
Luminous Sensitivity*	135	$\mu\text{a}/\text{lm}$
Gas Amplification Factor	5.5 max	
Anode Dark Current (at 25 $^{\circ}\text{C}$ )	0.050 max	$\mu\text{a}$

**MINIMUM CIRCUIT VALUES:**

Anode-Supply Voltage	80 or less	90	volts
DC Load Resistance:			
For average currents above 3 $\mu\text{a}$	0.1 min	—	megohms
For average currents below 3 $\mu\text{a}$	0 min	—	megohms
For average currents above 1 $\mu\text{a}$	—	2.5 min	megohms
For average currents below 1 $\mu\text{a}$	—	0.1 min	megohms

\*With light input of 0.1 lumen from a tungsten-filament lamp operated at a color temperature of 2870 $^{\circ}\text{C}$ . Range of luminous sensitivity is 75 to 205  $\mu\text{a}/\text{lm}$ .

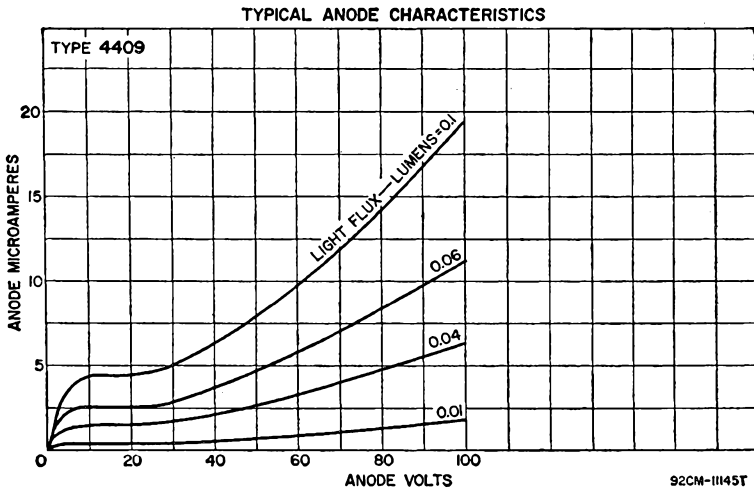

TEN-STAGE, ruggedized, flat-faceplate type having S-11 response. Wavelength of maximum response is  $4400 \pm 500$  angstroms. This type makes use of cesium-antimony dynodes and a flat-circular, cesium-antimony, semitransparent photocathode. Window material is Corning No. 0080 lime glass or equivalent. Tube weighs approximately 2 ounces.

# 4438 MULTIPLIER PHOTOTUBE

**DIRECT INTERELECTRODE CAPACITANCES (Approx.):**

Anode to Dynode No. 10 .....	4	pf
Anode to All Other Electrodes .....	7	pf

**MAXIMUM RATINGS (Absolute-Maximum Values):**

<b>DC Supply Voltage:</b>		
Between anode and cathode .....	1250 max	volts
Between anode and dynode No. 10 .....	250 max	volts
Between consecutive dynodes .....	200 max	volts
Between dynode No. 1 and cathode .....	300 max	volts
Average Anode Current .....	0.75 max	ma
Ambient Temperature .....	75 max	°C

**TYPICAL CHARACTERISTICS:**

DC Supply Voltage*	1000	750	volts
Radiant Sensitivity (at 4400 angstroms)	22000	2200	a/w
Cathode Radiant Sensitivity (at 4400 angstroms)	0.036	0.036	a/w
<b>Luminous Sensitivity:</b>			
At 0 cps**	27	2.7	a/lm
With dynode No. 10 as output electrode	16	1.6	a/lm
<b>Cathode Luminous Sensitivity:</b>			
With tungsten light source*	45	45	µa/lm
With blue light source**	0.028 min	0.028 min	µa
Current Amplification	600,000	60000	
Equivalent Anode-Dark-Current Input at 25°C			
at a luminous sensitivity of 20 a/lm	2.5 max	—	nlm
Equivalent Noise Input†	4	—	plm
Dark Current to Any Electrode except Anode at 25°C	0.75 max	—	µa

\*DC supply voltage (E) is connected across a voltage divider which provides 1/6 of E between cathode and dynode No. 1, 1/12 of E for each succeeding dynode stage, and 1/12 of E between dynode No. 10 and anode.

\*\*With light input of 10 microlumens from a tungsten-filament lamp operated at a color temperature of 2870°K. Range of luminous sensitivity is 10 to 300 a/lm at 1000 volts.

\*With light input of 0.01 lumen from a tungsten-filament lamp operated at a color temperature of 2870°K; 200 volts applied between cathode and all other electrodes connected as anode.

\*\*Same conditions as (\*), but a blue filter is used (Corning C.S. No. 5-58, glass code No. 5113, polished to 1/2 stock thickness).

†At tube temperature of 25°C and with external shield connected to cathode; bandwidth is equal to 1 cycle per second. A tungsten-filament light source at a color temperature of 2870°K is interrupted at a low audio frequency to produce incident radiation pulses alternating between zero and the value stated. The "on" period of the pulse is equal to the "off" period.

**TYPICAL ANODE CHARACTERISTICS**

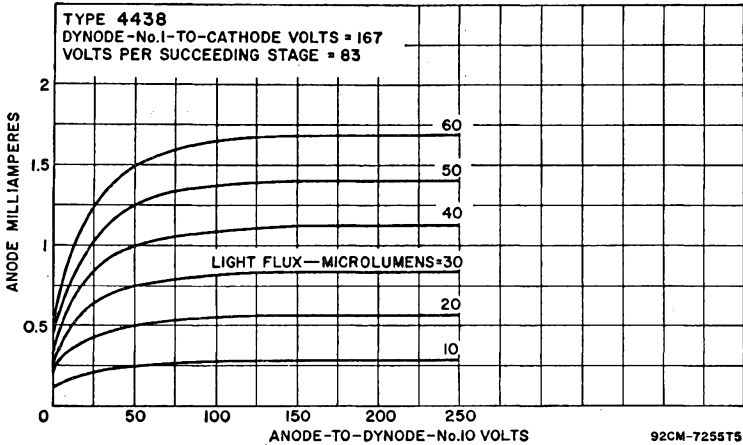

TYPICAL ANODE-DARK-CURRENT CHARACTERISTIC

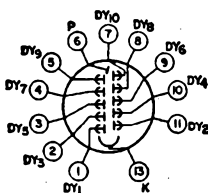
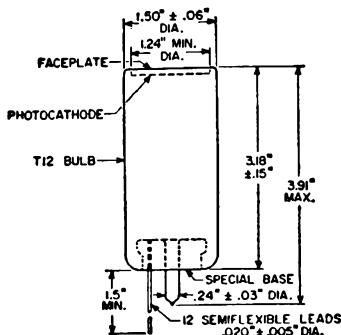
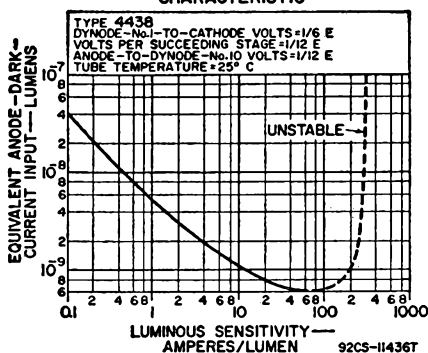

NOTE: Incident radiation is into end of bulb.

SENSITIVITY AND CURRENT AMPLIFICATION CHARACTERISTICS

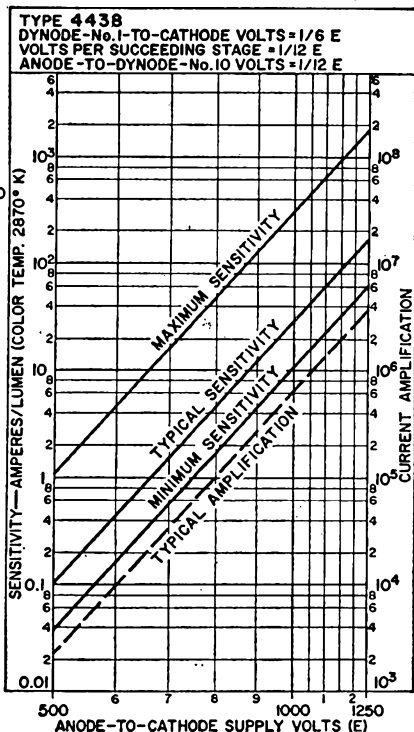

TEN-STAGE, ruggedized, flat-faceplate type having S-11 response. Wavelength of maximum response is  $4400 \pm 500$  angstroms. This type makes use of cesium-antimony dynodes and a cesium-antimony, semitransparent photocathode. Window material is Corning No. 0080 lime glass or equivalent. This type is identical to type 4438, but has a small-shell duodecal base attached to flexible leads. This base is for testing purposes and should be removed prior to installation.

**4439**  
**MULTIPLIER**  
**PHOTOTUBE**

# 4440 MULTIPLIER PHOTOTUBE

TEN-STAGE, ruggedized, flat-faceplate type having S-11 response. Wavelength of maximum response is  $4400 \pm 500$  angstroms. This type makes use of cesium-antimony dynodes and a flat-circular, cesium-antimony, semitransparent photocathode. Window material is Corning No. 0080 lime glass or equivalent. Tube weighs approximately 2.2 ounces and has a non-hygroscopic base. This tube is electrically identical to type 4438, but has a different outline and terminal connections.

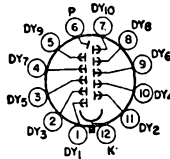
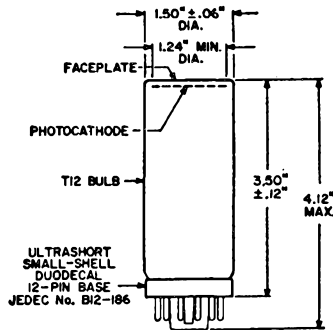

NOTE: Incident radiation is into end of bulb.

# 4441 MULTIPLIER PHOTOTUBE

TEN-STAGE, ruggedized, flat-faceplate type having S-11 response. Wavelength of maximum response is  $4400 \pm 500$  angstroms. This type makes use of cesium-antimony dynodes and a flat-circular, cesium-antimony, semitransparent photocathode. Window material is Corning No. 0080 lime glass or equivalent. Tube weighs approximately 3 ounces. This type has a special photocathode connection which assures continuous cathode contact under severe operating conditions. It is identical to type 4438 except for the following capacitances and dimensional outline:

**DIRECT INTERELECTRODE CAPACITANCES (Approx.):**

Anode to Dynode No. 10 .....	8.2	pf
Anode to All Other Electrodes .....	5	pf

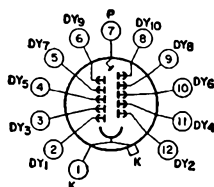

NOTE: Incident radiation is into end of bulb.

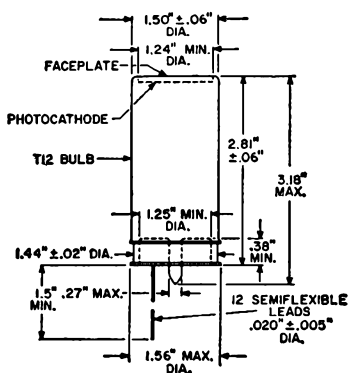

# 5581 GAS PHOTODIODE

SIDE-ON type having S-4 response. Wavelength of maximum spectral response is  $4000 \pm 500$  angstroms. This type makes use of a semicylindrical photocathode, and has a direct interelectrode capacitance of 2.6 picofarads. It weighs approximately 0.9 ounce. For outline and terminal-connection diagram, refer to type 1P40.

**MAXIMUM RATINGS (Absolute-Maximum Values):**

	Rating 1	Rating 2	
Anode-Supply Voltage (DC or Peak AC)	80 max	100 max	volts
Average Cathode-Current Density	60 max	30 max	$\mu\text{a}/\text{sq in}$
Average Cathode Current	6 max	3 max	$\mu\text{a}$
Ambient Temperature	75 max	75 max	$^{\circ}\text{C}$

**TYPICAL CHARACTERISTICS:**

Anode-Supply Voltage	90	volts
Radiant Sensitivity (at 4000 angstroms)	0.13	$\text{a/w}$
Luminous Sensitivity*	135	$\mu\text{a}/\text{lm}$

TYPICAL ANODE CHARACTERISTICS

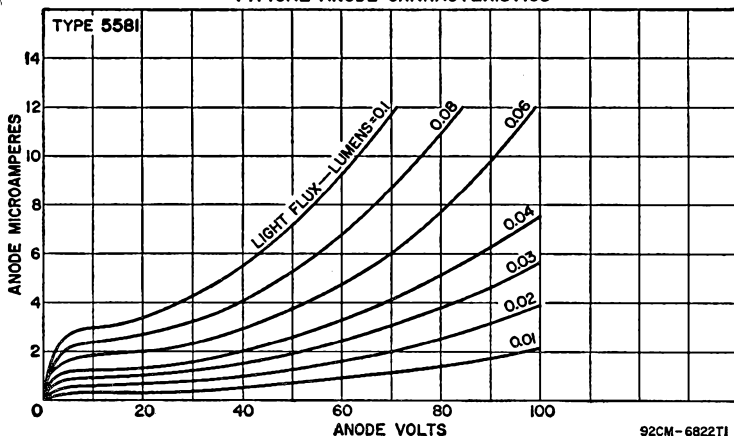

Gas Amplification Factor**	5.5 max	
Anode Dark Current (at 25°C)	0.05 max	μa

**MINIMUM CIRCUIT VALUES:**

Anode-Supply Voltage	80 or less	100	volts
DC Load Resistance:			
For average currents above 3 μa	—	0.1 min	megohms
For average currents below 3 μa	0 min	—	megohms
For average currents above 1 μa	—	2.5 min	megohms
For average currents below 1 μa	—	0.1 min	megohms

\*\*With light input of 0.1 lumen from a tungsten-filament lamp operated at a color temperature of 2870°K. Range of luminous sensitivity is 75 to 205 μa/lm.

\*\*Ratio of luminous sensitivities at 90 and 25 volts.

# 5582

## GAS PHOTODIODE

CARTRIDGE type having S-4 response. Wavelength of maximum spectral response is 4000 ± 500 angstroms. This type makes use of a semicylindrical photocathode, and has a direct interelectrode capacitance of 2.3 picofarads. It weighs approximately 0.4 ounce.

**MAXIMUM RATINGS (Absolute-Maximum Values):**

	Rating 1	Rating 2	
Anode-Supply Voltage (DC or Peak AC)	80 max	100 max	volts
Average Cathode-Current Density	40 max	20 max	μa/sq in
Average Cathode Current	4 max	2 max	μa
Ambient Temperature	75 max	75 max	°C

**TYPICAL CHARACTERISTICS:**

Anode-Supply Voltage	90	volts
Radiant Sensitivity (at 4000 angstroms)	0.12	a/w
Luminous Sensitivity*	120	μa/lm
Gas Amplification Factor**	5.5 max	
Anode Dark Current (at 25°C)	0.05 max	μa

**MINIMUM CIRCUIT VALUES:**

Anode-Supply Voltage	80 or less	100	volts
DC Load Resistance:			
For average currents above 3 μa	0.1 min	—	megohms
For average currents below 3 μa	0 min	—	megohms
For average currents above 1 μa	—	2.5 min	megohms
For average currents below 1 μa	—	0.1 min	megohms

\*\*With light input of 0.1 lumen from a tungsten-filament lamp operated at a color temperature of 2870°K. Range of luminous sensitivity is 80 to 175 μa/lm.

\*\*Ratio of luminous sensitivities at 90 and 25 volts.

**TYPICAL ANODE CHARACTERISTICS**

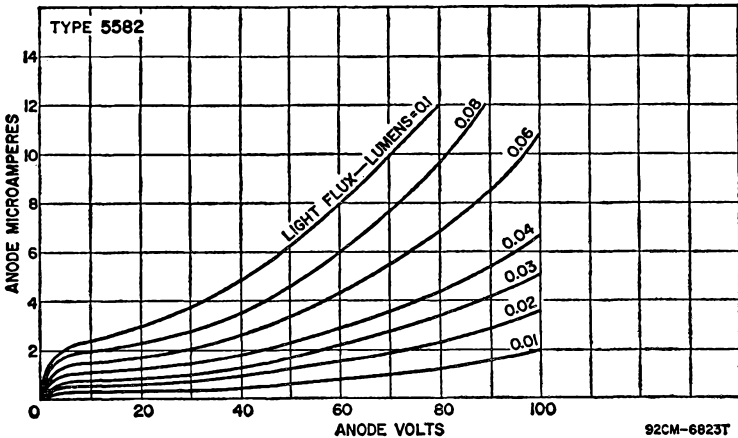



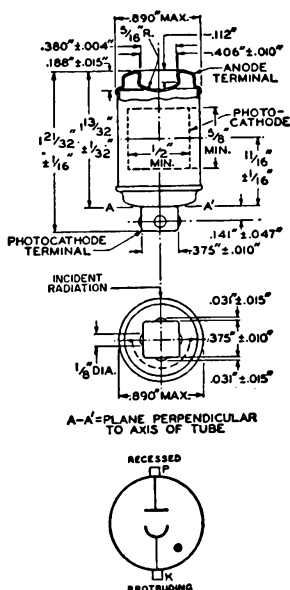

# 5583 GAS PHOTODIODE

SIDE-ON type having S-4 response. Wavelength of maximum spectral response is  $4000 \pm 500$  angstroms. This type makes use of a semicylindrical photocathode, and has a direct interelectrode capacitance of 2 picofarads. It weighs approximately 0.3 ounce. For curves of typical anode characteristics, refer to type 5581. For outline and terminal-connection diagram, refer to type 927.

**MAXIMUM RATINGS (Absolute-Maximum Values):**

	Rating 1	Rating 2	
Anode-Supply Voltage (DC or Peak AC)	80 max	100 max	volts
Average Cathode-Current Density	40 max	20 max	$\mu\text{a}/\text{sq in}$
Average Cathode Current	4 max	2 max	$\mu\text{a}$
Ambient Temperature	75 max	75 max	$^{\circ}\text{C}$

**TYPICAL CHARACTERISTICS:**

Anode-Supply Voltage	90	volts
Radiant Sensitivity (at 4000 angstroms)	0.13	a/w
Luminous Sensitivity*	135	$\mu\text{a}/\text{lm}$
Gas Amplification Factor**	5.5 max	
Anode Dark Current (at 25°C)	0.05 max	$\mu\text{a}$

**MINIMUM CIRCUIT VALUES:**

Anode-Supply Voltage	80 or less	100	volts
DC Load Resistance:			
For average currents above 3 $\mu\text{a}$	0.1 min	—	megohms
For average currents below 3 $\mu\text{a}$	0 min	—	megohms
For average currents above 1 $\mu\text{a}$	—	2.5 min	megohms
For average currents below 1 $\mu\text{a}$	—	0.1 min	megohms

\*With light input of 0.1 lumen from a tungsten-filament lamp operated at a color temperature of 2870°K. Range of luminous sensitivity is 75 to 205  $\mu\text{a}/\text{lm}$ .  
 \*\*Ratio of luminous sensitivities at 90 and 25 volts.

# 5584

## GAS PHOTODIODE

SIDE-ON, TWIN-UNIT type having S-4 response. Wavelength of maximum spectral response is  $4000 \pm 500$  angstroms. This type makes use of a quarter-cylindrical photocathode, and weighs approximately 1.1 ounces. For curves of typical anode characteristics, refer to type 5582. For outline and terminal-connection diagram, refer to type 920.

### DIRECT INTERELECTRODE CAPACITANCES (Approx.):

Cathode to Cathode .....	1.8	pf
Cathode to Anode (each unit) .....	1.6	pf
Anode to Anode .....	0.4	pf

### MAXIMUM RATINGS (Each Unit, Absolute-Maximum Values):

	Rating 1	Rating 2	
Anode-Supply Voltage (DC or Peak AC) .....	80 max	100 max	volts
Average Cathode-Current Density .....	20 max	10 max	$\mu\text{a}/\text{sq}$ in
Average Cathode Current .....	4 max	2 max	$\mu\text{a}$
Ambient Temperature .....	75 max	75 max	$^{\circ}\text{C}$

### TYPICAL CHARACTERISTICS (Each Unit):

Anode-Supply Voltage .....	90	volts
Radiant sensitivity (at 4000 angstroms) .....	0.12	$\text{a}/\text{w}$
Luminous Sensitivity* .....	120	$\mu\text{a}/\text{lm}$
Ratio of Luminous Sensitivities (Unit No. 1 to Unit No. 2) .....	2 max	
Gas Amplification Factor** .....	5.5 max	
Anode Dark Current (at $25^{\circ}\text{C}$ ) .....	0.050 max	$\mu\text{a}$

### MINIMUM CIRCUIT VALUES (Each Unit):

Anode-Supply Voltage .....	80 or less	100	volts
DC Load Resistance:			
For average currents above $3 \mu\text{a}$ .....	0.1 min	—	megohms
For average currents below $3 \mu\text{a}$ .....	0 min	—	megohms
For average currents above $1 \mu\text{a}$ .....	—	2.5 min	megohms
For average currents below $1 \mu\text{a}$ .....	—	0.1 min	megohms

\*With a light input of 0.04 lumen from a tungsten-filament lamp operated at a color temperature of  $2870^{\circ}\text{K}$ . Ratio of luminous sensitivities is 80 to 175  $\mu\text{a}/\text{lm}$ .

\*\*Ratio of luminous sensitivities at 90 and 25 volts.

# 5652

## VACUUM PHOTODIODE

COMPOSITE anode-photocathode, side-on type having S-4 response. Wavelength of maximum spectral response is  $4000 \pm 500$  angstroms. This type has two flat photoemissive electrodes positioned at right angles to each other, either of which can be used as a photocathode or as an anode. In addition, a balancing capacitance ( $C_2$ ) is provided within the tube. This type weighs approximately 1 ounce, and has a non-hygroscopic base.

### DIRECT INTERELECTRODE CAPACITANCES (Approx.):

Between base pins 4 and 8 ( $C_1$ ) .....	1	pf
Between base pins 3 and 4 ( $C_2$ ) .....	1	pf
Difference between $C_1$ and $C_2$ .....	0.3 max	pf

### MAXIMUM RATINGS (Absolute-Maximum Values):

Anode-Supply Voltage (DC or Peak AC) .....	250 max	volts
Average Cathode-Current Density .....	30 max	$\mu\text{a}/\text{sq}$ in
Average Cathode Current .....	4 max	$\mu\text{a}$
Ambient Temperature .....	75 max	$^{\circ}\text{C}$

### TYPICAL CHARACTERISTICS:

Anode-Supply Voltage .....	250	volts
Radiant Sensitivity (at 4400 angstroms) .....	0.044	$\text{a}/\text{w}$
Luminous Sensitivity* .....	45	$\mu\text{a}/\text{lm}$
Anode Dark Current (at $25^{\circ}\text{C}$ ) .....	0.01 max	$\mu\text{a}$

\*With light input of 0.02 lumen from a tungsten-filament lamp operated at a color temperature of  $2870^{\circ}\text{K}$ . Range of luminous sensitivity is 19 to 70  $\mu\text{a}/\text{lm}$ .

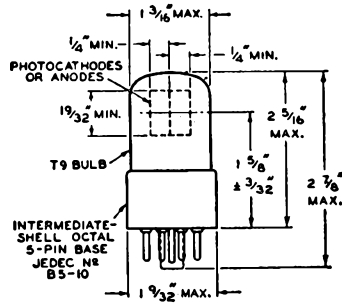
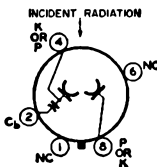

## 5653 VACUUM PHOTODIODE

SIDE-ON type having S-4 response. Wavelength of maximum spectral response is  $4000 \pm 500$  angstroms. This type makes use of a semicylindrical photocathode, and has a direct interelectrode capacitance of 2.6 picofarads. It weighs approximately 0.9 ounce. For curves of typical anode characteristics, refer to type 929. For outline and terminal-connection diagram, refer to type 1P39.

**MAXIMUM RATINGS (Absolute-Maximum Values):**

Anode-Supply Voltage (DC or Peak AC) .....	250 max	volts
Average Cathode-Current Density .....	25 max	$\mu\text{a}/\text{sq in}$
Average Cathode Current .....	5 max	$\mu\text{a}$
Ambient Temperature .....	75 max	$^{\circ}\text{C}$

**TYPICAL CHARACTERISTICS:**

Anode-Supply Voltage .....	250	volts
Radiant Sensitivity (at 4000 angstroms) .....	0.044	a/w
Luminous Sensitivity* .....	45	$\mu\text{a}/\text{lm}$
Anode Dark Current (at 25 $^{\circ}\text{C}$ ) .....	0.25 max	$\mu\text{a}$

\*With light input of 0.1 lumen from a tungsten-filament lamp operated at a color temperature of 2870 $^{\circ}\text{K}$ . Range of luminous sensitivity is 20 to 100  $\mu\text{a}/\text{lm}$ .

TEN-STAGE, head-on, curved-faceplate type having S-11 response. Wavelength of maximum response is  $4400 \pm 500$  angstroms. This type makes use of cesium-antimony dynodes and a curved-circular, cesium-antimony, semitransparent photocathode. Window material is Corning No. 0080 lime glass or equivalent. Tube weighs approximately 5.2 ounces and has a non-hygroscopic base.

## 5819 MULTIPLIER PHOTOTUBE

**DIRECT INTERELECTRODE CAPACITANCES (Approx.):**

Anode to Dynode No. 10 .....	4.2	pf
Anode to All Other Electrodes .....	6.5	pf

**MAXIMUM RATINGS (Absolute-Maximum Values):**

Supply Voltage (DC or Peak AC):		
Between anode and cathode .....	1250 max	volts
Between anode and dynode No. 10 .....	250 max	volts
Between dynode No. 1 and cathode .....	300 max	volts
Average Anode Current .....	0.75 max	ma
Ambient Temperature .....	75 max	$^{\circ}\text{C}$

**TYPICAL CHARACTERISTICS:**

DC Supply Voltage* .....	1000	750	volts
Radiant Sensitivity (at 4400 angstroms) .....	20000	2000	a/w
Cathode Radiant Sensitivity (at 4400 angstroms) .....	0.04	0.04	a/w

<b>Luminous Sensitivity:</b>			
At 0 cps**	25	2.5	a/lm
With dynode No. 10 as output electrode	15	1.5	a/lm
<b>Cathode Luminous Sensitivity:</b>			
With tungsten light source†	50	50	μa/lm
With blue light source**	0.04 min	0.04 min	μa
<b>Current Amplification</b>	500,000	50000	
<b>Equivalent Anode-Dark-Current Input at 25°C</b>			
at a luminous sensitivity of 20 a/lm	2 max	—	nlm
<b>Equivalent Noise Input†</b>	7	—	plm
<b>Dark Current at any Electrode Except Anode</b>			
at 25°C	0.75 max	—	μa

\*DC supply voltage (E) is connected across a voltage divider which provides 1/6 of E between cathode and dynode No. 1, 1/12 of E for each succeeding dynode stage, and 1/12 of E between dynode No. 10 and anode.

\*\*With light input of 10 microlumens from a tungsten-filament lamp operated at a color temperature of 2870°K. Range of luminous sensitivity is 10 to 300 a/lm at 1000 volts.

†With light input of 0.01 lumen from a tungsten-filament lamp operated at a color temperature of 2870°K; 167 volts applied between cathode and all other electrodes connected as anode. \*\*Same conditions as (\*), but a blue filter is used (Corning C.S. No. 5-58, glass code No. 5113, polished to 1/2 stock thickness).

‡At tube temperature of 25°C and with external shield connected to cathode; bandwidth is equal to 1 cycle per second. A tungsten-filament light source at a color temperature of 2870°K is interrupted at a low audio frequency to produce incident radiation pulses alternating between zero and the value stated. The "on" period of the pulse is equal to the "off" period.

TYPICAL ANODE CHARACTERISTICS

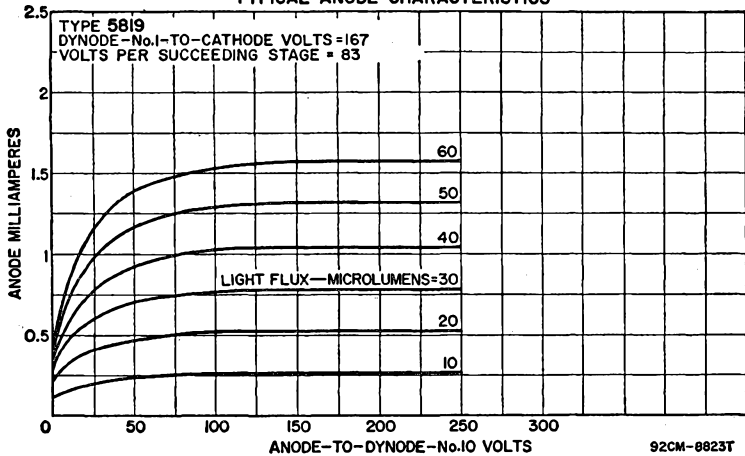

TYPICAL ANODE-DARK-CURRENT CHARACTERISTIC

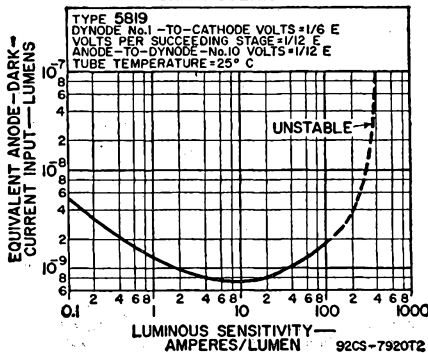

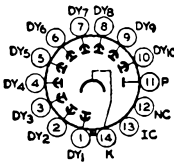
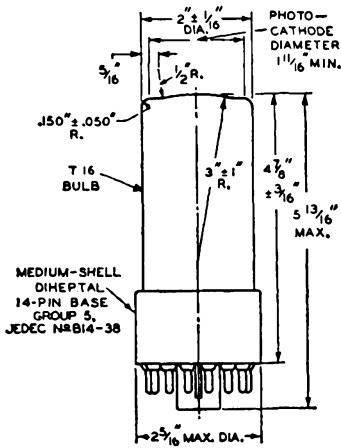

NOTE: Incident radiation is into end of bulb.

SENSITIVITY AND CURRENT AMPLIFICATION CHARACTERISTICS

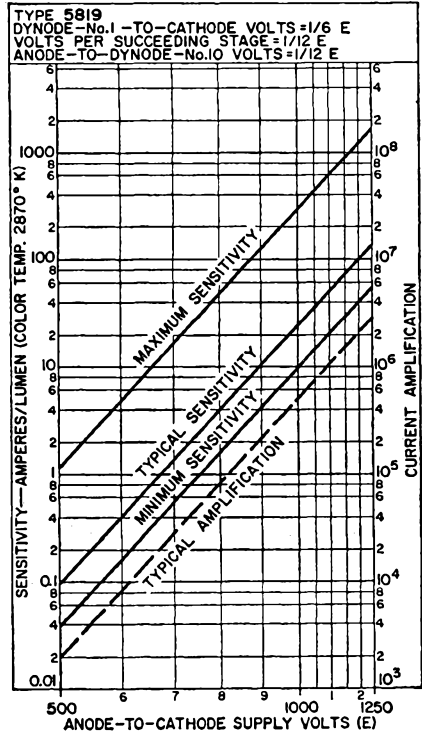

92CM-7258T4

TEN-STAGE, head-on, flat-faceplate type having S-11 response. Wavelength of maximum response is  $4400 \pm 500$  angstroms. This type makes use of a flat-circular, cesium-antimony, semitransparent photocathode. Window material is Corning No. 0080 lime glass or equivalent. Tube weighs approximately 2.2 ounces and has a non-hygroscopic base. An output of opposite polarity may be obtained by use of dynode No. 10 as the output electrode; with this arrangement, the anode serves only as a collector. For curves of typical anode characteristics, anode-dark-current characteristics, and sensitivity and current amplification characteristics, refer to type 4438.

**6199**  
**MULTIPLIER**  
**PHOTOTUBE**

**DIRECT INTERELECTRODE CAPACITANCES (Approx.):**

Between anode and cathode .....	4	pf
Anode to All Other Electrodes .....	7	pf

**MAXIMUM RATINGS (Absolute-Maximum Values):**

Supply Voltage (DC or Peak AC):		
Between anode and cathode .....	1250 max	volts
Between anode and dynode No. 10 .....	250 max	volts
Between consecutive dynodes .....	200 max	volts
Between dynode No. 1 and cathode .....	300 max	volts
Average Anode Current .....	0.75 max	ma
Ambient Temperature .....	75 max	°C

## TYPICAL CHARACTERISTICS:

DC Supply Voltage*	1000	750	volts
Radiant Sensitivity (at 4400 angstroms)	22000	2200	a/w
Cathode Radiant Sensitivity (at 4400 angstroms)	0.036	0.036	a/w
Luminous Sensitivity:			
At 0 cps**	27	2.7	a/lm
With dynode No. 10 as output electrode	16	1.6	a/lm
Cathode Luminous Sensitivity:			
With tungsten light source*	45	45	$\mu$ a/lm
With blue light source**	0.028 min	0.028 min	$\mu$ a
Current Amplification	600,000	60000	
Equivalent Anode-Dark-Current Input at 25°C			
at a luminous sensitivity of 20 a/lm	2.5 max	—	nIm
Equivalent Noise Input†	4	—	pIm
Dark Current at any Electrode Except Anode at 25°C	0.75 max	—	$\mu$ a

\*DC supply voltage (E) is connected across a voltage divider which provides 1/6 of E between cathode and dynode No. 1, 1/12 of E for each succeeding dynode stage, and 1/12 of E between dynode No. 10 and anode.

\*\*With light input of 10 microlumens from a tungsten-filament lamp operated at a color temperature of 2870°K. Range of luminous sensitivity is 10 to 300 a/lm at 1000 volts.

\*With light input of 0.01 lumen from a tungsten-filament lamp operated at a color temperature of 2870°K; 167 volts applied between cathode and all other electrodes connected as anode.

\*\*Same conditions as (+), but a blue filter is used (Corning C.S. No. 5-58, glass code No. 5113, polished to 1/2 stock thickness).

†At tube temperature of 25°C and with external shield connected to cathode; bandwidth is equal to 1 cycle per second. A tungsten-filament light source at a color temperature of 2870°K is interrupted at a low audio frequency to produce incident radiation pulses alternating between zero and the value stated. The "on" period of the pulse is equal to the "off" period.

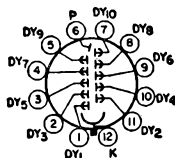
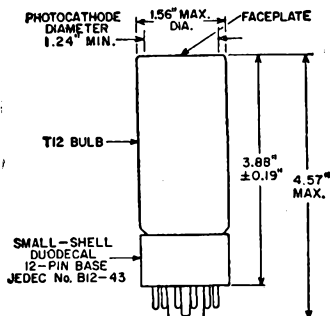

NOTE: Incident radiation is into end of bulb.

## 6217 MULTIPLIER PHOTOTUBE

TEN-STAGE, head-on, curved-faceplate type having S-10 response. Wavelength of maximum response is  $4500 \pm 300$  angstroms. This type makes use of cesium-antimony dynodes and a curved-circular, silver-bismuth-oxygen-cesium, semitransparent photocathode. Window material is Corning No. 0080 lime glass or equivalent. Tube weighs approximately 5.2 ounces, and has a non-hygroscopic base. For curves of typical anode characteristics, anode-dark-current characteristics, and sensitivity and current amplification characteristics, refer to type 4438. For outline and terminal-connection diagram, refer to type 5819.

## DIRECT INTERELECTRODE CAPACITANCES (Approx.):

Anode to Dynode No. 10	4.2	pf
Anode to All Other Electrodes	6.5	pf

**MAXIMUM RATINGS (Absolute-Maximum Values):**

Supply Voltage (DC or Peak AC):			
Between anode and cathode	1250 max		volts
Between anode and dynode No. 10	250 max		volts
Between dynode No. 1 and cathode	300 max		volts
Average Anode Current	0.75 max		ma
Ambient Temperature	75 max		°C

**TYPICAL CHARACTERISTICS:**

DC Supply Voltage*	1000	750	volts
Radiant Sensitivity (at 4500 angstroms)	12000	1000	a/w
Cathode Radiant Sensitivity (at 4500 angstroms)	0.02	0.02	a/w
Luminous Sensitivity**	24	2.4	a/lm
Cathode Luminous Sensitivity:			
With tungsten light source*	40	40	µa/lm
With red-infrared light source**	0.05 min	0.05 min	µa
Current Amplification	600,000	60000	
Equivalent Anode-Dark-Current Input at 25°C at a luminous sensitivity of 20 a/lm	25 max	—	nIm
Equivalent Noise Input†	40	—	pIm
Dark Current to Any Electrode except Anode at 25°C	0.75 max	—	µa

\*DC supply voltage (E) is connected across a voltage divider which provides 1/6 of E between cathode and dynode No. 1, 1/12 of E for each succeeding dynode stage, and 1/12 of E between dynode No. 10 and anode.

\*\*With light input of 10 microlumens from a tungsten-filament lamp operated at a color temperature of 2870°K. Range of luminous sensitivity is 10 to 300 a/lm at 1000 volts.

\*With light input of 0.01 lumen from a tungsten-filament lamp operated at a color temperature of 2870°K; 200 volts applied between cathode and all other electrodes connected as anode. \*\*Same conditions as (\*), but a red-infrared filter is used (combination of Corning C.S. Nos. 3-67 and 7-59, glass code Nos. 3482 and 5850, respectively).

†At tube temperature of 25°C and with external shield connected to cathode; bandwidth is equal to 1 cycle per second. A tungsten-filament light source at a color temperature of 2870°K is interrupted at a low audio frequency to produce incident radiation pulses alternating between zero and the value stated. The "on" period of the pulse is equal to the "off" period.

NINE-STAGE, side-on type having S-4 response. Wavelength of maximum response is 4000 ± 500 angstroms. This type makes use of cesium-antimony dynodes and a cesium-antimony, opaque photocathode. Window material is Corning No. 0080 lime glass or equivalent. Tube weighs approximately 1.6 ounces.

**6328  
MULTIPLIER  
PHOTOTUBE**

**DIRECT INTERELECTRODE CAPACITANCES (Approx.):**

Anode to Dynode No. 9	4.2	pf
Anode to All Other Electrodes	5.5	pf

**MAXIMUM RATINGS (Absolute-Maximum Values):**

Supply Voltage (Peak AC):			
Between anode and cathode	1400 max		volts
Between anode and dynode No. 9	250 max		volts
Between consecutive dynodes	250 max		volts
Between dynode No. 1 and cathode	250 max		volts
Average Anode Current	0.1 max		ma
Ambient Temperature	75 max		°C

**TYPICAL CHARACTERISTICS:**

With DC Supply Voltage\* = 1000 Volts

Radiant Sensitivity (at 4000 angstroms)	34000	a/w
Luminous Sensitivity at 0 cps**	35	a/lm
Dark Current to Any Electrode at 25°C	0.75 max	µa

With Supply Voltage\* = Adjustable 60-cps AC Voltage

Anode-to-Cathode Voltage (rms values)*	750	volts
Anode Dark Current at 25°C**	0.1 max	µa

\*Supply voltage (E) is connected across a voltage divider which provides 1/10 of E between cathode and dynode No. 1, 1/10 of E for each succeeding dynode stage, and 1/10 of E between dynode No. 9 and anode.

\*\*With light input of 10 microlumens from a tungsten-filament lamp operated at a color temperature of 2870°K.

\*With light input of 10 microlumens from a tungsten-filament lamp operated at a color temperature of 2870°K. Supply voltage is adjusted to give an anode current of 8 microamperes.

\*\*Under same conditions as (\*), but no radiant flux on photocathode.

TYPICAL ANODE CHARACTERISTICS

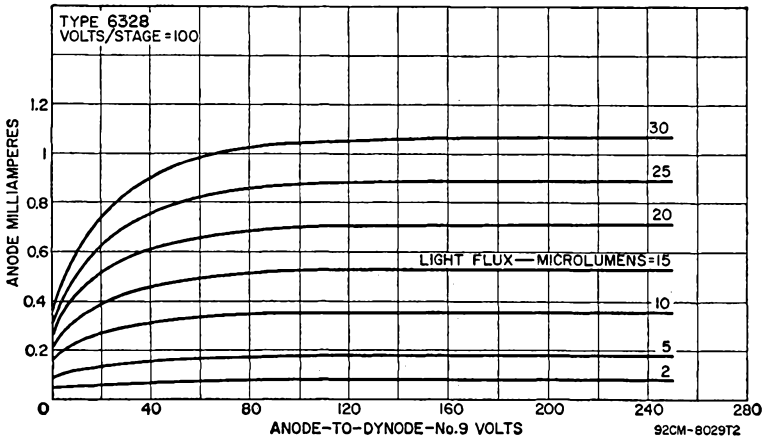

RANGE OF LUMINOUS SENSITIVITY

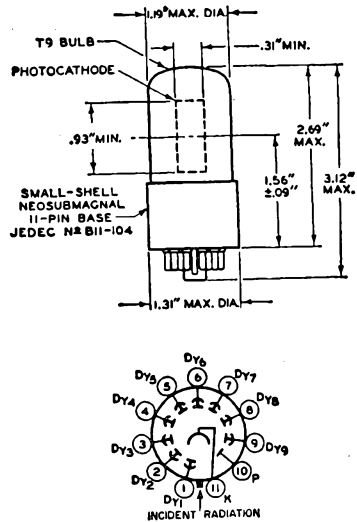
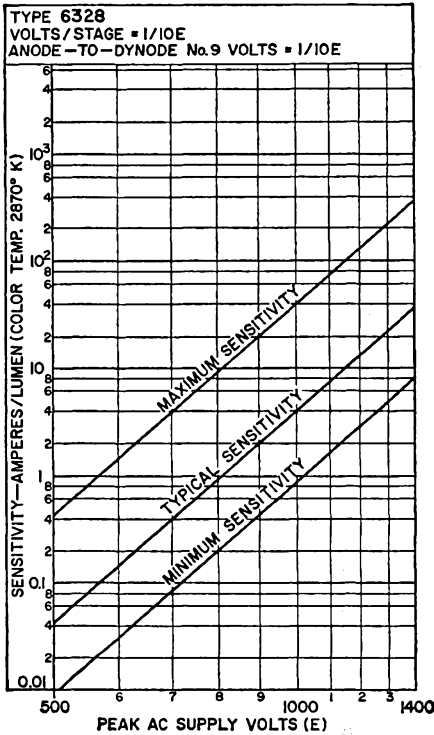



TEN-STAGE, head-on, flat-faceplate type having S-11 response. Wavelength of maximum response is 4400 ± 500 angstroms. This type makes use of copperberyllium dynodes and a curved-circular, cesium-antimony, semitransparent photocathode. Window material is Corning No. 0080 lime glass or equivalent. Tube weighs approximately 5.2 ounces and has a non-hygroscopic base.

# 6342A MULTIPLIER PHOTOTUBE

**DIRECT INTERELECTRODE CAPACITANCES (Approx.):**

Anode to Dynode No. 10 .....	4.4	pf
Anode to All Other Electrodes .....	7	pf

**MAXIMUM RATINGS (Absolute-Maximum Values):**

Supply Voltage (DC or Peak AC):		
Between anode and cathode .....	1500 max	volts
Between anode and dynode No. 10 .....	250 max	volts
Between dynode No. 1 and cathode .....	400 max	volts
Between focusing electrode and cathode .....	400 max	volts
Average Anode Current .....	2 max	ma
Ambient Temperature .....	75 max	°C

**TYPICAL ANODE CHARACTERISTICS**

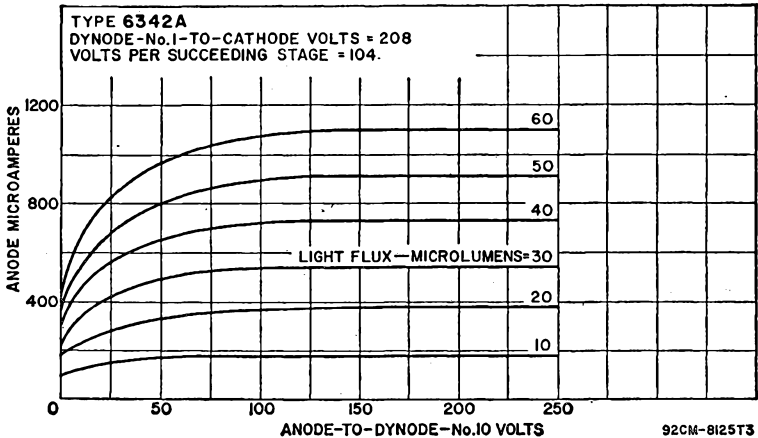

**TYPICAL CHARACTERISTICS:**

DC Supply Voltage*	1250	volts
Radiant Sensitivity (at 4400 angstroms)	14000	a/w
Cathode Radiant Sensitivity (at 4400 angstroms)	0.064	a/w
Luminous Sensitivity:		
At 0 cps**	18	a/lm
With dynode No. 10 as output electrode	10	a/lm
Cathode Luminous Sensitivity:		
With tungsten light source†	80	µa/lm
With blue light source††	0.05 min	µa
Current Amplification	225,000	
Equivalent Anode Current Input:		
At a luminous sensitivity of 20 a/lm	2 max	nIm
At 4400 angstroms	2.5 max	pw
Equivalent Noise Input:		
Luminous†	7	plm
Radiant††	0.0087	pw
Anode-Pulse Rise Time	3	nsec
Greatest Delay Between Anode Pulses:		
With radiation spot (centered on tube face)		
having a diameter of		
1-1/8 inch	1.3	nsec
1-9/16 inch	4	nsec

\*DC supply voltage (E) is connected across a voltage divider which provides 1/6 of E between cathode and dynode No. 1, 1/12 of E for each succeeding dynode stage, and 1/12 of E between dynode No. 10 and anode. Focusing-electrode voltage is adjusted to that value between 10 and 60 per cent of dynode-No. 1 potential (referred to cathode) which provides maximum anode current.

\*\*With light input of 10 microlumens from a tungsten-filament lamp operated at a color temperature of 2870°K. Range of luminous sensitivity is 7 to 120 a/lm at 1250 volts.

+With light input of 0.01 lumen from a tungsten-filament lamp operated at a color temperature of 2870°K; 200 volts applied between cathode and all other electrodes connected as anode.

\*\*Same conditions as (+), but a blue filter is used (Corning C.S. No. 5-58, glass code No. 5113, polished to 1/2 stock thickness).

†At tube temperature of 25°C and with external shield connected to cathode; bandwidth is equal to 1 cycle per second. A tungsten-filament light source at a color temperature of 2870°K is interrupted at a low audio frequency to produce incident radiation pulses alternating between zero and the value stated. The "on" period of the pulse is equal to the "off" period.

††Under same conditions as (†), but a monochromatic source radiating at 4400 angstroms is used.

**SENSITIVITY AND CURRENT AMPLIFICATION CHARACTERISTICS**

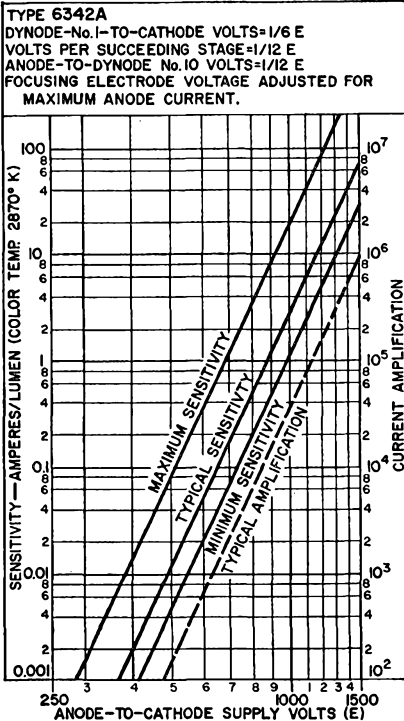

**TYPICAL ANODE-DARK-CURRENT CHARACTERISTIC**

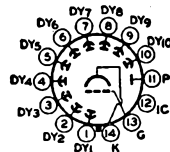
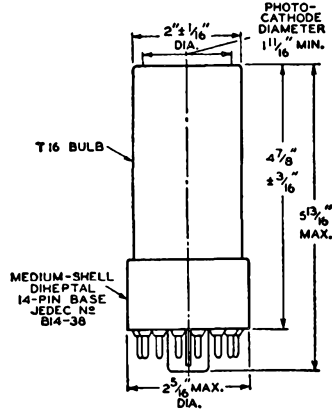
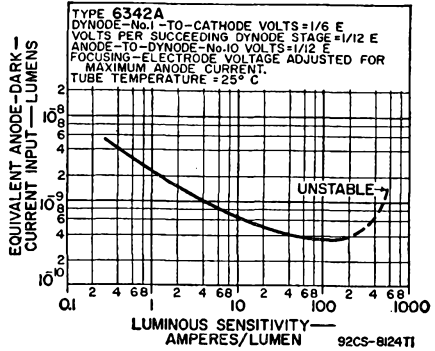

NOTE: Incident radiation is into end of bulb.

LOW-MICROPHONIC side-on type having S-1 response. Wavelength of maximum spectral response is  $8000 \pm 1000$  angstroms. This type makes use of a semi-cylindrical photocathode, and has a direct inter-electrode capacitance of 2.6 picofarads. It weighs approximately 1.3 ounces.

# 6405/1640 GAS PHOTODIODE

**MAXIMUM RATINGS (Absolute-Maximum Values):**

	Rating 1	Rating 2	
Anode-Supply Voltage (DC or Peak AC) .....	70 max	90 max	volts
Average Cathode-Current Density .....	50 max	25 max	$\mu\text{a}/\text{sq}$ in
Average Cathode Current .....	10 max	5 max	$\mu\text{a}$
Ambient Temperature .....	100 max	100 max	$^{\circ}\text{C}$

**TYPICAL CHARACTERISTICS:**

Anode-Supply Voltage .....	50	volts
Radiant Sensitivity (at 8000 angstroms) .....	0.0033	a/w
Luminous Sensitivity* .....	35	$\mu\text{a}/\text{lm}$
Luminous Sensitivity Difference		
Along Cathode Length .....	1.1 max	$\mu\text{a}/\text{lm}$
Gas Amplification Factor** .....	2.5 max	
Anode Dark Current (at 25°C) .....	0.1 max	$\mu\text{a}$

**MINIMUM CIRCUIT VALUES:**

Anode-Supply Voltage .....	70 or less	90	volts
DC Load Resistance:			
For average currents above 5 $\mu\text{a}$ .....	0.1 min	—	megohms
For average currents below 5 $\mu\text{a}$ .....	0 min	—	megohms
For average currents above 3 $\mu\text{a}$ .....	—	2.5 min	megohms
For average currents below 3 $\mu\text{a}$ .....	—	0.1 min	megohms

\*With light input of 0.1 lumen from a tungsten-filament lamp operated at a color temperature of 2870°K. Range of luminous sensitivity is 17.5 to 70  $\mu\text{a}/\text{lm}$ .

\*\*Ratio of luminous sensitivities at 90 and 25 volts.

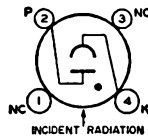
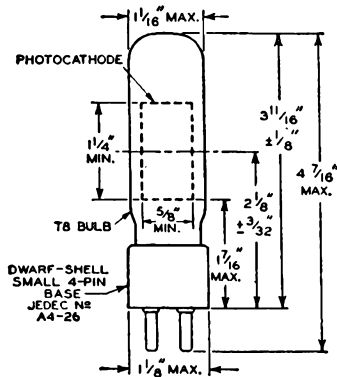

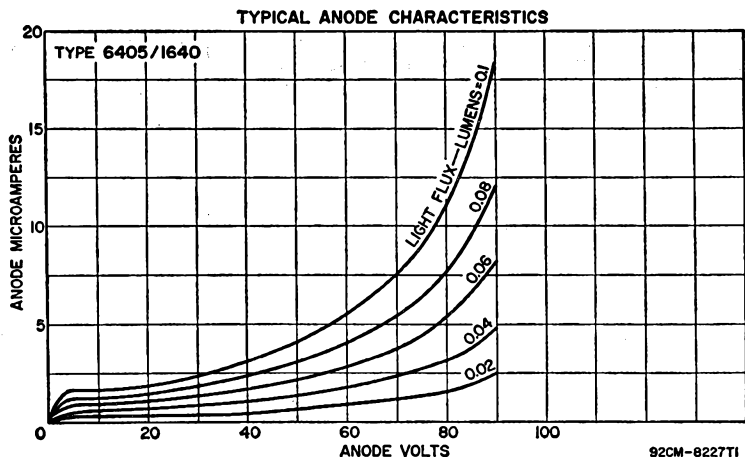

## 6472

### MULTIPLIER PHOTOTUBE

NINE-STAGE, side-on type having S-4 response. Wave-length of maximum response is  $4000 \pm 500$  angstroms. This type makes use of cesium-antimony dynodes and a cesium-antimony, opaque photocathode. Window material is Corning No. 0080 lime glass or equivalent. Tube weighs approximately 2 ounces.

**DIRECT INTERELECTRODE CAPACITANCES (Approx.):**

Anode to Dynode No. 9 .....	3.8	pf
Anode to All Other Electrodes .....	4.8	pf

**MAXIMUM RATINGS (Absolute-Maximum Values):**

<b>Supply Voltage (DC or Peak AC):</b>		
Between anode and cathode .....	1250 max	volts
Between anode and dynode No. 9 .....	250 max	volts
Between consecutive dynodes .....	250 max	volts
Between dynode No. 1 and cathode .....	250 max	volts
Average Anode Current .....	0.1 max	ma
Ambient Temperature .....	75 max	°C

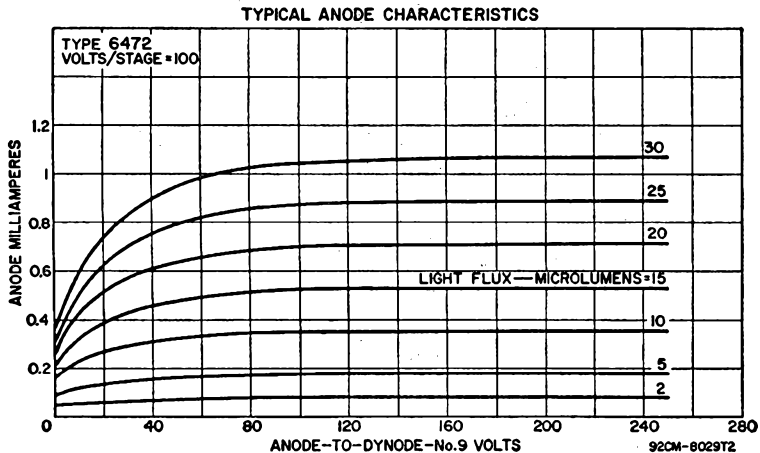

**TYPICAL CHARACTERISTICS:**

With DC Supply Voltage\* = 1000 Volts

Radiant Sensitivity (at 4000 angstroms) .....	34000	a/w
Luminous Sensitivity at 0 cps** .....	35	a/lm
Dark Current to Any Electrode at 25°C .....	0.75 max	μa

With Supply Voltage\* = Adjustable 60-cps AC Voltage

Anode-to-Cathode Voltage (rms values)* .....	775	volts
Anode Dark Current at 25°C+ .....	0.25 max	μa

\*Supply voltage (E) is connected across a voltage divider which provides 1/10 of E between cathode and dynode No. 1, 1/10 of E for each succeeding dynode stage, and 1/10 of E between dynode No. 9 and anode.

\*\*With light input of 10 microlumens from a tungsten-filament lamp operated at a color temperature of 2870°K. Range of luminous sensitivity is 5 to 250 a/lm at 1000 volts.

\*With light input of 1 microlumen from a tungsten-filament lamp operated at a color temperature of 2870°K. Supply voltage is adjusted to give an anode current of 7.5 microamperes.

\*\*Under the same conditions as (+), but with no radiant flux on photocathode.

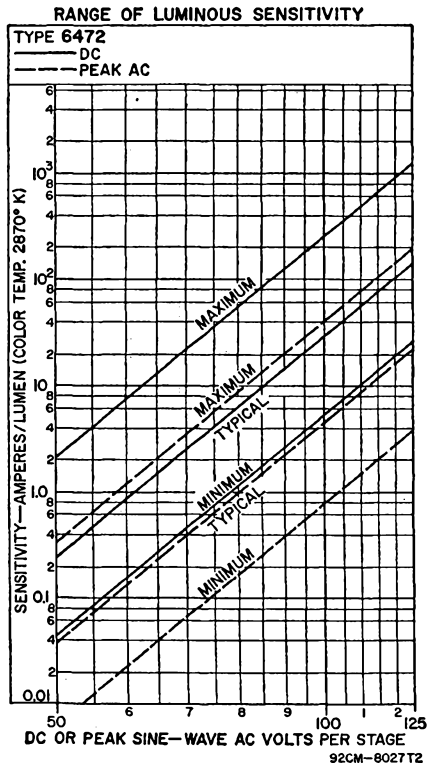
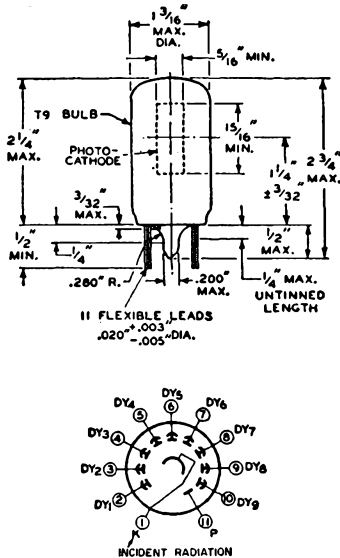

SIDE-ON type having S-1 response. Wavelength of maximum spectral response is 8000 ± 1000 angstroms. This type makes use of a semicylindrical photocathode, and has a direct interelectrode capacitance of 3 picofarads. It weighs approximately 1.3 ounces and has a non-hygroscopic base.

**6570**  
**VACUUM**  
**PHOTODIODE**

92CM-8027T2

**MAXIMUM RATINGS (Absolute-Maximum Values):**

Anode-Supply Voltage (DC or Peak AC) .....	500 max	volts
Average Cathode-Current Density .....	25 max	$\mu\text{a}/\text{sq in}$
Average Cathode Current .....	5 max	$\mu\text{a}$
Ambient Temperature .....	100 max	$^{\circ}\text{C}$

**TYPICAL CHARACTERISTICS:**

Anode-Supply Voltage .....	250	volts
Radiant Sensitivity (at 8000 angstroms) .....	0.0023	$\text{a/w}$
Luminous Sensitivity*	30	$\mu\text{a}/\text{lm}$
Maximum Luminous-Sensitivity Difference Along Cathode Length**	4.5	$\mu\text{a}/\text{lm}$
Anode Dark Current (at 25°C) .....	0.013 max	$\mu\text{a}$

\*With light input of 0.1 lumen from a tungsten-filament lamp operated at a color temperature of 2870°K. Range of luminous sensitivity is 20 to 40  $\mu\text{a}/\text{lm}$ .

\*\*With light input of 0.1 lumen (same conditions as above) and a light spot 1/2 inch in diameter.

**TYPICAL ANODE CHARACTERISTICS**

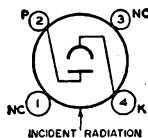
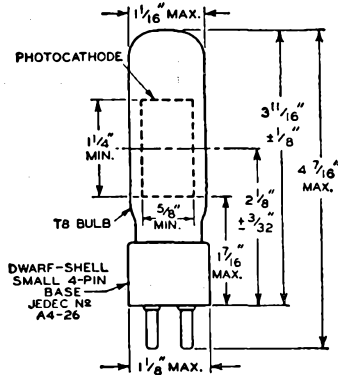
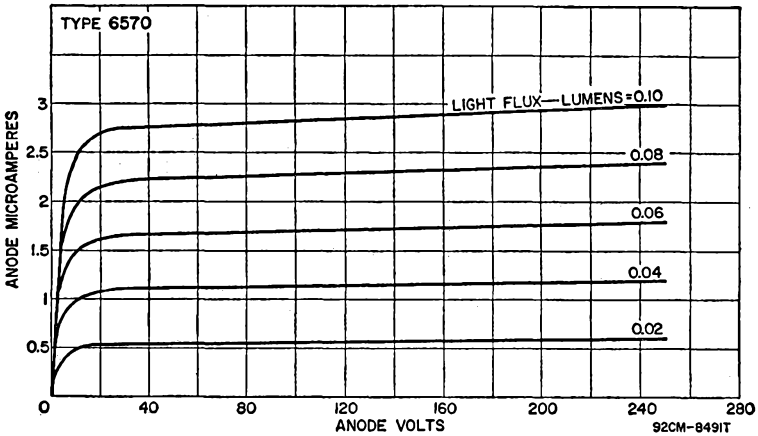

TEN-STAGE, head-on, flat-faceplate type having S-11 response. Wavelength of maximum response is 4400  $\pm$  500 angstroms. This type makes use of cesium-antimony dynodes and a curved-circular, cesium-antimony, semitransparent photocathode. Window material is Corning No. 0080 lime glass or equivalent. Tube weighs approximately 5.2 ounces and has a non-hygroscopic base. For outline and terminal-connection diagram, refer to type 6342A.

# 6655A MULTIPLIER PHOTOTUBE

**DIRECT INTERELECTRODE CAPACITANCES (Approx):**

Anode to Dynode No. 10 .....	4.4	pf
Anode to All Other Electrodes .....	7	pf

**MAXIMUM RATINGS (Absolute-Maximum Values):**

Supply Voltage (DC or Peak AC):		
Between anode and cathode .....	1250 max	volts
Between anode and dynode No. 10 .....	250 max	volts
Between dynode No. 1 and cathode .....	300 max	volts
Between focusing electrode and cathode .....	300 max	volts
Average Anode Current .....	0.75 max	ma
Ambient Temperature .....	75 max	$^{\circ}$ C

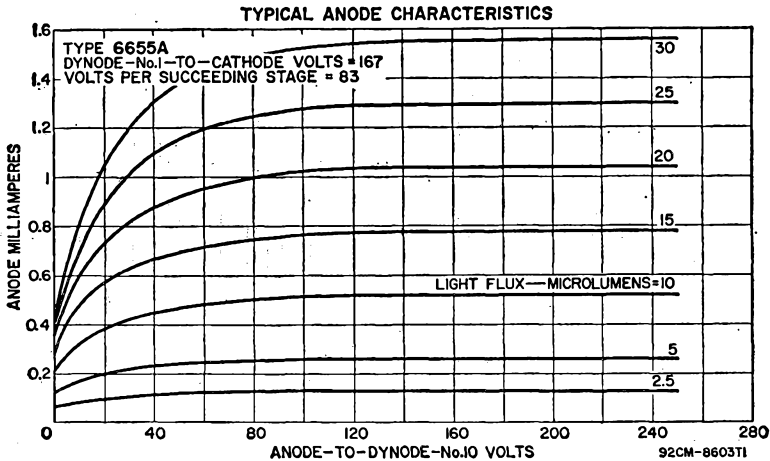

**TYPICAL CHARACTERISTICS:**

DC Supply Voltage*	1000	volts
Radiant Sensitivity (at 4400 angstroms)	40000	a/w
Cathode Radiant Sensitivity (at 4400 angstroms)	0.044	a/w
Luminous Sensitivity:		
At 0 cps**	50	a/lm
With dynode No. 10 as output electrode	36	a/lm
Cathode Luminous Sensitivity:		
With tungsten light source*	55	$\mu$ a/lm
With blue light source**	0.04	min $\mu$ a
Current Amplification	900,000	
Equivalent Anode-Dark-Current Input at 25 $^{\circ}$ C		
at a luminous sensitivity of 20 a/lm	2 max	nIm
Equivalent Noise Input†	7	pIm
Anode-Pulse Rise Time	3	nsec
Greatest Delay Between Anode Pulses:		
With radiation spot (centered on tube face)		
having a diameter of		
1-1/8 inch	1.5	nsec
1-9/16 inch	4.5	nsec

\*DC supply voltage (E) is connected across a voltage divider which provides 1/6 of E between cathode and dynode No. 1, 1/12 of E for each succeeding dynode stage, and 1/12 of E between dynode No. 10 and anode. Focusing-electrode voltage is adjusted to that value between 10 and 60 per cent of dynode No. 1 potential (referred to cathode) which provides maximum anode current.

\*\*With light input of 10 microlumens from a tungsten-filament lamp operated at a color temperature of 2870°K. Range of luminous sensitivity is 10 to 300 a/lm at 1000 volts.

+With light input of 0.01 lumen from a tungsten-filament lamp operated at a color temperature of 2870°K; 200 volts applied between cathode and all other electrodes connected as anode.

\*\*Same light conditions as (\*), but a blue filter is used (Corning C.S. No. 5-58, glass code No. 5113, polished to 1/2 stock thickness).

†At tube temperature of 25°C and with external shield connected to cathode; bandwidth is equal to 1 cycle per second. A tungsten-filament light source at a color temperature of 2870°K is interrupted at a low audio frequency to produce incident radiation pulses alternating between zero and the value stated. The "on" period is equal to the "off" period.

**SENSITIVITY AND CURRENT AMPLIFICATION CHARACTERISTICS**

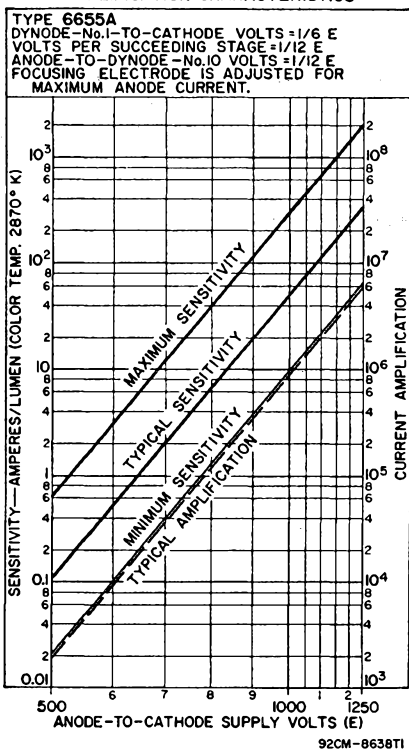

**TYPICAL ANODE-DARK-CURRENT CHARACTERISTIC**

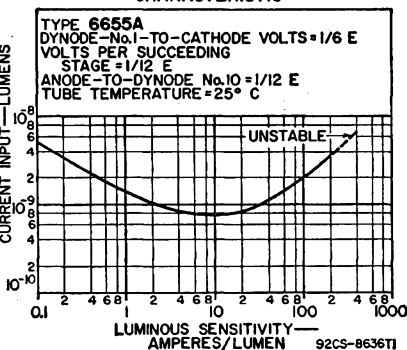

**6810A  
 MULTIPLIER  
 PHOTOTUBE**

FOURTEEN-STAGE, head-on, flat-faceplate type having S-11 response. Wavelength of maximum spectral response is  $4400 \pm 500$  angstroms. This type makes use of copper-beryllium dynodes and a curved-circular, semitransparent, cesium-antimony photocathode. Window material is Corning No. 0080 lime glass or equivalent. Tube weighs approximately 8 ounces and has a non-hygroscopic base.

**DIRECT INTERELECTRODE CAPACITANCES (Approx):**

Anode to Dynode No. 14 .....	2.8	pf
Anode to All Other Electrodes .....	6	pf
Dynode No. 14 to All Other Electrodes .....	7.5	pf



**MAXIMUM RATINGS (Absolute-Maximum Values):**

	Very-Low-Light Level Service†	High-Output Pulse Service‡	
Supply Voltage (DC):			
Between anode and cathode .....	2400 max	2800 max	volts
Between anode and dynode No. 14 .....	400 max	400 max	volts
Between accelerating electrode and dynode No. 13 .....	±500 max	±500 max	volts
Between consecutive dynodes .....	500 max	500 max	volts
Between focusing electrode and cathode .....	400 max	400 max	volts
Between dynode No. 1 and cathode .....	400 max	400 max	volts
Average Anode Current .....	2 max	2 max	ma
Ambient Temperature .....	75 max	75 max	°C

**TYPICAL CHARACTERISTICS:**

DC Supply Voltage*	2000	2400	volts
Radiant Sensitivity (at 4400 angstroms) .....	2,400,000	2,400,000	a/w
Cathode Radiant Sensitivity (at 4400 angstroms) .....	0.056	0.056	a/w
Luminous Sensitivity			
At 0 cps**	3050	3050	a/lm
With dynode No. 14 as output electrode .....	2100	2100	a/lm
Cathode Luminous Sensitivity:			
With tungsten light source†	70	70	μa/lm
With blue light source**	0.05 min	0.05 min	μa
Current Amplification (in millions) .....	43	43	
Equivalent Anode-Dark-Current Input at 25°C at a luminous sensitivity of 2000 a/lm .....	1.5 max	1.1	nIm
Equivalent Noise Input†	3.3	4.6	pIm
Greatest Delay Between Anode Pulses:			
With radiation spot (centered on tube face) having a diameter of			
1-1/8 inch .....	1	—	nsec
1-9/16 inch .....	3	—	nsec

†With supply voltage (E) connected across voltage divider which provides electrode voltages as shown in Column A of the accompanying table.

‡‡With supply voltage (E) connected across voltage divider which provides electrode voltages as shown in Column B of the accompanying table.

\*With focusing-electrode and accelerating-electrode voltages adjusted to provide maximum anode current.

\*\*With light input of 0.1 microlumen from a tungsten-filament lamp operated at a color temperature of 2870°K. Range of luminous sensitivity is 210 to 7880 a/lm at 2000 volts.

†With light input of 0.01 lumen from a tungsten-filament lamp operated at a color temperature of 2870°K; 200 volts applied between cathode and all other electrodes connected as anode. ††Same conditions as above, but a blue filter is used (Corning C.S. No. 5-58, glass code No. 5113, polished to 1/2 stock thickness).

‡At tube temperature of 25°C and with external shield connected to cathode, bandwidth is equal to 1 cycle per second. A tungsten-filament light source at a color temperature of 2870°K is interrupted at a low audio frequency to produce incident radiation pulses alternating between zero and the value stated. The "on" period is equal to the "off" period.

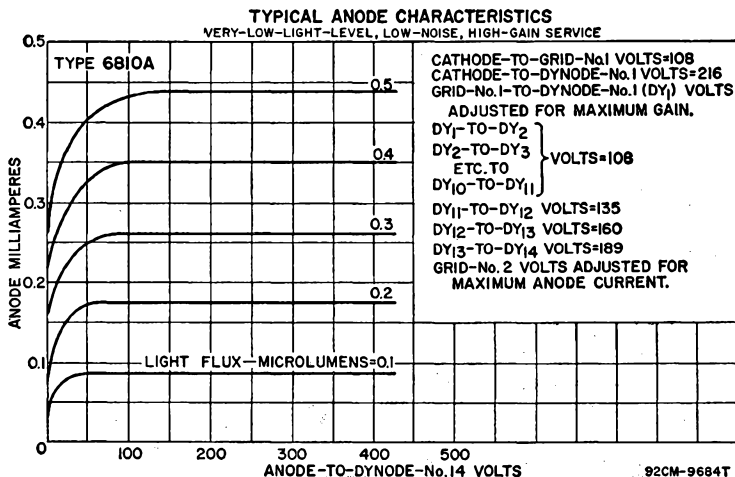

**SENSITIVITY AND CURRENT AMPLIFICATION CHARACTERISTICS**  
HIGH-OUTPUT-PULSE SERVICE

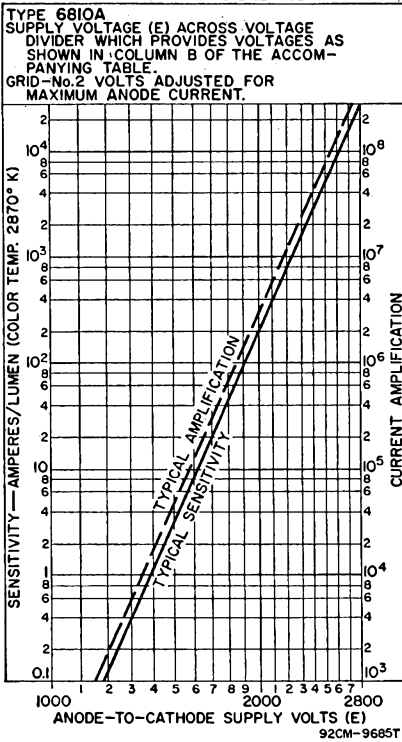

**SENSITIVITY AND CURRENT AMPLIFICATION CHARACTERISTICS**  
LOW-LIGHT, LOW-NOISE, HIGH-GAIN SERVICE

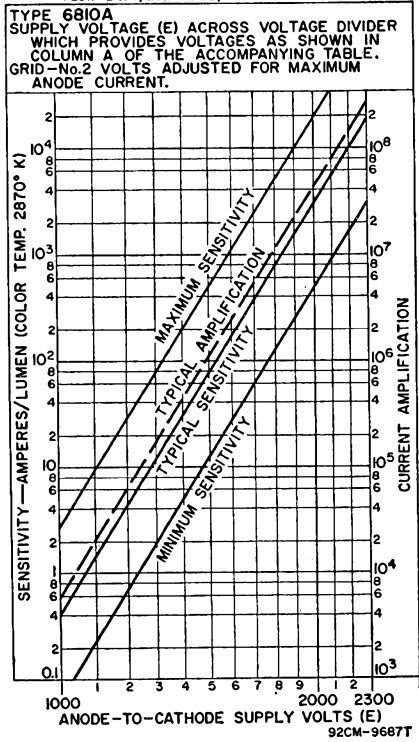

**VOLTAGE TO BE PROVIDED BY DIVIDER**

Between	COLUMN A	COLUMN B
	5.4% of Supply Volts (E) multiplied by	2.75% of Supply Volts (E) multiplied by
Cathode and Focusing Electrode	*	*
Cathode and Dynode No. 1	2	2
Focusing Electrode and Dynode No. 1	1	1
Dynode No. 1 and Dynode No. 2	1	1
Dynode No. 2 and Dynode No. 3	1	1
Dynode No. 3 and Dynode No. 4	1	1
Dynode No. 4 and Dynode No. 5	1	1
Dynode No. 5 to Dynode No. 6	1	1
Dynode No. 6 and Dynode No. 7	1	1.2
Dynode No. 7 and Dynode No. 8	1	1.5
Dynode No. 8 and Dynode No. 9	1	1.9
Dynode No. 9 and Dynode No. 10	1	2.4
Dynode No. 10 and Dynode No. 11	1	3.0
Dynode No. 11 and Dynode No. 12	1.25	3.8
Dynode No. 12 and Dynode No. 13	1.5	4.8
Dynode No. 13 and Dynode No. 14	1.75	6.0
Dynode No. 14 and Anode	2	4.8
Anode and Cathode	18.5	36.4

\*Adjusted for maximum anode current.

**TYPICAL ANODE-DARK-CURRENT CHARACTERISTIC**  
 VERY-LOW-LIGHT-LEVEL, LOW-NOISE, HIGH-GAIN SERVICE

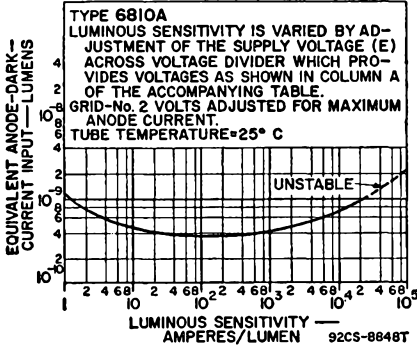

**TYPICAL ANODE-DARK-CURRENT CHARACTERISTIC**  
 HIGH-OUTPUT-PULSE SERVICE

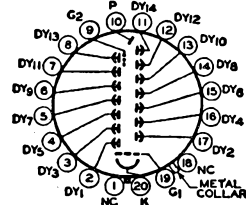
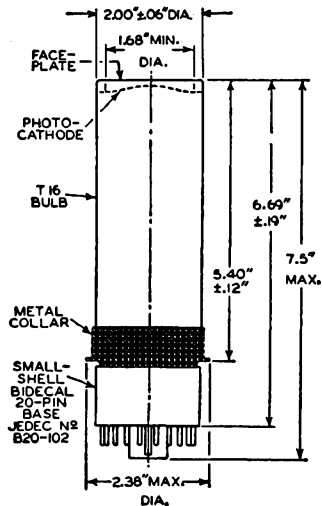
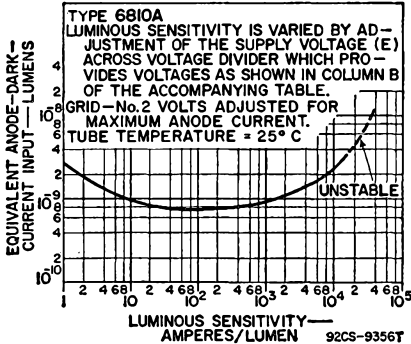

NOTE: Incident radiation is into end of bulb.

TEN-STAGE, head-on, flat-faceplate type having S-13 response. Wavelength of maximum response is  $4400 \pm 500$  angstroms. This type makes use of cesium-antimony dynodes and flat-circular, cesium-antimony, semitransparent photocathode. Window material is fused silica. Tube weighs approximately 5.8 ounces and has a non-hygroscopic base.

**6903**  
**MULTIPLIER**  
**PHOTOTUBE**

**DIRECT INTERELECTRODE CAPACITANCES (Approx):**

Anode to Dynode No. 10 .....	4.4	pf
Anode to All Other Electrodes .....	7	pf

**MAXIMUM RATINGS (Absolute-Maximum Values):**

<b>Supply Voltage (DC or Peak AC):</b>		
Between anode and cathode .....	1250 max	volts
Between anode and dynode No. 10 .....	250 max	volts
Between dynode No. 1 and cathode .....	300 max	volts
Between focusing electrode and cathode .....	300 max	volts
Average Anode Current .....	0.75 max	ma
Ambient Temperature .....	75 max	°C

**TYPICAL CHARACTERISTICS:**

DC Supply Voltage*	1000	750	volts
Radiant Sensitivity (at 4400 angstroms)	19000	1650	a/w
Cathode Radiant Sensitivity (at 4400 angstroms)	0.047	0.047	a/w
Luminous Sensitivity:			
At 0 cps**	24	2.1	a/lm
With dynode No. 10 as output electrode	14	1	a/lm
Cathode Luminous Sensitivity:			
With tungsten light source*	60	60	$\mu$ a/lm
With blue light source**	0.04	0.04	$\mu$ a
Current Amplification	400,000	35000	
Equivalent Anode-Dark-Current Input:			
At a luminous sensitivity of 20 a/lm	6 max	—	nlm
At 4400 angstroms	7.6 max	—	pw
Equivalent Noise Input:			
Luminous†	6.7	—	plm
Radiant††	0.0084	—	pw
Dark Current at any Electrode except Anode at 25°C	0.75	—	$\mu$ a

\*DC supply voltage (E) is connected across a voltage divider which provides 1/6 of E between dynode No. 1, 1/12 of E for each succeeding dynode stage, and 1/12 of E between dynode No. 10 and anode. Focusing-electrode voltage is adjusted to that value between 10 and 60 per cent of dynode No. 1 potential which provides maximum anode current.

\*\*With light input of 10 microlumens from a tungsten-filament lamp operated at a color temperature of 2870°K. Range of luminous sensitivity is 8 to 240 a/lm at 1000 volts.

†With light input of 0.01 lumen from a tungsten-filament lamp operated at a color temperature of 2870°K; 200 volts applied between cathode and all other electrodes connected as anode.

††Same conditions as (\*), but a blue filter is used (Corning C.S. No. 5-58, glass code No. 5113).

†At tube temperature of 25°C and with external shield connected to cathode; bandwidth is equal to 1 cycle per second. A tungsten-filament light source at a color temperature of 2870°K is interrupted at a low audio frequency to produce incident radiation pulses alternating between zero and the value stated. The "on" period of the pulse is equal to the "off" period.

††Under same conditions as (†), but a monochromatic source radiating at 2537 angstroms is used.

**SENSITIVITY AND CURRENT AMPLIFICATION CHARACTERISTICS**

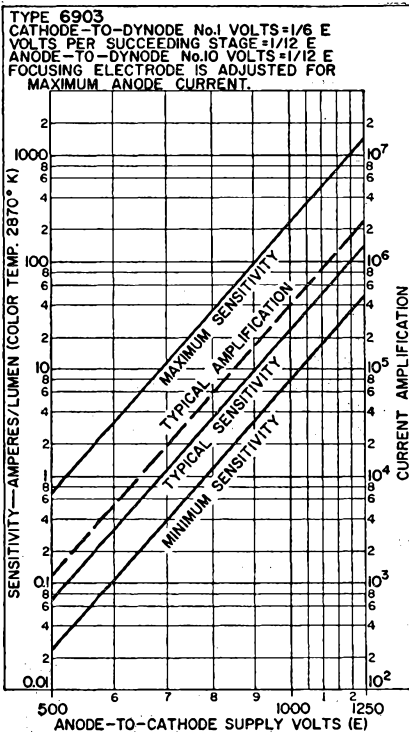

**TYPICAL ANODE-DARK-CURRENT CHARACTERISTIC**

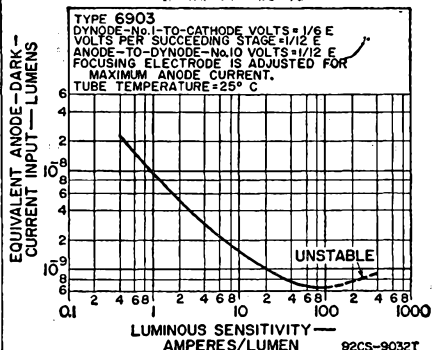

**EFFECT OF MAGNETIC FIELD ON ANODE CURRENT**

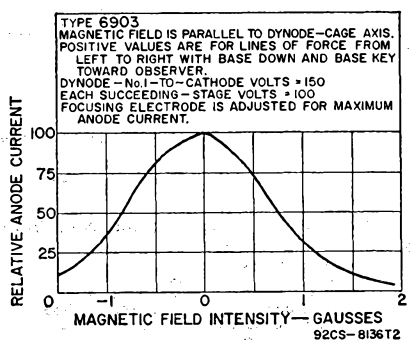

TYPICAL ANODE CHARACTERISTICS

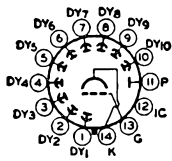
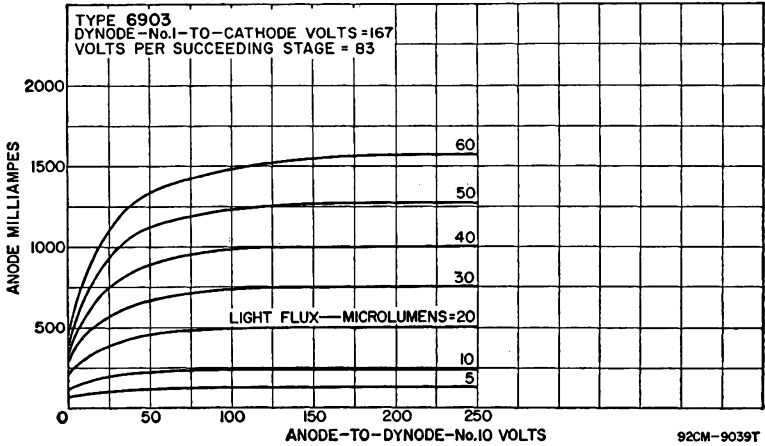

NOTE: Incident radiation is into end of bulb.

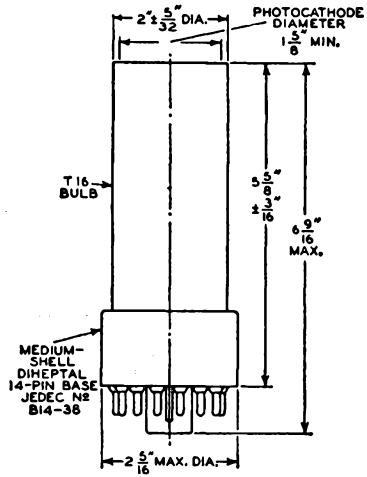

SIDE-ON type having unobstructed photocathode area and response. Wavelength of maximum spectral response is  $8000 \pm 1000$  angstroms. This type makes use of a semicylindrical photocathode, and has a direct interelectrode capacitance of 3 picofarads. It weighs approximately 0.9 ounce.

**6953**  
**GAS**  
**PHOTODIODE**

**MAXIMUM RATINGS (Absolute-Maximum Values):**

	Rating 1	Rating 2	
Anode-Supply Voltage (DC or Peak AC)	70 max	90 max	volts
Average Cathode-Current Density	60 max	30 max	$\mu\text{a}/\text{sq}$ in
Average Cathode Current	6 max	3 max	$\mu\text{a}$
Ambient Temperature	100 max	100 max	$^{\circ}\text{C}$

**TYPICAL CHARACTERISTICS:**

Anode-Supply Voltage	90	volts
Radiant Sensitivity (at 8000 angstroms)	0.019	a/w
Luminous Sensitivity*	200	$\mu\text{a}/\text{lm}$
Gas Amplification Factor**	10 max	
Anode Dark Current (at $25^{\circ}\text{C}$ )	0.1 max	$\mu\text{a}$

**MINIMUM CIRCUIT VALUES:**

Anode-Supply Voltage .....	70 or less	90	volts
DC Load Resistance:			
For average currents above 3 $\mu$ A .....	0.1 min	—	megohms
For average currents below 3 $\mu$ A .....	0 min	—	megohms
For average currents above 2 $\mu$ A .....	—	2.5 min	megohms
For average currents below 2 $\mu$ A .....	—	0.1 min	megohms

\*With light input of 0.1 lumen from a tungsten-filament lamp operated at a color temperature of 2870°K. Range of luminous sensitivity is 140 to 350  $\mu$ A/lm.  
 \*\*Ratio of luminous sensitivities at 90 and 25 volts.

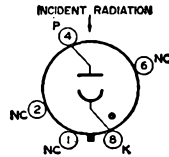
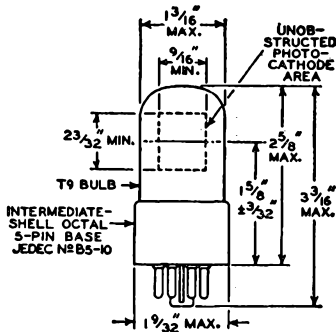
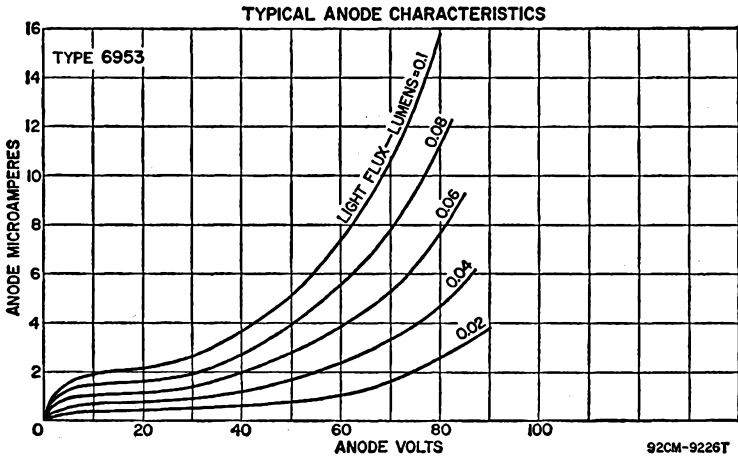

**7029  
MULTIPLIER  
PHOTOTUBE**

TEN-STAGE, dormer-window type having S-17 response. Wavelength of maximum response is  $4900 \pm 500$  angstroms. This type makes use of cesium-antimony dynodes and a cesium-antimony, semi-transparent photocathode on a reflective substrate. The shape of the photocathode is rectangular on a concave spherical surface. Window material is Corning No. 0080 lime glass or equivalent. Tube weighs approximately 3 ounces and has a non-gyroscopic base.

**DIRECT INTERELECTRODE CAPACITANCES (Approx.):**

Anode to Dynode No. 10 .....	4	pf
Anode to All Other Electrodes .....	7	pf

**MAXIMUM RATINGS (Absolute-Maximum Values):**

Supply Voltage (DC or Peak AC):		
Between anode and cathode .....	1250 max	volts
Between anode and dynode No. 10 .....	250 max	volts
Between dynode No. 1 and cathode .....	300 max	volts
Average Anode Current .....	20 max	$\mu$ a
Ambient-Temperature Range .....	-50 to 75	$^{\circ}$ C

**TYPICAL CHARACTERISTICS:**

DC Supply Voltage*	1000	volts
Radiant Sensitivity (at 4900 angstroms)	27000	a/w
Cathode Radiant Sensitivity (at 4900 angstroms)	0.085	a/w
Luminous Sensitivity**	40	a/lm
Cathode Luminous Sensitivity:		
With tungsten light source*	125	$\mu$ a/lm
With blue light source†	6 min	na
Current Amplification	320,000	
Equivalent Anode-Dark-Current Input at 25 $^{\circ}$ C		
at a luminous sensitivity of 20 a/lm .....	5 max	nIm
Equivalent Noise Input†	11	plm

\*DC supply voltage (E) is connected across a voltage divider which provides 1/11 of E per stage.

\*\*With light input of 1 microlumen from a tungsten-filament lamp operated at a color temperature of 2870 $^{\circ}$ K. Range of luminous sensitivity is 10 to 300 a/lm at 1000 volts.

†With light input of 0.001 lumen from a tungsten-filament lamp operated at a color temperature of 2870 $^{\circ}$ K; 100 volts applied between cathode and all other electrodes connected as anode.

‡Same conditions as (\*), but a blue filter is used (Corning C.S. No. 5-58, glass code No. 5113, polished to 1/2 stock thickness).

††At tube temperature of 25 $^{\circ}$ C and with external shield connected to cathode; bandwidth is equal to 1 cycle per second. A tungsten-filament light source at a color temperature of 2870 $^{\circ}$ K is interrupted at a low audio frequency to produce incident radiation pulses alternating between zero and the value stated. The "on" period of the pulse is equal to the "off" period.

**SENSITIVITY AND CURRENT AMPLIFICATION CHARACTERISTICS**

**TYPICAL ANODE-DARK-CURRENT CHARACTERISTIC**

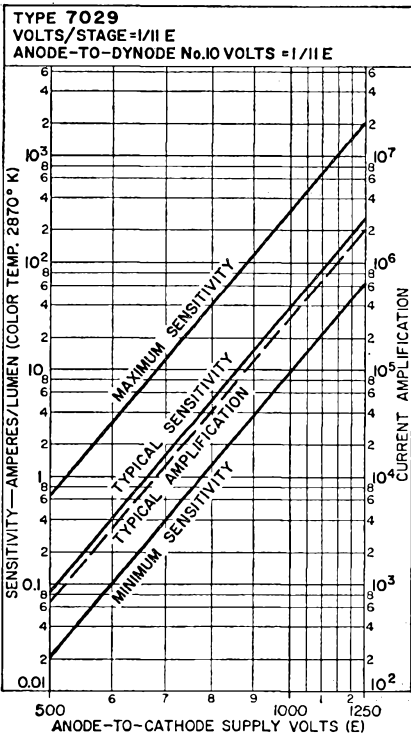
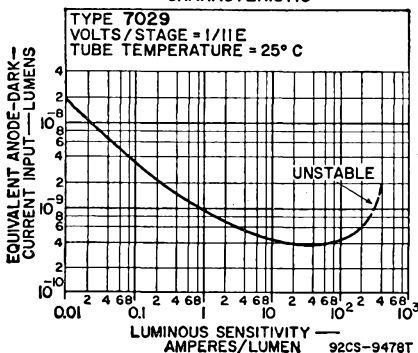

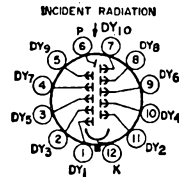
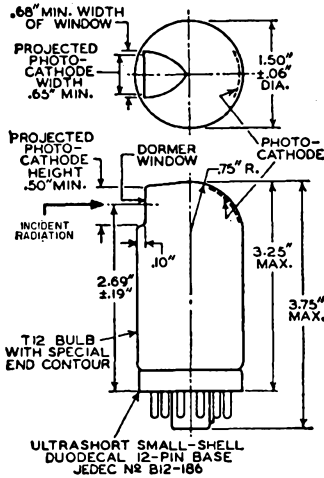
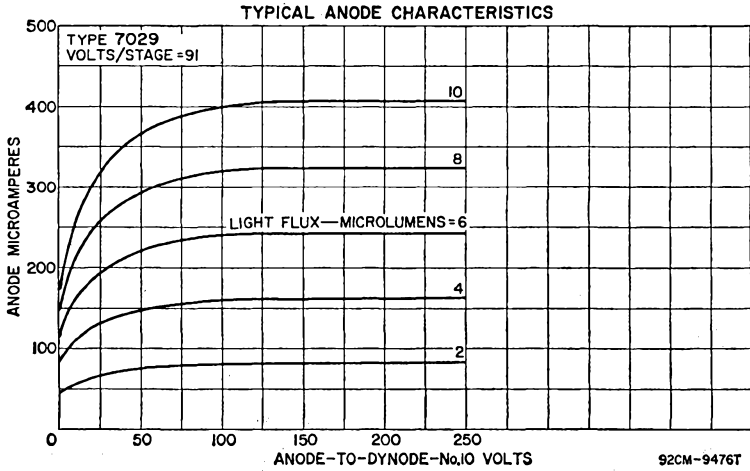

# 7043

## VACUUM PHOTODIODE

NON-DIRECTIONAL type having S-4 response. Wavelength of maximum spectral response is  $4000 \pm 500$  angstroms. This type makes use of a cylindrical photocathode, and has a direct interelectrode capacitance of 6 picofarads. It weighs approximately 1.4 ounces.

**MAXIMUM RATINGS (Absolute-Maximum Values):**

Anode-Supply Voltage (DC or Peak AC) .....	250 max	volts
Average Cathode-Current Density .....	25 max	$\mu\text{a}/\text{sq}$ in
Average Cathode Current .....	5 max	$\mu\text{a}$
Ambient Temperature .....	75 max	$^{\circ}\text{C}$

**TYPICAL CHARACTERISTICS:**

Anode-Supply Voltage .....	250	volts
Radiant Sensitivity (at 4000 angstroms) .....	0.044	a/w



Luminous Sensitivity:\*

At 250 volts .....	45	$\mu\text{a}/\text{lm}$
At 90 volts .....	41	$\mu\text{a}/\text{lm}$
Ratio of Luminous Sensitivities at 250 and 90 volts .....	1.25 max	
Luminous Sensitivity Uniformity** .....	1.55 max	
Anode Dark Current (at 25°C) .....	0.0125 max	$\mu\text{a}$

\*With light input of 0.1 lumen from a tungsten-filament lamp operated at a color temperature of 2870°K. Range of luminous sensitivity at 250 volts is 20 to 65  $\mu\text{a}/\text{lm}$ .

\*\*Ratio of highest sensitivity to lowest when tube is rotated about its axis through 360 degrees, with incident light perpendicular to major axis of photocathode, and with light spot 1/2 inch in diameter.

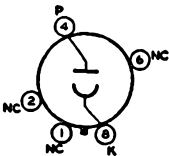
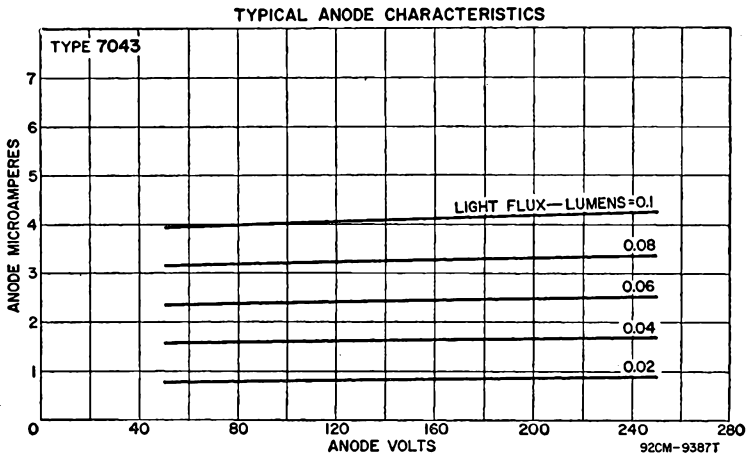

NOTE: Incident radiation is perpendicular to axis of photocathode.

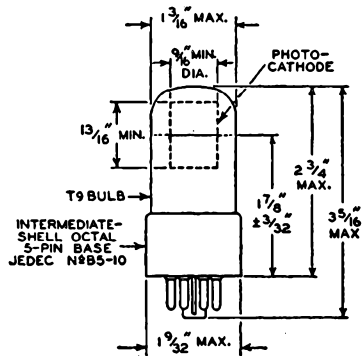

**7046**  
**MULTIPLIER**  
**PHOTOTUBE**

FOURTEEN-STAGE, head-on, flat-faceplate type having extended S-11 response. Wavelength of maximum response is  $4200 \pm 500$  angstroms. This type has a five-inch diameter and makes use of silver-magnesium dynodes and a curved-circular, cesium-antimony semitransparent photocathode. (This type may also be ordered with copper-beryllium dynodes.) Window material is ultraviolet transmitting glass (Corning No. 9741) or equivalent. Tube weighs approximately 30 ounces.

**DIRECT INTERELECTRODE CAPACITANCES (Approx.):**

Anode to Dynode No. 14	2.6	pf
Anode to All Other Electrodes	5.3	pf

**MAXIMUM RATINGS (Absolute-Maximum Values):**

<b>DC Supply Voltage:</b>		
Between anode and cathode	3400 max	volts
Between anode and dynode No. 14	400 max	volts
Between consecutive dynodes	400 max	volts
Between grid No. 3 and dynode No. 13	500 max	volts
Between grid No. 2 and anode	2300 max	volts
Between dynode No. 1 and grid No. 2	400 max	volts
<b>DC Supply Voltage to Grid No. 1</b>	1200 max	volts
<b>DC Supply Voltage to Grid No. 2</b>	1500 max	volts
Average Anode Current	2 max	ma
Ambient-Temperature Range	-80 to 75	°C

**TYPICAL CHARACTERISTICS:**

DC Supply Voltage*	2800	3400	volts
Radiant Sensitivity (at 4200 angstroms)	140,000	910,000	a/w
Cathode Radiant Sensitivity (at 4200 angstroms)	0.046	0.046	a/w
<b>Luminous Sensitivity:</b>			
At 0 cps**	180	1200	a/lm
With dynode No. 14 as output electrode	108	800	a/lm
<b>Cathode Luminous Sensitivity:</b>			
With tungsten light source†	60	60	µa/lm
With blue light source**	0.04 min	0.04 min	µa
<b>Current Amplification (in millions)</b>			
	3	20	
<b>Equivalent Anode-Dark Current Input:</b>			
At luminous sensitivity of 500 a/lm	12 max	—	nlm
At 4200 angstroms	15 max	—	pw
<b>Equivalent Noise Input:</b>			
Luminous†	10	—	plm
Radiant (at 4200 angstroms)	0.012	—	pw
<b>Greatest Delay Between Anode Pulses:</b>			
With radiation spot (on tube face)			
having a diameter of			
3 inches	0.5	—	nsec
4 inches	4	—	nsec

\*DC supply voltage is connected across a voltage divider which provides voltages as shown by the accompanying table. Grid-No. 3, grid-No. 1, and dynode-No. 1 voltages are adjusted to those values which provide maximum anode current.

\*\*With a light input of 0.1 microlumen from a tungsten-filament lamp operated at a color temperature of 2870°K. Range of luminous sensitivity is 80 to 3000 a/lm at 2800 volts.

†With a light input of 0.01 lumen from a tungsten-filament lamp operated at a color temperature of 2870°K; 200 volts applied between cathode and all other electrodes connected as anode.

\*\*Same conditions as above, but a blue filter is used (Corning C.S. No. 5-58, glass code No. 5113, polished to 1/2 stock thickness).

†At tube temperature of 25°C and with external shield connected to cathode; bandwidth is equal to 1 cycle per second. A tungsten-filament light source at a color temperature of 2870°K is interrupted at a low audio frequency to produce incident radiation pulses alternating between zero and the value stated. The "on" period is equal to the "off" period.

**TYPICAL ANODE CHARACTERISTICS**

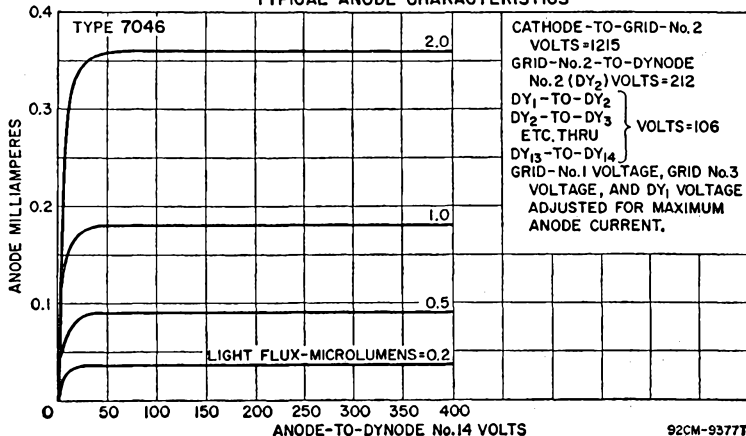

VOLTAGE TO BE PROVIDED BY DIVIDER	
Between	3.8% of Supply Volts (E) Multiplied By
Cathode and Grid No. 1	2 approx.*
Cathode and Grid No. 2	11.5
Grid No. 2 and Dynode No. 1	1 approx.*
Grid No. 2 and Dynode No. 2	2
Dynode No. 2 and Dynode No. 3	1
Dynode No. 3 and Dynode No. 4	1
Dynode No. 4 and Dynode No. 5	1
Dynode No. 5 and Dynode No. 6	1
Dynode No. 6 and Dynode No. 7	1
Dynode No. 7 and Dynode No. 8	1
Dynode No. 8 and Dynode No. 9	1
Dynode No. 9 and Dynode No. 10	1
Dynode No. 10 and Dynode No. 11	1
Dynode No. 11 and Dynode No. 12	1
Dynode No. 12 and Dynode No. 13	1
Dynode No. 13 and Dynode No. 14	1
Dynode No. 14 and Anode	1
Anode and Cathode	26.5

\*Adjusted for maximum anode current.

**SENSITIVITY AND CURRENT AMPLIFICATION CHARACTERISTICS**

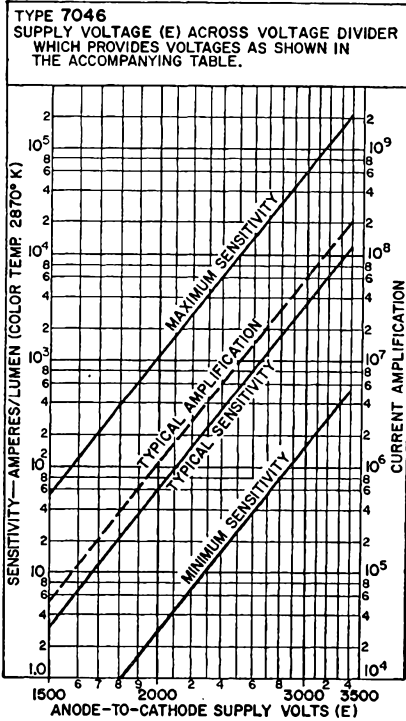

**SPECTRAL SENSITIVITY CHARACTERISTIC FOR EQUAL VALUES OF RADIANT FLUX AT ALL WAVELENGTHS**

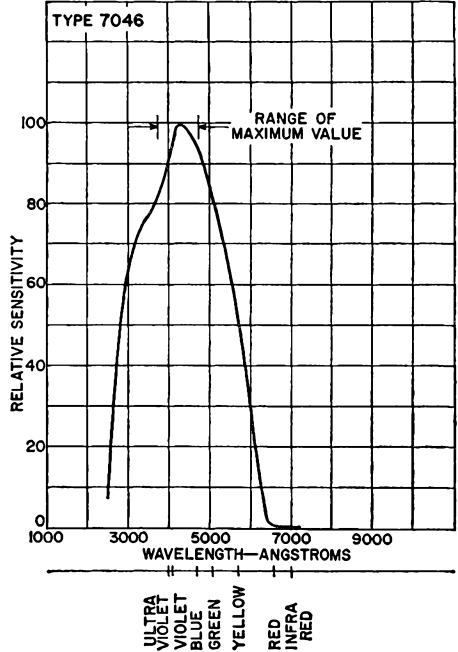

**EQUIVALENT-NOISE-INPUT CHARACTERISTIC**

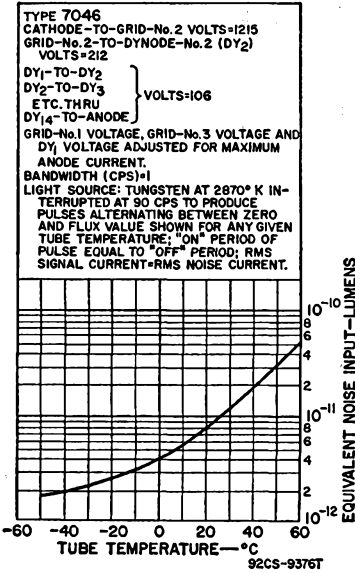

**TYPICAL ANODE-DARK-CURRENT CHARACTERISTIC**

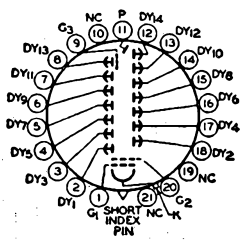
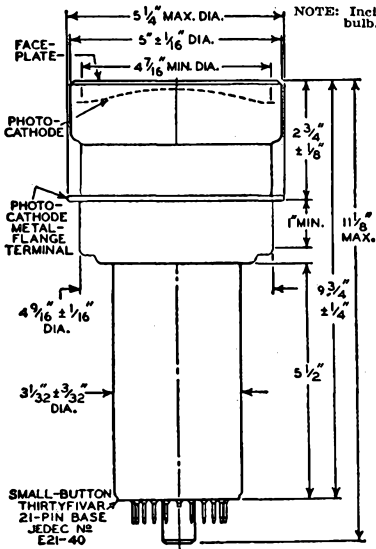
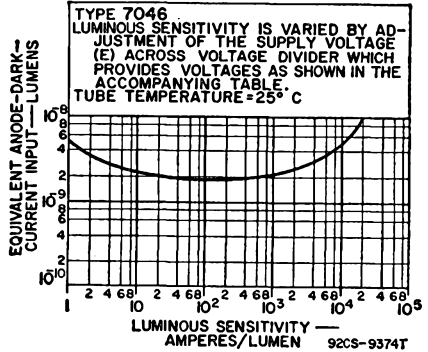

TEN-STAGE, head-on, flat-faceplate type having S-1 response. Wavelength of maximum response is  $8000 \pm 1000$  angstroms. This type makes use of silver-magnesium dynodes and a flat-circular, silver-oxygen-cesium, semitransparent photocathode. (This type may also be ordered with copper-beryllium dynodes.) Window material is Corning No. 0080 lime glass or equivalent. Tube weighs approximately 2 ounces and has a non-hygroscopic base. For outline and terminal-connection diagram, refer to type 6199.

# 7102 MULTIPLIER PHOTOTUBE

**DIRECT INTERELECTRODE CAPACITANCES (Approx.):**

Anode to Dynode No. 10 .....	4	pf
Anode to All Other Electrodes .....	7	pf

**MAXIMUM RATINGS (Absolute-Maximum Values):**

Supply Voltage (DC or Peak AC):		
Between anode and cathode .....	1500 max	volts
Between anode and dynode No. 10 .....	250 max	volts
Between consecutive dynodes .....	200 max	volts
Between dynode No. 1 and cathode .....	400 max	volts
Average Anode Current .....	10 max	$\mu$ a
Ambient Temperature .....	75 max	$^{\circ}$ C

**TYPICAL ANODE CHARACTERISTICS**

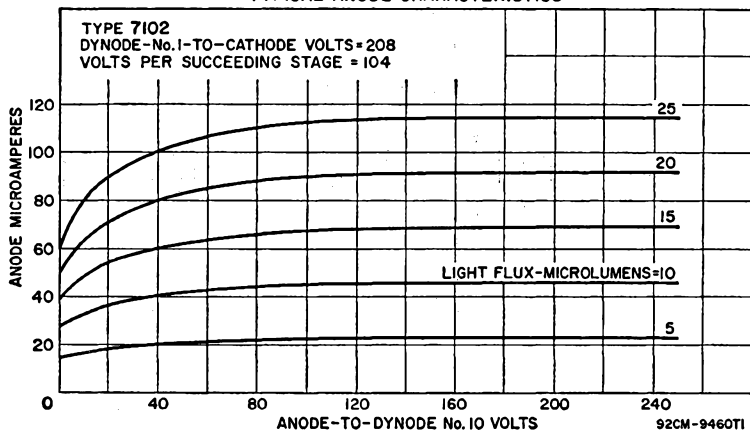

**TYPICAL CHARACTERISTICS:**

DC Supply Voltage*	1250	volts
Radiant Sensitivity (at 8000 angstroms)	420	a/w
Cathode Radiant Sensitivity (at 8000 angstroms)	0.0027	a/w
Luminous Sensitivity:		
At 0 cps**	4.5	a/lm
With dynode No. 10 as output electrode	2.7	a/lm
Cathode Luminous Sensitivity:		
With tungsten light source*	30	$\mu$ a./lm
With infrared source**	0.036	$\mu$ a
Current Amplification	150,000	
Equivalent Anode-Dark-Current Input:		
At a luminous sensitivity of 4 a/lm	5 max	$\mu$ lm
At 8000 angstroms	55 max	pw
Equivalent Noise Input:		
Luminous†	0.15	nlm
Infrared††	1.7	pw

\*DC supply voltage (E) is connected across a voltage divider which provides 1/6 of E between cathode and dynode No. 1, 1/12 of E for each succeeding dynode stage, and 1/12 of E between dynode No. 10 and anode.

\*\*With light input of 10 microlumens from a tungsten-filament lamp operated at a color temperature of 2870°K. Range of luminous sensitivity is 1 to 30 a/lm at 1250 volts.

+With light input of 0.01 lumen from a tungsten-filament lamp operated at a color temperature of 2870°K; 250 volts applied between cathode and all other electrodes connected as anode.  
 \*Same conditions as (\*), but an infrared filter is used (Corning C.S. No. 7-56, glass code No. 2540).

†At tube temperature of 25°C and with external shield connected to cathode; bandwidth is equal to 1 cycle per second. A tungsten-filament light source at a color temperature of 2870°K is interrupted at a low audio frequency to produce incident radiation pulses alternating between zero and the value stated. The "on" period of the pulse is equal to the "off" period.  
 ‡Under same conditions as (†), but a monochromatic source radiating at 8000 angstroms is used.

**SENSITIVITY AND CURRENT AMPLIFICATION CHARACTERISTICS**

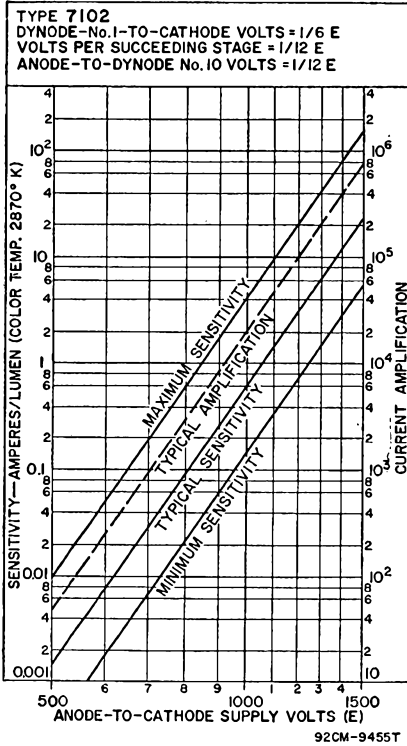

**EFFECT OF MAGNETIC FIELD ON ANODE CURRENT**

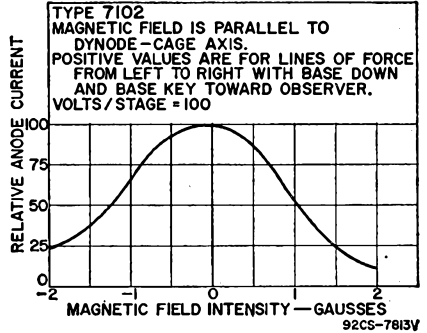

**TYPICAL ANODE-DARK-CURRENT CHARACTERISTIC**

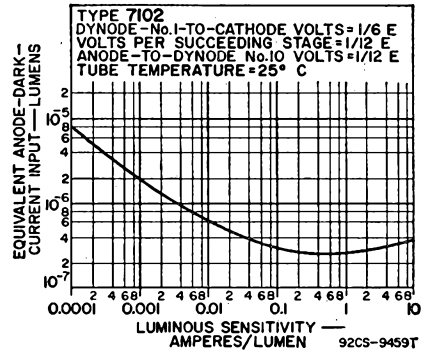

**EQUIVALENT-NOISE-INPUT CHARACTERISTICS**

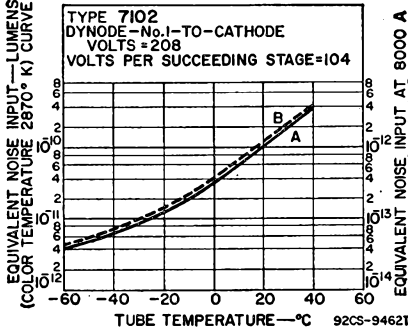

NINE-STAGE, side-on type having S-4 response. Wavelength of maximum response is  $4000 \pm 500$  angstroms. This type makes use of cesium-antimony dynodes and a cesium-antimony, opaque photocathode. Window material is Corning No. 0080 lime glass or equivalent. Tube weighs approximately 1.6 ounces. For outline and terminal-connection diagram, refer to type 6328.

# 7117 MULTIPLIER PHOTOTUBE

**DIRECT INTERELECTRODE CAPACITANCES (Approx.):**

Anode to Dynode No. 9 .....	4.2	pf
Anode to All Other Electrodes .....	5.5	pf

**MAXIMUM RATINGS (Absolute-Maximum Values):**

DC Supply Voltage:		
Between anode and cathode .....	1250 max	volts
Between anode and dynode No. 9 .....	250 max	volts
Between consecutive dynodes .....	250 max	volts
Between dynode No. 1 and cathode .....	250 max	volts
Average Anode Current .....	0.1 max	ma
Ambient Temperature .....	75	°C

**RANGE OF LUMINOUS SENSITIVITY**

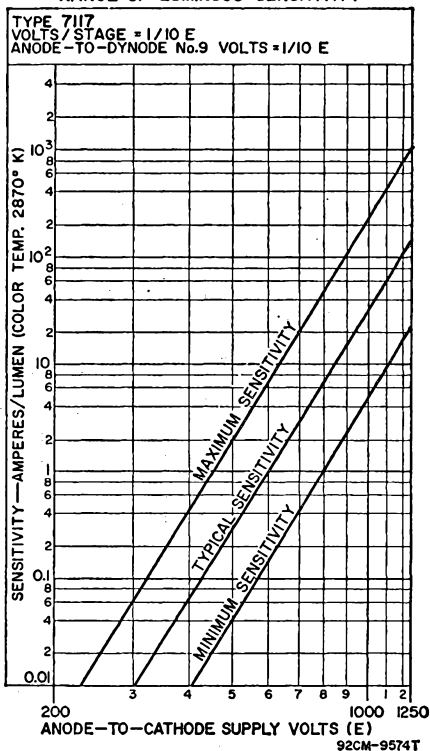

**TYPICAL CHARACTERISTICS:**

With DC Supply Voltage\* = 1000 Volts

Radiant Sensitivity (at 4000 angstroms) .....	34000	a/w
Luminous Sensitivity** .....	35	a/lm
Electrode Dark Current at 25°C:		
At anode .....	0.1 max	µa
At any other electrode .....	0.75 max	µa

With Supply Voltage\* = Adjustable DC Voltage

Anode-to-Cathode Voltage (dc value)\* ..... 900 volts

\*Supply voltage (E) is connected across a voltage divider which provides 1/10 of E between cathode and dynode No. 1, 1/10 of E for each succeeding dynode stage, and 1/10 of E between dynode No. 9 and anode.

\*\*With light input of 10 microlumens from a tungsten-filament lamp operated at a color temperature of 2870°K.

\*Same conditions as (\*\*), but a filter is used (Corning No. 3-67, glass code No. 3482). Supply voltage is adjusted to provide an anode current of 50 microamperes.

# 7200 MULTIPLIER PHOTOTUBE

NINE-STAGE, side-on type having S-19 response. Wave-length of maximum response is  $3300 \pm 500$  angstroms. This type makes use of cesium-antimony dynodes and a cesium-antimony, opaque photocathode. The window material is fused silica. Tube weighs approximately 1.8 ounces and has a non-hygroscopic base.

**DIRECT INTERELECTRODE CAPACITANCES (Approx.):**

Anode to Dynode No. 9 ..... 4.4 pf  
 Anode to All Other Electrodes ..... 6 pf

**MAXIMUM RATINGS (Absolute-Maximum Values):**

Supply Voltage (DC or Peak AC):  
 Between anode and cathode ..... 1250 max volts  
 Between anode and dynode No. 9 ..... 250 max volts  
 Between consecutive dynodes ..... 250 max volts  
 Between dynode No. 1 and cathode ..... 250 max volts  
 Average Anode Current ..... 0.5 max ma  
 Ambient-Temperature Range ..... -80 to 75 °C

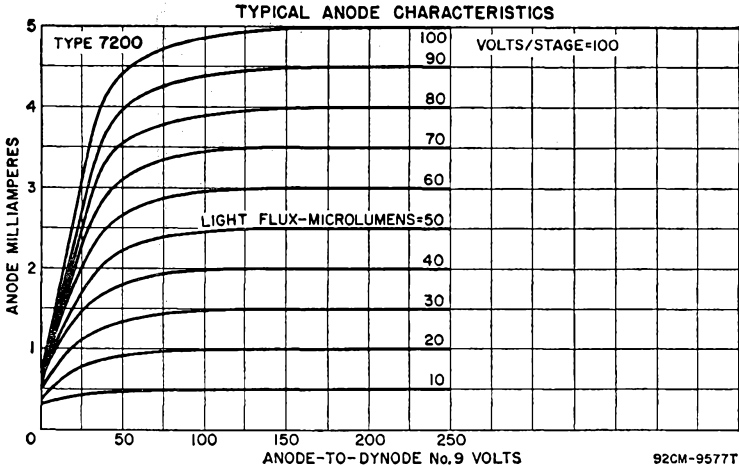

**TYPICAL CHARACTERISTICS:**

DC Supply Voltage\* ..... 1000 volts  
 Radiant Sensitivity (at 3300 angstroms) ..... 65000 a/w  
 Cathode Radiant Sensitivity (at 3300 angstroms) ..... 0.065 a/lm  
 Luminous Sensitivity\*\* ..... 40 a/lm  
 Cathode Luminous Sensitivity\* ..... 40 µa/lm  
 Current Amplification (in millions) ..... 1  
 Equivalent Anode-Dark-Current Input at 25°C  
 at a luminous sensitivity of 20 a/lm ..... 2 max nlm  
 Equivalent Noise Input:  
 Luminous\*\*  
 At 25°C ..... 0.75 plm  
 At -78°C ..... 0.04 plm  
 Ultraviolet†  
 At 25°C ..... 0.00066 pw  
 At -78°C ..... 0.00004 pw



\*DC supply voltage (E) is connected across a voltage divider which provides 1/10 of E between cathode and dynode No. 1, 1/10 of E for each succeeding dynode stage, and 1/10 of E between dynode No. 9 and anode.

\*\*With light input of 10 microlumens from a tungsten-filament lamp operated at a color temperature of 2870°K. Range of luminous sensitivity is 15 to 300 a/lm at 1000 volts.

\*With light input of 0.01 lumen from a tungsten-filament lamp operated at a color temperature of 2870°K; 100 volts applied between photocathode and all other electrodes connected as anode.

\*\*At tube temperature of 25°C and with external shield connected to cathode; bandwidth is equal to 1 cycle per second. A tungsten-filament light source at a color temperature of 2870°K is interrupted at a low audio frequency to produce incident radiation pulses alternating between zero and the value stated. The "on" period of the pulse is equal to the "off" period.

†Same conditions as (\*\*), but a monochromatic source radiating at 2537 angstroms is used.

TYPICAL ANODE-DARK-CURRENT CHARACTERISTIC

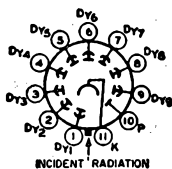
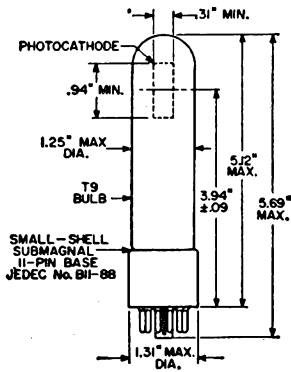
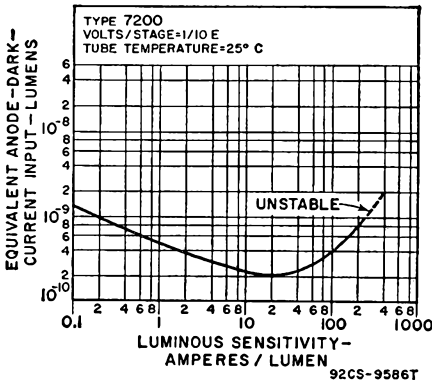

SENSITIVITY AND CURRENT AMPLIFICATION CHARACTERISTICS

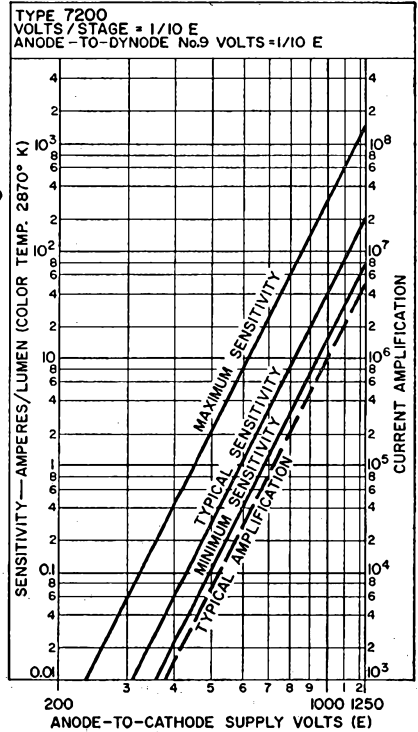

# 7264 MULTIPLIER PHOTOTUBE

FOURTEEN-STAGE, head-on, spherical-faceplate type having S-11 response. Wavelength of maximum spectral response is  $4400 \pm 500$  angstroms. This type makes use of silver-magnesium dynodes and a spherical-circular, cesium-antimony, semitransparent photocathode. (This type may also be ordered with copper-beryllium dynodes.) Window material is Corning No. 0080 lime glass or equivalent. Tube weighs approximately 8 ounces and has a non-hygroscopic base.

**DIRECT INTERELECTRODE CAPACITANCES (Approx.):**

Anode to Dynode No. 14 .....	2.4	pf
Anode to All Other Electrodes .....	5.5	pf
Dynode No. 14 to All Other Electrodes .....	7.5	pf

**MAXIMUM RATINGS (Absolute-Maximum Values):**

	Very-Low-Light-Level Service†	High-Output-Pulse Service‡	
Supply Voltage (DC):			
Between anode and cathode .....	2400 max	2800 max	volts
Between anode and dynode No. 14 .....	400 max	400 max	volts
Between accelerating electrode and dynode No. 13 .....	$\pm 500$ max	$\pm 500$ max	volts
Between consecutive dynodes .....	500 max	500 max	volts
Between focusing electrode and cathode .....	400 max	400 max	volts
Between dynode No. 1 and cathode .....	400 max	400 max	volts
Average Anode Current .....	2 max	2 max	ma
Ambient Temperature .....	75 max	75 max	°C

**TYPICAL ANODE CHARACTERISTICS**  
VERY-LOW-LIGHT-LEVEL, LOW-NOISE, HIGH-GAIN SERVICE

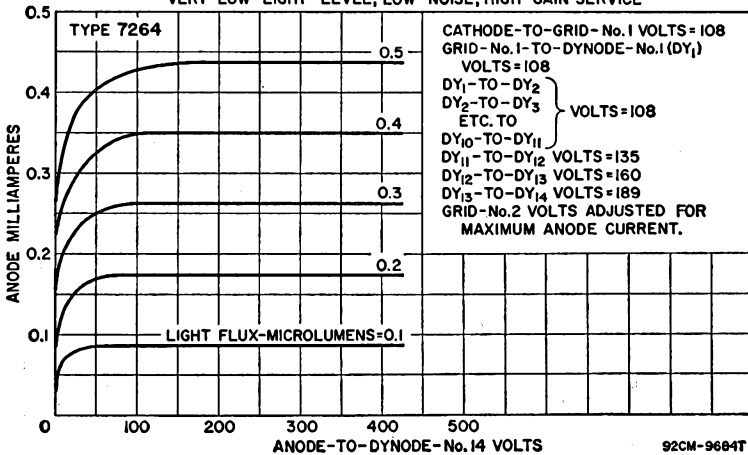

**TYPICAL CHARACTERISTICS:**

DC Supply Voltage*	2000	2400	volts
Radiant Sensitivity (at 4400 angstroms)	700,000	700,000	a/w
Cathode Radiant Sensitivity (at 4400 angstroms)	0.056	0.056	a/w
Luminous Sensitivity:			
At 0 cps**	875	875	a/lm
With dynode No. 14 as the output electrode	612	612	a/lm
Cathode Luminous Sensitivity:			
With tungsten light source†	70	70	µa/lm
With blue light source**	0.05 min	0.05 min	µa
Current Amplification (in millions)	12.5	12.5	
Equivalent Anode-Dark-Current Input at 25°C at a luminous sensitivity of 2000 a/lm	2 max	1.1	nlm
Equivalent Noise Input††			
At 25°C	3.3	4.6	plm
At -50°C	0.9	1.2	plm
Anode-Pulse Rise Time	3	—	nsec

Greatest Delay Between Anode Pulses:

With radiation spot (centered on tube face) having a diameter of

- 1-1/8 inch ..... 0.5 nsec
- 1-1/2 inch ..... 1 nsec

†With supply voltage (E) connected across voltage divider which provides electrode voltages as shown in Column A of the accompanying table.

††With supply voltage (E) connected across voltage divider which provides electrode voltages as shown in Column B of the accompanying table.

\*With focusing-electrode and accelerating-electrode voltages adjusted to provide maximum anode current.

\*\*With light input of 0.1 microlumen from a tungsten-filament lamp operated at a color temperature of 2870°K. Range of luminous sensitivity is 280 to 10500 a/lm at 2000 volts.

•With light input of 0.01 lumen from a tungsten-filament lamp operated at a color temperature of 2870°K; 200 volts applied between cathode and all other electrodes connected as anode. \*\*Same conditions as (+), but a blue filter is used (Corning C.S. No. 5-58, glass code No. 5113, polished to 1/2 stock thickness).

†At tube temperature of 25°C and with external shield connected to cathode; bandwidth is equal to 1 cycle per second. A tungsten-filament light source at a color temperature of 2870°K is interrupted at a low audio frequency to produce incident radiation pulses alternating between zero and the value stated. The "on" period is equal to the "off" period.

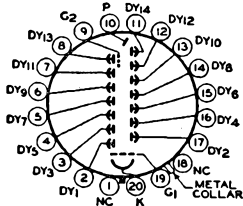
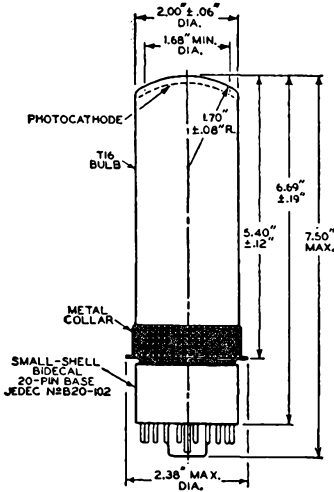

NOTE: Incident radiation is into end of bulb.

TYPICAL ANODE-DARK-CURRENT CHARACTERISTIC

VERY-LOW-LIGHT-LEVEL, LOW-NOISE, HIGH-GAIN SERVICE

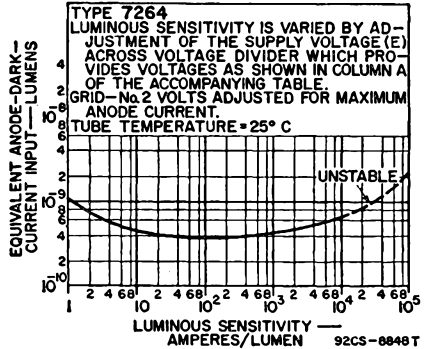

TYPICAL ANODE-DARK-CURRENT CHARACTERISTIC

HIGH-OUTPUT-PULSE SERVICE

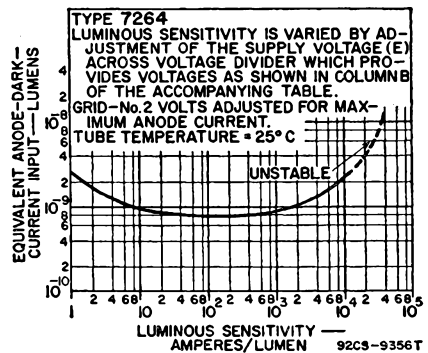

**SENSITIVITY AND CURRENT AMPLIFICATION CHARACTERISTICS**  
HIGH-OUTPUT-PULSE SERVICE

**TYPE 7264**  
SUPPLY VOLTAGE (E) ACROSS VOLTAGE DIVIDER WHICH PROVIDES VOLTAGES AS SHOWN IN COLUMN B OF THE ACCOMPANYING TABLE.  
GRID-No.2 VOLTS ADJUSTED FOR MAXIMUM ANODE CURRENT.

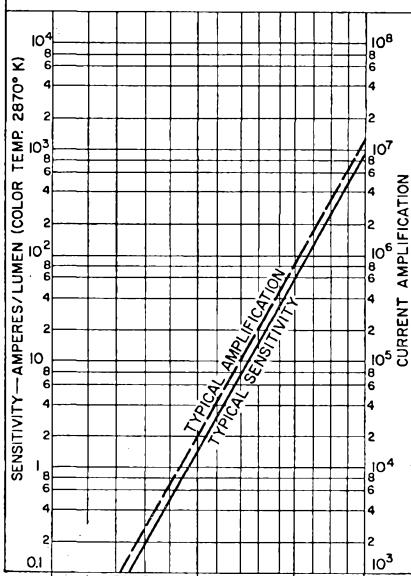

92CM-9685T

**SENSITIVITY AND CURRENT AMPLIFICATION CHARACTERISTICS**  
VERY-LOW-LIGHT-LEVEL, LOW-NOISE, HIGH-GAIN SERVICE

**TYPE 7264**  
SUPPLY VOLTAGE (E) ACROSS VOLTAGE DIVIDER WHICH PROVIDES VOLTAGES AS SHOWN IN COLUMN A OF THE ACCOMPANYING TABLE.  
GRID-No.2 VOLTS ADJUSTED FOR MAXIMUM ANODE CURRENT.

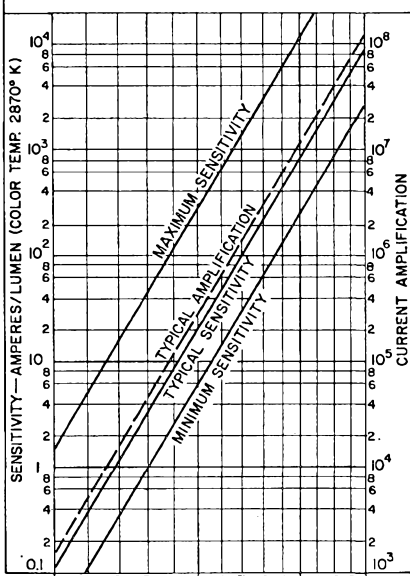

92CM-9687T

**VOLTAGE TO BE PROVIDED BY DIVIDER**

Between	COLUMN A	COLUMN B
	5.4% of Supply Volts (E) multiplied by	2.75% of Supply Volts (E) multiplied by
Cathode and Focusing Electrode	*	*
Cathode and Dynode No. 1	2	2
Dynode No. 1 and Dynode No. 2	1	1
Dynode No. 2 and Dynode No. 3	1	1
Dynode No. 3 and Dynode No. 4	1	1
Dynode No. 4 and Dynode No. 5	1	1
Dynode No. 5 and Dynode No. 6	1	1
Dynode No. 6 and Dynode No. 7	1	1.2
Dynode No. 7 and Dynode No. 8	1	1.5
Dynode No. 8 and Dynode No. 9	1	1.9
Dynode No. 9 and Dynode No. 10	1	2.4
Dynode No. 10 and Dynode No. 11	1	3.0
Dynode No. 11 and Dynode No. 12	1.25	3.8
Dynode No. 12 and Dynode No. 13	1.5	4.8
Dynode No. 13 and Dynode No. 14	1.75	6.0
Dynode No. 14 and Anode	2	4.8
Anode and Cathode	18.5	36.4

\*Focusing electrode is connected to arm of potentiometer between cathode and dynode No. 1. Focusing-electrode voltage is adjusted to give maximum anode current.

FOURTEEN-STAGE, head-on, flat-faceplate type having S-20 response. Wavelength of maximum spectral response is  $4200 \pm 500$  angstroms. This type makes use of copper-beryllium dynodes, and a curved-circular, semitransparent, antimony-potassium-sodium-cesium photocathode. Window material is Corning No. 0080 lime glass or equivalent. Tube weighs approximately 8 ounces and has a non-hygroscopic base.

# 7265 MULTIPLIER PHOTOTUBE

**DIRECT INTERELECTRODE CAPACITANCES (Approx.):**

Anode to Dynode No. 14 .....	2.8	pf
Anode to All Other Electrodes .....	6	pf
Dynode No. 14 to All Other Electrodes .....	7.5	pf

**MAXIMUM RATINGS (Absolute-Maximum Values):**

Supply Voltage (DC):		
Between anode and cathode .....	3000 max	volts
Between anode and dynode No. 14 .....	500 max	volts
Between accelerating electrodes and dynode No. 13 .....	$\pm 600$ max	volts
Between consecutive dynodes .....	600 max	volts
Between focusing electrode and cathode .....	500 max	volts
Between dynode No. 1 and cathode .....	500 max	volts
Average Anode Current .....	1 max	ma
Ambient Temperature .....	85 max	°C

**TYPICAL ANODE CHARACTERISTICS**

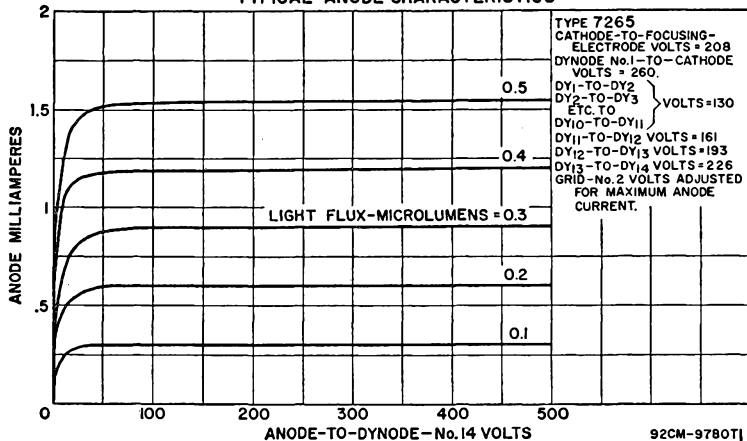

**TYPICAL CHARACTERISTICS:**

DC Supply Voltage*	2400	volts
Radiant Sensitivity (at 4200 angstroms)	1.3	$\mu\text{a/w}$
Cathode Radiant Sensitivity (at 4200 angstroms)	0.064	$\mu\text{a/w}$
Luminous Sensitivity:		
At 0 cps**	3000	a/lm
With dynode No. 14 as the output electrode	980	a/lm
Cathode Luminous Sensitivity:		
With tungsten light source*	150	$\mu\text{a/lm}$
With blue light source**	0.05 min	$\mu\text{a}$
With red light source†	0.3 min	$\mu\text{a}$
Current Amplification (in millions)	20	
Equivalent Anode-Dark-Current Input at 25°C at a luminous sensitivity of 1000 a/lm	0.8 max	nIm
Equivalent Noise Input:††		
At 25°C	0.75	pIm
At -80°C	0.1	pIm
Anode-Pulse Rise Time	3	nsec
Greatest Delay Between Anode Pulses:		
With radiation spot (centered on tube face) having a diameter of		
1-1/8 inch	1	nsec
1-9/16 inch	3	nsec

\*DC supply voltage (E) is connected across a voltage divider which provides electrode voltages as shown in the accompanying table. The focusing-electrode and accelerating-electrode voltages are adjusted to provide maximum anode current.

\*\*With light input of 0.1 microlumen from a tungsten-filament lamp operated at a color temperature of 2870°K. Range of luminous sensitivity is 360 to 15000 a/lm at 2400 volts.

\*With light input of 0.01 lumen from a tungsten-filament lamp operated at a color temperature of 2870°K; 200 volts applied between cathode and all other electrodes connected as anode.

\*\*Same conditions as (+), but a blue filter is used (Corning C.S. No. 5-58, glass code No. 5113, polished to 1/2 stock thickness).

†Same conditions as (+), but a red filter is used (Corning C.S. No. 2-62, glass code No. 2418).

††At tube temperature of 25°C and with external shield connected to cathode; bandwidth is equal to 1 cycle per second. A tungsten-filament light source at a color temperature of 2870°K is interrupted at a low audio frequency to produce incident radiation pulses alternating between zero and the value stated. The "on" period of the pulse is equal to the "off" period.

### TYPICAL ANODE-DARK-CURRENT CHARACTERISTIC

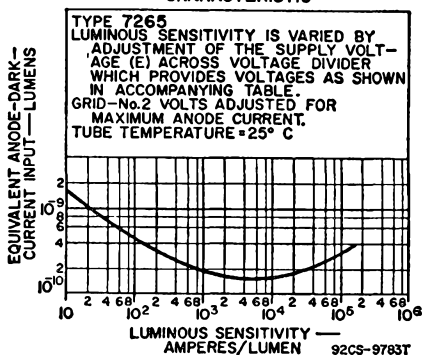

### VOLTAGE TO BE PROVIDED BY DIVIDER

Between	5.4% of Supply Voltage (E) multiplied by
Cathode and Focusing Electrode*	1.6
Cathode and Dynode No. 1	2
Dynode No. 1 and Dynode No. 2	1
Dynode No. 2 and Dynode No. 3	1
Dynode No. 3 and Dynode No. 4	1
Dynode No. 4 and Dynode No. 5	1
Dynode No. 5 and Dynode No. 6	1
Dynode No. 6 and Dynode No. 7	1
Dynode No. 7 and Dynode No. 8	1
Dynode No. 8 and Dynode No. 9	1
Dynode No. 9 and Dynode No. 10	1
Dynode No. 10 and Dynode No. 11	1
Dynode No. 11 and Dynode No. 12	1.25
Dynode No. 12 and Dynode No. 13	1.5
Dynode No. 13 and Dynode No. 14	1.75
Dynode No. 14 and Anode	2
Anode and Cathode	18.5

\*The metal collar (See Dimensional Outline) is connected internally to the focusing electrode. Extreme care should be taken in the design of apparatus to prevent operating personnel from coming in contact with the collar when the circuit application is such that the collar is at high potential.

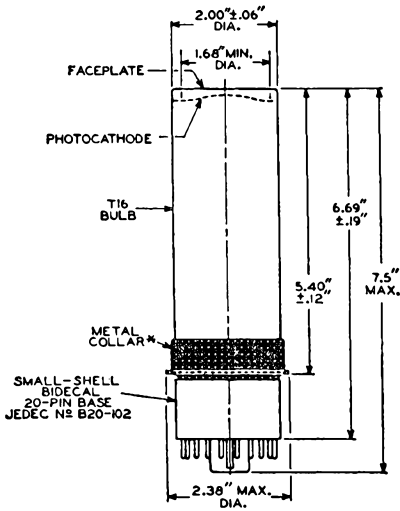

\* MUST BE ADEQUATELY INSULATED.

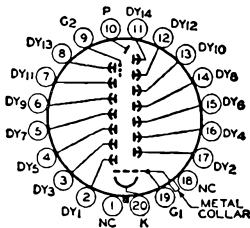

NOTE: Incident radiation is into end of bulb.

**SENSITIVITY AND CURRENT AMPLIFICATION CHARACTERISTICS**

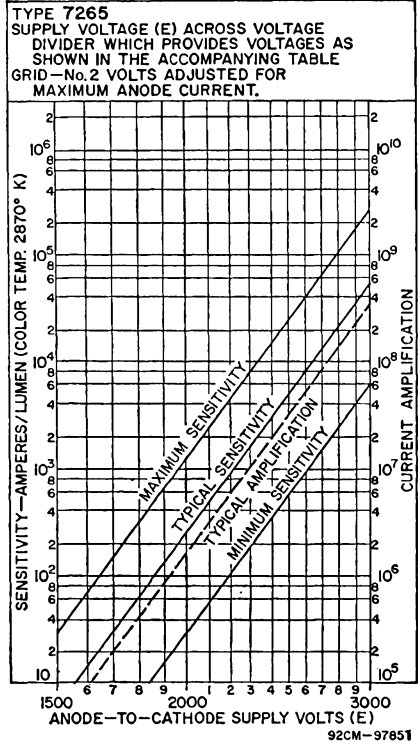

92CM-97851

TEN-STAGE, head-on, flat-faceplate type having S-20 response. Wavelength of maximum response is  $4200 \pm 500$  angstroms. This type makes use of silver-magnesium dynodes and a curved-circular, potassium-bismuth-sodium-cesium, semitransparent photocathode. (This type may also be ordered with copper-beryllium dynodes.) Window material is Corning No. 0080 lime glass or equivalent. Tube weighs approximately 6 ounces and has a non-hygroscopic base.

**7326**  
**MULTIPLIER**  
**PHOTOTUBE**

**DIRECT INTERELECTRODE CAPACITANCES (Approx.):**

Anode to Dynode No. 10 .....	4.4	pf
Anode to All Other Electrodes .....	7	pf

**MAXIMUM RATINGS (Absolute-Maximum Values):**

<b>DC Supply Voltage:</b>		
Between anode and cathode .....	2400 max	volts
Between anode and dynode No. 10 .....	500 max	volts
Between consecutive dynodes .....	600 max	volts
Between dynode No. 1 and cathode .....	500 max	volts
Between focusing electrode and cathode .....	500 max	volts
Average Anode Current .....	1 max	ma
Ambient Temperature .....	85 max	°C

**TYPICAL CHARACTERISTICS:**

DC Supply Voltage*	1800	volts
Radiant Sensitivity (at 4200 angstroms)	9600	a/w
Cathode Radiant Sensitivity (at 4200 angstroms)	0.064	a/w
Luminous Sensitivity**	22.5	a/lm
Cathode Luminous Sensitivity:		
With tungsten light source†	150	μa/lm
With blue light source**	0.05 min	μa
With red light source†	0.3 min	μa
Current Amplification	150,000	
Equivalent Anode-Dark-Current Input at 25°C:		
At a Luminous Sensitivity of 20 a/lm	1.4 max	nIm
At 4200 angstroms	3.3	pW
Equivalent Noise Input††:		
At 25°C	1.9	pIm
	0.004	pW
	0.3	pIm
At -80°C	0.0007	pW
	2.5	nsec
Anode-Pulse Rise Time		
Greatest Delay Between Anode Pulses:		
With radiation spot (centered on tube face)		
having a diameter of		
1-1/8 inch	1	nsec
1-9/16 inch	3	nsec

\*DC supply voltage (E) is connected across a voltage divider which provides 1/6 of E between cathode and dynode No. 1, 1/12 of E for each succeeding dynode stage, and 1/12 of E between dynode No. 10 and anode. Focusing-electrode voltage is adjusted to that value which provides maximum anode current.

\*\*With light input of 0.1 microlumen from a tungsten-filament lamp operated at a color temperature of 2870°K. Range of luminous sensitivity is 5 to 150 a/lm at 1800 volts.

†With light input of 0.01 lumen from a tungsten-filament lamp operated at a color temperature of 2870°K; 200 volts applied between cathode and all other electrodes connected as anode.

††Same conditions as (\*), but a blue filter is used (Corning C.S. No. 5-58, glass code No. 5113, polished to 1/4 stock thickness).

†Same conditions as (\*), but a red filter is used (Corning C.S. No. 2-62, glass code No. 2418).

†††At tube temperature of 25°C and with external shield connected to cathode; bandwidth is equal to 1 cycle per second. A tungsten-filament light source at a color temperature of 2870°K is interrupted at a low audio frequency to produce incident radiation pulses alternating between zero and the value stated. The "on" period of the pulse is equal to the "off" period.

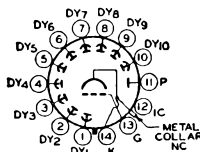
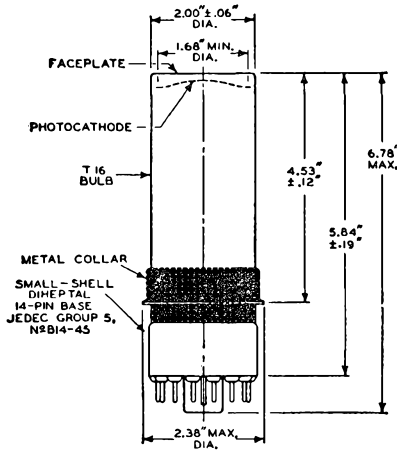

NOTE: Incident radiation is into end of bulb.



TYPICAL ANODE CHARACTERISTICS

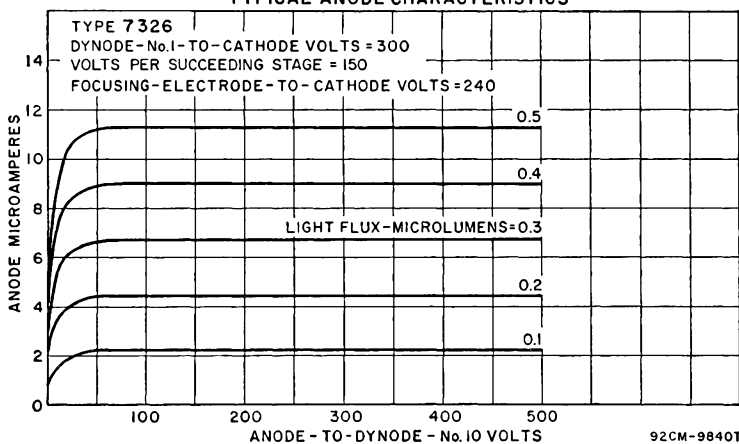

SENSITIVITY AND CURRENT AMPLIFICATION CHARACTERISTICS

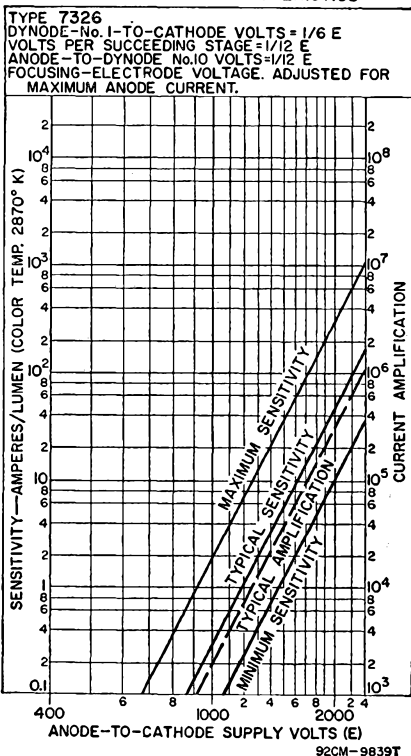

TYPICAL ANODE-DARK-CURRENT CHARACTERISTIC

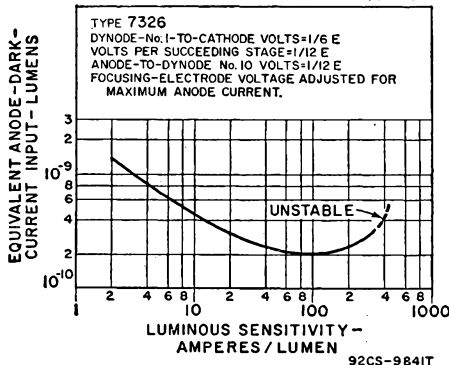

# 7746 MULTIPLIER PHOTOTUBE

TEN-STAGE, head-on, spherical-faceplate type having S-11 response. Wavelength of maximum response is  $4400 \pm 500$  angstroms. This type makes use of copper-beryllium dynodes and a spherical-circular, cesium-antimony, semitransparent photocathode. Window material is Corning No. 0080 lime glass or equivalent. Tube weighs approximately 6 ounces and has a non-hygroscopic base.

**DIRECT INTERELECTRODE CAPACITANCES (Approx.):**

Anode to Dynode No. 10	3.8	pf
Anode to All Other Electrodes	5.0	pf
Dynode No. 10 to All Other Electrodes	6.5	pf

**MAXIMUM RATINGS (Absolute-Maximum Values):**

Between anode and cathode	2500 max	volts
Between anode and dynode No. 10	400 max	volts
Between consecutive dynodes	300 max	volts
Between dynode No. 1 and cathode	600 max	volts
Between focusing electrode and cathode	600 max	volts
Average Anode Current	2 max	ma
Ambient Temperature	75 max	°C

**TYPICAL ANODE CHARACTERISTICS**

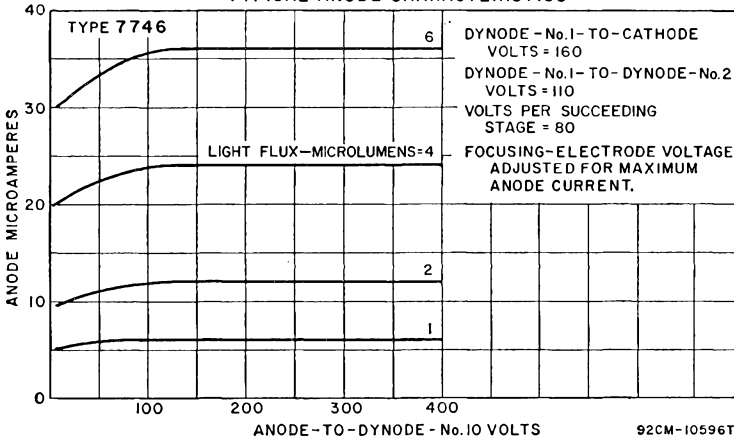

**TYPICAL CHARACTERISTICS:**

DC Supply Voltage*	2000	1500	1000	volts
Radiant Sensitivity* (at 4400 angstroms)	960,000	150,000	4800	a/w
Cathode Radiant Sensitivity* (at 4400 angstroms)	0.056	0.056	0.056	a/w
Luminous Sensitivity**	1200	130	6	a/lm
Cathode Luminous Sensitivity:				
With tungsten light source*	70	70	70	μa/lm
With blue light source**	0.05 min	1.8	0.086	μa/lm
Current Amplification (in millions)	17	1.8	0.086	
Equivalent Anode-Dark-Current Input at 25°C at luminous sensitivity of:				
230 a/lm	3.5 max	—	—	nIm
20 a/lm	—	2.5 max	—	nIm
6 a/lm	—	—	0.5	nIm
Equivalent Noise Input†	6	4	5	plm
Anode-Pulse Rise Time	2	—	—	nsec
Pulse Height Resolution††	—	8.5	—	per cent
Greatest Delay Between Anode Pulses:				
With radiation spot (centered on tube face) having a diameter of				
1-5/32 inch	0.3	—	—	nsec
1-19/32 inch	0.5	—	—	nsec

\*DC supply voltage (E) is connected across a voltage divider which provides voltages as shown by the accompanying table. The focusing-electrode voltage is adjusted to that value which provides maximum anode current.

\*\*With light input of 0.1 microlumen from a tungsten-filament lamp operated at a color temperature of 2870°K. The range of luminous sensitivity is 200 to 6000 a/lm at 2000 volts; 23 to 680 a/lm at 1500 volts; and 1 to 30 a/lm at 1000 volts.

+With light input of 0.01 lumen from a tungsten-filament lamp operated at a color temperature of 2870°K; 200 volts applied between photocathode and all other electrodes connected as anode.

\*\*Same conditions as (+), but a blue filter is used (Corning 5-58, glass code No. 5113, polished to 1/2 stock thickness).

†At tube temperature of 25°C and with external shield connected to cathode; bandwidth is equal to 1 cycle per second. A tungsten-filament light source at a color temperature of 2870°K is interrupted at a low audio frequency to produce incident radiation pulses alternating between zero and the value stated. The "on" period is equal to the "off" period.

††Measured with supply voltage equal to 1200 to 1300 volts; radiation source is an isotope of cesium having an atomic mass of 137 (Cs<sup>137</sup>); scintillation counter crystal is a cylindrical 2- by 2-inch thallium-activated sodium-iodide type.

VOLTAGE TO BE PROVIDED BY DIVIDER	
Between	8.06% of Supply Volts (E) multiplied by
Cathode and Dynode No. 1	2
Dynode No. 1 and Dynode No. 2	1.4
Dynode No. 2 and Dynode No. 3	1
Dynode No. 3 and Dynode No. 4	1
Dynode No. 4 and Dynode No. 5	1
Dynode No. 5 and Dynode No. 6	1
Dynode No. 6 and Dynode No. 7	1
Dynode No. 7 and Dynode No. 8	1
Dynode No. 8 and Dynode No. 9	1
Dynode No. 9 and Dynode No. 10	1
Dynode No. 10 and Anode	1
Anode and Cathode	12.4

Focusing electrode is connected to arm of potentiometer between cathode and dynode No. 1. The focusing-electrode voltage is varied to give maximum anode current.

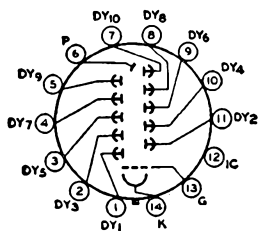

NOTE: Incident radiation is into end of bulb.

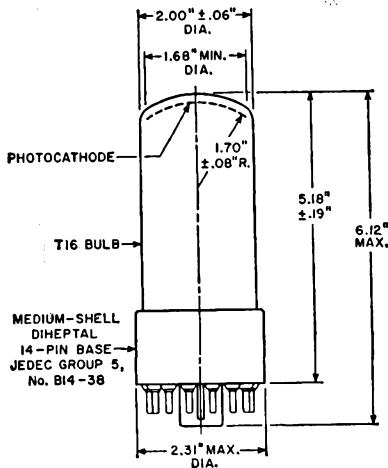

TYPICAL ANODE-CURRENT CHARACTERISTIC

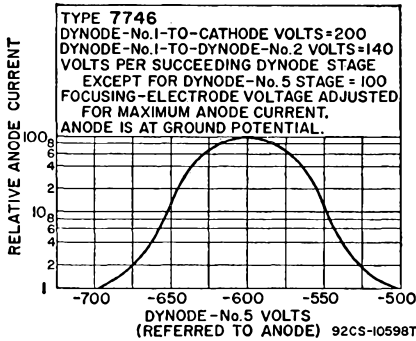

TYPICAL ANODE-DARK-CURRENT CHARACTERISTIC

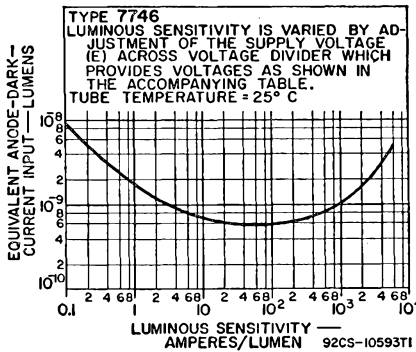

SENSITIVITY AND CURRENT AMPLIFICATION CHARACTERISTICS

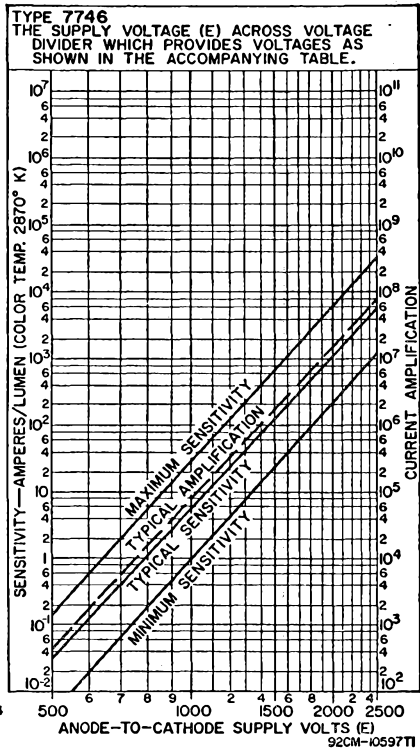

TYPICAL FOCUSING-ELECTRODE-VOLTAGE CHARACTERISTIC

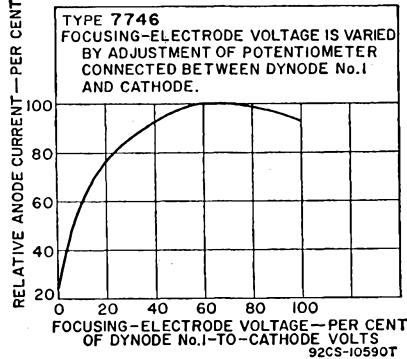

SIX-STAGE, head-on, flat-faceplate type having S-11 response. Wavelength of maximum response is  $4400 \pm 500$  angstroms. This type makes use of copperberyllium dynodes and a curved-circular cesium-antimony, semitransparent photocathode. Window material is Corning No. 0080 lime glass or equivalent. Tube weighs approximately 0.6 ounce.

# 7764 MULTIPLIER PHOTOTUBE

**DIRECT INTERELECTRODE CAPACITANCES (Approx.):**

Anode to Dynode No. 6	1.8	pf
Anode to All Other Electrodes	2.8	pf
Dynode No. 6 to all Other Electrodes	3.7	pf

**MAXIMUM RATINGS (Absolute-Maximum Values):**

Supply Voltage (DC or Peak AC):		
Between anode and cathode	1500 max	volts
Between anode and dynode No. 6	250 max	volts
Between consecutive dynodes	200 max	volts
Between dynode No. 1 and cathode	400 max	volts
Average Anode Current	0.5 max	ma
Ambient Temperature	75 max	°C

**TYPICAL CHARACTERISTICS:**

DC Supply Voltage*	1200	volts
Radiant Sensitivity (at 4400 angstroms)	240	a/w
Cathode Radiant Sensitivity (at 4400 angstroms)	0.048	a/w
Luminous Sensitivity**	0.3	a/lm
Cathode Luminous Sensitivity:		
With tungsten light source*	60	µa/lm
With blue light source**	0.06	µa
Current Amplification	5000	
Equivalent Anode-Dark-Current Input at 25°C at		
luminous sensitivity of 0.3 a/lm	30 max	nlm
Equivalent Noise Input†	26	plm

\*DC supply voltage (E) is connected across a voltage divider which provides 1/4 of E between cathode and dynode No. 1, 1/8 of E for each succeeding dynode stage, and 1/8 of E between dynode No. 6 and anode.

\*\*With light input of 10 microlumens from a tungsten-filament lamp operated at a color temperature of 2870°K. Range of luminous sensitivity is 0.1 to 1 a/lm at 1200 volts.

\*With light input of 0.01 lumen from a tungsten-filament lamp operated at a color temperature of 2870°K; 200 volts applied between photocathode and all other electrodes connected as anode.

\*\*Same conditions as (\*), but a blue filter is used (Corning C.S. No. 5-58, glass code No. 5113, polished to 1/2 stock thickness).

†At tube temperature of 25°C and with external shield connected to cathode; bandwidth is equal to 1 cycle per second. A tungsten-filament light source at a color temperature of 2870°K is interrupted at a low audio frequency to produce incident radiation pulses alternating between zero and the value stated. The "on" period of the pulse is equal to the "off" period.

**TYPICAL ANODE CHARACTERISTICS**

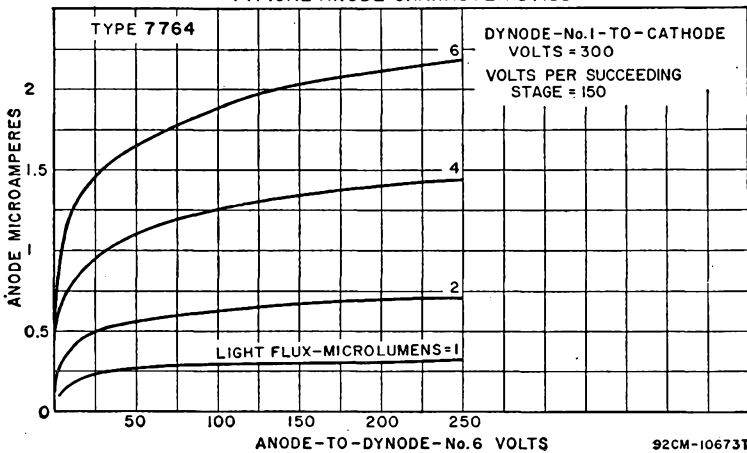

**SENSITIVITY AND CURRENT AMPLIFICATION CHARACTERISTICS**

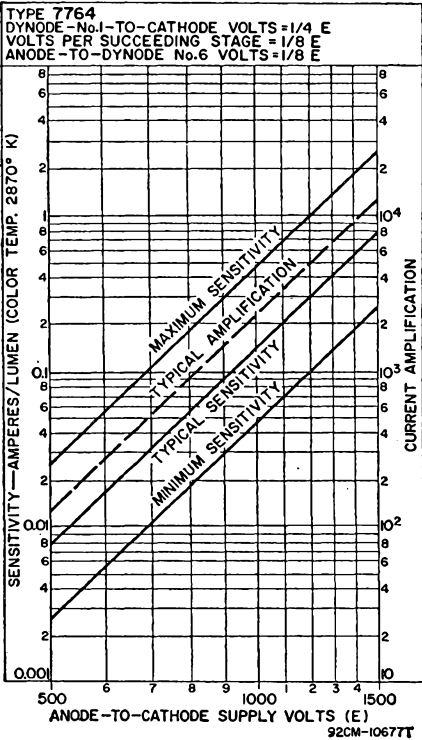

**TYPICAL ANODE-DARK-CURRENT CHARACTERISTIC**

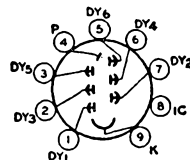
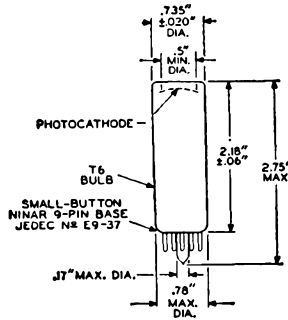
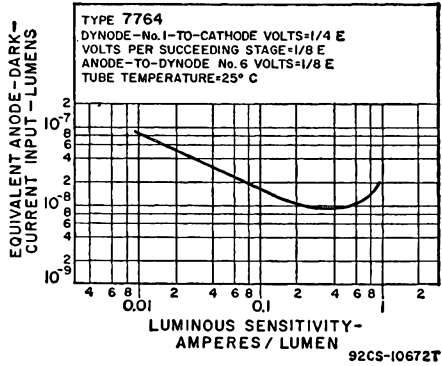

NOTE: Incident radiation is into end of bulb.

**7767  
 MULTIPLIER  
 PHOTOTUBE**

TEN-STAGE, head-on flat-faceplate type having S-11 response. Wavelength of maximum response is  $4400 \pm 500$  angstroms. This type makes use of copper-beryllium dynodes and a curved-circular, cesium-antimony, semitransparent photocathode. Window material is Corning No. 0080 lime glass or equivalent. Tube weighs approximately 0.9 ounce.

**DIRECT INTERELECTRODE CAPACITANCES (Approx.):**

Anode to Dynode No. 10 .....	2.4	pf
Anode to All Other Electrodes .....	3.2	pf
Dynode No. 8 to All Other Electrodes .....	3.6	pf
Dynode No. 6 to All Other Electrodes .....	4.3	pf
Dynode No. 4 to All Other Electrodes .....	4.6	pf

**MAXIMUM RATINGS (Absolute-Maximum Values):**

Supply Voltage (DC or Peak AC):		
Between anode and cathode	1500 max	volts
Between anode and dynode No. 10	300 max	volts
Between consecutive dynodes	200 max	volts
Between dynode No. 1 and cathode	400 max	volts
Average Anode Current	0.5 max	ma
Ambient Temperature	75 max	°C

**TYPICAL CHARACTERISTICS:**

DC Supply Voltage*	1250	volts
Radiant Sensitivity (at 4400 angstroms)	12500	a/w
Cathode Radiant Sensitivity (at 4400 angstroms)	0.048	a/w
Luminous Sensitivity**	16	a/lm
Cathode Luminous Sensitivity:		
With tungsten light source†	60	μa/lm
With blue light source**	0.06	μa
Current Amplification	267,000	
Equivalent Anode-Current Input at 25°C at a luminous sensitivity of 7.5 a/lm	5 max	n/m
Equivalent Noise Input	3	plm

\*DC supply voltage (E) is connected across a voltage divider which provides 1/6 of E between cathode and dynode No. 1, 1/12 of E for each succeeding dynode stage, and 1/12 of E between dynode No. 10 and anode.

\*\*With light input of 10 microlumens from a tungsten-filament lamp operated at a color temperature of 2870°K. Range of luminous sensitivity is 7 to 60 a/lm at 1250 volts.

†With light input of 0.01 lumen from a tungsten-filament lamp operated at a color temperature of 2870°K; 200 volts applied between cathode and all other electrodes connected as anode.

\*\*Same conditions as (\*), but a blue filter is used (Corning C.S. No. 5-58, glass code No. 5513, polished to 1/2 stock thickness).

†At tube temperature of 25°C and with external shield connected to cathode; bandwidth is equal to 1 cycle per second. A tungsten-filament light source at a color temperature of 2870°K is interrupted at a low audio frequency to produce incident radiation pulses alternating between zero and the value stated. The "on" period of the pulse is equal to the "off" period.

**SENSITIVITY AND CURRENT AMPLIFICATION CHARACTERISTICS**

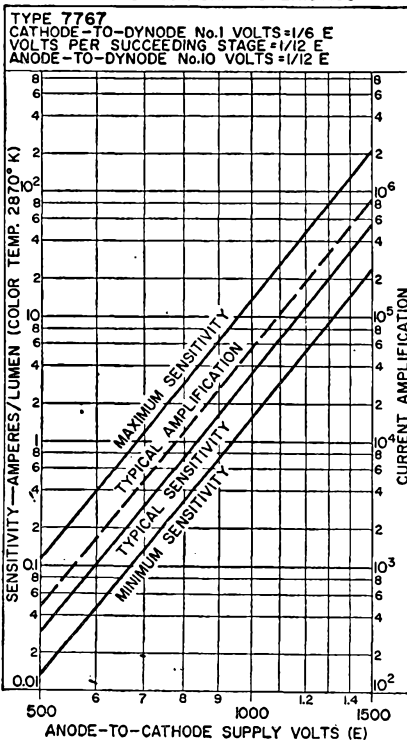

**TYPICAL ANODE-DARK-CURRENT CHARACTERISTIC**

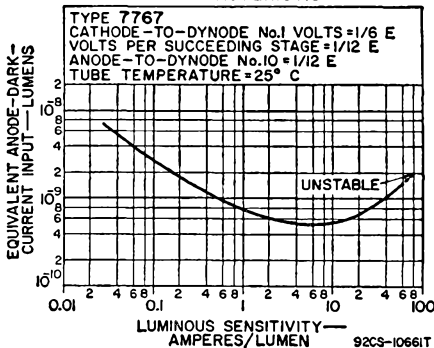

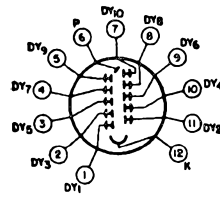
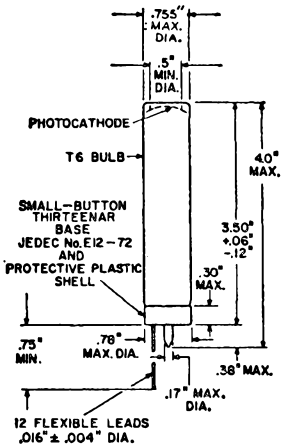
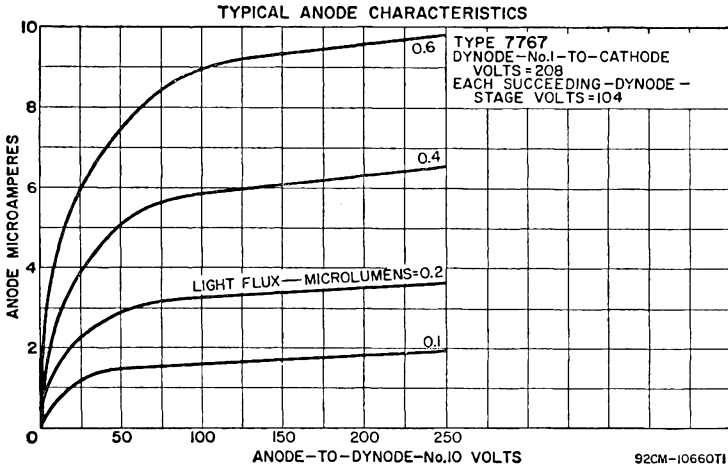

## 7850 MULTIPLIER PHOTOTUBE

TWELVE-STAGE, head-on, spherical-faceplate type having S-11 response. Wavelength of maximum response is  $4400 \pm 500$  angstroms. This type makes use of copper-beryllium dynodes and a spherical-circular, cesium-antimony, semitransparent photocathode. Window material is Corning No. 008J lime glass or equivalent. Tube weighs approximately 7 ounces and has a non-hygroscopic base.

**DIRECT INTERELECTRODE CAPACITANCES (Approx.):**

Anode to Dynode No. 12	3.8	pf
Anode to All Other Electrodes	5.7	pf
Dynode No. 12 to All Other Electrodes	6.8	pf



**MAXIMUM RATINGS (Absolute-Maximum Values):**

DC Supply Voltage:				
Between anode and cathode	2600 max			volts
Between anode and dynode No. 12	400 max			volts
Between consecutive dynodes	300 max			volts
Between dynode No. 1 and cathode	600 max			volts
Between focusing electrode and cathode	600 max			volts
Average Anode Current	2 max			ma
Ambient Temperature	75 max			°C

**TYPICAL CHARACTERISTICS:**

DC Supply Voltage*	2300	1800	1300	volts
Radiant Sensitivity (at 4400 angstroms)	4,800,000	510,000	29000	a/w
Cathode Radiant Sensitivity (at 4400 angstroms)	0.056	0.056	0.056	a/w
Luminous Sensitivity**	6000	640	36	a/lm
Cathode Luminous Sensitivity:				
With tungsten light source†	70	70	70	µa/lm
With blue light source**	0.05 min	0.05 min	0.05 min	µa
Current Amplification (in millions)	86	9.1	0.5	
Equivalent Anode-Dark-Current Input at 25°C and at luminous sensitivity of:				
6000 a/lm	2.5 max	—	—	nIm
160 a/lm	—	0.4	—	nIm
9 a/lm	—	—	2 max	nIm
Equivalent Noise Input†	3	2.4	3	pIm
Anode-Pulse Rise Time	—	—	—	nsec
Pulse Height Resolution††	2	—	8.5	per cent
Greatest Delay Between Anode Pulses:				
With radiation spot (centered on tube face) having a diameter of				
1-13/32 inch	0.3	—	—	nsec
1-19/32 inch	0.5	—	—	nsec

\*DC supply voltage (E) is connected across a voltage divider which provides electrode voltages as shown in the accompanying table. Focusing-electrode voltage is adjusted to that value which provides maximum anode current.

\*\*With light input of 0.1 microlumen from a tungsten-filament lamp operated at a color temperature of 2870°K. Range of luminous sensitivity is 1400 to 50000 a/lm at 2300 volts; 8 to 300 a/lm at 1300 volts.

†With light input of 0.01 lumen from a tungsten-filament lamp operated at a color temperature of 2870°K; 200 volts applied between cathode and all other electrodes connected as anode.

††Same conditions as (\*), but a blue filter is used (Corning C.S. No. 5-58, glass code No. 5113).

‡At tube temperature of 25°C and with external shield connected to cathode; bandwidth is equal to 1 cycle per second. A tungsten-filament light source at a color temperature of 2870°K is interrupted at a low audio frequency to produce incident radiation pulses alternating between zero and the value stated. The "on" period of the pulse is equal to the "off" period.

†††At supply voltage equal to 1100 to 1400 volts. The radiation source is a cesium isotope having an atomic mass of 137 (Cs<sup>137</sup>), and the scintillation-counter crystal used is a cylindrical 2- by 2-inch thallium-activated sodium iodide type.

VOLTAGE TO BE PROVIDED BY DIVIDER	
Between	6.95% of Supply Volts (E) multiplied by
Cathode and Dynode No. 1	2
Dynode No. 1 and Dynode No. 2	1.4
Dynode No. 2 and Dynode No. 3	1
Dynode No. 3 and Dynode No. 4	1
Dynode No. 4 and Dynode No. 5	1
Dynode No. 5 and Dynode No. 6	1
Dynode No. 6 and Dynode No. 7	1
Dynode No. 7 and Dynode No. 8	1
Dynode No. 8 and Dynode No. 9	1
Dynode No. 9 and Dynode No. 10	1
Dynode No. 10 and Dynode No. 11	1
Dynode No. 11 and Dynode No. 12	1
Dynode No. 12 and Anode	1
Anode and Cathode	14.4

Focusing electrode is connected to arm of potentiometer between cathode and dynode No. 1. The focusing-electrode voltage is varied to provide maximum anode current.

TYPICAL ANODE CHARACTERISTICS

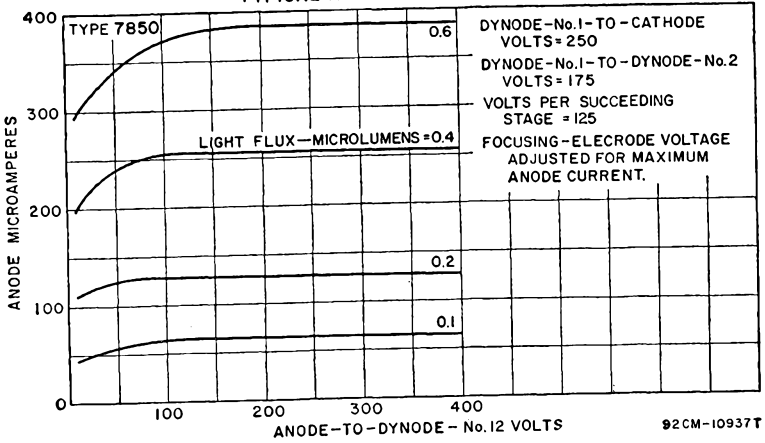

SENSITIVITY AND CURRENT AMPLIFICATION CHARACTERISTICS

TYPE 7850  
 SUPPLY VOLTAGE (E) ACROSS VOLTAGE DIVIDER WHICH PROVIDES VOLTAGES AS SHOWN IN THE ACCOMPANYING TABLE.  
 FOCUSING-ELECTRODE VOLTAGE IS ADJUSTED FOR MAXIMUM ANODE CURRENT.

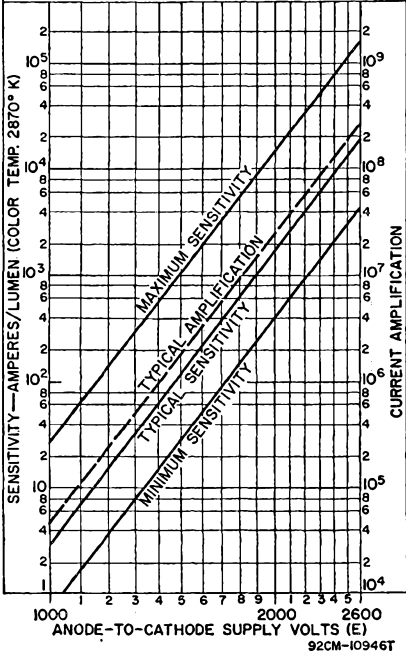

TYPICAL ANODE-DARK-CURRENT CHARACTERISTIC

TYPE 7850  
 LUMINOUS SENSITIVITY IS VARIED BY ADJUSTMENT OF THE SUPPLY VOLTAGE (E) ACROSS VOLTAGE DIVIDER WHICH PROVIDES VOLTAGES AS SHOWN IN ACCOMPANYING TABLE.  
 FOCUSING-ELECTRODE VOLTAGE ADJUSTED FOR MAXIMUM ANODE CURRENT.  
 TUBE TEMPERATURE = 25° C

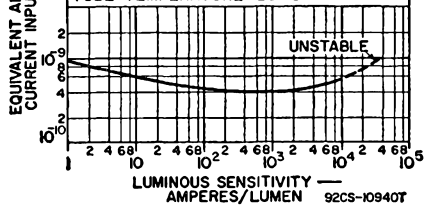

TYPICAL FOCUSING-ELECTRODE-VOLTAGE CHARACTERISTIC

TYPE 7850  
 FOCUSING-ELECTRODE VOLTAGE IS VARIED BY ADJUSTMENT OF POTENTIOMETER CONNECTED BETWEEN DYNODE No. 1 AND CATHODE.

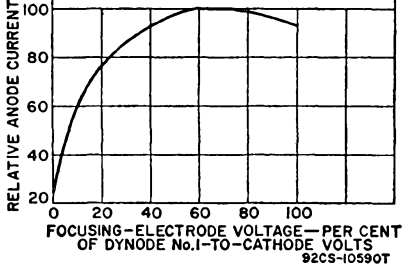

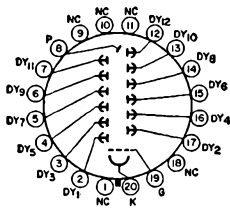

NOTE: Incident radiation is into end of bulb.

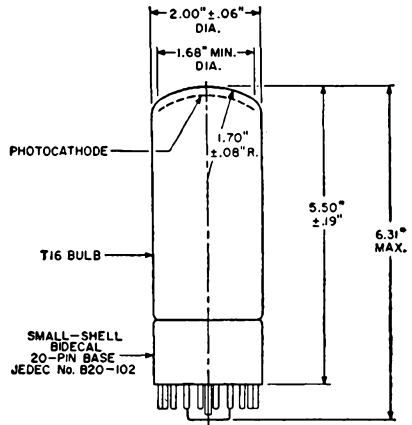

# 8053 MULTIPLIER PHOTOTUBE

TEN-STAGE, head-on, flat-faceplate, venetian-blind type having S-11 response. Wavelength of maximum response is  $4400 \pm 500$  angstroms. This type makes use of copper-beryllium dynodes and a flat-circular, cesium-antimony, semitransparent photocathode. Window material is Corning No. 0080 lime glass or equivalent. Tube weighs approximately 7 ounces and has a non-hygroscopic base.

**DIRECT INTERELECTRODE CAPACITANCES (Approx.):**

Anode to Dynode No. 10 .....	7	pf
Anode to All Other Electrodes .....	8.5	pf

**MAXIMUM RATINGS (Absolute-Maximum Values):**

<b>DC Supply Voltage:</b>		
Between anode and cathode .....	2000 max	volts
Between anode and dynode No. 10 .....	300 max	volts
Between consecutive dynodes .....	250 max	volts
Between dynode No. 1 and cathode .....	600 max	volts
Between focusing electrode and cathode .....	600 max	volts
Average Anode Current .....	2 max	ma
Ambient Temperature .....	75 max	°C

**TYPICAL CHARACTERISTICS:**

DC Supply Voltage*	2000	1500	1250	volts
Radiant Sensitivity (at 4400 angstroms)**	96000	15000	4800	a/w
Cathode Radiant Sensitivity (at 4400 angstroms)*	0.065	0.065	0.065	a/w
Luminous Sensitivity**	120	19	6	a/lm
Cathode Luminous Sensitivity†	75	75	75	µa/lm
Current Amplification	—	250,000	—	n/m
Equivalent Anode-Dark-Current Input at 25°C at 4400 angstroms	0.4	0.9 max	0.23	pw
Equivalent Noise Input at 4400 angstroms††	0.0053	0.44	0.00745	pw
	—	2.7	—	plm

\*DC supply voltage (E) is connected across a voltage divider which provides voltages as shown by the accompanying table. The focusing-electrode voltage is adjusted to that value between 50 and 100 per cent of dynode No. 1 potential (referred to cathode) which provides maximum anode current.

\*\*With light input of 10 microlumens transmitted through blue filter (Corning C.S. 5-58, glass code No. 5113, polished to 1/2 stock thickness), from a tungsten-filament lamp operated at a color temperature of 2870°K.

†Same as (\*\*), but a light input of 0.01 lumen is used; 200 volts applied between the cathode and all other electrodes connected as anode.

††With light input of 10 microlumens from a tungsten-filament lamp operated at a color temperature of 2870°K.

†With light input of 0.01 lumen from a tungsten-filament lamp operated at a color temperature of 2870°K; 200 volts applied between cathode and all other electrodes connected as anode.  
 ††At tube temperature of 25°C and with external shield connected to cathode; bandwidth is equal to 1 cycle per second. A tungsten-filament light source at a color temperature of 2870°K is interrupted at a low audio frequency to produce incident radiation pulses alternating between zero and the value stated. The "on" period of the pulse is equal to the "off" period.

VOLTAGE TO BE PROVIDED BY DIVIDER	
Between	8.3% of Supply Volts (E) multiplied by
Cathode and Dynode No. 1	2
Dynode No. 1 and Dynode No. 2	1
Dynode No. 2 and Dynode No. 3	1
Dynode No. 3 and Dynode No. 4	1
Dynode No. 4 and Dynode No. 5	1
Dynode No. 5 and Dynode No. 6	1
Dynode No. 6 and Dynode No. 7	1
Dynode No. 7 and Dynode No. 8	1
Dynode No. 8 and Dynode No. 9	1
Dynode No. 9 and Dynode No. 10	1
Dynode No. 10 and Anode	1
Anode and Cathode	12

Focusing electrode is connected to arm of potentiometer between cathode and dynode No. 1. The focusing-electrode voltage is varied to give maximum anode current.

## TYPICAL ANODE-CURRENT CHARACTERISTIC

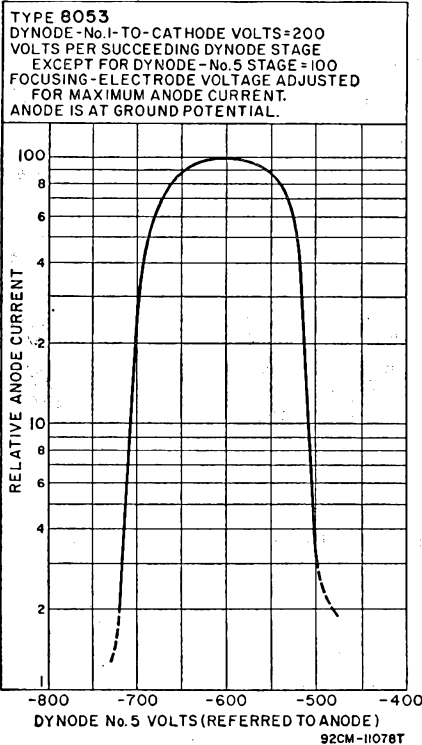

## SENSITIVITY AND CURRENT AMPLIFICATION CHARACTERISTICS

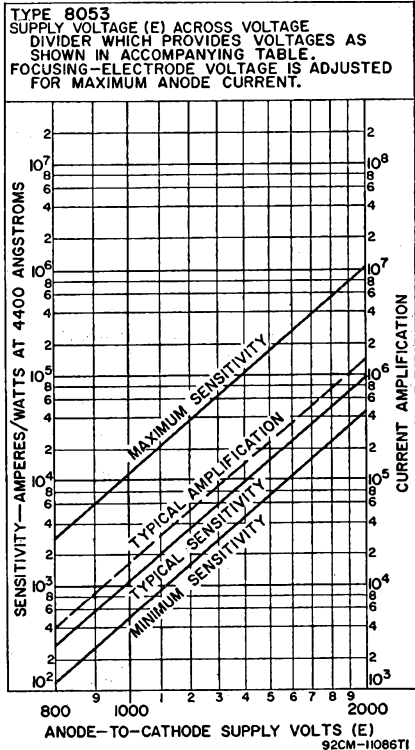

TYPICAL ANODE CHARACTERISTICS

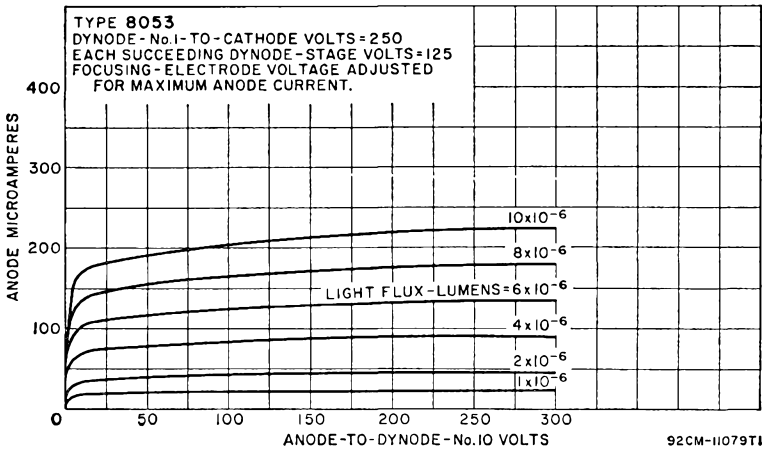

TYPICAL ANODE-DARK-CURRENT CHARACTERISTIC

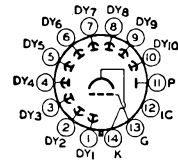
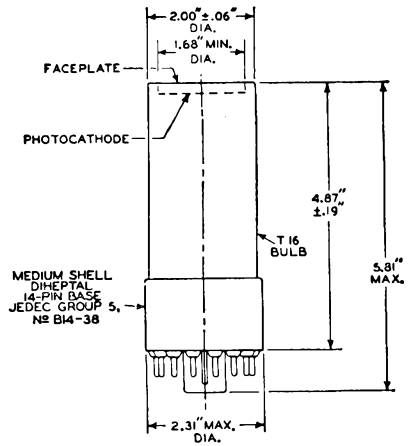
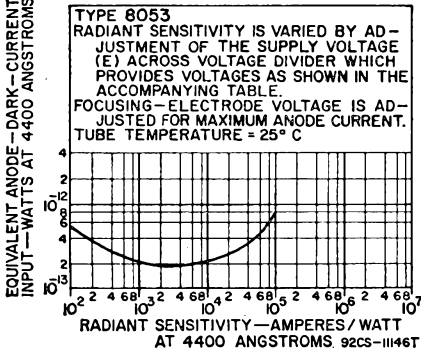

NOTE: Incident radiation is into end of bulb.

TYPICAL ANODE-CURRENT CHARACTERISTICS

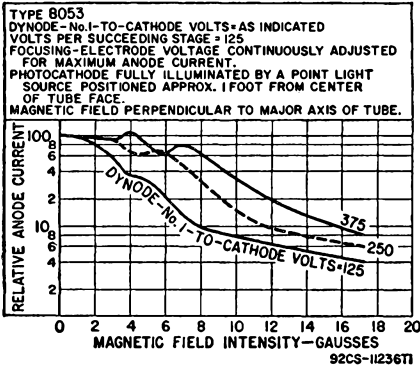

TYPICAL ANODE-CURRENT CHARACTERISTICS

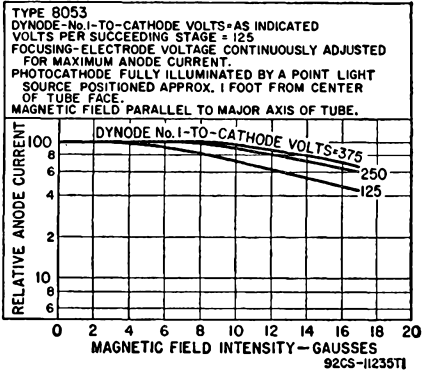

# 8054

## MULTIPLIER PHOTOTUBE

TEN-STAGE, head-on, flat-faceplate, venetian-blind type having S-11 response. Wavelength of maximum response is  $4400 \pm 500$  angstroms. This type has a three-inch diameter and makes use of copper-beryllium dynodes and a flat-circular, cesium-antimony, semitransparent photocathode. Window material is Corning No. 0080 lime glass or equivalent. Tube weighs approximately 9 ounces and has a non-hygroscopic base. For ratings, characteristics, and curves of typical anode characteristics, anode-current characteristics, and sensitivity and current amplification characteristics, refer to type 8053.

TYPICAL ANODE-CURRENT CHARACTERISTICS

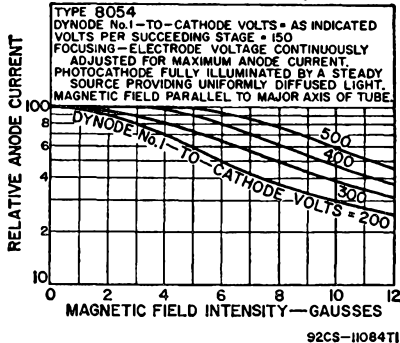

TYPICAL ANODE-CURRENT CHARACTERISTICS

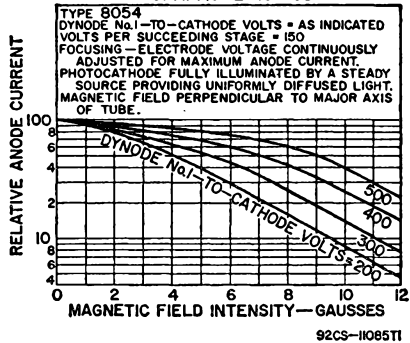

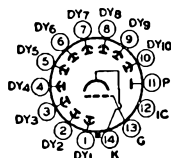
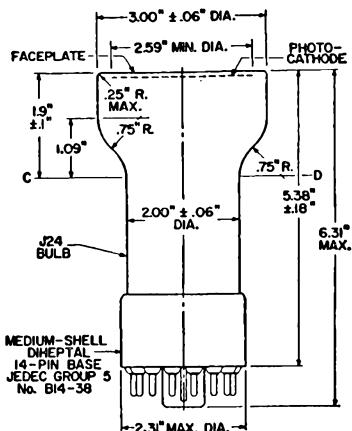
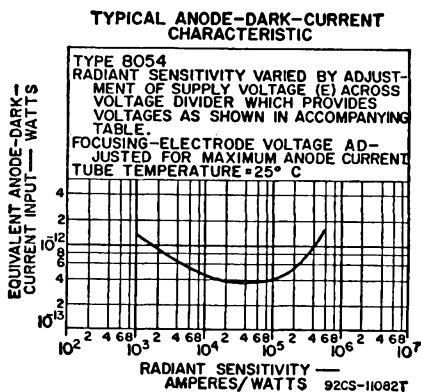

NOTE: Incident radiation is into end of bulb.

TEN-STAGE, head-on, flat-faceplate, venetian-blind type having S-11 response. Wavelength of maximum response is  $4400 \pm 500$  angstroms. This type has a five-inch diameter and makes use of copper-beryllium dynodes and a flat-circular, cesium-antimony, semi-transparent photocathode. Window material is Corning No. 0080 lime glass or equivalent. Tube weighs approximately 1 pound 7 ounces and has a non-hygroscopic base. For ratings, characteristics, and curves of typical anode characteristics, anode-dark-current characteristics, anode-current characteristics, and sensitivity and current amplification characteristics, refer to type 8053.

# 8055

## MULTIPLIER PHOTOTUBE

**TYPICAL ANODE-CURRENT CHARACTERISTICS**

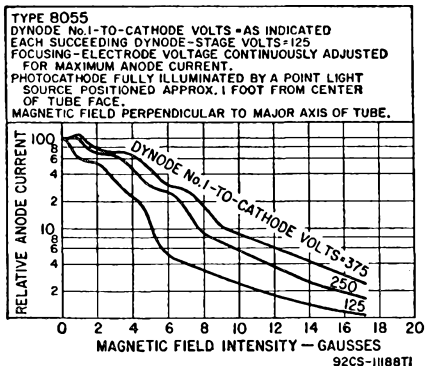

**TYPICAL ANODE-CURRENT CHARACTERISTICS**

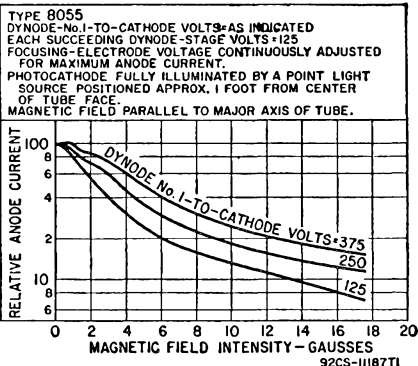

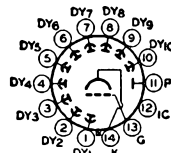
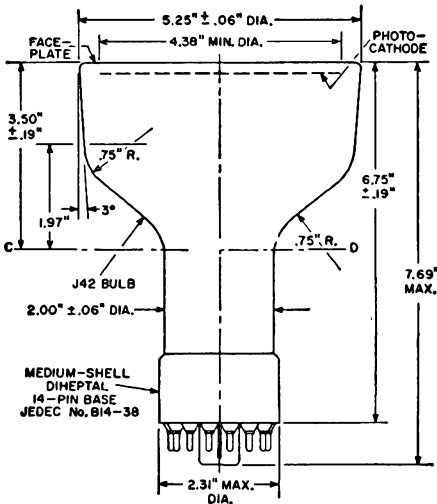

NOTE: Incident radiation is into end of bulb.

SOCKET AND SHIELDS FOR RCA PHOTOTUBES

RCA type	Socket Part No. (or equivalent)	Magnetic Shield Part No. (or equivalent)
1P21	Amphenol No. 78S11T	Perfection Mica No. P-101-1
1P22	Amphenol No. 78S11T	Perfection Mica No. P-101-2
1P28	Amphenol No. 78S11T	Perfection Mica No. P-101-3
1P29	Amphenol No. 77M1P4T	—
1P37	Amphenol No. 77M1P4T	—
1P39	Loranger No. 1935	JAN No. S-1181
1P40	Loranger No. 1935	JAN No. S-1181
1P41	Amphenol No. 78S3S	—
1P42	—	—
868	Johnson No. 122-224-100	—
917	Loranger No. 2093	—
918	Loranger No. 2093	—
919	Loranger No. 2093	—
920	Loranger No. 2093	—
921	Amphenol No. 146-121	—
922	Amphenol No. 146-121	—
923	Amphenol No. 77MIP4T	—
925	Eby No. 9729-127	—
926	Amphenol No. 146-121	—
927	Amphenol No. 78S3S	—
928	Loranger No. 2093	—
929	Cinch No. 9875	JAN No. S-1181
930	Cinch No. 9875	JAN No. S-1191
931A	Amphenol No. 78S11T	Perfection Mica No. P-101-4
934	Amphenol No. 78S3S	—
935	Cinch No. 9875	—
2020	Eby No. 9709-7	Perfection Mica No. P-100-2
2067	(has semiflexible leads)	—
4409	Loranger No. 1935	—
4438	(has semiflexible leads)	—
4439	Amphenol No. 59-402	—
4440	Amphenol No. 59-402	Millen No. 80802C



RCA type	Socket Part No. (or equivalent)	Magnetic Shield Part No. (or equivalent)
4441	(has semiflexible leads)	—
5581	Loranger No. 1935	JAN No. S-1181
5582	Amphenol No. 146-121	—
5583	Amphenol No. 78S3S	—
5584	Cinch No. 2154	—
5652	Amphenol No. 77MIP8T	—
5653	Amphenol No. 77MIP8T	JAN No. S-1181
5819	Eby No. 9709-7	Perfection Mica No. P-100-3
6199	Eby No. 9058	Perfection Mica No. P-104-1
6217	Eby No. 9709-7	JAN No. S-2004
6328	Amphenol No. 80801B	Millen No. 80801B
6342A	Loranger No. 2274	Millen No. 80802B
6405/1640	Cinch No. 2154	—
6472	(has semiflexible leads)	Perfection Mica No. P-107
6570	Loranger No. 2093	—
6655A	Loranger No. 2274	Perfection Mica No. P-100-4
6810A	Cinch No. 20-PM	Millen No. 80802E
6903	Amphenol No. 59-417	Perfection Mica No. P-108
6953	Loranger No. 1935	—
7029	Amphenol No. 59-402	Perfection Mica No. P-103
7043	Johnson No. 122-228-200	—
7046	Alden No. 435SBA	Millen No. 80805P
7102	Eby No. 9058	Perfection Mica No. P-104-3
7117	Amphenol No. 78S11T	Millen No. 80801B
7200	Amphenol No. 78S11T	—
7264	Eby No. 9778-1	Millen No. 80802E
7265	Eby No. 9778-1	Perfection Mica No. P-111-2
7326	Amphenol No. 59-417	JAN No. S-2002
7746	Amphenol No. 59-417	JAN No. S-2004
7764	Garlock No. 69005-7957	—
7767	(has semiflexible leads)	—
7850	Cinch No. 20-PM	—
8053	Cinch No. 3M14	JAN No. S-2004
8054	Cinch No. 3M14	Millen No. 80803J
8055	Cinch No. 3M14	JAN No. S-5018

## SOCKET MANUFACTURERS

Alden Products Company  
9140 North Main Street  
Brockton 64, Massachusetts

Amphenol Electronics Corporation  
1830 South 54th Avenue  
Chicago 50, Illinois

Cinch Manufacturing Company  
1026 South Homan Avenue  
Chicago 24, Illinois

Hugh H. Eby Company  
4701 Germantown Avenue  
Philadelphia 44, Pennsylvania

Garlock Inc.  
602 North 10th Street  
Camden 2, New Jersey

E. F. Johnson Company  
Waseca, Minnesota

Loranger Manufacturing Corp.  
86 Clark Street  
Warren, Pennsylvania

## MAGNETIC SHIELD MANUFACTURERS

James Millen Manufacturing Company  
150 Exchange Street  
Malden 48, Massachusetts

JAN Hardware Manufacturing Company  
38-01 Queens Blvd.  
Long Island City 1, New York

Perfection Mica Company  
1322 North Ellston  
Chicago 24, Illinois

# SPECTRAL RESPONSE CURVES

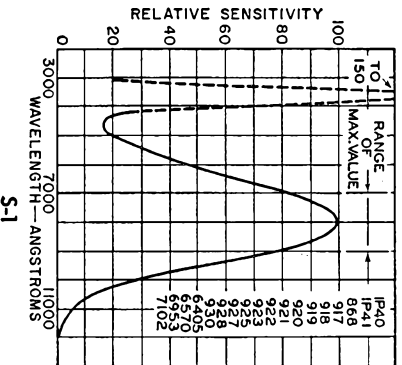

S-1

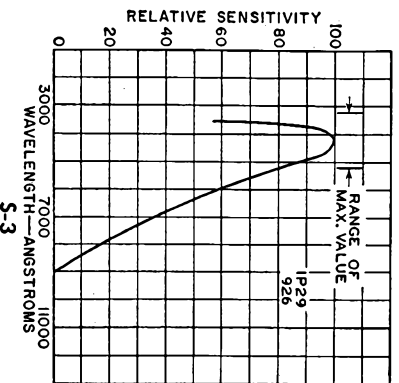

S-3

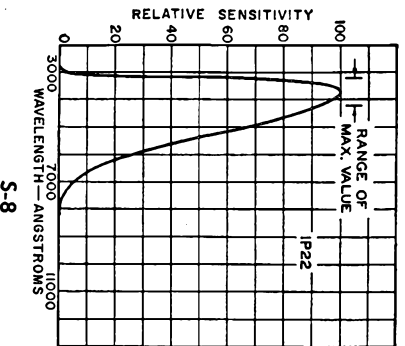

S-8

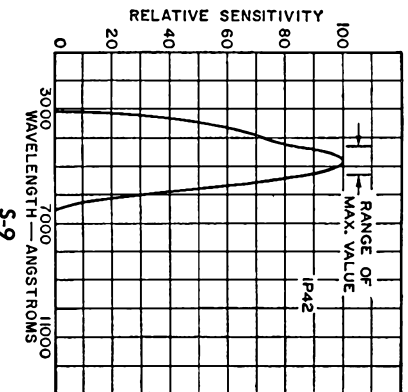

S-9

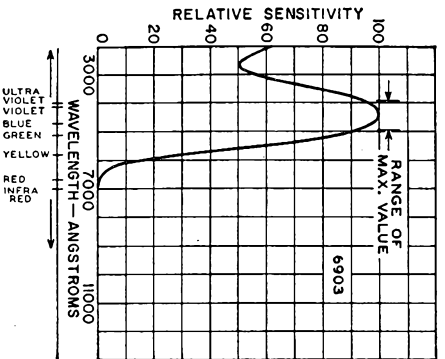

S-13

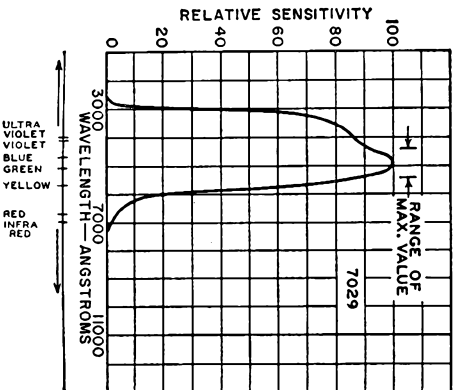

S-17

# FOR RCA PHOTOTUBES

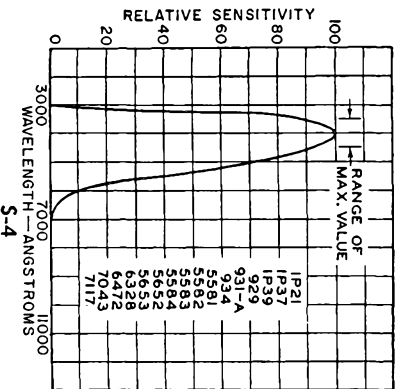

S-4

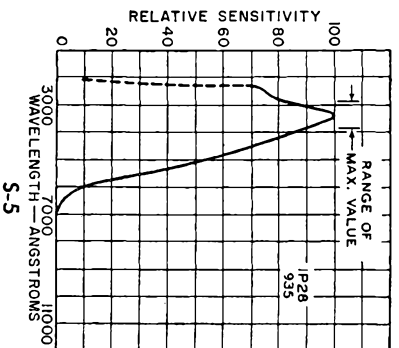

S-5

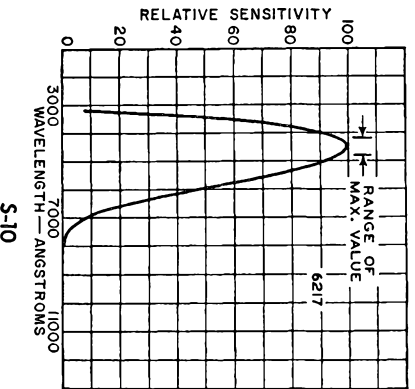

S-10

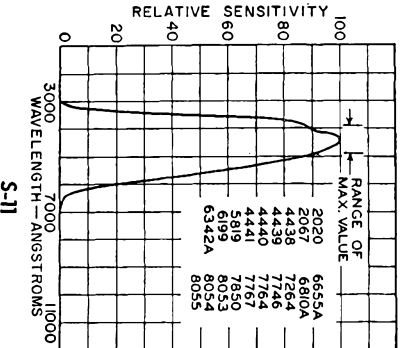

S-11

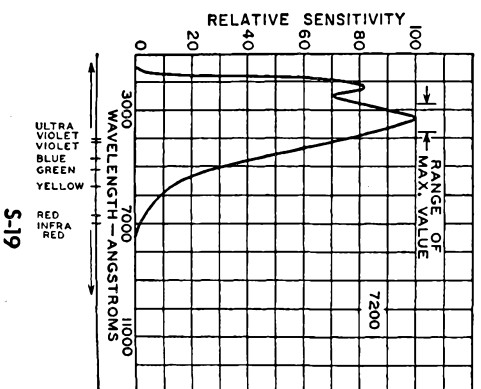

S-19

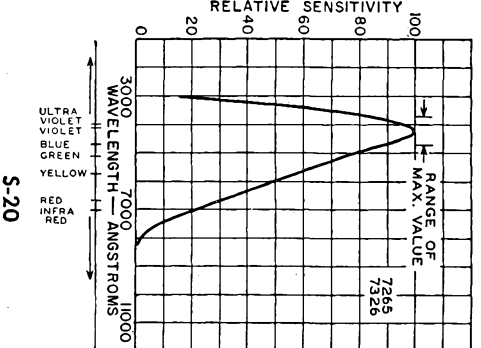

S-20

# RCA PHOTOCELL CHART

## PHOTOCONDUCTIVE CELLS

(Cadmium sulfide; S-15 spectral response except as noted)

RCA TYPE	Maximum Ratings				Characteristics at 25°C			
	DC or Peak AC Voltage Between Terminals	Power Dissipation** (watt)	Photo-current (ma)	Ambient Temperature Range (°C)	Volts between Terminals	Illumination (fc)	Photo-current (ma)	Maximum Decay Current (μa)
4402	200	0.05	5	-75 to 60	12(dc)	10	1.6 min	12
4403	250	0.3*	50	-75 to 60	50(ac)	1	7-16	78
4404	600	0.3*	50	-75 to 60	50(ac)	1	2.5-5	40
4413	110	0.05	5	60	12(dc)	10	1-2.75	12
4423	250	0.2	20	-75 to 60	50(ac)	1	1.5-4	40
4424	110	0.2	50	-75 to 60	12(dc)	1	3.6-14.5	80
4425	110	0.2	50	-75 to 60	12(dc)	1	3.6-14.5	80
4448	600	0.3*	50	-75 to 60	50(ac)	1	1.5-4	40
4453	600	0.3*	50	-75 to 60	50(ac)	1	3-7	40
6694A*	150	00.3	—	0 to 70	90(dc)	30	0.057-0.65	0.1
7163	600	0.3*	50	-75 to 60	50(ac)	1	1-3	40
7412	200	0.05	1	60	12(dc)	1	0.065-0.275	1
7536	200	0.05	1	60	12(dc)	1	0.065-0.275	1
SQ2500	250	0.2	20	-40 to 60	12(dc)	1	0.24-0.8	6
SQ2502	600	0.5**	50	-75 to 60	50(ac)	1	2.5-5	40
SQ2504	600	0.3*	50	-75 to 60	50(ac)	1	1.5-4	40
SQ2505	250	0.3*	50	-75 to 60	50(ac)	1	7-16	78
SQ2506	600	0.3*	50	-75 to 60	50(ac)	1	1-3	40
SQ2508	200	0.05	1	60	12(dc)	1	0.065-0.275	1

\*This type has S-12 spectral response.

\*\*Dissipation ratings apply up to the maximum rated ambient temperature.

\*This type has a "demand rating" of 0.75 watt. This rating is a dissipation rating to which the cell may be exposed in outdoor applications. The rating may be used twice every 24 hours for a period of 20 minutes, each time, provided the interval between demand services is not less than four hours.

\*\*This type has a demand rating of 0.8 watt.

## PHOTOJUNCTION CELLS—(Germanium p-n alloy; S-14 spectral response)

RCA TYPE	Maximum Ratings			Characteristics at 25°C			Maximum Dimensions	
	DC Volts Between Terminals	Power Dissipation (watt)	Ambient Temperature Range (°C)	DC Volts Between Terminals	Illumination Sensitivity (μa/fc)	Maximum Dark Current (μa)	Length (in.)	Diameter (in.)
4420	50	0.03	-40 to 50	45	0.7	35	1.10	0.350
7467	50	0.03	-40 to 50	45	0.7	35	0.875	0.350

## PHOTOVOLTAIC CELLS—(Silicon n-on-p type\*\*)

RCA TYPE	Characteristics at 27°C ± 1°C			Maximum Dimensions		Sensitive Area (Av.)		
	Minimum Current (ma)	Minimum Power Output (mw)	Minimum Efficiency (%)	Length (in.)	Width (in.)	Length (in.)	Width (in.)	Area (sq. in.)
SL2205	48	17.9	10	0.399	0.795	0.354	0.786	0.278
SL2206	101.5	37.8	10	0.791	0.791	0.746	0.786	0.586

\*\*Wavelength of maximum response is 8600 ± 750 angstroms; approximate spectral range at the 20 per cent points is 4000 to 10600 angstroms.

# SPECTRAL RESPONSE CURVES FOR RCA PHOTOCELLS

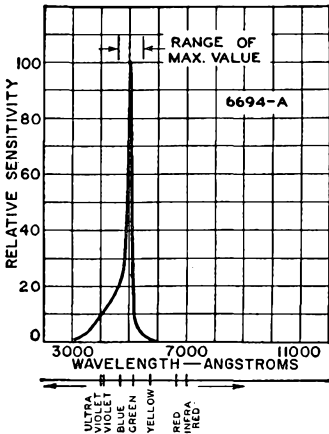

**S-12**

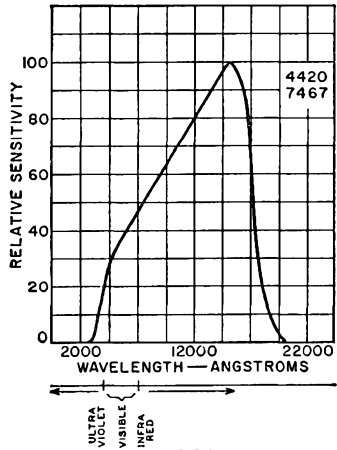

**S-14**

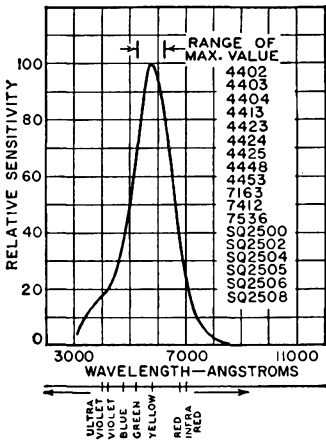

**S-15**

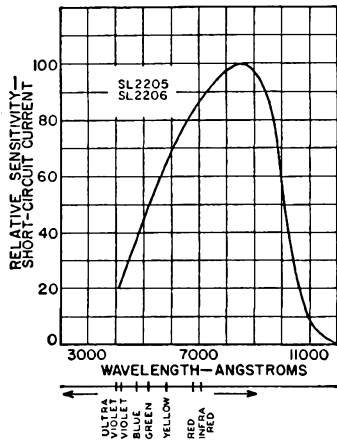

**PHOTOVOLTAIC**

# RCA Technical Publications

*on Electron Tubes, Semiconductor Products, Batteries,  
and Test and Measuring Equipment*

Copies of the publications listed may be obtained from RCA distributors or from Commercial Engineering, Radio Corporation of America, Harrison, N. J.

## Electron Tubes

- **RCA ELECTRON TUBE HANDBOOK—HB-3.** Five binders, each  $7\frac{3}{8}'' \times 5\frac{5}{8}''$   $W \times 2\frac{7}{8}''$  D. Contains over 5000 pages of loose-leaf data and curves on RCA receiving tubes, transmitting tubes, cathode-ray tubes, picture tubes, photocells, phototubes, camera tubes, ignitrons, vacuum and gas rectifiers, magnetrons, traveling-wave tubes, premium tubes, pencil tubes, and other types for special applications. Available on subscription basis. Price \$20.00\* including service for first year. Also available with RCA Semiconductor Products Handbook HB-10 at special combination price of \$25.00.\*
- **RADIOTRON† DESIGNER'S HANDBOOK—4th Edition** ( $8\frac{3}{4}'' \times 5\frac{1}{2}''$ )—1500 pages. Comprehensive reference covering the design of radio and audio circuits and equipment. Written for the design engineer, student, and experimenter. Contains 1000 illustrations, 2500 references, and cross-referenced index of 7000 entries. Edited by F. Langford-Smith of Amalgamated Wireless Valve Co., Pty., Ltd. in Australia. Price \$7.00.\*
- **RCA RECEIVING TUBE MANUAL—RC-22** ( $8\frac{1}{4}'' \times 5\frac{3}{8}''$ )—544 pages. Contains technical data on over 1000 receiving-type tubes for home-entertainment use and picture tubes for black-and-white and color TV. Features tube theory written for the layman, application data, selection charts, and typical circuits. Features lie-flat binding. Price \$1.25.\*
- **RCA TRANSMITTING TUBES—TT-5** ( $8\frac{1}{4}'' \times 5\frac{3}{8}''$ )—320 pages. Gives data on over 180 power tubes having plate-input ratings up to 4 kw and on associated rectifier tubes. Provides basic information on generic types, parts and materials, installation and application, and interpretation of data. Contains circuits for transmitting and industrial applications. Features lie-at binding. Price \$1.00.\*
- **RCA MAGNETRONS AND TRAVELING-WAVE TUBES—MT-301A** ( $10\frac{7}{8}'' \times 8\frac{3}{8}''$ )—48 pages. Operating theory for magnetrons and traveling-wave tubes, application considerations, and techniques for measurement of tube parameters. Price 60 cents.\*
- **RCA POWER TUBES—PG101E** ( $10\frac{7}{8}'' \times 8\frac{3}{8}''$ )—36 pages. Technical data on 200 RCA vacuum power tubes, rectifier tubes, thyratrons, ignitrons, and vacuum-gauge tubes. Includes terminal connections. Price 60 cents.\*
- **RCA RECEIVING-TYPE TUBES FOR INDUSTRY AND COMMUNICATIONS—RIT104C** ( $10\frac{7}{8}'' \times 8\frac{3}{8}''$ )—44 pages. Technical data on over 190 RCA "special red" tubes, premium tubes, nuvistors, computer tubes, pencil tubes, glow-discharge tubes, small thyratrons, low-microphonic amplifier tubes, vacuum-gauge tubes, mobile communications tubes, and other special types. Includes socket-connection diagrams. Price 35 cents.\*
- **RCA RECEIVING TUBES AND PICTURE TUBES—1275-K** ( $10\frac{7}{8}'' \times 8\frac{3}{8}''$ )—64 pages. Contains classification chart, characteristics chart, and base and envelope connection diagrams on more than 1050 entertainment receiving tubes and picture tubes. Price 50 cents.\*
- **RCA NUVISTOR TUBES FOR INDUSTRIAL AND MILITARY APPLICATIONS—1CE-280** ( $10\frac{7}{8}'' \times 8\frac{3}{8}''$ )—16 pages. Describes unique features of nuvistors and includes tabular data,

dimensional outlines, curves terminal diagrams, and socket information. Price 25 cents.\*°

● **RCA PHOTO AND IMAGE TUBES**—1CE-269 (10 $\frac{7}{8}$ " x 3 $\frac{3}{8}$ ")—32 pages. Includes data on RCA multiplier phototubes, gas and vacuum photodiodes, and image-converter tubes. Features quick selection charts for phototubes. Includes response curves, socket and shield data, and dimensional outlines. Price 60 cents.\*°

● **RCA STORAGE AND CATHODE-RAY TUBES**—1CE-270 (10 $\frac{7}{8}$ " x 8 $\frac{3}{8}$ ")—12 pages. Includes technical data on RCA display-storage tubes, computer-storage tubes, scan-converters, radechons, oscillograph-type cathode-ray tubes, and special-purpose kinescopes. Gives latest JEDEC "Kelley Chart" and descriptive material on characteristic of phosphors for RCA industrial tubes. Price 20 cents.\*°

● **RCA MICROWAVE TUBES AND PACKAGED SOLID-STATE DEVICES**—1CE-180E (10 $\frac{7}{8}$ " x 8 $\frac{3}{8}$ ")—16 pages. Includes technical data on RCA solid-state devices, traveling-wave tubes, pencil tubes, integral-cavity pencil tubes, magnetrons, and solenoids for traveling-wave tubes. Single copy free on request.

● **RCA PENCIL TUBES**—1CE-219 (10 $\frac{7}{8}$ " x 8 $\frac{3}{8}$ ")—28 pages. Contains operating theory for pencil tubes, electrical and mechanical circuit-design considerations, environmental considerations, application considerations, and data for commercial types. Price 50 cents.\*°

● **TECHNICAL BULLETINS**—Authorized information on RCA transmitting tubes and other tubes for communications and industry. Mention tube type desired. Single copy on any type free on request.

## Semiconductor Products

● **RCA SEMICONDUCTOR PRODUCTS HANDBOOK**—HB-10. Two binders, each 7 $\frac{3}{8}$ " L x 5 $\frac{1}{2}$ " W x 2 $\frac{7}{8}$ " D. Con-

tains over 1000 pages of loose-leaf data and curves on RCA semiconductor devices such as transistors, silicon rectifiers, silicon controlled rectifiers, tunnel diodes, and tunnel rectifiers. Available on subscription basis. Price \$10.00\* including service for first year. Also available with RCA Electron Tube Handbook HB-3 at special combination price of \$25.00.\*°

● **RCA TRANSISTOR MANUAL**—SC-10 (8 $\frac{3}{8}$ " x 5 $\frac{1}{8}$ ")—304 pages. Contains detailed technical data on RCA semiconductor devices. Easy-to-read text includes information on basic theory, application, and installation of transistors, silicon rectifiers, and semiconductor diodes. Includes circuit diagrams and parts lists for many typical applications. Features lie-flat binding. Price \$1.50.\*°

● **RCA TUNNEL DIODE MANUAL**—TD-30 (8 $\frac{3}{8}$ " x 5 $\frac{1}{8}$ ")—160 pages. Contains information on theory and characteristics, and on tunnel-diode applications in switching circuits and in microwave oscillator, converter, and amplifier circuits. Includes data for over 40 RCA tunnel diodes and tunnel rectifiers. Price \$1.50.\*°

● **RCA SEMICONDUCTOR PRODUCTS GUIDE**—60-S-16R5 (10 $\frac{7}{8}$ " x 8 $\frac{3}{8}$ ")—12 pages. Contains application guide, index, and ratings and characteristics arranged for easy access to RCA's entire line of semiconductor products, digital microcircuits, memory products, and photocells. Single copy free on request.

● **TECHNICAL BULLETINS**—Authorized information on RCA semiconductor products. Mention type desired. Single copy on any type free on request.

†Trade Mark Reg. U.S. Pat. Off.

\*Prices shown apply in U.S.A. and are subject to change without notice.

°Suggested price.

# Index

<b>A</b> bsolute maximum system . . . . .	85
Absolute rating system . . . . .	15
Acceptor impurities . . . . .	8
After-pulses . . . . .	60
Air mass one specification . . . . .	78
Air mass zero specification . . . . .	78
Amplification factor . . . . .	87
Angle of incidence of light . . . . .	49
Anode current . . . . .	50
Anode pulse rise time . . . . .	89
Anodes, vacuum phototube . . . . .	22
Application considerations 30, 37, 80	
<b>B</b> ialkali cathode . . . . .	48
Bismuth-silver-oxygen-cesium cathode . . . . .	47
Black-body radiation . . . . .	16
Box-type dynodes . . . . .	42
Breakdown voltage . . . . .	34
Brightness . . . . .	13
<b>C</b> adium-sulfide photoconductive cells . . . . .	71
Candela . . . . .	12
Candle . . . . .	12
Candlepower . . . . .	12
Cathodes, Bialkali . . . . .	48
Bismuth-silver-oxygen-cesium . . . . .	47
Cesium-antimony . . . . .	39
Multialkali . . . . .	47
Opaque . . . . .	46
Silver-oxygen-cesium . . . . .	39
Transmission . . . . .	46
Cathode luminous sensitivity . . . . .	87
Cesium-antimony material . . . . .	39
Characteristics, phototube . . . . .	85
Circular-cage dynode system . . . . .	43
Collected current . . . . .	58
Collection efficiency . . . . .	58
Current amplification . . . . .	87
<b>D</b> ark current . . . . .	50
Data-processing cells . . . . .	78
Decay current, photocell . . . . .	73

Definition of, Absolute maximum ratings . . . . .	85
Anode-pulse rise time . . . . .	89
Black body . . . . .	16
Candela . . . . .	12
Cathode luminous sensitivity . . . . .	87
Cathode radiant sensitivity . . . . .	87
Current amplification . . . . .	87
Equivalent anode-dark-current input . . . . .	52, 87
Equivalent noise input . . . . .	88
Fermi level . . . . .	5
Footcandle . . . . .	13
Forbidden gap . . . . .	7
Gas ratio . . . . .	34
Holumen . . . . .	15
Illumination . . . . .	13
Luminous flux . . . . .	12
Luminous intensity . . . . .	12
Luminous sensitivity . . . . .	86
Nit . . . . .	14
Photometric luminance . . . . .	13
Radiant sensitivity . . . . .	87
Spectral sensitivity . . . . .	85
Standard luminosity coefficient . . . . .	11
Stilb . . . . .	14
Transit time . . . . .	88
Transit-time spread . . . . .	89
Work function . . . . .	4
Donor impurities . . . . .	8
Dynode configurations Box-type . . . . .	42
Circular-cage . . . . .	43
Linear-cage . . . . .	43
Rajchman . . . . .	40
Venetian-blind . . . . .	42
Dynode properties . . . . .	38
Dynode-system coupling . . . . .	43
<b>E</b> lectron affinity . . . . .	7
Emitted current . . . . .	58
Environmental factors . . . . .	30, 37
Equivalent-anode-dark-current input . . . . .	52, 87
Equivalent noise input . . . . .	88
<b>F</b> atigue characteristics . . . . .	67
Fermi level . . . . .	5



- First law of photoelectricity ..... 6  
 Fluorescent effects ..... 53  
 Footcandle ..... 13  
 Footlambert ..... 14  
 Forbidden gap ..... 7  
 Frequency response ..... 28, 82  
 Frequency-response characteristics ..... 35
- G**ain characteristics ..... 44  
 Gas-filled phototubes  
   Application considerations .... 30  
   Construction ..... 22  
   Current-voltage characteristics 26  
   Environmental factors ..... 30  
   Frequency response ..... 28  
   Linearity ..... 27  
   Noise ..... 28  
   Principles of operation ..... 22  
   Spectral response ..... 24  
 Gas ratio ..... 34  
 Germanium infrared detectors .. 79  
 Germanium p-n junction photocells 76  
 Germanium/silicon infrared detectors ..... 79
- H**ololumen ..... 15
- I**llumination ..... 13  
 Impurities, acceptor and donor .. 8  
 Interpretation of data ..... 85  
 Ionization, gas-filled phototube .. 33
- J**unction photocells ..... 76
- L**ight ..... 11  
 Light level ..... 80  
 Life characteristics ..... 67  
 Linear-cage system ..... 43  
 Linearity,  
   Multiplier phototube ..... 64  
   Vacuum phototube ..... 27  
 Luminous flux ..... 12  
 Luminous intensity ..... 12  
 Luminous sensitivity ..... 86
- M**agnetic effects, multiplier phototube ..... 66  
 Maximum gain ..... 45  
 Maximum ratings, phototube .... 95  
 Measurements, photoelectric .... 11  
 Measuring circuits for,  
   Multiplier phototube sensitivity 86  
   Photodiode sensitivity ..... 86
- Spectral-response characteristics ..... 86  
   Time response ..... 89  
 Multialkali cathode ..... 47  
 Multiplier phototubes,  
   Construction ..... 38  
   Dark current ..... 50  
   Dynode configurations ..... 40  
   Dynode properties ..... 38  
   Dynode system coupling ..... 43  
   Gain characteristics ..... 44  
   Fatigue characteristics ..... 67  
   Life characteristics ..... 67  
   Linearity ..... 64  
   Magnetic effects ..... 66  
   Noise ..... 55  
   Principles of operation ..... 38  
   Rise time ..... 63  
   Spectral response ..... 46  
   Temperature effects ..... 64  
   Transit-time effects ..... 64
- N**it, definition of ..... 14  
 Noise ..... 28, 36, 55
- O**hmic leakage ..... 51  
 Opaque cathodes ..... 46  
 Origins of dark current ..... 55
- P**hotocathode ..... 22  
 Photocells,  
   Cadmium-sulfide cells ..... 71  
   Data-processing cells ..... 78  
   Germanium infrared detectors. 79  
   Germanium p-n junction photocells ..... 76  
   Germanium/silicon infrared detectors ..... 79  
   Junction photocells ..... 76  
   Silicon photovoltaic cells ..... 77  
 Photocell data chart ..... 186  
 Photoconductivity ..... 9  
 Photoelectric  
   Emission ..... 38  
   Measurements ..... 11  
   Theory ..... 3  
 Photometric luminance ..... 13  
 Photometry ..... 12  
 Photovoltaic effect ..... 10  
 Plateau characteristics ..... 60  
 Primary photocurrent ..... 38  
 P-type gold-doped germanium cell 79  
 Pulse-height resolution ..... 59
- Q**uantum efficiency ..... 5

- R**adiant energy ..... 16  
 Radiant sensitivity ..... 87  
 Radiation sources ..... 17  
 Rajchman linear-dynode structure ..... 9  
 Recombination center ..... 9  
 Rise time ..... 63  
 RMS noise current ..... 58
- S**cintillation counting ..... 58  
 Secondary electron emission ..... 38  
 Selection guide ..... 90  
 Semiconductor photocells ..... 8  
 Signal noise ..... 57  
 Silicon photovoltaic cells ..... 77  
 Silver-oxygen-caesium material .. 39  
 Silver-magnesium material ..... 40  
 Socket and shield data ..... 182  
 Solar simulator specification .... 78  
 Spectral energy distribution .... 81  
 Spectral response ..... 20, 46 184  
 Spectral-response characteristic . 85  
 Stilb, definition of ..... 14
- T**able Mountain specification .... 78  
 Technical data ..... 91  
 Temperature effects, multiplier  
 phototubes ..... 64
- Theory, photoelectric ..... 3  
 Time-response characteristics ... 35  
 Transit time, definition of ..... 88  
 Transit-time effects ..... 61  
 Transit-time spread ..... 43, 89  
 Transmission cathodes ..... 46  
 Transmission dynodes ..... 43  
 Trapping center ..... 9  
 Tungsten efficiency ..... 77
- V**acuum phototubes,  
   Application considerations .... 30  
   Construction ..... 22  
   Current-voltage characteristics 26  
   Environmental factors ..... 30  
   Frequency response ..... 28  
   Linearity ..... 27  
   Noise ..... 28  
   Principles of operation ..... 22  
   Spectral response ..... 24  
 Valence band ..... 7  
 Venetian-blind dynodes ..... 42
- W**ork function ..... 4
- Z**inc-germanium-silicon-alloy  
 cells ..... 79

# Key to Terminal-Connection Diagrams

*Diagrams show terminals viewed from the base end of the type.*

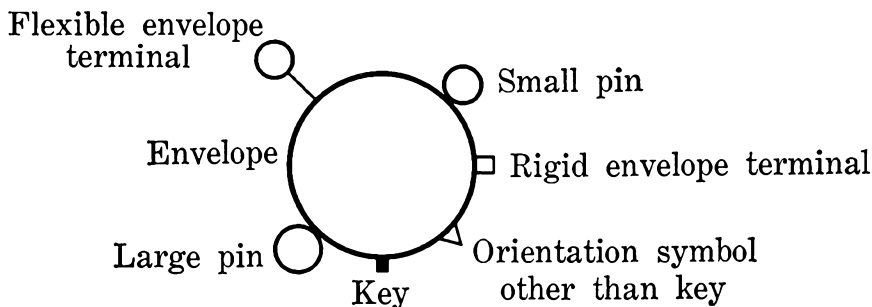

- $C_b$  — Balancing capacitance
- DY — Dynode
- G — Grid
- IC — Internal connection (do not use)
- NC — No connection
- P — Anode
- K — Photocathode
- U — Unit
- — Gas-type tube

Information furnished by RCA is believed to be accurate and reliable. However, no responsibility is assumed by RCA for its use; nor for any infringements of patents or other rights of third parties which may result from its use. No license is granted by implication or otherwise under any patent or patent rights of RCA.



**RADIO CORPORATION OF AMERICA**

**Electronic Components and Devices • Lancaster, Pa.**



RADIO CORPORATION OF AMERICA

Electronic Components and Devices • Lancaster, Pa.