

1942-1967

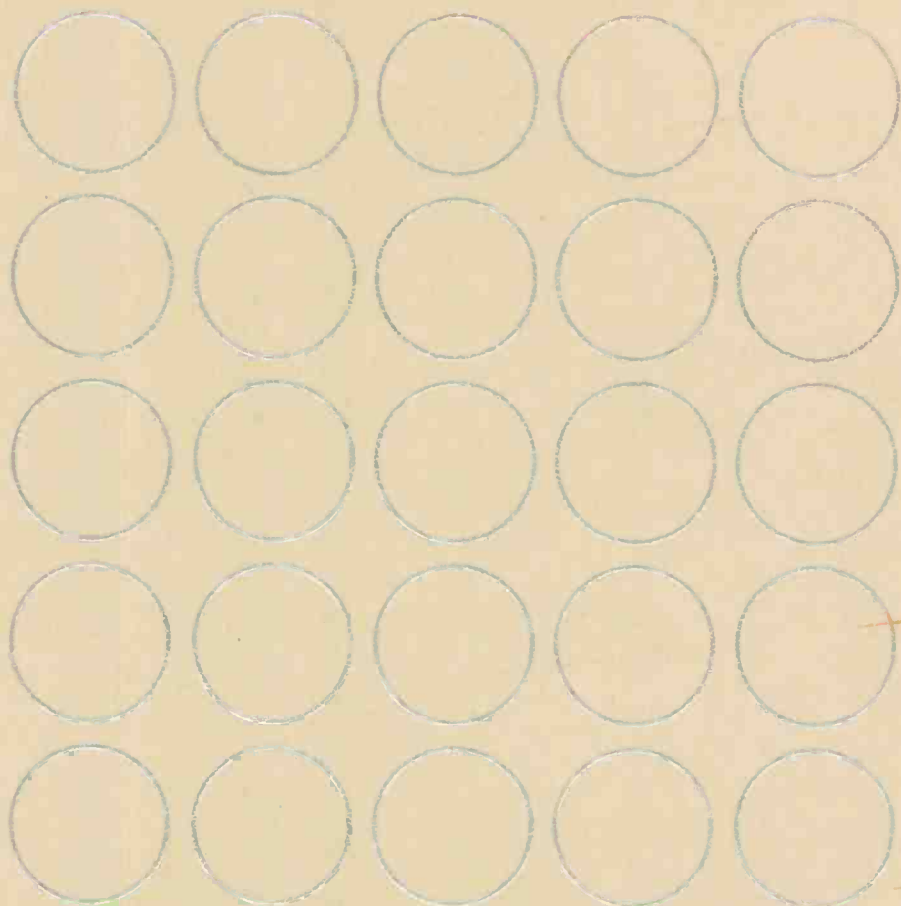

**twenty-five years at
RCA Laboratories**

1942-1967

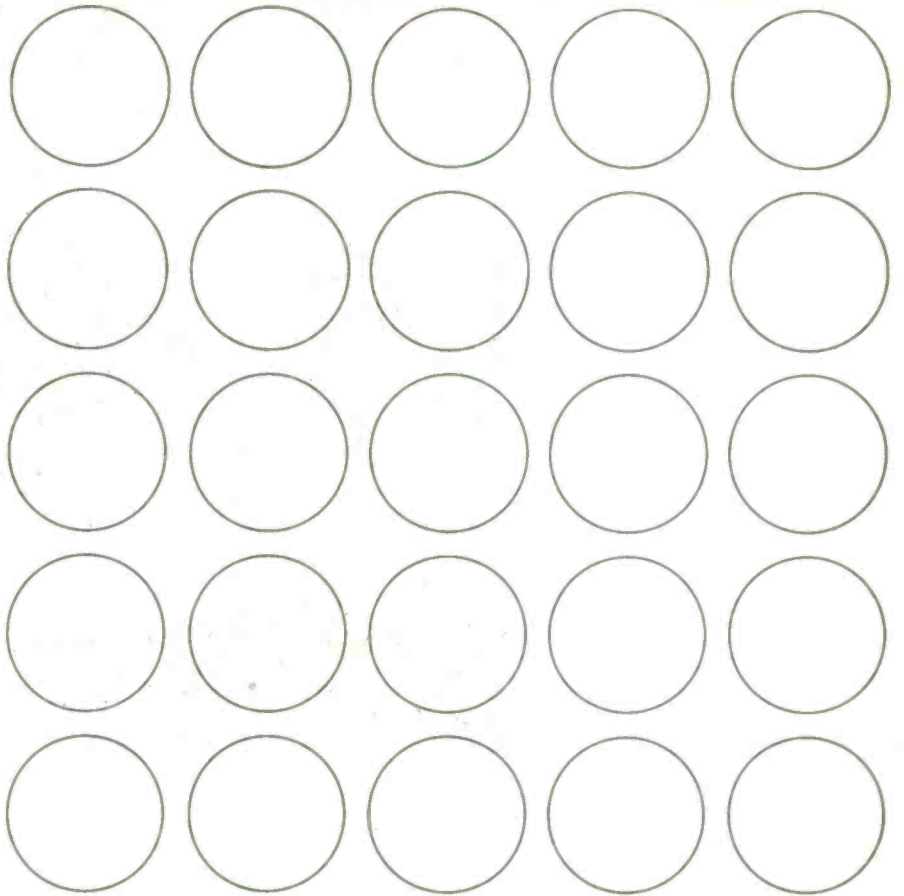

**twenty-five years at
RCA Laboratories**



RCA

1942-1967
twenty-five years at
RCA Laboratories



introduction

Yesterday, today and tomorrow.

All are vital to RCA Laboratories. Using the knowledge of *yesterday* and the intuition of *today*, we concentrate on building *tomorrow*. But occasionally it helps to pause, to reflect, to look back upon our *yesterdays*. From such reflection, one can go forward with a new sense of direction, purpose and vigor.

Certainly all of us at RCA Laboratories felt a sense of renewal after we paused for four brief days in the Fall of 1967 to observe our 25th Anniversary.

The warm, good feeling of achievement and dedication we felt in concert with our neighbors and friends, who came from throughout the world to help celebrate our Anniversary, is with us still.

With this commemorative book, we hope to record permanently something of those Anniversary days that will help rekindle that warm spirit in the *tomorrows* to come.

Yesterday, today and tomorrow are, in a sense, apt headings for the three sections of this book. *Yesterday* is a history of RCA Laboratories; the book's *today* is the pictured events of the Anniversary celebration; and *tomorrow* is described in the talks given by the distinguished scientists during the two Symposia that highlighted the Anniversary.

George H. Brown
Executive Vice President
Research and Engineering

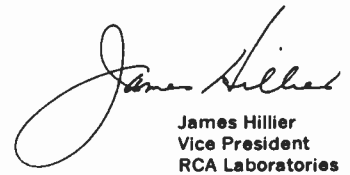
James Hillier
Vice President
RCA Laboratories

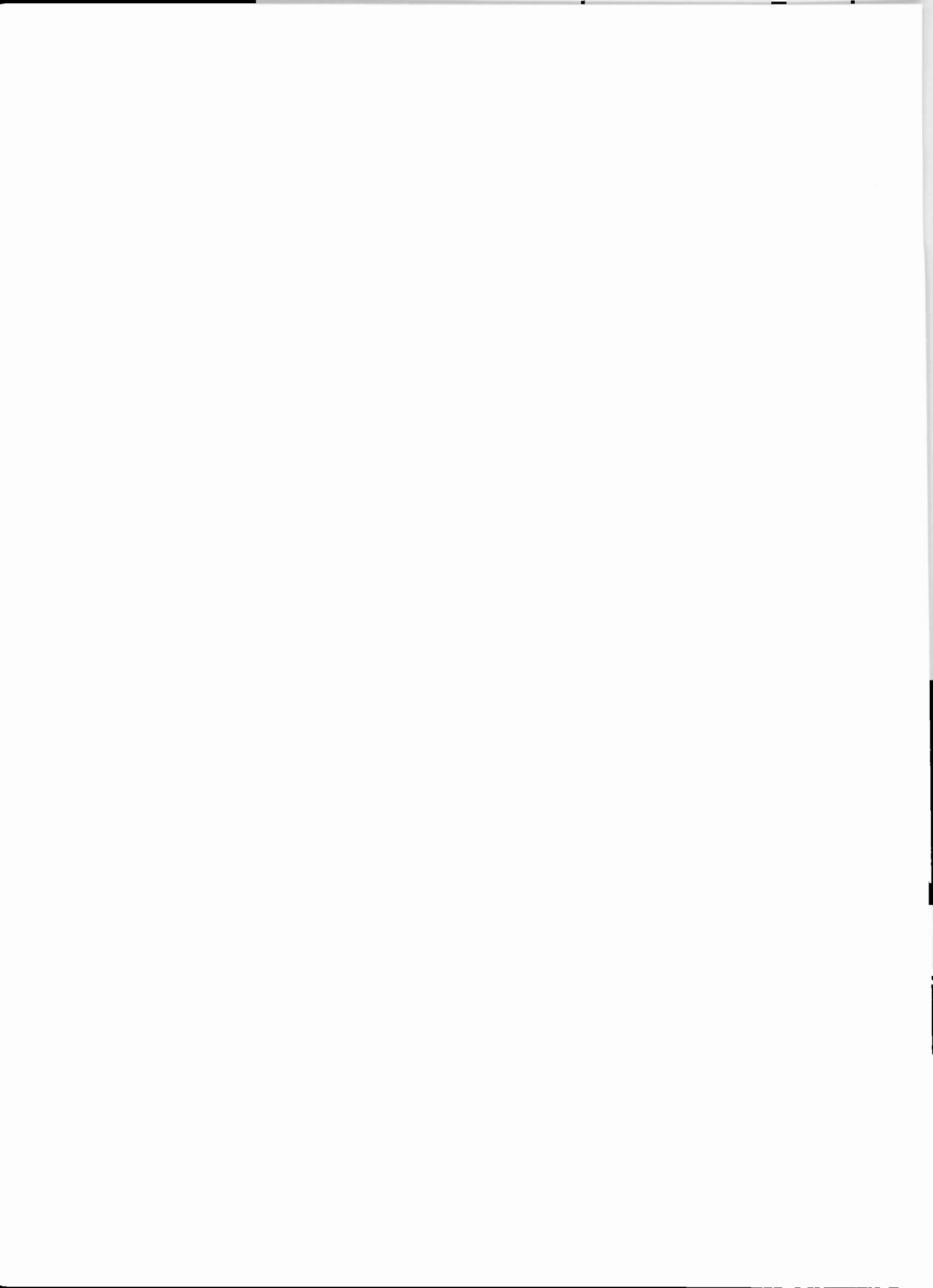

the 1990s, the number of people in the UK who are aged 65 and over has increased from 10.5 million to 13.5 million, and the number of people aged 75 and over has increased from 4.5 million to 6.5 million (Office for National Statistics 2000).

There is a growing awareness of the need to address the needs of older people, and the need to ensure that the health care system is able to meet the needs of older people. The Department of Health (2000) has published a strategy for older people, which sets out the government's commitment to improve the health and well-being of older people, and to ensure that the health care system is able to meet the needs of older people.

The strategy for older people is based on the following principles: (1) to improve the health and well-being of older people; (2) to ensure that the health care system is able to meet the needs of older people; (3) to ensure that older people are able to live independently; (4) to ensure that older people are able to participate in society; (5) to ensure that older people are able to live in their own homes; (6) to ensure that older people are able to live in their own communities.

The strategy for older people is based on the following principles: (1) to improve the health and well-being of older people; (2) to ensure that the health care system is able to meet the needs of older people; (3) to ensure that older people are able to live independently; (4) to ensure that older people are able to participate in society; (5) to ensure that older people are able to live in their own homes; (6) to ensure that older people are able to live in their own communities.

The strategy for older people is based on the following principles: (1) to improve the health and well-being of older people; (2) to ensure that the health care system is able to meet the needs of older people; (3) to ensure that older people are able to live independently; (4) to ensure that older people are able to participate in society; (5) to ensure that older people are able to live in their own homes; (6) to ensure that older people are able to live in their own communities.

The strategy for older people is based on the following principles: (1) to improve the health and well-being of older people; (2) to ensure that the health care system is able to meet the needs of older people; (3) to ensure that older people are able to live independently; (4) to ensure that older people are able to participate in society; (5) to ensure that older people are able to live in their own homes; (6) to ensure that older people are able to live in their own communities.

The strategy for older people is based on the following principles: (1) to improve the health and well-being of older people; (2) to ensure that the health care system is able to meet the needs of older people; (3) to ensure that older people are able to live independently; (4) to ensure that older people are able to participate in society; (5) to ensure that older people are able to live in their own homes; (6) to ensure that older people are able to live in their own communities.

The strategy for older people is based on the following principles: (1) to improve the health and well-being of older people; (2) to ensure that the health care system is able to meet the needs of older people; (3) to ensure that older people are able to live independently; (4) to ensure that older people are able to participate in society; (5) to ensure that older people are able to live in their own homes; (6) to ensure that older people are able to live in their own communities.

The strategy for older people is based on the following principles: (1) to improve the health and well-being of older people; (2) to ensure that the health care system is able to meet the needs of older people; (3) to ensure that older people are able to live independently; (4) to ensure that older people are able to participate in society; (5) to ensure that older people are able to live in their own homes; (6) to ensure that older people are able to live in their own communities.

virtually complete and on September 27, 1942, RCA Laboratories was dedicated and formally opened with a technical staff of 125 scientists and engineers.

Research accomplishments of RCA Laboratories during the intervening years since 1942 have been many and versatile. Not only have RCA scientists made observations of basic physical and electronic phenomena, they have contributed importantly to the fields of optics, acoustics, and communications, and have developed valuable tools and systems for our national defense. They have also carried out pioneering work in computer memories and systems, created new electroluminescent and thermoelectric materials and devices, developed facsimile and printing techniques, and designed electronic instruments for medical research. Finally, they have explored the more unusual areas of electronically creating sound and automatically controlling vehicles.

During the war years, the work of the Laboratories ranged over the whole electronic spectrum of the times. Research in acoustics produced a searchlight variation of sonar and an acoustical depth charge that played an important role in submarine warfare in the Atlantic during the latter part of the war. Development work on airborne radar systems contributed to improved bombing and automatic control techniques and laid the groundwork for further postwar progress in these fields. Work on antennas culminated in the development of the "slot" antenna used on high-speed military and commercial aircraft to maintain aerodynamic efficiency with no loss in performance. Infrared devices—the Sniperscope and Snooperscope—used for night combat and reconnaissance by American forces in the Pacific, were a product of continuing research in optics.

The highlight of wartime research in optics and television was the development of the Image Orthicon, started at Harrison in 1941 on the basis of much earlier work and completed at Princeton. With sensitivity 1,000 times greater than that of the Iconoscope, it provided in wartime a versatile pickup device for military television systems. For postwar television, it meant completely flexible operation in the studio or in the field.

In 1946 the aluminized picture tube was developed, which provided twice as much brightness with no increase in power needed. This process became standard in all picture tube production throughout the industry. The development of the Vidicon, a miniature pickup tube with a photoconductive surface, in 1949 pointed the way to smaller television cameras and portable systems. It became important for closed-circuit television in industrial and educational applications.

Such fundamental developments in all-electronic black-and-white tele-

vision helped to provide a base for RCA's pioneering research in color television.

Color television research in the 1940's and 1950's at RCA Laboratories might aptly be described in Charles Dickens' words, "It was the best of times, it was the worst of times." Only those who were part of that adventure can really appreciate "the trials and frustrations, the grueling work, the minor triumphs and the major triumphs," to quote Dr. George H. Brown's account of those days.

Some of the milestones of that research were the public demonstration of an all-electronic color television system in 1946; development of a high-definition, fully compatible color television system demonstrated to the FCC in 1949; the development of the three-gun shadow-mask color tube; and in 1953, the adoption by the FCC, on the recommendation of the NTSC, of an all-electronic compatible color television system as standard. A magnetic tape recording system for both color and black-and-white television programs was also developed and demonstrated in 1953.

In 1955 RCA Laboratories won the "Emmy" Award from the National Academy of Television Arts and Sciences for the color television picture tube as the best engineering technical achievement of the year in the field of television—"a development which made the commercial color receiver practicable."

RCA Laboratories' research in computer technology dates back to the late 1940's when research in magnetic ferrite materials led not only to the development of shorter television tubes with larger picture area, but also to the development of ferrite memory cores for computers.

In 1947 the "Selectron," an electrostatic storage tube with a matrix of 256 small memory elements for computer use, was developed. It was the first binary digital computer memory.

In 1950 the Laboratories built "Typhoon," the world's largest and most accurate electronic analogue computer, for the U.S. Navy to evaluate performance of guided missiles, airplanes, ships and submarines. It could work out a complex air-defense problem employing a theoretical guided missile in one minute, a record achievement at the time.

The continuing work in computer memories and components, aided by advances in materials technology and solid-state physics, has resulted in recent years in such developments as the laminated ferrite memory, the highest speed, most compact ferrite memory ever achieved; and the cryoelectric memory, a large-scale memory using superconductivity to achieve its high capacity and high-access speed.

With the advent of the transistor, RCA Laboratories, like its counterparts elsewhere, had turned its attention increasingly to solid-state technology. One of the early solid-state developments to come from the Laboratories was the alloy-junction "drift" transistor, which employed a precise arrangement of impurities within the region between emitter and collector and made possible far more rapid operation and higher frequency performance than had previously been achieved with transistors.

In the late 1950's the development of micromodules, solid-state devices achieving reductions of ten times or more in size of many basic electronic circuits, and an intense effort to develop direct-coupled-unipolar-transistor-logic were important advances toward the achievement of integrated circuits.

In 1961 the cadmium sulfide thin-film transistor was developed, the first practical amplifying device to be made entirely by evaporation techniques. This process was a breakthrough toward the mass production of ultraminiature transistor circuits. The metal oxide semiconductor (MOS) transistor, an insulated-gate field-effect device, which combined the best properties of transistors and vacuum tubes, was developed in 1963.

As research during the 1960's becomes increasingly oriented toward materials and related physical phenomena, the emphasis at RCA Laboratories is largely on fundamental material and device research. This emphasis is twofold, however. While much attention is focused on what happens *within* the material, consideration is also given to the possible device applications of each new material. As the central research activity of RCA, the Laboratories provides the "building blocks" that the product divisions use in developing new products.

A roll call of the various materials technologies directly corresponds to many of the major research advances of the past few years: germanium-silicon thermoelectric alloys for power generation; niobium-tin technology for superconducting magnets; gallium arsenide for light diodes and injection lasers; dysprosium-doped calcium fluoride for laser crystals, and lithium-doped silicon for radiation-resistant solar cells.

The solid-state physicist—a comparatively new breed of electronics scientist—has come to the fore. His tools are more apt to be paper and pencil and slide rule rather than the wires and electron tubes of twenty-five years ago. He often works with what he cannot see and charts the atoms in a crystal like so many pieces in a three-dimensional puzzle.

Today, the technical staff at RCA Laboratories numbers some 375 scientists—about one-third of them physicists—conducting basic research into electromagnetic radiation, the structure of materials, plasma

and nuclear physics, semiconduction, superconductivity, the generation and control of coherent light, and other puzzling phenomena.

The Laboratories' outlook on research has become truly international for in 1955 a basic research laboratory was established in Zurich, Switzerland, and in 1960, a second basic research facility was established at Tokyo, Japan.

Obviously, it has been impossible in this brief historical summary to recount all of the events and to recognize all of the technical achievements which have resulted from the establishment of RCA Laboratories, twenty-five years ago. Thus, we have been able to touch on only some of the highlights and to mention only a few of the people in this account and in the accompanying photographs.



2, 3



4

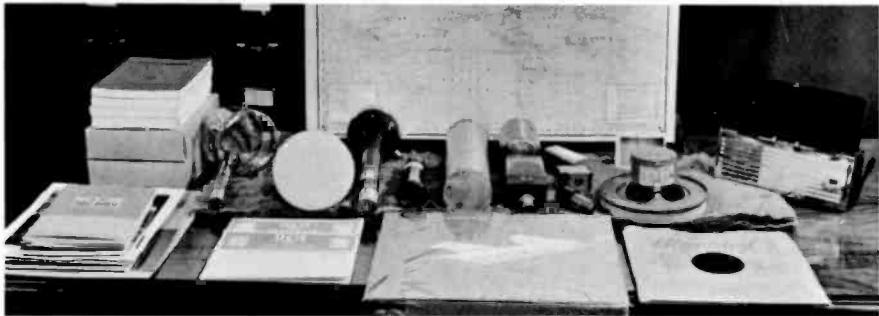

5, 6

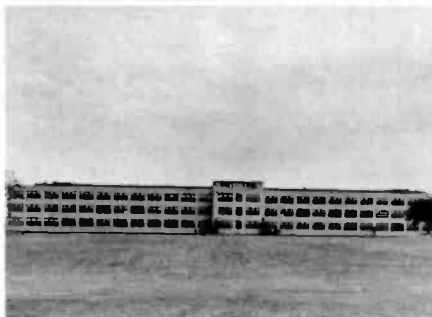

(6)

history

1. The first RCA Laboratory, in 1920, was in a tent at Riverhead, Long Island, when larger quarters were found in a shed, someone stole the tent one night!
2. Dr. Otto S. Schairer, Vice President in charge of RCA Laboratories (right), hands shovel to David Sarnoff, RCA President, for groundbreaking ceremony. At left is General James G. Harbord, RCA Board Chairman. Among those looking on in the background are Dr. Harold H. Beverage, Gerald D. Nelson, Dr. Charles B. Jolliffe, and Dr. Elmer W. Engstrom.
3. Page of program: Dedication of RCA Laboratories.
4. Contents of cornerstone included Iconoscope, Kinescope, cathode ray tube, special types of electron tubes, microphone, acorn radio tube and electron multiplier, loudspeaker, and a compact personal radio receiver.
5. RCA Laboratories in 1942.
6. At the entrance to the new Princeton Laboratories—October, 1942. Dr. Engstrom (center), Director, with Browder J. Thompson (left), and Dr. Vladimir K. Zworykin, Associate Directors.

7, 8



9, 10



11, 12

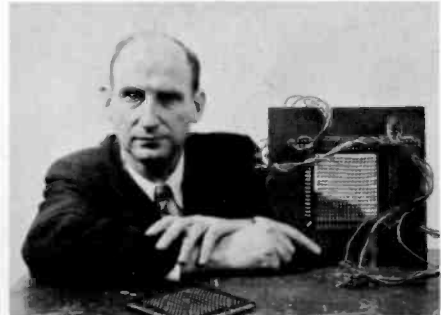

13, 14

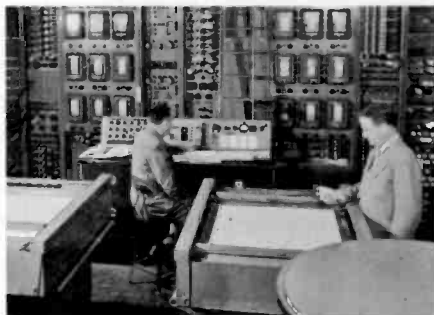

(7)

- 7. Dr. Beverage inspecting experimental facsimile transmitting equipment.
- 8. Dr. Irving Wolff with FM altimeter, used by Naval aircraft and both U.S. Army Air Force and RAF in WWII.
- 9. "Sniperscope" and "Snooperscope," infrared devices for night combat and reconnaissance developed at Laboratories during WWII.
- 10. Cyril N. Hoyler (left), Dr. George H. Brown, and Rudolph A. Bierwirth with penicillin dehydrating apparatus they developed.
- 11. Turnstile antenna for Empire State Building. L. to R.: Jess Epstein, Dr. G. H. Brown, Donald W. Peterson, and Oakley M. Woodward.
- 12. Dr. Jan A. Rajchman with ferrite core memory developed at RCA Laboratories.
- 13. Typhoon, world's largest and most accurate electronic analogue computer built for U.S. Navy to evaluate performance of guided missiles, airplanes, ships and submarines.
- 14. Charles J. Young (left) and Harold G. Greig examine photo print produced by "Electrofax," a high-speed electrostatic printing process.

15, 16

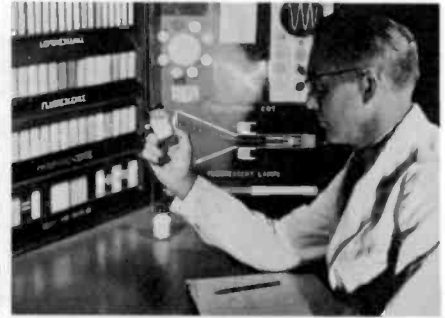
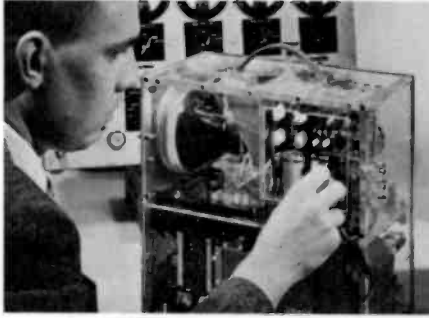

17, 18

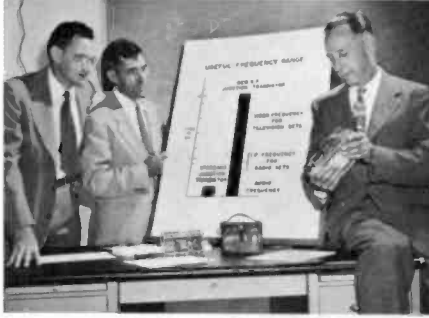

19



20, 21



(8)

15. Battery-operated TV receiver using transistors and no tubes except 5-inch picture tube is checked by Gerald B. Herzog at 1952 symposium on transistors.

16. Humboldt W. Leverenz conducts early research on electroluminescent materials.

17. Drs. Jacques I. Pankove and Charles W. Mueller, whose research led to radio-frequency junction transistor, with Loy E. Barton (right) who put the transistor to work in laboratory model receiver shown here.

18. Electron microscope with Dr. Zworykin (standing) and Dr. James Hillier, its developer, who designed vastly improved objective lens in 1947.

19. Nils E. Lindenblad with thermoelectric refrigerator built with no moving parts, operating by thermoelectric cooling.

20. Dr. George A. Morton (left) and Dr. John E. Ruedy with intensifier orthicon camera tube which can see in surroundings completely dark to human eye.

21. Dr. Harry F. Olson with phonetic typewriter built as part of study on voice control of machine actions.

22, 23



24, 25

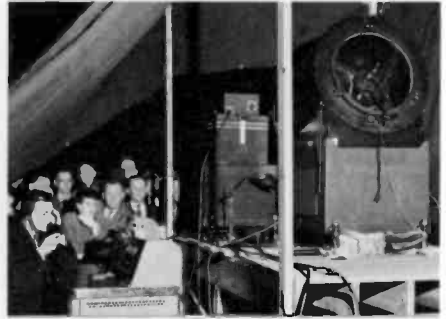

26, 27



28, 29



(9)

22. Electronic music synthesizer, installed at Columbia-Princeton Electronic Music Center, New York City, in 1959.

23. Electronic highway system, based on detector units in pavement, for highway safety applications or automatic vehicle control.

24. Co-inventors of the image orthicon for TV cameras, Drs. Albert Rose, Paul K. Weimer, and Harold B. Law, are shown with first model in 1945.

25. Theatre-type TV projection equipment set up on Laboratories grounds for Louis-Conn fight in 1946.

26. RCA scientists examine five types of tri-color TV picture tubes developed by RCA. L. to R.: Edward W. Herold, Dr. Engstrom, Dr. Law, and Dr. Zworykin.

27. General Sarnoff addresses press at demonstration of all-electronic color television in October 1946.

28. Illustrating progress in development of receivers for RCA color television system: right, research model demonstrated to FCC, October 10, 1949; left, developmental model demonstrated December 5, 1950.

29. Ray D. Kell checks component parts in all-electronic color TV receiver developed at RCA Laboratories.

46, 47



48, 49



50, 51



52, 53

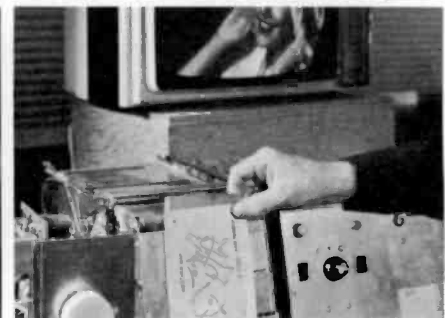
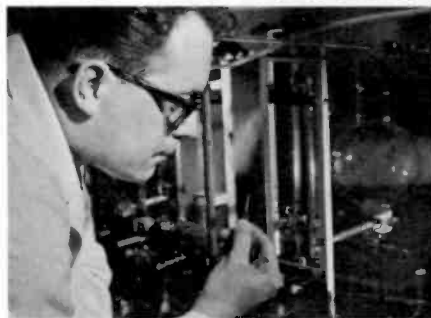

(12)

46. Metal oxide semiconductor (MOS) transistor developed in 1963 by Dr. Steven Hofstein, above, and Dr. Frederic P. Heiman.

47. Experimental superconductive magnet, using niobium-tin windings made by process developed at RCA Laboratories.

48. Dr. Benjamin Abeles watches test of thermocouple made of germanium-silicon alloy.

49. Silicon cell more resistant to radiation damage than solar cells now used is examined by Paul Rappaport.

50. Experimental superconductive memory about to be tested in liquid helium.

51. TV vidicon compared with thin-film transistor circuits that may lead to TV camera "eye" only $\frac{1}{2}$ " square.

52. Dr. James J. Tietjen, key developer of vapor phase growth process, inspects wafer of gallium arsenide.

53. Experimental system that can broadcast printed copy into the home along with standard TV programming.

the 1990s, the number of people in the UK who are aged 65 and over has increased from 10.5 million to 13.5 million, and the number of people aged 75 and over has increased from 4.5 million to 6.5 million (Office for National Statistics 2000).

There is a growing awareness of the need to address the needs of older people in the UK. The Department of Health (2000) has published a strategy for older people, which sets out a vision for the future of health care for older people. The strategy is based on the following principles:

- Older people should be able to live independently and actively in their own homes.
- Older people should be able to access the services they need to live well.
- Older people should be able to participate in decisions about their care.
- Older people should be able to live in a safe and secure environment.

The strategy also sets out a number of key objectives, including the following:

- To reduce the number of older people who are dependent on others for their care.
- To improve the quality of care for older people.
- To ensure that older people have access to the services they need to live well.
- To ensure that older people are able to participate in decisions about their care.

The strategy is a key document in the development of health care for older people in the UK. It provides a clear vision for the future of health care for older people and sets out a number of key objectives that need to be achieved.

The strategy is based on the following principles:

- Older people should be able to live independently and actively in their own homes.
- Older people should be able to access the services they need to live well.
- Older people should be able to participate in decisions about their care.
- Older people should be able to live in a safe and secure environment.

The strategy also sets out a number of key objectives, including the following:

- To reduce the number of older people who are dependent on others for their care.
- To improve the quality of care for older people.
- To ensure that older people have access to the services they need to live well.
- To ensure that older people are able to participate in decisions about their care.

the first two cases, the first two terms of the series are equal to the first two terms of the series.

In the third case, the first two terms of the series are equal to the first two terms of the series.

In the fourth case, the first two terms of the series are equal to the first two terms of the series.

In the fifth case, the first two terms of the series are equal to the first two terms of the series.

In the sixth case, the first two terms of the series are equal to the first two terms of the series.

In the seventh case, the first two terms of the series are equal to the first two terms of the series.

In the eighth case, the first two terms of the series are equal to the first two terms of the series.

In the ninth case, the first two terms of the series are equal to the first two terms of the series.

In the tenth case, the first two terms of the series are equal to the first two terms of the series.

In the eleventh case, the first two terms of the series are equal to the first two terms of the series.

In the twelfth case, the first two terms of the series are equal to the first two terms of the series.

In the thirteenth case, the first two terms of the series are equal to the first two terms of the series.

In the fourteenth case, the first two terms of the series are equal to the first two terms of the series.

In the fifteenth case, the first two terms of the series are equal to the first two terms of the series.

In the sixteenth case, the first two terms of the series are equal to the first two terms of the series.

In the seventeenth case, the first two terms of the series are equal to the first two terms of the series.

In the eighteenth case, the first two terms of the series are equal to the first two terms of the series.

In the nineteenth case, the first two terms of the series are equal to the first two terms of the series.

In the twentieth case, the first two terms of the series are equal to the first two terms of the series.

In the twenty-first case, the first two terms of the series are equal to the first two terms of the series.

In the twenty-second case, the first two terms of the series are equal to the first two terms of the series.

In the twenty-third case, the first two terms of the series are equal to the first two terms of the series.

In the twenty-fourth case, the first two terms of the series are equal to the first two terms of the series.

In the twenty-fifth case, the first two terms of the series are equal to the first two terms of the series.

anniversary events

To each of us at RCA Laboratories, the 25th Anniversary was a personal thing. It required a great deal of individual work in preparation, but it also provided each of us with a great number of personal pleasures.

First of all, there was the overall feeling of accomplishment and achievement of RCA Laboratories through the years. And then there was the pleasure of meeting and talking with the 200 leaders of science, government and industry who came from throughout the world to help celebrate our Anniversary. Also, we had the chance to explain and demonstrate our work to them and to more than 10,000 of our neighbors and friends from the Trenton-Princeton-New Brunswick community.

This section of our commemorative book attempts to recapture in pictures some of the events that took place during the 25th Anniversary—Thursday, September 28, through Sunday, October 1, 1967.

The Anniversary observance began informally Wednesday evening with two affairs. One was the Charter Members Dinner for present and retired employees who were part of RCA Laboratories when it began operations at Princeton; the other was a buffet dinner given by RCA Licensing for international guests.

The Anniversary opened officially on Thursday with the registering and welcoming of the 200 distinguished invited guests who joined us in commemorating the 25th Anniversary of RCA Laboratories. After that came guided tours of the almost 100 exhibits displaying the varied research projects at RCA Laboratories. Following the tours, the David Sarnoff Library was dedicated and opened for inspection.

Next came luncheon and the first of the two Symposia, "Electronics: Servant of Mankind." That evening, the 25th Anniversary Banquet was held in Princeton University's Dillon Gymnasium.

The wives of our invited guests, after a special guided tour of RCA Laboratories on Thursday, attended a special Ladies Luncheon and then toured historic Princeton and Princeton University. That evening they went to New York for dinner and a theater party.

The program on Friday was similar to that on Thursday. In the morning, our guests had the opportunity to see more of the exhibits in RCA Laboratories and also to "talk science" with their professional peers among the visitors and the RCA Laboratories staff. That afternoon the men attended the second Symposium: "Frontiers of Research," while the women toured historic Bucks County in Pennsylvania.

On Saturday and Sunday, RCA Laboratories held Open House for our friends and neighbors. During those two days, more than 10,000 men, women and children toured RCA Laboratories.





(15)

charter members dinner

1. Dr. Albert Rose, Charles J. Young, and Dr. Jan A. Rajchman (left to right).
2. Drs. Ross E. Shrader, David W. Epstein, George A. Morton, and Irving Wolff (left to right).
3. John P. Smith, George W. Leck, and Clarence W. Tuska (left to right).
4. Lowell E. Norton, Reginald A. Hackley, James L. Whittaker, Philip T. Smith, and Adolph R. Morgan.
5. Gerald D. Nelson, Dr. Harry F. Olson, and Nils E. Lindenblad.
6. Dr. John S. Donal, Jr., Dr. Jan A. Rajchman, Charles J. Busanovich, Dr. John E. Ruedy, Dr. Edward W. Herold, Dr. Vladimir K. Zworykin, and Harry Kihn (clockwise).

1, 2



3, 4



5



(16)

dinner for international guests

1. Shinya Maeda, of Hitachi, talks with Melvin E. Karns, Vice President, Patents and Licensing.
2. Overall view of dinner.
3. Mrs. Maurice Ponte, Dr. Ponte, of CSF; Stephen S. Barone, Staff Vice President, International Licensing; Dr. Erwin Holzler, of Siemens; and Tim Simokat.
4. Dr. Gustav Wagner, of Bosch; Prof. Kenjiro Takayanagi, Victor Co. of Japan; Prof. Seiichi Tanuma, Tokyo University; Dr. Tsuneo Harada, of Shibaura, and Hans A. Straus.
5. Sir Francis McLean (center), of BBC, with Harry L. Cooke and Dr. H. Russell L. Lamont.

1



2, 3



4, 5



(17)

registration

- 1. Dr. George H. Brown, Executive Vice President, Research and Engineering, greeting Walter K. MacAdam (center), of the IEEE, and Dr. Harold H. Beverage.
- 2. Dr. A. E. Pannenberg, of Philips (left), talks with Prof. Dr.-Ing. Werner M. Nestel, of Telefunken:
- 3. Dr. James Hillier, Vice President, RCA Laboratories, welcomes guests.
- 4. Guests registering for 25th Anniversary.
- 5. The lobby became crowded during Registration.

1



2, 3



4, 5



6, 7



(18)

guided tours

1. Dr. George H. Brown interrupts tour for chat with Dr. E. F. de Haan, of Philips.
2. Roy Nishida (second from left) explains speech recognition and analysis equipment to Shinkichi Hashimoto, of Hitachi. Looking on (left to right) are Shinya Maeda, also of Hitachi; Wesley C. Dixon and Dr. Martin C. Steele.
3. Dr. Robert J. Pressley (hand on tie) discusses laser exhibit with visitors.
4. Exhibit on phonographic recording is explained by Richard E. Werner.
5. Details of sonic film memory exhibit outlined by Henry S. Kurlansik.
6. Dr. James A. Amick (right) leads visitors on tour.
7. Dr. Alfred H. Teger (standing) explains computer pool game to visitor.

1, 2



3



4, 5



6



(19)

ladies tour

1. Mrs. James Hillier (right) chats with guest.
2. Mrs. Jayne F. Toussaint, Mrs. George H. Brown, and Humboldt W. Leverenz (left to right).
3. Ladies pause for tea and talk.
4. Dr. Edwin C. Hutter leads tour.
5. Nathan L. Gordon demonstrates computer time-sharing.
6. Laser exhibit interests wives of visitors.

1



2, 3



4, 5



(20)

david sarnoff library dedication

1. Dr. George H. Brown congratulates General David Sarnoff, who holds gold key to David Sarnoff Library.
2. General Sarnoff opens door to Library, as Dr. Brown looks on.
3. Opening the Library following Dedication ceremonies.
4. Pictures and books in David Sarnoff Library attract guests' attention.
5. Guests inspect Library exhibits.

1, 2



3, 4



5



6, 7



(21)

**anniversary banquet
arriving on a rainy night**

- 1. Dr. Elmer W. Engstrom
- 2. Dr. George H. Brown
- 3. Dr. James Hillier
- 4. General David Sarnoff
- 5. Dr. Irving Wolff
- 6. Dr. Robert F. Goheen
- 7. Governor Richard J. Hughes

1, 2



3, 4



5, 6



7



(22)

anniversary banquet

1. General David Sarnoff with Dr. Robert F. Goheen, President of Princeton University.
2. General David Sarnoff addresses the Banquet, as Dr. Elmer W. Engstrom looks on.
3. RCA President Robert Sarnoff with Dr. James Hillier and Dr. William O. Baker, of Bell Laboratories.
4. New Jersey Governor Richard J. Hughes with General David Sarnoff and Dr. George H. Brown.
5. Guests begin to gather for the Banquet at Dillon Gym.
6. Dr. Otto S. Schairer and Dr. Elmer W. Engstrom.
7. Overall view of 25th Anniversary Banquet.

1, 2



3, 4



5, 6



7, 8



(23)

open house

1. Charlie Brown and friends watch time-sharing computer terminal.
2. Open House visitors selecting gift records.
3. RCA Laboratories Choraliers entertain at Open House.
4. The end of a perfect Anniversary.
5. Glass blowing attracts visitors.
6. Acoustic demonstration in Free Field Sound Room.
7. John J. Hughes explains microwave exhibit.
8. Visitors inspect experimental computer output device.

the 1990s, the number of people with a mental health problem has increased in the UK, and the number of people with a mental health problem who are in contact with mental health services has also increased (Mental Health Act 1983, 1990, 1994, 1997, 2003).

There is a growing awareness of the need to improve the lives of people with a mental health problem, and to reduce the stigma and discrimination that they experience. This has led to a number of initiatives, including the development of mental health services that are more user-centred and more focused on the needs of people with a mental health problem (Mental Health Act 1983, 1990, 1994, 1997, 2003).

One of the key areas of focus is the need to improve the lives of people with a mental health problem who are in contact with mental health services. This includes people who are in contact with mental health services through the criminal justice system, and people who are in contact with mental health services through the health care system.

The aim of this paper is to explore the experiences of people with a mental health problem who are in contact with mental health services through the criminal justice system, and to explore the experiences of people with a mental health problem who are in contact with mental health services through the health care system.

The paper is structured as follows. First, we discuss the need to improve the lives of people with a mental health problem who are in contact with mental health services. Second, we discuss the experiences of people with a mental health problem who are in contact with mental health services through the criminal justice system. Third, we discuss the experiences of people with a mental health problem who are in contact with mental health services through the health care system.

Finally, we discuss the implications of our findings for the development of mental health services that are more user-centred and more focused on the needs of people with a mental health problem.

The paper is based on a review of the literature, and on data from a number of sources, including interviews with people with a mental health problem who are in contact with mental health services through the criminal justice system, and interviews with people with a mental health problem who are in contact with mental health services through the health care system.

The paper is intended to provide a starting point for discussion, and to provide a basis for further research into the experiences of people with a mental health problem who are in contact with mental health services through the criminal justice system, and the experiences of people with a mental health problem who are in contact with mental health services through the health care system.

symposium I

electronics: servant of mankind

GEORGE H. BROWN

I am now opening the first symposium on our program—Electronics: Servant of Mankind—with the same gavel used by General James G. Harbord, Chairman of the Board of the Radio Corporation of America, at the dedication of these laboratories on September 27, 1942.

On March 11, 1941, the Radio Corporation of America became the owner of 260 acres of farm land and two farmhouses in this community known as Penn's Neck, New Jersey. On a hot summer day, August 8, 1941, Dr. Otto Schairer and General David Sarnoff came to Penn's Neck to turn over a few spades of earth to signify the start of construction of the RCA Laboratories. They then called in an outside contractor who had much better equipment, with the result that by early fall, the foundations and the ground-floor slab were in place. The cornerstone was laid with appropriate ceremonies on Saturday, November 15, 1941.

Dr. Schairer, in his capacity as Vice President in Charge of RCA Laboratories and Chairman of the occasion, said, "Ladies and Gentlemen: On behalf of RCA Laboratories, it is my privilege and pleasure to extend to you a most cordial welcome to this ceremony. We trust that this will be but the forerunner of many happy meetings at this place." And today, we are having one of those happy meetings of which he spoke.

Mr. Gano Dunn, a member of the Board of Directors of RCA, and General Harbord then made remarks appropriate to the occasion. Mr. David Sarnoff, the President of RCA, spoke to us by short-wave radio from the S.S. Matsonia enroute from Honolulu to San Francisco. After the cornerstone settled into place, work progressed at a rapid pace. The building was completed and the dedication of the RCA Laboratories took place on September 27, 1942, the event which we are marking this week with these ceremonies.

Many of the members of the research staff and the executives of RCA who attended that dedication ceremony 25 years ago are present here today. I have already mentioned General David Sarnoff who was then President of RCA and is now Chairman of the Board of Directors, and Dr. Otto Schairer, who was the Vice President in Charge of RCA Laboratories.

Dr. Jolliffe was Chief Engineer, RCA Laboratories, and later succeeded Dr. Schairer as Executive Vice President of the RCA Laboratories Division.

Dr. Elmer Engstrom was Director, RCA Laboratories, twenty-five years

ago. He ran quickly up through various grades of vice-presidencies, becoming Senior Executive Vice President and President of RCA. He is now Chairman of the Executive Committee of the Board and Chief Executive Officer.

Dr. Harold Beverage was Director of Communications Research and Mr. Arthur Van Dyck was Manager of the Industry Service Section of RCA Laboratories. Dr. Vladimir Zworykin was Associate Director of the RCA Laboratories.

As I stated this morning, the original RCA Laboratories has evolved into the David Sarnoff Research Center. The David Sarnoff Research Center is now the base for the corporate Research and Engineering organization of the Radio Corporation of America. The David Sarnoff Research Center encompasses the RCA Laboratories, the corporate research activity directed by Dr. James Hillier, Vice President, RCA Laboratories. It is also the headquarters for the RCA Patents and Licensing activity, with Mr. Melvin Karns as Vice President, Patents and Licensing. Also, the corporate Research and Engineering staff, small in number but large in ability, has offices here in Princeton. Other staff-engineering functions which are part of the corporate Research and Engineering activities are located in Washington, New York, and Camden, New Jersey. Mr. Wendell Morrison, Staff Vice President, Product Engineering, has the responsibility for these activities.

A number of Affiliated Laboratories are sheltered here in Princeton. These are the advanced-development arms of the operating divisions, located here to bridge the gap between the research laboratories and the operating divisions.

introductory remarks

ROBERT W. SARNOFF

I feel greatly privileged to welcome so many distinguished guests, as well as the eminent participants in this symposium. The title of your discussion this afternoon, "Electronics, Servant of Man," seems especially appropriate when we recall the German proverb that reads, "Judge the master by his servant." In the coming decades, I believe, man will be judged by the uses he makes of his technology. He may train it as a trusted and versatile factotum or he may, as many seem to fear, turn it loose as a Sorcerer's Apprentice.

The subjects you will be discussing here are most fitting for an observance of the 25th Anniversary of the David Sarnoff Research Center. For the scientists and engineers of these laboratories have played a significant role in the advance of electronics into broad new fields of human endeavor. A history of this Center, in fact, tells much about man's efforts to harness the forces of the electron for his benefit. Much of its early research was devoted to refining the techniques for boiling electrons off into a vacuum and manipulating them with electrical and magnetic fields. The results of this research found their way into such technologies as radar, television and electron microscopy.

In recent years, our scientists have been probing into the nature of matter and learning to use the electron in its natural habitat—on the surface or deep in the bulk of various materials. Their findings have led to new solid-state devices that have vastly increased the proficiency of our electronic servant. The computer and other new electronic instruments are proving their usefulness in scientific research, education, business management, manufacturing, medicine, and even in the social sciences and humanities. The ultimate scope of their functions may be indicated by the prediction of a leading artist that electronic technology is the "palette of the future."

In its new roles, the electron is emulating the neuron and is complementing and amplifying the human nervous system, including the brain itself. Through the computer, moreover, electronics will tend to compound the collective intelligence of man, combining facts and ideas at accelerating rates to generate immense new amounts of knowledge. The availability of this vast and largely unpredictable potential has given rise to the fear that technology might develop a momentum of its own and slip from human control. The so-called "technophobes" warn that a runaway technology would threaten many basic human freedoms, if not human survival itself.

Such warnings must not be lightly set aside. They should be made integral to our thinking about technology at every stage of its development. They should be the special concern of the scientist and engineer, who have

(27)



ROBERT W. SARNOFF

President, Radio Corporation of America

Robert W. Sarnoff, President of RCA, has served for more than twenty-five years in communications. Prior to assuming his present position on January 1, 1966, he had been Chairman of the Board and chief executive officer of the National Broadcasting Company. A graduate of Harvard University in 1939, Mr. Sarnoff saw wartime service with the Navy and served with the Cowles organization and Look Magazine before joining NBC in 1948. He became President of NBC in 1955 and its Board Chairman in 1958. Among his many public service and academic associations, Mr. Sarnoff is Chairman of the Board of Trustees of Franklin and Marshall College, a trustee of the John Fitzgerald Kennedy Library Corporation, a director of the Roper Public Opinion Research Center of Williams College, a member of the Overseers Committee to Visit Harvard College and a member of the Board of Governors of the American Red Cross.

a deeper understanding of the technological forces at work and observe them with the special objectivity that Jacob Bronowski has described as the "habit of truth." Already the scientific community is being drawn into many of the great issues and decisions of our time. Its members are counseling us on the uses of nuclear energy, the exploration of space, the solution of such problems as air and water pollution, population explosions and technology gaps.

In the years immediately ahead, the physical scientist will be called upon increasingly for guidance in assigning electronic technologies to new and vital tasks. At the same time, social and behavioral scientists will become more intimately conversant with the potentials of the electron in filling human needs. As a result of these merging efforts, we will more clearly identify and more wisely choose among the multiplying alternatives offered by electronics and, in fact, by all science and technology. Now that new knowledge and new instruments can make almost anything possible, we must carefully decide what it is we want.

The choices will be increasingly complex and difficult. But they will be made by men, not machines, so long as we recognize that our inventions are the product of human intelligence and, as such, can be so devised as to be subject to human will. Viewed in this light, the technology of the future, like our tools of the past, can force us to enlarge our perceptions and our sense of concern—to evolve more fully as human beings.

Few activities can serve these ends more effectively than free discussion. It is vital, therefore, to encourage the continued exchange of new ideas and fresh viewpoints among those who stand close to the sources of new scientific knowledge and technology, and between the scientific and non-scientific leadership of the world community.

Thus a gathering such as this is especially significant, calling together as it does some of our brightest talents in the conduct and management of research and engineering. We look with high expectation to the discussions of these two days—both formal and informal. They provide opportunities to all of us to review current progress and gain the new knowledge and understanding that are basic to further progress.

(28)

These two symposia not only illuminate the ways but demonstrate the will to channel technical knowledge into social advance. For this initial discussion, we are particularly fortunate to have three authorities of such distinction to share with us their views on the uses of electronics in science, in education, and in business. I am confident that, with guidance such as they can provide, we will develop an electronic servant that will be a credit to its human masters.

electronics in quest of the nature of life

by **DETLEV W. BRONK**

For personal reasons that I will recount, I owe a debt of gratitude to the Radio Corporation of America and to those who have labored in her laboratories. So do all scientists and all others, too, for the institution that has become the Sarnoff Laboratories has contributed greatly to the furtherance of science and, through science, to the furtherance of human welfare.

The anniversary we celebrate today is a reminder of another significant anniversary of a relevant event in which these laboratories had their origin. Seventy years ago J. J. Thomson published in the *Philosophical Magazine* his classic paper in which he put forward the idea that cathode rays comprise particles that are universal constituents of all matter. He wrote:

"The experiments discussed in this paper were undertaken in the hope of gaining some information as to the nature of the Cathode Rays. The most diverse opinions are held as to these rays: according to the almost unanimous opinion of German Physicists they are due to some process in the ether to which, inasmuch as in a uniform magnetic field their course is circular and not rectilinear, no phenomenon hitherto observed is analogous: another view of these rays is that so far from being wholly ethereal they are in fact wholly material, and that they mark the paths of particles of matter charged with negative electricity. It would seem at first sight that it ought not to be difficult to discriminate between views so different, yet experience shows that this is not the case."

That I have read from the facsimile of "J. J.'s" handwritten manuscript which is reproduced in *J. J. Thomson and the Cavendish Laboratory in His Day* by his son, Sir George. I found that book last winter in a little news and book store in a Vermont village. To the proprietor of the shop I expressed my surprise that he had such a book as that for skiers and residents of a run-down mill town.

The shopkeeper replied: "Everybody depends on science. More people should know to whom they owe their radio, television, and recorders. Almost every aspect of life today is touched in some way by electronics."

George Thomson was pleased when I told him of this humble tribute to his father; I hope that General Sarnoff and his colleagues of RCA will be, too, for they are leaders among those who have harnessed the electron for man's use today.

(29)



DETLEV W. BRONK

President, The Rockefeller University

Detlev W. Bronk, President of The Rockefeller University, was born in New York City. He received an A.B. degree from Swarthmore College and his M.S. and Ph.D. degrees from the University of Michigan. He was Director of the Johnson Research Foundation of Medical Physics, 1929-1949, and President of the Johns Hopkins University, 1949-1953. He is Past President of several scientific bodies including the National Academy of Sciences, 1950-1962, Chairman of the National Research Council, 1946-1950, Fellow of the American Association for the Advancement of Science and President in 1952. He was a member of President Eisenhower's Science Advisory Committee and continues to be called on as a Consultant in Washington. He holds nearly fifty honorary degrees including awards from various scientific and medical organizations and is a foreign member of national academies in six countries and a foreign member of the Royal Society.

Enough of the anniversary of Thomson's classic paper; there are other anniversaries in a related sequence that show the continuity of the scientific endeavor and the pervading influence of electronics.

Forty years ago, thirty years after J. J.'s experiments in the Cavendish Laboratory, Lord Adrian, the physiologist, was studying the activity of the nervous system in his basement room. There, a few hundred yards from the Cavendish, Adrian used the controlled movement of electrons in a three-electrode electron valve amplifier to reveal for the first time how animals and men maintain neural contacts with their environment and how they control muscle movements and the movements of their bodies.

I vividly recall J. J.'s quiet pleasure when he heard these discoveries described at High Table in Hall at Trinity College of which he was then Master. He mused how improbable it would have seemed thirty years before that he was paving the way for fundamental neurological discoveries. Such is the sequential continuity of the scientific endeavor and the relevance of supposed unrelated fields of science.

Thirty years ago this fall the American Institute of Physics sponsored a symposium that was, I think, the first organized scientific meeting devoted to Biophysics. Three hundred fifty scientists from universities and industries gathered to discuss how the physical and biological sciences are related. Germer spoke on electron diffraction methods for studying organic films, Selig Hecht discussed the photochemistry of vision, Lee DuBridge speculated on how nuclear physics might be of possible interest in biology, and Herbert Gasser described the electrical signs of biological activity.

Throughout the historic conference that marked a new chapter in biology, almost every speaker told of research that had been accomplished by the use of controlled motion of electrons. And most of the electronic devices that had been used were manufactured by RCA. There were frequent reminders that the discoveries of physical scientists had fathered new electronic industries for the satisfaction of human needs; biologists, in turn, have been indebted to industry and industrial scientists for instruments that aid in quest of the nature of life.

(30)

That first symposium on Biophysics of which I have been speaking was held at the Eldridge Reeves Johnson Foundation for Medical Physics of the University of Pennsylvania. That suggests a tale regarding a little known role of RCA in the origin of Biophysics as a science.

This year is the one hundredth anniversary of the birth of Eldridge Reeves Johnson on the Eastern Shore of Maryland; he was an adventurous, inventive mechanic as were many early founders of American

industry. With Emil Berliner he developed the lateral movement, groove-driven stylus for the reproduction of recorded sound. That led to the creation and evolution of the Victor Talking Machine Company. In 1927 that company was bought by RCA; thus Johnson came into possession of millions of dollars of fluid funds; one of those millions he gave to create and endow the Johnson Foundation for research in Biophysics. Through the financial transaction between Victor and RCA, RCA had a major, if unwitting role, in the development of Biophysics.

With characteristic vision, Eldridge Johnson foresaw that physical, and especially electronic, devices could greatly further biological science. He once said to me: "Living things are composed of cells, all of which are small and many are quick. I believe that electronics will enable you to study those very small, rapidly acting, vastly numerous units of life."

The possibility he envisioned has been fulfilled. Vacuum tube amplifiers have enabled the recording of micro- and milli-volt fluctuations that are signs of activity in small cellular elements of tissues and organs. Cathode ray oscillographs make possible the observation of those rapid events. Electron microscopes have enabled us to see how molecules are arranged to form an organized cell and the surrounding membrane on which the electrical sign of activity is observed.

As the history of nations is often shaped by inventions such as the cross-bow and the fore-and-aft rig of Drake's Navy, so the progress of a science is often shaped by inventions that follow discoveries in other fields of science.

The nerve trunk-lines that run to the brain from light receptors in the eye, or tactile endings in the skin, contain thousands of microscopic fibers and so do the nerve trunks from the brain and spinal cord to muscles. Through the medium of these fibers, animal and human organisms are kept informed of their physical environment; through these fibers they regulate their muscles and thus control their movement. That there was a propagated change of electric potential coursing along the fibers as a sign of their conducted influence on the brain and muscles had long been known.

But the nature and context of the messages had remained unknown because of obstacles to understanding: the message in each of the many fibers was discrete and the electric sign of activity in each fiber would necessarily be a change of only a few millivolts or less and only milliseconds in duration. Finally "the code was broken" when the development of electron tube amplifiers and cathode ray oscillographs enabled Lord Adrian and his successors to record the messages in individual fibers.

With the aid of electronics the elemental nature of nervous control of life and of sensation has been revealed, and has now become common knowledge.

As electronics has thus enabled biologists to understand better the mechanisms of sensation, biologists have been better able to aid in the design of better instruments. This is so because an instrument is a device for increasing the capabilities of the human senses: increasing their sensitivity, their resolving power, their discrimination. Through the cooperation of the physical and biological sciences and research-supported industries, scientists have been enabled to see what they had not seen before, to see not only the electron-microscopic structure of the interior of living cells, but also distant scenes on television screens and far into the cosmos with radio-telescopes. With the sensory aid of electronic instruments that extend our auditory organs, every man can hear across great spans of space; we can hear sounds of the past that have been stored for future hearing.

With electronic devices we are able to feel what had been unfelt and are able to measure the mass and weight of objects with greater sensitivity and discrimination. By the use of amplifiers, oscillographs, photo-tubes, electron counters, microscopes, tracers, and countless other instrumental aids to human senses, the science of electronics and the electronic industry have vastly extended the scope and the very nature of human life.

A machine is a device to increase the power man can exert with his muscles, to make his movements with greater precision, to travel faster and in three dimensions. Control of these great new powers imposes requirements that often exceed the physiological capabilities of the human organism. Accordingly, a science and technology of physiological-related control mechanisms has been developed in order to enable biologically-limited man to use his machines. Here, too, electronics has aided men in quest of a greater range of life.

Chief among the limits to man's capacity to use modern instruments and machines and the growing fund of knowledge is his brain or mind. Aid to that central, uniquely human organ is the latest contribution of electronics to the technology of life. I refer, of course, to electronic storage and retrieval of information and to computers. By such devices man has been enabled to think as he has never thought before. He has been able quickly to solve complicated problems and make computations that would have required an inordinate amount of time. This new science and technology has made it possible to deal with the increasingly complex conditions of individual and social life that have been created by science and technology.

But the greatest asset of modern man for the wise use of his augmented powers in the creation of a more desirable environment and pattern of life is understanding of the laws of nature. In the dawn of modern science Francis Bacon said it thus: "If man would conquer nature, he must learn to obey her laws." In that quest, electronics has been a powerful instrument during the past half century.

Each new scientific discovery and every technological development presents us with more choices as to how we will use them—for benefit or harm for ourselves or others. The progression of science and technology enables us ever more rapidly to change our environment and our ways of life; wise decisions become more urgent. The challenge of Francis Bacon is more vital now than when he gave it.

President John Kennedy delivered his last public address at the Centennial of the National Academy of Sciences. On that memorable occasion he spoke these hopeful words: "I can imagine no period in the long history of the world where it would be more exciting and rewarding than in the field today of scientific exploration." I add: electronics, new instruments and machines, the genius of mankind has provided humanity with a supreme challenge and a supreme testing.

The President continued: "If the challenge and the testing are too much for humanity, then we are all doomed, but I believe that the future can be bright, and I believe it can be certain. Man is still the master of his own fate."

That is a challenge and an opportunity for all who work in laboratories such as these on the frontiers of knowledge. It is a challenge to industries such as RCA that translate discoveries such as those of J. J. Thomson into means whereby modern man has been enabled to widen the horizons of understanding and live a broader life.

"Our purpose holds to sail beyond the sunset . . .

Some work of noble note may yet be done."

education for such a time as this

WILLIAM L. EVERITT

As a minister's son I was brought up in the tradition that a serious talk should be centered around a text. I have not always followed this precept, but for our topic today, I think there is a most appropriate quotation from the Book of Esther. The story is of a period characterized by crises as terrible for the people involved as any thermonuclear threat of today. Haman, the king's deputy, had issued orders to the governors of the provinces, as recounted in the thirteenth verse of the third chapter of the Book of Esther, "to destroy, to kill, and to cause to perish, all Jews, both young and old, little children and women, in one day."

The only hope seemed to be an intercession with the king by Esther, but under circumstances which put her life in danger. Her uncle Mordecai persuaded her to take action, saying "and who knoweth whether thou art come to the kingdom for such a time as this?"

"For such a time as this." Whatever your religious persuasion, one cannot but be impressed with the simultaneity in history of the appearance of apparently insurmountable problems and the discovery of new means by which to solve them. Sometimes these means have been an unusual assembly of men of vision, as for instance at the birth of this nation. At other times they have been new discoveries or inventions, as the agricultural developments in the western world have shown the way to feed growing populations. Usually the most impressive solutions have involved a combination of imaginative and energetic people with new physical means at their disposal.

"For such a time as this." These are indeed times which seem to have no precedent—even though some sage has said "those who ignore the teachings of history will be forced to repeat it." Many claim there is no uniqueness to our present problems—it is just their size that overwhelms us. But dimensions themselves can be unique. The bomb at Hiroshima differed principally from its predecessors in size by a ratio of the order of 20,000 to 1, although it must be admitted that a new factor of radioactivity was added.

Outstanding among our problems of the day are how to cope with two other kinds of explosions:

- 1: The explosion of population
- 2: The explosion of information

(34)



WILLIAM L. EVERITT

Dean, College of Engineering, University of Illinois

William L. Everitt attended Cornell, the University of Michigan and the Ohio State University and taught at each of these and at the University of Illinois where he has been Dean of Engineering since 1949. He has had experience with the North Electric Manufacturing Company and the AT&T Company and as Director of Operational Research for the Signal Corps in World War II. He has been President of the Institute of Radio Engineers, the American Society for Engineering Education, the Engineers' Council for Professional Development and the Associated Midwest Universities. Among his awards are the Medal for Engineering Education of the American Institute of Electrical Engineers, the Kelly Telecommunications Medal of the Institute of Electrical and Electronics Engineers, the Lamme Award of the American Society for Engineering Education and a number of honorary doctorates. He is a Founding Member of the National Academy of Engineering.

Probably, thinking citizens would agree that the most frightening problems arise from the social unrest in our cities and the political unrest among the nations of the world. But I believe these crises are primarily due to the lack of adequate understanding of how to cope with the two explosions just cited. Much of this lack is in turn due to the inadequacy of our present national and international facilities for education. "For such a time as this," new approaches and new methods are demanded.

Education is primarily a problem of the processing of information. For modern processing of information we are turning more and more to electronics, and the relation of electronics to education was the topic assigned to me today. Most of the talks I have given on education concerned the problems of "what to teach" while today I will be discussing primarily new methods of "how to teach."

In using a word like "electronics" we often meet a semantic difficulty. Some of the most acrimonious, but at the same time meaningless, discussions occur when two people or two groups use a common word, but each with a different connotation. An example is the difference in the meaning of the word "democracy" when used on opposite sides of the Iron Curtain.

Once the board of deacons of a church were discussing the purchase of a new chandelier. In this church unanimous consent of the board was required for all purchases of over one hundred dollars. All but one member were agreeable to the purchase. However, in spite of the best persuasive efforts of the others this deacon persisted in his veto to the bitter end. Afterwards he was asked why he was so opposed to the purchase. He replied:

"In the first place I couldn't spell it."

"In the second place if we got one who would play it?"

"In the third place what this church needs is more light."

Some fifteen years ago in response to a request for an editorial in the *IRE Proceedings*, I suggested a redefinition of the word "electronics." The proposed definition aroused considerable discussion and was reprinted as far away as Australia, but it was not adopted by any standards committee. My proposed definition was: "Electronics is the science and technology which deals primarily with the supplementing of man's senses and his brain power by devices which collect and process information, transmit it to the point needed and there either control machines or present the processed information to human beings for their direct use." This definition is broad. It involves more than the flow of electrons, but I submit that electronics, as we know it, involves much more than an assembly of devices using vacuum tubes, transistors, or integrated circuits. Out of the

science and technology of electronics has come the recognition of such fundamental concepts as feedback, impedance matching, coding and decoding, and decision theory. It is true that when we have once recognized a fundamental concept like feedback we find it is all around us in the biological world. But its full potential was not realized until electronic engineering explained its fundamental concepts, showed how to plan for its utilization, and also analyzed some of the dangers, like instability, if certain boundary conditions were not met.

Like "electronics"—the noun "education" means different things to different people. We could spend many sessions debating what education is and what it should be. So, rather than suggest my own definition, I will quote the one given in the recent Random House dictionary—which seems appropriate in this location since Random House is now a subsidiary of RCA. Their definition of education is: "The act or process of imparting or acquiring general knowledge, developing the power of reasoning and judgment, and generally of preparing oneself or others intellectually for mature life." This definition indicates clearly that education is primarily a matter of "processing of information."

Traditionally education has involved a teacher and a student. The function of teaching, as analyzed in an impersonal way, involves as a minimum:

1. Acquiring knowledge of a subject from a reliable source.
2. Storing the knowledge in a memory.
3. Assessing the relevance of the knowledge, discarding the trivial and retaining the important, and arranging in a proper sequential form for presentation to students.
4. Repeating the knowledge in a programmed form to one or more students.
5. Setting interpretive tasks for the student to make use of the knowledge acquired which will reinforce the learning and give the student experience in relating relevant material.
6. Monitoring the performance of the student in the assigned tasks.
7. Adjusting the program of dispensing knowledge from the memory to properly allow for the ability of the student, and for defects in the original program.

This list of items is an over-simplification of the teaching function and the good teacher will contribute much more. But the items identified will be suitable as a basis to discuss some of the contributions of electronics and electronic systems to modern education, and it was for this reason that the impersonal analysis was adopted.

Note particularly the importance of feedback. Good teaching requires the teacher to measure the actual effect of his teaching. If there is a dif-

ference between what he wants and what he actually gets in the output from the student, he should take corrective measures as quickly as possible. For this reason a good teacher will correct his examinations quickly or the delay in the feedback can result in instability just as it will in a physical control network.

During the war my group, the Operational Research Staff of the Signal Corps, had a task of analyzing the use of a simulator in a training program for early warning radar operators. The students located and recorded targets, but there was no subsequent correlation of how accurate their measurements were. We found that after a two-week course of this type their effectiveness had decreased rather than improved.

For most of man's history, education was conducted solely by direct verbal communication. While written manuscripts contributed much to recording and transmitting the slowly developing information of early civilization, their reproduction was so laborious and expensive that they made accumulated knowledge available to only a few in any given generation. Education which depended primarily on vocal communication was completely inadequate even for ancient times. It is more than a coincidence that Gutenberg's invention of printing by movable type in the fifteenth century (which made books more generally available) occurred at the beginning of the Renaissance. Today education without books seems unthinkable—but I have visited countries where books are generally available only in libraries and are seldom owned by the individual students.

Books did not replace teachers, but they did supplement and support them and provided an effective method for the storage of information and repeating of the information to a student body, functions 2 and 4 of my teaching list. But the book is a one-way device for dispensing information—it cannot adjust the flow to the ability of the student nor can it assess how well he is doing. In the classroom this is the task of the teacher. A student engaged in self study can only do this by discarding a book he does not understand in favor of one more suited to his ability. However, books and other publications have greatly multiplied the ability of the good teacher to achieve the results he seeks.

Many feel that books, classrooms, laboratories, and good teachers are all that are required for today's educational needs. For a century and a half universities have been involved in "Education for Engineering," but the increasing demands for more and more education, both in numbers of students and in the requirements of each individual, call for better "Engineering for Education."

In the processing of information, no really dramatic changes other than the telegraph and telephone took place from the invention of printing

until the 20th Century when new concepts suddenly followed each other with a bewildering speed. From the standpoint of education I would select six major electronic developments which hold great promise for the future.

They are:

1. The recording of sound
2. Facsimile or Electro-writer transmission over audio channels
3. Television
4. Television recording
5. The computer
6. The marriage of the computer and television for Computer-Assisted Instruction

The RCA Select-a-Lesson-System makes use of voice recording and telephone lines. An installation of this system in Providence College makes it possible for students to choose some 24 different foreign language programs. This system shows promise of expansion into other fields in the future, including the use of TV recording.

From an educational viewpoint the recording of sound has had a major impact in three areas:

1. Music interpretation and appreciation.
2. Language teaching, with particular emphasis on conversation as contrasted with emphasis on grammar.
3. The teaching of public speaking by requiring students to hear themselves as others hear them.

While voice recording on records and films was well advanced before World War II, it was only after the development of cheap magnetic recording and instantaneous playback that this electronic aid came into its own. Now no high school language laboratory is well equipped without such facilities.

We have been teaching some extension courses at the University of Illinois this year by using an Electro-writer over ordinary long distance telephone connections. We are most enthusiastic about the results. The instructor is located on our campus and talks by voice simultaneously to four groups of students located in different cities in the state. Concurrently he makes sketches on a pad which are transmitted over the same lines and are projected on a screen (which is referred to as an electronic black-board) in each of the four classrooms. A faculty transmitting station is shown in Figure 1. The students can interrupt with questions which are heard at all points. One of the circumstances that has made this program particularly practical is that we have eight statewide WATS lines available. These are little used in the evening so that the telephone costs are negligible. In certain courses we require on-campus appearance of the

students for faculty consultation every third week and by this combination feel justified in giving graduate credit. However, only a limited number of such credits count toward a degree because we require a minimum of one semester of residence for a master's degree.

You will note that I have omitted voice broadcasting. This is a most important method for the dissemination of news and entertainment, and I would not wish to neglect its contribution to music appreciation, but I feel its role in formal education has been a minor one.

Television is another matter. It must be admitted that this development has not as yet had the impact on education that its most ardent advocates have promised. Its early limitations were fixed schedules, the lack of feedback, and poor programs. To quote the recent publication of the Fund for the Advancement of Education entitled *Learning by Television*: "Change in education does not come about smoothly—through empirical research, logical analysis, sweet reason, or a count of hands. Educational change is, more often than not, hotly contested. While most educators sit out the struggle, the leaders divide into those who feel threatened by the new ways, and those who complain that the change does not come fast enough." To quote the same report, dated August, 1966, "After more than a decade of intensive effort and the expenditure of hundreds of millions of dollars, has television made a real impact on America's schools and colleges? Has it made a worthwhile contribution to education? The short answer to such a sweeping question would probably have to be a 'No.' In short, TV is still far from fulfilling its obvious promise. Television is *in* education all right, but it is still not *of* education." The report points out that "the most conspicuous result of television has been an incidental byproduct; the medium has displayed in public what had hitherto gone on behind too many closed classroom doors—uninspired teaching."

However, I have quoted largely from the introduction to the report, which treats of the disappointments of the past. There have been many advances and the future looks bright.

There are currently 120 Educational Television Stations, and 240 are projected by the mid-1970's. The development of TV recording makes it possible to exchange programs through the National Instructional Television Library and other agreements. This in turn has made it feasible for individual stations to throw appreciable resources into individual programs with consequent improvements in quality.

There are also some 1000 closed-circuit installations and some of these provide feedback, mostly by audio channels, so that a student watching a lecture by television can quiz the teacher.

The most promising development in television for instruction is the availability of cheaper recorders. These free the classroom from fixed schedules, and the teacher can plan to use prerecorded material at the time it fits the class schedule. However, time delay in presentation makes feedback between student and TV lecturer impossible.

Bobbie Burns made one of his sagest observations when he said, "Oh wad some power the giftie gie us, to see ourselves as ithers see us." One of the most significant uses of TV recording in education is to monitor a teacher in his class presentation, and then have him observe himself and the mistakes in presentation he has made. Faculty reaction has involved personal embarrassment followed by marked improvement in teaching methods.

Greatly expanded resources for Educational TV programs are needed. The report of the Carnegie Commission on Educational Television is a major step forward. It involves a "Program for Action" including the establishment of a "Corporation for Public Television." This proposal is currently receiving major support in the Congress.

Probably the greatest single step in the processing of information since the development of printing is the computer. The computer can perform many of the functions of the teacher which I listed. It can receive information, store it in a memory, and dispense selected portions at the order of a programmer. By itself it is having a major impact on education, particularly in the collegiate world. The dean of faculties at a state university said, "The computer is an important tool of thought—not just in doing hard work fast, but in forcing people to state their problems clearly and think out what they want to do."

Engineering education, with which I am most familiar, is quite different than it was fifteen years ago because of the computer, and it will be even more so in the future because engineering practice is just beginning to realize the computer's potential. The fundamental job of the engineer is to seek answers to the question: If you want something, what do you put together to get it? Even more, his task is the optimum selection of materials and manpower utilization to achieve a desired result. It is in the field of optimization that the computer is an unchallenged aid. This is the field of computer-aided creative design. The electronic computer provides the engineer with the ability to obtain timely information conveniently on both physical and economic phenomena. Accordingly, no longer is the engineer "bottlenecked" by time-consuming, unrewarding strings of calculations to generate one or two pieces of numerical evidence to use in checking the validity of a "guess" at a physical behavior. No longer is he restricted to

the consideration of only one or two alternatives in combining components to manufacture a product economically. No longer is he required to use his limited time and energies in developing "approximate" measures of phenomena so that he can produce a satisfactory product within the time available. These restrictive influences inherent in the slide-rule and desk-calculator environment are non-existent in that of computer-aided design.

The era of computer-aided design requires our educational institutions to produce graduates who can participate effectively in the environment of the era. These young men must be more disciplined in their thinking process, more rigorous in their mathematical abilities, more knowledgeable of a broader spectrum of mathematics, less reluctant to change, more capable of treating larger and larger interdisciplinary problems, more tolerant of the social impacts of solutions, and more precise in the sorting-out of the value of numerical responses than any of us ever thought possible or necessary on our graduation days.

In addition to using the computer in the classroom, another great service to education promises to be as a means of locating library material. We are all frustrated at times by the flood of available periodicals and books. The volume of abstracts alone now being published equals the total volume of professional periodicals issuing at the time the abstract system was first developed. So we may need abstracts of abstracts and so on ad infinitum.

The computer has an infinite capacity for taking pains. Hence it provides an ideal method for indexing and locating library material. I am informed that several newly appointed directors of libraries have been chosen because of their mathematical or computer-oriented backgrounds. Significant work is proceeding on the programming methods necessary to identify items of interest. The Library of Congress is currently being automated, but the magnitude of the problem is enormous as their collection includes 12 million books and a total of over 30 million items. Linguists and semanticists are contributing much in the way of classifications. The impact of the computer will require a major reorientation in our library practice and library schools. Future libraries, large and small, will be tied together in cooperative networks and new applications of electronics using facsimile and other reproduction methods to make their material available will emerge.

But to my mind the great promise of the future from the field of electronics is the marriage of the computer with television in what is now called Computer-Assisted Instruction or CAI. In connection with the theme of our seminar today, it is of interest that a Professional Group on Human Factors

in Electronics has been established in the Institute of Electrical and Electronics Engineers. The June, 1967, issue of their *Transactions* was a special issue on Computer-Assisted Instruction. One quote from the summary article reads: "From a challenge from Professor W. McGill, then at Columbia University, to some members of the IBM Research Laboratories, the thought of using a general purpose digital computer to teach was probably first conceived. . . . The IBM Electric Typewriter Division had a contract with B. F. Skinner to develop a teaching machine for him using his patents. . . . Thus it came to be that the first computer teaching system was programmed, designed, and conducted by Miss H. S. Anderson, R. Branard, and G. J. Rath (associates of Dr. Skinner) in 1958. The first program was dedicated to teaching binary arithmetic." We will hear more about Dr. Skinner's work tomorrow.

Since that time major efforts have been continued by IBM, the Decision Sciences Laboratory at Hanscomb Air Force Base, by Bolt, Beranek, and Newman, the Systems Development Corporation, the University of Illinois, and by the Instructional Systems Division of RCA in cooperation with Stanford University. There may be others of which I am not aware.

Naturally I am most familiar with the extensive development at the University of Illinois which has occurred primarily in the Coordinated Science Laboratory of the College of Engineering, with the cooperation of many departments of the University. This system is known as PLATO, an acronym for Programmed Logic Automatic Teaching Operations. This activity has reached such proportions that a Computer-based Education and Research Laboratory (CERL) has been established within our graduate college as the University-wide coordinating agency. It is under the leadership of Professor Donald L. Bitzer, who, with the help of a large number of associates, has been primarily responsible for the development of PLATO.

The PLATO teaching system involves two-way communication between the system and each individual student. A student talks to PLATO by means of a typewriter keyset which includes both alphanumeric characters and control keys, while PLATO talks to the student via a television screen. The system uses the sophistication of a computer to adjust its presentation to the student through a prepared lesson plan which is modified as the teaching proceeds by the student responses to the lesson material. Figure 2 shows a block diagram of the system. Figure 3 shows a student at a station.

Information for the television screen comes from two sources under the control of the computer: (1) by selecting previously prepared slides (called the electronic book); or (2) by plotting characters and figures on

the student's individual electronic blackboard. The images from the blackboard and the slide selector are superimposed on the TV screen.

The rules that control the teaching process at any given time are included in the computer program which is read into the Central Control System. A complete set of rules is referred to as a teaching logic. The "tutorial logic" is outlined in Figure 4. This logic teaches in the common way of explaining a unit of a subject, followed by the setting of a task for the student to perform. The performance on this task tests whether he has learned the lesson or needs more detailed assistance. If needed, this assistance is given and is adjusted to the individual learning rate of the student, who can proceed as rapidly as his abilities allow.

After the system is turned on, a slide with explanatory text material similar to that on a page of a book is presented on the screen to a student. When he thinks he has absorbed this he pushes a CONTINUE key and a problem or question appears on the screen. He must then type his answer and push a JUDGE key. If he has the right answer an OK will appear and he can continue to the next reading material. If the answer is wrong a NO will appear on the TV screen. As an example, Figure 5 shows a simple question in number theory, requiring two numbers as the answer. Figure 6 shows the answers which might have been supplied by a typical student, one right, the other wrong, and the judging by the computer as it appears on the screen. If any answer is wrong the student cannot continue in the original lesson sequence, but must find the right answer. He can erase his answer and return to the original problem by means of an ERASE key. Perhaps he will wish to reread the original text. This he can do by pushing the REVERSE button after which the book material will reappear. Then he can come back to the problem with the CONTINUE button. Perhaps he feels he needs more explanation. Then he can push the HELP control key and a sequence of more detailed explanations are provided, checked in turn by simpler questions or problems. This leads by easier steps to the desired answer. The HELP sequence can in turn be provided with still more detailed sub-sequences, if experience shows them to be desirable. If all else fails and the student pushes the HELP button a final time, the answer is provided so that he is not blocked from proceeding along the original lesson sequence.

In going through a HELP sequence, if a student suddenly realizes the answer to the original question, he does not have to continue to the bitter end. Instead he says to himself "AHA—I've got it." So an AHA button is provided, and pushing this returns him to the original problem.

The primary sequence is adjusted for the brighter students who can

go zip-zip-zip along with little need for assistance or delay. On the other hand, the slower student gets the individual help he needs. Hence, the PLATO system can teach students with different levels of ability. Perhaps PLATO comes the closest of any method yet attainable to President Garfield's definition of the ideal educational system as "Mark Hopkins on one end of a log and a student on the other."

While the tutorial logic serves well for many purposes, there are types of problems in which even more control should be given to the student, as well as an opportunity to ask questions of the computer. To accomplish this, the "inquiry" teaching logics were developed.

An inquiry teaching logic permits a student to request information. The computer interprets the request and replies from stored information or calculated results. The student directs his learning by composing his own requests.

Many variations on this classification scheme are possible. Figure 7 shows how a student might have set up two experiments in a simulated laboratory to determine the specific gravity of several bodies of pure material and then determine the mix in a crown made up of alloyed material. He would do this by measuring the volume and weight of specific objects. He is given a choice as to the measurements to be made. The properties about which information can be obtained are the weight and overflow volume of the objects listed. The conditions available are the liquids in which a selected object is immersed. Figure 7 also illustrates the use of both graphical and numerical display of results.

Of course, PLATO would not be practical if each student required his own general purpose computer. But modern computers operate so quickly that it is feasible for them to switch from one student to another, process the information, control the display, and move on to the next station. Figure 8 illustrates symbolically how this can be done. Figure 9 shows our present classroom with twenty stations. Computation shows that a modern general purpose computer could simultaneously handle three to five thousand students on a number of different lesson plans without any one being aware that he did not have exclusive use of the computer. When a large number of different questions arrive simultaneously, PLATO gives the first word of each question's answer to each questioner; then it gives the second word to each questioner; then the third, and so on, so that no one of the students senses a time delay.

We have conducted experimental classes in such subjects as elementary arithmetic, high school algebra, French, electrical circuit theory, library usage, electromagnetic field theory, and nursing, and found them all

effective. The students learn as well or better than in the corresponding "control" classes in the same subjects. The preparation of a program requires more time for a teacher than a class, but a program once prepared is useful for many times with minor modifications as experience develops.

If you will recall the previous list of functions involved in teaching, you will observe that the PLATO system performs all those listed except Function 3: "Assessing the relevance of the knowledge—discarding the trivial and retaining the important, and arranging in a proper sequential form for presentation to students." This is still the task of the teacher who writes the programs. Furthermore it must be agreed that there still remain tasks for the imaginative and understanding teacher which the computer cannot take over. As someone has said, "Teachers who worry about being displaced by a computer—should worry."

Until this year the principal problem of expansion has been the cost of the individual stations. A storage tube and digital to analog conversion was needed at a cost of about \$5,000 per terminal. However, a new flat panel graphical display which is digitally addressed has been developed. This display also provides its own memory and should reduce the cost to about \$500 per terminal. Plots and printing on this tube can be handled in audio bands, so with local slide projectors it makes possible the use of terminals remote from the central computer and connected only by standard telephone lines. The incorporation of the new displays in inexpensive terminals will pave the way for the production of large-scale, highly flexible systems which can be placed in classrooms, dormitories, and homes, for education, information retrieval, and a variety of other computer-based activities.

We have always conducted our research and development work on PLATO with one central thought in mind, a thought that has been very well expressed by Llewellyn Thomas in his article *Human Factors in Design*: "Man is one of the best general-purpose computers available and if one designs for man as a moron, one ends up with a system that requires a genius to maintain it. Thus we are not suggesting that we take man out of the system, but we are suggesting that he be properly employed in terms of both his abilities and limitations."

Because at Illinois we have few morons for students and even fewer geniuses for instructors, we have not built the sort of machine Mr. Thomas deplors. Nor have we taken the man out of the system; we have simply provided him with an electronic tool to facilitate his difficult task of imparting knowledge to others.

1, 2

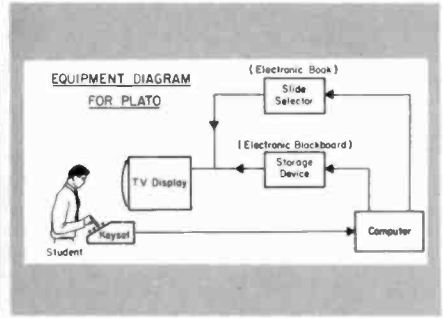
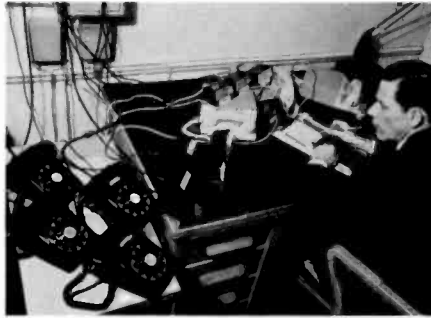

3, 4

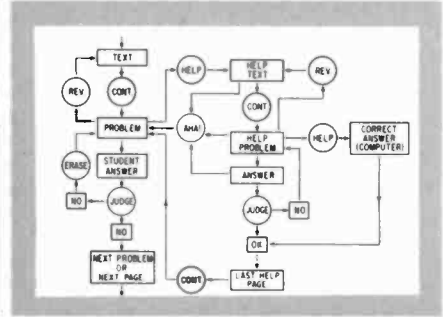

5, 6

QUESTION: GIVE THE POSITIVE,
NON-TRIVIAL DIVISORS OF 51
IN INCREASING ORDER.

$d_1 =$
 $d_2 =$

QUESTION: GIVE THE POSITIVE,
NON-TRIVIAL DIVISORS OF 51
IN INCREASING ORDER.

$d_1 =$ OK
 $d_2 =$ NO

8, 9

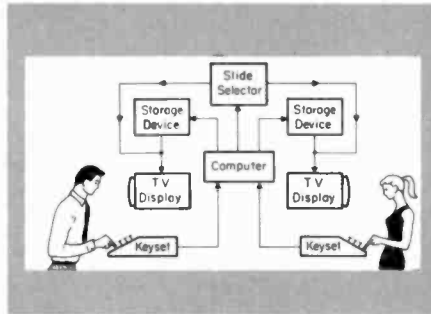

(46)

Figure 1. Faculty Station at the University of Illinois originating instruction by Electro-Writer
 Figure 2. PLATO System Diagram
 Figure 3. A PLATO Student Station
 Figure 4. Tutorial Logic for PLATO
 Figure 5. Typical question in Number Theory
 Figure 6. Possible response of student to question of Figure 5
 Figure 8. Multiple use of computer by PLATO
 Figure 9. PLATO Classroom at University of Illinois

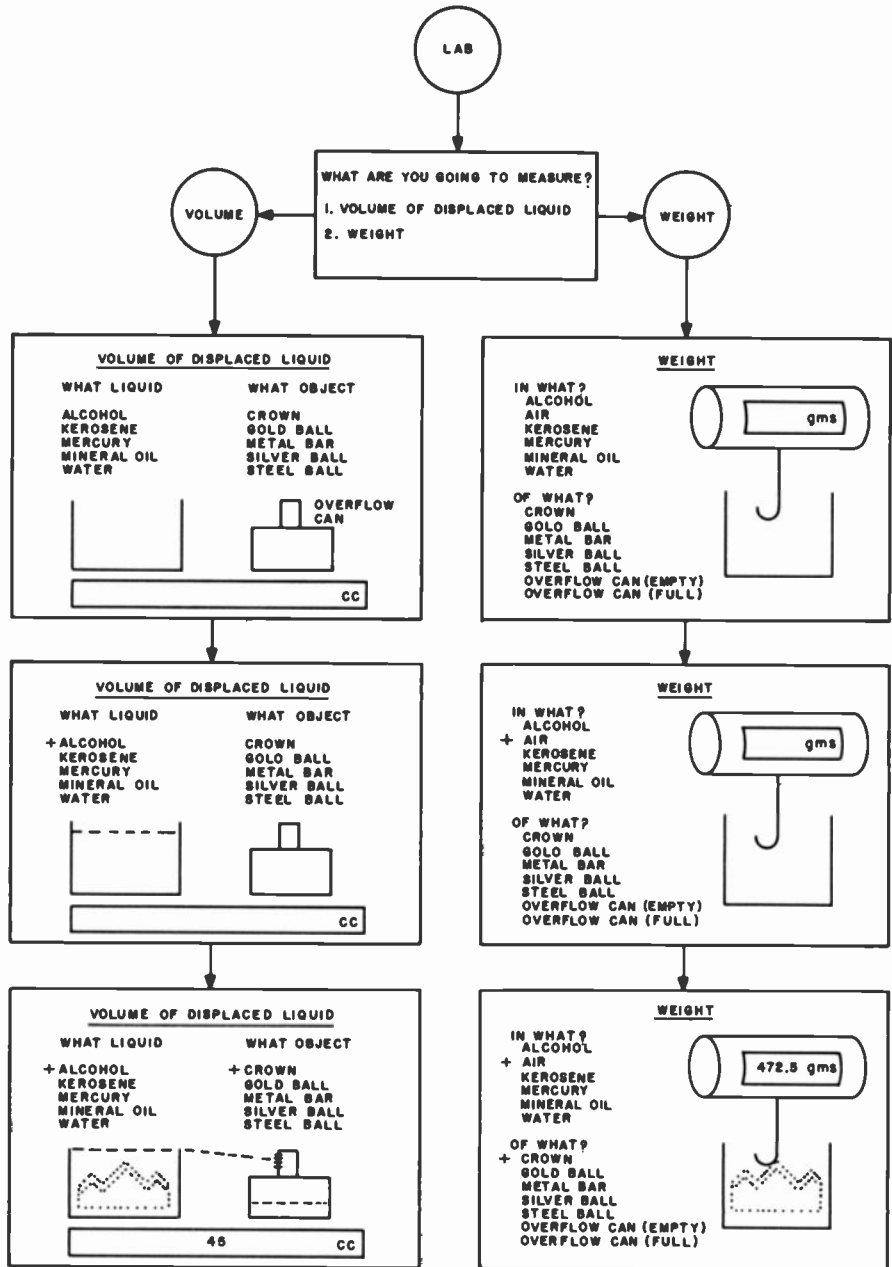

(47)

Figure 7. Example of PLATO Inquiry Logic

information systems for management

HERBERT A. SIMON

The first thing I would like to say this afternoon is a loud "amen" to both of the previous speakers; to Dr. Bronk for his vivid description of the role that electronics has already played and is playing in the life sciences, and to Dean Everitt for his equally vivid description of the role that electronics is just beginning to play in the educational venture. If these new developments succeed in their promise, as I am sure they will, it is soon not going to be true, as it has been in the past, that a university is an institution where amateurs educate professionals. Because we are going to learn something about the nature of the learning process, the educational process, that is going to allow us to design educational experiences in terms of our new understanding of those processes.

This is essentially the story I want to tell too, but as it applies not to the educational venture but to the process of management. Perhaps that is an educational venture too. It has some of the same peculiar qualities.

I would like to underscore also Dean Everitt's remarks about the significance of the new kinds of information processing devices that we have available to us now and, even more important, the new insights and understanding that we have of information processing. If we go through the familiar stages in the history of man's relation to energy, the early stage in which man used his hands and feet to do things he had to do, then the stage of tools where he found that he could get mechanical advantage by extending his arms in a variety of ways, we could say, looking at those developments, that power machinery—the steam engine and all that came with it—was just an extension of man's tool behavior. That, of course, would be an understatement and an underestimate of what the introduction of mechanical power meant to our society and meant to our world. If this was an extension of tool behavior, it was of such magnitude that it made a qualitative difference.

We can say the same thing about the other aspect of man's relation to nature—the way in which he used information as well as energy to accomplish his purposes. There was a great invention a long time ago. We don't know how long ago, because before the invention was made, people were not talking about it very much. I mean the invention of language. And then in a time that we do know a little about—a much later time—there was an invention of the first tool of information processing beyond language;

(48)



HERBERT A. SIMON

Professor of Computer Sciences and Psychology,
Carnegie-Mellon University

Herbert A. Simon is Richard King Mellon Professor of Computer Sciences and Psychology and Associate Dean of the Graduate School of Industrial Administration, Carnegie-Mellon University. After his doctorate at the University of Chicago, his work has been recognized by honorary degrees from Yale University, Case Institute of Technology and Chicago. He has served as consultant to government and business organizations, has been Chairman of the Board of Directors of the Social Science Research Council, is a member of the National Academy of Sciences and is Chairman-Designate of the Behavioral Sciences Division, National Research Council. His books on organizations and administration include *Administrative Behavior*, *Organizations*, and *The Shape of Automation*. During the past ten years he has been studying decision-making processes, using computers to simulate human thinking.

namely, ways of storing information, of writing down on a clay tablet the numbers that represented the debts that somebody owed you, so that, if he did not remember those debts, you could remind him or convince him that you had the right numbers.

Then many thousands of years after that, man succeeded in finding another information-processing tool that has also been alluded to today; namely, a tool for producing as many copies as he wanted of anything he had stored in mechanical memory by the process of printing.

With all of these developments and even with the important developments in electricity that began a century or so ago, the range of information processes that man had succeeded in mechanizing still fell very far short of the processes he needed to carry on all of his business of handling and using information. Even with writing and with printing, all he could do mechanically with information was to store it and to copy it. The telephone and the telegraph allowed him to transmit a copy to great distances, and removed the restriction that the information first had to be reduced to the form of written language. The telephone and the movies first made the information-processing technology, or an important part of it, available to the illiterate. None of these devices, however—the telephone, the telegraph, the movies, the radio, or the TV—still came close to spanning the whole scope of things that the human being does with symbols inside of his head—the whole range of things we call “human thinking.”

The first mechanized general information processors were the computers that came into our world 20 years ago. (They might have come into our world a hundred years ago if Babbage had been a little luckier with his technology and had had the vacuum tube.) When we estimate the present and the prospective significance of this new information-processing technology, we have to take the same standpoint that we took about the introduction of the steam engine. If the computer is simply an extension of the same things, simply a new tool, still it is an extension of such magnitude that it makes a qualitative difference.

Many of us believe that the computer has such a wide range of information-processing capabilities that the simplest way to describe it is to say that a computer is capable of thinking. I know there are many who do not particularly like that way of talking about computers. They point out that, after all, computers only do very simple things like reading symbols, writing symbols, storing symbols, copying symbols, transmitting symbols from one location to another, comparing symbols to see whether they are the same or different, and branching conditionally—that is doing one thing if certain symbols are found to be the same and doing another thing if

those symbols are found to be different. They point out that this is all computers do, and furthermore, that computers do it under the control of a program. That is perfectly true.

It is equally true, and has been demonstrated, that a wide range of activities, which were traditionally called "thinking activities" when carried out by human beings, require no more than this. Here we have a sufficiency proof: if we take activities that human beings did traditionally—activities where a human being was alleged to be thinking while he did them—if we can show that a system having only those information-processing capabilities which I mentioned can carry out those activities, then maybe a shorthand way of talking about such a system is to say that it can think.

I just remind you of some of the examples. Computers have been programmed to discover proofs for theorems in a variety of areas of mathematics and logic. Computers have been programmed to play chess, and although their chess playing has not been spectacular, one of them is now, I believe, a class C player in the American Chess Federation system of rating. Computers have been programmed to make investment decisions. I found in this Sunday's *Times* the following ad: "Now, computer analysis of any 3 stocks you choose. Because this is no time to guess which securities are today's best investment, the predictor makes this unprecedented offer: it will analyze and evaluate any 3 listed stocks of your choice with an IBM 360 computer. You'll receive the actual computer printout showing how the computer ranks your stocks considering technical action and all vital fundamental data and *in computerized buy, hold, sell, or sell short advice on each security.*"

I have not subscribed to that service, and I do not know whether it will make you all rich. I am not really advertising it here, but I want to observe that whether this particular advice is good or bad it is perfectly possible today—indeed verges on the trivial—to program computers, taking account of wide ranges of information of the sorts that professional financial analysts take account of, to arrive at decisions about such matters. There are a large number of professional activities (by professional activities, I mean activities which, up to the present time, were thought to be appropriate activities for professionally trained persons) that now can be performed by computer programs, and Dean Everitt alluded to some of these in the area of engineering design.

The existence of machines for generating, recording, interpreting, applying information—of machines that think (to use the shorthand that I like)—changes radically the potentialities for the design of information

systems, including management information systems. (And, as evidenced by Dean Everitt's talk, also for the design of universities as effective learning and teaching engines, shall we call them?)

If we look at the way in which we went about the design of those information systems we call businesses—business managements—in the oral stage of information processing, we see first of all that all of the active processing was done by people, all of the processing except possibly storing information or producing copies of information that had already been generated. Moreover, and most important, we had in the past no detailed knowledge of how people processed information, how thinking was done. So if we wanted to build an effective information-processing system, a business corporation, the main techniques we had available for its design were techniques for selecting people on the basis of past experience with the efficacy of their information processing. We could train people in a kind of shotgun, broadcast way that we have used in educational institutions in all of these years—that is, we expose them to problems and situations and hope that there was something infectious about them. But we could not analyze or design in detail the specific processes that were going on in people when they were performing professional management or, for that matter, professional engineering functions. By and large, the relevant knowledge for performing these tasks was mostly available only in the heads where it was stored.

It is true that we live in a society where there are lots of books, and where books are easily available. But I think any individual or any organization that has tried to get into a new technology simply from the written and printed literature, and without access to the knowledge stored in the human minds of those who have developed that technology and are skilled in it, realizes how little of the important and critical world's knowledge really can be found in books, and how much of it is still stored in individual heads in forms that human beings find very difficult to transfer to other heads.

We in the schools work at this transfer business with our students for twenty-four years—or however many it takes them now to get out of the educational system. In that time we succeed in transferring, we hope, and they succeed in acquiring, they hope, some very tiny fraction of the knowledge and particularly of the know-how that is stored in the human heads.

The stage at which we are just arriving in the design and operation of the information-processing systems we call "business managements," this third stage incorporating in it computers—machines that think—is radically different from the earlier stages in two ways. One way is obvious

and one is maybe a little less obvious, but perhaps the more important of the two. The more obvious one is that the boundary between the human and the mechanical, or nonhuman, information processing, is shifted and is going to be shifted as radically by the computer as the boundary between human and mechanical energy was shifted by the steam engine. I do not talk about human beings taken out of the system, any more than Dean Everitt was talking about human beings being taken out of the educational system. But I think we must re-examine every one of our assumptions, as computer systems increase in their flexibility and power, about the appropriate division of labor between the human components in the system and the mechanical components.

Given their underlying general purpose capabilities, the mechanized parts of the system are increasingly going to be technologically capable of doing more and more of the tasks that are now performed by human beings. Some of us again—the “radicals” if you like—think that in time they are going to be technologically capable of performing *any* of the functions of the system that human beings can perform. I do not need to emphasize in the bosom of a business corporation the difference between technological capability and economic feasibility—such questions as whether a teaching-machine design costs \$500, or \$5,000, or \$50 for each student console. Similarly, the questions in the design of business organizations and the design of the relation between the executive roles and the computer roles in business organizations are going to be less and less questions of what you can tease a computer into doing. (More and more you can tease it into doing most anything you have patience to tease it into doing.) The questions will be, “What are the parts of this total task in which computers have a comparative advantage, what are the things they are relatively especially good at, and what are the parts of the task in which man has the advantage?” For quite a long time in our society, there is going to be plenty of work for both.

The second and perhaps less obvious consequence of the computers we are getting, and also of the knowledge that has made those computers possible, is that the detailed nature of information processing, both by computer and by man, is becoming increasingly better understood. We have today at least large segments of an information-processing theory of thinking that tells us what a man does while he is thinking; what his elementary processes are, and how they are organized. We do not yet have this knowledge at a neurological level. We are no closer to a neurological understanding of thinking today, at least of the complex organization of thinking, than 19th-Century chemists were to a quantum theoretic ex-

planation of chemical reactions. I am talking rather of an increasing understanding of what goes on step by step, 100 milliseconds by 100 milliseconds, in a human being who is solving a problem and who is making a decision.

In a management system today, and probably indefinitely into the future, the largest part of the cost of the system is the cost of its human components; we pay \$8 for salary and wages for every \$2 we pay for equipment, or some ratio not too far from that. The largest productive resource we have in an economic system and particularly in its executive portions is the human part. It follows from this that an understanding of how human beings do their work—of how human beings solve problems, think, and make decisions—can lead to improvements in those processes and increases in the effectiveness of managements considerably larger than anything we can reasonably hope to achieve simply by automating with computers certain parts of the process. From many standpoints, the most exciting prospect ahead of us is not the prospect of having more computers in the business office (every man with a console in his office—although that may come too!), but that we will have a sufficiently deep understanding of what the executive process is all about to begin to do it right or at least half-way right.

In a sense, the title of my remarks today (although it is a title I selected), "Information Systems for Management," is a misnomer. It should be "The Design of Information Systems to Include Managers." Talking about information systems for management is horseless-carriage thinking. The recipe in the early days for making an automobile was to take a carriage, unhitch the horse and add a motor. With the small amount of experience we have had up to the present time with the computer, with our limited understanding of information processing, our recipe for making a modern organization is to take an old-fashioned one, remove the accountants from their high stools, and move in a computer. That may be the only way that we can go from the past into the present and the future. It certainly was the only way in which we created the automobile as we know it today. (When I think of the automobile, I'm reminded a little bit about Sorcerer's Apprentices that were mentioned earlier this afternoon. In some respects, the automobile has become one, and it is up to our skills, our understanding, our knowledge, to see that the computer does not.)

Perhaps the only way in which we can go from an era of carriages to an era of automobiles is to go through the horseless carriage stage; to think of automobiles in carriage terms, until we have had enough exposure to them and enough experience with them so that we can think of them in

more imaginative terms. And, likewise, perhaps the only way in which we will learn how to exploit our new understanding of information processing in business organizations is to go through a period in which we take accountants off stools and substitute computers for them in the office. This has at least the advantage, and I have seen that advantage very vividly in the university, of putting the computer where people can see it, where they can touch it, and more important, where it can react to them and by exposure begin to acquaint them with the real nature of the information-processing revolution it is producing. The computer, fortunately, is a device that is luxurious in its feedback. If you use even a modicum of sophistication in dealing with it, it tells you all about itself—often things you did not want to know about its innards.

Perhaps the stage that we are going through now, where large numbers of businesses and the executives in them are gradually getting exposed to computers simply by having them around doing all kinds of horseless-carriage things, is an essential stage in our education about them. It certainly is not predictive of the role that they are going to play in business organizations in the future. It is not a description of the way in which we are going to go about designing business organizations in the future.

Well, how are we? Now the clouds begin to gather over my crystal ball! The things I have been saying so far are largely descriptive of what has already happened and what is happening in the world today. The first requisite for the design of an organization is that the information system for management be not applied simply as a veneer over an existing organization. As we become sophisticated about information processing, we come to recognize that an organization is nothing but an information system; that an executive is a person who has certain symbols stored in his head, which we hope are sometimes informative, and who is capable under certain circumstances of producing those symbols orally or in writing, is capable of acquiring new symbols through oral and written communication, is capable of processing symbols that he is acquiring, producing appropriate indexes for them so that he can retrieve them at appropriate times, and so on—in short, that an executive in an organization built of executives is a huge information-processing system that can be described and analyzed and thought about in information-processing terms. Executives talk, they listen, they read, they write, they think, they decide, occasionally they smile. So they are at least information processors.

Here I have to turn to another *New York Times* ad. (I do not know why I find the ads so fascinating, sometimes more than the news stories.) It is

an indication of the new kind of language we are beginning to use, which I think is more than faddish. I think it reflects our new way of beginning to look at ourselves. Here is a large ad with a rather dramatic looking, space-type, handsome fellow in it, and above him it says "Man—Built-in Recovery System." I will not read you the whole text that goes with that, but just a sentence or two. "The presence of man aboard makes possible his bonus use as a recovery system for the expensive guidance and navigation equipment. His inherent bring-back ability makes it possible to expend cheaper and less sophisticated weapons at the targets."

I confess to feeling a certain discomfort at reading that prose, a discomfort that lots of people in our society feel, because I think we are prepared to resist the idea that human beings are, or are to be regarded as, nothing more than information processors. I am not saying that, or implying that we ought to say that. But we are beginning to think of human beings as information processors at least, and when we design complicated man-machine systems today, whether to go into space or to manage corporations, we do think of the human components in those systems in part in terms of particular kinds of information-processing functions, in terms of certain information-processing capabilities. We can say with a straight face in designing such systems, "Man—Built-in Recovery System," because that does describe one of the functions that has been built into the design for the human component of the system.

That leads to a corollary: if information systems are not to be designed simply as veneers on organizations, the human and computer components have to be designed in relation to each other. We cannot write the computer program to tell us what reports should come to the manager until we have written a scenario for the manager to tell what he ought to be doing about reports or whether he ought to be doing anything about reports, or whether, in fact, he ought to be getting reports at all.

Further, if we are to have organizational systems in which both the human components and the mechanized components have quite general purpose capabilities as they both now do have, then the efficiency of such systems will hinge in an important way on the ability of the human components and the computer components to communicate with each other in easy, flexible, and informal ways. It will simply become intolerable sooner or later for a programmer to stand between the executive and the computer. The executive must be able to talk to the computer, and the computer must be able to talk to the executive. This is already coming about on a large scale in engineering applications of computers under labels like "Computer-Aided Design." It is also just beginning to come

about in executive systems that allow executives, at least in limited ways, to begin to interrogate a mechanized information system in a language that is not too far from his native English or some dialect of that native English. Clearly, this development has been going on very rapidly in the past ten years, and it's going to go equally rapidly and much further in the next five or ten.

The allocation of functions, then, must be re-examined in terms of the basic functional characteristics of computer and executive. We have to ask the question, "Who is providing the information to whom?" We usually think of the computerized or mechanized part of an information system as a big store, a big memory bank, preferably a reasonably well-indexed memory bank so that an ingenious person can interrogate it and extract information from it. Maybe that is what information systems will mostly continue to be for quite a while, but we have to open up our minds to other possibilities. We have to consider the possibilities that in designing a management information system, some parts of it may consist of mechanized components whose task it is to retrieve information from human memories; where the human being will be the storage device and the computer will be the program that, by appropriate interrogation (hopefully the man will be properly indexed so that he will not say, "His name began with an 'S', but I don't remember exactly what it was"), will be able to extract information from him.

At least in very limited realms, that idea is already within the scope of technology. There are already devices that allow a human being to go through a series of movements or processes, allow those movements and processes to be recorded, to be transformed into a program which then can be executed by machine. This is a way of transferring from human memory into other forms certain contents of memory which in the past have been very difficult to communicate by verbal means. One might think of new forms of golf coaching in which instead of sage verbal comments from the coach or even demonstrations of swings, we will simply have an excellent golfer, by going through what he does, produce an output which then can become in one way or another an input to our program for that swing, and we will all become perfect golfers over night—which, of course, will spoil the game for recreational purposes!

What is going to be the task of executives in this kind of world? Increasingly, the task of executives will be, first, to understand and to be able to design their own information processing behavior. It is going to be increasingly unpopular, or inadmissible, to claim skills of intuition, judgment, or experience without being able to describe the programs that

account for those skills. It will become increasingly necessary for a man with judgement to be able to describe what the decision making program is that he applies when he is exercising his judgement. The means for doing this are becoming rapidly available to us, because we have succeeded within the past decade in writing computer programs, for example, that capture the judgement (maybe rather low-level judgement in this instance) of engineers in routine design of electric motors, transformers or what have you.

In the areas where we have done this, designing the individual device is no longer a major responsibility of the engineer. The responsibility of the professional engineer shifts more and more to responsibility for understanding and creating design processes which will, largely or totally, be executed by electronic devices unaided by human hands. The engineer in these applications has been moved one step back from the design process into the design of the design process, or into the underlying research to establish the numerical parameters and constants required in the design process, and to improve those constants. Almost anyone in this room can, after a few moments' thought, point to examples of exactly this kind of development within the walls of your own corporation.

We can take this as at least a very crude or rough model of the changing role of executives in business organizations. Hans, with his finger in the dike, is no longer an acceptable model of an executive. Somebody should have thought about preventive maintenance, and plugged the holes before the flood came along. But we have to go a lot further than taking our fingers out of the dike. The executive is going to be involved less and less in the minute-to-minute, the hour-to-hour, or even the day-to-day operation of the organization. He is going to be involved more and more in designing a system of effective information processes for carrying out the work of that organization, automating much of it, and improving that design from year to year.

In the generations ahead, we can anticipate that the information-processing systems we call "organizations" are going to be designed as carefully and technically as chemical processing plants and steel mills are designed today. I could cite illustrations of the difference between the level of technology and design we accept in the steel mill and in chemical processing today and the level of sophistication we accept in the design of executive behavior.

Let me cite just one example. The scarcest resource that an executive has is his time or attention. One of the things we have learned about human beings is they are basically serial devices, one-thing-at-a-time de-

VICES. I do not want to get into a detailed debate of serial versus parallel, because things serial at the millisecond level can be parallel at the one-second level by time sharing and the like, but in some relevant sense, human beings have a very limited capability for doing a variety of things at the same time. For this reason, the most valuable resource is the ability to allocate that time to one thing or another.

Let us then ask, in corporations today, "Who designs the priority system for answering long-distance phone calls?" Who sits down and, looking at himself as an information-processing system, says to himself, "To what extent, under what circumstances, and in what way should I allow my attention to be directed to certain matters and away from other matters by the fact that someone else in another city has decided to place a phone call to me?" That may seem a very simple example, and maybe you are one of those rare executives who has a very carefully thought-out long-distance call policy, and who has looked at all the consequences of his responses to stimuli and cues in the environment. If you have done this, and you have in your desk a program that you use to regulate your allocation of attention, then I am wasting your time and mine talking to you. But in going around corporations today, I do not see executives thinking about such matters in the same systematic ways they would use to design a new computer system for time sharing, let's say. I do not see this kind of systematic thinking going into such topics as executive attention, and I think it will have to begin.

So in this world ahead, we are going to design organizations with a thoughtfulness and a deliberateness and a self-consciousness we never have applied before—which we never could apply before, because we did not understand the underlying processes, we did not understand what was going on in a man's head when he was paying attention or exercising judgement. Participating in such design activities will be a major executive responsibility. Successful executives will increasingly understand their own thinking processes and will be able to employ them effectively as parts of a larger management information system.

symposium II frontiers of research

JAMES HILLIER

I now call to order the second session of our 25th Anniversary Symposium. Yesterday we peeked over some of the horizons that electronics will open up for us. We saw how electronics will serve mankind in just three different disciplines. Today, we change our vantage point slightly but significantly. We shall be still looking forward, but we shall be looking more *within* our own discipline. We shall try to see the trends of our sciences and the "building blocks" with which we shall be working as we attempt to implement the electronic services of the future.

To lead us into this hazy crystal ball, we have assembled a blue ribbon panel. All of this afternoon's speakers can truly be said to need no introduction. . . . In this respect, my role as chairman will be an easy one.

Our first speaker, who is a man of great influence in scientific matters in France, is really here because of a long-standing friendship with these Laboratories, and because of the profound influence he had on our program in those in-between years when we were making the transition from electrons in a vacuum to electrons in solids. Professor Pierre Aigrain is going to discuss "Frontiers in Solid-State Physics: Far-Off-Equilibrium Phenomena."

The invention of the transistor and the resulting increase in solid-state research was a revolutionary turning point in the electronics industry. It is only *partly* coincidental that our second speaker comes from the laboratory where the transistor originated. As the solid-state revolution has become ramified, we in electronics have recognized that the effects on our industry have been much more profound than the simple replacement of one device for another.

Chemistry, in all its different aspects, has, as a result, become a most important component of our research, our engineering, and our production. It is very appropriate to have Dr. William O. Baker, Vice-President, Research, Bell Telephone Laboratories, to talk to us on "Chemistry and Electronics: The Material and the Medium."

As you have looked at your program, I am sure some have wondered what human behavior has to do with electronics. (I could give an easy answer, as Manager of these Laboratories.)

But, that is not the point here. We, in research, have recognized that RCA is not in the home entertainment business only—it is not in the more

general communications business only . . . rather it is in the business of handling information . . . of which, the others are sub-divisions. Now, it is one thing to handle information—technically—electronically. It is still another to give the handling of information relevance in a human framework. In the future, as computers and communications systems become capable of handling more and more complex problems—even ambiguous problems, the significance of those systems to us will become very dependent on our understanding the other half of the total system . . . the human mind. I can think of no one more appropriate to discuss the future in the science of human behavior than Dr. B. F. Skinner, Professor of Psychology at Harvard University.

frontiers in solid-state physics— far-off equilibrium phenomena

by **PIERRE AIGRAIN**

When I was asked to deliver a lecture on the "Frontiers of Research in the Field of Solid-State Physics," it started me thinking about whether there could be any such things as frontiers of research, or whether there could be any such thing as research which was not a frontier. It is quite obvious that in any field what is research is precisely this borderline, this frontier between what is known and what is not yet known or understood. So all of research is on a frontier.

Still, in choosing the title for these second day's lectures, it is obvious that the organizers of this symposium implied—and I think they are right—that to somebody who is engaged in research, there are some fields which, in some sense, are possibly more of the frontier type than others. The other two speakers, who are going to speak to you about fields which the electronics specialists have not sufficiently known and appreciated up to now, are going to illustrate one of the ways in which research can be a frontier for somebody, that is a search for the unknown.

Let us refer to Figure 1. "A" is a field which is known, and "B" is one that is unknown, and the boundary line is the frontier of research advancing in the areas where all the people in this laboratory are collaborating. But this is an electronics laboratory and does not cover all the fields of science, only part of the front. The problem which arises is that it is obvious that you have to be interested in, at least, the neighboring sectors. Some are of great importance for electronics because, as in the field of, say, psychological sciences, they involve what electronics is supposed to serve . . . that is, the mind of man . . . or, as in the chemical sciences, they involve what are the building blocks of any electronic device, namely materials and compounds.

I have the hard task to speak about a field which is in part "C" of the diagram, the one which most people in the laboratory know very well, in which they feel that they have completely plotted the frontier, the border between known and unknown, and where I cannot possibly tell them anything brand new. Still, I thought it might be worth doing it, especially for the field of solid-state physics.

Solid-state physics has been probably the most important branch of physics for the electronics industry during the last twenty years. It can be said that the electronics industry was first the application industry for the

(61)



PIERRE AIGRAIN

Director of Higher Education, France
Professor of Physics, École Normale Supérieure

Pierre Aigrain, Director of Higher Education of the Ministry of National Education, Paris, France, and Professor of Physics at the École Normale Supérieure, served in the French Navy which sponsored his doctoral work at the Carnegie Institute of Technology from 1945 to 1948. He then earned another doctoral degree at the University of Paris in 1950. Although he is best known for his research in solid-state physics, he has contributed widely in many other areas of science. He was one of the youngest men ever to be appointed a Professor at any major French university, and he has taught at Lille, M.I.T., and the University of Brussels. He was Scientific Director of the Defense Ministry (Paris). His honors include the Ancel Prize, the Blondel Medal, Fellow IEEE, Honorary Member of the American Academy of Arts and Sciences and Chevalier of the Legion of Honor.

vacuum tube and the behavior of electrons in a vacuum, and then, for the last twenty years, that it has been the application industry for the behavior of electrons and other excitations in solids.

It can be said so, because we do not hesitate to abuse language. One of the speakers yesterday gave by far the best definition of electronics I have ever heard, but I am not sure it is wide enough. I believe that the only definition which really covers "electronics" nowadays is, "Electronics is what electronic-oriented companies or electronic-oriented departments in universities do better than others!" So, anything which an electronics-based company does becomes "electronics." The reason why solid-state physics has been so useful to electronics is that solid-state physicists have also learned that trick, and as soon as the field becomes interesting, they call it "solid-state physics." That way they are pretty sure that they can stay in the running.

But in spite of that, I have noticed in many of the people involved in research in solid-state physics during these last few years a feeling of some weariness after a time. They remember fondly—but I think one always remembers pleasant things better—that it was a good time 15 or 20 years ago, just after the discovery of minority carrier injections in semiconductors which was really the start of the application of solid-state devices to electronics. It was a good time, when any experiment always led to new results, when you always found in these new results that all had device possibilities; it was an easy life. All you had to do was think up something, and you made a discovery. This is not true any more.

I do not believe their memories are quite accurate. I think these people have not remembered how many experiments their predecessors or they themselves fumbled badly 15 years ago. They remember only the good ones and feel that it was an easier life and a more exciting one.

Three years ago at the semiconductor conference in Paris I said, "The field is obviously changing. We used to have a semiconductor physics (which is a part of solid-state physics), which was brand new and exciting. It is now getting more sophisticated." And I made an unhappy comparison. I said, "Well, it's just like Marilyn Monroe. In her first movie she was really exciting. In her latest movie, she became more sophisticated. Was she less exciting?" And when I came out, somebody told me, "Yes." Unfortunately, that does not give us much confidence about how solid-state physics is going to end!

I could have taken a better example. The field is becoming more sophisticated, that is true, but I believe that it is not in the bad situation it could be in, namely, on frontier "D" of the diagram. It could have been that there was an island of unknownness here which had not yet been

discovered and that the solid-state physicist would just be trying to reduce this enemy pocket within the territory already gained. And in that case, it is true, there would be some doubts about the future of solid-state physics and its application to electronics. It could become a classical field. Unfortunately, "classical" in matters of research often has a very academic meaning, and "academic" is not here taken in the best sense of the word. I do not believe this is the case, and this is what I want to tell you today.

I believe, on the contrary, that we have only skimmed—hardly scratched—the surface of the branch of solid-state phenomena which can be interesting and which can have device application. I believe the reason we have only touched it is because, in many ways, our methods of analysis of problems have not yet gone far enough, and that we may have, in the field of solid-state physics, a little fundamental re-thinking of some very basic physical problems to carry out so we can take the next steps. I say "next steps" because there are many directions in which solid-state physics could develop, and it is even possible that some of these directions may lead to new devices. Of course, I imagine the leaders of industrial laboratories hope that at least some of the research done in their laboratories may have device applications.

I would just like to select one of these fields, namely, the study of solid-state physics phenomena which involve large deviations from equilibrium. Such phenomena have been studied already in solid-state physics, and I will give just one example which is in everybody's mind, namely, the Gunn effect. It is a typical phenomenon which involves the behavior of the solid in conditions which are very far off the thermal equilibrium of carriers in a semiconductor. Although other phenomena of the same kind have been studied, they have not been quite as successful in the way of devices. However, I would like to remind you of the very brilliant work which was done here in this laboratory by Steele and Glicksman and Larrabee on oscillistor phenomena. Also, of some interesting proposals, which did not happen to lead to practical experiments, of Kroemer and Dousmanis on the possibility of achieving active devices by applying large fields in one direction and getting negative resistance in a perpendicular direction.

So, some experiments have been tried, but the very strange thing is that, in most cases, the discoveries in this field have been accidental. It is certainly true that the Gunn effect was an accidental discovery, wonderfully understood and exploited by its author, but it was accidental. Gunn was not looking for anything like the Gunn effect when he tried the experiment.

It is certainly true that the first experiment leading to so-called oscillator phenomena in the U.S.S.R. was done with a completely different purpose in mind. It was a study of hot electrons but without any device purpose. Most probably the discovery of something like an oscillation of current was felt by the physicist as an insult. It proves that an experiment which really brings something new into the knowledge is usually an experiment which does not give the result you expected. An experiment which gives the result you expect confirms what you already knew. An experiment which does not go right is the one which really leads to new knowledge.

One day I was speaking to a group of young engineers about research and how exciting life in research was, and one of them asked me this question: "How do you feel when you make a discovery?" I had to answer, "Intensely annoyed." Because when you make a discovery, usually it is because something has not been going exactly the way you planned, and you only realize it was a discovery some time later, sometimes very much later. I believe that any scientist can remember the time he made a discovery and, at the moment, he was very annoyed and wondering whether he really had something new or whether, much more probably, he had forgotten to plug in the equipment, or part of the equipment.

Most of these phenomena involving large deviations from equilibrium have been found experimentally by people who looked for something else. And most of those people who have tried to design an experiment in this field have not succeeded. I know certainly that most of the experiments we have designed in the field have given results which were completely unexpected, but not always completely unsuccessful. Sometimes they were the beginning of something else, but never of what we expected. And to take again a case inside RCA Laboratories, the Kroemer and Dousmanis proposal, for example, which was a very interesting one, did not lead to the expected result. All this is too bad, because really what we have found useful in devices is only a very small part of the properties of semiconductors.

(64)

A semiconductor is used in electron devices as a substitute for the vacuum of the vacuum tube. But it has a great advantage over vacuum, and this great advantage, besides the fact that it does not need to be enclosed in a glass bulb, is that the vacuum is a vacuum, and it always has the same properties, and there is nothing you can do about it.

In a semiconductor, by proper choice of doping levels and things of that kind, you can manage to change the properties of those particles you are going to use in it. For example, if you cannot build a vacuum

transistor, it is not because there is an intrinsic difference between a vacuum and a semiconductor, it is because the energy gap of a vacuum is, as Einstein showed, $2 mc^2$. That is approximately 1 mega-electron-volt, and that is a little high for operating any device comfortably close to room temperature. So what do we do? Well, we use various substances and we bring this to 1 electron-volt, $40 \times kT$, at room temperature and that is all right. You can start doing things.

In the same way, you cannot do anything about the electron mass in a vacuum, but you can do something about the electron mass in a semiconductor. You can, for example, reduce the effective mass, as you know, by a factor of a hundred and, as a result, achieve some behavior which is, in many cases, useful. But when we speak about electron mass, about gap and so on, we realize that we are describing the states of a semiconductor which are very close to the conduction band, or very close to the valence band. These states can be described with an extremely small number of parameters.

A few years ago, I supervised the establishment of a small table of semiconductor properties, and it was, in fact, a very, very small table, even though we looked at 15,000 different publications to get the numbers which are in it, and which are, by the way, all obsolete by now. But even though we looked at 15,000 publications, it turns out that the basic properties of a semiconductor which we make use of in present-day devices are very few. These are the band gap, the curvature of the bands very close (within one or two kT of energy) to the band edges, and possibly the interaction of the electrons and holes with light.

Probably you can describe a semiconductor for all practical purposes—for engineering use—by less than ten important parameters. That is all you have to know. But that also means that this is all you use of the tremendous possibilities which this new substance which you have been employing could give you. You are not making full use of what the semiconductor can bring you. And the proof is that if, with gallium arsenide, instead of being interested just in the band edges, or normal direct band gap, you make an experiment which involves secondary bands lying higher up as large effective masses come in, you may find brand new phenomena like the Gunn effect. The real reason why the Gunn effect provides something new is because we are heating up the electrons, we are putting enough energy into them so they do not stay in these bands we have known so well, and while we use them we transfer them to higher-lying bands. This has a very simple effect that, in these higher-lying bands, the electrons are less mobile, and so, as you put more and more energy into

them, they go slower and slower, and you get the differential negative resistance. The result is a very useful oscillator device.

Now the question arises, are there not many other phenomena produced by deliberately going far off equilibrium, either in semiconductors or in other materials with which we might achieve useful results? And if there are such phenomena, why are we not studying them more? And, as I have said, this criticism, if it is a criticism, does not especially apply to RCA, because you are probably one of the places that has been studying them more than most people have.

I believe that the reason for it lies to a great extent with the fundamental physicists who have not been providing other physicists with the proper methods of analysis of these phenomena. It lies with the education we have been giving to the physicists. Being now responsible for education, I have to say, "If industry doesn't work as it should, it's the fault of education." Well, of course, I don't fully believe that, but it is a standard way to present things. Industry says, "We don't work properly because the kind of people we get from the universities are not really usable." The university says, "Well, what can we do with the kind of people we get from the high schools?" The high schools say, "When they come to us, they do not even know how to read and write, so how can we teach them?" And in the primary schools and grammar schools, they say, "When their parents send them to us, they don't even know what they should have learned at home before even going to school." Then you turn to the mother, and she says, "Well, it's not astonishing. His father and his grandfather were like that before." So, this is part of the rules of the game. We can always blame it on the one preceding.

In this case, I believe that there has been a real lack of interest in pursuing the line which has been that of the evolution of physics over the last 150 years and therefore, as a result, we may miss right now a method to understand phenomena which lie far off equilibrium in general, and especially in solid-state physics. If we look at the evolution of physics in general, we realize immediately that it has always been a two-pronged evolution. There have been people who have been looking at new fundamental laws, relativity, quantum theory, and now people who are looking at high-energy nuclear physics, trying to understand fundamental laws. I leave that aside. Of course, they succeed in giving inferiority complexes to the other physicists, but I believe that we can safely assume that all the fundamental laws we need to understand any device which is going to be built by the electronic industry for the next thirty years are presently available.

But there has been another line of attack, which is that of the theories which explain complex phenomena in a simple way. The Gunn effect and the oscillistor are phenomena of such complexity that we have badly needed simplification. So many parameters are involved, such as the electric field, such as acousto-electric phenomena, such as pinching, and many other phenomena, that it takes a new method of analysis. It's one order of magnitude more complicated to analyze than the things we have been used to. Now, remember the purpose of the physicist at the beginning of the 19th century—and by that time physics was almost entirely concerned with mechanical motion—was to understand the behavior of an isolated system. It's still part of the game. In order to go any further, you want first to understand the behavior of a system which is isolated. When we speak about the band structure of a semiconductor, what we are describing is a property of a piece of semiconductor which it would have if it were isolated completely. We describe it in terms of quantum states, for example, and the properties of these quantum states.

A second problem arose when people started to realize they never worked with isolated systems. They always worked with systems in thermal equilibrium, and that area of thermodynamics with all its deviations and distortions and all its sometimes too-abstract approach. However, it was necessary to have thermodynamics or the modern form of it, which is statistical mechanics, to understand the behavior of the same system at a given temperature. Because, if the engineer were told he could do something with a piece of germanium provided he put it completely outside any thermal contact with the outside world, he would first say, "I don't know how to do that, so I'm not interested." Then he would add, "We can't do anything with a piece of germanium in this condition, because we're certainly going to put some power in it." He's not going to get anything for nothing, and the thing would overheat very quickly. So that the problem evolves, then, of understanding the behavior of a system which is coupled to a thermostat. I would like to remind you very quickly how we can go from this very simple problem of the isolated system to the very much more complex problem of the coupling of an unknown nature between a thermostat and the system under consideration. The answer is that the exchanges of energies which are involved are of a rather general but rather simple nature. They can always be thought of as causing transitions between the quantum states of the system under consideration, and these transitions are, in the first place, weak enough not to perturb in any way the quantum states of the system. And in the second place, the up-to-down transitions and the down-to-up transitions are in a given ratio

which has nothing to do with the system under consideration, but with a very general theorem about the density of states versus energy of the thermostat. And that is the one which applies to any thermostat and which says that the density of states increases like $\exp \beta E$, where β is some constant and E , the energy of the thermostat. Of course, if you identify β as $1/kT$, you get thermodynamics and all the results of it by the way.

But this is still not enough. This gives you only the behavior of a system which is exactly at equilibrium, and a system exactly at equilibrium is of no interest to an engineer, because what he wants is to study how the system responds to forces applied to it. So he goes one step further and applies the forces from, say, a battery, and what does he get? He gets a current flow, and he gets some relation between current and electric field—conductivity, and so on. And during these last forty years, some great progress has been made in the approach to off-equilibrium phenomena, but the theory has only been put in a really convenient form for the case when the deviation from equilibrium is a small one. There you have some well-known results, which you can use as a guide to understand the phenomena. Of course, we write general equations of the Boltzmann type to understand much better what is going on, and we can solve them. We can even solve them in many cases far off equilibrium, but we can only do that with the use of large amounts of computer time. The final result is that unless enormous progress is made in computer-aided physics—where the design of an experiment, and not only the design of a device, can be done with the physicist working with a computer—I don't believe that an equation which has to be solved numerically is ever going to be of great use to the intuition of an experimental designer. You need something simpler, you need something as simple as you can get—at least as simple as what you can get when you are close to equilibrium and when you know that you can linearize your Boltzmann equation, which means you do not have to solve it at all, because the type of results you get, you can feel without solving.

Now, the point I would like to make is that there may be ways to approach problems in which the battery, instead of applying a small voltage or field, applies enough to heat them. There may be ways to approach this problem which are just as intuitive as those we are familiar with and which have been used as a guide by engineers in finding the kinds of approach which have led to discoveries in solid-state physics over the last 15 years. It would take too long, of course, to discuss how to do it, but I would just like to give a very quick idea in a few words.

The problem is this. It is no more complicated really to look at the system which is subject to outside forces than one which is just in con-

tact with a thermostat. The only difference is the following one: If the system is in contact with the thermostat and nothing else, then all it can do is this kind of transition, and if a system has gone from one end of these states to any kind of complicated transition to another, you are sure that the probability of the up-and-down and down-and-up transition are in a ratio which is the Boltzmann factor, because the product of exponentials always leads to the same result. As soon as you apply force to it, it is not obvious that the system in this kind of state has gone through this type of a cycle. It may have gotten energy from an outside energy source. As a result, we cannot apply the Boltzmann factor indiscriminately. But it turns out, though nobody as far as I know has ever been able to prove it, that you still get the right result by just subtracting from the system energy the average energy it has been getting from the battery over infinite time, from minus infinity to zero. That is usually a very easy quantity to compute. As soon as you have this simple rule, by linearizing, you find all the classical results of Boltzmann's equation, and by not linearizing, you find something which is still practicable. It is probably false, because if it were not false it would have been proved long ago. But if well elaborated it is probably a sufficient guide to make it possible to look at uses of solid-state devices in which a lot more states, a lot more conditions, will be used than those which are very close to equilibrium.

This is just an example of a whole field which has hardly been studied. The question arises, could devices of a useful nature be made out of it? The answers are obvious. Some have been made out of far-off equilibrium semiconductors, for example. The same thing could be true of other fields—for example, the Gunn effect. The feeling one might have is that such devices might make use of a lot too much power. In order to drive this system far off equilibrium, you have to push hard on it. You always have to push hard in order to get anywhere, but you do not like to push hard because that means energy, that means heat, that means a limitation of miniaturization. In theory, this is true, and will always be every time you want to use so-called nonlinear phenomena. By the way, all the work which is being done now in nonlinear optics, is called solid-state physics by solid-state physicists, even though the opticians are competing with them. The opticians claim it is their job too. But a lot of work which is done on nonlinear optics also involves systems which are extremely far off equilibrium, optical equilibrium in this case—systems which involve many photons per mode whereas normal theories always apply to less than one photon per mode.

In all these cases, it is true that, in general, the energy densities involved are higher than what we have been used to in transistor physics.

But it does not prove that the total power needed to achieve a given result is necessarily larger. The efficiency is what counts finally, and, furthermore, devices are never used alone. They are usually used in a combination with other devices, and, in many cases, you can use a device which has a fairly large amount of power built into it, or else a driver which works at a low power level. So, the need for a lot of power to be put into a Gunn diode before it even starts oscillating is not necessarily a limitation. If one starts oscillating, you get a fair amount of efficiency and, as you know, there are ways to improve the efficiencies of such devices. So I would suggest that at least this field, which we are not yet able to really understand, lies just on the "B" side of the border in my diagram, implying the acquisition of new knowledge, of new methods of analysis which we don't yet completely have. There are many sectors of solid-state physics which have not yet been really looked at and which could have the same importance as those which have been studied. Now it does not mean, of course, that somebody is going to find another transistor in this field. That is a discovery which does not occur every year. But it means that the physicist at least will have lots of fun, provided he finds some device applications once in a while so the responsible industrialist will let him have fun in the best interest of electronics and the best interests of all the people who use it one way or another.

I could have chosen many other fields, because that of far-off equilibrium phenomena is just one example. I wanted to choose that particular one to indicate how very little of the solid-state physics capabilities of materials we are presently using and how much more we should do. We are very much in the situation of a man who has found a monkey wrench but has only been able to find one use for the monkey wrench and that is driving nails with it. I do not believe we are using our semiconductors to the limit of their potential, the same would be true for ferroelectrics, and the same would be true for magnetics. Even so, I believe that the magnetics people have done a much better job than the semiconductor ones. They have been getting more out of the properties of their material.

If we are careful—if we are interested in looking very far in this way—I am sure that there are very good years ahead for solid-state physicists in the electronics industry. And they do not have to worry about finishing as Marilyn Monroe did. They will live just as she did.

(70)

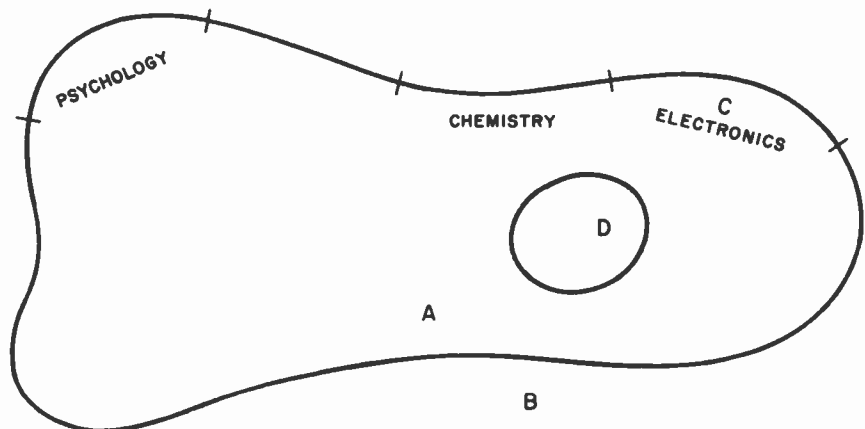

Figure 1. Frontiers in research.

chemistry and electronics: the material and the medium

WILLIAM O. BAKER

It is an honor to join this anniversary event in collaboration with those around the world who have participated in an era of new science and technology in industry and public service, in which the Radio Corporation of America and its founders and leaders have played so distinguished a part. As our previous speakers have demonstrated, the enterprise of communications among men has invoked a wide sweep of scientific endeavor by man, ranging from the deep study of matter, as Professor Aigrain has shown, to the high study of man, as Professor Skinner is about to reveal.

The science of solids established by the stimulus and the effort of communications is now one of the great intellectual domains. An even greater challenge, the science of man, which Professor Skinner will survey, appears also to involve heavily communication and information theory as well as the technology of digital logic machines. Both of these areas came from the electrical communications industry, whose respect for both the discovery and the applications of new knowledge is so fittingly demonstrated by these Sarnoff Laboratories and this celebration. So I cannot help but express a particular pleasure from the world of knowledge users as well as from the world of knowledge makers at these happy events at RCA.

At the beginning, electronics was *practiced* in space, in relation to waves thought to propagate through the "ether," as in radio, or those made to oscillate in circuits. But electronics was also *derived* from the movement of electrons in space, within a vacuum tube. Thus, the medium was electronics, and even before the physicist showed that electrons were waves in quantum mechanics, more classical electromagnetics had turned us toward the epic age of advance through communications and energy, whose science and technology we celebrate today. And, indeed, as those original electronics grew, physicists did cultivate the nearly free or spaceborne electron in great beam devices, like betatrons and in klystrons and magnetrons and, eventually, in such elegant manifestations as the powerful electron microscopes, to which Dr. Hillier has made such distinguished contributions.

Now, during the same time, another culture of the electron was being globally, though at first quite independently, evolved. This was its behavior in the molecule, and especially its energy states and excitations which caused the beautiful multiplicity and elegant changeability in the material world. This was modern chemistry, and atomic and molecular

(71)



WILLIAM O. BAKER

Vice President—Research, Bell Telephone Laboratories

William O. Baker, Vice President of Bell Telephone Laboratories, is responsible for scientific research programs. He joined the company in 1939 and worked in polymer and solid-state research. He has served on the President's Science Advisory Committee, National Science Board, the Science Information Council and a White House Board. He is a Consultant to the Department of Defense and Office of Science and Technology. He is a trustee of Carnegie-Mellon, Princeton and Rockefeller Universities, and a member of Harvard and Tulane Visiting Committees, and of the National Academy of Sciences, American Academy of Arts and Sciences, and American Philosophical Society. He was awarded the Perkin Medal, 1963, Priestley Medal, 1966, ASTM Executives Medal, and was Marburg Lecturer, 1967. He received his B.S., 1935, from Washington College and his Ph.D., 1939, from Princeton University; also honorary degrees from Georgetown, Glasgow, Pittsburgh, Stevens and other universities.

physics, and also the revolutionary technology associated therewith. But we now know, with the perspective of history, that this era was basically a time of learning about the molecular and atomic habitat of the electron, and of working out the quantum mechanics by which it controlled chemical structure and a change.

The great thrust of the mid-twentieth century was at the intersection of these new vectors of thought and discovery. The electronics in the vacuum, of the wave, and, indeed, of the electrical system, especially in instrumentation, intersected with the study of atoms, molecules, and chemical structure and change. The intellectual connection was clearly formed in the early 40's and the emergence of solid-state science in 1947 completed the first stages of the fusion.

However, we speak primarily today of the future, in accord with the spirit of these eminent Sarnoff Laboratories and their founders. The future of this union, between what is now especially the electronics of solids and their subsystems, of logic and memory and signals and waves, and energy converters and their controls, this union with the science and technology of chemical structure and synthesis, seems auspicious indeed. Let us see some of the promise, for both understanding and use, which is now appearing. The molecule and the crystal have merged. We can synthesize a single crystal of germanium, or gallium phosphide, whose geometrical and bonding perfection and purity begin to approach that formerly reserved for the proud identity of the single chemical species of benzene or water (Figure 1). (In these latter, in turn, we recognize, through the wave mechanics, alternate forms of benzene which can even be isolated and whose isomeric bonding is even recognized by commercial sale of the once purely hypothetical Kekulé bonding.) By the conjunction of electronics systems, such as the energy resonance of an electron with unpaired spin (the typical bonding unit of chemical links and the eager hook of chemical radicals), with radio frequency waves in a magnetic field, the now classic electron paramagnetic resonance spectroscopy was created (Figures 2 and 3). We determine with comparable ease the detailed energetics of a phosphorous doped silicon crystal for a semiconductor, or the condition for the ultra-violet excitation of certain groups in desoxyribonucleic acid, an effect related to the radiation induced mutation of genes, and thus, presumably, to the evolution of life itself.

Knowledge and control of the excitation of electrons, and especially in spin states leading to chemical bonding, will achieve new scope in the years ahead. In turn, the structures and compositions thus achieved will yield still greater advances in materials which will dominate electronics,

from the color-video panel to the personalized computer and global communication net (Figures 4, 5, and 6). And perhaps the greatest gains will be within us, for the electronics of living systems, ranging from neurophysiology to the chemistry of cell growth and differentiation, benign or malignant, are being revealed as electronics systems with exquisite feedback, signal coding, transmission, switching, energy conversion, and structural design. These systems will be the common domain of the physicist, chemist, and electrical engineer. But this will require a truly exact and deeply detailed mastery of what the electron does in its most intimate circuitry, that of the molecule and atom, as well as an equally specific comprehension of the larger domain between molecules in the crystal, the ionized plasma, the solution, and the highly solvated state which characterizes most of living tissue itself. To these ends, chemistry is now committed in an alliance with physics, biology, and electronics, so that the medium for communication and energy, for information and impulse, in the doings of man and nature, can be emplaced in materials both suitable and sensible.

This theme gathers force from the already historic but vigorously continuing interaction of the main basis of chemistry and electronics. One such basis is oxidation and reduction, the very essence of chemical principle beginning with Lavoisier and phlogiston, and underlying, of course, the whole of life force, and energy through metabolism. But electronics, before the solid-state era and still in important measure, depends on emission of electrons from a cathode, usually nickel, coated with oxides, usually barium and strontium oxides (Figure 7). It is now indicated that also reducing ingredients in exquisitely controlled amounts and access through the nickel are essential. At elevated temperatures, the reduction of the alkaline earth oxides produces carefully distributed and diluted free barium atoms. This permits the barium atom to function as a charge donor. The result, as shown by the pioneering applications of solid-state semiconductor principles to the remaining oxide matrix, is that an electron-emitting semiconductor is produced. These donor atoms must be constantly replenished, or maintained, at optimum levels. Thus the whole process of delicate, crucial chemical control includes diffusion of the reducing elements through the nickel substrate and the consequent oxidation-reduction reaction in the presence of competing reactions, such as from silicon impurities which set up a silicon dioxide barrier.

In the heroic age of electronics with vacuum tubes, many fascinating and effective technological, empirical improvements have been made, following these general principles of the physics and chemistry of oxida-

tion-reduction and electron emission. But, also, our foregoing concept, that the liaison of chemistry and electronics is really in its infancy, is strongly supported. That is, we are only now able, through metallurgy and chemistry, to control the quantities and access of the necessary, simple ingredients of the oxidation-reduction process, so that the resulting technology is showing its true potential. Of course, it is rather a joke on science and engineering that we are finding out about how to make really superior vacuum tubes, at the time that other forms of semiconductors than those comprising the cathode are displacing the whole electronic function of the vacuum tube. Nevertheless this is also a cheering irony, since we would expect, especially in the unifying influence of basic physics and chemistry, to see the great upsurge of knowledge of matter provided by the semiconductor era to apply to many related fields.

In any case, let us look a little further at the chemistry and metallurgy of cathode emission, since it is still essential, even in electronics-to-come, to have reliable and versatile sources of essentially free electrons. In brief, Olsen and his colleagues at Murray Hill have now succeeded in applying chemical and metallurgical control to nickel and its oxide coating. This is to a level wherein the elements copper, magnesium, iron, manganese, silicon, cobalt, titanium, carbon, sulfur, and oxygen, some ten, along with other traces, are present only so that no single one of them exceeds .005 of a weight percent in amount (Figure 8). None, in other words, represents more than 50 parts per million of the nickel crystals themselves! Then, with application of the modern principles of chemical and metallurgical diffusion and oxidation-reduction kinetics, based on our most sophisticated concepts of bonding and structure, and our ancient recognition of what chemical oxidation and reduction are, it was possible to synthesize an alloy of 2 weight percent tungsten, and .03 of a weight percent magnesium in the pure nickel so that, as shown, the resulting electronic vacuum tubes display 98 percent survival in two and a half years of continuous operation. This is compared to 60 percent for the very best empirically fabricated tubes currently produced after half a century of intense engineering development. Indeed, such applications of chemistry are notably energizing for manufacturing control as well (Figure 9). For the Western Electric Company has demonstrated an ability to manage the composition control of magnesium content, for instance, in 20 consecutive 200-pound melts, so that it varied only over the range of 0.028 to 0.034 percent.

So here are illustrated strong currents in the historic flow of work on chemical purity and reactivity. But underlying these familiar features is the

striking new and ever-broadening foundation of the science of solids and the theories of structure and electronic states. That same oxygen so vital in its presence and conventional in its symbol now appears as a generalized electron acceptor, modifying the whole crystal field in which it functions. That field, in turn, is determined not by nearest neighbors or next nearest neighbors, as classic chemical reactivity presumes, but by large shells of neighbors acting cooperatively to define the solid state.

Indeed the epochal new thrust in science and technology given by these unions of chemistry and electronics can be dramatized in many forms simply by observing still other new findings about oxygen, its ions and atoms. The crystal *zinc oxide* has been widely used from brightening our paints to lightening our graphic displays, as extended also ingeniously in these Sarnoff Laboratories. But as Lander, Thomas, and their co-workers found several years ago, zinc oxide is a playground for solid-state electronics. The oxide ions comprise a matrix where the electric fields and potential confirmations invite a host of visiting charges (a kind of lattice credit card system), in this case even literally *carte blanche!* The numbers of them are such that the best pure zinc oxide single crystals up to the present, which would contain per cubic centimeter about 10^{21} ions of presumably nicely neutralized and electrically insulating, compensated charges, possess no less than 3×10^{16} or 10^{17} actual charge carriers. Thus there would be some kind of mobile charge for every hundred thousand or so lattice units, a rather compelling complication of the usual chemical formulation and the usual electronic performance of an insulating oxide.

Indeed the application of solid-state theory and experiment to zinc oxide has opened a whole new domain of electronics and chemistry, in which the oxidation-reduction qualities of oxides, the basis for mineral processing and the age of metals depends. We see the donor-acceptor themes in crystals illuminating each stage of oxidation-reduction in a fashion which provides a continuous conceptual framework for the transition from virtually perfect insulators, which fully bound oxygen provides in nature, to the electronically profligate metal, where electrons in a democratic society wander with little constraint or direction. We cannot cover these other matters now, but an exciting new step in the synthesis and properties of zinc oxide has now been taken by Laudise, Hutson and their associates. Namely, crystals can be grown in aqueous solutions at water pressure of 25,000 pounds per square inch, at temperatures of about 350°C . These, particularly after subsequent heat treatment for diffusion, have effective carrier concentrations as low as 5×10^{14} per cubic centimeter, many orders of magnitude below ZnO crystals otherwise available.

Such levels of carrier concentrations were requisite for one of the most attractive areas of solid-state science and electronics, which used the controlled interaction between mechanical waves or thermal periodicities in the lattice, known as phonons, and electrical particles and waves.

A new set of electronic devices, involving amplifiers, delay line, memory and storage elements and various others, depend on the piezoelectric coupling between electrical carriers and mechanical vibrations of the solids through which they are moving. For this coupling to function right, the separation of the moving charges should be such that their so-called Debye screening length is about equal to the acoustic wavelength in the crystal. In general, the electrical frequency at which one may operate such an element is proportional to the square of the charge carrier concentration, and thus about 6×10^{13} carriers per cc are appropriate for one gigahertz functioning. The methods of achieving this careful control are a fascinating exercise in chemical synthesis, for it appears to Laudise and co-workers that the conditions for hydrothermal crystallization of zinc oxide are such that it will not form without a donor concentration in the range 3×10^{16} to 3×10^{17} per cc. Here we begin to sense the subtle complexity of modern synthesis at levels of purity where it was naively assumed for centuries that one just put together the atoms or molecules assigned to the chemical structure, ZnO, and then under conditions of any thermodynamic crystal stability, an appropriate pure solid would form. Our present knowledge of crystal quality, carrier concentration, and electrical states derived from physics, electronics, and chemistry, suggest that certain elegant conditions of charge distribution and field variation must obtain for the *kinetics* of crystal formation to succeed.

This insight led Laudise and co-workers to a startling tactic for the chemical production of appropriate zinc oxide crystals. They simply decided to add donors during the high pressure super-critical phenomenon of hydrothermal growth, of such chemical nature that such donors could be removed readily afterward. Both hydrogen and lithium had been identified by Lander and associates in early studies as important donors in zinc oxide and ones whose solubility and diffusion were quite well studied. Hence, Laudise and co-workers grew zinc crystals under high accompanying pressures of hydrogen, and also under conditions where lithium was installed at interstitial positions rather than inserted at zinc sites (in which latter circumstance it would act as an acceptor in the composition rather than a donor!). Incidentally, this latter quality is also a remarkable finding from the chemical and electronic studies. The results, as noted above, were excellent, especially with the lithium doping which, after an-

nealing in zinc vapor and subsequent heating in air for 17 hours, both at 750°C, gave room temperature carrier concentrations of 5×10^{14} per cc. Incidentally, the growth rate with the added donors became quite satisfactory, extending up to a rate of about 30 mils per day, in the hydrothermal autoclave.

The saga of oxygen and oxides extends to many other roles. The chemistry of oxidation and reduction is the essence of thin film and integrated circuitry, the heart of *microelectronics*. Here it is recognized we are able to carry on the marvelous interactions of electrons and matter through the medium and the material, without either quite taking the charge out of the crystal surface, as in the cathode of vacuum electronics, or without quite having the action go on deeply inside the crystal itself, as in the earlier stages of solid state electronics. Rather, we function with such control of both volume applications and of surfaces that the results, economically and technically, may compose the dawn of new systems still dimly forming in the years ahead. Many of us will know already that controlled oxidation of silicon, the performance of molecular-oxide systems, and most particularly the control of diffusion into silicon semiconductor surfaces by the techniques of oxygen transport and formation created by C. J. Frosch, are the dominant features of making integrated circuitry. Similarly, oxide formation for passive elements, such as tantalum oxide capacitors, various kinds of resistors, and so forth, comprise the essence of application of new fibers of chemistry into the whole fabric of electronics (Figure 10).

Some further little index of the diversity which awaits us in composing the metals and their progressively oxidized form appears in astonishing new ranges of electrical and magnetic capability. Thus, it was found several years ago, at Murray Hill by Morin, that vanadium oxide, through the phases VO, VO₂, and V₂O₃, displayed a transition from semiconductor to metallic performance. Perhaps, however, indicative of the very alterations in lattice and structure, which this variation in internal electronics implies, was a finding that as various temperatures of transition were imposed on these devices they broke into pieces. But this sharp temperature dependence is of great interest, since, for example, electrical contacts might be replaced by a bulk piece showing a transition between insulating and metallic behavior over a very short temperature range. This could then make or break an electric circuit through a slight electrically controlled, non-mechanical, temperature shift. But the first crystals shattered and would not tolerate the cycling through temperature. However, it has now been established by MacChesney and co-workers that porous ceramic sub-

strates, composed particularly of alumina, will preserve in films, dispersed in the microchannels, appropriate forms of vanadium oxides. These then exhibit the desired temperature transitions without physical instability, showing over a range of 2 or 3° in temperature, for instance between 68 and 71°C, a change of nearly a thousand fold in conductivity. Further, in studies in these systems of oxidization and reduction conditions, it was found that a range of states of oxidation could be achieved in the films dispersed in the porous substrate, such as $\text{VO}_{2.17}$, $\text{VO}_{2.33}$, and so forth. Again, as in the case of the barium oxides discussed at the outset, an appreciation of the electronics in bulk leads to new concepts of what the chemical entities can be when distributed in the appropriate electronic environ, such as a thin film or porous solid.

Indeed, the modern applications of semiconductor theory and practice, in such universal chemistry as oxidation-reduction and compound and crystal synthesis, have broadened the total vision of what is possible. So far, we have emphasized the new insights about purity, the extended conditions for crystal synthesis from solution involving the new concepts of dislocations and imperfections for lattice formation, and the behavior of aqueous systems under supercritical conditions. We have seen, as well, the alteration in actual physical stability and structure from the refined heterogeneity of chemical composites, such as films and other extensive interfaces in porous substrates. Another consequence of these shifts in conventional principles of chemical behavior, which will be felt strongly in the future, especially in electronics, involves *the delicate balancing of transport and reaction*. This involves diffusion or access of the reactants as precisely as it does the extent of the chemical change itself. As noted before, this is a dominant quality in the present flourishing of microelectronics, but we should expect it to spread far more widely, and to provide a remarkable supplement to such essential chemical processes in science and technology as heterogeneous catalysis.

Thus, Frosch found, in the case of integrated circuits, that the insertion of gallium to make p-type silicon in a silicon single crystal, and of arsenic to make n-type, in balanced combinations to control the total transistor or diode structure, was beautifully regulated by films of oxide on the surface of the silicon (Figure 11). Double diffusion was even possible, especially when the desired semiconductor *design* was represented by the oxide patterns first grown on the silicon (Figure 12). Under these conditions and appropriate diffusion vapor pressures and temperatures, the access and emplacement of the gallium in the silicon lattice was not appreciably affected by the SiO_2 surface layer, whereas that of the arsenic

was highly inhibited. On the other hand, the arsenic penetrates easily the unoxidized portions of the silicon, and by vapor regulation an elegantly precise arrangement of n- and p-diffusions is achieved simultaneously. Competitive access is thus also easily controlled, so that on the unoxidized surface, as we have said, the arsenic clearly predominates, giving an n-p diffused structure, with a single p-diffused layer below the oxidized surface alone (Figure 13).

Indeed, the use of various containments for chemical and physical-chemical synthesis and alteration promises profound effects on many futuristic elements of both chemistry and electronics. We have shown how the containment may be (1) an electrical or magnetic field, (2) direct matter field, whose effects are of course electromagnetic, (3) chemical transients and (4) physically extreme temperatures and pressures. Appreciation of these combinations through studies of chemistry associated with modern electronics has led to many other fascinating trends, in such areas as magnetism and superconductivity, where it is recognized that particularly extensive phenomena, with large field effects, result from very detailed, intensive alterations of chemical components. This realization, again, has impelled much chemical thinking into new areas, which we shall sample very briefly.

In the case of ferromagnetism, we are persistently uncomfortable about the massive structures and assemblies of atoms which we still use to make magnets, despite the historic improvements in ferrimagnetism from the initiation of the ferrites in the Philips Laboratories in Holland and the later discoveries of completely insulating and transparent ferrimagnetic systems, such as the yttrium iron garnets of Dillon, Néel and their contemporaries (Murray Hill and Grenoble) (Figures 14 and 15). The recent discovery by Wang and Kestjian of ferromagnetism below 87° absolute in the compound RbFeF_3 has been shown by Testardi, Levinstein, and Guggenheim to be associated with a paramagnetic state above 102° Kelvin, an antiferromagnetic state between 102° Kelvin and 87° Kelvin, and ferromagnetism between 87° and 4.2°, with some transition in this quality around 45° Kelvin. Thus, in a relatively simple chemical structure, we are likely to be finding new indicators of the particular electronic states, especially unpaired spins, which couple in their exquisite quantum mechanical ballet to yield a magnetic condition. And still another, and an even more intimate relation of the chemical arrays, which can give iron magnets has been revealed by Ginsberg, Martin, and Sherwood, in the very recent finding that the *linear trimeric coordination compound bis (acetylacetonato) nickel (II)* yields at low temperatures in the ground molecular state,

all spins coupled parallel. That is, the three nickel atoms are completely ferromagnetically coupled, for the first time exhibiting ferromagnetic spin coupling in a chemical cluster which is magnetically isolated. While previous studies of isolated clusters of magnetic ions had shown antiferromagnetism, we now know that at intercluster spin distances of greater than 8 angstroms, which is certainly too far for much spin-spin coupling, we can find an effective magnetic moment of 4.24 magnetons with a g value of 2.1 and a consistent behavior of ferromagnetism. Certainly, a new set of magnetic elements, resonances, and functions can be sought where a truly economical assembly of chemically ordered and distributed magnetic atoms is available.

Rather analogous new sets of chemically created functions are seen in various remarkable other types of modern compounds (Figures 16 and 17). For instance, the work of Robin, Andres, Geballe and their associates reveals a series of silver oxide clathrate salts showing superconductivity. In these of the general formula $Ag_7O_8^+X^-$ were included such structures as $Ag_7O_8NO_3$ and $Ag_7O_8HF_2$ (Figure 18). Incidentally, it was only the fascinating observation that nuclear magnetic resonance spectroscopy indicated *proton* nuclear resonance in the black, metallic-appearing salt that had been analyzed to be Ag_7O_8F that led to the correct chemical description of this remarkable structure. Aside from this, however, it was also found that the field provided by the HF-ingredient, and its interaction with the rest of the oxide system (the HF condition was intriguingly represented also by virtually free rotation in the clathrate cage of the silver oxide system, above 100° Kelvin) corresponded to what Robin has designated broadly as "mixed valence" compounds (Figure 19). The silver oxidation state (and here we see again the convenience of linking the old chemical concepts and the new understanding of them) corresponds to 2-3/7. Now doubly ionized silver has the $4d^9$ electronic energy level configuration and thus, in a coordination system, the salt would be paramagnetic. An interesting question is, what kind of coordination actually exists, and measurements recently made reveal only a Pauli paramagnetism not varying with temperatures significantly, and acting like that of a metallic lattice where there are low local moments. Gossard, Robin, Geballe and their co-workers have now deduced an interesting explanation arising from the nature of the coordination of the silver. This is cubically coordinated for the Ag^+ ion, and the other six silvers in the neutral Ag clathrate unit are structurally equivalent, five of them being diamagnetic in the $4d^8$ state in square planar coordination and the other one in the $4d^{10}$ state. Now, with all six being structurally equivalent, the two electrons typical of the state $4d^{10}$

resonate among all six atoms equally, and yield a conduction band based on the 4d, $2-y^2$ orbitals of silver and 2p orbitals of oxygen. This leads to the high electrical conductivity, as well as the observed kind of paramagnetism of the clathrate compound.

Likewise, the substance shows a superconducting transition at about 1.0° Kelvin, as related to the particular states and layer structure of the ions in accord with the most recent combination of physical and chemical interpretations for superconductivity in non-metallic solids. This extraordinary method of inhibiting local magnetic moments in the paramagnetic system is but another demonstration of the lively partnership between chemistry and electronics. For it is apparently the presence of strong local moments, as Matthias and Geballe have shown in such substances as chromium, manganese, iron, cobalt, and nickel, that prevent superconductivity. Indeed they found that 100 parts per million of iron completely suppressed the intrinsic superconductivity of the element molybdenum. The discovery of two years ago, of the high-yield superconductors, by Kunzler and co-workers, has already given great impetus to technological development which will notably react back on studies of chemical synthesis of new classes of such compounds. Indeed, processing metallurgical and chemical controls have led to remarkable practical development of superconducting magnets in these Sarnoff Laboratories.

Another truly astonishing chronicle of new ventures in chemistry and chemical synthesis, with immediate and reciprocal relations to the latest quantum electronics, appears in the examples of the YAG or yttrium aluminum garnet structures (Figure 20). These especially act as host lattices for rare earth ions, including holmium, erbium, ytterbium and thulium. Here, the chemist, Van Uitert, the physicist, Johnson, and electronics researcher, Geusic, have produced highly efficient laser action continuously at room temperature, with a pump from an ordinary tungsten lamp. The trivalent neodymium ion replaces a trivalent yttrium ion, and laser emission has been achieved with as little as 75-watt input into the lamp, and 2 watts of laser output has been obtained with 1,000-watt lamp input. Using an argon arc lamp of 100-kilowatt input, 200 watts of fabulously concentrated laser emission has been recently reported. With a flash lamp and Q-switching, 200,000 watts have resulted from a ten joule input, and the fundamental 1.06 micron laser emission has been readily converted to visible light at .53 micron through harmonics from the crystal lithium niobate. Also, by modulation, at a mode locking frequency, pulses of 8×10^{-11} seconds and less have been achieved. Also, energy transfer between various ions, skillfully incorporated in the host lattice of YAG,

has been widely achieved with highly efficient results. Trivalent holmium, Ho^{3+} , easily gains energy from chromium, Cr^{3+} , ytterbium, Yb^{3+} , erbium, Er^{3+} and thulium, Tm^{3+} (Figure 21). Fifteen watts of laser output from 300 watts of power input into the lamp has been obtained at 2.1-micron wavelength from Ho^{3+} ions in YAG, so here has been achieved a 5 percent efficiency of converting incoherent light to coherent light, a new high for an optically pumped crystal laser. Also, recently Johnson, Remeika and Dillon have been able to insert Ho^{3+} ions into the insulating magnetic lattice of YIG. A change in magnetization direction then alters the laser frequency, because the configuration of various energy levels of the Ho^{3+} ion depends somewhat on the direction of magnetization within the crystal (Figure 22). The possibility of such magnetic modulation is evidently large. Obviously, also, the whole domain of chemically pumped lasers, beginning with the observations of the carbon dioxide nitrogen system and the hydrogen chlorine reaction of Pimental, is one of the great prospects for the future.

So we have sampled hastily some of the present and of the prospects from the historic intersection of currents of 20th Century science and technology, in chemistry and electronics. As with all of science, probably the greatest interactions lie ahead. The most prominent seems to be the combination of chemistry, biology, and electronics which has already begun in molecular biology, especially applied to genetics, the polynucleotides, and the origin and evolution of life. For the future, however, and for the pace with which we approach it, let us learn a moment from the past. In 1866, a century ago, Mendel thought there must be a unit to carry genetic order from one generation to the next with mathematical regularity. In 1869, Miescher, an Austrian, isolated deoxyribonucleic acid in white "crystalline" (or powder) form. What would have happened if we had crystal chemistry and solid-state science sooner, only historians of the future can estimate. In 1944, Avery, McLeod and MacCarty, at the Rockefeller Institute, showed that DNA, taken from the nuclei of one kind of pneumococcus and fed to a different strain, converted the off-spring of the second into the function and habit of the first. Long before, the chemist had known that the main components of DNA were four nucleic acids, adenine, cytosine, guanine, and thymine (Figure 23). But only 15 years ago, Crick and Watson took up the elegant X-ray crystal and chemical studies of Linus Pauling, and with the diffraction studies of Wilkins in London, deduced that the DNA molecule was double-stranded and configured in Pauling's classic helical or twisted ladder shape, with the nucleic acids linked in pairs as the rungs (Figure 24). The rest is part of the

culture of today, in which it is indicated that the four (and perhaps many more derivative) nucleic acids provide a genetic alphabet and transform chemicals into "words," and then into "biological sentences," for control of genesis itself. Chemists and biologists merged their talents in this great saga of our century, and identified the role of *messenger DNA*, or messenger desoxyribonucleic acid, in which uracil replaced the thymine. In turn the RNA, in somewhat abbreviated form, goes out of the nucleus into the cell, and attaches to the ribosomes where it begins assembling a protein, the tissue of life, through the medium of *transfer RNA*, which itself accumulates the amino acids from which the proteins are then constructed.

Nierenberg and Ochoa then began the revelation of how the genetic code contained in the original desoxyribonucleic acid is actually applied to the construction of the protein, and also electronics and its by-products had begun to join the game. It is fitting that a cosmologist should have made one of the early plays. Already, in 1954, George Gamow had postulated that the same number of nucleotides would function as the code for each of the 20 specific amino acids, which make up all the proteins of vitality. Already, the concepts of communication theory founded by Shannon, at Murray Hill, for the representation of electronic telecommunications, was embedded in the hunt for how organic genesis went on. Decodability, error correction, synchronization and efficient use of the channel with the beautiful economy, which we have learned to expect in nature, were part of the regime. A "comma-free" code of Francis Crick, in 1956, looked promising at first with 4 of the 64 arrangements possible. With 3 out of the 4 nucleotides taken for each amino acid, the maximum number of words in a "comma-free" dictionary is just 20. But it took half a decade after it was clear that long sequences of nucleotides could be repeated 4 or 5 times in DNA, for Crick to show with one of the bacteriophages of the bacterium *E. coli* that a triplet code was indeed employed.

Ochoa and Nierenberg have given a strong impulse toward validation, however, that a degenerate triplet coding is indeed employed. This means that each of the 64 possible trinucleotides must be identified with 1 of the 20 amino acids or with nothing, leaving 21 categories. By information theory, each such assignment represents $\log_2 21$, equal to 4.392 bits of information. So the key to the information contained is 64 times this value, or 281.1 bits. Ochoa, Nierenberg, and a German chemist, Wittmann, of the Max Planck Institute in Tübingen, have already provided nearly a third of these bits, although the remaining ones leave 2^{200} ways of completing the dictionary, so there is work left to do. In addition, of course, we must find out the punctuation in the eventual code or, in other words,

the kind of instructions to start protein formation and to stop protein formation. In modern computer terms, information in the nucleic acid comprises program as well as memory.

Now the trends in chemistry itself stimulated by this epoch would already take many hours to outline. We might look at just one example, since it is nicely coherent with our theme, that the future of science depends on ability to deal with accumulated particulars and not on some grandiose breakthrough, breakup, or breakdown of human aspiration. We mentioned the work of Wittmann in 1962 on chemical mutants of tobacco mosaic virus deoxyribonucleic acid. He and his associates found that they could induce mutations in this information base for vital reproduction, by the reaction of nitrous acid, HNO_2 , with the polymer strand, which by deamination converts some nucleotides into others, for example, cytosine to uracil, and thus changes the sequence in the coding structure. Who knew beforehand that the simple reactions of nitrous acid on nitrogen bases would thus contribute some of the deepest insight into the regulation of organic form?

And so the work goes on, with various decipherments proceeding simultaneously all over the world. Khorana, Raj Bhandary and co-workers at Wisconsin have this year unraveled the nucleotide sequence in phenylalanine transfer ribonucleic acid, the one containing a trinucleotide sequence present only in the carrier for phenylalanine amino acid. This followed the work of Holley at the Department of Agriculture and Cornell University on alanine tRNA and that of Madison and co-workers at Ithaca in studying the tyrosine tRNA. Zachau at Tübingen in West Germany has traced the protein sequences from serine transfer ribonucleic acids, but the complexity advances with the revelations. Zachau found two or more transfer RNA's for the same amino acid, serine, from the same source, and found the nucleotides' compositions were different. Hall, at the Roswell Park Memorial Institute, confirmed Zachau's findings of 6-N-(3-methyl-2-butenylamino)-9- ρ -D-ribofuranosyl purine in transfer RNA taken from baker's yeast. (I am glad that bakers had some role in the isolation of that delightful nucleotide.) Incidentally, its structure was greatly illuminated by electronics-based techniques of nuclear magnetic resonance and mass spectrographic determinations. (In a delicate tribute to the confidence of chemists in these methods and in electronics generally, Dr. Hall and his associates confirmed the structure by independent organic synthesis.)

Indeed, up to now, about 30 complex modified nucleotides have been found in transfer ribonucleic acids in addition to the appealingly, decep-

tively, simple four bases of adenosine, cytidine, guanosine, and uridine. Does this foretell that, in Prof. Derek de Solla Price's alarming extrapolation of the rate of growth of science and scientists, the time he graphed out when everyone will be doing scientific research (which will then absorb the total gross product of all nations), there will be an era populated entirely by biologists, biochemists, biophysicists, bioengineers—which will then comprise all known bipeds?

However this turns out, let us complete our myopic vision for this afternoon by touching on a further main prospect of discoveries in chemistry, electronics, and biology. This has to do with the perennial concern of chemists with dynamics, beyond the statics of structure or configuration or coding per se. It involves how the information gets used, a cultural occupation which both chemists and electronics engineers have made fashionable and even profitable. Namely, chemistry and electronics are beginning to probe into the energetic states of biomolecules, such as the desoxyribonucleic acids. How do these actually pick up and link with the amino acids to form the proteins, how is the stopping and starting done? How do mutations occur and, thus, how has the vast sweep of organic evolution graced this planet? How do nucleotides and their genes react to external forces such as the radiation of the sun, of cosmic rays, of the grim nuclear fissions of man and nature? Finally, how do signals get moved through living matter to control the body, the mind, and per chance, the spirit of man?

Shulman, Eisinger and their co-workers at Murray Hill, among others, have found that many of the techniques and concepts of solid-state science and of modern electronics apply fruitfully to these complex matters. If we are a world of the sun, tied to its infinite cycles, let us see what ultraviolet photons are found to do, electronically speaking, in the bases comprising DNA. Already Kasha and co-workers found the first step of UV absorption to be excitation of a π or n electron to an open π orbital without change in spin orientation. This results in the excited singlet state. This state may (1) cause a photochemical reaction leading to a new molecule, (2) it may have the potential energy crossing to an excited triplet state if the promoted electron does flip its spin, (3) it may resonate its excitation energy with a neighboring chromophoric group if the total energy is thus decreased, (4) it might simply have a transition back to the ground state singlet, or (5) it may re-emit the radiation as fluorescence. Obviously, in addition, it will also interact with vibrational states of the molecule, but this will be so fast that not much change will be noticed. The excited singlet state, however, as pointed out by Kasha and Lewis, and Calvin may

last for 10^{-9} seconds, but the triplet states could endure from 10^{-3} seconds to 10 seconds, and this is time enough for almost anything to happen, and maybe it is the time in which events important for the evolution of the species have occurred. Also, as Hutchisson observed, this part of a DNA molecule, if it got to the triplet state, will be paramagnetic and thus should show electron spin resonance—as any modern electronics engineer knows without even thinking. Shulman, Eisinger, and Salovey found that what happens is that the base thymine forms a free radical, whose structure is well interpreted by hyperfine property analysis of the *ESR spectrum* (Figures 25 and 26). Indeed, this structure was further specified by introducing deuterated methyl groups in the free radical of thymine from DNA taken from *E. coli* t-. By various other deductions, including the quenching behavior from paramagnetic ions, such as cobalt 2+, it appears that the precursor to this radical is indeed the triplet state (Figure 27).

Further, a reaction which can occur from this condition is formation of the thymine dimer as found by Beukers and Berends. This is when adjacent thymines on the same strand of DNA form a cyclobutane ring, as shown by Wacker in Frankfurt. Setlow and Carrier, of the Oak Ridge National Laboratory, have indicated that a DNA thus reacted would be a repair mechanism for damage to the genetic regulation. Thus both Boyce and Howard Flanders, at Yale, and Setlow and Carrier showed that a cell cuts out the DNA molecules containing such dimers, as the living mechanism attempts to repair the damage from radiation. In other words, an error-correcting mechanism has indeed been indicated. But these findings are but the beginning of the puzzle. By the application of quantum theory and the use of electronically instrumented optical spectroscopy, Shulman and associates have found that the phosphorescence of DNA does not approximate that of the constituent bases, when studied also in synthetic polymer form. Rather, in the study of various conditions of ionization and pH's, it was found that *thymine in its particular DNA environment* is largely responsible for the observed spectra.

With respect to fluorescence, there were also significant changes. Here, they propose, based on the work of Förster and Casper, who made the first basic observations, and others, that the fluorescence comes from an excited dimer or *excimer* (Figure 28), a bimolecular association stable only in the excited state, and understood through the details of quantum mechanics. They studied many dinucleotides, which were known from optical activity investigations to have so-called stacked bases, and a particular environment for experimental observation was often at low temperatures in rather rigid glasses, such as ethylene, glycol water, as well as

under more normal environs. Such excimers, of course, greatly inhibited singlet energy transfer and may be a remarkable method of directing the effects of sunlight in growing systems into moderate or specific channels for mutation. Indeed, there seems to be no experimental evidence yet for long-range singlet energy transfer in DNA, but it does look as though the triplet state can move along chains in a random walk until something like a bound transition element ion, such as cobalt 2+, will quench it. Such a migrating triplet may easily cover 100 bases during its lifetime of about 2.4 seconds, corresponding to about 10^4 jumps. Is there here a hint of a whole realm of new chemical energetics and electronics implying not only signal transmission, but also control of synthesis when the energy is provided by some other source than external ultraviolet light?

Whatever may be the future, the challenges are clear and many. We should conclude on a human theme, which in the end is what science is all about and which, of course, Professor Skinner will explain. This is, that chemistry and electronics have come to where they stand because the insights of individual human genius are being increasingly joined through the community of knowledge and inspiration, which Teilhard de Chardin has called the "nōosphere." The medium of that nōosphere is composed of all the information machines, and the knowledge systems of mankind, with the printed and spoken words still acting above all. But electronics in communications, in telephones, in radio, in video, and of digital logic machines and computers are the wave of now and the future, for progress in human affairs and learning about nature and man. The founders and sponsors of these Sarnoff Laboratories felt the stirrings of this wave even before the institution, whose quarter-century we celebrate today, was begun. And, it is a happy event, indeed, that chemistry, as well as electronics and all of science and technology, will be helped onward to its great destiny in the service of man by what independent enterprise and human devotion have done here.

1, 2

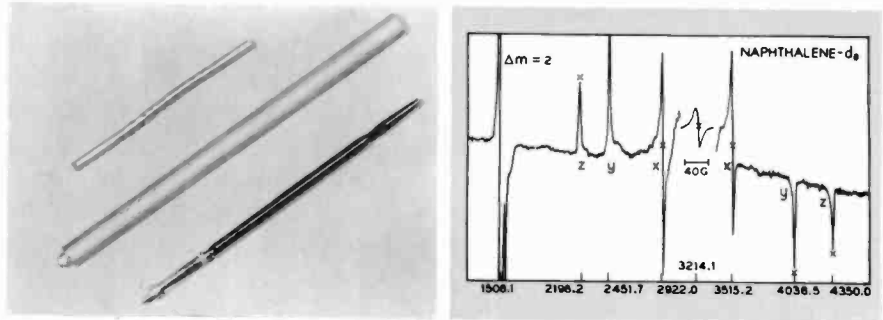

3, 4

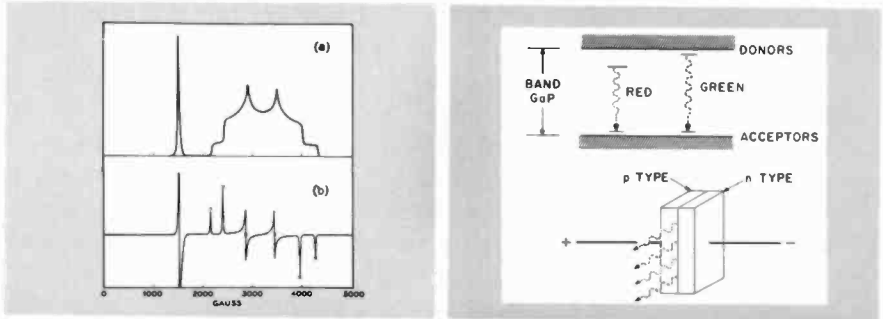

5, 6

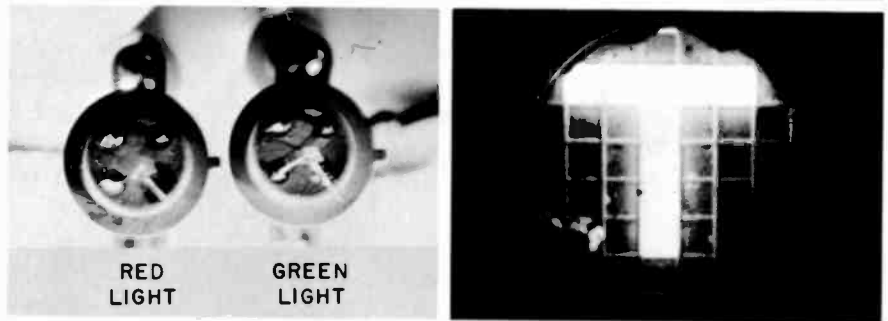

7

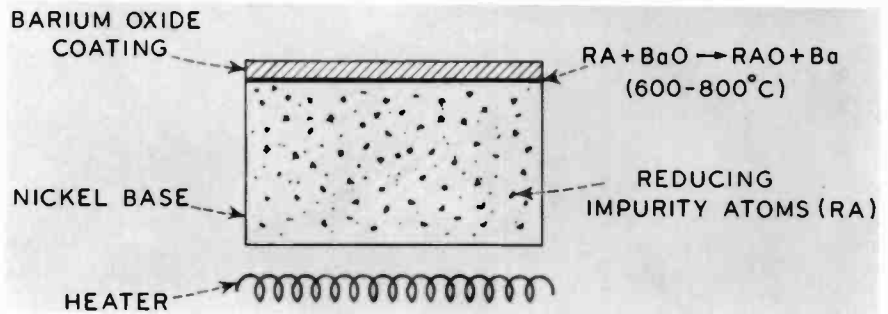

(88)

Figure 1. Single crystals of highest chemical purity and perfection after growth by zone leveling. The center crystal is germanium, the two outer, silicon, made by floating zone refining. Total impurity concentration is 10^{-12} per cc or less—perhaps the purest solids ever obtained.

Figure 2. Experimental spectrum of electron paramagnetic resonance of excited naphthalene, showing detailed fine structure of interactions of valence electrons.

Figure 3. Digitally computed electron spin resonance spectrum of naphthalene, demonstrating close correspondence of quantum electronic theory of molecule with observed spectrum of Fig. 2.

Figure 4. Photon emission at junction from hole and electron recombinations in single crystals forming a gallium phosphide diode.

Figure 5. Wavelengths given by various chemical modifications of gallium phosphide, photoluminescent crystals of unprecedented luminous efficiency.

Figure 6. Illumination of mosaic of gallium phosphide crystal diodes to form a display letter as might some time be done for solid state display screens for video.

Figure 7. Schematic of chemical configuration of the cathode emitter of electrons in typical vacuum tubes.

8, 9

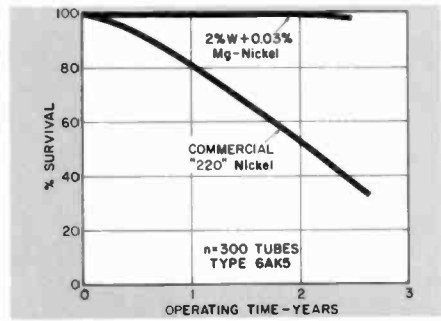
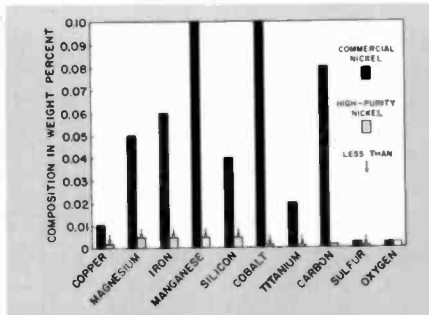

10, 11

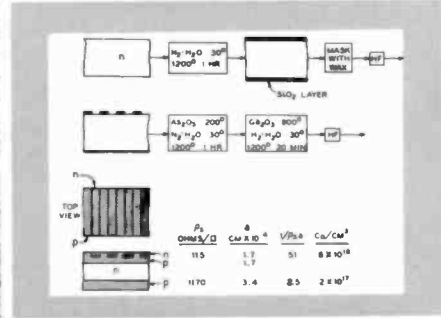
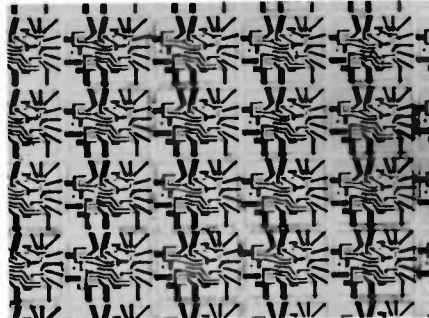

12, 13

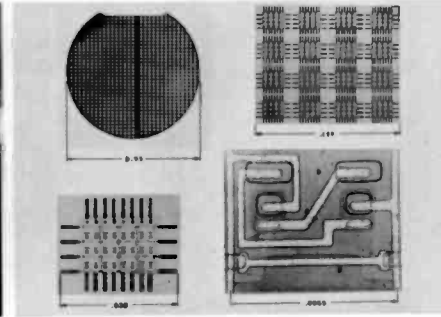
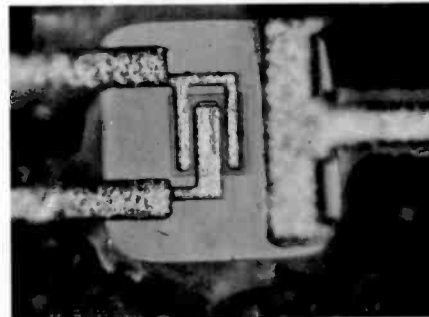

14, 15

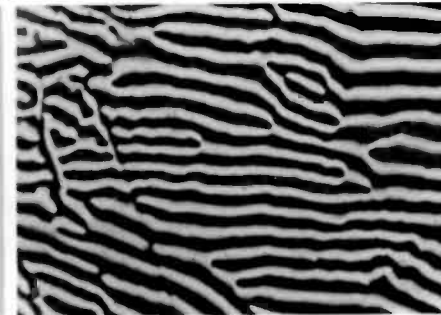
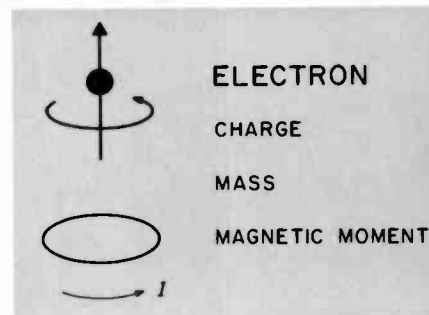

(89)

Figure 8. Chemical composition of commercially pure nickel, compared to that of high-purity element formed by new metallurgical and chemical processing.
Figure 9. Endurance of vacuum tubes made with conventional pure nickel (in the lower curve) compared to the same structures using chemically controlled additions of tungsten and magnesium to ultra-pure nickel (in the upper curve).
Figure 10. Photomicrograph of the surface of single crystal silicon chip on which, by chemical diffusion and etching, microelectronic integrated circuits have been made.
Figure 11. Technique of combined oxidation and oxide perfusion by which ultra-precise synthesis of n and p patterns and regions are controlled in making transistor and diode integrated circuits.
Figure 12. Highly enlarged photograph of transistor prepared on single crystal silicon by sequence of chemical processes yielding thin films.
Figure 13. Further examples of intricate pattern of active elements of semiconductors formed by chemical activation of single crystal silicon wafers.
Figure 14. Elemental magnet from single unpaired electron spin.
Figure 15. Insulating, optically transparent, magnet from assemblies of free spins in yttrium ion garnet single crystal, as revealed by magnetic domains affecting polarized light passage through a section of the crystal.

16A, 16B

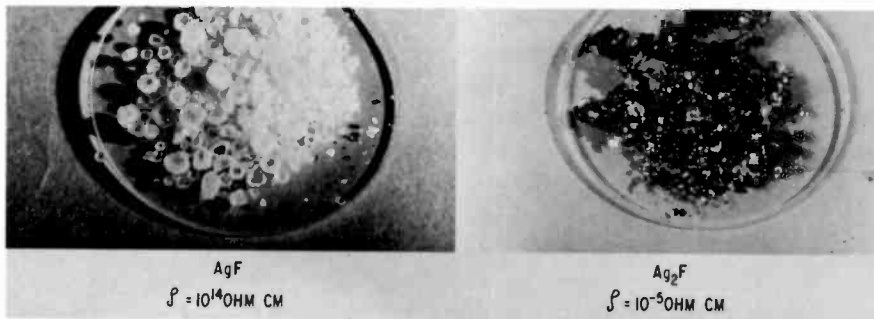

17, 18

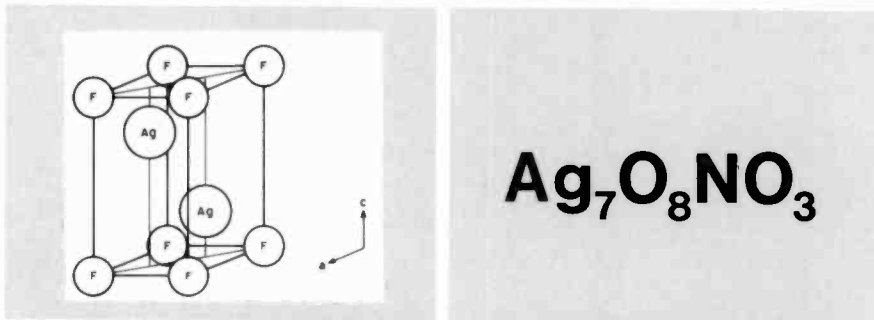

19, 20

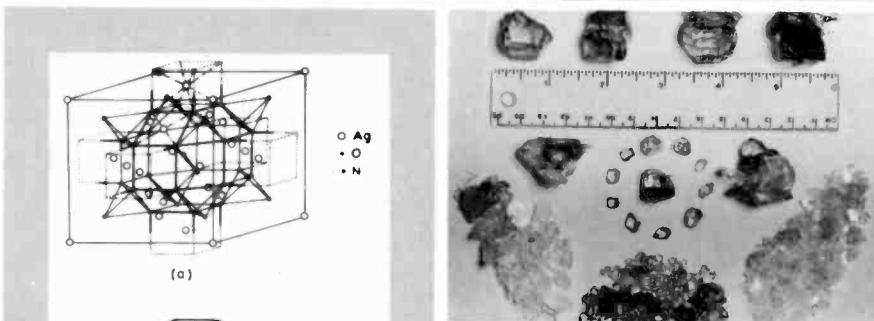

21

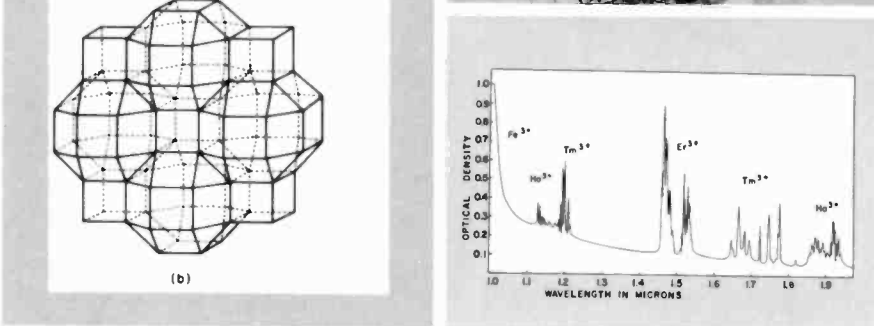

(90)

Figure 16A. Highly insulating crystals of transparent silver fluoride.
Figure 16B. Highly conducting opaque crystals of silver sub-fluoride, Ag₂F.
Figure 17. Schematic of the crystal cell of Ag₂F showing proximity of metal ion layers.
Figure 18. Typical formula of silver oxide cathrate salts such as the nitrate.
Figure 19. Cage-like crystal structure of these silver oxide cathrates showing open regions in the lattice.
Figure 20. Yttrium aluminum garnet (YAG) single crystals providing superior host lattice for rare earth ions yielding laser emission.
Figure 21. Special distribution of various ions in YAG lattice yielding 5% efficiency of conversion of incoherent to coherent light, and permitting pumping by ordinary tungsten bulb.

22, 23

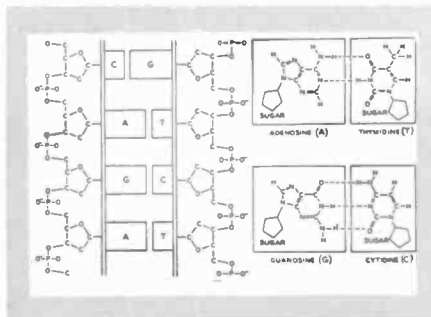
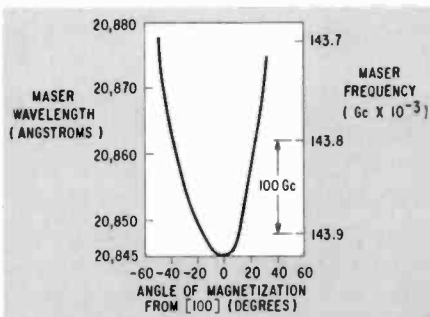

24, 25

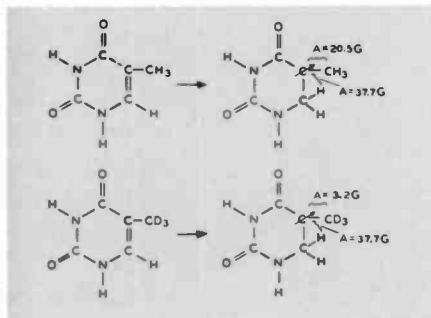
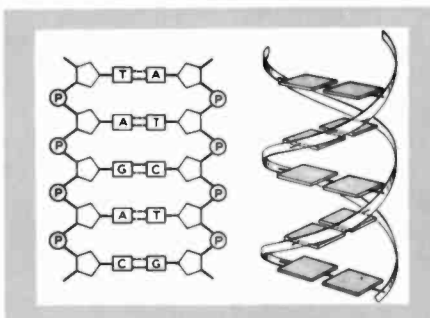

26, 27

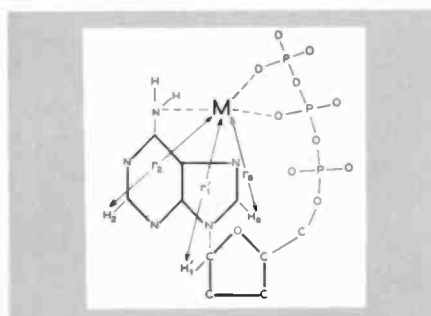
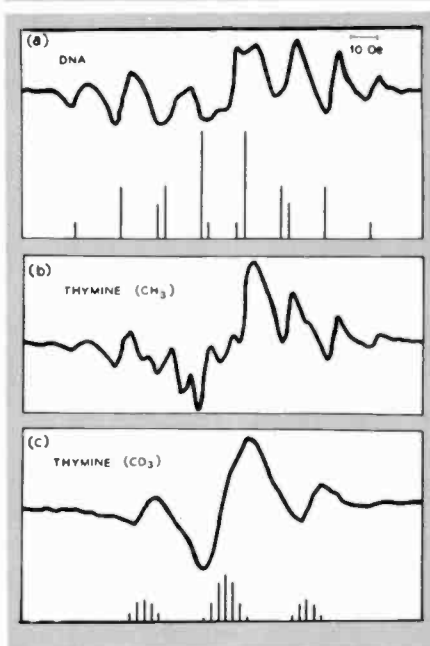

28

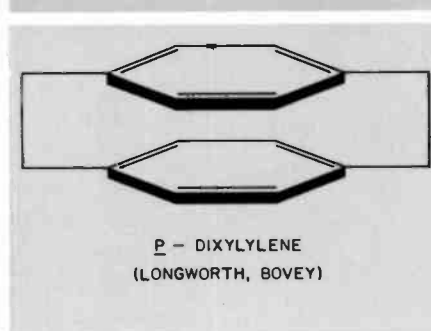

(91)

Figure 22. Effect on wavelength of laser emission by varying internal magnetization of YIG magnetic crystal which is also acting as host lattice for Ho^{3+} ions.

Figure 23. Chemical schematic of deoxyribonucleic acids, showing principal nucleotide bases combined with sugar and phosphate chains.

Figure 24. Structural representation of configuration of deoxyribonucleic acid, depicting chemical relations on the left and physical arrangement on the right.

Figure 25. Model structure for study of thymine radical formation by magnetic resonance spectroscopy including check of structure by use of deuterium substituted methyl group.

Figure 26. Spectra of model structures and deoxyribonucleic acid molecules showing primary influence of thymine on observed radical formation.

Figure 27. Conformation of deoxyribonucleic acid bases in relation to coordinated metal ion which affects optical quenching.

Figure 28. Typical representation of excimer structure corresponding to bonding because of adjacent excited residues.

the science of human behavior

B. F. SKINNER

Human behavior is surely the most fascinating of all subject matters. I would have said it with more confidence two days ago, but I still think it is true. It is the almost exclusive concern of the great literatures of the world: religious works, epic poems, drama, poetry, the novel, essays, diaries, and letters. Historians have tried to give some kind of factual account of it. Folklore has taught us what to do about it, and philosophy has, from time to time, tried to explain it. The explanations have never been very satisfactory, and, I think, for an obvious reason. All prescientific explanation follows a simple pattern. The most obvious, the most conspicuous example of cause and effect is our own action on the world around us. We push something, and it moves. We strike something, and it makes a noise. It is easy therefore to conclude, that when something moves or makes a noise, someone has pushed it or struck it. If we cannot see anyone doing this, we invent an invisible person who does it. All the gods in the Pantheon had duties of this kind, and so have various non-personified forces, essences, and so on. If the north wind blows, it is Boreas who is blowing it. If it is thunder, it is an angry Zeus.

Physics could get rid of that kind of explanation fairly easily. Once you have a real explanation of the north wind or thunder, you can forget about Boreas or Zeus. But in the case of human behavior, it is easy to move these invisible people inside the body, particularly into the head. Once there, it has proved very difficult to dislodge them. It is still a strong part of our current thinking to suppose that the body we see moves because another organism, a little man inside, is directing it, pushing and pulling it.

There was an example of this a few years ago in a science film broadcast nationally on television by a large company. I will not identify the company except to say that it was a large telephone company! It was called "Gateways to the Mind," and it explained why it is that, if we touch a hot surface, we immediately pull our hand away. The explanation went like this: the heat sends some nerve impulses up our nerves (in the animated cartoon, they looked like flashes of lightning). These arrive in the brain and cause flashes to appear on a television screen. There a little man, asleep at the switch, wakes up and sees the flashes on the screen. He reaches out and pulls a lever. This causes other flashes to go down the nerve to the muscle, and the hand is pulled away. I have waited for a number of years for the sequel to that, which would be another nationally

(92)



B. F. SKINNER

Professor of Psychology, Harvard University

B. F. Skinner attended Hamilton College and Harvard University where he received his doctorate in 1930. He has been a member of the faculties of the University of Minnesota and Indiana University and is now Professor of Psychology at Harvard. His book, *Behavior of Organisms* (1938), initiated one of the most active fields in contemporary psychology—the Experimental Analysis of Behavior. His research has been concerned particularly with "operant conditioning," the principles of which have been applied in such fields as pharmacology, verbal behavior, education (in programmed instruction and teaching machines), and psychotherapy. His utopian novel, *Walden Two* (1948), discusses the design of cultures in general. He received the Howard Crosby Warren Medal in 1942, and the Distinguished Science Contribution Award in 1958. He is a member of the National Academy of Sciences, the American Academy of Arts and Sciences, the Swedish Psychological Society, the American Philosophical Society and others.

televised film explaining how the little man works! How when *he* sees these flashes on the screen, the impulses go up the optic track to *his* brain, where a very much smaller man reaches out and pulls a much smaller lever, and so on. That is amusing, but it is also serious because we still think very largely in that way.

The dream of a scientific explanation of human behavior dates essentially from Newton, and there is in it an element of hope for a miracle. Newton seemed to put so much order into a chaotic universe so suddenly that men immediately began to wonder whether the same thing might not be done for human behavior and society. They began to talk about a science of human behavior and within a century, Jean Jacques Rousseau could explain, "Calculators, it is now up to you. Count, measure, compare." (He used the word "calculateurs" which I suppose might have meant "mathematician," but I like to imagine that he was clairvoyant and really meant "computers.") In any case, what was hoped for was some kind of small miracle which, through measurement and mathematics, would solve the problems presented by this dishearteningly complex field. Was there not some way to avoid the sheer labor of an empirical analysis? Was there not some magic formulation which would save us from an enormous amount of plain fact grubbing?

I hope I am not going to appear ungrateful if I suggest that some of the solutions implied or mentioned here yesterday and today show some element of that hoped-for miracle; information theory is an example. I have no quarrel with information theory in its proper place nor any less admiration for its achievements than anyone else. It has been applied, however—by psychologists in particular—to human behavior in a way which I think is not justified. It is true that the organism is an information-processing system. There is input, which is processed, and there is output. It is not really too far from the old stimulus-response theory. But the idea that somehow or other the dimensions of information will solve the complicated problem of analyzing the energy interchange between organism and environment is a little too much at the moment to hope for. The information model has not actually displaced the direct empirical study of the way in which an environment acts on the organism or the way which, in turn, the organism acts on the environment. Nor will cybernetics or general systems theories. Feedback is an important new element, but it is more than additional information, and in any case, we must describe the system we are analyzing before we can know that any information of that kind is indeed adequate to account for the facts. There is no miracle available here—and no way out of the complexity of the subject matter or the need for a direct experimental study.

Another search for a short cut comes from the habit we all have of looking inside to see how something works. In the case of behavior, the most important thing is the nervous system. It is an extremely complex organ with billions of elements interconnected in untold numbers of ways. At the moment, the nervous system is much less accessible than the behavior it is supposed to account for, but it could conceivably be simpler. If we had some way of dealing with the nervous system, perhaps we could explain behavior without the labor of an empirical science. Network theory, a highly developed discipline, has been applied to the brain by many distinguished people and with interesting consequences. DNA and RNA promise for a science of behavior something of what has already been achieved in genetics.

If you look at what is going on today in extending network theory or molecular chemistry to behavior, you find that, in general, they are used to explain the behavior, not of the organism, but of the little man. They are used mainly as a way of resolving our doubts about dualism. We are all unhappy about mentalism, but how are we to avoid it? One way is to assert that mental events are really just molecular events. Hence a flood of articles entitled "Mind and Molecule" or "Matter and Memory." I have no doubt whatsoever that behavior is mediated by the nervous system and other parts of the body, and the more we know about those things, the clearer our picture of behavior will be. But at the moment at least, no special knowledge about what is going on inside permits us to dispense with a direct study of behavior as such. And we'll never be able to show that any particular theory of the nervous system does indeed account for behavior until we know what behavior really is.

There is one last example of a hoped-for miraculous solution. Would we not know all there is to know about human behavior if we could construct a machine which behaved like a man? The simulation of behavior has a long history. Automata, devices which behave like living organisms, date back before the Greek era. They began, curiously enough, as toys. No one cared about saving labor in those days. Later they came to be used as labor-saving devices and more recently to save those subtle forms of labor called thinking.

There is no doubt that work in the field of simulation has alerted us to the need to analyze the behavior we are going to simulate. We must know what the behavior is in order to be sure we have simulated it. But there is another issue which takes us back again to that little man. A familiar toy is a little wooden pig with movable ears and tail. One catches an ordinary housefly and puts it inside the pig. So long as the fly lives, the pig moves its ears and tail. This is simulated pig. There is obviously

a "little man" inside. In the case of another automaton, the chess-playing Turk that Maelzel of metronome fame demonstrated in the United States in the early part of the 19th century, there was also a little man in the machine—a conveniently-diminutive chess player, and a very good one. The figure, dressed in a Turk's costume, would reach out and move the pieces. The man inside was getting the necessary information about the opponent's moves because magnets in the pieces operated telltales under the board. Although speculation was rife, the secret was kept for many years.

Shannon's chess-playing computer also has a midget inside. As Shannon himself points out, it would take hundreds of years for the most rapid computer to follow up the consequences of every move and hence to arrive at an optimal strategy. In order to simplify matters, part of the program which goes into the computer contains information about strong positions. These strong positions were arrived at by people who learned the game of chess much more quickly than computers are able to do.

But machines can play simpler games, and they can arrive at the strategies needed to do so. The machine itself is indeed solving the problems presented by the rules of a game. Even so, that little pig is not a real pig; the Turk was not a real chess player; and no machine, even though it behaves like a man, works in the same way. We have not yet got what we need to circumvent a scientific account of human behavior.

As you see, I am exhibiting my prejudices, which are in favor of an empirical approach. I see no alternative. Man as a behaving system is extraordinarily complex, and the world with respect to which he behaves is even more so, and the science of behavior must deal with both. It must analyze the complex interrelationships between them. However, we can avoid some trouble by throwing off prescientific conceptions of what behavior is like. We must take behavior for what it is—the movement of an organism in space—and the environment for what it is as the physicist sees it, not (as the psychologists urge us) as what it seems like to the behaving organism.

Actually, the problem of human behavior is not as disheartening as it may seem. There is no reason why we should account for all the various forms of behavior. There are taxonomists in every field. The botanists and zoologists of the old school simply collected all possible forms of life, but the physiologist and biochemist do not need all that information. They have their own problems, and can deal with them with respect to a few representative organisms. We do not need to account for all the diverse forms of human behavior in order to understand what behavior is like. The topography of an act is not the most important thing; what is important is the probability that it will occur. The basic datum in a science of

behavior is the probability that a man will behave in a given way upon a given occasion, and we can examine it without too much attention to a particular occasion or form of behavior. In a rather arbitrary way we can proceed to investigate ways in which that probability can be changed.

It is not easy to deal with probabilities, but one of those breakthroughs occurred more or less by accident a number of years ago. It was one of those happy times to which we look back, as Professor Aigrain has said. If one chooses a response which can be readily repeated without fatigue, then you can use *rate of responding* as a basic dependent variable. You can follow rate continuously in time. There are simple ways of making changes in rate conspicuous. I cannot suggest adequately here today the kinds of changes in rate which have been examined or the various conditions of which rate of responding is a function, but the formulation is valuable for other reasons. A concept has emerged which is something beyond those of information theory or cybernetics. It is a difficult concept, but I shall try to make it as clear as I can in the time available.

The term for it is "contingencies of reinforcement." A reinforcement is not far from reward or punishment, and the thought may occur to you that I am simply advocating some new version of hedonism, the philosophy that man acts to achieve pleasure and avoid pain, or some version of utilitarianism—the view, to put it roughly—that we behave as we do because of what we get out of it. These principles were roughly true, but they never quite made sense, and we now know why: from the fact that you know how much a man is paid, you do not know how hard he will work. From the fact that parents treat their children with affection or as martinets, you cannot predict whether the child will love or hate them. From the fact that a government is despotic or committed to welfare, you cannot predict whether a people will submit or revolt.

The consequences of behavior are important, but what was overlooked in those early principles were the contingencies, the detailed relationships, temporal and spatial, between behavior and its consequences. If you take into account what the organism is doing at the moment it receives a reinforcing consequence, then order appears, and it is sometimes an almost miraculous order. In early laboratory research, the contingencies could be exemplified in this way: a hungry rat, in the presence of a light, presses a lever and receives food. In the absence of a light, if it presses the lever, it does not receive food. What was observed was that the rate of responding in the presence of the light increased.

That there are now hundreds of laboratories in which the environment is sensitively controlled, in which various properties or dimensions of behavior are measured, and in which a variety of reinforcing consequences

are made contingent upon behavior in that environment. In many cases, on-line computer processing is used to pick up some subtle characteristic of behavior so that reinforcement can be made contingent upon it. The surprising result has been that all organisms studied are extremely sensitive to changes in contingencies. This sensitivity has led to a corpus of knowledge, a set of principles about behavior which is of an entirely new order of magnitude. It clearly shows, I think, that rate of responding is an important basic datum which leads to a rigorous scientific analysis.

I do not want to spend any more time on the basic analyses because I want to turn to the implications. In describing "contingencies of reinforcement," it is important to note that all three terms are essential—(1) the occasion upon which an organism behaves, (2) what it does, and (3), what follows. This is more than an input-output analysis, even with feedback. The relationships among these three terms have to do with motivation, with the inclination of the organism to behave in a given way. Such contingencies are an extremely important aspect of the world in which we all live—and when organisms acquired the sensitivity to respond to them, they made vast strides in the evolution of behavior.

So-called operant reinforcement accounts for the purposive or intentional character of behavior. The fact that consequences appear in the formulation means that we are dealing with the future, although it does not need to be taken into account as a final cause. The formulation points to features of the environment which account for aspects of behavior previously attributed to mental processes. Information theory, for example, makes a great deal of the processing, storage, and retrieval of information. These are things going on inside the organism. Take attention, for example; why do we not respond to all the stimuli impinging upon us at every moment? The answer is not that there is some inner Maxwell's Demon cutting off some information and allowing some to come through, but rather that certain contingencies of reinforcement have strengthened our behavior in response to some stimuli and not to others. In other words, external forces can account for aspects of behavior previously attributed to various imagined activities going on inside.

These basic advantages are abundantly supported by practical consequences, and I want to mention a few of these. The best known is probably education. Dean Everitt mentioned some applications yesterday. Programmed instruction came out of the study of lower organisms in a laboratory environment plus an interpretation of verbal behavior based upon our three-term contingency. It is easily misunderstood. I am sure you have all seen programs, many of them are boring, many of them are

poor. But there are good ones, and they really have a magical effect. Supplying an experimental analysis of behavior to education has emphasized the definition of terminal behavior. What do you want the student to do as a result of having been taught? If you can specify the terminal behavior, then these principles permit you to work out a program leading from ignorance to competence and to shape, as we say, or generate that behavior. That is too simple an account, but it will have to suffice here.

Equally important is the application to classroom management. Why do students come to school at all? Why do they sit quietly (when they do) and pay attention and study and learn and remember and use what they learn? It is all due to the contingencies of reinforcement in the classroom, and those who know how to arrange appropriate contingencies can create a quiet, attentive class. That has been demonstrated often enough now to prove that it can be done. Moreover, these contingencies account not only for the transmission of knowledge but for the teaching of thinking, for creative and original behavior. The difficulty is that ordinary philosophies of education are strongly mentalistic. They fall back upon explanatory fictions. In this morning's *Philadelphia Inquirer* there is an article by an educator commenting on the fact that students often do not pay attention. The explanation given is that they do not have certain "listening skills." If you knew how to put a listening skill into a student, you could solve the problem. Actually whether he pays attention or not depends upon whether paying attention pays off, whether there is anything happening in the classroom worth attending to. The teacher who knows how to arrange good contingencies of reinforcement can have attentive students.

The management of defectives is another area in which contingencies of reinforcement have been used. Psychotic patients and retardates are defective organisms. They also, as Freud himself recognized, behave in relatively uniform ways. Their behavior may look very strange at times, but is really fairly easily predicted. People who understand contingencies of reinforcement have gone into homes for retardates and wards for psychotics, and have arranged conditions under which the kind of behavior you want the individual to engage in does indeed have reinforcing consequences. Some of the results have been almost miraculous. A ward in which, for example, it took three attendants to shepherd the patients into the dining room over a half-hour period at every meal was converted, simply by making sure that the behavior of going to the dining room was reinforced, into a ward in which, when the dinner bell was rung, everyone went into the dining room within five minutes. What is ordinarily reinforced in a hospital ward is disturbing behavior; it is the only thing that gets the

attention of nurses and attendants. But if you arrange things properly, so that acceptable behavior is properly reinforced, the situation quickly changes for the better.

A very dramatic example of contingency management has occurred in a national training school for boys in Washington—actually what we used to call a reformatory. It is a school for serious delinquents—murderers, rapists, and what not—all minors. Two psychologists at the Institute of Behavioral Research reorganized the school so that the behavior of each boy was reinforced when it satisfied certain specifications. A boy could go on relief if he wanted to; he could get a nutritious diet, not very palatable, and a pad in the dormitory. He could, however, by acquiring points, buy special food, could rent a room for himself, could rent a television set, and so on. The only way to acquire points, except for a few janitorial services, was to learn something. Teaching machines and cheat-proof programs were available, and a bright boy who could really zip through such material could become a capitalist. He could live a very acceptable life. Many people object to a controlled environment of this sort, but the amusing thing is that it is really close to the ideal of the rugged individualist in American life.

Economic control outside of institutions is of the same nature. We heard yesterday from Dr. Simon about communication among people in management, but there are other questions to be answered. Why do people work at all? Why do they work either with enthusiasm or under compulsion in a begrudging way? Why do they work carefully or carelessly? The answers again concern contingencies. The weekly wage is not a positive reinforcer. No sensible organism works on Monday morning for a pay envelope on Friday afternoon. A supervisor is necessary. And men work during the week to avoid being discharged and deprived of that pay envelope on Friday. Behavior which is essentially escape or avoidance has many unwanted by-products. It leads to a minimal effort, a low rate, and carelessness. Incentive wages used to be an answer, but I am told by those who teach industrial management that they do not even mention the subject anymore because incentive wages have been so misused that everyone is opposed to them. However, it is an effective system and is still used in some cases. A salesman in the field, where no supervisor is possible, is paid a salary and a commission—a mixture of schedules of reinforcement which may produce a satisfactory level of behavior.

Schedules of reinforcement have been exhaustively studied in the laboratory. They have direct application to industry or any other area in which people are engaged in productive labor. I am sure you have all seen

a room full of people playing bingo. Here are people sitting and watching with extraordinary care a number of cards in front of them, listening acutely to letters and numbers being called out, placing counters with great precision and calling out instantly when a card has been filled in a certain way. What would industry not give to have employees who worked that hard and accurately! They could have them if they used the right schedules. Gambling schedules (so-called variable ratio schedules) are very powerful, and they are the same kind of schedule whether we are talking about horse racing or Las Vegas. They work as well on pigeons or monkeys as on man. People gamble because of an unpredictable schedule of reinforcement with an overall mean ratio of plays to wins. Curiously enough, it is usually a mean from which the net take is negative!

There is an interesting problem raised by the contingencies of reinforcement in the world of the future. Suppose, as Norbert Wiener predicted, we eventually find that the common man is unnecessary, and yet is still with us. He does not need to do anything, and the rest of us need only to push buttons, and effortless electronic buttons at that. This essentially is the ultimate world of welfare state, of the affluent society, of the negative income tax—or of the South Seas idyll of the 18th century. What will happen? Men will simply not do nothing. When they do not need to work productively for the big reinforcers in life, they will behave for lesser reinforcers on tricky schedules of reinforcement. They will behave in repetitive, compulsive ways, playing solitaire, or gambling, for example; or they may go into more productive fields of crafts, arts, or science. The problem of leisure is essentially the problem of designing contingencies of reinforcement which are not related to the exigencies of living.

The other speakers have offered RCA a little something in return for being invited here, so I am going to do the same. Contingencies of reinforcement bear on entertainment. Why do people watch television—turning it on, turning it off, or switching channels? This is behavior and must be controlled by the consequences. But the program builders miss many opportunities. They find out what is reinforcing people, what they want, and they pile it on. They come up with humor, brutality, the resolution of suspense, or what have you, but they overlook scheduling. How can the exciting moments be most effectively spaced in a program or in a series of programs? It is a matter of scheduling reinforcement. The great programs which really hold their audiences are football, baseball, and other sports, and they do so because a sport by its very nature schedules the exciting events on a variable ratio schedule, the same schedule as in gambling devices. The devotee of football or baseball is really "hooked." Very few

contrived programs make any effort to put the same scheduling to effect. It can be done, and it should be done.

Indeed, in one case it has been done. I was recently lecturing in San Francisco, and before my lecture a comedian whose name you would all know came to see me. He said his psychiatrist had solved a problem for him by recommending that he use a variable ratio schedule. He had been well known for one style of humor, but he was getting sick of it and wanted to change to a different style. When he made a sudden change, his audiences complained. So the psychiatrist, who knew something about scheduling, told him that he should plant the old material in the new on a variable ratio schedule and then, as we say, "stretch" the ratio. The old material got rarer and rarer as time went on, and eventually his audiences came around. He asked me to come over and see him at a night club where he was playing to prove how effective the scheduling had actually been.

To return to serious issues, contingencies of reinforcement are involved in government. We sometimes say that a government is defined as the power to punish. We are pouring in enormous quantities of positive and negative reinforcers into Vietnam. So far as I know, no one has really set down the kinds of behavior on the part of both the North and South Vietnamese that we want to strengthen. Certainly the contingencies are about as bad as they could be. Our domestic problems go unanalyzed too. Traditional efforts to understand the ghettos in terms of alienation, frustration, and what not, remind us of "little man" theories. But it is external conditions which need to be changed, and they would be changed much more successfully if we understood their role as reinforcers.

I will not go into the obstacles which stand in the way of extending the notion of contingencies of reinforcement to the design of a better way of life. There are very few people who really understand how to do this kind of thing, and unfortunately you cannot communicate it simply by imparting a few general principles. It takes the expertise resulting from laboratory research to go, let us say, into a ghetto and arrange the contingencies of reinforcement which will bring about a substantial change. There is also the matter of opposing theories. Industry and the services have made much better use of recent changes in education, for example, than our public schools because schools are in the hands of educators who continue to use outmoded and invalid theories of the learning process—or very often none at all.

A fresh look at human behavior should make possible a new kind of government in the broadest sense. A science of behavior does not mean gadgets. It does not mean prestigious terms borrowed from other sciences.

It means the definition of a subject matter and the application of established principles of scientific analysis. We are within reach of a more effective way of thinking about human behavior, and it is about time. Our problems are extraordinarily serious and grow steadily worse. Education is not really improved in spite of everything that has been done to improve it. The ghettos, racism and nationalism throughout the world, over-population, nuclear war—these are all problems involving human behavior. We need everything science can offer to deal with them effectively. We need to replace our current inadequate skills with a genuine technology, and nothing short of a science of behavior can do the job.

concluding remarks at the end of the symposia

GEORGE H. BROWN

We have come now to the conclusion of the events marking the 25th anniversary of RCA Laboratories in Princeton, and the two symposia which provided us with so many stimulating thoughts.

We are appreciative of the strenuous efforts of our associates at the David Sarnoff Research Center for all the effort they have put into making this a memorable occasion. I want to express my gratitude particularly to Mr. Harry Cooke, Dr. Edward Herold, and Dr. Ernest Linder, whose team effort was devoted to the detailed planning and execution of all the arrangements.

And I want to thank you, my friends, who have come from many places to join with us in marking a milestone in the history of RCA Laboratories and the David Sarnoff Research Center.

We are proud of our record in electronic science and of the part that the people and programs of RCA Laboratories have played in creating it over the past 25 years. Yet the one thing scientific research teaches above all else is that, in this incredibly complex world, man's knowledge is never complete, his works never perfect, and his solutions never final. Therefore, even as we celebrate the accomplishments of our past, we look forward with enthusiasm and excitement to still greater achievements in the future.

thanks to all

A. E. PANNENBORG

This is a transcript of an extemporaneous expression of thanks by Dr. Pannenberg, Director of Philips Research Laboratories, Eindhoven:

If you will allow me to address through you to those of your associates who have made these two days so memorable to us, I am thankful for this opportunity on behalf of your overseas guests. I'd like to speak words of gratitude for your hospitality extended, words of gratitude for the extremely interesting papers given at the two symposia, and above all, words of admiration for the fine work which has resulted in the many interesting exhibits which were so freely on show. So freely on show points to an opinion which is held by the population of this fine laboratory that the real safeguards of future industrial interest lie not in the findings of today, but in the power of the team which will bring the results of tomorrow.

This gathering has been looking into the future. It is an anniversary of 25 years. If I look back in those 25 years, I do so only to thank you also on behalf of many guests for the very friendly and open relations we have had over that long period. The question was asked here what human factors had to do with science. Dr. Hillier, you already gave part of the answer, and we know that the human factor in this laboratory stands very high on the list. From persons like you and Dr. Brown, who is a very great practical joker, we have seen many times that you can't divide the human being from the subject area. Industrial research has a kind of middle position in between pure science and business. In the many guests which have come together here this is reflected, and it is a great pleasure to see how this brotherhood of scientists communicates and has its good relations.

Industrial science has a task of translation and addition . . . translation from pure science into terms of technology as is needed by industry, and the addition of that pure science which is not provided by university research. We have felt again that, throughout the nations, we can live together on a basis of mutual respect. I'd like to thank all of you for everything we have experienced, and I should like to add with all the best wishes for a bright future of this great international corporation, RCA and its Research Laboratories especially.

credits

Designed by RCA, DCSD Graphic Arts, Camden
Photography by RCA Laboratories Photographic Studio, Princeton
Type by Typographic Service Inc., Philadelphia
Printed by Smith-Edwards Company, Philadelphia

