

# 1975 Radio TV Repair

Elementary  
Electronics  
Do-It-Yourself  
& Save Guide!

1975 EDITION \$1.25

## Do-It-Yourself Repair Saves Dollars & Time

### Tips and Techniques on Fixing Your—

- Color & B-W Tee-Vee • Stereo Tape Player •
- Steam/Spray Iron • Clock Table Radio •
- Stereo Cassette Player • CB Walkie Talkie •
- Playroom Phono • TV Antenna System •

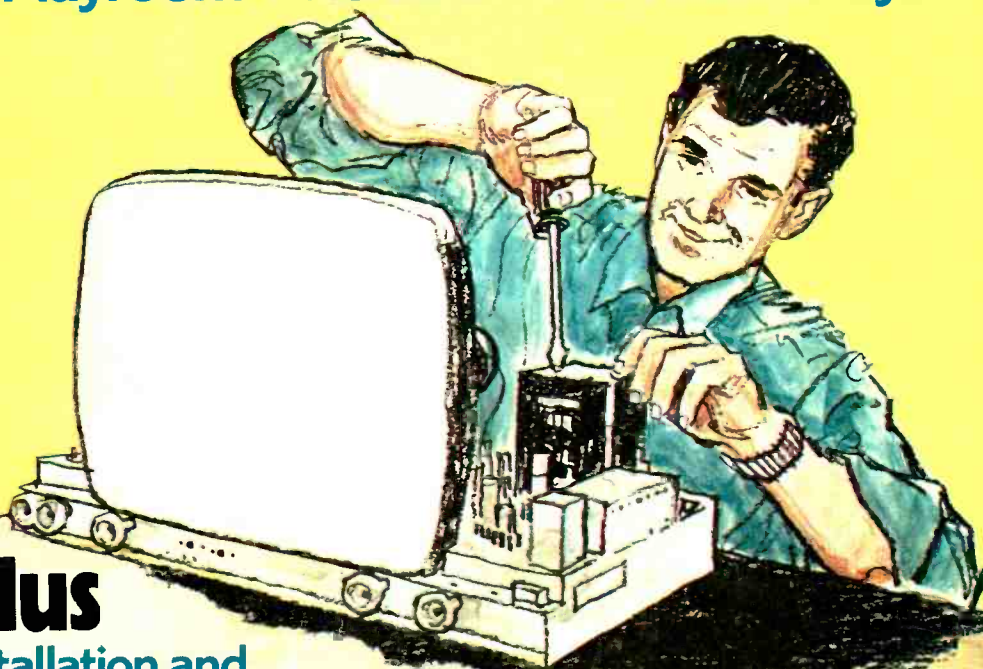

## Plus

Installation and  
application information  
on home electronic gadgets

# Where do the pros get their training?



**Almost half of the successful TV servicemen have home study training and with them, it's NRI 2 to 1.** It's a fact! Among men actually making their living repairing TV and audio equipment, more have taken training from NRI than any other home study school. More than twice as many!

Not only that, but a national survey,\* performed by an independent research organization, showed that the pros named NRI most often as a recommended school and as the first choice by far among those who had taken home study courses from *any* school. Why? Perhaps NRI's 60-year record with over a million students...the solid training and value built into every NRI course...and the designed-for-learning equipment originated by NRI provide the answer. But send for your free NRI catalog and decide for yourself.

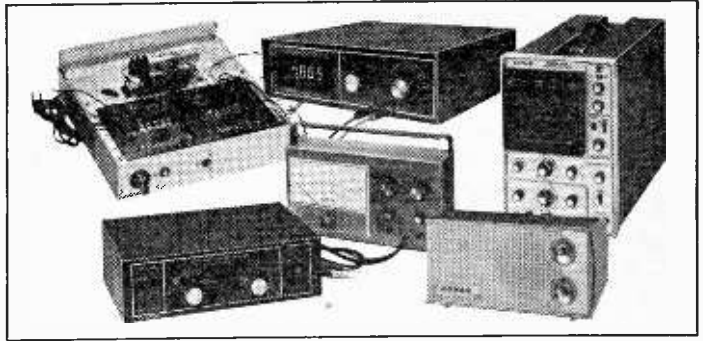

### 25" Diagonal Color TV... Professional Instruments

As a part of NRI's Master Course in TV/Audio servicing, you build a big-screen solid state color TV with every modern feature for great reception and performance. As you build it, you perform stage-by-stage experiments designed to give you actual bench experience while demonstrating the interaction of various stages of the circuitry. And your TV comes complete with console cabinet, an optional extra with other schools.

### Widest Choice of Courses and Careers.

NRI doesn't stop with just one course in TV/Audio servicing. You can pick from five different courses (including an advanced color course for practicing technicians) so you can fit your training to your needs and your budget. Or, you can go into Computer Technology, learning on a real, digital computer you build yourself. Communications with famous Johnson transceiver. Aircraft or Marine Electronics. Mobile radio, and more.

### Free Catalog... No Salesman Will Call.

Send the postage-paid card for our free color catalog showing details on all NRI electronics courses. Lesson plans, equipment, and career opportunities are fully described. Check card for information on G.I. benefits. No obligation, no salesman will call. Mail today and see for yourself why the pros select NRI two to one!

If card is missing, write to:



### Two Famous Educators... NRI and McGraw-Hill.

NRI is a part of McGraw-Hill, world's largest publishers of educational material. Together, they give you the kind of training that's geared for success...practical know-how aimed at giving you a real shot at a better job or a business of your own. You learn at home at your convenience, with "bite-size" lessons that ease learning and speed comprehension. Kits designed to give you practical bench experience also become first-class professional instruments you'll use in your work.

Likewise, NRI's instruments are a cut above the average, including a 3½ digit precision digital multimeter, triggered sweep 5" oscilloscope, and integrated circuit TV pattern generator. They're top professional quality, designed to give you years of reliable service. You can pay hundreds of dollars more for a similar course and not get a nickel's worth extra in training and equipment.



**NRI SCHOOLS**  
McGraw-Hill Continuing Education Center  
3939 Wisconsin Avenue,  
Washington, D.C. 20016

\*Summary of survey results upon request.

# RADIO TV REPAIR

1975

EDITION

## FEATURES

- 15 Save Big Money on TV Repairs**  
Mail order your TV tuner troubles away
- 17 21-Second TV Cure-All**  
It's as simple as looking at the tube
- 23 CTS Futura V Speaker System**  
Build a best-buy for your hi-fi
- 24 11 Steps to Walkie-Talkie Repair**  
Keep the kids on the air and out of your hair
- 27 9th Life for a Kiddie Phono**  
Don't throw it out—it's a breeze to fix!
- 29 Put Your Electric Iron Back on the Line**  
Get the steam going with no fuss
- 34 Pop-Up TV Makes the Scene**  
Hide the big eye away when your eye's not on it
- 35 Erecting a Rooftop Tower**  
Save a buck and get a better picture too
- 40 Your TV Set Will Get You if You Don't Watch Out**  
Some safety tips that will pay off
- 42 10 Steps to Cassette Player Repair**  
Fix-it facts from a top technician
- 46 8 Steps to Car Tape Player Repair**  
Keep your music on the move
- 50 Those Minor Tape Troubles**  
How you can remedy them yourself, with ease
- 53 Put a Tape Player in Your Car**  
Cartridge or cassette, it's your choice
- 57 Electronics for Weekend Mechanics**  
Analyze your engine for peak gas dollars
- 62 Put that Clock Radio Back on the Job**  
If the clock's still good try this two-prong tip
- 66 4-Channel Takes Four Speakers**  
And where you place 'em makes all the difference
- 69 Ten Timely Tips for Resistance Measurement**  
Made-to-measure hints that'll really suit you
- 74 Photographing the TV Scene**  
Catch the news live, and keep it, with this snappy setup
- 77 How to Change a Color TV Tube**  
Replace it yourself and save fifty bucks at least
- 83 Build a Better Battery Tester**  
This simple unit keeps tabs on battery life
- 87 Skyhooks Start at Ground Zero**  
A maintenance-free TV tower you can put up yourself
- 96 Foreign Tube Replacement Guide**  
Domestic equivalents are easy to find with this table

## DEPARTMENTS

- |                              |                              |
|------------------------------|------------------------------|
| <b>6 New Products</b>        | <b>10 Classified Ads</b>     |
| <b>8 Reader Service Page</b> | <b>12 Literature Library</b> |
| <b>9 Ask Hank, He Knows!</b> | <b>14 Cartoon Page</b>       |

ORDER NOW & SAVE!

# electronics books from the Davis Magazine Mart

- Lowest price! • Guaranteed delivery despite paper shortages!
- Single copies home-delivered at no extra charge! • Protection against future price increases!

**ELEMENTARY ELECTRONICS** — For newcomer and hobbyist. In each issue theory articles and construction projects. General rules of electronics trouble-shooting techniques, much more.

**COMMUNICATIONS WORLD** — For shortwave listeners to overseas radio, and to local 2-way transmissions. Serves users of monitor equipment. Includes complete White's Radio Log as bonus.

**ELECTRONICS HOBBYIST** — For beginner and advanced buff. Information, complete plans, tips, instruction on projects for home, car, out-of-doors and on the job.

**101 ELECTRONIC PROJECTS UNDER \$15** — For beginners and the experienced. 100-plus projects in general circuits, passive circuits and integrated circuit projects.

**ELECTRICAL GUIDE** — For the homeowner. How to maintain, repair and modernize home electrical system. New tools and products. Departments for furthering interest or finding a career in electricity

CLIP & MAIL TODAY

TO: **Davis Magazine Mart**  
229 Park Avenue S., N.Y., NY 10003

Enclosed is \$\_\_\_\_\_ in payment of below indicated order.

Subscription to **ELEMENTARY ELECTRONICS**

- 1 yr. (6 iss.) \$2.67     1½ yrs. \$3.97

**COMMUNICATIONS WORLD**

- Spring/Summer '75 Ed., \$1.35 \*1/23/75

**ELECTRONICS HOBBYIST**

- Spring/Summer '75 Ed., \$1.35 \*1/21/75

**101 ELECTRONIC PROJECTS UNDER \$15**

- '75 Ed., \$1.35 \*5/15/75

**ELECTRICAL GUIDE**

- '75 Ed., \$1.25 \*8/21/75

\*On-Sale Date

85037

Name \_\_\_\_\_ (please print)

Address \_\_\_\_\_

City \_\_\_\_\_

State \_\_\_\_\_

Zip \_\_\_\_\_

# 19 **RADIO TV REPAIR** 75

*Editor-in-Chief*

**JULIAN S. MARTIN, WA2CQL, KGK3915**

*Technical Editor*

**PETER L. DEXNIS, WA3LOQ**

*Repair Editor*

**STEPHEN B. GRAY**

*News Editor*

**JEFFREY APTER**

*Workbench Editor*

**HANK SCOTT**

*Art Director*

**JIM MEDLER**

*Cover Art Director*

**IRVING BERNSTEIN**

*Associate Art Director*

**RALPH RUBINO**

*Advertising Director*

**DAVID J. MILLER**

*Production Director*

**CARL BARTEE**

*Production Manager*

**GERTRUD BORCHARDT**

*Assistant Production Manager*

**PHILIP CLARK**

*Newsstand Circulation Manager*

**DON GABREE**

*Subscription Circulation—Marketing Director*

**ROBERT V. ENLOW**

*Subscription Circulation Manager*

**GEORGE ROWELL**

*Instruments Division Manager*

**WILFRED M. BROWN**

*Director of Market Development*

**JAMES C. WEAKLEY**

*Electronics Group Coordinator*

**JULIAN S. MARTIN**

*President, Chairman of the Board (1957-1972)*

**B. G. DAVIS**

*President and Publisher*

**JOEL DAVIS**

*Vice-President and General Manager*

**LEONARD F. PINTO,**

*Vice-President and Treasurer*

**VICTOR C. STABILE, KBPØ681**

RADIO-TV REPAIR is published annually by Davis Publications, Inc. Editorial, business offices: 229 Park Ave. South, New York, N.Y. 10003. Advertising offices: New York: 229 Park Ave. South, 212-673-1300; Chicago: 520 N. Michigan Ave., 312-527-0330; Los Angeles: J. E. Publishers Rep. Co., 8732 Sunset Blvd., 213-659-3810

EDITORIAL CONTRIBUTIONS must be accompanied by return postage and will be handled with reasonable care; however, publisher assumes no responsibility for return or safety of manuscripts, art work, or photographs. Contributions should be addressed to the Editor, RADIO-TV REPAIR, 229 Park Ave. South, New York, New York 10003.

© Copyright 1975 by Davis Publications, Inc.



## RF PROBE FOR VOM

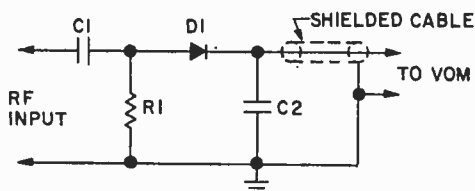

Assemble this accessory in a metal can, add a shielded cable and you'll make relative measurements of RF voltages to 200 MHz on a 20,000 ohms-per-volt multimeter. RF voltage must not exceed approximately 100V, the breakdown rating of the 1N4149.

### PARTS LIST FOR RF PROBE FOR VOM

- C1**—500-pF, 400-VDC capacitor  
**C2**—0.001- $\mu$ F, disc capacitor  
**D1**—1N4149 diode  
**R1**—15,000-ohm, 1/2-watt resistor

## RF PROBE FOR VTUM

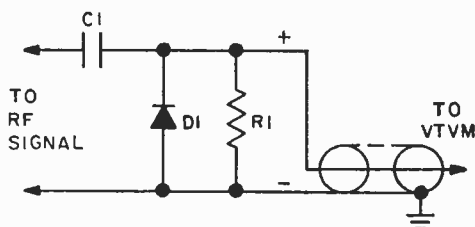

Three components are all that's needed to make a VTVM measure RF voltage up to 200 MHz (depending on the diode used). The probe should be built in a metal can with shielded wire for the connecting lead to the VTVM. Connect the shielded wire to the metal can and solder if possible. The diode rectifies the RF voltage, while the capacity of the shielded cable provides filtering. The output of the probe is positive, with the VTVM indicating the peak value of the RF waveform. To determine the RMS value, multiply the VTVM reading by 0.707. The maximum RF voltage that can be applied is limited by the diode. A 1N60 is limited to 30V peak RF voltage. For higher voltage-handling capacity, substitute a higher voltage small signal detector diode.

### PARTS LIST FOR RF PROBE FOR VTVM

- C1**—50-pF disc capacitor  
**D1**—1N60, Calectro K4-550 diode  
**R1**—20-megohm, 1/2-watt resistor



• THE SHOPPING CENTER FOR ELECTRONICS  
 (our catalog index of Mfrs extends from ADC to XCELITE)

• HOBBYISTS . . . EXPERIMENTERS . . . SERVICE  
 TECHNICIANS . . . ENGINEERS •



Your Satisfaction is Our Target  
 Top Name Brands . . .  
 Low Prices

AMPLE STOCKS—including  
 those hard-to-find Parts

whether you want a 15 $\phi$  capacitor,  
 a \$50 FET-VOM, or a \$450 stereo  
 system—you can get it at EDI!  
 (updated 5 times a year)

Send for your FREE catalog Today.

RUSH FREE CATALOG

Name \_\_\_\_\_

Address \_\_\_\_\_

City \_\_\_\_\_ State \_\_\_\_\_ Zip Code \_\_\_\_\_

**ELECTRONIC DISTRIBUTORS INC.**

Dept. TA-2, 4900 Elston

Chicago, Ill. 60630

CIRCLE #6 ON PAGE 8.

**PARTS!** **CORNELL** **TUBES!**

FREE Send For FREE  
**CORNELL'S**  
 New Color  
 Catalog

**33¢** per tube  
**36¢** per tube

48 Pgs. New Items IN LOTS OF 100 IN 24 HOURS!  
 ORDER FREE IF NOT SHIPPED

4219 E UNIVERSITY AVE. SAN DIEGO, CALIF. 92105

### HOW THE RICH MAKE MONEY IN 30 DIFFERENT WAYS

Gold & Silver. . . Real Estate. . . Art. . . Oil. . .  
 Stocks. . . Business Opportunities

Receive up to \$178 worth of Money-making publications for only \$9. Here's how you can receive the same confidential newsletters whose advice the rich seek in 30 different money-making areas: art, commodities, gold, silver, stocks, business opportunities, etc. Through this bargain-packed offer, SELECT INFORMATION EXCHANGE, America's leading financial publications subscription agency, makes available to you 1-5 issue current trials to 30 of these money-making publications. Their regular annual price ranges as high as \$325 apiece. Your price for the entire package under this amazing, one-time-only offer is \$9, or 40¢ apiece. To order the entire package of 30 sample subscriptions, send your name and address together with this ad and your \$9 remittance to:

**DAVIS PUBLICATIONS INC.**  
 229 Park Avenue South  
 New York, N.Y. 10003

RT-75

Package #24

# So Watt?\*

How big you succeed in electronics today—bigger pay...better job...personal enjoyment—depends on how far you take the basics!

\* Your reading this page now gives you the head start you need. And we'll match it with a Special Introductory Offer to keep you ahead

It always has been a matter of *knowing the basics*. Of the thousands of opportunities that are open to you in the electronics field today, you can be sure that all depend on *your understanding of basic electronics theory*. New electronic advances are triggered by yesterday's basics... just as tomorrow's amazing breakthroughs will spring from today's fundamentals.

Your taking advantage of the offer shown in the coupon below puts you in a better position to get the rewards electronics gives you today—and will offer you in the years ahead!

**For Beginner or Expert—Elementary Electronics is valuable!**

*It shows a novice where to begin—an expert where to improve.* Each issue features a *Basic Course* in an important area of electronics. Written by experts in an easy-to-follow style, with clear illustrations and diagrams, you get a practical understanding of special circuits... semi-conductors... power supplies... transformers... transistors... pulse circuitry, much more. You'll see general rules of electronics, develop trouble-shooting techniques, know how to calculate changing effects.

You may be earning an income now in electronics and hope to increase it soon. Or you may be an electronics hobbyist looking for new ideas to use at home and for recreation. Either way, for pleasure or profit, you shouldn't be without Elementary Electronics.

**HI-FI • CB Radio • Shortwave • New Products • Projects in every issue!** You'll find a lot more in Elementary Electronics—a fantastic variety of new

and exciting electronic information. More on today's CB activities and Shortwave Listening... expanded coverage on Product Testing from batteries and cells to stereo... new Build-It Projects for home and shop... portable music centers, weekend experiments, new products, bonus construction projects, electronic gadgets for fun and profit.

Try it. Try Elementary Electronics under the no-risk subscription offer shown in the coupon. Just fill in and mail the coupon to Elementary Electronics, P.O. Box 2600, Greenwich, CT 06830. Send in your order TODAY.



## PUBLISHER'S DISCOUNT SAVINGS CERTIFICATE

Good for up to **\$3.94** off the subscription price of **ELEMENTARY ELECTRONICS**

Enter my trial subscription for 8 issues of Elementary Electronics, for only \$3.98. (Regularly by subscription, \$7.92)

New Subscription  Renewal Subscription

Name \_\_\_\_\_  
(please print or type clearly)

Address \_\_\_\_\_

City \_\_\_\_\_ State \_\_\_\_\_ Zip \_\_\_\_\_

**SEND NO MONEY, WE'LL BILL YOU LATER 85047**  
MAIL TO: ELEMENTARY ELECTRONICS  
P.O. Box 2600, Greenwich, CT 06830

# NEW PRODUCTS

## Useful Products are Fun to Buy and even more Fun to Use!

### Jr. Electronic Workshop

Youngsters can have fun building up to 35 different experiments while they learn the basics of electronics with the new Heathkit Jr. JK-18A Electronic Workshop. Connections are solderless spring terminals, and power is supplied by 4 inexpensive, safe "D" cells (not supplied). Simple schematic diagrams of each experiment teach circuit and component identification. Circuits that can be built with the JK-18A include: code flasher, continuity

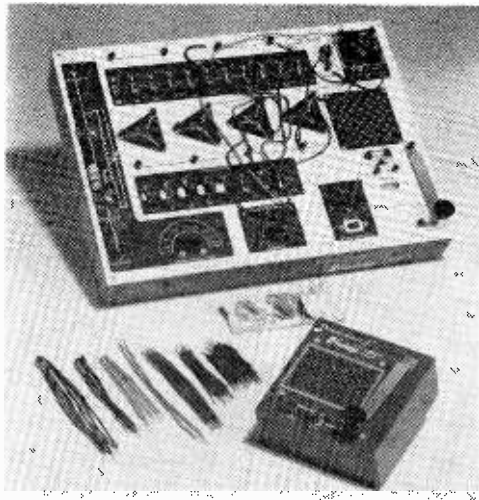

Circle No. 1 on Reader Service Page

tester, battery tester, diode tester, transistor tester, rain alarm, timing relay, listening device, P.A. amplifier, intercom, voice relay, earphone code oscillator, loudspeaker code oscillator, flasher, multivibrator, electronic organ, burglar alarm, metronome, siren, light meter, light sensing alarm, target "hit" alarm, light dependent flasher, light dependent oscillator, sound level meter, 2, 3 and 4-transistor radios, light dependent radio, field strength indicator, code transmitter, voice transmitter, capacitance relay, Wheatstone bridge, and capacitance bridge. Mail order price is \$34.95 (less batteries) F.O.B. factory. For more information, write Heath Company, Benton Harbor, MI 49022.

### Parts Jars for Pegboard

Forget those old mayonnaise jars full of nails and screws stuck to your ceiling. Handy little pegboard containers attach by their covers to standard  $\frac{1}{8}$ -in pegboard. Just unscrew, take where needed, replace. Simple, more convenient, neater. See-through unbreakable



plastic container is  $3\frac{1}{4}$ -in. high,  $2\frac{1}{4}$  in. diameter and release with a quick quarter-turn. Top stays put but is easily relocated. Package of 10 pegboard containers, \$4.40 postpaid or send \$1.00 for one year's subscription (six issues) of Hard-To-Find Tools Catalog to Brookstone Company, 3427R Brookstone Building, Peterborough, NH.03458.

### Audio Control Center

A new two-in, four-out audio control center, the new MP-2 Multi-play switcher, accepts one or two signal sources and allows the outputs to be fed to one, two, three or four pairs of stereo speakers. Each of the four stereo output channels has its own constant impedance L-pad volume control to permit any speaker pair to be adjusted in volume without affecting the loudness of the others. Any assortment of speaker efficiencies and impedance ratings may be used with the MP-2 without overloading the amplifier's output stage. The use of heavy duty controls with 20 watt continuous ratings permits the MP-2 to handle even high powered amplifiers on music programs without burning out. The Russound MP-2 Multi-play Audio Control Center is available from most audio dealers at \$69.95. If



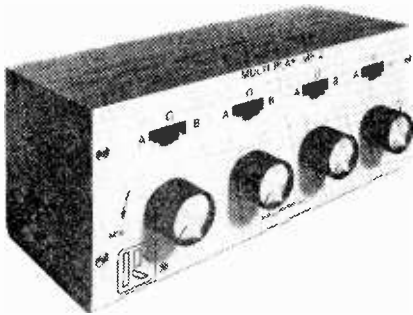

**Circle No. 24 on Reader Service Page**

it is unavailable in your area, send a check for \$69.95 plus \$1.75 shipping to Rus sound/FMP, Inc., Canal Street, North Berwick, Maine 03906. Or send for full product information and list of dealers in your area.

**Just for Probing**

Hunter Associates announces two new universal laboratory probe kits. Each kit consists of two insulated probe handles (red or black) connected by cables to insulated tip handles. Both probe handles and tip handles have threaded inserts so that an assortment

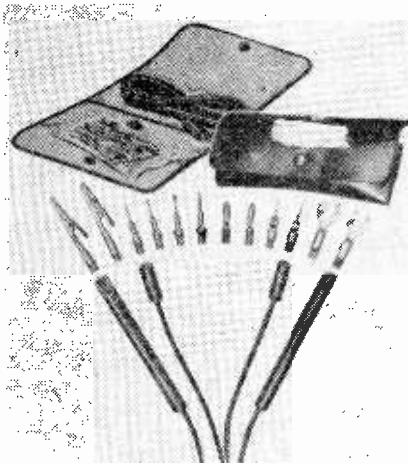

of accessories may be screwed into probe handles or tip handles to make almost any required test-lead combination. Included are phone tips, needle tips, banana plugs, alligator clips and spade lug tips. Complete with vinyl case. Model #699 is the standard set while Model #679 is the miniature version. They sell for \$5.50 each. For more information, write to Hunter Associates, 792 Partridge Drive, Somerville, NJ 08876.

**It Functions**

Heath is offering a new function generator combining wide frequency range and compact

size in a low-cost package. The instrument generates sine, square or triangle waveforms from 0.1 Hz to 1 MHz. A short-circuit-proof output amplifier supplies a 10-volt peak-to-peak signal into a 50-ohm load. A calibrated step attenuator adjusts from 0 to 50 db (10V p-p to 30 mV p-p) in 10 dB steps. Variable attenuator control gives up to 20 dB additional attenuation for each step for a total of

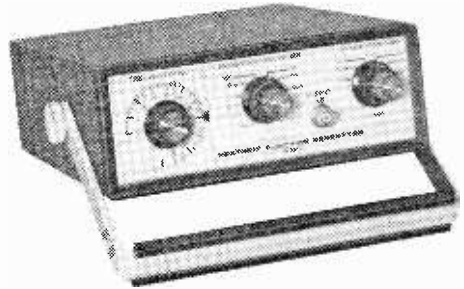

**Circle No. 1 on Reader Service Page**

70 dB. Selection: Kit version, IG-1271 is \$99.95; assembled version, SG-1271 is \$140.00. Both prices are mail order, F.O.B. factory. For further information and complete catalog, write Heath Company, Benton Harbor, MI 49022.

**Keep On Shining**

One spray application of Brookstone Silicone Metal Protector keeps all metals bright, protects them against tarnish, corrosion and  
*(Continued on page 13)*



# 1975 Radio TV Repair READER SERVICE PAGE

● The Editor of RADIO-TV REPAIR—1975 Edition offers readers an easy way to get additional information about products and services advertised in this issue. To become proficient in your home and repair projects you must obtain the correct quality parts, knowledge, test gear, tools and many other items. Become a knowledgeable buyer by obtaining information on the products and services mentioned in this issue and keyed with a Reader Service Number. The coupon below is designed for your convenience. Just circle the numbers that appear next to the advertisement or editorial mention that interests you. Please limit your selections to 10 or less. Then, carefully print your name and address on the coupon. Cut out the coupon and mail to RADIO-TV REPAIR, Box 886, Ansonia Station, New York, N.Y. 100203. Do it today! Allow 4 to 6 weeks for delivery.

Mail Coupon to:

This offer expires September 13, 1975

## RADIO-TV REPAIR 1975

Box 886, Ansonia Station, New York, N.Y. 10023

● Okay, I want some information. Please have the literature whose numbers I've circled sent to me as soon as possible. I understand I must limit the circled items to 10. Allow 4 to 6 weeks for delivery.

1	2	3	4	5	6	7	8
9	10	11	12	13	14	15	16
17	18	19	20	21	22	23	24
25	26	27	28	29	30	31	32

Name \_\_\_\_\_

Address \_\_\_\_\_

City \_\_\_\_\_ State \_\_\_\_\_ Zip \_\_\_\_\_

Mail Coupon to:

This offer expires September 13, 1975

## RADIO-TV REPAIR 1975

Box 886, Ansonia Station, New York, N.Y. 10023

● Okay, I want some information. Please have the literature whose numbers I've circled sent to me as soon as possible. I understand I must limit the circled items to 10. Allow 4 to 6 weeks for delivery.

1	2	3	4	5	6	7	8
9	10	11	12	13	14	15	16
17	18	19	20	21	22	23	24
25	26	27	28	29	30	31	32

Name \_\_\_\_\_

Address \_\_\_\_\_

City \_\_\_\_\_ State \_\_\_\_\_ Zip \_\_\_\_\_

# service shop tips

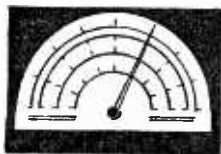

by Hank Scott, Workshop Editor

## Iron Age

My wife's one-year-old (out of warranty) steam iron doesn't spritz steam anymore. What can I do about it. I know it isn't an electrical problem, but you must know something about irons, Hank.

—R.K., Lombard, IL

We must have the same irons, but I got mine to "spritz" without costly repairs. Take the iron apart carefully and you'll be able to remove the plastic boiler innards that is replaceable. In fact, my iron had ordering information printed on it. Replace this plastic water boiler and spritz on. Regards to the Mrs.

## Fixing Fixtures

Since speaker wire is a lot cheaper than lamp line cord, can I use it to wire electrical fixtures?

—M.A., Elmsford, NY

Don't do it! Speaker wire is a mite smaller in copper size. Also, I'm not sure, but most wire of this type is not "UL Approved." In fact, it's made for low-voltage work. Stick to line cord or any substitute offered by your local electrical supply house.

## Zap, Zap, Zap

Has anyone made a laser unit for burning off the copper from a foil laminate so printed circuit boards can be made without chemicals?

—D.S., Santa Clara, CA

Yes, but the plans were buried with the inventor after he accidentally cut himself in half.

## You Don't Have to Lump It

I have a lot of trouble removing lumps of solder from PC boards. Should I use a wick or a desoldering bulb?

—M.F., Paducah, KY

I prefer a desoldering bulb or plunger type mechanism. It's quicker and cleaner. The wick is fair, but takes too long on large blobs of

solder. The extra heat required may lift the copper foil from the board.

## First Roll it Down

Please tell me how to use a standard inexpensive walkie-talkie mobile from my car.

—H.A., Douglas, AZ

Stick the antenna out the window.

## I Hear Music—Squawkkkk!

My transistor radio does not work in my office area, but it works fine out-of-doors and at home. Why?

—E.G., Schenectady, NY

Iron building construction and buildings with air conditioning insulation very seldom permit satisfactory operation of inexpensive portables. Besides reducing the overall signal level of all stations, fluorescent lamps add masking noise, as does rotating machinery. In fact, as I type this, the freight elevator is moving. It gives off a characteristic static profile over my transistor radio. You'll find that the performance improves considerably as the transistor radio is brought near a window.

## Plastic Shaft

I replaced a potentiometer in my TV set with an almost identical unit. The difference being that the original had a plastic shaft. The new unit has a metal shaft. The TV works fine. Is everything okay? My wife worries.

—G.A., Geneva, AL

The plastic shaft is used to isolate the TV innards from the outer metal shell and people. If the TV set is housed in a metal cabinet, be sure the shaft does not touch the metal. Also, keep a plastic push-on knob on the shaft at all times. Do not use a knob with a set-screw—the screw is a good conductor.

## No Fixie CBie

I've raised the power of my CB walkie-talkie transceiver from one milliwatt to about 5 watts. Now, how can I alter the antenna for maximum efficiency?

—R.S., Corte Madera, CA

Try sticking it in a full rain barrel. This way you stay out of the slammer. Don't believe me—ask the FCC fuzz!

## Slam, It's Off

I installed an AM/FM cassette tape unit in my car two months ago and it worked fine until this week when it became erratic. When I close the car door hard, it turns off sometimes. Is something wrong with the car's wiring?

—S.S., Piedmont, SC

What happens is you may have skipped installing the rear strap bracket from the top of the dash to the rear of the radio. This mounting strap is very important to obtain a good electrical ground from the unit's chassis to the car

(Continued on page 91)

# CLASSIFIED Market Place

FOR BIGGER PROFITS! NEW CAREER OPPORTUNITIES!  
READ AND REPLY TO THESE CLASSIFIED ADS

Classified Ads 75¢ per word, each insertion, minimum 15 words, payable in advance. For information on Classified ads—to be included in our next RADIO-TV REPAIR—write to R. S. Wayner, Mgr., Classified Ad Dept. 229 Park Avenue South, New York, N.Y. 10003.

## AGENTS WANTED

PART Time Help Needed. Crystal Palace, Box 111, Roseville, CA 95678.

## BOOKS & PERIODICALS

FREE Gift Catalog. Write: Enterprises, Drawer 570-A, Wetumpka, AL 36092.

FREE Lists! 740 World Famous interesting "Blue Books" Inexpensive! DC CHASSEY, 21 Ridge Road, Danbury, CT 06810.

## BLUEPRINTS, PATTERNS & PLANS

NEW CRAFT PRINT CATALOG—Choose from over 100 great easy-to-build plans. Send \$1.25 (completely refunded with your first order). BOAT BUILDER, (CP Div.)—229 Park Avenue South, New York, NY 10003.

## BUSINESS OPPORTUNITIES

I MADE \$40,000.00 Year by Mailorder! Helped others make money! Free Proof! Torrey, Box 318-TT, Ypsilanti, MI 48197.

MAKE Magnetic Signs. Big Profits. Details. Universal, Lenora, KS 67645.

1000% PROFIT Bronzing Baby Shoes. Free Literature. NBC-DG, Gower, MO 64454.

HOW To Make Money Addressing, Mailing Envelopes. Offer Details 10¢. Lindbloom Services, 3636 Peterson, Chicago 60659.

FREE Secret Book "2042 Unique, Proven Enterprises." Fabulous "Little Knowns" Work Home! HAYLINGS-E14, Carlsbad, CA 92008.

\$30.00 HUNDRED Stuffing Our Circulars Into Stamped Addressed Envelopes. Immediate Earnings, Beginners Kit \$2.00. COLOSSI, 1433-61 Street, DC-3, Brooklyn, NY 11219.

ADDRESSEES - Mailers - Homeworkers Needed! 50 Firms listed. Information Rush 25¢, stamped, addressed envelope. RBE, Box 3002-C, Des Moines, IA 50316.

FREE BOOK "999 Successful, Little-Known Businesses." Work Home! Plymouth 23FF, Box 1056, Weston, CT 06880.

ADDRESSEES-MAILERS-HOMEWORKERS NEEDED! 50 Firms Listed. INFORMATION: Rush 25¢, STAMPED, ADDRESSED ENVELOPE. BRACET INTERNATIONAL, 8163 YARMOUTH, RESEDA, CA 91335.

## DETECTIVES

CRIMEFIGHTERS! Investigators-Detectives-Police, Catalog \$1.00 Refundable. Don-Q, Box 548, Seattle, Washington, 98111.

## DO IT YOURSELF

OVERHEAD Garage Doors, All Types Since 1949, Complete Doors, Parts, Springs, Instructions. Electric Operators, Radio Controls, Get Facts TOLL FREE, Compare our Wholesale Prices. 800-631-5655 Nationwide. (New Jersey Residents—800-872-4980) Ridge Door, Monmouth Junction, NJ 08852.

## EDUCATION & INSTRUCTION

ACUPUNCTURE TRAINING Correspondence Course, Supplies! Tsang, Box 219W, Toronto, Canada M6M 4Z2.

COLLEGE DEGREES BY MAIL. Free Information. Write: Success Institute, 1455 North Belford, Dept. B4HP, Pasadena, CA 91104.

## FARMS, ACREAGE & REAL ESTATE

GOVERNMENT LANDS DIGEST. A Monthly review of government Real Estate offerings throughout the U.S.A. . . . Free subscription information! DIGEST, Box 25561-DP, Seattle, WA 98125.

## FOR INVENTORS

INVENTIONS IDEAS WANTED developed, Marketed by leading professional organization for Cash/Royalty sales. FREE EXAMINATION and CONFIDENTIAL REPORT of the Commercial Features of your Patented/Unpatented Invention. FREE COPY "How to Safeguard and Market your Invention to Industry" Write or Call: LAWRENCE PESKA ASSOCIATES, Dept. DP, 500 Fifth Ave., N.Y.C. 10036, (212) 354-9696, 150 S. Wacker Dr., Chicago, IL 60606, (312) 346-1172, 1 Biscayne Tower, 2 So. Biscayne Blvd., Miami, FL 33131. (305) 358-1366, 44 Montgomery St., San Francisco, CA 94164, (415) 956-1212, 1888 Century Park East, Los Angeles, CA 90067 (213) 552-2020.

## HOME WORKSHOP SUPPLIES

25 WEEKEND BUILD-IT PROJECTS—Practical designs for home/shop buffs who enjoy working with wood, tools, materials and techniques. Send \$1.25 for your copy (includes postage) to Davis Publications, Inc., 229 Park Avenue South, New York, NY 10003.

## LOGIC

LOGIC NEWSLETTER, Design, Theory, Construction, Sample copy \$1.00. Logic Newsletter, POB 252, Waldwick, NJ 07463.

## MISCELLANEOUS

NEVER WON ANYTHING? Anyone can win sweepstakes contests! Free details. Services, Box 644-SFD, Des Moines, IA 50303.

MOONSHINE WHISKEY! Learn exactly how it's made and where it's found. \$2.00. Mountain Publications, Box 2847-B, Huntington, West Virginia 25728.

DON'T Die Without A Will! Blank Will Form protects your family. Only \$2.00—Guaranteed! Order Today! NOMEKA, Box 725, Dept. 1114, Collinsville, VA 24078.

HOW INTELLIGENT are you? Self-scoring test reveals I.Q. in 45 minutes! Send \$3 today. Guaranteed!! Tests, PASHKO, Box 8021, Dept. 1E4, Fresno, CA 93727.

## MONEYMAKING OPPORTUNITIES

STUFF MAIL ENVELOPES!! \$250.00 profit per thousand possible. Offer details: Stamped self-addressed envelope. Kings, B-21487K-45, Ft. Lauderdale, FL 33316.

\$35.00—HUNDRED. Put our Brochures into preaddressed-stamped envelopes. Details: \$1.00 F&F, 720C East South Blvd., Troy, MI 48064.

STUFF ENVELOPES \$500/Thousand. Free details. Send stamped addressed Envelope. Mantor House, Dept. 8, PM4, Minoa, NY 13116.

MAKE YOUR CLASSIFIED AD PAY. Get "How to Write a Classified Ad That Pays." Includes certificate worth \$2.00 towards a classified ad. Send \$1.25 (includes postage) to R. S. Wayner, Davis Publications, Inc., 229 Park Avenue South, New York, N.Y. 10003.

MAKE MONEY WITH YOUR IDEAS. Turn your ideas into cash. Booklet shows how anyone can do it. Just \$1.50. Laugh 'N House, 6990 Lake Ellenor Dr., Suite 122-D, Orlando, FL 32809.

IMAGINE YOU getting TWICE the value you've EARNED. SKYROCKET your financial future NOW. Send SASE for free details. Carter Enterprises, P.O. Box 523, Pottstown, PA 19464.

THERE IS NO CHARGE FOR THE ZIP CODE—PLEASE USE IT IN YOUR CLASSIFIED AD

# CLASSIFIED MARKET PLACE

(Continued from page 10)

## MONEYMAKING OPPORTUNITIES Cont'd

\$25.00 HUNDRED STUFFING ENVELOPES. Immediate earnings. Send Self-Addressed Stamped envelope. JAKOB, 1005 S. East NO. 212DP, Appleton, WI 54911.

MAKE MONEY writing mail order pamphlets for me. Amazing Royalty Plan can make you Rich. Age 30 or over only. \$5 Refundable. Box 1226DB, Avalon, CA 95704.

60 FANTASTIC MONEYMAKING OPPORTUNITIES! Details Free! Goodwill. 13103-A Vickery, Houston, TX 77039.

## OF INTEREST TO WOMEN

\$35.00 DAILY Possible addressing-stuffing envelopes. Typewriter-longhand. Information! Send stamped addressed envelope. Ame 7, Box 310, LeMars, IA 51031.

SAVE by servicing home equipment yourself. Send \$1.25 for magazine. RADIO-TV REPAIR—229 Park Avenue South, New York, New York 10003.

## PERSONAL

JAPANESE Introductions! Girls' photographs, descriptions, brochure, details, \$1.00. INTER-PACIFIC Box 304-SC, Birmingham, MI 48012.

SINGLE? Widowed? Divorced? Nationwide introductions! Identity, Box 315-DC, Royal Oak, MI 48068.

CONTRACEPTIVES for Men—by mail! Thirty top brands—Trojan, Nuforn, Jade, and many more. Twelve assorted samples—\$3. Deluxe sampler: \$8. Free illustrated catalogue with every order. Plain package assures privacy. Fast and reliable service. Satisfaction guaranteed or your money refunded in full. POPLAN, Box 2556-Dept. DCG-12a, Chapel Hill, NC 27514.

## PERSONAL—cont'd

JAPANESE Girls Make Wonderful Wives. We have large number of listings. Many interested in marriage. Only \$1.00 brings application, photos, names, descriptions, questionnaire. Etc. Japan International, Box 1181-AA, Newport Beach, CA 92663.

"DATE WITH DIGNITY" Professional Matching. Drawer 6765, Fort Worth, 76115 (817) 921-0281 Anytime.

WHO wants the suffering and pain of heart attack? Avoid or over come. Satisfaction guaranteed. Free literature. Steward's Report, P.O. Box 312RTV, Grandville, Michigan 49418.

BEAUTIFUL MEXICAN GIRLS Wanting American Boy-Friends. Details. Photos "Free". World, Box 3876-DC, San Diego, CA 92103.

MARRY Me: 1200 Lonely Ladies. Fotos/Details free. International Partners: Box 737, Ft. Lauderdale, FL 33302.

X-FILMS—Lovelace, Others. Sample \$1.00 (Refundable). Action, 217DP, Port Richey, FL 33568.

## PHOTOGRAPHY—PHOTO FINISHING & SUPPLIES

SAVE HUNDREDS OF DOLLARS!!! Make your own S & M Densitometer. Send \$3.00 for detailed drawings and instructions. A must for successful photography in your darkroom. Order direct: S & M Instruments, Dept. RTV, 229 Park Avenue South, N.Y., NY 10003.

## PRINTING, MIMEOGRAPHING & MULTIGRAPHING

100 LETTERHEADS \$3.00 postpaid, envelopes same. APCO, Box 4333, Hayward, CA 94596.

## PRINTING, MIMEOGRAPHING & MULTIGRAPHING—cont'd

SMALL Quantity Business Printing. Graphic, Dept. R-TV45, 604 Marlborough Road, Brooklyn, NY 11228.

## RADIO & TELEVISION

TV TUBES 36¢ each. Send for Free 48 page color catalog. Cornell, 4217-W University, San Diego, California 92105.

## SPECIAL SERVICES

INFORMATION On Anything! Authoritative! \$2.00 (Deductible). Metzler Research, Box 2206PA, Long Island City, New York 11102.

ELITE membership organization desires exceptionally intelligent individuals. Send \$1.00 for intelligence rating form and information. Brotherhood. 1200 C. NW, Childress, TX 79201.

## STAMP COLLECTING

OLDER U.S. on approval. Surprisingly good. Adults only, please. Rivertown, Box 188C, Lowell, Michigan 49331.

## START YOUR OWN BUSINESS

FREELANCE NONFICTION WRITING is highly profitable! Cash in on your talent! Details airmailed. WRITER'S UTOPIA, Box 2606RTV, Vancouver, WA 98661.

## SURPLUS EQUIPMENT

GIANT Bargain Packed Canadian Surplus Catalogs \$1.00. Etco Electronics-DG, Box 741, Montreal "A".

## TIPS FOR THE HOME, ETC.

PRACTICAL tips for home, garden and workshop are in "1001 How-To Ideas." Send \$1.00 for your copy includes postage to 1001 How-To Ideas, 229 Park Avenue South, New York, NY 10003.

## FOR OUTSTANDING OPPORTUNITIES— READ and ANSWER THESE CLASSIFIED ADS

## FOR GREATER CLASSIFIED PROFITS, RESULTS AND SAVINGS

Place your ad in one of our SPECIAL COMBINATIONS: Business, Science & Mechanics, or Davis Combination. Each Combination is designed to give your ad the largest audience available. For further information write to R. S. Wayner, Manager, Classified Advertising, Science & Mechanics, 229 Park Avenue South, New York, N.Y. 10003.

### WHICH ARE THE 30 MOST POPULAR INVESTMENT ADVISORY SERVICES?

Receive short 1-5 issue current trials to the 30 most popular investment advisory services based upon the confidential sales records of SELECT INFORMATION EXCHANGE, America's leading financial publications subscription agency covering almost 800 different investment publications. Send your name and address together with this ad and your \$21 remittance to receive all 30 publications.

DAVIS PUBLICATIONS INC. RTR75  
229 Park Avenue South  
New York, N.Y. 10003

Package # 1

### SPECULATIVE-TRADING-AGGRESSIVE INVESTING ADVICES

Comprehensive Coverage for the  
Sophisticated Securities Trader

Receive short 1-5 issue current trials to 30 different advisory services specializing in highly speculative situations, aggressive investing and trading securities advices from SELECT INFORMATION EXCHANGE, America's leading financial publications subscription agency covering almost 800 different investment publications. Send your name and address together with this ad and your \$21 remittance to receive all 30 publications.

DAVIS PUBLICATIONS INC. RTR75  
229 Park Avenue South  
New York, N.Y. 10003

Package #10





# LITERATURE LIBRARY

101. Kit builder? Like weird products? EICO's 1975 catalog takes care of both breeds of buyers at prices you will like.

102. International Crystal has a free catalog for experimenters (crystals, PC boards, transistor RF mixers & amps, and other comm. products).

103. See brochures on Regency's 1975 line-up of CB transceivers & scanner receivers (for police, fire, weather, & other public service/emergency broadcasts).

104. Dynascan's new B&K catalog features test equipment for industrial labs, schools, and TV servicing.

105. Before you build from scratch, check the Fair Radio Sales latest catalog for surplus gear.

106. Get Antenna Specialists' cat. of latest CB and VHF/UHF innovations: base & mobile antennas, test equipment (wattmeters, etc.), accessories.

107. Want a deluxe CB base station? Then get the specs on Tram's super CB rigs.

108. Compact is the word for Xcelite's 9 different sets of midgeet screwdrivers and nutdrivers with "piggyback" handle to increase length and torque. A handy show case serves as a bench stand also.

109. Bomar claims to have C/B crystal for every transceiver . . . for every channel. The catalog gives list of crystal to set interchangeability.

110. Turner has colorful booklets on their Signal Kicker antennas, which are computer optimized for CB. Another booklet covers their communication microphones.

111. Midland's line of base & mobile CB equipment, marine transceivers & accessories, and scanner receivers are illustrated in a new full-color 16-page brochure.

112. The EDI (Electronic Distributors, Inc.) catalog is updated 5 times a year. It has an index of manufacturers literally from A to Z (ADC to Xcelite). Whether you want to spend 29 cents for a pilot-light socket or \$699.95 for a stereo AM/FM receiver, you'll find it here.

113. Get all the facts on Progressive Edu-Kits Home Radio Course, Build 20 radios and electronic circuits; parts, tools, and instructions included.

114. From Olson get their new, bargain-packaged 36-page, full-color tabloid (a new issue every 2 months). It contains their latest electronics parts, supplies, and hi-fi components. Pick up a copy at Olson stores coast-to-coast or send for a free copy today.

115. Trigger Electronics has a complete catalog of equipment for those in electronics. Included are kits, parts, ham gear, CB, hi fi and recording equipment.

116. Get the HUSTLER brochure illustrating their complete line of CB and monitor radio antennas.

117. Teaberry's new 6-page folder presents their 6 models of CB transceivers (base and mobile); 1 transceiver for marine-use, and 2 scanner models (the innovative "Crime Fighter" receiver and a pocket-size scanner).

118. CB'ers, GC Electronic's 8-page catalog offers the latest in CB accessories. There are base and mobile mikes; phone plugs; adaptors and connectors; antenna switchers and matchers; TV1 filters; automotive noise suppressor kits; SWR Power and FS meters, etc.

119. Browning's mobiles and its famous Golden Eagle base station, are illustrated in detail in the new 1975 catalog. It has full-color photos and specification dates on Golden Eagle, LTD and SST models, and on "Brownie," a dramatic new mini-mobile.

120. Edmund Scientific's new catalog contains over 4000 products that embrace many sciences and fields.

121. Cornell Electronics' "Imperial Thrift Tag Sale" Catalog features TV and radio tubes. You can also find almost anything in electronics.

122. Radio Shack's 1975 catalog colorfully illustrates their complete range of kit and wired products for electronics enthusiasts—CB, ham, SWL, hi-fi, experimenter kits, batteries, tools, tubes, wire, cable, etc.

123. Get Lafayette Radio's "new look" 1975 catalog with 260 pages of complete electronics equipment. It has larger pictures and easy to read type. Over 18,000 items cover hi-fi, CB, ham rigs, accessories, test equipment and tools.

124. Mosley Electronics reports that by popular demand the Model A-311 3-element CB beam antenna is being reintroduced. Send for the brochure.

125. RCA Experimenter's Kits for hobbyists, hams, technicians and students are the answer for successful and enjoyable projects.

126. B&F Enterprises has an interesting catalog you'd enjoy scanning. There are geiger counters, logic cards, kits, lenses, etc.

127. There are Avanti antennas (mobile & base) for CB and scanner receivers, fully described and illustrated in a new 16-page full-color catalog.

128. A new free catalog is available from McGee Radio. It contains electronic product bargains.

129. Semiconductor Supermart is a new 1975 catalog listing project builders' parts, popular CB gear, and test equipment. It features semiconductors—all from Circuit Specialists.

## Radio-TV Repairs

Box 886

Ansonia Station

New York, N.Y. 10023

Please arrange to have this literature whose numbers I have circled at right sent to me as soon as possible. I am enclosing 50¢ to cover handling. (No stamps, please). Allow 4 to 6 weeks for delivery.

Indicate total number of booklets requested.

Sorry, only 10 circled items maximum.

1975

101	102	103	104	105	106	107	108	109	110
111	112	113	114	115	116	117	118	119	120
121	122	123	124	125	126	127	128	129	130
131	132	133	134	135	136	137	138	139	140
141	142	143	144	145	146	147	148	149	150
151	152	153	154	155	156	157	158	159	160
161	162	163	164	165	166	167	168	169	170

NAME \_\_\_\_\_

ADDRESS \_\_\_\_\_

CITY \_\_\_\_\_

STATE \_\_\_\_\_ ZIP \_\_\_\_\_

Not Valid After September 13, 1975

## NEW PRODUCTS

(Continued from page 7)



Circle No. 21 on Reader Service Coupon

eliminates need for repeated polishing. Long-lasting, nonoily, invisible coat protects ferrous, non-ferrous metals, brass, gold, silver, aluminum, magnesium—solid or plated. Won't discolor, chip or crack, dries in minutes. Easily removed with common solvents. Harmless to cured paints, plastics, fiberglass. 10-oz. can, \$4.65 postpaid or write for new 60 page catalog of "Hard-To-Find-Tools and Other Fine Things" to Brookstone Company, 9505R Brookstone Building, Peterborough, NH 03458.

### CB On Your Finger

Not every hobbyist can wear a ring to show off his hobby, but now the lucky CBER can! Regal Lapidaries, Inc. is the manufacturer of this beautifully designed CB ring. The ring is a masterpiece in sculpture, depicting the handclasp of friendship, a mike, and an antenna, all beautifully done in three-dimensional form. The ring is available to all CBERs, and is priced at \$9.95. The company invites all clubs to write in for special club information. Their address is: Regal Lapidaries, Inc., 420 Madison Ave., New York, NY 10017. ■

130. Heath's new 1975 full-color catalog is a shopper's dream—chockful of kits and gadgets everyone would want to build and own.

131. E. F. Johnson's new full-color catalog for CB transceivers and accessories is now available. Send for a free copy. They also have a free brochure on their line of scanner receivers.

132. If you want courses in assembling your own TV kits, National Schools has 10 from which to choose. There is a plan for GIs.

133. Get the new free catalog from Howard W. Sams. It describes 100's of books for hobbyists and technicians—books on projects, basic electronics and related subjects.

134. Sprague Products has L.E.D. readouts for those who want to build electronic clocks, calculators, etc. Parts lists and helpful schematics are included.

135. The latest edition of *Tab Books'* catalog has an extensive listing of TV, radio and general servicing manuals.

136. Leader's catalog features "Instruments to Believe In." They have a complete line for industry, education and service, featuring oscilloscopes/vectorscopes, many generators, accessories, etc.

137. Pace Communications has a packet of information for you. The "Citizens two-way radio" answers all the questions from how to op-

erate one to how much they will cost to operate. A booklet on Pace's scan/monitors to keep you informed is included.

138. Pearce-Simpson has a booklet, "Citizens Band Radios & Scanners," which pictures and describes the various models in this line. A section on CB antennas is included.

139. For the latest information on CB transceivers by Courier, send for their literature.

140. Featured in *Siltronix's* brochure are single sideband/AM citizen band transceivers, pictured and described with extra features and specifications listed. VFO sliders for monitoring are pictured as well as export models of linear amplifiers.

141. Lee Electronics Labs has an inexpensive circuit analyzer, which is featured in this catalog.

142. Available from Royce Electronics is a 28-page, full-color catalog for CBERs (base, mobile and handheld transceivers; accessories; and test instruments).

143. A set of Abraxas/4 speakers contains a rugged 12-inch long-throw woofer with a 22-oz. Alnico magnet, a 5-inch sealed-back rubber-damped midrange, and two 3-inch dome tweeters from *Designers Audio Products*.

144. For a packetful of material, send for SBE's material on UHF and VHF scanners, CB mobile transceivers, walkie-talkies, slow-scan TV systems, marine-radios, two-way radios, and accessories.

145. For CBERs from *Hy-Gain Electronics Corp.* there is a 50-page, 4-color catalog (base, mobile and marine transceivers, antennas, and accessories). Colorful literature il-

lustrating two models of monitor-scanners is also available.

146. *Robyn International* has 4-color "spec" sheets for each model of their CB (base and mobile) transceivers and monitor-scanner lines.

147. *Telex's* 4-page, 2-color folder illustrates their new line of boom microphone head-sets for CBERs and hams, as well as their line of communications headphones.

148. *Surveyor Manuf. Corp.* offers you two catalogs in 4-color. One features their *Electronics 2000/Surveyor CB*, pictured with descriptions and specifications. Their *Monitor/Scanner, Surveyor Model 4H 4U*, is featured in the second catalog.

149. *Cush Craft* has a catalog on *Citizens Band Antennas* for every purpose. The *Ringo* base antenna is featured, as is the new *Superfire 8*-element horizontal/vertical power beam.

150. For TV or communications towers, aluminum spells rugged strength. An 8-page brochure from *ASCOM* details 30 models to fit every need for CB, ham, commercial 2-way radio, or home/institutional installations.

151. For a complete audio accessory line—TV, tape, phono and radio for home and auto, send for *Audiotex* catalog FR 73-A.

152. Send for the new, free descriptive bulletin from *Finney Co.* It features the *Finco* line of VOM multimeters (and accessories) for electronics hobbyists and service technicians.

153. A full-color brochure on *Tennelec's* scanners is available. They have portables, 3 bands—12 channels and 3 bands—16 channels. Outstanding features and specifications of the tri-bands are listed

Use Coupon on Left!

# SIGNS OF OUR TIMES

by Jack Schmidt

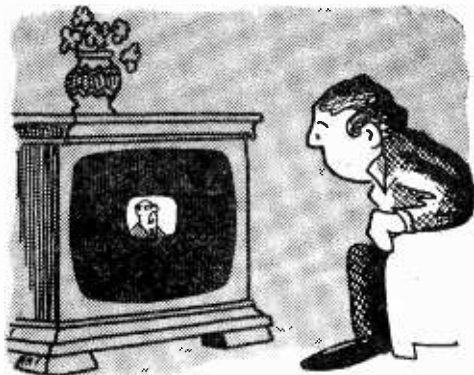

"Con Ed reports that the slight reduction in the size of your TV picture is due to a very slight voltage reduction. . . ."

CHECKS CASHED HERE



"Our grocery bill exceeded the capacity of our electronic calculator!"



"I gave my son a ham rig for his dorm . . . it cut my phone bill in half!"



"... remember the good old days of the 80 and 90 MPH chase?"

PRICES SLASHED



"That's right, sir . . . they're slashed below what they will be tomorrow!"

# SAVE BIG MONEY ON TV REPAIRS

DO WHAT YOUR SERVICEMAN SHOULD DO . . .  
AND SAVE OVER ONE-HALF THE REPAIR BILL!

**O**THER than replacing a color CRT, one of the most expensive TV repairs is the tuner—the *front end* as it is often termed. Most repair shops charge up to \$55 to “fix” a tuner, yet in most instances the repair shop will send the tuner off to a professional tuner rebuilding service such as Tuner Service Corp., who for something like \$9.95 will rebuild the tuner to like-new performance.

In short, less than \$10 represents the cost

The price is right if you do it yourself. Once the tuner is removed from your receiver, minus all brackets, Tuner Service Corp., 537 So. Walnut St., Bloomington IN 47401 will fix it for only \$9.95 plus \$1.25 for tubes and \$1.00 for transistors, if needed. Combination UHF/VHF TV tuners cost \$15.00. For information on repairs, replacement tuners and customized service, circle No. 32 on Reader Service Coupon on page 8.

of repair; the remaining \$45 or so is charged for simply changing the tuner. Since changing a tuner usually involves nothing more than a few screws and some minor soldering, you might as well do it yourself and put the \$45 or so in *your* pocket.

The important thing to keep in mind before you tackle your tuner is that, contrary to rumor, you do not have to make any electrical adjustments if you use a tuner repair service such as Tuner Service. The tuner

by the RADIO-TV REPAIR  
EDITORIAL STAFF

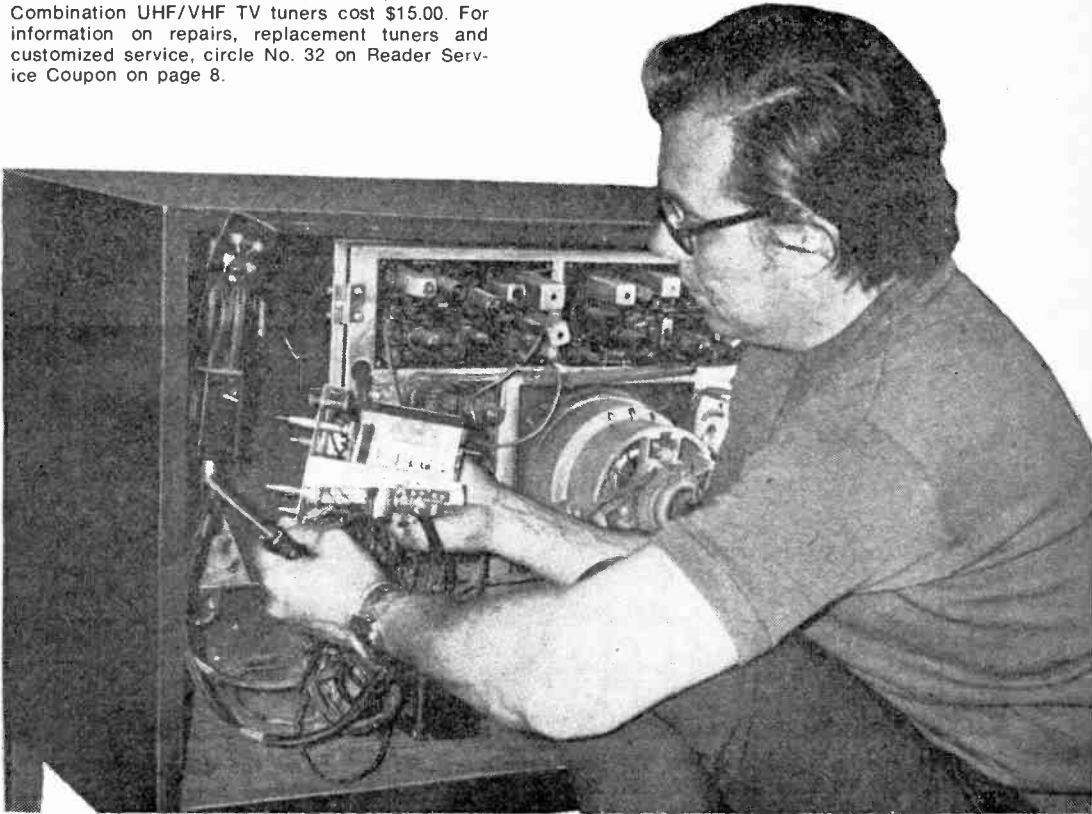

# TIRED OF TV TUNER TROUBLES?

is returned to you completely overhauled, aligned and air-checked. A certificate included with the repaired tuner indicates exactly what checks were made, and the best you can do is to keep your hands off the adjustments. In fact, worn components that don't cause trouble at the present will also most likely be replaced. In the tuner shown, new coils were substituted for coils with worn, though operable, contacts.

**How to.** First step is to remove the tuner from its mount. This usually involves simply removing two to four screws. Next, remove any plug-in cables which might come from an associated tuner, or which might be the connection to the main IF amplifier.

Make a diagram or sketch of the tuner and indicate where the plug-in cable was connected. Then, using a small soldering iron or gun, remove the power and control wires. To avoid a mixup when the "new" tuner is installed, tag each wire as it is removed and indicate its connection.

Remove all knobs, drive shafts, etc. from the tuner—but leave the tubes in place—and ship the tuner off to the repair service. If the repair service has sent you a complaint card, make certain you check off those complaints that most accurately reflect what is wrong. If you don't have a complaint card be sure to include a *short* description of the problem.

**Back in.** In about a week you'll have your tuner back rebuilt to like-new specs. You'll note it is packaged for a trip to the

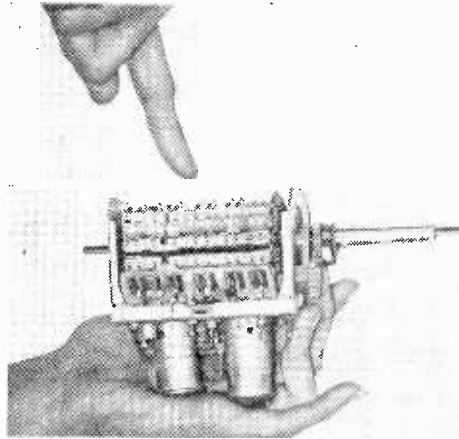

**Tuner Service Corp. replaces tuner coils if required. Get all the facts by circling No. 32 on Reader Service Coupon.** moon! It is now a delicate instrument and should be handled as such.

Resolder the connecting wires, taking extreme care to double-check the tags and your sketch. Plug in the wires with connectors and secure the tuner to the cabinet or chassis with the original hardware. That's the whole bit. Your TV is ready for use, and you have an extra \$45 or so in your pocket. One note, most problems that occur after a rebuilt tuner is installed are traceable to the AGC circuit. Make the AGC adjustment and the picture will pop in.

Of course, the question comes up: "What happens if my tuner is just beyond repair?" Such an instance is rare, but if it happens the professional repair service will tell you so and will generally offer you a brand new tuner replacement for about the same price; a lot cheaper than you'll get from a TV repair shop. ■

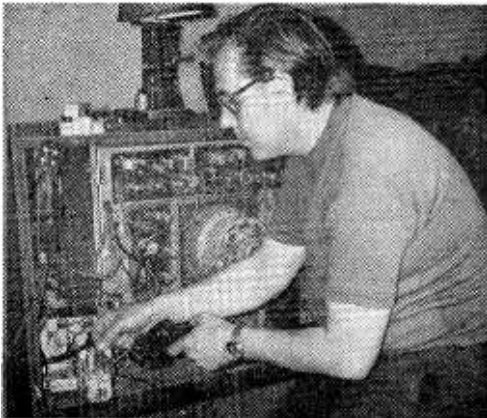

**Three easy steps save you TV tuner repair money: 1. Remove the defective tuner. 2. Mail to tuner repair center. 3. Solder and remount repaired tuner in TV set.**



# 21-SECOND TV CURE-ALL

By Homer L. Davidson

Nothing pleases like an AOK TV set (well, almost nothing, let's say), and nothing irks like a TV set on the fritz. Thing is, TVs have a way of telling you what—if anything—ails them with a message plain as the nose on your face. It's the image on the picture tube that tells the story; the problem lies in interpreting what it's trying to say. But that's easy—our 21-Second TV Cure-all includes 21 of the most frequently encountered TV ills, tells where the fault lies and how to go about correcting it. Let's start with the nicest story of all—a properly displayed test pattern on an AOK TV set.

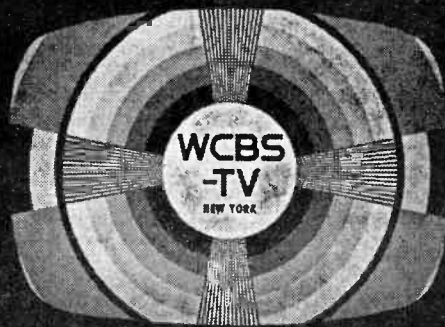

**1** Typical TV test pattern is transmitted perfectly round, perfectly centered, and with all wedges of equal length. Height and width have 3:4 ratio.

*(Continued overleaf)*

# TV CURE-ALL

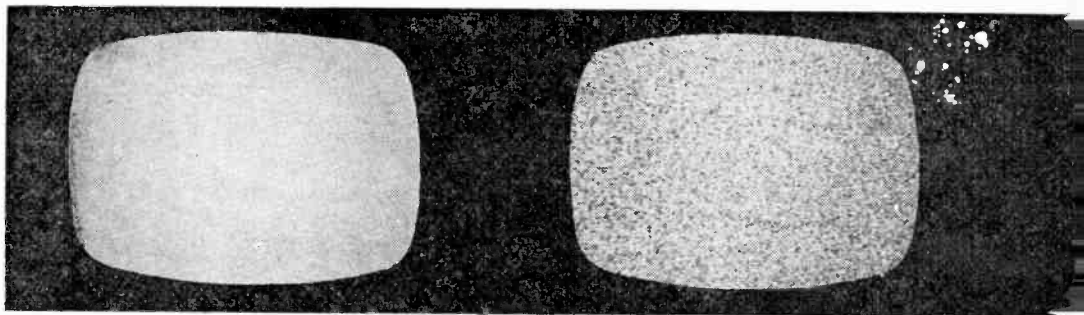

**2 WHITE ALL OVER.** OK, so your set isn't pouring forth with the beautiful TV test pattern shown on the preceding page. Let's say all you can see is a white screen with raster lines. There may be a tweeting sound or perhaps no sound at all coming from the speaker. First thing to check is the local oscillator tube. Next, check the first RF tube. If there's still no picture, check the IF and first video tubes. If you're still up the TV creek, check the IF tuner cable between tuner and chassis; a loose or poor soldered connection will result in no picture or an intermittent picture on the TV screen. As a last resort, check the AGC and second detector tube. And if yours is an older set, check even the sound output tube. Reason is that sets have been made where the sound tube actually furnished voltage to the tuner and IF stages.

**3 RUSH, RUSH, RUSH!** Here we have a TV screen with no picture, snowy screen, and a loud rushing sound issuing from the speaker. Switching the tuning selector from channel to channel has no effect whatever. And while the screen can be lightened or darkened, there's still no picture or intelligible sound. Thing to do is check the first RF amplifier tube in the tuner (most RF tubes are located at the rear of the tuner). If the oscillator tube in the tuner were defective, there would be no snow on the screen or rushing sound in the speaker. And since we have plenty of both in this picture, replacing the RF tube should do it. If not, check the antenna lead-in. Assuming this passes with flying colors, take a close look at the antenna matching coils on the top of the tuner next to the lead-in. These may be shorted or open.

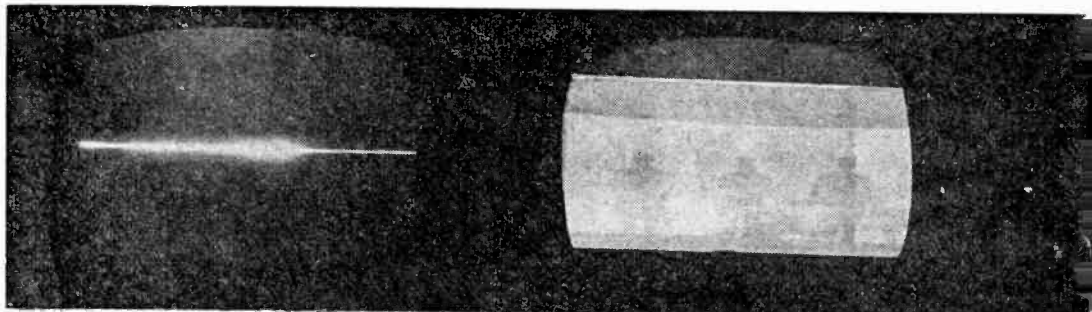

**6 LIKE A LASER BEAM.** A horizontal white line on the screen indicates lack of vertical sweep. First things to check are the vertical oscillator and vertical output tubes (dual-purpose tubes are often found in late-model TV receivers). Also check adjustment of vertical linearity height controls. Be sure to first turn the brightness control down so only a faint white line remains, however, since leaving a bright horizontal line on the screen can easily burn a line across the phosphor on the pic-tube face. If you're handy with a VOM, you may want to pull the TV chassis. This done, check voltages on the vertical oscillator and output tubes, then give the vertical output transformer a resistance test.

**7 SHORT AND SQUATTY.** Trouble here is plain and simple: insufficient vertical sweep. Best bet for locating culprits is to check both the vertical output and oscillator tubes, though you might start by checking the settings of the vertical linearity and height controls. A shorted or vertical transformer winding will cause the same trouble. Can't find the vertical output tube? Here's a quick rundown—in consoles: 6AQ5, 6BL7, 6CG7, 6CM6, 6CM7, 6CS7, 6CW5, 6CZ5, 6CY7, 6DE7, 6DR7, 6EA7, 6EM7, 6EW7, 6FD7, 6GE7, 6GL7, 6K6GT, 6KY8, 6S4, 6SL7, 6SN7, 6U8, 12AT7, 12AU7, 12AX7, 12BH7, 12BZ7, 12B4; and in portables: 5AQ5, 5CZ5, 5V6, 7AV7, 8CG7, 8CM7, 8CW5, 8CS7, 10CW5, 10DE7, 10DR7, 10EM7, 10GF7, 11CY7, 13DE7, 13DR7, 13FD7, 13GF7, 15KY8.



**4 ALL WASHED UP.** Even with the contrast control wide open, the best we can get out of this one is a light, washed-out picture. While local stations can be picked up, distant stations come in ever so faintly or not at all. The problem is likely a weak video or IF tube or perhaps the AGC control setting. In the event the picture has a slight trace of snow, check the RF tube or TV antenna. For the record, common video tubes for AC sets are 6AC7, 6AG5, 6AG7, 6AM8, 6AN8, 6AW5, 6AS8, 6AU8, 6AW8, 6AZ8, 6BA8, 6BH8, 6BK5, 6BK8, 6CB6, 6CH8, 6CL6, 6CL8, 6CV8, 6CX8, 6EB8, 6GN8, 6FH8, 6HL8, 6JV8, 6K6GT, 6KV8, 6LF8, 6U8, 6V6GT, 6W6GT, 12BH7, 12BY7, 12GH7; common video tubes in portables are 3BU8, 5AM8, 5AN8, 5AQ5, 5AS8, 5U8, 5V6, 8AU8, 8AW8, 8BA8A, 8BH8, 8CX8, 8EB8, 8GN8, 8JV8, 10GN8, 10HF8, 10JA8, 11KV8, 11LQ8, 12AT7, 12L6, 12W6, 16GK6, 25BK5.

**5 LOOKS LIKE SNOW.** A snowy picture can be caused by a weak RF or oscillator tube. First step is to replace the RF tube, and, if that doesn't pay off, replace the oscillator tube. Also, check the lead-in going to the TV tuner and try rotating the fine-tuning control to clear up the picture. If a lightning- or thunderstorm has been in the area, check for a burned or open antenna coil. Some coils are mounted on top of the tuner close to the lead-in cable; others are mounted within the TV tuner itself. Still another thing to check is the outside antenna for a broken lead-in wire. Then, too, wind or rotator may have turned the antenna in the wrong direction. And, last but not least, the antenna may actually have damaged elements.

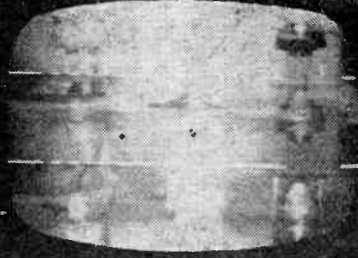

**8 TALLER THAN TALL.** A distortion of the sort pictured here would never be the case with a properly adjusted TV set, so it's obvious that this set's owner didn't take full advantage of the TV test pattern shown in case No. 1. If you go in for fun-house mirrors, you may also dig the TV equivalent. Lacking this rather rare proclivity, you'll no doubt want to adjust the set so it displays an image as faithful to the original as possible. The vertical linearity control is your tool in this case. And while you could try to alter its setting until heads here assumed reasonable proportions, you would be far better advised to make such adjustment with a test pattern. Also, remember that many sets incorporate not one but two controls affecting vertical linearity (the second is usually termed an auxiliary control), so both must be adjusted.

**9 RUNNING UPHILL.** Though a picture can roll both up and down, the site of the trouble is almost always the same: the vertical sync section. Best remedy is to replace both the vertical oscillator and sync tubes (often found in the one and same envelope). If this doesn't solve the problem, try adjusting both the vertical height and linearity control settings. In some TV sets, incorrect adjustment of these two controls will result in a rolling picture. Physically check the vertical hold control for possible loose or poorly soldered connections. Should the vertical hold control let the picture roll in one direction only, look for a defective resistor or capacitor in the plate circuit of the vertical oscillator tube. And should vertical fold-over occur only at the bottom of the TV screen, it's a safe bet that the trouble is the vertical output tube.

*(Continued overleaf)*

# TV CURE-ALL

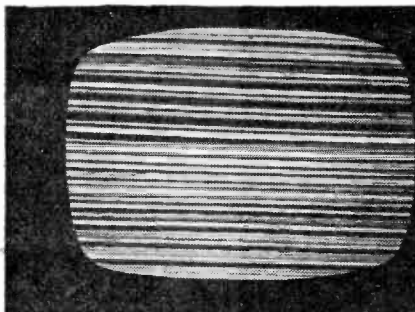

**10 THE LINES HAVE IT.** A screenful of black and white lines can be caused by a defective horizontal oscillator tube. First, check to see if the horizontal hold control is properly set. Once it is, check the horizontal oscillator frequency setting as well as the AFC and sync clipper tube. Since the AFC tube has been replaced by a dual-diode solid-state receiver in many of the newer sets, you may discover such a unit either plugged into a socket or soldered directly into the PC board. However, all is not lost—you can replace the soldered job by snipping off the three leads close to the body of the diodes, then forming small loops in new diode rectifier leads and soldering them to the ends of the leads you just snipped off. Bear in mind that there are two basic types of hookups: a series and a parallel.



**11 TILT!** A tilted picture can be caused by only one thing: a loose mounting screw on the deflection yoke assembly. In other words, the deflection yoke has turned on the neck of the picture tube, which can easily happen if the mounting bolt on the deflection yoke is the least bit loose. Most older TV sets have a wing nut at the top of the yoke assembly; newer ones generally have a metal yoke band with a 1/4-in. cinch-nut tightener. In the latter case, the metal band fits over the plastic tabs of the yoke assembly and snugs against the neck of the picture tube. In both instances, the procedure is exactly the same: you first set the yoke level with the frame of a picture at the top of the TV screen, then adjust this picture into position with the vertical hold control. You then recheck the level, and lock the yoke in place.

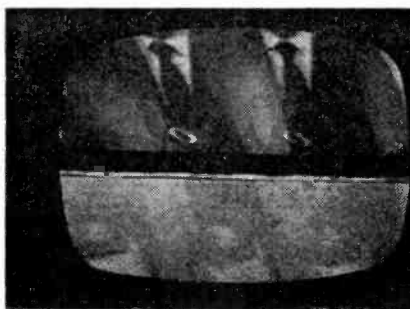

**14 BOTTOMS UP!** Any TV picture running sideways or up-and-down is sure indication that sync trouble is at hand. Check both the horizontal and vertical sync tubes, bearing in mind that these tubes may be in two separate envelopes or, conversely, snug as a bug in a rug in but a single vacuum bottle. Can't find the sync tubes? In consoles, the most probable types are 6AL8, 6AM8, 6AN8, 6AU6, 6AU8, 6AX8, 6HZ8, 6BE6, 6BH8, 6BU8, 6BY6, 6CG7, 6CH8, 6CS6, 6CQ8, 6CU8, 6CX8, 6EA8, 6EB8, 6GN8, 6GW8, 6GY6, 6HF8, 6JV8, 6KA8, 6LC8, 6SN7, 6U8, 12AU7, 12AX7, 12BZ7; and in portables, 3BU8, 3BY6, 3CS6, 3GS8, 4BU8, 4CS6, 4GS8, 4HS8, 5AM8, 5AN8, 5EA8, 5U8, 7AU7, 8AU8, 8AW8, 8CG7, 8CN7, 8CX8, 8EB8, 8GN8, 8JV8, 8KA8, 8LC8, 9AU7, 10GN8, 10HF8, 10JA8, 11KV8, 11LQ8, 12AT7, 12AU7, 12BH7, 12SN7.



**15 SQUEEZED AND SQUASHED.** Bigger-than-life objects on an advertised-in-Life TV are normally the result of a defect in the low-voltage power supply. In older consoles, you can suspect a rectifier tube of some description; in later model sets and portables, you can expect to find a selenium rectifier or a silicon diode in its place. Pinpointing a defective solid-state job with a voltmeter is a pretty simple task: with the lead between the positive terminal and chassis ground, a half-wave rectifier should produce a voltage of 125 to 150 VDC. And given a full-wave job or a voltage-doubler, output should be something on the order of 225 to 260 VDC. Should this approach prove fruitless, you might also check for improper setting of the tube positioning magnet on the rear of the deflection yoke (it can also produce roughly the same symptoms).

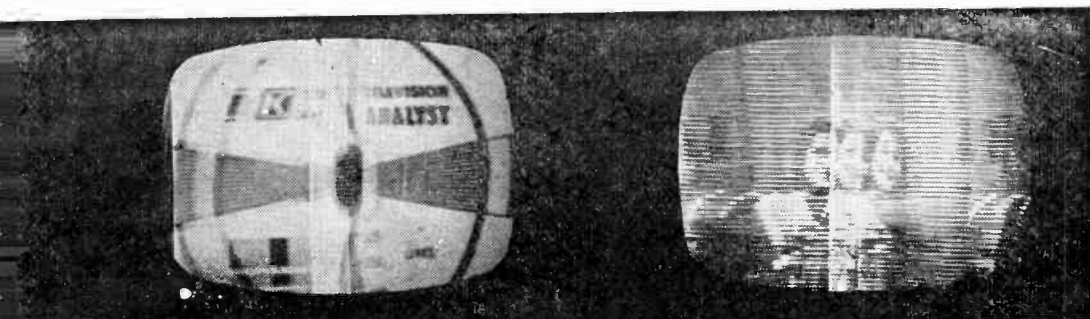

**12 CHRISTMAS IS HERE!** An extreme condition known as the Christmas tree effect, this problem stems from a horizontal oscillator tube or a horizontal output tube. (It generally takes the form of a vertical white bar somewhere on the screen.) Also worth checking are the horizontal drive and horizontal frequency controls. First, make sure that the horizontal drive trimmer isn't more than  $\frac{1}{2}$ -turn from its tight-up position. Next, set the horizontal hold control to its center-rotation position, then adjust the horizontal frequency slug within the horizontal oscillator coil with a plastic adjustment tool. Turn the slug until the fine horizontal lines become wider and then pop into a full picture (if the slug is turned too far, the lines will slant in the opposite direction). Once this looks satisfactory, try rotating the station selector to see if the picture stays in view.

**13 FOLDED GRILLE.** Looking much like the dented grille of a brand-spanking new chrome-plated gas-eating chariot, this condition can result from the very same ills that were responsible for the problems in photo 12. The demon may be the horizontal oscillator tube. Again, it may be the dual-diode AFC rectifier, so if replacing the horizontal oscillator tube doesn't help, the next thing to tackle is the AFC diodes. Should a shorted or leaky dual-diode rectifier be the defective component, you'll generally hear a high-pitched whistle or peeping sound from the speaker. In this case, your course of action is to replace those lousy diodes as outlined previously, turn on the set, and search for a folded grille that hopefully will be no more.

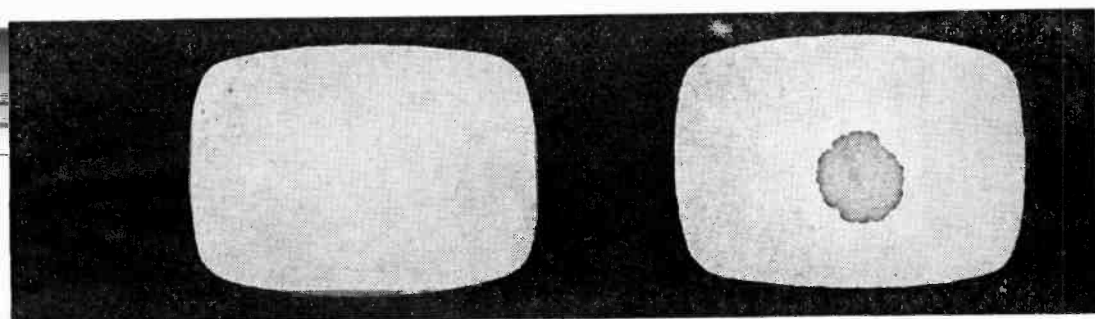

**16 WIGGLE WORM.** Though a trifle hard to show photographically, wiggles on a TV screen are ordinarily due to a 60- or 120-Hz component in the low-voltage power supply. They normally evidence themselves by causing the image to wobble back and forth; oftentimes, there will also be one or two dark stripes across the screen. First thing to suspect is an electrolytic capacitor in the doubler circuits. To remedy the situation, simply bridge a 100- $\mu$ F, 450-V electrolytic capacitor across the suspect. Should things improve, replace the tired and testy old job with a brand-new one, having the exact capacity and voltage ratings. Also worth knowing is the fact that a defective input filter capacitor in AC/DC portables can even result in no picture, no sound, or no raster!

**17 SPOTTED SCREEN.** The trouble shown above started with a spot the size of a pin head, which, within two weeks, had grown to be big as an orange. Wha happen? Simple! The phosphor on the pic-tube was burning off. And the only remedy is replacement of the pic tube itself. Thing to watch for here, with older TVs at least, is incorrect setting of the ion trap (newer TVs are devoid of this device). The ion trap should always be set as close as possible to the picture-tube pin base so as to produce the greatest possible brightness. Still another way to ruin a pic tube is to operate a set having a defective vertical oscillator tube. As pointed out in case No. 6, the single horizontal white line across the screen will produce devastating destruction in short order, unless the brightness control is turned way, way down.

*(Continued overleaf)*



# TV CURE-ALL

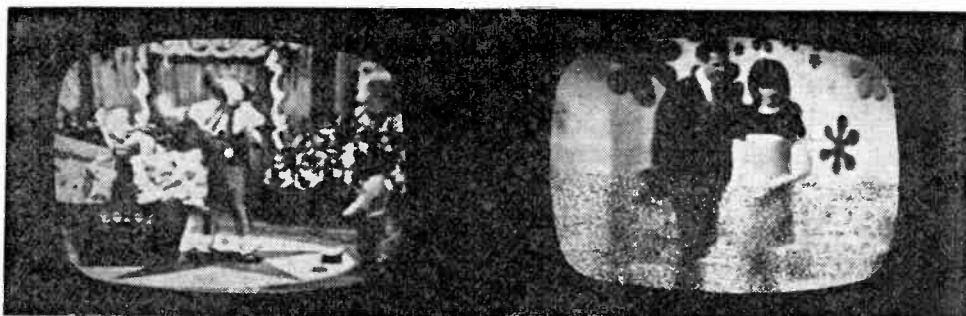

**18** **BLURRY, FUZZY, AND DIM.** TV pic tubes that come on with all the speed of a turtle in Tipperary are probably tired as a fleet-footed floozy after an 8000-meter race. For like all tubes, boob tubes begin their journey to tube burying ground the first time they're turned on. Eventually, images are blurred and fuzzy, even though brightness and contrast controls are wide open; closeups of faces reveal extreme white and blotchy areas even though such blemishes aren't present in the flesh. Tube brighteners or a special process called charging can stave off the inevitable for a time, but stalling for time is only delaying the inevitable. Best bet is to do the thing you'll eventually have to do—replace the picture tube.

**19** **ROAR! ROAR! ROAR!** Though images of this sort make for anything but pleasurable viewing, there's really little you can do to relieve the situation. The particular form of TV interference (TVI) shown here was caused by a defective power transformer somewhere on the same power line; roughly half the picture is covered with dots and dashes, and there is a good deal of picture tearing. Since there are so many causes of TVI—police radio, CB equipment, hams, even radio-TV stations—pinpointing the culprit may take some time. Installing a TVI trap in series with the antenna lead-in sometimes helps. And anything you can do to increase signal strength at the receiver itself is also worth trying. Among the various steps in this direction are installing a narrow-band (yagi) antenna; raising the antenna in height; and using shielded lead-in cable between antenna and TV set.

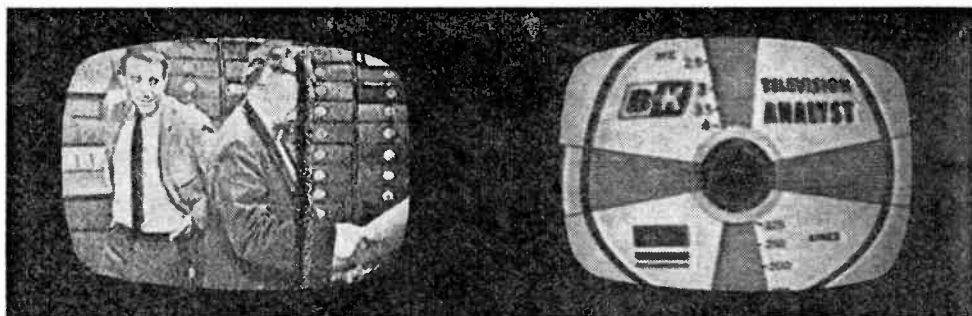

**20** **STRING OF ROPE.** A vertical weaving line down the TV screen is generally evidence of Barkhausen, snivets, or RF oscillation (Barkhausen and snivet lines predominate on VHF channels). First step is to replace the horizontal output tube, which, though it may check out OK in a tube tester, may still be oscillating and causing interference. In many cases, this same type of oscillation will become more pronounced on weak or distant stations. Dressing the antenna leads away from the high-voltage cage should help. Should there be a white vertical line present on the screen, the horizontal drive control should be backed off until the line disappears. In extreme conditions, it may also be necessary to replace the horizontal output and oscillator tubes.

**21** **TEST PATTERNS, AGAIN!** Having examined case after case of typical TV ills, we're back again to the faithful test pattern. The reason is easy to explain: nothing else tells you half as much about a TV set's performance—good or bad. When you come right down to it, there are dozens of TV test patterns, since each station transmits its own particular version (the one shown in case No. 1 is that transmitted by New York's WCBS-TV; the one above is that produced by the B&K Television Analyst). But regardless of which pattern you have at your disposal, you can use it to determine whether your set is properly adjusted for aspect ratio, linearity, and contrast; and how it stacks up in terms of line count, line resolution, and low-frequency phase shift. In short, TV happiness is a properly displayed test pattern!

# Save a buck by building the...

## CTS FUTURA V SPEAKER SYSTEM



It's a sure bet for console sound

Do you look at your pip-squeak sound system and vicariously substitute an ultimate supersound layout you've been planning for years? And whenever your buddy takes the plunge and comes up with a new stereo console, do you drool?

Keep cool, friend. With a reasonably good hi-fi stereo amplifier you can update your speaker system to sound as good as those speakers in his multi-\$ console. Here's how.

A manufacturer of literally millions of custom-design loudspeakers—who until now dealt with manufacturers only—offers seven speakers from its line for home construction through mail order. The company, CTS, has supplied its speakers to every major home equipment manufacturer in the U.S. Now CTS offers both the speakers and applicable crossover components for use in a do-it-yourself enclosure.

The Futura V system includes hardware needed for a complete high quality speaker

except for the cabinet. Priced at \$63.91 it includes a 12 in. woofer, 4½ in. honker (midrange) and 3 in. tweeter. Also included are three coils and three condensers for the crossover network, and two level controls—one for the honker and one for the tweeter.

Basically, the builder does what we all did back in the early days of hi-fi, he uses component hardware with an enclosure built and finished to his own specifications. If the wife wants a Mediterranean, or even Roman finishing, there's no hassle; you simply add the necessary cabinet trim and stain or paint lacquer. If you don't feel like paying for finishing material because the speaker will be used in the shop or playroom, simply leave the cabinet *au naturel*. Unlike complete factory assembled speaker systems you don't have to pay for finishing if you don't need it.

**Woofed Sound Spreads.** The photographs show a typical unfinished enclosure assembled with the Futura V components. As usual, the woofer is mounted near the bottom of the cabinet; it has no directional characteristics so its position is really unimportant. But if placed near the top, the center of gravity would be much too high for good cabinet stability—it would easily be tipped over.

The midrange honker is positioned above the woofer, and the tweeter is located near  
*(Continued on page 93)*

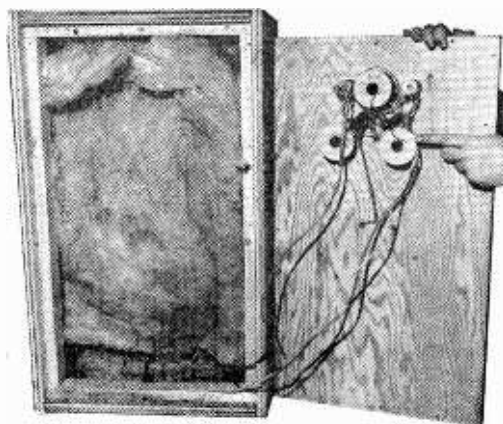

**Three way crossover has full control over high and midrange speakers. Mount crossover components on rear panel for strength. Circle No. 28 on page 8 for information.**

# 11 STEPS TO WALKIE-TALKIE REPAIR

by Homer L. Davidson

**D**on't give up on that sick walkie-talkie! You can fix it yourself by following our 11 steps to CB walkie-talkie repair. You don't have to be a CB expert nor an expert technician to make minor repairs. Most troubles are simple and easy to locate. Only a few hand tools are needed, and five will get you ten they're in your workshop now! Have a little patience and proceed with our step-by-step guide. Remember, most CB troubles are easy to repair. It's finding the trouble that takes knowledge, and this we offer you in steps.

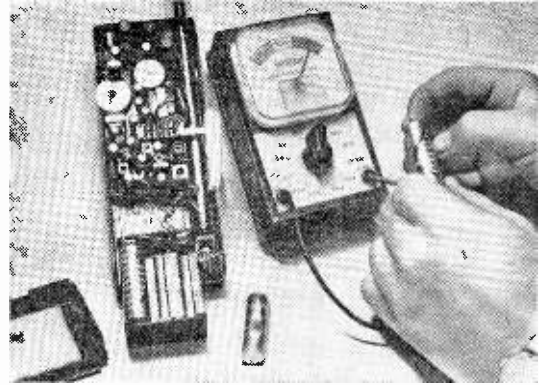
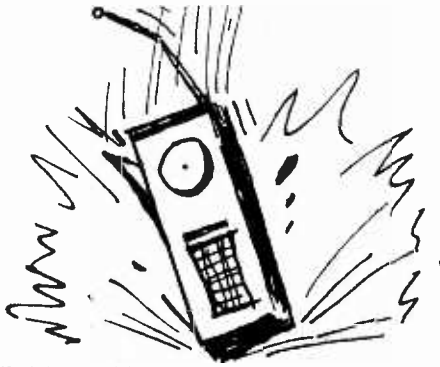

**1** Check those small dry cells first! If you don't have a battery tester, check voltage with the "talk" button depressed. If one or more dry cells are low, replace all. Be sure dry cell contact surfaces are shiny bright or else you lose volts.

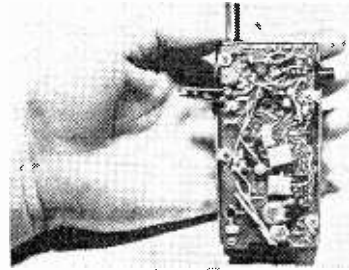

**4** If you can't turn your walkie-talkie on and the batteries are good, then you got switch trouble. The on-off switches in most portables are flimsy and break easily. Use an alligator clip across the switch connections—if this works, a new switch is needed.

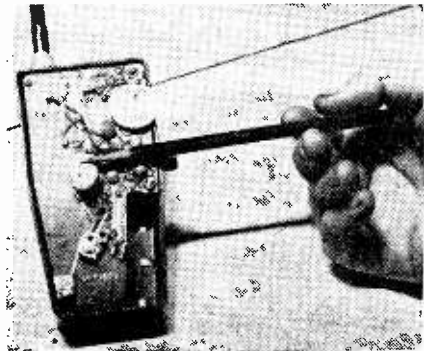

**5** If your unit will not go on the air, then it's time to push, poke, and pull to detect loose components, snapped wires, etc. Poor or marginal connections are responsible for most transmitter problems. Better go back to Step 2 and do some careful inspecting and soldering.

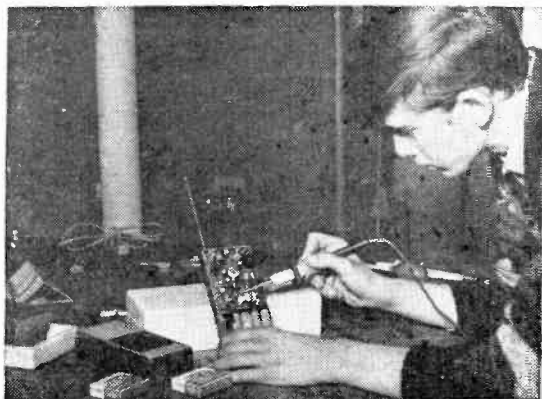

**2** One big headache common to battery equipment is loose battery leads. Use a small-tip, low-wattage solder iron while making repairs. Apply enough heat to make a good solder joint and stop. Nose around for other loose connections or cold solder joints in the printed circuit board. Check switch connections, too!

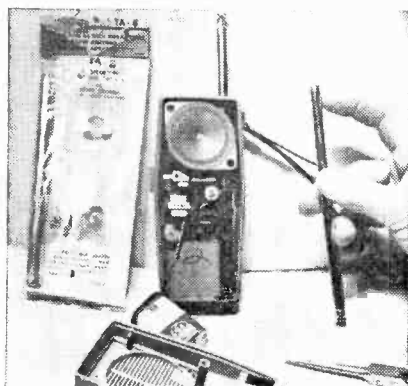

**3** Walkie-talkie antennas usually break with time because of the abuse they take. Don't toss out the unit because its sky hook snapped. Multi-section antennas are available at most parts suppliers and can be installed in your unit. Be sure to select an antenna that comes close in length to the original. A longer antenna does not mean better reception or more signal out—it may mean poorer operation because of detuning.

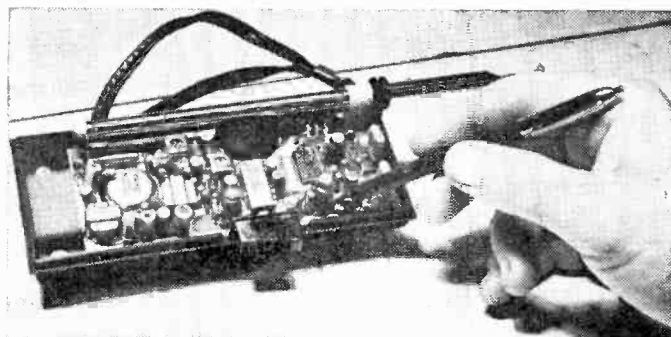

**6** No reception? In super-hot models this means trouble in unit's front end as a rule. Check antenna coil for broken leads or loose connections. Travel from antenna to audio section touching transistor leads as you go. As soon as buzz comes from speaker, you know trouble is in previous transistor stage. Check for physical defects and damage before yanking out any transistors.

**7** One good way to get rid of bugs is to spray them dead with electronic Raid. Push-to-talk switches cause a lot of trouble because of dirty contacts. It's not the switch's fault. The unit's low cost prevents use of hermetically-sealed switches, so dirt and dust will louse up the contacts. Use one of the many contact cleaners currently on the market place. A short spray and a dozen switch pushes should clean up any trouble in your rig.

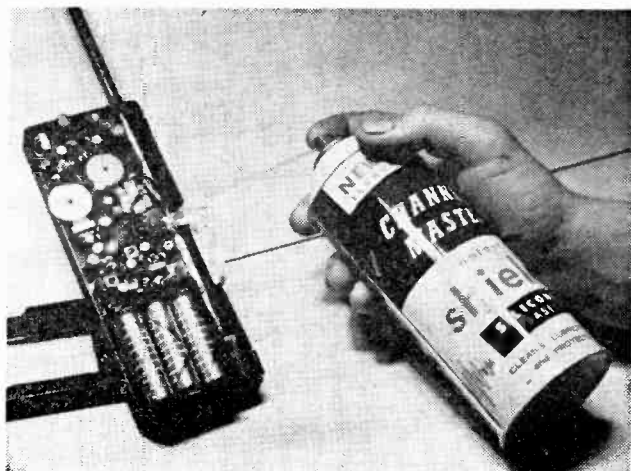

(Turn page)

# WALKIE-TALKIE

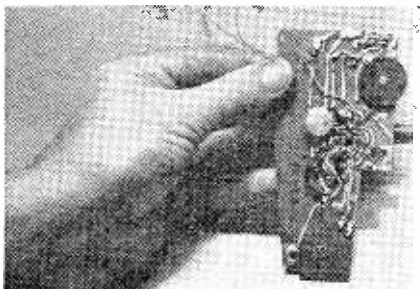

**8** Let's face it, you drop a walkie-talkie and you have to pay the price. In this case it means removing the printed circuit board and patching it up if necessary, not to mention the epoxy work needed on the case.

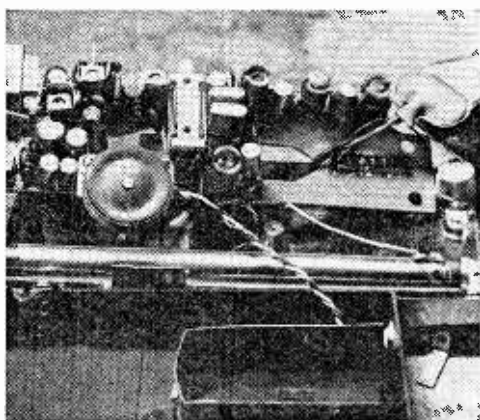

**11** If the first ten steps do not get your walkie-talkie on the air, you're in for some dog work. Most rigs come supplied with schematic diagrams—use them to pinpoint troubles. Make resistance measurements and continuity checks. Use the lowest scale setting when possible and likewise for voltage checks. If a transistor tester is available, check each transistor. It's a good idea to compare measurements against your other unit if you own a pair. It's up to you now, we ran out of space.

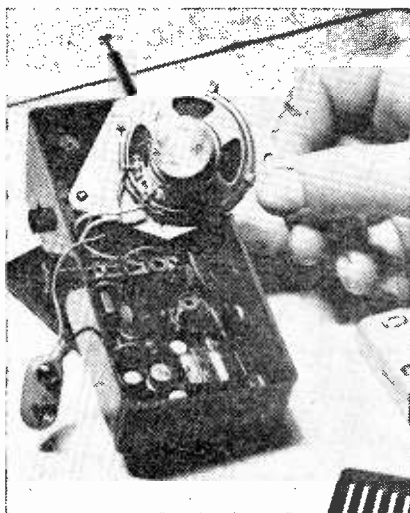
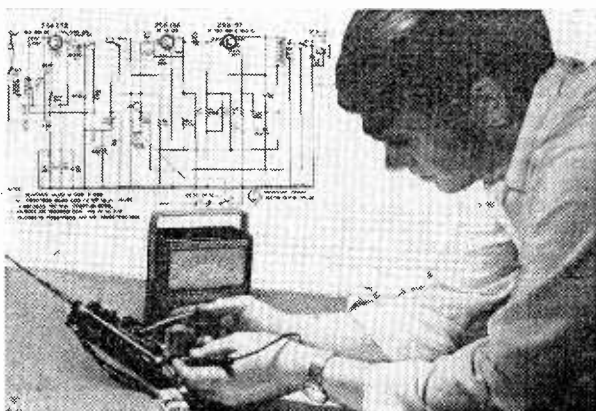

**9** The sound from walkie-talkies is never hi-fi, but it can get worse with time because dirt, dust, humidity, and what-not tear, jam, warp, etc., the speaker cone. A quick test is to listen to the receiver at low volume—if it still sounds bad, it's time for a new speaker. Most jobs are 8-10 ohm units available from electronic supply houses. Pick a PM speaker replacement with the exact dimensions as the original.

**10** If your receiver looks like it was salvaged from a vacuum cleaner bag, it's due for a thorough cleaning. Here's where old-fashioned GI spit and polish will pay off. Use Q-tips and water-color brushes to wipe and brush away the gook. You'll be surprised at the defects that can be uncovered this way.



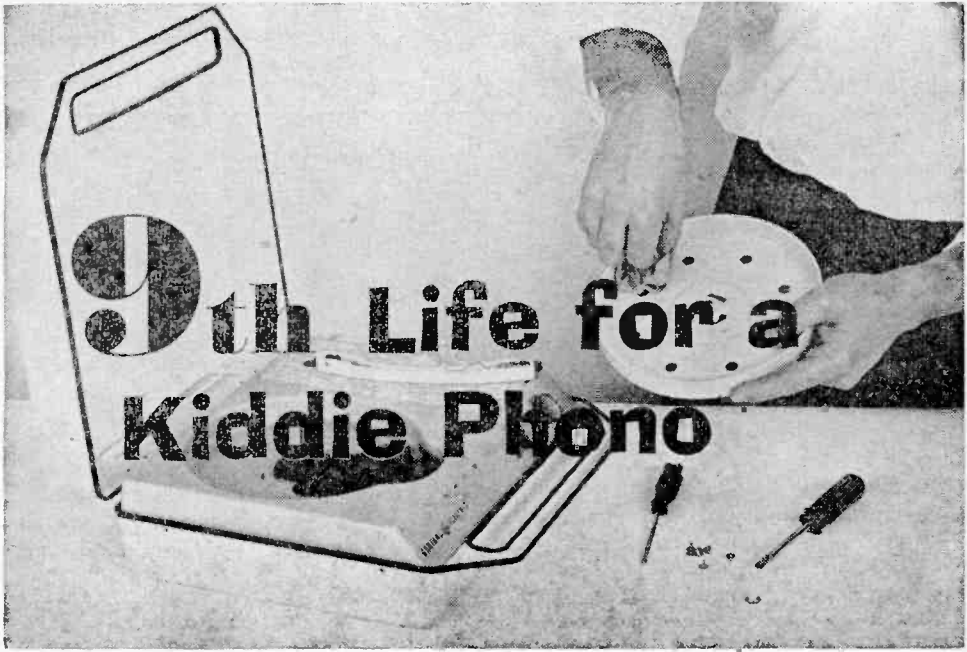

■ If your child's phonograph has given up the ghost for what you insist *has* to be the last time, think again. For a kiddie phono is so simple a gadget it's bound to have nine lives (perhaps even ninety-nine) before it ends in the trash can. And whether due for its ninth or its ninety-ninth life, any kiddie phono requires a minimum of skill to return to working order.

One of the reasons kiddie phonos are such a breeze to repair stems from the fact that there is really very little that can go wrong. Basically, any kiddie phono consists of a

motor and turntable, a pickup and cartridge, an amplifier and speaker—plus a cabinet to house the lot. And aside from a broken cabinet, most repairs to kiddie phonos center around one of these three basic areas. In other words, it's either the motor and turntable, the pickup and cartridge, or the amplifier and speaker that the due for your servicing attention.

Unless the motor has conked out completely—in which case the entire assembly should be replaced, a general cleanup will probably put things back in the AOK cate-

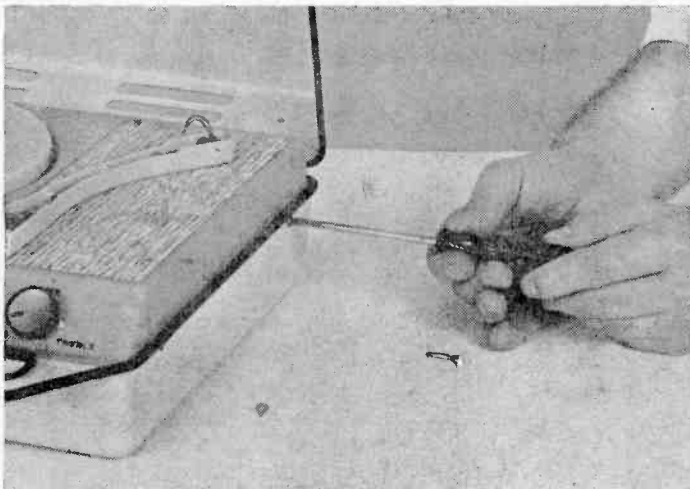

Kiddie phonos vary widely in general mechanical layout and construction, but this General Electric player is not unlike several other brands that have been on the market at one time or another. Disassembling this unit required unplugging line cord from socket at rear, then removing series of Phillips-head screws with a screwdriver.

# Kiddie Phono Repair

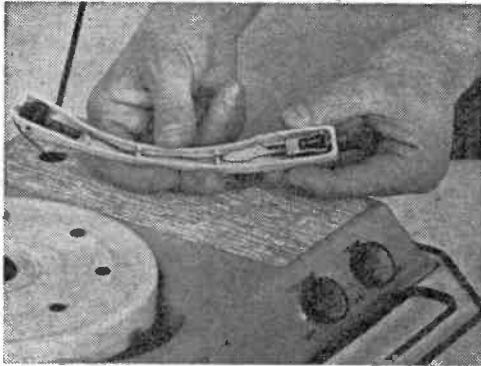

Cartridge and tone arm easily fall prey to injury (note absence of tone-arm base in player above). Needle should almost always be renewed with exact replacement, as should both tone arm and cartridge, if condition warrants.

gory. This can easily be accomplished by removing the pin or E-ring from the turntable, carefully pulling the turntable from the spindle, then cleaning the underside of the turntable as well as the motor shaft and idler assembly with a suitable solvent—a small bottle of GC carbon tetrachloride being a good choice. Use the cleaner sparingly on rubber parts, and be certain to clean the rim of the turntable thoroughly (see photo at top of facing page).

A new needle (now generally referred to as a *stylus*) should put the arm-and-cartridge

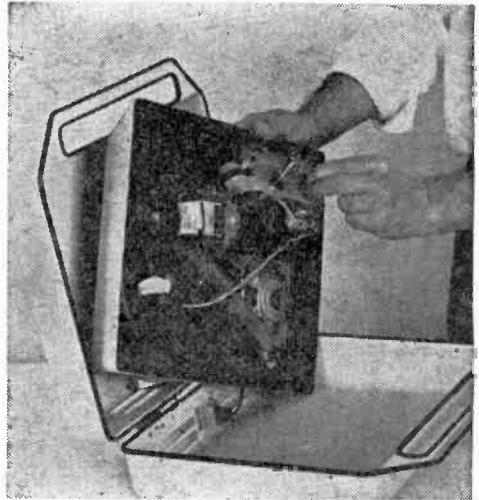

Amplifier/speaker section of kiddie phono generally contains one or two tubes in an AC/DC circuit. Inoperative amplifier usually stems from burned-out tube; damaged speaker often proves to be the cause of distorted sound.

combo back in like-new condition unless either or both has been damaged. If they have, it's usually best to replace both with a new arm-and-cartridge assembly as shown in the photos.

As for the amplifier and speaker, burned out tubes and punctured speaker cones account for something like 90% of kiddie phono troubles in this area. Effecting a cure is almost child's play—plug in a new tube or toss in a new speaker, and you'll have every reason to expect that the set will play like new again.—Ron Mitchell

After carefully noting wiring of leads running into amplifier from cartridge, leads were unsoldered, then single hex nut was unscrewed to permit removal of tone-arm assembly. Since new tone arm was virtual duplicate of damaged unit, fitting it in place called for little more than a reversal of disassembly procedure.

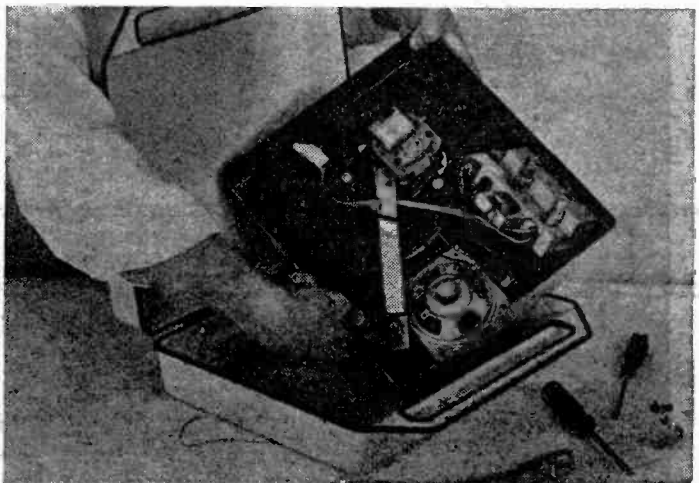

# PUT YOUR ELECTRIC IRON BACK ON THE LINE

by John McNarney

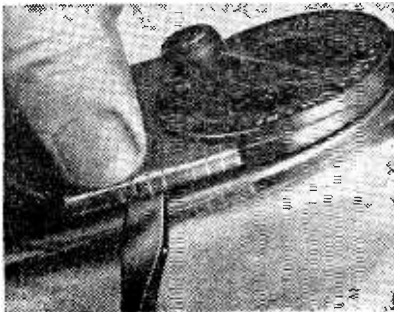
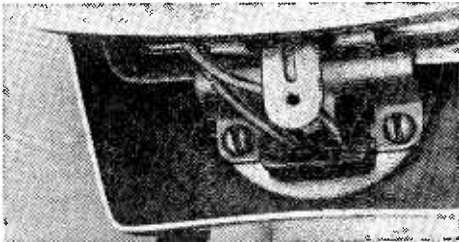
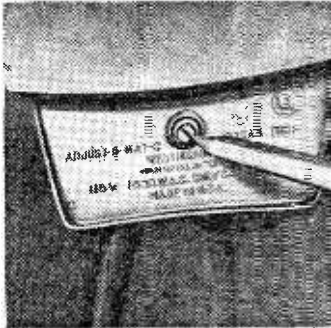

A toaster that won't toast, a mixer that won't mix, a heater that won't heat and an iron that won't iron can very well have one common fault—a defective line cord. There's no need to throw out the appliance, just replace the line cord—it's that easy!

The photos show clearly the problems involved in changing the line cord on a Westinghouse steam and dry iron. This electric iron was singled out mainly because too many are discarded solely because the average home repairman believes that an iron of this type is beyond his repairing skills. This, we will show you, is not so. As a bonus, tips are tossed in to cover other repairs in an electric iron. Numbers in parentheses ( ) refer to photos.

First off, locate the identification plate (1). Model number will come in handy when ordering parts from dealer located through the yellow pages. On some irons, plate may conceal a hinge for easy opening. Others may have a stud under the control knob to release the hinge. You'll have to poke around the decorative handle and trim, or control knob, to release a catch to unhinge the iron.

This iron (2) is built without a hinge as discovered by removing the identification plate. The handle must be removed. To do so, remove some trim (3) to discover the screws that are hidden. Be careful not to damage decorative trim or plates when prying them off.

Unfortunately, after lifting the trim

4

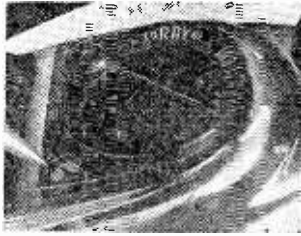

plate from this iron (4) it was discovered that both the handle and the temperature control knob are secured from inside the case on top of the iron. Next step, open the iron! You see, we did not pick an easy example.

A close look at the valve assembly (5) shows that a hex nut on top of the stem is recessed into a chrome trim follower. The follower does not move when the water knob is turned.

Inspection showed that when the knob is turned to the lowest (dry) position, it is possible to remove the hex nut. It pays off to examine what you are about to do very carefully!

Now, stop! This is a good time to get a picture of the lay of the parts (6).

With the hex nut and follower out of the way, but before lifting out the control knob, check the location of all parts and openings for all switch control settings. In fact, it pays not to trust to memory. Draw a sketch of the relationships of the parts to each other now and reassembly will be easier, even if it's done the following day or week.

With the control knob out of the way (7), the valve can be unlocked with a pair of pliers. Again, the original positions of the openings should be observed. In this case, the top of the assembly is cast in one piece and just about a quarter turn will release it. Be careful—cast metal pieces break easily with pressure from tools. On some irons you might find a snap ring used here, or a flanged ring threaded into the mouth of the tank. Don't fret—once the assembly is out in the open, the method of removal is fairly obvious.

Here is a view of the valve stem assembly (8) and the lugs which engage the tank nut and lock the top of the iron in place. Lift the valve stem assembly and the lugs which engage the tank nut. The valve stem can be lifted out and cleaned, but the tip is easily damaged and should be treated gently. An old tooth brush will do the cleaning job well. Again, the position of any springs, washers or spacers should be noted during disassembly to ensure that reassembly is correct.

Finally, with the tank nut and valve stem assembly removed, the iron can be opened, exposing the line cord

5

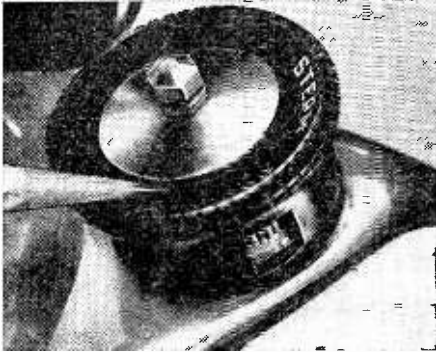

6

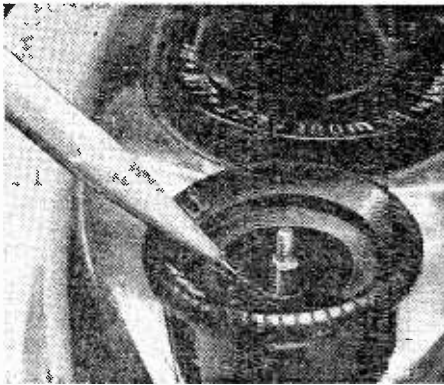

7

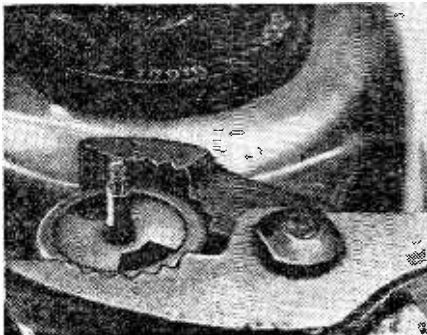

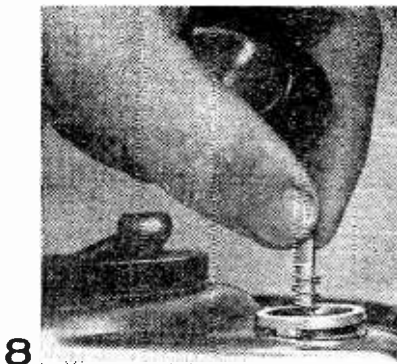

8



9

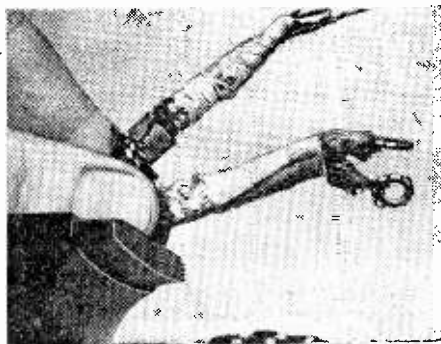

10

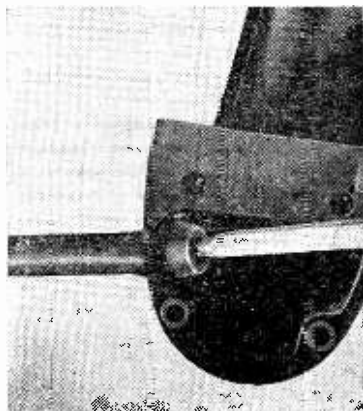

11

terminals. In this case, the old taped cord has jammed in the handle and had to be cut away. This view (9) also shows the stem of the temperature control emerging near the center of the tank and the mouth of the tank near the lip.

While not necessary when changing the line cord, the tank itself would be easy to remove. It is held in place by a shoulder on the valve seat. Depending on the make of the iron, the valve seat can be unscrewed and withdrawn through the mouth of the tank.

It's always wise to follow the leader—especially when the leader is the manufacturer of the iron. The manufacturer has more experience with his own electric iron than a legion of repairmen. When it comes to installing the metal strain relief on the new line cord (10), keep the old line cord handy to measure exact position from ends. If you are lucky and use an exact replacement, the manufacturer may have the strain relief molded on the cord—no sweat here.

If a new line cord sleeve is used (11), install it first. Under no circumstances should you leave this part out of the final assembly. The rubber sleeve serves as an oversized grommet that keeps the line cord from fraying or kinking at the point where it enters the iron. The sleeve prevents almost sure line cord replacement after a few weeks' use. Also, the sleeve helps keep the line cord away from the iron while in use.

One point should be stressed before we proceed with our picture story. Use only exact replacement line cords made by the manufacturer or suitable products designed for electric irons. Under no circumstances are you to use plastic-coated or rubber-coated wire intended for products that do not generate large amounts of heat. One quick visual check of a line cord is to look for the asbestos insulation wrapped around the line cord's leads under an exterior cloth-weave covering. If the asbestos is not there, do not use that line cord on the iron. Also, check for mechanically fixed eyelets or lugs that are secured to the line cord. These offer the best mechanical connection. Wire wrap-around connections are hazardous at best. (Turn page)

12

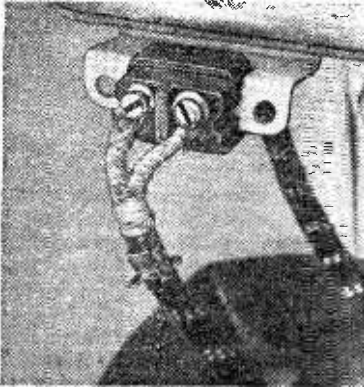

The new line cord is now in position (12) and mechanically secured. Note the clean connection the eyelets make under the screw heads without any frayed wires sticking out. Also, the metal strain relief is mounted on the cord—the iron can now be reassembled.

With the cover in place (13), but before replacing the valve stem assembly and tank nut, be sure that the stem from the thermostat is properly engaged in the heat control knob. This will be easier if the stem is set in either at the HIGH or OFF position before the cover is lowered.

Don't trust to your skills alone. Pull out your ohmmeter and check continuity between the two prongs on the line cord's plug. Also, short both prongs with one test lead and check for short or leakage from the prongs to the iron's metal body. Skip this step and you're fooling with serious hazards like electrocution and fire!

If you cannot obtain replacement parts for your electric iron locally from the maker's authorized dealer or repair service, then write directly to the manufacturer. Be sure to give the manufacturer all the facts of your unit's nameplate and identification plate. Try to describe the parts needed. A line cord is easy to describe, but small parts may not. So, draw a simple sketch—this will help. You can also write to SECO Division, Simmons Electric Company, 112 South 20th St., Birmingham, Ala. 35233. For only 50¢ they can send you a catalog that every appliance repairman at home should own. Get a copy—parts replacements on tough dogs will be easier whether it's an iron, mixer, hair dryer, or what not!

The differences between a coffee maker, a rotisserie, and the steam iron shown on these pages are a lot more apparent than their similarities. Yet, in a surprising number of cases when a what-ever-it-is just sits there on your workbench sneering, the fault will be found in the power link between the wall outlet and the output side of the unit's on-off switch. You'll discover that the basic techniques used successfully on an electric iron will be found to apply with other appliances, too! Now, fall out and attack those defective appliances and put them back on the line. ■

13



14

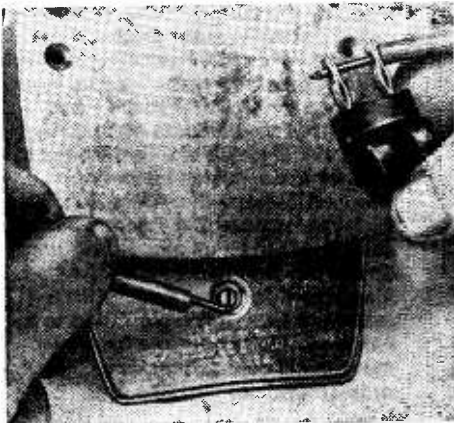



# Move up to a key position in Electronics...

This FREE Book can help you get there...faster!



A Government FCC License can be the key that finally unlocks the door to success in many rewarding career fields.

Take broadcasting. If you want to work in television or radio as a Chief Engineer, Federal law requires a First Class Radiotelephone License. And, if you're in charge of operating or maintaining other types of transmitters, such as two-way mobile communications systems, microwave relay stations or radar signaling devices, you must have at least a Second Class FCC License.

Even if the job you want doesn't require an FCC License, some employers prefer a licensed person. This valuable document certifies a thorough test of your electronics knowledge and capabilities . . . it's Government proof of your electronics know-how!

Send today for CIE's FREE Book on FCC Licenses. Find out what jobs and industries require licenses and permits . . . how Government FCC exams are organized . . . sample questions and answers . . . where and when exams are held . . . and how you can prepare at home for your FCC License exam with your choice of a wide range of CIE career courses that include FCC License preparation. All carry our special FCC License refund warranty which is explained in full in this FREE book.

Fill out and mail the coupon to CIE — Cleveland Institute of Electronics, Inc., 1776 East 17th Street, Cleveland, Ohio 44114.

We'll try to have a school representative contact you. All CIE career courses are approved for educational benefits under the G. I. Bill. Send for your FREE Book, now.

**CIE** Cleveland Institute of Electronics, Inc.  
1776 East 17th Street, Cleveland, Ohio 44114  
Accredited Member National Home Study Council

**YES! Send me your FREE book about FCC Licenses today. I am especially interested in:**

- |  |  |
|--|--|
| <input type="checkbox"/> Electronics Technician  | <input type="checkbox"/> Industrial Electronics  |
| <input type="checkbox"/> FCC License Preparation | <input type="checkbox"/> Electronics Engineering |
| <input type="checkbox"/> Color TV Technology     | <input type="checkbox"/> Other .....             |
| <input type="checkbox"/> Mobile Communications   | .....  |

Print Name \_\_\_\_\_

Address \_\_\_\_\_

Apt. \_\_\_\_\_

City \_\_\_\_\_

State \_\_\_\_\_

Zip \_\_\_\_\_

Age \_\_\_\_\_

Check box for G. I. Bill Information.  Veteran  Serviceman

RT-05

# POP-UP TV MAKES THE SCENE

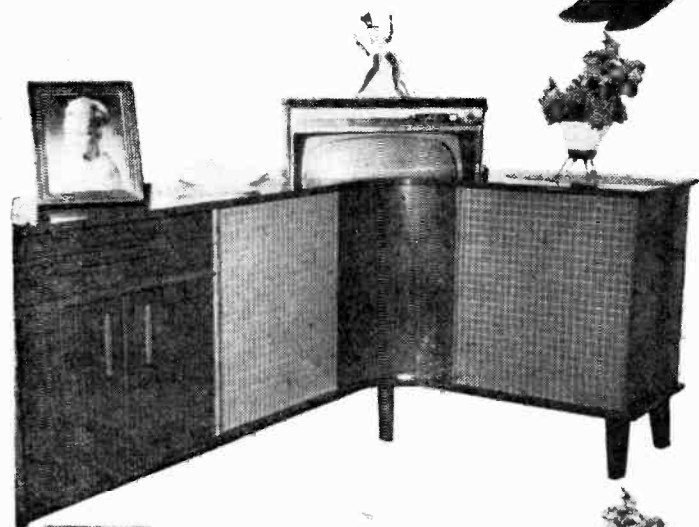

**TV**'s big eye can bug the decor out of any room setting. The Mrs. spends considerable time and your hard cash to make the living room or play room an attractive area for the family to meet, entertain and be entertained. But the big ugly eye scans the scene even when not in use. So, H. L. Miller of Sarasota, Florida tells his TV to bug out.

It is easy to do provided you take the pains. Mr. Miller cut a hole in the top of his hi-fi console and installed a movable platform that goes up and down at the press of a button. Guide rails eliminate the shimmy and shake as the TV is raised and lowered on the platform. A fractional horsepower motor does the work by turning a drum that winds or unwinds a pully system.

A limit switch at the top and bottom travel position of the platform turns off the motor automatically reversing it for the next trip. No modifications are required on the TV whatsoever—just be sure to leave enough slack in the power cord and antenna lead-in wire. Also, the platform trips an on/off power switch that controls the juice to the TV. Think of pop-up TV the next time you want to say,

**By Emmett Fluffin** "Bye-bye," to the big eye! ■

# ERECTING A ROOFTOP TOWER

Forget about masts, guy wires, and dizzying heights—a rooftop TV antenna require less money,

By Homer L. Davidson  
wires, and dizzying heights will take less time, and give plenty of zonk!

**D**o you really want to climb Mount Everest to get good TV reception? Are you waiting for the moment when your mast gets the shakes and comes toppling down during a storm that was never supposed to show up?

If you get the wim-wams thinking about all the complications that might come up when erecting a mile-high TV antenna—or if you've already been through the mill—this guide to erecting a roof-

top antenna should give you courage. Actually, it's not as bad as it first seems. If you're willing to sacrifice some height to gain a goof-proof installation, not only will you sleep better at night and feel better in your pocket, but your neighbors will appreciate a good job.

We've come up with some groovy photos that show a young fella going about his work. As you can see, he's got a sturdy roof (good shingles and joists), a few tools, and the roof mounting antenna. That's it.

With screwdriver, pliers, and crescent wrench in hand, all you do is select the right tower for your particular receiving area. This depends on the kind of signals you wish to receive (uhf, vhf, FM, etc.), distance from the transmitter, and the obstructions in between. Your local TV shop will probably give you some advice on just what you need.

**Here To Stay.** A rooftop tower has many advantages over a mast. It's easier to install, it has a much better appearance, it's more secure, and you eliminate vibrating guy wires that run endlessly from the

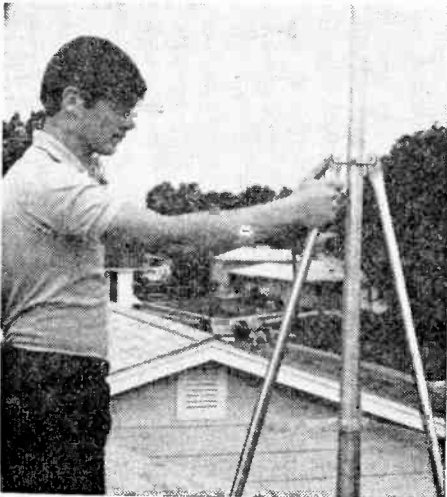

# TV Tower

mast to your house. Very few rooftop antennas blow over during severe storms, so they prevent additional damage to your roof. Should the boom or any of the elements be damaged they can be reached with no trouble at all.

Only a few holes are needed to install the tower on your roof. Before you get started, check and make sure that your antenna will be no higher than other installations in your neighborhood. If necessary, check the local city ordinance for TV antenna installations. Some cities have very exact requirements and even a permit fee. Better to be safe now than sorry later.

Small TV towers come in lengths of 18, 30, and 36 in., as well as 5- and 10-ft. lengths. While they are sturdy and cost little, a tower mounted on a 1½- to 2-story home should provide adequate reception even in a fringe area. If you're really out in the cold, a hi-gain Yagi-type antenna will help to put you in the ball park.

**Selecting a Sight.** Once on the roof, select a likely spot for a three-legged tower. We'll help you out by recommending dead center on the roof peak (you get a ground-plane effect this way that will reduce local RF interference somewhat); just count the total number of shingles and divide by two to reach *Ground Zero*. Mounting the antenna to one side of the roof is possible, but less effective.

Make sure you're clear of tree limbs, etc., and in the line of sight of some TV stations. At all cost, keep away from power lines of any description.

In extreme fringe areas you can mount the tower on the highest part of your roof. But if you've got more than 10 ft. of antenna skyward (extending above the tower), it will have to be guyed properly. Under normal circumstances, however, guy wires shouldn't be necessary. A good rule of thumb is: a 5-ft. mast extended out of a 30- to 36-in. tower; a 10-ft. mast extended out of a 5- to 10-ft. tower.

If you're mounting the tower on a flat surface (with no peak), simply center it by using the roof corners as a guide. A friend can hold the boom at the approximate dead center while you take sightings from alternate corners.

**Mounting Boom.** Before securing the

three-legged tower, check that all three legs are located *over* a roof joist (i.e., supporting beam). The towers have adjustable legs so this is possible. You can locate the joist by taking a hammer and tapping lightly over the surface of the roof. The first solid thump indicates you've got a beam where you need it.

Temporarily place the legs of the tower on the corresponding joists. Place the two adjoining legs (i.e., the two that form the base of the triangle) in the direction where winds are excessive. It's usually north winds or northwesterlies that cause most problems, but it pays to make sure for your particular area.

Level the tower before securing (lagging) it to the joists. A carpenter's level will prove to be a worthwhile investment, but should one be lacking, place the boom on the tower anyway and sight it against house outlines and other reference points. When using a level, level the tower in two opposite directions with the boom installed.

Now you can secure the legs to the joists using the supplied screws. Be sure to place at least two screws in the base of each supporting leg. If they don't go directly into the joist you will have to sound out the joist's location again. Probably a shift of ¼ in. is all that will be needed. Make sure that all screws are flush with the roof surface and as tight as possible.

**Antenna Up and Away.** Remove the antenna from the packing carton and prepare it for mounting. Most TV antennas can be unfolded in a second and the antenna rods will lock into position. Simply push or pull the elements into the correct configuration and clip them into place. You'll find it easier to assemble the antenna on the roof, but take care not to damage shingles while you're working. Wherever you work, leave plenty of space for the job.

To connect the 300-ohm lead-in wire to the assembled antenna, use either small eyelet connectors or form an eyelet with the bare wire. Place the lead under a lock washer, tighten the connection, and place some electrical tape over the antenna terminals. This will insulate the antenna connections from erosion due to wind and moisture.

If the antenna has a fairly long boom, two brace supports should be used to support it. Place a standoff on the front support brace while the antenna is still being prepared for mounting.

**Two Types.** In this installation a uhf *bow-tie* antenna will be mounted below the

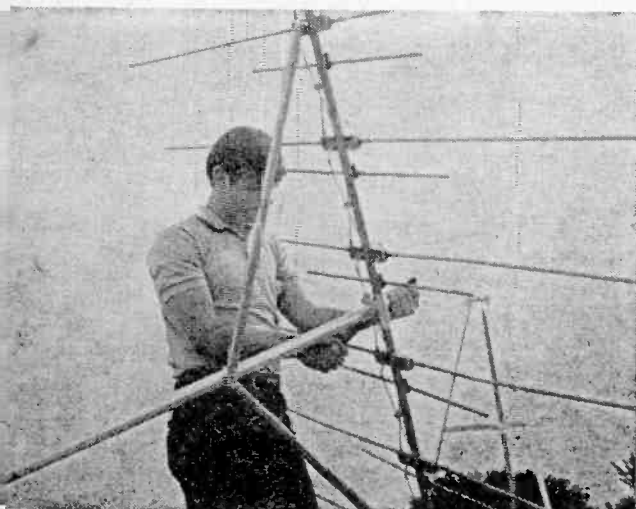
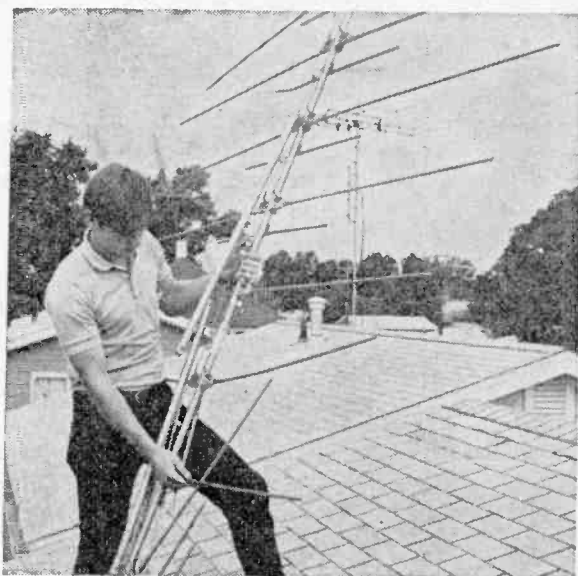

*Before securing tower to roof, place TV mast in position so that tower can be properly leveled (see photo on previous page). Once antenna has been installed, final leveling can be achieved with small set screws on support braces. At least two set screws should be used to secure legs to joist. Carefully remove vhf antenna from carton, fold out all elements, check their configuration, and then lock them into place. Hook up lead-in cable to antenna, and with cable in place, mount a standoff on one arm brace to hold it in position. Now that antenna lead-in is installed, mount antenna to 5 or 10 ft. mast. Tighten all bolts and pull up brace supports so that antenna will be level.*

# TV Antenna

all-channel vhf boom. Since the latter is the basic unit it is mounted first. *Remember*—many antennas combine elements for both uhf and vhf reception, so you'll only need the bow-tie (or equivalent) if you're in a fringe area or the uhf signals are not in the same plane with the vhf signals.

Choose the correct length of mast to install in the tower. This will depend on reception requirements (also, check rule of thumb already mentioned for tower measurements). Most likely it will be either a 5- or 10-ft. piece. Bolt the antenna to the mast, level the bay, and tighten the mounting bolts. Pull up the brace supports so the antenna is in a level line and snug up the "U" bolts on the brace. Try not to flatten out any of the aluminum pipe.

Once you've lowered the mast into the tower, you can raise or lower it to get best reception. Rotate it so that the smallest elements on the boom are pointing toward desired stations; in fringe areas this may simply mean *snow-free* reception.

Some receiving areas require a uhf translator antenna. This is usually a bow-tie having several "V" elements and a reflecting screen. Gain is sometimes as high as 12 dB at distances up to 50 miles. If a translator antenna isn't required (as mentioned before), you can forget about the next steps.

Unfold the uhf antenna's mounting elements and bolt them into place. Connect the polyethylene lead-in cable to the antenna terminals and feed it through standoffs down the front of the antenna (or back through the screen). Now mount the bow-tie on the mast with two clamps just below the vhf boom. Point the bows toward the station you want; reflector remains flush behind them.

**Leading Question.** The lead-in cables for both antennas are fed down the mast and tower by way of standoffs (one for each lead). Bring the cables down one leg of the tower, pull them tight, and rotate the twin lead until you have a spiral that's taut so it won't flap in the wind. Crimp the insulating washers in the standoffs to hold the spiral in place. If you've got coax, however, you can tape it to the mast (see section on rotators).

Check to see at what point your leads will come off the roof and start down to the set. Position two screw standoffs here, fasten

down the two leads, and pull them tight. Keep on making a taut spiral with the twin lead as before.

Going across the roof, place a screw standoff every 4 ft. and keep the two leads taut as they are inserted. This should make for a neat installation.

Once the tower legs, screw standoffs, etc., are in place, use plastic roof cement to cover up all the screws for a weather-proof installation. Smear the stuff over any metal part that penetrates the roof's surface.

The antenna leads should now be brought down the side of the house. Place two screw standoffs just under the roof overhang and two more standoffs at the bottom where the leads will be fed into the house proper (through a window or the siding). Again, the leads should be taut, with more standoffs added wherever necessary. Try to keep the cables away from metal rain spouts, power lines, or other obstructions.

**Rotating the Beam.** If an antenna rotator is added to your installation it should be mounted *before* the vhf boom. Place the mast into the tower brace supports and mount the assembled rotator to this piece of pipe. If you use a 10-ft. tower, place the rotator on the tower mast as opposed to the antenna mast. This way it's easier to lower the vhf boom into the rotator assembly.

Connect the 4-, 5-, or 8-wire cable to the rotator. Make a note of the correct terminals for both ends of the cable. Terminal 1 on a flat 4- or 5-wire cable will be silver so start with it. Connect each wire to the rotator and tape the cable to the mounting bracket. The rotator's cable can be brought down either by taping it to the mast or using more standoffs.

Be sure to leave a 1½- to 2-ft. loop in your antenna leads where they run past the rotator. This permits the antenna to turn a full 360 degrees without binding or pulling the leads out of position. Use a standoff above and below the rotator to hold the loop in position. These standoffs should be in position before you tape the rotator cable to the mast. This way you won't pierce these wires with one of the standoffs; this could ground the rotator's cable.

Check the correct direction for the rotator before leaving the antenna in one position. Rotator mechanisms have either a north or south starting position. When the antenna is in its correct starting position, bolt it into place. See if the antenna loop is free so it will rotate through a full 360 degrees. ■



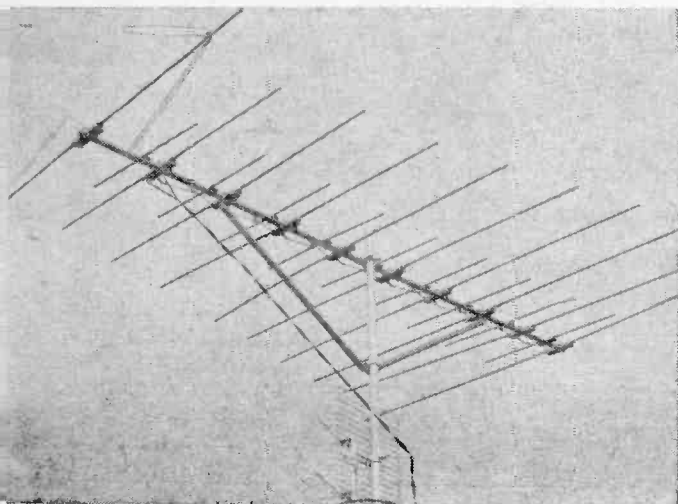
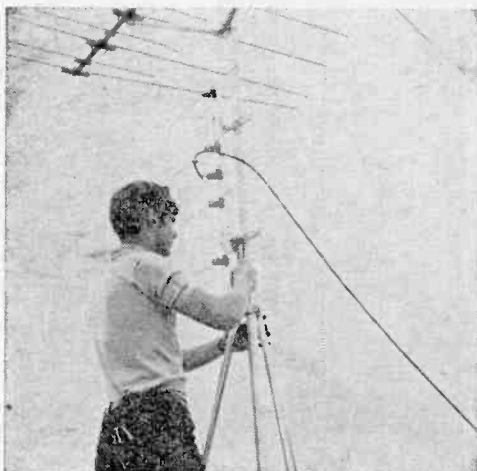

Remove uhf antenna from carton (if needed—see text) and fold out all elements. Remember, if you're going to install a rotator it should be mounted before either the vhf or uhf arrays are bolted to tower's boom. Mount uhf antenna below vhf antenna and point bow ties towards desired TV stations. Now bring two lead-in cables down mast along one leg of tower. Standoffs should be used to keep leads in position. Loop of 1½ to 2 ft. is necessary to allow rotator to turn full 360 degrees. If you have no rotator, leads may be taut. Use plastic cement to cover all metal surfaces that penetrate roof's surface. At left, both antenna arrays have been mounted on boom and pointed towards major TV stations in area. Final leveling adjustment can now be made.

# YOUR TV SET WILL GET YOU IF YOU DON'T WATCH OUT

by Jackson Kay



**S**creaming sirens and tires tear down the street with skinner lights flashing red. Dark red hulks rumble past your home to a conflagration elsewhere. Lucky? You bet your are' if you didn't give your television receiver the care and protection it needs and deserves. Ambulances can give you the same scare action as they whiz by, but they are painted white. No matter what the color, keep these emergency vehicles away from your door by following the safety points and tips that'll keep your TV set safe and operable.

## Location and Protection

- Never place your TV set on an unstable TV cart or stand. Should it fall, pull out the power plug at once and call your TV service technician. Do not move the set!
- Your TV set has slots in the cabinet for ventilation purposes, to provide adequate convection cooling to prevent overheating. Don't cover these slots with cloth, plastic or any other material.
- Never block the bottom ventilation slots of a portable TV set by placing it on a bed, sofa, plush rug, towel, etc.
- Never place your TV set near or on a radiator, heat register, oven, dishwasher, toaster or any appliance that gives off heat.
- Avoid exposing the TV set to rain or extreme moisture as this may result in a fire or shock hazard. Never operate a TV set if liquid has spilled into it. Have your TV service technician check out the set before you turn the power on.
- When installing an outside antenna, use a lightning arrester which is U. L. listed.
- For added protection during a lightening storm, and when the set is to be left unattended for a long period of time, unplug it. Old man weather can zap your house and TV set with lightning or cause extreme power line surges. Either action will cause damage to your set and possibly start a fire.

## Operation and Service

Everyone is a TV set repair expert simply because they own one. Yet everyone has an appendix, but how many friends would you trust to remove yours? Here is some advice on how to operate and service your TV set and stay alive to enjoy it.

- Some sets are equipped with a polarized AC line plug—one blade is wider than the other. This polarized plug will fit into a power outlet only one way. If you have trouble fitting it into a power outlet or require a special polarized extension cord, contact the TV dealer who sold you the set.
- TV sets equipped with a polarized plug or

three-prong plug should not be tampered with to defeat the safety purpose of the specialized plug. Do not replace these plugs with standard two-prong plugs—you'll cause a severe shock hazard in many cases.

- Do not remove the back cover of the TV set as this will expose you to very high voltages. Voltages above 100, 200, 300, even 400 volts are common, not to mention picture tube voltages over 20,000 volts. Remember, 100 volts or more can kill, if not burn or seriously injure your body!

- Never push or poke objects into the TV set through cabinet slots, as it is possible to contact dangerous voltages or short circuits.

- Be sure the TV receiver is turned off before you clean the face of the picture tube. Do not use water or excessive liquids. Do not use scouring powders packaged for sinks—they may scratch the tube.

- Adjust only those controls on the back of the set that are covered in the operating instructions. Mess with anything else and your TV service technician will present you with a larger bill.

- Do not defeat the fuse or circuit breaker by jumping the circuit. When replacing fuses be sure to use the exact replacement.

- Turn the set "off" when it is not being viewed. This procedure will increase the set's useful life.

### Call the Service Technician Now!

- There will be a time when your television receiver needs the expert servicing of a technician. You will know this is a certainty when you're unable to restore normal operation by adjusting the user's controls. When this happens, call your TV service technician.

- It is normal for some TV sets to make popping or snapping sounds, particularly when being switched on or off. If sounds are frequent, call your service technician.

- Always request your service technician verify that the replacements have the same safety characteristics as the original part.

- Never add, or permit a technician to add extension speakers, or jacks for record players or tape recorders to a TV set that has not been designed for this purpose. Such additions may result in an electrical shock hazard.

### Safety First

One good guide by which you should govern yourself when puttering about an apparently defective TV set, is not to perform any adjustment, poking, prying, snooping, cleaning, etc., that you would not permit a six-year-old child do. After all, why is a child's life dearer than yours when TV service technicians are available to do the task efficiently and safely? ■

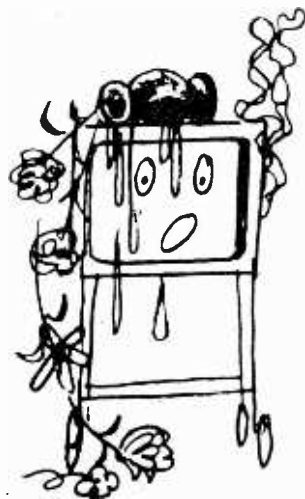
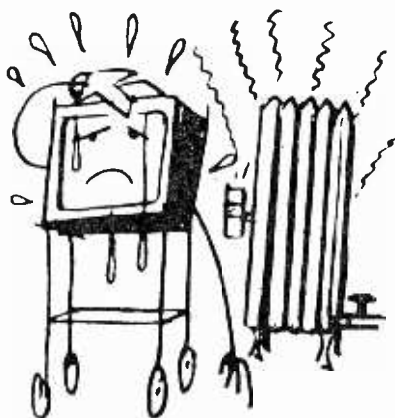

# 10 STEPS TO CASSETTE PLAYER REPAIR

by Homer L. Davidson

Cassette recorders come in every size and shape. They play on dry cells, AC line or operate right in the car. Generally, the portables are monophonic while table and console models are stereophonic. New cassette decks may feature "pop-up" cassette loading, level meter, remote control mike, push-button controls, tag-along speakers, and AC bias erasing system, to name only a few. After many hours of rough handling these cassette units will require servicing. Our 10-step approach to troubleshooting will give you an edge in the unknown world of cassette repair.

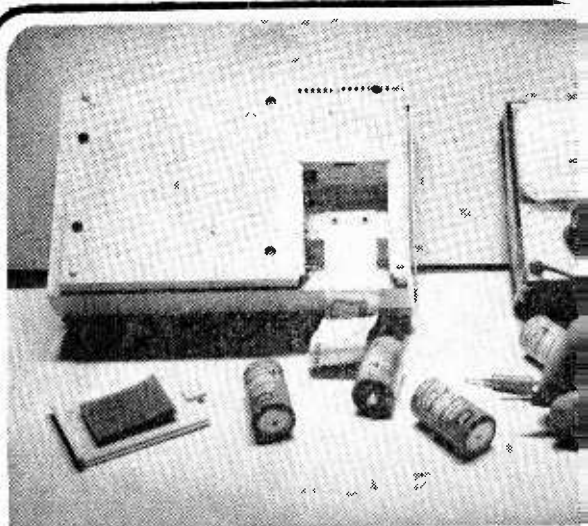

**1** In case the recorder will not play, check the batteries. Check for corroded battery terminals or broken wires. Clean battery terminals with a knife or emery board. Disconnect one battery wire and insert VOM switched to low milliammeter scale. No current indicates a defective on/off switch, bad battery connections or dead batteries. Excessive current indicates a short in motor or amp circuit. If unit works on batteries and not on AC suspect trouble in the power supply. A step-down transformer and rectifier produces this DC. Check AC voltage at rectifier and DC voltage at motor.

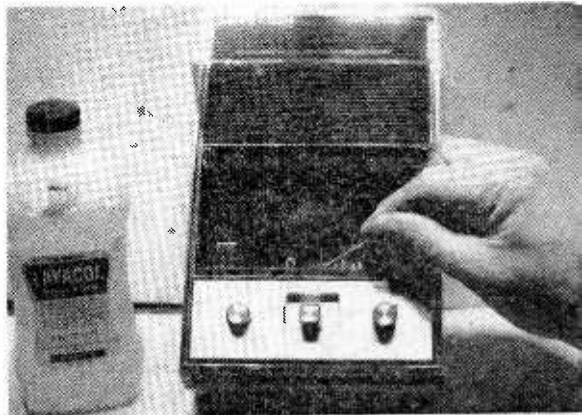

**2** Low volume and background noise caused by a dirty tape head. Excessive oxide dust will accumulate and pack upon the tape head. Tape heads should be cleaned every sixty days to keep them in tip-top condition. Clean head with tape-head cleaner or just plain rubbing alcohol. Use a cotton swab, dip in alcohol and remove the oxide dust. A special tape head cleansing cassette can also be inserted in place of the cassette. Don't forget to clean around and under the tape head assembly. Always try to keep magnetized screwdrivers away from the tape head.

If the tape plays slow, suspect a worn or stretched drive belt. In case the tape won't move, check for a broken belt. Oil on the drive belt or capstan pulley will result in slow tape movement. Clean the belt, idler, and motor pulleys with rubbing alcohol. If the speed is erratic (wow), check for oil upon belt and capstan drive pulley. A belt partially off the track or a misaligned capstan assembly can cause wow conditions. Defective cassette or motor can produce erratic speed or wow conditions. After a good clean-up with alcohol, check the capstan flywheel for dry bearings. A drop of light oil on motor bearings will clear up a noisy motor. Some small motors are self-contained and do not require oiling. Just a drop will do; do not over-lubricate any bearing. Wipe off excess oil to prevent dripping upon drive belt.

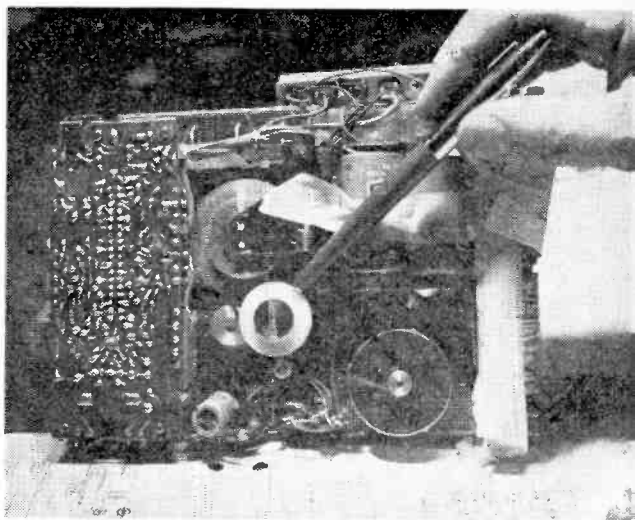

**4** Suspect mechanical trouble when there is no tape motion and power is applied to the motor. Spin motor belt and see if the capstan drive wheel takes off. If not, remove the drive belt and see if the motor shaft is free. If not, clean out motor and bearings with alcohol, assemble and lubricate bearings. If starting is intermittent, remove drive belt and hold the motor pulley between fingers. Switch the power off and on. Sometimes under load, the motor armature will have a flat side and will not rotate. Replace defective motor. A frozen or binding capstan drive wheel will result in slow or no tape motion. Remove the capstan flywheel assembly, clean and lubricate. Wipe off excess oil. Especially, suspect dry bearings on plastic pulleys working on metal posts. Don't overlook a possible defective cassette.

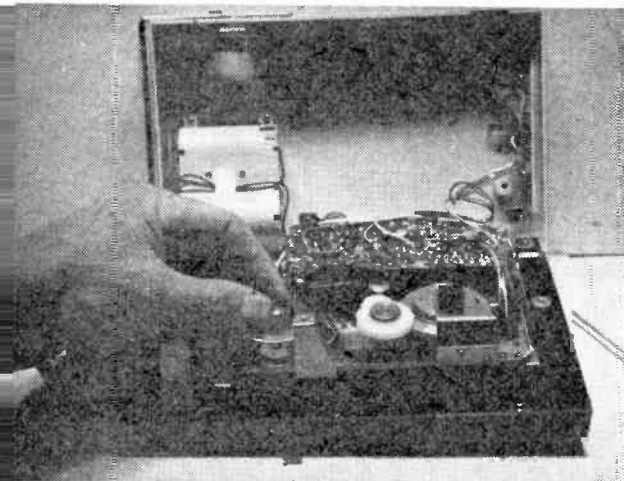

Most mechanical troubles are related to the drive or switch cassette mechanism. **5** Remove the outside case of the cassette player so you can see the mechanical action. Check the sequence of operation and try to isolate the cause of trouble. For instance, if the record button will not stay down suspect a bent lever or locking pin. In some of these small recorders the thin levers are quite fragile and bend rather easily. Remove the lever and bend back in shape. Be careful not to compound the trouble. Many of these metal parts are rather difficult to obtain and you may have to repair them. Check for broken or loose springs. You can spot these springs rolling around in the case and fall out in removing the outside covers. Spring replacement is rather difficult unless you have an exploded drawing of the mechanism.

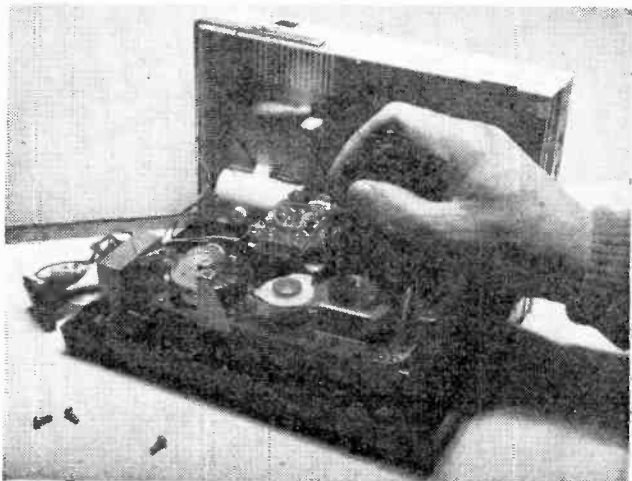

# CASSETTE PLAYER

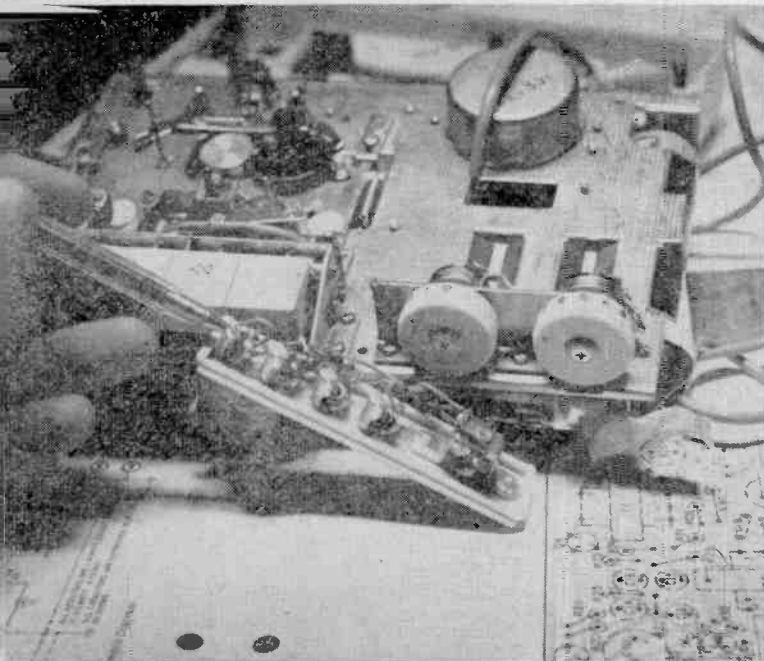

**6** A broken remote mike cable will result in intermittent or no power supplied to the cassette player. When hum or intermittent recording is noted, suspect a defective cable. These breaks are found where the wire enters the mike or at the male plug. If the remote unit will not shut off the recorder, check for a bent female plug or defective switch. Check to see if the cassette recorder will operate without a remote unit plugged in. If not, check shorting contacts of female remote-control jack. Continuity of the remote power switch can be checked with an ohmmeter. Cut off the broken section of cable and resolder mike or plug. Be real careful in soldering the small shielded cable so that you do not solder the shield to the shielded wire. Recheck continuity with an ohmmeter.

If the unit will not record, **7** check the microphone and mike jack. If the unit will play back a cassette, the amplifier and speaker are functioning. The trouble must be in the microphone circuit, play/record switch or switch transfer linkage. Clean and spray the play/record switch contacts. Then, check for poor soldered switch connections on PC board. Make sure the switch can be fully engaged and make contact. In case the unit will not play or record, turn volume wide open and touch the ungrounded wire from the tap head to the amplifier. You should hear a loud hum if the amplifier is working. If not, inject a signal from an audio generator at the volume control. Signal trace the defective amplifier by going from base to collector terminal of each transistor. Make voltage and transistor tests where the signal is lost. If you hear hum and the recorder will not play or record suspect the tape head.

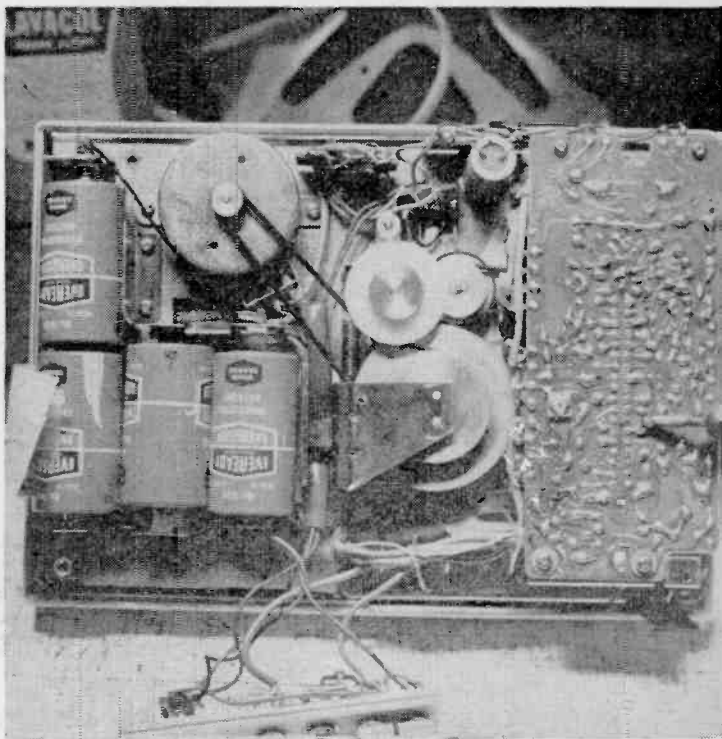



Suspect a scored or rough tape drive assembly when the unit repeatedly tears tape. **8**

Check for sticky substance on capstan (tape drive) shaft. Clean the tape drive with alcohol and check for roughness. Packed tape oxide or small pieces of tape may be wound around the drive shaft and will pull or tear tapes. Make sure the drive belt is properly installed. If a new drive belt has been installed, it may be around the wrong idler pulley. This will let the tape bunch up, pull and tear out the tape. Bunching and tearing of tape may be caused by a defective cassette. Some tapes will bind and cause wow conditions. Stop the recorder if the tape has bunched up in the small plastic window. Quickly, rewind the tape and start once again. In case the tape pulls or seems to form a loop, check the rubber drive belt and take-up pulley.

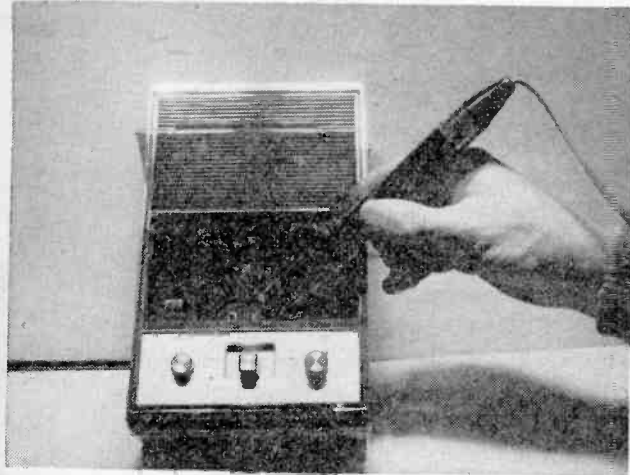
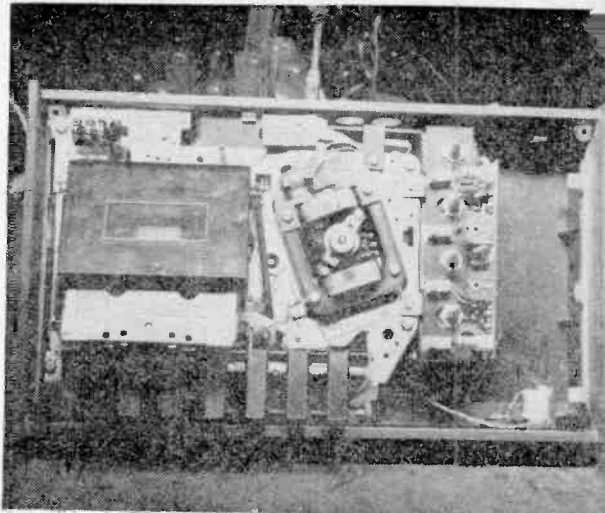

**9** Is your cassette player unusually noisy? Try to isolate the noisy condition in amplifier or tape head assembly. Make sure the tape head is clean and demagnetized. If the player is still noisy, see if the noise exists in a pre-recorded tape cassette. Try a few new pre-recorded cassettes. Now, turn the volume down and see if noise is still present. Generally, noise produced in the amplifier is caused by leaky AF or driver transistors. Also, check for a poor ground on the PC board. The noisy transistor can be isolated by substitution or removing the collector terminal from the circuit. When the noise disappears you have located the noisy transistor or stage. A popping noise can be caused by a defective output transistor or burned resistor.

Two recordings heard at the same time indicate crosstalk. Excessive crosstalk and poor frequency response are caused by either poor erase or improper tape head alignment. **10** Adjust the height and azimuth screws, located at the rear and side of the tape head, to correct. Use a cassette audio test cartridge in making these adjustments. Before performing these tests clean up the tape head. Connect a 40, 47 or 49 bulb across the speaker leads. Adjust the volume control so the bulb rarely glows and then adjust the tape head height and azimuth. ■



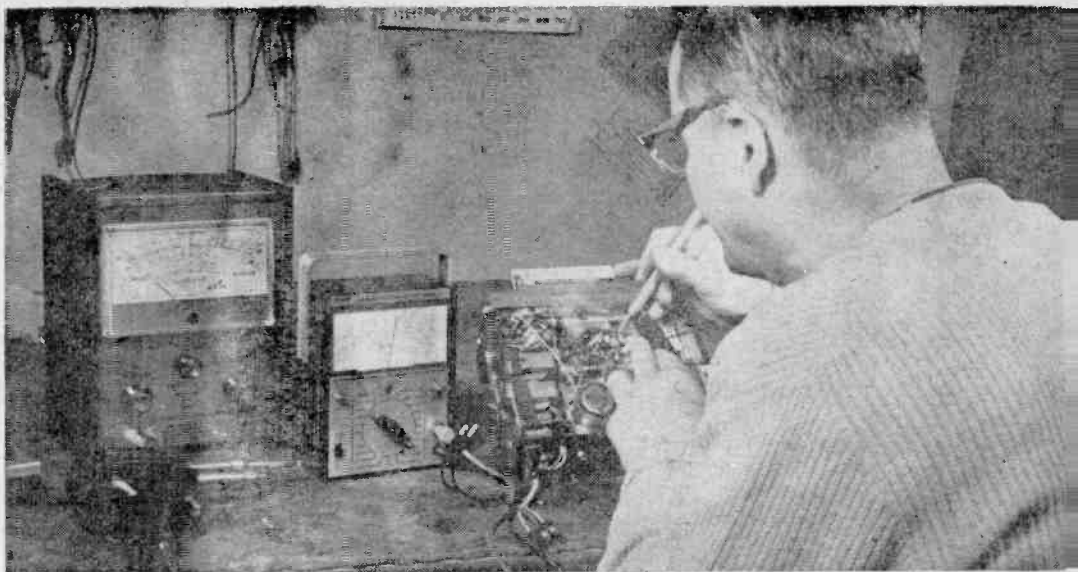

# 8 STEPS TO CAR

**U**NCLE SAM is spending millions to place men on the moon (rumor has it, in fact, that Rosemary's baby is scheduled for a moon landing, though nobody's saying just when). No one's denying that the Apollo missions are expensive and quite complicated electronically. Auto tape player repairs are expensive too, though unlike Apollo missions they needn't be—not if you fix your own.

In the Eight Steps you're about to see, you'll find meat enough to move you well along the way toward truly enjoyable music on the move. Only a few hand tools will be

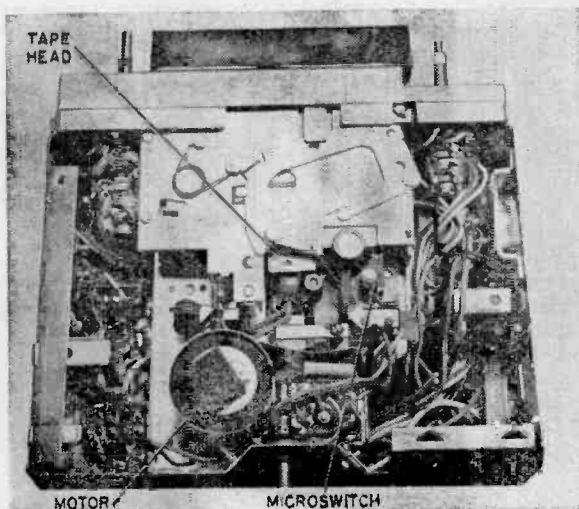

**1** Keep your eyes open as well as your mind when you remove the car tape player from under your dash, to the time you remove the chassis covers on your workbench. Very often a loose connection or screw can be fixed putting the player in tip top playing form. Once the covers are off, do some eyeball poking to turn up the trouble. Remember, most stereo tape player troubles are mechanical. Stop, think and try to isolate the trouble quickly before digging any deeper. And be sure not to misplace any hardware.

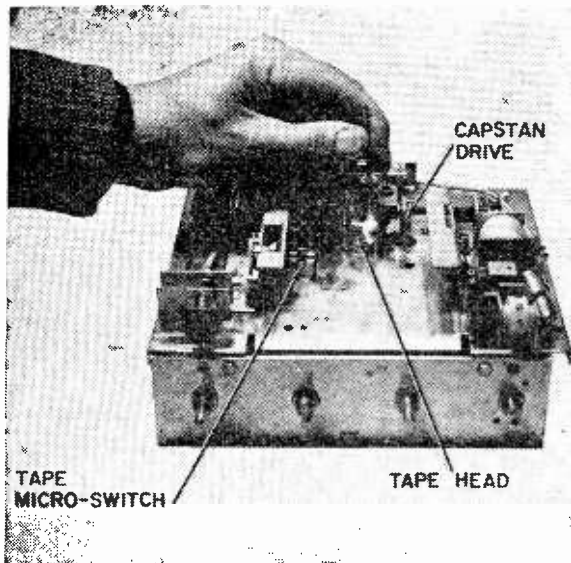

**2** The most common trouble with auto tape machines is excessive dirt and dust. To ensure crisp tape reproduction, keep that tape head clean. A handy gadget to own is a tape head cleaning cartridge. At least once a week insert the cartridge to clean the head. At least once a year, or whenever playback reproduction is not up to par, do a thorough cleaning job. Clean tape head and tape guides with tape cleaning fluid. Apply fluid with a Q-tip. Denatured alcohol can be used. Also, remove tape oxide dust from head and motor capstan drive. Poke around and clean it all up. However, be sure not to throw any tape guides out of position.

by Homer L. Davidson

# TAPE PLAYER REPAIR

needed for most repairs. Just remember to use a pencil-type soldering iron when working in solid-state circuit boards, and don't forget that adage about fools rushing in where angels wouldn't be caught dead. Take your time, take things easy, and think! If you have a signal tracer, VTVM, and/or transistor tester around the shop, by all means drag 'em out and put 'em to work—if you can find work for them. But since most tape player troubles are mechanical in nature, the bulk of the problem rests with you. Ready to take the time to stop, think, and try to isolate that trouble? Then read on.

**3** In many cases, dirt and grease will collect on the motor drive pulley and nearby metal parts. Simply remove all dirt and grease with denatured alcohol. Also, check that capstan flywheel and clean it if necessary. A bright slick-looking flywheel indicates slippage between the drive belt and flywheel. Clean thoroughly. If at all possible, try to find a replacement drive belt. You may have to write to the manufacturer. Power output transistors are installed with hardware that can loosen, causing poor electrical connection. Also, if not seated tightly on their heatsink surface, the power output transistors can overheat and destroy themselves. Be sure they are secured in their sockets.

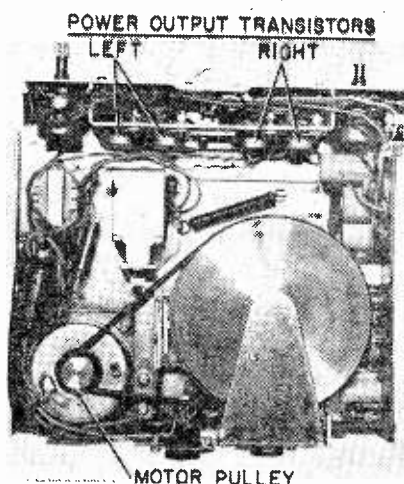

## TAPE PLAYER REPAIR

**4** Excessive tape oxide dust within the flywheel bearing will cause slow and erratic tape speeds. Most capstan flywheels can be removed by pulling out a small keeper pin at the bottom bearing assembly. Now it will be easy to clean all bearing parts and surfaces nearby. Put a drop of oil into both bearings and re-assemble. Let the tape player run for a few minutes on the test bench and check for any oil that may work on the flywheel drive surface. Over lubrication may undo any good achieved.

**5** Does the tape refuse to change to another channel? Or perhaps, the solenoid is working and the channel indicator does not move? To find out what's up, connect power to the unit and listen to determine whether the solenoid is operating or not. A channel change can easily be heard while watching the ratchet. Determine whether the ratchet is turning over a small cam that lifts and lowers the tape head. Eyeballing it here will pinpoint simple mechanical problems that you can adjust to

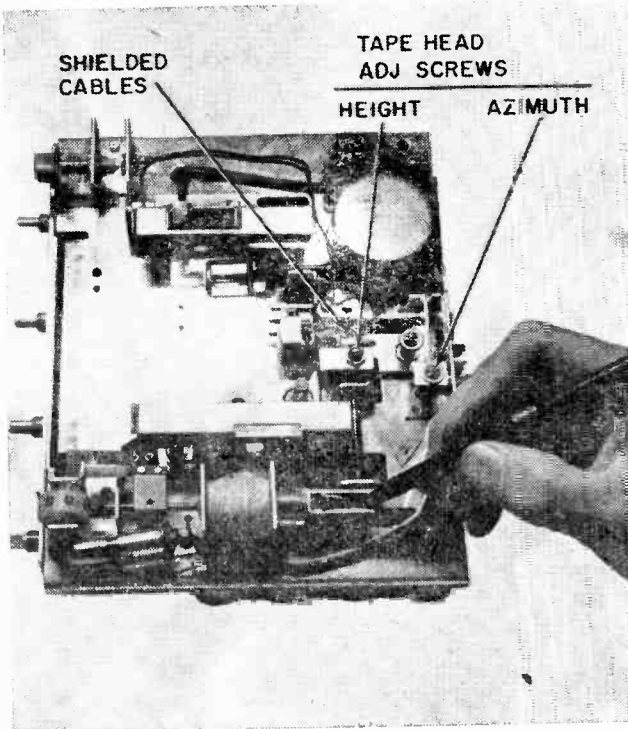
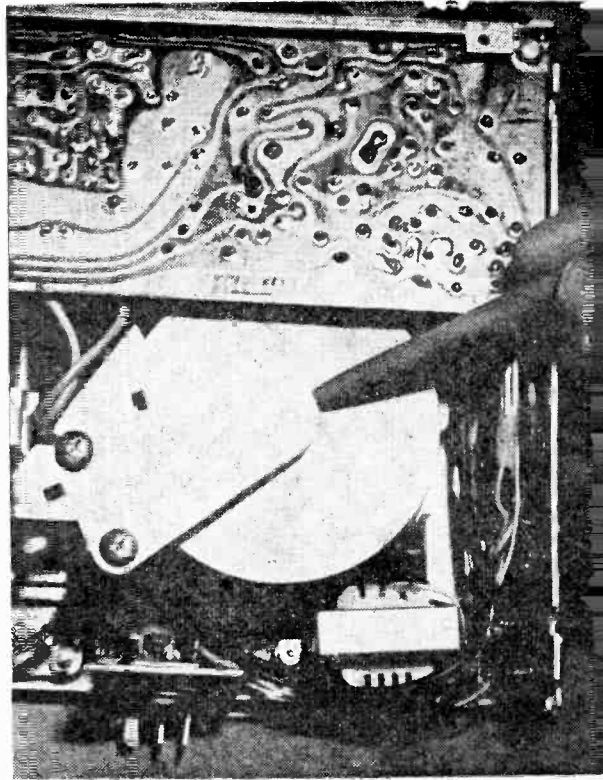

normal operation order. If the solenoid does not operate, it may be shorted out or have an open coil—call your VOM into action. If your playback is erratic or dead, check the shielded cables to the tape head. They can cause lots of trouble. If inspection does not pinpoint the cause of the trouble, you'll need the services of a signal tracer or injector. Be sure the volume control is set wide open.

**6** In case the stereo tape player will not manually change channels, suspect a dirty or broken manual change switch. Momentarily short the two contacts at the back of the change switch. If the solenoid is operating, the tape head will change positions. If not, trace out the wiring and look for a cold solder joint or break. If the switch is loose, it will promote frayed and broken wires. Try to determine cause of failure to prevent its recurrence.

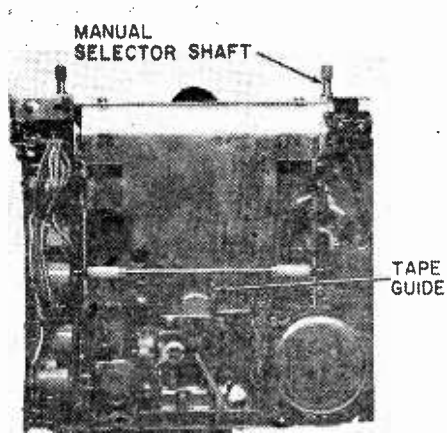

**7** Generally, when the tape becomes wound up into the capstan drive assembly, suspect a rough capstan drive or a poor cartridge. Do not allow the machine to run when jammed with tape. The motor will overheat. In this particular model, the motor protection resistor in series with the power supply burned out and was replaced. Most values are low—like 2.2 ohms. However, check the unit's schematic diagram to determine correct value and wattage. Of course, overheated motors often become defective and replacement is mandatory.

MOTOR PROTECTION RESISTOR

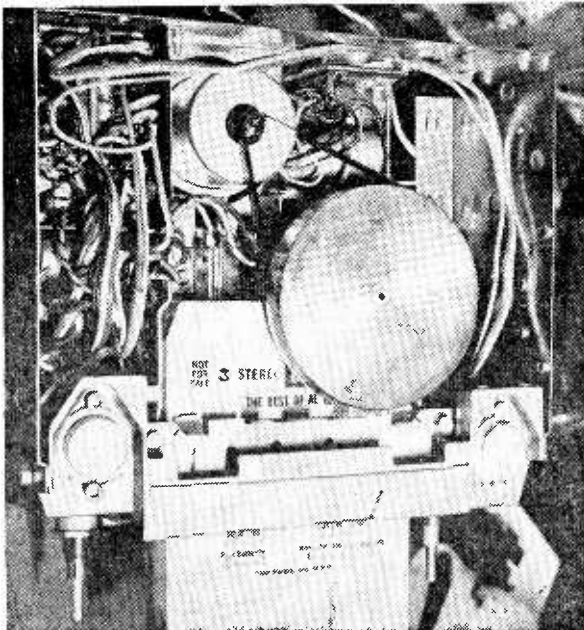
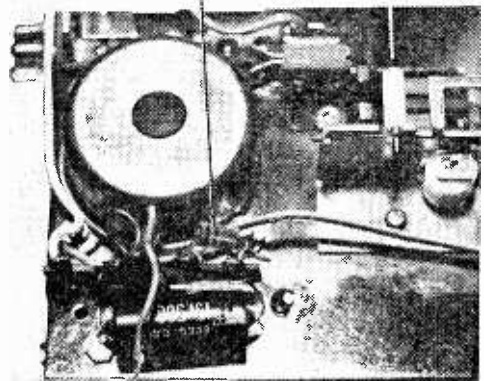

**8** Before clamping the lid on a stereo tape player, give it a good bench preventative maintenance checkup. First, demagnetize the tape head. There are several inexpensive demagnetizers on the market. Second, use a test tape and check both amplifier channels and speakers for proper functioning. If you have the know how and manufacturer specs, check and align the tape head in azimuth and height. Next, install the machine under your dash, make power and speaker connections, snap in a tape cartridge. Now sit back and enjoy good stereo. ■

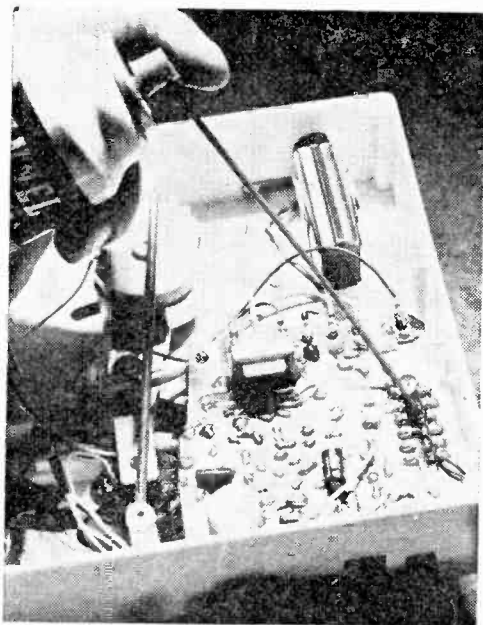

Oil has caused more tape troubles than it has cured, though it can be a godsend if used sparingly. But oil mechanical parts only.

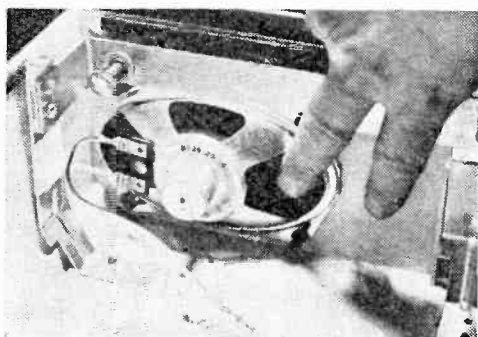

Speaker is often responsible for distorted sound, particularly if finger pressed against cone corrects trouble. Remedy is new speaker.

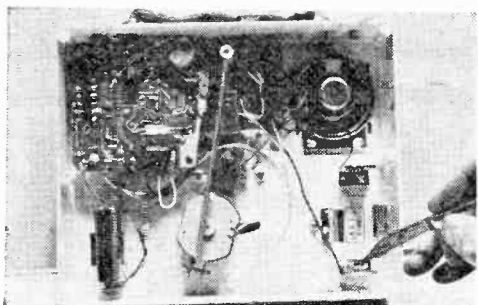

Batteries (if used) should be replaced often and removed whenever recorder is stored. Knife here points to corroded terminals.

# THOSE MINOR TAPE TROUBLES

... and what you  
can do about them

By HOMER L. DAVIDSON

■ Ben Franklin wasn't thinking of tape-recorder repair when he observed that "a penny saved is a penny earned," but the fact is that you *can* cut service calls by making minor recorder repairs yourself. Our photos present a rogue's gallery of common tape-recorder ills, with the suggested remedy indicated in each case. A quick perusal will no doubt reveal what you have long suspected—that the answer to your tape troubles lies right in your own two hands.

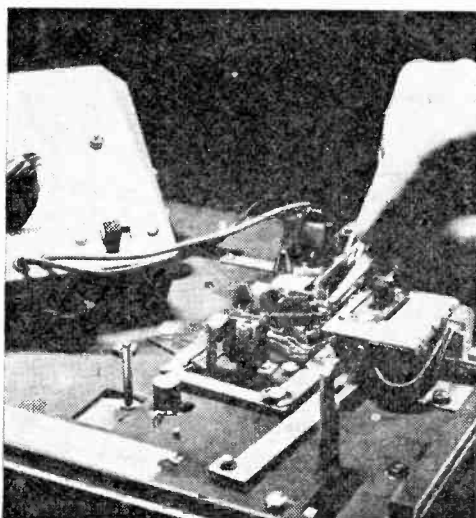

Tubes or transistors are chief reason for loss of record/play functions. Audio generator should quickly pinpoint defective one.



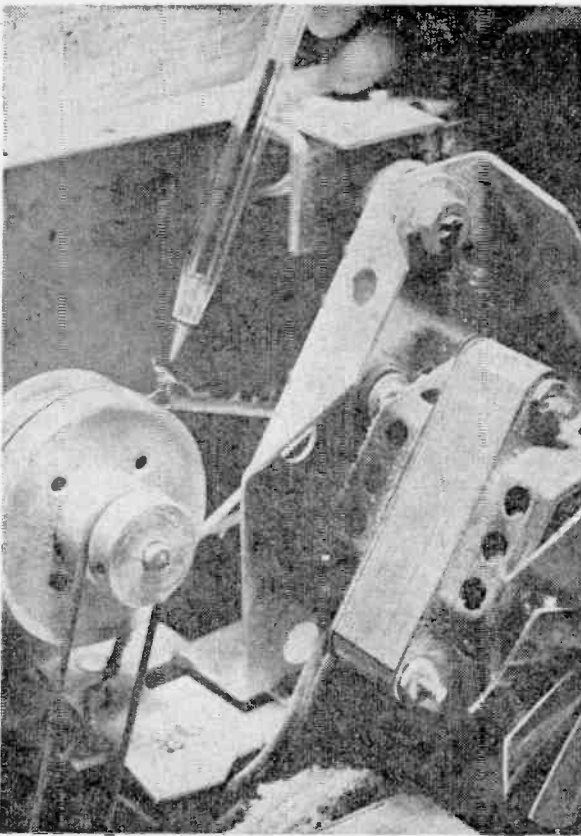

Drive belt may be culprit in recorder with too-slow tape speed. Clean belt with fluid; be certain idler pulley(s) are well oiled.

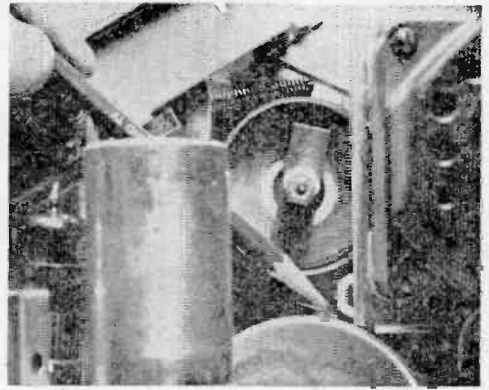

Capstan flywheel, if oily, can result in slippage, as can hardened rubber drive assembly. Remedies: clean flywheel, replace drive

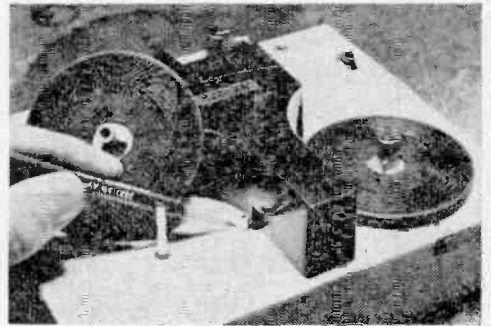

Tape guides and levers can slow tape, even stop recorder if bent or otherwise damaged. To fix, check and correct tape path.

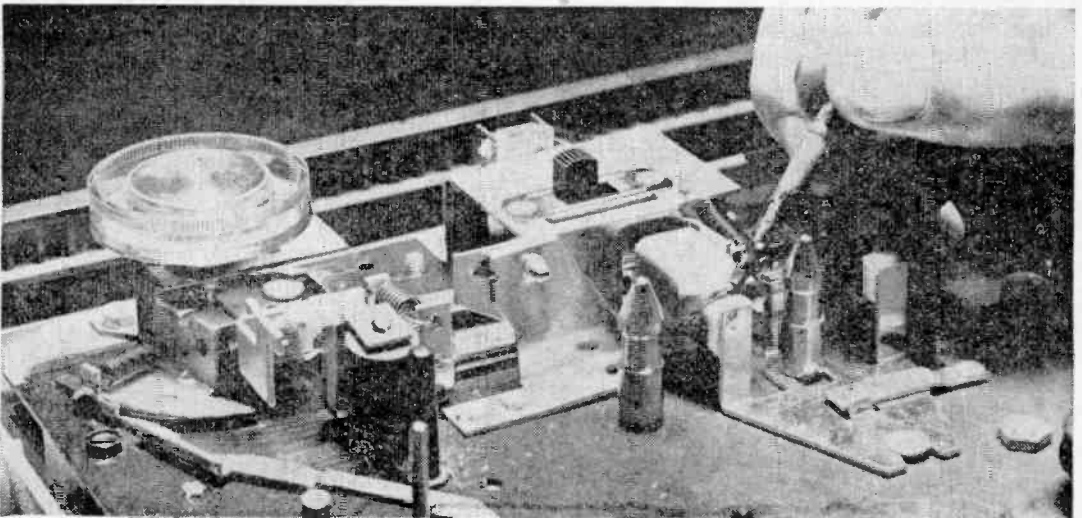

Record/play head holds key to proper operation of any recorder and can be source of weak, noisy, or distorted recordings. Use Q-tip moistened in head cleaner to remove dirt; use demagnetizer to remove residual magnetism and place head in neutral state. (Turn page.)

# TAPE TROUBLES

*Continued*

Rubber pressure roller can result in uneven tape motion, particularly if badly worn (as is roller being held by hand in photo). Since a worn roller cannot be repaired, an exact replacement must be secured from either the manufacturer or his agent.

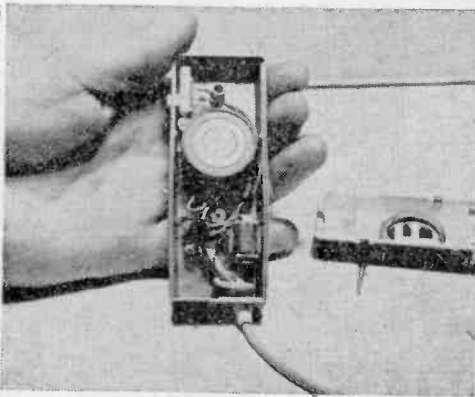
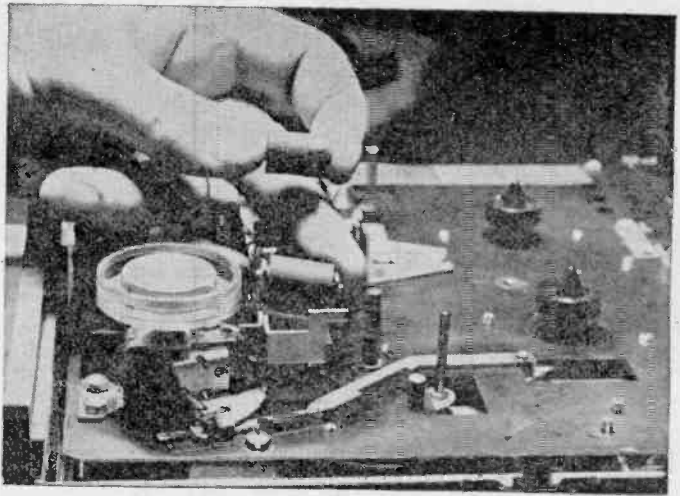

Mike cord can be explanation for intermittent recording, and mike can go completely dead if one or more wires in cable are broken. New cord or mike will solve problem.

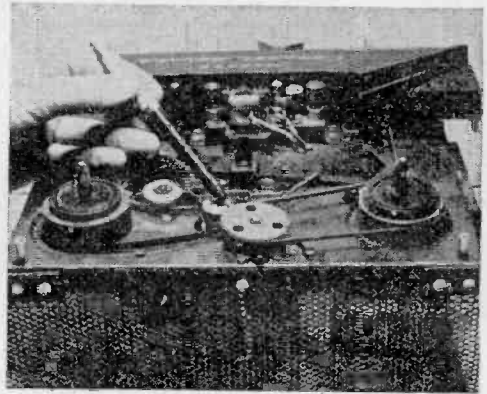

Rewind drive wheel can prevent proper operation during rewind function if it is bent or otherwise defective. In portable units, batteries can also be to blame.

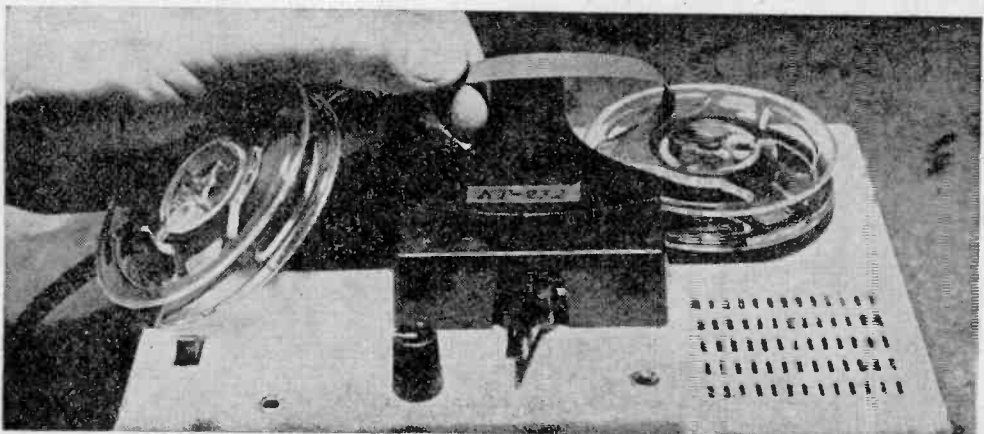

Tape itself holds clue to many a minor trouble. Dull side of tape must face heads if recorder is to function properly; tape must be fully erased if recording is to be clean and unblemished (virgin or bulk-erased tape being the best bet for good recordings).

# PUT A TAPE PLAYER

## IN YOUR CAR

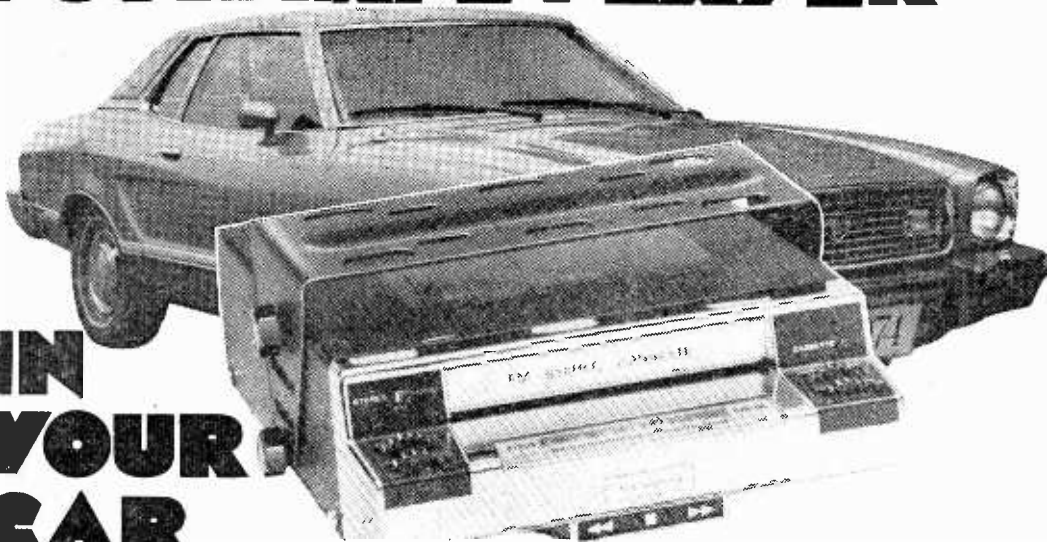

It might not come out as high fidelity, and most certainly the sound will be fighting road noise for your attention, but from every viewpoint an automobile tape player will give you endless hours of pleasurable sound-in-motion. No longer will you have to put up with hard-sell announcers squeezing obnoxious commercials between musical selections *they* think are the top forty. Fact is, some stations just keep repeating their idea of the *top ten*.

In all likelihood, *your* personal top forty, or thirty, or ten are the records and tapes you purchased for in-home high fidelity listening. And while you might not believe it, if you're a typical record collector the investment runs well into several hundred dollars worth of records alone, not including reel-to-reel tapes, cassettes and cartridges (either pre-recorded or dubs).

Yet it takes less than \$100 to equip your automobile with a cassette or cartridge player that will allow you to utilize your record and tape collection on the road. Fact is, you can not only dub your hi-fi collection onto cassettes and cartridges for auto use, you can get prerecordings of golf tips from the pros and even language lesson tapes to turn those hours of concrete-ribbon watching into productive hours for which you usually don't have the extra time.

**Do-it-yourself!** Of course, if you've investigated adding a tape player to your car you've probably run into estimates of \$150, \$200 or even more, and its more than likely you've

been turned off by the high costs. But the plain truth is that these estimates represent a *shop installation*, and installation fees often run several times the basic cost of the equipment. As a typical example, if your car presently has two rear speakers (or two dash speakers) all you need for stereo listening is a tape player which sells as low as \$30, a speaker switch worth about a buck, and about an hour of your time for installation. But if you can't, or won't, put in an hour's effort, and you depend on a shop for installation, the total cost of the tape player system can easily run upwards of \$125, not to forget the "extra" equipment you might be talked into: like "high fidelity" coaxial speakers, trunk-mounted reverberation generators, or an anti-theft lock for the tape player (once a thief is inside your car he can take the player *and* the locking device).

**Start Planning.** All things considered, the rockbottom cost way to go sound-in-motion is by doing the installation yourself. First thing to consider is *do you want cassette or cartridge*. If you go the cassette route you are limited to stereo reproduction (the least expensive installation). If you chose cartridge you have a choice of stereo or discrete 4-channel (quadraphonic), though the equipment costs for 4-channel can run in excess of \$100. As a general rule it is wise to utilize the same type of equipment in your car as you do in your home: this way, you can easily make your own tape dubs from records or other tapes.

## IN YOUR CAR

First trick is to find a 12-VDC line from the battery to power the tape player. Select one from the batch that comes from the ignition switch. Connect a meter to the line and determine whether it's hot full-time, only when the ignition is on. Pick the one you want.

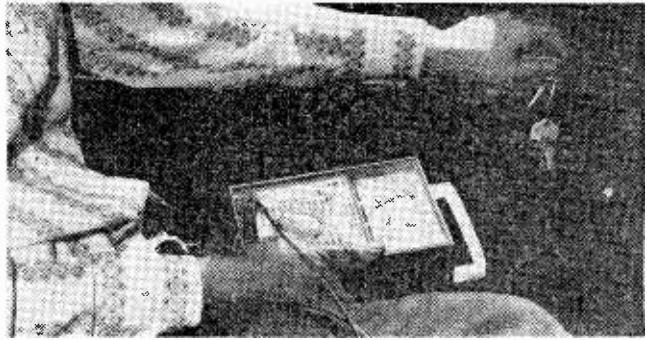

Next step is to consider what you already have built into the car in the way of speaker equipment. Some modern cars are supplied with two front speakers for an ordinary AM radio or an optional FM stereo radio. The speaker wiring in a car is of the plug-and-socket variety, easily spliced into, so the speakers can be switched to a tape player. A typical installation wiring diagram is shown in Fig. 1. Any DPDT toggle switch available from auto supply or electronic stores can be used.

**Hard Work Is Done.** Most modern cars have speaker mounting holes pre-cut in the deck behind the rear seat. These holes are covered by the "cardboard" trim of the deck which is easily trimmed away with a pocket knife or simply punched out with your fist. You can obtain low cost "stereo speakers" with matching grills which exactly fit the pre-cut holes. In this manner your front speakers serve for the radio while the rear speakers handle the tape player. Keep in mind that the large space of the trunk, into which the rear of the speakers work, makes an excellent speaker enclosure and the rear speakers will usually provide a richer, more mellow sound in comparison to dash-mounted speakers.

Finally, if you don't care to rewire the

dash speakers or work through the trunk to the deck you can always obtain "auto" speakers—small, usually decent quality speakers mounted in a sloping enclosure specifically intended for mounting and installation directly on the dash or deck. In the typical installation shown in the photographs we have selected "auto" dash-mounting speakers simply to illustrate the maximum equipment needed.

After you have decided on your speaker arrangement or connections it's time to install the player. Every player we have seen is supplied complete with power and speaker cables. All the wires you'll need to complete the installation. Often, the wires are pre-soldered to a connector which plugs into the player, though many rock-bottom priced players have the wires connected directly to the player.

**Get Started.** Select a mounting location for the player as close as possible to the driver so he can reach the tape slot without undue stretching, but make certain the player does not interfere with the driver's right foot—the one that works the gas and brake pedals. A choice location is under the dash directly above the transmission hump, or directly on the hump itself. Most players are supplied with a mounting brack for un-

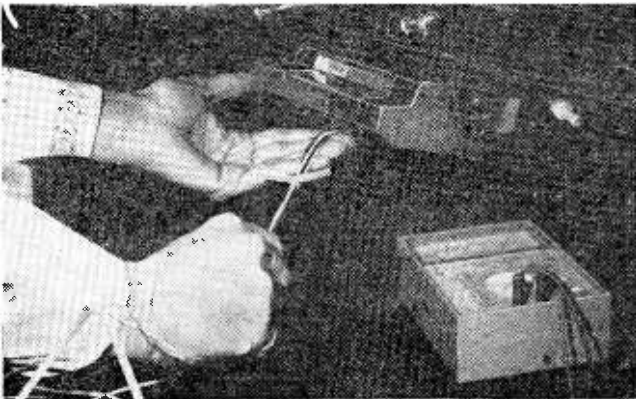

The player should be mounted under the dash so that its controls and tape loading slot are convenient to the driver.

Make certain the player's location does not interfere with the driver's right foot.

To dress speaker wires so they do not fall or flop about, use wire twists that come with packages of plastic food bags.

Speakers can be attached to the kick panels located to the sides and under the dash. They are easy to remove, so take them out and mount the speakers. Before you do so, check to see that you clear the parking brake pedal. Next, attach about 20 inches of wire to the speakers. This wire can be cut from the harness supplied with the tape player. Be sure to observe color code requirements.

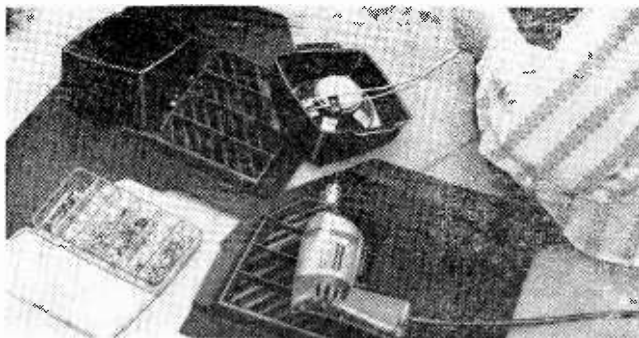

der dash installation. The players intended for mounting on the hump are supplied with specially shaped mounting assemblies.

After the mounting bracket is installed, locate a wire behind the dash which has "full time" battery voltage. For example, the cigar lighter, or the accessory connection on the fuse block if the block is easily accessible. You do not want to use a power wire which only has voltage when the lights or other electrical accessory are in operation. After all, you might like to just sit in the car and listen to music without the engine running or having the lights on. Best way to be certain you have a full-time power wire is to check with a voltmeter: if the meter reads 12 VDC without the key in the ignition lock and all accessories are off you have located the correct power wire.

If your tape player has a power/speaker connector socket install the power cable at this time. Either splice directly into the power wire or use (preferably) a Scotch no-solder splice: a plastic device that is slipped over the power wire and the wire to the player. When the device is squeezed with pliers a metal bar pierces the insulation on both wires, providing a solid, fully insulated splice. The splicing device is usually supplied with all but the unexpensive units.

Next step is to install the speakers. Life will be a lot easier if you connect about 20

inches of wire to the speaker terminals before the speakers are installed—regardless of the type speakers used. If you cut off a 20 in. section of speaker wire from the cables supplied with the tape player you'll find they are *polarized*: one wire is usually copper colored while the other is aluminum, or the insulation is of different colors. Connect the same wire to the same terminal on each speaker. If you don't use part of the wire supplied with the player get a small spool of plastic insulated wire specifically labeled "speaker wire," as this wire is similarly *polarized*. Make certain you solder the wires to the speaker terminals. Don't just wrap the wire around the terminals and assume it will stay in place—it won't.

After the speakers are mounted, secure the tape player in its mount, connect the speaker and power wires and *install the fuse in the power wire's fuse holder*. Do not assume the fuseholder has a fuse in it because you haven't found a loose fuse. For some reason, many tape players we've seen have been supplied with an empty fuseholder, and no fuse to be found in the shipping carton. If this happens to you just hop down to your local auto supply shop—it's a standard automotive type fuse.

**Final Check Out.** When you are certain all wires are correctly connected and the player is rigidly secured to its mount it's a good

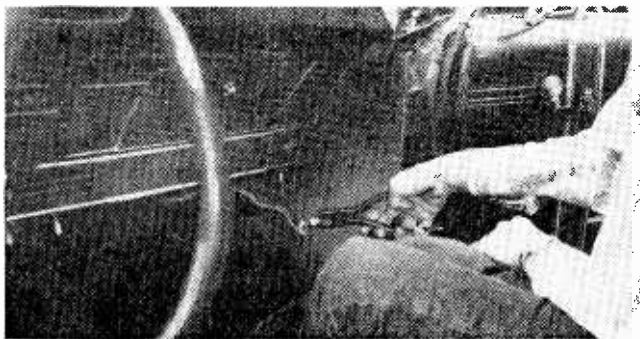

While you can always splice the cut ends of the speaker harness wires, it's easier to use Scotch no-solder splicing clips. Available in automotive supply stores, the clips speed splicing and give a safer, surer connection and insulation. One squeeze of a pier does the job. Stow away all cables carefully under the dashboard.

# IN YOUR CAR

Kathi, our CB editor, takes the wheel for a spin down the highway listening to her favorite cassette recording. Right now she's on a Billy Paul kick. That's good, because the editors get very upset when anyone takes their Lawrence Welk tapes from the office.

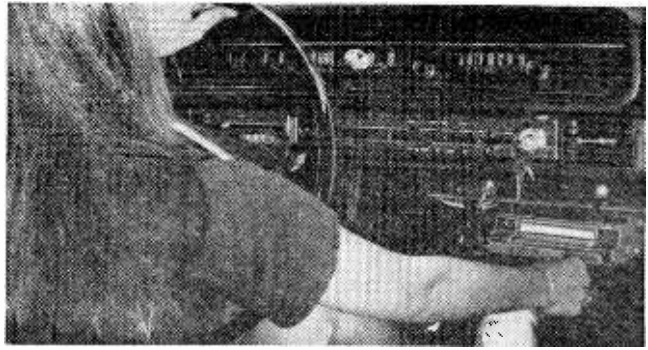

idea to test if the *ground* (common) connection is actually a low resistance connection to the car's body. In most tape players both the common speaker wire and the negative battery connection are the same wire and/or terminal, with the connection to the car body made through the player's mount. Clip the negative lead of a DC voltmeter rated 0-15 VDC or higher to the dashboard (make certain the paint isn't insulating the test lead from the metal dash) and the positive lead to the tape player—any exposed metal part or the mounting screws. The meter should indicate zero (no voltage). Turn on the tape

player or insert a cartridge or cassette to apply power and make certain the meter still reads zero. If the meter shows a voltage reading under either condition, the player requires a separate ground wire to the car body. Ninety nine times out of a hundred a tape player does not require a separate ground wire, but every once and a while the ground connection through the tape player's mount is a relatively high resistance, so don't be surprised if it happens to you.

If the ground checks out you're all set for music. Just plug in a cartridge or cassette, sit back, enjoy, and watch the road. ■

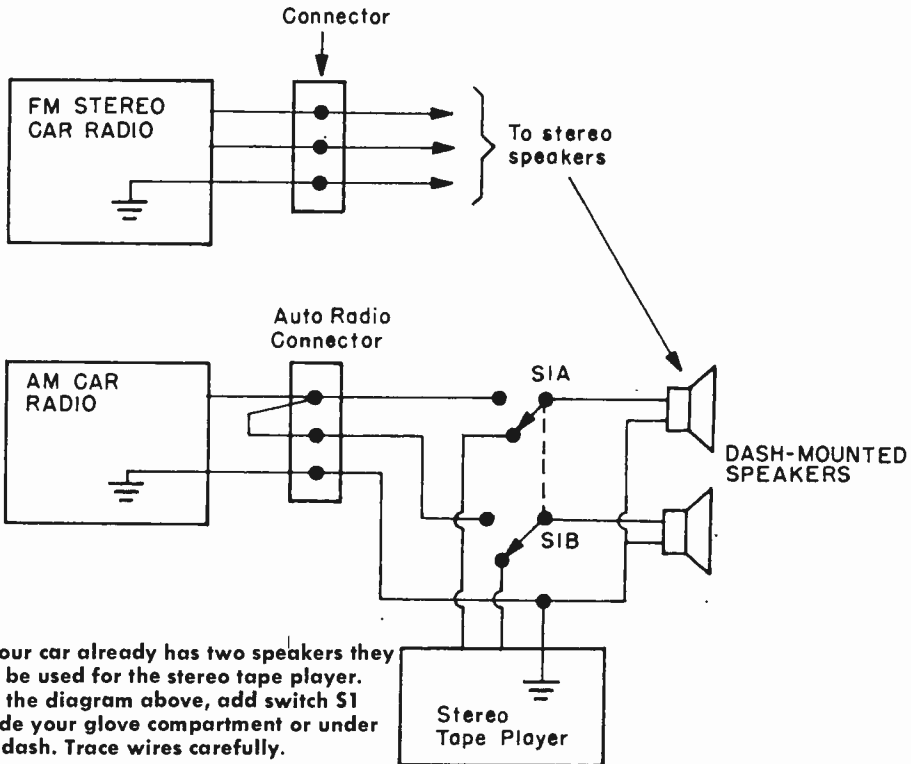



# ELECTRONICS FOR

## WEEKEND MECHANICS

by Jorma Hyypia

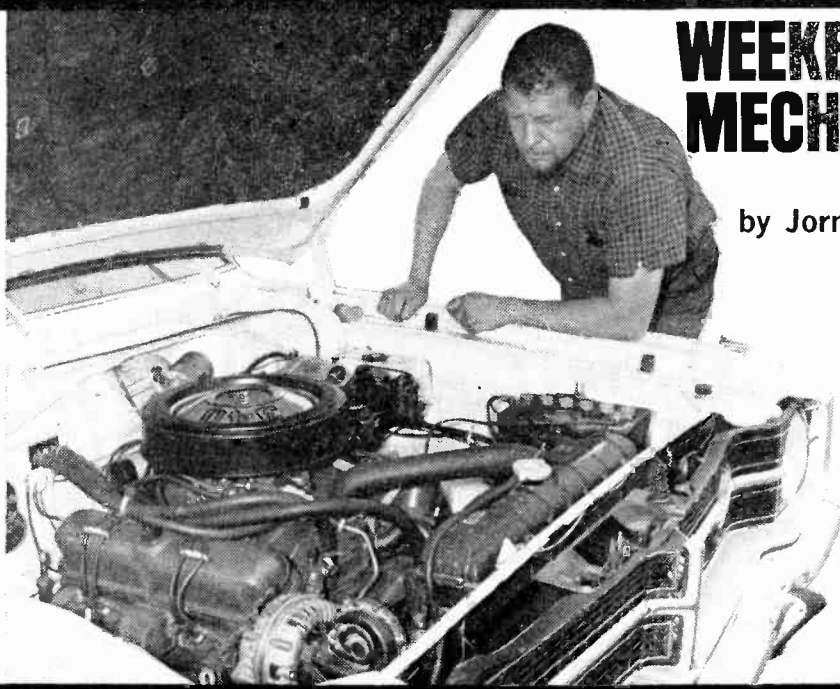

### Improved automobile tune-up analyzers keep the family buggy operating at peak performance!

**E**ver have a secret desire to sneak out into the garage on a dark night and sabotage your own car? Maybe mess up a spark plug, or loosen a couple of distributor cables? Stupid question? Not if your new electronic engine analyzer has just told you, for the tenth time, that your car engine couldn't be healthier. After all, what's the fun in having nice, new troubleshooting equipment if you can't find any trouble to shoot?

But fear not. Sooner or later your fondest hopes will be realized. One day you'll hear an unusual burp or wheeze from under the hood, and your engine analyzer will confirm that the beast has an electrical head cold. What's more, you will be able to determine exactly what causes the ailment—and that's more than your family doctor can usually do when you complain of a headache.

Question: Why spend money on automotive diagnosis equipment if you don't happen to know enough about car engines to make your own repairs? Answer: a professional repairman won't be able to sucker you in to paying for un-needed repairs if you can tell *him* what's wrong with the engine. Moreover, you will soon discover that many service jobs related to engine tune-up or other electrical systems functions are ridiculously easy to do yourself. For example, there's no trick to replacing a spark plug; but you have to know which spark plug needs cleaning or replacement.

Every piece of equipment described in this article can be connected to the car engine in seconds, *without* removal of engine parts that might be difficult to replace. Also, each test instrument comes with clear, step-by-step instructions. You will be able to per-

## WEEKEND MECHANIC

form engine tests correctly on the first try, and you will understand what the test results mean. If you are unfamiliar with automotive test equipment, your main problem is deciding what type of equipment would be most useful to you. It's easy to go overboard and buy too much test gear; or you can err by wasting money on equipment that will not serve all your needs. This round-up of automotive tune-up analyzers will clue you in on the types of instruments that have the broadest general appeal and usefulness. But you should do some extra looking around in shops where the analyzers are sold, and study catalog specs to make sure that you are getting the most per dollar invested.

Three "musts" for engine tune-up testing are: a tachometer to measure engine rpm; dwell meter to measure the performance of the cam that operates the distributor breaker points and a timing light to determine whether the No. 1 spark plug is sparking at the correct time in relation to piston position on the compression stroke. To test the car's electrical system more completely, you should also have a DC voltmeter, DC ammeter reading up to 90 amperes, and an ohmmeter for resistance checks. If you already own some or all of this more common variety of electronic test equipment, just look for a timing light, and for tach and dwell meters—either as separate or combined instruments. If you lack all or most of the desired equipment, you can save money by investing in an engine analyzer that combines all of these test functions in one portable unit.

If you are already confused by some of

the automotive terminology, get a couple of library books and read up on automotive ignition systems. Also check your electronics supply store for informative paperbacks; for example, Tab Book No. 604, *Using Electronic Testers for Automotive Tune-Up*.

**Timing Lights.** Each engine spark plug must fire at precisely the right time, in relation to its piston position; if spark timing is off, the engine may overheat, suffer loss of power, exhibit poor acceleration, waste fuel, and perform poorly in other respects. To check the all-important spark timing you need a stroboscopic timing light.

One cable of the timing light is connected to an AC or DC (car battery) power source, depending on the type of light; the other cable is connected to the No. 1 spark plug. Very low cost neon timing lights require only one connection, to the spark plug. Each time the spark plug fires, the timing light flashes. This flashing light is aimed at a stationary, calibrated marker and at a moving indicator mark located on the engine's crankshaft pulley, or flywheel. As the indicator mark spins around, the stroboscopic light makes it *appear* to stand still at a specific point next to the marker scale. If the timing is off, the indicator mark will appear to be in the wrong position. This

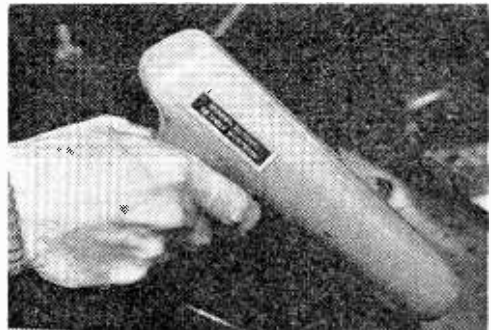

**Heathkit's Inductive Pickup Light is powered by the car battery. Pickup can be attached to spark plug lead even with engine running.**

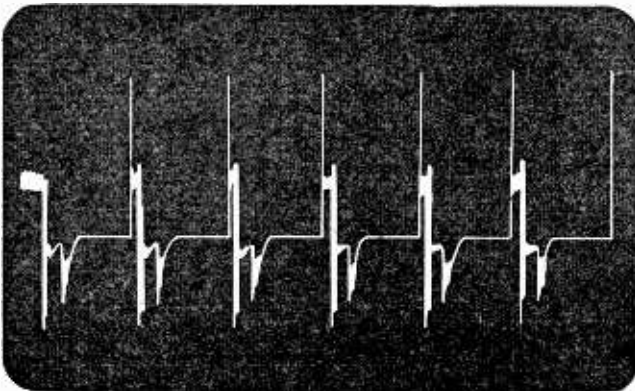

**Normal "parade" pattern of auto ignition for a 6-cylinder engine. Each re-occurring pattern should be identical for engine operating normally.**

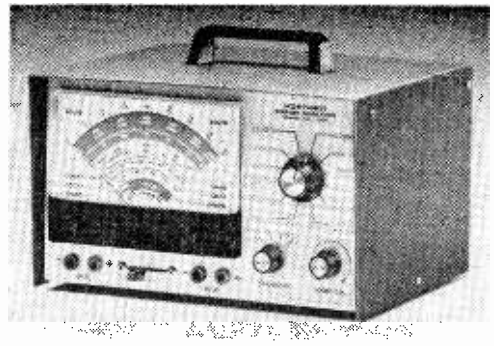
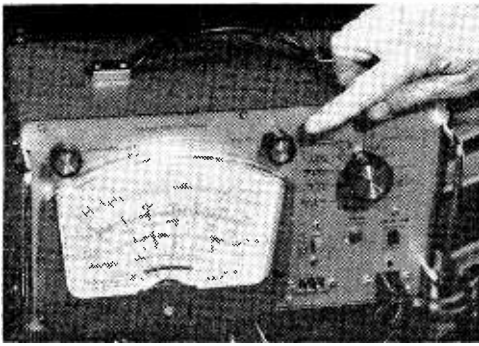

Two kits by Archer (Radio Shack) and Heath let you assemble your own engine analyzer. Get catalogs by circling No. 1 and 30, respectively, on Reader Service Coupon on page 8.

initial timing test is usually performed with the distributor vacuum hose disconnected. If the timing needs correcting, all you need do is loosen a hold-down bolt on the distributor and twist the distributor body slightly until the indicator mark moves to the proper scale position. It's that easy. So why waste time and money hiring a garage mechanic to perform this simple job?

The same timing light can be used to make a *rough* check of the centrifugal and vacuum advances of spark timing. More accurate testing and adjustment of these advances requires the use of a special ignition advance tester—a timing light having a built-in meter. You might want an advance tester some day, but chances are you can get along nicely with the basic timing light.

You can buy a *neon* timing light for under \$5, but the red light is so weak that you will probably have to use it in a darkened garage or under a blanket thrown over the car hood. These lights are completely accurate: you merely save money by sacrificing convenience. You can find these neon lights in department and discount stores having automotive sections, and in auto supply stores. Lafayette Radio offers one neon light for only \$3.39, and another with a remote starter cord for \$7.50.

*Powered* timing lights that use high-voltage (300-600 VDC) *xenon* flash tubes can be used in broad daylight without eye strain. These lights are also connected to the No. 1 spark plug which acts as a trigger mechanism for the synchronized flashing. Some lights work off a 110-volt AC power line, others draw power from the car battery. The AC jobs are usually priced lower than the DC models which can be used anywhere. For example, Radio Shack sells a DC power timing light for \$21.95, and Lafayette

has a similar unit priced competitively at \$22.95; Lafayette's AC light sells for only \$12.95. You can save more money by purchasing the Lafayette lights in kit form for \$16.96 for the DC model or \$10.95 for the AC version. Lafayette also offers a ready-to-use Karcheck Professional DC Power Timing Light for \$26.95.

To further illustrate the variety of timing lights available on the market, we might mention a Penske DC Power Timing Light sold by Sears for \$26.95. Incidentally, Sears also offers a neon light for only \$3.98, a DC-boosted neon light for \$5.99, and an AC "white" light for \$16.98.

**Heath Has a Bright Idea.** We chose Heathkit's new 12-volt Deluxe Timing Light (Model CI-1040, priced at \$29.95 F.O.B. factory) as our test unit because it utilizes an additional convenience feature—a new-style, low-voltage inductive trigger pickup that clips onto the spark plug cable even when the engine is running. You don't have to fuss with spark plug adapters of the kind that must be used with other types of timing lights. A coil inside the clamp picks up triggering pulses from the spark plug cable without actual physical contact with the ignition circuit.

Following Heathkit's characteristically clear assembly instructions, the author's 13-year old son put the timing light together in a few hours: an experienced kit-builder can do the job in a couple of hours. You should run into no problems assembling the simple solid-state inverter circuit and xenon flash tube, and the inductive pickup. To balance the triggering circuit, you adjust a 200-ohm control in the circuit using a built-in neon indicator or a voltmeter as voltage indicator to obtain the required 600 VDC. If for some reason the timing light fails to function

## WEEKEND MECHANIC

properly after these adjustments, do not assume that some component is defective. The assembly manual doesn't mention this additional step that saved us from wasting time checking perfectly good components. Just connect the light to the car engine as for a normal timing test (but with the unit's

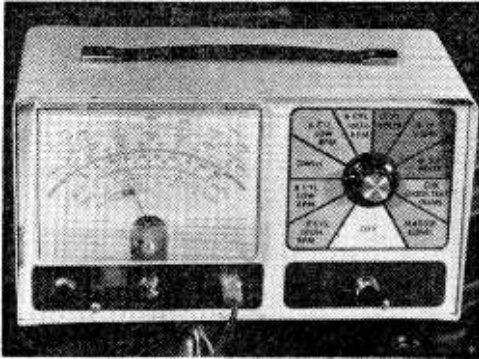

**Lafayette's solid-state engine analyzer includes a tach, dwell meter, VOM and master condenser for substitution testing.**

Circle No. 26 on Reader Service Coupon.

case open), start the engine, and again adjust the 200-ohm control. Chances are you will have the timing light flashing normally within seconds.

Incidentally, if thirty bucks seems a bit too much for a timing light having these obvious convenience features, you can settle for Heathkit's CI-1020 model selling for \$19.95. This light also features solid-state circuitry and a bright-light xenon flash tube; but it lacks the convenience of the inductive pickup.

**Engine Analyzers:** Engine tune-up equipment, including dwell meters and tachometers, come in a bewildering variety of model types ranging from simple, hand-held jobs serving limited test functions to more costly multi-functional unit. If you already own conventional electronic test equipment (voltmeter, ohmmeter and DC ammeter) perhaps all you need to buy is a relatively inexpensive combination dwell meter and tachometer. Because there are just too many choices to permit detailed listing here, we can only suggest that you consult the catalogs of such mail-order houses as Sears, Lafayette and Radio Shack, and that you prowl about in local auto supply outlets.

Assuming that many readers might be more interested in the multi-functional analyzers, we selected a Radio Shack kit and a Lafayette factory-wired model for comparative examination. These units are modestly priced when compared to, say, Penske analyzers sold by Sears for \$85 and \$129.

Heathkit's new CM-1050 Engine Analyzer (\$64.95), is worthy of serious consideration. This "professional-grade" instrument tests conventional, magneto, transistor, and most capacitive discharge ignition systems regardless of voltage or type of grounding. Its functional components include a tachometer, dwell meter, voltmeter, ohmmeter, ammeter, substitution condenser, and provision for testing spark output. Except for ohmmeter adjust, no in-use recalibration of the instrument is required. Accuracy is claimed to be  $\pm 3\%$  on all measurement ranges, and metal-film resistors are used at critical circuit locations to ensure stability over wide temperature range. The analyzer operates off three C cells.

**Radio Shack Analyzer.** Radio Shack's ArcherKit Universal Auto Analyzer kit (\$54.95) went together easily in about six hours, and performed without hitch on the first try. In addition to clear assembly and operational instructions, you get a 56-page engine specifications manual detailing useful tune-up information for both domestic and foreign cars, and trucks made in the 1960 to 1970 period.

The 7-inch, 10-scale meter is easy to read. All scales (except the ohms scale) read from left to right, and each scale is color-coded to the proper position of the function selector switch. The completely portable instrument is powered by four C cells located in a rear compartment that is also used to store two connecting cables and reference literature.

There are two rpm scales (0-1200 and 0-6000 rpm ranges) and four selector switch positions for choosing the right range and to adjust the circuitry for 4, 6 or 8 cylinder engines. This tachometer requires preliminary calibration which is accomplished with a special cable that provides a 60Hz signal from the house power line; this is a one-time calibration. However, to ensure accurate rpm readings, you must use the RPM CAL and RPM SET controls to adjust the meter pointer to full-scale indication before each rpm measurement. It's a simple procedure requiring only seconds to accomplish.

Two cam dwell scales provide 0-45, 0-60

## WHAT THE IGNITION ANALYZER SHOWS

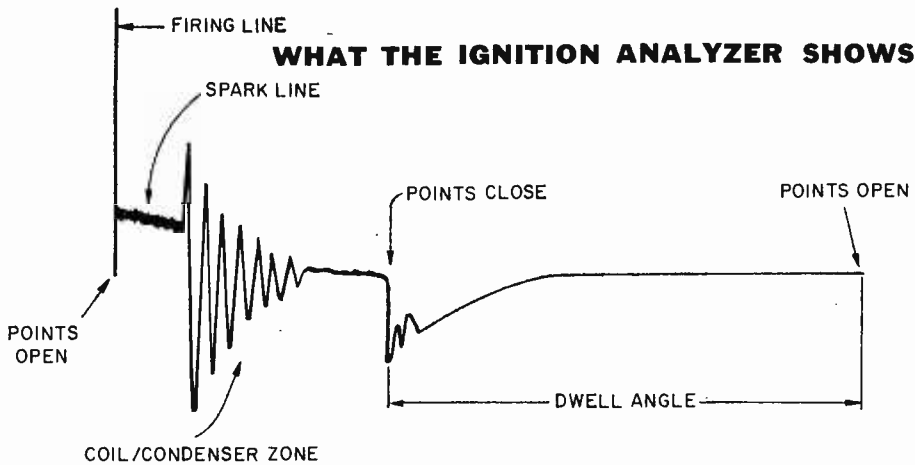

Shown above is a normal secondary ignition pattern, for a standard ignition system, as seen on the CRT screen of an ignition scope. Abberations in the indicated zones reveal the malfunctions listed below. The pattern produced by a capacitive-discharge ignition system is different, but it too can be used to diagnose ignition problems.

**Firing Line:** Shows voltage needed to break down plug and rotor gaps; these lines should be about the same for all cylinders.

**Spark Line:** Indicates the voltage needed to sustain the spark. Depending on whether this line is too long and low, too short and high, slanted, broken or absent, the following problems can be spotted: shorted or fouled plug; too close or too wide plug gaps; defective resistance wire to spark plug; excessive gap between end of rotor and spark plug wire contact in distributor cap; open plug or wire; defective distributor; resistive plug or wire; defective distributor rotor.

**Coil-Condenser Zone:** Reveals dissipation of energy after the spark plug fires. If these

oscillations are low or absent, look for a defective condenser or coil.

**Points Close Signal:** Breaker points close. If the first oscillation is not the largest, points are not closing properly. Excessive cam wobble is indicated if the degree of variation in this area is greater than specified by the manufacturer.

**Dwell Angle:** Length of this section indicates the time during which the breaker points are closed. Use the CRT screen scales to measure the dwell angle. Random flashes along the dwell line indicate a loose connection in the primary circuit, anywhere between breaker points and distributor and battery.

**Points Open Location:** Breaker points open. Look for a sharp 90-degree rise indicating desired production of high voltage (the "Firing Line" for the next cylinder). Intermittent flashing at this location indicates that points are arcing.

**Jittery Pattern:** If the entire waveform has the jitters, look for a loose or corroded high-tension lead.

and 0-90 degree measurements for 8, 6 and 4 cylinder engines respectively. The separate 0-3.2 VDC and 0-16 VDC scales are used to test battery voltage or battery capacity (make voltage readings while cranking the engine); also for checking voltage drop in cables, to check solenoid operation, and to pinpoint broken or loose connections in the low-voltage point and distributor wiring.

The ammeter, which has a 0-90 ampere range, is used to check the car regulator, generator or alternator system: a special connecting cable, with shunt bar, is provided for this purpose.

The ohmmeter (0-20,000 ohm range) is

used to check the ignition coil, the resistance of spark plug resistance wire, open circuits in fuses and bulbs, and electrical continuity in any wiring circuit.

A "Hi-Lo" diode/leakage scale provides a quick test for condenser leakage. Another sure way to test a suspected condenser is to use the substitute condenser contained in the analyzer. Diodes used in alternators are also tested using the diode/leakage scale. And, finally, there's a spark output indicator light on the front panel: this and the Hi-Lo spark scale are used to compare the relative potencies of sparks in different engine cylinders.

(Continued on page 94)

# Put that Clock

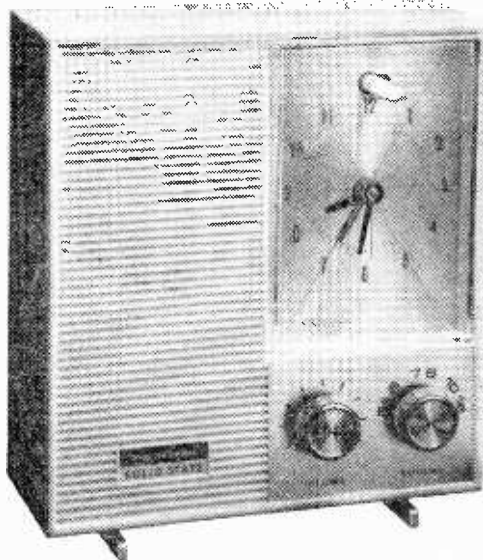

By F. J. Bauer W6FPO

When the clock radio blows, it is hardly worth your while trying to find out why the radio chassis quit. Unless the trouble is something obvious like a bad electrolytic capacitor or output transistor, why not replace the AM radio chassis with a new one? If you have a portable transistor radio with a broken case or a bad speaker, you can use it as a replacement chassis by making a simple change in the clock radio power supply. If you have no spare transistor radio, you could install a code practice

oscillator in place of the radio. It will not awaken you to music, but it will wake you up with the tone of your choice.

**Radio-Fix-It.** If you decide to replace the AM radio chassis with working unit, it is a good idea to retain the tuning capacitor and audio gain control of the original clock radio. The original knobs may then be used without the bother of having to mate them to replacement control shafts. The only catch is that the tuning capacitor of both receivers should be electrically identical for proper tuning.

Simply remove the mounting plate with the controls on it from the defunct chassis and wire the assembly to the replacement chassis after removing the old tuning capacitor and gain control. The additional lead lengths make no difference in the performance of the replacement set. Also, the modification will not affect tuning dial settings noticeably, since these receivers have only an approximate tuning scale. However, play it smart, keep the leads reasonably short. This completes the mechanical job of adapting the replacement AM chassis to the cabinet.

Many clock radio chassis run on a 15-VDC supply instead of the usual 9 VDC for portables. If your replacement chassis is designed for 9 VDC, you may still use the

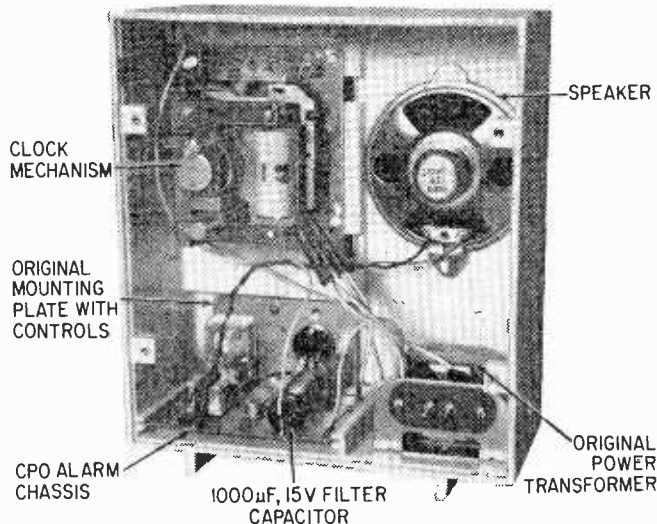

Here's a great way to salvage a good clock that caught radio failure! The Rx includes either a new transistor radio chassis or your own home-built one-transistor tone generator. Either way, your sack-time terminator doesn't sound quite as harsh when you revamp it yourself. Or does it?



# Radio Back on the Job...

original power transformer in the clock radio, but it will be necessary to add a dropping resistor in the DC filter circuit of the power supply. See the *Power Supply* schematic diagram. Experiment with the value of the series dropping resistor, R1, until the voltage to the chassis is about 9 VDC. Start with, say, 1000 ohms and *gradually decrease* the resistance value until the proper voltage is obtained with the AM radio volume set at minimum. A convenient way to do this is to use a potentiometer. There is no danger of damaging the potentiometer since the power dissipated is only a fraction of a watt. Remove the potentiometer from the circuit and replace it with a one-watt fixed resistor that closely approximates the potentiometer setting. Insert the fixed resistor into the circuit and recheck the voltage.

Now check the performance of the receiver at normal volume. The power supply voltage will drop on volume peaks, but not enough to cause serious distortion.

**Add A Tone.** If you have no suitable AM chassis available as a replacement, why not install a code practice oscillator instead? Its

dulcet tone will awaken you just as readily as any local radio station would. A suggested circuit for the CPO, using a minimum of parts, is shown in the *CPO* schematic diagram. The oscillator requires 3 volts, or so, for proper operation and a series dropping resistor, R1, in the filter circuit should be selected as described previously to give this output voltage.

The 5000-ohm potentiometer, R2, should be adjusted for a pleasing tone and, if you prefer, replaced with a fixed, 1/2-watt resistor of the nearest standard value. In some cases, it may be necessary to add a capacitor, C2, across the primary of T2 to get the tone you want, since the frequency of oscillation of the oscillator depends to a degree upon the characteristics of the transformer used. Do not use a capacitor larger than .25  $\mu$ F. It may result in unstable oscillation and low output. After the capacitor is permanently installed readjust R2 for a pleasing tone and check the oscillator for prompt starting.

That's all there is to giving the old clock radio a new lease on life. Pleasant dreams! ■

## A BUILD IT FAST PROJECT

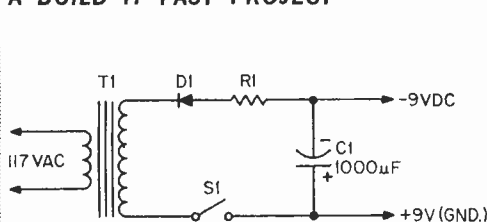

### PARTS LIST FOR POWER SUPPLY

- C1—1000- $\mu$ F 15-VDC electrolytic capacitor. (Use capacitor in clock radio or replace.)
- D1—Diode rectifier, 200 PIV, 1A (Use unit in clock radio or replace.)
- R1—1/2-watt resistor (See text for selecting value)
- S1—SPST switch (Alarm switch in clock movement)
- T1—Power transformer (Use unit in clock radio or replace with 115-VAC primary; 12-VAC, 1.2-A secondary.)

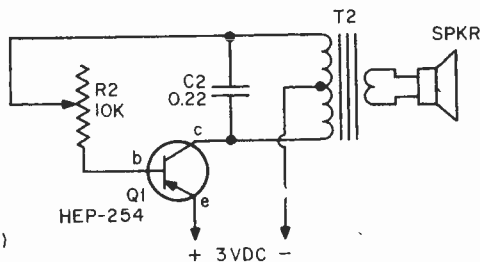

### PARTS LIST FOR CPO

- C2—0.22- $\mu$ F, 100-VDC disc or tubular capacitor.
- Q1—Audio transistor, PNP, 2N427, 2N396, SK3004, HEP-2, HEP-254, etc.
- R2—5000 or 10,000-ohm potentiometer, taper not critical.
- SPKR—Use original unit in clock radio or replace with speaker with same physical dimensions.
- T2—Audio output transformer, 500-ohms CT primary; 3.2-ohms secondary (Lafayette 33-85580 or equiv.)

# It takes more learn about

Bell & Howell Schools introduces three fascinating learn-at-home programs featuring some of the finest equipment available as your "teachers." Choose the program you prefer—then mail card for free details today!

Experience is the best teacher, without a doubt. And when it comes to learning electronics, we feel it's "hands on" experience with state-of-the-art equipment that counts the most. That's why with Bell & Howell Schools' learn-at-home programs you work with some of the most up-to-date equipment. Equipment that's being used today—and will be used tomorrow. So the skills and knowledge you acquire will be useful for years to come.

Of course, with all our learn-at-home programs you'll have plenty of lab manuals and basic principles to work with. And you'll also get exciting "teachers" to help make electronics come alive...

**Lab Starter Kit gives you hands-on experience with the very first lesson.**

We get you started with the basics in an exciting way! At the very beginning you get a fully-assembled volt-ohm meter as well as design panels, modular connectors, experimental parts and battery. So you don't just read about electronics principles, you actually see them at work!

**You build your own Electro-Lab® electronics training system.**

Whatever program you choose, you get your own home laboratory including oscilloscope, digital multimeter and design console to give you actual experience in wiring, soldering, assembling, testing, trouble-shooting and circuit analyzing.

## I. Learn new skills in the field of Home Entertainment Electronics including building the new generation color TV

What better or more exciting way to learn digital electronics! Once you have the basics under your belt and get into color theory and service, you'll build a 25" diagonal color TV and probe into the digital technology behind digital channel numbers that flash on the screen... a digital clock that flashes the time to the second and an automatic channel selector.

As you put the set together, you'll discover how advanced integrated circuitry works, how to trouble-shoot it and much more. Upon completion of the program you'll have gained the specialized occupational skills to service color TV's plus the principles that you can apply to repair a variety of home electronic equipment. And you'll have the foundation to understand and work with new product applications as they're developed, too!

## II. Use professional communications equipment as you delve into Communication Electronics.

Here's how to pick up skills in the vital field of two-way radio, widely used in public safety, marine, industrial and transportation areas. Bell & Howell Schools Communication Electronics Program can help prepare you for the FCC licensing exam, right through to 1st class radiotelephone operator. And teach you skills in two-way radio, radar or commercial broadcasting.

For a refundable deposit, you get to use the special two-way radio equipment lab featuring an FM transceiver, frequency meter, and modulation meter. All regular, first-rate commercial grade test equipment.



Electro-Lab® is a registered trademark of the Bell & Howell Company  
Simulated TV Picture/Test Pattern

# More than books to electronics.

### III. Digital Trainer helps you learn the latest in Industrial Digital Electronics.

Digital technology is setting new standards of accuracy and beginning a revolution in industry. For example, more precise control in refining, manufacturing plants, food processing and transportation. And now you can learn about this technology with Bell & Howell Schools unique Digital Trainer. You'll analyze and experiment with various types of

integrated circuits so you'll have a solid background in modern digital electronics and its applications to industry.

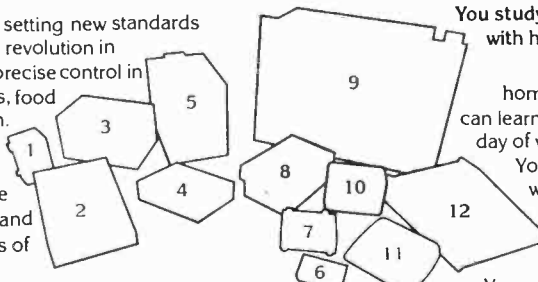

You study at home in your spare time... with help as close as the telephone.

Because these are home study programs, you can learn electronics without missing a day of work or a single paycheck.

You study at your convenience—without being a classroom captive. If you ever have any questions, you can call our toll-free number for help.

You can also meet and talk shop with fellow students and instructors at "help sessions" held in 50 cities at various times throughout the year.

Bell & Howell Schools tries to give you more personal attention than any other learn-at-home program.

**Decide which exciting program you're interested in... you can check more than one. Then mail postage-paid card today for free information—no obligation!**

Taken for vocational purposes, these courses are approved by the state approval agency for Veterans' Benefits. Please check box on card for free information. Naturally, we cannot offer assurance of income opportunities.

1. Power Output Meter
2. Design Console
3. Modulation Meter
4. Digital Multimeter
5. Triggered Sweep Oscilloscope
6. Lab Starter Kit
7. Frequency Meter
8. FM Transceiver
9. 25" Diagonal Color TV
10. Alignment Generator
11. Lesson Tape Player
12. Digital Trainer



723R2

If card has been removed, please write to:

An Electronics Home Study School  
DEVRY INSTITUTE OF TECHNOLOGY  
ONE OF THE

**BELL & HOWELL SCHOOLS**  
4141 Belmont, Chicago, Illinois 60641

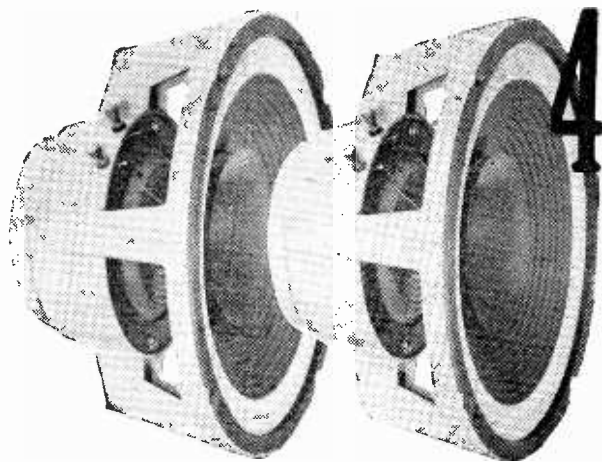

# 4-CHANNEL FOUR

... and some common sense!

**F**our-Channel Sound. It's *stupendous!* It's *colossal!* It's *magnificent!* And it is also a *bomb!* The plain truth is that most hi-fi dealers are having a difficult time moving 4-channel equipment: many won't touch the hardware, and many of the dealers that do stock and demonstrate 4-channel do their absolute best to dissuade you from buying any 4-channel gear with the worst possible demonstration of 4-channel "surround sound."

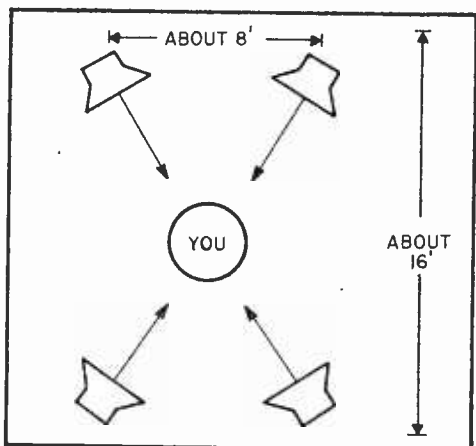

Figure One. A showroom arrangement of 4-channel speakers.

Yet in all honesty, 4-channel sound—of any variety; discrete-surround, SQ or derived ambient—is a better sound *if you ever get a chance to hear it.* Or rather, if you ever get to hear it as it would sound in your own home *after the hardware gets integrated with your furnishings.*

**The Showroom.** To illustrate the problem, assume you have just heard a superb

demonstration of discrete-surround in the showroom. You are suitably impressed by the surround effect of four speakers spaced about 8 feet apart, beaming sound at you from all directions, as illustrated in the typical "surround-sound" speaker placement shown in Fig. 1. You love it—a new dimension in listening pleasure: you tuck the extra hardware under your arm and head for home.

Now what? Are you going to place four speakers in the center of the living room and sit on a hard kitchen chair just so you can be "in the sound center"? Maybe for the first 15 minutes. But is this what you're going to demonstrate to your neighbor? Is the spouse going to tolerate this new furniture arrangement for more than one evening? Not a chance.

After the initial thrill is worn off, the front speakers go back where they were—or belong; the rear speakers get pushed into some non-conspicuous location like behind the couch and you become another unimpressed 4-channel user; unimpressed along with your friends and neighbors who

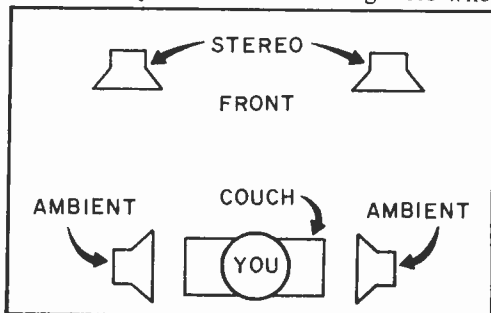
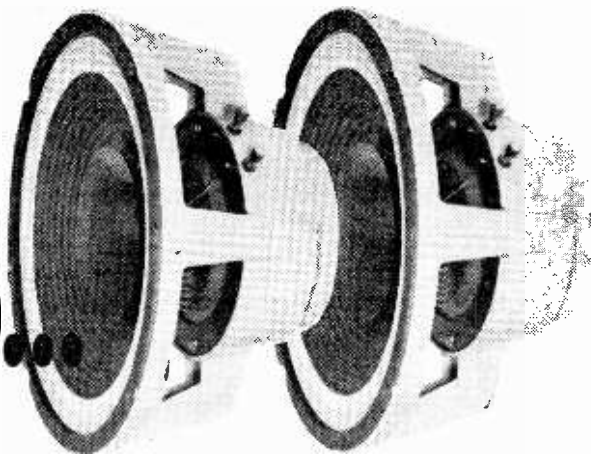

Figure Two. The usually suggested placement for 4-channel ambient-sound speakers.

# TAKES SPEAKERS.



by Herbert Friedman

were smart enough not to “upgrade” until they heard what *your* money bought.

Let’s look at another example. This time, derived ambient 4-channel. The usual speaker arrangement suggested, commonly demonstrated in showrooms, is shown in Fig. 2. There you sit, standard stereo up front and the ambient speakers blasting a thin, reverberant sound (usually with lots of distortion) directly into your ears. C’mon! Who ever heard that in any concert hall? Sure it sounds great in a showroom; but in your living room? In your living room it sounds like *two* stereo systems: a good system up front and a pair of \$14.95 child’s phonographs immediately adjacent to your ears—one on each side.

importantly, know in advance what you are going to get in the way of 4-channel sound, or rather, know how you can obtain the most pleasing sound from a compromised speaker arrangement.

The exact speaker arrangement depends on the type of 4-channel sound you expect to use most frequently, for there is no ideal arrangement that will accommodate all the 4-channel systems.

**Discrete.** The most spectacular 4-channel system is *discrete surround*, in which the program material is deliberately split up into four individual channels. Each channel can contain all the direct musical information for a particular instrument or section. You must, theoretically, place yourself at the sound center if you are to hear the program as it was intended to be heard. Under ideal conditions this would require the speaker arrangement shown in Fig. 1.

Slightly less—or much less—or spectacular, depending on your point of view, is SQ 4-channel, in which the program material is encoded in such a manner that when played back through a suitable decoder the listener hears essentially the same surround

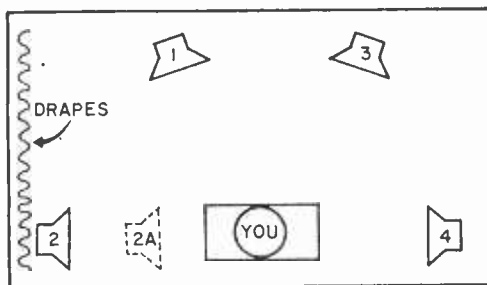

Figure Three. An optimum starting point for placing SQ and discrete 4-channel speakers.

To obtain the true benefits of 4-channel sound *in your home* takes a lot of common sense when it comes to locating the speakers. Firstly, you must acknowledge that in general you are not prepared to redecorate the entire listening room just to squeeze in two more speakers. Somewhere along the line you must compromise on the speaker placement. Secondly, and more

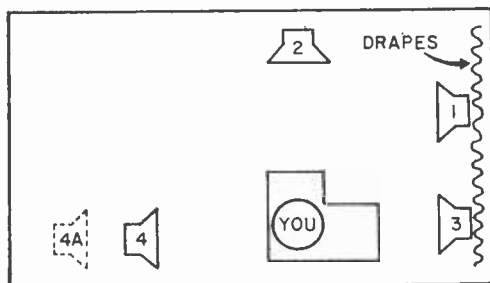

Figure Four. A compromise starting point for SQ and discrete 4-channel speakers.

# 4-Channel Speakers

effect as if the program were in four discrete channels. This, of course, is a joke. SQ is nowhere near the equal of discrete 4-channel. Optimum separation is about 6 dB between channels (at the present time). In a slightly reverberant room the whole effect is less spectacular than if you just placed two remote stereo speakers behind you. Obviously, outside the showroom, the recommended speaker arrangement of Fig. 1 is not going to produce any "new dimension in sound." Other matrix (encoded) 4-channel systems are in the same boat.

**Derived Ambient.** The third 4-channel system is *derived ambient*, whereby a decoder extracts the ambient sound of the recording location that is "accidentally" encoded by the stereo microphones. Except that there can be little or no ambient from a mix-down recording, as used for pop music, where the band is recorded on Monday on tracks 1, 2, 3, etc.; and the vocalist is recorded on Tuesday on tracks 4 and 5, and the chorus gets paid overtime for coming in on Saturday to record tracks 6, 7 and 8. The recording engineer puts it all together by mixing the eight (or maybe 16) tracks into two stereo tracks. Your chance of getting an ambient rear output from a mix-down recording is as good as your imagination.

But putting aside any unusual problems—such as getting true ambient sound from mix-down, there are three basic 4-channel reproduction systems, of which only the discrete system has inherent capacity for a spectacular surround-sound effect. The other two systems are going to require considerable juggling of speaker locations to obtain all the advantages of 4-channel.

**SQ Sound.** Let's start with SQ, because if the SQ sounds good the discrete 4-channel will also sound good. Under the best of circumstances—recording techniques, decoding, etc.—the sound from each of the four channels is a direct sound and should therefore reach your ears with essentially the same degree of room reverberation and time delay as from any other speaker. This is most easily accomplished by having each speaker an equal distance from your listening location, and by having an equal reflective surface in front of the speaker. Getting equal distance is no problem, most of the time.

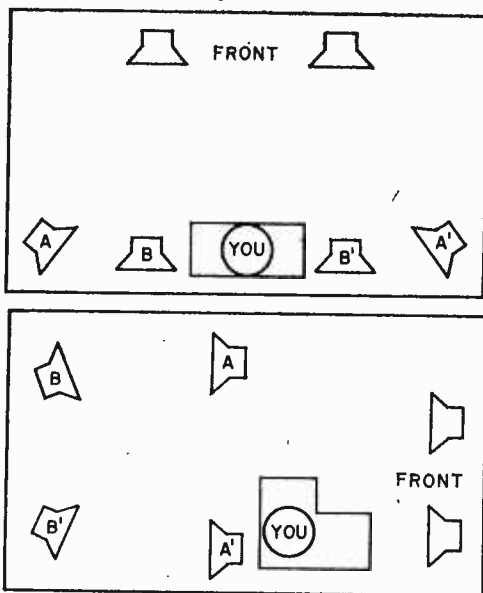

Figure Five. Suggested starting points for diffuse ambient sound.

Figures 3 and 4 show two possible speaker arrangements. Figure 3 is optimum; Fig. 4 is a compromise because of the seating location, but it is typical of what can be expected because of furniture placement. Note that though the speakers are "scattered" they are more or less equidistant from the listener, thereby retaining the surround-sound effect. Now we must allow for drapes or curtains placed in front of windows. In Fig. 3 the sound from channel 2's speaker would reflect off the opposite wall and you, the listener, would hear channel 2's reverb coming from the direction of the channel 4 speaker. Channel 4's speaker, however, sees the drapes on the opposite wall so there would be little reverb coming from the direction of channel 2's speaker; there would be a disconcerting unbalance in liveness. To balance the sound you must either remove the drapes (! ! !), or move the channel 2 speaker to position 2A. Moving the speaker to position 2A will reduce the reverb path length and place more direct sound at the listening location.

In Fig. 4 we have a similar problem created by drapes or curtains, but here we are limited in how far, or where we can reposition channel 3's speaker. We might cure the unbalance by increasing the reverb-path length of channel 4's speaker by positioning the channel 4 speaker at location 4A.

(Continued on page 92)



# Ten timely tips for resistance measurement

By Marchall Lincoln, W7DQX

**R**esistance measurements must be one of the most misunderstood tasks undertaken by electronic's buffs. Why? Because a good many of us don't really understand how resistance is actually measured.

Since the meter we use can't think for itself, we must use it properly to obtain the correct results. Like all electrical instruments, of course, a meter performs according to electrical laws which cannot be violated. But it may not give us the results we want, or the results *we think we're getting*, unless we use it properly.

**1** For our first tip, all we need do is look at the ohmmeter scale on the face of our handy VOM. Notice how the numbers indicating resistance are squeezed

together near the high end of the scale? Down at the low end, the numbers are spread out where we can easily read them—the number 1 is a fair distance from 2, and 2 is almost as far from 3 and so on.

But up at the high end, we see that 200 is about as close to 500 as 1 is to 2. And 1k and 2k are practically on top of each other.

This compression at the high end of the scale is normal for an ohmmeter, and there's nothing we can do about it. But what we can do is make use of this situation so it works to our advantage.

How? Very simple—just remember to use the right two-thirds or so of the scale, where the numbers are spread out the most, whenever possible. This will allow you to read much more clearly just exactly what calibration is being indicated by the meter needle. If the pointer stops far to the left, where the

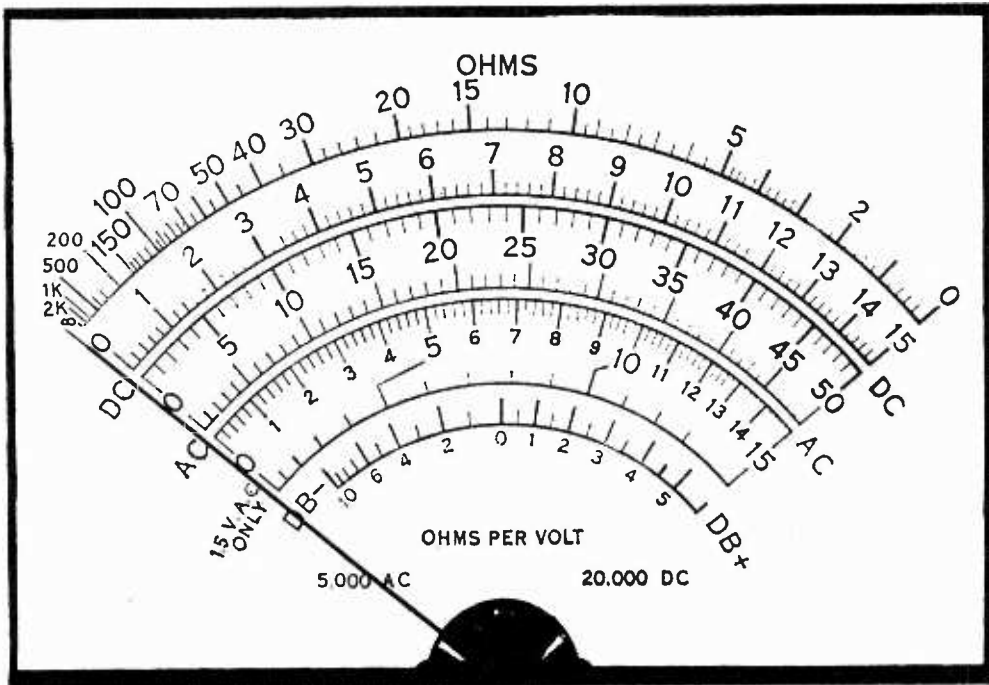

# 10 TIPS

scale calibration is greatly compressed, the thing to do is switch the meter's range switch to a higher resistance range so the needle will drop to a more usable part of the scale. And don't forget to re-check the zero-set adjustment when you do this, since it may need re-setting for the new range.

If you're already using the highest resistance range, then to achieve a more accurate reading you'll have to use a different method for measuring high resistance, as explained in *Tips 8 and 9* which follow.

**2** Our second tip is another simple item often overlooked. Did you ever notice, when holding ohmmeter prods tightly against the leads of a resistor, that the ohmmeter needle couldn't seem to make up its mind just where to stop? Then you probably discovered that as you pressed the test prods tighter against the resistor leads, you got an indication of lower resistance on the meter.

*Ah ha, you thought, there's some corrosion on the resistor leads and I'm pressing the test prod through it and getting better contact with the wire.* This may have been true. But there more probably was another reason for this occurrence, or for the major part of the effect.

It's simply that the meter was measuring not only the resistance of the little resistor you held against the prods, but the resistance of your body as well! When you pressed harder on the prods, you also brought more skin area into contact with them.

So, you should be sure, especially when using a high-resistance range, that you don't touch the metal tip of the test prods. Or if you do touch a prod, touch only one—never both. Use an alligator clip on one lead so

you don't have to hold it in contact with the resistor lead.

On low-resistance ranges, the effect won't be noticeable, since your body resistance is rather high. For this reason, connecting it in parallel with the resistor you're measuring will have little effect.

**3** Another often-overlooked item that can have a large effect on the accuracy of an ohmmeter is the condition of its battery. Every ohmmeter has a small battery inside its case to supply the small current which passes through the resistance being measured. The amount of current which flows gives us the ohmmeter indication.

However, if the battery is weak, the indication may become false if we hold the test prods on the resistor for any length of time. Reason is that the battery voltage may drop during this time. And if the battery voltage changes after we set the meter to zero, we'll get a false meter indication.

There's a simple way to check the battery condition without opening up the meter case and removing the battery. When you touch the prods together and adjust the zero-set knob to prepare to make resistance measurement, hold the prods together for several seconds longer and watch the meter

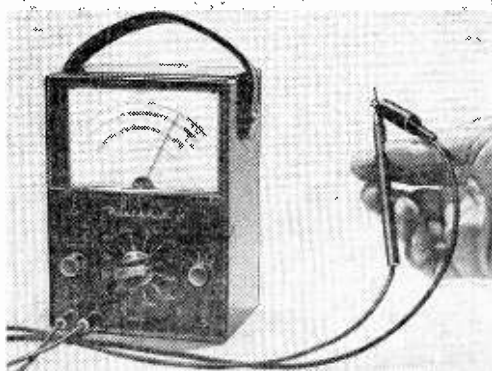

**Above**—Be sure battery in your VOM is putting out enough voltage if you want accurate resistance readings. Keep test leads together for a few seconds to be sure zero setting remains constant. **Left**—Never hold both test probes in your hand when checking resistance, your body resistance in parallel with resistor being measured affects reading.



needle closely. If it stays at zero, the battery voltage is holding steady. But if the needle begins to slowly move upscale, the battery voltage is dropping, and the battery should be replaced.

Make a habit of performing this test each time you use your ohmmeter. This way, you'll always know for sure if the battery is in condition to give you accurate measurements.

**4** An ohmmeter can be put to handy use in checking for one of the peskiest of all troubles that may occur in a vacuum tube—an intermittent short between elements. This is a condition that may not show up on a conventional check in a tube tester.

This test is made with the tube plugged into its regular socket in radio or amplifier or whatever. The heater should be lit, but there should be no voltage on either plate or screen. After the tube is thoroughly warmed up, use the ohmmeter to check for continuity between each pair of tube socket terminals in all possible combinations. Be careful, though—don't connect the ohmmeter across the heater pins!

Tap the tube firmly with the rubber eraser on the end of a pencil while making each of these checks, and watch the ohmmeter closely. If there's a momentary flicker of the ohmmeter needle, there is contact between tube elements, and the tube should be scrapped. A stable resistance reading between two tube pins could indicate a resistive short between two tube elements. Then, too, it could merely be caused by a resistor, capacitor, or coil in the circuit. Check the stage's wiring to be sure.

**5** Got a box full of battered and scraggly-looking diodes—and you don't know which ones are good and which ones are open or shorted? Fortunately, there's a quick way to tell. And while you're at it, you can find out the correct polarity of those that have the cathode marking band rubbed off.

To make this simple test, you'll need to know which ohmmeter lead goes to the positive terminal of the ohmmeter battery and which goes to the negative battery terminal. Generally, the ohmmeter in a VOM is wired so that positive (+ or red) jack on the meter case goes to the negative

battery terminal, and the common or negative (— or black) jack goes to the positive battery terminal.

If you have the wiring diagram for the meter, or care to open the case and trace the wiring, you can find out for sure. Or, you can make this check: switch the ohmmeter to a medium range and touch the prods to the leads of a rectifier which you know is good. You'll get the lowest resistance indication when you have the positive lead touching the anode and the negative lead touching the cathode.

To test unknown diodes, connect the ohmmeter to their leads first one way, then the reverse. The two resistance indications you obtain should be considerably different—one should be quite high and the other rather low. If this occurs, you have reasonable assurance the rectifier is good, since it passes current much more readily in one direction than it does in the opposite direction. If you get resistance indications that are nearly the same, the diode is shorted. And should you get indications of a high resistance in both directions, the diode is open. When you get the lower resistance reading, you have the positive ohmmeter lead connected to the anode and the negative lead connected to the cathode.

**6** Transistors also can be checked with an ohmmeter . . . or can they? Yes, they can . . . sometimes. (How's that for a straight-forward answer?)

The reason it's impossible to give an absolute *yes* or *no* is that there are so many types of transistors in the world today. Many of them can be safely checked with an ohmmeter; others, being on the delicate side, can't be. Assuming you want to be perfectly safe, you should never touch an ohmmeter lead to a transistor. But if you follow this precaution, you'll be passing up many golden opportunities to check transistors which can be safely tested with an ohmmeter—if you do it properly.

To determine whether or not to even try it, you'll have to refer to a transistor manual for the particular type of transistor you want to check, then do a few calculations. Always use the lowest ohmmeter range available for the test. This will assure minimum current flowing through the transistor as you make the check.

By knowing the polarity of your ohmmeter battery, as explained in *Tip 5*, you

# 10 TIPS

can determine if each section of the transistor has the proper relationship of low resistance in one direction and high in another. Which way is which will of course be determined by whether you're checking a *pn*p or *n*pn transistor, and which leads you're touching with the ohmmeter prods.

For example, with the positive ohmmeter lead connected to an *n* lead and the negative ohmmeter lead connected to a *p* lead, you'll get a higher resistance indication than with the leads reversed, if all is normal. As with a diode, equal readings would indicate a short, and excessively high readings would indicate an open.

**7** Some rudimentary checks of capacitors can also be made with an ohmmeter. Most common of these is checking an electrolytic capacitor. Even so, you can learn at least a little about the health and well-being of coupling and bypass capacitors as well.

A capacitor, unless shorted or leaking shouldn't conduct current. When an ohmmeter is connected across a capacitor, the battery in the ohmmeter supplies current which charges the capacitor. As this is done, the meter seems to indicate that the capacitor is conducting current. But once the charge begins to build up on the capacitor plates, this charging current drops off.

In the case of an electrolytic capacitor, which has a fairly large capacity, enough current flows when you first connect the ohmmeter prods to the capacitor leads that you will get an indication of very low resistance. This is normal, as long as this resistance indication quickly increases, within a few seconds, to a value of several hundred thousand ohms.

However, if the apparent resistance remains rather low, then the capacitor has excessive leakage and probably should be discarded.

Other types of capacitors, such as coupling capacitors, have much lower capacity. This means that usually you'll get no indication on the meter that the capacitor is charging. Reason is that the capacitor requires so little current to take on a full charge that the ohmmeter battery supplies this current very quickly. The meter movement barely flick-

ers—if it budes at all.

With such capacitors, you should get an indication of infinite resistance with the ohmmeter. If you do get an indication of low or medium resistance, then the capacitor is leaking or shorted, and should be discarded.

**8** By adding a simple external modification to your ohmmeter, you can extend its range upward to accurately measure resistances much higher than what you normally can read on the meter scale.

Fig. 1 shows how this is done. What you do is add a battery and resistor in series with one ohmmeter lead. The positive battery terminal is connected to the negative ohmmeter lead, so that the internal and external battery voltages add. The external battery voltage should be nine times the voltage of the ohmmeter battery; similarly, the external resistor, *R*, should be nine times the total resistance of the ohmmeter high resistance range circuit.

The result of this external range extender will be to multiply the ohmmeter's high range by 10 times. With this hookup, for instance, a resistance which produces an indication on the meter of 2 megohms would actually be 20 megohms.

The exact external battery voltage and resistance needed will vary, depending on the meter you're using. For the Simpson 260 VOM, for instance, the manufacturer gives the values as 67.5 Volts and 1.08 megohms. But keep in mind that other meters may require different values.

To determine what you must add to your meter to use this range extension method, consult the operating manual for the meter. If this fails to cover the matter, write the manufacturer, enclose a copy of the dia-

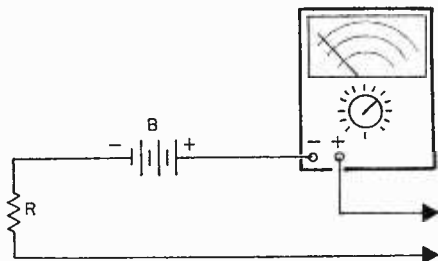

Fig. 1—External battery and resistor are used in this manner to extend range of your VOM for resistance measurements beyond normal range of your test set.

gram in Fig. 1, and explain what you want to do.

In case you find you need a rather peculiar external battery voltage, such as 54 or 13.5 Volts, remember that this doesn't have to be just one battery—you can connect a series of flashlight cells together to add up to the required voltage.

**9** There's an alternate method of accomplishing high-resistance measurements which, unlike Tip 8 just given, doesn't even involve using an ohmmeter. The circuit for this method is shown in Fig. 2.

For clarity, the diagram shows two meters. However, you can use a single VOM to make the two measurements required. The unknown resistance is connected in series with the VOM and with a DC power supply of several hundred volts.

Start with the highest current range your meter offers so as to guard against the possibility of throwing the meter off scale, then switch down to lower ranges until you obtain a usable reading.

After measuring the current flowing through the unknown resistor, you now need to measure the voltage across the resistor. If you use the same VOM to make this voltage measurement, remember to close the circuit where the current meter is shown in the diagram when you remove this meter to connect it across the resistor.

With these two measurements made, apply Ohm's law to determine the value of the unknown resistance. If, for example, you measured 700 volts across the unknown resistor and 10 microamps flowing through it, your calculations would be:

$$R = \frac{E}{I} = \frac{700}{.00001} = 70 \text{ megohms}$$

Before trying this method, be sure you are really dealing with a large amount of DC

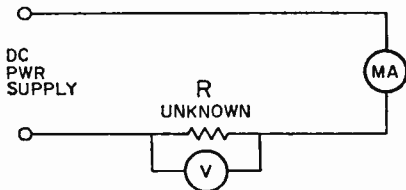

Fig. 2—Here's how to measure high resistance. Using a high voltage source, measure current and voltage and then apply Ohm's Law to calculate resistance value.

resistance. With the voltages you'll have to use, you could easily damage your meter or burn out the unknown component if it turned out to actually have only a medium amount of resistance.

**10** A technique very similar to that illustrated in Tip 9 can be used to measure very low values of resistance using a low voltage. A pair of dry cells connected in series will be fine, though you may get by with a single dry cell if your VOM has a millivolt range.

The test hookup is shown in Fig. 3. In addition to having the unknown resistance connected in series with the current meter and the flashlight cell, there's also a second resistor, about 5 to 10 ohms, in the series loop to limit the current flow. The value of this resistor isn't critical. However, if it's too large, you'll have difficulty getting meter readings large enough to be usable.

First, measure the current in the circuit. Then remove the meter, close the circuit again, and measure the voltage across the unknown resistance. Again, a simple calculation with Ohm's Law gives the value of the unknown resistance.

For example, suppose you got a current indication of 160 milliamperes and measured 0.08 volts across the unknown resistor. The calculation would be:

$$R = \frac{E}{I} = \frac{0.08}{0.16} = 0.5 \text{ ohm.}$$

Since you'll be measuring a pretty small voltage across a tiny resistance, a VOM with a millivolt scale would be handy. However, if your meter doesn't have such a scale, try using two or three dry cells instead of one. This will cause more current to flow, which will increase the voltage drop across the unknown resistance to the point where it should be easier to measure. ■

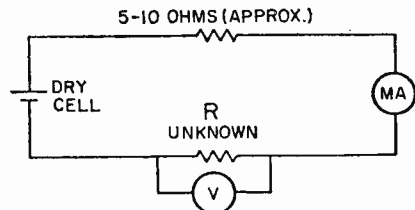

Fig. 3—Very low resistance values require higher current than available from VOM cell; with external source as shown in Fig. 2 read V and A and apply Ohm's Law.

# PHOTOGRAPHING

**H**ow would you like to photograph President Nixon in the White House? Hank Aaron clouting one over the fence? A U.S. Olympic track star winning a Gold Medal? Or how about your favorite actress receiving an Academy Award? You can snap your camera's shutter at home while focused at your black-and-white or color television set.

**Camera and Film.** You can use almost any camera for taking black-and-white pictures of television images. However, you'll get better results with an automatic or adjustable camera. If you have a simple camera without exposure or distance settings, you must use a high-speed film, such as Kodak Tri-X Pan Film. For taking color pictures, you should use a camera with an  $f/2.8$  or faster lens and a shutter that you can set at  $1/8$  second or slower. If you want to take movies, you'll need a movie camera with an  $f/1.9$  or faster lens. Check your cameras now!

To determine the correct exposure, you can use an automatic camera or a *reflected-light* exposure meter. If you don't have either of these, you can set your camera according to the Exposure Table.

TV images are quite dim compared to average subjects in daylight. Therefore, to avoid using large lens openings and very slow shutter speeds, you may want to use a high-speed film such as Kodak Tri-X Pan Film—ASA 400—for black-and-white prints, or *Kodak High Speed Ektachrome Film (Daylight)*—ASA 160—for color slides.

**TV Set Set-Up.** To obtain the best quality in your photographs, adjust your TV set so that the contrast of the television picture is slightly lower than normal. Adjust the brightness control so that both the high light and shadow areas of the TV image show detail. The shadows should not be light gray or completely black. Adjust the controls on a color set for a pleasing color picture on the screen.

Reflections on the face of the television tube can ruin your photographic attempt! To help eliminate reflections, turn off all of the room lights. Eliminating the light in





# THE TV SCENE

Jackson Kaye



the room also helps make the area surrounding the TV image appear black in your photographs. A black area surrounding the TV image is usually more pleasing than a lighter area showing part of the room or the border around the picture tube.

Don't use flash or flood lighting to photograph television images. These light sources actually reduce the brightness of the TV image, and your pictures would show a blank television screen.

**Shutter Snapping.** Move in close to the television screen with your camera. If the minimum focusing distance for your camera will allow it, move in until the TV screen fills the picture area in your viewfinder.

If your camera is a single-lens reflex with through-the-lens viewing, when you look through the viewfinder you'll see exactly what you'll get in your close-up pictures. But if the viewfinder on your camera is separate from the lens, it may not show you exactly what will be included in the picture.

**Shutter Speed.** Television images are composed of 525 straight horizontal lines called "scanning lines." The image is formed in your TV set by a moving electron beam which scans the picture in two sections. All the odd-numbered lines are traced in  $1/60$  second to produce an image. As soon as this cycle is completed, the picture is scanned again in  $1/60$  second, this time tracing the even-numbered lines. Therefore, it takes  $1/30$  second to make a complete picture on the screen. That's why you must use a shutter speed of  $1/30$  second or slower to record at least one complete picture cycle. Otherwise you may get a dark band across your photograph. If your camera has a focal-plane shutter, you should use a shutter speed of  $1/8$  second or slower to obtain uniform exposure. For sharp pictures, make the exposure when the subject on the screen is not moving. Put your camera on a tripod or other firm support, such as a table. Books and boxes can be used if the tables you have are too tall. Do not tilt camera up or down to capture picture. Rather, raise or lower

# Photographing TV

camera until picture is framed properly.

**Color Pictures.** Use *daylight* color film for photographing TV images. Color pictures of color television will have a somewhat blue-green appearance because the film's sensitivity to the TV picture is different from the eye's sensitivity. You can improve color rendition in your pictures by using a Kodak color compensating filter, CC40R (gelatin), over your camera lens to help bring out the reds. When you use the CC40R filter, increase exposure by 1 stop. You can pick up this filter from your photo dealer.

**Automatic Cameras.** Fill the picture area in the viewfinder with the TV image so that the exposure meter in your camera "sees" only the TV screen. If your automatic camera (with built-in exposure meter) is too far away from the TV screen, the exposure meter "sees" too much of the dark area surrounding the TV image, resulting in overexposure on your film.

When you're taking pictures, the low-light indicator may appear in your camera viewfinder. Usually you can ignore this "warning" and take pictures anyway. You'll probably get satisfactory results, although your pictures may be on the dark side.

If your automatic camera has a separate peep hole for the light meter, you must cover this peep hole with the CC40R filter when the lens is so covered. If not, your photos will be overexposed.

**Adjustable Cameras.** If you have an adjustable camera with a built-in exposure meter, when you make the meter reading be sure the TV screen fills the picture area as recommended for automatic cameras. If your camera doesn't have a built-in meter, you can use a separate reflected-light exposure meter to determine the exposure. Hold the meter close to the TV screen so that it reads only the screen. Position your meter to read approximately equal parts of light and dark areas of the TV picture.

**For Simple Cameras.** The camera settings in the Exposure Table apply to most television sets. However, since individual adjustments of TV pictures can vary, and since improvements are continually being made in the picture tubes for color television, the suggested exposures are approximate. You may want to bracket your exposure to be sure of getting a properly exposed picture

of an especially important subject. Take one picture at the suggested exposure, one at  $\frac{1}{2}$  the exposure and another at 2 times the suggested exposure. Remember do not use shutter speeds higher than  $\frac{1}{30}$  second or  $\frac{1}{8}$  second for a camera with a focal plane shutter.

**Movie Cameras.** To make good-quality movies of television images, you would need a special camera synchronized with the television set to record successive picture cycles on successive frames of movie film. Of course this isn't practical for the amateur-

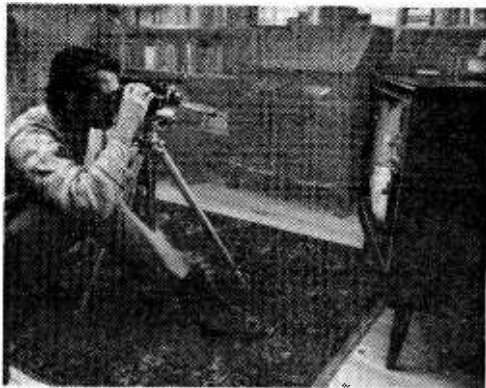

**New high speed Super-8 makes color TV movie photography a snap. You can also use regular Kodachrome II, see how below.**

movie maker. However, you can still obtain satisfactory results with an ordinary movie camera that has an  $f/1.9$  or faster lens.

Operate your camera at the normal camera speed of 16 or 18 frames per second. Since your movie camera is not synchronized with the TV picture cycle, your projected movie will show a slightly uneven, or banding, effect.

With a camera that has an  $f/1.9$  lens, you can make recognizable, though somewhat dark movies of black-and-white and color TV images when you use Kodachrome II Movie Film (Daylight); or Kodachrome II Movie Film (Type A) with a No. 85 filter. This filter is built into all super 8 cameras and some 8mm cameras. When using these films, turn up the brightness control on your TV set for maximum brightness without losing too much detail. If your camera has manually adjustable lens openings, set the lens at its largest opening.

You can obtain brighter movies of *black-and-white images* by using the Type A film without a No. 85 filter. The black-and-white  
(Continued on page 91)

# HOW TO CHANGE

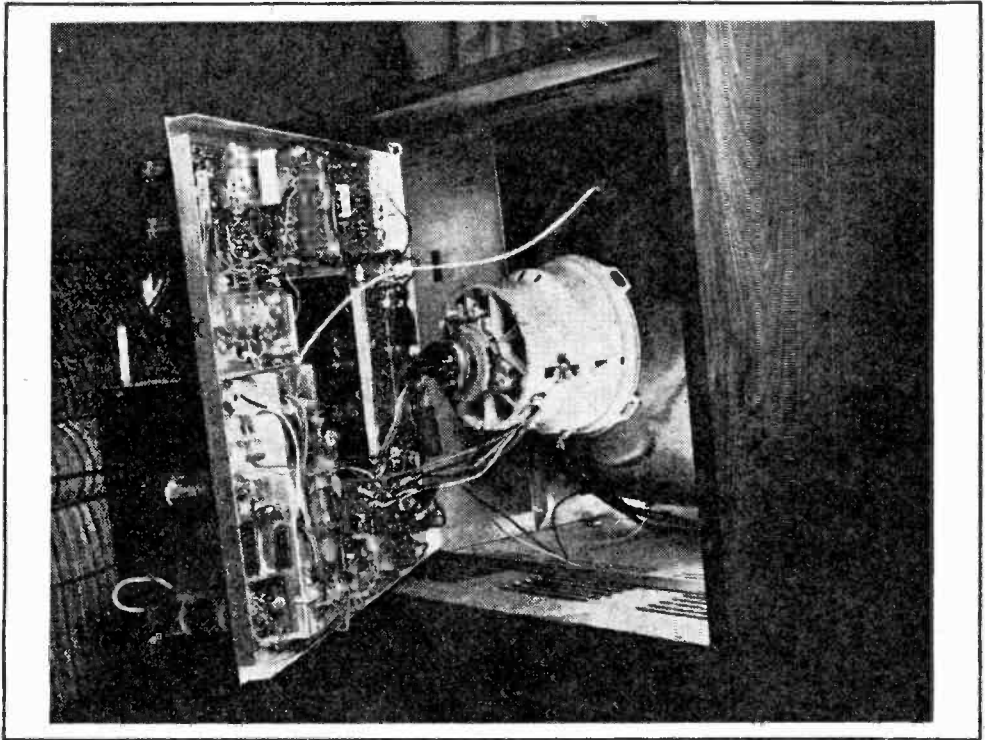

## A COLOR TV TUBE

By HOMER L. DAVIDSON

■ When your color picture tube becomes dim and one or two colors are real weak, you can replace that color tube yourself. Follow the photos and text in this article and you can save yourself some dough. This article shows how to replace the round and rectangular color picture tubes. The sizes are 21-inch round, 25-, 23-, and the 19-inch rectangular color CRT's.

The initial preparation consists of taking the TV chassis from the cabinet. First, remove all knobs and the rear cabinet cover from the TV receiver (Fig. 1). Discharge the high-voltage charge of the tube with a long, insulated-handle screwdriver—from anode connection to the TV chassis. Be real careful, and do a good job of grounding out the high-voltage cable. In older TV re-

ceivers, the high-voltage cable must be unfastened from the metal box before you open the lid of the box. This lead will pull out of a pin socket. In newer TV sets, the high-voltage lead unplugs from the glass picture tube. Unbolt the TV chassis and unplug all wires going to the TV chassis.

This includes the picture tube cap or socket, yoke leads, and speaker leads. All the colored wires going to the deflection yoke are marked on the yoke where they are plugged in. There is little danger of getting them wrong when replacing them. Unhook the blue grounding lead from the blue lateral magnet. Unplug the convergence yoke cable from the TV chassis and also loosen the antenna terminal assembly.

Before pulling out the chassis, be sure

# Change Color Tube

all cables and wires are disconnected. On the older models, pull out the chassis three or four inches and loosen the 1/4-inch metal screw, holding down the small-controls assembly. Slide the assembly back and pull up. Now the chassis is free (Fig. 2).

**The Tube Comes Out.** The cabinet should be turned over on its face before removing the color tube. Be sure to lay a blanket or thick padding upon the floor to keep the cabinet in ship shape. Have a friend (Fig. 3), or the wife, help place the TV cabinet front down upon the padding.

In the older color sets the dynamic convergence magnet assembly (Fig. 4) slides

separately off the neck of the tube. In the rectangular 25-inch sets the yoke assembly also contains the convergence coils and fits tightly against the color tube.

Four nuts hold the picture tube in place—two at the top and two at the bottom. A metal flange surrounds most tubes, near the face of the tube. In the newer color sets, the automatic degaussing coils (ADG) are fastened to this framework. In the 25-inch sets the metal flange must be removed before you can get to the nuts holding the color tube in place.

Now remove the components from the neck of the color picture tube. In case you are not familiar with the location of these components, measure their position (Fig. 5) on the neck of the color picture tube. This procedure is quite helpful when replacing

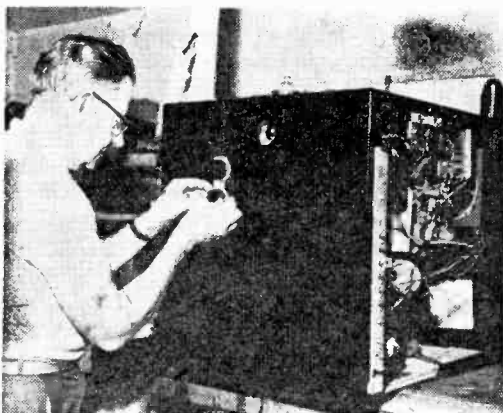

Fig. 1. (top, left) Removing the control knobs.

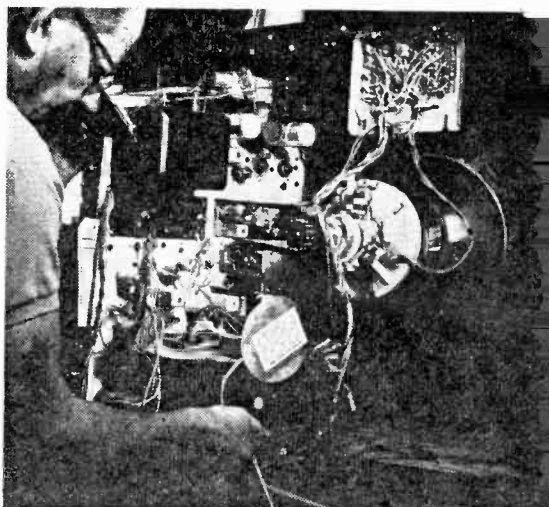
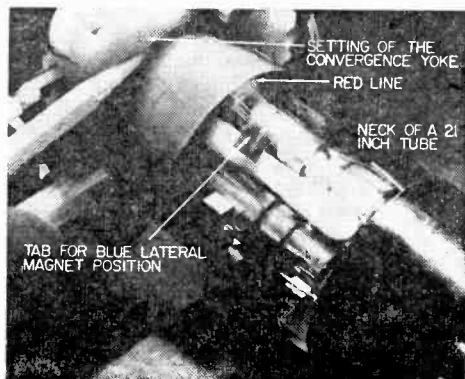

Fig. 2. (above) Don't be afraid to make notes about various connections as you disconnect chassis from CRT and yoke. It can save you a little hunting later.

Fig. 3. (below) Place cabinet face down on folded blanket to protect pic tube and finish.

Fig. 4. (right) Point of pencil indicates the setting of convergence yoke and red band.



these components to the neck of the new color tube. *As a safety precaution, wear safety glasses when working close to the picture tube. Do not put pressure on neck of CRT or let tube rest on neck.*

**Clear the Neck.** Place the kinescope face down on a drop cloth or newspaper to protect the face from scratches. Now remove the components from the neck of the tube. When you remove the blue lateral magnet, you will notice that it sets over a tab or clip inside the tube neck (Fig. 6).

In the older sets, the purity ring sets over the red ring marked inside the tube. Note that the blue wires from the convergence assembly (Fig. 7) go to the top of the picture tube over the blue gun, the red wires at the left side, and the green wires on the right going to the green dynamic convergence coils.

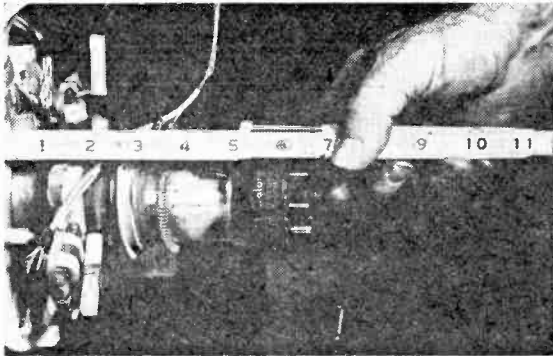
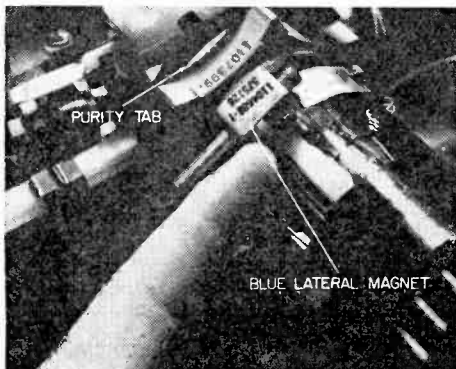

Fig. 5. (top) Be sure to mark down measurements so you can replace the yoke assembly.

Fig. 6. (below) Here author is pointing to blue lateral magnet and the tab inside the neck of the CRT. Tab is not obscured by blue lateral magnet in Fig. 4. By first replacing the components according to the measurements most adjustments are minor.



The large deflection yoke is loosened with a 1/4-inch nutdriver (Fig. 8) and can be lifted off the neck of the tube. It is very heavy; do not drop it! Be especially careful not to rap the CRT with a tool or heavy object. *The CRT must be handled with care since it can implode and cause serious damage to you and the set.*

The masking must be removed from the front edge of the CRT, as in Fig. 9. On the rectangular tubes, a strap with corner flanges must be removed by loosening a side-bracket bolt. Remove the bracket (i.e., masking) assembly from the old CRT and place it upon the new tube.

Be sure the CRT is laying in the same position as mounted in the TV cabinet. Now place the strap in place on the new CRT and tighten up the bracket assembly. Be sure the high-voltage (anode) button is at

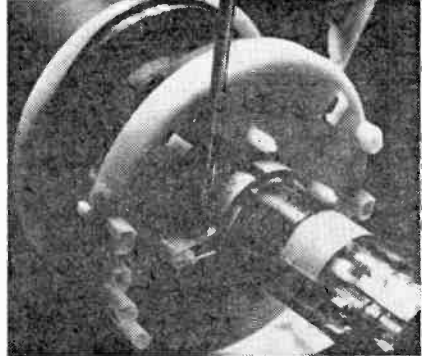

Fig. 8. (above) After yoke assembly has been loosened with nutdriver it can be removed. Assembly is quite heavy—don't drop it.

Fig. 7. (below) All components of the yoke assembly are indicated. Once you can tell the difference between a dynamic convergence yoke and a purity magnet you have an easier job of following these instructions.



# Change Color Tube

the top of the set on a 25-inch picture tube (Fig. 10). The 23-inch and 21-inch round-CRT anode connections (Fig. 11) are on the side of the tube.

**Reassembly.** Place all components back on the neck of the CRT. Use the previously taken measurement for their approximate position. In the older sets the yoke must be mounted so it will slide back and forward for purity checks. The 25-inch yoke assembly fits snugly against the bell of the tube. This yoke slides back and forward inside of the large yoke assembly. Two small screws are loosened on each side of the plastic yoke assembly.

Tubes that are not bonded have a safety

glass—be sure the glass is clean. Wash it with soap and then rinse with clear water. Make sure there is no lint or dirt on the face of the new CRT (Fig. 12). Seat the tube in its place in the cabinet and bolt it to the front brackets. Replace the metal shield and degaussing-coil assembly, if the set has one.

Now set the cabinet upright and fasten the convergence board in place (Fig. 13). Install the TV chassis and connect all cables. Make certain that all parts are replaced and tightened. Banging against metal parts will sometimes induce magnetism into these parts and a second job of degaussing may be required. Be sure that all cables are connected and in place. Turn on the color receiver and leave it on for 15 to 20 minutes before purity or convergence checks are made.

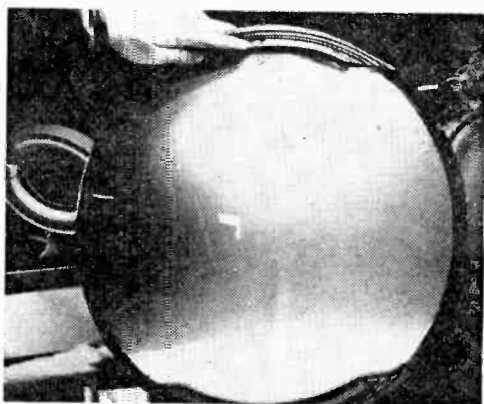
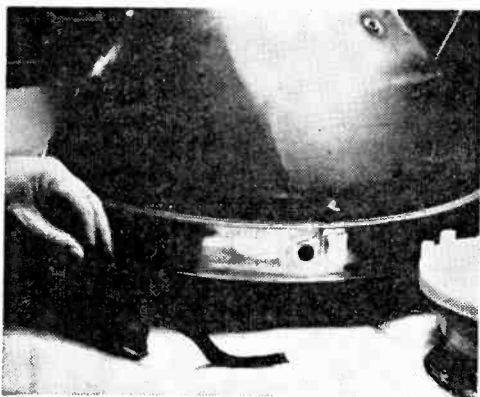

Fig. 9. (top, left) Make careful note of how the front protective mask is removed from CRT to make replacement much easier. Plastic mask on 21-inch CRT must be placed evenly (top, right) before taping in place.

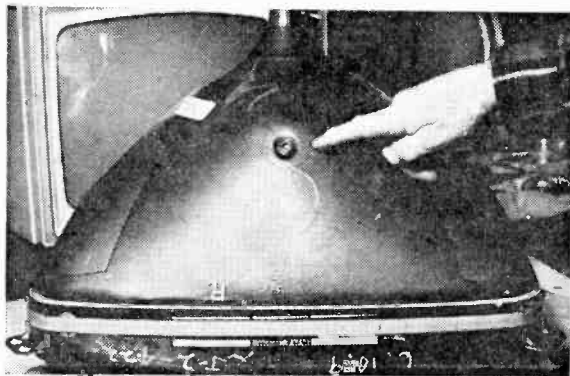
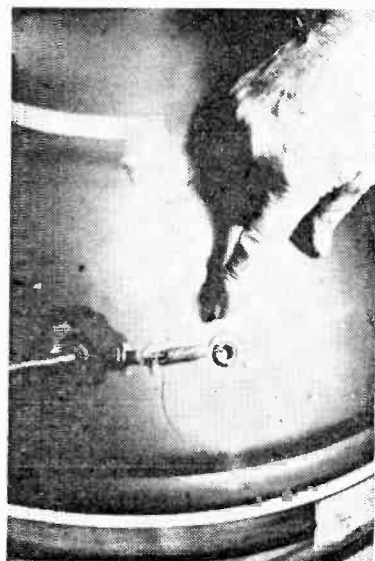

Fig. 10. High-voltage connector is at top of 25-inch CRT's—on side of 19- and 23-inch CRT's. Make sure!





**Basic Adjustments.** Color-TV convergence can take time and may require skill. You may want to degauss and converge the color TV yourself, if correct equipment is available. If not, get help from a good reliable color-TV serviceman and pay him to finish the job.

If you want to do it yourself, here goes: Position a degaussing coil near the picture tube (Fig. 14) to completely neutralize any induced magnetism. This step will help insure proper purity and convergence when the picture tube is converged. Hook up the Dot-Bar color generator and let it warm up as the color-TV set warms up. When replacing the CRT, even sets with built-in degaussing coils should be degaussed just as if one was not built into the TV cabinet.

Take a quick look at the TV screen and if there are any color shaded areas the set

should be put through a purity check up.

To start the purity adjustment (Fig. 15), turn off the set and unplug the IF cable going to the tuner. Plug the AC-interlock cord back in, let the receiver warm up, and short out the green and blue grids through a 100K resistor. (There are commercial kinescope grid-shortening switch boxes on the market for just this purpose.) At the moment the screen should be red. Adjust the center purity ring for a center red coloring. Then push the yoke back and forth and adjust the purity ring until the entire screen has an even red tint. The red-, blue-, and green-grid connections are generally on the top of the chassis. These three colored wires go to the picture-tube socket.

If the purity adjustments are done correctly, the green and blue shading will fall in line. It is always best to check each one

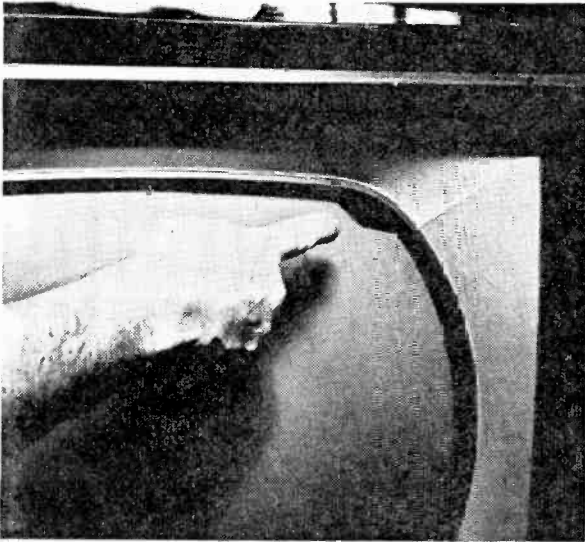

Fig. 12. (top, left) When replacing CRT's that are not bonded, safety glass must be cleaned of fingerprints and lint. Double check mask to make sure it is aligned properly in set.



Fig. 13. (top, right) When convergence board has been reinstalled and all nuts and machine screws have been tightened the chassis can be returned to the cabinet and secured too.

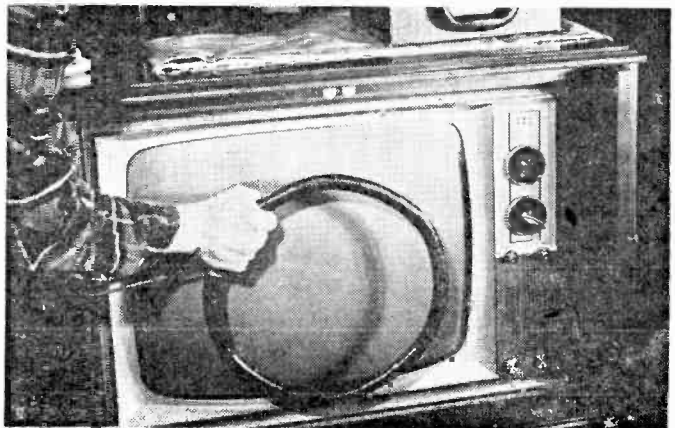

Fig. 14. (right) Degauss the CRT even if there is a built-in degaussing coil.

# Change Color Tube

separately by shorting the other two grids to ground through a 100K resistor. If a little shading persists, try degaussing the CRT again and start over with the red adjustment procedure again.

At this time, check the level of the picture and see if the picture is in focus. Sometimes it is difficult to do a good job of convergence with the set out of focus. When you reset the focus control, convergence dots are way off.

**Getting a Picture.** Convergence is relatively easy on the new color receivers. The older models require patience and plenty of time. Connect the Dot-Bar generator to the antenna terminals. Remove the convergence board from the back of the set and place it on the slots at the top and back of the set. Tighten the two metal screws so the board is solidly in place. Watch the wires that connect the board to the yoke assembly so that they do not get tangled.

If the receiver was in convergence when the color CRT went bad, the dynamic convergence controls will generally need only a touch up. Set the generator to get dots on the CRT screen and check the dots down through the center of the screen. Short out the blue gun with the 100K resistor. Bring the red and green dots together on a center dot. Slide the red and green magnets in on top of one another. Readjust the setting, if needed.

If they won't quite come together, remove

and rotate the red magnet a half turn and reinsert it, and adjust again. Now, once the red and green dots are centered, short the green grid and line up the red and blue dots. (The blue-beam magnet moves the blue dot up and down. The blue lateral-beam moves the blue dot horizontally. Place them on top of one another). Go back and check the red and green guns once again. Check that all three dots are together. You should now have a white dot. The amplitude and tilt controls should not be adjusted unless the dots fail to converge.

Now, step back and take a look at the screen from a distance. Tune in a black-and-white program from a local station and check for color fringing. Generally, the convergence board does not need to be adjusted unless tampered with.

If the dots do not converge at the ends, top, and bottom, the vertical and horizontal adjustments must be made. Use the manufacturer's convergence and adjustment information and follow their alignment procedure. It is best to go over color convergence several times and then get away from the dots. Go back in a few minutes and recheck.

Follow the factory adjustment for black-and-white setup. The newer TV color receivers have a *service-normal* switch mounted at the rear of the chassis. When this control is thrown to the *service* position the raster collapses into a thin white line. You adjust the three screen controls until the vertical line is perfectly white. Now flip the switch to *normal* and the picture is black and white. ■

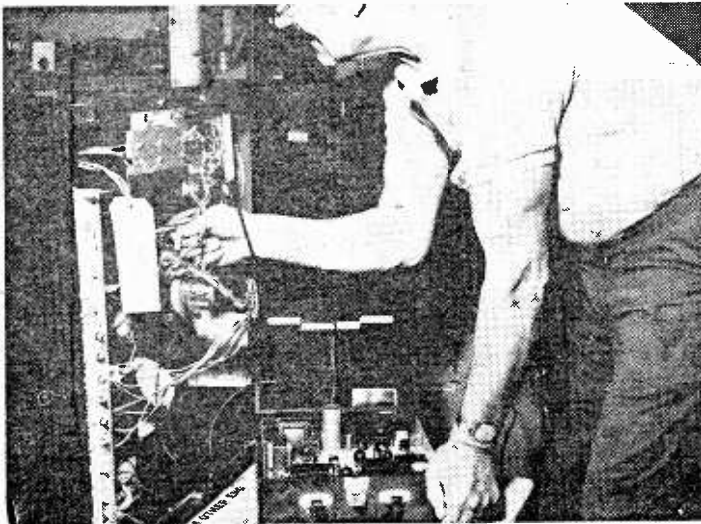
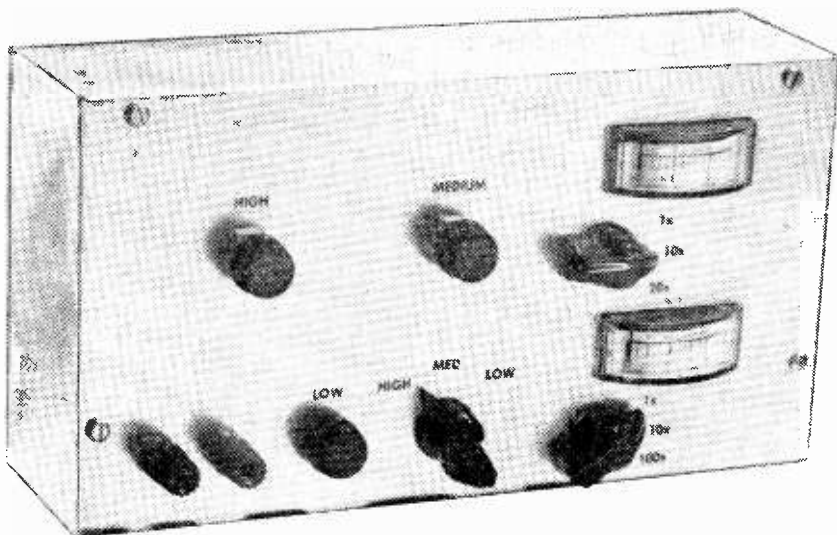

Fig. 15. The last step is the most crucial of all the steps in the replacement of a color CRT. Color purity has a lot to do with the overall enjoyment you get when watching your favorite programs. No one can thrill to faces that are tinged with green, or grass that has a purplish tinge. If you don't have the necessary equipment you can have your local TV service technician do both the color purity and convergence adjustments. Fee is much less than paying for complete job by TV technician.



# A BETTER BATTERY TESTER

by Marshall Lincoln

**E**ACH OF US today uses a surprising number of batteries in daily living—more of them than we realize until we sit down to count all the battery-operated devices we have in home and shop. But how many of us have a good way to test all the various sizes and kinds of batteries we use, to learn when each should be replaced (or in some cases, recharged)?

Mostly, we must rely on the old method of using a battery until it seems to be getting weak, and then replace it. If we want to be cautious, we may replace it sooner than necessary “just to be sure,” and never really know if the old battery was really worn out.

Sometimes we may keep a couple extra batteries on hand for the most important devices in the household. These may go dead on the shelf before we get around to using them. So, the next time, we put off buying a replacement until we need one and then find the store is out of the size we need. Any way you look at it, we wind up with a feeling that “there must be a better way.”

**Naturally, There Is.** It's through use of a battery tester that will check all the many types of batteries we have in the house. And to do the job right, it must do more than just measure the voltage—it must also put the correct *load* on the battery while measuring the voltage.

The little testers you find on the counter at an electronics parts store do this in a limited fashion. It's easy enough to build a similar tester to check just one or two types of batteries this way for yourself. But with so many different types of batteries in common use today, these simple testers still don't do the complete job. What you need is a battery tester with a built-in load which can be adjusted to suit any common type of battery which you are likely to have. The better battery tester illustrated here does just that, and yet is not much more complex than a simple tester which may work with only a few selected types of batteries.

Using commonly-available components and inexpensive, yet suitably accurate meters, this battery tester enables you to test just about any household or workshop battery you're likely to encounter, from the little button cells used in hearing aids and photographic exposure meters, up through medium-voltage radio “B” batteries.

**A Terminal Voltage?** This tester has both a voltmeter and a milliammeter, and so it enables you to check the battery voltage while at the same time observing the amount of current being drawn from the battery. By adjusting the tester so it draws the amount of current for which the battery is rated by the manufacturer, you can quickly see if its

# Battery Tester

terminal voltage drops significantly under this load.

Three rheostats, of different resistance values, are used in the tester to give you continuously-variable control of the load placed on the battery. This is the key to use of this better battery tester—it gives you the ability to easily impose the proper load on the battery so you can observe the effect this load has on the battery's terminal voltage.

Each of the tester's two meters has three ranges, selected with a rotary switch just below the meter. Voltage ranges are 0-3, 0-30, and 0-60 volts. Current ranges are 0-5, 0-50, and 0-500 mA.

Three rheostats give you a selection of load resistance from zero to 20,000-ohms. Only one rheostat is used at a time, with S1 used to select the rheostat in use. By covering the load resistance range with three rheostats whose resistance values overlap, this tester allows you to select a medium or low resistance setting with greater precision than if a single rheostat were used for the load.

**Overrated Rheostats.** When you look at the parts list, you may be surprised at the power ratings of these rheostats—they range from 12½ watts up to 50 watts. Why such a high power dissipation rating for the load resistors to be used on household batteries, which don't produce nearly that much power?

These high power ratings are needed to give you the flexibility to test a wide range of batteries. The power rating on a rheostat applies only to the full resistance of the rheostat. When you turn the slider to a lower resistance point, as you will do when

using this tester, the power rating of the portion of the rheostat which is being used is reduced accordingly.

You certainly won't be sucking 50 watts of power out of the batteries you test, but you need rheostats heavy enough to safely dissipate lesser amounts of power when set for less than their full resistance.

In using the tester, you'll adjust a rheostat used as a load on the battery being tested until the milliammeter shows you this load is drawing from the battery the amount of current for which it is rated. To determine this "load current," refer to the accompanying battery table, which covers many of the commonly-used batteries you're likely to encounter, or refer to a battery manual from the manufacturer of the batteries you use.

For example, the normal full rated load current for a 1.5-volt size "D" flashlight cell is shown as 150 milliamperes. To test such a cell on this better battery tester, follow this procedure.

1. Plug a pair of test prods into the two banana jacks at the lower left corner of the tester. Set the voltmeter range switch to "1x" (for the 0.3 volt range) and the milliammeter range switch to "100x" (for the 0-500 mA. range).

2. Set the load range switch to "low." This will select load resistor R3.

3. Touch the positive test prod to the positive battery terminal and the negative test prod to the negative battery terminal. Turn the "low" rheostat control (R3) until the milliammeter shows you are drawing 150 milliamperes from the battery, and as you do this, also watch the voltmeter. If it continues to indicate nearly 1.5 volts as the current flow is adjusted upwards until it reaches 150 milliamperes, the cell is in good condition, since you can see it is supplying

S1, S2, S3 are SP3T, Centralab 1461

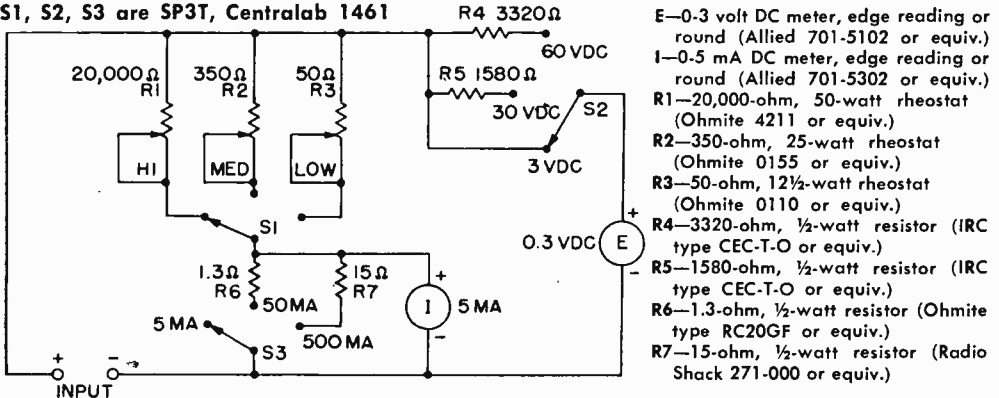

- E—0-3 volt DC meter, edge reading or round (Allied 701-5102 or equiv.)
- I—0-5 mA DC meter, edge reading or round (Allied 701-5302 or equiv.)
- R1—20,000-ohm, 50-watt rheostat (Ohmite 4211 or equiv.)
- R2—350-ohm, 25-watt rheostat (Ohmite 0155 or equiv.)
- R3—50-ohm, 12½-watt rheostat (Ohmite 0110 or equiv.)
- R4—3320-ohm, ½-watt resistor (IRC type CEC-T-O or equiv.)
- R5—1580-ohm, ½-watt resistor (IRC type CEC-T-O or equiv.)
- R6—1.3-ohm, ½-watt resistor (Ohmite type RC20GF or equiv.)
- R7—15-ohm, ½-watt resistor (Radio Shack 271-000 or equiv.)

## BATTERY TEST REFERENCE CHART

Maximum Current (mA)	Manufacturer Type Number					Type and Application
	RCA	Burgess	Eveready	Ray-O-Vac	NEDA	
<b>1.5 Volts</b>						
25	VS034A	Z	915	7R	15E	AA flashlight cell
80	VS035A	1	935	1C	14F	C flashlight cell
150	VS036	2	950	2D	13F	D flashlight cell
20	VS073	NE	904	716	910	Key chain lights & novelties
20	VS074	7	912	4D0	24F	AAA flashlight cell
25	VS334	930	1015	15	15	Transistor radios AA size
80	VS335	130	1035	14	14	Portable radios C size
150	VS336	2R	1050	2LP	13	Portable radios D size
25	VS734	920	815BP			Photoflash AA size
80	VS735	120	835BP			Photoflash C size
150	VS736	220	850			Photoflash D size
200	VS1074	AL-7	E92	MN-2400	24F	Alkaline AAA size
300	VS1334	AL-9	E91	MN-1500	15A	Alkaline AA size
500	VS1335	AL-1	E93	MN-1400	14A	Alkaline C size
500	VS1336	AL-2	E95	MN-1300	13A	Alkaline D size
<b>4.5 Volts</b>						
250	VS067	F3	736	A3	3	Portable "A"
<b>6 Volts</b>						
250	VS040C	F4M	509	941		Lantern service spring terminals
25	VS068	Z4	724	A2	2	Portable "A"
500	VS317	TW1	731	918	918	Lantern service binding posts
<b>7.5 Volts</b>						
70	VS065	C5	717	9	9	Portable radio "A"
50	VS129	B5	713	8	8	Portable radio "A"
80	VS315	D5	707	26	26	Portable radio "A"
<b>9 Volts</b>						
9	VS300A	P6	226	1600	1600	Transistor radios
150	VS301	D6PI	2506	1601	1601	Transistor radios
15	VS305	2N6	246	1602	1602	Transistor radios
30	VS306	D6	276	1603	1603	Transistor radios
20	VS322	M6	266	1605	1605	Transistor radios
8	VS323	2U6	216	1604	1604	Transistor radios
7	VS327	L6	206		1611	Transistor radios
80	VS330	C6X	2356N		1612	Transistor radios
<b>12 Volts</b>						
250	VS342	TW1S	732			Lantern service
<b>13.5 Volts</b>						
10	VS304	XX9	239	1900	1900	Transistor service
<b>15 Volts</b>						
1.5	VS704	Y10	504		220	Photoflash BC units
<b>22.5 Volts</b>						
2.5	VS084	U15	412	215	215	Photoflash BC units, transistor service
<b>30 Volts</b>						
2.5	VS085	U20	413	A210	210	Transistor radios
<b>45 Volts</b>						
40	VS014	A30	W359	206	206	Portable radio "B"
25	VS015	Z30	738	205	205	Portable radio "B"
4	VS086	U30	415	213	213	Portable radio "B"
50	VS112	5308	762S	709	709	Portable radio "B"
70	VS344	B30	484	207	207	Portable radio "B"

# Battery Tester

its rated load current without a significant drop in voltage. However, if the voltmeter shows you the voltage dropped excessively as the current was adjusted upward to the value that's normal for this particular cell, then you know the cell is weak.

Incidentally, if you compare battery ratings published by different manufacturers of similar battery types, you may find a few variations in ratings. However, the versatility of this battery tester permits you to operate it to fit virtually any ratings to be found for low and medium voltage batteries.

Some batteries that have just a little life left will produce their rated load current for a short time before their terminal voltage begins to drop off. So, even if the cell tests good at first, hold the test prods in place for a minute or so and watch the voltmeter closely. If the voltage begins to drop off, you know the cell may be all right for short periods of operation, but that it is nearing the end of its useful life.

**For Unknown Loads.** In describing the test procedure for a size "D" flashlight cell, it was said to use the *low* resistance rheostat load. That's because the author, who designed this tester, knew from his calculations which load to use. Many times though, you may not be sure which rheostat to use, so just follow this simple rule. Start a test using the *high* rheostat (R1) set for its highest resistance, and work down from there. This is easy to do if you wire the unit so each rheostat will be set for maximum resistance when it is turned fully counter-clockwise as viewed from the front of the panel.)

In making a test, turn the resistance knob to the right, which will reduce the resistance, as you seek a setting that will produce on the milliammeter an indication of the current for which the battery is rated.

If you find you must turn the rheostat nearly fully clockwise to obtain the amount of current you want to draw from the battery being tested, you will find it's very hard to set the rheostat precisely enough to hold the milliammeter steady. This will happen because you will be attempting to work with a very tiny portion of the rheostat's full resistance range.

When this happens, the thing to do is set

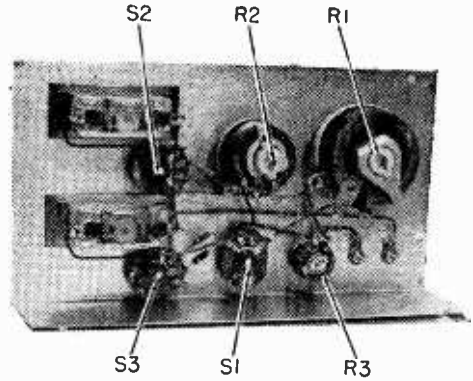

**Once parts are assembled mechanically, it's a fast and simple matter to wire a tester. Choose a panel meter that fits your design.**

the load selector switch (S1) to *medium* and try again, using the medium rheostat (R2). If the same thing occurs with R2, then set S1 to *low* and use the low rheostat (R3).

As a general rule, you'll find the high rheostat will be used on tests requiring fairly low amounts of current from low voltage batteries, and the low rheostat will be used for high amounts of current from low and medium voltage batteries. The medium rheostat will be used to conveniently bridge the gap between these two general categories. However, because of the wide variety of voltage and current combinations now available in the many battery types, it's not practical to set an iron-clad rule to determine which rheostat to use in every case. So, just follow the procedure of starting with a high resistance and working down until you reach the proper load for the battery you're testing.

**Construction.** Building the battery tester is very simple and straightforward, as you can see from the photos. Any type of metal or plastic utility box may be used. The one shown here is a 5 x 9½ x 2¼-in. steel convert-a-box, which is a little easier to work with than the more common mini-box.

Drill ⅜-in. holes for the switches and rheostats. Drill large enough holes for the two binding posts to accommodate fiber shoulder washers so the binding post mounting screws will be insulated from the metal panel, and cut rectangular holes for the meters.

One or two evenings should be sufficient to complete the unit, and then you'll have a battery tester that we think you'll be proud to own and wise to use. ■



# SKYHOOKS START

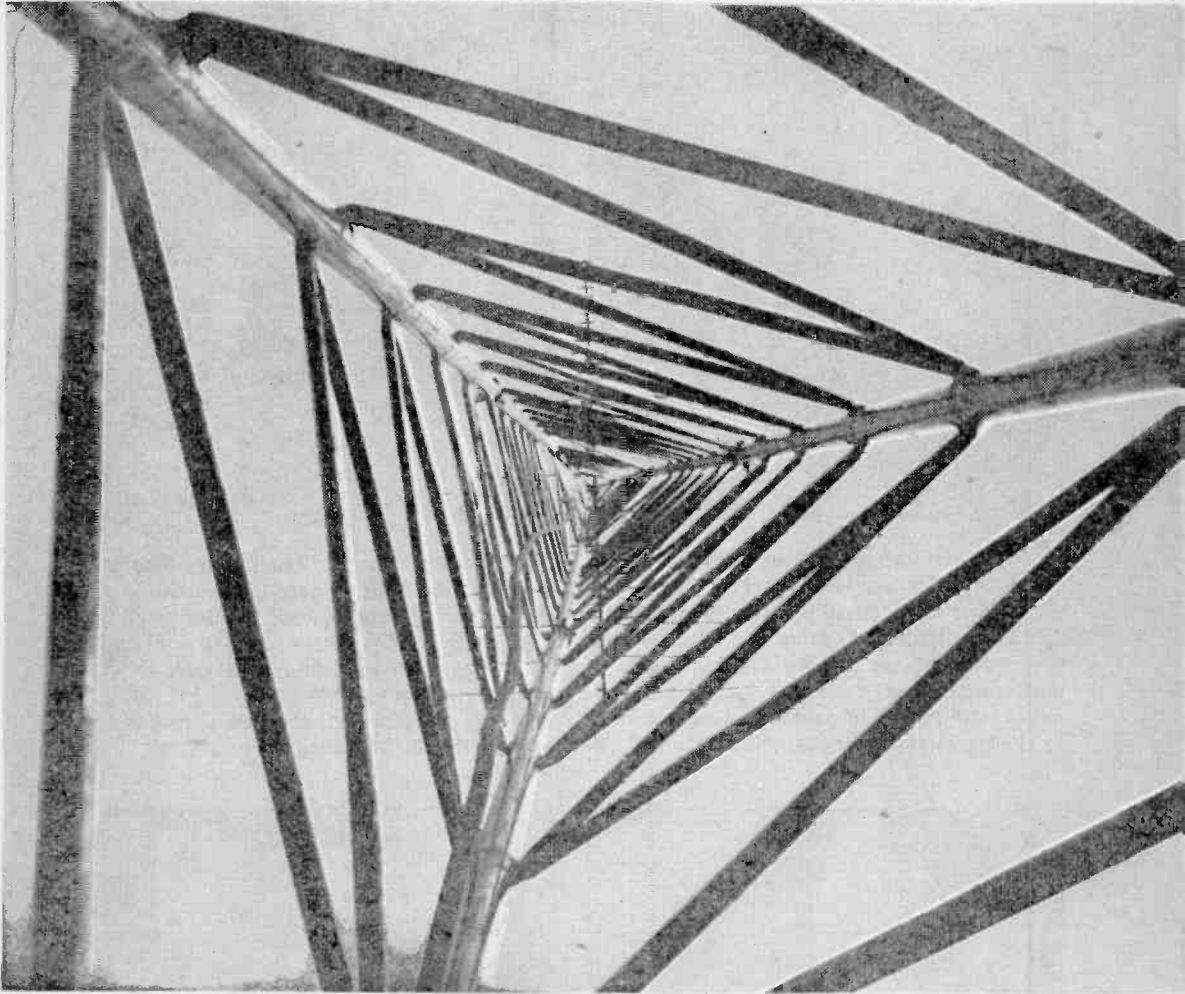

## AT GROUND ZERO!

Here's a maintenance free antenna tower you erect yourself...with your feet on the ground

by Peter L. Dexnis, WA3LOQ—Technical Editor

**“H**OW CAN I IMPROVE MY TV RECEPTION?” To look for an answer to this key question often asked by readers, let's go to the TV transmitter site. A broadcaster knows that ERP (effective radiated power, a product of antenna gain and transmitter power) and antenna height above average terrain play important parts in his station's coverage area. Broadcasters' antennas must be high because VHF

and UHF wavelengths assigned to TV broadcasters by the FCC cannot travel (propagate, as radio engineers say) much beyond the horizon seen by the antenna. If a broadcaster increases the height of his transmitting antenna, the distance to his “radio horizon” increases and a greater coverage area for his station exists.

We can't do much about ERP at our end,  
*(Continued on next page)*

# Antenna Tower



Ascom/Universal aluminum towers come in various heights and wind load factors ranging from 30-ft. with a 35-sq ft. wind load to a giant 90 feet and 2 sq ft wind loading. We selected a 50 ft model delivered as you see it above, telescoped into two packages easily carried by one person. Total weight is only about 97 pounds. Get information by circling 23 on Reader Service Compon. ▼

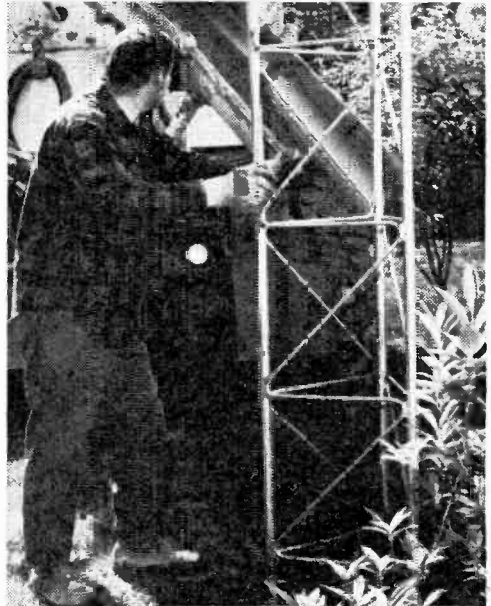

Bolt the lower 10 feet of tower to the base and place it in the hole. Be sure tilt direction is common for all base legs and oriented properly as concrete is poured. Here you have a choice. An average tower requires 2 cubic yards or less of concrete. You can mix your own, but having ready mix delivered costs about the same if you consider the cost of renting equipment. ▼



Cut or unwind the wire binding each package and lay out each ten foot section end to end in proper sequence; begin by placing the bottom section where the tower will stand. This checks for enough clearance when you later walk the tower up to standing position. Digging the proper size hole, here a 3 x 3 x 4 foot deep pit, is the most energetic part of your project.

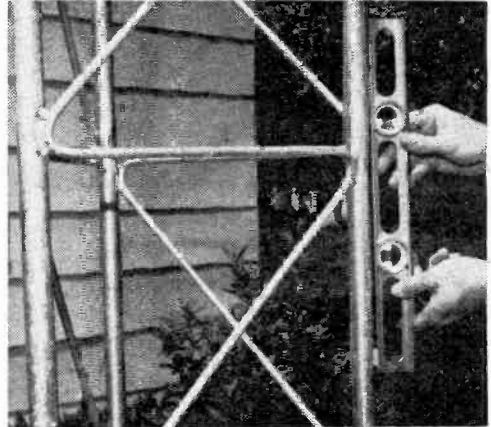

Get it plumb! This very important step insures your vertical dimension. You have a good hour, under normal circumstances, to plumb (make perfectly vertical) the lower 10 feet of tower. Remember it's important to keep the base pivot points three inches above the concrete. Also, be sure to use the 3500 mix concrete for your base. It usually costs no more than a lighter mix.

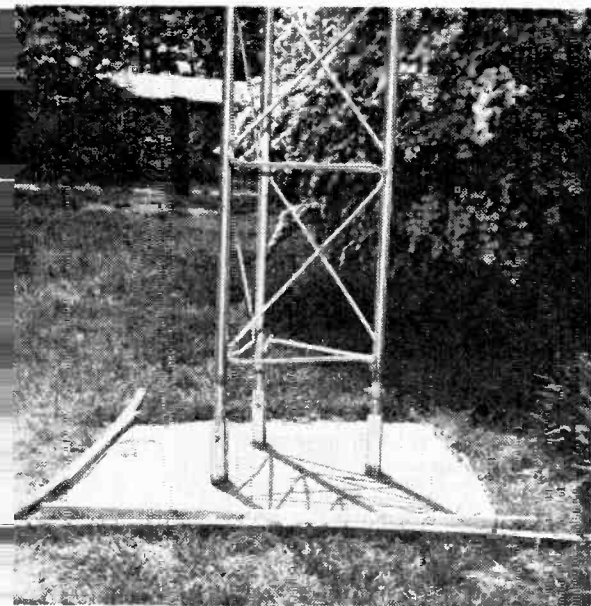

Do a neat job of smoothing the top of your concrete base, and shore up the sides with pieces of flat molding, before or after the concrete has been poured, for neat edges. Remember your first ten feet of tower hold tripod base poles in the correct position during 3 to 4 day wait for the concrete to set. Do not put undue pressure on this first assembly. ▼

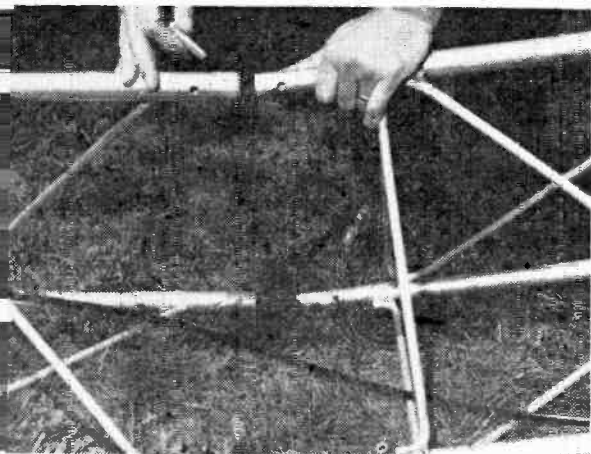

When concrete has set, fit and lock the ten foot upper sections together. Run cable inside tower and fasten your antenna to the upper section with a 5-foot steel pipe. Taping at intervals keeps cable still during windy weather. But be sure to use proper lead in. Do not use 300-ohm ribbon cable. Use only 75-ohm coax—if antenna accepts it—or shielded 300-ohm twin lead.

but if we boost our antenna *height* just a little, we may be able to snag some of his signal as it propagates out into space beyond his radio horizon.

Fortunately, you don't need the kind of height he has to greatly improve your fringe area reception. The broadcaster did most of the work already. Unless you're way down the wrong side of a mountain, a better signal is up there—often just a few tens of feet above the surface—waiting to be grabbed by the electronic tentacles of a multi-element antenna.

*Incidentally*, there's nothing in the rule book that says you can't mount your Action Band monitor antennas on your tower. You can benefit from the extra antenna height when copying mobile stations on the move. Characteristic flutter on mobile VHF transmissions, coupled with the relatively low power of mobiles, can interrupt reception to the point of "closing over" the signal by your receiver's own squelch. If that's your problem, a thirty foot or more boost to a gain-type antenna can make a big, big difference. Also, as this is being written, there is a docket before the FCC to raise the 20-foot height restriction of CB transmitting antennas to a towering 60 feet! (There's no general restriction, by the way, on CB antennas used for receive only.)

On the following pages we show how easy it is to erect a sturdy ASCOM antenna tower. Based on a simple two-point pivot and aluminum construction, it gives you a tilt-up tower that can be assembled on the ground and "walked up" into position by one, two at the most, people. You can also order tower accessories for roof guyed towers, and rotor mounts to support popular antenna rotators.

*Take a tip* from broadcasters. Boost *your* antenna and give a natural boost to fringe area reception. And remember, if you're fifty, sixty or more miles from a large metropolitan area—even though you may have a local station or two—there's a good chance a whole 'nother set of channels is up there just waitin' to be plucked! Take a drive through the Northeast section of Philadelphia, PA. You'll see a large number of tall skyhooks and super-fringe antennas pointed to good old NYC ninety miles away. Guess the Mets have some mighty loyal fans even in Philly land! (*More photos next page*)

# Antenna Tower

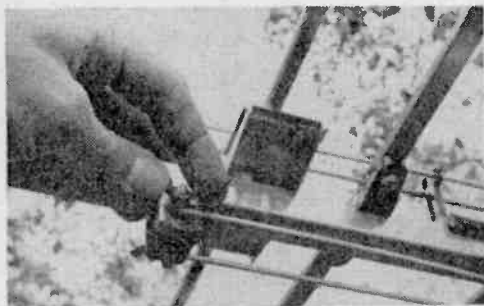

Poor connections at the antenna can make your entire system inefficient. Tighten securely and use tape to remove all pressure from connection.

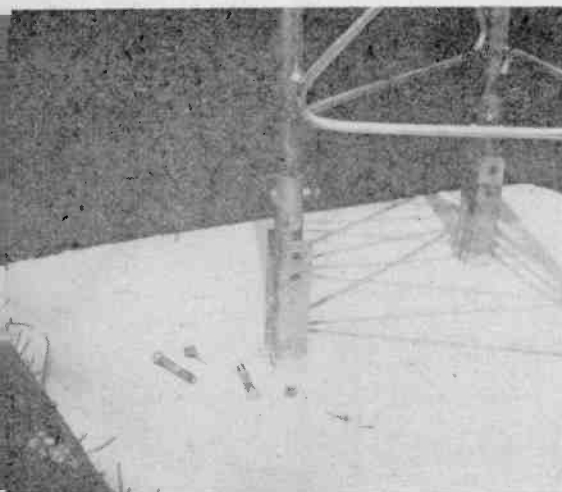

Remove bolt from each front leg and both from rear as shown. Tilt 10 foot section to ground and make final connection to upper part of tower. Walk up tower after orienting antenna in direction of distant station. Replace bolts.

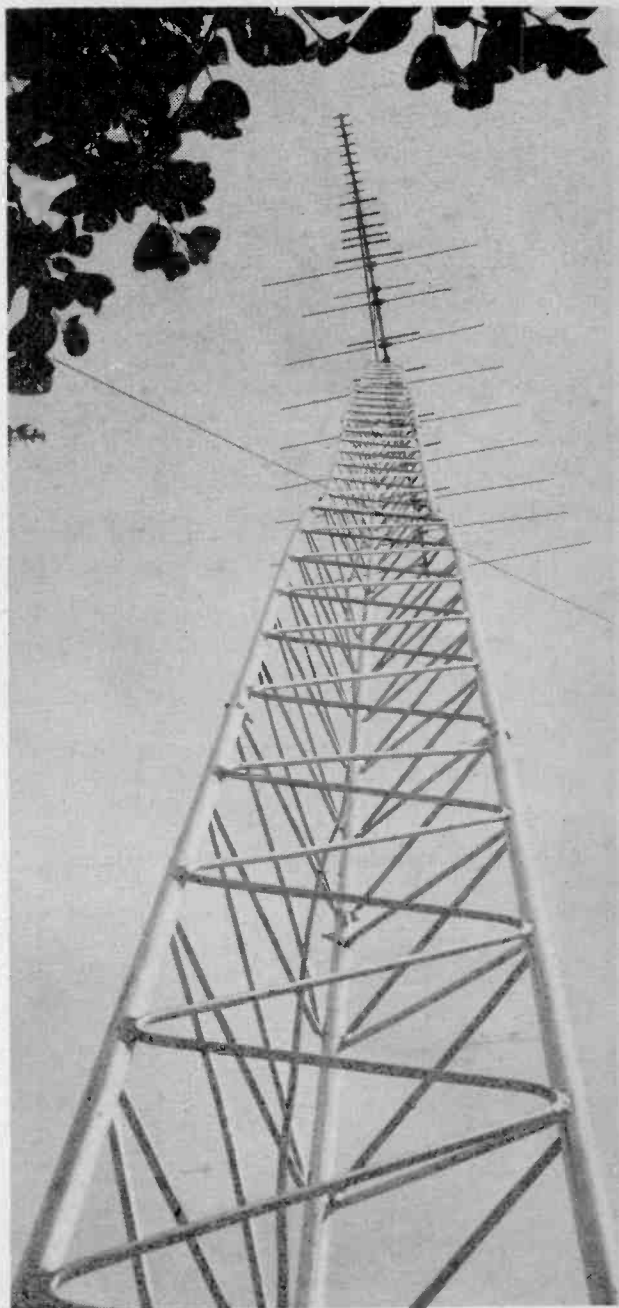
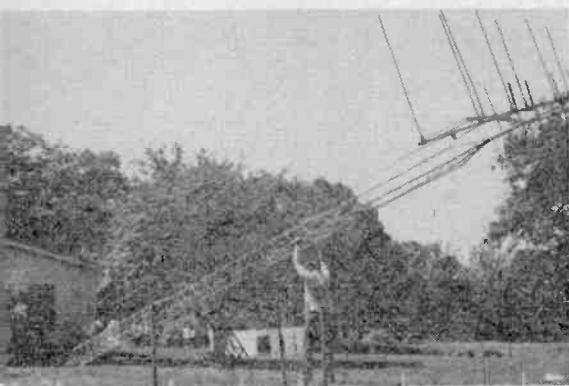

Perched a full 53 feet above ground zero, a long range UHF/VHF TV antenna "looks" over nearby trees to provide full-time reception from transmitters 70 miles away. Antenna model 70-23B is one of the 70 Series color spectrums from Finco. Get more info from Finco, circle No. 25. For more Ascom/Universal tower products info, circle No. 23 on Reader Service Coupon. ■

## Ask Hank, He Knows

*Continued from page 9*

frame. Without it the radio will shake loose. Install the bracket and your problems may be ended, otherwise look inside the player unit. The car's wiring is probably good.

### Play Ball

To record code on cassettes for practice purposes, I rigged my signal generator through a code key and into a cassette recorder. The hookup was made with ordinary zip-cord (which was all I had). After pounding away for awhile, I realized I had forgotten to turn on my generator. Just for the heck of it I played the tape back, but instead of the usual soft hissing of an erased tape, I heard a baseball game broadcast from radio station KRLD (1080) in Dallas! I repeated the procedure several times and each time I recorded the baseball game. The recorder had no built-in radio and there was no radio playing in the house. What caused this?

—H.J., Mesquite, TX

Your entire hookup external to the cassette served as an antenna picking up a strong local signal. Some non-linear element either in the external circuit or cassette player rectified the signal and filtered it into a recordable audio

signal. This happens often in unshielded input circuits feeding high impedance inputs. Load down the input circuit with a 470-ohm resistor and see what happens.

### Never Buy Toys for a Man's Job

My channel 14 walkie-talkie interferes on our television set, making it snowy: What could cause this?

S.V., Squamish, B.C.

Overmodulation is usually the reason, coupled with poor design. Your unit is generating harmonics, or just plain old noise, spilling past the channel limits and doubling, tripling up to higher and higher frequencies. I'm for reducing all Part 15 transceivers to Part 7.5—that's right, break them in half.

### Junior Junkman

Do you know of any place where I can obtain any Japanese electronic surplus equipment? An outfit in Japan, maybe? Hank, I am serious—no jokes, please!

—B.S., Oconto, WI

I'm not kidding when I say that the American marketplace is cluttered with Japanese junk right now. All those used and discarded amplifiers, radios, transceivers, etc., that were dumped as trade-ins for new goods are now on our side of the Pacific. Why look to import? Honestly, I don't know where you can turn to unless you advertise.

## Photographing TV

*Continued from page 76*

images in your movies will be somewhat bluish, but will certainly be acceptable. Your camera manual will tell you how to move the No. 85 filter out of the light path in the camera.

If you have a super 8 camera, you can



Expensive equipment is nice but not necessary. Ordinary fixed focus camera is fine for photographing live-from-the-moon TV at home from large-screen set.

*(Exposure table of suggested camera settings on next page)*

use a high-speed black-and-white movie film—Kodak Tri-X Reversal Film 7278—ASA 200. Your photo dealer may have to order this film for you. Although some cameras are not designed to expose this film properly under normal lighting conditions, most cameras will give satisfactory exposure for movies of television programs. To make movies on this film, you can leave the TV brightness control at its normal setting. If you have a manually adjustable camera, try a lens opening halfway between  $f/2.8$  and  $f/4$  for both black-and-white and color television.

**A New QSL Idea.** Here's a good idea which will pay off rich rewards in the future. Collect autographed pictures of people who will soon become famous. Photograph first-year professional athletes while they are competing in a game. Send a print to the player addressed to care of the player's club. You'll receive an autographed photo with a personal note, in most cases. Imagine snapping Willie Mays twenty years ago. Don't shoot superstars—they have too much mail to answer. Results will be poor. ■

## EXPOSURE TABLE

(Suggested Camera Settings for Pictures of Television Images)

Film (Use)	Black-and-White Television Set		Color Television Set	
	Leaf-Type Shutter	Focal-Plane Shutter	Leaf-Type Shutter	Focal-Plane Shutter
Verichrome Pan Plus-X Pan (Black-and-White)	1/30 sec f/4	1/8 sec f/8	1/30 sec f/2.8	1/8 sec f/5.6
Tri-X Pan (Black-and-White)	1/30 sec f/5.6-8	1/8 sec f/11-16	1/30 sec f/4-5.6	1/8 sec f/8-11
Kodachrome-X (1) (Color Prints)	1/8 sec f/2.8	1/8 sec f/2.8	1/4 sec f/2.8	1/4 sec f/2.8
Kodachrome-X (1) Ektachrome-X (1) (Color Slides)	1/15 sec f/2		1/8 sec f/2	1/8 sec f/2
High Speed Ektachrome (1) (Daylight)—with Normal Processing ASA 160 (Color Slides)	1/15 sec f/2.8-4	1/8 sec f/4-5.6	1/8 sec f/2.8-4	1/8 sec f/2.8-4
High Speed Ektachrome (1) (Daylight)—with ESP-1 Processing for a Speed of ASA 400 (Color Slides)	1/30 sec f/4	1/8 sec f/8	1/30 sec f/2.8	1/8 sec f/5.6

NOTE: When two lens openings are given, such as f/4-5.8, lens setting is midway between these stops.

(1) Pictures of color television taken without a filter will look blue-green. With the color films in the table, you can use a Kodak color compensating filter, CC40R, over your camera lens to help bring out the reds in your pictures. Increase the exposure suggested in the table by 1 stop.

### 4-Channel

Continued from page 68

Admittedly, both examples are oversimplifications, but they do illustrate what you are likely to encounter in your particular listening environment, and some methods to optimize the sound distribution.

Applying the principles of Figs. 3 and 4 to a 4-channel discrete system usually works well, primarily because the separation between speakers is maximum; you will always get the feeling of surround-sound. While SQ is supposedly also surround-sound, its sharply reduced separation can easily be turned into surround-mono in a reverberant room. Greater SQ separation can be obtained two ways: (1) move the speakers further away from the listening area in a "dead" room, or (2) in a reverberant room, rotate the speakers slightly, just enough so the reverb path does not come straight back at you from the walls opposite the speakers.

If you have one of the newer "logic" type

SQ decoders, you will not have as much problem with reduced SQ separation because the decoder's logic circuits automatically reduce the gain of the three "weaker" channels, thereby creating the illusion of greater separation. (The effect is buried in what is conveniently excused as "psychoacoustics.") It might not be "real" 4-channel surround-sound—if such actually exists, but it is a most pleasant effect.

If your listening environment is such that much of the surround-sound effect is being lost regardless of how the speakers are arranged and oriented, try to move them in as close as possible so as to provide the highest ratio of direct-to-reverberant sound at the listening location. Since reverb tends to blend the higher frequency sounds from the four speakers (and it is the higher frequencies that are directive), reducing the blend by increasing the direct/reverb ratio often creates the illusion of greater separation, though it will also tend to make the sound slightly *flatter*, or lacking brilliance. (Again psychoacoustics!)

But just as you would want to reduce



the reverberation blend for SQ, so would you want to *boost* the blend for derived ambient sound. Why? Because derived ambient is supposed to simulate the concert hall, or rock club. Now, when was the last time you attended a live anything and heard the sound from anywhere's other the front? The ambient sound of the hall—the reflections from the walls, floor, ceiling, furniture, and the absorption by the audience, create a vague spaciousness and overall tone quality we might define as "warm." "cold" or maybe "full bodied." Whatever the ambient sound does, it does not change the point or origination of the sound source, which is *up front*. (Yes, there are a few halls where a few seats appear to get their sound from the right and/or left side.)

Most speaker recommendations for ambient sound place the speakers as shown in Fig. 2, with the ambient "rear" speakers literally pouring the sound into the listener's ears. Just forget for a moment that nowhere does the ambient sound pour into the ear at a *noticeable* level, or from a specific direction. Consider, instead, that, depending on the record, the "rear ambient" might have considerable frontal energy and/or distortion in the form of "groove rattle" or intermod. Is this what you want?

**Diffuse Ambient.** Nothing in this world is going to duplicate a concert hall in your living room through speakers. At most, you will obtain a feeling of spaciousness which is a lot better than "standard stereo," and which might conceivably *start to approach* concert-hall realism. But you get this effect by diffusing the ambient sound either by a long path from the ambient speakers (which are at a *very low* level), or by blending the sound via rear-wall bounce. Some typical

speaker arrangements for a diffuse ambient sound are shown in Fig. 5. The pairs of ambient speaker are indicated as A/A and B/B'. Again, the arrangements serve only to illustrate a starting point. Regardless of the finalized speaker arrangement the balancing should be such that the ambient can barely be heard when the front speakers are off. While this is not going to "pour it down your ear" as it is done at a hi-fi showroom, after a few minutes of listening you will note a general depth to the sound field, with the sound orientation at the front where it belongs. In the *long* run, properly diffused and balanced rear ambient is the most enjoyable of all the 4-channel formats.

Lastly, we should point out that most all sounds in life have a specific orientation or direction. Even the ear-damaging sounds of low-flying commercial jetliners have a recognized point of origin, even when we are feeling pain. The failure of most 4-channel speaker arrangements and sound-field balancing is that the subconscious, expected sound orientation is disturbed. While the overall immediate (short-term) effect might be spectacular, it either wears quickly or the listener perceives *less than standard stereo* in terms of overall musical performance. However you arrange and level-balance your speakers for any 4-channel system, certain sounds should retain a familiar orientation: vocalists and soloists should be up front—predominantly up front. Of course there will always be the A & R man or engineer that sticks one vocalist left front, another vocalist right front and a chorus spread out twenty feet across the rear. Just buy another record; it's simply another version of stereo ping-pong—and that ain't 4-channel sound. ■

---

## CTS Futura V

*Continued from page 23*

the top to spread the highs which are more directional and, require top billing.

A crossover network is mounted on the rear panel. Note that the coils are large and are wound with heavy wire, so connections can be simply twisted and soldered; there's no need for terminal strips or fancy lead dress.

When everything is mounted and connected, you simply fill the enclosure with loose-packed fiberglass (the type used for

house insulation will do), screw in the back, and the speaker is ready for use. If you intend to finish the cabinet we suggest you get everything assembled for a trial run. If all is okay, remove the components before the final finishing operations. No useful purpose is served by loading speaker cones with sawdust, varnish or stain!

Both the honker and tweeter level controls have a full off-to-on range, so just about any degree of midrange and high frequency performance can be user adjusted—unlike many commercial speaker systems with *brilliance* and *brightness* controls that have a limited adjustment range.

**Listener's Report.** Our listening panel



judged the finished system—in the cabinet we built from scratch—to have a good “console” sound, comparing favorably or even better than the systems supplied in many high-cost complete equipment consoles. The low end goes down low enough for a full, rich sound, but not so low to produce an annoying rumble from low cost turntables or record changers.

The overall sound quality is well suited for modern sounds; the *hard* midrange sound being well suited to rock, soul and folk music. The wide range of honker and

tweeter level adjustments proved particularly good at adjusting the overall sound to match what each listener considered optimum for modern music.

The Futura V speaker system is rated at 8 ohms so it can be used with just about every solid-state and tube-type amplifier made. It can even be used to improve the performance from portable phonographs and compacts.

For additional information circle No. 28 on the Reader Service Coupon on page 8. Do it today! ■

## Weekend Mechanic

*Continued from page 61*

**Lafayette Analyzer.** The Deluxe Solid-State Engine Analyzer (\$49.95) sold by Lafayette is a factory-assembled unit that is quite similar to the Radio Shack analyzer just described. It features a 6-inch d'Arsonval meter with nine easy-to-read scales which are very prominently color-coded with the function selector switch. Every attempt has been made to keep the number of controls at a minimum. Aside from the function selector, you find only an ohms-adjust knob and a toggle switch that selects either the general test input or the amperes input jack.

The two voltage scales handle three ranges—0-3.2, 0-16 and 0-32 volts. The DC ammeter has a -5 to +90 range, and the ohmmeter has a 0-100,000 ohms range. These three functions have broader ranges than those found on the Radio Shack analyzer. However, the dwell and rpm ranges are comparable, and there's a substitute test condenser, a capacitor and coil testing scale, but no spark output indicator. Diodes are tested by measuring the resistance in two directions, as with the Radio Shack analyzer.



but a separate diode Hi-Lo scale is not provided. There's no need to preset the meter pointer before each rpm measurement.

The Lafayette analyzer is powered by a single size D cell located in a rear compartment which is also used to store cables and reference material.

The instrument can be used to test all 4, 6 and 8 cylinder engines. Test readings on an 8-cylinder engine, using the Lafayette and Radio Shack analyzers, yielded virtually identical results. Both units are equally simple to connect to the engine. For example, to measure dwell angle or rpm, just fasten one alligator clip to ground and the other to the primary terminal of the coil, set the function selector switch to the proper position, and start the car engine. A very minor shortcoming of the Lafayette analyzer is the relatively modest engine specifications booklet provided with the instrument. But this information is easy to acquire for any car: in fact, most of the specs you need are on a label somewhere near your radiator or engine.

**Heathkit Ignition Scope.** Most weekend

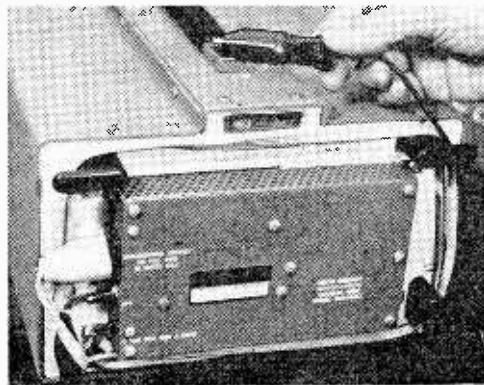

Heathkit ignition Analyzer CO-1015 displays ignition system waveforms on CRT screen. Optional 12-volt inverter (right) fits on back of analyzer.

mechanics can get along very nicely with the types of tune-up instruments already described. But if you ever see an ignition oscilloscope in operation, you are going to want one—for sure. The only problem is that a factory-wired, professional scope costs upward from \$250, a bit too much for most amateur mechanics. But if you can swing a relatively modest outlay of \$129.95, you can have an excellent scope by assembling Heathkit's CO-1015 Solid State Ignition Analyzer. Thanks to the excellent assembly instructions, and provision of a special wiring harness, the kit goes together easily. And when you get through, you have a really spiffy-looking instrument that's almost too nice to take into a greasy garage. The scope is powered by 110-volt AC current, but for an extra \$24.95 you can have an optional power pack (COA-1015-1) that permits operation of the scope off the car battery for road tests; just plug into your car cigar lighter, and you're in business. If you build this scope, you won't throw your other test equipment out of the window: but the scope is the *first* instrument you will reach for when an ignition check is in order.

This solid-state scope, in a housing measuring about 7 x 10 x 17 inches, features a circuit with 24 transistors, 9 diodes and a 5-inch diameter CRT display tube contained in an anti-magnetic shield. A connecting cable, 12 feet long, terminates in four different clamps that can be attached quickly to the car engine. Alligator clips are used for ground and coil primary connections, a T-clamp is for the coil's high-tension lead, and an inductive pickup, very much like the one used with the Heathkit timing light, clamps onto the No. 1 spark plug wire. The scope can be used on 3, 4, 6 or 8 cylinder engines having standard, transistor, or capacitive-discharge ignition systems.

Most of the information is displayed as a waveform on the CRT screen, but there's also a small tachometer having 0-1000 and 0-5000 rpm ranges. You will want to use the larger scale on your more conventional tachometer for accurate rpm measurements, but the scope tach is handy for checking rpm while making other observations or measurements with the scope.

You can select waveforms representing either the primary or secondary circuits of the ignition system. The primary pattern is mainly useful for locating poor electrical connections between the vehicle battery and grounded side of the breaker points. The

secondary pattern is the real workhorse because it provides a wealth of information about what is going on in the engine. You can view the waveform three different ways. In the so-called "parade" pattern the waveforms for all cylinders are shown simultaneously in their normal firing sequence; thus you can instantly compare all cylinders and spot such malfunctions as a mis-firing spark plug—and know which spark plug is at fault. Another way to detect malfunction that is not immediately evident through observation of the parade pattern is to superimpose all cylinder waveforms to create one composite pattern; if one or more cylinders are out of step, you know it immediately. The third method of analysis is to go back to the parade pattern, then use the horizontal expand and position controls to enlarge the pattern of any one cylinder for closer inspection. It is this capability that makes the instrument such a unique diagnostic device. You can easily measure the cam dwell angle using scales on the CRT screen, and by comparing various portions of the overall waveform with reference drawings provided in a comprehensive manual that comes with the instrument you can spot all sorts of ignition troubles.

The chart that accompanies the drawing of a normal waveform for a standard ignition system reveals the remarkable versatility of an engine analyzer scope. The waveform produced by a capacitive—discharge ignition system has a different shape, but it can be used in similar fashion to spot malfunction in the ignition circuitry. After testing our Heathkit scope we could think of only one significant improvement that you can easily add. If you use the scope in an unusually bright area, you will be able to see the scope pattern more easily if you construct a viewing tube—from wood, metal or cardboard—that you can place between the scope screen and your eyes. This is a minor problem because the trace is plenty bright enough to be easily visible under most observation conditions. And one more advisory comment. If you buy the optional power pack and use the scope for road tests, be *sure* to place the instrument where the driver cannot possibly see the screen; the CRT display is so fascinating to observe that the most well-intentioned driver won't be able to resist frequent glances. And that could lead to an accident and more serious and costly repairs than just touching up the ignition system. ■

# FOREIGN TUBE REPLACEMENT GUIDE

Anyone who's gone past the tuning knob of a foreign-built shortwave receiver has discovered an unexpected twist or three—unorthodox-looking capacitors, metal-film resistors, possibly some outstanding point-to-point wiring. Another distinguishing feature of foreign electronic gear is tube designations, which often bear no resemblance whatever to those current in American circles. The following listing equates foreign tube types with their closest American equivalent. Though slight differences exist in some cases, in general any tube of a pair is directly interchangeable with its mate.

1C1	1R5	CV578	6A8	CV1938	6K6GT	DL91	1S4	KT32	25L6GT
1F3	1T4	CV580	6A8	CV1941	6K7	DL92	3S4	KT63	6F6G
1FD9	1S5	CV581	6C5	CV1943	6K7	DL94	3V4	KT66	6L6GC
1P10	3S4	CV585	6C6	CV1944	6K8	DL95	3Q4	KT71	50L6GT
1P11	3V4	CV587	6Q7G	CV1946	6K8	DM70	1M3	KTW63	6K7
5B250A	807	CV589	6Q7	CV1947	6L6GC	DP61	6AK5	KTW74M	12K7GT
6BK8	6267	CV591	6S17	CV1950	6L7	DY86	1S2	KTZ63	6K7
6C16	6BL8	CV614	75	CV1956	6N7GT	DY87	1S2A	L63	6J5GT
6D2	6AL5	CV617	80	CV1958	6N7GT	E2157	12A77	L77	6C4
6F22	6267	CV686	0C3	CV1959	50C5	E2163	12AU7A	LZ319	9A8
6F29	6EH7	CV692	0Z4	CV1961	12AU6	E2164	12AX7A	LZ329	9A8
6F30	6EJ7	CV697	12SJ7	CV1969	6SC7	EB34	6H6	M8212	5726
6FD12	6DC8	CV717	5R4GYB	CV1970	6SC7	EB91	6AL5	N16	3Q5GT
6G5G	6U5G	CV728	5V4GA	CV1978	6S67	EB90	6AT6	N17	3S4
6H5	6U5G	CV753	1A3	CV1981	6SK7	EB91	6AV6	N18	3Q4
6L12	6AQ8	CV755	1A5GT	CV1985	6SL7GT	EBF89	6DC8	N19	3V4
6L13	12AX7	CV756	1A5GT	CV1988	6SN7GTB	EC90	6C4	N148	7C5
6M1	6U5G	CV782	1R5	CV1990	6SQ7	EC97	6FY5	N379	15CW5
6P15	6BQ5	CV783	1S4	CV2129	5763	ECC32	6SN7GTB	N709	6BQ5
6PL12	6BM8	CV784	1S5	CV2500	3524GT	ECC81	12A77	N727	6AQ5A
12D77	12AX7	CV785	1T4	CV2514	43	ECC82	12AU7A	OM10	6K8
13D2	6SN7GT	CV797	2D21	CV2524	6AU6A	ECC83	12AX7A	PCF80	9A8
30C1	9A8	CV818	3Q4	CV2526	6AV6	ECC85	6AQ8	PCF82	9U8A
30P18	15CW5	CV819	3Q5GT	CV2747	6U5	ECC88	6DJ8	PCF801	8GJ7
30PL12	16A8	CV820	3S4	CV2901	6267	ECC91	6J6A	PCL82	16A8
63ME	6U5G	CV850	6AK5	CV2975	6BQ5	ECC189	6E88	PCL84	15DQ8
150C2	0A2	CV858	6J6A	CV2984	6080	ECC230	6080	PCL84	15CW5
150C3	0D3	CV877	7A7	CV3523	6146A	ECF80	6BL8	PL500	27GB5
B36	12SN7GTA	CV885	7C5	CV3908	6BH6	ECF82	6UB8	PM04	6BA6
B65	6SN7GTB	CV887	7C6	CV3909	6BJ6	ECF86	6HG8	PM05	6AK5
B152	12A77	CV901	7Y4	CV3912	1U5	ECH35	6K8	QV03-12	5763
B309	12A77	CV918	12K7GT	CV3998	6E88	ECL82	6BM8	QV05-25	807
B329	12AU7A	CV924	12SL7GT	CV4007	5726	ECL85	6V8	QV06-20	6146
B339	12AX7A	CV925	12SN7GTA	CV4009	5749	ECL86	6W8	R52	524
B719	6AQ8	CV1186	6F6G	CV4012	5750	EF86	6267	STV150/30	0A2
BPM04	6AQ5A	CV1287	25L6GT	CV5041	6CL6	EF93	6BA6	5U1	5Y3GT
CV124	807	CV1347	6K8	CV5042	12BH7A	EF94	6AU6A	U52	5U4G
CV133	6C4	CV1377	5AR4	CV5072	6CA4	EF95	6AK5	U70	6X5GT
CV140	6AL5	CV1633	3V4	CV5073	6AM4	EF183	6EH7	U74	3524GT
CV283	6AL5	CV1741	6CA7	CV5074	6AF4A	EF184	6EJ7	U76	3524GT
CV452	6AT6	CV1800	1A7GT	CV5215	6BL8	EH90	6C56	U78	6X4
CV453	6BE6	CV1802	1A7GT	CV5307	807	EK90	6BE6	U147	6X5GT
CV454	6BA6	CV1818	1H5GT	CV5331	6E88	EL34	6CA7	U709	6CA4
CV455	12A77	CV1820	1H5GT	CV5358	6DJ8	EL84	6BQ5	UU12	6CA4
CV491	12AU7A	CV1823	1N5GT	CV5365	6BQ7A	EL90	6AQ5A	VFT6	6U5
CV492	12AX7A	CV1831	2A3	CV5434	6F6G	EM84	6F6G	W17	1T4
CV493	6X4	CV1832	0A2	CV5810	6EJ7	EN91	2D21	W63	6K7
CV504	6U5	CV1833	0B2	CV5831	6EH7	EZ35	6X5GT	W76	12K7GT
CV509	6V6GTA	CV1856	5Y3GT	D63	6H6	EZ80	6V4	W727	6BA6
CV511	6V6GTA	CV1862	6AQ5A	D77	6AL5	EZ81	6CA4	X14	1A7GT
CV522	7B7	CV1863	5Z4	D152	6AL5	EZ90	6X4	X17	1R5
CV525	12A6	CV1870	6A7	DAC32	1H5GT	GZ30	5Z4	X61M	6K8
CV543	12SK7	CV1893	6B8	DAF91	1S5	GZ31	5U4G	X63	6A8
CV544	12SK7GT	CV1900	6D6	DD6	6AL5	GZ34	5AR4	X65	6K8
CV546	12SQ7	CV1906	6E5	DF33	1N5GT	HBC90	12A76	X77	6BE6
CV547	12SQ7GT	CV1911	6F6G	DF91	1T4	HBC91	12AV6	X147	6K8
CV553	25L6GT	CV1928	12BA6	DH63	6Q7	HD14	1H5GT	X727	6BE6
CV562	35L6GT	CV1929	6H6	DH77	6AT6	HF93	12BA6	Y61	6U5
CV564	35Z3	CV1931	6H6	DH118	14L7	HF94	12AU6	Y63	6U5
CV571	50L6GT	CV1932	6J5GT	DH149	7C6	HK90	12BE6	Z14	1N5GT
CV572	6X5GT	CV1934	6J5GT	DK32	1A7GT	HL92	50C5	Z63	6J7
CV574	6X5GT	CV1935	6J7	DK91	1R5	HM04	6BE6	Z729	6267
CV575	5U4G	CV1937	6J7	DL33	3Q5GT	HY90	35W4	ZD17	1S5

# So Watt?\*

How big you succeed in electronics today—bigger pay... better job... personal enjoyment—depends on how far you take the basics!

\* Your reading this page now gives you the head start you need. And we'll match it with a Special Introductory Offer to keep you ahead

It always has been a matter of *knowing the basics*. Of the thousands of opportunities that are open to you in the electronics field today, you can be sure that all depend on *your understanding of basic electronics theory*. New electronic advances are triggered by yesterday's basics... just as tomorrow's amazing breakthroughs will spring from today's fundamentals.

Your taking advantage of the offer shown in the coupon below puts you in a better position to get the rewards electronics gives you today—and will offer you in the years ahead!

## For Beginner or Expert—Elementary Electronics is valuable!

It shows a novice where to begin—an expert where to improve. Each issue features a *Basic Course* in an important area of electronics. Written by experts in an easy-to-follow style, with clear illustrations and diagrams, you get a practical understanding of special circuits... semi-conductors... power supplies... transformers... transistors... pulse circuitry, much more. You'll see general rules of electronics, develop trouble-shooting techniques, know how to calculate changing effects.

You may be earning an income now in electronics and hope to increase it soon. Or you may be an electronics hobbyist looking for new ideas to use at home and for recreation. Either way, for pleasure or profit, you shouldn't be without Elementary Electronics.

**Hi-Fi • CB Radio • Shortwave • New Products • Projects in every issue!**

You'll find a lot more in Elementary Electronics—a fantastic variety of new

and exciting electronic information. More on today's CB activities and Shortwave Listening... expanded coverage on Product Testing from batteries and cells to stereo... new Build-It Projects for home and shop... portable music centers, weekend experiments, new products, bonus construction projects, electronic gadgets for fun and profit.

Try it. Try Elementary Electronics under the no-risk subscription offer shown in the coupon. Just fill in and mail the coupon to Elementary Electronics, P.O. Box 2600, Greenwich, CT 06830. Send in your order TODAY.



## PUBLISHER'S DISCOUNT SAVINGS CERTIFICATE

Good for **\$2.78** off the newsstand price of  
up to **ELEMENTARY ELECTRONICS**

- Enter my trial subscription for 1 year (6 issues) of Elementary Electronics, for only \$2.67. (I save \$1.83 off the newsstand price.)
- I prefer 1½ years (9 issues) for \$3.97 (on the newsstand \$6.75).
- New Subscription       Renewal Subscription

Name \_\_\_\_\_  
(please print or type clearly)

Address \_\_\_\_\_

City \_\_\_\_\_ State \_\_\_\_\_ Zip \_\_\_\_\_

**SEND NO MONEY, WE'LL BILL YOU LATER**

MAIL TO: ELEMENTARY ELECTRONICS  
P.O. Box 2600, Greenwich, CT 06830 85057

# EDU-KIT RADIO

## and Electronics Circuits

Reg. U. S.  
Pat. Off.



Training Electronics Technicians Since 1946

### PROGRESSIVE HOME RADIO-TV COURSE

**Now Includes**

- ★ 12 RECEIVERS
- ★ 3 TRANSMITTERS
- ★ SQ. WAVE GENERATOR
- ★ SIGNAL TRACER
- ★ AMPLIFIER
- ★ SIGNAL INJECTOR
- ★ CODE OSCILLATOR

- ★ No Knowledge of Radio Necessary
- ★ No Additional Parts or Tools Needed
- ★ EXCELLENT BACKGROUND FOR TV
- ★ SCHOOL INQUIRIES INVITED
- ★ Sold In 79 Countries

### YOU DON'T HAVE TO SPEND HUNDREDS OF DOLLARS FOR A RADIO COURSE

The "Edu-Kit" offers you an outstanding PRACTICAL HOME RADIO COURSE at a rock-bottom price. Our Kit is designed to train Radio & Electronics Technicians, making use of the most modern methods of home training. You will learn radio theory, construction practice and servicing. THIS IS A COMPLETE RADIO COURSE IN EVERY DETAIL. You will learn how to build radios, using regular schematics; how to wire and solder in a professional manner; how to service radios. You will work with the standard type of punched metal chassis as well as the latest development of Printed Circuit chassis. You will learn the basic principles of radio. You will construct, study and work with RF and AF amplifiers and oscillators, detectors, rectifiers, test equipment. You will learn and practice code, using the Progressive Code Oscillator. You will learn and practice trouble-shooting, using the Progressive Signal Tracer, Progressive Signal Injector, Progressive Dynamic Radio & Electronics Tester, Square Wave Generator and the accompanying instructional material.

You will receive training for the Novice, Technician and General Classes of F.C.C. Radio Amateur Licenses. You will build Receiver, Transmitter, Square Wave Generator, Code Oscillator, Signal Tracer and Signal Injector circuits, and learn how to operate them. You will receive an excellent background for television, Hi-Fi and Electronics.

Absolutely no previous knowledge of radio or science is required. The "Edu-Kit" is the product of many years of teaching and engineering experience. The "Edu-Kit" will provide you with a basic education in Electronics and Radio, with many times the low price you pay. The Signal Tracer alone is worth more than the price of the kit.

### THE KIT FOR EVERYONE

You do not need the slightest background in radio or science. Whether you are interested in Radio & Electronics because you want an interesting hobby, a well paying business or a job with a future, you will find the "Edu-Kit" worth-while investment.

Many thousands of individuals of all ages and backgrounds have successfully used the "Edu-Kit" in more than 79 countries of the world. The "Edu-Kit" has been carefully designed, step by step, so that you cannot make a mistake. The "Edu-Kit" allows you to teach yourself at your own rate. No instructor is necessary.

### PROGRESSIVE TEACHING METHOD

The Progressive Radio "Edu-Kit" is the foremost educational radio kit in the world, and is universally accepted as the standard in the field of electronics training. The "Edu-Kit" uses the modern educational principle of "Learn by Doing." Therefore you construct, learn schematics, study theory, practice trouble shooting—all in a closely integrated program designed to provide an easily-learned, thorough and interesting background in radio.

You begin by examining the various radio parts of the "Edu-Kit." You then learn the function, theory and wiring of these parts. Then you build a simple radio. With this first set you will enjoy listening to regular broadcast stations, learn theory, practice testing and trouble-shooting. Then you build a more advanced radio, learn more advanced theory and techniques. Gradually, in a progressive manner, and at your own rate, you will find yourself constructing more advanced multi-tube radio circuits, and doing work like a professional Radio Technician.

The "Edu-Kit" course are Receiver, Transmitter, Code Oscillator, Signal Tracer, Square Wave Generator and Signal Injector Circuits. These are not ordinary "breadboard" experiments, but genuine radio circuits, constructed by means of professional wiring and soldering of metal chassis, plus the new method of radio construction known as "Printed Circuitry." These circuits operate on your regular AC or DC house current.

### THE "EDU-KIT" IS COMPLETE

You will receive all parts and instructions necessary to build twenty different radio and electronics circuits, each guaranteed to operate. Our Kits contain tubes, tube sockets, variable, electrolytic, mica, ceramic and paper dielectric condensers, resistors, tie strips, hardware, tubing, punched metal chassis, instruction Manuals, hook-up wire, solder, selenium rectifiers, coils, volume controls and switches, etc.

In addition, you receive Printed Circuit materials, including Printed circuit chassis, special tube sockets, hardware and instructions. You also receive a useful set of tools, a professional electric soldering iron, and a self-powered Dynamic Radio and Electronics Tester. The "Edu-Kit" also includes Code Instructions and the Progressive Code Oscillator, in addition to F.C.C. Radio Amateur License training. You will also receive lessons for servicing with the Progressive Signal Tracer and the progressive Signal Injector. High Fidelity Guide and Quiz Book. You receive Membership in Radio-TV Club, Free Consultation Service, Certificate of Merit and Discount Privileges. You receive all parts, tools, instructions, etc. Everything is yours to keep.

### PRINTED CIRCUITRY

At no increase in price, the "Edu-Kit" now includes Printed Circuitry. You build a Printed Circuit Signal Injector, a unique servicing instrument that can detect many Radio and TV troubles. This revolutionary new technique of radio construction is now becoming popular in commercial radio and TV sets.

A Printed Circuit is a special insulated chassis on which has been deposited a conducting material which takes the place of wiring. The various parts are merely plugged in and soldered to terminals.

Printed Circuitry is the basis of modern Automation Electronics. A knowledge of this subject is a necessity today for anyone interested in Electronics.

### • SET OF TOOLS

- SOLDERING IRON
- ELECTRONICS TESTER
- PLIERS-CUTTERS
- VALUABLE DISCOUNT CARD
- CERTIFICATE OF MERIT
- TESTER INSTRUCTION MANUAL
- HIGH FIDELITY GUIDE • QUIZZES
- TELEVISION BOOK • RADIO TROUBLE-SHOOTING BOOK
- MEMBERSHIP IN RADIO-TV CLUB
- CONSULTATION SERVICE • FCC AMATEUR LICENSE TRAINING
- PRINTED CIRCUITRY

### SERVICING LESSONS

You will learn trouble-shooting and servicing in a progressive manner. You will practice repairs on the sets that you construct. You will learn symptoms and causes of trouble in home, portable and car radios. You will learn how to use the professional Signal Tracer, the unique Signal Injector and the dynamic Radio & Electronics Tester. While you are learning in this practical way, you will be able to do many a repair job for your friends and neighbors, and charge fees which will far exceed the price of the "Edu-Kit." Our Consultation Service will help you with any technical problems you may have.

### FROM OUR MAIL BAG

J. Stataitis, of 25 Poplar Pl., Waterbury, Conn., writes: "I have repaired several sets for my friends, and made money. The "Edu-Kit" paid for itself. I was ready to spend \$240 for a course, but I found your ad and sent for your Kit."

Ben Valerio, P. O. Box 21, Magna, Utah: "The Edu-Kits are wonderful. Here I am sending you my questions and also the answers for them. I have been in radio for the last seven years, but like to work with Radio Kits, and like to build Radio Testing Equipment. I enjoyed every minute I worked with the different kits; the signal Tracer works fine. Also like to let you know that I feel proud of becoming a member of your Radio-TV Club."

Robert L. Shuff, 1534 Monroe Ave., Huntington, W. Va.: "Thought I would drop you a few lines to say that I received my Edu-Kit, and was really amazed that such a bargain can be had at such a low price. I have already started repairing radios and phonographs. My friends were really surprised to see me get into the swing of it so quickly. The Trouble-shooting Tester that comes with the kit really swells, and finds the trouble, if there is any to be found."

Progressive "Edu-Kits" Inc., 1189 Broadway, Dept. 518DK Hewlett, N.Y. 11557

Please rush me free literature describing the Progressive Radio-TV Course with Edu-Kits. No Salesman will call.

NAME.....  
ADDRESS.....  
CITY & STATE..... ZIP.....

### PROGRESSIVE "EDU-KITS" INC.

1189 Broadway, Dept. 518DK Hewlett, N.Y. 11557

CIRCLE #5 ON PAGE 8.