

RADIO TV REPAIR

J S TACK

SPECIAL SECTION ON COLOR TVs

1969 EDITION 75¢

DOLLAR- SAVING IDEAS FOR THE HOME SERVICEMAN

- How to Get the Most from your TV
- What to Do When Color's Gone
- How to Change Any Picture Tube
- Easy AM Tune-Up Techniques
- How to Adjust your Color Set
- Simple Repairs for Portable TVs
- Minor Tape Troubles You Can Handle



Discover the ease and excitement of learning Electronics with programmed equipment NRI sends you

When you train at home with NRI, you train with your hands as well as your head. You learn the WHY of Electronics, Communications, TV-Radio the NRI pioneering "3-Dimensional" way. NRI training is the result of more than half a century of simplifying, organizing, dramatizing subject matter, and providing personal services unique for a home study school. You get the kind of technical training that gives you priceless confidence as you gain experience equal to many, many months of training on the job.



NRI—The 53 Year Leader in Electronics Training

APPROVED UNDER NEW GI BILL

If you served since January 31, 1955, or are in service, check GI line in postage-free card.



*Earn \$5 or more an hour
spare or full time in*

TV-RADIO SERVICING

Color Television has arrived. Sales are soaring, along with the continuing popularity of other home entertainment equipment like portable radios, tape recorders, hi-fi sets, phonographs and auto radios. TV-Radio servicing is one of your best routes to spare-time earnings, a good paying job or a business of your own. NRI not only trains you quickly and expertly, but also shows you how to get started in Servicing soon after you enroll, earning as you learn. NRI trains you in today's methods of installing and repairing all Electronic equipment for the home—including booming Color TV. You even build, experiment with and keep to enjoy your own solid-state radio and your choice of black-and-white or Color TV receiver. Like thousands of others, you can be earning \$5 or more an hour extra in spare time starting soon.

*There's money and
success awaiting you in*

BROADCASTING— COMMUNICATIONS

The experience you gain from intensely practical NRI training in Complete Communications equals as much as two years of training on the job. With NRI, you can train for a choice of careers ranging from mobile, marine and aviation radio to TV broadcasting and space communications. You learn how to install, maintain and operate today's remarkable transmitting and receiving equipment by actually *doing* it. You build and experiment with test equipment, like a VTVM you keep. You build and operate amplifier circuits, transmission line and antenna systems, even build and use a phone-cw transmitter suitable for transmission on the 80-meter amateur band. Whichever of five NRI Communications courses you choose, you prepare for your FCC License exams, and you *must pass your FCC exams or NRI refunds your tuition in full.*

*Move ahead in America's
fast growing industry as*

ELECTRONICS TECHNICIAN

Electronics touches everyone's lives. This vast field of opportunity is open to you with NRI training. Industrial/Military Electronics training—like all NRI courses—prepares you quickly, thoroughly the practical "hands on" way. You build with, and learn to understand the functions of, today's miracle solid-state components like printed circuits, diodes and transistors. You build and experiment with Electronic circuitry used in automation, data processing, ultrasonics, telemetry. Whatever your interest in Electronics, NRI training can fill your needs. Prove to yourself what nearly a million NRI students could tell you . . . that you get more for your money from NRI. Check the postage-free card and mail it today for your FREE NRI Color Catalog. No salesman will call. NATIONAL RADIO INSTITUTE, Electronics Division, Washington, D.C. 20016.

YOU GET MORE FOR YOUR MONEY FROM NRI — Build, test, explore, discover. Everything you see here is included in one NRI course—including Color TV. Other courses equally complete. And you'll be surprised at the low tuition costs. Text for text, kit for kit, dollar for dollar—you get more for your money from NRI.



RADIO TV REPAIR

1969

EDITION

CONTENTS

The Most From Your Black & White TV Set Tuneups to bring you the peak of picture perfection	11
What To Do For Truest Blue The right way to adjust your color set	19
Let's Tackle That Totable TV Fixing a portable is duck soup to those in the know	27
Foreign Tube Replacement Guide All the U.S. equivalents for every foreign type	38
The Thinking Man's Answer To TV Servicing You'll make quick work of dirty work if you'll only plan ahead	39
How To Change A Color TV Tube You can, and you'll be money ahead for your efforts	43
Pardon For The Color Killer Things you should know about your color set's silent sentinel	49
What To Do When Color's Gone Step-by-step procedures for bringing color back	54
Discarded Portable Becomes Test Speaker You convert a junk-box item into a useful test-bench accessory	59
Those Minor Tape Troubles A rogue's gallery of tape-recorder ills and remedies	60
Tuning Up The All-American 5 All you need to know about aligning any 4- or 5-tube set	63
So You Want To Replace A Boob Tube Installing a new picture tube is easier than you think	69
Ninth Life For A Kiddie Phono Delight your child and yourself by fixing that old player	76
When Color Won't Stay Put Zeroing in on lack of color sync	77
Facts & Fantasies In A Phono Front End Highly useful info on needle and cartridge care	83
Soup-up For SW Sets Follow these guidelines, and better DX is a certainty	91
DEPARTMENTS	
Service Shop Tips	8
Classified Market Place	99
Cartoon Page	100

The New 1968 Improved Model 257 **A REVOLUTIONARY NEW**
TUBE TESTING OUTFIT

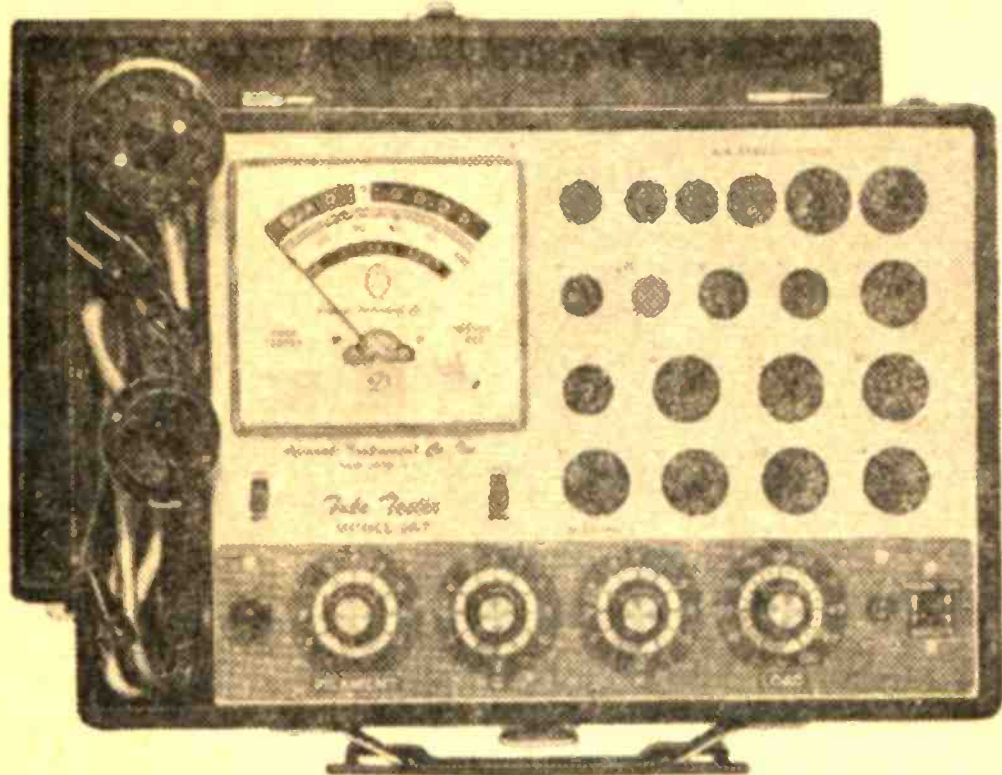

**COMPLETE WITH ALL
 ADAPTERS AND ACCESSORIES,
 NO "EXTRAS"**

STANDARD TUBES:

- ✓ Tests the new Novars, Nuvistors, 10 Pins, Magnovals, Compactrons and Decals.
- ✓ More than 2,500 tube listings.
- ✓ Tests each section of multi-section tubes individually for shorts, leakage and Cathode emission.
- ✓ Ultra sensitive circuit will indicate leakage up to 5 Megohms.
- ✓ Employs new improved 4½" dual scale meter with a unique sealed damping chamber to assure accurate, vibration-less readings.
- ✓ Complete set of tube straighteners mounted on front panel.

- Tests all modern tubes including Novars, Nuvistors, Compactrons and Decals.
- All Picture Tubes, Black and White and Color

ANNOUNCING...for the first time

A complete TV Tube Testing Outfit designed specifically to test all TV tubes, color as well as standard. Don't confuse the Model 257 picture tube accessory components with mass produced "picture tube adapters" designed to work in conjunction with all competitive tube testers. The basic Model 257 circuit was modified to work compatibly with our picture tube accessories and those components are not sold by us to be used with other competitive tube testers or even tube testers previously produced by us. They were custom designed and produced to work specifically in conjunction with the Model 257.

BLACK AND WHITE PICTURE TUBES:

- ✓ Single cable used for testing all Black and White Picture Tubes with deflection angles 50 to 114 degrees.
- ✓ The Model 257 tests all Black and White Picture Tubes for emission, inter-element shorts and leakage.

COLOR PICTURE TUBES:

- ✓ The Red, Green and Blue Color guns are tested individually for cathode emission quality, and each gun is tested separately for shorts or leakage between control grid, cathode and heater. Employment of a newly perfected dual socket cable enables accomplishments of all tests in the shortest possible time.

The Model 257 is housed in a handsome, sturdy, portable case. Comes complete with all adapters and accessories, ready to plug in and use. No "extras" to buy. Only

\$47⁵⁰

NOTICE

We have been producing radio, TV and electronic test equipment since 1935, which means we were making Tube Testers at a time when there were relatively few tubes on the market, 'way before the advent of TV. The model 257 employs every design improvement and every technique we have learned over an uninterrupted production period of 32 years.

Accurate Instrument Co., Inc.

SEND NO MONEY WITH ORDER
PAY POSTMAN NOTHING ON DELIVERY

Try it for 10 days before you buy. If completely satisfied then send \$10.00 and pay the balance at the rate of \$10.00 per month until the total price of \$47.50 (plus P.P., handling and budget charge) is paid. If not completely satisfied, return to us, no explanation necessary.

ACCURATE INSTRUMENT CO., INC.

Dept. 6J3 2435 White Plains Road, Bronx, N. Y. 10467

Please rush me one Model 257. If satisfactory I agree to pay \$10.00 within 10 days and balance at rate of \$10.00 per month until total price of \$47.50 (plus P.P., handling and budget charge) is paid. If not satisfactory, I may return for cancellation of account.

Name _____

Address _____

City _____ Zone _____ State _____

Save Money! Check here and enclose \$47.50 with this coupon and we will pay all shipping charges. You still retain the privilege of returning after 10 day trial for full refund.

The New 1968 Improved Model 257 **A REVOLUTIONARY NEW**
TUBE TESTING OUTFIT

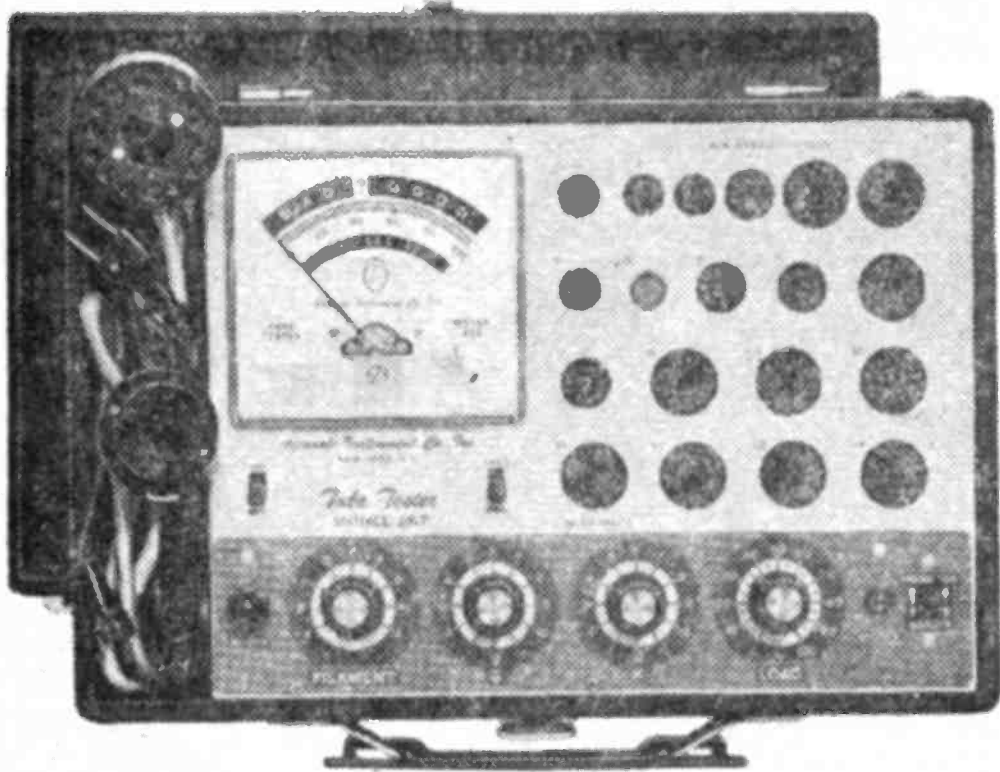

**COMPLETE WITH ALL
 ADAPTERS AND ACCESSORIES,
 NO "EXTRAS"**

STANDARD TUBES:

- ✓ Tests the new Novars, Nuvistors, 10 Pins, Magnovals, Compactrons and Decals.
- ✓ More than 2,500 tube listings.
- ✓ Tests each section of multi-section tubes individually for shorts, leakage and Cathode emission.
- ✓ Ultra sensitive circuit will indicate leakage up to 5 Megohms.
- ✓ Employs new improved 4½" dual scale meter with a unique sealed damping chamber to assure accurate, vibration-less readings.
- ✓ Complete set of tube straighteners mounted on front panel.

- Tests all modern tubes including Novars, Nuvistors, Compactrons and Decals.
- All Picture Tubes, Black and White and Color

ANNOUNCING...for the first time

A complete TV Tube Testing Outfit designed specifically to test all TV tubes, color as well as standard. Don't confuse the Model 257 picture tube accessory components with mass produced "picture tube adapters" designed to work in conjunction with all competitive tube testers. The basic Model 257 circuit was modified to work compatibly with our picture tube accessories and those components are not sold by us to be used with other competitive tube testers or even tube testers previously produced by us. They were custom designed and produced to work specifically in conjunction with the Model 257.

BLACK AND WHITE PICTURE TUBES:

- ✓ Single cable used for testing all Black and White Picture Tubes with deflection angles 50 to 114 degrees.
- ✓ The Model 257 tests all Black and White Picture Tubes for emission, inter-element shorts and leakage.

COLOR PICTURE TUBES:

- ✓ The Red, Green and Blue Color guns are tested individually for cathode emission quality, and each gun is tested separately for shorts or leakage between control grid, cathode and heater. Employment of a newly perfected dual socket cable enables accomplishments of all tests in the shortest possible time.

The Model 257 is housed in a handsome, sturdy, portable case. Comes complete with all adapters and accessories, ready to plug in and use. No "extras" to buy. Only

\$47.50

NOTICE

We have been producing radio, TV and electronic test equipment since 1935, which means we were making Tube Testers at a time when there were relatively few tubes on the market, 'way before the advent of TV. The model 257 employs every design improvement and every technique we have learned over an uninterrupted production period of 32 years.

Accurate Instrument Co., Inc.

SEND NO MONEY WITH ORDER
PAY POSTMAN NOTHING ON DELIVERY

Try it for 10 days before you buy. If completely satisfied then send \$10.00 and pay the balance at the rate of \$10.00 per month until the total price of \$47.50 (plus P.P., handling and budget charge) is paid. If not completely satisfied, return to us, no explanation necessary.

ACCURATE INSTRUMENT CO., INC.
 Dept. 6J3 2435 White Plains Road, Bronx, N. Y. 10467

Please rush me one Model 257. If satisfactory I agree to pay \$10.00 within 10 days and balance at rate of \$10.00 per month until total price of \$47.50 (plus P.P., handling and budget charge) is paid. If not satisfactory, I may return for cancellation of account.

Name _____
 Address _____
 City _____ Zone _____ State _____

Save Money! Check here and enclose \$47.50 with this coupon and we will pay all shipping charges. You still retain the privilege of returning after 10 day trial for full refund.

SHOOT TV TROUBLE FAST

With H. G. Cisin's Copyrighted RAPID "TV TROUBLE SHOOTING METHOD"

Without experience or knowledge, this guaranteed new method of servicing TV sets enables you to DIAGNOSE TV troubles as rapidly as an expert. NO THEORY—NO MATH—you can locate all faults in record-breaking time regardless of make or model. "TV TROUBLE SHOOTING METHOD" is the most valuable aid to TV servicing ever written. Be a TV Trouble Diagnostician. Increase your present earnings. Open your own Profitable Business or get a high-paying skilled job.

It's all in this book . . .

Nothing more to Pay—Nothing else to Buy

Alphabetically listed are 85 picture troubles, over 58 raster and 17 sound troubles. By this unique copyrighted method you know EXACTLY WHERE the trouble is; plus step-by-step instructions, including 69 RAPID CHECKS, help to find faulty part. 13 IMPORTANT PRELIMINARY CHECKS NEED NO INSTRUMENTS! Of the 69 Rapid Checks, OVER 45 ALSO REQUIRE NO INSTRUMENTS! Rapid checks include emergency checks for distorted pictures, defective tubes including PIX tube, plus 57 others ALL EXPLAINED IN SIMPLE LANGUAGE. PERFORMED WITHOUT INSTRUMENTS. MANY CHECKS USE THE PICTURE TUBE AS A GUIDE.

H. G. Cisin, the author, is the inventor of the AC/DC midget radio. He licenses RCA, AT&T, etc. He has also trained thousands of technicians now owning their own prosperous TV service organizations or holding highly paid TV positions. His years of experience are embodied in this remarkable new book.

Guaranteed Money Back in 5 Days if Not Satisfied!

ABSOLUTELY FREE with each order: Your choice of Cisin's newest books: BASIC ELECTRICITY—Vol. 1 or TV-RADIO TUBE SUBSTITUTION GUIDE. These sell for 50c ea. ACT NOW—get 2 books postpaid at cost of only one!

\$1 Post-paid

RUSH COUPON NOW!

H. G. CISIN, Consulting Engineer—Dept. RE-11
Amagansett, N. Y.

Enclosed find \$1. Rush Trouble Shooting Method and free book marked above (If not marked Basic Elec. will be sent).

Send all 3 books. Enclosed find \$1.50

Name

Address

City..... Zone..... State.....

LEARN DRAFTING AT HOME

U.S. Labor Dept. says "42% more Draftsmen needed next 10 years." Send for FREE "DRAFTING CAREER KIT." No salesman will call.

NAME..... AGE.....

ADDRESS.....

CITY..... STATE..... ZIP.....

NORTH AMERICAN SCHOOL OF DRAFTING, Dept. 4472

Accredited National Home Study Council 4500 Campus Drive, Newport, California 92660

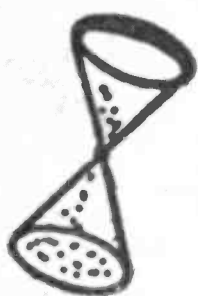

Hours of "How-To" Fun
For Pro & Novice

SPRING/SUMMER 1969
ELECTRONICS HOBBYIST

ON SALE NOW!

Now you can buy the newest, most exciting magazine for those whose interest in electronics is on the hobby level. The ELECTRONICS HOBBYIST contains easy to build, tested and proven construction projects of every description.

FOOLPROOF DESIGN! EASY CONSTRUCTION!

Each construction project has been carefully researched and tested by experts. Each article is complete with theory, construction tips, parts lists, diagrams and photos to make construction easy and foolproof.

For your personal home-delivered copy, send \$1.25 (includes postage and handling) to:

ELECTRONICS HOBBYIST, Dept. RTVR-69
229 Park Ave. S., New York, N. Y. 10003

RADIO TV REPAIR

Editor

RICHARD A. FLANAGAN
KQD2566

Service Editor

CLIFFORD L. FORBES
KBQ8535

Editorial Assistant

HELEN PARKER
KQD7967

Art Editor

JIM MEDLER

Editor-in-Chief

JULIAN M. SIENKIEWICZ
WA2CQL, KMD4313

Art Director

ANTHONY MACCARRONE

Cover Art Director

IRVING BERNSTEIN

Associate Art Director

JOHN YUSKO

Art Associate

JACK GOLDEN

Advertising Director

JIM CAPPELLO

Production Director

CARL BARTEE

Production Assistant

MARILYN VARGAS

Instruments Division Manager

WILFRED M. BROWN

President and Publisher

B. G. DAVIS

Executive Vice-President and Assistant Publisher

JOEL DAVIS

Vice-President and Editorial Director

HERB LEAVY, KMD4529

Vice-President and Production Director

LEONARD F. PINTO

Vice-President and Treasurer

VICTOR C. STABILE, KBP0681

RADIO TV REPAIR is published annually by SCIENCE & MECHANICS PUBLISHING CO., a subsidiary of Davis Publications, Inc. Editorial, business offices: 229 Park Ave. South, New York, N.Y. 10003. Advertising offices: New York: 229 Park Ave. South, 212-673-1300; Chicago: 520 N. Michigan Ave., 312-527-0330; Los Angeles: J.E. Publishers Rep. Co., 8380 Melrose Ave., 213-653-5841; Atlanta: Pirnie & Brown, 3108 Piedmont Rd., N.E., 404-233-6729; Long Island: Len Osten, 9 Garden Street, Great Neck, N.Y. 516-487-3305; Southwestern advertising representative: Jim Wright, 4 N. Eighth St., St. Louis, 314-241-1965

EDITORIAL CONTRIBUTIONS must be accompanied by return postage and will be handled with reasonable care; however, publisher assumes no responsibility for return or safety of manuscripts, art work, or photographs. Contributions should be addressed to the Editor, RADIO TV REPAIR, 229 Park Ave. South, New York, New York 10003.

Copyright 1969 by Science & Mechanics Publishing Co.

RADIO-TV REPAIR

Cast your ballot for a successful future!

266 ICS COURSES



You get the widest choice from ICS—oldest, largest home study school. Check the list. (Also available, programs tailored to your special needs.) You receive individual instruction, plus success-proved facts

and theory you can apply immediately. Mastery of subject is assured. No skimping. You earn your diploma.

Why mark time when you can mark the coupon and get a fast, sure fix on your best course to success.

ACCOUNTING

Accounting (U.S.A.)
Accounting (Canadian)
Accounting for Business Programmers
Accounting for Management Decisions
Auditing
Business Law (U.S.A.)
Cost Accounting
CPA Review (U.S.A.)
General Accounting
Income Tax (U.S.A.)
Industrial Accounting
Junior Accounting
Office Accounting
Practical Accounting
Public Accounting
Small Business Accounting (U.S.A.)
Starting and Managing a Small Bookkeeping Service (U.S.A.)

ARCHITECTURE AND BUILDING

Architectural Drawing and Designing
Architecture
Building Contractor
Building Estimator
Building Inspector
Building Maintenance
Carpenter-Builder
Carpentry and Millwork
Fundamentals of Urban Planning
House Planning and Interior Design
Mason
Painting Contractor
Reading Arch. Blueprints
Review in Architectural Design and Practice
Review of Mechanical Systems in Buildings

ART

Amateur Artist
Commercial Art
Commercial Cartooning
Illustrating with Options:
—Magazine
—Advertising Layout and Illustration
Interior Decorating
Oil Painting for Pleasure
Show Card and Sign Production
Show Card Writing
Sign Painting and Design's
Sketching and Painting

AUTOMOTIVE

Automatic Transmission Specialist
Automobile Body Rebuilding & Refinishing
Automobile Elec. Tech'n
Automobile Engine Tune-Up
Automobile Mechanic
Automobile Technician
Diesel-Gas Motor Vehicle Engines

BUSINESS

Advertising
Business Administration
Business Practice (Cond.)
Canadian Business Course
Condensed Marketing
Direct Mail and Mail Order Advertising
Industrial Psychology
Inventory Control
Mag. & News'p'r Adv.
Managing a Retail Business
Managing a Small Store
Marketing Management
Marketing Research
Modern Executive Mgmt.
Office Automation
Office Management
Production Management
Purchasing Agent
Retail & Local Advertising
Retail Bus. Management
Retail Merchandising
Retail Selling
Systems and Procedures Analysis

BUSINESS: SALES

Creative Salesmanship
Real Estate Salesmanship
Salesmanship
Sales Management

BUSINESS: SUPERVISION

Basic Supervision
Industrial Foremanship
Industrial Supervision Management,
Salesmanship and Sales
Modern Woman as a Supervisor
Personality Development
Personnel-Labor Relations (U.S.A.)
Supervision

CHEMICAL

Chemical Engineering
Analytical Chemistry
Chemical Engineering Unit Operations

Chemical Laboratory Tech'n
Chemical Process Operator
Elements of Nuclear Energy
General Chemistry
Instrumental Laboratory Analysis

CIVIL ENGINEERING

Civil Engineering
Construction Eng'r'g Tech.
Highway Engineering Tech.
Principles of Surveying
Reading Highway Bl'pts
Reading Structural Bl'pts
Sanitary Engineering Tech.
Sewage Plant Operator
Structural Eng'r'g Tech.
Surveying and Mapping
Water Works Operator

COLLEGE COURSES

American History
Calculus Economics

COMPUTERS

COBOL Programming
Fortran Programming for Engineers
Programming for Digital Computers
Programming the IBM 1401 Computer
Programming the IBM System/360 Computer, Introduction

DRAFTING

Aircraft Drafting
Architectural Drafting
Design Drafting
Drafting Technology
Drafting Technology
Electrical Eng'r'g Drafting
Electronic Drafting
Introductory Mech. Drafting
Mechanical Drafting
Pressure-Vessel and Tank
Print Reading
Sheet Metal Layout for Air Conditioning
Structural Drafting

ELECTRICAL

Electrical Engineering—Electronics Option
—Power Option
Electrical Appliance Serv'g
Electrical Appliance Serv'g with Equipment Training
Electrical Contractor
Electrical Eng'r'g Tech.
Electrical Home Maint.

Electrical Home Maint. with Equipment Training
Electrical Instrument Tech.
Electric Motor Repairman
Industrial Electrical Tech.
Power-Line Design & Const.
Power Plant Operator—Hydro Option
—Steam Option
Practical Electrician
Practical Electrician with Equipment Training
Practical Lineman
Reading Electrical Bl'pts

ENGINEERING (Refresher Courses for Graduate Engineers)

Chemical Civil Electrical Industrial Mechanical Sanitary Structural

ENGLISH AND BETTER WRITING

Better Business Writing
English for Spanish (U.S.A.)
Free Lance Writing for Fun and Profit
Introductory Tech. Writing
Modern Letter Writing
Practical English
Short Story Writing

HIGH SCHOOL

High School Business
High School (Canadian)
High School General
High School Mathematics
High School Secretarial
High School Vocational
High School College Preparatory—Arts
High School College Prep.—Eng'r'g and Science
Preparatory Course for High School Equiv. Test

MACHINE SHOP PRACTICE

Drill Operator
Foundry Practice
Industrial Metallurgy
Lathe Operator
Machine Shop Inspection
Machine Shop Practice
Metallurgical Eng'r'g Tech.
Milling Machine Operator
Multicraft Maint. Mech.
Practical Millwrighting
Reading Shop Prints
Rigging
Tool Engineering Tech.
Tool Grinder Tool Making

Turret Lathe Operator
Welding Engineering Tech.
Welding Process

MATHEMATICS

Advanced Mathematics
Math and Mechanics for Engineering Technicians
Math and Physics for Engineering Technicians

MECHANICAL

Mechanical Engineering
Aircraft and Power Plant Mechanic
Hydraulic & Pneu. Power
Industrial Engineering
Industrial Eng'r'g Tech.
Industrial Instrumentation
Machine Design
Quality Control
Safety Engineering Tech.
Tool Design
Vibration Analysis and Control

PETROLEUM

Natural Gas Production and Transmission
Oil Field Technology
Petroleum Production
Petroleum Production Engineering Technology
Petroleum Refinery Oper.
Pipeline Engineering Tech.

PLASTICS

Design of Plastic Products
Plastics Technician

PLUMBING, HEATING AND AIR CONDITIONING

Air Conditioning
Air Conditioning Maint.
Domestic Heating with Gas and Oil
Domestic Refrigeration
Heating
Heating & Air Conditioning with Drawing
Industrial Air Conditioning
Industrial Heating
Pipe Fitting Plumbing
Plumbing and Heating
Plumbing & Heating Est.
Practical Plumbing
Refrigeration
Refrigeration and Air Conditioning

PULP AND PAPER

Paper Machine Operator
Paper Making Pulp Mak'g
Pulp & Paper Eng'r'g Tech.

SECRETARIAL

Clerk-Typist Commercial Secretary, Engineering Secretary, Legal Secretary, Medical Secretary, Professional Shorthand Stenographic Typewriting

STEAM AND DIESEL POWER

Boiler Inspector
Industrial Building Eng'r
Power Plant Engineering
Stationary Diesel Engines
Stationary Fireman
Stationary Steam Eng'r'g

TEXTILES

Carding
Carding and Spinning
Dyeing and Finishing
Loom Fixing Spinning
Textile Designing
Textile Mill Supervision
Textile Technology
Warping and Weaving

TRAFFIC

Motor Traffic Management
Railway Rate Clerk
Traffic Management

TV-RADIO-ELECTRONICS

Color Television Principles and Servicing
Electronics Instrumentation and Servo Fundamentals
Electronics Technician
First Class Radio-telephone License
Fundamentals of Electronic Computers
General Electronics
General Electronics with Equipment Training
HI-FI Stereo and Sound System Servicing
Industrial Electronics Tech.
Numerical Control
Industrial Heating
Practical Telephony
Principles of Semiconductor
Radio & TV Servicing
Radio & TV Servicing with Equipment Training
Second Class Radio-telephone License
Sound Systems Specialist
TV Servicing and Repair
Telephony, Electronics, & Radio Communications

Clip coupon here . . . take your first step to real success!

ICS, Scranton, Penna. 18515

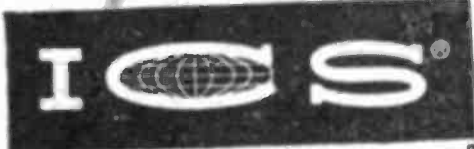

Approved for veterans under the G.I. Bill.
Accredited member, National Home Study Council.
Convenient payment plan.
Special Canadian courses in French and English.
Special rates to members of the U.S. Armed Forces.

INTERNATIONAL CORRESPONDENCE SCHOOLS Dept. N2484B, Scranton, Penna. 18515
(In Hawaii: P.O. Box 418, Honolulu. Canadian residents mail to Scranton address—further service handled by ICS Canadian Ltd.)

I'm interested in a program of independent study. Send me your free 3-booklet Success Kit:
(1) "How to Succeed," 30 pages of valuable job tips,
(2) Sample self-instruction text, (3) Catalog for subject indicated.

(Print name of course. See list.)

Miss _____ Age _____
Mrs. _____
Mr. _____
Address _____ State _____ Zip Code _____
City _____
Occupation _____ Employed by _____ Working Hours _____ A.M. to _____ P.M.

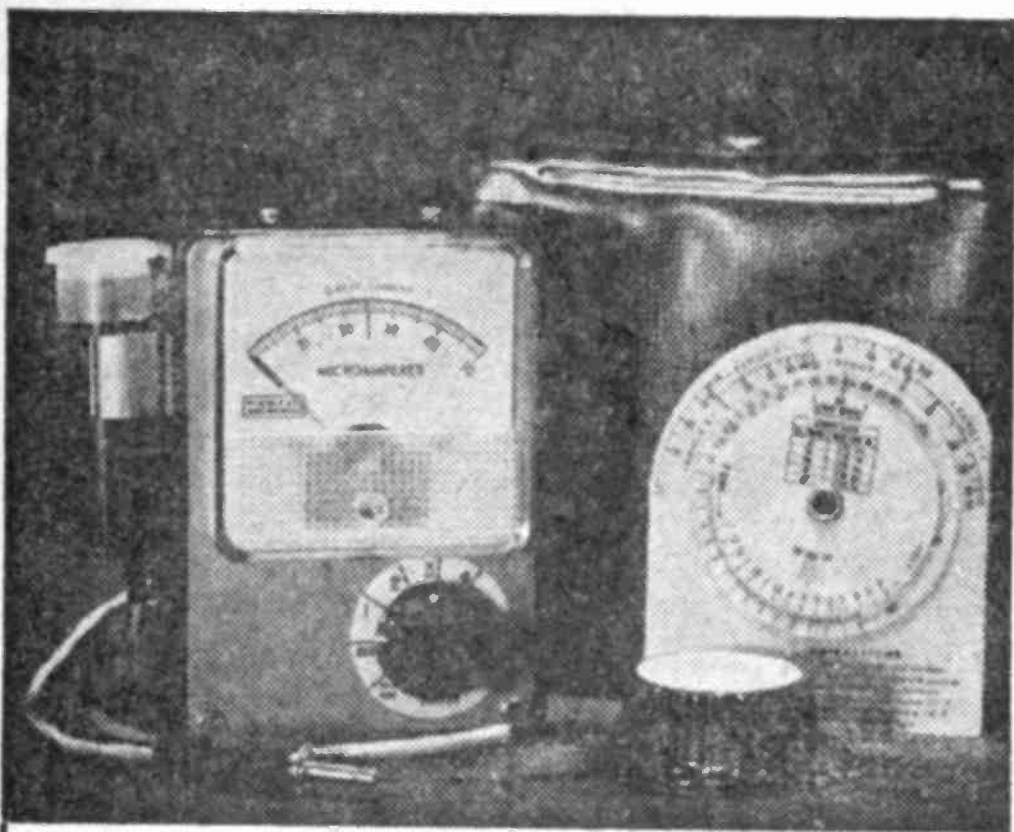

NOW, BETTER THAN EVER the new and improved S&M supersensitive photo meter

Here is a precision instrument that meets the highest standards of any meter available. It offers consistently accurate readings at very low light levels, which, if required, can be converted to ft.-candles from a graph supplied. Researchers, scientists, educators and hobbyists have confirmed that this meter can read light levels as low as 0.000245 ft.-candles.

The S&M Supersensitive Photo Meter uses the newest Clairex Corp. CL-505L Cadmium Sulfide Light Cell to measure light levels from twilight to bright sunlight at ASA speeds of 3 to 25,000. A new 5/8" high easel type probe and also a miniature probe are now available as accessories. The Computer included gives F stops from .7 to 90; lists exposure time from 1/15,000 sec. to 8 hrs.; 4 range selection; EV-EVS-LV settings; weighs only 10 ounces.

Used extensively in Photo Labs, Physics and Research Labs, Hospitals, High Schools, Universities and numerous industries. Also used with movie or still cameras, microscopes and telescopes and IS A MUST FOR PHOTOMICROGRAPHY.

FREE BOOKLET included on Photomicrography

SCIENCE & MECHANICS—INSTRUMENTS DIV. RTV-2/3
229 Park Ave., S., New York, N.Y. 10003

Enclosed is \$_____ Please send me the new S&M Supersensitive Photo Meter. If I am not satisfied, I may return the meter within 10 days for a complete refund.

(Prices subject to change without notice)

Model 102 Photo Meter

- | | |
|--|---|
| <input type="checkbox"/> \$36.95 with standard probe + carrying case | <input type="checkbox"/> Add'l. Standard Probe \$7.50 |
| <input type="checkbox"/> Microscope Adapter \$5.00 | <input type="checkbox"/> \$2.00 carrying case |
| <input type="checkbox"/> Add'l. Computer \$2.00 | <input type="checkbox"/> 3/8"-mini Probe \$7.50 |
| | <input type="checkbox"/> Easel Probe \$7.50 |

Add 10% for Canadian and foreign order. New York City residents add 5% sales tax. (No Stamps)

Name _____ (please print)

Address _____

City _____ State _____ Zip _____

Service shop tips

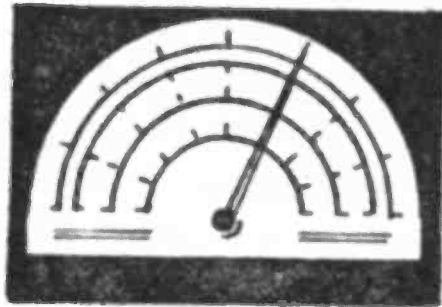

Whip and Peak

I have an antenna hook-up for BCB DX as shown. Antenna A is a whip; antenna B is homebrew. Whenever I connect these antennas, selectivity is decreased, but volume is increased. How can I improve selectivity without using a bandspread in the receiver?

—L. C., Auburndale, Mass.

Connect point X to ground. Add a 455-kHz

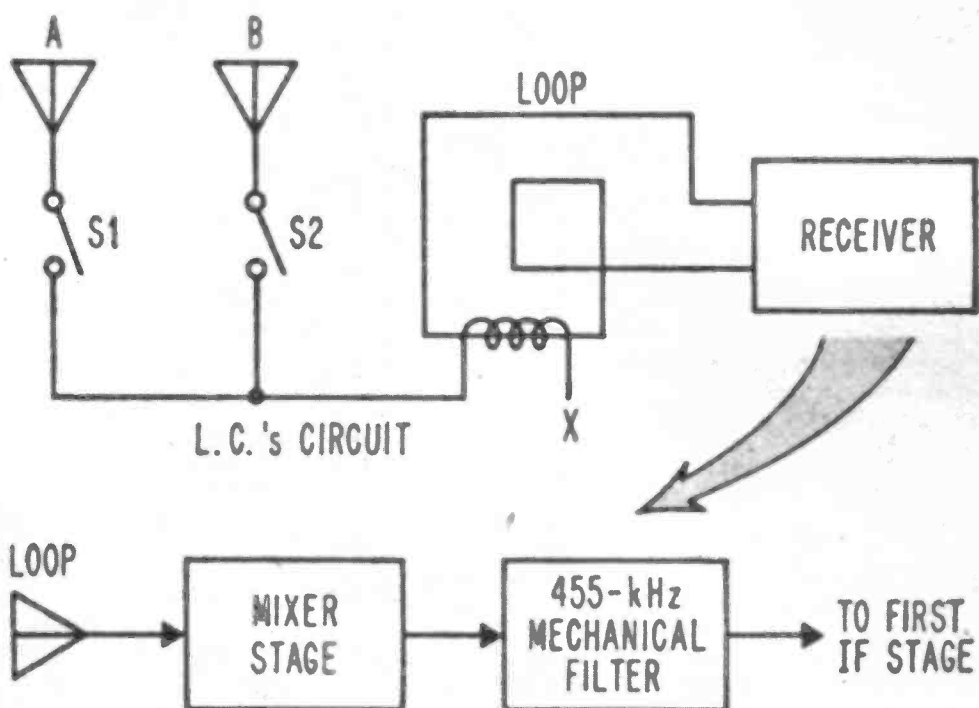

mechanical filter ahead of the IF stage as shown in the block diagram. Wiring instructions should come with the filter. You can probably get one from Lafayette Radio, 111 Jericho Tpke., Syosset, N.Y. 11791. But don't expect too much from such a patchwork setup.

Teutonic Efficiency

How can I improve the selectivity and sensitivity of my Grundig 2440U AM/FM, short-wave receiver? The AM and shortwave IF is 460 kHz and available selectivity filters are for 455 kHz.

—R. B., Cincinnati, Ohio

Your schematic reveals that your six-tube receiver has two RF stages and one IF stage and that one of the tubes is a tuning indicator. It looks like you have a cleverly designed receiver, but don't expect super-pro performance on shortwave with so few tubes. You can add a

455-kHz IF filter at the output of the mixer if you return the IF transformers from 460 kHz to 455 kHz, but dial calibrations would then be off.

AC-Line Filtering

I need circuits for power line filters to cut out noise caused by neighbors' vacuum cleaners, etc. I get the noise on AC radios but not on transistor portables at the same locations.

—C. L. D., Homestead, Fla.

A noise filter circuit is shown in the diagram. The chokes can consist of bell wire wound for two or three inches on a half-inch diameter form. I have the same problem in my steel-

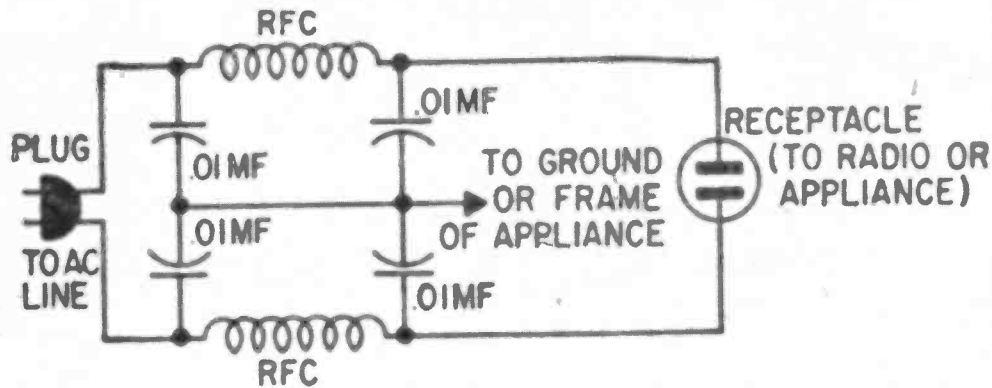

framed New York City apartment where radio signal pickup is poor and noise level is high. My transistor radios don't pick up the noise. You might try a Viking (830 Monroe Street, Hoboken, N. J.) Model 958 line filter (\$12) designed for CATV system use, connected between a radio and an AC outlet. It is supposed to provide 60 dB of attenuation. Radio noise is best suppressed at the source.

Ham and Beacon

I recently bought a portable AM/FM/SW receiver of fairly good quality. On AM and SW every station is heterodyned by a CW beacon. I assume the beacon is operating around 455 kHz since it is received across the dial. Is there a simple remedy such as the addition of another tuned circuit in the loop antenna? I don't have any test equipment and only limited parts from other radios.

—Pfc. Salerno, Vietnam

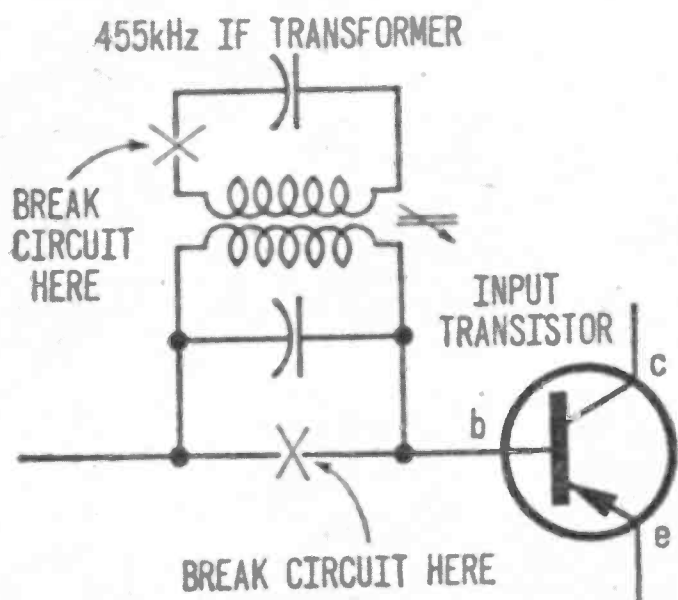

It is possible that the interfering station is very close to you and is overloading the receiver's front end. You might try connecting a

(Continued on page 98)

DAVIS PUBLICATIONS, INC. RTV 2/3
229 Park Ave. S./New York, N.Y. 10003

Yes! I want to find the key to electronics.

■ Begin my subscription to both **RADIO-TV EXPERIMENTER** and **ELEMENTARY ELECTRONICS** at your special low-subscription rate of **\$7.00**

Bill me later. Check enclosed.

Name

Address

City State..... Zip.....

(Outside U.S.A. & Canada add \$1.50 pstge. & hndlg.)

Can't find the key to electronics?

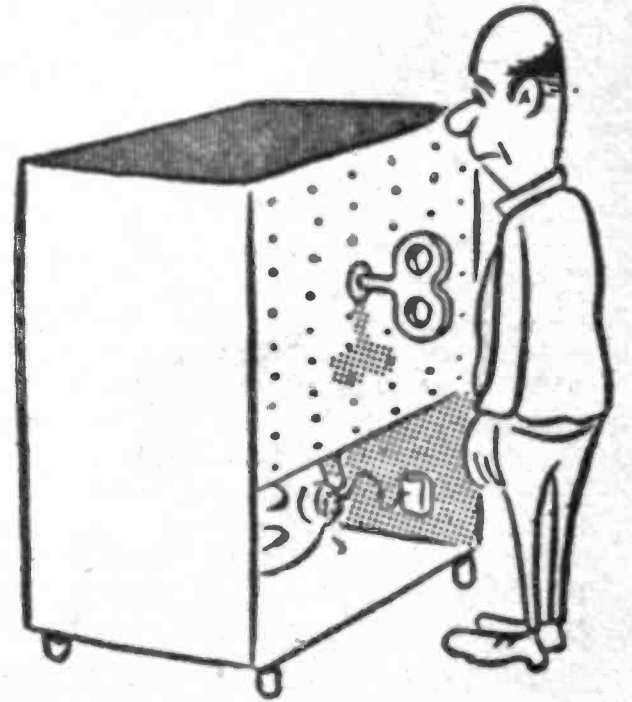

—then get your electronics cool with this introductory offer to the two leading electronics magazines! Use coupon at top.

—Now, both of these fine magazines will be delivered to you at the special subscription rate of just \$7.00 . . . save \$2 from newsstand price.



ELEMENTARY ELECTRONICS

The magazine that serves up electronics theory in pleasant spoonfuls and reinforces the knowledge you gain with exciting and useful projects.

RADIO-TV EXPERIMENTER

The magazine dedicated to the hobbyist—the man who wants to obtain a fuller and broader knowledge of electronics through the applications of his hobby



Yours FREE

this valuable guide to
MONEY-MAKING OPPORTUNITIES
with your NO RISK TRIAL
subscription to the new
INCOME OPPORTUNITIES
Newsletter

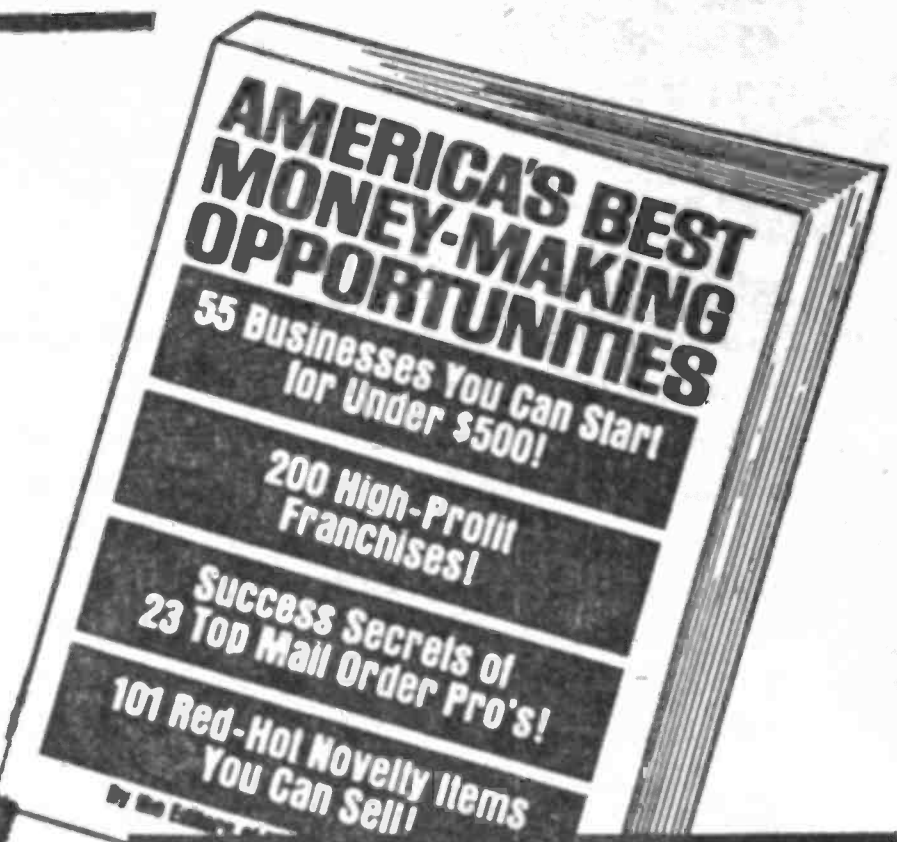

**NOT FOR SALE at any price...
but you can get a copy FREE
by returning the coupon below.**

HUNDREDS OF IDEAS that can mean big money for you assembled by INCOME OPPORTUNITIES staff in a special report can be yours FREE when you mail the coupon below accepting a NO RISK Charter subscription to the new INCOME OPPORTUNITIES Newsletter—the new confidential reporting service that brings you exclusive reports of new business breakthroughs FAR IN ADVANCE of any other source.

YOUR FREE SUCCESS GUIDE contains these powerful profit-makers:

- Success secrets of millionaire mail order professionals!
- 200 high-income, low investment opportunities!
- 55 Businesses you can start right now for under \$500 investment!
- 101 Red-hot novelty items you can sell for phenomenal commissions!

EACH MONTH this exclusive confidential newsletter reporting service will bring you exclusive advance news of opportunities in every area... always with the names and addresses of the sources so that you can take full advantage of money making opportunities and can go into action immediately long before anyone else has even heard of them.

OUR NATIONWIDE STAFF of reporters and the editors of INCOME OPPORTUNITIES, the world's leading magazine in this field, are in constant touch with EXCLUSIVE sources of inside information about unusual opportunities of increasing your income... and this information is rushed to subscribers in fast-reading newsletter format... together with special in-depth reports of information you can get nowhere else.

YOU TAKE NO RISK WHEN YOU SUBSCRIBE SINCE YOU MUST BE 100% SATISFIED

To get your FREE exclusive report on AMERICA'S BEST MONEY-MAKING OPPORTUNITIES, all you need do is mail the post card facing this ad or the coupon below to enter your NO RISK trial subscription to the new INCOME OPPORTUNITIES Newsletter. The cost is less than 5¢ a day... and a single idea you get from it can be worth many times the cost of a year's subscription.

THESE SPECIAL REPORTS are included with your subscription as an EXTRA VALUABLE BONUS

22 MAIL ORDER FIRMS THAT WILL PUT YOU IN BUSINESS!

Top-notch, reputable firms... each with a profit-producing mail order program. Choose your own hours... work full- or part-time.

33 SELECT FRANCHISES FOR UNDER \$5,000!

Choice franchises selected to return maximum profit for an investment within your means. Restaurants, automotive, stores, and many, many more!

25 HOME-BASED, SPARE-TIME MONEYMAKERS

For anyone who would want additional income—laminating specialty mail order, secretarial services. Full details on how to get customers and how to price your product for profit!

DIRECT SELLING DIRECTORY!

Leaders in the direct selling field—Saladmaster, Tupperware, Stanley, and many others help put you on the path to financial independence selling nationally known products... and earning commissions of up to \$1,000 monthly!

20 FASTEST GROWING RETAIL BUSINESSES!

Survey and report of independent businesses which are currently booming—coin-op car wash, beauty/wig salons, poodle grooming parlors... economic indicators to help you make the wisest choice for a profitable business!

AND REMEMBER... THIS SUCCESS GUIDE IS NOT FOR SALE, anywhere else, AT ANY PRICE!

TO GET YOUR FREE report on AMERICA'S BEST MONEY-MAKING OPPORTUNITIES, mail the coupon below to enter a NO RISK Charter subscription to the new INCOME OPPORTUNITIES Newsletter—the confidential report that brings you exclusive advance news of money-making opportunities month after month.

HUNDREDS OF EXCLUSIVE IDEAS YOU CAN USE TO MAKE MORE MONEY

THE REASON we want to send you this valuable report on AMERICA'S BEST MONEY-MAKING OPPORTUNITIES as a FREE gift with your NO RISK subscription to INCOME OPPORTUNITIES Newsletter is we know that once you become a reader you will never want to be without it.

22 MONEY-MAKING HOBBIES!

Hobbies are not only for fun, but can be profitable as well! Here's how to turn your coin/stamp collecting, your tropical fish or even your own art and craft items into a substantial secondary source of income!

HERE'S THE EXCLUSIVE VALUABLE INFORMATION

You'll find in your FREE copy of AMERICA'S BEST MONEY-MAKING OPPORTUNITIES:

55 BUSINESSES YOU CAN START FOR UNDER \$500!

Proven profit makers which offer independence and financial security... many can be started on a part time basis... with addresses for obtaining detailed information.

200 HIGH-PROFIT FRANCHISES!

Selected franchise profit-making opportunities with initial investment of under \$5,000... covers all major areas such as: services... products... schools... sports and recreation... stores... vending machines... cosmetics... health aids and much more.

SUCCESS SECRETS OF 23 TOP MAIL ORDER PROS

The inside success stories behind the big mail order money makers... and full details you can use to get into the big mail order field.

101 RED HOT NOVELTIES FOR SALESMEN

How to get your share of the multi-billion dollar advertising specialties industry which offers unlimited opportunities to salesman.

SEND NO MONEY NOW to get your FREE Money-Making Opportunities Report.

Enter my Charter NO-RISK subscription to the new INCOME OPPORTUNITIES Newsletter including 6 special reports listed above and send me FREE the exclusive report: AMERICA'S BEST MONEY-MAKING OPPORTUNITIES. The cost is \$1.50 per month payable annually or semi-annually.

Bill me Annual Basis Semi-Annual Basis

I understand I may cancel my subscription at any time and will receive a FULL REFUND with no questions asked for all issues still due me at that time. The cost of my subscription is TAX DEDUCTIBLE as a business expense.

NAME _____

(Please PRINT — It prevents errors)

STREET ADDRESS _____

CITY _____

STATE _____

ZIP CODE _____

CHECK HERE TO GET AN EXTRA MONTHS' SERVICE FREE.

Enclose your payment of \$18.00 now and save us bookkeeping costs and we'll add an extra month to your subscription. SAME NO RISK GUARANTEE. You may cancel your subscription at any time for a FULL PROMPT REFUND for all undelivered issues.

Mail to:

INCOME OPPORTUNITIES Newsletter
229 Park Avenue South, New York, N.Y. 10003

RTV-69



THE MOST

**RADIO
TV
REPAIR**

**FROM
YOUR**

**BLACK
AND**

WHITE

TV

By H. B. Morris

■ You can bet an old fuse that TV sets have controls for mighty good reasons. Knobs in front let you scrimmage with the image until it agrees with your idea of a good picture. Further back are non-operating controls that need occasional touch-up. They'll shore up sagging tubes or aging components that can warp and shrink the picture.

Adjust controls and you'll delay the day the set needs tube replacement, maybe chassis repair. Best of all, controls keep the picture a pleasure to view, even on old sets. Why see fuzzy cowpokes wearing 40-gallon hats ride off into the black margin of a setting picture tube? Grip the pots, twist the tabs, and you'll be in Marlboro country!

You may argue that adjusting front controls is a matter of personal taste. True, but let's consider tricks that might improve your dialing technique—and reception. For though the main channel selector is nearly foolproof, other controls aren't so precise. Here's why.

Fine-Tuning. Anyone knows this one is turned for best picture and sound. Trouble is that best settings for sound and picture often don't agree, especially in weaker signal areas. Fine tuning must be a compromise. And the quickest way to find the best point is hunting for what's affectionately called "worms in the picture." Play around with the fine tuning control and you'll see that

turning it in one direction causes the picture to slowly fade. But turn it in the opposite direction and the screen should break into a mass of wriggles. Best adjustment of fine-tuning occurs if you back off *slightly* until the worms *just* disappear.

The slithery pattern is actually the sound carrier spilling into the picture. Use the tuning technique just described, and you can perfectly balance sound and picture as intended by the circuit designer. This method lets you capture good picture detail in the shortest possible time.

Vertical Hold. If the picture's not rolling, you say, that's proof the vertical hold control is properly adjusted (see Fig. 1). Sorry about that. Even if Flipper seems as stable as a snoozing Moby Dick, the control may not be perfectly adjusted. Thing is, TV pictures operate on *interlaced scanning*. It means the picture beam swings down and illuminates the screen on every other line (1, 3, 5, etc.). Then it repeats the scan for the missing (2, 4, 6) lines. This is a crafty trick to reduce flicker in the picture. But to do the job well, the set's vertical oscillator must perfectly lock to the station's sync signals. And that's where tuning technique can make or break it.

If you adjust the control carelessly the picture may stand still—but the sync signal may have to work hard to keep it there. The result could be "jitter" or "pairing."

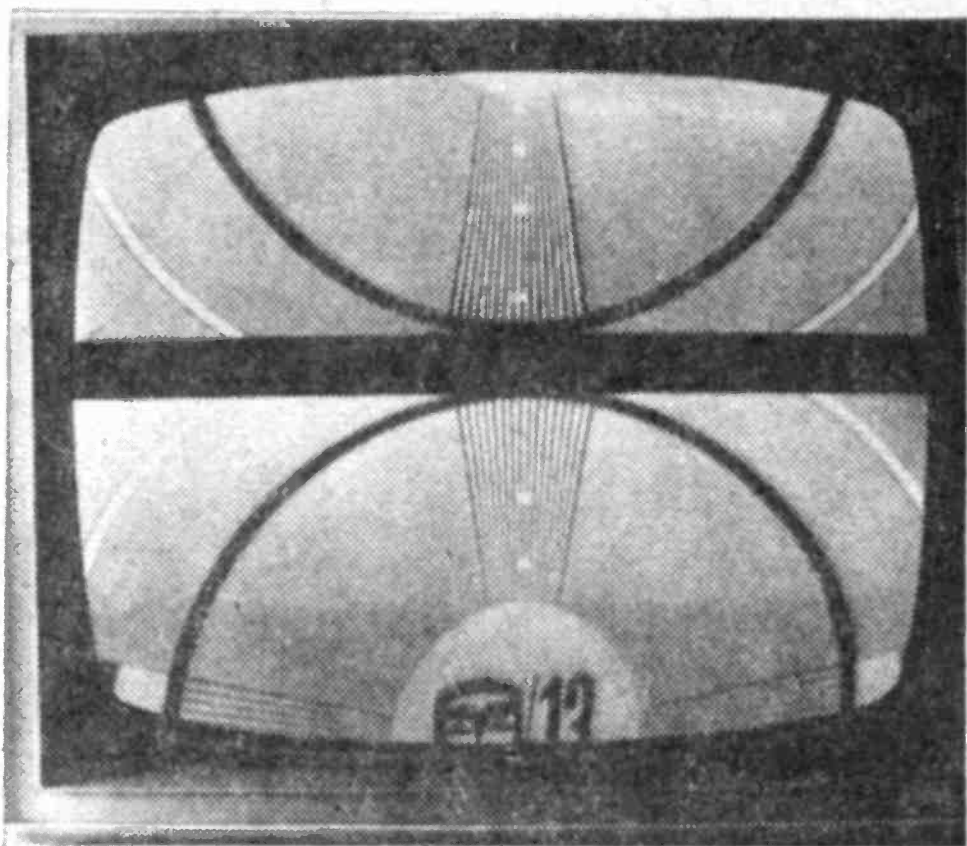

Fig. 1. Even if picture isn't rolling as above, vertical hold control may not be set properly.

Fine scanning lines on the screen bounce or run together, which, of course, steals sharpness from the image. You can avoid it by setting the vertical hold with this simple technique.

Turn the control until the picture starts rolling in a *downward* direction. Next, turn the knob *slowly* the opposite way until the image moves *upward*. Soon the frames begin to snap into place. When the picture's finally locked in, remove your hand from the knob. Always stop tuning on an *upward* roll of the picture. A close look at the screen should reveal well-separated, motionless scanning lines.

Horizontal Hold. There's much leeway in this adjustment, since TV horizontal circuits are semiautomatic. A grossly misadjusted control will produce slashing diagonal bars (Fig. 2). As the knob approaches correct setting, the number of bars diminishes

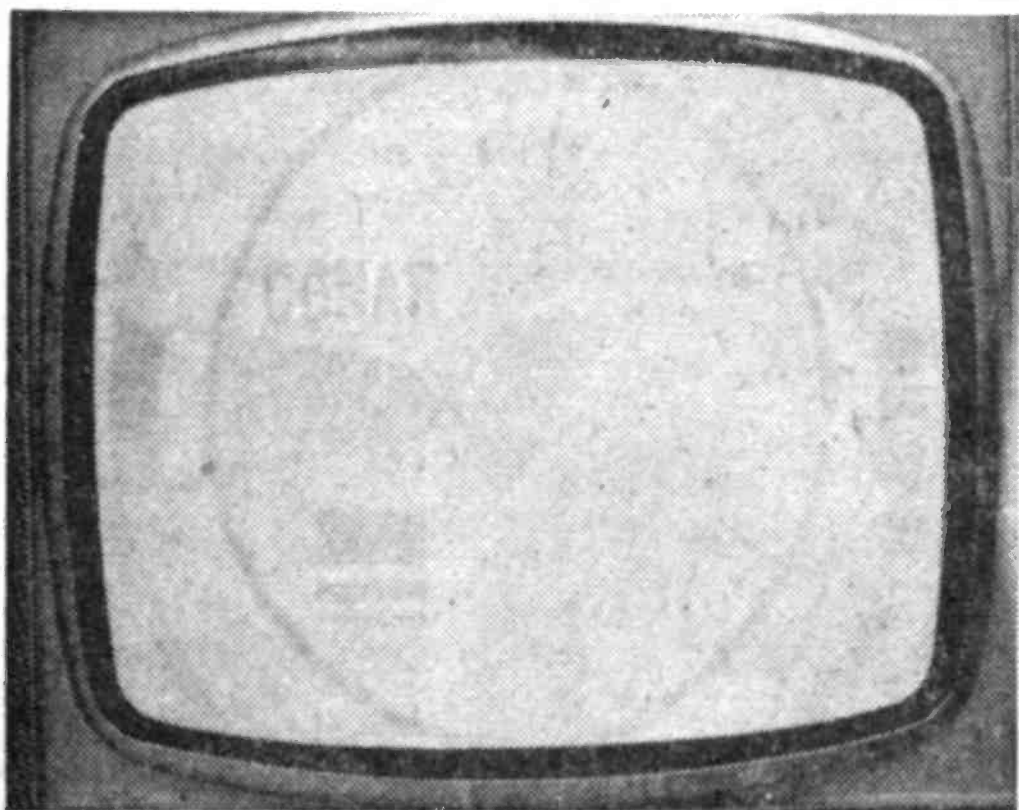

Fig. 4. Setting brightness control too high will cause a picture detail to wash out.

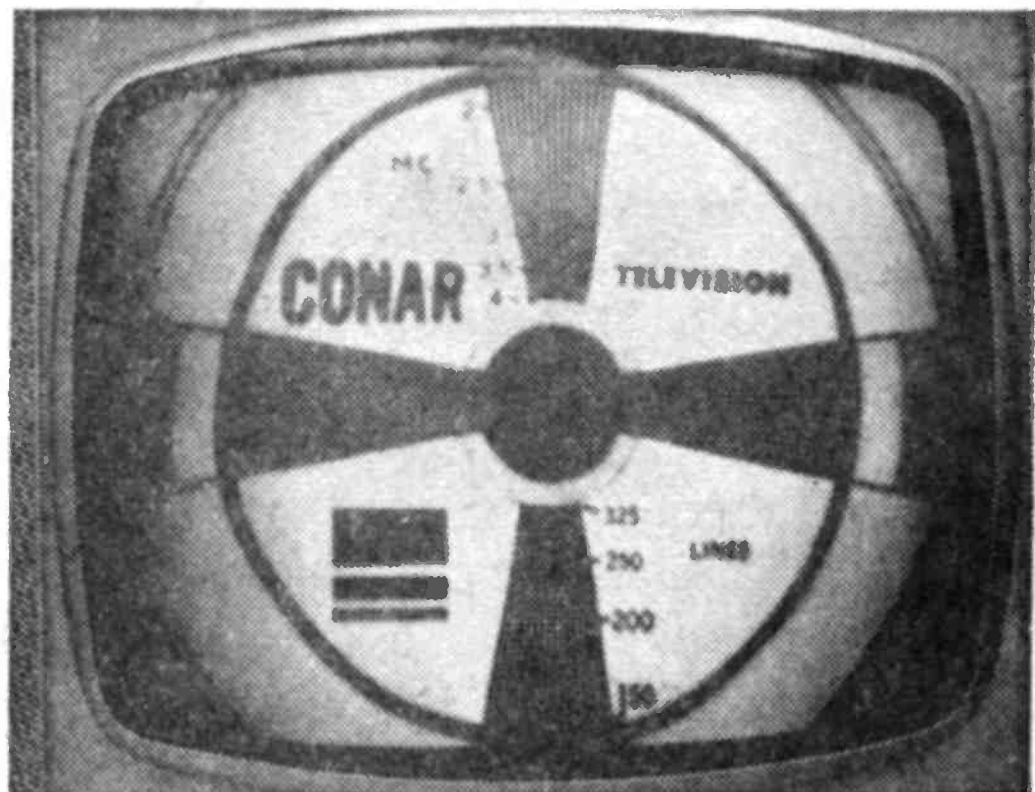

Fig. 5. Excessive contrast results in loss of picture detail and subtler gray shadings.

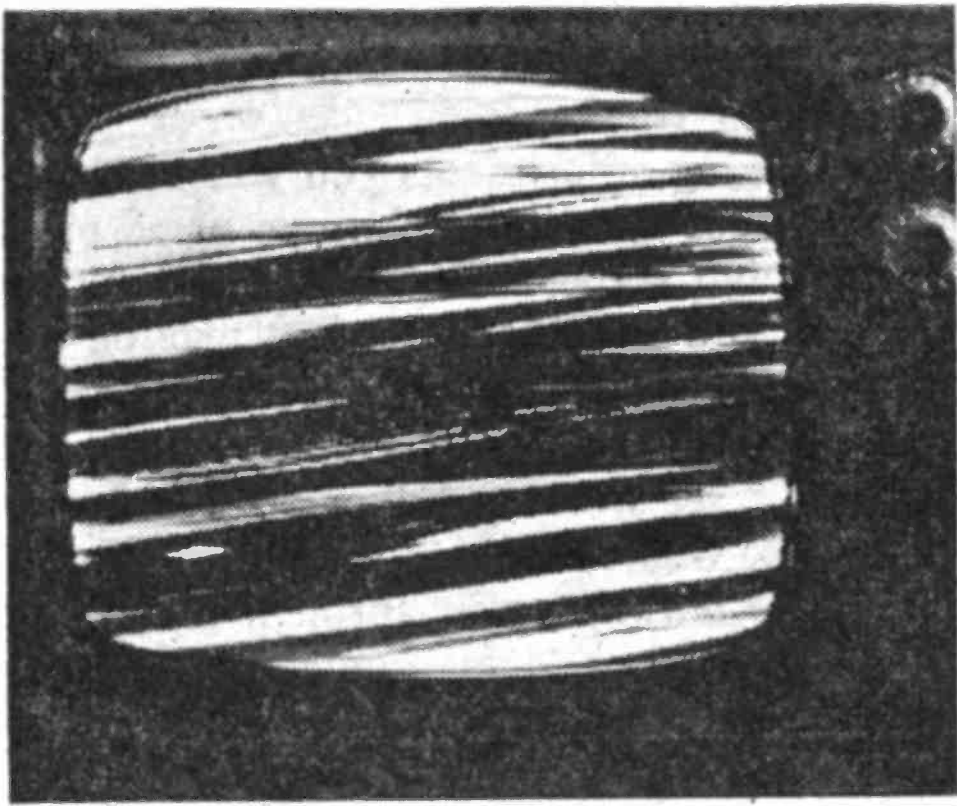

Fig. 2. Horizontal hold should be set so picture is stable after channel is changed.

until the picture stands up straight. Yet there is margin for error.

First, be sure the setting is stable, quickly checked by flipping among all receivable channels. There should be no loss of horizontal sync—even temporarily—each time the main channel selector lands on a new channel. Check the picture for any distortion or whitish areas, especially at the left. This control may be located at the rear in some sets (see Fig. 3).

Contrast and Brightness. Little can be said about these controls since their effects are well known and settings mostly a matter of preference. Excessive brightness (Fig. 4) washes out the picture and may cause a few diagonal white lines to appear at the top of the screen. They're eliminated by slightly reducing brightness or increasing contrast. Pour on excessive contrast (Fig. 5), and the picture assumes a grainy texture of strong

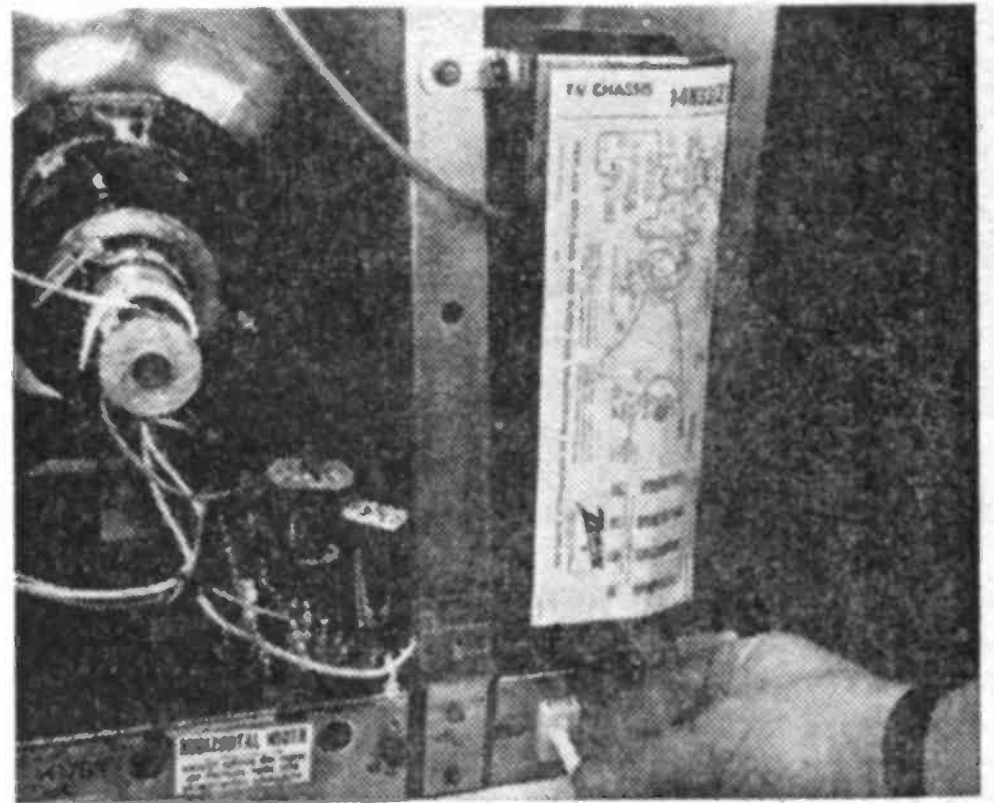

Fig. 3. Many late-model sets have horizontal-hold control located on the back of cabinet.

blacks and whites with loss of detail. Snowy reception is usually aggravated by too much contrast.

On some sets, excessive contrast might cause "sync clipping," which could cause a wavy unstable image (Fig. 6). If it happens when contrast is weak, chances are the set needs a tube or repair in the IF or front-end stages. The range of contrast is often determined by the set's AGC circuit (automatic gain control). If one is provided in your set, check its adjustment, as described in a later section.

That takes care of up-front, user-operated controls that let you trim picture and sound for daily viewing. For the next group of adjustments—non-operating controls that need only occasional attention—you'll have to penetrate more deeply into the set. Some are accessible through holes; others require removal of the back cover (Fig. 7).

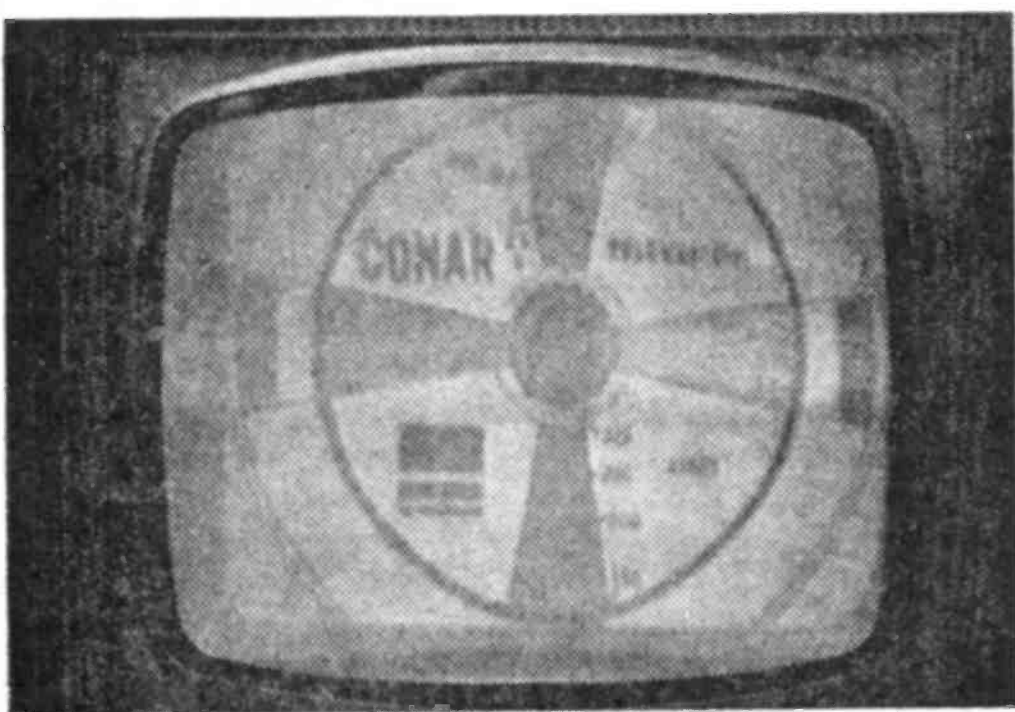

Fig. 6. Unstable picture with low contrast may indicate need for AGC control adjustment.

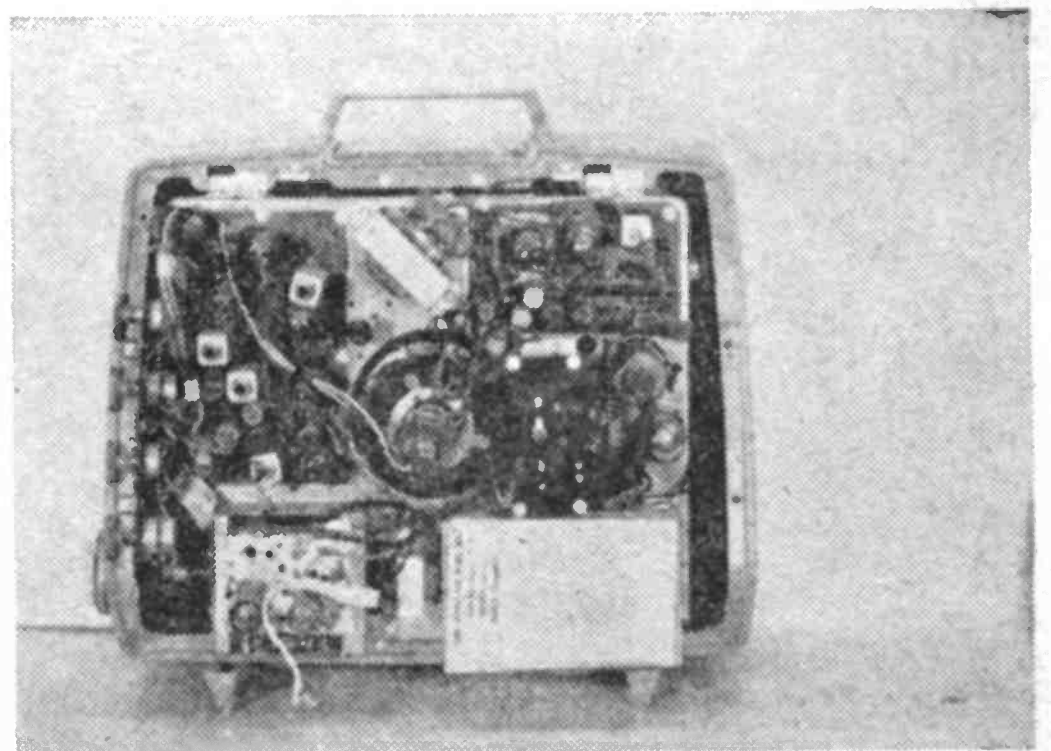

Fig. 7. Back of set may have to be removed for access to little-used controls.

If you can't locate a certain control there are several possibilities. One is that the manufacturer has completely omitted it (the horizontal width control is a casualty in some recent sets). Two, the control may not be readily apparent. An example is focus. Many sets eliminate a control and use adjustable metal strips on the picture-tube pins instead.

Since this and other controls may be difficult to find, you'll save time if you first obtain the service folder on your model. But before you touch anything inside the set, consider these precautions while you let the set warm up for 15 minutes.

The Shocking Truth. High voltages required to operate the various parts of a television receiver present an extremely dangerous shock hazard. To protect the user from dangerous shocks, most TV sets have an interlock switch or special line cord attached to the back cover. When the back cover is removed, the interlock switch opens or the line cord is disconnected, opening the power supply circuit. A caution label containing this information is affixed to the back cover of most TV sets.

To gain access to such controls as the ion trap magnet, deflection yoke, and on many TV sets, the positioning and focus controls, you must remove the back cover. This means that you will either have to detach the line cord from the back cover, or use a separate line cord (cheater cord) to connect the set to the power outlet. On sets using an interlock

switch, you will also have to secure the switch in the closed position, possibly with masking or friction tape.

In making adjustments you will be working in close quarters, relatively near parts having high voltage. The following precautions should be observed when making adjustments inside the cabinet while the set is operating. (1) Do not adjust controls inside your set while standing on a concrete floor. (2) Make sure that there are no metal objects or wiring nearby through which you might make accidental contact to a good electrical ground. (3) Always keep one of your hands in your pocket when making your adjustments. This will prevent you from making a contact that could produce an unpleasant or dangerous shock. (4) Avoid contact with all parts having high voltage, especially the picture tube anode, or, in the case of a metal shell, the tube. (5) In general, stay way from all tubes to avoid burns. A burn caused by a hot tube, or an electrical shock, can result in cuts or bruises from striking other parts as your hand is withdrawn from the source of danger. (6) Use only moderate pressure to adjust any of the controls on the neck of the picture tube. Undue pressure or a jar can break the glass envelope causing the picture tube to explode.

If you follow these safety rules and use sound and careful judgment, you can safely and correctly adjust your television set.

Test Patterns. Many TV stations transmit a test pattern for short periods before and after their regularly scheduled programs. Test patterns are a valuable servicing aid in making rapid checks of the performance and adjustment of a TV receiver. If no test pat-

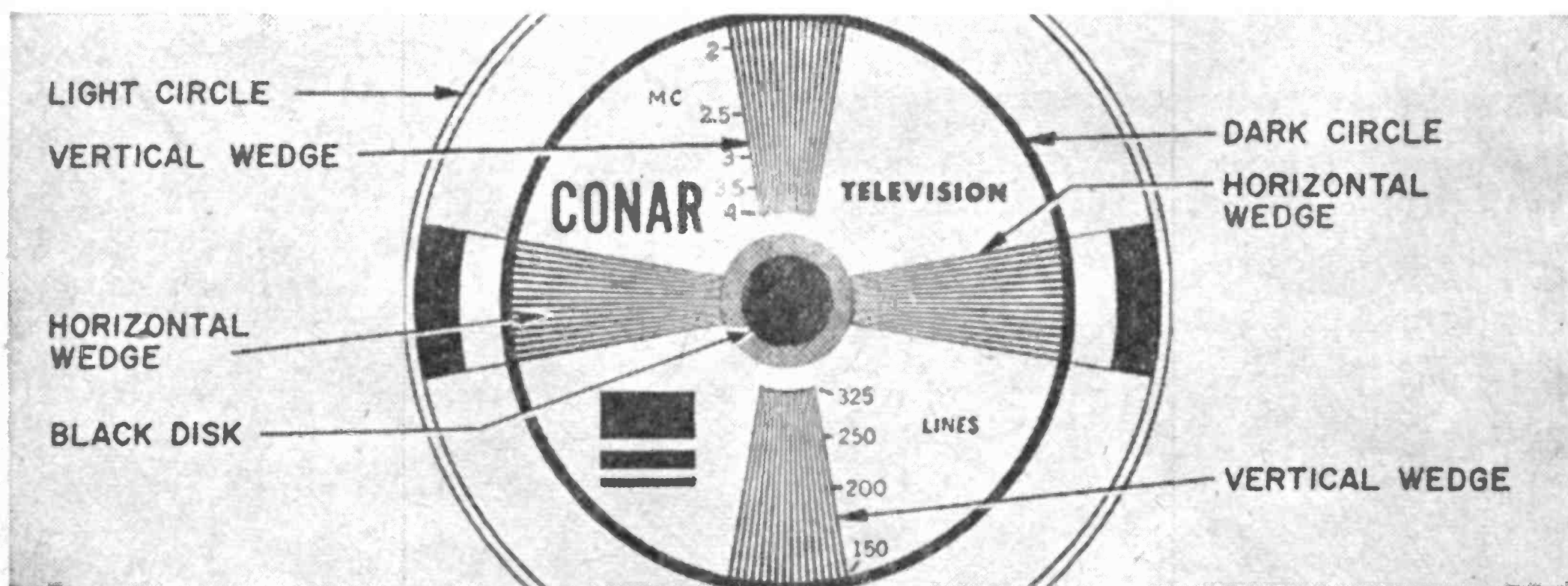

Fig. 8. Test pattern transmitted by most TV stations before and after regular programming is invaluable for adjusting set's controls. Important elements are labeled above.

tern is available at the time you adjust your set, you can use the actual picture to check the adjustment of the various controls.

A mirror placed in front of the set will enable you to observe the picture on the screen while you make adjustments from the rear of the set. Fig. 8 shows the appearance of a typical test pattern. Whenever the controls on any TV receiver are correctly adjusted, the test pattern should have the same general appearance as shown.

The elements of the test pattern are labeled in Fig. 8 and should conform to the following specifications. The light circle should appear just inside the edges of the mask when the horizontal and vertical size controls and the centering controls are properly adjusted. The dark circle and the edge of the black disc are perfectly round when the horizontal and vertical linearity controls are properly adjusted. Wedges are vertical and wedges are horizontal when the deflection yoke is properly positioned. The lines in the wedges are sharp and distinct when the focus control and ion trap magnet are properly adjusted. The concentric circles are of different shades from light gray to black, when the brightness, contrast, and AGC controls are properly adjusted. Let's consider how to adjust each control.

AGC (Automatic Gain Control). The AGC control when properly adjusted enables you to tune to different channels having various signal strengths without requiring you to readjust the contrast or volume controls each time you change channels. If the AGC control is improperly adjusted, a strong signal will cause the picture to have excessive contrast, and a hum will be heard in the audio. Often, the picture becomes com-

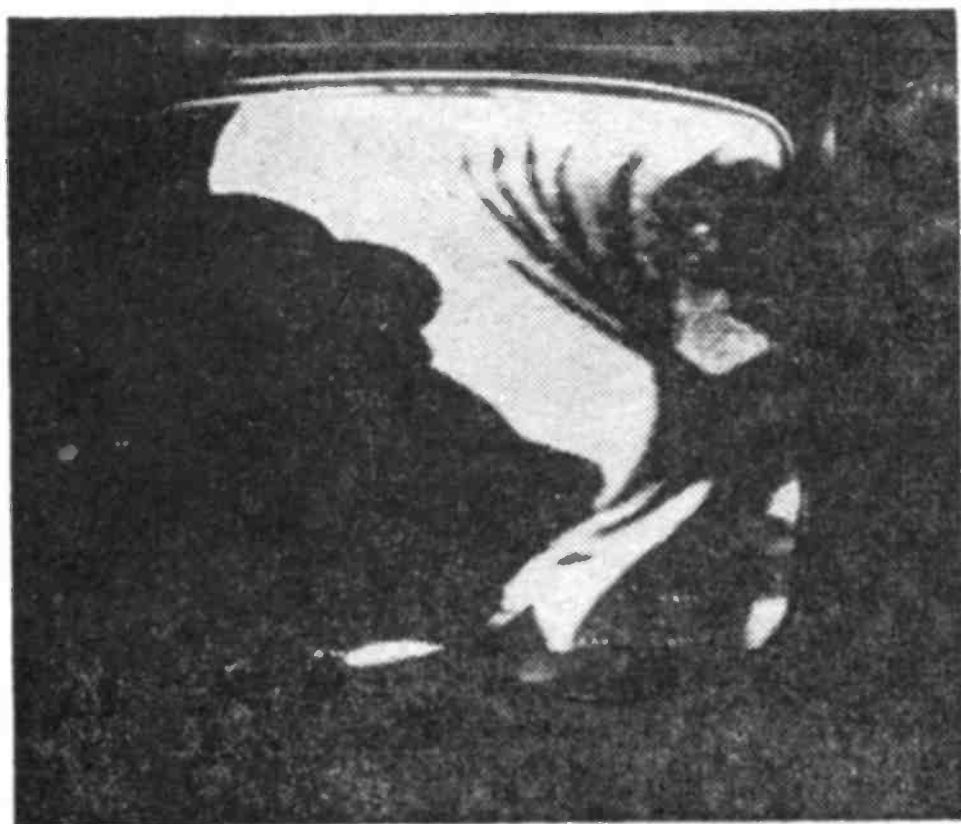

Fig. 9. Improper setting of AGC control causes variety of symptoms like one above.

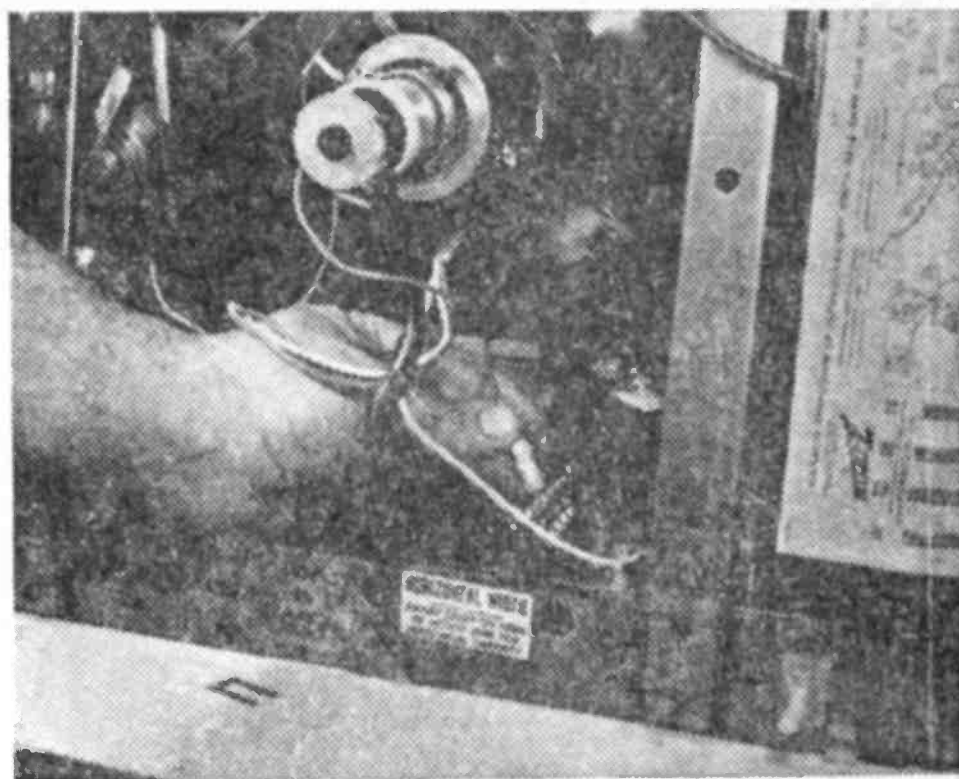

Fig. 10. One type of focusing arrangement is adjusted simply by selecting proper tap.

pletely distorted or it may even become completely negative.

Fig. 9 shows this condition. To adjust the AGC control, tune the receiver to the strongest channel in the area and rotate the AGC control clockwise until you notice excessive picture contrast, buzzing sound, and pulling or tearing at the top of the picture. Then rotate the AGC control counterclockwise until the picture becomes normal once more.

What AGC actually does is allow your set to work well under a variety of conditions. For example, AGC will tend to hold contrast at a constant level even though signal strength varies markedly. (Without AGC, you might well be readjusting contrast for every channel you tune in!)

Focus Control. There are three types of focus controls in use on TV sets. One type uses a magnet located on the neck of the picture tube. This can be adjusted by a shaft

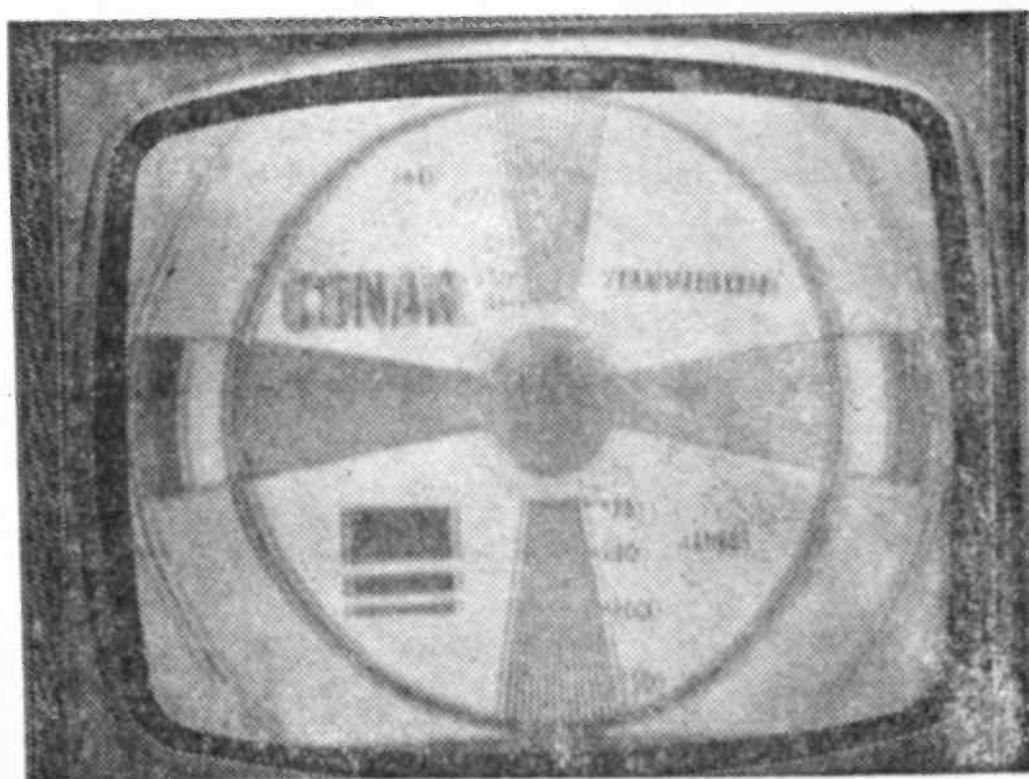

Fig. 11. Typical indication on screen when picture tube requires focusing adjustment.

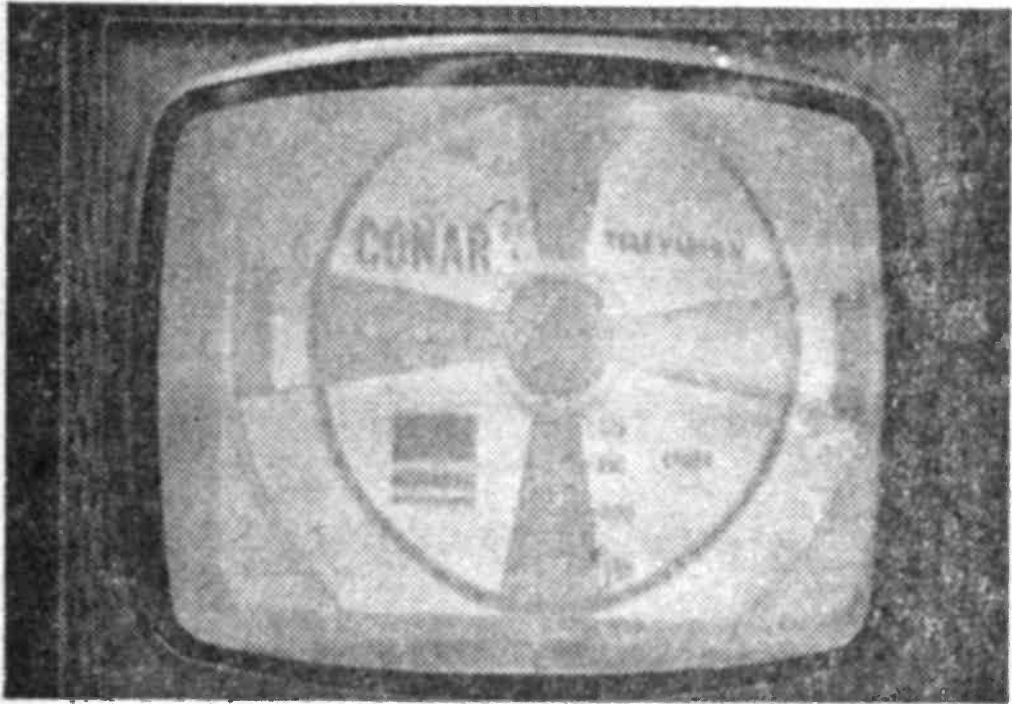

Fig. 12. Sets with sync stability control will require adjustment of this control when the condition in the photo is observed.

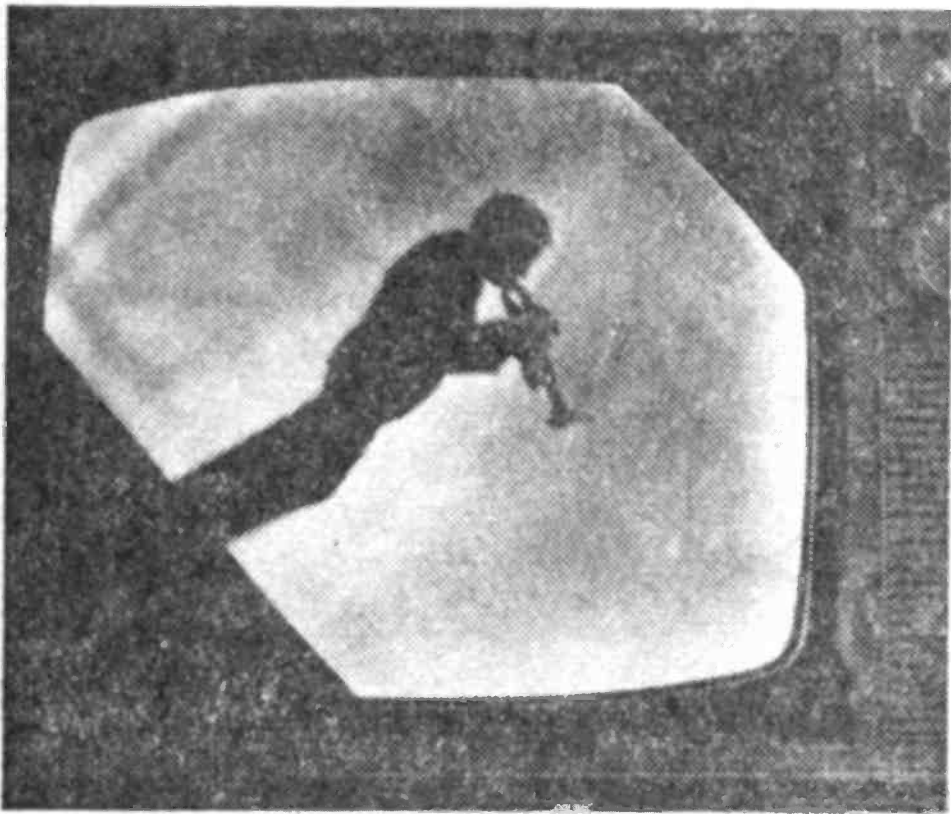

Fig. 13. Tilted picture occurs when yoke has rotated on picture tube neck, usually as a result of set being sharply jarred.

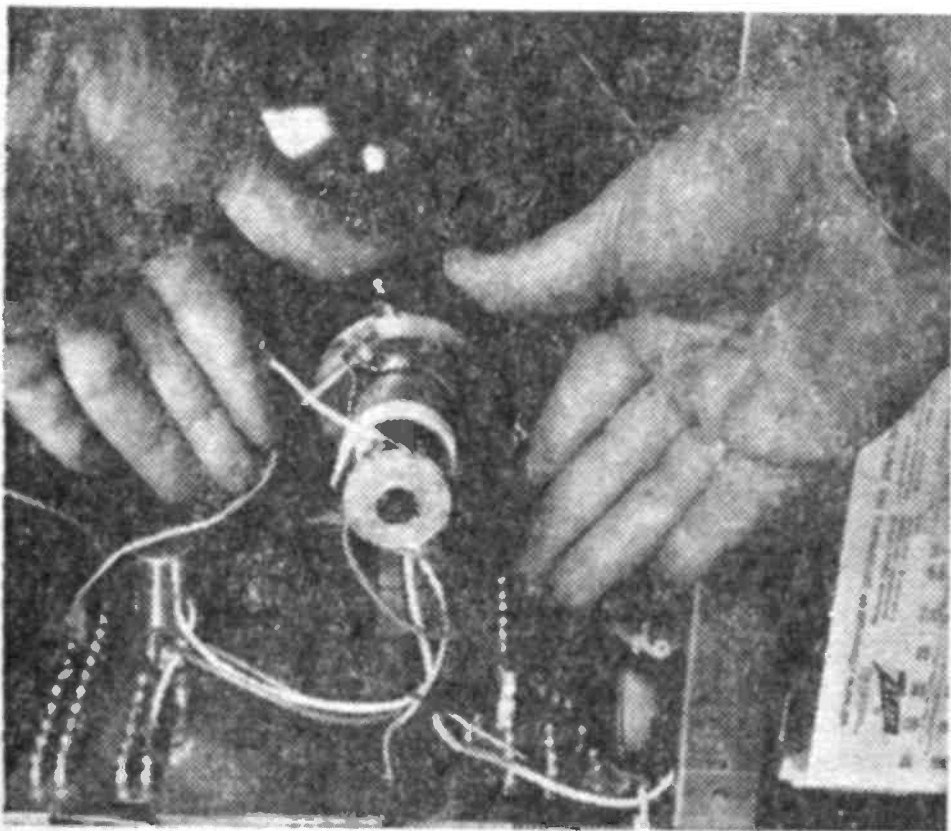

Fig. 14. To adjust yoke, loosen clamp screw, hold only insulated part, and rotate carefully.

extending from the back of the set, or you may find it necessary to adjust several screws to correctly position the focusing magnet.

A second type of focus control uses a control to electromagnetically focus the beam.

A third type focusing arrangement uses a series of taps or terminal connections to which the focusing electrode is attached to give the best possible focus (see Fig. 10). Fig. 11 shows the effect of an improperly adjusted focus control. Note the lack of definition in the image as compared with the normal test pattern. The focus control should be adjusted to give the sharpest, clearest picture possible.

Sync Stability Control. Fig. 12 shows the effect on the picture of improper adjustment of the sync stability control. Note the bending of the image in the top of the pattern. This control adjusts a noise rejection circuit so that noise in the picture signal will not upset the sync. To properly adjust the sync stability control, observe the picture on the strongest local station with the AGC control properly set, and rotate the sync stability control counterclockwise until the picture bends at the top. Then back off the adjustment until the bending stops.

Buzz Control. Some late model, quality TV receivers, such as the Conar Custom 70, have a buzz control. This control is adjusted to the position at which hum, or buzz, in the sound is minimum.

Correct adjustment of the fine tuning control, the AGC, and Contrast Controls also help eliminate buzz. These controls should be checked first for proper adjustment, then the buzz control should be adjusted for minimum buzz.

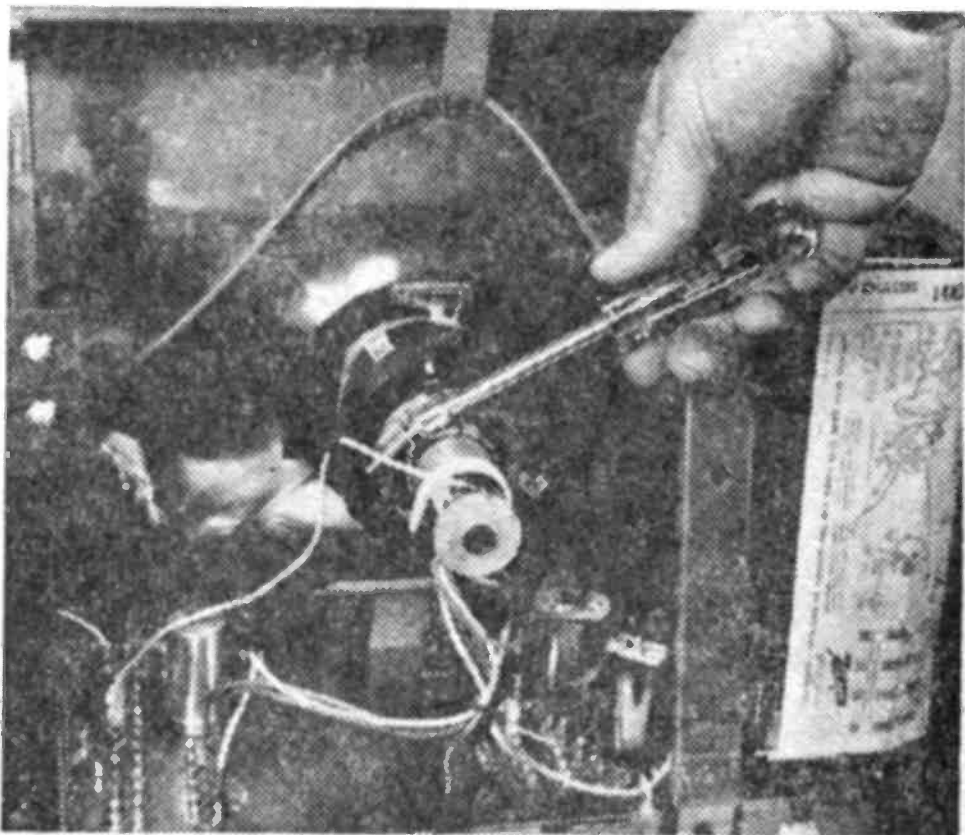

Fig. 15. When yoke is positioned, tighten clamp screw, being careful not to over-tighten.

Ion Trap Magnet. To adjust the ion trap magnet, move it back and forth along the neck of the picture tube, rotating it slightly at the same time, until you obtain maximum brightness on the face of the picture tube. Next, adjust the focus and positioning controls (described below) and re-adjust the ion trap magnet. You may have to adjust the ion trap magnet so that the brightness is decreased slightly in order to improve the focus.

Many modern TV sets do not use an ion trap magnet. The phosphorous coating on the face of the picture tube is backed with a thin layer of aluminum. Electrons readily pass through this aluminum layer to strike the phosphor coated screen, but the heavier ions are blocked by the aluminum layer. The aluminum layer also reflects the light back to the viewing side of the screen that normally would radiate into the back of the picture tube. This type tube both dispenses with the ion trap magnet and will give a brighter picture than the type which does not have the aluminum layer.

Deflection Yoke. The deflection yoke is located on the neck of the picture tube. Its purpose is to produce the varying magnetic field necessary to deflect the electron beam vertically and horizontally to produce the scanning raster on the screen of the picture tube. If the yoke is not correctly positioned, a tilted picture will result (see Fig. 13). To correct a tilted picture, first make certain the yoke is positioned as far forward on the neck of the picture tube as the bell will allow, and then rotate the yoke (Fig. 14) until the picture is level. When the yoke is properly positioned, it should be secured

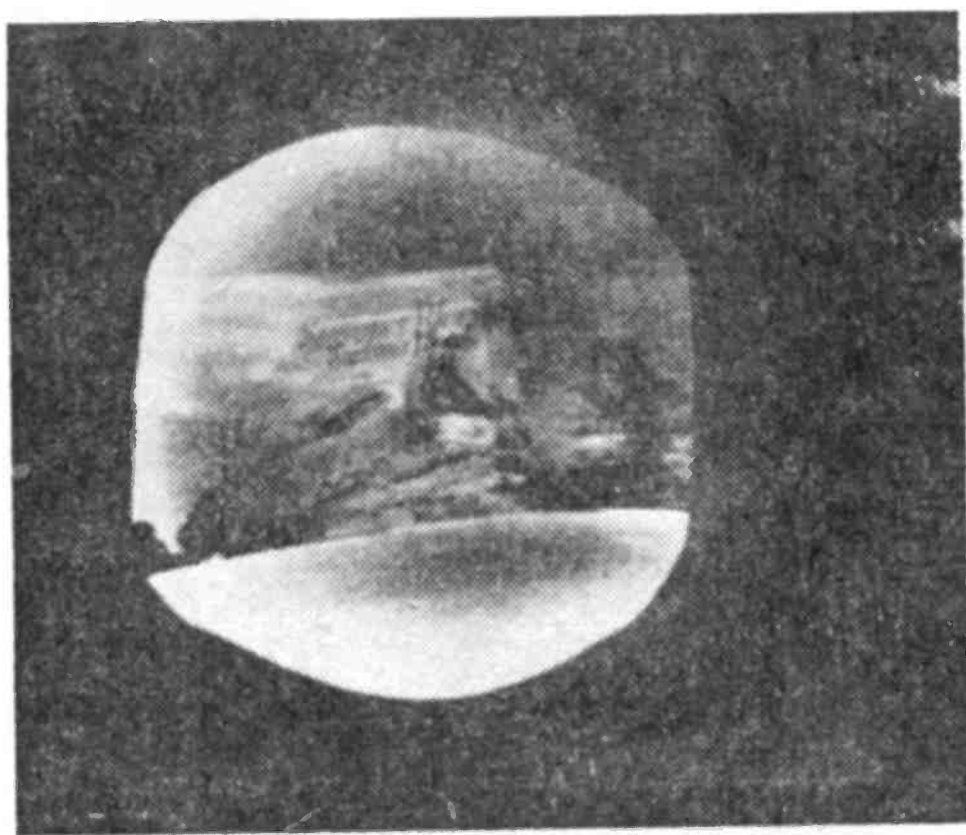

Fig. 16. If picture doesn't fill screen, yoke isn't properly seated against picture tube.

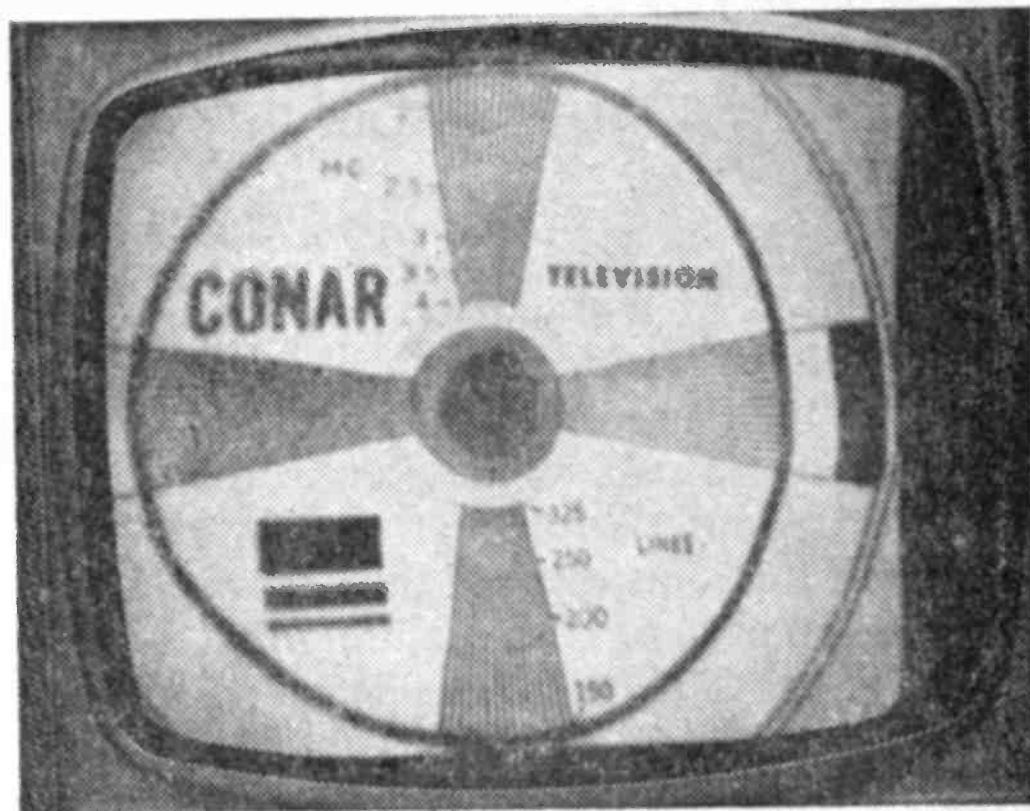

Fig. 17. Unfilled screen on either side indicates that horizontal centering controls generally are incorrectly set, though problem can also stem from electrical defects in circuits.

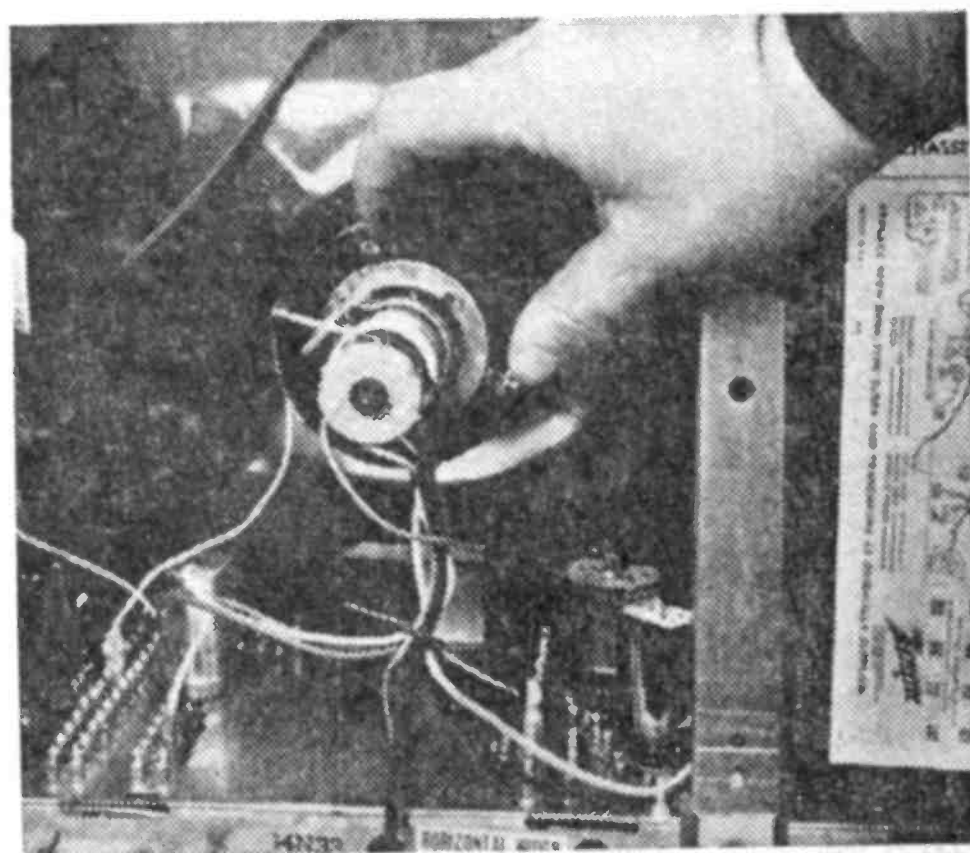

Fig. 18. Magnetic rings on picture tube neck behind yoke are used to center picture. The two tabs are rotated around neck for both correct horizontal and vertical centering.

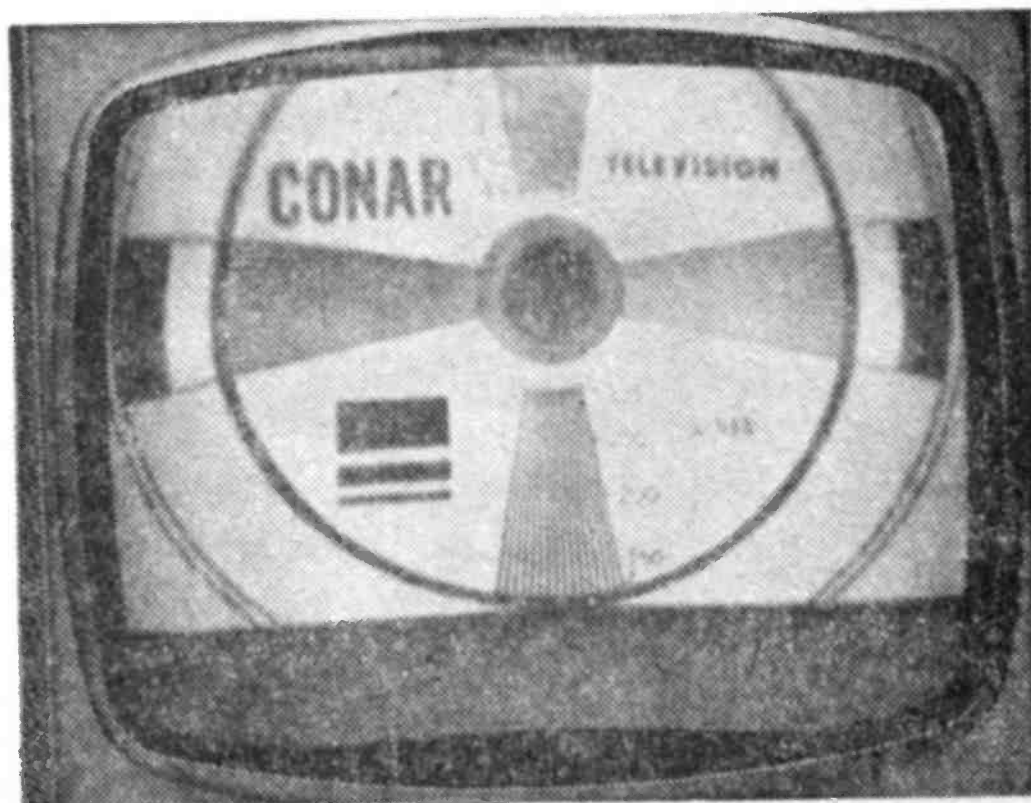

Fig. 19. Incorrect vertical centering in photo above is adjusted as shown in Fig. 18.

in position by a clamp or lock screw (Fig. 15). Note in Fig. 16 that the picture doesn't fill the screen if the yoke isn't against bell or flared part of the picture tube.

Horizontal Centering Control. The effects of misadjustment of the horizontal centering control on the picture may be seen in Fig. 17. To center the picture horizontally, move the metal rings on the yoke cover (see Fig. 18) until the picture assumes the desired position.

Vertical Centering Control. This control is accomplished in a similar manner to horizontal centering. Actually it is necessary to adjust for both vertical and horizontal cen-

tering at the same time. Fig. 19 shows a picture with the vertical centering control out of adjustment.

Horizontal Linearity Control. The horizontal linearity control may be adjusted to change the horizontal radius of the picture from the center to the left or right side. Fig. 20 shows the effect of a misadjusted horizontal linearity control. Note the elongated left side of the picture compared with the right side. To adjust the horizontal linearity control, rotate the shaft until the horizontal radius of the picture from the center to the left side is equal to the radius from the center to the right side. It's often necessary to adjust the horizontal size control along with the horizontal linearity control.

Width (horizontal size and drive) Control. In some instances there are two con-
(Continued on page 95)

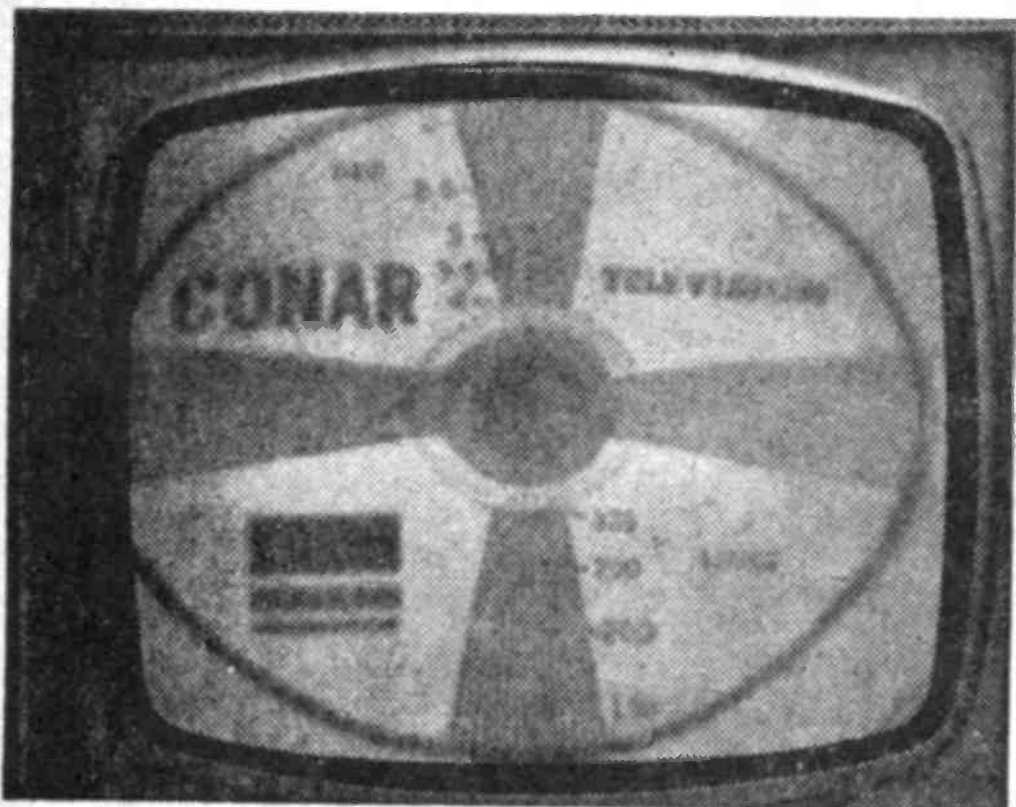

Fig. 20. Condition above is corrected by adjustment of both the horizontal linearity control and the width or drive control.

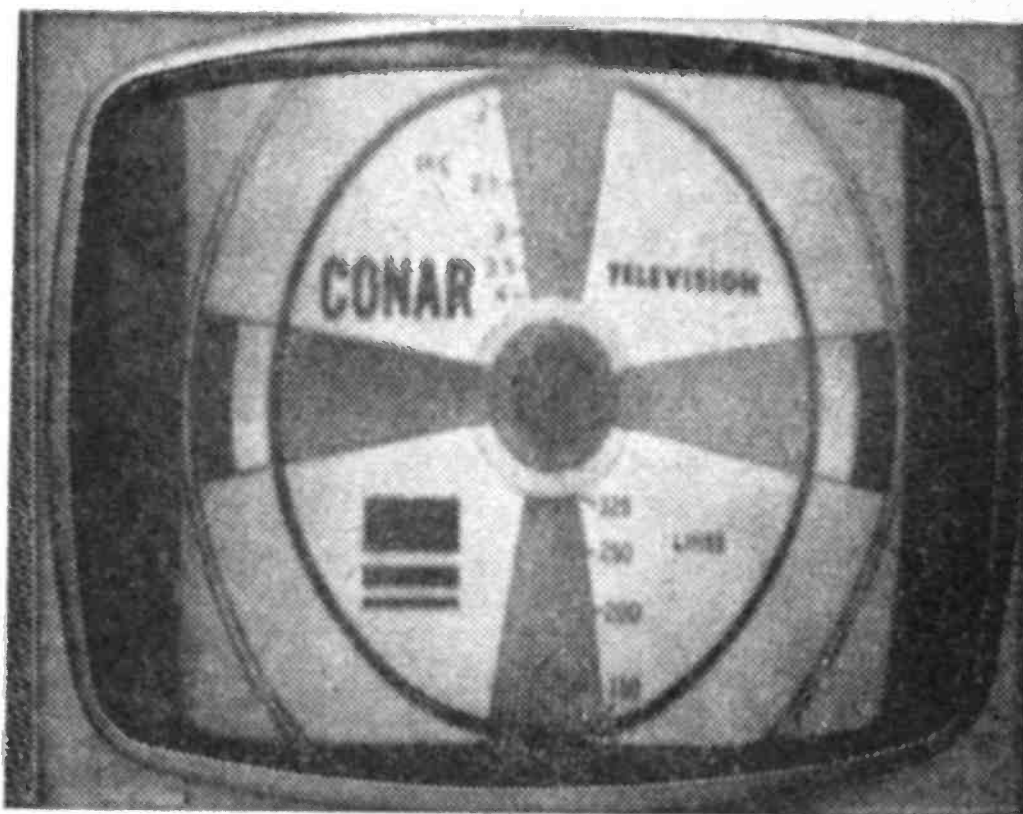

Fig. 21. Picture with insufficient width to fill screen can be corrected by simply adjusting width control until picture is wide enough.

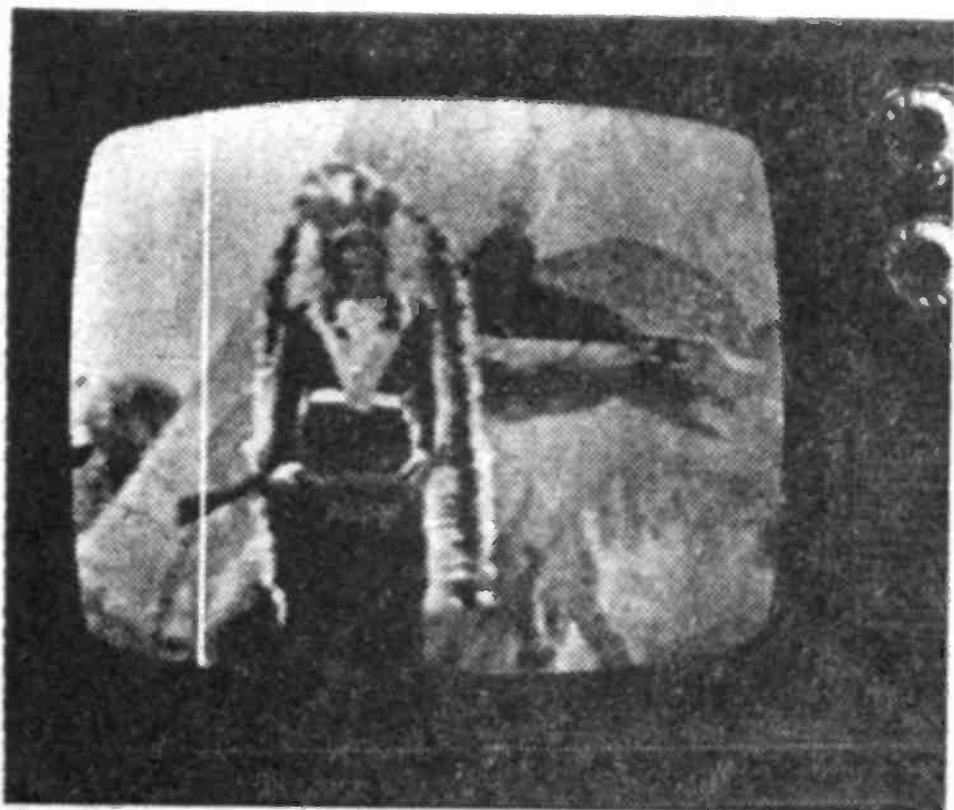
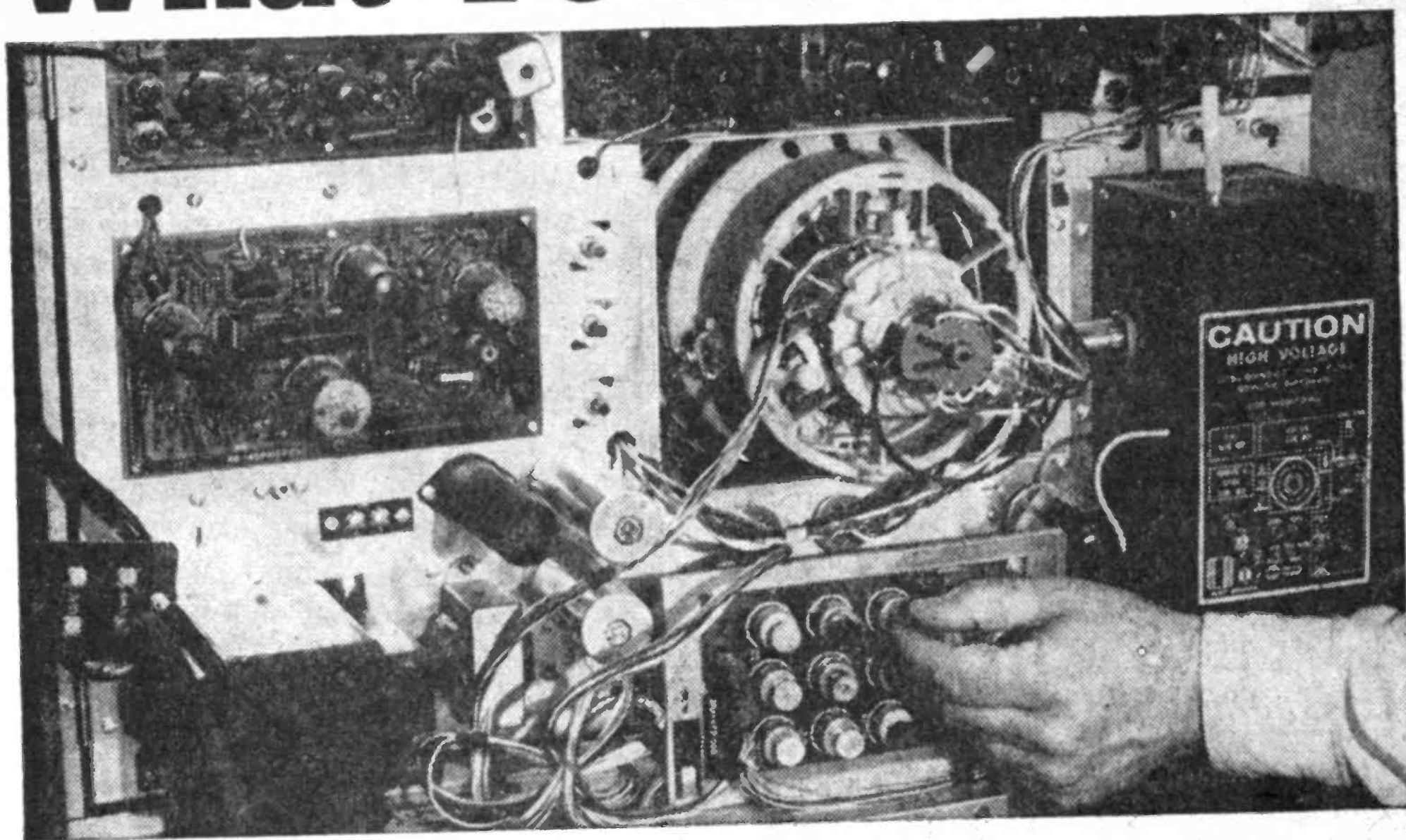

Fig. 22. Too much horizontal drive causes vertical white line to appear on screen.



Fig. 23. Long skinny people can be cut down to size by adjusting vertical height control.

What To Do



For Truest Blue (and red) (and green)

Though color-TVs can be frighteningly complex instruments for the uninitiated, they ultimately turn into old friends for the owner-in-the-know

By LEN BUCKWALTER

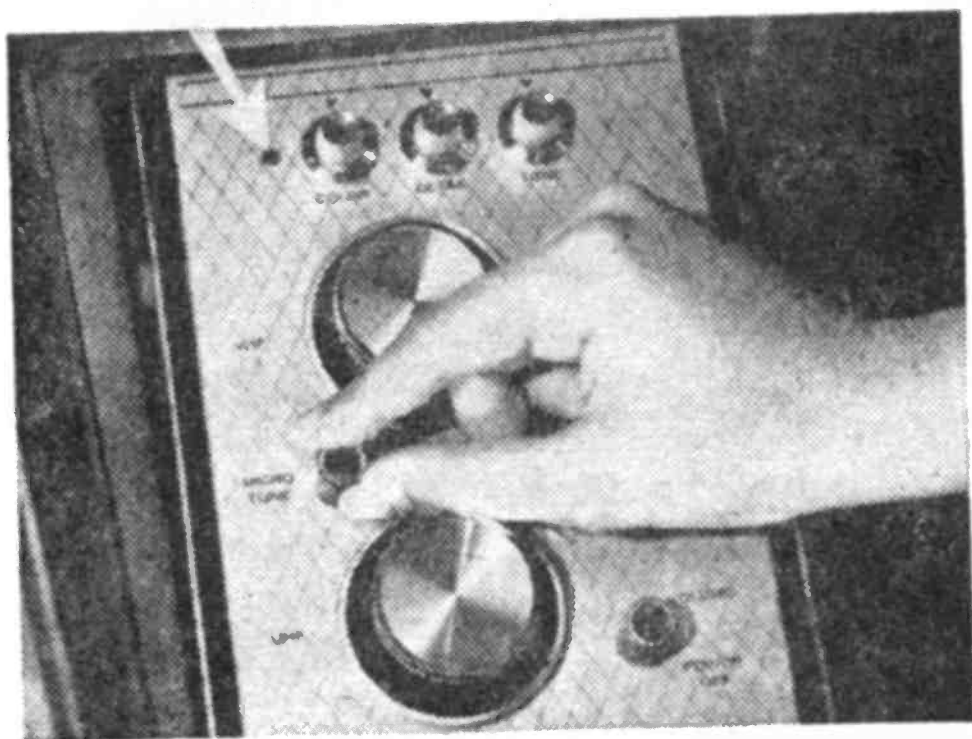

Fine-tune control and indicator light (arrow) make for easy tuning on many modern color-TVs, but they can't correct misadjustments.

Anyone who has switched from black-and-white TV to color viewing makes a disturbing discovery. No longer do little picture distortions—out-of-round circles or misshapen figures—sink into the background. Color permits less of a compromise. Misadjustments may spring out at the viewer to clutter the picture with a spectrum of colorful smears, nightmarish tints and ghoulish hues. We don't mean "fault"-type problems—outright failure of tubes, parts or antenna. These need servicing. Rather, it is the slow drifting that comes with time, or the intrusion of other factors which affect performance of an otherwise trouble-free set. The manufacturer anticipates such problems with a whole series of adjustments for correcting such error. Not just the user knobs on the front panel, but a complement of in-back controls that need an occasional touching up. They keep colors clean and the monochrome picture truly black and white.

Besides long-term drift, another significant force is at work. It is the stray magnetic field. So sensitive is the color receiver to magnetic forces that just moving the set around the room could deteriorate color, not to mention

going from room to room or house to house. Even the earth's weak magnetic field has been singled out as a disruptive influence. Stray magnetism and inevitable drift, however, are readily corrected in the steps to follow.

It's probably occurred to some viewers that symptoms of misadjustment may really be signs of deeper trouble. In many instances this is true. But until you've developed a sharp eye for these differences, there's the trusty trial-and-error approach to provide the answer; if routine adjustments to be described won't restore performance, chances are the circuits need servicing. Adjustments can be performed without major chassis removal, often requiring little more than removing the back cover.

How difficult? It follows the old law: the beginner flounders around at first, the experienced adjuster breezes through the job in mere minutes. So don't expect push-button precision at first. It takes a little time to get the feel and effect of the various controls. One thing in your favor: the set, though uncomfortable to view, may be just slightly out of adjustment. This means you can avoid time-consuming confusion by not moving any controls more than just a slight amount while observing the desired result. And don't despair over two factors peculiar to color TV: (1) you rarely set a control once and leave it there. Interaction is the rule, so be prepared for much repetition and (2) aiming for utter perfection is not only impossible but often a waste of time. Color TV is still a miracle despite traces of color error, especially at screen edges, or some color fringing around some objects in the black-and-white program. The adjuster tends to see the screen with a far more critical eye than when he sits five or more feet away as a program viewer.

Required Equipment. Unlike the simpler black-and-white receiver, which usually can be adjusted by eye, the color set needs at least one test instrument. It's the color generator, a device which displays on the screen a pattern of dots, bars and other images which serve as a reference. Without such a unit, the adjustment job becomes hopelessly complex. At least one kit manufacturer markets a suitable generator in kit

form for approximately \$65. Commercially wired units begin at higher prices. Clipped to the antenna terminals of the TV receiver, the generator "transmits" the desired pattern selected by a knob on the front panel. Not only is the device needed for critical color adjustments but also serves for lining up certain black-and-white adjustments.

Next piece of equipment is the degaussing coil, the unit which demagnetizes stray pick-up by the picture tube. Although such units are available, one may be inexpensively assembled by following the illustration in Fig. 1. You'll need about four pounds of No. 20 enamel-covered ("magnet") wire. This is wound around some temporary form of 12-

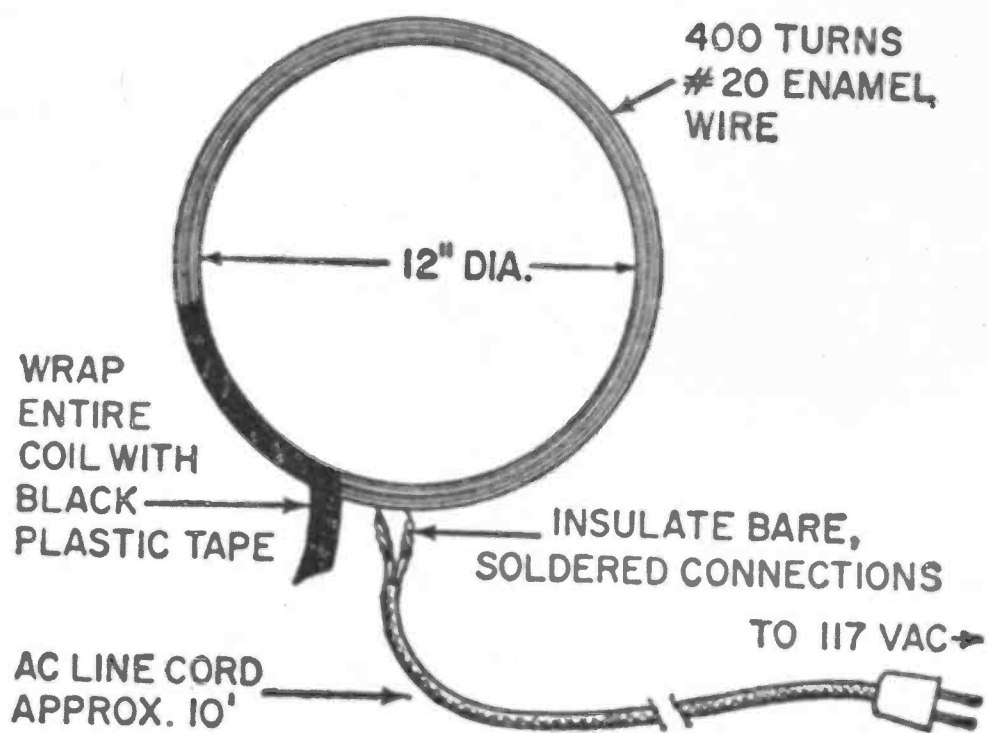

Fig. 1. For color TV receivers without automatic degaussing, a simple degaussing coil is needed.

inch diameter for 400 turns. After removal from the form, the coil is held together by a wrapping of black plastic tape. A long AC cord (with plug) is attached to the two free ends of the coil.

A handy accessory during adjustments is a mirror. It's awkward, if not impossible, to get a good view of the entire screen while manipulating certain controls from the rear of the set. The mirror should be large enough to give a total view of the screen when placed in front of the set. A chair provides a good support of approximately correct height. (Two additional items, "cheater" cord and hex tool, are described later.)

Finally, the set's service manual should be on hand. Now that numerous TV makers have entered the color field, there are apt to be variations in location and set-up of controls from one set to the next. The step-by-step discussion to follow applies generally, but the manufacturer's special comments should also be checked.

Major Steps. Adjusting the color set requires no grasp of complex theory, but a quick preview of major steps (see Fig. 2) and why each is performed could prove helpful. The job begins with:

① CONVENTIONAL ADJUSTMENTS (PICTURE HEIGHT, WIDTH, ETC.)

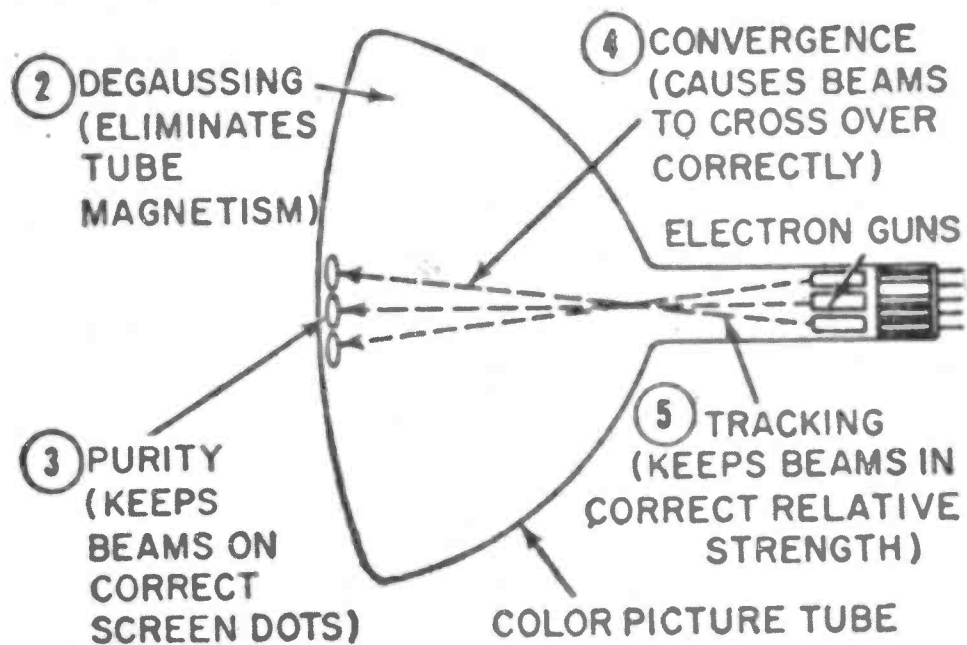

Fig. 2. The five major steps to accomplish in adjusting color TV for optimum performance.

1. Conventional Adjustments. These are the familiar controls found on all TV receivers, monochrome or color. They include height, width, focus and linearity (see Fig. 3). Unless preset for proper performance, adjustments which control color will be seriously affected. Even setting of horizontal and vertical hold controls should be done with care. Misadjustment of horizontal hold can cause fanning out at the top of the picture, while a vertical hold set improperly may produce slanting retrace lines. (A suitable crosshatch pattern from the color generator can serve as a guide for these initial picture adjustments.)

2. Degaussing. This is the demagnetizing step mentioned earlier. It cancels out magnetism picked up by the metal shell of the picture tube and surrounding parts. The operating principle of the degaussing coil is similar to that of an erase head in a tape recorder: by applying a rapidly changing magnetic field (provided by 60-cycle house current), the magnetized object is returned to a neutral state. (Degaussing will not be required for the newly-announced receivers by RCA; it's done automatically by an internal circuit.)

3. Purity. If the color set cannot produce single, pure colors, it cannot be expected to properly render thousands of color mixtures required during a color program. This in-

roduces purity—first major color adjustment. Done in two steps, it lines up three beams from the electron gun in the neck of the tube so they fall precisely on their respective screen color dots—red, blue and green. Actually, purity is accomplished by using the red beam only. The other two colors will automatically fall into place.

4. Convergence. Not only do the three beams have to center properly on the screen, they must also come to a point just before reaching their corresponding screen dots. The beams are magnetically squeezed together (converged), and form a point just before striking the screen. Travelling a slight distance further, they cross over, fan out slightly, then strike their corresponding dots. To achieve this focusing effect for the entire screen surface, convergence is done in two steps. The first sharpens the image at screen center, the second corrects the problem of variable distance between guns and screen. (The beams must travel farther to hit the edges of the screen.)

5. Tracking. Although the receiver is designed for color reception, its black-and-white performance is still critical. This final adjustment keeps color out of the monochrome image. Since the black-and-white picture is created by mixing red, blue and green in a fixed amount, any upset intro-

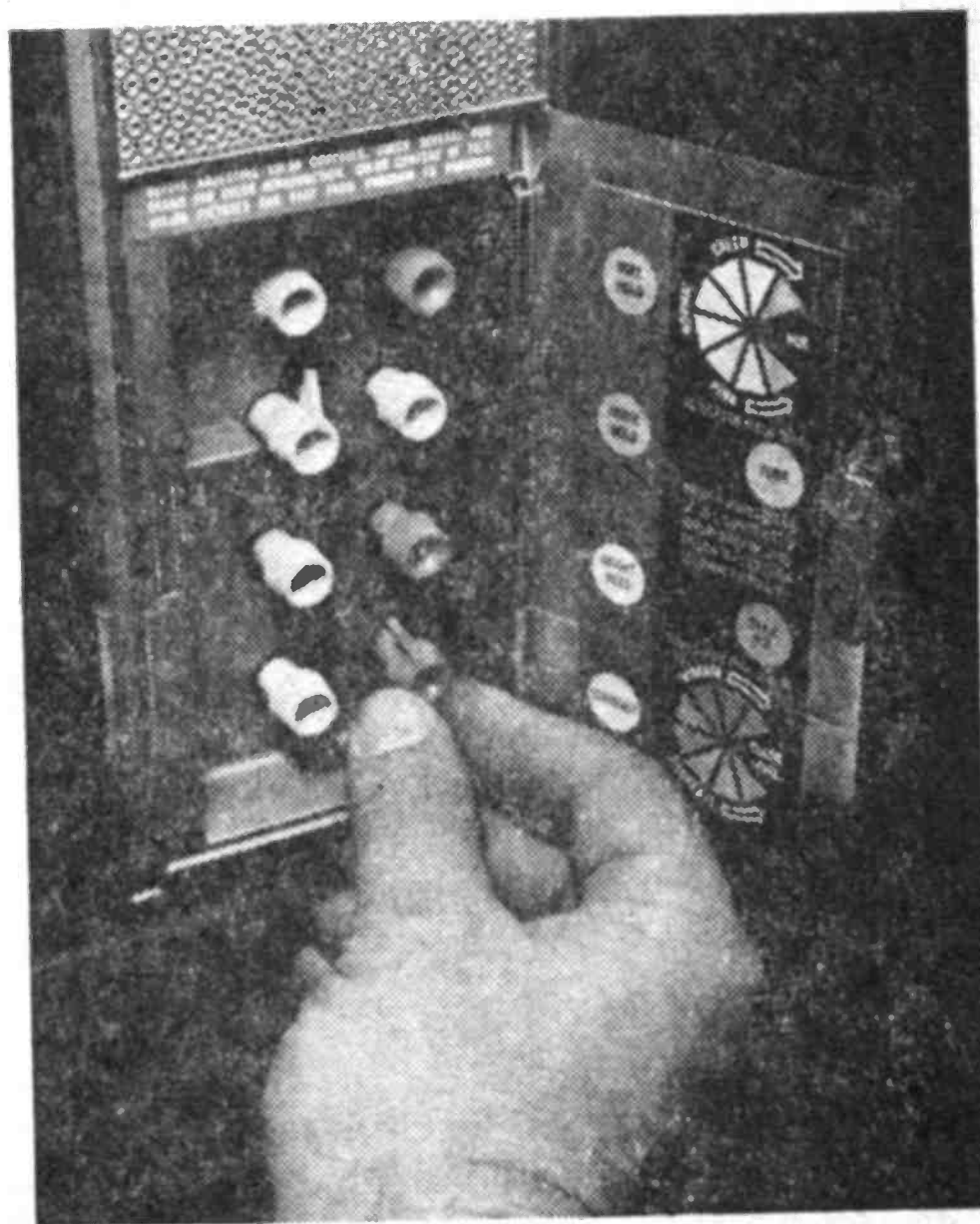

Fig. 3. All conventional controls—hold, width, linearity, etc. must be carefully adjusted first.

duces undesired color tinting. This is corrected by adjusting the beam strength of each electron gun for the proper gray shading.

Preliminary Set-Up. Decide now where the set is to be located in the room for normal viewing—and leave it there throughout the whole course of adjustments. Some of your work will be undone if the cabinet is moved to a convenient area for better access, then returned to its permanent place. Plumbing pipes, air vents or other masses of metal unpredictably warp the surrounding magnetic fields which influence purity and convergence.

Room lighting is another factor which may be considered. Is the set to be viewed as daylight enters the room, or under artificial illumination? Photo fans will see the analogy; outdoor color film is balanced against the blueness of natural light, while the indoor film type takes into account the yellowish hues of artificial light. In adjusting the color set, these lighting factors affect the outcome. A set adjusted during the day for a good black-and-white picture, for example, can assume a hue of color under lamplight. Adjustments, if possible, should be made under normal viewing conditions. Since most viewing is ordinarily done in the evening, it's helpful to adjust at that time or draw the shades and exclude natural light.

Other preparations. Turn on both set and test generator in advance. Both units should be allowed about 20 minutes to warm up and stabilize at operating temperature. Also, the back cover of the set is removed. There is some variation in interlocks here, devices which automatically kill dangerous voltages when the cover is removed. This safeguard is designed to protect against accidental shock. During adjustments, however, the set must be fully powered with the cover off. This usually requires the use of a special "cheater" cord to defeat the interlock. A suitable one for the particular set should be obtained, if necessary.

The matter of safety is even more critical for color than in the conventional black-and-white receiver. Voltages in color circuits run up to some 24,000 volts. While none of the adjustment points bear voltage, care should be exercised to avoid any accidental

contact with nearby, exposed parts. There is no need to open the high-voltage cage or remove the cap plugged into the picture tube.

Some sets have removable top or side panels for access to certain internal controls. Others may have a springy wire which shorts the high voltage when the back cover is removed. These and other variations should be checked in the manufacturer's literature. Let's consider now, step-by-step, the various color adjustments. It's assumed that the conventional black-and-white settings (width, height, etc.) have been properly set.

Degaussing. (In this first step the receiver may be warming up, but it does not matter if the set is off during degaussing.) Degaussing is a simple procedure but one that requires careful technique. Don't be surprised if the coil warms up after plugging it into house current. It is designed solely to be powered for the short time required for the job. (Some sets may have "rim" or "field-neutralizing" magnets. If so, they must be retracted before turning on the degaussing coil.)

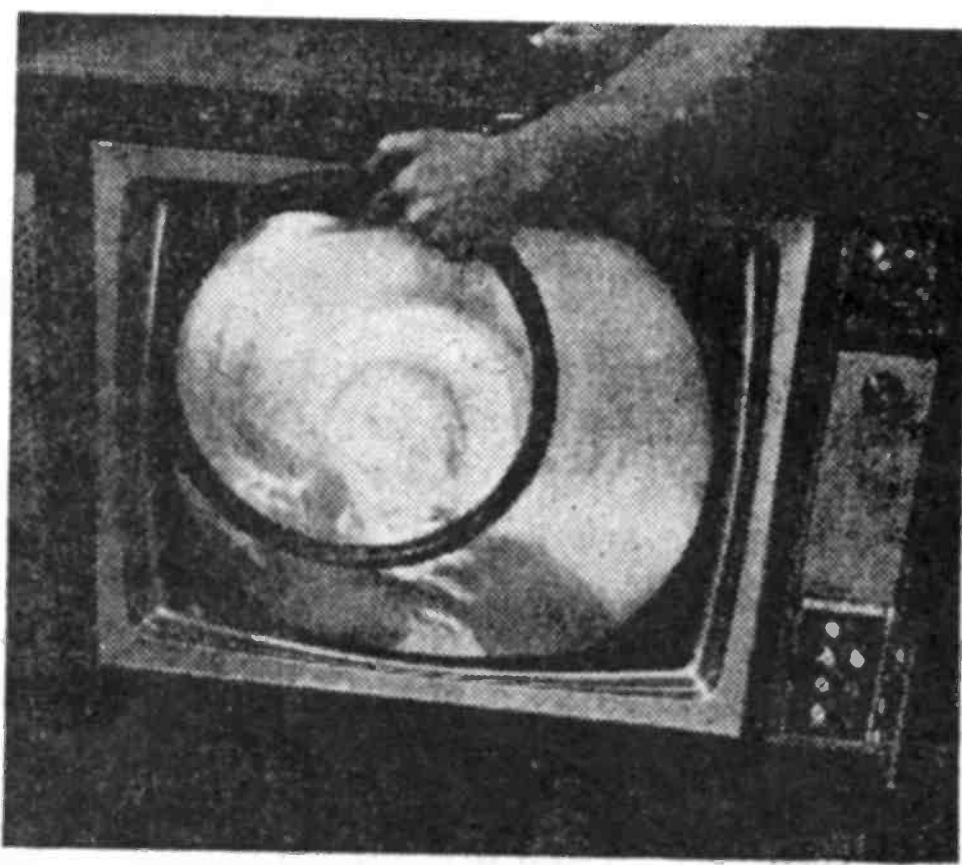

Fig. 4. Degaussing rids picture tube and other parts of stray magnetism that affects color.

As shown in Fig. 4, the coil is held with its flat side about an inch from the screen. Move it in circles over the whole area of the screen's face-plate and overlap into the bordering mask area to rid that region of possible magnetism. This part of the operation is done for about a minute. Now *slowly* back away with the coil, holding it in the same parallel position as before. When you've reached a distance of about six feet, turn the coil at right angles to the screen (nar-

row side points toward set). Now it's safe to pull the plug out of the wall. Another precaution: don't use a plug that is loose in the wall socket. Any make-break in AC power during degaussing can remagnetize the tube.

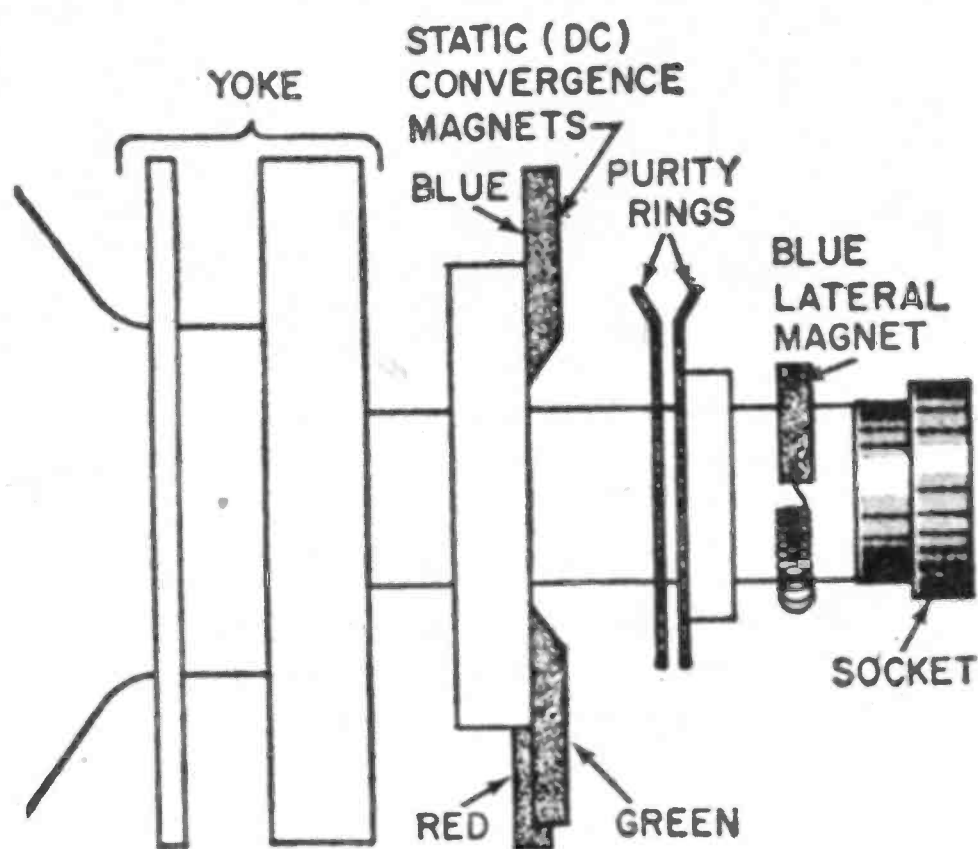
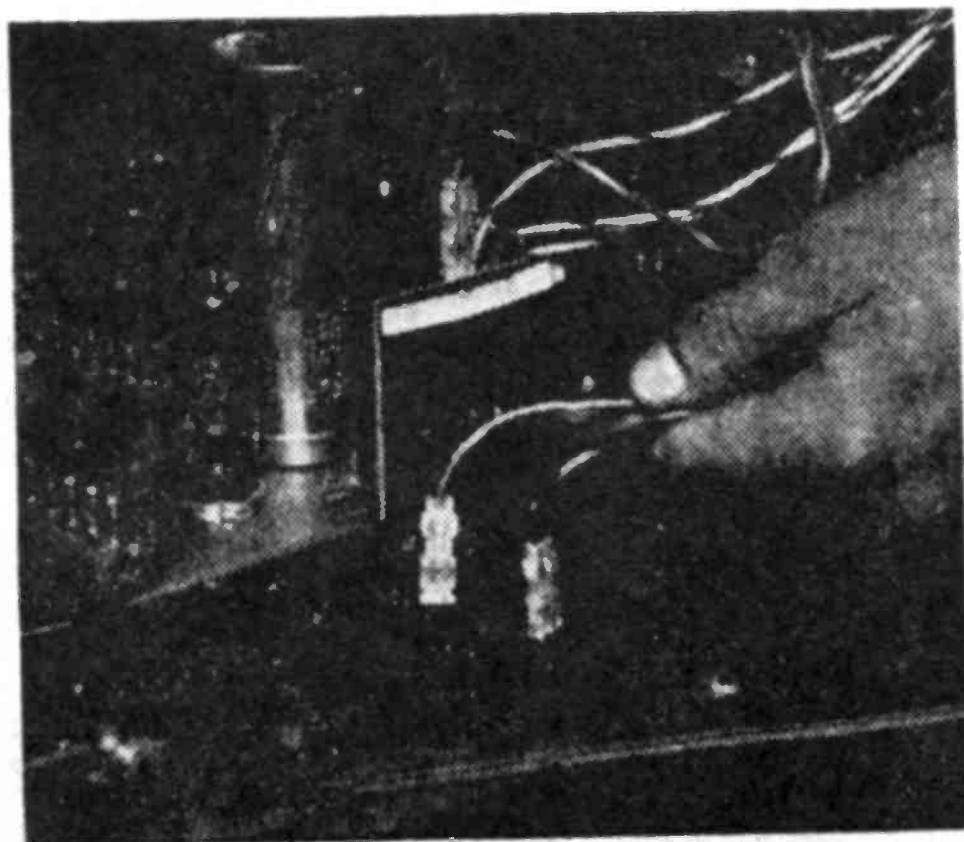

Fig. 5. Purity and static convergence adjustments are made on picture tube behind yoke.

Purity. This 2-step job (Fig. 5) begins by eliminating any possible source of interference on the screen, done simply by removing one of the receiver's I.F. tubes, or unplugging the I.F. cable running from tuner to chassis. (Don't forget to replace these after purity adjustments are completed.) Next is completely disabling blue and green electron guns in the picture tube. Only red

Fig. 6. Before making purity adjustments, disable blue, green guns by method set provides.



will operate at this time. In the recent receiver illustrated in Fig. 6, note that blue and green guns are deactivated by removing two clip leads from a terminal strip. For other sets, a small commercial adapter is plugged into the picture-tube base. It has switches for disabling desired guns. (Such adapters are often provided with the color dot-bar generator.) Some manufacturers specify clip leads for shortening out the guns.

Turn the set's contrast control fully off, brightness control to about halfway. The screen should now be essentially red. Locate the movable tabs (see Fig. 7) on the purity

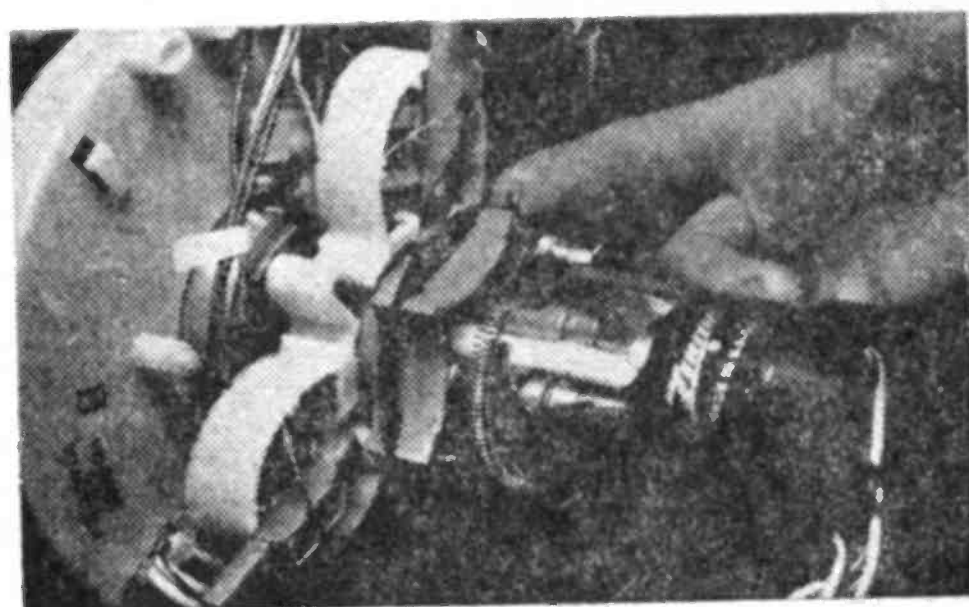

Fig. 7. The red area on the screen is moved to the center using the tabs on the purity rings.

rings and make the red color move to the center area of the screen. Some back-and-forth adjusting might be necessary. Not only should the red area predominate at the center, but its color be as uniform as possible. Step 2 in the purity adjustment is sliding the yoke back and forth to cause the red area to fill the entire screen (see Figs. 8 and 9). (There's a screw clamp to loosen the yoke.) Note that the yoke does not nudge up against the bell-shape rear of the picture tube as in

① BRING RED AREA TO CENTER OF SCREEN WITH PURITY-RING ADJUSTMENT

② FILL COMPLETE SCREEN WITH RED BY SHIFTING YOKE POSITION ON TUBE NECK

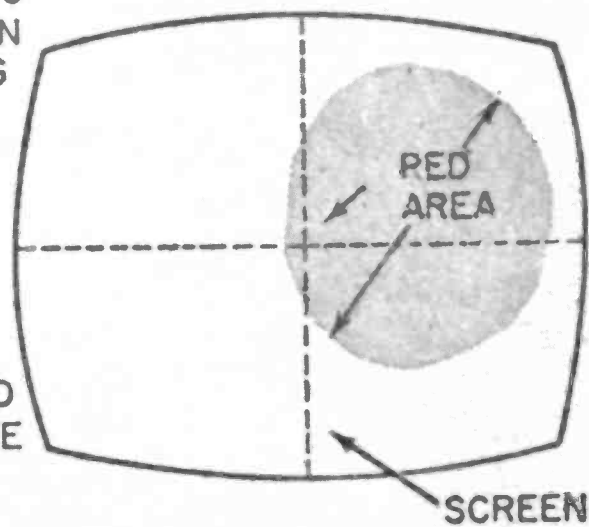

Fig. 8. The red area of the TV screen has to be centered and then expanded to fill the screen.

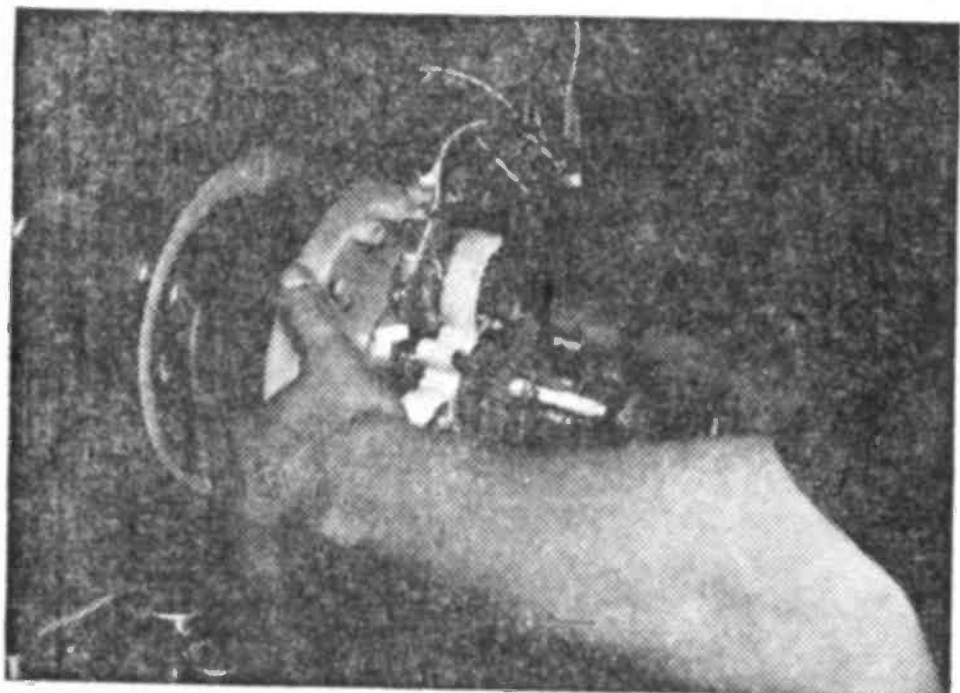

Fig. 9. Shifting the yoke along the tube axis causes a beam deflection that covers screen.

black-and-white sets. There is some play to permit purity adjustments.

The result of these steps should be uniform, uncontaminated red that slightly extends beyond (overscans) the borders of the picture-tube mask. In some sets, rim magnets around front the edges of the picture tube are adjusted for correcting color impurity existing out at the edges of the screen.

Convergence. For this step, the color generator is clipped to the antenna terminals in the set-up illustrated in Figs. 10 and 11. (Be sure the I.F. tube or plug removed earlier is back in place.)

The aim of convergence is a series of adjustments to produce pure white dots throughout the complete screen (see Fig. 12). Done in two major steps, static (or

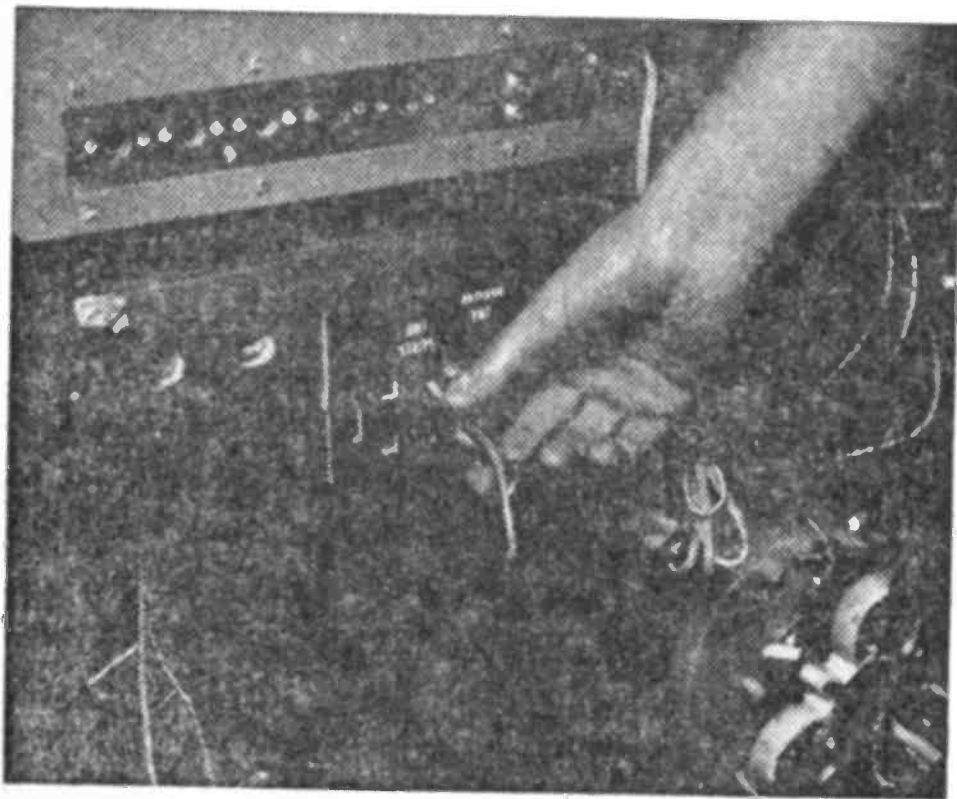

Fig. 10. The color generator output is coupled to the television receiver's antenna terminals.



Fig. 11. Color generator is tuned to frequency of an empty channel and set to generate dots.

DC), and dynamic convergence, it should be possible to apply the right amount of correction. Begin with static convergence, done with three movable magnets (see Fig. 13) which can be slid in and out of their holders. During this step kill the blue gun, but keep red and green guns active. By careful oper-

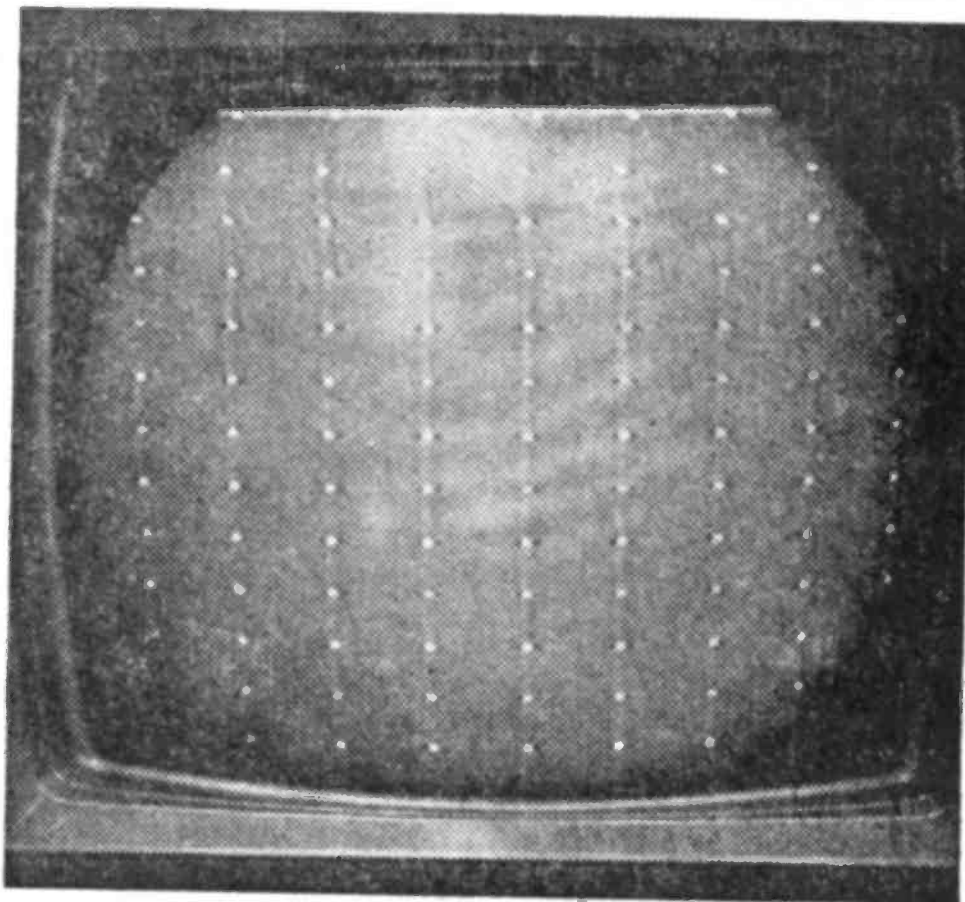

Fig. 12. Dot pattern is used during most color adjustments; is also used for conventional ones.

ation of red and green magnets it should be possible to bring together close-spaced red and green dots on the screen. As they merge, they form a single yellow dot. It's especially important that these static-convergence adjustments be made while viewing dots only at the *center* area of the screen, as shown in Fig. 14. Now activate the blue gun. Its magnet is slid to cause the blue dot to overlap the yellow dot. An additional control—the blue lateral magnet clipped on the tube neck near the base—permits side motion of the blue dot. As in other adjustments, static

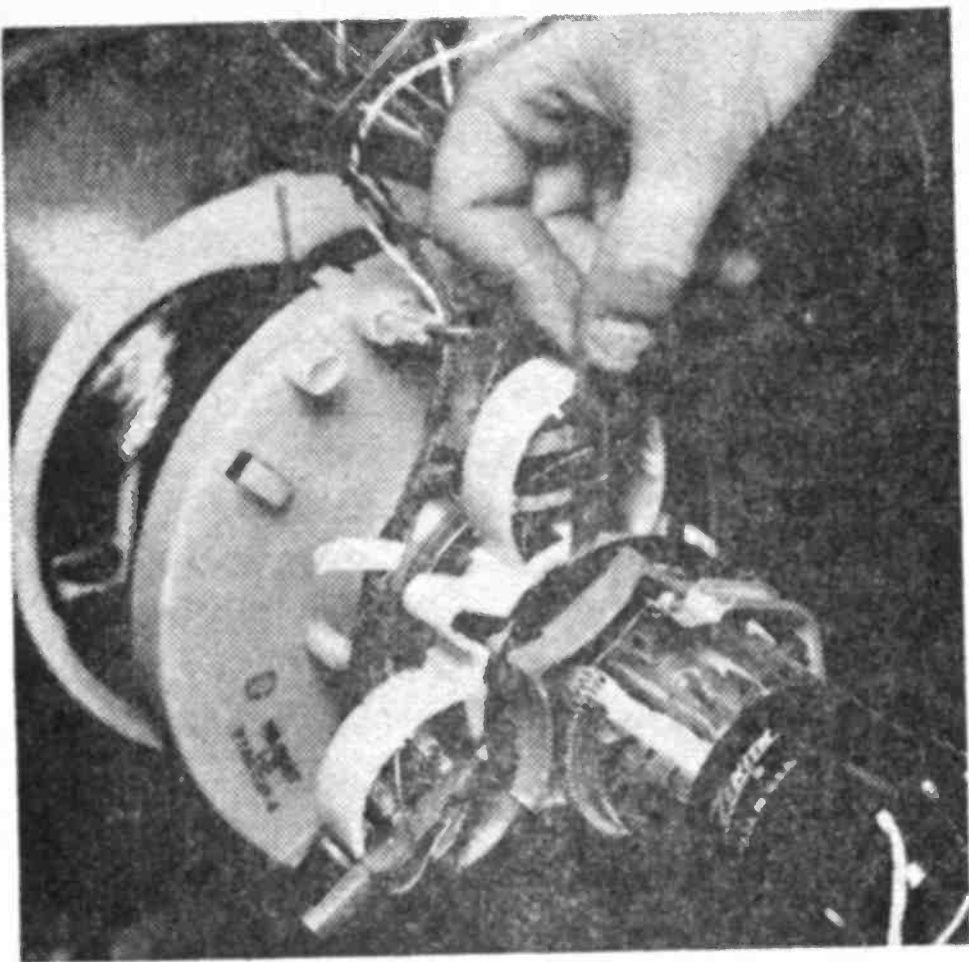

Fig. 13. Static convergence magnets are located in holders clamped around neck of tube.

convergence requires some juggling back and forth among controls to achieve satisfactory results. The end product should be pure white dots in the central screen area.

Controls for dynamic convergence, which bring together dots lying outside screen center, are generally mounted on a separate "convergence board." In many instances (see Fig. 15) long cables to the board permit it to be mounted conveniently on the rear top edge of the cabinet. Note how it is temporarily fastened in place by two screws. Thus, controls are accessible while the screen is viewed directly (Fig. 16).

A typical convergence board layout appears in Fig. 17. The various controls are divided into two major screen areas; horizontal and vertical. With the color generator producing the same dot pattern used earlier, begin with vertical convergence, the six knobs on the board's left side. During these

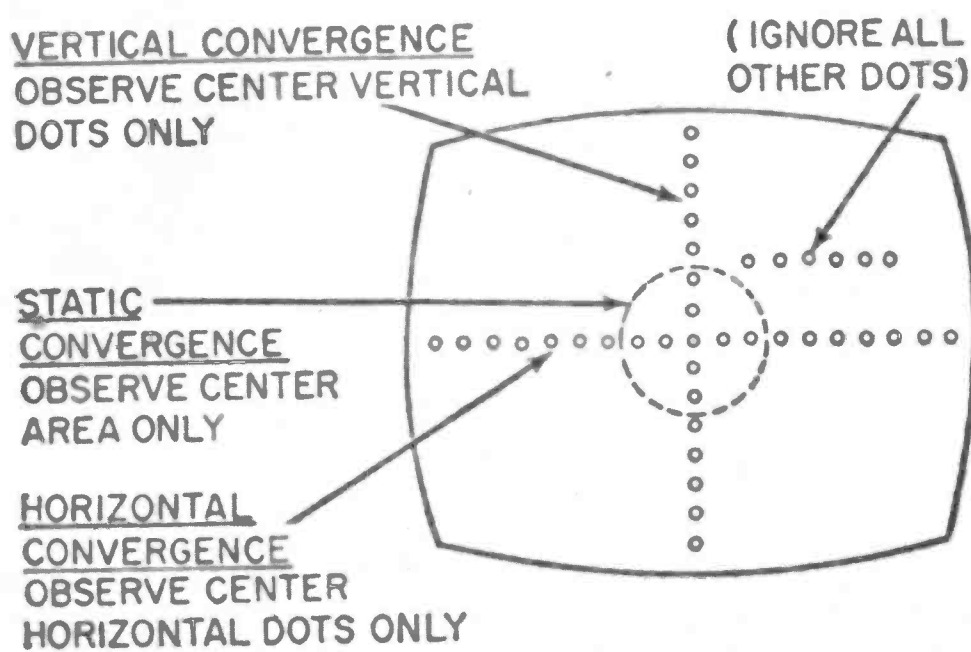

Fig. 14. In static convergence adjustments, observe only dot pattern in center area of screen.

adjustments, it is important to view only the *middle vertical row* of dots, as pictured in Fig. 14. All others are ignored. Red-green controls can be adjusted first, and the blue gun turned off at this time. While watching the vertical column of dots, carefully turn Red Tilt, Red Amp, then Green Tilt and Green Amp in an effort to merge red and green dots so they form single yellow dots. Following this, the blue gun is restored and Blue Tilt and Blue Amp adjusted so the blue dot overlaps the yellow dot for the desired result; a pure white dot, more specifically, a complete vertical row of white dots.

This process is apt to be confounding at first due to interaction—turning of one control upsets the setting of another. And, in fact, when upper and lower dots appear to be perfect, *center* dots in the vertical row go out of whack. This is to be expected. The remedy is to go back and touch up the magnets used earlier for static convergence to re-align the center.

There's another approach to dynamic convergence which might prove helpful until more experience is gained. This is to leave the blue gun on, then adjust red and green controls to bring those dots into line with blue (which serves as a reference). Also, some technicians prefer not to use the dot pattern at all for convergence. They switch the generator for a crosshatch pattern (see Fig. 18). Here, only the vertical column or line at the center of the TV screen is

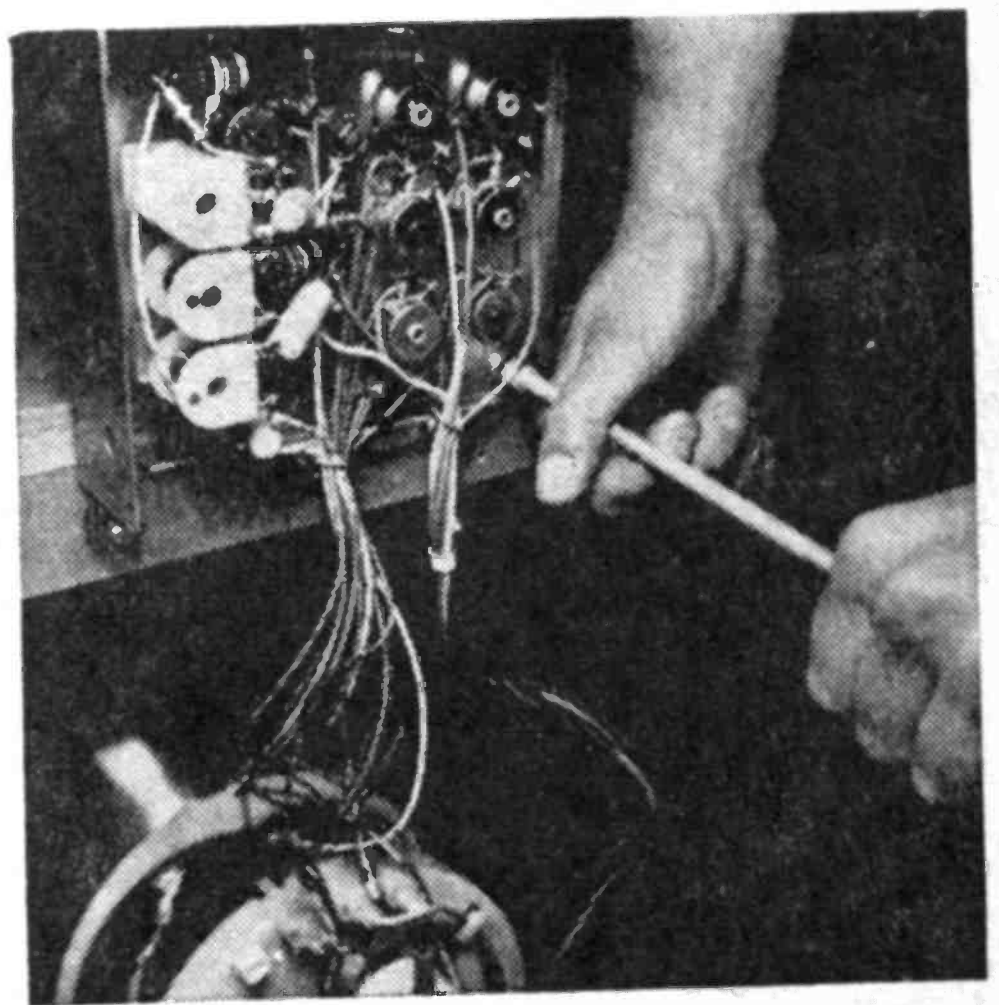

Fig. 15. For convenience, remove the dynamic convergence control board and secure where accessible for your tools and for visibility.

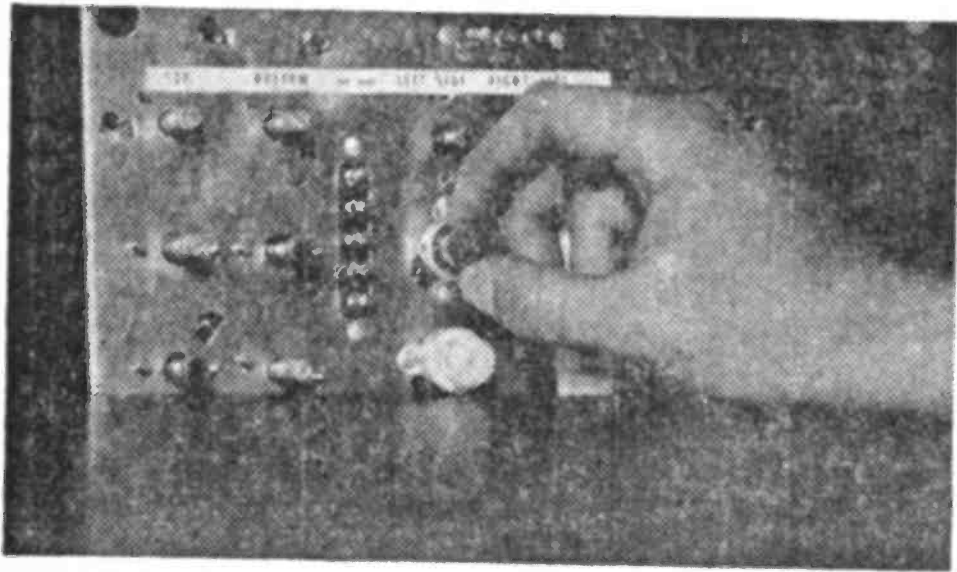

Fig. 16. When "board" is secured to top rear of set, it can be adjusted while viewing screen.

VERTICAL		HORIZONTAL	
(TOP)	(BOTTOM)	(LEFT)	(RIGHT)
RED AMP	RED TILT	RED-GRN LEFT	RED- GREEN RIGHT
GREEN AMP	GREEN TILT	RED-GRN LEFT	RED- GREEN RIGHT
BLUE AMP	BLUE TILT	BLUE LEFT	BLUE RIGHT
CONTROL(S)			COIL(S)

Fig. 17. The dynamic convergence board layout conveniently groups horizontal and vertical controls into logical position and color pattern.

viewed for vertical convergence adjustments.

Horizontal convergence is next, a procedure not unlike the one above, only now the *middle horizontal row* of dots (or lines for crosshatch) comes under adjustment (see Fig. 14). There is a difference; red and green occur *together* on each of the two left and right controls. Thus, the red and green color dots will move at the same time. Blue, as shown, has its own individual controls. Also, the extreme right-hand controls are not usually provided with knobs, but require the insertion of a plastic hex-type aligning tool. After turning off the blue gun, the various red-green controls are used to produce single yellow dots on *right* and *left* halves of the screen over the entire middle horizontal row. When yellow dots are visible, activate

the blue gun and adjust the two blue controls. As blue overlaps yellow the desired white dots should appear. Those blue controls only move the blue dots up and down. For side to side motion, it is necessary to return to the blue lateral magnet mentioned earlier. Again, static convergence (on screen center) may be affected by dynamic convergence, so some back-and-forth adjusting might be in order. It's a good idea, too, to make a final check of color purity, described in the preceding section.

Tracking. After purity and convergence are completed, output of red, blue and green electron guns is adjusted. This assures that a correct proportion of primary colors will be delivered for creating the black-and-white picture. The controls are usually at the rear.

Although tracking controls may differ in number and marking, the general idea is as follows: First tune to an unused channel and turn the set's contrast and front-panel color controls to minimum. This should fill the screen with white light (or raster). With the brightness control turned up (though not to maximum) adjust red, green and blue screen controls for best, color-free white light. If, for example, blue is apparent, back off slightly on that control.

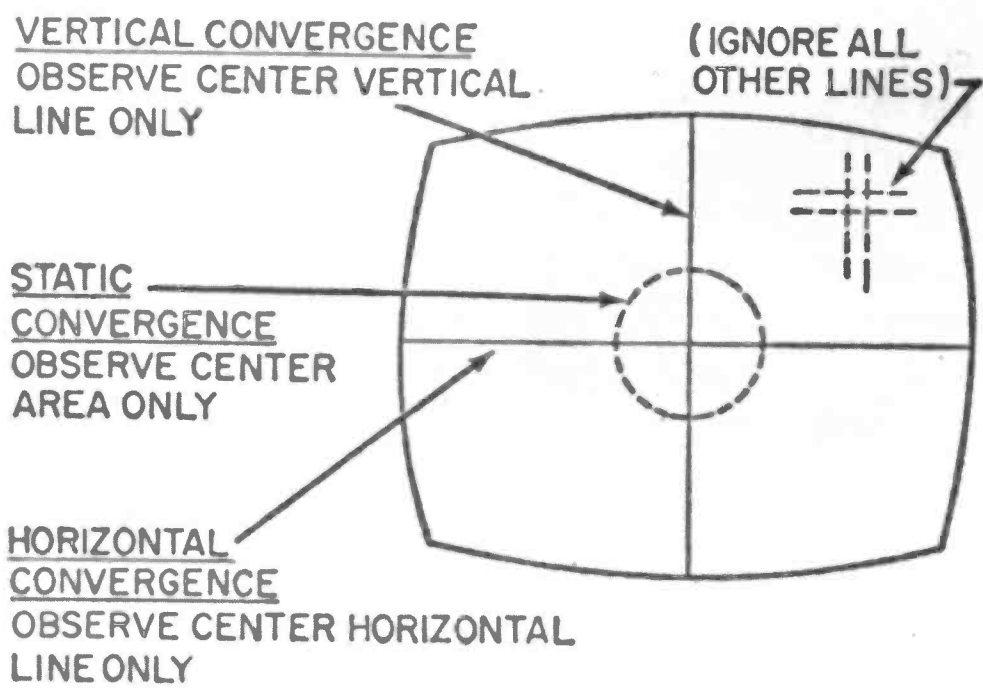
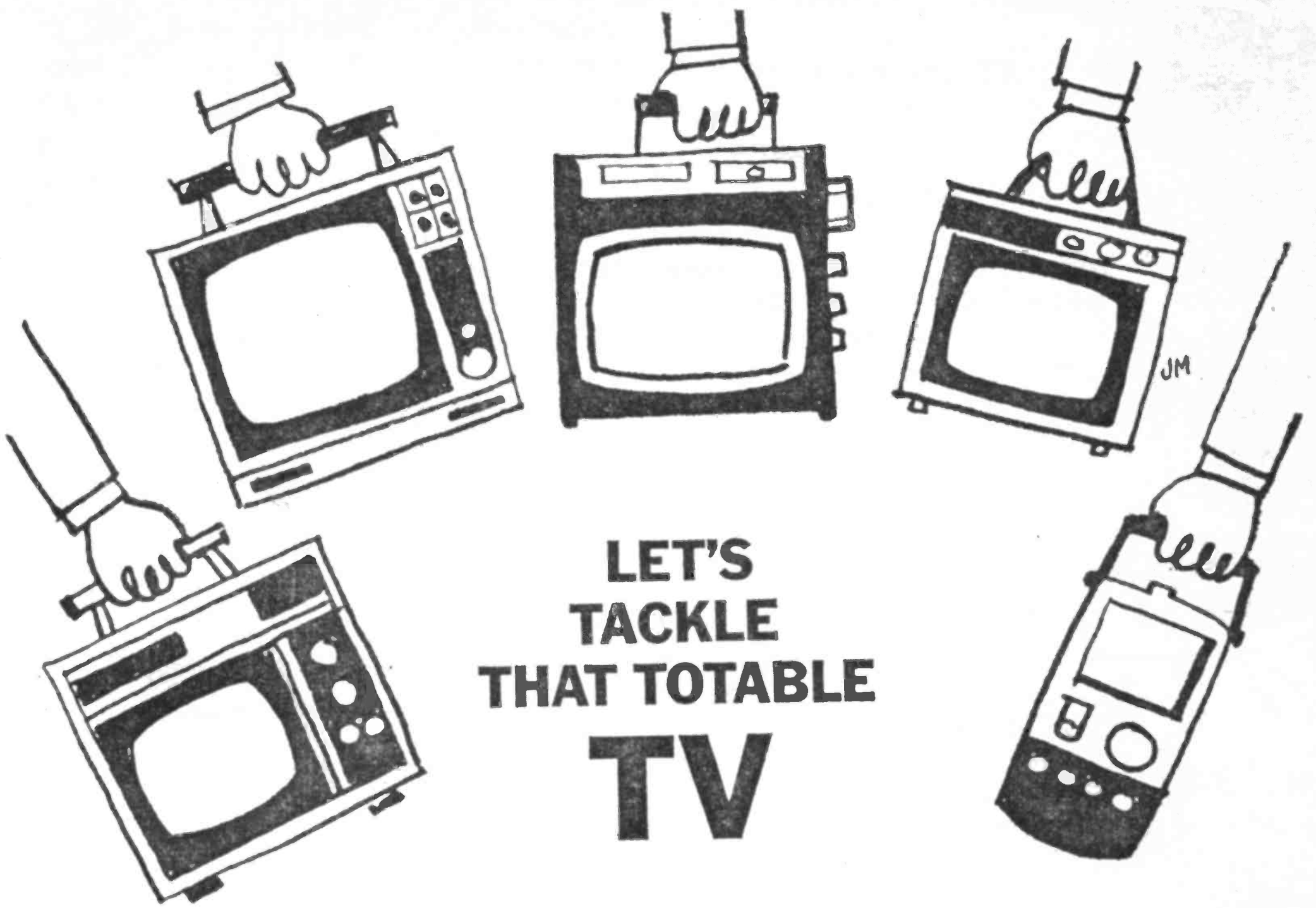

Fig. 18. Color generator can be set to give a crosshatch pattern for convergence adjustments rather than dot patterns discussed.

This completes the job. How well does a color TV stay in adjustment? There is no set period, but you can expect that, with normal conditions, convergence remains fixed for fairly long periods, say upwards of two years or more. Any jostling, magnetizing or moving the set especially affects color purity. But knowing when to repeat the job is the easiest step of all. During day-to-day viewing, your eye will make that decision. ■



LET'S TACKLE THAT TOTABLE TV

By Homer L. Davidson

Fixing that portable takes a knowing hand; here a pro lends his!

When that portable TV is on the blink, you've got two choices: figure on spending a bundle having it fixed, or doing it yourself. Of course, doing it yourself can be a problem even if you've had experience with big-brother console. That's because size considerations makes for design and construction differences. But take heart—the most common problems of a portable TV are often the easiest to repair. And with a few items of test gear and a little know-how you can tackle that misbehaving portable with confidence.

No Nothing. This symptom is the easiest trouble of all to correct. Let's take a look at the block diagram in Fig. 1. We see that practically every stage gets power from the low-voltage power supply. Let's begin right here.

Roll up your sleeves and pull the TV back cover off. First, see if the portable is an AC/DC or power-transformer type. The AC/DC portable TV receiver does not have a power transformer like the one shown in Fig. 2. All filaments in the AC/DC portable are hooked in series. In the power-transformer variety, the transformer supplies 6.3

VAC to all tubes in a parallel circuit.

Now check the circuit breaker on the rear apron of the TV chassis. In most late-model sets, it's in the form of a small protruding red rod. Push this and the circuit breaker will reset. If this was the problem, the filaments should begin lighting. Often a tube in the sweep circuit, such as the damper tube, will arc over, kicking out the circuit breaker. If the tube starts arcing when the circuit breaker is reset, replace the tube.

Fused Fuse. Take a look and see if all tubes light up. If they don't, check for a defective fuse. Some portable receivers have a circuit breaker and a low-ampere fuse in the AC line. Check the continuity of the fuse with an ohmmeter. Just looking at the fuse may not tell the tale. OK, the fuse is blown, so in goes another one. In some cases, only the type designed for the set will plug into the fuse holder.

Look at the schematic of your set and see if the fuse in the low-voltage power supply is like the hookup in Fig. 3. Here is a 2-A fuse protecting the overload that may occur in the low-voltage power supply if

associated circuitry suddenly shorts out.

What makes the fuse blow in the low-voltage power supply? Check for a shorted selenium or silicon diode rectifier. Then go to the filter capacitors and check for other possible defective components that can be shorted causing an overload in the B+ line.

string portable TVs (transformerless) is shown in Fig. 4. Here the fuse is a 0.4-amp type at the output of the power supply. After checking the fuse, go directly to plug-in resistor, R113 and see if it has burned open.

Now check the front-to-back resistance of SR101 and SR102, the two silicon diodes. Remember to always cut one lead loose for accurate measurement. If they're OK, then check the voltage-doubler capacitor, C111. These capacitors will dry out after several

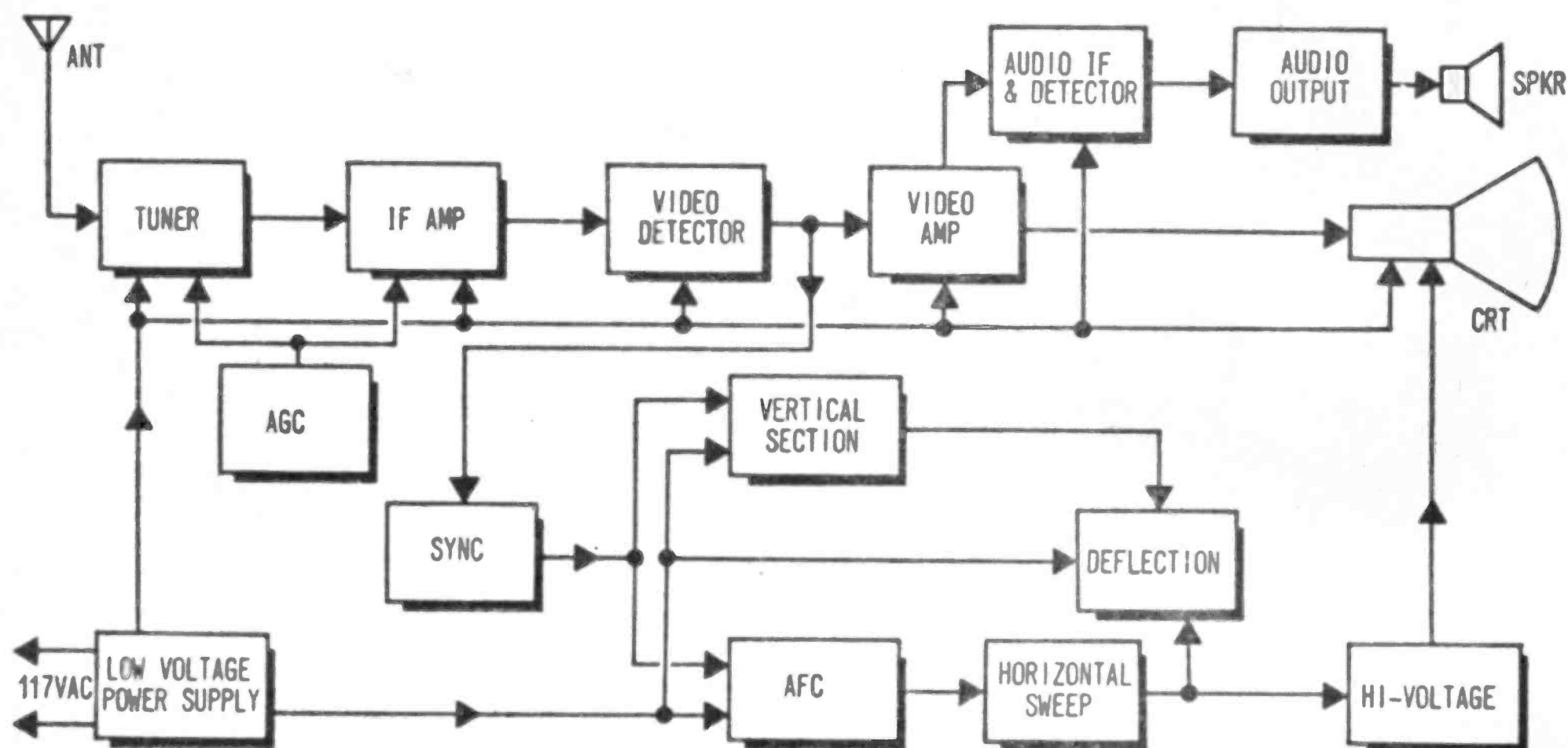

Fig. 1. Block diagram of standard TV set is useful when attempting to track down power supply troubles.

You can make a quick check of silicon diodes with the low-ohms scale of the VOM. Remove one end of the suspected diode, then place the ohmmeter leads across the diode rectifier. You should have a 5- to 15-ohm reading in one direction. Now reverse the ohmmeter leads. Does the ohmmeter still read 5 to 15 ohms? If so, the diode is shorted. A very high resistance reading should be noted with reversed ohmmeter leads. Very rarely do silicon diodes go open; they usually short out.

Smelly Selenium. Selenium rectifiers will have a resistance reading from 20 to 25 ohms in one direction and over 3000 in the other. You can easily spot a defective selenium rectifier by its pungent smell. Also, black burned spots form on the selenium side of a defective rectifier of this type.

Let's say, for instance, the fuse is good but there's still no output voltage from the low-voltage supply. In this same circuit (Fig. 3), check to see if the 3-ohm resistor is open.

A voltage-doubler circuit used in series

years of use. A white substance may have leaked out at the bottom of the filter, indicating the capacitor is defective.

To check the capacitor, shunt a new one across it. If that cures the problem, replace the defective capacitor.

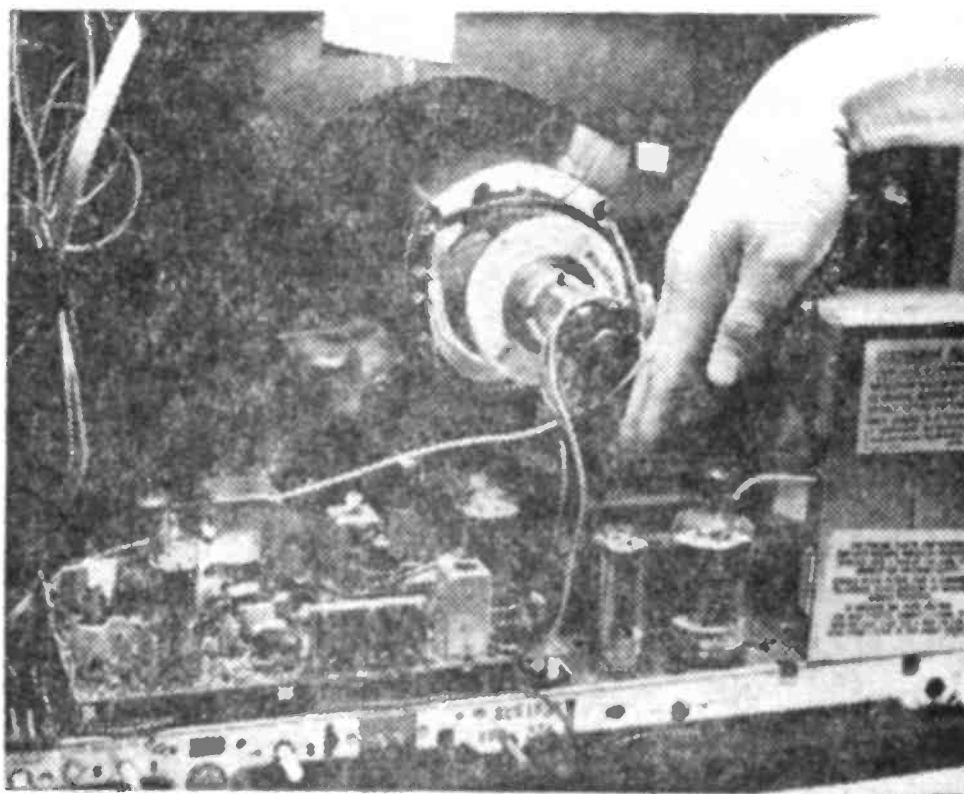

Fig. 2. Hand points to power transformer in transformer type set. The absence of this or similar transformer indicates TV set is of the series string variety, which the majority of low-cost portables are.

Fig. 3. Schematic shows typical transformerless low-voltage power supply used in many current portable TV models. Here, a 2-Amp fuse is used to protect set from damage in case of short circuit developing in the B-plus line or associated components.

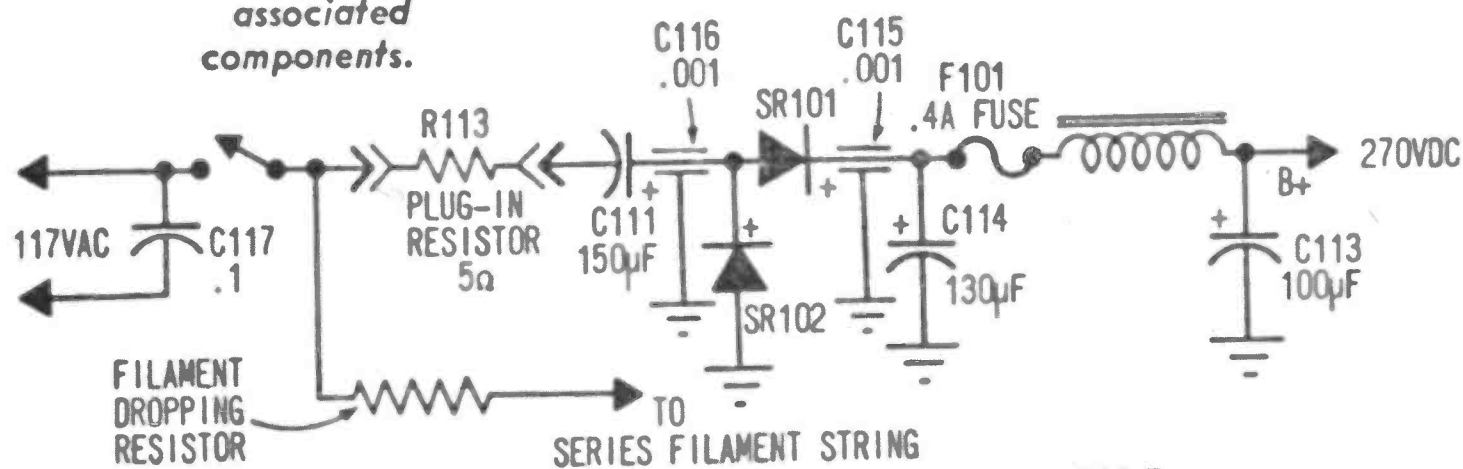
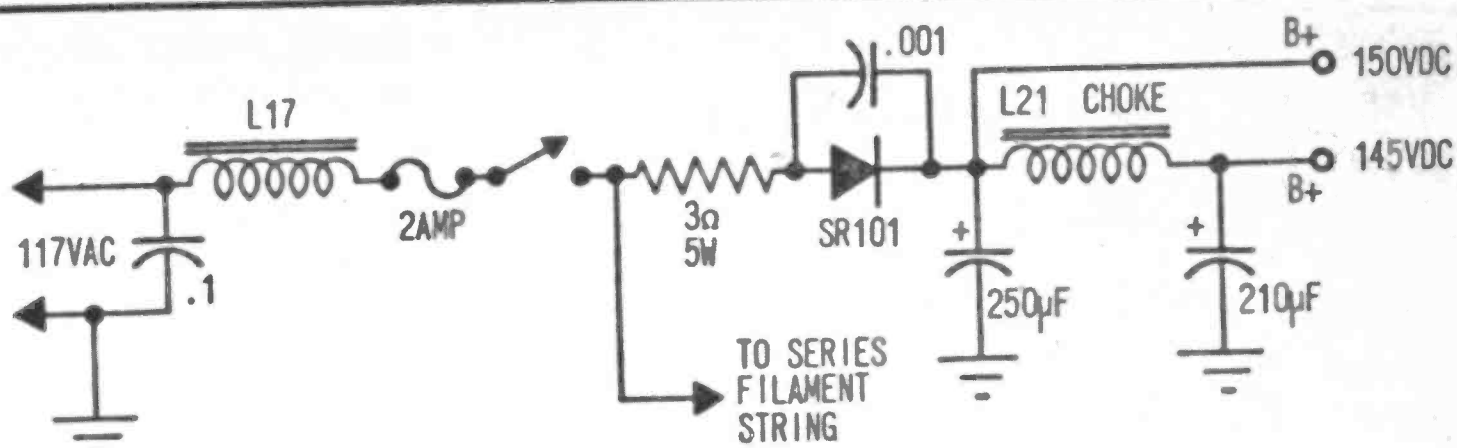
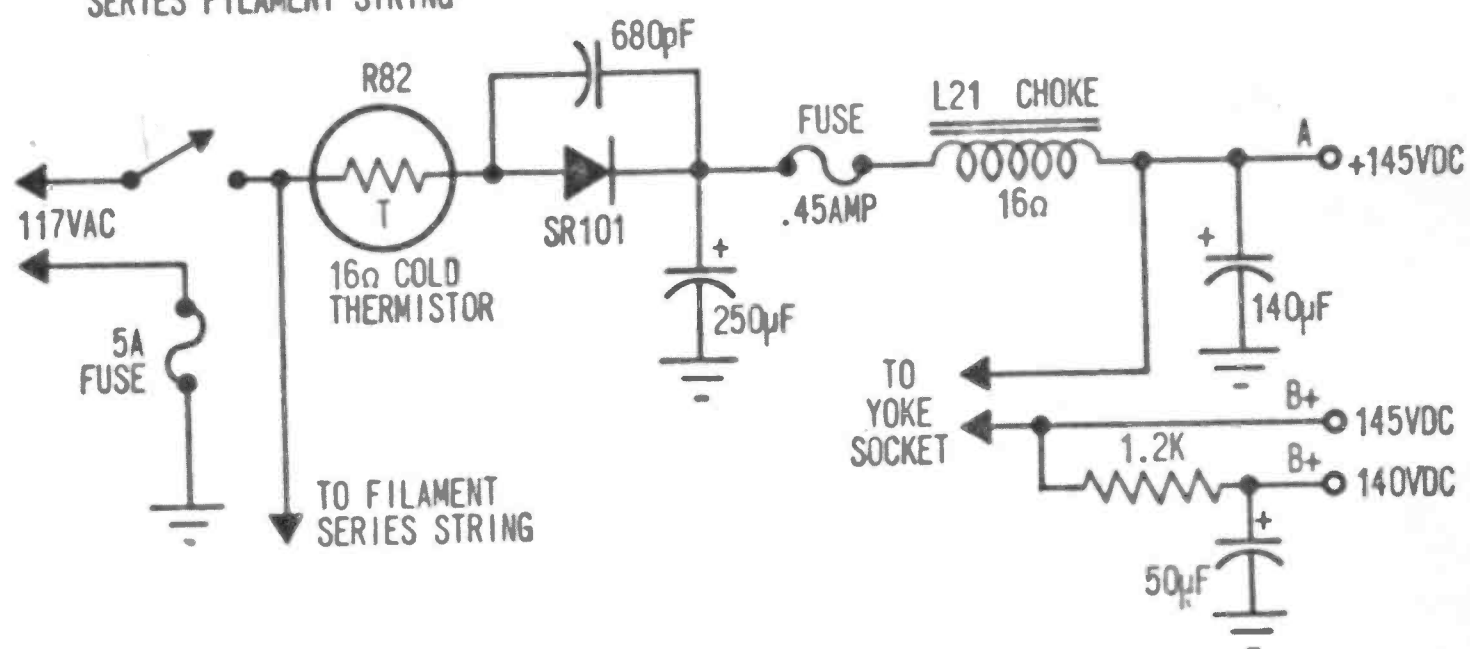

Fig. 4. In this power supply circuit, the B-plus output is fused by F101 and the AC line protected by fusible resistor R113. This hookup is a voltage doubler, the output being twice the input rms value.

Fig. 5. In some sets, a thermistor is connected in series with the AC line to prevent voltage surges from damaging set when turned on. The thermistor protects set by having high initial resistance which then drops as thermistor warms up.



Hummm . . . If there's hum in the sound or dark bars across the screen, check the filter capacitor in your set equivalent to C113 and C114 in Fig. 4. Shunt a new capacitor of at least 450-VDC rating across the suspected filter capacitor and see if the hum disappears—if so, you've located the fault. When checking the power supply, always have the AC switch turned *off* while clipping the test capacitor across a suspect filter capacitor.

In Fig. 5 is another low-voltage power supply using a silicon diode as rectifier. Notice the thermistor resistor ahead of the diode. This resistor protects the series-string tubes by preventing surge voltage from being applied to cold tubes.

After several years' usage, the wires soldered to each side of the thermistor can pop off or come loose, leaving a high-resistance or open-current path. The results are intermittent or no output from the low-voltage power supply.

A low-voltage power supply circuit using a power transformer is shown in Fig. 6. The

secondary winding is wired up for full-wave rectification with two silicon diodes in each leg. Notice the circuit breaker in the center leg of the transformer. In case heavy current drain in the B+ results because of defective components or a short circuit, the circuit breaker will kick out.

No H.V.? When this type of set is dead, check the B+ output supply voltage with a DC voltmeter. Also check the resistance of the two silicon diodes. Generally, when one is found defective, both silicon diodes in that leg should be replaced. If the circuit breaker keeps kicking out after it's been reset a few seconds, short across the terminals with an alligator clip. Occasionally, the circuit breaker will become defective and will not hold under the ordinary power load and will have to be replaced.

The second winding on the power transformer is the heater circuit. Tubes in transformer-type portable sets usually all operate on 6.3 VAC. This particular heater winding (hot side) has a 1-in. piece of #28 fuse wire so that in case of a filament or

pilot lamp short circuit, the wire will open, protecting the transformer winding from overload. If the filaments don't light, check for an open fuse wire—if OK, check for an open transformer winding with an ohmmeter and one transformer lead disconnected.

When the tubes are dark in a series-string set, all tubes will have to be checked for an open filament because if one goes out, none will light. So with a tube filament checker as

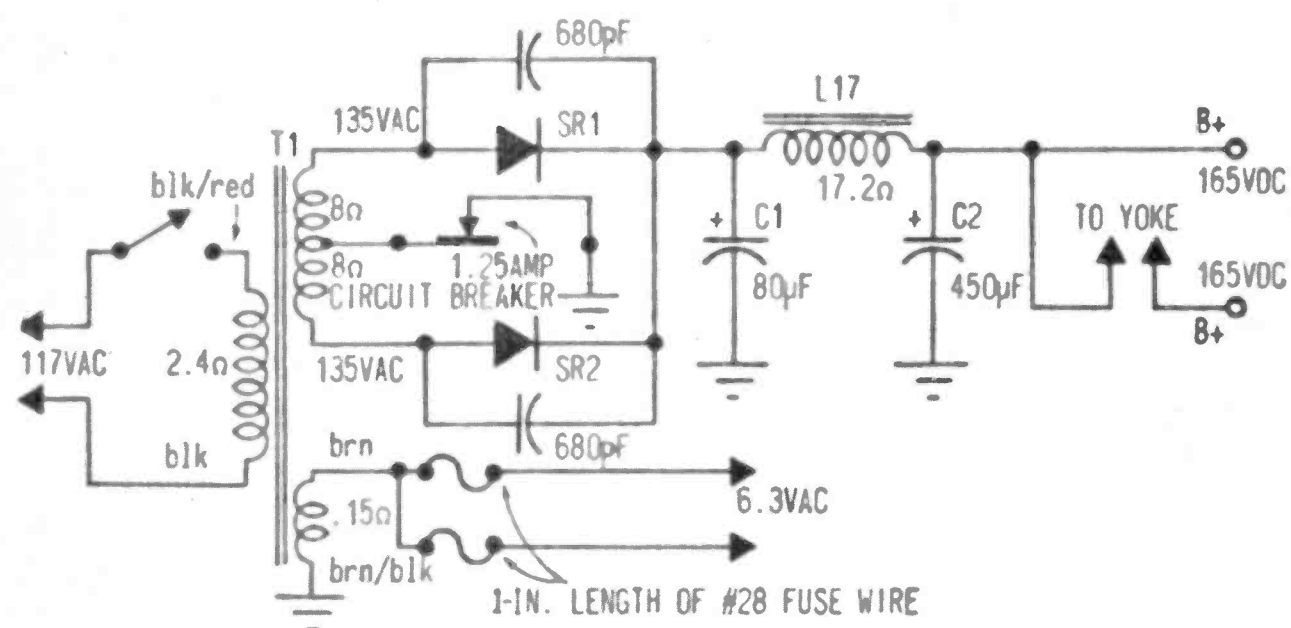

Fig. 6. Transformer power supply is used in better portable TVs. Typically, a circuit breaker is used in either AC line or in B-plus circuit as shown here. Full-wave rectification is provided by the use of two silicon diodes in this configuration, or in some cases, a bridge circuit employing four diodes. Typical DC-ohms values shown on transformer windings and choke lets them be easily tested with an ohmmeter.

shown in Fig. 7 or with an ohmmeter, check filament continuity.

Continuity Check. We know that one of these tubes, or possibly two, may have an open heater element. Take one tube out at a time and check it for continuity. Start with the horizontal output tube, damper, and sound output tube, in that order. These tubes run hot and are most likely to have a defective filament.

When checking filament continuity with an ohmmeter, switch to a low-ohm scale and place the probes across the heater terminals. The larger the heater voltage required by the tube, the greater the filament resistance measured should be. See Fig. 8 for a filament resistance chart.

In case the problem hasn't been found after checking tube continuity, bring out the AC voltmeter (see Fig. 9). Switch the voltmeter to the 150-VAC scale. Place the voltmeter probes across the *on/off* switch—it could be open. If this checks out OK, put one voltmeter lead to the *on/off* switch and trace the heater wires starting at the grounded side (Fig. 10).

Most tuner tubes are located at the grounded side of the series filament string. Quickest way to eliminate a possible defec-

tive tube socket or broken heater wire in the tuner is to clip a shunt wire from the brown heater wire going from the tuner to the chassis ground. If the problem is in the tuner, the other series string of tubes will light up when the set is turned on. If so, you have isolated the heater trouble to the tuner section.

Mostly Series. Remember that most portable receivers are of the series heater variety. When one tube goes out, the whole string is open like a cheap string of Christmas tree lights.

Fig. 11 shows a typical power transformer heater circuit with all tubes wired in parallel. In this type, one or two tubes may not light

up indicating they are dead or their heater wiring defective. If all the tubes are dead in a power-transformer TV set, check for defective power transformer, broken heater wires, or open fuse wire.

When the picture tube has a raster, but there is no sound or picture, the trouble is probably in the tuner. The tuner is just behind the station selector knob. Substitute or check the RF and oscillator tube. If substituting tubes here doesn't produce picture or

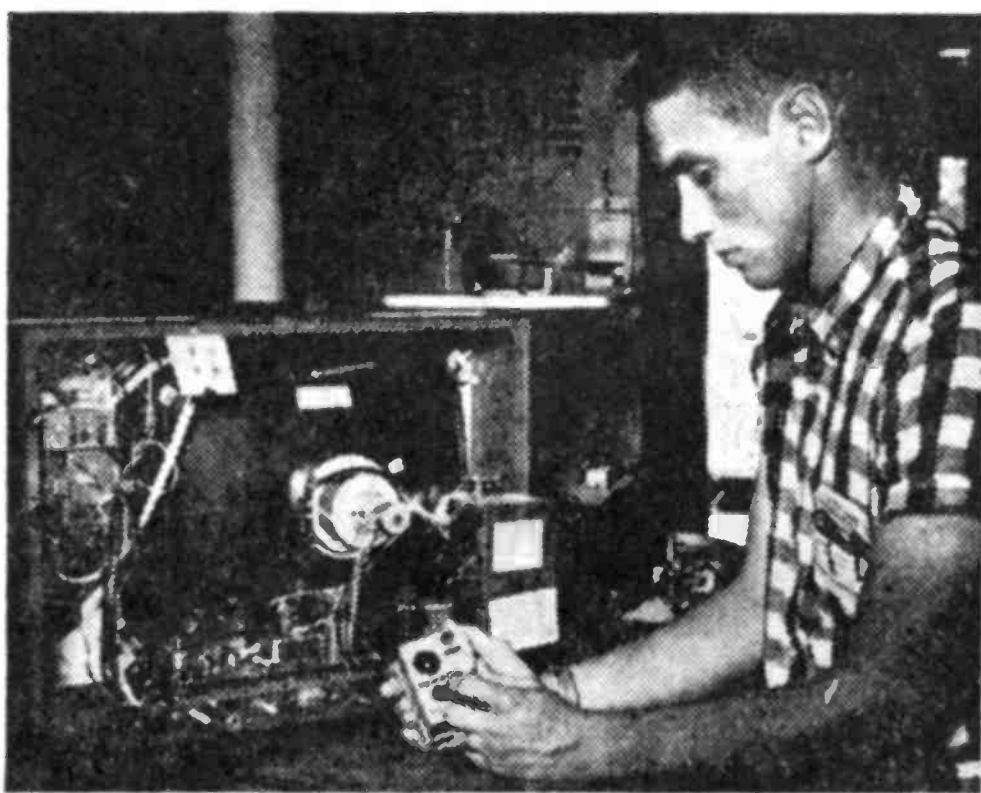

Fig. 7. Easiest way to check many tube filaments in a series-string TV is with simple continuity tester. What happens in this type of set is that when one filament burns out, none of the tubes will light up.

TUBE HEATER RATINGS

VOLTAGE (VOLTS)	3	6	12	17	25	35	50
RESISTANCE (OHMS)	1-1½	2-5	3-12	5-12	10-20	30-50	50-60

Fig. 8. If a continuity tester isn't available, tube filaments can be checked with an ohmmeter. Listed above is the approximate resistance value for tubes of various voltage ratings, e.g., 12BQ6 is 3-12.

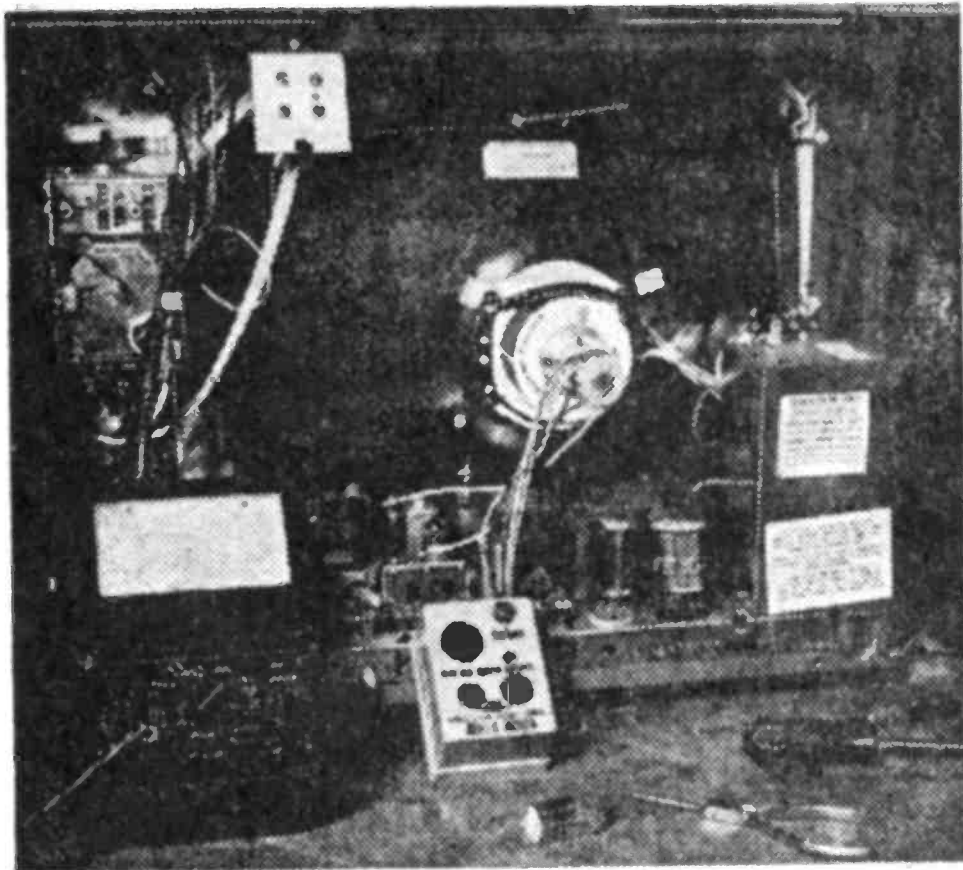

Fig. 9. If all tube filaments check out good, test the AC power switch with an AC voltmeter. If switch is good, no voltage should be indicated when on, 117 VAC should be indicated when off.

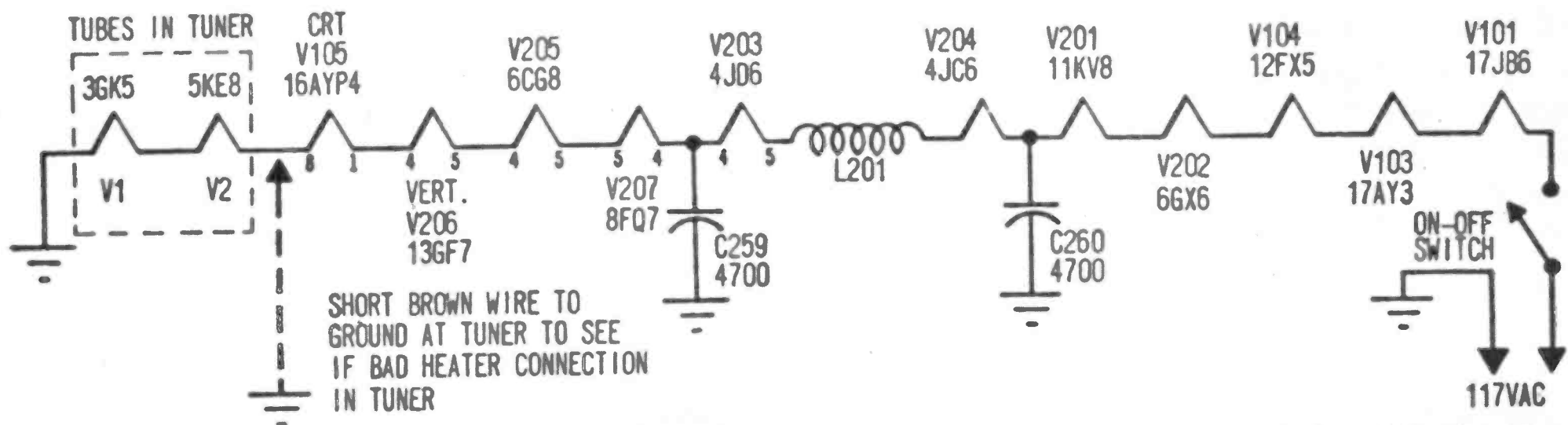

Fig. 10. Typical series-string hookup can be quickly traced with AC voltmeter to locate break in circuit.

sound, check the IF and video output tube. Always replace these tubes if any element indicates shorted on a tube tester.

If the problem persists, try pulling the AGC (automatic gain control) tube out of its socket (with the set on) and see if the picture or sound returns for a split second. If so, your set has AGC troubles. A defective AGC tube can cut off both picture and sound. Another method for checking AGC is to turn to a weak TV station. The picture and sound may appear on a weak signal but can be blocked by AGC action on a strong TV station.

No Picture — Raster — Good Sound. When there is sound, a good raster, but no picture, the trouble is likely to be in the video circuits. Most portable TV sound circuits are connected to the beginning of the video circuit, so the problem will be somewhere after this point. Substituting or checking the video amplifier tubes will usually solve this problem.

The cause of excessive picture smear and tearing can usually be found in the video amp circuits. Open peaking coils in the video output circuit will result in a smeary picture—see Fig. 12. An open or leaky coupling capacitor from video amp to CRT can also cause picture smear.

Another possibility is a shorted picture tube. Simply tap near the end of the CRT, but *gently*, while watching the picture in a hand mirror. If the fault comes and goes while you're tapping, replacement of the CRT is the answer.

No Sound—Good Picture. When everything is fine but the sound is missing, go directly to the sound amplifier section and check the sound tubes, starting with the output tube—see Fig. 13. A defect here can cause no sound, extreme distortion, or excessive hum. If a tube is not at fault, check

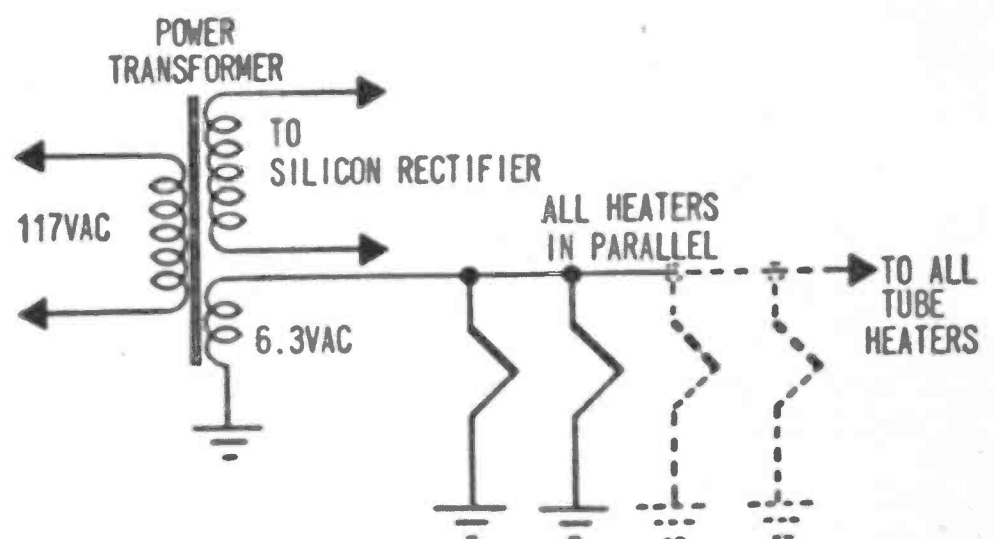

Fig. 11. In transformer type set, one or two filaments may not light up indicating tube or associated heater wiring is defective. If no tubes light up in this type of set, check the power transformer, fuses in AC or filament line or circuit breaker, and AC switch.

Fig. 12. Picture smear with complete loss of detail is caused by defects in either the video amplifier circuit or a shorted picture tube. Easy way to check picture tube is to tap it gently on the base and neck while watching picture in mirror.

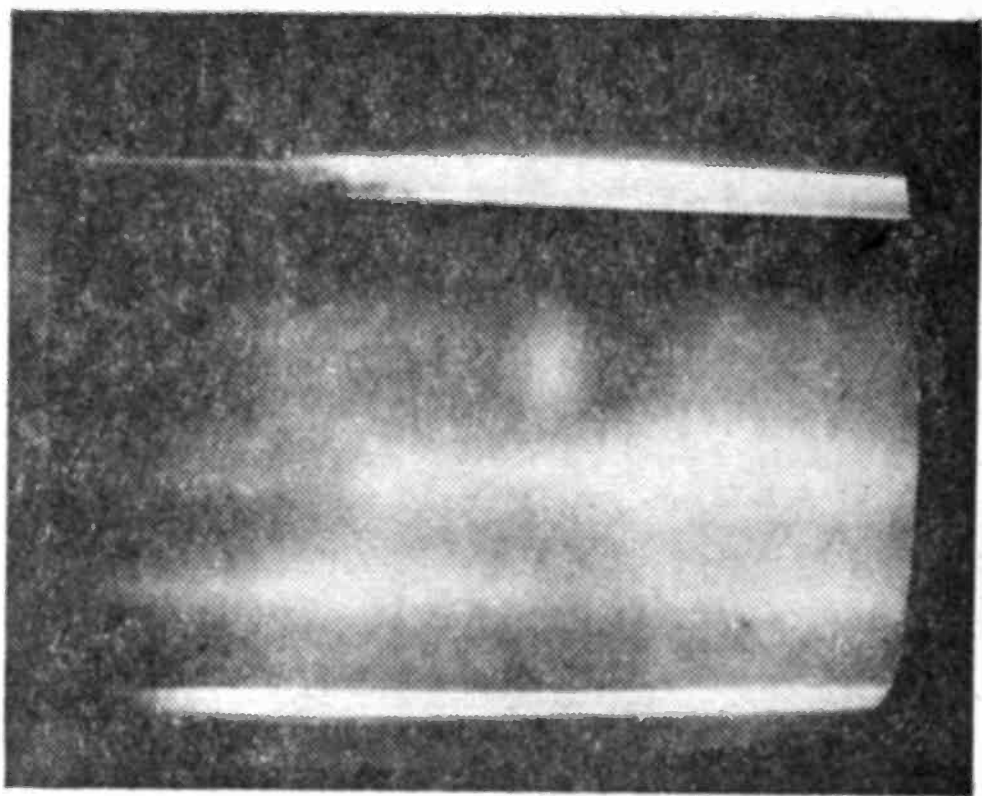
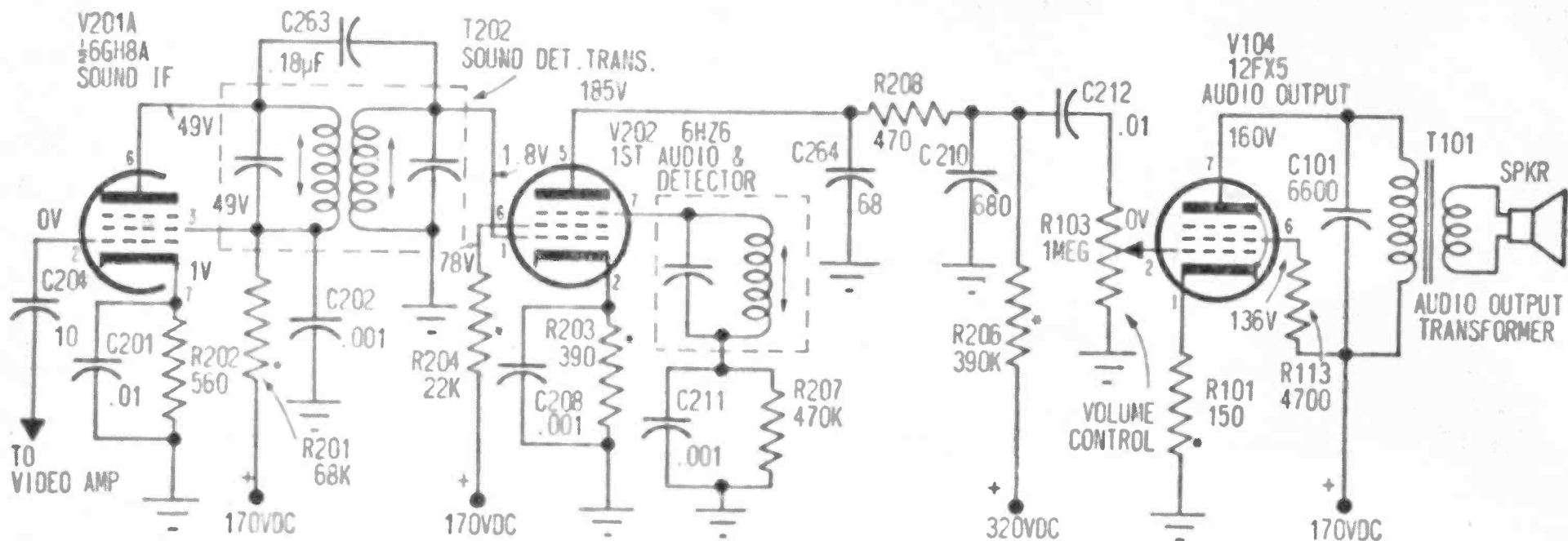

Fig. 13. The audio circuitry in your portable TV will look very much like this. If poor, distorted or weak sound is the problem, start by checking these tubes or their counterparts in your set. The next thing to check is the speaker (see text).



the speaker and cable connections. Also check for a defective output transformer. This can easily be accomplished with an ohmmeter continuity check. Distorted sound can be caused by the cone resting on the center pole piece, in which case the speaker must be replaced. Small holes poked into the speaker cone can be repaired with glue.

Intermittent sound can be caused by a cracked PC board. Push and move the small parts on the PC board with an *insulated* tool

while the set is on. Intermittent IF and detector coils may have cold solder connections inside the metal can.

Black Screen—Good Sound. Here we probably have a horizontal sweep problem (but be sure it is not just the brightness control turned all the way down). Be extremely careful when working in this section as **LETHAL** voltages exist. Keep the set turned *off* unless stated otherwise. The CRT capacitively stores up to a 20,000-volt charge

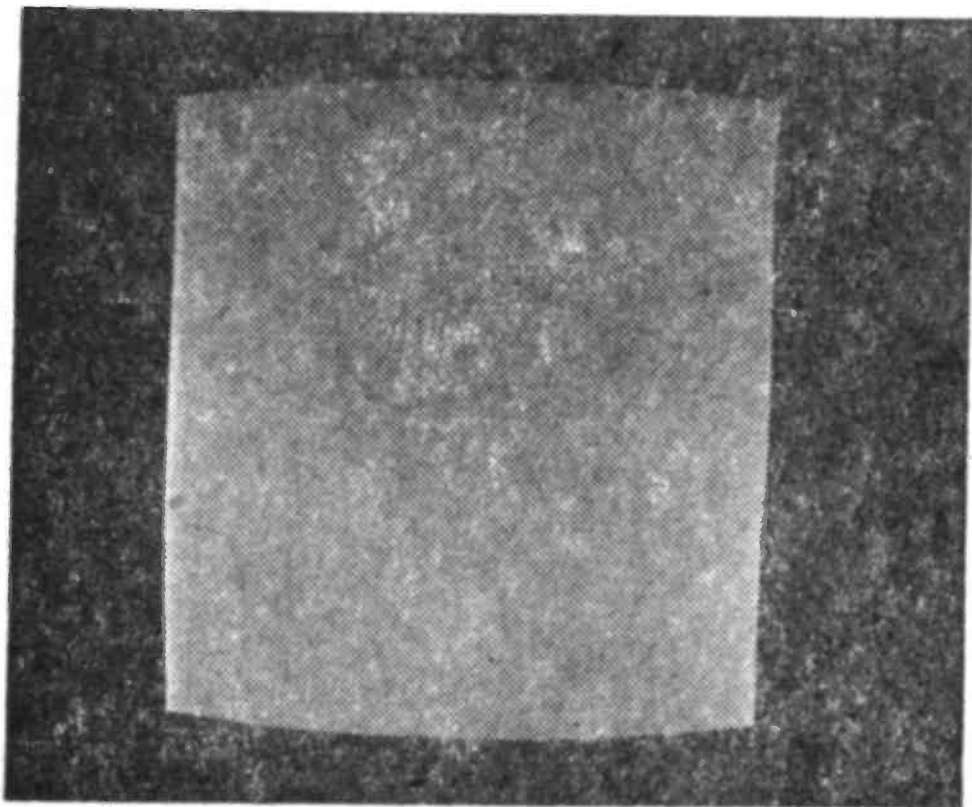

Fig. 14. Insufficient width is caused by the horizontal sweep voltage being low. This problem is most often traced to a weak or defective horizontal output or damper tube, but can also be low B-plus voltage.

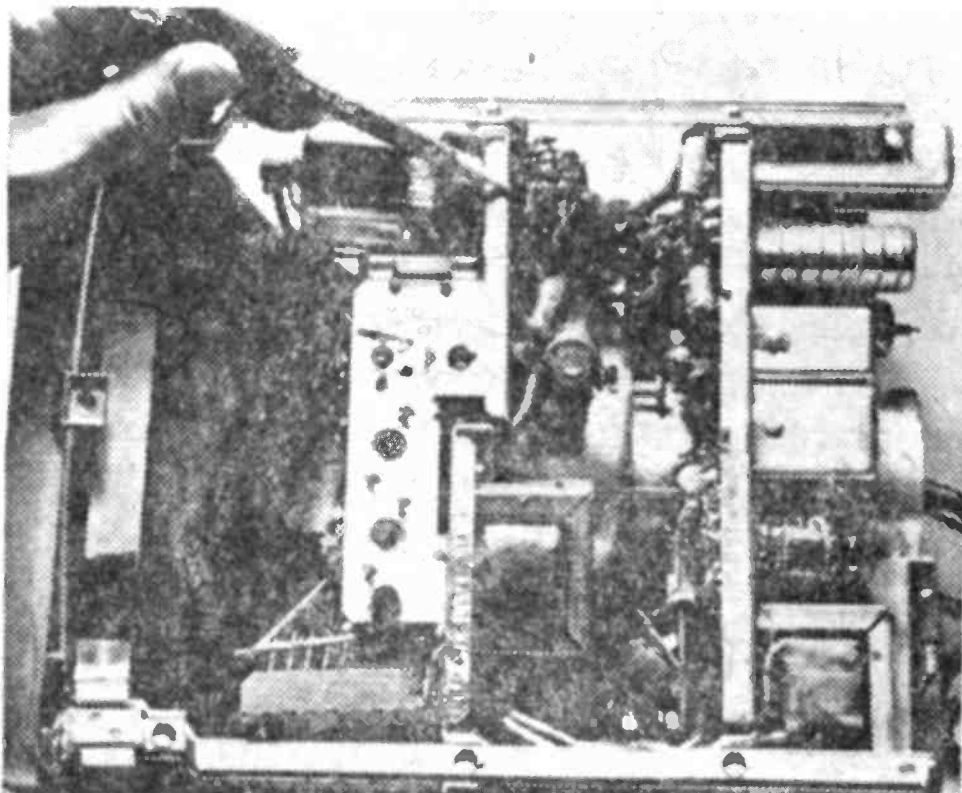

Fig. 15. If tubes are not the cause of a narrow raster, circuit components associated with the horizontal and damper tubes are likely candidates. The pencil points to the horizontal output tube circuit.

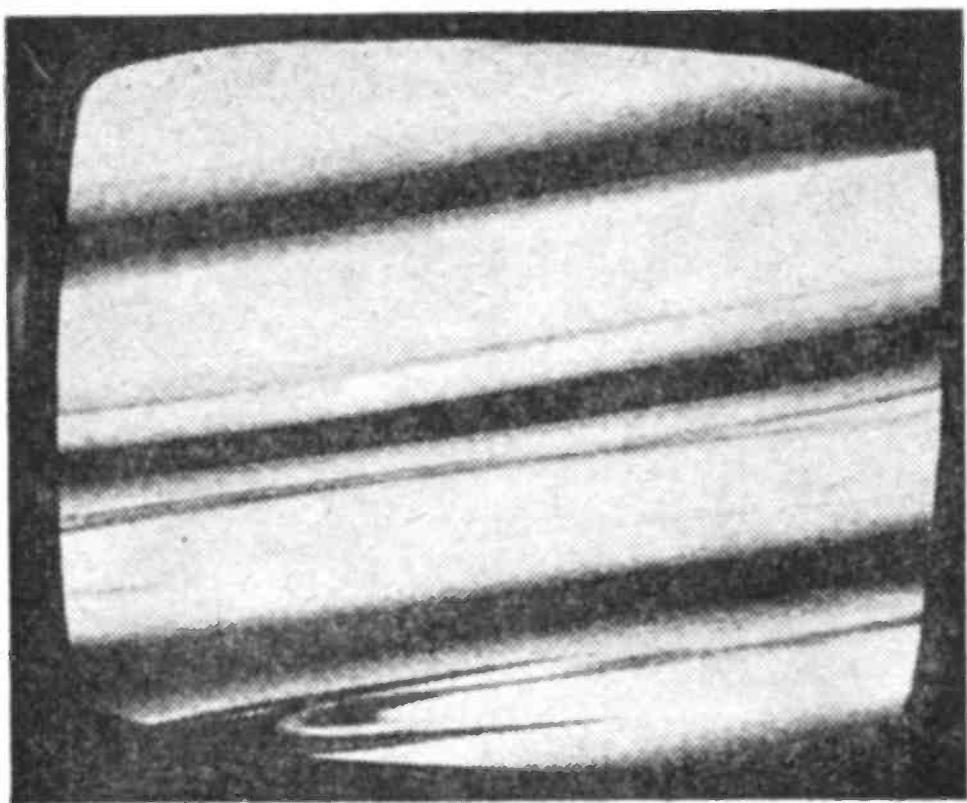
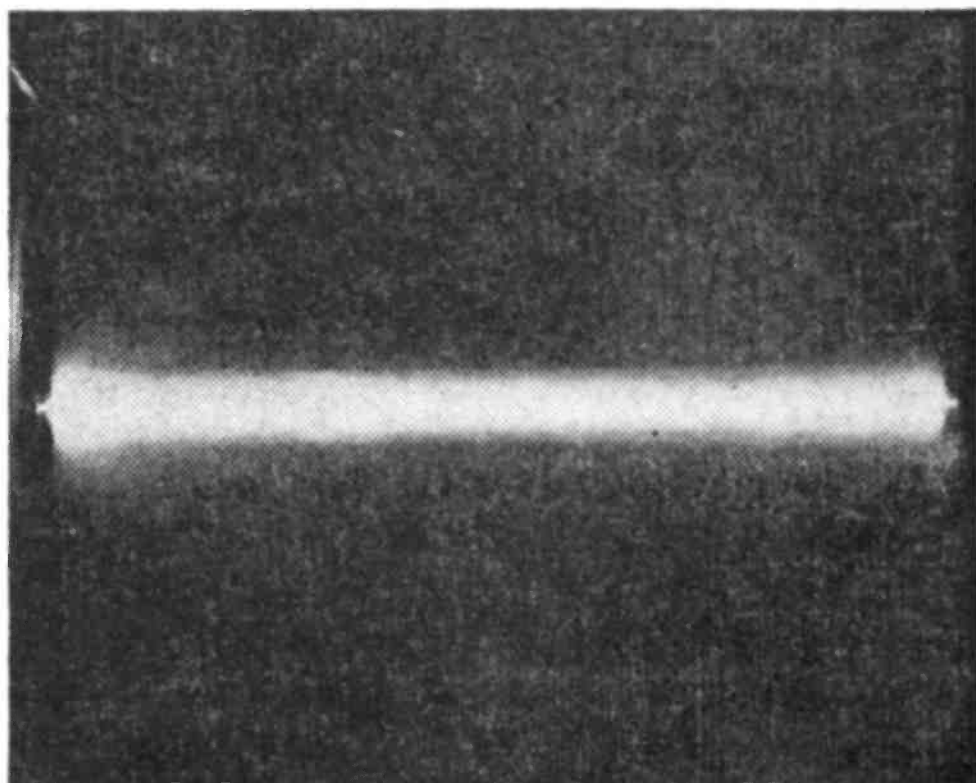
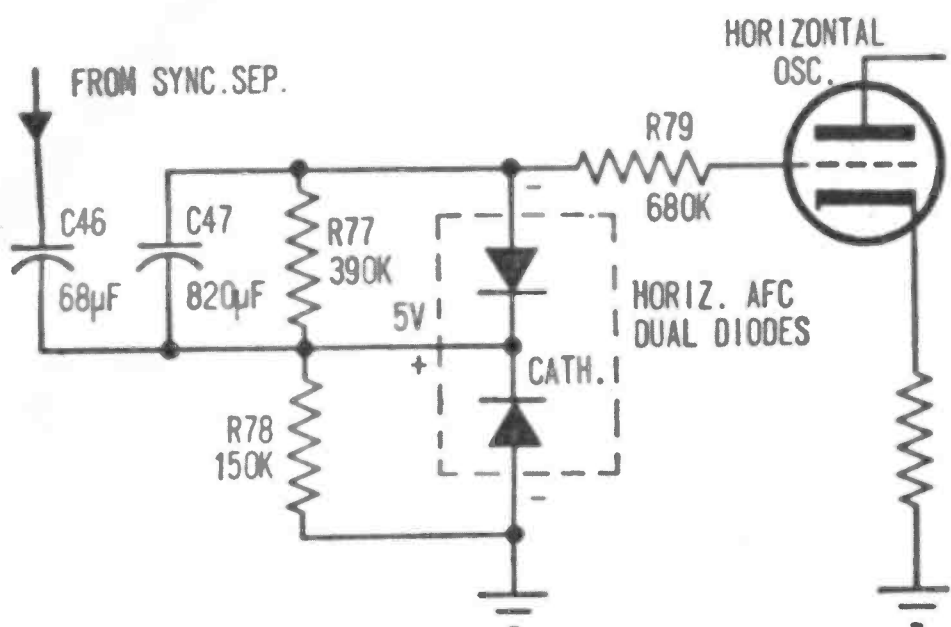

Fig. 16. When the horizontal won't lock in, check the horizontal oscillator and output tubes. If alright, try adjusting the horizontal frequency coil slug, usually on rear skirt of set.

Fig. 17. If horizontal still can't be locked in, the next thing to check is the AFC (automatic frequency control) diodes. They are usually in the form of a single common-cathode three-lead package.

Fig. 18. A single bright horizontal line usually means the vertical oscillator or output tube is defective. Also try adjusting the vertical height and linearity controls (see text).



so do not touch the high voltage nipple—even with the set *off*. As a further precaution, keep one hand *behind* your back, away from the ground or chassis, working with the other. This will keep possible shock from being dangerous.

First off, check the horizontal output, damper, and horizontal oscillator tube, in that order, with the set *off*. Then check the high-voltage rectifier tube after shorting all exposed high-voltage cage connections to

ground to assure everything is discharged.

Look closely for a burned spot on the fly-back transformer indicating it is defective and may have to be replaced. Then take a small, *well-insulated* screwdriver blade, slip the blade under the horizontal output cap while the set is *on* and draw a small arc from the plate terminal. If no arc appears, there is probably insufficient drive voltage to the horizontal output tube. Take a voltage reading at the grid pin; it should be from -5 to -25 VDC.

All of these checks can be made from the top of the chassis. Never measure the cap, or plate, voltage on a horizontal output tube. You can easily wrap the meter hand around the stop terminal. To measure the grid drive voltage, pull the plate cap off the horizontal output with the set *off* and then turn set *on*. If the voltage is normal, the horizontal oscillator section is performing. The trouble must be between the horizontal output tube to the CRT.

Careful Now. With the set *off*, carefully pull the cap off the high voltage rectifier tube with a pair of insulated long-nose pliers.

Fig. 19. The vertical oscillator circuit can also cause the absence of vertical sweep. The pencil points to the oscillator feedback coupling capacitor, one possible suspect; also check the vertical transformer.

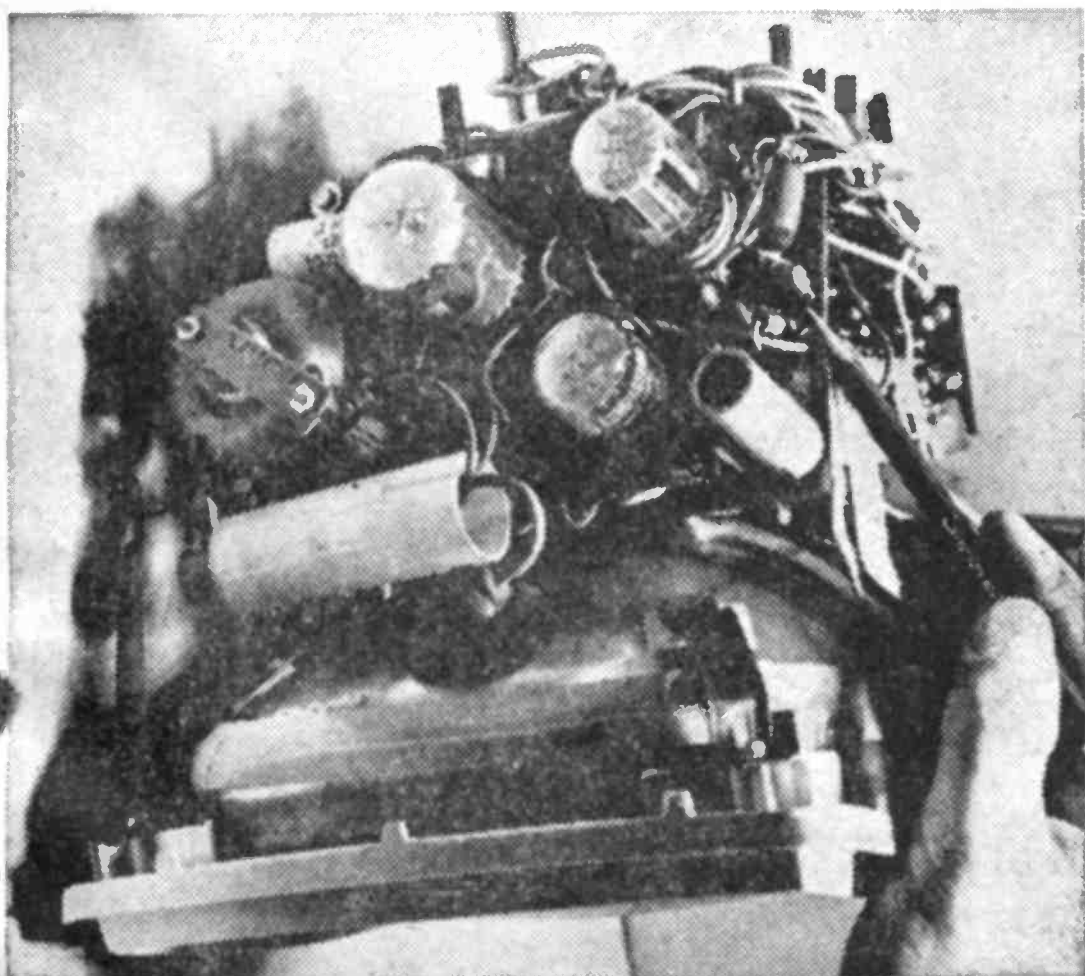

Turn the set *on*, let it warm up, and then arc the screwdriver blade to the terminal inside of the high voltage cap. A good hot arc can be drawn up to half an inch long, if the horizontal sweep section is working properly. Turn the set *off* and replace the tube cap.

To see if the high voltage is being applied to the CRT, short the high voltage nipple on the CRT to chassis ground with a long, *well-insulated* screwdriver. Be extremely careful here. Placing the metal screwdriver

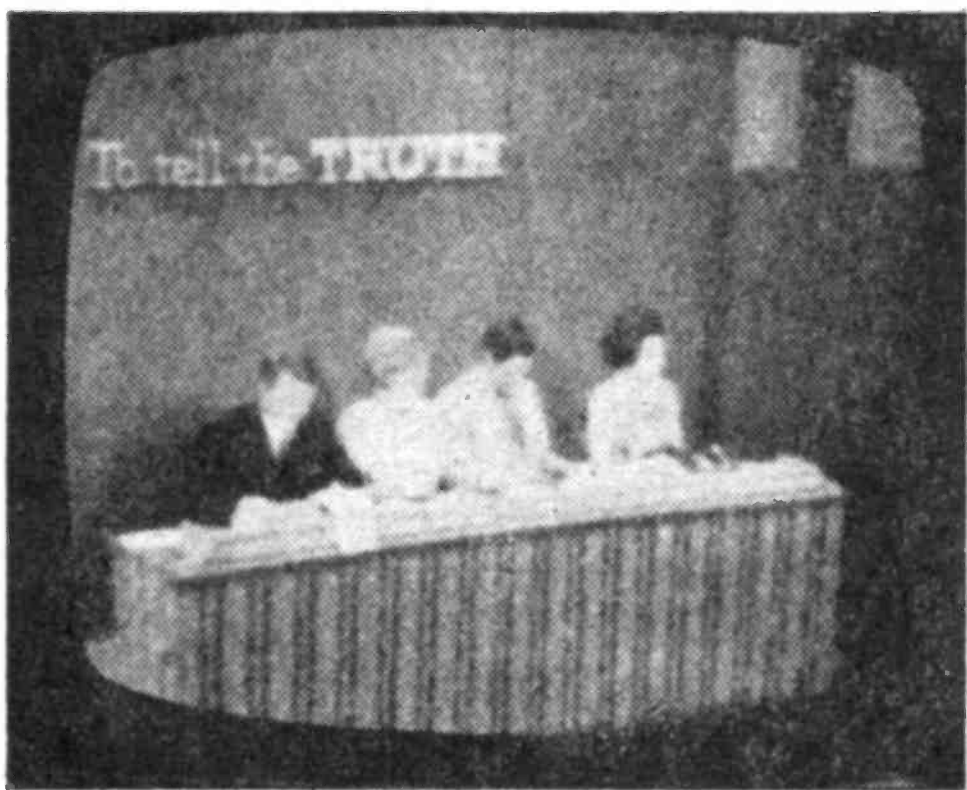

Fig. 20. A snowy picture with little contrast and weak detail is often caused by a weak RF amplifier tube in the tuner. This symptom can also mean a broken lead-in wire, shorted antenna, or open antenna coils.

to the ground and sliding it to the high-voltage anode connection should produce a sharp high-voltage arc.

If not, shut down the TV. Short the picture tube high-voltage cap to chassis ground. Also discharge the CRT by using two large screwdrivers, one on the anode connection and the other to black CRT coating. Snap

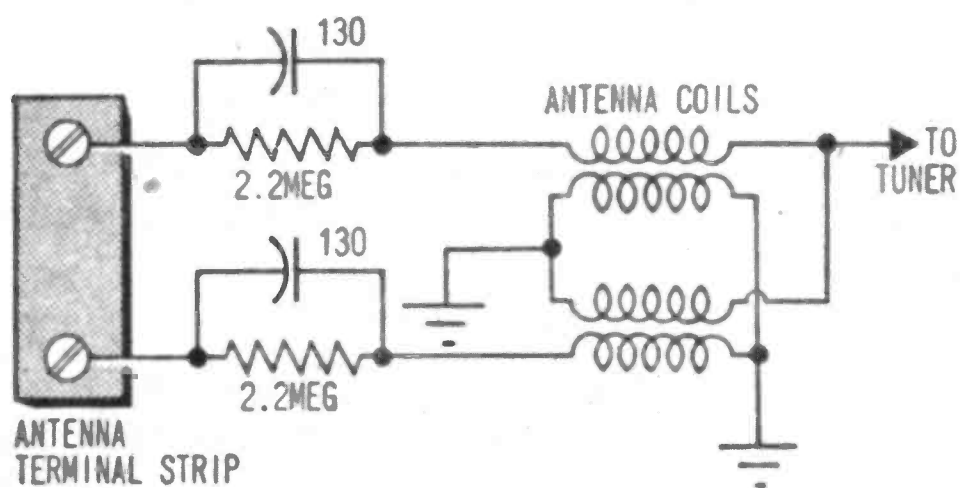

Fig. 21. The antenna coils are usually hooked up in this way. The capacitor/resistor network is designed to prevent lightning from damaging tuner. Check that capacitors, resistors and coils haven't been damaged.

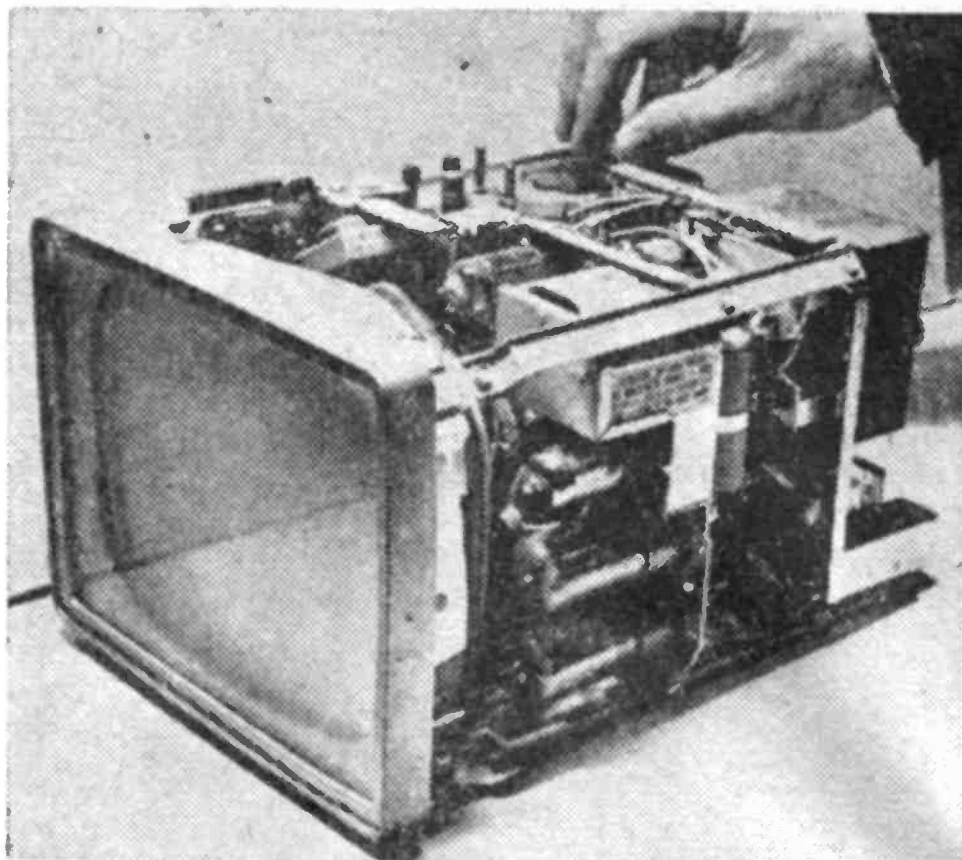

Fig. 22. If the picture jumps around every time you touch the channel selector, the tuner probably needs cleaning. Get a good spray lube and spray it on the contacts while briskly rotating the selector knob.

out the high-voltage cable and fire up the receiver. Arc the high-voltage cable to chassis and a sharp-high-voltage arc should occur. In case there is plenty of high voltage, the picture tube is probably defective.

Sides Pulled In. Insufficient horizontal width indicates insufficient high voltage on the CRT. The trouble can be a weak horizontal output, damper, oscillator tube, or all three. Don't overlook the possibility of a weak low-voltage rectifier tube that supplies power to the horizontal sweep stages. Check the setting of the horizontal linearity or width coil, as shown in Fig. 14.

The screen-grid resistor and bypass capacitor of the horizontal output tube are likely components to check if insufficient width is
(Continued on page 96)

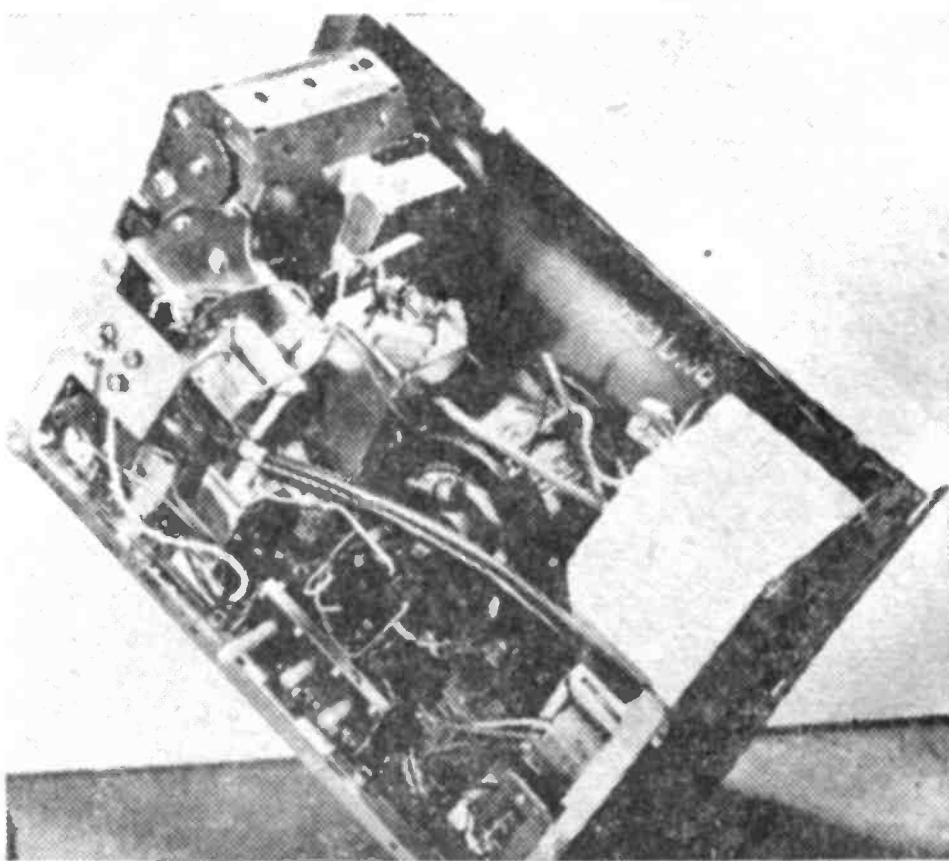

Fig. 23. Attempts at reducing overall size of portable TV sets have resulted in very crowded chassis layouts. This makes the portable a great deal more difficult to work on and care must be used not to damage set.

10 Reasons why RCA Home Training is

your best investment for a rewarding career in electronics:

Transistor experiments on programmed breadboard — using oscilloscope.



1 LEADER IN ELECTRONICS TRAINING

RCA stands for dependability, integrity and pioneering scientific advances. For over a half century, RCA Institutes, Inc., has been a leader in technical training.

2 RCA AUTOTEXT TEACHES ELECTRONICS FASTER, EASIER

Beginner or refresher — AUTOTEXT, RCA Institutes' own method of Home Training will help you learn electronics faster, easier, almost automatically.

3 THOUSANDS OF WELL PAID JOBS ARE OPEN NOW

RCA Institutes can help you qualify for a rewarding career if you have an interest in electronics. Every year, thousands of well paid electronics jobs go unfilled just because not enough men take the opportunity to train themselves for these openings.

4 WIDE CHOICE OF CAREER PROGRAMS

Select from a wide choice of courses and career programs ranging from basic Electronics Fundamentals to advanced training including Computer Programming and Electronics Drafting. Each

Career Program begins with the amazing AUTOTEXT method.

5 SPECIALIZED ADVANCED TRAINING

For those working in electronics or with previous training, RCA Institutes offers advanced courses. Start on a higher level. No wasted time on material you already know.

6 PERSONAL SUPERVISION THROUGHOUT

All during your program of home study, your training is supervised by RCA Institutes experts who become personally involved in your efforts and help you over any "rough spots" that may develop.

7 VARIETY OF KITS, YOURS TO KEEP

At no extra cost, a variety of valuable specially engineered kits come with your program—yours to keep and use on the job.

8 TRANSISTORIZED TV KIT AND VALUABLE OSCILLOSCOPE

You will receive in most career programs a valuable oscilloscope. Those enrolled in the TV Program or courses receive the all-new Transistorized TV Receiver—exclusive with RCA. Both are at no extra cost.

9 TWO CONVENIENT PAYMENT PLANS

Pay for lessons as you order them. No contract obligating you to continue the course. Or, you can take advantage of RCA's convenient monthly payment plan.

10 RCA GRADUATES GET TOP RECOGNITION

Thousands of graduates of RCA Institutes are now working for leaders in the electronics field; many others have their own profitable businesses... proof of the high quality of RCA Institutes training.

RCA INSTITUTES, INC. Dept. RT-29
320 West 31st St., N.Y., N.Y. 10001

Canadians: These same RCA courses are available to you in Canada. No postage. No customs. No delay. Your inquiry will be referred to our school in Canada.

All courses and programs approved for veterans under new G.I. Bill.

CLASSROOM TRAINING ALSO AVAILABLE. FREE CATALOG ON REQUEST.

If Reply Card Is Detached—Send This Coupon Today

RCA INSTITUTES, INC.

Home Study Dept. RT-29
320 West 31st Street
New York, N.Y. 10001

Name _____

Address _____

City _____

State _____

Zip _____

Check here if interested in Classroom Training

ACCREDITED MEMBER National Home Study Council

Construction of Oscilloscope.

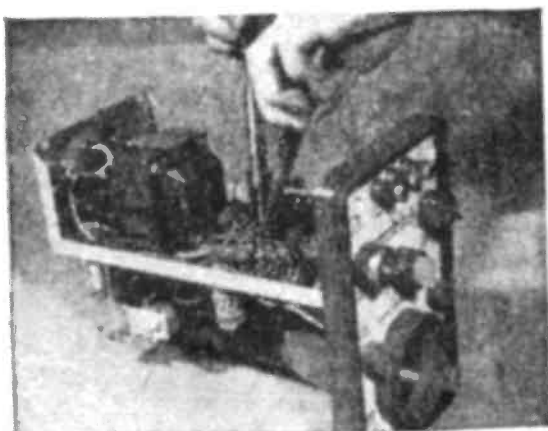

Construction of Multimeter.

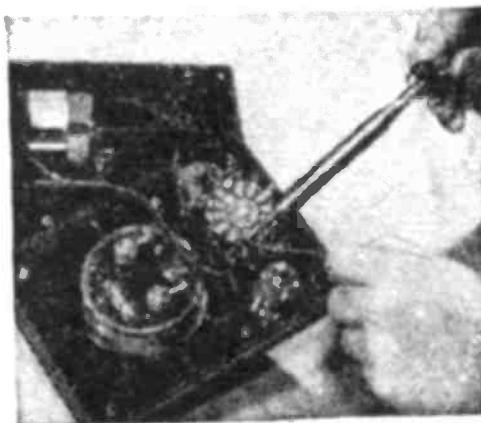

RCA

FOREIGN TUBE REPLACEMENT GUIDE

Anyone who's gone past the tuning knob of a foreign-built shortwave receiver has discovered an unexpected twist or three—unorthodox-looking capacitors, metal-film resistors, possibly some outstanding point-to-point wiring. Another distinguishing feature of foreign electronic gear is tube designations, which often bear no resemblance whatever to those current in American circles. The following listing equates foreign tube types with their closest American equivalent. Though slight differences exist in some cases, in general any tube of a pair is directly interchangeable with its mate.

1C1	1R5	CV578	6A8	CV1938	6K6GT	DL91	1S4	KT32	25L6GT
1F3	1T4	CV580	6A8	CV1941	6K7	DL92	3S4	KT63	6F6G
1FD9	1S5	CV581	6C5	CV1943	6K7	DL94	3V4	KT66	6L6GC
1P10	3S4	CV585	6C6	CV1944	6K8	DL95	3Q4	KT71	50L6GT
1P11	3V4	CV587	6Q7G	CV1946	6K8	DM70	1M3	KTW63	6K7
5B250A	807	CV589	6Q7	CV1947	6L6GC	DP61	6AK5	KTW74M	12K7GT
6BK8	6267	CV591	6SJ7	CV1950	6L7	DY86	1S2	KTZ63	6K7
6C16	6BL8	CV614	75	CV1956	6N7GT	DY87	1S2A	L63	6J5GT
6D2	6AL5	CV617	80	CV1958	6N7GT	E2157	12AT7	L77	6C4
6F22	6267	CV686	0C3	CV1959	50C5	E2163	12AU7A	LZ319	9A8
6F29	6EH7	CV692	0Z4	CV1961	12AU6	E2164	12AX7A	LZ329	9A8
6F30	6EJ7	CV697	12SJ7	CV1969	6SC7	EB34	6H6	M8212	5726
6FD12	6DC8	CV717	5R4GYB	CV1970	6SC7	EB91	6AL5	N16	3Q5GT
6G5G	6U5G	CV728	5V4GA	CV1978	6SG7	EBC90	6AT6	N17	3S4
6H5	6U5G	CV753	1A3	CV1981	6SK7	EBC91	6AV6	N18	3Q4
6L12	6AQ8	CV755	1A5GT	CV1985	6SL7GT	EBF89	6DC8	N19	3V4
6L13	12AX7	CV756	1A5GT	CV1988	6SN7GTB	EC90	6C4	N148	7C5
6M1	6U5G	CV782	1R5	CV1990	6SQ7	EC97	6FY5	N379	15CW5
6P15	6BQ5	CV783	1S4	CV2129	5763	ECC32	6SN7GTB	N709	6BQ5
6PL12	6BM8	CV784	1S5	CV2500	35Z4GT	ECC81	12AT7	N727	6AQ5A
12DT7	12AX7	CV785	1T4	CV2514	43	ECC82	12AU7A	OM10	6K8
13D2	6SN7GT	CV797	2D21	CV2524	6AU6A	ECC83	12AX7A	PCF80	9A8
30C1	9A8	CV818	3Q4	CV2526	6AV6	ECC85	6AQ8	PCF82	9U8A
30P18	15CW5	CV819	3Q5GT	CV2747	6U5	ECC88	6DJ8	PCF801	8GJ7
30PL12	16A8	CV820	3S4	CV2901	6267	ECC91	6J6A	PCL82	16A8
63ME	6U5G	CV850	6AK5	CV2975	6BQ5	ECC189	6ES8	PCL84	15DQ8
150C2	0A2	CV858	6J6A	CV2984	6080	ECC230	6080	PL84	15CW5
150C3	0D3	CV877	7A7	CV3523	6146A	ECF80	6BL8	PL500	27GB5
B36	12SN7GTA	CV885	7C5	CV3908	6BH6	ECF82	6U8A	PMO4	6BA6
B65	6SN7GTB	CV887	7C6	CV3909	6BJ6	ECF86	6HG8	PMO5	6AK5
B152	12AT7	CV901	7Y4	CV3912	1U5	ECH35	6K8	QV03-12	5763
B309	12AT7	CV918	12K7GT	CV3998	6688	ECL82	6BM8	QV05-25	807
B329	12AU7A	CV924	12SL7GT	CV4007	5726	ECL85	6GV8	QV06-20	6146
B339	12AX7A	CV925	12SN7GTA	CV4009	5749	ECL86	6GW8	R52	5Z4
B719	6AQ8	CV1186	6F6G	CV4012	5750	EF86	6267	STV150/30	0A2
BPM04	6AQ5A	CV1287	25L6GT	CV5041	6CL6	EF93	6BA6	U50	5Y3GT
CV124	807	CV1347	6K8	CV5042	12BH7A	EF94	6AU6A	U52	5U4G
CV133	6C4	CV1377	5AR4	CV5072	6CA4	EF95	6AK5	U70	6X5GT
CV140	6AL5	CV1633	3V4	CV5073	6AM4	EF183	6EH7	U74	35Z4GT
CV283	6AL5	CV1741	6CA7	CV5074	6AF4A	EF184	6EJ7	U76	35Z4GT
CV452	6AT6	CV1800	1A7GT	CV5215	6BL8	EH90	6CS6	U78	6X4
CV453	6BE6	CV1802	1A7GT	CV5307	807	EK90	6BE6	U147	6X5GT
CV454	6BA6	CV1818	1H5GT	CV5331	6ES8	EL34	6CA7	U709	6CA4
CV455	12AT7	CV1820	1H5GT	CV5358	6DJ8	EL84	6BQ5	UU12	6CA4
CV491	12AU7A	CV1823	1N5GT	CV5365	6BQ7A	EL90	6AQ5A	VFT6	6U5
CV492	12AX7A	CV1831	2A3	CV5434	6FG6	EM84	6FG6	W17	1T4
CV493	6X4	CV1832	0A2	CV5810	6EJ7	EN91	2D21	W63	6K7
CV504	6U5	CV1833	0B2	CV5831	6EH7	EZ35	6X5GT	W76	12K7GT
CV509	6V6GTA	CV1856	5Y3GT	D63	6H6	EZ80	6V4	W727	6BA6
CV511	6V6GTA	CV1862	6AQ5A	D77	6AL5	EZ81	6CA4	X14	1A7GT
CV522	7B7	CV1863	5Z4	D152	6AL5	EZ90	6X4	X17	1R5
CV525	12A6	CV1870	6A7	DAC32	1H5GT	GZ30	5Z4	X61M	6K8
CV543	12SK7	CV1893	6B8	DAF91	1S5	GZ31	5U4G	X63	6A8
CV544	12SK7GT	CV1900	6D6	DD6	6AL5	GZ34	5AR4	X65	6K8
CV546	12SQ7	CV1906	6E5	DF33	1N5GT	HBC90	12AT6	X77	6BE6
CV547	12SQ7GT	CV1911	6F6G	DF91	1T4	HBC91	12AV6	X147	6K8
CV553	25L6GT	CV1928	12BA6	DH63	6Q7	HD14	1H5GT	X727	6BE6
CV562	35L6GT	CV1929	6H6	DH77	6AT6	HF93	12BA6	Y61	6U5
CV564	35Z3	CV1931	6H6	DH118	14L7	HF94	12AU6	Y63	6U5
CV571	50L6GT	CV1932	6J5GT	DH149	7C6	HK90	12BE6	Z14	1N5GT
CV572	6X5GT	CV1934	6J5GT	DK32	1A7GT	HL92	50C5	Z63	6J7
CV574	6X5GT	CV1935	6J7	DK91	1R5	HM04	6BE6	Z729	6267
CV575	5U4G	CV1937	6J7	DL33	3Q5GT	HY90	35W4	ZD17	1S5



The Thinking Man's Answer to TV Servicing

By ROBERT F. LEWIS

TVs can be a cinch to service, but only if you first take careful aim and mix a little method with your madness

■ When it comes to do-it-yourself TV servicing, do you use the "shotgun" method to locate bad tubes? If you're the average, non-technical, television set owner you probably do, since you couldn't be expected to know exactly where the target is. What do I mean by the "shotgun" method? Well, here's how it works:

Your TV set is acting up. So you pull out all or most of the tubes, cart them down to the corner drug store or supermarket, and run them through the do-it-yourself tube checker. You find two or three that show a "bad" or "questionable" reading, so you buy some new ones. When you get home and plug in the new tubes, you may find that you still haven't cured the sickness. Even if you have, there's a good chance you've replaced some tubes needlessly, since a questionable tube-checker reading doesn't always indicate a bad tube.

First Step Forward. What can you do to avoid this unnecessary expense? Here are some tips that may save you considerable cash and frustration the next time you tackle the one-eyed monster!

First, unless you have some technical knowledge of television, you shouldn't ordinarily attempt to carry servicing beyond the tube-changing point. You don't have to be

an engineer or technician just to change a TV tube, but it does help to have a little familiarity with the inner workings of your set. This isn't as complicated as you might think; you can learn enough about it in the time it will take you to read this article.

Second, most TV receivers have, pasted somewhere inside the cabinet, a tube location diagram. This gives you a wealth of information; it tells you the type and location of each tube, plus the kind of job it does.

Now, with these two pieces of knowledge at hand, you should be able to direct most of your troubleshooting efforts to smaller sections of your set—to zero in on the exact tube or tubes ruining your viewing. You shouldn't have to use the expensive scatter-gun approach.

Before we go any further, let's agree to concern ourselves only with black-and-white TV. Unless you have considerable servicing know-how, it's best to leave most color TV repairs, even tube changing, to a competent repairman, since many of the circuits in color TV sets require critical adjustment for proper color rendition.

A Little Theory. What is a television picture composed of? If you look at any newspaper photograph—called a "halftone" illustration—through a magnifying glass you will

see that it is made up of rows of fine black dots. In the light areas of the picture the dots are very small, leaving considerable white space between. In the darker areas the black dots are larger, leaving less white space. At a distance your eye sees the whole mass as a complete picture, since it can't distinguish between the individual dots.

Now, turn on your TV set and tune it to some channel where no picture is being transmitted. Look closely at the screen. See how the picture is made up of a series of horizontal lines of light? These lines are actually traced on the screen by a rapidly moving spot of light produced when a sweeping electron beam inside the picture tube strikes the screen. The spot travels across the screen, starting at the upper left-hand corner and working down to the lower right-hand corner, in the manner shown in Fig. 1. For

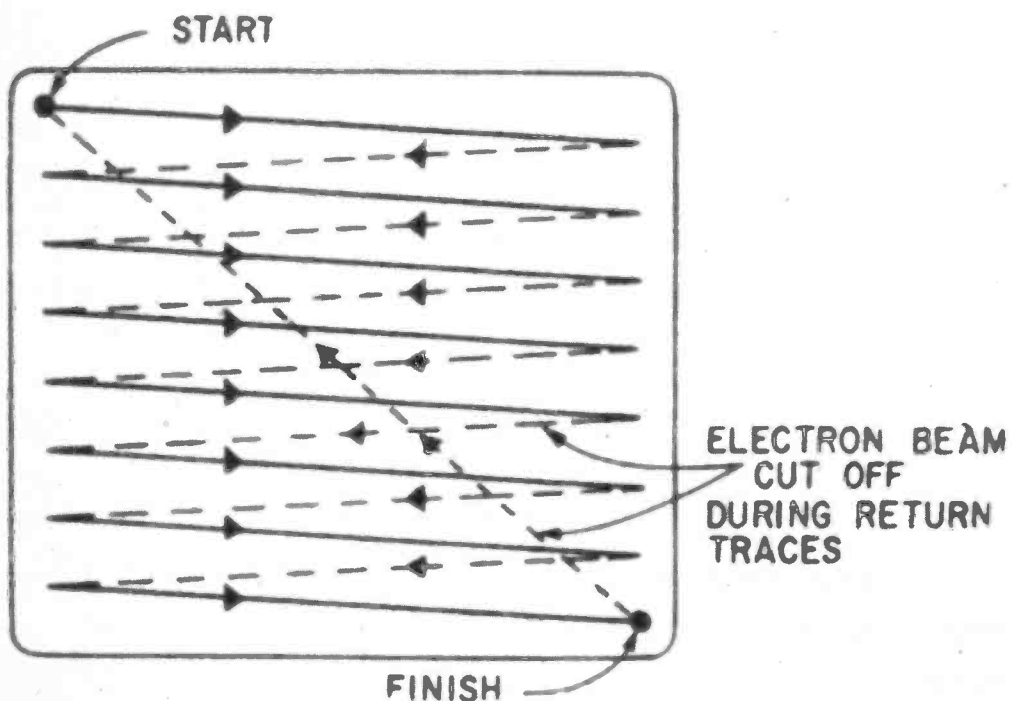

Fig. 1. Simplified diagram of TV raster does not show complicated interlacing.

the sake of clarity, we have shown the lines much farther apart than they really are on your TV screen. There are actually over 400 of these lines on the screen.

When the spot gets to the lower right-hand corner, it returns almost instantly to the starting point and repeats the trace. This screen "painting" process is repeated at such a rapid rate that your eye cannot detect the movement of the spot, but sees the screen as though it were continuously lighted. The technical name for the lighted screen is the "raster." Keep this term in mind. We'll use it again later.

At the Studio. Now, if we were to break up the horizontal lines into dots of varying brightness, we would have all of the neces-

TV TROUBLESHOOTING CHART

Symptom	Possible Source of Trouble
No picture, sound or raster	Low-voltage rectifier. Filament burned out in one tube of series-connected string. Fuse.
Picture dim, does not fill screen. Sound weak.	Low-voltage rectifier.
Picture and sound weak or dead. Raster OK.	RF amplifier, oscillator, mixer, video IF amplifier, video amplifier.
Picture dead or has low contrast. Raster OK. Sound may be dead in some sets.	Video amplifier.
No sound. Picture OK.	Sound IF amplifiers, ratio detector, audio amplifiers.
Picture does not fill screen vertically. Cannot be corrected with height control.	Vertical oscillator and vertical output, low-voltage rectifier.
Picture rolls vertically. Cannot be stabilized with vertical hold control.	Vertical oscillator, sync separator, sync amplifier.
Picture does not fill screen horizontally. May also be dim.	Horizontal oscillator, horizontal output, damper, low-voltage rectifier.
Picture flops over sideways and rolls vertically.	Sync separator, sync amplifier.
Picture flops over sideways. Cannot be stabilized with horizontal hold control.	Horizontal oscillator, sync separator, sync amplifier.
Picture dim but raster fills screen. Sound OK. Sync OK. Cannot be brightened with brightness control. Image sometimes "blooms" around edges when brightness control is turned up.	High voltage rectifier, damper, picture tube.
Picture does not fill screen either horizontally or vertically.	Low-voltage rectifier.
Picture contrast fades up and down, excessively.	AGC, RF and IF amplifier tubes.

sary elements for a picture, as we saw in the newspaper illustration. In practice, this is essentially what is done. The light and dark portions of a TV picture are produced by simply varying the intensity of the electron

beam as it paints the screen. The signals that produce this variation originate in the camera in the TV studio. The image "seen" by the camera is swept by an electron beam in the same manner we have just described for the receiver picture tube. But instead of painting a scene, the camera breaks the image it sees into bits, like the dots in the newspaper illustration. These bits are sent out in sequence by the TV station, received by your TV set, and reassembled on the picture tube screen in exactly the same order and position. To create the illusion of a complete picture, these bits are broken down and reassembled at an incredibly rapid rate, several million per second. Other signals transmitted by the TV station synchronize the picture tube in your set with the studio TV station synchronize the picture tube in your set with the studio TV camera so that both will begin "painting" at exactly the same instant. The third signal transmitted by the station is the sound or "audio" signal. If the picture is in color, additional color-information signals are transmitted. Sounds fantastic, doesn't it?

same as, or similar to, those indicated on our diagram. In some cases you'll notice that a single tube does several jobs, possibly in completely unrelated sections. This is because many tubes contain two or three sets of elements in one envelope, a space-saving trick.

Sound, picture, and synchronizing signals from the TV station arrive via your receiving antenna and are all processed in the *RF amplifier, mixer, oscillator, and video IF amplifier* tubes.

These signals continue on to the *video detector* and *video amplifier* tubes where they are further processed. The picture signal is extracted and applied to the picture tube where it controls the variations between dark and light on the screen.

The synchronizing signals are routed through the *sync amplifier* and *sync separator* tubes, then applied as locking signals to the *vertical oscillator* and *horizontal oscillator* tubes.

The sound signal is separated at this point and passed through the *sound IF amplifiers*,

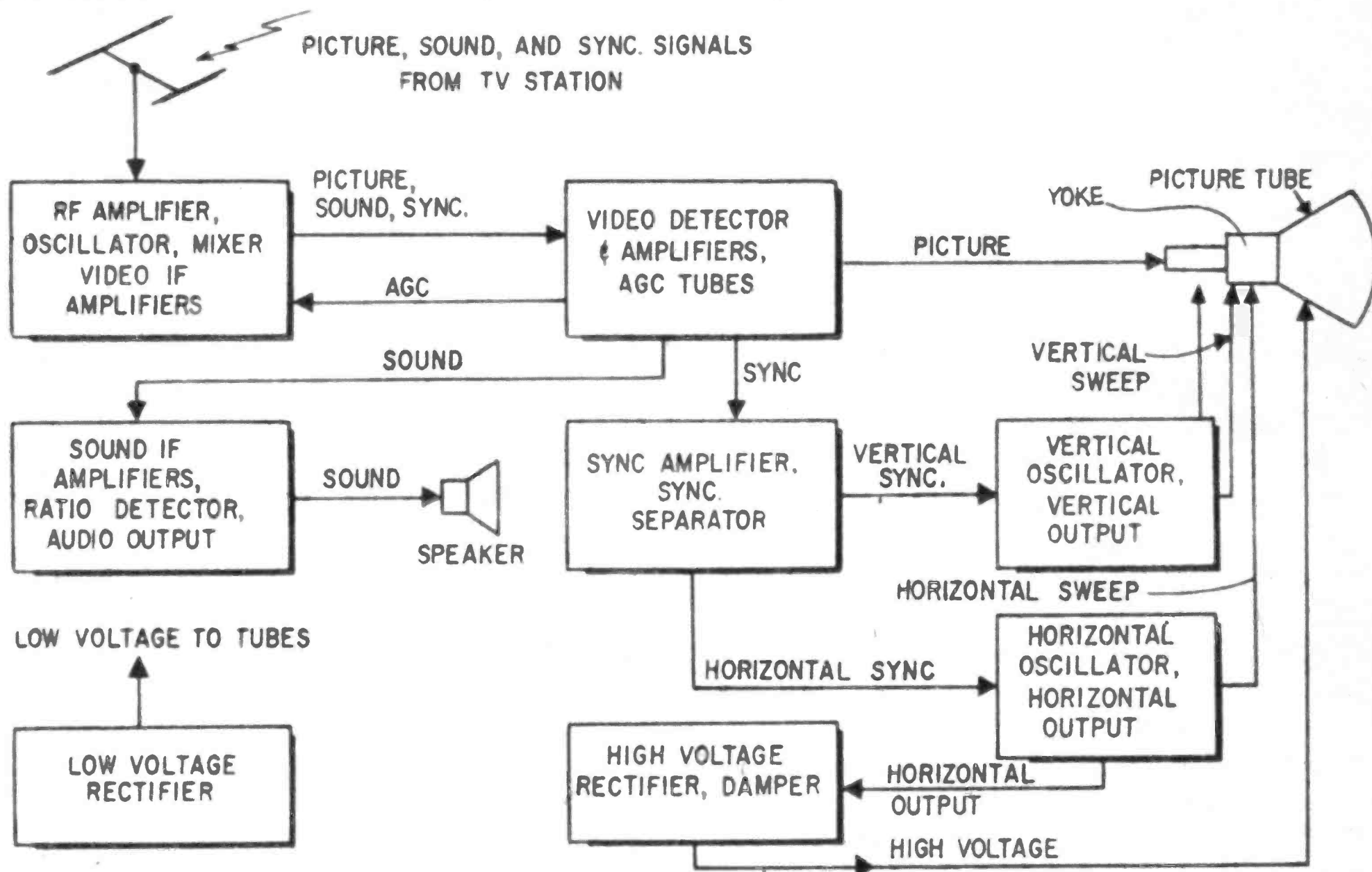

Fig. 2. Block diagram of TV circuitry is just about the same for all black & white TV sets.

Around the Block. Now, let's take a look into your TV set. Fig. 2 is a simplified block diagram showing the electronic-tube circuits in a *typical* black-and-white television set. Let's trace the routing of signals through the diagram. As we do this, refer to the tube location diagram in your own set and see if you can find tubes whose functions are the

ratio detector, and *audio amplifier* or *output* tubes, then to the loudspeaker.

Another circuit is the AGC or automatic gain control.

The purpose of the AGC tubes is to minimize fading or fluctuations in the picture contrast that may occur when the incoming TV signals vary in intensity. This often hap-

pens when an airplane is flying overhead.

The *vertical oscillator* and *vertical output* tubes control the vertical sweeping of the electron beam in the picture tube. The horizontal sweeping of the beam is controlled by the *horizontal oscillator* and *horizontal output* tubes.

Every picture tube requires a potential of somewhere between 10,000 and 25,000 volts for its operation. This voltage is generated by the *horizontal oscillator*, *horizontal output*, *high voltage rectifier*, and *horizontal damper* tubes. Very little *current* is developed in most high-voltage systems, so it is generally not dangerous to human life; although if you get a jolt from it, it can be startling and uncomfortable—something like getting a shock from an automobile ignition system.

Finally, the *low voltage rectifier* tube supplies all of the lower voltages to the other tubes in your TV set. In the more recent models, a metallic rectifier is used instead of a tube for this purpose.

Zeroing In. Now that you have more than a nodding acquaintance with your TV set, how can you use this newly gained knowledge? Here's an example, a typical troubleshooting situation:

Let's assume that your picture tube screen is brilliantly lighted and that the raster completely fills the screen. Yet there is no sound and no picture. Looking at our block diagram, you can see that the sections that are common to both picture and sound are the ones that include the *RF amplifier*, *mixer*, *oscillator*, *video IF amplifiers*, *video detector*, and *video amplifier* tubes. So you proceed to check these tubes. Forget the others.

Another common TV complaint is vertical "rolling." The image keeps slipping up or down and cannot be stabilized by adjusting the *vertical hold* control. This symptom indicates that your TV set is not synchronized with the camera at the TV station. It is likely to be caused by a faulty *vertical oscillator tube*, or perhaps by a weak *sync amplifier* or *sync separator*. This narrows your search down to two or three tubes; no need to use the "shotgun" system. Our troubleshooting chart directs you to source of still more symptoms in a malfunctioning set.

Picture Tubes. The TV picture tube gen-

erally gives long life if properly installed and adjusted. Loss of electron emission due to old age is a common problem, however, and is indicated by a gradual dimming of the picture that cannot be restored by adjusting the brightness control or by replacing small tubes. The life of a picture tube that shows aging can often be extended by installing a *picture tube brightener*. However, you should not use a brightener on a perfectly good picture tube, since it increases the heater voltage and may reduce the life of the tube or even burn it out.

If you are going to use a picture tube brightener, first determine if your TV set has *series* or *parallel* connected tubes; then buy the corresponding type of brightener. If all of the tubes in your set (except the high voltage rectifier and picture tube) begin with the number 6 or 12, the tubes are probably parallel connected. If the tube designations start with various numbers other than 6 or 12, series connection is most probable.

Pulling Tubes. Here are a few tips to keep in mind when replacing the small tubes in your TV set.

1. Be sure to turn off the receiver and disconnect the power plug before working inside the cabinet.

2. Wait for the tubes to cool enough to handle before trying to pull them out.

3. Discharge the stored high voltage from the picture tube by connecting one end of a *well-insulated* wire to the TV set chassis and touching the other end of the wire to the high-voltage terminal which connects to the side of the picture tube envelope. You'll probably have to slip the wire under the edge of the rubber insulator to make contact with the high-voltage terminal.

4. When you replace a tube, be sure that the new one is the correct type number as marked on the tube location diagram. Don't switch tubes around just because they look alike, unless they have the same number.

5. Be careful not to bend the pins on miniature tubes. Be sure the pins are straight before attempting to insert tubes in sockets.

6. If you doubt some of the readings you get on a do-it-yourself tube tester, recheck the tubes on another machine before investing in a new tube.

If your diagnosis fails to turn up a faulty tube because the trouble lies deeper, then you'd better turn the job over to your serviceman. However, if you're successful, you can sit back and bask in the glow of your TV set and the cash savings you've made! ■

HOW TO CHANGE

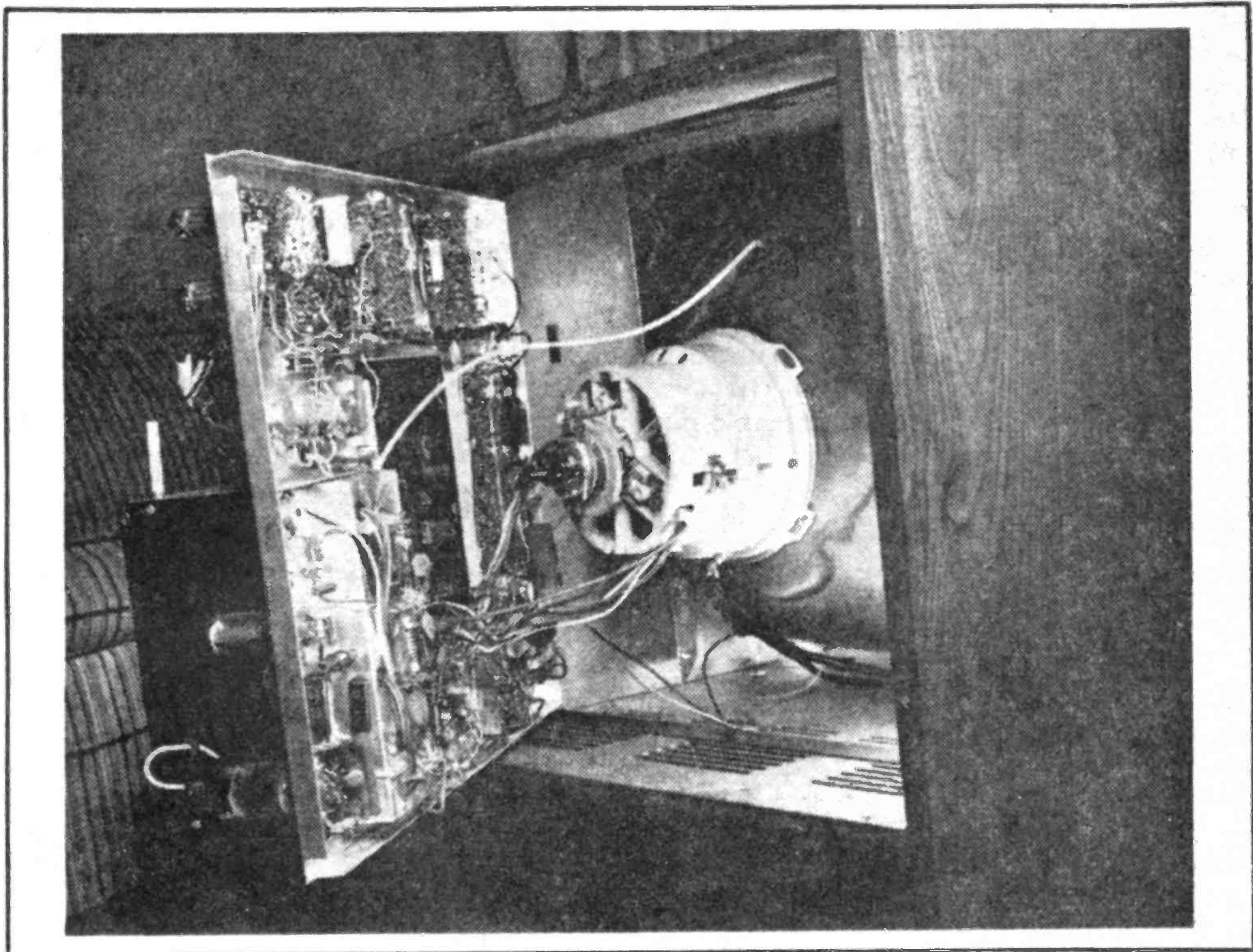

A COLOR TV TUBE

By HOMER L. DAVIDSON

■ When your color picture tube becomes dim and one or two colors are real weak, you can replace that color tube yourself. Follow the photos and text in this article and you can save yourself some dough. This article shows how to replace the round and rectangular color picture tubes. The sizes are 21-inch round, 25-, 23-, and the 19-inch rectangular color CRT's.

The initial preparation consists of taking the TV chassis from the cabinet. First, remove all knobs and the rear cabinet cover from the TV receiver (Fig. 1). Discharge the high-voltage charge of the tube with a long, insulated-handle screwdriver—from anode connection to the TV chassis. Be real careful, and do a good job of grounding out the high-voltage cable. In older TV re-

ceivers, the high-voltage cable must be unfastened from the metal box before you open the lid of the box. This lead will pull out of a pin socket. In newer TV sets, the high-voltage lead unplugs from the glass picture tube. Unbolt the TV chassis and unplug all wires going to the TV chassis.

This includes the picture tube cap or socket, yoke leads, and speaker leads. All the colored wires going to the deflection yoke are marked on the yoke where they are plugged in. There is little danger of getting them wrong when replacing them. Unhook the blue grounding lead from the blue lateral magnet. Unplug the convergence yoke cable from the TV chassis and also loosen the antenna terminal assembly.

Before pulling out the chassis, be sure

CHANGE COLOR TUBE

all cables and wires are disconnected. On the older models, pull out the chassis three or four inches and loosen the ¼-inch metal screw, holding down the small-controls assembly. Slide the assembly back and pull up. Now the chassis is free (Fig. 2).

The Tube Comes Out. The cabinet should be turned over on its face before removing the color tube. Be sure to lay a blanket or thick padding upon the floor to keep the cabinet in ship shape. Have a friend (Fig. 3), or the wife, help place the TV cabinet front down upon the padding.

In the older color sets the dynamic convergence magnet assembly (Fig. 4) slides

separately off the neck of the tube. In the rectangular 25-inch sets the yoke assembly also contains the convergence coils and fits tightly against the color tube.

Four nuts hold the picture tube in place—two at the top and two at the bottom. A metal flange surrounds most tubes, near the face of the tube. In the newer color sets, the automatic degaussing coils (ADG) are fastened to this framework. In the 25-inch sets the metal flange must be removed before you can get to the nuts holding the color tube in place.

Now remove the components from the neck of the color picture tube. In case you are not familiar with the location of these components, measure their position (Fig. 5) on the neck of the color picture tube. This procedure is quite helpful when replacing

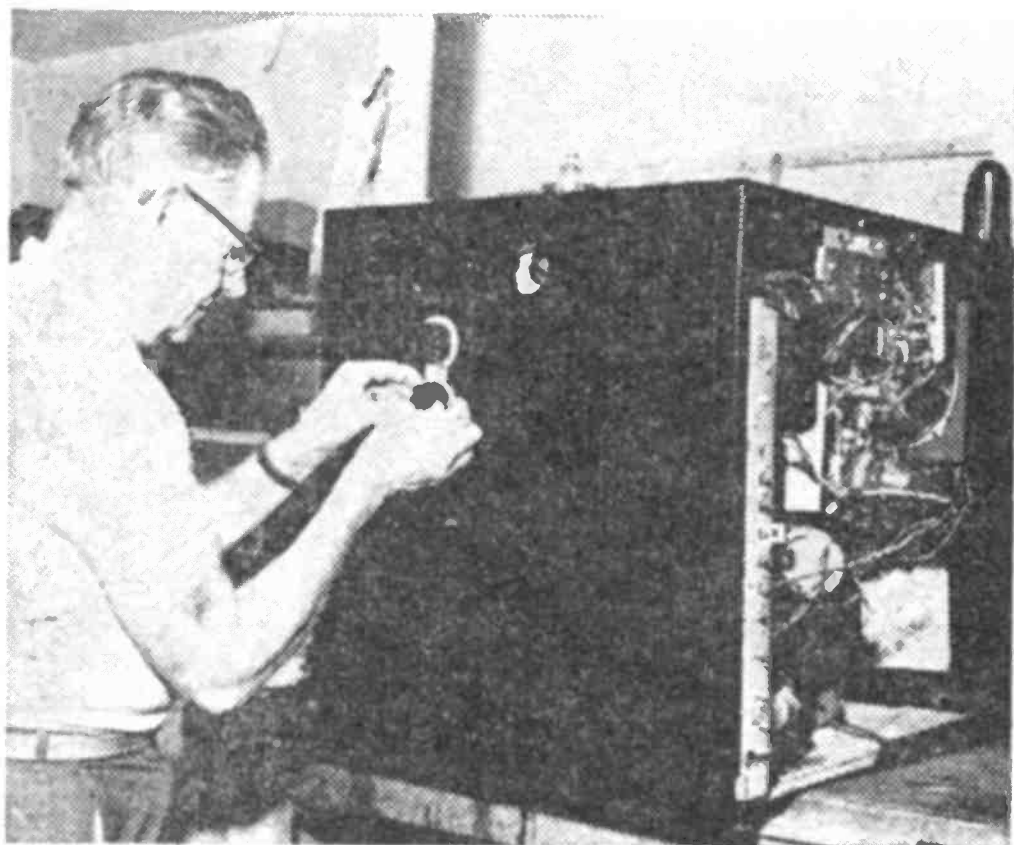

Fig. 1. (top, left) Removing the control knobs.

Fig. 3. (below) Place cabinet face down on folded blanket to protect pic tube and finish.

Fig. 4. (right) Point of pencil indicates the setting of convergence yoke and red band.

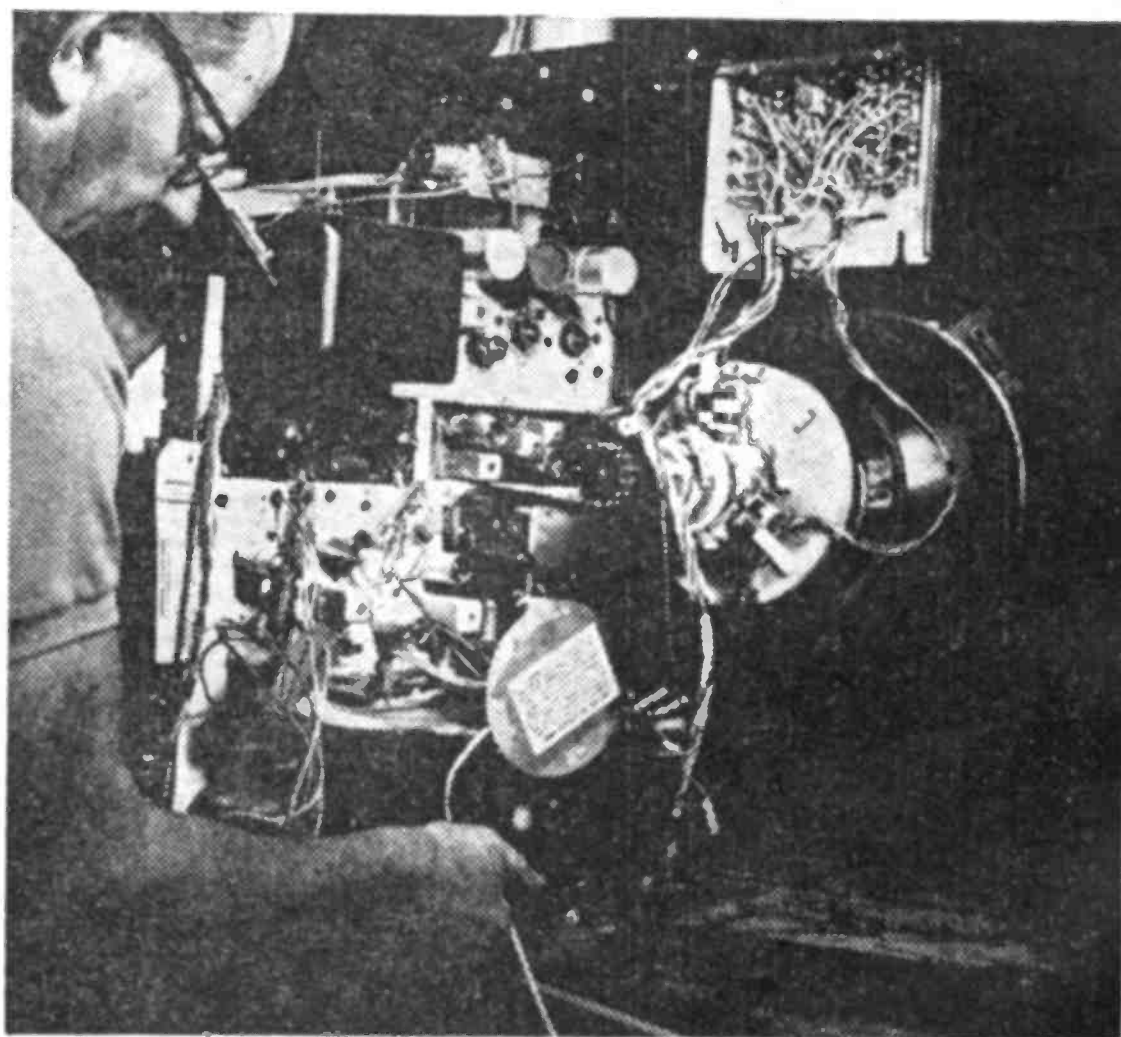
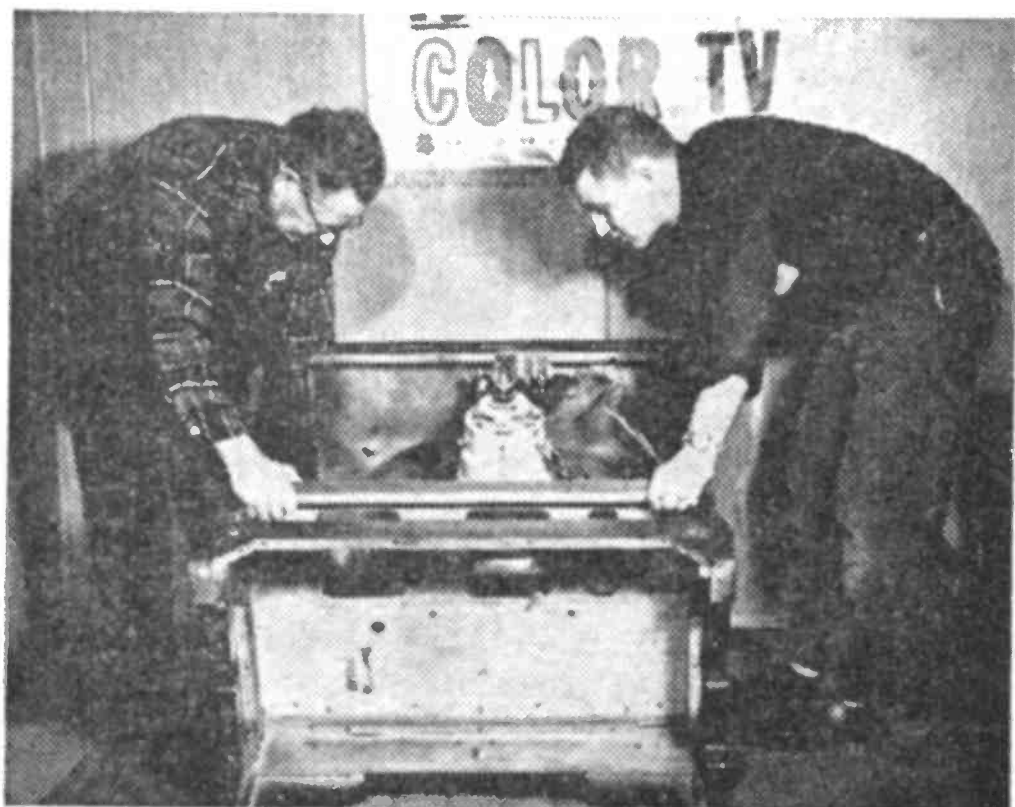
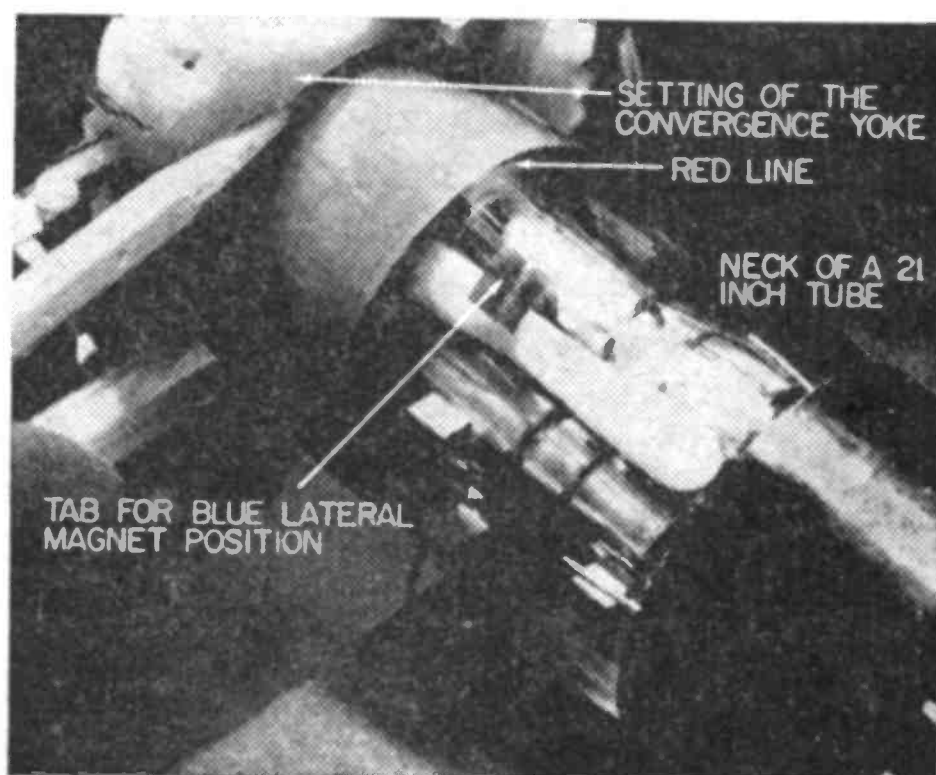

Fig. 2. (above) Don't be afraid to make notes about various connections as you disconnect chassis from CRT and yoke. It can save you a little hunting later.



these components to the neck of the new color tube. *As a safety precaution, wear safety glasses when working close to the picture tube. Do not put pressure on neck of CRT or let tube rest on neck.*

Clear the Neck. Place the kinescope face down on a drop cloth or newspaper to protect the face from scratches. Now remove the components from the neck of the tube. When you remove the blue lateral magnet, you will notice that it sets over a tab or clip inside the tube neck (Fig. 6).

In the older sets, the purity ring sets over the red ring marked inside the tube. Note that the blue wires from the convergence assembly (Fig. 7) go to the top of the picture tube over the blue gun, the red wires at the left side, and the green wires on the right going to the green dynamic convergence coils.

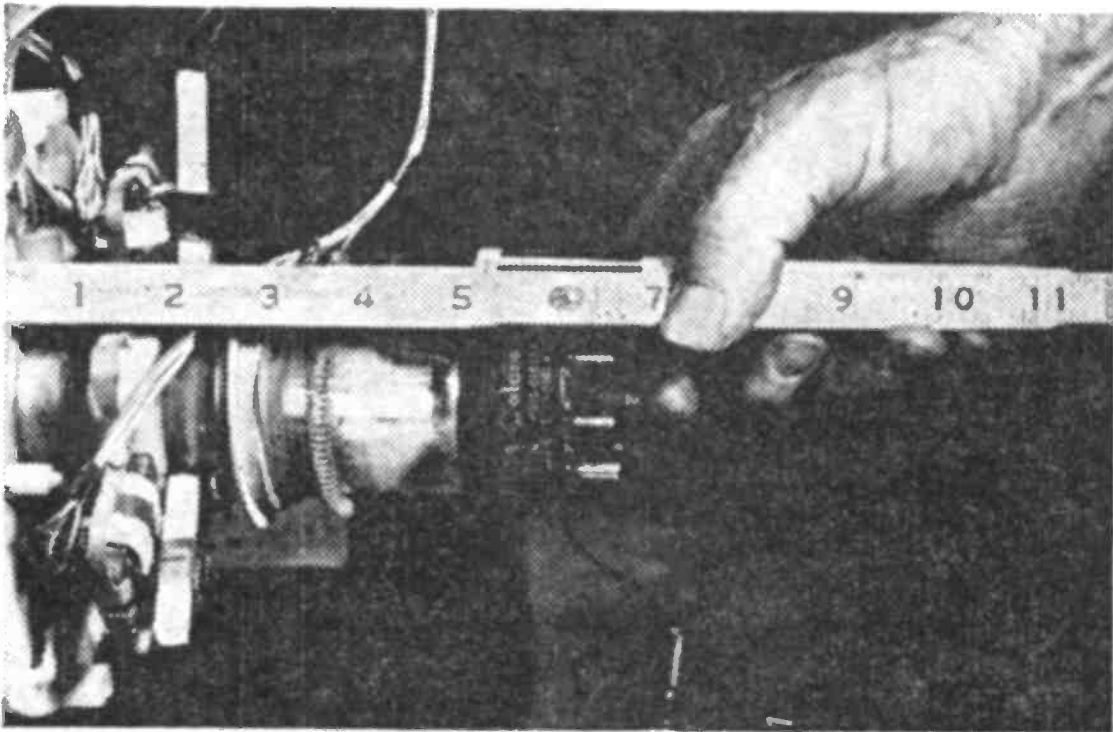
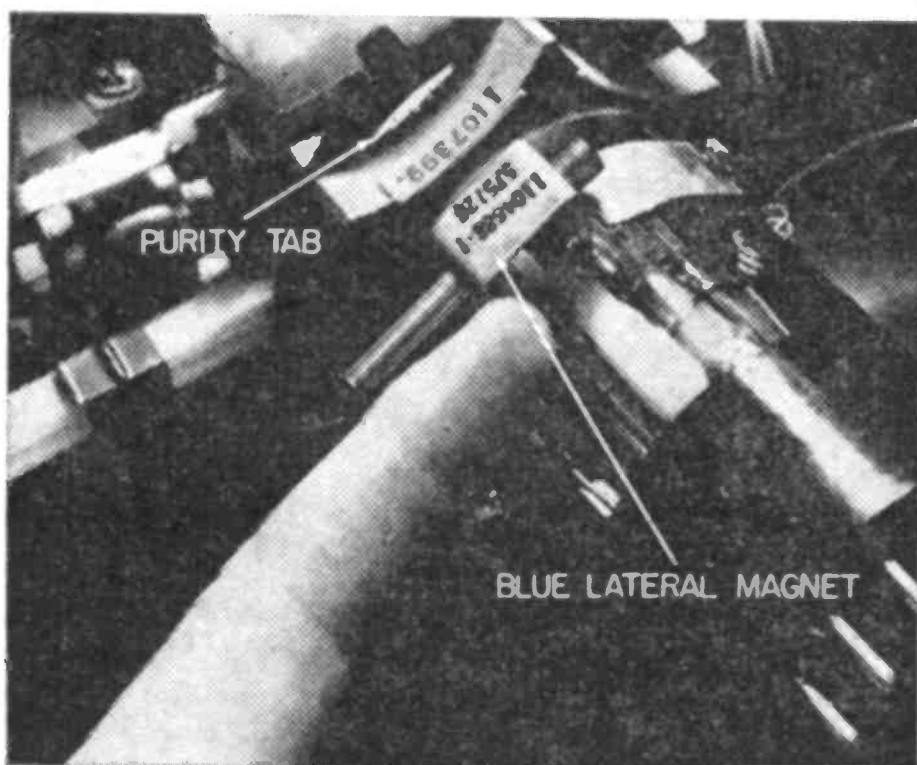

Fig. 5. (top) Be sure to mark down measurements so you can replace the yoke assembly.

Fig. 6. (below) Here author is pointing to blue lateral magnet and the tab inside the neck of the CRT. Tab is not obscured by blue lateral magnet in Fig. 4. By first replacing the components according to the measurements most adjustments are minor.



The large deflection yoke is loosened with a 1/4-inch nutdriver (Fig. 8) and can be lifted off the neck of the tube. It is very heavy; do not drop it! Be especially careful not to rap the CRT with a tool or heavy object. *The CRT must be handled with care since it can implode and cause serious damage to you and the set.*

The masking must be removed from the front edge of the CRT, as in Fig. 9. On the rectangular tubes, a strap with corner flanges must be removed by loosening a side-bracket bolt. Remove the bracket (i.e., masking) assembly from the old CRT and place it upon the new tube.

Be sure the CRT is laying in the same position as mounted in the TV cabinet. Now place the strap in place on the new CRT and tighten up the bracket assembly. Be sure the high-voltage (anode) button is at

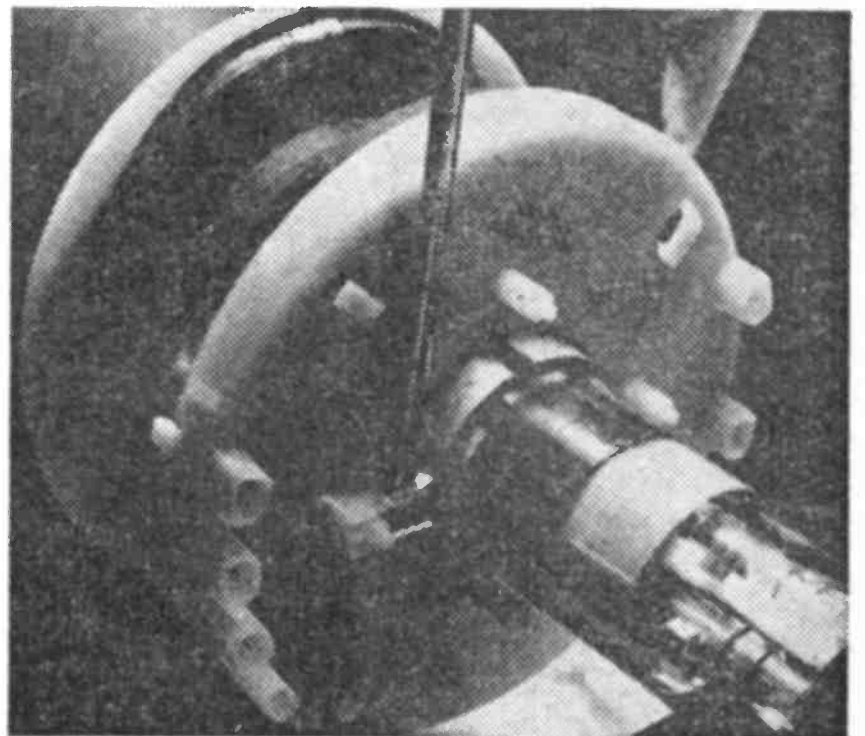
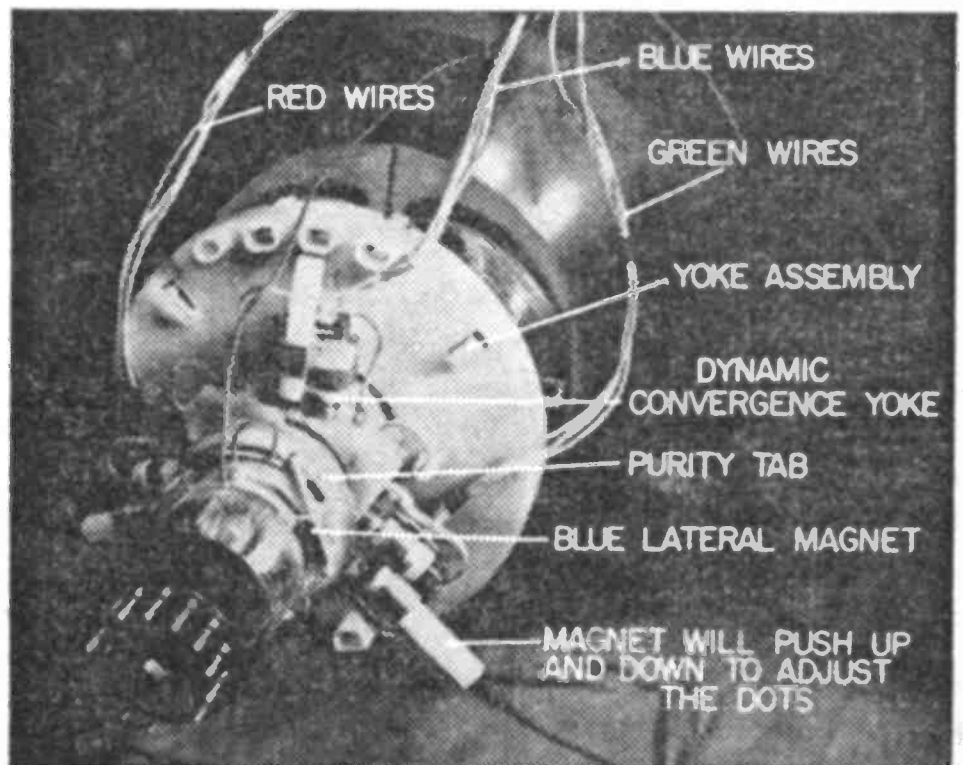

Fig. 8. (above) After yoke assembly has been loosened with nutdriver it can be removed. Assembly is quite heavy—don't drop it.

Fig. 7. (below) All components of the yoke assembly are indicated. Once you can tell the difference between a dynamic convergence yoke and a purity magnet you have an easier job of following these instructions.



CHANGE COLOR TUBE

the top of the set on a 25-inch picture tube (Fig. 10). The 23-inch and 21-inch round-CRT anode connections (Fig. 11) are on the side of the tube.

Reassembly. Place all components back on the neck of the CRT. Use the previously taken measurement for their approximate position. In the older sets the yoke must be mounted so it will slide back and forward for purity checks. The 25-inch yoke assembly fits snugly against the bell of the tube. This yoke slides back and forward inside of the large yoke assembly. Two small screws are loosened on each side of the plastic yoke assembly.

Tubes that are not bonded have a safety

glass—be sure the glass is clean. Wash it with soap and then rinse with clear water. Make sure there is no lint or dirt on the face of the new CRT (Fig. 12). Seat the tube in its place in the cabinet and bolt it to the front brackets. Replace the metal shield and degaussing-coil assembly, if the set has one.

Now set the cabinet upright and fasten the convergence board in place (Fig. 13). Install the TV chassis and connect all cables. Make certain that all parts are replaced and tightened. Banging against metal parts will sometimes induce magnetism into these parts and a second job of degaussing may be required. Be sure that all cables are connected and in place. Turn on the color receiver and leave it on for 15 to 20 minutes before purity or convergence checks are made.

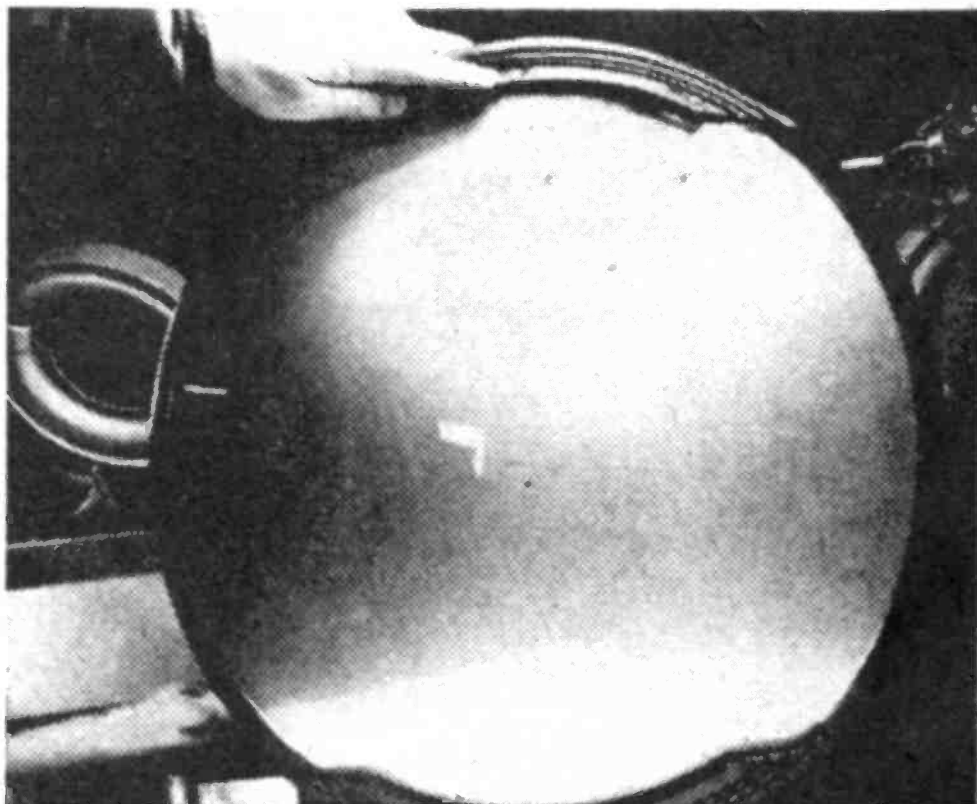
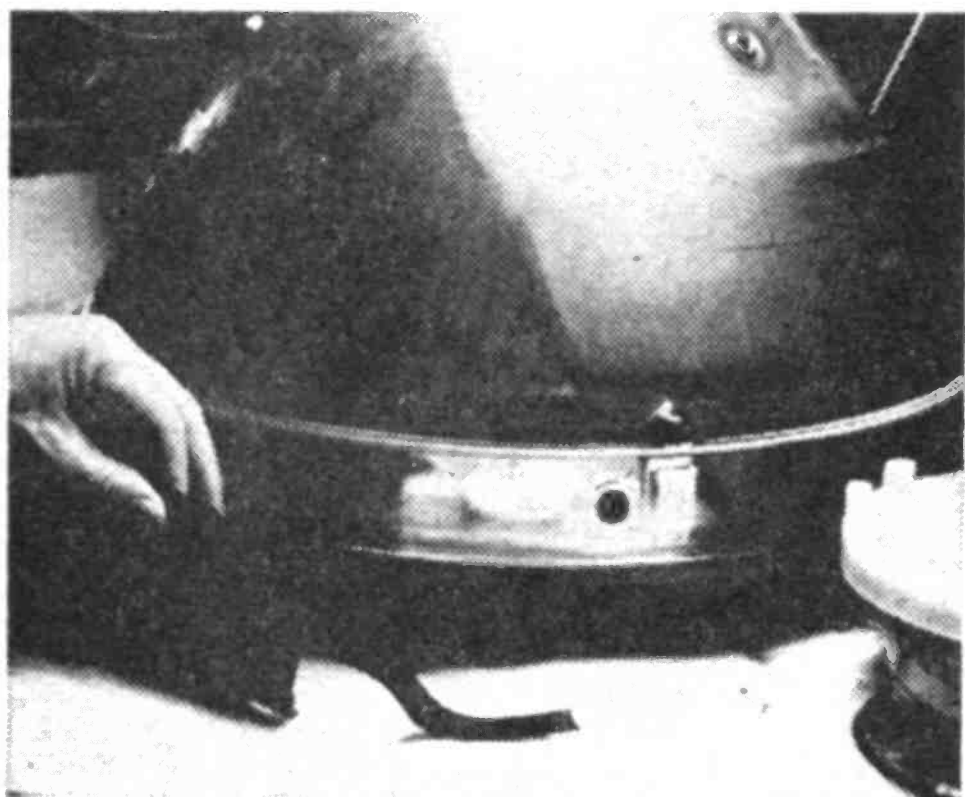

Fig. 9. (top, left) Make careful note of how the front protective mask is removed from CRT to make replacement much easier. Plastic mask on 21-inch CRT must be placed evenly (top, right) before taping in place.

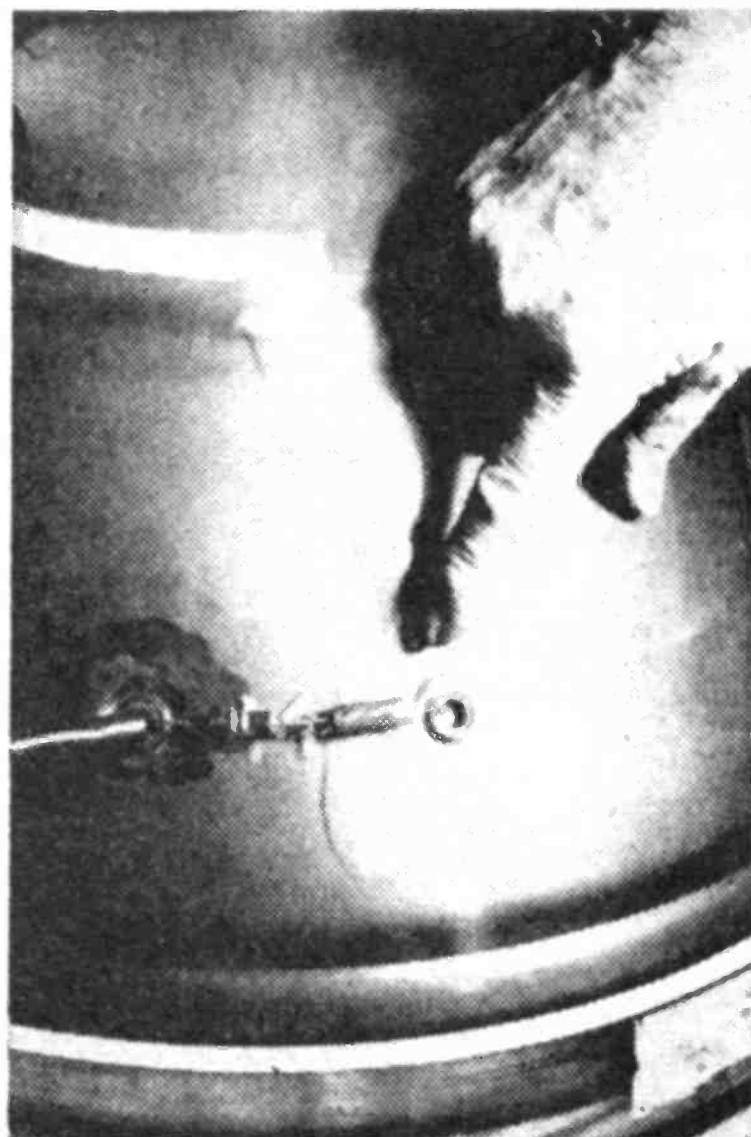
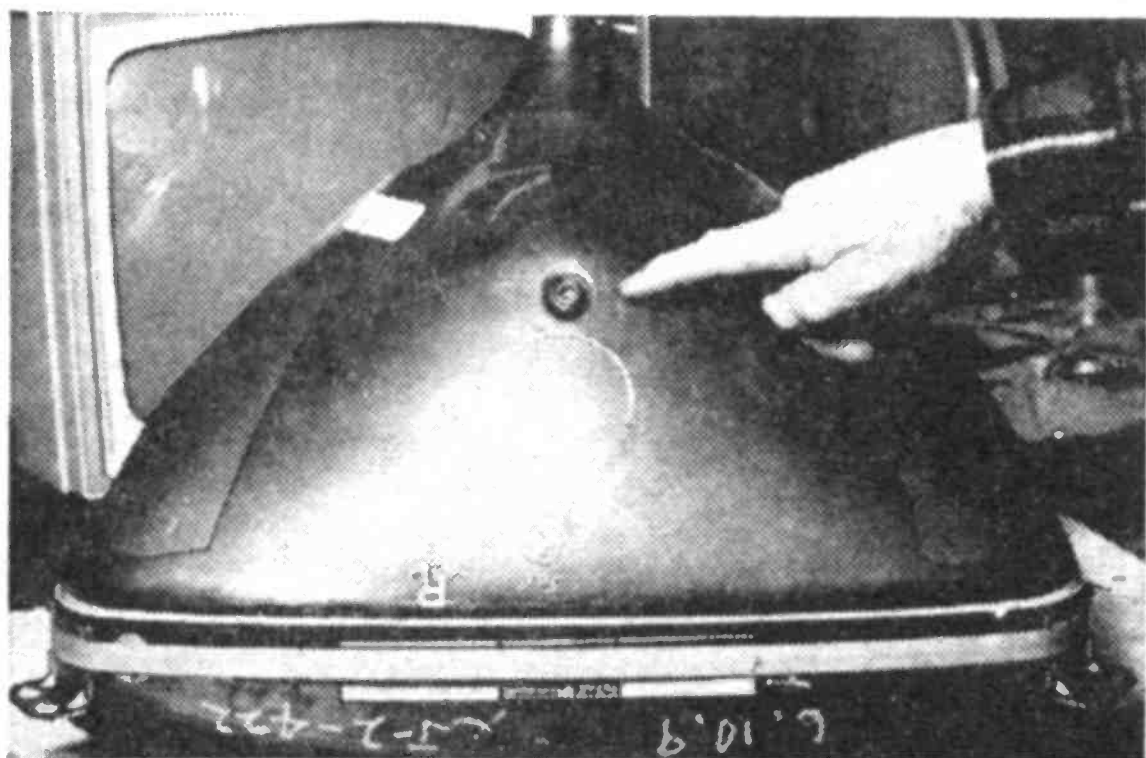

Fig. 10. High-voltage connector is at top of 25-inch CRT's—on side of 19- and 23-inch CRT's. Make sure!
Fig. 11. Resistor, with spring, bridges anode buttons.

Basic Adjustments. Color-TV convergence can take time and may require skill. You may want to degauss and converge the color TV yourself, if correct equipment is available. If not, get help from a good reliable color-TV serviceman and pay him to finish the job.

If you want to do it yourself; here goes: Position a degaussing coil near the picture tube (Fig. 14) to completely neutralize any induced magnetism. This step will help insure proper purity and convergence when the picture tube is converged. Hook up the Dot-Bar color generator and let it warm up as the color-TV set warms up. When replacing the CRT, even sets with built-in degaussing coils should be degaussed just as if one was not built into the TV cabinet.

Take a quick look at the TV screen and if there are any color shaded areas the set

should be put through a purity check up.

To start the purity adjustment (Fig. 15), turn off the set and unplug the IF cable going to the tuner. Plug the AC-interlock cord back in, let the receiver warm up, and short out the green and blue grids through a 100K resistor. (There are commercial kinescope grid-shortening switch boxes on the market for just this purpose.) At the moment the screen should be red. Adjust the center purity ring for a center red coloring. Then push the yoke back and forth and adjust the purity ring until the entire screen has an even red tint. The red-, blue-, and green-grid connections are generally on the top of the chassis. These three colored wires go to the picture-tube socket.

If the purity adjustments are done correctly, the green and blue shading will fall in line. It is always best to check each one

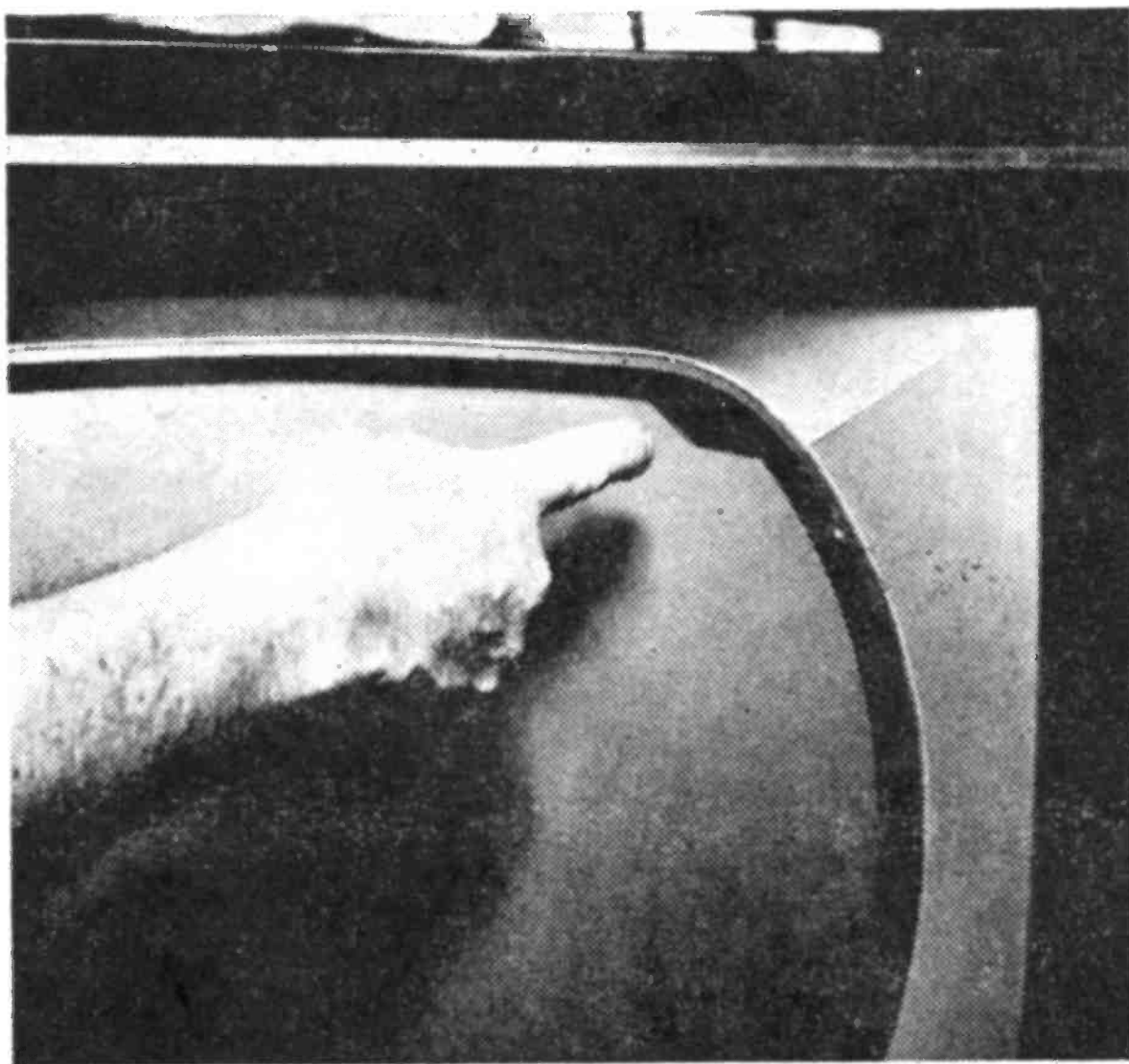
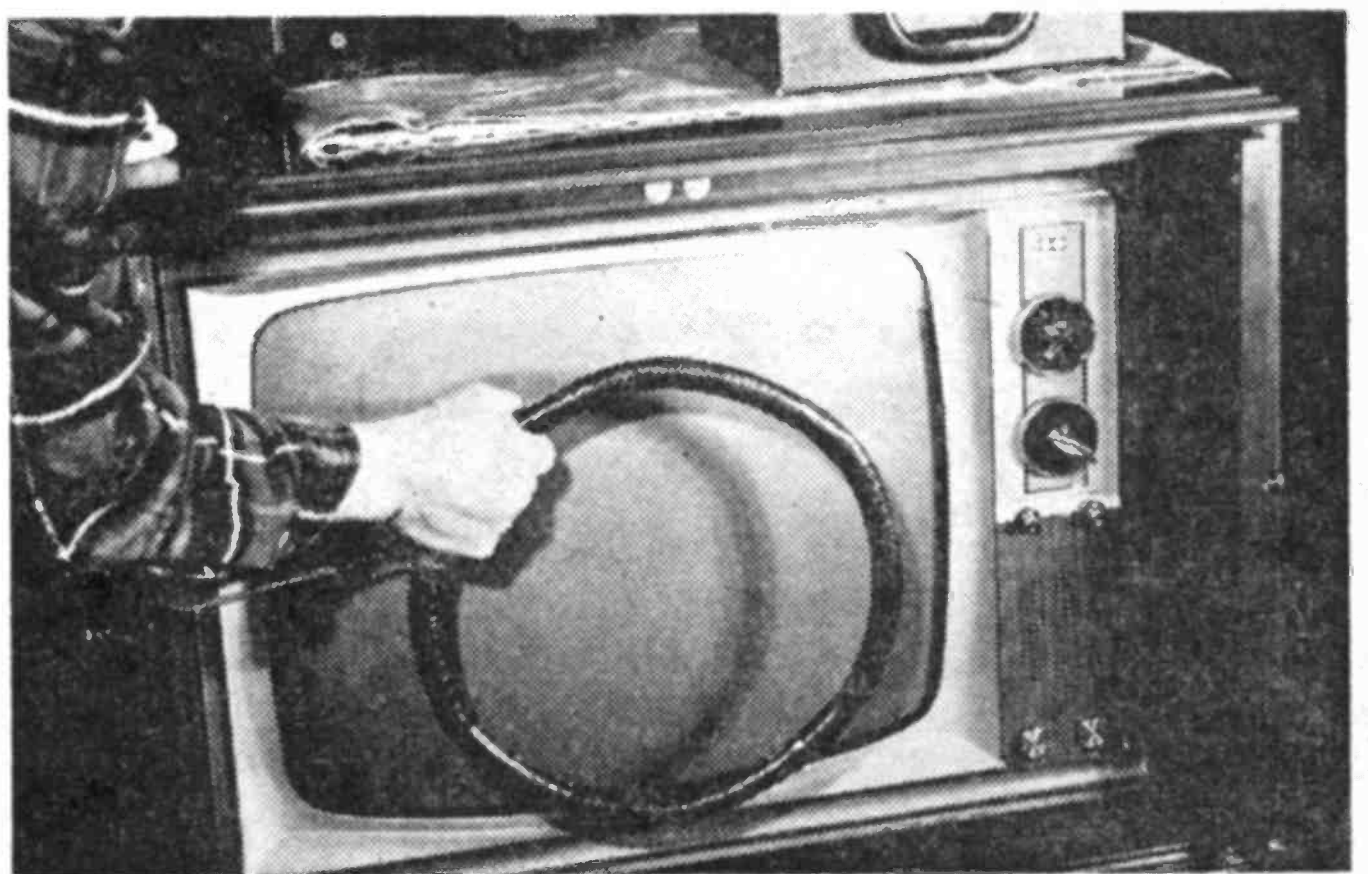

Fig. 12. (top, left) When replacing CRT's that are not bonded, safety glass must be cleaned of fingerprints and lint. Double check mask to make sure it is aligned properly in set.

Fig. 13. (top, right) When convergence board has been reinstalled and all nuts and machine screws have been tightened the chassis can be returned to the cabinet and secured too.

Fig. 14. (right) Degauss the CRT even if there is a built-in degaussing coil.



CHANGE COLOR TUBE

separately by shorting the other two grids to ground through a 100K resistor. If a little shading persists, try degaussing the CRT again and start over with the red adjustment procedure again.

At this time, check the level of the picture and see if the picture is in focus. Sometimes it is difficult to do a good job of convergence with the set out of focus. When you reset the focus control, convergence dots are way off.

Getting a Picture. Convergence is relatively easy on the new color receivers. The older models require patience and plenty of time. Connect the Dot-Bar generator to the antenna terminals. Remove the convergence board from the back of the set and place it on the slots at the top and back of the set. Tighten the two metal screws so the board is solidly in place. Watch the wires that connect the board to the yoke assembly so that they do not get tangled.

If the receiver was in convergence when the color CRT went bad, the dynamic convergence controls will generally need only a touch up. Set the generator to get *dots* on the CRT screen and check the dots down through the center of the screen. Short out the blue gun with the 100K resistor. Bring the red and green dots together on a center dot. Slide the red and green magnets in on top of one another. Readjust the setting, if needed.

If they won't quite come together, remove

and rotate the red magnet a half turn and reinsert it, and adjust again. Now, once the red and green dots are centered, short the green grid and line up the red and blue dots. (The blue-beam magnet moves the blue dot up and down. The blue lateral-beam moves the blue dot horizontally. Place them on top of one another). Go back and check the red and green guns once again. Check that all three dots are together. You should now have a white dot. The amplitude and tilt controls should not be adjusted unless the dots fail to converge.

Now, step back and take a look at the screen from a distance. Tune in a black-and-white program from a local station and check for color fringing. Generally, the convergence board does not need to be adjusted unless tampered with.

If the dots do not converge at the ends, top, and bottom, the vertical and horizontal adjustments must be made. Use the manufacturer's convergence and adjustment information and follow their alignment procedure. It is best to go over color convergence several times and then get away from the dots. Go back in a few minutes and recheck.

Follow the factory adjustment for black-and-white setup. The newer TV color receivers have a *service-normal* switch mounted at the rear of the chassis. When this control is thrown to the *service* position the raster collapses into a thin white line. You adjust the three screen controls until the vertical line is perfectly white. Now flip the switch to *normal* and the picture is black and white. ■

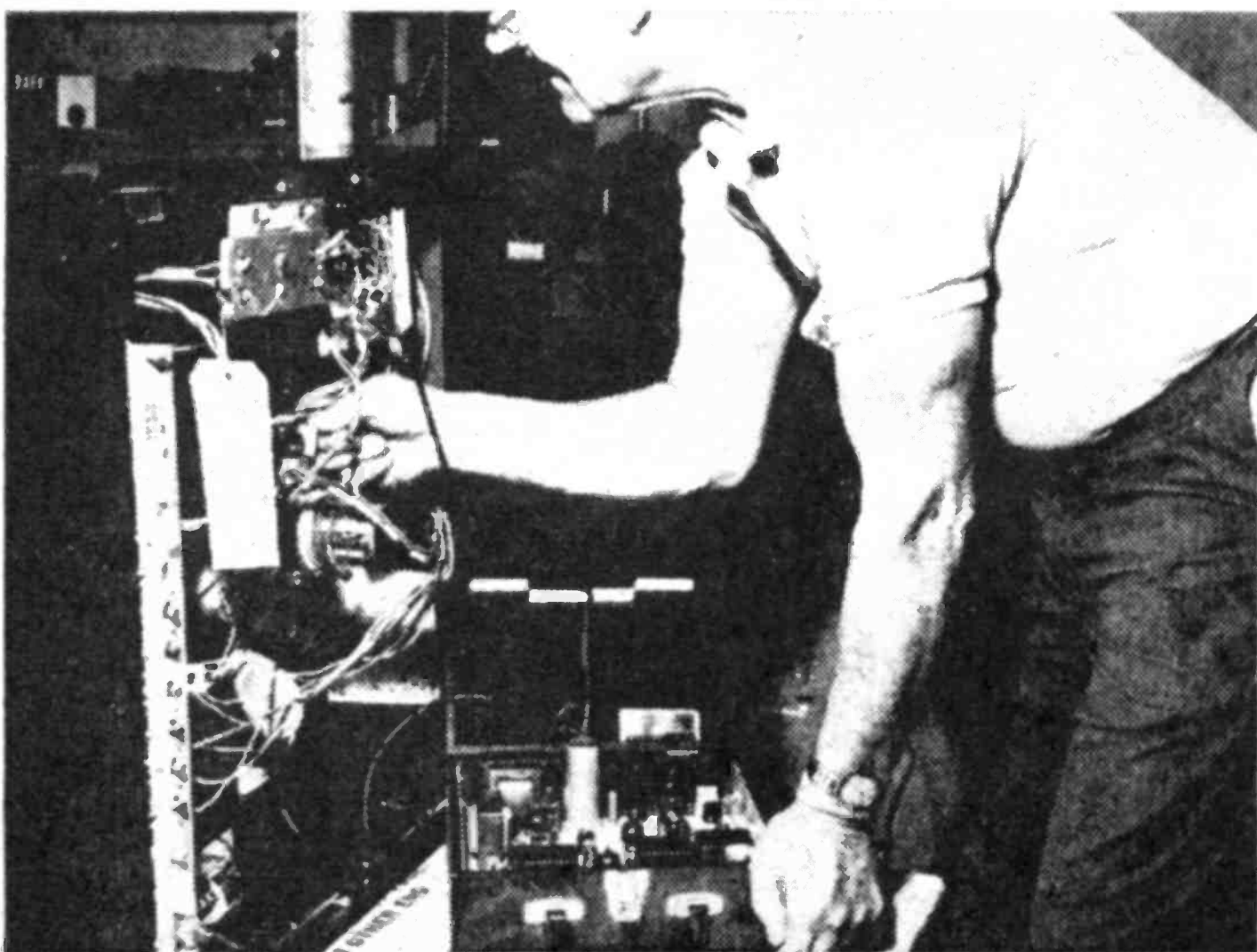

Fig. 15. The last step is the most crucial of all the steps in the replacement of a color CRT. Color purity has a lot to do with the overall enjoyment you get when watching your favorite programs. No one can thrill to faces that are tinged with green, or grass that has a purplish tinge. If you don't have the necessary equipment you can have your local TV service technician do both the color purity and convergence adjustments. Fee is much less than paying for complete job by TV technician.



Pardon for the Color Killer

Here's the dope that'll give your TV a new lease on color.

The most avid color-TV viewer sometimes wishes his receiver didn't show color. Like when he's watching a black-and-white program. After all, good old Bogart looks better in gray and Count Dracula shouldn't be caught dead wearing a yellow cape and pink gloves. So color TV receivers are equipped with a circuit called a color killer. When it's working properly, the set won't murder the monochrome.

The color killer is first cousin to the squelch found in CB and other communications gear. Squelch automatically switches off audio when no signal is received, thus you don't hear annoying static and electrical interference in the speaker. Once an incoming carrier trips the squelch, the audio section comes alive and it's automatic: the squelch circuit can sense the presence of the carrier and take it from there.

That's similar to the operation of the color killer in TV. Only the static is false color spilling into a black-and-white picture.

The color-killer circuit doesn't have an easy time of it. Before it acts, it must decide whether you've tuned to a station transmitting in color. Also, it shouldn't disturb normal black-and-white reception. These are tall restrictions when you consider that in much of the receiver, color and black-and-white are as inseparable as a Mars bar and its wrapper around mid-July. Yet there is one electronic clue that instructs the color killer to paralyze color circuits at just the right time. That clue, as we'll see, is a re-

ceived signal that's called the "burst."

The Human Killer. Early color receivers required the viewer to be the color killer. The viewer selected a channel and visually decided whether it transmitted in color. If not, he flipped a switch and disabled any circuits likely to feed false color to the screen (Fig. 1). Though that block diagram is greatly simplified, it illustrates the point. All frequencies which make up the video signal—black-and-white plus color—arrive at the upper left. Frequencies for black-and-white travel to the picture tube. (These frequencies span a range up to about 3 MHz and represent picture brightness and detail.)

You can see, too, that the video signal is split and also applied to the bandpass amplifier. Purpose of this stage is to snatch out color information contained in the complete video signal. It is actually a tube with tuned circuits which peak between about 3

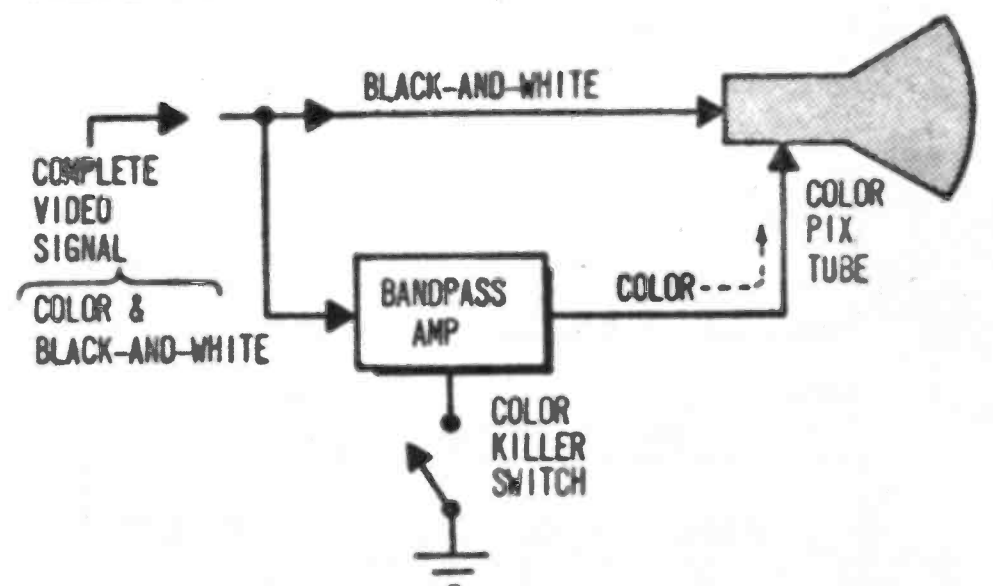

Fig. 1. Basic color killer turns color circuits on/off at appropriate time.

to 4 MHz, where color resides. After color information is trapped by the bandpass amp, it undergoes further processing until it reaches the picture tube to control the electron guns.

The bandpass amp can cause problems during black-and-white reception if permitted to remain alive. Noise, static or other interference could reach up into the color region of 3 to 4 MHz. These spurious signals are amplified by the bandpass stage and blotches of willy-nilly color appear on the screen. This stage should be completely disabled during monochrome reception.

As shown in Fig. 1, there's a switch for turning the bandpass on and off. Now the viewer may completely disable the stage to block the interference path. Some hash can still reach the screen over the black-and-white path but it's far less annoying when it appears as old-fashioned, black-and-white snow. If it sneaks through the bandpass, though, it fills the screen with heinous multi-colored "confetti."

Murder, Inc. The trend in electronic equipment, however, is toward total automatic control. And since the set is already cluttered with many knobs, why not try to eliminate one? So the manually operated switch of the color killer has evolved into an all-electronic technique that's found in just about all modern color receivers. The switch is supplanted by a special sensing circuit that latches on to a portion of the color signal. It results in a go, no-go condition of the bandpass amplifier.

A Thirst for Burst. As mentioned earlier, color and black-and-white signals are closely tied together. What's more, they experience constant change as picture scenes and color vary. These wandering signals, therefore, cannot directly operate a color killer. There is one part of the color signal, though, that's

an electronic Old Faithful. It's the "burst." This signal is transmitted in machine-gun fashion at the end of each picture line scanned across the screen. Not only does it repeat regularly, but is indifferent to program content. Since the burst is transmitted by the TV station only during a color program, it's a good reference for controlling the killer stage.

Before looking at the circuit, it should be said that the burst is not created solely for operating the color killer. Its main purpose is controlling a crystal oscillator located elsewhere in the receiver. This oscillator provides an accurate color sub-carrier signal needed during color detection. Nevertheless, we can steal a small sampling of burst signal and make it perform admirably well for operating the killer circuit.

Automatic Slaughter. The simplified block diagram in Fig. 2 reveals how the main part of the color receiver relates to the burst and color killer stages. The transmitted signal enters the antenna and travels to the video amp. Black-and-white proceeds to the picture tube even during a color program since it supplies the brightness, or "luminance," portion of the picture. The complete video signal also descends on the bandpass amp. Along with it rides the burst, shown as a series of cycles. (Each burst occurs at a frequency of 3.58 MHz. We're not concerned at this time with further details on the burst except to note that it always occurs when the program is in color.)

The burst is a fragile signal so a burst amp is placed in the circuit to beef it up and get rid of other components of the color signal that might interfere with the following operations of automatic color killing.

The amplified burst signal is next applied to the killer detector. Purpose of this section is to convert the burst—a high-frequency RF signal—into a negative DC signal that is more manageable for control purposes. The control signal is next handed to the color killer stage, an amplifier that boosts the negative control signal. Finally, the color

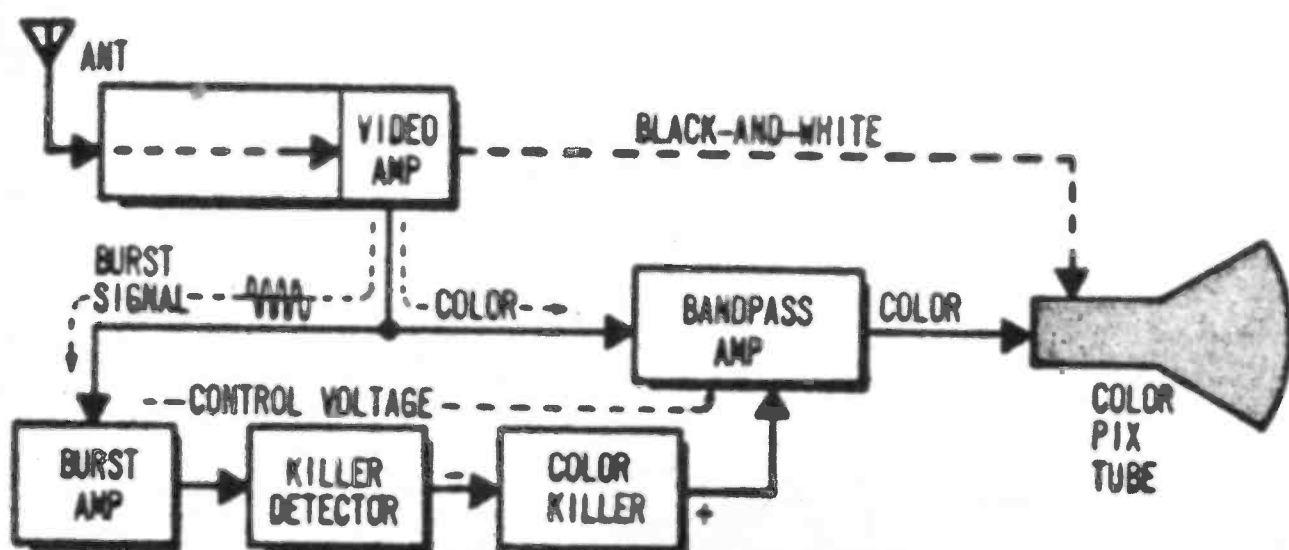

Fig. 2. Block diagram of automatic color killer circuit showing how burst signal is used to operate killer stage which in turn controls bandpass amplifier.

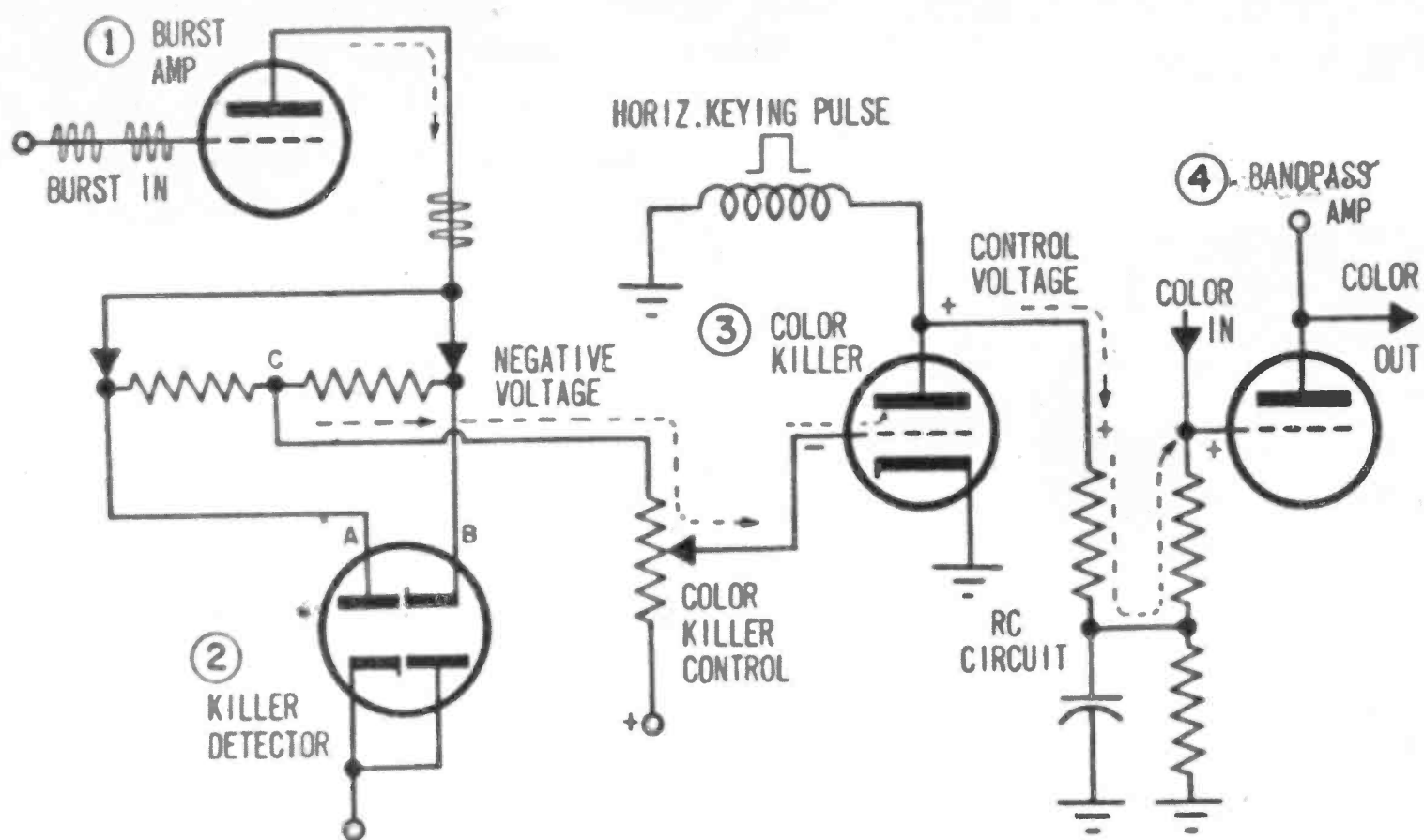

Fig. 3. Simplified schematic of typical killer circuit. Gating of killer stage by horizontal keying pulse makes circuit operation virtually immune to noise.

killer is hooked up to control the bandpass amplifier's operation.

Now when a burst signal appears in the receiver, it's converted to a control signal that electronically switches on the bandpass amp. Color signals may now flow from the video amp, through the bandpass amp and following stages in the long hard trip to the picture tube.

Before looking at an actual schematic, consider another detail in the operation of the color killer stage. Note in Fig. 2 that a negative control signal is entering this stage—but it emerges as a positive signal. The change in signal phase is typical of amplifier stages; when the tube grid is driven negative, the output signal is not only amplified but made opposite in polarity. This is an important effect in the color killer circuit. The positive signal (produced whenever burst is present) is applied to the grid of the bandpass amplifier. This creates a positive bias that turns on the stage, allowing it to pass color signals. When burst is absent, the bandpass grid is very negative and blocks color signals.

Tracing the Schematic. A simplified diagram of the killer circuitry in many of today's color sets is in Fig. 3. We can begin at the burst amp (1) shown receiving the burst signal. After amplification, the burst is applied across the killer detector (2). This stage is a pair of diodes such as might be found in the detector of an FM receiver and the function is similar: it converts a radio signal (here, 3.58 MHz) into DC by acting as a rectifier. Burst voltage is applied across the dual-diode tube, at plate A and cathode B. Resultant current flow through the stage creates a negative voltage between the load resistors (see point C).

The negative voltage is next applied across a potentiometer—the color killer control. Although the total circuit is automatic in operation, the control is adjusted when the color TV receiver is first installed, or when the antenna is changed. It permits the circuit to be set up for a threshold adjustment, or compromise, for stations of different strength. (More on this when killer troubles are considered.)

Next, the negative signal moves to the grid of the color killer (3). Here it is amplified and reversed in phase, as described earlier. Notice a special feature of this tube: its plate is not powered by the usual B+ supply voltage. Plate potential for this stage, rather, is picked up via a winding on the receiver's horizontal output transformer (also known as the flyback or high-voltage transformer). Purpose for this arrangement is to power the color killer only as the burst signal is transmitted. By keying-on the tube during this period only, the killer becomes immune to other signals (picture, noise, etc.) that could sneak through burst and detector stages and operate the killer at the wrong time and allow color to contaminate the black-and-white picture. The horizontal transformer can provide a properly timed keying pulse since it produces voltage in the interval between each picture scanning line, precisely the same time the burst is received.

Output of the color killer, now a positive signal, is applied to the bandpass amplifier (4). It biases the grid positively so the tube is able to conduct normally. The color signal, also applied to the grid, may now be tuned and amplified for further processing. Note that the positive control signal has also passed through a resistor-capacitor (RC) network just before reaching the bandpass

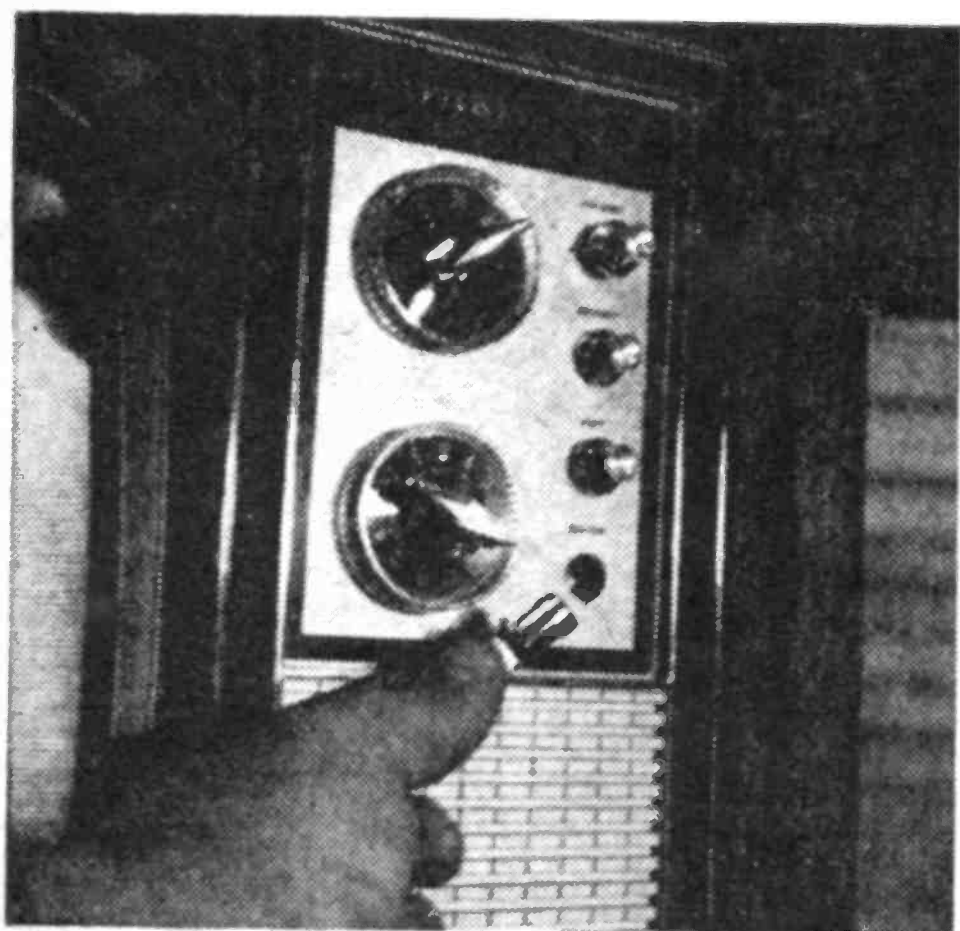

Fig. 4. Adjustment of color killer threshold may be required if antenna installation is changed or as result of aging components.

grid. This network forms a time-constant, or storage, circuit that extends the length of the positive signal. This delay enables the original, short-term control signal to stretch its effect over one full picture scanning line on the screen. The bandpass amplifier now remains alive for a period far longer than did the original burst.

Controlling A Killer. The color killer control must be properly adjusted for satisfactory operation in the circuit. The adjustment is often done by turning a potentiometer shaft located at the rear of the set or behind a front control as shown in Fig. 4. In a typical receiver, the killer is adjusted in this fashion: Tune to a weak station transmitting a black-and-white program. There should be snow on the screen. If not, tune to an unused channel and observe the snow caused by atmospheric noise. By rotating the control in one direction, you should reach a point where flashing dots of color appear on the screen. Correct adjustment is obtained when the control is turned so the multicolored snow just disappears. Don't turn it too far or you'll affect reception on color telecasts, especially in a fringe area.

The adjustment is checked by turning to all stations you can receive in your area. There should be no colored confetti on any black-and-white program, and no disturb-

ance to the picture during color reception.

Clues To The Killer's Crimes. Before attempting to analyze trouble in the color killer section, be sure the problem isn't originating elsewhere in the receiver. The set should be producing good black-and-white pictures and normal sound. Any problem that weakens the received signal could affect the killer circuits. A weak front-end tube, a damaged antenna or lead in, for example, might cause erratic color-killer operation. These faults, however, usually affect black-and-white reception as well. Thus if color creeps into a black-and-white program that otherwise appears normal, this is a sign of trouble in the color killer.

Four major symptoms, shown in Fig. 5, help spot trouble in the color killer. Always begin by checking to see if the killer threshold adjustment is correctly set, as described above. Inability to obtain the desired action with the control strongly suggests trouble in the killer circuits. Then consider and analyze the following clues.

In the first symptom in Fig. 5 (A) the set is tuned to a station transmitting black-and-white. If the signal is on the weak side, snow might appear as colored confetti flashing over the screen. When a station is strong and no snow appears, a faulty color killer might cause color to appear around the edges of people or objects in the picture. (This shouldn't be confused with mis-convergence, another problem. You can tell it's the killer if the fringes of color consist of rainbow-like hues, rather than single strokes of color.)

In symptom B, the set is receiving a color program. The image on the screen, however, is perfect black-and-white—the same as if you'd turned down the color or chroma control on the front panel. The absence of any hue suggests that the color killer stage is falsely cutting off the bandpass amplifier and interrupting the color signal. A trouble of this kind might be caused by a component that has radically changed value—say a burned-out resistor or open capacitor.

Again in the C, the set is picking up a color telecast. But now the color image is satisfactory only when the signal is strong. Weak color stations are seen in black-and-white. This in-between type fault suggests a component that has changed value (rather than burned out or shorted). Only a strong signal creates enough voltage to open up the bandpass amplifier.

When color reception is intermittent (D)

trouble, carefully check circuit connections for a cold-soldered joint or hairline crack in the printed-circuit board, if one is used in your set (see Fig. 7).

Further investigation requires a VTVM and the set manufacturer's service literature giving socket and test point voltages. These items enable you to check for correct DC voltages at each stage. Chances are these readings can help locate many major faults which afflict the killer. These include burned-out and shorted resistors, and shorted, possibly leaky, capacitors. With the receiver turned off, resistance checks with the VTVM's ohmmeter section provide valuable information in finding the fault.

In Fig. 8, there's a typical color killer schematic with voltage points that can be measured by a VTVM. Note that the plate is identified as pin 3 and voltage at this point should be $-50V$. At the grid, pin 2, voltage reads $0.5V$ when no signal is in the receiver, but increases to $-12V$ when a color signal is present. These schematics also give such detail as how various controls are set while taking measurements and permissible voltage error (usually about 20 percent). Note in this circuit an additional feature not mentioned earlier. It's the "Color Off" switch. Since the color killer might not remove confetti from extremely weak black-and-white images in fringe areas, this manufacturer adds a manual switch. Operation however, is usually automatic.

Tough Dog Killers. These simple checks will localize most trouble. But those tough
(Continued on page 97)





	PROGRAM	PICTURE	SYMPTOM
A	BLACK-AND-WHITE		COLORED "CONFETTI" OR MULTICOLORED OUTLINES on B&W PICTURE
B	COLOR		BLACK-AND-WHITE PICTURE OK, BUT COLOR COMPLETELY MISSING
C	COLOR		COLOR PICTURE OK, BUT RECEIVED ONLY WHEN TUNED TO STRONG STATION(S)
D	COLOR		COLOR IN PICTURE INTERMITTENT OR MIGHT CHANGE IN STRENGTH AT RIGHT SIDE

Fig. 5. Four common indications that the time has come for the color killer to be investigated and possibly administered corrective action.

—color fades in and out of the black-and-white image—it could mean there's an intermittent component in the killer circuits. In some sets, fading color toward only one side of the picture might also suggest killer trouble since bias on the bandpass stage may not be holding constant over the span of each picture line.

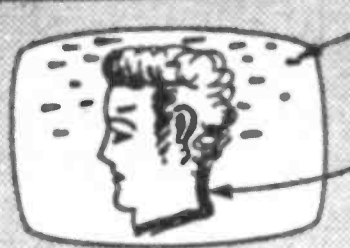
Find-A-Fault. If all symptoms point toward the color killer stages, begin by checking tubes associated with that section. They're the stages shown shaded in Fig. 6. In many instances, one tube type will contain more than one stage. (For example, color killer and bandpass amp might be in a single 6EA8.) If a tube doesn't cure the

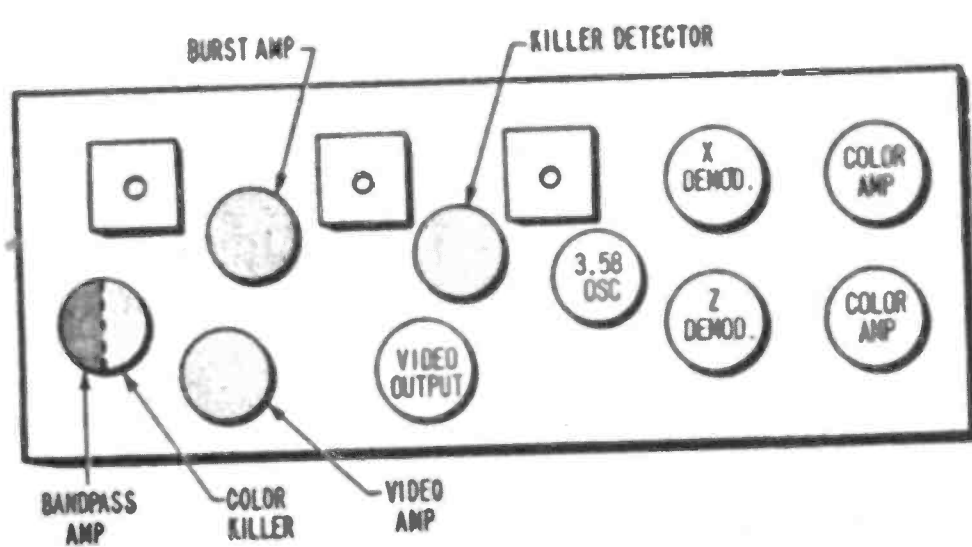

Fig. 6. Typical chroma board found in modern TV sets contain most color tubes. Killer circuit tubes are shown shaded.

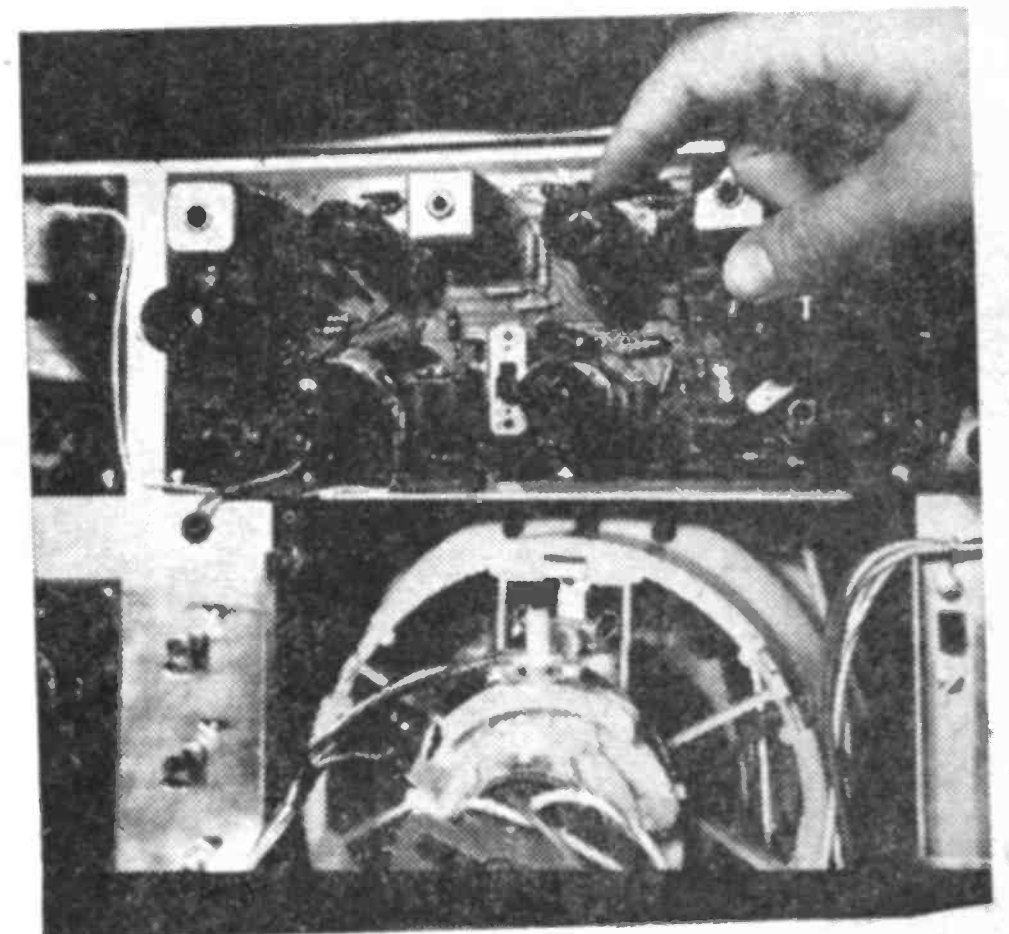

Fig. 7. Problems in color reception can usually be traced to tubes on chroma board. Finger points to killer detector.



WHAT TO DO WHEN COLOR'S GONE

BY
LEN BUCKWALTER, K1ODH

The troubles that plague a color TV could fill a volume of "Who's Hue." There's *runny* color, where tints sprint across the screen. There's *wrong* color that makes a bowl of tomato soup resemble crankcase sludge. But one of the most outstanding symptoms is *no* color. And it's about as exciting to look at as our peacock without a tail.

Missing color first seems like total disaster. Could the costly picture tube (about \$100-plus) have expired? Fortunately, whenever color *only*—not the black-and-white image—disappears, it probably means an inexpensive repair. Total color loss can be traced to a few stages in the receiver.

Pre-operative Procedure. Before taking off the back of the set, carefully check symptoms. In the case of the missing color, it's assumed the set is receiving normal black-and-white pictures (even on color programs as in Fig. 1). This proves that a vast section of the receiver, including the precious picture tube, is above suspicion. First, be certain the set is tuned to a station known to be transmitting color. Since the color signal tends to pop in at a narrow setting of the fine tuning control, run the knob over its complete range. No hue? Check if the chroma or color control on the front panel is turned up. Jiggle the knob a few times just in case a control is intermittent. If proper color flashes on the screen, you've located the trouble. If not, here's how to check further.

Up Tight Color Killer. There's a good chance the color killer is set too "tight." This adjustment, found on the rear chassis apron or behind a front panel knob, disables color circuits during black-and-white programs (Fig. 2). Though correctly set at one time, the passage of time might shift circuit components enough so the killer is squelching color, too. Turn the control full range to see if you can restore color. Then try it on an unused channel. At some point in the color killer adjustment, snow on the screen should turn to colored confetti. (The proper setting of this control is usually at the point where color in the snow just disappears.)

If you're convinced that loss of color is not due to any of these superficial reasons, consider the antenna system. Although it's not common for an antenna to kill color completely, you might be victim of the exceptional case. Color signals are fragile and could be sliced away if the antenna has too little bandwidth. Consider this if the antenna

is new and one not specifically rated for color reception. (A good black-and-white antenna usually works well for color). Another weak point in the antenna system is the lead-in. Reflected signals along twinlead could cause some phase cancellation of color. This is especially troublesome if one wire in the twinlead is broken or disconnected at the antenna elements or at the back of the set. Wet weather or poor antenna orientation are other possibilities.

Running Down The Block. Before pulling off the back of the set, consider likely trouble spots that cause the no-color trouble. These can be spotted in the block diagram of Fig. 3. Since we're assuming the set is able to receive black-and-white programs—

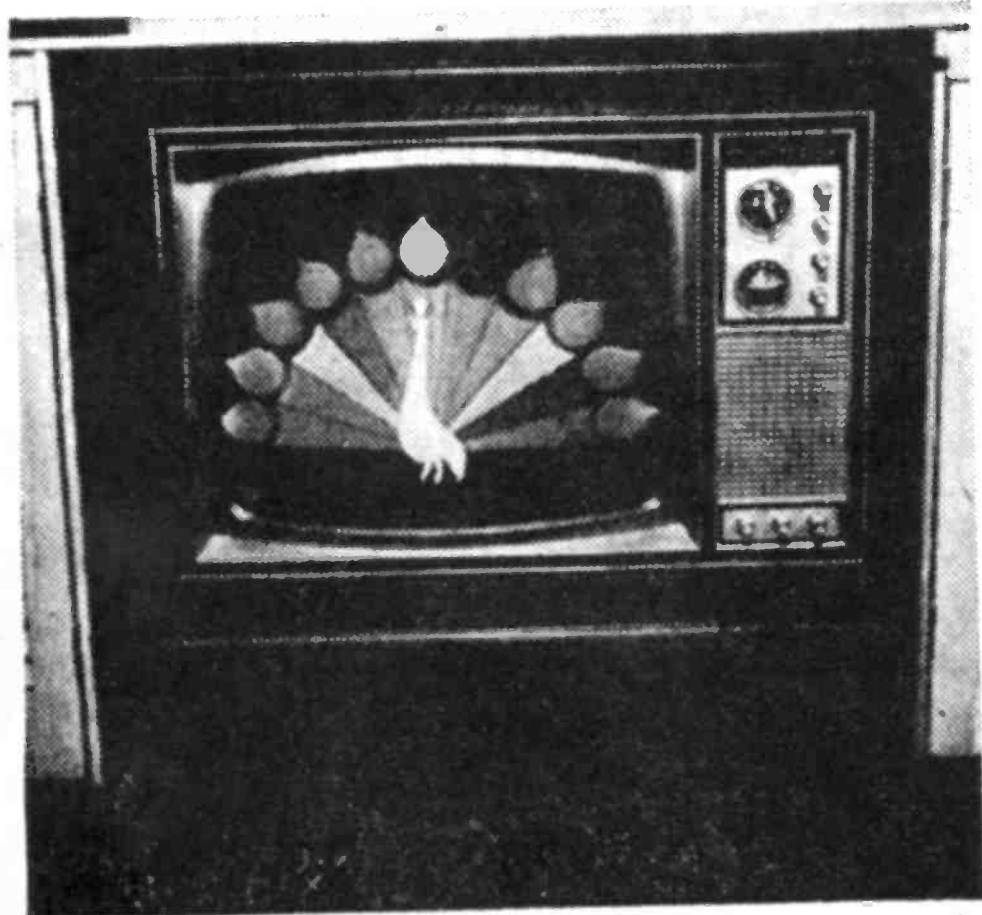

Fig. 1. TV showing perfect black-and-white picture during color program provides important clue to nature of problem and shows that majority of set's circuits is functioning correctly.

or color shows in black-and-white—the block marked "Black-and-White" is trouble-free. That includes tuner, IF strip and video amplifiers. It's also evidence of a good picture tube since red, blue and green guns are firing color at the screen in the correct proportions to produce a scale from black to white. What's missing is color information that's simultaneously applied to the picture tube. Called "chroma" signals, they unbalance the guns so they no longer add up to black-and-white, but appropriate color mixtures. Consider the other blocks in Fig. 3 (see next page):

Color Amplifier. This is the first point where the incoming color signal is split from

black-and-white. Thus it comes under suspicion in the no-color symptom. A dead tube here, for example, prevents the complete color signal from penetrating further into the chroma circuitry of the receiver. It may easily explain why you can receive perfect black-and-white and absolutely no color.

You're apt to encounter different designations for stages in this region of the receiver. We've shown it as Color Amplifier, but some call it Chroma IF or Chroma Bandpass. You'll note in Fig. 3 there is another block marked "Bandpass Amp." Whatever the name, the purpose of this stage (which may occupy two tubes) is to separate color from the black-and-white signal. It does it by suitable coils and capacitors



Fig. 2. Lack of color can be caused by incorrect setting of color killer control. On set above, this control is accessible after removing color knob though most sets have control on rear apron.

which tune only a portion of the incoming frequencies. The black-and-white signal at this time is ranging from about 0 to 3 MHz. (Large details of the BW picture occupy the low frequency section; small details occur at the higher frequencies.) The color signal is borne in the vicinity of 3.58 MHz. So the Color or Bandpass Amplifier is designed to be selective in the color-signal region and thus prevent black-and-white from disturbing the following chroma stages.

Demodulators. The demodulator section of the block diagram in Fig. 3 appears in a dotted line because only in rare instances does it remove all color from the picture. But it's included since it's helpful

to know its function as a guide to other important stages that do affect overall color reception.

The demodulators take raw color signals transmitted in the 3.58 MHz region and convert them to a form which is usable by the picture tube. And since demodulators consist of several stages working with more than one color, any trouble in this section rarely leads to total color loss on the screen. A defect here generally knocks out just one hue. So the demodulator circuits are probably the last points to check.

It would be a remarkable coincidence if all circuitry failed at once. (One exception, though, is a defect in the power supply leg which powers the demodulators and the red, blue and green amplifiers which they operate.)

3.58 MHz Oscillator. The 3.58 MHz crystal-controlled oscillator aids the demodulator in converting transmitted color to the form required by the picture tube. Complete failure of this stage to oscillate can disable the demodulators and thus cause the no-color condition. In some sets, the picture goes completely green when this stage is inoperative, so watch for this useful clue.

The 3.58 MHz oscillator must generate a carrier which is exactly in step with the carrier at the transmitter. To lock receiver

and transmitter in perfect synchronization, the TV station broadcasts a string of short 3.58 MHz bursts. (The burst system conserves spectrum space, and keeps the color signal narrow.)

In most cases, failure of the burst amplifier causes loss of color sync on the screen; colors are incorrect or they ripple across the screen. But it may also cause complete absence of color.

Color Killer. This stage, as mentioned earlier, prevents color from intruding into a BW program. Since it controls the bandpass amplifier(s), a defect in the killer might block the total color signal as well. The color killer is turned on and off at appropriate times by the burst amplifier.

Thus, the block diagram reveals that missing color can spring from a number of stages in the "chroma" section of the receiver. Certain circuits, like color or bandpass amplifiers, are prime suspects since they stand directly in the path of the total color signal. In remaining circuits—burst, killer, demodulator—there might be color loss, but often there will be a lack of color sync, too.

Troublesome Bottles. Tubes are usually the major cause of trouble so check them first. Since the no-color problem is almost always in receiver circuitry that handles only color, you won't have to look very far. It is common practice for the manufacturer to localize all chroma stages in one area. In many cases it is a separate printed circuit board, as in Fig. 4. And usually the function of one or more chroma stages is con-

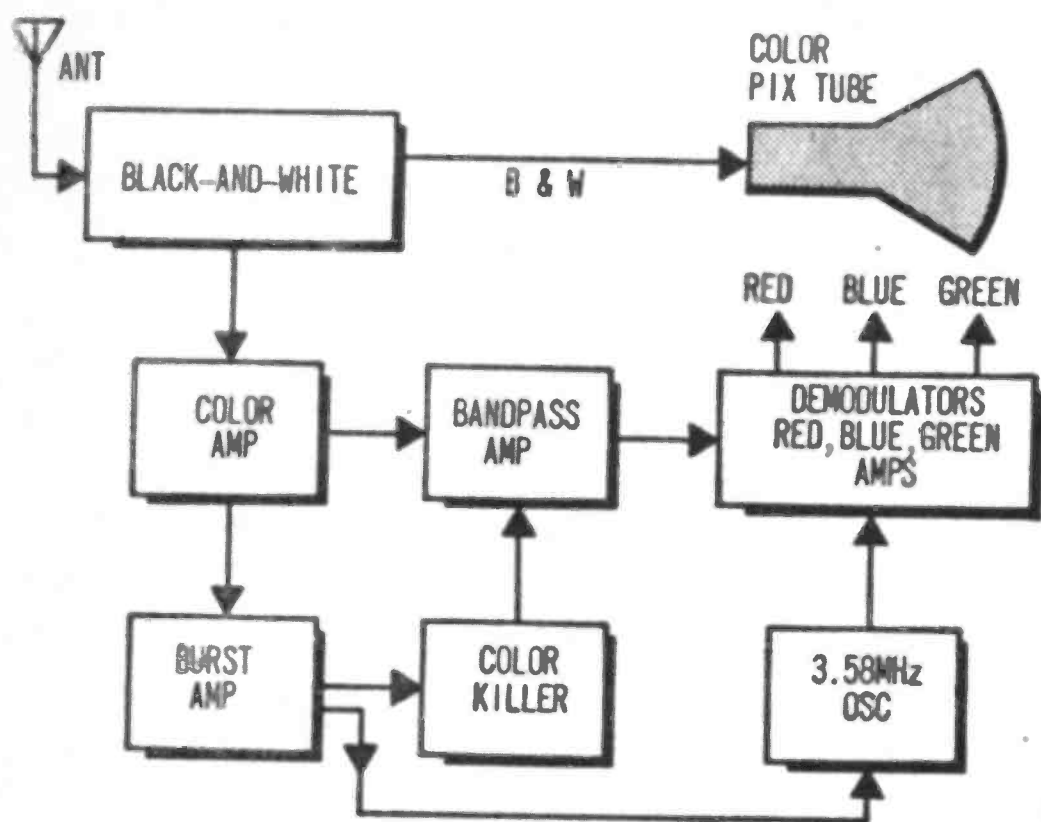

Fig. 3. When color's gone, these are the circuits to check first. Since defective tubes cause the majority of TV troubles, checking the tubes in these stages will often solve the problem.

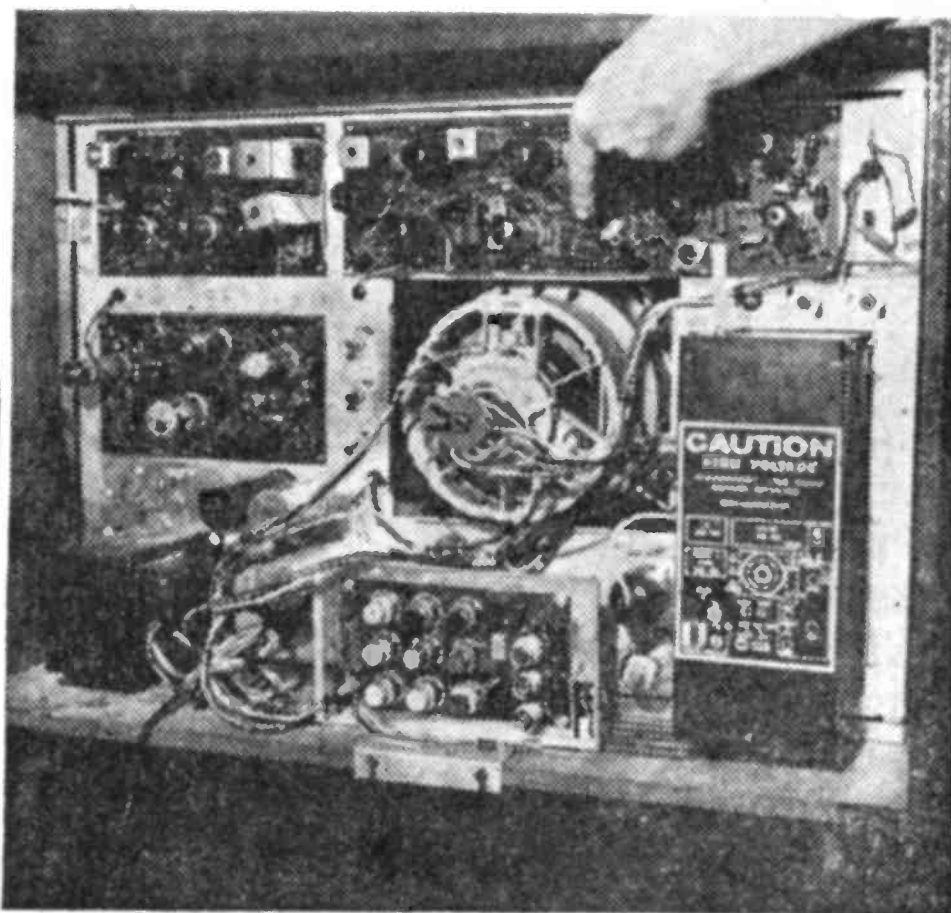

Fig. 4. Most color circuits are located on the "chroma" board. In typical set above, finger points to chroma board that occupies most of top half of chassis.

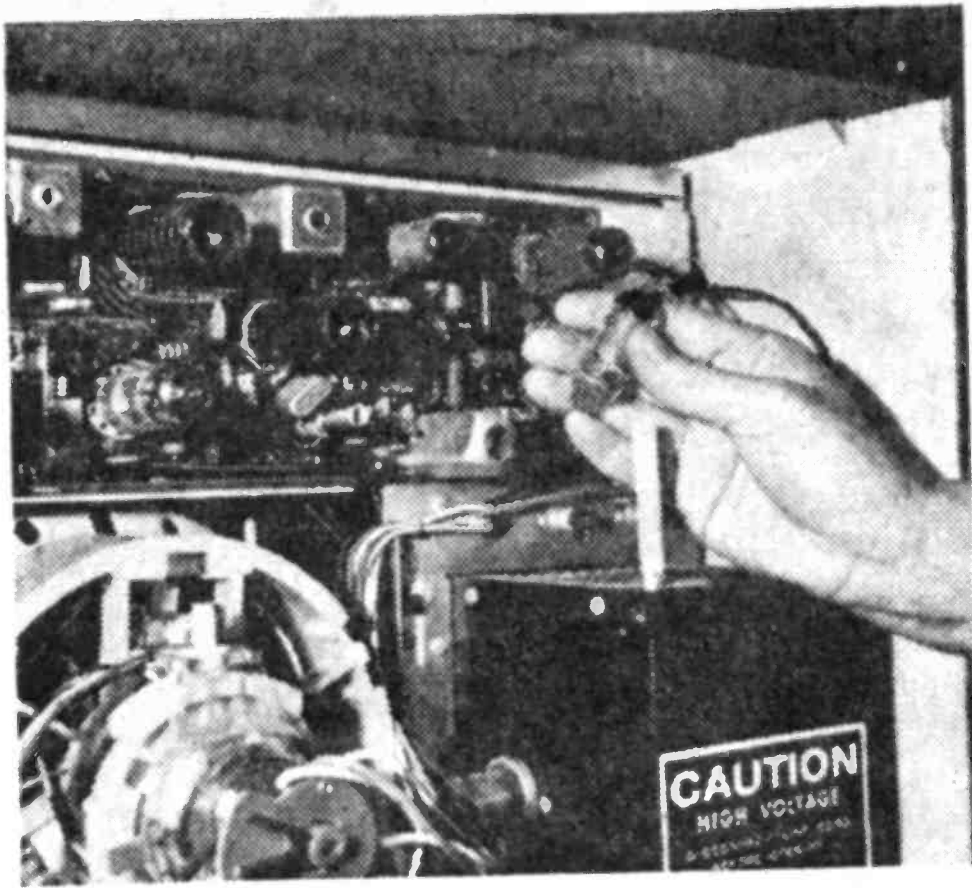

Fig. 5. The best way to check for defective tubes on chroma board is to substitute with new ones.

tained within a multi-purpose tube. There might be eight or nine separate stages in the schematic of the chroma section, but often they add up to approximately five tubes.

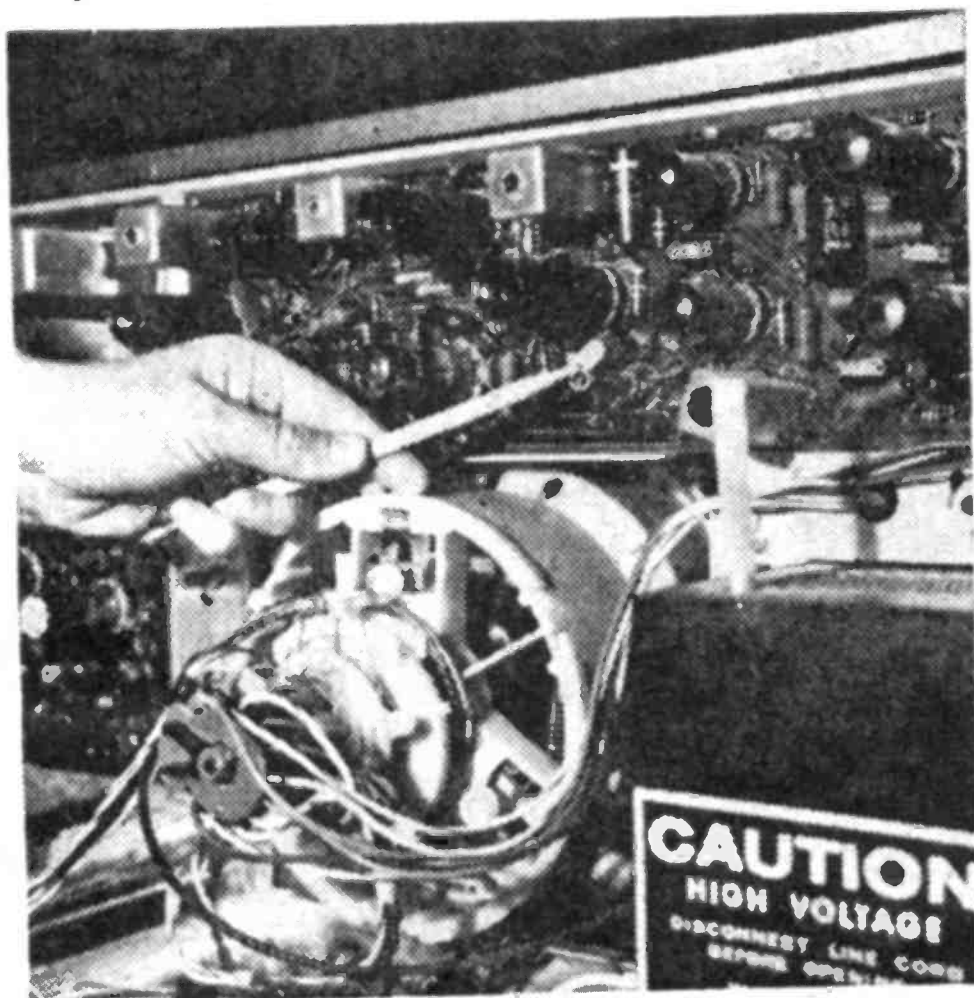

Fig. 6. If tubes don't seem to be causing the problem, try checking the 3.58 MHz crystal.

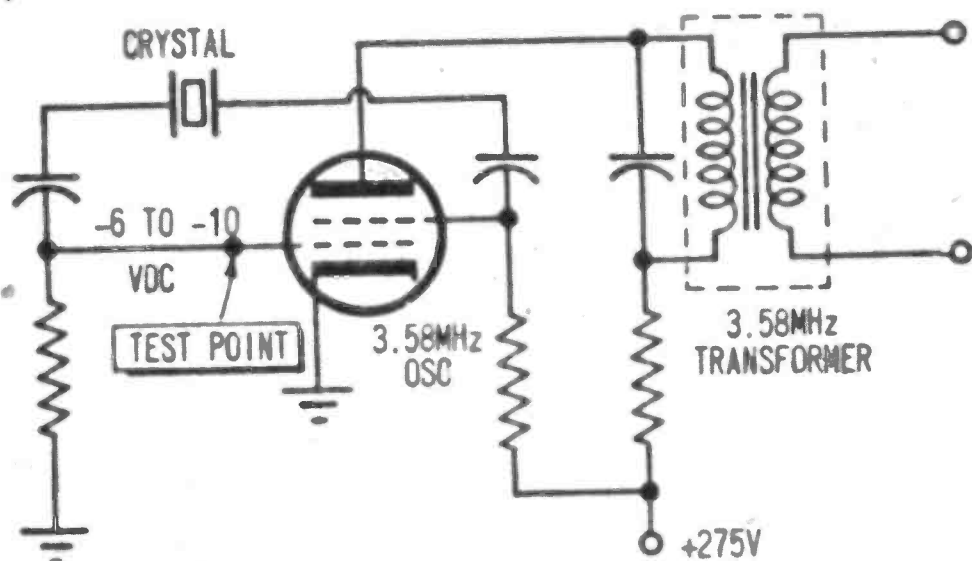

Fig. 7. Circuit of typical 3.58 MHz oscillator. A voltage check with a VTVM will determine if it's OK.

Some typical combinations in a single tube envelope: bandpass amplifier and color killer; 3.58 MHz oscillator and its reactance control; phase detector and color demodulator.

The recommended system for tube checking is substitution (Fig. 5). Plug a known good tube into the socket of a suspicious stage. It's a good idea to try only one new tube at a time and note if color returns. Substituting all new tubes in the chroma section simultaneously is wasteful since you won't isolate a bad one.

Crystal Oscillator. If tubes don't restore color, you'll need a VTVM to do some further checking. And a good place to start is at the 3.58 MHz oscillator (Fig. 6). Set makers often provide a test point for measuring grid voltage developed by the oscillator during normal operation. Voltage in a typical oscillator (see Fig. 7) is about -6 to -10 VDC.

If a check at this point produces no reading in this range, the oscillator transformer

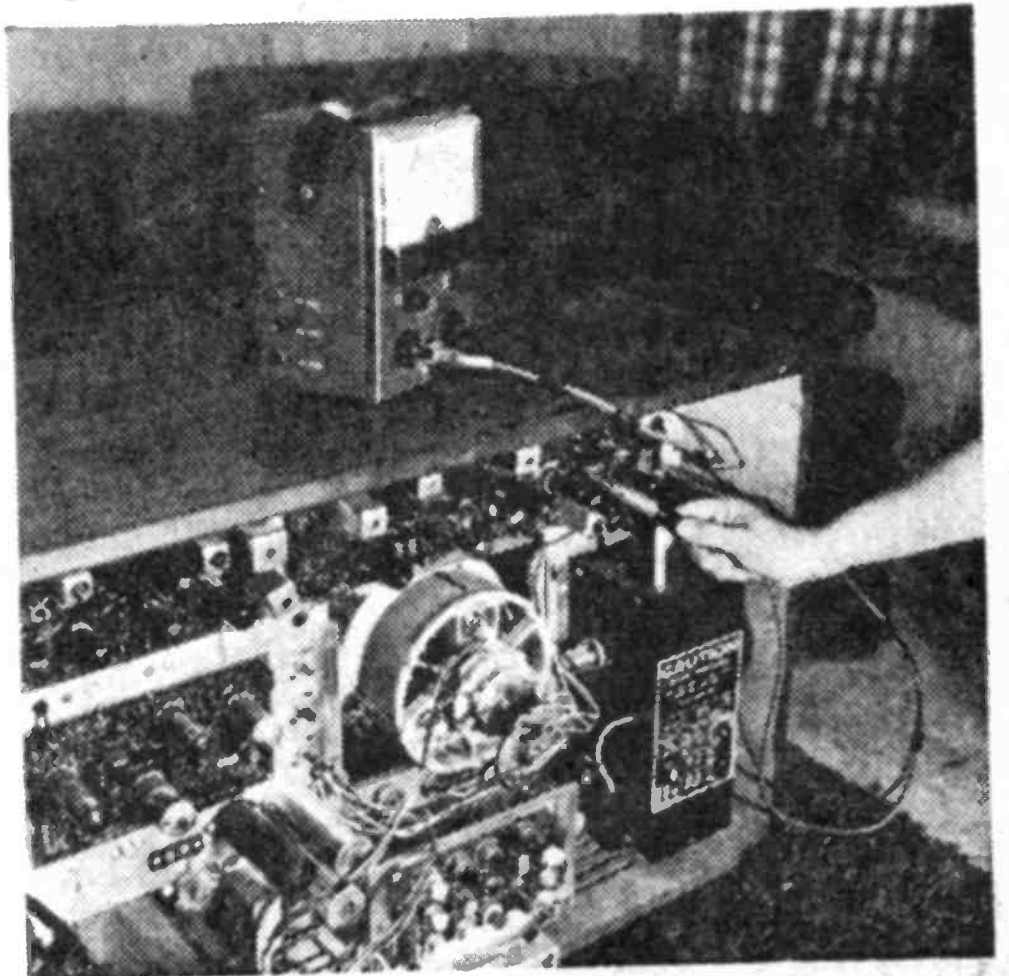

Fig. 8. Manufacturer's service literature is very helpful when locating test points for voltage checks.

may need to be adjusted with a tool that matches its alignment slug. While observing the VTVM, try to obtain highest negative reading (Fig. 8). Failure to obtain a peak could mean a defective crystal. But before replacing the unit, be certain no other part associated with that stage is at fault. Voltage and resistance tests should agree with those supplied by the service literature for your particular set.

Bandpass Amplifier. This stage is another major cause of missing color. As you can see in Fig. 9, it is little more than an

amplifier tube that feeds the bandpass transformer. Since the transformer has a specially shaped response curve (to favor color and reject BW), don't attempt to adjust it. This must be done with a signal generator, oscilloscope and precise markers. Anyway, the transformer will rarely go out of adjustment and normally needs no attention. There is, however, a possibility of an open winding, or a resistor or capacitor in the associated circuit could short and pull excessive current through the windings. This will become evident in continuity checks you perform.

Output of the bandpass usually has a front-panel color control for adjusting the intensity, or saturation, of color that appears on the screen. This control is subject to the usual weakness of any potentiometer; it becomes dirty with age or loses spring tension.

be -14 VDC measured at the killer plate. Any fault which causes high negative voltage at this point during color reception will also cut off color.

Investigate the color killer's threshold control, often placed at the grid of the tube, as shown. This potentiometer should be operating with proper resistance since it governs action of the killer tube.

Problems Resolved. The stages discussed

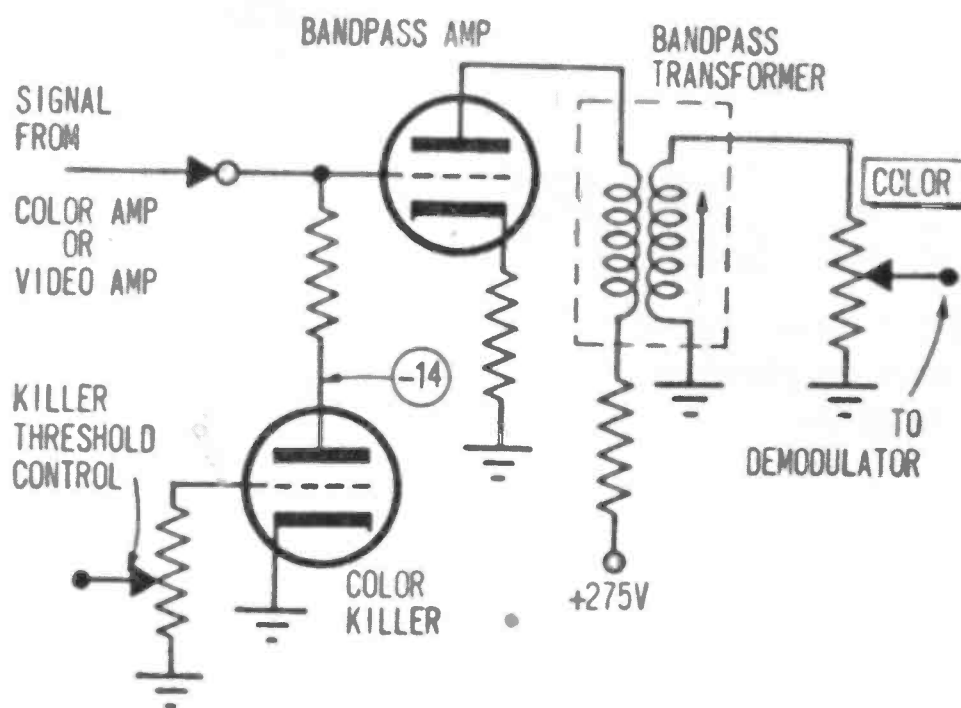

Fig. 9. The bandpass amplifier is another likely candidate when color's gone. Voltages given are typical but will vary from set to set.

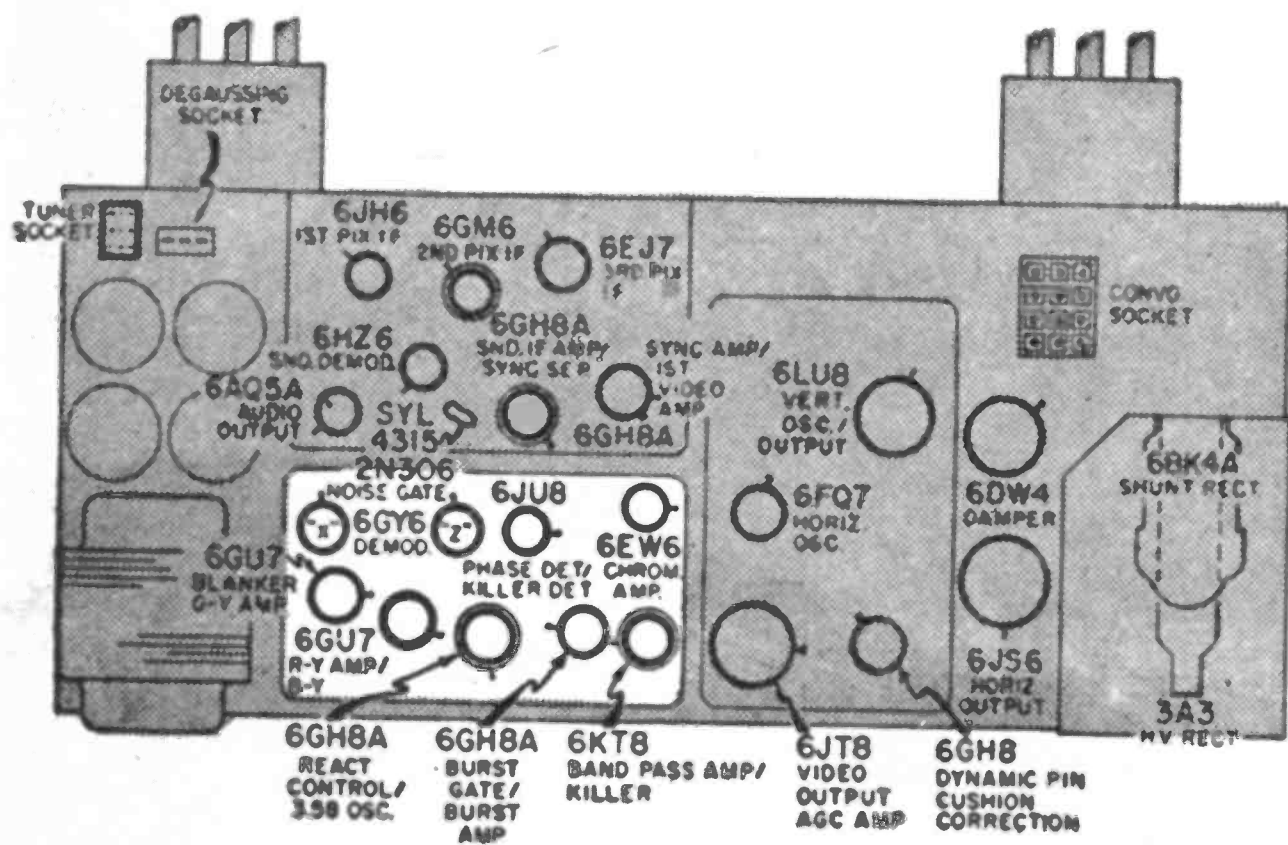

Fig. 10. This is the color section of a Sylvania DO2-1 color chassis. Color section is easily identified by tube location chart pasted in set or on back cover.

These faults may interrupt the signal on its way to the demodulators and kill all color. So be sure to check it for proper action and correct value.

Color Killer To Bandpass. Notice also in Fig. 9, that the color killer is tied into the grid of the bandpass amplifier. This enables the killer to control color-signal amplification of the bandpass (depending on whether the burst is being transmitted). When the receiver is picking up a BW program, a relatively high negative voltage is sent from the killer plate to the bandpass grid. This cuts off the bandpass and prevents false color from interfering with reception. In our example, the manufacturer states in his literature that with no signal in the receiver, there should

to this point will be responsible for many no-color cases you're apt to encounter. Chances are that close examination of circuit values will pinpoint the culprit. There is, too, the occasional instance where a stage in the chroma section is indirectly influencing, say, the bandpass or oscillator stage. Some sets have automatic color control circuits which might also cause color-bearing stages to go away. A burst amplifier may be dead and cause the color killer to turn off the bandpass stage. But despite the complexity of color circuits, you should be able to measure DC voltages or resistances with a VTVM on the five or so sockets found in the chroma region of the chassis. Shown in Fig. 10 is another typical chroma board—note its position.

Exotic Problems. When voltage and resistance measurements won't locate trouble, signal tracing should provide the answers. One item you'll need is a color generator, which injects standard color signals into the circuit. If a stage is functioning properly, the signals emerge with correct shape and level. Viewing the signals is done on an oscilloscope rated at a bandwidth of 5 MHz. The probe used with the scope must be a low-capacity type to prevent any possible detuning of the color signal as it passes through the various stages.

Service literature prepared for your specific model is a virtual necessity in signal tracing. And most manufacturers go to great lengths to provide guideposts you'll need in troubleshooting. A good example is in Fig. 11 which shows the various signals in the chroma circuits of a Heath chassis. Here are some details which should be of assistance in using such information.

Scope Points. The shaded arrows on the schematic (see Fig. 11) refer to points where the oscilloscope is connected. If we locate the one near the bottom right, we see it's at the plate of the 6EW6 burst amp. Then, if we study the two waveforms below, it's seen the scope should display 15750 Hz at 180 volts peak-to-peak when the stage is functioning normally.

Literature To Service By. Service literature also provides other important information you'll need. On many Philco chassis, for example, the manufacturer states that to observe these waveforms, the generator is applied to the antenna terminals and adjustments made to the set's controls until .5 volt appears at a given point.

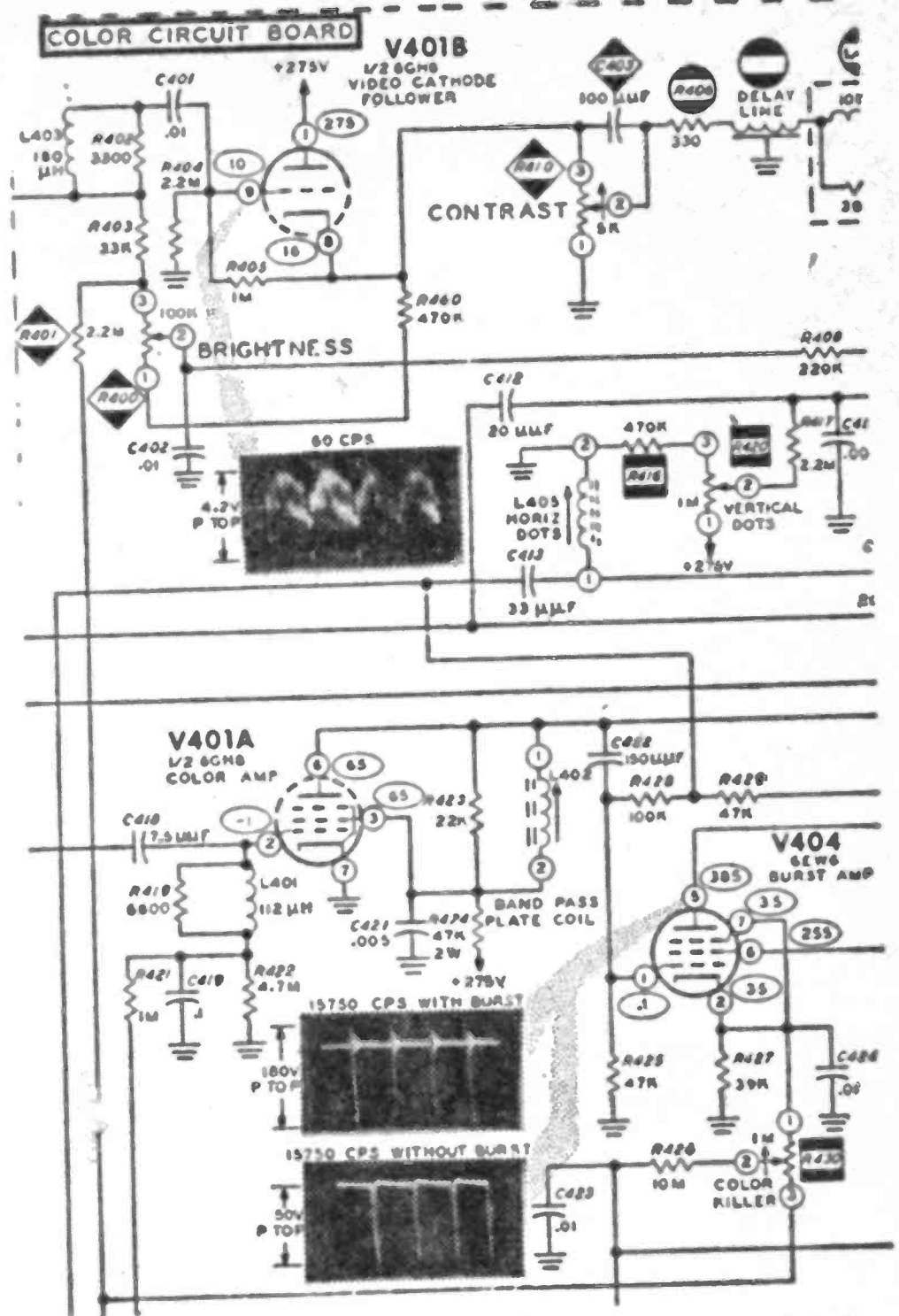
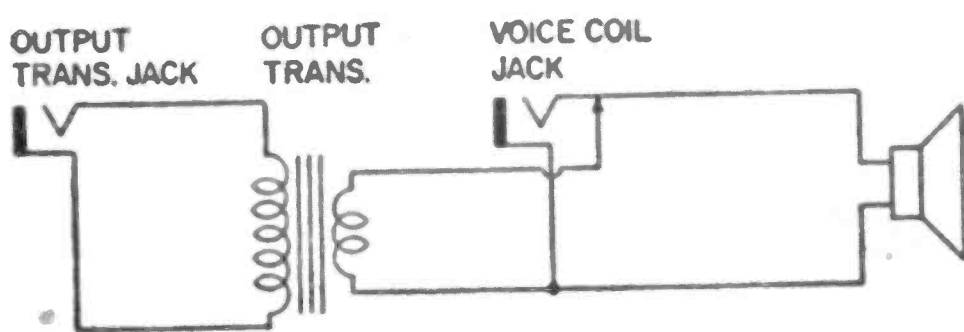

Fig. 11. Tough-dog problems can be tracked down using service literature, VTVM, and scope.

This establishes the same standards used by the manufacturer in obtaining normal waveforms. Once you learn how to handle this kind of information—and gain a bit of experience with a set in good operating condition—much of color's complexity fades out, and hue fades in. End result is a color-TV in prime working order.

DISCARDED PORTABLE BECOMES TEST SPEAKER



■ If you own an old tube-type radio portable that's ready for the garbage can, you're in for a windfall by simply converting it to a portable test speaker.

Begin by scrapping all of the set's guts except the PM speaker and output trans-

former. Now scrounge up open-circuit and closed-circuit phone jacks (see schematic diagram), phone plug, wire, and two alligator clips with rubber sleeve insulators. Wire up the portable case as shown in the schematic diagram and label the cabinet's front panel so you will know which jack is which.

Now wire up a patch cord using 3 feet of rubber test lead lengths to the phone jack and install the alligator clips to the wire's free ends. What you will end up with is an extremely versatile unit which you can connect to either the speaker terminals or into audio plate circuits at will.

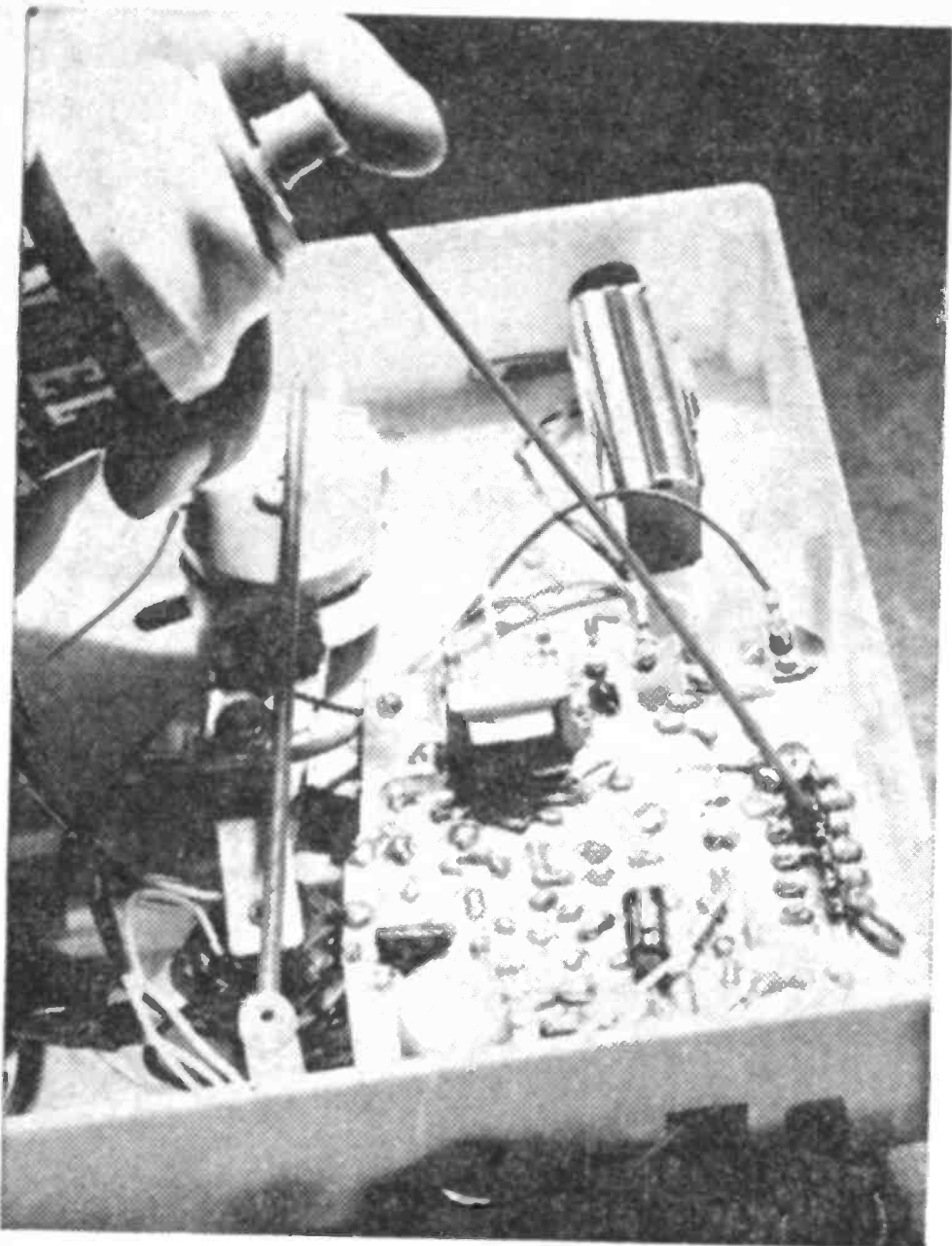

Oil has caused more tape troubles than it has cured, though it can be a godsend if used sparingly. But oil mechanical parts only.

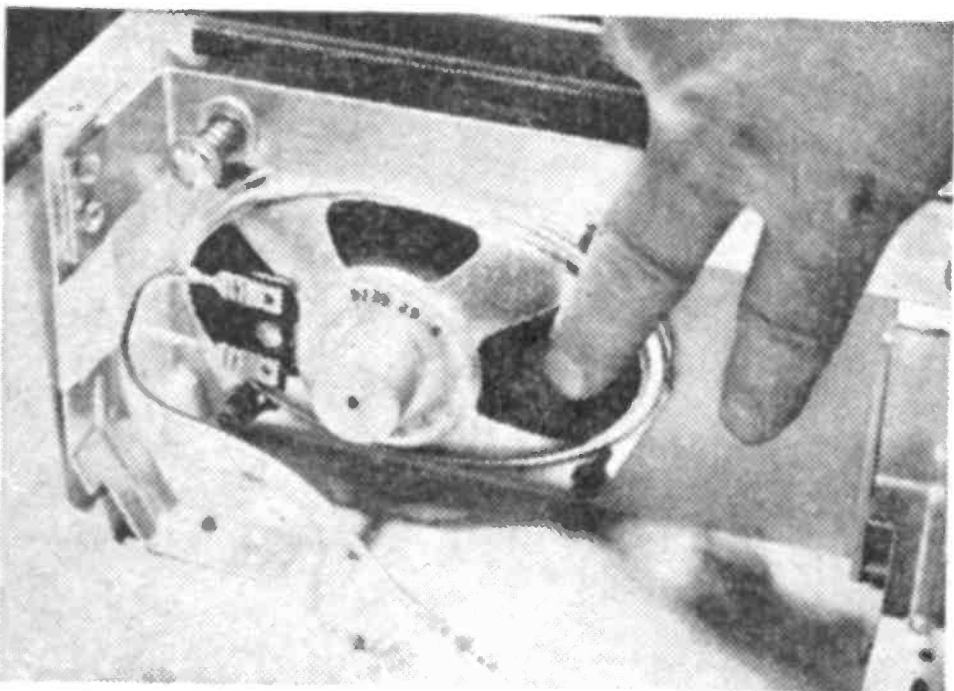

Speaker is often responsible for distorted sound, particularly if finger pressed against cone corrects trouble. Remedy is new speaker.

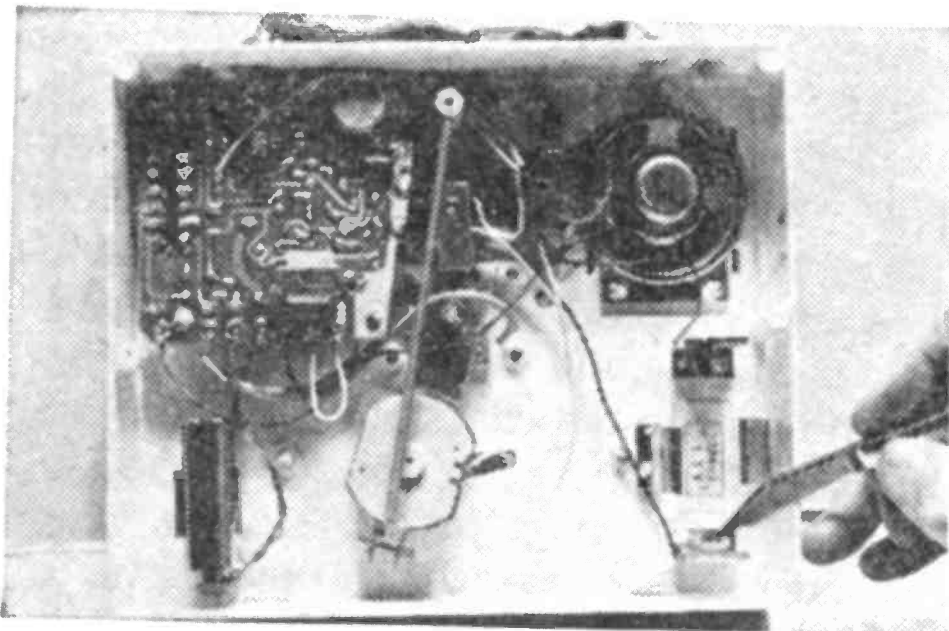

Batteries (if used) should be replaced often and removed whenever recorder is stored. Knife here points to corroded terminals.

THOSE MINOR TAPE TROUBLES

... and what you
can do about them

By HOMER L. DAVIDSON

■ Ben Franklin wasn't thinking of tape-recorder repair when he observed that "a penny saved is a penny earned," but the fact is that you *can* cut service calls by making minor recorder repairs yourself. Our photos present a rogue's gallery of common tape-recorder ills, with the suggested remedy indicated in each case. A quick perusal will no doubt reveal what you have long suspected—that the answer to your tape troubles lies right in your own two hands. ■

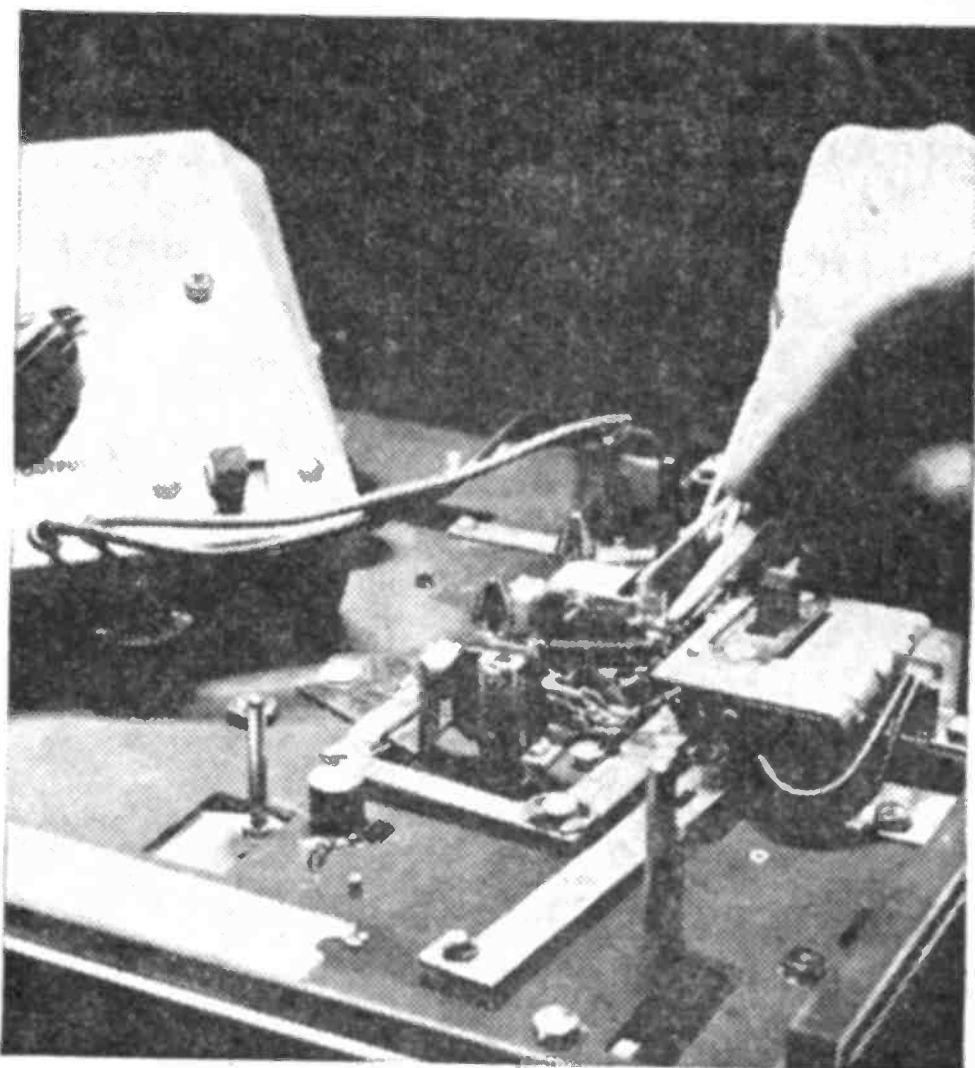

Tubes or transistors are chief reason for loss of record/play functions. Audio generator should quickly pinpoint defective one.

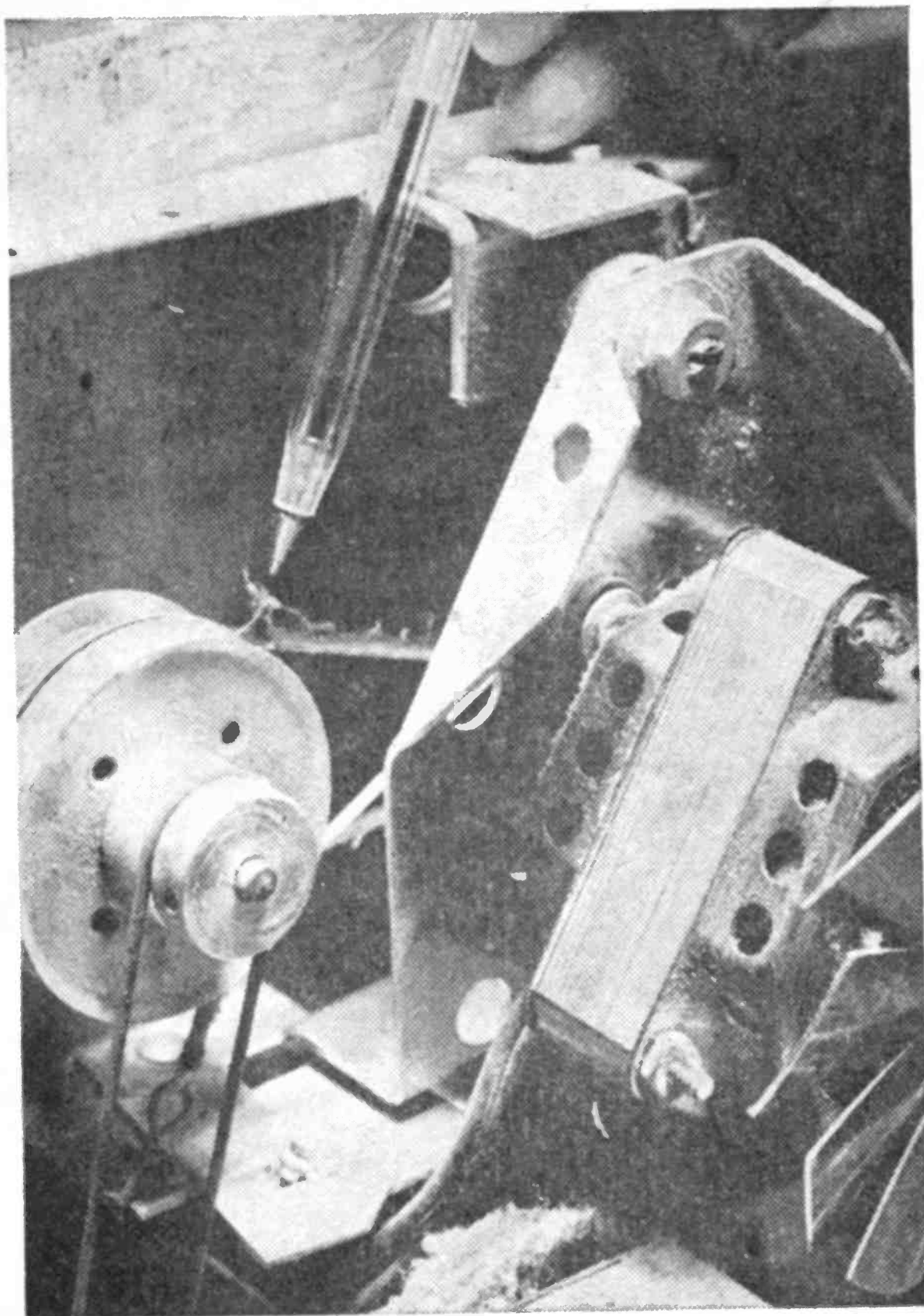

Drive belt may be culprit in recorder with too-slow tape speed. Clean belt with fluid; be certain idler pulley(s) are well oiled.

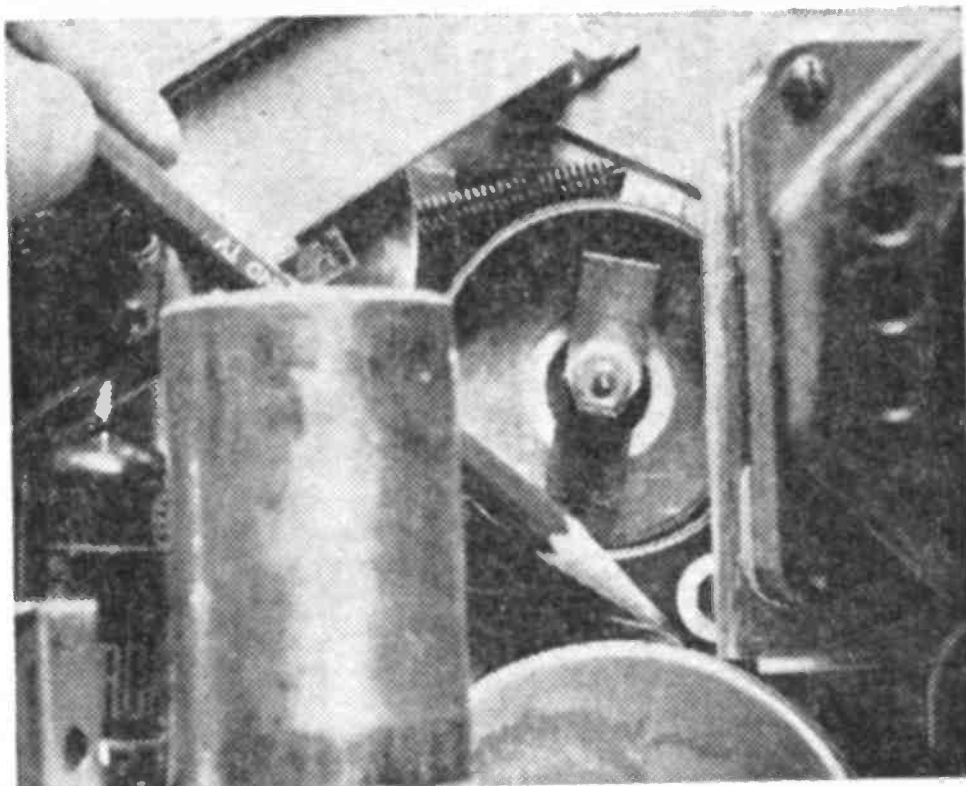

Capstan flywheel, if oily, can result in slippage, as can hardened rubber drive assembly. Remedies: clean flywheel, replace drive.

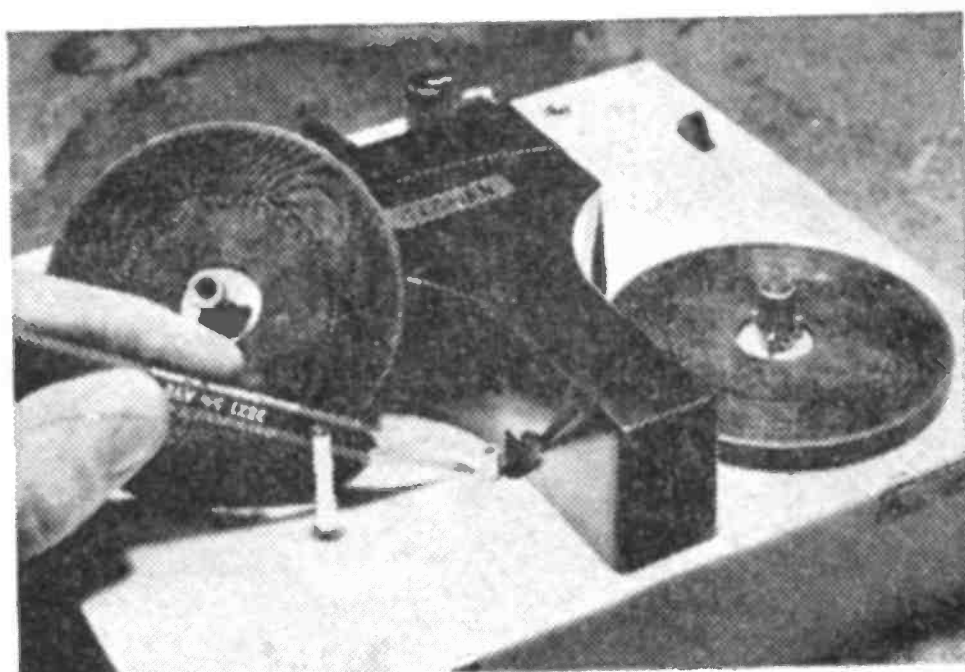

Tape guides and levers can slow tape, even stop recorder if bent or otherwise damaged. To fix, check and correct tape path.

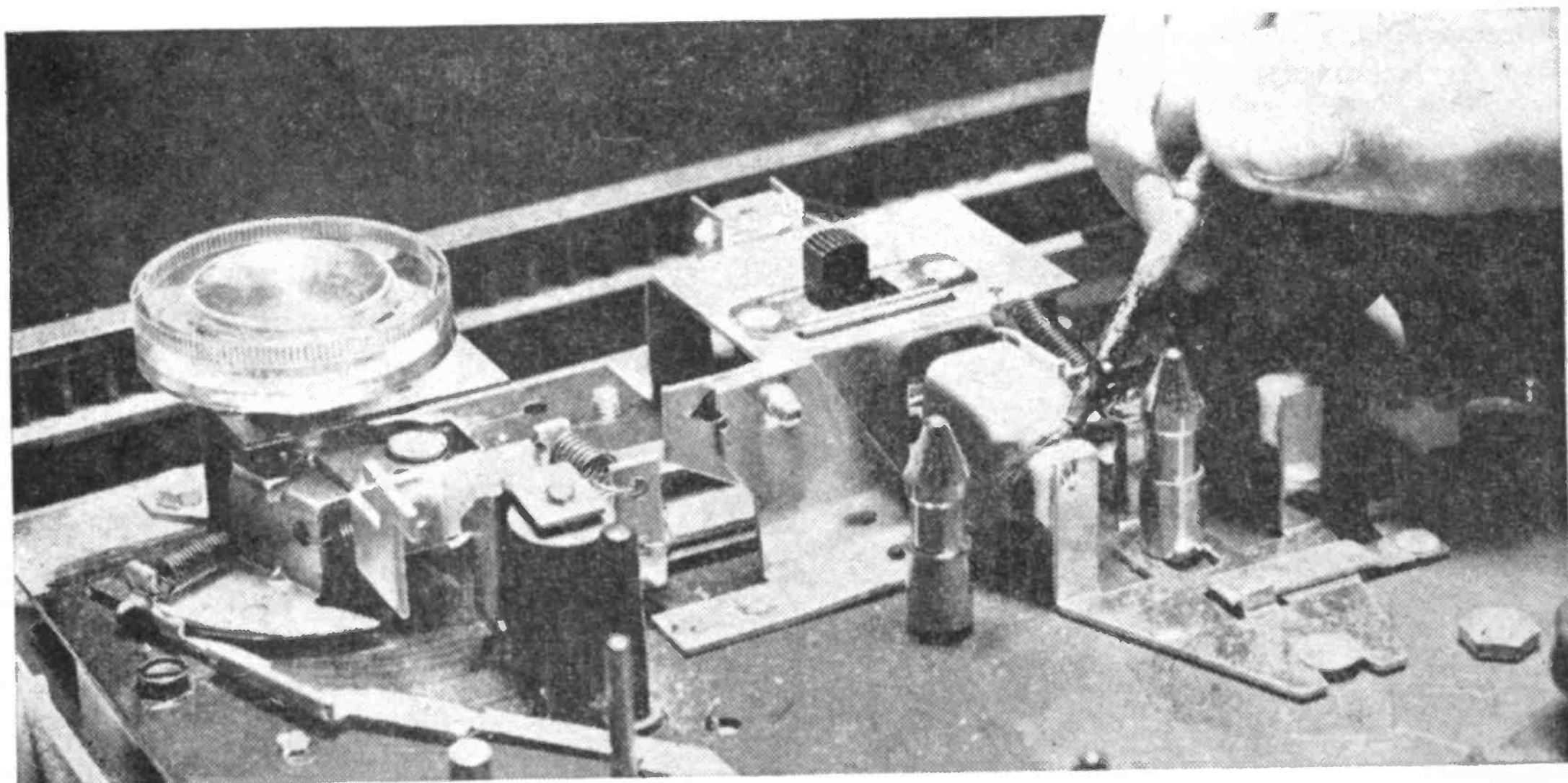

Record/play head holds key to proper operation of any recorder and can be source of weak, noisy, or distorted recordings. Use Q-tip moistened in head cleaner to remove dirt; use demagnetizer to remove residual magnetism and place head in neutral state. (Turn page.)

TAPE TROUBLES

Continued

Rubber pressure roller can result in uneven tape motion, particularly if badly worn (as is roller being held by hand in photo). Since a worn roller cannot be repaired, an exact replacement must be secured from either the manufacturer or his agent.

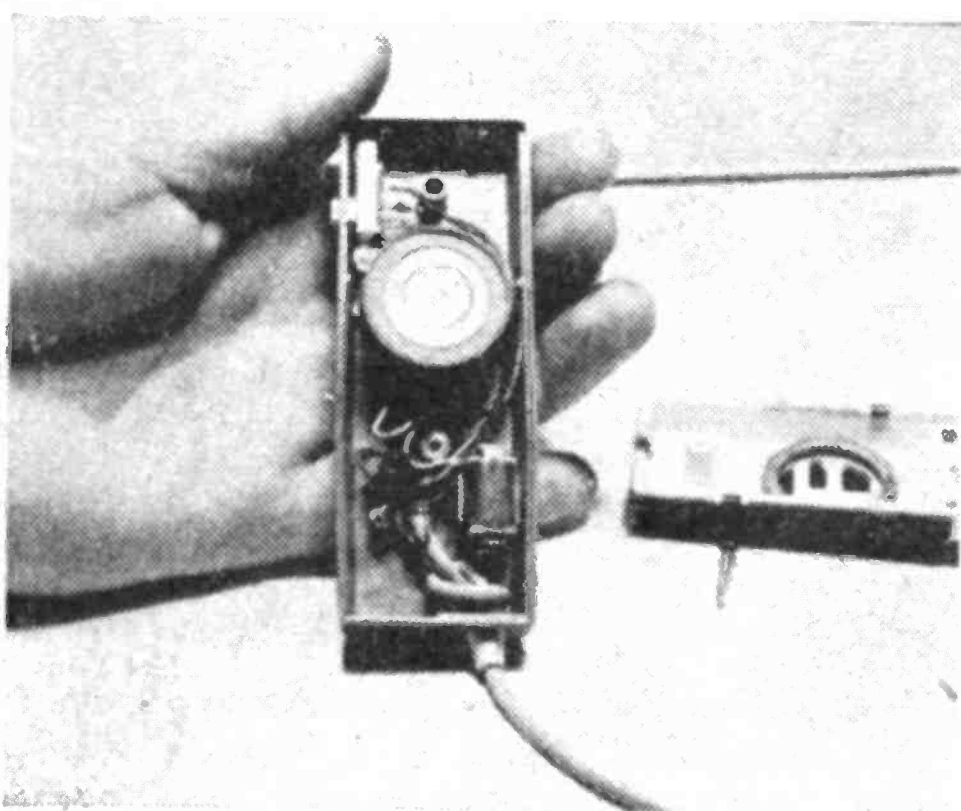
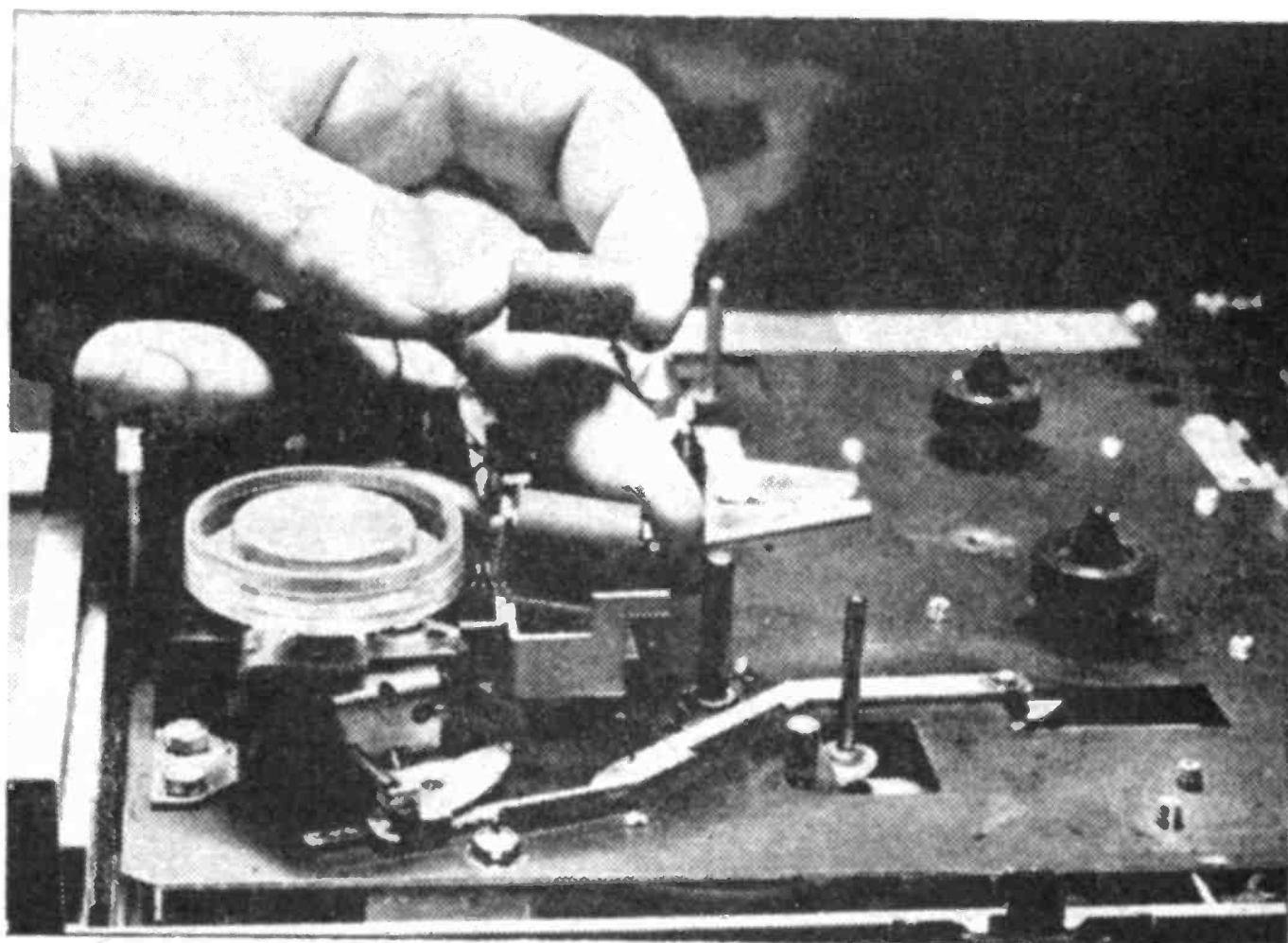

Mike cord can be explanation for intermittent recording, and mike can go completely dead if one or more wires in cable are broken. New cord or mike will solve problem.

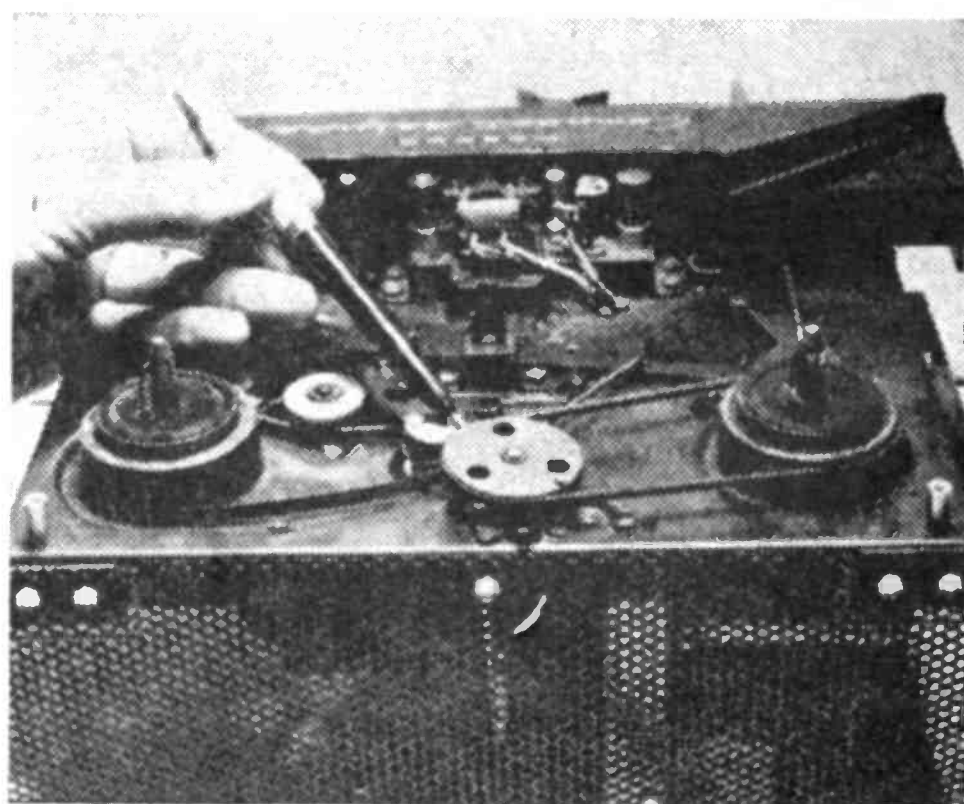

Rewind drive wheel can prevent proper operation during rewind function if it is bent or otherwise defective. In portable units, batteries can also be to blame.

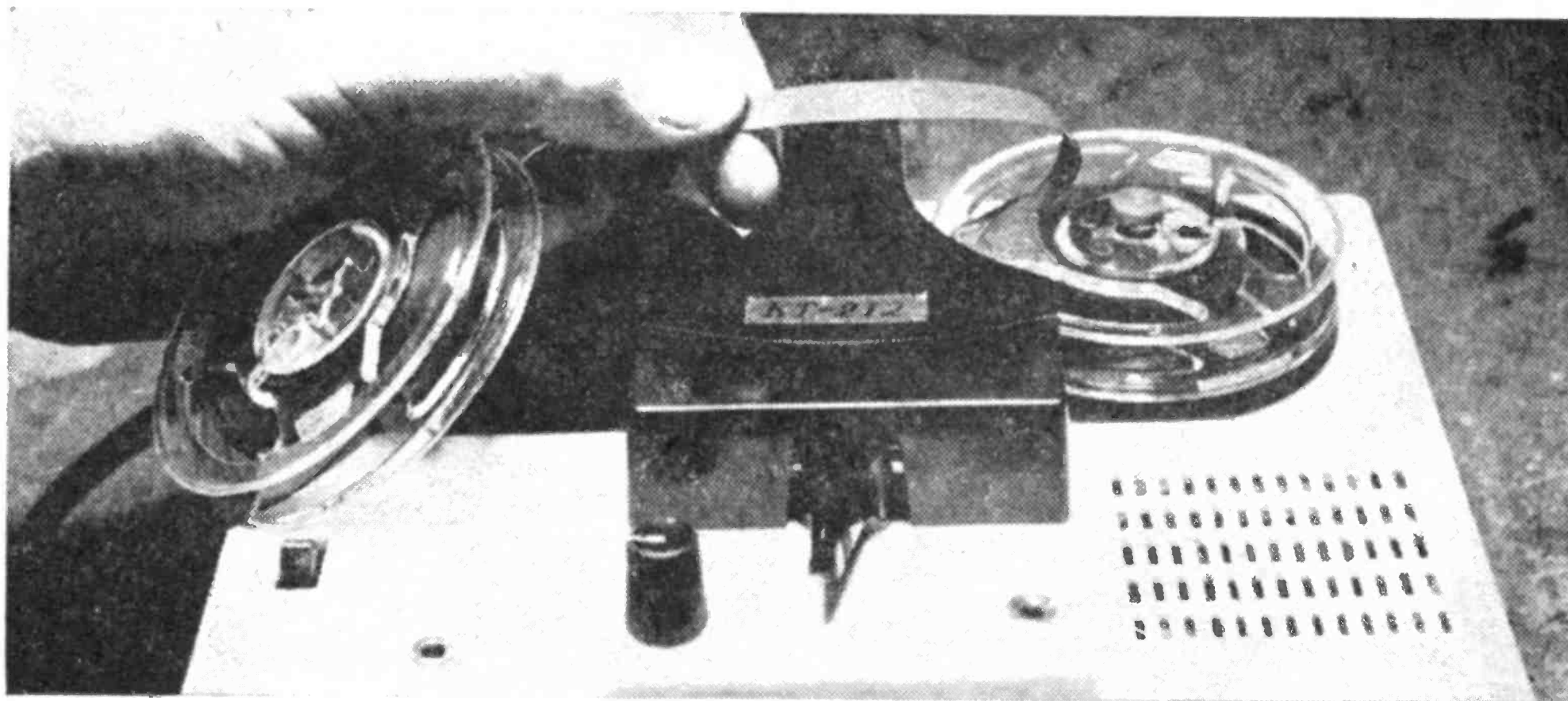

Tape itself holds clue to many a minor trouble. Dull side of tape must face heads if recorder is to function properly; tape must be fully erased if recording is to be clean and unblemished (virgin or bulk-erased tape being the best bet for good recordings).

TUNING UP THE ALL AMERICAN 5



By Mannie Horowitz

Modern radio as we know it today, is due to one great invention—namely the superheterodyne receiver. Sure people used radios before the circuit was widely adapted. The multi-dial TRF (tuned radio frequency) set was quite popular in the '20's—especially if you could afford one. However, commercial five tube radios as we know them today, originated with the low cost superheterodyne circuit. This circuit has proven itself so fine and effective that it has been adopted for use in practically every FM receiver as well as for the popular five-tube, AM radios flooding this country.

As was the case with the TRF receiver, the RF signal is selected by varying the capacitor in the resonant circuit. This signal

is fed to the first tube, known as the mixer, converter, first detector, or anything else you may wish to call it. Along with this RF signal, a second signal, which is generated in the receiver, is fed to the mixer. The frequency of the signal generated by this local oscillator in the receiver, is 455 kHz above the frequency of the radio station. Thus, if the radio station broadcasts on a frequency of 1100 kHz, the oscillator frequency is set to 1100 + 455 or 1555 kHz. If the radio station broadcasts on a frequency of 880 kc, the frequency of the oscillator is set to 880 + 455 or 1335 kHz. The frequency generated by the local oscillator is varied by a capacitor in the oscillator circuit, as shown in Fig. 1.

It is quite simple to accomplish the varia-

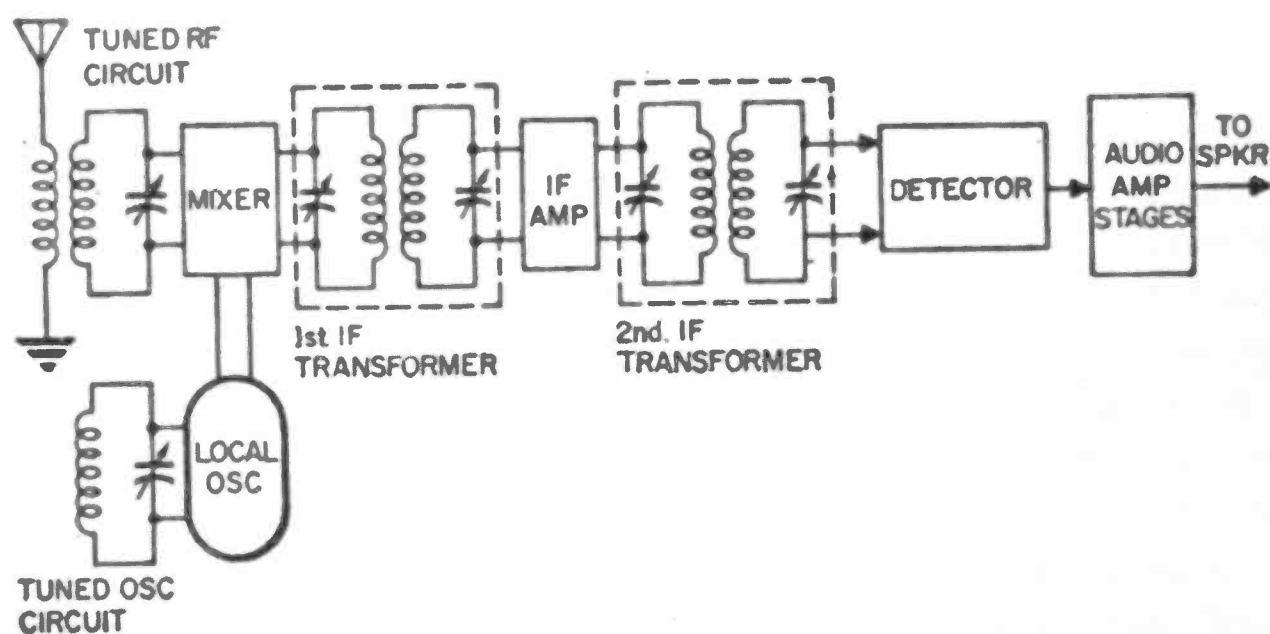

Fig. 1. In the superheterodyne receiver, the incoming RF signal is reduced to an intermediate frequency in the mixer.

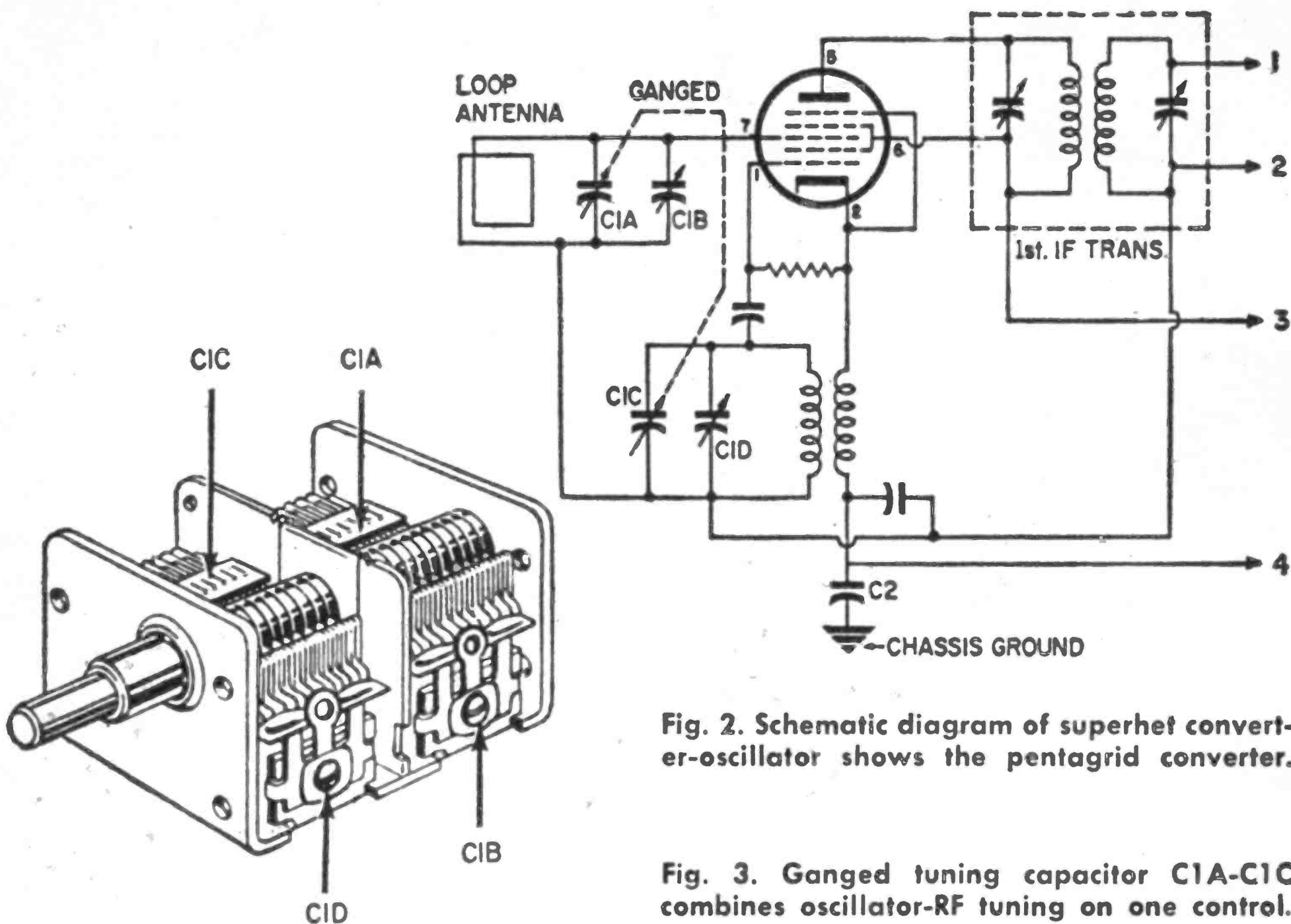

Fig. 2. Schematic diagram of superhet converter-oscillator shows the pentagrid converter.

Fig. 3. Ganged tuning capacitor CIA-CIC combines oscillator-RF tuning on one control.

tion of the oscillator frequency with the variation of the frequency of the resonant circuit in the RF section. The capacitors which tune the oscillator and the RF signal are actuated by one knob. Thus, when a specific station is selected by the RF section of the capacitor, the corresponding oscillator frequency is selected by the oscillator section of the capacitor.

The two signals are combined in the mixer stage. The output from this stage is the 455 kHz difference between the two signals. The 455 kHz difference in frequency is maintained between the oscillator and radio station; thus the difference frequency is available for all radio stations over the tuning range. It should be noted that the audio signal, which was received by the antenna as intelligence riding on top of the RF signal, is now transferred to the 455 kHz IF or *intermediate frequency* signal.

IF Amplifiers. This 455 kHz signal must now be amplified. The 455 kHz is carefully selected by two IF transformers. Between these two transformers is a stage of IF gain involving a vacuum tube or transistor. This

is not unlike a standard tuned RF stage, except here, only one frequency must be selected and only one frequency must be amplified. This can be done most efficiently.

In the remainder of the unit, the IF signal is detected to separate the audio from the IF carrier, the IF is discarded, the audio is amplified, and sent on to the speaker.

Why the choice of any specific IF frequency, is difficult to determine. It seems that 450 kHz or 500 kHz would be a more logical choice. Is there less interference or better sensitivity using 455 kHz? Or is it just a choice someone made and the number happened to stick? Whatever the reason, the industry has accepted this as the standard. We have no choice but to use this figure when aligning a radio.

Alignment Requirements. Although no outline of exact procedures has been described, the above discussion of the superheterodyne radio indicates the alignment requirements. There are two precise factors which must be satisfied.

First, the IF transformers must be aligned so that they will pass the 455 kHz IF frequency while rejecting all other signals.

Second, the variable capacitor must be adjusted so that the difference in frequency between the RF signal and oscillator is 455 kHz over the entire broadcast band.

Exact procedures using a signal generator and an output meter will be discussed below. However, before this is done, it would be helpful to discuss the circuit of a typical superheterodyne receiver. We will consider the receiver one stage at a time. If you would hook-up the leads (with arrowheads) represented by identical numbers in two successive stages (or two successive schematic figures), you have the schematic diagram of a complete superheterodyne receiver.

Typical 5-Tube Superhet. The first tube of the superhet (see Fig. 2) serves several functions. First, it is the oscillator—pins 1 and 2. Then, it receives the RF signal at pin 7. Finally, the two signals mix through the maze of grids to give the final IF frequency—455 kHz at the plate. The first IF transformer is tuned to this 455 kHz. Other RF frequencies that happen to get to the plate circuit are bypassed to ground via the power supply by the action of the 1st IF transformer.

Because these receivers are quite sensitive, the RF signal does not have to be picked up by an antenna on the roof. Instead, a loop antenna at the receiver is usually used. This may consist of several turns of wire on a flat piece of cardboard, or several turns of wire on a ferrite rod. The ferrite material is composed of iron and other metallic oxides combined with ceramic material for rigidity. This ferrite rod is also known as a loopstick.

The loop antenna works in conjunction with capacitor C1A (see Fig. 3) to form a resonant circuit to tune to the radio station. A small variable mica capacitor, C1B, is usually mounted on C1A and connected in parallel with it by the manufacturer of the capacitor. This C1B is used in the alignment procedure. It is known as a trimmer capacitor and is used to trim the combined values of C1A and C1B so that it will resonate at the proper frequency with the loop antenna coil, and at the proper setting of the tuning dial.

The oscillator coil, in junction with C1C and C1D form the resonant circuit to determine the frequency which the oscillator will generate. Capacitor C1C (see Fig. 3) is the main tuning capacitor for the oscillator, and C1D is the trimmer, arranged very

much like the combination discussed above for C1A and C1B in the RF section.

Capacitors C1A and C1C are attached to one shaft. One knob is used to turn both capacitors simultaneously. Screwdriver adjustment screws are set in the variable mica capacitors which are mounted on its respective large air capacitor.

You can usually tell which section of the capacitor refers to the oscillator and which to the RF circuit. The oscillator resonates at a higher frequency than does the RF circuit. Therefore the oscillator section usually has less or smaller plates than does the RF section. This is very much like musical instruments where higher pitched notes come from smaller instruments.

In Fig. 4, a simple IF amplifier stage using the 12BA6 and a second IF transformer, is shown. These are used to amplify the signal from the converter and first IF transformer and provide better selection of the IF frequency. These, in turn, are connected to the detector diodes in the 12AV6, the triode voltage amplifier in the 12AV6 and finally the power amplifier 50C5 which drives the speaker. All this is shown in Fig. 5.

The AC-DC power supply used to provide the necessary DC voltages to operate the radio circuit, is shown in Fig. 6, using a 35W4. Some radios used selenium or silicon rectifiers instead of a tube.

The various interconnections between sections are self-evident. Lead 1 is the link connecting the output from the IF transformer in Fig. 2 to the input of the IF amplifier tube in Fig. 4. Lead 3 in Fig. 2, 4, 5 and 6 is used to interconnect the B+ supply to all stages. Lead 4 in these figures is the common B- ground. (Turn page)

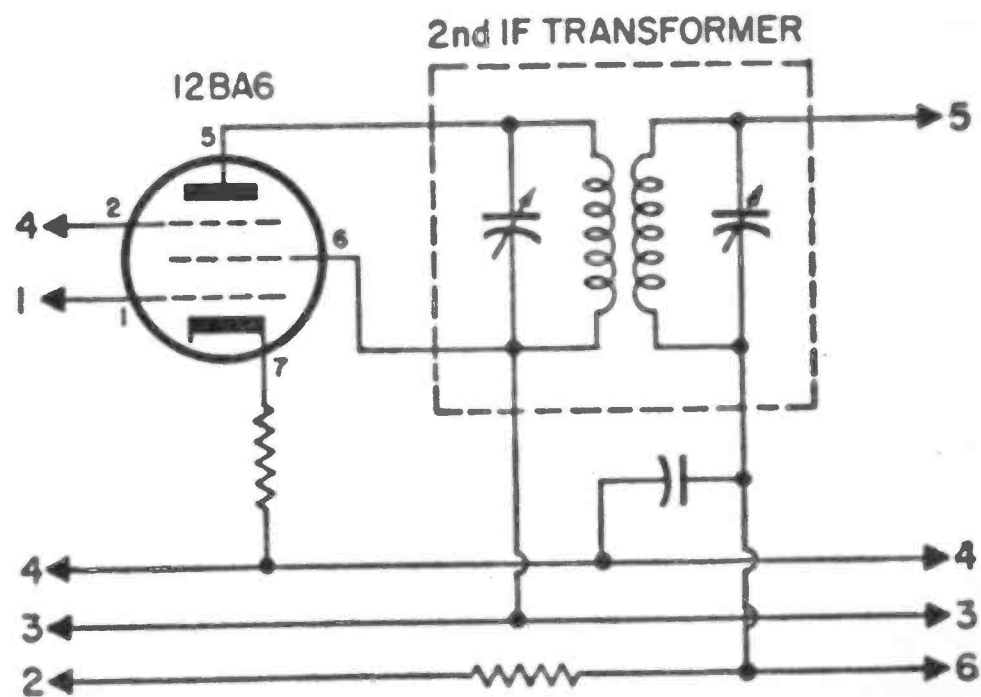

Fig. 4. IF amplifier tube 12BA6 boosts signal; second IF transformer increases selectivity.

Lead 5 in Figs. 4 and 5 connect the second IF transformer to the detector, while lead 6 connects the audio to the volume control through a resistor.

Introducing AVC. Only lead 2 requires some additional discussion. This lead is used to conduct part of the detected signal back, as DC, to the earlier stages. This DC controls the gain of these stages. On strong signals, the gain of the IF and mixer amplifiers is reduced due to this DC. Thus, this lead completes an Automatic Volume Control (AVC) circuit. It sort of equalizes the strength of the final output signal for all stations. In alignment procedures, AVC action is undesirable, for it limits variations in gain at the output. During alignment, the test signal levels are kept low so that AVC action will be negligible.

One other factor should be observed in this circuit. The chassis is not used as a ground for the B-. Because B- is connected to the AC line, grounding the chassis to B- and hence the AC line, can be hazardous. To keep the chassis from floating, it is connected to B- ground through a small capacitor. This is shown as C2 in Fig. 2.

Aligning Instruments. Two instruments are necessary in this procedure. One is to be used as a signal source. The second is to be used to measure the output.

In the alignment procedure, three signals should be used. An audio signal should be fed to the audio amplifier section of the receiver (Fig. 5) to be certain that it is operating.

Next, a 455 kHz signal modulated by an audio tone should be fed to the IF stages. The IF stages are adjusted for maximum

output by monitoring the audio signal strength at the speaker.

Finally, two modulated RF signals are required to permit adjustment of the RF and oscillator circuits. One RF signal must be at the high end of the band and the other RF signal must be at the low end of the band.

Several signal generators are available that are capable of producing all these signals. They are shown in the photograph in Fig. 7. The switch positions given in the following text are for the EICO 324 unit which is typical of the units available.

The audio output can be gotten from the two jacks at the lower left hand corner of the unit. The Signal Selector knob is to be set at the "Int. Mod/AF Out" position to get an internally modulated audio output. The "AF Mod/Output" control is used to adjust the amplitude or strength of the modulated audio signal output from the generator. None of the other controls have any effect on the audio. They are concerned only with the RF signal.

The connector at the lower right hand corner of the unit is used for the RF and IF output. The Signal Selector knob is set at its previous position for a modulated output signal. The frequency is selected by use of the Band Selector switch and the rotary frequency control knob. Thus if 455 kHz is required, the Band Selector is set at "B," for this band covers the range from 400 kHz to 1.2 MHz (marked near the tuning scales). The tuning knob is then rotated until 455 kHz appears under the pointer in the window. A similar procedure must be followed for any RF frequency that may be required.

The amount of RF signal output is controlled by the RF Course and RF Fine controls. These are usually kept near minimum during the alignment procedure.

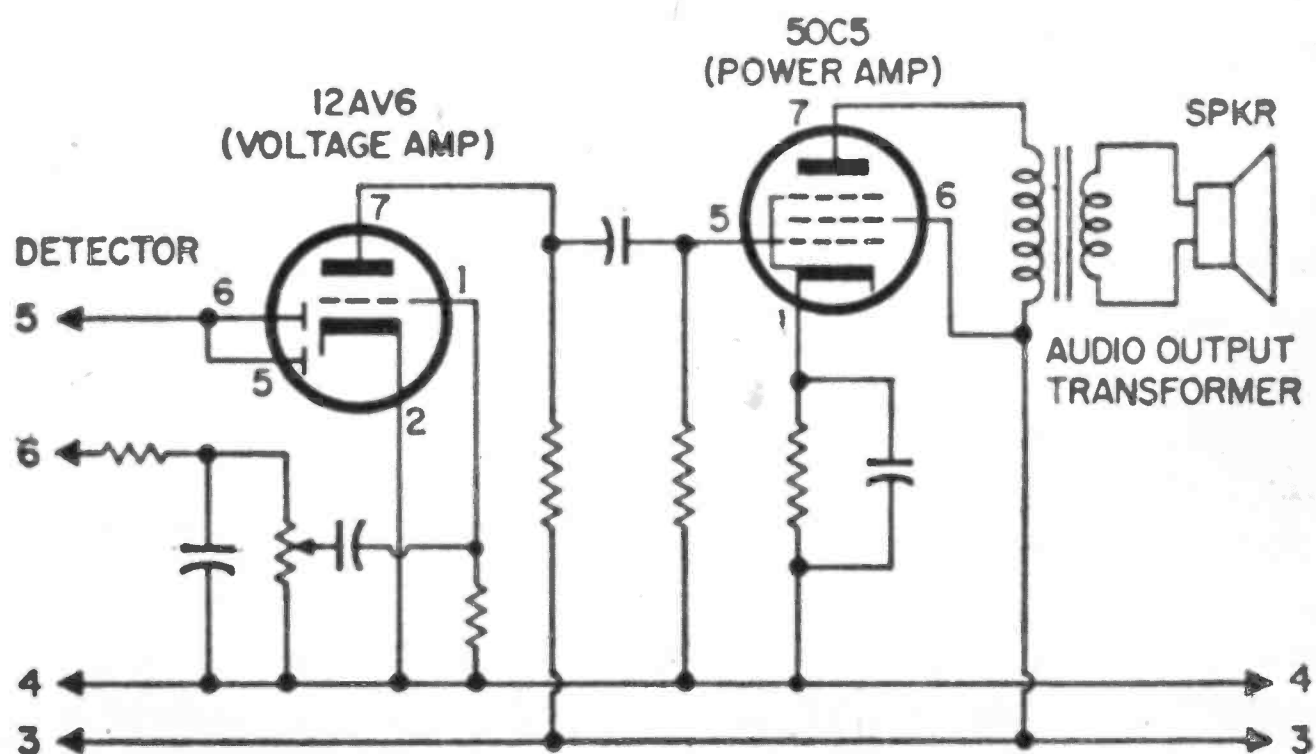

Fig. 5. The audio amplifier section of the receiver combines detection and voltage amplification in the 12AC6 tube, and power amplification in 50C5.

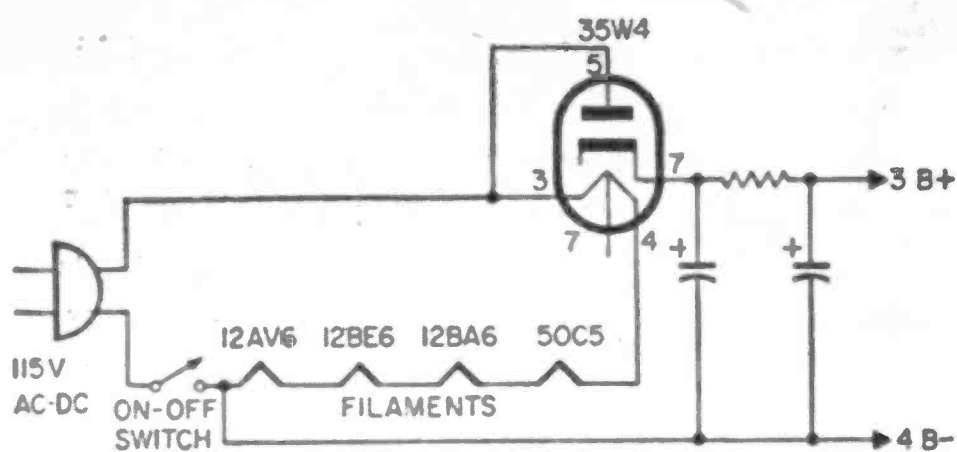

Fig. 6. The power supply that provides the DC voltages for receiver utilizes 35W4 diode tube in filtered half-wave rectifier circuit.

Finally, the output from the radio must be monitored in some way or other to perform a proper alignment. The low voltage AC scale on any multimeter can be used to measure the output voltage.

If no meter is available to monitor the output, the signal level may be checked audibly by listening to the speaker and judging the levels.

The Test Setup. When the receiver, generator, and meter are interconnected, details and precautions should be carefully observed.

The meter should be connected to the speaker leads in Fig. 6. If one of the speaker leads is connected to a chassis of B- ground, connect the common lead from the meter to this point. If you use the instrument illustrated, it is the lead with the alligator clip.

Connect the AC probe to the remaining lead to the speaker. If the speaker has no grounded leads, the meter may be connected in either direction. If you use a meter which does not have to be connected to the AC power supply, such as a VOM, the leads may be connected in either direction to the speaker.

Now set the Function switch on your meter so that it will read AC. Set the range switch to the lowest range above 1 volt. The output meter is now set up for the entire alignment procedure.

The common from the signal generator must be connected to the B- ground. During the alignment procedure, the signal will be injected from the Audio and RF outputs to various points in the radio. Just where to inject the signal will be discussed in the procedure methods.

Several precautions must be observed when making this setup.

1. Make all connections to the receiver when it is turned off.

2. Excess hum during test may be reduced by reversing the position of the AC power plug in its socket.

3. Never connect an external ground (radiator, water pipe, etc.) to any point on the receiver.

4. In conjunction with caution #3, never place the chassis on a metal bench, steam heat radiator, or any grounded object. If you must use a metal bench, be certain that the power plug is not in the socket or that there is some insulating material between the receiver with the instruments and the table. A large piece of cardboard will do. To avoid shock, do not touch the metal bench and the receiver or instruments simultaneously.

5. To avoid shock when aligning the unit, do not touch any grounded electrical conductors.

6. Use insulated or special aligning tools so that the alignment will not change when you remove the tool from the adjustment screws. A small insulated metal screwdriver may be used.

With this in mind, we can now proceed with the actual alignment procedure.

Aligning the IF's. Before touching the IF cans, you must be certain that the audio section is working properly. Connect the top (hot) lead from the audio output of the generator to the hot side of the volume control. This is the top, ungrounded end of the control in Fig. 5. Turn the volume control on the radio and the gain control on the generator to give the maximum output. Now, turn the output level control on your generator down until the sound comes through clean and undistorted to the ear. Note the voltage. During the remainder of the procedure, never let this meter read more than $\frac{1}{2}$ this voltage. If it should rise above this value, decrease the output from

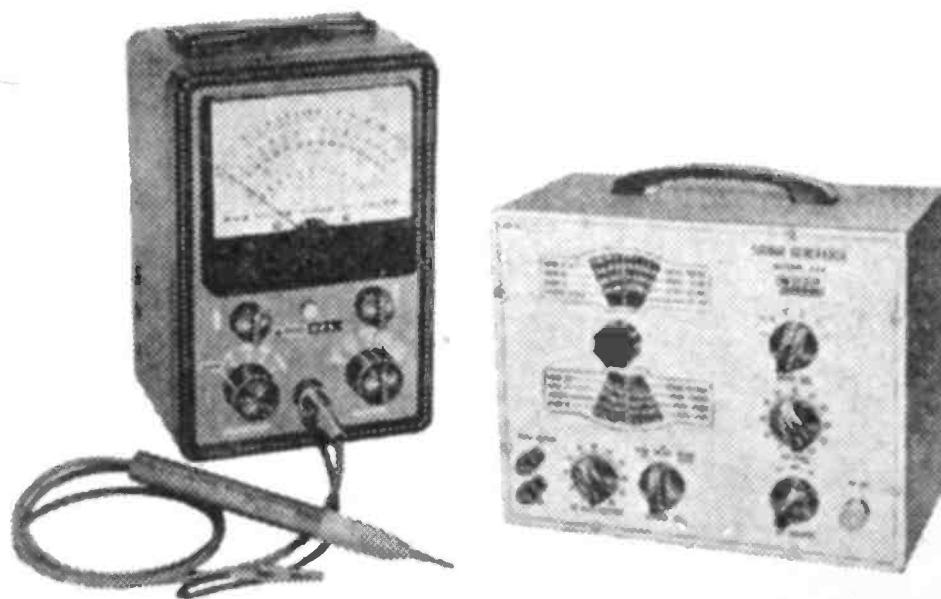

Fig. 7. VTVM and signal generator are all you need to align superheterodyne receivers.

the generator with the appropriate control.

Now set the generator to produce a modulated 455 kHz signal. Adjust the modulation control to less than 100% modulation. This is easy with most generators, since they are either not capable of this much modulation or use fixed modulation with no front panel controls.

Connect the RF output from the generator, through a .01 μ F capacitor, to the grid of the tube preceding the final IF transformer. In Fig. 4, it would be pin 1 of the 12BA6. Adjust the trimmers in the final IF transformer for the maximum output. Keep the oscillator output low enough so that the maximum desirable output voltage level, discussed above, will not be exceeded.

Now, connect the same probe to the RF grid of the converter stage. In Fig. 2, it is pin 7 of the 12BE6. Because of impedance conditions, the level of the output from the generator will probably have to be increased to get a reading on the meter. If no reading can still be made, it will be necessary to temporarily disconnect the tuned RF circuit. This tuned circuit consists of C1A, C1B and the loop antenna in Fig. 2. Now adjust the trimmers in the first IF transformer for the maximum output. Be certain to reconnect RF circuit after alignment is complete.

RF Alignment. The big problem with RF alignment is to find a convenient point at which to inject the RF signal.

If there is an antenna terminal, connect the output from the generator to it, through a capacitor. If there is no antenna terminal, as is the usual case, wind several turns of wire into a small coil or "hank." The size is only important in that it should be convenient to place it a few inches away from the flat loop or loopstick antenna, without shifting its position relative to the antenna. A small hank of four loops or turns of ordinary insulated hook-up wire wound in circles of about 3 inches in diameter will do nicely for this coil. The various turns can be held together at several points with masking tape. The masking tape can be used to hold it near the antenna during the alignment procedure.

If you made the RF loop discussed, disconnect both the RF and AF generator leads

from the chassis or B- ground. Connect the two leads from the hook-up wire loop to the RF leads from the generator. Should this loop stop the generator from oscillating (as noted by no output in the receiver) more turns will be required. Just how many turns can be found by trial and error.

If there is an antenna terminal on the receiver, do not disconnect the generator from ground, but connect the RF lead through a 200 μ F. capacitor to the antenna terminal.

Feed a 1400 kHz modulated signal to the receiver. Set the dial on the receiver to 1400 kHz. Adjust the oscillator trimmer condenser, C1D, for the maximum output.

Now feed a 600 kHz modulated signal to the receiver and set the dial on the radio to 600 kHz. Adjust the oscillator padder condenser,* if any, for maximum output. If there is no padder condenser, there is usually a screwdriver adjustable slug in the oscillator coil. Adjust this for maximum output.

Next, recheck the 1400 kHz adjustment. Repeat both adjustments (the one at 1400 kHz and the one at 600 kHz) until you get the maximum output and best tracking.

Now that the oscillator section has been adjusted, the RF circuit must be adjusted. Once again, feed a 1400 kHz modulated signal to the receiver. Tune the radio to 1400 kHz. Adjust the RF trimmer condenser (C1B in Fig. 2) for maximum output.

Next, feed the 600 kHz signal to the receiver and set the dial to 600 kHz. Adjust the padder condenser or slug in the antenna coil, if either exists. In some units, it is possible to adjust the position of the coin on the loopstick for maximum output signal. In other units, where no padder facilities exist, the trimmer must be adjusted to give the best maximum output compromise at 600 kHz and 1400 kHz.

If your listening habits favor one end of the band over the other, or one station more than another, it is best to adjust the RF trimmer for the maximum output at the frequency of the favored station.

Repeat the RF alignments at 1400 kHz and 600 kHz until the best compromise is achieved. Alignment is complete when you remove the leads from the signal generator and the RF coil you made. ■

* Some receivers have a capacitor between the parallel combination of C1C-C1D and the oscillator coil. This is the padder condenser. A padder condenser may be placed in a similar position in the RF circuit.

So you
want to
replace a

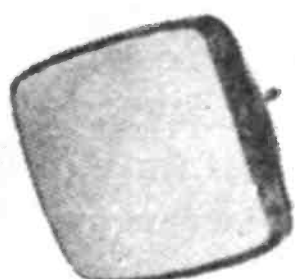
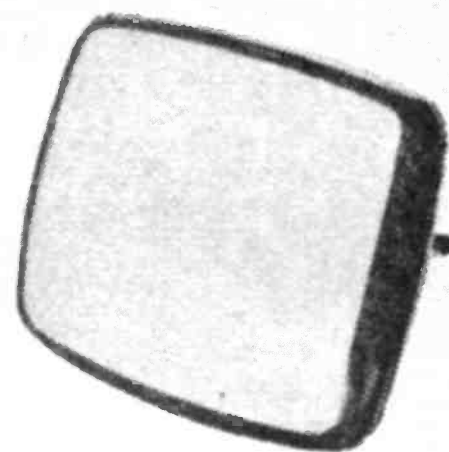

BOOB TUBE

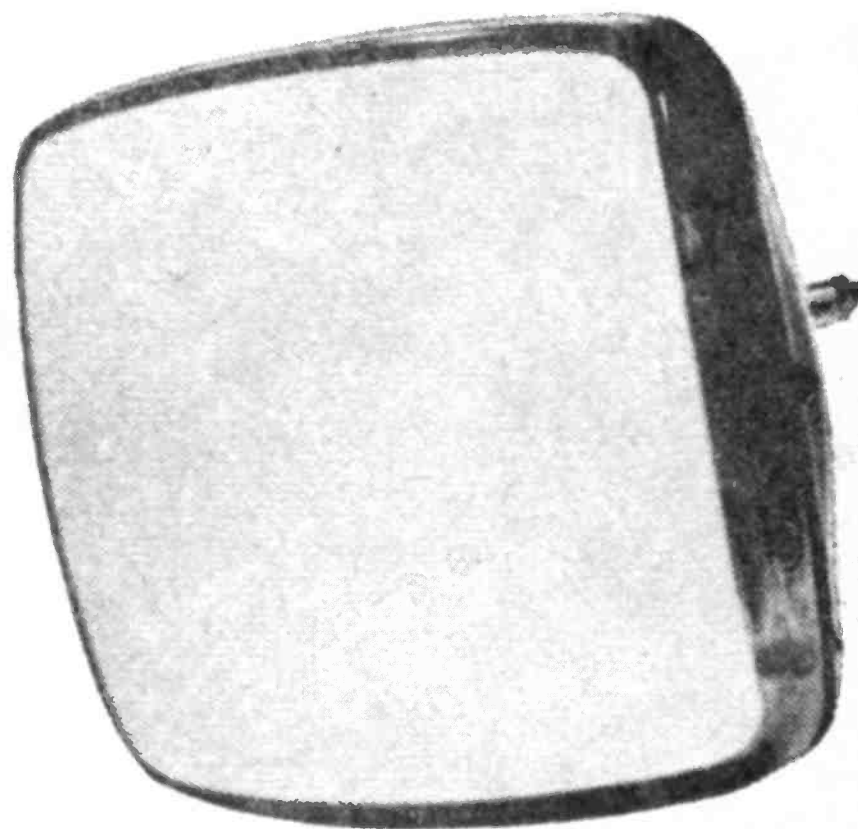
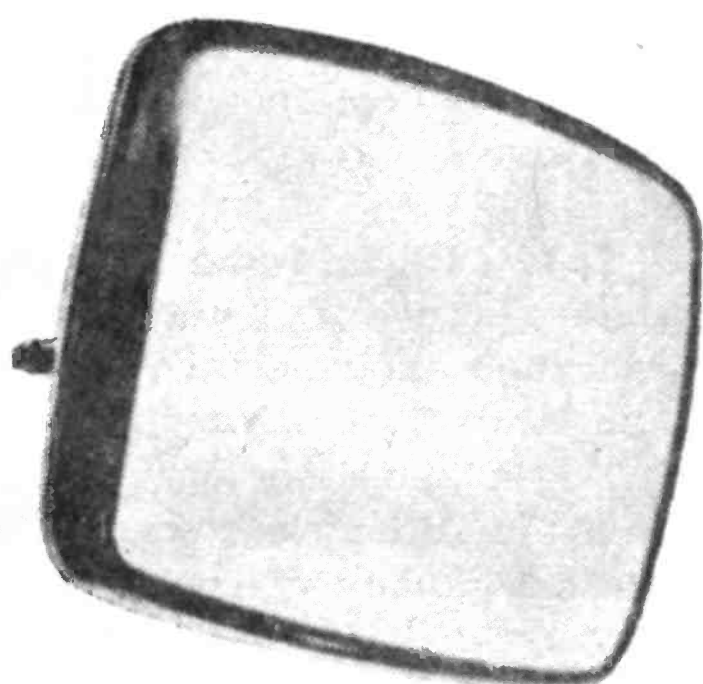

By Len Buckwalter, K10DH

■ Can anyone change a picture tube? Not the yank-'n pull mechanic; he could fudge the job. The careful worker, however, can reap a double reward: a husky saving in cash and the satisfaction of restoring a good-as-new picture to an aging TV set. Significantly, success doesn't depend on an intimate knowledge of electronics. There are few mysteries surrounding the removal and re-installation of the picture tube. The big factor is a healthy respect an installer must have for the tube. Fragile glass construction can't tolerate rough handling. So if you are willing to handle the TV picture tube with loving care—avoiding

REPLACE BOOB TUBE

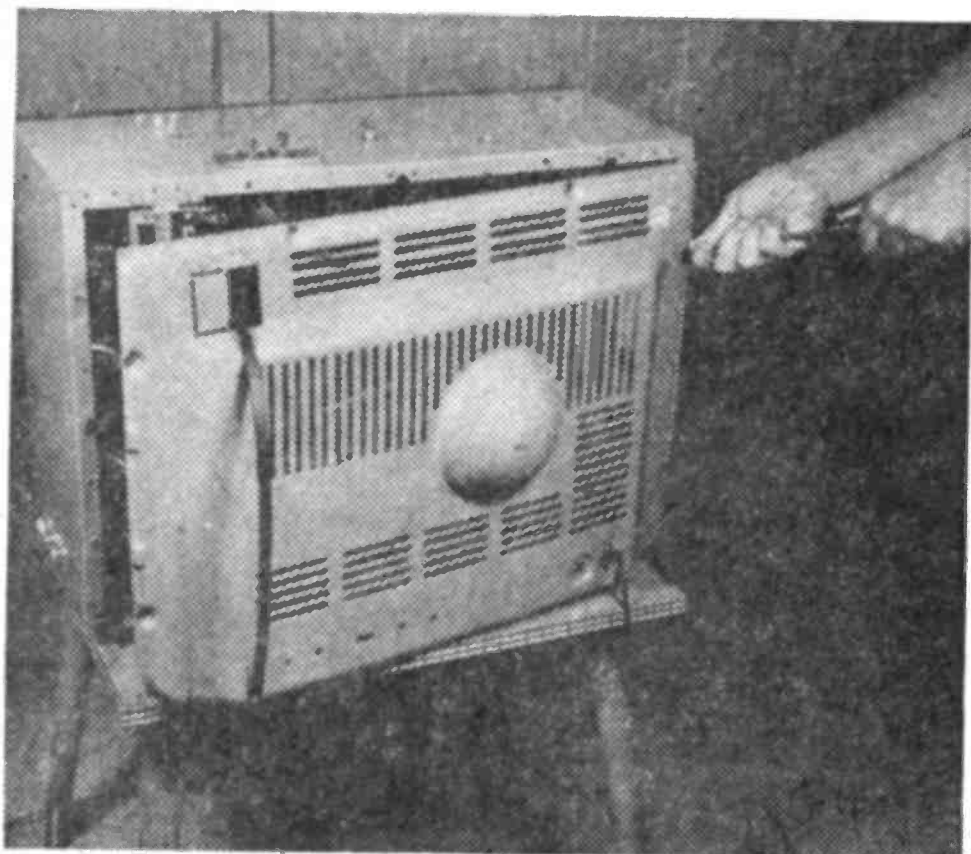

Removing back cover of TV is first step in replacing picture tube. AC cord, interlocked to back cover (lower right), comes off with it.

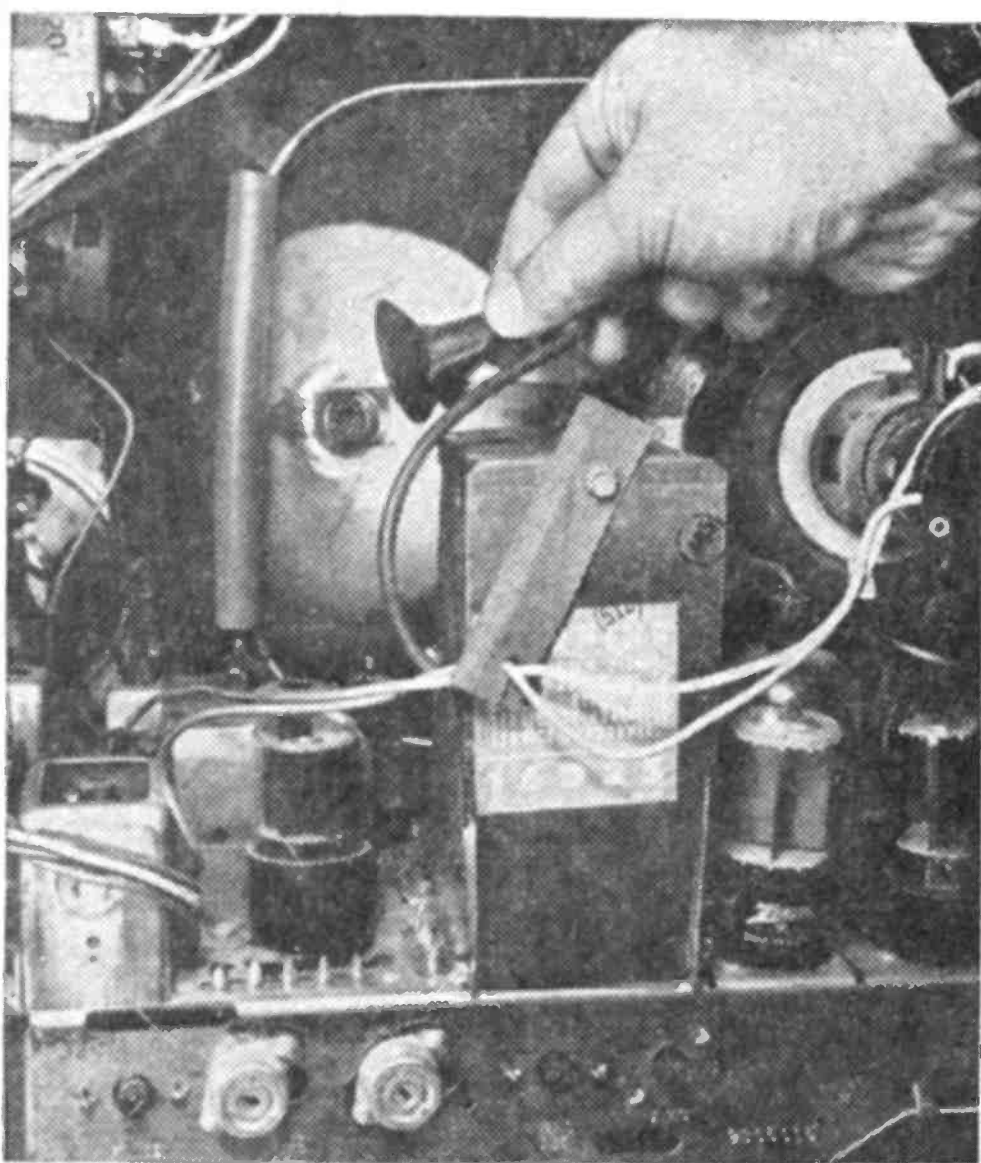

Carefully remove rubber anode cap plugged into the side of the picture tube by simply pulling or, if a clip type, by squeezing.

Short circuit the anode cap against chassis several times to dissipate any charges that might be present.

accidental strain, bumps or scratches—the job shouldn't prove too difficult.

Is the tube really at fault? This is a crucial first question. It's a crushing experience, as some have learned, to buy and install a picture tube—only to find the old trouble pop up on the new screen. Some faults give the exact same symptoms as a bad picture tube. So pinpoint the culprit.

Complete Loss of Brightness. The picture tube needs high voltage to produce brightness. Check for this voltage by finding the anode cap shown in the step-by-step photos. With power turned off, unplug the cap from the side of the tube (grasping only the rubber part). Now tape the cap so it sits about a quarter or half-inch away from its socket. Move away and turn on the power. If high voltage is present, you'll see and hear it; a blue spark should jump the gap and produce a sputtering, crackling sound. Some small chassis tubes which can kill high voltage are the horizontal oscillator, horizontal amplifier, high-voltage rectifier or damper. A blown high-voltage fuse is also a possibility. These items may be identified by the diagram pasted inside the set's cabinet or with the aid of a schematic. If these stages are causing high-voltage trouble, a new picture tube won't work.

Gradual Loss of Brightness. If this occurs over a long period, it's a good sign of a failing picture tube. You can milk additional months of service with a booster, but this is only a delaying action. Another possibility is the build-up of dirt on the screen (high voltage attracts dust like a magnet). In some sets, it can be cleaned from the front of the set if the manufacturer has provided a re-

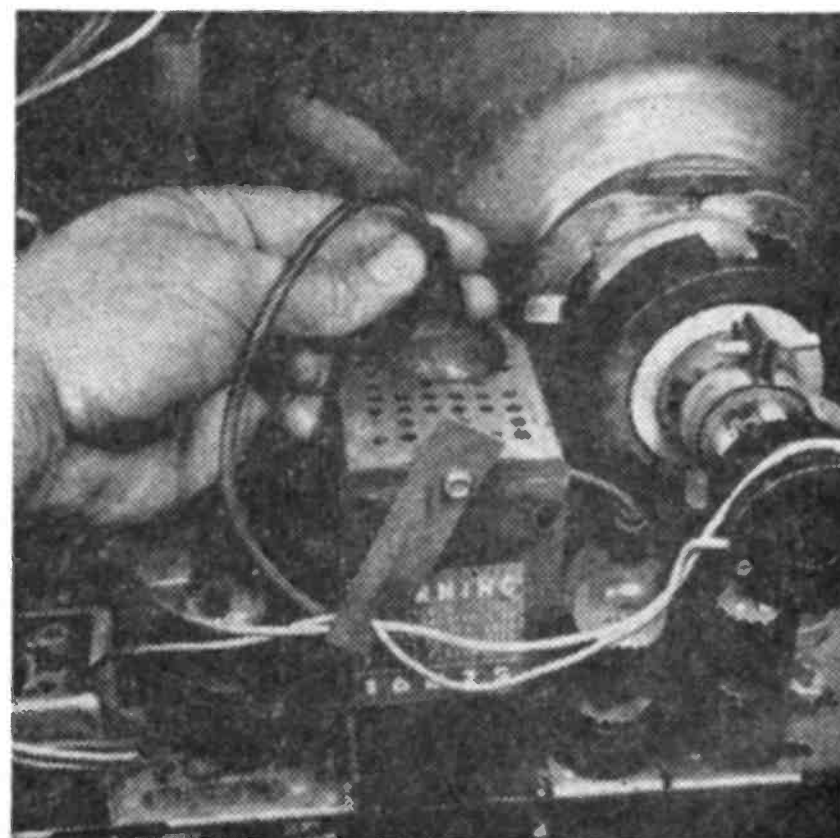

movable safety glass. Otherwise, the tube must be removed to gain access to the screen surface. (If you have a late-model set with a bonded safety glass, usually stated in the advertising literature, dirt can't accumulate inside.) In any case, a good cleaning of the screen surface in older sets can yield a remarkable increase in brightness, especially if there's more than one year's accumulation.

The darkening screen, however, which inevitably occurs some two or more years after the set is purchased, spells decreasing emission from the tube's electron gun. A good clue to this condition is the length of time it takes for the set to warm up and produce a usable picture. Low-emission tubes take two or three times longer to heat than when the set was new.

Other clues. Turning the brightness control has no effect; the picture stays bright. This is an excellent sign of a shorted grid in the picture tube. Such tubes deserve replacement, but there are two tricks for delaying the job. One is to purchase a special picture-tube booster which also can isolate the shorted grid. (It works only in some cases.) The other is a hit-or-miss method which might produce results, for a while anyway. Very gently tap the neck of the tube with the end of a pencil. This could dislodge the shorted element and unshort it.

Another valuable sign of a bad picture tube occurs when the picture goes negative; that is, blacks reverse to whites. This is caused by air seepage into the tube, molecule by molecule, over a long period of time. Such "gassy" tubes should be replaced. One misleading symptom is picture "blooming." As the brightness control is turned up to a nor-

mal position, the whole image expands like an inflated balloon. Image brightness dims as the picture grows in size. This is not caused by a bad picture tube. In nearly every case the reason is a bad high voltage rectifier, a small tube which is unable to keep high voltage up as electron-beam current rises to create more brightness.

Filament. Many people will tolerate a dimming image as the picture tube ages, but few will accept the condition which causes most outright failures. It is the burned-out filament. Investigating a dead filament should begin at the picture-tube neck. With the power on, a dull orange glow should be seen near the end of the neck, next to the socket. One exception may occur in the series-filament set, one without a power transformer. A burned-out filament in any of several small tubes could also cause the picture-tube filament to darken. Thus, dark or cold tubes in the series set must be checked individually before assuming that the trouble lies in the picture tube filament.

Occasionally, a picture-tube filament grows dark due to a mechanical fault in the socket, usually a loss of tension in the spring clips which grasp the tube pins. This may be detected by applying gently pressure to the socket, in all directions, and observing if the tube filament lights during any of these movements. If so, a new socket can be wired into place.

The professional installer usually makes a direct measurement of the filament to verify failure. One method is with an ohmmeter touched to the picture tube pins (after the socket is removed). An unbroken filament reads a few ohms resistance. Most tubes

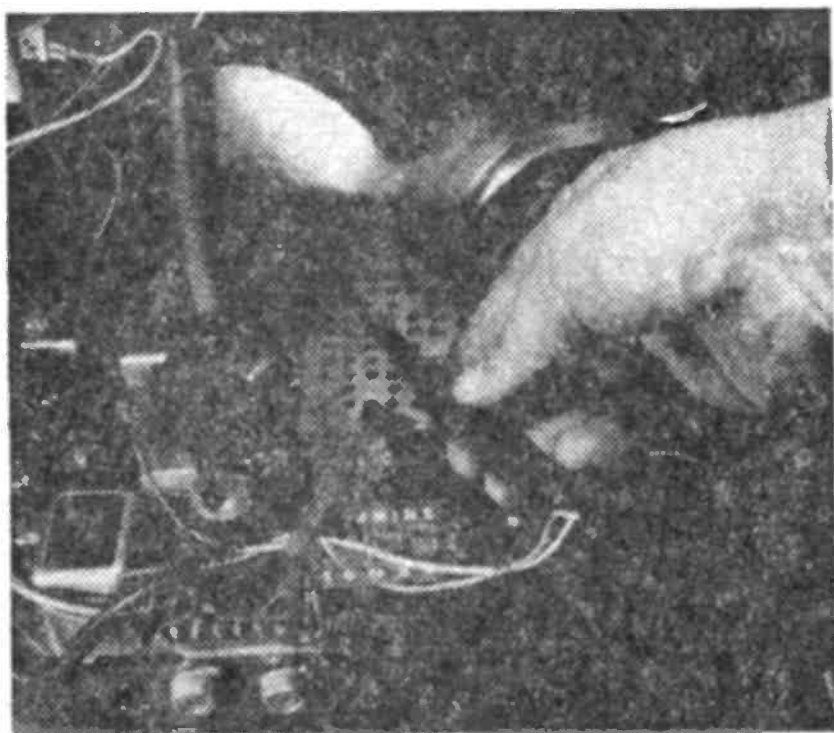

Short circuit voltage stored in picture tube by touching insulated screwdriver to anode and chassis a few times.

Now remove the picture tube socket from the tube pins at the base of the neck. A slight rocking action will probably be necessary.

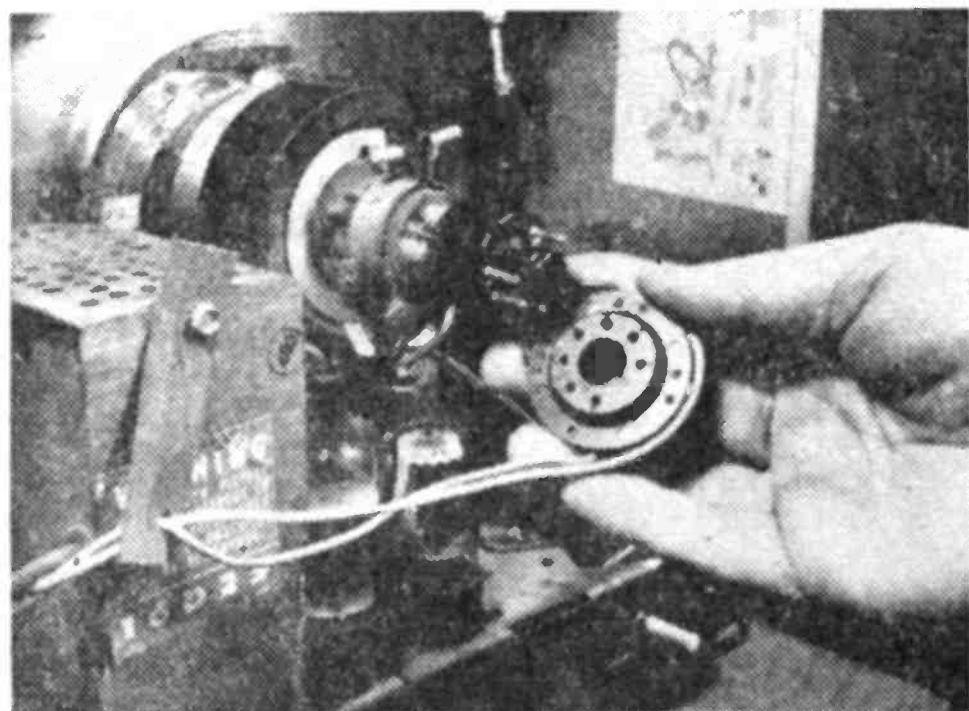

REPLACE BOOB TUBE

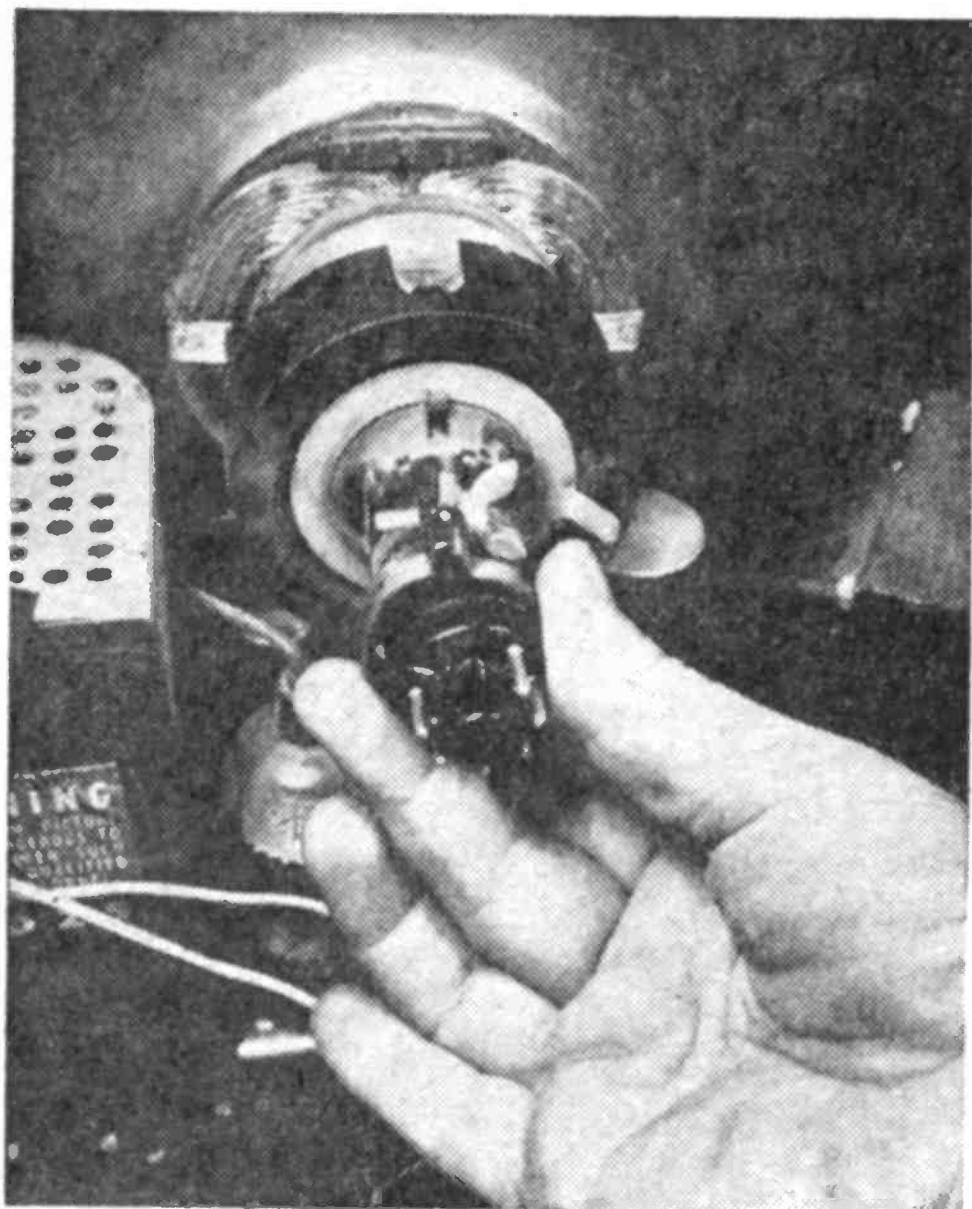

First loosen wing nut, then slide off yoke clamp. (In many sets this will be ion-trap magnet held by a spring around tube neck.)

use one of the following filament-pin combinations: 1-8; 1-12; 3-4; or 4-5.

After you've determined that the picture tube is bad, the next consideration is the type of replacement to purchase. Unless you have a private pipeline to one of the big producers, you cannot get a *new* TV picture tube. All TV replacement tubes are rebuilt. This may imply a compromise in quality. Not so in

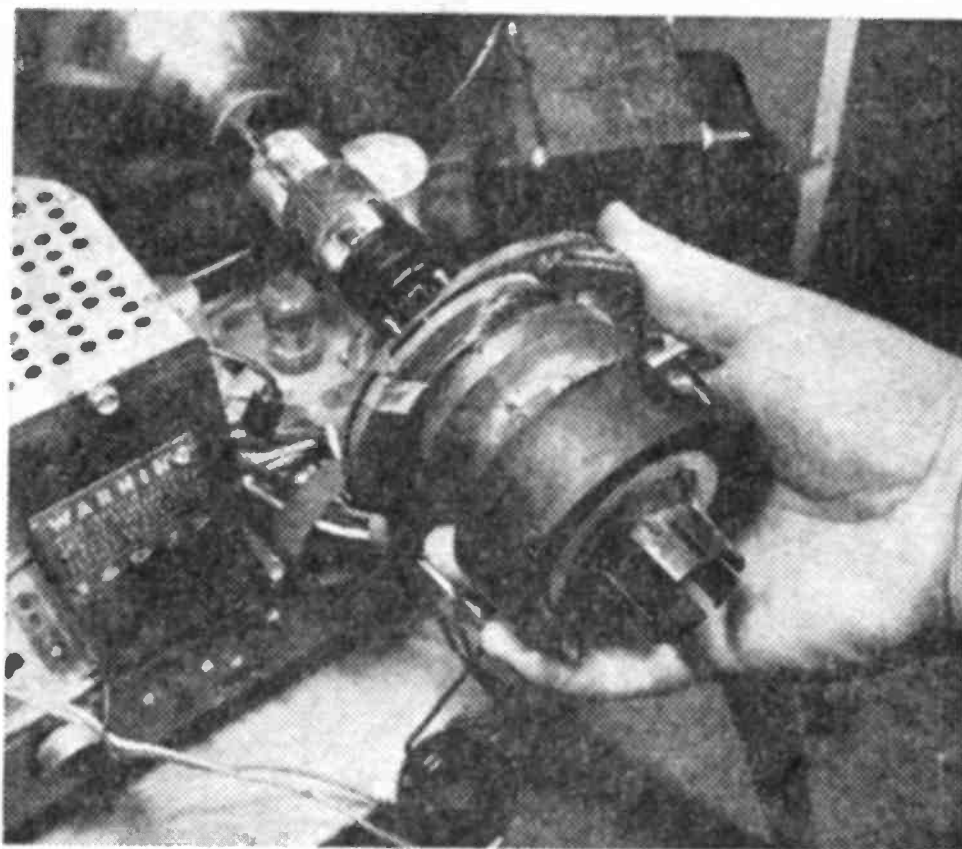

Slide off yoke and centering magnet assembly (usually in one piece). If a yoke clamp isn't used, loosen the wing nut on top of the yoke.

most cases. Only the glass envelope is re-used in the rebuilt tube; screen and electron gun are new. Yet, there is still a range in price. If a budget-priced rebuilt is purchased, it could run nearly half the cost of a rebuilt from a big-name producer—GE, RCA, etc. In this writer's experience, the budget-price rebuilds are economically attractive, but in numerous cases have failed to maintain proper emission (and therefore brightness) much beyond the 1-year guarantee period. It could be due to poor quality control by some small rebuilding houses. The choice is left to the buyer. Whatever the purchase, a replacement containing an aluminized screen, if available in your number, is highly recommended. The difference in tube performance is considerable; light is not wasted in the rear end of the tube, but reflected back to the viewer's eye.

Removal. The precautions shown for discharging high voltage retained by the tube

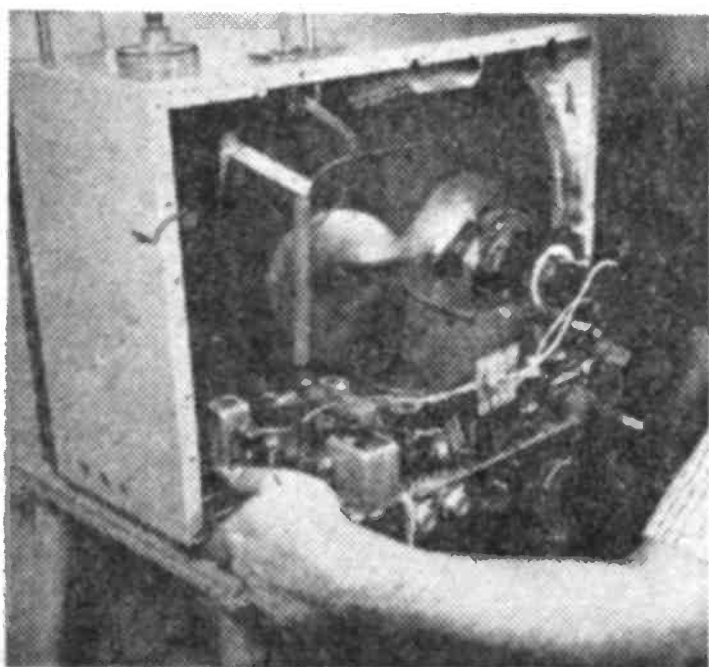

In this set, tube and chassis are removed together. When this is the case, make sure the tube face isn't held by cabinet.

Remove mounting hardware from all around the front rim of the tube. Be sure to retain all clamps, screws.

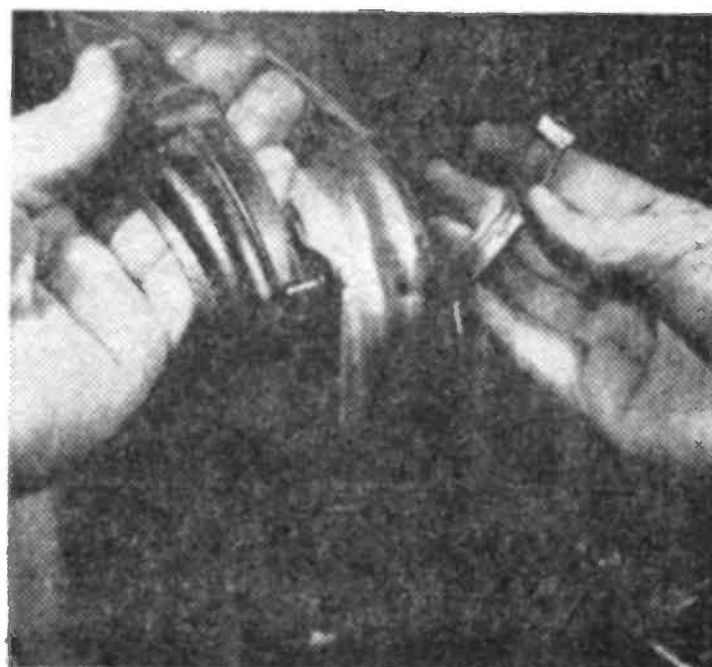

If it's necessary to remove chassis from cabinet (see text), remove all of the control knobs from the set first.

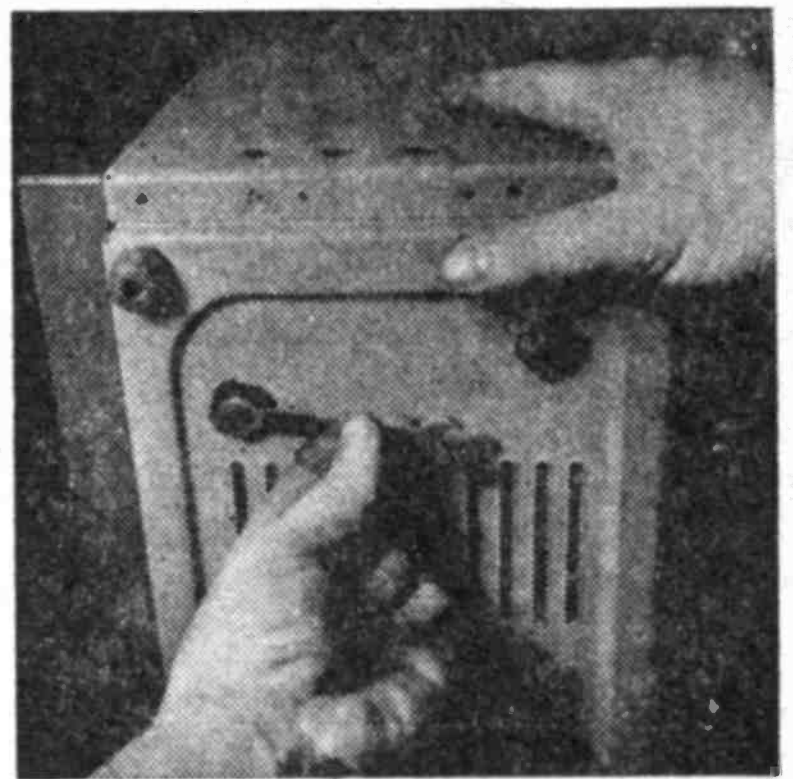
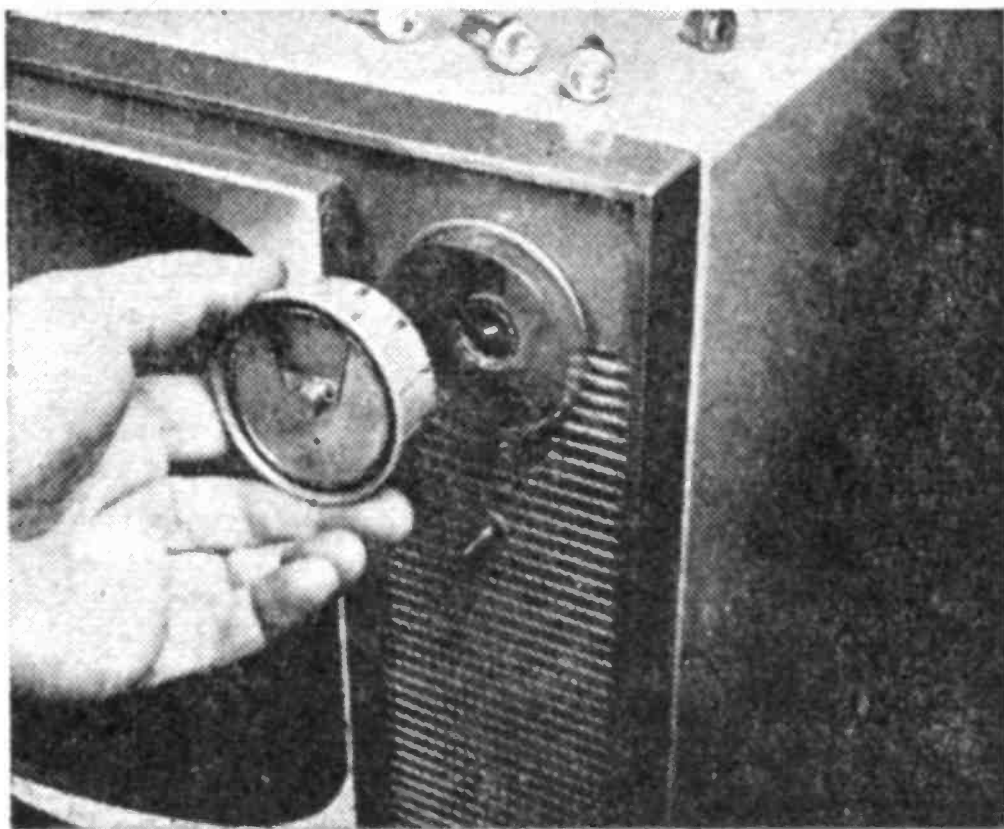

Chassis is usually secured to cabinet (shown here tilted) with bolts. Keep cabinet level when loosening.

are mainly intended for protecting against breakage. The charge is not electrically dangerous. Rather, it may cause a person to jump back or jerk his arm while holding the tube, and thereby dropping it. Be sure to discharge the tube repeatedly for about a minute to get rid of the last tickle. Never hold the tube by its neck alone. It's the weakest part. Neck-holding may be done for balancing, but not for support of the tube weight. To further increase the safety factor, it's recommended that the installer wear a pair of safety goggles and apron, or other substantial piece of clothing. A fractured tube can implode and fling dangerous glass splinters.

Since the step-by-step photos show the general technique for removing the picture tube, let's consider variations from one set to the next. The first major consideration is observing how the tube is mounted, for this

determines whether the chassis has to be removed from the cabinet. There are two principal systems: in the first, the tube is mounted directly to the front panel of the cabinet, true for many large, or 21-inch, sets; and, the second, where the tube is fastened directly to the chassis. (The model in the photos is of the latter type.) The system can usually be discovered by close observation of the tube. Frequently, a large tube will be seen fastened to a bracket around its forward rim. After items on the tube neck are removed (such as the deflection yoke) unbolting the forward tube support frequently permits the tube to be withdrawn while the chassis remains in place. That is, if the chassis presents no obstructions. Small tubes blocking the way may be temporarily removed, but if a transformer presents an obstacle, the chassis will at least have to be pulled out part way. In the chassis-mounted tube, both chassis and

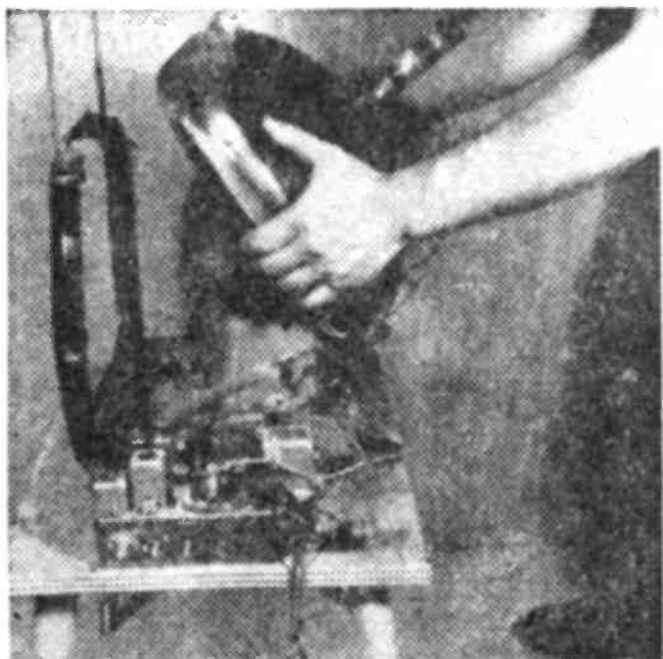

The picture tube must be withdrawn very carefully to avoid disturbing the other components on receiver's chassis.

Carry picture tube by supporting all its weight with your hand under screen; grasp neck only for balance.

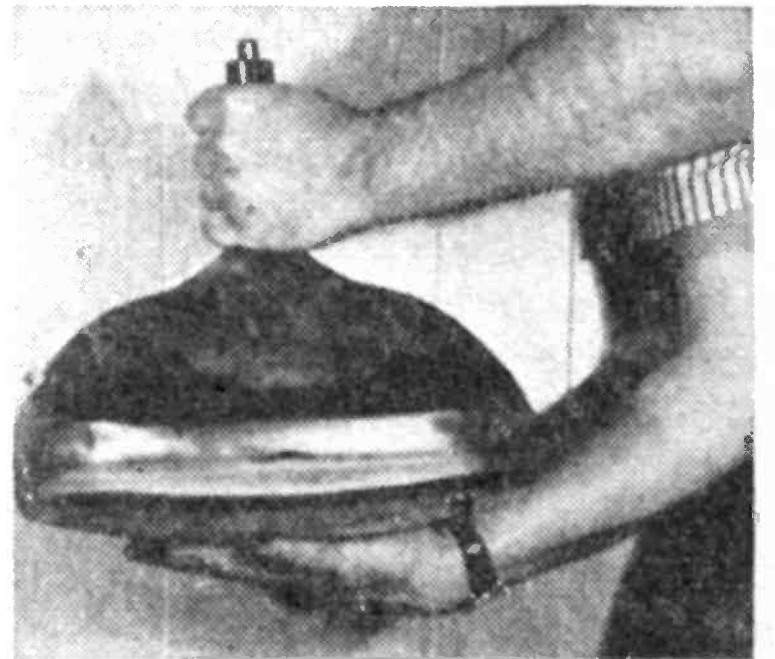

REPLACE BOOB TUBE

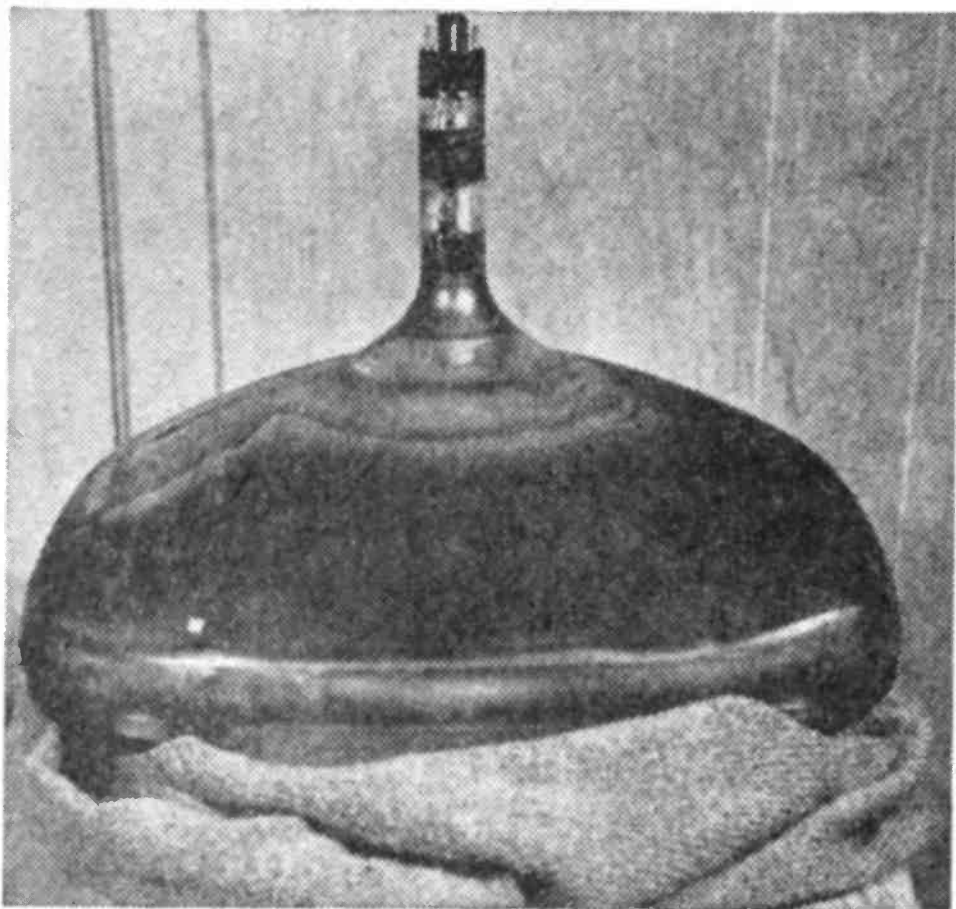

Avoid scratching face of old tube by placing on soft surface. Scratches increase danger of implosion and could affect trade-in value.

tube emerge from the cabinet as one piece. Generally, this type requires the removal of screws which fasten the top rim of the tube to the front cabinet panel.

Some Differences. The sequence of removing components from around the tube neck is subject to some variation. If the chassis does not have to be removed, neck components must be dismantled before the tube is taken from the cabinet. In the tube-on-chassis type, it is simpler to slide off the neck parts after the chassis is out of the cabinet. The neck components vary considerably in different sets, but this should present little problem as long as they are replaced according to the original layout. The first part to be removed is the tube socket. In many older sets it will not easily pull off. Gently insert a screwdriver at several points around the socket rim and pry it away gradually. In some sets, the next item is the ion trap. It is a small, square magnet clipped around the tube neck and held by a spring. (The set in the photos uses no ion trap.) Since the trap presents the most critical adjustment after installing a new tube, it's advisable to carefully note its position on the neck of the tube. This, at least, will provide an approximate starting point later on. (Some ion traps have a small

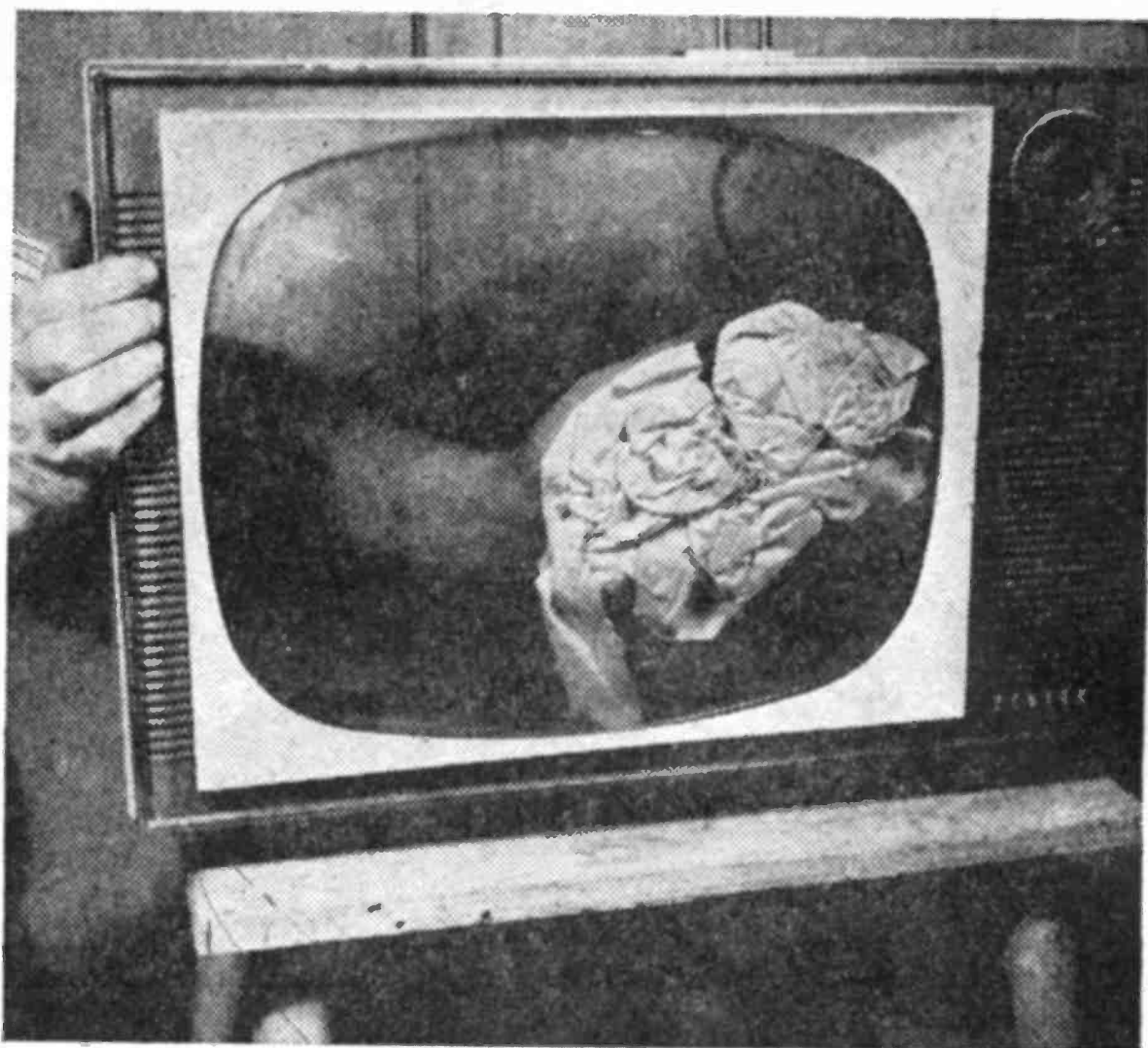

While picture tube is out of cabinet, take advantage and give safety glass a thorough cleaning with water and a drop of detergent.

arrow, which indicates the front of the set.)

Next on the tube neck is a focus coil or centering magnet assembly. It is unfastened and slid off. Finally, there is the deflection yoke which fits snugly against the flare, or bell-shape, portion of the tube. The usual fastening for this component is a wing nut, which is loosened. (Through age, the yoke may stick. Very gently work it loose.)

Installation. The new tube is inserted and mounted in the reverse order. Again, gentle handling is important. Just before the tube is strapped and bolted into its mounting, check the position of the anode socket. It should be on the correct side of the chassis to receive the anode cap. Also, check if the tube sits squarely in the mount; not slightly askew. One guide can be the marks indented by the old tube into the rubber or other soft material which retains the front rim of the tube.

The neck components are installed as closely as possible in their original locations. These positions, however will rarely be absolutely accurate, so don't give them a final tightening at this time. After you've checked everything for completeness, don't turn on the set. The following step applies if the tube uses an ion trap. Turn the brightness control about half-way up. Place a mirror in front of the set (if necessary) so the screen can be viewed while you're at the rear of the

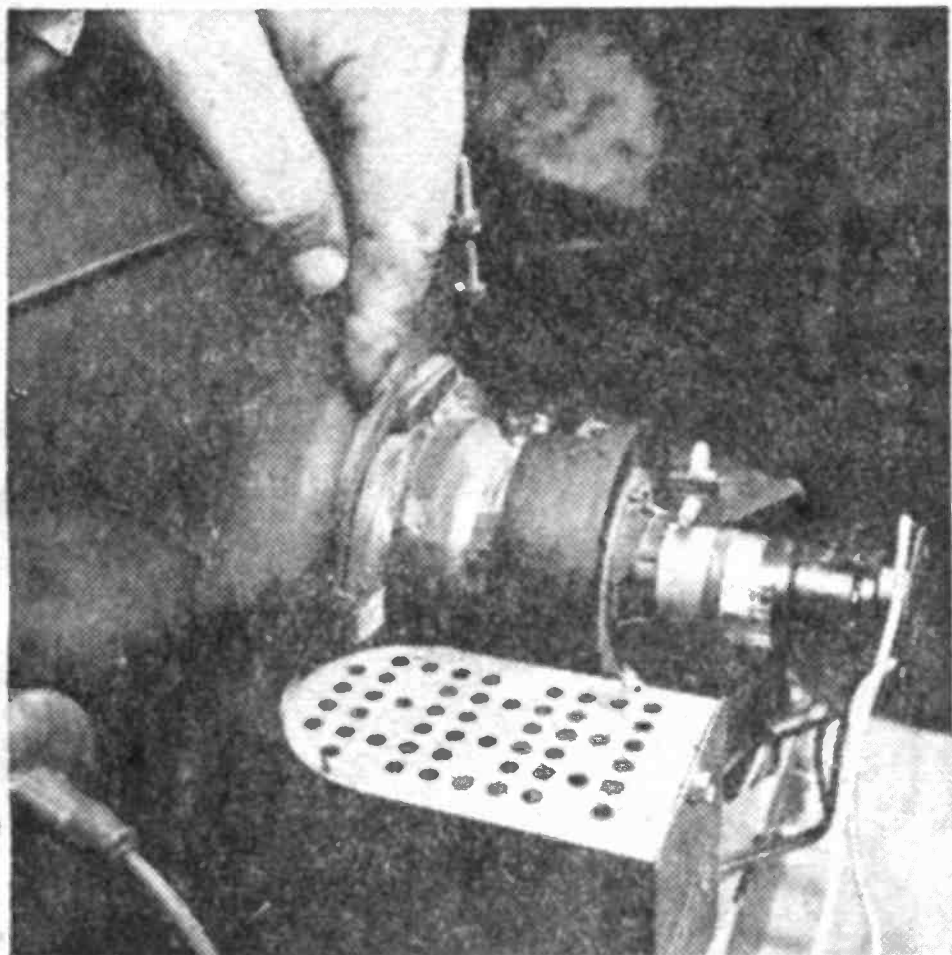

When replacing yoke on a new tube, make sure it seats against flare of tube, or picture won't fill screen.

Before replacing the back cover, check the picture for alignment on the screen. If it isn't horizontal as here, the yoke must be rotated on the tube neck.



set with one hand on the ion trap. Now have someone turn on the power. Quickly rotate the trap about the neck, and move it back and forth, until brightness appears on the screen. If two positions provide light, use the brighter of the two. This position should be found within a minute to prevent heavy ions in the electron gun from bombarding the screen and causing possible damage. Now, move the trap slightly to find the point of maximum brightness. (If you're a photo fan, you can use this trick: an exposure meter placed in front of the screen makes the job easier; watch pin for highest indication.)

Back in Focus. Now get a picture on the screen. Are its fine horizontal lines slanting? If so, small rotation of the deflection yoke permits correction. Just be sure that the yoke remains snugly against the bell of the picture tube or the image may not fully fill the screen. When grasping the yoke, hold only its insulated portion. It may be difficult, while adjusting the yoke, to check the picture for its true horizontal position (unless words, for example, appear on the screen). A convenient method is to adjust the set's vertical hold control so a thick black bar appears on the middle of the screen. This serves a good horizontal reference. Corner shadows or incorrect picture position are corrected by moving the tabs on the centering assembly. Finally, touch up ion trap again; other adjustments may have thrown it off slightly. ■

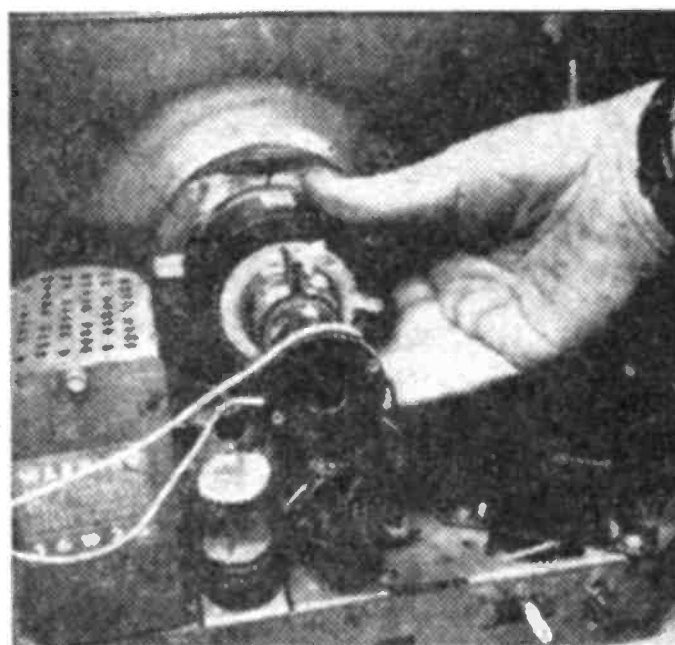

When rotating the yoke around the tube neck, grasp only the insulated cover of the yoke.

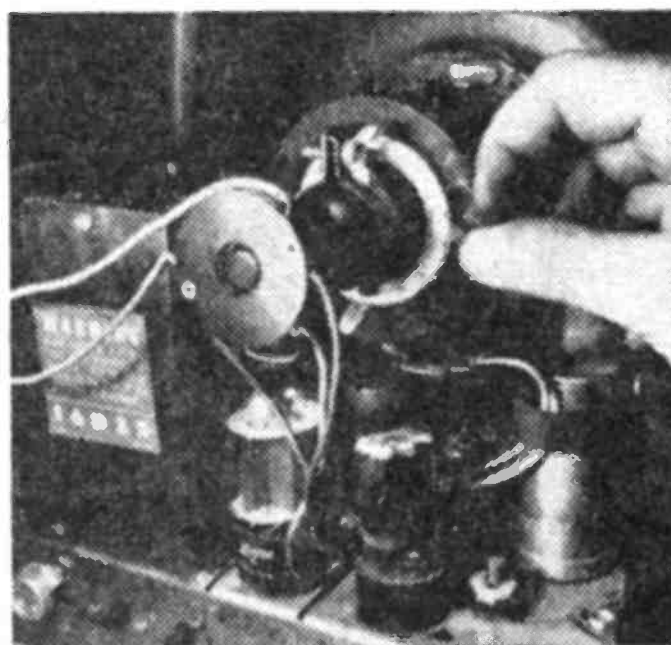

To center picture on screen adjust the two metal tabs on the centering of magnet assembly.

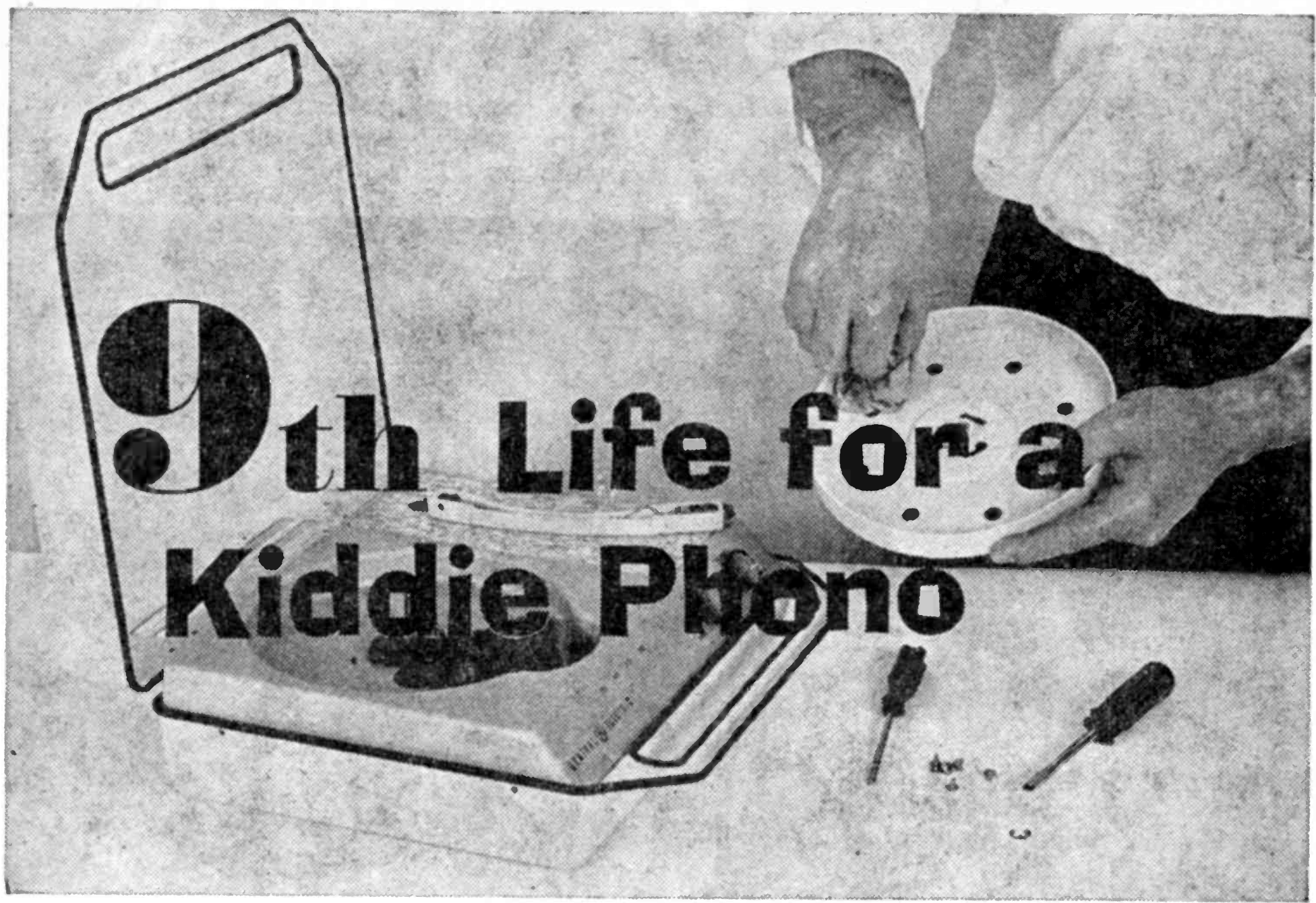

■ **If your child's** phonograph has given up the ghost for what you insist *has* to be the last time, think again. For a kiddie phono is so simple a gadget it's bound to have nine lives (perhaps even ninety-nine) before it ends in the trash can. And whether due for its ninth or its ninety-ninth life, any kiddie phono requires a minimum of skill to return to working order.

One of the reasons kiddie phonos are such a breeze to repair stems from the fact that there is really very little that can go wrong. Basically, any kiddie phono consists of a

motor and turntable, a pickup and cartridge, an amplifier and speaker—plus a cabinet to house the lot. And aside from a broken cabinet, most repairs to kiddie phonos center around one of these three basic areas. In other words, it's either the motor and turntable, the pickup and cartridge, or the amplifier and speaker that are due for attention.

Unless the motor has conked out completely—in which case the entire assembly should be replaced, a general cleanup will probably put things back in the AOK cate-

(Continued on page 94)

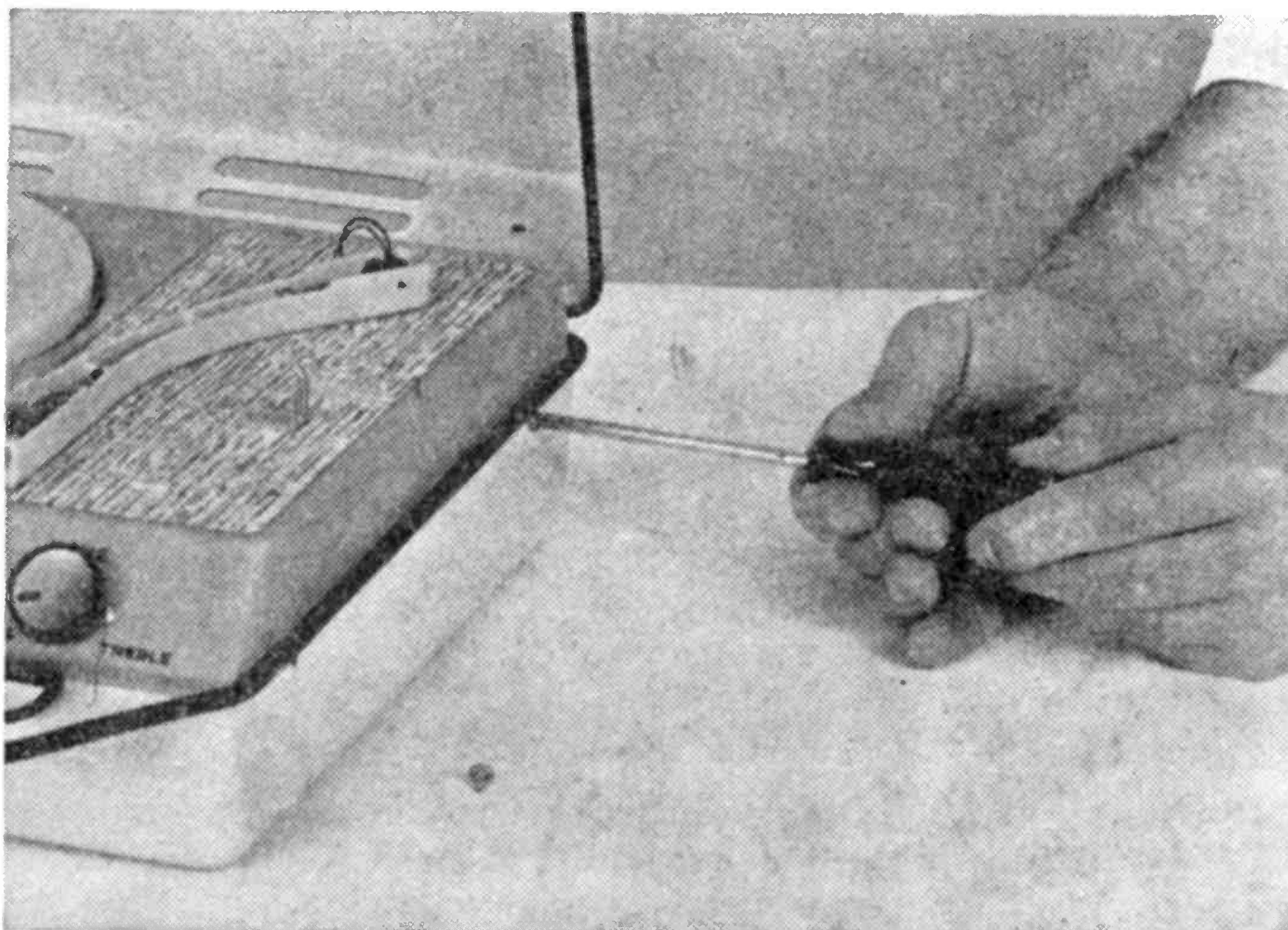

Kiddie phonos vary widely in general mechanical layout and construction, but this General Electric player is not unlike several other brands that have been on the market at one time or another. Disassembling this unit required unplugging line cord from socket at rear, then removing series of Phillips-head screws with a screwdriver.



Color sync has been the cause of many a good man's cop-out, but take heart! Here's what to do

WHEN COLOR WON'T STAY PUT

By Len Buckwalter, K10DH

Of all the troubles that attack the color TV screen, running hue is one of the easiest to spot. It produces a number of weird patterns, but there's always one revealing symptom—color seems to separate from the black-and-white image. The monochrome picture keeps operating normally while color washes in waves across the screen. Stripes can drift horizontally, vertically, or diagonally. They might rush by at dizzying speed or float lazily to and fro. Worse yet, width of roaming color stripes often varies from narrow to broad.

This classic symptom—separation of color from the black-and-white picture—is strong evidence that the problem is “lack of color sync” (synchronization). A similar effect in a black-and-white receiver is uncontrolled vertical rolling, or a slashing of the image into horizontal lines. In those troubles, the receiver's vertical and horizontal stages are not in step with signals transmitted by the TV station. When color sync is lost, the receiver also fails to mesh with transmitted signals.

Sync-ing Fast. There's good reason why the color set must latch onto the transmitting station. When today's color system was approved, the FCC decided color must not interfere with regular black-and-white reception. To fulfill the requirement, engineers created a vehicle to carry color in a manner the black-and-white set would ignore. They came up with the “color subcarrier.” When color voltages from the studio camera are modulated onto a frequency of 3.58 MHz, the color subcarrier, it was found they would drop into “holes” already existing in the black-and-white signal. Now color and monochrome receivers could co-exist in a compatible system.

But the color receiver must have special circuits to recover the subcarrier. Reason is that color *modulation* is transmitted, but the subcarrier remains behind. (Color modulation exists just above and below 3.58 MHz.) This system proves technically economical. Since the subcarrier is killed at the transmitting end (after it's done its job of creating color modulation frequencies), it simply

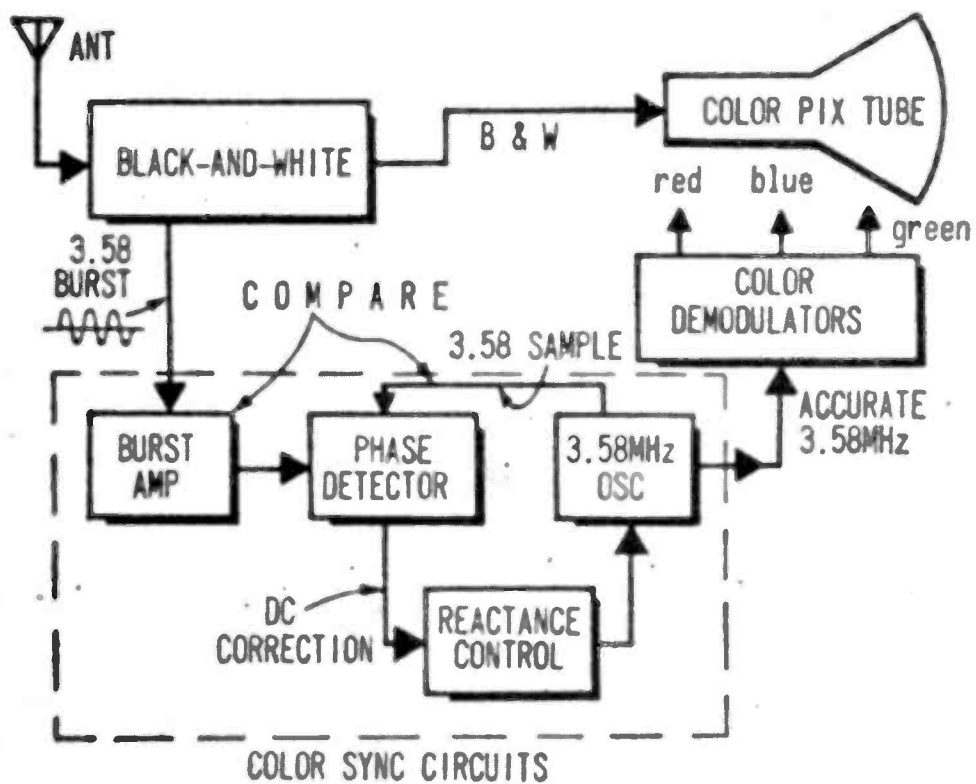

Fig. 1. Color sync circuits are enclosed in dotted line. To maintain correct color on screen, both frequency and phase of 3.58-MHz Oscillator is locked-on to station signal.

isn't present to interfere with black-and-white reception. The color receiver, however, must create a *local* subcarrier to serve as a key for decoding, or demodulating, the original color signal generated at the studio.

Just Like CW. This action can be compared to tuning a ham or shortwave receiver for code reception. Code enters the receiver as a radio-frequency signal which can't be fed directly to the speaker. So the receiver provides a local radio signal (from a BFO, or beat-frequency oscillator) and the resulting mixture creates an audio tone. In the color receiver, the subcarrier reconstructs the original camera signals so they can be fed to the picture tube.

Because of incredible accuracy needed for good color, the color circuits have a few refinements.

For one thing, the station transmits only a tiny sampling of the 3.58 subcarrier. Since it's about 8 cycles long, it's aptly called the "burst." So brief is the signal that it can be squeezed in during the time the screen is dark for a fraction of a second at the end of each horizontal scanning line. The burst, though, is long enough to inform the receiver of the correct subcarrier frequency. This is the initial step in synchronizing color between transmitter and receiver.

As for that subcarrier, the color receiver generates its own on 3.58 MHz. It's done with a stable, crystal-controlled oscillator.

Nevertheless, the oscillator can't approach the required accuracy, and the incoming burst is used to kick it on frequency.

Another element of the color sync system is a control "loop." As we'll see, this will tie the incoming burst—the reference—to the local crystal oscillator. Anything which disturbs this system causes running color, an aimless spilling of tints off the basic black-and-white image.

A Trip On AFPC. In Fig. 1 is a block diagram of major stages for color sync. This is the set's AFPC, or Automatic Frequency Phase Control system. As the name implies it controls both frequency and phase of the receiver's locally generated subcarrier. Actually, frequency and phase are mostly a matter of degree. When the oscillator is a few dozen cycles above or below 3.58 MHz the system may be considered controlling frequency.

But as the burst signal and oscillator start

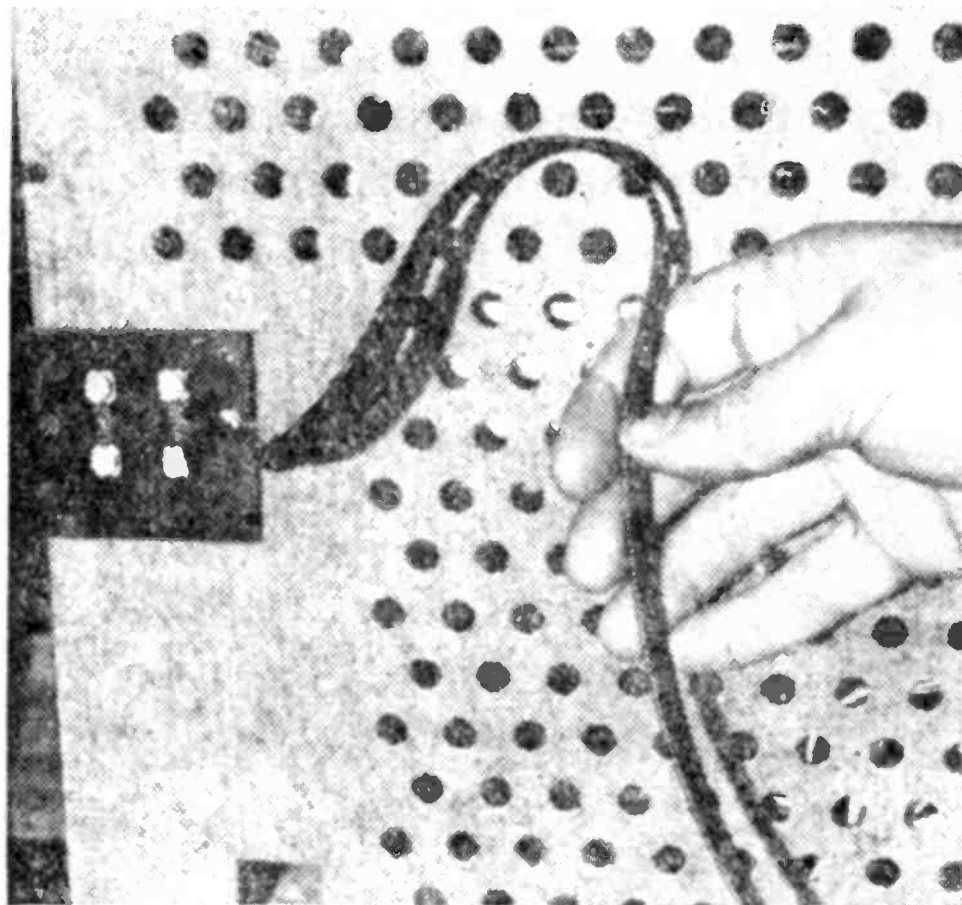

Fig. 2. Poor sync or runny color can sometimes be traced to a defective antenna or lead-in. Flat twin-lead exposed to the elements is especially subject to color-wrecking damage.

to get into step, the control system operates on the more precise level of phase; that is, both signals must begin at zero at exactly the same instant, then alternate through 360 degrees together. Unless locking action is total, picture hues may shift toward the green or purple end of the scale. Major functions of the color-sync section, blocked in Fig. 1, are as follows.

Burst Amp. An incoming colorcast travels through the conventional part of the receiver at upper left. Note that it is basically a black-and-white receiver that feeds

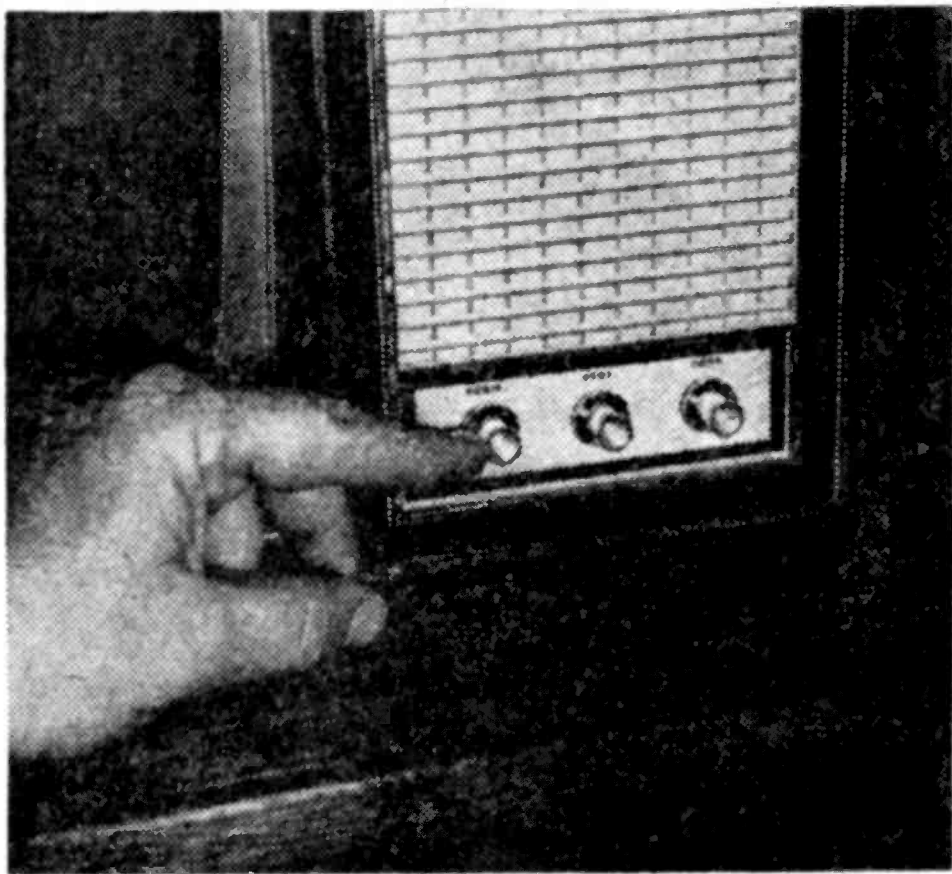

Fig. 3. Before tearing into the color TV to look for causes of poor color sync, make sure that all the controls are properly set—especially the horizontal hold control.

the specialized color circuits found below. Synchronizing action begins as an incoming burst signal reaches the Burst Amp. This is the rapid-fire group of cycles sent as a reference by the TV station and thus they become the reference for the complete control system. They are strengthened by the Burst Amplifier before proceeding further. Notice that the burst is next applied to the Phase Detector.

Phase Detector. An electronic comparison occurs here. The stage is designed to accept two signals, then produce one output voltage which encodes any differences between the original signals. The burst is one signal; the other is from the 3.58 MHz Oscillator.

3.58 MHz Oscillator. This crystal-controlled oscillator generates the local color subcarrier. As mentioned earlier, it is stable, but not accurate enough. A small portion of oscillator signal is sent to the Phase Detector as a 3.58 MHz sample. The Phase Detector is now receiving two signals for

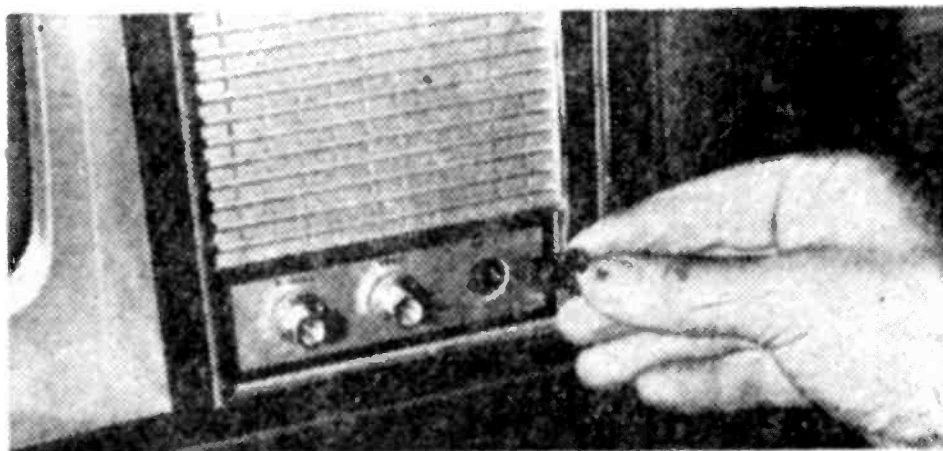

Fig. 4. Another adjustment that can affect color sync is the AGC. Here, control is located behind a front-panel knob, though usually it's on the rear apron. Set AGC as described in text.

comparison and it produces an output (shown as the DC correction).

Reactance Control. This tube serves as an electronic tuning capacitor, much the same as the tuning capacitor used to tune any radio. Only it has no moving plates. Its capacity can be controlled by the DC correction voltage supplied by the Phase Detector. Further, the Reactance Tube is connected as a variable capacitor across the tuning circuits of the 3.58 MHz Oscillator.

To sum up the overall action of Fig. 1: an incoming burst signal is compared with the local 3.58 Oscillator at the outset. The Phase Detector senses error between the two, then operates the Reactance Control. Capacity changes then re-tune the 3.58 Oscillator until it is on the exact subcarrier frequency. Note that the oscillator produces a continuous signal, though it is being controlled by the burst.

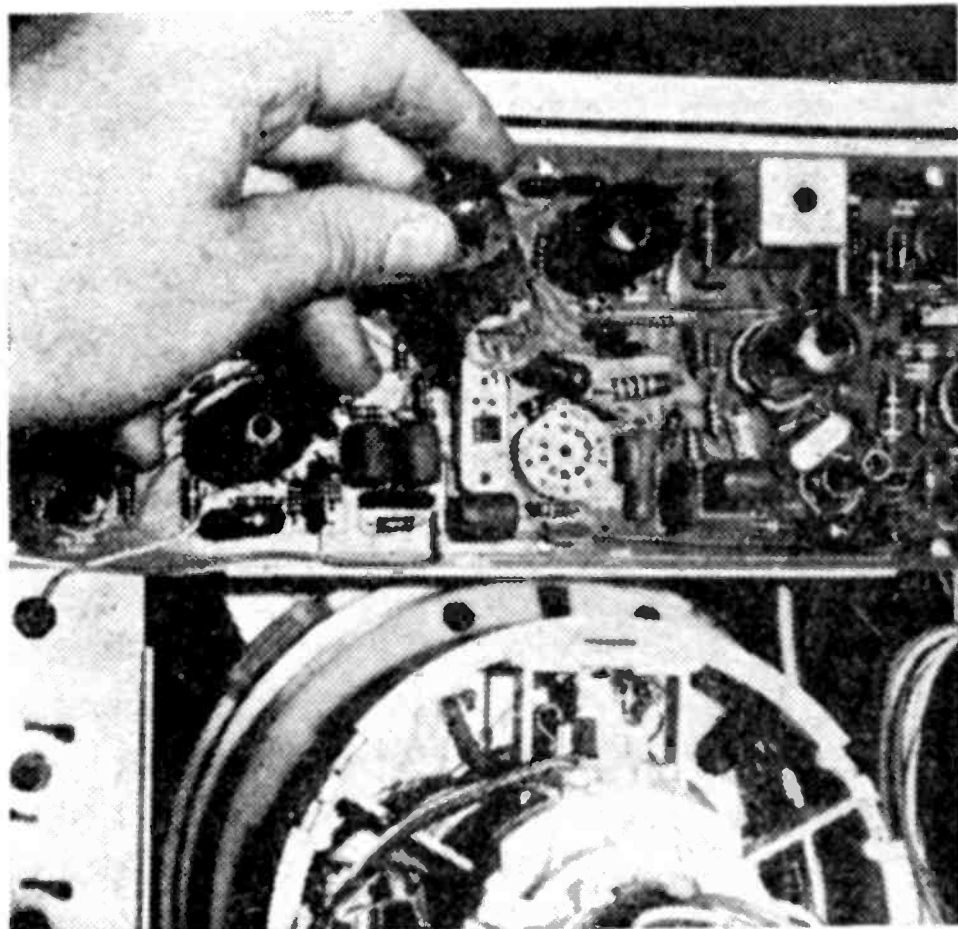

Fig. 5. Tubes account for most sync circuit troubles. They will usually all be found on the set's chroma board; checking by substitution is the easiest way to find a bad one.

The 3.58 signal, now precisely correct, goes to the Color Demodulators which produce correct voltages for operating the picture tube guns. At this point, any loss of sync detaches color from the black-and-white image.

Manual Control. When color sync acts up, there are a couple of initial checks which will determine whether it's caused by something outside the chassis. We'll assume the set is receiving a normal black-and-white picture in order to rule out problems which might originate in other sections of the receiver. The antenna and lead-in (Fig. 2) are also considered to be in good condition and aren't deteriorating the color signal before it enters the receiver.

COLOR WON'T STAY

Turn to a color program and carefully adjust the fine-tuning control. This is critical to stable color reception since it places the burst into correct position within the set's tuning circuits. If the burst is attenuated, it won't be available to control the crystal oscillator. Another adjustment that might

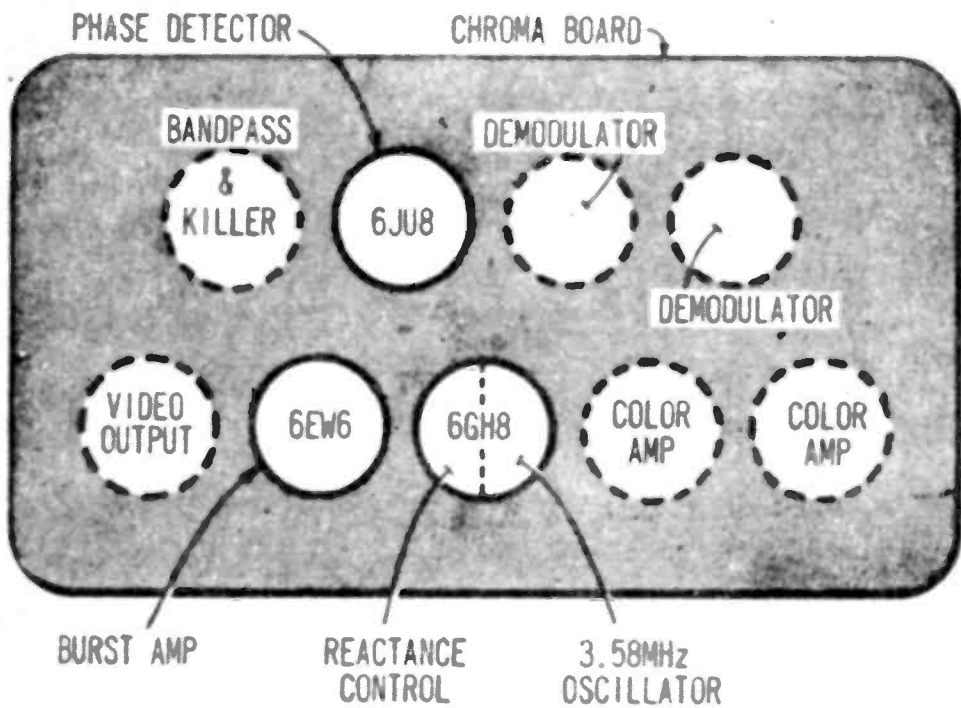

Fig. 6. On this typical chroma board, stages directly concerned with color sync are shown in solid circles. Poor sync is usually caused by one or more of these tubes being defective.

affect the burst signal is the horizontal hold control (Fig. 3).

Though these circuits occur in different sections of the receiver, there is some interaction. You may recall that a burst occurs at the end of every horizontal scanning line. To help keep the Burst Amplifier firing properly, it is locked into the set's horizontal scanning section. Mistuning of the horizontal hold control is apt to disturb the timing. For this reason, always set the horizontal hold

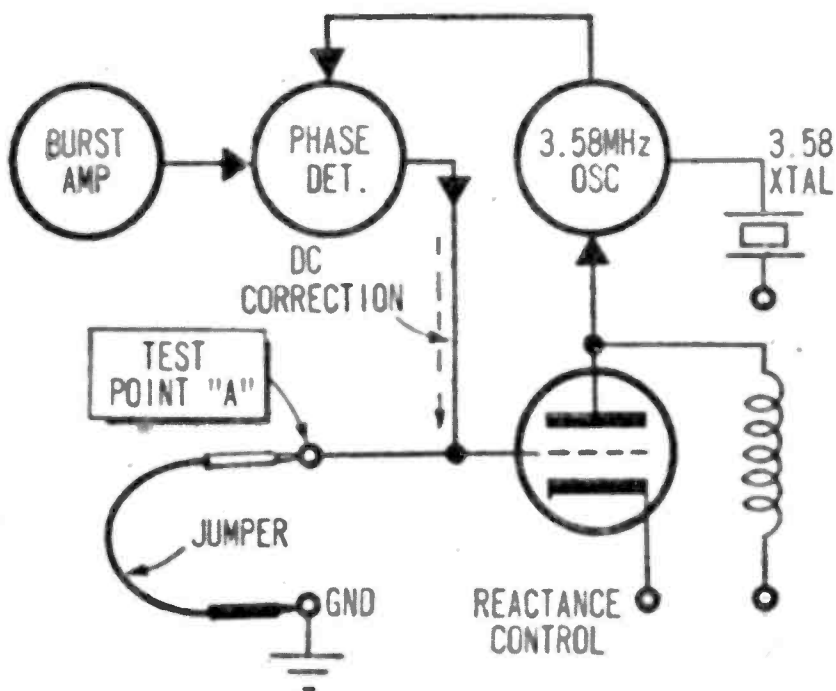

Fig. 7. If tubes are not the problem, shorting the grid of the reactance tube to ground may isolate trouble. Manufacturer's service literature may be needed to locate test point.

so the picture is centered on the screen. (You'll note the hold is able to shift the picture slightly left or right before the image breaks up.)

Consider The Killer. Another adjustment to check is the Color Killer. This circuit doesn't directly participate in color sync but it could have an effect. The "killer" is a stage which closes off the receiver's color stages during black-and-white reception to keep color from accidentally spilling through and disturbing the image.

If the killer is set at a critical point, it's possible for a part of the color signal to be wiped away, which could lead to unstable operation. Turn the control fully off to check if this is the sync problem. The correct setting is one that doesn't produce colored "confetti" on the screen when the set is tuned to an unused channel. Location of the killer control is usually along the rear

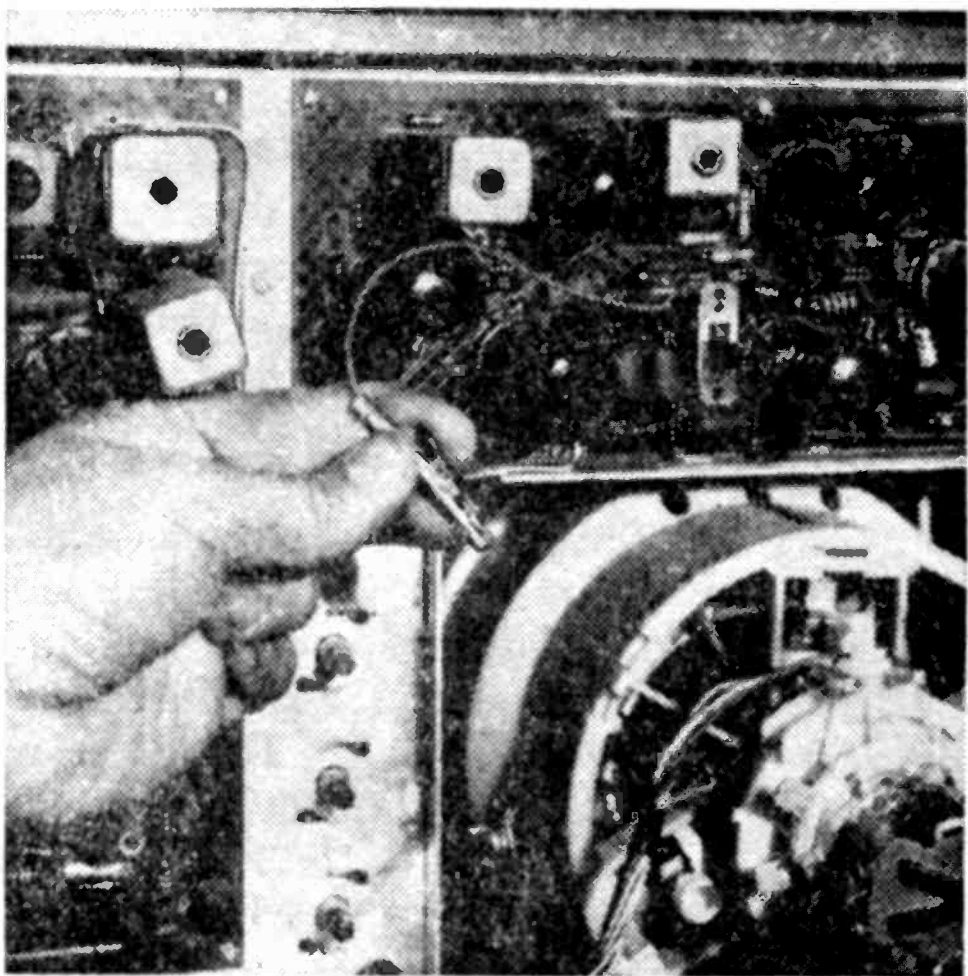

Fig. 8. If color sync improves when reactance tube grid is grounded, reactance and oscillator stages are probably alright. Be careful not to disturb yoke components while working on set.

chassis apron: on some sets it's accessible when one of the front-panel knobs is removed.

Finally, check the AGC (automatic gain control) adjustment if the set has one (Fig. 4). Should AGC be set too high (thereby severely reducing gain of the receiver's front-end), there could be partial clipping of the color signal. The usual adjustment for AGC is done while viewing the strongest local channel. The control is turned until the picture starts tearing or turns negative, which indicates overload. Then the control is re-

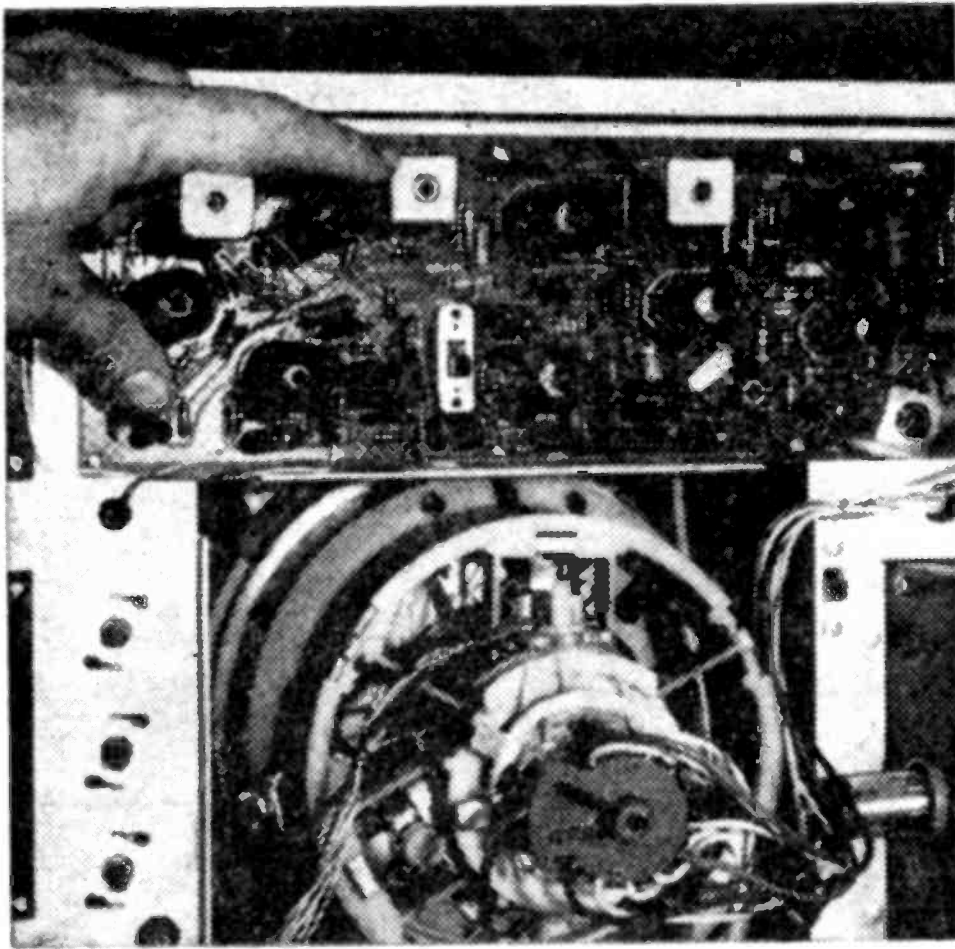

Fig. 9. Alignment of transformers in the color section should not be disturbed since realignment is complicated. However, transformer windings can readily be checked for continuity.

One useful test point indicates whether the fault is in the Burst Amp and Phase Detector stages or the Reactance Control and 3.58 Oscillator stages. If the simplified diagram in Fig. 7 is traced, it is seen that a test point (A) occurs in the grid of the Reactance Control tube. This is the stage that acts like a variable capacitor across the oscillator and continuously adjusts frequency with a DC correction voltage.

The test point enables you to ground the DC correction voltage and observe certain effects. Watch the color picture when you ground the test point with a clip lead to the chassis (Fig. 8). If it improves color sync—color stops moving through the picture—it's a good sign the Reactance Control and oscillator stages are not at fault.

No Reactance Volts. During this test, you removed the action of the Burst Amplifier and Phase Detector from the circuit. Further, in grounding the test point, you

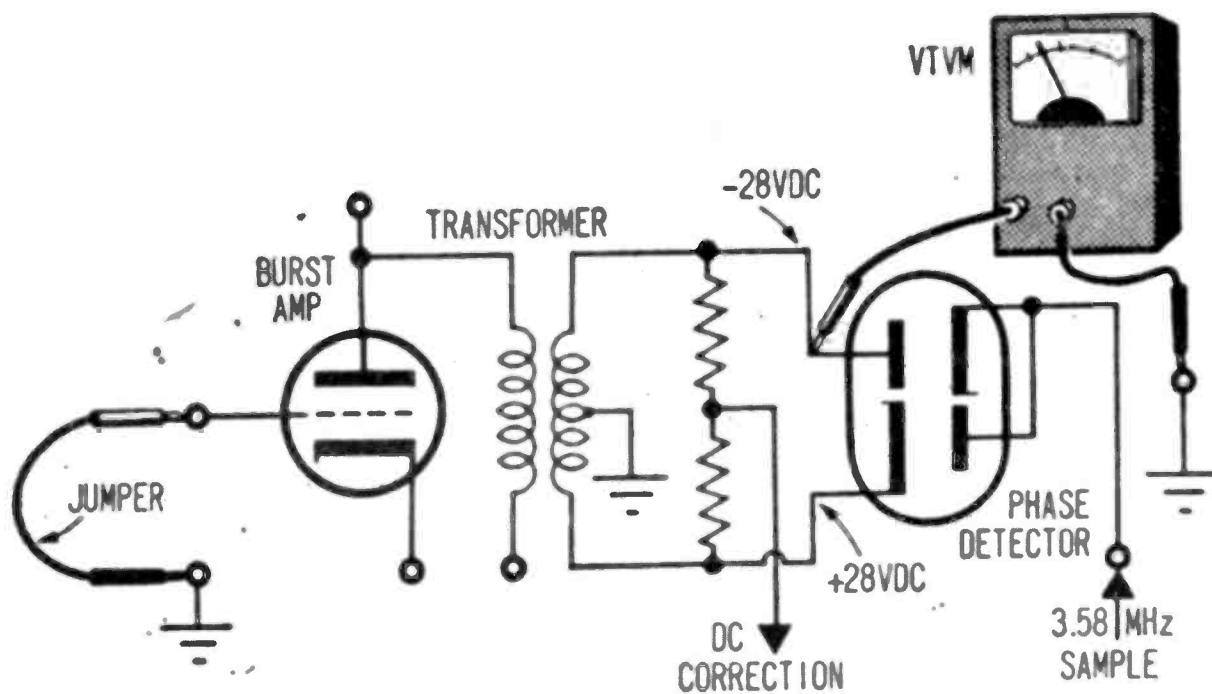

Fig. 10. To determine if Burst Amp and Phase Detector are working properly, ground the Burst Amp grid as shown, then measure the voltages (with a VTVM) on the transformer side of the diode. The actual voltages will vary from set to set, but should be equal and of opposite polarity.

tarded slightly until a normal image is obtained. If these preliminaries don't cure a case of color instability, the back cover of the set is removed for the next step.

Troublesome Tubes. As in most other circuits, tubes account for the bulk of color-sync faults. You can locate tubes (Fig. 5) associated with color sync by examining the set's chroma (or color) board. It's usually a subchassis or printed circuit that bears most circuitry for processing color signals. The layout of a color board used in a recent Westinghouse receiver is shown in Fig. 6. When color sync acts up, check those tubes by substituting known good ones before probing more deeply into the set.

Manufacturers often provide convenient test points on a color chassis to help pinpoint trouble spots. Thus, it's a good idea to obtain the service literature for a particular set if you wish to probe further into a color sync problem.

placed zero volts on the grid of the Reactance Control stage, a voltage which is about right during normal reception. If color sync improves, you have proved that both reactance and oscillator stages are capable of approximately normal operation.

We say "approximate" since color may

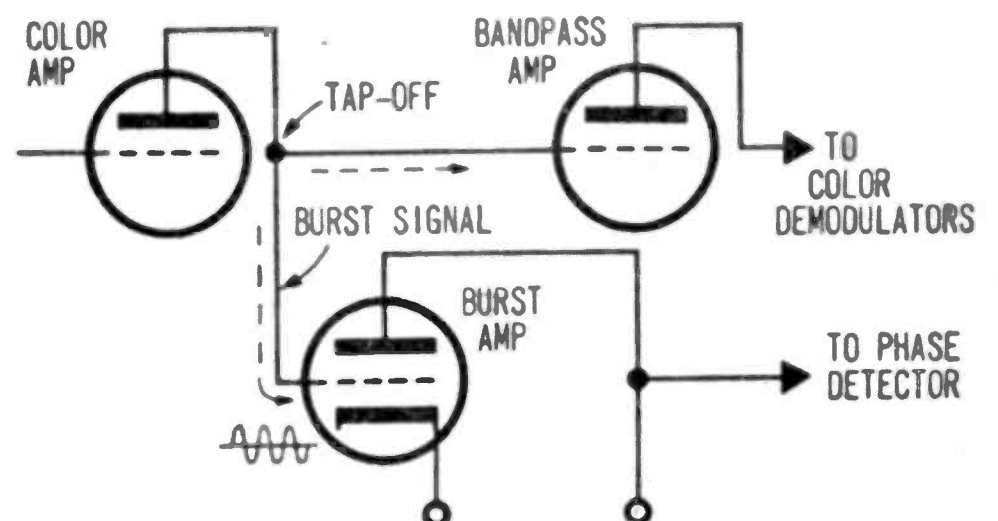

Fig. 11. The next circuit to have a close look at is the Burst Amp. If Phase Detector voltages are incorrect, perhaps the burst signal is being interrupted between Color and Burst Amp. The only way to find out is with a scope.

COLOR WON'T STAY

not lock completely in place, but possibly drift slowly across the screen. If you get this action, shift suspicion to the burst and detector stages. Measure tube-socket values of voltage and resistance to find the faulty component. Leaky capacitors are frequently the trouble, followed by resistors which have changed value (rarely will a 3.58 crystal go bad). Alignment of various coils or transformers in this section (Fig. 9) shouldn't be touched unless you've exhausted all other test possibilities.

Slap In The Phase. One shortcut helps tell whether Phase Detector or Burst Amp is at fault. In Fig. 10 is a simplified schematic of these stages, as used in an RCA color chassis. During operation, the Burst Amp is boosting the received burst signal and applying it to the Phase Detector. Here the signal is split in the transformer leading to a tube with a pair of detector diodes. At the same time, a 3.58 MHz Sample is applied to the other side of the diodes. This circuit com-

(Continued on page 98)

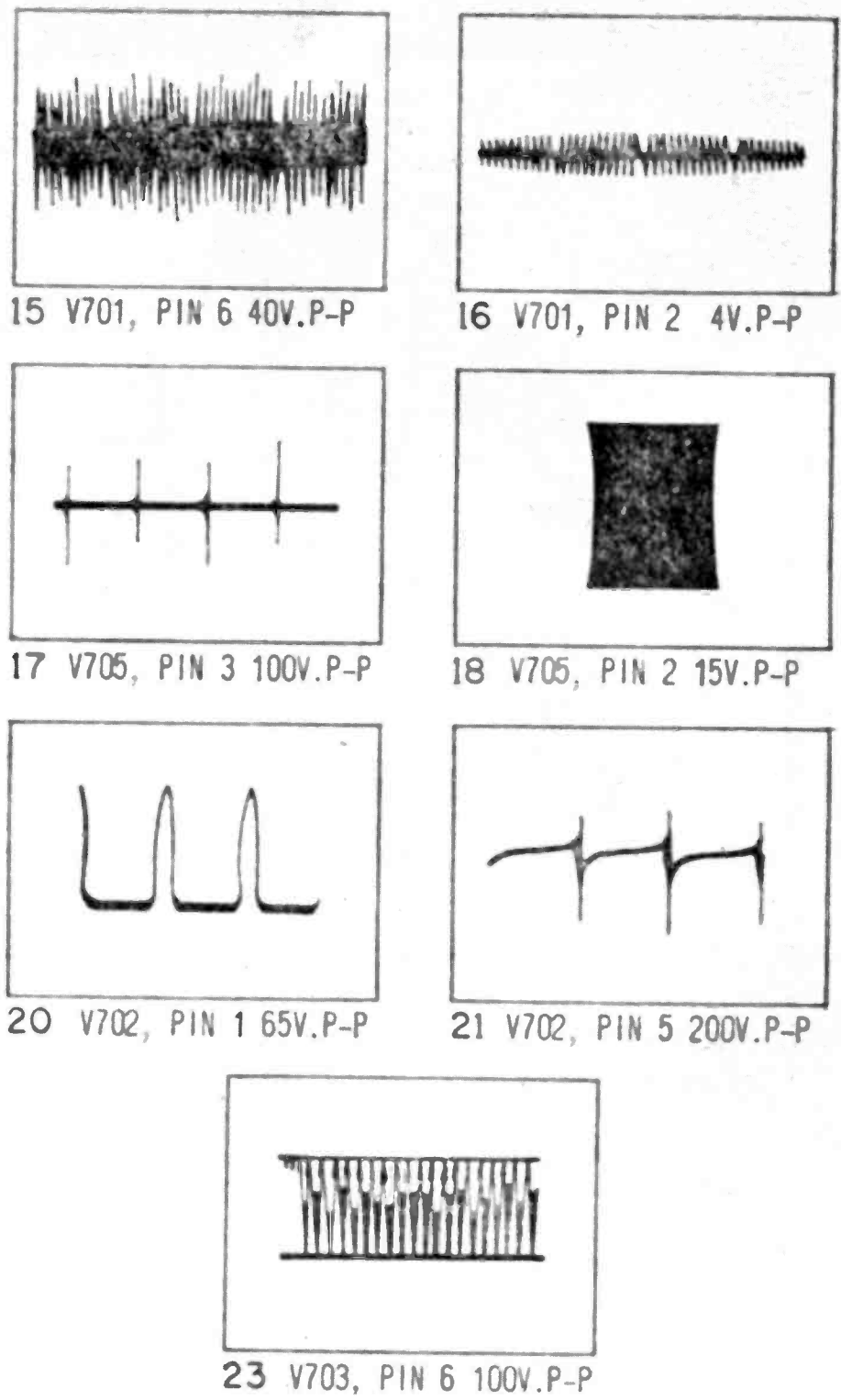
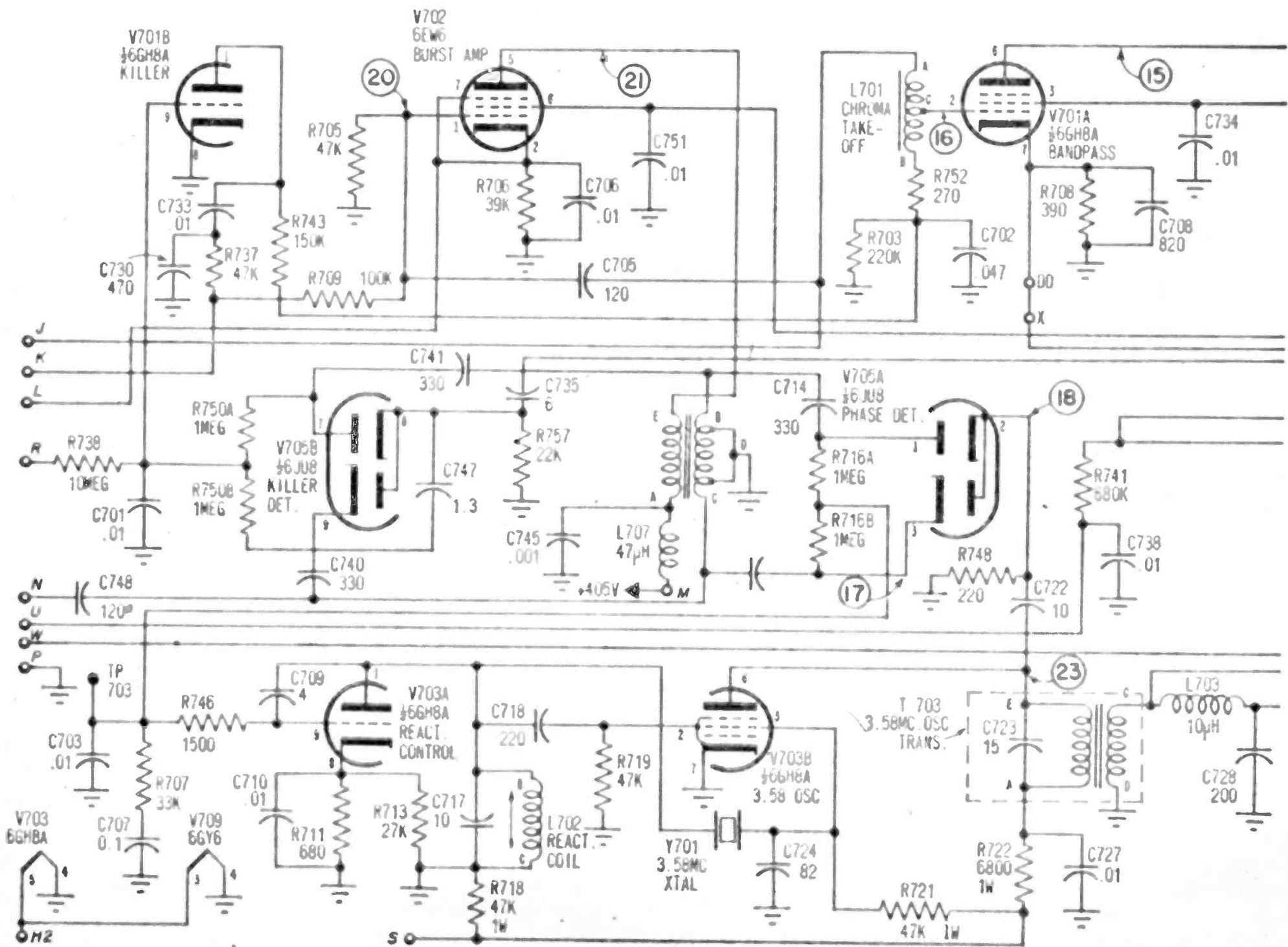

Fig. 12. Typical service literature provides waveforms at different circuit points so that burst and other signals can readily be traced through various stages with an oscilloscope.



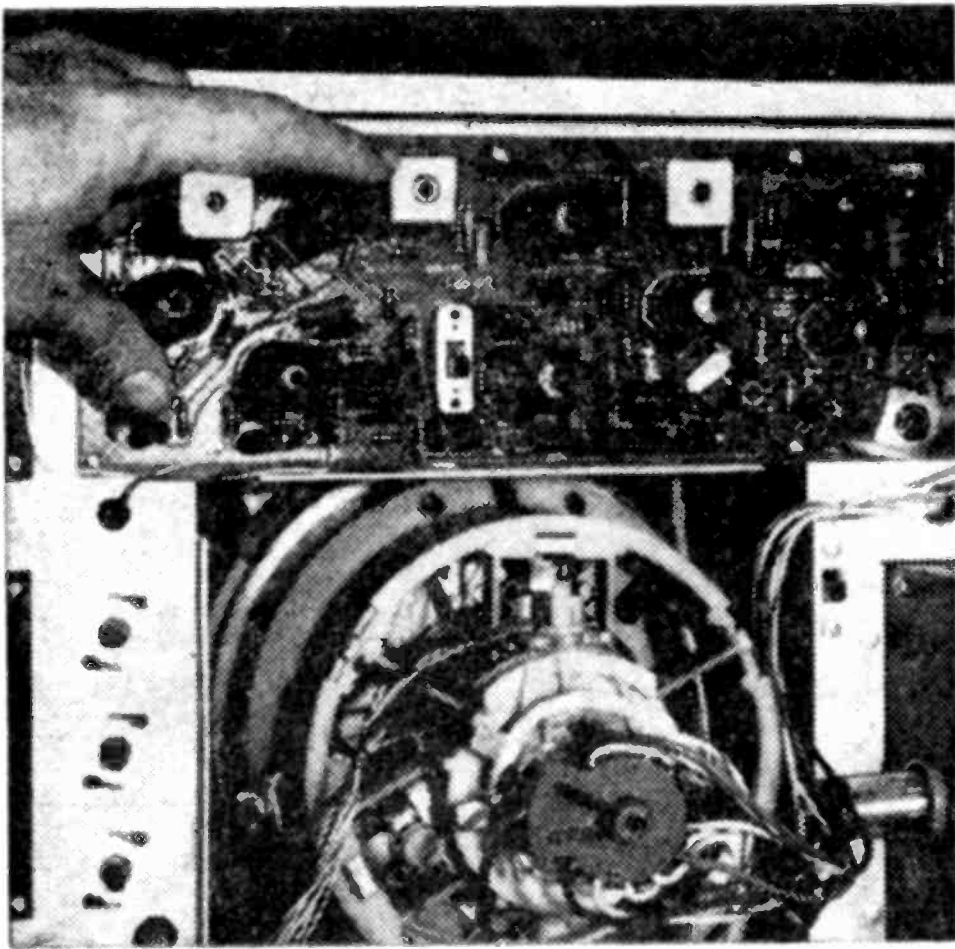

Fig. 9. Alignment of transformers in the color section should not be disturbed since realignment is complicated. However, transformer windings can readily be checked for continuity.

One useful test point indicates whether the fault is in the Burst Amp and Phase Detector stages or the Reactance Control and 3.58 Oscillator stages. If the simplified diagram in Fig. 7 is traced, it is seen that a test point (A) occurs in the grid of the Reactance Control tube. This is the stage that acts like a variable capacitor across the oscillator and continuously adjusts frequency with a DC correction voltage.

The test point enables you to ground the DC correction voltage and observe certain effects. Watch the color picture when you ground the test point with a clip lead to the chassis (Fig. 8). If it improves color sync—color stops moving through the picture—it's a good sign the Reactance Control and oscillator stages are not at fault.

No Reactance Volts. During this test, you removed the action of the Burst Amplifier and Phase Detector from the circuit. Further, in grounding the test point, you

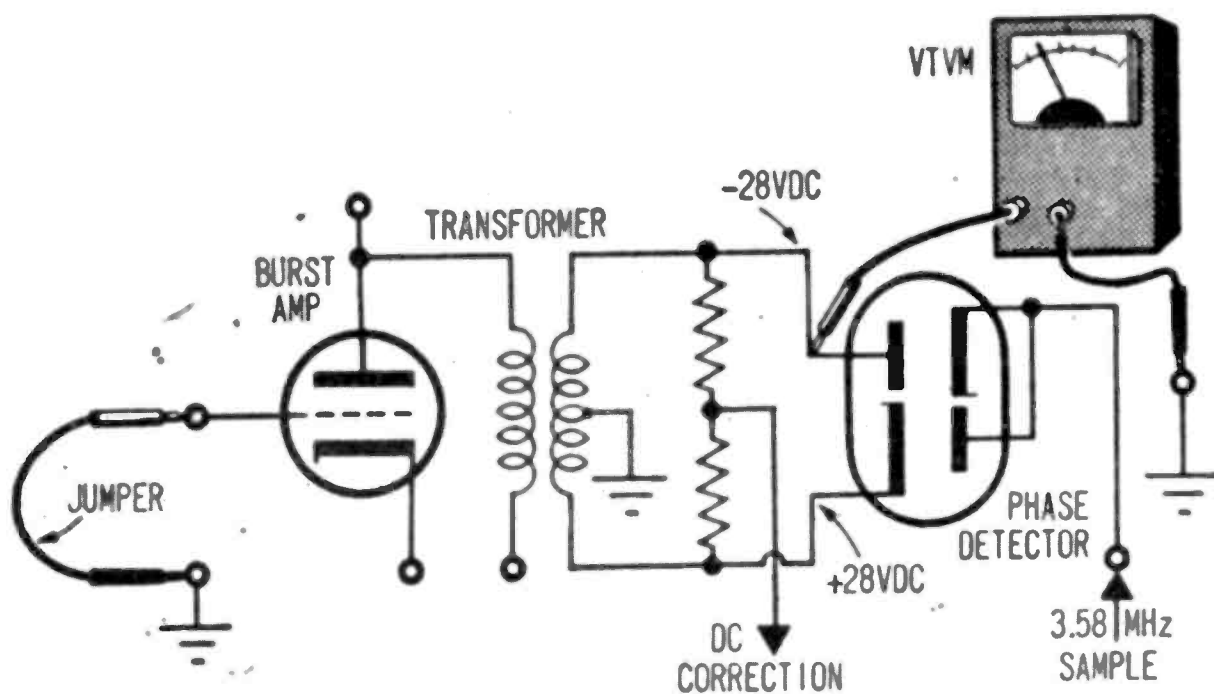

Fig. 10. To determine if Burst Amp and Phase Detector are working properly, ground the Burst Amp grid as shown, then measure the voltages (with a VTVM) on the transformer side of the diode. The actual voltages will vary from set to set, but should be equal and of opposite polarity.

tarded slightly until a normal image is obtained. If these preliminaries don't cure a case of color instability, the back cover of the set is removed for the next step.

Troublesome Tubes. As in most other circuits, tubes account for the bulk of color-sync faults. You can locate tubes (Fig. 5) associated with color sync by examining the set's chroma (or color) board. It's usually a subchassis or printed circuit that bears most circuitry for processing color signals. The layout of a color board used in a recent Westinghouse receiver is shown in Fig. 6. When color sync acts up, check those tubes by substituting known good ones before probing more deeply into the set.

Manufacturers often provide convenient test points on a color chassis to help pinpoint trouble spots. Thus, it's a good idea to obtain the service literature for a particular set if you wish to probe further into a color sync problem.

placed zero volts on the grid of the Reactance Control stage, a voltage which is about right during normal reception. If color sync improves, you have proved that both reactance and oscillator stages are capable of approximately normal operation.

We say "approximate" since color may

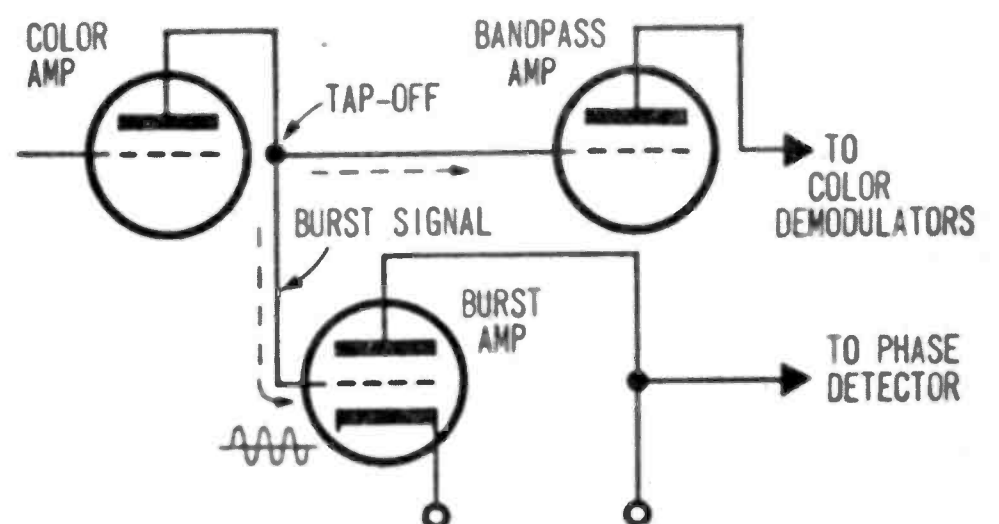
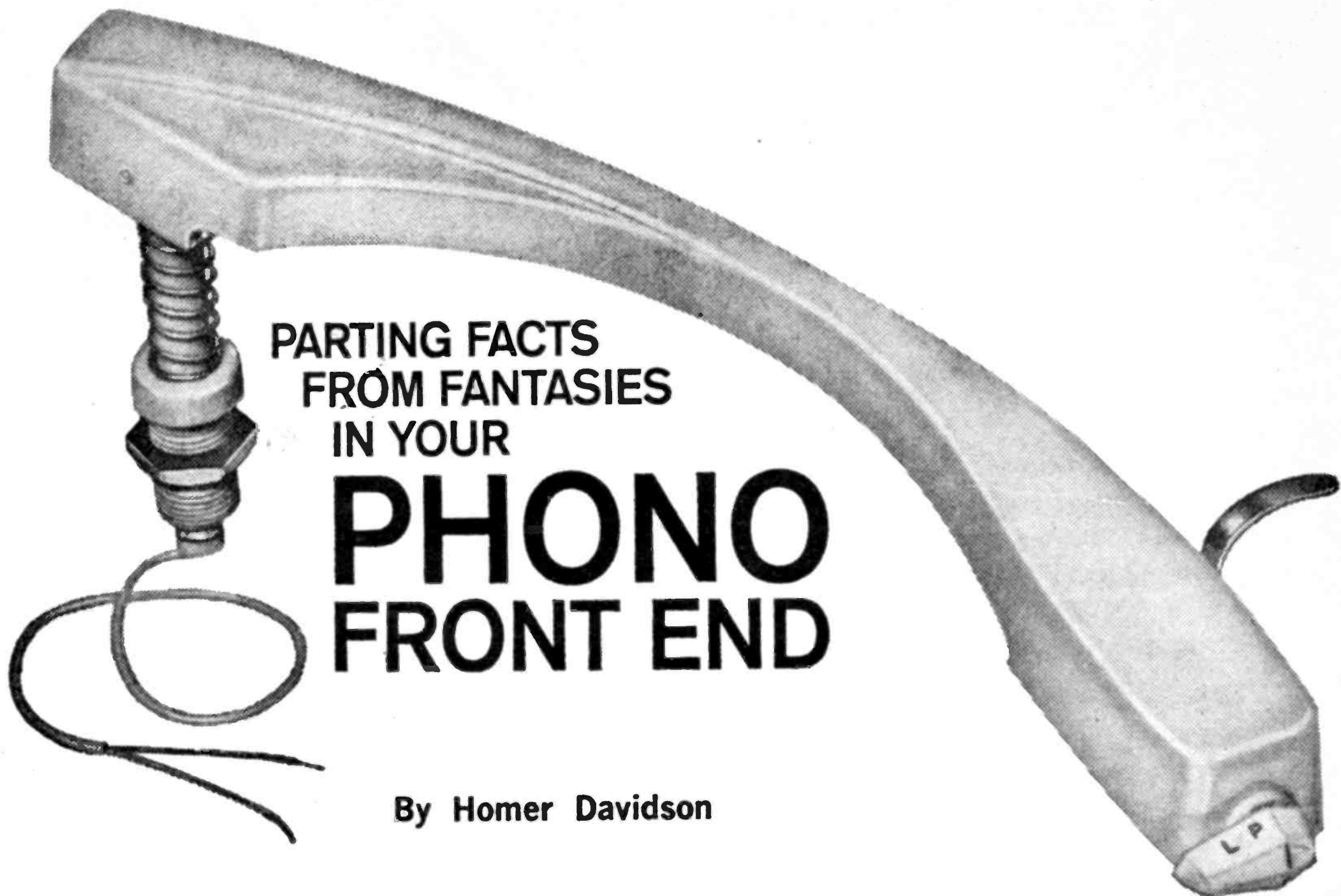

Fig. 11. The next circuit to have a close look at is the Burst Amp. If Phase Detector voltages are incorrect, perhaps the burst signal is being interrupted between Color and Burst Amp. The only way to find out is with a scope.



PARTING FACTS
FROM FANTASIES
IN YOUR
**PHONO
FRONT END**

By Homer Davidson

■ There's lots more to needle, cartridge and record care than meets the eye and these are the items subjected to the most abuse of all the components in a phonograph. The basics of servicing and maintenance of "what's up front" in a phono are simple—once you know them. So come with us as we present the hows and whys essential to keeping your disc show on the road. And if you're an old timer that knows all about it, this may be just the refresher needed to keep you heading right.

First Of All. How do you know that your phono needle (stylus) is defective? To find out, there are several simple tests you can make. If the tone arm of the phonograph slides across the record after setting down, change the stylus. This check should be made on a new (unwanted or unloved) record.

Now take a look at the stylus to see if dirt or dust is lodged between it and cartridge. If there is, brush it out, using a small camel's hair brush.

Play the record once again. Often, dust or dirt will cause mushy music. If there is still no improvement, let's try another check.

Take a new record or one that is clean. Set the changer to manual position, and play

about one inch of the record. See Fig. 1 on the next page. Is the one inch played-space duller looking? If so, replace the stylus.

Other Ways. Another method is to take a clean white cloth and wipe the record after it has been played. If the stylus is defective and cutting the groove, you'll pick up small black record chips (black or dark dust) on the cloth. Replace the defective stylus.

Another way is to take a magnifying glass, like Grandpa used to read with, or a low-power microscope, and take a good look at the tip of the stylus. A sharply-pointed one will chisel out the groove of the record. Maybe there is a flat spot on the point. Replace the stylus in the above cases.

A good stylus will go towards a sharp point, but will be rounded off at the pointed end as shown in Fig. 2.

Check to see if you have excessive noise or scratchy *needle-talk*. This test should also be made on a fairly new record. (Be sure the volume is down when making this check.) Bend down close to the record and you should hear a little *needle-talk* even under good conditions. With a very bad needle or defective record, you can hear the noise from quite a distance.

(Continued overleaf)

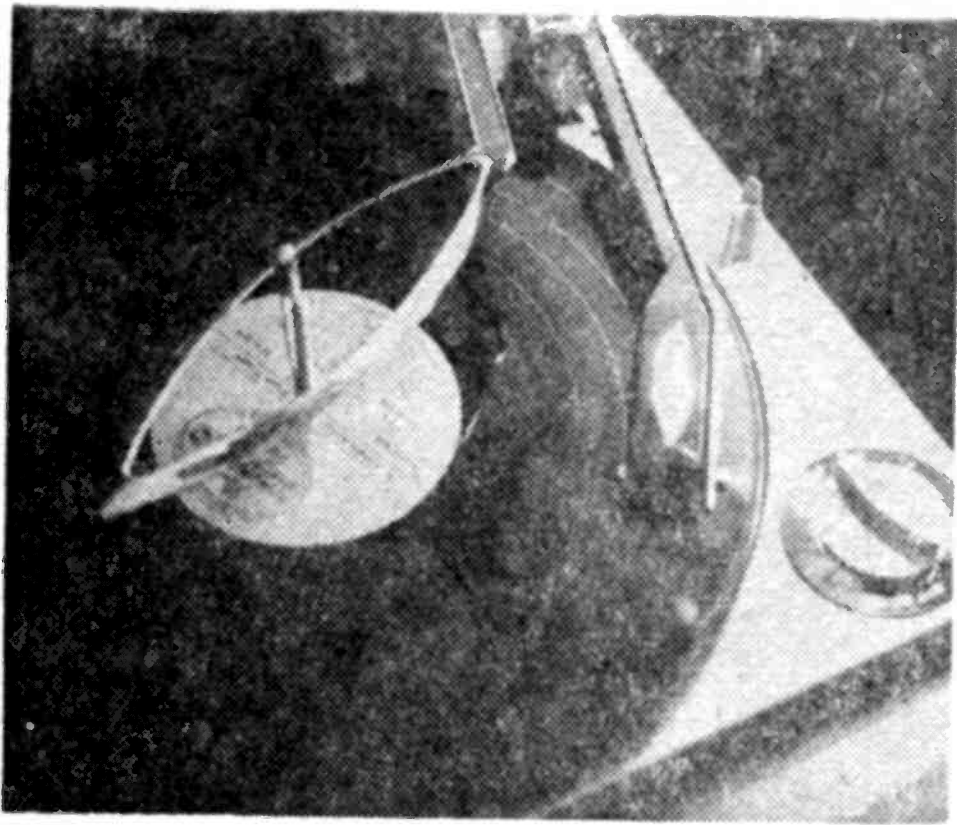

Fig. 1. A chipped or worn stylus will cut the grooves of a record, making them dull-looking; if so, better get a new stylus.

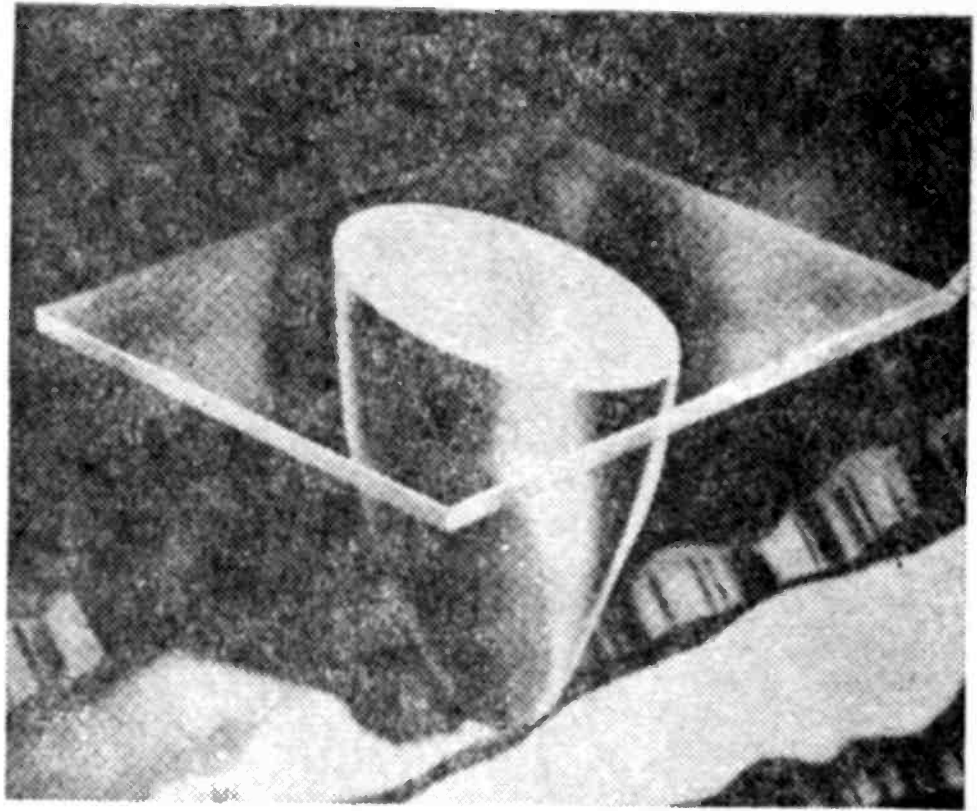

Fig. 2. The tip of a good stylus is actually a rounded "ball" that won't chisel into the soft vinyl record groove.



PHONO FRONT END

Record Wear. Most phonograph records will last for years if proper care is used. Before any record is played, wipe it off with a *record* cloth. Handle all records by the edge. Don't grasp them in the middle or with one hand. Little hands should not handle expensive records. Sticky fingers will smear the record with grease which will lodge dust and dirt into the record groove.

Don't leave a stack of records on the spindle center post or turntable after shut-

ting off the record player. They will start to warp and on a very warm day may begin to droop. Phonograph records left on the turntable will also collect dust. Return all records to their jackets or record cabinet.

Watch Your Speed. Watch for correct speed settings and correct stylus position for the record being played. For instance, if a 78 stylus is played on a 45 or 33 $\frac{1}{3}$ record, damage can be done. Also the pickup arm will tend to skate on the record.

Can a new record be defective? It certainly can be. Check for a poor cut in the record grooves. Also, if the starting cut is too shallow or narrow, the pickup arm may drop off the record or start ahead of the music (Fig. 3). Check to see if the finish

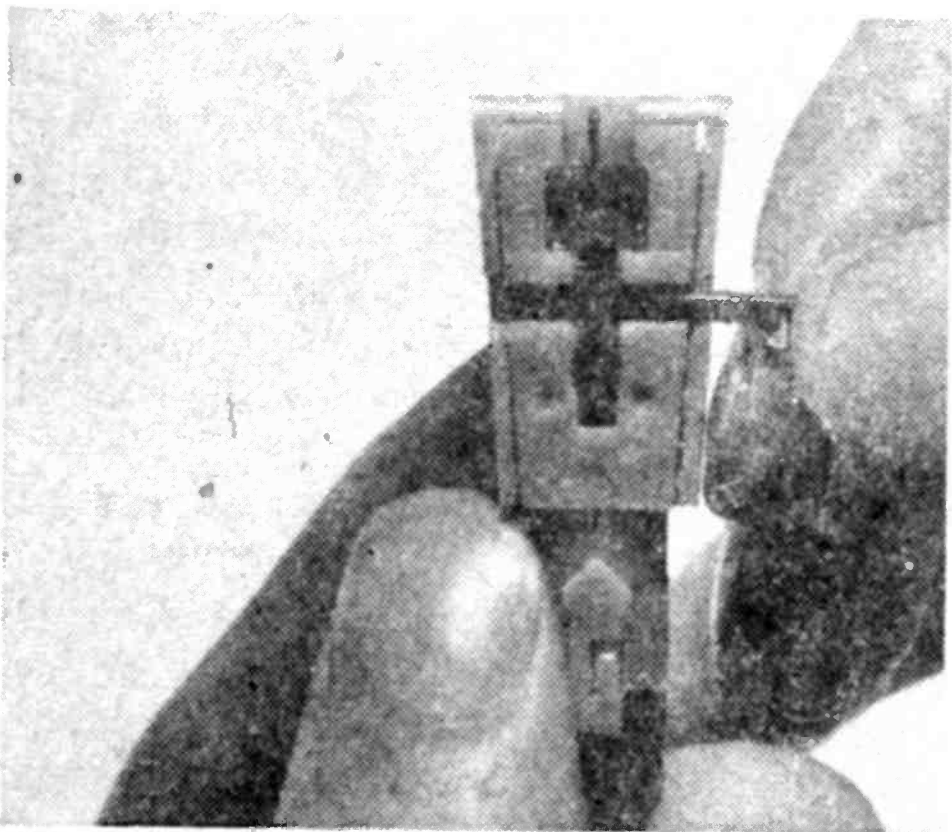

Fig. 6. On this popular cartridge, the stylus shank simply snaps into the plastic cartridge body.

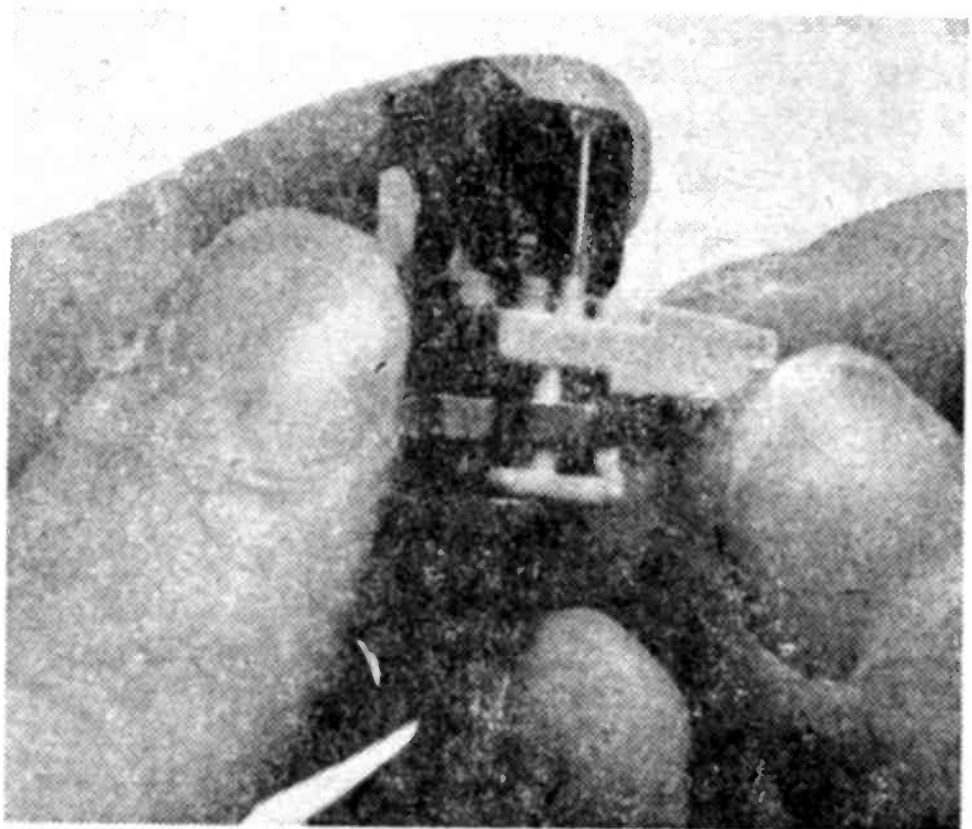

Fig. 7. To remove the stylus assembly from this type cartridge, position the turnover lever as shown.



Fig. 3. Poor sound can also be the fault of the record even if it's a new one. Compare sound against other records.

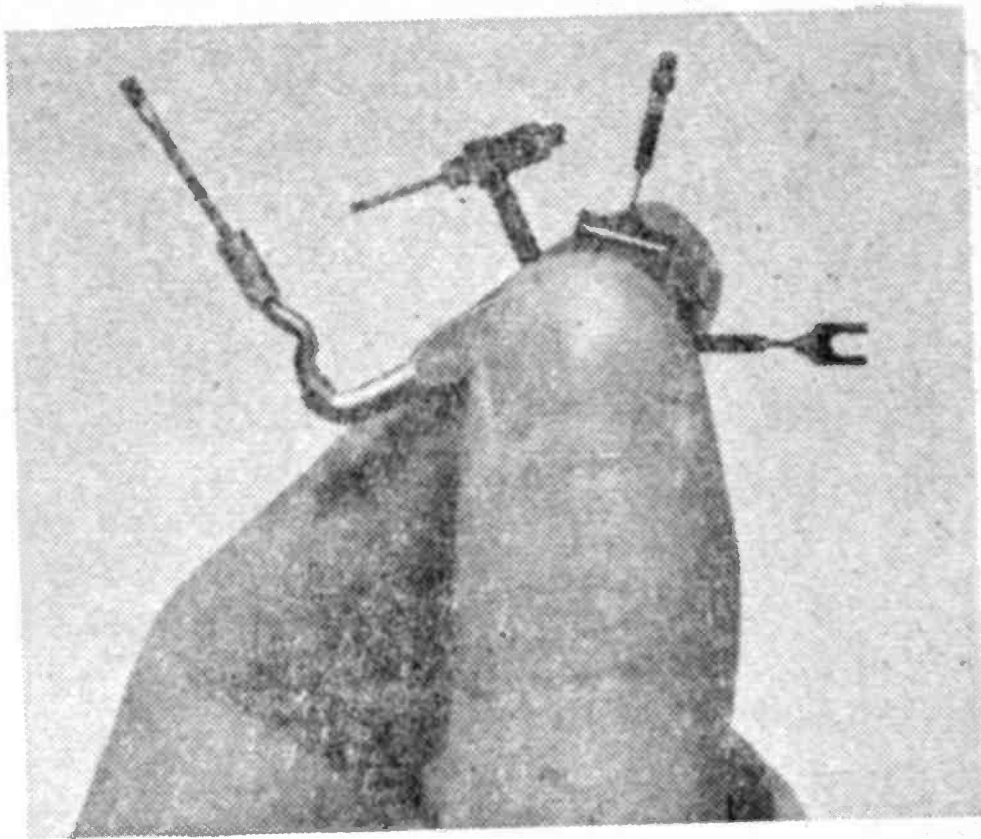

Fig. 4. Dozens of different types of styli can make for confusion on your part. Four typical styli are shown here.

track of the record is triggering the changer. If other records play at these settings, you have purchased a defective record.

In case a new record doesn't drop down from the center post, it's possible the center hole is not perfectly round. Generally a defective record will stand alone while all other records play perfectly.

To avoid getting a defective one, select a new record in its original sealed jacket. One that has been opened may have been played several times before. Also, buy only good known brand records to make sure you don't get stung.

Diamond Or Sapphire. What type of replacement stylus should you buy? There are pros and cons on whether to buy a dia-

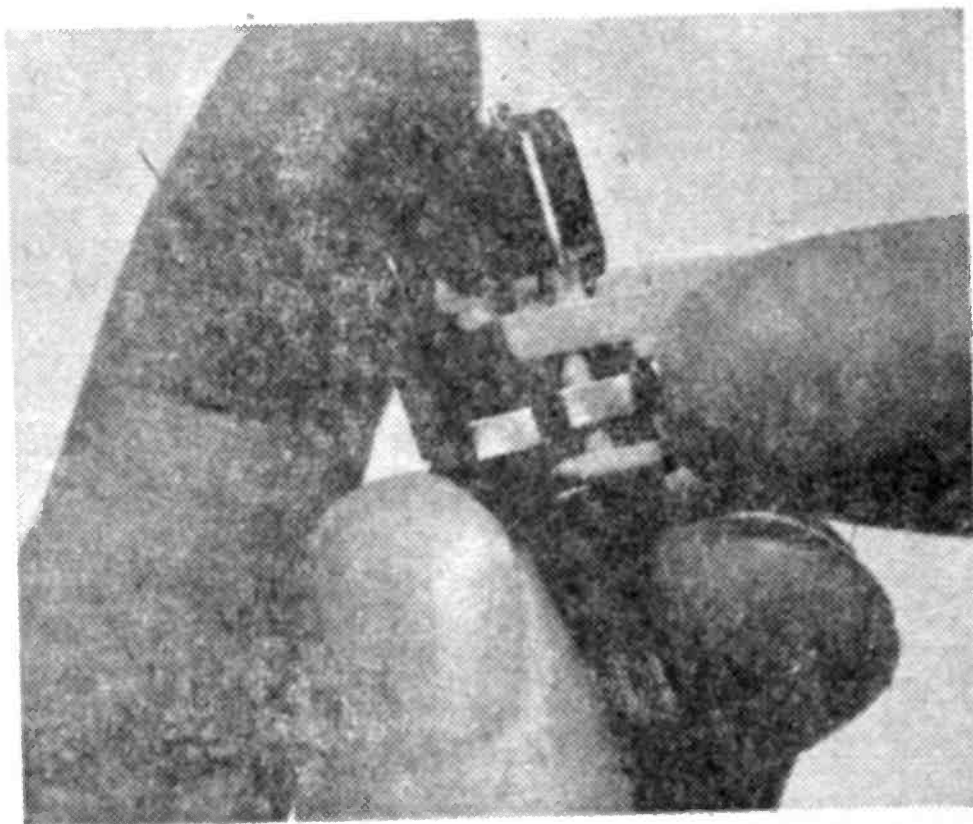

Fig. 5. When removing the stylus for replacement, first check to see how it is attached to the cartridge.

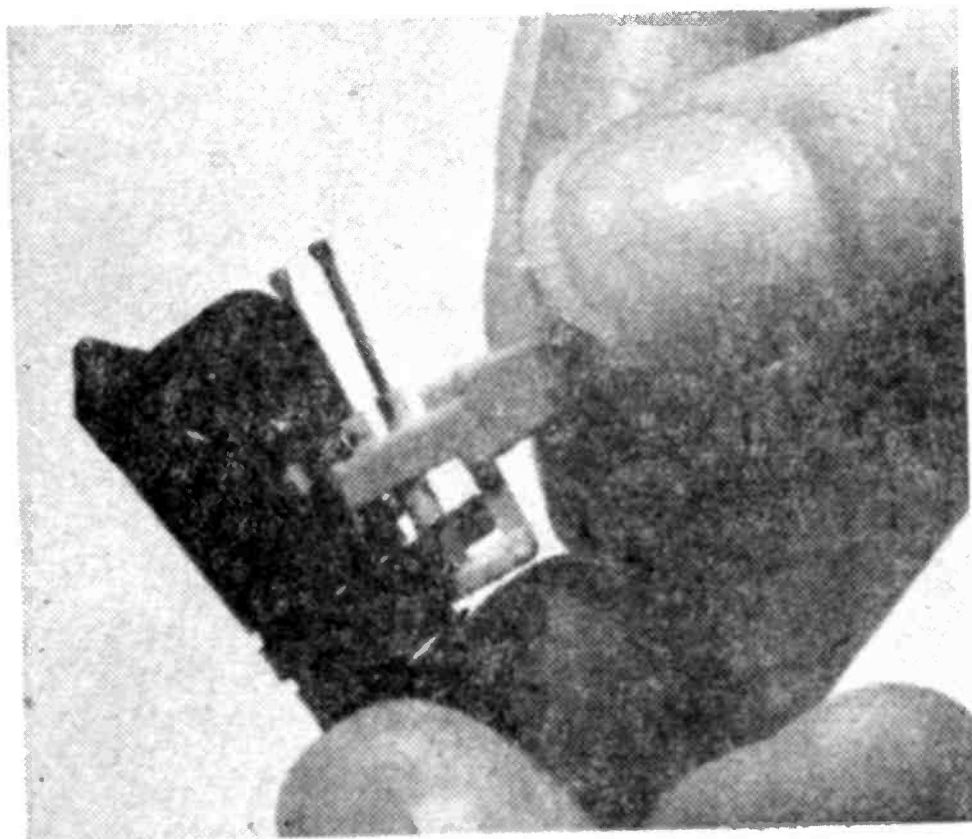

Fig. 8. Gently pull up and away on the stylus assembly; the metal clip gives way with very little pressure.

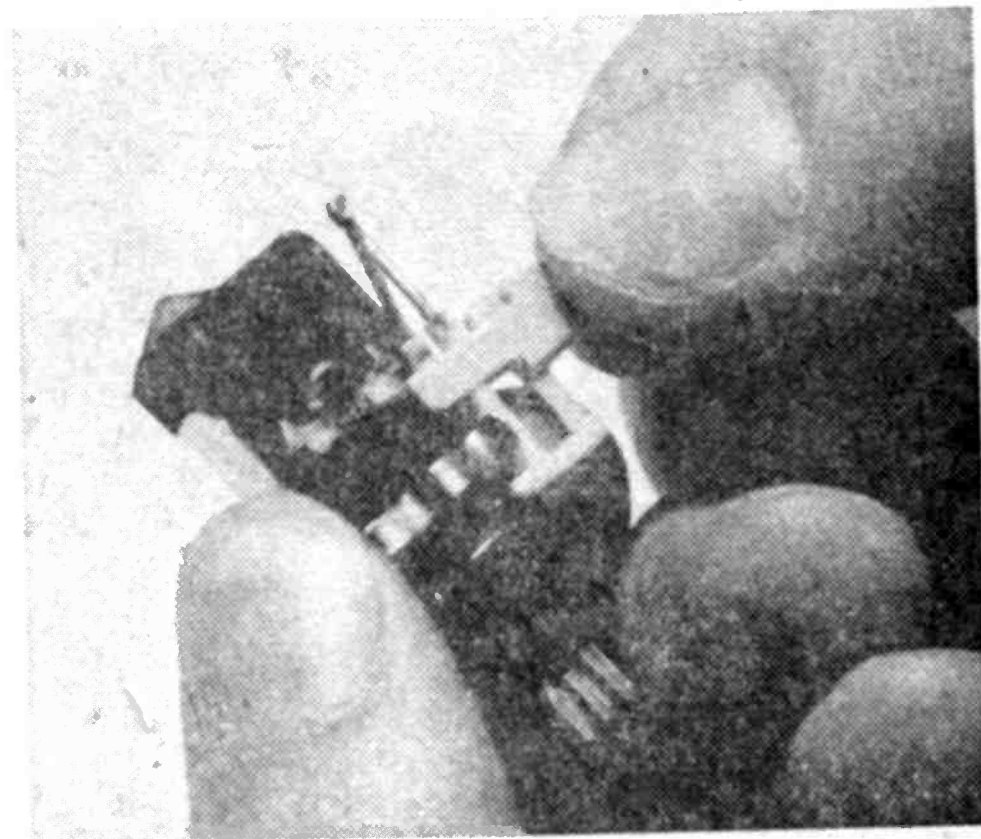

Fig. 9. Pull the stylus assembly clear being very careful not to put strain on the stylus shank or "saddle."

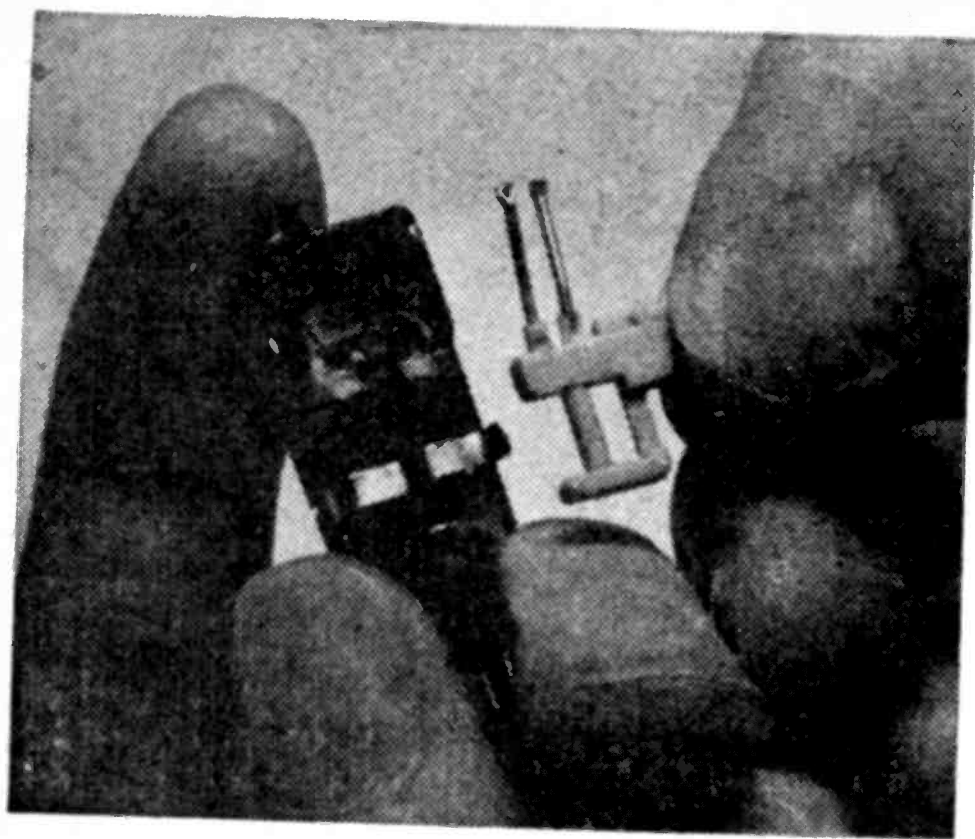

Fig. 10. Replacement of this type of stylus is exactly the reverse process of the removal procedure.

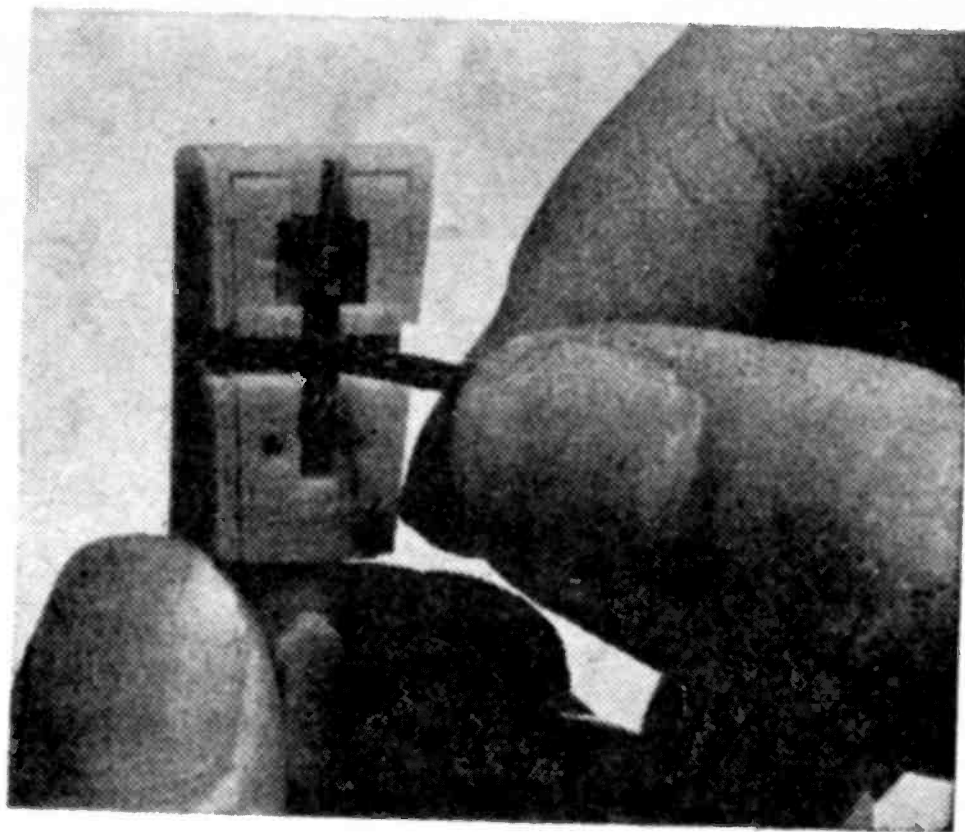

Fig. 11. To remove the stylus assembly in this type of phono cartridge, first turn the stylus-flip lever straight out.



PHONO FRONT END

mond or sapphire stylus. Don't replace the "small fry" phono stylus with a diamond. You're throwing good money away.

A new diamond stylus will give a great many more plays than the sapphire. But then diamond, as every girl knows, is more costly than sapphire. The sapphire stylus will cost from \$1.50 to \$4.50, while the diamond will vary from \$4.95 on upwards. However, on an hours-of-play-per-dollar basis, the diamond stylus outshines them all. A handful of

typical and vastly different replacement styli are shown in Fig. 4.

Some people get more hours per stylus than others. But this is the choice of the operator. One person may hear a worn stylus before another.

Some hi-fi bugs will replace the stylus when it has less than 500 plays. Other music enthusiasts replace the stylus four or five times a year—with the seasons.

On really good records, a diamond stylus should be used. Extra record care can save you money.

Stylus Replacement. Can you replace your own stylus? Certainly, by knowing how and using a little care. Pull the arm up and take a glance at the stylus and cartridge.

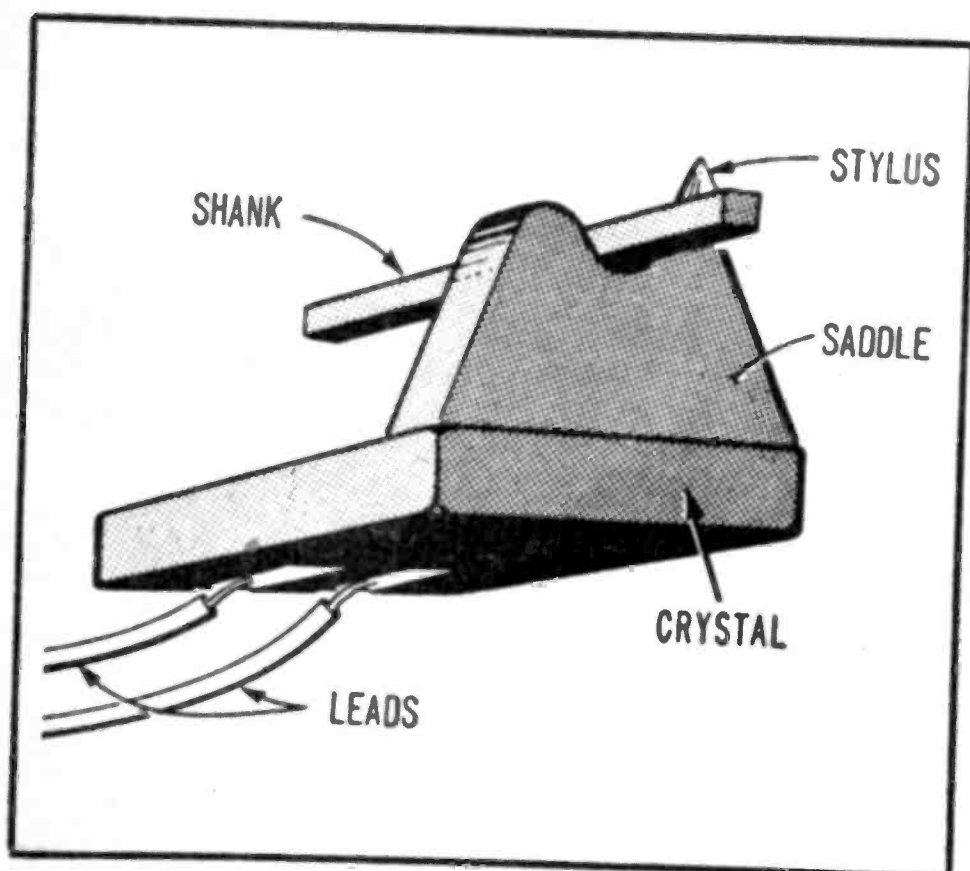

Fig. 15. Stylus shank rides in saddle which is connected to the cartridge element that turns groove wiggle into sound.

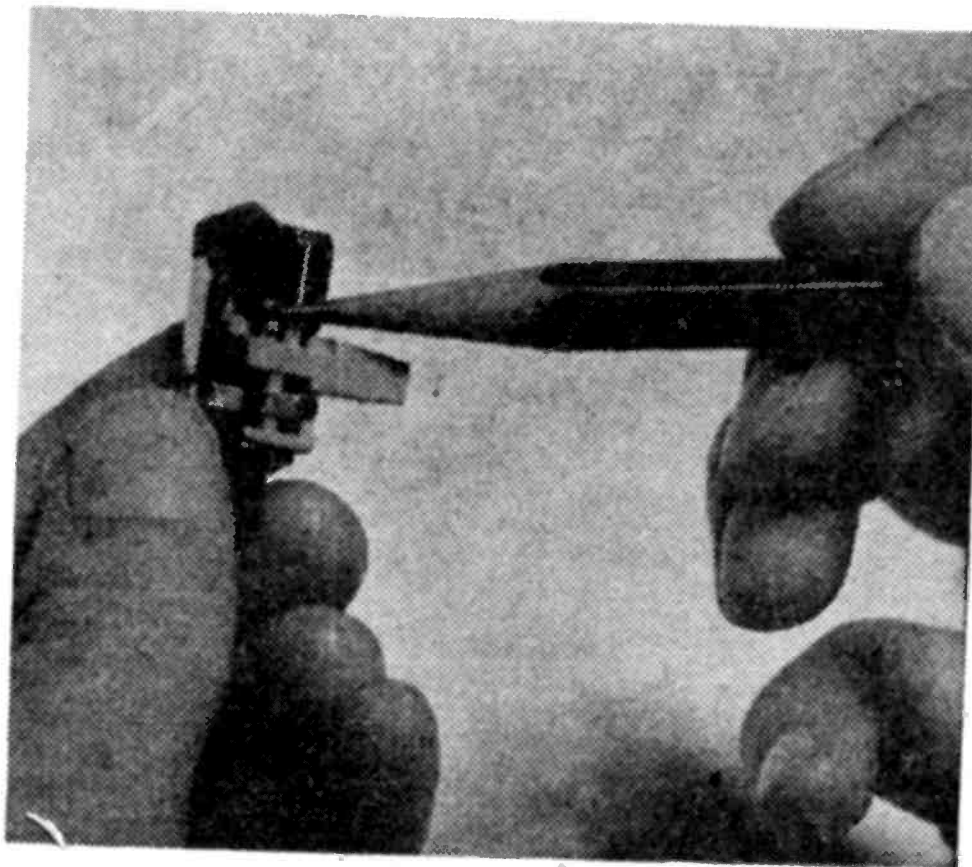

Fig. 16. The pencil points to the U-shaped saddle in a typical cartridge. Be sure stylus shank is properly seated in saddle.

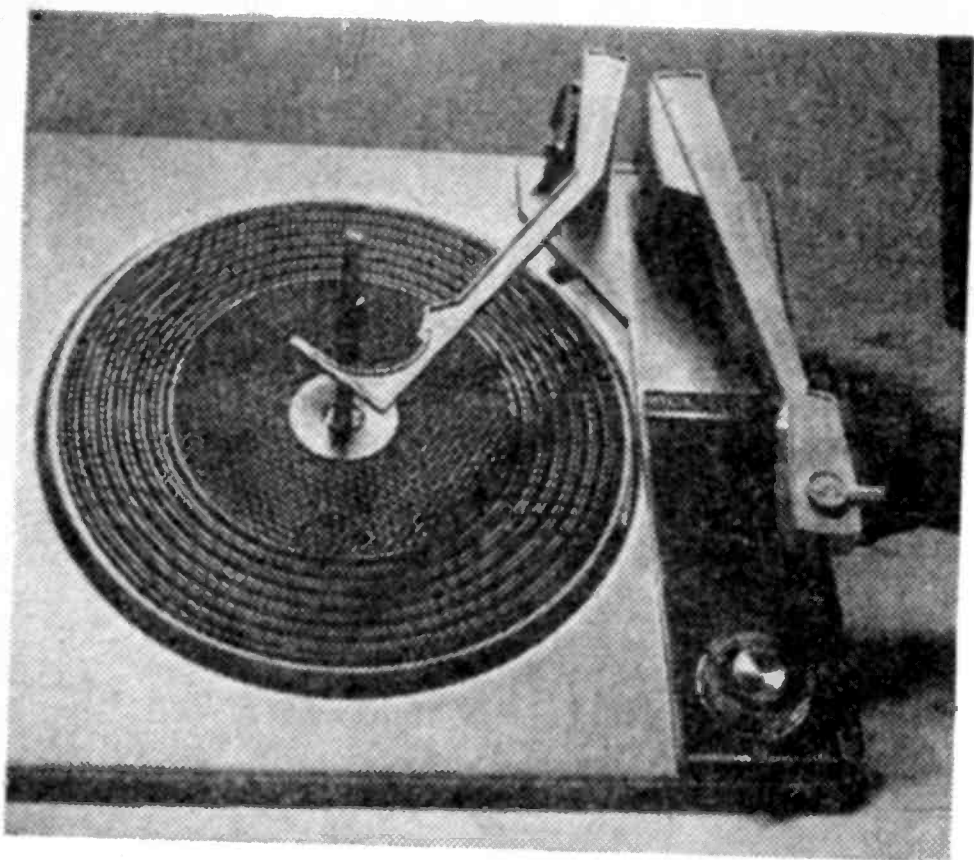

Fig. 19. Using a changer in "manual," be careful not to drop arm as record, stylus, and cartridge may be damaged.



PHONO FRONT END

replacement stylus carton for further directions.

Fragile-Don't Drop. One thing to be careful of—don't damage the cartridge. If you do, you may end up spending a few unnecessary dollars. The stylus and also the stylus assembly are extremely vulnerable, so exercise care here, too.

Take a close look at the front end of the cartridge for a "U" shaped saddle (shown in Fig. 15). This saddle, or plastic piece, goes down into the cartridge and fastens to

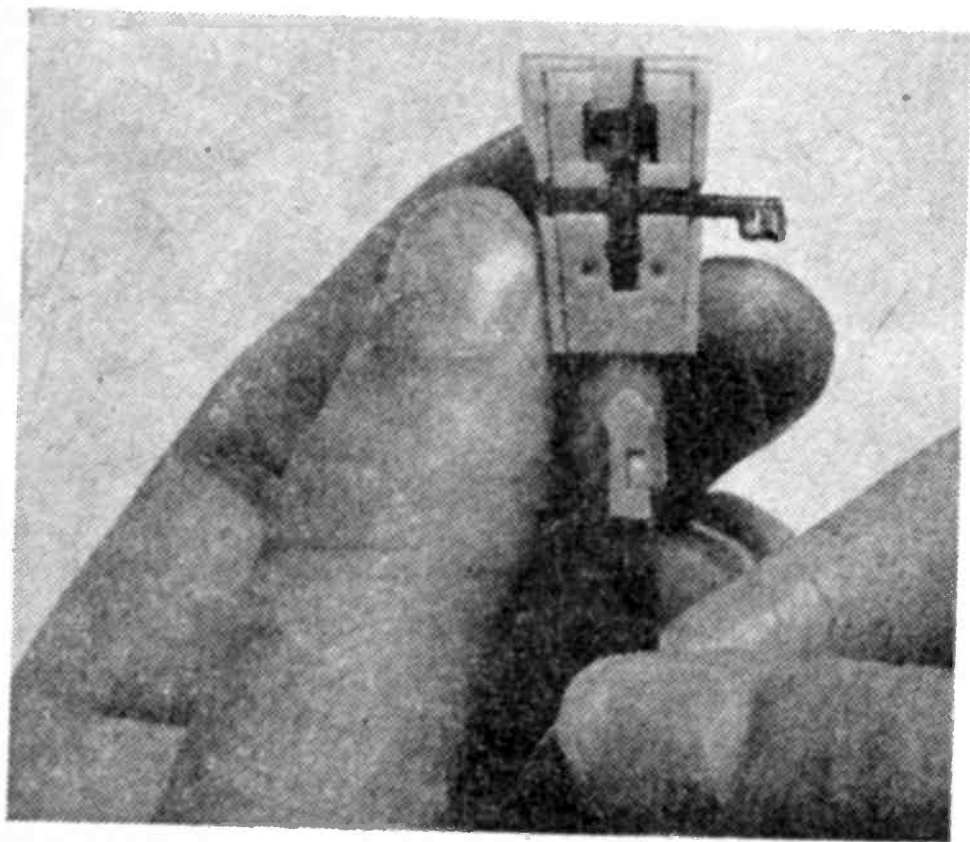

Fig. 22. On this type cartridge, the connecting wires are soldered to a small adapter which then plugs on to the cartridge.

the crystal element. Do not put any pressure on or disturb the saddle: accidentally dropping the pickup arm may also destroy or crack the cartridge.

The defective stylus should be removed and taken to a record shop or TV dealer for replacement. If it has broken into several pieces, take all of them with you to help identify the part.

You can also locate the stylus replacement part number by referring to the manufacturer's operation booklet. If the booklet is lost, look at the back of the console or underneath the back cover for a model number. If possible, the original stylus should be replaced with one carrying the same part number. But in case the brochure has been thrown away and the model number of the phonograph torn off, take the old stylus with you.

In A Haystack. Perhaps the stylus has dropped out and can't be found; draw the outline of it as you remember it. Since there are dozens of different styli types, you're not likely to describe it properly and hope to return with the right one.

It is wise to scotch- or mask-tape the old stylus carton number to the back of the record compartment. The next time you need a new one, the information is close at hand. Don't leave the whole carton in the record compartment; during cleaning it can easily be thrown away.

After the stylus has been replaced, be sure its shank is lying in the "U" shaped saddle shown in Fig. 16. The stylus might be bent out of place, not touching the saddle—the result will be no music. A lot of styli are destroyed or lost when the cleaning cloth snags it during routine dusting.

It may be rather difficult to replace the stylus if the pickup arm will only pull up a few inches. In this case, drop the phono cartridge down by loosening the two side mounting screws and then replace the stylus.

Cartridge Check. Before removing the stylus, always check to see if the cartridge is functioning. Take your thumb or finger and lightly draw across the stylus. You should hear a thumping or rumbling noise. If so, the cartridge and amplifier are working.

In case there is no noise at all, the cartridge, amplifier or speaker is dead. Turn the volume on the amplifier wide open. If a hum is heard, suspect a defective cartridge.

Remove the cartridge hook-up wires and place a finger or the blade of a small screwdriver against one of the unshielded wires.

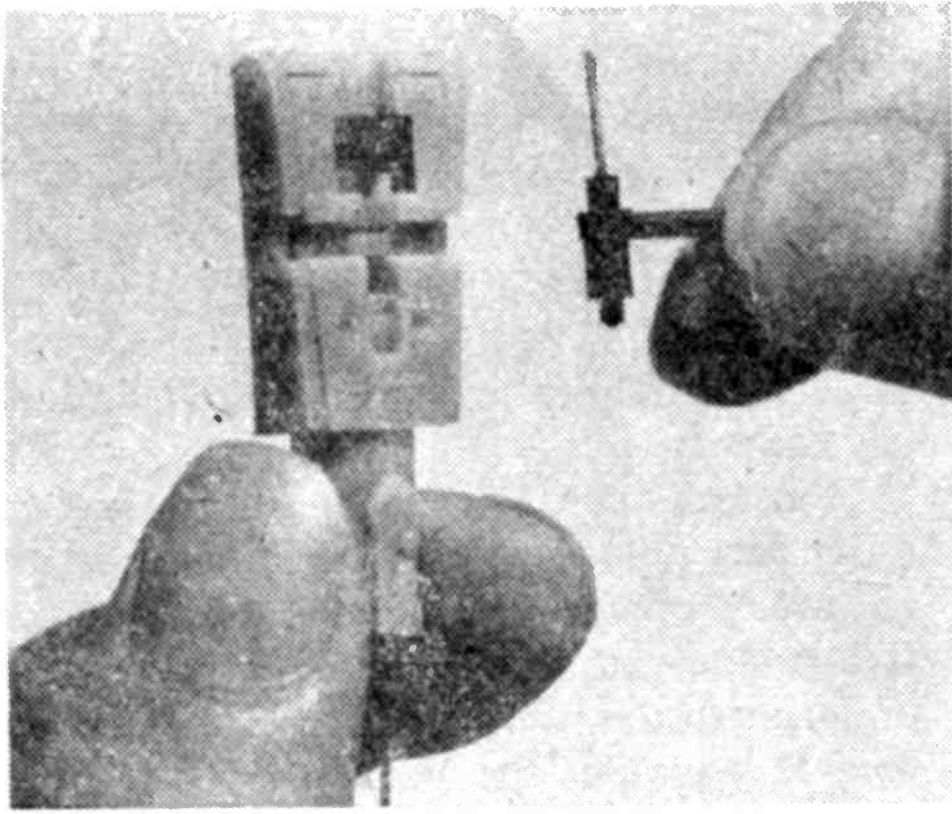

Fig. 12. Then pull it straight away from the cartridge body. To replace the stylus, use the reverse procedure.

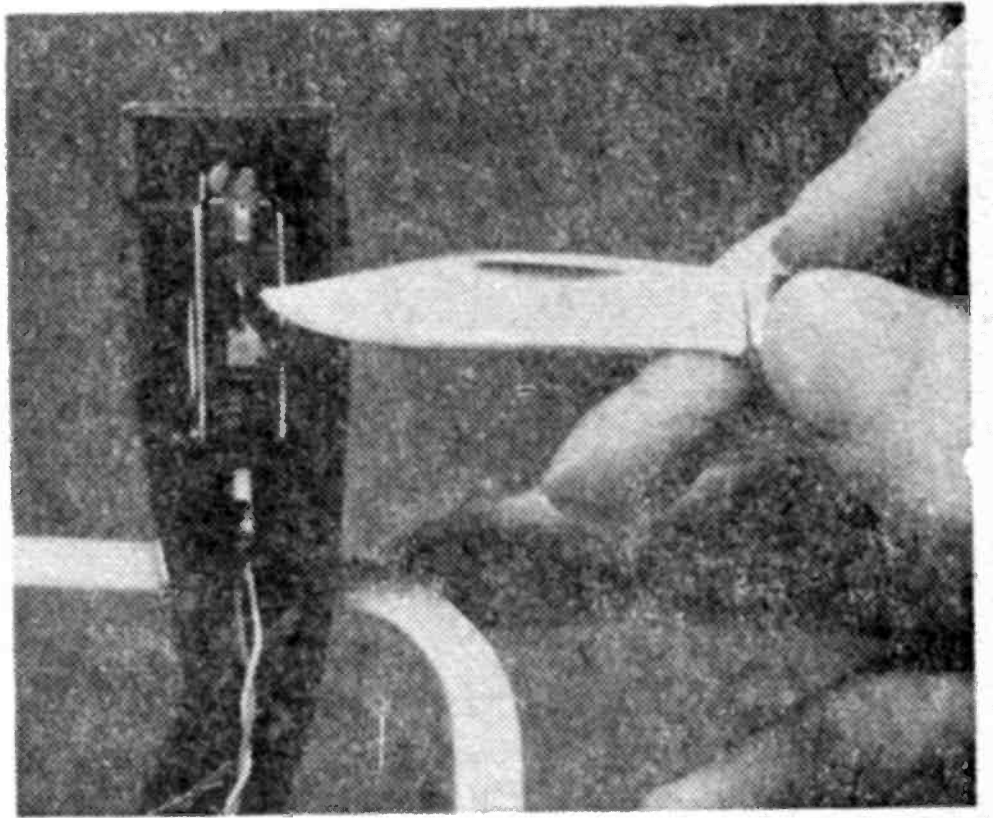

Fig. 13. Another type of stylus mounts on a rubber grommet and can be removed by carefully popping it off with a knife.

Some styli are held down with a metal clip as in Fig. 5; some snap into position as in Fig. 6. Others plug into a slot or are bolted in place with a small nut. With a steady hand, anyone can replace a stylus. If nervous, let someone else do it.

Figs. 7-10 show you how to change a stylus in a clip type of cartridge. There are many types of styli on the market but they all replace fairly easily. Figs. 11-13 shows another typical stylus replacement procedure. In some cases it may be necessary to drop the cartridge out of the holder before the stylus can be replaced, as seen in Fig. 14.

Instruction booklets that come with the phonograph will illustrate how to replace the stylus. Look at the instructions on the

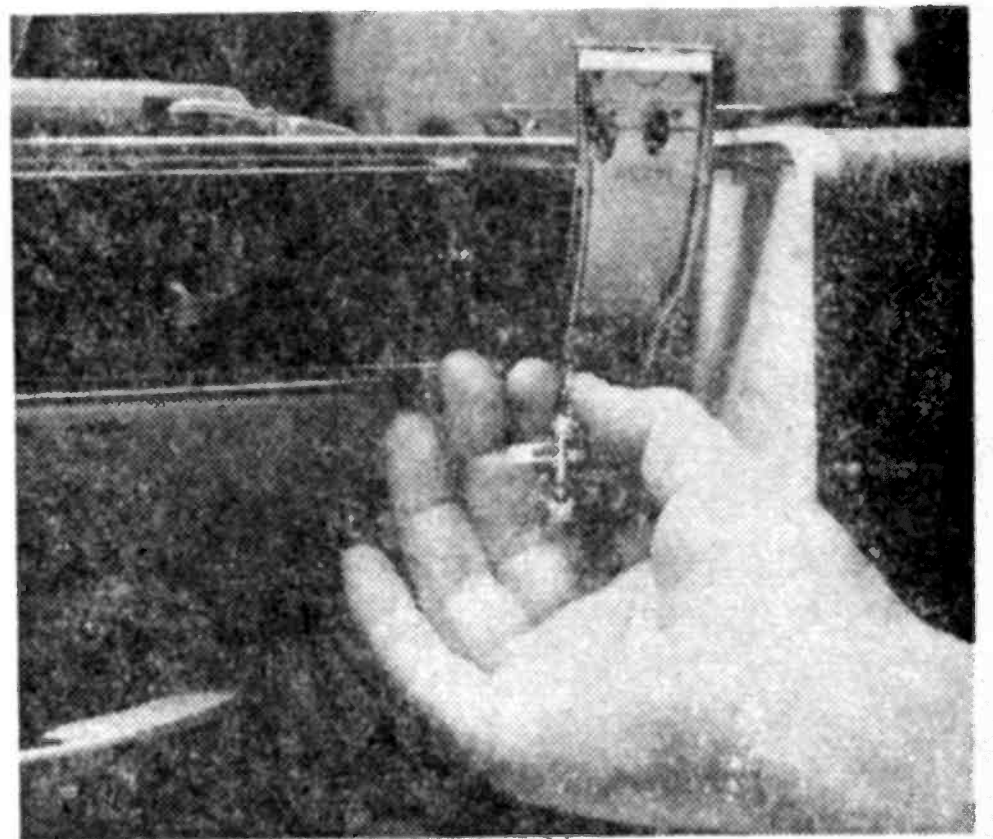

Fig. 14. If the tone-arm has limited vertical movement, cartridge can be removed for easier stylus replacement.

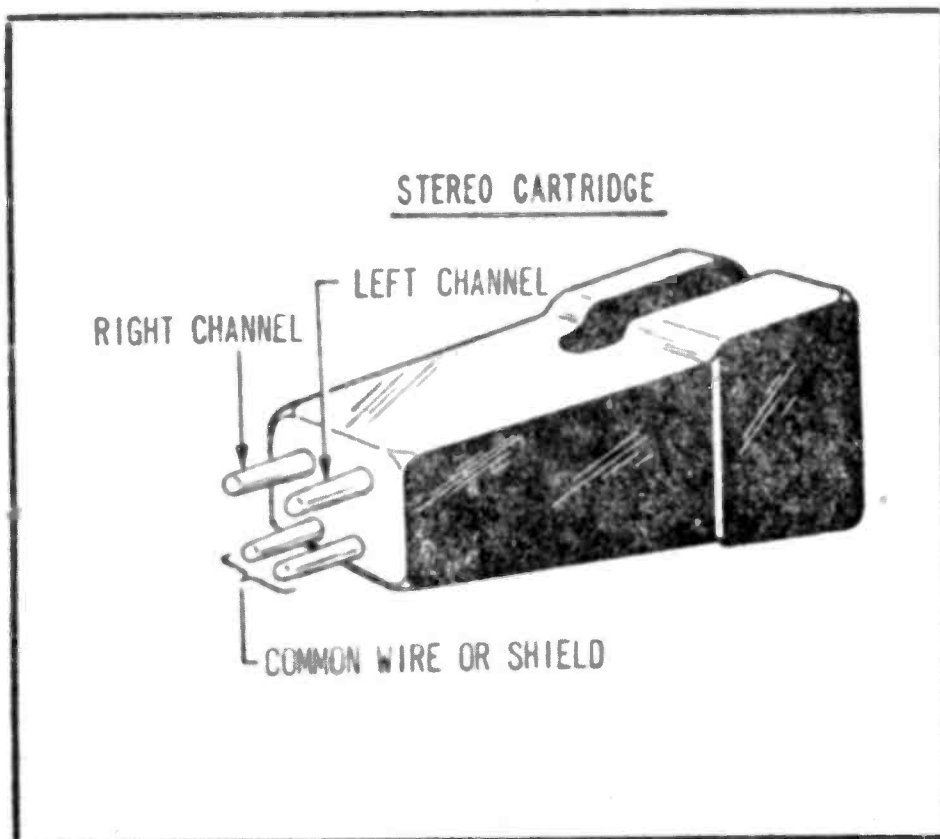

Fig. 17. Typical stereo cartridge has four terminals but only three connecting wires since ground connection is shared.

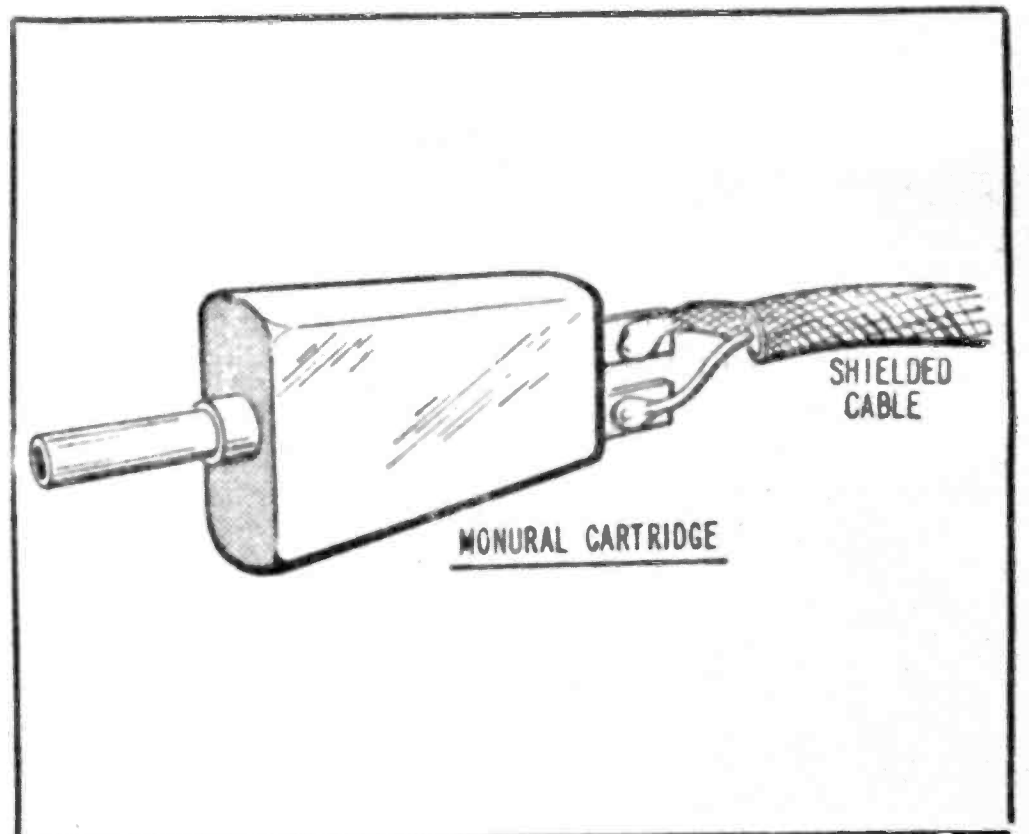

Fig. 18. Mono cartridge is usually hooked up with a shielded cable though in cheapies, it may be just a twisted pair.

You should hear a loud hum. If so, the cartridge is defective. If not, the amplifier or speaker is dead.

There may be two, three or four wires leading to the phono cartridge. The monaural cartridge has only two wires connected to it, as shown in Fig. 17. It may consist of a small shielded cable. Some low-priced phonographs have two separate, unshielded wires.

A phono cartridge with three or four wires indicates a stereo unit. Generally, the ground or shielded wire goes to each side of the cartridge with the "hot" or grid wires being inside of the braided shield, as indicated in Fig. 18.

Defective Cartridge. A defective phono cartridge may be cracked, become weak, and produce distorted, intermittent or mushy sound. The weak or dead cartridge will produce mushy or no sound in the speaker. A cracked cartridge will work intermittently. A cracked cartridge may result from dropping the pickup arm. See Fig. 19.

It is possible to have distortion or intermittent pickup in only one stereo channel. You can isolate the cartridge by switching the two channel hook-up cables. Either switch the cable at the amplifier or the cartridge hook-up wires.

For instance, if the left channel is good and the right channel is mushy, distorted, or intermittent, switch the outside cartridge hook-up wires. If the right channel is still inoperative, you know the cartridge must be replaced.

Intermittent. Now check for intermittent conditions while the switched wires are in this position. Simply place a new record on the turntable and apply a little pressure on the pickup arm. Be careful and use one finger to push up and down on the pickup arm. The intermittent cartridge will snap off and on with intermittent music. In case the amplifier is defective, a good place to start is to check all tubes.

Replacing The Cartridge. Some phono cartridges are bolted to the pickup arm while others snap into position. Hold the pickup arm up where you can see the cartridge. Usually, mounting screws will be located on each side of the cartridge assembly. A short Phillips screwdriver may be needed to get to the screws. Snap-in type cartridges will pull down from the front end of the unit.

Other turn-over cartridges may be removed by first removing the small set-screw in the turn-over knob. A typical turn-over

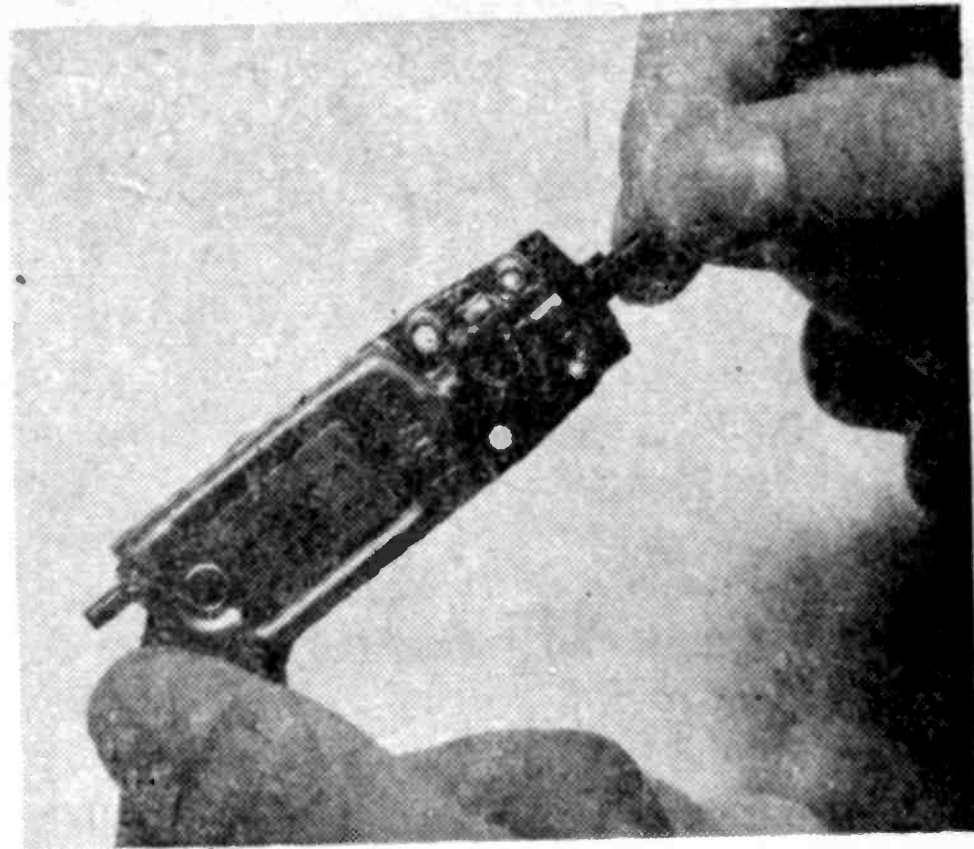

Fig. 20. Old turnover type crystal cartridge mounts and pivots on front shaft; it's removed by taking turnover knob off.

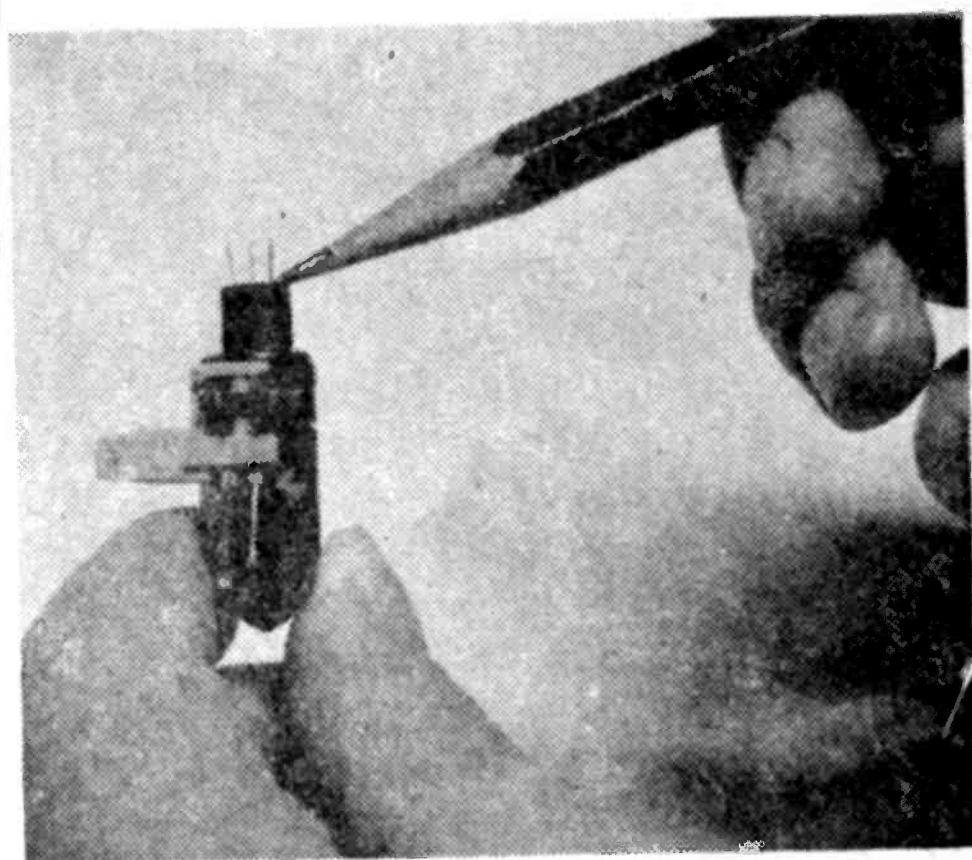

Fig. 21. Some stereo cartridges have only three terminals with center one being common ground for both sides of cartridge.



Fig. 23. Replacement cartridges often come with a choice of different mounting brackets to suit different tone-arms.

cartridge appears in Fig. 20. A thin screwdriver blade is needed to remove the small recessed screw. Be careful not to lose the small screw or tension spring on removing the cartridge.

After the phono cartridge has been dismounted, unhook the small connecting wires. Write the color code of each wire on a piece of scrap paper. Look for a ground wire under the cartridge mounting screws—see Fig. 21. Most connecting wires just plug into the cartridge. Others solder to a plug-on adapter as in Fig. 22.

Clip Care. Be careful when replacing or removing small wire clips. In case the wires are frayed at this point, resolder the clip connection; be sure it is removed from the cartridge when soldering, as excessive heat can destroy the cartridge.

Use rosin-core solder sparingly, as excessive solder can run into the clip and plug up the connection hole. It is best to grasp the clip with a pair of long-nose pliers close to the area to be soldered so solder can't run into the plug or connection.

Connecting wires on a turn-over cartridge can break off or become frayed and short against one another. Poor or no sound can result from this condition. Check the wire connection on all replaced cartridges for possible trouble.

Excessive hum from the phonograph may be caused by an open ground or connecting

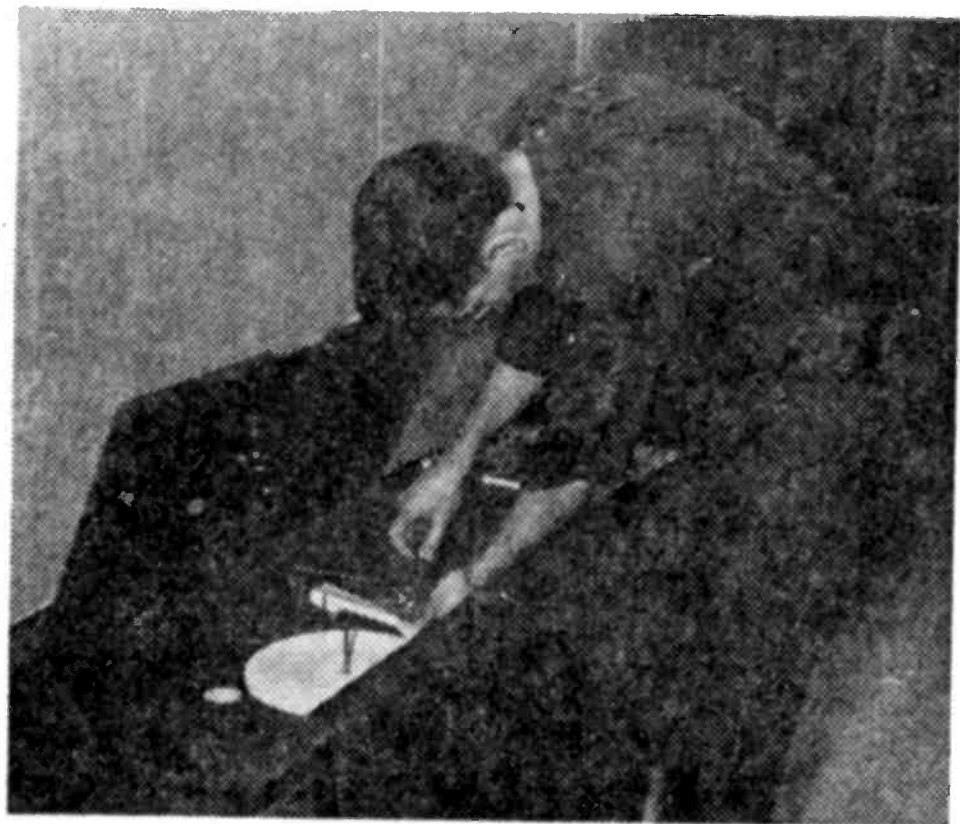

Fig. 24. Most changers can be removed for servicing by unscrewing the two bolts on each side of the base plate.

wire. Turn the volume down to see if hum originates in the amplifier or tone arm. If the hum is still present, check for a dried-out electrolytic filter capacitor in the amplifier and replace it.

In case the hum disappears when the volume is down, look for a broken wire or shielded cable. A defective cartridge can induce hum when the amplifier volume is wide open. This is the result of the cartridge output voltage failing to override the open ground or grid line. Try reversing the two cartridge wires in a monaural phonograph. Check the common center ground wire in a stereo pickup arm for an open circuit.

Genuine Parts Only. A cartridge should be replaced with the original part if possible. If not, there are many replacement cartridges on the market—see Fig. 23. Be sure the new cartridge has approximately the same output voltages and weight as the original. Correct weight may be checked if a stylus pressure gauge is handy.

Check the cartridge for correct wiring connections after installing the new cartridge. See that the stylus is riding in the "U" shaped saddle. If the cartridge is the turn-over type, rotate the turn-over knob to see that the small wires and clips do not touch. Now turn the volume up and thumb the needle of the new cartridge. A rough sound should be heard.

Check The Changer. While replacing the stylus or cartridge, a few, quick checks should be made on the record changer.

See if the pickup arm sets down at the starting point of the record. If not, look for adjustment screw on back or underneath the arm. Adjust until satisfied that the landing point on two or three different records is correct.

Now check the inside reject point. This adjustment is under chassis and it is wise to let a known radio-TV repair shop make this and other critical adjustments. If 45-rpm records don't change as they should, use talcum powder on the large spindle.

You may even want to pull the record changer or record board from the cabinet to clean up properly. See Fig. 24. Generally, several Phillips head screws hold the turntable to the cabinet. To check adjustments on the record changer, you can prop it up on two quart paint cans.

Armed with the straight dope, the future care and feeding of your record player shouldn't be a problem, and can even be downright fun. Happy playing. ■

By Herb Friedman

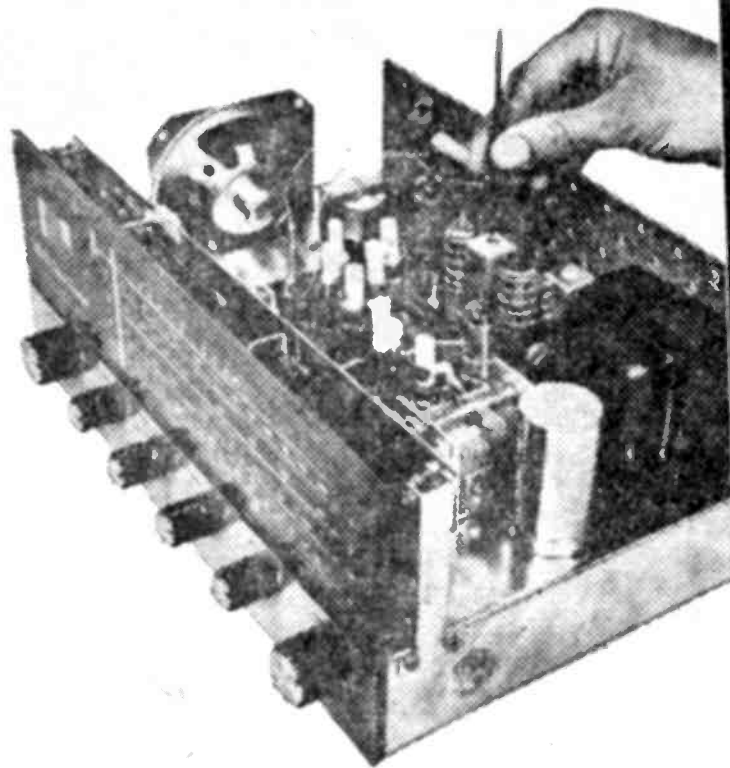

soup-up for S-W sets

Old shortwave receivers seldom die—they just try to fade away

■ From the instant it's first turned on, the performance of even the most expensive shortwave receiver slowly deteriorates. And after a year or so, the SW bands get less and less crowded as weaker stations disappear into the receiver's inherent noise level.

Fortunately, most SW receiver ills are caused by normal aging of components in the tuned circuits. And this in plain terms means that a good alignment job should restore like-new performance. We say *should* rather than *will* because receiver alignment, while not normally difficult, can be somewhat tricky. Get sloppy on just one tuning adjustment and any extra care given the other tuned circuits is worthless.

Good receiver alignment requires the technician to have a single point of focus: *maximum gain*. For with rare exception, maximum sensitivity, selectivity, AGC action, and noise reduction are obtained only when all circuits are tuned for maximum gain. In fact, it's only when the receiver has special high selectivity circuits such as a crystal filter that there is a slight departure from the focus of maximum gain.

Why Alignment? The block diagram of a basic SW receiver (see next page) illustrates the importance of alignment. Strange as it seems, it is the IF amplifier that primarily determines which signal (of many) is received.

For the sake of discussion, let's assume two signals are received by the RF amplifier. One signal is at 2 MHz, the other at 2.01 MHz; the difference (separation) between the two signals is 10 kHz. Since RF amplifiers are normally not sharp tuning devices, both signals will pass through. To be

sure, one will be amplified more than the other, depending on the RF amplifier tuning. But both will still pass through.

Now these two signals are "beat" together in the mixer with the local oscillator which is at, say, 2.455 MHz. The output of the mixer will consist of several frequencies, one of which will be the difference between 2.455 MHz, and 2 MHz, or 455 kHz; the other will be the difference between 2.455 MHz and 2.01 MHz, or 445 kHz. Obviously, any received signals which fall between 2 and 2.01 MHz will now fall between 455 and 445 kHz at the output of the mixer.

If the IF amplifier following the mixer were tuned to 445 kHz the input signal of 2.01 MHz would be the received signal. On the other hand, if the IF amplifier were tuned to 455 kHz it would be the 2 MHz signal that would be received. Now assume the IF were originally tuned to 455 kHz to receive the 2 MHz signal, but that it had somehow



Three things needed to bring back that SW rig are a service-grade signal generator, a VOM or (preferably) VTVM, and a little patience.

drifted (detuned) to 450 kHz. In this case, the IF amplifier would no longer give maximum gain to the 2-MHz signal but to some signal 5 kHz higher than 2 MHz. As you see, the IF amplifier tuning determines which of many signals fed into the RF amplifier gets maximum gain. Therefore, the IF amplifier should be the first step in alignment procedure.

IF Alignment. Somewhere in the receiver's instruction manual is the IF frequency—or frequencies, in the instance of double-conversion receivers—for your particular receiver. If yours is a double-conversion set, the second IF strip should be aligned first. Set the output frequency of a signal generator to the given frequency and connect a VTVM across the AVC bus. (If you don't have a VTVM, connect an AF output meter or a VOM on its AC range across the speaker terminals.) This done, set the meter to its lowest usable range.

Using a 0.001 μ F capacitor (or the value

suggested in the generator or receiver manual) in series with the generator's hot output lead, connect the generator to the input grid of the mixer or the first IF amplifier (whichever is suggested by the receiver manufacturer). Next, employing the lowest possible generator output voltage that will cause the VTVM or VOM pointer to just barely rise, adjust the top and bottom slugs of each IF transformer for maximum meter reading. As the adjustment causes the meter pointer to rise, keep reducing the generator's output to the lowest usable level.

Some manufacturers suggest that alignment be done stage by stage, working back from the grid of the last IF amplifier. However, this procedure generally isn't necessary unless an IF transformer or coil has been replaced and the signal can't be fed through the entire IF amplifier as detailed above.

Since adjustment of one IF slug often upsets the adjustment of the other slug, the top and bottom slug of each transformer should be adjusted in pairs several times until no further improvement can be obtained. Further, if the receiver has a crystal filter that requires special alignment techniques, make certain you follow the manufacturer's

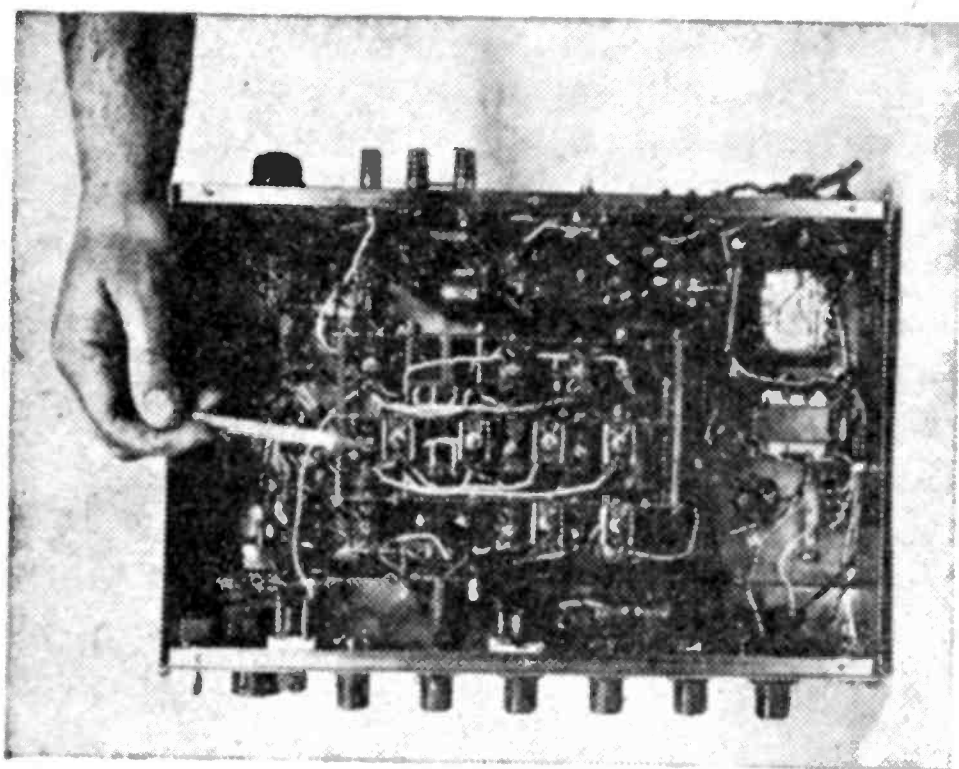

Strip arrangement (see pencil) is common for RF circuits in high-quality receivers.

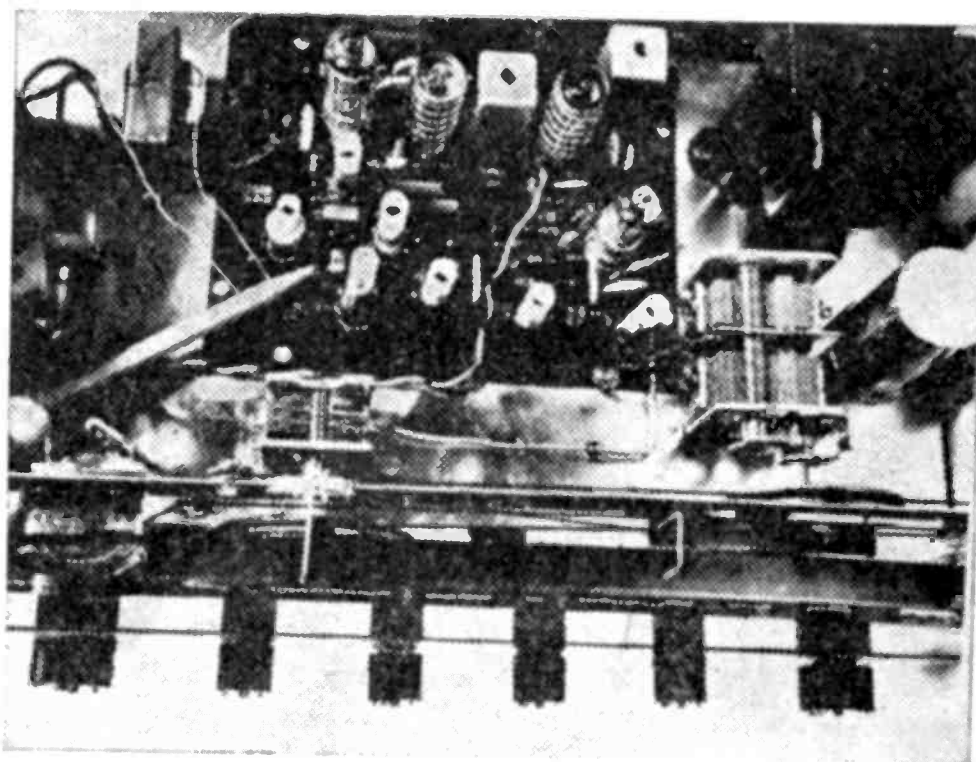

Pencil indicates screw of piston-type trimmer capacitor used in front end of newer SW rigs.

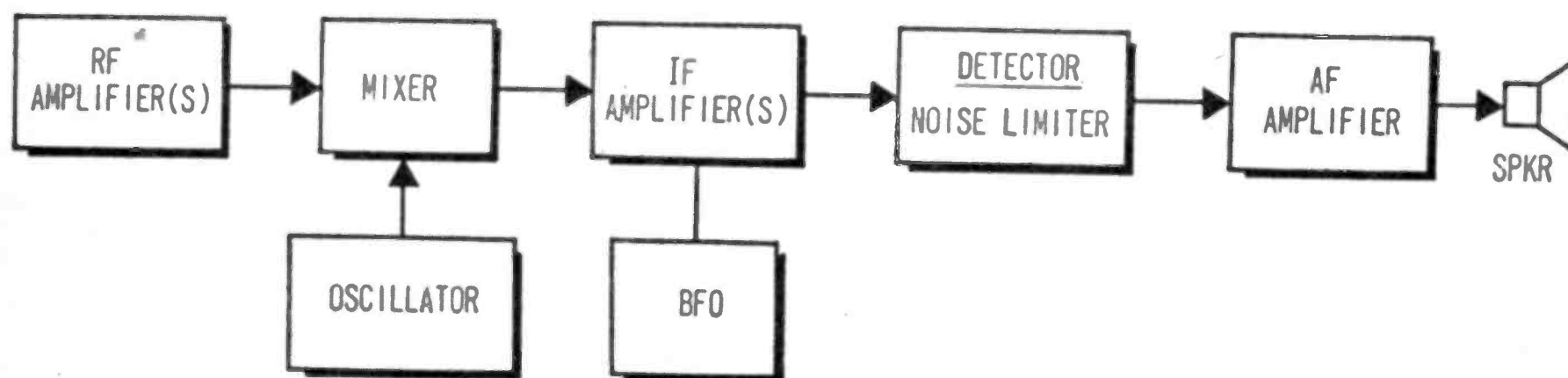

Block diagram shows major sections of typical single-conversion SW receiver.

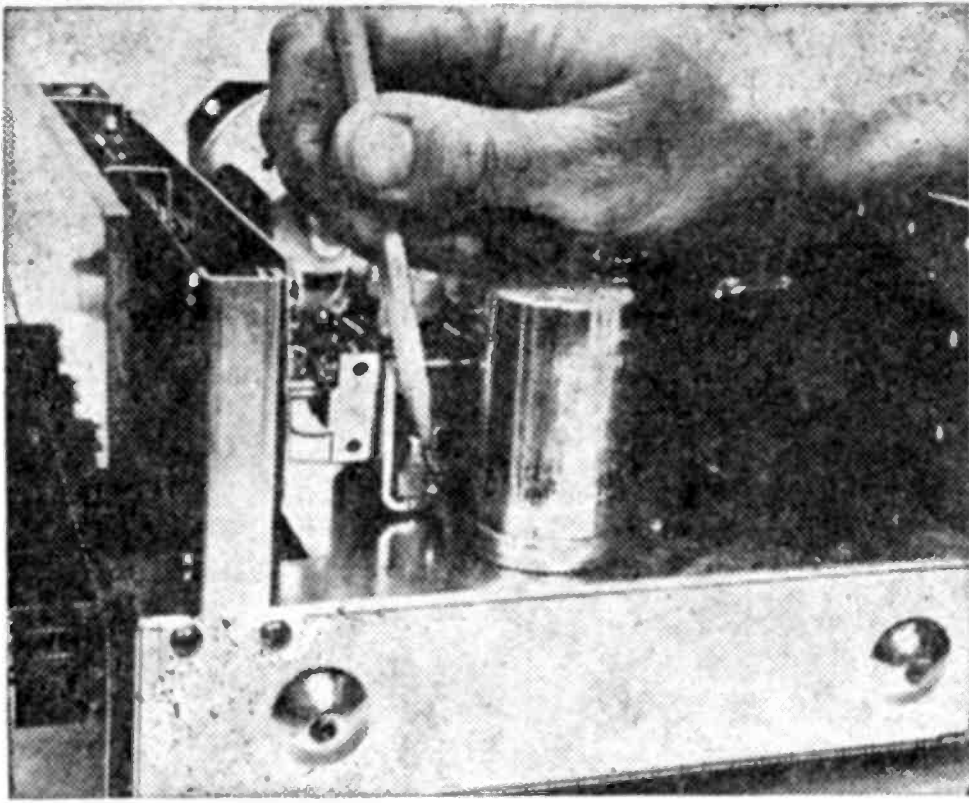

On some receivers, the Broadcast Band trimmer capacitor is located on tuning capacitor.

procedure to the letter. A misaligned crystal filter can easily destroy overall receiver performance.

The Front-End. After you're certain the IF amplifier(s) is critically aligned, it's time to do the front-end—the RF amplifier and the oscillator tuning.

The front-end performs three functions. First, it provides amplification of the RF signal, which in turn provides a good signal-to-noise ratio by providing a high-level RF input to the mixer. Second, it sharply discriminates against other RF signals not at the desired frequency, thereby reducing or effectively eliminating image response. (Image signals are signals removed from the desired frequency by a factor of 2X the IF frequency. If the front-end cannot reject the image frequency signals, the image frequency will also be fed through the IF amplifier.) And third, the front-end provides the local oscillator that heterodynes (beats) the RF signal to the IF or first-IF frequency.

Though there are many combinations of front-end alignments that will produce received signals, there is only one alignment that will result in accurate dial calibration. And in fact, front-end (or RF alignment as it's often termed) does two things: it adjusts the local oscillator (if it isn't crystal-controlled) so that the dial corresponds to the frequency being received, and it adjusts the tuning of the RF amplifier so that regardless of the position of the tuning control the RF amplifier provides maximum gain at the received signal frequency.

Band By Band. Each band has its own front-end tuning adjustments. If the receiver has five bands there are five sets of tuning adjustments, though the tuning adjustment

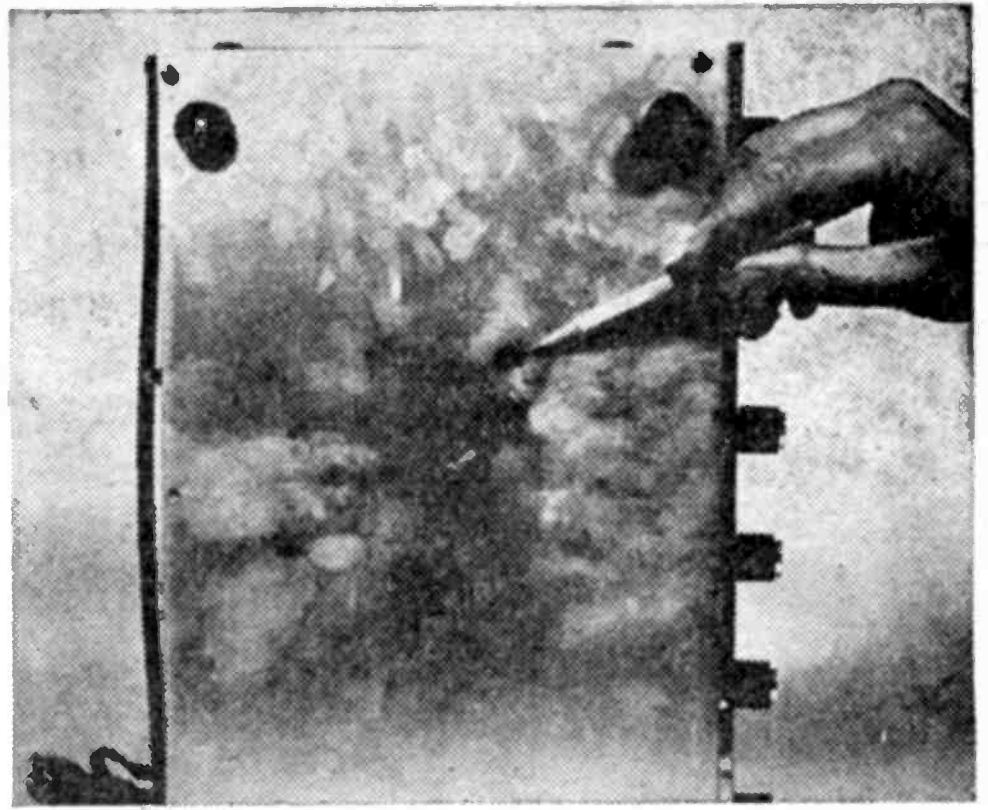

Trimmer capacitors accessible through bottom cover should be aligned with cover in place.

for the Broadcast Band might differ from those for the various SW bands. The most important part of the alignment, next to accurate calibration of the oscillator to the dial calibration is the tracking.

Each tuned circuit in the RF amplifier and the oscillator has at least one coil and one trimmer (some older receivers have two trimmers). The object is to adjust the coil for tracking at the low end of the band and the trimmer capacitor for high end tracking.

Since the adjustment of the coil affects trimmer adjustment, and vice versa, it's necessary to repeat the coil/trimmer adjustments for each band many, many times, until no further adjustment can be obtained. When the oscillator's coil and trimmer adjustments are correct, the dial calibration should be accurate across the entire band, not just at the high and low end. Similarly, the RF amplifier should have maximum gain across the entire band in step with the oscillator tuning.

Test Equipment. As a general rule, most service-grade signal generators are more than adequate for the average SW receiver alignment, and only a VTVM or VOM is needed to complete the test set-up. However, if the technician desires to compare the receiver's re-aligned vs. when-new performance, a calibrated signal generator is required (such generators have meters to directly indicate the RF input level fed to the receiver).

In reality, though, this is really gilding-the-lily; for the calibrated generator offers no effective advantage as far as the actual alignment is concerned. In fact, in meaningful terms, the \$50 service grade generator will do just as good an alignment job as the \$500 calibrated generator. ■

Kiddie Phono Repair

Continued from page 76

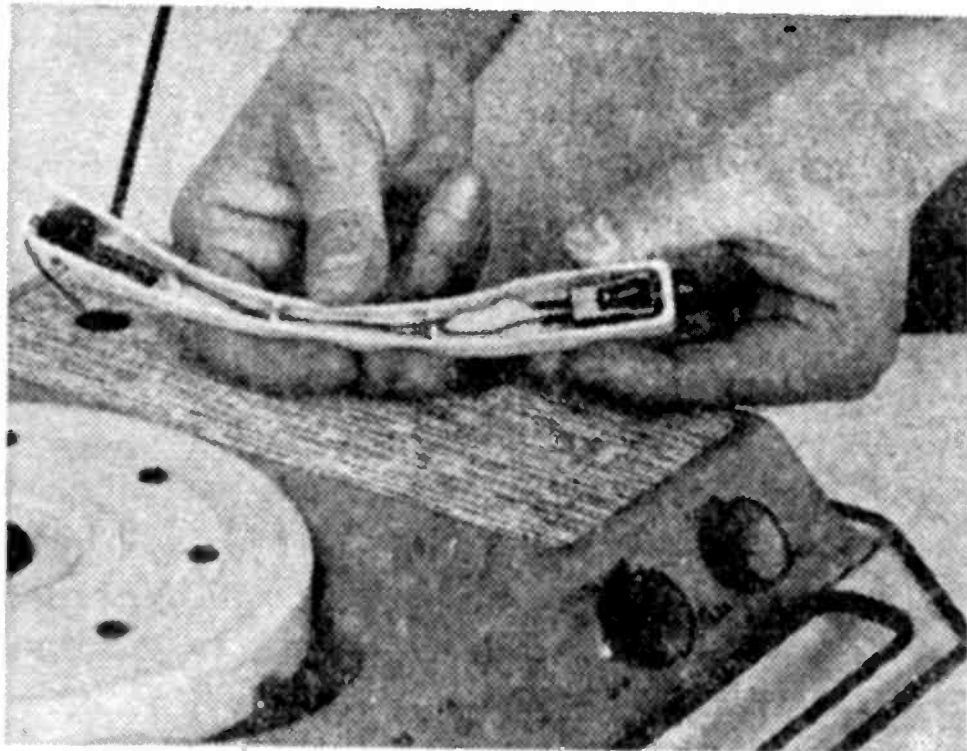

Cartridge and tone arm easily fall prey to injury (note absence of tone-arm base in player above). Needle should almost always be renewed with exact replacement, as should both tone arm and cartridge, if condition warrants.

gory. This can easily be accomplished by removing the pin or E-ring from the turntable, carefully pulling the turntable from the spindle, then cleaning the underside of the turntable as well as the motor shaft and idler assembly with a suitable solvent—a small bottle of GC carbon tetrachloride being a good choice. Use the cleaner sparingly on rubber parts, and be certain to clean the rim of the turntable thoroughly (see photo at top of facing page).

A new needle (now generally referred to as a *stylus*) should put the arm-and-cartridge

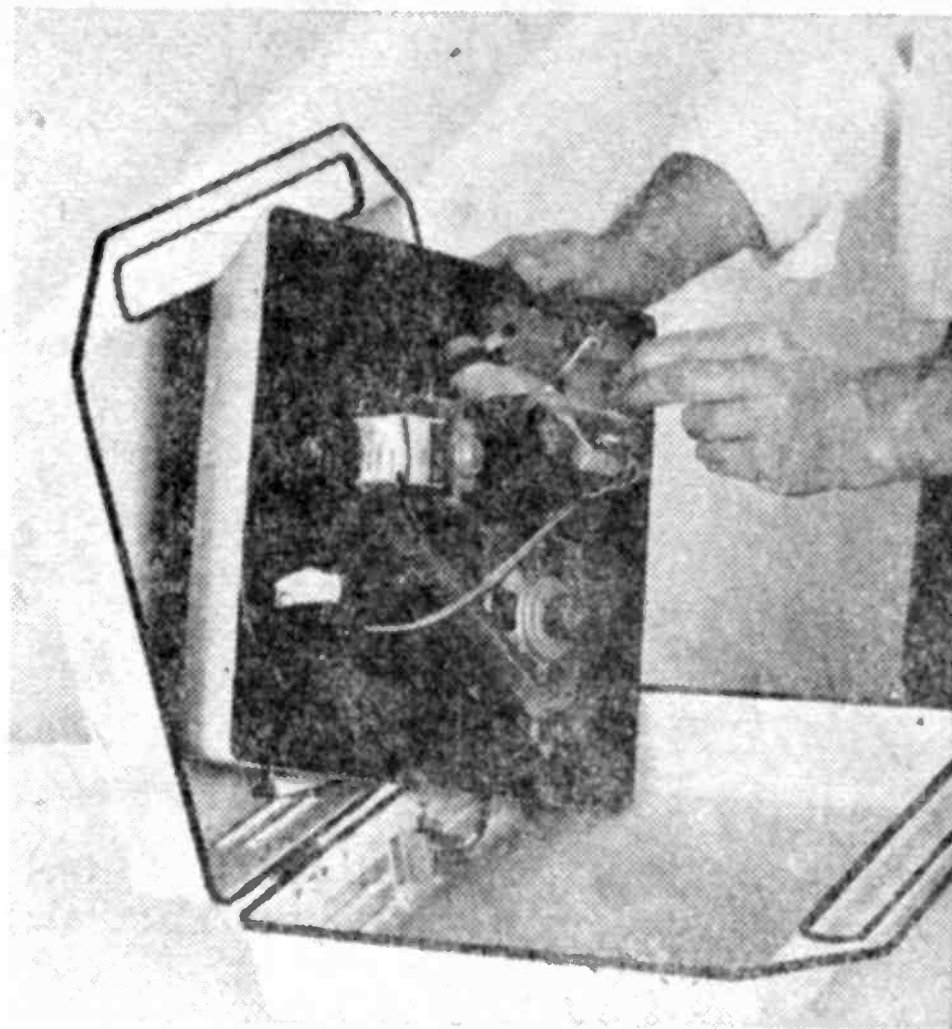

Amplifier/speaker section of kiddie phono generally contains one or two tubes in an AC/DC circuit. Inoperative amplifier usually stems from burned-out tube; damaged speaker often proves to be the cause of distorted sound.

combo back in like-new condition unless either or both has been damaged. If they have, it's usually best to replace both with a new arm-and-cartridge assembly as shown in the photos.

As for the amplifier and speaker, burned out tubes and punctured speaker cones account for something like 90% of kiddie phono troubles in this area. Effecting a cure is almost child's play—plug in a new tube or toss in a new speaker, and you'll have every reason to expect that the set will play like new again.—Ron Mitchell ■

After carefully noting wiring of leads running into amplifier from cartridge, leads were unsoldered, then single hex nut was unscrewed to permit removal of tone-arm assembly. Since new tone arm was virtual duplicate of damaged unit, fitting it in place called for little more than a reversal of disassembly procedure.

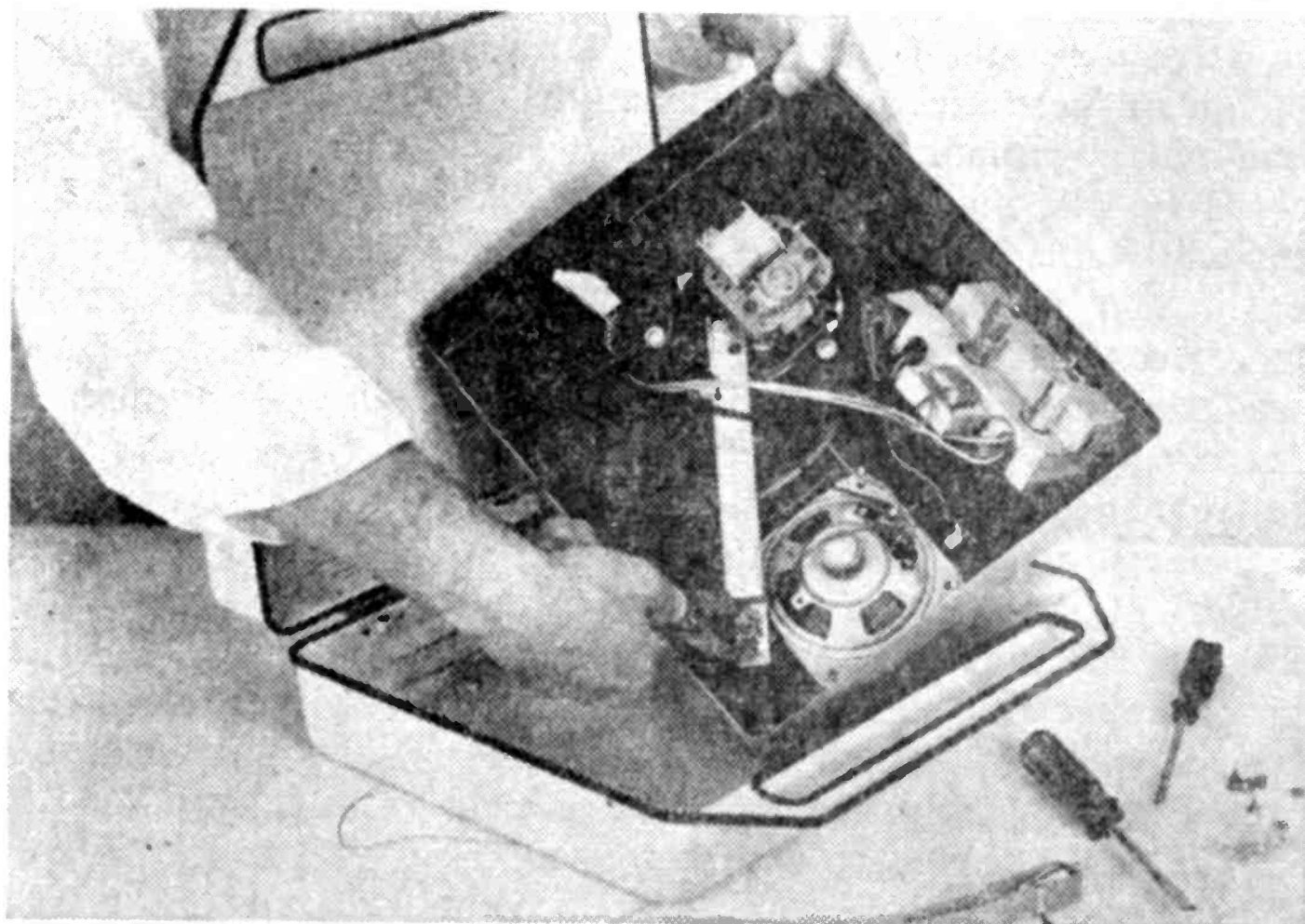

Most from B & W TV

Continued from page 18

trols for adjusting the correct width of the picture. These are the width and horizontal drive controls. If the picture is too wide or too narrow, first adjust the width control until the picture approaches as near as possible the correct width. (Fig. 21 shows a picture that is too narrow.) Then adjust the drive control until the picture fits the mask. If the drive control is incorrectly adjusted to give excessive drive, a vertical white line (overdrive line) will appear on the screen. Fig. 22 shows the effects of excessive drive on the picture.

Height (or vertical size) Control. Fig.

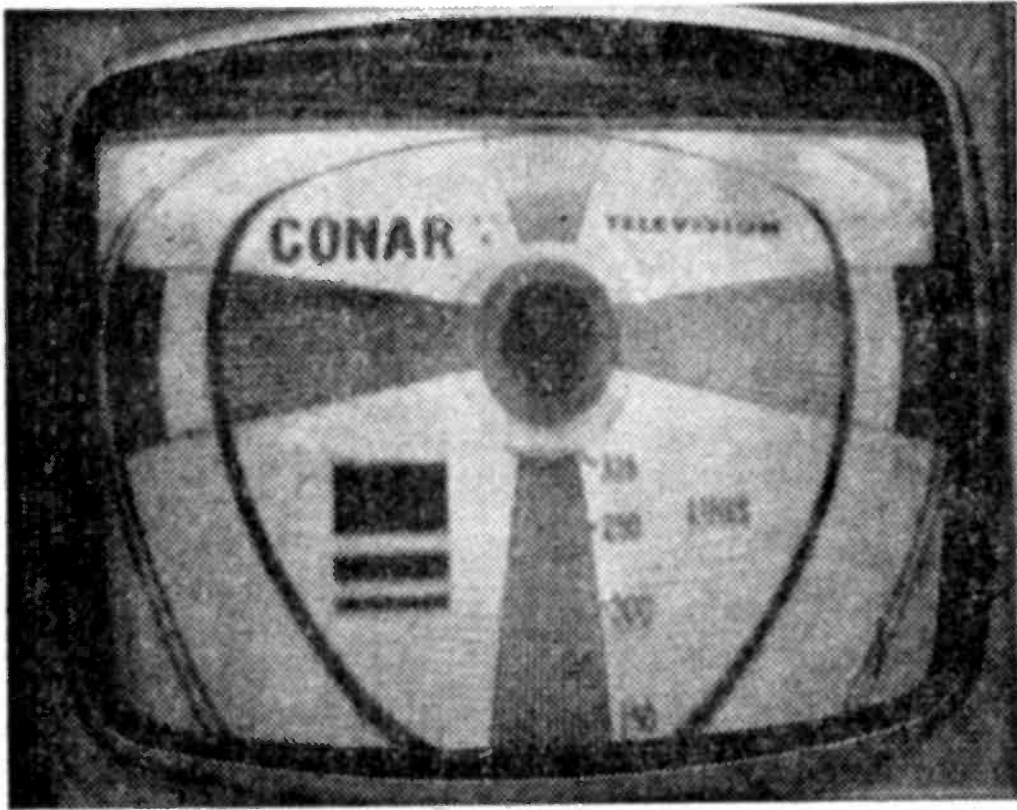

Fig. 24. Flat-topped circle can be made round again by adjusting both the vertical linearity and the vertical height controls together.

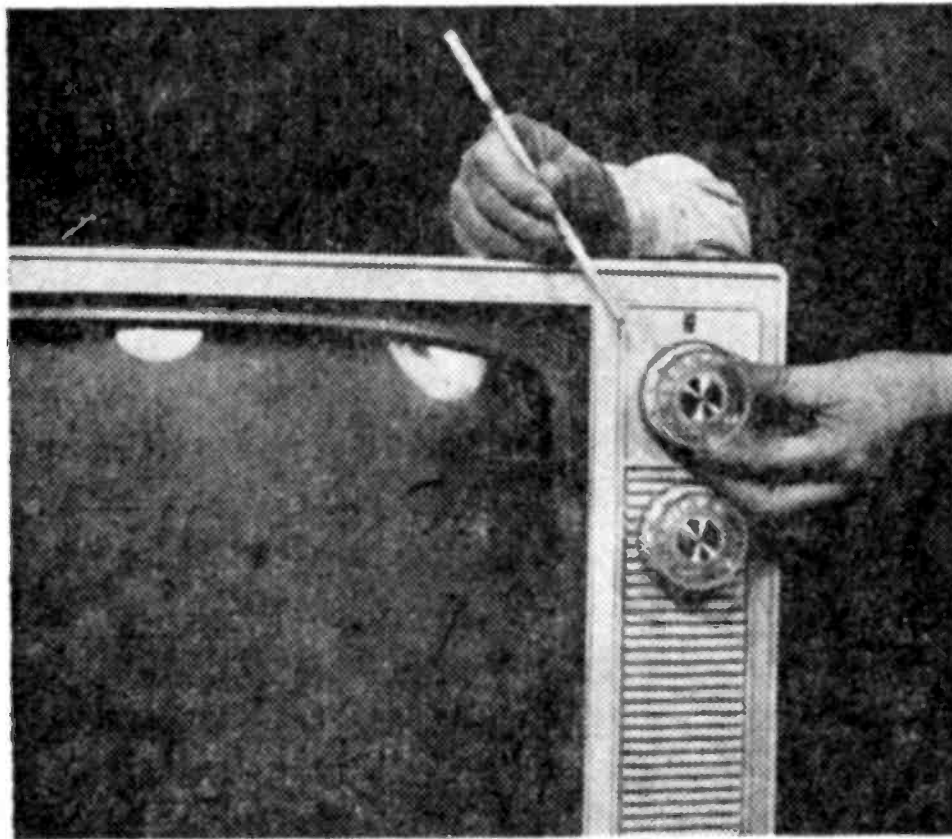

Fig. 25. Final tune-up consists of adjusting tuner slugs to center range of fine-tuning.

23 shows the effect on the picture of an incorrect adjustment of the vertical size or height control. In this illustration the picture is too narrow from top to bottom, but symmetrical with respect to the center.

Vertical Linearity Control. Fig. 24 shows a picture in which the vertical linearity control is misadjusted. In this case the picture is cramped from top to center while the bottom half is elongated. To adjust the vertical linearity control, rotate the shaft until the picture dimensions from top to center and from bottom to center are the same. To do this it is usually necessary to adjust the vertical linearity and vertical size controls alternately until the picture is linear and fits the screen.

The End (!). If you've taken a half hour or so to make various adjustments, the set is warm enough for the next step. By retuning slugs in the TV tuner's local oscillator, you can shift the fine-tuning control so it centers on each channel. (This is not necessary on late models that have pre-set or "memory" fine tuning.)

Begin by pulling off both main and fine-tuning knobs (VHF only), as shown in Fig. 25. This should reveal a small access hole in front of the tuner. Turn to your highest channel and set the fine-tuning shaft at the center of its rotation. Insert a non-metallic screwdriver into the access hole and tune the slug for best picture and sound, repeating this for every channel you receive. (Temporarily put back the main channel knob to flip to the next channel, but leave fine tuning undisturbed.)

Tired of all that tuning and adjusting? If so, our special televised message in Fig. 26 should prove reassuring. ■



Fig. 26. The final result of these adjustments is a great picture that's the living end.

Tackle That Totable TV

Continued from page 34

the trouble and the tubes are O.K. Check for low grid drive voltage on the output tube and check the associated components. Most width problems are found in the horizontal output sweep circuit (see Fig. 15).

Also look for a brass sleeve (on some portables) around the CRT gun and yoke assembly. Loosen up the yoke assembly screw and pull the brass shim out toward the picture tube socket to increase picture width. On deluxe portables with a horizontal drive control, check that it's set correctly. Try adjusting the control for correct width. Going too far will produce one or two white vertical drive lines from the middle to the left side of the CRT screen, in which case the control should be backed off a bit.

Horizontal Lines. Check the horizontal tubes when lines are lying across the CRT and cannot be straightened up with the horizontal hold control (see Fig. 16). If this doesn't do the job, adjust the horizontal frequency coil slug. Set the horizontal hold control in the center of rotation and adjust the horizontal frequency coil slug until the picture locks in. Now switch the channel selector knob to another channel and see if the horizontal circuit stays locked in. If not, it may be necessary to make another fine adjustment of the horizontal frequency coil.

When the horizontal lines will not straighten up or the raster goes into a *Christmas-tree* effect or jagged horizontal lines, check for a defective AFC circuit. In current portables, a duo-diode rectifier with three leads serves as the AFC component as shown in the schematic in Fig. 17.

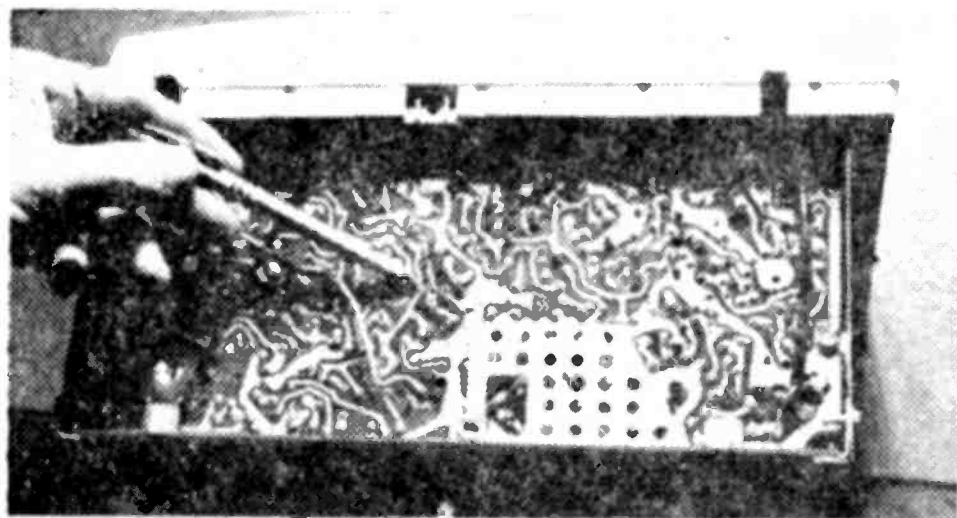

Fig. 24. Last but not least in the stable of portable TV troubles is the printed circuit board. Check it for cracks and cold solder joints in the area of the defective circuit, especially around heavy components.

To remove the duo-diode, cut off the leads about $\frac{1}{2}$ in. from the PC board. Now you can solder a new AFC diode (or the old one) to these leads. Take a resistance measurement of the duo-diode rectifier; these are usually of the common cathode type (the center terminal is common to the two outside leads). Connect the ground lead from the ohmmeter to the center diode terminal. Now measure the resistance from each outside lead; the reading should be around 20 K. Reversing the ohmmeter leads should produce a zero-ohms reading. A leaky duo-diode will show a low resistance both ways.

A keystone, or triangular, picture is caused by a shorted deflection yoke and can only be remedied by replacing it with a new one. Bending and pulling of the picture can be caused by a defective horizontal oscillator or output tube. Excessive blooming of the picture when the brightness control is cranked up is caused by weak horizontal output or high voltage tube.

Bright Horizontal Line. If the picture consists of a single horizontal line, replace the vertical oscillator and multiplier tube. The bright horizontal line indicates the vertical sweep is not operating (see Fig. 18).

If tube replacement does not help, try adjusting the vertical height and linearity controls, or both. It is possible for the vertical height control to have a burnt spot, causing the vertical sweep to collapse. Check for continuity of the vertical output transformer windings. Also check to see if the feedback coupling capacitor shown in Fig. 19 is leaky.

For insufficient height, at top or bottom of the raster, adjust the vertical height and linearity controls. A weak vertical oscillator or output tube can cause this problem, too.

Constant vertical rolling of the picture can often be cured with a new vertical oscillator tube. If the picture is unstable both vertically and horizontally, the fault lies in the sync section. Replace both vertical and sync separator tubes. Some portables have both features in one tube, while others may have these sections in a separate tube or located in one-half of another dual-function tube.

Snowy Picture. A picture very light in detail with a lot of snow on the screen as in Fig. 20 is usually caused by a defective RF tube in the tuner. Substitute a new RF, oscillator, and first IF tube and see if the situation improves.

Picture still snowy? Then dig into the antenna coils and lead-in connections. Most portable receivers have isolating capacitors in the antenna input terminals. These capacitors protect the antenna coils and tuner (see Fig. 21).

In case lightning has struck your antenna, you may find one or both of these capacitors blown open. With an ohmmeter, check continuity of both antenna coils. You will find the antenna coils located on top at the rear, or inside, of the tuner cover. Be sure and replace damaged antenna coils with direct factory replacements.

Stations Won't Stay On Channel. In case the picture will not stay on channel or becomes snowy when the channel selector is jogged, clean the tuner (Fig. 22) with a good tuner spray lube. With the strip or turret-type tuner, clean the contact points with rag and cleaning solution. Bear down with the clean section of the rag to brighten up the contacts. Apply contact grease over the clean contacts and don't forget to spray the contact springs located under the tuner drum.

Many small tuners use a rotating multi-section wafer switch. Spray these contacts and rotate the tuner shaft at the same time. Select a good tuner spray that won't be harmful to plastic parts in the tuner assembly.

Conclusion. There are many troubles that can develop in a portable TV. Remember to go slow and easy. Look, listen, and try to isolate which section the trouble is in. Be careful not to break off any control knobs on the rear of the chassis or damage the set in any other way.

You will find that all tubes and parts are quite close together in portables. Some of the tubes and parts are hard to get at, so proceed with caution (see Fig. 23). If the set has been subjected to abuse, don't forget to check the PC board for possible intermittent condition (see Fig. 24). Especially on the earlier sets, PC boards were subject to many problems.

But with care and a little use of the old think tank, most portable TV problems can be easily solved. So, go to it with confidence and save a few bucks while you're at it. ■

Color Killer

Continued from page 53

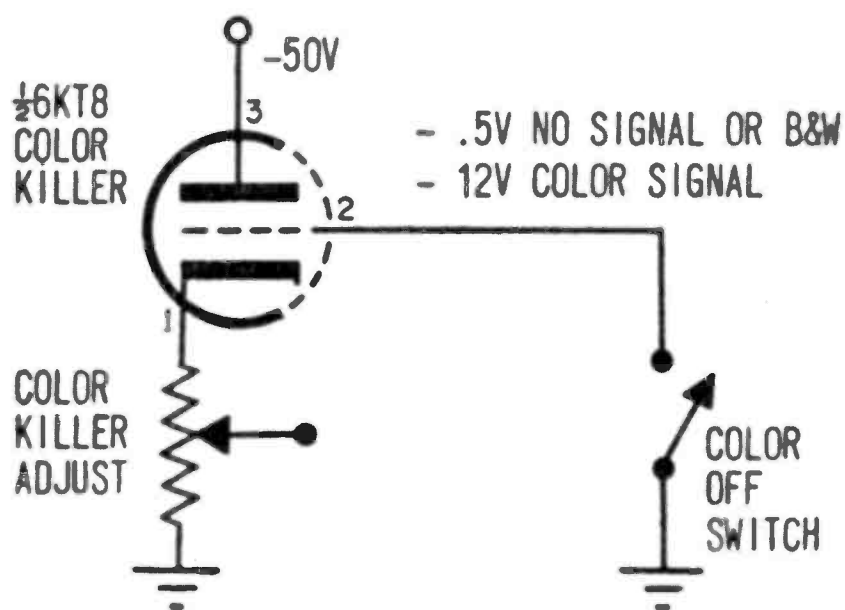

Fig. 8. Color killer stage operating voltages are set up so when no signal comes from burst amp, killer stage will not conduct. Color killer adjust control is set so that weak color signals will just deactivate killer stage.

dog cases require an actual look at the signal as it passes through the killer circuitry. You'll need a reasonably good scope—one rated up to 5MHz—and a low-capacitance probe. This combination permits you to measure the circuit without upsetting its normal operation. Again, the manufacturer's service literature comes to the rescue. As shown in Fig. 9 he supplies actual scope

waveforms spotted at important points in the circuit. The scope should not only display the same shape for these waveforms, but voltages must be fairly close as well.

Voltage is almost always shown as P-P, or peak-to-peak, when it refers to a scope waveform. This means the scope must have a built-in calibrator to serve as a reference or you must use an external voltage calibrator. Fig. 9 comes from the burst amp found in an RCA set. You can see that the burst signal applied to the grid should be 65 volts peak-to-peak, while the emerging signal at the plate is 200 volts peak-to-peak. If you see the input signal on the scope, but fail to observe the output, this is a sure sign of trouble in the stage. ■

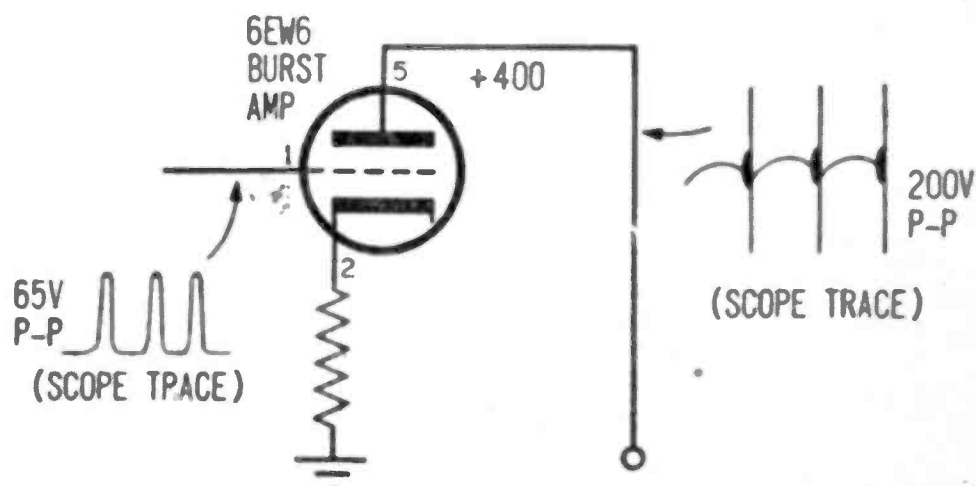

Fig. 9. Tough dog problems can be tracked down with the aid of the manufacturers' service literature showing voltages and waveforms, and a scope.

When Color Won't Stay Put

Continued from page 82

compares burst and 3.58 oscillator frequencies and creates the DC correction voltage.

But for comparison action to occur, the diodes in the Phase Detector must be electrically balanced, even when no burst is present. This provides a basis for a simple test. First, place a shorting jumper from grid to ground of the Burst Amp, as shown. This kills any incoming burst which would disturb the test.

Then place a VTVM across the plate of the Phase Detector and to ground. If your circuit is typical of many, you should read approximately -28 VDC at this point. Next measure the diode cathode to ground for a reading of $+28$ VDC. Voltages in different circuits may vary, but the important feature is that they are typically equal and opposite. This is a good indication of proper balance in the stage. Resistors and capacitors should be checked if voltages are unequal.

O.K. Phase. If there's good voltage balance in the Phase Detector, shift attention to the Burst Amplifier. Voltage and resistance checks here stand a good chance of revealing the trouble. If you can't pinpoint the culprit, perhaps the incoming burst signal isn't reaching the Burst Amp.

We've shown the source of the burst in Fig. 11. Note that it's from a tap-off point from the Color Amp. If any components between this point and the grid of the Burst Amp are defective, there could be an interruption of the burst signal. So check resistors, capacitors, or coils in this part of the circuit. If you're getting color on the screen, even if it's out-of-sync, chances are the other stages shown in Fig. 11 are functioning. Explanation for this fact is that the color signal must traverse those stages in order to reach the picture tube.

Thus, with little more than a VTVM and a jumper wire, you should be able to track down most troubles in color sync circuits. The simple tests described help locate the general area, or even a particular stage that's upsetting color stability.

If you run into an exotic problem that won't yield to these tests, chances are you'll need an oscilloscope to examine actual signals in transit through color-sync stages. Fortunately, set manufacturers usually provide ample information and scope traces to serve as a guide.

A typical schematic by RCA is illustrated in Fig. 12. Note that the scope waveforms seen at the bottom correspond to numbered points in the diagram. Both the shape of wave and its P-P (peak-to-peak) voltage are given for running comparisons with what you see on your scope. ■

Service Shop Tips

Continued from page 9

455-kHz wave trap in series with the input to first transistor as shown in diagram. You can use a 455-kHz IF transformer. Adjust the active IF coil's slug until the interference is minimized.

Buzz Bomb

When I turn the volume all the way down on my Panasonic radio hum can be heard. What is the matter and how can it be fixed?

—J. S., N.Y., N.Y.

Offhand it sounds like a defective volume control. But, without knowing the model number, we can only guess. Why don't you try the Panasonic Service Center in New York City?

Color Tattler

How can I add a color TV tuning indicator to a color TV set?

D. R., Los Angeles, Calif.

It depends greatly upon the circuitry of your set. The diagram shows a color indicator circuit based on the one used in some Olympic models. If you make one as an outboard device, install the barrier terminal strip on the back of the TV receiver. The transistor is powered by a 6.3-volt filament transformer whose output is rectified by D and filtered by C. When the TV set is tuned to a color program, the bandpass amplifier and blanker cathode voltages rise because of the presence of the 3.58-MHz color burst. This provides forward bias on the transistor, causing the lamp to glow.

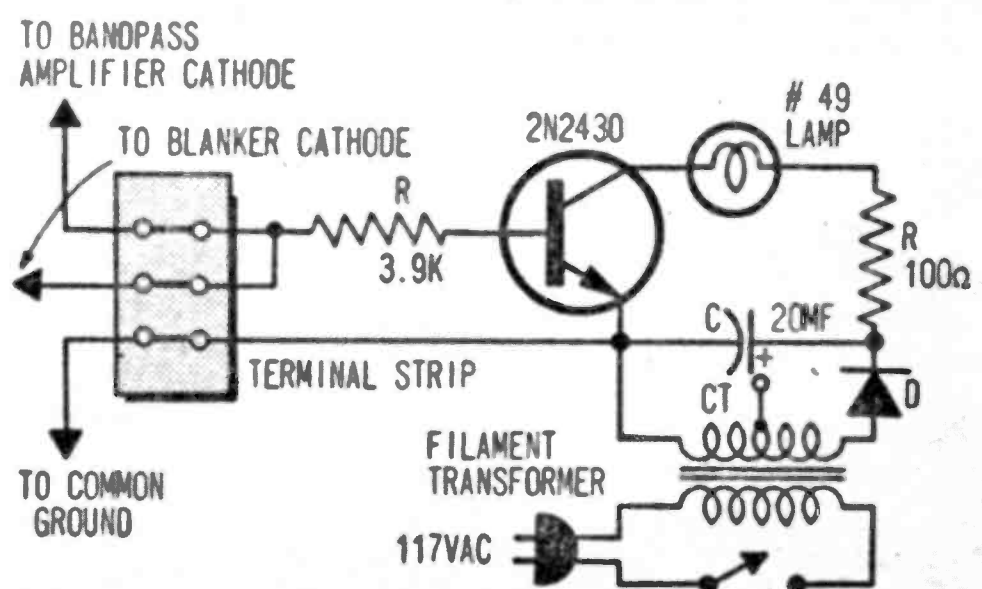

CLASSIFIED Market Place

FOR BIGGER PROFITS! NEW CAREER OPPORTUNITIES!
READ AND REPLY TO THESE CLASSIFIED ADS

Classified Ads 65¢ per word, each insertion, minimum 10 words, payable in advance. For information on Classified ads—to be included in our next RADIO-TV REPAIR—write to C. D. Wilson, Mgr., Classified Advertising, 229 Park Avenue South, New York, N. Y. 10003.

ADDITIONAL INCOME

MONEY—Sparetime Opportunity Panelists At Home Wanted By New York Researcher. Leading research firm seeking people to furnish honest opinions by mail from home. Pays cash for all opinions rendered. Clients' products supplied at no cost. For information write: Research 669, Mineola, N. Y. 11501. Dept. 633-RTVR.

FREE! The World's Leading Money-making Magazine. How and when to earn a Second Income, develop a Spare-time Business, get into Profitable Franchising, become a successful Agent. For your free copy—write Income Opportunities, 229 Park Avenue South, New York, N. Y. 10003.

BOOKS & PERIODICALS

TERRIFIC, New Army Written Book. Basic Theory And Application of Transistors, \$1.40 Postpaid. Devices, Box 136B, Bronx, N. Y. 10463.

CATALOG of all Science & Mechanics Craftprints. Send 25¢ to cover postage and handling to Craftprint Div., Science & Mechanics, 229 Park Avenue South, New York 10003.

BUSINESS OPPORTUNITIES

I MADE \$40,000.00 Year by Mailorder! Helped others make money! Start with \$10.00—Free Proof! Torrey, Box 318-T, Ypsilanti, Michigan 48197.

FREE Book "990 Successful Little-Known Businesses." Fascinating! Work home! Plymouth 311-T, Brooklyn, N. Y. 11218.

CAMERAS & PHOTO SUPPLIES

AMAZING! Revolutionary! New photo album. Inquiry requested. Dennis, 17718 Sunset Way, Sonoma, Calif. 95476.

COINS, CURRENCY & TOKENS

COINS Discounted! Catalogue 25¢. Buying Catalog 50¢. Sullivans, #3330-FB, St. Paul, Minn. 55101.

EARTHWORMS

BIG Money Raising Fishworms and Crickets. Free literature. Carter Farm-O, Plains, Georgia 31780.

EDUCATION & INSTRUCTION

EARN Your Degree In Electronics Engineering. Highly Effective Home Study Courses In Electronics Engineering Technology And Electronics Engineering Mathematics. Free Literature. Cook's Institute Of Electronics Engineering, P. O. Box 36185, Houston, Texas 77036. (Established 1945.)

GIFTS THAT PLEASE

FREE, Gift Catalog. Selective and Distinctive. True Values SMC, Box 903, Salt Lake City, Utah 84110.

GIVE the best reading in the Mechanical Field—give Science & Mechanics! \$4.00 for year's subscription. Science & Mechanics, 229 Park Avenue South, New York, New York 10003.

INVENTIONS WANTED

WE either sell your invention or pay cash bonus. Write for details. Universal Inventions, 298-10, Marion, Ohio 43302.

MAGNETS

MAGNETS. All types. Specials—20 disc magnets or 2 stick magnets, on 10 small bar magnets, or 8 assorted magnets. \$1.00. Maryland Magnet Company, 5412-R, Gist, Baltimore, Md. 21215.

MISCELLANEOUS

ROOT BEER Formulas. Instructions \$3.00. Tomarch, 1114-41st, Brooklyn, New York 11218.

QUART dried hops \$1.00, with 101 recipes—Homebrewing, Winemaking, Hop-breads, Sourdoughs, and supplies catalogue. Nichols Nursery, Northpac, Albany, Oregon 97321.

SURPRISE Package \$1.00. Catalog Free. Tom Carson, 208-C-SE, Ardmore, Okla. 73401.

HIGH voltage shocker module \$5.95. For fun, pranks, property protection. Effective. Non-lethal. Satisfaction guaranteed. Catalog 20¢. Franks Scientific Co., P.O. Box 156, Martelle, Iowa 52305.

JUST out! Confidential spy, clandestine, spacecraft frequencies & schedules. \$1.00. Date-A, P.O. Box 2396, Champaign, Ill. 61820.

MONEYMAKING OPPORTUNITIES

INSTANT Money! Plastics are the wave of the future. Big profits now! At home! Spare time! Materials costing 11¢ bring \$2.58 profits immediately! Free information! Rush name on postcard to: Warner, 1512 Jarvis, Dept. CL-107-A, Chicago, Ill. 60626.

MAKE Your Classified Ad Pay. Get "How To Write a Classified Ad That Pulls." Includes certificate worth \$2.00 towards classified ad in S & M. Send \$1.25 (includes postage) to C. D. Wilson, Science & Mechanics, 229 Park Avenue South, New York, N. Y. 10003.

RADIO & TELEVISION

THOUSANDS and thousands of types of electronic parts, tubes, transistors, instruments, etc. Send for Free Catalog. Arc-turus Electronics Corp., EME, 502-22nd St., Union City, N. J. 07087.

KITS, Metal Detector \$5.95. Audio Telescope \$5.95. Others. Lectronix, Box 42, Madison Heights, Mich. 48071.

BUILD Distance Crystal Sets. 10 plans—25¢; 18 different—50¢; 20 different—50¢. Catalog. Laboratories, 12041-G Sheridan, Garden Grove, Calif. 92640.

POLICE — Fire — Aircraft — Marine — Amateur calls on your broadcast radio! Free catalog. Salch Company, Woodsboro EE14, Texas 78393.

SCIENCE & CHEMISTRY

POWERFUL! Converging! Stellar Radiations Cause Gravitation. \$1.00. Car-nahan, 2007 Easton, Austin, Texas 78723.

STAMP COLLECTING

FREE 121 Different Flag Stamps. W-B Stamp Company, Wilkes-Barre, Penna. 18703.

TIPS FOR THE HOME, ETC.

PRACTICAL tips for home, garden and workshop are in "1001 How-To Ideas." Send \$1.00 for your copy includes Postage, to 1001 How-To Ideas, 229 Park Avenue South, New York, N. Y. 10003.

THERE IS NO CHARGE FOR THE ZIP CODE—PLEASE USE IT IN YOUR CLASSIFIED AD

For Greater Classified Profits
why not try the new combination classified ad medium
Your classified ad will appear in SCIENCE & MECHANICS MAGAZINE as well as in a minimum of four other SCIENCE & MECHANICS PUBLICATIONS. Write now for information to C. D. Wilson, Manager, Classified Advertising, SCIENCE & MECHANICS, 229 Park Avenue South, New York, N. Y. 10003.

What A Way To Earn A

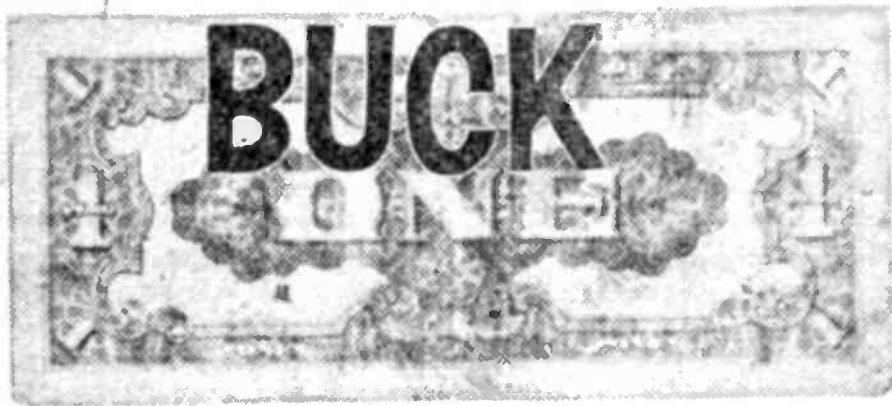

By Gene Lyons



"Well, with a list that long, your TV needs a mortician, not a technician!"



"Look, lady, when I work on this model, I always bring my lunch!"

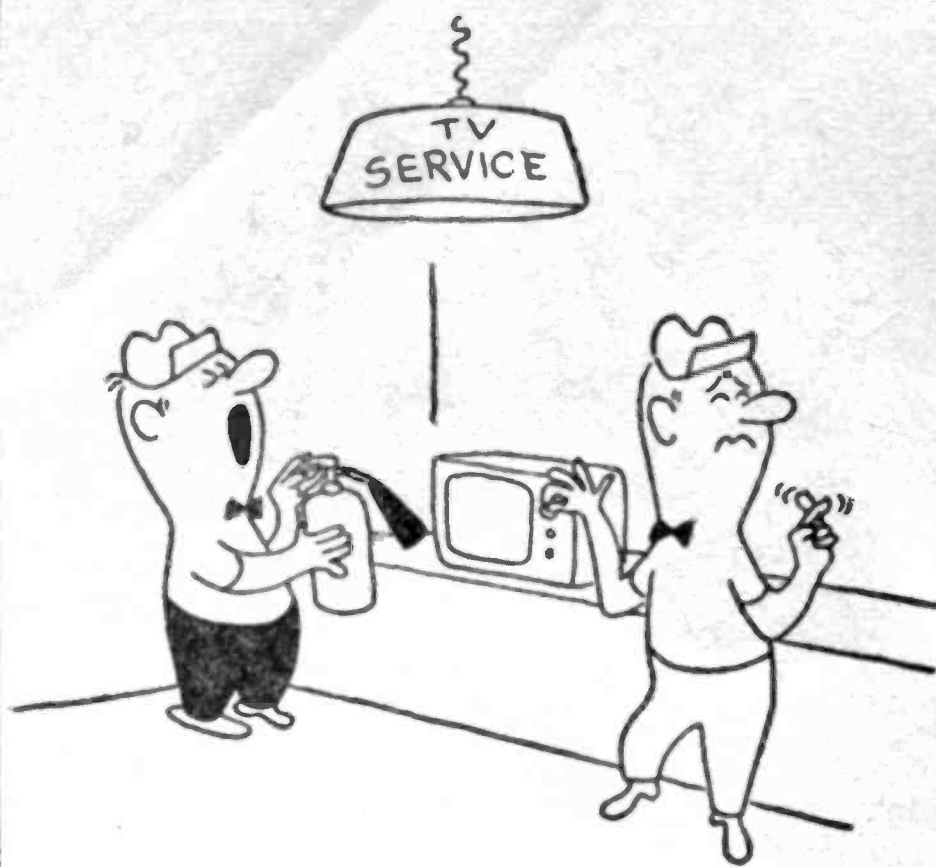

"Now!"



"Enough is enough! Will you please get that new technician a tube caddy?"

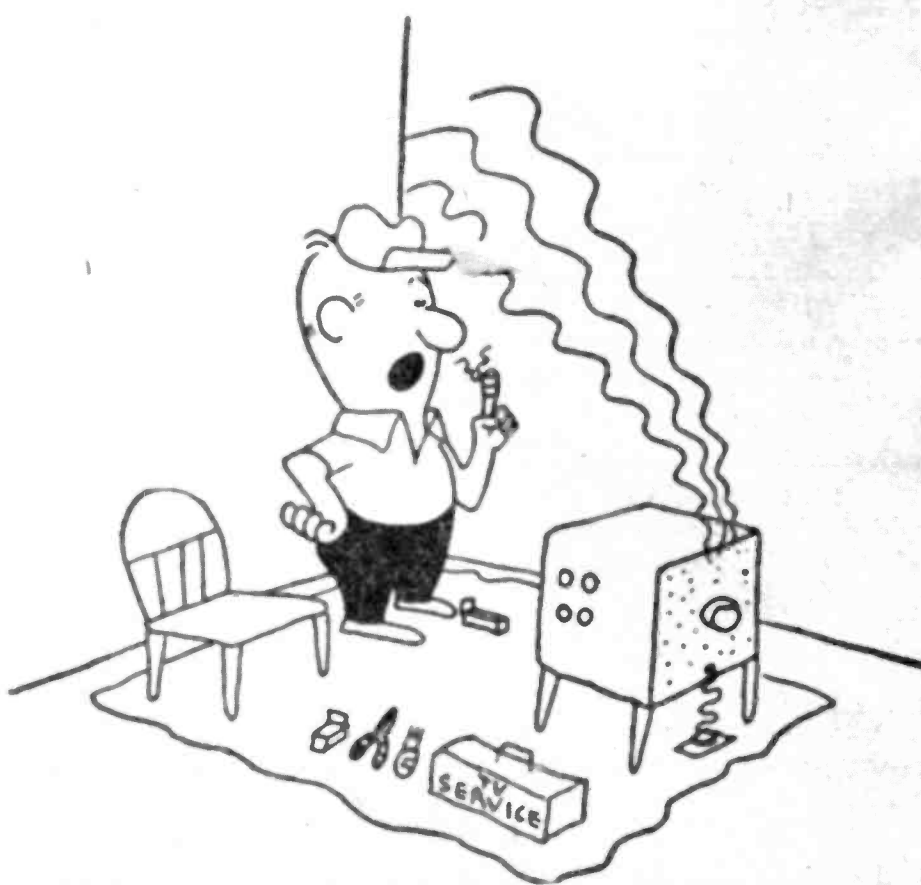

"Oh yeah, I've got to replace that shorted electrolytic capacitor."

Money Back Guarantee

Use this coupon to order any one or all six books. Complete satisfaction guaranteed or your money refunded in full. Simply return the book within 10 days of receipt.

DAVIS PUBLICATIONS

229 Park Avenue South, N. Y. N. Y. 10003

Please send me the latest copy of the magazine(s) I have indicated. I am adding 25c to the price indicated to cover postage & handling.

Electrical Guide 75c
 Furniture 75c

Woodworker 75c
 Home Workshop 75c

Radio-TV Repair 75c
 Wood Projects 75c

NAME _____ (please print)

ADDRESS _____

CITY _____ STATE _____ ZIP _____

Choose Your Favorite At-Home Projects!

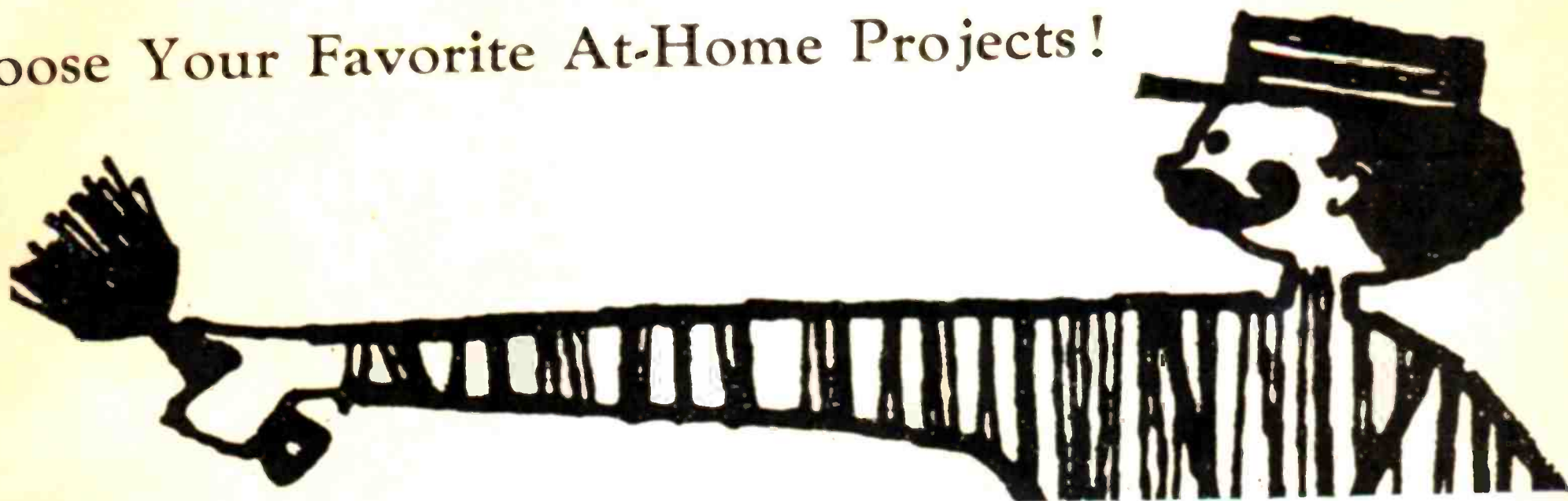

NOW AVAILABLE 75¢ EACH

"How-To" Annuals For The "Do-It-Yourself" Enthusiast!

- * Save Costly Repairs
- * Hundreds of photos, diagrams & theory lessons

* Easy to learn tested and proven construction projects

* Meticulously researched and tested by experts

* Hours of at-home fun for pro & novice



Electrical Guide—An indispensable guide for the home owner or apartment dweller who wants to know how to get the most out of electric current coming into his home. Projects to make, install and repair. Installations are graphically explained.



Woodworker—Relieve the pain of "impossible" projects with this veritable how-to treasure for the home handyman. Tells how to set up the workshop, gives detailed tool tests, covers new equipment and accessories.



Furniture Step-by-step details for building, repairing and refinishing furniture the way the experts do—for every room in the house as well as outdoor use. Projects range from colonial to ultra modern stylings.



Home Workshop—Rewarding projects for the craftsman with full detailed text and profuse illustration for working in wood, metal, plastics and other fields.

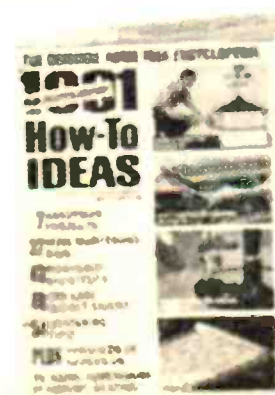

1001 How-To Ideas—Loaded with practical money-saving tips for do-it-yourselfers. Kinks cover home maintenance, automotive, child care, household hints, decorating, boating, sports, cooking and baking tips, electronics and scores of other subjects.

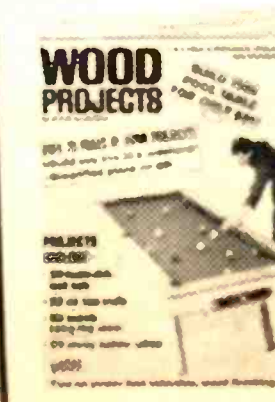

Wood Projects—Syndicated columnist Steve Ellingson is sure to excite the home handyman with this collection of projects which can be built with common hand and power tools. Thrill family and friends by your easily gained "expertise" in creating new and unusual furniture for your home.

BUILD 20 RADIO

Reg. U. S.
Pat. Off.

CIRCUITS AT HOME
with the New Improved
PROGRESSIVE RADIO "EDU-KIT"®

only
\$26⁹⁵



Training Electronics Technicians Since 1946

A Practical Home Radio Course

Now Includes

- ★ 12 RECEIVERS
- ★ 3 TRANSMITTERS
- ★ SQ. WAVE GENERATOR
- ★ SIGNAL TRACER
- ★ AMPLIFIER
- ★ SIGNAL INJECTOR
- ★ CODE OSCILLATOR

- ★ No Knowledge of Radio Necessary
- ★ No Additional Parts or Tools Needed
- ★ EXCELLENT BACKGROUND FOR TV
- ★ **SCHOOL INQUIRIES INVITED**
- ★ Sold In 79 Countries

YOU DON'T HAVE TO SPEND HUNDREDS OF DOLLARS FOR A RADIO COURSE

The "Edu-Kit" offers you an outstanding PRACTICAL HOME RADIO COURSE at a rock-bottom price. Our Kit is designed to train Radio & Electronics Technicians, making use of the most modern methods of home training. You will learn radio theory, construction practice and servicing. THIS IS A COMPLETE RADIO COURSE IN EVERY DETAIL. You will learn how to build radios, using regular schematics; how to wire and solder in a professional manner; how to service radios. You will work with the standard type of punched metal chassis as well as the latest development of Printed Circuit chassis.

You will learn the basic principles of radio. You will construct, study and work with RF and AF amplifiers and oscillators, detectors, rectifiers, test equipment. You will learn and practice code, using the Progressive Code Oscillator. You will learn and practice trouble-shooting, using the Progressive Signal Tracer, Progressive Signal Injector, Progressive Dynamic Radio & Electronics Tester, Square Wave Generator and the accompanying instructional material.

You will receive training for the Novice, Technician and General Classes of F.C.C. Radio Amateur Licenses. You will build Receiver, Transmitter, Square Wave Generator, Code Oscillator, Signal Tracer and Signal Injector circuits, and learn how to operate them. You will receive an excellent background for television, Hi-Fi and Electronics.

Absolutely no previous knowledge of radio or science is required. The "Edu-Kit" is the product of many years of teaching and engineering experience. The "Edu-Kit" will provide you with a basic education in Electronics and Radio, worth many times the low price you pay. The Signal Tracer alone is worth more than the price of the kit.

THE KIT FOR EVERYONE

You do not need the slightest background in radio or science. Whether you are interested in Radio & Electronics because you want an interesting hobby, a well paying business or a job with a future, you will find the "Edu-Kit" a worth-while investment. Many thousands of individuals of all

ages and backgrounds have successfully used the "Edu-Kit" in more than 79 countries of the world. The "Edu-Kit" has been carefully designed, step by step, so that you cannot make a mistake. The "Edu-Kit" allows you to teach yourself at your own rate. No instructor is necessary.

PROGRESSIVE TEACHING METHOD

The Progressive Radio "Edu-Kit" is the foremost educational radio kit in the world, and is universally accepted as the standard in the field of electronics training. The "Edu-Kit" uses the modern educational principle of "Learn by Doing." Therefore you construct, learn schematics, study theory, practice trouble shooting—all in a closely integrated program designed to provide an easily-learned, thorough and interesting background in radio.

You begin by examining the various radio parts of the "Edu-Kit." You then learn the function, theory and wiring of these parts. Then you build a simple radio. With this first set you will enjoy listening to regular broadcast stations, learn theory, practice testing and trouble-shooting. Then you build a more advanced radio, learn more advanced theory and techniques. Gradually, in a progressive manner, and at your own rate, you will find yourself constructing more advanced multi-tube radio circuits, and doing work like a professional Radio Technician.

Included in the "Edu-Kit" course are Receiver, Transmitter, Code Oscillator, Signal Tracer, Square Wave Generator and Signal Injector Circuits. These are not unprofessional "breadboard" experiments, but genuine radio circuits, constructed by means of professional wiring and soldering on metal chassis, plus the new method of radio construction known as "Printed Circuitry." These circuits operate on your regular AC or DC house current.

THE "EDU-KIT" IS COMPLETE

You will receive all parts and instructions necessary to build twenty different radio and electronics circuits, each guaranteed to operate. Our Kits contain tubes, tube sockets, variable, electrolytic, mica, ceramic and paper dielectric condensers, resistors, tie strips, hardware, tubing, punched metal chassis, Instruction Manuals, hook-up wire, solder, selenium rectifiers, coils, volume controls and switches, etc.

In addition, you receive Printed Circuit materials, including Printed Circuit chassis, special tube sockets, hardware and instructions. You also receive a useful set of tools, a professional electric soldering iron, and a self-powered Dynamic Radio and Electronics Tester. The "Edu-Kit" also includes Code Instructions and the Progressive Code Oscillator, in addition to F.C.C. Radio Amateur License training. You will also receive lessons for servicing with the Progressive Signal Tracer and the Progressive Signal Injector, a High Fidelity Guide and a Quiz Book. You receive Membership in Radio-TV Club, Free Consultation Service, Certificate of Merit and Discount Privileges. You receive all parts, tools, instructions, etc. Everything is yours to keep.

Progressive "Edu-Kits" Inc., 1186 Broadway, Dept. 511DK, Hewlett, N. Y. 11557

UNCONDITIONAL MONEY-BACK GUARANTEE

Please rush my Progressive Radio "Edu-Kit" to me, as indicated below:

Check one box to indicate choice of model

- Regular model \$26.95.
- Deluxe model \$31.95 (same as regular model except with superior parts and tools plus valuable Radio & TV Tube Checker).

Check one box to indicate manner of payment

- I enclose full payment. Ship "Edu-Kit" post paid.
- Ship "Edu-Kit" C.O.D. I will pay postage.
- Send me FREE additional information describing "Edu-Kit."

Name

Address

City & State Zip

PROGRESSIVE "EDU-KITS" INC.

1186 Broadway, Dept. 511DK, Hewlett, N. Y. 11557

FREE EXTRAS

• SET OF TOOLS

- SOLDERING IRON
- ELECTRONICS TESTER
- PLIERS-CUTTERS
- VALUABLE DISCOUNT CARD
- CERTIFICATE OF MERIT
- TESTER INSTRUCTION MANUAL
- HIGH FIDELITY GUIDE • QUIZZES
- TELEVISION BOOK • RADIO TROUBLE-SHOOTING BOOK
- MEMBERSHIP IN RADIO-TV CLUB: CONSULTATION SERVICE • FCC AMATEUR LICENSE TRAINING
- PRINTED CIRCUITRY

SERVICING LESSONS

You will learn trouble-shooting and servicing in a progressive manner. You will practice repairs on the sets that you construct. You will learn symptoms and causes of trouble in home, portable and car radios. You will learn how to use the professional Signal Tracer, the unique Signal Injector and the dynamic Radio & Electronics Tester. While you are learning in this practical way, you will be able to do many a repair job for your friends and neighbors, and charge fees which will far exceed the price of the "Edu-Kit." Our Consultation Service will help you with any technical problems you may have.

FROM OUR MAIL BAG

J. Statatis, of 25 Poplar Pl., Waterbury, Conn., writes: "I have repaired several sets for my friends, and made money. The "Edu-Kit" paid for itself. I was ready to spend \$240 for a Course, but I found your ad and sent for your Kit."

Ben Valerio, P. O. Box 21, Magna, Utah: "The Edu-Kits are wonderful. Here I am sending you the questions and also the answers for them. I have been in Radio for the last seven years, but like to work with Radio Kits, and like to build Radio Testing Equipment. I enjoyed every minute I worked with the different kits; the Signal Tracer works fine. Also like to let you know that I feel proud of becoming a member of your Radio-TV Club."

Robert L. Shuff, 1534 Monroe Ave., Huntington, W. Va.: "Thought I would drop you a few lines to say that I received my Edu-Kit, and was really amazed that such a bargain can be had at such a low price. I have already started repairing radios and phonographs. My friends were really surprised to see me get into the swing of it so quickly. The Trouble-shooting Tester that comes with the Kit is really swell, and finds the trouble, if there is any to be found."

PRINTED CIRCUITRY

At no increase in price, the "Edu-Kit" now includes Printed Circuitry. You build a Printed Circuit Signal Injector, a unique servicing instrument that can detect many Radio and TV troubles. This revolutionary new technique of radio construction is now becoming popular in commercial radio and TV sets.

A Printed Circuit is a special insulated chassis on which has been deposited a conducting material which takes the place of wiring. The various parts are merely plugged in and soldered to terminals.

Printed Circuitry is the basis of modern Automation Electronics. A knowledge of this subject is a necessity today for anyone interested in Electronics.