

STEREO

HI-FI HANDBOOK

A FAWCETT

75c

HOW-TO BOOK

432

by Joseph Marshall



• UNDERSTANDING
STEREO SOUND

• THE SEVERAL
ROADS TO STEREO

• WHAT YOU CAN
HEAR WITH STEREO

• AVAILABLE STEREO
DISKS AND TAPES

*What You Should
Know About...*

- LOUSPEAKERS
- AMPLIFIERS
- PREAMPLIFIERS
- PICKUPS
- TURNTABLES
- RECORD CHANGERS
- TUNERS
- TAPE RECORDERS
- ASSEMBLING AND
ADJUSTING STEREO
SYSTEMS

Yes, there is a difference in Stereo Components*



Of course you will compare components for your stereo system before buying. To help you in your selection, we present here some of the significant reasons why it will be to your advantage to carefully consider British Industries components.

Garrard —the World's Finest RECORD CHANGERS

The best in stereo STARTS with a Garrard changer... for example, the incomparable RC-88. This great changer actually outperforms most so-called "professional" turntables; combines a superb turntable with a precision, resonance-free aluminum tone arm which tracks at correct specified stylus pressure. Records can be played manually or automatically... handled even more gently than by the human hand.

The Garrard line includes changers, manual players and transcription turntables. Seven models—\$12.50 to \$89.00.

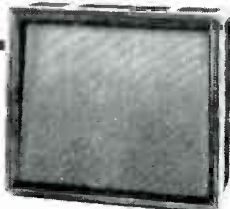


The new, beautifully styled **LEAK** Stereo Amplifiers and Preamplifiers keep distortion down to an infinitesimal 1/10 of 1% (0.1%) at full rated power... lowest ever achieved! This insures natural stereo sound enjoyed without fatigue.

The Leak Stereo Line includes two amplifiers and a preamplifier. Also available: Leak monaural power amplifiers and preamplifiers, and a brand new, matching FM Tuner, ready for both regular and multiplex reception.

Shown are the **Wharfedale** Super 12/FS A1 Speaker, the compact WS/2 and the sand-filled SFB/3 Speaker Systems. Designed by England's G. A. Briggs, Wharfedale speakers are preferred for their natural, non-strident reproduction, undistorted by electronic, mechanical or acoustical coloration.

The Wharfedale line includes full range, bass and treble speakers, plus two-way and three-way speaker systems.



R-J speaker enclosures are ideal for any stereo system, used with any speakers. Their splendid sound results from the patented R-J design principles. This means that no other small speaker enclosures can match the R-J in performance, even though they may look alike.

The R-J line includes 5 enclosures... shelf and floor models.

Other quality endorsed stereo components of British Industries Corp. are Genalex, the original KT-66 and KT-88 Tubes, S. G. Brown Headphones, River Edge Cabinets and Kits, Erskin Multicore 5-Core Solder.

* We have prepared a series of Comparator Guides covering the various BIC product lines and will be happy to send them to you. Please mail the coupon, checking the BIC products which interest you, to Dept. AY-1349.

BRITISH INDUSTRIES CORPORATION
PORT WASHINGTON, N. Y.

Please send free Comparator Guides for:

- | | | |
|--|--|---|
| <input type="checkbox"/> Garrard Record Changers & Turntables | <input type="checkbox"/> Wharfedale Speakers & Systems | <input type="checkbox"/> S. G. Brown Headphones |
| <input type="checkbox"/> Leak Amplifiers, Preamplifiers & FM Tuner | <input type="checkbox"/> R-J Enclosures | <input type="checkbox"/> River Edge Cabinets & Kits |
| | <input type="checkbox"/> Genalex Tubes | <input type="checkbox"/> Multicore Solder |

Name: _____
Address: _____
City: _____ State: _____

How to pass a genius



All of us can't be geniuses. But any ordinarily talented mortal can be a success—and that's more than some geniuses are.

Now, as in Aesop's time, the race doesn't always go to the one who potentially is the swiftest. The *trained* man has no trouble in passing the genius who hasn't improved his talents.

In good times and bad times, in every technical and business field, the *trained* man is worth a dozen untrained ones, no matter how gifted.

The International Correspondence Schools can't make you into a genius. For more than 67 years, however, I. C. S. has been helping its students to become *trained, successful leaders*—and it can do the same for you.

Mark your special interest on the coupon. Don't be like the unsuccessful genius who wastes his life in dreaming of what he intends to do. **Act now!**

For Real Job Security—Get an I. C. S. Diploma! I. C. S., Scranton 15, Penna.

Accredited Member,
National Home Study Council

INTERNATIONAL CORRESPONDENCE SCHOOLS



BOX 59563M, SCRANTON 15, PENNA.

(Partial list of 258 courses)

Without cost or obligation, send me "HOW TO SUCCEED" and the opportunity booklet about the field BEFORE which I have marked X (plus sample lesson):

- | | | | | |
|--|--|--|---|---|
| <p>ARCHITECTURE and BUILDING CONSTRUCTION</p> <ul style="list-style-type: none"> <input type="checkbox"/> Air Conditioning <input type="checkbox"/> Architecture <input type="checkbox"/> Arch. Drawing and Designing <input type="checkbox"/> Building Contractor <input type="checkbox"/> Building Estimator <input type="checkbox"/> Carpenter Builder <input type="checkbox"/> Carpentry and Millwork <input type="checkbox"/> Carpenter Foreman <input type="checkbox"/> Heating <input type="checkbox"/> Painting Contractor <input type="checkbox"/> Plumbing <input type="checkbox"/> Reading Arch. Blueprints <p>ART</p> <ul style="list-style-type: none"> <input type="checkbox"/> Commercial Art <input type="checkbox"/> Magazine Illus. <input type="checkbox"/> Show Card and Sign Lettering <input type="checkbox"/> Sketching and Painting <p>AUTOMOTIVE</p> <ul style="list-style-type: none"> <input type="checkbox"/> Automobile <input type="checkbox"/> Auto Body Rebuilding and Refinishing <input type="checkbox"/> Auto Engine Tuneup <input type="checkbox"/> Auto Technician | <p>AVIATION</p> <ul style="list-style-type: none"> <input type="checkbox"/> Aero-Engineering Technology <input type="checkbox"/> Aircraft & Engine Mechanic <p>BUSINESS</p> <ul style="list-style-type: none"> <input type="checkbox"/> Accounting <input type="checkbox"/> Advertising <input type="checkbox"/> Business Administration <input type="checkbox"/> Business Management <input type="checkbox"/> Cost Accounting <input type="checkbox"/> Creative Salesmanship <input type="checkbox"/> Managing a Small Business <input type="checkbox"/> Professional Secretary <input type="checkbox"/> Public Accounting <input type="checkbox"/> Purchasing Agent <input type="checkbox"/> Salesmanship <input type="checkbox"/> Salesmanship and Management <input type="checkbox"/> Traffic Management <p>CHEMICAL</p> <ul style="list-style-type: none"> <input type="checkbox"/> Analytical Chemistry <input type="checkbox"/> Chemical Engineering <input type="checkbox"/> Chem. Lab. Technician <input type="checkbox"/> Elements of Nuclear Energy <input type="checkbox"/> General Chemistry <input type="checkbox"/> Natural Gas Prod. and Trans. <input type="checkbox"/> Petroleum Prod. and Engr. <input type="checkbox"/> Professional Engineer (Chem) <input type="checkbox"/> Pulp and Paper Making | <p>CIVIL ENGINEERING</p> <ul style="list-style-type: none"> <input type="checkbox"/> Civil Engineering <input type="checkbox"/> Construction Engineering <input type="checkbox"/> Highway Engineering <input type="checkbox"/> Professional Engineer (Civil) <input type="checkbox"/> Reading Struc. Blueprints <input type="checkbox"/> Sanitary Engineer <input type="checkbox"/> Structural Engineering <input type="checkbox"/> Surveying and Mapping <p>DRAFTING</p> <ul style="list-style-type: none"> <input type="checkbox"/> Aircraft Drafting <input type="checkbox"/> Architectural Drafting <input type="checkbox"/> Drafting & Machine Design <input type="checkbox"/> Electrical Drafting <input type="checkbox"/> Mechanical Drafting <input type="checkbox"/> Sheet Metal Drafting <input type="checkbox"/> Structural Drafting <p>ELECTRICAL</p> <ul style="list-style-type: none"> <input type="checkbox"/> Electrical Engineering <input type="checkbox"/> Elec. Engr. Technician <input type="checkbox"/> Elec. Light and Power <input type="checkbox"/> Practical Electrician <input type="checkbox"/> Practical Lineman <input type="checkbox"/> Professional Engineer (Elec) <p>HIGH SCHOOL</p> <ul style="list-style-type: none"> <input type="checkbox"/> High School Diploma | <ul style="list-style-type: none"> <input type="checkbox"/> Good English <input type="checkbox"/> High School Mathematics <input type="checkbox"/> High School Science <input type="checkbox"/> Short Story Writing <p>LEADERSHIP</p> <ul style="list-style-type: none"> <input type="checkbox"/> Industrial Foremanship <input type="checkbox"/> Industrial Supervision <input type="checkbox"/> Personnel-Labor Relations <input type="checkbox"/> Supervision <p>MECHANICAL and SHOP</p> <ul style="list-style-type: none"> <input type="checkbox"/> Diesel Engines <input type="checkbox"/> Gas-Elec. Welding <input type="checkbox"/> Industrial Engineering <input type="checkbox"/> Industrial Instrumentation <input type="checkbox"/> Industrial Metallurgy <input type="checkbox"/> Industrial Safety <input type="checkbox"/> Machine Shop Practice <input type="checkbox"/> Mechanical Engineering <input type="checkbox"/> Professional Engineer (Mech.) <input type="checkbox"/> Quality Control <input type="checkbox"/> Reading Shop Blueprints <input type="checkbox"/> Refrigeration and Air Conditioning <input type="checkbox"/> Tool Design <input type="checkbox"/> Tool Making <p>RADIO, TELEVISION</p> <ul style="list-style-type: none"> <input type="checkbox"/> General Electronics Tech. | <ul style="list-style-type: none"> <input type="checkbox"/> Industrial Electronics <input type="checkbox"/> Practical Radio-TV Eng'g <input type="checkbox"/> Practical Telephony <input type="checkbox"/> Radio-TV Servicing <p>RAILROAD</p> <ul style="list-style-type: none"> <input type="checkbox"/> Car Inspector and Air Brake <input type="checkbox"/> Diesel Electrician <input type="checkbox"/> Diesel Engr. and Fireman <input type="checkbox"/> Diesel Locomotive <p>STEAM and DIESEL POWER</p> <ul style="list-style-type: none"> <input type="checkbox"/> Combustion Engineering <input type="checkbox"/> Power Plant Engineer <input type="checkbox"/> Stationary Diesel Engr. <input type="checkbox"/> Stationary Fireman <p>TEXTILE</p> <ul style="list-style-type: none"> <input type="checkbox"/> Carding and Spinning <input type="checkbox"/> Cotton Manufacture <input type="checkbox"/> Cotton Warping and Weaving <input type="checkbox"/> Loom Fixing Technician <input type="checkbox"/> Textile Designing <input type="checkbox"/> Textile Finishing & Dyeing <input type="checkbox"/> Throwing <input type="checkbox"/> Warping and Weaving <input type="checkbox"/> Worsted Manufacturing |
|--|--|--|---|---|

Name _____ Age _____ Home Address _____

City _____ Zone _____ State _____ Working Hours _____ A.M. to P.M. _____

Occupation _____ Canadian residents send coupon to International Correspondence Schools, Canadian, Ltd., Montreal, Canada. . . . Special low monthly tuition rates to members of the U. S. Armed Forces.



STEREO

HI-FI HANDBOOK

by Joseph Marshall

A FAWCETT BOOK • NUMBER 432
 LARRY EISINGER • EDITOR-IN-CHIEF
 GEORGE TILTON • MANAGING EDITOR
 SILVIO LEMBO • ART EDITOR

W. H. Fawcett, Jr. President
 Roger Fawcett General Manager
 Gordon Fawcett Secretary-Treasurer
 Roscoe Fawcett Circulation Director
 Ralph Daigh Editorial Director
 James B. Boynton Advertising Director
 Al Allard Art Director
 Ralph Mattison Associate Art Director
 George H. Carl Production Director

RAY GILL EDITOR
 Lois Bianchi Editorial Assistant

Staff Artists

NICK CARLUCCI . . . ASSOCIATE ART EDITOR
 Harold E. Price • Michael Gaynor
 Larry Flanagan • Stanley Moskowitz
 John S. Selvaggio • Bob Vatter
 Mike Eastman • Frank Bermudez
 Phyllis J. Bendremer Production Editor
 Benita Mills Assistant Production Editor



STEREO HI-FI HANDBOOK, by Joseph Marshall, Fawcett Book 432, is published by Fawcett Publications, Inc., Greenwich, Connecticut. Editorial and Advertising Offices: 67 West 44th Street, New York 36, New York. General Offices: Fawcett Building, Greenwich, Connecticut. Printed in U.S.A. Copyright 1959 by Fawcett Publications, Inc.

Cover photos by Grayson Tewksbury; Jensen Speakers courtesy of Ben-Jay Associates and Grand Central Radio Corp.; Sherwood Tuner courtesy of Sherwood Electronic Laboratories and Harvey Radio Corp.; Pilot Preamp-Amplifier courtesy of Grand Central Radio; Weathers Turntable courtesy of Hudson Radio Corp.; Ampex Tape Recorder from Ampex and Harvey Radio.

EARN WHILE YOU LEARN

NOTHING ELSE LIKE IT!

See How DeVry Tech Prepares You for a Good-Paying Career in

TELEVISION RADIO ELECTRONICS

Hundreds of men, 17 to 55, started to make money in the Electronics field before they even finished their DeVry Tech program. Many made the training pay for itself as they learned! Because DeVry Tech's program is so practical, YOU should be able to do the same. You work scores of projects; you learn by watching home training movies; you follow clear, step-by-step instructions. You really learn principles and master many skills. No wonder DeVry Tech men are found in so many real-pay, bright-future jobs in this great, growing field!



A BIG DeVRY EXTRA!

Build Your Own 6-Speaker Stereophonic & Hi-Fi Sound System

NOW, you may build and keep your own top quality High Fidelity 6-Speaker Stereophonic Sound System, as shown below. You Learn-By-Doing for a BETTER JOB or to ADD TO YOUR PRESENT INCOME. As a bonus, you and your family can enjoy the thrills of this marvelous sound system for years to come.

Special **SHORT COURSE** in High Fidelity Sound Reproduction including Stereophonic Systems also available. Ideal for hobbyists, music lovers and men seeking **NEW OPPORTUNITY**. Mail coupon.

GET A BETTER JOB OR BE BOSS OF YOUR OWN BUSINESS

NO ADVANCED EDUCATION OR PREVIOUS TECHNICAL EXPERIENCE

NEEDED! At home in your spare time, you use the same basic method followed by students in our Chicago and Toronto laboratories. You learn to use tools, follow diagrams, when you build any or all of this valuable equipment: the STEREO SYSTEM . . . or a 5-INCH OSCILLOSCOPE and VACUUM TUBE VOLTMETER . . . or a 21-inch TV SET. You have many choices! DeVry Tech's program is so thorough that you will likely be surprised at your progress. Send the coupon for details.

EMPLOYMENT SERVICE



Frequently, we simply don't have enough graduates available to fill all the jobs on our list! DeVry Tech has an Employment Service that really works. It is available to graduates without additional cost.

MILITARY SERVICE

If you are subject to military service, you will find the information we have for you very helpful. Mail the coupon today and get the facts.

GET TWO FREE Booklets!

"POCKET GUIDE TO REAL EARNINGS" and
"ELECTRONICS AND YOU"



Real down-to-earth details are presented to help the man who wants to get ahead. Both booklets are yours FREE! Fill out coupon and mail today.

MAIL TODAY FOR FREE FACTS

DeVry Technical Institute
4141 Belmont Ave., Chicago 41, Ill., Dept. AS-P
Please give me your two FREE booklets, "Pocket Guide to Real Earnings" and "Electronics and You," and tell me how to prepare to enter one or more branches of Electronics.

NAME _____ AGE _____

STREET _____ APT. _____

CITY _____ ZONE _____ STATE _____

Check here if subject to military training.
DeVry Tech's Canadian Training Center is located at
2051 626 Roselawn Avenue, Toronto 12, Ontario

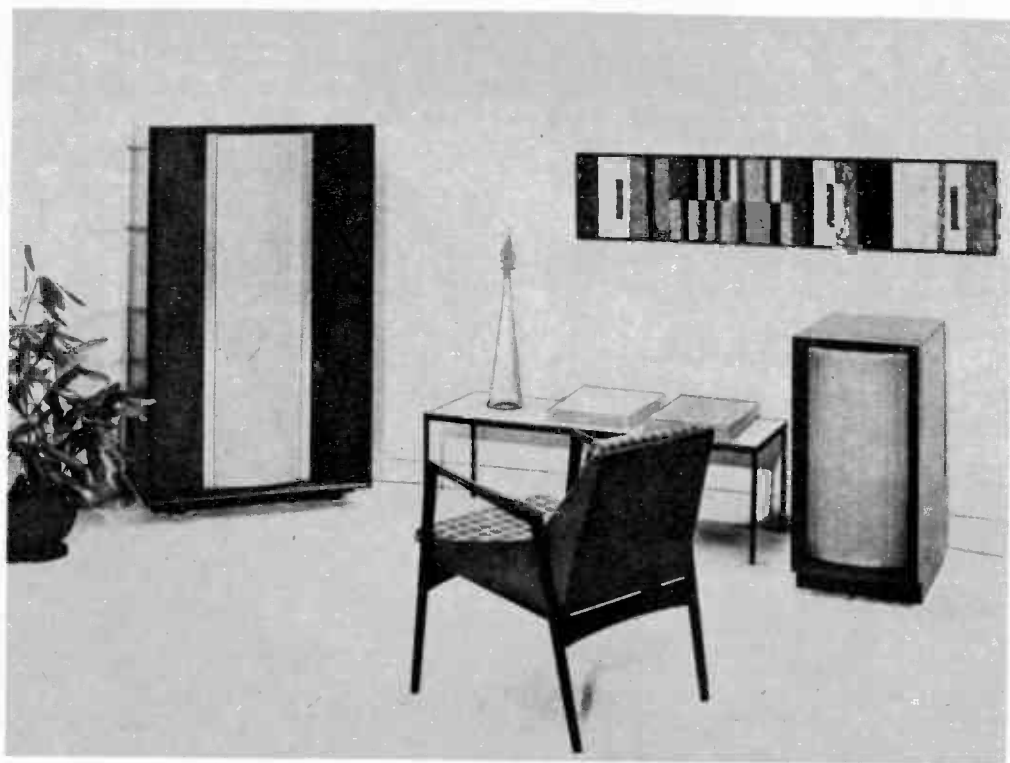
DeVRY Technical Institute

4141 BELMONT • CHICAGO 41, ILL. • Formerly DeFOREST'S TRAINING, Inc.
Accredited Member of National Home Study Council



"One of America's Foremost
Electronics Training
Centers"

ONE OF THE BIGGEST OPPORTUNITY FIELDS OF THE CENTURY!



CONTENTS

CHAPTER 1	Understanding Stereo	8	CHAPTER 6	Pickups and	98
				Turntables	
CHAPTER 2	The Several Roads	20	CHAPTER 7	Tuners for Stereo	118
	to Stereo				
CHAPTER 3	What You Can Hear	32	CHAPTER 8	Tape Recorders	132
	With Stereo				
CHAPTER 4	Loudspeakers	48	CHAPTER 9	Assembling	138
				and Adjusting	
CHAPTER 5	Amplifiers and	72	CHAPTER 10	Available Discs	142
	Preamplifiers			and Tapes	

new AMPEX RECORDS STEREO

and plays
both
2-track
and
4-track
tapes



Record stereo off the air; copy stereo tapes and discs

Here's stereo recording of full professional quality. The Ampex Universal Series 950 recorder/reproducer enables you to build a stereo tape library of highest quality at lowest cost. Records monaurally, too, from radio, tv sound, phonograph records, and "live" from microphone.

Benefit from traditionally fine Ampex engineering features

With the Universal's instant-acting head switch, you can shift from 2-track to 4-track operation at will, and play back as long as 4 hours and 16 minutes of stereo music on a single-reel of tape (2400.ft.). Automatic stop at end of reel.

Enjoy years of flawless, trouble-free operation

The Universal's performance will be within specifications the day you install it and for years afterwards. Its three precision dual head stacks (one each for record, playback and erase) are built to tolerances as close as 10 millionths of an inch. Twin pre-amplifiers provide output to match either your own amplifier-speakers or Ampex units.

MAIL COUPON TODAY FOR COMPLETE SPECIFICATIONS AND DETAILS

AMPEX STEREO

SIGNATURE OF PERFECTION IN SOUND

AMPEX AUDIO, INC. • 1058-F KIFER ROAD • SUNNYVALE, CALIFORNIA

Please mail me full information on the
UNIVERSAL "A" (900 series):

Name _____

Address _____

City _____ Zone _____ State _____

INTRODUCTION



Photograph of the author by Grayson Tewksbury

JOSEPH MARSHALL has been identified with high fidelity from its inception. In the '30s and early '40s, he belonged to that enthusiastic group of amateur experimenters who worked to achieve the best high-fidelity reproduction possible, utilizing the limited knowledge and components then currently available. Some of the earliest equipment was constructed and designed by Joe Marshall—the best known is the Golden Ear series of amplifiers, used throughout the world. Mr. Marshall has also served as a consultant to some of the major hi-fi manufacturers. Among his other achievements was the pioneering of objective tests of high-fidelity equipment and the review of records from the high-fidelity viewpoint.

As the boom in high fidelity gained more and more momentum, Mr. Marshall began to write extensively about hi-fi for a large number of the audio journals and periodicals in the field. He has also written the first series of articles on servicing high-fidelity equipment and his book MAINTAINING HIGH FIDELITY is considered to be the definitive work in this field.

Mr. Marshall has learned high fidelity through close association with its development, and has not only expert knowledge of the subject, but also has the experience in writing technical material to communicate his knowledge. It is his purpose in writing this book to give you a basis for understanding, planning, buying, assembling, operating and enjoying a stereophonic high-fidelity system. It is the aim of the author to be helpful even to those who have very little knowledge of high fidelity or stereophonic sound, but this is not a reference book. It is, like all other Fawcett How-To books, a practical book; the intent is to make it honest, objective, practical and simple. In a field as new as stereo, a knowledge of the basic principles is needed as a foundation for a practical application; these principles are presented simply with the stress on the practical how-to aspect, the available equipment and down-to-earth advice on purchasing and assembling the components.

The book can be divided into two parts. The first few chapters tell what stereophonic high fidelity is all about and how, in general terms, it is achieved. The rest of the book describes the components needed to obtain good stereo, how to choose, buy and put them together prudently so you will get the most for your money.

Ray Till — Editor

REK-O-KUT AUDAX

they make wonderful music together!

Rek-O-Kut STEREO TABLES!

Each model shown is powered by the fabulous Rek-O-Kut hysteresis motor!

Performance and prestige unmatched — in a variety of models for every need and budget.

Audax Paraflex Speaker Systems!*

Designed and manufactured by Audax, division of the Rek-O-Kut Co. — the newest, most advanced speakers of the year — featuring Paraflex Foam

Suspension for "natural sound" — removable, 3-dimensional Dynel Acoustiscreen grille and many other innovations!

* Pat. App. For



N-33H StereoTable—33 $\frac{1}{3}$ single speed, belt-driven. \$69.95



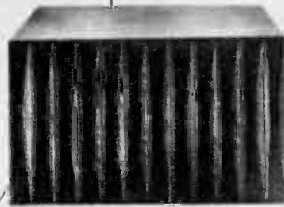
K-33H StereoTable in Kit Form—33 $\frac{1}{3}$ single speed. Assembles in 30 minutes or less. \$49.95



Two speed StereoTables—L-34H, 33 $\frac{1}{3}$ and 45 rpm. L-37H, 33 $\frac{1}{3}$ and 78 rpm. \$79.95



B-12GH StereoTable — 3 speeds (33 $\frac{1}{3}$ -45-78) with deluxe features. \$99.95



Audax CA-80 Speaker System, 12" x 12" x 24", oiled finish walnut on 4 sides. \$99.95



World's Largest Selling Tonearm:
S-120, 12" Stereo Tonearm, \$27.95
S-160, 16" Stereo Tonearm, \$30.95

Audax CA-100 Speaker System, 15" x 12" x 25", oiled finish walnut on 4 sides. \$139.95

Bases from \$8.95

Famous industrial designer, George Nelson, shown above, styled

the incomparable STEREO TABLES and Audax Speaker Systems.



SEND FOR COMPLETE STORY AND NAME OF YOUR NEAREST DEALER

- Rek-O-Kut StereoTables and Tonearms
 Audax Paraflex Speaker Systems

Name _____

Address _____

City _____ Zone _____ State _____

Rek-O-Kut Co., 38-19 108th St., Corona 68, N. Y. • Export: Morhan Exporting Corp., 458 Broadway, N. Y. 13 • Canada: Atlas Radio Corp., 50 Wingold Ave., Toronto 19

REK-44

CHAPTER

1

Understanding Stereo

Having left the experimental stage it is beginning to live up to its promises.

THE EASIEST WAY to understand stereophonic sound is to start by asking ourselves the question: "What is high fidelity trying to do?" The answer is that high fidelity tries to recreate a recorded or broadcast program so faithfully as to produce the illusion in the mind of the proud possessor, sitting in the comfort of his own living room, that he is, instead, in the concert hall, the studio or the theater listening to the actual live performance.

There are a lot of angles to the problem of creating this illusion. For example, it is pretty obvious that we must deliver to the ear the best possible facsimile of the sound actually produced in the concert hall, the studio or the theater by the performers. We must neither take away anything from the original sound nor add anything to it.

But between the original performers in the concert hall and the eventual listener

in his living room there is a chain of a dozen or two gadgets beginning with the microphones and ending with the loudspeakers. Passing the sound through that long chain without adding anything to it, or taking anything away from it, is quite an order. And high fidelity comes very close to doing it almost perfectly. In fact, with the best available equipment and the best techniques today, high fidelity can deliver the sound of a single instrument so faithfully that even the most critical ears need a direct comparison with the original to tell the two apart.

Despite the faithfulness with which it reproduces the tonality of the sound, however, single-channel or monophonic high fidelity does not quite manage to create that illusion of actually being there at the live performance. The reason it fails becomes quite obvious if we analyze the

Good stereo adds to the fidelity of reproduction to a degree unobtainable with monophonic methods.

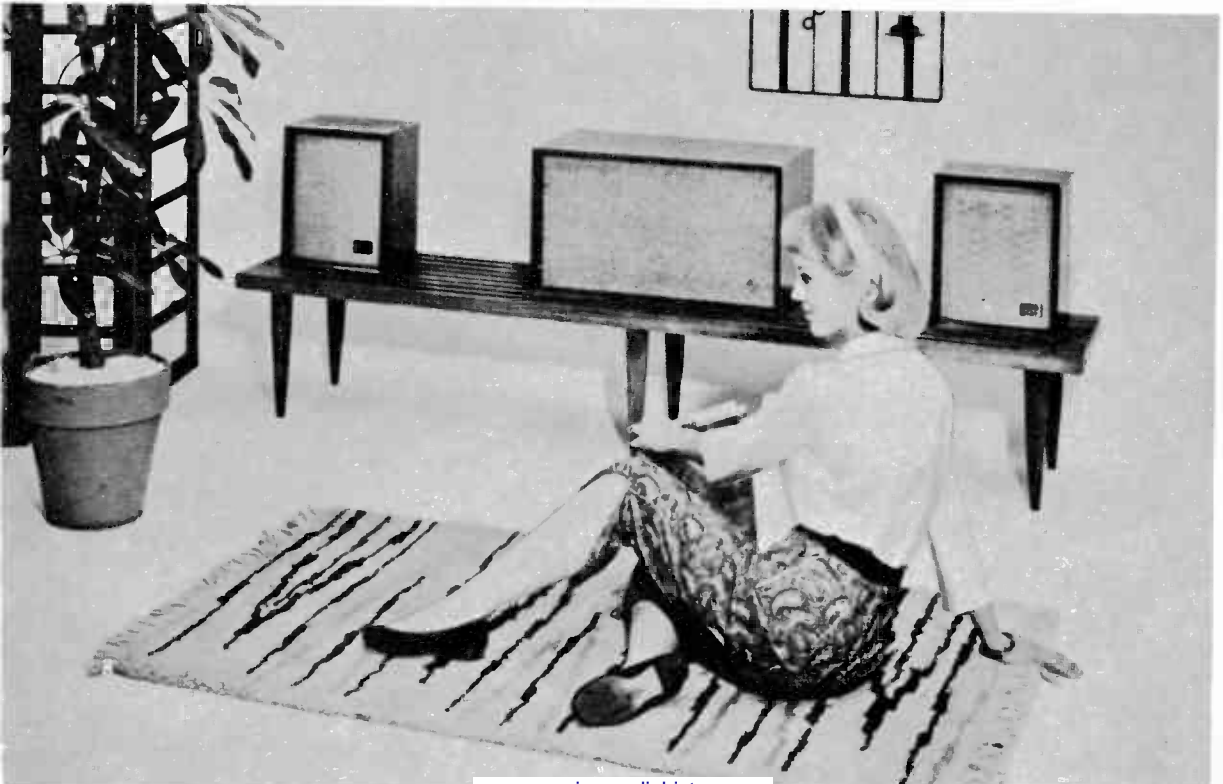
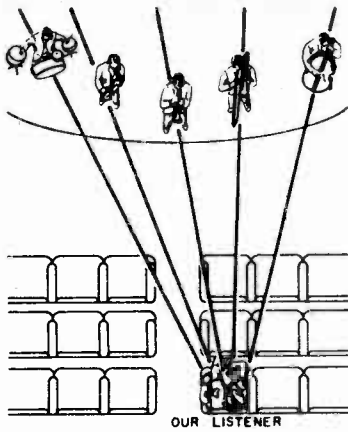


Fig. 1



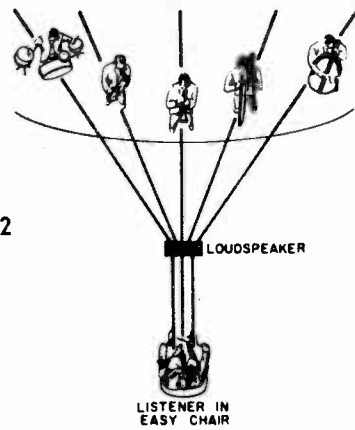
In an auditorium the sounds from individual instruments reach the ear separately, by different paths, then combine in the ears to create the overall tonal picture in panoramic sound.

problem, not in terms of the faithfulness of the tonality of the sound, but in terms of the distribution of that sound in the living room. Take a glance at Fig. 1. Here we have a symphony orchestra spread out on a stage in a more or less typical arrangement—with 50 to 100 individual instruments and performers arranged in various choirs of strings, basses, woodwinds, brasses, percussion, etc. In the concert hall the listener sits anywhere from twenty to one hundred feet away from the orchestra. Each instrument in the orchestra sends forth its own sound into the concert hall. These individual sounds reach the listener separately and combine in his ears to create the overall tonal effect.

The situation is very much different in the living room between the listener and his monophonic high fidelity set. Instead of the 50 to 100 individual sources of sound spread over a full stage, there is now only one source of sound, the loudspeaker. This may, in fact, be a single speaker or a group of carefully correlated individual speakers, each covering a portion of the audible range. There may be a slight difference in the location of each of these several speakers, but this difference seldom exceeds a matter of inches or, at the most, a foot or two. On the face of it, it is clearly impossible for that one speaker system, no matter how faithfully it reproduces the tonalities, to do a good job of replacing 50 or 100 separate instruments.

Moreover, the sound reaches the ears in the living room through a different route. As we said previously, in the concert hall, the separate sounds from the individual instruments arrive at the ears more or less separately and are combined in the ears. The ears are able to distinguish between

Fig. 2



In the home, when listening to a recording of the orchestra or band, the sound from all the instruments is combined into one complex sound which is like hearing the music through an open door.

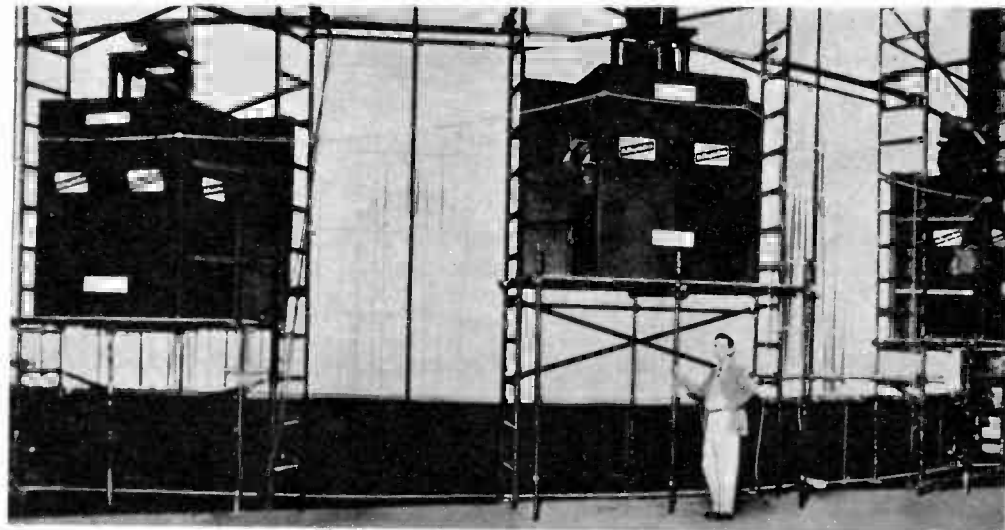
the separate instruments not only because of their different tonal qualities but also because they arrive from different directions.

This is not true when we listen to the same program through a single loudspeaker system. In the recording and transmission process the individual sounds of the separate instruments are combined and they are radiated into the living room by the loudspeaker as a *single complex* of sound and reach the ears through a single path. The ears can recognize the individual instruments by the differences in their tonalities but they can no longer distinguish them spatially since they all come from the same spot.

Therefore, when we are listening to a single channel high fidelity system we are hearing the sound coming out of the small end of a funnel, as it were, as indicated in the diagram Fig. 2. At best the effect is like that of listening to the orchestra through an open window or open door. It always seems just on the other side of the wall and never quite gets into the room.

It is obvious that so long as we try to make one speaker system do the job which a number of individual instruments did originally, we cannot successfully create this illusion of taking the listener to the concert hall. We can only bring him to an adjoining room and let him listen through a window or door.

The ideal way to create the illusion, of course, would be to have a separate speaker for each instrument and to spread these speakers through the living room, more or less in the same arrangement that the original instruments occupied in the concert hall. With these individual speakers spread throughout the room we



Array of Altec-Lansing theater speakers which was used behind screen for the Cinerama seven-channel stereophonic sound. Other channels are on sides and to rear of the theater for 260° aural perspective.

would once again present to the ears the distribution of sound that actually occurs in the concert hall. The ears would be able to distinguish again between the separate instruments not only through the differences in their tonal qualities but also through the fact that the sound of each one is coming to the ears from a different spot in the room. Obviously this would be about as practical as letting each man have three wives, a blonde, a brunette and a redhead.

Clearly then, to give some approximation of the distribution of the sound that occurs in the concert hall, we need more than one speaker. The question is: How many more than one speaker? We have had a lot of experimentation on this point over the past 30 years. And we have had some very successful examples of stereophonic sound in theater work utilizing from three to nine separate speakers fed by separate channels. Almost twenty years ago now, the remarkable moving picture *FANTASIA* achieved a very startling illusion of this "presence." More recently, *CINERAMA* has charmed and amazed millions of theater-goers with multichannel reproduction.

The consensus of all these experiments is that three channels would do a pretty good job of creating this illusion in the home. Unfortunately, three channels is still too many. It is not simply a matter of complication—of having three different sets of speakers, amplifiers, preamplifiers, etc. Far more serious is the problem of trying to record three channels in some form cheap enough and convenient enough to be usable in the home.

For various reasons disc recordings are the most practical medium for home reproduction. After many years of experi-

mentation we have finally learned how to put two channels in the single groove of a disc; and even this has presented some very serious problems which we are only now resolving satisfactorily. So it appears that two channels is the practical maximum for a usable home stereo system.

The question then is: Can we do the job with only two channels? And the answer is: Yes. By using some stratagems, we can overcome the deficiencies of using only two channels and make them do the work of three.

Let us take a look at Fig. 4. Here we have the same orchestra as in Figs. 1 and 2. But we now divide it, in effect, into two parts by using two microphones. One responds largely to the left half of the orchestra, the other to the right half. We feed the output of each of these microphones into a two-channel reproducing system so that in the living room it now comes out of two speakers, and the ears now hear two sources of sound. Of course, each of the speakers radiates a single complex sound and if all the instruments on either side were playing at once we could not separate the individual instruments on that side. But, we would be able to distinguish that some of the instruments came from the left speaker and some from the right speaker. As a matter of fact, the instruments in an orchestra play in unison only part of the time. Most of the time one or two instruments, or choirs, are leading and the rest sort of noodling in the background. So, even with only two channels, most of the time we would be able to distinguish, for instance, the first violins from the violas, not only because they have a different tone, but also because the fiddles came from the left speaker while the violas came from the right. If the two

In **STEREO**

and Mono Hi-Fi... the experts say
your best buy is

EICO

"The overall design of the HF-81 is conservative, honest and functional. It is a good value considered purely on its own merits, and a better one when its price is considered as well."

— Hirsch-Houck Labs (HIGH FIDELITY Magazine)

- Advanced engineering • Finest quality components
- "Beginner-Tested," easy step-by-step instructions
- LIFETIME service & calibration guarantee at nominal cost
- IN STOCK — compare, then take home any EICO equipment — right "off the shelf" — from 1500 neighborhood EICO dealers.



Stereo Amplifier-Preamp HF81

HF81 Stereo Amplifier-Preamp
"Excellent" — SATURDAY REVIEW; HI-FI MUSIC AT HOME.
"Outstanding quality... extremely versatile."
— ELECTRONICS WORLD LAB-TESTED.
Kit \$69.95. Wired \$109.95. Includes cover.

HF85 Stereo Preamp
"Extreme flexibility... a bargain." — HI-FI REVIEW.
Kit \$39.95. Wired \$64.95. Includes cover.

New HF87 70-Watt Stereo Power Amplifier
Kit \$74.95. Wired \$114.95.

HF86 28W Stereo Power Amplifier
Kit \$43.95. Wired \$74.95.

FM Tuner HFT90
"One of the best buys in high fidelity kits." — AUDIO-CRAFT. Kit \$39.95*. Wired \$65.95*. Cover \$3.95.
*Less cover, F.E.T. incl.

New AM Tuner HFT94
Kit \$39.95. Wired \$65.95. Incl. cover & F.E.T.

New FM/AM Tuner HFT92
Kit \$59.95. Wired \$94.95. Incl. cover & F.E.T.

New AF-4 Stereo Integrated Amplifier
Kit \$38.95. Wired \$64.95.

HF12 Mono Integrated Amplifier
"Packs a wallop." — POPULAR ELECTRONICS
Kit \$34.95. Wired \$57.95. Includes cover.

New HFS3 3-Way Speaker System Semi-Kit
In unfinished birch \$72.50; walnut, mahogany or teak \$87.50.

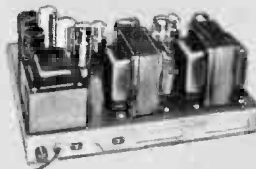
New HFS5 2-Way Speaker System Semi-Kit
In unfinished birch \$47.50; walnut, mahogany or teak \$59.50.

HFS1 Bookshelf Speaker System \$39.95.
LGS-1 Brass Tip Matching 14" Legs easily convert HFS-1 into attractive consolelette. All brackets & hardware provided. \$3.95.

Omni-Directional Speaker System HFS2 (not illus.)
"Fine for stereo" — MODERN HI-FI
Mahogany or Walnut \$139.95. Blonde \$144.95.



Stereo Preamp HF85



70W Stereo Power Amplifier HF87
28W Stereo Power Amplifier HF86



FM Tuner HFT90
AM Tuner HFT94



Stereo Integrated Amplifier AF4



12W Mono Integrated Amplifier HF12
Other Mono Integrated Amplifiers:
50, 30, & 20W (use 2 for stereo)



2-Way Bookshelf Speaker System HFS1
2-Way Speaker System HFS5
3-Way Speaker System HFS3
Omni-Directional Speaker System HFS-2 (not illus.)

Write for FREE catalog FSA-60.

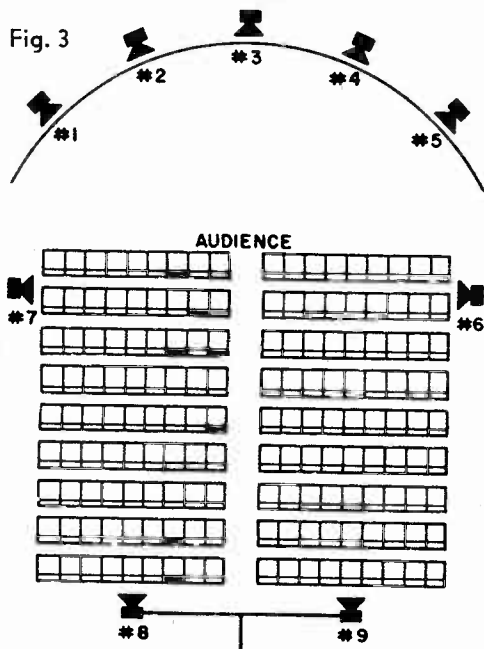
EICO, 33-00 Northern Blvd., L. I. C. I., N. Y.

Over 1 MILLION EICO Instruments in use throughout the world.



Add 5% in the West.
Copyright 1959 by Electronic Instr. Co., Inc. 33-00 N. Blvd., L. I. C. I., N. Y.

Fig. 3



Cinerama uses nine speakers fed by seven channels to achieve 360° sound perspective desired.

speakers were arranged a good distance apart in the room, the violins might well seem to be anywhere from 5 to 20 feet away from the violas.

There is one problem. If the two channels are sharply isolated and the left-right directionality is too sharp, you get the effect of an orchestra divided into two parts—one way out in left field, the other way out in right field, with nothing (but rumble) in the infield. In other words, this arrangement leaves a hole in the middle, and the listener is rather in the position of the audience on the sideline, and right at the net, of a tennis game, snapping its collective head to follow the ball from one court to the other. It appears to be a human reflex to turn the head to the direction a sound comes from; the Ping-pong effect of this division of the sound into two, widely separated sources, is highly fatiguing, whether the listener actually turns his head, or forcibly resists the natural impulse to keep snapping his head from left to right and vice versa.

Of course, this two-channel hole-in-the-middle effect is highly dramatic. You can tell immediately that here is something very different from the sound of a monophonic or ordinary hi-fi. And lots of people are enchanted by it. Unfortunately, it is also very different from what one hears in a concert hall—unless one is standing beside the conductor. The differences in direction to the listener sitting from 30 to 100 feet from the stage are

never so violent as to require him to snap his head back and forth. In fact, most people are scarcely aware of directionality in the concert hall.

Furthermore, this clear separation of the two channels results sometimes in all sorts of weird effects which, though highly interesting, are far from realistic. Thus, if the trumpet player starts a solo with his trumpet pointed to his right, and then, as trumpet players love to do, swings the trumpet in an arc to his left, the listener at home is astonished to hear the trumpet all of a sudden walk across the room, or even jump about 10 feet in a fraction of a second from left to right.

Clearly, if two-channel stereo is going to be anything but a curiosity, something has to be done with that hole in the middle. Happily we have found a number of ways of filling in that hole—in the original recording or pickup process, or in reproduction in the home.

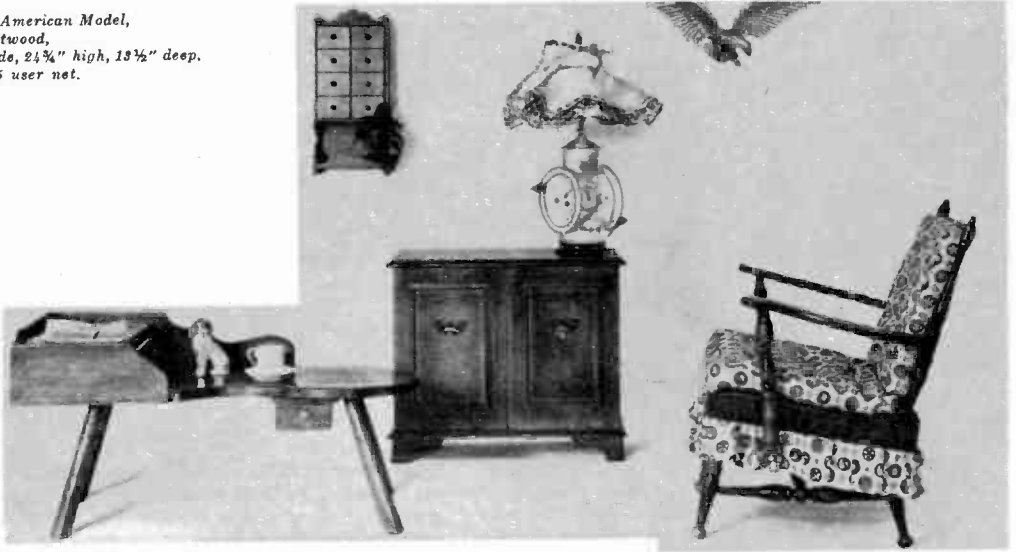
The most obvious way is just to add a third speaker in the middle. Of course, with only two channels, we cannot feed an independent signal into this third channel. But we can take a fraction of the program from each of the two channels, blend this and radiate it through a third speaker in the middle. This will fill in the hole and still keep enough directionality to give us that wide spread of sound we desire.

Still another way is to place the two speakers close together, less than 4 or 5 feet apart. The hole is then made narrower and the directional effects are less exaggerated. The two speakers are often placed in a single cabinet for this reason.

But there is an even simpler way: As it happens, if we radiate the exactly identical sound, in phase, and of exactly the same loudness through two speakers separated by from 5 to 20 feet, a listener sitting in front and center, will hear the sound as if it were coming from a point halfway between the two speakers. So, if we cross-feed a portion of the sound of each of the two stereo channels into the other channel, they will both be radiating a signal which has an identical component, and that component will fill in the hole in the middle.

This cross-feeding and blending can be done either in the recording process or in the reproducing process. Actually, today most stereo recordings are recorded with a blended middle; this can be done by permitting the pickup pattern of the mikes to overlap the middle of the orchestra as shown in Fig. 5. More often three mikes are used, one left, one right, and one in the middle; and three channels are recorded on the original tape. However, when the master tape is edited into a two-channel

Early American Model,
in fruitwood,
30" wide, 24 1/4" high, 13 1/2" deep.
\$279.95 user net.



Furniture courtesy of Lopipero Inc.



Containing two complete multi-speaker systems in one compact enclosure, the 'Tridimensional' TMS-2 projects frequencies of both channels to the rear and side walls of the room. Thus, one large wall area becomes channel A; another channel B... exactly as if you had a series of widely distributed speakers for each channel.

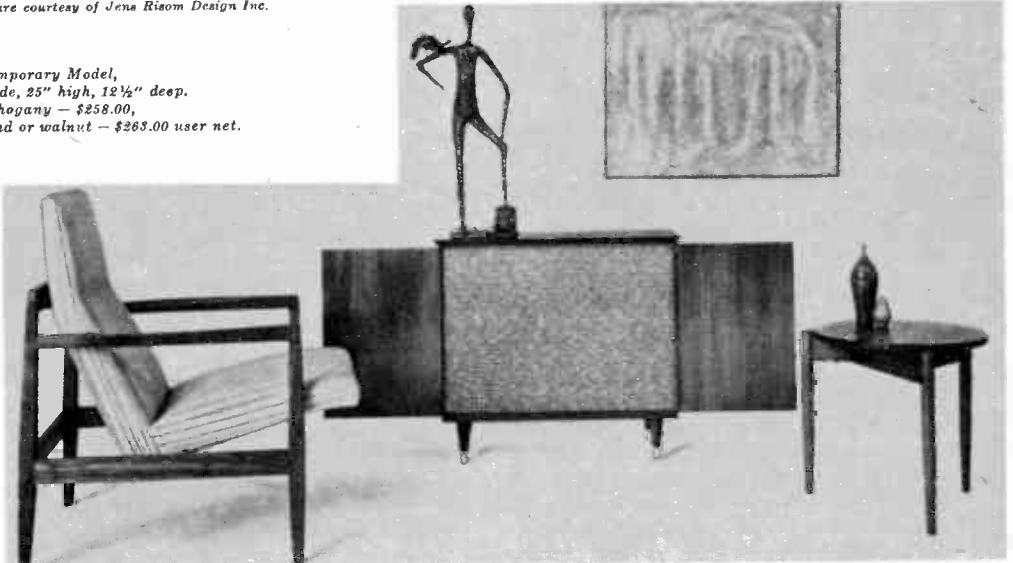
TMS-2... most sensational advance in stereo reproduction

When you listen to the TMS-2, you will experience stereophonic reproduction that no conventional system can ever achieve. Its entirely new principle of operation permits every listener throughout the room to enjoy fully balanced sound with such extraordinary breadth and three-dimensional depth that it seems to originate beyond the confines of the room itself. Full controls and adjustable doors allow the 'Tridimensional' TMS-2 to be placed *anywhere* — along wall or corner — without affecting its performance capabilities. The full TMS-2 story is a fascinating one. Write for it today.



Furniture courtesy of Jens Risom Design Inc.

Contemporary Model,
30" wide, 25" high, 12 1/2" deep.
In mahogany — \$258.00,
in blond or walnut — \$263.00 user net.



WRITE DESK W-11, UNIVERSITY LOUDSPEAKERS, INC., WHITE PLAINS, N. Y.

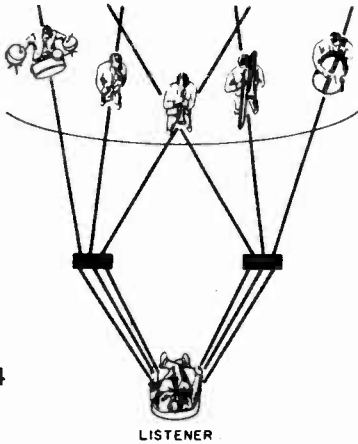


Fig. 4

With two-channel stereo, band is divided into two parts and arrives at the ears from two different directions. If channels are too sharply divided a discernible "hole-in-the-middle" effect occurs.

tape, a portion of the pickup of the middle mike is fed into and blended in with each, the right and left, channel. On playback, this common middle component will be heard between the speakers and thus minimize the gap or hole between the two directional channels.

David Hafler developed a simple way to fill in the middle at home. Two or three playback stereo preamplifiers, notably the Dynaco and the Lafayette Remote Control, utilizing his idea, have *blender* controls which permit the listener to blend the two channels for filling in the middle to any degree he desires, and thus enable him to make corrections for recordings that have too much Ping-pong effect.

A unique solution is provided by the Jim Lansing Ranger speaker systems. Here the speakers of the two channels are pointed at a curved wood reflector between them. As the sound hits this curved surface the channels are, in part, blended acoustically and the result is a complete absence of any hole-in-the-middle effect.

In these ways, which can be combined, we can make two channels actually energize three speaker systems, or sound as if there were a phantom third speaker in the middle. The result is that, to the ears of the listener sitting in the middle, in front of the speakers, the orchestra appears to be spread out across the end or side of the room. The directionality, though not exaggerated, is sufficient to spot that the instruments have different positions. Actually, the ears can discern only three arbitrary directions, left, right and middle. But this is enough to create an excellent illusion—much like that of hearing a symphony in the first row of the balcony, which

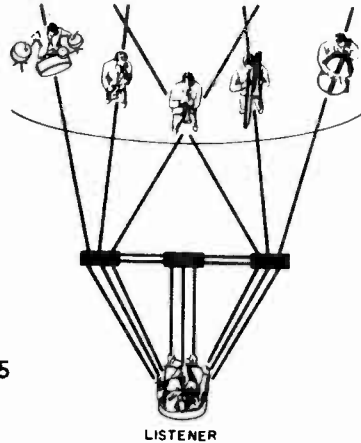


Fig. 5

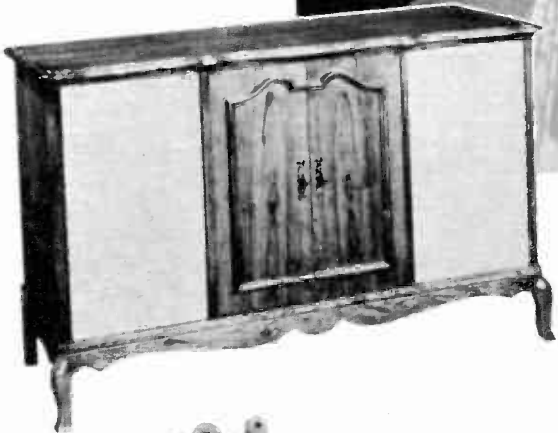
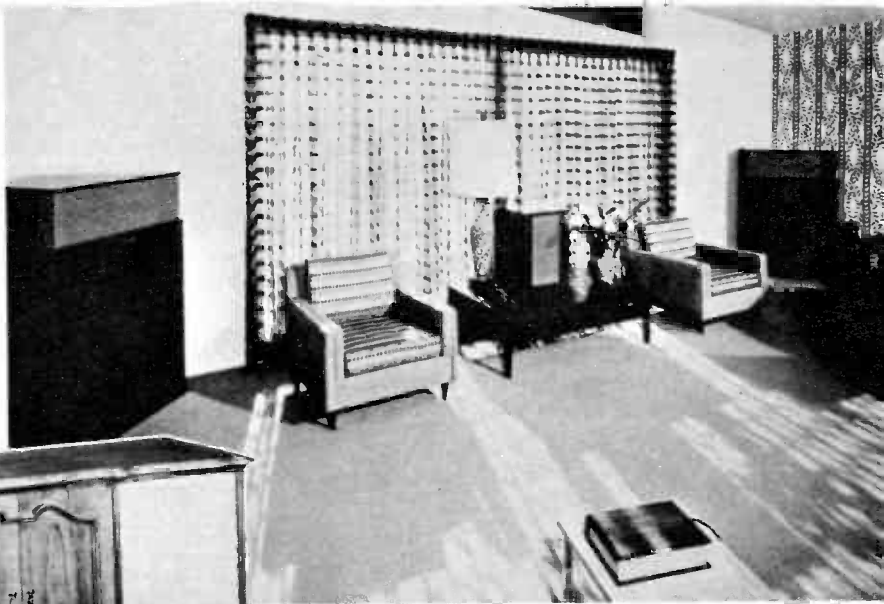
When an actual or "phantom" third or middle channel is added, the hole which is filled in results in an integrated curtain of sound filling end of room corresponding to original instruments on stage.

is, indeed, one of the very best places in most auditoriums to hear it.

Thus, present stereophonic high fidelity is a two-channel system as far as the information transmitted is concerned—but it radiates most of the time as if it were a three-channel system. It is this third channel, whether it is actual or a phantom, which makes the system work satisfactorily,

Some readers will have noticed that nowhere, up to this point, have I said anything about binaural or two-eared hearing. I have not done so because this is a matter of no particular relevance to the kind of stereophonic sound we're talking about and you will be buying. Everything I have said so far would apply with equal effect to a man with only one ear. It is true that a man with one-eared hearing hears things differently; but a symphony orchestra heard live in the concert hall, will sound just about as different from a recording of the same orchestra played back through a single-channel hi-fi to a one-eared human as to a two-eared human. Similarly, a good stereo system will sound a lot closer to the original to the one-eared as well as the normal two-eared humans.

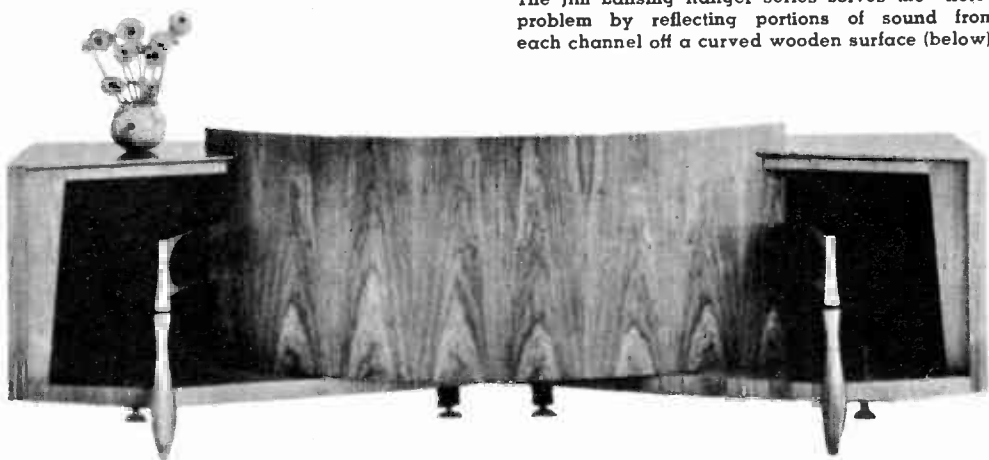
The fact is that the injection of discussion about binaural hearing has been a serious source of confusion—even among those responsible for stereo designs. To be sure, there is such a thing as binaural sound and properly exploited it can be so real as to make the listener feel like a disembodied ghost. At the Rosenwald Museum of Science and Industry in Chicago there is still, we believe, a remarkable working exhibit of binaural sound set up



Paul Klipsch, designer of famous Klipschorns, developed method of driving a third, middle speaker, by feeding portion of each channel to fill "hole."

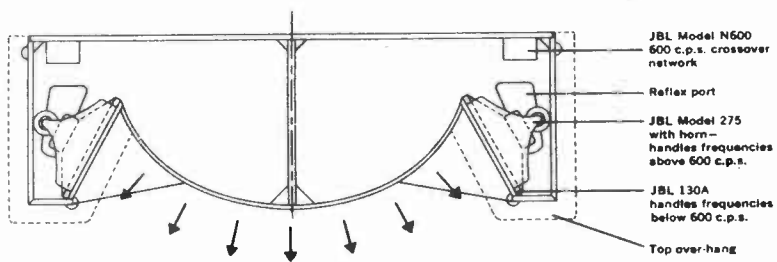
Two speakers, spaced close together, as in the Fisher combination, left, minimizes hole-in-the-middle but compresses stereo directional effect.

The Jim Lansing Ranger series solves the "hole" problem by reflecting portions of sound from each channel off a curved wooden surface (below).



CABINET SIZE:
Height: 30"
Width: (top) 73 1/4"
Depth: (from curved panel) 22 1/2"

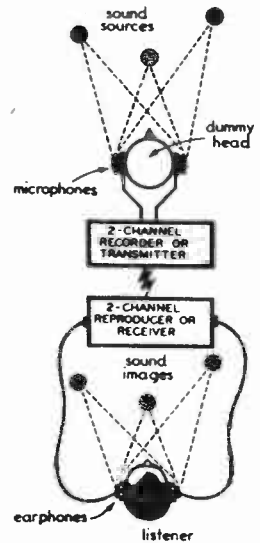
Patent Pending



The curved refractor panel used exclusively in JBL integrated stereo systems combines the two separate stereo channels into a single three-dimensional sound source. It not only produces a smooth transition from one source of sound to the other, but disperses the sound pattern over a wide area.



Binaural sound is not the same as stereo. It calls for dummy with microphones for sound pickup and requires headphones, right, for listening. Capable of absolute realism, is not practical for home use.



"Oscar," at left, a dummy with microphones on each side of head, was used in early Bell Lab experiments with stereo and binaural sound—was the center of binaural demonstration at the Chicago World's Fair.

by Bell for the World's Fair of 1933. Visit it by all means and you will learn not only how remarkable it is but also that it has little relevance to what we want from stereophonic high fidelity.

For one thing, binaural sound requires the use of headphones. While there may well be occasions when headphones are most helpful and useful for stereo listening, and while they are getting better year by year, most people would rather do without hi-fi than take to wearing headphones. But more important, our aim in high fidelity is not to produce two-eared hearing—it is, I repeat, to create the illusion that the listener, whether he hears with one ear or two, is sitting in the concert hall or that the orchestra has been brought into the living room. This illusion can only be produced in both one- and two-eared listeners by multiple loudspeakers. So forget talk about binaural sound or hearing; concentrate instead on the target we have discussed and you won't have difficulty understanding stereo hi-fi or, what's more important, achieving it.

Thus we see that in order to do the job that high fidelity sets out to do—to create the illusion that the listener is actually in the concert hall, or that the orchestra is in the listening room, we must have not only the faithful reproduction of the sound that high fidelity yields, but also we must have at least two sources of the sound in the listening room. In other words, it is not just a case of stereo being an improvement, or adding something to high fidelity. Stereo—some minimal form of stereo—is absolutely essential to achieve high fidelity

—that is, to achieve that best possible facsimile of the illusion of being there, at the original performance in the concert hall, the studio or the theater.

Actually we have known this for almost thirty years. In the early 30's the Bell Labs conducted some experiments which are still considered definitive in this field. And, as I have already pointed out, in the intervening years we have had a number of very fine examples of the verisimilitude that multichannel stereo can provide.

You may well ask: "If that is so, why haven't we had home stereo before this?" The answer is that we *have* had home stereo for a number of years—on tape. As a matter of fact, commercial stereo tapes have been produced and sold for at least 5 years. We even had some stereo disc recordings as long as 6 or 7 years ago. Emory Cook, one of the most imaginative of the high fidelity pioneers, produced stereo disc recordings with two bands on each side of the disc, which were played back with two pickups displaced by a distance of about two inches. But Cook's discs were wasteful of space and presented some serious problems in tracking. As for tapes, they possessed, and still possess, two limitations: First, nobody has figured out a simple tape duplication system that is as cheap and as adaptable to mass production as disc pressings. Thus tape is considerably more expensive for a given length of program time than discs. Secondly, it is an awful lot easier and cheaper to build a good disc turntable or changer than it is to build a good tape playback mechanism.



Ten years ago hi-fi pioneer Emory Cook developed "binaural" disc records using two normal pickups spaced about two inches apart. One channel was recorded on outer, other on inner half of disc.

About two years ago, attempts to work out an acceptable system of stereo disc recordings came to a dramatic climax with the development of the Westrex 45/45, or vector, system. This development came at just the right time to exploit the hunger for more realism from high fidelity. Quickly the commercial recording companies agreed to standardize on the Westrex recording system and the stereo revolution in high fidelity went into high gear.

However, before the Westrex disc recordings arrived there had been many experiments, many demonstrations of the impressive effects that stereophonic distribution of the sound added to high fidelity reproduction; and we had also, through our work with tape and film stereo recordings, worked out solutions to many of the problems of bringing stereo into the home. Thus there was a lot of know-how waiting for some method of recording that would appeal to a market big enough to justify commercial exploitation of stereo. By making possible a cheap and convenient source of program material, the stereo disc made stereophonic hi-fi practical for commercial exploitation and distribution and therefore made it available to the ordinary nontechnical music lover or listener.

Granting that stereo is necessary to create the illusion of actually being there, is this illusion necessary to enjoy the reproduction of music, or at least does it add enough to the enjoyment to justify the additional cost? Or is it merely something exclusively for the sound crank and audio enthusiast?

I know a number of fine musicians who

are perfectly content to listen to music through a cheap table phonograph that I would not permit my baby grandchild to use for fear that it would pervert her ear and tastes. But almost everybody else who has done any serious music listening will agree that music alive and in the concert hall is both more enjoyable and more revealingly and effectively presented. In exactly the same way, stereo reproduction, if it is good, enhances the enjoyment of music not only by creating the illusion of presence but by presenting more of the music more clearly, more revealingly and more effectively. There are some good reasons for this aside from this illusion we have discussed. . .

For one thing, *assuming that we use first class equipment*, stereo presents music and other program material with greater definition—that is, the detail is revealed more clearly. The individual instruments stand out more sharply from each other, and the sound emerges—as in the concert hall—in a mosaic of many individual parts and colors instead of a blurred blend of sound. You hear things in even the very familiar music that you did not hear before.

This is easy enough to understand. When we divide the original program into two channels, each of the channels carries only part of the information it would have to carry if it had to do the entire job alone. What it carries now stands out more distinctly.

Also, the signal each channel carries is less complex and therefore is more easily reproduced without aberrations and distortion; and thereby less is added to the music to blur the details.

Furthermore, because of this added definition, and because the directional effect also helps distinguish between the various components of music, the ears and the mind do not have to work quite so hard to try to hear all the detail. The nearsighted person without glasses has to squint and focus sharply to discern details of remote objects—but if the object is brought close to him, he can see the detail without this fatiguing squinting and focusing. In the same way, by bringing the orchestra "closer" to the listener, stereo hi-fi makes the job of the ears much easier and simpler; with the same effort they can hear and discern a great deal more.

As a result of this superior definition, the subtleties of the music are more evident and the complexities more effectively resolved.

A virtue of stereo that may appeal to the distaff members of the household, is that, with stereo, the volume level can be lower.

The tendency of the audiophile to operate his hi-fi at "room level"—which can be described as "not quite loud enough to bring the cops"—has been a trial for wives and neighbors. Stereo may not cure this, but it appears that most audiophiles are content with a somewhat lower level in stereo. Actually, this figures; the principal reason why the audiophile cranks the volume control of his monophonic hi fi up so high, is to try to bring the orchestra through that door or window we talked about earlier, and into the room. He never manages this, but the louder the sound the closer he feels to the band. With stereo the illusion of presence is achieved even at relatively low levels, and after a while the temptation to crank the volume way up becomes less and less compelling.

Finally, there is a last and rather screwy reason why a stereo system justifies the extra cost. Strangely enough, ordinary monophonic recordings and radio programs sound a lot better and more cleanly defined when played back through the two channels and the two spaced speakers of a stereo system. There is no directionality when monophonic material is played through a stereo system; but there is an improvement in just about every other respect. The bass is bigger, the highs are brighter and cleaner, the definition is better and the spreading out of the sound source has an excellent psychological effect. The improvement is so great that I never play monophonic records through my original monophonic system alone but always through the stereo system; and even if stereo should die tomorrow and there were no more stereo recordings, I

would still use my stereo system for monophonic records.

As for the added cost, it may not be as great as you think. To be sure, in stereo, you will need two of everything. However, in the last couple of years our hi-fi manufacturers, conscious of the fact that people would balk at doubling the investment, have performed what almost amounts to miracles of design to hold down the cost of stereo.

For example, there has been a virtual revolution in loudspeakers. Three or four years ago a speaker system capable of going down to 40 cycles on fundamentals clearly would have set you back well over \$250 and would fill a good part of any living room. Today, under the compulsion of producing good compact speakers at a price low enough so that people could afford to buy two of them, we have a number of speaker systems that go down to 40 cycles and even lower, yet cost \$100 to \$150 apiece and take very little space.

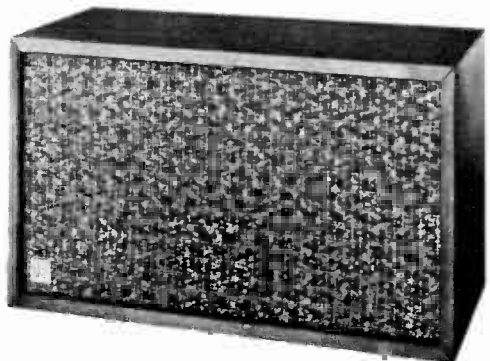
Actually, in any given quality class, you can figure that stereo will cost you about 50%, rather than 100%, more than a monophonic system. And for most people who have made the investment the answer to the question "is stereo worth the extra cost" has been—yes.

This affirmative answer will be more emphatic beginning now, simply because we are now well out of the experimental stage of stereo and most of the bugs have been taken out. For one thing, the early stereo records were very much inferior to the fine LPs. We are now, however, getting some excellent stereo recordings, approaching in quality the better mono-



New Stromberg-Carlson stereo packages "float" the speaker enclosures within the cabinet to minimize acoustic feedback. Wide variety of styles, prices.

Demand for stereo has stimulated the production of compact, moderately priced speakers like this Acoustic Research Model 2 which covers the range between 35 and 16,000. Is only 2 feet long. \$95.



phonic records, and they continue to improve month to month.

For another thing, we have pretty well solved most of the faults of stereo—such as the hole in the middle we talked about earlier. For still another, manufacturers of equipment have also passed out of the experimental stage. The craze for stereo was premature and caught the industry flat-footed. Everybody knew when the first crude stereo discs were demonstrated that stereo was arriving. Nobody expected it to arrive so fast, however, and nobody was really ready for it. Stereo equipment was improvised as rapidly as possible to try to satisfy the hunger for it. There wasn't adequate knowledge to begin with and little time was given engineers to experiment and test. Today, two years later, it's a different story. We have learned an awful lot—especially to bury our mistakes. This year's equipment is the product of adequate engineering and tests and is far better than the improvisations we have had to use so far.

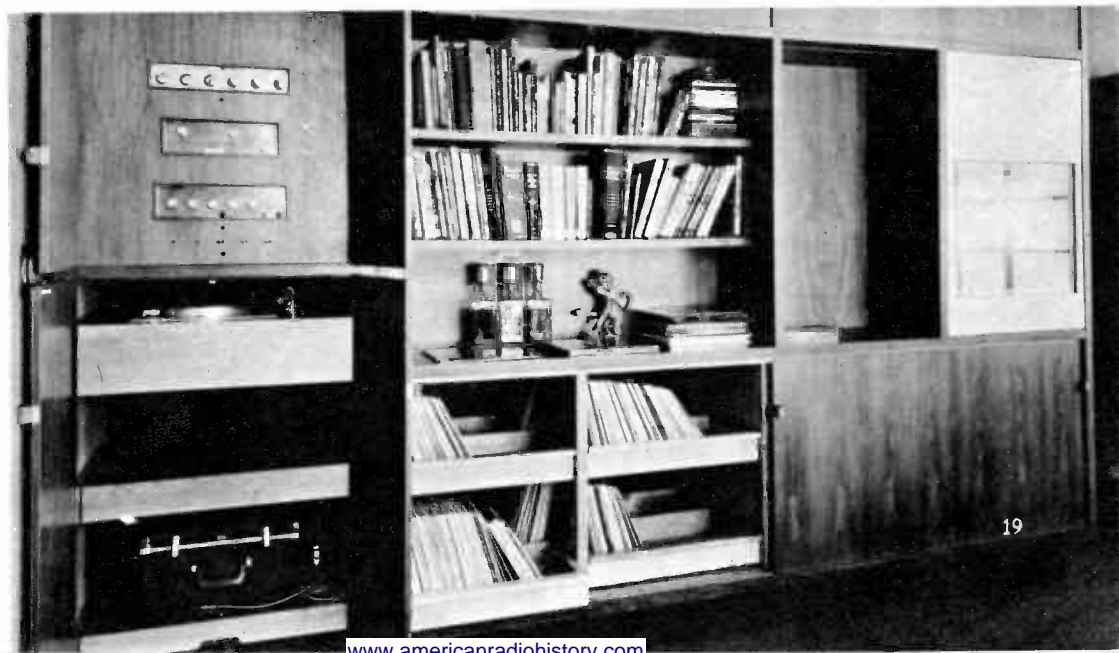
Please note, however, that I qualified earlier by saying "with first-class equipment." Junk stereo is not only no better than junk hi-fi, it is worse and more likely to drive the family to bickering and despondency through fatigue—induced headaches. Lousy, distorted sound is even more unbearable for long listening periods when radiated through two speakers than through one—although it may sound more opulent at first hearing. Some of the purveyors of mass produced hi-fi appear to have bought the idea that stereo can hide all sorts of defects in the equipment. And this is true in exactly the same way that

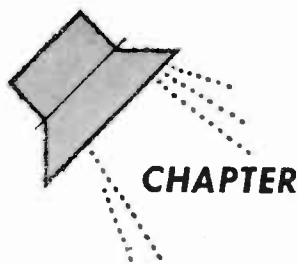
a gal can hide certain imperfections with a pair of falsies. Neither stratagem will stand the test of familiarity.

The fact is that for stereo the equipment, from one end to the other, has to be *better* than for monophonic sound. This is especially true when disc stereo recordings are played. The biggest fault of stereo discs is that they generate a high component of second harmonic distortion. This is a vice we would all much rather do without, but unfortunately it arises from the very principle employed and nobody has yet figured out a way to get rid of it. However, it happens that the ear does not object too strenuously to the second harmonic distortion—provided it stays second harmonic. To keep it that, the playback equipment must be practically free of distortion because any distortion will convert a good part of that relatively unobjectionable second harmonic distortion into high order distortion that is harder to live with than the legendary wife with the tongue of an asp or a shrewish mother-in-law with a lisp.

Yes, good stereo hi-fi not only adds to the fidelity of reproduction, but enhances it to a degree that is unattainable at any price in a monophonic system. Now that stereo has left the experimental phase and is coming of age, stereo hi-fi is at last beginning to live up to its promises. There is available today a variety of fine equipment capable of bringing that promise alive in your home; and if you are prudent in what you buy you take little risk of dissatisfaction. And that is exactly what we are here for—to give you the information and advice you need to be prudent. •

Stereo pickups will play your library of LPs but don't play stereo records on monophonic pickups.

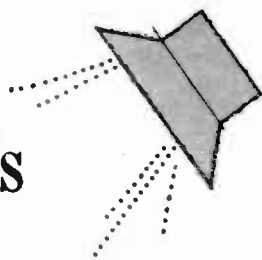




CHAPTER

2

The Several Roads to Stereo



Learn how to find the one that is best for you.

NOW THAT WE UNDERSTAND the general idea behind stereo sound, let us take a look at the practical ways of achieving it and explore the several roads to good stereo in the home.

At the recording or, in the case of a broadcast, the pickup end, two microphones are used. Each covers about half of the orchestra, choir or whatever. The information picked up by each mike is recorded or transmitted in a separate channel.

In the case of radio broadcasts, one channel may be transmitted over an AM station the other over an FM; or both may be transmitted over one FM station through the use of a specialized technique called multiplexing, which permits two independent signals to be transmitted by one radio station over one radio channel. More about this later.

In the case of tape recordings, the two channels are simply recorded on two parallel tracks of the tape. In disc recordings, by a remarkable process we'll describe in a later chapter, the two channels are carried in one groove, simply by cutting one channel into one side of the groove and the other channel into the other side.

In any event, to reproduce any of these several types of stereo program material, we obviously have to continue the separation of the two channels, all the way to the loudspeakers. This does not quite mean doubling the equipment. For stereo tape, we still need only one tape player—though a special stereo form of it. For stereo discs, we need only a single turntable, and a single pickup, though again a very special type of stereo pickup. For stereo simulcasts over a paired FM and AM station setup, we need both AM and FM tuners

The satisfied Miss below has started along the stereo path with a record changer and two speakers.



capable of being used at the same time. But these can be on a common chassis and are also usable individually for monophonic reception of either AM or FM. The additional expense of an arrangement suitable for stereo is not very great. For multiplex FM, any FM receiver can be adapted with an external multiplex adaptor and, in some older types, a slight modification internally.

But from this point on, we need two of everything. Two phono preamps and equalizers; two control units, with two sets of tone controls; two amplifiers, and two loudspeakers. We end up with a layout which we diagram in block form on this page.

Although we said "two of everything" in the above paragraph, this does not necessarily mean a multiplicity of units. Whether you will actually have to double the number of units or not will depend on where you start from and how you proceed. There are two alternatives: Either you will start completely from scratch, or you already have a good monophonic hi-fi and want to convert to stereo.

Starting from scratch is far simpler and gives you more leeway. You will need a turntable or changer, suitable for stereo; a stereo tape play-back (if you like); an AM-FM stereo tuner (if stations in your area are broadcasting stereo); a stereo preamp, a pair of amplifiers; and finally a pair of speakers.

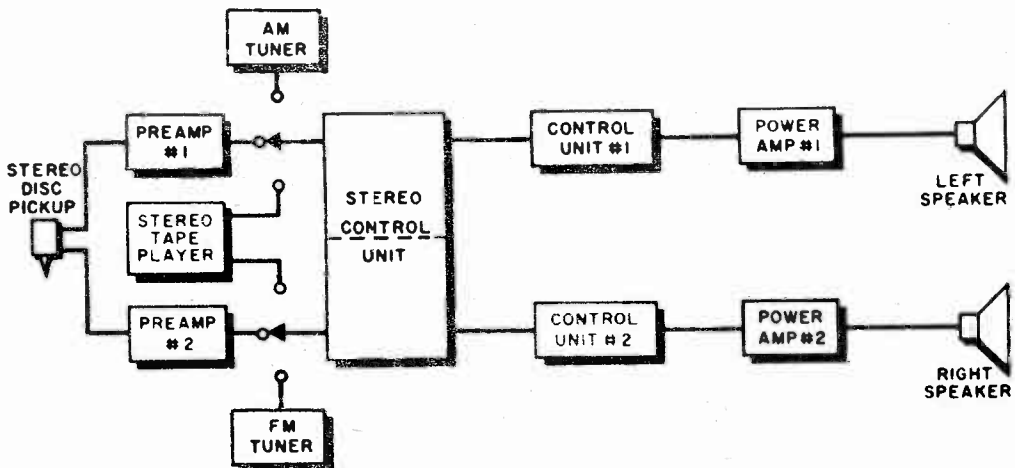
That does not necessarily mean six pairs

of units. There are all sorts of "unitized" combinations which offer two or three of the above pairs in one unit. For example, there are pairs of power amplifiers on a single chassis; there are paired stereo preamps on a single chassis and with a single set of knobs; there are single combinations that include the two preamps and two power amplifiers in a single unit; and there are even single units that combine the AM-FM stereo tuner, the two preamps and the two power amplifiers in a single unit. Assuming you can do without a tape play-back, you could thus achieve stereo reproduction from disc recordings and radio broadcasts with as few as four units in all—the turntable, the combined receiver-amplifier, and two loudspeakers. You can reduce all this to two or three pieces of furniture, by putting the turntable (or changer), tuner, preamps, and amplifiers into one piece. The two speakers can be in a single cabinet or in two smaller ones.

At this point some of you may say: "Wait a minute, I can do better than that. I can buy a complete stereo in one cabinet and for \$159.95." Or, "I can get it in two pieces, a console or table phonograph and a separate speaker which I can stick anywhere and for only \$79.99."

Sure you can. Just like you can buy a quart of moonshine in many parts of the country for a dollar or less which will get you even drunker and give you an even

Block diagram of home stereo system indicates 12 units, but good results can be obtained with less.



bigger hangover than six-dollar bourbon.

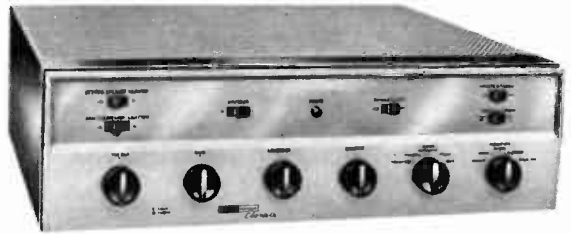
These bargain stereos may well give you the piccolo on one side of the room and the drum on the other side. But, if the piccolo sounds like a penny whistle, the drum like a child's drum, and Beethoven's Fifth Symphony like Haydn's Toy Symphony played on dime store instruments, you'll still be an awfully long way from the kind of high fidelity we're talking about. Furthermore, high distortion, when listened to for long periods, can produce headaches, grouches and bad tempers as hard to live with as those produced by cheap liquor.

I do not want to give a blanket indictment of all one-package hi-fis or stereo hi-fis. There are a few such units, mostly produced by people who also produce hi-fi components, that will do a pretty good job; but these cost several times \$159.95.

There is a very good technical reason why a one-package hi-fi and particularly a stereo hi-fi, is not likely to be as good as one in which the speakers are separated from the other components. If the loudspeakers have a good bass response, the cabinet will vibrate and this vibration will result in two bad effects. One, it can produce a type of feedback similar to that produced when a microphone and the loudspeaker are in the same room and the microphone picks up part of the sound radiated by the speakers. The phonograph pickup is a transducer of mechanical vibration into sound. Stereo pickups are particularly liable to be excited by sound vibrations of a cabinet because of necessity they are as responsive to vertical motion as to lateral. Second, a particularly big bass transient may actually cause the pickup

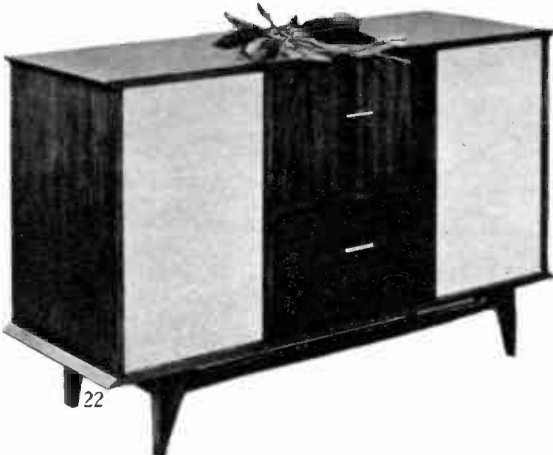


The EICO unit above combines two preamps, stereo controls and two amplifiers, at a moderate price.

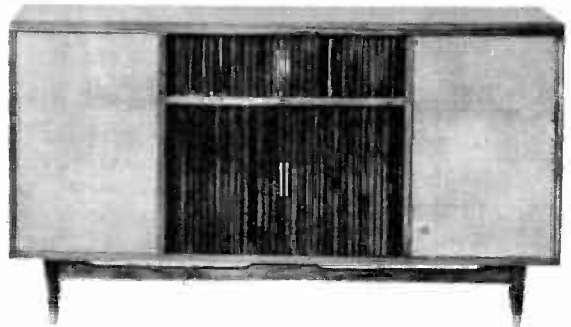


The Harman-Kardon Chorale model, shown above, combines two preamps and two amplifiers in one.

The Fisher Coronet Model 808 is a stereo radio-phonograph, available in walnut and teak finish.

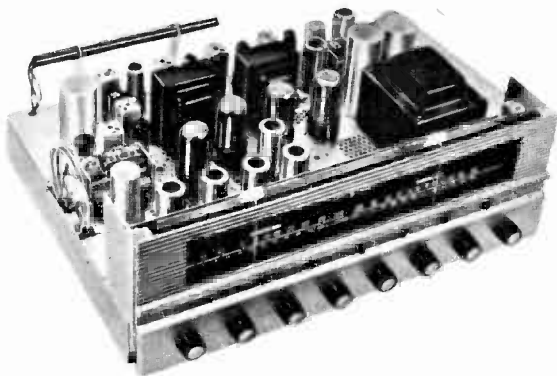


The Fisher Statesman 1010 is the modern radio-phonograph, below. Mahogany, walnut, teak.



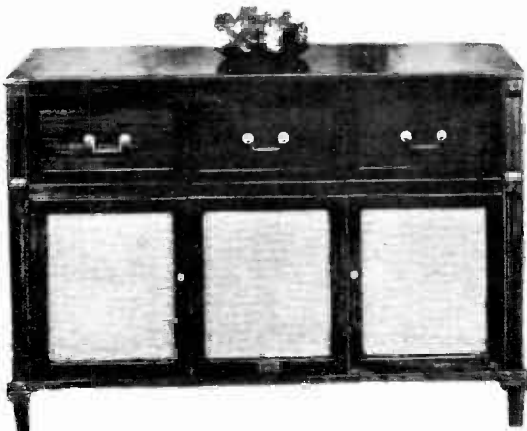
to jump grooves in the record. It is possible to isolate the turntable from such vibrations by floating it carefully; and Stromberg-Carlson "floats" the two-speaker systems in a common cabinet, thus eliminating the coupling. But, all things considered, a better and finer bass is possible when the turntable is in a separate cabinet remote from the speakers. As a result of these dangers, in most one-unit hi-fis, whether stereo or monophonic, the bass response is deliberately cut off at the bottom end by various means, or a heavier than necessary pressure is used on the pickup to minimize the possibility of these troubles.

One of the arguments in favor of the one-package outfit in a single cabinet is that it involves no skill in putting together. This is true. But even the one-package



With Harman-Kardon TA230, only a record player and two speakers are needed for complete stereo.

Pilot Model SC-1100, below, is a single package unit which makes use of Pilot's fine components.



stereo outfit has to be positioned in a room to suit the acoustics and to obtain the best possible stereo effect. An effort to manhandle a big hunk of furniture around the room may make the job as onerous as the few steps needed to interconnect separate units.

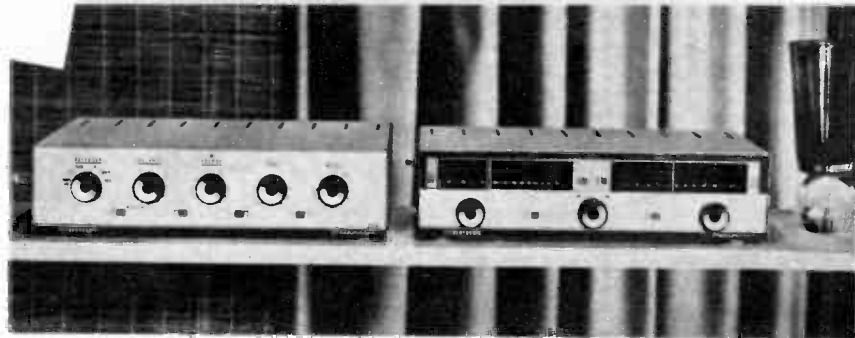
Another argument for the packages is that they are more slightly or less unsightly than a number of individual components. This argument no longer has the force it once had because today hi-fi components have profited from some good modern design and many are highly decorative as well as functionally practical. Others, such as power amplifiers, are made so they can be put away out of sight in closets, the basement or even under or behind the davenport.

For a given quality of performance, the one-package job is inevitably the costliest because a big portion of your dollar pays for the cabinet. Good furniture costs money to build and all furniture, good and bad, is expensive to ship. When you buy a factory-made package of this type you not only pay the original cost of building the cabinet but also the cost of shipping and transshipping it two or three times—from the factory to distributor, from distributor to dealer and from dealer to you. Each of these costs is marked up as it passes through these several hands. Consequently, a good proportion of your hi-fi dollar goes for these added costs, instead of for performance.

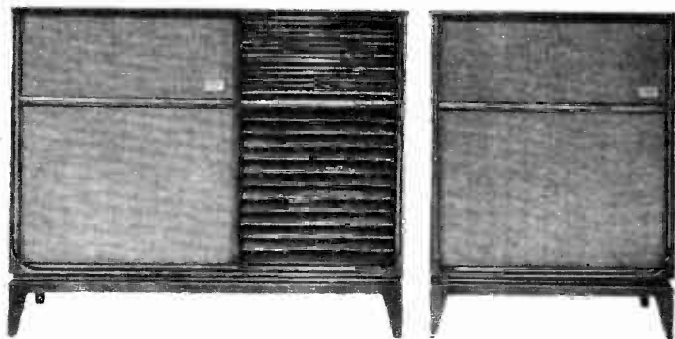
From all the above, you will gather that I favor the use of "components" and assembling them into a complete system. Definitely, I do. Your dollar will buy a lot more high fidelity that way. Furthermore, you will have far greater leeway in your choice of individual components to suit your particular needs and pocket-book.

Some people cannot believe that the small manufacturers of component hi-fi—all of them very small business by any definition—can produce and sell more performance per dollar than the giants of the radio and television industry. But it happens to be true by a strange inversion of what we used to think were the hard facts of economic laws.

It happens that the big giants are caught by the distribution system they have built up. This system has at least three steps. First there is the factory which has to bear the initial cost of production and make a profit. Then comes the distributor or wholesaler who has a mark up for his costs and profits. Finally, there is the retailer



The Pacemaker units from Bell, shown at left, have the clean simple lines of efficient modern design.



The radio-phonograph unit 1090 by Pilot, at the left, combines fine design with excellent stereo fidelity.



Sherwood tuner and stereo amplifier fit in a simple cabinet, while two compact speakers flank the ends.



Ampex now offers elegant furniture-styled stereo systems, using a variety of their own fine components.

from whom you actually buy who has an additional mark up to cover his selling costs and profit.

The "components" manufacturer cuts out one of these steps—the distributor. He sells directly to the retailer who sells to you. The elimination of this step not only makes it possible for him to compete with the giants but actually to provide a higher value in performance per dollar of retail price. In this respect the components dealer, small as he is, has the advantage the chain store, supermarket or discount house enjoys.

The difficulty of assembling and interconnecting individual components into a system has been greatly exaggerated. Actually when you buy from a local dealer he will usually make the installation for you. And, if you buy by mail you will find that manufacturers of individual units supply, in their instruction booklets, quite clear directions for interconnecting their units with a variety of other units. Furthermore, the general principles are quite simple as we shall see as we go along. But, if you do not feel confident of your ability to do the job, I am sure that you need not go farther than a block or two in a city or suburb, or your nearest town in rural areas, to find a radio or TV serviceman or a helpful neighbor who can do the job.

But how, you ask, will you know what to get? That is our principal task and we hope that by the time you have finished this book, you'll have enough information to make a prudent choice. But also, if you go to a good dealer of component hi-fi who carries several of the lines mentioned or pictured in this book, I am sure you will find him both willing and capable of being helpful. Most component hi-fi dealers are in the business because they are enthusiastic about hi-fi themselves. They believe in it and know what the problems and solutions are. The proportion of unscrupulous people in the components hi-fi business is far smaller than in any business I know of. Furthermore, the reputable component manufacturers have learned that their lines sell better and stay sold better when handled by people who know what they're doing. They are more careful, therefore, in choosing their dealers than most manufacturers of consumer products. By and large, if you go to a dealer who handles the products of several of the manufacturers whose units are mentioned in these pages, you have pretty good assurance not only of getting a square deal but of helpful counseling.

Finally, most component dealers when

dealing with reputable citizens, are quite liberal about selling on an approval basis—subject to the equipment working satisfactorily in the specific room where it will be installed. This is particularly important in the case of loudspeakers. However, this will not hold true of "discount" dealers and understandably so. The margin of profit on component hi-fis is often not as great as in other consumer product lines. If it is cut by discounts, you cannot expect the dealer still to give you all the service and approval options that a dealer with the full profit margin can give you. In this as in other lines you must expect to pay for special attention and service.

While we're on the subject of discounts it might be well to point out that while there are possibilities of picking up good bargains in hi-fi components in discount stores, special sales, etc., whether a hi-fi bargain turns out to be real or a lemon will depend a good deal on your own discretion and knowledge. It is possible, especially in the period when new models are coming in, to pick up discontinued models at attractive discounts. And often these discontinued models will yield a high ratio of performance per dollar. But this is not as true of stereo hi-fi as it is of

Hi-fi components like these Bogen-Presto units are decorative in themselves and need no cabinet.





Stereo ensemble above has a Pilot tuner and preamp-amplifier, and a Garrard changer in a Pilot cabinet.

The Bell Home Music Center features Bell stereo components arranged in an attractive custom installation.



conventional monophonic hi-fi. Stereo hi-fi has just stepped into long pants, and at this moment the industry is making the transition from experimental and improvised equipment to fully developed and tried units. By and large the new models either yield better performance or equal performance with greater simplicity of controls. To take advantage of discontinued-model bargains you need to have considerable knowledge or be prepared to put up with some inconvenience if not inferior performance. On the other hand, the man who is converting a present good hi-fi to stereo may well find in the older models of both stereo and monophonic components not only a means of saving money but also the road to better performance. We'll say more about this at a later, appropriate point.

But suppose you have no local hi-fi components dealer and have to buy by mail from one of the mail-order electronic distributors or hi-fi dealers? First, we will try in this book to give you a good background of information. Second, these mail-order dealers have expert hi-fi counsellors who will give you counsel by mail. Third, almost all of them also have a series of "component packages" using various combinations of components of various manufacturers which they know work well in combination. Such packages are offered in a number of price ranges to suit the

purse and needs of almost anybody. They come with all connecting cables and instructions for assembling the units into a system.

How about do-it-yourself hi-fi kits? Some of the finest available hi-fi equipment comes in kits and in general, the kits of the principal distributors of hi-fi kits—Dynaco, Heathkit, Eico, Grommes, Knight, Lafayette, Acrosound—are very well engineered, use first rate parts, and are capable of yielding performance equal or superior to that of ready-built units of equivalent class or grade. In the output of kits from these manufacturers there is a very wide range of choice, ranging from what are undoubtedly the cheapest units capable of genuine hi-fi performance, to units which are standards of comparison throughout the world; thus the buyer who can take advantage of these kits, can obtain the most performance per dollar.

How much do you have to know to put these kits together successfully? Can the complete neophyte who knows nothing about electronics do it? I didn't use to think so. But I know several people, with no previous experience or knowledge, who bought kits against my advice and made that advice seem awfully foolish by ending up with a craftsmanlike job that delivered fine performance. The above-mentioned distributors of kits have gotten very clever in designing them and working out assem-

Demonstration room at Allied Radio, Chicago, is typical of facilities of hi-fi dealers, offering a chance to compare components, get good advice.



Allied Radio's technical correspondence department, pictured below, each day answers thousands of letters, supplying information and quotations.



bly methods and instructions that are almost foolproof. On the other hand, other friends made fully as big a mess as I had predicted. A very patient, careful and meticulous novice can succeed—especially if there is a neighbor with knowledge accessible for help when problems and doubts arise or errors are made.

I still do not recommend electronic kits lightheartedly to people with no previous experience in building electronic equipment. Speaker, turntable, phono arm and other mechanical kits, on the other hand, should not faze anybody who has successfully put together knockdown toys or furniture. There are people who specialize in putting kits together and the cost may still be well below that of factory-built units. Some dealers who handle kits have them made up in their own shops, and sell them assembled at a premium over the kit price.

Assuming I have persuaded you of the advisability of using components rather than a completely integrated one-hunk-of-furniture-stereo outfit, you can, as I said earlier, make the system as complex or as simple as you like or can afford. I pointed out the availability of a variety of unitized components to reduce the number of units you have to buy and find room for. Which is better, to use these unitized components, or a greater number of individual units?

That will depend on whether you have a

golden complex—and by that I mean, whether you want the nearest approximation of the ideals of hi-fi, and have a purse to match; or whether you will be, or have to be, content with some small compromises.

Some unitizing involves little or no compromise with ideals. Thus, a combined AM-FM stereo tuner makes complete sense and there is no reason why it can't deliver performance as good as the best independent AM or FM tuner. Also, a stereo preamp—with the two-control units combined in one package, and with a single set of knobs—can be just as good as two independent ones and provide far simpler operation. Similarly, two power amplifiers of up to 35 watts output apiece, can be put together on one chassis and use a common power supply, and still give performance substantially the same as that of two independent amplifiers of the same design.

Some greater compromises have to be made as unitization goes beyond this point and one has to accept some reduction in performance capabilities in return for greater simplicity and compactness. This is particularly true of the wholly unitized tuner-preamp-amp combinations. It is simply not possible to crowd all of these things on one chassis without making some sacrifices. The principal one is in power output capabilities which is usually limited

to about 10 watts per channel. There simply isn't room for the big transformers needed for higher outputs. Where 10 watts will do the job acceptably, these combinations, like the Harman-Kardon, Scott and Fisher, will serve very nicely.

In short, if you want the best possible stereo hi-fi, you'll have to find room and money for more individual units; on the other hand, where cost, space and simplicity are important, the unitized set-ups are most useful and at not too great a cost in loss of performance.

Now let's consider the situation of people who now have an excellent monophonic hi-fi and want to go into stereo. The first question that needs answering is this one: Should you dispose of what you have and start from scratch, or should you convert what you have to stereo?

That depends on three things: 1) What you now have; 2) whether you have any market for your present system; and 3) just how much dough you can afford in your search for a good stereo hi-fi.

If your present outfit is not over, let us say, four years old and uses what were top quality components when you bought them, the chances are that your best bet is to keep as much of what you have as is usable and add the stuff you need to convert to stereo.

Here are some guideposts for decision: If your power amplifier is a Williamson type, even of the best make, try to dispose of it and replace with the newer types which are far more satisfactory and stable. But, if you have a recent amplifier using

the Dyna or Mullard type front end, and EL34, EL84 or KT88, or 6550 output tubes, it is still as good as present amplifiers and there is little point in replacing it.

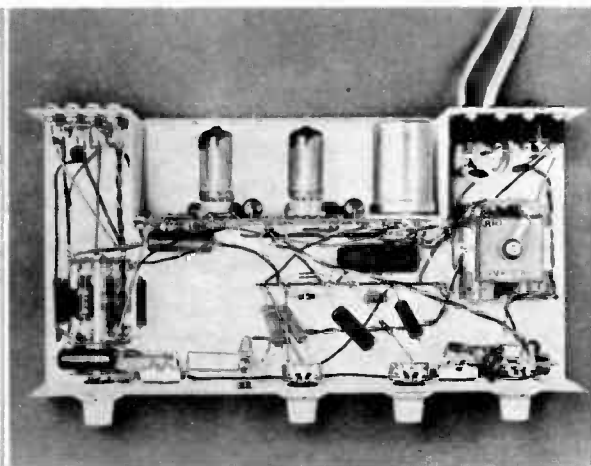
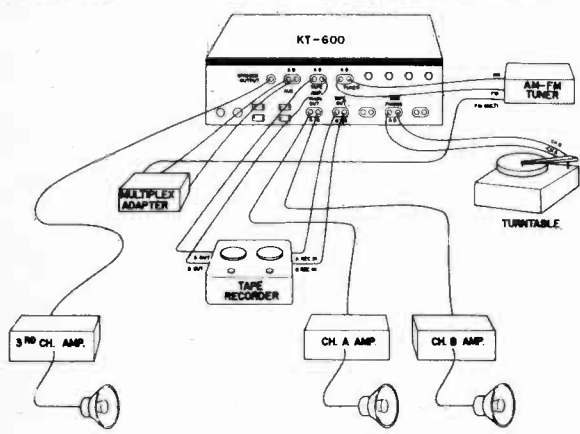
As for preamps, unless you have a first class preamp—and among these I'll include the Dyna, Marantz, McIntosh, Eico, Fairchild, Sherwood, Quad, Leak and the top grade of the Scott, Fisher, Harman-Kardon, Bell, Bogen, Pilot, Grommes, etc., lines—you will end up with a better and simpler setup by getting rid of the present preamp, and buying a new stereo preamp.

Almost no changers made previous to about 1956 are suitable for stereo. The rumble is much too high, and the tone arms are not designed for the low-pressure tracking that is desirable with stereo pickups. First class, low rumble turntables, several years old may or may not work for stereo. The only thing to do is to try them. Even those which had very low rumble originally may have developed enough through wear to be unsatisfactory for stereo.

A few pickup arms will do if modified, but where you want the best performance, it is best to figure on a new arm and preferably the arm manufactured or recommended by the manufacturer of the stereo pickup. However, this may not involve a waste. With one or two possible exceptions, no stereo pickup is as good on monophonic discs as the best monophonic pickups. Furthermore, stereo discs are recorded at a lower level and if the stereo pickup pressure is adjusted for optimum tracking and pressure on stereo discs, the

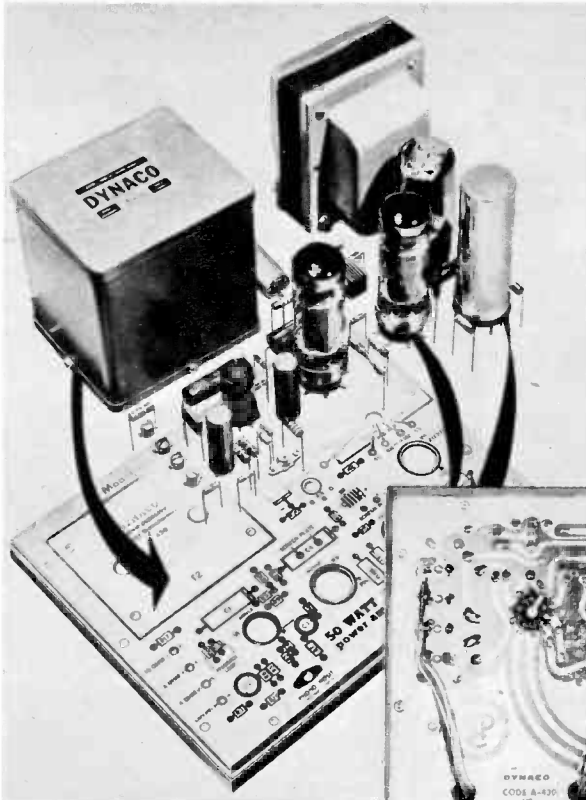
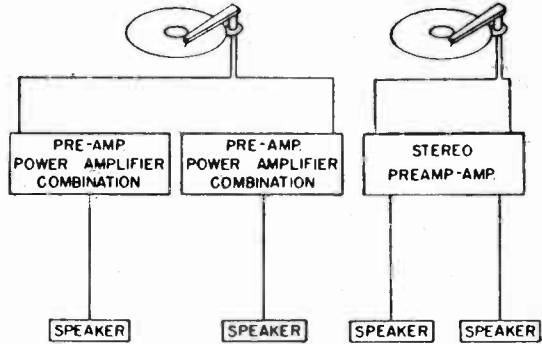
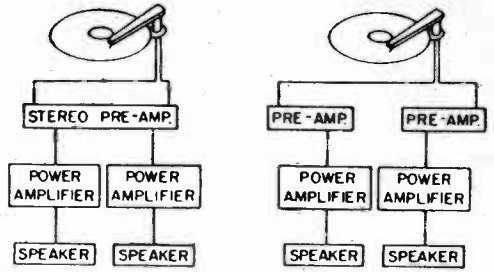
Clear diagrams, like this one for Lafayette kit KT600 Stereo Master Control, simplify assembly.

Simple layouts, clever engineering and precise instructions are found with this Dynakit preamp.



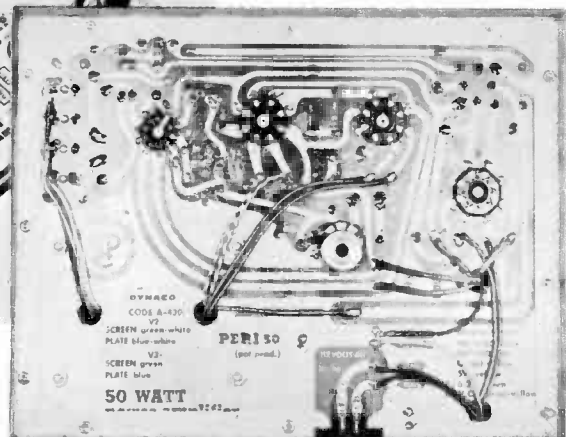
pressure will be too light for tracking perfectly on monophonic discs. On the other hand, if you increase the pressure the wear on stereo discs is severe. Thus, if you want the best monophonic as well as stereo disc reproduction, you may want to use a separate pickup and arm for stereo and monophonic. Of course, you have to have a stereo pickup to play stereo discs.

As for tuners, the only kind of combination that is not suitable for stereo is the kind that has the AM and FM on the same chassis and uses a common IF for both. These are easy to recognize because they will not permit simultaneous use of FM and AM. This you must have to receive simulcast stereo programs, which are broadcast with one channel on AM and the other on FM. If in your region you can get satisfactory reception of such simulcasts, you will want either independent AM and FM tuners, or a stereo AM-FM tuner—which is simply a pair of independent AM-FM tuners on a single chassis, using a common power supply. On the other hand, in remote areas acceptable reception



The variety of units on the market in kit form, allows the do-it-yourselfer very many combinations of components.

An exploded view of a Dynaco amplifier shows simplicity of Peri-50's plug-in construction. The deep-etched copper circuit board, below, limits soldering to the barest minimum. "Touch soldering" attaches components' wires to the board's underside. The solder and the soldering iron are included in the kit.



of simulcast is not possible anyhow. Either the FM or the AM station, usually the latter, cannot be received without interference and noise. In that event simulcasts are not for you, and there is no point spending money for it. Furthermore, eventually we will have some kind of multiplex stereo and any good FM tuner can be converted for this.

Single channel tape recorders can be converted to stereo but this is a real job and not recommended unless you have a broadcast type recorder and you just can't make a good deal for a new one.

As for speakers, this is a really serious problem and before you make a decision on this, you had better read the chapter on loudspeakers.

The market offers a wide variety of equipment for converting to stereo—a variety sufficient to meet any need you may have even after culling some units out as a result of the analysis given above. You can add on at some portion of your system, and replace completely in other portions. Thus for example, there are add-on units of the following types: 1) Dynaco, Scott, Knight, Bogen, Lafayette, Marantz and others offer stereo adapters which are small units to couple two entirely independent preamps and amplifiers; 2) the McIntosh add-on preamp, which provides an additional preamp, plus the stereo controls for function, balance, etc.; 3) the Harman-Kardon

add-on which has a two channel stereo preamp plus an additional 20-watt power amplifier; and 4) the Pilot Stereo-tuner and preamp needs only two amplifiers to fill out a full stereo system.

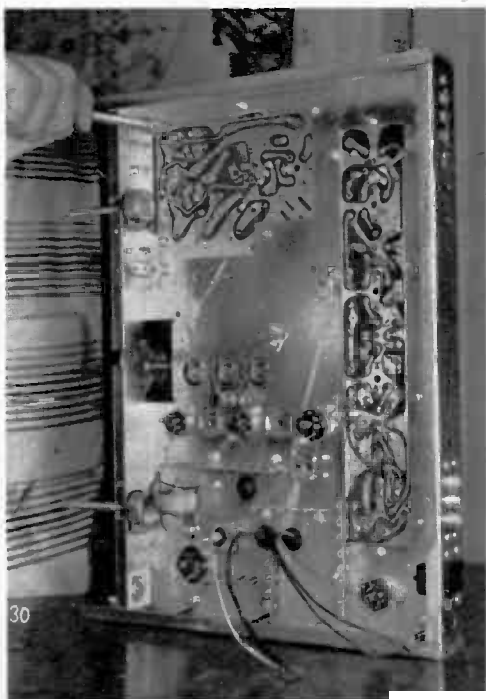
Deciding just which is the best combination to convert your own system is admittedly going to be a bit of a job. You may have to pore over catalogs and spec sheets, and make diagrams for a few days before figuring out the most practical working combination.

Stereo works best if the two channels are absolutely identical. If your present system is topnotch, you may work out a very fine system simply by picking up duplicates of your present units second hand, and coupling them with one of the stereo adapter units.

How about the cost of stereo hi-fi? Well, you can buy a package of components for a stereo phonograph system for as little as \$160; or about \$230 if you add an AM-FM tuner. Heathkit offers a complete stereo unit in kit form, including cabinets, for \$160 less tuners. You can go up from there to several thousand dollars. These minimal component packages will give you a minimal form of stereo which comes close to meeting minimum standards of hi-fi. To give the manufacturers credit, they do not claim anything more than that for these inexpensive packages.

Personally, if I had less than \$300 to

Manufacturers of hi-fi components more and more are supplying the demand by do-it-yourself fans for kits. However, complex units like the AM-FM tuner shown below, should not be undertaken by the novice.



spend on a hi-fi system, I would buy the best monophonic system I could put together for that money and wait until my pocketbook fattened up to add stereo. And, I would choose my units so they would convert easily. For example, I would get a good double amplifier—like the Dynakit 70 in kit form, or Pilot 260A assembled, among others—and use the two channels in parallel for monophonic use. Or I might get a stereo preamp, instead of a single preamp, but use it with one amplifier and monophonic pickups. I would choose a speaker suitable for use in pairs for stereo like the AR2, or Jensen Tri-Ette, etc., working toward the eventual filling out into a stereo system.

It will take about \$450 as a minimum for a stereo system that really qualifies as high fidelity as well as stereo. You can shave this down as much as \$100 or even \$150 by buying kits. Lower priced outfits may satisfy those who are not critical—or who just cannot afford anything better—and higher priced ones will approach the ideals of high fidelity more closely. Still it is notable that the cost of stereo high fidelity is actually no greater than the cost of a monophonic system of equal specifications per channel was a few years ago.

Conversion of a monophonic system to stereo may cost you from \$200 to \$400 as a minimum, depending on how much of what you now have you can use, and on whether

you use kits or the fully assembled units.

In view of this investment, it is fair to ask how long the investment can be expected to give satisfactory service. Hi-fi components are well made and can last a long time. From that standpoint they can well have a life expectancy of 10 years. But this is only part of the answer. The bigger hazard is obsolescence. How about this?

The first aspect to be looked into to answer this question is whether stereo is here to stay or merely a temporary fad? This is a problem of far greater seriousness to the industry than to the consumer.

What the industry means when it asks this question is really this: Is the market for stereo equipment going to be a mass market or a specialized market? However, because stereo is necessary for high fidelity, there will be many people who will continue to want it, whether the general public does or not. For the buyer of stereo today, the question is really, "If I buy stereo today will I be able to buy records to feed it two, three, five or ten years from now?"

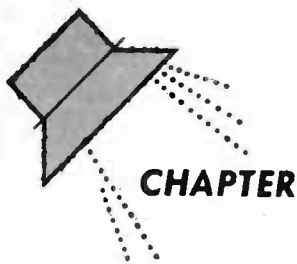
I am sure the answer to that is yes. The mass production boys who need a market in the millions may drop out if the millions lose their present interest in stereo; but there will still be a big enough market to make things worthwhile for the little fellows, both in the equipment and in the record fields. •

From Allied Radio comes this handsome Knight KN 1500 equipment cabinet, for housing components.



The Knight speaker, Model KN 1275, shown below, can serve as the perfectly matched co-ordinate.

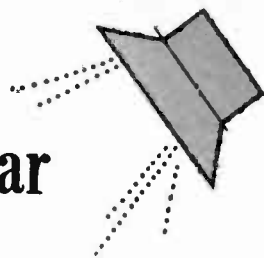




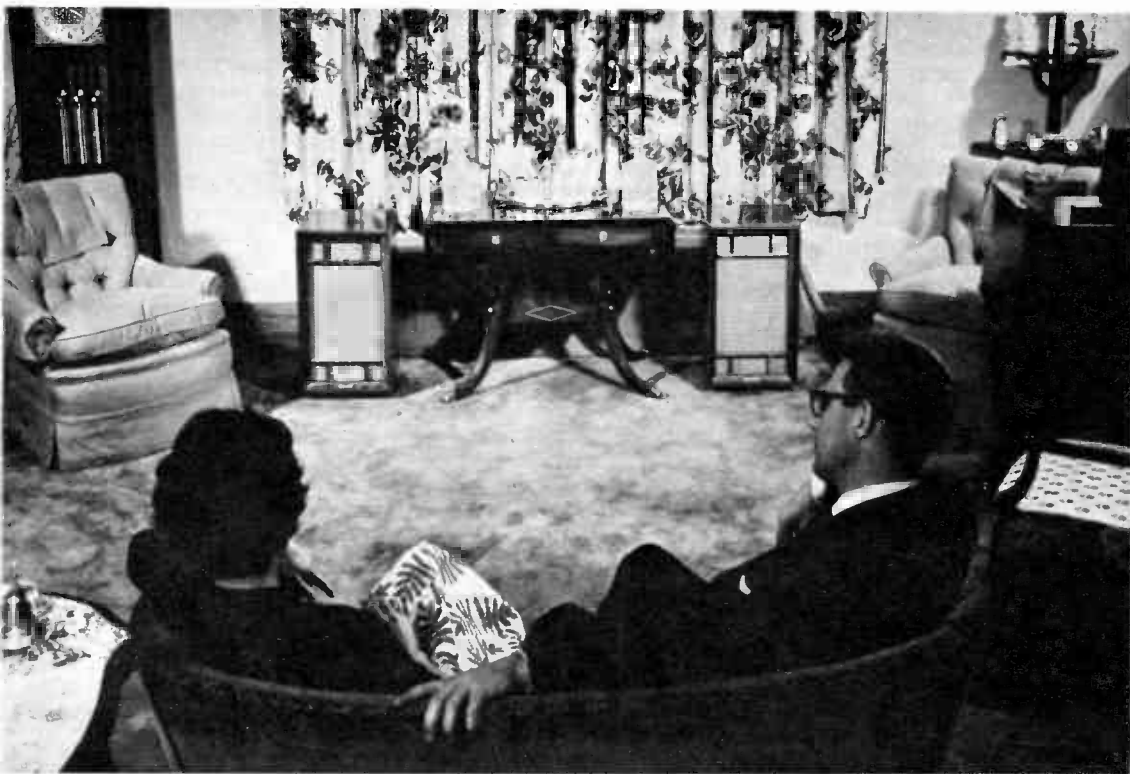
CHAPTER

3

What You Can Hear With Stereo



More and more discs, tapes, multiplex and simulcasts.



While there is a continuing trend to stereo in all fields, a quantity of material is now available.



THEY TELL THE STORY of the rancher out West who, having heard of the miracles of color television, invested the better part of \$1000 purchasing one and having it hauled out to his remote ranch, only to discover after it arrived that the only TV station he could receive did not broadcast color television. Most people are more prudent than that. Hence, it may well occur to those who may have become sold on stereo by the preceding two chapters, to ask: "What can I hear with stereo high fidelity?"

The answer should be reassuring. Even in the more remote parts of the country I imagine you can today purchase stereo records in any store that handles ordinary records. In the larger cities and suburbs adjoining the same, you will even find stereo recordings in the supermarkets and super drugstores. The catalog of stereo disc recordings now includes several thousand different titles under several scores of different labels at prices ranging from \$1.98 up, in every field of music from great classics, top pops, jazz, country music, rock and roll, and, in addition, a growing library of recordings of events and sounds that are particularly effective and tailored for stereo listening. As a matter of fact, in some parts of the country you may have more trouble finding a monophonic version of recent recording than a stereo version. Stereo disc sales now account for something between 20 to 30 per cent of total sales.

Before the coming of stereo discs, tape was the only source of stereo material. Something like a thousand different stereo tapes were in the catalogs, and many are still available. The stereo discs, offering more program time for a much lower price, were a serious setback to stereo tape. However, the introduction of 4-track stereo tapes in magazines and normal reels promises to revive tape as a stereo medium by lowering the cost per minute of playing

time to a level which can compete with discs, and possibly it will go even lower. This year stereo tape is expected to make a lively comeback. Since stereo tape possesses some advantages over discs in certain qualities, there is every prospect that within a year or two there will once more be a big catalog of stereo tapes.

In all the large metropolitan centers experimental stereo broadcasts are now occupying a small percentage of the broadcast time of some 100 stations. A number of stereo broadcast systems have been advanced, and the Federal Communications Commission is expected soon to study these and to authorize the use of one or more of them in regular broadcasting. Some stereo boosters confidently expect most AM and FM stations to offer stereo broadcasts on a full-time basis in a few years. Even if this doesn't happen, it is a pretty sure bet that a good proportion of FM stations will be sending out stereo broadcasts full time in a few years. Thus the purchaser of a stereo system need have no fear that he will find his stereo system standing idle for lack of material to feed it.

The stereo disc, of course, is the staple of stereo program material not only in the home but also for broadcasting. The development of the stereo disc is one of the minor technological miracles of our time. Actually, stereo recordings are nearly as old as the phonograph. Way back in 1902 a patent was filed for an acoustic phonograph using two needles and two horns to add depth and realism to recordings. Stereo discs were demonstrated experimentally in England in the early 30's and in this country by Bell Telephone Labs in 1936. Some six or seven years ago, as I mentioned previously, Emory Cook actually offered a series of "binaural" discs to the high fidelity market.

Cook's discs recorded one channel on the outside half of a disc and the other channel on the inside half. Two pickups



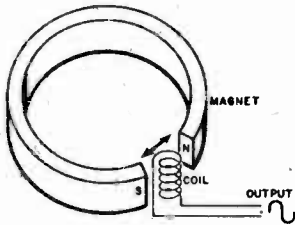


Fig. 1

Principle of one type of pickup: A small coil of wire moved between two poles of a magnet will generate a small voltage proportional to swing.

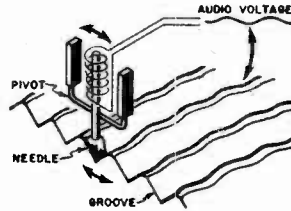


Fig. 2

In pickup, diamond or sapphire tip is vibrated by wiggles in groove causing wire winding around needle rod to move between magnetic poles, above.

WHAT THE WESTREX SYSTEM IS ALL ABOUT

THE WESTREX SYSTEM is based on a happy thought. To understand it, let us first consider how the normal pickup, used on ordinary records, works. The problem is to translate mechanical motion into an electrical current. There are several types of transducers or generators that can change motion into electrical current. Possibly the easiest to understand is the coil-type magnetic movement. In Fig. 1 we have a simplified diagram. Here we have a magnetic gap between the two poles of a magnet. Inside this gap we suspend a coil of wire. If we move this coil from side to side between the two poles of the magnet, a current will be generated in the coil. This current will be proportional to the movement of the coil—the wider the swing, the higher the voltage. Moreover, the current will vary with speed of the movement. Thus if the coil is moved at a rate of 100 cycles a second, the current will also vary at the rate of 100 cycles per second.

Fig. 2 shows how this principle is applied to a monophonic record pickup. The coil is now attached to a rod or pin, pivoted in the middle and at the end of the pin we have the needle. The disc is cut with a groove with side-to-side wiggles. Resting in the groove, the needle follows the erratic ridges; this causes the pin or rod and the coil to vibrate from side to side, and this in turn generates an audio current in the coil which we can feed into our amplifiers and, eventually, into the loudspeakers. A very important fact for stereo is that a current will be generated only with a side-to-side movement of the coil; an up-and-down movement makes no change in the magnetic field and therefore generates no current. This is true because the pivot permits the coil to move from side to side only.

The inspiration behind the Westrex system came from the realization of the obvious fact that you do not have to agitate both sides of the needle to obtain this effect. Take a big comb and hold it in your hand. Take also a toothpick or a wooden match and move the match or toothpick over the teeth of the comb.

The match will go up and down as it traces the spacing between the teeth of the comb.

Similarly, in Fig. 3, let us imagine that we have turned the simple pickup of Fig. 2 so that it is inclined at an angle of 45 degrees, and now rides on only one side of the groove of the record. Although only one side of the needle is now in contact with the erratic ridges in the groove, the needle will nevertheless still vibrate the rod and coil from side to side between the poles of the magnet and thus generate the current we want. Thus by using this 45-degree inclination we need only the ridges on one side of the groove to generate our audio signal.

Clearly, if we now took another similar pickup, and inclined it in the opposite direction, so that it was actuated by the erratic ridges on the other side of the groove, we would get another set of audio signals in that pickup.

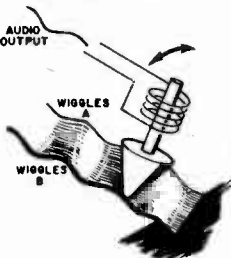
You will recall that earlier we pointed out that in this kind of pickup, an up-and-down motion or vibration of the rod and coil, will not generate a current in the coil. This makes it possible for us to actuate two pickups with a single needle. Let us take another look at Fig. 3. The side of the needle rests on the ridges A, the end of the needle on ridges B. The A ridges will move the coil from side to side; the B ridges will move the entire movement up and down, but the up-and-down motion will not energize the pickup. Therefore, although the two different sets of ridges move the needle in both directions, only the A ridges result in an audio signal.

As a result it is perfectly possible for us to couple two pickups to a single needle as in Fig. 4. The needle will be actuated by the ridges on both sides of the groove, but the wiggles of side A will energize only pickup A and the ridges of side B will actuate only pickup B.

This is a very simplified picture. In actuality the needle movement is more complex, and the two pickups are not quite as independent as indicated.

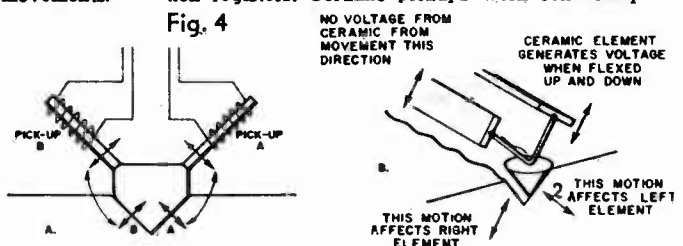
If pickup needle is inclined 45° so that it picks up wiggles on only one side of groove it will reproduce them, ignoring up and down movements.

Fig. 3



A single needle, therefore, can operate two pickups as shown below, center. Only sideway vibration registers. Ceramic pickups work conversely.

Fig. 4



spaced about two inches apart, but carried on the same arm, were needed to reproduce them. This was not only awkward, but it led to some complications in maintaining synchronization and proper phasing. Cook's records were never much more than a high fidelity novelty and curiosity.

It was obvious to everybody that to be acceptable for wide usage, it would be necessary to find some way of obtaining true stereophonic reproduction with a single groove and a single needle. There have been two types of disc recordings almost from the beginning of the recording era. One of these is the lateral recording in which the groove is cut with a horizontal or side-to-side vibration of the needle in correspondence with the wave form of the signal; this, of course, has become the universal recording throughout the world. Edison, however, preferred the vertical type where the groove was cut with an up-and-down vibration to produce a "hill-and-dale" groove. The vertical type was also preferred for broadcast transcriptions right up to the 40's.

It had occurred to many to combine these two types for stereo, using the lateral cut and vibration for one channel and the vertical cut and vibration for the other channel. The early experimental stereo discs made in this country and abroad were based on this idea. However, this presented some technical difficulties which were hard to resolve. In 1957 Westrex, a subsidiary of the same Bell System that had done so much other pioneering in stereo, came up with a new approach (see page 34) the so-called 45/45 or vector recording, which resolved some, though by no means all of the problems.

There is one serious difficulty with this system—and all other lateral disc recordings—which is particularly troublesome in stereo. This is the so-called pinch effect which results in heavy distortion. Grooves are cut with a V-shaped chisel, with sharp edges on the sides. The groove itself is cut with the wide side of the cutting chisel, but as the chisel is vibrated with the audio signal the sharp narrow sides of the chisel cut the indentations on the side of the groove. When there is no vibration and the chisel is pulled straight, the width of the groove is constant. But when the chisel begins to vibrate with an audio signal fed into it, the width of the groove begins to vary, being narrower where the chisel makes the side-to-side cuts, and wide where it makes the cut parallel to the direction of the groove. This is indicated in Fig. 5.

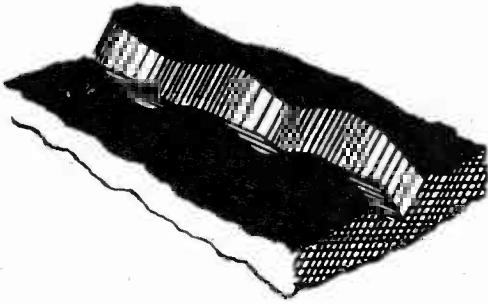
The playback needle is round. Therefore the needle is the same width front-to-

back as it is side-to-side. The whole needle fits snugly in the groove in the wide portions of the groove; but when the groove narrows, the needle has to ride upward. Thus the pinch effect causes the needle to trace an up-and-down, vertical path, in addition to the side-to-side path forced on it by the lateral cut in the record. This up-and-down motion is at a rate twice as great as the side-to-side motion. In other words, if the side-to-side vibration is at 2000 cycles per second, the up-and-down vibration due to the pinch effect is 4000 cycles per second. Clearly this 4000 cycle vibration is a hitchhiker on the original signal. It adds a component that was not in the original signal and is therefore a type of distortion. The pinch effect is most noticeable at the higher frequencies above 4000 cycles where the effects of the sharp edges of the cutting chisel are most pronounced.

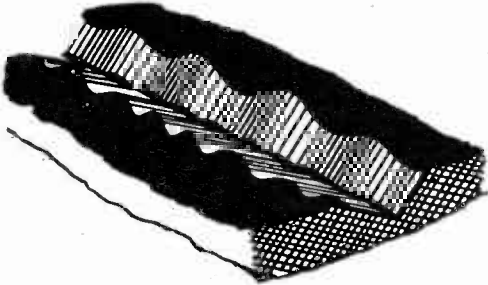
The pinch effect occurs in both monophonic and stereophonic records. In fact, it is inescapable (except in hill-and-dale recordings) as long as we have to use a chisel-shaped needle for cutting and a round needle for playback. However, the pinch-effect motion is a vertical motion. In the monophonic pickup of Fig. 2, we have noted that vertical motion produces no current in the pickup. Therefore, although the pinch effect exists in monophonic records, the lack of vertical response in effect suppresses the pinch-effect distortion.

But when we incline the pickup to 45 degrees, it becomes responsive to vertical as well as lateral motion. Therefore, the pinch-effect distortion is not only not suppressed, it energizes the pickup just as much as the desired groove modulation. The second harmonic pinch-effect distortion can be very high by high fidelity standards—30% and even more.

Of course, we would all rather do without this or any other distortion. But things are not quite as bad as a first glance at this pinch effect would indicate. In the first place, second harmonic distortion is not as objectionable to the ear as higher order or intermodulation distortion—as long as it remains second harmonic distortion and nothing else. If the rest of the system does not have much distortion it will remain second harmonic distortion. But if there is distortion in the rest of the system, some of the second harmonic distortion will be converted into highly objectionable high order distortion. Intermodulation distortion will also be created. Then the pinch-effect distortion may become very serious. This is one reason why I have stressed the importance of using the best possible equipment for stereo. Poor equipment



MONOPHONIC RECORD GROOVE



STEREOPHONIC RECORD GROOVE

Fig. 5

In a monophonic record both walls carry the same signal. In a stereophonic record each wall has a different signal as well as a common component.



First good stereo was provided by tape systems like this Concertone with compact speaker-amps.

cannot handle this pinch effect without converting it into highly objectionable distortion and the result is a stereo system that, while it may produce a dramatic stereo effect, is intolerable to listen to for long periods.

Since the pinch effect is most serious in the range above 4000 cycles and the second harmonic distortion falls above 8000 cycles, one way to deal with the problem is simply to cut off response in the pickup and/or the amplifier above 8000 cycles. Cheap stereo outfits still use this way out. Though we thus take care of the worst part of the distortion, we also throw out the window some of the desired signal which is most important for realism and high fidelity. We especially degrade the transient response which is needed not only for natural reproduction of the sound, but also to communicate the stereo effect.

Another saving feature is the fact that pinch-effect distortion is due largely to the lateral cut of the groove. But a stereo recording has a large vertical cut component. So in a stereo recording the distortion is most serious only when the lateral cut is dominant; this occurs only a portion of the time.

The problem becomes acute when a stereo cartridge is used to play back a monophonic record. A monophonic record is all lateral, and the only vertical component is that due to the pinch effect. The distortion thus stands out distinctly. Fortunately, this is not hard to minimize. It happens that the pinch-effect distortion in

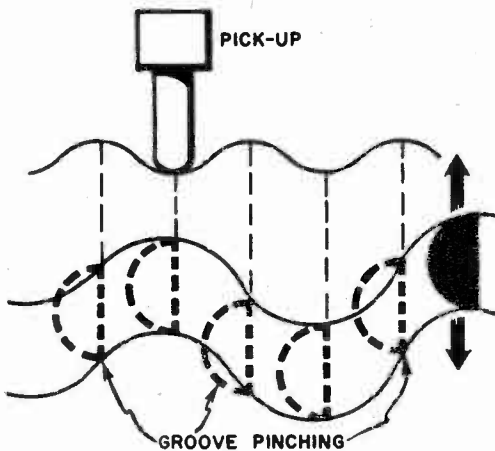
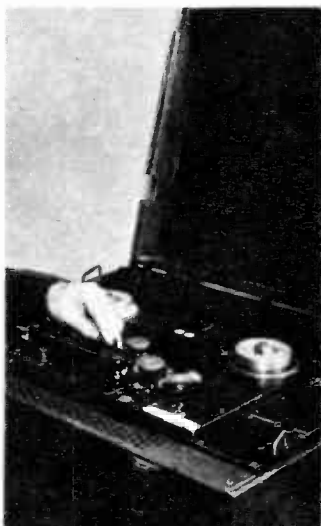
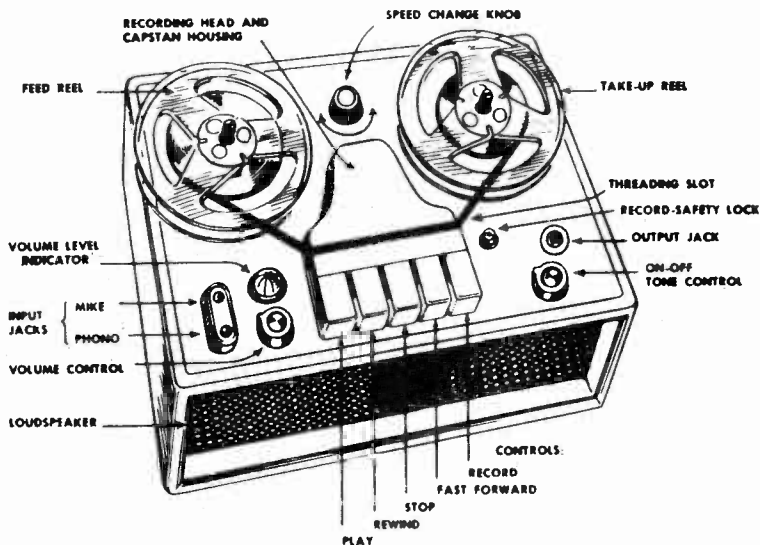


Fig. 6

Chisel-shaped cutting needle cuts groove of varying width—round playback needle rises in narrow parts, falls, causing second harmonic distortion.



Orradio photo



3-M Company drawing

Pioneer German-made Magnétophone, above left, and modern home push-button tape recorder, top right.

the two pickups is out of phase. Therefore, if when playing monophonic discs, we connect the two sides of a stereo pickup in parallel, the distortion will largely be canceled. For this reason it is highly important first, that for playing monophonic discs the control unit provide a means of paralleling the two pickup movements. This is easily done and all good stereo control units provide this means. Secondly, it is important that the two sides of the system, including the pickup, be as equal and identical as possible. Only the equal components cancel out. When the distortion or signal level is higher on one side than the other, the cancelation will be no greater than the side with lower distortion or the lower level. Because of the pinch effect and also because the best monophonic pickups are still better on monophonic discs than the best stereo pickups, critical people prefer to use a stereo pickup for stereo and a monophonic pickup for monophonic records.

In any event, one of the advantages of the Westrex system, over systems using a combination of vertical and lateral modulations, is the fact that it minimizes the pinch-effect distortion on stereo records, and allows suppression of it on monophonic records.

Naturally, the pinch effect is not well advertised. On the contrary there is a disposition to overlook the pinch effect and pooh-pooh it as unimportant. A lot of people have even managed to convince themselves of this. If you bring the sub-

ject up you will very likely be assured that it is a factor only when monophonic discs are played with stereo pickups. This overlooks the fact that you cannot avoid lateral cutting in a stereo disc and therefore there is no way to avoid the pinch distortion. There is, I repeat, only one way to deal with it: use a system in which the pinch-effect distortion will not be compounded, and that means using high quality components all along the line.

And let me make clear that when this is done, the pinch-effect distortion is not only tolerable but unnoticeable, except to the most critical and most highly trained ear. It is a small price to pay for the virtues of stereo discs. This is one point in which stereo tapes are superior and the greater definition and sharpness of tapes over discs is largely due to the absence of the pinch effect.

When the Westrex disc was first introduced claims were made that they were completely compatible with monophonic discs and monophonic equipment—that is, that they could be played with a monophonic pickup as well as with a stereo pickup. This turned out to be one of those theoretical truths like the statement that all men are created equal. Let's resolve this matter of compatibility clearly.

Westrex stereo discs can be played by monophonic pickups all right; but most such pickups—in fact practically all of them—will ruin a stereo disc, and the only difference is how long it will take. Most monophonic pickups will produce ruin in

a few playings; some may not finish the job until a score or more playings. The finest monophonic pickups have pretty good vertical as well as lateral compliance; but it is still far below that of a stereo cartridge. The average monophonic cartridge has practically no vertical compliance. This deficiency has the effect of greatly increasing the vertical pressure of the needle and thereby increasing the wear on the record grooves. Therefore, there is only one safe thing to do: *Never play a stereo disc with a monophonic pickup.*

This is an unfortunate fact. Had the stereo discs really been compatible, it would have been possible to stop making monophonic records and make only stereo discs that could be played with either stereo or monophonic equipment. Of course, when played with monophonic equipment, there would be no stereo effect. Stereo discs would sound like monophonic discs.

However, something like this may yet happen. A stereo pickup can be used to play a monophonic disc as well as a stereo disc provided, as we have noted, that the two sides are paralleled to suppress the pinch-effect distortion. If everybody used stereo pickups the stereo recording could be standardized. It would be playable as a monophonic record on monophonic systems; and as a stereo record on stereo systems. A system using a stereo pickup could play the old monophonic records as well as stereo records. Compatibility would be pretty complete. Meanwhile, let us repeat, stereo records should not be played with monophonic pickups, unless one doesn't give a darn if they only last several playings.

At any rate, the Westrex system with its inspired solution of some of the bothersome problems of the stereo disc, hit the high-fidelity scene at a most opportune time. For two or three years previously,

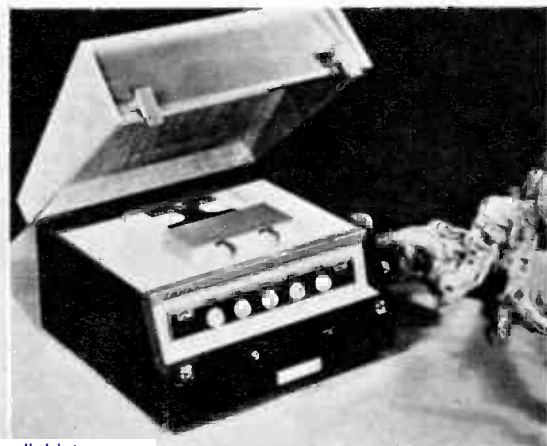
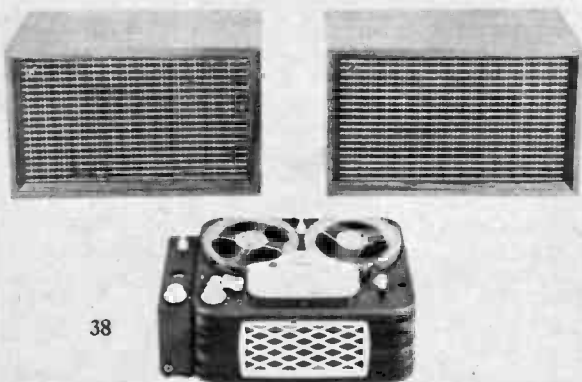
stereo with tape as a source, had begun to win high acceptance among high-fidelity enthusiasts. The big deterrent to wide acceptance of stereo was the high cost of stereo tapes—about four times the cost of a monophonic LP disc for the same program material. Various record manufacturers were working in the laboratories on a practical stereo disc, and there were rumors that one or another of them was about to pre-empt the field with a new system of stereo recording.

I suspect that no one was more surprised at the avidity with which the industry seized the Westrex system than Westrex itself. Sidney Frey who had leaped from nothing to considerable prominence in the recording field with his Audio Fidelity label is generally credited with generating the stampede that led to the quick adoption of the Westrex system as the standard for the industry. While the big companies were still carrying on slow experiments with the new system in December, 1957, less than 60 days after Westrex demonstrated its system, Audio Fidelity offered manufacturers of pickups, high fidelity manufacturers, and dealers stereo demonstration-recordings free. These were actually mastered by Westrex themselves, to still Frey's loud protests that Westrex was favoring the big recording companies by selling its cutters to them only.

As a subsidiary of the Bell System and A. T. and T. which are always under suspicion by antimonopoly and antitrust agencies of the government, Westrex had no desire to be stuck with accusations of being a monopoly. Though they would not sell Frey a cutter then, they did offer to master some trial discs for him. These first stereo discs will never be remembered for their quality. There is a suspicion that Westrex deliberately degraded them with noise, clicks and pops to discourage any ideas Frey may have had to put them into

Tanberg M-5 tape recorder needs only two Tanberg or other speakers to make complete stereo system.

This is the "Playmate"—portable model of the Bell Stereo-Pak. Has accessory stereo speakers.



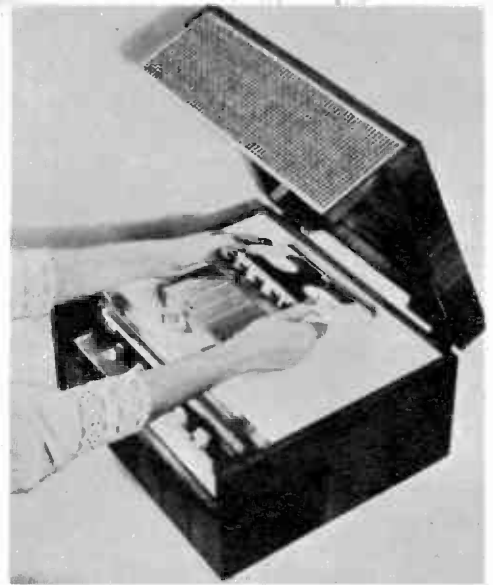
commercial channels. But they *were* stereo discs, they were available to almost anybody in the industry who had any legitimate use for a stereo demonstration or test disc, and they whetted the appetite for more like the first drop of any kind of alcohol whets a dipsomaniac's thirst.

They also made it obvious to other record manufacturers that there was indeed gold in them thar stereo hills and those who hesitated might find themselves too far in the rear to cash in. The experimental Westrex cutters were transferred from the laboratories to the factories and put to work, cutting actual marketable discs. Meanwhile, the industry went into a quick huddle and came out of it accepting the Westrex system as the standard for the entire industry. The stampede to stereo was on, and with all the confusion and disorder that accompanies all stampedes.

There is no greater evidence of the vitality of the stereo idea than the fact that stereo has survived those first quick stereo recordings. They were first heard in any numbers at the Audio and Hi-Fi shows of 1958, beginning with the one in Washington in February. Golden ears, myself included, found the sound almost intolerable. There were varieties of opinion on which sounded the worst, but among those who knew high fidelity best there was almost unanimous agreement that these stereo recordings had set high fidelity back a good five years. Actually, to be completely just, the records were not entirely to blame. The early pickups were no more advanced than the discs; and most of those demonstrating stereo systems with these recordings and pickups had not as yet heard of the need for proper phasing of the two channels.

It took several years of development in cutters, pickups and recording techniques to turn the first rather crude microgroove LP into the high-fidelity disc as it is today,

While tape editing has become a profession with many spectacular results—simple editing is easy.



Bell player for RCA Stereo-Pak magazine tapes, above, is economical, has four tracks, slow speed.

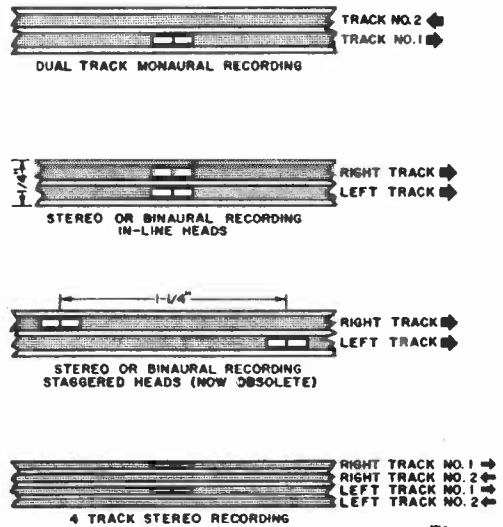
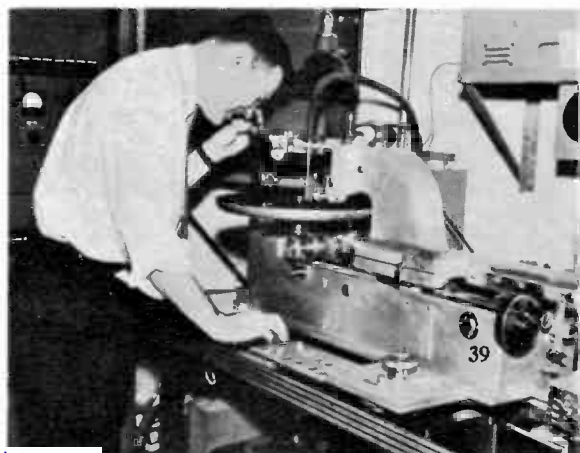


Fig. 7

One, two and four track tapes are shown above. Below, edited tape is transferred to master disc.



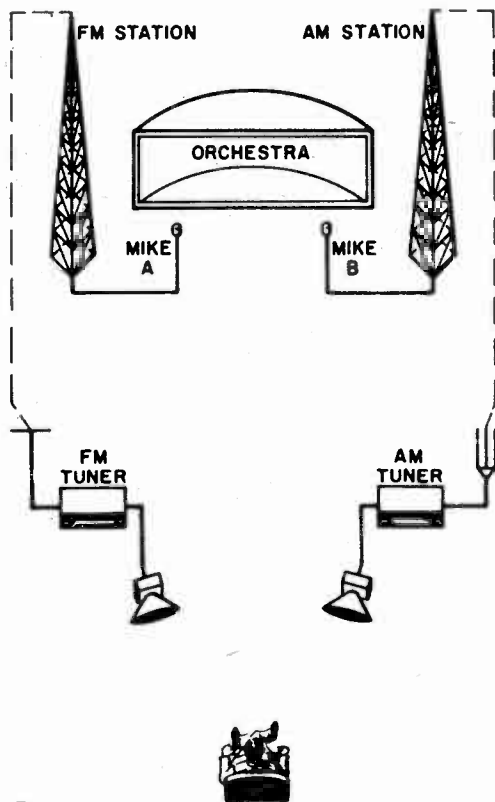
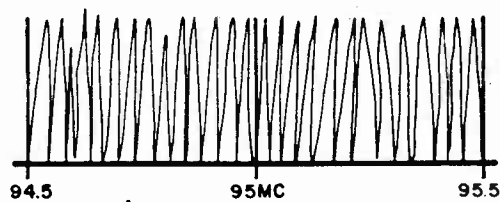
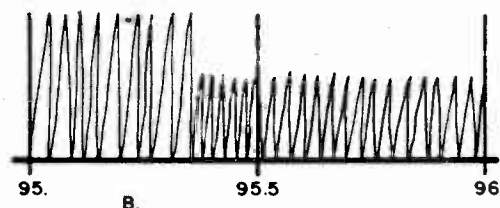


Fig. 8

In stereo simulcasts one channel goes out over AM radio, other over FM—result: stereo sound.



A. NORMAL FM TRANSMISSION



B. SIMPLE MULTIPLEX WITH 50 KC SUB-CARRIER WHICH IS MODULATED WITH SECOND CHANNEL

Fig. 9

Diagrams above show how multiplex is transmitted by adding hitchhiker to normal carrier frequency.

capable of reproducing not only the full frequency range, but a good approximation of the full dynamic range with very low distortion and minimum of extraneous noise. The first stereo discs were about on the level with those first LPs. The frequency response was limited and in some instances deliberately cut off above 6 or 7 thousand cycles and below 60 cycles to minimize the distortion of the cutters, available playback pickups, and the rumble of cutting lathes, and playback turntables. Distortion was high. The separation between the two channels was highly exaggerated to make the directional effects the more obvious and the hole in the middle was consequently big enough to drive a truck through.

Improvement, however, was rapid. At first there was only the one cutter, the original Westrex, and this was an experimental design hastily put into limited production. Improvements were quickly made in the Westrex cutter and several others became available. Engineers apparently worked overtime and in crash programs to perfect stereo recording techniques. In any event, by late 1958 some excellent stereo discs were appearing and by mid-1959 most stereo discs had acceptable quality and many were approaching the best monophonic discs. Playback pickups, too, have improved rapidly. Today there are several that approach or equal the best monophonic pickups—even on monophonic recordings.

The exaggerations of stereo, the deliberate stretching out of the ping-pong effect, are less and less prevalent. It is natural when a development is new to dramatize it by exaggeration. When high fidelity was new, there was a similar tendency. Thus, we had a long streak of LPs, played by orchestras that apparently used drums six feet in diameter struck by drummers using sledge hammers, and with percussion sections placed in front and center where the triangles and other percussion hardware could override the entire orchestra. Scheherazade, Gaite Parisiennes and other works scored for the tinkling percussion instruments achieved a distribution that must have roused their composers from their graves with joy. Symphony orchestras sometimes sounded as if they played in a barn surrounded by herds of belled cows and next door to a blacksmith shop. These records demonstrated the differences between ordinary and high fidelity reproduction with ear-catching authority, but no orchestra on earth ever sounded like that. As listeners became more sophisticated and high fidelity came to be taken more for granted, listeners de-

manded, and recording companies supplied, records which reflected the sound of an orchestra in a concert hall more naturally.

Similarly the first stereo recordings, both on tape and discs, exaggerated the ping-pong effect to show dramatically how stereo differs from plain high fidelity. Some were recorded with the perspective of a listener standing beside the conductor, or even one of the players in the orchestra. The trick stereo effects are by no means absent in modern stereo recordings. But more and more they tend toward the natural perspective of a listener in the usual listening position.

It would be an exaggeration to say that tape recording made high fidelity possible; but it certainly was a big factor and particularly in simplifying the whole process of recording, and making it far easier to produce high-fidelity recordings. The tape recorder was a German development and one about which we did not learn until World War II was well along. From the moment the first captured German tape recorders were brought to this country tape recording was recognized as the most promising recording medium and American engineers hastened to develop American tape recorders and American tapes. Colonel J. Herbert Orr, now president of Orradio, makers of Irish tape, with SHAEF during the occupation of Germany, headed a team charged with discovering and putting together all German knowledge of the tape recording processes. The information thus gathered was made available to all American manufacturers and progress was amazingly rapid. Within a few years, for example, the American made Ampex recorder became the standard of the world.

The first German machines operated at a speed of 30 inches per second. At this speed a frequency response to 20,000 cycles was readily possible. American engineers, however, were able to achieve a similar response at a speed of only 15 inches per second. Today at least one tape recorder (the 4 track Tandberg) achieves this response at 7½ inches per second.

But the beauty of tape goes beyond its wide frequency range. Tape can be edited. It can be cut apart and put together again. Thus clicks and pops and even the musician's bloopers, can be cut out. It had long been common practice to take several "takes" of a performance, even with disc recorders. It was possible to combine a portion of one "take" with a portion of another, but it was not easy with disc recorders. With tape it is a cinch. All that is necessary is to splice together portions of

any number of "takes." Tape editing has become a profession.

For the past 10 years all original recordings have been made on tape. After editing, the tape is used to feed the cutters of a disc recorder to make a "master" from which discs themselves are subsequently mass produced.

The virtues of tape had great appeal to high-fidelity enthusiasts. There was one disadvantage, however. At 15 inches per second you could get only about 15 minutes of program on a 7-inch reel of tape. The time could be doubled by cutting speed to 7½ ips and by using improved heads, a response to 15,000 cycles could still be maintained. That made 30 minutes for a reel of tape. This was better but still put the cost way above disc recordings.

Somebody then got the idea of putting two tracks on one ¼-inch tape, one on the top half and one on the bottom half. By using recording and playback heads that covered just under half the tape width, we could record or play back first the top track and then by reversing the reels, the bottom track. This doubled the program time and now made tape only about twice as costly as discs.

As soon as we had two-track recorders, we had the means for a stereo recording. Obviously one channel could be recorded on the upper track, the other on the lower track. Played back with a head that had actually two heads, stacked one above the other, we would have an excellent source of stereo sound. Two-track stereo tapes, and tape players to reproduce them, began to appear around 1954. In 1955 Ampex came out with a compact complete stereo system using one of their fine small tape machines and two amplifier-speakers. This combination was small and could be arranged in almost any room to produce a good stereo effect. What had hitherto been the province of serious experimenters now began to be a playground for anybody who could afford the price of the outfit. The first flame of the stereo boom was kindled, and it looked like tape and stereo were going to be inseparably married, and discs were going to be left out in the cold for stereo.

But stereo tapes were costly. A 7-inch reel had about a half hour of stereo program and cost more than \$10. At this time 12-inch LP discs were selling between \$1.95 and \$3.95 and some of them had as much as one hour. Also tape is not the ideal medium for home use. It is harder to store, harder to put on the player, and it is not as easy as on a disc to choose a desired selection in the middle of the tape. Furthermore, it has turned out to be lots easier to pro-

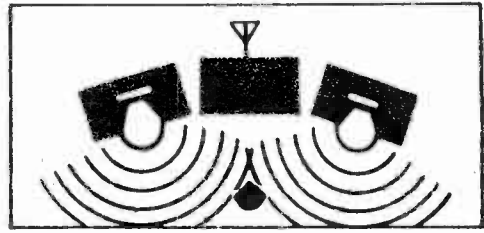
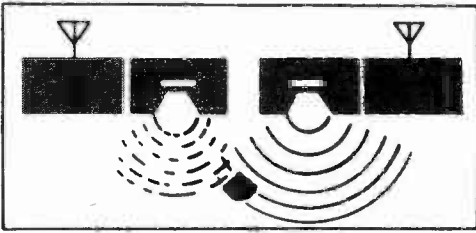


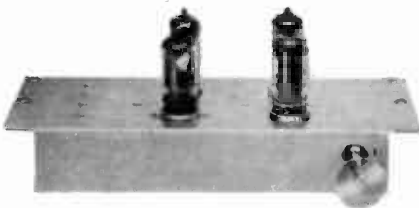
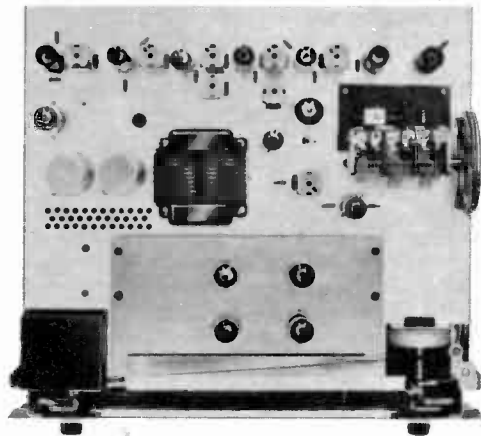
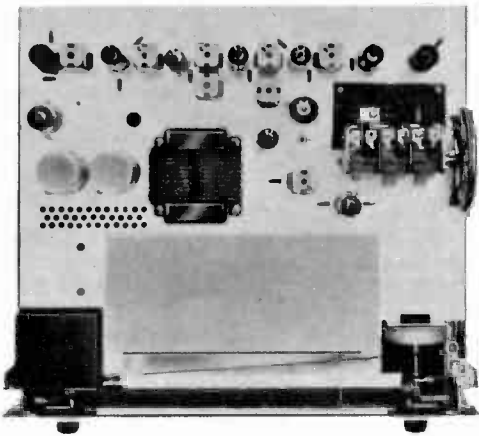
Fig. 10

Noncompatible double-transmission stereo reception of simultaneous AM and FM broadcasts suffers from sound quality differences (above left). FM is noise-free hi-fi, AM is not. Stereocast using the multiplex system (above right) provides full-fidelity FM sound for stereo reception, yet does not force the monophonic listener to lose out on his expected full measure of the original FM broadcast program.

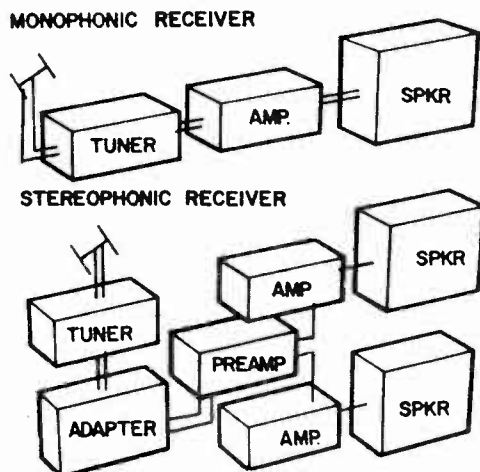
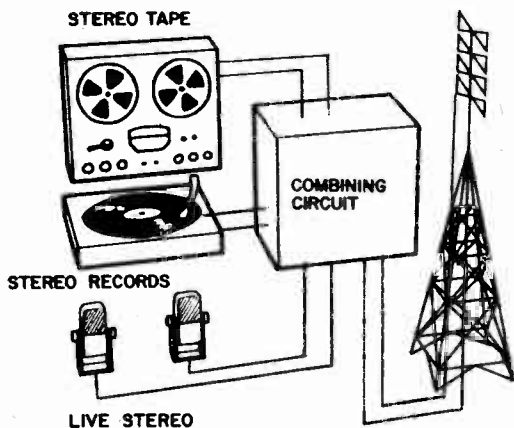


Fig. 11

With noncompatible double-transmission stereocast, monophonic listener gets just one channel—half the program (left, above). One of several solutions offered, Crosby's sum-and-difference (right, above) method doesn't cheat the monophonic listeners but delivers full measure to either as the case may be.



Top view of the Harman-Kardon Model T250 AM/FM tuner (left, above) shows space for adding plug-in multiplex adapter (Model MA250, shown at left). Photo directly above shows same tuner chassis but with the adapter installed; still a compact unit.



In the studio, the output of both channels (stereo records, stereo tape or live stereo) is modulated on the main carrier in-phase and on the sub-carrier out-of-phase and is thus transmitted through space in a scrambled state. The monophonic listener hears the program like any normal broadcast. The stereophonic listener gets scrambled signals in FM tuner, unscrambles them in multiplex adapter, feeds each channel back to its respective amplifier and speaker; result: excellent reception, depending on equipment.

duce and sell good disc players than good tape players. Finally, the duplicated tape is inferior to the original tape and, indeed, at $7\frac{1}{2}$ ips inferior to the highly developed microgroove discs in frequency response.

There were two strong incentives, therefore, for the development of stereo discs. On the one hand, disc manufacturers could see that they might be left out in the cold if a stereo boom arrived. On the other hand, for many reasons discs were a more suitable medium for home use. As we have seen, the stereo disc arrived in a hurry just when tape was on the verge of establishing itself as the stereo medium.

The stereo disc with from 30 to 50 minutes of program material for \$4.95 was too much competition for stereo tapes with 30 minutes for \$10. The demand for stereo tapes slowed down to a mere trickle and indeed by the spring of 1959 only a few stereo tapes were being issued.

Apparently, while Westrex was working on its stereo disc system, RCA had its bets down on a new stereo tape system. Shortly after Westrex introduced the stereo disc, RCA announced this new tape system. It called for using four tracks on $\frac{1}{4}$ -inch tape, one pair to be played while the tape was going forward, and the other pair while it was going back. This, of course, doubled the program time of a given length of tape. Secondly, RCA proposed to use a speed of $3\frac{3}{4}$ ips. This would double the time again. With this combination a 5-

inch reel of tape would give one hour of stereo program. Finally RCA proposed to use a magazine for the tape so it could be put in a new type of player without threading. With all this, tape could be made competitive with stereo discs and just about as convenient to use at home.

This RCA system did not arouse any great enthusiasm in high fidelity circles. There were several objections to the system. First, the critics said lower speed would degrade the quality not only by narrowing the frequency response but also by increasing the noise level. Secondly, although a magazine had certain advantages, it called for special machines not compatible with any other equipment and could require all new equipment by everybody.

However, a little reflection indicated that, if the RCA system was not completely acceptable in the form suggested, it was capable of modifications that might well bring tape back into the hi-fi stereo picture. There was no reason, for example, why 4-track tapes had to be put in non-compatible magazines. They could just as easily come on the same reels that had become standard for all tape recordings.

Moreover, Tandberg already was producing a tape recorder which had as good a response and noise figure at $3\frac{3}{4}$ ips as most other recorders had at $7\frac{1}{2}$ ips. So the slower speed might not be hopeless, after all. In fact, Tandberg's new 4-track stereo recorder has a response to 15,000 cycles at

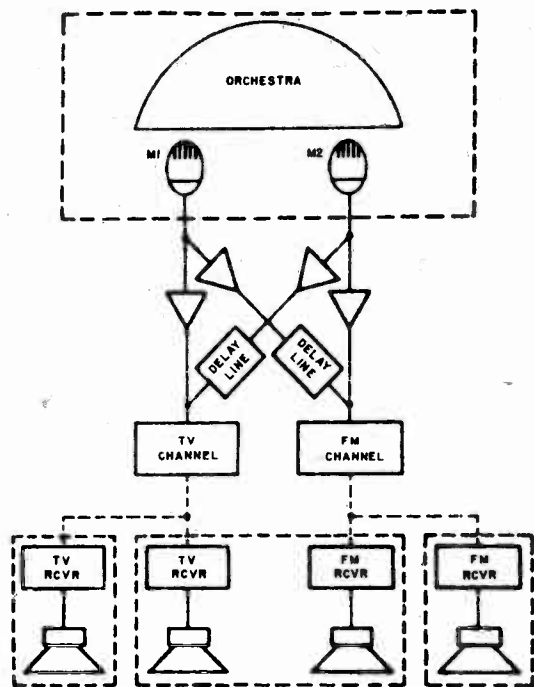


Fig. 12

Bell Telephone Labs system makes any simulcast compatible by exploiting the precedence effect.

3¾ ips, or as good as most professional tape players have at 15 ips. Thus it is quite possible to approach disc quality as well as economy with tape.

But there was a simpler solution to the quality problem. Why not 4-track tapes at 7½ ips? Even cheap, home type players go beyond 10,000 cycles at this speed, and professional types go to 15,000 or above. Granting that a 7½ ips stereo tape would cost more than a 12-inch disc, it could provide certain superiorities which would give it considerable appeal to those who want the best possible stereo. For one thing, tape has no pinch-effect distortion. For another, it has a better dynamic range. Tapes are also superior in transient response and over-all definition. Many stereophiles would not mind paying more for tape to achieve the best possible stereo reproduction.

Thus in the middle of 1959 the tape industry began to come off the floor after its knockout by the stereo disc. Four-track stereo tapes at 7½ ips have begun to appear on normal reels. They need tape players with special 4-track heads, as well as the two channels, amplifiers, etc., needed for stereo. But the 1959 and later models of most tape recorders offer 4-track heads either as standard or optional equipment.

It is also expected that about the time we go to print there will be 4-track stereo tapes at 3¾ ips on normal reels. Thus the new tape players will be able to play both the 7½ ips and the 3¾ ips stereo tapes, as well as the older 2-track monophonic and stereo tapes.

Meanwhile, RCA has not abandoned its magazine idea and the first commercial models also became available toward the end of 1959. Tape producers have announced that they will produce 4-track tapes either in RCA type magazines or on normal reels so they can be played on normal recorders as well as the special RCA types. Thus stereo tapes are expected to make a resurgence and to add to the choice of program material available for the stereo high-fidelity system.

In 1925 radio station WPAJ in New Haven, Conn., transmitted the first stereo or, rather binaural, programs by using two 50-watt radio transmitters, one on 1100 Kc and the other on 1320 Kc. They used microphones spaced 7 inches apart, fed the output of one to one transmitter and the output of the other to the other transmitter. By using two receivers, and feeding the output of one to one earphone, and the output of the other to the other earphone, of a head set, the listener experienced binaural reception.

In 1952 radio station WQXR, the famous high-fidelity station in New York, inaugurated the first regular stereo or binaural transmissions. They used two-track tape as the source, and transmitted one channel over their AM station and the other channel over their FM station. The listener has to have both an AM receiver and an FM receiver to enjoy this type of stereo reception. This system of using two radio stations has become known as *simulcasting*. In many parts of the country AM stations owned FM stations and in many instances had been using them to broadcast the same program, though not in stereo. The simulcast system presented an easy way for these people to broadcast stereo and gradually many stations throughout the country began to offer such AM-FM stereo simulcasts. Today, such simulcasts are available for a considerable portion of the broadcast time of about 100 stations.

Although this system is simple, it has some serious disadvantages. For one thing, quality of AM and FM transmission is by no means equal. WQXR may be transmitting a signal of full audio range on AM as well as FM. But most AM stations are inferior in frequency response to their FM affiliates. Even in the exceptional cases where the frequency range is comparable, the AM reception has more noise. Also

there are differences in AM and FM transmission characteristics. Thus one may fade out while the other comes in more strongly. There may also be differences in phase between the two transmissions. So that, the two channels are not equally good and this is not the best possible way to transmit stereo from a quality point of view.

It is also pretty wasteful to use two radio stations to transmit one program. There are ways of transmitting the two stereo channels on one station channel, by a method called *multiplexing*. Multiplexing is quite old and has been used for years in telephone work to make one line do the work of two or more. The basic principle of multiplexing is that of using a sub-carrier to the main carrier frequency. Consider Fig. 9. At the center we have the main carrier frequency of a FM radio station.

In ordinary transmission we modulate this carrier with the desired audio within the audio range of 20 to 15,000 cycles, let us say. But we could also modulate it with signal above the audio range, let us say a 50,000 cycle or 50 Kc signal. And we can in turn modulate this 50 Kc signal with audio signals. Thus, in effect, we can put a hitchhiker on the main station transmissions. When this signal with sub-carrier is received by a conventional FM receiver, the main modulation is heard, but the sub-carrier is above audibility and will not be heard. We can, however, add another special detector circuit to demodulate this supersonic sub-carrier separately, and we will then have its program available.

This simple type of multiplexing has been employed by FM stations for some time to provide a special service called *storecasting* as a money making hitchhiker on their regular transmissions. These storecasts consist largely of background type music without announcements or commercials for use in supermarkets, restaurants, clubs, etc. A special receiver is needed to take this hitchhiker storecast off the transmission. The restaurants and stores using these storecasts purchase these special receivers and pay a fee to the radio station for this service.

It would obviously be possible to use this type of multiplexing to transmit the two channels over one FM station. But there are drawbacks. First, the sub-carrier is much less efficient than the main carrier and as a result there is a big difference in the signal-to-noise ratios of the two transmissions as well as in frequency response and signal level. Storecasts are not high fidelity and the deficiency is not serious for

them. But it would be for high fidelity stereo.

There is a second, more serious drawback which applies also to the simulcast system. It is lack of compatibility. Neither stereo simulcasts nor simple stereo multiplex gives a square deal to listeners who do not have stereo setups. If you listen to either the AM or FM station of a simulcast pair, you will hear only one channel and therefore only part of the music. In the case of some recordings you might hear only the rhythm section if you listened to the AM station or only the brass if you listened to the FM station. Similarly in a simple multiplex stereo system if you did not have a receiver that provided the sub-carrier component, and heard only the program transmitted by the main carrier, you would hear only one channel. Thus you might well have grounds for complaining that stereo was getting a break at your expense. Clearly, the ideal stereo broadcasting system should be one that is completely compatible. It should give stereo results to listeners equipped with stereo equipment. It should also give good results (though not stereo) to those who listen with ordinary, monophonic equipment.

Several proposals have been advanced to make this possible, some for use on the AM band, others for use on the FM band. Bell had proposed one that makes simulcasts compatible.

The most widely discussed multiplexing system is the Crosby system for FM multiplexing, which not only provides full compatibility but also removes the imbalance that exists with simple multiplexing.

The Crosby system starts with the idea of using a sub-carrier as we explained above. But, instead of putting channel A on the main carrier and channel B on the sub-carrier, it combines and divides the two channels in a rather complicated way. It is not necessary to understand it fully to appreciate how it works, but a brief explanation may be interesting.

It is possible to add and subtract two alternating currents by manipulating their phase. Two signals that are in-phase add; two signals that are out-of-phase subtract. The manipulation of the phasing and consequent addition for subtraction is called *matrixing* and involves a combination of phase inverters and mixers. In the Crosby system the audio of channel A and channel B are fed into a *matrixing* system which produces one signal that is the sum (A+B) of the two and another that is the difference (A-B) of the two. The sum (A+B) signal is used to modulate the main carrier; the difference signal (A-B) is



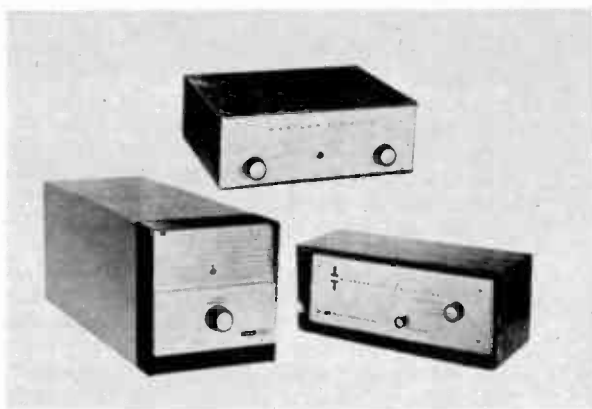
The output jack for a multiplex adapter, usually located on the rear chassis skirt, is identified as "multiplex" or, as on the McIntosh MR-55 here shown, is marked (in middle) "unfiltered output."

used to modulate the sub-carrier. Thus scrambled, the stereo signal is transmitted by the FM station.

What happens at the receiving end depends on the type of tuner the listener uses. Let us take the case of the listener who does not want stereo and has the ordinary type of tuner. The signal goes through the tuner in normal fashion through the detector. As in the case of the simple multiplex system, the sub-carrier is above audibility and is not heard at all. The main carrier modulation is delivered to the single amplifier and single loudspeaker. The listener has the complete program because the main carrier has A+B, or both channels added together. He does not get stereo, but he misses none of the music or voices or noises or whatever.

The listener who wants stereo has a tuner with a special multiplex adapter. The signal goes through the detector in the normal way. But at this point it is routed through the adapter which contains another matrixing system that adds and subtracts the two signals. At the output of the multiplex adapter we get two signals: One of them is $[(A+B) \text{ minus } (A-B)]$ and if you know your simple algebra you will see that this comes out $2B$. The other is $[(A+B) \text{ plus } (A-B)]$ which, of course, adds to $2A$. Thus we again have the two channels separated and if we feed them into a stereo system we will get good stereo reception. Not only does this system produce compatibility but it also results in a good balance between the two channels, and in an improvement in noise figure.

The Crosby system would appear to fill the bill very nicely and it was seized upon



Among the multiplex adapters for any FM/AM tuner are: left, Harman-Kardon MX-20, \$69.95 (enclosure \$8.95 extra); top, Madison Fielding MX-100, at \$49.95; right, Karg MX-1, \$99.50 (cabinet extra).

by stereo enthusiasts as the road to the promised land. WBAI-FM in New York was the first to use the Crosby system in actual broadcasts. A number of manufacturers of FM equipment offered multiples adapters, among them Sherwood, Madison-Fielding, Harman-Kardon, Fisher and indeed almost everybody who made FM tuners. For some time most FM tuners had been manufactured with a jack on the back marked MULTIPLEX OUTPUT. This was to enable those who used the storecast services to use such tuners for receiving such programs by simply adding a storecast adapter. Actually, however, any FM tuner can be used with very simple modification which any serviceman can make, to feed a multiplex adapter.

But there was one group that objected strenuously to the Crosby system. This was the storecast crowd—because the multiplex adapter could be used not only for hearing the Crosby multiplex stereo programs, but also to hear the storecasts. The radio stations who were selling storecasts to stores and restaurants did not welcome the possibility that anyone equipped to receive the multiplex stereo broadcasts on one station could also receive the storecasts of other stations. Of course, the law makes it illegal to pick up storecasts without subscribing to the service. But if thousands or millions of receivers capable of getting the storecasts were sold all over the country, how in the world could you enforce the law? they hollered. Storecasters therefore have protested to FCC against licensing the Crosby system.

It does not follow that the FCC will necessarily go along with the storecasters. There are many who feel that a commercial

service like storecasting has no business operating on broadcast bands anyhow. It was permitted in the first place only because FM stations were having a hard time getting along at that time, as a way of keeping the FM band in service at all. But by all statutory precedents, the interests of the broadcast listener should take precedence over commercial interests in the broadcast bands. Indeed, in authorizing storecasts the FCC went counter to the intent of Congress and all previous precedents. There is no reason why it should perpetuate the exemption if stereo multiplexing is in the public interest.

On the other hand, it is possible that storecasting might be saved and multiplex stereo made possible, too. Several variations of the Crosby system have been offered that claim to do this. Unfortunately, these variations would call for two sub-carriers and this would lead to some degradation of the stereo portion of the broadcasts. In any event the FCC has a problem in making a decision here. As in the case of color television, the radio industry is offering to be helpful. It will be recalled that a special committee of the radio industry was formed to recommend a compatible color TV system and this committee recommended the present system which was authorized by the FCC. Similarly, the Electronics Industries Association has organized the National Stereo Radio Committee chairmanned by Dr. W. E. G. Baker, for many years vice-president of GE and now at Syracuse University. This committee proposes to develop and recommend one or more systems of compatible stereo broadcasting and offer them to the FCC.

We have concentrated so far on FM multiplexing because it offers higher fidelity than AM. However, several proposals have been advanced for stereo broadcasting on the AM band. The first of these was the RCA system. On the AM band the carrier is modulated on both side bands at the same time. This is a wasteful use of the radio spectrum because the modulations on one side are sufficient to communicate the program material. In commercial and amateur communications single-sideband transmissions have become common. Here only one side band is modulated. Thus, for a given audio band-width only half the radio space is occupied. Why not modulate one sideband with channel A of a stereo program and the other side band with channel B? Why not indeed? This is what RCA proposes.

As in the case of FM multiplexing, only a single receiver is needed, with stereo adapter. With such an adapter the two

channels could be separated and used to feed a stereo system. On the other hand, those with no adapter would still hear the entire program because the receiver without an adapter would demodulate and combine both sidebands and thus deliver the entire signal mixed for monophonic use. Thus there would be complete compatibility. This system could be put into use without too much revolution in either transmitter or receiver design. Transmitters could be modified with adapters; and so could receivers. Philco has proposed another system and in this area, too, the FCC will have to make a choice if it decides that some form of AM stereo broadcasting should be authorized.

Meanwhile, too, the Bell Labs have come up with a system that makes simulcasts compatible, and will work with any combination of AM, FM and TV transmitters. The Bell system is based on the fact that the ear marks directionality by several means and among these is the difference in arrival time of two signals.

Suppose the sound sources A and B are the two speakers of a stereo system. Suppose we feed them with exactly the same signal, of exactly the same loudness, but delay the one in B slightly. The ear will actually hear both signals, but it will give precedence to the sound that arrives first. Therefore, the listener will have the illusion that the sound is coming entirely from speaker A, and that speaker B is silent.

Bell utilizes this precedence-of-arrival effect cleverly to produce a very simple way of making simulcasts compatible. This is diagrammed in Fig. 12. We start with the regular two microphones of a stereo setup and as usual we feed mike A into channel A which might go over a TV station; and mike B into Channel B which might go over an FM station. We cross-connect from each microphone to the opposite channel two delay lines that give a delay of a few milliseconds. Thus the output of mike A is also fed into channel B, but delayed; and the output of mike B is also fed into channel A, but delayed.

Now let us see what happens at the receiving end. If you are listening only to the TV or only the FM station, you get the entire program though with a rather different type of "liveness" because of the delay in part of the material.

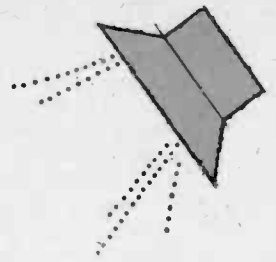
Meanwhile several score stations are broadcasting stereo simulcasts, and a few are broadcasting Crosby multiplex on an experimental basis. Fortunately, the doubt as to future action need not influence the decision about going into stereo. There is enough stereo broadcasting at the moment to make stereo tuners worthwhile. •



CHAPTER

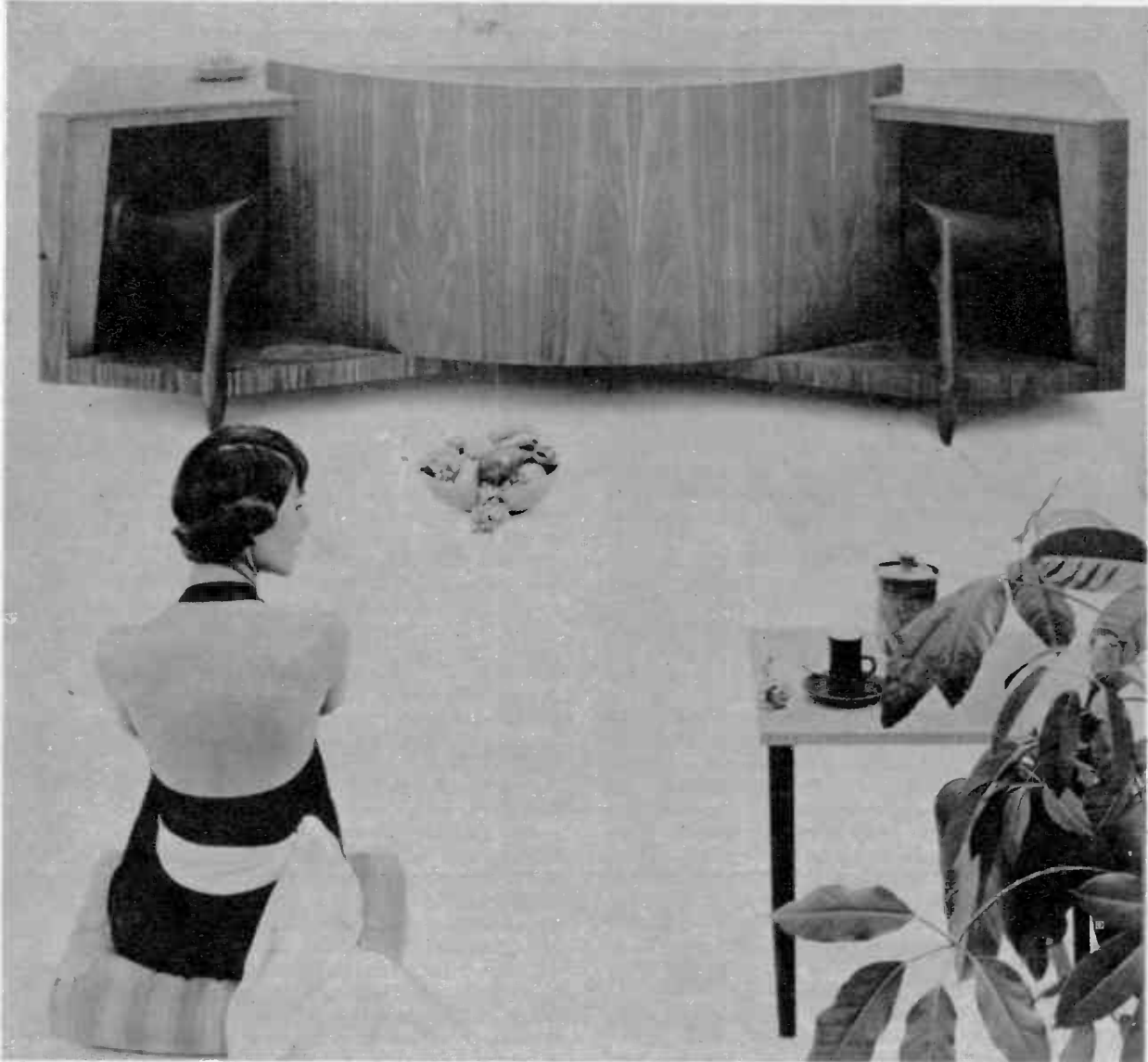
4

Loudspeakers



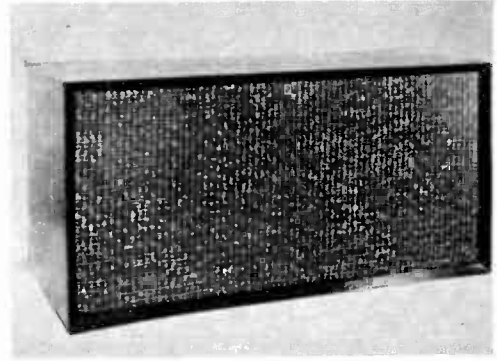
Performance of any system
depends on the quality of its speakers.

Great and ever-growing interest in stereo has prompted manufacturers to design quality speaker systems.





Bozak's two-speaker system permits direction of high and midrange by adjustment of side doors.



Altec-Lansing's compact speaker, at \$80, is said to cover full range from 20 to 18,000 cycles.

THE LOUDSPEAKER SYSTEM is the key item in any high fidelity setup, whether it is monophonic or stereophonic. No system is any better than its loudspeakers and in most homes they present the greatest problem from the standpoint of performance, size and cost. This is especially true in stereo. Therefore, the planning of any high fidelity system should start with the choice of the speaker system.

There are three principal considerations in choosing a speaker system for stereo, namely: the quality of its performance, the amount of money that can be budgeted for the speaker system, and the space available in the listening room. The quality is pretty much dependent on the price you can afford to pay and the space you can find for the system in your room. When both space and the budget are unlimited there is no problem except that of choosing between the several types of speaker systems capable of providing the highest quality of reproduction. But when the budget and/or the space are limited some compromise in the performance is almost inevitable. Fortunately, the large interest in stereo and growing market for it, have stimulated the manufacturers to designing and producing relatively compact and low cost speaker systems capable of providing extremely high quality of performance.

In the case of those who already have a monophonic system, there are some additional considerations. These we will consider later, however, after we have looked into the general principles and surveyed the types of stereophonic speaker setups that are desirable and available.

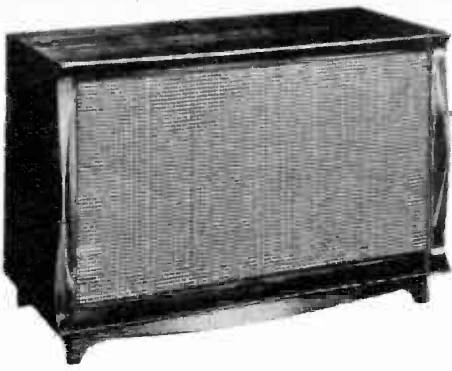
As for cost, somewhere between 33 $\frac{1}{3}$ and 50% of the total budget for a stereophonic system should be allocated for the

speaker system. In Chapter Two we mentioned that \$450 would buy a stereo system that met high fidelity standards. This would mean that somewhere between \$150 and \$225 would be budgeted for the speaker system. There are a number of excellent systems within this price range, among them the Acoustic Research AR-2 at between \$90 and \$105 per speaker, the Electro-Voice Regal 1A at \$100, the Jensen Tri-Ettes at \$115, the University S10 series beginning at \$125 and the Wharfedale WS/2 at \$85.

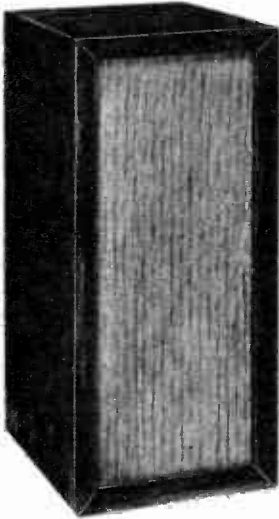
While these differ in their performance characteristics and the quality of the sound, and some will prefer one over the others, all of them will cover the sound spectrum from below 40 to above 15,000 cycles and thus are capable of reproducing faithfully the stereo recordings on the market today.

Where the purse is so thin that this investment is too high, it is possible to shave the cost to between \$155 and \$170 without too great a sacrifice in performance. The Jensen Du-Ettes at \$80 apiece, the Stephens 816 at \$80, and Altec-Lansing Monterey Jr. at \$80 for example, cover the same range as the above-mentioned speakers though possibly not quite as smoothly. The Radio Shack of Boston offers a Japanese-made system called the Realistic Delta 7 for \$154.50 a pair and Allied Radio offers a similar system at a comparable price; both of these give excellent performance. Also there are a number of kit type systems in this price range whose performance is in the above class.

When we go below this price class, however, we have to make some sacrifices in performance. There are a number of speaker systems selling between \$50 and

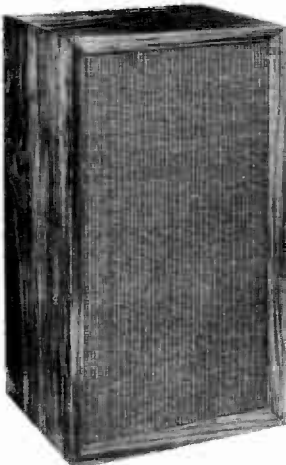


Jensen Tri-Ette produces a most impressive sound with three loudspeakers. Price, \$115 per speaker.



Kingdom line uses Lorenz speakers. Audette III, above, sells for \$57.50 and \$64.50 per speaker.

Omega I, top system in the Kingdom line, is \$110 and \$120, depending on type of wood and finish.



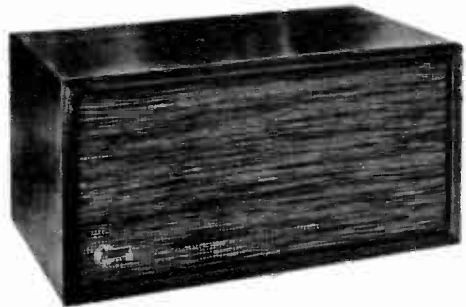
\$70 which cover the range between 50 and 12,000 cycles quite adequately. Among these we might mention the GE LH-6 speakers at \$57 apiece, the RJ speakers at between \$50 and \$60 apiece, depending on the finish, the University Companionette at \$60, the Electro-Voice Wolverine series ranging from \$53 to \$67.50, and in kit form the Heathkit SS-2 and EICO HFS-1 at \$40.

In this price area, also, we might mention the Weathers Harmony speaker system, of which we will have more to say later on. This compact, complete system costs around \$125, yields fine performance.

When you get below this price range you are leaving the field of high fidelity. There are cheaper speaker systems, but their range is limited and their performance will not do full justice to the recordings available today. They will provide stereo but not high fidelity. In this respect they are in about the same class as most mass-produced packaged stereo so-called "hi-fis."

Space is no longer the problem it was in the early days of stereo, unless you have a very small room which already contains a large monophonic stereo system, and even then there are many solutions to the space problem. In the past two years speaker designers have worked what almost amounts to miracles with loudspeakers. The speakers we mentioned above in the \$100 class, for instance, are about 2 x 1 x 1 foot in size and yet provide performance which previously was available only in very large speaker systems. For that matter the three units of the Weathers Harmony system could be placed satisfactorily even in the fourth floor back room of an old-fashioned brownstone rooming house. The bass speaker can be

Wharfedale WS/2 system offers full range performance. Price is between \$80 and \$95 per speaker.



placed anywhere, even under or behind a davenport or bed, and the two side speakers are scarcely larger than a small dictionary. To be sure there is still the most important problem of locating a pair of speakers, no matter how small, in a room so that they will yield a satisfactory stereo illusion.

As might be expected, the spacing and location of the speakers in a room is most important to achieve the best stereo effect in any given room. But there are no hard and fast rules about this. The optimum placement in any room will depend on several things, namely: the size and shape and acoustics of the room; the radiation characteristics of the speakers; and the listening position and listening area to be covered. In many rooms the combination of these factors makes the best placement very critical, while in other rooms and with other speakers, there is considerable tolerance. In most cases, it will take some experimenting to find the best location.

If it were possible in the home to duplicate with the speakers the exact spacing and placement of the microphones in the studio or concert hall, the problem would be simplified. Unfortunately, this is not practical. The mikes may be spaced as much as 40 or 50 feet apart in the case of a symphony orchestra, but in the case of a trio might be as little as seven or eight feet. The best listening position will also vary with the spacing of the mikes and speakers. Thus with the wide spacing the listener needs to be 40 or 50 feet from the speakers, whereas with the narrower spacing he could be as little as 8 or 10 feet away. The ideal arrangement would be to have the speakers on tracks so that the spacing

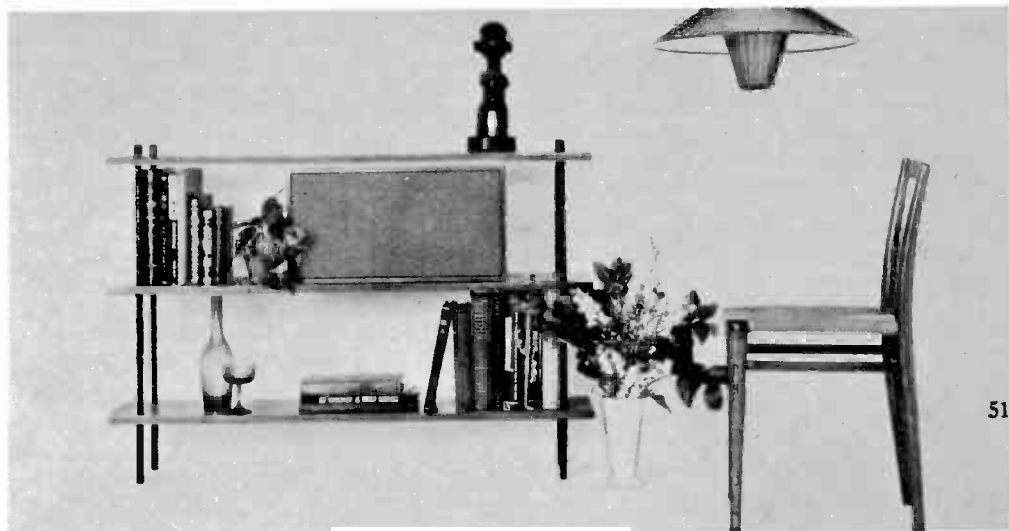
could be varied to suit the recording; but this is like asking for a garage that could be stretched or shrunk to provide an exact fit for anything between a Fiat 500 and a Lincoln Continental.

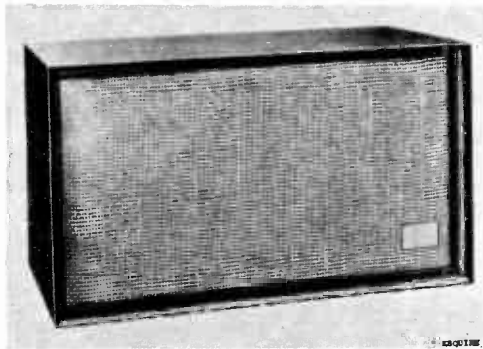
In practice, therefore, some compromises are necessary to achieve an arrangement that will work best with most recordings.

In principle the arrangement of the speakers ought to be such that the sound from each speaker reaches the corresponding ear at the same time. If the left ear, for example, is closer to the left speaker than the right ear is to the right speaker, the left channel will predominate except when the right channel is very much louder. Obviously, the best listening position is one that is an equal distance from both speakers. But it is obvious that the number of spots in a room that are an equal distance from both speakers is very limited. So, it follows that even when the speakers are placed properly, the listener has to be in the right place, too, to get the best stereo effect. This is a disadvantage we have to put up with. However, although the stereo effect will not be best in other positions, with stereo the sound will still be superior from any position in the room. The directional effects will not be so obviously evident, but the sound will be rounder and fuller, more resonant and room-filling.

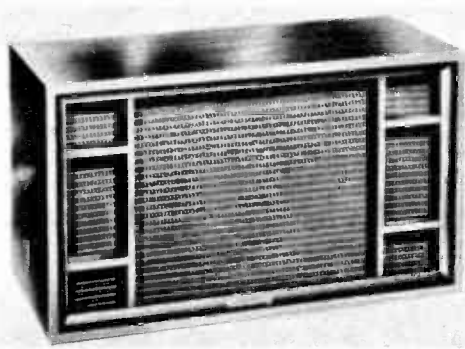
A rough estimate of the desirable location for the stereo speakers in your living room can be made in the following way: First, decide the direction you want to face when listening. If the room is square, any of the four directions will do equally well. But if the room is rectangular, the choice is usually in favor of facing one of the two narrower walls. This not only stretches the area in which the stereo effect is best, but

A pair of University S-80 speakers will provide response from below 50 cycles to above 15,000; \$80 to \$100.





Electro-Voice speakers are priced from \$52.50 up beyond \$500. Esquire model, above, is about \$125, performs well between 40-16,000 cycles.



University was among the first to use low compliance speakers in compact ducted port enclosures to achieve a response covering full range.

usually also provides the speakers with the best acoustic coupling to the room.

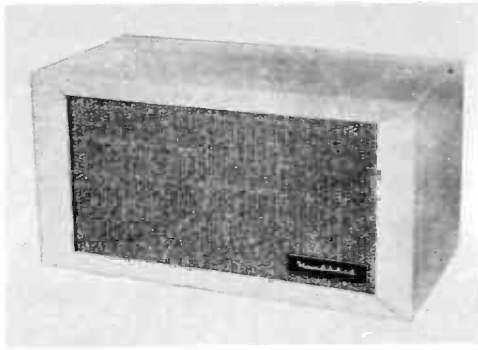
In any event, now locate the position in which you will want to sit when doing most of your listening. This ought to be at least 9 or 10 feet from the opposite wall, along which you will space your speakers. Facing straight ahead, locate a spot on the opposite wall directly in front. If your sitting position is in the middle of the wall or the room, this spot will be in the middle of the opposite wall. Now estimate or measure the distance from your sitting position to this spot on the opposite wall. From the above center spot on the opposite wall, mark off a distance in each direction, along the wall, equal to one half the distance from your sitting position to the wall, but in any event no more than six feet. Thus if your preferred chair is 8 feet away from the wall, mark off a distance of 4 feet on each side from this center spot; but if your preferred sitting position is 12 feet or more away, mark off a distance of 6 feet.

This angle will provide a good, integrated stereo effect with speakers of average directivity. A narrower angle will reduce the directional effects; a wider angle will emphasize them but run into danger of the "hole in the middle."

If the arrangement of the room and the furniture permits you to locate the speakers in these two spots, the chances are nine out of ten that the effect will be satisfactory with or without minor adjustments. But suppose for one reason or another it is not possible or convenient to place the speakers there. You can narrow or widen the spacing up to a point. It is best to do this by splitting the difference on each side of center, so that the preferred listening position is still equidistant from

both speakers. If this is not possible, you can choose the best possible positions along the wall that are separated by the distance you determined above. Then you can consider moving the listening position over so that it is centered in respect to the position of the speakers. If this is not possible or feasible, and the displacement is not great, you will probably be able still to get a good effect by unbalancing your stereo system loudness, so that the output of the speaker farthest from you is a little louder. Although the optimum stereo is experienced when the ears are equal distances from the two speakers, there is still a satisfactory effect in the entire triangle where the radiation patterns of the two speakers come together. The more the two channels are separated in the recording or in the adjustment of the playback equipment, the more noticeable and sharp the directional effects. With sharp separation the stereo effect will even be experienced when the listener is standing in front of one of the speakers. But when the two channels are integrated to produce a curtain of sound, rather than two separate bundles of it, the directional effects are lessened as the listener moves from the optimum position, and when the listener is in a position where the output of one of the channels is dominant, the sound approaches that of a monophonic system although there is still a greater opulence and presence.

It will not be possible in all cases to approximate the desirable conditions outlined above. Some speakers have much sharper directivity of the middle and high frequencies which largely determine the stereo effect. With such speakers a narrower separation is desirable to avoid a hole in the middle and to make the listen-

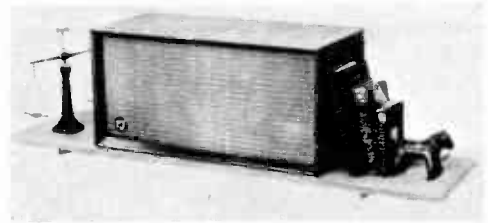


Heathkit SS-2, at low price of \$39.95, covers the range between 50 and 12,000 cycles with two speakers. It meets minimum hi-fi specifications.



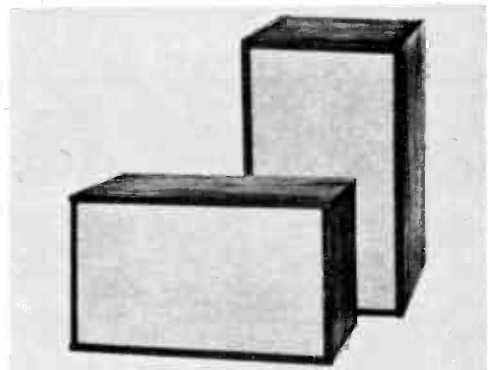
In the lowest price range of speaker systems for stereo is the EICO HFS-1 speaker kit selling for \$39.95. The audio range is 70 to 12,000 cycles.

ing position less critical. On the other hand, other speakers have a broad radiation pattern and with these the spacing can be increased. A special case is provided by the EICO speakers in which the highs are directed upward and forward in a 180-degree radiation pattern. With such a pattern the dangers of a hole in the middle are minimized and in many rooms these will work better if spaced 15 or even 20 feet apart. Conversely, where the arrangement of the room or its furniture calls for wide spacing, these are an excellent solution. Speakers with this wide radiation pattern are also more successful in very small rooms where the listening position has to be quite close to the two speakers.



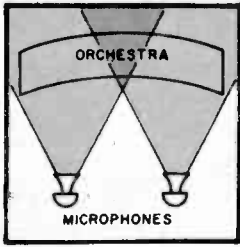
Wharfedale RJ Super 8, in \$60 price range, uses a special type of ducted enclosure. It can also be purchased in unfinished form for a low \$50.

Horn speakers usually require the use of a corner. It is difficult to match the efficiency and tonal qualities of a horn except with another horn. Since it is always best to use identical speakers, we ought to use another horn speaker in the opposite corner. But suppose this calls for a distance greater than the 12 feet we specified as the normal maximum spacing in a living room? Well, in the first place, horns in a corner radiate at an angle into the room as indicated in drawing. With this angle, you will note, the area in which the patterns of the two speakers overlap is much larger; hence, greater separation is possible with horns than with direct radiators set flush against a wall. There should be no serious problems as long as the separation does not exceed 15 to 18 feet; but when this separation is exceeded, the hole in the middle will present a problem. Paul Klipsch solves this problem for Klipschorns with a third speaker in the middle.

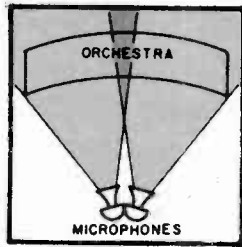


In most cases, it is best to face the speakers so they radiate straight forward,

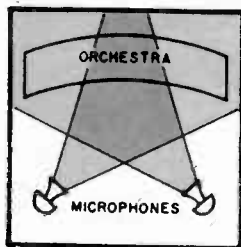
Janzsen Z-400 speaker system is compactly designed to be placed either vertically or horizontally on a shelf. Range goes down to 30 cycles.



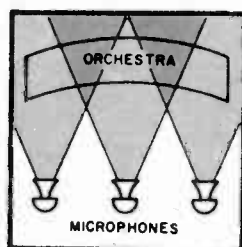
A



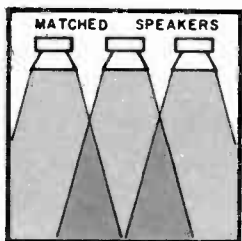
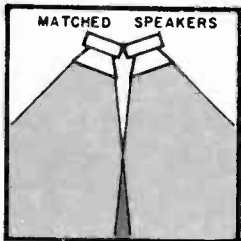
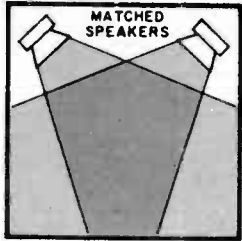
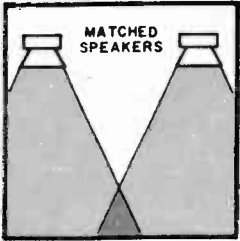
B



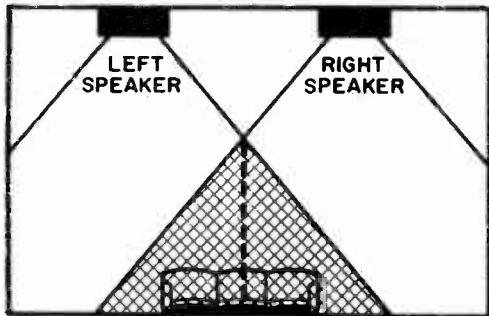
C



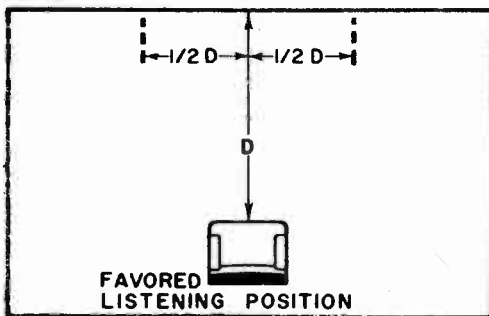
D



Ideally, speakers should follow spacing of mikes in making recordings. Diagrams in the top row above show some of the simplest mike setups. Below each is the corresponding speaker setup. Unfortunately, such rearrangement of speakers for different records is impractical, and compromises become necessary.



Stereo effect is best where radiation patterns of speakers overlap. Optimum listening spot is where both speakers are equidistant from ears.



Separation of speakers should equal the distance from listener to wall where speakers are placed.

but if the spacing is wider than desirable, it may help to angle them so they face inward. On the other hand, in some cases it may be advantageous to turn the speakers so the sound is reflected from a wall. The Jensen Director series of speakers has the midrange and high-end speakers mounted on a pivot so they can be revolved to produce the optimum effect from any position. In the Bozak and University stereo pairs doors may be moved to direct the sound for best effect.

Stereo works best and presents the fewest problems when the entire system is identical throughout both channels. Therefore, when you are starting from scratch, you should consider no other alternative but that of using either an identical pair of speakers, or one of the three-speaker systems that we will consider a little later.

Any speaker system suitable for high fidelity is suitable for stereo high fidelity, although one or two types present some special problems in stereo. For example, some of the finest speaker systems are corner horns like the Klipschorn, the Electro-Voice Patrician and Jim Lansing Hartsfield; but they must have a corner, and a pair obviously must have two corners. The two corners ought not to be too far apart either. If they are there will be a problem of a hole in the middle. Aside from corner speakers, any large speakers complicate the stereo problem simply because their bulk makes it more difficult to find room



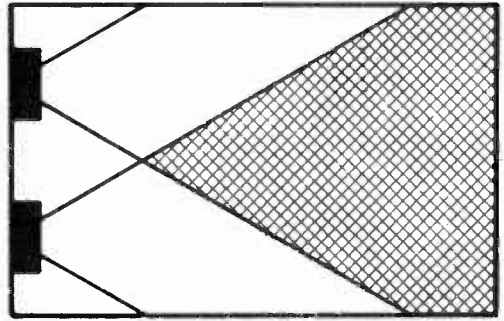
EICO Hegemann speaker, shown above, uses two slot-loaded folded horns to cover the bass range.

for them and to arrange them in such a way as to produce a good stereo effect. Two small speakers are obviously easier to place in any room. Still, those who want the highest possible performance and have the means to afford it, can overcome these problems.

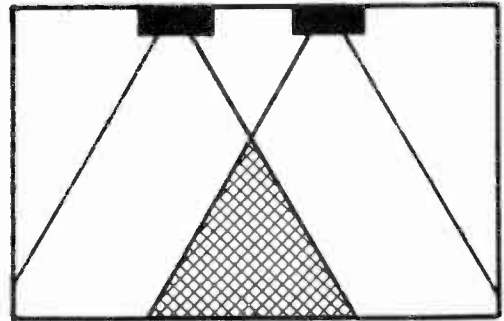
In many rooms it would be more convenient to use a single speaker assembly for stereo; and as we pointed out in an earlier chapter, the close spacing of a pair of stereo speakers in one cabinet helps to minimize the hole-in-the-middle-effect and to produce an integrated stereophonic sound. There are many such unitized pairs of speakers in very handsome cabinets. Among these we might mention the Bozak, which come in both modern and period designs; the Jensen Stereo Director DS100; and the unique Jim Lansing Ranger series which now includes the miniature Minigon.

There is an alternative to the two-speaker stereo system. This is the so-called "common-bass plus two side speakers" system which is available in several forms from several manufacturers. This system was originally developed as a way of converting a monophonic system to stereo, but it possesses some virtues in space-saving and cost which make it attractive also for consideration when starting completely from scratch.

The theory behind this system goes back to the very early experiments by the Bell Telephone Laboratories on stereophonic



A

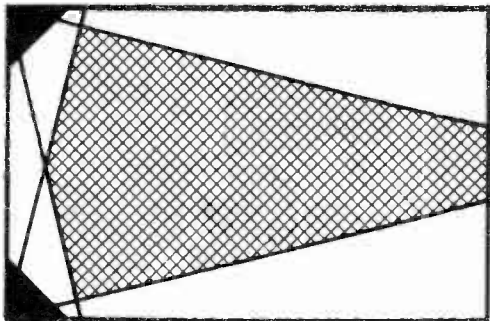
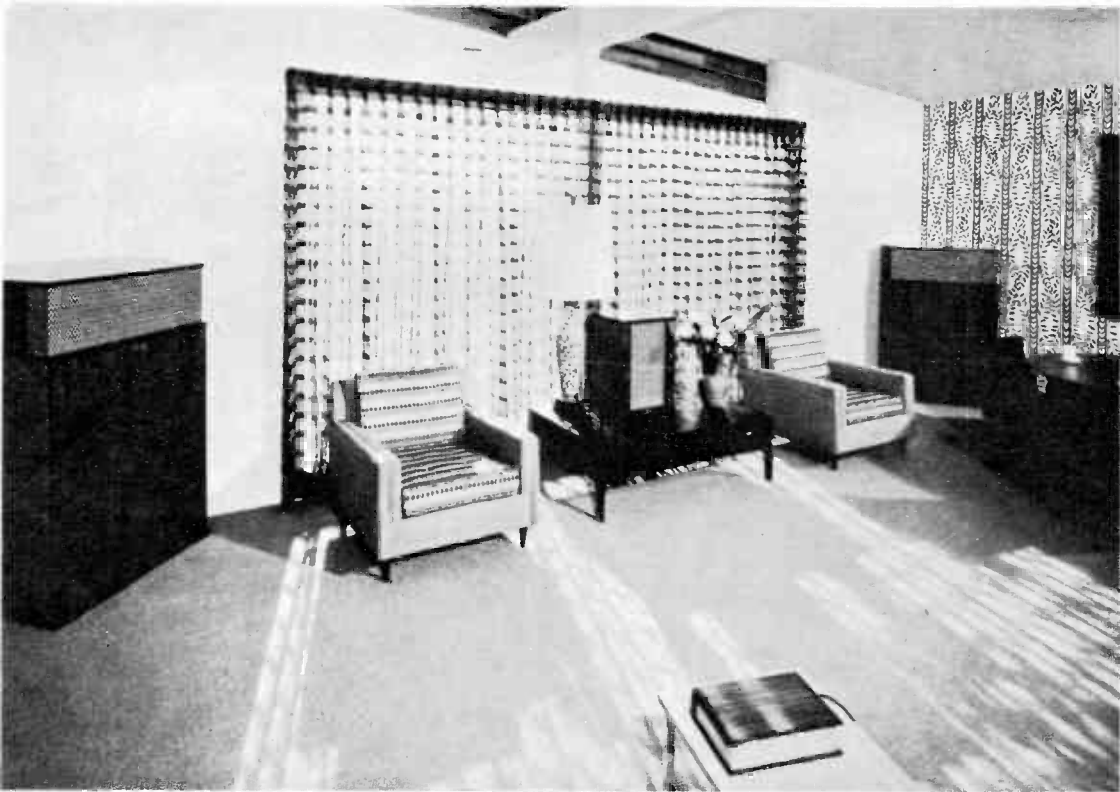


B

The placement of speakers along the narrow side of a room provides for a larger area of stereo enjoyment than when speakers are placed on the long side of a room, as shown in diagrams above.

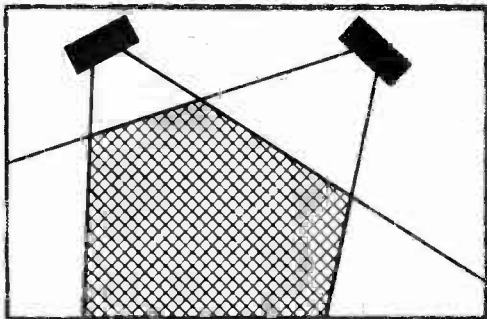
Components below include Fisher 90R tuner, 2 C4P McIntosh preamps, 2 Fisher basics, 2 Tannoy DCL-12 speakers, Garrard RC88 w/Shure stereo cart.



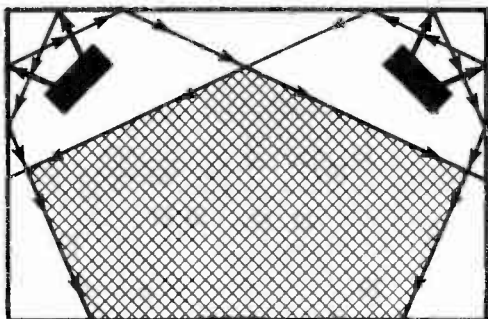


Above, two Klipschorns are used in widely separated corners. A center speaker is recommended, such as the KA-1 which was designed for such use.

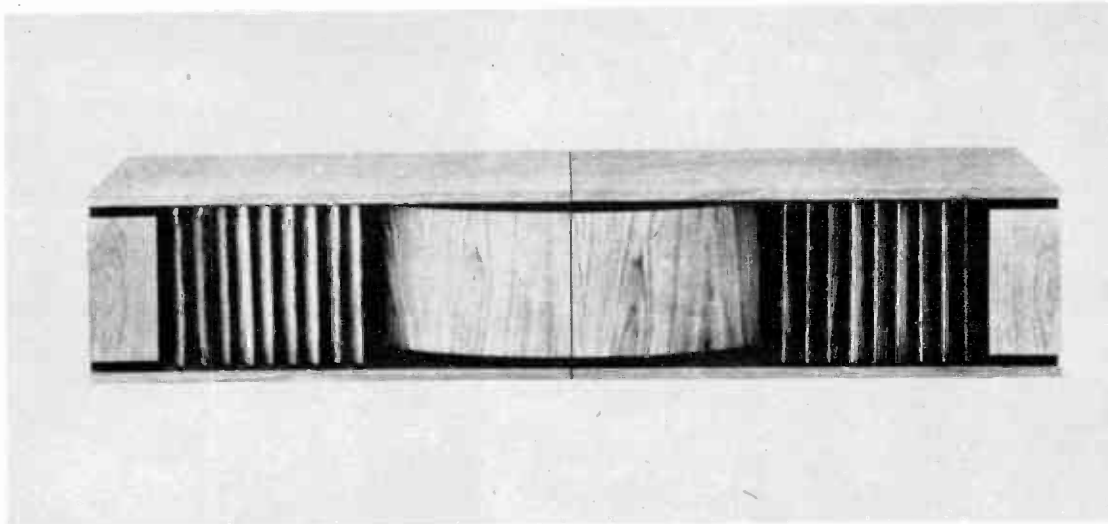
Corner horns, as diagrammed here, provide much wider overlap of radiation patterns. Thus, wider spacing is possible with them. Although facing speakers flat against wall is usually best, in some cases angling them toward listener extends and blends stereo area. In other cases, a more pleasing effect is sometimes achieved by facing speakers to corners to reflect sound from walls.



A

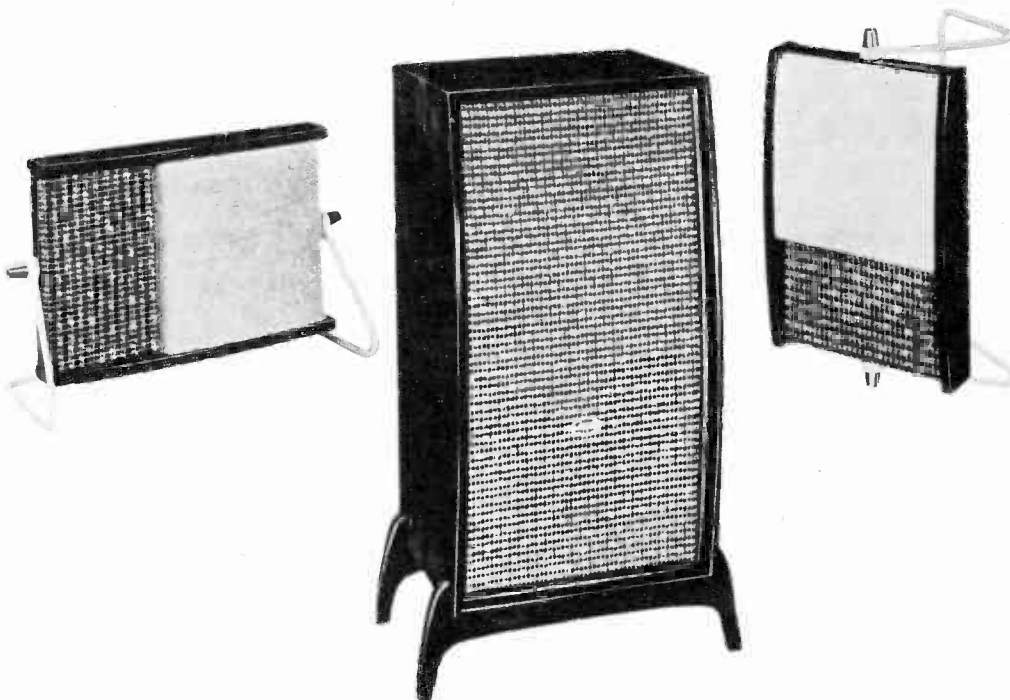
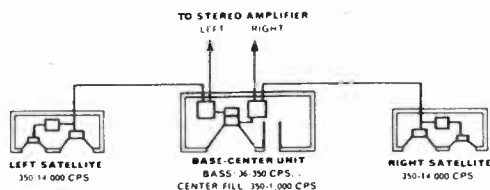


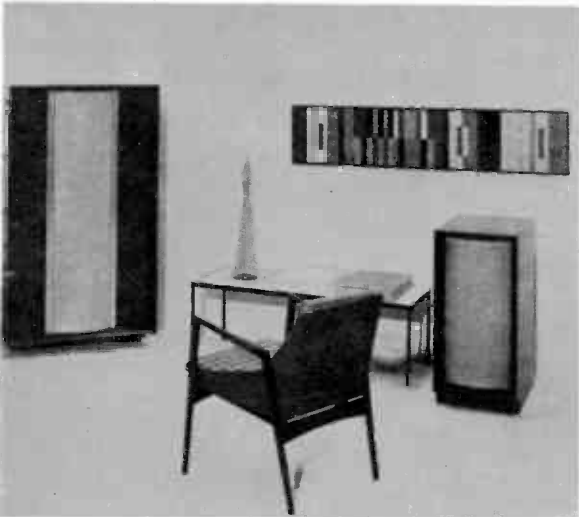
B



Jim Lansing Minigon comes in two parts which can be used either separately or together to suit the room.

Diagram at right is Jensen Galaxy system. In the common-bass system, the largest speaker radiates bass from both channels. Satellite speakers provide stereo effect. Compact Satellites, seen below, can be placed on shelves or hung from wall.

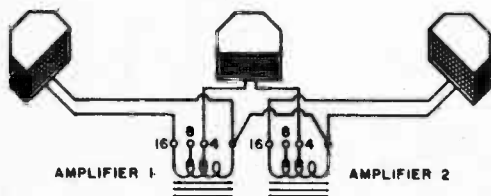




Big speaker of Electro-Voice Stereon 200 uses a 30-inch woofer to generate bass below 20 cycles.

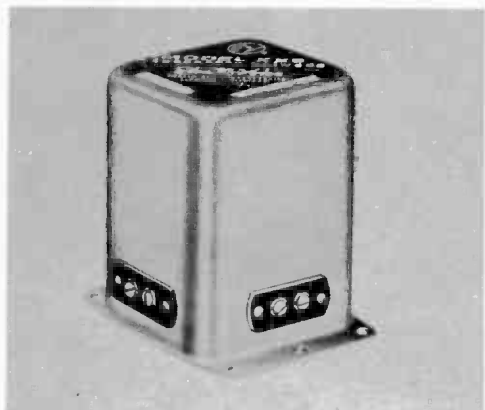


Side-speakers of Weather's Harmony system are size of a thick book. Entire system costs \$125.



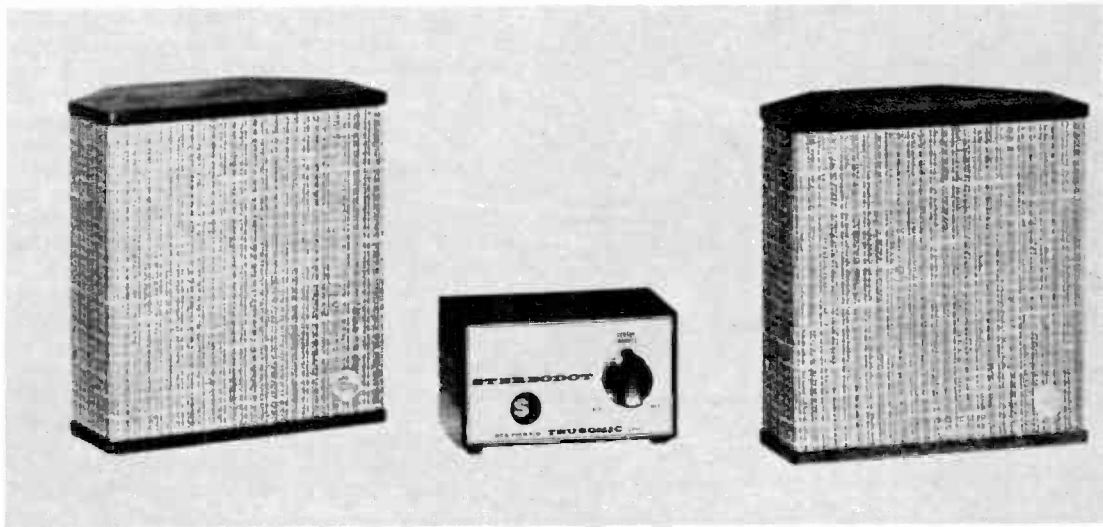
One solution for "hole-in-the-middle" effect of two-channel stereo is to reconstruct third channel by setting up a "phantom" speaker connection.

Electro-Voice XT-1 stereo mixer transformer converts monophonic systems to stereo; permits adding one or two speakers for a common-bass layout.



and binaural sound reproduction. It appeared from these experiments that the distribution of the bass frequencies is essentially non-directional. Their experiments showed that sounds with a wavelength of $2\frac{1}{2}'$ or more, which is 300 cycles or less, are heard exactly alike by the two ears. From this it would appear that the directional effects are produced largely by the higher frequencies—above 300 cycles. Now it is the frequencies below 300 cycles that require the big cabinets. It occurred to stereo designers that if the bass frequencies are nondirectional, a good stereo effect might be produced by using only one bass speaker to reproduce the bass from both channels, and two smaller speakers, covering the high frequencies, spaced for the stereo directional effect. On the basis of this reasoning a number of manufacturers have produced components for this "common-bass plus two side speakers set-up."

There is a good deal of controversy about these systems. Some people like them, some do not. The Jensen Galaxy Satellite and the Weathers Harmony systems are the latest of these. Sketch illustrates how the Galaxy system operates. The main and largest unit is the bass unit. It covers the range between 35 and 350 cycles. The speaker used in this bass unit is a special model of Jensen's high compliance "Flex-air" woofers with two voice coils. One of the voice coils goes to the output of the right amplifier, the other to the output of

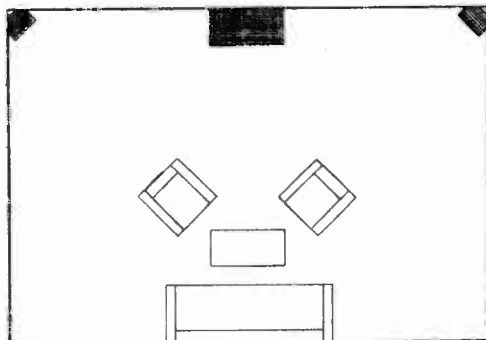


Stephens Stereodot system can be used to convert monophonic system into a common-bass stereo system. Present speaker radiates common-bass and third channel. Stereodots can be placed anywhere in room.

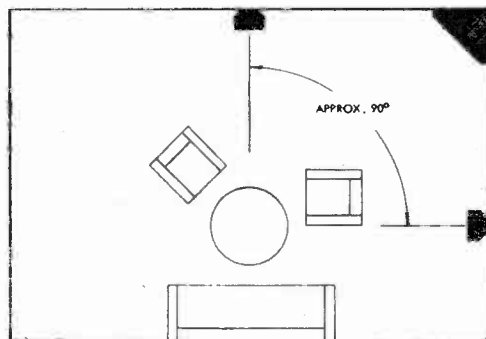
the left amplifier. The two side speakers, or satellite units, are only $7\frac{1}{2} \times 11\frac{1}{2} \times 1\frac{1}{2}$ " and come with a bracket so that they may be placed either on a shelf or hung from the wall. These are the stereo pair. The bracket on the satellite permits the aiming of the two speakers for the best directivity. The entire system costs \$170 complete, or \$93 without the bass cabinet, but with all the components, for those who do not mind building their own cabinet.

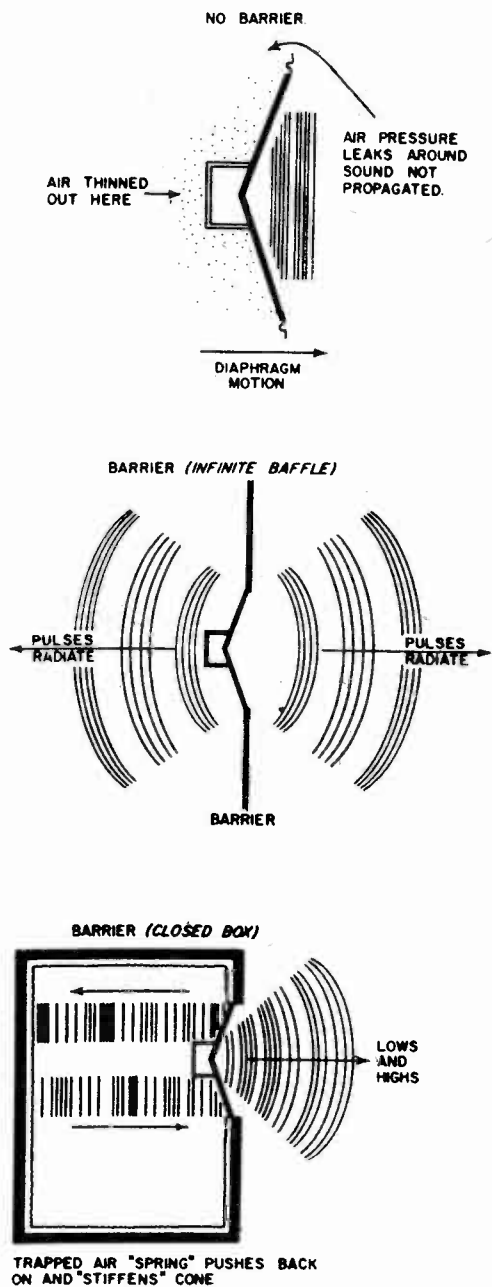
There is one trouble with both the theory and the operation of this common bass system. It may be true that the ear does not distinguish directionality below 300 cycles, but it is also true that there are no instruments that are limited in their response to the frequencies below 300 cycles. Even the bass drum has harmonics beyond 5,000 cycles and the bass viol almost to 10,000 cycles. Because of this some rather remarkable but unnatural effects are possible with these common-bass systems. For example, should you place your bass speaker on one side, and the treble range of a piano should happen to be coming from the satellite speaker on the other end of the room, the piano might seem to be stretched out the full length of the room—the bass end in one corner and the middle and high end in the other corner.

Similarly, other instruments of the orchestra, part of whose range is below 300 cycles might well seem to jump back and forth between the two sides of the room, depending on whether they were playing



Diagrams above and below show arrangements suggested by Stephens for use with their Stereodot system. Arrangement below should be adopted with present corner horns in stereo conversion.





Top: Speaker without baffle permits front and back waves to cancel out and there is no sound. Center: Placing speaker in wall isolates front and back waves, providing an infinite baffle. Bottom: Box can be used as infinite baffle, but enclosed air raises resonance to audible range.

above 300 cycles or below 300 cycles. This can be minimized if the bass speaker is in the middle and if the two side speakers are not displaced too far from it on each side. But even then at times some odd effects occur. Jensen minimizes this in the Galaxy by also feeding into the bass unit a small portion of each channel's output in the middle range of frequencies. This helps to fill in the middle and to minimize such disjointed effects.

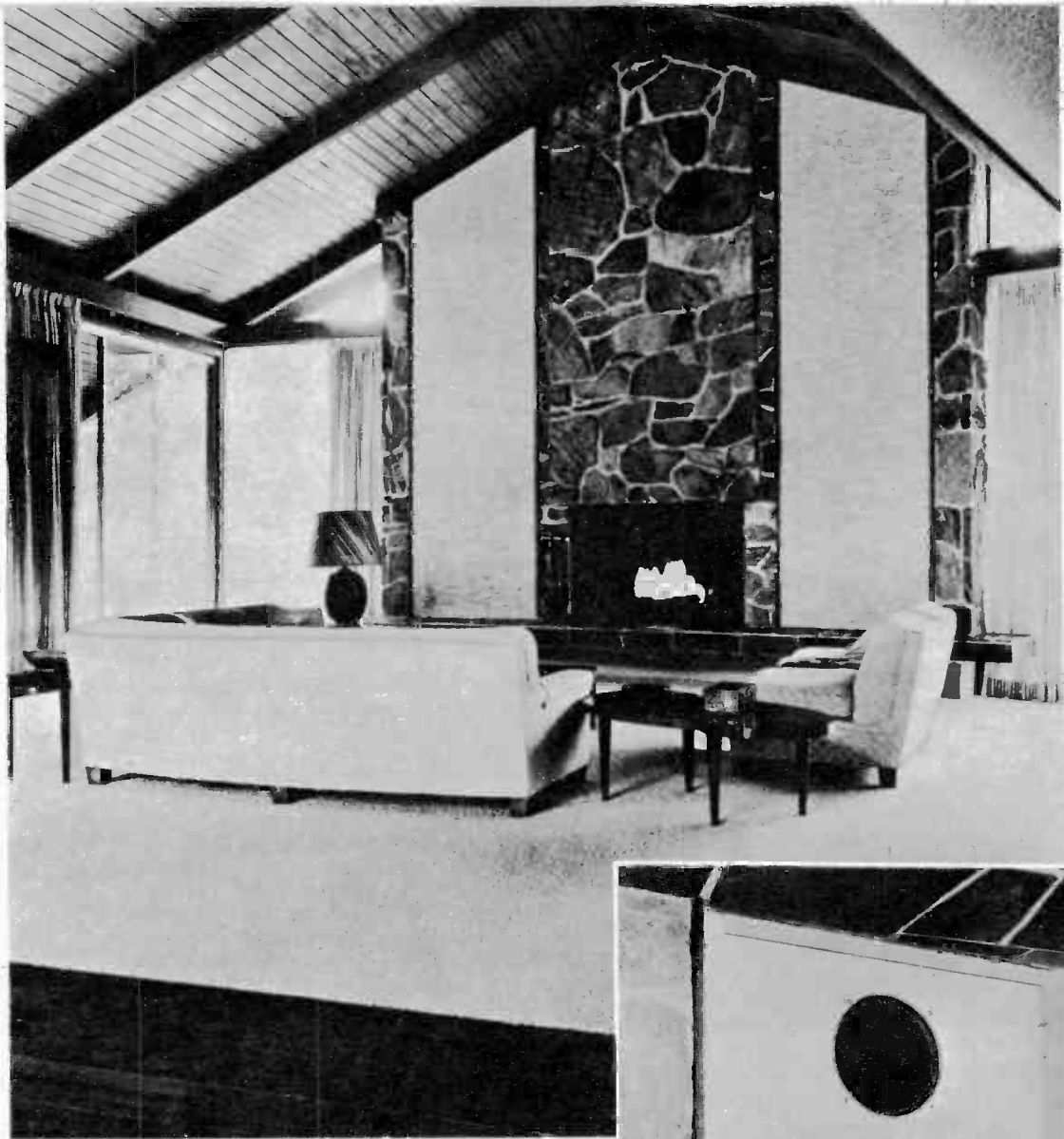
In its Stereo Director system, the complete speaker system in a single cabinet, Jensen also used the common-bass principle. However, here the three speakers are close together. Also the two side speakers are mounted on a pivot so that they can be turned either to disperse or to concentrate the two channels. The close spacing helps to minimize the disjointed effect.

Paul Weathers in his Harmony system uses a slightly different approach. His bass speaker does not reproduce the sounds above 100 cycles. Although almost every instrument in the orchestra gets below 300 cycles, only the tympany, bass and snare drums, bass viol, tuba and organ have any range below 100 cycles; thus Weathers reduces the possibility for this disjointed confusion.

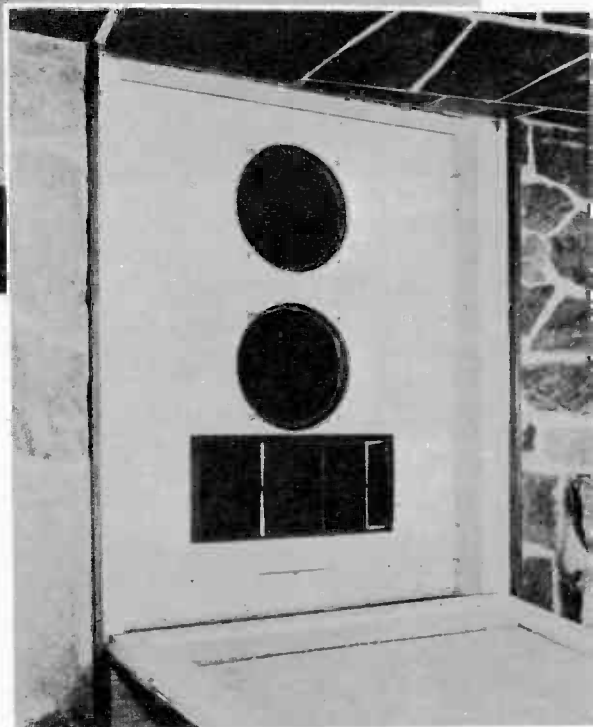
Other manufacturers who offer these common-bass systems are University with the Stereoflex system, Electro-Voice with the Styron system, and Stephens with the Stereodot system.

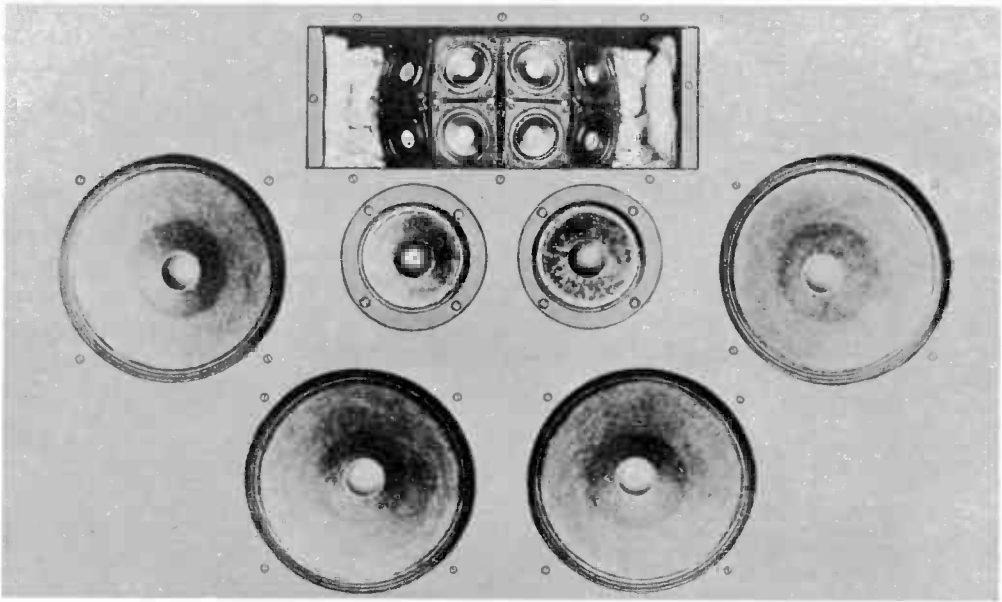
Some of these systems were designed originally to modify an existing monophonic system to stereo by converting the present wide-range speaker into the common-bass speaker and adding the two side speakers. This is an approach that is worth considering when space and the budget are important considerations. In general, however, I am sure even the manufacturers and designers of these systems will agree that two identical full-range speakers are to be preferred where space and the budget permit. As always where a short cut is involved, there is a sacrifice to be made.

While we are discussing these three-channel common-bass systems, a word might be in order about adding an actual third channel to the two-channel stereo system using full-range speakers. Especially when the two speakers have to be widely separated, the hole-in-the-middle problem can be quite serious. This is particularly true if two horns are used in opposite corners of a wide room. We pointed out in Chap. 1 ways of filling in the middle

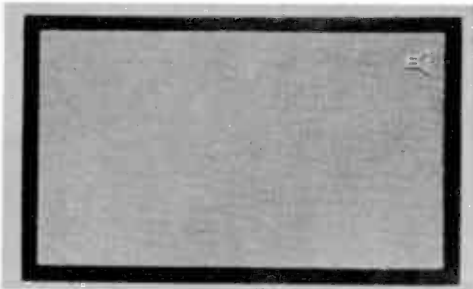


Building speakers into walls provides an inconspicuous system with high performance. Two Altec-Lansing speaker system, shown in inset photo, are built into walls in infinite baffles on each side of fireplace above. The speaker panels are hinged, making them accessible for adjustment.

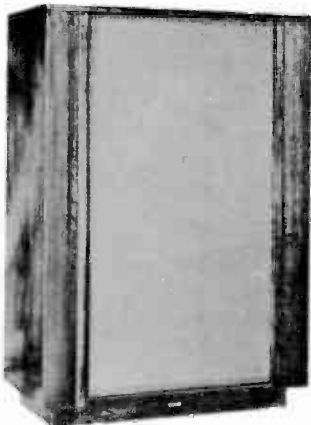




Installing the speaker system in walls between rooms achieves real infinite baffling and produces excellent sound. Bozak offers several combinations which are mounted on boards, ready to frame into walls.

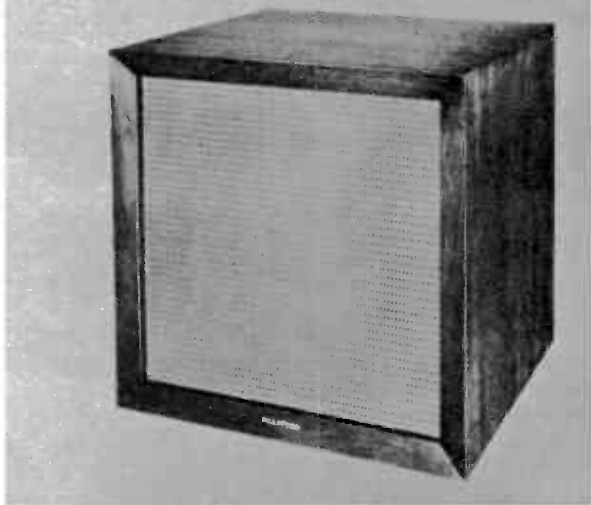


Bozak speakers, shown above and below, come in many sizes, with from one to fourteen speakers.

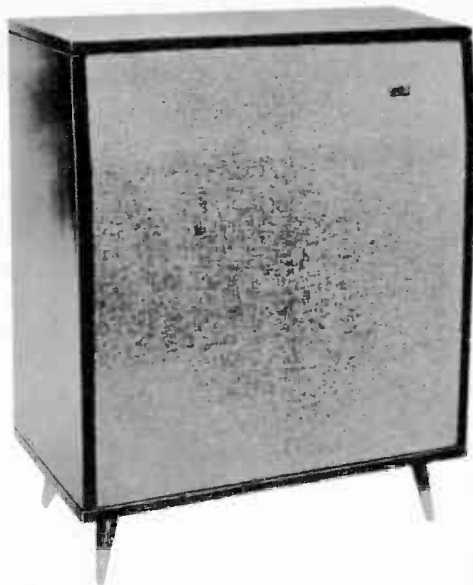


by blending the two channels to create a phantom third channel; but when the spacing is very wide, this phantom channel is difficult to achieve and it also has a tendency to take a different position depending on where the listener is sitting. Therefore, an *actual* third, middle channel may well be desirable. It is not difficult to add a third speaker to a two-channel stereo system. The two leads from the third speaker are simply connected to the lower taps on the two amplifiers as indicated on page 57. A lower tap must be used than the one used for the two side speakers because we want to feed in only a fraction of the output of each channel to this middle channel. The easiest way to do this is simply by connecting this to one of the lower taps—the 4 ohm tap, for instance, when one of the two side speakers are 16 ohm speakers. Usually the two ground taps are already grounded to the chassis and no connection is necessary from G to G. However, we indicate this in the event that the amplifier in question should be an exception to this rule.

A better way to use an actual third channel is to use a third amplifier as well as a third speaker and to feed it with a pre-amplifier which has a bridging channel and a bridging or blending control, such as the Lafayette Professional Control unit, or the Lafayette Remote Stereo Control Adaptor. The Harman-Kardon units also provide outputs for third channels to feed a middle



Bradford infinite-baffled enclosure has a small door on a very compliant hinge which is said to relieve air pressure and prevent resonance by opening when air is compacted by cone movement.



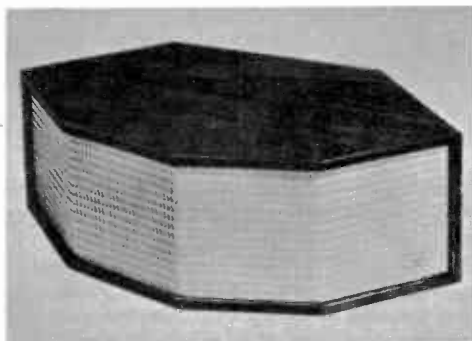
Janszen systems come in several sizes and prices. Woofers are in infinite baffles; tweeters are electrostatic. Separate tweeters, such as one in photo below, are considered among most perfect.

speaker. In this way the third speaker can be fed a carefully controlled portion and blend of the two channels to produce the best effect with specific recordings or programs.

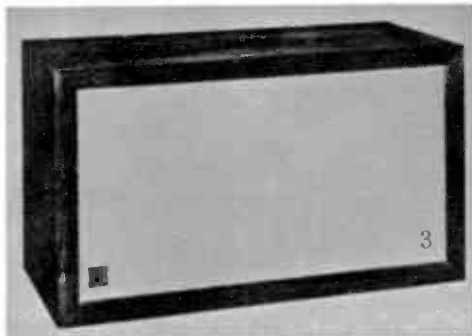
There are so many speaker systems available, all differing in some degree, that a decision is always difficult, even for the expert. And this is also the most difficult area in which to offer advice.

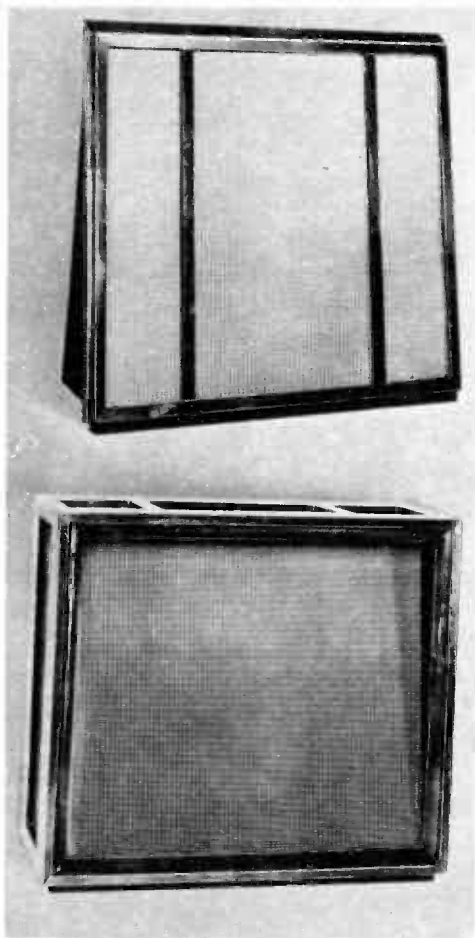
In a very real sense choosing a speaker system is like choosing a wife. The character of the listener, of the speaker system and of the home have to be compatible. Furthermore, speaker systems differ almost as much as women. Some are brighter, some duller, some sharper, some mellower; some big, some small; some more efficient; some handsomer; and some are almost as expensive as blondes. Just about every speaker designer has a different idea of how a good speaker should sound, or what sound most people prefer from a speaker. This is confusing, to be sure, but on the other hand it has provided a variety of speakers sufficient to meet just about any combination of taste, need and purse.

If you have preferences as to the quality of sound, the only thing to do is to visit a high fidelity emporium that offers a good selection of speakers and listen to them in their listening room. When you have found one whose sound you like, ask if you can



Acoustic Research's AR3 speaker system is infinite-baffled. It employs a new type of midrange speaker and tweeter to cover the upper range.





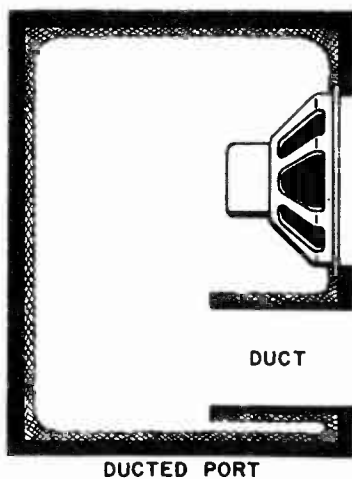
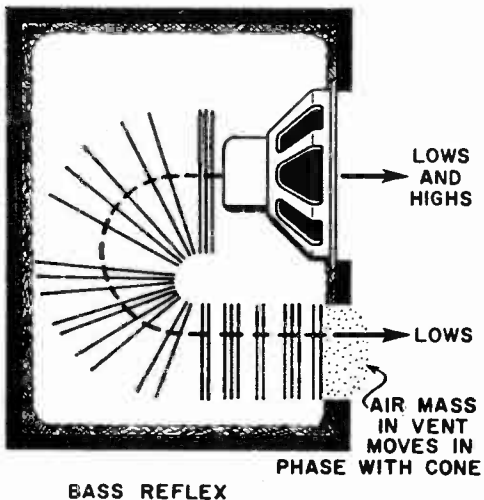
Wharfedale 3-way speakers above use a small flat baffle, are made of sand-filled wood sandwiches.

purchase them on an approval basis—that is, subject to their being satisfactory in your own living room.

The acoustics of a room make a tremendous difference. For example, a bright resonant system may sound exactly right in the highly damped listening room in the dealer's establishment, but may turn out to be overbearingly resonant in a very live living room with hard walls, lots of glass and few sound-absorbing furnishings. So remember to take the character of your room into account when listening in the dealer's show room. Generally speaking, a live room in which sound tends to reverberate, takes most kindly to a highly damped speaker system. On the other hand, a dead room with little echo, needs a more reverberant speaker system to make up for lack of room resonance.

If you have no prejudices or preferences as to tonal qualities and your room is average, you can choose your speakers on the basis of their availability, cost and the way they would fit into your room, decor and budget. They say in Kentucky that there are only two kinds of whiskey: "good and bettah." Not having tasted all whiskeys, I'm not in a position to give this a personal endorsement. But I have heard practically all of today's high fidelity speaker systems produced by the reputable high fidelity firms and sold by reputable high fidelity dealers—the kind advertised and mentioned in this book—and I can say this is true of these speakers. They do differ and some people like one better than others

By adding port to box, phase of rear wave is inverted. It now radiates through port and augments bass response of speaker. By extending port into a duct, as shown below, much smaller box can be used.



and, generally speaking, the more you pay for a system the better it is; but you are not likely to be throwing your money away whichever you decide to get.

Speaker systems can be divided into infinite baffle types, bass-reflex and ducted port types and horns.

A speaker cannot operate effectively at low frequencies unless it is "baffled." The reason is quite simple. The waves produced in the air by the front of the cone are out-of-phase with the waves produced by the back of the cone. If these two out-of-phase wave fronts are not kept apart, they will tend to cancel each other and thus produce no sound. Ideally, the front and back of the speaker cone ought to be separated by a baffle which provides an infinite distance between front and back cones—in other words, which provides complete separation of the front and back waves.

If, for example, we mounted the speaker in the wall between two rooms which are entirely separated and closed off from each other, we would have such an infinite baffle. This is, indeed, an excellent kind of arrangement, and where conditions permit mounting the two stereo speakers in a wall in this way, an excellent sound is produced. The character of the sound in such an arrangement is almost entirely determined by the character of the speaker; there is no coloration except that provided by the speaker itself.

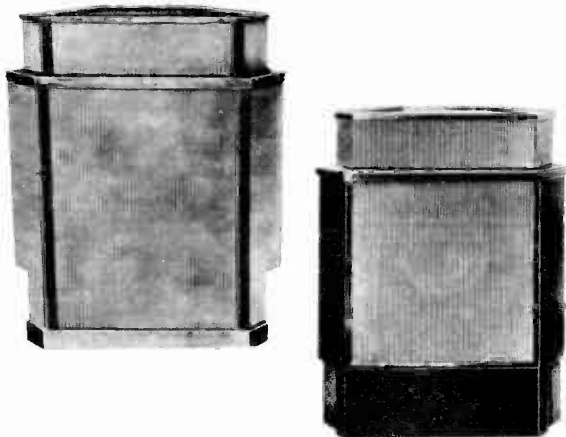
Unfortunately, not every home, or every landlord, will permit such an arrangement.

What happens if we reduce the space behind the speaker until it is only a box of a size we can use in the living room? The isolation between the two sides is still maintained. However, as we reduce the space behind the box the air resistance is increased and the speaker cone is more heavily loaded as it tries to compress the air in the smaller space. Furthermore, air enclosed in any closed space has a resonance. If the space is a room the resonant frequency is very low and has no appreciable effect; but in a box of any practical size, the resonance begins to come up into the audible range somewhere below 100 cycles. The smaller the box the higher the resonant frequency. Thus the enclosure begins to affect the performance of the speaker and to add its own coloration to the sound. Still, by clever engineering and mating of speaker to box, we can obtain excellent performance in a box of a reasonable size. Such portable and compact infinite baffle speaker systems, if properly designed, have excellent tonal qualities and are favored by many critical people. Outstanding infinite baffle speakers are the Bozaks, Hartley and the Janszens.

An outstanding achievement in reducing the infinite baffle type system to a compact size is provided by the Acoustic Research speakers. By using a revolutionary combination of ideas, these speakers provide the performance of true infinite baffling in enclosures only 2 cubic feet in volume.

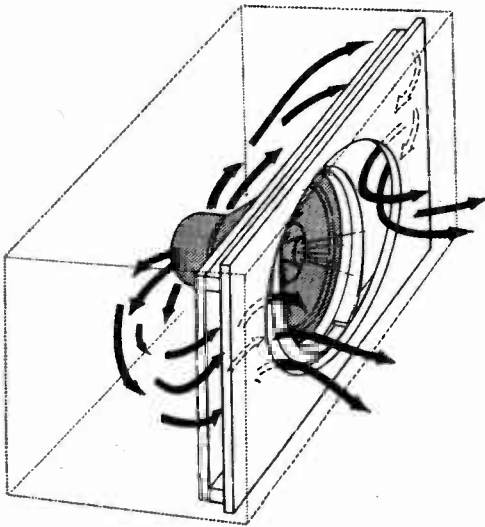
An interesting special case is provided by Wharfedale SFB series. Here we have a

Riveredge produces these sand-filled bass reflex enclosures for systems using Wharfedale speakers.



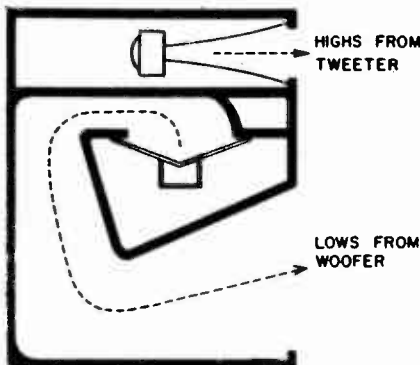
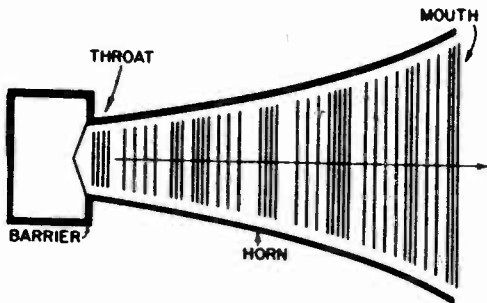
The Altec-Lansing Theater speaker, shown below, has been used for years in homes and theaters.





The Lafayette "Eliptoilex" system, above, uses a special form of the ducted port design in which the port is common to front and back of cone.

Horn loads speaker better, continues sound waves into narrow radiation pattern. High efficiency if horn is big; long "folding" horn reduces size.



finite baffle. The speakers are mounted in effect on a flat plane some 40 inches square and the distance from front to back of the cone is considerably below the minimum needed to prevent cancellation at low frequencies. Nevertheless, these systems deliver excellent quality. The fact is that cancellation is never quite complete and in these speakers the bass is augmented by coupling two bass speakers together for higher efficiency. These speakers are notable for the fact that the baffle is made of a sandwich in which the space between two plywood panels is filled with sand. The sand damps the resonances of the wood and thus prevents the panels from stealing the power delivered by the speakers and wasting it in the form of vibration.

The infinite baffle system has the disadvantage that the back wave is suppressed and dissipated and therefore wasted. There is a way to use this back wave to augment the front wave. This is done in the "bass-reflex" enclosure which is diagrammed on page 64. Here we have an additional opening in the closed box about the same size as that of the cone of the speaker. By a process too complicated to explain in this treatment, in this kind of enclosure the phase of the back wave is inverted so that, when it issues from the port, it is in-phase with the front wave and thus augments it. In this way, at low frequencies, the efficiency is doubled. Since generating the low frequencies is most difficult and takes most power, this added efficiency is highly advantageous.

However, there is a price to pay for everything—especially efficiency. The bass reflex enclosure is highly resonant. In fact, it is in effect a sort of musical instrument. The body of a violin or double bass with its F holes, works exactly on the same principle first described by Helmholtz and named for him as the Helmholtz Resonator. In the early days of the bass-reflex enclosure this resonance resulted in a coloration that many people disliked. However, in recent years clever engineering and careful matching of the speaker and cabinet have overcome this resonator effect, and modern bass-reflex systems provide excellent performance with a minimum of coloration.

If we turn the port of a bass reflex into a "duct" by adding a tube behind it, the resonant frequency of the cabinet is reduced. Thus we can reduce the size of the cabinet for a given resonance. This principle has become most handy in designing compact speakers for stereo. By using highly compliant speakers with very

low resonant frequencies, in ducted port enclosures, it has been possible to produce very compact speaker systems whose performance equals or exceeds that of much larger ones. Most of the new compact speaker systems use this ducted port type enclosure.

Everybody knows that if we talk or shout through a megaphone or a rolled up tapering tube of paper, our voice will carry very much farther. The reason is obvious. The rolled up tube or the megaphone couples our voice more efficiently to the air.

Horn speakers work on this principle. The cone of the speaker itself is coupled to an expanding horn and this coupling, by providing an optimum load and by concentrating the radiation into a narrow angle, results in very high efficiency. Whereas, infinite baffle systems have efficiencies usually well below 5%, and bass-reflex systems not much over 5%, a good horn system like the famous Klipschorn may have an efficiency of 40 to 50%.

Again, however, there is a corresponding price to pay for the efficiency. First, to cover the lowest bass range a horn has to be huge both in mouth area and length. The problem of length is solved by "folding" the horn—in exactly the same way that the length problem is solved by folding the horn of a trumpet, French horn or tuba. The mouth area is more difficult. To radiate 40 cycles, a horn ought to have a mouth somewhere between 6 and 10 feet in diameter. This is obviously impractical for home use. However, there is a way of approximating this with a horn of moderate size. This is by coupling the end of the horn in the cabinet, to the corner of a room. The walls, ceiling and floor then become extensions of the horn and the room itself becomes, as it were, the mouth of the horn. The most famous of the horns is the Klipschorn, considered to be one of the finest of all speaker systems. The Electro-Voice Patrician series was also designed by Klipsch and follows his principles and the Lansing Hartsfield is also in this class.

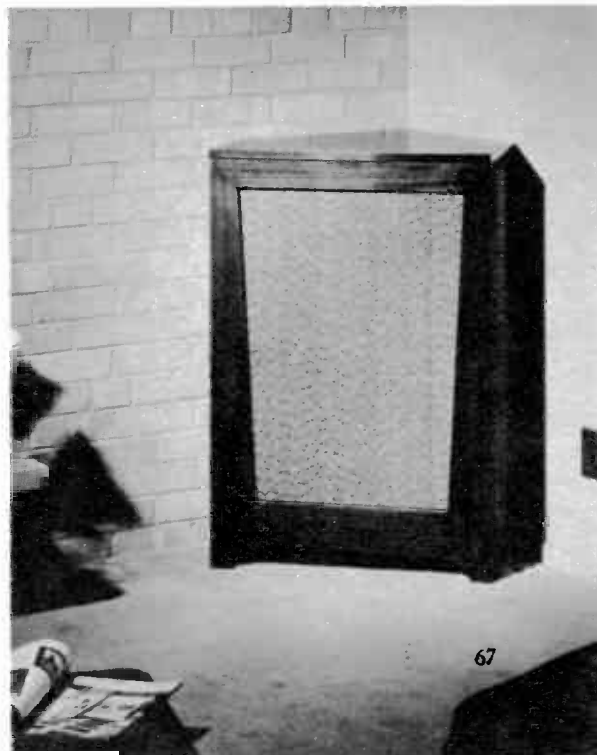
There are many smaller horns with excellent performance, though they do not have the bass range of these big horns.

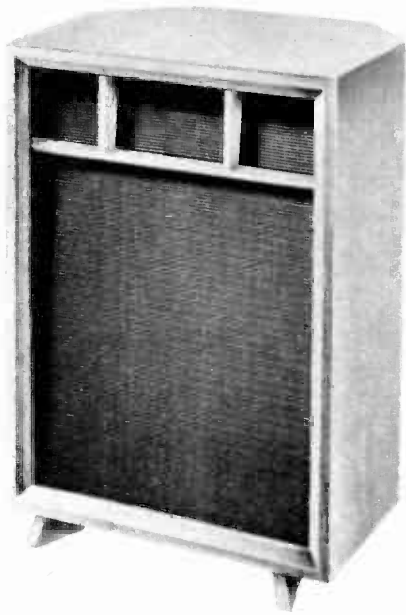
Each of these types tends to have a characteristic sound. The infinite baffle types tend to be highly damped, and to yield a dry sound. The bass-reflex types tend to have a brighter and more resonant sound; and the horns are also bright and have an assertive and projecting quality rather like that of the horns in the orchestra. But the differences are far smaller today than they used to be, and each class includes systems



First and most renowned of all corner horns is the Klipschorn, above. Thought one of the best systems, its efficiency is between 40 and 50%.

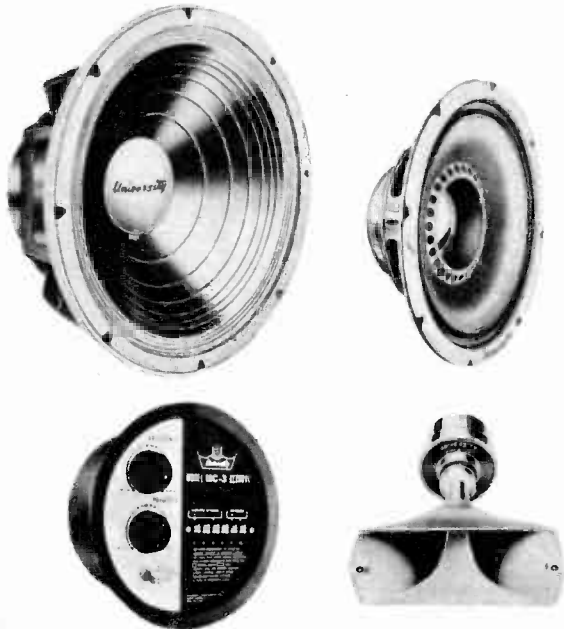
Klipsch Shorthorn is a smaller, less expensive version of the folded corner horn. Gives clean sound, but doesn't go as far down as a big horn.





Many kits are available for the various types of enclosures. For example, the University Folded Horn Kwidit, pictured above, is the same as the factory model though it costs only half as much.

Also available are kits which contain components for high quality speaker systems. The University RRL Ultralinear kits provide fine performances. Their ducted port enclosures are easy to build.



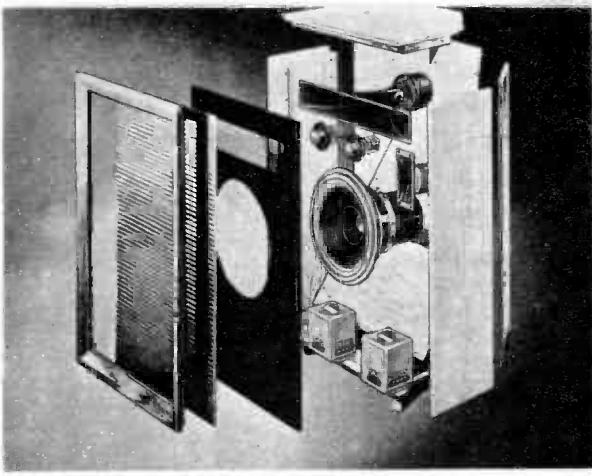
that are considered among the finest of available systems.

It is difficult—and possibly impossible—to cover the full audio range with a single speaker; and therefore, most speaker systems employ either more than one speaker, or a special speaker which is in effect two or more speakers. Thus we have Biflex two-cone speakers, co-axial speakers, tri-axials and even quadraxials. Many systems use three or even four separate speakers, each one covering a portion of the range. The systems using the several speakers have this advantage: they usually come with level controls so that the mid-range and treble response can be adjusted to fit the acoustics of the room.

The compact speakers are unquestionably attractive for stereo because of their space-saving features. The question is: How good are they? And the answer is that the best are as good as the largest available systems. Thus the AR1 and AR3 are generally included among the top four or five systems regardless of size. There is no longer any necessary correlation between size of the enclosure and the performance. Indeed, some of the compact speakers actually go down farther into the bass range than the big horns or infinite baffles. Judge the speakers by their specifications and performance, regardless of size.

In fact, the same comment can be made about speakers in general. Although all of these types of arrangements have their virtues and vices, none of these alone is determining. The speaker system is the sum of all the factors put together. Designers compensate the vice of one factor with the virtue of another. There is no single best road to the finest speaker system. The same end can be reached by a great variety of combinations of speaker, enclosure and other factors. Speaker design is far more an art than a science and demands good judgment of sound quality as much as good knowledge of engineering. Even the expert cannot make judgments of individual speakers on the basis of the technical specifications alone. In the end the ear is the final test. The newcomer is advised to pay less attention to the technical specifications than to the sound of the speaker systems. Certainly, no one should prejudge a system solely on the basis of one or two of the factors alone.

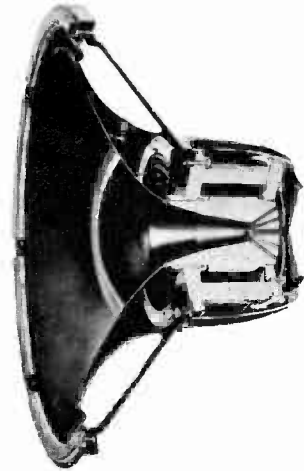
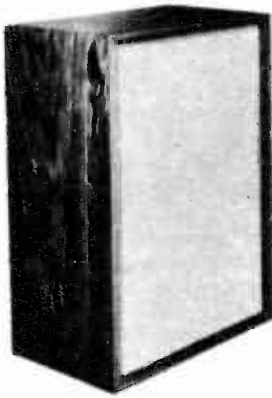
The safest thing for the newcomer to do is to purchase a complete system already assembled. However, money can often be saved by assembling combinations of enclosures and speakers or building systems from kits. The complete kits are far safer



Electro-Voice Aristocrat enclosure kit is space saving; folded horn corner enclosure costs \$39. Choice of 8 speaker combinations from \$65 to \$223.



Above is an Electro-Voice 30-inch loudspeaker, capable of reproducing 18 cycles. Cone is molded polystyrene. Used in the Patrician 700 system.



British Tannoy speakers have a fine reputation, can be used in various enclosures. Above, left, is a special Tannoy enclosure. Above, right, is a cutaway showing construction of the Tannoy DC Monitor.

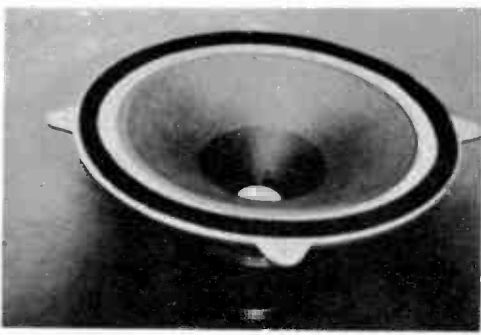
and less critical. Anyone who has had any experience putting knockdown furniture together successfully should have no trouble assembling speaker kits, if he follows instructions faithfully and carefully.

Those who are skilled in woodworking can even build their own enclosures for certain speakers. The combination of low-compliance speakers and the ducted port offers enough tolerances so that the enclosure can be built quite safely by the user. Be sure to follow the recommendations of the manufacturer of the speaker exactly in regard to the volume of the enclosure and the length and diameter of the duct.

Building the speakers into the walls of

a room has great attraction in economy and getting the speakers out of the way. The simplest way to do this with a complete guarantee of satisfaction, is to purchase two of the compact systems complete with cabinets and just build those cabinets into the wall or room divider or whatever.

Conversion of a monophonic system to stereo presents special problems in the loudspeaker end. The first decision that must be made is whether to keep the present speaker system at all. The use of two different types of speaker systems is troublesome. Speakers differ in efficiency and in tonal qualities. Differences in efficiency present problems in obtaining and



The British Barker speaker was one of the first high compliance speakers using a flexible rubber surround. It is used in the Bradform enclosure.

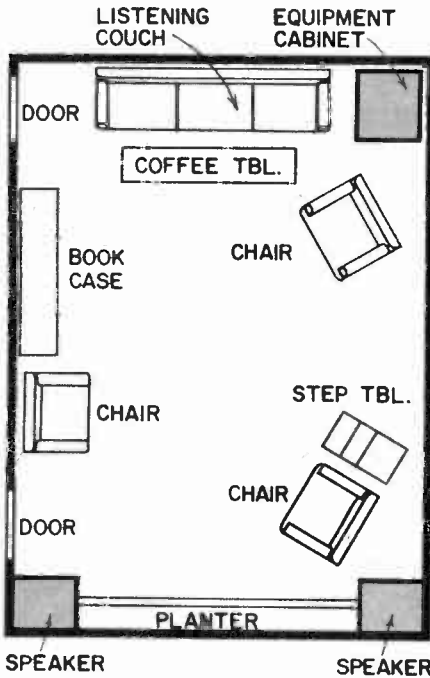


Diagram of the living room above shows that comfort and livability do not have to be incompatible with stereo.

In the handsome stereo setup shown at right, 2 unobtrusive speakers flank the eye-pleasing planter wall display. Concealed lighting adds further to the effect.



maintaining stereo balance. Differences in tonal qualities will disturb the balance at some points in the frequency range and lead to odd effects. Thus a horn with 40% efficiency is very difficult to balance with an infinite baffle system with 2% efficiency. The latter will take 20 times the power to produce the same sound level. In other words we would have an electrical unbalance of 26 db between the two channels for an accurate acoustic balance. The balance controls of many preamplifiers readily permit an adjustment of this magnitude; but one side is going to be driven harder and the distortion may well be higher. Also with a difference of this magnitude it may be difficult to maintain balance as volume is changed.

Tonal differences can produce very strange effects. For example if one speaker system goes cleanly down to 30 cycles, but the other stops at 60 cycles, there will be a tendency for the bass instruments to double in the lowest range. Thus when the big speaker is reproducing the big drum in a deep, well-damped thump, the other speaker will seem to add another smaller drum an octave higher.

Even if the range is the same, but there are different peaks in the range, the two sides will produce a different coloration and in consequence a violin may sound quite different when it appears in the right or the left speaker. Some equalization of tonal balance can be achieved by the tone controls but this is limited to the two extreme ends of the sound spectrum.

The best way to solve these problems is to avoid them in the first place. By all odds, therefore, you should carefully consider first the addition of another speaker identical to the one you already have. If this cannot be done for some reason, the next best bet is to try to sell your present one and buy two other identical ones.

When neither of these alternatives is possible, you have three choices left. One is to convert to a "common-bass-plus-two side speaker" setup. Electro-Voice, Stephens, and University offer pairs of side-speakers with the required matching and dividing networks for assembling such a common-bass system, using your present speaker as the common-bass channel.

An elegant, but more costly alternative, would be to convert to an out and out three-channel system by getting a pair of good compact stereo speakers, and using your present system for the third or middle channel.

Finally, you can do your best to find another speaker system that comes as close as possible to matching your present system. Obviously, when trying to match, it is best, even if the speaker cannot be duplicated, to use the same type. If you have a horn and room for another, the best bet is to try to find another horn of different make that will work well with the present one. If you have a bass-reflex, then another bass-reflex or ducted port speaker is the best bet; and another infinite baffle type goes best with a present infinite baffle.

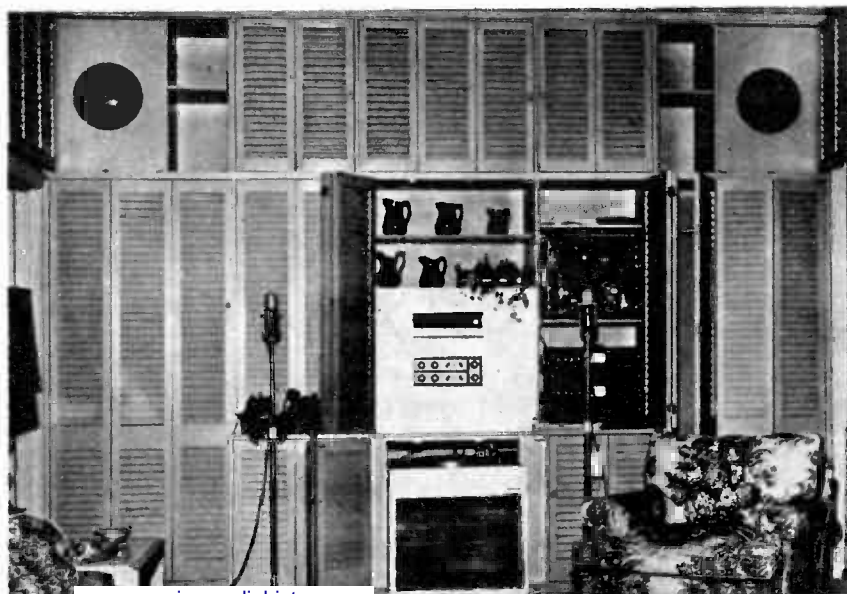
Provided the response covers the same

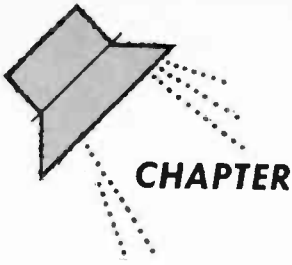
bass range, differences in the bass end are not as noticeable as differences in the treble end. This is because in the bass end the final bass will be a blend of both speakers, and the differences between the two will tend to be washed out. This presumes, I note again, that both speakers go down, for instance, to 40 cycles cleanly and with reasonably similar efficiency, and the same lack of distortion, so that the doubling we mentioned before does not occur.

The effect of differences is somewhat more pronounced above 300 cycles, and the effects of differences are somewhat more annoying there because this is the region in which directionality is clearly evident.

The biggest problem of all is presented in the case where the present speaker is a big and expensive horn, like the Klipschorn or Patrician. Nobody wants to give away one of these and yet few people can afford to pay for or find the space for two of them. The other speaker must have a good response in the bottom range. Several of the compact speakers go down to 40 cycles or lower and while their coloration is different they can be made to work together with the horn if the other parts of the system take the differences in efficiency into account. A more powerful amplifier should be used for the new speaker. I would suggest also, using two independent control units coupled together with a stereo adapter. This will provide the greatest leeway in obtaining and maintaining channel, tonal and dynamic balance between the two channels. •

Here's another example of an attractive way to build a stereo system into a wall. Speakers and the enclosures are built into top corners.

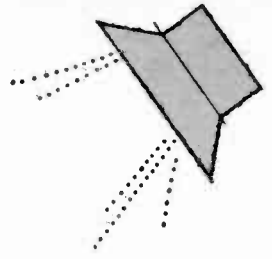




CHAPTER

5

Amplifiers and Preamplifiers



These make it possible to reproduce full volume.

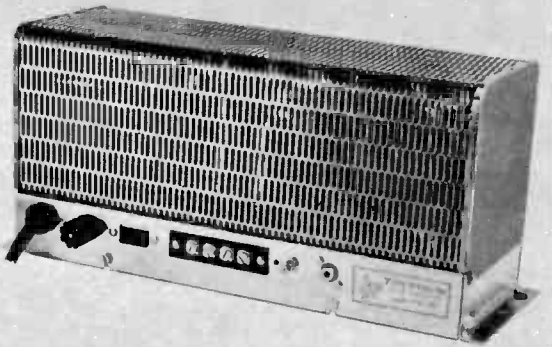


To achieve true hi-fi an amplifier must make a weak signal strong enough for delivery by a speaker.

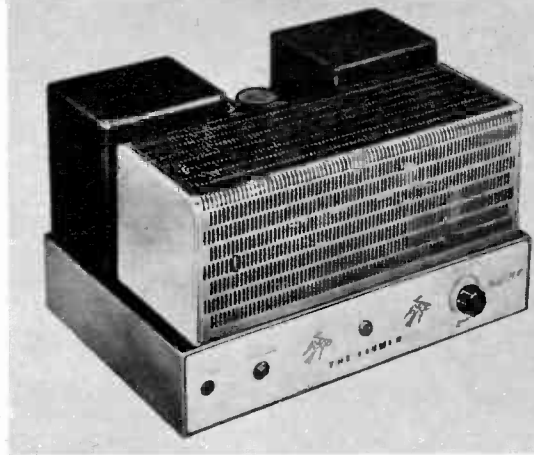
IT IS POSSIBLE to reproduce the volume of a full symphony orchestra in the home with a power of between $\frac{1}{4}$ and 1 acoustic watts, depending on how large the room is. Unfortunately, with the exception of horns, loudspeakers are very inefficient. The Klipschorn has an efficiency of nearly 50 per cent and other horns approach that figure; but most other types of speakers have efficiencies between 1 and 7 per cent. So that, depending on the speaker, and the size of the room, it may

take anywhere from $\frac{1}{2}$ to 50 watts to drive the loudspeaker to the desired volume level. It is the job of the amplifier to amplify the weak signal delivered by a phonograph pickup or a tuner until it is powerful enough to apply this $\frac{1}{2}$ to 50 watts of audio power to the loudspeaker. In a stereo system we have to drive two loudspeaker systems.

There is a way to use one amplifier to drive both stereo loudspeakers, and it is used in some inexpensive one-package



The Fisher Model 30-A amplifier is shown above.



Pictured is Fisher's Model 200 60-watt amplifier.

stereo hi-fis and in the Heathkit SD-1M kit. This ingenious method was developed by CBS Laboratories and is called the "Matrixing" or "sum and difference" technique. The technique depends on the characteristics of a push-pull amplifier diagrammed in block form in Fig. 1. In the push-pull amplifier two tubes are connected as a symmetrical pair to work into an output transformer with a center tapped primary and a single secondary winding. The transformer is a matching device. Like any generator of power, a power amplifier has to be worked into a matched load to generate power efficiently. However, the output impedance of vacuum tubes ranges from 500 to 10,000 ohms whereas the impedance of dynamic loudspeakers is in the range between 4 and 16 ohms. Obviously a loudspeaker connected directly to the tube or tubes would provide a very poor load. The matching transformer in effect magnifies the impedance of the speaker to match the impedance of the tubes. Aside from matching the load to the tubes, the transformer transfers the power developed by the tubes to the speaker.

Let us examine the operation of such a push-pull stage. Let us suppose first that we feed identical in-phase signals—both positive or both negative at the same time—to the two grids. The currents of the two tubes will rise and fall simultaneously flowing through the two halves of the output transformer toward the center tap and through it to the power supply, in the direction indicated by the arrows. This change of current will produce a voltage change in each half of the transformer and this voltage change, in turn, will be transferred to the secondary winding which feeds the speaker directly. Notice that the

arrows face each other. This means that the current flowing in the top half of the transformer is out of phase with the current flowing through the bottom half. Therefore, if the amplification of the two sides is identical, the AC voltages produced by the two currents will cancel and the speaker will receive no signal. Thus, when a push-pull amplifier is fed with signals that are equal and in-phase the signals will cancel out in any common load. However, when the currents meet in the line from center tap to power supply they add and produce a large current and voltage swing in this line.

But, suppose we now feed identical but out-of-phase signals—that is, when the upper signal is positive the lower signal is negative and vice versa. As the current in the upper tube is increased, the current in the lower tube decreases proportionately. The flow of the current in the primary of the transformer is now as indicated by the arrows—the arrows point in the same direction, and there is a large up or down swing of voltage in the entire primary. Thus a single large voltage is reflected into the secondary and fed to the loudspeaker. On the other hand, in the center tap line the rise of current of the upper tube is balanced by the fall of current in the lower tube and there is no current or voltage swing in this line. This is the normal configuration used in almost all power amplifiers.

Let us assume that we feed both in-phase and out-of-phase signals to the two sides simultaneously. The out-of-phase signals will reach the loudspeaker, the in-phase signals cancel out in the transformer and do not energize the speaker. This is exactly what happens to hum and distortion generated within the stage; being in-

Fig. 1

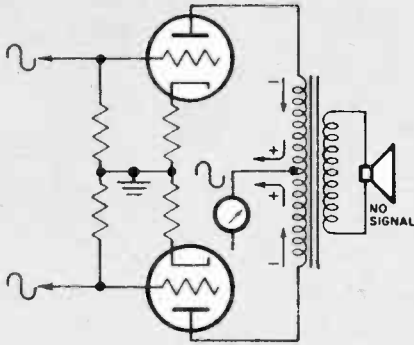


Fig. 2

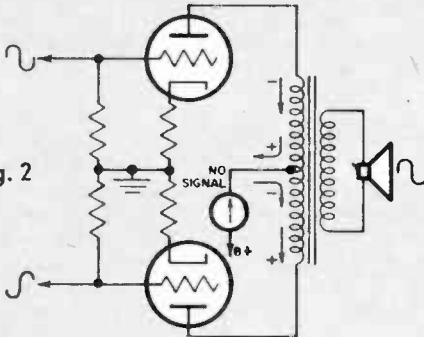


Fig. 3

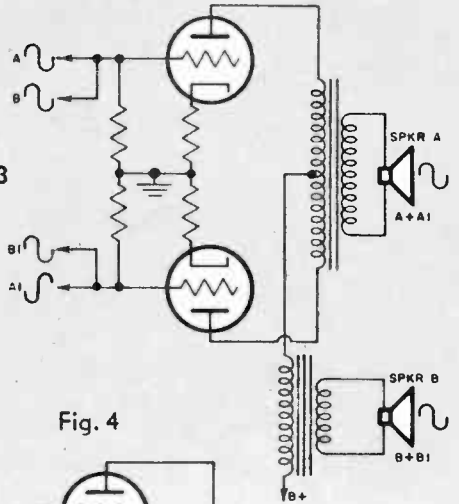
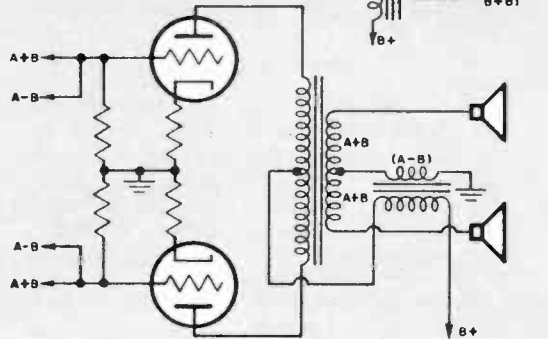


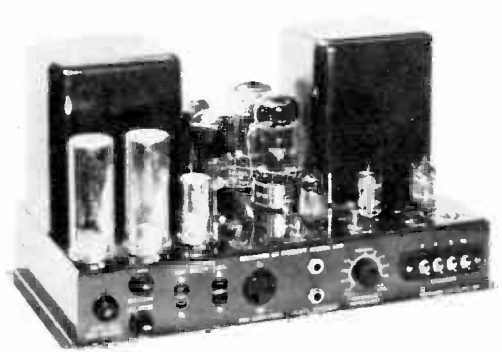
Fig. 4



The diagram above shows how the CBS Simplex stereo amplifier works. Fig. 1: When a same or in-phase signal is fed to push-pull amplifier, currents in both halves of output transformer are in opposite direction. Voltages transferred to secondary are out-of-phase, cancel out, and no sound is delivered to speaker. In center tap lead to power supply the current is increased by the sum of the increases in each tube, and a big voltage swing is produced. Fig. 2: When out-of-phase signals are fed into push-pull stage, current in upper tube goes up while current in lower tube goes down. Thus there is a large swing in primary current in one direction and in phase. A single voltage is transferred to secondary and energizes the speaker. In the center lead to power supply, the upward swing of upper tube is balanced by downward swing of lower tube. Thus there is no current or voltage swing in this portion of circuit. Fig. 3: If another transformer is added in series with center tap, two channels can be handled. Channel A is handled by out-of-phase input A & A1, which comes out of Speaker A; Channel B is in-phase signal which appears in Speaker B. Both speakers are isolated from the other channel by cancellation effects illustrated in Figures 1 and 2. Fig. 4: This drawing shows the final form of the CBS amplifier. Since stereo channels do not differ in phase, it is necessary to use a complex system of electronic arithmetic in order to make the system work with present stereo records.

The Grommes speaker 221A has a 20-watt output.

Grommes amplifier Model 260A has 60-watt output.



phase they cancel in the common load. And this is the big reason why push-pull amplifiers are preferred for high fidelity.

But let us not overlook one thing. Although the current produced by the in-phase signals cancels in the transformer it does not cancel in the center tap but adds and flows through the center tap to the power supply. If we connect a meter in the center tap we will find that the current is flowing there and varying as the signal varies. If we now connect another transformer in the center tap circuit as indicated in Fig. 3 we find a condition exactly opposite to the one we have discussed so far. This transformer will transfer a signal to the loudspeaker when the amplifier is fed in-phase signals but will deliver no voltage when the amplifier is fed out-of-phase signals.

So that in Fig. 3 we have a configuration that is capable of handling independently two distinctly different sets of signals, and therefore can handle the two channels of a stereo signal. All we have to do is to arrange matters so that one channel feeds an in-phase signal to the amplifier, and the other channel feeds an out-of-phase signal to the same amplifier. The out-of-phase signal will appear in speaker "A" fed by the transformer that is parallel connected to

the two tubes; the in-phase signal will appear in speaker "B" connected to the series connected transformer. Furthermore, the isolation will be quite complete because in-phase signals will cancel out in the parallel channel, and out-of-phase signals will cancel out on the series channel.

The only remaining problem is how to arrange matters so that channel A is in-phase and channel B is out-of-phase. This is where matters get a little complicated. As it happens, our methods of recording and transmitting stereo were not developed with this possibility in mind. The two channels are not distinguished by differences in phase. In fact, for good stereo with conventional systems it is necessary that they remain in phase. So, the CBS boys resort to some clever electronic arithmetic, as follows:

Because of the nature of the Westrex cutting system, the lateral component of the cut groove represents the *sum* (A plus B) of the similar portions of the signals in the two channels; and the vertical component represents the *difference* (A minus B) in the signals of the two channels. They connect the stereo pickup cartridge so that when the stylus moves laterally it develops an out-of-phase signal; and when it moves vertically it develops an in-phase

HOW MUCH DISTORTION CAN WE TOLERATE IN AN AMPLIFIER?

LOW DISTORTION is the *sine qua non* in high fidelity. Everything else is secondary, and indeed distortion pretty well determines everything else. Both tests and calculations agree that at around 1000 cycles the average ear will not notice distortion of around .7% and the critical ear about .4% at a moderate sound level. They also agree that distortion is less noticeable in short high level peaks and may be entirely lost in the noise at very low levels. The tolerance depends also on frequency and complexity of the sound.

Distortion at low frequencies is less noticeable and may be double that at 1000 cycles before being noticeable. In music the distortion can be higher before it is readily discerned, and it is more readily discerned on voice than music.

These figures are for *overall* distortion—the distortion of the sound as it is delivered to the ear, and in a hi-fi system it would be the total of distortion from that on the record to that produced by the speaker system. Amplifier distortion is only one—and in today's amplifiers—the least of the distortion-producing elements. Except in the best low-level

portions of the best recordings or tapes, it is doubtful that any system exists which delivers to the ear a sound with as little as .7% distortion. Speaker systems, particularly, exceed this "inaudible" level of distortion. And yet, strangely enough, even when a system is contributing 2 or 3 or more per cent distortion, critical ears can tell the difference in total distortion between amplifiers with only .1% and amplifiers with .5%.

It has been an "informal" standard for some years that to class as hi-fi, amplifiers should have no more than 2% IM or harmonic distortion at maximum output. In fact, maximum output is often rated as the point where the amplifier distortion reaches 2%. In home use, the occasion when a peak would reach this maximum output point—usually more than 10 watts—is infrequent. What is important is the distortion between 10 milliwatts and 10 watts—the range in which most home systems operate. Most critical experts are agreed that both IM and harmonic distortion should be well below .5% in this range—not merely in the amplifier, but the combined preamp and amplifier of the system.

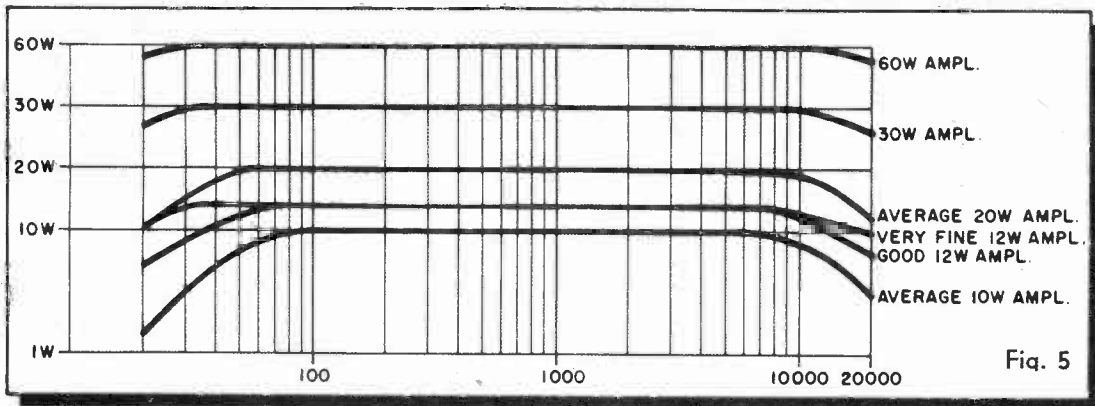
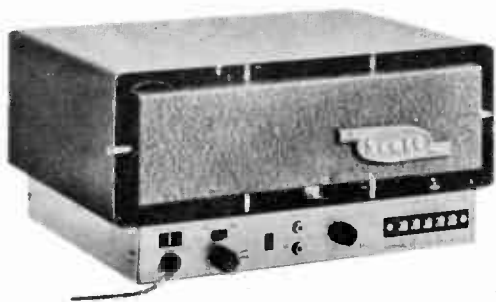


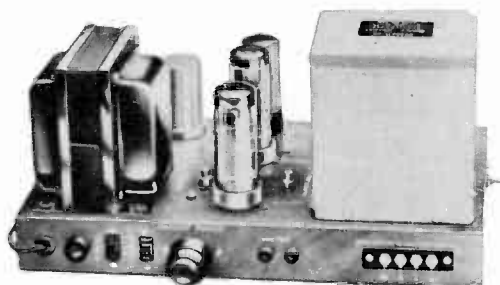
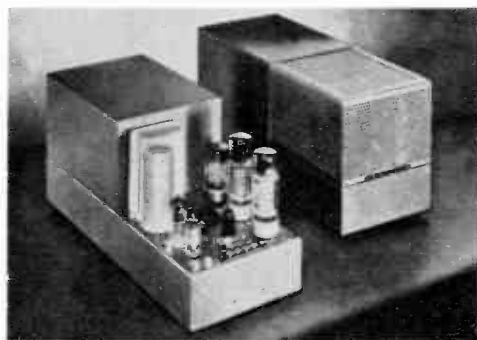
Fig. 5

Compact amplifiers are deficient in power at low and high ends—should deliver 10w from 20-20,000 Kc.



The Scott 250 Lab Amplifier, at left, gives 40 watts with very low distortion. Priced \$129.95.

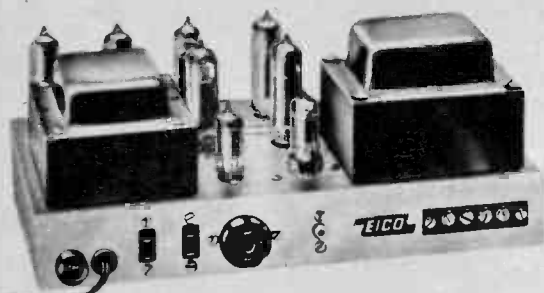
Marantz 40w, below, considered one of the best amplifiers, has an adjustment meter, costs \$147.



EICO now offers a full line of amplifiers in kit form. In the picture at the left is Model HF 50.

Shown below is EICO Model HF 30, which delivers full output over full audio range. Costs \$39.95.

The EICO Model HF 14, shown in the photo below, is available in kit form, is priced at \$23.50.



signal. They also connect the series transformer as in Fig. 4 so the secondary is in series with the secondary of the other transformer and the two signals will now be mixed or matrixed in both transformer secondaries. The pickup now feeds two different signals into the amplifier. The A plus B signal is out-of-phase and therefore appears in the transformer secondary, but not in the series transformer; the A minus B signal is in-phase and will appear across the series secondary. However, by much the same sort of electronic arithmetic that makes the Crosby multiplex system work, the two signals add and subtract so that the original channel A signal energizes speaker A and the original channel B signal energizes speaker B. And the result is stereo.

Although this ingenious system is attractive because of the economy it offers in the power stage, it is not widely employed in deluxe stereo outfits and is not likely to be for several reasons. First, there are some vices to the operation of the circuit itself. We have noted that in a regular push-pull amplifier fed with push-pull or out-of-phase signals, hum and distortion generated within the stage will cancel out. This is the great virtue of the push-pull amplifier. It permits economies in filtering the power supply. It also permits us to produce amplifiers with very low distortion since a high proportion of the distortion is generated in the power amplifier itself and in a push-pull amplifier this distortion is canceled out.

This is still true in the matrix amplifier so far as the *out-of-phase component* or channel is concerned. But hum and distortion are not canceled out of the other, or in-phase, channel. Therefore, some of the economy is washed out by the need for a more highly filtered power supply and a

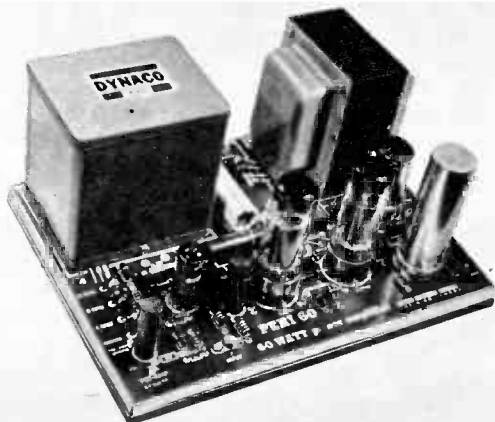
more carefully designed amplifier to reduce hum and distortion in the second channel. Obviously, no matter what we do we cannot balance the hum and distortion characteristics of the two channels—one will always be a little worse than the other. Moreover, the pinch-effect distortion, we talked about in Chapter Three, being vertical and in-phase, goes entirely through channel B. But this is the channel with poorest distortion characteristics. Therefore, the aberrations of pinch-effect distortion are likely to be far more serious.

An even more serious fault is simply that, as we have noted, stereo records, tapes and broadcasts do not operate on the in-phase and out-of-phase principal. In the case of stereo discs we can obtain this condition by connecting the pickup in an abnormal way. But present stereo broadcasts do not provide a signal that meets this condition; nor do tapes. Hence the system is presently applicable only to stereo discs played with a specially arranged pickup.

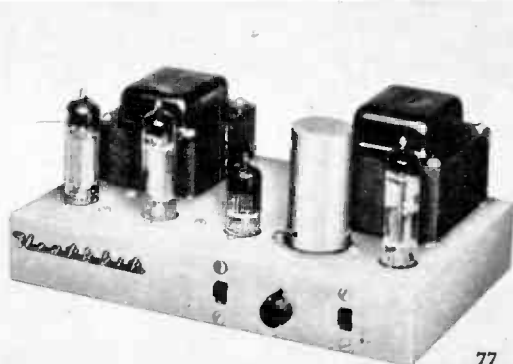
Finally, the matrix system requires that the entire chain of amplifiers be push-pull from beginning to end. This requires the doubling of tubes all along the line and also tends to wash out the economy. In the stereo systems presently using the matrixing technique this is offset by using a ceramic pickup which is a high voltage device and needs fewer stages of amplification. Most critical high fidelity users prefer a magnetic cartridge which is not as suitable and which would require additional stages of amplification.

Therefore, although the matrixing system has attractive advantages for simple, inexpensive stereo systems, it does not deliver the full stereo and high fidelity advantages delivered by an out-and-out

The Peri 60, built entirely on a printed circuit board, is a 60-watt kit amplifier, shown below.



Heathkit UA-1 is a 12-watt amplifier. \$21.95, it meets strict standards over full audible range.



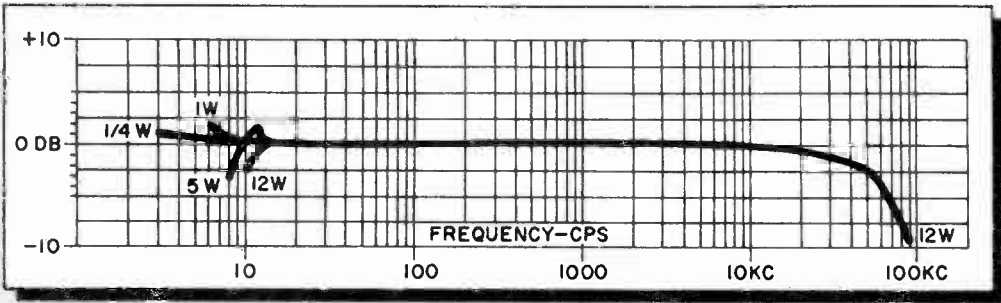


Fig. 6A

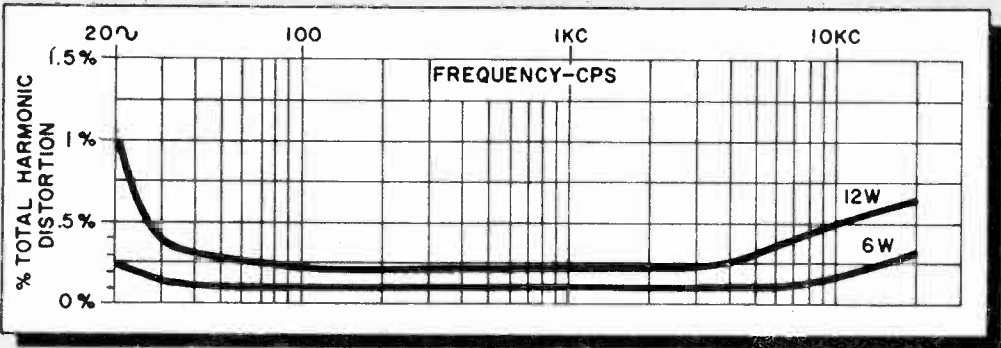


Fig. 6B

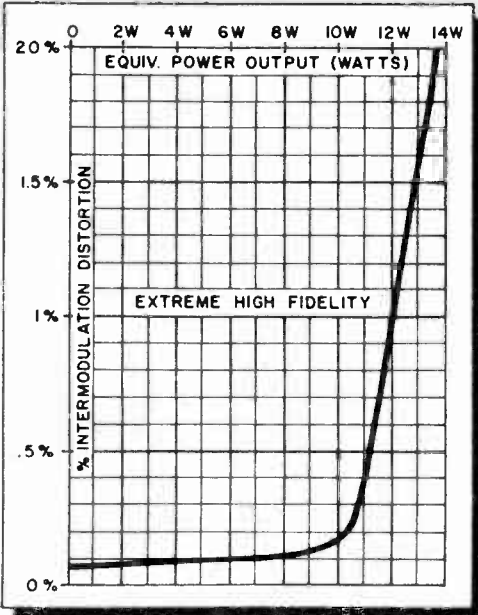


Fig. 6C

The graph at the top of this page is a frequency response chart. The middle graph shows the per cent of harmonic distortion versus frequency at full power and at half power level. The graph at bottom of page shows intermodulation distortion.

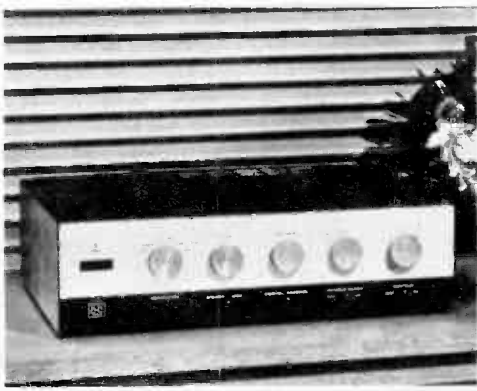
two-channel amplifier system. To obtain equal quality from the matrix system we would have to take measures which would very likely more than offset the economy provided by using a single power amplifier.

Consequently, to feed the two speakers of a fine stereo system we have to have two power amplifiers, though this does not necessarily mean two individual units.

Leaving aside for the moment questions of size and cost, there are three important considerations in choosing amplifiers, namely: 1). Power output capabilities; 2). Distortion characteristics; and 3). Stability.

The power output required, as we have already noted, depends on the listening level preferred by the listener, the size of the room, and the efficiency of the loud-speaker system. The louder one likes his music, the larger the room, and the less efficient the speaker, the more power output is required.

The speaker problem is actually simpler than you might think. Only two types of speakers have extraordinary demands for power output on the part of the amplifier. First, very efficient horns can get by with

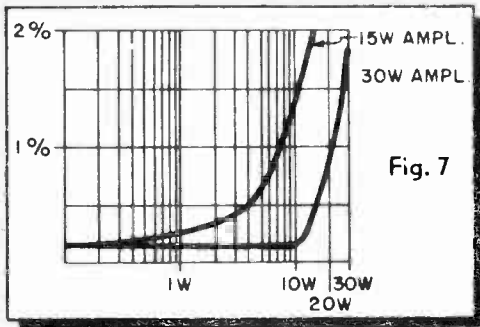


The Knight KN-740 amplifier is shown above. It provides 20 watts per channel, sells for \$99.50.

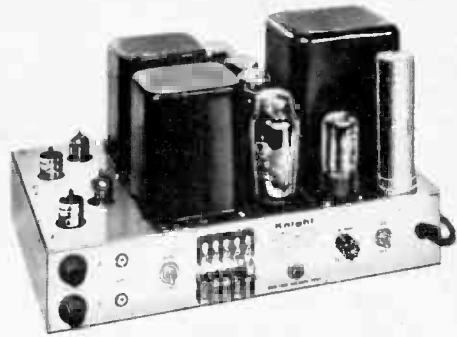


The larger Knight amplifier, Model KN 760, which delivers 30 watts per channel, is priced \$149.50.

Graph below illustrates that a higher power amplifier has less distortion at low volume levels.



The Knight-Kit 60-watt stereo basic amplifier delivers 30 watts per channel. Kit costs \$84.50.



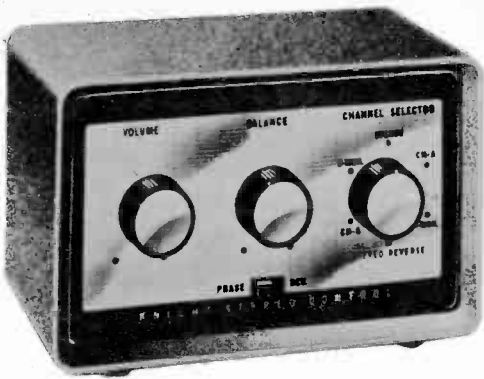
relatively low power amplifiers. Theoretically, a Klipschorn could be driven to enough loudness in any reasonably sized living room with 1 or 2 watts. However, people with money enough to buy Klipschorns are likely to be perfectionists. Hence, most Klipschorns are driven by big (20 or more watt) amplifiers whose capabilities are almost never put to a full test. They operate in the part of their range where they have little distortion even by laboratory standards.

The problem with Klipschorns is not in the power amplifiers but in the preamplifiers. Most amplifiers will drive a Klipschorn with a very low input signal—well below 1 volt. Therefore, the gain of the preamp has to be kept low and the volume and/or loudness control is turned down to the lowest quarter of its range. Unfortunately, not all preamps give good results when this is done. First, in some preamps the distortion is high at this point. Second, in many preamps the response slopes at the high end, above 10,000 cycles, when the volume control is turned way down. Finally, if a loudness control is used, the

compensation is excessive for the actual volume level produced by the speaker, and the bass tends to be overwhelming. Many people, of course, like this whether it is natural or not.

So if you plan to use a Klipschorn or another horn speaker of high efficiency, by all means get a good amplifier—placing stress on distortion and stability rather than power output. But be careful of the preamp. One I can recommend without hesitation, for this purpose especially, is the Dynakit.

The other speakers that present a special problem are the low efficiency air suspension types like the Acoustic Research and KLH. The manufacturers recommend nothing less than 20 watts for the lesser models in their lines, and more than that for the top models. This is no problem today when there are any number of good amplifiers in this class at quite reasonable prices. But I might point out that you can break this rule provided you plan to operate your system at a low level and in not too big a room. I have myself driven the AR2s with complete satisfaction with



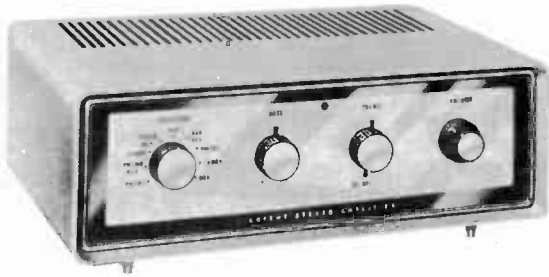
Knight-Kit stereo control center, \$9.95, above, operates between power amplifiers and speakers.



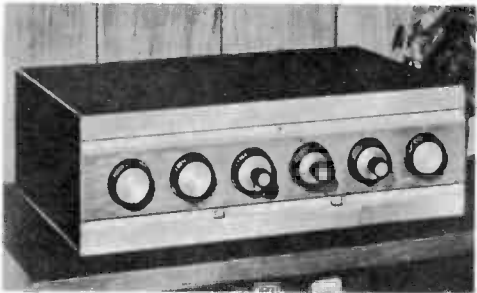
The Pilot 590 is a combination tuner and stereo preamp, which keeps all controls in one place.



The Knight KN-520 stereo amplifier, above, meets the minimum hi-fi standards, is priced at \$62.50.



Knight-Kit 20-watt stereo amplifier is flat between 35 and 15,000 cps at 5 watts per channel. Above.



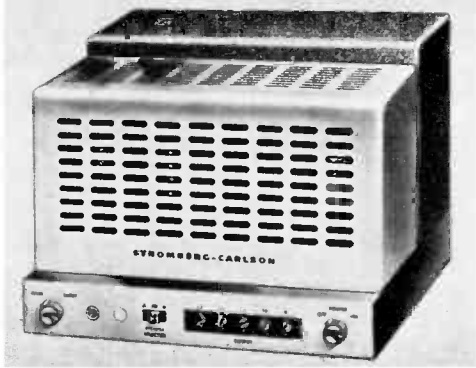
The Knight-Kit stereo preamplifier, above, is an unusually versatile unit. It is priced \$62.50.

good 10- and 12-watt amplifiers in good-sized apartment living rooms. This, however, assumes that the amplifier will deliver a clean 10 watts from 30, and preferably 20, cycles to at least 15,000 cycles. Not too many so called 10- and 12-watt amplifiers will do this.

As far as all other types of speakers are concerned you can treat them as having pretty equal power demands. They may differ in efficiency by factors of 2 or even 3 to 1; but this variation is well within the capabilities of all good high-fidelity amplifiers, provided they are not crowded into the upper limits of their output capacities.

The minimum high-fidelity amplifiers are in the 10- to 15-watt range. At present amplifiers are usually rated by their manufacturers for power output at either 400 or 1000 cycles. But a high-fidelity amplifier has to deal with the entire audible range from 20 to 20,000 cycles. As far as I am personally concerned the only power output rating that makes high fidelity sense is this one: The highest output at which the amplifier will deliver a response flat to 1 or 2 db over this full range. This is an amplifier of entirely different tone color and, naturally, cost. There are 15-watt amplifiers that deliver 15 watts at 1000 cycles, but cannot deliver more than 7 watts at 30 cycles and 20,000 cycles, and nothing over 2 watts at 20 cycles. With a little tolerance I might call this a 7-watt amplifier but no more.

A deficiency in output above 15,000 cycles can be tolerated because there is very little material in any ordinary music, or even sound effects, above 15,000 cycles that is likely to call for the maximum output. But a deficiency on the low end is going to make itself felt quickly, even to an uncritical ear. It is in the lower range that greatest power is required. This is true partly because it takes more power to move a lot of air at low frequencies. But



Stromberg Carlson offers a 40-watt power single amplifier, which is shown in the picture above.



Despite its few knobs Stromberg Carlson ASE-434 preamp gives good control over a stereo system.

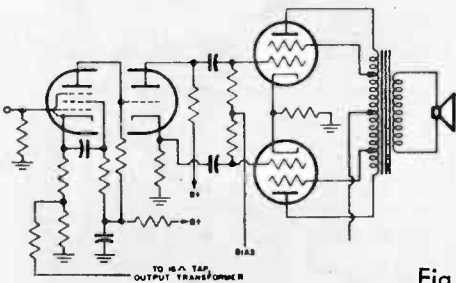


Fig. 8A

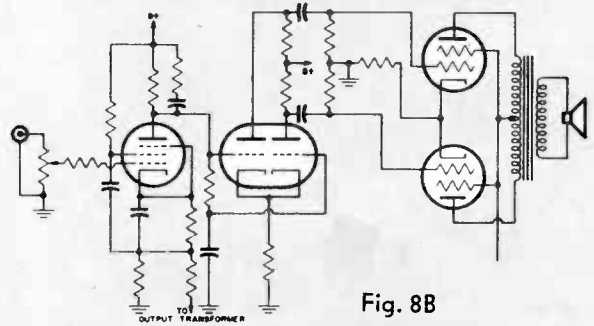


Fig. 8B

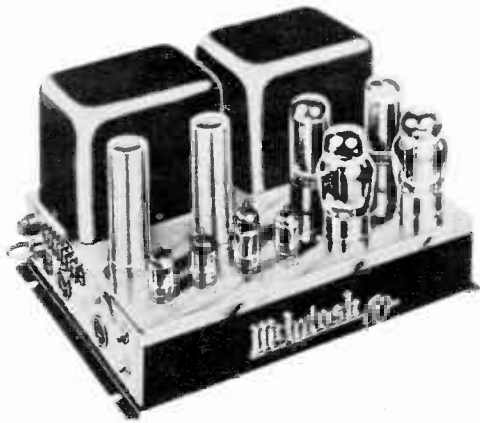
The two circuits diagrammed here appear, with some modifications, in 9 out of every 10 high-fidelity amplifiers. The figure at the left shows the Dyna circuit; that at the right is the Mullard circuit.

another factor is that few speakers are really flat down to, let us say, 40 cycles. Furthermore, most people tend to prefer a heavier than natural bass, consequently they like to boost the bass end. Also at lower than original levels the ear is less sensitive to the bass and has to be supplied a heavier bass, which also means boosting. Therefore, just about any amplifier is going to be called upon to supply at least 2 to 5 times more power in the range below 50 cycles than at 1000 cycles. Obviously, an amplifier that is capable of supplying only half as much power in that range as at 1000 cycles is behind the well-known eight ball to begin with. And the effects can be very serious. An amplifier that overloads in this range is going to generate a lot of distortion even at normal listening levels when it ought to be loafing, and presumably free of distortion.

Though the distortion directly affects the low frequencies, it will *indirectly* increase overall distortion by increasing intermodulation distortion which is the most unpleasant kind.

There are a few 12- to 15-watt amplifiers that will meet my standards at 10 watts but not many. One that does is the Heath-kit UA-1. See Fig. 5. To get a lot of power at low frequencies you have got to have output transformers with a lot of iron, and that means big and expensive ones. A 12-watt amplifier that is really flat at 12 watts over the full range is little cheaper than a 20-watt amplifier that is flat at 15 or 16 watts, and has a hard job competing for your money with the 20-watt amplifier. So, the manufacturer makes a Solomon type decision: when he wants to give you an amplifier flat from 20 to 20,000 cycles above 10 watts, he offers you a 20-watt amplifier; on the other hand, to give you a compact, inexpensive amplifier, he gives you a 12-watt amplifier which will deliver somewhere between 5 and 8 watts at 20 or, more usually, 30 cycles.

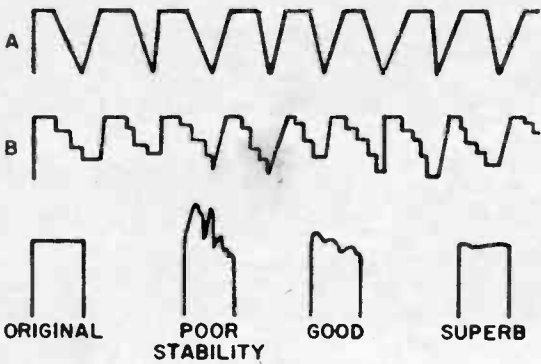
So far as you, the customer, are concerned, you have a Hobson's type choice: If you want adequate power reserve at the low frequencies you had better figure on a 20 or more watt amplifier; on the other



McIntosh amplifiers use unique circuitry. They are considered to be among the best in the world.

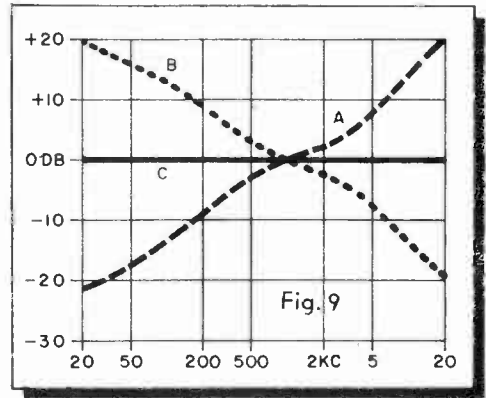


The 30-watt McIntosh amplifier shown above sells for \$143.50. The 60-watt, above left, is \$198.50.



A shows clean wave form of snare drum pulses. B shows how hangover compounds pulses. Square wave response indicates the stability of amplifiers.

Acrosound kit preamp includes third channel output and a most logical layout of its controls.



In chart above, records are recorded with Curve A. To achieve flat response C, we must equalize in preamp with complementary playback Curve B.

hand, if you haven't the space or the money for a 20-watt amplifier and have to buy a 12-watt amplifier, you will do well not to figure on running your outfit at very loud levels or giving your speakers a big bass boost.

In stereo the demands on each of the two amplifiers are not quite as severe as in monophonic systems. Neither of the two amplifiers is likely to be driven as hard in a stereo system as one amplifier would be in the same room by the same listeners in a monophonic system. So the 7 watts at 20 or 30 cycles of a compact "12-watt" amplifier will not be quite as much of a limitation. Still if you have room and can afford it, it is better to go up to the next class—the 20-watt amplifier or better yet the upper class of 35 watts or more. They will sound a lot better because at the same level their

distortion will, of course, be much lower.

Assuming we split this distortion between amplifier and preamp we can allow .25% for each at the most. It is a lot easier to achieve this low figure below 10 watts in a 30-watt amplifier than in a 15-watt amplifier. Fig. 6C for example, gives the curves of intermodulation distortion for two excellent amplifiers, one of 15-watt and the other of 30-watt rating. The 30-watt amplifier meets the specs completely. The 15-watt gets down to .25% only below 3 watts.

The bigger amplifier has an even greater advantage in harmonic distortion. Below 10 watts the distortion is not greater than .25% over the full range from 20 to 20,000 cycles; the smaller amplifier stays within that range between 100 and 8 or 9 thousand cycles; but goes above .5% at the extremes.

Again we see that the bigger amplifier yields better results within the low listening levels normal to a living room. And conversely, if a small amplifier must be used, the owner must expect to keep the dynamic range down to a lower level to hold the distortion down.

Whatever, the power output or distortion characteristics of an amplifier it is close to useless if it is not stable. The amplifier should merely pass the signal fed into it. It should never generate signals of its own. Unfortunately, the techniques of negative feedback which are employed to

produce this desired result, also tend to make an amplifier temperamental and capable under severe stimulation of throwing a tantrum and generating signals of its own—usually in the sub or supersonic ranges.

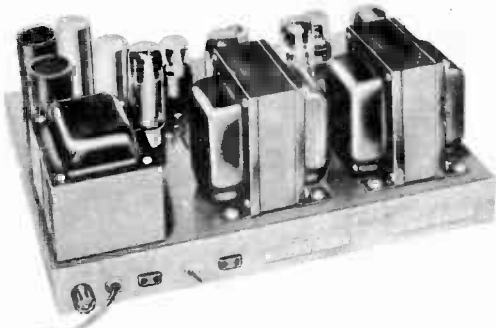
Although these self-generated, parasitic, signals are not always heard, themselves, their effects can be very horribly audible. On the bass end, the parasitics fall into the range from 20 cycles down to 1 or 2 cycles a second. If the speaker has very low distortion, they may produce little or no sound. The effect is then called "breathing". But they will drive the speaker into very wide excursions which will distort the higher, audible frequencies. Unstable amplifiers do not always go into a continuous oscillating condition; they may merely oscillate momentarily, or just repeat the signal like an echo, for a cycle or two. This is called hangover and will very seriously degrade the transient response of the system—that is, the ability to reproduce the very sharp and steep waveforms with which many musical waveforms begin. For example as a musician hits a drum, a piano key, or mouths a mouthpiece, the initial sound rises very sharp and steeply and occupies an extremely small interval. The variation in this initial shape of the waveform is one of the most important differences between the various instruments and plays a big part in determining

The new American tubes pictured here, have been especially designed for high fidelity usage by RCA. These tubes can be found in a great number of the newer stereophonic preamplifiers and amplifiers.

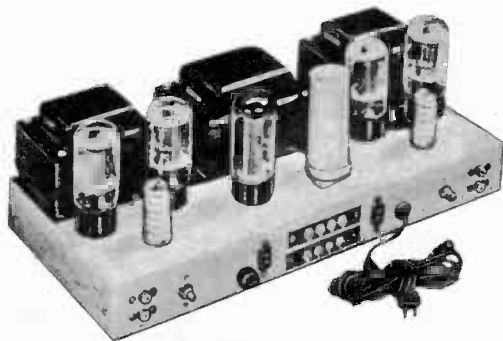


TWIN AMPLIFIERS

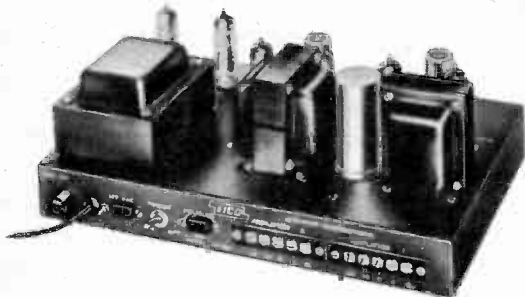
Up to 35 watts per channel, two power amplifiers on one chassis offer as good performance as do individual amplifiers. A wide variety of these is available in both factory assembled and kit form.



EICO HF 87 with two 35w amplifiers, \$75 in kit.

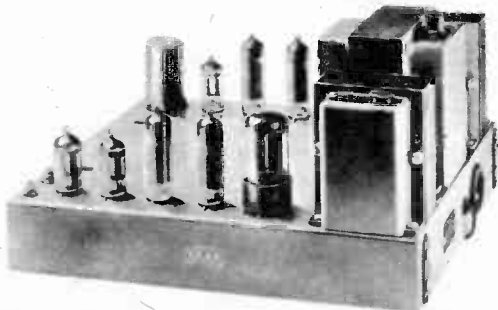


Arkay SPA-55 has two 27½ amplifiers, \$65 in kit.

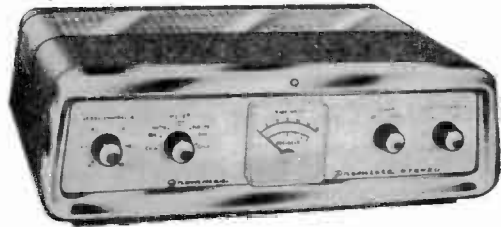


EICO HF 86 has two 14-watt amplifiers, \$44 in kit.

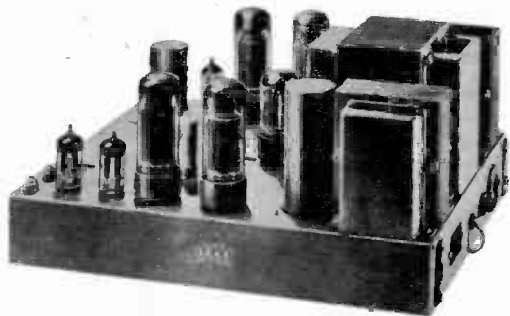
Below, Leak Stereo 20 has two 10-watt amplifiers.



Pilot's SA-232 is \$89.50, has two 16w amplifiers.



Grommes 240, 2 20w amplifiers, checking meter.

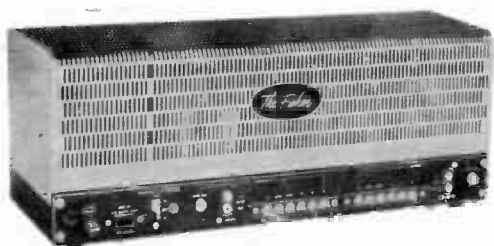


Leak Stereo 50, above, has two 25w amplifiers.



Pilot's SA-260, above, has two 30-watt amplifiers.

Fisher SA-300, below, has two 30-watt amplifiers.





The Fisher Model 400-C is a deluxe preamplifier for stereo, as shown above. It features push button selection of sources, independent tone controls, and an optional remote control unit, above at right.

their characteristic tonal color. Also, many musical sounds are a series of rapid pulses. The sound of a snare drum is the pre-eminent example. Hangover adds echoes to the pulses or to the opening transients, thus multiplying them and making the individual pulses less sharp and distinct. The differences between a good and a superb amplifier today is largely in the transient response and this, in turn, is largely a factor of stability.

On the high end, the parasitics are likely to occur in the region between 50 Kc and 200 Kc—way above audibility. But again the result on the audible signals is disastrous. Distortion increases throughout the range because the amplifier is operating way in the non-linear portion of its range. When an unstable amplifier does not go into outright oscillation it will “ring.” This is a curious effect that is hard to describe or even to recognize but is awfully hard on the ears and results in great fatigue, headaches and irritability. Many cheap hi-fi outfits sound pretty good for a little while; but if they are kept on for many hours listeners get irritable and begin to demand to shut the darn thing off or turn it down. This is usually a sign of a ringing amplifier.

Early high-fidelity amplifiers tended to be unstable. This was especially true of the Williamson types which for some years were the standard of the industry. Today’s amplifiers are far superior in this respect. That is one reason why I do not recommend as a money-saving proposition the purchase of old high-fidelity amplifiers, even

if at the time they were new they were considered the best available. Almost any genuine hi-fi amplifier made today is superior in stability to the best of the older ones.

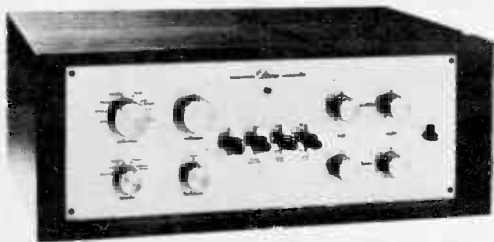
Frequency response is not a consideration today. Any true high-fidelity amplifier today has a response flat over the full audio range at low output levels. Many are flat, below 1 watt, from as low as 2 cycles to as high as 200,000 cycles. This is so true that whenever I see any advertising that stresses the frequency response of the amplifier, it is hard for me not to suspect that the amplifier has nothing else to recommend it.

Today’s power amplifiers are a good deal simpler in circuitry than the old ones, which is one reason why they are more stable. Ninety-nine out of 100 have three stages—1). the push-pull output stage which is the one that develops the power; 2). an inverter stage, which converts a single-ended input signal into the push-pull signal needed to drive the power stage; 3). a voltage amplifier which amplifies the input signal to the 15 to 55 volts needed to drive the output stage. The fewer the stages the easier it is to keep an amplifier stable.

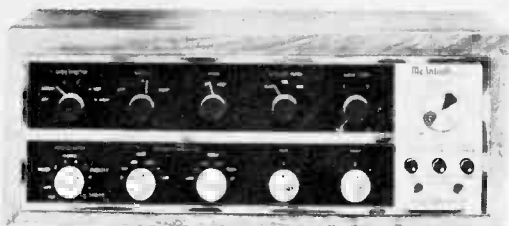
There are two configurations for these three stages that with minor variations will be found in nine out of ten amplifiers. Fig. 8A is the Dynaco configuration. Here we have a pentode voltage amplifier direct coupled to a split-load inverter which in turn is capacitor coupled to the output

Stereo Preamps

Marantz Stereo Console has low distortion. \$249.



McIntosh preamp has ganged tone controls. \$225.



Pilot SP-210 has automatic power shutoff. \$108.



Pilot 216A, deluxe professional unit, costs \$200.



Leak Point One Stereo preamp is priced at \$109.



stage. Fig 8B is the Mullard configuration. Again we have a pentode amplifier, this time direct coupled to a "cathode-coupled" inverter, which is coupled by capacitors to the output tubes.

One variation used in low-powered amplifiers of the 10- to 15-watt class, is to substitute a triode for the pentode voltage amplifier in either of these configurations. The tubes used in the output stages of these low-power amplifiers need only 12 to 18 volts of drive and a triode will supply the needed amplification to supply that much.

In some units of the Grommes line, a twin-triode is used as a cascode amplifier instead of the pentode. In the Acro amplifiers the cathode-coupled inverter is used at the very front, direct coupled to push-pull voltage amplifiers. This results in an amplifier that is push-pull from beginning to end.

There was a time when triode output tubes were considered the *sine qua non* for high-fidelity amplifiers. But triodes are inefficient and are hard to keep stable. Lower priced amplifiers often use the pentode configuration of B in Fig. 8. Once frowned upon by hi-fi purists, pentodes can deliver very good results, and have the advantage of high efficiency. But by far the most popular output tube circuit today is the ultra-linear, shown in A. This circuit combines the better features of triode and pentode operation, results in a highly stable amplifier with relatively high efficiency.

There are always exceptions to all rules and the outstanding one in the amplifier field is the very fine McIntosh amplifiers; they use four stages instead of three and pentodes in Class AB2 (a mode which though very efficient has always been frowned upon in hi-fi circles). Nevertheless, it is one of the finest of all amplifiers. It is possible for McIntosh to break the hi-fi rules and still attain a superlative result because of the unique output circuit. It is called unity-coupling and involves dividing the load between the plates and the cathodes of the output tubes, through a very special output transformer. This configuration produces an unusually high amount of feedback.

The McIntosh exception points up the fact that there is no such thing as the "best" high-fidelity circuit. With careful engineering and high standards, the various separate units of design can be combined in many ways to produce similar results.

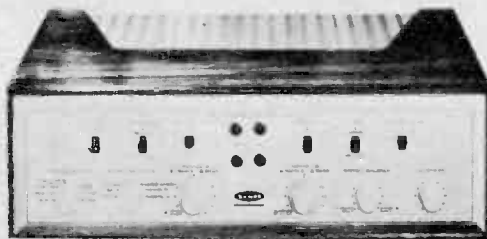
The key component of a high-fidelity amplifier is the output transformer. Good ones are big, heavy and expensive. They

use special types of core material, and special types of windings. It is not always true that the heaviest output transformer is the best, but there is a definite correlation between weight and quality. This is where the more compact amplifiers, especially those unitized with other portions of the system, have to make sacrifices. If you have to fill a chassis of a reasonable size with a lot of other components, you obviously do not have room for big and heavy output transformers. The smaller output transformers account for the low power output below 50 cycles of one-unit stereos. Most manufacturers of such unitized units are frank in telling the prospective purchaser that they do not claim for these units the performance available from their higher priced and bulkier units. You can't expect anybody to pour a magnum of champagne in a quart *vin rose* bottle.

Until the 1959-60 models began to come out, high-fidelity amplifiers very largely used foreign tubes, especially in the output stages. This was not because of any lack of patriotism; nor was it an effort to cut corners by buying cheaper foreign substitutes. The fact is that American tube manufacturers had simply given the market for hi-fi tubes to foreign sources by default. They considered the market too small apparently to be worth cultivating. Only one American manufacturer, Tong-Sol, took the trouble to design power tubes specifically for high-fidelity audio use, producing the excellent 5881 and 6550. On the other hand, British manufacturers did some excellent work and produced a whole series of tubes for hi-fi use, among them the KT66, the EL34, the EL84, and the KT88. By 1959 these tubes were found in 99% of all American high-fidelity amplifiers.

Belatedly, American manufacturers woke up and in 1959 began to produce specially designed high-fidelity tubes, the 6173, 7027A, 7199 and others, with very fine characteristics. Increasingly, these are being found in the new amplifiers and are giving the foreign tubes a good run for the money in terms of performance.

One of the most obvious ways to unitize for stereo is to put two power amplifiers on a single chassis. This makes sense not only in terms of convenience but also in terms of cost. A single power supply can be used to power two amplifiers—up to a point; and thus both cost and space can be saved. I said up to a point because there is a limit to the load that can be placed on one power supply without degrading performance, especially the ability to handle



Scott 130, above, features four indicator lights.

The Grommes Premiere features presence control.



Peri kit has separate filters for each channel.



Arkay kit SP-6. Ganged controls, separate filters.



EICO HF85 with clutch type controls is \$39.95.

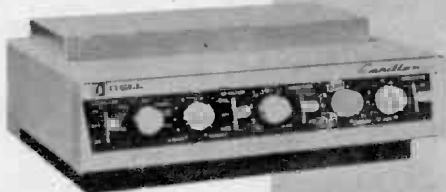


Heathkit SP-2 can be single or stereo unit. \$57.



INTEGRATED PREAMP-AMPLIFIER COMBINATIONS

The combination unit which includes stereo pre-amplifier and amplifier is the most popular and delivers good performance. Most manufacturers offer one or more models, either factory built or in kit form. Variety is shown on these pages.



Bell Carillon, above, has separate tone controls.



Fisher 101A has two 20-watt amplifiers. \$189.50.

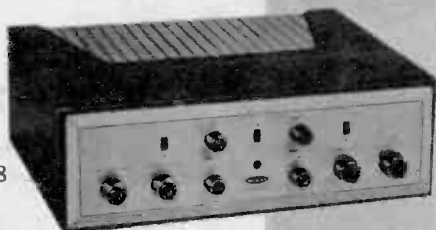


Pilot 245A. Two 20w amplifiers, automatic shutoff.

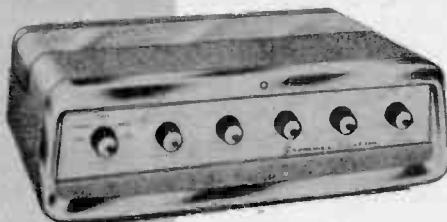


Scott 299, above, has provisions for a third channel.

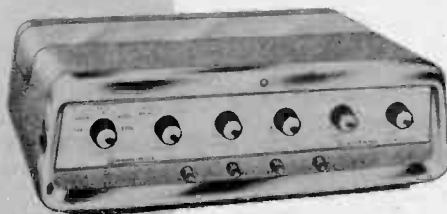
Scott 222, below, has two 12-watt amplifiers. \$140.



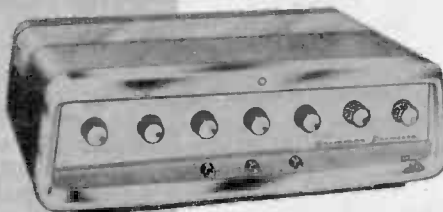
Grommes 20LJ, above, has two 10-watt amplifiers.



Grommes Model 24PG has two 12-watt amplifiers.



Grommes 28PG, above, has two 14-watt amplifiers.

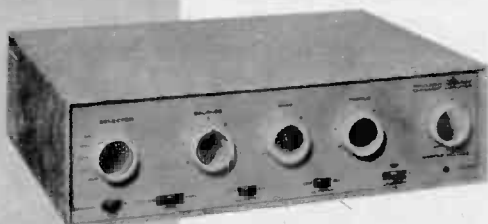


Grommes Model 40PGA has two 20w amplifiers.



Rauland HF1530 has independent channel controls.

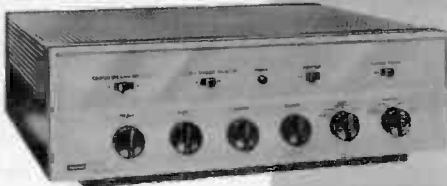
The HF1531 has ganged controls, 2 15w amplifiers.



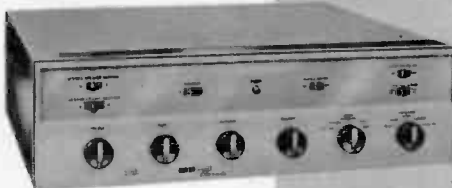


The Harman-Kardon Lute, above, is priced at \$80.

Harman-Kardon's Ballard, has clutch controls.



Harman-Kardon deluxe Chorale, 30w amplifiers.



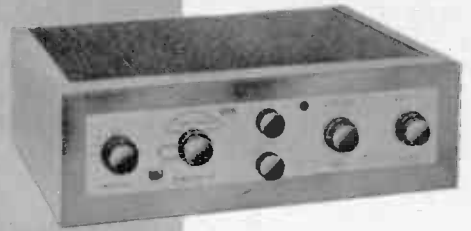
The Sherwood S-5000 has two 20-watt amplifiers.



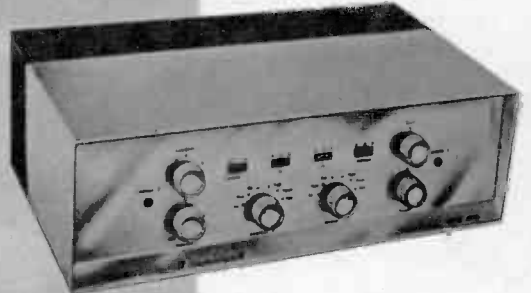
Pilot 240 delivers 20 watts per channel. \$200.



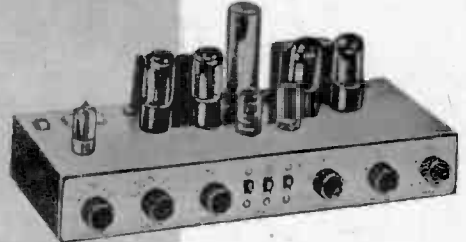
Bogen 212A, below, has 20w per channel. \$115.



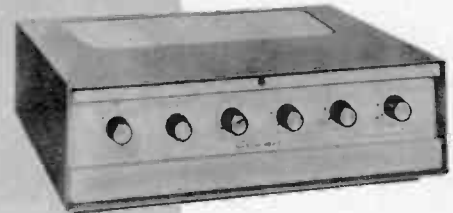
EICO HF61 above, is a kit; 14 watts per channel.



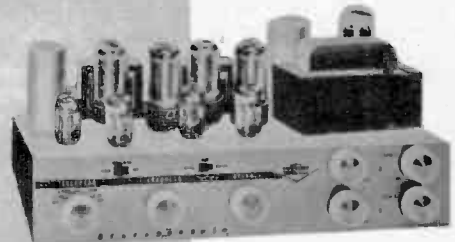
The Arkay CS-28, above, \$65 in kit, \$100 built.



Arkay CS-12 kit delivers 12 watts, costs \$37.95.



Above is the kit form of the Grommes Model 20LJ.



Qual-Kit above has 12-watt amplifiers. \$39.95.

Paco SA-40 below has dual tone controls. \$79.95.



Shell Westbury model is a factory-built economy stereo unit with single-ended power amplifiers.



Heathkit SA-3 is stereo preamp-amp for \$29.95, with 3 watts per channel from 50 to 20,000 cps.



high level peaks and transients. Power supplies have internal resistance and therefore a voltage drop. A sudden surge of current increases the voltage drop. When two amplifiers are fed by one supply, this effect is compounded. Thus power supply regulation has to be better.

For this reason, as well as in the interests of greater reliability and durability, there is a growing trend toward the use of silicon diode rectifiers in power supplies, especially in unitized components. Silicon diodes can be made to handle heavier loads with better regulations. Heathkit pioneered in this use of silicon diodes in kits, and Harman-Kardon in wired units. The practical limit for unitized two-channel amplifiers lies somewhere around 35 watts of output per channel. Higher output would either require a bulk and weight which would be hard to handle, or the sacrifice of some performance. Therefore, the two-channel amplifiers run from 10 to 35 watts of output per channel. Where higher output is desired, it is best to use individual amplifiers.

Just about every amplifier manufacturer offers at least one twin amplifier of this type, and the choice is therefore very wide both as to price range and performance.

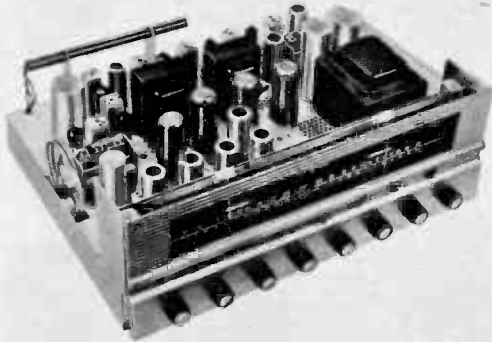
Most power amplifiers are made without any controls so they can be tucked away, out of sight. They can be put almost anywhere, provided there is enough ventilation to dissipate the heat they produce. Generally speaking amplifiers will dissipate in heat at least as much power as their power output. Thus two 35-watt amplifiers will dissipate at least 70 watts and very likely 100 watts. Enclosing them would be like boxing in a 100 watt bulb, which

as you well know throws out a lot of heat. Keep this in mind when finding a place to put them away and play safe by seeing to it either that there is air circulating around, or that the space in which the amplifiers are enclosed is large enough so that it will not become too highly heated by the heat discharged by the amplifiers.

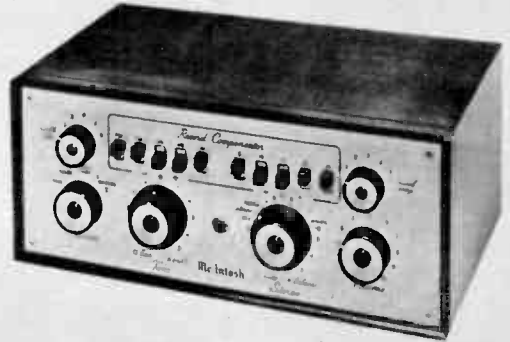
The preamplifier or control unit is the hardest worked of all hi-fi components and is called upon to do more jobs than the operator of a one-man band. First, it must provide preamplification of the very weak signal delivered by the phonograph record, tape or radio tuner. Secondly, it must restore the original tonal balance to the signal which for various reasons, as we shall see, arrives unbalanced. Third, it provides a means for modifying the tonal balance to correct imperfections in the recording, the equipment, or the acoustics of the room, or the area, or the preferences of the listener. Fifth, it provides a proper means of controlling the volume, and, in a stereo system, the balance between the two channels. Finally, it is the central control unit and provides means for choosing the program source—radio, disc or tape, TV, etc.—and the mode of operation—monophonic, stereo, etc.

Let's take a quick look at some of these functions. The erratic ridges in a disc recording are pretty minute. They can be magnified mechanically by use of the lever principle up to a point; but even so the pickup produces a relatively low voltage signal. Ceramic and crystal pickups can deliver as much as 1 volt, but the magnetic pickups preferred by most critical high fidelity listeners, deliver from 1 to 50 millivolts. Thus, they may need preamplifica-

Harman-Kardon Stereo Festival is complete in one unit. Delivers 20 watts per channel, costs \$260.



McIntosh C-8S add-on preamp converts monophonic systems to stereo, costs \$99 without a cabinet.



tion of as much as 1000 times to reach a level that can be fed to a power amplifier. Actually, the amplification has to be a good deal higher because *equalization* involves a 90% or greater loss at some frequencies. So the preamp may need a gain of as much as 10,000.

At least two stages of preamplification are needed to achieve this gain. In most preamps this is obtained with the two sections of a twin-triode 12AX7 (or one of the newer low-noise equivalents). In some preamps a pentode and a triode or two pentodes are used because two triodes can give a maximum gain of between 1500 and 3500 before feedback and, far less, of course, after feedback.

The problem of achieving this much gain is complicated by problems of hum and tube noise. Special precautions and tubes are needed to keep these inaudible. Stereo makes these problems more critical because stereo recordings are cut at a lower level and deliver a lower output. The finest preamps, including some inexpensive kit types, use DC filament supplies to keep the hum inaudible, and low noise resistors and tubes to keep the random noise inaudible. Others, have a hum-balancing control to minimize hum. When the output of a pickup is below 10 millivolts, the preamplifier should have at least the hum-balancing control; and when the pickup output is below 5 mv a DC filament supply is almost essential.

For very good reasons, disc recordings are cut with the high end boosted and the low end attenuated. Once upon a time every manufacturer had his own ideas as to the amount of cut and boost and as a result there were nearly as many recording

curves as there were labels of records. In 1955 the industry adopted the RIAA curve and all recordings made since that time, both monophonic and stereo, are recorded with this curve, which is indicated in the broken line curve of Fig. 9. To restore the original flat curve, the preamplifier should have an equalizer that has a response exactly opposite to that of the recording curve—like the dotted curve. If the playback equalization is correct we will have restored the signal to its original flat response as in the solid curve.

Preamps made before stereo arrived on the scene, gave a choice of several equalizers so that records made before the RIAA curve was adopted could be properly equalized. Most stereo preamps made today provide only one disc equalizer with the RIAA curve. This is the only curve needed for *stereo* records because all of them have been recorded with the RIAA characteristics.

People who have a lot of monophonic records may wonder whether this will limit their pleasure in using the older recordings with LP or AES or other curves. Actually, most of the older records will—*should* be perfectly all right when played back with an RIAA equalizer. The difference between the RIAA and the AES, on the one hand, or the RIAA and the LP, on the other hand, is not greater than 2 db at most portions of the curves. This difference will not be heard by most people. What difference there is can be compensated for by a little trimming up of the tone controls. London FFRR records will suffer more, but can also be heard satisfactorily with a little adjustment of the tone controls. So the one equalizer will be quite satisfactory to



The Bogen Model SRB20 is one of two complete stereo tuner-preamp-amplifiers. With two 10-watt amplifiers, at \$200.

The Bogen Stereo combination unit at right is the Challenger RC-12 with two 6-watt amplifiers. It is priced at \$170.



everybody except those who want to play or re-record old shellac records.

Tape recordings also require equalization but to a different curve. Tape recorders provide equalization as well as preamplification. However, when only playback of tapes is desired, it is possible to cut costs by purchasing a tape playback deck only, without amplifiers. The output from the heads can then be fed into the preamplifier for amplification and equalization. Most new preamps provide facilities for plugging in such a stripped-down tape player, and an equalizer tailored to the NARTB curve which is the standard for tape.

FM stations transmit a signal with the highs boosted. However, equalization is provided in the FM tuner and therefore, the preamp does not have to provide for this.

Following the preamplifier portion, the control unit has one or more switches to choose between disc, tape and radio signal sources. In a stereo preamp, there is also a function switch so that the system can be adjusted to handle either monophonic or stereo sources, properly. It is important that when this switch is turned to the monophonic position, the circuit provides for paralleling the outputs of the two sides of the phono preamplifier. This is necessary to cancel out the pinch-effect distortion. Most preamps do this. The Dynakit does not have a function switch as such, man-

ages instead to do the same job as a function switch (as well as the additional job of blending the two channels to fill in the center with a phantom channel) with a volume control with switching positions at both ends of rotation.

The function selector or mode switch usually provides for reversing the channels. This is a marginal control which I feel sure will be eliminated eventually. It is helpful, however, where dissimilar speakers are used and one has a better response in some portion of the range, particularly the bass. Thus, if on a particular recording the basses are on the right speaker but your left speaker has a better bass response, you can reverse the channels. There is little if any point to this, however, when identical systems are used.

Another marginal stereo feature on some preamps is a phase-reversal control. There should be no need for reversing phase, after the initial system setup. Recordings and broadcasts should be properly phased as they come. There have been instances of improper phasing due to an error in recording or transmission, and this has prompted some designers to include provision for reversing phase in their preamps. However, the incidence of such errors should be increasingly small and, while this feature may appeal to those who want to be prepared against any contingency, the lack of a phase reversing provision should not mark heavily against a preamp which

provides so many other desirable features.

Some means is needed to adjust the tonal balance of a high fidelity system. For one thing, loudspeakers are not absolutely flat in their response. Even if the speakers are perfectly flat, the acoustics of the listening room seldom are. Finally, people's ears have different responses and are not perfectly flat either. To compensate for these factors, it may be desirable to cut or boost at some points to restore tonal balance. The departure from flatness occurs largely at the two extremes—above 8000 cycles and below 500 cycles. Hence, tone controls that handle this part of the range are adequate. All genuine high-fidelity preamplifiers provide independent controls to adjust the bass and the treble separately. These provide a cut or boost at 20 and 15,000 cycles of between 12 and 20 db. The extreme cuts or boosts are seldom used, but it is good to have the range just in case.

In a stereo system, we have to have two channels and therefore two sets of tone controls. The earlier tendency was to gang the tone controls for both channels, in the interest of reducing the number of knobs. With this system the tonal balance of the two channels cannot be adjusted independently. There are occasions when independent adjustments are desirable. On the other hand, when two completely independent sets of tone controls are provided, it is more complicated to maintain a balance when the program material calls for changing tonal balance in both channels.

A new type of ganged control has been developed which solves the problem quite satisfactorily. The bass, or treble, controls of both channels are ganged with co-axial or concentric controls and two knobs. However, there is a built-in clutch. When the outer knob is pulled out the two controls are made independent so that either or both can be adjusted separately. Once the two are balanced, the knob is pushed in and now turning either knob will turn both controls. Thus, with these clutch type controls we have a choice of either independent or ganged operation. There are also concentric controls that have friction clutches. With these, turning either knob will turn both shafts; but if one knob is held in place with one hand, the other knob can be adjusted separately. The effect is much the same.

Curiously enough, one of the toughest problems in designing a good preamplifier is that of controlling volume. For one thing the position of the volume control is more important than might seem. If it is put toward the front, following the phono

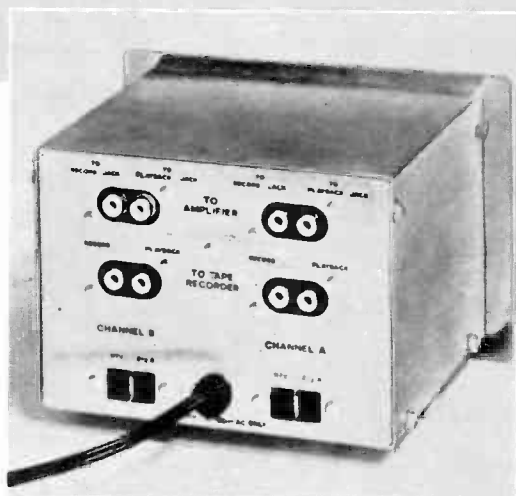
preamplifier the hum and noise level are likely to be higher when there is no signal or at low volume levels. If it is put toward the end, the noise figure is improved because the more the control is turned down, the more the noise from early stages is cut. But then a real possibility exists of overloading the early stages, and thus increasing the distortion. Preamplifiers with DC filament supplies can use the volume control at the front position and this provides just about complete insurance against overload distortion and also, usually, results in the distortion being lower at low levels. Some amplifiers with volume controls toward the end of the preamp chain, have "input level controls" on the back of the chassis for the radio and auxiliary inputs. This permits adjusting the input signal of these external units so that the preamp will not be overloaded. Some deluxe units solve this problem by using two ganged volume controls, one at the front and the other toward the rear, operating simultaneously.

In a stereo system we have to have two sets of volume controls, one for each channel. Of course, it is desirable to be able to change the volume of both channels simultaneously. Ganging the controls is the obvious solution, but ganging brings on other problems. The two channels of a stereo system have to be balanced if the best stereo effect is going to be achieved. There are two generally employed solutions. One is to add another pair of volume controls, arranged with opposite characteristics but a common shaft—so that when the knob is turned the volume of one channel increases, while the volume of the other decreases, and vice versa. This is called a balance control. The controls are designed so that at mid-rotation, there is equal loss in both channels; but when the knob is turned either way from mid-point, the gain of the two channels is unbalanced, in favor of one side or the other. With this balance control it is possible to compensate for the different efficiencies of speakers, differences in amplifiers, a listening position that is off center, etc. Some controls provide an infinite range from exactly equal gain, to a situation of unbalance so complete that one channel is completely cut out. Others provide a narrower range. The infinite range type is preferred when the two channels use different amplifiers and/or speakers; the limited type is fully adequate when the two channels are identical.

The other solution for the problem of balance, is that of using the clutch or friction type ganged controls. With the outer



Scott Stereo Adapter helps convert a monophonic system to stereo. It can be used between preamps and amplifiers or with 2 preamp-amplifiers that have tape monitoring jacks and switches. \$24.50.



records or radio programs are going to be heard in the home. But few people can or want to reproduce the records at the original full loudness. Unless something is done to compensate for this fault of the ears, we will not hear the program with the original tonal balance. In fact, if we play the stuff back softly, we will lose portions of the music, especially in the bass end, completely.

Of course, we can compensate for this effect by changing the tone controls to provide a boost at the low and high ends. But there is one trouble with this—the fact that in this way we can compensate correctly only at one given loudness level. If we change level the tonal balance will also change because the response of our ears changes. If we decrease volume the bass will seem attenuated; if we increase it will seem boosted. Thus, it is necessary, if perfect compensation is desired, to change the tone control settings every time the volume is changed significantly. Many people prefer this method; but others find it a nuisance and would like to have some automatic way of providing compensation for changes in loudness level.

I guess every preamp provides some form of loudness compensation, that varies the tonal balance as the volume control is turned. Some use very elaborate methods to provide a wide choice of curves to meet

knob pulled out, the two volume controls can be adjusted independently until the system is balanced. Then, the knob is pushed in to lock the two controls and further changes in the overall volume can be made by turning just one knob.

This does not end the problem of controlling volume properly. The response of the ears is not uniform at all volume levels. At very high levels it is reasonably flat and in any event as flat as ears can be. But when the volume level is lowered, the ear becomes less sensitive to the low frequencies and, to a lesser degree, to the very high frequencies.

But recordings and radio programs are cut and transmitted with the flat response of the original sound. This is the only practical course because, obviously, nobody can foresee, much less allow for, the level the

various preferences and listening situations. Practically all have a switch to disable the loudness control. Some use a separate control for volume and for loudness and, by using different combinations of both, a wide variety of needs can be met. The solutions for the loudness effect are simpler in stereo preamps than they used to be in the older monophonic preamps. For one thing, a stereo preamp requires so many controls that some simplification somewhere is necessary. For another, the newer speakers have a flatter response at the low end and not as much bass boost is needed to satisfy the ear as in the olden days, when a good part of the bass boost in the loudness compensator was needed to flatten the speaker response. Also, the two speakers of a stereo system provide more bass than a single speaker.

In addition to taking care of these main functions, many preamps provide various combinations of special features, for both monophonic and stereo use. For example, some provide a rumble filter to reduce the annoyance of changer or turntable rumble. These reduce the response at the rumble frequencies between 20 and 30 cycles. Rumble filtering, however, is not a good substitute for a good low rumble turntable. The rumble filter also attenuates the bass in the lowest octave below 40 cycles, and in many cases above 40 cycles as well.

Some preamps also have a scratch filter which rolls off response of the preamp at high frequencies. With a good pickup operating at the low pressures permissible with good pickups, scratch on new recordings should be negligible and there should be no serious increase in scratch for many playings if the pickup is properly adjusted. Also the roll off cannot be confined to the scratch only. Any roll off effective in reducing scratch will also attenuate desired high frequencies of music. I point this out not to deprecate the incorporation of a scratch filter. It is useful for playing old shellac recordings of LP and stereo discs that have been abused. But, I want to point out first that the presence of a scratch filter does not mean that you will have to worry about scratch on stereo recordings if you play them with proper equipment; and second, to warn you that it is far better to use a proper pickup, check the needle, and take all the other precautions to preserve your records, than to depend on the scratch filter to make abused records sound good. In any event, these are marginal features and I would not discount a preamp which was satisfactory in other respects just because it did

not include either a rumble or scratch filter.

It obviously makes good sense to combine the two preamps needed for stereo in a single unit. There are three ways in which this can be done:

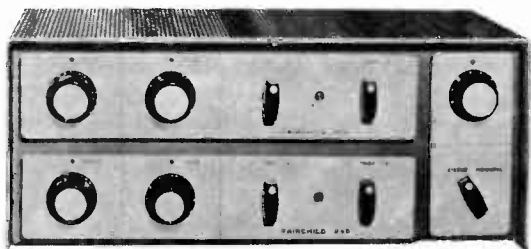
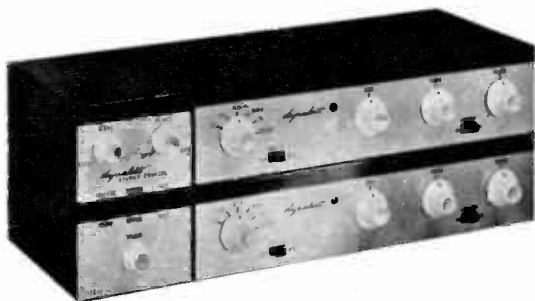
First, we can use two entirely independent preamps plus a stereo control unit or adapter which ties the two units together for stereo purposes and provides the controls needed for choosing mode of operation and providing good stereo.

The stereo version of the Dynakit preamps is the outstanding example. Actually this consists of two Dynakit preamps and the Dynakit adapter, tied together with a common metal panel. This combination provides high versatility because of the individual controls in the two preamps, and is especially suited for use with mixed amplifiers and speakers, since the gain and response of each channel can be adjusted individually over a great range. Although this combination has 11 knobs and 4 switches once the system is properly balanced only the three controls and switches on the stereo control panel are going to be used most of the time.

Second, we can combine and completely gang the two preamps so that there is only one knob for each function, as in a monophonic preamp. This was an approach used in the earlier stereo preamps but has been just about abandoned in favor of the third approach which is a combination of ganging and individual controls. Generally, the function, mode, equalization, program source, etc., switches and the volume and balance controls are ganged, while the tone controls use the concentric, double-knob controls with clutches so that the two knobs on each shaft may be adjusted individually and then when locked the control can vary tone for both channels.

The trend is entirely in the direction of this last arrangement and it is fast becoming universal. Even Dynakit in its newest stereo preamp is taking this course, though the older preamps will still be available.

A useful feature which unfortunately is found in only a few preamps is the provision for a third channel. The Lafayette master stereo control unit, for example, not only provides this third channel bridging arrangement, but also a separate volume control which can be used to blend the two channels to any desired degree for the third or middle channel. Other preamps have a bridged output which combines both channels but without the bridging or blending control. The bridged output should be fed into an amplifier that has an input volume control so the proportion



The Dynakit Model PS-1, above right, and the Fairchild Model 248, above left, are stereo amplifiers that combine two of their fine preamps with a stereo control system, thus offering great flexibility.

fed to the middle speaker can be adjusted to fit the circumstances.

The accommodations furnished by the preamplifier for versatility are important; but here as in everything else in the hi-fi field, the most important consideration is low distortion. There was a time, and not long ago, when the preamp was guilty of contributing most of the distortion in the electronic portion of the hi-fi system. Great progress was made in reducing the distortion of amplifiers to what was, for all practical purposes, a vanishing point. But preamps were overlooked and often an amplifier with distortion at normal levels of .2% was being fed by a preamp with distortion of more than 1%. The preamps made today are vastly superior to the older ones in this respect and in some of them distortion is insignificant even by laboratory standards.

Hum and noise figure are also very important in stereo preamps and need to be significantly better than in monophonic preamps. Stereo discs are recorded at a lower level and stereo pickups are less sensitive. Therefore, the hum and noise figure of a stereo preamp ought to be at least twice as good as in a monophonic one.

Check the possibility of overload. Most amplifiers today can be driven to full output with 1.5 to 2 volts and many with less than 1 volt. Most preamps can deliver well in excess of this but, as we noted earlier, some have better distortion characteristics than others when the volume control is only partly on.

There is, as we noted earlier, a trend toward combining various units in integrated single units. A natural combination is that of the preamps and amplifiers of a stereo system. This is usually done with the lower powered amplifiers simply because in the case of high powered amplifiers the big transformers needed leave little space in any practical-sized chassis for a stereo preamp. Also a big power trans-

former has a bigger magnetic field and problems of hum are compounded. In most cases there is no significant sacrifice of performance in such combinations and they yield just about the same performance as individual preamps and amplifiers of the same type would yield.

A nice feature on some of the new amplifiers and complete preamp-amplifier combination, is an arrangement of the speaker terminals that makes the addition of a third speaker for a middle channel a simple job. The Harman-Kardon 1960 line includes this as a regular feature. As a matter of fact, this line includes provisions for a wide variety of speaker combinations, running from two monophonic systems in two separate rooms, to two three-channel stereo systems in two separate rooms.

Late 1959 saw the arrival of several complete combinations with AM-FM tuners, preamps and amplifiers all on one chassis. In most of these the amplifiers are in the 10- to 12-watt class, though the Fisher has 20-watt amplifiers. There is some sacrifice in these units of power output at very low frequencies because it is difficult to find space for big transformers. However, most of them will deliver 8 or 10 watts at 30 cycles, and 3 or 4 at 20 cycles.

If they are used with speakers of reasonable efficiency and the volume level is held down, they will yield quite acceptable performance at a considerable saving in cost as well as space. But they should not be expected to deliver the performance of more complex and bulkier individual combinations.

A combination that is coming into favor is that of the combined AM-FM tuner and stereo preamplifier. This makes very good sense because it places all the controls in a single unit, and does not present any really serious problems, either in space or performance. In one way this combination is superior to that of preamp and amplifiers. Running a long string of audio stages from



To convert to stereo, Sherwood S-4400 has complete stereo preamp and a single 36w amplifier.

The Dynaco Mark III, at right, produces 60 watts over full audio range. In kit form, it's \$79.95.



a single power supply presents problems in maintaining stability. It is therefore, always safer to feed the preamp from a power supply that is independent of the power amplifier. In terms of hum filtering the demands of the tuners are rather similar to those of the preamp and this, too, favors the combination. Finally, the total power demands of this combination are very modest and a relatively small transformer can supply them. The hum field is more easily held down and thus hum problems are easier for the designer to handle.

There are a number of special combinations designed for converting present monophonic systems to stereo. The best way to convert a present system without abandoning the present units, is simply to duplicate the present amplifier and pre-amplifier and add a stereo adapter to tie the two together for stereo. We have already mentioned the Dynakit adapter. This is intended to be inserted circuit-wise in the middle of the preamp circuits. No internal modification is necessary with the Dynakit preamps or other preamps which have a tape-monitor switch and tape monitoring arrangement. In this case, short interconnecting cables only are needed. Cleverly enough, the tape-monitoring feature is preserved and in stereo form. It can also be used between preamps and amplifiers. The Marantz and H. H. Scott 135 stereo-adapter are similar in this respect.

The Lafayette remote control stereo adapter, can be used between the two preamps and the two amplifiers. It has a net gain of 6 db and low input and output impedances so that it can be used (with shielded cables) at distances as great as 50 feet from the preamps and amps. Some manufacturers have adapters that are usable, without modification, only with their own line of preamps and amplifiers.

McIntosh provides a unit especially designed to convert McIntosh systems but also usable with other preamps and ampli-

fiers. It consists of a preamp, identical with their monophonic preamp, plus a stereo control center which goes between the two preamps and the amplifiers—like the Lafayette adapter. This does not have a self-contained power supply but comes with a cable which is meant to plug into one of a pair of McIntosh power amplifiers. It could be made to work with other amplifiers if the amplifier is equipped with a power socket and this socket is rewired to fit the McIntosh plug—which is not standard in wiring.

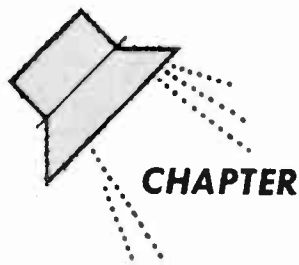
Another approach to conversion implies getting rid of one of the present components. Thus Harman-Kardon in its AX-20 unit combines a stereo preamp with a single 20-watt amplifier. The old preamp is disposed of, and this combination with the present amplifier provides the entire preamp-amplifier portion of a stereo system. Sherwood has a similar arrangement in its S-4000 add-on unit.

Another approach is to replace the present preamp with a stereo preamp and then add another amplifier; or to buy one of the tuner and preamp combinations and another amplifier.

You can also get a combined stereo preamp and twin amplifier, but use the two power amplifiers as a single amplifier for one channel and your present amplifier for the other channel. The Harman-Kardon line, among others, permits this arrangement.

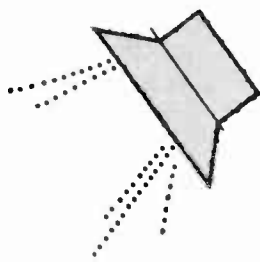
Which of these approaches to use depends on the particular circumstances. The general principle in converting is to work toward identical channels as much as possible. If this is not possible or practical, then discarding part of the system, if that will help arrive at identical or closely similar channels, is better than trying to work with an unbalanced combination.

Always check the manufacturer of your units to see what he has available for conversion or what he recommends. •



6

Pickups and Turntables



How to choose components that are right for you.

OFFHAND it would seem like getting music out of the record groove and into an amplifier doesn't present much of a problem. After all, you have only to figure some way to revolve the disc, and some way to fix a pickup so it will follow along the spiral as the needle rides the groove and vibrates in response to the wiggles. This defines the basic problem all right—unfortunately every solution advanced for it has merely brought on other problems. It is now about 50 years since the first attempt was made and, while our solutions come a lot closer to the ideal, today's engineers are still trying to lick the problem completely and taking different roads to do it.

The disc must not only be revolved but it must be revolved at a constant and uniform speed. This is not as easy to do as it is to say.

The simplest type of phonograph motor is the two-pole motor diagrammed roughly in A of Fig. 1. An armature revolves between the poles of two electromagnets. Each cycle of the alternating current energizes the poles. The magnetic attraction exerts a pull which causes the armature to revolve. Obviously in any one revolution the armature is pulled only twice and has to coast between the pulls. This is not quite as bad as it sounds because the electric motor does not revolve the turntable directly. Motors revolve at 1800 revolutions

Allied Radio Corp.



per minute whereas we desire the disc to revolve only 33 revolutions per minute. The motor has to be geared down so it takes about 60 revolutions of the motor armature to revolve the turntable one revolution. The unevenness is somewhat wiped out by this reduction. Things are helped further by the flywheel effect of a heavy turntable. The heavier the turntable, especially on its perimeter, the better the flywheel effect and the more the uneven driving pulses of the motor are smoothed out.

Thus, the two-pole motor can be made to work *pretty* well. Unfortunately the two-pole motor develops a very high magnetic field which can induce high amounts of hum in the pickup. With very sensitive pickups of the crystal or ceramic types which develop high voltages and do not have coils to pick up hum, the hum is far enough below the signal level not to be too noticeable. But the magnetic pickups favored for highest fidelity are very insensitive to the signal and develop a low voltage. To make matters worse they have coils which are highly susceptible to hum fields. This combination makes the two-pole motor quite unsatisfactory where the finest results are desired. Therefore, the two-pole motor is found only in the cheap-

est, poorest record players and changers.

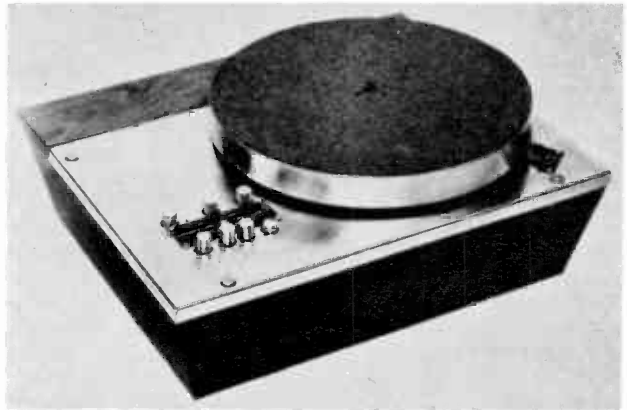
A four-pole motor produces a big improvement. Its four poles give four pushes for each revolution of the motor and with a good flywheel effect a very constant speed can be achieved.

Equally important is the fact that a four-pole motor vibrates less than a two-pole, just as a four-cylinder gasoline engine vibrates less than a two-cylinder. The less the vibration of the motor the less rumble is likely to be picked up by the pickup. Furthermore, the hum problem is only half as bad. As a result the four-pole motor has become the minimum standard for high fidelity and is found in the low and medium priced units suitable for high fidelity.

A recently developed type of electric motor which has ideal characteristics for a turntable is the hysteresis synchronous motor whose principle is difficult to explain but whose performance is almost flawless for this purpose. It maintains the most uniform speed, vibrates the least and has the lowest hum field. Almost all, but not quite all, of the top quality turntables employ these hysteresis motors. So much for the motor.

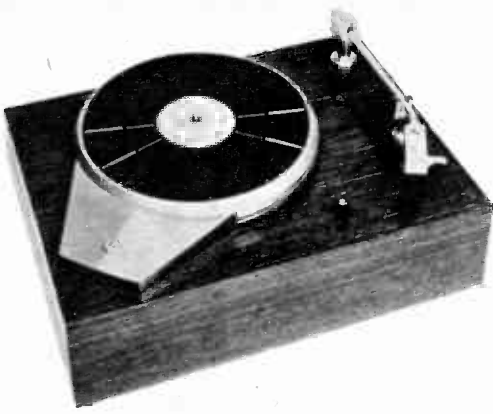
The next problem is to couple the motor to the turntable. The most obvious way is by direct coupling, but this is not possible

The Scott turntable provides 3 speeds with rumble reduced to almost nothing with most speakers. Each speed can be adjusted by individual knobs and a built-in stroboscope.



Fairchild turntable is belt driven with hysteresis motor. Rumble is rated at 43 db by NARTB standards but is 12 db better by standards used to rate most other turntables.





The Bogen-Presto T-3 turntable offers belt drive with a hysteresis-motor, with the low rumble, wow and flutter they provide, for a modest \$59.50.



The Stromberg-Carlson PR-499, which is pictured above, is a belt driven turntable. This machine grips the records with two narrow bands of cork.



The Gray turntable above is available in either finished or kit form. It has minimum rumble, low wow and flutter, is priced from \$49.50 to \$79.50.



Pickering Gyropoise turntable floats in magnetic field with no mechanical linkage except through very soft drive wheel. The rumble figure is 65 db.

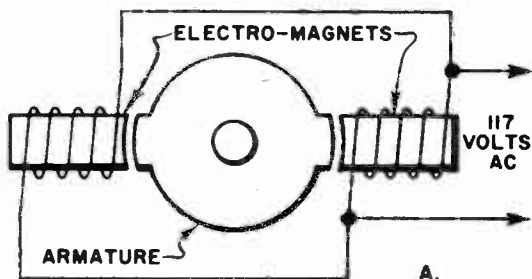
because of the difference in the speed of the motor and the desired speed of the turntable. Gears can be used to provide a geared mechanical drive directly to the turntable. There are two serious disadvantages to this. The direct mechanical coupling will not only communicate the torque of the motor to the turntable but also its vibration. This vibration will energize the pickup and result in rumble at a frequency somewhere around 30 cycles. The rumble is not only unpleasant in itself but it also muddies up matters by injecting an unwanted signal of high amplitude in a part of the range where both amplifiers and loudspeakers generate most distortion. When speakers had little response below 50 or 60 cycles, rumble could be tolerated because it was low and heard only when there was no music and not much even then. But when speakers began to get down to 30 cycles, the rumble became an

extremely annoying and limiting factor.

Also, unless the gears are cut very carefully and fit perfectly the play in them will result in variations in speed and increase *wow* or variation in pitch. In heavy duty broadcast service and in recording lathes, where torque is a problem, the direct coupling through gears is nevertheless employed; but the coupling is through shafts with vibration damping elements, and the gears are precision cut. This is expensive but results in a very satisfactory heavy duty turntable in which the loss of torque is minimized.

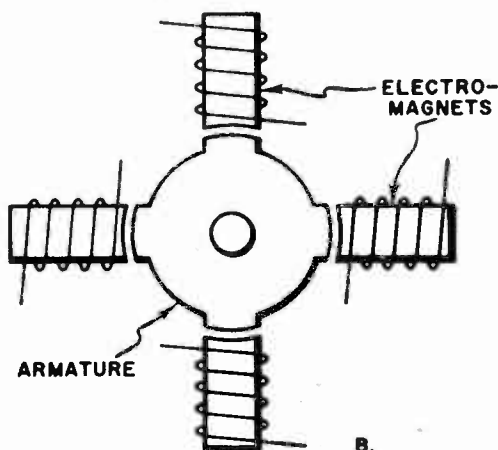
A simpler and cheaper way of direct coupling is offered by using friction drive rather than gears for reduction and transfer of motor torque to turntable. The arrangement is extremely simple as diagrammed in Fig. 2. The small shaft of the motor drives a rubber-tired idler of larger diameter which in turn engages the rim of

Fig. 1



Above, a 2-pole synchronous motor, one type of turntable motor, gives two pulls per revolution.

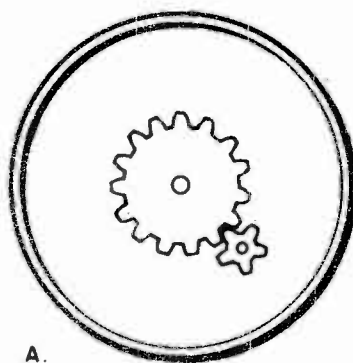
Four-pole motor below gives four pulls per revolution, is smoother, with less vibration and hum.



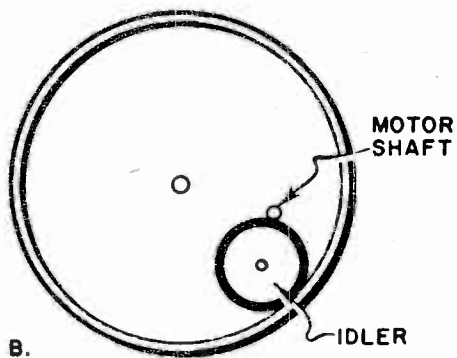
the turntable and revolves it. The rubber tire of the idler provides not only the friction to transfer the torque, but also damps a portion of the vibration and therefore reduces rumble. Because the coupling or transmission is flexible, the motor does not have to be rigidly mounted. It can be suspended on flexible rubber mounts which absorb and filter out motor vibration and still further reduce the rumble. This is the most universally used drive system found in a majority of low and medium priced turntables and practically all changers. Combined with the four-pole motor it yields acceptable performance with monophonic discs; and with a hysteresis motor it can be very good with stereo discs.

The Scott turntable, one of the finest on the market, uses a combination of friction and gear drive with mechanical coupling. A four-pole motor drives a cone. There are three equal rubber-tired idlers, any

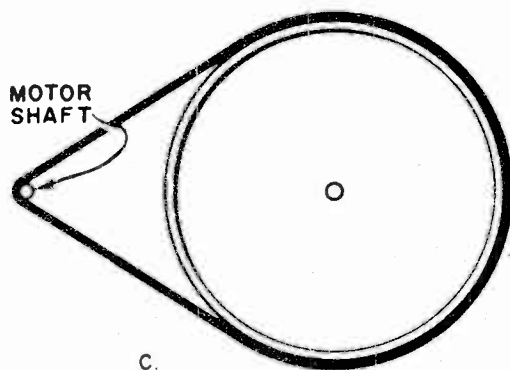
Fig. 2



Gear drive of a turntable motor, above is positive, has high torque, but transmits vibration.



With friction drive, rubber-tired idler, revolved by motor shaft, revolves turntable at the rim.



In belt drive, illustrated in the diagram above, a flexible belt drives the turntable at the rim.

one of which can be pressed down with a push button to engage the cone on one side, and the drum on the other side. As in the simple idler system these idlers damp out vibration while transmitting the motor torque. When the idler closest to the motor engages the large diameter portion of the cone the wheel revolves at highest speed (to produce 78 rpm turntable speed); the middle wheel engages a smaller diameter and revolves at a lower speed to produce 45 rpm rotation; the wheel at the small end of the cone revolves most slowly to produce 33 rpm rotation. There is a shaft from the drum to a gear box (G), but this shaft has two

highly flexible artificial rubber couplings which damp out some more motor vibration. The gear box transmits the motor motion to the spindle at the proper reduction to produce the desired speeds. The motor and transmission assembly are mounted on sensitive springs to damp out vibration. The turntable mount, gear box and the wooden board on which the pickup is mounted, are independently suspended also on sensitive springs. Thus the turntable is isolated from the vibrations of the motor by no fewer than five damping elements as indicated in the block diagram Fig. 3. With this complex coupling and despite the use of a four-pole rather

The Rek-O-Kut single speed, belt-driven Model K-33 turntable is belt driven by a 4-pole motor, has rumble figure of 47 db. In kit form it costs \$39.95. The N33H factory built model is \$69.95.

Garrard has three single-plate turntables. The 4HF, below, has 4 speeds, comes with a Garrard transcription tone arm. Model T is also 4 speed. The 301 Professional can be used with any arm.



The Bogen-Presto PA-1 tone arm has a micrometer pressure adjustment with an easy-to-read gauge. B-60 turntable, below, has 4-speed performance.

An Audiogersh Miraphon 4-speed single play turntable has automatic shut-off and plug-in heads that take all stereo and monophonic cartridges.



than a hysteresis motor, the Scott turntable achieves one of the lowest rumble figures on the market.

Stereo has made rumble a more critical problem than ever before. In most turntables a large part of the vibration is vertical. A monophonic pickup needs no vertical response and many are incapable of it by the very nature of the design. Thus the vertical vibration does not generate rumble. But a stereo pickup has to be equally sensitive to vertical and to horizontal motion; it is therefore sensitive to the vertical vibrations and thus is far more susceptible to rumble. To achieve a rumble figure as good with stereo pickups, far

greater care is necessary. Many of the pre-stereo turntables, the above-mentioned Scott included, are just about as good with stereo as with monophonic records. But others which had excellent monophonic characteristics, turned out not to be acceptable for stereo. This led to redesign of almost all turntables and changers and also brought forward into greater popularity another method of propulsion—belt drive. This is extremely simple. The motor is placed outside the turntable and a belt is run from the motor shaft to the outside of the turntable itself. See Fig. 2C. The somewhat flexible belt is an extremely good damping element. The vibration, in effect, is dissipated in the belt between the shaft and the turntable. The combination of belt drive with a four-pole motor produces excellent results and superb performance with a hysteresis motor.

The Pickering Gyrapoise turntable is unique in its approach to the rumble problem. The turntable in the Gyrapoise is suspended in a magnetic field without mechanical linkage to the base and thus the only way motor rumble can be communicated to it is through the motor linkage which, though simple, presents high damping to motor vibrations. Though relatively inexpensive at \$59.85 this turntable claims a noise level 62 db down, one of the best noise figures available at any price.

Another even more remarkable approach is that of Paul Weathers, who in the Weathers ML-1 turntable breaks most of the rules of turntable design and not only gets away with it but produces a turntable whose rumble is unmeasurable with present test records and test instruments. We noted that one way to maintain constant speed is with a heavy turntable with a big flywheel effect. But a heavy turntable needs a powerful motor to drive it and this increases the problems of hum and rumble. Weathers takes the revolutionary approach of using an extremely light turntable—less than one lb. He drives this with a small synchronous clock motor. The motor is very stable and, being small, is quiet and vibrationless. The clock motor is geared down. A soft neoprene idler directly on the shaft drives the rim of the very light turntable. There is only one disadvantage. The torque of the motor is low and the turntable works well only with pickups whose pressure is not over 8 or 10 grams. Fortunately this includes most high-fidelity arm and cartridge stereo combinations.

Again we see that it is not possible to be categorical. Generally speaking, a hystere-

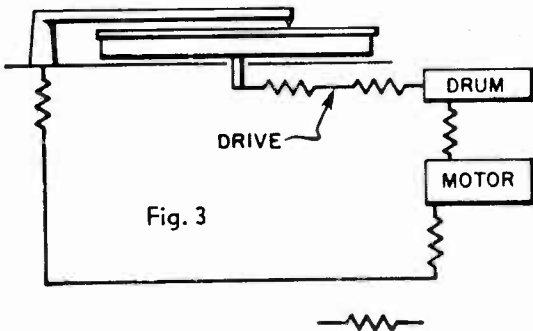


Fig. 3

The Scott turntable, illustrated in the diagram above, has 5 rumble-absorbing damping elements.

Cutter always travels as a tangent to the groove. Playback pickup on arm outside turntable can be tangent only over part of a recording. Tracking error must be held down as much as is possible.

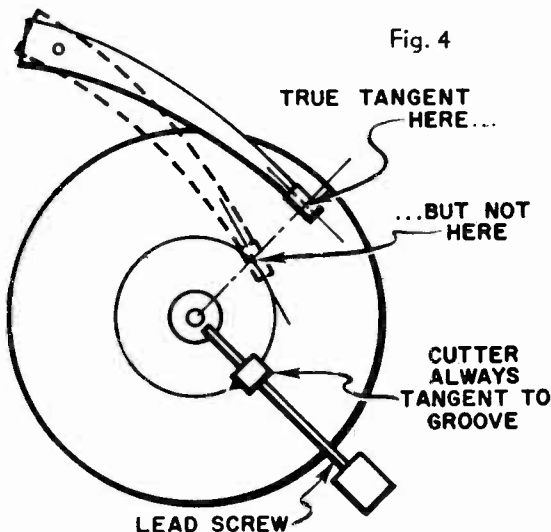


Fig. 4



The Glaser-Steers Model 77 changer is very low on rumble, has many versatile features. Stylus pressure changes only about one gram from first to last record. Changer above is priced \$59.50.

Current line of Garrard changers has 3 models, all with 4-pole motors. Standard model Triumph II is \$54.50. Deluxe model Crown II is \$67, and Renown II, convertible to single play, is \$42.50.

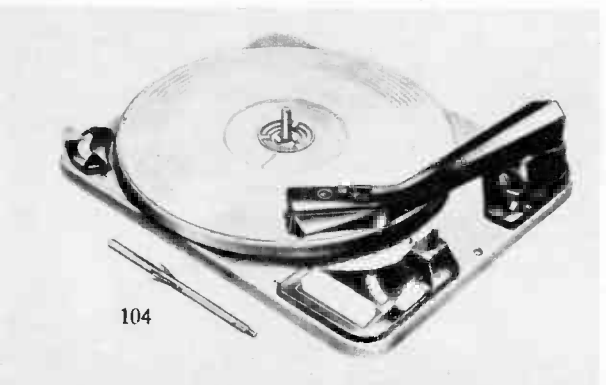


Audiogersh Miracord XS-200, above, is one of the most versatile changers. It can be used as turntable or changer at 4 speeds, and provides automatic repeat and variable pause between records.

The Heathkit Model RP-3 changer, pictured below, is offered in kit form. It has excellent rumble figure. This record changer provides for all 4 of the playing speeds and all sizes of records.



United Dual changer operates at all 4 speeds as single play turntable or changer, and will track and cycle with pressures as low as 1½ gr. \$70.



sis motor is superior to a four-pole synchronous motor; a heavy turntable is superior to a light one and belt drive is superior to direct idler or gear drive. But the Scott and Pickering achieve very good rumble figures with four-pole motors; the Weathers pushes the ideals with a thin aluminum stamped turntable; and a number of friction-drive turntables have as good rumble figures as belt driven ones.

Rumble is rated in terms of so many db below "reference" level. The reference level, unfortunately, is not always specified exactly and not always the same for all manufacturers. Fairchild uses the NARTB standard for rating their turntable, and



The Italian made Lesa changer has 4-pole motor, 4 speeds, plug-in heads and many other features which make it a good value at a price of \$39.95.

Webcor changers are among the most widely used. The custom model below is available with various cartridges or plug-in heads. The Imperial model has speedy counter-balance pressure adjustment.



this gives what appears to be a poor rumble figure. Actually it has a very fine rumble figure. Most manufacturers use as a standard the level of the 1000 cycle test tone on a test record and this is equivalent to a moderately loud portion of a musical

PIEZO-ELECTRIC PICKUP

Fig. 5

Ceramic Element.

Distribution of Charge in Ceramic Element.

Drawings show how voltage is developed in piezo ceramic cartridge when distorted by stylus motion. A has zero voltage. Left bending (B) causes left side to become positive, developing a voltage.

may have rumble as high in amplitude as the soft sounds on a record. I would say that for stereo use a rumble figure of at least 45 db is the minimum; 50 to 55 is good; and anything over 60 is likely to be inaudible.

Integrated combination of Electro-Sonic Laboratories Professional arm and cartridge features fingertip adjustment of pressure and calibrated pressure scale.



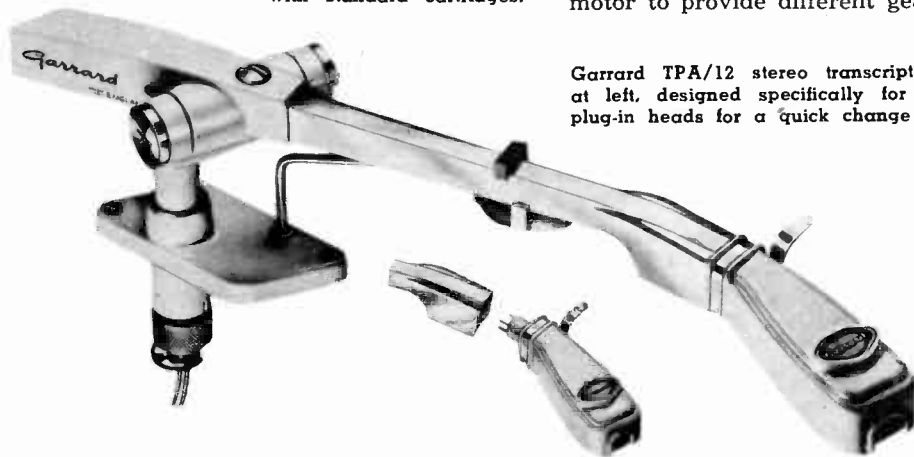
The ESL Gyro/Balance arm, above, requires no leveling of the turntable and plays records at any angle including 90 degrees, with standard cartridges.

signal, the turntable can't have too good a rumble figure. There is no point whatever in spending a lot of money on a speaker that goes down to 30 cycles or lower if you're going to save money on a turntable with an inadequate rumble figure. You'd be a lot better off with an equally poor loudspeaker.

Turntables come in either single speed or multiple speed types. The single speed is almost always 33 $\frac{1}{3}$ rpm. If you're going to concentrate on stereo records a single speed turntable is all you need. All stereo records are 33 $\frac{1}{3}$ rpm. Two- or three-speed turntables are naturally more expensive, especially in low-rumble types. The most satisfactory type of speed-change from a rumble point of view is that used in some Fairchild and available now also for the Weathers turntables. This involves a special power supply to feed a synchronous motor with power of different frequencies—i.e. 60 cycle for 33 rpm, about 135 for 78 rpm and 30 cycle for 16 rpm. This type involves no change whatever in the transmission and, therefore, there is no complication in the coupling system to aggravate rumble.

Speed changes are not hard to achieve in friction drive turntables by shifting the idler up or down a stepped shaft on the motor to provide different gearing ratios.

Garrard TPA/12 stereo transcription tone arm at left, designed specifically for stereo, offers plug-in heads for a quick change of cartridges.



Belt drive offers a more difficult problem, except with a variable frequency power source. However, variable speed machines are available in practically all the types we have discussed for those who need them.

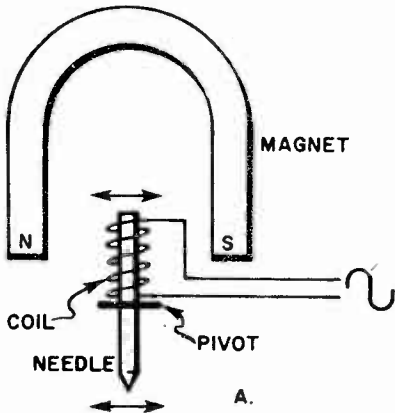
The record changer has a great attraction. The idea of stacking up to 10 long playing records on a spindle of some kind to provide two or three hours of playing without attention is beguiling. There is no denying the convenience, especially when the music is going to be used for background rather than attentive listening. And changers have been vastly improved in recent years. But there are many disadvantages, especially for stereo, which ought to be considered carefully.

First of all, it is very difficult to turn out a changer with a really good rumble figure. The need for a changing mechanism dictates a mechanical coupling which simply cannot be damped or isolated from the turntable and pickup as thoroughly as in a turntable. Furthermore, a more powerful motor is needed and this increases problems of smoothness and vibration. There are, finally, all kinds of mechanical levers, gears and what-not to communicate this vibration to the turntable and pickup. By some really heroic engineering we have a number of turntables that fall in the 35 to 50 db rumble class. So you have to be

prepared to pay the price in higher rumble for the convenience of a changer. But, you may say, I've heard dozens of changers, and in the cheaper kind of hi-fis you don't like, where there was no rumble at all. No doubt. But on that kind of outfit you also didn't hear the real deep boom of a big drum, or the rough, down-deep growl of a double bass, let alone the floor-vibrating sensation of the organ pedal. In these outfits the bass is cut off sharply below about 60 cycles and there is practically no response at all below 50.

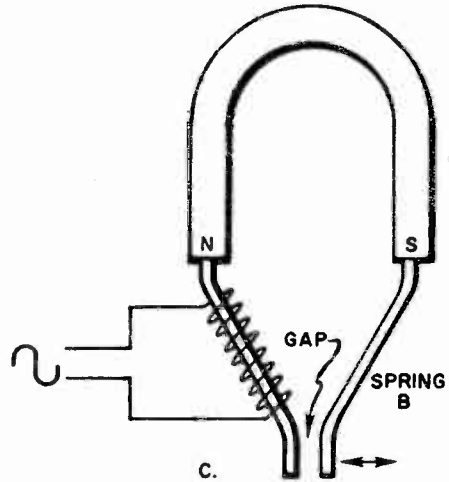
If you want the convenience of a changer, be sure to get the changers carefully designed for stereo high fidelity, or be prepared to throw away that part of the range which imparts so much awe to a really good high fidelity system.

Secondly, in a changer, both the angle of the needle in the groove and the pressure it exerts on the record vary with the number of records on the table. This was not too serious in monophonic discs; but it is a real consideration in stereo discs. The .5 or .7 mil needle of a stereo pickup exerts a far greater stress on a record for a given pressure than the one mil needle of a monophonic pickup. The stress actually increases as the square of the decrease in needle radius. In other words, a 1/2 mil needle places four times as much stress on

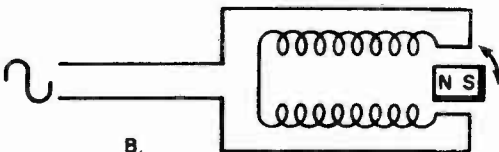


One type of magnetic pickup movement is a moving coil, above. Vibration of the coil between poles of the motor generates the voltage in the coil.

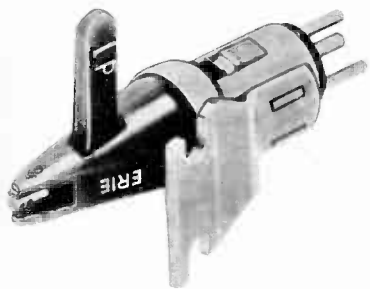
Fig. 6



Above, variable reluctance. Vibrating spring B varies flux in gap, generating voltage in coil.

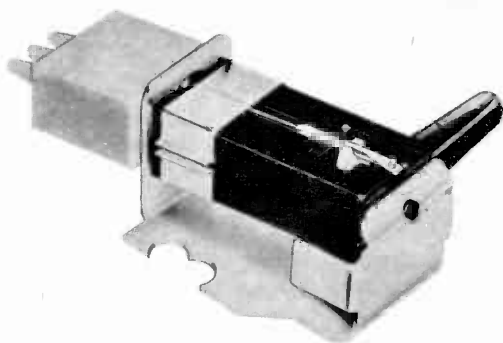


Left, moving magnet. Rotating a small powerful magnet between coils generates current in coils.

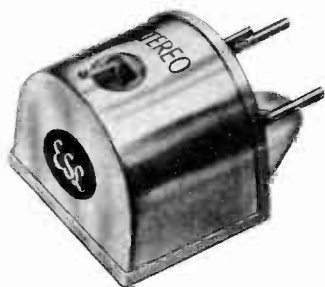


Erie ceramic stereo cartridge at left is turnover type including needles for microgroove and 78 rpm records. \$24.50 with diamond.

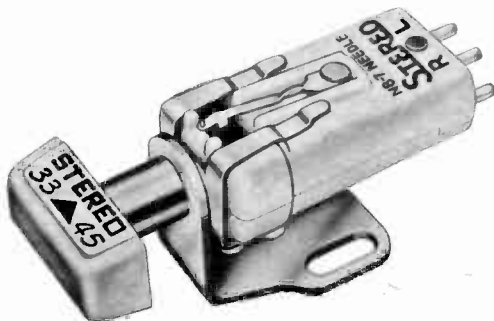
The Electro-Voice 20 Series ceramic stereo cartridge at right is now available at a lowered price. The cost is \$15 with a diamond stylus.



The ESL Gyro-Jewel stereo cartridge, left, uses the unique D'Arsonville movement. This new cartridge ranks with the top pickups.



The picture at the right is the new Astatic 76TB stereo cartridge. This model can also be used, when you turn it over, for 78 rpm records.



the groove at the same pressure as a one mil needle. Thus deformation of the groove and wear are more serious factors. Actually, with a 2 gram pressure, the .7 mil stereo needle is far easier on records than a one mil microgroove needle is at the 5 or 6 grams that most monophonic pickups require. To preserve this advantage the pressure should be kept as low as possible. Most changers—but not all—will not operate well with a pressure of less than 3 grams.

Also, this pressure is established by a spring which, in effect, pulls the pickup upward. Obviously, if we lift the pickup the tension on the spring is decreased and the pressure on the record is increased. A stack of records may lift the pickup an inch or more and this can change the pressure by a very significant factor.

In stereo it is far more important that the angle of the needle to the surface of the groove be optimum. As of this moment there is no standard and this differs to some degree from one label to another. But clearly, if we raise the pickup we will change the needle angle. Thus if we set the pressure and needle angle for optimum with one record on the table, both will get worse as the stack piles up and by the time the last record comes down, both may be seriously away from the ideal.

Mechanical damage to records is minimized in modern changers. You will note

that most records have a molding around the outer edge. This is designed with the changer in mind. In a stack the records are supposed to touch each other only along this molding and the grooved surfaces are not supposed to contact each other. The handling of records by today's changers is far gentler and more foolproof also.

My own most serious objection to a changer, however, is that the needle does not get enough cleaning. Needles accumulate lint very rapidly and when a ball forms, the needle no longer contacts the groove properly. It then not only tends to skate and skip grooves but also the point rattles around in the groove doing considerable damage and, furthermore, producing a most unacceptable sound. The necessity for changing a disc on a single-play turntable forces attention to the cleaning of the needle, and assures satisfactory, undistorted sound and long life for the records.

Actually, it is not much nuisance to get up every 15 to 30 minutes to change the record on a turntable. But, many people are willing to put up with these disadvantages for the positive convenience of a changer. And for them, let us say, that today's changer is a far superior creature to yesterday's in every respect. Some are convertible to single-play turntables; some will change records of any size, and even change the speed of the changer, so that,



The CBS Professional ceramic cartridge pictured above, comes with plug-in equalizers to assure flat response. These equalizers fit into preamp jacks and pick-up plugs go into the equalizers.

for example, microgroove LPs and 45s can be stacked together, and will play automatically. Some have controls for varying the delay between records so that, for example, for a dance you can have a 5-minute intermission between records. One has a built-in pressure gauge. And a lot of them have a better noise figure than good turntables had a couple of years ago. Among these there is one sure to meet your needs. Look them over carefully, be sure one you buy is compatible with your speaker, and then keep it in good adjustment and keep your records really clean.

The support or suspension of the pickup in the groove is also a problem with more aspects than first meets the eye. The universal arrangement is to place the pickup in an arm pivoting around a point outside the turntable. This presents a serious problem in itself. The masters of records are cut by a cutter which is mounted very differently—on a screw which runs from the spindle in the middle of the record, to the outside, and thus directly on a radius of the disc. Being thus mounted the needle maintains a uniform aspect to the circumference from the outer edge to the inner edge of its spiral cut. An arm pivoting at a point outside the circle simply cannot maintain this uniform aspect. Ideally the pickup should be supported so that the axis of its movement is a tangent to the groove. A tangent, I might remind you is a

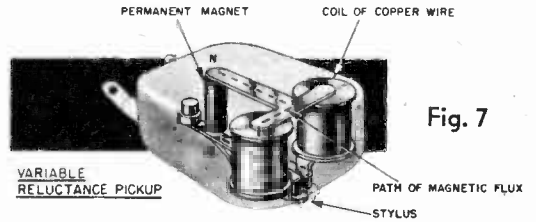
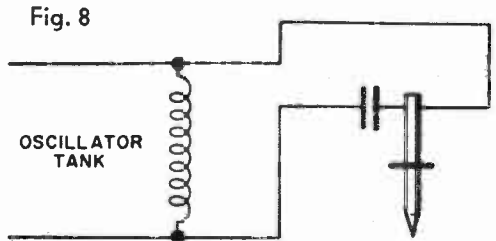


Fig. 7

In the diagram shown above, a practical version of the variable reluctance pickup is illustrated.



Weathers FM pickup is in effect a small variable capacitor, diagrammed above. Vibrations of the needle vary capacitance. This variation is applied to the oscillator to frequency-modulate it.

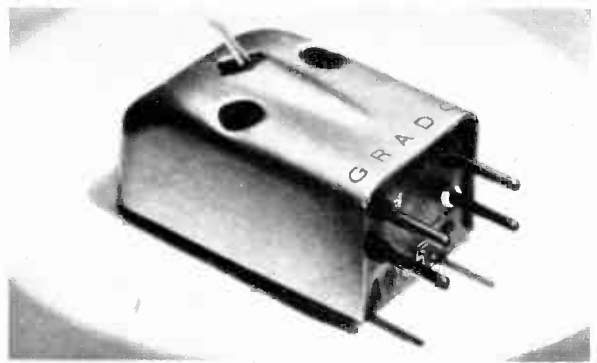
straight line touching the edge of a circle which is at right angles to the radius of the circle. It is possible, with an arm outside the circle, to adjust it so that in a few grooves at some point this condition is met. But at all other points the angle is going to be greater or lesser than a right angle. Thus an arm mounted this way cannot reproduce the tracking of the cutter.

All sorts of stratagems have been devised to reduce this tracking error to a minimum. Thus the longer the arm the smaller the error. A curved or offset arm has a smaller error than a straight arm of the same length. Actually the problem is insoluble as long as the arm pivots outside but after all these years we have learned to obtain an error small enough not to be significant. The important point to remember about this is: Always follow carefully and exactly the manufacturer's instructions for mounting an arm.

The arm should hold the needle firmly in the groove but be free to follow the spiral without exerting any pull or drag on the needle. A drag will press the needle more tightly on one side of the groove than the other and increase wear on that side; an arm that pulls, will have the same effect on the other side of the groove. This is not quite as serious in monophonic discs as it is with stereo because in a monophonic disc both sides carry the same information and wear on one side, though



Grado Master Moving Coil stereo cartridge, above, claims response from 10 to 30,000 cps. The new models have radio-active element to destaticize.



Grado Custom stereo cartridge, above, is lower priced version designed specially for changers. Both Grado cartridges now have output of 5 mv.



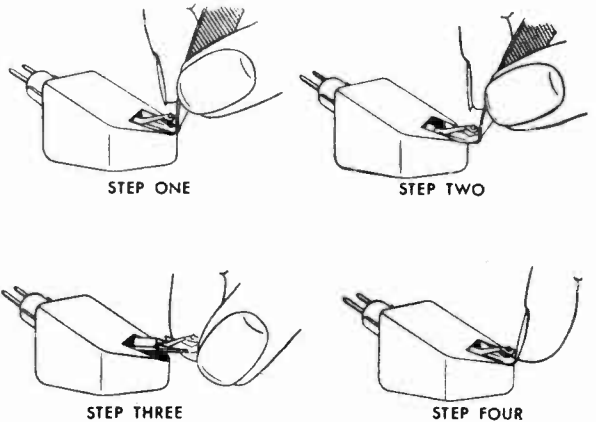
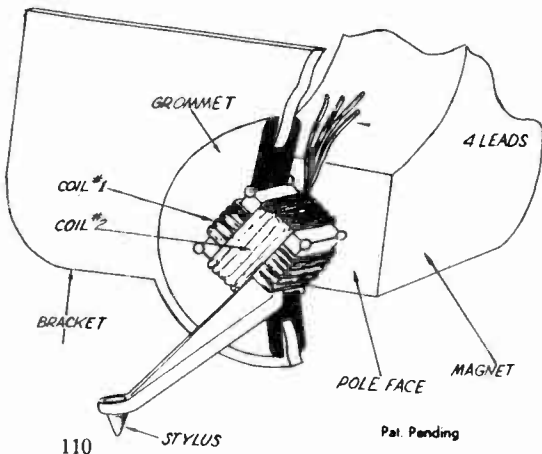
Fairchild's new cartridge SM-1 tracks at 3 gr., has response to beyond 15,000, is shown above. More expensive model 232 offers wider response.



Shure Professional Dynetic stereo cartridge can be used with any arm and most changers. Optimum pressure is 4 grams but 6 can be used if needed.

The enlarged sketch of a Grado stereo cartridge, below, indicates how two moving coil movements can be combined on a square bobbin and actuated by a single needle to get stereo reproduction.

The simple steps required for changing a Shure cartridge are drawn below. Other cartridges may require factory replacement of needle. However, at low pressure, diamond needles may last a year.



it might degrade the performance somewhat, would not reduce the information delivered too greatly. But wear on one side of a stereo groove tends to wipe out the information of one channel. Since pressure on a stereo needle is (or at least ought to be) lighter, the effect of the arm is likely to be greater. Thus, stereo places more stringent conditions on proper performance here, too.

The pivot of the arm should be very free—but not too free. If slightly too free the pickup will tend to get kicked out of the groove and will skip and skate. If very much too free the needle will move the whole arm, instead of just the needle and thus the energy imparted by the groove will be stolen by the arm. Again the lower pressure of a stereo pickup compounds this problem.

An interesting solution is provided by the viscous damped arm. In this type of arm, pioneered by Gray, the arm pivots not on a mechanical bearing but in a film of special viscous fluid. When you first see and try one of these viscous damped arms you will say that they cannot possibly work. The friction seems very high—so high that it may take several seconds for the arm to fall if raised and released.

It would seem that such an arm would force a terrible drag on the needle. Actually it doesn't, because of the nature of the viscous damping material. Although this material has high resistance to a sharp force, it has little more resistance than a free bearing to the onward pull of the spiral

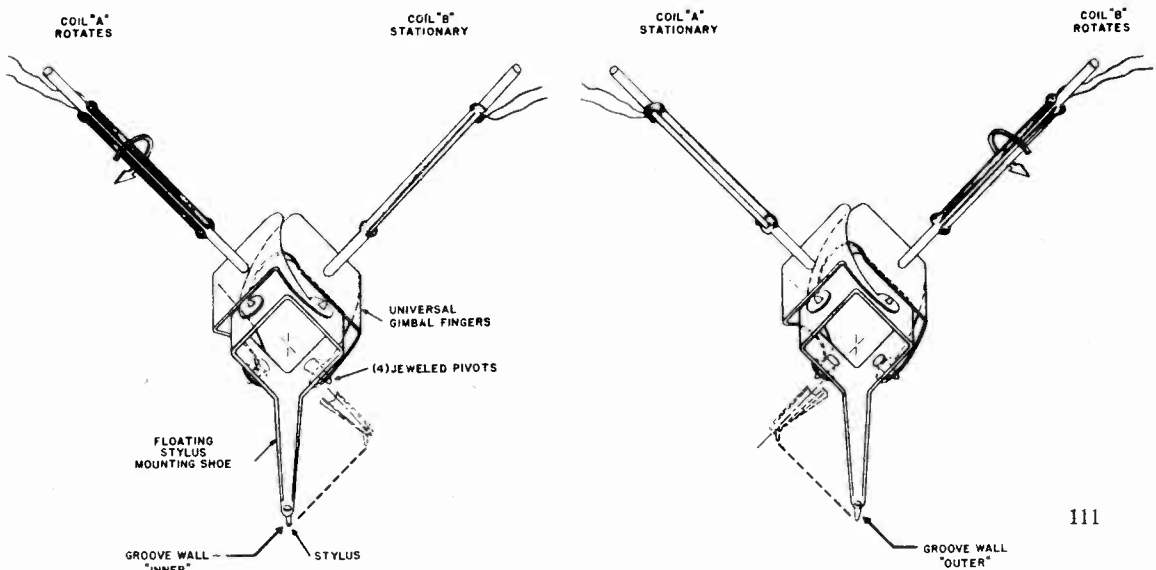
of the groove. These arms are especially valuable for tough service, as in broadcast stations, where they are handled all day long, or under circumstances where the turntable is subject to shock or vibration—as aboard a train or car, or in a room through which there is a lot of foot traffic. But they are also highly favored for home use by many.

You may ask, why don't they make an arm that is suspended over the record like the recording cutter? They have. Several of them. Unfortunately, nobody has successfully figured out how to let the pickup slide along a rod without significant drag. Actually, one or two gave pretty good results on monophonic records where pressures of 5 grams or more are tolerable. But the low pressure needed by stereo, as well as the greater damage done by drag, have compounded the problem and so far no one has come up with a solution. Undoubtedly, some day someone will.

It is highly important that the arm is mounted level so there will not be any gravitational pull on the arm. Level the turntable carefully.

Thus for stereo you need a better arm than for monophonic records. My own preference is to use the arm produced by the manufacturer of the pickup because it will be tailored to the needs of the pickup. However, there are several good, more or less universal, arms which will work very well with a lot of cartridges and have the adjustments necessary to accommodate them. Some of them come in kit form and

ESL cartridge shows one way the moving coil principle is applied to stereo. When the stylus of this cartridge is put on a record, the motion from the inner wall of the record groove rotates Coil A, while Coil B remains stationary. Motion from outer wall turns Coil A, while Coil B remains stationary.



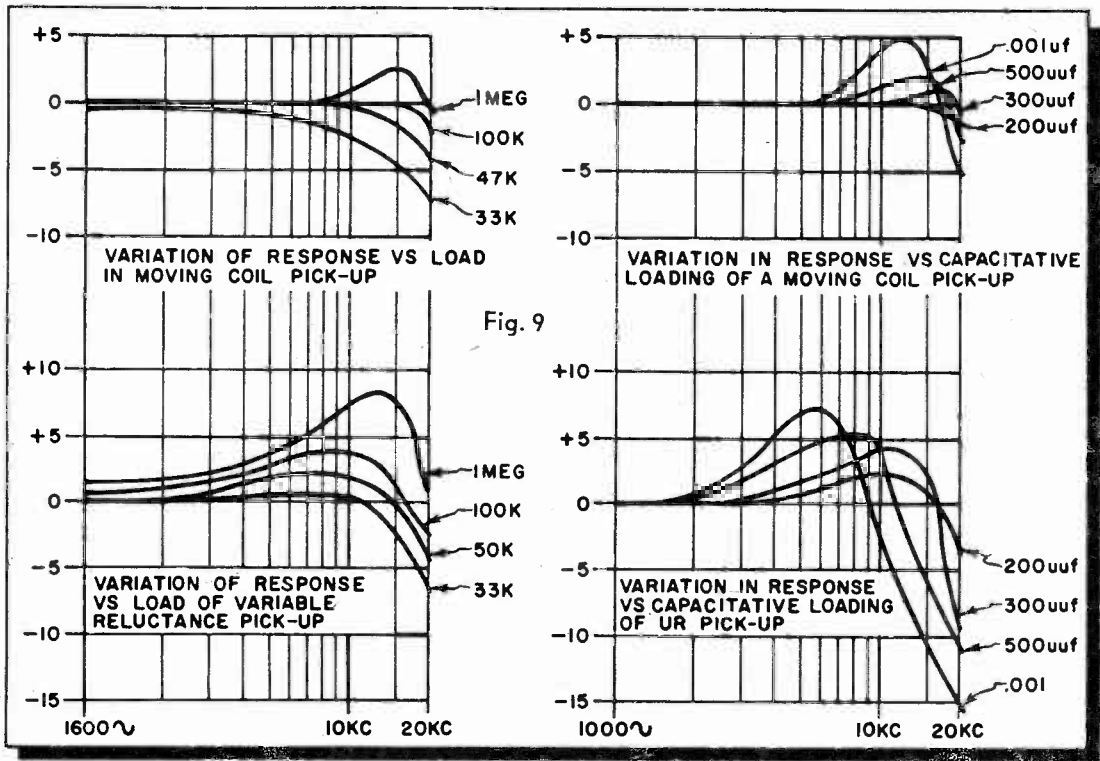


Fig. 9

Diagram (Fig. 9) illustrates the way that loading and cable capacitance can effect pickup response.

offer a saving (worth considering) in cost.

No portion of the high fidelity chain has offered as difficult problems as the phonograph pickup; and just about the time designers had arrived at satisfactory solutions of most of them and began to offer pickups that could cover the entire audio range smoothly and without distortion, stereo arrived with a new set of problems and demands and the job had to be started all over again.

There was a time and only a few years ago when the pickup presented the biggest obstacle to achieving almost perfect reproduction. Hypercritical golden ears, who were satisfied with every other portion of their systems, would buy every new pickup in the hope that they would at long last remove the final serious imperfection in their systems. And a few arrived which left very little in their performance to quibble about. The monophonic Weathers FM and the Shure Studio Dynetic, for example, are flat all through the audio range and a little beyond on both ends, track perfectly with only one gram of pressure and, properly adjusted, generate negligible

distortion. The coming of stereo with its demand that the pickup do twice the work twice as well complicated the pickup problem twice as much.

There are a number of ways of translating a small motion into an electric current but modern pickups are based on only three: the piezzo-electric, the magnetic, and the capacitive. A few crystalline substances will generate an electric current when they are bent or twisted, among them quartz, Rochelle salts, and some synthetic ceramics usually made of barium titanate. This is called the piezzo-electric effect. Fig. 5 shows how a ceramic pickup element is formed, how the electric current is produced and how the element is assembled into a monophonic pickup.

Crystal cartridges achieved practically universal use in the pre-hi-fi 30s and 40s. They were inexpensive and yielded excellent performance by the standards of those days. They are still widely employed in inexpensive record players and in lower priced hi-fi systems. There are several monophonic high fidelity ceramic cartridges with a very respectable frequency

response. But whether justly or unjustly, they never found favor with the real hi-fi aficionados.

The piezzo-electric pickup is readily adaptable to stereo and the first hi-fi stereo cartridge to reach the market in commercial quantities was the Electro-Voice crystal. Many manufacturers of crystal cartridges who had not ventured into the hi-fi field before stereo, entered the stereo market and there are on the market today many very good crystal or ceramic stereo cartridges. It must be admitted that the prejudice against them is not fully justified by their performance. Many of them approach closely the average magnetic in frequency response and distortion characteristics. Indeed, the Weathers ceramic stereo cartridge claims the most extended response (to beyond 30,000 cycles) and one of the highest compliances of any stereo cartridge made today and has won considerable favor with critical users.

Crystal or ceramic pickups have the virtue of being very sensitive, generating as much as one volt of output from a standard recording. Thus they do not need much amplification. They are often advertised as not requiring any equalization; in other words that are supposed to be able to reproduce RIAA recordings with a flat response. This is true if certain conditions are met. Unfortunately the conditions differ for different cartridges. They will come quite close to doing this job if they work into a high load—from 2 to 5 megohms. But unless an amplifier is especially designed for a crystal cartridge the load will be far short of this—usually 500,000 ohms. The lower load results in a slope in the bass end. In actuality, therefore, when crystal or ceramic cartridges are used with high fidelity equipment they do require equalization, or they are used with a network which converts their response to that of a magnetic and are then equalized by the regular magnetic equalizer in a hi-fi preamp. CBS in their new professional model includes plug-in equalizers so that the cartridge will be properly equalized without the need for any internal or external modification, a fine idea which deserves extensive copying.

Magnetic cartridges work on the principle that a coil of wire in a varying magnetic field will generate a voltage proportional to the variation in the magnetic field. There are three general types: The variable reluctance, the moving coil and the moving magnet. The difference is merely in the method of varying the magnetic field.

We looked into the operations of the

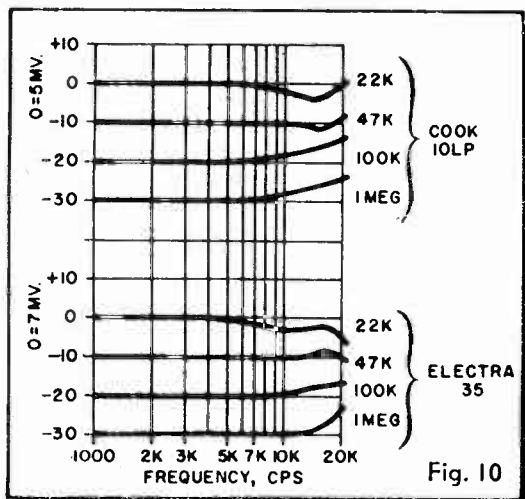
moving-coil type pickup in Chapter Three. In this type the coil is wound around the shaft to which the needle is attached and itself moves within the magnetic field. Fairchild, Grado, and ESL are examples of moving coil types.

The moving-magnet reverses this. The magnet moves within the coil thus varying the field and generating a current within the coil. This type became practical only recently when new and powerful but very light magnets were developed. The Shure, the new Fairchild, and the Knight, are examples of this interesting type.

The variable reluctance type is a little more complicated. In C of Fig. 6 let us imagine we have extended one pole of a magnet through a strip of metal bent like the strip A, and on this we wind a coil; let us further imagine we have extended the other pole with another but springy strip so that it is parallel to the end of the first strip and a gap of perhaps one eighth of an inch is formed. If we now vibrate the straight piece, the gap will be alternately narrowed and widened. This will vary the magnetic field and this in turn will generate a voltage in the coil proportional to the swing. An actual pickup is more complicated as D shows. The G-E is the best known variable reluctance cartridge but there are many others, among them the Pickering, the Stereotwin, the Dynakit B & O, and Recoton.

The Weathers FM pickup differs from all others because it does not translate the mechanical movement directly into an electrical current. Basically the Weathers is a tiny variable capacitor. The needle moves a small plate carefully spaced from another fixed plate. The vibration of the needle moves the plate back and forth, varying the distance between the plates and therefore, varying the capacitance between the two plates. The pickup is connected into a tiny radio frequency oscillator operating at a high frequency in such a way that the variation of the capacitance of the pickup frequency modulates the oscillator. The resulting FM signal is passed through a demodulator and the audio is then available for feeding into a preamplifier. The Weathers FM consists of the cartridge in a delicate wooden arm, plus a small chassis containing the oscillator, demodulator and equalizers.

All of these movements have their virtues and disadvantages. In the variable reluctance cartridge only the needle and its support has to move. These can be made quite light and thus the mass can be kept low and the compliance high. But the variation of the magnetic field is rather slight and rela-



Response (Fig. 10) of Shure Stereo Dynetic vs. load on two test discs shows how response varies with plastic materials as armature resonance shifts.

tively large coils have to be used. The inductance is thus high. There is a lot of distributed capacitance in the coil. Moreover, the shielded lead which must be used to connect the pickup to the preamplifier has considerable capacitance; so has the input of the preamp. The combination of inductance and capacitance may be high enough to produce a resonance within the audio range between 10,000 and 25,000 cycles. This places a peak in the response. The peak can be flattened out and made harmless by properly loading the pickup. On the other hand, it can be compounded by improper loading. Fig 9 shows what happens to pickups as the resistive and capacitive load is varied. It is important, therefore, especially with a VR pickup, to have the proper load and especially to keep the capacitance low by using low capacitance cable and keeping it as short as possible.

On the positive side, the VR pickup is sturdy, quite foolproof and makes possible very simple needle change.

The moving coil pickup of necessity has to use a small coil to keep the movement sensitive. The coil resonance can be kept above the audible range, and therefore it is easier to extend the response beyond 15 or 20 and it is not as sensitive to loading. But, it has a lower output. Whereas VR cartridges can deliver as much as 25 millivolts, moving coil movements have an output usually well below 10 millivolts. Therefore they need more preamplification and present bigger problems in hum and tube noise control. These movements are

also very delicate in design and construction and usually have to be sent to the factory for a change of needles.

Shure's moving magnet pickup moves only the needle and shaft. The weight or mass of these can be held down to a very low level by the use of new magnetic materials, and the compliance can be made very high. The coil is intermediate in size between that of the VR and moving coil types. In its best models Shure manages to keep the resonance above 20 Kc, but a variation from the optimum will produce either a rising or sloping high end as indicated in Fig. 10. The output is higher than that of moving coil and approaches that of VR cartridges.

The Shure is notable for the low pressures it permits. The monophonic Professional Dynetic with integrated arm will track most records with one gram of pressure. With this pressure, record wear is insignificant and the possibility of damaging a record by skating is very slight. The stereo version needs a slightly higher pressure—1½ to 2 grams.

The capacitive movement of the Weathers also permits an extremely small needle mass and very high compliance. There is no problem of coil resonance and, theoretically, the response is limited only by the ability of the needle to follow the small cuts at high frequencies. In any event, in the available models, the response goes beyond 20,000 cycles when the needle is new and on the outer grooves of the record. In early models the Weathers suffered from instability of the oscillator. It would drift and eventually drift out of the straight portion of the demodulator curve with a consequent sharp increase in distortion. For some years now, however, this problem has been licked and when properly adjusted these pickups approach the ideal.

All pickups suffer to some degree from another type of resonance: armature, or needle-to-groove resonance. The structure holding the needle, whether it is a cantilever or a pivoted rod, has a resonance. The movement of the coil can be magnified by the use of the lever or cantilever principle. Unfortunately, the longer the lever or cantilever is made to achieve this, the lower its resonant frequency. Thus there is a point where the leverage has to be stopped to keep the armature resonance above audibility. This resonant tendency has to be discouraged and in practically all pickups the movement is damped by some material that absorbs the resonance. Various materials are used either solid or with some viscosity. In some cases these

materials can be damaged or removed by too violent cleaning of the needle or by a rupture caused by a sudden blow or hard use. Extreme care should be used with all pickups to avoid such a possibility. The needle needs frequent cleaning to remove the accumulation of lint and dust. But this should be done with a very soft brush and gently. Always read the instructions carefully in this regard. The London-Scott, for example, specifies that the brushing should be done from the back forward and not sideways.

The resonance of the armature is compounded by the grooves of the record. The plastics of which records are made are soft and elastic. The thin walls between grooves will combine with the armature of the pickup—like the inductance and capacitance of a tuned circuit—to form a resonant peak. This varies with the material the record is made of. The old shellacs were very stiff and this type of resonance did not occur below 15 or 20 Kc. But the micro-groove plastics are much softer and the resonant peak is usually below 20,000 cycles.

Because of this effect the plotted response curves of pickups are actually curves of the pickups and the particular recording. Thus a pickup that is flat on a record where the groove resonance falls above 20,000 cycles, might have a peak of some size between 10 and 20 Kc on a more average recording; and one that had a slope might well be flat on an average recording. Furthermore, the plastics differ and thus all pickups are flatter on records of some makes than on others. This is indicated, for example, in Fig. 10 which gives the response of one pickup on two different test records. This type of resonance can be compounded by the coil resonance and if both happen to fall in the same range, a terrific resonant peak can develop. Of course, pickup designers take these factors into consideration and licking the problem of these resonances is what earns them their salaries.

The demands of stereo compound all of these problems. To begin with, the needle has to move two movements instead of one and consequently the needle mass is increased. Thus it is very difficult to equal the compliance possible on monophonic records.

Furthermore, in a stereo pickup the compliance ought to be equally good in both directions. In monophonic pickups it is possible to achieve high lateral compliance at the expense of vertical compliance. This is a cheap price to pay because vertical compliance needs to be only good

enough to keep wear from being too great. You can't pay that price in stereo.

Stereo records are cut with a lower amplitude and thus the output of pickups is lower. This increases problems of hum, noise and scratch. The needle radius of a stereo needle is between .5 and .7 mils as against the one mil of the average monophonic needle. But the stress on the record increases by the square of the decrease in needle radius. Thus pressure has to be reduced if record wear is to be held down to that experienced with monophonic cartridges. Finally, the armature and needle-to-groove resonance problems are compounded because the greater mass of the armature lowers the resonant frequency.

Nobody has had a tougher problem accommodating to stereo than the pickup manufacturers. The first stereo pickups were pretty crude as compared with their highly developed monophonic counterparts. But progress has been rapid. It is doubtful that any stereo cartridge is quite as good as the best monophonic pickups, but the 1960 models of magnetics indicate that the gap is closing rapidly. Thus, the Shure Stereo Studio Dynetic integrated arm and pickup has a response curve which is just about as good as the monophonic version and differs mostly in needing 1½ grams of needle pressure; the Grado Master stereo cartridge is possibly better than its monophonic predecessors; indeed there is striking improvement in all the high quality pickups. These improvements will undoubtedly continue but, as things stand today, only those who are determined to travel the very last inch of the road to perfection will hold their breaths awaiting those perfect models.

Stereo cartridges can be used to play back monophonic records. Some stereo pickups will do a better job of this than many highly developed monophonic pickups. But there are a few problems. We have noted repeatedly that stereo discs are cut at a lower level than monophonic discs. Thus stereo pickups can be adjusted to a lower pressure to play stereo discs. Unfortunately, this lower pressure will not, in most cases, give optimum performance on the more heavily cut monophonic discs. So there is a Hobson's choice. The pickup can be adjusted for optimum performance of stereo or monophonic discs but not both. If adjusted for the low pressure suitable for stereo discs, they will distort on some monophonic peaks; if adjusted for the higher pressure to give undistorted reproduction of monophonic discs, the wear on stereo discs will be higher than necessary.

This will be no problem for those who will concentrate on stereo discs—and that will include most people. But it does pose a problem for those who have large libraries of monophonic discs and want to keep them. It is possible to readjust pressure for the type of record. Highly critical audiophiles use a monophonic pickup for monophonic records and a stereo pickup for stereo. In this way they also avoid the pinch-effect distortion on monophonic discs. The Shure Studio Dynetic permits changing plug-in heads in a few seconds for optimum performance of both.

The most important quality of pickup is the compliance. This is rated by the displacement in centimeters per dyne of force and the figure looks like this 3.0×10^{-6} centimeters per dyne. In today's pickup the first figure is the important one and the higher it is the greater the compliance. The highest claimed compliance is that of the Weathers FM with $20. \times 16^{-6}$. In magnetics it is the Shure Studio Dynetic with 9.0×10^{-6} . The compliance of other hi-fi stereo pickups ranges down to 2.5×10^{-6} . Because the compliance reflects so many aspects of the design it is a good, but not necessarily absolute, measure of overall merit.

The needle tip radius of stereo cartridges will run between .5 and .7 mils. The smaller radius will trace the very high frequencies better, but it will require a lighter pressure to hold wear down to a comparable level.

Needle pressure is not a factor of the cartridge alone but is related to the arm also. Thus manufacturers usually give a minimum pressure possible with the best arms, and a range of permissible upward pressures. The Shure arm and pick-up combination permits the lowest pressure—1.5 to 2.5 grams. The Dynaco B & O will track stereo records perfectly with 2 grams in the Grado arm, to my personal knowledge, and I understand in other arms, too. Most other stereo pickups operate with 3 to 4 grams.

Changers require higher pressures than turntables—with the exception of the United changer which permits pressures between 1.5 and 2 grams, with pickups that work satisfactorily with this low pressure.

The optimum pressure for any combination of arm and cartridge is the lightest pressure that yields undistorted sound on most records. This will usually be a little higher than the minimum pressure recommended by the manufacturer. A low pres-

sure that produces distortion will actually cause greater record wear than a higher pressure that keeps distortion to a minimum.

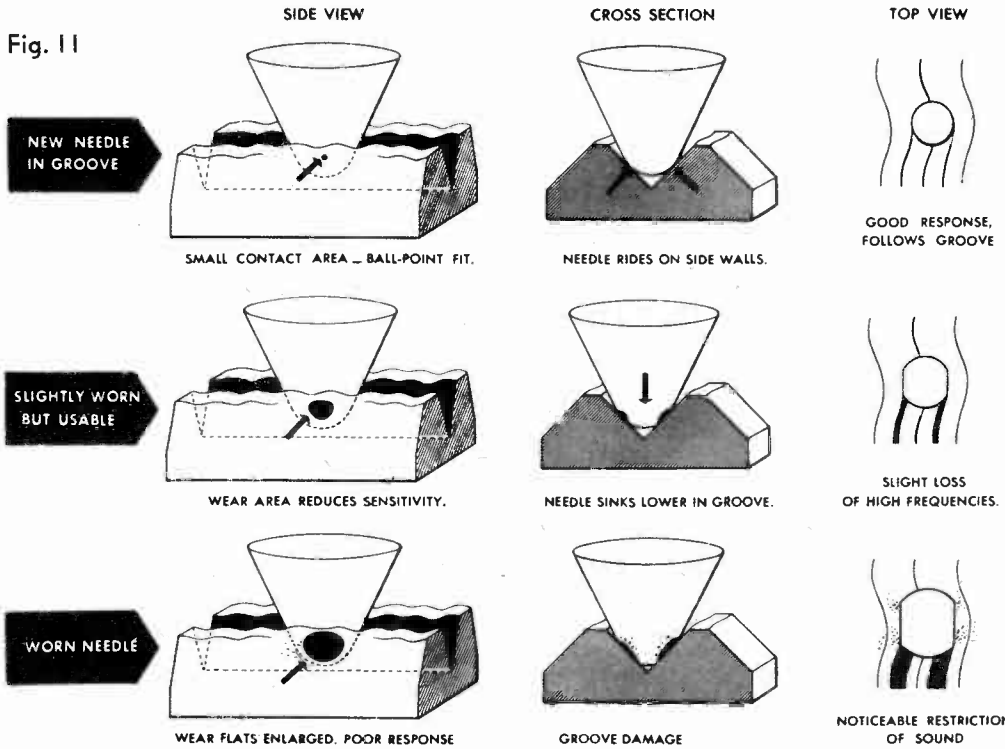
Output is given in millivolts for a standard reference recorded amplitude. In stereo cartridges it will run from 2 mv up. Most stereo preamplifiers will handle cartridges with outputs as low as 2 mv without transformers, but tube noise and hum may be a problem.

Frequency response is given as 20 to 20,000 cps \pm 2.5 db or some similar figure. I have noted that this will depend on the type of record used and unfortunately not all manufacturers use the same record—on the contrary, each uses the one that gives the best picture of his pickup. Frequency response is, of course, very important but not determining as a measure of merit. For first class stereo the response ought to be reasonably flat at least to 15,000 cycles and without peaks greater than 2 or 3 db. Perfectionists will want response to 20,000 cps and such an addition will improve the transient response; but the difference between a 15,000 and a 20,000 cps pickup will not be noticeable to most ears, assuming other qualities are similar.

Channel separation is highly important. It should be at least 20 db at 1000 cps and preferably more. The Dynaco B & O has the highest separation (in excess of 30 db) of any pickup I have used and tested. Good separation not only maintains a good stereo effect but also improves definition.

Most high quality magnetic cartridges come only with diamond needles. Lower priced magnetics and most crystal ones come with a choice of sapphire or diamond. The diamond is more costly. There is no difference in performance between a diamond and a sapphire, assuming that all other things are equal. The only significant difference is that a diamond wears less and therefore will yield good performance for a longer time. With use "flats" are worn on the sides of the needle. This has two effects: first, the flat, in effect, increases the radius of the needle at the very high frequencies—it no longer follows the very small undulations closely, but skips over them. The response above 8000 cycles falls off, particularly on the innermost grooves where the wiggles are narrowest. This effect is indicated in Fig. 11. Secondly, the flats produce sharp edges and these begin to cut the wiggles and damage them. Since diamonds are harder, it takes much longer to produce flats and thus they give good performance longer.

Fig. 11



Courtesy The Tetrad Co.

Drawings (Fig. 11) illustrate how needle wear can cause poor response as well as damage to records.

This does not mean that all diamonds are better than any sapphire. The small .5 to .7 mil radius needles needed for stereo are especially hard to cut and polish smoothly. Cheap diamond needles may actually be rougher than good sapphires. When the needle pressure is reduced to 2 grams or lower, wear is far less significant as a factor. There are some critical users who actually prefer a sapphire at these low pressures simply because they can obtain very smooth sapphires more easily. On the other hand, at such low pressures the wear on diamonds can be insignificant and a diamond needle if good to begin with may last for years. Manufacturers of high quality pickups generally inspect their needles carefully and you can be pretty sure you will get a good diamond. When replacing, it is always best to get the replacement needle from the manufacturer of pickup.

There is only one safe way to check a needle for wear and that is to take it every few months, if you play a lot of records, or twice a year in any case, to a dealer who has a good microscope and knows how to use it. This is quite a trick, requiring special lights and knowledge of what to look

for, since in the very small needles flats are evidenced not so much by the direct appearance of the needle as by the way they reflect light.

The recommended load for a pickup is important. Most preamps provide a load of 50,000 ohms. Pickups that require this load can be plugged in directly with no fear of a change in performance. But a pickup that requires a substantially lower or higher load may perform poorly with this standard load, as we have indicated before and illustrated in the curves of Fig. 10. It is not difficult to lower the load by wiring in very small resistors across the output of the pickup. This will parallel the load in the preamp and reduce it. The formula is that the net load will be

$$\frac{1}{\frac{1}{R1} + \frac{1}{R2}}$$

Thus, for a 25,000 load, add a 50,000 ohm resistor or resistors.

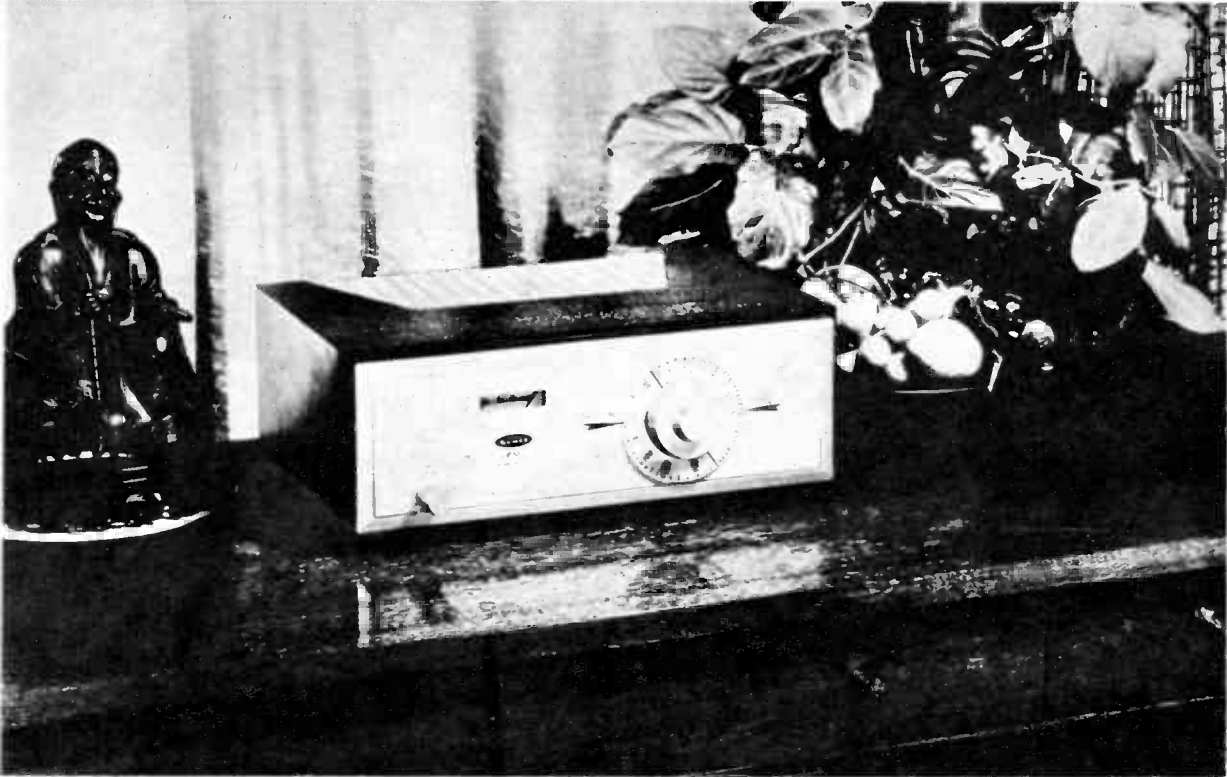
The manufacturer of the pickup usually gives proper values of load and adjustment of load in his instruction sheet for the pickup. •

CHAPTER

7

Tuners for Stereo

Greater than ever is the choice
you have of size, style and price range.



A simply styled tuner, like the Scott shown here, will blend in beautifully with any type of decor.

IN MANY AREAS of the country, where there are several FM stations broadcasting high-fidelity programs full time and stereo programs for part of their schedule, the tuner provides the most economical source of program material. In the New York and Washington areas, for example, a dozen or more FM stations can be received with high-fidelity quality, and several stations broadcast stereo programs in either simulcasts or multiplex FM broadcasts. A tuner also, of course, puts all monophonic radio programs at the disposal of the high fidelity listener and in superior quality to that available in ordinary radio.

The tuner is a more highly refined and

high performance radio receiver. It differs from the household radio principally in that it has no audio amplifiers or self-contained speakers, but instead feeds the audio into the high-fidelity system. Tuners can be divided into three general groups, namely: 1. Individual tuners that cover the standard AM broadcast band or the FM broadcast band, but not both; 2. Combined AM-FM tuners that permit reception of both AM and FM stations, one at a time, but not simultaneously; 3. Stereo AM-FM tuners that permit reception of both AM and FM stations, either individually, or simultaneously for simulcast reception.

All of these types may be used for certain



A tuner need not be expensive to be good. Above, the modestly priced Heathkit FM-4 is a fine buy.



The Heathkit model C-1 is another example of an inexpensive tuner that offers excellent service.

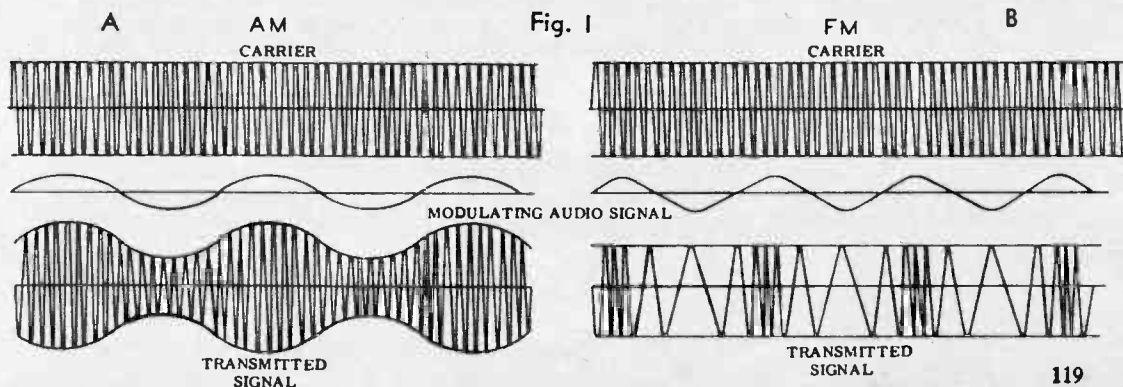
types of stereo reception. An FM tuner, for example, can be used for reception of FM multiplex stereo if equipped with a multiplex adapter. There is no type of multiplexing at present on the broadcast band, but if any is authorized the AM tuner presumably will be usable for receiving such broadcasts with the addition of an adapter. Separate AM and FM tuners can be used together to receive AM-FM simulcasts.

The combined AM-FM tuner that permits reception of either but not both simultaneously can be used with adapters for AM or FM multiplexing, but not for simulcasts. The stereo tuner has two entirely independent tuners on a single chassis and permits every type of stereo reception. Obviously this last type is the most versatile from a stereo point of view and probably represents the best investment for those who are starting completely from scratch. It provides facilities for receiving every type of present monophonic and stereo broadcasts and will be adapt-

able for just about any type of future stereo broadcasts.

The combined tuner is the poorest buy from a stereo point of view, because it does not permit reception of the most widely available type of present stereo broadcasts—the simulcasts. On the other hand, that does not mean necessarily that those who already have such tuners should dispose of them or replace them. For one thing, if you live in an area where simulcasts are not available there is clearly no point to investing in equipment that permits simulcast reception. If you live in the fringe area of stations broadcasting simulcasts, it is probable that simulcast reception will not be satisfactory anyhow. Either the FM station or the AM station—usually the AM station—will come in too poorly to provide good stereo reception. In that event the investment in equipment to permit simulcasts would not be justified. Furthermore, simulcasts are a temporary expedient. Assuming that any stereo broadcasting

In amplitude modulation (AM) the amplitude of a constant frequency RF signal (carrier) is varied (modulated) in accordance with the intelligence being transmitted. For frequency modulation (FM) the carrier amplitude is held constant and the instantaneous carrier frequency is varied above and below the unmodulated carrier frequency at a rate determined by the intelligence being transmitted.



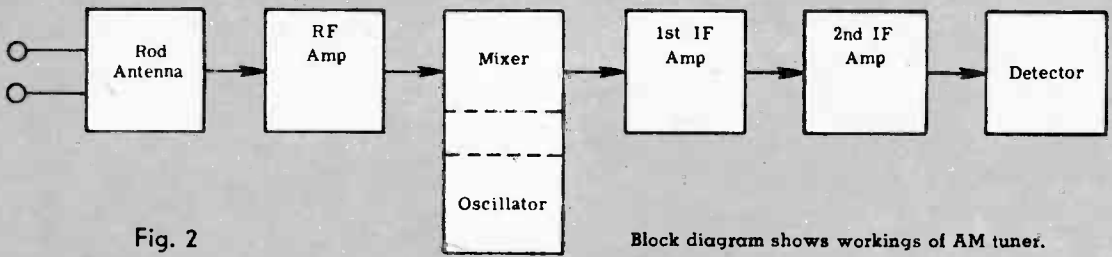
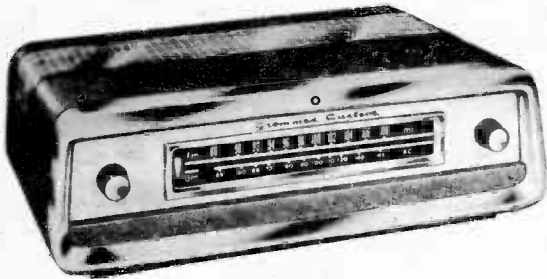
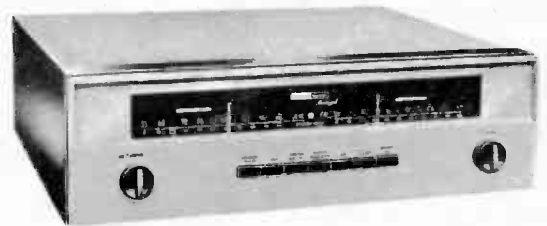


Fig. 2

Block diagram shows workings of AM tuner.



The Grommes "combined" AM-FM tuner, shown above, provides fine reception on either AM or FM.



Harman-Kardon's AM-FM tuner Model ST360 permits the reception of all types of stereo broadcasts.

system is authorized by the FCC, it will undoubtedly be some form of multiplexing which the combined AM-FM tuner will be able to receive with the addition of adapters. Thus, the chances are that in a few years simulcasts will be obsolete. So, unless good simulcasts are available in your area right now, there is little point in replacing your present combined tuner.

On the other hand, if simulcasts are available you can consider two alternatives, depending on the quality of the present equipment. If the performance of the present tuner is really good on either the AM or FM band, the simplest and cheapest solution is just to add an individual AM or FM tuner. Which tuner to choose would depend on the quality of reception yielded by the present tuner. If the FM reception is really good, with good noise suppression and low distortion, the addition of an AM tuner would be the cheapest way out. On the other hand, if the FM tuner leaves something to be desired in its performance, it would be wiser to get another FM only tuner. The FM band will undoubtedly be more important for stereo and permits better fidelity. Hence it is more worthwhile to invest in good FM equipment.

Practically all tuners whether AM or FM use the superheterodyne circuit which is also used in most radios and TVs. This circuit provides the best combination of sensitivity, selectivity, and interference re-

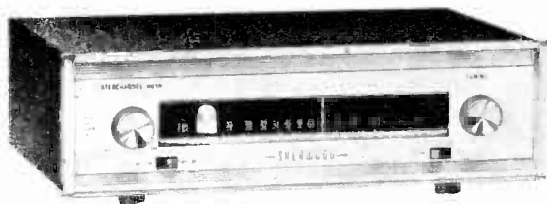
jection. AM and FM tuners differ only in some details. For one, they operate in different portions of the radio spectrum—the AM at the relatively low frequencies between 540 and 1600 kilocycles, and the FM at the relatively high frequencies between 88 and 108 megacycles. For another, the type of modulation is very different and hence different methods of demodulating or detection are needed. In AM transmissions the audio signal varies the amplitude of the carrier, as in A of Fig. 1. In FM, the audio varies the frequency of the carrier, as in B. The louder the audio frequency the wider the swing.

The big advantage of FM modulation is that it provides a way of minimizing static and other noises picked up during the transmission of the signal. Both atmospheric and man-made interference modulates a radio signal in *amplitude*. In AM transmissions it is not possible to get rid of this static without also affecting the audio program material, because both modulate the carrier in amplitude and so far no one has discovered any way to separate the two and suppress only the noise component.

In FM, however, the desired program *frequency* modulates the carrier and the noise *amplitude* modulates it. Thus the two are separate and distinct. We can now deal with the noise in two ways. First we can chop off the amplitude of the signal with a limiter. This also chops off the amplitude



Sherwood tuners have won an enviable reputation for having high sensitivity and low distortion.



The Sherwood Model S-3000 II, above, is FM only. S-2200, above left, is AM-FM stereo combination.



Fisher tuners are widely used in fringe areas. The FM-100, FM only, is among the most sensitive.



The Fisher stereo AM-FM tuner 101-R can also be bought with walnut, mahogany or blonde cabinet.

of the carrier but has no effect on the audio modulation, as indicated in Fig. 4. Secondly, we use a detector which responds to frequency variation but not to amplitude variation; the remaining noise is thus eliminated in the detection process and only the desired program modulation comes out. The process of limiting results in a weaker signal being delivered to the detector than is the case in AM. But this is easily corrected by using additional amplification.

The amount of noise suppression depends on the amount of limiting. The stronger the signal the greater the limiting. Complete noise suppression occurs only on signals strong enough to saturate the limiters—or provide the maximum possible limiting. Weak signals will not saturate the limiters completely and therefore will not have as much suppression of noise. The limiting also provides a form of automatic volume control. Once the limiters are saturated the signal delivered to the detector is of constant amplitude. So, the limiters also take care of fading signals.

It follows from this that the sensitivity of the FM tuner is very important. In the primary area of an FM station where the field strength of the signals is high, it is not necessary to have a very sensitive receiver since most signals will saturate the limiters. But in the outer or fringe areas, where the signal is weak, it is essential that the tuner

be very sensitive so that it will provide the fullest possible noise suppression on weak signals. The sensitivity of FM tuners is rated in terms of the lowest signal that will provide satisfactory reception.

For complete noise suppression, the noise ought to be at least 40 db below the desired signal. However, it is possible to have a minimal enjoyment when the noise is only 20 db or 30 db down. Thus, until recently, it was customary to rate FM tuners in terms of the input signal in microvolts needed to provide 20 db or 30 db suppression of noise. Recently, however, a new standard has been established called the IHFM (Institute of High Fidelity Mfgs.) standard. This rates "usable" sensitivity in terms of the minimum signal that will provide reception with not more than 3% of noise and distortion. This new standard is more stringent and takes into account not only the noise suppression ability but also the distortion characteristics of the tuner. Thus, the IHFM standard is much rougher than the old informal standards. A tuner that would provide 20 db limiting on a signal of 1.5 microvolts might well require an input of 3 or more microvolts to satisfy the IHFM standard.

A large factor in determining the noise figure of any tuner, whether AM or FM, is the noise generated by the tuner itself in the very first tube of the chain. All tubes generate a certain amount of noise. Ob-

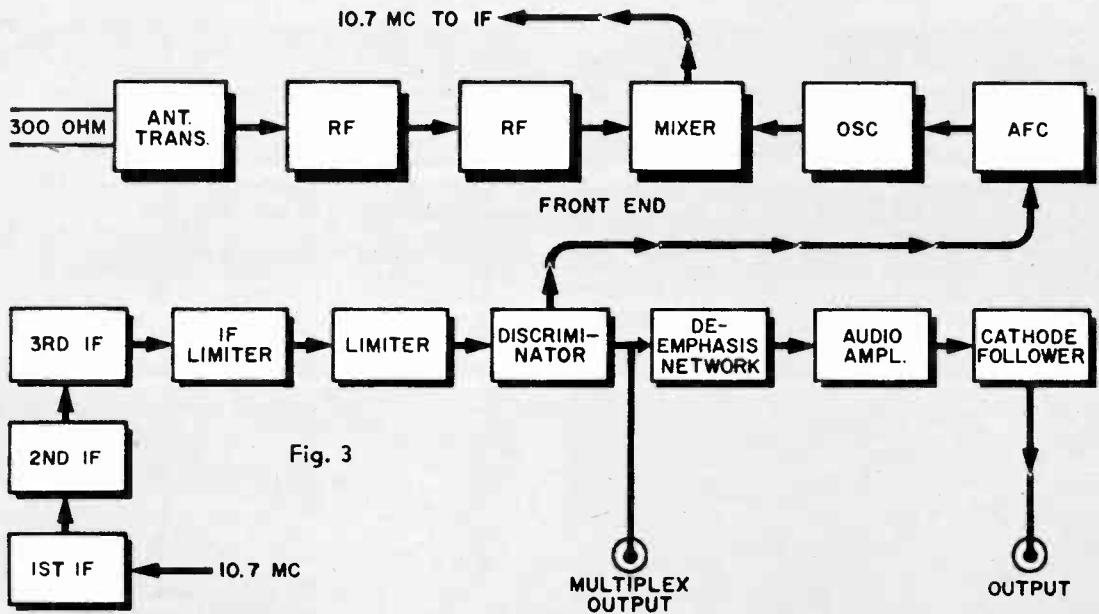
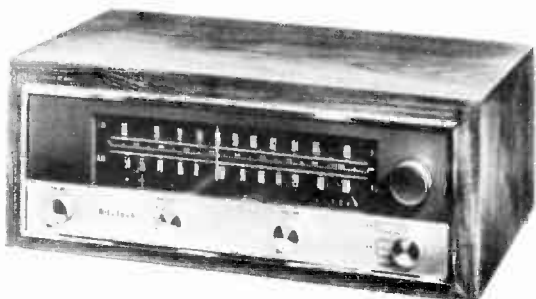


Fig. 3

The block diagram above illustrates, in step-by-step detail, the workings of a deluxe model FM tuner.



The long-awaited McIntosh tuner, above, has top craftsmanship and exceptional sensitivity, capture ratio, low distortion and very high stability.

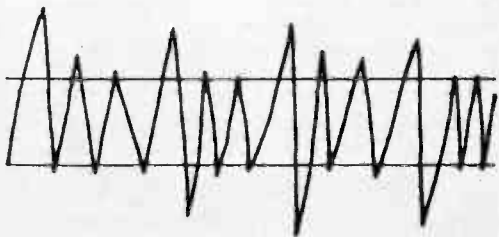


Fig. 4

When limiters clip the amplitude along the lines indicated above, most noise is also clipped out.

viously, a signal so weak that it approaches or is below the tube noise is behind the eight ball to begin with. Therefore, to obtain highest sensitivity it is necessary to use a "low-noise" input stage. In the case of AM tuners operating on the broadcast band, the noise figure is not quite so important, and the ordinary pentode usually has a good enough noise figure. But for FM the pentode is not so good and several special types of low-noise RF stages have been designed for use in FM (and TV) tuners especially the grounded grid triode and the cascode.

The noise figure of a grounded-grid stage is excellent, but the gain is low. Thus the noise added by following stages can be a significant factor. A better arrangement is one called the *cascode*. This is actually a two-stage amplifier in which the two stages are in series. The result is an amplifier with the noise figure of a triode but the gain of a pentode. The signal at the output is now so high that the noise added by subsequent stages is less of a factor than in the case of a simple grounded-grid stage. Therefore, many of the most sensitive FM tuners use the cascode type RF stage; tuners of medium sensitivity are more likely to use the grounded-grid RF stage while tuners of low sensitivity are most likely to use a plain pentode. FM tuner sensitivity runs from a little under 1 micro-

ALIGNED RECEIVER

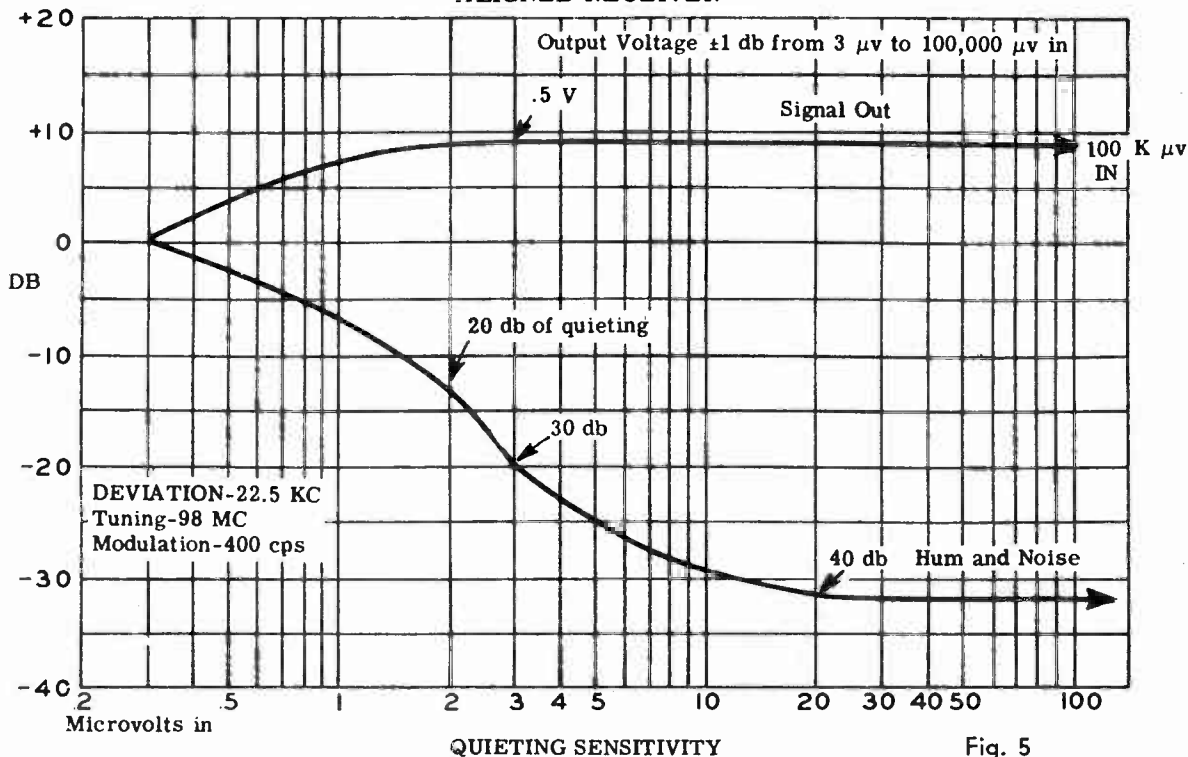


Fig. 5

The diagram above illustrates that the stronger the signal the greater the limiting and the noise suppression; 40 db gives noiseless operation. Tuner sensitivity is rated at 20 or 30 db quieting.



Pilot tuners, 3 of which are shown here, have a well deserved reputation for ease of tuning.

The Pilot model 580, pictured above left, is a stereo AM-FM tuner. The 660, above, is FM only.

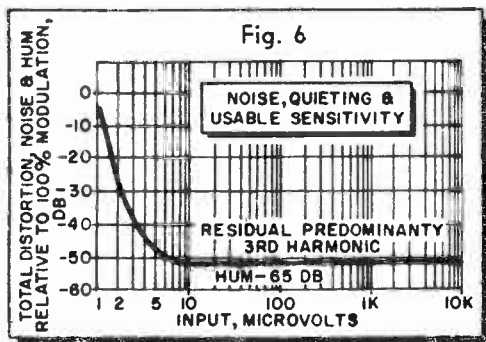
volt all the way up to 25 or even 50 microvolts.

Sensitive AM tuners usually have an RF stage using a pentode. Medium or low sensitivity tuners do not have an RF stage. Sensitivity of AM tuners is rated in terms of the input signal that will produce a signal to noise ratio of about 10 db and ranges from 1 microvolt up.

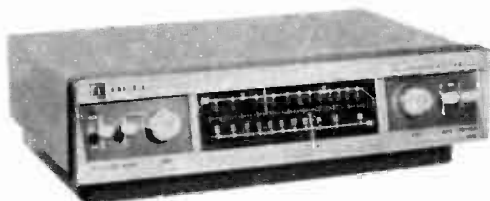
In both AM and FM tuners the RF stage is followed by the converter stage which consists of a converter and a companion radio frequency oscillator. In AM tuners this is almost always achieved with a single tube which combines two tubes in one envelope.



The Pilot tuner shown above is the model 680, a really fine deluxe stereo AM and FM instrument.



The new Institute of High Fidelity Manufacturers standard now rates usable sensitivity at input where the distortion and noise together are 30 db down. This is a tougher standard than their previous one. The tuner above would be rated at about 2.2 uv—near the top of the rating scale.



Bell-Carillon tuner has silver-plated shielding for high sensitivity and a minimum of interference.



Scott tuners were first to use wide band detectors for low distortion and high capture ratio.



The new line of Scott tuners included two units that are FM only, like one in center of column.

In FM tuners the converter and oscillator tubes are most often separate. Triode converters are very popular because they have a low noise figure. The combination of the cascode RF stage and a triode converter provide the best noise figure. The combination of a grounded-grid RF stage and triode converter is another favorite with only a slightly inferior noise figure. The combination of a cascode and a pentode converter also produces a good noise figure.

In FM tuners where the local oscillator operates at frequencies between 80 and 120 mc, stability is a real problem. Even a small change in temperature or operating voltages can produce a big change in frequency. If this were not corrected, the tuner would have to be retuned constantly. Stability can be improved by temperature compensation and in some cases the variation can be made so small in this way that there is no problem at all. The Eico FM tuner is a case in point, with a total drift of less than 20 Kc, and most of that in the first few minutes, this inexpensive kit type tuner is one of the best in drift characteristics on the market.

The most common solution is to use automatic frequency control—a circuit that corrects the drift and maintains a more or less constant frequency.

There is a price to pay for AFC. With AFC in the circuit tuning is broad and the tendency is for weak stations that are adjacent to strong stations to be suppressed completely. For this reason almost all tuners with AFC have a switch to disable the AFC when it is desired to tune in weak stations, or to tune in strong stations exactly.

Early FM tuners, even those with AFC, were very unstable and had to be retuned frequently to insure distortionless reception. Current tuners, whether they have AFC or not, are quite stable and provide freedom from retuning after the first half hour of warm up.

A unique solution to the drift problem is provided by the Karg tuners which use

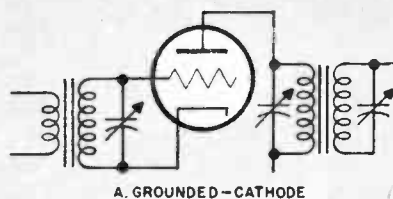


Also in the new Scott line are two stereo tuners with very high sensitivity, above and at right.

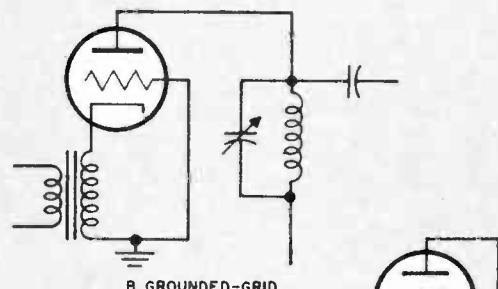
quartz crystals to control the oscillator and achieve rock-stable stability. They are tuned simply by a switch which chooses different crystals for the desired stations. However, this permits the reception of only a limited number of stations and requires different crystals for different areas.

Stability is not a problem in AM tuners because of the much lower frequencies at which they operate. A moderate amount of simple temperature compensation will provide nearly perfect stability and most tuners do not have even this. Instead of AFC broadcast band tuners have AVC (automatic volume control) so that the loudness of the station does not increase or decrease with fading of transmissions.

The converter in both AM and FM tuners is followed by the intermediate frequency or IF amplifier which contributes most of the amplification. In AM tuners one stage is average, though a few of the deluxe tuners have two stages. The bandwidth of the IF amplifier is very important. On the broadcast band, stations are separated by 10 Kc although in any given area the stations are separated by far more than this. In any event, this separation limits the possible fidelity of AM transmission and reception. If two stations are 10 Kc apart, the sidebands of both will occur in the 10 Kc between their station frequencies. This will result in interference in the form of "jingle bells and monkey-chatter". If the

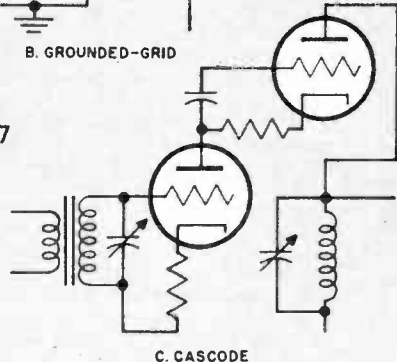


A. GROUNDED-CATHODE

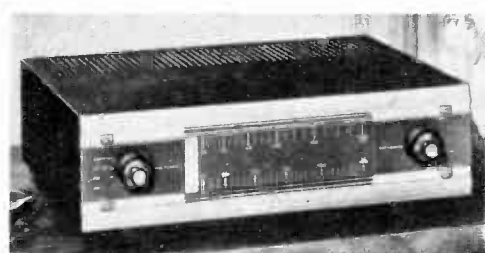


B. GROUNDED-GRID

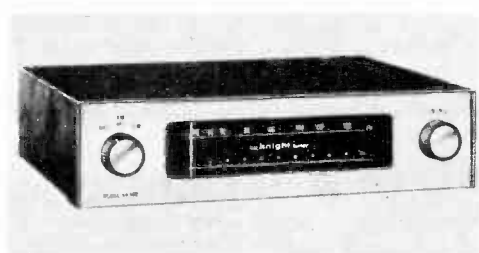
Fig. 7



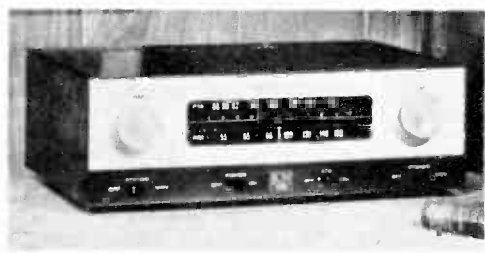
C. CASCODE



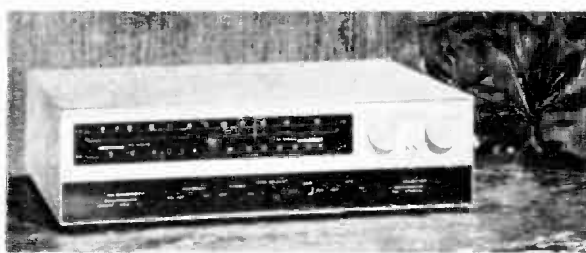
Allied Radio's Knight line includes the kit type stereo tuner above. At \$87.50, it has DSR feature.



The Knight Model KN-140, shown in photo above, is an FM only tuner, which is priced at \$44.50.



Above is the Knight KN-135 stereo tuner, priced at \$79.50 and rated for FM sensitivity at 4 uv.



The deluxe Knight Model KN-125 is a stereo tuner with Dynamic Sideband Regulation. \$139.95.

POINTS THAT OUGHT TO BE CONSIDERED WHEN BUYING A TUNER

● **SENSITIVITY**—Strictly from the quality of signal it delivers, the more sensitive the FM tuner the better even for local reception. High sensitivity assures full limiting on all signals and therefore the best noise suppression. This assumes that the tuner operates perfectly. However, the more sensitive the tuner the more delicately all the factors in its design and construction have to be balanced to produce stable as well as high performance. Therefore, the most sensitive tuners are also the most expensive. They also need a little more care in operation to insure the high quality they are designed to give and maintained more carefully to preserve the performance. In these respects they are like a highly tuned version of a sports car.

If the receiving location is within 20 or 25 miles of the most-listened-to stations, a sensitivity of about 5 microvolts will be all right. Tuners with 5 mv sensitivity are moderately priced. As one moves farther away from the FM stations high sensitivity becomes more and more important; and beyond 50 miles you won't have too much sensitivity.

Sensitivity is not so important in AM tuners. In fact, for high-fidelity reception the less sensitive tuner is the more desirable one simply because it will not pull in so many distant stations on adjacent channels to cause interference.

● **DISTORTION**—In tuners as in every other high-fidelity component, this is a primary consideration. Low distortion is all the more needed in hi-fi tuners because the signals transmitted by most stations, whether AM or FM already have at least 1% distortion as transmitted or, rather, will generate at least that much distortion in most tuners. This is pretty large by our high-fidelity standards and most tuners cannot reduce it. There is one exception. The Knight 120 tuner has a unique circuit called Dynamic Sideband Regulation which is capable of reducing the distortion—or rather the capacity for generating distortion—of a transmitted FM signal. Tuners with wide-band IF amplifiers and wide-band detectors will also generate less distortion with a given signal. It is highly desirable that the distortion be held down to 1% or less on a 100% modulated signal and the newer tuners are achieving and surpassing that figure.

● **NOISE SUPPRESSION**—Noise must be 40 db or more down to be insignificant and more than 60 db down to be inaudible. The usable sensitivity given by the IHFM standard would give us a signal of marginal quality. It will be tolerable but not really of high-fidelity quality because 3% noise and distortion will be quite audible. Even though this gives us a good figure of merit, it does not mean that good hi-fi reception will be possible on such weak signals. For high fidelity the input signal needed to provide complete or full quieting is the more significant measure of performance.

● **FREQUENCY RESPONSE**—Should be 20 to 20,000 cycles in FM tuners. AM tuners are another story. For the best possible fidelity on local stations the AM tuner ought to have a reasonably flat response to 7500 cycles, or higher in the broad selectivity setting, and to 4500 or so in the narrow.

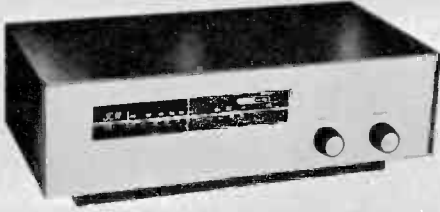
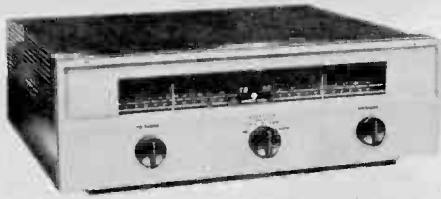
● **CAPTURE RATIO**—One of the peculiarities and virtues of FM is that if there are two signals on the same channel, the stronger of the two will take over and suppress completely the weaker one. In other words, the stronger station captures the tuner. The ability to suppress the weaker station varies with the tuner. The best tuners in this respect will suppress a weaker station if it is as little as 3 db (about 20%) weaker than the stronger one; but the average tuner will not give complete suppression unless the weaker station is somewhere between 50% and 25% of the stronger. Capture ratio is not very important in local areas. But it can be a big thing in remote fringe areas where stations can be received from several cities. With the help of a good rotatable antenna a tuner with a good capture ratio will permit the reception of two or more stations on the same channel, and thus might well give a better choice of programs.

● **SELECTIVITY**—The ability to separate stations on adjacent channels. For reception of AM stations at a distance, the selectivity should be sufficient to reject a station 10 Kc away. On the other hand, for highest fidelity of local reception, the selectivity should not be as great. Selectivity is specified in terms of bandwidth at 6 db down. A 10 Kc bandwidth at 6 db down gives sharp selectivity; a bandwidth of 15 Kc or more gives broad selectivity. Selectivity is a problem in FM only in the fringe area where stations from different areas can be received. Even the wide-band tuners with IF bandwidths of 200 Kc or more, however, will be good enough, especially since the capture ratio is usually better in wide-bandwidth tuners.

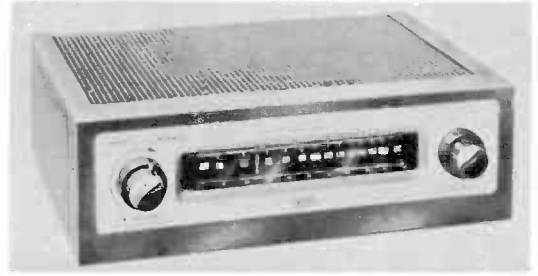
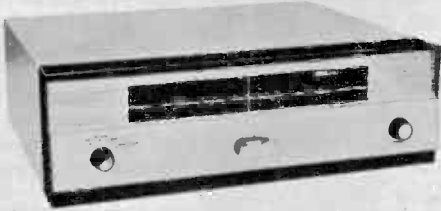
● **HUM AND NOISE**—Generated within the tuner should be at least 60 db or better below the level of a 100% modulated signal.

● **MUTING**—As tuners become more sensitive the problem of noise between stations becomes more serious. Some FM tuners are so sensitive that if a resistor were placed across the antenna terminals and warmed with a match, the noise produced by the heating would be plainly audible. Even with a low-noise input tube the noise at the grid of the first stage can well be nearly 1 microvolt. When this is amplified by the following stages it can be very annoying. There is a trend for adding an interstation muting or squelch circuit to very sensitive FM tuners. With such a circuit there is no noise whatever and no sound whatever until a station is tuned in. Squelch circuits can hide weak signals, however, and therefore there should be a switch to disable the squelch or muting circuit when weak station reception is desired.

Muting or squelch circuits generate big transients as they switch in and out. They are not audible as such, but they can have devastating effects on unstable amplifiers. This is the principal reason why they were not used until recently. The older Williamson type amplifiers were very likely to be driven to breathing or motorboating by these transients. The new amplifiers have enough stability to withstand these transients. Don't try to use a squelch tuner with an unstable amplifier.

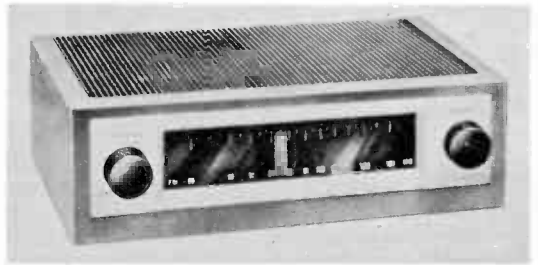


Harman-Kardon tuners are noted for high performance at moderate prices. The line now includes two FM only tuners, as well as two stereo tuners, in two price ranges.



EICO has matched individual AM and FM tuners in kits. Above and below are two assembled models.

These EICO kits use a printed circuit technique. Easy to assemble, they offer fine performance.



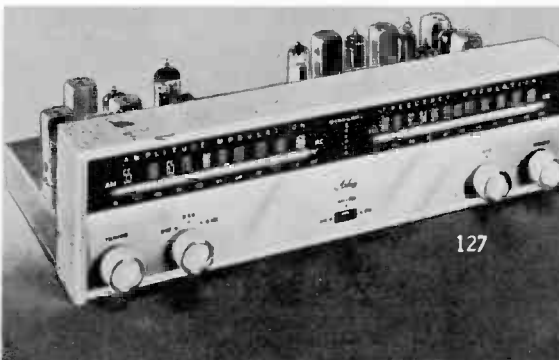
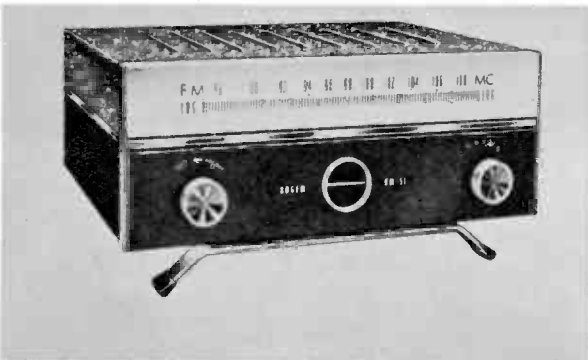
The popular Bogen line of tuners includes AM-FM stereo tuners as well as several FM only units.



Above are pictured two of the Bogen AM-FM stereo tuners, Model ST-562 at left, and Model ST-442.

Below is a Bogen FM only tuner, Model FM-51. It is one from a large variety of sizes and prices.

The compact Arkay kit tuner, below, has variable selectivity and whistle filter in the AM section.





This Bogen complete stereo tuner and amplifier offers all elements except speakers in one unit.



Fisher 600 includes a stereo AM-FM receiver and tuner, master audio control, 40-watt amplifier.

two stations on adjacent channels are to be separated and heard without interference, the receiver must have sharp enough selectivity to keep them apart. For almost complete freedom from interference the bandwidth of the tuner should not be greater than about 10 Kc in all. But this means that the audio response is limited to not more than 5000 cycles. Thus high-fidelity reception is difficult.

The nature of transmission in the broadcast band is such that, especially at night, stations from great distances can be received. Thus it is difficult to avoid having adjacent channel interference. The one exception is in close proximity to a radio station where an insensitive receiver will serve—one so insensitive that only the strongest stations will produce a usable audio output. Actually, under such conditions a sensitive receiver will also become insensitive because the strong signal will reduce gain by the automatic volume control circuit until the tuner is insensitive.

Because of this limitation most AM stations transmit a narrow bandwidth stopping somewhere around or just over 5000 cycles and most radios and some tuners have a bandwidth not much over 10 Kc. However, some high-fidelity AM stations transmit the frequencies up to and even beyond 10 Kc. In such cases, receivers with a wide bandwidth can provide a reasona-

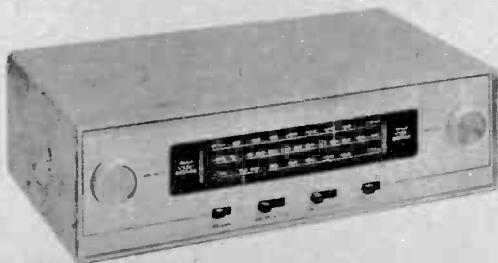
ble approximation of high-fidelity reception. To make a single receiver usable for both high-fidelity listening in local areas, and for low-fidelity listening where there is interstation interference, deluxe AM tuners provide a choice of two or three IF bandwidths—broad for high-fidelity reception of local stations where interference is no problem, and narrow for long-distance reception or for interference problems.

Two carriers 10 Kc apart will beat together to produce a 10 Kc beat note or whistle. For this reason, broad band tuners have a whistle filter. This is a rejection filter tuned to 10 Kc which produces a notch in the response at 10,000 cycles.

Bandwidth is equally or even more important in FM reception. We noted that the deviation of the FM carrier varies with the amplitude of the modulation. Under current standards the deviation can be plus or minus 75 Kc. Hence the bandwidth ought to be at least 150 Kc. If the bandwidth is too narrow distortion will be produced; greatest at highest frequencies.

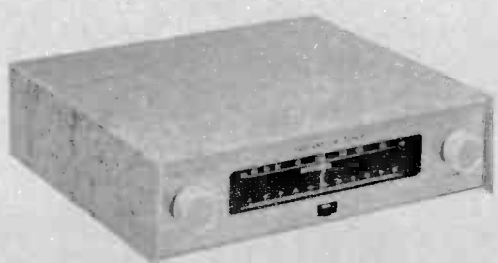
Interference from adjacent stations is less of a problem in FM. The separation is 200 Kc, but in any local area it is never less than 400 Kc. Secondly, FM transmission is limited in distance and reception is pretty well limited to local stations within a range of 50 to at most 200 miles. About the only time adjacent channel interfer-

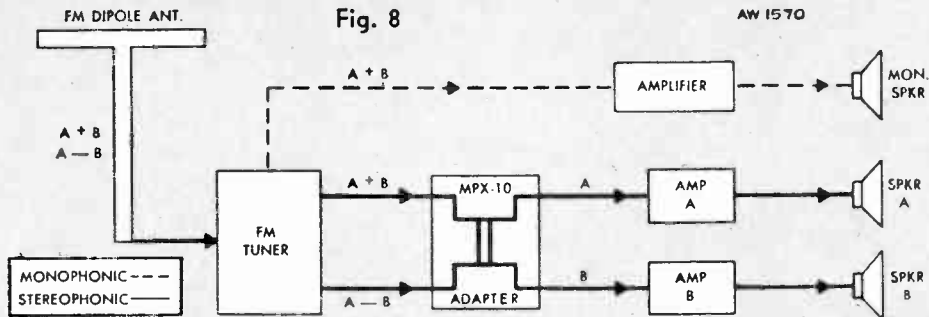
The Rauland stereo tuner, pictured below, has a low-noise front end and a power line FM antenna.



128

The photograph below shows the Rauland FM only tuner, with same features as its stereo partner.





Block Diagram Multiplex Stereo Reception

ence is likely to be a problem is in the case of receiving positions that are halfway between two large cities (like New York and Philadelphia). And here such interference can be minimized or avoided entirely by using antennas which strongly favor one direction over another.

The IF amplifiers are followed by the detector in an AM tuner, but by the limiters in an FM tuner. Simple FM tuners using a ratio-detector often have no limiters at all. They depend on the detector for all the noise suppression. These serve all right in local areas on strong signals though not as well as tuners with limiters. A limiter is merely an amplifier stage so arranged that it amplifies only when presented with very weak signals and then saturates and provides no further amplification regardless of how strong the input signal. In better tuners two limiters are used in cascade to increase limiting ability. In such cases the limiters may chop off well in excess of 99% of the signal with a corresponding reduction in noise. In some deluxe receivers a third IF stage also becomes a limiter on very strong signals.

After being amplified to a level that will provide an audio signal of from 1 to 2 volts the carrier is demodulated by the detector. In AM a rectifier is used as a detector. In effect, the rectifier is a valve that is actuated only by the amplitude variations of

the signal. Thus at its output we have the audio signal separated from the RF carrier.

Some recent tuners use a pair of crystal diodes in a push-pull detector. This is an especially favorable type.

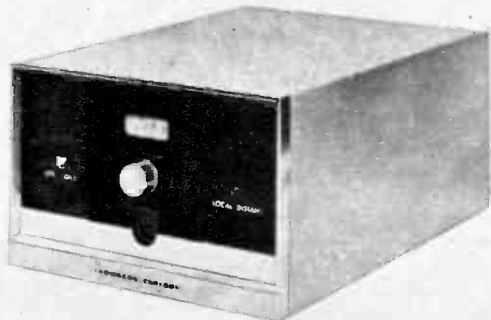
Where FM stations are transmitting multiplex stereo programs a multiplex adapter is very much worthwhile. A number of these are available as separate units. Recent tuners, like the Sherwood and some Harman-Kardon tuners, have provisions for plugging-in a multiplex adapter into the chassis.

FM antennas are highly important. Two types can be used for local reception. Tuners with a grounded-grid input stage often work best with a short length of wire from 3 to 4 feet long. Some will give noisier performance with a dipole than with this straight wire. Usually the instructions that come with the tuner give recommendations.

Long-distance reception is not the only justification for a good FM antenna. A good outside antenna may make all the difference between marginal and high-fidelity reception even in the primary area.

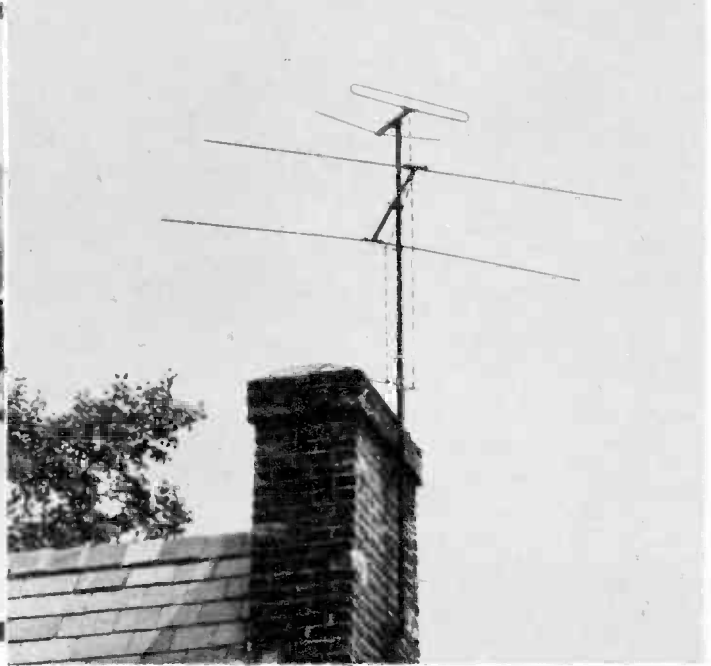
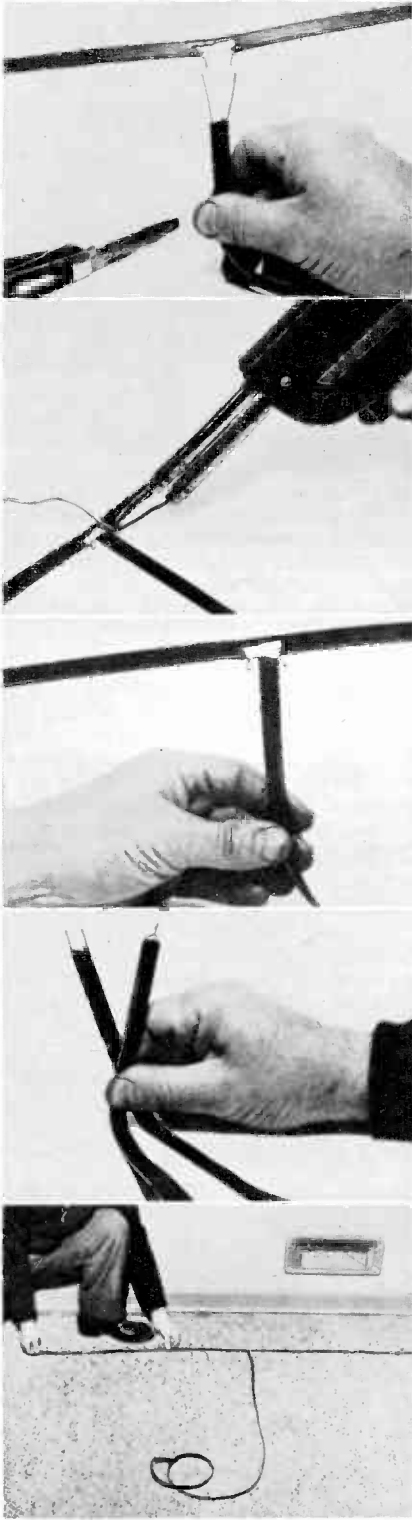
The "Haywire V" is a simple and inexpensive antenna with excellent gain. It consists simply of two lengths of wire arranged in a V with an enclosed angle of between 20 and 40 degrees. Each leg should be a multiple of 5 feet, the longer the better. Fig. 10 diagrams such a setup. •

The Stromberg Carlson tuners shown on this page are notable for their unusually compact shape.



Stromberg Carlson's FM only tuner, Model FM-443 is pictured below. At left is the Model AM-441.





Conventional TV antennas like the one above, can double satisfactorily for FM reception as well.

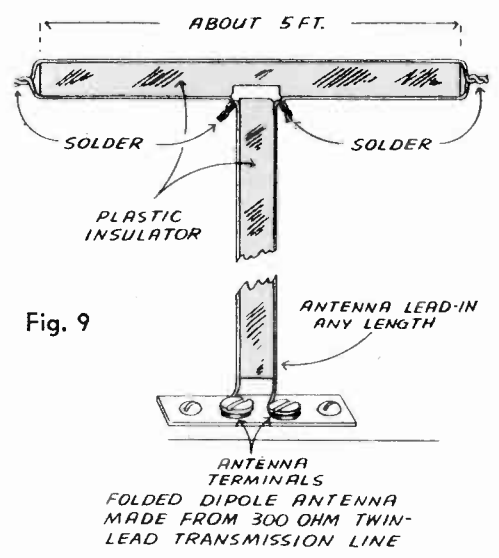
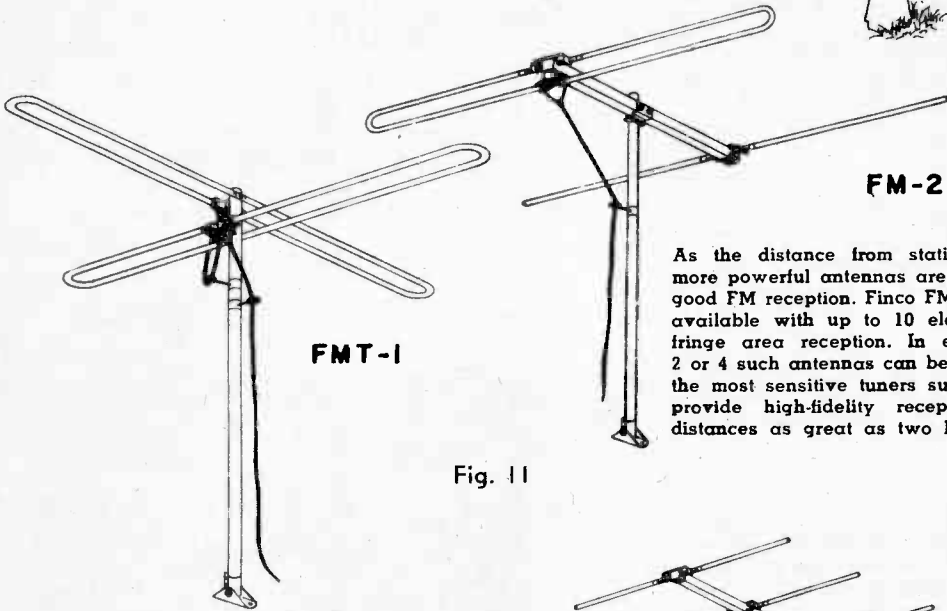
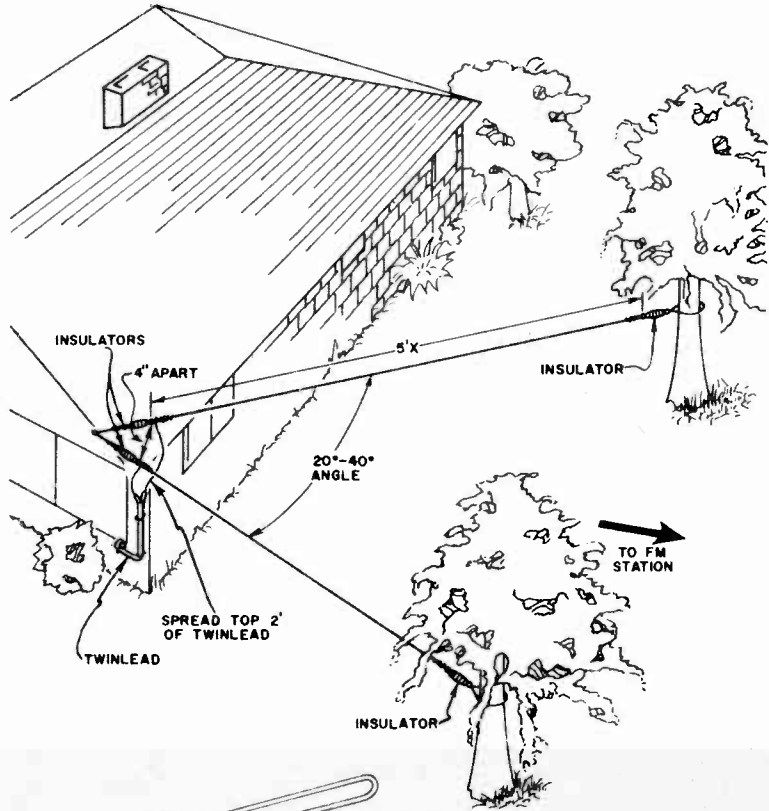


Fig. 9

Photos left show connecting tuner lead to TV antenna. Top piece of folded dipole antenna is 5 feet of TV twin-lead. Cut 1 wire in center. Tuner lead can be any length. Scrape wires clean, twist ends together, secure with solder. Remove 1/2 inch of insulation from far ends of 5-foot antenna, scrape, twist and solder.

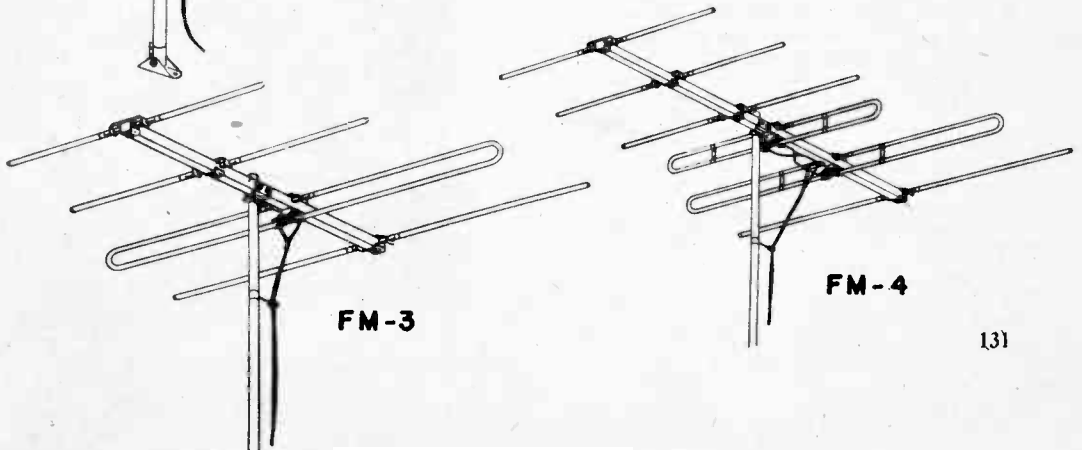
Fig. 10

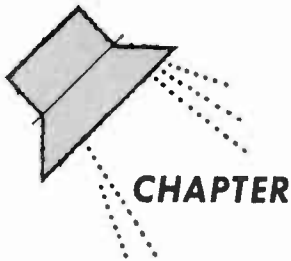
Haywire V antenna gives good results and is inexpensive. Length of each leg should be a multiple of five feet. To connect the twin lead, split two feet of end and connect one lead to each of the legs as shown in the diagram here.



As the distance from stations increases, more powerful antennas are needed to get good FM reception. Finco FM antennas are available with up to 10 elements for the fringe area reception. In extreme cases, 2 or 4 such antennas can be stacked. With the most sensitive tuners such arrays can provide high-fidelity reception even at distances as great as two hundred miles.

Fig. 11

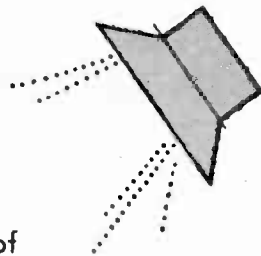




CHAPTER

8

Tape Recorders



Separate pickup heads and lack of mechanical problems make tape stereo superior.

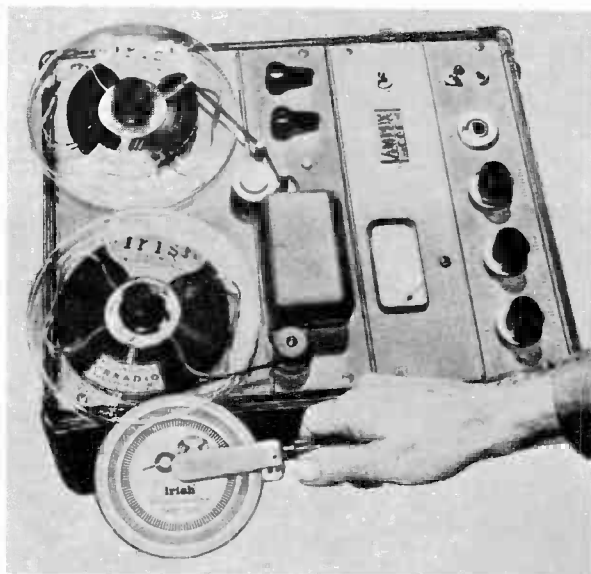


RCA tape magazine brings simplicity and low cost of discs to the tape field. Special tape container is merely slipped into machine, turned over to play other side. Though speed is only $3\frac{3}{4}$ ips quality can be as good as older $7\frac{1}{2}$ ips recorders.

Irish tape has come up with this clever stroboscope device for checking speed, flutter and wow of tape recorders. Constant and correct speed will keep pattern on card cover standing still.

FROM THE POINT OF VIEW of sound quality, tape can be the best source of stereo program material. For one thing, tape does not suffer from pinch-effect distortion. For another, since the process of tape recording is entirely electrical, problems of mechanical inertia or momentum do not arise, as they do with a mechanical cutter or a disc pickup. Consequently, the ability of tape to reproduce transients sharply and cleanly and without hangover is superior. Also, two separate heads are used in stereo tape recording for the two channels whereas in stereo discs, a single needle is necessary for both channels. Therefore, stereo tapes are capable of much better channel separation and less interaction between the two channels. Finally, there is no rumble problem with tape. There are problems of flutter and wow to be sure, but even when these problems are not completely solved, the effect on reproduction is not as damaging as turntable rumble.

On the other hand, tape has its disadvantages. It is more expensive even in the



new 4 track forms than discs. The process of duplicating tape is more costly and has certain imperfections. Duplicated tapes are by no means as good as the originals and do not deliver the full quality of performance of which tape is capable. Although the top quality tape recorders used for making original recordings are capable of the best frequency response so far attained in any recording process, this does not carry down to the playback tape machines used in most home hi-fi systems. There are any number of disc pickups capable of response to 15,000 cycles or beyond at 33 rpm; but only the better and more expensive tape playback machines are capable of this response. Most home type machines do not have much useful response beyond 10,000 cycles, and many are really flat only to 7500 cycles. However, the new narrow-gap heads developed for 4 track stereo have extended the response at the high end by up to a half-octave.

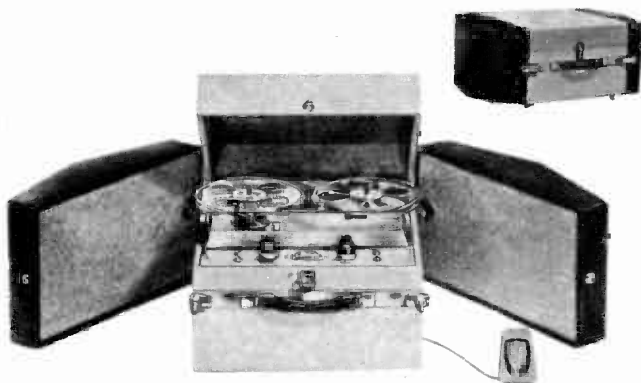
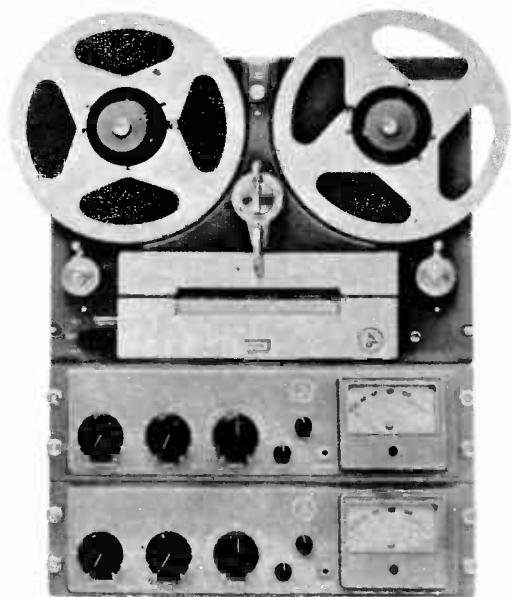
In short, the higher capabilities of stereo tape are realized only when first-class equipment is used; whereas pretty good results can be obtained with medium quality disc equipment.

To balance this, however, is the fact that if a tape recorder is used, rather than a tape playback machine, you have facilities for recording your own programs in stereo or monophonic form, from the radio, from discs, or from live sources. The capabilities for fun and enjoyment are almost limitless. Many people nowadays, for example, exchange tape recordings instead of letters. Many also use the tape recorder as a rec-

ord of the progress of the family from the first lusty bellows of the baby to the reminiscences of grandfather. Camera fans use tape to provide an accompanying commentary for a program of color slides. A new breed of candid tape recording fans are recording the sounds of the world around them and portraits in sound of the memorable personalities they meet.

The principle of tape recording is rather simple. File a piece of iron with a fine file so the particles fall on a piece of paper. Spread them around in a compact thin layer in the middle of the paper. Take a simple dime-store horseshoe magnet and bring it *under* the paper close to the filings. All particles will be magnetized and they will move and arrange themselves in a pattern around the two poles of the magnet. If you move the magnet away slowly, the pattern will remain.

In tape recording a strong plastic tape is coated with a very thin uniform film of iron oxide particles in a binder which though firm enough to hold the oxide to the tape still permits the individual molecules to rearrange themselves. The recording head is a horseshoe electro-magnet with a very narrow gap—less than one ten-thousandths of an inch. As the coil is energized, the head becomes magnetized, and as the energizing voltage varies, the magnetization will also vary. For example, if the coil is energized with a 20 cycle per second alternating current, the electromagnet will be alternately magnetized and demagnetized at the rate of 20 times a second. As the tape is passed over the head at a speed of

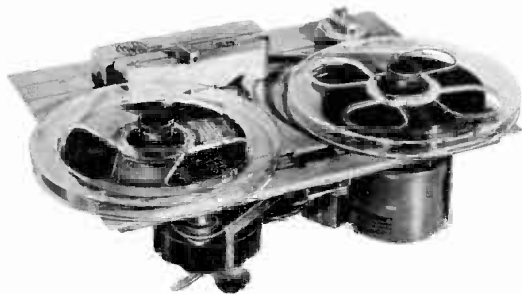


Excellent for all general purposes is the stereo portable Pentron Model TR-20 (Aristocrat II) above.

The American Concertone, left, one of the finest recorders, is used in many radio stations as well as in deluxe hi-fi installations. It is available in various combinations of heads and tape speeds.



Heathkit TR-1A series of tape recorder kits is progressive, can be purchased for full 4-track stereo or first as monophonic, converted later.



Viking tape decks have won great reputation for fine performance at low cost. New 85 series with two motors is big value in prices from \$120 up.



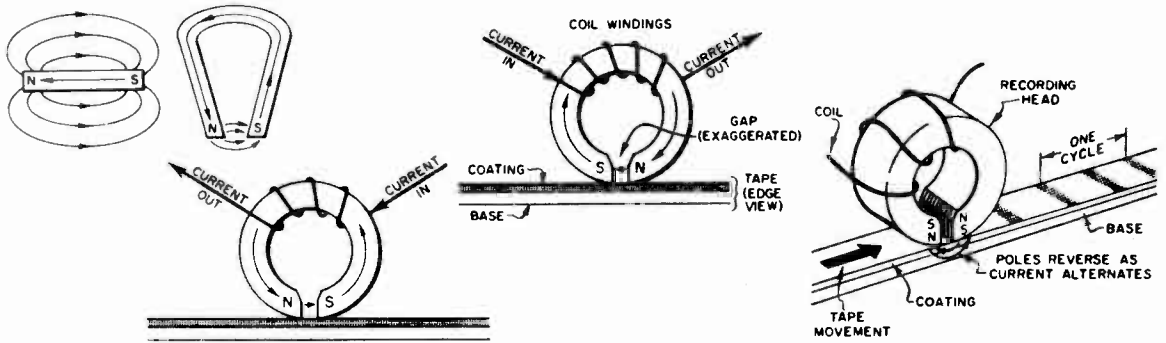
Japanese-made Sony Superscope stereo recorder offers semipro performance, relatively low cost; \$395 for 2 track, \$470 for both 2 and 4 track.

To extend usefulness of its line of recorders, Ampex offers various kits of accessories including two matched mikes and headset units, below.



from 2 to 30 inches per second, the iron oxide particles, like the iron filings in our simple experiment, are subject to the varying magnetic field in the narrow gap. They become magnetized in a pattern that corresponds to this variation.

Translating this simple principle into a working gadget presents problems that need not concern us in detail. One important one is that of keeping the tape running across the head at a constant speed. The tape comes on a reel and is taken up on a reel after it passes over the head. Obviously we cannot pull it past the head with the take-up reel because if the take-up reel turns at a constant speed, the tape would travel past the head faster when the reel is full than when it is empty, and indeed it would be impossible to maintain a constant speed. The only way to keep the tape moving at the same speed is to pull the tape itself. So the tape is pinched between a turning shaft and a rubber idler that holds it firmly against the shaft. This is called a capstan drive. The speed of the motor may vary at least slightly. It is not easy to maintain a uniform "pinch" on the tape. Furthermore, the tape surface is rather slick and so is the capstan; the tape varies a little in thickness and smoothness. So there is inevitably a variation in speed. If the variation is less than about 20 cycles per second the result will be a variation in the pitch of the sound on the tape which we call "wow." It is particularly noticeable on long sustained tones, and on piano music. If the variation is higher in frequency, it is called flutter because it gives a fluttering effect to the sound. To have no noticeable audible effect, both flutter and wow would have to be on the order of .1% or less—or 60 db down. Only the finest professional tape machines achieve such figures. Semi-professional types keep the flutter and wow below .2% which would be about 54 db



How it's done: As audio signal goes through electromagnet the field in the gap varies. Tape has thin film of iron oxide particles which change their position as magnetic field passes overhead. In playback the variation of magnetic field on the tape varies field in gap in head, produces current in coil.

down, but most home machines have a wow and flutter figure of around .3% or 50 db down.

Since the motor has a great influence, here as in disc turntables, constant speed motors are important. The best tape recorders use hysteresis synchronous motors; medium quality recorders use 4-pole motors.

The take-up reel has to pick up the tape after it passes over the head and wind it firmly on the reel. The take-up reel must have a speed which varies as the tape fills the reel—fast when empty and slow when nearly full. This variation is achieved by using a clutch (or a slipping belt) on the shaft which slips just enough to keep the reel turning at the right speed. The original reel needs to have a little friction on it to maintain a constant tension on the tape; this is done by another slipping clutch or belt.

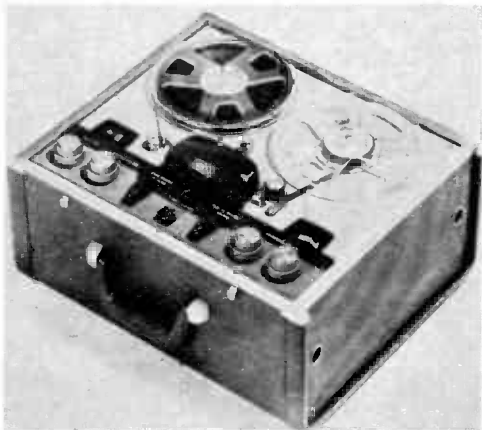
We must rewind the tape on the original reel and it is desirable to do this rapidly. It is also desirable sometimes to be able to wind the tape forward at a rapid rate—as for instance to find a passage on the tape we particularly want to hear. So we have three different transport problems. In the finest professional machines three separate motors are used to get these jobs done. In home type recorders the need for keeping cost down dictates the use of a single motor for all three jobs. This is asking a lot of a single motor—and of the engineer who has to design a method to do it. But it has been done, with greater and lesser success, in a big variety of ways. Generally speaking, the more motors the better the recorder; but not always. Some single motor jobs achieve results as good as many three-motor jobs.

We are concerned with stereo and obviously any tape machine should provide facilities for playing all types of stereo

tapes. Older stereo tapes were 2 track; new ones are 4 track. The 4 track head can play two track tapes but the 2 track head cannot play 4 track tapes. Thus, any tape machine you buy for stereo should have 4 track heads. All present stereo tapes are recorded with so called "stacked" heads — one mounted immediately above the other and both covering exactly the same part of the tape. Some early stereo tapes were recorded with staggered heads—displaced by around two inches. These are now obsolete and there is no practical need for taking care of these.

There are four speeds in common use today: 15 ips, 7½ ips, 3¾ ips and 1⅞ ips. The faster the speed, the easier it is to get a good high-frequency response; this is obvious after a little reflection. Clearly it is easier to put 15,000 cycles of magnetization and demagnetization on 15 inches of tape than on a little less than 2 inches. Fifteen ips is standard speed at which original recordings are made. However, this uses tape fast and it is only possible to put about 15 minutes of program on a 7-inch reel of tape. The amount of program time doubles as the speed is halved and thus you can get 30 minutes at 7½, 1 hour at 3¾ and 2 hours at 1⅞ ips. To get still more program time on a reel, a thinner tape can be used. There are two types, one that gives about 50% more program time and one that gives 100% more program. However, the thinner tape raises problems in "print-through". The latter is a transfer of signal from one layer of tape to the next on the reel. The thinner the tape, the closer the adjoining turns and the greater the print-through or echo. The print-through effect is being reduced by various ways but nevertheless for minimum print-through or echo the standard thickness of tape is best, and this is the tape used for most commercial recorded tapes.

Most tape recorders permit a choice of



Famous for top quality, Ampex offered the first practical stereo packages, first 4-track heads as standard; 900, above, for home, semipro use.



Webcor Regent stereo tape recorder is latest of this well-known low and medium-priced line. It provides 3 speeds, 4-track recording and playback.

There are kits for converting older 2-track recorders to 4 track to play new type stereo tapes. Complete kit, below, for Ampex A series is \$50.



136

two speeds and some of three speeds. Professional and semipro types usually give a choice of 15, and $7\frac{1}{2}$ and possibly $3\frac{3}{4}$ ips. Home types usually skip the 15 ips speed and give a choice of $7\frac{1}{2}$ and $3\frac{3}{4}$, and a few home recorders are $1\frac{1}{8}$ ips speed. Stereo tapes are being issued at both $7\frac{1}{2}$ and $3\frac{3}{4}$ ips tapes and hence any tape machine used for stereo reproduction should provide these two speeds.

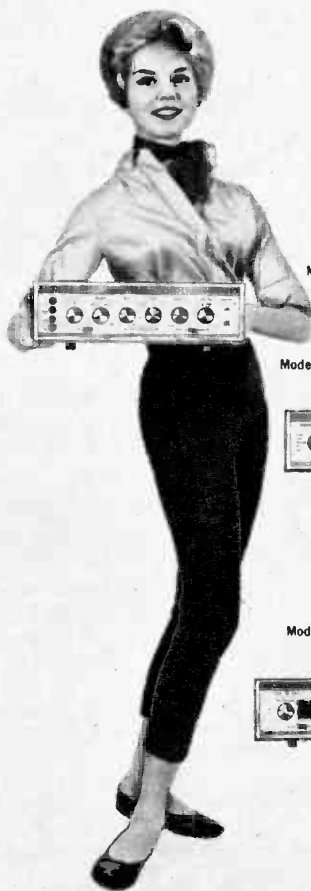
The narrower the gap of the head, the better the high frequency response. The new 4 track heads have much narrower gaps than were used previously, therefore provide a better high frequency response at a given speed. What can be achieved with the narrow heads is evidenced by the newest Tandberg model 5 stereo recorder which specifies a response to 20,000, at $7\frac{1}{2}$, 15,000 at $3\frac{3}{4}$, and 10,000 at $1\frac{1}{8}$ ips. Maintenance of high-frequency response is dependent on keeping wear of the head down. Iron oxide is a very fine abrasive. One form of it called "jeweller's rouge" is used for final polishing of rare metal, jewels and lenses. The tape has to be held in firm contact with the head, but the rubbing of the oxide will wear the head and enlarge the gap, thus reducing high-frequency response. To reduce wear the pressure of tape on head should be just enough to maintain contact. This is a tough thing to achieve, requiring high precision as well as good design. Generally speaking, the recorder is more costly when the high-frequency response is very good. Medium priced machines generally get up to 10 or 12,000 at $7\frac{1}{2}$ and between 7,500 and 10,000 at $3\frac{3}{4}$ ips.

If you are interested in playback of tapes only, you can purchase only the tape-deck and not the amplifiers. The tape heads will connect to your stereo preamp. Practically all current preamplifiers have inputs for tape heads and provide equalization for the standard NARTB tape recording curve. However, the actual response, as in the case of pickups for discs, will vary with the heads, especially at the high end. Such playback decks can be bought for a much lower price than complete recorders.

Machines are now available to play magazine tapes which are the newest thing on the market. The standard magazine is the RCA which is entirely self-contained. It operates at $3\frac{3}{4}$ ips, and can be used only on the special machines built for it. The magazine tape is even easier to use than a disc. It is simply slipped into place on the machine with no threading or alignment.

The magazine player can be used only with magazines and hence it is not as versatile as the regular tape recorder. •

Discover for yourself why Sherwood is the most honored line of high fidelity components in the field. Sherwood Tuners (the first ever to achieve sensitivity under 0.95 microvolts) feature: Inter-Channel Hush, a noise muting system which makes FM tuning easier than ever • FM Multiplex Output • "Feather-Ray" Tuning Eye • Automatic Frequency Control • Flywheel Tuning. Combine these tuners with either of Sherwood's "mated" stereo amplifier choices; 20+20 watts or 36+36 watts. And only Sherwood offers all these features: Single/Dual Bass & Treble Controls • Mid-Range Presence Rise • Stereo-Mono Function Indicator Lights • Phase-Reverse Switch • Damping Factor selection. Sherwood also offers either 36 or 60 watt monaural amplifiers, FM Multiplex Adapters and a complete decorator-styled line of cabinetry and 3-way speaker systems —The Finest in High Fidelity, Sherwood Electronic Laboratories, Inc., 4300 N. California Avenue. Chicago 18, Illinois.



Model S-4400, Stereo Preamp. + 36W Amp.—\$159.50

Model S-5000, 20 + 20W Stereo Dual Amplifier—\$189.50



Model S-3000 II, FM Tuner—\$105.50



Model S-1000 II, 36W Monaural Amplifier—\$109.50



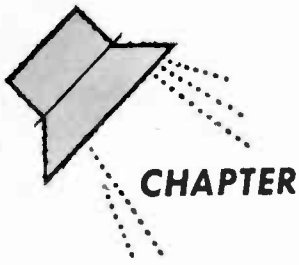
Model S-2000 II, FM-AM Tuner—\$145.50

only for those who want the ultimate

SHERWOOD HIGH FIDELITY

For complete technical details write Dept. FA5-12

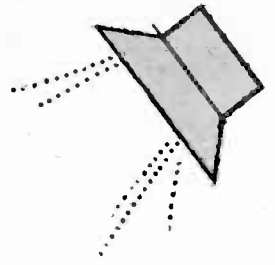
BURTON BROWNE ADVERTISING



CHAPTER

9

Assembling and Adjusting



You can do it—but don't hesitate to ask advice.

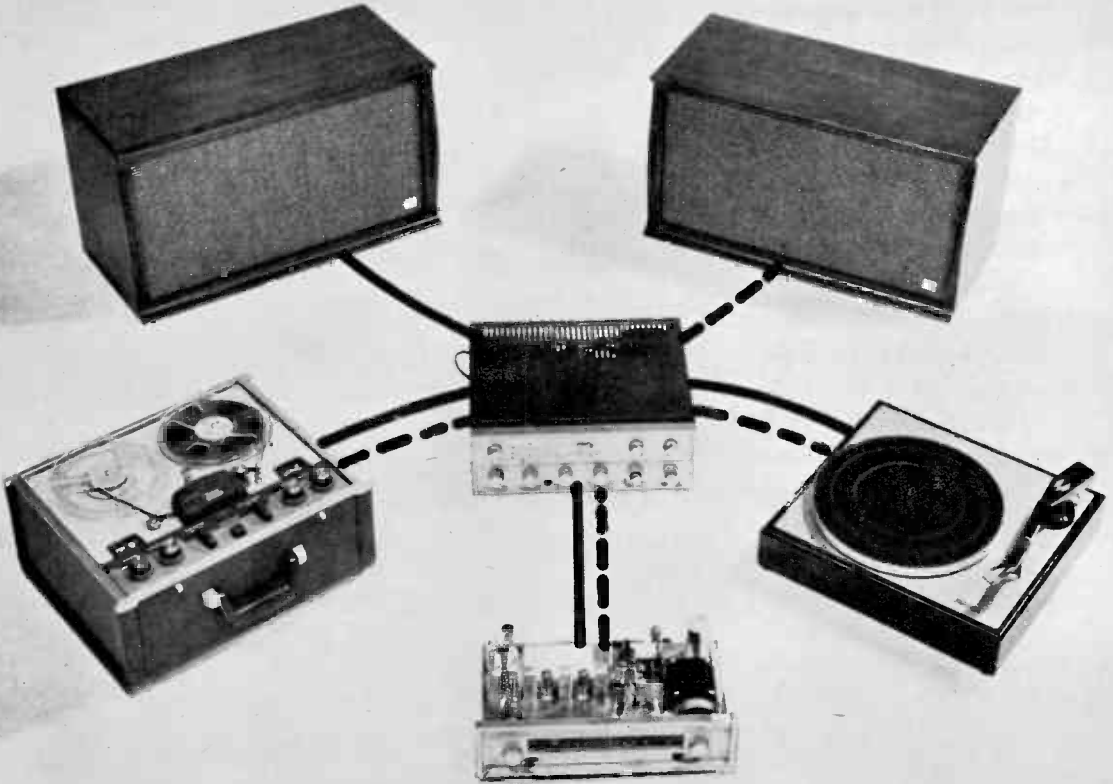


Photo by Grayson Tewksbury

These are the components shown on the cover of this book: Jensen speakers; Pilot preamp-amplifier; Ampex tape recorder; Weather's turntable; Sherwood tuner. Once balance is achieved—stop fiddling.

SO YOU HAVE DECIDED to invest in a stereo system. You have pored over the catalogs or visited the demonstration rooms of your local dealer. You have made your choice of components and they have been delivered to you. The big pile of cartons is stacked before you, and now comes the job of putting the stuff together into a workable system. Perhaps you're

having a few second thoughts about your temerity in thinking that you could assemble it yourself.

Actually, the job is not difficult. All you have to do is read and understand simple instructions.

The first step is to open the cartons and take out the instruction booklets or sheets for each component. Study these carefully.

New H. H. Scott 222 Stereo Amplifier puts top quality within your budget!

A high fidelity system is a long term investment, so it is essential that your amplifier . . . the heart of your system . . . be the very best you can afford. The new H.H. Scott 222 offers you features, versatility, and advanced engineering to meet your needs now, and in the future. Its conservatively designed output stages will drive even inefficient speaker systems. Examine the features below to see why you should plan your system around the new H.H. Scott 222 24 watt stereophonic amplifier.

\$139.95*



Equalization switch lets you choose between RIAA compensation for monophonic and stereo records; NARTB, for tape heads.

Special switch positions for accurate balancing, for playing stereo, reverse stereo and for using monophonic records with your stereo pickup.

Separate Bass and Treble controls on each channel let you adjust for differences in room acoustics and different speaker systems.

This position lets you play a monophonic source such as an FM tuner or a tape recorder through both power stages and speakers.

Effective scratch ritter improves performance on older worn records and improves reception on noisy radio broadcasts.

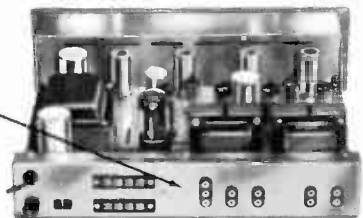
Exclusive center-channel output lets you use your present amplifier for 3-channel stereo or for driving extension speakers. Separate stereo tape-recorder outputs.

Channel balance control adjusts for different speaker efficiencies and brings channel volumes into balance quickly and easily.

Master volume control adjusts volume of both channels simultaneously. Also functions as automatic loudness control whenever desired.

SPECIFICATIONS: Dual 12 watt channels; 0.3% 1M distortion; 0.8% harmonic distortion; frequency response 20 to 30,000 cps; extremely low hum level (-80db); DC operated preamplifier heaters; Inputs for stereo or monophonic recorders, tuners, phono cartridges and tape heads. Phono sensitivity 3 mv. Sub-sonic rumble filter prevents overload from noisy changers or turntables.

Price \$139.95*



*West of Rockies \$143.25. Accessory case extra.

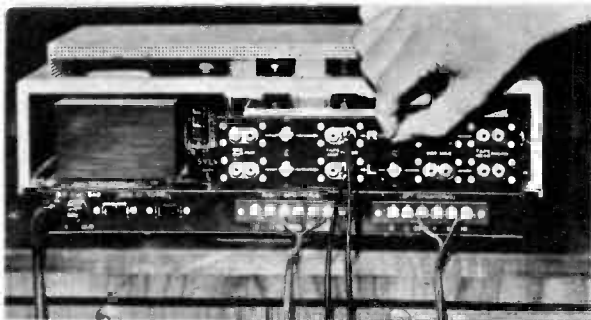


SEND NOW FOR FREE
HI-FI GUIDE AND CATALOG

H.H. SCOTT INC. Dept. ASF, 111 Powdermill Road, Maynard, Mass.
Export: Telesco International Corp., 36 W. 40th St., N.Y.C.

Rush me complete details on your new Model 222 and your complete 1960 Hi-Fi Guide and Catalog.

Name _____
Address _____
City _____ State _____



Adjusting level control on rear of stereo amplifier. Follow the simple instructions accompanying unit.



Despite multiplicity of knobs in stereo system, once basic balance is achieved control is easy.

You will probably find that one or more of the components need preliminary assembly. Assemble these components first. The changer or turntable, for example, may have to be mounted on a base or in a cabinet. There will be a paper template to guide you in this process. Follow it carefully. The pickup arm may have to be mounted on the turntable base, and the pickup cartridge in the arm. Follow all instructions very carefully in doing this.

Adjust the pickup pressure to the middle of the range recommended by the manufacturer. You want the lowest pressure that will give you good clean reproduction of the high level passages or peaks.

If reducing pressure results in distortion on peaks, increase it gradually until the distortion is minimized. With the finest pickups you will get distortion-free results on most records with a very light pressure.

Check that the needle angle is perpendicular to the record surface when looked at from the front. Most arms permit adjustment of these angles.

If the tuner, amplifier, preamp, etc., are to be mounted in a cabinet do this next.

Place the speakers in position in the room. If they go in bookshelves or are built into the walls, connect zip-type lamp cord to the speaker terminals before putting them in place.



"BUCK STRETCHER" HI-FI VALUES!

Expand the buying power of your Hi-Fi dollar at Sun Radio with substantial savings on new, fully guaranteed name brand Hi-Fi and Stereo components!

Dept. ST9, **SUN Radio & Electronics Co., Inc.**
650 6th Ave., New York 11, N. Y. Phone: ORegon 5-8600

I am interested in your special price quotations and your Hi-Fi package specials! Please send data at once.

Name _____

Address _____

City _____ Zone _____ State _____

If you have several components you will have several line cords and plugs. It would be a nuisance if you had to turn all the units on and off everytime you wanted to put the system on. All preamps and amps have several AC outlets on the back which are controlled by the on-off switch. Plug the line cords from the tuner, the tape recorder, and the power amplifier into these outlets on the preamp or control unit. If there is an additional outlet you can also plug in the cord from the changer or turntable, if not, plug the changer or turntable cord into the amplifier or into the house convenience outlet. The cord from the pre-amplifier goes to the house convenience outlet. With this arrangement, turning on the preamplifier will automatically turn on all the other units.

Now connect the speaker leads to the amplifier speaker terminals. Connect the knotted one to the terminal designated G, and the other one to the one with the same impedance as the speaker. That is, if the speaker is a 16-ohm speaker, connect the other lead to the screw marked 16.

If the amplifiers are separate from the preamp, interconnect the two with two shielded cables. The jacks on both chassis will be marked either L and R or channel A and channel B. Connect like jack on one unit to like jack on the other unit. If one has L and R marks, and the other A and B marks, connect A to L.

At this point turn on the power switch. Check the amplifier for an on-off switch. Flick it to on and leave it on.

The preamplifier is likely to have a hum control. Turn the volume control on full. Put the selector switch in the tuner or auxiliary position. If the hum is low, turn the bass tone control to maximum boost. Now adjust the hum control for lowest hum. If the amplifiers are separate and also have hum controls, adjust them similarly. Turn down the volume control to a position about 1/4 on and the tone controls to the flat or center position, and turn off.

Now connect the two cables from the turntable or changer to the proper pickup jacks on the preamplifier.

Put on a record, and again turn the outfit on. It is best to use a stereo test record, but in a pinch any kind of record, stereo or monophonic will do. The procedure for balancing and phasing the system will vary with the preamplifier. Instructions for the specific preamp should be followed.

If you run into any trouble, your best bet is to call the dealer or a reliable serviceman who has had some experience with stereo high-fidelity equipment. •

trading?

audio exchange
makes the **BEST**
Trades!*

*See HI-FI Magazine, May 1959, page 39

We have the franchise for these exclusive manufacturers



- PROMPT SERVICE • LARGEST SELECTION of guaranteed used equipment
 - TRADE BACK PLAN — write for details
- Write Dept. RA9 for our unique Trade-Back plan



audio exchange

Registered Component Dealers



The Hi Fi Trading Organization
153-21 Hillside Ave., Jamaica 32, N.Y.
Closed Mondays • Parking at all stores
Brooklyn 836 Flatbush Avenue
White Plains . 367 Mamaroneck Avenue
Manhasset 451 Plandome Road

CHAPTER 10 Available Discs and Tapes

A STEREO SYSTEM is no better than the records fed into it. There are now several thousand stereo recordings of every imaginable type. Several hundred new ones are released each month.

Of course, when you set your stereo system up you will want recordings that will show it off to the best advantage. To help you find the best stereo records, we asked

record manufacturers to send us their best stereo recordings. We listened to them on several stereo systems and from these we have chosen the following 200 as the best and most representative examples of what stereo can do to improve the reproduction of music and sound. To simplify still further, we list what we consider the 20 best stereo recordings of those received. •

TOP TWENTY STEREO RECORDS

1. Demonstration Records

SOUNDS IN SPACE RCA-Victor SP-33-13
Stereo demonstration with voice narration. Pop and classical music plus sound effects.

LISTENING IN DEPTH Columbia SF-1
Sampler of pop and classical music without narration but excellent technical notes. Excellent three channel stereo.

STEREO STEREO STEREO Westminster WSS-2
Classic and pop sampler. Spectacular sound.

DESTINATION STEREO RCA-Victor LSC-2307
Classic sampler with spectacular stereo sound.

THIS IS STEREOGRAMA Epic BN-1
Pop sampler with nicely balanced stereo.

YOUNG PERSONS GUIDE TO ORCHESTRA Capitol SP8373
Almost perfect demonstration of stereo spacing and depth with fine clean sound.

2. Spectacular Examples of Stereo

QUEEN'S BIRTHDAY SALUTE Vanguard VSD 2011
Complete with 21 gun salute and with top stereo system you are there on the spot. Play it loud.

BILLY THE KID, Copland Everest SDBR 3015
With finest stereo systems the illusion of being right there at the concert is complete.

LE SACRE DU PRINTEMPS Columbia MS 6010
Clear demonstration of how stereo can bring more of the music to the ear. Spectacular.

HAYDN: Military and Clock Symph. Vanguard SRV-109-SD
Awesome drums, nice highs, fine stereo balance.

3. Fine Classical Stereo

SCHEHEREZADE Angel S35505

SYMPHONIE FANTASQUE Audio Fidelity FCS 50,003

BRAHMS: Symphony #1 Columbia MS 6067

TCHAIKOVSKY, BORODIN ETC. Epic BC 1002

GAITE PARISIENNE RCA-Victor LSC-2267

MERRY WIDOW WALTZ Vanguard SRV-111-SD

PETER AND THE WOLF Vanguard-VSD-2010

GERSHWIN: Piano Concerto Westminster WST 14038

4. Outstanding Pop Stereo

DUKES OF DIXIELAND Vol. III Audio Fidelity AFSD 5851

SOMETHING FOR BOTH EARS World Pacific HFS-2

CLASSICAL STEREO RECORDINGS

BEETHOVEN Ninth Symphony Angel S 3577

PROKOFIEV: Cinderella Angel S 35529

LOLLIPOPS Beecham Favorites Angel S 35506

TCHAIKOVSKY: Sixth Symph. Audio Fidel. FCS 50,002

DEBUSSY: La Mer RAVEL: Daphne et Chloe } Capitol SP8395

THE ORCHESTRA Capitol SSAL 8385

RUSKAYA Capitol SP8384

BEETHOVEN: Symphony #3 Columbia MS 6036

HANDEL: Organ concertos Columbia M2S 604

SCHEHEREZADE Columbia MS 6069

GRAND CANYON SUITE Disneyland STER 4019

BACH: Violin concertos Epic BC 1018

BEETHOVEN Piano Con. #4 MOZART: Piano Con. #25 } Epic BC 1025

BRAHMS: Piano Con. #1 Epic BC 1003

DVORAK: Symphony #4 Epic BC 1015

HANDEL: Water Music Epic BC 1016

POP CONCERT USA Epic BC 1013

STRAUSS: Till Eulenspiegel DON JUAN, Death & Transfiguration } Epic BC 1011

WORLD'S GREATEST MUSIC Kapp KC-9031-S

D'INDY: Symp. on Mt. Air RAVEL: Piano Concerto in G } RCA Vic. LSC-2271

HOVHANNES: Mysterious Mt. STRAVINSKY: Fairy's Kiss } RCA Vic. LSC-2251

MENDELSSOHN: Symp. #4 & #5 RCA Vic. LSC-2221

PROKOFIEV: Lt. Kije Suite STRAVINSKY: Nightingale } RCA Vic. LSC-2150

THE REINER SOUND RCA Vic. LSC-2183

SCHUMANN Piano Con. in A-m. RCA Vic. LSC-2256

VICTORY AT SEA Vol. II RCA Vic. LSC-2226

WAGNER: Excerpts RCA Vic. LSC-2255

SHOSTAKOVICH: Symp. #1 United Artist UAS 8004

BARTOK: Concerto for Orch. VOX ST-PL 10,480

TCHAIKOVSKY: Symp. #4 VOX ST-PL 511,190

GABRIELI: Processional Vanguard BGS 5004

LISZT: 4 Hungarian Rhaps. Vanguard SRV-108-SD

SERENATA Vanguard VSD-2013

DEMONSTRATION AND SAMPLER RECORDINGS

DEMONSTRATION AND SOUND EFFECTS Aud. Fid. AFSD 5890

STEREO TEST RECORD Aud. Fid. FCA 50,000
Test tones on one side, sampler on other.

THE STEREO DISC Capitol SWAL 9032
Commentary on one side, sampler on other.

BIG BAND STEREO Capitol SW1055
Pop sampler of big band jazz.

STARS IN STEREO Capitol SW1062
Sinatra and 9 others in good pop sampler.

MORE STARS IN STEREO Capitol SW1162
10 more popular stars in pop sampler.

THIS IS STEREOGRAMA (Classic) Epic BC 1
Sampler of 10 classic selections.

DEMONSTRATION IN STEREO SOUND Kapp KST-1
Pop sampler with sharp stereo separation.

STEREO, the visual sound Liberty LST 100
Pop sampler with excellent sound effects.

JOURNEY INTO STEREO London PS 100
Demonstrator and sampler with clever British type commentary and good sound effects.

STEREO SPECTACULAR Mayfair 90005
Pop sampler with good stereo sound effects.

POPULAR MUSIC IN STEREO

SOUND SPECTACULAR, Ray Anthony Cap. ST 1200

JUMPIN WITH JONAH (Jones) Cap. ST 039

SOUNDS OF THE GREAT BANDS, Case Loma Orchestra Cap. SW 1022

JET FLIGHT, Norrie Parmor Cap. ST 10190

BLACK SATIN, Geo. Shearing Cap. ST 858

THEY SAID IT COULDN'T BE DONE, Mighty Accordion Band Cap. ST 1212

VELVET BRASS, Jackie Gleason Cap. SW 859

RENDEZVOUS WITH KENTON Cap. ST 932

CONCERTO, Freddy Martin Cap. SW 1066

JOY OF LIVING, Nelson Riddle Cap. ST 1148

SOUNDVILLE, Jack Marshall Cap. ST 1194

JACKIE DAVIS MEETS TROMBONES Cap. ST 1180

BAL MASQUE, Duke Ellington Col. CS 8098

SOUND IDEAS, Les and Larry Elgart Col. CS 8002

JIMMY DORSEY'S GREATEST HITS, Lee Castle & Dorsey Orch. Epic BN 529

PLAYING THE NUMBERS, Mundy Epic BN 526

POPULAR VOCALS

- TWO TIME WINNERS, Andy Williams
Cadence CLP 25026
- FRED WARING AND THE PENNSYLVANIANS
Cap. SW 845
- SINATRA SINGS FOR ONLY THE LONELY
Cap. SW 1053
- JUST ONE OF THOSE THINGS, Nat Cole
Cap. SW 903

DIXIELAND

- FIVE PENNIES, Castle Jazz Band
Good Time Jazz S 10037
- FIREHOUSE FIVE GOES TO SEA
Stereo Records S7005
- DUKES OF DIXIELAND Vol. III
Audio Fidel. ASFD 5851

MODERN JAZZ

- BILLY MAYS BIG FAT BRASS Cap. ST 1043
- BELLS ARE RINGING, Shelley Manne
Contemporary S7559
- GIGI, Previn & His Pals Stereo S7020
- MY FAIR LADY, Shelley Manne Stereo S7002

INTERNATIONAL POPS

- MOLTO ITALIANO, Johnny Puleo Harmonica Band
Aud. Fid. AFSD 5883
- PORTS OF PLEASURE, Les Baxter Cap. ST 868
- LOMBARDO GOES LATIN Cap. ST 1191
- EXOTICA, Martin Denny Liberty LST 7034

ORGAN

- MEDLEY TIME, Don Baker Cap. ST 997
- MOST HAPPY HAMMOND, Davis Cap. ST 1046
- ORGAN ON THE MARCH, Gart Kapp 1119
- CADET CHAPEL ORGANIST VOX ST-VX 25.800

BRASS BAND

- THE MILITARY BAND Cap. SW 1056
- PARADE FIELD IN STEREO ABC Para. ABCS 242
- HALFTIME Liberty LST 7115
- SOUSA IN STEREO Warner Bros. 1209

MUSICAL SHOWS

- THE MUSIC MAN Cap. SW 0990
- MY FAIR LADY Col. OS 2015
- ONCE UPON A MATTRESS Kapp KD 7004-S
- REDHEAD RCA Vic. LSO-1048

NOVELTIES & ODDITIES

- SHOCK MUSIC IN STEREO
ABC—Param ABCS 259
Creepy music with creepy sound effects.
- SPACE ESCAPADE, Les Baxter Cap. ST 968
Mood music for a trip in space.

FOLK MUSIC

- HI FI IN AN ORIENTAL GARDEN
ABC Par. ABCS 224
- KINGSTON TRIO AT LARGE Cap. ST 1199
- MOVIN WEST, Merril Staton Choir Epic BN 502
- STEPHEN FOSTER SONGBOOK
RCA Vic. LSC-2295



save on
Stereo
hi-fi

SEND FOR THE 1960
ALLIED CATALOG

free

SAVE MOST! Here's your complete money-saving guide to Hi-Fi. See how you save on ALLIED-recommended complete Stereo systems. Choose from the world's largest stocks of famous name components (amplifiers, tuners, changers, speakers, enclosures, accessories); save most with KNIGHT deluxe components. Build your own—save even more with our exclusive Hi-Fi KNIGHT-KITS. Easy terms available. For everything in Hi-Fi and Electronics, get the 1960 ALLIED Catalog!

ALLIED RADIO

FREE
Catalog

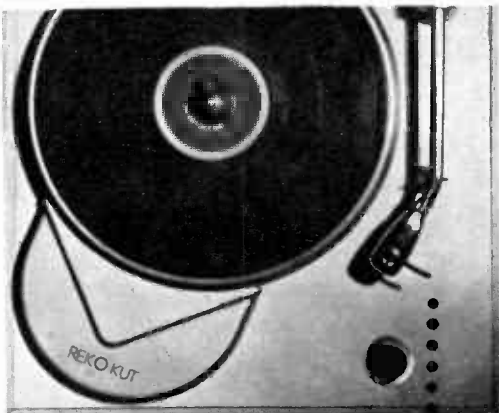
ALLIED RADIO, Dept. 160-O
100 N. Western Ave., Chicago 80, Ill.

Send FREE 1960 ALLIED Catalog

Name _____

Address _____

City _____ Zone _____ State _____



WHY PAY MORE?

Assemble your own stereo phono system and SAVE! Pictured above is the REK-O-KUT K33-H turntable kit (33 1/3 rpm) with hysteresis motor, matching REK-O-KUT S-120 12" arm, and unfinished base kit. Total assembly time is less than one hour. Only \$92.85. With your purchase of the above, you will receive the Shure M7D magnetic stereo cartridge FREE.

All units in factory sealed cartons. Full mfg'r's warranty. Shipments f.o.b., N.Y.C. Ask for audio discount catalog A-10.

KEY ELECTRONICS COMPANY
120 LIBERTY ST., N. Y. 6, N. Y.

free



SHURE
M7D
REG. NET VALUE
\$24.00

Here's all you need to build a HEATHKIT®...

... these tools and **NO EXPERIENCE**

We say "NO ELECTRONIC EXPERIENCE NEEDED" . . . and we mean it.

Recognized by leading consumer research organizations as the best in the field of kit construction manuals, the Heathkit step at a time instructions leave absolutely nothing to question. Giant size pictorial diagrams and everyday, non-technical language make every Heathkit easy for anyone to build. No electronic or soldering experience is required; the Heathkit manuals teach you the right way to do a professional job the first time.

No matter what your field of interest, building a Heathkit will be one of your most exciting, rewarding experiences.

And you'll save 50% or more on the world's finest electronic equipment. Send today for your *free* Heathkit catalog—or see your nearest authorized Heathkit dealer.

EVERYTHING FOR STEREO



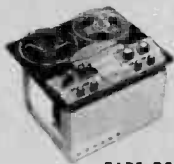
AMPLIFIERS



TUNERS



CHANGERS



TAPE DECKS



HEATH COMPANY

 a subsidiary of Daystrom, Inc.

Benton Harbor 2, Michigan

Please send the latest Free Heathkit Catalog.

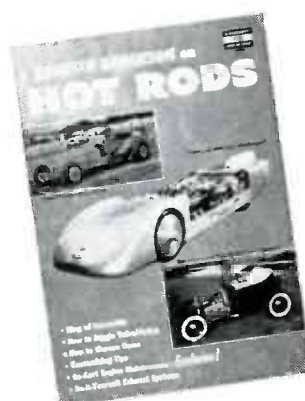
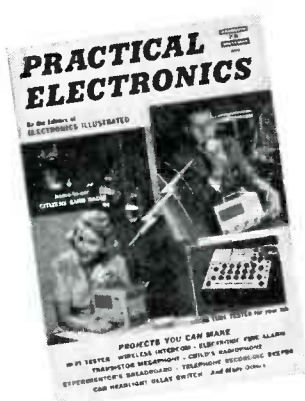
NAME _____

ADDRESS _____

CITY _____ ZONE _____ STATE _____

Mail the coupon Today!

FAWCETT HOW-TO BOOKS



BUILD IT • Plans, photos, illustrations, easy-to-make projects: indoor, outdoor furniture, built-ins. (No. 429)

PRACTICAL ELECTRONICS • Tube tester, wireless intercom, fire alarm, child's radiophone, etc. (No. 428)

Griffith Borgeson on **HOT RODS** • Valve timing, exhaust systems, go-kart engines, customizing tips. (No. 427)

HANDY MAN'S HOME MANUAL • Block flooring, insulation, built-ins, fences, swimming pool, etc. (No. 426)

Peter Basch Photographs **GLAMOROUS WOMEN** • Fashion, theater, foreign pin-ups, 200 photos. (No. 425)

Electronics Illustrated **HI-FI HANDBOOK** • Preamps, cartridges, changers, tuners, AM, FM, stereo. (No. 424)

HOME IMPROVEMENTS You Can Do • Build kitchens, basement playroom, garage, closet, built-ins. (No. 423)

GOOD PHOTOGRAPHY • Beauty portraits, animals, closeups, nudes, fog photos, jazz impressions. (No. 422)

STOCK BUYING GUIDE • Investment clubs, mutual funds, retirement, penny stocks, debentures. (No. 421)
Also available in hard cover edition at \$2.50 per copy.

ATTIC AND BASEMENT IDEAS • Proper planning, stairways, panel walls, ceilings, flooring, etc. (No. 420)

FRED RUSSELL'S CAR CARE • Power steering, carburetors, radiators, tires, batteries, brakes. (No. 419)

LUCIAN CARY ON GUNS • Streamlined firepower, preserve shooting, air guns, rifles, equipment. (No. 418)

RUSSIA and THE BIG RED LIE • Exposes hoax of Soviet supremacy; missiles, air power, space. (No. 417)

Electronics Illustrated **HAM RADIO HANDBOOK** • Mobile rigs, transmitters, receivers, codes, etc. (No. 416)
Also available in hard cover edition at \$2.50 per copy.

PRIZE WINNING PHOTOGRAPHY • Nudes, portraits, children, news, glamour, sport, animals, action. (No. 415)

PLYWOOD PROJECTS You Can Build • Headboards, desk, cabinets, tables, racks, bookcase, divider. (No. 414)

How To Build and Race HOT RODS • Go Karts, dragsters, sports rods, soup T-Bird & Chev V-8, etc. (No. 413)
Also available in hard cover edition at \$2.50 per copy.

PHOTOGRAPHING GLAMOUR • Gowland, Ornitz, Meyer, Yulsman, Jerger and many others. (No. 412)

WATER SKIING HANDBOOK • Fundamentals, equipment, driving boats, motors, jumping, shows. (No. 411)

PHOTOGRAPHY HANDBOOK • Underwater nudes, camera tricks, offbeat glamour, montages. (No. 410)

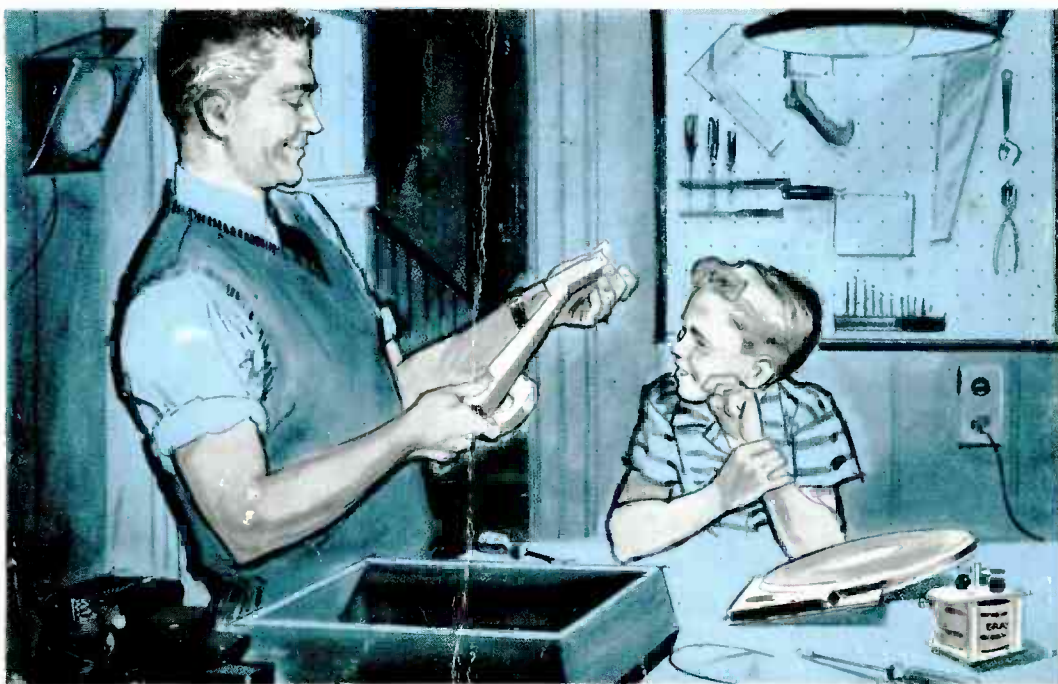
TV REPAIR AND MAINTENANCE • Receivers, tubes, sockets, sound, antennas, trouble shooting. (No. 409)

NEW GOLF SECRETS OF THE PROS • Hogan, Venturi, Snead, Middlecoff, Casper, Ford, etc. (No. 408)

To order direct, send 75c per copy for regular edition or \$2.50 per copy for De Luxe edition to: **FAWCETT BOOKS, Dept. 432, Greenwich, Conn.** Add 10c per copy mailing charge for all books. Specify title and number. Canadian orders cannot be accepted.

A FAWCETT HOW-TO BOOK 75c

AT YOUR LOCAL NEWSSTAND, LEADING DRUG STORE, SUPER MARKET, HARDWARE STORE AND BUILDING SUPPLY DEALER



START YOUR HIGH FIDELITY SYSTEM WITH A GRAY COMPONENT **KIT OR ASSEMBLED**

...GRAY COMPONENTS for expert workmanship at low cost to you



GRAY Hysteresis-Synchronous Turntable Kit

Precision engineered parts. Balanced for both stereo and monophonic use. 33 1/3 RPM belt drive.

HSK-33 turntable . . . \$49.50
SAK-12 tone arm . . . 23.95
TBA base 17.95



GRAY Custom DeLuxe turntable, arm and base

Factory assembled components that give you all the extras you need for the most complex system.

33 H (Hysteresis-Synchronous) Turntable \$79.95
212 SX 12" arm 34.00
33 C Wood Base 23.95



GRAY Tone Arm Kit

Outstanding features such as linear fluid damping, quick-change cartridge slide, adjustable static balance, and versatile wiring for all cartridges makes SAK-12 tone arm your best buy.

SAK-12 12" arm kit \$23.95



GRAY Micro-Balanced Pressure Gauge

Indicates pressure on record surface so that adjustments can be made for proper tracking. A true balance without springs.

PG 200 gauge \$2.50

Visit your friendly quality Gray dealer for a full demonstration. Write to us for complete literature.

GRAY

our 61th year in communications . . .

High Fidelity Division

DEPT. A • 16 ARBOR STREET, HARTFORD 1, CONN