

HI-FI manual

Special Section on TAPE RECORDING



Record Turntable



AM & FM Radio Tuner



Pre-Amp & Amplifier



Tape Recorder

By Donald Carl Hoefler

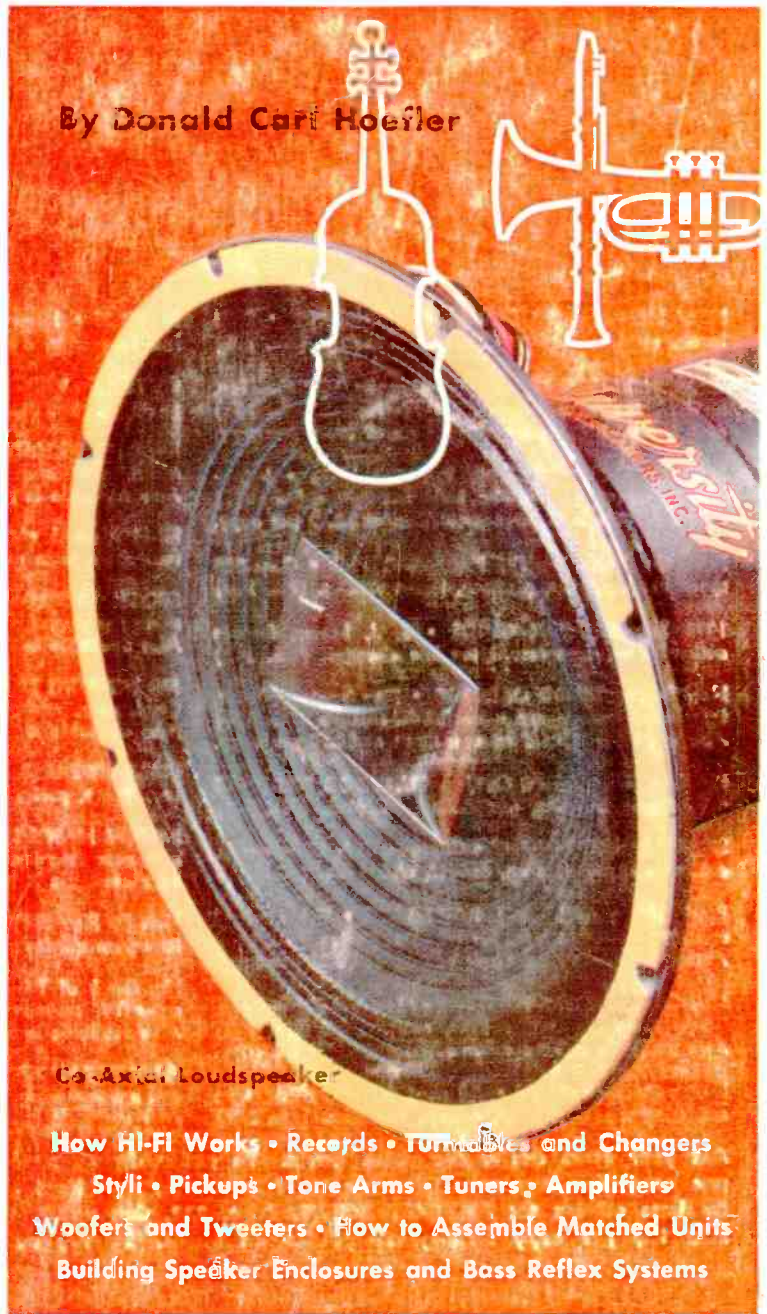

Co-Axial Loudspeaker

How HI-FI Works • Records • Turntables and Changers
Styli • Pickups • Tone Arms • Tuners • Amplifiers
Woofers and Tweeters • How to Assemble Matched Units
Building Speaker Enclosures and Bass Reflex Systems

FAWCETT HOW-TO BOOKS

AT YOUR FAVORITE NEWSSTAND

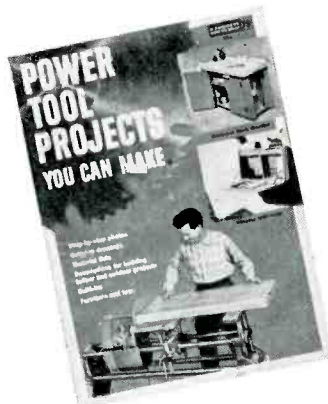
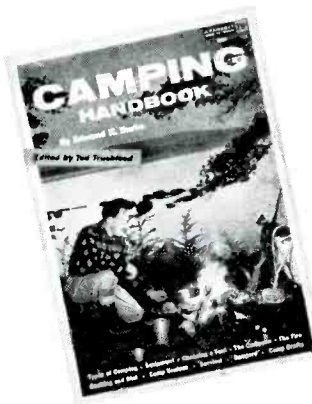
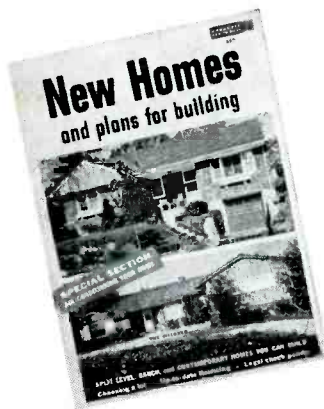

NEW HOMES AND PLANS FOR BUILDING • Split levels, ranches. Buying land, new financing. (No. 253)

CAMPING HANDBOOK • Choosing site, tent, cooking, survival, crafts, equipment. All illustrated. (No. 252)
Also available in hard cover edition at \$2.00 per copy.

POWER TOOL PROJECTS You Can Make • Indoor and outdoor items, built-ins, furniture. Photos. (No. 251)
Also available in hard cover edition at \$2.00 per copy.

Peter Gowland's FIGURE PHOTOGRAPHY • Over 200 spectacular pin-ups, glamour, figure studies. (No. 250)

1955 INCOME TAX GUIDE • S. J. Lasser, famous authority, explains recent tax law changes. (No. 249)

How To Do WOOD CARVING • Step-by-step photos, templates for carving popular birds, animals. (No. 248)
Also available in hard cover edition at \$2.00 per copy.

Handy Man's Indoor & Outdoor PLYWOOD PROJECTS • Furniture, built-ins, remodeling, building. (No. 245)

SALON PHOTOGRAPHY • Glamour, distortions, nudes, available light, children, candid, club news. (No. 243)

Frank Ellison on MODEL RAILROADS • The dean of modelers complete book for RR fans. Photos. (No. 242)
Also available in hard cover edition at \$2.00 per copy.

How To REFINISH FURNITURE • New and old surfaces, brush, spray finishing, repairs, remodeling. (No. 236)
Also available in hard cover edition at \$2.00 per copy.

Lucian Cary on GUNS • All new! Shotgun clinic, trap and wing shooting, rifles, scopes, gun care. (No. 238)

BUILD IT • More than 50 home workshop projects in how-to photos, construction drawings, text. (No. 240)

GOOD PHOTOGRAPHY • Fabulous photos by the best photographers. Nudes, glamour, children, pets. (No. 235)

INVENTOR'S HANDBOOK • Patents, copyrights, trademarks, venture capital, inventors' markets. (No. 233)
Also available in hard cover edition at \$2.00 per copy.

HI-FI Manual • Speakers, amplifiers, tuners, pickups, turntables, tape recorders. Fully illustrated. (No. 232)

STOCK BUYING Guide • Stocks for income, growth, safety; mutual funds, penny stocks. Photos. (No. 231)
Also available in hard cover edition at \$2.00 per copy.

100 HOUDINI TRICKS You Can Do by DUNNINGER • Card, coin, parlor, stage illusions. Photos. (No. 228)
Also available in hard cover edition at \$2.00 per copy.

PRIZE WINNING PHOTOGRAPHY • Top national winners. Nude, portraits, children, press, candid. (No. 227)

HANDY MAN'S HOME MANUAL • Latest edition of a famous favorite. Repairs, maintenance. (No. 224)
Also available in hard cover edition at \$2.00 per copy.

How To Play BETTER GOLF • Famous champion Lloyd Mangrum will lower your score. Many photos. (No. 223)

Handbook of TV REPAIR • Tube testing, tools, UHF, color TV, antennas, fringe area reception. (No. 222)
Also available in hard cover edition at \$2.00 per copy.

ARCHERY HANDBOOK • Target shooting, hunting, bow and arrow making, equipment. How to shoot. (No. 221)
Also available in hard cover edition at \$2.00 per copy.

Ask your news dealer for these books. To order direct, send 75¢ per copy for regular edition or \$2.00 per copy for hard cover De Luxe edition to: **FAWCETT BOOKS, Dept. 232, Greenwich, Conn.** Add 10¢ per copy mailing charge for all books. Specify number.

A FAWCETT HOW-TO BOOK 75¢

A FAWCETT BOOK

NUMBER 232

LARRY EISINGER • EDITOR-IN-CHIEF • FAWCETT BOOKS

GEORGE TILTON • MANAGING EDITOR

HI-FI manual

by Donald Carl Hoefler

W. H. Fawcett, Jr. President

Roger Fawcett General Manager

Gordon Fawcett Secretary-Treasurer

Roscoe Fawcett Circulation Director

Ralph Daigh Editorial Director

Al Allard Art Director

Lee Wilson Production Director

WM. T. McKEOWN EDITOR

Jean Galloway Editorial Assistant

HAROLD KELLY ART EDITOR

Nick Carlucci Art Associate

Silvio Lembo Art Associate

Lew Louderback Art Associate

Al Jetter Art Associate

Jack Borgen Art Assistant

Bob Thornton Art Assistant

Anne Buccheri Production Editor



Hal Kelly photo

Donald Carl Hoefler, author and engineer, has been engaged in music and sound activities since high fidelity created a first flurry in America in the nineteen-thirties. One of the pioneer frequency-modulation broadcast engineers, he was for several years associated with Major Edwin H. Armstrong, the inventor of FM. He later designed and built FM stations, and served as Chief Engineer of the Continental FM Network. Now devoting much of his time to recording, where he has been responsible for a number of innovations in magnetic tape techniques, he speaks with the authority of broad experience gained throughout the United States and Europe.



Contents

Why Hi-Fi?	3	Loudspeakers	92
Sound and Electronics	12	Enclosures and Cabinets	104
Radio and Records	24	Tape Recording	110
Turntables	38	Assembling Your System	124
Reproducers	50	A Few Sour Notes	134
Compensators and Pre-Amps	62	Sound Expectations	137
Broadcast Tuners	70	Hi-Fi Directory	140
Power Amplifiers	78	Glossary of Terms	141

SECOND PRINTING, 1955

HI-FI MANUAL, Fawcett Book 232, is published by Fawcett Publications, Inc., Greenwich, Connecticut. Editorial and Advertising Offices, 67 West 44th Street, New York 36, New York. General Offices: Fawcett Building, Greenwich, Connecticut. Trademark of Fawcett Publications, Inc. Printed in U.S.A. Copyright 1954 by Fawcett Publications, Inc.

Cover layout designed by Jack Borgen; color photographs by Michael Bonvino, Fawcett Studio.

David Bogen Co. Lenco record turntable; David Bogen AM & FM Radio Tuner; Brook Electronics Co. pre-amp & amplifier; Berlant Associates Concertone tape recorder.



Leopold Stokowski, in collaboration with his recording engineers, is credited with having evolved many of the modern high fidelity sound techniques in use today. A pioneer in the recording of symphony orchestras, he has become closely identified through his concerts, broadcasts, motion pictures, and records, with the progress of music in America. Dr. Stokowski's recent RCA Victor releases, Tchaikowsky's Fifth Symphony, the Enesco "Romanian Rhapsody" and the modernist "Poems of William Blake," show his tremendous versatility. In addition to conducting abroad, Leopold Stokowski has directed six orchestras, including the Cincinnati, the Philadelphia, the NBC Symphony, and the New York Philharmonic.



The recording of symphonic and operatic music today is on the threshold of extremely important developments which will accomplish even greater fidelity than has been achieved in the past. Immense strides have been made in the history of recording which so far have covered three main epochs. The first, of course, was mechanical recording in which the orchestra was crowded into an enormous horn. The second epoch was electrical recording on wax—a major milestone both to the artist and the engineer.

And now with the development of magnetic or tape recording and its advantages of much greater intensity and frequency range, we have entered an era of enlarged sound impression. In the concert hall, music comes to us reflected from many surfaces—the several walls and the ceiling. When we listen to an orchestra in a concert hall, the music is coming to us from players on the right side of the stage, in the center, on the left side and from the back. All these varying impressions of music, which reach our ears from many directions, create a wonderfully rich pattern of sound.

In recording music today the length of reverberation in the hall or theater, is also of great importance. Each kind of music needs a different length of reverberation for its best recording and reproduction. A composition may sound in many different ways according to the enclosed space in which it is performed. For example, the quality of sound in Carnegie Hall in New York or in the Academy of Music in Philadelphia varies to an enormous degree from that of Kingsway Hall in London, or the Gewandhaus in Leipzig. All these differences must be taken into account in developing a greater degree of high fidelity.

New recording techniques will advance the development of binaural sound. Then it will correspond to the way we hear music in the concert hall with our two ears. This we partly achieved in the Walt Disney recording of "Fantasia." Very recently we also made experimental recordings for RCA Victor of a new performance of Enesco's Romanian Rhapsody in binaural sound.

I am convinced that in days to come, recorded music will have further developments than those I have just mentioned. We cannot foresee those yet. The potentialities are infinite; so is the inventive power of the human mind.

A handwritten signature in dark ink, which appears to read "L. Stokowski". The signature is fluid and cursive, with a large initial 'L'.

Leopold Stokowski

Pride of the Victor Talking Machine Company in 1906 was the Morning Glory Horn. With spring-wound motor, this instrument graced many parlors.

Why Hi-Fi?

Nearest possible approach to true fidelity of all sound reproduction throughout the audible range is the goal of high fidelity fans.



RCA Victor

HIGH FIDELITY—that magic phrase—means many things to many people. To the musical artist it is a means of expression; to the engineer it is the best known means of collecting, storing and reproducing sound; to the phonograph record and equipment manufacturers it means new markets and more profits. But what about you and me? What does high fidelity really mean to us?

For you and me high fidelity should be the means of erasing the barriers of space and time between a fine musical performance and our own private listening enjoyment. And while that is quite a wonderful proposition, it doesn't really have to involve all of the occult mumbo jumbo which has been foisted upon us by some of the high priests of hi-fi. The part which we can play in high fidelity—and it is only a part—is quite simple and straightforward. We want the best possible sound reproduction we can get without at the same time ruining our budgets. This can be accomplished most effectively when we know the various possible approaches to our objective, and then *plan* carefully the system which will be best for us.

Lest we get involved in a useless argument about hi-fi semantics, let's get established at the outset that there is no generally-accepted definition of high fidelity today. The Radio Manufacturers Association established standards years ago, but they are now totally obsolete. The Federal Trade Commission recently took a look at the possibility of their setting up standards, but they soon ran off like scared maidens, muttering something about the business being too young.

So let us simply define high fidelity as the nearest possible approach to *perfect fidelity*, which we can in turn define as the reproduction of the exact psychological impression of presence at a live

musical performance. Thus the smaller the barrier becomes, the higher the fidelity goes. This is a nice elastic definition, suitable to any occasion, and guaranteed to save your time and temper when among other audiophiles.

The important thing to remember about high fidelity is that you have control only over the last link in the chain. Before the sound ever reaches your system it may have already gone through microphones, mixers, amplifiers, filters, telephone lines, transmitters, recorders, and "the luminiferous ether." And if any one of these elements happens to be having a hard day, you may as well look elsewhere for your high fidelity material.

Most of the postwar milestones of this audio age are well known: tape recording, plastic records, microgroove disc recording, magnetic reproducers, London's smart promotion of their *ffrr* system, and the application of video amplifier techniques to audio. But that does not mean that high fidelity was in the dark ages until a few years ago. On the contrary, there has been a constant upward swing in the techniques of sound transmission covering a period of fifty or sixty years. In order to bring the

entire picture into focus, we should have a quick look at some of the high spots of that era.

Acoustical Recording

All scientific progress is the result of the cumulative efforts of many inventive minds, and the development of high fidelity is no exception. It is difficult to say for certain where it all began, but certainly one of the first significant developments was the *Phonautograph* of Leon Scott, invented in France in 1857. This machine, when actuated by sound waves, traced an impression of them in the form of a laterally wavy spiral line on a rotating cylinder coated with lampblack. Thus was proven the feasibility of recording sound. But the reproduction of recorded sound was not to become a reality for another twenty years.

In 1877, Thomas Edison repeated the Scott experiments using waxed paper as the recording medium, and a few weeks later ordered his assistant, John Kreusi, to construct a device which employed tinfoil as the medium. The success of this experiment is well known, and every schoolboy has heard of Edison's hearing a facsimile of his own voice reciting "Mary Had

RCA Victor

Though inventor of the talking machine, Edison visualized his instrument not as the source of music and entertainment, but as business machine.

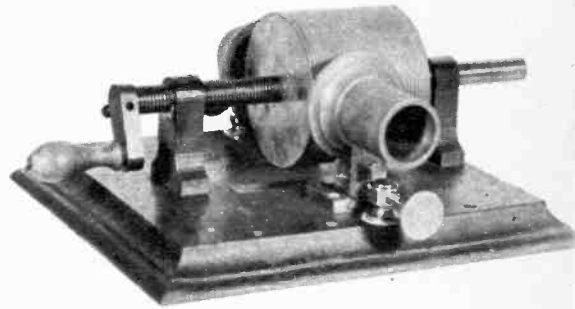

First phonograph is now in Thomas A. Edison Foundation Museum, West Orange, N. J. Original sketches of 1877, below, also from the museum, give Edison's experimental directions, remarks.

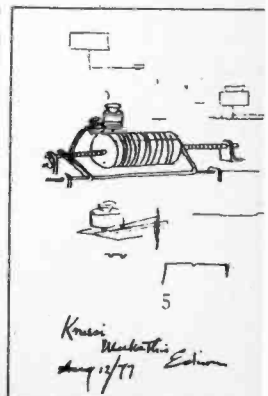
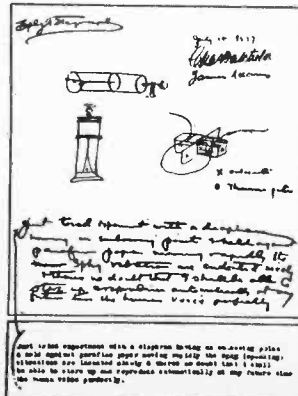

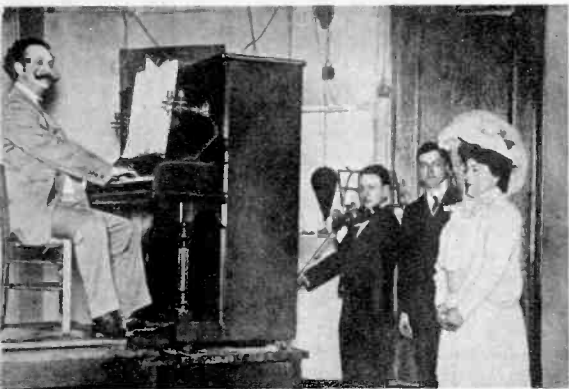

Nellie Melba recorded for Victor in this primitive studio in early 1900's. Note horn in rear wall. Mme. Melba's records are still available today.

Exploitation of their wide range for recordings by London Records did much to popularize hi-fi.



London Records

a Little Lamb." Not so many, perhaps, have heard of Kreusi's flabbergasted reaction. All he could manage to blurt out was "Mein Gott in Himmel!"

It may be that Edison's recorder was responsible for the use of the word "tinny" in reference to sound, for in 1881 Chichester Bell and Charles Tainter conceived the idea of wax as an improved medium of recording. There is no way of knowing whether they were influenced by Edison's original wax-paper experiment, but the

idea must have been eminently sound, for wax continued to be used for original commercial recordings right up until World War II, when certain ingredients became unavailable.

Emile Berliner, in 1888, introduced the first flat disc record, which reverted to the original Scott idea of a side-to-side movement of the groove, as opposed to the vertical "hill-and-dale" system employed by Edison and Bell. Berliner also used lamp-black once again as the medium, but the

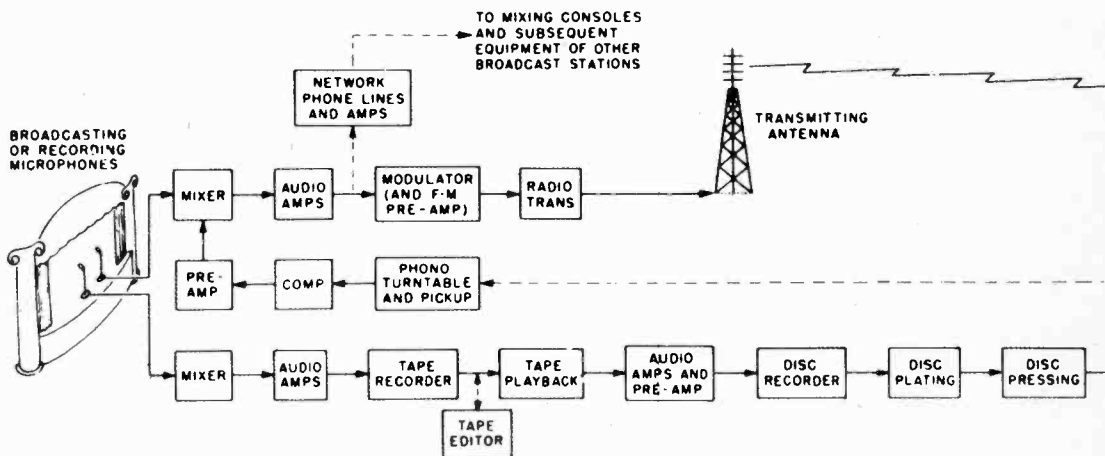

All above steps must be perfect in order for the home units to have faithful sound to recreate.

significant advance here was the first attempt at mass duplication of records, for he also developed an etching process which enabled the delicate original groove to be permanently transferred to copper or nickel.

By 1895 Berliner had developed a system which consolidated the best ideas of his own and his contemporaries. Combining Scott's lateral groove on his own flat disc coated with Bell and Tainter's wax, he introduced the system which was to become the industry standard for the next fifty years. At the same time he improved upon his original etching idea by the development of an electroplating process of the original. In this way there was created the negative master, which is still the basis of commercial duplication of phonograph records.

Berliner then became connected with a machinist from Camden, New Jersey, named Eldridge Johnson. Many mechanical improvements evolved from this joint effort, including the spring-wound motor for reproducer turntables. Furthermore, Johnson had the creative imagination to foresee the commercial potential of the phonograph, as opposed to Edison, who said:

"I don't want the phonograph sold for amusement purposes. It is not a toy."

But the Columbia Phonograph Corporation had nevertheless been formed for this very purpose in 1886, and Johnson jumped into the fray with his Victor Talking Machine Company in 1900. Edison begrudg-

ingly and belatedly entered the race, first with cylinders and later with discs, but he soon had to give it up. The other two companies, meanwhile, have continued their growth and intense rivalry right up to the present day.

The basic recording system first employed by the industry was known as *acoustical*, in that the actual sound produced by the artists was the sole source of energy for actuating the system. The sound was collected in one or more large horns, which had a sensitive diaphragm at their apex connected to a cutting stylus. Microphones and amplifiers were as yet entirely unknown. But while the phonograph people continued their exploitation of mechanical systems of sound transmission, others were considering the sending of sound by *electronic* means.

Radio Broadcasting

The radio which was patented by Guglielmo Marconi in 1896 was in reality a system of wireless telegraphy, and it was not possible to use it for the transmission of sound until the development of Dr. Lee DeForest's *audion* ten years later. Using his newly-developed vacuum tube, Dr. DeForest gave a few lonely wireless operators the surprise of their lives, when on a quiet night in 1907 he "sneak previewed" the coming era of radio broadcasting. For on that night something new was added to the dots and dashes which these operators were accustomed to hearing. Suddenly and without warning there came out of the air the voice of Mme. Eugenia Farrar, a young

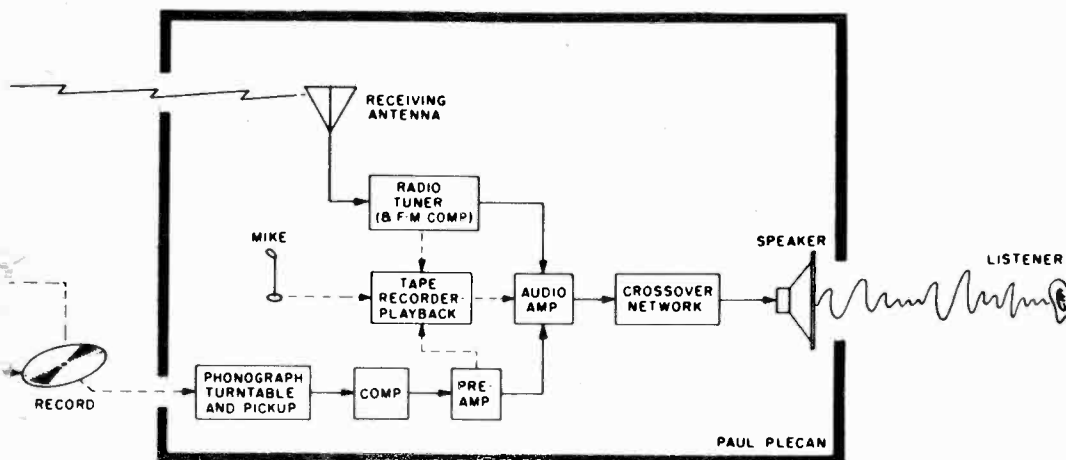

Record or radio waves are now dependent on the quality of components above, and proper use, for hi-fi.

ANCESTORS

of today's phonograph

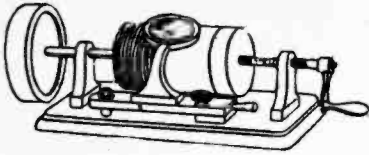

1877... THE EDISON

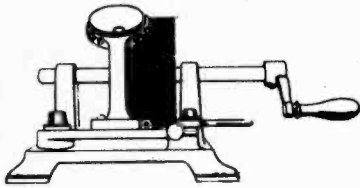

1881... THE BELL AND TAINTER

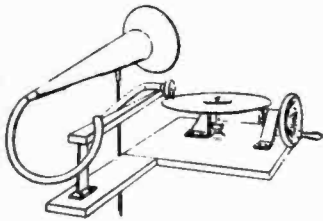

1888... THE BERLINER

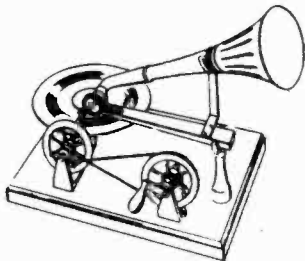

1895... THE BERLINER (II)

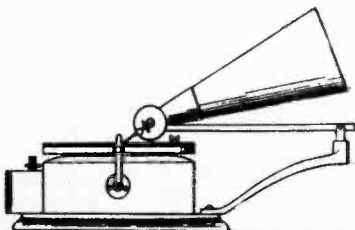

1898... THE ELDRIDGE JOHNSON

Swedish concert singer, offering "I Love You Truly" and "Just A-Wearyin' For You." This was the beginning of modern radio broadcasting, an industry which within twenty years boasted over a thousand stations, and which marked another surge forward in the quest for high fidelity.

In 1926 the Bell Telephone Laboratories published a very significant article by H. C. Harrison and J. P. Maxfield, which described in great detail how telephone transmission theory and electronic amplification could be applied to a system of phonograph recording. But the record manufacturers were quite smugly satisfied with their acoustical systems, and would have nothing to do with this new-fangled idea—at least not yet. But by 1927 Columbia had succumbed to the lure, and when Victor learned of that a couple of months later, they fell all over themselves trying to catch up. Thus was begun the manufacture of electrical recordings, a direct result of the keen rivalry between these two great companies.

Sound Movies

The competitive picture opened up new vistas in another area as well. The Warner brothers were having tough sledding in the motion picture business, because they had no facilities for distributing and exhibiting their product. They could make good pictures, but they couldn't get them into the theaters owned by their competitors. Something drastic had to be done to get them public attention, and they gambled everything on the system of "talking pictures" which Western Electric had been trying unsuccessfully to peddle to every major producer in Hollywood. This system employed 16-inch discs rotating at 33½ r.p.m. and running in synchronism with the projected film. It received its first public showing at the Warner Theater in New York on August 6, 1926. The program consisted of seven musical short subjects and the feature, "Don Juan," with John Barrymore. The feature had no dialogue, but was accompanied by a musical score performed by the New York Philharmonic Orchestra. Despite the great acclaim given this event by public and press, all of the major producers continued to remain aloof from the sound picture—all, that is, except one.

William Fox agreed with the Warners that sound pictures were here to stay, but he was also convinced that the picture and the sound had to be somehow wedded on the same film base. Dr. DeForest had in 1924 produced a sound-on-film picture with Una Merkel, and Fox believed that

Courtesy HUBER NEWS, from the J. M. Huber Corp., Borger, Texas



Record cutting, in days before microphone, found the musicians grouped in front of a horn. Voices and instruments generated power to move needle.

HUBER NEWS



Here is the same Victor studio at Camden, N. J., in 1925 on the historic occasion of the first electrical recording session. Bourdon conducted.

RCA Victor



Dr. Lee DeForest, famous radio pioneer and inventor of the vacuum tube that made broadcasting possible, is shown at an early radio telephone.

Western Electric

HUBER NEWS



Sound reproduction in early broadcasting was fairly crude and little attempt was made at sound correction other than draped windows as in this studio.

NBC photo

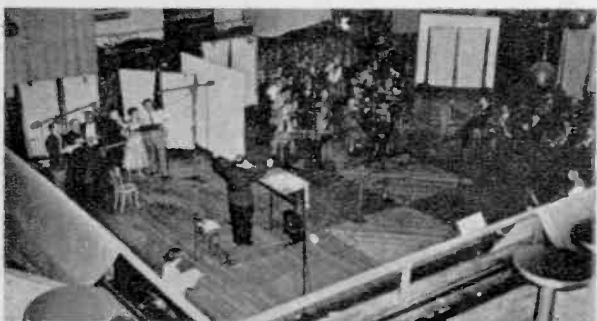

Hi-fi fan listens to the results of the recording process in special rooms like this at Allied Radio in Chicago. Speakers and amplifiers are compared.

In modern recording, as shown at left at an RCA Victor session of "Lucia de Lammermoor," special paneling and padding are set up for best acoustics.

This contraption of cogs and valves was used for train noises in one of the first sound movies at Warner Bros. studios. Sound on film is at right.





Music at Home is the latest magazine to join Tape and Film Recording, High Fidelity, and other publications which provide information for hi-fi fans.

the sound picture must ultimately take this form. Perhaps he also had in mind the failure of the sound-on-disc picture produced by D. W. Griffith in 1914. At any rate, the first film to use the Fox Movietone system, a newsreel, was presented at the Roxy Theater in New York on October 28, 1927, and within a few years Fox's contention was proven. Sound-on-film marked another significant advance in the art of high fidelity recording, an event which was not surpassed until the advent of magnetic tape recording twenty years later.

But one significant event stands out above all others as the dawn of the modern high fidelity era. This was the establishment of the first permanent Frequency Modulation broadcast station by its inventor, Major Edwin H. Armstrong. The standards established for this service represent the ultimate in fidelity as we know it today, and they are the criteria which the commercial phonograph record has yet to meet.

Hi-Fi System Elements

The *FM tuner* or radio set, then, is one of the cornerstones of the modern high fidelity system. There are three other basic units to complete the setup: the *rec-*

ord player converts the wiggles in a record groove to small electrical voltages; the *amplifier* builds up these minute voltages to rather large powers; and the *loud-speaker* reconverts this electrical power to sound. Each of these items can be further subdivided and analyzed, of course, but these four units are all it takes to assemble a complete high fidelity system.

Prices of equipment vary widely, and while you might assemble a pretty fair set for around a hundred dollars, you can also spend thousands if your budget permits it. Whatever you expect to spend, however, you should know something about pricing policies. In the radio and electronic fields in the past, it has been the practice to establish a list price, from which a standard trade discount was deducted, this discount being 40% on most items. This fact soon became generally known, however, and hardly anyone paid the list price. Manufacturers have recently come to recognize this, and most of them have dropped the fictional list price. Most prices are now simply stated as "audiophile net," which means one standard price to all.

There are still bargains to be found, however, and a little careful shopping will often turn them up. Some of the best sources are mail-order distributors, such as those listed in the directory at the back of this book. They carry all of the standard lines, but also sometimes buy up odd lots, discontinued items and distress merchandise, and this equipment is often of very good quality. Most of these distributors have public showrooms as well, and almost all of these now include a "high fidelity salon." In these salons you will usually find a very elaborate switchboard arrangement which will enable you to listen to any combination of high fidelity components you may select. But we're getting ahead of our story. Before you begin assembling your own system, you'll want to know a little more about this high fidelity art.

Clubs and Publications

One good way to pick up ideas is to join in with other people of like interest. The Audio Engineering Society, which now has chapters in a number of major cities, offers you an opportunity to meet with other audiophiles and to hear of the latest developments in the field. Although this is basically a technical group, its membership includes many hobbyists like yourself, and while the discussions may occasionally get a little over your head, you will definitely find them to be interesting and beneficial.

But if you should feel that this group doesn't quite fill your requirements, then

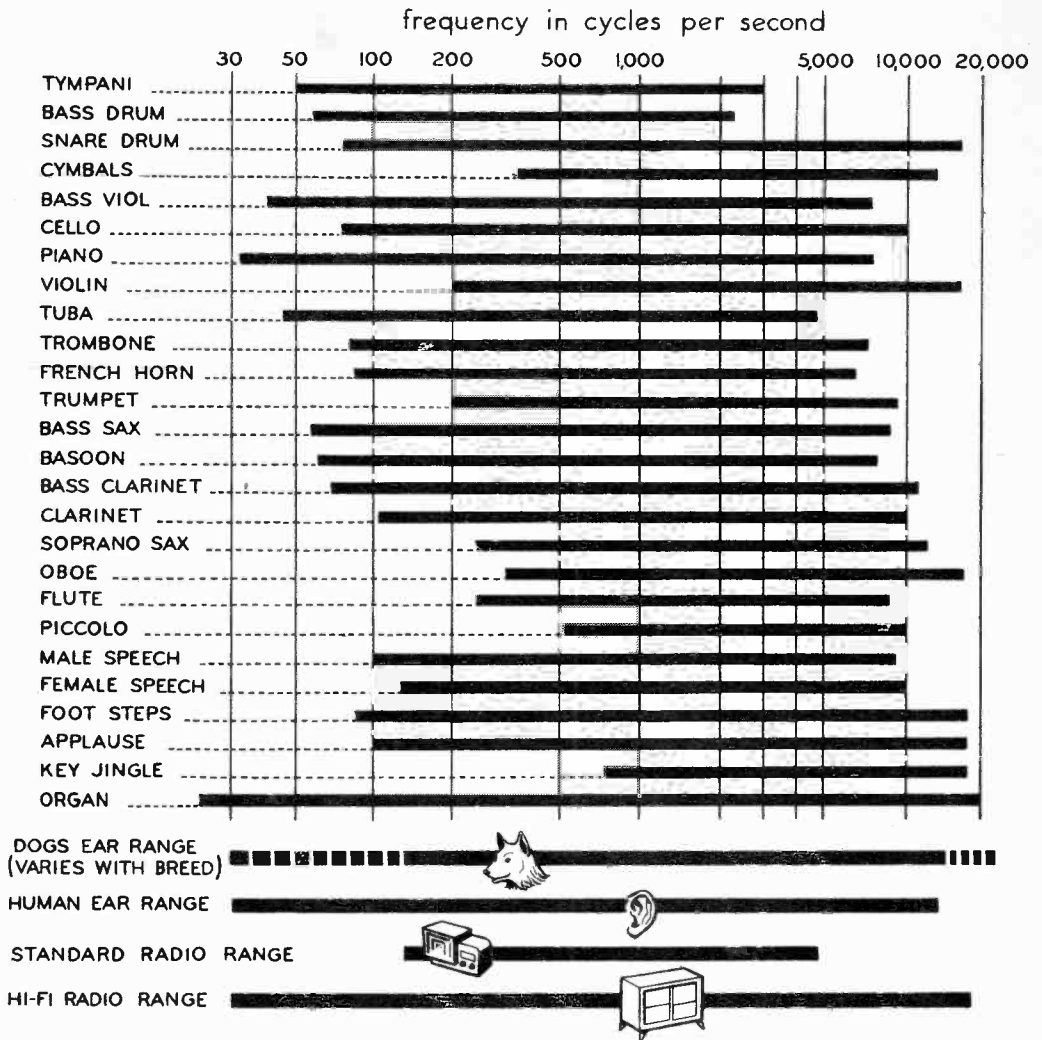

High fidelity set must give balanced reproduction of sounds covering the complete audible spectrum.

the Society of Music Enthusiasts very likely will. This group is interested in music in all its forms, live as well as recorded or broadcast, and treats high fidelity more as an art than as a science. If you are simply interested in good listening, and don't care so much about the ways and means to that end, then this is the group for you.

By the same token, the two periodicals in the field aim their publications at these two schools of thought. AUDIO is mostly

concerned with equipment and techniques, while HIGH FIDELITY takes a more subjective approach.

The purpose of this book is to show you how to assemble a high fidelity system with the best results at the lowest cost, but in order to do this you must first have a clear picture of your objective—the reproduction of high quality sound. Our discussion will therefore begin with a consideration of music and sound, and of their effects upon your ear and mind. •

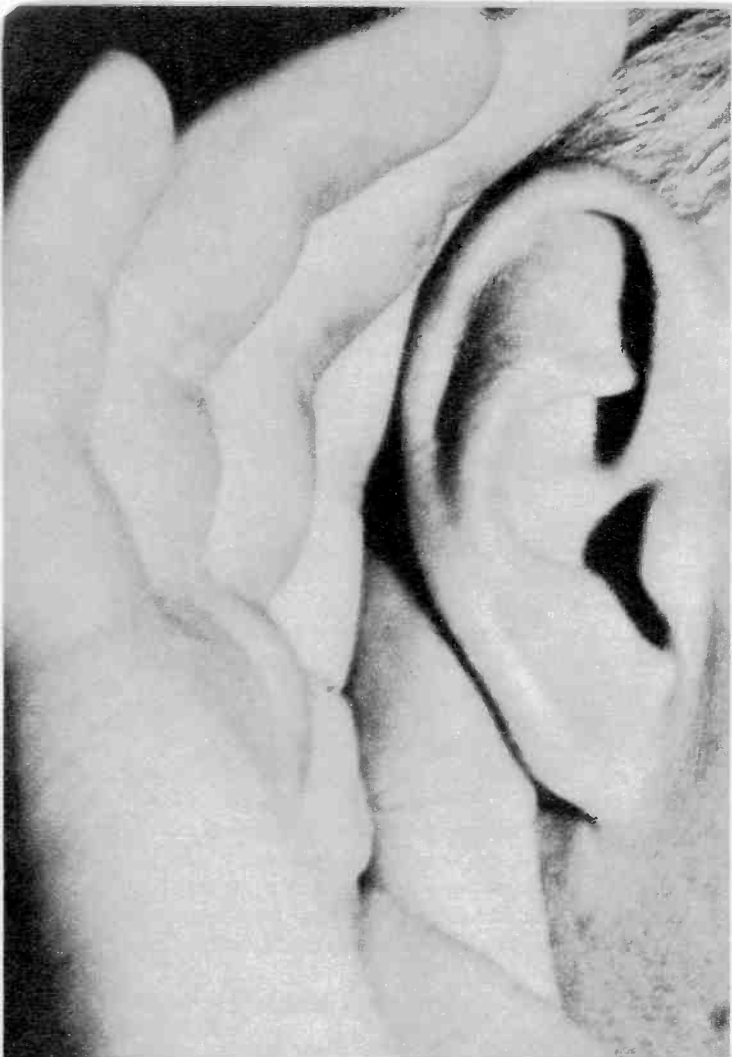

Sound and Electronics

Sounds collected by the external ear are funneled into the inner chambers and passed on to the brain. Noise is differentiated from speech and music in the hearing process. No two ears are exactly the same in appearance or hearing ability; final choice of hi-fi equipment must be based on recommendations of other experienced listeners plus your personal preference.

Ultimate test of your high fidelity equipment will be your own hearing. Here is how your ear receives and judges the sound sent out to it.

SOUND is *vibration*—vibration of any elastic medium. But we are concerned only with those vibrations which are at a rate which can cause the human eardrum to transmit a message to the brain. This means that sound is also the auditory sensation produced in the brain by these vibrations. The medium of transmission of sound to our ears is almost always air, and the original sound can be produced by a voice, musical instrument or any device which makes a noise. Thus sound really is a chain of several events: its original production, its transmission in the air by means of rapid and minute changes in atmospheric pressure, and its impinging on the eardrums and ultimate transmission from the ear to the brain.

The Human Ear

Since the high fidelity enthusiast is one who *listens*, he should know something about the hearing apparatus which enables

him to appreciate and enjoy quality sound reproduction. The ear is regarded as having three parts, known as the outer ear, middle ear and inner ear. The outer ear is the part normally visible at either side of the head, along with the canal which directs the sound inside. Stretched across the inner end of this canal is the membrane known as the eardrum, which is the beginning of the middle ear. When the eardrum is set in motion by sound in the air, it transmits this vibration to a mechanical lever system of three bones in the middle ear known as the *hammer, anvil and stirrup*. At the end of the stirrup is a second and much smaller membrane, known as the oval window, which marks the entrance into the inner ear. Due to the lever action of the bones in the middle ear, and the relative sizes of the two membranes, the pressure exerted upon the inner ear is 30 to 60 times as great as that of the outer air striking the eardrum. The inner ear is a snail-shaped cavity in the skull, which is filled with a liquid. Finally the vibrations set up in the inner ear are transmitted through the liquid to the brain over a network of thousands of tiny nerve fibers.

There have been many theories concerning the means by which the nervous system converts sound waves in air into an auditory sensation in the brain. The important thing to us, however, is that we do

ultimately receive the sensation of sound, and that this sequence is an integral part of our high fidelity system.

It is possible for sounds which the ear cannot hear to be in the air. The footsteps of a fly, for example, have been picked up and amplified by sensitive microphones, but no human ear has ever heard them without the aid of such devices. Sounds which are not loud enough to be heard are said to be below the *threshold of audibility*. Above this threshold, the ear responds to a wide range of sound intensities, but the intensity can ultimately become great enough to cause pain. This level is called the *threshold of feeling*.

The Mind

In addition to the pure physical sensation of hearing, the brain generates several secondary responses. Listening to music involves more than the use of the physical ear, for the appreciation of music as an art involves also the *mind*. The beginning of a musical composition is the short melodic phrase, consisting of notes placed in a given sequence, which is colored and shaded by the addition of rhythm and harmony. The combination of these phrases by logical design of the composer results in a finished musical work. The human ear hears the performance of the composition, but the human mind decides whether or not the

Courtesy Bell Telephone Laboratories

Here are the intricacies that make hearing possible. Sound pressure waves striking eardrum are magnified 30 to 60 times by small bone levers which pass impulses to fluid of inner ear, and by nerves to brain.

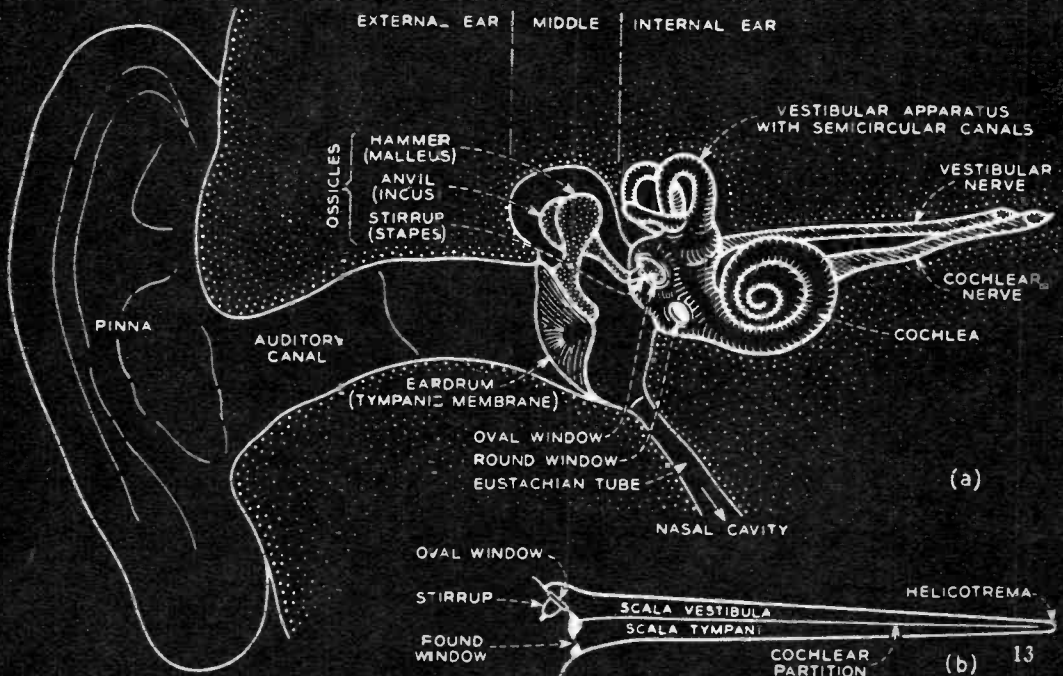



Music is made up of sounds with uniform vibrations, colored by the voices and instruments which produce them. Here Fred Waring conducts his Pennsylvanians, one of the few television programs, so far, working for musical fidelity.



Careful listening requires concentration, as shown in a variety of forms at a Columbia recording session. Johnnie Ray, popular records chief Mitch Miller, and the Four Lads quartet hear a play-back to study taped result of their performance.

resulting in satisfying sensation to hearer.

Music also has the ability to effect us emotionally. It can make us happy or sad, or it may sometimes fill us with nostalgia. All of this goes far beyond the already remarkable job done by the ear in the perception of sound.

There may be great differences in what each of us hears. Slight differences in the configuration of any of the parts of the ear, either inherited or resulting from illness or accident, could cause entirely different results to be transmitted to the brain. The ear may be trained to a higher than normal degree of acuity, just like any other part of the body, with the result that minute changes of pitch or volume become much more significant than with the average ear. Special training in music may cause one person to analyze the harmonic or tonal structure of a particular piece of music, while another person may be swept away by the poetic quality of the lyrics. To still another, the same piece of music may be

reminiscent of that first date, or instead it may have been the annoying tune which was blaring out of the radio on some sadly-remembered occasion. And so music, and the high fidelity reproduction of it, means many different things to different people.

Noise, Speech, Music

The rumble of a freight train, the clap of thunder, the jingling of a set of keys, the crash of breaking glass—all of these are sounds which have no definite pitch. We can tell whether they are high or low, but we cannot assign to them a comparable note which might be struck on the piano. These "unpitched" sounds we call *noise*. We can think of them as mixtures of great numbers of tones, with no single one predominant enough to establish a definite pitch. The full reproduction of most noises, then, will encompass substantially the entire audible range. For this reason, various types of noises are often used to test the response of high fidelity systems.

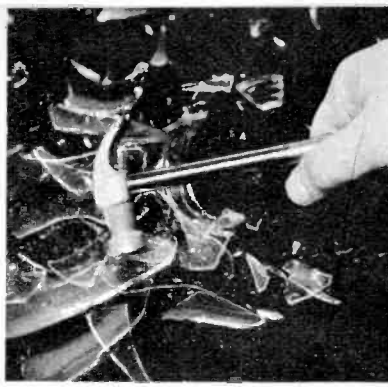
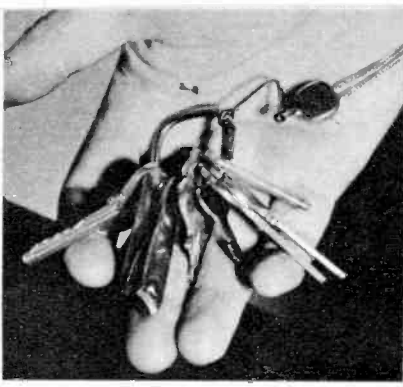

Jingle of keys or breaking glass are noises, compared with timbre, harmonics of oboist Mitch Miller.

Vocal sounds are those produced by the human organs of speech. Their pitch is more or less definite, with the average female voice lying just about an octave above that of the average male. The vowel sounds, which are the most powerful in speech, are produced by employing the lungs as a bellows to produce an air stream which is set into vibration by the vocal cords. The unvoiced sounds, such as *f*, *k*, *p*, *ch*, *sh* and *th*, do not involve the vocal cords at all, but are produced by directing the air stream through small openings or over sharp edges of the teeth, lips and tongue. The voiced consonants, such as *h*, *w* and *y*, are really only special ways of beginning the vowel sounds, and are produced by a combination of the two processes.

Musical sounds are those in which the rate of vibration is uniform. They have a constant and definite musical pitch. The overall tonal range of all orchestral instruments is considerably greater than that of the human voice, extending nearly three octaves below the lowest male voice, and almost an octave above the highest female voice. Thus the requirements of a high fidelity system for the reproduction of music are considerably more exacting than those for the reproduction of speech. The production of sound by musical instruments has been accomplished in a variety of ways. String instruments, for example, can be caused to vibrate by plucking, as in the harp or guitar, by bowing, as in the violin or cello, or by striking, as in the piano. The wind instruments all use forced air in some fashion to produce a tone. The air reed group employs a steady stream of air which is caused to pass over or under an opening in the side of a tube. The air stream breaks against the sharp edge of the orifice, and is thus set into a flutter which results in a musical tone. Examples of musical instruments in this family are the flute and pipe organ. Other instruments, such as the clarinet and saxophone, employ a single mechanical reed for the production of their

tones. The mouthpiece is a hollow beak-shaped device, with the point squared off and the underside flattened to hold a thin cane reed. When the instrument is blown, the reed is set into vibration, thus causing variations in air pressure to result in a musical tone. The double mechanical reed instruments, such as the oboe and bassoon, employ the same general principal, but the mouthpiece is replaced by a second reed on top of the first one, and an air stream is set into pulsation as it passes through a small opening between them. The lip reed family of instruments comprises the brasses, such as the trumpet and trombone. In this group the original tone is produced by the vibrating lips of the instrumentalist, throttling the air stream produced by the lungs. The horn simply shapes and colors this original tone. The final group is the percussion section, in which a sound may be produced by striking a great variety of objects. Some of these produce tones of definite pitch, as in the xylophone, chimes and tympani. Others, such as the drums, triangle and cymbals, are of rather indefinite pitch.

Characteristics of Musical Sounds

We have been referring repeatedly to pitch, which is the relative position of a tone on the musical scale, but in our high fidelity work we will often employ a closely related term known as *frequency*. We know that the sensation of sound is the result of periodic alterations in air pressure striking our eardrums. Beginning with a constant atmospheric pressure, the production of a sound will cause that pressure in the immediate vicinity to increase by a small amount and return to normal, then decrease by a like amount and return to normal. This up and down disturbance of the air will continue as long as the sound is produced. Each full excursion of the pressure from normal to the highest peak and back to normal, then to the lowest peak and back to normal, is

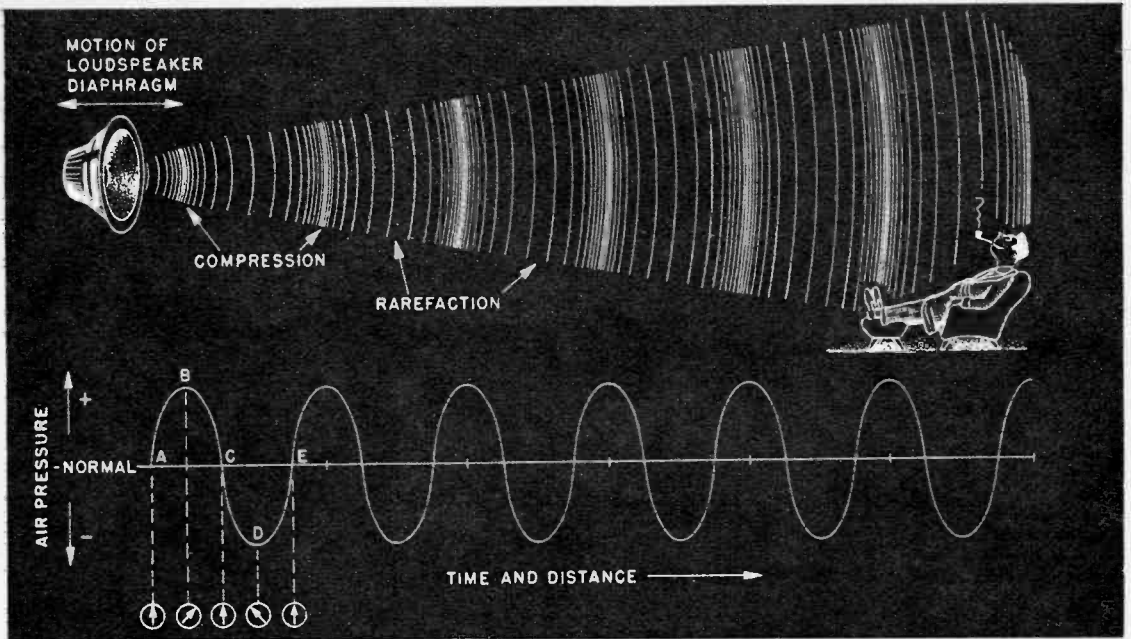

Sound is caused by alterations of air pressure, first an increase and then a decrease, with one up and down pattern called a cycle, and number of cycles occurring in one second known as the frequency.



Sounds, from the lowest to the highest which can be heard, are pictured this way in the Electro-Voice Co. booklet "Temples of Tone." Fundamental piano tones range from 27 to 4186 c.p.s. but harmonics extend to highest audible range.

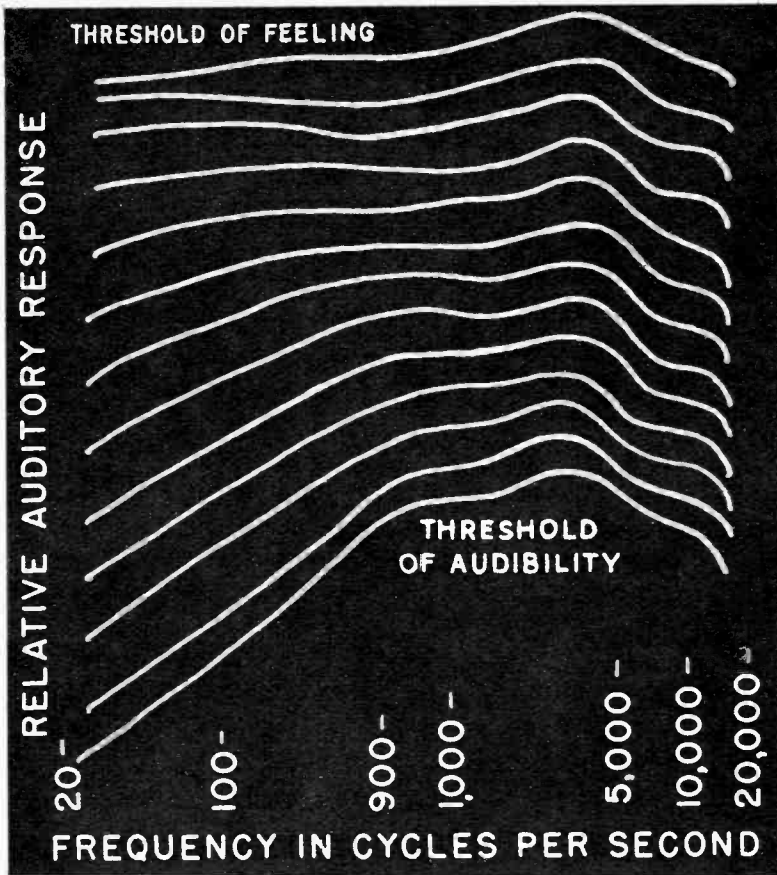

Between soft sounds, barely audible, and loud noises that can almost be felt, the human ear response varies widely. Note bass deficiency at lower levels.

called a *cycle*. And the number of cycles a sound wave goes through in a specified interval of time is known as the *frequency*. One second is the usual period employed in the measurement of sound, and we can therefore define pitch as the number of *cycles per second*. The term *cycles* is often used alone when *per second* is meant to be implied, but more precise terminology is the abbreviation *c.p.s.*, which shall be used throughout this book.

The higher the musical pitch, then, the greater will be its number of vibrations in cycles per second. Middle *A*, for example, is 440 c.p.s., while the low *E* string on a bass viol vibrates at 41.2 c.p.s. and the highest *C* on the piano is tuned to 4186 c.p.s. An interval of a musical octave comprises a two-to-one relationship between the frequencies of the two tones. Thus when middle *A* is 440 c.p.s., the *A* one octave above it is 880 c.p.s., and an octave above that is 1760 c.p.s. Similarly, middle *C* is 261.63

c.p.s., an octave below it is 130.81 c.p.s., and an octave below that is 65.41 c.p.s.

The loudness of a sound is its relatively high intensity as perceived by the human ear. The unit of measurement of loudness is the *decibel*, which is a statement of the ratios of two acoustic powers. Thus we might say that the maximum sound available from a bass saxophone is 7.5 decibels (abbreviated *db*) above that of a clarinet. In the same manner we can say that turning up the volume control of our high fidelity system by a given amount has increased the output by 5 *db*.

The reason for the use of ratios in the measurement of sound levels can best be understood by consideration of a specific example. Suppose that the average output of a given amplifier is increased from 2 to 5 watts. This three-watt increase is in a ratio of 2.5 to 1, or 4 *decibels*. But if another amplifier is raised from 10 to 13 watts, the same three-watt increase is in a ratio

27.50	A
30.87	B
32.70	C
36.71	D
41.20	E
43.65	F
49.00	G
55.00	A
61.74	B
65.41	C
73.42	D
82.41	E
87.31	F
98.00	G
110.00	A
123.47	B
130.81	C
146.83	D
164.81	E
174.61	F
196.00	G
220.00	A
246.94	B
261.63	C
293.66	D
329.63	E
349.23	F
392.00	G
440.00	A
493.88	B
523.25	C
587.33	D
659.26	E
698.46	F
783.99	G
880.00	A
987.77	B
1046.50	C
1174.66	D
1318.51	E
1396.90	F
1567.99	G
1760.00	A
1975.52	B
2093.00	C
2349.31	D
2637.02	E
2793.80	F
3135.99	G
3520.00	A
3951.08	B
4186.00	C

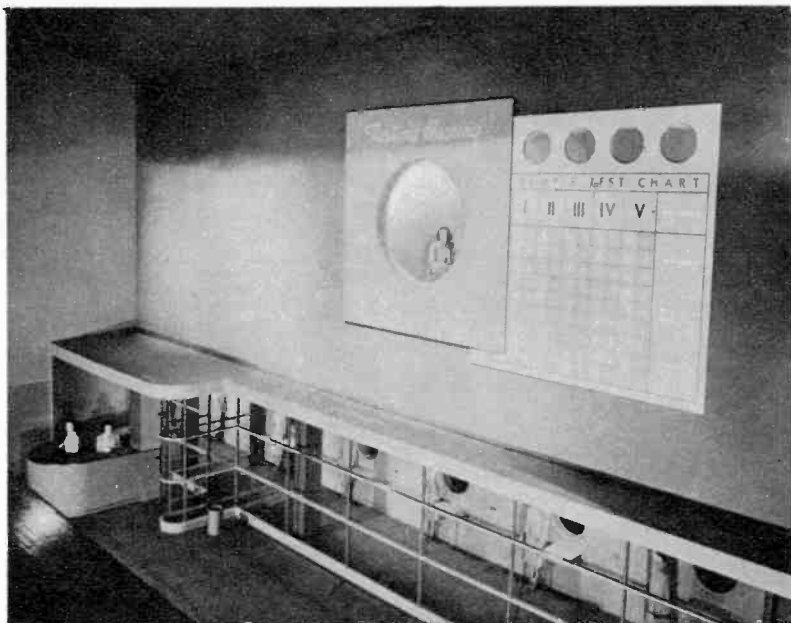

Much of our present knowledge of the ear's response to sound is the result of tests made by the Bell Telephone Laboratories at the World's Fairs at New York and San Francisco in 1939-40. Visitors sat in small booths and noted down words and tones if they could hear them.

of 1.3 to 1, or barely over 1 decibel. The 4 db increase would be quite significant to the ear, while 1 db would probably be entirely unnoticed. Thus it is essential that we know our starting point before we can analyze intelligently any change in sound level.

The middle A sounded by an oboe when an orchestra tunes up presents a distinctly different sound impression from that same A when played on a trumpet. This very significant difference in the sounds of various musical instruments is called the *timbre* or *tone quality*. It derives from the fact that no instrument produces an absolutely pure tone. A musical tone is actually a very complex wave consisting not only of the pitch frequency, known as the *fundamental*, but various subsidiary vibrations as well, called *overtones* or *harmonics*. The frequencies of these harmonics are always multiples of the fundamental, the second harmonic being twice the fundamental frequency, the third harmonic being three times the fundamental frequency, the fourth harmonic being four times the fundamental, etc. The frequencies and relative strengths of the various harmonics are almost wholly responsible for the differences in quality between instruments.

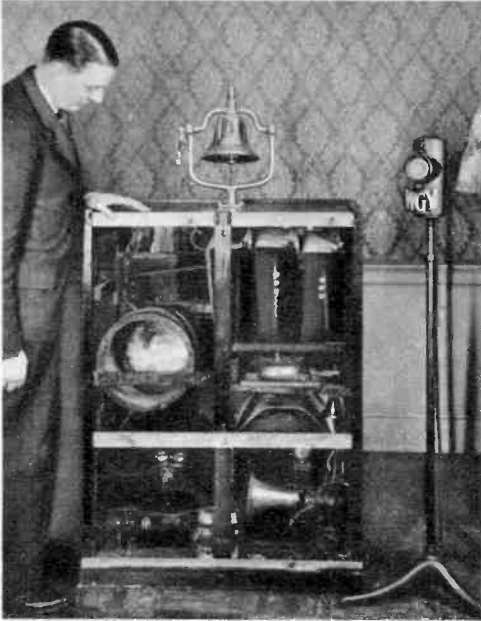

Sound effects have been an important part of radio programs since the earliest days of broadcasting. Announcer Jimmy Wallington is shown above at the sound effects cabinet in a 1924 radio studio.

Characteristics of the Human Ear

If a pure tone, without harmonics, is held at a constant level while its frequency is slowly varied, high and low frequency points will be reached beyond which the ear is incapable of hearing. Tones below about 20 c.p.s. are felt rather than heard, while those above about 20,000 c.p.s. are unheard by most ears. The average frequency range of most adult ears is around 30 to 15,000 c.p.s., and this range decreases markedly with advancing age, particularly at the high frequency end.

Suppose a pure tone is varied in frequency throughout the audible spectrum while the volume is adjusted so that it appears to the ear that it is equally intense at all times. When this is done, it will be discovered that considerable adjustment is necessary at the various frequencies in order that the tone seems to be of constant loudness. From this we conclude that the ear is not equally sensitive at all of the frequencies which it is capable of hearing. Extensive data on this subject was gathered by the Bell Telephone Laboratories when they conducted hearing tests upon thousands of the visitors to their exhibits at the New York and San Francisco World's Fairs in 1939-40. The information they have

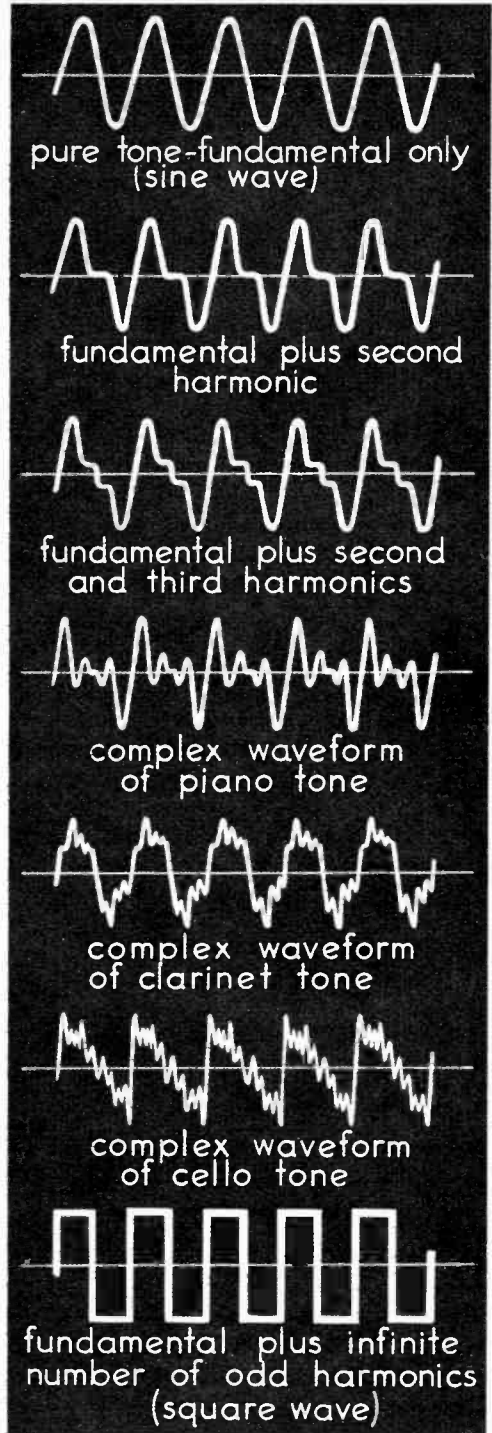

Sounds make these visual patterns on the screen of an oscilloscope. Harmonic components of a tone give it the quality of a voice or instrument.

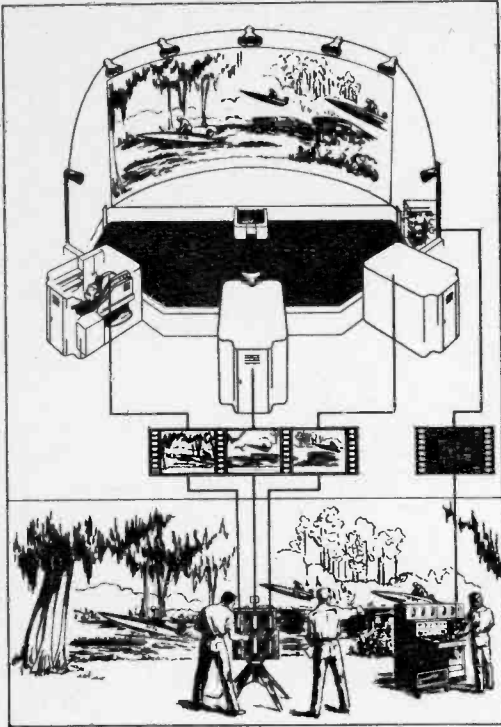

Full range recording and reproduction are finally being used by the movies, with stereophonic sound in such systems as Cinerama, diagrammed above.

Hazard Reeves, below, who developed the stereophonic sound for Cinerama, above, is shown with magnetic film which carries six different tracks.



given us is of inestimable value in the design and operation of our high fidelity equipment. We have learned from them, for example, that the sensitivity of our ears is greatest around 3,500 c.p.s. and drops off from there toward either end of the spectrum. We also know now that the sensitivity at various frequencies depends also upon the average loudness. We can prove this to ourselves when we listen to a radio at fairly high level and then turn the volume down quite low. When we do this, the highs and lows seem to disappear, with only the mid-range remaining. All of these factors must be taken into account if we are to enjoy true high fidelity.

Another important result of this discriminatory response of the ear is an effect known as *masking*. This is a deafening of the ear to high frequencies when very strong low frequencies are present. It explains why it is necessary to shout in order to carry on a conversation in a noisy location, and also explains how a very loud tympani roll can completely blot out a violin solo.

The evolution of musical instrument design and performance, and more recently that of high fidelity design, has proceeded with only one objective in mind—to please the listener. Instruments of every description have been invented and later discarded, simply because they did not satisfy that basic requirement. The instruments of

Technicians for Cinerama must monitor six separate sound tracks to give audience impression of extra dimension of sounds which move and surround.



today's orchestra, taken together, encompass the entire range of frequencies and dynamics acceptable to the human ear. The largest pipe organs, which have the greatest range of all, can produce *fundamental* tones extending from around 16 c.p.s. all the way up to about 8,000 c.p.s. Likewise, they are capable of *pianissimos* which are barely above the threshold of audibility and *fortissimos* which approach the threshold of feeling. None of the smaller instruments can approach these ranges, but each has its special job to do, from the whisper of a muted violin to the solid beat of drums and string bass in a dance orchestra.

We have observed that the great differences between the tonal qualities of the various instruments is dependent upon the number and relative strength of the harmonics they produce. It has been discovered that the human ear must hear at least up to the third harmonic (three times the fundamental frequency) in order to be able to distinguish accurately between instruments. But the difference doesn't end there. For the human ear itself produces additional tones which are not present in the original sound but which are sum and difference combinations of the originals. The sums usually appear in the supersonic region, where they are of little significance, but the difference tones often are in the audible range and are quite important. These additional sounds which are not in

the air, but only in the ears and brain of the listener, are named *subjective tones*, and they may be produced by the interaction of harmonics as well as fundamentals. It is therefore quite obvious that musical sounds as they are perceived by the ear are exceedingly complex waves, and that the proper transmission and reproduction of music by a high fidelity system is no small task.

Requirements of a High Fidelity System

From our consideration of the production of musical sounds and of the characteristics of the human ear you can begin to see the requirements of the high fidelity system which will be interposed between those two elements. It would seem at once that the system should be capable of transmitting all of the sounds which the human ear can hear, and that it should not alter these sounds in any way. This means, first, that the equipment must handle all audible frequencies with absolutely no discrimination, which implies a *frequency response* which is *flat* from around 30 to 15,000 c.p.s.

Efforts to extend the frequency range of audio equipment date from the very beginnings of sound recording and radio broadcasting, when equipment was incapable of handling both the very low and very high frequencies, and which exhibited undesirable peaks in parts of the spectrum which

Listening tests indicate that quality suffers as soon as audible sounds are removed from the reproduction. A bass response that was limited to 100 c.p.s., for example, would rate only 85%. A high frequency, held to 7,500 c.p.s., typical of most motion pictures, means a loss of the top 12% of quality.

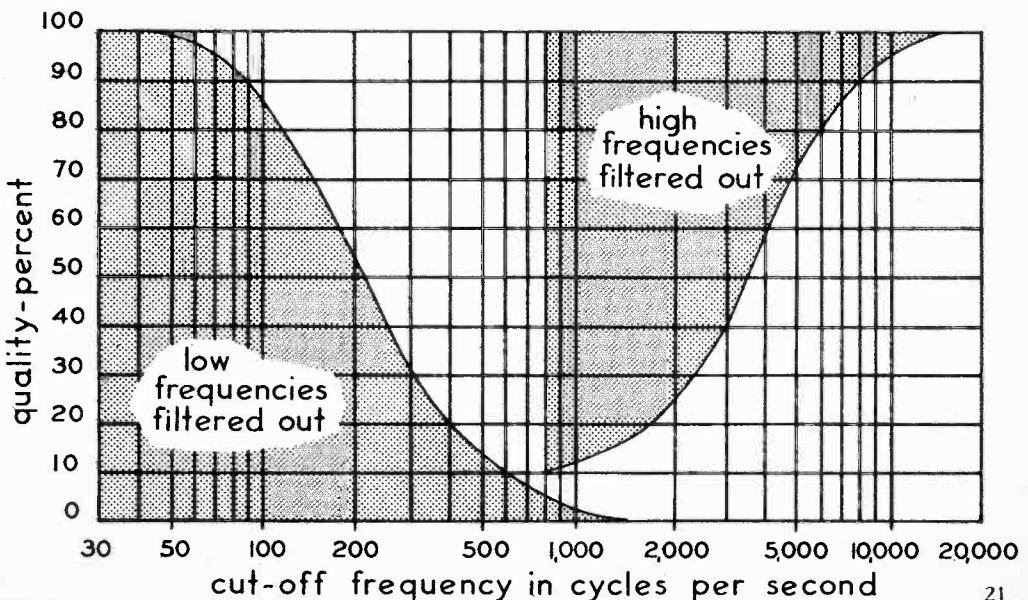

was transmitted. Particularly troublesome has been the upper region, and the great emphasis which has been placed on the problem has led to the erroneous impression that high fidelity is synonymous with high frequency.

Much sound argument has been presented to prove that extended high frequency response is neither high fidelity nor even very desirable. On the contrary, the detractors say, people want *mellow* music. It has been shown, for example, that the very best musical instruments have been designed by craftsmen who have made a deliberate effort to inhibit the lower harmonics. It is also argued that people have for years been listening to broadcasts of the finest classical music on low-quality equipment, with apparently no serious dissatisfaction. Juke boxes, too, and the wired music services have equipment of decidedly limited frequency range, and it seems that the public prefers it that way. There have even been audience-reaction tests conducted wherein direct comparisons were made between wide-range and limited-range production, and the greater preference was shown for the limited range. Until the advent of the new *stereophonic* techniques, the motion-picture industry had settled upon a standard system which cut off around 7,500 c.p.s., a full octave below our supposed ideal. And finally it is argued that an extended frequency range succeeds only in calling attention to inherent noise, distortion and other defects.

Now if all this be true, where does it leave us in our efforts to find true high fidelity? Well, at the outset we must remind ourselves that we are not considering the theoretical ideal of *perfect fidelity*, but only that goal which we have dubbed high fidelity. But if that goal is really worthwhile, then there must be some logical answer for its critics.

It is unquestionably true that the finest musical instruments are weak in the low-order harmonics, but it is also equally true that those overtones are still definitely present in some degree, and are an integral part of the character of the instrument. To reduce still further the strength of these harmonics in a limited-range audio system would be disastrous to the quality of reproduction.

Public taste in the matter of high-quality reproduction has undergone considerable change in recent years, and it is doubtful that conclusions reached concerning it even a few years ago would have the same validity today. People pretty generally like what they are accustomed to, and until very recently many people had never heard

either live music or high fidelity reproduction. For such people, a wide-range system is strange, even "tinny" sounding, at first listening. But within a very brief period, its true quality is recognized, and the sound of the old table model radio with the three-inch speaker becomes unbearable. There is no disputing the fact, however, that a low-quality recording does sound better on limited-range equipment, for wide range only magnifies the shortcomings without contributing any improvement. This may very well explain the results of some listener tests indicating preference for low fidelity reproduction.

It is also a proven fact that high fidelity requires more listener attention than "mellow" music. It is definitely not cocktail music, dinner music, conversation music, or music to read by. It is music to *listen* to. When background music is wanted, even the most enthusiastic high fidelity "bug" will soon learn to turn down the tone control.

The decision of the Motion Picture Academy to adopt audio standards with a top limit of around 7,500 c.p.s. was predicated on factors which do not obtain for high fidelity listening in the home. Many theaters are still in use whose design pre-dates the advent of talking pictures. Many of them are of poor acoustical design and much more reverberant than the average living room. Furthermore, a movie soundtrack is usually reproduced at a level many decibels higher than it was recorded. Since the frequency response of the ear depends upon the average loudness level, the ear itself will tend to hear more bass and more treble than was present in the original recording. Finally, the motion-picture industry appears to be taking careful stock of

Dimitri Mitropoulos sits alone before an acoustic reflector as he listens intently to the playback of a composition conducted for Columbia Records.

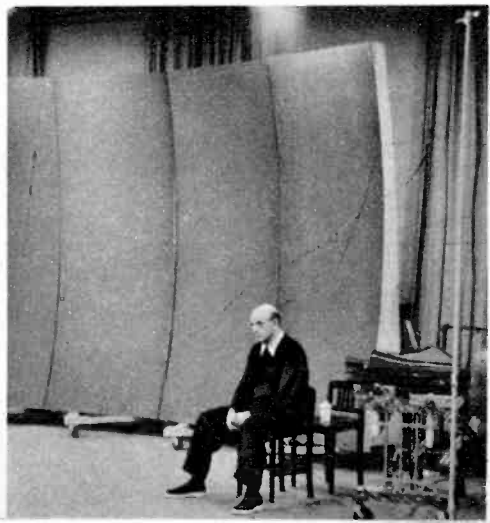

its past practices, for the new stereophonic systems, as exhibited by *Cinerama*, *Cine-mascope*, and others, do employ full range recording and reproduction.

It would appear, then, that the most serious objection to high fidelity is that it does rip away the veil which has been masking the inherent imperfections in our recording and broadcasting techniques. Surface noise, ticks, pops, thumps, "static," hum, squeal, pitch variations known as *wow* and *flutter*, and the many other possible forms of distortion—all these come through with as remarkable clarity as does the music on a high fidelity system.

Our answers to this problem—the answers which have made present-day high fidelity possible—have come to us from the many research laboratories everywhere in the audio industry. FM broadcasting, tape recording, microgroove disc recording, the vinylite record, improved amplifier and speaker design, and better techniques and quality controls throughout the chain have resulted in a truly wide-range system.

Today's high fidelity system exhibits not only a wide frequency range, but also a full dynamic range, which some experts regard as even more important. The full volume range of a symphony orchestra, from lightest pianissimo to loudest fortissimo, encompasses an area of perhaps 80 decibels, but very few people have ever heard such a range outside of a concert hall. This is due to a technique which has heretofore been standard practice in broadcasting and recording studios, known as *monitoring*, *limiting*, or *volume compression*. It involved the deliberate alteration of the dynamic characteristic by raising the level of the softest passages and lowering the loudest parts, so that both extremes of

the range were reduced out of their proper perspective. This was done to avoid having the low levels completely masked by the innate noise of the system, and to prevent the peaks from causing overload distortion. Such practices are now obsolescent, due to the tremendous advances in recent years in facilities and techniques. The modern high fidelity listener may be certain that a live FM broadcast or recent recording is providing him with all of the useful dynamic range present in the original performance.

We should now be able to summarize the theoretically ideal requirements of a perfect fidelity system, and to determine how closely our present high fidelity measures up to these standards. The perfect system would exhibit the four following basic characteristics:

1. The full frequency range of the human ear
2. The full dynamic range of a symphony orchestra
3. Absolute freedom from distortion of any sort
4. Absolute freedom from extraneous noise

The first requirement can be quite adequately fulfilled by a modern high fidelity system. Dynamic capabilities are very nearly perfect. All measurable forms of distortion can be held to 1% or less. Noise generated within the system itself can be at least 60 db below the peak signal level.

All of this taken together means that high fidelity today is very close to absolute perfection. To surmount the remaining difficulties presents a challenge of huge proportions. But the challenge will be met, and the problems will be solved, and before many more years have passed high fidelity will be supplanted by *perfect fidelity*. •

Standing before the NBC Symphony orchestra is Arturo Toscanini, who directed them in recordings of many outstanding performances for RCA Victor records. Noted for his precision and articulation of instruments, he produced records which take advantage of many of the capabilities of a high fidelity system.





NBC photos

Music was early an important part of broadcasting. The Cities Service orchestra with Jessica Dragonette is shown above in 1926. Below, right, is conductor Walter Damrosch at the inaugural WEAF broadcast.



Radio and Records

Here is how these two main sources of high fidelity handle the sound before it comes into your system.

OF all of the industries which are interested in the use of sound, radio broadcasting has been consistently in the forefront of the movement toward high fidelity.

Good music was broadcast even in the very earliest days of radio. In the early nineteen-twenties, WEA^F (now WN^{BC}) took its microphones and audio equipment into Carnegie Hall and began a series of broadcasts of the New York Philharmonic, then conducted by the beloved Dr. Walter Damrosch. In 1926 the National Broadcasting Company was formed, with WEA^F as the key station. On their inaugural broadcast, Dr. Damrosch and the orchestra appeared, along with many other famous names in the world of music, including Dr. Edwin Franko Goldman's Band, the Gilbert and Sullivan Light Opera Company, and Titta Ruffo of the Metropolitan Opera. Not long afterward, the Metropolitan broadcasts became a regular fixture in many American homes.

The broadcast engineers, meanwhile, continued to keep pace with the art, and the quality of their transmissions was always far better than most radios were capable of receiving. But still they were not satisfied. There was a major roadblock which had to be somehow circumvented.

Limitations of Ordinary Radio

The radio transmission of sound involves the superimposition of an audio wave upon a radio wave, known as the *carrier*. The resulting composite wave, which is said to be *modulated*, is transmitted through the air to the antenna of a radio set, wherein it is *demodulated* or *detected*, with the audio portion being reconverted to sound in the loudspeaker. The earliest method of superimposing a sound wave upon a radio wave, and the one still in most common use, is called AM, an abbreviation for *amplitude modulation*. In this system the audio wave causes the power output of a radio transmitter to be alternately increased and decreased in accordance with the frequency and dynamics of the sound of the performance. The carrier frequencies of broadcast stations in the United States are far above those which can be heard by the human ear, being on assigned channels in the area between 550 *kilocycles* (a kilocycle is one thousand cycles) and 1,600 kilocycles.

When sounds are added to the carrier wave, the amplitude of the wave is modulated in AM broadcasting, while in FM the frequency is altered.

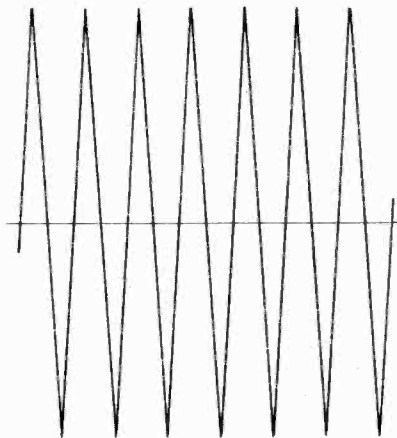

unmodulated radio-frequency carrier wave

PLUS

audio-frequency modulating signal

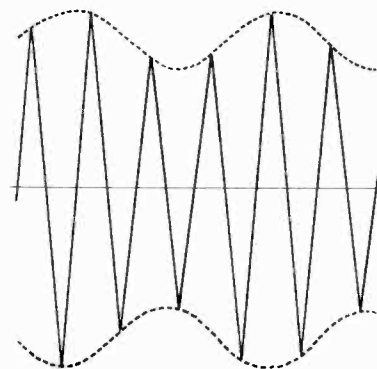
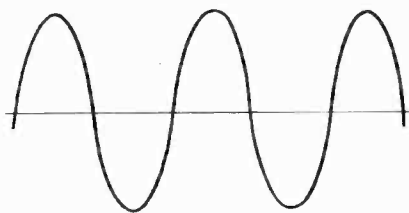

resultant AM radio wave

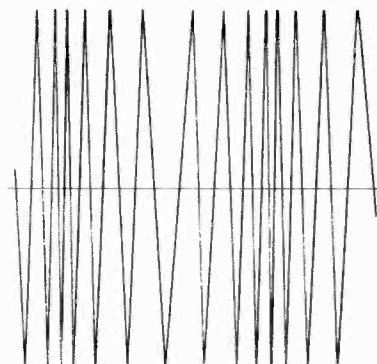

resultant FM radio wave



Major Armstrong's experimental transmitting tower on the Hudson palisades near Alpine, New Jersey, is 400 feet high and 1,000 feet above sea level.



The late Major Edwin H. Armstrong, at right, did the development work at Columbia University resulting in FM radio. Assistant John Bose at left.

When an AM wave is modulated by a sound wave, not only are the two original frequencies present, but two additional frequencies are generated, which are sum-and-difference combinations of the originals. These additional frequencies are known as *sidebands*. Thus a radio station operating at 800 kilocycles (abbreviated *kc*), for example, when modulated by an audio wave of 2,000 c.p.s. (or 2 *kc*), would be radiating sidebands of 802 and 798 *kc* in addition to the carrier frequency. In order to transmit the full audio range of 15,000 c.p.s., then, it would be necessary to be able to transmit sidebands of plus-and-minus 15 *kc* away from the assigned carrier frequency. But AM stations are allowed by law to use a channel which is only 10 *kc* (plus-and-minus 5 *kc*) wide. This means that they must restrict themselves to an upper audio limit of 5,000 c.p.s. And while the broadcast engineers soon found that they were able to perfect audio equipment which had much wider frequency range, the quality of their program transmissions was limited by the crowding of the stations on the AM channels. The road-block, then, was not with the audio, but with the radio part of the operation, and a whole new approach to the problem of modulation and transmission seemed due.

Frequency Modulation

The idea of some other method of modulation was proposed very early in the history of radio, but it was not very warmly received. In 1922, an article which appeared in the official publication of the Institute of Radio Engineers made the following obser-

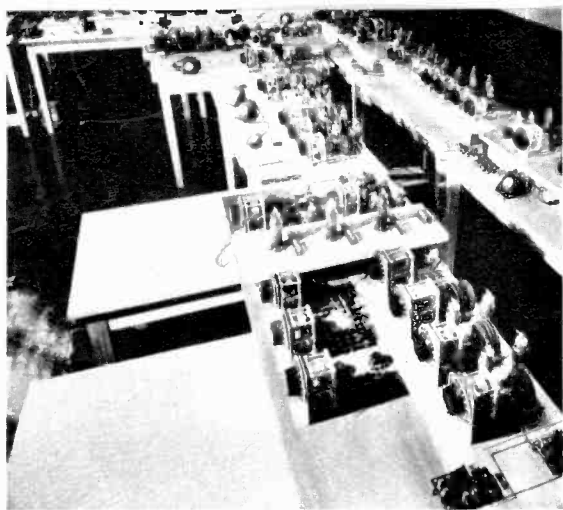

This temporary "breadboard" FM setup was used during the early months of experimental transmitting from the Empire State Building, New York.



Chief engineer Perry Osborn is shown with equipment installed at Alpine, New Jersey. Multiplex modulators put several broadcasts on one carrier.
Columbia University photos

vation concerning *frequency modulation*:

"This method of modulation inherently distorts without any compensating advantages whatsoever."

The fundamental error of this argument was not to become generally known until fifteen years later. But by 1925, Maj. Edwin H. Armstrong had become skeptical of the earlier conclusions, and set about to determine if something had not been overlooked in the earlier research. He engaged in some very time-consuming development work in his laboratory at Columbia University, and finally in 1934 established an experimental FM broadcast transmitter atop the Empire State Building in New York. This experiment, which lasted only a few months, was sufficient to convince him that he had a feasible system, and in early 1937 he built his own high-powered FM transmitting plant at Alpine, New Jersey, to prove to the industry and the public that FM was vastly superior to the old AM method.

Frequency modulation, as its name implies, involves varying the frequency, rather than the amplitude or power, of a radio carrier wave—the rate and quantity of the deviation being determined by the character of the audio signal. The amount by which the FM carrier wave varies from its center, or rest, frequency will be determined by the loudness of the sound wave, not by its frequency as was the case in the AM sidebands. Therefore the necessary channel width will not be increased by the higher audio frequencies, and it is entirely possible to modulate an FM wave with even the highest audio frequencies. It

was decided at the beginning, then, that the FM system should be a wide range one, and the standards adopted for it called for an audio range extending from 30 to 15,000 c.p.s. Thus we have actually had, in one area at least, full high fidelity for well over fifteen years.

Now that high fidelity audio systems have become common in so many homes, we cannot overlook the radio broadcast as a most important source of high fidelity sound. In order for the reproduced sound to seem natural and pleasing to the listener, it must begin in the proper acoustical environment in the broadcast studio. Reverberation in the studio is picked up by the microphone along with the original sound. Reverberation in the listening room adds to the sound emitted from the loudspeaker. Thus we have two entirely independent and unrelated sets of room acoustics working in combination to present the final aural effort at the ear of the listener. Until fairly recently, the theory has been that a studio should have somewhat less reverberation time than a comparable concert hall, with the acoustics in the home expected to make up the difference. Today there is considerably less weight given to the reverberation surrounding the loudspeaker, with the result that studios are considerably more *live*.

One of the most important factors in high fidelity reproduction is the re-creations of the spatial relations existing at the original source. The desire today is not to bring the symphony orchestra into the home, but to bring the listener into the concert hall. This means that the matters of *presence*

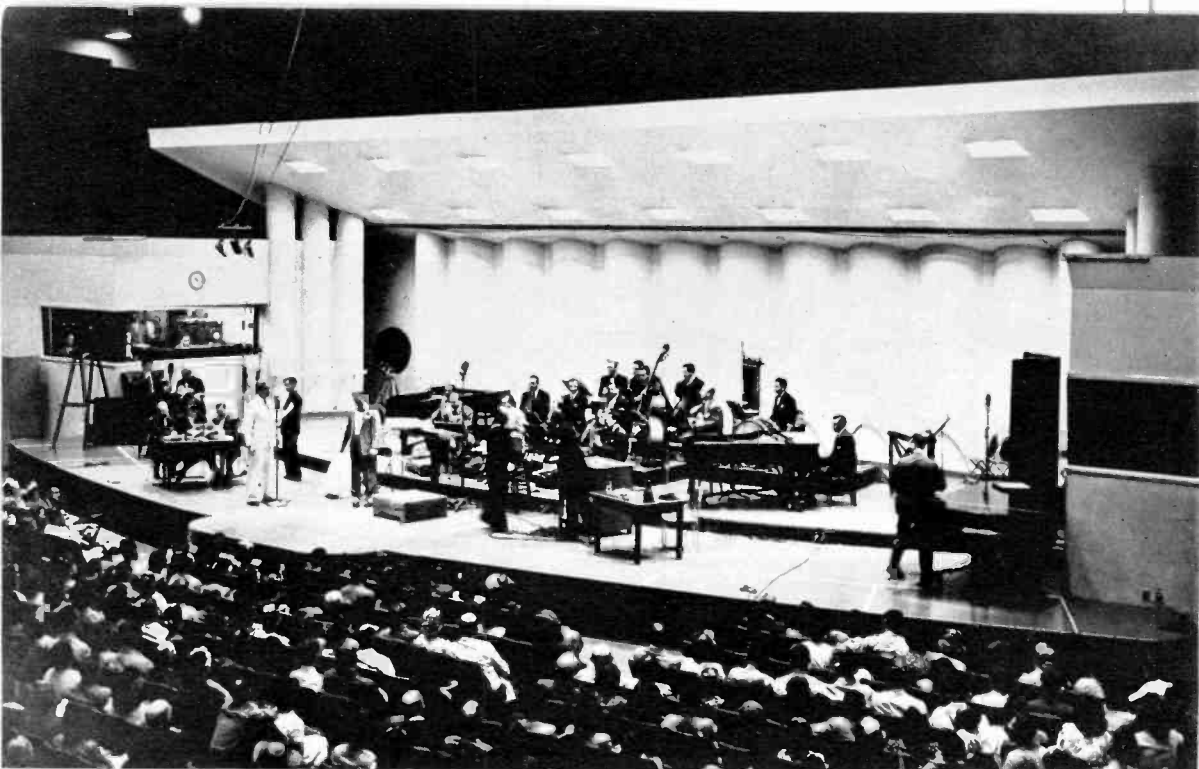

NBC's studio 8-H in Radio City, New York, was the largest of its day built to meet high acoustical requirements. It is now converted for television.

RCA Victor engineer Richard Gardner operates a tape recorder. Tape has now replaced disc cutting performance in all professional recording.



and *definition* are much more critical than ever before at the point of the original sound pickup. In the past it has been the practice to use a large number of microphones, often one for each section of the orchestra, all feeding into a *mixing console*. Then a mixing engineer was kept very busy adjusting the volume controls on the various microphone circuits so as to maintain the proper acoustic balance. But the effect was unnatural, for it seemed to put the ear of the listener into several widely-separated positions simultaneously, which resulted in confusion and listener fatigue. The better practice today involves the use of one main pickup microphone, placed in a choice location in the hall. The musicians are then seated so that the best acoustic balance will arrive at the microphone. And while additional microphones may be employed at times for special emphasis or to pick up a soloist, most of the work is done by one main microphone and mixing is held to a minimum.

Phonograph Records

At the same time that radio broadcasting was enjoying its period of most vigorous growth, the phonograph record industry was financially and creatively in the doldrums. It continued to adhere to outmoded procedures until competitive pressure

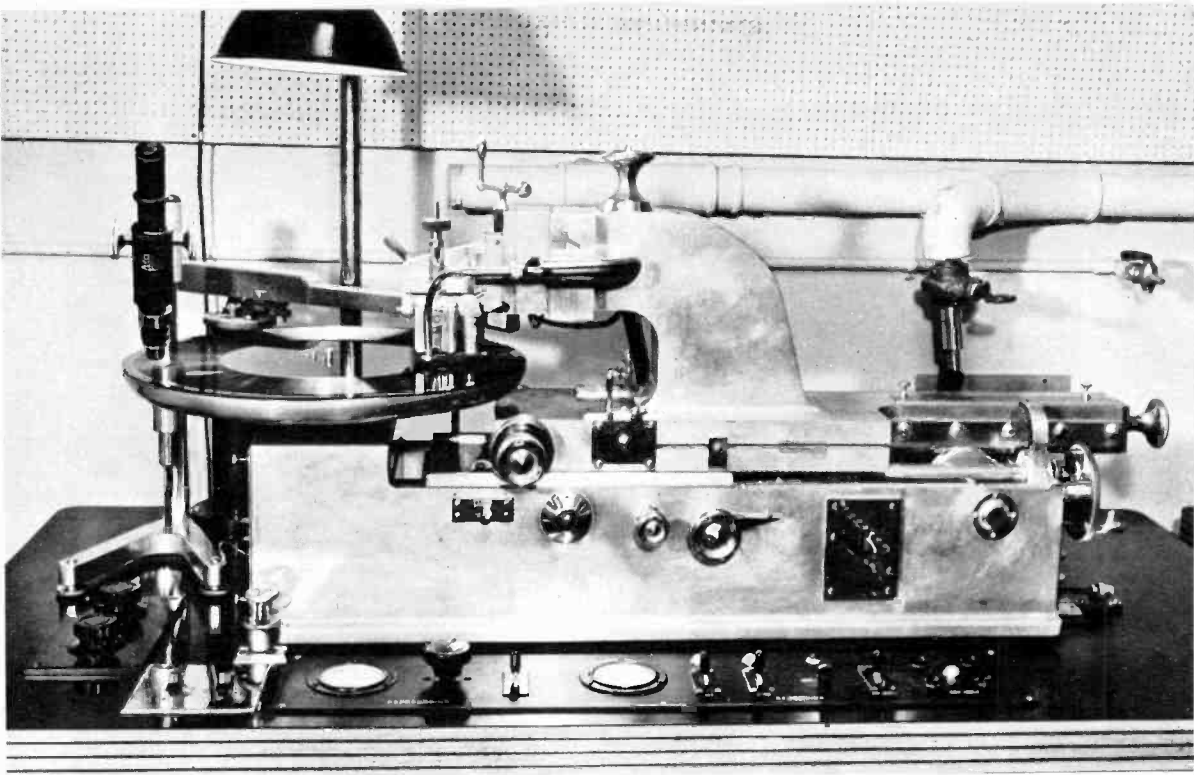

NBC Photo

made a revision in thinking absolutely necessary for survival.

But since the end of World War II there has been a major revolution in the industry. The studio techniques which were pioneered by the broadcasters are now employed to advantage by the recording people, who have gone further and made several really significant contributions to the high fidelity art.

Tape recording, which is capable of extremely high fidelity, is now used as the medium for all original recordings. It is customary to record several times on tape each performance at a recording session. Very often the best parts of each of these several *takes* are later used to make up the performance for the final record. By a process known as *tape editing*, the actual sections of tape on which the selected parts are recorded are spliced together to form a *composite* recording. Thus the final record is better than one would ever be likely to hear in a concert hall, being really a synthesis of the best of many performances.

When a finished tape has been approved for release, a disc recording is made from the master tape. A disc cutting machine, along with its associated amplifying equipment, receives the sound from a tape playback machine and converts it into mechanical motion in an engraving stylus. The

A performance recorded on tape is transferred to master disc with this Scully professional recording lathe. It can cut from 90 to 300 grooves per inch.

Cutting into the lacquer coating of the master disc, the recording stylus makes grooves which transfer to the disc the sounds recorded on tape.

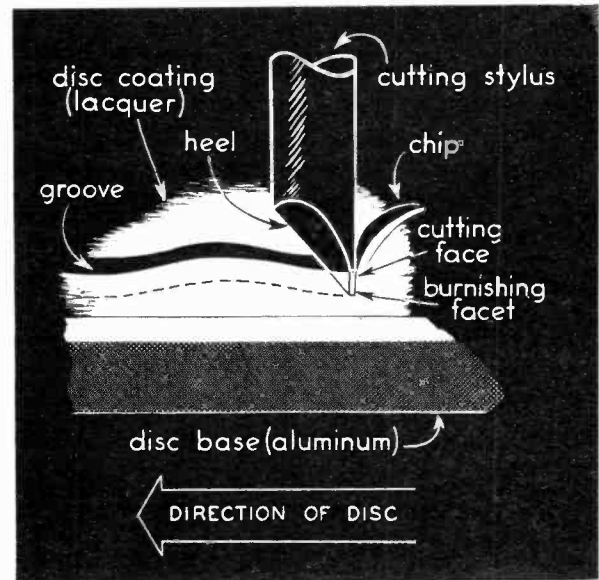

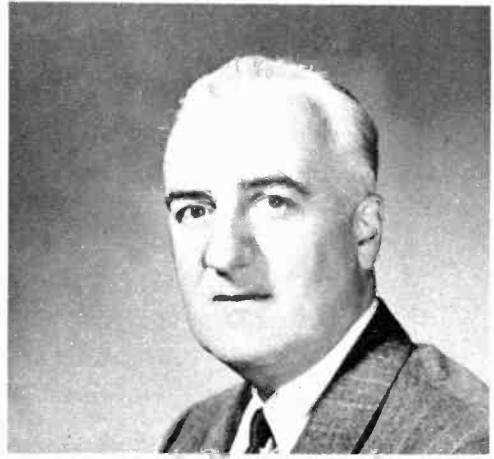

Final fidelity of a record is the responsibility of the chief recording engineer. RCA Victor's chief, at left, is Albert A. Pulley, while at right is Vincent J. Liebler, chief recording engineer for Columbia.

The recording stylus has a sharp chisel face edge in order to cut the master disc. Playback stylus has smooth rounded point in order not to damage grooves of pressing.

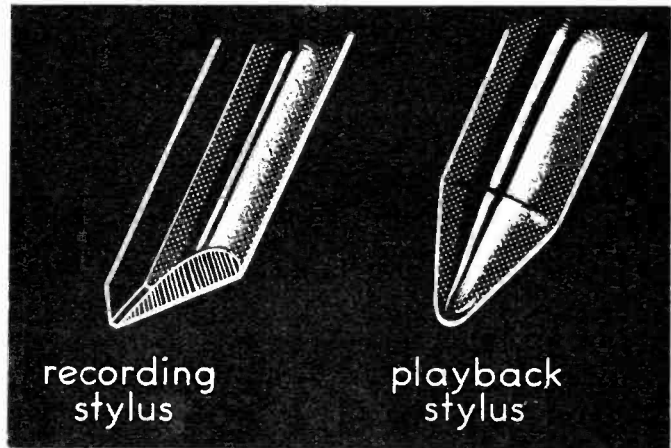

blank recording disc, on which the sound grooves are engraved, is a plate of thin aluminum covered with an exceedingly smooth coating of soft black lacquer. This lacquer is a compound of *cellulose nitrate*, although similar *acetate* lacquer is often employed for amateur work. (Acetate doesn't present the fire hazard which is inherent in the nitrate thread removed when the stylus cuts a groove.) When the recording is completed, the lead-out grooves and eccentric circle are cut, and the record is ready for processing.

The Recording Characteristic

In order to record the maximum musical information in the smallest possible groove area, the frequency characteristic of a disc record cutter is deliberately distorted, and this intentional distortion is called *pre-equalization*. It consists basically of in-

creasing out of proportion the high end of the audio spectrum, so that a better ratio of recorded sound to high-frequency surface noise will result. At the same time, the powerful low-frequency sounds are reduced in level, so that they will not cause *overcutting* into the adjacent grooves. Although the record industry now seems on the verge of adopting a standard *recording characteristic*, up until now each company has had its own ideas about the precise manner of accomplishing this. And since the *playback characteristic* should be the exact complement of the recording characteristic, the high fidelity fan must have equipment which is adjustable to the idiosyncrasies of each record in his collection.

Record Processing

Regardless of the recording characteristic, however, the basic methods of manu-

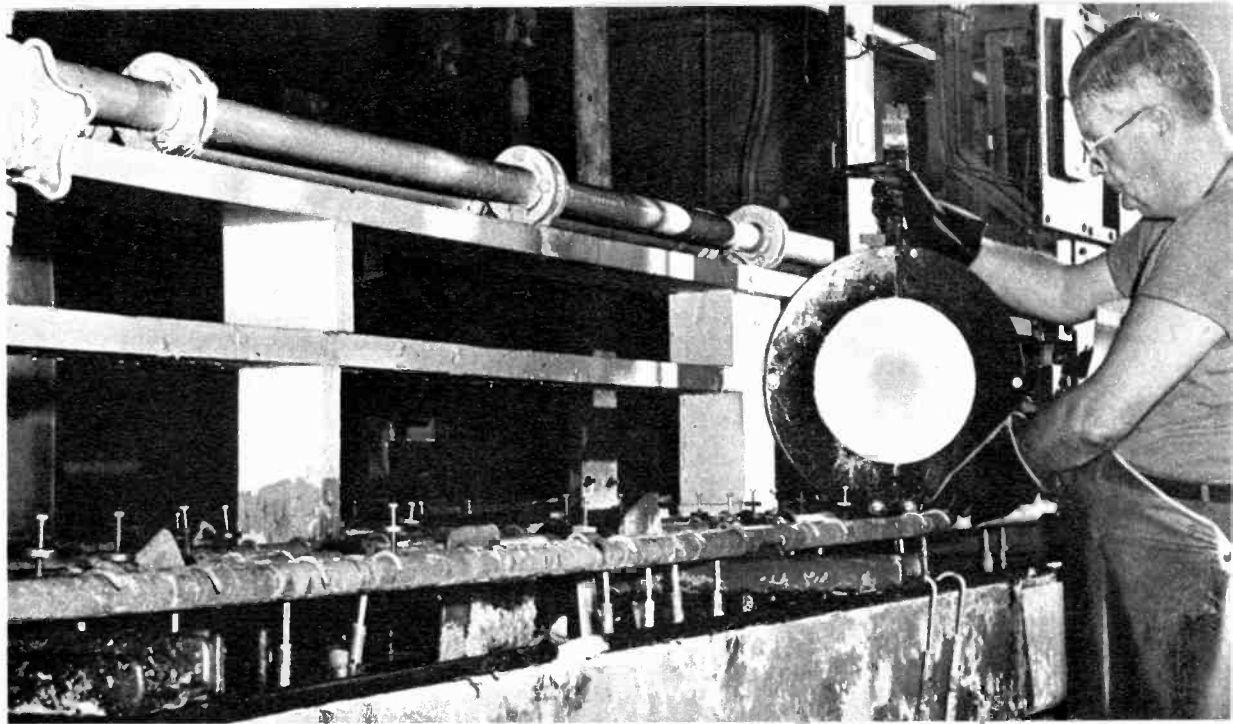

The stampers are prepared by electroplating. Here stamper is formed by plating against master.

After tape recording is inscribed on the lacquer master, one or three-step process forms stamper.

RCA Victor photo

facture are identical for any record. The original disc made from the master tape is known as a *lacquer mother* or *master*, and an exact reproduction of it appears on the finished phonograph record. The first step in this reproduction process consists of an aural and electrical test of the playing qualities of the lacquer. If it is approved, it then goes to the record plant, where it is placed in a cleaning solution and then spray-rinsed under pressure.

The lacquer surface is then coated with a thin film of silver, which is chemically deposited by a process similar to that used for the manufacture of mirrors. The record is now electrically conductive, and it is possible to electroplate a heavy layer of copper over the silver. The metal layers are then stripped away from the lacquer, and it is seen that they constitute a precise negative impression of the record, with ridges on its surface corresponding to the grooves in the lacquer. This metal negative may be used to press out finished phonograph records, in which case it is called a *stamper*. There may be two additional steps before pressing, however, in which case the first negative is regarded as a *metal master*. In this three-step processing, the master is further electroplated to form a metal positive, known as a *metal mother* and this in turn is electroplated again to provide another negative, which becomes the final stamper.

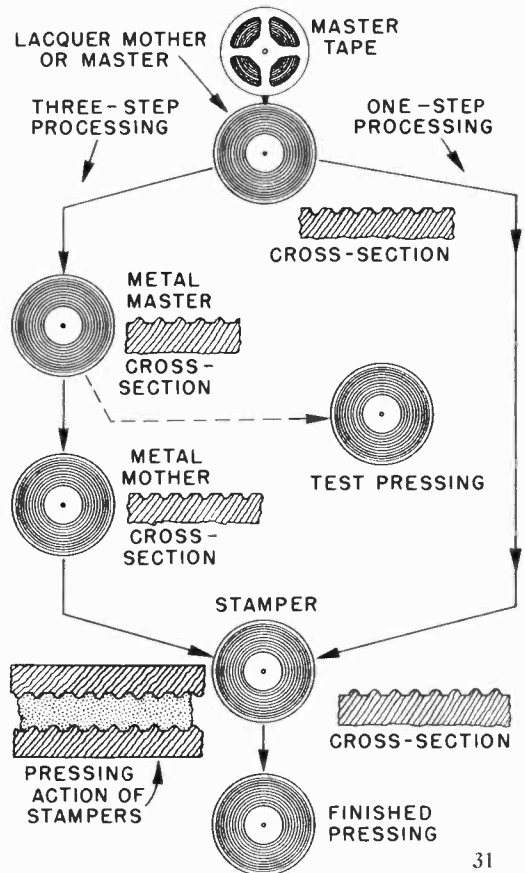



After going through the plating tank process, the stamper is gently separated from lacquer master.
RCA Victor photo

With this system it is possible to make a large number of mothers and stampers from the single metal master, while in the one-step system it is necessary to cut a new lacquer mother whenever a stamper wears out. The major record companies are in disagreement as to which method is the best, but all seem to produce about equally acceptable end products.

The stamper, whether it be produced from a lacquer mother or a metal mother, finally receives a plating of chromium on its face before it is inserted in the record press. This machine looks something like a huge waffle iron, except that it has steam and water lines running into it where the electrical elements would be. Two stampers, representing opposite faces of the record, are fastened into the press to form the "grids." A label is placed facing either stamper at its center, and a pre-heated biscuit of record material placed on the lower stamper. The stampers are then brought together under pressure against the biscuit, while steam is passed through the hollow dies of the press. After a short period the steam is cut off and replaced by a stream of cold water. When the disc is cool and hard, the press is opened and the

pressing removed. The spilled-over material around the edge of the disc is trimmed away, and the finished record is then ready for packing and shipment.

This compression molding system has been in use since the beginning of the mass production of disc records. In the past few years, however, another method has been introduced. This system, known as *injection molding*, was originally used by the manufacturers of 7-inch records for children, but all of the major companies are now experimenting with it, and Columbia Records is using it for a rather large share of their production. The record material in this case is a styrene plastic, which is heated to a molasses-like consistency and then squirted into the cavity between the two stampers. It is then cooled, hardened, and removed from the machine, after which labels are applied to the molded disc. The biggest advantage of this method to the manufacturer is reduced cost, but it is also claimed that the resulting record has better frequency response at both the high and low ends, less surface noise than vinylite, and slightly better wearing qualities. Whether or not these claims be true—and the proponents of compression molding are

far from ready to concede the point—the resultant competition is a healthy sign which will inevitably result in even better high fidelity records.

Why Three Speeds?

Phonograph records are now manufactured to operate at three different speeds, a fact which precipitated the famous post-war "Battle of the Speeds" and crippled the entire industry as you and I sat on the sidelines and waited to see who would win.

Lack of a standard speed is not new to the record industry, but all previous discussion was at least in the vicinity of 80 r.p.m., and by the late nineteen-thirties there was rather general agreement on a turntable rotation speed of 78.26 r.p.m. This speed had a distinct disadvantage, however, in that it could accommodate no more than about 5½ minutes of music on a twelve-inch record. This was not nearly long enough to encompass any major work of classical music, and it discouraged the composition of anything in the popular vein which was longer than the prescribed limits for a 78-r.p.m. record.

The first effort at circumventing the problem was the Long Playing record introduced by the Victor Company in 1932. This was a record which used the same groove dimensions as the 78 disc, but which rotated at 33⅓ r.p.m. The abortive attempt

Columbia Records photo

Plastic slab "biscuits" are heated and then placed in record press. Here an LP record is being made.



failed, however, largely due to the severe limitations of the reproducing equipment of the time, and the project was abandoned.

In 1948, however, Columbia Records announced that their engineers, under the direction of Dr. Peter Goldmark, had succeeded in perfecting a practical high-quality Long Playing Record. This record also rotated at 33⅓ r.p.m., but unlike the earlier Victor version it employed a groove which was about one-third the size of that on a regular 78-r.p.m. disc. The combination of the much lower rotational speed and many more grooves per inch resulted in an increase of playing time from the old maximum of 5½ minutes to as much as 30 minutes per side.

The old 78-r.p.m. record has many disadvantages other than short playing time, and it was to these shortcomings that the RCA Victor people addressed themselves in a research project undertaken in 1939. They were particularly interested in accomplishing the following improvements:

1. An automatic record changer which would cause no damage to records.
2. A single standard record size, eliminating adjustment of the changer for size.
3. A shorter and more silent record-changing cycle.
4. A simplified changer mechanism with fewer moving parts.

RCA Victor photo

After coming out of the stamper, the molded record is placed in the edger, which trims excess plastic.





While William S. Bachman, director of engineering for Columbia Records, watches at right, record being cut on lathe is examined by Dr. Peter Goldmark, the man who perfected the $33\frac{1}{3}$ r.p.m. long playing record.

Columbia Records photo

5. Reduction in size of the record and changer.
6. Reduction of surface noise and distortion.

The results of this effort were first announced to the public in 1949 as the RCA Victor "45" system. It was announced that "for the first time in the history of recorded music, there has now been evolved a record with a matching player, a player with a matching record." Certain aspects of this new record bore a striking similarity to the Columbia LP, particularly in the matter of groove dimensions and *pitch* (number of grooves per inch). But whereas the LP rotated at $33\frac{1}{3}$ r.p.m., a speed which had been standard for years for radio broadcast transcriptions, the RCA system introduced a third and entirely new speed of 45 r.p.m. It was contended that this new speed was necessary, because comparable quality was not obtainable at $33\frac{1}{3}$, while a speed of 78 r.p.m. would have required a disc of larger dimensions.

Another radically different feature of this record was an increase in the size of the center hole from $\frac{5}{16}$ to $1\frac{1}{2}$ inches. This larger opening enabled a changer design which operated entirely from the center spindle, thus eliminating the danger of chipping the outer edges of the record.

As it was originally designed, the record had a large blank area between the label and the last sound groove, this area being regarded as out of the "Quality Zone" and not suitable for recording. Playing time was thus limited to 5 minutes 20 seconds. Improved techniques in the cutting of a record, however, caused this theory to be abandoned and the full available area of the record is now being used for recording. This newer version of the "45" is called an Extended Play record and has a playing time of about eight minutes.

All 45-r.p.m. records have a standard outside diameter of $6\frac{7}{8}$ inches, but other speeds of records are available in several sizes. The public seems to have stepped

in as referee in the speed battle and decreed its choice about as follows:

- 7" LP—Popular singles (nearly obsolete)
- 7" 45—Popular singles, show albums, and a few short classical works
- 7" 78—Children's records and some popular singles
- 10" LP—Popular albums and some major classical works
- 10" 78—Popular singles
- 12" LP—Major classical works and some popular albums
- 12" 78—A very few short classical works (obsolescent)

Since we have decided that the standard FM frequency response of 30-15,000 c.p.s. would be desirable for our entire high fidelity system, you may well ask if this full range is available on a modern phonograph record. And the only truthful answer to this question is "almost, but not quite." Such records have unquestionably been cut in the laboratory, but the limitations of mass production, both in the cutting and the processing, have restricted the high-frequency response to about 12,000 c.p.s. The low end is entirely adequate, however, and distortion is well under 1%.

The best records today are made of a pure plastic, such as vinylite or styrene. They are unbreakable, except through deliberate abuse, and have a very low surface noise level. If a record is labeled as "break-resistant," it may be assumed that it is made of *filled vinylite*, which is the plastic to which a cheap binder has been added to lower the cost. Such a record is cheaper, unbreakable with reasonable care, but has a somewhat higher surface noise. The cheapest material still is *shellac*, which has been used in the manufacture of records for years. It is quite brittle and therefore fragile, and its surface noise is rather high. This does not mean to imply that all manufacturers turn out all records in three grades. But since you now know that there are basic differences in the qualities of pressings, you will be better equipped to make value comparisons in your record purchases. •

All the 78 r.p.m. records stacked at the left are held, as recorded on 33 1/3 r.p.m. long playing discs, by Dr. Goldmark, the man who made them practical.





An ultimate choice of many hi-fi fans, this 3-speed, 16-in. transcription turntable by Rek-O-Kut has hysteresis motor, professional studio quality, for \$250.

Turntables

Absolute accuracy of turntable speed is your goal for good fidelity from records. Wow, flutter, rumble or hum can distort reproduction unless you choose your turntable with care.

SINCE the reproduction of sound from a phonograph record involves a pickup stylus which follows the quivers in a winding groove, it is obvious that there must be motion between the disc and the stylus. A stationary record whose grooves were traced accurately by a moving stylus would produce entirely acceptable sound, but for mechanical reasons it is much easier to design a means of rotating the record while the pickup follows complacently in the groove. This is the job which must be performed by the play-back turntable and its associated drive mechanism.

This job is today an exceedingly complicated one, in that the



The home craftsman can easily build a custom mounting for his turntable assembly. No automatic changer is needed if records used are predominantly long-playing type.

HYSTERESIS SYNCHRONOUS

2 POLE MOTOR

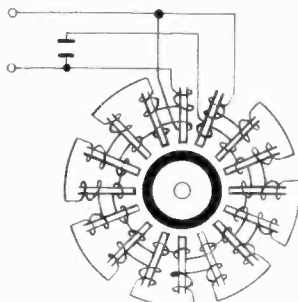
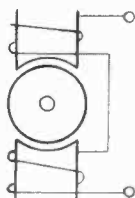

4 POLE MOTOR

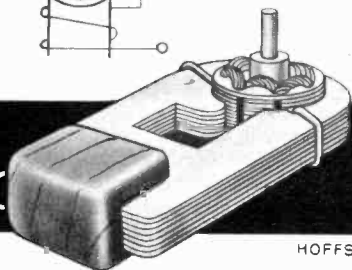
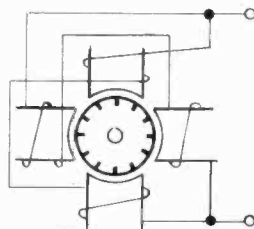

HOFFSCHMIDT

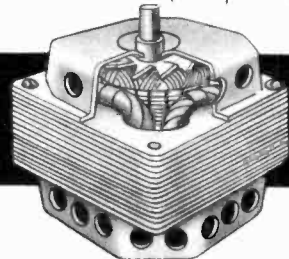

Simplified diagrams of motor types are shown above. For dependable hi-fi use, hysteresis is best, 4-pole next, 2-pole least desirable.

Presto Corporation, another manufacturer of professional radio equipment, sells this quality 3-speed manual turntable assembly for \$53.50.

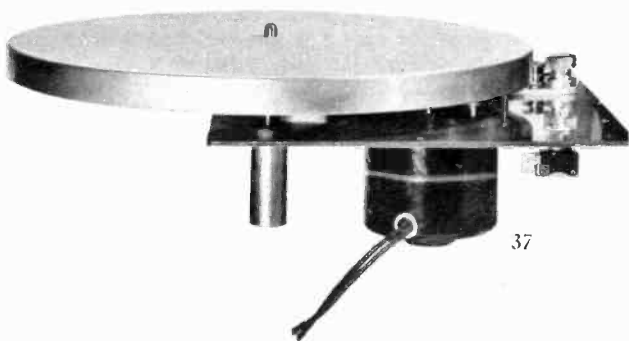

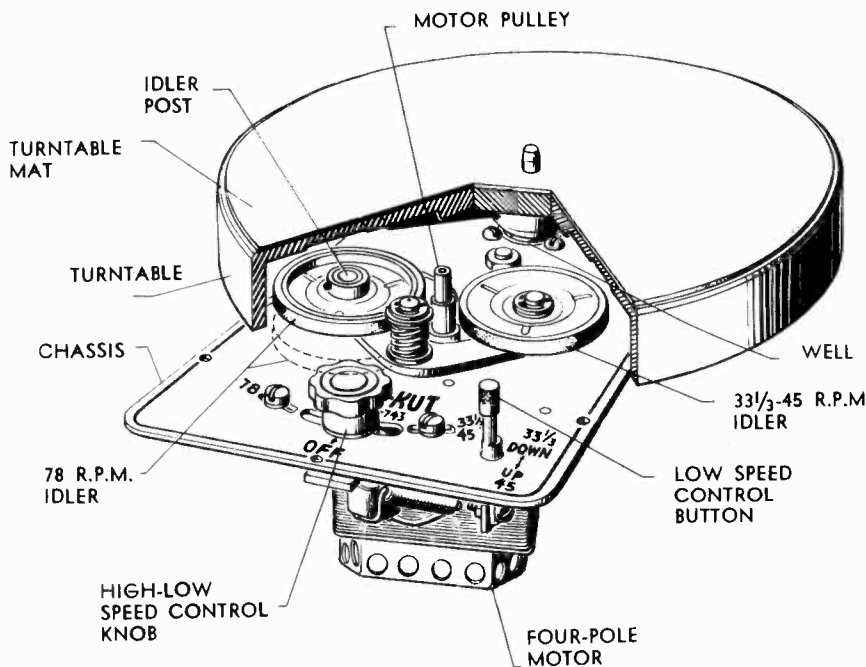

Sturdy parts, machined to close tolerances, provide the stability and even speed required for fidelity.

same turntable may be called upon to rotate at precisely $33\frac{1}{3}$, 45, or 78.26 r.p.m., without perceptible variation and without introducing any extraneous noise. It must be capable of handling all three standard record sizes, namely 7, 10 and 12 inches, and as a final test of its versatility it should be able to accommodate center hole diameters of either $\frac{5}{16}$ or $1\frac{1}{2}$ inches.

All of this assumes only the "simple" type of record player, with no consideration of the additional burden placed upon a changer mechanism for all of these various types of records. It is a truly formidable design problem, and it is positively amazing what excellent results have been achieved by some of our engineers and manufacturers. Of course, not all of them have been equally successful, and there are some "jack-of-all-trades" players on the market.

Not nearly enough consideration has been given to the fact that the turntable is as fundamentally important as any other unit in the audio chain. As one manufacturer stated recently, "We don't kid ourselves that the turntable is the only thing that matters in a hi-fi system. But what is the sense of using a cheap table with a quality setup? It's like putting a bicycle tire on a Cadillac." We might very well heed those wise words, and avoid disappointment and needless expense by a careful examination of all the factors which constitute good turntable design.

The Motor

The heart of the turntable is its source of motive power, which in the early days was a hand-cranked spring, and which today is an electric motor. The amount of power required is not nearly so important as is the fact that it must be smooth and silent. This means an entirely new concept in electric motor design, and it took some little time for the manufacturers to adjust their thinking to it.

The simple induction type motor, so common in small power applications, is totally unsuitable for high fidelity turntable use. Its speed of rotation is determined by the line voltage supplying it, which in some locations may vary by as much as 20% or even more. The resultant pitch variation during musical reproduction would be intolerable.

But while the electric power companies cannot maintain a perfectly constant line voltage, they can and do hold the frequency of their alternating-current circuits to a point of hair-splitting accuracy. Thus a motor whose speed could be determined by the power line frequency would be most desirable for this application. Such a motor is said to be *synchronous*, and it is the first essential of a high fidelity turntable system.

The most elementary synchronous motor, and the one which is used in the least expensive equipment, has only *two poles*. This means that each armature coil passes a

point of maximum torque development only twice in each 360° of rotation. The rotor is then almost coasting during a large part of each revolution, receiving an additional push only every half-turn. This makes for uneven rotation, with consequent pitch variation during reproduction. The two-pole motor also radiates a very bad magnetic field which is almost impossible to shield. Serious hum troubles are thus an ever-present problem with this type.

A considerable refinement of the synchronous motor is in the *four-pole* type, which cuts these previous troubles just about in half. The improvement is analogous to the greater smoothness of operation of a four-cylinder engine over a twin. The rotor receives twice as many propelling impulses in each revolution, and the delivery of power is considerably less uneven. At the same time the hum problem is reduced by a similar amount. This type of motor is standard equipment on all medium-priced high fidelity equipment, and no one with a wide-range system should settle for anything less.

But despite the near-perfection of the four-pole motor, it still leaves something to be desired. It generates some noise in the

Photo below shows heavy turntable and idler wheels of two-speed hysteresis-motor player.



This 12-in. transcription turntable features noise level 30 db below average recording level, for \$60.

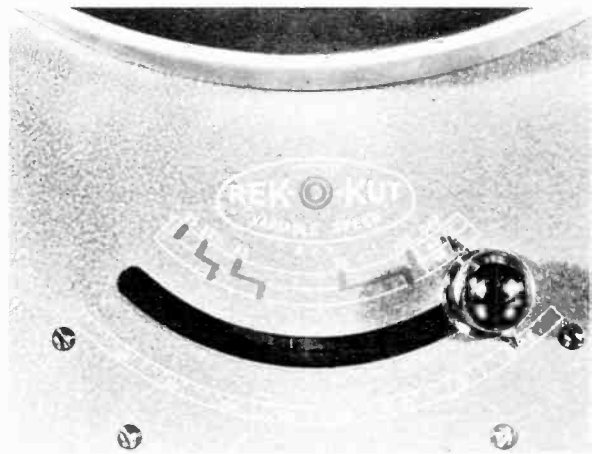

Rek-O-Kut also makes a continuously variable-speed turntable for between 20 and 100 r.p.m.

Portable sound systems, recording amplifiers, and record cutting mechanisms are made by Rek-O-Kut.

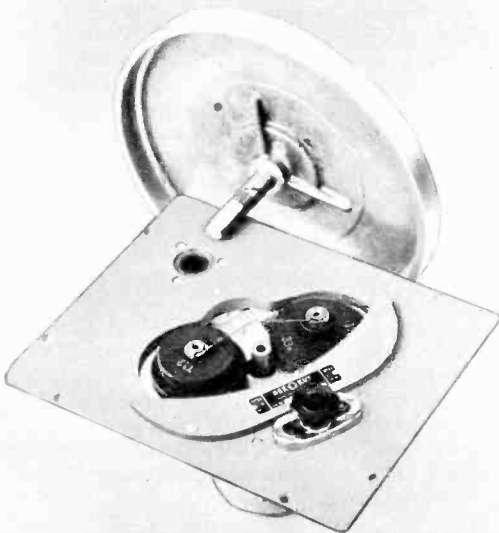

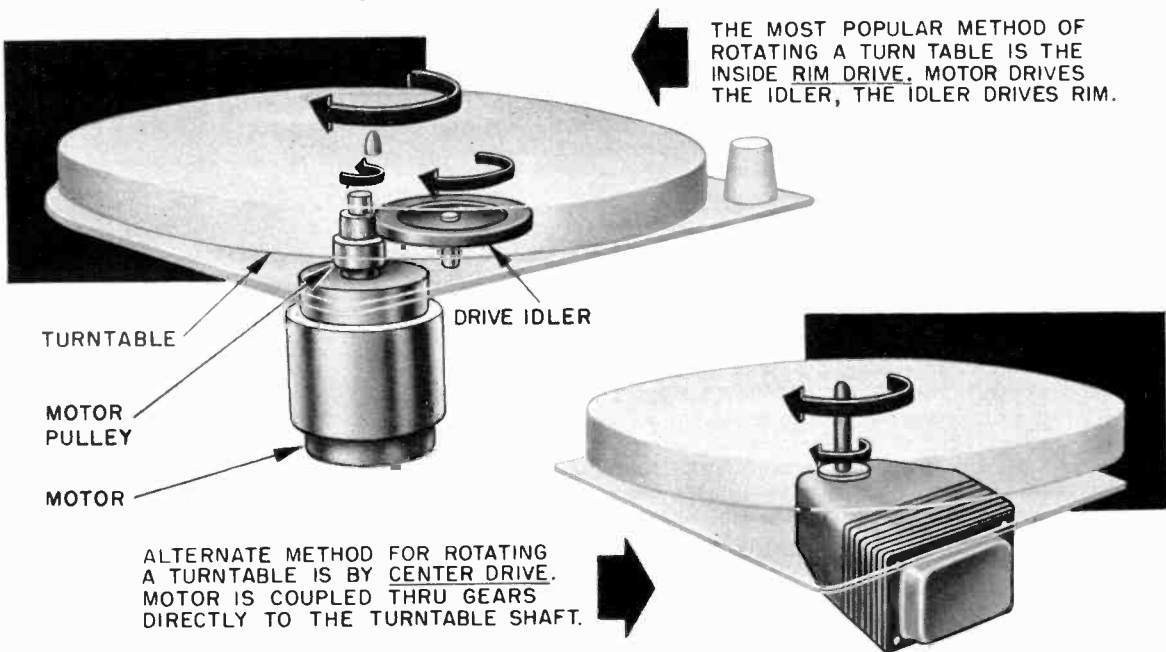

Turntables use various methods for changing speed. The motor pulley, shown at left, has three sizes. Position shown will make idler drive rim at 45 r.p.m.: small diameter is for 33 r.p.m. and large for 78 r.p.m.

30 to 60 c.p.s. range, which interferes markedly with the bass response in that bottom octave. The only way to avoid this is to cut off the system response below 50 or 60 c.p.s.—or to use a *hysteresis* synchronous motor. This new type of motor represents the highest state of the art today, with a degree of smoothness of operation which is unapproachable by any other type. Its cost is about double that of a comparable system with a four-pole motor, but the results speak for themselves. For a system with a bass response which is flawless in every other respect, hardly any other choice is possible.

Motor Speed

A good motor for high-fidelity turntable use operates in the vicinity of 1800 r.p.m. This speed represents about the best compromise point for the requirements of efficiency, smoothness of operation and adequate cooling. It is obvious then that some sacrifices must be made in the design of a multi-speed turntable which achieves its speed changes by altering the motor r.p.m. Such a motor will almost certainly be subject to overheating, vibration or poor speed regulation. A much more satisfactory approach is a constant r.p.m. for all turntable speeds, with the variation being taken care of in the power linkage between motor and table.

Power Linkage

The most obvious means of transmitting the motor rotation to the turntable would be simply to attach the table to the motor shaft. But in that case the motor would itself have to rotate at turntable speed, and this we have already ruled out. Furthermore the amount of noise transmitted from the motor into the system would be excessive. This method of power linkage is the basis of a *direct-drive* system, which you may very likely have heard is the best possible means of propelling a turntable. But the truth of that statement is subject to some very serious qualifications. The direct-drive systems employed in commercial practice actually have a set of gears and some means of vibration filtering interposed between the motor and turntable. Such a system is unquestionably the best, *provided* that its components are machined throughout to an exceedingly high degree of precision. And even then, it is better only because it can withstand the wear and tear of heavy-duty service, such as in broadcast stations or wire music services. But the average hi-fi fan will never be subjecting his equipment to such constant abuse, and many equipment manufacturers have learned to their sorrow that they cannot produce a popular-priced direct-drive system which will stand up even under ordinary home use.



Turntable made by Thorens of Switzerland has a variable speed direct drive motor. Helical gears of sound-absorbing material, plus a special speed governor, makes possible exact 78, 45, or 33 r.p.m.



Table at left plays single records automatically. Changer above takes 10-in. and 12-in. records intermixed. Controls provide repeat, reject, adjustable pause. Muting switch cuts sound between records.

Since a precision-machined set of gears is an exceedingly expensive proposition, the objective in the design of a reasonably-priced turntable assembly is some other means of stepping down the motor r.p.m. to the desired record r.p.m., while at the same time meeting the requirements of smoothness and quietness. The gearless system which has been evolved employs a smooth motor pulley bearing against a smooth *idle-wheel*, or *idler*, which in turn bears against the turntable rim. This rotation method is called *friction drive*. When properly designed and built, this rim drive system will perform every bit as satisfactorily as the most expensive direct-drive assemblies. And it can be purchased at a much more reasonable price, simply because there are far fewer precision parts. The idler is made of rubber and therefore subject to deterioration, but it can be replaced quickly and inexpensively by even the rankest amateur. A mangled gear box, on the other hand, calls for a major overhaul—or possibly even the trash barrel.

Variable-Speed Turntables

Several manufacturers are now offering turntables with speed controls which are continuously variable between perhaps 15 and 100 r.p.m. One of these employs a conical motor shaft, with the position at which the idler rides against the shaft determin-

ing the turning ratio, and hence the resultant speed. In another the idler is set at right angles to the turntable where it bears against the table's underside. With the idler speed fixed, it will drive the table more and more slowly as it is moved farther away from the center shaft. Still another uses a continuously variable speed motor.

A turntable of this sort has been stoutly praised as the ideal one for the music lover, as it permits correction for pitch deficiencies in the original recording. It is also argued that such an arrangement will accommodate any new speeds which—heaven forbid—may descend upon us. Now admittedly the speed problem was of some consequence in the early days of recording, when every manufacturer had his own theories about the ideal standard speed. And discs which were recorded at 80 r.p.m. will sound about a quarter-tone flat when reproduced at 78 r.p.m. Thus there may be some justification for a continuously variable system if your collection houses many very old records, and if your musical hearing is acute enough to be offended by slightly false intonation.

But all reputable record manufacturers today go to very great lengths to assure that their recordings are precisely on pitch for reproduction at the standard speeds—and these precautions extend to the re-issued collectors' items. Thus the need for

COMMON METHODS OF CHANGING SPEEDS

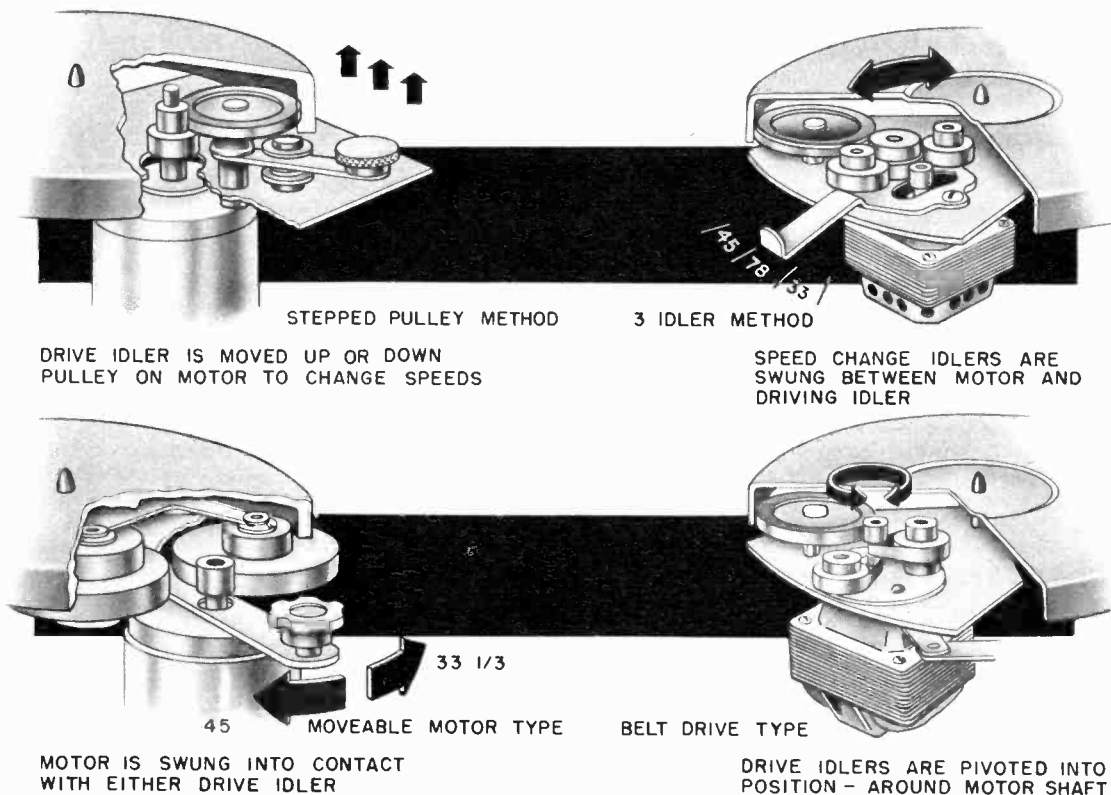

Shown above are various speed shifting mechanisms used with rim driven turntables. For high fidelity use all parts must be sturdy and machined to close tolerances to insure level rotation at exact speeds required.

pitch correction with modern records on a turntable operating at correct standard speed is practically nil. And, of course, any future speeds can be just as readily accommodated by the manufacturers as have new speeds in the past. Any gain to be made by the use of a continuously variable system is usually offset by mechanical problems, such as slippage in the power linkage or unevenness in the motor. The system does offer advantages for educational use, to vary pitch and tempo, and for special dramatic effects. And the more forthright manufacturers offer their variable systems *only* for such use, not for serious high fidelity listening.

Table Design

The table itself, when properly designed, can do much to aid in the smooth rotational movement, for it will act as a flywheel and

oppose any tendency toward speed fluctuation. A cheap turntable is simply a flat flanged disc stamped out of a piece of sheet metal. But a really good table is made of a heavy casting, precisely machined for perfect balance and smooth fit of its moving parts. Since most high fidelity phonograph pickups operate on magnetic principles, it is essential that the table be made of a *non-magnetic* metal, such as aluminum or brass. When in operation, the pickup lies in such close proximity to the turntable that any residual magnetic fields would seriously interfere with the reproduction.

The surfaces of cheaper turntables are usually covered with a spray coating of *flock*, consisting of tiny plastic fibers. This material does not wear very well, it has a great attraction for dust particles, and very often induces an electrostatic charge into plastic records so they, too, catch dust.

Wool or cotton felt has been used for years as a turntable covering, with a fair degree of success. But while static is no problem, this material also has a rather poor wear factor, and it does become imbedded with dust.

Many of the better tables today have rubber mats on which the record rests. This provides a fairly rugged surface, although rubber is subject to deterioration in time. The slightly tacky mat provides a positive non-slip grip, there is no static, and it is quite easy to clean. Some manufacturers mold a ridged surface into the mat, which reduces contact with the disc by 60 or 70%. This, of course, greatly reduces the possibility of the transfer of dust from turntable to disc, but at the same time it reduces traction by a like amount.

Perhaps the best turntable surface available today is one of cork impregnated with neoprene rubber. This is considerably more rugged than rubber alone, has a longer life, has no static attraction, and is less susceptible to imbedded dust particles. Slippage is no problem, and the surface is smooth and flat.

Turntables for home use are available in sizes from as little as four inches and up to twelve inches in diameter. The smallest size has the advantage that it supports only the label area of the record, while the sound grooves on the underside never touch the surface of the table at all. The dust problem on the discs is thereby minimized, but, of course, the flywheel effect of such a small table is negligible, and slippage between the table and disc could be serious. Whenever a turntable supports a record larger than itself, the soft plastic record will sag slightly under the weight of the pickup. The stylus will therefore ride somewhat more heavily on the outer groove wall, resulting in uneven wear and distortion. Thus considering the cost of an LP record, it would seem to be false economy to employ a turntable having a diameter smaller than a full twelve inches.

The chassis which supports all of the turntable elements must likewise be large and sturdy. A flimsy stamped chassis will be subject to vibration from a number of sources, not excluding its own sympathetic resonance. And since there must be a true and positive connection between the several elements in the power train from motor to turntable, the chassis must be strong enough to resist stresses and strains which might throw the linkage out of alignment. A heavy casting of non-magnetic metal seems to be the best means of eliminating these troubles at their source and providing a firm foundation.

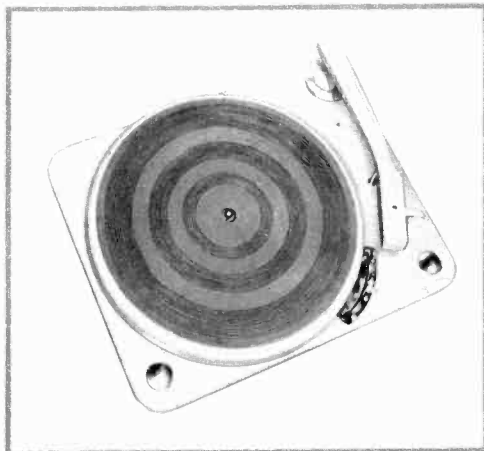

Manufactured in Switzerland for David Bogen Co., the Lenco turntable can vary speeds from 29 to 86 r.p.m. Pickup arm allows adjustable pressure.

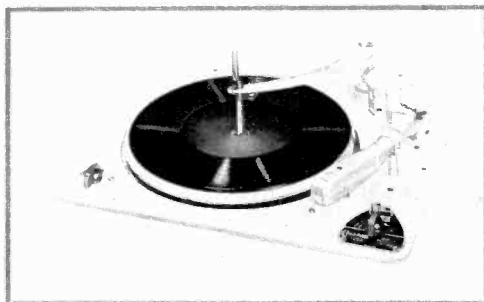

Collaro automatic record changer takes intermixed 10- and 12-in. records, has three speeds, four pole motor, automatic muting switch, plug-in cartridges.

Phantom picture, below, of General Industries' four-pole motor turntable shows rim drive idler wheel and the three-speed adjustment mechanism.

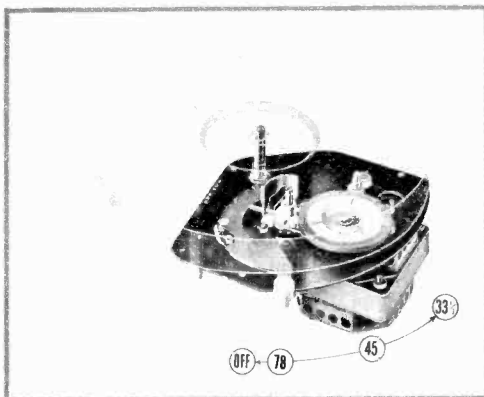



Record changer for Stromberg-Carlson's "Custom Four Hundred" set of matched hi-fi components is this modified Garrard RC-80 "Triumph" changer.



V-M Tri-o-matic three-speed player uses a four-pole motor, plug-in tone arm heads for various pick-up cartridges, precision turntable, automatic muting.

Turntable Troubles

The most obvious turntable trouble is *wow*, a slow wavering in pitch of the reproduced music, often due to a once-per-revolution variation in speed. The two-pole motor is a prime offender in this case, but there are other sources as well. Eccentricity in the mounting of the turntable center shaft will cause it, as will a flat spot on the idler, roughness on the motor shaft or rim wall, ill-fitting gears, or lack of a perfect right-angle fit between the table and shaft. This latter difficulty can be spotted readily by playing a record on the table and noting if there is any vertical motion of the pickup.

Most of these troubles are problems in original design and manufacturing, and wise purchasing in the beginning will avoid most of them before they start. Precision machining of all moving parts is essential. If the turntable employs an idler system, it should be so designed that the idle wheel drops out of contact with the motor shaft and rim when the table is not operating. Otherwise flat spots will develop on the wheel and cause uneven rotation.

A first cousin to *wow*, and just as undesirable, is *flutter*. This is simply *wow* at a faster rate, resulting in all of the music being modulated with a vibrato effect which the musicians never performed. This, too, is caused by rough surfaces or loose fit in any of the moving parts, such as motor bearings, center shaft, pulley, idler, gears or rim. Good design and preventive maintenance are the only sensible answers

to this problem. Any attempt to cure this trouble after it exists will prove to be expensive if not impossible.

The low-frequency vibration which superimposes noise upon the reproduction is known as *rumble*. This is a problem which we hardly knew existed until very recently, because very few systems were capable of providing bass response which would reproduce it. Today, however, it is a really serious matter, and the only adequate answer to it is the proverbial ounce of prevention. The two-pole motor is notorious for this trouble, but we have already ruled that one out on several other counts. The four-pole motor, even the best, does definitely have some rumble, but you may find it good enough for you, provided that the rest of the unit is heavy and solidly constructed. The hysteresis motor, however, has proven itself as the best rumble-free source of power available today.

The low-frequency noise known as *hum* is seldom a problem in well-designed turntable systems. The motor must be well shielded and grounded, and the chassis and table should be of non-magnetic materials if a magnetic or dynamic pickup is used. The pickup arm and its associated wiring should be kept as far as possible from the motor and its power supply line. This is standard practice with manufacturers of complete units, and if the table and pickup are purchased separately the manufacturer will furnish mounting recommendations which should be followed with care.

Record Changers

A serious drawback to the enjoyment of

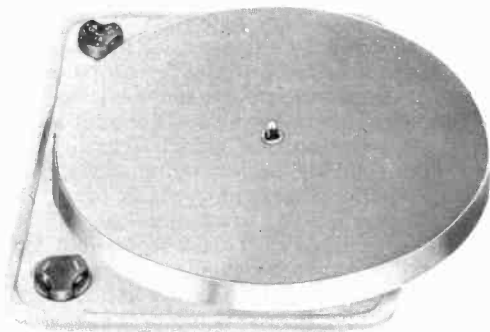

The Garrard three-speed transcription turntable has a heavy counterbalanced table for smooth fly-wheel action; knobs, at left, for speed changes.

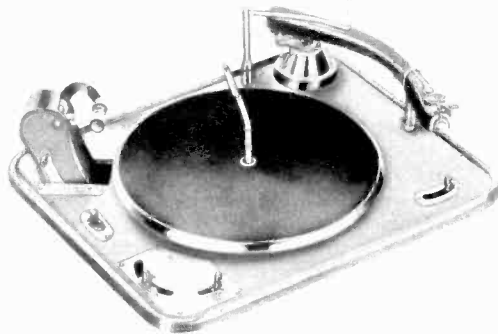

Imported Garrard RC-90, English made, has three speeds plus fast-slow adjustment, stylus pressure adjustment, four-pole motor, automatic muting.

disc-recordings was for many years the very short playing time of the 78-r.p.m. record. The most logical and satisfactory answer to this vexing problem came with the development of the long-playing record. But prior to LP, a partial solution was the record changer, which permitted the consecutive playing of a number of 78-r.p.m. records with only brief pauses between sides, and with no manual attention required until the completion of the last side. But since we now have the LP, we should ask ourselves if a record changer is really necessary. And what is more important, can it meet the stringent requirements of high fidelity service?

At first glance the function of a changer is deceptively simple: when a record has finished playing, another record must be put on the turntable and the pickup placed in its lead-in groove. But let us consider the number of separate operations necessary to perform that simple task. When the end of the record is reached, the pickup must move, first vertically upward, and then laterally to a point outside the turntable periphery. There it must wait while the next record is put into place. Then follows another two-step motion, usually consisting of lateral movement of the record away from the stack, followed by the vertical movement of dropping the record into place. Finally the pickup arm must move laterally and vertically to engage the lead-in groove at the proper diameter of the particular record being played. The complexity of cams, gears, levers, pulleys, belts, pawls, ratchets and drums necessary to perform this action are complex enough

to provide nightmare fare for any hi-fi fan.

Almost all changers manufactured today for home use are of the *drop mechanism* type, in which a stack of records is supported several inches directly over the turntable, and each record is dropped in turn onto the table as it reaches the bottom of the stack. In early systems of this type, much of the weight of the stack was supported by a small cam or key protruding from the spindle. At the proper time this key recessed or rotated out of the way just long enough—supposedly—for the bottom record to drop from the stack to the table. These devices seldom performed as advertised, however, although they were very efficient at gouging out the center holes of the records, with consequent wow in reproduction.

Another type was the *rotating gate* which should have been known as the *guillotine*. This had a sort of scissors-shaped pair of platforms at opposite sides of the table. The stack of records rested upon the bottom blades until the next record was called for. At that time the bottom pair of blades rotated out of the way while the top pair knifed its way in between the bottom record and the remainder of the stack. At that point the bottom record was free to drop, whereupon the blades rotated back into their original position, with the stack resting on the bottom pair. This changer was very gentle to the center holes of the records; it concentrated mainly on chipping the edges or simply cracking the disc straight across.

Most changers today involve some variation of the *pusher* platform. In this system

the stack is supported at two points, by a fixed platform at the edge and by an offset in the center spindle. When a new record is called for, a small arm in the outer platform simply pushes the edge of the bottom record until it falls off the platforms and down the spindle, while the remainder of the stack drops into place on the platform.

The RCA 45-r.p.m. system employs a seven-inch record with a center hole 1½ inches in diameter. All of the support for the stack is provided by two small shelves which protrude from the large center spindle. During the changing cycle, the two shelves recede into the spindle and a pair of blades simultaneously moves out of the spindle into the space between the bottom record and the rest of the stack. After the record has dropped, the blades disappear and the shelves emerge to support the stack once again. This system has an interesting protective feature, in that the records are thicker in the label area than in the recorded portion. Thus the grooved surfaces never touch each other when the records are stacked. In order to play these discs on conventional changers, some manufac-

turers provide oversize spindles which may be slipped over the regular ones. In other cases it is necessary to obtain 1½" plugs with $\frac{5}{16}$ " center holes, known as *spiders*, which are inserted into the records to play them in the conventional manner.

Some changers provide such additional features as a muting switch which kills the audio during the changing cycle, and an automatic stop switch which turns off the changer power after the last record has finished playing. This is just about the height of luxury for the lazy man, but a price must be paid for it. All record changers have at least some of the following disadvantages:

1. Abrasion between groove surfaces when records are stacked.
2. Possible damage to center holes or edges, from the platforms.
3. Wear on the center hole, as the spindle remains stationary while playing.
4. Change of pickup angle with respect to record as height of stack changes.
5. Possible sacrifice of motor smoothness in favor of more power to operate

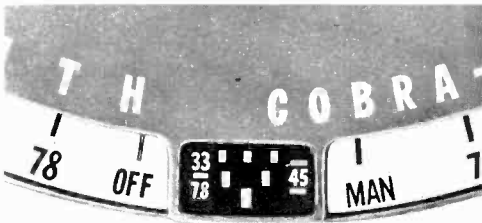

A "stroboscope speedometer" is a feature of the new Zenith Cobra-Matic changer. Detail, above, shows the markings for fluorescent light check.



Turntable by D & R, Ltd., has external idler rim drive, four-pole motor positioned to eliminate hum, silent operation at 33, 45, and 78 rotations.

Zenith provides adjustments for size of record, and variable speeds between 10 and 85 r.p.m. Diamond stylus is supplied in pick-up of deluxe units.

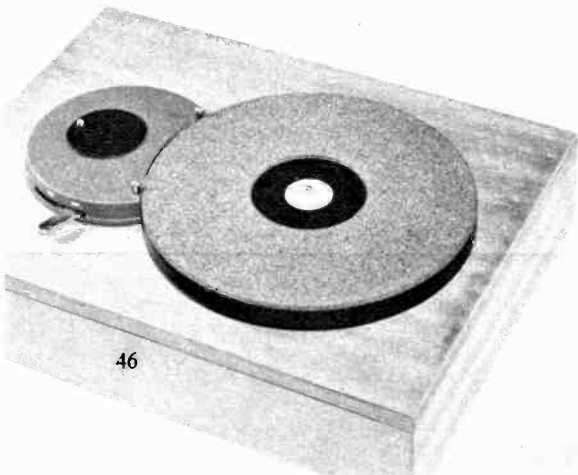

The Select-O-Matic "200," made by J. P. Seeburg Corp., holds 100 45-r.p.m. records. Control will choose one or both sides, offering up to 200 plays.

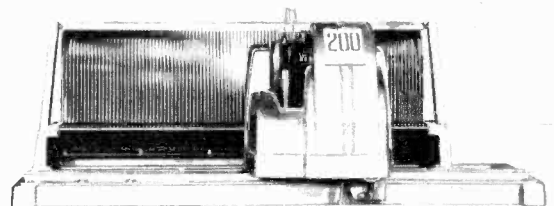



Needle clinics, like this by the Walco Company, have been set up in record and radio stores across the country. Microscope for stylus examination, replacement needles, and anti-static sprays are provided.

Reproducers

From the stylus, into the pickup cartridge, and on through the tone arm the sound impulse travels from the record into your amplifier system.

HAVING the motive power for our records, we are now ready to consider a means of translating the striations on the disc face into the comparable electric currents which will eventually emerge as high fidelity sound.

The device which follows the wiggles in the groove, often called the phonograph needle, is more correctly known as the reproducing *stylus*. The term "needle" is really a misnomer, for the stylus does not and should not have a sharp point.

Perhaps under theoretically ideal conditions, the reproducing stylus which would provide the most accurate groove tracing would



An old-fashioned steel needle tip looks this way before use.

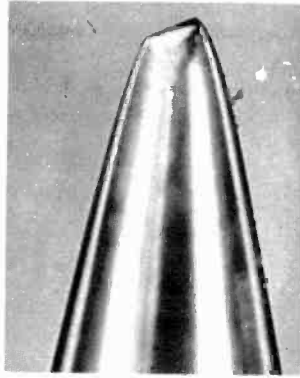

After only one playing the steel is worn this amount.



After eight hours use an osmium stylus shows a flat spot.

An osmium tip, after 50 hours, runs this chisel over records.

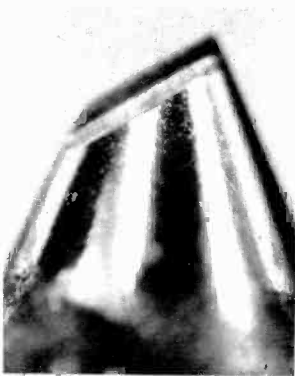

Microphotos by Tetrad Co.

Size and shape of stylus are made so that tip rides midway down walls of groove, neither along bottom or top edges.

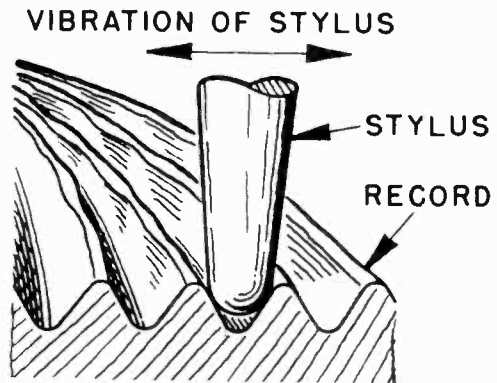

be one which would have the size and shape of the recording stylus which originally cut the record. But the cutting stylus is a chisel-shaped device, and in order for it to be used for reproduction it would have to have absolutely perfect compliance, that is, zero friction and zero inertia. Otherwise, it would seriously damage the record. But there we run directly into the hard facts of physical impossibility, and we must find some means of compromise.

The Stylus Shape

The early method of stylus shaping was purely one of brute force. The *steel* needle was manufactured to a shape roughly approximating that of the groove, and it was then worn in during playing by the abrasive action of a filler in the record material. This method was pretty hard on all concerned: the needle, the record, and the ear of the listener. Obviously a better one had to be found.

One approach to the problem involved the use of a much softer material, the needle of the *cactus* plant. These were much easier on the records, as the cactus absorbed most of the wear. But the needle therefore had a very short life, and it was also highly inefficient at the higher frequencies. This high-frequency discrimination was very effective in filtering out the surface noise, but the musical reproduction was too greatly impaired at the same time.

The next approach involved an about-face to a metal much harder than steel, which would itself resist wear, and which would be so shaped and polished that it would exert minimum wear on the record. The material chosen was *osmium*, a very hard bluish metal of the platinum family, and osmium styli became the first of the so-called "permanent" types. The results were very encouraging. Better record wear was immediately evident, along with greater

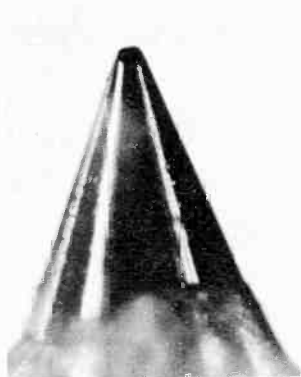

Though sapphire is harder, tip above is showing worn spot.

Diamond, best of all styli, is shown before being used.



After 1,000 plays sapphire has been badly worn down.

Diamond shows no wear after several hundred hours.



Badly worn osmium stylus, left, or sapphire, right, could ruin records.

Grooves appear this way under microscope if properly played.

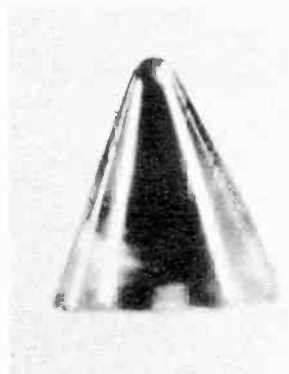

Record has been played with badly worn stylus.

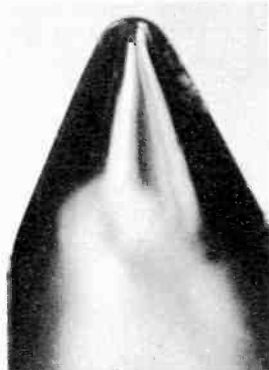

Abused record with scratches will produce clicks.

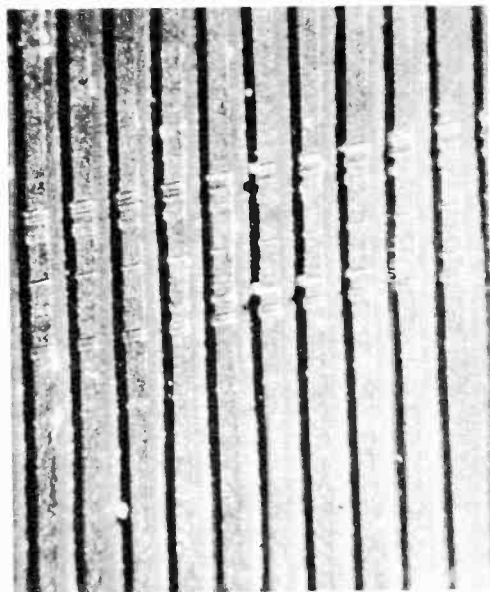
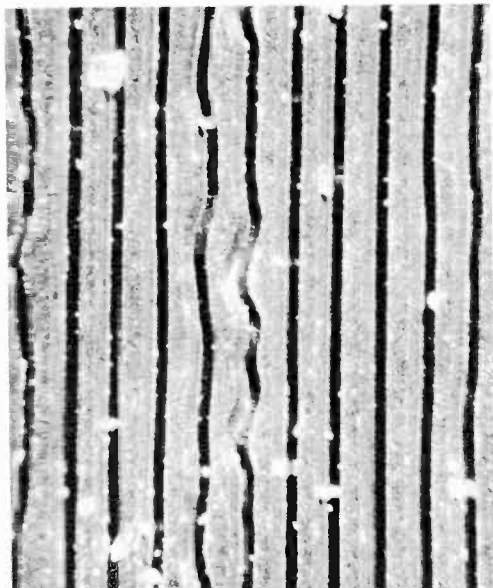
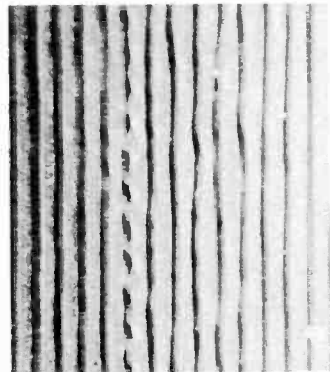

Tetrad photos



GOOD STYLUS PICKS UP HIGH FREQUENCIES;
POOR ONE SKIPS THEM AND DAMAGES RECORD



GOOD—STYLUS IN GOOD CONDITION RESTS ON
SIDES OF GROOVE.

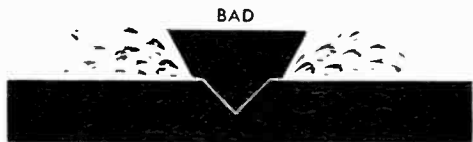

BAD—CHISEL-LIKE, WORN OUT STYLUS SINKS INTO
BOTTOM OF GROOVE AND SCRAPES MUSICAL
IMPRESSIONS OFF GROOVE WALLS.

clarity of reproduction. The stylus did wear, however, especially with records compounded with an abrasive formula, and the rough edges produced on the stylus tip would ultimately damage the record.

But the success of the osmium stylus seemed to indicate that increased hardness of the point was a step in the right direction, and a further effort was made to find even harder materials which would adapt themselves to this purpose. The search led quite logically to the precious stones, which are noted for their hardness. There was also available a wealth of industrial experience in the fabrication of these materials to small sizes and close tolerances, as they had been used for years in the bearings of fine watches, meters and other delicate mechanisms.

Sapphire and Diamond Styli

The years just prior to World War II saw the introduction to the public of the *sapphire* stylus, along with fantastic claims for its performance. This was in many respects the best stylus to date, but at that point limitations elsewhere in the system assumed increasing importance. The record surfaces were so hard and gritty, and the pickups and tone arms were so heavy, that the brittle sapphire chipped rather readily and thereafter plowed up the records unmercifully.

In the radio broadcast industry, meanwhile, transcriptions had been developed which were pressed from a plastic com-

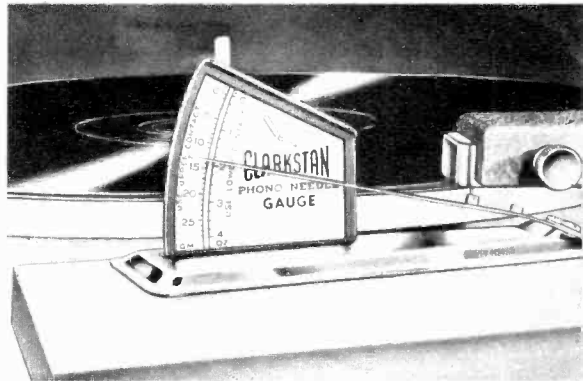

Special scales are available for measuring exact weight of pickup arm. Too much weight wears the record while too little allows the stylus to skip.

For best reproduction, stylus must ride part way down the groove, as shown at left. Worn point will gouge grooves and produce distorted sound.

Tetrad

pound instead of the abrasive shellac used by the record manufacturers. At the same time pickups and arms were getting lighter, and the broadcasters were discovering that their maintenance and replacement problems were very much eased by the use of an even harder stylus material. They were using the *diamond*, the hardest gem known to man. This seemed to be the perfect material for use with plastic records. Reproduction was excellent and wear was minimized. And with the recent adaptation of broadcast techniques to amateur high fidelity equipment, the diamond stylus has been included as an integral part of a good hi-fi system.

Diamonds are quite expensive, of course, and you may be wondering if you can get along for a while with a sapphire instead. The answer to this is definitely *yes*. For with all other factors being equal, there is absolutely no difference in the musical reproduction afforded by either type.

Why, then, should we want the diamond at all? First we must remember that all styli, diamond included, are subject to wear. Terrifically high temperatures are generated at the points of contact between the tip and the groove walls, and if the stylus is not replaced or resharpened and repolished in time, it will ultimately become a chisel causing irreparable damage to the records. It is not possible to specify a given number of satisfactory plays which any stylus will perform, due to the many variables including record material, turn-

Many radio and record shops now have needle clinics where a microscope check of stylus, as at right, shows actual condition, and when to replace.

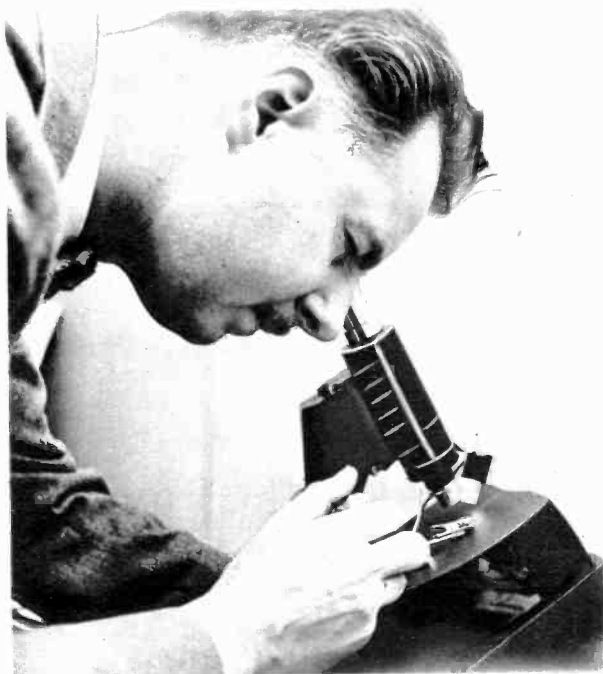

The Weathers stylus pressure gauge, shown testing a Weathers tone arm, is of the balance type. The proper weight directly affects fidelity and wear.

table speed, stylus pressure and tone arm mass. Experience has shown, however, that a diamond stylus will generally outlast a sapphire by at least twenty to one. Thus despite the higher initial cost of the diamond, it will have to be resharpened or replaced far less often than the sapphire, and it is therefore truly the better buy.

It would seem that lower stylus pressures would permit greater wear, but this is only true up to a point. The tip must be positively seated in the groove, without bouncing back and forth between the walls, and there is a definite minimum point beyond which distortion and wear increase. The ideal pressure varies with pickups and arms, and the manufacturer's recommendations should be observed to the letter. Most modern pickups call for vertical forces from 12 grams on down, one operating at only 3 grams. Several gauges are available for the measurement of stylus pressure, and every hi-fi system should have one.

Groove Shape and Stylus Size

The size and shape of the stylus is dependent upon the groove from which the sound is to be reproduced. The size and shape of the groove is in turn dependent upon a number of mechanical factors, such as playing time of the record, and the necessity for a clean quiet cut, which can be successfully recorded, processed and reproduced. The more grooves that can be inscribed in a given space on a record, the more playing time the record can accommodate. There is a definite limitation to the closeness of groove spacing, however, as it is the side-to-side undulation of the groove which represents the sound, and each groove therefore must have enough "elbow room" to swing back and forth without cutting into those at either side of it. Smaller grooves closely spaced would permit additional playing time, and this fact, along with slower rotational speeds, is the basis of the LP and 45-r.p.m. records.

The groove is cut in the shape of a V, with the two sides, or *walls*, forming approximately a right angle. The distance between opposite edges at the top of the groove is about 2.5 mils (0.0025 inch) for LP and 45, about 5.5 mils for transcriptions, and around 7.5 mils for 78-r.p.m. records. The playback stylus has a rounded tip of such size that it rides about midway down the walls of the groove. If it rides near or on the bottom, reproduction will be excessively noisy; if it rides too close to the top, the pickup may jump grooves (the trouble known as *groove skating*) on loud passages, the records will wear rapidly and distortion will appear.

It is quite obvious then that a precise stylus size must be used for correct reproduction from each of the various types of records to be played. The proper stylus tip radius for each type is as follows:

LP and 45.....	1.0 mil
Transcriptions	2.5 mils
78 r.p.m.	3.0 mils

No compromise is possible which will produce a "universal" stylus to play both microgroove and standard groove records. Some cheap sets have styli with tips of about 1.5 or 2.0 mils, which are totally unsatisfactory. They won't track properly on microgroove, and they are exceedingly noisy and subject to undue wear on standard grooves.

Since broadcast transcriptions are seldom available for home use, except through *sub rosa* channels, the average hi-fi bug will not require the 2.5 mil point. Besides, the 3.0 mil size will usually do an acceptable job. But since most record collections do house both microgroove and standard groove discs, it is imperative that the reproducing system include both 1.0 and 3.0 styli. Most pickups manufactured today have some sort of "flipover" mechanism, in which a very quick adjustment will bring into play either tip size in the same cartridge. And as the 78 record is becoming obsolete, you may find it wise economy to equip your system with a 1.0 mil diamond and a 3.0 mil sapphire, if you play the older records only sparingly.

The Duotone Company, makers of needles, discs, and recording tape, supplies this 50 power microscope, designed for frequent home check of stylus.

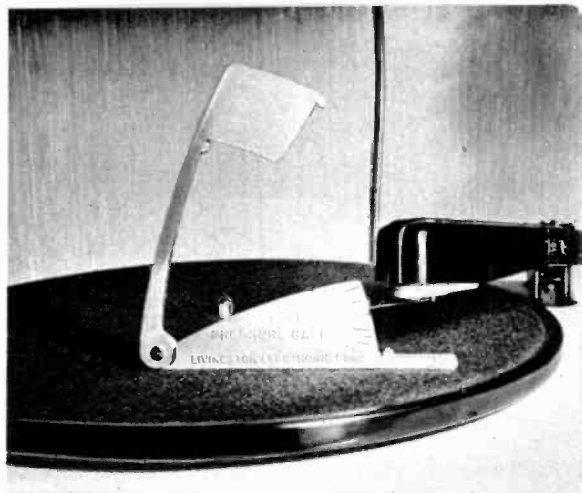

Pressure gauge made by Livingston Electronics measures tone arm weight in grams. Cantilever scales of this type should be used on turntable.

When To Change Styli

The time to change the stylus can be a knotty problem, for when stylus wear becomes evident in reproduction, severe damage is already being done to the records. The best answer is a periodic examination of the tip under a microscope. As soon as the length of the worn *flat* exceeds the tip radius, the stylus is due for replacement or resharpening. If you don't have access to a microscope, you might get the stylus test record manufactured by the Audak Company. This disc has soundless grooves on which bad stylus wear becomes visible. The pickup is placed on the "Stylus-Disk" as it rotates at usual operating speed for the tip under test. If the grooves take on a grayish appearance, a new stylus is in order. Since only a few grooves need be used for each test, the record is good for about 20 tests on the LP side, and around a dozen on the 78 r.p.m. side.

Pickup Requirements

With the stylus tracing the winding path of the groove, the next step is the reproducer, or *pickup*, which must accurately translate this mechanical motion into an audio-frequency electric current. The first



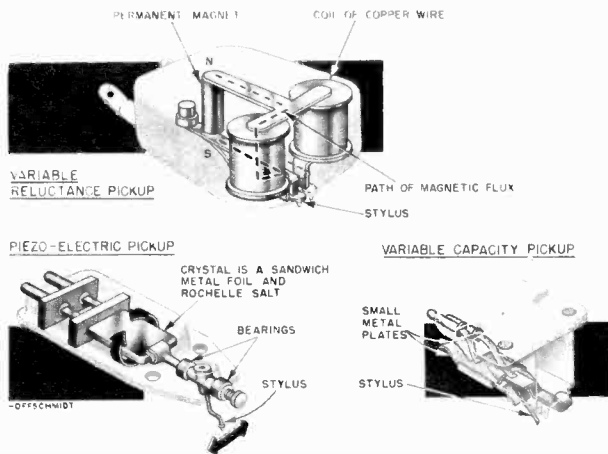

Shown above are various methods for transforming mechanical record grooves into electrical impulses.

Since cutting stylus does not twist to face groove direction, cuts are steep and narrow for high frequencies, forcing playback stylus up and down.

Grooves A and B, exaggerations of same high frequency recorded at outside and inside of record, illustrate how tracking is more difficult at inside.

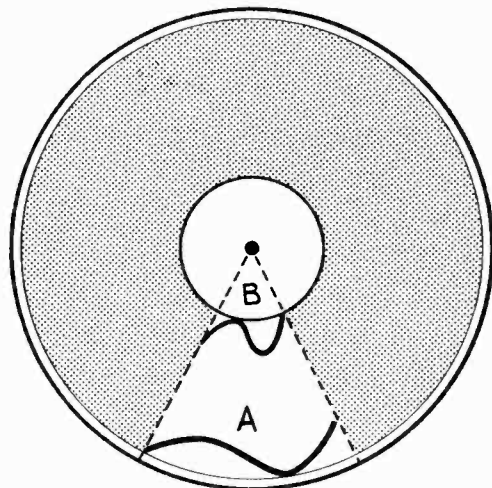
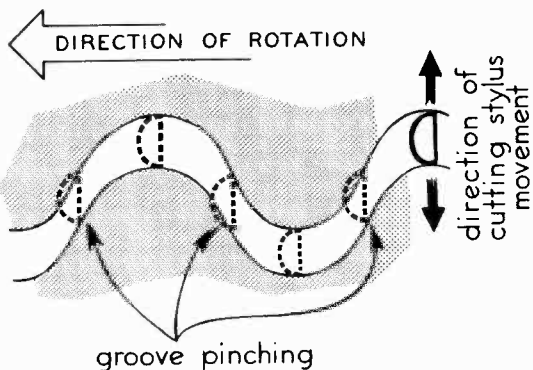

requirement of the pickup, then, is that it do as little as possible to impede the motion of the stylus. This means that the pickup must exhibit excellent *compliance*, not only in the lateral plane, but vertically as well, due to an effect known as *pinching*. This is a narrowing of the groove, particularly noticeable at high frequencies. But while the pickup must permit this vertical motion, it must not respond to it electrically, for all of the desired sound information is contained in the lateral movement of the groove.

The earliest electrical phonograph pickups were of the *magnetic* variety, but their weight and stiffness were so great that they were soon replaced by other types. The next development in cartridges were those which depended upon the

piezo-electric effect, in which certain substances tend to twist out of shape when an electric voltage is applied to them, and which also generate an electric voltage of their own when their shape is distorted. The material employed for pickup cartridges is a Rochelle salt crystal, which is responsible for the name of the device, the *crystal* pickup. These units are widely used today, as they are light in weight, low in price, and have a characteristic which makes them readily adaptable to phonograph record reproduction. Their disadvantages include a rather high fragility, sensitivity to temperature extremes, and a frequency range which seldom exceeds 10,000 c.p.s. The typical crystal cartridge, then, is not capable of true high fidelity performance.

Magnetic Pickups

Since the crystal seemed doomed to failure, the thoughts of the design engineers returned to magnetic pickups, all of which are based on a simple law of physics which states that whenever magnetic lines of force are cut by a conductor, a voltage will be induced in that conductor. The principle was not new, but much stronger and lighter magnets had been developed meanwhile, which eliminated much of the earlier objection to magnetic pickups. One of the first of the newer types was the "tuned-ribbon," introduced by the Audak Company. It employs a very thin metallic ribbon which is stretched laterally across the underside of the cartridge. In the center of the ribbon is mounted the stylus, and attached to it is a shaft and a small coil of wire. Surrounding the coil is the field of a permanent magnet. When the stylus moves, the coil is moved through the magnetic field, lines of force are cut, and the voltage thus generated is fed into the amplifying system.

The General Electric "variable reluctance" system employs two fixed coils and a moving magnet. The stylus is mounted at one end of a cantilever spring, while the magnet is at the other. When the magnet moves in accordance with the stylus motion, its field intersects the turns of the coils, with the consequent induction of an audio-frequency voltage.

In the Pickering pickup, both the magnet and the coil are stationary. The only moving part is a very light steel tube, which extends straight up from the stylus, and attaches at the top to a cantilever spring mounted at right angles to it. Surrounding the tube is a coil, and surrounding that is a permanent magnet. Since the steel is a much better conductor of magnetic energy than is the air surrounding it, the field from the magnet will tend to expand and contract as the tube is moved back and forth within it. The varying field will thus

Pickering cartridges are available with varying clips and mounts for differing makes of tone arms. Only 4 to 6 gram pressure is required.

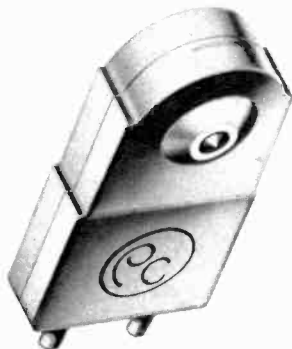

A wide range dual stylus which can be turned for use on either 78, 45, or 33 r.p.m. records is made by General Electric for their VR cartridge.

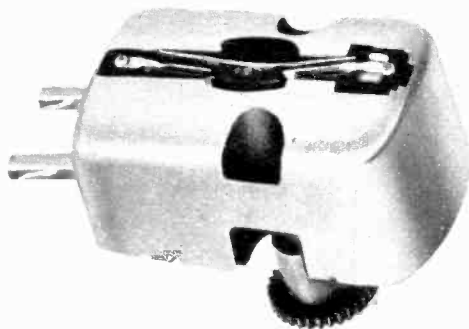

The General Electric triple play cartridge has a reported response of from 30 to 15,000 cycles. Replaceable diamond and sapphire styli are used.

Model 260 Pickering magnetic cartridge offers a turnover lever and diamond styli for 78, 45, or 33 r.p.m. microgroove disc record reproduction.

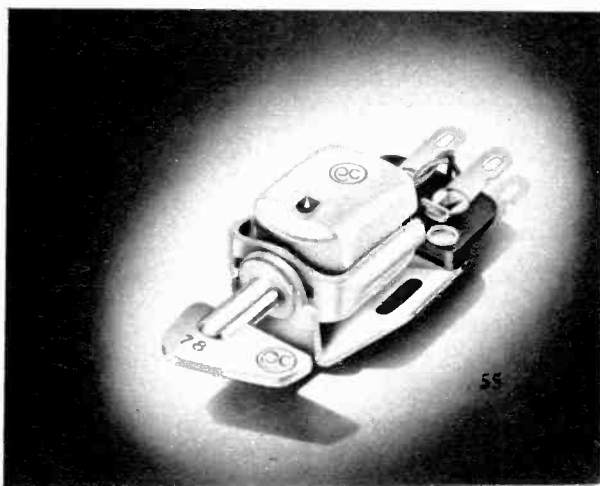

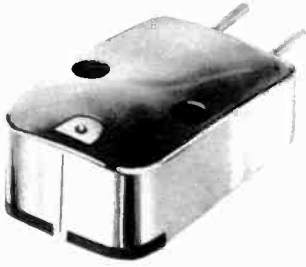

Cobra pickup arm of Zenith players uses a metal vane moves by the stylus to modulate AM radio waves which are locally generated by an r.f. oscillator.

Fairchild Series 215 moving coil cartridge has a lack of stiffness which permits accurate tracking, providing clarity without distortion or audible hum.

The Collaro Studio model cartridge, at right, is a twin-stylus, sealed-cartridge type with a wide response range and minimum distortion tracking.



Development of recording characteristics is diagrammed below. First three show groove recorded at constant amplitude with frequency increasing from base to treble. Next, constant velocity cutting shows amplitude decrease with frequency. Bottom diagrams illustrate modern recording characteristics. Constant amplitude occurs in the bass, constant velocity in mid-range, and constant amplitude again in treble. Output voltage at pickup terminals is therefore not a flat characteristic, so must be compensated.

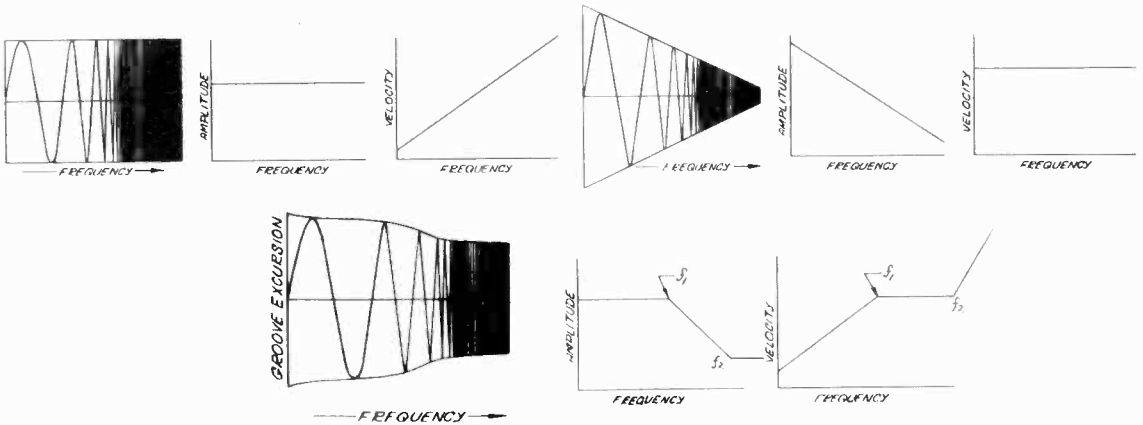

intersect the coil and develop a voltage in it.

The Fairchild dynamic pickup employs a moving coil which is wrapped directly around the duraluminum stylus mounting. Movement of the stylus causes the coil to oscillate within the field of a small permanent magnet, resulting in the audio induction.

Thus it can be seen that all of these devices represent various mechanical modifications, all working toward the identical electrical result. The mechanical problems involve a constant search for greater compliance, reduced mass, and avoidance of any resonances in the audio-frequency region.

Since in all of these systems the stylus assembly itself must do the work of generating the voltage, many experimenters have considered the possibility of having the pickup act as a sort of "lever," to modify an already existing voltage. The idea would be to generate independently a very small radio-frequency voltage, which would be directly modulated by the stylus motion, making the whole unit in effect a tiny broadcasting station. This radio signal would then be detected by the usual means, and finally amplified as any other audio signal. Hundreds of patents have been granted on systems embodying this radio-pickup principle, and a couple of them have developed into workable sys-

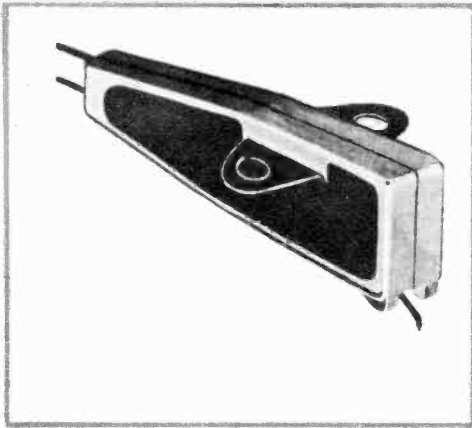

Remarkable new product of Electro-Voice Company is the Ultra-Linear 84, with very wide response; tends to compensate recording characteristics.

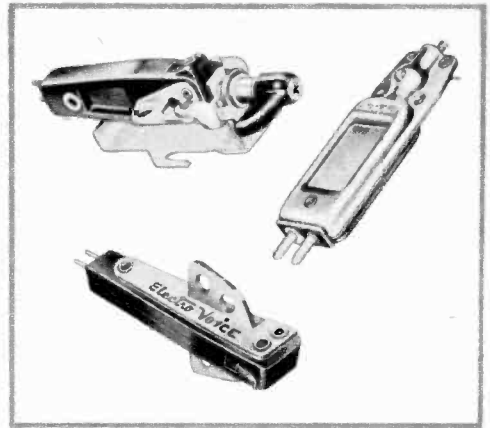

Electro-Voice makes a variety of cartridges, both ceramic and crystal, to fit differing requirements and mount characteristics, as illustrated above.

Sontone Titone cartridges, below and at right, are latest products of the company which developed ceramic principle. Both offer replaceable styli.

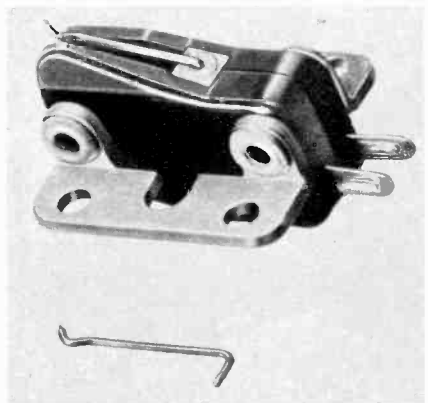
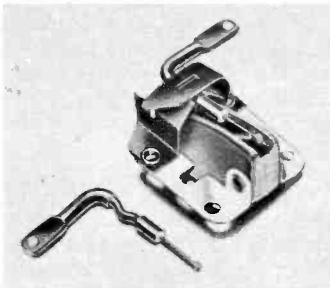

tems which are commercially available today.

Radio Pickups

The Zenith "Cobra" pickup employs a round flat metal vane attached to the stylus assembly. Next to the vane is a small coil which is part of a radio-frequency oscillator. As the vane moves with the stylus, the amount of radio energy surrounding the coil is varied, resulting in *amplitude modulation* of the signal.

Another radio type pickup, this one employing *FM* principles, has been introduced by Weathers Industries. Here the stylus assembly becomes one plate of an electrical condenser. With the other plate fixed in position, the movement of the stylus causes a change in the air gap between them, resulting in a change in capacitance and a modulation of the frequency of the oscillator. This system has provided a wider

frequency range and lower distortion than anything previously known.

Ceramic Cartridges

But while the various magnetic pickups have held the center of the stage in recent years, there has been much behind-the-scenes activity in crystal development. Collaro has introduced a new pickup exhibiting the previously unheard of range of 50 to 12,000 c.p.s. There have also been introduced several ceramic cartridges, originally developed by the Sonotone Corporation, which employ synthetically-produced materials having piezo-electric properties. The most exciting of these, emanating from the Electro-Voice people, may very well put the magnetic devices back into the shade. This unit, known as the Ultra-Linear, covers the full audible range, and does it with a characteristic which is very nearly the perfect comple-

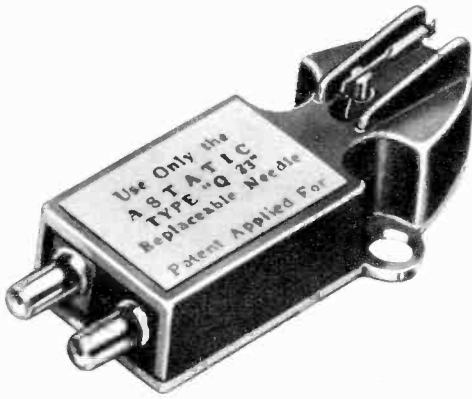

Designed for slow speed records, the Astatic CAC-J crystal cartridge was internally equalized for the characteristics of LPs by CBS Engineering Dept.

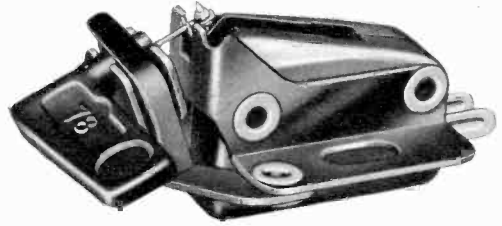

The Astatic 55-T is a ceramic cartridge which was designed for high fidelity response. Sealed against humidity, it gives reliable performance.

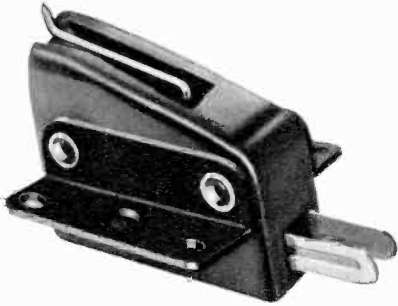

Model 51-1-J Astatic pickup cartridge is a low cost single needle type. Ceramic, it has a rubber stylus chuck, needs little pressure for tracking.

Special feature of the Weathers cartridge is its small brush. This takes part of pickup weight and allows light stylus touch as it dusts record.

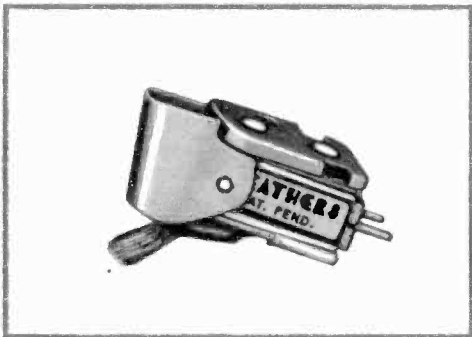

ment of the average recording curve. This fact would obviate the need for a playback compensator for most applications. Furthermore, the output of this unit is high enough that no pre-amplifier is required, and finally, the price is very reasonable. This is one to watch.

The Tone Arm

The primary purpose of the tone arm is the transporting of the pickup, while maintaining the stylus in the proper relation to the record grooves. It also carries the electrical wiring which connects the pickup to the amplifying system. Since the arm must not do anything to impede the motion of the stylus and pickup, it too must have little mass or stiffness, and a high order of lateral and vertical compliance. Thus a good arm will always have finely-machined bearings at all pivot points.

Despite the apparent simplicity of the functions of the arm, many varying ideas have been introduced into the design of this element. It is generally conceded that the arm should be as long as possible. This permits the pickup to swing in a flatter arc, in which it will remain more nearly tangent as it tracks the record. It also means that vertical motion of the pickup will cause less change in the relative angle between stylus and disc. But here the ideas begin to conflict, for the change in stylus angle will be greater for a longer arm only if the vertical pivot point is well toward the end of the arm. This is the case in many designs, but some employ a cantilever

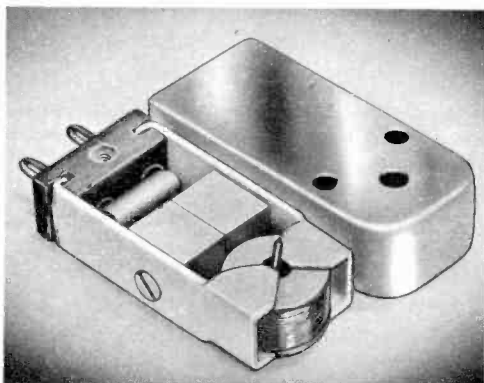

Clarkstan RV model 201, wide range variable reluctance magnetic cartridge, has only one moving part and provides flat response with low distortion.

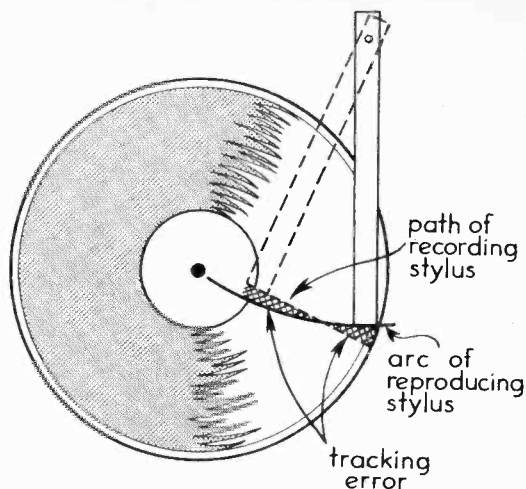
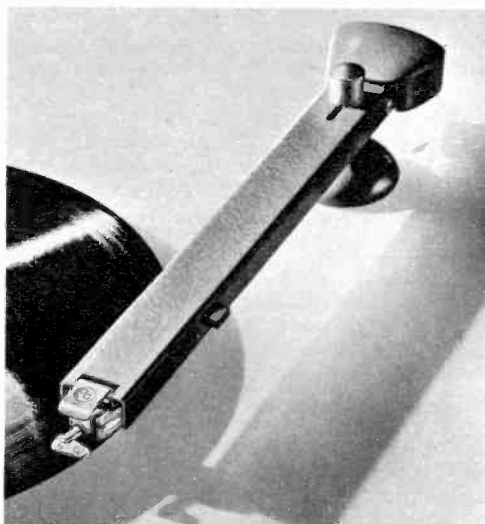

Since cutting stylus moves straight across to make record, playback with arm moving in arc causes a tracking error. Long arm helps to reduce this.

Pickering's newly designed 109D arm, left, has vertical pivot with "wrist action" at forward end, offset head reducing tracking error, adjustments.

Polyphase cartridge made by Audak Company has a pivot mounting which makes possible change from 78 r.p.m. to microgroove without removal.



which extends out from the horizontal pivot and provides a vertical pivot point somewhere near the middle of the arm length. The extreme in this is found in the Pickering and General Electric reproducers, where the arm itself is a cantilever and supports the pickup from vertical pivot points at its very end. Thus only the mass of the pickup itself is involved in the vertical motion, resulting in a system which is particularly suited to the tracking of badly warped records.

The design and adjustment of the tone arm have much to do with the matter of stylus pressure, which is usually established by a system of sliding counterweights or springs. With present-day stylus pressures being on the order of only a few

grams, a change in pressure of just a gram or two is very significant, and for that reason the stylus force should be tested and adjusted periodically.

When the stylus is properly mounted in the pickup, the pickup in the tone arm, and the arm on the motor board, the stylus should definitely not lean to either side. It must be perfectly vertical to avoid uneven wear on the groove walls. Since the stylus is rather well concealed when playing a record, it is often difficult to determine its angle by visual examination. You can accomplish this, though, by the use of a small mirror, preferably one about the thickness of a phonograph record. The mirror is placed on the turntable and the pickup placed gently on the mirror. The stylus

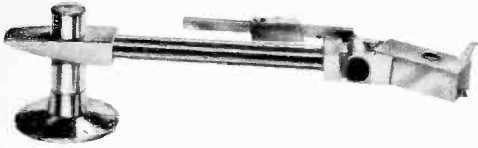

General Electric's "Baton" A1-500 cantilever-type tone arm has vertical pivot well forward of lateral.

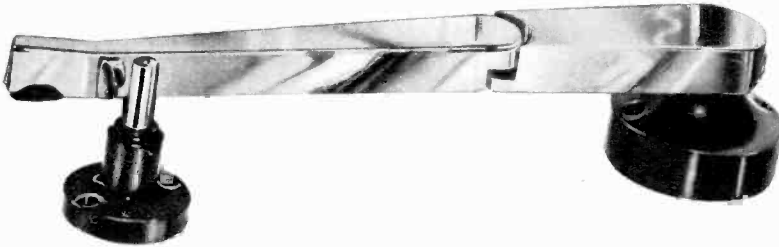

Astatic pickup, model FLT, was designed for studio and transcription work. It has anti-resonant arm.

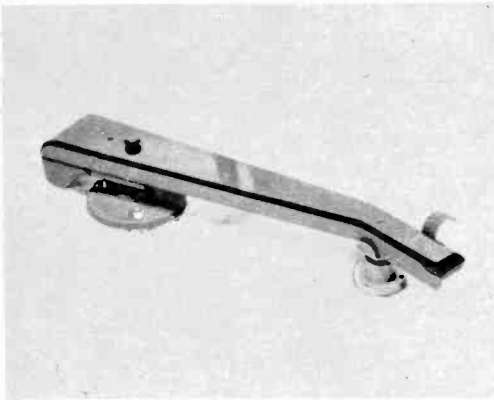

Viscous-damped arm, made by Gray Research, prevents damaged records, plays 16 in. transcriptions.

Made from light magnesium, the standard Gray has adjustable counterweight for exact pressure.

and its reflection should then be perfectly in line when viewed from all angles. If there is any angular break between the two, the need for adjustment is indicated.

Mounting the Pickup and Arm

The chuck and set-screw mounting of styli is obsolescent today, and the stylus is almost always firmly attached to the pickup at the factory. Removal of the tip for sharpening or replacement is a very delicate operation, and should only be performed by competent professional personnel.

Most of the standard arms today have adapters which permit them to accept the usual commercial cartridges, either by means of a screw mounting, or by a plug-in arrangement. In some systems, however, the pickup and arm constitute an integral unit and are not available separately. With the wide choice of designs available today, it is important when selecting your cartridge and arm that you determine in advance that the two units are compatible. Since some salesmen have a very limited technical knowledge of the components they are selling, you would do well to write directly to the manufacturers for this information if you have any doubt.

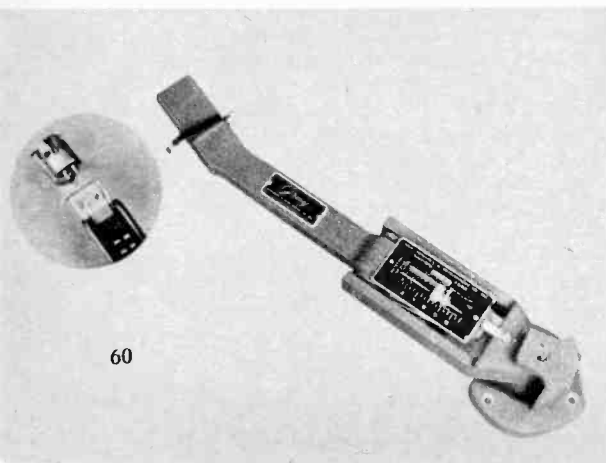

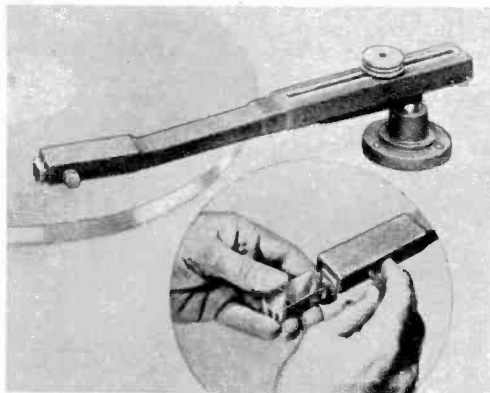

The Clarkstan 213 arm, by Pacific Transducer, changes cartridges quickly and adjusts weight.

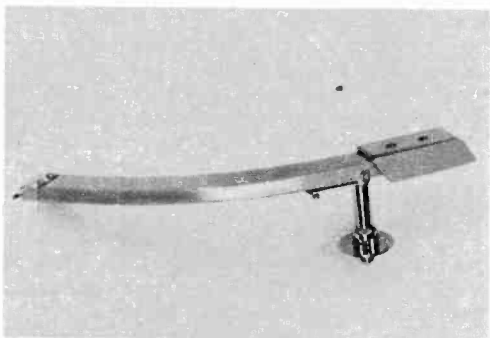

Livingston universal plays 16-in. records, has counter weight adjustment, low arm resonance.

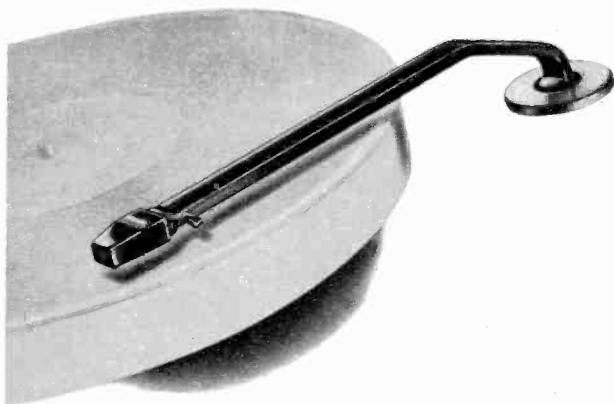

Ferranti ribbon pickup, designed by D. T. N. Williamson, has shock absorption; low weight, friction.

Weathers Deluxe Professional arm is available in blonde or ebony wood; uses FM transmission principles.



Tracking Error

The cutting stylus on a commercial recording machine moves in a straight line across the record, while the playback stylus moves in an arc. The difference between these two motions is known as *tracking error*. Many efforts have been made to eliminate it by the use of parallelogram arms or offset cartridges, but most systems today simply try to minimize it by the use of fairly long arms which are correctly mounted. Manufacturers' specifications usually call for a mounting which places the stylus about $\frac{3}{16}$ inch beyond the spindle when the arm is swung over the center of the turntable. You should also receive a template which will make accurate mounting an easy matter with simple hand tools.

The pickup leads are connected to a standard phono plug, which is simply inserted into the next piece of equipment in the chain. •

Weathers diagram shows typical mounting. Stylus is $\frac{3}{16}$ in. beyond spindle for pickup arm placement which will give a minimum of tracking error.

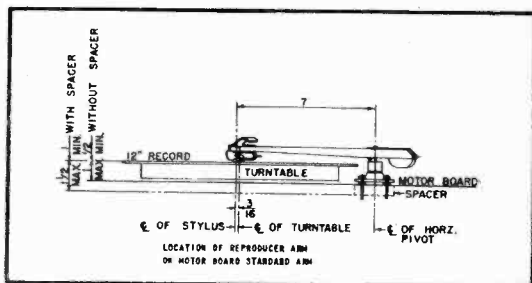

Compensators and Pre-Amps

Sounds from a groove need special treatment to regain their fidelity.

OUR high fidelity sound reproduction has now reached the stage where it is in the form of a minute electrical voltage at the ends of a pair of wires connected to a phonograph pickup. At this point we have a signal which is an exact facsimile of the original sound from which the record was made. Or do we?

Well, no we really don't have an exact facsimile yet. In fact, if we should amplify and reproduce this signal just as it is, the resulting sound would be pretty awful. It would be thin and screechy, with hardly any bass at all. Just about all we could say in its favor would be that it was an accurate representation of the modulation that

was recorded into the record grooves.

But if this be true, then the sound in the grooves is *distorted*—and badly. And if it's distorted, how can we hope to have high fidelity, and why must we be so particular about having distortion-free equipment?

To answer the first question we must concede that the sound on the record is distorted—and deliberately so. This is true, incidentally, not only of disc recording, but also of tape, film and FM radio. From these facts we might be able to infer answers to our other questions, and to guess that deliberate distortion is admissible at some point in the audio chain, provided that it is of a known value, so that corrective measures may be taken at a later point.

So far so good. But still you must have some doubts. Now you want to know why this distortion and correction is necessary at all. Why this roundabout approach? Why not a distortionless system throughout? In order to appreciate fully the complex functioning of your high fidelity system, and in order to know how to get the very most out of your records, you *must* have the answers to these important questions.

Contrary to what you may have heard, this practice is *not* simply a matter of habit with the record manufacturers, and certainly is *not* an effort to make electrical recording conform to the standards of acoustical records. Rather than that, it really provides two distinct advantages to you and me as record buyers:

Recording characteristics, simplified here, prevent bass overcutting, push highs above surface noise.

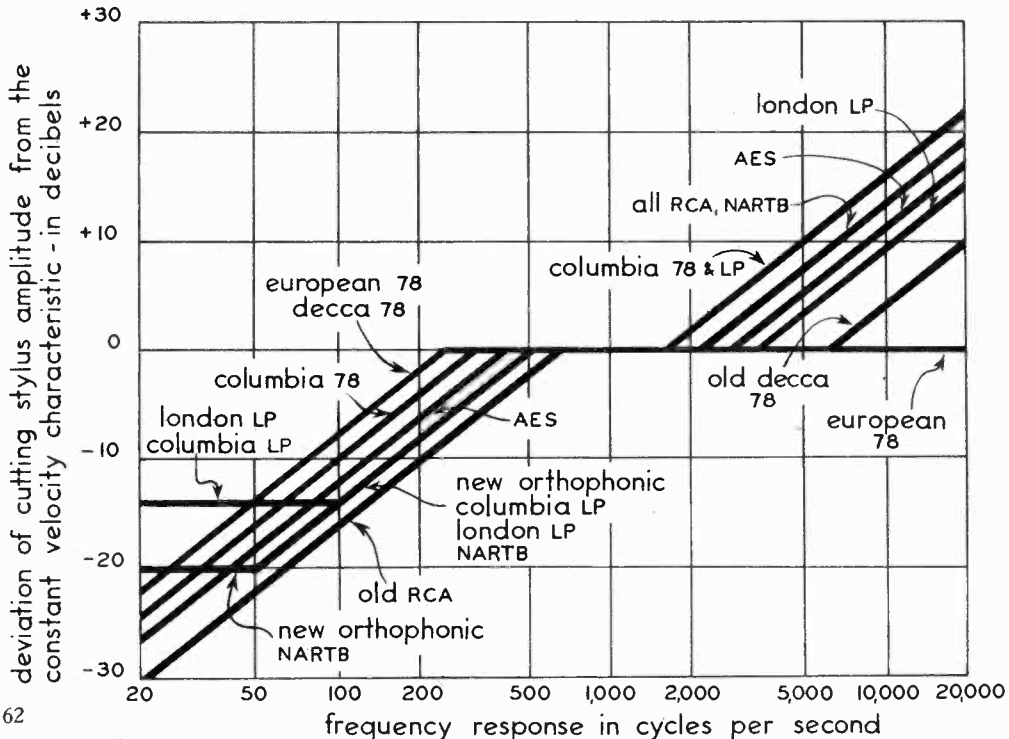



1. Much more music for our record dollar;
2. Much less extraneous noise during reproduction.

The specific manner in which the wave shape is altered as a master record is cut, is known as the *recording characteristic*. As we learned in Chapter 3, this process is basically a matter of reducing the amplitude of the low frequencies while increasing the high tones. The middle range of frequencies is left unaltered. Now we should examine the evolution of a recording characteristic, to break it down into its principal parts, and to attempt to see our way through the present hodge-podge in which there are just about as many recording characteristics as there are record labels.

The winding zig-zag course which is pursued by the groove as a record is cut is in fact a combination of three separate motions:

1. The *steady* rotation of the turntable at a pre-determined number of revolutions per minute.
2. The *steady* movement of the cutter toward the center of the record at a pre-determined number of grooves per inch.
3. The *varying* side-to-side motion of the cutting stylus, which is determined at any instant by the frequency and amplitude of the audio voltage.

Now let's imagine the cutting of a record with a perfect piezo-electric cutter. You will remember that one of the properties of a piezo-electric crystal is its tendency to twist out of shape when a voltage is applied to it. If the voltage is alternating, the crystal will twist back and forth as it follows the reversals in direction of the current. Then if we should attach a stylus to this crystal, the stylus will swing from side to side with the torsion of the crystal. Now when we make this stylus and crystal a part of a record cutting system, it will engrave a wavy groove in a soft recording disc.

In this system the distance which the stylus swings the groove from side to side away from the center position is determined solely by the *amplitude* of the voltage fed into the cutter. Thus regardless of the frequency of the actuating voltage, doubling the amount of that voltage will simultaneously double the groove displacement. A recorder which behaves in this fashion is said to be employing a *constant amplitude* system. This term is a little misleading, and perhaps "proportional amplitude" would be a better one. For the important fact is that the displacement of the stylus and the groove it cuts is directly proportional to the amplitude of the voltage which is driving the cutter.

Now let us digress just slightly and consider what happens when we connect a battery to a d-c electric motor. When voltage is applied the motor will rotate at constant speed. If we transpose the two wires, the motor will reverse direction. Thus we see that the direction of rotation of a d-c motor is determined by the direction, or *polarity*, of the current which feeds it. Next let's insert a switch between the battery and motor which will enable us to reverse the current direction very rapidly. The motor will then rotate back and forth, changing direction just as rapidly as we throw the switch. Now if we insert an additional battery in series with the first one, the motor will rotate twice as fast, thus demonstrating to us that the speed of the motor is directly proportional to the voltage which supplies it.

This in essence is the principle of a phonograph record cutter operating on magnetic principles. The stylus displacement (i.e., the amount of motor rotation) will continue right up to the point where the current reverses and sends it back in the other direction. Since a low frequency voltage has less current reversals in a given time than a high one, the stylus will then have more time to travel farther at the low end of the spectrum. This means that the *stylus displacement is inversely proportional to the driving frequency*. But we also know that the speed of rotation, the *stylus velocity, is directly proportional to the voltage*. A cutter which operates under these conditions is known as a *constant velocity* device.

Now to review the basic operation of the two systems:

1. A *constant amplitude* system is one in which the amplitude of stylus displacement is directly proportional to the amplitude of the driving voltage.
2. A *constant velocity* system is one in which the velocity of stylus travel is directly proportional to the amplitude of driving voltage.

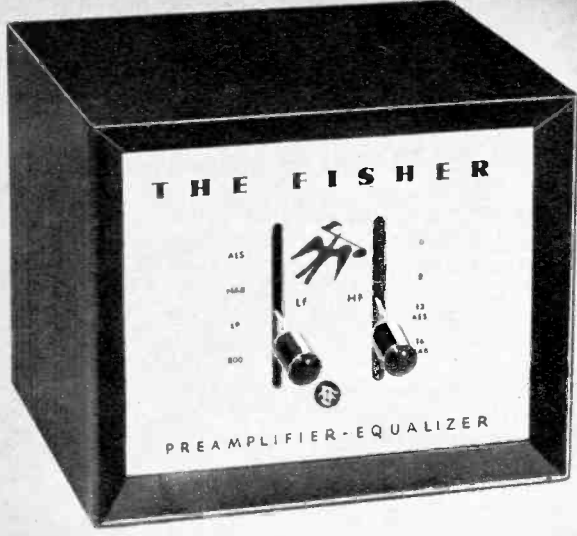

The Fisher pre-amplifier-equalizer gives proper tone balance, with corrections for foreign and domestic records by high and low frequency controls.

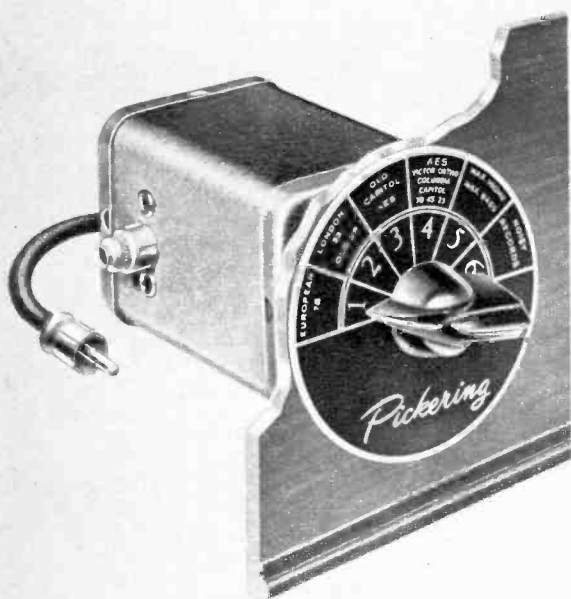

It would seem at first glance that either method should be equally acceptable for the cutting of a record, provided that the reproducer be a device of the same type. But each of these systems has inherent advantages and disadvantages which vary with the part of the audio spectrum in which they are operating. Part of the development of a recording characteristic, then, consists of an effort to use each system in that part of the audio range where it will be the most advantageous.

The early acoustic cutters had a characteristic which was, in its limited way, essentially that of constant velocity. Then the first electrical cutters were of the magnetic variety, and these were likewise of the basic constant velocity form. Since it has never been possible to design a good constant amplitude cutter, which would operate satisfactorily throughout the entire audio range, all disc recorders in commercial use today are still of the magnetic constant velocity type.

But in a constant velocity cutter, as we have seen, the stylus displacement is inversely proportional to the frequency, with the result that the bass notes will force the stylus into exceedingly wide excursions. Thus the groove area traversed on low tones will be much greater than would otherwise be necessary. We can avoid this complication in two ways. The first method would be simply to keep the grooves widely separated so that they do not interfere with one another. But this expedient would seriously shorten the playing time available on the record. The other method, and the one employed in commercial practice, is to modify the constant velocity characteristic so that it becomes constant amplitude below a certain frequency. The point at which the characteristic changes is known as the *turnover frequency*.

We now have a modified constant velocity curve, which is constant amplitude in the bass region, and constant velocity in the middle and upper regions. A characteristic such as this, with a turnover frequency around 250 c.p.s., was generally employed in Europe as the standard for 78-r.p.m. records until very recently. But unfortunately there has as yet been no such

The Pickering record compensator is mounted between pickup and pre-amplifier and has settings for different makes, as well as old and noisy records.

A four-position equalizer made by Clarkstan Corp. has settings for NAB roll-off for LP microgrooves and two positions for sharp high frequency cut-off.

agreement on turnover frequency among the American record manufacturers. Instead of this, each company assumed the characteristics of the average home instrument, and then selected a turnover frequency which *they thought* would provide the right amount of bass when reproduced on that equipment. To make matters worse, they jealously guarded this information, and it was not until very recent times, under tremendous pressure from the high fidelity groups, that it became readily available.

The condition of our recording characteristic thus far in this discussion is still not ideal, for the amplitude of the constant velocity signal is pitifully weak at the high frequencies. We have here two seriously conflicting factors, for at the same time as the signal amplitude is decreasing with increasing frequency, the surface noise of the record is characteristically much greater in the high frequency region. Thus our signal-to-noise ratio is exceedingly poor under these conditions.

We therefore counteract this drooping high frequency characteristic of the constant velocity curve by inserting treble boost, or *tip-up*. This rising characteristic, which is in effect a change to constant amplitude once again, begins somewhere between 2,000 and 5,000 c.p.s., and continues on to the upper limit of the system. Now we have a curve which is a sort of lazy S shape, flat in the middle, with a drooping low end and a tipped-up high end. Each of the bends in the curve really represents a turnover frequency, but in order to avoid differentiating between two of them, we usually describe the tip-up in terms of the number of decibels increase at 10,000 c.p.s.

In very recent times even another wrinkle has been added to the recording characteristic. In order to obtain a more favorable signal-to-noise ratio in the rumble region of 50 or 100 c.p.s. and below, the systems employed by Columbia and RCA change the characteristic once again to constant velocity in that area.

Now let us analyze the several parts of the full characteristic curve as it is employed in cutting a modern phonograph record, beginning at the bass end of the audio spectrum:

1. First there is a very low frequency constant velocity "shelf" extending up to around 50 or 100 c.p.s. (Not all records have this.)
2. Then we have in the remaining bass region a constant amplitude curve extending up to between 300 and 600 c.p.s.
3. Next there is the basic constant

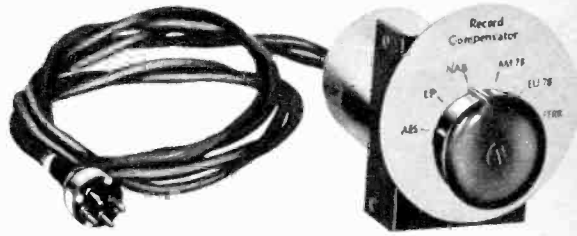

Plugging into the back of the Bogen amplifier, the Bogen EQR record compensator for use with magnetic pickups gives six-position equalization control.

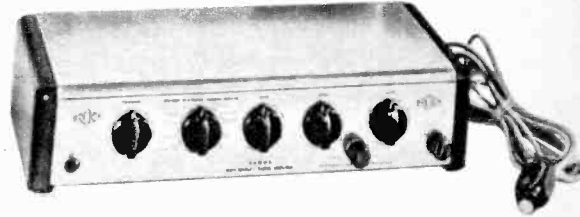

Rated as one of the best units available, the Brook 4-B pre-amplifier has controls for channel selector, playback characteristics, bass treble, and volume.

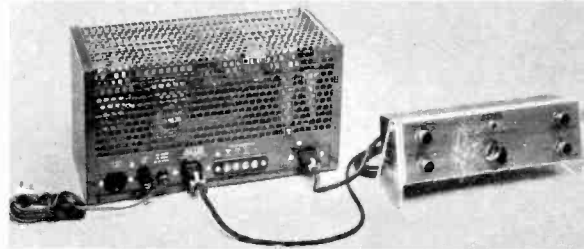

Altec Lansing's pre-amplifier, shown above with the amplifier, has controls for channel selection, crossover, bass and treble rise and droop, volume.



Made by the McIntosh Company, this equalizer and pre-amplifier has controls for bass and treble, magnetic cartridge input, five input channels.

RECORD EQUALIZATION GUIDE

MANUFACTURER	RECORD SPEED RPM	LOW FREQUENCY TURNOVER	TREBLE ROLL-OFF AT 10 Kc
ALLEGRO	33	LP	NARTB
AMERICAN REC. SOCIETY	33	AES	AES
ANGEL	33	NARTB	AES
ATLANTIC	33	NARTB	NARTB
AUDIOPHILE	78	NARTB	—B
BACH GUILD	33	LP	NARTB
BANNER	33	LP	NARTB
BARTOK	33	AES	AES
BLUE NOTE	33	AES	AES
CAEDMON	33	NARTB	NARTB
CAPITOL	33	AES	AES
	45	NARTB	AES
	78	AES	AES
CAPITOL-SORIA	33	AES	AES
CETRA-SORIA	33	LP	NARTB
COLISEUM	33	LP	NARTB
COLUMBIA	33	LP	NARTB
	45	NARTB	NARTB
	78	300*	NARTB
CONCERT HALL	33	LP	NARTB
COOK	33	NARTB	AES
CORAL	33	AES	AES
	78	AES	AES
DECCA	33	AES	AES
	45	AES	AES
	78	AES	AES
DIAL	33	LP	NARTB
ELEKTRA	33	NARTB	NARTB
EMS	33	AES	AES
EPIC	33	LP	NARTB
ESOTERIC	33	AES	AES
FESTIVAL	33	LP	NARTB
GOOD TIME JAZZ	33	AES	AES
HANDEL SOCIETY	33	LP	NARTB
HAYDN SOCIETY	33	LP	NARTB
LONDON	33	LP	—10.5 R
LYRICHORD	33	LP	NARTB
MERCURY	33	AES	AES
	45	AES	AES
	78	AES	AES
MGM	33	NARTB	NARTB
	45	NARTB	NARTB
	78	NARTB	NARTB
MONTILLA	33	ORTHO ‡	ORTHO ‡
NEW RECORDS	33	LP	NARTB
OCEANIC	33	LP	NARTB
OXFORD	33	LP	NARTB
PERIOD	33	NARTB	NARTB
PHILHARMONIA	33	AES	AES
POLYMUSIC	33	NARTB	NARTB
RACHMANINOFF SOCIETY	33	LP	NARTB
RCA VICTOR	33 (Old)	800	—B
	45 (Old)	800	—B
	78 (Old)	800	—B
	33 (New)	ORTHO ‡	ORTHO ‡
	45 (New)	ORTHO ‡	ORTHO ‡
	78 (New)	ORTHO ‡	ORTHO ‡
REMINGTON	33	NARTB	NARTB
RENAISSANCE	33	LP	AES
STRADIVARI	33	LP	NARTB
TECHNICHORD	78	800	AES
TELEFUNKEN	78	AES	0
TEMPO	33	LP	NARTB
URANIA	33 (Old)	LP	NARTB
	33 (New)	AES	AES
VANGUARD	33	LP	NARTB
VOX	33	LP	NARTB
WESTMINSTER	33	LP	NARTB
	33	AES †	AES †

* Where 300-cycle turnover is not available, use AES.
 R Where —10.5 db treble roll-off is not available, use AES.
 ‡ Where ORTHO position is not available, use NARTB on low frequency turnover and AES on treble roll-off.
 † Use only when jacket specifies AES.

Shown above are settings for proper equalization of recording characteristics. On opposite page are playback curves, complements of recorded curves.

General Electric unit, below, has bass and treble controls, volume regulator, plus five-position compensator. Characteristics shown on next page.

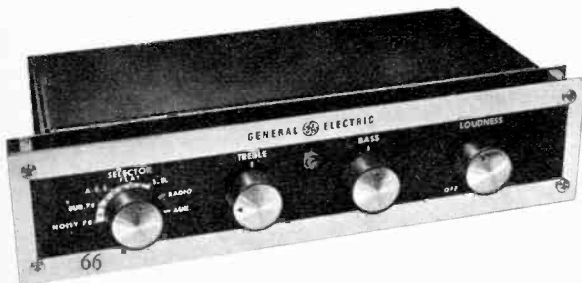

velocity region in the middle range extending up to between 2,000 and 5,000 c.p.s.

- Finally we find the constant amplitude high end tip-up, extending to the top of the range. (Most European 78-r.p.m. records have not had this.)

Now our problem in obtaining accurate reproduction from any disc recording is in the design of a system which will have a playback characteristic which is the exact complement of the recording characteristic. When we have done this properly, we will have corrected all of the pre-distortion on the record and regained a linear or flat response. Thus we must have a reproducer which, when referred to a constant velocity characteristic, will provide bass "boost" and treble "roll-off."

But how much boost and how much roll-off—and where? That is where our trouble really begins. Not only has each manufacturer had his own ideas about the recording characteristic, but on the several occasions when trade organizations have attempted to establish standards for it, they have succeeded only in adding to the confusion rather than eliminating it. You and I therefore have no alternative but to equip ourselves with a piece of equipment which can provide us with playback characteristics which will complement all of the many recording characteristics presently in use.

This is the all-important job of our reproducing equalizer or compensator. The simplest units, which are connected between the pickup and the amplifying equipment which follows, usually provide a choice of four or five of the most commonly needed curves. A system like this cannot begin to provide all of the possible combinations of characteristics, but at least some choice is possible, and a reasonably close match can be obtained. Operation of this unit simply involves rotating the selector switch to the characteristic which is nearest that of the record to be played.

A much more flexible system is one in which the bass boost and high roll-off are adjusted separately. Thus with four bass positions plus four high positions, for example, sixteen different reproducing characteristics are possible, a number which will meet just about all normal requirements.

Since the signal voltage to be amplified is the result of the combined actions of the pickup and compensator working together, it is essential that the electrical characteristics of these two components be matched to each other. Since the pickup itself is characteristically either a constant amplitude or constant velocity device, depend-

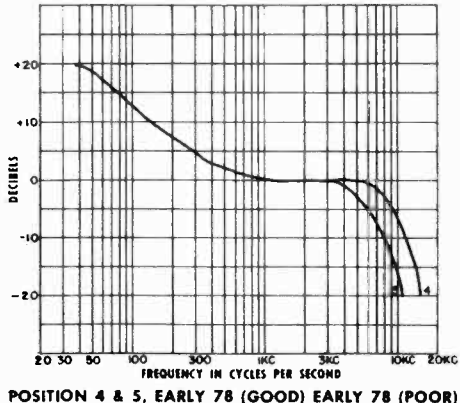
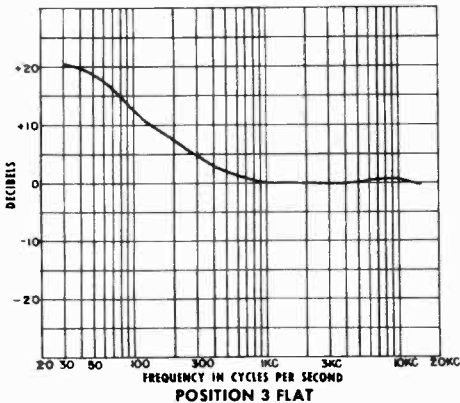
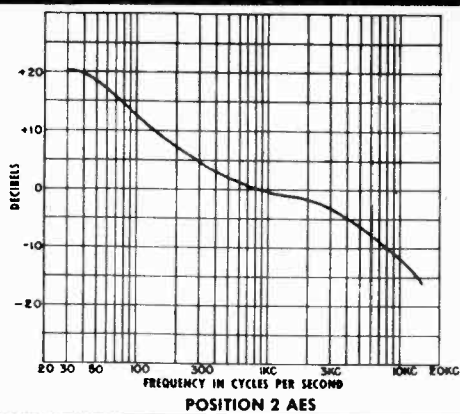
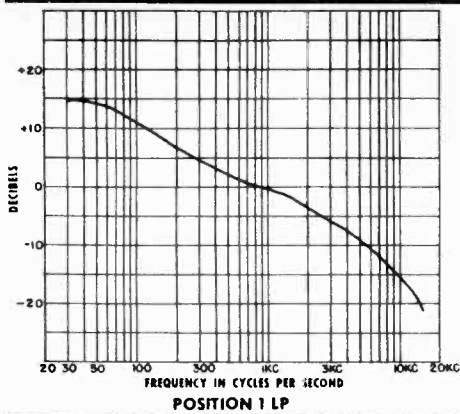

(POSITION 1)

LP POSITION The LP (Long Playing) playback response is intended basically for use with Columbia 33½ RPM recordings and modern Columbia 78 RPM shellac pressings. This position is used with any record having the LP recording characteristic.

(POSITION 2)

AES POSITION The AES (Audio Engineering Society) playback response has been proposed as a compromise response for all modern recordings. It has somewhat greater bass (below 100 cps) and treble response than the LP curve, and may be used in preference to the LP when such increased response is desired. It may be used to advantage with RCA 33, 45, and 78 RPM recordings, and with many other recent recordings.

(POSITION 3)

FLAT POSITION The flat position has no roll-off or attenuation of response beyond 1000 cps, which results in maximum high frequency response. Records having low background noise and distortion may be reproduced in this position with maximum

brilliance. This position has no effect on the circuit, and the corresponding curve is therefore the response curve of the pre-amplifier and G. E. cartridge (with no cartridge loading resistor) based on constant stylus velocity.

(POSITION 4)

GOOD (early 78) This position is intended for records having a noticeable amount of high frequency distortion or where the background noise is excessive and composed of frequencies higher than those recorded. It is particularly useful for 78 RPM shellac pressings that are in good condition. Brilliance is obtained through the useful portion of the response with sharp, attenuation occurring at all frequencies beyond 7500 cps.

(POSITION 5)

POOR (early 78) This position is intended for early 78 RPM shellac records having limited high frequency response and a high noise level. Moderately sharp attenuation occurs at all frequencies above 4000 cps.

Compensating curves of typical five-position unit are shown above. Curves are compromise to some degree.

ing upon its design, the compensator which is to work with it must take that fact into account. Most high fidelity pickups today are of the magnetic (constant velocity) type, and most compensators are designed to work with such pickups. But you must be sure that *your* two units are compatible, or the resulting sound may be worse than with no compensation at all.

The interconnected units must also have matched *impedances*. Impedance is an electrical term designating the opposition of a device to the flow of alternating current, with a value expressed in *ohms*. If a given pickup has an output impedance of 50,000 ohms, for example, then the compensator

to which it is connected should have an input impedance of about the same value. The sales literature describing the various components should include these specifications, but whenever you are in doubt about any combination a postcard to the service department of the manufacturer will elicit prompt and accurate information.

The Pre-Amplifier

Following the compensator, and preceding the main high fidelity amplifier, there is usually a small pre-amplifier. You may immediately question the need for this, and wonder why all of the necessary amplifi-



Turnover and roll-off bass and treble positions of the Brociner A-100 pre-amplifier-equalizer give corrections plus magnetic cartridge amplification.

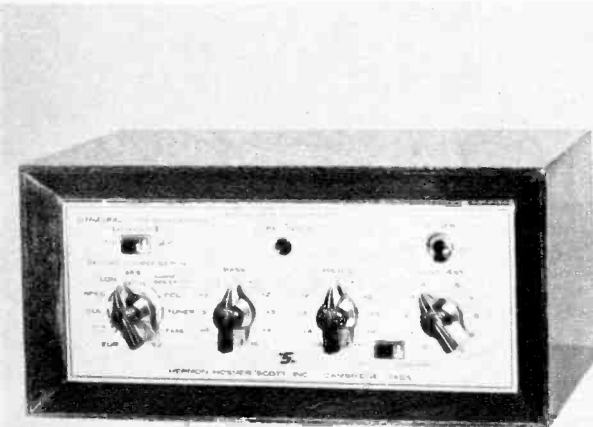

H. H. Scott equalizer pre-amplifier has all standard controls plus switch for accessory dynaural noise suppressor which cuts turntable rumble, record hiss.

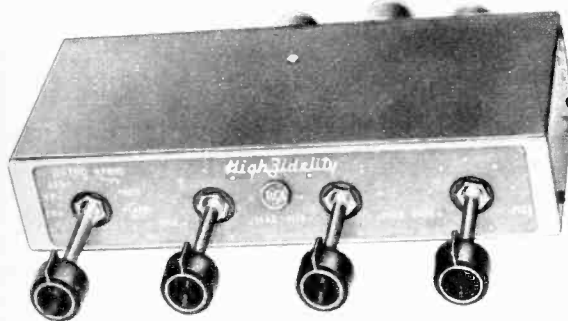

RCA pre-amplifier SV-1, designed for use with RCA matched power amplifiers, has four positions for equalization plus switching for radio, TV and tape.

cation cannot be contained in one single unit. This is entirely possible, as a matter of fact, and it is sometimes done. But there is logical argument for having the pre-amplifier separate, and this is worthy of some careful consideration.

Let us begin by assuming a main audio amplifier which is able to accommodate directly the output of a crystal pickup, radio tuner or crystal microphone. Such an amplifier *cannot* accommodate directly the output of a magnetic pickup, for this unit has a voltage which is only around one-hundredth that of these other devices. Additional amplification is therefore necessary to bring the level of the magnetic cartridge up to par. This extra gain is not needed otherwise, and would be wasted in a system which didn't use a low output pickup. The very small voltage developed by the magnetic pickup is even lower by the time it reaches the pre-amplifier, due to the *insertion loss* of the compensator. This device supplies no gain of itself, the apparent boost at the low end actually being due to losses inserted elsewhere.

The simplest pre-amplifier is essentially a fixed-gain device, without volume control or other adjustments. Its sole function is to increase the feeble output of the pickup-compensator combination to a value which is comparable to that of the other common signal sources. The requirements of the pre-amplifier are very exacting, for any noises which might get into the system at this point would become exceedingly serious after the tremendous amplification which follows. Thus it is much easier from a design standpoint to keep the pre-amplifier completely isolated from the main amplifier, rather than take the additional precautions necessary to avoid noise induction from associated equipment. A separate pre-amplifier, then, is usually to be preferred over one which is included as part of the main amplifier.

Very often, however, the pre-amplifier and compensator are constructed as a single unit, and this is an entirely logical and useful combination. The unit may have a self-contained power supply, or it may obtain its necessary operating voltages from the same supply as the main amplifier. The self-contained unit is naturally more expensive, but it avoids possible troubles in obtaining satisfactory isolation between pre-amp and the main unit.

There has recently been a trend toward combining several other system functions at this point into a single device known as a *control amplifier*. This unit often performs all of the following:

1. Selector switch for any of several

sources, such as pickup, tuner, microphone or tape machine.

2. Pre-amplifier for low-level inputs.
3. Low frequency phonograph compensation.
4. High-frequency phonograph compensation.
5. Bass tone control.
6. Treble tone control.
7. Volume or loudness control.

If a pre-amplifier is included in this system, the selector switch is so connected that the pre-amp is by-passed when it is not needed, that is, when some device other than a very low level pickup is in use. The two compensator positions may be combined into one, although separate switching allows much greater flexibility. The tone controls allow additional adjustment for timbre. When the performance and microphone technique are top-notch, tone controls should be entirely unnecessary. They are really a luxury refinement, and whether or not to have them is entirely a matter of individual choice. Insertion of a volume control at this point obviates the need for any others, with the result that the tuner and power amplifier, for example, may be purchased in their most basic form.

Installation

Installation of any of these units is a relatively simple matter, but certain precautions must be observed. Since we are at the very front of our system, working with a minute signal which is due to be amplified hundreds or even thousands of times, it is absolutely essential that we avoid the possibility of any extraneous noises sneaking in at this point. This means that the unit must not be installed in close proximity to motors, transformers or loudspeakers. Also be certain that the tools you use are not magnetized, for if they in turn magnetize some part of the unit, the hum level may be permanently increased.

The unit should be mounted where it will receive a reasonable amount of ventilation, and preferably in a location where you will have ready access for changing tubes. The chassis of the unit should be firmly grounded to the pickup arm and turntable frame. The bare end of a piece of wire is secured under the head of any convenient mounting screw on the frame, and connected to a similar point at the tone arm base. Finally a wire connection is made from this point to the shield surrounding the pickup lead. When the pickup wire is plugged into the jack on the unit, it is automatically grounded to the chassis.

We now have at last an exact electrical

replica of the original sound as it was picked up by the microphone. This signal is ready to be raised to its final output value by the main power amplifier. •



Fairchild model 240 has seven input channels plus six equalization positions, volume control, and selectors for bass boost, high frequency roll-off.

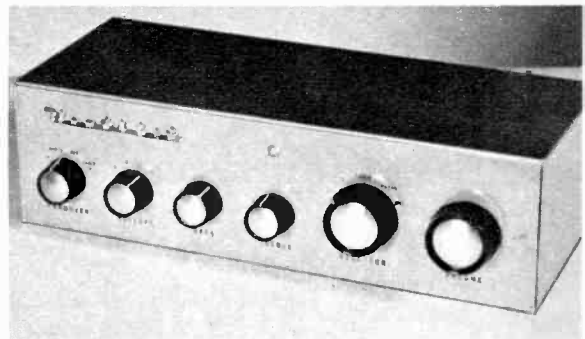

Heathkit units, like this four-position equalizer and pre-amp, come in kit form ready for assembly. Poster-size diagrams, direction book are provided.

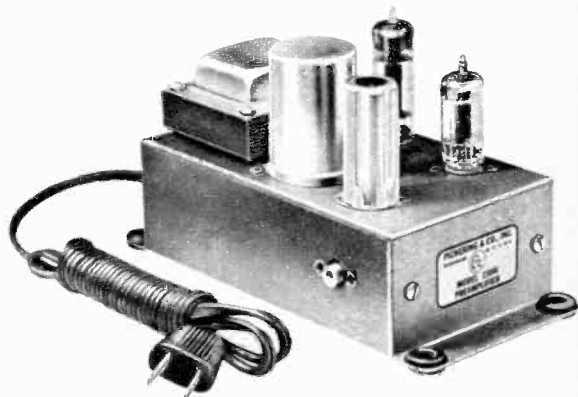

Special preamplifier for their pickup cartridge is provided by the Pickering Co. Pickup output goes through pre-amp into the record compensator.



Designed for hi-fi by Fisher radio, 50-R tuner has channels for TV, phono, AM, FM. Rear is shown below.

Broadcast Tuners

Special AM and FM receivers are made for use as components in your high fidelity sound system.

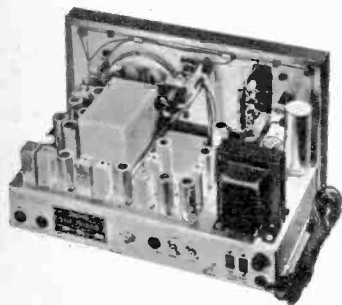

RADIO broadcasting of live musical programs should be the absolute ultimate in hi-fi fare, but seldom is that promise fulfilled. Live music is in fact fast disappearing from the radio scene, and despite the ceaseless opposition of Mr. Petrillo, the networks and individual stations are just as relentlessly trimming their schedules and budgets.

But even more woeful than the economic factors which have caused this dearth is the fact that even live music is seldom truly high fidelity after undergoing radio transmission. Not that it couldn't be: the engineers have done their part and the facilities are there. The broadcasters simply have yet to awaken to the existence of the high fidelity movement.

But what about FM, you ask? Isn't that supposed to be the ultimate in audio transmission? Of course it is, but an FM transmitter is only as good as the quality of sound fed into it. You must remember that the large majority of FM stations are

simply subsidiary properties of AM stations, duplicating the AM programs. If a live musical program originates in the studios of the station to which you are listening, it will presumably be transmitted on FM with full fidelity. But if it originates outside the studios, it will probably have travelled some distance over telephone lines. And while telephone circuits have been developed which pass the full FM range, the AM stations and networks seldom purchase lines with any better high frequency response than 10,000 c.p.s.; much oftener an 8-kc or 5-kc circuit is used. Thus even live music on FM can be sub-standard, if there are a few weak links in the chain between the performers and you.

The place to look for high fidelity radio, then, is on the independent FM station, which adheres to FM standards throughout. Some of these stations have done admirable jobs—usually on pitifully small budgets—in bringing live high fidelity music into the home via the wonderful medium of FM radio.

Records on the Air

The phonograph disc has been the mainstay of small broadcasters almost since radio began. The disc jockey with his popular records and commercial spiels is familiar to all, but an amazingly large number of radio stations are now also programming a few hours weekly of classical recorded music. The results you will obtain in reproducing such programs will depend as much upon the station equipment as your own, and as a rule radio broadcast equipment is of the very highest quality.

The playback compensation for records is provided at the studio, and no further correction is necessary at the receiving end. For reasons of efficiency in a fast-moving operation, however, the playback compensators employed in most broadcast stations are of the more simple "compromise" type, having four or five positions. Thus there may be times when a record as played over the air will not sound as good as it might on your own playback equipment.

The AM system employs a flat channel throughout, but FM inserts an equalization characteristic known as *pre-emphasis*. This operates only at the high end of the audio spectrum, and is used primarily to insure excellent high frequency response and an improved signal-to-noise ratio. Unlike the confused situation in the phonograph industry, however, there is only one FM pre-emphasis characteristic, which appears as a tip-up of 16 db at 10,000 c.p.s. All FM receivers and tuners have the standard *de-emphasis* circuit to match, and no adjustment is necessary in the audio reproducing system.

The tuner is simply the front end of a radio receiver—AM or FM or both—a receiver without an audio amplifier or loudspeaker. This arrangement makes for greater flexibility and lower cost, as a single power amplifier system can then be used for all sound sources. The tuner's first function is to tune and select the desired radio signal from all of those striking the receiving antenna. The degree of selectivity must be fairly precise, for if it is too great the audio frequency response will suffer, and if it is too small there may be adjacent-channel interference. Then the

Altec 303C tuner receives AM and FM and has amplifier controls as well.



The Fisher "Fifty" series has matched tuner, master audio control, amplifier.



Made by H. S. Martin Co., this AM-FM tuner also has amplifier controls, and choice of finishes.

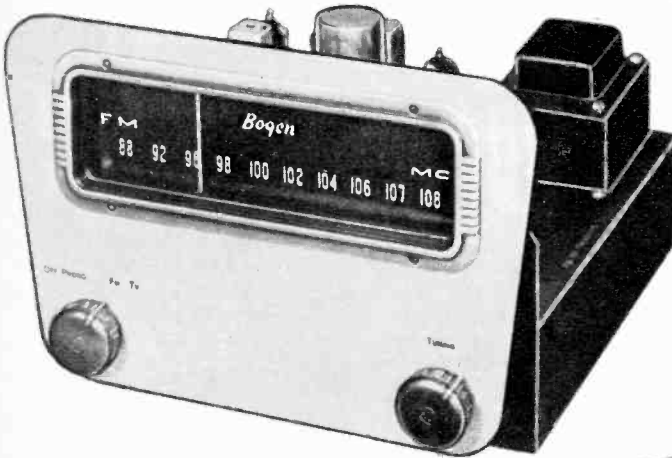

David Bogen, famous for hi-fi equipment, makes this FM801 tuner for FM use with amplifier.

For areas where FM is not received, AM901 by Bogen gives the best in AM without frills.

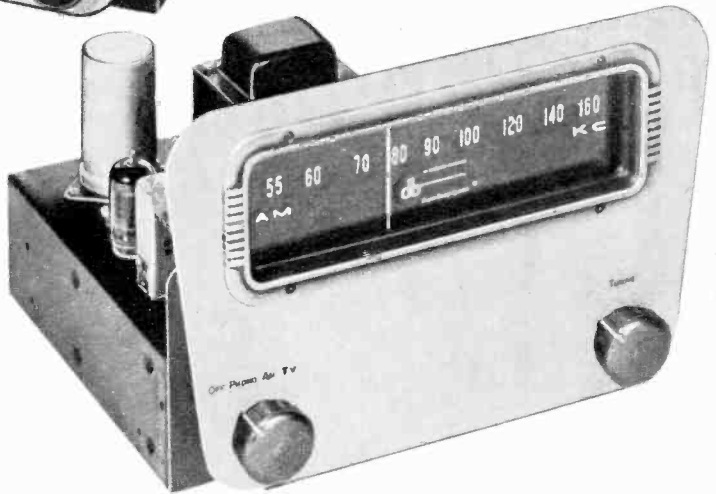

Top Bogen tuner, model R701 has AM, FM, push-button AFC, tuning, volume, tone, selector.

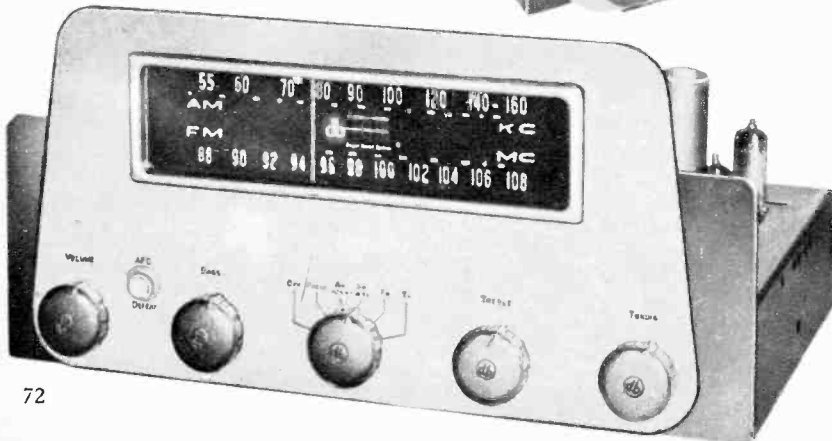

Unlike the many varied equalization curves used in recording of discs and tape, FM broadcasting has a fixed preemphasis curve which gives excellent high frequency response and signal-to-noise ratio. Your FM receiver then automatically de-emphasizes this curve on receiving signal.

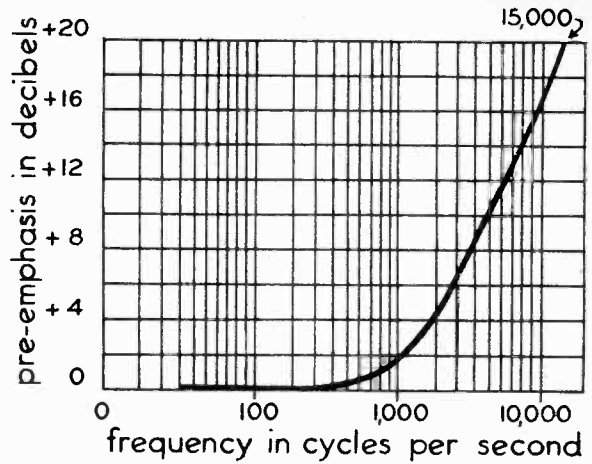

tuner must amplify the feeble radio signal to a point where it will develop an audio voltage sufficient to be fed into the power amplifier. Finally it must remove the audio modulation from the radio carrier. This process of *demodulation* or *detection* is also a critical one, for it is very easy for distortion to creep into the system at this point.

AM vs. FM

The amplitude modulation system is really an outmoded one, and it might today be totally obsolete but for the public preoccupation with television, which has overshadowed the very great superiority of frequency modulation radio. AM still does offer a few advantages, however, largely because of its firmly entrenched position. A greater variety of program fare is available in most areas, and there still are locations where AM is the only type of radio available. Its disadvantages, on the other hand, include a limited frequency response, serious fading and interference at night, and inability to discriminate against noise.

Frequency modulation is a vastly better system, but it has nevertheless had to fight a continuous uphill battle against public apathy, a major war, television, and the most strenuous opposition of certain AM broadcasting interests. Hardly any other proof of its fundamental rightness is needed than the very fact that it has continued to survive. But the FM system has continued to grow because its signal is constant and interference-free at all hours, it practically eliminates noise, and best of all, its audio signal is truly high fidelity. The disadvantages in the operation of an FM receiver are the greater difficulty in tuning, and the tendency of some sets to

detune or *drift* while they are warming up. The first difficulty can be overcome by the use of a satisfactory tuning indicator, and the better sets include frequency correction circuits which counteract drift.

Selecting the Tuner

Tuners are available in a wide variety of forms, from kits of parts to completed units which perform several other functions in addition to radio reception. The very simplest form of tuner has no more than tuning and volume controls, while many models incorporate a phono compensator and pre-amplifier, and the most elaborate include all of the functions of the control amplifiers previously described. In order to avoid duplication of controls and needless expense, you should decide at the outset just what functions you will desire from your tuner, and consider how it will be integrated into the overall system.

If all of the programs which are important to you are available on FM in your area, you will save money by the purchase of an FM-only tuner. If this is not the case, you would be better satisfied with an AM-FM combination. But if you are in an area with no FM and little prospect of getting it, then you unfortunately will have to settle for an AM-only system.

Tuners are available self-contained in their own cabinets, or with chassis and front panel only, ready for installation in your own enclosure. The one for you will depend upon cost, space available, and your own system design.

The sensitivity rating of an FM tuner is an important factor, for this is an index of the ability of the unit to reject noise. It is usually expressed in terms of the amount of radio signal necessary at the antenna in

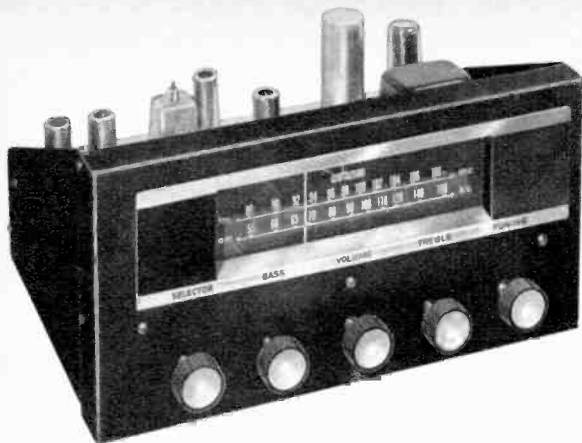

The C800 made by Radio Craftsmen, Inc., is AM-FM tuner plus compensating system.



Made by Thordarson-Meissner, this tuner is matched to a Meissner amplifier for hi-fi use.

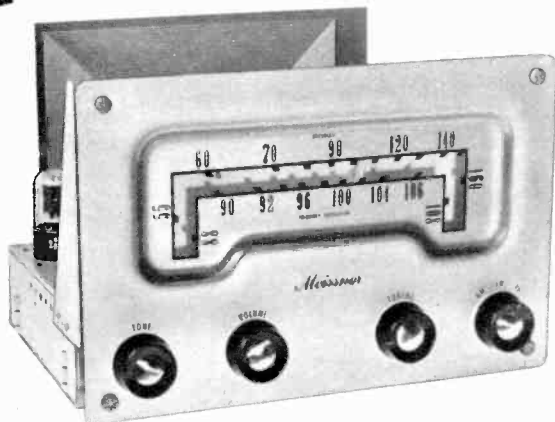

Signal increase over ten times is reported for this Electro-Voice FM signal booster.

order to produce a given signal-to-noise ratio. Thus a good set might be such that a signal of 5 microvolts provides 30 db of quieting. Less signal or more quieting would of course indicate an even better set.

Frequency response in an AM set should be at least 50 to 5,000 c.p.s., while an FM tuner should cover at least from 30 to 15,000 c.p.s. The FM set should also include some form of tuning indicator and *automatic frequency control*. The AFC circuit will correct for drift due to temperature changes in the tuned circuits, but it will also occasionally reject a desired weak signal in favor of a strong one on an adjacent channel. The tuner should therefore have a means of removing the AFC when necessary.

The number of tubes in the set is a rough indication of its quality, but the functions of these tubes should be carefully studied. Any tuner should have at least one stage of radio-frequency amplification ahead of the mixer or converter tube. Following this

there should be at least a couple of stages of intermediate-frequency amplification. The method of demodulation in the FM set may be either *discriminator* or *ratio detector*, but it is essential that either type be preceded by at least one *limiter* stage. Despite claims to the contrary, almost no noise rejection takes place during the detection process. Thus without a limiter, FM's great static-free characteristics are almost completely lost. Following the detector and de-emphasis there is usually at least one stage of audio amplification from which the power amplifier will be fed. Distortion at this point should be 1% or less, and innate noise in the system should be at least 60 db below rated output.

Installing the Tuner

The first consideration in the installation of a radio tuner is ease of operation. Since the set will be retuned rather often, it should be placed in a location where its controls will be readily accessible and

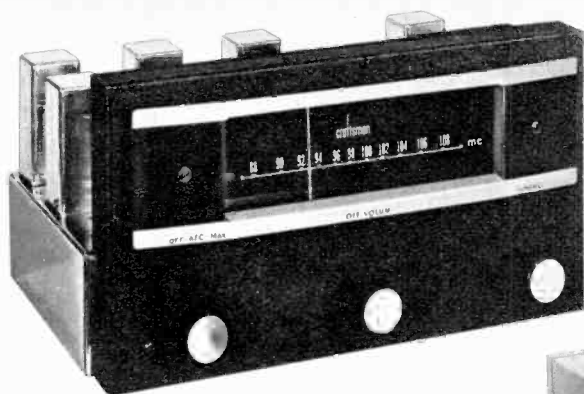

Craftsman's FM tuner assembly component. unit has high sensitivity, low distortion.

Radio Engineering Labs, broadcast equipment makers, designed this quality tuner.



An AM-FM tuner made for high fidelity use is this set by FM pioneer Freed-Eisemann.



clearly visible. The tuner has a fairly high output, and can therefore be located at some distance from the power amplifier—perhaps adjacent to your favorite easy chair—if you so desire. The maximum distance depends upon the specific design, but manufacturers' recommendations usually allow at least 25 or 30 feet of cable between tuner and amplifier. Some tuners are so designed that they may be mounted on their sides with the dial facing up. But unless this is definitely suggested in the installation instructions, it should not be contemplated without first consulting the manufacturer, for some types of tubes and other components have much shorter operating lives when mounted in any position other than vertical.

Some thought should also be given to "getting under the hood" with ease. It will occasionally be necessary to gain access to the working parts of the unit, to change a tube or make some minor test or adjustment. A good installation will avoid need-

less loss of time when servicing is necessary. And, of course, provision should be made for easily reaching the audio and antenna terminals, usually at the rear of the chassis.

Adequate ventilation should be provided to dissipate the heat generated by the tubes. If the unit must be fully enclosed, it is a good idea to cut vents in the rear of the cabinet above and below the chassis. The heat will then create a draft which will pull in cool air through the bottom ports and exhaust the warm air through the top. If the cabinet top is directly over the tuner and therefore subject to heat deterioration, it can be protected somewhat by tacking a reflective surface of bright sheet metal to its underside.

Any radio set, be it AM or FM, must have some sort of antenna to intercept the incoming radio signal. A few inches of wire is sometimes sufficient to do the job, but even that must be there to have a radio-frequency voltage developed in it, which is



One of several AM-FM tuners made by Stromberg-Carlson for "Custom 400" series is this SR-401.

A well-known maker of hi-fi tuners and amplifiers, Bell Sound Systems produce this 2210 tuner unit.

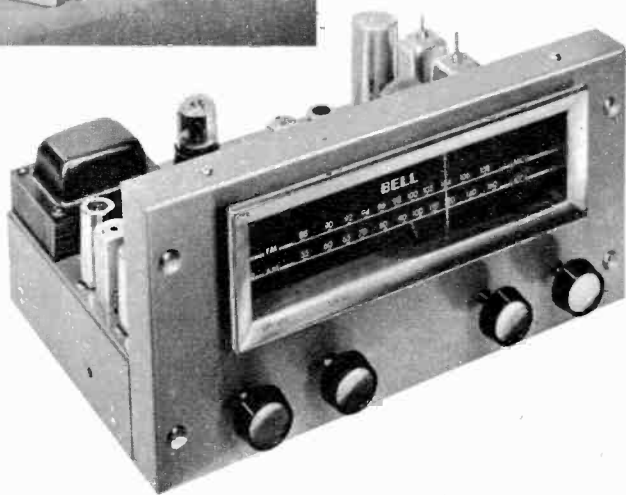

then tuned, amplified and detected. A very simple approach to this problem is employed in some low-priced sets, which make the a.c. power cord perform double duty and act as an antenna as well as the source of operating voltage. But this system is only useful in very strong signal areas, and it can be dangerous in the case of breakdown of certain components. A built-in loop antenna is often satisfactory for AM, but it usually is quite inefficient at FM frequencies, and thus is only good for powerful local signals.

The importance of a good antenna for perfect FM reception cannot be overemphasized. FM operates in the same very-high-frequency region that television uses, the FM band in fact lying directly above TV channel 6. Thus any of the antennas which are used for v.h.f. television will be equally suited to FM. Even the very antenna installation which you now have for

your TV system can be used to feed your FM tuner in addition. Since there might be some undesirable interaction between the two sets, small decoupling resistors should be inserted in the tuner lead-in. This is done by attaching a 470-ohm resistor to each of the terminals at which the antenna lead-in is connected to the TV set. Then another piece of the same flat ribbon-type transmission line is connected from the resistors to the tuner antenna terminals. As a final precaution, a single ground wire should be firmly connected between the two chassis. If no TV antenna is available, a very efficient *folded dipole* may be easily and cheaply constructed of transmission line, as shown in the accompanying illustrations.

The remaining connection of the set is very simple. The a.c. plug is inserted in a wall socket, and the shielded cable is fastened to tuner and amplifier.

If your reception is inadequate due to an insensitive set, or weak signals, or a poor antenna system, you may still have a chance of obtaining good FM. There are available a couple of FM pre-amplifiers, which operate very much like the familiar TV boosters. They provide additional stages of radio-frequency amplification and therefore much greater sensitivity.

When a tuner is purchased without a cabinet, the manufacturer provides complete mounting instructions, with template, hardware, escutcheon and knobs. Unless you are "all thumbs" with simple hand tools, you should experience no difficulty in completing a very creditable installation.

The operation of an AM receiver is very familiar to all, but the correct handling of an FM set is a little more complicated. It is

extremely important that the receiver be tuned to exactly the center rest frequency of the carrier wave. Since the intelligence contained in an FM signal is in the form of frequency excursions above and below the center point, it is essential that the plus and minus swings produce exactly equal voltages in the detector tube. If they do not, noise and distortion will result.

Perhaps the most accurate tuning of the FM set can be done with the automatic frequency control off, using the tuning eye to obtain an accurate setting. Then the AFC is turned on to "lock in" the station.

Even with the dearth of live music on FM today, a good tuner should provide you with many hours of sound enjoyment. After all, you at least have someone else to change the records for you. •

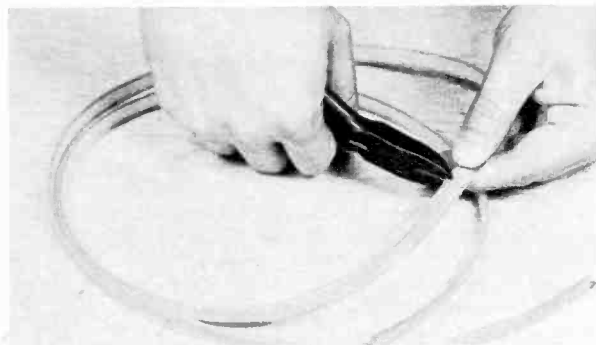
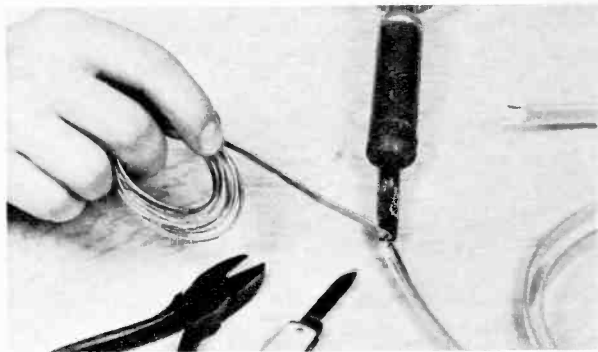
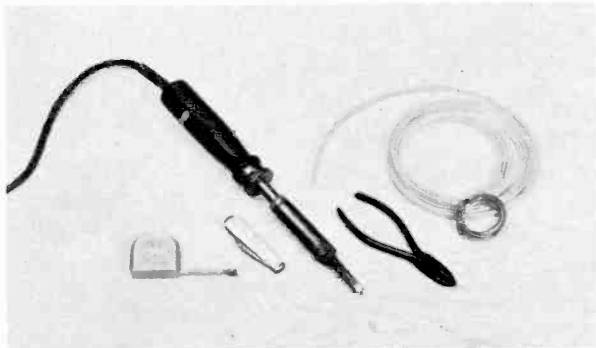

Here is how to make a folded dipole FM antenna for 30c. cost of transmission line, upper left.

Cut this ribbon-type 300 ohm line to 60 in. Trim $\frac{1}{2}$ in. off each end, then twist, solder, and trim.

Cut one conductor only at exact midpoint, left. Strip back insulation from lead-in piece of line.

Twist and solder lead-in to antenna. Connect other ends of lead to tuner. It is now ready for mounting.

Antenna length must be exact; this tunes it to middle of FM band. Mount at 90° to the signal.

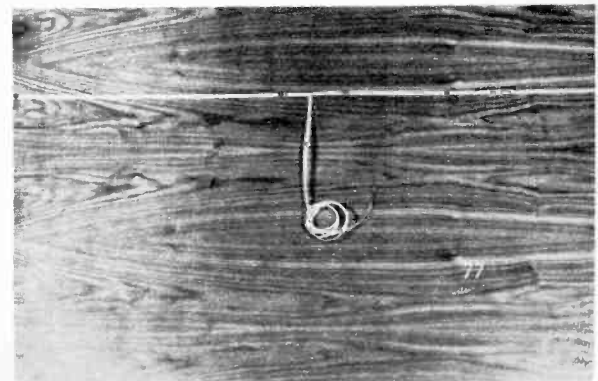
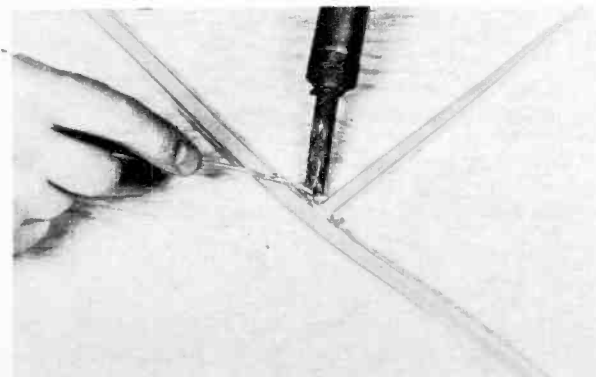

Sound enters our next component, the power amplifier, as the small voltage from pickup or tuner is now plugged into this central unit.



Power Amplifiers

Powerhouse of your audio system, the main amplifier converts the small signal-source voltage to high power for your loudspeaker.

THE main power amplifier is designed to receive audio signals at its input on the order of a half volt or so, and to build them up to the full rated power output of the system, whence they are used to drive the loudspeaker. Since crystal pickups and the newer ceramic cartridges develop voltages of this magnitude, they can be used to feed directly into the main amplifier. The same thing is true of most of the cheaper microphones, especially those of the public-address variety. High quality microphones, however, usually require some pre-amplification. The output of the microphone pre-amplifier, as well as of those used with magnetic pickups, is more than sufficient to drive the input of the power amplifier. Tuners also deliver voltage to spare. The job of the power amplifier, then, is to take any of these relatively small voltages and to convert it into quite a few watts of electrical power, while at the same time avoiding noise and distortion.

Frequency Response

One of the first criteria of amplifier performance is *frequency response*. Since we are dealing with sound and hearing, it is reasonable to say that the audio amplifier must be capable of passing everything that the ear can hear. Now we know that human hearing abilities vary widely, but we have adopted the standard range of 30 to 15,000 c.p.s. as one which will equal or exceed the response of most human ears. Many amplifiers today, however, have response characteristics which

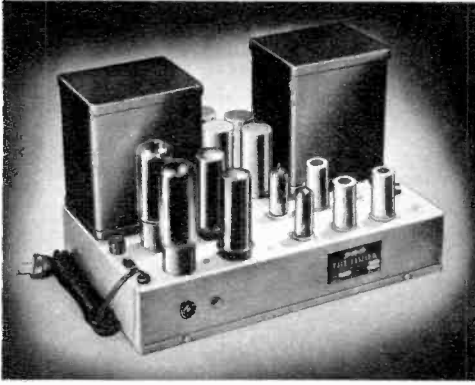

Amplifiers made by Fisher Radio Corp. are now available as separate high fidelity components. Model 50-A Laboratory Standard is above; Master Control unit, front and rear, is shown at right.

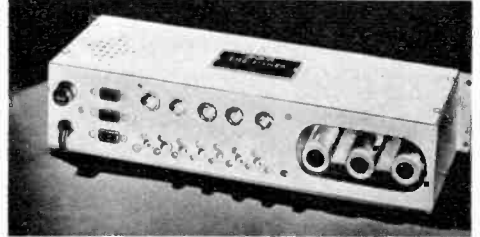
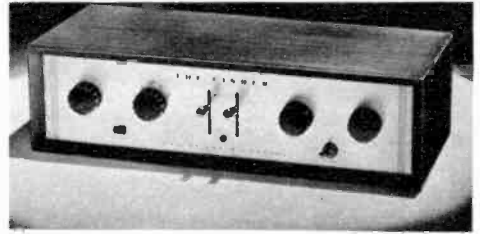

Courtesy Liberty Music Shops, N. Y. C.

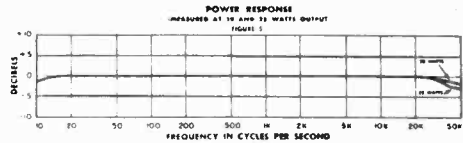
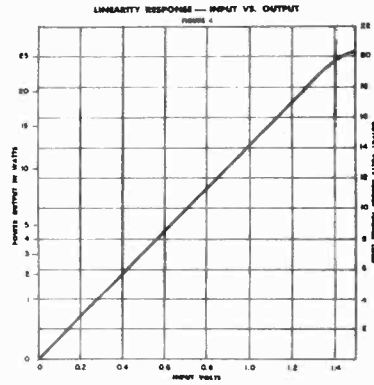
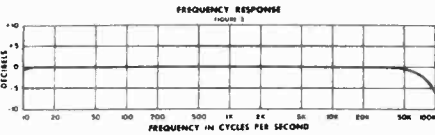
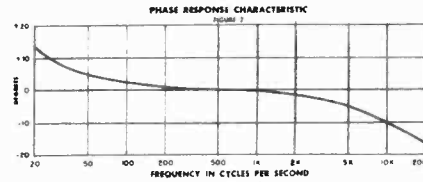
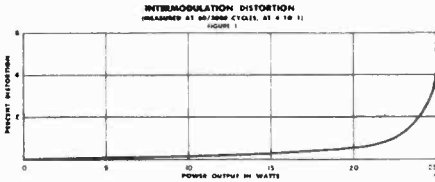

Complete set of operating characteristic curves, above, for smaller Fisher 70-A amplifier, are the type which every amplifier manufacturer should make available for careful study by prospective purchasers.

are much greater, perhaps from 20 to 20,000 c.p.s. But before you lay down any of your hard-earned cash for those extra cycles, ask yourself three important questions:

1. Can you hear such an extreme range?
2. Do any of your sound sources, as they arrive at the power amplifier input, encompass such a range?
3. Can your loudspeaker reproduce this range?

If you don't honestly answer NO to at least one of these questions, put this book

down right now. You're way out of the class of the rest of us.

The big bugaboo that we are constantly fighting in audio reproduction is *distortion*. Since the sound system is yet to be built which will provide the *exact* aural impression of a tenth row center seat at Carnegie Hall, we do always have some forms of distortion. But the problems already surmounted have been tremendous. Perhaps someday we will be listening to that perfect fidelity system, but meanwhile let's have a closer look at the progress already made.

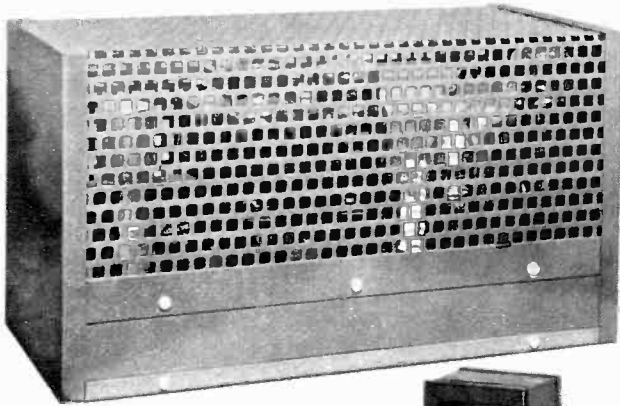

Product of the Altec-Lansing Corp., Altec basic amplifier is remotely controlled and can be installed out-of-the-way. It has high power, response.

Model 10C4 30 watt amplifier made by Brook Electronics, Inc., was top rated in test by Consumers' Research, Washington, N. J.

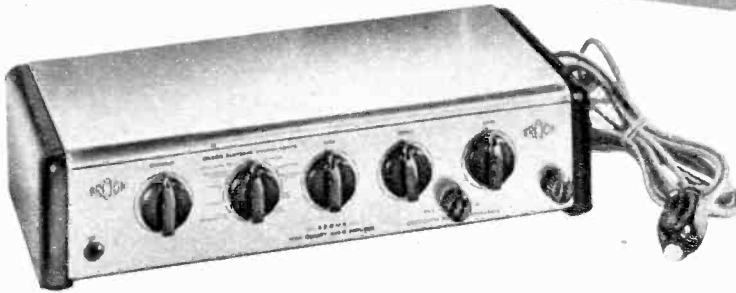
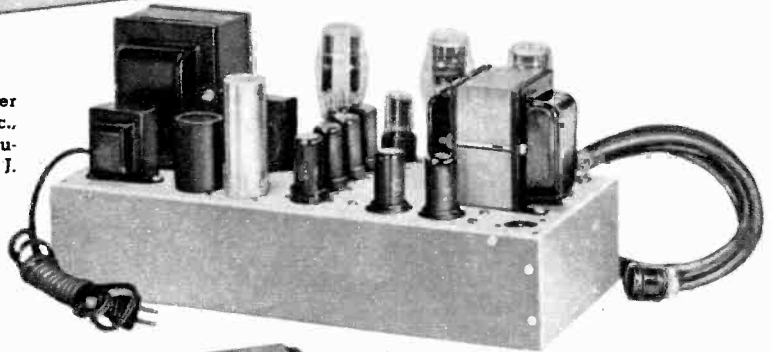

Forms of Distortion

Frequency-response distortion occurs whenever the amplifier fails to pass the entire audio range, usually resulting in cutting off at the extreme bass or upper regions, or when the response curve has humps or depressions within the range. The frequency response should be *flat*, that is, equal amounts of voltage input should produce equal amounts of power output at any frequency in the audible range. Distortion of this type is no longer a problem in any of the electronic equipment, but still may be a source of trouble in loudspeakers.

At the same time that extensive efforts were being made to extend the frequency range, the one type of distortion which was fairly well understood was *harmonic distortion*. This is the addition of spurious harmonics and subharmonics to the signal

as it passes through the system. Harmonic distortion is seldom of any consequence in a well-designed amplifier, unless it is being driven beyond its capacity, and you shouldn't be fooled by a sales talk which is based solely on an exceptionally low figure for this item.

The most serious forms of distortion are those which occur when more than a single pure tone is fed into the amplifier simultaneously. Since all of our high fidelity work comprises music as the audio signal, and since most music is made up of chords of tones and their harmonics, the resultant waveform which must pass through the system is very complex indeed. A type of distortion which often occurs under these conditions is known as *intermodulation*. This occurs when two or more audio frequencies in the amplifier combine to form sum-and-difference tones in the output.



Hi-fi has to be prohibitively expensive? This good low cost Challenger amplifier sells for only \$36.

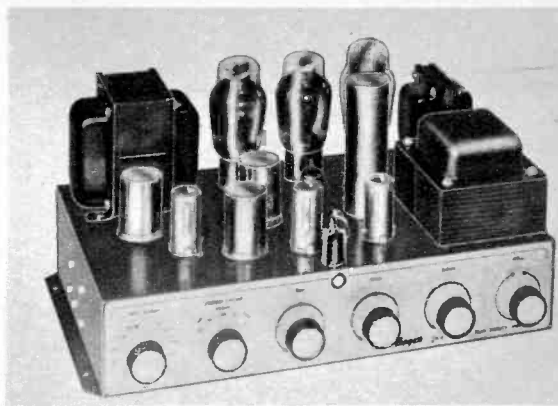

David Bogen amplifier DB20 was called the best available in a national survey of hi-fi amplifiers.

Cutaway drawing below shows details of a typical miniature glass tube often used in audio amplifiers.

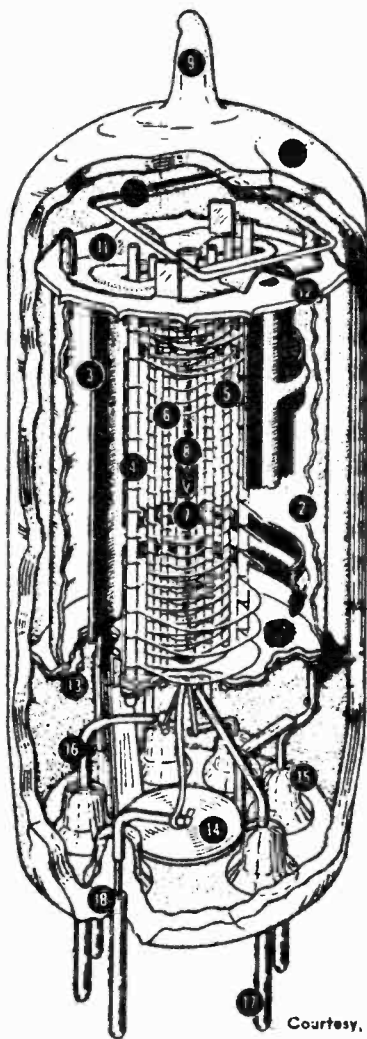

Courtesy, RCA

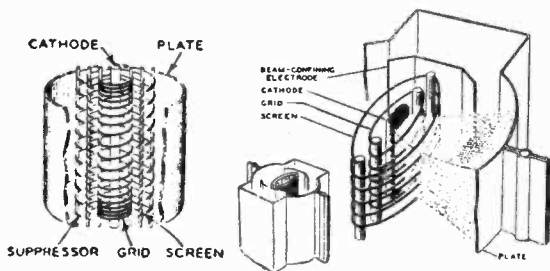

Typical pentode (five-element tube) has three grids. Triode looks similar but has no screen, suppressor. Cutaway beam power tube, right, is a modified pentode. 6L6 tube, in output stages, is of this type.



This loudness control, made by Bogen, compensates for ear response deficiencies at low levels. Highs and lows are boosted as shown in diagram below.

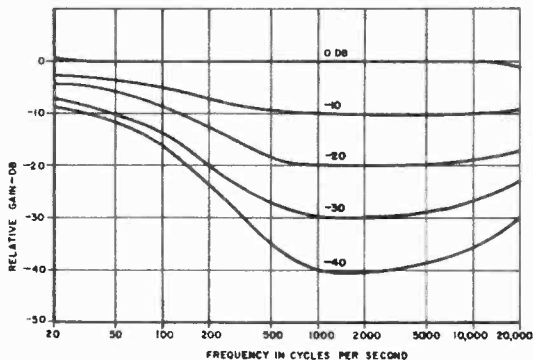



You can build your own with the Heathkits made by the Heath Company, Benton Harbor, Mich. Complete parts, large diagrams and instructions are supplied for A-7B, left, or Williamson-type W4-M, right.

When this same thing occurs within the ear, the results are known as subjective tones and are accepted as part of normal hearing phenomena. But since the additional tones produced are not harmonically related to the music, their occurrence within the amplifier is exceedingly undesirable. As a practical matter, the average ear will probably tolerate up to about 5% intermodulation distortion, a specification which is met or surpassed by most of today's high fidelity equipment. Under these conditions, harmonic distortion is usually far under this figure, being perhaps 1 or 2%, an amount which is perfectly acceptable to all but the most exacting.

When two or more signal frequencies enter an amplifier simultaneously, they may not receive equal treatment by the system, and one of them may be delayed in passage slightly more than another. When various frequencies are displaced in time with respect to one another, the resulting effect is known as *phase distortion*, and is expressed in terms of electrical degrees of rotation. As an example, if one tone were caused to lag another by a quarter-cycle, the amount of phase delay would be 90° . Similarly, a half-cycle delay would be 180° and a full cycle would be 360° . There is considerable disagreement concerning the importance of phase distortion, many authorities claiming that the ear simply cannot detect it. At any rate, we can usually regard it as inconsequential when the other forms of distortion are held to tolerance, and under these conditions a phase shift of 15° or less is not uncommon.

One of the newer indexes of amplifier performance to be added to the catalogue is the important matter of *transient response*. This is the reaction of the system

to steep waveforms, that is, to attacks and releases. Whenever a musician tongues a note, or depresses a key, or strikes a drum, there will be a very brief instant between the initial impact and the point of maximum amplitude. Similarly, at the end of the tone there will be a decay period, which is usually not so steep. The system which can react instantly to these sharp parts of the wave is said to have low transient distortion. This distortion is sometimes expressed in terms of the manner in which it alters the shape of a square wave passed through it, observed on an oscilloscope. But since transient response is an instantaneous phenomenon, the square wave test is at best an indirect measurement, and the only truly satisfactory indicator is your own ear. When considering a given amplifier, then, listen carefully to its handling of program material containing a lot of sharp attacks, staccato, pizzicato and sforzando passages. These should all be perfectly clean, without "hash" or "ringing." The loudspeaker is a far worse offender in this regard than the amplifier, for it is a mechanical device which has a very real moment of inertia. The amplifier can help alleviate this problem by the proper design of its output circuit, which will tend to act as a short circuit to transient distortions set up in the speaker. The ability of the amplifier to do this is determined by the ratio of its output internal impedance to the impedance of the loudspeaker voice coil. This figure is known as the *damping factor*, which is effective up to a point in holding down this form of distortion. In practice, a damping factor of from 3:1 to 5:1 is about the useful maximum before instability and decreased bass response set in.



McIntosh Laboratory amplifiers offer a large number of compensating settings.



Deluxe 10-watt RCA amplifier above is one of a number of units made by RCA as matched components for assembly of hi-fi sets with low distortion.



Imported by British Industries Corp., the Leak "Point One" amplifier and "Vari-Slope" remote control pre-amp have fine response, workmanship.

What Amplifier Power?

Under usual home listening conditions, the average power output of the high fidelity system is quite small, perhaps on the order of a watt or less. But there are instantaneous peaks in most music which will drive the power output to many times the average value. You'll want to know then whether you need to equip yourself with an amplifier with 30 or 40 watts of reserve power, just to be able to handle those occasional peaks. Ideally, of course, your amplifier should encompass the entire dynamic range of any of your source material. But as a practical matter you can probably countenance some clipping of these peaks without seriously impairing your musical enjoyment. The important consideration here is the cleanness with which the peaks are clipped. This means

that you'll have to do some careful listening to a number of amplifiers to determine their overload characteristics. If the peaks are clipped cleanly, without sounding ragged, then you may find 10 or 15—or even less—watts entirely adequate. If, on the other hand, you will accept no compromise with quality, then you will require two or three times that power capability.

Amplifier Design Features

Audio amplifiers, like automobiles, all employ the same basic principles, but within that broad framework there are enough variations in approach to make each product a unique and distinctive design. Since these technical distinctions often comprise the major selling points for various makes of amplifiers, we should know something about them in order to decide intelligently which unit best suits



Bell 12-watt amplifier is one of several models by Bell with flat response, variable controls.

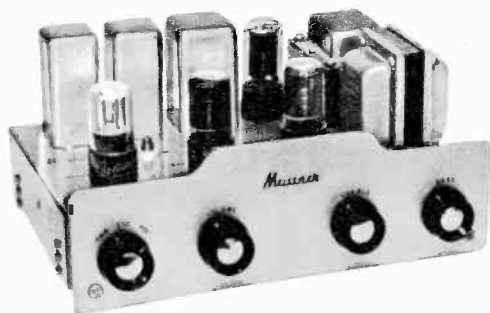

Made by Thordarson-Meissner, the Meissner power amplifier is one unit in their matched hi-fi set.

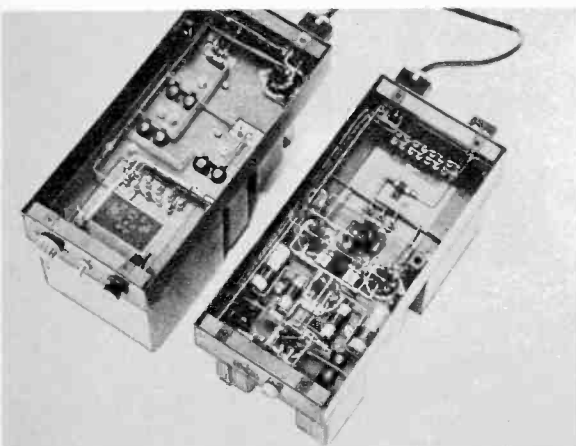

The original Williamson "Hallmark," imported by British Radio Electronics, shows matchless wiring.

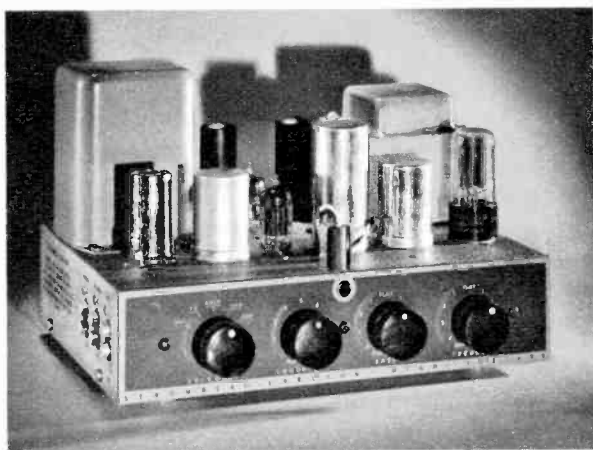

Part of Stromberg-Carlson's "Custom 400," 10-watt unit has channel selector and multiple controls.

our individual hi-fi tastes and purposes.

Any audio power amplifier is really a series of smaller amplifiers in cascade, and each of these sub-units is known as a *stage* of amplification. The number of stages in an amplifier simply indicates the number of amplifying processes the signal goes through between input and output. Each stage will most often comprise a single vacuum tube, although there may be two or more.

The means by which the signal is transferred from the output of one stage to the input of the next is known as the *coupling*. Audio amplifiers have been built which are *transformer-*, *impedance-*, *resistance-*, and *direct-coupled*, but only the latter two are in common use for amplifiers today. The transformer and impedance systems involve very large and expensive components for performance which is comparable to that of the other methods, and they

are now generally regarded as obsolete.

Resistance coupling really involves a network of resistors and condensers between the *plate* circuit of the previous stage and the *grid* circuit of the following tube. The function of the coupling condenser is to pass the audio signal between stages while at the same time preventing the high d.c. plate voltage from getting to the grid of the next tube. But the reactance of the condenser to the audio signal is not the same at all frequencies, and this unit may therefore be a source of frequency response and phase distortion.

The direct-coupled circuit is essentially resistance coupling without the condenser. In this system the high plate voltage on a given stage does apply to the grid of the next stage. The plate voltage of that following stage is then raised very much higher so that the proper relationship between grid and plate voltages within each

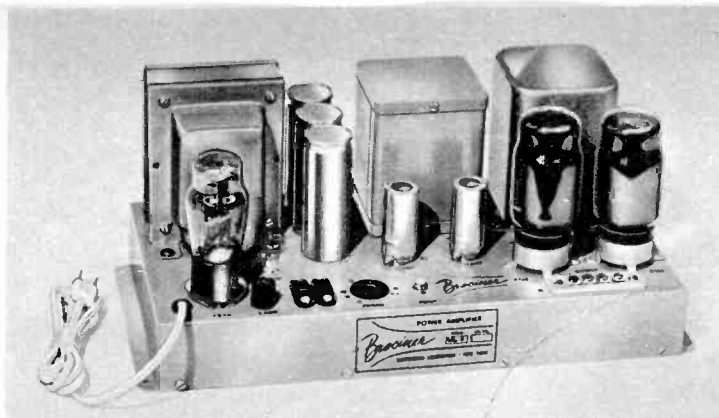

Brociner UL-1 Ultra Linear power amp is a basic unit of 20-watt output of modified Williamson circuit, designed with CA2 pre-amp.

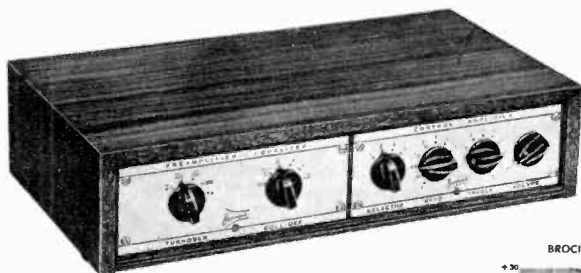

Model CA2 Brociner control amplifier is a self-powered remote pre-amp designed for use with any amplifier. Possible adjustments are shown in curves below.

Range of possible equalizing settings with pre-amp above are in Brociner diagram at right.

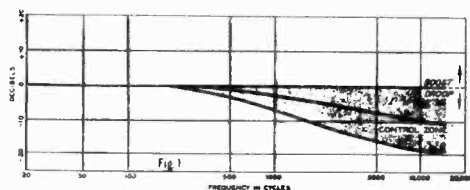

Compare inadequate range of normal radio-TV tone adjustment with overall control, right.

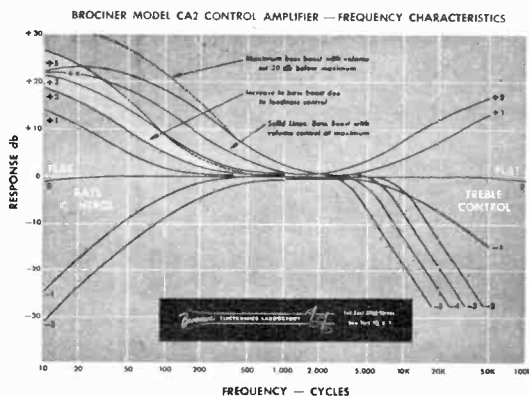

stage is maintained. Obviously, a direct-coupled amplifier having very many stages will require an exceedingly high-voltage power supply. This amplifier is therefore more expensive to construct and difficult to adjust, but it does have inherently better frequency response, particularly at the low end, along with lower distortion.

A rather special type of coupling is the *cathode follower*, in which the output signal is taken from the tube at the cathode circuit rather than the plate. This unit is actually a loss device—that is, its output is less than its input. But it also has a very low internal impedance, which is very useful in some applications. It is sometimes used to couple the amplifier output to the loudspeaker, where it provides an exceptionally high damping factor.

When more than one tube is used in a single amplifier stage, the connection of the tubes is usually in *push-pull*. In this

arrangement the signal is fed simultaneously into both tubes, in such a phase relationship that a positive peak at the output of one tube coincides with a negative peak at the output of the other. Thus the operation of this circuit is somewhat analogous to alternating fire in a two-cylinder gasoline engine. This system has inherently less hum and harmonic distortion, and permits the use of smaller and less costly output transformers. All good amplifiers have a push-pull final stage, and many are push-pull throughout.

The proper phase relationships at the input of a push-pull stage may be established by a center-tapped transformer, but the more common device is the *phase inverter* stage. This is simply a means of using resistance coupling to connect the output of a single-ended amplifier tube to the input of a push-pull stage. Phase inversion has the advantages common to any

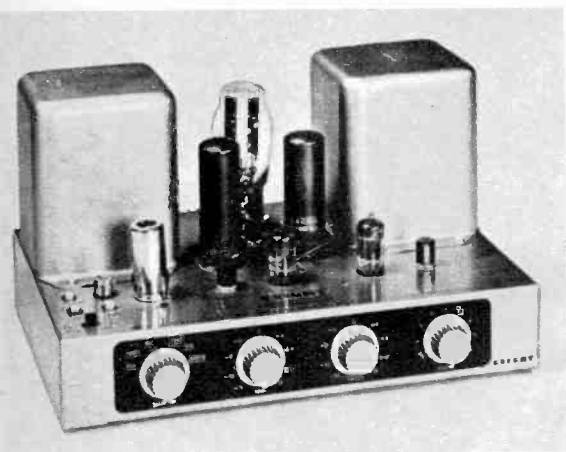

Golden Knight 24-watt amplifier is supplied by Allied Radio Corp.; has equalizing, tone settings.

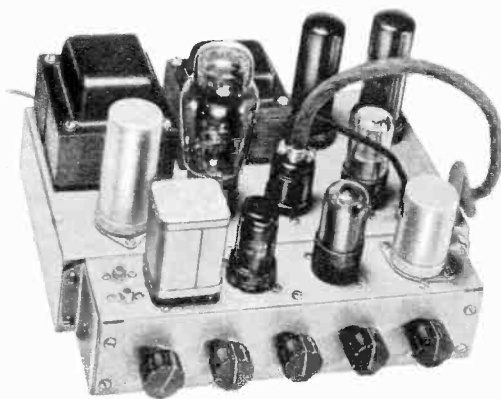

Designed for custom installations, Rauland-Borg's 25-watt 1825 has detachable pre-amp, equalizers.

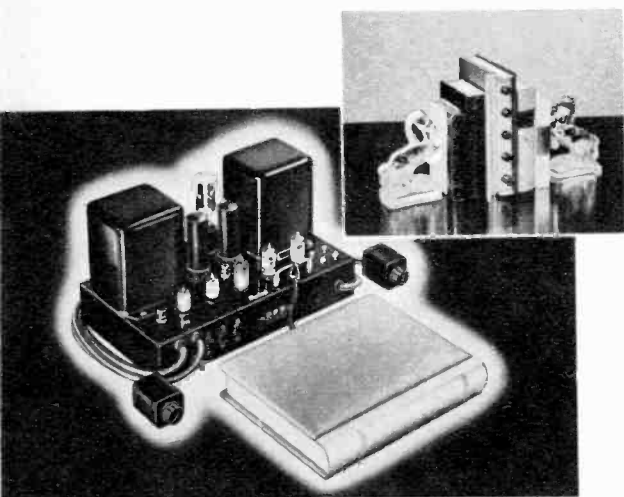

Rauland Libretto remote control pre-amp resembles a book, plugs into the model 1826 master amplifier.

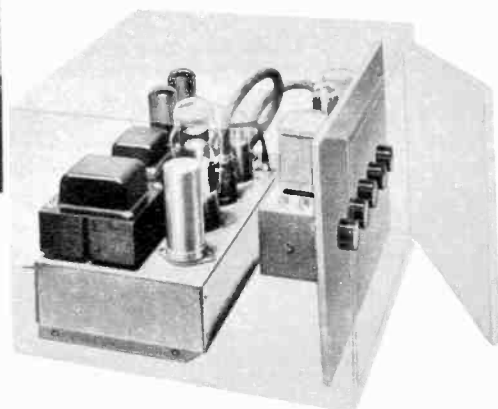

Here is the same amplifier as shown above, but with the pre-amp now mounted on a control panel.

resistance coupling, namely better frequency response and the elimination of expensive transformers.

Audio amplifiers have been designed which are allocated variously into classes as A, AB and B. The class of operation of an amplifying tube depends upon its operating voltages, which in turn determine the method of use of the tube's *characteristic curve*. Class A is the method in which tube plate current flows at all times and the tube operates only over the *linear* portion of the curve. The other systems offer greater efficiency, but the tube operates in a non-linear fashion, that is, the output is not precisely proportional to the

input. This means distortion, which would later have to be cancelled out by some form of trick circuitry. Thus a truly high fidelity amplifier *always* operates with a Class A system throughout.

In some audio amplifiers, a portion of the output of the system is returned to the input. The signal which is fed back is out of phase with the incoming signal and therefore reduces it. This action is known as *degeneration*, and the system is called *negative*, or *inverse*, *feedback*. It results in some loss of signal, of course, but it also causes a much greater reduction in noise and distortion. Thus inverse feedback is desirable in limited amounts, although ex-



The General Electric basic 10-watt A1-300 power amp is a component of the GE custom music system.

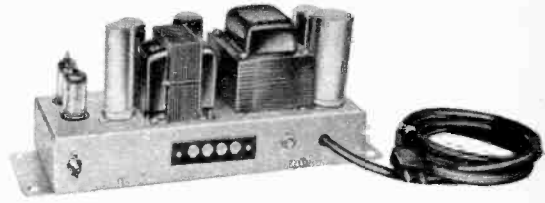

An open view of the A1-300 amplifier shows the heavy duty transformers of this high response unit.

cessive degeneration will result in instability on peaks and high distortion on overloads.

Triodes vs. Pentodes

There are two basic types of vacuum tubes used as audio frequency amplifiers. One is the three-element tube known as a *triode*, and the other is a five-electrode device called the *pentode*. A third type, known as the *beam power* tube, operates on the same principle as the pentode, with a somewhat different form of construction.

Much heated discussion has revolved around the relative merits of these two tube types for audio applications, and no agreement is in sight yet. Classic theory tells us that the triode has less innate distortion, although the pentode exhibits greater efficiency. But many engineers argue that proper circuit design will enable the pentode to equal the triode in quality, and they can prove it with any sort of distortion measurement. To that the triode school retorts that there must still be some forms of distortion which we have not yet indexed and catalogued, because a good triode amplifier sounds unmistakably cleaner to the ear than the best pentode rig.

You take it from there. A triode amplifier will cost more than a pentode unit of the same power output, because more stages will be necessary to achieve the same gain. If you can hear a difference, and if your budget can stand it, get an all-triode amplifier. If you can find a pentode circuit which sounds fine to you, then take it by all means.

Amplifier Controls

The controls on audio power amplifiers vary all the way from exactly zero up to nearly a dozen. In the basic amplifier, it is assumed that the control functions are performed by the individual source units or by a separate control amplifier. The most elaborate units, on the other hand, have all controls included in the power amplifier, and the preceding source devices

have fixed characteristics. There is no particular technical advantage in one system over the other, the matter being entirely one of personal taste and convenience. You would be wise to give it careful consideration, however, while planning your system, in order to avoid overlapping controls and additional expense.

In the early days of radio, some enterprising manufacturer decided that he could increase the saleability of his product by the addition of a so-called tone control to his radio receivers. This device was in reality nothing but a "hash filter," which severely attenuated the high-frequency response and simultaneously minimized the effects of noise and distortion. Since most persons at that time resented the intrusion of the noise and distortion more than they did the limited frequency range, the tone control on most sets was turned to the full roll-off position at all times. From this it was inferred that the general public all had "tin ears," and that the tone control was a worthless abomination.

The tone control on a modern high fidelity amplifier is much more than the simple high frequency filter of the early radio sets. It usually has separate controls for bass and treble, and is capable of boosting or rolling off either the high or low end, or both. Thus it provides for a smooth tapering of the normally flat response curve in any direction desired.

The primary function of the tone control is to permit local correction for deficiencies in the source. If the recording or broadcast studio techniques have been faulty, and if the musical balance is not accurate, you may be able to compensate for this lack by the judicious use of your own tone control system. Furthermore, if your playback compensator is not precisely adjustable to the recording characteristic needed, or if the record manufacturer has failed to meet his own published standards, some slight touching up with the tone controls may provide a better overall result. Ideally, then, the day should arrive when studio techniques are impeccable, and a single

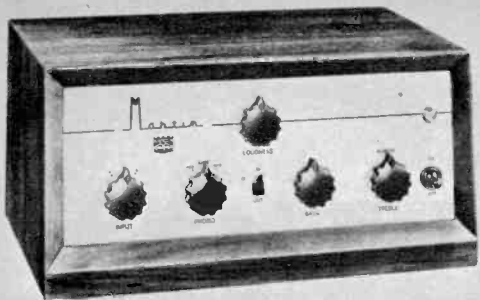

Control Amplifier model 352CA made by H. S. Martin acts as control section for basic amplifier.

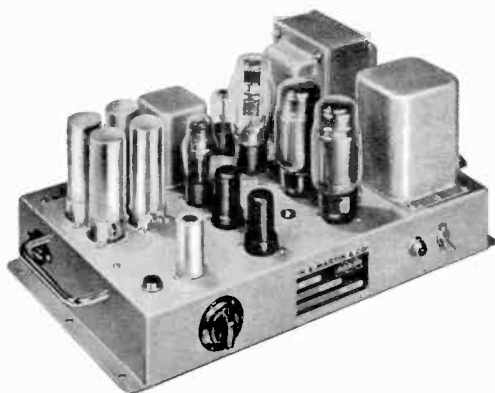

H. S. Martin Co. basic amplifier 352CA delivers 25-watt output with high response, low distortion.

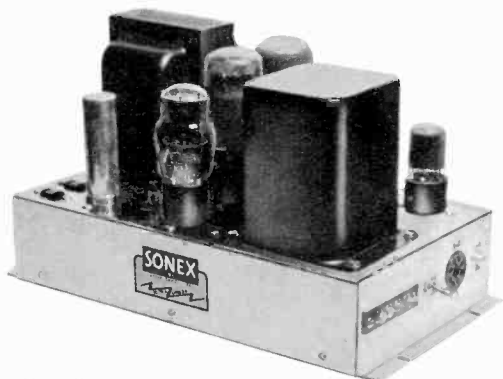

The Sonex Ultra-Linear amplifier gives 25-watt output with modified type of Williamson circuit.



Pilotone AA-903 by Pilot Radio, a Williamson-type amplifier, was rated "best buy" in recent survey.

standard recording characteristic is adopted, at which time the need for tone controls should fade into nothingness. But the millenium hasn't arrived, so you'd better plan to include a set of tone controls in your system.

The volume control in most sets is simply a variable loss device, usually inserted between two stages within an amplifier, and used to control the amount of signal voltage passing through the system at that point. But here we come to grips with a major problem in our high fidelity enjoyment, due to the fact that we normally cannot listen to reproduction in our homes at the same loudness level as we would have heard the original performance. And since the human ear, as we have already observed, has a frequency response which varies with changing loudness levels, our whole perspective is distorted when we are forced to operate our systems at normal room volume.

So once again we have to *compensate*. Our problem would be solved if we had a special volume control which would alter the amplifier response at various settings, in precisely the opposite manner that our hearing varies with loudness. Thus, knowing our hearing characteristics at the loudness level of a symphony concert, and also knowing how our ear behaves at normal home listening levels, we need a volume control which will make up the difference and boost the bass and treble ends as our own hearing response droops. We have this special device, and it is known as a *loudness control*. It is considerably more expensive to manufacture than the simple potentiometer volume control, of course, but the results justify the additional expenditure. But if you don't feel that you can afford this luxury, you can achieve approximately the same result by the manipulation of a good set of tone controls.



H. H. Scott Co., noted name in radio, makes this 210-B dynaural with noise suppressor and filter.

Special accessory is the Hermon Hosmer Scott dynaural noise suppressor and distortion filter.



Special Amplifiers

The suppression of record surface noise and radio static has always been possible through the use of the old roll-off tone control, or of a fixed "scratch filter," which cuts off all tones above a predetermined frequency. These systems are quite successful in attenuating noise, but they also do a devastating job on the musical harmonics.

Another approach to this noise problem is the *dynamic noise suppressor*, developed by Herman Hosmer Scott. This system is

basically an amplifier whose frequency response is determined at any given instant by the amplitude of the signal. Thus on loud passages, when the signal-to-noise ratio is reasonably good, the amplifier will operate at wide range. But on soft passages the frequency response is narrowed appreciably.

Opinions concerning this system vary widely, and your own ear will have to decide whether this is the method for you. There is no question but that it does a much better job on old noisy records than an ordinary fixed filter. But some persons



The Stevens Tru-Sonic "Citadel" direct drive amplifier claims distortion-free performance by the elimination of transformers in the circuit. Matched speakers are made by Stevens for use with it.

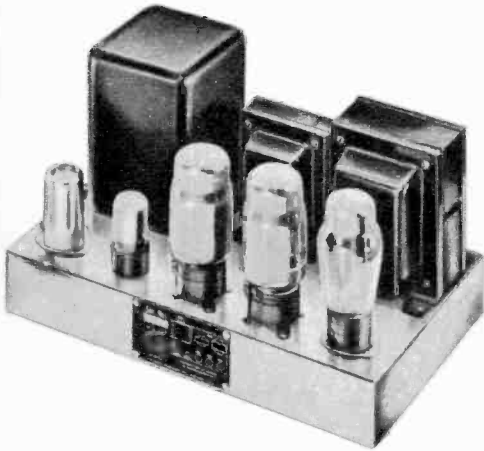

Product of Radio Craftsmen, Inc., the Craftsmen model 500A Ultra Fidelity has 15-watt max. output.

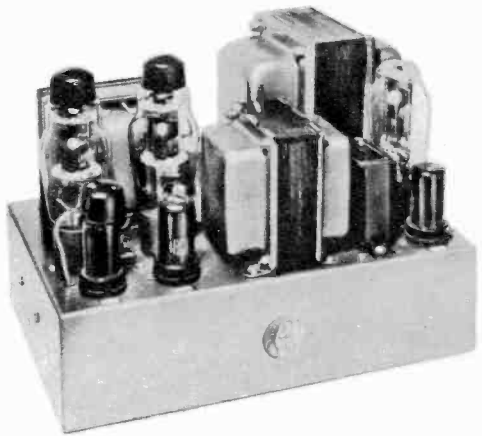

The Hartley 20-watt high fidelity amplifier has a reported flat frequency range of 20 to 20,000 c.p.s.

find the varying noise level almost as bothersome as noise at a high constant level, and very soft passages of high pitched music are attenuated almost to the vanishing point.

As we learned earlier, many recording companies and radio stations have been in the habit of compressing the dynamic range of the sound in their systems. The soft passages are often increased somewhat to override the noise level, and the loudest parts are held down to avoid overloading.

The thought has occurred to some ex-

perimenters, then, that the reproducing system should be capable of counteracting this process, should be in effect a *volume expander*. It is quite possible to build such an amplifier, wherein the signal level controls to some degree the gain of the system. Thus the signal itself forces the amplifier to make the loud passages even louder and the soft passages even softer.

But one must wonder whether volume expansion is really desirable for home listening, considering the usual level of room noise and the proximity of neighbors who

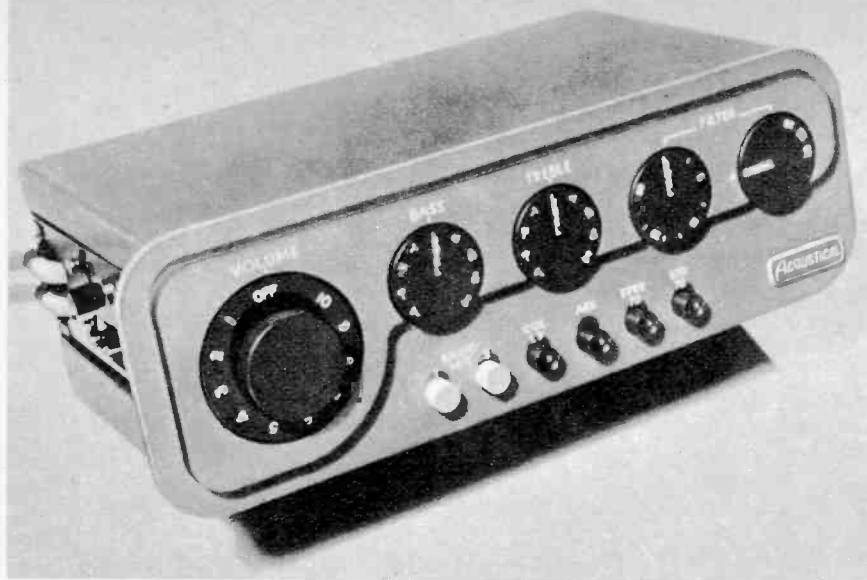

Beam Instruments Corp. are American distributors for the Quad Acoustical amplifier. It has a separate control unit, left, which provides multiple channels, controls for equalization, bass and treble balance.

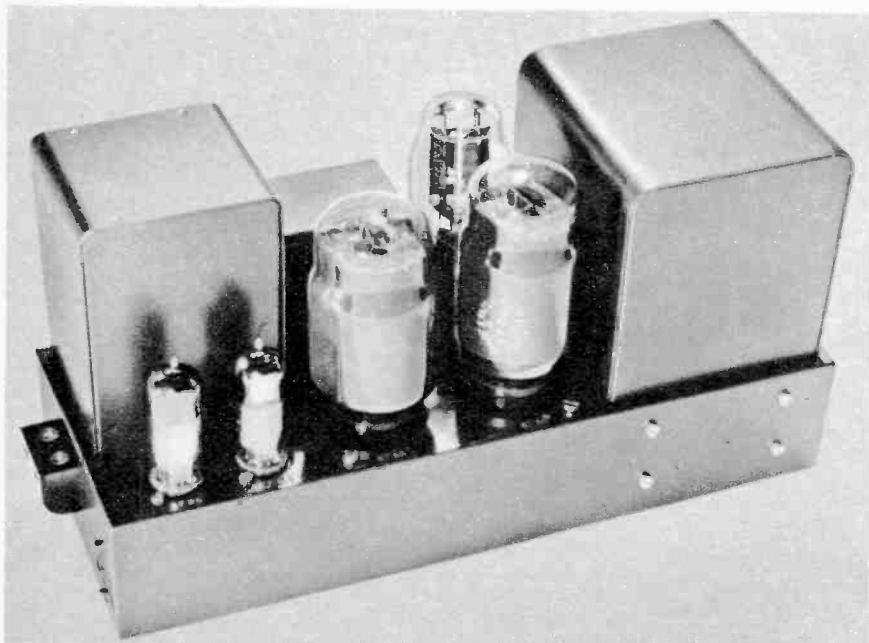

Amplifier to go with control unit above, this translates push-button equalization of records into high-response sound. Amp is rated at 15 watts; it has typical grade English workmanship.

may be somewhat less enamored of your high fidelity system. Furthermore, it is virtually impossible to know what compression characteristic, if any, was used, especially since much of it is often done manually by the control engineer. But when all of these variables are worked out, and when the volume expansion is perfectly adjusted for the performance being played, listening to such a system can be a truly exciting experience.

Connection of the power amplifier output

is somewhat different from that used between the other components. Since the impedances of crossover networks and loudspeakers are not as well standardized as are those of most of the other units, the amplifier output must be able to be matched to a variety of impedances.

The selection of our matched loudspeaker is one of the most important decisions to be made in the assembly of the high fidelity system, and a few pointers on this essential operation follow. •



Exploded view of General Electric 1201D 12-in. hi-fi loudspeaker shows the necessary components.

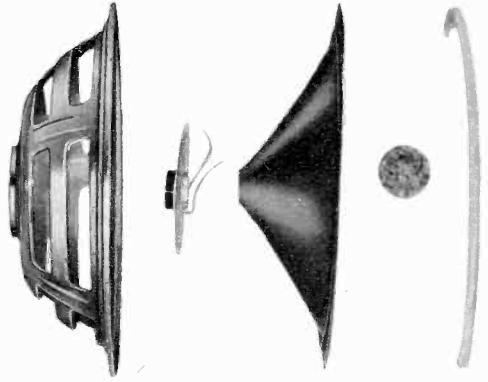

Loud Speakers

Tremendous job of duplicating all the original sounds belongs to the speaker.

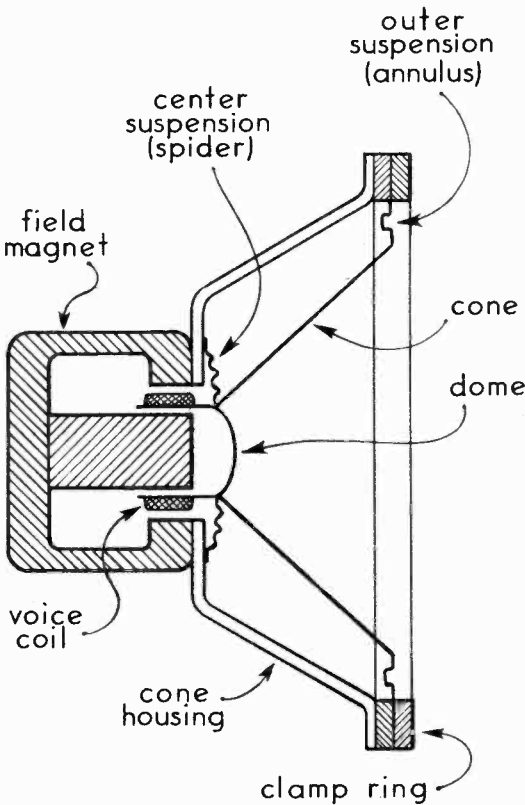

CROSS-SECTION OF A SIMPLE DIRECT-RADIATOR LOUDSPEAKER

THE watts of electrical power which have been developed in the power amplifier are now ready for reconversion to sound, and the instrument which must perform this function is the loudspeaker. All modern speakers are built in some variation of a horn shape, which makes this instrument just about the most versatile horn ever perceived by the ears of man. Recalling from Chapter Two the many ways in which a musical sound is produced, it is small wonder that our present-day loudspeaker has some difficulty in successfully mimicking all of the tone colors produced in a modern symphony orchestra.

For this reason, the loudspeaker has gone through more stages of development, and is probably now being subjected to more diligent research than any other element of the high fidelity system. At the present state of the art, the only speaker in common use is the moving-conductor type, usually referred to as *dynamic*. This unit operates on electromagnetic principles, in which two magnetic fields alternately attract and repel one another, resulting in a movement which is used to set molecules of air in motion and thus produce sound.

Dynamic Speaker Elements

One of these magnetic fields is fixed in value, and is produced by the *field magnet*, or "pot." This is the big mug-shaped device at the rear of the unit, and may be an electromagnet which is externally energized from a d-c source, but much more commonly is a permanent magnet. The size of this magnet is a rough indicator of speaker

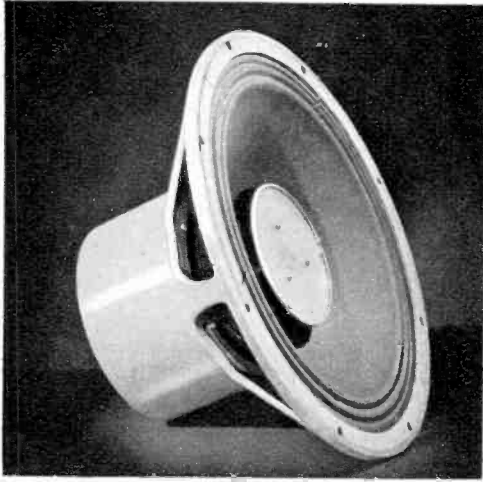

Stromberg-Carlson's RF-475 "Custom 400" 15-in. speaker is part of their matched high fidelity set.

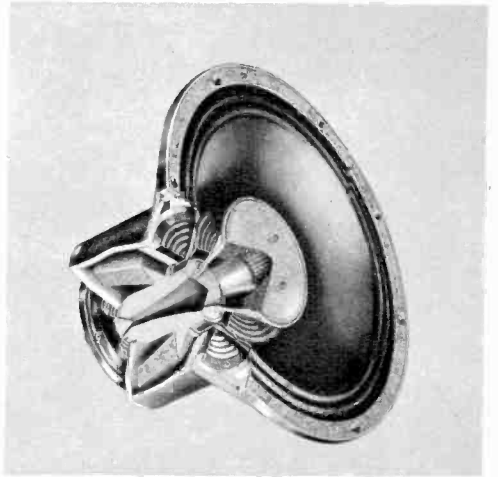

Cutaway of the RF-475 coaxial speaker shows the "acoustic lens" for high frequency dispersion.

quality, as more powerful magnets help to damp out distortion, increase efficiency, and extend the frequency response.

Within the air gap of this field magnet is a very small coil, consisting of a hundred turns or so of fine wire, called the *voice coil*. The entire output of the amplifier is fed into this tiny voice coil, resulting in the establishment of an audio-frequency magnetic field, which alternately attracts and repels the fixed field generated by the pot. The voice coil is thus caused to move back and forth in accordance with the audio signal. This section of the loudspeaker is known as the *driving motor*, and it in turn is attached to the *acoustic radiator*. The radiator is usually a cone of specially-treated paper, which acts to compress and rarefy the air in front of it, and thus reconvert the electrical signal to sound. The size of the cone determines the amount of air it can move, and is therefore an important factor in the determination of the bass response of the speaker.

The acoustic radiator may also be a fixed horn, which has at its throat a diaphragm attached to the voice coil. The diaphragm itself produces the sound, which is then shaped and radiated by the horn. A horn loudspeaker, when properly designed, offers far better frequency response and efficiency than the cone type.

But correct design implies some rather strict dimensional requirements, which make the horn impractical for usual home applications. In order to reproduce 30 c.p.s., for example, the horn would require

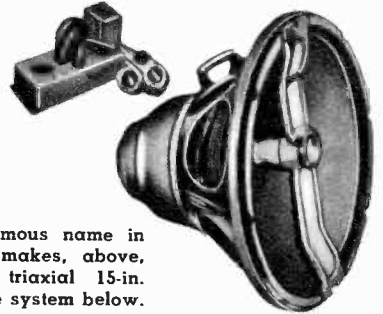
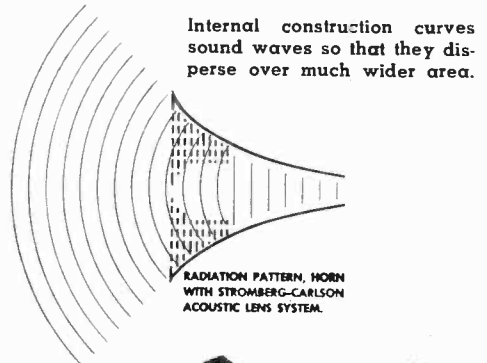

Jensen Co., famous name in loudspeakers, makes, above, Model G-610 triaxial 15-in. speaker, Duette system below.

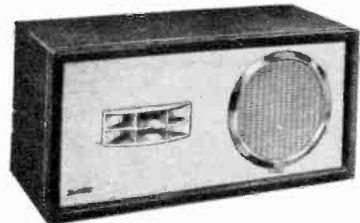

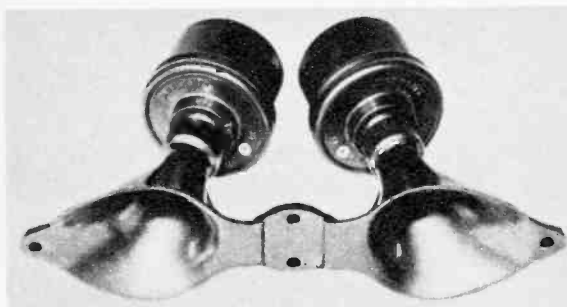

DUAL TWEETER

MODEL

4402

RESPONSE	2,000-15,000 CPS
IMPEDANCE	5-8 OHMS (Units in par)
POWER	12 WATTS H.F.
HOR. DISTRIBUTION	100°
VERT. DISTRIBUTION	50°
DIMENSIONS	9 1/2" W x 2 3/4" H x 5" D

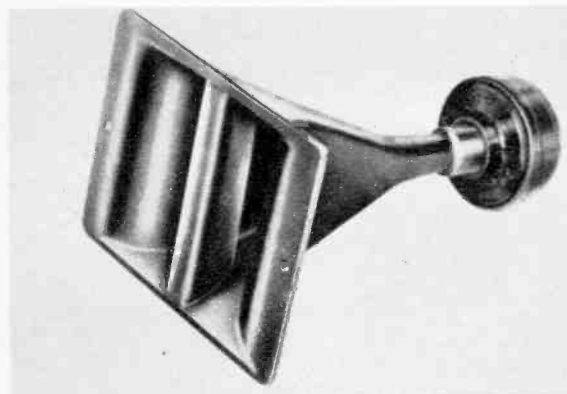

WIDE ANGLE TWEETERS

MODEL

4408

4409

RESPONSE	400-15,000 CPS	400-15,000 CPS
IMPEDANCE	12 OHMS	8 OHMS
POWER	6 WATTS H.F.	25 WATTS H.F.
HOR. DIST.	80°	80°
VERT. DIST.	40°	40°
DIMENSIONS	5 3/4" H x 7 3/4" W x 1 1/4" D	5 3/4" H x 7 3/4" W x 1 1/4" D

Models 4410-4420

Cross Over Networks

4410

4420

Crossover	600 cps	2,000 cps
Impedance	6-16 ohms	6-16 ohms
Height	4-1/8"	3-3/8"
Length	9-1/4"	7-7/16"
Depth	3-5/16"	2-3/16"

Built in variable attenuators.



University makes a variety of hi-fi speakers, including tweeters above.

a mouth diameter of about 9 1/2 feet! Many attempts have been made at reducing these dimensions, but the results never equal those of a true *exponential horn*—a horn, that is, whose cross-sectional area doubles for equal increases in its length. This horn, incidentally, should not be confused with the horn-type enclosures used with some cone loudspeakers. These are really directional baffles, which will be discussed in the next chapter.

And now we begin to comprehend the dilemma encountered by loudspeaker de-

signers. In order for the speaker to have little inertia and therefore good transient response, the cone must be very light. At the same time it must be rigid enough that it does not break out into its own spurious vibrations when driven by the motor. The high frequency response will be determined by the size and weight of the cone, with small size units responding better at the high end. But at low frequencies the speaker must move large masses of air, and a bigger unit will afford the better bass response.

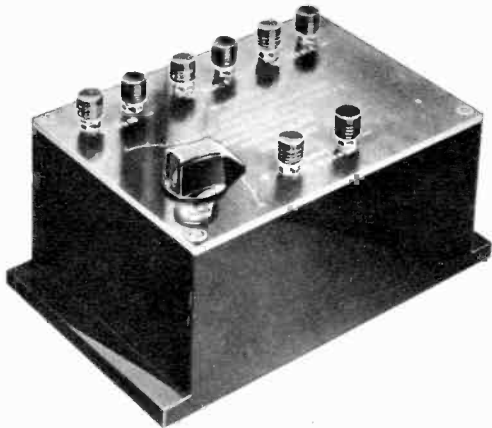

English Wharfedale crossover network is available through British Industries Corporation, N. Y. C.



This unique RCA accordion-edge mechanism provides unusual fidelity for a speaker of only 7 in.

University 12-in. Diffusicone shown below disperses high frequencies, gives good sound at a low cost.

Altec Lansing 601A is a 12-in. hi-fi coaxial dual woofer and tweeter with wide, matched response.



Dual Speaker Systems

The motion picture industry decided some years ago that these divergent requirements were irreconcilable, and thereupon set up a system of theater sound reproduction employing two separate types of loudspeakers. In this system, one type specializes in low-frequency reproduction, and another concentrates on the treble end. These two units have acquired the rather prosaic appellations of *woofer* and *tweeter*, respectively.

The simplest type of dual system em-

ployes two cone-type loudspeakers, each operating only over its allotted portion of the audio spectrum. The low-frequency, or woofer, unit may be 12 to 16 inches in diameter, while the tweeter might be around 3 inches. But with the simplest system such as this, we soon find that we have another very real problem, in that the high frequency radiation is confined to a very narrow area directly in front of the speaker. When seated right on the center axis, we hear well balanced sound; but off at the sides the treble end completely disappears.

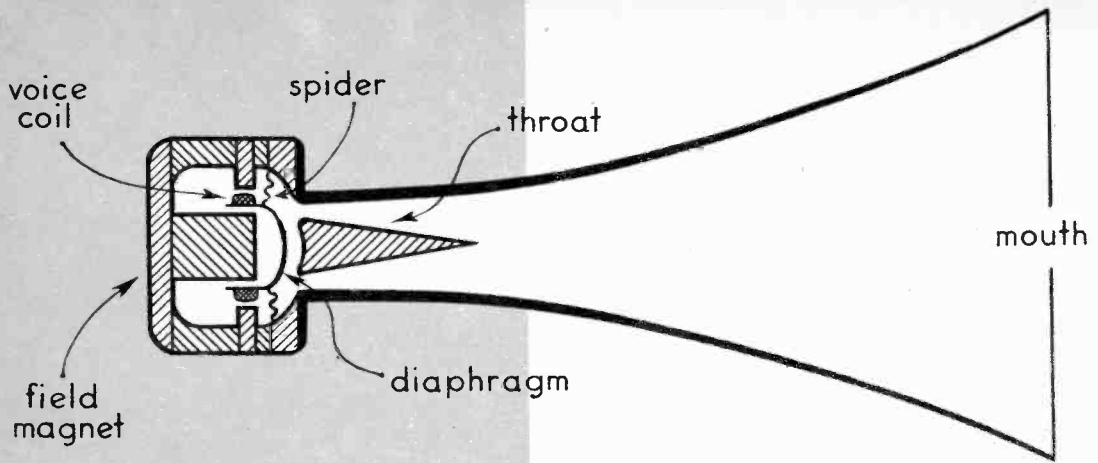

CROSS-SECTION OF A SIMPLE HORN-TYPE LOUDSPEAKER

The horn speaker above, seldom used for low frequencies due to size limitations, is the basis for principles used in most high fidelity tweeters.

Model 6201

DUAL RANGE COAXIAL SPEAKER
WITH BUILT IN
LC TYPE CROSSOVER NETWORK

POWER	25 WATTS
RESPONSE	45-1500 CPS
SOURCE IMPED.	8 OHMS
SHIPPING WT.	7 LBS.

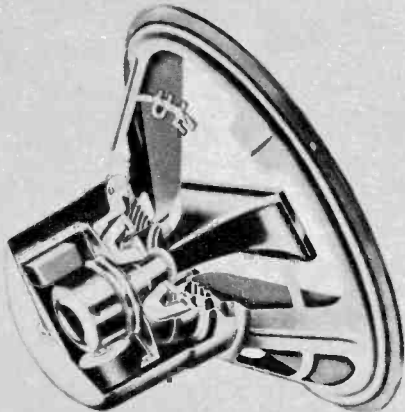

Cutaway loudspeaker, left, is the University model shown above and on the cover. It has outer woofer with inner coaxial tweeter for high frequencies and has a reported response of from 50 to 15,000 cycles.

Obviously, something must be done to give the high end the same sort of dispersion exhibited in the bass region.

One way of doing this is through the use of the exponential horn. Since this instrument has a rather sharp cut-off frequency below a point which is determined by its dimensions, a horn of quite small size operates very well as a radiator of high frequency sound. If the horn is square or round, dispersion will be about equal in all directions. But since the normal listening area is seldom less than three or more than six feet above the floor, a more efficient distribution of high frequency energy would be obtained if the tweeter were to concentrate its radiation within that area.

The tweeter horn is therefore sometimes modified into a "multi-cellular" arrangement, in which the high frequency radiator is a double row of small square-mouthed horns, often totalling six or eight. It is interesting to note that the widest horizontal distribution occurs when the multicell is stacked vertically. This phenomenon was not clearly understood for a long time, until it was realized that high frequency sound waves, being highly directive and difficult to bend, were actually behaving very much like beams of light.

From this notion evolved the concept of the *acoustic lens*, which is used in conjunction with some tweeter horns. This is a series of baffles in the mouth of the horn, which are progressively thicker at their outer edges. The sound wave thus meets less opposition and travels farther in a given period of time through the center of the lens than it does around the edges. The beam therefore becomes more spherical and divergent as it passes through the lens system.

Very many high fidelity speaker systems employ tweeter horns designed on the audio diffraction principle, another theory borrowed from the field of optics. The horn is squeezed into a narrow oblong shape, so that it acts like an optical slit. When its width is less than the wavelength of the sound passing through it, there is a wide dispersion in the direction of the narrower dimension. Thus the horn itself becomes a directional radiator, without the intervention of honeycombs or baffles.

Multiple Speaker Systems

The success of the woofer-tweeter system has encouraged some experimenters to carry the idea further, in the belief that more speakers operating over narrower ranges will result in smoother and more efficient response. Thus some systems today incorporate three or even four specialized



DIFFRACTION PRINCIPLE

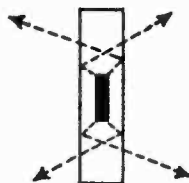

The Electro-Voice T-35 very high frequency driver is designed for response of 3500 to above audible range, high frequency dispersion at right angles, left.

Uses the new acoustic application of optical slit diffraction for perfected smooth sound dispersion virtually independent of frequency.

RCA LC-1A duo-cone 15-in. has famed Olson acoustical domes that kill bass-treble interaction.

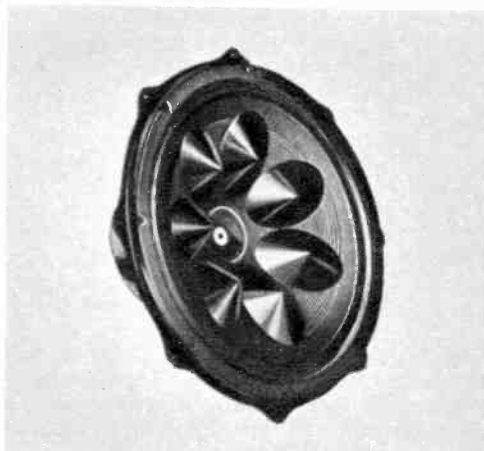

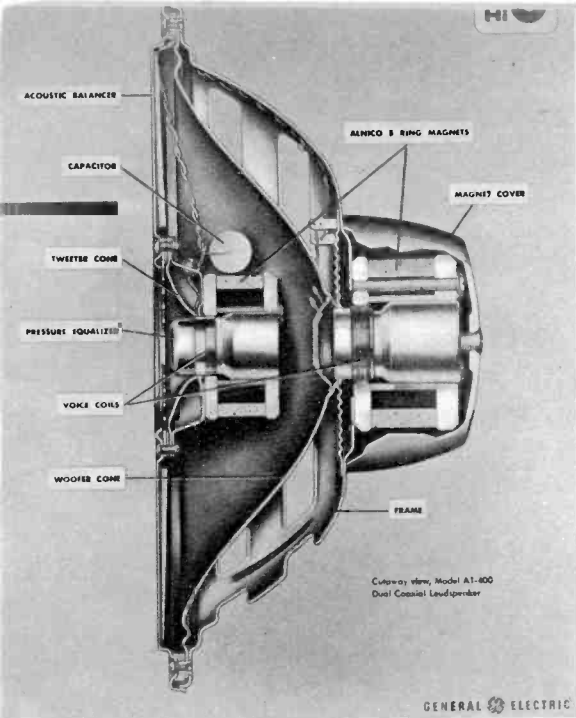

As shown cutaway at the left, the General Electric A1-400 uses a speaker inside other for wide range.

speakers, each operating in a different part of the audio spectrum.

It is important to note that each of these speakers is especially designed for the job it has to do, and you should not think that adding a 3-inch speaker to the 12-inch unit you already have will automatically produce a woofer-tweeter system. But if you already have a good big speaker with satisfactory bass response, there are some high frequency units which may be added to it, and which will very satisfactorily extend the treble reproduction.

But when several separate speakers are used, the discriminating ear can often detect the difference in directions of the sources. This disparity has led to the development of the *coaxial* speaker, which has all of its radiating elements mounted on a common axis. The simplest arrangement of this type involves two completely self-contained cone-type speakers, the tweeter being suspended by arms extending toward the center from the supporting ring of the woofer. More elaborate models employ a high frequency horn within the woofer cone, having its own voice coil which works against the same field magnet as does the low frequency element. Even fancier is the *triaxial* system, which has three driver units, and most elaborate of all is the *quadruplex*, which employs four separate voice coil drivers working against two field magnets, all concentrically mounted in one unit.

Crossover Networks

Whatever the method of mounting, however, it is essential in a multiple speaker system that each unit receive electrical energy only from that part of the audio spectrum at which it is designed to operate. Sometimes the mechanical construction of the units is relied upon to accomplish this, but it is more properly done with a group of electrical dividing filters known as a *crossover network*. The choice of the proper crossover frequency is a matter of compromise. If it is very low, the tweeter will have to be of comparatively large size, which begins to defeat the purpose of the multiple system. If the crossover is fairly high, the construction of the tweeter and the network itself will cost less, but then the efficiency at the high end of the woofer range may begin to droop. When the factors of cost and space are included, a crossover frequency of 800 c.p.s. is a good compromise, although an octave lower would be more nearly ideal. Hardly any high fidelity equipment made for home use has a crossover this low, however, and many go higher, up to around 1,500-2,000 c.p.s. Thus your rule-of-thumb for the crossover frequency of a two-way system is "the lower the better"—or as low as your budget can stand.

An integral part of a good crossover network is a *balance control*, which determines the relative amounts of power fed

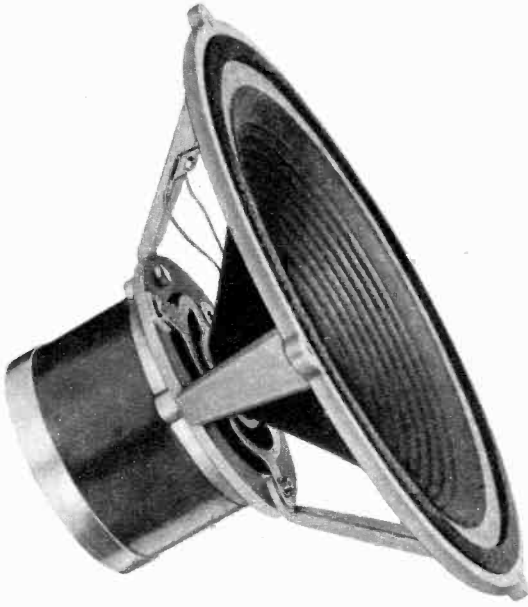

Famous Wharfedale speaker, British made, uses cloth-suspended cone for clean, wide-range response, good bass register.

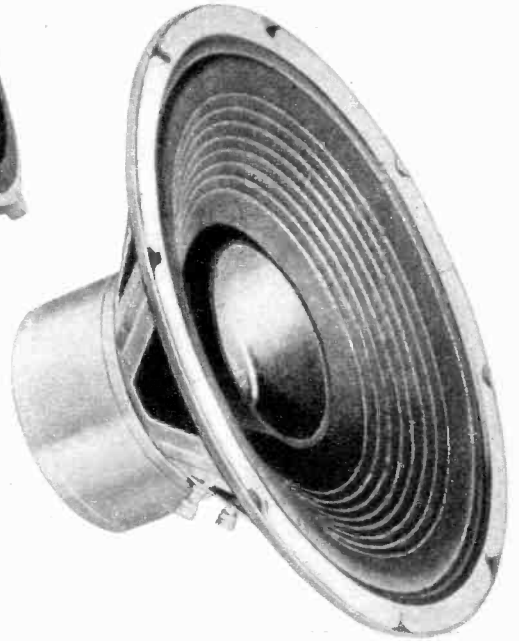

Electro-Voice Radax loudspeaker has three lb. magnet, aluminum voice coil for high quality response at low cost.



Permoflux Super Royal speaker, left, uses slotted cone at A, below, for added low frequency response, special stiffening at B for high frequencies.

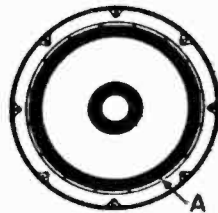

to the individual speakers. This will compensate for differences in speaker efficiency, the acoustic environment of your listening room, and your own personal taste.

The dividing network is ordinarily connected between the output of the main power amplifier and the inputs of the various speakers, but smoother results are obtained when it is inserted farther ahead in the system, and a separate amplifier used for each speaker. Under these conditions the impedance relationships between amplifier and speaker will be more stable, and the network handles less power and can therefore be cheaper, but the additional

expense of more amplifiers is rather prohibitive for most hi-fi fans of moderate financial means.

Economical Speakers

Even if your budget cannot stand the cost of the cheapest multiple systems, you still needn't despair of having a quite good reproducing setup. The loudspeaker manufacturers have not completely lost sight of your needs, and several of them offer exceptionally good single speakers at very reasonable prices.

In order to reconcile the demands of cone lightness and stiffness for high frequency

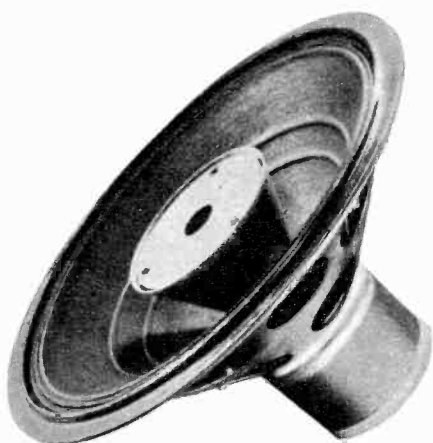

Duotone, manufacturers of styli and discs, also make hi-fi speaker above, response curve below.

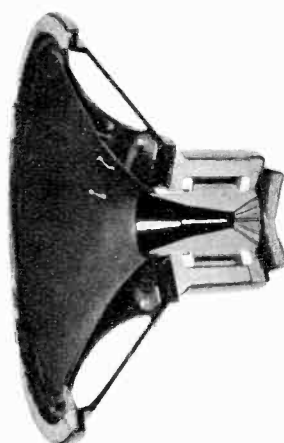

Tannoy, Ltd., Toronto, Canada, make this fine hi-fi model of their much admired heavy duty war unit.

Duotone speaker above has this frequency response. Ticonal magnet is rated at twice Alnico strength.

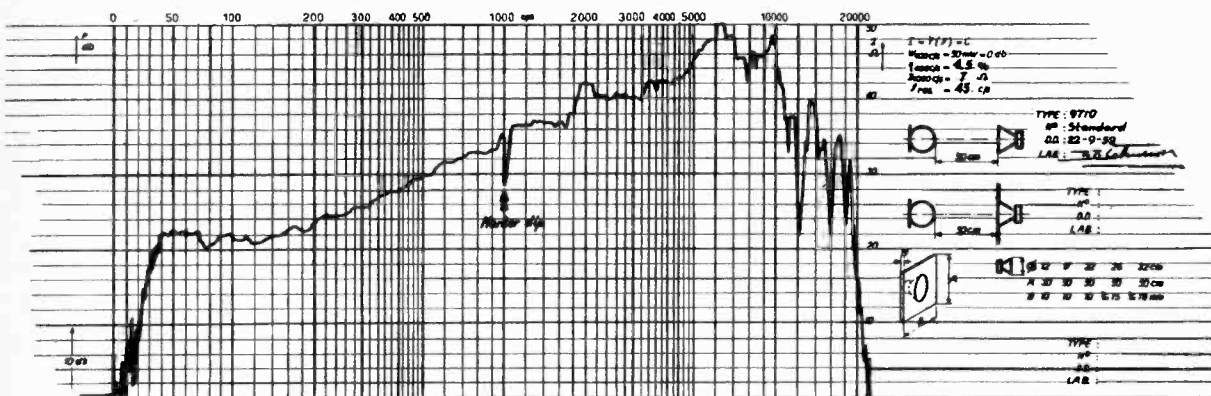

response, and the requirement of large size and softness for a smooth bass response, many speakers are built with varying degrees of hardness in a single cone. The radiator is divided into two or three bands of about equal width, with the hardest section being at the apex. Thus the stiff inner section acts as a small high frequency horn at the same time as the entire cone acts as a woofer. In another system, two separate coaxial cones are driven by the same voice coil. This is the basic idea of the *Radax* principle employed in the Electro-Voice economy line.

The University *Diffusicone* employs an acoustic director at the dividing line be-

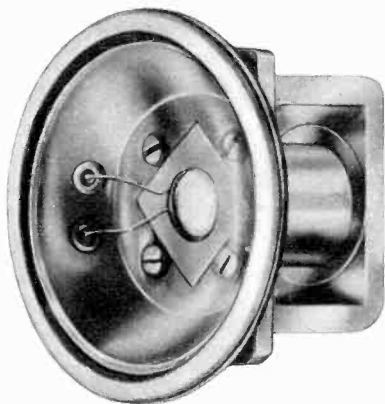

Kingdom Products, Ltd., handles this Lorenz model LP65 tweeter for high quality treble response.

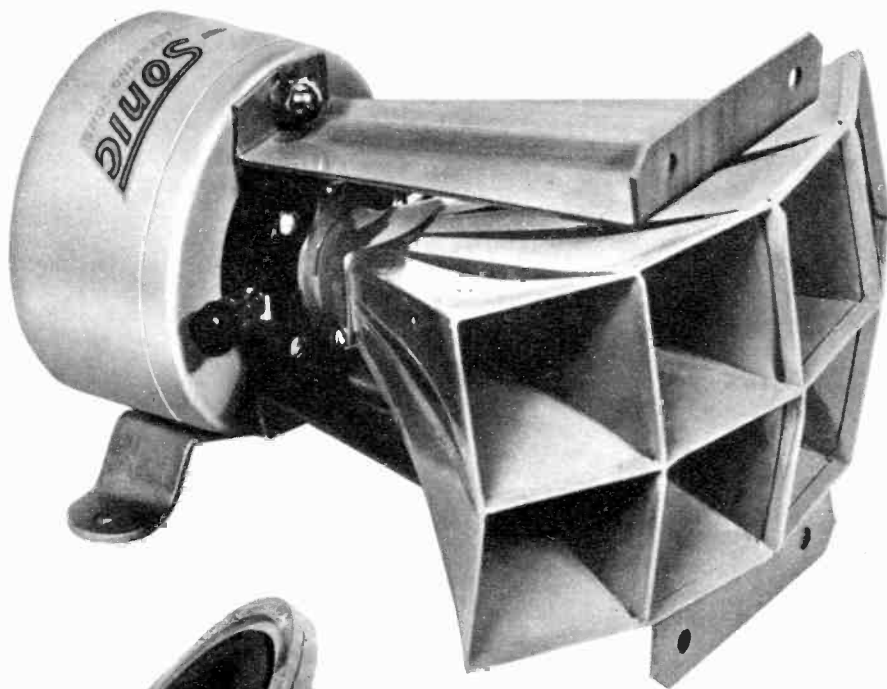

Multi-cellular tweeter made by Stevens, Inc., gives wide dispersion, covers 5,000 to 22,000. Model 214 has one inch voice coil, Dural diaphragm.



The Hartley 215 loudspeaker, imported heavy duty unit, has a reported range of 1 to 18,000 c.p.s. without resonance, is matched to Hartley amplifier.

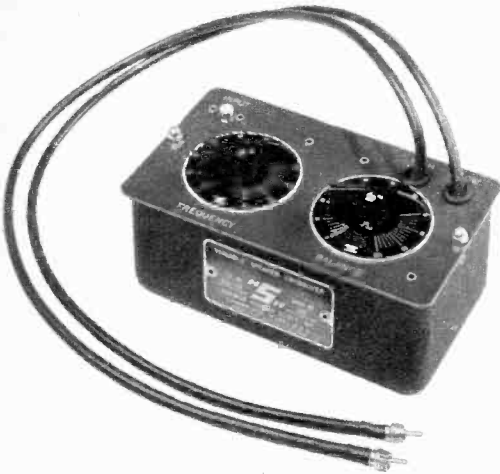

This H. H. Scott Variable Speaker Crossover allows continuous frequency and balance adjustments.

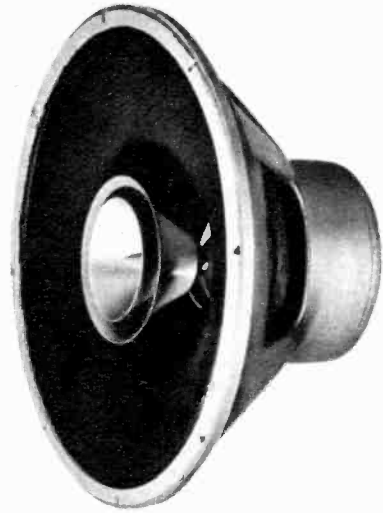

The Stevens Tru-Sonic hi-fi co-spiral speaker gives wide diffusion of highs plus bass response.

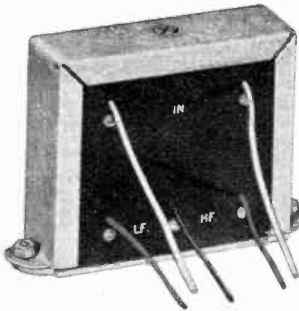

Beam's plug-in unit for crossover matches their Stentorian hi-fi direct radiator plus tweeter.

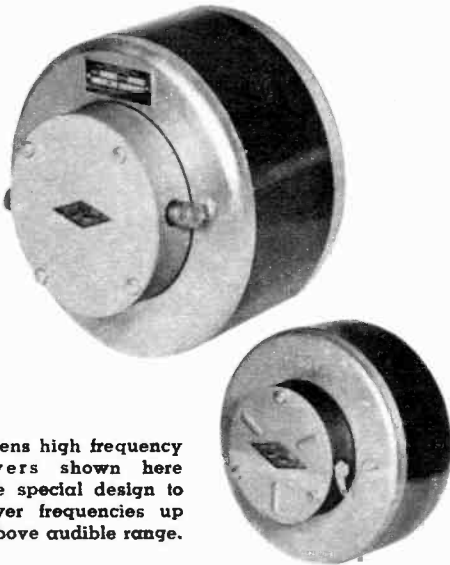

Stevens high frequency drivers shown here have special design to deliver frequencies up to above audible range.

tween the two segments, which provides diffraction at the higher frequencies and smoother overall dispersion. Most of these speakers also have a dome-shaped aluminum diaphragm at their apex, which causes the high frequency element to act more like a true horn. The Permoflux *Super Royal* line uses a flared cone rather than the usual straight-sided one, which along with a stiffened throat provides exceptional high frequency response for a single-element speaker. Its cone also has a number of radial slots around the mouth opening, with consequent lowering of the resonant frequency by about an octave for improved bass response. The RCA *accordion cone* speaker has the outer edge of the cone floating, without contact with the supporting ring. Support is then obtained by folding back the cone material accordion-wise to meet the frame. This seemingly small modification very greatly smooths out the response characteristics over an extended frequency range. This speaker is manufactured only in a 7-inch size, but very excellent bass response is obtainable through the use of *two* of these low-priced units in the same enclosure.

Selecting Your System

If any element in the high fidelity system can be said to merit more careful buyer consideration than the others, the speaker and its associated enclosure are first in

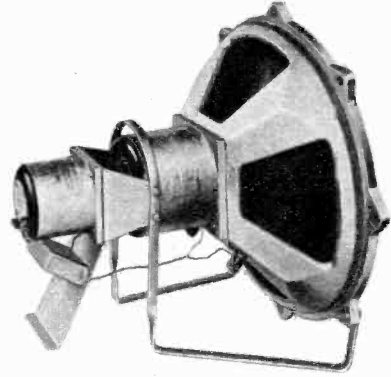
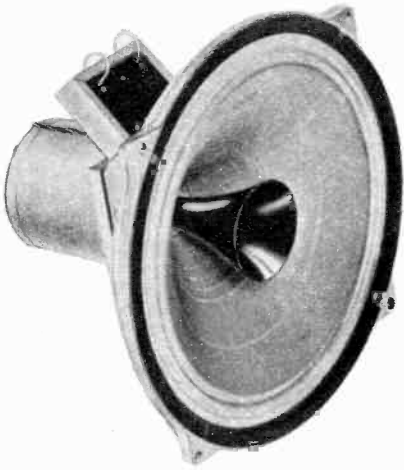

Largest of Beam's high fidelity units is this 18-in. British-made unit by Famous Whitely Electric Radio.

Beam Full Range Duplex 12-in. speaker includes built-in crossover network in this "Stentorian."

line. This is not because the speaker is any more important, but only because it is so deficient as compared with the rest of the system. Differences in amplifying equipment today are almost purely academic, but disparities in speakers are tremendous. Thus your purchase of a satisfactory speaker system will require a wholly disproportionate expenditure of your time and—perhaps—money. Tremendous improvements in speakers have been accomplished, of course, but the challenges which the designers have yet to meet are greater here than anywhere else.

There is only one sure way to choose a speaker which is suitable for you, and that is to listen, listen, and then listen some more. Listen in homes and listen in high fidelity salons, wherever you can find good sound systems. Listen under varying degrees of loudness and listen to all types of music. Watch out for exaggerated thudding bass, harshly brittle highs, hollow mid-range, and extraneous "ringing." Eventually a pattern will emerge and you will have separated the fuzzy speakers from the clean ones. Finally your choice will be narrowed down to three or four. After that your pocketbook will help you decide, and you may be pleasantly surprised to learn that the speaker which fits your needs can be obtained at very reasonable cost. Now your only worry is a suitable enclosure which will be best for your speaker. •

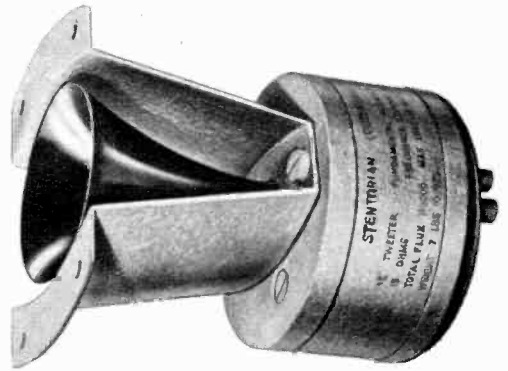

Beam "Stentorian" tweeter has an edgewound aluminum wire speech coil, giving from 2 to 20 kc.

Stevens Company's model 800 crossover network crosses at 800 c.p.s. between bass, treble units.



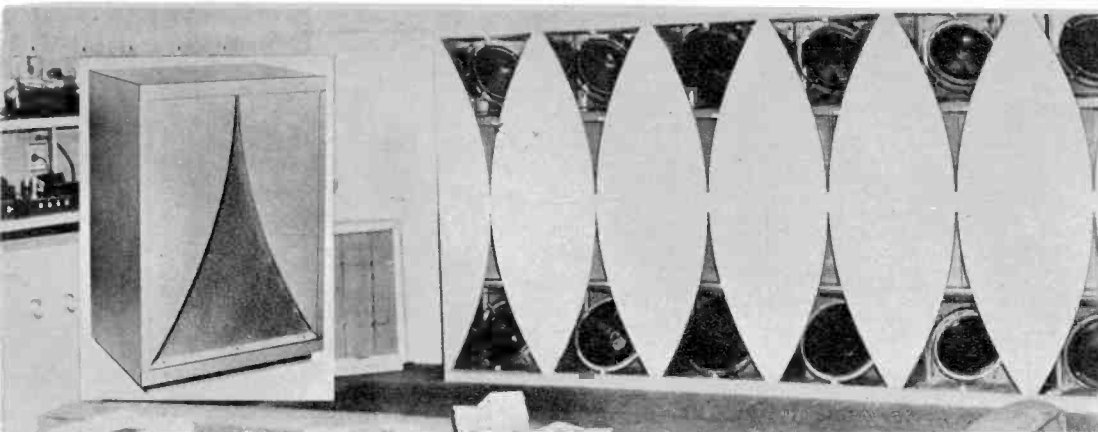

Karlson Enclosure, inset left, is used by Hudson Radio's Newark, N. J., store for comparing 12 speakers.

Enclosures and Cabinets

Essential for high fidelity of sound, the loudspeaker housing shapes sound waves to give least cancellation and the truest bass response.

THE cabinet which houses the loudspeaker may also contain other units of the high fidelity system, and it may be a decorative piece of furniture, but above all it must act as a *baffle* for the speaker system.

Any direct-radiator produces actually two sets of sound waves simultaneously, for at the same time that the molecules of air in front of the cone are being compressed or rarefied, a similar but opposite action is taking place at the rear. The two waves are then said to be 180° out of phase, and when they are permitted to meet there will be a partial cancellation of the opposing pressures, an effect which is more pronounced at the long-wavelength bass end of the audio spectrum. In order to effect good low frequency response in a speaker, then, it is necessary to include some means of preventing this back-to-front cancellation.

Flat Baffles

The simplest means of doing this is by the use of a *flat baffle*, which is simply a board with a hole in it, against which the speaker is mounted. The back wave must then travel out to the end of the baffle and turn around to the front before it can cause any interference. In order to avoid this effect completely, then, the flat baffle would have to be infinitely large. The closest practical approach to this condition is reached when the speaker is mounted in a wall

between two relatively large rooms. This system has the advantages of simplicity, freedom from cabinet resonances, and saving of floor space.

A more practical form of the flat baffle is obtained when the edges have sides attached to them at right angles, thereby forming an open-backed box. But this method, which is the type often utilized in commercial radios, sets up its own sympathetic low-frequency vibrations, causing an unnatural booming bass response.

Closing off the back returns us to the idea of the wall-mounted infinite baffle, with the large room to the rear being replaced by a small box. As the dimensions of the enclosure decrease, however, the natural resonant frequency of the speaker is increased, which once again causes booming bass and very poor response below the resonant frequency.

Phase Inversion

At this point we might inquire if the back wave could be useful to us if it could go through some sort of phase inversion process, and then ultimately appear in phase with the front wave so that it would add to it. This could be done if our baffling inserted a time delay of just the right period, and since the velocity of sound is constant, the time delay could be determined by the length of the back-to-front path. But the wavelength of sound varies with its frequency, so that the phase re-

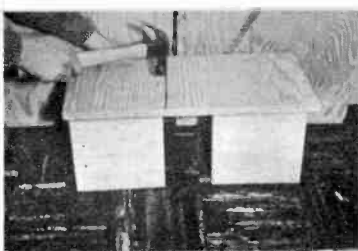

Supplied in both completed form and in pre-cut plywood kits is the Karlson enclosure.

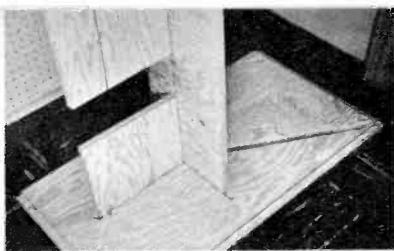

Hammer, clamps, nails, and glue are all that is needed to assemble the pre-slotted pieces. Heavy plywood is material used.

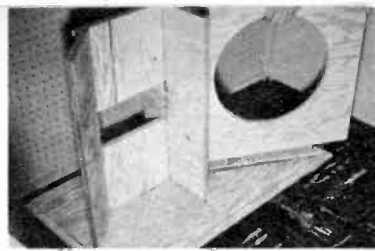

Loudspeaker mounting board is set at angle for radiation of sound waves.

Speaker mounting opening is made for 15-in. unit; adapters are sold for 12 or 10-in. units.

All parts must be glued as well as nailed. Reproduction of a full orchestra builds up large pressures inside the speaker baffles.

Kit can be finished with paint or veneer. Ready-made units use Formica.

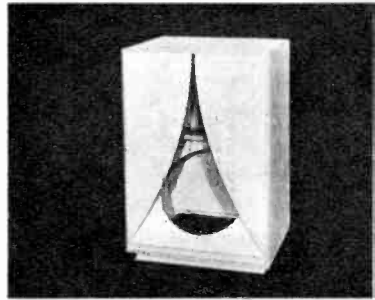
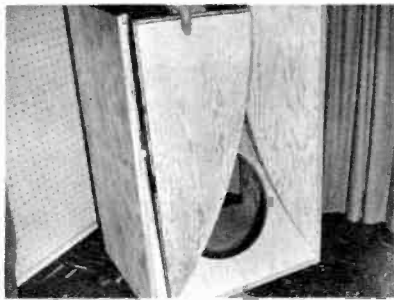
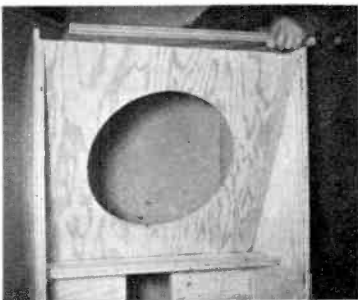

relationships would also vary with frequency for a given period of time delay. In practical phase inverters, then, the time delay is chosen for an in-phase reinforcement of the normally deficient bass frequencies, while at the same time absorbent material in the cabinet damps out the higher tones which might cause cancellation effects or undesirable peaks.

One practical form of the phase inverter is the *acoustic labyrinth*, an old idea which has been dusted off and is achieving renewed popularity. As its name implies, it is a series of baffles which provides a "mystic maze" pathway for the low frequency back wave resulting in an in-phase bass boost. This system had fallen out of favor only because of its relatively complex construction, but since so many of today's designs are even more complicated, this one is showing signs of a real comeback.

The Bass Reflex

If we cut a small port or vent in the front of our fully-enclosed box, we then have the beginnings of a tuned box or *bass reflex* enclosure, which is another form of phase inverter. This system cuts off about an octave above the labyrinth characteristic, but it has the advantage of unusually good bass response for so small an enclosure. The box is ordinarily tuned to a frequency somewhat below the speaker's own resonant peak. It then extends the bass characteristic to a new low and also

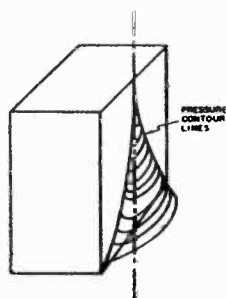
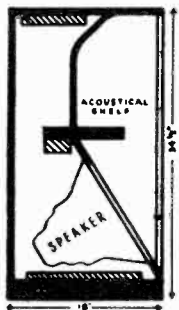

Inner baffles help drive sound through opening.

broadens the speaker resonance somewhat, resulting in much smoother over-all bass response. Because of its simplicity, low cost, and small size, the bass reflex unit is unquestionably the most popular enclosure in use today.

Most experimental effort on high fidelity enclosures today has as its objective an even better bass response than is exhibited by the bass reflex, while at the same time retaining its advantages of simplicity and small size. Designers in the field are coming more and more to regard the speaker and enclosure as a musical instrument, and to apply to its development the principles of musical physics.

A prime example of such reasoning is the *R-J* enclosure, which is based upon the principle of the *Helmholtz resonator*. The body of a guitar, for example, is such a

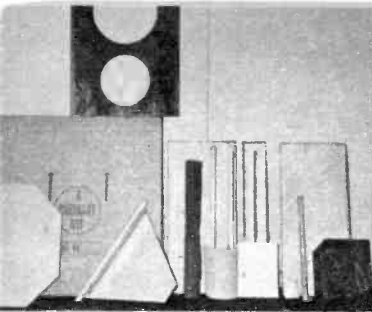

Cabinet enclosures made by G&H Wood Co. come in kit and in completed form.

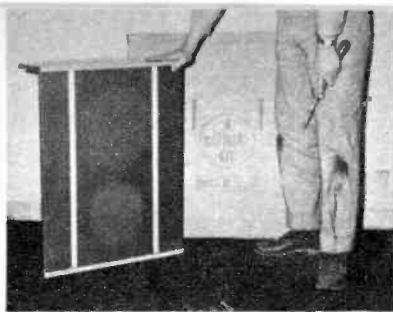

Cabinet, completed at home from kit at left, is a Klipsch designed true corner horn enclosure for 12 or 15-in. speaker.

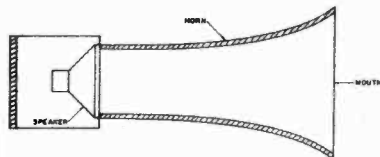

Directional baffle of exponential horn type, above, is ingeniously folded in a Klipschorn.

Cutaway illustration of the Fortissimo enclosure, right, uses multi-speaker design.

Made by Permoflux Corp., this Fortissimo unit has dual 8-in. woofers plus tweeter. Cabinet design below forms a folded exponential horn.

A Klipschorn sectional shows baffles which make the walls a horn.

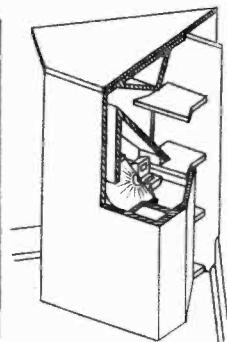
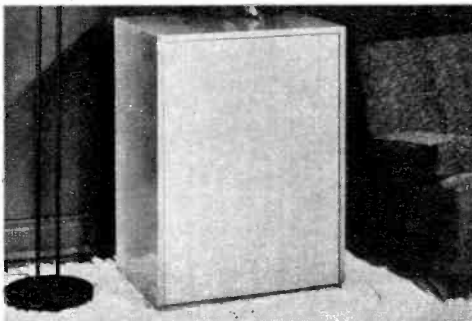
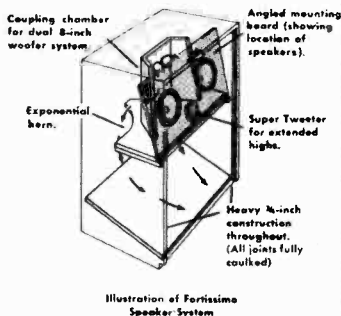

resonator, and it has the very desirable characteristics of small dimensions as compared to the wavelength of sound at its resonant frequency. It would seem to be a logical assumption, then, that such a box might serve well as a loudspeaker enclosure, with good musical response in a reasonable size.

To understand the operation of the resonator, let's consider what happens when a guitar is held face up and the strings are strummed. Air is set into motion by the string vibrations, and some of this air pushes up and down over the sound hole, and against the mass of air enclosed in the body. This action is analogous to a weight on a spring, and is reminiscent of the childhood trick of jumping up and down on a bed spring. As any kid soon learns, he can time his jumps so that he can derive maximum upward push from the springs with a minimum of effort on his part. This period of maximum efficiency can be regarded as the *resonant frequency* of the mechanical system.

The Helmholtz resonator, too, as its name implies, has a resonant frequency, and a very sharp one. This means that the air pressures built up at resonance will be very much greater than those at any other frequency, even those close by. Since sharp peaks in the system response are very un-

desirable, some means would have to be found to broaden this resonance curve, if such a system is to be useful as a speaker enclosure.

In the R-J enclosure the speaker is mounted within the cabinet on a baffle board which is somewhat smaller than the dimensions of the cavity. The face of the cabinet has a rectangular or oval sound hole, and the speaker board is separated from the front board by an inch or so. This construction forms a duct through which the back wave can travel to join the front wave, and both emerge from the sound hole together. Proper dimensioning of this duct is the secret of a broadened resonance curve. The unit is padded internally, of course, so that only the bass frequencies are radiated. The result of all this is an enclosure providing about an additional octave of clean bass response and excellent transient response as compared with the bass reflex, and it is accomplished in a cabinet only 20 inches square and 16 inches deep!

Directional Baffles

An ever-present problem in the design of loudspeaker systems is the very low efficiency at which these units operate. The acoustic power radiated by a speaker alone may be only 5% of the total electrical

power delivered by the amplifier to the voice coil, and one of the important functions of the enclosure is the more efficient coupling of the speaker source to the air load surrounding it. One such arrangement uses a short horn directional baffle which flares out beyond the speaker cone. An enclosed box lined with sound-absorbing material completely surrounds the rear of the speaker, thus preventing any radiation of the back wave. At low frequencies the cone functions as a piston, providing efficiencies on the order of 25%.

An ingeniously compact design based upon these principles is found in the *Klipschorn*, employing a directional baffle in which the horn folds back upon itself several times before forming the mouth. Despite the radical curvature, the taper follows an exponential rate of expansion. Furthermore, it is designed to be fitted into a corner, so that the walls of the room act as a natural extension of the walls of the horn. While the low frequencies will follow freely the sharp folds in the enclosure, the high frequencies will be dissipated. Thus this unit has a frequency response of only about 15 to 1,500 c.p.s., and is equipped with a separate unit for high-frequency reproduction.

The need for two completely separate

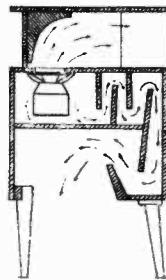
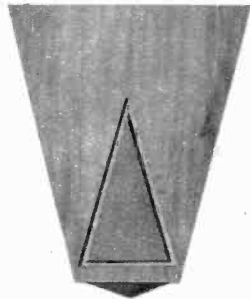
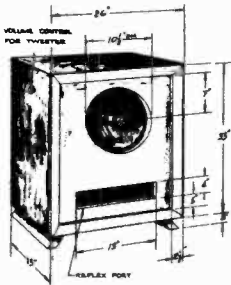

University Loudspeakers supply diagrams, as left, for bass reflex cabinets. Kingdom Products' Lorenz Sound Corner hangs woofer and tweeter high on wall. Ceiling and walls act as horn extension.

The Brociner model 4 corner enclosure uses a small high quality English speaker as the driver in this baffled unit. High frequencies come out the grill at top of cabinet; lower bass travels through the baffles and comes out bottom or sides as shown left.

Noted Klipschorn, at right, is made by Klipsch & Associates, and by other licensed manufacturers. Enclosure by Electro-Voice, left, shows phantom speakers inside, following the Klipsch design.

Cutaway of Stromberg-Carlson's Custom Four Hundred acoustical labyrinth with coaxial speaker shows travel of bass reinforcement. Consoles in limed oak and other finishes assemble as at right.

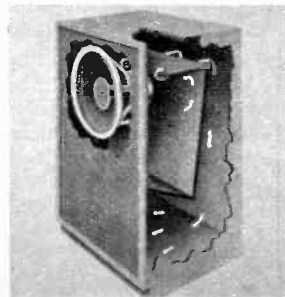
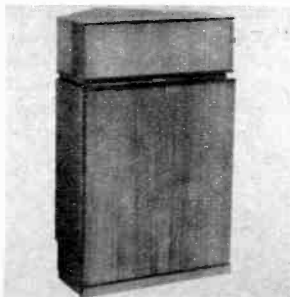

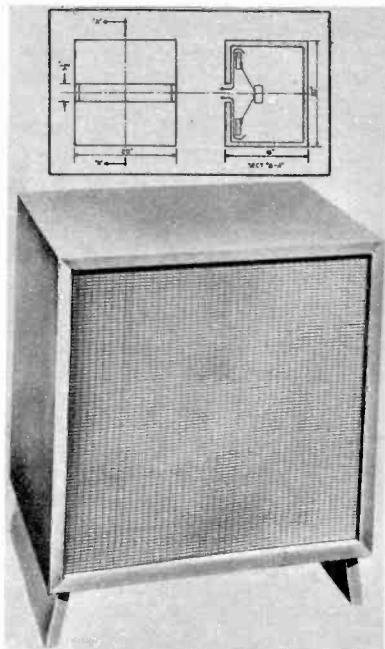
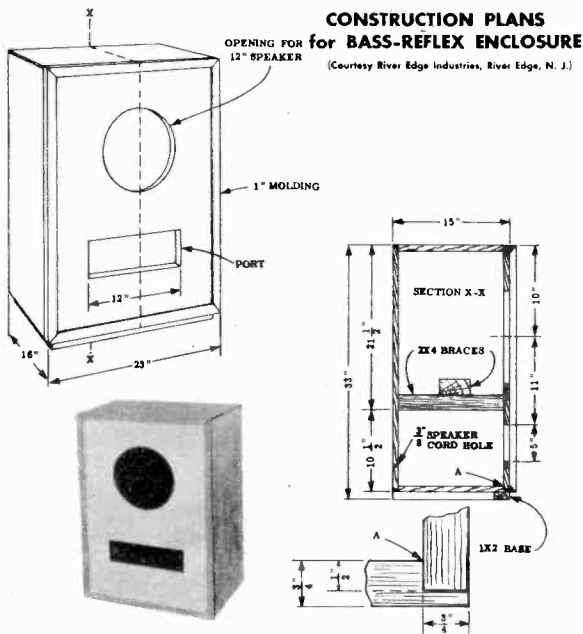

Radio Craftsmen, Inc., provide make-it-yourself plans from famous enclosure makers to accompany their hi-fi components. Jensen and Electro-Voice folded horn plans are also available.

Excellent response from a small cabinet is provided by the R-J Audio Products cabinet. Helmholtz principle is used.

proper dimensioning of a piece of transmission line, the section will act as a matching device between two unlike impedances. Now since sound will travel readily through hollow structures, perhaps such a device could be used for audio, with the speaker source at one end of the matching section, and the air load at the other.

This idea is employed in the *transflex* unit, which is a part of "The Reproducer of the Future," developed by the Jensen Manufacturing Company. This unit is used for the very low bass response only, cut off by a crossover network at 45 c.p.s. The range from 45 to 600 c.p.s. is handled by a back-loading folded horn, and two tweeters transmit the ranges from 600 to 4,000 c.p.s., and from 4,000 c.p.s. up to the limits of audibility.

The Karlson Coupler

John E. Karlson has employed these basic concepts, but has come up with a much different result in the *Karlson Ultra-Fidelity Enclosure*. The inventor modestly describes this unit as "no miracle, just the application of well-known basic theory," but it is in fact a truly beautiful piece of scientific reasoning, with an ultimate solution which should please even the most highly critical. With a high quality speaker, the performance of this system is unsur-

passed, despite the fact that it is only 22x34 inches high, and 18 inches deep.

The basic idea of this enclosure is that of the *closed pipe*, a common musical device which is used in the piccolo, flute, and some organ pipes, which are open at one end and stopped at the other. When such a pipe is appreciably longer than it is wide, it will resonate at a frequency whose wavelength is four times the length of the pipe itself. It will also resonate at all of the odd harmonics of this frequency, or if it is producing a tone, the sound will be rich in the odd harmonics of the fundamental. But if a tapered slot is cut into the open end of the pipe, the resonant peaks will be broadened considerably, and if the slot is extended to a point where it is longer than two-thirds of the total pipe length, the resonant condition just about disappears. Now if the slot is given an exponential taper, and if the pipe is of correct dimensions, it will have absolutely uniform response throughout the audible range, while at the same time retaining the "acoustic transformer" effect of a quarter-wavelength matching section of transmission line.

The Karlson enclosure, then, is an adaptation in cabinetry of the slotted pipe, which enables the most efficient use of coaxial speaker systems and eliminates the phase distortion characteristics of multiple

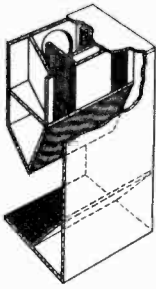

Back-loaded folding horn for 15-in. Jensen loudspeakers, shown above and below, is one of many Jensen designed cabinets supplied by them completed or as plans for home construction. Even 8-ft. transflex enclosure is planned.

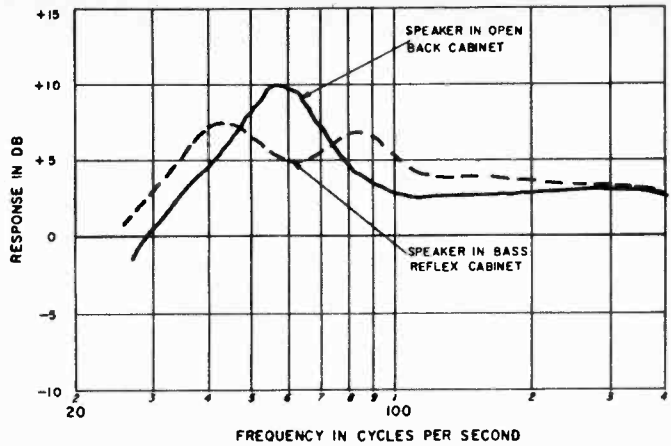

Importance of enclosure is shown in this graph from the David Bogen book, "Understanding High Fidelity." Passage of sound through a Klipsch folded horn is shown in Electro-Voice "Patrician" plan below.

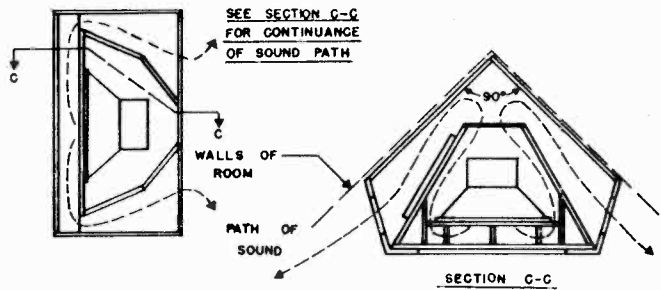

systems, where various parts of the audible spectrum arrive at the ear from separated sources. It is absolutely free from resonance, has optimum transient response, and has a radiation pattern which is essentially uniform at all frequencies throughout a solid conical angle of around 120° . It is a new departure in speaker system design, and a new standard of performance.

Construction and Installation

When building your own enclosure, sturdiness and rigidity are essential to avoid vibration. All joints should have an air-tight fit, and be held with glue and screws. The stock should be heavy, $\frac{3}{4}$ -inch plywood being recommended for most applications. Sound-absorbent materials which have been found useful for the interiors include 2-inch-thick Fiberglas or rock wool. This is readily available at lumber yards, and should be obtained with paper backing on only one side. It should be installed *before* the speaker is mounted, to prevent small fragments from getting into the driver mechanism, and a further excellent precaution is to cover the pads with cheesecloth. The speaker can then be bolted or screwed into place, taking care that *all* of the holes provided in the mounting are used.

The output terminal strip of the amplifier usually has a common connection point—sometimes marked *G*—and one of a pair of wires is connected from this terminal to one of those on the speaker. Several transformer taps also terminate at this strip, and since most loudspeaker voice coils have an impedance of 6 to 8 ohms, the remaining wire is usually connected from the terminal marked *8* to the other point on the speaker. When crossover networks and multiple speakers are involved, the connections become a little more complex, but the manufacturer will always provide you with detailed instructions which apply to your particular installation.

And now we are at the end of our system, and yet it is really only the beginning. For the process of reconverting electrical energy into sound is absolutely the most formidable task to be performed anywhere in the entire high fidelity chain. As we have already noted—and cannot repeat too often—your speaker system is of primary importance. Nowhere else in the system is there such a very great difference between components of various manufacturers. So proceed slowly, make your choice carefully, and you will choose wisely. When you do, true sound pleasure awaits you. •

Tape Recording

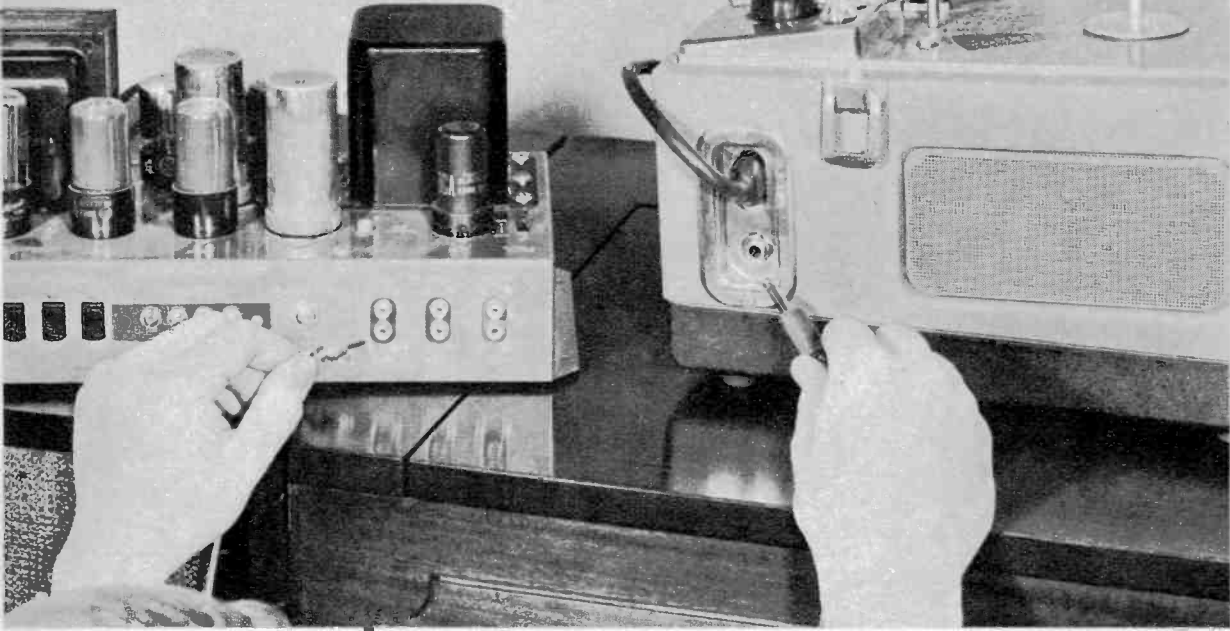

Adding a tape recorder to your hi-fi system is usually as simple as plugging it into the amplifier.

Tape is capable of reproducing the complete sonic range, and high quality tape recorders now make possible transcribing sound with great fidelity.

WE usually regard magnetic recording as a recent development, a war baby born out of the need of our Armed Forces for a ruggedly portable means of recording military information. It is surprising to learn, then, that a magnetic wire recorder was patented in Denmark in 1898 by Vlademar Poulsen, less than twenty-five years after Thomas Edison invented the phonograph.

Early development in the United States also centered around wire as the recording medium, although the Bell Telephone Laboratories did considerable work with steel-tape machines, and the tape-recorded weather report became a familiar telephone service in major cities before World War II. During the war, the Germans perfected the use of magnetically-coated paper and plastic tapes, and it soon became evident that this method

Word "Tape" appears this way when made visible by special 3M Scotch recording tape process. Visi-Mag, from Magneccessories, does this also.

of recording sound was vastly superior to anything previously known.

Recording tape as we know it today consists simply of a quarter-inch ribbon of cellulose acetate, coated with a red iron oxide which looks very much like ordinary rust. The dull red oxide becomes the face of the tape on which the sound is recorded, while the shiny plastic base provides the backing. This oxide is very finely powdered, with no particle being larger than 1/25,000th of an inch. Thus we can think of recording tape as billions of microscopically tiny magnets arranged at random on the surface of the plastic ribbon. The job of the tape recorder is to rearrange these particles into a specific magnetic pattern which is determined by the sound at the input of the machine. And it must also "read" this magnetic pattern, and from it recreate an exact facsimile of the original sound. Let's see how it does it.

Recorder Operation

A common experiment of many boys of scientific bent consists of wrapping a coil of insulated wire around an iron nail and connecting the ends of the coil to an electric battery. Within a few moments the nail becomes permanently magnetized. This same basic principle is employed in the making of a tape recording. The audio currents in a recorder are constantly varying, however, and if we continuously magnetized the same section of tape, each succeeding change in the current would rearrange the magnetic pattern and obliterate what had gone before. We can therefore see that the tape must be constantly in motion, with a fresh section of tape



always in position to receive the magnetic impulse of the latest change in the audio current.

The device which pulls the tape through the machine is called the *tape transport mechanism*, and the system employed in most commercial machines is known as *capstan drive*. The capstan is simply a flat metal or rubber cylinder, mounted on the end of a motor shaft. The tape wraps partly around the capstan as it is pulled from the supply reel, past the recording heads and onto the takeup reel. The need for perfectly constant speed in the transport mechanism is about twice as critical as it is in a disc playback turntable. For while the speed variation in a commercial record is rather negligible, any wow or flutter which is introduced in the making of a tape recording will be just about twice as bad when it is reproduced on the same machine. This is an extremely important factor in your listening pleasure, and you would be wise to look into it carefully before investing in a tape recorder. Most people can detect a speed variation of 0.5%, which is the usual rating of the lowest priced machines. The best amateur equipment is rated at 0.25%, while professional equipment has 0.1% or less. Of course your own ear is still the final judge, but these figures will at least provide you with a starting point.

Latest Ampex tape unit, this recorder is one of those which meets professional standards at home.

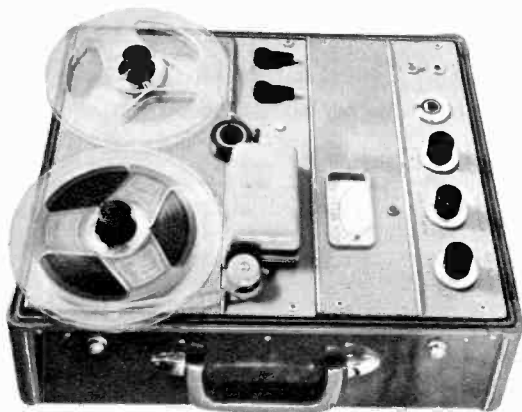

This playback unit by Ampex does not record but can be used with the new pre-recorded selections.

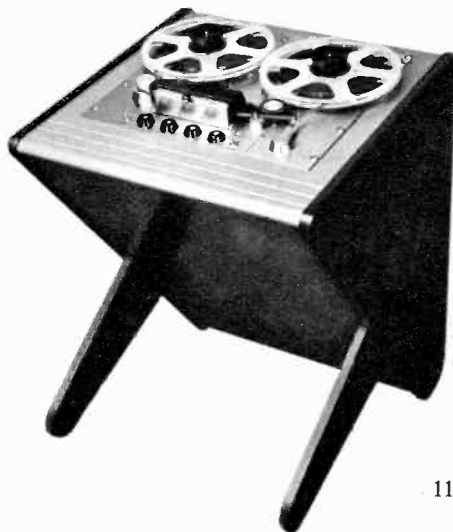

QUALITY IMPAIRMENT OF SOUND DUE TO TWISTING OF RECORDING WIRE

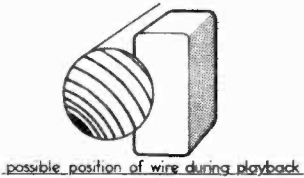
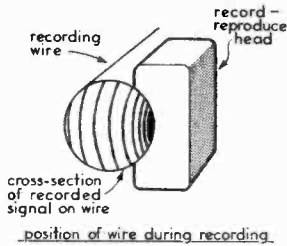

Wire, though practical for voice recording, does not give high fidelity. It may twist on playback.

Concertone 1500, made by Berlant Associates, is another unit approaching-professional fidelity.

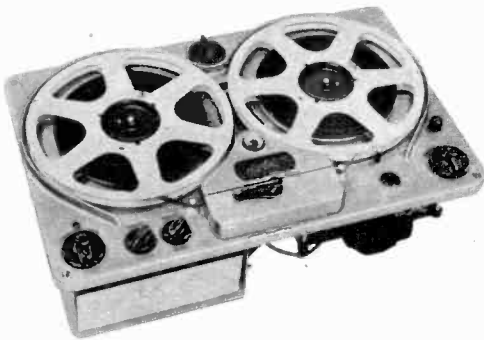

Erasing Tape

One of the many advantages of tape recording lies in the fact that a recorded tape may be played repeatedly with no loss in quality, or the same tape may be used for recording again whenever desired. When the tape is to be reused, the old sound is removed from it just a fraction of a second before the new sound is recorded. This process of removing the existing sound is known as *erasing*. If you have ever lain on a beach and written messages with your finger in the sand, you can readily understand what this means. Your finger didn't actually change the sand; it simply rearranged some of the grains. And if you "erased" the writing by smoothing over the sand with your arm, you once again rearranged the grains so that they all looked alike, each indistinguishable from the other. And so it is with the erasing process in a tape recorder. The tiny mag-



Continuous Tape Reproducer provides new use for tape. It can play eight hours without stopping.

Current flowing through electro-magnetic head re-arranges microscopic magnets coated on the tape.

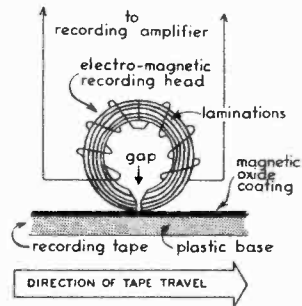

nets which have previously been arranged in a pattern during recording are completely scrambled up so that no distinguishable pattern remains. The tape is then said to be "blank" and ready once again for recording.

We have been talking all this time about the magnetic rearrangement of the particles in the tape, but there is nothing about these changes that the human eye can see. It is absolutely impossible for us, when looking at a tape, to tell whether or not it has any sound on it. The only way to be certain what sound, if any, is on a given tape, is to play it. And if there is any doubt, it is a mighty good idea to do exactly that. More than one valuable recording has inadvertently been destroyed by erasing and re-recording on a tape which was supposedly available for use. You can avoid this by labeling all recordings as you make them, and by keeping your permanent tape

library well separated from your usable stock. Remember that *all tape looks alike*. Listen *before* you re-use a tape for recording.

All tape recorders contain an erase head, a special electromagnet or permanent magnet which the tape passes before it reaches the recording head. Neither of these heads is activated, however, until you place the recorder control switch or button into the RECORD position. A very large amount of power is required to energize the electromagnetic erase head and to permit it to erase completely and quietly. Since some of the lower-priced recorders are unable to develop sufficient erasing power, you should test the machine for this before buying. Place a recorded tape which can be erased on the machine, and put the recorder into operation in the RECORD position, with the volume control turned all the way down. After the machine has run for a few moments, rewind the tape and play back the erased section with the volume control turned up rather high. If you



can still hear traces of the erased sound, or if the noise level seems unduly high, you won't be very happy with the performance of this machine for your high fidelity work.

As the tape leaves the influence of the erase head it passes the record head, which subjects it to a strong magnetic field which is varying in accordance with the sound coming into the machine. The tape is then magnetized with the sound pattern and is immediately ready for playback. In the more expensive equipment the record head is followed by a playback head, which permits reproduction from the tape only a brief instant after recording. Most amateur equipment, however, uses a single head for

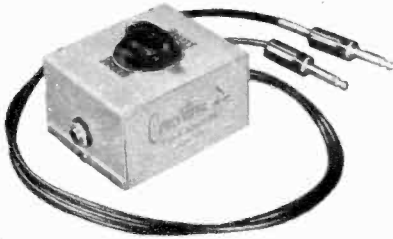

Concertone S-O-S sequential adapter allows sound-on-sound recordings, adding to previous recordings.

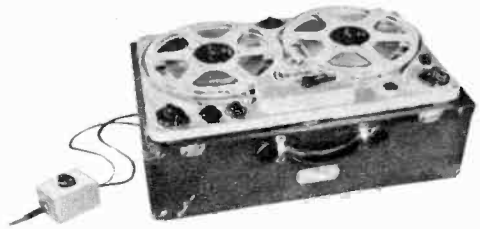

Concertone units are available unmounted for custom installation, and in carrying cases, as above.

Cabinet below is one of the cabinet recording consoles made by Ampex for professional studio use.

The Concertone Network Recorder model NWA-1 is made in two units, records at 7.5 or 15 i.p.s.

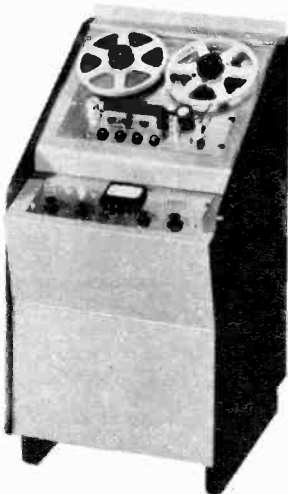



Magnecorder M80-ACC, made by Magnecord, Inc., has console mounting and professional controls.

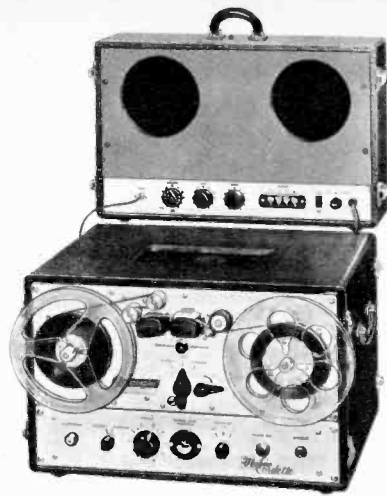

The Magnecordette provides high quality tape recording in portable form, with added twin speakers.

Magnecorders PT63JAH, at the left, and model PT6JAH, at right, are portable units delivering studio quality recording. Unit at left features twin speakers for record and playback monitoring; single speaker right.

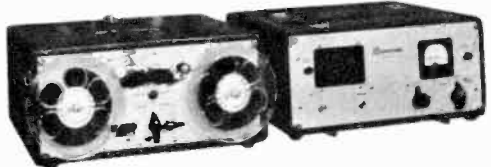
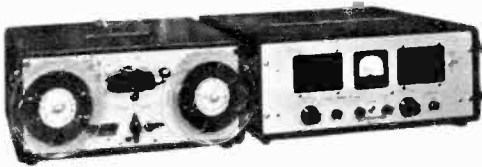

both recording and reproduction, with the result that it is impossible to hear a playback from the tape until recording has been completed.

Tape recorders also have a high-frequency pre-emphasis characteristic, for better signal-to-noise ratio. But the tape recorder manufacturers, like the phonograph companies, have never reached agreement on standards. A given tape recording, therefore, may sound somewhat different when reproduced on various machines. Since tape machines do not normally have variable playback compensators, the only way of correcting such a discrepancy is by the judicious use of your amplifier tone controls.

Dual-Track Recording

The cost of tape usage has been cut in

half by the introduction of an ingenious system known as dual-track recording. In this method only a little less than half the width of the tape is used for recording at a given time. Thus it is possible to record along the entire length of a tape *twice*, once on each half. This system has the disadvantage that it is impossible to splice out any unwanted part of one track without at the same time cutting into the opposite track. But if the other track is blank, or if the program on it needn't be saved, then it is just as easy to edit this type as single-track tape.

Once a tape recording has been properly made, with reasonable care it will last almost indefinitely. Tapes have been played in laboratory experiments well over ten thousand times with no appreciable detriment to the music, as opposed to the de-

Courtesy 3M Scotch Recording Tape

HERE IS A TABLE TO HELP YOU DETERMINE HOW

LONG YOU CAN RECORD ON A TAPE RECORDER

LENGTH	SINGLE TRACK		DUAL TRACK		
	3¾" per sec.	7½" per sec.	15" per sec.	3¾" per sec.	7½" per sec.
150 ft.	7½ min.	3¾ min.	15 min.	7½ min.
300 ft.	15 min.	7½ min.	3¾ min.	30 min.	15 min.
600 ft.	30 min.	15 min.	7½ min.	60 min.	30 min.
1200 ft.	60 min.	30 min.	15 min.	120 min.	60 min.



terioration which begins to set in after a very few hundred playings of a disc recording. And while the LP record affords us around a half-hour playing time per side, this can't begin to compare with a time of up to four hours available on some tape recorders. The machine is also exceptionally rugged and portable, while a disc recorder is rather cumbersome and requires very precise adjustment before each use. The tape itself is much less susceptible to the scratching, warping and breakage which plague disc records. Tape recorders can be bought today for less than \$100, and their cost of operation is slight. Tape can be reused repeatedly and its efficiency may be doubled again by the use of a dual-track system. In a single-track system it is possible to edit the tape in any fashion you desire. You can snip out anything you don't want, from a brief click or single word to a complete symphony. You can rearrange the sequence of various re-

cordings on your tape into whatever sort of program suits your fancy.

Yes, there is much to be said for tape recording. But it also has a couple of significant drawbacks which may rule out altogether your including it in your high fidelity system.

Quality vs. Cost

Let's consider frequency response for example. The maximum high end response of low-priced tape recorders is roughly a thousand cycles for each inch-per-second of tape travel. This means that most machines, which operate at speeds of 3.75 or 7.5 i.p.s. will exhibit an upper frequency limit of around 4,000 or 8,000 c.p.s., respectively. And since we recognize 15,000 c.p.s. as the minimum criterion of high fidelity response, we cannot avoid losing an entire octave of important harmonics.

The other big drawback of tape recorders in the low-price field is the matter of speed

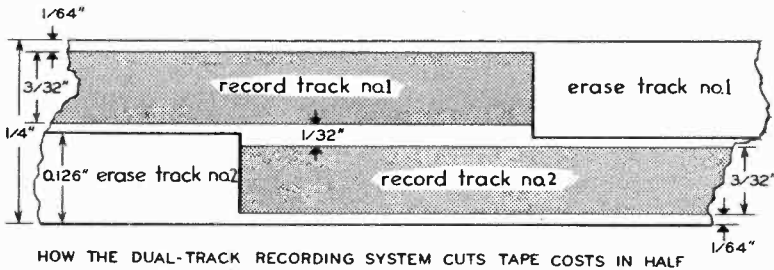

Shown above is the dual-track recording system. By using only half of the standard 1/4 in. tape at one time, recording time is doubled.

Stancil-Hoffman model R5M, right, has three microphone inputs, hysteresis motor, multiple controls, wide range recording response.

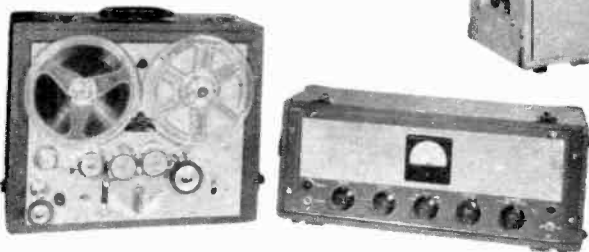
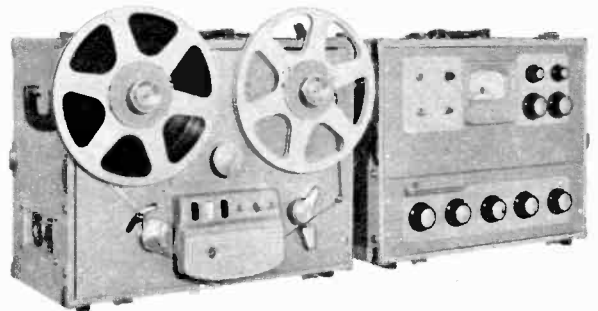

Presto, a well-known name in the recording field, makes this portable, left, as well as professional-type studio models.

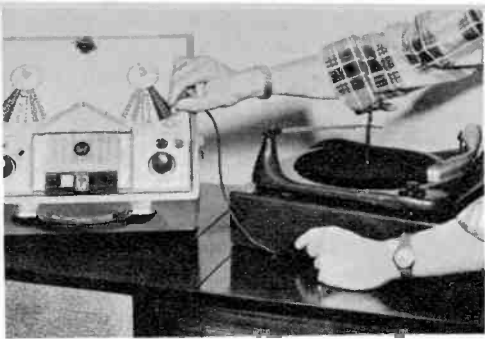

To record directly from record player, plug phono cable into low gain input rather than mike jack.

Alternate method is to connect tuner "amplifier" output to low gain recorder "radio, phono" input.

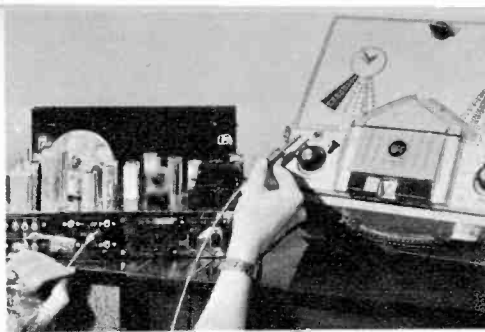

To record from radio tuner, run shielded cable from tuner output (marked "amp.") to high gain input.

Recording from radio or TV, cord can be clipped to low impedance speaker leads for low gain jack.

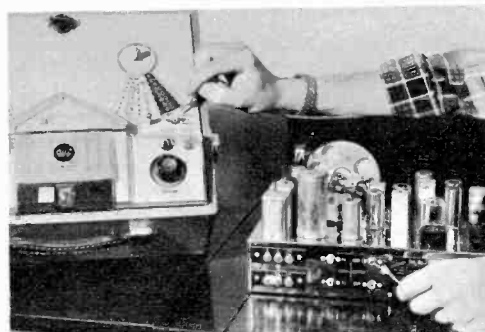

Photos at Gopher Electronics by Minnesota Mining and Mfg. Company, St. Paul, Minn.

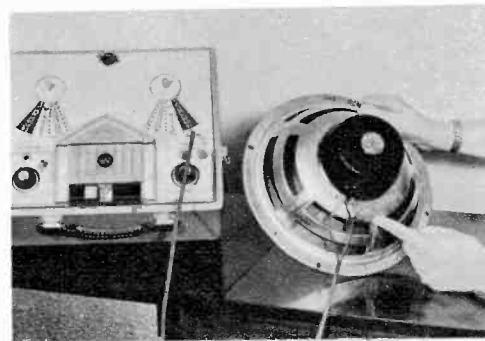

variation, which shows up as wow or flutter, or both. As we have already learned, these machines have speed variations averaging around 0.5%, an amount which does not tread lightly on the discriminating ear.

And so it would seem that, for the present at least, your tape recorder will not nearly measure up to the rest of your system—not, that is, unless you are prepared to spend around \$500 for it alone. In this price range, however, there are several exceptionally fine pieces of equipment manufactured by *Ampex*, *Concertone* and *Magnecord*. The exciting new *Ampex 600*, for example, offers the full range of 30 to 15,000 c.p.s. at 7.5 i.p.s., with very low noise and excellent stability of the drive mechanism. It also provides many other operating features which were heretofore available only on expensive professional equipment. For maximum performance at a moderate price, this recorder is hard to beat.

But unless you can afford a unit such as this, you would do well to consider carefully before buying any tape recorder. If, however, after repeated listenings you find the sound of a certain machine to be still pleasant, even if it is not truly high fidelity, then by all means make the investment. You will discover numerous ways in which

your machine will provide you with many hours of enjoyment.

So let us suppose then that in your mind the advantages outweigh the disadvantages, and you are definitely going to include a tape recorder in your system. You will spend a lot of time shopping and listening, and finally will hit upon a machine which you are certain is the very best value for the amount of money you wish to spend. As soon as you get it home and unpacked you will probably want to begin immediately to record the sound of your own voice. But wait a moment! First *be sure* that you are thoroughly familiar with the contents of the instruction book supplied by the manufacturer. Your machine is rugged, yes, but don't risk expensive damage to your investment by failing to put it into service properly.

Finally, however, you will feel that you have a speaking acquaintance with your recorder. So you'll pick up the microphone, start the machine, set it on RECORD and say a few words. Then you'll rewind the tape, play it back—and be dead certain that something is very wrong, because you *know* that your voice doesn't sound like that. But don't be too hasty—better let someone else listen. They'll probably tell you the shocking truth that that *is* the way

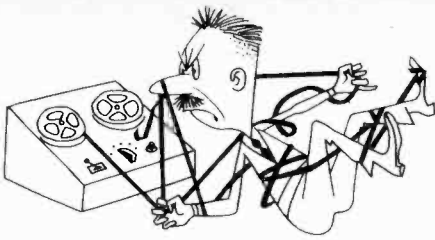

you sound. It may be difficult for a while to accept this fact, but you will eventually realize the truth of it, gain confidence in your machine and prepare to use it for your serious high fidelity work.

Off-the-Air Recording

One of the simplest, and yet most rewarding, projects you can undertake with your tape recorder is the recording off-the-air of radio and television broadcasts. Here you have the world's great performers, producers and engineers working

for you free of charge, enabling you to assemble your own tape library of outstanding performances which you might otherwise never hear again. You may not employ these recordings for any commercial purpose, of course, but you may retain them for your own personal pleasure, to be enjoyed over and over again whenever you desire.

As you put a new roll of tape into service, it is good practice to place the full reel on the takeup spindle at the right of the machine and rewind it fully onto an empty

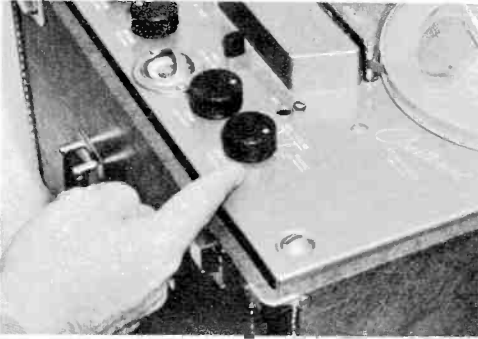

Some units, like this Crestwood 401, have selector for "play," "microphone," "radio," and "phono."

Single jack of Revere, upper right, has two sets of inner contacts for its different purpose plugs.

Crestwood 401, which requires external amplifier and speaker, has two inputs and one output, right.

To play tapes through external speaker, clip cord from "extension speaker" output to speaker input.

Magnecord amplifier, below right, has standard screw terminal board and cannon plug connections.

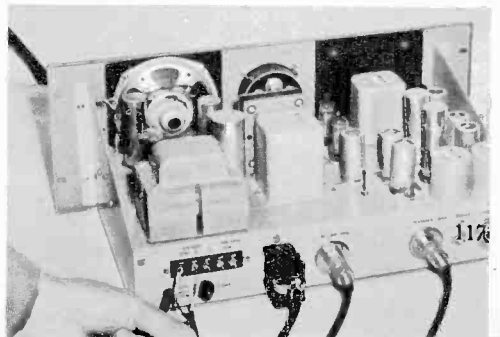
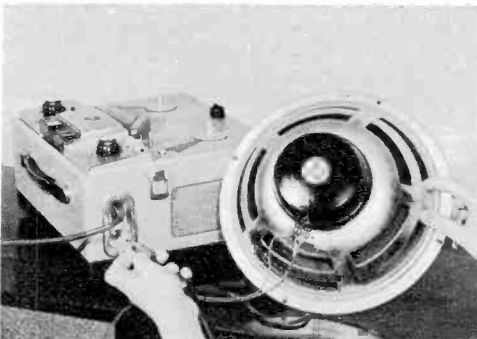
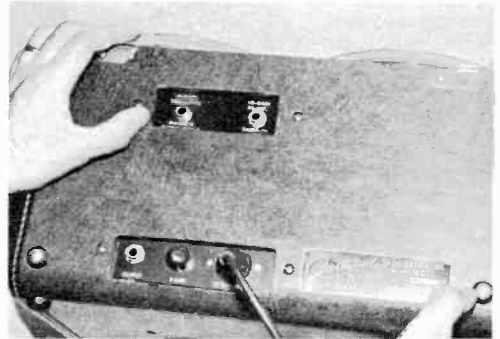

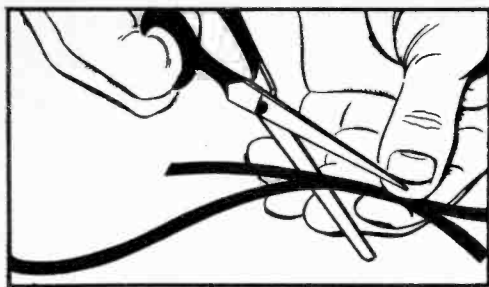

To splice tape for noiseless joints, first overlap ends and cut through both at a 45 degree angle.

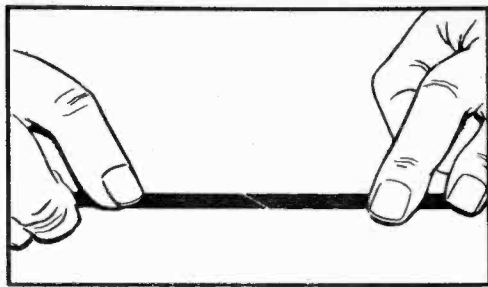

For a splice that cannot be detected, next position the tape ends so that they butt perfectly.

Over the back of the splice, apply a short strip of splicing tape. Ordinary tape will gum reels.

Now trim off excess tape, as shown below. Make cuts slightly concave, trimming into spliced tape.



3M Scotch Tape photos

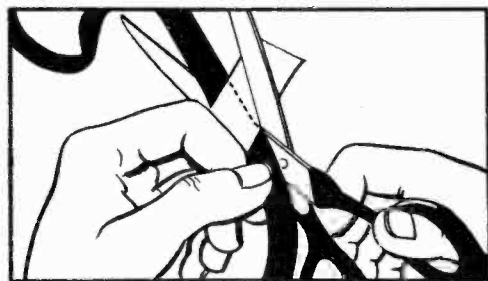

reel on the supply side to your left. This will loosen up any sticky spots which the tape may have acquired in shipping and storage, and will also leave it rewound at proper tension for use with your machine. Both of these conditions can cause jerkiness in the movement of the tape past the heads, resulting in wow, flutter, or a third form of distortion known as *tape skip*.

There are several common methods for connecting the tape recorder into the high fidelity system, and your instruction manual will recommend the form which is best for your machine. With the equipment connected and power turned on, the first step in off-the-air recording involves setting the tuner or TV receiver to the desired station and adjusting the speaker volume to a comfortable level. When the tape recorder has had a few minutes to warm up, start the recording operation with the volume control on the machine turned all the way down. Then gradually raise the volume until the recording level indicator shows that the proper signal is being applied to the tape. The correct level is one in which the sound is well above the inherent noise level of the tape, while not so loud as to cause overload distortion.

Volume Indicators

The simplest and most common type of level indicator on tape machines is a single neon bulb, which flickers whenever a predetermined peak signal is being fed into the recorder. The volume control should be adjusted so that the bulb lights to full brilliance only occasionally, and on the very loudest peaks. When this indicator is used properly, a perfectly modulated tape will result. A refinement of this system employs two neon bulbs, one designed to ignite at peak levels and a second intended to operate at the lower average levels. With this system the volume control is adjusted so that the "average" indicator operates almost constantly, while the "peak" indicator lights only occasionally.

Another type of level indicator employs the *magic eye* type of tube which was commonly used as a tuning indicator on the better radio sets some years ago. The face of this tube contains a fluorescent-coated target which glows with a ring of light when power is applied. This ring is broken by a wedge-shaped shadow fanning out from its center. The width of this wedge decreases with increasing signal, finally narrowing down to a single straight line.

The volume control should be adjusted until the shadow *just barely* closes down on maximum peaks.

The most precise means of measuring level in common use is the volume indicator meter. This instrument gives an exact indication of the relative levels being applied to the tape at every instant. The scale on such a meter reads in percentage of modulation, or volume units, or both. Whichever notation is used, the largest area of the scale, which is in black, should be regarded as the normal working range. Above this range the scale extends for an additional three decibels, marked in red, which might be thought of as the "safety area." The volume control is adjusted so that an occasional signal peak drives the meter pointer to the top of the working



range (marked as 100% or 0 VU), but *almost never* "spills over" into the red safety area.

With the level properly set, make a note of the setting of the volume control on the recorder and then turn it fully down. Make no further adjustment to the volume setting on the radio, or you will have to calibrate all over again. Now rewind the tape to the beginning of the reel and place it in readiness to start the final recording. Lis-

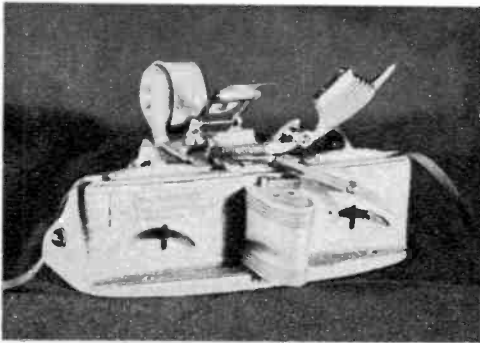

Convenience for professional or amateur editor with much splicing is this Soundcraft Hollywood.

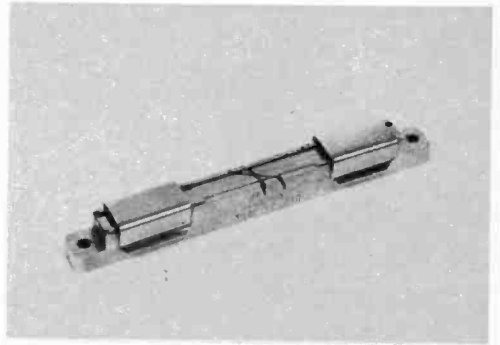

This small handy splicer is made by the Carson Co. Provision is made for diagonal or straight cuts.



A special splicing tape. Scotch Tape No. 41, is made with an adhesive that will not ooze or gum up the adjacent layers of tape.



Irish Professional Grade tape, above, Scotch High Output 120, below, as well as Reeves Soundcraft and Audiotape, not shown, are among best for hi-fi.

Leader and Timing Tape, No. 43, has white and colored sections, each representing one second on a 3 3/4 i.p.s. machine, half second on a 7 1/2 i.p.s.

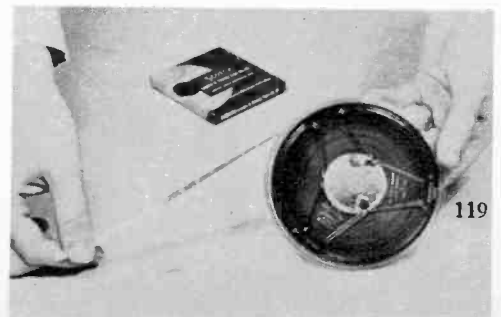
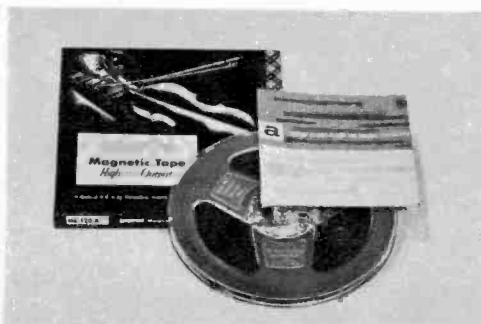



At the forefront in the rapid development of magnetic tape has been Dr. Wilfred W. Wetzel, Director of Magnetic Research, Minnesota Mining & Mfg. Co.

The Telectro-Tape portable, small efficient recorder shown below, produces fine sound for its low cost. Truthful maker, unlike some, does not call it "hi-fi."



Magnemite recorder, left, is one of a number of special purpose recorders made by Amplifier Corp. of America. They also produce binaural mike head.



ten to the program until the part you wish to record is about to begin. Then turn on the recorder and let it run with the volume control turned down until the desired performance begins. A little practice will enable you to anticipate what is going to happen well enough in advance so that you can eliminate from the tape those parts you don't want. At the same time you will quickly fade up the volume control to the pre-set point so that you won't miss anything from the desired part of the performance. By using this method, you will be able to hear what is happening on the air at all times, even when you are not recording. Thus you can do a considerable amount of "editing" out of station breaks, commercials and other extraneous material simply by careful operation.

Copying Disc Records

Other record collectors and your public library are good sources of disc recordings which you may borrow for re-recording onto tape. And if any of your own records are irreplaceable, you can save wear and possible damage by transferring them permanently to tape. Obviously you wouldn't want to infringe upon the record manufacturer's rights by putting such copies to commercial use, but rather would confine such activity to your own private library, building up a tape collection of your best discs and those of your friends.

The method of connection is similar to that for off-the-air recordings, but the techniques are somewhat different. In this case, especially if the records are old and noisy, you will want to minimize the sur-

face noise under the music, and to eliminate it completely during the lead-in and lead-out. You will begin by adjusting the compensator and tone controls for the sound quality which you want to preserve on tape. Next the level is set, in the same manner as was done for off-the-air work. Then listen carefully to the last few grooves of the record, noting the manner in which the last reverberation dies away. Your final preparation will consist of *cueing up* the record. This is done by starting to play the record, but stopping the turntable as soon as music begins. Then, with the needle still in the groove, rotate the record counterclockwise for about three revolutions ahead of the beginning of sound. Now the main volume control is turned all the way down, and you are ready to make your disc-to-tape transfer. Start the tape machine, start the turntable, and then count the number of turns of dead grooves to which the record was cued. If you have difficulty counting the turns, you might try placing a small slip of white paper between one edge of the record and the turntable, to act as a marker. Just before the completion of the last turn, quickly fade up the volume control to the estab-



lished setting, and the performance should begin without any extraneous surface noise ahead of it. Finally, as soon as the record is completed, fade out again with your volume control. You will now have a perfect tape copy of the music on your disc.

Microphone Technique

Sooner or later you will reach a point where you will want to do some serious "live" recordings of your own. Perhaps you are acquainted with an amateur chamber music group, or possibly a small jazz combo. And while the microphone furnished with your tape recorder is understandably not of broadcast quality, it can nevertheless provide you with quite acceptable results if you will observe a few simple rules with respect to its use.

The first thing to consider is that your mike is probably of the *unidirectional* type.



As well as making regular and high output recording tape, Scotch Tape division of Minnesota Mining & Mfg. makes labels to solve the lost-reel problem.

Crestwood 400 recorder, made by Daystrom Electric, has two speeds, dual track, includes recorder and pre-amp only, plugs into hi-fi amplifier unit.

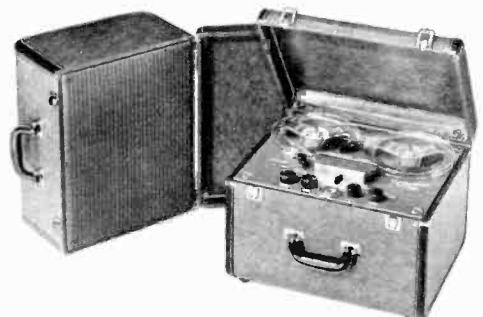



Pentron HT-225, above, has two woofer speakers plus detachable cover with tweeter for separate placement. Units below allow custom installation.

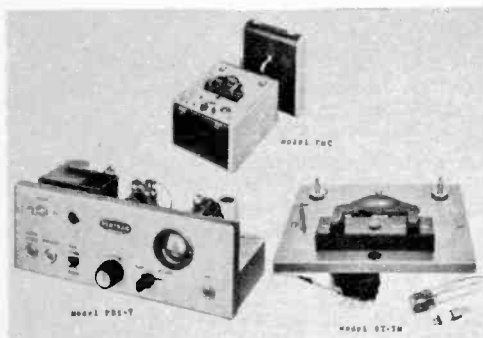

This means that it is highly sensitive only on its open, or grille side. You might regard it as a collector of sound with an imaginary funnel feeding into it from a total included angle of about 150 degrees. In the average living room with eight-foot ceilings, undesirable sound reflections will be minimized when the mike is placed or hung midway, or at about four feet. Similarly, it should be approximately equidistant from the side walls, and several feet out from the wall at its back side. The room does not have to be acoustically dead, but if it has a picture window or other large reflecting surface, the drapes should be drawn or the area covered with blankets. The problem now is simply the correct seating of the musicians in the "funnel" with respect to the microphone. The effect we are seeking is one of proper musical balance, with each instrument heard distinctly and in correct proportion. The volume ranges of various instruments differ greatly, of course, so we place the weaker voices near the mike and the louder ones further back. In the front semicircle you would place the strings, such as violin, viola, cello or guitar. The second line would

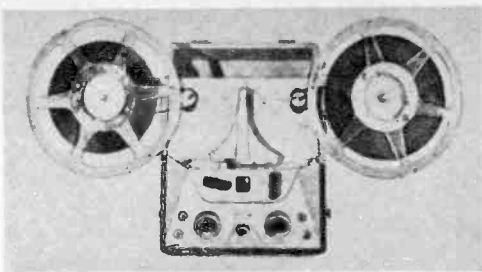

Among Pentron accessories is detachable 10 1/2-in. reel adapter kit above. Standard 2400 foot broadcast reels are used for doubled recording time.

Pentron microphone mixer shown below can be used with Pentron or other units. Several microphones or mike with radio or phono can be mixed.



include piano, harp, saxophone, clarinet and flute. In the third rank fall the oboe, bassoon, and English and French horns. Behind them are the percussion, string bass and tuba, and finally we have trumpets and trombones. With the particular instruments you are recording fanned out into their respective groups, you are ready to make a few tests. Careful listening may dictate that you should shift an instrument here or there, or perhaps even move the mike slightly. But with this basic setup as a starting point, you won't be far off.

Commercial Tapes

Another source of sound on tape is the *pre-recorded tape* which several companies now have on the market. You can buy such tapes just as you would a phonograph record, and most of them are available at either 3.75 or 7.5 i.p.s., some in dual track as well as single track. (A single-track tape can be played on a dual-track machine, but not vice versa.) With RCA Victor having announced its intention of entering this field, it is likely that the other major record companies will follow suit, and there should soon be available an ex-

ceedingly wide range of material. Present catalogs already include organ solos, vocals, string quartets, salon orchestras, pop concert orchestras, full symphonies, special music for children, dramatic readings and even foreign language lessons. It would appear that the pre-recorded tape is here to stay, and that in a fairly short time you will be able to buy tape recordings of all your favorite artists.

Tape editing involves the removal of unwanted parts of a recording, or rearranging the sequence of recorded material. The problem, of course, is to find the right place to cut a tape on which nothing can be seen. This is accomplished first by playing the tape at normal speed and stopping it in the vicinity of the desired spot. The tape is then manipulated back and forth past the playback head by turning the reels manually. After some practice it will be possible to locate the part you want, bearing in mind that the sound you hear in the



speaker is on the tape at the point directly against the playback head. You'd better experiment with expendable material until you get the knack, for while the tape may be re-used, the recording itself may be ruined by improper editing and splicing.

And now you should have a basic idea how a tape recorder can become a valuable adjunct to your high fidelity system. Practice with it, don't be afraid to experiment, and above all—have fun! •

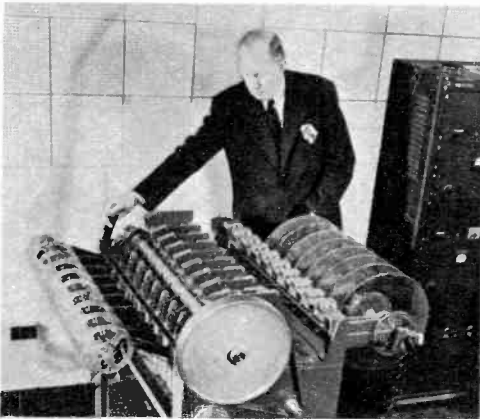

Pre-recorded high fidelity tapes are gaining new popularity. Multiple tape duplicator was made by 3M Co., used by Toogood Recording, Chicago.



Among tape recording accessories made for the high fidelity fan by Minnesota Mining and Mfg. Co., are these Scotch Tape Library Packs for storage.

Wilcox-Gay, makers of recorders and Recordio Tape, build this console tape unit, the Recordio Grand. Cabinet houses a bass reflex speaker.





Assembling Your System

You have to live with your hi-fi components as well as listen to them. Here are attractive ways to connect and fit them into your home.

Units like those below were assembled and arranged in the ingenious and pleasing way, shown above and right, by Mr. & Mrs. Paul Hickin, N.Y.C.

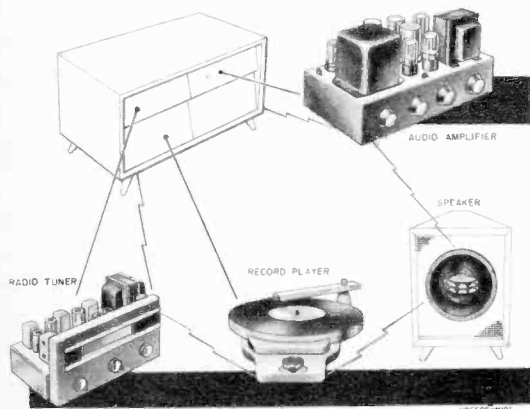

NOW that you are familiar with all of the components of a high fidelity system, you must decide whether you will assemble a group of these components for yourself, or whether you will be content with a mass-produced commercial home instrument. Since the radio manufacturers have begun to make such instruments with at least reasonably high fidelity, you can get a fairly good system at moderate cost. So if you lack the time—or the courage—to embark on an all-out effort to assemble and connect the necessary components of a truly high fidelity system, at least you need not miss out completely on the enjoyment of this new art. But before you take the easy way out, consider the possible pitfalls. Below you will find enumerated some shortcomings encountered in most radio-phonograph combinations, even those advertised as offering “high fidelity”:



Recording engineer Hickin removes the sliding doors from a liquor cabinet unit to form enclosure.

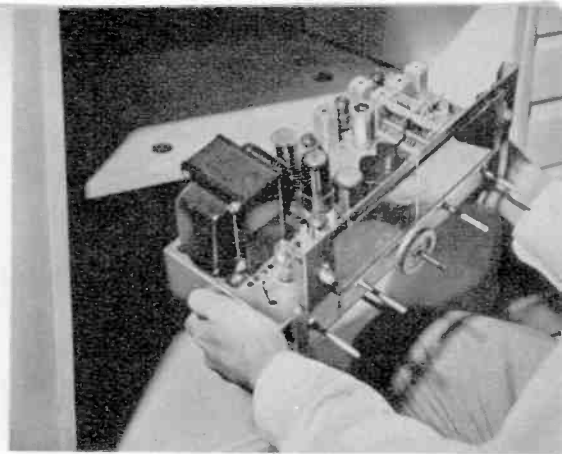

The top shelf is used to hold the amplifier and radio, a Bogen amplifier and AM-FM combination.



Bottom cabinet space is used as enclosure for the loudspeaker. The mounting board bolts into place.



Note slots on each side of coaxial speaker. These were designed to give proper bass reflex response.



Pressed-wood board with openings cut was covered with fabric and fitted into old sliding-door slot.



Knobs to match cabinet wood color are now fitted on protruding shafts of the tuner-amplifier unit.

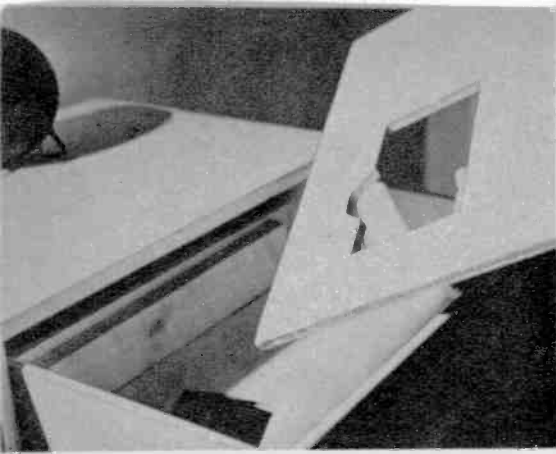

Top drawer of the adjoining matched cabinet is used for installation of the turntable motor unit.

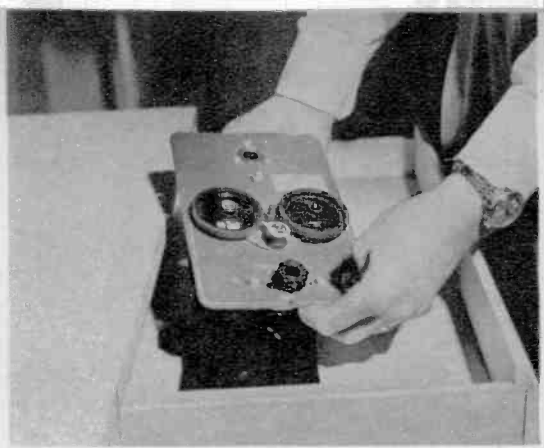

After cut-to-shape mounting board, left, is fastened into the drawer, motor is fitted into place.



Motor is screwed to board and then turntable is installed. Power wire runs through drawer bottom.



Mounting of pickup arm completes the assembly. Cabinet top was removed, refastened with hinges.



1. Osmium or sapphire styli, not readily changeable.
2. Low-fidelity crystal pickups.
3. Cheap record changers, with hum, wow, and rumble.
4. Inadequate or non-existent record compensation.
5. Inadequate tone controls.
6. Single speaker systems, deficient in extreme highs and lows.
7. Undersize and poorly-designed speaker enclosures.

When you add to this the rather high cost of freight and handling of such an instrument, plus the heavy dealer markup, it would appear from all angles that you would do better to follow the unit assembly system. It really isn't so very difficult, and

Drawer can now be pulled out for playing small records, top lifted to accommodate discs to 16 in.

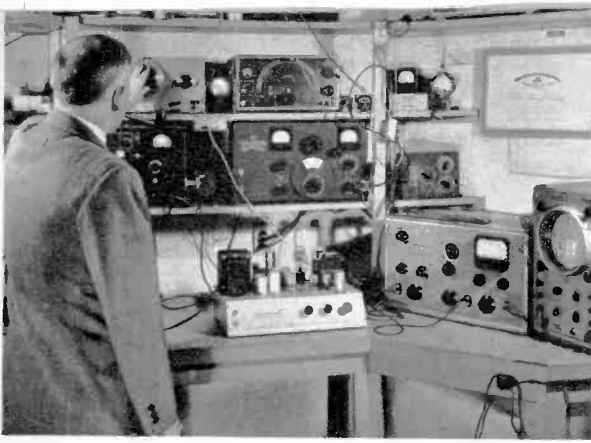

To choose components, first check expert reports. Consumers' Research Bulletin lab, above, tests unit.



Next make "A-B" listening comparisons in one of the new hi-fi salons like Hudson Radio's, above.

you positively will obtain better reproduction for less cost. And furthermore you will have the profound satisfaction of having done it all yourself.

The illustrations in this book have given you a good general idea of the various makes and prices of components commercially available. Now you should obtain the latest and most complete information. Write for literature to the manufacturers and distributors listed in the directory at the back of the book, and study all of it carefully. After a time you should become familiar with who makes what products, what claims he makes for their performance, and what prices he charges for them. But before attempting to evaluate the various products, you might now begin to consider your own personal requirements in a high fidelity system.

Selecting the Components

One of your first considerations will probably be the matter of cost. If you intend to buy the most basic system which can legitimately claim to be high fidelity, you will probably allot around \$150. Your budget for such a system should be roughly cut into thirds, with fifty dollars allotted for the record player, fifty for the amplifier, and the last fifty for speaker and enclosure. Any additional money should be given first to the speaker system, then more for a better turntable and reproducer, and finally an additional allowance for a larger amplifier.

Closely allied to this is the matter of your own musical taste. If jazz is your meat, you obviously won't need the extreme low frequency response necessary for the reproduction of a bourdon organ pipe, nor the

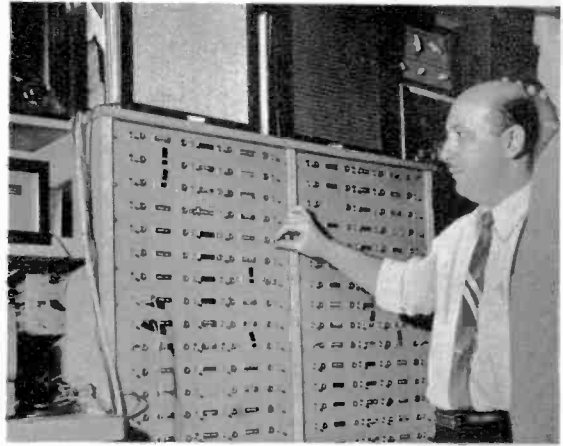

Component selection board is demonstrated, above, by Jerry Rappaport, hi-fi expert at Harvey's, N. Y.



Oscilloscope for visual check is included in this "auditioner scoreboard" at Allied Radio in Chicago.



Assembling matched components can be done with minimum tools. Screwdriver joins these Altec units.

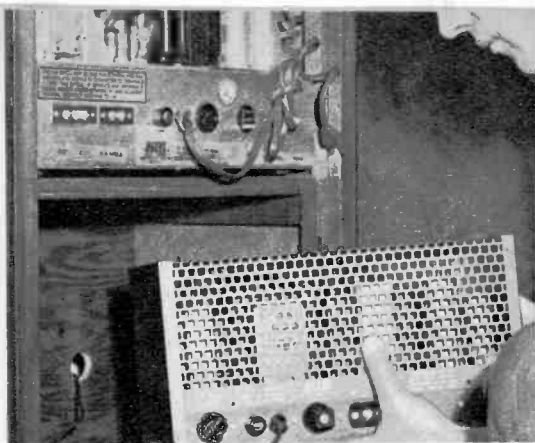

Radio tuner has been placed in the top compartment of chair-side cabinet. Amplifier fits bottom.

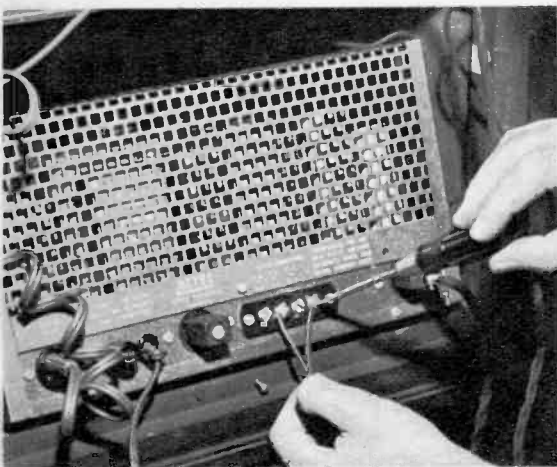

Loudspeaker leads, above, are connected to amplifier output. Note that most connections are plugs.

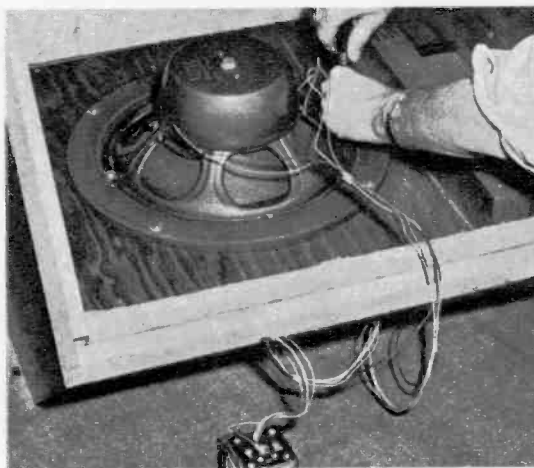

A 12-in. speaker uses "doughnut" adapter here to fit it to enclosure cabinet with 15-in. opening.

extreme highs required for perfect reproduction of all of the delicate nuances of a virtuoso violinist. There's no snobbery attached to this at all. It's just good sense not to waste hard-earned money on extra range which you neither want nor need.

At this point it is time for a family conference on fitting the high fidelity system into the home decorating scheme. The first question to be decided is whether the system is to be built-in or "built-out." A very popular built-in arrangement places all of the components in a closet adjacent to the listening room, with the speaker and controls mounting through a door or wall. This set-up causes perhaps the least disruption to the normal functioning of the household, it is neat in appearance, and if you happen to be a poor cabinetmaker, all of your wood-butchered crimes will be concealed.

Another common built-in scheme employs existing book shelves, which are often deep enough to house the various components and a bass reflex enclosure as well.

If you intend using a cabinet, the question of decor assumes much greater importance. After you have decided on a general design which will harmonize with your decorative scheme, you can build your own, construct from one of the many available kits, or buy a finished cabinet ready to house your components.

Now we must recognize another most serious consideration, and that is the question of size of components against available space. Overlooking this seemingly obvious point has caused untold grief to hi-fi constructors, and it can all be so easily avoided simply by proper forethought and planning.

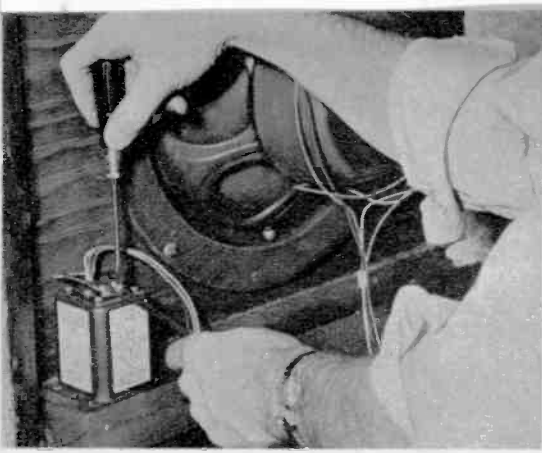

Speaker connections are now screwed to crossover network. Use care not to damage the speaker cone.



Completed assembly shows speaker enclosure, left, and chair-side cabinet with tuner and changer.



Custom 400 Stromberg-Carlson components are shown assembled at left. Below are other arrangements with the units in a storage wall, end-table unit, and matched cabinets.

Attachment for Columbia 360 two-way speaker set, rear, is the XD speaker-clock, at right, giving additional sound dimension.

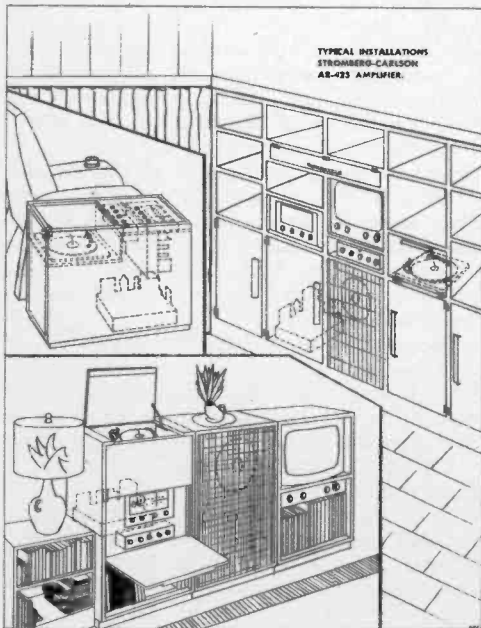

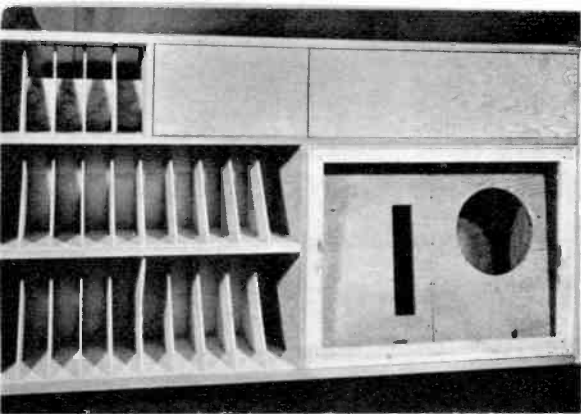

Many craftsmen will want to build a special custom unit for their hi-fi set, as shown above and right.

Sketching the Installation

It is a good idea now to begin drawing to scale a sketch of the mounting area or cabinet you intend to use. The units should fall in the order that they have been discussed in this book, that is, as the signal travels from source to speaker. You can get an idea of the physical size of the components from the catalogs, and sketch them in on your drawing also. If space is tight, size may have to be the determining factor in your decision to favor one unit over another. And if at all possible, you should allow for expansion in your original plan, so that any elements not purchased at the beginning may be fitted into place later without having to re-arrange the whole setup.

Now you know what components you will be acquiring at the beginning, the approximate price you will be paying for them, and the available space into which they must fit. This still leaves you with a rather wide choice among the available units. The next step is the elimination of any elements which would make for needless duplication of controls. If you are using a remote control amplifier, for example, you don't need a separate compensator, nor do you require an elaborate set of controls on the power amplifier or tuner. So you must decide in terms of your particular requirements where the control functions will be performed in the system, and then eliminate from consideration any components which would make for useless controls elsewhere.

Matching Components

You should also ascertain that any of the units still under consideration will work together with any other, that is, that they are matched. The input impedance of any device must be the same as the output impedance of the unit feeding it, and compensators must be designed to work with the



Plans for this set are available from Douglas Fir Plywood, Tacoma, Wash. Note movable TV base.

type of pickup to be used. Much of the equipment available today allows a choice of various input and output circuit impedances, so that matching is quite simple. The only precaution is to ascertain *in advance* that the particular combinations which you are considering are really compatible.

Several of the high fidelity manufacturers offer complete "packages" of matched components, which obviates any possibility of error in selection. But at the same time it seriously restricts your choice, and you may have to take something you don't want. For example, you may find a package that suits your needs perfectly, except that you may want a manual turntable while the package includes a changer. Or any number of similar exceptions may crop up, which make a given package almost—but not quite—perfect for you.

Furthermore, there is probably no high fidelity manufacturer in business today who himself manufactures a complete line of equipment from input to output. Each of these small businesses comprises a group of specialists—and that is as it should be. But as a result, any package you buy will almost certainly contain one or more components which are actually made by some other manufacturer, with only the brand name changed. There is nothing particularly wrong about this, except that it makes for some inconvenience when servicing is necessary.

Suppose, as an example, that you buy a package from a manufacturer whose specialty is amplifiers, and then you encounter trouble with your loudspeaker which he in turn purchased from someone else. You will have to get your service or adjustment from your own supplier, who in turn may or may not send your defective unit to the original manufacturer who knows it best. At any rate, it is at best a roundabout method, and in some cases may deprive you

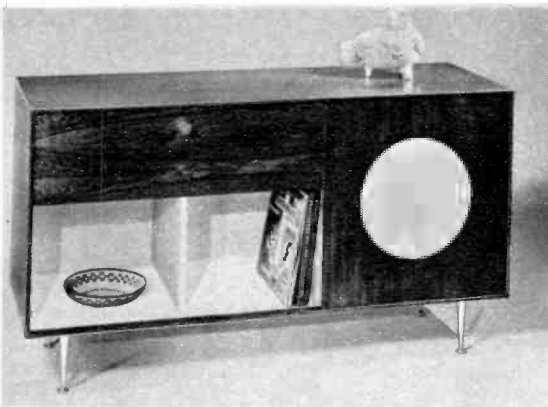

Custom furniture units are designed for hi-fi by George Nelson, made by Herman Miller Furniture.

of rights to which you might otherwise be entitled.

Build It Yourself

If you are handy with a screw driver and soldering iron, you can save real money by assembling much of your amplifying equipment, as well as the cabinetry, from pre-fabricated kits. Amplifiers, pre-amplifiers, record players and tuners are available in *Heathkits*, which the manufacturer claims are particularly designed for the novice kit builder, requiring no specialized knowledge or equipment for successful assembly and operation. Several manufacturers offer knocked-down kits of cabinets and enclosures, and the Douglas Fir Plywood Association of Tacoma, Washington, has several build-it-yourself plans of high fidelity installations.

Having eliminated many possible components by virtue of cost, physical arrangement, or function, we now arrive at the point where we must evaluate the remaining possibilities and make final selection. As we have already stated, the ultimate judge of any high fidelity system is your own pair of ears. Even if established theory is circumvented, if you find a given system to provide you with pleasant listening, that is all that matters. But sometimes deficiencies crop up which were overlooked at the beginning, and it turns out that the system doesn't "wear well." For that reason, any competent advice which will help you to make intelligent decisions should be employed to the utmost.

Consumer Testing

One of the best ways of getting such advice, which is particularly important if you are unable to conduct extensive listening tests on your own, is through the journals of the consumer testing organizations. The *CONSUMERS' RESEARCH BULLETIN*, published at Washington, New Jersey, has

been reporting on high fidelity matters for nearly twenty years, and has performed extensive rating tests on all of the well known hi-fi components.

These tests fall into two general categories: objective performance measurements, and subjective listening tests. The performance tests involve the measurement with laboratory instruments of all the criteria of response and forms of distortion which we have discussed. These require the use of a host of delicate and expensive instruments, such as sine-wave, square-wave and sweep-frequency generators, distortion and noise meters, intermodulation analyzers, oscilloscopes, sound-level meters, vacuum-tube voltmeters, and wow and flutter meters. It is highly unlikely that even the most affluent amateur would have the time or facilities to subject dozens of pieces of equipment to such an exhaustive battery of tests, but this work has been done dispassionately by professional engineers, and the results are readily available to everyone.

The second phase of the tests involves comparative audition by a jury of trained listeners, usually musicians, audio engineers and music critics. Such comparisons are usually called "A-B tests," and are accomplished by the fairly rapid switching back and forth, in and out of the circuit, of the two components under test. Often the "A" position is held by a standard reference system, with which the unit in the "B" channel is compared. The listeners then give the "B" unit a progressive rating as being equal to, better than, or worse than the standard reference on the "A" side. It

This RCA Victor unit planned for wide-range reproduction houses the noted Olson-design speaker.

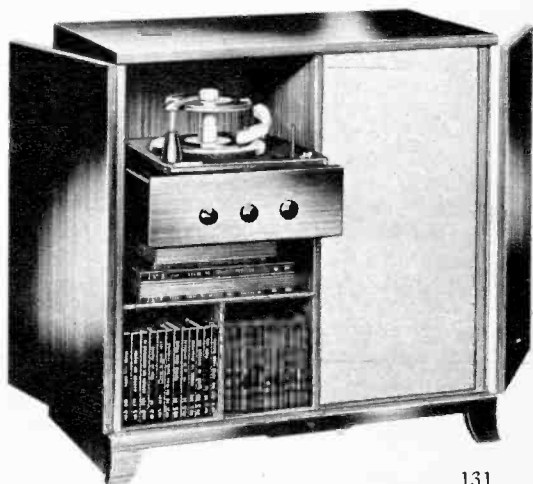

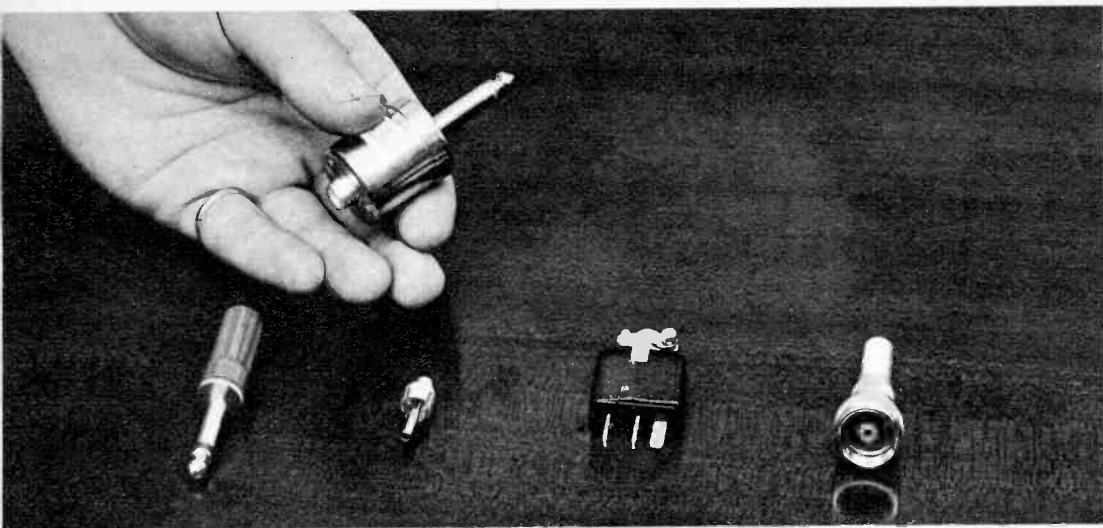

Modern high fidelity sets can be assembled with these simple connectors. No special skill is needed.

is, of course, essential to the operation of an A-B test that only one unit be changed at a time, the two channels otherwise being identical. Obviously, if there is more than one variable, the validity of the conclusions becomes practically nil.

Listening Tests

With all of the foregoing data at hand, you should now be able to exercise excellent judgment in the selection of the components for your own system. But the results you obtain might be even more satisfactory if you could actually hear with your own two ears the various units you have under consideration. Since no set of test instruments and no-one else's ears can determine precisely what you like to hear, it would be very desirable for you to run your own series of listening tests before you finally make up your mind.

Most of the electronic distributors in the larger cities have high fidelity salons which provide facilities for A-B testing of a wide variety of components. Connections to and from all of the units terminate at a master control panel, which permits interconnection of any combination of components which you select. And while this method cannot duplicate the acoustic environment of your own listening room, and even though you will often be subjected to various distractions, it nevertheless affords an opportunity for a better direct comparison between units than almost any other items you normally buy. Have you ever had the chance to A-B test a series of automobiles, for example, or power tools, or cans of

beans, trying first one and then the other? Despite the fact that hearing is largely a subjective process, you can nevertheless approach your listening tests with logic and objectivity. Perhaps we can offer a few hints which will enable you to get the most out of them.

You should bear in mind at the outset that this sort of testing, and the consumer ratings as well, fall into the category which the statistician describes as "sampling." That is, a single unit of given manufacture is placed under test, and it is inferred from the results that all such units coming off the same production line are identical. But this is not always the case, as many of the companies engaged in high fidelity manufacturing are small, young organizations, and their quality controls are not always held to as narrow tolerances as would be desirable. Consequently, there occasionally rolls off the line an exceptionally good unit, and now and then there appears a "lemon" or two.

This is not true of all manufacturers, of course, but you can hedge against it by being sure that you can hear the identical unit which you will carry out of the store. Normally you will not hear the same unit which is to be delivered to you, since the units on the shelves are more or less permanently installed. But once your decision is made, it is not unreasonable for you to ask that the fresh unit which you receive be connected up for an on-the-spot test before you accept it. If you are buying by mail-order and are unable to hear your system in advance, then you should make

doubly sure of the reliability of the distributors and manufacturers, and of their guarantees. All of the reputable houses bend over backwards to insure your satisfaction, and will readily make good on defective merchandise.

Choice of Speaker

Since the loudspeaker and its enclosure are so susceptible to variation, it is a good plan to select them first. If you intend to make your own enclosure or console cabinet, see to it that the speaker is mounted in a baffle which is very similar to the one which you intend using. Ask that the speakers which you are considering be connected to a high quality amplifier and program source, preferably records or tape with which you are quite familiar. Listen at various loudness levels for frequency response, freedom from distortion, and transient response. Play some material having a lot of high frequency sounds, such as triangle and cymbal, and walk back and forth in front of the speaker to test the angle of radiation. The speaker should be able to disperse the high frequencies well enough for you to hear them in full when you are 45 degrees away from the center axis. Then having finally decided on a speaker system, continue to use it for the remainder of your tests.

Amplifier Selection

Next try out various amplifiers, again listening at several loudness levels. Notice the performance of the controls at all levels. Does the equipment have a loudness control, or can the deficiency of the ear at low levels be compensated by the tone controls? You should test this with several records of different manufacture, as practice varies between companies. Note particularly the bass boost, and determine whether the lowest bass range is being increased, or whether the control is actually operating only over the lower mid-range. If the bass response is smooth, there will be no "one-note" bass, an indication of low-frequency resonance.

The male voice is a good test for hi-fi systems, affording an examination of the smoothness with which the system reproduces the low frequencies, while at the same time providing sibilant sounds which require a clean treble response, free from thinness or harshness. Even if you haven't attended many concerts in your lifetime, you do hear human voices every day, and you will quickly spot any unnaturalness of reproduction.

Selection of the pickup, compensator and pre-amplifier follows the same general pro-

cedures. Note particularly the action of the compensator. Does it really make a difference in the quality of reproduction when it is varied while playing the same record? And does the position which is recommended for a given make of record actually provide unmistakably the best results? Although the recording industry seems much closer to agreement on a standard characteristic curve, if your record library is already extensive and varied, you will do well to select this component with great care, for inaccurate compensation can easily ruin otherwise flawless reproduction.

Installation

Installation of your components is now simplicity itself. The electrical connections are mostly by means of phono plugs, which makes the procedure just about as difficult as plugging a lamp into a wall socket. Mounting is likewise a small problem. If any drilling or cutting of cabinets or shelves is necessary, templates are supplied with the various components.

The variety, flexibility and operating simplicity of high fidelity components today is something undreamed of even five years ago. But you no longer have to dream. You know now how it's done. With just a little effort you too can be enjoying high fidelity with the rest of us. •

Made by the Kelton Co., Cambridge, Mass., this enclosure houses their Lang-designed sound system.



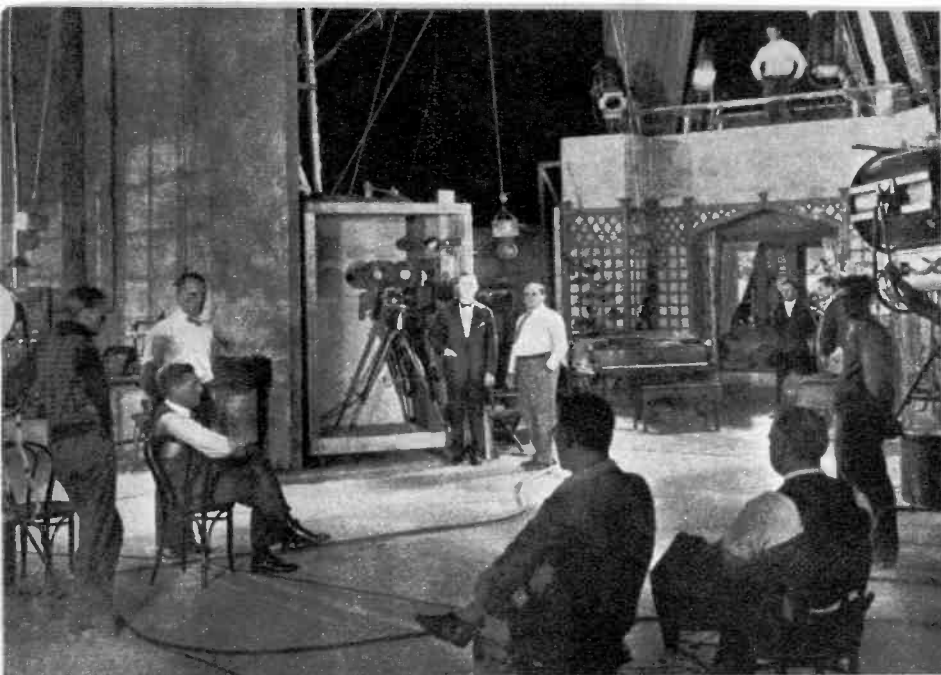

On the first Warner Bros. sound stage in Brooklyn in 1926, sound-on-disc movies were filmed by fixed camera in sound-proof booth. Now TV sound has similar growing pains. Warner Bros. photo

A Few Sour Notes

Hi-fi may make fans demand better sound—and soon get it.

HIGH fidelity, in common with all other young arts, must have its extreme radical wing in order to help outline the middle-of-the-road position for the majority. But one must wonder sometimes if the hi-fi extremists are really performing any useful service to the art or its adherents.

What useful purpose is served by operating a system at such extremely high volume that it disturbs the whole neighborhood? Or turning the treble tone control all the way up, because "it isn't hi-fi unless you can hear the needle scratch"? Or listening over and over and over again to a flashy percussion passage? Or demanding audio (?) amplifiers which are flat from one cycle to one megacycle?

If you haven't met any characters who engage in such weird practices, be thankful, brother. They are the ones who have caused some writers to refer to all of us in print as hi-fi "bugs," or out of print as hi-fi nuts. This small coterie of screwballs is giving the whole hobby a bad name, and the sooner they pack up their noisy toys and head for some desert island, the better off all of us will be.

The popular music business, traditionally on the make for a fast buck, has not failed to heed the clarion call of the gilt-edged hi-fi market. Nearly every record and nearly every phonograph is now touted as being high fidelity, and since there are no formal standards nothing can be done to prevent it.

"Gimmick" Records

Some of the very worst offenses are committed on those popular records which have become known in the trade as "gimmicks." Any queer sound, regardless of its aesthetic value, which will give a record a "new sound" is seized upon by the music maharajahs for mass exploitation. Several years ago they discovered the *echo chamber*, a highly reverberant room which can make a record sound like it was made in a subterranean grotto. It was first used many years ago in broadcast stations and film studios for special dramatic effects with spoken dialogue. Now it is used to obfuscate that fact that almost all pop tunes recorded today are positively miserable, and thus every well-equipped recording studio must have one.



TV sound can be good. Perfectionist Jack Webb proves this in his *Dragnet* shows, produced on film.



The *Garroway at Large* show, beamed from Chicago a few years ago, also had very good audio.

Listen to some of Frank Sinatra's records of several years ago with Columbia for balanced sound.



Perry Como, shown with engineer Les Chase, is another artist who insists on gimmick-free sound.



The groove geniuses have also borrowed another gimmick from the motion picture industry. In film recording, a *dialogue equalizer* is often used to brighten voice quality, since the level of reproduction in theaters is much louder than the original spoken word. This equalization takes the form of a rather pronounced peak in the response curve in the vicinity of 3,000 to 5,000 c.p.s. Although the listening conditions for popular records are in no way analogous to those in movie houses, except possibly when a juke box is used to fill a large dance hall, this peaking is now used constantly by almost all record companies. It would appear, in fact, that RCA Victor and Decca are the only ones remaining who don't follow this practice.

Most of the popular records on the market today consequently sound harsh, strident and excessively sibilant. To prove this to yourself, listen to a recent Frank Sinatra record of the past year or so, and then compare it against some that he made for Columbia five or ten years ago. The new one has greater range and crispness, but I'm sure nobody would argue that it sounds natural or more pleasant. Fortu-

nately these practices are employed sparingly and intelligently in classical and jazz recordings, which are the areas of greatest concern to those who are seriously interested in the high fidelity reproduction of music.

Television Sound

In television today, where a picture has been added to radio broadcasting, we have a situation which is directly comparable to the advent of sound motion pictures. When this happened, years of experience in picture-making technique was temporarily forgotten as the sound man became king of the movie set. The cameraman and his equipment were placed in a stationary soundproof box, and dolly shots, pans, and unusual camera angles were dropped overnight. The industry finally got back to an even keel again, of course, and each of the cinema arts assumed its rightful place, but television unfortunately hasn't yet grown up.

Video directors and producers are still so enchanted with the idea of sending a picture through the air, they haven't yet learned that a soundless picture is also just

about meaningless. They have cast aside most of the knowledge gained from the experience of broadcasting, recording and film production, so that today the audio man on most television crews is treated like a fifth wheel. Consequently most of the sound pickups range from bad to horrible. And film shows, which have an opportunity to review and correct their mistakes, are even worse. The distortion, hiss, thumps and rumble are incredibly bad in view of the technical state of the audio art.

There are a few exceptions, however, which prove that all of the bad jobs are the result of carelessness or unconcern. The old *Garroway at Large* show was the first to prove that good audio was not incompatible with good video. Fred Waring also demands and gets excellent sound, despite the many complex production problems of his presentation. Jack Webb is another perfectionist, and his *Dragnet* shows prove it. This program is on film, and on a medium which is overloaded with film fare, it stands almost alone as one which presents truly good audio along with good video. It seems inevitable the new enthusiasm for high fidelity will help speed improvement.

Over-editing of Tape

As we have already noted, tape recording allows for considerable latitude in corrective re-recording and sound editing. This fact has been a godsend to many recording artists who cannot or will not present a competent beginning-to-end performance of a work of music for recording. Thus the recordings are often made in bits and pieces, and the artist decides which parts he wishes used.

It is interesting to note that the record companies are not usually to blame for this practice, except for the fact that they readily accede to the demands of their artists. But one must wonder who is the real artist here, performer or tape editor?

The editor may receive instructions to use various passages from a number of different takes, to alter the pitch on this passage, to correct the dynamics on that, even to change the timbre overall. This results in a record which is possibly better than any single public performance ever given by the artist. And it is really a *synthetic* performance. It may sound fine, but is it music? Is it art? Is it *high fidelity*? •



Complicated productions can be planned to produce good sound as proved by the Fred Waring program, shown left. The Voice of Firestone, simulcast for both radio and TV, was another show delivering fine audio.

Tape editing has reached a fine art in tape editing rooms like this of the Empire Broadcasting Co., New York. Empire is a unique organization which records commercials or whole programs to order in their studios for later use. All original recording is now done here on tape; after editing, "spots" are usually recut on discs.



Author Don Hoefler listens to a binaural tape recording at Harvey Radio in New York City. Dual-track tape recorded from two microphones simultaneously gives "presence" to reproduction of performance.



Sound Expectations

New audio perfection is seen for hi-fi's future.

THE tremendous increase in public interest in audio matters can be attributed directly to the many great improvements in broadcasting, recording and reproduction, culminating in the art which we call high fidelity. Now it appears that the exhilaration of public acceptance is spurring our inventors and researchers on to much greater heights, and it may very well be that the audio art as we know it today is only the promise, not the fulfillment.

We usually consider the long playing record to be one of the major milestones in the field, but hardly have the sounds of the battle of the speeds died down than we now see before us another new record speed. This time it is half the LP speed, or about 16 r.p.m. But this new speed has been developed for a purpose, and a good one.

Talking Books

For a number of years the American Foundation for the Blind, working under the auspices of the Library of Congress, has recorded "talking books." These are readings of fine works of literature, cut at 33 $\frac{1}{3}$ r.p.m. on standard 16-inch transcriptions. With the advent of the LP, Columbia Records, and later RCA Victor, began producing such records for general con-

sumption and Caedmon Records was established solely for this purpose.

The Audio Book Company, of Los Angeles, California, realizing that the recording of the voice required neither the frequency range nor dynamic scope of orchestral music, reasoned that it should be possible to develop a still slower speed with acceptable reproduction. So they cut the LP speed in half, increased the number of grooves per inch by about 30%, and came up with an Audio Book which provides a half-hour of playing time on a 7-inch record.

Their first production was an *Audible Edition of the New Testament*, and there have since been recorded works of many of the great names in literature. The only problem is a means of playing these records, and that isn't really as difficult as it might seem. Rek-O-Kut, V-M and Zenith each have turntables which will operate at this speed, and several other companies are known to be considering it. But even a new turntable isn't necessary, as there is available an adapter, selling at under three dollars, which will provide this speed on your present 33 $\frac{1}{3}$ r.p.m. table. With this gadget you should find it easy to absorb many of the great works of literature which you just never quite got around to reading.

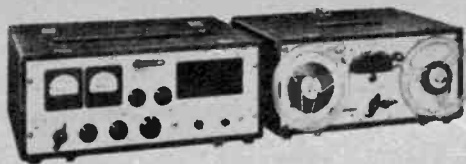

PT6BN PT68AM Binaural Magnecorder

Used with earphones or twin speakers, these binaural units give an added dimension to sounds.



Emory Cook Laboratories have developed these units for binaural playback of twin-band records.

Stereophonic Sound

As we rapidly approach perfection in our single-channel high fidelity system, we realize that something is still lacking—that we still don't have that exact psychological impression of presence. Our sound is still two-dimensional, and we still don't have the feeling of depth, or of being able to pinpoint exactly the direction of origin of various musical sounds.

The reason for this is that our system is *monaural*, which is about the same as listening with one ear closed. We need a separate means of sound transmission for each one of our ears, that is, a *binaural* system. Our sense of depth and direction in sound is due to the very slight difference in arrival time at each of our ears. And with a monaural system, this helps us only to locate the source of sound as a single loudspeaker, but it of course is useless in providing a feeling of being immersed in the performance.

In one of the earliest experiments relating to this problem, the National Broadcasting Company set up a dummy head, with a microphone in each ear, each feeding a separate channel up to a pair of earphones. This system has the striking effect of placing the ears of the listener right at the position of the ears of the dummy head,

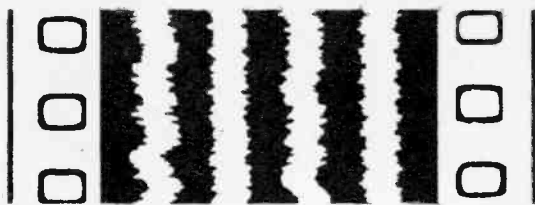

An early attempt at a stereophonic reproduction. Walt Disney's *Fantasia* used sound tracks above.



An accessory pickup head, attaching to standard head for binaural records, is made by Cook Co.

a sensation which simulates realism itself.

Today, with dual-track tape, it is fairly simple to build a recorder which uses both tracks simultaneously, one for each ear channel. This is still best when using the dummy head and earphone arrangement, but since earphones will probably never regain the popularity they enjoyed during the crystal radio days, some method which employs conventional loudspeakers will have to be perfected.

One approach involves the use of a number of rather widely separated microphones, whose signals ultimately drive several similarly separated speakers. This system, however, is applicable only to large installations such as motion picture theaters, where it has been used with considerable success. It was first used commercially in the Walt Disney production of *Fantasia*, which employed completely separate films for picture and sound, the sound film having its entire area covered with optical audio tracks.

A similar idea is used in the *Cinerama* system, which uses three picture films, and another magnetically-coated film for the audio. In *Cinemascope*, all of the picture and sound are on a single film, and every bit of the film outside of the picture, even the area beyond the sprocket holes, is coated with magnetic oxide for the record-

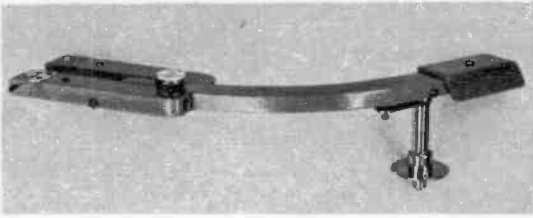

Livingston makes this twin-head pickup arm which tracks inner and outer bands of binaural records.

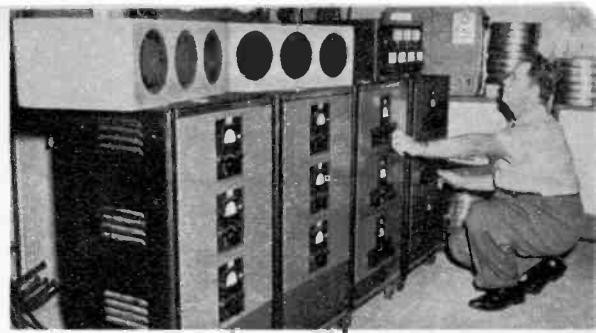

Multiple recording and reproducing channels are used by Cinerama, shown at Oyster Bay studio.



Station WQXR, New York City, makes special binaural broadcasts using combined AM and FM.



Gen. Sarnoff of RCA shows the tape which can now record television pictures as well as the sound.

ing of the several audio tracks used here.

For home use, however, two channels are just about all that can be normally accommodated. And while the placement of the speakers and the position of the listener is rather critical, a quite good stereophonic effect is possible by this means.

Recording on dual-track tape has been mentioned, but it is also being done successfully on disc. Emory Cook uses the LP as the basis of his system, the record having two bands of grooves, one beginning conventionally at the outside of the disc while the second begins at the mid-point between lead-in and lead-out grooves. Records of this sort are already commercially available from the Cook Laboratories, as well as the Polymusic and Atlantic labels, and binaural pickups and amplifiers are now listed by many suppliers.

In radio broadcasting, some stations have experimented with the use of their FM and AM carriers simultaneously, each carrying a signal from one of the microphone "ears." WQXR in New York City has had such excellent response to their work along these lines that they have scheduled such programs on a regular basis. At Columbia University, Major Armstrong and his associate John Bose developed a system of *multiplex* for FM stations, which permits them to apply two separate audio signals

simultaneously to the same carrier. This system may be used for two different programs, or it may be employed for excellent binaural transmission.

Video Tape Recording

The great superiority of magnetic tape for the recording of sound makes it an ideal medium for the recording of television pictures as well. Bing Crosby Enterprises and the RCA Victor Laboratories, working independently, have each demonstrated experimental systems which do exactly that.

Since video signals encompass a range of up to 4,000,000 c.p.s., the problem of recording is considerably greater than is encountered with audio. But once again the advanced video techniques will be put to good use by the audio industry, and as a result you and I will in a few years be able to buy much better and cheaper sound tape recorders. We may even have our own video tape equipment eventually, which may be used to make home movies or to take off-the-air recordings of television shows.

With these few glimpses into the wondrous future before us, none can dispute the profound words of Dr. Stokowski when he says, "The potentialities are infinite; so is the inventive power of the human mind." •

HI-FI DIRECTORY

STYLI, PICKUPS, ARMS, COMPENSATION

Audak Co.
500 Fifth Avenue
New York 36, N. Y.

Duatone Co., Inc.
Locust Street
Keyport, N. J.

Fairchild Recording & Equipment Co.
154th St. & Powells Cove Blvd.
Whitestone 57, N. Y.

Ferranti Electric, Inc.
30 Rockefeller Plaza
New York 20, N. Y.

Gray Research and Development Co.
586 Hilliard Street
Manchester, Conn.

Livingston Electronic Corp.
Livingston, N. J.

Pacific Transducer Corp.
11921 W. Pico Boulevard
Los Angeles 64, Calif.

Pfanstiehl Chemical Co.
106 Lake View Avenue
Waukegan, Ill.

Pickering & Co., Inc.
Oceanside, L. I., N. Y.

Sonotone Corp.
Elmsford, N. Y.

The Astoric Corp.
Conneaut, Ohio

The Diatone Co.
31 West 47th Street
New York 36, N. Y.

The Televox Co.
5565 Netherland Avenue
Rivendale 71, N. Y.

The Tetrad Co.
62 St. Mary Street
Yonkers, N. Y.

Walco Products, Inc.
60 Franklin Street
East Orange, N. J.

Weathers Industries
66 E. Gloucester Pike
Barrington, N. J.

TURNTABLES AND CHANGERS

General Industries
3637 Taylor Street
Elyria, Ohio

J. P. Seeburg Corp.
1500 Dayton Street
Chicago, Ill.

Rek-O-Kut Co.
38-05 Queens Boulevard
Long Island City, N. Y.

Thorens
Atlantic & Stewart Avenue
New Hyde Park, N. Y.

V-M Corporation
Benton Harbor 4, Mich.

AMPLIFIERS AND TUNERS

Altec Lansing Corp.
161 Sixth Avenue
New York 13, N. Y.

Beam Instruments Corp.
350 Fifth Avenue
New York 1, N. Y.

Bell Sound Systems, Inc.
555 Marion Road
Columbus 7, Ohio

Bohn Music Systems
550 Fifth Avenue
New York, N. Y.

British Industries Corp.
104 Duane Street
New York 13, N. Y.

Brocimer Electronics Laboratories
344 E. 32nd Street
New York 16, N. Y.

Brook Electronics Co.
34 DeHart Place
Elizabeth 2, N. J.

Browning Laboratories, Inc.
Winchester, Mass.

Califone Corp.
1041 N. Syracuse Avenue
Hollywood 38, Calif.

Challenger Amplifier Co.
29 Ninth Avenue
New York 14, N. Y.

Collins Audio Products Co., Inc.

P.O. Box 368
Westfield, N. J.

David Bogen Co., Inc.
29 Ninth Avenue
New York 14, N. Y.

Don McGohan, Inc.
3700 W. Roosevelt Road
Chicago 24, Ill.

Espey Manufacturing Co.
528 E. 72nd Street
New York 10, N. Y.

Fisher Radio Corp.
41 East 47th Street
New York, N. Y.

General Electric
Electronics Park
Syracuse, N. Y.

H. A. Hartley Co., Inc.
521 E. 162nd Street
New York 51, N. Y.

H. H. Scott, Inc.
385 Putnam Avenue
Cambridge, Mass.

H. S. Martin Co.
1916 Greenleaf Street
Evanston, Ill.

I.D.E.A. Inc.
Regency Division
7900 Pendleton Pike
Indianapolis 26, Ind.

Kelton Co., Inc.
55 Amary Street
Boston 19, Mass.

McIntosh Engineering
Laboratories, Inc.
320 Water Street
Binghamton, N. Y.

Mark Simpson Manufacturing
Co., Inc.
Long Island City 3, N. Y.

Meissner Manufacturing Co.
Mt. Carmel, Ill.

Newcomb Audio Products Co.
6824 Lexington Avenue
Hollywood 38, Calif.

Philca Corp.
Philadelphia, Pa.

Pilat Radio Corp.
37-06 36th Street
Long Island City, N. Y.

Precision Electronics, Inc.
9101 King Avenue
Franklin Park, Ill.

Radio Engineering Laboratories, Inc.
36-40 37th Street
Long Island City, N. Y.

Rauland Borg Corp.
3515 West Addison Street
Chicago 18, Ill.

RCA Victor Division
Camden, N. J.

Roland Radio Corp.
Mt. Vernon, N. Y.

R. T. Boxak Co.
90 Monroe Avenue
Buffalo 14, N. Y.

Steelman Phonograph & Radio
Co., Inc.
Mt. Vernon, N. Y.

Stromberg-Carlson Co.
1225 Clifford Avenue
Rochester 21, N. Y.

Tech-Master Products Co.
443-445 Broadway
New York 13, N. Y.

The Hallcrafters Co.
Fifth & Kostner Avenue
Chicago 24, Ill.

The Magnovox Co.
Fort Wayne 4, Ind.

The Radio Craftsmen, Inc.
4401 N. Ravenswood Avenue
Chicago 40, Ill.

Vector Laboratories
217 3rd Avenue
New York, N. Y.

Video Corp. of America
229 West 28th Street
New York 1, N. Y.

Zenith Radio Corp.
6001 W. Dickens Avenue
Chicago 39, Ill.

SPEAKERS, ENCLOSURES AND CABINETS

Angle-Genesee Corp.
107 Norris Drive
Rochester 10, N. Y.

Cinandagraph Speakers
7334 North Clark Street
Chicago 26, Ill.

Creative Audio Associates
150 South Harrison Street
East Orange, N. J.

Custom Electronics, Inc.
813 Charles Street
New Orleans, La.

Electro-Voice, Inc.
425 Carroll Street
Buchanan, Mich.

Harrison Associates
80-30 210th Street
Queens Village 34, N. Y.

Herman Miller Co.
Zeeland, Mich.

James B. Lansing Sound, Inc.
2439 Fletcher Drive
Los Angeles 39, Calif.

Jensen Mfg. Co.
6601 So. Laramie Avenue
Chicago 38, Ill.

Karlson Associates, Inc.
1379 East 15th Street
Brooklyn 30, N. Y.

Kingdon Products, Ltd.
23 Park Place
New York 7, N. Y.

Klipsch & Associates
Hope, Ark.

Ozark Wood Products Co.
311 Park Avenue
Glendale, Mo.

Permaflox Corp.
4900 W. Grand Avenue
Chicago 39, Ill.

Rockbar Corp.
211 East 37th Street
New York 16, N. Y.

Shrador Custom Sound
2803 M Street, N.W.
Washington 7, D. C.

Stephens Manufacturing Corp.
8538 Warner Drive
Culver City, Calif.

Symphonic Radio & Electronics Corp.
160 North Washington Street
Boston 14, Mass.

Tannoy (Canada) Ltd.
36 Wellington Street E.
Toronto, Ont.

The Electronic Workshop
Bleeker at 10th Street
New York 14, N. Y.

University Loudspeakers
80 S. Kensica Avenue
White Plains, N. Y.

Utah Radio Products Co., Inc.
1350 Monroe Street
Huntington, Ind.

Voice & Vision, Inc.
316 N. Michigan Avenue
Chicago 1, Ill.

Yark Furniture Corp.
208 East 47th Street
New York 17, N. Y.

TAPE RECORDERS & ACCESSORIES

Ampex Electric Corp.
934 Charter Street
Redwood City, Calif.

Amplifier Corp. of America
398 Broadway
New York 13, N. Y.

Ampro Corp.
2835 North Western Avenue
Chicago 18, Ill.

Berlant Associates
4917 W. Jefferson Boulevard
Los Angeles 16, Calif.

Crescent Industries, Inc.
5900 W. Taubey Avenue
Chicago 30, Ill.

Crestwood Division of Daystrom
Electric Corp.
837 Main Street
Poughkeepsie, N. Y.

DuKane Corp.

St. Charles, Ill.

Eicar, Inc.
1501 West Congress Street
Chicago 7, Ill.

Federal Manufacturing & Engineering Corp.
199-217 Steuben Street
Brooklyn 5, N. Y.

Magnecessaries
Box 6960
Washington 20, D. C.

Magnecord, Inc.
225 West Ohio Street
Chicago 10, Ill.

Magnetronics Corp.
4312 N. Kexvole Avenue
Chicago 41, Ill.

Miles Reproducer Co., Inc.
812 Broadway
New York 3, N. Y.

Minnesota Mining & Manufacturing Co.
900 Fauquier Avenue
St. Paul 6, Minn.

National Hollywood
1475 El Mirador Drive
Pasadena 6, Calif.

Pentron Corp.
221 E. Cullerton Street
Chicago 16, Ill.

Presto Recording Corp.
High Fidelity Sales Division
Paramus, N. J.

Prestaloc Manufacturing Corp.
37-27 33rd Street
Long Island City, N. Y.

Revere Camera Co.
Chicago 16, Ill.

Stancil-Hoffman Corp.
921 N. Highland Avenue
Hollywood 38, Calif.

Telectronics Corp.
35-18 37th Street
Long Island City 1, N. Y.

The Brush Electronics Co.
3405 Perkins Avenue
Cleveland 14, Ohio

The Transcriber Co.
172 Green Street
Boston 30, Mass.

Webster-Chicago
5610 W. Bloomingdale Avenue
Chicago 39, Ill.

Webster Electric Co.
Racine, Wis.

Wilcox-Gay Corp.
70 Washington Street
Brooklyn 1, N. Y.

Wireway Corp. of America
44 W. Superior Street
Chicago 10, Ill.

CONSTRUCTION KITS

Arky Radio Kits, Inc.
120 Cedar Street
New York 6, N. Y.

Eagle Electronics, Inc.
43 Lisenard Street
New York, N. Y.

G. & H. Wood Co.
75 N. 11th Street
Brooklyn 11, N. Y.

Heath Co.
Benton Harbor, Mich.

Meissner Mfg. Co.
Mt. Carmel, Ill.

River Edge Industries
5 River Edge Road
River Edge, N. J.

Tech-Master Prod. Co.
443 Broadway
New York, N. Y.

MAIL ORDER DISTRIBUTORS

Allied Radio Corp.
100 North Western Avenue
Chicago 80, Ill.

Concord Radio
55 Vessey Street
New York 7, N. Y.

Grand Central Radio Co.
124 East 44th Street
New York 17, N. Y.

Harvey Radio Co., Inc.
103 West 43rd Street
New York 36, N. Y.

Hudson Radio & TV Corp.
48 West 48th Street
New York 36, N. Y.

Lafayette Radio
100 Sixth Avenue
New York 13, N. Y.

Leonard Radio, Inc.
69 Cortland Street
New York 7, N. Y.

Liberty Music Shops, Inc.
450 Madison Avenue
New York 22, N. Y.

Sun Radio & Electronics
122 Duane Street
New York 7, N. Y.

Terminal Radio Corp.
85 Cortland Street
New York 7, N. Y.

DISC AND TAPE RECORDING

Angel Records, Ltd.
38 West 48th Street
New York 36, N. Y.

A-V Tape Libraries, Inc.
730 Fifth Avenue
New York 19, N. Y.

Capital Records, Inc.
1730 Broadway
New York 19, N. Y.

Columbia Records, Inc.
799 7th Avenue
New York, N. Y.

Cook Laboratories
114 Manhattan Street
Stamford, Conn.

Decca Records, Inc.
50 West 57th Street
New York, N. Y.

Electronics & Music Ind. Sales Ltd.
38 West 48th Street
New York 36, N. Y.

Hack Swain Productions
Sarasota, Fla.

London Records, Inc.
539 West 25th Street
New York, N. Y.

Orradio Industries, Inc.
T-120 Marvyn Road
Opelika, Ala.

RCA-Victor, Inc.
630 Fifth Avenue
New York 20, N. Y.

Riverside Jazz Records
418 West 49th Street
New York 19, N. Y.

Westminster Records, Inc.
275 Seventh Avenue
New York, N. Y.

Consumers' Research Bulletin
Washington, N. J.

Consumers Union Reports
38 East 1st Street
New York, N. Y.

High Fidelity
Great Barrington, Mass.

Music at Home
207 East 37th Street
New York 16, N. Y.

Radio & TV News
366 Madison Avenue
New York, N. Y.

Radio-Electronics
25 West Broadway
New York, N. Y.

Review of Recorded Music
110 Greene Street
New York 12, N. Y.

Tape & Film Recording
Severna Park, Md.

The Record Changer
418 West 49th Street
New York, N. Y.

PUBLICATIONS

Audio
204 Front Street
New York, N. Y.

Audio Fair Directory
67 West 44th Street
New York 36, N. Y.

Audiophile Bulletin
379 East 15th Street
Brooklyn, N. Y.

GLOSSARY OF HIGH FIDELITY TERMS

AF — Abbreviation for audio frequency.

AES — Audio Engineering Society. (AES has recommended a recording characteristic used by some record manufacturers.)

AM — Abbreviation for amplitude modulation; the type of transmission utilized by the standard broadcast stations.

Amplification — Magnification (see gain).

Amplifier — An electronic circuit which increases the amplitude of an electric voltage or power.

AFC — Abbreviation for automatic frequency control; an electronic circuit used in FM tuners to correct inaccuracy in tuning a station.

Arm (phonograph) — A movable bracket which holds the pickup in proper position over the record (also Tone Arm).

Attenuation — Reduction of an electric voltage or current; the opposite of amplification.

Audio — The range of frequencies from approximately 30 to 15,000 c.p.s. Also an adjective used in reference to the electronic and acoustical equipment concerned with the reproduction of sound.

Audiophile — A person who is interested in improving musical reproduction for his own personal listening, by use of the latest audio equipment and techniques.

Background Noise — The total system noise, regardless of whether or not a signal is present.

Baffle — A barrier or partition designed to separate the sound waves generated by the front and back of a loudspeaker cone.

Bass Reflex — An enclosed type of speaker enclosure or baffle with a small window opening to provide for improved bass response.

Beam Power — A design of vacuum tube characterized by abundant power and unusually high amplification used as the output tube in power amplifiers.

Cartridge — Another name for the phonograph "pickup"; the device which converts the mechanical energy stored in the record grooves into electrical energy.

Chassis — The metal box, framework or other support to which the components of a tuner or amplifier or other device are attached. The term is also used to designate the entire equipment (less cabinet) when assembled.

Compensator — An electronic circuit for altering the frequency response of the amplifier system to achieve a specified result. In general this refers to such things as record equalization or loudness correction.

Constant Amplitude — The disc recording characteristic wherein the groove displacement is directly proportional to the signal amplitude.

Constant Velocity — The disc recording characteristic wherein the groove displacement is inversely proportional to the signal frequency.

Crossover Network — A filtering circuit used on multiple speaker systems which separates the high frequencies from the low frequencies and channels them respectively to the tweeter and woofer speaker units.

Crystal — Used in reference to a phonograph cartridge, it is a small slab of piezo electric material used to convert mechanical motion to an electrical voltage.

De-Emphasis — A form of equalization complementary to pre-emphasis.

Decibel —
(1) A logarithmic measure of the acoustical level of sound intensity. 0 db is the threshold of human hearing while 130 db is the threshold of pain, i.e. the intensity level at which physical pain is felt.

(2) A logarithmic unit of measure used to express the voltage or power gain of an amplifier. With a minus sign it is also used to express the loss in attenuating circuits.

Because the ear measures differences in sound level logarithmically rather than arithmetically (if sound A is twice as loud as sound B, it will appear to the ear to be only slightly louder), and because decibel numbers can be used to represent large figures in a convenient manner (60 db equals a power ratio of 1,000,000 to 1), the decibel system is universally used by electronic engineers.

Distortion — The modification of the input signal by the discrimination against some frequencies, or by the introduction of additional frequencies not present in the original.

Equalizer — A synonym for "compensator."

Feedback — The combining of a portion of the output signal with the input signal.

(a) Degenerative (Inverse or Negative) Feedback is the type which reduces the distortion caused by vacuum tubes and improves the frequency response characteristic.

- (b) Regenerative (Acoustic) Feedback is the type which causes distortion or sustained "howling" — as between the loudspeaker and cartridge.
- Flutter** — The frequency deviation resulting from irregular motion during recording, duplication or reproduction.
- FM** — Abbreviation for frequency modulation; the type of radio transmission which can provide truly high fidelity with practically no static or background noise.
- Gain** — An increase in electrical energy supplied by an amplifier which produces an increase in volume.
- Head** — The erasing, recording or reproducing element of a tape recorder.
- Hum** — The extraneous portion of the output signal deriving from unwanted introduction of the power line frequency and its harmonics into the circuit.
- Impedance** — The opposition to an electrical current, usually measured in ohms.
- Input** — The terminals or connections to which wires carrying the electrical current are attached. Also refers to the electrical energy which is being fed into an amplifier, etc.
- Lateral Recording** — The common form of disc recording in which the groove modulation is perpendicular to the motion of the disc and parallel to its surface.
- Load** — The component or device which is being supplied with electrical energy from a source such as an amplifier.
- LCS** — Abbreviation for loudness contour selector. A circuit for altering the frequency response of an amplifier so that with various levels of loudness the characteristics of the amplifier will more closely match the requirements of the human ear.
- Loudspeaker** — The electro-acoustical device which converts electrical current to mechanical motion, which in turn creates sound waves.
- Matching** — The technique of selecting and connecting equipment so that each unit works at its peak performance capabilities.
- Micro** — One one-millionth (prefix).
- Milli** — One one-thousandth (prefix).
- N.A.R.T.B. or N.A.B.** — National Association of Radio & Television Broadcasters. A recording characteristic suggested by N.A.R.T.B. is used by some record manufacturers.
- Noise Suppressor** — An electronic circuit which reduces high frequency hiss or noise. It is utilized primarily with old records.
- Ohm** — The fundamental unit of measure of electrical resistance and impedance.
- Output** — The terminals or connections to which the load is connected. Also refers to the electrical energy being supplied from the device.
- Peak** — A point in the frequency range where a component delivers excessive energy, i.e., departs from a "flat" characteristic. Also used to denote the maximum instantaneous output of a device.
- Pickup** — The device which converts the vibrations of the stylus or needle to an electrical current which can be amplified. (Cartridge)
- PM** — Permanent magnet. Used as an adjective to differentiate from previous designs of speakers which required an electrical current for magnetization.
- Pre-Emphasis** — The introduction of additional amplification over a limited range of frequencies. FM stations introduce pre-emphasis in the treble range to override atmospheric noise.
- Pressing** — A disc recording produced in a record-molding press from a master or stamper.
- Quieting** — Denotes (in rating tuners) the degree to which noise in the receiver is reduced below the signal.
- RF** — Abbreviation for radio frequency. This refers to that range beyond the limit of hearing which is suitable for transmission through the air by means of broadcasting.
- Response** — A contraction of "frequency response" which is the reaction of an amplifying system to a range of signal frequencies. See also "peak."
- Reverberation** — The persistence of sound in a room due to repeated reflections from walls, ceiling, floor, furniture and occupants.
- Roll-Off** — A term used in connection with recording to describe a reduction in the intensity of the high bands of frequencies to provide a specified deviation in the frequency response. It is used when playing phonograph records which have been recorded with pre-emphasis, and also in FM receivers.
- Rumble** — A low frequency vibration mechanically transmitted to the turntable and appearing in the reproduction as noise.
- Signal** — The designation given to those impulses generated by a pickup, a microphone, or received from a broadcasting station via the antenna. These signals are the electrical energy corresponding to the music or speech.
- Signal-Noise Ratio** —
- (1) The basis for rating sensitivity in an FM tuner. The ratio between the signal and background noise, expressed in decibels, at a stated input signal.
 - (2) The ratio in an audio system between the rated output power and the noise and hum content — usually expressed in decibels.
- Speaker** — A short form for "loudspeaker."
- Stroboscope Disc** — A device for measuring the speed of a rotating object such as a phonograph turntable.
- Stylus** — The correct name for "needle." A rounded point of specified radius which is inserted into a pickup and rides a record groove.
- Stylus Pressure** — The downward force exerted on the disc by the reproducing stylus, expressed in grams or ounces.
- Selectivity** — The ability of a tuner to select and separate between two broadcasting stations which are close together on the dial.
- Sensitivity** — A measure of a tuner's ability to receive weak signals.
- Triode** — A type of tube used in amplifiers. It is characterized by very low distortion.
- Turnover** — A specified point in the lower frequencies where the recording signal is decreased in amplitude. In order to obtain proper fidelity on playback, equalization or increase of the lower frequencies is introduced in the amplifier.
- Tweeter** — A loudspeaker intended to reproduce the very high frequencies.
- Turntable** — A rotating disc upon which a phonograph record is placed.
- Woofer** — A loudspeaker designed to reproduce the lower range of frequencies.
- Wow** — A low frequency flutter.

Now IN YOUR OWN HOME Learn

TELEVISION RADIO ELECTRONICS

the Amazingly Effective

D. T. I. WAY

—with the aid of BOTH
HOME EQUIPMENT
and HOME MOVIES

NO PREVIOUS EXPERIENCE NEEDED

NOW... get
**EVERYTHING
YOU NEED**

for real Laboratory-
type training
AT HOME

Above:
Work over
300
fascinating
experiments
with this
equipment

What will mailing the coupon below do for YOU? Just this! You'll find out about one of today's most remarkable... practical ways to prepare to get into America's amazing billion dollar opportunity field of TELEVISION-RADIO-ELECTRONICS. You'll see how to get into fascinating work that pays well... that offers one of America's most promising futures... that enables you to start your own business almost "on a shoe string," if you prefer this to a job opportunity.

And above all, you'll get some GOOD NEWS especially welcomed by men anxious to earn REAL MONEY in this thrilling field. For you'll see that NOW you can get the kind of practical, laboratory-type training so desirable for making real progress in Television-Radio-Electronics AND WITHOUT LEAVING HOME.

You'll see that DeVry Technical Institute sends everything needed to set up your own HOME LABORATORY.

You get and keep the same type of basic electronic equipment used in our modern Chicago Training Laboratories. You get home training that includes the knowledge and experience gained from training thousands of students first hand in Chicago.

And to top it all, you use DTI's amazingly effective and exclusive home training aid—**INSTRUCTIVE MOVIES**. But why not get the complete story? Mail coupon today for information-packed literature.

MODERN LABORATORIES

If you prefer, get all your preparation in our new Chicago Training Laboratories—one of the finest of its kind. Ample instructors, modern equipment. Write for details!

MILITARY SERVICE!

If you're subject to military service, the information we have for you should prove very helpful. Mail coupon today.

Get this
information-packed publication

**89 WAYS
TO
EARN
MONEY
IN TELEVISION
RADIO-ELECTRONICS**

FREE!

Mail Coupon Today

1. Build over 300 fascinating experiments from 16 BIG SHIPMENTS of Electronic-Radio parts which you KEEP.
2. Build valuable commercial-type test equipment—as shown to the left—which you KEEP. This includes a quality 5 INCH oscilloscope and jewel bearing Multi-Meter—both highly useful for Television work.
3. Build and keep a big 21 INCH TV Set. (D.T.I. offers another home training in Television-Radio-Electronics, but without the TV set.)
4. Use a 16 mm. movie projector and new series of highly instructive movies—a wonderful aid to help you grasp important fundamentals faster... easier... better.
5. Enjoy well-illustrated, easy-to-read lessons with handy FOLD-OUT diagrams.
6. Get an honest-to-goodness EMPLOYMENT SERVICE to help you get a good job after graduating—or assistance in starting your OWN SALES AND SERVICE BUSINESS. Mail coupon today for the complete details.



Oscilloscope

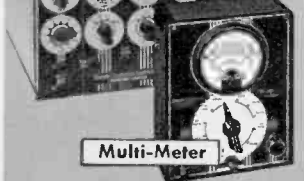

Multi-Meter



21 INCH

Build and keep this BIG DTI Engineered TV set—easily converted to U.H.F. (DTI offers another home training, but without the TV set.)

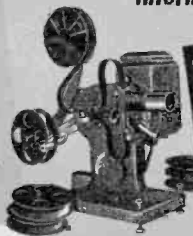

"ONE OF
AMERICA'S FOREMOST
TELEVISION
TRAINING
CENTERS"



DEVRY TECHNICAL INSTITUTE

AFFILIATED WITH
DEFORREST'S TRAINING, INC.
CHICAGO 41, ILLINOIS

DEVRY TECHNICAL INSTITUTE Dept. HFH-7-K
4141 BELMONT AVE., CHICAGO 41, ILL.

I would like your valuable information-packed publication showing how I can get started toward a good job or my own business in Television-Radio-Electronics.

Name..... Age.....
Street..... Apt.....
City..... Zone..... State.....



I'll Train YOU at Home in Your Spare Hours for Big Pay Job • Your Own Business • Exceptional Opportunity in

RADIO-TELEVISION

ON *New* NO-OBLIGATION PLAN!

**I Send You
18 BIG
KITS
OF RADIO-
TELEVISION
EQUIPMENT**

**TRAIN AT
HOME IN
SPARE HOURS**

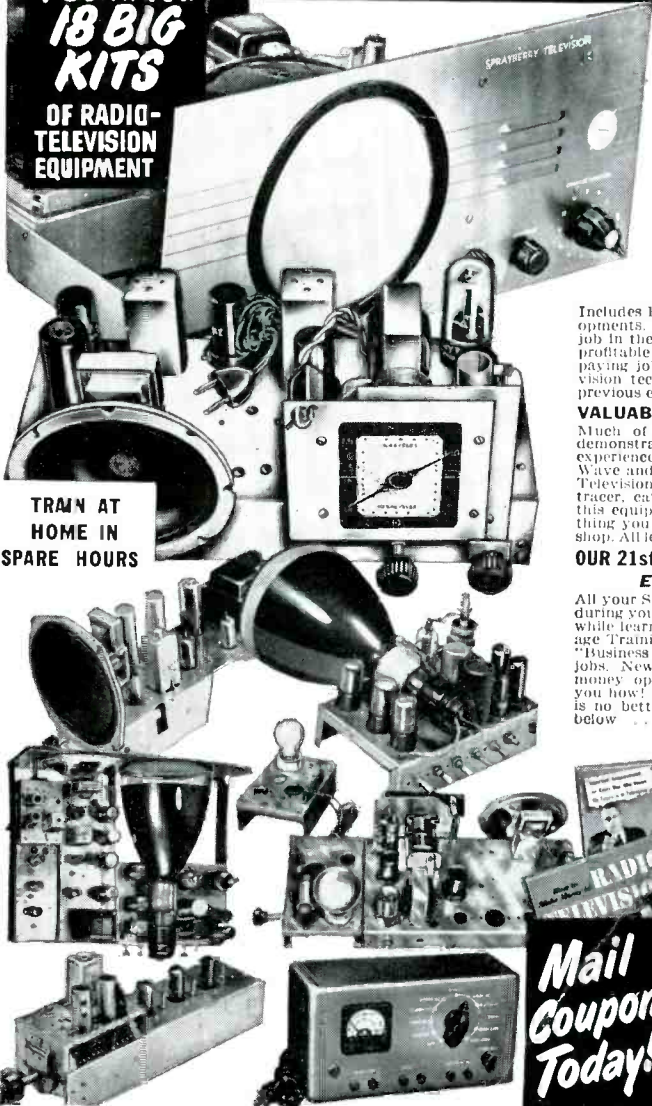

**IF YOU ARE
EXPERIENCED IN RADIO**

Men already in Radio who seek a short intensive 100% TELEVISION Training with FULL EQUIPMENT INCLUDED are invited to check and mail the coupon at the right.

You Have NO MONTHLY PAYMENT CONTRACT to sign... you pay for your training as you learn and earn... ENROLL NOW! Be Ready in Little as 10 MONTHS!

Now you can get into Radio-Television, today's fastest growing big money opportunity field, in months instead of years! My completely new "package unit" training plan prepares you to qualify as a Radio-Television Technician in as short a time as 10 months, or even less! I offer you my training with no monthly payment contract to sign—this NO RISK and NO OBLIGATION for you! This is America's finest, most modern and really practical training.

Includes FM • UHF Television and all the most recent developments. My training gets you ready to handle any practical job in the booming Radio-Television industry. Start your own profitable Radio-Television Service Shop . . . or accept a fine paying job. I have trained hundreds of successful Radio-Television technicians—and I can train you regardless of lack of previous experience. Mail coupon and get all the facts—FREE!

VALUABLE EQUIPMENT INCLUDED WITH TRAINING

Much of your Sprayberry Training is actual construction, demonstration and experimentation. You get priceless practical experience this way. You build the 6 tube Sprayberry Short Wave and Broadcast Training Radio Receiver, the Sprayberry Television set, multi-range test meter, signal generator, signal tracer, cathode ray oscilloscope and many other projects. All this equipment is yours to keep. You have practically everything you need to set up your own profitable Radio-Television shop. All lessons and books I send you remain your own property.

OUR 21st YEAR TRAINING MEN FOR RADIO-TELEVISION

Earn Extra Money While You Learn

All your Sprayberry Training is given IN YOUR OWN HOME during your free time. Keep on with your present job and income while learning Radio-Television. With each Sprayberry "Package Training Unit" I include money-making plans and special "Business Builders" for spare time Radio-Television service jobs. New Television stations opening everywhere open big money opportunity for men to install UHF antennas—I tell you how! If you expect to be in the Armed Forces later, there is no better preparation than Radio-Television. Mail coupon below . . . get facts FREE. No salesman will call.

FREE TO YOU 3 BIG RADIO-TELEVISION BOOKS

I invite you to get all the facts—

I want you to have ALL the facts—without cost! Rush coupon for my three big Radio-Television books: "How to Make Money in Radio-Television" PLUS my new illustrated "Television Bulletin" PLUS an actual sample Sprayberry Lesson—ALL FREE. No obligation and no salesman will call. Mail coupon!

SPRAYBERRY ACADEMY OF RADIO
Dept. 50-O, 111 North Canal Street
Chicago 6, Illinois

**Mail
Coupon
Today!**

SPRAYBERRY ACADEMY OF RADIO
Dept. 50-O, 111 N. Canal St., Chicago 6, Ill.

Please rush to me all information on your 10-MONTH Radio-Television Training Plan. I understand this does not obligate me and no salesman will call. Include 3 books FREE.

Name..... Age.....

Address.....

City..... Zone... State.....

Are you Experienced? No Experience

