

022  
A FAWCETT  
75c  
HOW-TO BOOK

W. R. WHERRY,  
By Donald Carl Hoefler

353

# Low cost HI-FI

**Hi-Fi Down to Earth**

**Bargain Components in Packages and Kits  
Improving Your System  
The Latest in Stereo Sound  
The Big Comeback of FM**



**AM-FM Tuners**

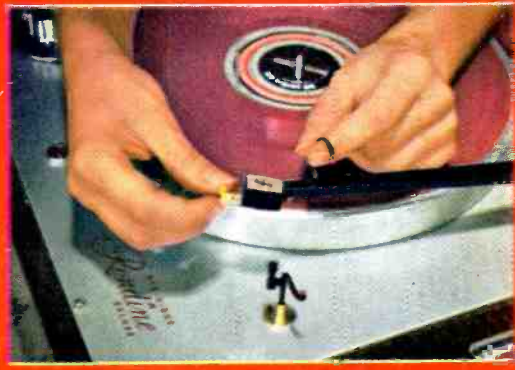

**Pickup Arms and Turntables**



**The New Amplifiers**

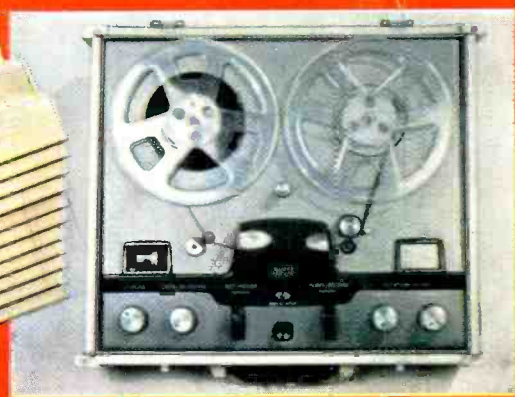

**Tape Recorders**



**Special Section:**  
**HOW TO REPAIR HI-FI EQUIPMENT**

Why you need every feature of these

# NEW UNIVERSITY FOLDED-HORN ENCLOSURE KwiKits

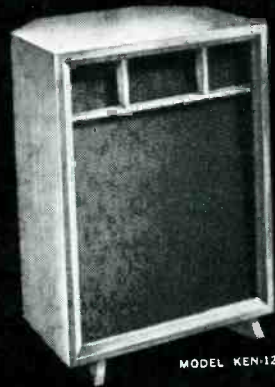

MODEL KEN-12

Because... In performance, mechanical design, construction and ease of assembly, these new KwiKits are unquestionably the very finest enclosure kits—at any price!

**KEN-12** For 12" speakers & systems  
15½" D x 21½" W x 29½" H **\$44.75**  
USER NET

**KEN-15** For 12" / 15" speakers & systems  
18½" D x 29" W x 35¼" H **\$59.50**  
USER NET  
Adapter for mounting 12" speakers in KEN-15 \$1.50 User Net

## ROOM-BALANCED PERFORMANCE

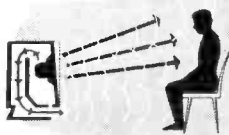

KwiKit acoustic design and tilted baffle combine direct speaker radiation and compensated rear horn loading in a way that blends bass, middle and treble ranges perfectly... for uniform response throughout the listening areas of a room.

## HEAVIER CONSTRUCTION



Heavy ¾" first grade, fully cured lumber for top, bottom, sides and back... not flimsy ½" wood commonly used in "kits." Bigger, sturdier—at much as 30% heavier than others in the same price class. Eliminates spurious resonances so detrimental to achieving richer, cleaner bass reproduction.

## PRECISION MECHANICAL DESIGN



Exterior and interior elements, even the cleats, fit snugly within close tolerance "rabbeted" grooves. Gluing and screwing of each piece results in reliably air-tight, permanent joints. No nails used. No pencil markings necessary. Mitering and plenty of glue blocks and bracing for truly rigid construction.

## PLACE ANYWHERE IN ROOM

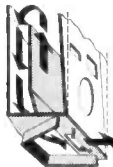

Underside view shows how advanced design, self-contained folded horn extends to the front of the cabinet, projecting low frequencies out into the room... not back into a corner, splashed against the walls. Small slot in base is resistively controlled vent which equalizes woofer diaphragm excursions in compression chamber. KwiKits are therefore independent of room furnishings, shape or placement and can be used against a flat wall, in a corner... even up in the air!

## FOOLPROOF ASSEMBLY



All pieces are pre-cut and pre-drilled... engineered to go together quickly. All you need is a screwdriver! Baffle board is pre-cut... blank plugs and adapters supplied for easy installation of additional components as your system expands. Your KwiKit includes all required hardware, plastic wood, glue, sandpaper, Tufflex insulation, easy-to-follow instructions and... special attention is given to packaging of KwiKits to insure safe, intact delivery to your door.

## PROFESSIONAL RESULTS



There's no end of decorative treatment you can give your KwiKit enclosure. Genuine Korina veneer is same as used in fine furniture, and provides a beautiful finish. Decorative front mouldings have been designed to complement and enhance your present decor. Exquisite, textured grille fabric is equally at home in settings of any period and is acoustically correct to prevent high frequency attenuation.

## KWIKITS...THE PERFECT COMPLEMENT FOR P.S.E.\*

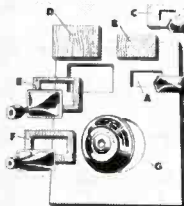

A—Hole cut out for HF-206.  
B—Blank plug supplied when tweeter isn't used.  
C—Adapter supplied cut out for UXT-5.  
D—Blank plug supplied.  
E—Adapter supplied cut out for 4409.  
F—Adapter supplied cut out for H-600 horn.  
G—Takes 312, UXC-123, Diffusicone 12, UXC-122, Diffaxials, 6200, 6201 wide-range speakers and C-12W woofer.

### MODEL KEN-12

takes any 12" wide-range or woofer cone speaker and any tweeter or mid-range speakers.

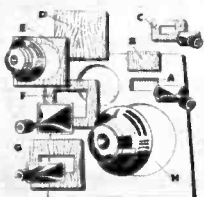

A—Hole cut out for HF-206.  
B—Blank plug supplied when tweeter isn't used.  
C—Adapter supplied cut out for UXT-5.  
D—Blank plug supplied.  
E—Adapter supplied cut out for C-BW or Diffusicone 8.  
F—Adapter supplied cut out for 4409.  
G—Adapter supplied cut out for H-600 horn.  
H—Takes 315-C, 6303, Diffusicone 15, Diffaxials, and C-15W, C-63W woofers.

### MODEL KEN-15

takes any 15" wide-range or woofer cone speaker and any tweeter or mid-range speakers.

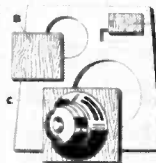

A and B—Blank plugs supplied.  
C—Takes 312, UXC-123, Diffusicone 12, UXC-122, Diffaxials, 6200, 6201 wide-range speakers and C-12W woofer.

### MODEL KEN-15

takes any 12" wide-range or woofer cone speaker when 12" adapter board (optional) is used.

\* University's Progressive Speaker Expansion Plan

REMEMBER... if you like to build your own and save money too, the KwiKit is made to order for you... SEE YOUR DEALER TODAY!

UNIVERSITY LOUDSPEAKERS, INC. 90 SOUTH KENSICO AVENUE, WHITE PLAINS, N. Y.

LISTEN

University sounds better



when it sounds like this...



instead of this...



it's time for...

*University*

When your hi-fi wears out its welcome... tires your ears with shrill, discordant highs, muddy lows and general tonal fuzziness... you've probably got a case of "listening fatigue." It's a common trouble for which a University loudspeaker or system is the cure!

The reproduction of music is a fine art... as skillful in its way, as creating it. Since the speaker is the last link of your high fidelity chain, University spent two decades perfecting the craft of making this link the strongest.

When next you visit your hi-fi center...

**LISTEN**

A FEW OF UNIVERSITY'S MANY



**WOOFERS AND TWEETERS,**



**MID-RANGE AND NETWORKS,**

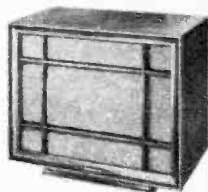

**DIFFAXIALS AND SYSTEMS,**

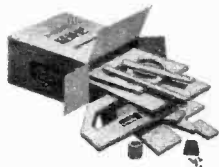

**ENCLOSURES AND KWIKITS**

FROM THE WORLD'S LARGEST SELECTION TO GRATIFY EVERY NEED AND BUDGET

MAIL COUPON TODAY FOR FREE LITERATURE

Desk W-1; University Loudspeakers, Inc., 80 So. Kensico Ave., White Plains, N. Y.

Gentlemen: I would like your free literature. I am checking the subject (or subjects) of interest to me.

- Complete Speaker Systems  
 Speaker Enclosure Kits  
 Speaker Components

NAME \_\_\_\_\_

ADDRESS \_\_\_\_\_

CITY \_\_\_\_\_ ZONE \_\_\_\_\_ STATE \_\_\_\_\_

*University sounds better*



UNIVERSITY LOUDSPEAKERS, INC., 80 SO. KENSICO AVE., WHITE PLAINS, N. Y.



# Low Cost Hi Fi

By Donald Carl Hoefler

A FAWCETT BOOK • NUMBER 353  
LARRY EISINGER • EDITOR-IN-CHIEF  
GEORGE TILTON • MANAGING EDITOR  
HAROLD KELLY • ART EDITOR

W. H. Fawcett, Jr. . . . . President  
Roger Fawcett . . . . . General Manager  
Ralph Daigh . . . . . Editorial Director  
James B. Boynton . . . . . Advertising Director  
Al Allard . . . . . Art Director  
Ralph Mattison . . . . . Associate Art Director  
Annette Packer . . . . . Production Director

**JOSEPH DAFFRON . . . . . EDITOR**

SILVIO LEMBO . . . . . ASSOCIATE ART EDITOR  
Nick Carlucci . . . . . Assistant Art Editor  
Harold E. Price . . . . . Art Associate

Phyllis J. Goodman . . . . . Production Editor  
Nancy Kay . . . . . Assistant Production Editor

LOW COST HI FI, Fawcett Book 353, is published by Fawcett Publications, Inc., Greenwich, Connecticut. Editorial and Advertising Offices: 67 West 44th Street, New York 36, New York. General Offices: Fawcett Building, Greenwich, Connecticut. Gordon Fawcett—Secretary-Treasurer, Roscoe Fawcett—Circulation Director. Trademark of Fawcett Publications, Inc. Printed in U.S.A. Copyright 1957 by Fawcett Publications, Inc.

Cover photos of the James B. Lansing tweeter, McIntosh tuner, Pickering arm and Rek-O-Kut turntable, Sargent-Rayment amplifier and Ampex tape recorder, were taken by Grayson Tewksbury in the Fawcett Studios. Unless otherwise credited, the photos in this book appear through courtesy of the manufacturers of the products pictured or mentioned in the accompanying caption matter.

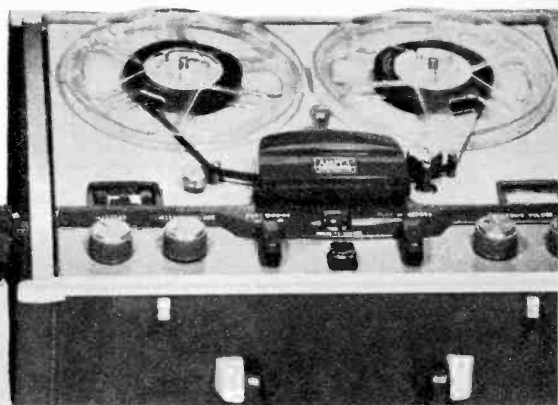





**More Home-Listening Pleasure  
when you add this "component"  
to your hi-fi system!**

Every month, HIGH FIDELITY—America's best selling home-listener magazine—will steer you to the best equipment and record buys . . . save you money, time and temper. Among the regular features you'll enjoy:

Tested-in-the-home equipment reports . . . cover every important new hi-fi product marketed — from a stylus pressure gauge to a complete sound reproduction system.

More record reviews than any other publication — nearly 150 a month. And all fields are covered—popular, jazz, the music between, classical, opera, etc.

"Discographies" that list and review all the available LP recordings of a single composer or artist.

Articles about — and often by — the world's leading musicians, singers, composers and conductors.

Plus many other features to heighten your enjoyment of music in your home.

**FREE** copy of the new issue. Use this coupon today!

**HIGH FIDELITY • 3 Publishing House • Great Barrington, Mass.**

Please send me **ABSOLUTELY FREE**, a copy of the new issue of HIGH FIDELITY and bill me for a one year subscription—to start with the next issue—at the money-saving rate of only \$6.

I prefer 3 years at \$15

I prefer 2 years at \$11

(Add \$1 per year for subscriptions outside the U. S. and Canada)

NAME .....

ADDRESS .....

CITY.....ZONE.....STATE.....

**NO RISK GUARANTEE:** I may cancel my subscription and pay nothing if my free issue does not live up to expectations.

## CONTENTS

How to Spot a Bargain . . . . .	6
Hi Fi Down to Earth . . . . .	11
Three Roads to Hi Fi . . . . .	20
Kits Cut Costs . . . . .	28
Hi Fi's Best Buys . . . . .	42
Hi-Fi Tape Arrives . . . . .	54
FM's Big Comeback . . . . .	64
Repair Your Own and Save . . . . .	70
Speaking of Speakers . . . . .	82
New Ideas in Sound . . . . .	92
Major Recording Session . . . . .	98
The Latest in Stereo . . . . .	104
Yours for the Asking . . . . .	116
Glossary . . . . .	130
Where to Buy It . . . . .	141

## ABOUT BOOK AND AUTHOR

THE VETERAN hi-fi fan will need no introduction to author Donald Carl Hoefler who is seen at an RCA-Victor control console in the photograph at the right. But for newcomers to the great listening experience and those poised for the plunge a few words about him are in order.

Don has been closely associated with sound reproduction since high fidelity was little more than a bull-session subject. An assistant to Major Edwin H. Armstrong, the inventor of FM radio, he has served as a sound engineer, designed FM stations, developed new magnetic tape techniques, and authored earlier best sellers, among them *Hi-Fi Manual* and the *Mechanix Illustrated Hi-Fi Guide*. So, you see, Don speaks with the authority of broad experience.

In this book, he speaks of sound in relation to your budget. What is high fidelity? How can you get the best for the least money? You'll find Don's answers here. Too, you'll find the claims of certain publicists exploded as their pet new products are examined with a critical eye.

If you are contemplating your first hi-fi purchase, special attention is directed to the chapter on best buys. There, you will find balanced sound systems to fit every pocketbook, with components listed brand by brand. Each is a best buy in its own right. That chapter alone can save you a great deal of money. We are sincerely convinced that it will.



*Joseph Daffner*

Learn **PRACTICAL RADIO-TV**  
with **25 BIG KITS**

of equipment I send you while  
you train with me . . . for valuable  
shop bench experience . . .

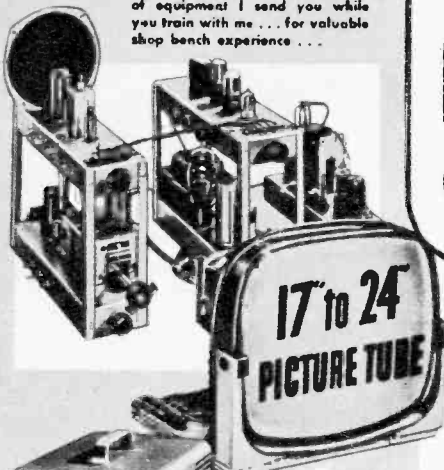

This is the new Sprayberry Training Television receiver, built and tested in sections for gradual instruction value.

I now offer this fine modern oscilloscope to help you learn practical television servicing.

You will build this powerful short wave and broadcast superhet radio receiver for valuable shop instruction practice.

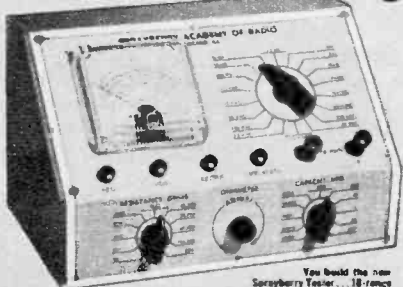
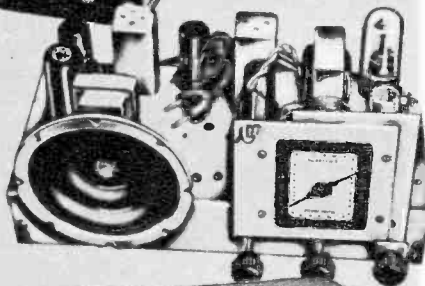

You build the new Sprayberry Tester . . . 18-ounce Volt-Ohm-Milliammeter readings plus output meter and condenser and resistor substitution selector.

**I will train you at home in Radio-Television on liberal no obligation plan!**

**Prepare for a Good Paying Job—Or Your Own Business**

**"I Will Train You at Home in  
RADIO-TELEVISION  
On Liberal No Obligation Plan!"**



Frank L. Sprayberry  
Educational Director

**New Equipment! New Lessons! Enlarged Course! The true facts are yours in my big new catalog . . . YOURS FREE . . . JUST MAIL COUPON!**

I can train and prepare you in as little as 10 months to step into the big opportunity Radio-Television service field. Train *without* signing a binding contract . . . without obligating yourself to pay any regular monthly amounts. You train entirely at home in spare hours . . . you train as fast or as slowly as you wish. You'll have your choice of **THREE SPRAYBERRY TRAINING PLANS** . . . planned for both beginners as well as the more experienced man. Get the true facts about the finest most modern Radio-Training available today . . . just mail the coupon for my big new 56 page fact-filled catalog plus sample lesson—both **FREE**.

**Train the Practical Way—with Actual Radio-Television Equipment**

My students do better because I train both the mind and the hands. Sprayberry Training is offered in 25 individual training units, each includes a practice giving kit of parts and equipment . . . all yours to keep. You will gain priceless practical experience building the specially engineered Sprayberry Television Training Receiver, Two-Band Radio Set, Signal Generator, Audio Tester and the new Sprayberry 18 range Multi-Tester, plus other test units. You will have a complete set of Radio-TV test equipment to start your own shop. My lessons are regularly revised and every important new development is covered. My students are completely trained Radio-Television Service Technicians.

**NEWEST DEVELOPMENTS**

Your training covers UHF, Color Television, F.M., Oscilloscope Servicing, High Fidelity Sound and Transistors.

**See for Yourself . . . Make Your Own Decision . . . Mail Coupon Today!**

The coupon below brings you my big new catalog plus an actual sample Sprayberry Lesson. I invite you to read the facts . . . to see that I actually illustrate every item I include in my training. With the facts in your hands, you will be able to decide. *No salesman will call on you.* The coupon places you under no obligation. Mail it now, today, and get ready for your place in Radio-Television.

**SPRAYBERRY ACADEMY OF RADIO-TELEVISION**  
1512 Jarvis Ave., Dept. 141-T, Chicago 26, Ill.

**Mail This Coupon For Free Facts and Sample Lesson**



SPRAYBERRY ACADEMY OF RADIO-TELEVISION  
Dept. 141-T, 1512 Jarvis Ave., Chicago 26, Ill.

Please rush all information on your ALL-NEW Radio-Television Training Plan. I understand this does not obligate me and that no salesman will call upon me. Include New Catalog and Sample Lesson **FREE**.

Name \_\_\_\_\_ Age \_\_\_\_\_  
Address \_\_\_\_\_  
City \_\_\_\_\_ Zone \_\_\_\_\_ State \_\_\_\_\_



# How to Spot a Bargain

You must know where to look, and when, to get the most out of your high-fidelity dollar

**E**VERY large retail establishment has personnel on its payroll who are known professionally as comparison shoppers. When you embark upon your campaign of tracking down and acquiring your hi-fi components, you, too, must be a comparison shopper. There are many companies in the field competing for your patronage. Make them earn it. Compare manufacturers on the basis of price and quality, and compare distributors on the basis of price and service.

Basic price information will come from manufacturers' publications, and you will then compare this with the offering prices of the various supply houses. There won't be a great deal of variation in prices, but special deals do come along occasionally. You will know of these as they happen if you get your name and address on the list of each of the suppliers doing a mail-order business. You can get their names from the directory in the back of this book. Their catalog prices will be rather well standardized, but from time to time you will receive "flyers" and bargain sheets which will list worth-while offers.

You can and should expect your dealer to provide whatever information you need and to stand behind the products he sells. If they are not right after the sale is made, he has the responsibility for making it right, or acting on your behalf with the factory so that they will correct the trouble. Your best yardstick for service is simply reputation. Phonies come and go in this business, like any other, but the important thing is that they do go, and rather fast.

You should keep in mind always that you will save the most money by selecting a basic system.

Your individual decision will, of course, be based largely upon the uses to which your system will be put. If you want it to double as a public-address system, or for advanced musical or acoustical studies,



**ALLIED RADIO** of Chicago has its own brands plus others' for the bargain-hunter's comparison.

then your requirements will be quite different from one who merely wants pleasantly low-level music to read by. Get everything you will need, but *don't* get anything which is worthless to you. This is the beauty of the component method of hi-fi assembly: you can tailor-make your individual system to suit your individual needs.

Occasionally you can effect some minor savings by buying equipment sold under a *house label* or *private brand*. These are items which bear the trade name of a distributor or retailer but which were not actually manufactured by him. They may have been made by a company whose name you know very well, or they may have been manufactured by someone you never heard of. This latter case does not mean that the product is inferior.

Even though price policies at the consumer level are fairly well stabilized, you can save by buying a "package." Most large distributors put up sets of components, offered together in a single deal, at a better purchase price than the individual items could be bought separately. If none of these quite fit into your concept of the ideal hi-fi system, you can probably save anyway by assembling your own package of components, purchased from the same source at the same time.

You can also save more by pooling your buying, an idea which has great possibilities, but which has been little explored in the hi-fi field. Its method of operation is simple. The chances are that you are already a member of an audio club or music society. This is the logical starting point for your buying pool. Then suppose that your club membership determines that amplifier "X" is an excellent buy, and suit-

[Continued on page 8]

# Attention Record Collectors!

## Ask your record dealer for the 192-page Schwann LONG PLAYING RECORD CATALOG

**A complete, accurate, well printed catalog of over  
25,000 long playing records.**



- ★ the selection on the back of the record clearly identified.
- ★ new releases of over 318 companies every month (starred).
- ★ composer, title, performers.
- ★ composers' dates of birth and death.
- ★ size of record, record number, number of records in sets.
- ★ classical records listed by composer.
- ★ collections by orchestras, performer, or instrument.
- ★ popular, musical shows, children's, listed by title or artist.
- ★ ballets, operas, operettas, folk music, speech . . . all in ONE booklet.
- ★ complete price list.

### AN OUTSTANDING GUIDE FOR BUILDING YOUR OUTSTANDING RECORD COLLECTION

If you are a real music lover you shouldn't be without SCHWANN LONG PLAYING RECORD CATALOG. Issued monthly, it lists and classifies all generally available longplay records. New releases as well as discontinued numbers clearly marked for your convenience in making your selections.

Whether your preference is classical or popular—you'll find it in SCHWANN. The Schwann Catalog is available every month at more than 3600 record stores. Ask your regular record dealer for it. If he doesn't have it, send us his complete name and address as well as your own, plus 10 (cents), and we will send you a SAMPLE copy of the Schwann Catalog.

#### SCHWANN LONG PLAYING RECORD CATALOG

137 Newbury Street  
Boston 16, Mass.

Gentlemen:

Please send me a sample copy of the SCHWANN CATALOG. Enclosed is 10¢ to cover the cost of handling.

MY NAME .....

DEALER'S NAME .....

STREET .....

STREET .....

CITY..... STATE.....

CITY..... STATE.....

[Continued from page 6]

able to the needs of most of your membership. Furthermore, quite a number of you want to get an amplifier, and so you decide that you'll all get this model. Then all of you who want to participate in the deal will delegate one of you to approach suppliers with an offer of an order for the required number of "X" amplifiers. He certainly will be able to do better than you alone could in the purchase of one "X" amplifier.

Equally important is the correct timing of your purchases. Buy when the price is right, which is to say *not* when almost everyone else is buying. Every autumn, for example, you may attend one or more of the audio exhibitions, hearing one more-thrilling sound after another. Your enthusiasm mounts to the point where you hate yourself for having left your checkbook at home. WAIT just a moment, my friend. You know that the last quarter of the year is the season of the most feverish buying activity. And when business is good, you don't really expect to find any bargains, do you?

But when should you set out to lay in a few hi-fi supplies? Well, on a hot afternoon in August, for example, when everyone is lying around trying to get cool, when even the hi fi sounds muggy, when the salesmen are playing poker for lack of customers, and the merchant's overhead keeps going on just the same. Perhaps he's willing to go pretty far to make a few sales at this time, and perhaps this is the time for you to get out there and make yourself a deal.

And finally, if you are on the lists of the mail-order houses, as we've suggested, you can note the timing of the greatest frequency of flyers and bargain sheets. When you find your mail box fairly inundated with these, it's a sure indication that business is slow. That's the time for you to act fast.

The marketing structure of high-fidelity equipment is a most unusual one in American business, and one for which the audiophile owes a large debt of gratitude to the amateur radio operator, the well-known *ham*. In the early days of radio there was the usual manufacturer-distributor-dealer arrangement, but the dealer, of course, handled only products which were of consumer interest, such as ready-made sets and receiving-type tubes.

When the ham came upon the scene, he required professional materials, such as transmitting tubes and parts, which the dealer didn't carry. His only choice was to go directly to the distributor, who handled

such items regularly for his professional trade, such as radio broadcast and communication stations. Then other advanced amateurs, such as audio experimenters, wanted to get the same deal.

Some enterprising distributors soon realized that the interest in these fields was not confined only to the major cities, and therefore the idea of doing business by mail should be a profitable one. They were soon offering complete catalogs of both radio and audio equipment, which was available to everyone at regular distributor prices.

Since the distributors, both the mail-order operators and those who had stores, had long been in the audio business catering to the experimenter and public-address trade, they were the first to sense the increasing general interest in hi fi, and to offer such equipment at their usual low prices. And although others in the retail business have made inroads, the radio parts distributor is still the foremost source of supply for hi-fi equipment.

And the fact that the distributor has been so active in the field means that you and I save considerable money every time we make a hi-fi purchase. Up until recently the price structure in this field had an equipment retail list price by which the distributor buys at 60% off and sells at 40% off. Thus the distributor mark-up is only 50% gross profit, a very small figure for a business which deals directly with the public.

A true bargain that many newcomers to high fidelity seem to overlook is the build-it-yourself field. The home handy man who wouldn't hesitate to tackle the intricacies of a leaky faucet will pale at the sight of a radio diagram.

Today when you buy a kit you will find explicit plans. These will include a parts list which you will first check against all enclosures in the kit to be sure there are no shortages. By the time you have finished you will already be acquainted with the parts by name and will have learned something about color coding of condensers. Your radio store can supply a color code chart if one is not included. The fact that all these pieces have to be soldered together will show you why you are saving labor costs and possibly 50% on the price.

And now that you know the tricks of the hi-fi buying trade, before you set out to put these principles to work let's pause to consider a great service which we too often take for granted. I refer to radio broadcasting, which is free of charge. You'll hardly find a bigger bargain anywhere in your quest for high fidelity. •



# FREE

## ... the new issue of **audiocraft**

America's first and only HI-FI HOW-TO-DO-IT MAGAZINE

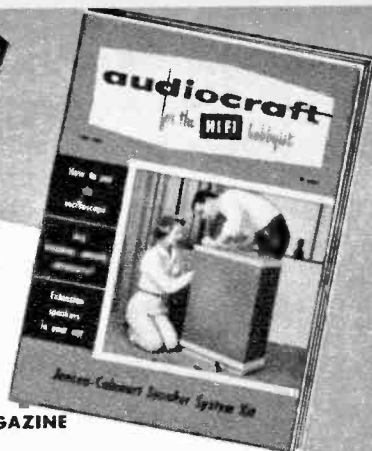

Here is the magazine edited and published specifically for do-it-yourselfers like you!

Every monthly issue of AUDIOCRAFT contains easy-to-follow articles about home sound equipment—how it works . . . how to build and maintain it. Plenty of step-by-step photographs, too, that guide beginners and experienced hi-fi hobbyists alike to outstanding home sound systems—at minimum cost.

Every month, articles like: Choosing and Building a Speaker System . . . Adding Tape to Your System . . . Low Cost Amplifier Kit and How to Assemble It . . . How to Work With Printed Circuits . . . Build Your Own Pick-up Arm . . . Trouble-shooting Without Test Instruments.

Regular Features Include: Reviews of highest-fi disc and tape records . . . The Grounded Ear . . . Audio News . . . Tips for the Woodcrafter . . . Tape News and Views . . . and more!

With AUDIOCRAFT as your hi-fi guide, you have fun . . . you learn . . . you wind up with a home sound system that will be the envy of your neighborhood! Act now to get your free copy.

USE  
THIS  
COUPON  
**TODAY!**

AUDIOCRAFT • 4 Publishing House • Great Barrington, Mass.  
Please send me, ABSOLUTELY FREE, a copy of the latest issue of AUDIOCRAFT, and bill me for a three year subscription to start with the following issue. This is at your money-saving price of only \$9.00.

I prefer 2 years at \$7.00 (24 issues)  I prefer 1 year at \$4.00 (12 issues)

NAME .....

ADDRESS .....

Add \$1 per year for subscriptions outside the U. S. and Canada.

**NO RISK GUARANTEE** — If my free copy does not live up to expectations, I may cancel my subscription and pay nothing.

**YOUR high-fidelity equipment... Here's how the B.I.C. GROUP lines up**



Today you can assemble your entire high-fidelity phonograph with B.I.C. quality-endorsed components each the finest... fully guaranteed... uniformly better, yet priced competitively with ordinary components. Your continuing satisfaction is assured by really complete spare parts and service facilities. For literature, write Dept. S687. Please specify product.



For example—**New!**  
**Garrard RC 88**  
"Triumph II"  
**World's Finest Record Changer**  
4 speeds... full manual and automatic positions. True-turret drive... uses no belts. 4 pole "induction Surge" motor. Foolproof Garrard Pusher Platform. \$54.50 net

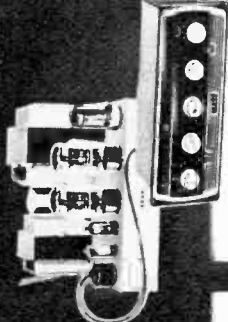

For example—**New!**  
**LEAK "TL/50 Plus"**  
Britain's Finest Amplifier. Sets a new standard in quality and circuitry. Total harmonic distortion 0.1% for 50 watts output... \$149.50 net (25 watt and 12 watt models also available) with **VARISLOPE III** Pre-amplifier. Only preamp. in the world featuring a variable turnover control with an infinite variety of adjustments! \$79.00 net ("Point One" preamp. also available)



For example  
**Wharfedale**  
Super 12/75/AL  
12" full-range Loudspeaker  
... by world-renowned G. A. Briggs.  
Response over entire range.  
Especially full-bodied, non-strident tone. Unique foam suspension and felt buffer rim; aluminum voice coil. \$78.50 net  
Other models: full range, woofers treble; from \$22.50 to \$78.50

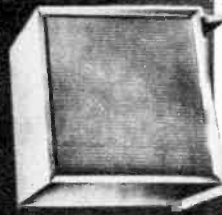

For example—  
**R-J Floor model**  
The original small-space loudspeaker baffle. Patented R-J design principles assure unobstructed highs.  
Model F:12-M Mahogany \$52.50  
Model F:12-B Korina \$57.50

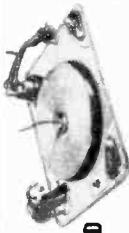

**New!**  
**GARRARD RC 98**  
"Crown II"  
Super Changer. All RC 88 features including full manual position and true-turret drive. PLUS continuous + or - variable speed control on all 4 speeds \$67.50 net



**New!**  
**GARRARD 301**  
"Professional" Transcription Turntable. Supreme in its class! All speeds variable and adjustable. Each machine tested perfect, with individual written inspection report on wow, rumble, flutter... \$89.00 net



**New!**  
**GARRARD RC 121**  
"Raven"  
4-speed Mixer Changer. Garrard's most compact, economical changer fits any cabinet. Simple Mix Operation. Includes 4 speed record player, 4 pole motor. 4-pole motor. Manual position. \$42.50 net



**New!**  
**GARRARD T "Mark II"** Manual Player. The answer for a quality budget system. Incorporates all record playing features of the Garrard automatic changers. 4-pole motor; automatic stop. \$32.50 net



**NEW! LEAK COMBINATIONS**  
3 new Amplifiers • 2 new Pre-amplifiers

Amplifier	Pre-amplifier	Net Price
"TL/50 Plus"	VariSlope III	\$228.00
"TL/50 Plus"	Point One	204.00
"TL/25 Plus"	VariSlope III	188.50
"TL/25 Plus"	Point One	164.50
"TL/12 Plus"	VariSlope III	168.00
"TL/12 Plus"	Point One	144.00

**Genalex... Final Audio tubes**  
The original KT66 power-amplifying tetrode. Fits same socket as U.S. #6L6... \$35.00 net  
The original 2729 low turn input tube. \$2.99 net  
**New! KT66**—high performance 600 watt audio amplifying tetrode. \$4.50 net

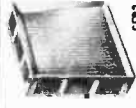

**New!**  
**Wharfedale**  
Briggs-designed 3 way Speaker System... Ready to Play



(Other complete Wharfedale Systems available)



**R-J Shelf-model Loudspeaker**  
Maximum Bass. Minimum Space.  
Thrilling performance from any loudspeaker in cabinet only slightly larger than the speaker itself. Single shelf and double shelf models, and R-J Wharfedale unit incomplete with special Briggs designed speaker! \$26.50 to \$60.00 net.

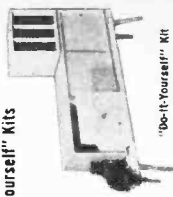

**Customized Cabinets and "Do-it-Yourself" Kits by River Edge**  
29 models: 10 finishes Equipment and loud-speaker cabinets to fit components of all manufacturers. Finished cabinets shipped—unpainted "Do-it-Yourself" Kit.



Finished cabinet

**BRITISH INDUSTRIES CORPORATION • Port Washington, New York**

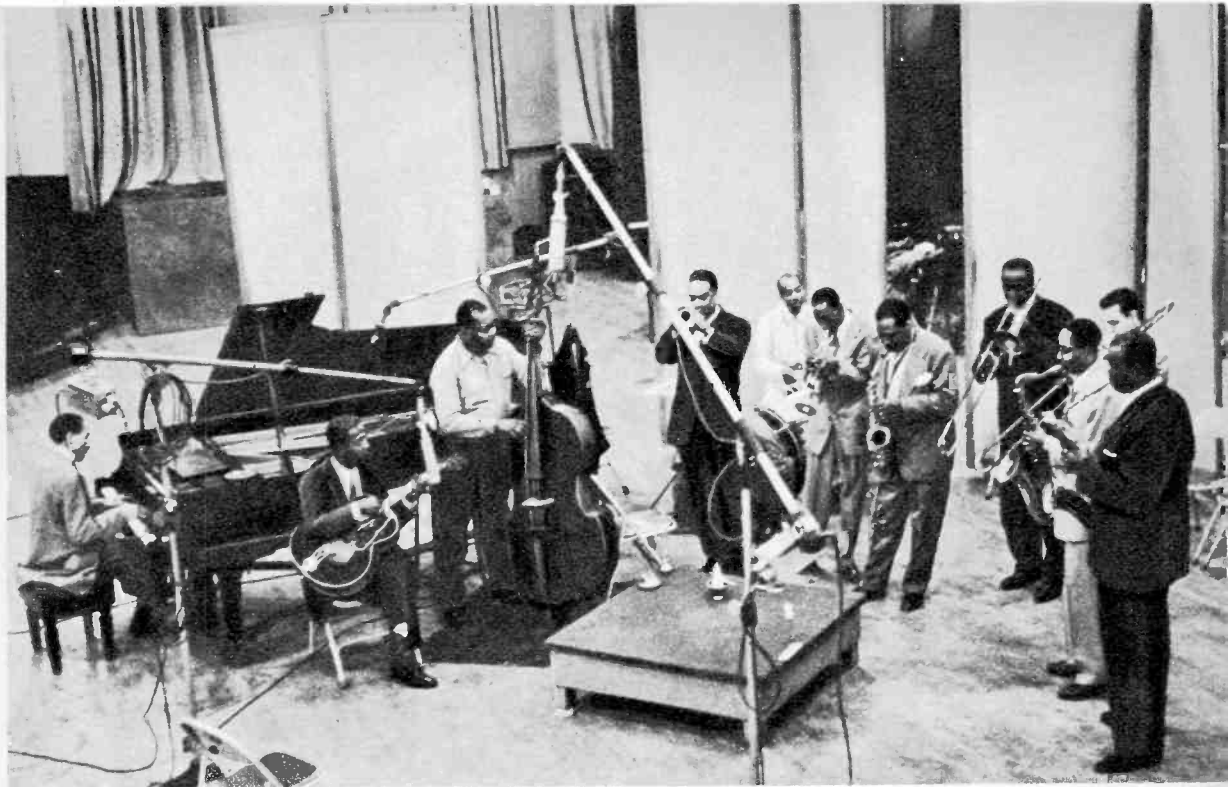

MULTIPLE-MIKE pickup used in recording gives listener the effect of being in several places at once.

## Hi Fi Down to Earth

Away with vague theories and pseudo-science! The reason for acquiring hi fi is simplicity itself—it's fun

**W**HAT IS HIGH FIDELITY? A simple little four-word question like that can ignite arguments of warlike proportions, and start authors tearing out their already-sparse hair. Yet anyone considering pursuing this hobby should have a few concrete notions about it.

Like another artistic hobby, photography, hi fi has many varied uses, moods and hues. Just what it means to you will depend largely upon you, yourself.

Literally, high fidelity means faithfulness—faithfulness to an original. It has been defined as the nearest possible approach to date to perfect fidelity, this illusory term in turn being called the exact psychological impression of presence at an original performance.

This little definition is nice and pat, but if it told all there is to say about hi fi, many of us wouldn't want to waste our

time with it. For there is one inescapable fact we may as well face right at the outset. Good as high fidelity is, it's still light-years away from perfect fidelity.

As a former broadcast and recording engineer who has walked a good many miles between studios or auditoriums and control rooms, I think I have had the best possible comparisons between live sound and that electronically reproduced. And believe me, old friend, there's a difference—a *big* difference.

### Perfect Hi Fi?

Yes, there have been audience tests purporting to prove that the hi-fi millenium is here, but the conclusions were hardly valid. They usually involved comparison between a record and an instrument of rather limited upper harmonic range, such as a piano or human voice, playing rather



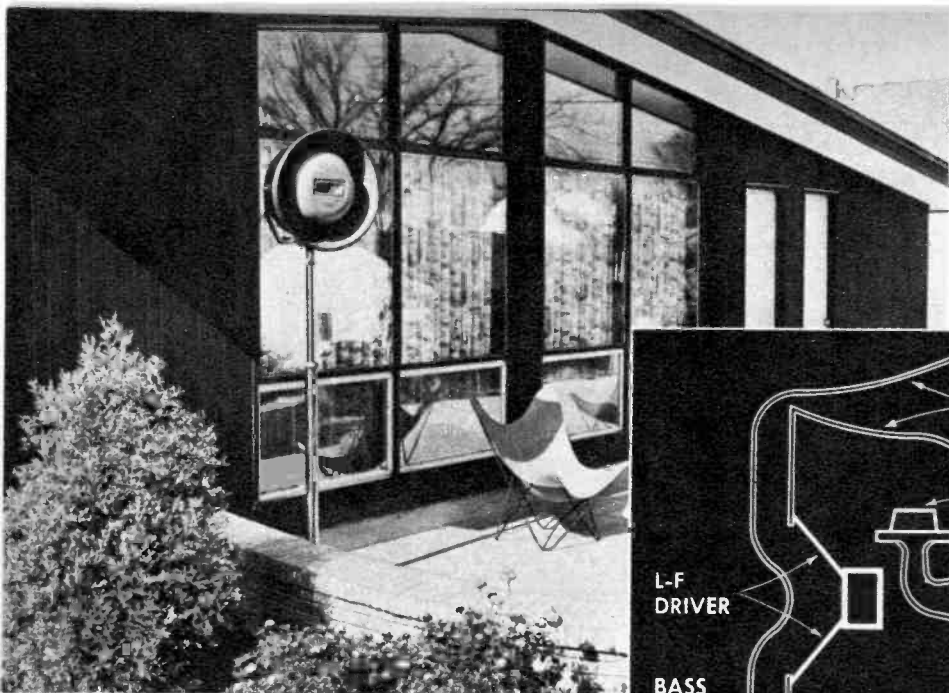

**OUTDOOR HI FI** is becoming increasingly popular though outdoor installations obviously require waterproof speaker. Pictured is a Jensen model.

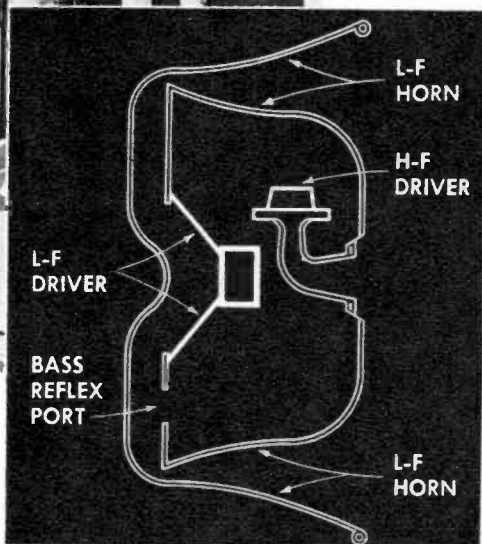

softly and in a low register. Then with fairly rapid switching back and forth between the two sources, when the audience as a whole fails to detect less than half the switches, the promotion boys run out crying *Eureka!*, and more pseudo-scientific nonsense is foisted on the public.

It is true that certain kinds of sounds are reproducible with near-perfect fidelity. But anyone who can honestly say that the recording heard in his living room of complex sounds such as those of a symphony orchestra, closely resemble what he heard at Carnegie Hall last night—well, he needs a new set of earmuffs for his tin ears.

So all right, you ask me, if high fidelity isn't close to perfect fidelity, then why should you waste your time and money on it, and how do I propose to fill nearly 150 pages in a book telling you about it? To answer the first question, I advise anyone who is interested in the performing arts to acquire a good hi-fi system simply because it adds just one more dimension to one's esthetic enjoyment. In short, hi fi is good because it's *fun*. And as for your second question, I hope to give you a few tips which will enable you to shop for your

equipment more intelligently and to tell you how to get the most out of it after it's yours.

### Besting Mother Nature

Getting back to our photography analogy, no one rejects it as a hobby because it cannot precisely reproduce nature, because it can't quite make you feel that you are on the scene. Sure, such movie techniques as *Cinerama* and *Cinemascope* come remarkably close sometimes, but even so you must give your imagination free rein.

But sometimes a photo or movie, or a story, play or painting grips us because it seems to go Mother Nature even one better. It has an ethereal effect or fantasy quality which piques our senses and makes us feel that here is a creation which is both different and satisfying.

And so it is with hi fi. When properly done, hi fi can give you a non-existent seat which is really *better* than any seat in the house. You'll hear things that even the conductor doesn't hear. And this is really hi fi's justification for being. While it can't quite equal nature, it can present sounds and sense impressions which don't even occur in nature itself.

This impressionism begins right in the recording hall itself with the placement and usage of microphones. This subject is one which has been hotly debated in the industry for years, but most engineers and producers now agree that the technique employed will depend upon the desired effect, and that no single method is ideal for every situation.

Proponents of the single-mike technique argue that the one microphone, properly placed, puts the listener in the best seat in the house, and he therefore hears exactly what the mike hears. More than one microphone, they say, will actually present a distorted picture by putting the listener's ears in a half-dozen places at once, or even instantaneously jump him about from place to place.

The multiple-microphone operators concede that they convert the listener into a sort of aural octopus, but that this is desirable, a part of the "going-one-better" technique. In this way, the listener can sort of "zero in" on each soloist or featured performer, to partial exclusion of other parts.

### "Doctored" Records

The recording becomes even more unreal after it leaves the studio and goes to the editing and re-recording rooms. All recording is originally done on tape now, but the finished disc record may be several generations removed from the original.

Editing involves physical cutting of the tape, with the best parts of each performance "take" spliced together to make a synthetic composite master. The unreality becomes marked if the editing is badly done and abrupt cuts, skips or drop-outs are heard, but an expert tape editor can patch together a performance in which the changes from one take to another are absolutely indiscernible.

At this point the tape can go to a dubbing channel for re-recording from tape to master disc, but it is very likely that it will instead go through an intermediate process of re-recording tape-to-tape. And here is where the magic potion really begins to bubble.

The tools of the re-recording engineer are filters, equalizers, faders, echo cham-

**RE-RECORDING** for special effects stems from movie methods. Sound-track dubbing here is at Warner Bros.

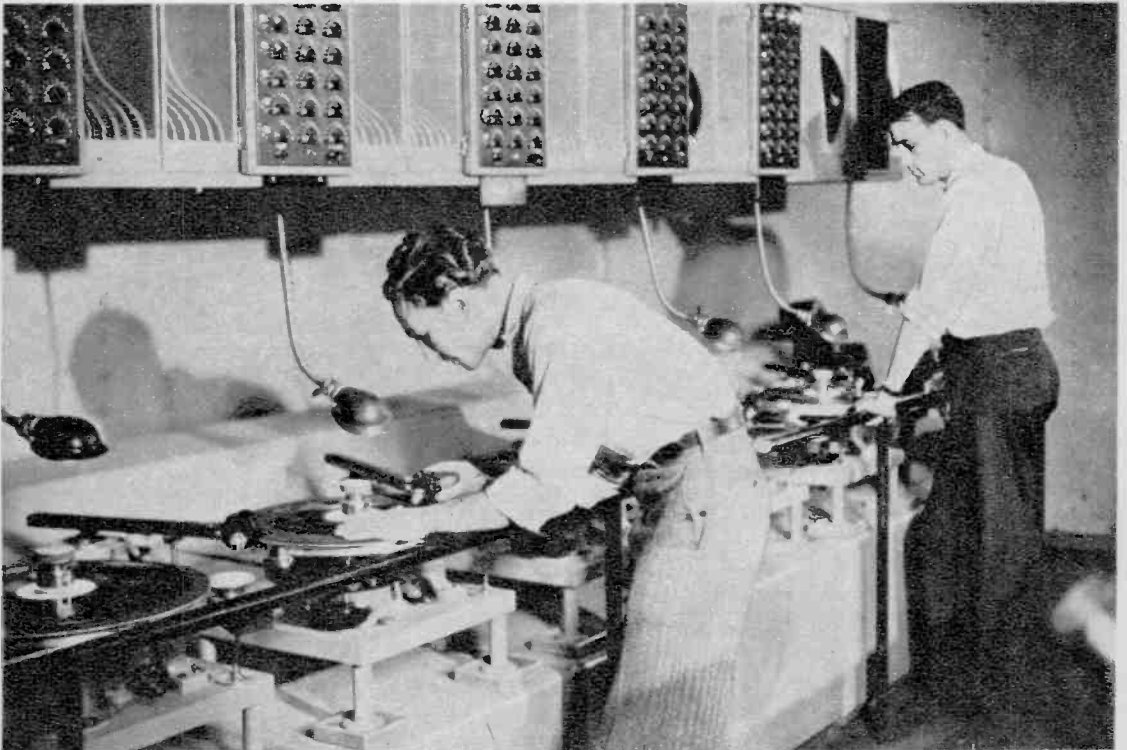

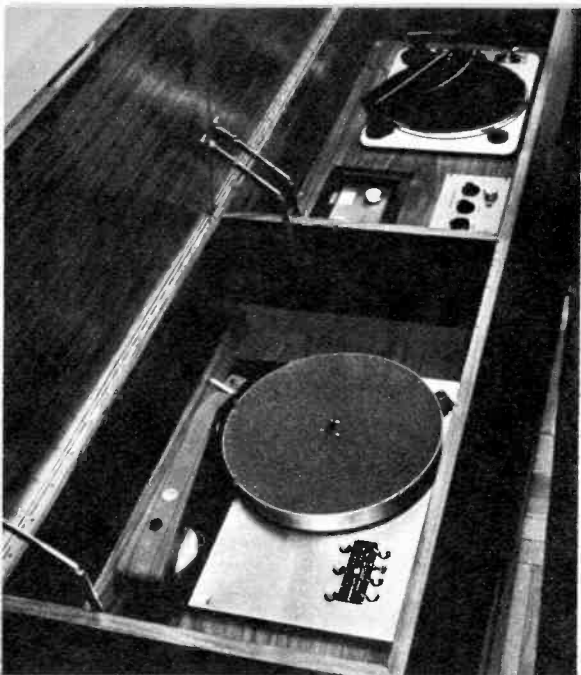

**TURNTABLE-versus-changer dilemma was resolved by simply installing both, as shown in this photo.**

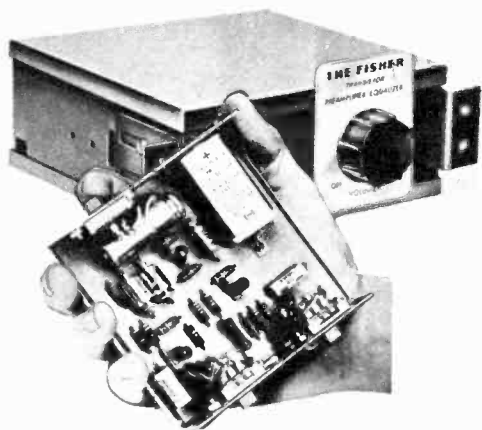

**FISHER transistor equalizer-preamp was the first all-transistor product to appear in hi-fi field.**

**LAFAYETTE'S 5-transistor audio amplifier is sold as kit. Transistors are yet low-powered for audio.**

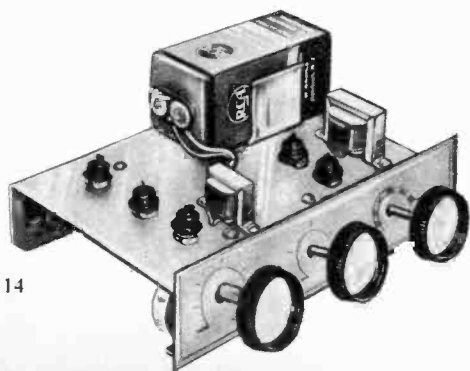

bers and reverberation units. With these he can produce a new tape which may be quite unlike the original. If a singer's voice is too harsh, he can make it mellow; if it's too distant, he can give it presence. If even a single note in a performance is inconsistent by being too strong, too weak, too rough or too sweet, that can be corrected, too. And reverberation generators, such as echo chambers, tape regenerators and spring vibrators, can provide a variety of special effects ranging all the way from a little added liveliness to making the sound seem it must have been performed in a cool green grotto under cerise spotlights before an appreciative audience of werewolves.

All of the tricks in recordist's kit bag are used to make you, the record buyer, hear something you've never heard before, and like it well enough to put out some of your hard-earned *dinero*. It's Technicolored sound to be sure, and not very closely related to the classic definition of fidelity. But as Alfred Tonnelle has said, "The artist does not see things as they are, but as he is." Perhaps high fidelity has now achieved the status of an art, in which case maybe it's time to give it a new and less contradictory name.

### Hi Fi Is Big Business

But enough of the art of hi fi for the moment. Let's get down to business. The hi-fi business has become so competitive in recent years that some manufacturers have resorted to the "hard-sell" techniques used in promoting such everyday products as soap, toothpaste, patent medicines and cigarettes. As a consequence the prospective hi-fi purchaser finds himself bombarded by a welter of claims and counter-claims, pseudo-scientific doubletalk, and tons of hot air.

This is not at all to say that every hi-fi manufacturer is a shyster or charlatan. Far from it. There are many fine products on the market, conscientiously built and sold, and one of our purposes in this book will be to help the reader separate the wheat from the chaff.

But no one is in the hi-fi business for his health, any more than you go to work because of undying love for your employer, or than I give my nights and weekends for several months to the preparation of this book just because I like to hear the staccato rattle of typewriter keys. And this just means that the buyer must look after his own interests just as the seller looks after his.

An executive of one of the biggest and



best-known record companies, whose product has been severely criticized in the trade press, told me recently: "Sure, we know the competitor's product is better than ours. But if we improved our own and took a lot of business away from them maybe we'd be in trouble for trying to monopolize the market. Anyway, our sales and profit picture is as good as any in the industry. When that picture shows signs of changing, then we'll worry more about product quality."

This sounds shockingly calloused, doesn't it? And yet maybe the man is right. As long as you and I find reasons for buying his records, whether we know they are inferior or we don't, why should he make a change and risk upsetting the applecart? The time will come, of course, when his company has a rough season or two when the public gets wise and he has to adopt the technological advances to catch up. But this is human nature, and it's the pattern of American business, and we should all realize that businessmen are neither more nor less generous than the rest of us.

#### Dusting off Rejects

But sometimes the play gets a little rough. In recent seasons, for example, we have seen a rash of "innovations" in hi-fi products based on old and long-discarded principles. Occasionally technological advances will make practicable an old idea which has been lying on the shelf. Magnetic recording, for example, is over a half-century old, while stereophonic sound has been around for at least twenty years.

In addition to worth-while advances such as these, however, we also see far too many gimmicks and expensive junk based on ideas which years ago were tried, found wanting, and discarded because they were basically unsound. Some of these gadgets have found their way into this book simply because of their curiosity or news value. They are interesting in the same way as would be a Stanley Steamer with a 1958 body. The reader is invited to look them over for their historical interest, without investing a single sou.

Closely related to these are the novelty gadgets, such as remote-control tuning for television, or portable pants pressers. Because they have little true usefulness, these items almost inevitably sink to their own level and disappear from view, but only after a lot of money has changed hands. The hi-fi tyro should consider carefully any such gimmickry to determine if it will really perform as claimed, and whether its function is really a needed advantage.

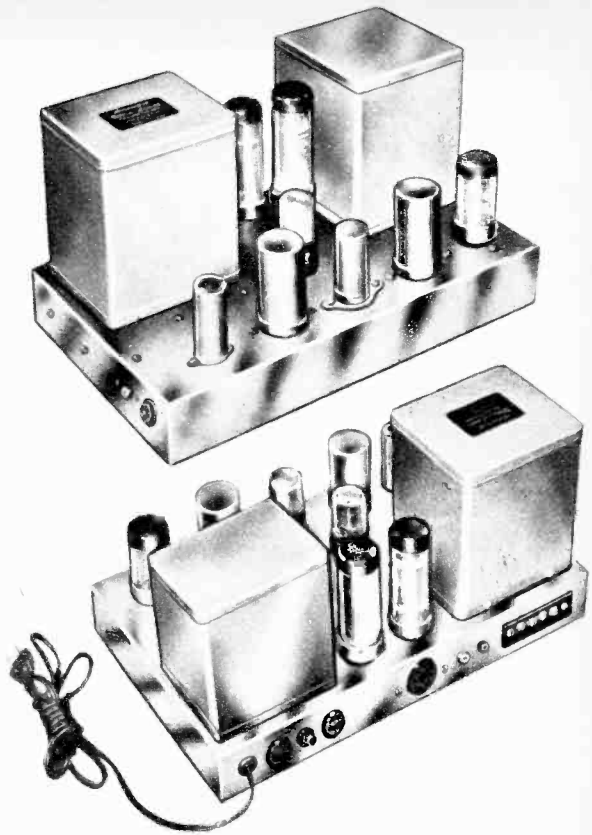

ULTRA-LINEAR amplifier with rated output of 60 watts is new Lafayette kit shown here in two views.

RECORD CARE is all important; therefore a turntable level and stylus pressure gauge are essential.





WHEN BUILT-INS are considered as housing for high-fidelity components the possibilities that present themselves are unlimited. Tuner and amplifier are set in pegboard in this handsome bookshelf setup.

Since a hi-fi investment involves several hundred dollars at least, the beginner should arm himself with all of the facts he can get his hands on. You already know that, of course, or you wouldn't be reading this book. I bow to you. But while we try to keep you posted on developments and trends in hi fi, we simply don't have space for extensive product evaluations.

I therefore earnestly suggest that you spend some time at the library with the publications which do specialize in this field, such as *Consumers' Research Bulletin* and *Consumer Reports*. At odd times each of them may lapse into a questionable method of gathering data, or of a conclusion which seems based more upon opinion than fact, but for the most part their evaluations are fair and scientifically sound.

#### What Shall I Buy?

One of the favorite subjects in my mail from readers is a request for specific recommendations for a group of components in a given price range. Publishing a list of his personal choices is a good way for an author to get clobbered. The manufacturers who feel slighted (but not all of them, thank goodness) are quick to claim a foul or collusion. Even worse is the recommendation of a piece of gear which has just been superseded by a new model. I can only say that the suggestions you will find later in this book are just one man's opinion, no better than anyone else's, except that they are based on many years of experience in the audio field.

Any hi-fi setup worthy of the name will

include not only a fine record-playing system, but also a good radio tuner. This should definitely provide for FM reception unless you are completely beyond the range of any FM broadcast signal. This is highly unlikely, except in a few scattered areas of the far West. FM programming today is vastly superior to that of AM stations, with a very few exceptions, and it is seldom marred by overbearing commercials.

Just how this can be is a mystery to me. Having spent some years in the highly unprofitable FM business, I cannot understand how the FM broadcasters stay in business with shoestring revenues. But many of them do, bless them, and with full broadcast days, too. The Federal Communications Commission only requires a minimum six-hour day for FM, but many of these small operators provide pleasant listening from early morning to late at night.

#### Tuners vs. Radios

The hi-fi radio tuner is quite a different thing from the ordinary home radio. Just about everyone knows by now that the audio amplifiers and loud-speakers on home sets are worthless, but some audiophiles have had the idea that they might economize by using the front end of an old radio as a tuner and running it into their hi-fi audio system. This is technically feasible, of course, but the results won't be very satisfactory.

The difference is that the ordinary set is  
[Continued on page 17]

*better*  
**DO IT ^ YOURSELF...**

with **Altec Lansing** components



Discriminating high fidelity fans know that there is no substitute for a home music system which is "customized" to their individual needs. This personalization is the difference between an ordinary installation and a "designer-matched" system which utilizes professional quality Altec Lansing high fidelity components to achieve outstanding performance.

One of the outstanding combinations available from the complete line of 27 Altec Lansing high fidelity components is the 306A tuner, 440C control preamplifier, 340A amplifier, and 604C speaker. This system achieves a professional level of performance, at a price of \$642.00.

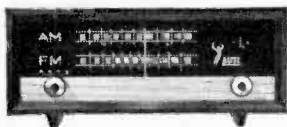

**The 306A AM-FM broadcast tuner** features maximum sensitivity and selectivity and lowest distortion. It is the finest high fidelity tuner on the market, and an integral part of any installation where you desire to take advantage of the limitless entertainment available on AM and FM radio.

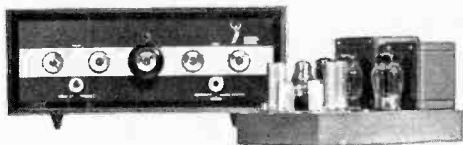

**Altec's famous 340A-440C** combination provides distortion-free amplification of 35 watts continuous power or 70 watts peak power. The exclusive control panel on the 440C features a single master volume control, plus six controls for selection of any one of 25 crossover combinations, tone control, and operation of the five inputs, two outputs and the special tape monitoring circuit.

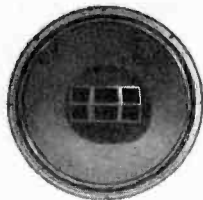

**Finest of the famous "Duplex" speakers** is the 604C, which operates as two separate speakers to achieve a *guaranteed* frequency range of 30 to 22,000 cycles when mounted in a proper enclosure. The 604C may be mounted in the wall or an existing piece of furniture, or in any of the Altec Lansing bass reflex enclosures.

Ask to hear this superb high fidelity system at your Altec dealer's, where you will also find designer-matched Altec Lansing systems ranging in price from \$190.00 to \$1,100.00



**ALTEC FIDELITY IS HIGHEST FIDELITY**  
1515 S. Manchester Ave., Anaheim, Calif.  
161 Sixth Avenue, New York 13, N.Y.

Rush catalog of Altec Lansing high fidelity components and brochure on speaker enclosures.

NAME \_\_\_\_\_

ADDRESS \_\_\_\_\_

CITY \_\_\_\_\_

ZONE \_\_\_\_\_

STATE \_\_\_\_\_

Laboratory  
Standard

for your home

MC-60

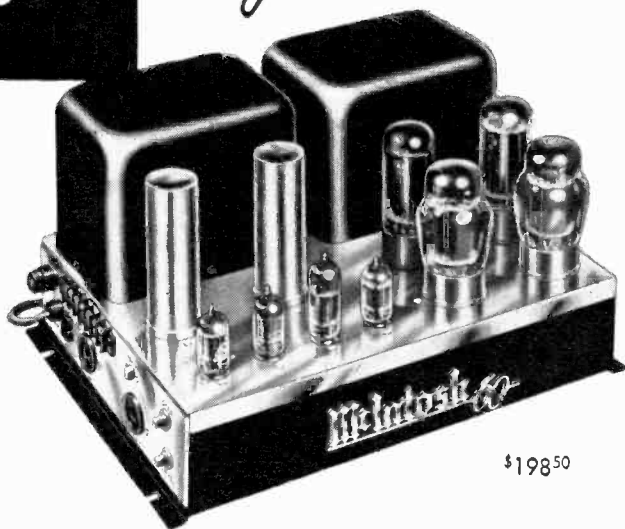

\$198.50

The crowning achievement in a line of distinguished amplifiers is the McIntosh "60." The patented McIntosh output circuit guarantees performance, distortionless and noise free, in your living room. You can hear its outstanding difference. McIntosh makes your "Dream Set" come true with the McIntosh MC-60.

### PROFESSIONAL AUDIO COMPENSATOR C-8



Without cabinet  
\$88.50

Unlimited flexibility plus unlimited performance equals the McIntosh C-8 professional Audio Compensator. No other preamplifier can give you such dramatic results. Lifelike, realistic sound is yours with the McIntosh C-8.

Sold Through Franchised Dealers from  
Coast to Coast. For Complete  
Brochure Write to Dept. FB-2.

**McIntosh**  
LABORATORY, INC.

4 Chambers St., Binghamton, N. Y.  
Export Division: 25 Warren St., New York 7, N. Y.  
Cable: SIMONTRICE N. Y.

FP-57-O HF

In Canada manufactured under license by McCurdy Radio Industries, Ltd.  
22 Front Street W., Toronto, Canada



A SMART SETTING of contemporary modern furniture often provides an excellent location for high-fidelity music systems. This beautiful cabinet was designed by the well-known Patrica Harvey, A.I.D.

designed for maximum gain and sensitivity, which is incompatible with hi-fi requirements. Since the transformers are peak-tuned, they rather sharply attenuate the highs and lows, leaving only the mid-range. A wide-band system, which passes the entire audio spectrum without discrimination, is less sensitive, requires more tubes, and is typically found only in hi-fi tuners. In the case of FM, of course, it is quite possible that an older set is of adequate quality and may be hooked up to a hi-fi audio system. But it is extremely unlikely that any ordinary AM radio can be converted for use as a hi-fi tuner.

Tape recording, one of the true marvels of the hi-fi era, but which can be mongrelized just as easily as a cheap radio, has been beyond the reach of most audiophiles. This situation is now rapidly improving. Three years ago, in the *Hi-Fi Manual*, I cautioned readers to go slow on tape for the simple reason that the only tape equipment then worth having in a hi-fi system was very expensive professional gear.

#### Hi-Fi Tape Recorders

But as time went on the important manufacturers, such as Ampex, Magnecord and Concertone, moved into the consumer field with very respectable products. Shortly thereafter, a few of the cheapie producers raised their sights and brought out upgraded models which could hold their own in a quality system. There is little doubt that we can regard tape as an integral part of the complete hi-fi system.



STYLING TREND in hi-fi components today is to the low, narrow look, as in these Bell units.

PROTECTIVE sleeves are available that make dust-free storage of records a simple matter.





The development of the transistor a few years ago heralded tremendous advancement for the field of electronics, but this entire area is in a great state of flux, and the transistor has not yet meant too much to hi fi. The future of this device is, of course, unlimited, but its development is still in its infancy. A few transistor units have been offered for hi fi, but the low power of the device limits its present applications. This is not to say that revolutionary changes are not on the horizon for hi fi because of the transistor. They definitely are, but I feel they're a few years away yet.

The trend toward higher power in amplifiers has shown a tremendous upward surge in the past year. Prices are being held in line, especially since the kit manufacturers are now entering the high-power race. The arguments for higher power in amplifiers are much like those for higher power in automobiles, namely that the system doesn't have to work so hard, and it has a ready reserve for unusual peak demands.



TELEVISION audio has come of age with such popular programs as The Lawrence Welk Show.



LOW-COST BARRIER was first broken in the tape-recorder field by Ampex 600 model displays here.

It can't be denied that a 60-watt amplifier will sound cleaner on 10-watt peaks than will a 10-watt amplifier. But since a couple of watts average is more than adequate to fill most home listening rooms, the audiophile has to consider whether he wants and can afford the luxury of a lot of seldom-used reserve.

### Turntable or Changer?

The battle of record changer vs. turn-

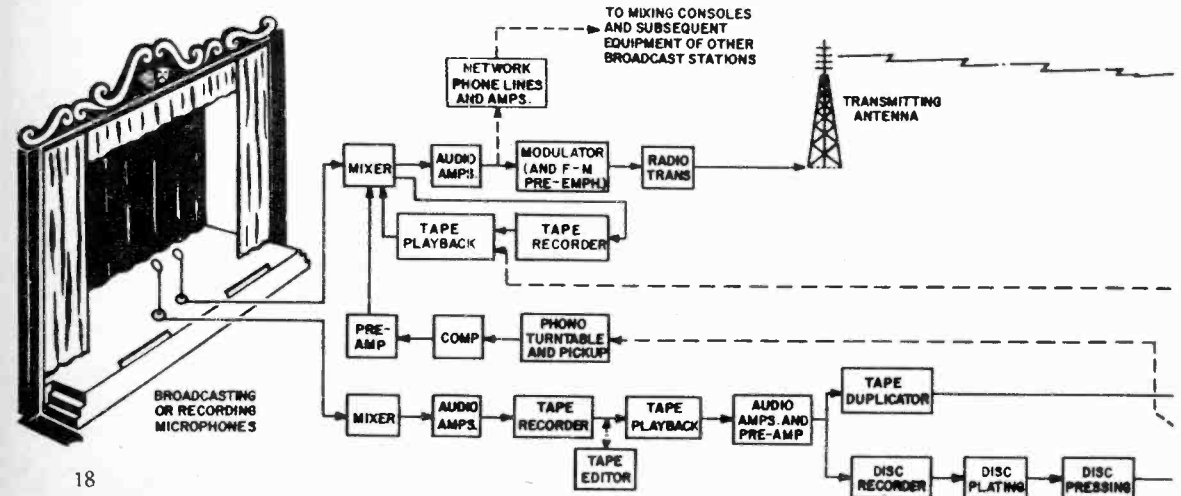

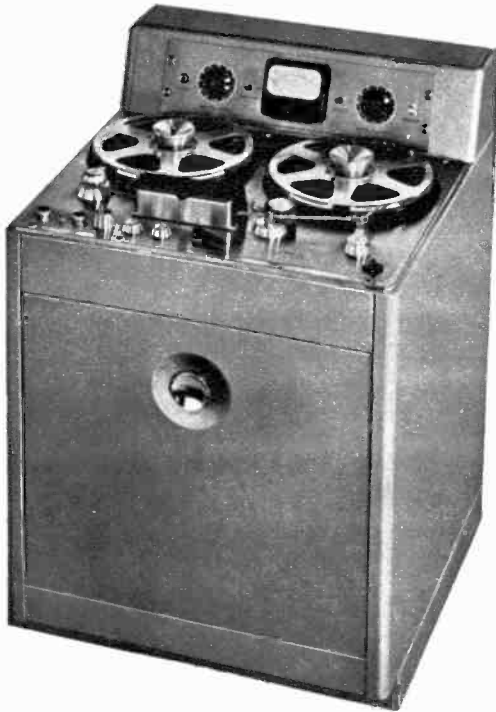

AMPEX professional model tape recorder is interesting for contrast with the 600 shown left.



TAPE CONSOLES, such as this trim Bell number, are at last beginning to appear on the market.

table continues unabated. There can't be much argument but that the changer is a lot rougher on records, and the turntable is probably lower in mechanical noise, such as rumble. But when it comes to convenience the changer has it hands down.

There is some evidence that record manufacturers are again beginning to cheat on the matter of compensation. You will remember that not so long ago every manufacturer made his records so as to sound

best in his opinion on the "typical" record player of that day. As a consequence there were about as many record equalization characteristics as there were companies in the business.

This was largely cleared up with the adoption of the RIAA curve industry-wide, with *London* the only major holdout. Now some of the boys are reverting to characteristics which they feel will sound even better when played back at the RIAA setting. If the practice becomes widespread, the RIAA curve will be meaningless.

Now that we have a little background on the present state of hi fi, let's consider the several different methods of building up a hi-fi system. •

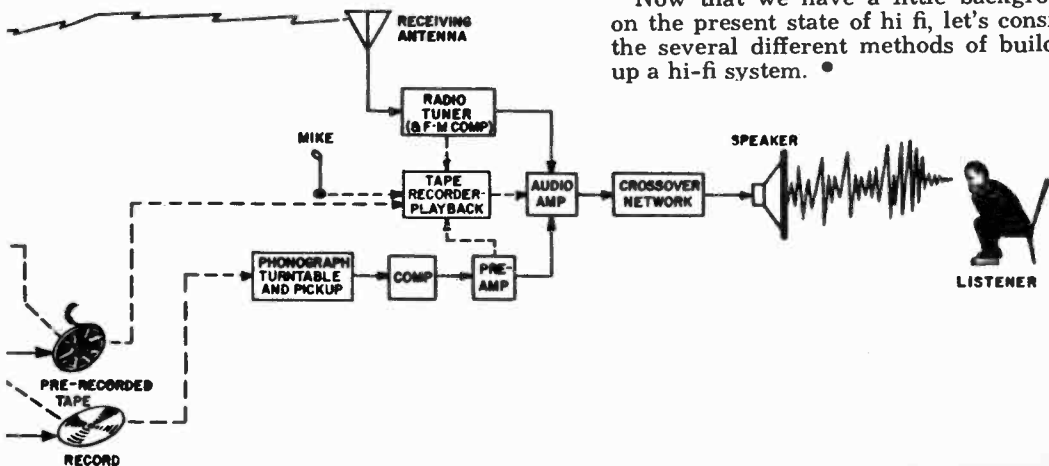

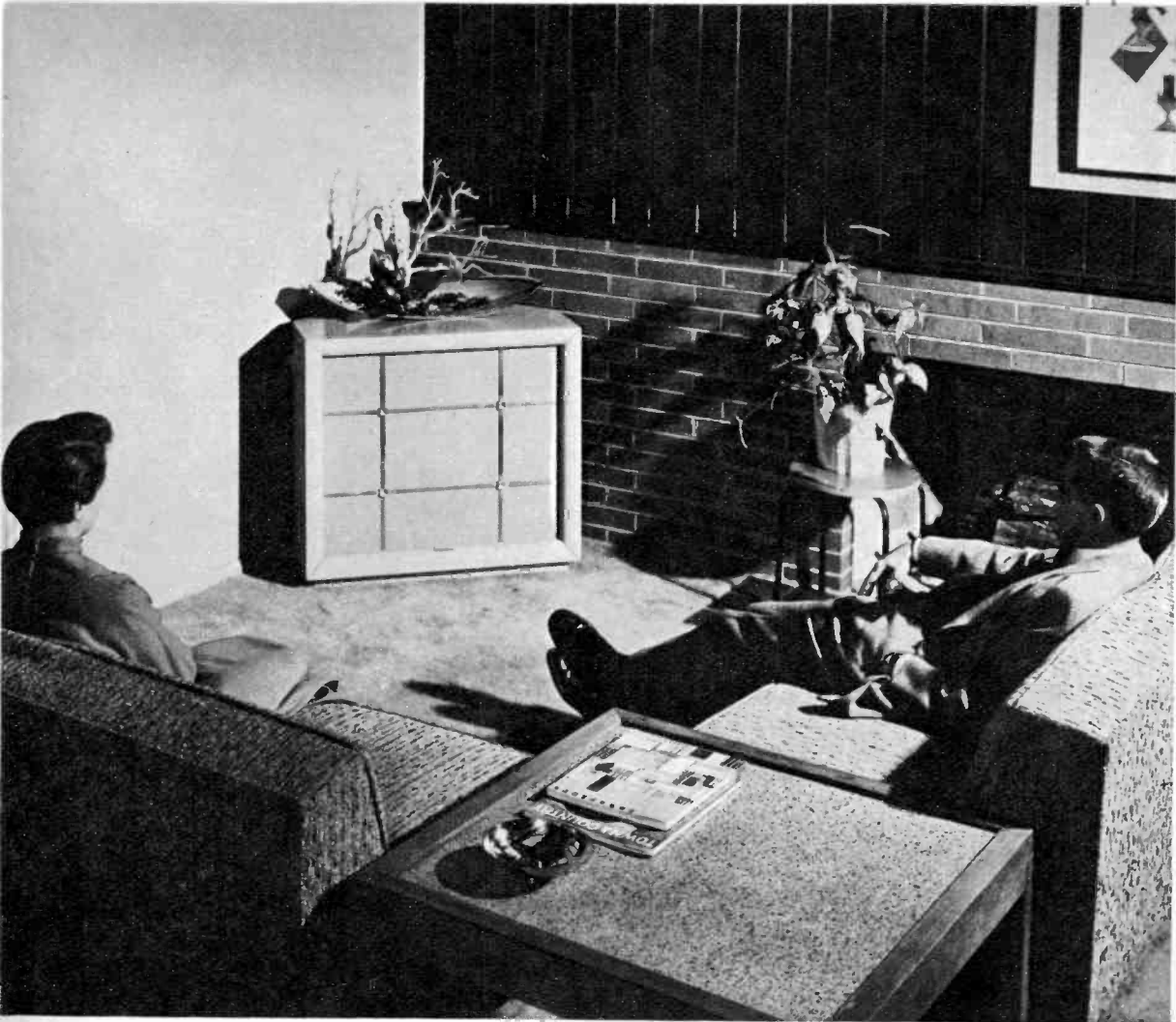

Electro-Voice, Inc.

## Three Roads to Hi Fi

Package, component, and construction-kit routes have placed its pleasures within the reach of all. Decide which best suits you

**H**IGH FIDELITY today is no longer the exclusive province of the engineer and the egghead. Anyone who wants hi fi can have it, no matter what his budget, personal tastes, background or abilities. The art has come of age, and can now meet the demands of everyone.

There are presently three distinctly different methods of assembling a complete hi-fi system. For the person whose budget

is severely limited, as well as the one who simply prefers to do it himself, the *construction kit* fills the bill perfectly. If you have a little more money, or less ambition, the *component assembly* method would be your choice. For the most affluent, particularly if he is also the *unhandy-type* man, the complete hi-fi *package* provides the very simplest means of getting a rig into operation.

### Kit Construction

The hi-fi kit maker is essentially a designer of audio systems and a purchaser or manufacturer of parts. When you buy a kit, you get a box full of parts, a metal chassis which usually has all of the necessary holes punched in it, plus an instruction book which tells you how to combine this batch of strange-looking objects into a workable piece of hi-fi gear. At first look the entire prospect is terrifying, but that is no time to back out, for a lot of fun and genuine satisfaction are the rewards of the hi-fi kit constructor.

The initial stages of construction involve the mounting on the chassis of the larger parts, such as transformers, choke coils, tube sockets, terminal strips and controls. This is done with machine screws and bolts, and requires only the ability to handle a screwdriver and pliers or small wrench.

Following this the smaller components and wire interconnections are added, nearly all of this operation taking place on the underside of the chassis. Insulated wire will be connected between a number of various points, as will the wires which are integral parts of the components. All of the wiring is secured, of course, by soldering.

The components' wires will usually be overlength, and must be trimmed to fit. The hookup wire must be cut to length and the insulation trimmed off each end for a quarter inch or so. In some kits, all of the

hookup wires are already cut and stripped. In others, hookup wire isn't even furnished as part of the kit. In this case you furnish your own roll of wire, and cut and strip it yourself as needed. It is very important, therefore, that the buyer determine in advance just how much prefabrication has been done for him.

### Assembly Instructions

The instruction books of the major companies, such as Heath and Allied, are very well produced, and anyone who can read English and use a few simple hand tools can follow them in building a complete hi-fi system. But on the other hand, there are still a few companies who seem to feel that every buyer holds a college diploma in one hand while he reads the instruction book held in the other. This type of kit is recommended exclusively for four-handed people.

Since the organization of the instruction book is every bit as important as the design of the system or the quality of the parts furnished, this is something the prospective purchaser should look into before he buys. Most of the reputable companies are quite willing to send individual copies of their instruction material to prospects, either at a nominal price or even free of charge.

The greatest advantage of the kit method of hi-fi assembly is economy. This is the one way to get the very most for your

**REPRESENTATIVE** of the finest in hi-fi packages is the Fisher President Series. Measuring 70 by 33 inches, it has tape recorder-reproducer, record changer, and storage in pull-out drawers at its center.

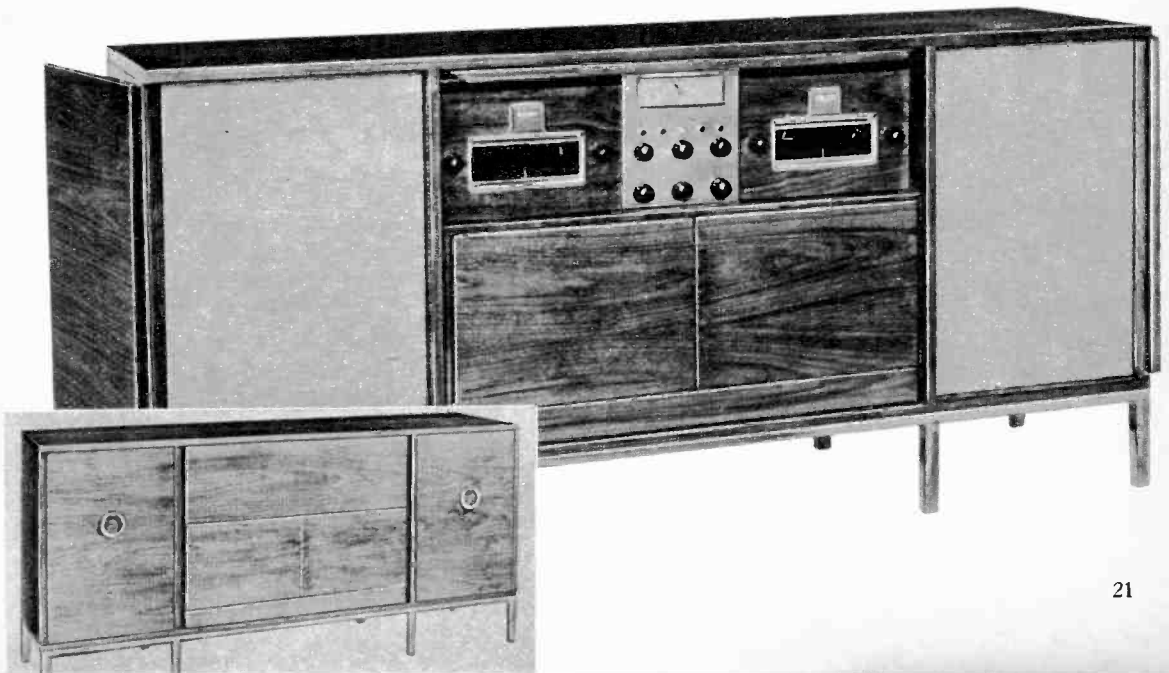



**CHANGER, amplifier, and two-way speaker** are included in the compact, attractive Dictograph package. It is also available in mahogany or oak wood.



**PACKAGED** high fidelity is available in lovely cabinetry to fit any decorative scheme. The striking model shown above is by Jens Risom Design, Inc.

money. Perhaps the next most important feature, as any experienced constructor will tell you, is the very real sense of personal gratification one feels when he looks at his own finished handiwork, and actually hears it working. This is a thrill which is unknown to the no-kit members of the hi-fi fraternity.

Another important advantage is the fact that kit buyers usually deal directly with the manufacturer, since most of the kit suppliers have strictly mail-order operations. This is especially important if your assembled kit fails to operate, or if you need service or wish to consult with the factory engineers. This kind of transaction can be most exasperating when salesmen, dealers or distributors stand between you and the man you really want.

### Disadvantages, Too

The biggest disadvantage of kit construction, as compared to other methods, is simply that it is a lot of work. A lot more of *you* has to go into a kit-assembled system. Furthermore it is difficult, and often impossible, to see and hear completed systems assembled from the kits you'd like to buy. Some of the kit companies work through regular distribution channels, of course, and in those cases the criticism doesn't apply.

But for the mail-order companies, about the only way you can attend a demonstration of their products is to find their displays at one of the trade shows. Even this is no longer very easy, as the hi-fi trade association has, for rather mysterious reasons, frozen the big mail-order operators out of membership, and they are therefore barred from some of the shows.

This needn't be of serious concern to the kit buyer, however, as the larger mail-order companies are of the highest integrity. Some of their top executives have come up from organizations such as Montgomery Ward and Sears Roebuck, where the seller stands behind the product at all cost.

When a group of kits is assembled into a hi-fi system, it is basically the same as a set of factory-assembled components, and its installation is identical.

### Component Assembly

Building a hi-fi system from a group of components is the "traditional" method employed by experimenters and musicians for years to obtain quality sound reproduction in their homes. When the inadequacies of the usual radio-phono combination became painfully apparent, those



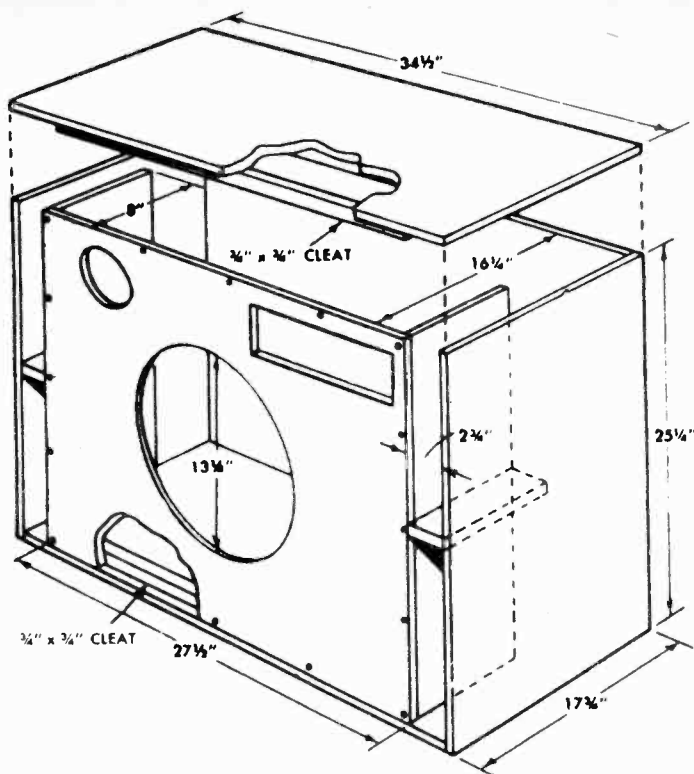

**SPEAKER KITS** make substantial savings possible. Only pliers, screwdriver, and stapler are needed to assemble the Cabinart cabinet, diagrammed at left and the Jensen three-way speaker kit that's shown below.

who couldn't design and build their own systems naturally turned to professional components, manufactured for broadcast, motion-picture or public-address applications. The component-assembly method of hi fi today is a direct outgrowth of this original adaptation of professional equipment to home use.

Each component in the chain is factory-assembled, such as the turntable, amplifier, radio tuner or loud-speaker, but the group of components must then be combined to comprise a complete system. The choice of components will depend upon the intended investment, as well as the compatibility of any given group. This has to do not only with electrical compatibility, but with logical combination as well. It would be ridiculous, for example, to buy a 50-watt amplifier and a 6-inch speaker, and expect to use them in combination.

To get a good comprehensive picture of the entire field, write to the companies advertised in this book, requesting their catalogs and literature. From these you can learn relative price ranges, performance specifications, operating features and dimensions.

With a tentative system worked out, if you live near any of the larger cities, you can go to one of the hi-fi distributors who will actually hook up the component combination you have in mind. You can see it,



**PARTS** of Jensen KT-32 speaker kit. Prefinished dress kit has been added to completed unit below.

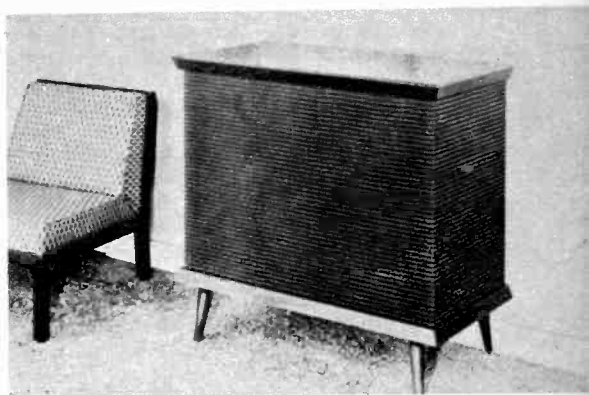



**PART OF PACKAGE** for those who want a separate changer and player in their system is the Melodist amplifier, shown here being displayed to author Don Hoefler by Marvin Kline of Altec, its maker.

hear it, and decide from the demonstration whether you'll be able to live with it.

### Connecting the Components

Interconnection of the several system components at home is very simple. Most of the connections will be through simple shielded phono cable, with small plugs at each end to fit chassis receptacles. In a few cases the bare ends of wires are held in place by the screws on a terminal strip.

Many components are rather spartan in appearance, and are therefore best concealed in cabinets or built into some part of the structure, such as a wall, bookcase, closet door or balustrade. The question of built-in vs. built-out is one which you must decide for yourself, but the odds are that the components will be concealed in some fashion soon after the lady of the house see them.

One of the greatest advantages of this hi-fi approach is the fact that the desired combination can be heard in a dealer demonstration. Also, the amount of construction work necessary to put the system into operation initially is slight. And for any kind of custom installation, the only sensible approach is through components, either from kits or factory-made. Any desired kind of cabinetry, finish, or built-in arrangement is possible, without having to discard any useless trimmings first.

On the other hand, while hi-fi components are all right for installations in the

shop or recreation room, it is just about mandatory that some kind of customizing be done on a living-room installation. There are few components which will fit well with such decor. Furthermore, with the exception of Electro-Voice, Altec-Lansing, and possibly a few others, the majority of the hi-fi manufacturers specialize in only parts of a complete system.

Thus there are few single sources one can go to for a complete system of one manufacture. And this always invites buck-passing when your system doesn't work, with the amplifier manufacturer blaming your speaker, the speaker manufacturer suggesting your tuner may be at fault, and so on.

### No Standards Yet

In this same connection is the deplorable lack of standards still existing in this young industry. There is no equivalent of SAE horsepower in hi fi. One man's 25-watt amplifier might be rated at only 20 watts by a more conservative manufacturer. A claim of 1% distortion by one might actually test at 2% by more refined methods. This sort of thing even goes to the ridiculous extreme that there is no agreement on what may legitimately be advertised as high fidelity. Under these circumstances, as we have already said, the prospective purchaser must keep his wits about him when he decides to take the plunge into hi fi.

The term *package* as applied to hi-fi systems really has two quite different meanings today, one of them actually referring to a group of components. Many distributors will get together a system of matched components, which they will offer at a reduced price in a package deal. But the package we have in mind here is the hi-fi component which is already enclosed in its own attractive furniture.

The installation of a packaged hi-fi system involves nothing more than plugging into the nearest wall outlet and playing. It is therefore somewhat similar to the low-fi home instrument, but with several important differences.

The components in a hi-fi package are truly high fidelity, with adequate frequency and power response, a far cry from

the flimsy restricted-range radio-phonograph-TV combination. Furthermore, the speaker and its enclosure *must* be isolated from the electronic elements, to avoid feedback, rumble and distortion. This identifying feature is always characteristic of the true hi-fi package, never of the low-fi home instrument.

### Packages Are Simple

Probably the greatest advantage of building a hi-fi system on the package principle is the sheer simplicity of it all. There is simply no brain-teasing work involved in getting it into operation. You just plug in and play, that's all. And once you have done that the installation is complete and permanent.

In the low-priced package field are such

**HANDSOME** high-fidelity speaker systems such as the corner model by Altec at the left are marketed in preassembled form.

**INPUT LEAD** connects by screws to back of low-boy model below, another in the Altec line of preassembled hi-fi speaker systems.

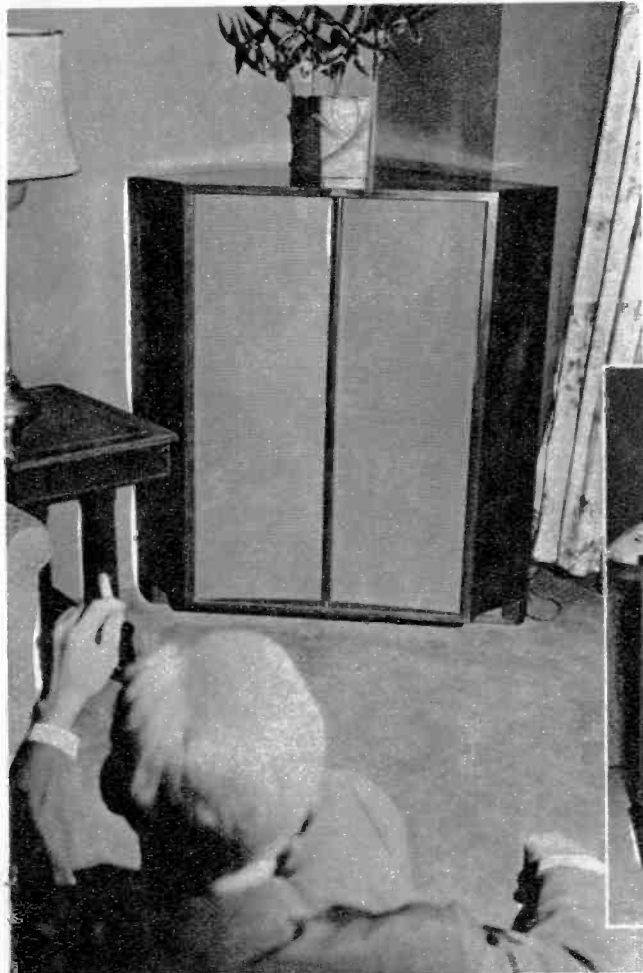

COMBINED AM-FM tuner-preamplifier and 20-watt amplifier by Sargent-Rayment require only speaker system and record player for complete system.



EICO components, such as the control preamp pictured at the right, are available as construction kits as well as in preassembled versions.



names as Dictograph and Radio Craftsmen, while in the medium price range is the fine line of Altec-Lansing. It would seem that these companies have much to offer the hi-fi addict who would like to avoid the fuss and bother of kits or components, but there are still many veterans of the home-instrument wars who suspect anything which comes with a hunk of furniture wrapped around it. But anyone can easily separate the hi-fi package from the trash by the observance of Altec's five simple Hi-Fi Rules-of-Thumb, which state that the package *must have*:

1. Separate speaker cabinet
2. Three or more record compensation curves
3. Separate bass and treble controls
4. Genuine two-way speaker
5. At least two cubic foot speaker enclosure

Another advantage of the package proposition is the far greater attractiveness of the components *and* furniture. For the audiophile who can't be bothered working out a custom installation, or whose better half won't give the components house room, the hi-fi package is the ready answer.

Furthermore, you now deal with only one source of supply. In most cases the

packagers actually manufacture nearly all of the components and furniture themselves, but even where they don't, your recourse in the case of failure is right back at the one place, with no excuses and no buck-passing.

These advantages have to be paid for, however, and it is obvious that the packaged system is the most expensive in hi-fi. There is also a rather limited choice available today, as compared with components. There are relatively few concerns in the package field, and while their products are excellent, the wide variety of the components field is not to be found here.

So there are your choices. Kits are cheapest, many think they are the most fun, and all agree they are the most work. Packages involve hardly any effort at all, and they are by far the best looking, but also the most expensive. Components are a compromise between these two extremes, and are preferred by the vast majority of those in hi-fi already. Kits and packages are coming up fast, however, and there is every reason to believe that each will have its own group of adherents, and will continue to prosper and grow. •

COMPONENTS are often mounted out of sight as are these fine Fisher units. Adequate ventilation is needed; closet-ceiling louvers provide it here.

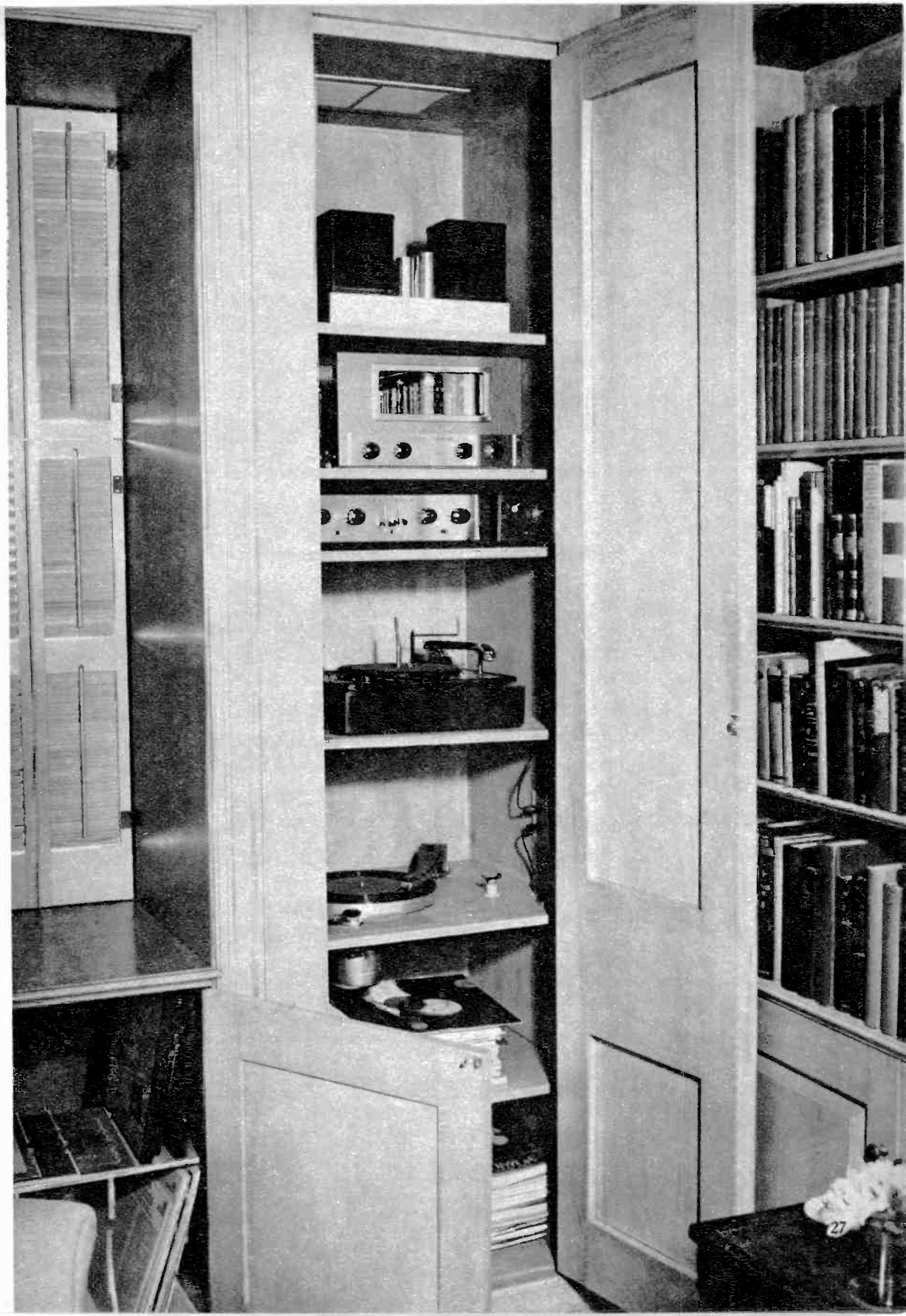





## Kits Cut Costs

You'll find assembly goes faster and is more fun if  
you're familiar with the hand tools discussed here

**"I'VE GOT** more time than money" is an ancient lament, but it still must apply to a lot of us, for the man who wants to spend more time and less money is the man who has made the kit business such an important factor in hi fi today. Nothing in this world is free, least of all hi fi, but you can save the most money with kits if you are willing to invest your time instead.

Ah, but I note by that gleam in your eye that you can see a way to cut one more corner and save even more. Instead of buying a kit and letting the kit-supplier earn his profit, you will simply buy the parts and build your own. Okay, try it. Plenty of others have—but not successfully.

The kit maker will even co-operate with

you. Very likely he will send you his instruction book, complete with picture diagrams, schematic diagrams, step-by-step assembly instructions, servicing information, and even a complete parts list.

Now all you need do is run through the parts list, make out your order from any standard supplier catalog, and soon you'll be on your way. But oh, oh! Something must be wrong. Must have made a mistake in the addition. The bunch of parts seems to cost more than the complete kit.

But how can this be? We learned in math class that the whole is equal to the sum of the parts, but yet here the sum of the parts equals more—a lot more—than the whole kit. And then on top of that you'll have to punch and drill the chassis

**ANYONE** can do it. The young lady applying her talents to a Norelco speaker, photograph at the left, finds assembling from a kit no trick at all.

yourself. And don't forget solder and hookup wire. And postage and the cost of the checks. And when you're all finished the job can't possibly look as good as the kit job. But how can this be?

### Careful Buying Is Important

The answer is that the kit makers are not only some of the keenest merchandisers in the business, they are also some of the sharpest bargain hunters anywhere. They buy tubes and parts from all over the world, wherever they can get them best and cheapest. And they buy in huge quantities. And when necessary they modify a design slightly to accommodate parts acquired in a special purchase.

So the purchasing agent calls up the chief engineer and says, "Hey, Joe. I've got a terrific buy on an output transformer that's almost the same as the one you're using in the XYZ-4-A. There's two samples on my desk right now. Want me to send them over?"

Then the chief engineer has his crew give the new transformer the onceover. They report back that the transformer will indeed work in the XYZ-4-A, but that there is a little more distortion which can be cured if they also change the values of a couple of condensers and add a resistor.

Now the chief engineer is in all likelihood a refugee from the home instrument business, and he has reduced the cutting of production costs to a fine art. So he gets out his slide rule and figures to the fractional part of a cent whether the change makes sense economically.

This fine hair-splitting is a continuous process in a kit plant, and it explains why nobody can match them by buying a batch of parts on the open market. Then consider that they also give an instruction book, and solder and hookup wire (sometimes), and a pre-punched chassis, and specially-designed escutcheons, dials and nameplates, and a *guarantee*, and it soon becomes obvious why the build-it-from-scratch idea is nowadays simply a laboratory curiosity.

The other saving is where you come in. If you check the prices of the manufacturers who offer the same system either pre-assembled or in kit form, you'll find that there is quite a difference between the two. That difference is labor and overhead, plus a reasonable profit on those

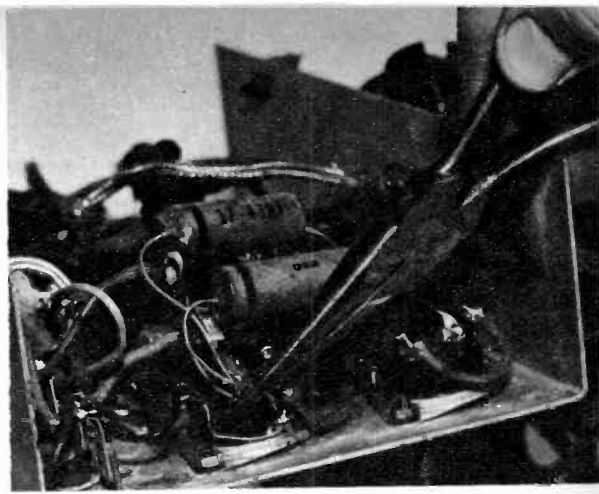

**LONGNOSE PLIERS** are for holding and crimping, the kit assembler's most important tool. Below, they hold pushback wire which needs no stripping.

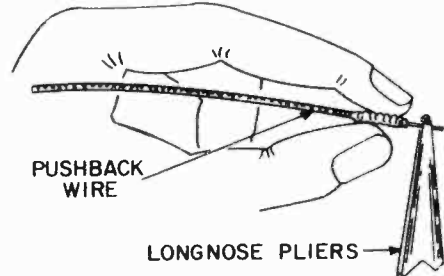

**DIAGONAL CUTTERS** are indispensable unless wire is pre-cut. This method of use lessens danger of dropping them on delicate, fragile parts.

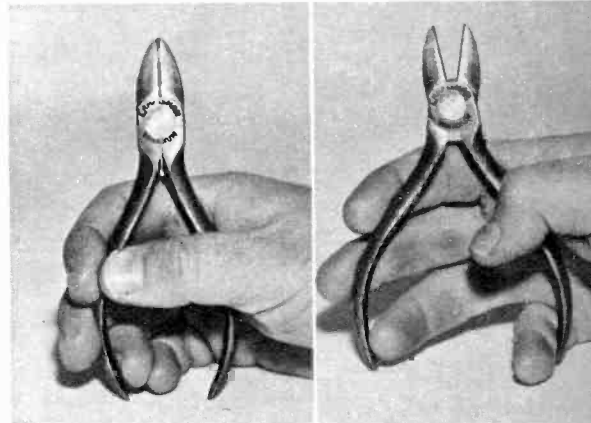

Robert Hertzberg photos

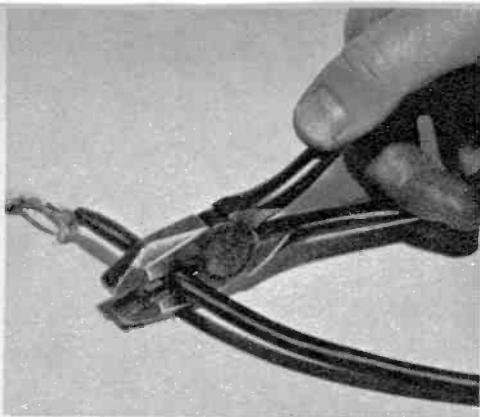

**LINEMAN'S PLIERS**, rather than longnose, are used for heavier cutting and holding operations.

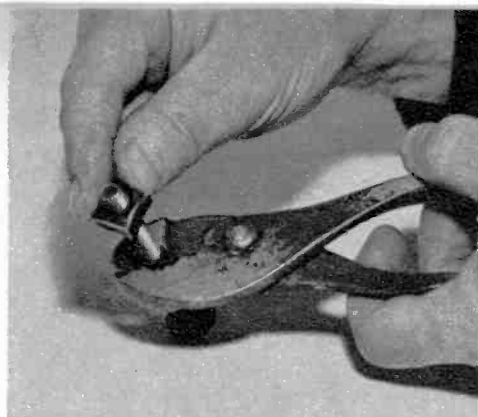

**ORDINARY GAS PLIERS**, with slip joint and serrated jaws, remain the jack-of-all-trades tool.

**ASSORTED SCREWDRIVERS**, such as those shown below, are important to the serious kit builder.

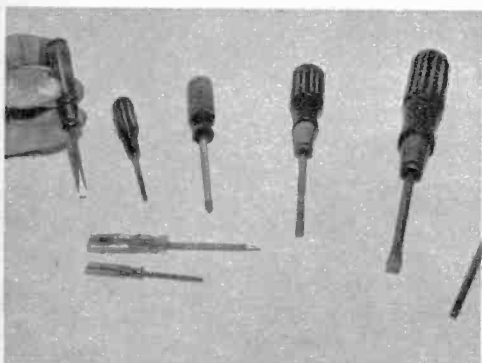

**BACK OF KNIFE BLADE** (dull edge) should be used for cleaning wire after it has been stripped.

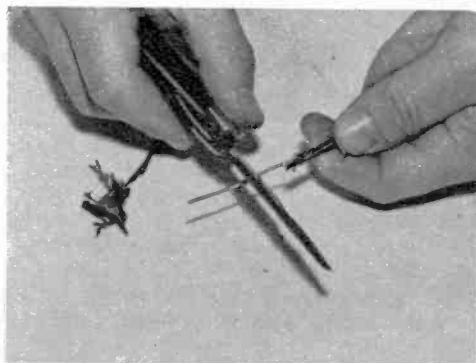

**CONTROL KNOBS** are often held by set screw. Do not tighten so much as to strip threads in plastic.

**SCISSORS** are handy for light cutting work, such as trimming away the ground shield shown.

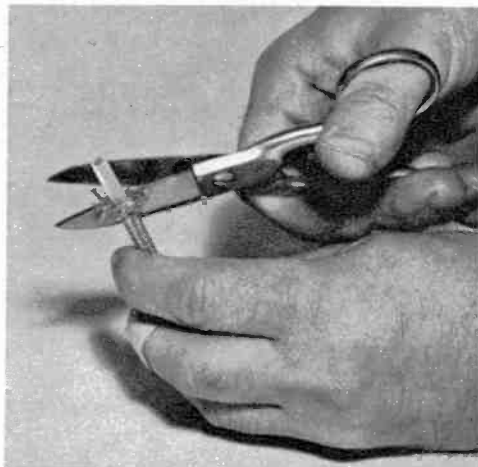
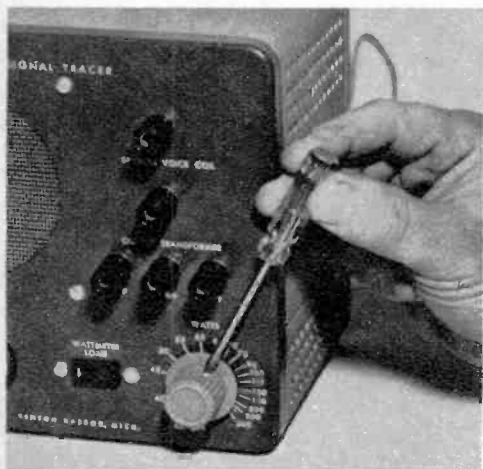

items. If you build from a kit, it's *your* labor and *your* overhead. And it's your considerable saving.

### Some Investment Necessary

But you will have to make some investment in a few tools if you don't already have them. This could easily total \$10, depending somewhat upon the quality and where you buy them. But if you are really strapped for cash, there are a great number of jobs the ordinary pair of lowly gas pliers can be made to do. And since the work is not of a heavy nature, it isn't necessary to buy the most rugged and most expensive tools. Now let's see just what those tools are that should be in every audioman's shop, what they do and how they should

**END WRENCHES**, open and closed, are useful in mounting parts and can be purchased cheaply.

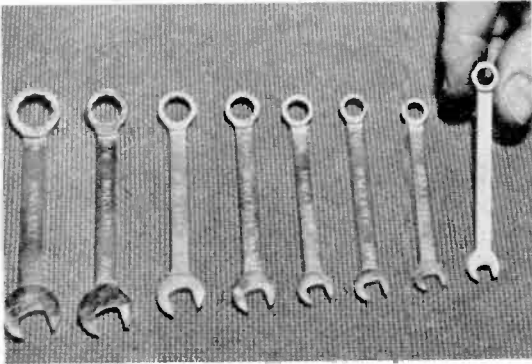

**OPEN-END WRENCHES** solve the tightening problem in areas too small for handle-type wrenches.

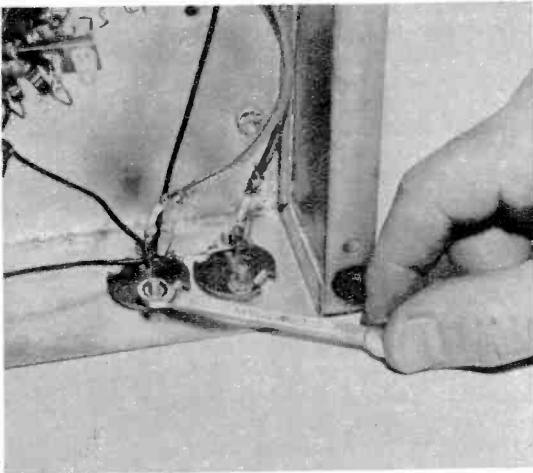

be employed to obtain satisfactory results.

First, you should have a good workbench with plenty of light. In a pinch this can be the kitchen table or even a card table, but if you have the space and funds for a good bench, by all means build or buy one.

Although it isn't absolutely essential to audio construction work, a vise will certainly pay its own way in added convenience. This is primarily a device for holding objects, leaving both hands of the workman free. There are two precautions to observe when working with this handy tool.

First, when filing, cutting, drilling or grinding, be careful to prevent the tools from marring the vise. And conversely, be careful that the hardened steel jaws of the

**SOCKET WRENCHES**, or nut drivers, are preferred by many of the more experienced constructors.

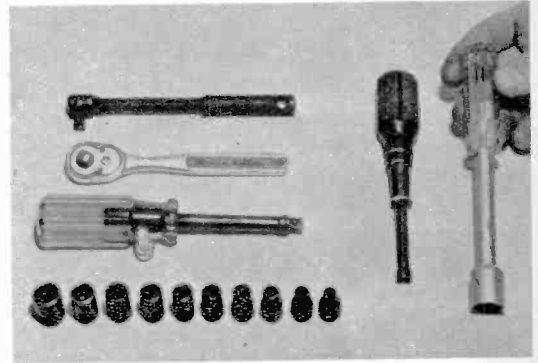

**NUT DRIVER'S CONVENIENCE** in mounting parts on electronics equipment is evident in this shot.

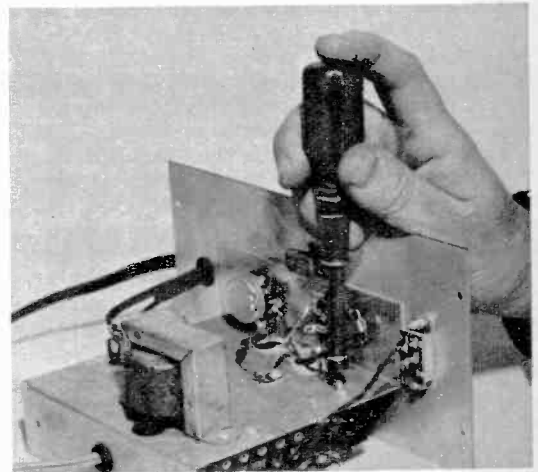

Robert Hertzberg photos



SOLDERING IRONS of three types: standard electric type, small "pencil" type, and soldering gun, which heats instantly and only when needed.

"COLD-SOLDER" joint and well-soldered joint are shown above. Hold iron against the work so that part melts solder as in the drawing below.

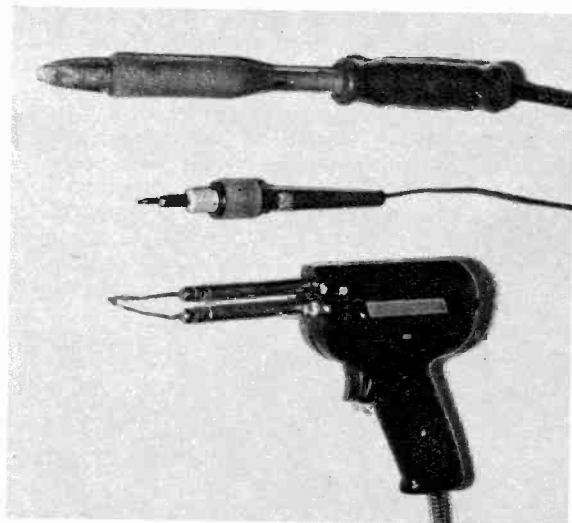
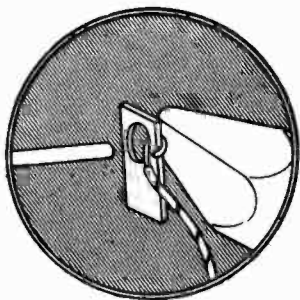

vise don't dull the cutting tools. In other words, keep the tools and the vise from coming in contact with each other.

Second, be careful that the jaws of the vise don't mar the surfaces of the object they are holding. It is often advisable to insert a couple of blocks of wood or even a few layers of cloth between the vise jaws and the work.

There is a large family of tools called pliers, and several members of the family should be on every well-equipped audio bench. Probably first in importance is the long-nose variety, which is used primarily for light holding operations, particularly in confined areas. They are also used for shaping the bare ends of wire into loops for screw-terminal mountings, or for crimping wire ends onto solder terminals.

The most important thing to remember about long-nose pliers is that it is a light-duty tool. It is often misused by being forced to do jobs too heavy for it, resulting in jaws which are broken or bent so that they can no longer grip small objects. Most useful sizes of this tool to the audioman are 5 or 5½ inches.

Similar to the long-nose is the needle-

nose pliers, which has circular instead of semi-circular jaws. This is not a holding tool at all, but is used only for wire shaping, such as forming loops for attachment to a binding post. Since the ordinary long-nose will do the job almost as readily, this tool is really unnecessary for the budget-conscious audiophile.

Since long-nose pliers often have side cutters behind the gripping surfaces of their jaws, they can also substitute in a pinch for the next most important tool. This is the diagonal-cutting pliers, often shortened to "diagonals" or "dikes."

The diagonal jaws are two cutting edges set at an angle of 15° to 20° with the length of the tool, which construction permits them to cut off a wire end very close to its point of attachment. The chief misuses of this tool are trying to cut sheet metal with it, cutting wire of too heavy a gauge, or skinning insulation off a wire. The 5- to 6-inch size is adequately husky for all audio work, while a knife is the tool for wire-skinning, and snips or a hack saw should be used for cutting metal.

Side-cutting or lineman's pliers have

[Continued on page 37]



## assembling the "legato" speaker kit

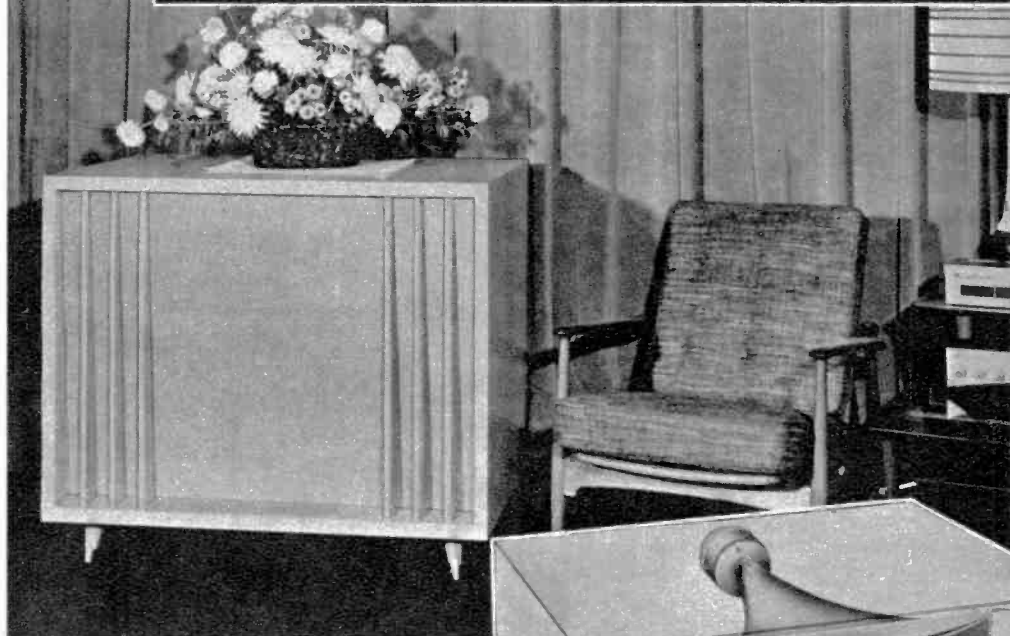

**ENGINEERED** by Altec-Lansing, the Legato Heathkit can be had in light or dark woods, contemporary as well as traditional design.

**WIRING** of the Legato is foolproof when drawings, such as the one below, are placed beside the component you are working on.

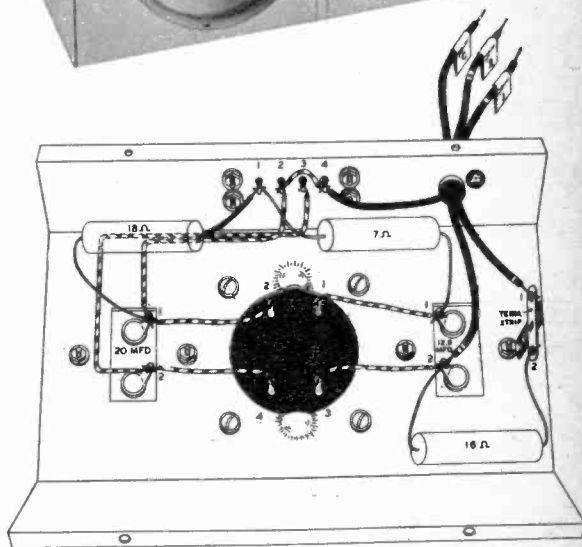
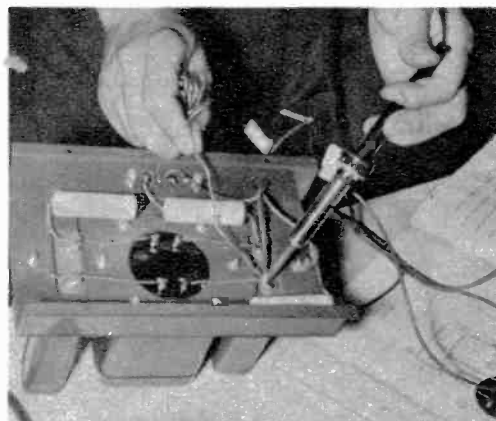
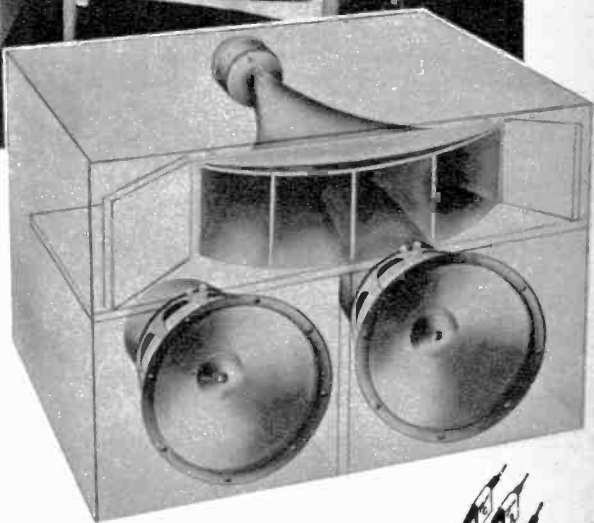



VENEERED-PLYWOOD box is first constructed as author Hoefler shows. Drawings which clarify each step are reproduced from kit's instructions.

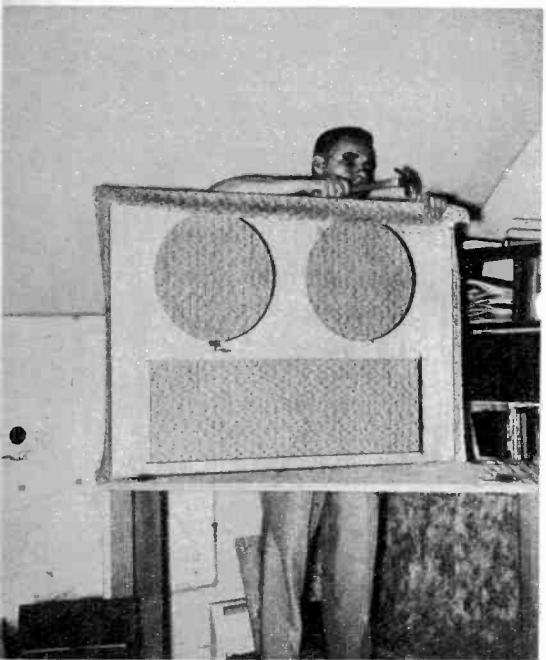
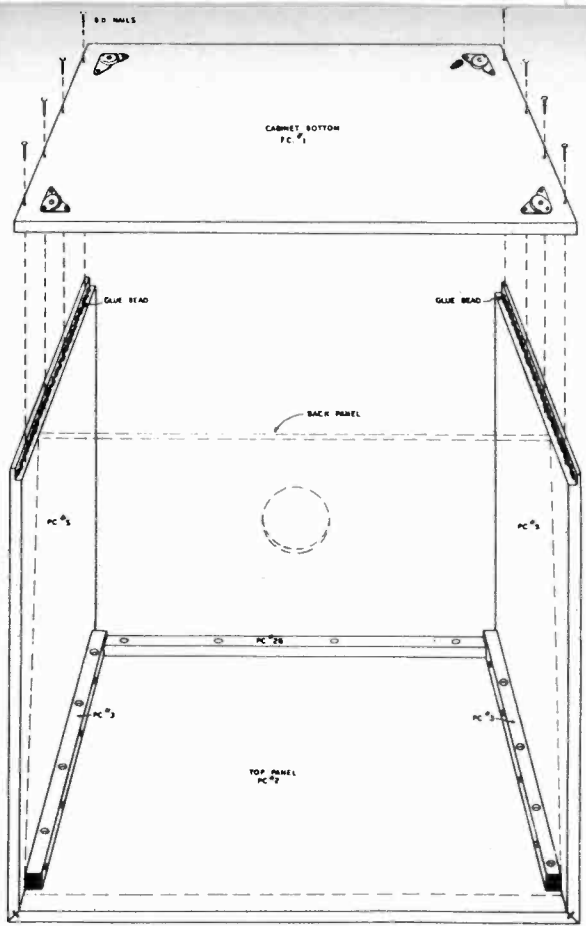

GRILLE CLOTH is next tacked to the front panel and trimmed. No workshop, only simplest of tools are required in clean, simple assembly of kit.

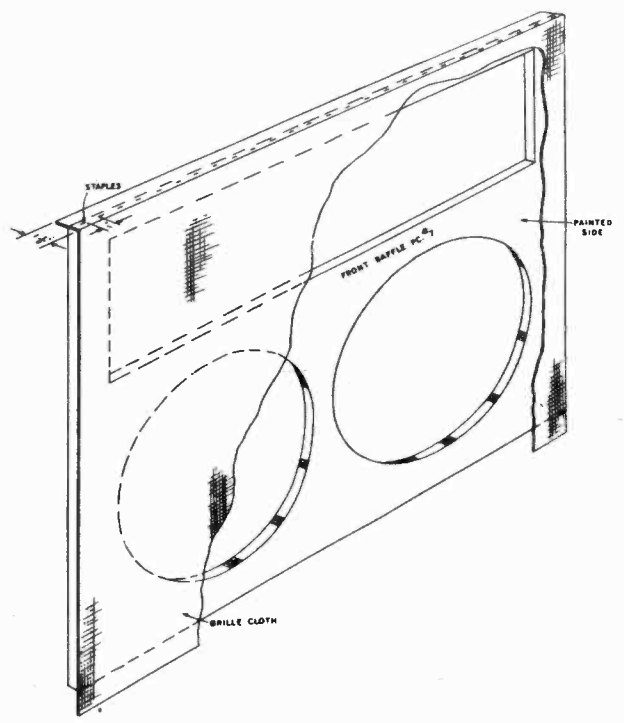

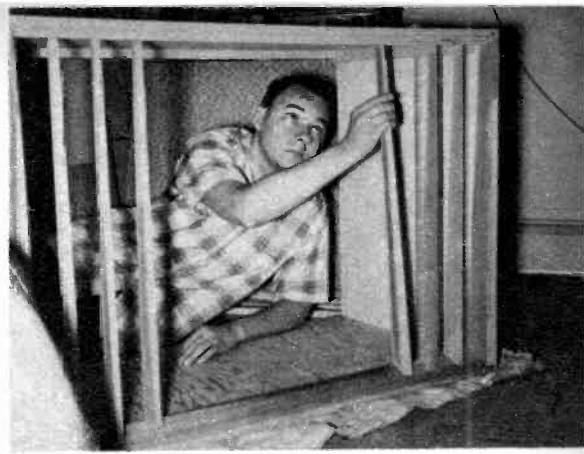
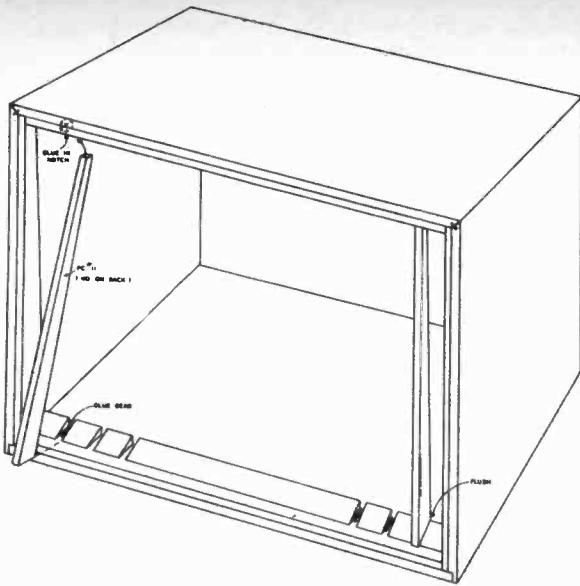

**GRILLE BARS** are glued into place. Note the packing-material blanket that protects the veneer.

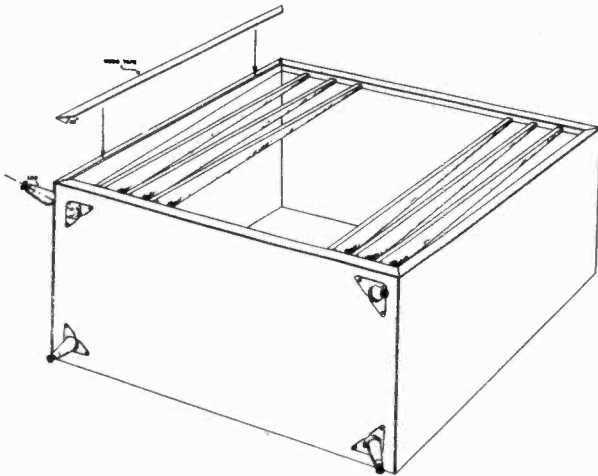

**ROUGH EDGES** of plywood are surfaced with Woodtape. Young David Hoefler intently assists.

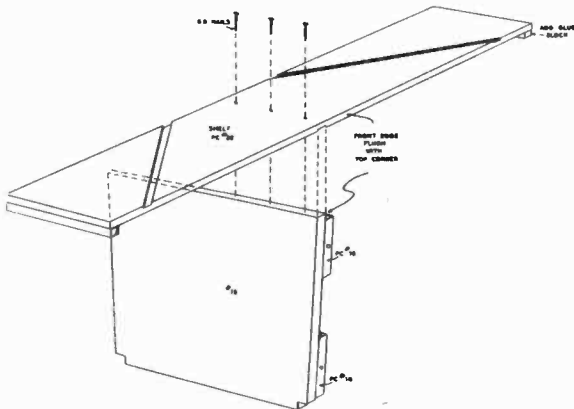

**WITH front speaker panel in,** wing partition is fitted to separate three speakers' sound chambers.

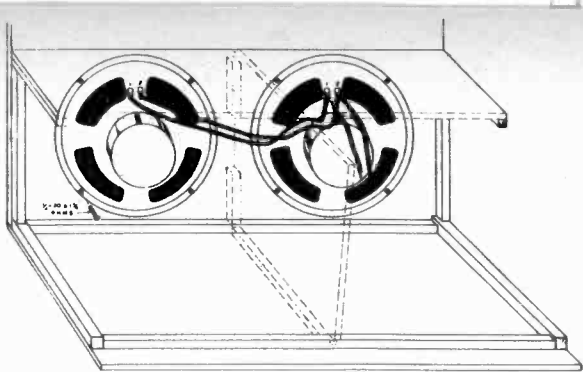
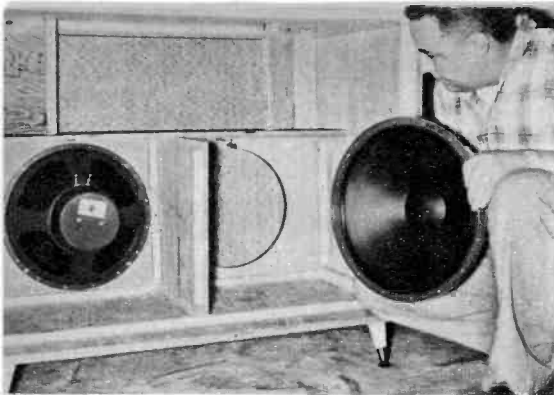

**WOOFER SECTION** of the Legato consists of two 15-inch speakers which are connected in parallel as evident in the drawing. In this photograph, with first woofer affixed, author installs the second woofer.

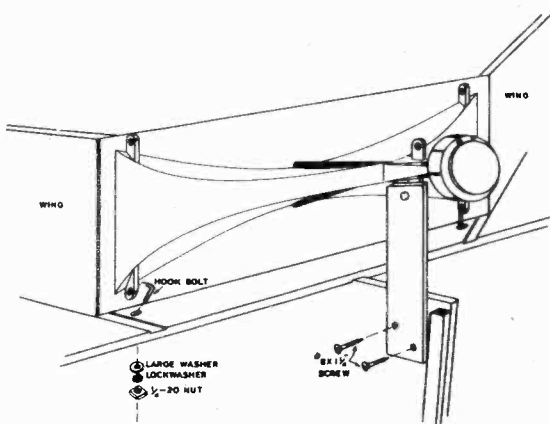

**TWEETER UNIT**, a sectoral exponential horn, is now to be mounted. You will note that the crossover network is already in, having been attached to the side of the center partition with wood screws.

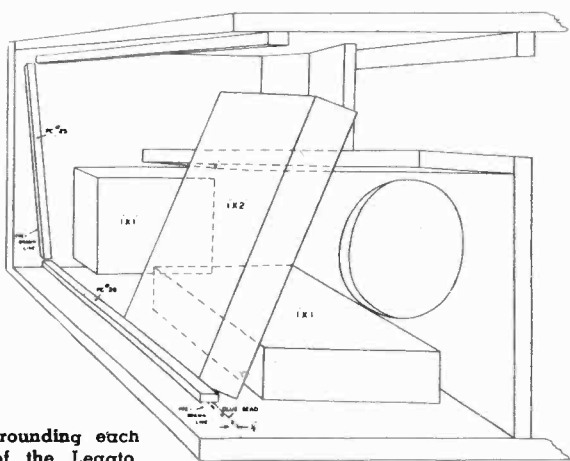
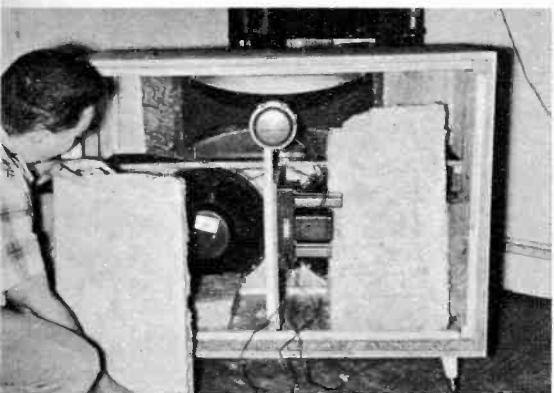

**FIBERGLAS** batting, 3 inches thick, is installed surrounding each woofer unit. This serves to absorb backwaves of the Legato.

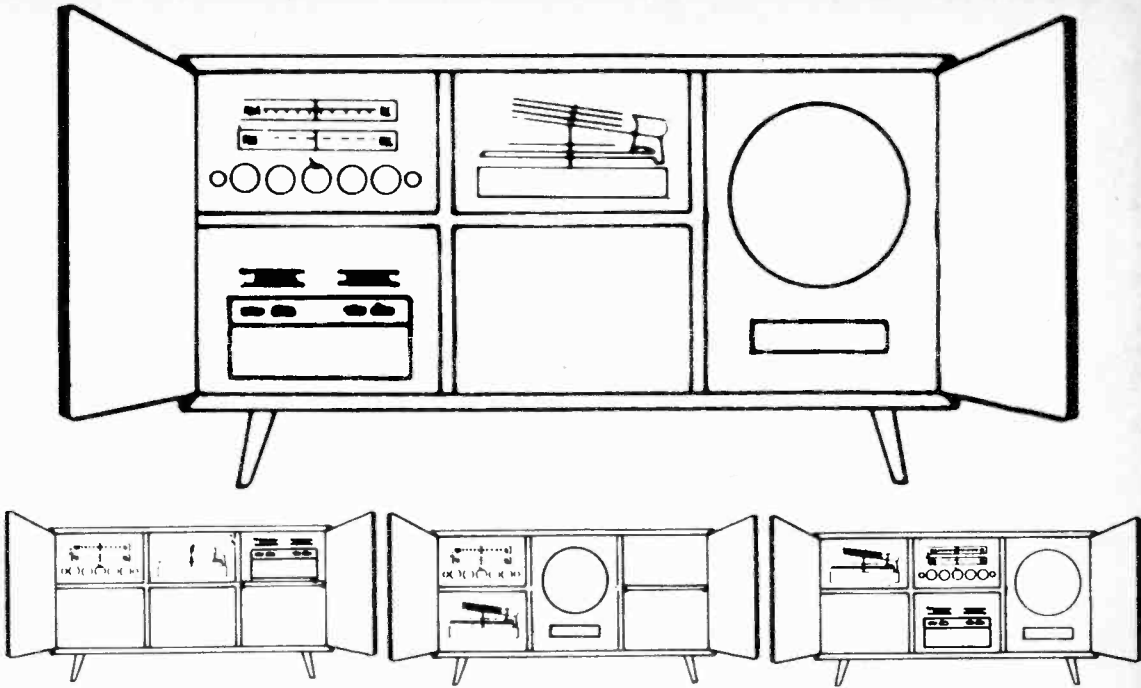

THIS CABINART KIT offers the "do-it-yourself" audiophile great flexibility. Top drawing shows the basic kit. However, purchaser may specify that front panels be pre-cut for any of the arrangements shown.

[Continued from page 32]

square gripping surfaces on the ends of the jaws. Behind these are cutting blades in line with the handles. This tool is for larger gripping jobs and for cutting heavier gauges of wire. It is not needed nearly as often as the long-nose and diagonals in light electronic work, but is a handy addition to the tool kit if you have a few bucks to spare. A good size for this work is the 6-inch model, while the 8-inch size would certainly be the largest you'd ever require.

The lowly slip-joint or gas pliers have square-nose gripping jaws at the end, with a second pair of concave serrated jaws between the nose and the hinge. Every book ever written about hand tools will tell you that this is a makeshift tool, a poor substitute for a half-dozen good tools, and it should never be used. The theory is fine, but I have yet to see a workshop, even the best equipped, which doesn't have at least one pair of slip-joints, nor a workman who doesn't keep one handy at all times. I therefore suggest that you forget the textbooks and follow the lead of experienced mechanics.

An all-purpose tool I would not recommend, however, is the so-called combination pliers. This thing has serrated jaws, wire cutters, one handle shaped into a reamer, while the other handle is a screwdriver. It doesn't do any of these jobs

well, so don't waste your time and money on it.

#### Proper Use of Knife

A pocket knife, on the other hand, is indispensable to the electronic technician. Its most common use is in the skinning of insulation off a wire at the end, so that the bare wire can make electrical contact to a terminal point. There are a number of insulating materials used on wires, and the knife is useful with all of them. Among these are rubber, plastic, cloth, varnish, enamel and paper. The two most commonly used on hookup wire, however, are plastic and rubber, which may be removed without injury either to you or the wire by use of the following method. The description is for a right-handed person, so if you are left-handed just read each instruction for the opposite hand.

Hold the insulated wire in your left hand with the end to be stripped pointing toward your right. With the knife in the right hand, place the blade against the side of the wire away from your body, at the point where the insulation is to be cut away. The hands should be against the body and just below the chest, so that the lower arms are in line with each other and the thumbs grasp the wire at a point opposite the blade.

At this point the usual procedure is simply to ring the insulation with the knife until it cuts all the way through. But this

## the peri-50 amplifier kit

THE PERI-50, a 50-watt amplifier kit, can be assembled by a novice in 90 minutes or less, says its maker, Printed Electronics Research. Hi-fi enthusiast and Hollywood actress Martha Hyer is at work on one here.



practice is bad for several reasons. First, you stand a good chance of nicking your thumb along with the insulation. Second, you'll probably nick the wire as well. This lowers the wire conductivity and defeats the purpose of selecting a given wire size. It also weakens the mechanical strength of the wire, greatly increasing the possibility of a future breakdown. And finally, it isn't good for the sharp edge of the knife blade to have to cut metal. These problems can be avoided or at least minimized by the following procedure:

Instead of holding the blade at right angles to the wire, hold it almost parallel, with the sharp edge pointing toward the end to be stripped. Then while rotating the wire with the left hand, move the knife in the right with a paring motion, and peel the insulation away just as you would pare the outside of a carrot. This causes the insulation to taper from its outer surface down to the outside of the wire, which is perhaps not as nice looking as a neat right-angle cut. But it is much more foolproof,

especially for the beginner, and I therefore recommend it. The wire is finally cleaned by scraping it with the *dull* edge of the knife.

Scissors are very handy for snipping away loose bits of insulation, cutting very fine wires, and cutting out templates. Your tool kit should have a pair, but be sure that this set doesn't get mixed up with your tape editing materials. The scissors in your shop will almost certainly become magnetized sooner or later, and this can wreak havoc with your tape operation.

### Variety in Screwdrivers

Everyone knows what a screwdriver is, and nearly everyone misuses this common tool. A screwdriver is *not* a pry bar, punch or chisel. In its commonest form it is simply a flat-bladed tool which fits into the slot of a screw head in order to tighten or loosen the screw.

The important thing to remember about the screwdriver is that its blade should just about fill the slot of the particular



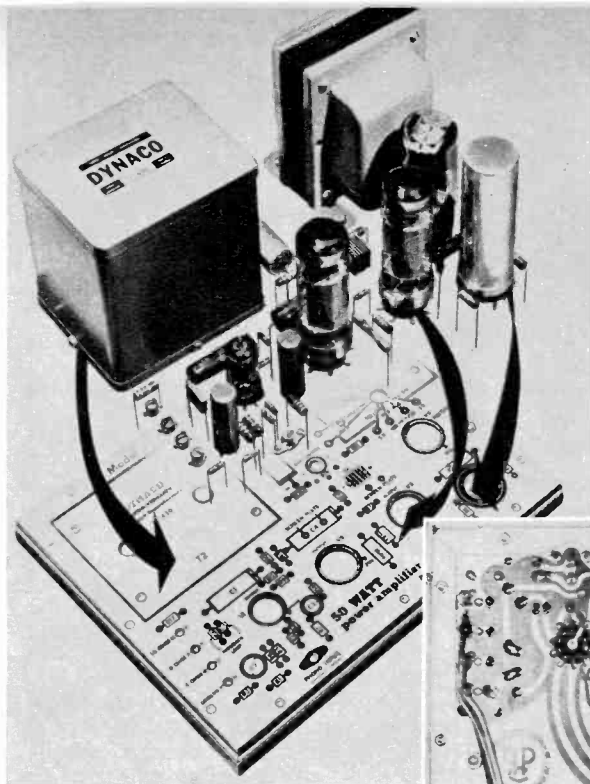

EXPLODED VIEW shows simplicity of Peri-50's "plug-in" construction. A deep-etched copper circuit board, below, restricts soldering to the barest minimum. "Touch" soldering attaches components' wires to board's underside. Needed solder and soldering iron are included in kit.

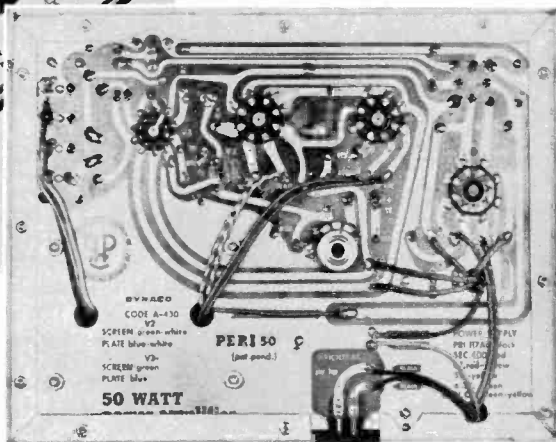

screw being worked on. If it is too small or too large, you can't get proper leverage and will probably damage the blade or screw head as well.

This means that the well-equipped shop will have a number of assorted sizes of screwdrivers. Some ratchet screwdrivers have a chuck on their handle which permits interchangeability of blades to fit the work. You should also have two or three Phillips-type screwdrivers, as the cross-slotted screw is quite commonly used in audio construction.

The wrenches used in audio construction grip and turn nuts or bolt heads for tightening or loosening. The non-adjustable open-end wrench is a common type, usually having different sized openings at each end. Thus each wrench can handle two sizes—and only two—of nuts and bolt heads.

Improper use of an end wrench usually involves working with the next size larger than the correct one. Although this makes for a sloppy fit, it will usually engage the

nut enough to tighten it. But in the bargain the nut may become burred and the wrench jaws nicked, sprung or broken.

End wrenches are available in a variety of sizes, but a small five-piece set with sizes ranging from  $\frac{5}{16}$  inch to  $\frac{3}{4}$  inch is quite adequate for audio work. There is also available a single adjustable end wrench which will cover this range and take the place of a set of wrenches.

Another approach to the problem, and probably the most popular among experienced audiomen is the socket wrench set. This comprises a group of sockets of graded sizes, each designed to fit closely over a nut, with one or more handles to fit the sockets. In some cases each socket has its own handle permanently attached, in which case the tool is often referred to as a nut driver.

### Correct Use of Solder

The use of these few hand tools is simple and straightforward, but there is one operation the prospective kit assembler must



TECH-MASTER'S 60-watt amplifier shows trend to hi-power hi fi. Available as kit or assembled.

CANTATA tuner for FM by Tech-Master has isolation transformer between set, power line for safety.



know well. I would strongly advise you not to try assembling any electronic kit until you have mastered the knack of soldering. It isn't at all difficult, but if it isn't done right you can run into all kinds of grief later.

Soldering is a process of uniting two or more metals by first heating their junction, and then applying to the joint a fusible alloy called solder. Thus the whole system can be broken down into three simple elements:

1. How to join the metals.
2. How to heat them.
3. What solder to use and how to apply it.

Now let's discuss each one in order.

Nearly all of your soldering will involve attaching a piece of hookup wire or a wire built into a component to some fixed point such as a tube socket, control, tie point or terminal strip. In any case the wire is first cut to length, stripped and cleaned, and then attached to the terminal so that it is mechanically secure.

The physical strength of the joint should not depend upon the solder. The wire is therefore doubled back on itself for about  $\frac{1}{8}$  inch at the end and crimped with the long-nose pliers so that it is clamped to the terminal. Before soldering, of course, make certain that the wire is going to the correct point and only to that point. When working on miniaturized components in confined quarters it is quite easy to have the bare end of the wire brushing against some point where it doesn't belong.

Now that the metals are properly joined, the next question is how to heat them preparatory to soldering. The heat is usually applied by contact with a piece of hot copper, which itself is usually heated by electricity. The chunk of copper is the tip end of a tool misnamed a soldering iron.

The electric soldering iron may take several forms. The older and better-known type has a tip which is indirectly heated by a resistance element. For most work such an iron in a 75- or 100-watt size is quite adequate, with a  $\frac{3}{8}$ -inch tip. Many audiophiles feel that an iron this size is not necessary, and they prefer a pencil-type, having a power rating of about 30 watts with a tip around  $\frac{1}{4}$  inch.

If you do use a pencil-type, you'll probably require a larger size occasionally. For while the little baby will handle about 95% of your requirements, you will probably find times when there just isn't enough heat on larger elements to flow solder correctly.

The other approach to electric soldering is the *gun*, which is really a step-down transformer with a switch, forcing a high current at low voltage through a copper-wire tip. The tip is therefore directly heated by the current passing through it. It heats instantaneously, and therefore the trigger is pulled to apply heat only as it is needed. One advantage of the soldering gun is that the tips are usually pre-tinned, while the user of the iron must go through this process before he is ready to solder.

### How to Handle the Iron

Before attempting to solder with an iron, the part of the bit which comes into contact with the joint must be covered with a coating of solder, or *tinned*. In the case of a new iron you will begin by plugging in the power and rubbing solder against the tip every few moments. The iron, of course, won't be hot enough to melt the solder at first, but continue the operation so that solder begins to flow the instant the temperature becomes high enough. The reason for this is to have the tinning accomplished before the copper tip gets a chance to oxi-

**BASIC power amplifier by Eico delivers 60 watts, features the Accrosound Ultra-linear transformer.**



**EICO'S hi-fi master control has 9 input positions, including 5 common recording curves for LP, 78.**

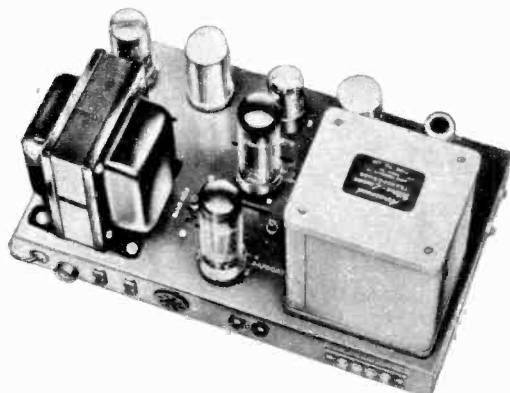

dize. With molten solder flowing freely over both faces of the tip of the iron, wipe off the excess with a rag rolled up into a ball, thus exposing a thin, shiny layer of metal covering the tip. After some hours of use the tinning will become dull and flaked, and the tip may even become pitted. When this occurs, simply dress down the tip faces to the bare copper, using an old file, and then repeat the procedure.

Finally we come to the question of what solder to use and how to use it. The solder employed in radio and audio work is an alloy of two metals, lead and tin, and usually has a flux built into its hollow core. The purpose of the flux is to prevent rapid oxidation of the metals as they are heated.

Some types of fluxes are highly corrosive, which is not a great handicap in some types of work, but can't be tolerated on any electrical installation. There is always the possibility of small amounts of the corrosive flux remaining in the joint and in time eating through the connection and opening the circuit. Furthermore, the use of a corrosive acid flux on any kit you build will automatically void your guarantee. The kit packagers are most co-operative in helping you out if you strike a snag in construction, or if the unit fails to operate after you're done. But if you have used acid-core solder in your work all bets are off.

The flux commonly used for audio work is rosin, and if it is included within the solder, the material will probably be known as *rosin core radio solder*. Flux is also available in paste, liquid and powdered form, but the flux-core solder is so convenient it is now used almost universally.

### **Kinds of Solder**

Solder used in audio work is known as soft solder, as opposed to silver and alumi-

num solders which have much higher melting points. The best flowing solder, and therefore the easiest for the beginner to handle, consists of 60% tin and 40% lead. The 50-50 alloy is a little better for electrical work, but it has a higher melting point and is a little harder to work. You might therefore try a small kit using the 60-40 type, and when you feel that you have the soldering technique well in hand, switch to 50-50.

Having the joint securely crimped and mechanically solid, hold the heated iron in such a way that the iron heats the joint and the joint melts the solder. Unless the joint gets hot enough to fuse the solder itself, a cold solder joint will result, which may in time result in an open circuit. Finally, use as little solder as possible. Since its electrical conductivity is only 1/7 that of copper, there should be a minimum of solder separating the conductors.

And with these facts in mind you are ready to have some fun assembling any of a wide variety of kits now on the market. The big news in kits this year is the better-quality designs available. The budget-minded audiophile hasn't been forgotten, but the kit boys are moving into the big leagues as well. Eico, for example, while announcing a new 12-watt Williamson-type amplifier kit, also offers a 50-watt job. The Peri-50 is a new printed-circuit system of 50 watts, with much of the tedious work eliminated. Tech-Master has a 60-watt job and Heathkit is ready with one of 70 watts.

Heathkit also has the fine new Legato speaker system, using Altec-Lansing components. The price is high as kit prices go, but very low for the quality it contains. Quality like this has been very rare in kits up till now, but this seems to be typical of the new trend. •

# Hi Fi's Best Buys

Here are complete, balanced systems to fit every pocketbook. They represent the market's biggest bargains



**T**HERE have been very few days of my life in recent years when someone hasn't told me he has X dollars to spend on hi fi, and asked me to tell him how he should spend it. Now I can't tell him, or you or anyone else, how he should dispose of his hard-earned lucre.

The best I can do is express my own personal opinion to tell how I would spend my money for a system in a given price range. But it's strictly my own opinion, and I'm just as much subject to prejudices as the next fellow.

My main qualifications for expressing my opinions stems from the fact that I've been engaged in this field as amateur and professional for about twenty years. I am not in the employ of anyone having a financial interest in the hi-fi industry. And the only one who pays me for what I set down here is my publisher, whose Editor-in-Chief has never tried to put words in my mouth.

Having made my position abundantly clear, I shall expect to receive not more than ninety-seven letters from irate readers. Of these, ninety-four will be from hobbyists who are certain I must be blind and tin-eared for having overlooked a pet component of theirs. The remaining three will be from manufacturers who are certain that I must be blind, tin-eared and in pay of the enemy for having overlooked a pet component of theirs.

And so with reluctance and resolution I begin my recommendations with

#### SYSTEM I—\$165

Garrard RC-121 Changer with G.E. Cartridge with Diamond and Sapphire .....	\$59.29
Lafayette LA-40 18-watt Amplifier with Preamplifier and Controls .....	46.50
Lafayette LT-40 FM-AM Tuner .....	67.50
Lafayette SK-58 12-inch Coaxial Speaker .....	29.50

**\$202.79**

Each of these items is a best buy in its own right at the prices quoted, but that's only the beginning. The difference between the total and the figure in the sub-headline is due to the fact that this combination is being offered by Lafayette Radio in New York as special-deal HF-155 for only \$169.95. It seems incredible, but I checked with Lafayette to be sure there hadn't been some error, and the price is right. Then I searched all over looking for a competing deal to match it, but I couldn't find one. Therefore in this price class the system stands alone.

LAFAYETTE RADIO'S "package" offering, System I, is seen in use at the left. The amplifier has a frequency response of 20-40,000 cycles. The speaker cabinet is not included; woofer, with chemically-processed fiber cone, and 2½-inch tweeter are at right. Crossover network, with crossover point of 3,000 cps, is built in.

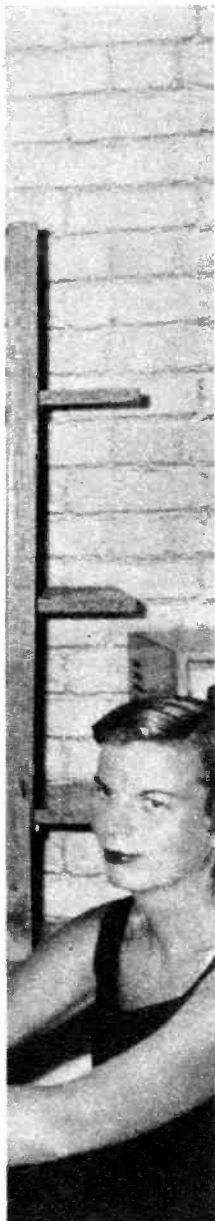



**GARRARD RC-121** changer features 4-pole motor, stylus pressure and pickup height adjustments.

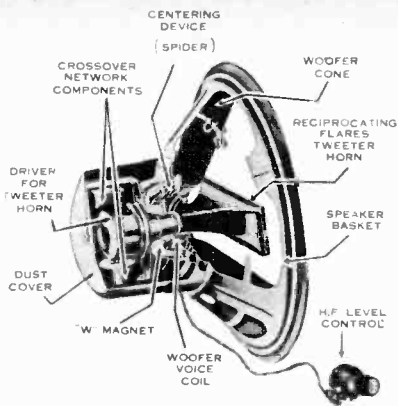

**UNIVERSITY Model 6201** is a dual range coaxial speaker. Its response is 45-15,000 cps; 25 watts.

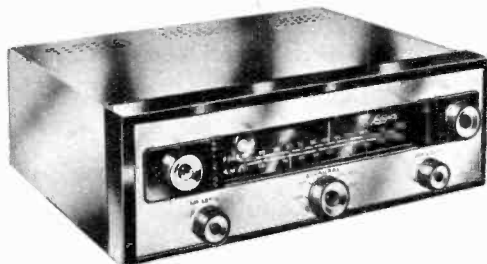

**LAFAYETTE LT-40** tuner has discriminator, AFC, AFC defeat, temperature compensated oscillator.

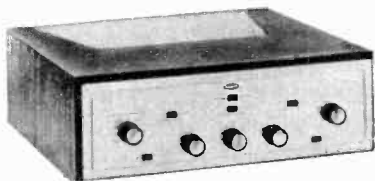

**SCOTT 99-D** has two magnetic inputs; 5-position record compensator includes NARTB tape curve.

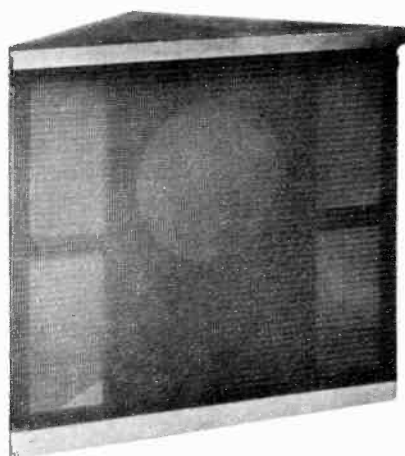

**CABINART 61** enclosure is approximately 32 in. wide at front, is constructed of 3/4-in. plywood.

### SYSTEM II—\$300

Garrard RC-121 Changer with G.E. Cartridge	
with Diamond and Sapphire .....	\$59.29
Lafayette LT-40 FM-AM Tuner.....	67.50
Scott 99-D 22-watt Amplifier with	
Preamplifier and Controls .....	99.95
University 6201 12-inch Coaxial Speaker .....	48.51
Cabinart 61 Corner-Folded Horn .....	19.95
	<hr/>
	\$295.20

This, too, represents a lot of good equipment for the money. Some of the prices shown here are below manufacturer's list, but they are the going prices in many areas. Shop around and dicker a little bit if necessary.

The changer is the Garrard *Renown*, the economy model in this line. The mechanism is different from that in the higher-priced models, but still quite good. The G.E. cartridge is the triple-play type, with a 3-mil sapphire for 78's and a 1-mil diamond for 33's and 45's.

The tuner uses the Armstrong system in the FM section, with a meter (not a tuning eye) to indicate precise on-channel tuning. The amplifier has inputs for two magnetic cartridges, a ceramic or crystal cartridge, tuner, tape and TV. It also has scratch and rumble filters which may be switched in at will.



### SYSTEM III—\$450

Miracord XA-100 Changer with G.E. Cartridge	
with Diamond and Sapphire .....	\$78.45
Harmon-Kardon T-12 FM-AM Tuner .....	84.50
Eico HF52 50-watt Amplifier with	
Preamplifier and Controls .....	109.95
Jensen G-600 15-inch Triax Speaker .....	129.50
R-J F-15 Enclosure .....	52.50
	\$454.90

We've moved up to the Miracord changer now, but with the same G.E. cartridge setup. This changer has a built-in scratch filter available at will, and a pause selector which permits intervals between records to be preset to points between 5 seconds and 5 minutes.

The Harmon-Kardon *Overture II* tuner is the improved 1958 version of their T-10 model with a 7-tube Armstrong circuit plus selenium rectifier. The Eico amplifier delivers a lot of watts for the money, from a total of six inputs, two low-level and four high-level. The price quoted is for the completed amplifier, although you can save another \$40 by building it from a kit.

The Jensen G-600 is brand new this season, an economy model of the well-respected G-610 Triaxial. The R-J system of speaker enclosures is well-known for its efficiency and quality in small size. It fits well in this system, and at a very reasonable price.

**HARMAN-KARDON** *Overture*, left, has FM AFC, broadband superhet AM with AVC, ferrite antenna.

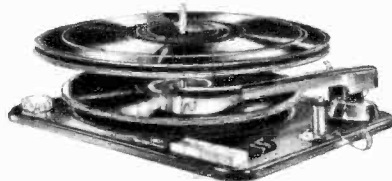
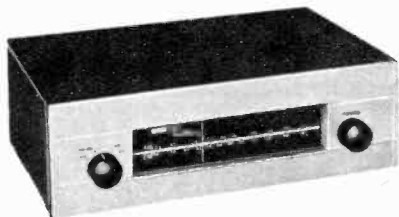

**MIRACORD XA-100** features heavy-duty 4-pole motor. Plastic arm is suspended in ball bearings.

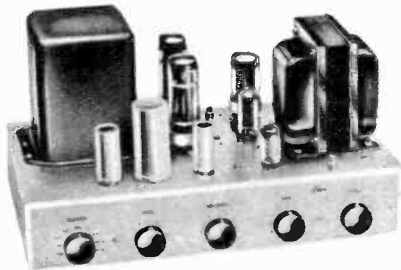

**EICO HF-52** amplifier employs printed circuit, prewired loudness control, separate level control.



**JENSEN G-600** compression supertweeter ranges from 4,000 cps to the limits of audibility. R-J F-15 enclosures, right, are suitable for any room's decor.

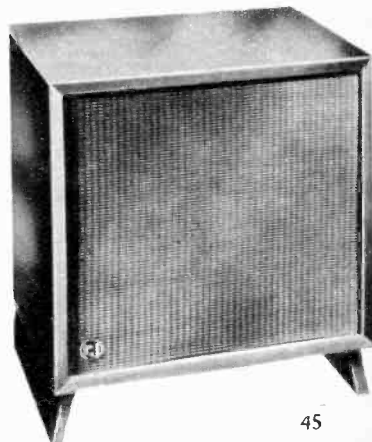

### SYSTEM IV—\$750

Components PBT Turntable .....	\$99.50
Pickering 194D Arm with Fluxvalve Cartridge with 1-mil Diamond Stylus .....	59.85
Pickering T-Guard 3-mil Diamond Stylus .....	18.00
Bogen R660 FM-AM Tuner .....	119.50
Electro-Voice PC2 Music Control Center .....	67.00
Bogen DO70 70-watt Amplifier .....	129.50
Electro-Voice 15TRX 15-inch Speaker .....	149.00
Jeff Markell S101B Speaker Enclosure .....	99.00

\$741.35

We're approaching the big leagues now, and I would assume that anyone willing to spend this kind of money would not consider using a changer with expensive records. We've chosen a turntable by Components Corporation here, and while this one will never win any beauty contests, it does do a fine job. Instead of the usual idler-wheel drive used in most phono systems, this one uses an endless-belt system around the outer circumference of the table and extending to a step pulley on the motor. It sounds a little cumbersome, and it is, but it does offer certain mechanical advantages.

The mechanical filtering effect of the belt along with the flywheel effect of the 25-pound turntable combine to provide a motion which is substantially free of vibration, rumble, wow or flutter. An interesting refinement is an expanding collet spindle which aids in centering records with oversize center holes.

The Pickering Unipoise arm is brand new this season, and it incorporates the well-known Fluxvalve cartridge with one diamond stylus included in the basic price. If you don't need facilities for 78-rpm records, you can stop right there and avoid paying \$18 for the 3-mil stylus.

In this system we are using a separate preamplifier-control unit, which is quite simple and straightforward, with selector, volume and two tone controls. The Bogen tuner is a 10-tube unit including Armstrong FM circuitry with two noise-limiting stages, a tuning meter, and automatic frequency control coupled with a temperature-compensated oscillator for minimum drift.

The power amplifier is a basic unit, without controls except a variable damping factor. A built-in selector switch permits operation, either separately or simultaneously, of two speaker systems with impedance matching automatically adjusted within the amplifier.

The E-V designation of the 15TRX as a 3-way speaker is a little

**COMPONENTS PBT** turntable gains overall shock mounting with tempered steel springs on its legs.



**PICKERING** Unipoise arm, Model 194-D, features T-guard stylus, built-in hum rejection circuit.

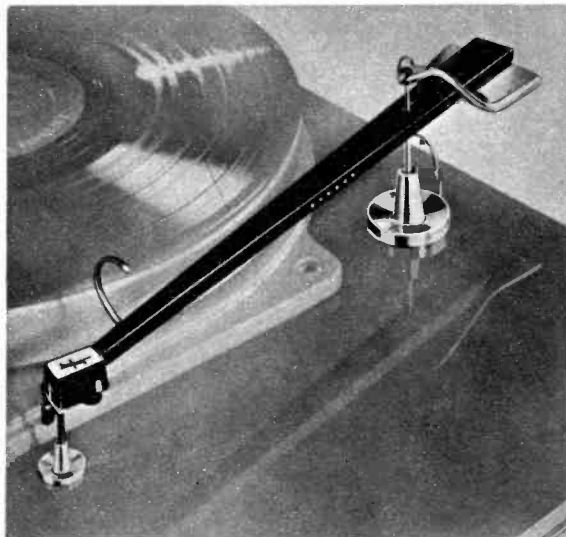

misleading. There is a "mechanical crossover" claimed at 2,000 cps, while electrical separation between the two driven units actually occurs at 3,500 cps. But if you overlook the manufacturer's overexuberance, the speaker is quite good and worth the price.

Jeff Markell has been one of the leaders in helping hi-fi gear to shake off that refugee-from-the-test-bench look. His designs are not only esthetically pleasing but technically sound. His speaker enclosure therefore gets my vote in this system.

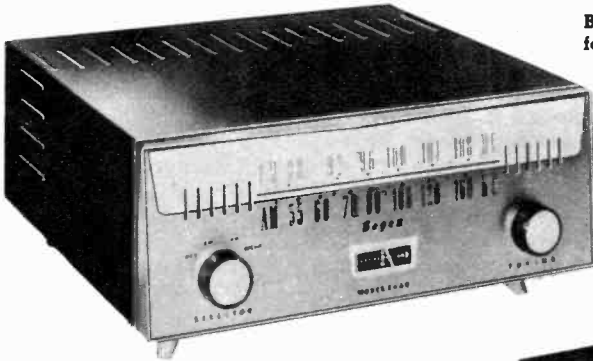

**BOGEN R660** tuner has AFC defeat, meter for simple tuning with least noise, distortion.

**DO-70**, Bogen's 70-watt amplifier, peaks to 300 watts. Freq. response: 0.5 db, 5-100,000 cps.



**E-V PC-2** music control center, left, provides control for amp, has self-contained power supply.

**ELECTRO-VOICE 15TRX** features response of 30-15,000 cps. RETMA sensitivity rating is 51 db.

**JEFF MARKELL S101B** enclosure measures 6½ cubic feet internally, comes in varied finishes.

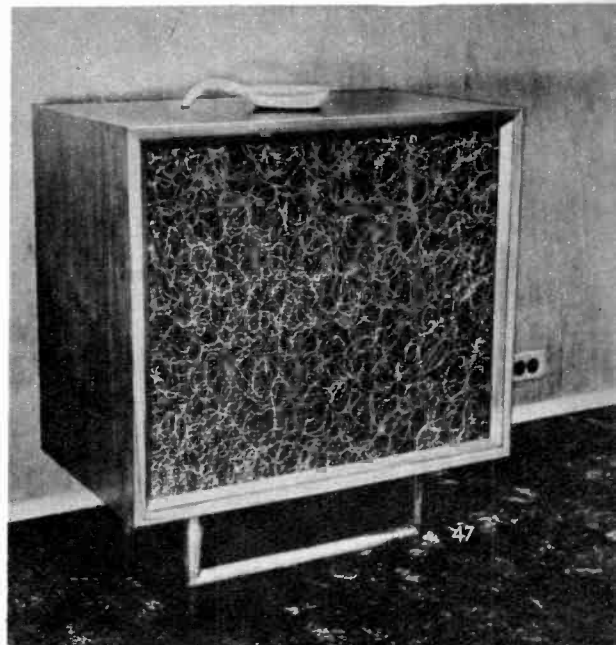

### SYSTEM V—\$1,000

Scott 710-A Stroboscopic Turntable .....	\$125.00
Rek-O-Kut 120 Turntable Arm .....	26.95
Fairchild 225A Cartridge with 1-mil Diamond Stylus....	37.50
Fairchild 225C Cartridge with 3-mil Diamond Stylus....	37.50
Fisher 80-T FM-AM Tuner .....	199.50
McIntosh MC-60 60-watt Amplifier .....	198.50
Jensen G-610A 15-inch Triaxial Speaker .....	252.75
Electro-Voice Regency Enclosure .....	130.00

\$1,007.70

The Scott turntable in this system is particularly recommended for listeners with perfect pitch. Although it doesn't happen nearly as frequently as it used to, off-pitch records still come off the presses at times, and the only way to correct this is to adjust the turntable to the speed at which the disc was made. The Scott system permits this through a vernier adjustment which will make speed corrections as much as 5% either side of the three standard speeds.

There's nothing fancy about the Rek-O-Kut arm, but I can't see any reason why there should be. The mechanical design is as good as any you can find, so why waste money on frills?

This system has the controls and preamplifier as part of the Fisher tuner. The unit has six record compensation positions, separate bass and treble controls and loudness control. The four input circuits include a separate tape head playback preamplifier with NARTB equalization.

With all control functions taken care of in the tuner, the amplifier need only be of the basic type, in this case the McIntosh. Since System IV featured a 70-watt amplifier, it might be wondered why we are apparently retrogressing here to something smaller. The answer lies in the lack of rating standards we discussed previously. Specifically, Bogen's curves show about 0.7% harmonic distortion and around 1.7% intermodulation for the DO-70 at 75 watts. McIntosh, on the other hand, claims for the MC-60 only 0.25% overall at the same power. Now which amplifier is really the higher powered?

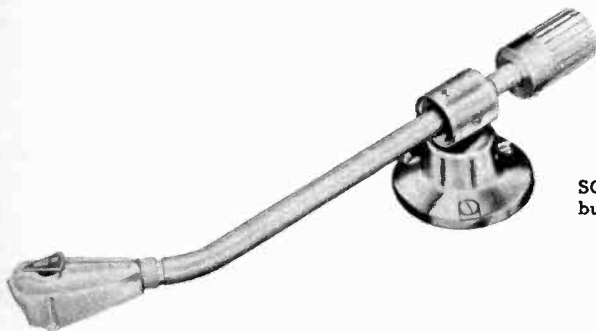

REK-O-KUT 120 arm is of tubular aluminum with die-cast cartridge shell, counterweight.

SCOTT 710-A stroboscopic turntable features a built-in provision for the mounting of pickup arm.

FAIRCHILD 225-A with diamond stylus weighs approx. 12 grams.

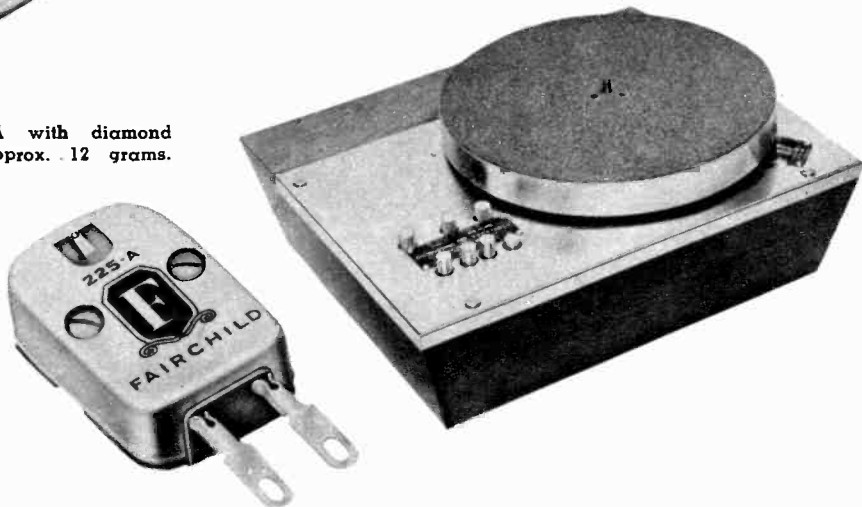



FISHER 80-T tuner claims a first with separate tape head playback preamplifier.

McINTOSH 60-watt amplifier has a noise-hum level 90 db plus below rated output.

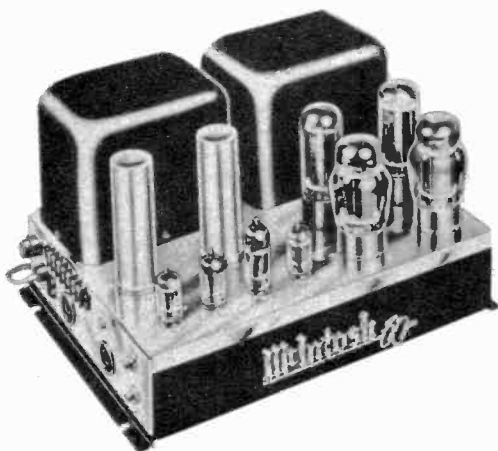

JENSEN G-610A Triax features cross-overs at 600 and 4,000 cycles per second.

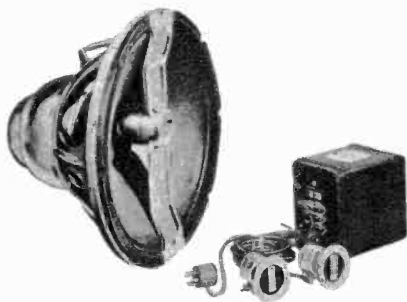

E-V REGENCY has "built-in corner"; can also be used against a flat wall.

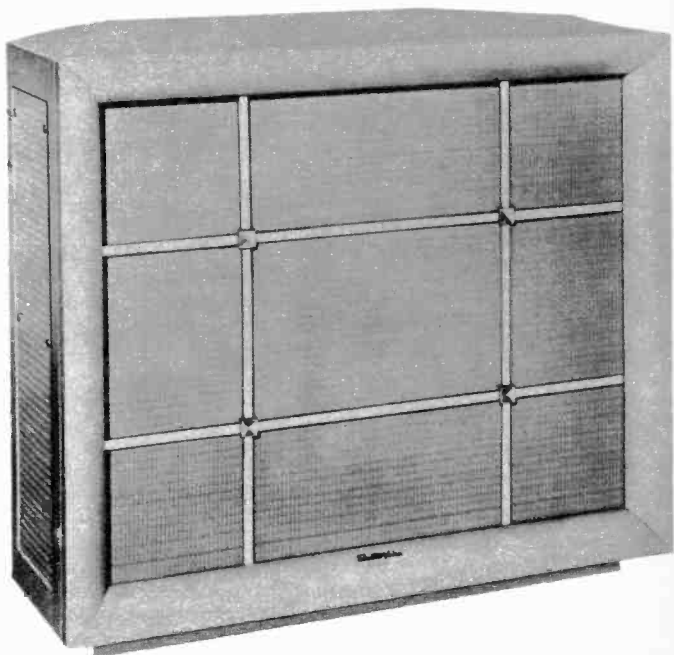



SCOTT 331-B tuner is for monaural or stereo. Tonal controls include separate bass and treble.



FISHER 90-watt amplifier's hum and noise level is better than 92 decibels below its full output.

SHURE M-16 arm is column-shaped, of light, high-strength aluminum, reinforced at its midpoint.

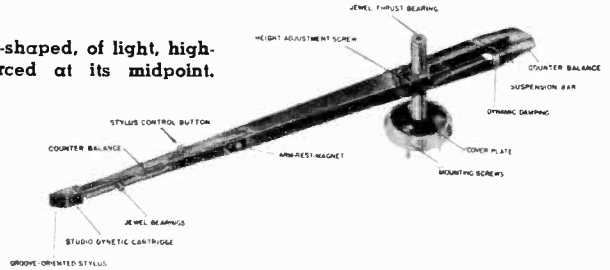

ALTEC 820C speaker system guarantees smooth frequency response, 30-22,000 cps.

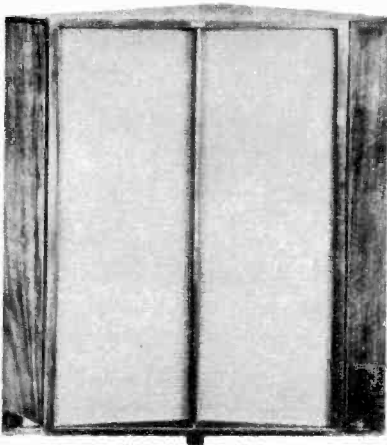

REK-O-KUT B-12-H features custom-built hysteresis synchronous motor.

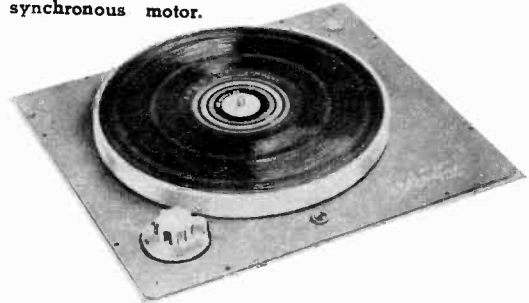
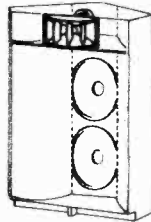

**SYSTEM VI—\$1,235**

Rek-O-Kut B-12-H Turntable .....	\$129.95
Shure M-16 Studio Dynetic Reproducer with 0.7-mil Diamond Stylus .....	79.50
Shure M-2 Cartridge with 2.7-mil Diamond Stylus.....	42.00
Scott 331-B AM-FM Tuner .....	229.95
Fisher 90-A 90-watt Amplifier .....	229.50
Altec 820C Speaker System .....	525.00

**\$1,235.90**

Turntables may come and go, but the performance of the B-12-H still puts this one at the head of the class. Rek-O-Kut puts a lot of loving care into this one, and the results speak for themselves.

The Shure magnetic reproducer and arm are brand new this season, but the performance of this fine new product merits it a place among the best.

The Scott tuner may be used as part of a stereo system for binaural AM-FM combined broadcasts, as well as in the conventional fashion for monaural broadcasts on either AM or FM. There are three selector positions for AM reception known as AM wide-range, AM normal and AM distance. NARTB equalization for tape is also included. Now let's look at a couple of kit systems in diverse price ranges.



## KIT SYSTEM I—\$165

V-M 935 Changer with G.E. Cartridge	\$43.90
with two Sapphires .....	
Tech-Master FM-18 FM Tuner .....	29.50
Eico HF-20 20-watt Amplifier .....	49.95
Eico HFS1 Speaker System .....	39.95
	\$163.30

There's no such thing as a complete kit system as yet, of course, as mechanical items such as changers and tape recorders are not available in kit form. The V-M changer is a basic unit which will require mounting on a motor board or in a cabinet.

The Tech-Master tuner is FM only, employing a no-drift ratio detection circuit. The sensitivity is 4 microvolts for 20 db of quieting. The basic unit includes a front panel and controls. A cabinet costs an additional \$7.50.

Eico is the source of both the amplifier and speaker system. The amplifier is a Williamson-type with a complete set of controls. Six inputs are available as well as an output feed for a tape recorder. The bookshelf speaker system comprises an 8-inch woofer and a compression horn tweeter with balance control. The enclosure is already assembled, requiring only installation of components and external finishing. Wiring time is just 15 minutes.

**TECH-MASTER FM tuner kit offers tuning range 87-109 mcs, 200 kc IF bandwidth, manual AFC cutoff.**

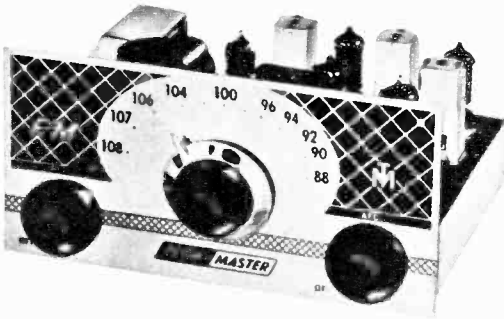

**V-M MODEL 935 changer plays fourteen 7-, twelve 10-, ten 12-inch records of 33 1/3, 45 or 78 rpm.**



**EICO HF-20, a 20-watt amplifier kit that peaks at 34 watts, includes preamplifier and equalizer.**

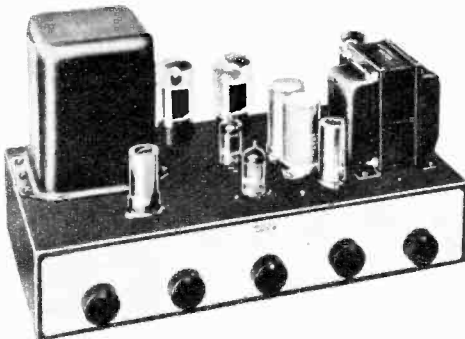

**MODEL HFS-1 speaker by Eico is 23x11x9 inches. The solid birch molding frames the grille cloth.**



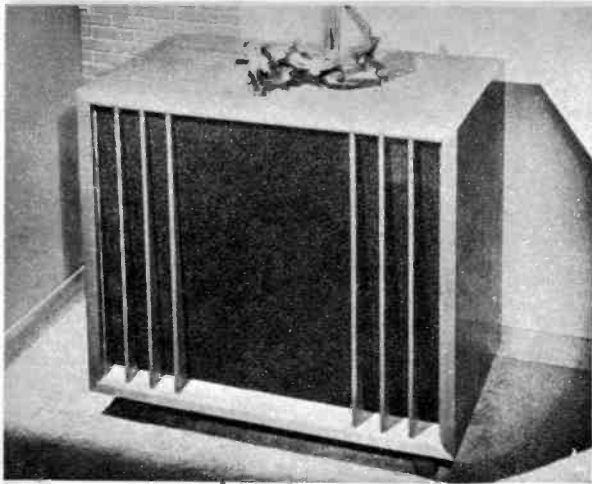

HEATHKIT Legato assembly details are included in the chapter "Kits Cut Costs." (See pp. 33-36.)

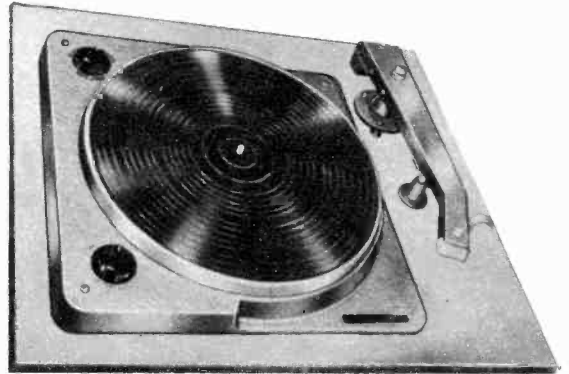

LAFAYETTE PK-100 is of cast aluminum, rim driven, and has a 4-pole constant-speed motor.

### KIT SYSTEM II—\$575

Lafayette PK-100 Turntable Package with Fairchild Cartridge .....	\$87.50
Lafayette KT-100A FM-AM Tuner Kit .....	34.95
Heathkit W-6 70-watt Amplifier with Preamp .....	129.70
Heathkit HH-1-C Speaker System .....	325.00
	<hr/>
	\$577.15

Here is a really sweet buy in a phono system, with a heavy-duty turntable with 4-pole motor and an imported viscous-damped arm made under CBS license. The Fairchild cartridge tops it off to make up a very fine system. As it stands it will play microgroove records only. For 78-rpm reproduction as well, it would be necessary to invest an additional \$37.50 in a second cartridge.

The tuner employs the Armstrong FM system with discriminator and limiter, as well as automatic frequency control for minimum drift. The AFC may be switched out at will, however, to permit tuning weak signals. A phono input permits feeding in a ceramic or crystal cartridge, although it is not necessary in this system.

The new Heathkit amplifier is conservatively rated at 70 watts, using type 6550 output tubes working into a Peerless transformer. Several choices of speaker connections are available.

So there you have my choices for this year. But don't take my word for it. Shop around, listen carefully, and choose wisely. •

KT-100A FM-AM tuner kit by Lafayette has AFC defeat with front-panel control. 20 to 20,000 cycles per second response.

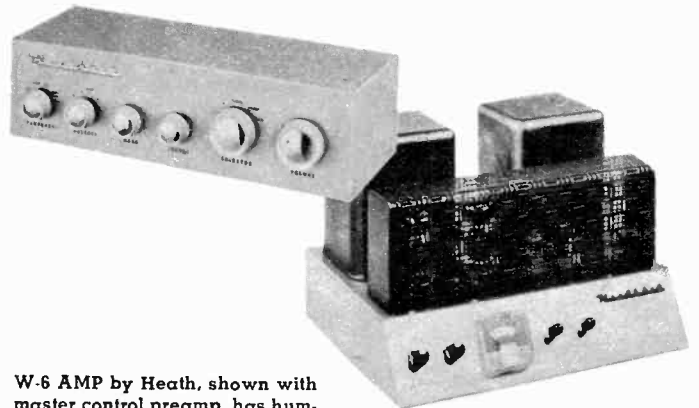
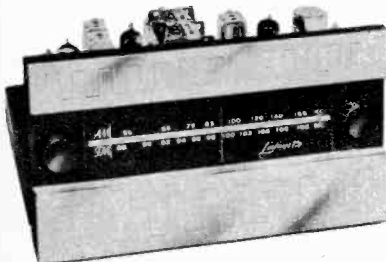

W-6 AMP by Heath, shown with master control preamp, has hum-noise level 88 db below output.

IF YOU THINK THAT ALL BRANDS

OF RECORDING TAPE ARE ALIKE...

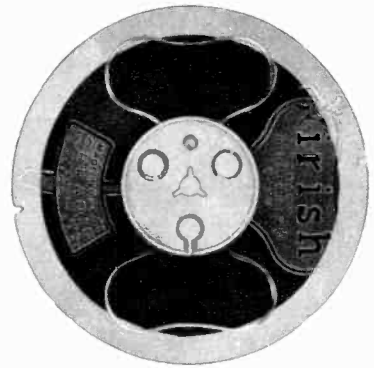

...WAIT TILL YOU TRY **irish** FERRO-SHEEN!  
BRAND

# Hi-Fi Tape Arrives

Magnetic tape recording of respectably low wow and flutter factors can now be added to your high-fidelity system at reasonable cost

**A**T LONG LAST the audiophile can include magnetic tape recording in his system without spending a small fortune for the privilege. Readers of the earlier *Fawcett Books* on hi fi are well aware of this author's previous bearish attitude on tape for home use.

Tape recording is, of course, the highest attainment of the art, and, for the professional recordist with several thousand dollars to invest, it has always been money well spent. But for the average guy with a few hundred bucks at most, there simply was nothing available which could com-

pare in quality with the rest of his system. But there is presently such a variety of equipment on the market at very reasonable prices that I think the time to include tape is now.

The difficult problem in tape, as in other types of hi-fi gear, was mechanical. The electronic components of low-priced tape recorders were at least roughly comparable to those in professional equipment. But the mechanical arrangements just didn't compare at all.

The result was that reproduction, while reasonably free of noise and distortion, was

**TAPE** can be added inexpensively using tape deck since it renders duplication of electronics unnecessary.





**MR. DAN W. HEDIN** of St. Paul, Minnesota, adjusts his tape controls prior to making dubs from discs on changer. Note speaker system in high background of this home-built setup.

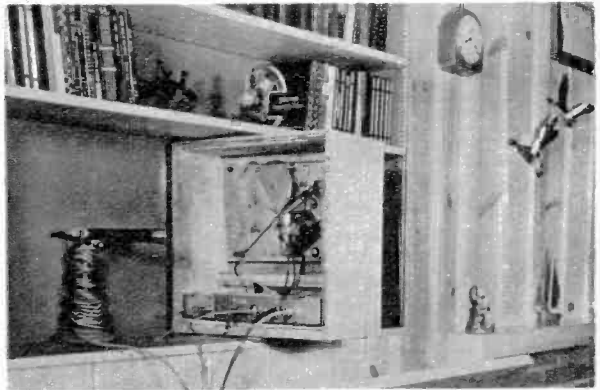

**SIMPLICITY** of the tape deck and connections is obvious in rear view. The box that houses the deck also contains a Viking record/playback amplifier, a playback preamplifier.

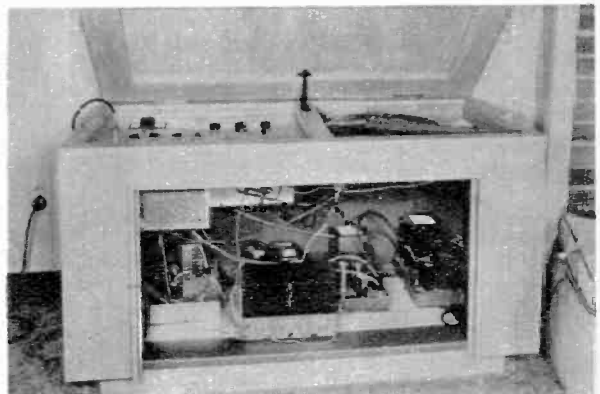

**THIS VIEW** of the main system shows two power amplifiers for stereo, Heathkit electronic crossover, freqd. Hedin can record at 40 to 12,000 cps, playback at 40 to 14,000. Minnesota Mining & Mfg. Co. photos

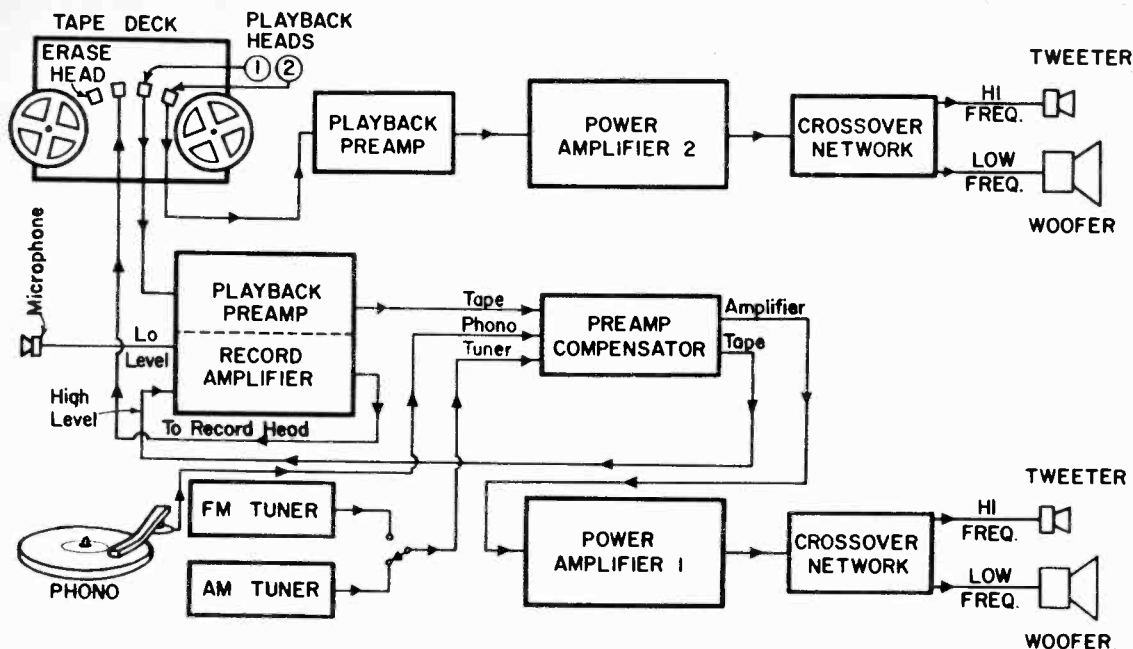

**BLOCK DIAGRAM** shows components of the system on preceding pages. There are provisions for stereo tape reproduction and monaural tape recording from any source included in system: AM, FM, and records.

just loaded with wow and flutter. This is the seasick sort of sound you also get with a record which is off-center or badly warped. And it was all due to the so-called tape transport mechanism.

Just as the rotation of a record turntable must be steady and unflinching, so must be the movement of the tape past the record and reproduce heads. Despite this, most of the low-price machines have attempted to have one small electric motor drive the tape transport, and also handle the take-up and rewind functions. Which brings us to our first standing rule in the selection of a tape recorder.

The complete mechanism must have *three* motors, one on the tape transport, another on the takeup reel, and still another on the supply reel. The usual method of tape transport is known as capstan drive, the capstan being a metal (preferably) or rubber cylinder mounted on the end of the motor shaft. A second free-running pressure roller holds the tape against the capstan, whose rotation pulls the magnetic ribbon through with a sort of "squeeze" effect. The complete sequence of tape travel is then off the supply reel, past an erase magnet, past the record-reproduce head(s), through the capstan drive and onto the takeup reel.

The need for perfectly constant speed in

this transport mechanism is even greater than for a turntable, for any wow or flutter encountered in recording will be doubled when the tape is played back on the same machine. Since this has always been the weak spot in the system, the percentage of speed variation is an excellent index of overall tape recorder performance.

As a specific example, almost anyone can hear wow and flutter of 0.5%, but that figure is just about par for the course on low-cost recorders. This isn't hi fi, whatever the frequency response and distortion figures may be, so don't waste your time with it.

At the other extreme we have the expensive professional equipment, whose speed variations usually run on the order of 0.1% or even less. These refinements are beyond the budgets of most audio hobbyists, but it is now possible to get equipment at reasonable prices having wow and flutter factors of a very respectable 0.2 to 0.25%. This performance is quite adequate for a home hi-fi installation, and it can be had for around \$200 to \$500, depending upon the components and specific operational features.

Among tape's many advantages is its ability to be played over and over without any change in quality. Yet when the rec-



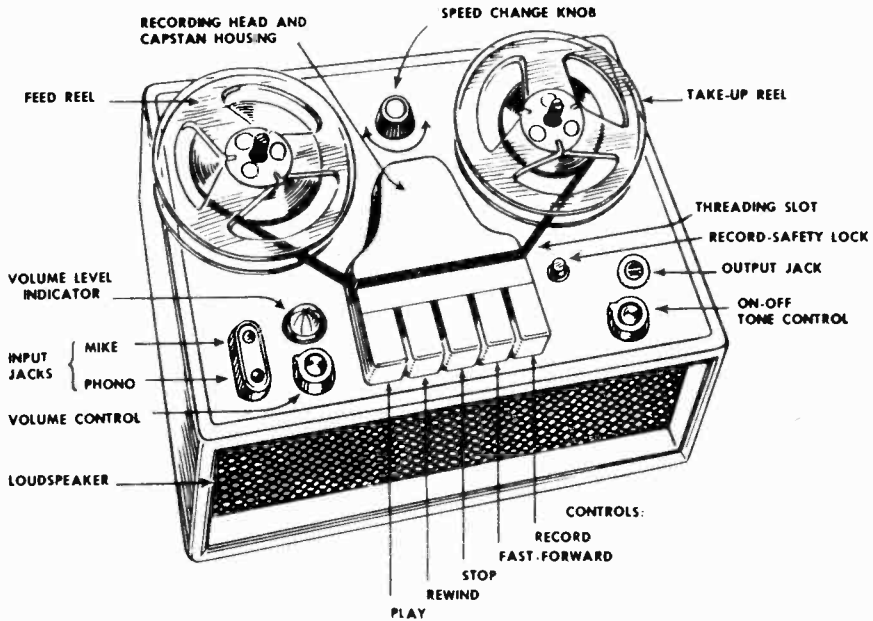

THIS DRAWING shows a typical two-speed home tape recorder with push-button controls. The quality of machines such as this one has improved steadily. Now many of them can truly be called high fidelity.

ord is no longer needed, the same tape may be reused for recording whenever desired. When the RECORD button on the machine is pressed, the old sound is removed from the tape just a fraction of a second before the new sound is recorded, the process being known as *erasing*.

The many very tiny magnets on a tape are arranged in a definite pattern during recording, but are completely scrambled up so that no distinguishable pattern remains after erasing. The tape is then said to be blank and once again ready for a new recording.

Since these billions of tiny magnets are really of molecular dimensions, this change in magnetization of the tape is totally invisible. It is therefore impossible to tell, simply by looking at a tape, whether or not it has any sound on it. Thus the only way to be certain of what is recorded on a tape, or if it is blank, is to play it.

It is so very easy to destroy a wanted tape simply by energizing the erase circuit, that one should be exceedingly careful when dealing with valuable material. This fundamental point was brought home to me with considerable force just a few months ago.

A tape was brought into my studio on which a radio broadcast had been recorded. Just a few days after he had appeared on



DUAL TRACK MONAURAL RECORDING

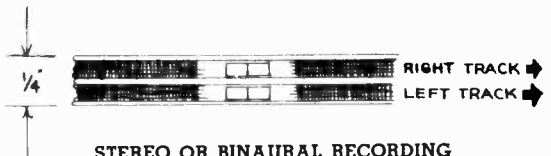

STEREO OR BINAURAL RECORDING  
(in-line heads)

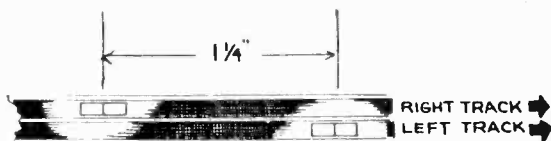

STEREO OR BINAURAL RECORDING  
(staggered heads)

DUAL-TRACK recording saves money, requiring only half as much tape. System of playback-head alignment is unimportant in monaural, vital in stereo. Purchased tape must be recorded for the type of heads employed in your reproducing unit.



**THIN BASE Audiotape LR** offers more recording time per reel, saves money, requires less changes.

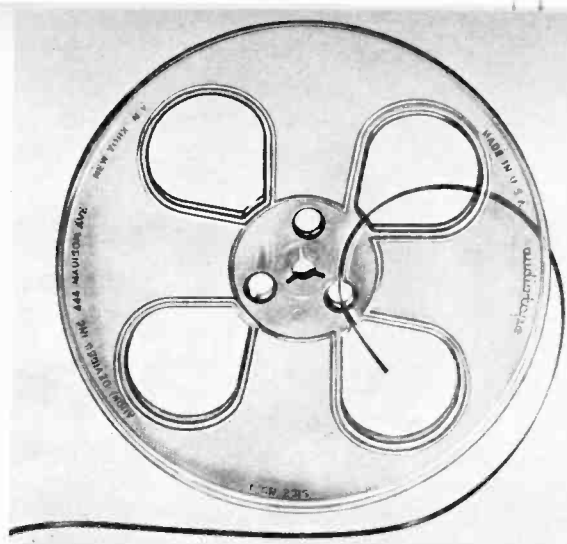

**ADDED CONVENIENCE** in threading is noteworthy feature of this new plastic reel by Audio Devices.

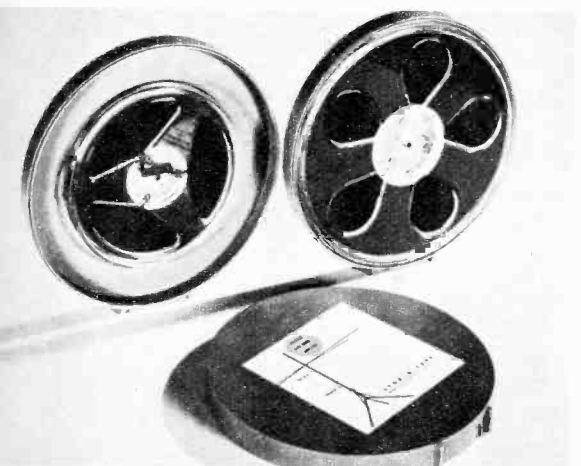

**STOR-A-TAPE** conveniently stores either 5- or 7-inch reels on edge in your permanent tape library.

**ORRADIO'S** 5 $\frac{3}{4}$ -inch reel is said to equalize tape tension and to afford smoother recorder operation.

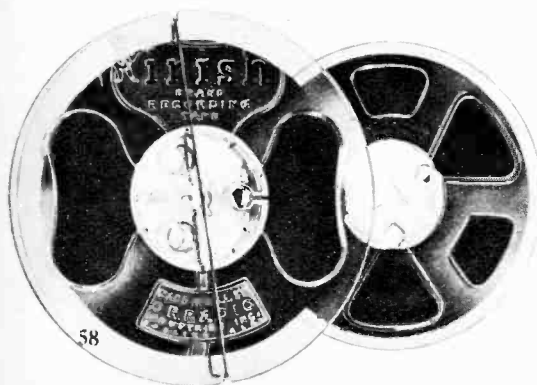

the program, the guest speaker died. This tape was therefore the last recording of his voice. Naturally, his family was anxious to have the tape, and the broadcast station was happy to give it to them. But unfortunately it had already been erased and put back into stock.

Since it had not yet been recorded over, and erasure was incomplete, we thought we might be able to save it. We could hear modulation, and while it was definitely identifiable as a human voice, the noise level was so high that the speech was unintelligible.

We tried everything we could think of to get a usable signal off that tape, even enlisting the aid of the Research Director of a leading tape manufacturer, but no one could build up this small residual magnetization to anything useful. That recording had been destroyed forever.

So always remember that all tape looks alike, whether brand new, erased, or presently recorded. But once erasure has taken place, the process is not reversible. Label your tape recordings carefully as soon as you make them. Keep your permanent tape library well separated from your usable stock, and even then play it safe by first auditioning any tape you propose to re-record.

All tape recorders (as opposed to some of the newer playback-only units) have an erase head, which is either an electromagnet or a permanent magnet. The tape always passes over this magnet and the record head even when it is being played back. Neither of these two heads is energized, however, until the recorder controls

# TAPE PLAYING TIME

FOR VARIOUS SPEEDS AND REEL SIZES—All tapes are standard 1½ mil except as indicated

REEL SIZE (in.)	TAPE LGTH. (feet)	SINGLE-TRACK PLAYING TIME FOR VARIOUS TAPE SPEEDS AND TAPE LENGTHS				DUAL TRACK PLAYING TIME	
		TAPE SPEED—inches per second				3¾ ips	7½ ips
		1⅞ ips	3¾ ips	7½ ips	15 ips		
3	150	15 min.	7½ min.	3¾ min.	1⅞ min.	15 min.	7½ min.
3	225*	22½ min.	11¼ min.	5½ min.	2¾ min.	22½ min.	11¼ min.
4	300	30 min.	15 min.	7½ min.	3¾ min.	30 min.	15 min.
4	450*	45 min.	22½ min.	11¼ min.	5½ min.	45 min.	22½ min.
5	600	1 hour	30 min.	15 min.	7½ min.	1 hour	30 min.
5	900*	90 min.	45 min.	22½ min.	11¼ min.	1½ hours	45 min.
7	1200	2 hours	1 hour	30 min.	15 min.	2 hours	1 hour
7	1800*	3 hours	90 min.	45 min.	22½ min.	3 hours	1½ hrs.
7	2400**	4 hours	2 hours	1 hour	30 min.	4 hours	2 hours
10½	2400	4 hours	2 hours	1 hour	30 min.	4 hours	2 hours
10½	3600*	6 hours	3 hours	90 min.	45 min.	6 hours	3 hours
14	4800	8 hours	4 hours	2 hours	1 hour	8 hours	4 hours
14	7200*	12 hours	6 hours	3 hours	90 min.	12 hours	6 hours

\*Long play tape 1 mil film. \*\*Double play tape ½ mil film.

Courtesy Orradio Industries, Inc.

are placed in the **RECORD** position. For that reason this control is usually located at some distance from the other functions, or clearly marked or even shielded, so that it cannot accidentally be pressed or turned.

Permanent magnet erase is not good enough for your hi-fi system, so be sure that the recorder you are considering has an erase oscillator and an electromagnet erase head. It takes a lot of power to erase a tape completely and quietly, and most of the cheap machines just can't make the grade. This was the case with the broadcast tape I mentioned earlier.

You can check the erase system fairly well by ear, using a recorded tape which can be erased. Thread the tape onto the machine and start it up, with the **RECORD** switch on but the volume control at zero. After a few minutes, rewind the tape and play it back with the volume control turned up full. If you can still hear fragments of the erased sound, or if the background noise seems much higher than that of a piece of brand new tape played on the same machine, forget it and try another model or brand.

As soon as the tape leaves the influence of the erase head, it immediately passes the record head. At this point it is subjected to an intense magnetic field which varies with the audio signal fed into the recording amplifier. The tape is then magnetized with this new sound pattern and is ready for instantaneous playback.

If the machine has a separate playback head (and all of the better ones do) the recorded sound may be heard only a fraction of a second after recording. Thus

there is possible an immediate check of recorded quality. In fact it is usually possible to "A-B test" the input signal against the playback to be sure that the recording is as good as the original.

You'd better try this a few times, however, before doing it on an important recording, as sometimes there are switching noises put on the tape. In the cheaper machines this isn't possible at all, as a single head is used for both record and playback, as well as a single amplifier for both those functions. Since they can't do both jobs simultaneously, you'll have to wait until a tape is recorded and rewound before you can play it back.

Tape recorders also have a built-in recording characteristic, but this isn't nearly the nuisance that the disc characteristic is. The treble end of the spectrum is automatically boosted as the tape is recorded, and again rolled off when the tape is reproduced. This characteristic is fairly well standardized now, and it is possible to record a tape on one machine and play it back on another without change in quality. This also applies to purchased pre-recorded tapes.

More and more is dual-track recording being adopted for all but the most exacting uses. In this system only a little less than half the width of the tape is used at a time. Thus a tape is recorded along its full length twice, once on each half. Since this method slices tape costs in half, its disadvantages don't seem so important, but they do exist.

For one thing, the noise level is a little higher than it would be on a full-width recording. Also "skips" and "drop-outs"



**TANDBERG** 3-speed tape recorder combines furniture cabinet and transport case in one unit.

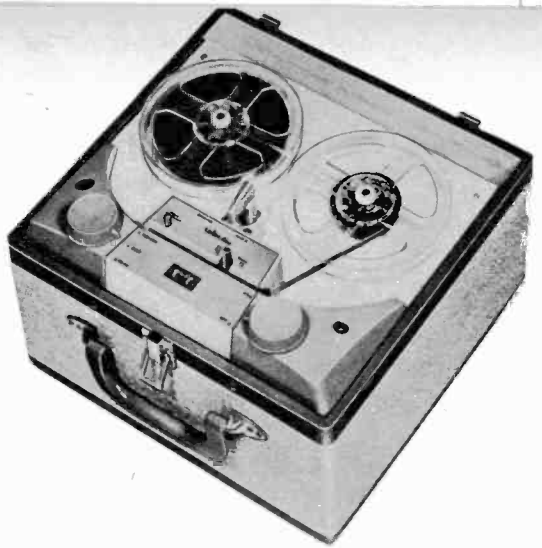

**TELECTRO** 2-speed model 1960 has 6-inch speaker, 2-tone luggage-type case, weighs only 15 pounds.

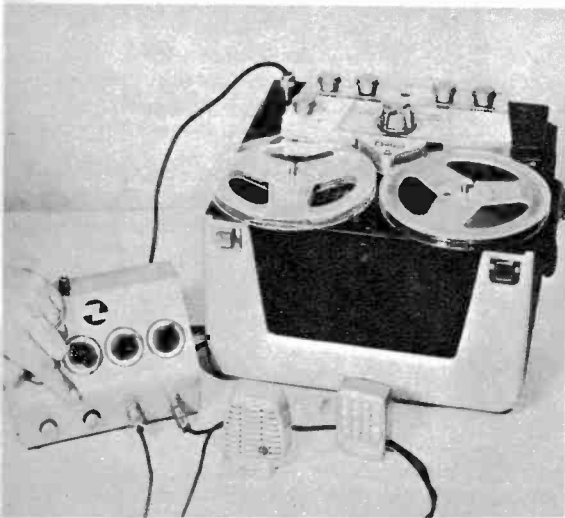

**EKOTAPE** recorder with mixer through which signals can be fed from several sources at once.

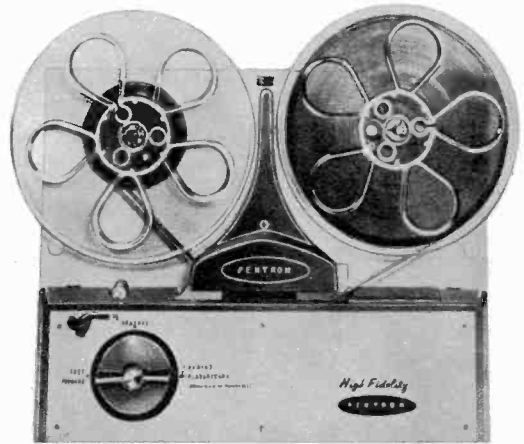

**PENTRON** offers flexibility in selection of tape deck and tape preamplifiers for custom installation.



**BOGEN TR-30**, which has just appeared, is a push-button tape recorder of professional quality.



**PLAY/RECORD** preamp by Pentron features safety interlock record button, hum adjustment control.

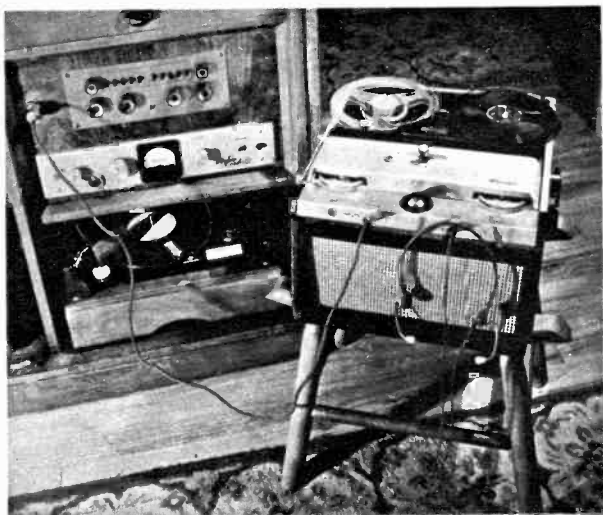

**SHOWN HERE** is the setup customarily used for making tape recordings from high-fidelity system.



**AUDIOPHILE** Irving Greene monitors with ear-phones while "riding gain" on his tape recorder.

are more noticeable. Finally, it's not possible to edit a desired track without also cutting the adjacent track.

Dual-track is pretty good despite these minor annoyances, and it has made possible for the first time for home use, something approaching true binaural recording and reproduction. Stereophonic sound, which will be discussed in more detail later, uses two completely separate audio channels, just as stereo photography requires a separate picture for each eye. These two signals can be applied simultaneously to a dual-track system, with one signal on each track.

This doesn't mean that every dual-track tape recorder is readily convertible for stereo work. Actually, two completely separate audio channels are required, which means just about double the usual electronics in a conventional system.

One of the most significant developments in tape recording for audiophiles has been the introduction of the tape *deck*. This idea is a natural for custom installations. The basic concept is simply a tape transport mechanism, mounted on a chassis with controls but none of the electronics except that which isn't found in the hi-fi amplifying system itself. There are no power amplifiers, no loud-speakers, and no carrying case or cabinet. The system is instead permanently panel-mounted by the hi-fi constructor. It is then an integral part of the hi-fi system, instead of an odd-ball

item which has been shoe-horned into place. Unless portability is a must with you, be sure to give the tape deck a careful look.

The choice of tape in today's market is rather vast. All tape today comprises a plastic base on which is bonded a layer of some form of iron oxide. The many different tape types are due to variation in the type or thickness of the plastic base material, or in the chemical composition of the oxide.

The tape base may be of cellulose acetate or of a polyester film, usually marketed under the DuPont trade name *Mylar*. The polyester type has greater stability with respect to temperature and humidity, as well as greater strength and resistance to shock.

These advantages comprise a mixed blessing, however, for polyester tape will stretch considerably before breaking, while the acetate type is more likely to snap under strain. And while a simple break can be readily repaired by splicing, a stretched tape is out of business for good.

The standard tape thickness, and still the safest in terms of resistance to damage, is 1½ mils. A newer thickness of 1 mil gives a playing time about half again as long, while the most recent thickness (or thinness) of ½ mil affords just about double the playing time.

Professional recordists, who must work hurriedly, despise the thinner tapes, as well

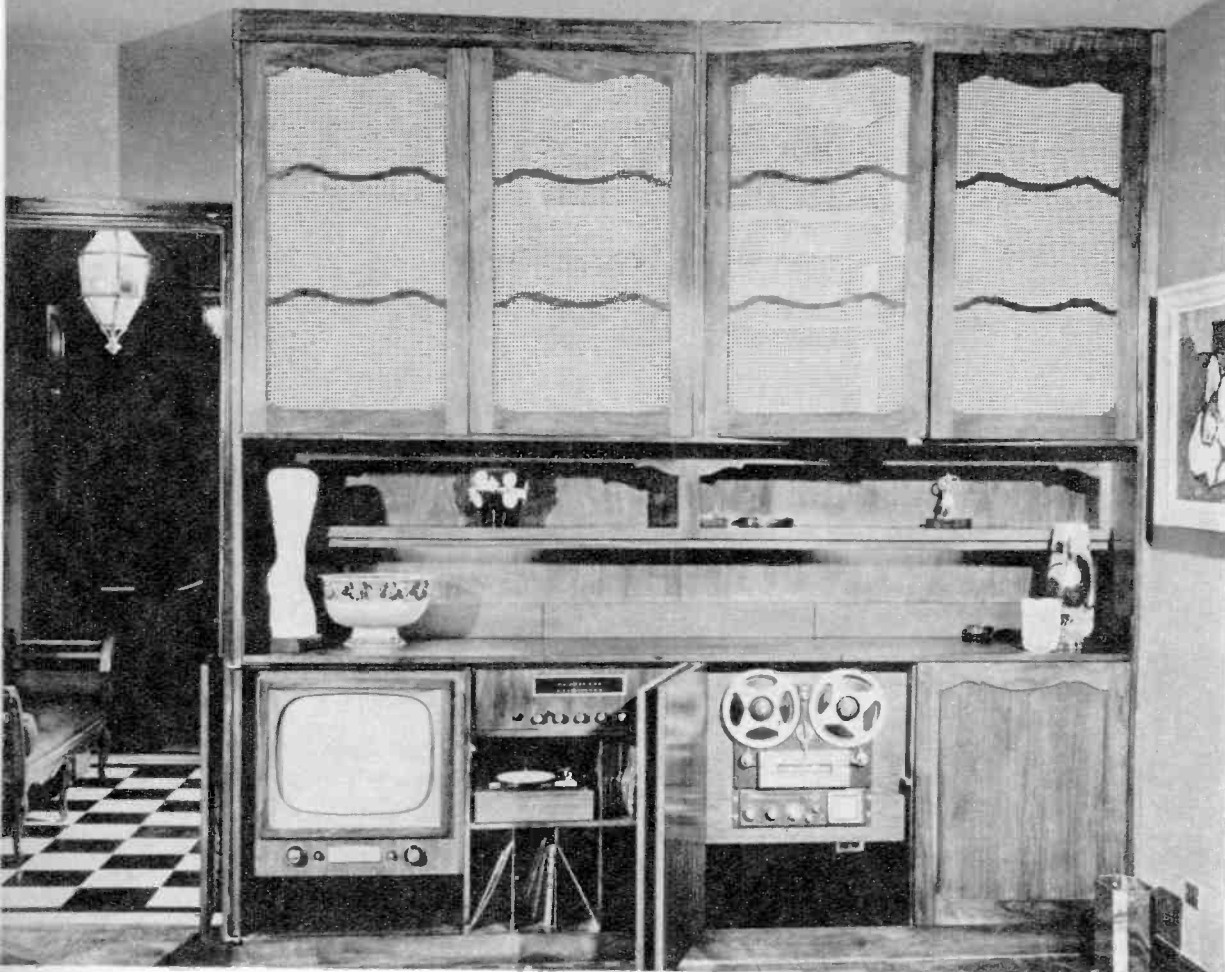

BEAUTIFUL custom installation in existing cabinetry features a Concertone tape recorder.

as polyester in any thickness. But to the serious hobbyist, who is budget-conscious and who can give the extra time and care that are essential, the thin tapes represent good value.

The final variant is in the character of the oxide coating. The black oxide so familiar on the early paper tapes is now extinct. The reddish-brown oxides are now the most common, and are all more or less alike. Each manufacturer has his own special refinement or two, but the similarities in formulation are greater than the differences.

The green oxide, represented by the 3M HO series, is a more sensitive compound, requiring less recording level. This allows for greater output, better signal-to-noise ratio, less distortion and greater dynamic range.

The newest oxide is one which the boys

at Audio Devices have been diligently working over for several years. They were particularly concerned with the problem of print-through, the magnetization of a layer of tape on a reel by the magnetic field of its neighbor. This results in pre- and post-echo effects, which seem to grow considerably worse as the tape ages.

The newest Audiotape is claimed to have solved this problem, or at least to have minimized it dramatically. I don't know what sort of accelerated life tests they used to prove this, but if true it will certainly prove a boon to the industry. Many priceless masters of great performances made only a half-dozen years or so ago are already beginning to show signs of deterioration in record company vaults. If this attrition can be stopped, every music lover in the world will benefit. •



Louis  
"Satchmo"  
Armstrong

sounds  
of our time  
are timeless on  
**SOUNDCRAFT TAPES**  
with **MYLAR\*** BASE

Ageless "Mylar" base and ageless plasticizer-free Soundcraft oxide coating—these are the reasons why lifelike sound is yours forever, only with Soundcraft "Mylar" base tapes. Because no other tapes offer comparable quality, a Soundcraft product is inevitably the choice of those who immortalize historic events, masterworks in music, or the sound in a great CinemaScope film! When you record sounds worth saving...enjoy their re-creation...their re-living...on Soundcraft "Mylar" base tapes! Write for free booklet! Buy these Soundcraft tapes:

**PLUS 50** - 50% longer play— **PLUS 100** - twice as much on a reel —  
**LIFETIME** - guaranteed for life

\*DuPont Trade Mark



REEVES SOUNDCRAFT CORP., 10 E. 52 St., N.Y. 22, N.Y. West Coast: 338 N. LaBrea, L. A. 36, Cal.



THE NEW YORK Philharmonic-Symphony, heard over CBS, is representative of superb current FM. Seen here are portions of the orchestra's brass and string sections. Dimitri Mitropoulos, inset, conducts.

## FM's Big Comeback

The demands of audiophiles have finally won recognition for this vastly superior system

**FM** RADIO is finally coming back and the public interest is at last becoming a primary consideration. After a war of attrition that lasted nearly twenty years and ultimately shattered its inventor, FM is finally being recognized by the public as the vastly superior system it is and has been for two decades.

As this is being written, the latest statistics indicate that the number of FM stations on the air is increasing, a reversal of a downward trend which had been going on for several years. Even more significant is the fact that there are about twice as

many stations authorized and now under construction as a year ago, and the number of new requests now pending before the Federal Communications Commission is nearly *four times* what it was a year ago.

The reasons for this resurgence are clear to see. The insistent demand by audiophiles for better fare than the trash usually available on AM broadcasts has finally forced the broadcasters and set manufacturers to bow to the will of the public. But they have had to have their arms twisted pretty far before giving in. They never welcomed this baby with open arms.

You see, despite the tremendous advantages to the listening public, FM posed a serious threat to certain vested interests in AM. For FM was the great equalizer, since every FM channel was as good a program carrier as any other. This meant that the nice juicy clear channels (each held by only one AM broadcaster in the entire country) would become a thing of the past. And the tremendous advantages in signal strength of the lower channels, say between 550 and 850 kc, would also disappear.

There would be an entirely new deal for the listener, with the whole broadcast business up for grabs. Every station would stand or fall strictly on the merits of its programs. No longer could a broadcaster offer an advertiser a larger audience based solely on his clear channel, higher power or lower frequency. No more would there be the little 250-watt local peanut whistles grubbing for the leftover crumbs from the 50-kilowatt clear-channel behemoths. The little fellow could compete against the big fellow, and if the little fellow's programs were the best, he would get the lion's share of the audience. In fact, many little fel-

lows in AM were proving the point with their FM subsidiaries which actually were grabbing the greater part of the FM audience. And when the big boys in AM and the networks realized what was about to happen, they hit the panic button.

The methods attempted to kill FM, sometimes subtle and often crude, would take many pages to describe. For us right now the important thing is that they didn't succeed. They nearly did, but not quite. But now the shoe is on the other foot. AM radio is hardly in the best of health, and the top network spokesmen are bearish about the future of their radio operations. In the face of all this there is evidence that the hi-fi movement is about to do for FM what it has already done for the record business. And now that we have so much interest in stereophonic sound, we find another advantage in FM. For a method has been devised for multiplexing, where only one FM channel can carry the two signals necessary for stereo reproduction. But for now let us consider the fundamental differences between AM and FM, and just why we say that FM is so much better.

Radio transmission of sound involves

**FAMOUS** for years, the Voice of Firestone, now seen, too, via ABC, is an FM treat for audiophiles.

**STRIDES TV'S** sound (FM) has made in recent years is personified by the Lawrence Welk Show.



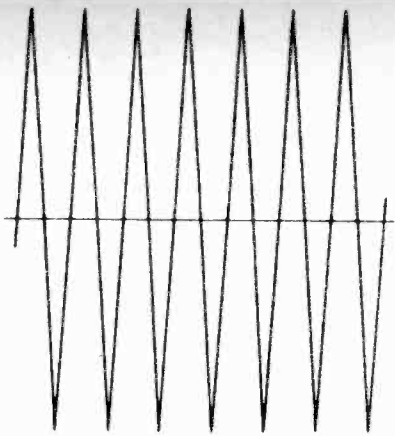

unmodulated radio-frequency carrier wave

PLUS

audio-frequency modulating signal

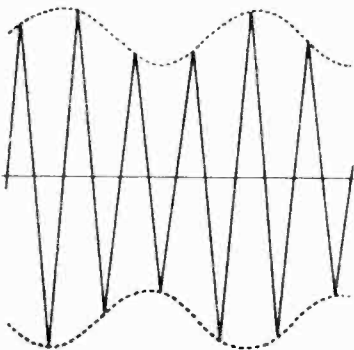
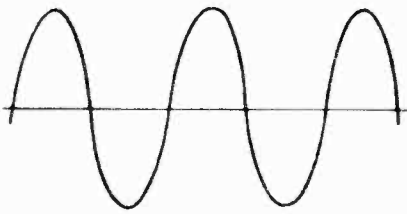

resultant AM radio wave

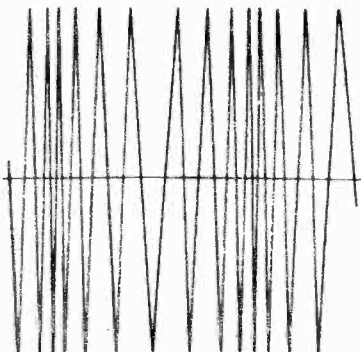

resultant FM radio wave

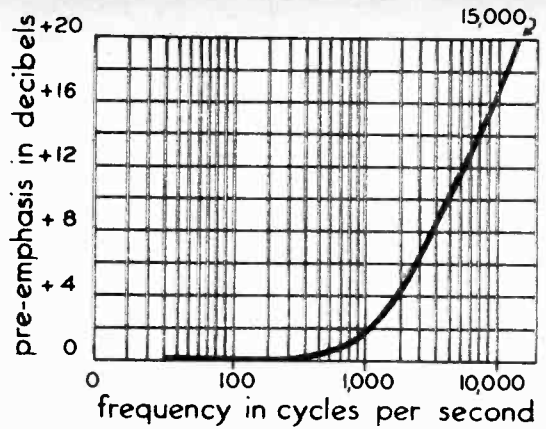

CHART above shows the fixed pre-emphasis curve used in FM broadcasting. Receiver automatically de-emphasizes this curve on receiving the signal.

superimposing an audio wave upon a radio wave called the carrier. The resulting composite signal, known as a modulated radio wave, is transmitted through the air to the receiving antenna of a tuner or receiver. At this point the signal is demodulated or detected, with the audio portion being reconverted to sound in the loud-speaker.

The early method of superimposing the audio on the radio carrier is known as amplitude modulation, commonly abbreviated AM. In this system the audio wave causes the power output of the radio transmitter to be alternately increased and decreased in accordance with the program signal.

When a radio wave is amplitude modulated, not only are the two original radio and audio frequencies present, but two additional frequencies pop up as well. These are sum-and-difference combinations of the originals known as sidebands. Thus a radio station operating at 800 kc when modulated by an audio wave of 2 kc would be radiating sidebands of 802 and 798 kc in addition to the center carrier frequency. Then in order to transmit the top of the audio range of 15,000 cps, it would be necessary to transmit sidebands of plus-and-minus 15kc away from the assigned carrier frequency.

The standard AM channel is nominally only 10 kc (plus-and-minus 5 kc) wide, however, which implies an upper audio limit of 5,000 cps. The purpose of this limitation is to avoid adjacent-channel interference, but some years ago the FCC

WHEN sounds are added to the carrier wave, the amplitude of the wave is modulated in AM broadcasting, while in FM the frequency is altered.

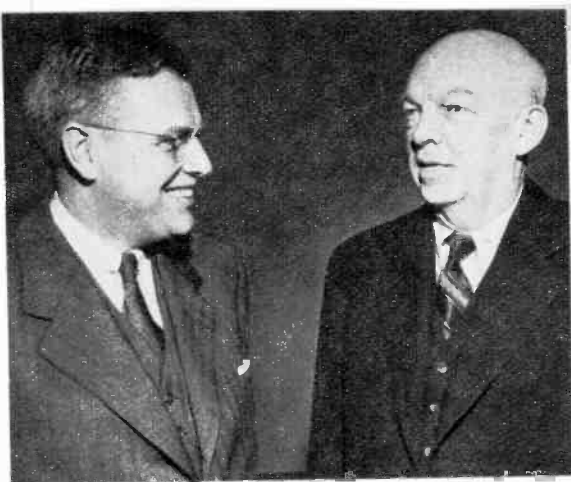

**DEVELOPMENT** work that resulted in FM radio was performed at Columbia U. by the late Edwin H. Armstrong, right. Asst. John Bose is at left.

permitted an experimental station in New York City, W2XR, to try "high-fidelity" AM transmissions with a channel width of 20 kc (plus-and-minus 10 kc). This station eventually went commercial as WQXR and for some years identified itself as "the high-fidelity station."

The competition didn't particularly care for this sort of apparent favoritism, however, with the result that the commission found it expedient to overlook excursions outside the assigned bandwidth by others, and WQXR decided to drop the "hi-fi" tag in their announcements. Whatever the present legal status of AM bandwidth, the practical fact is that receiver designers still limit the sets to the 5 kc range to avoid interference. There are some so-called hi-fi AM tuners available now which don't follow this practice, but it seems a little foolish to spend much money on them if you can receive FM signals where you live.

The idea of another method of audio modulation was proposed very early in the history of radio, and even then it had its opponents. In 1922 there was a technical paper printed in the official publication of the Institute of Radio Engineers which said of FM: "This method of modulation inherently distorts without any compensating advantages whatsoever."

But one hardy genius didn't buy this argument, and by 1925 Major Edwin H. Armstrong was busily engaged in his laboratory at Columbia University trying to work out a feasible FM system. In 1934 he set up an experimental FM broadcast transmitter in the Empire State Building with the cooperation of the National Broadcasting Company. That happy arrangement didn't last long, however, and within a few months NBC had learned



**IN 1937,** Armstrong built this experimental transmitting tower on the Hudson palisades. It is 400 feet high and 1,000 feet above sea level.



PILOT HF-30 is a medium-powered FM-AM tuner, preamp-equalizer, 12-watt amplifier in metal case.



FISHER FM-40 has center-of-channel tuning meter, 300-ohm ribbon or 72-ohm coaxial antenna line.



OFF STATION



ON STATION-AM



ON STATION-FM

PRECISE TUNING of the HF-30 can be noted visually by alignment of lighted areas, as shown.



KNIGHT FM tuner features printed circuit, pre-aligned IF transformers, cathode follower output.



GRANCO'S popular-priced T-160 model features built-in antenna, five tubes and plastic case.

enough to invite Armstrong to pack up and get out.

By this time, however, Armstrong was convinced that he had something rather sensational, and he was determined to prove it. He scraped together some capital and in 1937 built his own high-powered FM transmitting plant at Alpine, New Jersey. Daily broadcasts emanated from there right up to the time of his death.

Frequency modulation, as its name implies, involves varying the frequency, rather than the amplitude or power, of a radio carrier wave. The amount by which the FM carrier wave varies from its center, or rest frequency, is determined by the loudness of the sound wave, not by the audio frequency as in the case of AM sidebands. The necessary channel width will therefore not be increased by the higher audio frequencies, and it is entirely possible to modulate an FM wave with the maximum audible range.

It was decided at the outset that full advantage should be taken of these possibilities, and that FM radio should become a wide-range system. The standards adopted called for an audio range flat from 30 to 15,000 cps. Thus we have actually had, in one area at least, full fidelity for over twenty years.

The other advantage of FM, and the one Armstrong was primarily striving for even when he developed the superheterodyne during the Model T World War, was freedom from noise and interference. When it became known that most of this "static" was similar in character to an AM wave, then it was obvious that a good FM system was the answer to the problem. The important thing here is that the tuner or receiver respond only to FM signals, and completely reject anything which is AM.

Many sets have been built which do not



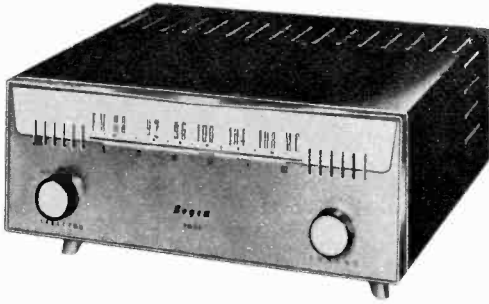

**BOGEN FM-50** boasts sensitivity of 2.5 microvolts for 30 db quieting, discriminator, limiter.

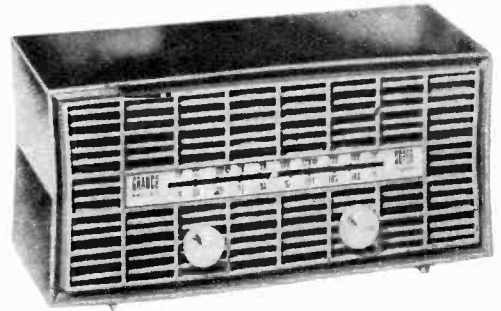

**GRANCO "Super"** is compact, AM-FM tuner with built-in antenna, hum level 60 db below signal.

have adequate noise rejection or quieting, a fact which, of course, tends to give the medium a bad name, or at least waters down its claims. The device in the set which rejects AM noise is known as a limiter, and every FM set should have at least one, and preferably two.

The lack of standards in presenting technical specifications in consumer advertising is equally apparent in this case. A given piece of copy may state "sensitivity 4.0 microvolts for 30 db quieting." This means that a certain signal level at the antenna will deliver a sound output having a given signal-to-noise ratio. And here is where the possible duplicity comes in.

The published measurements must have been made under conditions similar to those in a home, and using the very same type of antenna as recommended by the manufacturer for home use. Otherwise the figure is simply the result of a laboratory experiment, with no validity whatever as a basis for product comparison.

Similarly, 30 db (decibels) is the more-or-less standard quieting figure. Quite a few manufacturers, however, are now giving their specifications in terms of only 20 db, and some hedge by giving them for both 20 and 30 db. But if a 30 db quieting figure is not stated at all, you can probably assume the quantity is outrageous.

Finally, as far as noise is concerned, the better set will be the one with less antenna microvolts for the most quieting. In other words, the lower the microvolts and the higher the db, the better. But don't try to compare 20 db statistics of one set with 30 db figures of another, unless the signal levels are roughly the same. For example, if one set requires 4 microvolts for 20 db of quieting while another requires 4 microvolts for 30 db of quieting, the latter system is obviously the better one. •

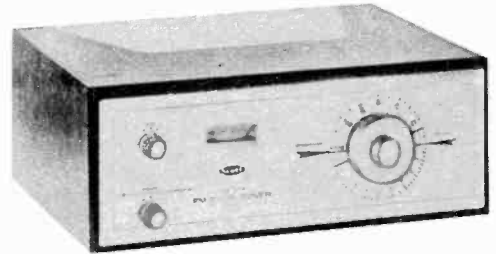

**SCOTT 310-B** features silver-plated cascade RF section for greater sensitivity, three IF stages.

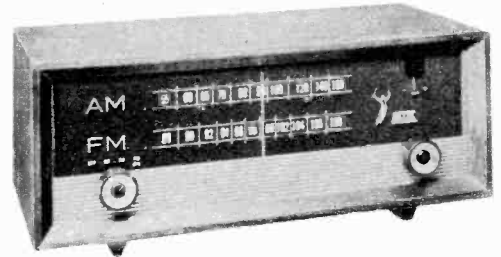

**ALTEC 306A**, an AM-FM tuner, boasts eight tubes, built-in loopstick, external antenna connection.

**GRANCO 620**, an FM receiver, has 7-inch extended-range speaker, six tubes. Operates on AC or DC.





Grayson Tewksbury photo

# Repair Your Own and Save

You needn't possess engineering genius or ornate test equipment to correct most troubles that will crop up in high-fidelity systems

**H**I-FI EQUIPMENT is very similar in principle to radio and television sets, and is subject to many of the same sort of simple troubles. It is true that many problems require a trained specialist with complete bench facilities and elaborate test equipment. But probably 80% or more of the common hi-fi troubles are of the do-it-yourself variety. Making your own simple

repairs in these cases will save you money and save the serviceman's time.

There are two basic classes of trouble: either the set is totally inoperative, or operation is in some way faulty. The case of total inoperation is by far the easier to trouble-shoot, especially if the fault is intermittent. But the initial procedures are the same in any case.

The first objective is to *isolate* the difficulty as completely as possible. Determine if only one of the signal sources is at fault by switching the input between the record player, tuners, tape recorder and any others in the system. If only one unit fails to perform, then that is the faulty one and it can be assumed that the rest of the system is all right. But if the system is inoperative on all inputs, then the trouble is either following the sources or it is something common to all, such as a blown fuse in the house AC circuit.

Just like the home handy man who dismantled a floor lamp looking for trouble which was actually due to a burned-out bulb, we sometimes forget to check the commonest and most obvious possibilities. Even if there is no fuse or breaker blown in the house wiring system, there still may be no power at the wall socket due to a switch being turned off.

And even if there is power at the receptacle, there may be a switch off somewhere in the equipment. If all of the equipment is plugged into receptacles on the back of one of the amplifier chassis, nothing will turn on until the master power switch on that amplifier is thrown. And if you're picking up your power from the time switch on a clock radio, be sure it's set properly before placing the blame elsewhere.

### Fuses Are Common Culprits

The next suspects would be the fuses in the equipment itself. The better grades of hi-fi units always are individually fused, and it's a good idea to know all of their locations and electrical values, and to keep a few spares of each type on hand. The fuses are usually of the miniature tubular glass cartridge type, and a quick visual check will show if the link has burned through.

The fuse holders are ordinarily mounted on the metal chassis of the equipment, with either a knurled knob or screw-top cap for removal. Whenever checking equipment fuses, be sure to remove system power.

A burned-out fuse should be replaced with one of identical value, and the power then turned on again. If the set operates satisfactorily, the fuse was probably blown by a momentary overload and there is no serious problem. But if fuses continue to blow, difficulty is more deep-seated.

Many causes of blown fuses can be detected by visual inspection. Frayed power cords, misplaced or dangling wires, and some types of internal short-circuits, will be obvious by the burn marks on them from arcing or sparking. Any such faulty com-

ponent will simply have to be repaired or replaced.

Trouble may also lie in faulty interconnections or a wiring failure. Since the component building-block method of hi-fi assembly involves a number of interconnecting cables, there is always the possibility of one of these being improperly installed. Perhaps the tuner output is plugged to the phono input on the amplifier. Or perhaps the tape recorder output is connected to the tape input feed from the amplifier.

All plugs must be fitted completely into their jacks, or they may short or fail to make connection. The interconnecting cables themselves are a common source of trouble. Quite frequently the insulation between center conductor and outer braid breaks down due to excessive heat from a soldering iron when the plug is installed. This causes a short between the two conductors which can often be detected by visual inspection.

This is one of the many areas where servicing by *substitution* is a most useful technique. It involves the temporary replacement of a suspected part with one known to be good. If the trouble clears it is obvious that the suspicion was correct. This can also be done with tubes, plug-in condensers and other parts.

If the set is brand new and just doesn't sound good, a common source of trouble is misadjustment of the controls. The tone controls should be set at normal, with neither boost nor rolloff until you establish what sort of touching up you must do to compensate for room acoustics. If listening to records be sure that the compensator setting is correct. Duplication of controls is another possible source of trouble. At no time should one volume control in the chain be set wide open while the next succeeding one is near OFF. It's a good idea to start with all volume controls about half open and then experiment with a combination of settings which establishes a comfortable level with minimum system noise and distortion.

### Tube Talk

Tubes can be responsible for a number of faults, including distortion, howls and squeals, low output or total inoperation. Sometimes a tube filament will burn out, just as a light bulb will. This may cause any of the troubles mentioned, depending upon the tube's place in the circuit.

If the tube has a glass envelope and no orange glow is visible, while all the others are obviously lit, it probably has an open filament. The glow is sometimes rather hard to see, however, and in the case of

# seven ways to remove needles

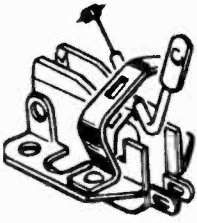

Release spring, pull needle out.

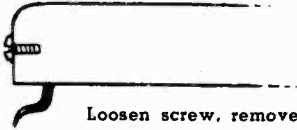

Loosen screw, remove needle.

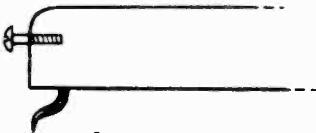

Loosen screw, remove needle.

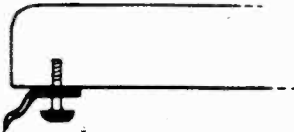

Loosen screw, remove needle.

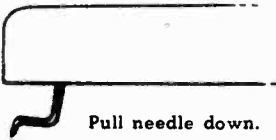

Pull needle down.

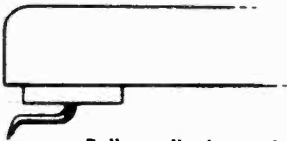

Pull needle forward.

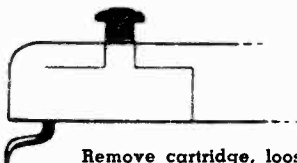

Remove cartridge, loosen nut. C-washer, pull needle out.

metal tubes it's impossible, so it's better to wait until the set is fully warmed up and then compare the temperatures of the various tubes. If any of them is very cool, it is probably not operating. This can, of course, be confirmed by the substitution test or by the tube checker at the corner store.

Removal and replacement of octal and loctal type tubes is fairly simple, as they locate themselves through a keyway in the base which fits a notch in their socket. Since all such sockets are identical, however, many different tubes will fit them, and one must be certain which type goes in what socket. If the types are not clearly marked on the chassis, or if there is no tube location diagram in the cabinet, then by all means sketch one before removing any tubes.

Miniature tubes are more difficult to handle, as they are extremely fragile. Instead of the heavy prongs of the larger types, their pins are simply short lengths of solid wire. Furthermore they have no positioning guides such as the key-and-notch arrangement. When removing a miniature tube from its socket, it should be pulled straight up and out. It may be rocked if necessary to loosen it from the socket, but only slightly.

Placing a miniature tube in its socket is an even more ticklish proposition. Since there is no keyway, the only guide to orienting the tube to the socket is the pin spacing. The 7-pin miniature socket has seven equidistant holes in a circle, with a blank space where an eighth hole could fit. The noval has nine holes with space for a tenth. Thus the wide spacing of the

**TONE-ARM ADJUSTMENTS** on this V-M changer are simple and typical. Other makes are similar.

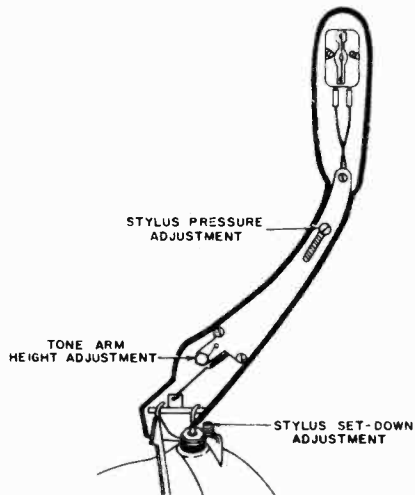

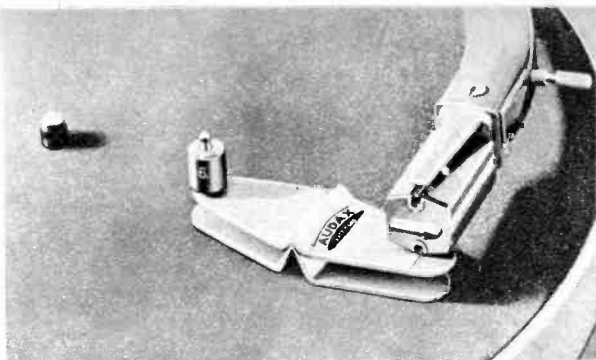

**STYLUS PRESSURE** is best measured by a balance, such as the Audax model shown in this photo.

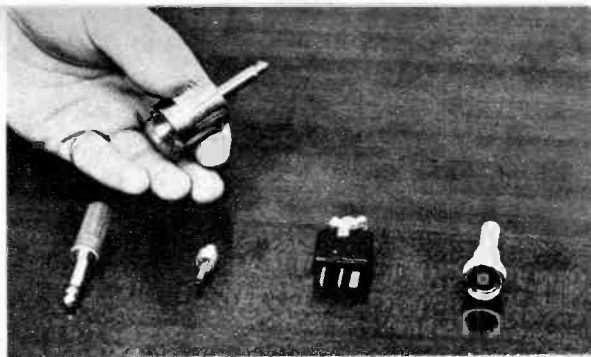

**CONNECTORS** are l. to r. phone plug, pin-to-phone adapter, pin plug, Jones plug, Amphenol screw-on.

tube pins—between pins 1 and 7 or 1 and 9—must correspond with the blank space on the socket.

It is not advisable to try locating the tubes in their sockets simply by touch, for any twisting of a tube will almost certainly bend the wire pins. Each tube must be properly placed over its socket so that it can be dropped straight down into place. The job will be easier if the chassis is well lighted, and a small mirror will often prove helpful.

Tube types are identified by number. Often encountered in hi-fi work are such designations as 6SN7, 12AY7, Z729, 807 and KT-66. These numbers sometimes give a hint as to some of the electrical characteristics of the tubes, but often they are entirely arbitrary. Sometimes there are letter designations following the type numbers, such as 5U4G, 6V6GT or 6SN7GTA. These final letters refer only to physical characteristics of the tube, namely that they are in glass envelopes of a given size. Since they are electrically identical to the metal types, they are normally interchangeable, except where space prohibits.

Tubes may also be noisy or microphonic, and these effects are usually intermittent. But the tube may sometimes be induced

to malfunction by subjecting it to mechanical shock. With power turned on and the back off the set, tap the tubes one by one, rather sharply with the eraser end of a pencil. Then observe the effect on the output. If the sound becomes noisy or distorted, squeals or goes dead, the tapped tube is at fault and should be replaced. Likewise, if the tube itself sparks, or exhibits a deep blue vapor, or if its elements become red hot, it must come out.

Audio distortion is often due to overloading, and if you are certain that your volume adjustments are correct, the trouble may be due to weak tubes. The next-to-last stage is often the offender, but the output tubes may also be at fault. A very tricky circuit is the one using four output tubes in a push-pull parallel arrangement. If any one of the four is even just a little weaker than the others, there can be a serious imbalance and distortion. This can be tested by trying all four tubes in a tube checker, or by substitution.

The inverse feedback circuit, so common in hi-fi amplifiers, can also act up and cause trouble. The feedback which is supposed to be degenerative may actually become regenerative, and the amplifier may take off in parasitic oscillations. This

**PANEL MOUNTING** of fuses is typical of hi-fi equipment. Remove by unscrewing the holder.

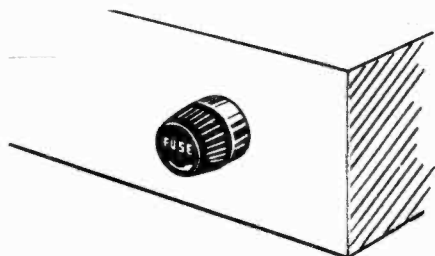

**TYPICAL FUSE** used in hi-fi systems. If metal element is broken, the fuse must be replaced.

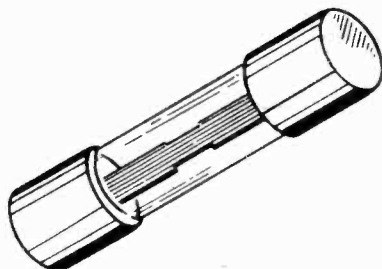

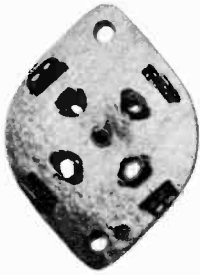

FOUR-PIN

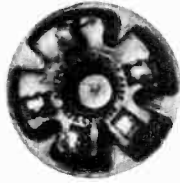

FIVE-PIN

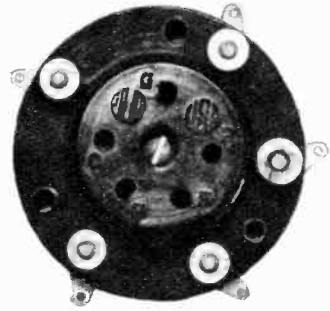

FIVE-PIN  
TOP-OF-CHASSIS TYPE

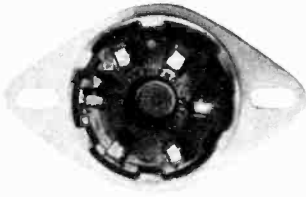

SIX-PIN

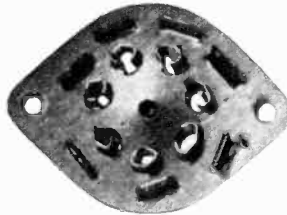

SEVEN-PIN

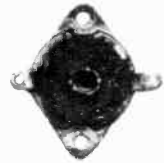

SEVEN-PIN MINIATURE

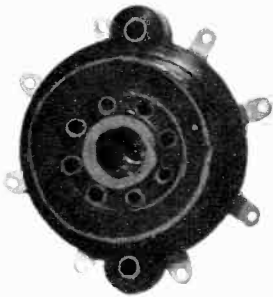

OCTAL UNIVERSAL  
MOUNTING TYPE



OCTAL (NOTE KEYWAY)

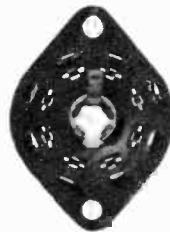

LOCTAL



NINE-PIN NOVAL

**STANDARD TUBE SOCKETS** commonly used in high-fidelity equipment. It is well to be familiar with them when you repair your own gear. But for the five-pin and octal universal all are shown from bottom.

can cause distortion, overloading of components, may even burn out a tweeter.

The trouble is that parasitic oscillations may occur at super-audible frequencies, so your ear can't tell you what is going on. But these oscillations can be made audible by a process of *heterodyning*, or "beating down" the parasitics to the range of human hearing. Fortunately, everyone has a miniature signal generator in his home in the form of the radio, a superheterodyne receiver. This is really a small broad-

casting station, so when it is placed in close proximity to the audio amplifier and the power turned on, it will induce a radio-frequency signal into the amplifier.

Then as the radio set is tuned across the band, its own local oscillator radiations will combine with the parasitic oscillations in the amplifier. The result of this combination will be sum-and-difference tones in addition to the two originals. The sum of the two is of no interest to us, but if the local oscillator is tuned so that the differ-



ence between its own frequency and the parasitic frequency is, say, a few thousand cycles, this is in the audible range and will be heard as a squeal in the hi-fi loudspeaker. If tuning the set changes the pitch of the squeal, and if turning it off kills it completely, it is very likely that the audio amplifier is oscillating parasitically.

One possible cause of parasitics may be tubes, so the first check will be the substitution test. If this doesn't clear the trouble, either some component has failed or changed in value, or the original design is faulty and the stage must be "neutralized." In either of these later events, repairs are indicated which are beyond the scope of our discussion.

### Distortion

Distortion in a tuner may have numerous causes, but if it seems to vary from station to station, the trouble may be the location of the antenna. If the antenna is receiving signals from several reflected paths as well as the direct one, an echo effect may occur just as "ghosts" appear on a TV screen from the same cause. The cure is to keep the antenna away from any large metal objects nearby, and to rotate it for maximum signal consistent with minimum distortion.

A worn stylus can play havoc with the quality of disc reproduction, not to mention the excessive record wear. It's rather difficult to detect flats on a stylus at home, although the substitution test is good here, too. Otherwise, the stylus should be taken in periodically for a microscopic or shadowgraph check. If the point is not perfectly round and polished, it should be reground or replaced.

Poor tonal balance, especially at the low end, is often the result of poor compensation. Although most records are now made with the RIAA characteristic, some of the less expensive systems with fixed compensation are adjusted to the older AES curve. This results in excessive bass, which in some cases may be desirable, but in others definitely is not. It may also be that a ceramic pickup has been installed without proper equalization. While it has often been said that the ceramic unit requires no equalization, this is somewhat of an exaggeration. It does inherently approximate the RIAA curve, but some correction is required in the form of a fixed resistance-capacitance network between cartridge and amplifier. If the set doesn't have this, it should be installed with values as recommended by the cartridge manufacturer. Any minor variations in balance due to these causes or to peculiar room acoustics, can sometimes be taken care of by adjusting the tone controls.

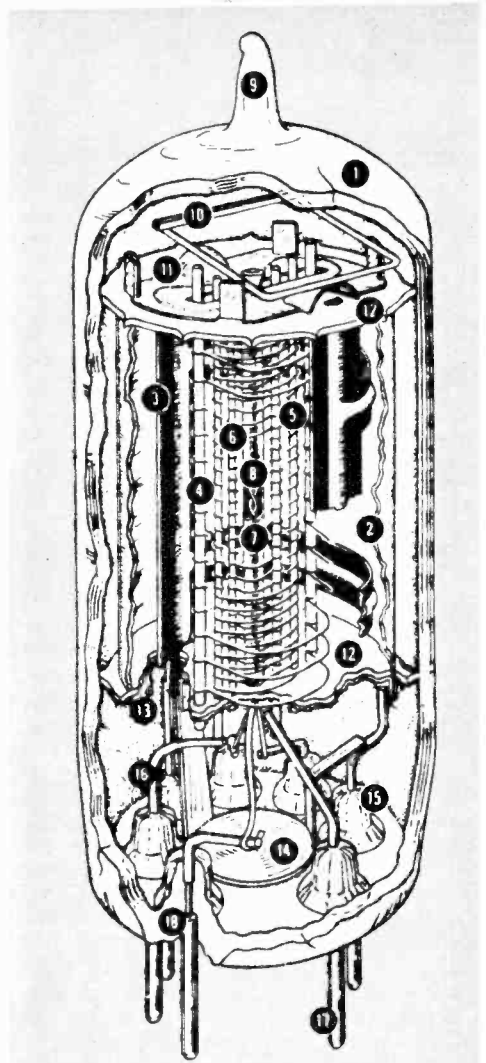

### tube construction

CUTAWAY DRAWING by RCA shows internal construction details of typical "miniature" glass tube used in television receivers. Sketch is two and one half times actual size, and component parts are as follows:

- |                             |                             |
|-----------------------------|-----------------------------|
| 1 Glass Envelope            | 10 Getter                   |
| 2 Internal Shield           | 11 SpacerShieldHeader       |
| 3 Plate                     | 12 Insulating Spacer        |
| 4 Grid No. 3 (Suppressor)   | 13 Spacer Shield            |
| 5 Grid No. 2 (Screen)       | 14 Inter-Pin Shield         |
| 6 Grid No. 1 (Control Grid) | 15 Glass Button-Stem Shield |
| 7 Cathode                   | 16 Lead Wire                |
| 8 Heater                    | 17 Base Pin                 |
| 9 Exhaust Tip               | 18 Glass-to-MetalShield     |



**SHIELDS** in preliminary stages must be twisted and removed before tubes can be taken out.

If reproduction is good at medium levels, but with bass distortion on peaks, chances are that the output transformer is saturated due to an imbalance in the final tubes. Again the best method of combatting the problem is through the substitution test, until you find a set of tubes which are well matched in the circuit.

Loss of highs may be due to a malfunctioning feedback circuit, either directly or indirectly due to a burned-out tweeter. This is probably an indication of parasitic oscillations, so by all means make the parasitic test already described—and clear the trouble—before putting in a new tweeter. Another cause of attenuated highs may be simply a grille cloth which is too heavy. Compare the quality with the grille (but not the baffle) removed. If this is the trouble, replace it with a cloth specifically designed for hi-fi use.

Hum may often be reduced by proper adjustment of the hum-balance controls. If more than one piece of equipment had such a control, each one should be adjusted for minimum hum as heard on the speaker. Excessive hum may often be due to an imbalance in the output tubes. With the tube preceding the final stage removed, adjust the hum balance control for minimum output. If the adjustment is at or near either extreme of its range, tube substitution should be tried until the minimum is somewhere in, say, the middle half of the range.

### Tape Talk

Now that hi-fi tape recording is here at low cost, we should also consider what we can do to save a few repair bills in this department as well. As far as the electronic elements are concerned, the record and/or playback amplifier, the erase oscillator and bias circuit, are similar in principle to the other hi-fi equipment described, and servicing will follow the same lines.

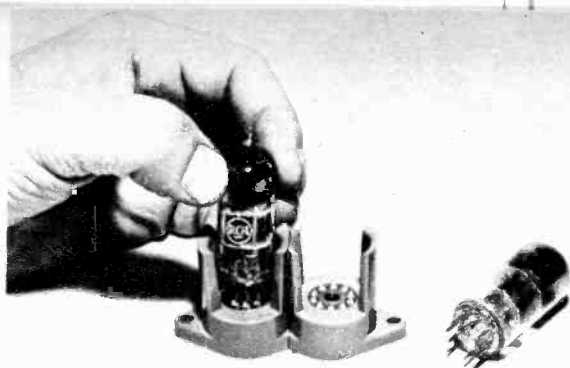

**DELICATE PINS** of miniature tubes can sometimes be repaired with 7- or 9-prong pin straightener.

The first step would again be the isolation of the offending circuit. Is the system completely dead, or does the playback amplifier work satisfactorily on previously recorded tape? If the playback is all right, can the machine erase recorded tape? If the playback and erase are both satisfactory, does the recording system appear faulty? If so, is it failing to record at all, or is the sound distorted or weak?

These and other troubles, once they have been isolated, can be cured the majority of the time by the trouble-shooting procedures already outlined. But if the trouble is distortion, weak recording and playback, poor frequency response, or increased wow or flutter, perhaps you'd better look to the electromechanical elements before going too far with the electronic.

Three main troubles, all due to lack of maintenance, can limit the performance of your recorder rather drastically. These are dirt, magnetic oxide or other foreign materials getting into the wrong places, wear of the friction surfaces bearing on the tape, and one or more of the heads going out of alignment.

Servicing begins by removing all covers or shields from the top of the chassis to expose the heads, capstan, pressure pads and pressure roller. Remove the reels and other foreign objects so that the top deck is "stripped down" as much as possible.

If your machine has pressure pads holding the tape against the heads when in operation, remove the spring holder on which the pads are mounted, either by lifting it off its pivot or by loosening a couple of screws. Chances are that the little felt pad is badly worn, and this is almost certain to cause a change in tape speed as well as distortion from the tape being held unevenly against the head.

If replacement felts aren't available from the manufacturer, cut up an old felt hat to make some new pads. Chances are these



**TUBE CHECKERS**, conveniently located at the corner drugstore, simplify maintenance, eliminate the need for purchasing your own costly test equipment. This one is at the obliging Jomar Chemists, Flushing, N. Y.

homemade pads will wear better anyway. Remove the old pads from the springs, cleaning the residue from the springs with a pen knife or a little acetone to soften the cement. Then cement a new pad to the spring, using ordinary household cement or a drop of the new white glue. If a single thickness of the old felt hat isn't sufficient, make a sandwich of two layers. After the cement has dried hard, set the pad mounting aside until the rest of the assembly has been thoroughly cleaned.

The tiniest bit of dust or oxide which keeps the tape from full contact with the head gap, even by as little as a thousandth of an inch, can impair frequency response and introduce distortion. All head surfaces, particularly at the center gaps, should be cleaned thoroughly. A soft lint-free cloth or cotton swab dipped in alcohol or carbon tetrachloride will do the job quite well. Use as little solvent and as little pressure as possible, but do remove all of the impurities.

Since the capstan is the tape drive element, it, too, must be completely free of foreign materials. Dirt on the capstan can cause slippage, wow and flutter. It is cleaned in the same way as the heads.

The capstan's partner in the tape transport is the pressure roller, which must also be cleaned for the same reasons. The face of this element must rest flatly against the capstan when the system is energized. If it is badly worn, pitted, gouged, scored, or out of round due to flat spots, it should be removed and replaced.

Since both the capstan and pressure roller are rotating parts, their bearings require lubrication. The pressure roller usually must be removed for this job. A drop or two of light machine oil will do the trick, but be very careful not to spill any on the surfaces of the capstan or roller. Use the oil sparingly, or when the system is in operation little droplets may splash on the tape and drives. If any oil is spilled, it should be wiped off immediately and thoroughly with a rag dampened with the cleaning fluid.

The tape guides, arms or rollers, over which the tape must pass in getting from one reel to the other, will also require cleaning. The tape often sheds small particles at these points. The process is cumulative, and in time quite a residue piles up.

The cleaning agent on these parts should likewise be alcohol or carbon tetrachloride. *Never* use an "oily" type cleaner, such as kerosene or coal oil, on any part of the machine which makes contact with the tape. Better yet, don't use it at all, anywhere. Finally the remaining parts of the top deck are cleaned with the rag, brush, or vacuum cleaner.

Now it's time to flip the deck over and work on the underside. After removing the screws holding the deck in the case, lift the front edge just a couple of inches or so. Peer inside to determine what electrical connections must be broken before the chassis can be completely removed.

[Continued on page 81]

## how to clean and repair your tape recorder

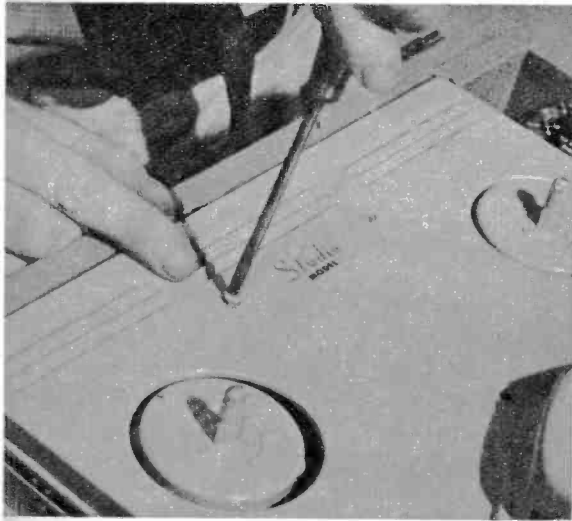

**FIRST STEP** is to remove cover plate, if heads, capstan and pressure pads are enclosed by it.

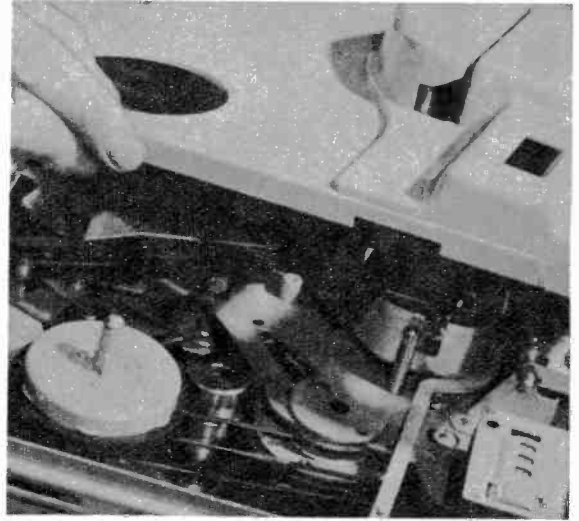

**THIS IS** accomplished by simply removing screws and lifting off the plate as demonstrated here.

Photos courtesy of Minnesota Mining & Mfg.

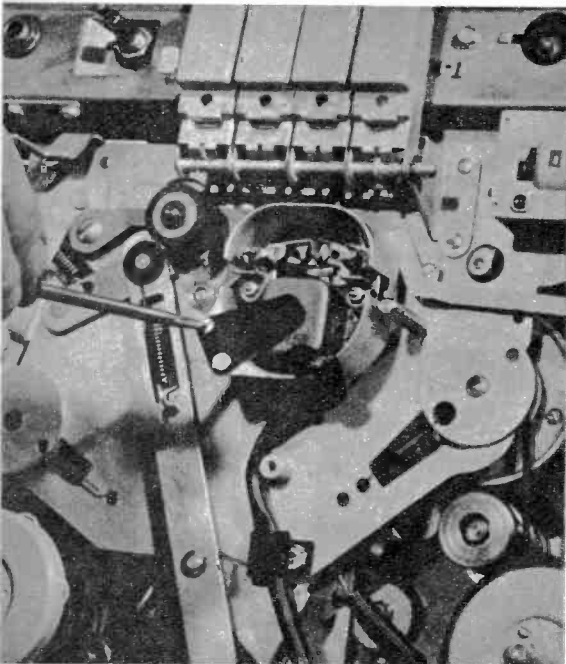

**IF NECESSARY** for access, remove flat spring that holds head in place. Note condition of pressure pad.

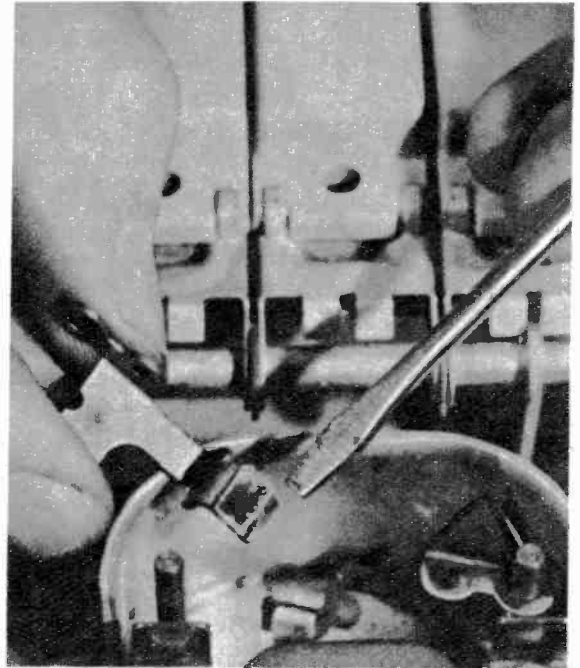

**WORN PAD** changes tape speed, causes distortion of sound by holding tape unevenly against head.

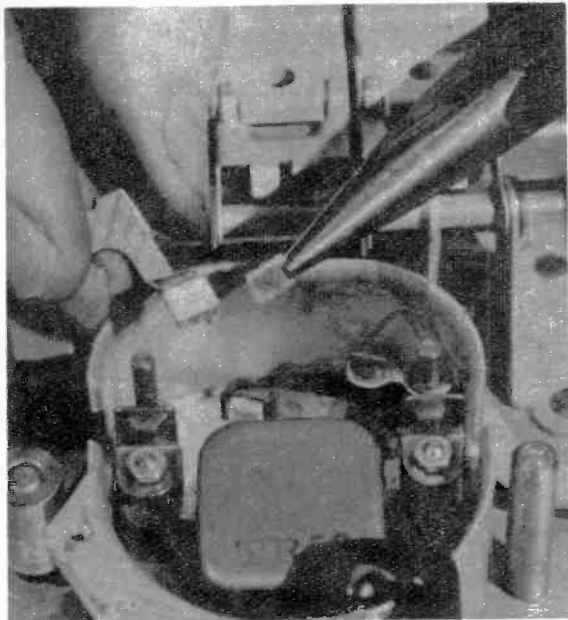

**COMPARE** new one, cemented in place. If pad pressure adjusts, set so that tape speed is right.

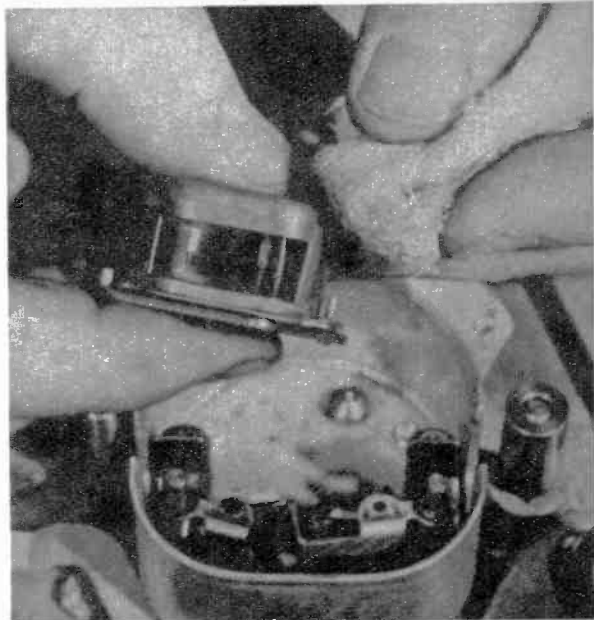

**LIFT HEAD** from plate, wipe its face, recording and erase gaps with lint-free cloth, carbon tet.

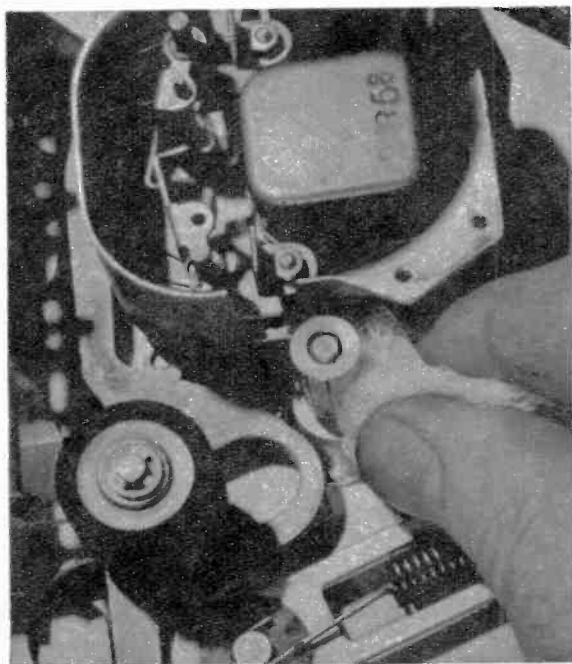

**CLEAN CAPSTAN'S** surface similarly and dry. Dirt causes uneven tape motion, wow, flutter.



**SOME CAPSTANS** have threaded mounts, permitting easy removal for changing speed, cleaning.

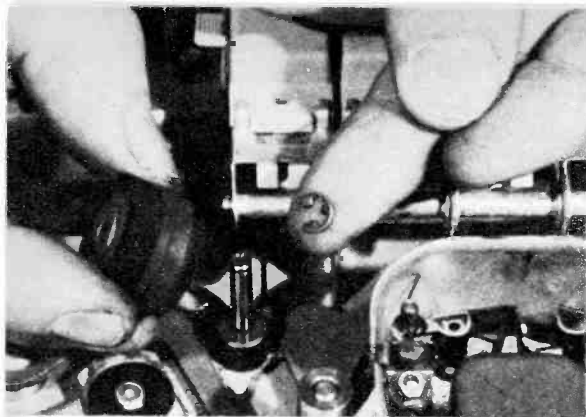

**REMOVE PRESSURE ROLLER** from bearing; oil bearing only with a thin grade of machine oil.



**CLEAN ROLLER** with alcohol or carbon tet. Dirt can cause wow and flutter and distorted sound.

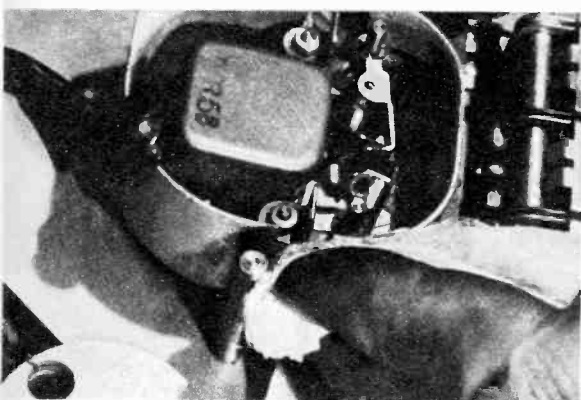

**TAPE GUIDES** must be cleaned same way. Never use oily cleaner on a part that touches the tape.

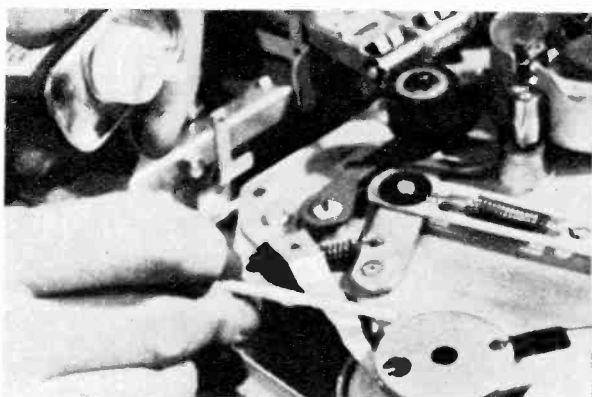

**ROTATING** or sliding parts can be lightly oiled. Remove oil that drips on capstan, pressure roller.

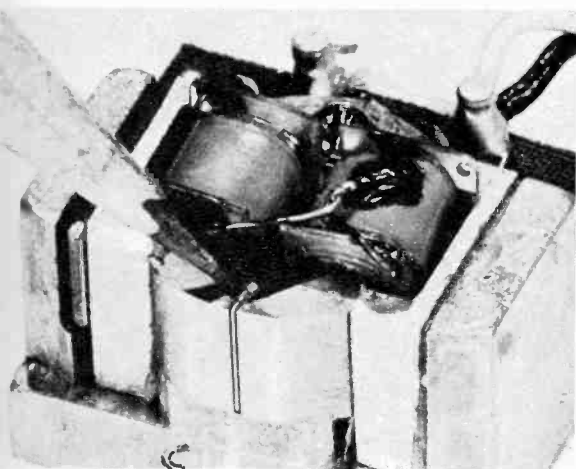

**HEAD GAP** (indicated by pencil) must be at exactly right angles to the tape for top fidelity.

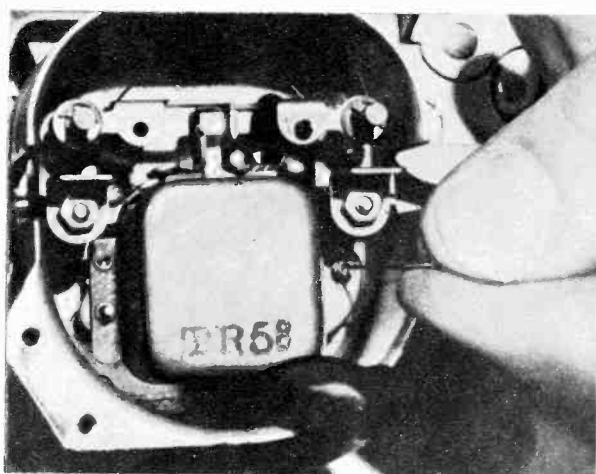

**ADJUST** head alignment for loudest sound with test tape on machine. Allen wrench aligns head here.



[Continued from page 77]

There is usually a plug-and-socket arrangement mounted in the middle of each cord which is simply pulled apart. When you are certain there are no more entanglements tending to restrain the deck, it can be lifted out of the case.

In order to work on the underside of the deck it should be turned upside down. It should *not*, however, be placed with its weight resting on the tape spindles or head assembly. The best system is either to place the deck right back on its case with the motors upward, or to block up each corner of the pan with, perhaps, two or three tiers of children's building blocks or a couple of short lengths of two by four turned edgewise.

The first step is a thorough cleaning with rag, brush and vacuum cleaner. Then the underside should be given a careful inspection for loose screws, disconnected springs and dislocated parts. If all is well, the rotating and sliding parts may be lubricated, using a bent pipe cleaner moistened with a little machine oil, once again being careful not to drip on the capstan or any other parts over which the tape passes.

Finally the inside of the case should be cleaned, the deck righted, electrical connections made, and the unit set back in the case and bolted or screwed into place. Now it is time to put the pressure pad springs back into place.

The pressure of these pads is an important factor in determining tape speed, so the springs should be carefully adjusted. The best way of determining correct speed is through the use of a strobotape, which like the stroboscope disc, gives an accurate speed indication when illuminated by an AC light source. If none is available, play a musical tape with which you are familiar and adjust the pressure pads until the pitch sounds correct.

If a tape seems noisier after being played on the machine, chances are one or more of the heads has become permanently magnetized. Although there is no residual magnetism in the recording heads when they are new, they may accumulate some after repeated playings of magnetized tape. This magnetism may in turn be induced back into the tape and thereby cause noise and distortion. If this is the case, the heads must be subjected to a demagnetizer, a fairly inexpensive and easily-used tool.

Regardless of the frequency response of the electronic system in a tape recorder, the reproduction may nevertheless be quite deficient in high frequencies if the

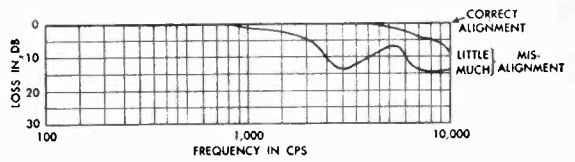

*Typical Azimuth Misalignment Effects.*

**IMPROPER azimuth alignment of record, reproduce heads seriously impairs high-frequency response.**

recording and reproducing heads are not properly aligned. The position of the head gap with respect to the tape is known as *azimuth*.

For best results the head gaps must be aligned exactly at right angles to the edge of the tape. This is accomplished through the means of a special alignment tape which is commercially available.

The head is usually adjustable, often with an Allen wrench, and it is set for maximum output when the azimuth tape is played. This is best accomplished with the aid of an output meter, although a reasonably good job can be done with a sharp ear. Once the playback head is adjusted, the record head should be aligned to conform to it.

This requires an outside source of high-frequency tone, such as a test record. Record on a fresh tape the tone from the record and adjust the *record* head this time for maximum output from the playback head. With this done, both heads are in alignment.

All of the tests and adjustments described in this chapter can be performed without special tools or instruments. Their careful use should save you considerable money. But there are two precautions. First, whenever working on the chassis of any equipment with the power on, *keep one hand in your pocket at all times*. If you are careful you should never have to worry about electric shock, but if perchance you should get a poke, it is infinitely better to get it in the hand than to have it pass through your whole body, including the vital organs.

Secondly, if you have a hi-fi servicing problem which is obviously beyond your scope, call in a reliable repairman. When hi fi was in its infancy, few TV-oriented servicemen were capable of doing an adequate audio job, but this is no longer true. Go to one if the job is over your head. Otherwise you may do more harm than good, and there is no low cost hi fi in *false economy*. •

# Speaking of Speakers...

With a wide selection of systems available, your budget, allotted space and home decor will determine the one you choose



REGARDED by many as the best ever made, this Hartsfield corner horn system has straightforward design; no expense spared to do good job.

**I** DON'T KNOW how you feel about it, but I always find it a bitter pill to compare the performance and price tag of a hi-fi amplifier against the price tag of a roughly comparable speaker system. Many of us are prone to look upon the speaker as a sort of appendage, an afterthought, and we are brought up short when we realize that we have to lay out the price of an amplifier for the speaker system—a setup which is definitely inferior in performance to that amplifier.

Now it's very easy to point the finger at the speaker system as the weak link in the chain, as against some amplifiers which will operate virtually distortion-free from zero cycles up to radio frequencies and back again. And it's also very easy to ask where the research-and-development boys in the speaker business have been hiding while tremendous electronic advances have been made. But in that very question we also find the beginning of an answer.

In the first place we are comparing a purely electronic device such as an amplifier with an electromechanical device, in this case the loud-speaker. And just a cursory glance at the physics of the problem will quickly convince us that the magnitude in the case of the speaker is very much greater than in an electronic device. After all, getting electrons to behave in wires, gasses, a vacuum, or various other types of impedances has become second nature with us. But that elusive perpetual-

motion machine is just as illusory as ever.

The rest of the problem is purely economic. Let's face it, the quality of the electronics in our hi-fi systems is a gift, a mere by-product of research in other areas having nothing whatever to do with high fidelity. Television and military electronics have borne the brunt of the research load in this field. Both of them have had need of amplifying systems with characteristics which were readily adaptable to hi-fi use. But the military has precious little tactical use for hi fi, and television has demonstrated precious little interest in it.

And so, fellow audiophile, further research and development in the loud-speaker field is going to be borne by you, you and me. Not by paying our taxes, and not by buying Crunchy-Wunchies at the corner supermarket, but by getting up the loot for a speaker system now. If some great white father comes along with a bulging pocketbook and a pressing need for some kind of electromechanical transducer which can be adapted for hi-fi audio, then speakers will improve, and fast. Meanwhile, loud-speaker research must come out of the manufacturer's sales dollar, and there's no use in our complaining.

The loud-speaker boys have been doing an excellent job, considering that they haven't been the recipients of any such scientific largess as has befallen the electronics end of the business. Speakers are not at all bad today. It is interesting to

**THIS SMALL** corner horn for an 8-inch speaker is the *Baronet*, made by Electro-Voice. It fits gracefully into the spirit of modern decoration.



**PLAYBACK** of recent record holds attention of Buddy Hackett and Alan Dale as they hear reproduction through a *Voice of the Theatre* speaker.



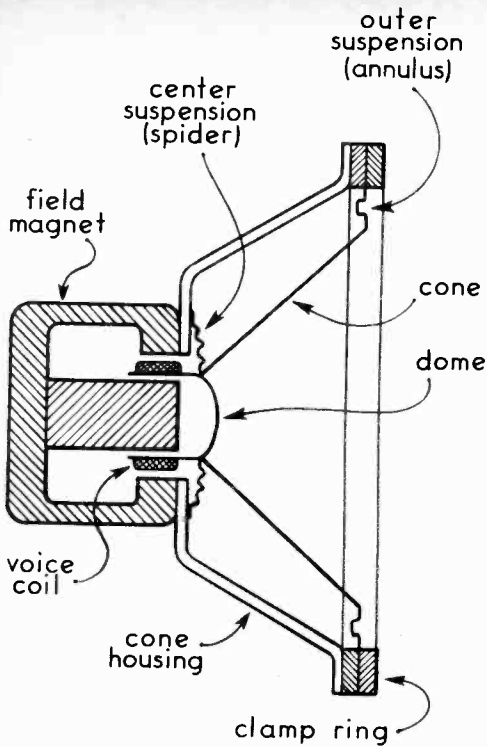

IN SIMPLE single-element dynamic loud-speaker, sound production is by cone vibration, actuated between the fixed field magnet and voice-coil electromagnet through which audio current flows.

speculate on what our hi fi would be like if speakers were not outclassed by amplifiers, but this is certainly not to say that speakers aren't in the same league. Today's hi-fi speaker system is really very good, and it might be well for us to dissect one to see what makes it tick.

It is important to realize first that the speaker itself is only one part of a complete speaker system, and it's the system as a whole which requires such careful selection. The entire arrangement will have at least two speakers, one for bass and another for treble, and may often have three or more, depending upon the individual design. But no matter how many speakers comprise the complete system, it is almost mandatory that they be of the same manufacture, and intended to work together.

The type of speaker in most common use today, and for many years past, is the moving-conductor or *electrodynamic* type. In this system, two magnetic fields, one fixed and one movable, alternately attract and repel one another, resulting in a movement which is used to set molecules of air in motion and thus produce sound.

The fixed magnet also has a constant electrical value, produced by a large field

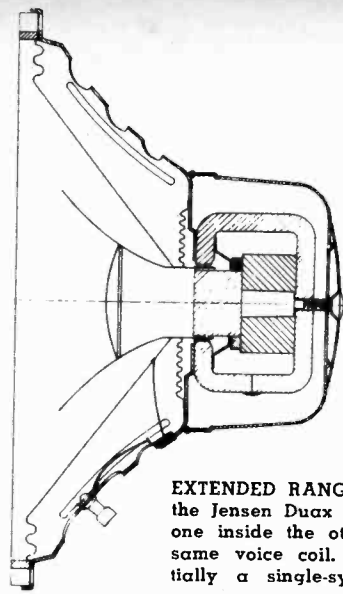

EXTENDED RANGE speaker like the Jensen Duax has two cones, one inside the other, driven by same voice coil. This is essentially a single-system speaker.

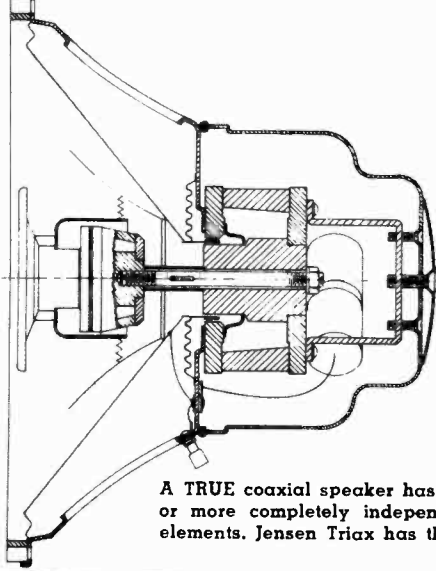

A TRUE coaxial speaker has two or more completely independent elements. Jensen Triax has three.

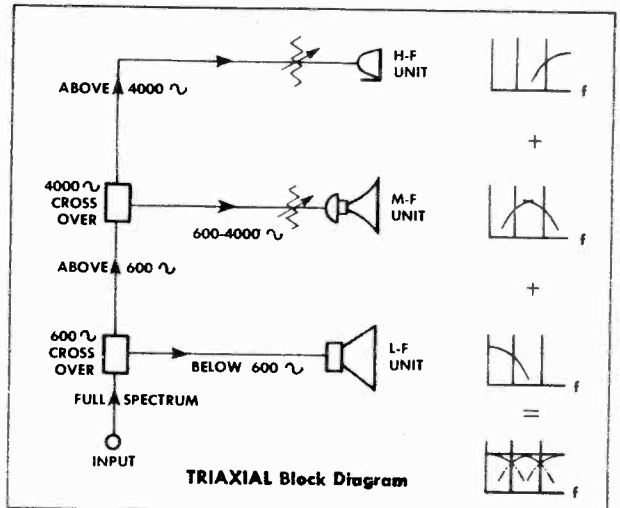

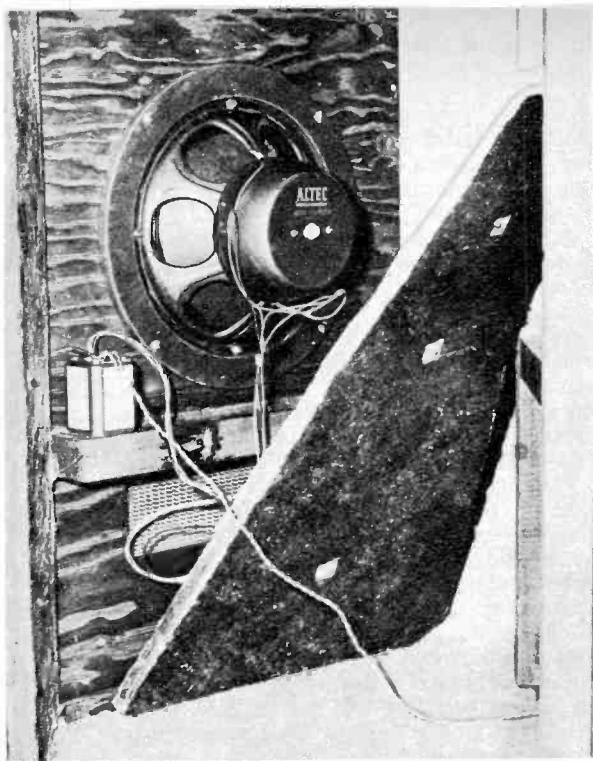

**WHEN MOUNTED** in bass reflex cabinet, coaxial's baffle lets only bass wave escape through port.

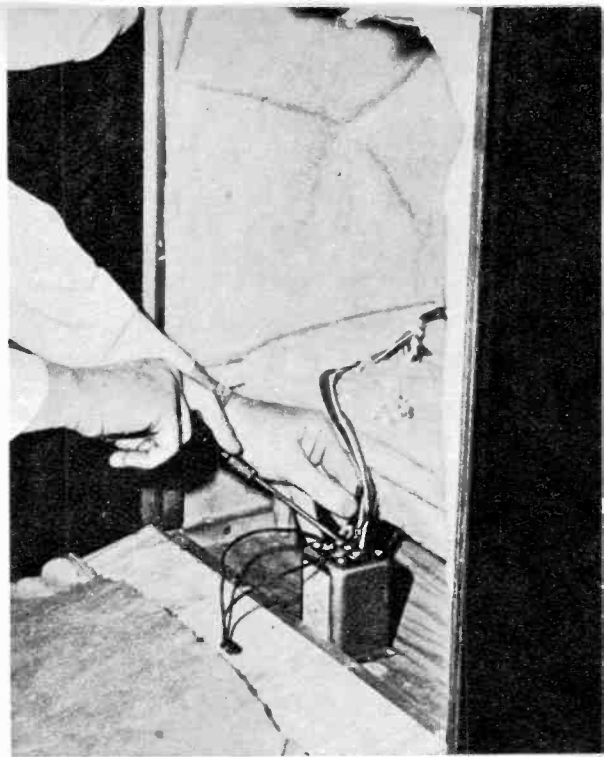

**ADJUSTMENT** of crossover network for balance control is made on screw-terminal connections.

magnet or pot. This is the big mug-shaped device at the rear of the unit, and may be an electromagnet externally energized from a DC source, but much more commonly it is a permanent magnet. The size of this magnet is a rough indication of speaker quality, as more powerful magnets help to damp out distortion, increase efficiency and extend frequency response.

Within the gap of the field magnet is a small coil of wire, misnamed the *voice coil*. The output of the powerful audio currents from the amplifier is fed into this small voice coil, resulting in the establishment of an audio-frequency magnetic field, which alternately attracts and repels the fixed field generated by the pot. The voice coil is thus caused to move back and forth in accordance with the audio signal. This section of the speaker is known as the driving motor, and it in turn is attached to the acoustic radiator.

The radiator is usually a cone of specially-treated paper, which acts to compress and rarefy the air in front of it, and thus reconvert the electrical signal to sound. The size of the cone determines the amount of air it can move, and is therefore an important factor in determining the bass response of the speaker.

The acoustic radiator may also be a fixed

horn, which has at its throat a diaphragm attached to the voice coil. The diaphragm itself produces the sound, which is then shaped and radiated by the horn. A horn loud-speaker, when properly designed, offers far better frequency response and efficiency than the cone type. But since for a 30-cps tone the mouth of the horn must be about nine and one-half feet in diameter, the horn type is used mostly for the higher frequencies in multi-speaker systems.

There are several variations of the basic cone-type speaker which the audiophile would do well to understand before making his decision to buy. In many cases the cone is designed with greater stiffness near the center than at the outside, so that it vibrates as a whole at the low frequencies while only the center vibrates on the highs. This is a perfectly legitimate way to extend speaker range, but when the advertising literature begins talking about the difference between the two vibrating modes as a "mechanical crossover," it comes rather too close to implying that the speaker is a true two-way system, which it is not.

A further refinement on this system uses two separate cones, one large and one small, coaxially mounted on the same single driving motor. This is quite freely referred to

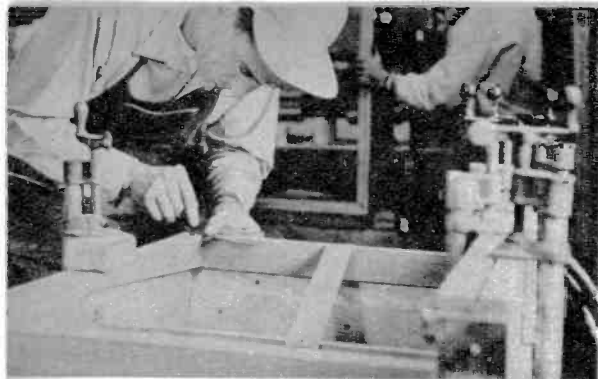

**SPEAKER** enclosures are built by expert furniture craftsmen. Clamps are used while glue sets.



**ASSEMBLY** of diaphragm for high-frequency unit of JBL speaker is intricate and painstaking task.

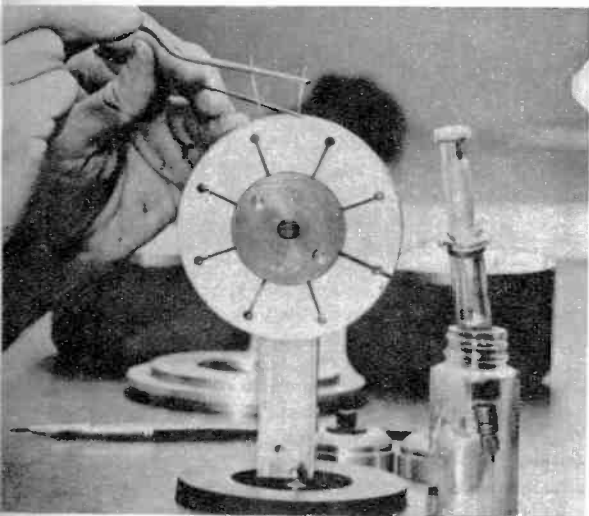

**MEDICAL** syringe is useful in the assembly of voice-coils. Fine wires are being brought out here.

as a two-way system with mechanical crossover, but it is still really nothing more than an extended-range speaker. Referring to it as anything better only degrades the value of the real thing.

A true two-way speaker system has two separate radiators driven by two separate motors. They may be coaxially mounted, attached side-by-side, or at some distance from each other. But unless they are electrically and mechanically distinct, the system is not truly two-way. A crossover network between amplifier and the two speakers is used to divert the appropriate part of the spectrum to each unit.

The three-way speaker must similarly be a true three-speaker system, whether mounted coaxially or otherwise. Here again certain advertisers have been guilty of a little flummery in calling an actual two-way system three-way, just because one of its elements had range-extending construction with a mechanical crossover. If a three-way system is what you want, be careful or you may not get it. This problem doesn't exist in four-way systems, as none of them is mounted in a unitary array.

The other equally important part of the speaker system is the mounting or enclosure. If this element is not selected with the same care given the speakers themselves, they can never sound as good as the designer intended. Since the job of the speaker is to set air in motion, the proper mounting provides the efficient linkage between cone and air, permitting the cone to get a better "grip" on the air particles.



**CONE** must be microscopically centered, so the craftsman resorts to use of powerful magnifiers.



At this point a question always arises concerning the size of the enclosure—must they really be so huge? Well, there just isn't a simple yes-or-no answer to this one. If there were, speakers would all be of uniform size. Instead, it depends upon what the listener wants out of his hi-fi system.

Remember that the sounds made by a symphony orchestra or even a dance band can be very, very loud. This means that huge quantities of air are being moved with great power. But nobody can stand sounds of this size in his living room or study. So even the loudest of hi-fi reproduction is really a *scaled-down* version of the real thing. We hope, of course, that the miniature replica of the original has lost no detail in the transition. This, after all, is the meaning of high fidelity.

We would like our reproduction to appear without any "coloration," which is the current polite term for old-fashioned distortion. We'd like to retain the same contrast between the loudest and softest passages, this being known as *dynamic range*. And we'd like the complete audible *frequency range*, or at least all of those tones and overtones which were present in the original.

And right here is where we run smack into some of the unrepealed laws of physics. We all know that one of the reasons a violin can never sound like a string bass is simply that it isn't big enough. And a tuba sounds much lower than a cornet because it has a lot more and larger tubing in it. The low bars on a xylophone are larger than the

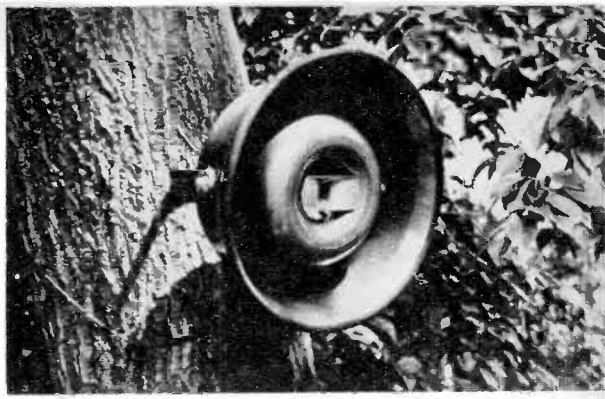

WHEN BLC is mounted on a tree, speaker volume is controlled by an "L" pad on nearby building.

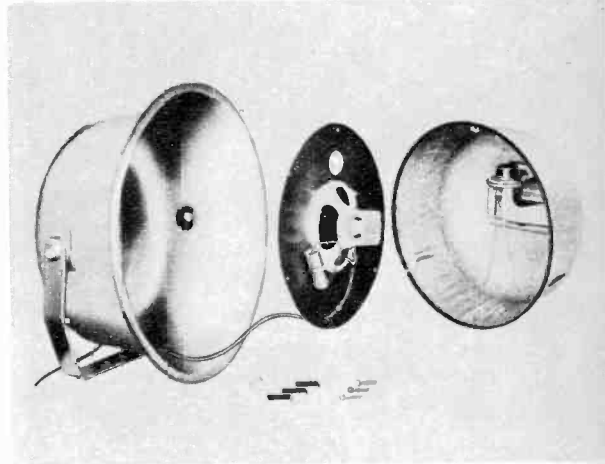

SHOWN here disassembled, the Jensen HF-100 is model used for outdoor installation, photo above.

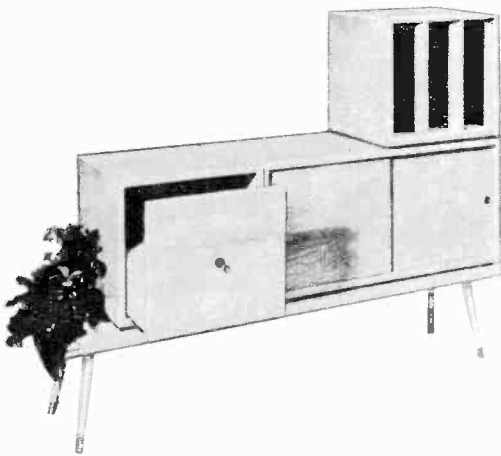

AN ARRANGEMENT of hardwood kits by River Edge; 60-inch bench supports the set of cabinets.

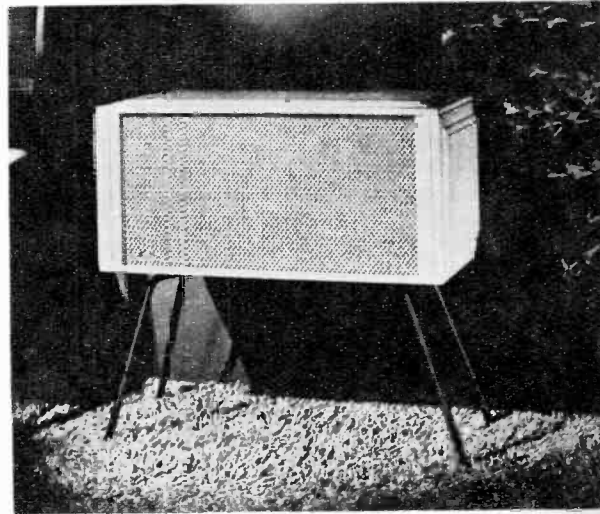

A TWO-WAY Treasure Chest system by Jensen employs 8-inch woofer, compression-driver tweeter.

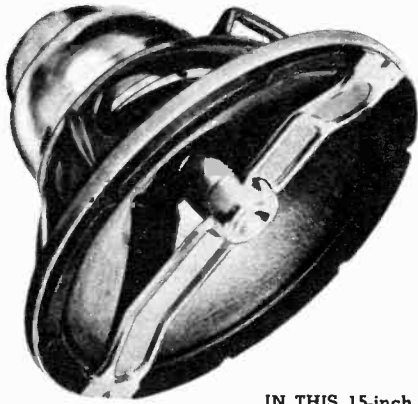

ONE of the few true 3-way systems in unitary array is typified by the Jensen Triaxial at left.

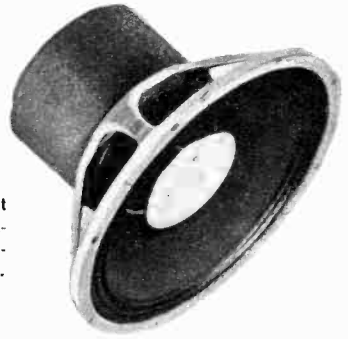

COAXIAL speaker at right by Stromberg-Carlson employs the honeycomb acoustic lens to disperse the h. f.

IN THIS 15-inch extended range speaker made by Lansing, great advantages lie in large voice coil.

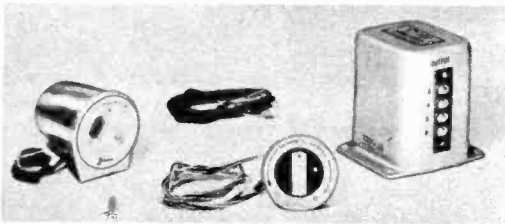

RANGE extender kit by Jensen enables you to add a supertweeter to existing speaker system.

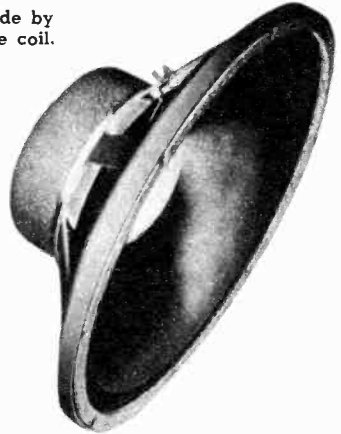

high ones; the high strings on a harp are much shorter than the low ones. And so it goes throughout all the different families of instruments.

From this it would seem that we might draw an arbitrary rule of thumb saying that the bass element of our speaker system must be at least as big as the lowest instrument we intend to reproduce. And in practice it very nearly works out that way for the cleanest and truest bass reproduction. But there has also been a goodly amount of laboratory magic conjured up in recent years, and it is possible to obtain a surprisingly good approximation of full bass response from some extremely small boxes.

When a loud-speaker cone begins vibrating in air, it is actually setting up two sets of opposing sound waves simultaneously, one from its concave surface and another from the rear. When these two waves combine, they can either add together and sound boomy, or subtract one from the other and sound weak and thin. The first objective of the mounting or enclosure is to keep these two waves completely sepa-

rate—or to control carefully the way they combine.

Now with these simple facts in mind, we can take the seemingly endless variety of speaker systems on the market today and assign each a place in one of only *three* possible categories. These are:

1. the *direct radiator*, in which the back wave is never permitted to join the front wave;
2. the *resonator*, in which the back wave joins the front wave under carefully controlled conditions;
3. the *horn*, which is a direct radiator with the addition of a flared opening at the front, presenting a partially enclosed volume of air for the cone to push against.

The mounting for the direct radiator is often called a baffle, and in its simplest form is just a board with a hole in it, through which the speaker is mounted. Then the back wave can't interfere with the front until it travels out to the end of the board and back around the other side. To prevent the back wave from ever joining the front wave, the board would have to be infinitely

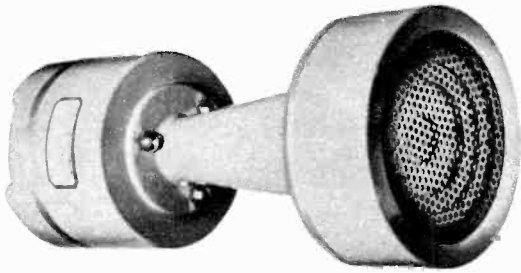

RADIATION of sound is dispersed in a wide angle by the Lansing 175DLH, which resolves problem of h.f. beaming.



WIDE-ANGLE horns are employed by University Reproducers. The "reciprocating flare" is employed in the one pictured.

A RING is the vibrating element in the Lansing 075. Its stiffness gives freedom from resonance.

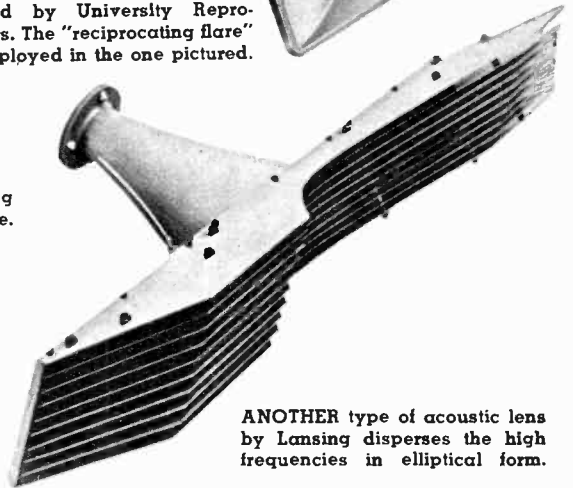
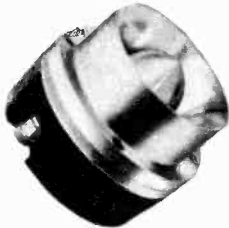

ANOTHER type of acoustic lens by Lansing disperses the high frequencies in elliptical form.

large, which has given rise to the name *infinite baffle*.

A good approximation of the infinite baffle is the wall of a room, with the front of the speaker cone working into the listening room, while the back wave bounces around the next room. Reducing the whole thing in scope, the speaker can be mounted in a closet door, while the back of the cone works against the much smaller cushion of air in the closet. Carrying the reduction to the extreme, the infinite baffle can be just a completely enclosed small box. This has always been frowned upon by designers, however, as it has meant a pronounced peak in part of the bass range, with almost no response below that peak.

The classic objections to the small infinite baffle have been overcome, according to the claims made by Acoustic Research for their new AR-1 system. By redesigning the moving parts of the speaker to have much less stiffness, and relying upon the cushioning effect of the air in the box for the correct elasticity, a very wide range reproducer is possible in a box measuring only about two feet wide and one foot deep

by fourteen and one half inches high. This size and shape is ideal for bookshelf installations. Although the system is admittedly inefficient by current standards, this is no great problem with the relatively low cost of amplifier power today.

The resonator type of enclosure was probably concocted by a parsimonious engineer who couldn't stand to see all of that nice backwave going to waste. And he must have been right, for the enclosures in this family are by far the most popular today.

The basic principle of all resonator types is *phase inversion*, in which the back wave is shifted around so that when it joins the front wave it adds to it and reinforces it. Since it is still the bass end which is most troublesome, the treble is usually soaked up within the enclosure, so that the part of the back wave arriving at the front is in effect a bass boost.

One common type of resonant phase inverter is known as an *acoustic labyrinth*, in which a sort of "mystic maze" pathway is provided for the back wave in getting around to the front. Typical commercial



MANY styles are available in hi-fi furniture. This is the River Edge Provincial Combination.

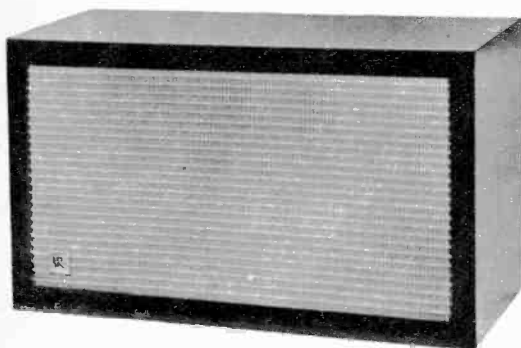

NEW principles provide unusual bass response in small areas, as in AR-1 by Acoustic Research.

examples of the labyrinth are the Stromberg-Carlson series and the Acousti-Magic kit. Performance of this type is very fine, but due to its complexity in construction and higher cost, other types of resonator enclosures are more popular.

By far the most common type of speaker enclosure is still the old bass reflex. This is just a padded box with two holes in it, one for the speaker, with a "port" below it to allow escape of the backwave. It is simple, low in cost, small in size, and easy for the home constructor to build.

But whether buying or building the bass reflex, it is essential that the enclosure be one designed for the speaker to be used in it. The size and shape of the box, as well as the size and position of the port opening, are rather critical and depend upon the size and resonance characteristics of the speaker. This is not a serious problem, however, as most speaker manufacturers

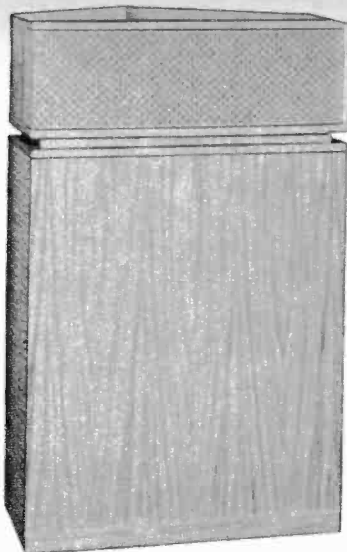

FOLDED exponential horn with cone-type driver as woofer is feature of world-famous Klipschorn.

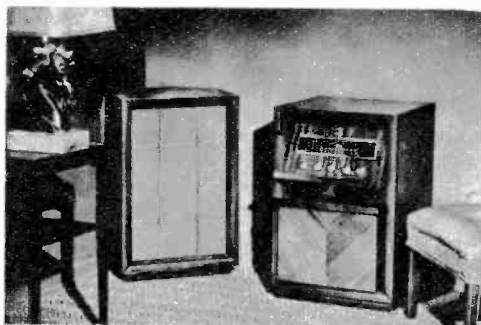

ENCLOSURE such as Aristocrat by Electro-Voice accommodates 2- or 3-way system with folded horn.

are most willing to provide construction drawings of bass reflex enclosures specifically designed for their products.

Other types of resonant enclosures, which also feature very good bass response with small size, include the *R-J* system and the *Karlson Coupler*.

The true horn loud-speaker employs a diaphragm driver, which vibrates the air in the narrow neck of a straight flaring trumpet. One of its advantages over other types is an efficiency several times greater. But as we have noted, in order to reproduce the lowest audible tones it has to be around ten feet long, with a mouth about ten feet in diameter.

This is a little large for the average living room, although a few sturdy hi-fi zealots have built them in. One fellow mounted such a horn vertically in his attic, with the mouth covering the entire gridded ceiling. Another filled his attached garage with one

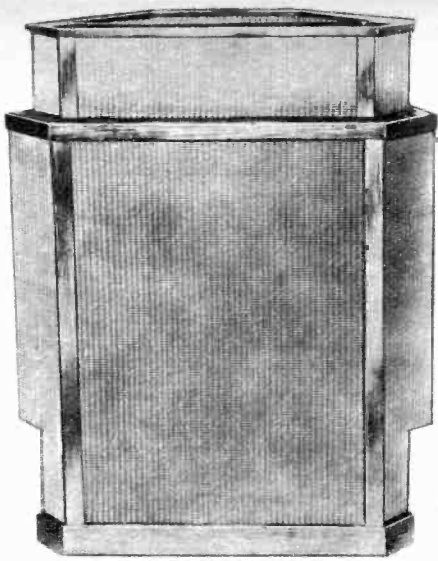

**BRIGGS 3-way corner horn system employs 25 lbs. of sand in 2-inch layer to avoid the low-frequency resonance or vibration.**

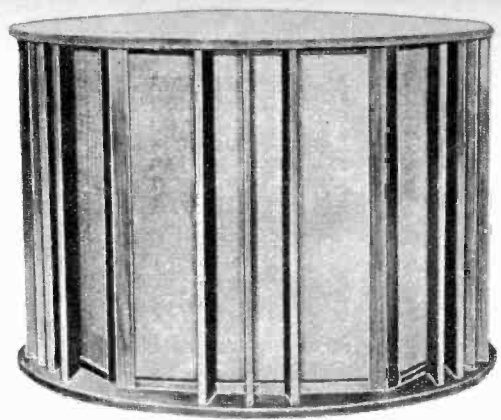

**THREE completely separate amplifying systems are embodied in the Ercona system, Tri-Channel.**



**THIS CHAIRSIDE equipment cabinet by River Edge can include a built-in R-J enclosure for loud-speaker units measuring up to the size of 8 inches.**



**EMPIRE, the low-boy design by Electro-Voice, will accommodate 2- or 3-way systems with woofer of 15 inches—bass reflex type.**

of the monsters, with the mouth of the horn appearing where the living room wall used to be. Few of us have a wife as understanding as these guys' spouses, however, so for us there have been attempts made at domesticating the horn.

Since the brass family of musical instruments are all *folded* horns, it would seem logical that a horn-type speaker enclosure could be similarly folded. This was first tried in movie theater systems, and it worked, but these were still a little cumbersome for home use. Remember that the mouth size must still be very large for those bottom bass tones.

The *Klipschorn* gets around this by a room corner mounting, where the two walls continue the horn taper and in effect open out to the wide mouth necessary for the best bass reproduction. Since the upper tones can't make it so well around the sharp turns, the folded horn is used only

for a solid bass, while other elements reproduce the middle and top.

Each type of speaker system has its own advantages and loyal boosters, who swear by their pet and swear at writers who don't agree with them. And each of them is right, really, for he got the things he wanted most in a speaker. Since each of us has different requirements and limitations in budget, space available, and musical taste, there is good reason for the wide selection of systems available today.

Anyone bent on acquiring a system would do well first to reacquaint himself with the sound of live music. Attend concerts, go to dances, see a few Broadway musicals, if possible, and maybe do a little night-clubbing. Then head for your nearest hi-fi dealer. When you hear the sound you like most on the music you like best, search no more. That's the time for you to make a deal. •

# New Ideas in Sound

Some represent great strides and others are of dubious value. All will fascinate the audiophile

**T**HIS PAST YEAR has seen more activity and new developments in the audio field than most previous seasons. Some of the recently introduced devices are really new and useful. Others are simply retreads of old crackpot ideas which were discarded long ago. Still others are new crackpot ideas which will ultimately go the way of the older ones.

All three types are presented here, either because they should prove useful to the serious audiophile, or as another chap-

ter of history repeating itself, or possibly strictly for laughs.

Since we have yet to discover a single loud-speaker system which will deliver clean reproduction throughout the audible range, it is necessary to split up the signal by frequency and feed each part of the band to its own specialized speaker. Much has been said about performing this division electronically before amplification, but none of the systems yet devised actually do this. Normally they are con-

**HIGH-EFFICIENCY** transistors make possible true portable radios that need only flashlight batteries.





nected beyond the preamplifier, with a power amplifier following this point for each speaker.

But although most top-grade speakers are three- or four-way systems (with the notable exception of Altec), most of the electronic dividers have been of the two-way variety. The result was that only part of the frequency division took place at low level, with the treble region divided again following the power amplifier in a conventional crossover circuit.

The English Tri-Channel system was one of the first exceptions to this, but it is a complete integrated rig comprising a control unit, three-channel amplifier and three-way speaker. This is fine for the guy starting from scratch with a loose \$795 in his jeans, but not very compatible with the building-block methods employed by most budget-conscious audiophiles.

Now comes the Colbert three-channel electronic divider which includes one ten-watt amplifier. This can be used with either a two- or three-way system. Let's say you now have a two-way speaker system and hope eventually to expand it to three, but meanwhile want electronic crossover. In this case you just connect the Colbert input to your control amplifier, while its amplified output goes directly to your tweeter, and its unamplified output goes to your present power amplifier. The PA output is connected directly to the voice coil of the woofer. Your present crossover network is no longer used.

Then the Colbert is set to two-way, the crossover controls adjusted, and you're in business. Now you have a complete two-way system, with your present amplifier handling the bass channel and the Colbert taking the treble. When you add a super tweeter to convert a three-way system, you already have the electronic crossover in the Colbert, but will require an additional small power amplifier to drive the

third speaker. The Colbert system is therefore a three-way electronic crossover system with necessary controls, plus one channel of amplification.

From Chicago comes the sensational announcement that the new Sherwood S-3000 FM tuner is the "first ever to achieve under one microvolt sensitivity." In making this announcement, Sherwood V-P Edward Miller said, "There's been a lot of talk about the importance of tuner sensitivity being exaggerated. Sensitivity means range, and range means more people can listen to and enjoy the benefits of FM music. In achieving 0.95 microvolt for 20 db quieting we have, in effect, extended FM station broadcast range to over 100 miles."

Careful readers of the FM chapter in this book will recognize the 20 db figure in this statement as somewhat akin to winning an automobile economy run with Canadian gallons of gasoline. We can't tell from this statement what the sensitivity is for the standard quieting level of 30 db. The chances are that it's pretty good, though.

This tuner does appear to have better sensitivity than most of those currently on the market. It certainly has some very desirable features, including a local-distance switch, flywheel tuning, automatic frequency control, delayed automatic gain control, and FM multiplex output. For under \$100 it sounds very good. But one-microvolt sensitivity? No.

We've already noted that the transistor is not yet very significant in hi fi, so I wouldn't try to kid you that this next item is high fidelity. But it is useful and interesting, and I think you'd like to know about it. It's a new transistor portable AM radio, built from Heath Kit Model XR-1 for under \$35 including excise tax.

It isn't so very many years ago that self-powered portable radios cost a fortune to buy and a couple of fortunes to operate. Not nearly so important as the moderate

**MULTI-CHANNEL** reproduction problem is solved by the Colbert system shown here with a three-way electronic divider plus one amplifier channel.

**QUIETING** characteristics of the new frequency modulation tuner below are said by its manufacturer, Sherwood, to be the finest yet attained.

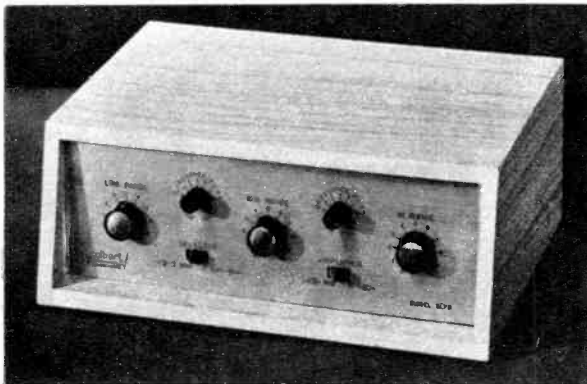



**ELECTRONIC** speed variation of Fairchild turntable is first available out of recording studios.

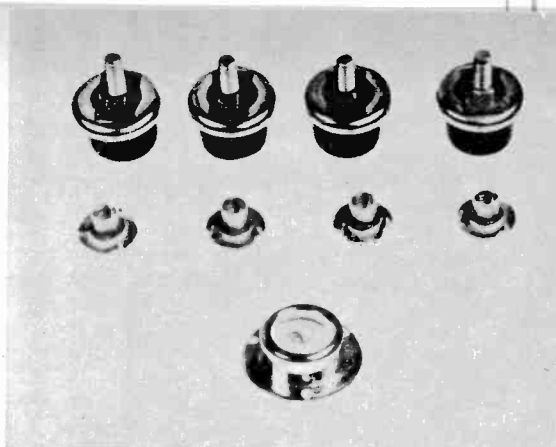

**LEVELOR KIT.** by Cabinart, permits leveling of any turntable or changer easily and accurately.

initial cost of this set is the fact that it operates for 500 to 1,000 hours on nothing but six standard flashlight cells. Even if you pay 15 cents for your batteries and only get 500 hours out of them, that is well under 2/10 of a cent per hour. And if you pay a dime a cell and get 1,000 hours, your cost is exactly 6/100 cent per hour.

And this radio really does play anywhere. At this operating cost it makes sense to use it inside the house as well as out. But it also works—and well—inside a car, on the train, at the beach, while fishing or camping, at the ball game, or while re-

laxing out on the terrace, porch or patio.

The system uses six Texas Instrument transistors and a 4x6-inch oval speaker driven by a push-pull stage. I regularly pull in New York City stations from over 70 miles away with mine, with no interference whatsoever. This little job is also handy as a civil defense standby set, since it carries its own power and has the two Conelrad frequencies clearly pointed out on the tuning knob.

Several years ago, when it became fashionable for record companies to reissue "collectors' items" in their catalogs, when

**ALL-TRANSISTOR** portable radio shown below in three views is new Heathkit. It features a built-in ferrite antenna and oval speaker, and is amazingly sensitive and selective. Its case is gray plastic.

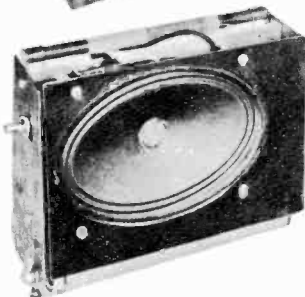
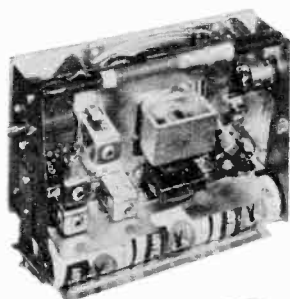
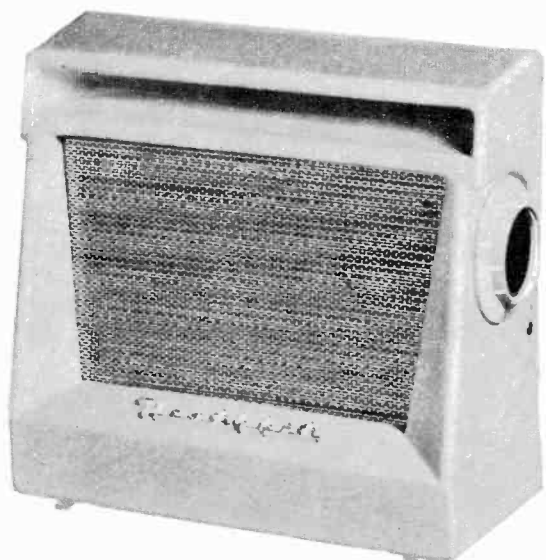

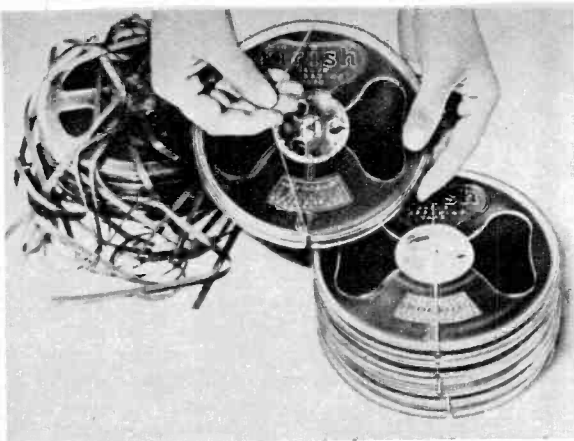

**NOTCHED TAPE REEL**, made by Orradio, holds tape in place with rubber, needs no adhesives.

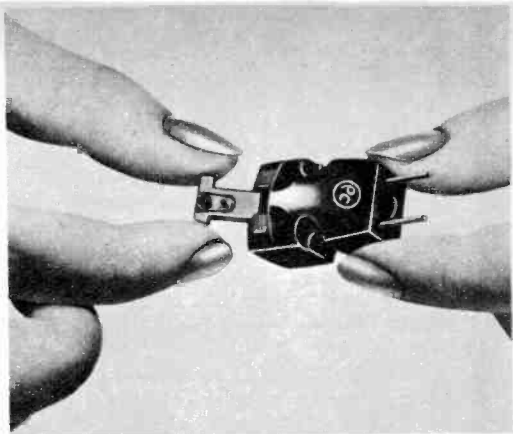

**MINIATURE FLUXVALVE** by Pickering makes available "T-Guard" styli in a variety of sizes.

rerecording from old shellac discs it became embarrassingly obvious that many of them were not at correct musical pitch. Obviously they had not been recorded correctly at any of the present standard speeds. To correct for this it was necessary to have a precise method of adjusting playback turntable speed to match original recording speed.

The method employed used a local variable-frequency power supply for the turntable motor. Since the motor was synchronous—that is its speed would depend upon the frequency of the power supplied to it—feeding something other than the standard 60 cps to the motor would permit varying its speed. Now Fairchild has applied this principle to a turntable for home hi-fi use.

The system has a hysteresis motor with an electronic drive system which is not continuously variable, but supplies the motor either 30, 60, 81 or 141 cps, thus making the hysteresis motor a four-speed motor and the turntable part of a four-speed reproducer. Minor speed variations of as much as plus-or-minus 3% are possible for pitch correction. There are therefore no changes of gears, belts, pulleys, or idler wheels necessary for altering speed. The external appearance stems from a Raymond Loewy design, and the system is every bit up to professional standards.

We all know that record wear will be minimized when the playback turntable is perfectly level, and we also know that few turntables have built-in leveling adjustments. This shortcoming is easily remedied by a Cabinart gadget, called their Levelor Kit, in which four rubber-tipped, screw-type feet adjust independently to allow for any sags. The kit includes a level, leveling mounts and installation



**PARALLELOGRAM IDEA** for avoiding tracking error is revived in B-J arm, Electro-Sonic import.



**"DUST BUG,"** another ES import, cleans record as it rotates, is independent of the tone arm.

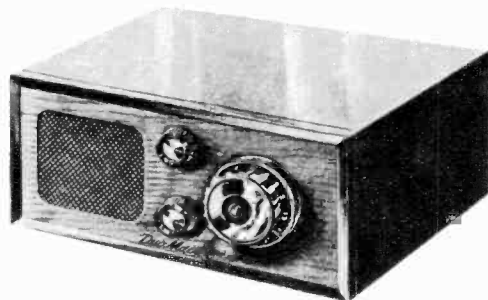

**ADAPTER** by Tech-Master delivers the best of TV audio for high-fidelity systems, tape recorders.

hardware, and sells for about two dollars.

Everyone who has worked with magnetic tape knows the annoyance of keeping the outer end of the tape on the reel. One solution is a short piece of adhesive tape stuck to the end of the recording tape and then affixed to the back of the next inner layer of tape. This works well in holding the tape in place, but it can often be very exasperating when trying to get the tape free again.

The best thing I have seen yet to answer this problem is the no-spill reel introduced by the Irish tape people. This little gadget has the "why-didn't-I-think-of-that?" look, it's so simple. All they have done is slot the reel flanges so that a rubber band will wrap around it and stay in place and hold the tape secure with it. This is certainly far better than adhesive end tabs which usually must be replaced with each use. Other advantages of this reel include easier access to the threading eye at the center, and twenty-eight square inches of indexing space on the four large flange areas, two on each side. All Irish brand tape on seven-inch reels is now being delivered on the no-spill reel at no extra cost.

The well-known Pickering Fluxvalve

cartridge is now available in a miniaturized version known as the 370 series, which will fit all standard tone arms for both turntables and changers. When changing from one record groove size to another it is still necessary to replace the familiar "T-Guard" stylus. Not content with the two customary stylus sizes, Pickering has five standard sizes available from stock, ranging from 0.5 mil to 2.7 mil. And that's not all. Seven other sizes ranging from 0.8 to 3.0 mil are also available on special order.

When a standard pivoted tone arm moves across a record it describes an arc, but the original cutter which engraved the grooves moved in a straight line. The difference between these two paths is called tracking error and there have been numerous attempts at circumventing it dating back twenty-five years or more.

The original Edison radial tone arm, for example, actually employed a lathe arrangement with a feed screw, which operated in identical manner to the original cutter. But when the groove pitch (number of grooves per inch) varies as widely as it does today, this is obviously impractical. A couple of years ago the Ortho-

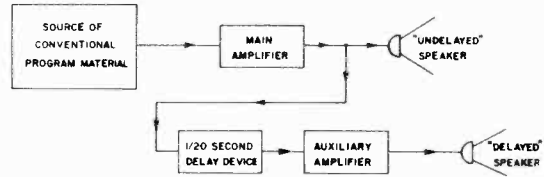
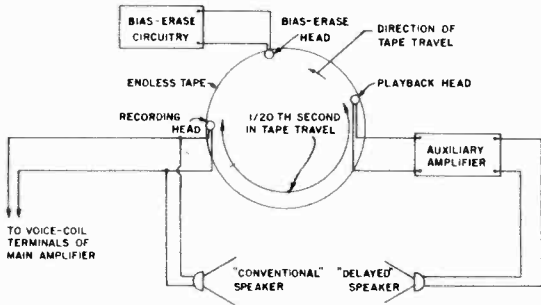

"ECHO CHAMBER" is built into Xophonic system by Radio Craftsmen, shown here in picture and diagrams. Tape echo tried at first proved too expensive so an acoustic delay line was employed.

INPUT

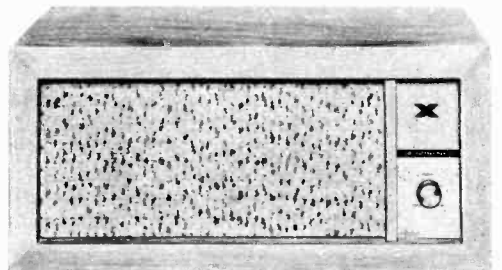
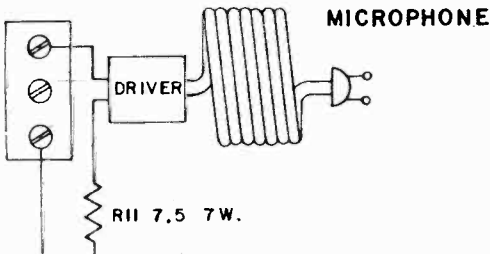

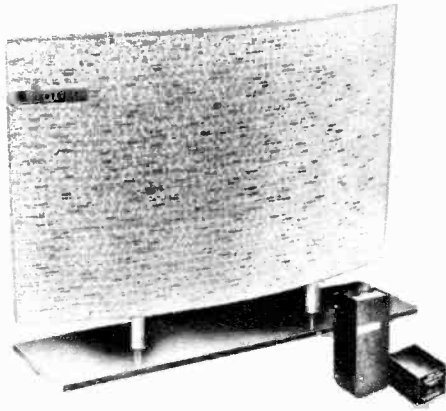

**CONDENSER-TYPE SPEAKER.** Pickering's Isophase. is an old idea, revived for hi fi for first time.



**IONOVAC TWEETER** by E-V will remind old-time radiomen of the "singing arc" of many years ago.

Sonic appeared, which is an overhead mechanism moved along by the spiralling groove itself.

Now another old idea, the parallelogram principle, has been resurrected. This time it is the BJ-Super 90 made in England by Burne-Jones and imported by Electro-Sonic. Since the stylus is at all times tangent to the groove, the manufacturer can claim "only BJ arms overcome tracking error."

But this idea has been tried and found wanting repeatedly, because the groove has to do all of the work of maintaining tangency. And there is so much more mass and friction in a gadget like this, that any advantage of minimizing tracking error is more than overcome by the inherent losses. In other words, we have reduced record wear from one source to a negligible amount but have added even more from another source.

Another Electro-Sonic import, this one from Watts of England, really looks good. It's called the "Dust Bug" and it's a record cleaner which works. A rolling brush of very soft nylon bristles set in its own "tone arm" cleans the records and deposits a very thin film of ethylene glycol and water on the record surface.

The Duo-Master is another gadget which should appeal to hi-fi fans. It is marketed as a TV remote control, but it is actually a complete super-sensitive tuner of TV audio, which is of course an FM signal. Although it has provision for plugging in headphones and has a self-contained speaker, the important thing is that it also has an external take-off for feeding into a hi-fi amplifier or tape recorder.

A new gadget by Radio Craftsmen per-

mits the audio bug to add his own echo effects to records. Evidently beginning with the thesis that recordists and broadcasters are babes-in-the-woods regarding acoustics, they now offer you the means of correcting all this. It consists of a second amplifier and speaker channel whose reproduction is delayed 1/20 second, thus providing a sort of echo effect. Since true reverberation consists of a multiplicity of delayed sounds, and this reverberation is very carefully controlled in broadcast and recording studios, why bother?

Pickering, who make some of the finest phono reproducing gear in the business, have decided to invade the sphere of speakers with an updated version of the ancient condenser speaker idea. Since it never has been, and still isn't, possible to derive much power from such a system, this is actually another form of tweeter which must be used in conjunction with a conventional cone woofer. Although many home instruments now have condenser speakers, this one is alone in the hi-fi field. Perhaps there's a reason.

Another hoary old idea, the ionic loud-speaker, is now getting another go-round. This is truly a speaker without moving parts, now offered in commercial form as the Electro-Voice Ionovac. In it a cloud of ionized air is modulated by the audio signal, which directly produces the compression and rarefaction of sound waves. The idea of a speaker without mass, friction or moving parts is highly intriguing, and perhaps this is the direction for hi-fi speakers of the future. But for the present it is too noisy and too restricted in range.

Oh well, trial and error is the only way to true progress. •

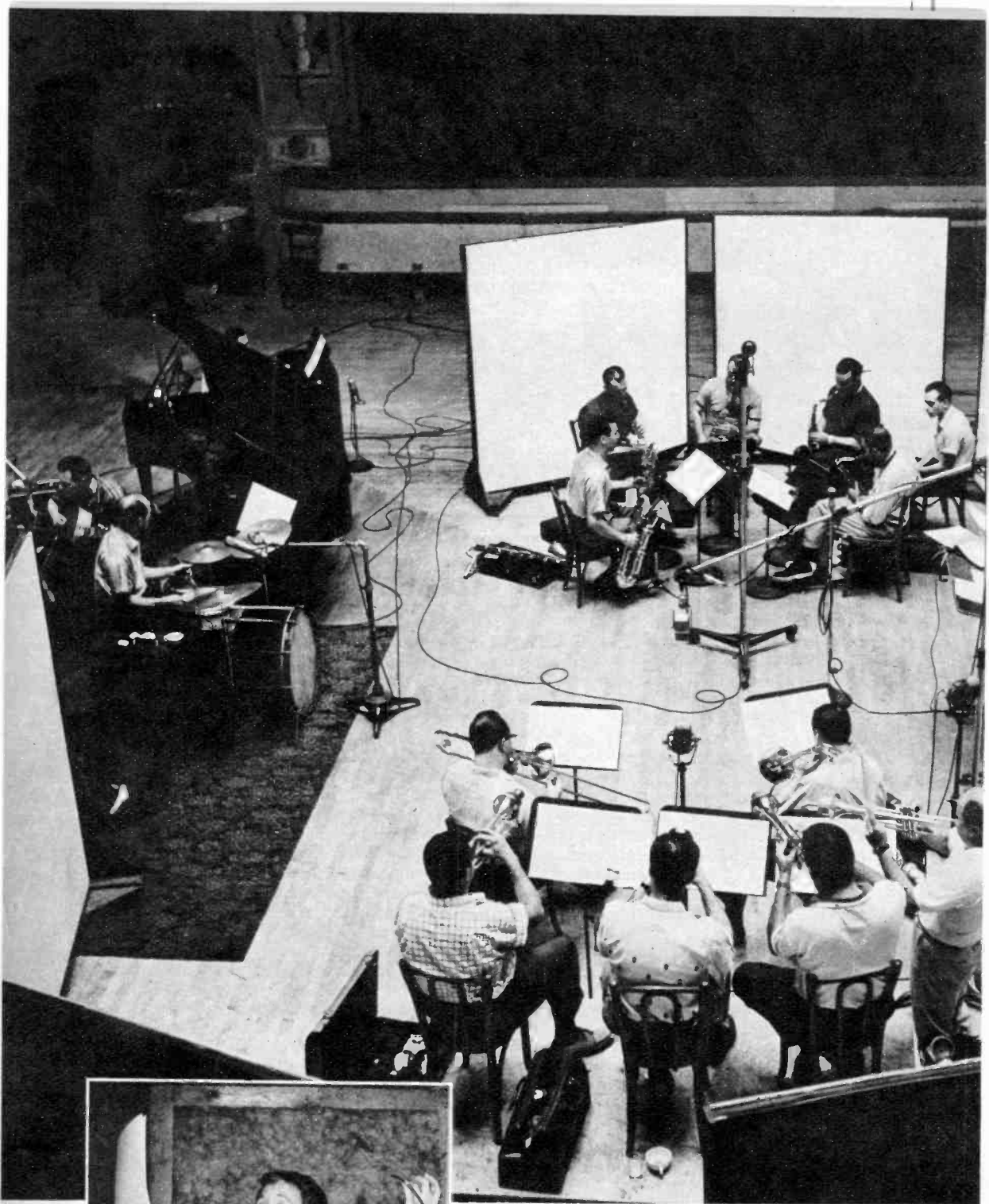

All photos by Ed Pryor



**BILL FINEGAN** was fronting, **Billy Butterfield** playing his trumpet when we got there. We were free to shoot except when a red light said "Recording in progress." **Lee Wiley** usually sang from a soundproof booth. She gave an impromptu solo a cappella for this shot.



# Major Recording Session

Take a look backstage and see what it's like when the most famous names in jazz are working on a new high-fidelity album

**I**T WAS a pleasantly warm summer's evening, with the day's work done, when editor Joe Daffron and I were sitting around batting a barely existent breeze. "You want to see what goes on at a recording session?" I asked. "They'll be blowing some pretty good jazz at Victor in a little while."

Now Joe comes from one of the cradles of jazz below the Mason-Dixon line. But when I told him that singer Lee Wiley would be there, along with Eilly Butterfield's band and other great names including Bob Haggart, Al Cohn and Bill Finegan, his interest perked up considerably.

"I'll see if Ed Pryor wants to come along and bring his camera," he said. "Maybe we can get a picture or two for the book." And so before long the three of us were headed for a big old place on Manhattan's lower east side.

Much of RCA-Victor's recording is done in this building, which carries a name vaguely reminiscent of orators, dictionaries and cigar butts. But it wasn't selected for its history or faded-trollop appearance. Victor settled on it after a long search because of its superb acoustics, and their records have never sounded better.

We arrived to find a group of the country's top musicians and one of the greatest of the jazz gal singers, obviously enjoying their work playing and singing the music they like best. Artists-and-Repertoire man Fred Reynolds told us that this was to be a part of a Lee Wiley album titled *A Touch of the Blues*.

We were invited to join the party, relax and listen, and shoot whatever pictures we wanted. We got a few more than the one or two the editor wanted, but we thought they were so good that you should see them, too. Here they are. •

TENOR SAX man Al Cohn, a bandleader in his own right, did some of the arrangements for the album. Since this was recording—not video—he was informally dressed: sneakers, dungarees and two-day growth. Before the first downbeat, Artists-and-Repertoire man Fred Reynolds gave final instructions.





**FIRST CHORUS** included a Butterfield solo. At times, his smooth style got a little guttier and sounded like Satchmo himself. Lee liked, obviously. Bill led through modulation into her first solo.



**AT STEREO** speakers, four pairs of ears listened intently for balance and extraneous noise. They belonged to technician Al Fath, engineer John Norman (at console), Fred Reynolds and musician contractor Kay Finegan.



**AFTER** the first rundown, the group worked over rough spots while Wiley, Butterfield, and Finegan conferred. Kay (yes, she's Bill's wife) came bouncing out with new instructions. Everybody seemed to be getting into the act.

IT ISN'T EASY to get the best of everyone's ideas, reconcile differences, get a show like this on the road. Parts were rewritten hastily. Lee and drummer Don Lamond weren't too happy. "Hey, Bill—what did you do? Those were my best eight bars you cut!"

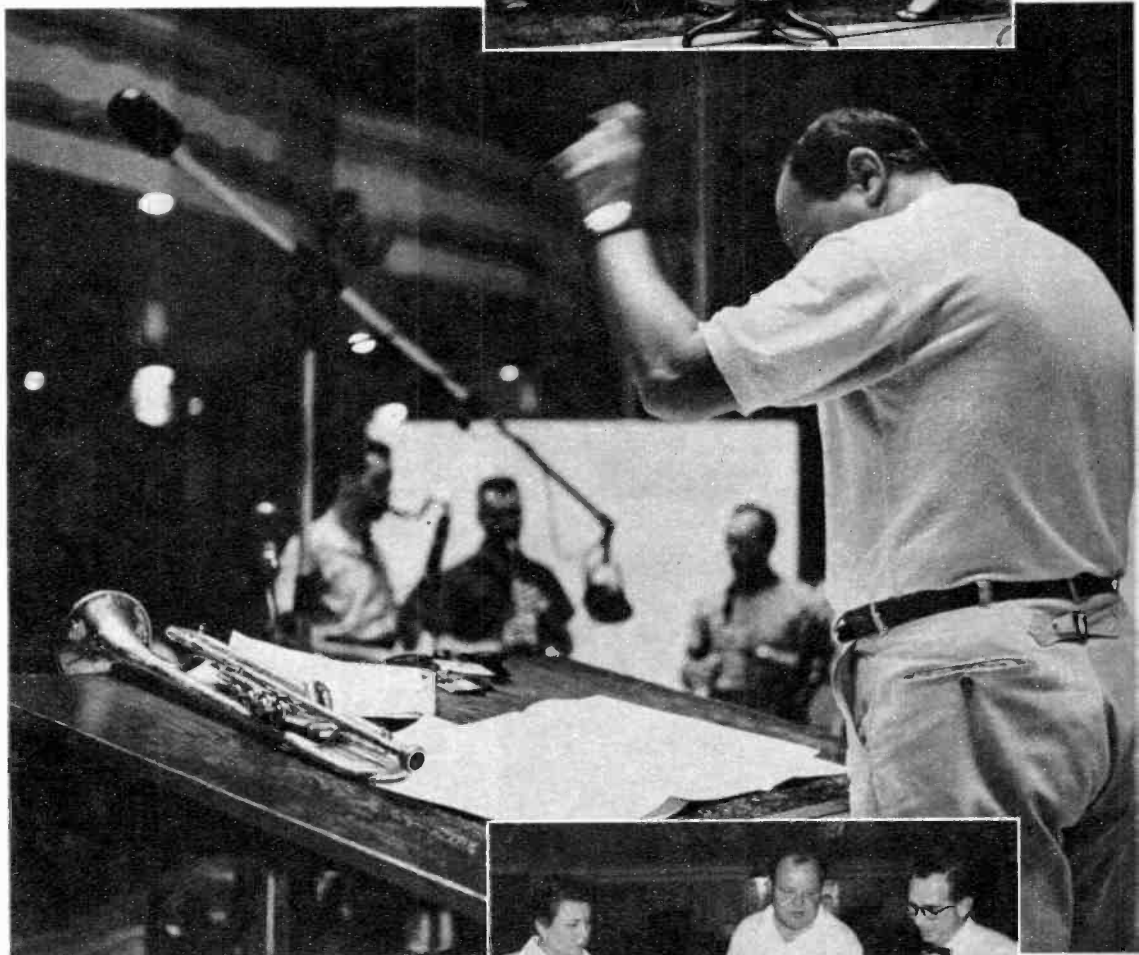

THE BAND was quickly off again, with Billy flailing furiously. It seemed to end on a sour note—a clash of artistic temperament—but Bill Finegan stood firm and had his way, which, we gathered, is not at all uncommon.

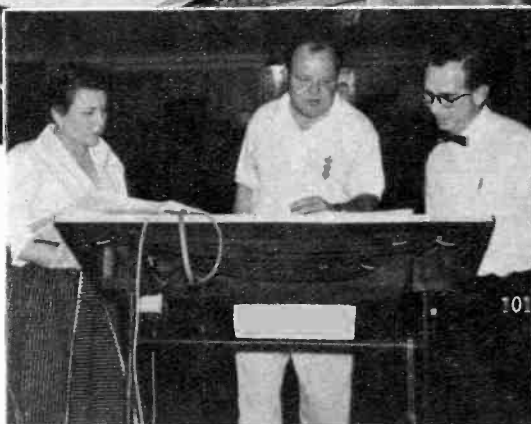

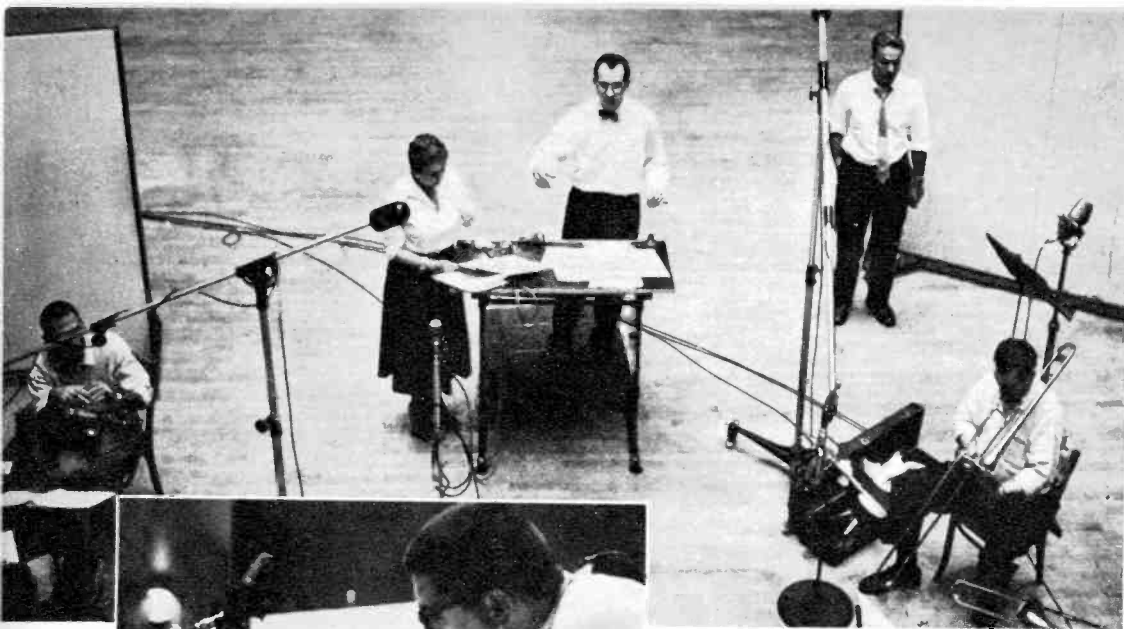

**BILL FINEGAN** takes over the stand now. As a former Tommy Dorsey arranger, the man responsible for most of the Glenn Miller book, and his leadership of the Sauter-Finegan Orchestra, he has the respect of all.



**ONCE MORE** everybody digs in. "Trumpets, at bar 65 instead of an E flat we want . . ." This was a familiar sight throughout the session. The pencil is also an important instrument to the hard-working musician.



**NOW** they were really rolling. It sounded great. The three-man trumpet section, augmented by the famous horn of Billy Butterfield, blended on a smooth, muted passage.



**LEE WILEY** liked; Bob Haggart liked. It was obvious in their expressions. Bob wasn't really trying to saw the top off that telefunken mike, as it appears. Actually, his bow rests on the music rack, as he chats.



NOW everything was ready for the final take. "Hold it down, boys—Miss Lee Wiley is the star." This take should do it. No one hoped so more than the watcher, inset, our canny cameraman had spotted.

THE PLAYBACK followed. All gathered about the speaker to listen. They had it down now. "It's great, Billy—wonderful sound. Relax a little."

THE ELDERLY gentleman had his wish. The artists had finished. He could clean up and head for home now. "A Touch of the Blues" was down on tape.





# The Latest in Stereo

Though its growth has been slow and steady, there are now definite signs of wonders on the way

**T**HE SEASON 1957-1958 will probably go down in history as the beginning of the big stereo sound boom, for on every hand we see signs that stereo is bustin' out all over. It has been growing steadily, but slowly, for several years, but there are now encouraging signs that stereo is really ready to take off.

While the demand for stereo tapes was fairly small, it was met by just a handful of small record companies. They did a splendid pioneering job, but their repertoire and their resources were just too limited to enable them to put over stereo in a big way. Performances were for the most part by little-known orchestras and artists, and due to the tremendous expense of recording an opera or even a major symphony, such releases were few and far between.

Both the hi-fi stereo fan and the dealer alike were waiting and hoping for the day when one of the major companies, with their vast roster of artists and adequate income from records, would take the stereo

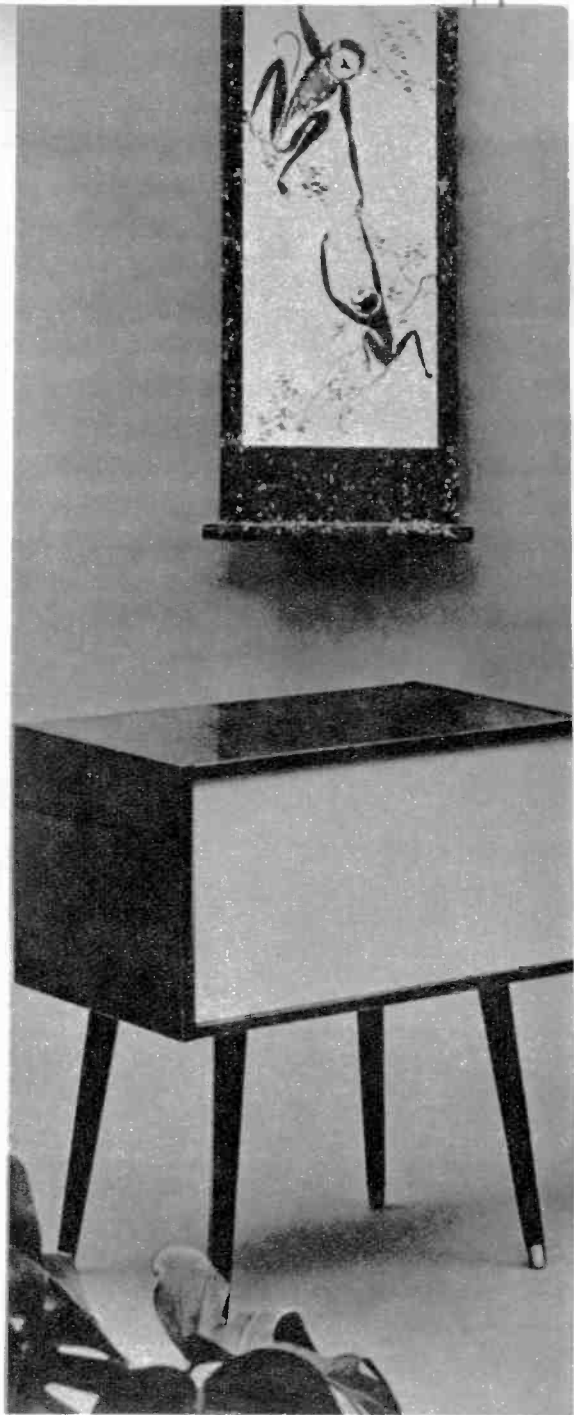

A HANDSOME stereophonic system that fits into any decorative scheme is the Concertone custom model. Tape transport and speaker-amp systems are encased in Accousti-Craft cabinets.

MONAURAL tape recorder at the left is the VM Celeste. It can be converted to stereo, or three-dimensional sound, by adding second speaker, second amplifier. Legs are available.





plunge. Finally RCA-Victor did break the ice and jump in, to be followed in quick succession by just exactly nobody.

The other major companies hung back and sat on their hands, and the war of nerves was on. Now the thing that was needed was just one more major company to add their weight on the side of stereo,

and almost surely the others would capitulate. But this particular log jam was to be a long time breaking.

Now at last Mercury steps forward, with their fine artists and excellent recording techniques, to get the bandwagon rolling at least in second gear. Their first release includes stereo recordings by the Minne-

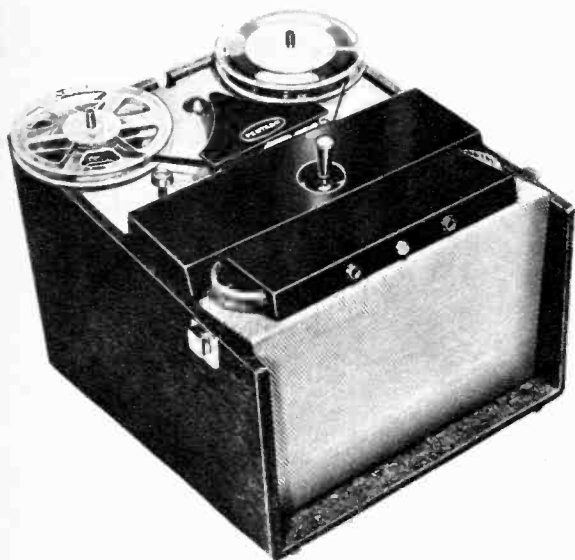

TWO SPEEDS ( $3\frac{3}{4}$ ,  $7\frac{1}{2}$  ips), two tracks or stereo, Unimagic control, are features of the Pentron T-series which are for playback only.



ECONOMY model of the Pentron line is the NL-1 shown in this picture. It has a single control for play, record, fast forward, fast rewind.

apolis Symphony, Eastman-Rochester Symphony, Detroit Symphony and the English Halle Orchestra. Two or three other major record manufacturers are reported to be on the verge of entering the stereo field, and if they do the major equipment manufacturers will not be far behind with new stereo reproducers. Meanwhile, over in England, "His Master's Voice," one of the oldest and largest labels, is offering recordings by the Philharmonic Orchestra, the Glyndebourne Festival Orchestra, pianist Jacques Abram, cellist Paul Tortelier, and the Glynden-

DEVELOPED by the Emory Cook Laboratories for the binaural playback of twin-band records were these units. One at right contains twin preamps.

bourne Festival Opera Company on what they call "stereosonic" tapes.

But no matter what it is called, stereo already is making obsolete the ordinary old-fashioned monaural sound most of us know today. The effect of this system, the added dimension it gives to sound reproduction in the home, is absolutely unbelievable until one has actually heard it. The difference is every bit as dramatic as the difference between black-and-white and full-color photography.

The excellence of this system is no surprise to the engineers who have been nurs-

ACCESSORY pickup head shown here is easily attached to the existing head for binaural records. Also a product of the Cook Laboratories.



ing it along in the laboratories for so many years. It has even had public exposure from time to time over these years, without any terrific demand being built up. The surprising thing now is that the public hears it, likes it, wants it.

Walt Disney used a form of stereo sound in "Fantasia." The Bell Telephone Laboratories long ago showed their stereophonic sound-film system. WQXR in New York has been presenting stereo broadcasts for several years. Cinerama has a form of it; so does Cinemascope. Yet none of these systems has captured the public fancy as has stereo recordings on tape for home use. More and more, at hi-fi shows and audio exhibitions throughout the country, the exhibitors demonstrating stereotapes and stereo reproducing systems are the ones drawing the big crowds.

Often one sees a visitor wandering aim-

lessly from exhibit to exhibit, seemingly bored and dazed by the cacaphonic onslaught to his eardrums, until he comes within hearing of a stereo demonstration. Immediately his eyes brighten a little, he cocks his ear in the direction of this new sound—and he's hooked. In he goes to hear a little more of this new sound, and ever after the old non-stereo stuff seems pale.

The basic principle of stereo is an effort to complement more perfectly the hearing mechanism. It is the fact that we have two ears that enables us to tell from which direction a sound is coming, even though we may not be able to see the source. But with ordinary monaural reproduction everything seems to be coming from the same place—the loud-speaker; or worse yet, the reproduction is so jumbled and confused that it is impossible to tell just

[Continued on page 110]

**BINAURAL** reproducer head is optional with the new Presto R-700 tape recorder. It mounts in rack, console or carrying case.

**SPEEDS** of 7½ and 15 or 3¾ and 7½ ips, two record and playback preamps are featured by Concertone Custom Model 23.

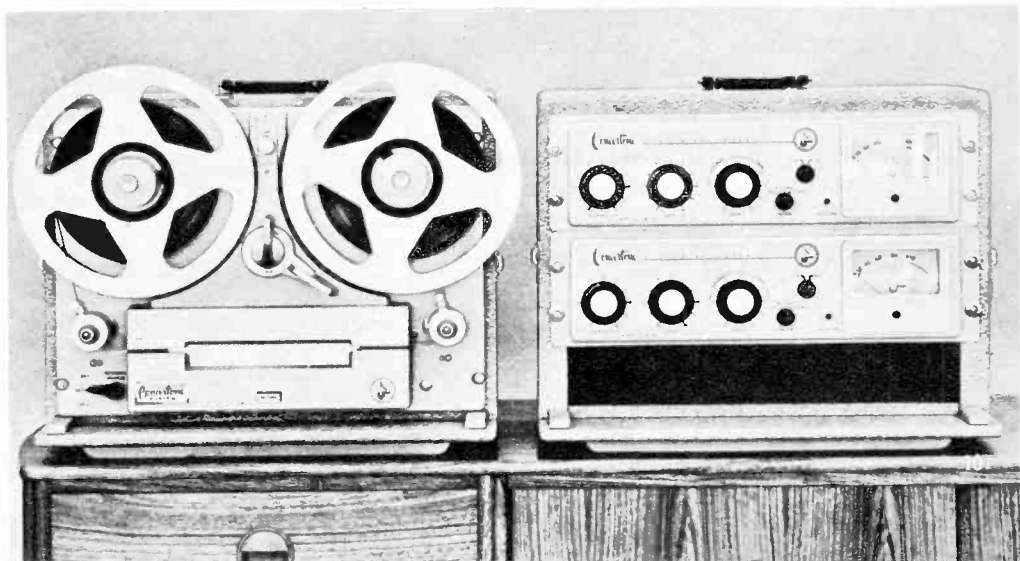

## how stereo recordings are made

IN RCA-Victor studios in New York City, engineer Ray Hall adjusts controls while recording an original stereo tape. The watcher is Roy McClay.

ORIGINAL binaural tape is then loaded onto a high-speed duplicating machine, which is known as a "master." Each of these feeds six "slaves."

RCA-Victor photos



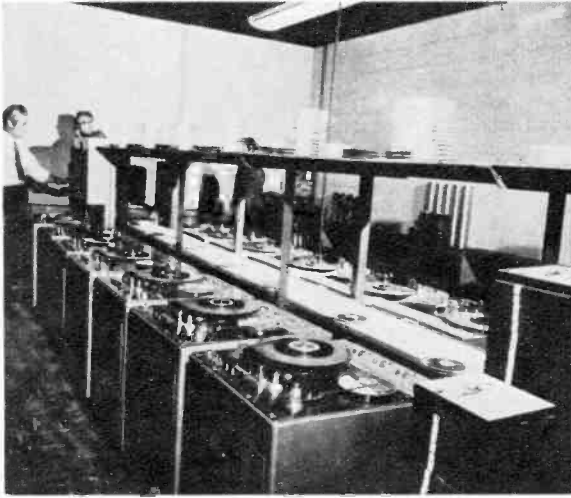

"MASTER" is at the far left; engineer has just pressed button to start "slaves." Note conveyor.



CONVEYOR carries the stereo tapes to testers, foreground, who make selective tests of output.

COMPLETED stereophonic tapes are packed and shipped to a plant in the midwest for warehousing. This photo, taken in the tape vaults of the New York studios shows tapes from "master" machines being filed.

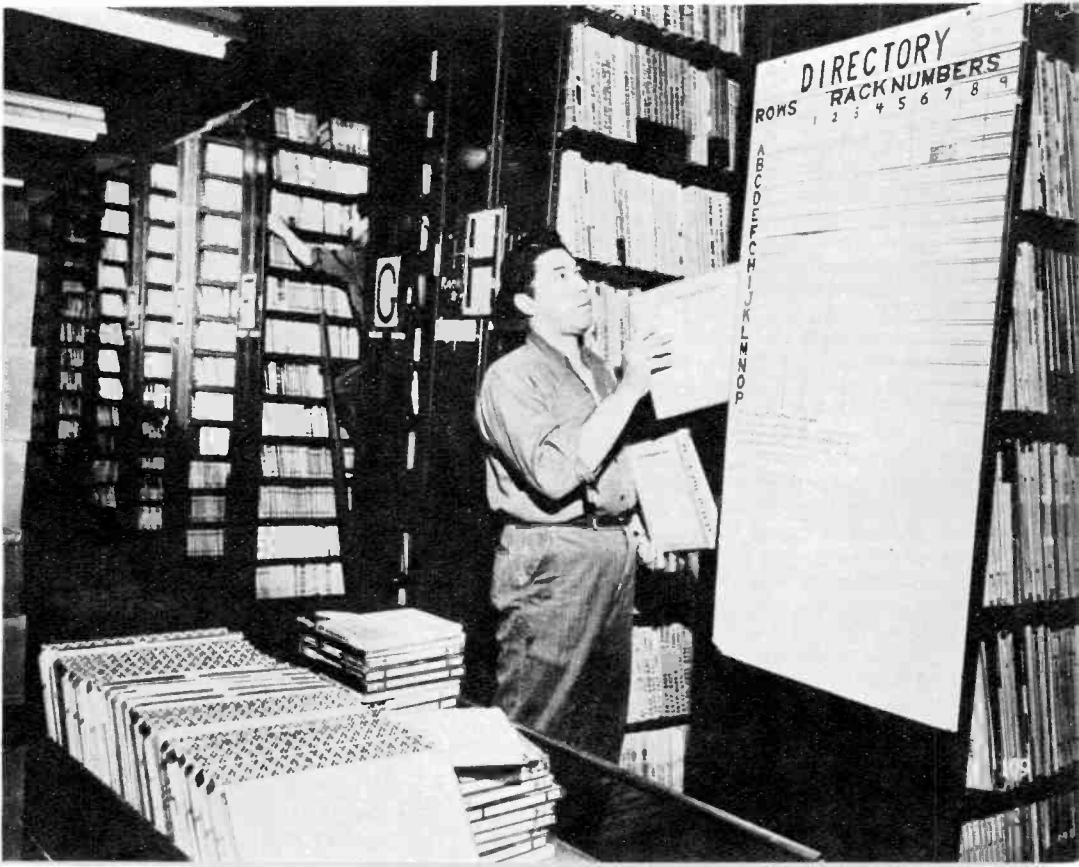



COMPLETE with FM-AM radio, phono and tape, this handsome Ampex system includes two amplifiers and two speakers for the playback of stereophonic tape.

[Continued from page 107]

which sounds were originally performed where.

But with stereo reproduction, using just two speakers properly placed, the sound immediately takes on a spaciousness and perspective which defies comparison. Instead of now sounding as if it were coming from two points rather than one, the music actually seems to come from definite locations, behind the speakers, in front of them, even *between* them. If the singer accompanied by orchestra was at stage center during the original recording session, the sound of her voice will now seem to come from right smack in the middle of those two loud-speakers. If the reader finds this hard to believe when he sees it in print, he shouldn't dismiss it lightly. It still seems incredible even when you're right there.

Stereo sound involves two completely separate recording and reproducing channels. Just as there is always some difference in loudness and time between sounds arriving at each of the two ears, so this principle is used in the setting up of two different recording channels. When duplicate tapes are made for public sale, the recorded sounds from one channel appear on about half of the tape width, while those of the second channel occupy the other half of the tape.

The tape reproducer in the home then has two separate playback heads, one to scan channel 1 and another to scan chan-

nel 2. It also must have two separate playback amplifiers, two separate sets of cables, two separate audio power amplifiers, and two complete and independent loud-speaker systems. The setup is admittedly more complex and expensive, but the outstanding results more than justify the investment.

While complete stereo systems are available for those who are just beginning in hi fi, if you already have a sizable investment in audio gear, you need not junk it. Chances are it can be easily augmented and incorporated into a complete stereo hi-fi system. More and more tape recorder manufacturers are offering modification kits or factory changeovers for converting monaural tape systems to stereophonic.

But whether buying a conversion or a whole new system, be careful to avoid the confusion surrounding the recording of tapes today. Some manufacturers offer tapes which have comparable sections of each channel directly opposite each other, while others make their tapes with one channel displaced lengthwise from the other. Some manufacturers even make both types.

When the channels are directly opposite, the two tape reproducer heads are, of course, directly over one another and are said to be *in-line* or *stacked*. But when the two tracks are displaced, the two heads, of course, must conform, and are then said to be *staggered*.



COMPACT three-unit table-top system by Ampex shown in this photograph includes one Model A-121 tape player/recorder and two A-621 amplifier/speakers.



Some, but not all, stereo tape reproducers can be switched from stacked to staggered operation at will. Although there now appears to be a definite preference for the stacked type, the trend isn't yet strong enough to insure standardization. Meanwhile, the poor audiophile finds himself in a quandary.

The best you can do is try to get a reproducer which is compatible with both methods. If this is not possible, then you will have to standardize at least in your own operation. Examine catalogs of the various tape libraries and determine which type has most of the music you will want to hear. Then get a tape reproducer of that type, and purchase tapes of that type exclusively.

For you who are expanding your system to stereo, it is strongly advisable for you to duplicate those parts of the system you already have. This is particularly true of speaker systems, and to a somewhat lesser degree of power amplifiers. Since the equalizer-preamplifier is required strictly for phono reproduction, it will not be necessary to duplicate these units for stereo tape. Having both channels identical will simplify the accurate balancing of the system.

The three main elements in a stereo reproducing system, then, are as follows:

1. A stereo tape reproducer (with heads stacked, staggered, or both)

2. Two power amplifiers (preferably identical)
3. Two loud-speaker systems preferably identical)

But don't stop there. You may soon find yourself buying a new turntable and tone arm as well! We have already seen that practical stereo sound first was demonstrated on optical film track, then magnetic film, and finally tape. But this isn't all. Remember that we have also had commercial stereo discs as well in the form of the Cook series. Did you know that the Bell Telephone Laboratories had a stereo record 30 years ago?

The Cook system, of course, uses two separate bands of grooves on the disc, with a coupled pair of pickups tracking each set of grooves simultaneously. The Bell unit, on the other hand, achieved the two-eared effect by engraving a groove which was both lateral and hill-and-dale at the same time.

The side-to-side motion of the groove represented the signal for one channel, while the up-and-down movement generated a signal which was fed to the other channel. Although the recording process was reasonably successful, there was difficulty at the time in developing a pickup which could adequately separate this complex combination of motions into two separate and distinct audio signals. But times have changed since then and pickups have improved.



**STEREO** can be economically added to existing high-fidelity systems with the Bogen ST10. Dual preamp, 10-watt amplifier are in the one unit.



**AM AND FM** binaural outputs as well as complete equalizer and preamplifier are included in the Scott 331-B AM-FM tuner shown in this photograph.



**STEREO** dual channel playback preamp, the Pen-tron Model CA-15 has separate equalization controls for each channel plus master gain control.



**COMPLETELY** self-powered is the E-V model 3303, a stereo FM-AM tuner. Its FM channel is Armstrong superhet with two stages of limiting.

At the recent London Audio Fair, Arnold Sugden, who manufactures hi-fi products under the trade name "Connoisseur," demonstrated his version of a stereo disc, and created quite a sensation with it. The basic principle is the old vertical-lateral system of Bell Labs. The difference is that Sugden has been able to reproduce with a satisfactory isolation between channels.

Meanwhile in the United States at least two concerns are reported to be at work on new methods of recording and reproducing stereo from disc. Trade rumor has it that Westrex in California, a Bell Telephone subsidiary, and Columbia records in New York both have systems under development which are said to differ from the vertical-lateral method. Since they are also presumably different from each other, these added to the Cook and Sugden systems make at least four ways now in the works.

One of the problems for the research and development engineer is to come up with a system which is "compatible," which can also be used on present monaural equipment. The Cook system is completely compatible, as either track may be played separately by a single pickup. The Sugden method is also said to be, as conventional equipment can reproduce only the lateral component of the groove.

Still another approach has been developing in the New York recording studios of M-G-M. Quietly and without fanfare they have already proven that their Perspecta-Sound system, originally developed for movie soundtrack, can and does work on disc. This is a three-speaker system with an audio signal which is essentially monaural. The relative level of reproduction from each channel, however, is determined by one of three sub-audible control signals

THE TWIN-HEAD pickup arm shown in photograph below tracks the inner and outer bands of binaural disc recordings. Maker is Livingston.



which are engraved in the groove right along with the audio signal. These varying levels then give the impression of perspective and direction. Here again the problem is one of reproduction, although it is economic rather than engineering. The device which performs the separation and controlling of the signals is known as an integrator and it costs a theater owner around \$800. The Perspecta people would like to bring this down to around \$150, in which case Perspecta-Sound on disc may become a commercial reality.

Whatever method is finally arrived at as the standard, it is obvious that the phonograph record industry very much wants a stereo disc. Such a development would give tremendous impetus not only to records, but to home-instrument manufacture as well. And with the soft state of the TV set market today, this is something they could well use. All of which augurs well for the hi-fi music fan. And there are some industry sources who think this will be introduced to the public in 1958.

So now we have stereo on film, tape and disc. But there is still a fourth means of enjoying stereo sound reproduction. We have already mentioned the AM-FM simulcast, where one channel goes onto the AM carrier while the other is carried by FM. There have also been successful experiments carried on by two co-operating FM stations, each broadcasting one channel. Many AM-FM tuners are equipped to receive the former type of stereo reproduction, while the latter requires two separate FM tuners. But there is still another method of stereo broadcasting in which both channels are carried on only one FM carrier. This system is known as multiplexing.

In the FM multiplex system, which was the last important contribution by Major Armstrong prior to his death, a conventional modulator superimposes an audio

BINAURAL amplifier shown in this photograph is a product of Bell Sound Systems. Its smart slim styling and compactness are noteworthy.



signal on the FM carrier in the usual way. At the same time a supersonic frequency is imposed on the FM carrier and audio superimposed on that as well. Thus the supersonic signal acts as a sub-carrier for the second audio signal, which really makes the system FM within FM.

Since there is absolutely no interaction between the two signals noticeable at the receiver, it is of course possible to present two completely separate programs on the same carrier. But it is also possible to present both "ears" of the same program in a true stereo setup. Many of the better hi-fi FM tuners now have built-in circuitry to accommodate multiplex signals. All we need now is more FM stereo broadcasts.

Hi-fi fans can afford to be patient, though, for all of these budding wonders are definitely on the way. So hang on to your hats. Activity is increasing and the prospects are exciting. •

BEAUTIFUL luggage-type portable stereophonic tape recorder pictured below is a bright new addition to the large Ampex line of tape gear.

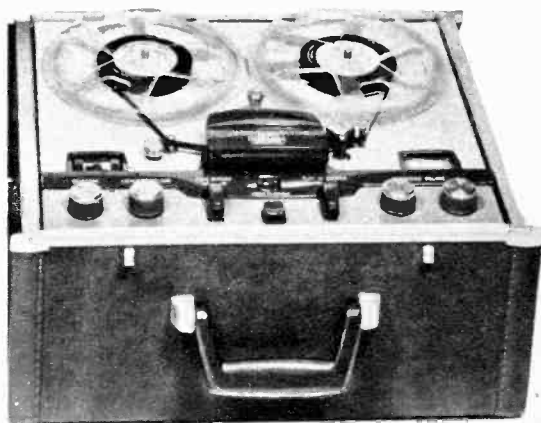

# The World's Most Extensive

## Now you can select your Jensen loudspeaker

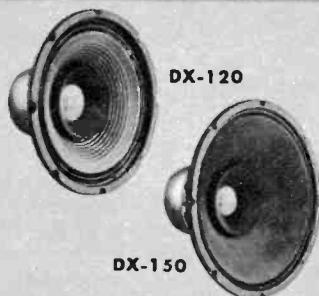
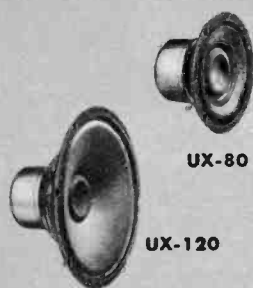

## New Performance Levels in New Price Ranges

### UNAX\* SINGLE ELEMENT

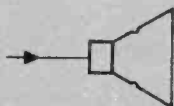

The new Jensen UX Series provides a new high in single-cone single voice coil loudspeakers at unusually low cost, actually outperforming comparable (and even more complex) units selling for much more. A listening test will convince you that this is a maximum value buy in hi-fi listening pleasure.

Of course, there are special design elements that enable us to give so much for so little. The cone is artfully dual acting, the center sector operating effectively for unusually extended highs, while the whole moves to reproduce the lows.

Withal, there is superb balance and cleanliness. And, if you choose, you can step up performance later with the inexpensive KTX-2 Step-Up Kit which substitutes a compression driver tweeter for the top.

**UX-80.** 8-in. Speaker. Net \$14.50  
**UX-120.** 12-in. Speaker. Net \$19.50

### DUAX\* 2-ELEMENT SYSTEMS

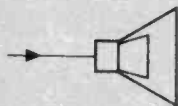

A step-up in the reproduction scale is the DX Series in which two carefully coordinated cones are driven by one voice coil. (Some call these "coaxials," but we reserve the name for still more elaborate systems and higher performance.)

The separate auxiliary radiator gives the designer a chance to attain a wider frequency range than with a single cone (albeit dual acting as in UX Series). The result is, with low cost, additional performance and added listening pleasure. We know of no similar speakers with equal sound, none with as high efficiency or as low distortion at anywhere near DX Series cost. Again you can step-up performance easily at anytime with KTX-2 Kit to substitute high-order compression driver tweeter operation at the high end.

**DX-120.** 12"; 1-lb. mag. Net \$25.50  
**DX-150.** 15"; 1-lb. mag. Net \$35.50

### COAXIAL 3-ELEMENT SYSTEMS

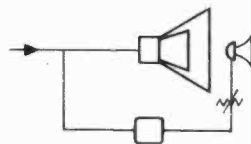

Still better than the "all paper" system with single voice coil is the use of a compression driver tweeter for the highs. The least expensive way to do this is to nestle a supertweeter coaxially inside the cone; it must cross over high in the frequency scale at 3500 to 4000 cycles. The third element is the diffusion radiator which shapes and disperses middle-high response. (Some call such speakers "Triaxial," though Jensen alone is entitled to use this registered name, applied by us to true 3-way speakers only.) Again, we guarantee more and better sound, cleaner hi-fi at lower cost, than all comparable speakers. And you can step up performance correctly and impressively with a real C.D. horn 600-4000 cps mid-channel (KTX-2 Kit) that leaves you with a real 3-way system.

**12" Models.** CX-120\* ..... \$49.50  
CX-225 ..... \$59.50  
**15" Models.** CX-150\* ..... \$66.50  
CX-255 ..... \$76.50

\*Denotes 1-lb. magnet; others 1 1/2 lbs.

### SELECTING A HI-FI SPEAKER? YOU'LL WANT THESE HELPFUL, INFORMATIVE BOOKS

"How to Select a High Fidelity Loudspeaker." A comprehensive, authoritative manual covering all types of high fidelity loudspeakers and systems, their operating principles, performance and relative advantages. 24 pages, profusely illustrated. Write for Manual 1061. Price 25¢.

"Guide to Jensen High Fidelity Loudspeakers." Complete specifications and detailed descriptive information on all Jensen high fidelity loudspeakers and accessories. 24 pages. Send for Brochure 1021. Price 25¢.



# High Fidelity Loudspeaker Line

from this new complete range of types and sizes.



...All with Traditional Jensen Quality

## COAXIAL 2-WAY SYSTEMS

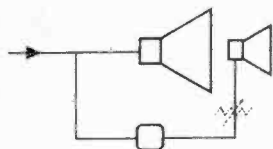

By using two completely independent (but carefully coordinated) speakers, each with its own magnetic system, voice coil and cone, the true two-way system spans the frequency range to obvious advantage in smoothness and extent, cleanness, low distortion and uniformity of angular dispersion.

Coaxial mounting makes them a convenient unitary package. Please note that we at Jensen use the term "coaxial" only in referring to a speaker with two completely independent systems.

Lowest in cost in the Jensen coaxial family is this fine group of speakers employing "cone" type direct radiator units for both tweeter and woofer. Available in 8, 12 and 15-inch models, they provide a maximum of value in true two-way system speakers.

**K-80.** Coaxial, 8-in. Net \$16.75

**K-210.** Coaxial, 12-in. Net \$27.50

**K-310A.** Coaxial, 15-in. Net \$39.75

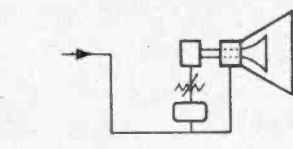

The highest type of performance in the coaxial two-way loudspeaker is attained by the use of a compression-driver horn-loaded tweeter for the high end. When properly designed, there results an outstanding clarity, realism and instrumental separation not achieved by lesser designs. By adopting the expensive "thru bore" construction, the tweeter horn can be made long enough to operate at the lowest practicable crossover frequency, a very desirable feature for the very best sound.

In this manner, the very popular Jensen H-222 and H-520 give you the "tops" in fine coaxial performance. Crossover is at 2000 cycles. Though many will see no need to, you can step-up performance to full three-way with KTX-1 Range-Extender Supertweeter Kit.

**H-222.** Coaxial, 12-in. Net \$62.50

**H-520.** Coaxial, 15-in. Net \$79.50

## TRIAxIAL® & TRIAX® 3-WAY SYSTEMS

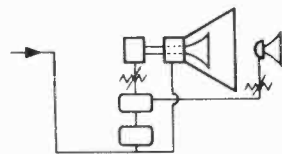

The true three-way speaker system divides the range in three parts with three electrically and acoustically distinct and independent elements, each designed to perform near-ideally in its portion of the range.

The famous G-610A TRIAXIAL was the first (and until our new G-600), the only speaker made in accordance with this concept! It employs a heavy woofer and two compression driver horn-loaded elements for m-f, and h-f channels. (The woofer cone acts as the final section of the m-f horn.) Its performance is so outstanding that it easily rates as the world's most wanted hi-fi speaker.

Now, for those who would like a G-610A, but are dissuaded by the price tag, Jensen announces the new lighter, less expensive G-600 TRIAX with similarly outstanding features and performance.

**G-610A.** Triaxial, 15". Net \$252.75

**G-600.** Triax, 15". Net \$129.50

**Jensen** MANUFACTURING COMPANY  
6601 South Laramie Ave., Chicago 38, Illinois

SEND FOR FREE DATA  
SHEET 165-B



## Yours for the Asking

The lowest cost hi fi is yours when you accept the gifts and special offers awaiting your mail request

**A**LL OF THE SPECIALS on the following pages are being offered to you because you are a very special person. You are a hi-fi audiophile, and the manufacturers and distributors in this hobby of ours want to know you better, and they want you to become acquainted with them and their services.

Each of these offers is genuine and has been personally verified by a member of our editorial staff. There are no catches, no gimmicks. If a small service charge is requested, it is noted here. If not, you pay nothing, either now or later.

Please do not send your requests directly to us. We are not making these offers. We only hear of them—or in some

cases suggest them—and pass the word along to you. In each case the concern making the offer is clearly listed.

As a final word, please don't ask for anything you can't use. All of your friends can make requests, too, but the offers are limited to one request per letter.

### Installation Plans

Construction details for a Demountable Music Wall, shown above, comprising simple interchangeable plywood cabinets, which house all audio, radio and TV equipment, and the record library as well. If not available free from your local lumber dealer, send 10c for Plan No. 8 to Douglas Fir Plywood Association, Tacoma, Wash.



"You'll Have The Best  
in Hi-Fi Sound with  
a Jensen Speaker System!"

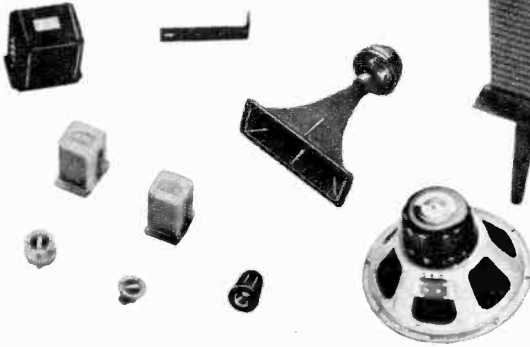

## ADD YOUR OWN TOUCH TO HI-FI...and SAVE!

You'll enjoy hi-fi music doubly when you put together your own easy-to-assemble Jensen speaker kit... and you don't need a work shop. The acoustically correct Jensen-designed Cabinart enclosure kit and the famous Jensen loudspeaker kit can be assembled right in your living room without any messy woodworking or wood finishing. Everything is accurately pre-cut and *pre-finished* with a professional furniture finish in your choice of mahogany, walnut or blonde mahogany. You'll have the same fine matched speaker components used in Jensen's factory assembled complete high fidelity reproducers—and at far less cost, too!

Send 50¢ for your copy of Manual 1060 for full information about selecting and building Jensen speaker systems.

System Type	"Woofer" Size	Equivalent Jensen Reproducer	Jensen Speaker Kit		Type	Cabinart Cabinet Kits			
			Model	Price		Basic Cabinet Kit	Price	Dress Kit	Price
3-Way	15"	Imperial	KT-31	\$184.50	Corner* Horn	K-101	\$89.00	P-201	\$54.00
3-Way	15"	Triplex	KT-32	169.50	Corner* Bass-Ultraflex	K-103	48.00	P-203	39.00
3-Way	15"	Triplex	KT-32	169.50	Low Boy Bass-Ultraflex	K-105	48.00	P-205	39.00
2-Way†	15"	—	KT-21	99.50	Corner* Bass-Ultraflex	K-103	48.00	P-203	39.00
2-Way†	15"	—	KT-21	99.50	Low Boy Bass-Ultraflex	K-105	48.00	P-205	39.00
2-Way†	12"	Concerto	KT-22	73.00	Corner* Bass-Ultraflex	K-107	39.00	P-207	36.00
2-Way†	12"	Concerto	KT-22	73.00	Low Boy Bass-Ultraflex	K-109	39.00	P-209	36.00
2-Way†	8"	Contemporary	KDU-10	24.75	Corner* Bass-Ultraflex	K-111	23.00	P-211	25.00
2-Way	8"	Duette Treasure Chest	KDU-10	24.75	Duette	K-113	18.00	P-213	21.00

\* Gives excellent results against sidewall. Bass-Ultraflex is a Jensen trademark.  
† Cabinet provides for expansion to 3-way system of any time with Jensen KTX-1 Range Extender Supertweeter Kit, price \$43.75.  
‡ Available in Mahogany or Korina Blonde.

BURTON BROWNE ADVERTISING

**Jensen** MANUFACTURING COMPANY  
6601 SOUTH LARAMIE AVE., CHICAGO 38, ILLINOIS

Division of The Muter Co.—In Canada: Copper Wire Products, Ltd., Toronto

JENSEN LOUDSPEAKERS . . . WORLD'S QUALITY STANDARD FOR MORE THAN A QUARTER CENTURY

## Yours for the Asking

### Typical Installation Diagrams

A beautiful book, showing drawings of typical hi-fi installations, necessary components and their interconnection. Included are a number of color photos of tape recorders and amplifiers in typical surroundings. Ask for Catalog No. 101. Write to Bell Sound Systems, Inc., 555 Marion Road, Columbus 7, Ohio.

### Audiocraft Magazine

This is the new how-to-do-it magazine of home sound reproduction. Regularly features articles on electronic construction, sound servicing, woodcrafting, and system design. This magazine sells everywhere for 35c, but our readers may obtain a copy free by writing Audiocraft, 4404 Publishing House, Great Barrington, Massachusetts.

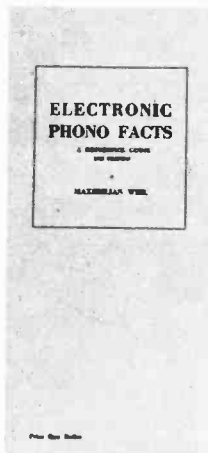

### Electronic Phono Facts

A 1956 revised edition of this well-known reference guide by the famous audio pioneer, Maximilian Weil. Includes data on pickups, styli, tone arms, turntables, compensation, and record care. Regularly sells for \$1.00, but now available free from Audax Division of Rek-O-Kut., Dept. LC, 38-19 108th St., Corona 68, N. Y.

### Schematic Diagrams

You can receive free a schematic diagram and an outline of electrical and physical specifications of any Heathkit. First get a Heathkit catalog, then order the free diagrams you want by model number. Both of these items are available from Mr. C. M. Edwards, Heath Company, Benton Harbor, Michigan.



### Long-Playing Record

This is a 10-inch double-face LP, containing excerpts from many Capitol FDS recordings, by artists such as The Pittsburgh Symphony, Hollywood String Quartet, Billy May, and Les Baxter. Information on how to get it is available from Mr. Ted Leonard, Dictograph Products, Inc., Jamaica 35, N. Y.

### Hi-Fi Bibliography

A listing of the best books on hi fi by title, author, publisher, and price. Also included are a number of article reprints and interesting drawings on the use and care of styli. Request your packet from Mr. E. J. Marcus, The Tetrad Company, Inc., 62 St. Mary Street, Yonkers 2, N. Y.

### Consulting Service

Answers to all questions concerning the choice of loudspeakers, either for a complete system or to supplement existing speakers; loudspeaker enclosures and their design for use with any speakers in existence or contemplated; problems concerning the application of hi-fi loudspeakers. Write Mr. Karl Kramer, Jensen Manufacturing Co., 6601 South Laramie Ave., Chicago 38, Illinois.

### Review of Recorded Music

This is a monthly publication devoted solely to unbiased appraisals of all current classical and popular records. In addition, each issue contains feature articles by writers well-known to audiophiles. The publishers offer a special six months trial subscription for \$1.00. Write Review of Recorded Music, 119 West 57th Street, New York 19, N. Y.



"99" Complete Amplifier \$99.95

# Here's why you should plan your Hi Fi system around the H. H. Scott '99'...

your **BEST BUY** at \$99<sup>95\*</sup>

At the right you'll find just a few of the reasons for choosing the H. H. Scott '99'. This expertly engineered control and power center is easy to install, easy to connect, and easy to play. Its years ahead features defy obsolescence. Be sure you listen to H. H. Scott amplifiers, tuners, and turntables before you choose your components.

*\* All prices slightly higher west of rockies.*

## BEFORE YOU PLAN YOUR SYSTEM WRITE FOR H. H. SCOTT'S FREE CATALOG AND HI FI GUIDE

H. H. Scott, Inc.  
385 Putnam Avenue, Cambridge, Mass.

Export: 36 W 40th St., New York City. Cable Code TELESCOMM

Rush me your new catalog C-1 showing the complete H. H. Scott line, including question and answer section explaining hi-fi.

NAME \_\_\_\_\_

ADDRESS \_\_\_\_\_

CITY \_\_\_\_\_ STATE \_\_\_\_\_



- Green Dot Controls
- 22 Watts Undistorted Power Output
- 5 Position Record Equalizer
- Tape, Tuner and TV Inputs
- Separate Rumble Filter
- Separate Scratch Filter
- Volume-Loudness Switch
- Separate Loudness Control
- 2 Magnetic Inputs with Selector Switch on Front
- NARTB Tape Playback Preamp
- Separate Tape Outputs for Recording and Monitoring
- Separate Bass and Treble Tone Controls
- Accessory AC Outlet
- Output Connections for Any Speaker Impedance
- Frequency Response Flat 20 cps to 30 kc
- Harmonic Distortion Less Than 0.8%
- First-Order Difference — Tone Intermodulation Distortion Less Than 0.8%
- Separate Level Control To Match Any Cartridge
- Hum Level: 80db below Full Output
- Beautiful Accessory Mahogany Case
- Compact Only 15½" x 5" x 12½"
- Easy to panel Mount
- Crystal Input With Compensation

For Many More  
Reasons, See Your  
H. H. Scott Dealer.

## Yours for the Asking

### Phono-Tape Replacement Manual

Complete data on the modernization and replacement of any phono cartridge or magnetic recording head. Also complete technical data on phono cartridges, recording heads, and styli. Ask for Manual RM-56 from Department 270, Shure Brothers, Inc., 222 Hartrey Avenue, Evanston, Illinois.



### How's Your Cartridge?

A colorful folder entitled *What's the IQF of Your Cartridge* is offered by the makers of the famous fluxvalve. This tells in non-technical terms how you can evaluate the characteristics and performance of any phono pickup. A chart and graph are included for ready reference. For your free copy write Pickering and Co., Inc., Dept. QF, Oceanside, N. Y.

### Technical Paper

The engineering story of the Studio Dynetic Reproducer, originally presented before the Institute of Radio Engineers, will be sent to you on request. Write to Shure Bros., Inc., 222 Hartrey Avenue, Evanston, Illinois.

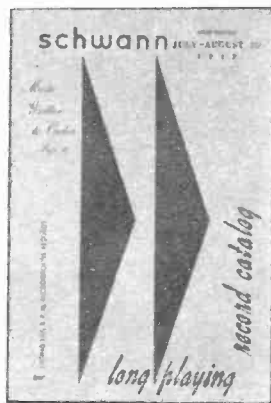

### Complete LP Record List

A monthly catalog containing a complete list of over 25,000 LP records, conveniently classified for easy reference, plus a wealth of other material of value to the collector, is available at over 3,600 record stores. If your dealer doesn't carry the Schwann Catalog, you may have a sample copy by sending his name and address along with your own and 10c to W. Schwann, Inc., 137 Newbury Street, Boston 16, Mass.

### Understanding Hi Fi

A thoroughly instructive and entertaining book of hi-fi fundamentals, brought up-to-date in a third revised edition. For your copy of this 56-page book, send 25c to Mr. Larry LeKashman, David Bogen Co., Inc., P. O. Box 500, Paramus, N. J.



### Recorded Tape Identification

The problem of identifying reels of recorded tape is solved by the Irish Reel Tab. Now made in two sizes, they fit snugly beneath the edges of any 5- or 7-inch reel, regardless of how much tape is on it. Made of sturdy stock, they have plenty of room on both sides for writing or typing. For a free supply, write stating which size you want to Mr. Nat Welch, ORRadio, Inc., T-120 Marvyn Road, Opelika, Alabama.

# When you build your High Fidelity sound system, use THE VERY BEST

## LOUDSPEAKERS YOU CAN GET



You are planning to build, or improve, your high fidelity sound system. Unstintingly, you will pour out your enthusiasm, time, and energy to get the finest music reproduction you can bring into your home. Get a loudspeaker that will do full credit to your handiwork... Install a JBL Signature Extended Range Loudspeaker, or two-way speaker system, in your enclosure.

JBL Signature Loudspeakers are made with the same careful craftsmanship, the same precision forming and fitting that you yourself would use if you set out to make the finest loudspeaker the world had ever heard. JBL Signature precision speakers are the most efficient loudspeakers made.

With a JBL Signature Loudspeaker in your high fidelity system, you can exhibit your components with pride, confident that those you have made yourself are being demonstrated in the most effective way possible.



**MODEL D130—15" extended range loudspeaker** The only 15" extended range speaker made with a 4" voice coil is the world-famous JBL Signature D130. The large voice coil stiffens the cone for crisp, clean bass; smooth, extended highs. Your basic speaker, the D130 works alone at first, later becomes a low frequency driver when you add a JBL Signature high frequency unit and dividing network to achieve the ultimate excellence of a JBL Signature two-way system.



**MODEL D123—12" extended range loudspeaker** With outstanding "presence" and clean response throughout the entire audio spectrum, the D123 features an unusual shallow construction. Only 3 3/4" deep, it is designed to mount flush with the wall, between studding, in any standard wall partition. Frequently, the D123 is used in multiples in "infinite baffle" wall installations. In this case the JBL Signature 075 is a logical high frequency unit to add when you advance to a two-way system.



**MODEL D208—8" extended range loudspeaker** A precision transducer in every sense of the word, the famed JBL Signature 8" D208 is made with the same care and precision as the larger units in the James B. Lansing Sound, Inc., line. If space and cost are major considerations, the D208, properly enclosed, provides the most lastingly satisfactory sound you can get. It is widely used in top quality systems where extension speakers are desired for areas other than the main listening room.



**MODEL 175DLH high frequency assembly** The acoustical lens is only available on JBL Signature high frequency units. The 14 element lens on the 175DLH disperses sound within the listening area over a 90° solid angle, smoothly, with equal intensity regardless of frequency. The acoustical lens is the greatest contribution to lifelike high frequency reproduction in 20 years, and it was developed for use with high fidelity equipment by James B. Lansing Sound, Inc. In addition to the lens, the 175DLH consists of a high precision driver with complex phasing plug and a machined aluminum exponential horn. Designed for crossover at 1200 cycles with the JBL Signature N1200 Network.



**MODEL 075 high frequency unit** Another exclusive for James B. Lansing Sound, Inc. is the ring radiator in the JBL Signature 075 high frequency unit. A ring, rather than a diaphragm, radiates into the annular throat of an exponential horn. The result is high frequency reproduction of unmatched smoothness and clarity, absolutely free of resonances and strident peaks. The horn is beautifully machined from aluminum, the entire unit a gratifying, solid piece of fine craftsmanship. Designed for crossover at 2500 cycles with the JBL Signature N2500 Network.

### JBL Signature two-way systems are available as kits

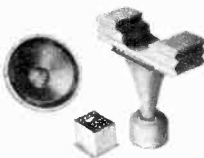

**086 KIT** This two-way system is made up of units which have been acclaimed by impartial authorities as the finest available anywhere today. Included in the kit are the 150-4C Low Frequency Driver, N2500 Network, 075 High Frequency Driver, 537-509 Horn-Lens Assembly. These are the same units — including the serpentine acoustical lens — which are used in The Hartfield... units designed originally for installation in the most modern theaters in the world.



**002 KIT** Including some of the newest speakers made, the JBL Signature 002 Kit includes a D123 for low frequency reproduction, N2500 Network, 075 High Frequency Unit. The 002 KIT is moderately priced, yet gives the user all the advantages of a two-way system made with independent drivers.



**001 KIT** Probably the most popular high quality two-way system on the market, the JBL Signature 001 system consists of a 130A Low Frequency Driver, N1200 Network, 175DLH High Frequency Assembly. The D130 may be substituted for the 130A without disturbing the balance or coverage of the system.

There are many more kits and loudspeakers in the JBL Signature line. Whatever your needs, you will find exactly the right unit or system in the complete JBL Signature catalog. Send for your free copy. A limited number of technical bulletins are also available. Please ask only for those in which you are vitally interested.

**JBL** means  
**JAMES B. LANSING SOUND, INC.**  
2439 Fletcher Drive • Los Angeles 39, California

Please send me the following:

- Free Catalog of JBL Signature Products  Name and address of Authorized JBL Signature Audio Specialist in my community

TECHNICAL BULLETINS ON:

- D130  D123  D208  175DLH  075  130A  150-4C

Name \_\_\_\_\_

Address \_\_\_\_\_

City \_\_\_\_\_ Zone \_\_\_\_\_ State \_\_\_\_\_

## Yours for the Asking

### Free Home Trial

All Pentron tape recorders are available on a 10-day free home trial plan. See your local hi-fi dealer or write The Pentron Corporation, 777 South Tripp Ave., Chicago 24, Illinois.

### Look or Listen?

A provocative article suggesting that the way to judge a loudspeaker is by listening rather than by checking frequency range or response curve statistics. Included is a suggested system for rating speakers, a field where standards are badly needed. Ask for *Shall We Look or Listen* from Mr. Karl Kramer, Jensen Manufacturing Co., 6601 South Laramie Ave., Chicago 38, Illinois.

### Audio Record Subscription

A fine periodical having articles of timely interest on all phases of sound recording. Included is the annual Tape Recorder Directory, which contains performance data, features and prices on all available mag-

netic recorders. A free subscription to *The Audio Record* is available from Audio Devices, Inc., 444 Madison Avenue, New York 22, N. Y.

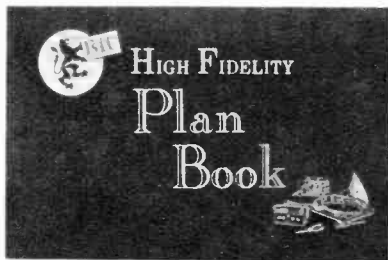

### Hi-Fi Plan Book

Answers the important questions about how much to spend, suggested components, installation for best appearance, and where to buy a true hi-fi system. Ask for the *BIC High Fidelity Plan Book* from British Industries Corporation, Port Washington, N. Y.

### Tape Recording Magazine

The only publication devoted exclusively to magnetic recording. Features how-to-do-it articles, how-to-build-it, plus the



## new hi-fi cartridge from Holland

## Ronette Superfluid\* TX-88

A new, wide range hi-fi cartridge with characteristics and performance that are years ahead of known practices in today's recording industry. Tropic powered, the Ronette TX-88 features highest compliance, perfect tracking and assures longest record life.

- Requires no preamp, however, when used with preamp performance exceeds expensive magnetic pickups.
  - Response: flat from 30 to 24000 cps.
  - IM distortion negligible even at very high velocities because of extremely small moving mass.
- Ronette exclusive Styromatic\* design permits quick and positive styli replacement with no tools whatsoever.
  - No hum problems — no turntable pull.
  - With 1 and 2.5 mil sapphire styli.
  - Diamond styli available.

ACOUSTICAL CORP., 190 Earle Ave., Lynbrook, N. Y.

\*trade mark





Everything  
You Need

FM-AM TUNER  
AUDIO CONTROL  
30-WATT AMPLIFIER

On One Compact Chassis!

# THE FISHER "500"

**F**ISHER MATCHES THEM FOR YOU — all three basic high fidelity components, laboratory engineered and professionally combined *on one compact chassis!* THE FISHER "500" features an extreme sensitivity FM-AM tuner, powerful 30-watt amplifier and Master Audio Control. Simply add a record player and loudspeaker and you have a *complete* high fidelity system. The "500" is the simplest and most economical manner in which to acquire matched components of traditional FISHER quality.

### Outstanding Features of THE FISHER "500"

■ Extreme sensitivity on FM and AM. ■ Meter for micro-accurate tuning. ■ Full wide-band FM detector for maximum capture ratio. ■ Powerful, 30-watt amplifier; handles 60-watt peaks. ■ Uniform response. 16 to 32,000 cycles. ■ 4 inputs, including separate tape playback preamp-equalizer. ■ 4, 8 and 16-ohm outputs match all existing speakers. ■ Recorder output ahead of volume and tone controls. ■ 7 Controls, including 9-position Channel Selector (AM, FM, AES, RIAA, LP, NAB, TAPE, AUX 1 and AUX 2), Loudness Contour (4-position), Volume, Bass, Treble, AC-Power, Station Selector. ■ Beautiful die-cast, brushed brass escutcheon and control panel. ■ Pin-point, channel indicator lights. ■ Smooth, flywheel tuning. ■ Largest, easy-to-read, slide-rule dial, with logging scale. ■ High efficiency FM and AM antennas supplied. ■ 18 tuned circuits. ■ 14 tubes plus 2 matched germanium diodes. ■ SIZE: 13 $\frac{3}{8}$ " wide x 13 $\frac{3}{8}$ " deep x 6 $\frac{1}{8}$ " high. ■ SHIPPING WEIGHT: 26 pounds.

Chassis Only, **\$249.50**

Mahogany or Blonde Cabinet, **\$19.95**

WRITE FOR COMPLETE SPECIFICATIONS

FISHER RADIO CORP. · 21-35 44th DRIVE · L. I. CITY 1, N. Y.



Just the  
Facts...

**Electro-Voice**

**HI-FI**

**LIBRARY**

**High-Fidelity Systems and Enclosures.** Find out how to choose your loudspeaker system and enclosure for fullest enjoyment of true high-fidelity music.

**High-Fidelity Speakers and Components.** Pointers to help you choose the speaker equipment suited to your budget and your musical taste.

Learn how you can save 50% and more by using E-V Do-It-Yourself Enclosure Kits or Construction Books.

Everything you need to know about hi-fi, everything you need for building "Temples of Tone" in your own home.

All about E-V amplifiers and your next step toward hi-fi perfection.

Facts on high-fidelity cartridges.

Everything about E-V high-fidelity products.

"The A B C's of Microphones." Just what its name implies; easy to read, many illustrations.

What do Compound Diffraction Projectors, the unique E-V public address speaker, have to do with hi-fi? This bulletin tells all.

... this free and easy education is all yours for the asking.

JOT YOUR NAME AND ADDRESS IN THE MARGIN AND SEND THE WHOLE AD TO

**Electro-Voice**

ELECTRO-VOICE INC. • DEPT. 57 • BUCHANAN, MICHIGAN

**Yours for the Asking**

latest in new products and doings in the world of tape. Also has a regular review section of music on tape. For a free copy of the very excellent *Tape Recording*, write Mr. Mark Mooney, Tape Recording, Se-verna Park 10, Maryland.



**Stroboscope Disc**

Your sound reproduction will not be truly hi fi unless your turntable is on speed and the music on pitch. You can readily determine whether your table is operating correctly by use of this free indicator. Accurate for all three standard speeds, under either 50 or 60 cycle illumination. Write Department 30, 38-19 108th St., Corona 68, N. Y.

**Phono Modernization Manual**

Covers both the theoretical and practical aspects of ceramic cartridge operation. Tells how they work, where they can be used, hints on using, input circuits, and mechanical aspects. Well illustrated with line drawings, characteristic curves, and schematics. Send 10c for *Phonograph Modernization Manual* to Electronic Applications Division, Sonotone Corporation, Elmsford, N. Y.

**Tape Playing Time Chart**

Complete and up-to-date, this gives playing time for all speeds, all reel sizes, and all types of tape, including newer Long Play and Double Play types. Write Mr. Nat Welch, ORRadio Industries, Inc., Shamrock Circle, Opelika, Alabama.

# Three to build on- from SONOTONE®

# 1.



## NEW CA-12 12-INCH COAXIAL LOUDSPEAKER

- Full range (40-14,000 cycles)
- Wide dispersion from elliptical cone tweeter
- Complete L-C dividing network built in

**\$19.50 NET** Zone 2—\$21.00

# 2.

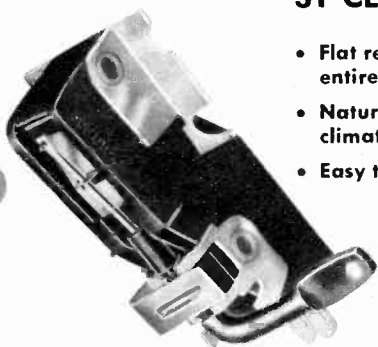

## 3T CERAMIC CARTRIDGE

- Flat response "unusually smooth over its entire range"\*
- Naturally equalized...no magnetic hum or climate problems
- Easy to install...snap-in needle replacement

**\$24.00 LIST** (3T-5D)

for diamond-sapphire model

\*Audio League Report—April, 1956  
—the impartial listening authority

# 3.

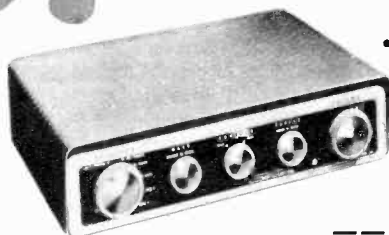

## NEW HFA-150 AMPLIFIER

- 15-watt power...10-watt price
- Only amplifier in its price range with D.C. filaments
- Only amplifier in its price range with separate continuous contour control

**\$79.50 NET** (less cover)

Zone 2—\$82.00 (less cover)

Ask your dealer for a  
demonstration.  
Send in this coupon for  
full details.

### SONOTONE® CORPORATION

Electronic Applications Division  
Dept. LW-107, Elmsford, N. Y.

Please send me complete details on:

- CA-12 loudspeaker       3T cartridge  
 HFA-150 amplifier

NAME \_\_\_\_\_ ADDRESS \_\_\_\_\_

CITY \_\_\_\_\_ ZONE \_\_\_\_\_ STATE \_\_\_\_\_

LW-107

## TRADE IN

**YOUR PRESENT HI-FI  
EQUIPMENT** for the new

# FISHER



### FM 90X Gold Cascade FM TUNER

FM reception brought to the theoretical limits of sensitivity. Uses gold cascade R.F. amplifier in special circuit.

**\$16950**

.....  
**BUY AT AUDIO EXCHANGE  
AND TAKE ADVANTAGE OF AUDIO  
EXCHANGE'S UNIQUE SERVICES  
SUCH AS:**

- Liberal Trade-Ins
- Attractive Time Payment Plan  
(Metropolitan N. Y. Customers Only)
- Experienced & specialized  
Hi-Fi Consultants
- Famed Service Department (only for  
equipment bought from us)
- Custom Installations by Experts
- Write Dept. FA57 for our unique  
Trade-Back plan, Trading information  
and catalog



## audio exchange

159-19 Hillside Ave. • Jamaica 32, N. Y.  
AXtell 7-7577

367 Mamaroneck Ave. • White Plains, N.Y.  
WHite Plains 8-3380

836 Flatbush Ave. • Brooklyn 22, N. Y.  
BUckminster 2-5300

Meter Parking at all stores

## Yours for the Asking

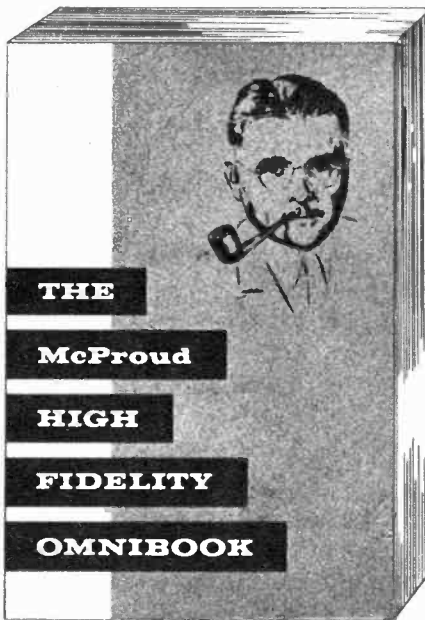

### Hi-Fi Omnibook

Audio Library division of Audio Magazine has announced a limited free edition of the McProud High Fidelity Omnibook to be given in a special promotion by the company. Full details may be obtained by writing to Audio Magazine, Dept. AF, Box 629, Mineola, N. Y.

### Technical Advice

The Technical Service Department of University Loudspeakers is ready at all times to answer consumer inquiries on loudspeakers, enclosures and systems. Hi-fi enthusiasts and technicians are invited to avail themselves of this service without obligation. Write to Mr. Larry Epstein, University Loudspeakers, Inc., 80 South Kensico Avenue, White Plains, N. Y.

### Turntable or Changer?

Each side of this argument has its proponents, and you should carefully consider both before making an investment. For a forthright discussion of this question, ask for a copy of *Shall I Buy a Turntable or a Record Changer?*, from Department 30, Rek-O-Kut Company, 38-19 108th St., Corona 68, N. Y.

# IMPORTANT HI-FI NEWS!

We are proud to announce the merger of the **AUDAX COMPANY** pioneer in audio-electronics with the

## REK-O-KUT CO., INC.

The reputation of both companies for producing quality products is known to all in the growing high-fidelity industry. The combined resources and specialized experience of both organizations are now at work on the completion of the

### "DISCRIMINATOR"

a new phono cartridge which will represent one of the most important contributions to high-fidelity reproduction.

### WATCH FOR THE ANNOUNCEMENT

## the MOST WANTED TONE-ARM . . .

New Audax in Kit Form—*at HALF price!*  
 accommodates ANY MAKE cartridge  
 including the famous AUDAX Hi-Q7

**AUDAX KT-12: KIT, \$14.55 NET**

*Factory-assembled, \$24.00 NET*

**AUDAX KT-16: KIT, \$17.55 NET**

*Factory-assembled, \$30.00 NET*



The new KT models exactly duplicate the Audax "Compass-Pivoted" transcription arm long recognized as top "blue chip." These new arms are the crowning achievement of a quarter-century of constant refinement and re-engineering of the very first commercial electronic pickup arm (Audax 1928) . . . to the fewest possible parts. It is this very *nth degree* engineered simplicity that makes the new KT arms possible. Anyone can assemble a KT arm in about 10 minutes—and save 50%! The "Selector-Index" permits instant adjustment for any stylus-pressure. The newly-designed cartridge-housing enables checking of the all-important stylus-to-groove alignment at a glance.

You do-it-yourself with no tools other than a nail-file or small screwdriver.

" . . . The most original of the late developments. . ." Harvey Radio, N. Y.

" . . . What amazed me most, however, is the highest grade workmanship at such a low price. . ." From a letter

" . . . The big news in tone-arms! . . ." Practical Electronics

" . . . a very fine unit. . ." Audio Engineering  
 " . . . exactly duplicates the famous Audax transcription arm, long recognized as a leading design. . ." Popular Electronics

# Audax

the Standard by which others  
 are judged and valued

division of **REK-O-KUT Co., Inc.**

38-19 108th St., Corona 68, New York

Audax Company, Division of REK-O-KUT Co., Inc., Dept. LC-1  
 38-19 108th Street, Corona 68, New York

Please send me your FREE Illustrated Brochure on your new "Discriminator" cartridge

Name .....

Address .....

City ..... Zone..... State.....

## Yours for the Asking



### Famous Designers Plans

Plans for a simply-built hi-fi storage wall, as featured in *Life* magazine. Designed by George Nelson, who also did the Herman Miller Furniture line. Included is a handsome color photo of the finished project. Ask for Bulletin SA-184, price 25c, from United States Plywood Corp., New York 36, N. Y.

### Better Listening Magazine

This is a fine little monthly with a number of how-it-works, how-to-do-it and record review pieces in each issue. Free subscriptions are available through many hi-fi dealers. If yours doesn't have it, send his name as well as your own to St. Regis Publications, Inc., 7 West 44th Street, New York 36, N. Y.

### Hi-Fi Consultation

Free technical advice concerning any problems of individual hi-fi systems is offered to our readers by Electro-Voice. If your system has you stumped, write Technical Service Department, Electro-Voice, Inc., Buchanan, Michigan.

### The Diffaxial Speaker

Reprint of a technical paper by A. B. Cohen, describing a new concept in multi-element speakers mounted in a unitary array. The author argues that the Diffaxial is an integrated version in one assembly of the design principles of multi-speaker systems. Rather heavy going for the amateur reader, but still worth looking into. Write Mr. Larry Epstein, University Loudspeakers, Inc., 80 South Kensico Avenue, White Plains, N. Y. •

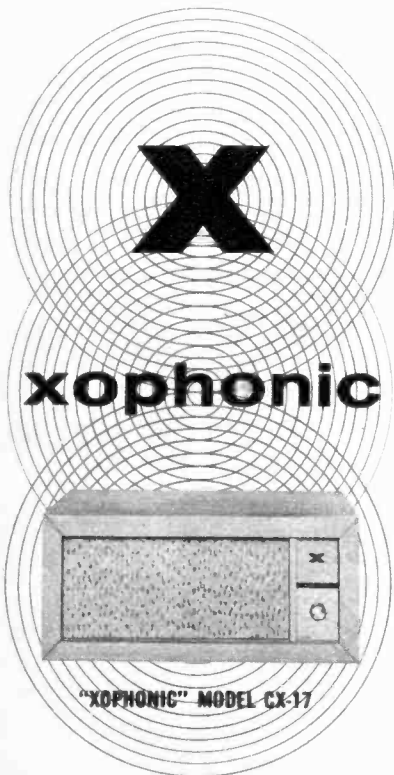

## 3<sup>rd</sup> dimensional sound

A startling new invention by Radio Craftsmen, Pioneer maker of high fidelity equipment. Introducing an entirely new concept in sound reproduction. Add thrilling third dimensional sound to your present high fidelity system, conventional radio or phonograph.

Write for free Xophonic booklet. Xophonic is an exclusive development by

RADIO **craftsmen**

4223 HFA W. JEFFERSON BLVD., LOS ANGELES 16, CALIF.

(Some dealerships and distributorships available. Write for information on the entirely new market created by the XOPHONIC.)





# demand 100% IQF\*!

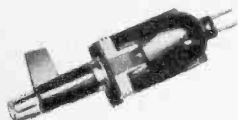

Series 350 TWIN  
FLUXVALVE from \$24



Series 370 SINGLE  
FLUXVALVE from \$17.85

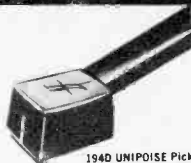

1940 UNIPOISE Pickup Arm with  
FLUXVALVE from \$59.85

Choice of the *best* phonograph pickup can *only* be resolved by comparison! What is the yardstick? . . . How can you tell? . . . What do you look for? . . . the answer is 100% **Important Quality Features!**

PICKERING has had long experience in the cartridge field, supplying the finest quality products for recording studios, broadcast stations, wired music services, and high fidelity home music systems. As a result of this extensive experience, PICKERING has developed the **FLUXVALVE** . . . the *one* cartridge which incorporates *all* of the **Important Quality Features** . . . so necessary for high fidelity reproduction from records.

Before you choose a cartridge . . .

**LISTEN AND COMPARE . . . demand 100% IQF\*!**

Feature	FLUXVALVE	Cartridge A	Cartridge B	Cartridge C
Frequency Response: Flat 20-20,000 cps $\pm$ 2 db (see curves on right)	YES 20 Points	NO 0 Points	NO 0 Points	NO 0 Points
Low Tracking Force, 2-4 grams	YES 20 Points	NO 0 Points	YES 20 Points	NO 0 Points
High Output, No Transformer Required	YES 10 Points	NO 0 Points	NO 0 Points	YES 10 Points
Replaceable Styli	YES 10 Points	NO 0 Points	NO 0 Points	YES 10 Points
1/2 Mil Stylus	YES 15 Points	NO 0 Points	NO 0 Points	NO 0 Points
One Cartridge For LP's and 78's	YES 5 Points	NO 0 Points	NO 0 Points	YES 5 Points
Anti-Hum Design	YES 10 Points	YES 10 Points	YES 10 Points	YES 10 Points
Hermetically Sealed	YES 10 Points	NO 0 Points	NO 0 Points	NO 0 Points
<b>TOTAL POINT VALUE</b>	<b>100%</b>	<b>10%</b>	<b>30%</b>	<b>35</b>

**THE FLUXVALVE** . . . chosen time and again as the *top* cartridge solely on the basis of *listening quality* . . . by panels of qualified experts . . . tests which have proven that it is *actually* less costly to own a **FLUXVALVE**

The **FLUXVALVE** preserves the quality and prolongs the life of your record since there is complete absence of resonances throughout the audio frequency range.

It may interest you to know that the **FLUXVALVE**, because of its ability to make *precise* and *reproducible* record measurements, is used for calibrating recording channels and record masters.

Make the **IQF\*** test today . . . listen to your favorite record reproduced with a **FLUXVALVE** . . . the gentle pickup.



**IMPORTANT QUALITY FEATURES**

—so necessary for high fidelity reproduction from records.

## only *fluxvalve* has 100% IQF\*!

At better Hi-Fi Dealers everywhere, for complete brochure and name of nearest dealer write Dept. FB-1



*"For those who can hear the difference"* FINE QUALITY HIGH FIDELITY PRODUCTS BY  
**PICKERING & COMPANY, INC., Plainview, N. Y.**

EXPORT: AD. AURIEMA, INC., 89 BROAD ST., NEW YORK / CANADA: CHARLES W. POINTON LTD., 6 ALCINA AVE., TORONTO

### RESPONSE CURVES

Peaks and/or resonances in the stylus assembly at any recorded frequency will distort; and, damage the record groove. Therefore, any deviation from flat response over the recorded frequency band results in eventual breakdown of the groove wall. Deviations of from 3-6 db distort the record material as much as 60-100%.

#### FLUXVALVE

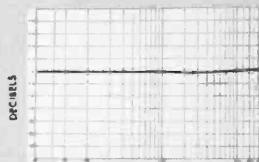

#### CARTRIDGE A

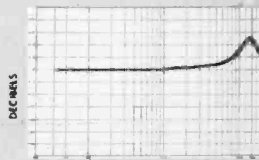

#### CARTRIDGE B

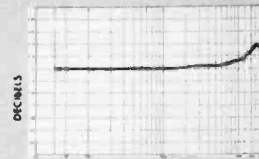

#### CARTRIDGE C

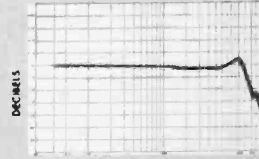

Spectacular New  
Tape System Components

# PENTRON

• STEREO • MONAURAL

Select only the TAPE UNITS you want!

Pentron combines professional features and custom styling with building-block flexibility. Add components when you desire—from the simplest monaural system to the all-inclusive stereo systems.

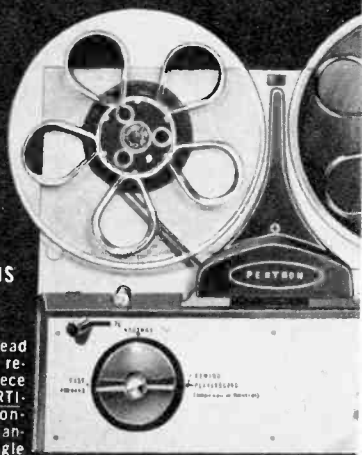

### 3 MECHANISMS AVAILABLE

Featuring —

Professional head assembly with removable pole piece • Mounts VERTICALLY, horizontally or at any angle • Simple single rotary control • 4 outputs plus 2 AC convenience outlets • Speed change lever at front panel • Automatic self-energizing braking.

### 3 PREAMPLIFIERS

All CA units have same physical dimensions and require same cutout.



CA-11: Tape Playback only. Response: 20-20,000 cps. Signal-to-Noise: 55 db

CA-13: Tape Playback preamp and record amplifier. Response: 20-20,000 cps. Signal-to-Noise: 55 db



CA-15: Stereo Dual Channel Playback. Response: 20-20,000 cps. Signal-to-Noise: 60 db

Hear Fabulous Pentape Recorded Tapes

**PENTRON**

796 S. Tripp Avenue  
Chicago 24, Illinois

Send brochure on Tape Components.

Name \_\_\_\_\_

Address \_\_\_\_\_

City and State \_\_\_\_\_

Canada: Atlas Radio, Ltd., Toronto

# Glossary

The serious audiophile should have a proper understanding of this high-fidelity terminology

**A-B Test**—Direct comparison of sound of two tape recorders made by simultaneously playing identical recorded selections on both machines and successively turning on the speaker of first one, then the other.

**AES**—Audio Engineering Society.

**AF**—Abbreviation for audio frequency.

**AFC**—Abbreviation for automatic frequency control; an electronic circuit used in tuners to correct inaccuracy in tuning a station.

**AM**—Abbreviation for amplitude modulation; the type of transmission utilized by the standard broadcast stations.

**Amplification**—Magnification (see Gain).

**Amplifier**—An electronic circuit which increases the amplitude of an electric voltage or power.

**Arm (phonograph)**—A movable bracket which holds the pickup in proper position over the record (also Tone Arm).

**Attenuation**—Reduction of an electric voltage or current; the opposite of amplification.

**Audio**—The range of frequencies from approximately 30 to 15,000 cps. Also an adjective used in reference to the electronic and acoustical equipment concerned with the reproduction of sound.

**Audiophile**—A person who is interested in improving musical reproduction for his own personal listening, by use of the latest audio equipment and techniques.

**Background Noise**—The total system noise, regardless of whether or not a signal is present.

**Baffle**—A barrier or partition designed to separate the sound waves generated by the front and back of a loud-speaker cone.

**Bass Reflex Speaker Enclosure**—Type of extension loud-speaker cabinet frequently available as accessory item for tape recorders. Design employs a "port" or opening which greatly reinforces the bass, yet requires but a relatively small cabinet.

**Capstan**—The spindle or shaft (often the motor shaft itself) which rotates against the tape, pulling it along at a constant speed on recording and playback.

**Cartridge**—Another name for the phonograph "pick-up"; the device which converts the mechanical energy stored in the record grooves into electrical energy.

**Chassis**—The metal box, framework or other support to which the components of a tuner or amplifier or other device are attached. The term is also used to designate the entire equipment (less cabinet) when assembled.

**Compensator**—An electronic circuit for altering the frequency response of the amplifier system to achieve a specified result. In general this refers

# Learn all about HIGH FIDELITY the easy "Picture-Book" way!

## Rider's BASIC AUDIO COURSE

by Norman H. Crowhurst, world famous high-fidelity authority

Now you can master the basics of the exciting new high-fidelity hobby easily, rapidly and thoroughly with this new 3-volume "Picture-Book" course covering the principles and practices of audio.

### More Enjoyment

The full enjoyment of high fidelity is opened up to you because you will have complete understanding of the part that each component plays in bringing new sound sensations to you. Now you can build, design and assemble your own high-fidelity system.

### It's So Easy To Learn

Here's how this easy, illustrated course works: Every page covers a complete idea! There's at least one big illustration on that same page to explain it! At the end of every section, you'll find a review that highlights the important topics that you've just covered. You build a thorough step-by-step knowledge at your own pace—as fast as you yourself want to go.

### No Previous Experience or Education Needed

Rider's "Basic Audio Course" uses the same methods that have proven so successful in famous Rider "Picture-Books" on electricity, electronics and television. This comprehensive course presents the basics of audio in simple, down-to-earth language that everyone can understand—regardless of previous education. Every phase of audio is made instantly clear—explained in plain English and supported by carefully prepared, large and exciting drawings that make every idea crystal-clear.

### 3 Complete Volumes

Each component that plays a part in the reproduction of sound

is thoroughly discussed—microphone, amplifier, preamp, tuner, record changer, turntable, loudspeaker, speaker enclosure, etc. Volume 1 covers the theory of acoustics, microphones, speakers, audio measurements and music. Volume 2 deals with amplification theory and problems, and the design of amplifiers. Volume 3 deals with feedback theory and circuitry, functions of the tone controls, audio power supplies, disc and tape recording, acoustic fundamentals such as damping and sound waves, and stereophonic sound. Each volume covers an important phase of high fidelity. In effect, the presentation is like a spiral—first an overall view of the whole, and then the detailed explanation of each part. . . . The most perfect modern teaching technique. The result—maximum understanding.

### Learn At Home—No Correspondence

This course is so complete, so different—there's no need for the usual letter writing, question-and-answer correspondence. You learn in the comfort of your home, in your spare time . . . at your own pace.

### 10 Day Examination—Money Back Guarantee

Send today for this exciting new training course—you risk nothing! When you receive the volumes, examine them in your own home for 10 full days. If, at the end of that time, you are not completely satisfied, simply return the books and we will return your full purchase price! Total cost for this 3-volume course (Cat. #201) is only \$6.95! Individual volumes are \$2.50. #201-H, Cloth Edition (all 3 volumes in a single binding) only \$8.50. In Canada, prices approximately 5% higher.

Available December 1, 1957.

## These RIDER BOOKS consistently top the list of HI-FI BEST SELLERS!

### HIGH FIDELITY SIMPLIFIED

by Harold D. Weiler

Gives you the complete hi-fi story, and answers all questions about tuners, changers, amplifiers, tape recorders, speakers, record players, etc. There is no other book like it!

Soft cover, 224 pp., 5½ x 8½", illus.

#142 . . . . . only \$2.50

### GUIDE TO AUDIO REPRODUCTION

by David Fidelman

For the audio enthusiast with a technical background and the electronics experimenter. Treats the design, construction, assembly, and testing of sound reproduction systems and components. Discusses pick-up devices, preamps, amplifiers, A-F networks, loudspeakers and enclosures.

Soft Cover, 240 pp., 5½ x 8½", illus.

#148 . . . . . only \$3.50

### HI-FI LOUSPEAKERS AND ENCLOSURES

by Abraham B. Cohen

A classic volume in hi-fi literature. Completely covers the subject. Answers all your questions about loudspeakers and enclosures, design, cross-over networks, construction of own networks, etc.

Leather finish MARCO cover, 368 pp., 5½ x 8½", illus.

#176 . . . . . only \$4.60

#176-H Cloth Bound . . . . . only \$5.50

### HOW TO SELECT AND USE YOUR TAPE RECORDER

by David Mark

Written for the user of magnetic tape recorders—and to serve as a guide in selecting a machine that most suitably meets individual requirements. For all those who have had little or no formal training in the science of electronics.

It's a book that "shows you how"! Illustrates actual set-ups for the many different applications of tape recorders. Read this book before you buy a tape recorder . . . it will save you many dollars! NO OTHER BOOK LIKE IT!

Soft cover, 148 pp., 5½ x 8½", illus.

#179 . . . . . only \$2.95

### REPAIRING HI-FI SYSTEMS

by David Fidelman

Deals with finding the troubles and repairing faults in hi-fi equipment with no test instruments, with simple equipment, or with elaborate equipment. Encompassing the repair of high-fidelity equipped such as tape recorders, record players and changers, AM and FM tuners, preamps, amplifiers and loudspeakers, the approach is gradual, easy to understand, and down-to-earth. Typical troubles are analyzed and repaired through a system of logical steps. Takes care of every situation encountered by the owner or technician. A very valuable addition to the hi-fi equipment library. Will save time and money!

Soft cover, 170 pp., 5½ x 8½", illus.

#205 . . . . . only \$3.90

### HOW TO SERVICE TAPE RECORDERS

by C. A. Tuthill

Discusses the tape recorder and its operation. Explains the types of circuits, drive mechanisms, troubleshooting and repair.

Soft cover, 160 pp., 5½ x 8½", illus.

#167 . . . . . only \$2.90

Order today. These books are sold by electronics parts jobbers and book stores. If your dealer doesn't have the books you want, mail this coupon to us.

### JOHN F. RIDER PUBLISHER, INC.

116 West 14th Street, New York 11, N. Y.

I have enclosed \$\_\_\_\_\_ Please rush the books I have circled.

201 201-H 142 148 176 176-H 179 205 167

Name \_\_\_\_\_

Address \_\_\_\_\_

City \_\_\_\_\_ Zone \_\_\_\_\_ State \_\_\_\_\_

HFG-57

JOHN F. RIDER PUBLISHER, Inc. 116 West 14th Street, New York 11, N. Y.

to such things as record equalization or loudness correction.

**Constant Amplitude**—The disc recording characteristic wherein the groove displacement is directly proportional to the signal amplitude.

**Constant Velocity**—The disc recording characteristic wherein the groove displacement is inversely proportional to the signal frequency.

**Crossover Network**—A filtering circuit used on multiple speaker systems which separates the high frequencies from the low frequencies and channels them respectively to the tweeter and woofer speaker units.

**Crystal**—Used in reference to a phonograph cartridge, it is a small slab of piezoelectric material used to convert mechanical motion to an electrical voltage.

**Crystal Microphone**—Inexpensive piezoelectric type microphone supplied with many tape recorders which employs a natural crystal, usually Rochelle salt, as its element. As the diaphragm moves it causes the crystal to generate electrical voltages. Should be handled with care, however, and never exposed to heat. Provides best quality of all inexpensive microphones.

**Cycles Per Second**—The unit for measuring the frequency or pitch of any musical sound. Abbreviated cps.

**Decibel**—

(1) A logarithmic measure of the acoustical level of sound intensity. 0 db is the threshold of human hearing while 130 db is the threshold of pain,

i.e. the intensity level at which physical pain is felt.

(2) A logarithmic unit of measure used to express the voltage or power gain of an amplifier. With a minus sign it is also used to express the loss in attenuating circuits.

Because the ear measures differences in sound level logarithmically rather than arithmetically (if sound A is twice as loud as sound B, it will appear to the ear to be only slightly louder), and because decibel numbers can be used to represent large figures in a convenient manner (60 db equals a power ratio of 1,000,000 to 1), the decibel system is universally used by electronic engineers.

**De-Emphasis**—A form of equalization complementary to pre-emphasis.

**Distortion**—The modification of the input signal by the discrimination against some frequencies, or by the introduction of additional frequencies not present in the original.

**Dual Track Recorder**—Usually a tape recorder with a recording head that covers about half of the tape width, making it possible to record one track on the tape, then turn the reels over and record a second track in the opposite direction. Sometimes called a half-track recorder.

**Dynamic Microphone**—High quality electromagnetic microphone which employs a moving coil in a magnetic field to produce varying voltages.

**Dynamic Range**—The ratio between softest and loudest sounds a tape recorder or other device

**CONCERTONE**  
... professional  
quality  
designed for  
home  
enjoyment

Until you've heard the startling perfection of stereophonic sound on a Concertone Tape Recorder, you haven't heard Hi-Fi at its best. The Concertone is a magnificent instrument that permits you to record stereo with professional fidelity and on the same instrument play back your own stereo recordings or full or half track pre-recorded hi-fi tapes with lifelike reproduction.

Professional features include 3 separate motors for the utmost accuracy and fidelity, automatic cut-off, erase safety, straight line threading and use of 10½" reels.

Write for Bulletin No. 5001.1

Audio Division  
**AMERICAN ELECTRONICS, INC.**  
655 West Washington Boulevard  
Los Angeles 15, California

# Bogen High Fidelity



"A marvelous hi-fi value!"  
—Anton Schmitt, Harvey Radio,  
New York City

...because it sounds better

"Price and features have sold me on Bogen."

—Richard B. Roetter, Newark Electric Company, Chicago

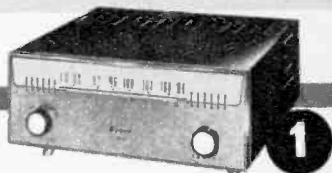

1

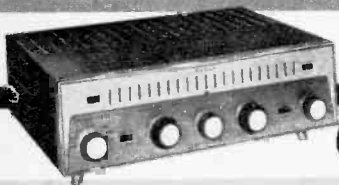

3



2

"'Blue chip' in the world of sound."

—Vollmer Hetherington,  
Radio Shack, Boston

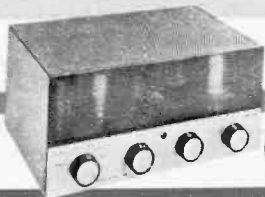

4



5

Audio consultants, such as those quoted here, don't use words like "marvelous", "superb" and "blue chip" lightly. Their studied opinions, and the fact that more Bogen high-fidelity components are in use today than any other brand, are ample proof that for more engineering "firsts", more years of brilliant performance, more rugged good looks — the choice is Bogen.



6

**TUNERS:** 1 FM 50 FM TUNER: \$84.50. Enclosure \$7.00. 2 R775 DeLUXE TUNER-PREAMP: \$249.50. Enclosure, \$8.00. **AMPLIFIERS:** 3 DB130 35-WATT AMPLIFIER: \$115.00. Enclosure, \$7.50. 4 DB110 12-WATT AMPLIFIER: \$64.50 including enclosure. 5 DO70 70-WATT POWER AMPLIFIER: \$129.50 including enclosure. **RECEIVER:** 6 RR550 FM-AM 25-WATT RECEIVER: \$224.50. Enclosure, \$8.00. **STEREO PLAYBACK:** 7 ST10 DUAL PREAMP and 10-WATT AMPLIFIER: \$52.50. With enclosure, \$59.50. Write for complete catalog and/or send 25c for new 56-page "Understanding High Fidelity," David Bogen Co., Inc. Box 500, Paramus, New Jersey

"Superb instruments that please the connoisseur."  
—Harry Shaffer, Hollywood  
Electronics, Hollywood

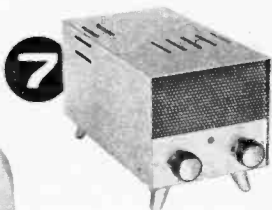
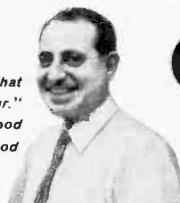

7

**Bogen**  
HIGH FIDELITY  
A UNITRONICS CORPORATION AFFILIATE

# "TAB"

OUR TWELFTH YEAR  
That's a Buy!!!!

Headquarters for HiFi  
Complete HiFi Packages  
Individual or Components  
All at Great Savings To You!

We Carry All Lines  
Disgusted of "Hi" Hi-Fi Prices?  
C "TAB" B4U buy HiFi!!

We Buy! Sell & Trade as Well!  
Write for Catalog

## SPECIAL! SPECIAL! SPECIAL! NEW PREAMP & 60 WATT HIFI AMPLIFIER



U-Build-It Preamp & Amplifier Tech-Master  
Model 19, 20 to 40,000 cycles at 60 watts  
with minimum distortion. Bass & Treble  
Tone Controls, 5 point Record Selector,  
Phono-Pickup Selector, Signal Selector,  
Tape Recorder Input, 25 lb. Hi-Fi Out-  
put Transformer feeds 4, 8 or 16 ohm  
speakers & electrostatic units also, 2  
power outlets. The Newest, Latest and  
built with professional look.

Finest design easily  
KIT ..... \$ 79.95  
Cover Grill Cabinet..... \$ 7.50  
Model 19 Assembled ..... \$108.00

## NEW IMPROVED "TAB" HI-FI SPEAKERS



With Inbuilt Network Ticonal Atico  
5 Plus Magnet 4 to 8 ohms V. C.

15" TRIAX, 25 Watt 20-20,000 Cycles ..... \$37.50  
MODEL F15HX3  
12" TRIAX, 20 Watt/40-20,000 Cycles ..... \$28.50  
MODEL F12HX3  
12" COAX, 20 Watt/35-18,000 Cycles ..... \$22.00  
MODEL F12HX2  
SONOTONE CA12/COAX 12 Watt/40-14,000 Cycles ..... \$19.11

## "TAB" SPECIALIZES U-BUILD HIFI KITS!\* FOR THE BEST DEAL SEE "TAB" B4U BUY HIFI!

10 Watt—Amp & Preamp ARKAY A12 ..... \$22.95 GROMMES LJK ..... 24.95	30 Watt—Amp & Preamp ARKAY FL30 ..... \$49.95 50 Watt—Amp & Preamp EICO HF 52 ..... \$69.95 TM 15 K ..... 79.95
12 Watt—Amp & Preamp ARKAY FL 10 ..... \$28.95 EICO HF 12 ..... 34.95	20 Watt—Power Amp TM 15 A ..... \$49.95
20 Watt—Amp & Preamp BOGEN KDB20 DF ..... \$59.50 EICO HF20 ..... 49.95 GROMMES 61 PGK ..... 59.50	50 Watt—Power Amp DYNA MARK II ..... \$69.75 EICO HF 50 ..... 57.95
Preamps DYNA PREAMP ..... \$34.95 EICO HF61 ..... 29.95 EICO HF 61A ..... 24.95	60 Watt EICO HF 60 ..... \$72.95 DYNA MARK III ..... 79.00

\* We build or rebuild all kits at 140¢ cost!  
Professional Wired 50 Watt Dyna Mark II ..... \$79.00

## G.E. PHONO CARTRIDGES

Original Boxed, Money Back Gtd.

RPX041A or APX040A Single Sapphire ..... \$ 8.89	RPX050A .001 & .003 (SS) ..... 6.75
RPX052A Golden Treasure (DS)* ..... 19.25	RPX053A Golden Treasure (DD)* ..... 28.00
RPX061A or RPX063A Single Diamond ..... 17.95	* S: Sapphire; D: Diamond

## REPLACEMENT NEEDLES—DIAMOND & SAPPHIRE SOLD ON MONEY BACK GUARANTEE

RPJ013A Dual (DS) .001D & .003S ..... \$ 9.49
RPJ01D or RPJ03D Single (D) Diamond ..... 8.49
RPJ01S or RPJ03S Single (S) Sapphire ..... 1.65
RPJ003 or RPJ01 Single (D) Diamond ..... 8.49
MG or 78 Single (D) Diamond ..... 8.49

## Gtd. PHONO Replacement NEEDLES

All Makes and Cartridges LP & 78

One Diamond \$8.49	Two Diamonds \$17.49
Diamond & Sap \$9.49	Two Sapphires \$ 2.39
One SAPPHIRE LP or 78	..... \$ 1.49

Please send cartridge name and number

## "TAB" FINEST HI-FI RECORDING TAPE

7" Reel—1200 Ft. Per Reel  
Sold on Money Back Guarantee \$1.45 of 12

Highest quality Hi-Fi Precision, Coated & Silt, ERIN-SHEEN processed, quality controlled, constant output, Noise Free, Splice Free Plastic Tape. Freq. 7 1/2 IPS, 40 to 15,000 cycles Oxide Wnd. In. "TAB" at 1.59 ea.; 3/1.50 ea. New 1st quality "MYLAR" 2400 Ft.-7" Reel Ferro-Erin processed Recording Tape at \$4.49; 3/512.

## "TAB"

TERMS: Money Back Gtd (cost of mdsf only) \$5 min order  
F.O.B. N.Y.C. Add shpg charges  
or for C.O.D. 25% Dep.  
Prices shown subject to change.

Dept. 111HV Liberty St., N. Y. 6, N. Y.  
Phone RECTOR 2-6245—Cable "TABPARTS"

can reproduce without undesirable distortion. Usually measured in db.

**Editing**—Selecting certain sections of a tape recording, or of a number of different tape recordings, then splicing them together in the desired sequence.

**Equalization**—Either boosting or decreasing the intensity of the low, middle or high tones of a recording during recording or playback or both. This compensation serves to correct any deficiencies in the recording system and to increase the signal-to-noise ratio.

**Erasure**—Neutralizing the magnetic pattern on tape by placing it in a strong magnetic field, thereby removing the recorded sound from the tape.

**Feedback**—The combining of a portion of the output signal with the input signal.

(a) Degenerative (Inverse or Negative) Feedback is the type which reduces the distortion caused by vacuum tubes and improves the frequency response characteristic.

(b) Regenerative (Acoustic) Feedback is the type which causes distortion or sustained "howling" —as between the loud-speaker and cartridge.

**Feed Reel**—Reel on the recorder which supplies the magnetic tape.

**Fidelity**—A measure of the exactness with which any sound is duplicated or reproduced.

**Flat Response**—The ability of a sound system to reproduce all audible tones in their proper proportion. A hi-fi sound system might be specified as having a flat response, plus or minus 1 db, from 30 to 15,000 cycles per second.

**Flutter**—Very short, rapid variations in tape or turntable speed causing similar variations in sound volume and pitch, not present in the original sound. A form of distortion.

**FM**—Abbreviation for frequency modulation; the type of radio transmission which can provide truly high fidelity with practically no static or background noise.

**Frequency Range**—The range between the highest and lowest pitched sounds which a tape recorder or other sound system can reproduce at a usable output or volume level.

**Frequency Response**—The output level of a recorder or sound system over a given range of frequencies. A more specific term than frequency range. Usually in the form of a curve plotted on a chart.

**Gain**—The ratio between the input and output levels of a piece of sound equipment. Gain is increased by means of an amplifier.

**Gap**—The tiny distance between the poles of the recording head, measured in mils. The head gap of most home recorders may range from 1 mil down to 1/4 mil. The smaller the gap, the higher the frequency range of the tape recorder can be.

**Head**—The ring-shaped electromagnet across which the tape is drawn and which magnetizes the iron oxide-coated tape in a series of patterns. Most tape recorders employ a combination record-playback head and also an erase head. Some professional machines also employ a monitor head for listening to the recorded sound a split second after it has been put on the tape.

**Head Alignment**—Positioning of the record-playback head on a tape recorder so that its gap is exactly perpendicular to the path of travel of the tape.



# FOR ULTIMATE FIDELITY

# SHERWOOD\*

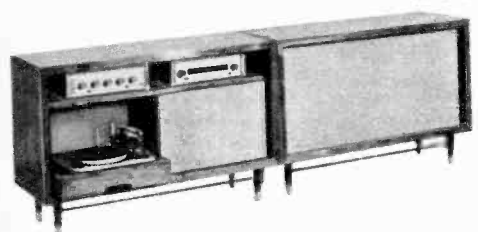

No matter where your music comes from—FM, your own discs, or tape—you will enjoy it at its best coming from Sherwood's complete home music center... most honored of them all! Sherwood tuners for example—the first ever to achieve under one microvolt sensitivity. And amplifiers—a check against eleven other manufacturers' own published claims revealed Sherwood to be ahead of its nearest competitor by at least six major features.

- The all new S-1000 II Amplifier
- Sensitive FM-AM or FM Tuners
- Unparalleled cabinet design and craftsmanship
- "Realistic" 3-way speaker systems

\* outstanding honors bestowed by many recognized testing organizations—details on request.



New "Presence" Rise Button

**S-1000 II—36 Watt Amplifier.** This all new amplifier is designed to bring maximum pleasure to music lovers—the greatest joy to the Hi-Fi expert.

Controls are simple, easy-to-handle, yet complete—include 6-db presence-rise switch, equalizer control for 4 record compensation choices or microphone and tape-playback equalization, inverse-feedback type bass and treble controls, Sherwood exclusive "center-set" loudness control, loudness compensation switch, 12 db/octave scratch and rumble filters, phono level control, tape-monitor switch, and selection of 6 inputs (including 2 with high-gain pre-amplifier)—all on front panel. Speaker-damping selector switch on rear. Phono preamp features DC filament supply for elimination of hum. Power output: 36 watts (72 watts peak) at 1½% IM Distortion (60:7kc/4:1). Inverse Feedback: 23 db, plus current feedback selection. Frequency Response at 36w: 20-30,000 cps ±1 db. Preamp Sensitivity: 3mv. Size: 14x10½x4 in. high.

Models from \$109.50



"Feather-Ray" Tuning Eye

**FM-AM Tuner S-2000.** Engineered and styled to match the performance of the incomparable S-1000 II Amplifier, this tuner offers features not previously available in this price range. These include 0.95 uv (20 db quieting) FM sensitivity, cascode 6BS8 balanced input, automatic frequency control, flywheel tuning, wide/narrow AM switch (15-kc "hi-fi" bandwidth or 5-kc selective bandwidth), precision calibrated dial, directable AM rod antenna, cathode-follower output, output level control, FM multiplex output, 10-kc "bridged-T" AM filter. Delayed AGC on FM reduces IM distortion to below ½% at 100% modulation. 11 tubes plus rectifier. New "Feather-Ray" tuning eye. Dimensions: 14x10½x4 in. high. 47 watts, fused. Shipping weight: 18 lbs.

Model S-2000 FM-AM Tuner ..... \$139.50 net  
Model S-3000 FM only Tuner ..... \$ 99.50 net

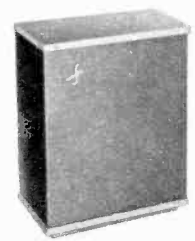

Forester 3-Way Speakers

This three-speaker system with horn loaded cabinet features a 300-cps crossover network, formerly obtained only in expensive "dream systems." Available in a variety of cabinet styles from \$189.00 to \$239.00 complete. Low-Boy speaker style (featured above) has matching equipment cabinet at \$149.50.

"Do-it-Yourself" Forester System Kits \$129.00 complete; speakers and crossover only \$79.50... also available, crossover networks only.



"The complete high fidelity home music center"



Write for literature: Dept. HFG

# Sherwood

 ELECTRONIC LABORATORIES, INC.

2802 W. Cullom Ave., Chicago 18, Illinois

quality makes the difference in the  
**FAIRCHILD** cartridge

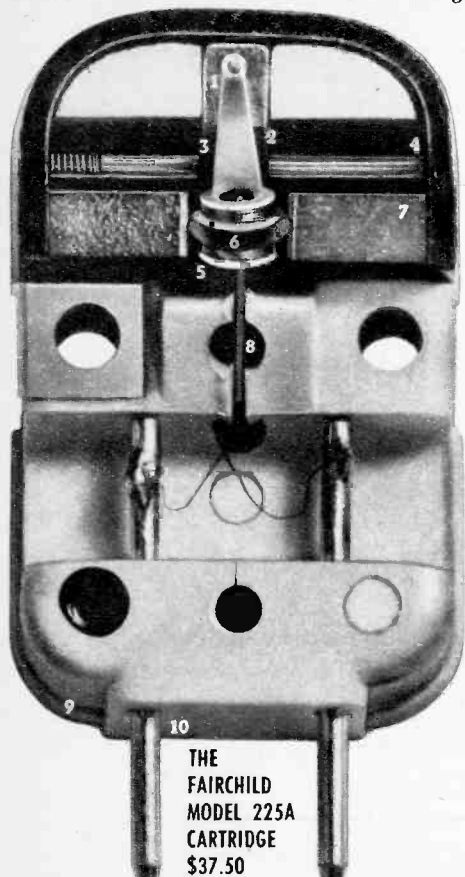

THE  
 FAIRCHILD  
 MODEL 225A  
 CARTRIDGE  
 \$37.50

1 Precision ground diamond stylus fitted to stylus arm. 2 Center beam support insures precise placement of stylus arm. 3 Special alloy aluminum stylus arm—low moving mass provides improved tracking. 4 Micradjust Screw—permits exact factory setting of damping, assures uniform flux gap and proper centering of stylus arm. 5 Moving coil wound on nylon bobbin with triple gold plated wire. 6 Special composition silicone rubber damping ring. 7 Alnico V magnet for greatest energy product has special alloy flux return path for maximum sensitivity. 8 Mylar vane anchors coil. Flexure pivot construction provides extreme freedom of motion. 9 Rubber impregnated molded base impervious to moisture absorption. 10 Gold plated terminal lugs.

FAIRCHILD RECORDING EQUIPMENT CO., Long Island City 1, N. Y.

Enclosed find 10c for informative booklet "In the Groove" and complete literature.

NAME \_\_\_\_\_

ADDRESS \_\_\_\_\_

CITY & STATE \_\_\_\_\_

**Head Demagnetizer**—Device to eliminate any magnetism built up and retained in a recording head.

**Hum**—The extraneous portion of the output signal deriving from unwanted introduction of the power line frequency and its harmonics into the circuit.

**Impedance**—A rating in ohms of the input and output of any electrical component, referred to in a general way either as high or low impedance. Importance is that, in connecting any two components, the output and input impedances must match. Most home tape recorders use a high-impedance microphone and require a relatively short shielded connecting cable. Low-impedance microphones used on professional recorders can use much longer cables with no loss in high frequencies.

**In-Line Heads**—Arrangement of stereophonic heads on a tape recorder so that gaps are directly in line. One head is mounted directly above the other. Also called stacked heads.

**Input**—The terminals or connections to which wires carrying the electrical current are attached. Also refers to the electrical energy which is being fed into an amplifier, etc.

**Inverter**—Device to change one type of electrical current to another type. Frequently used to change 6-volt or 12-volt direct current to 110-volt alternating current for operation of a tape recorder in an automobile.

**IPS**—Abbreviation for tape speed in inches-per-second.

**Jack**—Receptacle for a plug connector leading to the input or output circuit of a tape recorder or other piece of equipment.

**Lateral Recording**—The common form of disc recording in which the groove modulation is perpendicular to the motion of the disc and parallel to its surface.

**LCS**—Abbreviation for loudness contour selector. A circuit for altering the frequency response of an amplifier so that with various levels of loudness the characteristics of the amplifier will more closely match the requirements of the human ear.

**Level Indicator**—A device on the tape recorder to indicate the level at which the recording is being made, and which serves as a warning against under-recording or over-recording. It may be a neon bulb, a magic eye or a VU meter.

**Load**—The component or device which is being supplied with electrical energy from a source such as an amplifier.

**Loud-speaker**—The electro-acoustical device which converts electrical current to mechanical motion, which in turn creates sound waves.

**Matching**—The technique of selecting and connecting equipment so that each unit works at its peak performance capabilities.

**Magnetic Tape**—A high-quality plastic or paper tape which has been precision-coated with a layer of magnetizable iron-oxide particles.

**Micro**—One one-millionth (prefix).

**Milli**—One one-thousandth (prefix).

**Mixer**—Device by which signals from two or more microphones can be fed simultaneously into a tape recorder at the proper level and balance.

**Monaural Recorder**—Standard type tape recorder which uses a single-channel system consisting of one microphone, amplifier and recording head, as opposed to a binaural or stereophonic recorder.

*it's easy . . . it's fun*  
**build your own**



**HEATHKIT  
 HIGH FIDELITY FM TUNER KIT**

This FM tuner is your least expensive source of high fidelity material! Stabilized oscillator circuit assures negligible drift after initial warmup. Broadband IF circuits assure full fidelity, and 10 microvolt sensitivity pulls in stations with full volume. High-gain cascode RF amplifier, and automatic gain control. Ratio detector gives high-efficiency demodulation. All tunable components prealigned. Edge-illuminated dial for easy tuning. Here is FM for your home at a price you can afford. Shpg. Wt. 7 lbs.

**MODEL FM-3A \$25.95 (with cabinet)**

**HEATHKIT 25-WATT  
 HIGH FIDELITY AMPLIFIER KIT**

The 25-watt Heathkit model W-5M is rated "best buy" in its power class by independent critics! Faithful sound reproduction is assured with response of  $\pm 1$  db from 5 to 160,000 CPS at 1 watt, and harmonic distortion below 1% at 25 watts, and IM distortion below 1% at 20 watts. Hum and noise are 99 db below rated output, assuring quiet, hum-free operation. Output taps are 4, 8, and 16 ohms. Employs KT66 tubes and Peerless output transformer. Designed to use WA-P2 preamplifier. Express only. Shpg. Wt. 31 lbs.

**MODEL W-5M \$59.75**

**HEATHKIT "MASTER CONTROL"  
 PREAMPLIFIER KIT**

This unit is designed to operate as the "master control" for any of the Heathkit Williamson-type amplifiers, and includes features that will do justice to the finest program material. Frequency response within  $\pm 1\frac{1}{2}$  db from 15 to 35,000 CPS. Full equalization for LP, RIAA, AES, and early 78's. Five switch-selected inputs with separate level controls. Bass and treble control, and volume control, on front panel. Very attractively styled, and an exceptional dollar value. Shpg. Wt. 7 lbs.

**MODEL WA-P2 \$19.75 (with cabinet)**

**HEATHKIT "BASIC RANGE"  
 HI-FI SPEAKER SYSTEM KIT**

This speaker system employs two Jensen speakers to cover the frequency range for 50 to 12,000 cps. Response is within  $\pm 5$  db through this range. Built-in cross-over functions at 1600 cps. System rated at 25 watts, with nominal impedance of 16 ohms. Enclosure is a ducted-port bass reflex type. The attractive "picture frame" molding blends with any decoration scheme. You merely assemble the cabinet, wire the speakers and crossover network, and treat the furniture-grade plywood in the finish of your choice. Shpg. Wt. 30 lbs.

**MODEL SS-1 \$39.95**

**HI-FI and save!**



**FM TUNER**



**25-WATT AMPLIFIER**

*Get the enjoyment  
 of truly fine  
 performance  
 and save . . . up to  
 one-half with  
 HEATHKITS  
 world's finest  
 electronic equipment  
 in kit form.*



**PREAMPLIFIER**

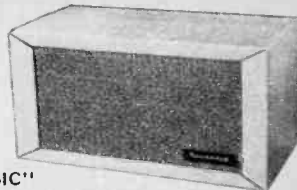

**"BASIC"  
 SPEAKER SYSTEM**

**HOW TO ORDER**

Identify kit by model number and send check or money order. Don't hesitate to ask about the Heath Time Payment Plan.

*Pioneer in  
 "do-it-yourself"  
 electronics*



**HEATH COMPANY**

A subsidiary of Daistrom, Inc.

**BENTON HARBOR 7, MICH.**  
 Please send **FREE** Heathkit Catalog.

**NAME** \_\_\_\_\_

**ADDRESS** \_\_\_\_\_

**CITY & STATE** \_\_\_\_\_

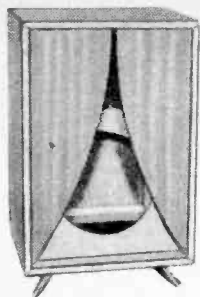

Pat.  
Applied  
for

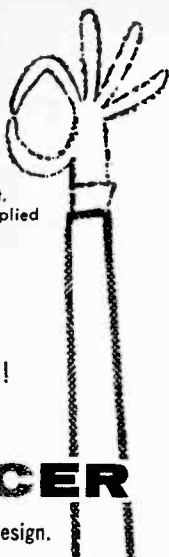

unsurpassed by  
costlier systems!

## KARLSON TRANSDUCER

a new departure in speaker system design.

Through a new invention for converting mechanical energy into sound . . . the Karlson perfectly couples your speaker to air over the entire audio range! The result—a system that pleases the most critical . . . a system that has no equal regardless of price! This is our belief—and it is based on very extensive tests! It will be yours too when you hear the Karlson at your dealer.

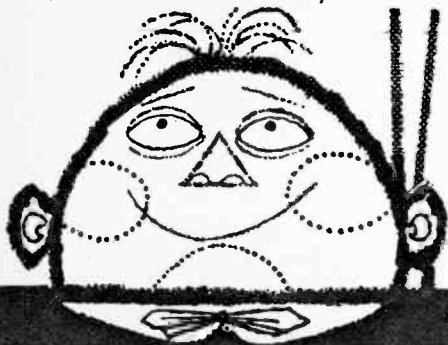

### Self-Assembling Kits—Hardwood Exteriors

Karlson 8	Karlson 12	Karlson 15
\$18.60	\$42.00	\$57.00

Fully Assembled Models—Available in unfinished fine hardwood exteriors—Karlsonite and Karlson Luxorwoods. . . from \$26.70 to \$174.00.

See Your Dealer • Send for Catalog Information Kit

### KARLSON ASSOCIATES INC.

Dept. HFA, 1610 Neck Rd., Bklyn. 29, N. Y.

**Monitor Head**—Additional playback head featured on some tape recorders making it possible to listen to the material off the tape while the recording is being made.

**Motor Board**—Also called tape transport mechanism. The platform or assembly of a tape recorder on which the motor(s), reels, heads and controls are mounted. It includes those parts of the recorder other than the amplifier, pre-amplifier, loud-speaker and case.

**NARTB Curve**—Standard tape recording and playback equalization curve set by National Association of Radio and Television Broadcasters. The NARTB disc curve is the same as RIAA.

**Noise Suppressor**—An electronic circuit which reduces high frequency hiss or noise. It is utilized primarily with old records.

**Ohm**—The fundamental unit of measure of electrical resistance and impedance.

**Output**—The terminals or connection to which the load is connected. Also refers to the electrical energy being supplied from the device.

**Oxide**—Microscopically small particles of ferric oxide dispersed in a liquid binder and coated on a tape backing. Red oxide is most common, although High Output tape employs a dark green oxide. These oxides are magnetically hard, that is, once magnetized they remain magnetized permanently, unless they are demagnetized by exposure to another strong magnetic field.

**Patch Cord**—Sometimes called attachment cord. A short cord or cable with a plug on either end, or with a pair of clips on one end, for conveniently connecting two pieces of sound equipment such as a phonograph and tape recorder, or an amplifier and speaker. Not used for 110-volt current.

**Peak**—A point in the frequency range where a component delivers excessive energy, i.e., departs from a "flat" characteristic. Also used to denote the maximum instantaneous output of a device.

**Pickup**—The device which converts the vibrations of the stylus or needle to an electrical current which can be amplified. (Cartridge)

**Playback Head**—Magnetic head used to pick up signal off a tape. Often same head as used for recording, but with circuitry changed by means of switch.

**PM**—Permanent magnet. Used as an adjective to differentiate from previous designs of speakers which required an electrical current for magnetization.

**Polyester Backing**—Plastic film backing for magnetic tape used for special purposes where strength and resistance to humidity change are important. Often referred to by the DuPont trade name Mylar.

**Power Amplifier**—An amplifier designed to operate a loud-speaker.

**Power Cord**—Cord for connecting the tape recorder to 110-volt AC current.

**Pre-amplifier**—An amplifier that raises extremely weak signal levels such as those from a microphone, magnetic playback head, or a phonograph pickup to a level usable by the power amplifier.

**Pre-Emphasis**—The introduction of additional amplification over a limited range of frequencies. FM stations introduce pre-emphasis in the treble range to override atmospheric noise.

**Pressing**—A disc recording produced in a record-molding press from a master or stamper.

**Pressure Pads**—Felt pads mounted on spring brass arms which hold the magnetic tape in close contact with the heads on some machines.

**Pressure Roller**—Also called capstan idler or puck. A rubber-tired roller which holds the magnetic tape tight against the capstan by means of spring pressure to insure constant tape speed and prevent slippage.

**Print-Through**—Transfer of the magnetic field from layer to layer of tape on the reel.

**Quieting**—Denotes (in rating FM tuners) the degree to which noise in the receiver is reduced below the signal.

**RF**—Abbreviation for radio frequency. This refers to that range beyond the limit of hearing which is suitable for transmission through the air by means of broadcasting.

**Recorded Tape**—Usually a recording on tape that is commercially available. Also called a pre-recorded tape.

**Recording Noise**—Noise induced by the amplifier and other components of the recorder. High quality magnetic tape itself is inherently noise-free.

**Reluctance Microphone**—Inexpensive electromagnetic type microphone supplied with many tape recorders which is extremely rugged and durable but generally not as high quality as crystal or ceramic types. Employs a metal "wand" which moves in a magnetic field to produce varying voltages.

**RIAA Curve**—Standard disc recording and playback equalization set by the Record Industry Association of America.

**Response**—A contraction of "frequency response" which is the reaction of an amplifying system to a range of signal frequencies. See also Peak.

**Reverberation**—The persistence of sound in a room due to repeated reflections from walls, ceiling, floor, furniture and occupants.

**Roll-Off**—A term used in connection with recording to describe a reduction in the intensity of the high bands of frequencies to provide a specified deviation in the frequency response. It is used when playing phonograph records which have been recorded with pre-emphasis, and also in FM receivers.

**Rumble**—A low frequency vibration mechanically transmitted to the turntable and appearing in the reproduction as noise.

**Selectivity**—The ability of a tuner to select and separate between two broadcasting stations which are close together on the dial.

**Sensitivity**—A measure of a tuner's ability to receive weak signals.

**Signal**—The designation given to those impulses generated by a pickup, a microphone, or received from a broadcasting station via the antenna. These signals are the electrical energy corresponding to the music or speech.

**Signal-Noise Ratio**—

- (1) The basis for rating sensitivity in an FM tuner. The ratio between the signal and background noise, expressed in decibels, at a stated input signal.
- (2) The ratio in an audio system between the rated output power and the noise and hum content—usually expressed in decibels.

## SAVE MONEY ON EVERYTHING IN HI-FI

**FREE**

**ALLIED'S**  
404-PAGE  
1958  
CATALOG



FEATURING THE WORLD'S  
LARGEST STOCKS OF  
HI-FI COMPONENTS  
AND SYSTEMS



### Save on Everything in Hi-Fi

Here's your complete money-saving guide to Hi-Fi. Shows you how to select a custom Hi-Fi music system for your home at no more than the cost of an ordinary phonograph. If you prefer to assemble your own system, tells you what to look for and how to save money on each unit. Offers you the world's largest selection of latest Hi-Fi systems as well as amplifiers, tuners, changers, speakers, enclosures, stereo sound units, recorders and accessories from which to make your money-saving choice. Want to build your own?—see the famous Hi-Fi KNIGHT-KITS. For everything in Hi-Fi—for *everything* in Electronics, get the FREE 1958 ALLIED Catalog. Write for your copy today!

America's Hi-Fi Center • Our 37th Year



**ALLIED RADIO**

Send  
for FREE  
Catalog

ALLIED RADIO CORP., Dept. NN-8  
100 N. Western Ave., Chicago 80, Illinois

Send FREE 1958 ALLIED 404-Page Catalog

Name \_\_\_\_\_

Address \_\_\_\_\_

City \_\_\_\_\_ Zone \_\_\_\_\_ State \_\_\_\_\_

**Single-Track Recorder**—A tape recorder which records only one track on the tape. Usually a full-track recording head is used which covers the full width of the 1/4-inch tape, although some machines use a narrower half-track recording head which records a single track down the middle of the tape.

**Splicing Tape**—A pressure-sensitive non-magnetic tape used for splicing magnetic tape. Its hard adhesive will not ooze and consequently will not gum up the recording head, or cause adjacent layers of tape on the reel to stick together.

**Stacked Heads**—Arrangement of recording heads used for stereophonic sound where the two heads are located directly in line, one above the other.

**Staggered Heads**—Arrangement of recording heads used for stereophonic sound where the heads are located 1-7/32" apart. Stereo tapes recorded using staggered heads cannot be played on recorders using stacked heads, or vice versa.

**Stereophonic Sound**—Dimensional or directional sound reproduction achieved through use of two or more sound tracks, or channels, heard simultaneously through loud-speakers arranged in the same relative positions as were the microphones during the recording. In practice two channels are used, one on each track of a standard tape, with a recording head for each channel.

**Stroboscope Disc**—A device for measuring the speed of a rotating object such as a phonograph turntable.

**Stylus**—The correct name for "needle." A rounded

point of specified radius which is inserted into a pickup and rides a record groove.

**Take-up Reel**—Reel on the tape recorder which accumulates the tape as it is recorded or played.

**Tape Deck**—Tape recorder designed for use in a hi-fi music system. Usually consists only of motor-board mechanism and does not include preamplifier, power amplifier, speaker or case.

**Tone Control**—Control knob on tape recorder amplifier used to vary bass and treble response to achieve most desirable balance of tone.

**Triode**—A type of tube used in amplifiers. It is characterized by very low distortion.

**Turnover**—A specified point in the lower frequencies where the recording signal is decreased in amplitude. In order to obtain proper fidelity on playback, equalization or increase of the lower frequencies is introduced in the amplifier.

**Volume**—An acoustical, rather than electrical, measurement which refers to the pressure of the sound waves in terms of dynes per square centimeter. The louder the sound, the greater the pressure. Most technicians prefer to talk in terms of decibels.

**VU Meter**—A volume-unit meter which indicates the relative levels of the various sounds being recorded by measuring the electrical voltages.

**Woofer**—A loud-speaker designed to reproduce the lower range of frequencies.

**Wow**—Slow variations in tape speed causing similar variations in sound volume and pitch not present in the original sound. A form of distortion.

**NOW  
Rumble  
50 db  
BELOW**

**N.A.R.T.B.  
STANDARD  
REFERENCE  
LEVEL \***

Don't let  
Turntable rumble  
defeat your High  
Fidelity System.

\*Reference velocity of 7 cm/sec. at 500 cps corresponds to National Ass'n of Radio & Television Broadcasters standard reference level.

**METZNER**

*Starlight*

**HIGH FIDELITY  
TURNTABLE**



The incomparable Starlight has been brought even closer to dreamed-of total silence in operation and now actually exceeds even the most rigid professional standards. In fact, if checked by the reference level used by some turntable manufacturers, it would show as much as 80 db signal-to-rumble ratio! And all this at no increase in price!

- ★ Illuminated Stroboscope — reads while the record is playing
- ★ Continuously variable speed control — precise settings for all 4 speeds.
- ★ Wow & flutter less than 0.2% RMS. Again better than NARTB standards

See your nearest dealer for a "proof-of-the-pudding" demonstration or write for illustrated brochure.

Starlight **\$59.50**  
Model 60  
(less base and arm)

Model 672 (illustrated)  
Complete unit with model 60  
turntable, base and push-  
button transcription arm . . . \$97.00  
Model 07 push-button  
transcription arm . . . 22.50  
Model 002 (blonde) and  
Model 004 (ebony finish)  
1" laminated hardwood  
base . . . 17.50

Prices include Fed. excise tax  
where applicable.

**METZNER ENGINEERING CORPORATION**

1041 N. SYCAMORE AVE., Dept. HA-7, HOLLYWOOD 38, CALIF.



# Where to Buy It

A listing of the manufacturers whose products are mentioned in this book. Contact them direct

ACOUSTICAL DEVELOPMENT CORP.  
Box 572  
Hempstead, N. Y.

ACOUSTIC RESEARCH, INC.  
24 Thorndike Street  
Cambridge 41, Mass.

ALLIED RADIO CORP.  
100 North Western Avenue  
Chicago 80, Ill.

ALTEC LANSING CORP.  
161 Sixth Avenue  
New York 13, N. Y.

AMPEX CORPORATION  
405 Lexington Avenue  
New York 17, N. Y.

AMPLIFIER CORP. OF AMERICA  
398 Broadway  
New York 13, N. Y.

ASTATIC CORP.  
Conneaut, Ohio

AUDAX COMPANY  
38-19 108th Street  
Corona 68, N. Y.

AUDIO  
204 Front Street  
Mineola, N. Y.

AUDIO DEVICES, INC.  
444 Madison Avenue  
New York 22, N. Y.

AUDIO FIDELITY, INC.  
465 W. 51st Street  
New York 19, N. Y.

AUDIOGERSH CORP.  
514 Broadway  
New York 12, N. Y.

BEAM INSTRUMENTS CORP.  
350 Fifth Avenue  
New York 1, N. Y.

BELL SOUND SYSTEMS, INC.  
555 Marion Road  
Columbus 7, Ohio

BERLANT CONCERTONE  
655 W. Washington Blvd.  
Los Angeles 15, Calif.

DAVID BOGEN CO., INC.  
Box 500  
Paramus, N. J.

BOZAK SALES CO.  
Darien, Conn.

BROCINER ELECTRONICS LABORATORY  
344 East 32nd Street  
New York 16, N. Y.

BROWNING LABORATORIES  
750 Main Street  
Winchester, Mass.

Please enter my name for 8 issues of **AUDIO\*** Magazine at 50¢ per copy. I understand that with this order, total cost \$4 which includes everything - postage and handling, I am to receive FREE, 8 extra issues -  $\frac{2}{3}$  of a year, making 16 issues in all Enclosed is a check or money order for \$4.

AUDIO MAGAZINE, Desk FB  
P.O. BOX 629  
Mineola, New York

Name \_\_\_\_\_

Address \_\_\_\_\_

City \_\_\_\_\_ Zone \_\_\_\_\_ State \_\_\_\_\_

\*AUDIO...the original and longest established publication in the hi-fi field... shows HOW-TO-UNDERSTAND-IT BETTER and DO-IT-MORE-EASILY!

**AMERICA'S OLDEST and  
MOST AUTHORITATIVE  
RECORD REVIEW MAGAZINE**

# The REVIEW of RECORDED MUSIC

A monthly publication devoted to unbiased appraisals of all current classical and popular record releases.

*Each Issue Contains:*

**THE MONTH'S BEST**

**REVIEWING THE CLASSICS**

**HI-FI AND MUSIC**

A monthly article by  
**ED. TATNALL CANBY**  
one of America's leading Hi-Fi authorities

**LISTENING WITH BOTH EARS**

a monthly column by  
**FRED GRUNFELD**  
of WQXR "Music Magazine" Fame

**CONNOISSEUR'S CORNER**

**TOPS IN POPS**

All to be found every month in  
the 32 page Review of Recorded Music

*To be fully informed of all that is new in  
the world of Recorded Music, fill out the  
coupon below.*

Review of Recorded Music, 119 W. 57 St., New York 19  
Please enter my subscription to the Review of  
Recorded Music for a six month's trial period,  
for which I enclose \$1.00.

1 year \$2.00    2 years \$3.50    3 years \$5.00

NAME \_\_\_\_\_

ADDRESS \_\_\_\_\_

CITY \_\_\_\_\_ STATE \_\_\_\_\_

- BRUSH ELECTRONICS LABORATORY  
3405 Perkins Avenue  
Cleveland 14, Ohio
- CONSUMERS' RESEARCH, INC.  
Washington, N. J.
- COOK LABORATORIES, INC.  
114 Manhattan Street  
Stamford, Conn.
- COUNTRY WORKSHOP  
95 Rome Street  
Newark 5, N. J.
- DIAMOND STYLUS CORP.  
31 West 47th Street  
New York 36, N. Y.
- DICTOGRAPH HI-FI PRODUCTS  
95-25 149th Street  
Jamaica 35, N. Y.
- DU KANE CORP.  
St. Charles, Ill.
- DUOTONE COMPANY  
Locust Street  
Keyport, N. J.
- EICO  
84 Withers Street  
Brooklyn 11, N. Y.
- ELECTRO-SONIC LABORATORIES  
35-54 36th Street  
Long Island City 6, N. Y.
- ELECTRO-VOICE, INC.  
404 Carroll Street  
Buchanan, Mich.
- FAIRCHILD RECORDING EQUIPMENT CO.  
10-40 45th Avenue  
Long Island City, N. Y.
- FISHER RADIO CORP.  
21-21 44th Drive  
Long Island City, N. Y.
- G & H WOOD PRODUCTS (CABINART)  
99 N. 11th Street  
Brooklyn 11, N. Y.
- GARRARD SALES CORP.  
80 Shore Road  
Port Washington, N. Y.
- GENERAL ELECTRIC CO.  
Electronics Park  
Syracuse, N. Y.
- THE GENERAL INDUSTRIES CO.  
Olive and Taylor Streets  
Elyria, Ohio
- GRANCO PRODUCTS, INC.  
36-17 20th Avenue  
Long Island City 5, N. Y.
- GRAY RESEARCH & DEVELOPMENT CO.  
659 Hilliard Street  
Manchester, Conn.
- HARMAN-KARDON, INC.  
520 Main Street  
Westbury, N. Y.
- HEATH CO.  
Benton Harbor, Mich.
- HIGH FIDELITY  
Great Barrington, Mass.
- JEFF MARKELL ASSOCIATES  
764 Sixth Avenue  
New York 10, N. Y.
- JENSEN MANUFACTURING CO.  
6601 South Laramie Avenue  
Chicago 38, Ill.
- KARLSON ASSOCIATES, INC.  
1610 Neck Road  
Brooklyn 29, N. Y.

KINGDOM PRODUCTS, LTD.  
514 Broadway  
New York 12, N. Y.

KLIPSCH & ASSOCIATES  
P.O. Box 64, Hope, Ark.

LAFAYETTE RADIO  
165-08 Liberty Avenue  
Jamaica 33, N. Y.

JAMES B. LANSING SOUND, INC.  
2439 Fletcher Drive  
Los Angeles 39, Calif.

LIVINGSTON AUDIO PRODUCTS CORP.  
Box 202  
Caldwell, N. J.

MAGNAVOX, INC.  
Fort Wayne 4, Ind.

McINTOSH LABORATORY, INC.  
4 Chambers Street  
Binghamton, N. Y.

METZNER ENGINEERING CORP.  
1040 N. Sycamore Avenue  
Hollywood 38, Calif.

MINNESOTA MINING & MFG. CO.  
900 Fauquier Street  
St. Paul, Minn.

MUSIC AT HOME  
207 East 37th Street  
New York 16, N. Y.

NESHAMINY ELECTRONIC CORP.  
Neshaminy, Penna.

NORELCO  
230 Duffy Avenue  
Hicksville, N. Y.

ORRADIO INDUSTRIES  
T-120 Marvyn Road  
Opelika, Ala.

ORTHO-SONIC INSTRUMENTS, INC.  
66 Mechanic Street  
New Rochelle, N. Y.

OZARK WOOD PRODUCTS CO.  
311 Park Place  
Glendale, Mo.

PENTRON CORP.  
777 South Tripp Avenue  
Chicago 24, Ill.

PICKERING AND CO., INC.  
309 Woods Avenue  
Oceanside, Long Island, N. Y.

PILOT RADIO CORPORATION  
37-06 Thirty-Sixth Street  
Long Island City, N. Y.

PRESTO RECORDING CORP.  
Box 500  
Paramus, N. J.

PROGRESSIVE "EDU-KITS," INC.  
497 Union Avenue  
Brooklyn 11, N. Y.

RADIO CRAFTSMEN, INC.  
4223 W. Jefferson Blvd.  
Los Angeles 16, Calif.

RADIO-ELECTRONICS  
154 W. 14th Street  
New York, N. Y.

RADIO & TELEVISION NEWS  
1 Park Avenue  
New York, N. Y.

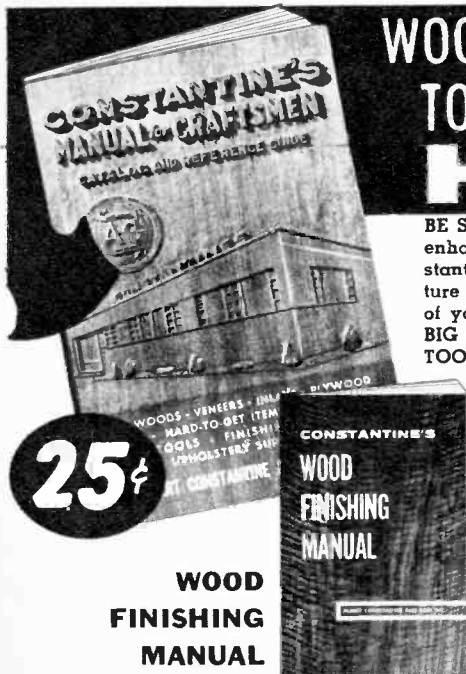

## WOOD FINISHING MANUAL

Contains complete information to make you an expert at finishing furniture and other wood work.

Tells how to prepare, stain, seal, fill, highlight and grade. Send only 25¢ today!

# WOODS • VENEERS • MATERIALS • TO BUILD AND FINISH YOUR HI-FI cabinets

BE SURE to do justice to "what's in the box." Make your cabinets enhance your listening pleasure . . . and they will if you use Constantine's fine woods, veneers and finishes. Build really fine furniture to match any decor, fit any systems and increase the value of your hi-fi.

**BIG HOW-TO-DO-IT BOOK CONTAINS EVERYTHING IN WOODS, TOOLS, MATERIALS AND HARD-TO-GET ITEMS FOR HOBBYISTS.**

Loaded with articles on wood-finishing, veneering, making inlays, cabinets, tables, etc. It's a complete book of rare and domestic woods, veneers, lumber, plywood, inlays, panels, unusual Hi-Fi hardware and cabinet items, plans. Over 126 pages, many in full color and everything at low prices. Send for your copy today and we will include **FREE "Chips and Chats"**—Constantine's newsy periodical of craftsman projects, activities and bargains in supplies. Remember 1 year's subscription free with each catalog request.

### MAIL COUPON TODAY!

ALBERT CONSTANTINE and SON, INC.

2050 Eastchester Road, New York 61, New York, Dept. HFM

I enclose 25¢. Send Manual for Craftsmen.  
(25¢ refunded on your first order)

I enclose 25¢. Send Wood Finishing Manual.

Name .....

Address .....

City..... Zone..... State.....

# Mammoth 1957 Wholesale Tool Catalog

**\$1**

**puts You In  
Business**

The opportunity now awaits you to own and operate your own business on a part time or full time basis in the lucrative field of **HARDWARE, HAND TOOLS, FANS, POWER TOOLS, MOTORS, PAINTS, etc., or BUY TOOLS FOR YOUR INDUSTRIAL OR INSTITUTIONAL USES.**

**TOOL CATALOG**



**YOUR NAME**

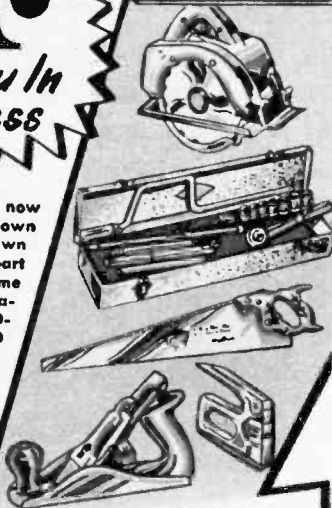

Buy Nationally Advertised Tools for Resale or Industrial or Institutional Use

**NO INVESTMENT REQUIRED. BUY AS YOU NEED IT. A MILLION DOLLAR INVENTORY AT YOUR FINGER TIPS.**

**Discount**  
UP TO **50%**

\$1.00 refund on first purchase or refund if you are not 100% satisfied.

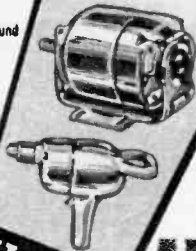

Every one needs tools. Meet the demands of the growing "Do-it Yourself" markets. Sell direct from the jumbo buying guide—your cost is known only to you.

ENCLOSE \$1.00 FOR DEALER'S CARD & 1957 MAMMOTHTOOLCATALOG.

**JUST FILL OUT  
COUPON**

## SILVO HARDWARE COMPANY

Dept. FAW 57-34, 108 Market St., Philadelphia 6, Pa.

I am enclosing \$1.00. Rush me your dealer's card and big Catalog Today. If I am not completely satisfied with your plan, I understand that I can return the Dealer's Card and Catalog for refund, and if I decide to order, my \$1.00 will be deductible from my first order.

NAME .....

ADDRESS .....

CITY ..... ZONE ..... STATE .....

RCA-VICTOR RECORDS  
155 E. 24th Street  
New York, N. Y.

REEVES SOUNDRAFT CORP.  
10 E. 52nd Street  
New York 22, N. Y.

REK-O-KUT CO.  
38-19 108th Street  
Corona 68, N. Y.

R-J AUDIO PRODUCTS, INC.  
164 Duane Street  
New York 13, N. Y.

RONETTE — HOLLAND  
135 Front Street  
New York 5, N. Y.

SCHWANN LP CATALOG  
137 Newbury Street  
Boston, Mass.

H. H. SCOTT, INC.  
385 Putnam Avenue  
Cambridge 39, Mass.

SHERWOOD ELECTRONIC LABORATORIES  
2802 W. Cullom Avenue  
Chicago 18, Ill.

SHURE BROTHERS, INC.  
222 Hartrey Avenue  
Evanston, Ill.

SONOTONE CORP.  
P.O. Box 200  
Elmsford, N. Y.

STANCIL-HOFFMAN CORP.  
921 N. Highland Avenue  
Hollywood 38, Calif.

STEPHENS MFG. CORP.  
8538 Warner Drive  
Culver City, Calif.

STROMBERG-CARLSON CO.  
1700 University Avenue  
Rochester 10, N. Y.

TANNOY LIMITED  
36 Wellington Street, East  
Toronto 1, Ontario, Canada

TAPE RECORDING  
Severna Park, Md.

TECH-MASTER PRODUCTS  
75 Front Street  
Brooklyn, N. Y.

TELECTROSONIC CORP.  
35-18 37th Street  
Long Island City 1, N. Y.

TETRAD CO., INC.  
62 St. Mary Street  
Yonkers 2, N. Y.

TRANSCRIBER CO.  
98 County Street  
P. O. Draw 478  
Attleboro, Mass.

UNITED AUDIO PRODUCTS  
202 E. 19th Street  
New York 3, N. Y.

UNIVERSITY LOUDSPEAKERS, INC.  
80 South Kensico Avenue  
White Plains, N. Y.

VECTOR LABORATORIES  
217 3rd Avenue  
New York, N. Y.

Y-M CORPORATION  
280 Park Street  
Benton Harbor, Mich.

WALCO PRODUCTS, INC.  
60 Franklin Street  
East Orange, N. J.

**THE MOST EXCITING HIGH FIDELITY PERFORMANCES EVER OFFERED  
TO NEW MEMBERS OF THE COLUMBIA (LP) RECORD CLUB**

**FREE-ANY 3**  
OF THESE SUPERB HIGH-FIDELITY  
**12" COLUMBIA (LP) RECORDS**

If you join the Club now—and agree to purchase at least 4 selections during the coming 12 months

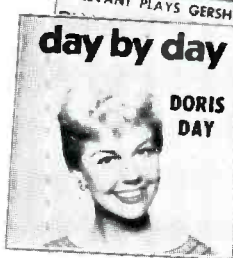

**YES!** You may have, FREE, ANY 3 of these best-selling 12" Columbia (LP) records. We make this unique offer to introduce you to the money-saving program of the Columbia (LP) Record Club... a program that selects for you each month the greatest works in every field of music—performed by the world's finest artists, brilliantly reproduced on Columbia (LP) records.

**HOW THE CLUB OPERATES**

To enjoy the Club's benefits—mail the coupon, indicating which one of the four Club Divisions best suits your musical taste: Classical; Jazz; Listening and Dancing; Broadway, Movies, Television and Musical Comedies.

Each month you will receive free the Club Magazine which describes the current selections in all four Divisions. You may accept or reject the monthly selection for your Division... or take records from the other Club Divisions... thereby assuring you the widest possible

choice of recorded entertainment. Or you may tell us to send you NO record in any month. Your only obligation is to purchase at least four selections from the more than 100 that will be offered during the next 12 months. The records you want are mailed and billed to you at the regular list price of \$3.98 (original cast Musical Shows somewhat higher), plus a small mailing charge.

**FREE BONUS RECORDS GIVEN REGULARLY**

The three records sent to you now represent an "advance" of the Club's bonus system—given to you at once. After you have fulfilled your membership obligation by purchasing four records, you will receive an additional free Bonus record of your choice for every two additional Club selections you accept. Bonus records are superb 12" Columbia (LP) records—the very best of the world-famous Columbia (LP) catalog—just like those shown here.

Indicate on the coupon which three records you want free, and the Division you prefer. Then mail the coupon at once. You must be delighted with membership or you may cancel it by returning the free records within 10 days.

**COLUMBIA (LP) RECORD CLUB Terre Haute, Indiana**

**AN \$11.94 VALUE SENT TO YOU AT ONCE—MAIL ENTIRE COUPON NOW!**

Columbia (LP) Master Reg.

**COLUMBIA (LP) RECORD CLUB, Dept. 282  
TERRE HAUTE, INDIANA**

Please send me as my FREE gift the 3 records indicated here: (Select the records you want by circling 3 numbers in the list at the right)...and enroll me in the following Division of the Club.

(check one box only)

- Classical       Listening and Dancing       Jazz  
 Broadway, Movies, Television and Musical Comedies

Each month you will send me the Columbia (LP) Record Club Magazine which describes the records offered in all four Club Divisions. I have the privilege of accepting the monthly selection in the Division checked above, or any other selection described, or none at all. My only obligation is to purchase four records in the next 12 months at the regular list price plus a small mailing charge. After accepting four records, I will receive a free Bonus record for every two additional records I purchase. If not delighted with membership, I may cancel within 10 days by returning all records.

Name.....  
(Please Print)  
Address.....  
City..... Zone..... State.....

CANADA: Prices slightly higher. Address 11-13 Soho St., Toronto 2B  
If you wish to have this membership credited to an established Columbia Records dealer, authorized to accept subscriptions, please fill in the following information:

Dealer's Name.....  
Dealer's Address.....62

**CIRCLE THE NUMBERS OF THE  
3 RECORDS YOU WANT**

- Tchaikovsky: Nutcracker Suite; The Sleeping Beauty Ballet Philadelphia Orchestra, Ormandy, cond.
- The Voice Frank Sinatra in 12 songs that first made him famous—*Lover, Fools Rush In*, etc.
- King of Swing: Vol. I Benny Goodman and Original Orch., Trio, Quartet, *Ridin' High, Moonglow*—9 more.
- Li'l Abner Percy Faith and his Orchestra play music from this gay hit show.
- Bernstein: Fancy Free—Ballet Suite; Copland: El Salón México; Milhaud: La Création du Monde Leonard Bernstein conducting the Columbia Symphony in brilliant performances of three modern works.
- Moonlight Becomes You Here's mood music in Hi-Fi—Paul Weston and his Music from Hollywood. 12 songs.
- Ellington Uptown Duke Ellington and Orchestra perform *Skin Deep, The Mooche, Perdido*—2 more.
- Levant Plays Gershwin 3 works—*Rhapsody In Blue; Concerto in F; An American in Paris*.
- Day By Day Doris Day sings 12 popular songs—including *The Song Is You, Autumn Leaves*, etc.
- Rimsky-Korsakov: Scheherazade Philadelphia Orch., Ormandy, conductor. A superb performance of this exotic score.
- Music of Jerome Kern Andre Kostelanetz and his Orchestra play 20 Kern favorites.
- Concert by the Sea Erroll Garner in an actual jazz performance at Carmel, Calif. *Teach Me Tonight, Where or When, I'll Remember April*—8 more.



# REK-O-KUT

Leading high fidelity manufacturer... tells you

## HOW TO AVOID A COSTLY MISTAKE IN YOUR HIGH FIDELITY SYSTEM

Here are three decisions you must make — wisely — if you are building a high fidelity system.

1. Shall I buy a changer or a turntable? No matter what other components you choose, you cannot hope to achieve high fidelity reproduction unless your records are played on a quality turntable. The eight reasons why this is so are discussed and illustrated in our new colorful booklet offered in the coupon below. Get a copy — you'll find it helpful.

2. Which make turntable shall I choose? Check all the specifications, features and the reputation of every brand. Then listen to a Rondine at your dealer! You'll find that Rek-O-Kut Rondines are unquestionably ahead on every count. For the art of crafting a turntable as enduringly silent as Rondine — is enjoyed by Rek-O-Kut alone — and acquired as the result of being the leading designer and manufacturer of equipment for broadcast studios.

3. Which Rondine model shall I choose? — The Rek-O-Kut Catalog tells you how to select the Rondine turntable suitable for your particular system. Whether you choose the Rondine, Rondine Deluxe or Rondine Jr. — You can be sure of lasting satisfying performance!



**Rondine Jr.** — 2 speed  
custom Rek-O-Kut motor.  
**\$59.95**

Model L-34 — 33-1/3 & 45 rpm  
Model L-37 — 33-1/3 & 78 rpm

from **\$59.95**



**Rondine Deluxe, Model B-12M** — 3-speed and hysteresis synchronous motor. **\$129.95**

**Rondine, Model B-12** — 3-speed and custom Rek-O-Kut induction motor. **\$84.95**

The famous Rek-O-Kut turntable arm.



12" Arm — \$26.95 16" Arm — \$29.95

The closest approach to free cartridge suspension... Provides better compliance... finer tracking... and lower resonance than any other tone arm available today! Micrometer gramweight permits adjustment for correct stylus pressure without use of a scale!

Rek-O-Kut bases available in Walnut and Blonde.

THESE AIDS FREE, SEND COUPON:

- Strobe Disc
- Booklet — Turntable or Record Changer... which shall I buy?
- Catalog

## REK-O-KUT COMPANY, INC.

38-19 108th Street, Corona 68, New York

Name \_\_\_\_\_

Address \_\_\_\_\_

City \_\_\_\_\_ Zone \_\_\_\_\_ State \_\_\_\_\_