

All About HI-FI TAPE RECORDING

By Donald Carl Hoefler

- Choosing Your Tape Recorder
- What Kind of Tape?
- Recorder Care and Maintenance
- Taping Off the Air
- Recommended Pre-Recorded Tapes
- Accessories
- Tape Data You Can Get Free



Editing Your Tapes

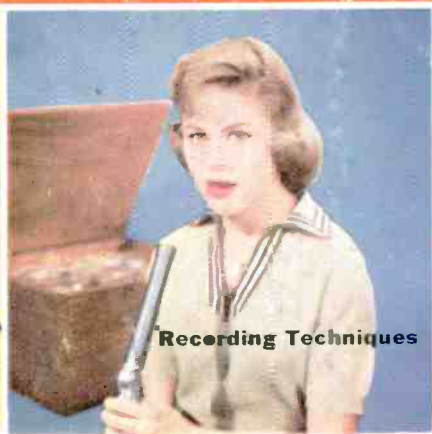

Recording Techniques

Special Stereo Section:

- Adding Stereo to Your Set-Up
- Making Your Own Stereophonic Tapes



**if you think
that all brands of
recording tape are alike ...**

**wait
till
you
try**

irish

BRAND

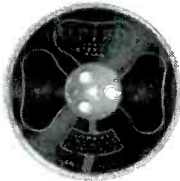

ferro-sheen

available wherever quality recording tape is sold



ORRadio Industries, Inc., Selma, Alabama
Export-Mechan. Exporting Co., New York, N. Y.
Central Sales Co., Toronto, Ontario

about that orchestra
in your living room . . .

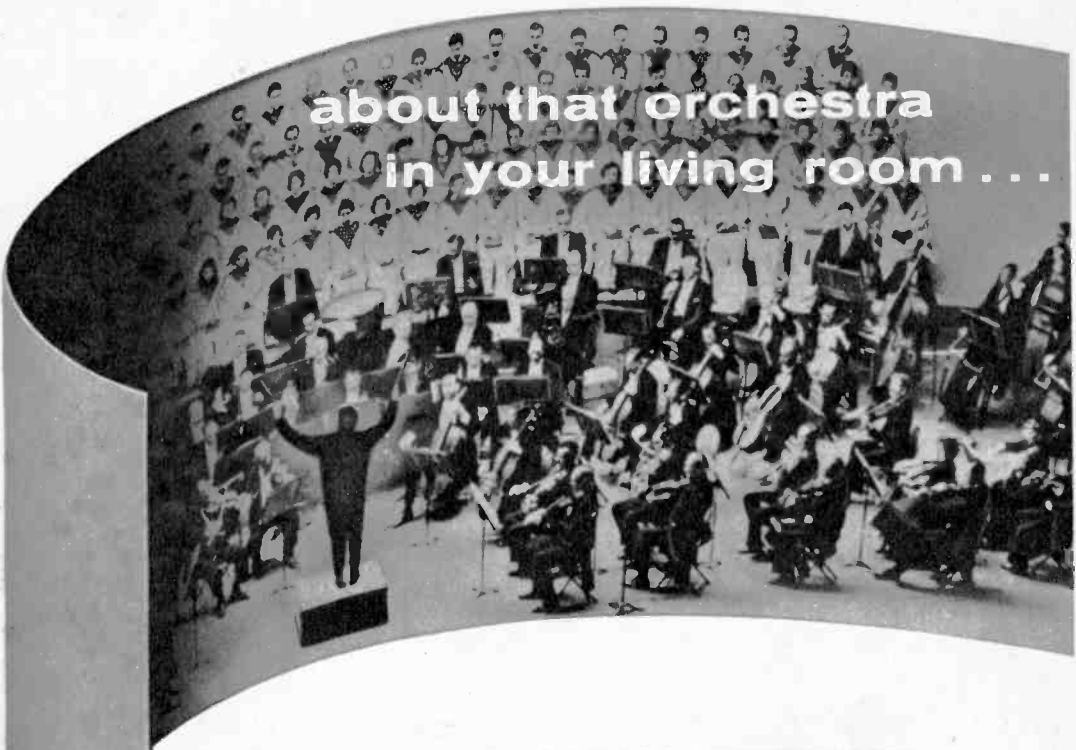

... from LIVINGSTON, I PRESUME!

THE MAGIC OF LIVINGSTON STEREOPHONIC TAPE

is as exciting as the live performance itself. With Livingston *Living Sound Tapes*,* you'll transform your favorite chair into a "front row seat" . . . thrill to concert hall realism and dynamic range . . . almost *feel* the breeze of the conductor's baton!

Livingston, pioneer in stereo tapes, assures you of this premium performance every time. Recorded and duplicated to the highest standards on the finest equipment, Livingston offers not only the *best* but the world's largest library of stereo tapes as well.



Ask your dealer or write for the new Livingston Catalog of

 **SYMPHONIC**
 **POPULAR**
 **JAZZ**
 **FOLK MUSIC**

| | | | |
|------------------------------|------------------------------------|----------------------------------|--------------------------------|
| NEW . . . THIS MONTH! | Jose Melis....."TONIGHT".....2017C | Elsa Maxwell.....1105F | |
| Lenny Herman Quintet | Tchaikovsky | Beethoven | Sam Donahue & Orch. |
| For Me and My Gal.....1108F | Capriccio Italien | Symphony No. 2 Egmont Overture | Body And Soul2012C |
| Let A Smile Be Your | Graz Philharmonic | Graz Philharmonic | Livingston Stereo |
| Umbrella1104F | Gustav Cerny, Cond.2016C | Mitades Caridia, Cond.4003K | Showcase, Vol. 4LS8C |

*"C" series (800 ft.) \$8.95

"F" series (1200 ft.) \$11.95

"K" series (1800 ft.) \$17.95

Living sound from

 **LIVINGSTON**
Audio Products Corp., Box 202, Caldwell, N. J. Dept. FA

All About HI-FI TAPE RECORDING

By Donald Carl Hoefler

A FAWCETT BOOK • NUMBER 382
LARRY EISINGER • EDITOR-IN-CHIEF
GEORGE TILTON • MANAGING EDITOR
HAROLD KELLY • ART EDITOR

W. H. Fawcett, Jr. President
Roger Fawcett General Manager
Ralph Daigh Editorial Director
James B. Boynton Advertising Director
Al Allard Art Director
Ralph Mattison Associate Art Director
Annette Packer Production Director

JOSEPH DAFFRON EDITOR

SILVIO LEMBO ASSOCIATE ART EDITOR
Nick Carlucci Assistant Art Editor
Murray Cooper Art Associate
Harold E. Price Art Associate
Michael Gaynor Art Associate
Larry Flanagan Art Associate
John S. Selvaggio Art Associate
Howard Katz Art Associate
Mike Eastman Art Associate
David Weiss Art Associate
Bob Van Osten Art Associate
Bob Vatter Art Associate
John M. Kane Art Associate

Phyllis J. Goodman Production Editor
Nancy Kay Assistant Production Editor

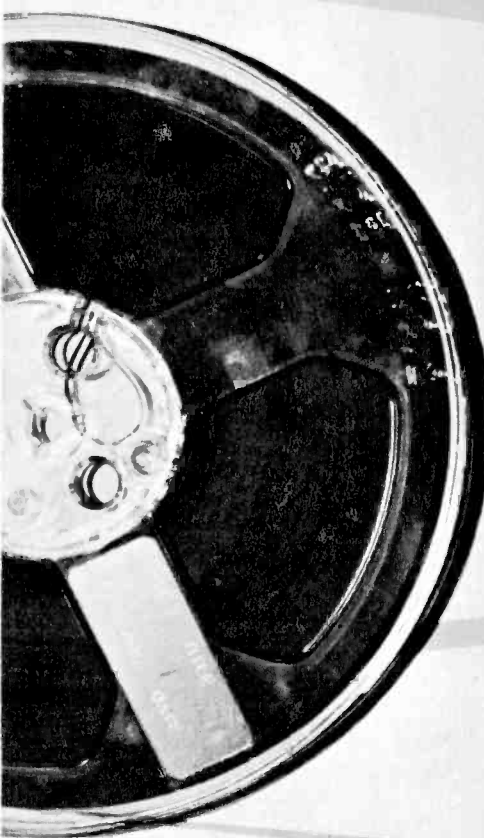

All cover photographs by Grayson Tewksbury. Large background photo is the Ampex Model A121-W. Telectrosonic Corporation's Model 1970 and Robins Industries' Gibson Girl splicer are shown in tape-editing photo; Electro-Voice microphone, courtesy Hudson Radio, NYC, is featured in the other small inset photograph.

ALL ABOUT HI-FI TAPE RECORDING, Fawcett Book 382, is published by Fawcett Publications, Inc., Greenwich, Connecticut. Editorial and Advertising Offices: 67 West 44th Street, New York 36, New York. General Offices: Fawcett Building, Greenwich, Connecticut. Gordon Fawcett—Secretary-Treasurer. Roscoe Fawcett—Circulation Director. Printed in U.S.A. Copyright 1958 by Fawcett Publications, Inc.

A NORELCO MODEL 9762M 12-inch loudspeaker, finest unit in the NORELCO line. Peak power-handling capacity is 30 watts. Dual-cone construction, common to all NORELCO speakers, extends frequency response from 35 to 18,000 cps. Efficiency is 14% at 400 cps, due to extra-long air gap and unusually powerful Ticonal magnet.

B NORELCO MODEL 9710M 8-inch dual-cone loudspeaker, offering performance practically indistinguishable from that of most 12-inch units. Peak power-handling capacity is 15 watts; frequency response extends from 40 to 20,000 cps; the Ticonal magnet is exceptionally large.

C COPPER RING, fitted into the deep air gap of NORELCO speakers, maintains constant voice coil impedance throughout the entire frequency range and assures correct matching to the amplifier output stage. Extra-long air gap makes for linear voice coil movement.

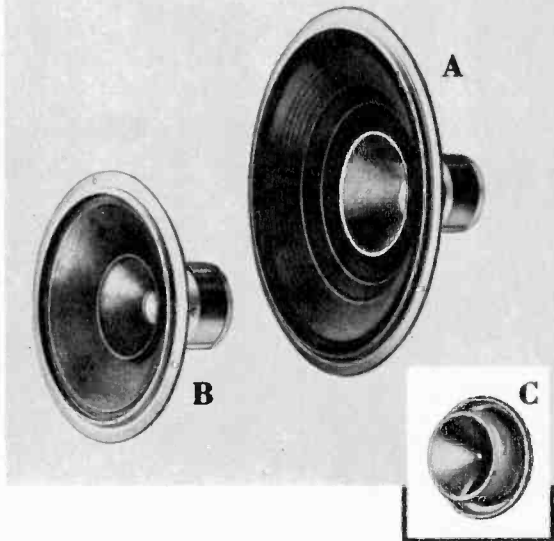

Conversion to Stereo Made Easy by Versatile NORELCO Hi-Fi Speakers

STEREO is here to stay. Pre-recorded stereophonic tapes are breaking all sales records. Sooner or later, most hi-fi enthusiasts will own a stereo tape recorder, if not one of the coming new stereo disc phonographs. Newcomers to high fidelity are showing a strong tendency to start with stereo tape right from the beginning.

Selecting a suitable loudspeaker system becomes doubly a problem with stereo, since a minimum of two speakers is required, and both must fit into the owner's space and budget allotment without undue stretching. That is where the NORELCO high-fidelity speaker line comes in.

Designed by world-renowned Philips of the Netherlands, largest electronics concern outside of the United States, these moderately priced, high-quality loudspeakers come in all sizes from 5 to 12 inches and are virtually

tailor-made to the space and cost requirements of the typical hi-fi stereo installation. Not only do they take up remarkably little room in their handsome, acoustically matched NORELCO enclosures, but their sound is definitely in the "big speaker" class, with the suave, uncolored, undistorted quality which is so important in the revealing medium of stereo.

The special design features illustrated here are altogether exclusive to NORELCO loudspeakers in their price class and, together with exceptionally careful workmanship and quality control, are the main factors in the achievement of superior sound without extravagant spending.

Further information may be obtained by writing to North American Philips Co., Inc., High Fidelity Products Division, Dept. FT, 230 Duffy Avenue, Hicksville, L. I., N. Y.



D NORELCO SPEAKER ENCLOSURES are acoustically engineered to match the exact characteristics of NORELCO loudspeakers. Ingenious base arrangement permits choice of either horizontal or vertical cabinet placement. The enclosures are available in three sizes, with mahogany, walnut or blonde custom finishes.

E NEW STEREO VERSION of the famous NORELCO "Continental" 3-speed portable tape recorder, soon to be available, will permit NORELCO sound quality from the very beginning of the stereo reproduction chain.

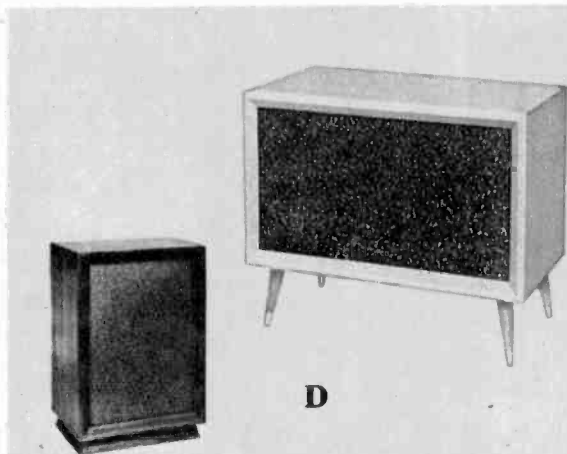



Contents

| | |
|--|-----|
| How It Works | 8 |
| Choosing Your Recorder | 16 |
| What Kind of Tape? | 22 |
| Accessories | 30 |
| Adding Tape to Your Hi-Fi System | 44 |
| Stereo on Tape | 54 |
| Recorded Tapes | 68 |
| Taping Off The Air | 74 |
| Living Sound | 82 |
| Taping Your Records | 92 |
| How to Edit Tapes | 102 |
| Make Your Own Sound Effects | 108 |
| Caring for Your Tapes | 118 |
| Recorder Maintenance | 122 |
| One On The House | 132 |
| Tape Terms | 136 |
| Where to Buy It | 140 |



AMPEX MODEL A 124-U—UNMOUNTED
RECORDER-STEREOPHONIC REPRODUCER.

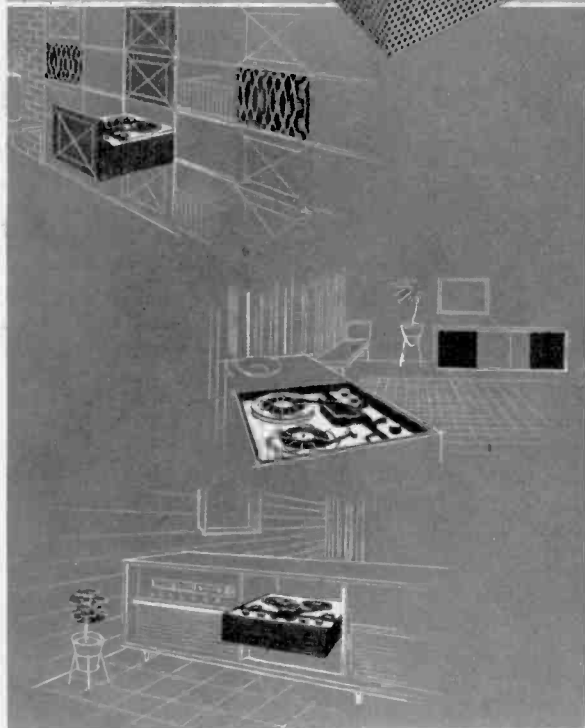

AMPEX STEREO

SIGNATURE OF PERFECTION IN SOUND

takes you
beyond the Hi-Fi
barrier!

Add Ampex Stereo to your system, and you've pierced the last barrier that stands between you and the long-sought goal of actually experiencing the complete realism of the original performance. Hear it once, and you'll never be satisfied with anything less.

Ampex is most-wanted because it is best-engineered. You can install this precision tape-deck in the secure knowledge that it is not only the finest equipment available today, but years from now will still be outperforming everything in the field.

In addition to the Ampex Model A124-U recorder-stereophonic reproducer shown here, there are portables, modular units, and consoles complete with their own AM-FM tuners and record changers.

WRITE TODAY FOR NEW ILLUSTRATED LITERATURE:

AMPEX AUDIO, INC., 1055 KIFER ROAD, SUNNYVALE, CALIF.



Ed Pryor photo

ABOUT THE AUTHOR

DONALD CARL HOEFLER has been closely associated with the reproduction of sound since high fidelity was little more than an abstract term. He has been an airways radio officer, an assistant to the late Major Edwin H. Armstrong, the inventor of FM radio. As an RCA-Victor sound engineer, he was responsible for many innovations in magnetic tape techniques. The author of other volumes in Fawcett's high-fidelity series, among them *Mechanix Illustrated Hi-Fi Guide* and *Low-Cost Hi-Fi*, he is a regular contributor to *Electronics Illustrated*. In the adjacent photograph, Don blends the sound from several microphones before feeding it on to the tape machines.

An Introduction

HIGH-FIDELITY TAPE RECORDING has arrived. Long restricted by high cost to the recording, broadcast, and film studios, it has arrived for those of us who have only a limited amount of money to invest in tape gear. Today, there are many fine recorders on the market, modestly priced. Some are not of themselves true high fidelity. But they can be. Connect them to other units of your hi-fi system and you have sound reproduction of the highest quality. This book will show you how to do it.

You may not yet own a tape recorder and be considering the acquisition. Where do you start to shop? What features should you look for? Should the machine have one motor or more, and of what type? Should it have only one head, or separate heads for the record, reproduce, and erase functions? You'll find the answers here, and they'll help you select the instrument best suited to your own needs.

If your present hi-fi system is already rather extensive and includes tape, you may want to add the wonder of stereo. It need not render your present fine equipment obsolete. Here you'll learn how to utilize it to the fullest, while adding the necessary components most economically.

Regardless of the specific area of your interest in tape recording, you'll find much valuable information on these pages. Included are professional recording tricks, and maintenance tips. Sound effects, taping off the air, and tape editing are explained in detail.

Within its scope, this book is complete. It can make major contributions to your tape-recording skill and pleasure. We are sincerely convinced that it will.

Joseph Daffron

THE EDITOR

ROBERTS TAPE RECORDERS

*The only recorders with a
HYSTERESIS SYNCHRONOUS
motor in their price class!*

Audiophiles, professionals or non-professionals, are all delighted with the performance, quality and modest price of the all new ROBERTS. The clean, functional design, complete portability (28 lbs.) and versatility are unsurpassed. Each ROBERTS is a complete unit... integral amplifier, extended range speaker, and high-sensitivity microphone.

There is a ROBERTS dealer near you. Why not see him today for an ear-opening demonstration. He can give you complete technical information, too.



Brand New! ROBERTS *is now available in a* **STEREO** Playback Model

Here indeed is news! Combine all the many features of the monaural model with more amplifier, stereo heads and you have a performing wonder that is equally outstanding on single or double-track tapes.

Priced at \$349.50, there just isn't anything on the market to compare with the ROBERTS. No need to put off stereo sound any longer - just order your ROBERTS today.

this is the
ROBERTS

- The only recorder with a hysteresis synchronous motor in its price class.
- Completely portable (15 $\frac{3}{4}$ " x 14 $\frac{1}{2}$ " x 9 $\frac{1}{4}$ ", 28 lbs.)
- A complete unit with integral amplifiers and extended range speaker.
- VU meter for positive recording levels.
- Professional, cast aluminum construction.
- Wow and flutter 0.18% RMS
- Response 40 to 15,000 CPS
- Timing accuracy to 0.2%
- Dual record/play heads
- 7" reels
- 3 $\frac{3}{4}$ or 7 $\frac{1}{2}$ inch tape speeds
- Safety interlock controls
- Complete with case and high-sensitivity microphone
- Wrap around tape threading

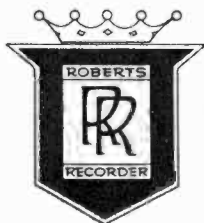

ROBERTS ELECTRONICS INC.

1028 N. LA BREA AVENUE, LOS ANGELES, CALIFORNIA

How It Works

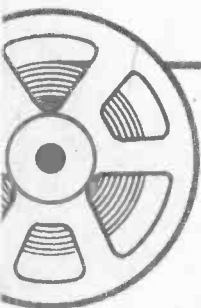

A proper understanding is required to
get the most out of tape recording

HI-FI TAPE recording has at last come out of the limited confines of broadcast, recording and film studios. Now it is available for anyone to enjoy in the privacy of his own home. The quality of the home recorder has improved so greatly that the differences between home and professional equipment are now mostly in ruggedness and serviceability rather than quality of performance.

Today anyone can make an acceptable recording just by pushing a button and twisting a knob or two. But so can he take an acceptable photograph just by pushing a button on a box camera. The difference between the salon photographer and the weekend snapshot artist is just a matter of *technique*.

And the difference between the hi-fi recordist and the character who thinks the tape recorder is just a dandy little toy—is nothing more than technique. If everybody could make perfect recordings just by pushing a button, then there would be no need for this book. But it just isn't quite that simple.

Our job here, then, will be to show you how to get out of your tape machine all of the fine quality built into it. You will learn how to get the best possible reproduction, and when you record your own tapes, how to get the best sound onto those little ribbons. We'll also discuss the selection of equipment, tape and accessories, and how to care for all of them. In short we hope





RCA-Victor photo

MODERN home recorder of the push-button type is seen above, and at right the controls of such a machine. Today, home tape recorders differ little from professional equipment in the quality of performance.

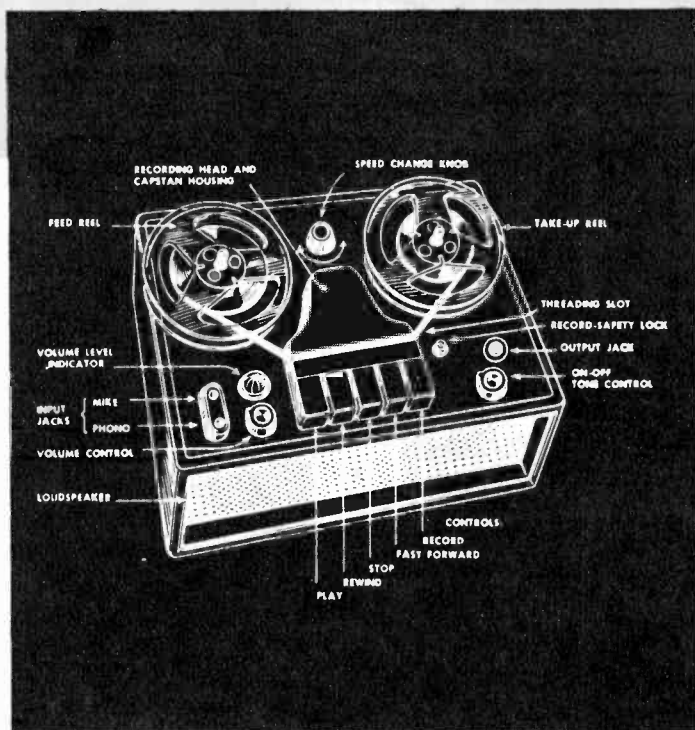

3-M Company drawing

TWO TAPE pioneers: J. Herbert Orr and the German-made Magnetophone. Mr. Orr brought this particular instrument, one of the first tape recorders ever made, to the U. S. at the close of World War II.

Orradio photo

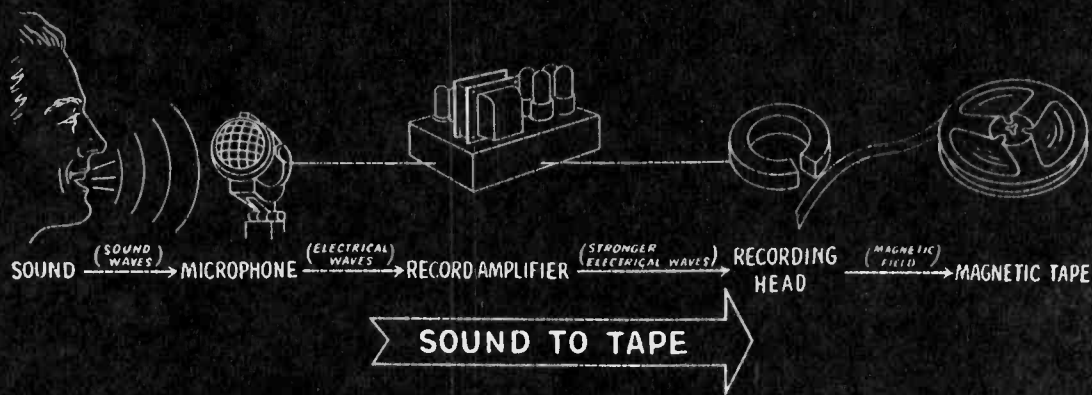

DRAWINGS above and on the facing page show differences and similarities in tape recording and reproduction. You will note that a single amplifier can perform both functions with an electromagnet at the output or input as needed.

MAGNETIC polarity is determined by direction of current through exciting coils. Audio current changes polarity of recording head as flow reverses. Varying force-field induces magnetism on tape's coating—a cycle per peak of like polarity.

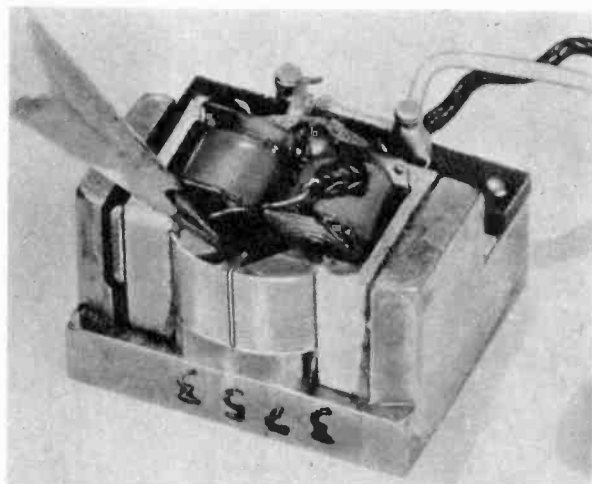
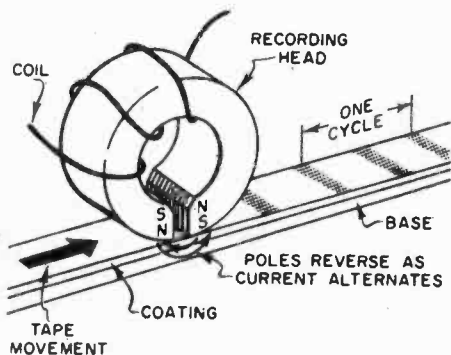
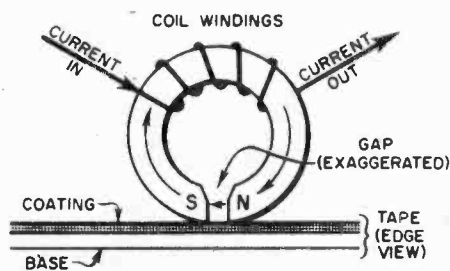
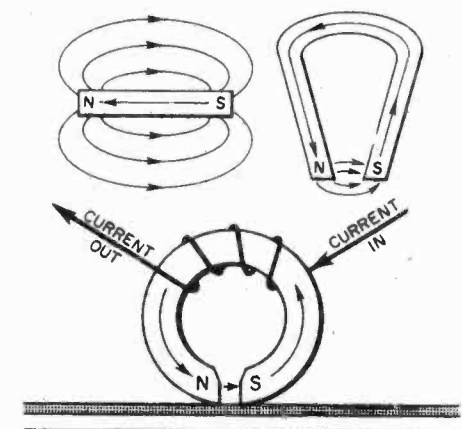

3-M Company photo

HEAD GAP is all important in high-frequency audio response. Exaggerated in drawing, shown by pencil above it may be as little as 0.00025 inch.

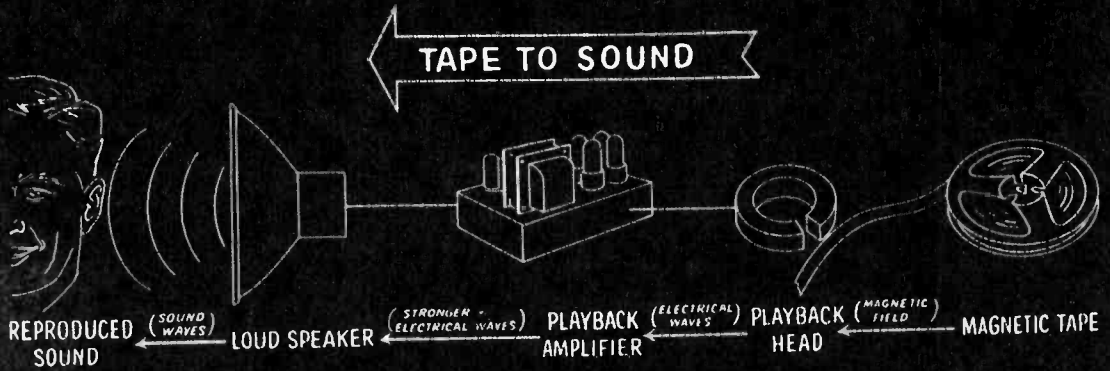

to show you how to get the very most out of your tape recorder.

Sound Fundamentals

A non-technical discussion of the materials of your hobby would seem to be a good starting point, so let's get on with it. As a recordist you are primarily concerned with *sound*, which rushes through the air in waves or pulses. A diagram of this wave motion on a graph usually shows the wave strength or amplitude in one direction and time in the other. Thus we have a convenient picture of two of sound's important characteristics, *loudness* or volume, and *pitch* or frequency.

The peak of the wave on the graph will therefore indicate its intensity, while the number of times the wave repeats itself in a second is its frequency. Sound loudness is often expressed in decibels, with the abbreviation *db*. The louder the sound, the greater the number of *db*.

Similarly, the number of complete waves in a second—cycles per second or *c.p.s.*—determines the pitch. The more *c.p.s.*, the higher the pitch. The human ear can hear vibrations from around 30 up to about 15,000 *c.p.s.*

Now the whole secret of recording lies in the fact that electrical voltages and currents may be made to move in waves within such devices as tubes, wires, coils and the like—just as sound waves move through the air. And these audio-frequency voltages can in turn put a similar magnetic waveform on a piece of moving tape.

Recording Is Simple

There you have in its essentials the entire recording process. First, sound waves in the air strike a microphone which gen-

erates corresponding electrical waves. Then an amplifier builds up the feeble electrical voltages and applies them to an electromagnetic record head, which in turn magnetizes the tiny grains in the coating of the tape.

In playing a recorded tape the process is almost exactly the opposite. The magnets in the moving tape generate a voltage in an electromagnetic reproduce head. This signal is built up in an amplifier and then fed into a loudspeaker, which converts electrical voltages back into vibrations in air, or sound.

Although the complete tape recorder has refinements which are a little too sophisticated for our discussion here, we can now see what its basic electronic elements are. First we need transducers to change sound to electricity (microphone) and electricity to sound (loudspeaker). Then we need an electrical amplifier, which may be used both for recording and reproduction. Finally, we must have an electromagnet, which may similarly double as a recording and playback head.

The one element which is peculiar to magnetic recording is the head, so let's examine it in a little more detail. You can make an electromagnet of your own simply by wrapping a few turns of wire around a large iron nail, and connecting the ends of the wire to the terminals of a battery. The voltage of the battery will send current through the wire and the nail will become a magnet.

Surrounding the nail and coil will be a field of magnetic attraction (or repulsion), whose strength is expressed in terms of lines of force. The more lines of force there are in a given area, the stronger is the magnetic effect. These lines of force emerge from one end of the magnet, make



American Electronics photo

DIFFERING from other push-button model is this handsome machine of near-professional quality, a stereophonic set-up. (See chapter on stereo.) The operating controls of such a machine are shown right.

a circuit through the air around it and reenter at the other end.

Magnetic Poles

Physicists have determined that the end from which the lines emerge shall be known as the north pole, while the end they enter is called the south pole. Thus magnetic lines of force move from north to south in the air outside the magnet, and from south to north within the magnet itself. In the case of an electromagnet, however, reversing the direction of the current will also reverse the direction of the magnetic field, and hence the polarity of the magnet.

The strength of the magnetic field will depend upon such factors as the number of turns of wire, the current through it, the material in the magnet, and its shape. If we bend the magnet core around in a U shape, the lines of force won't have so far to travel in the air and they will therefore be more concentrated. This is the reason for the familiar horseshoe shape of many permanent magnets, but the heads in a tape recorder carry the process even farther.

The tape recording head is bent around into a circular shape with the poles so close that they almost touch. The space between them is often as little as 0.00025 inch, usually referred to as a quarter-mil. This space is called the head gap, and in addition to concentrating the magnetic field it also is an important factor in the high-frequency audio response.

Not all materials can be magnetized. Of

those that can, some can be magnetized temporarily, some permanently. Some will have a surrounding magnetic field only while the electrical magnetizing force is being applied, while others will retain their magnetism after the exciting force is removed.

The materials which form temporary magnets are said to be magnetically *soft*, while those making permanent magnets are called *hard*. In magnetic recording both types are absolutely essential to us. The core material of the recording head is soft, while the coating on the tape is hard. Let's see how this works out.

It Starts at the Mike

As the diaphragm or ribbon of the microphone is vibrated by the sound waves in air, it sets up an alternating voltage which the amplifier in turn feeds to the record head. Every time the sensitive element in the microphone changes direction, the magnetic field across the head gap must change direction.

The higher the pitch of the sound, the faster the microphone element will vibrate, and the more rapidly the head must alternate in polarity. The louder the sound, the farther the microphone element travels and the stronger the magnetic field must be. Obviously a magnet which must perform this kind of fancy dancing would be hopelessly lost if it were made of a hard material.

In the tape itself, however, permanency is essential. The coating material is finely

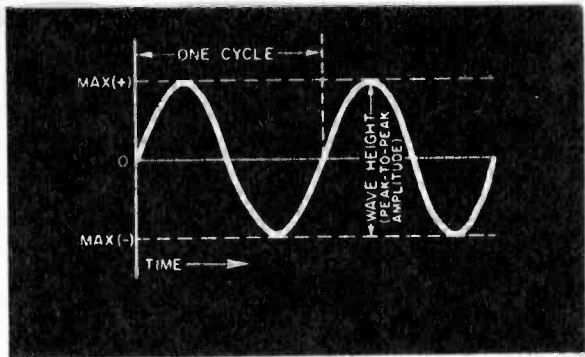
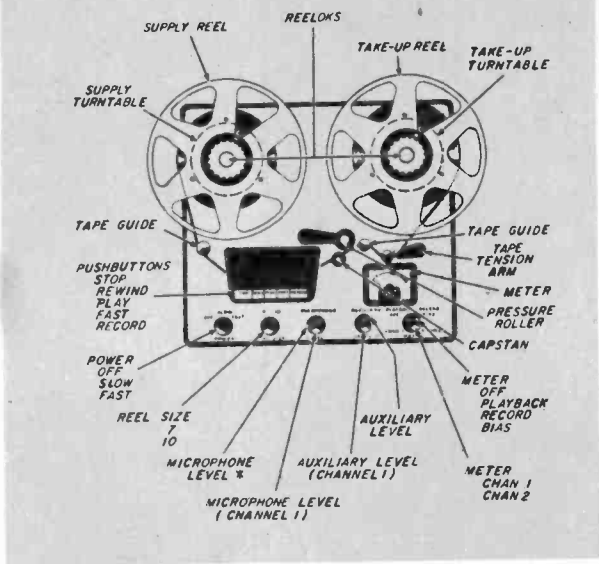

SOUND and alternating current waves are diagrammed as shown above. Height of the sound wave indicates loudness or intensity. Height would mean voltage or current in an electrical wave.

powdered iron oxide, and when it is in contact with the head it provides a less "reluctant" path for the lines of force. Consequently most of them get across the gap by passing through the oxide.

As the lines of force jump the gap through the tape coating, in the process they make tiny magnets of each of the granules of iron oxide. These tiny magnets then in effect add up to a much larger magnet. The result is that the section of tape in contact with the head becomes itself a bar magnet.

An instant later, as the alternating sound wave sets up a chain reaction which reverses the polarity across the head gap, an effort would be made to reverse the magnetism in the section of tape just magnetized. This doesn't happen, however, as that section of tape has passed out of the picture.

Tape Magnets

Remember that the tape is constantly in motion, so the varying magnetic field across the head gap is repeatedly creating a new bar magnet on a fresh section of tape, sort of like stacking a string of railroad ties side by side. And the strength of each little magnet, its polarity, and the rapidity with which it follows its neighbor will have originally been determined by the character of the sound being recorded.

Let's suppose for example, that a low A —55 c.p.s.—is struck on a piano and magnetically recorded. This will cause the polarity of the electromagnetic record head

to swing from north to south and back again 55 times a second. The magnetic pattern on the tape will therefore comprise 55 bar magnets whose north pole is at one edge, alternated with another 55 whose south pole is at the same edge, for every second that the sound continues.

And now it becomes apparent how important tape speed and head gap size are to high-frequency response. If the tape is moving at 7½ inches per second in the preceding example, then 110 magnets will appear in 7½ inches of tape. But if the tape operates at only 3¾ i.p.s., then those 110 magnets must be crammed into just half the space.

Going to the upper audible limit of 15,000 c.p.s., we speak of 30,000 magnets in each second's worth of tape. Obviously a point will be reached where we run out of space. Either the magnets must get smaller or the tape must get longer. The magnets do get smaller as we decrease head gap, and a second's worth of tape becomes longer as we increase the speed.

Recording Speed

When tape was first introduced, it was absolutely essential to operate at 30 i.p.s. for full frequency recording. As improvements were made in recording heads, however, and the gaps became smaller, it became possible to lower the speed and do as good a job. Lower speeds, of course, mean less tape used and consequently less expense.

Today the standard professional speed

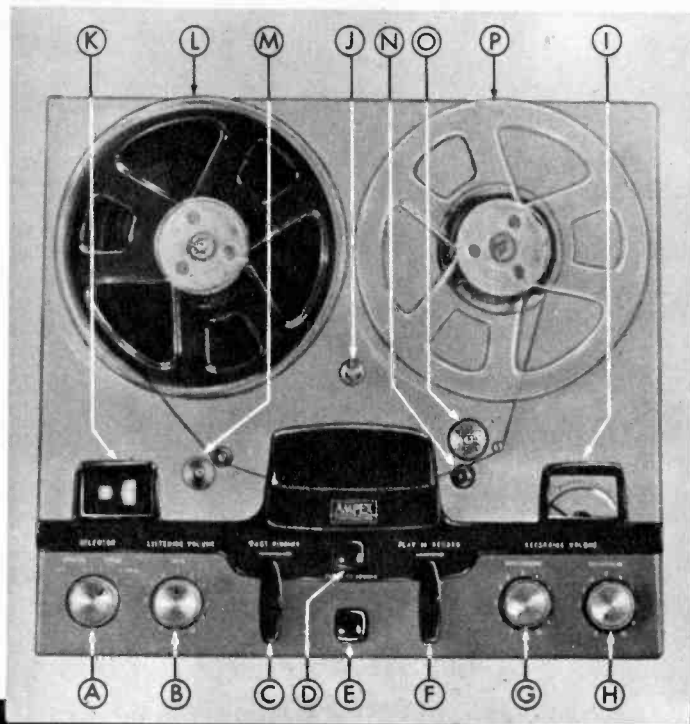

ANOTHER popular type home recorder is the portable model shown at the right. Controls, which differ to some degree, are shown above. (K) is a tape position indicator that permits quick return to any point on a recorded tape; (G) a volume level control is for recording from radio, disc, another tape recorder, or television sound; (J) tape speed selector.

Ampex photos

is 15 i.p.s., while most home hi-fi recordists use $7\frac{1}{2}$ i.p.s. And the difference in results between the two is scarcely noticeable. The biggest reason the pros use a faster speed is to give them a greater safety factor, or less margin for error.

Reproduction of a recorded tape depends upon the basic electrical law that a wire or coil will have a voltage induced in it whenever it is intersected by magnetic lines of force. As the series of tiny bar magnets on the tape passes the playback head, they surround the electromagnet coil as well.

And since the polarity and strength of each following magnet differs from the preceding one, the fields surrounding the coil are constantly expanding and collapsing, and thus cutting through the turns of wire. The voltage which this action sets up in the coil is an exact duplicate in waveform of the sound originally recorded. This voltage is then amplified until it is powerful enough to drive a loudspeaker, and the speaker then converts it back to sound.

Recorders invariably have an erase head which the tape must pass before it goes by the record head. The job of this head is to remove any prior magnetization from the tape. It does so by scrambling the polarities of the many tiny granules in the coating so that they are in a random state, with no recognizable magnetic pattern remaining.

More expensive recorders also have separate amplifiers and separate heads for the recording and reproducing operations. Thus there will be three heads, with the record in the middle between erase and reproduce. The biggest advantage of this arrangement is that it permits checking of the recording quality on the tape only a fraction of a second after the record is made.

Tape Transport

The recorder also must have a mechanism for transporting the tape. Reels of tape are somewhat similar to narrow-gauge movie film, and loading a recorder is similar to threading up a projector. The



drive arrangement, however, uses a capstan and pressure roller in place of the sprocket teeth and claw of a projector. The usual path of the tape is then from a supply reel past the heads, then through the drive and finally onto the takeup reel.

The controls and indicators on the recorder are rather few in number and fairly simple. Since most recorders today have at least two operating speeds, there is a speed control switch. For hi-fi, the highest available speed is always used.

The main power switch is usually included in either the volume or tone control. The tone control, incidentally, is usually operative only on playback and has no effect on the recording. The volume level indicator may be a neon bulb, a magic-eye tube or a meter. The meter is by far the best, of course.

Most machines have a safety lock which prevents leaving the machine in recording position, so that a valuable tape might be inadvertently destroyed. Very few machines outside the professional class, however, also have a warning light which indi-

cates when the erase and record circuits are in operation.

Input and Output

The other control functions usually include start, stop, fast forward and fast reverse. More elaborate models include input circuits for several microphones, preamplifier, tuner or another tape recorder. If your machine only has a single mike input, however, we'll show you here how to add these other functions.

The simplest tape machine has a direct connection to a built-in speaker and nothing else. Others include output connections for a remote speaker, to be operated either alone or simultaneously with the recorder speaker. Also included are outputs to feed a preamplifier, power amplifier or another recorder. Here again, we'll show how to make the simpler machines stand up and do these tricks, too.

But perhaps we're getting ahead of our story. You may not have a recorder yet and be wondering which is best for you. Answers begin on the following page. •



Wollensak Optical Co.

BABY TALK! If the prime purpose of your acquisition is to record baby's first words, as the Ted Briskins of Chicago do above, your choice is unlimited. Determine your individual needs. Monaural portability is afforded by the model at lower left, stereo and portability by the setup at lower right.

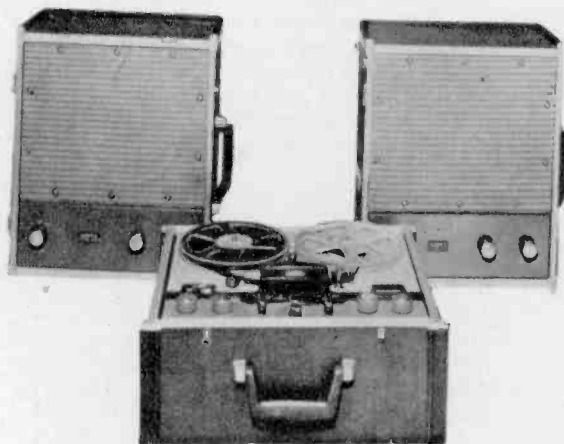

Stereotone

Ampex Audio, Inc.

Choosing Your Recorder

The uses you plan for it will determine your selection. But here are points to consider when you start to shop

MOST ADVICE to prospective buyers of tape recorders begins with the suggestion that one consider the purpose for which the machine will be used. Recorders are now available in such a wide variety of styles, qualities and prices that the equipment one would pick for hi-fi stereo listening could be very different from that used to record a wedding ceremony or subsequent christening.

As a reader of this book you are primarily interested in tape for high fidelity. Although your field is more limited, you still have before you a wide choice in tape equipment. Perhaps the first question you should ask yourself is whether you want to listen only to tapes which someone else has recorded, or if you also want to be able to record your own.

Do you want monaural only, stereo only, or both? Do you want portability, or do you want a custom installation in your own cabinet? Do you want a completely self-contained system, or only the essentials of a tape mechanism which can tie in with your present hi-fi setup? Answers to these questions will vary with each person's individual requirements.

Frequency Response

One of the first criteria of tape performance is frequency response. In hi-fi we usually regard 30-15,000 c.p.s. as the minimum acceptable range, as these figures are about the extreme limits of human hearing. Many hi-fi amplifiers exceed these figures by a considerable margin, especially at the higher frequencies. Tape recorders do not.

Even among the most expensive professional machines, very few lay claim to anything better than 30-15,000 c.p.s. It is obvious then that the hi-fi fan will have to make some small compromise—or else a large investment. As a practical matter, most recorders in the medium price range (\$200-400) have an advertised response of 40-12,000 c.p.s.

Equally important as the limits of the response, however, is the *flatness* within that range. Large peaks or valleys in the reproduction are at least as annoying as rolloffs at the ends. Most people can't discern a variation in sound level of 2 decibels, and so a better standard of frequency response is the region in which the recorder is flat *plus-or-minus 2 db*. Using this reference, we find that the range of the medium-price recorders is actually about 50-10,000 c.p.s.

HI-FI SETUP already rather extensive? A tape deck such as this one may be the solution to your problem since it eliminates duplication of electronics.

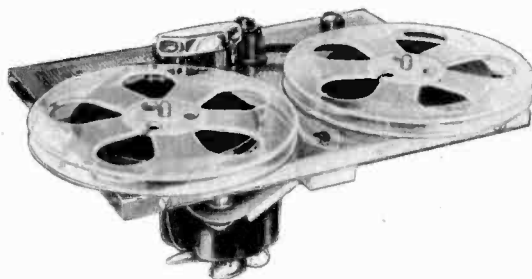

Viking of Minneapolis

Overall Frequency Response Curve of a Typical T-200 Series Transport Used in Conjunction with One RP-120 Record/Playback Preamplifier (using standard professional recording tape)

20 to 15,000 cycles ± 4 db, 40 to 10,000 cycles ± 2 db (record and playback at 7½ ips).

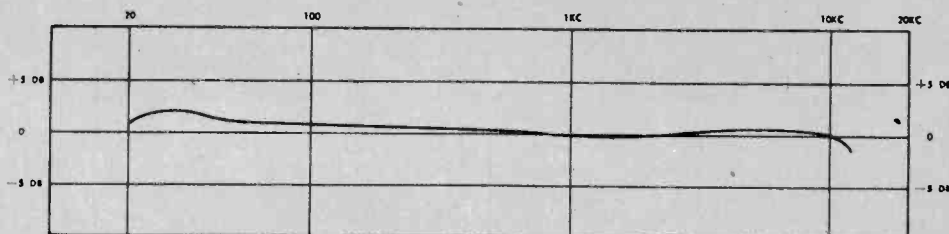

FREQUENCY RESPONSE is important when you choose a tape recorder. Performance specifications above are realized only when the preamps designed for these Bell transports are used. To run a frequency response curve on a particular transport, feed in test signal at least 15 db below normal recording level. High-frequency preemphasis used in the record channel will saturate the tape at high frequencies if the test signal is fed in at normal level, thus causing inaccurate readings.

And here is where we shall draw the line. Good clean response within this range is really quite adequate for all except the most exacting hi-fi requirements, but anything less than this cannot be considered hi-fi. It should be understood, though, that these published figures almost always refer only to the magnetic and electronic systems, and *not* to the built-in speaker, if any. It stands to reason that a small speaker in a tape recorder case cannot possibly provide the performance of your own hi-fi speaker, and you should always use a true hi-fi extension speaker for best reproduction from any recorder.

Speed, Wow and Flutter

Now we come to the problems which have been the most vexing to audiophiles who have had to wait for the quality of home tape recorders to approach the rest of the hi-fi system. These all have to do with the mechanical tape transport system and its smoothness of movement. They are speed accuracy, wow and flutter.

Speed accuracy is least important to one who plays each tape only on the machine that recorded them. If a machine is running a little fast—say 7.75 i.p.s.—it doesn't matter much as long as tapes are both recorded and reproduced at that speed. But tapes made on that machine and played on another at the standard speed of 7.5

i.p.s. will be flat in pitch. Similarly, tapes recorded at 7.5 i.p.s. will sound sharp when played on the faster machine.

If a little difference in pitch or in playing time is unimportant to you, this factor can be ignored. If not, there are a couple of ways of checking the machine you're considering. You can simply play a recorded tape which you know to be correct on pitch, and listen. If the reproduced sound is flat, the machine is slow. If it's sharp, the speed is too fast. The other method is to use a strobotape, which works on the same principle as the strobe disc used to check turntable speed. Under the correct illumination, the black-and-white segments on the moving tape will appear stationary. If they move to the left, the speed is slow, while creeping to the right indicates excessive speed.

A closely related problem, with results which are much more annoying, is wow and flutter. This is an up-and-down variation in pitch which occurs repeatedly. If it occurs slowly, like the rolling of a ship, it is called wow. If it occurs more rapidly, like a hot rod bouncing over a washboard road, the term flutter is more apt.

Your own ear is always the final judge in hi-fi matters, but there are a few figures you can use for reference. Wow and flutter measurements are expressed in percentage, and the best professional

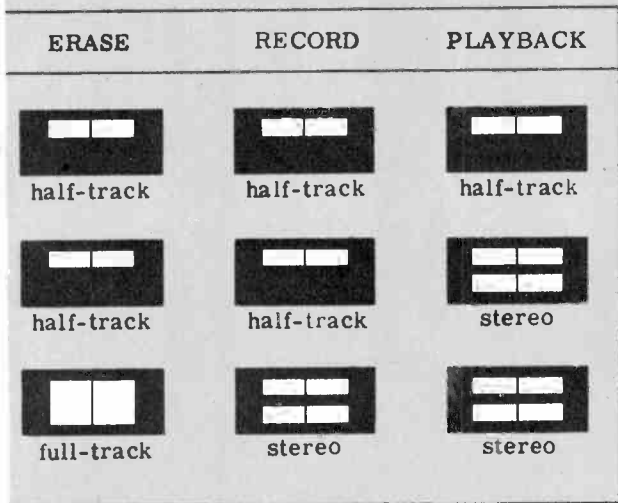

Concertone

SOME of the head arrangements possible in tape recorders. For optimum quality there must be separate heads to erase, record and reproduce.



"RIDING GAIN," while monitoring with earphones. It's often possible to find a good average setting and leave it fixed.

equipment usually has a figure of 0.1% or less. Semi-professional and home hi-fi equipment has wow and flutter figures ranging from about 0.2% to 0.3%. The cheap equipment goes on up from there. Thus there is no good reason for the hi-fi recordist to settle for anything poorer than 0.3%.

Motor Types

Wow and flutter performance will be partly determined by the kind and number of motors used. As with turntables, there are three basic types of motors employed: two-pole, four-pole and hysteresis synchronous. The two-pole motor is completely out of the question for hi-fi work, while the hysteresis unit is the best.

Since motors are used not only to drive the capstan, but also to apply tension to the two reels, and to turn one or the other of them during fast forward or rewind, it is asking a lot to expect one motor to do all this work. This is usually the case in the lower-priced recorders, however, wherein the single motor is connected by a series of belts to the driven elements. The most expensive units, on the other hand, have three motors, one on each reel shaft and one on the capstan. The single-motor systems have been vastly improved, but it is obvious that one should be doubly cautious about wow and flutter when con-

sidering sinking his dough in one of them.

Distortion figures are not very reliable bases for comparison of recorder quality. There are a baker's dozen varieties of distortion, and unless you know which ones have been measured, and how the measuring was done, the resulting figures are not very useful. Furthermore, you seldom know whether the figures refer to the record function, or playback, or both. As far as distortion is concerned, your ear must be the judge.

Some of the same objections may be raised for signal-to-noise ratio figures, although this factor is probably a little more reliable for comparison. It refers to the difference in volume level between the loudest program material and the noise generated by the system. This includes tube hiss, hum, tape hiss, rumble and the like. The higher the signal-to-noise ratio, the less internal noise is generated. About 60 db is the best figure achieved in professional recorders to date. Most home hi-fi tape systems have a ratio of around 45-50 db, which is quite satisfactory for most purposes.

When recording your own tapes, both distortion and signal-to-noise ratio will depend in part upon your own techniques. The setting of the volume level recorded on the tape must be high enough to override the noise at all times, but never so



VOLUME LEVEL indicators are seen here. Input would be diminishing with the greater angle of shadow of the magic-eye type. VU meter is superior, providing a more accurate indication. It is used exclusively in broadcasting, recording, film studios.

high as to cause overload distortion. It is usually possible to find a good average setting and leave it fixed. But if the program has a very wide dynamic range, from less than pianissimo to more than fortissimo, then it may be necessary to compress the level by "riding gain." This means increasing the setting above the average during the softest passages, and decreasing below average at the loudest times.

Volume Indicators

Correct volume level is indicated by either of several methods. Those most commonly used in recorders include one or more neon bulbs, a magic-eye tube, or a volume-indicating meter. The neon bulb simply indicates that the volume has exceeded a predetermined level. Two bulbs, adjusted to trigger at different levels, provide greater accuracy. The volume is then set so that one bulb is flickering most of the time, while the other one lights infrequently. There is nothing wrong with the neon-bulb idea, provided enough lamps are used. With a bank of 15, covering a range of 45 db in 3-db steps, as once used in Hollywood, one could get along just fine. But just two lamps are not enough.

The magic-eye tube, familiar for many years as a tuning indicator on radio sets, is a very accurate monitor of volume levels. This has a varying wedge-shaped shadow over a green background which is about the size of a quarter. The width of the shaded area depends upon the signal level. With no signal the angle of shadow is greatest, and as signal increases the angle narrows down.

Although this little tube is highly ac-

curate, it has two major shortcomings. First, the screen is so small that even the recordist with 20/20 vision has difficulty following the rapidly-changing audio peaks. Furthermore, the volume must be adjusted so that the peaks just barely close down the beam angle, but when signals go above this point into the distortion zone, there is no way of knowing this for certain. That is, when the eye closes down for a peak signal level which is just right, it just stays that way if the signal is strong enough to cause serious overmodulation.

The best method of volume indication is the volume unit (VU) meter. This gives an accurate indication of signal level at all times, including as much as 3 db of overmodulation.

Tape and Economy

Tape cost can be cut in half by the method of dual-track recording, with only a slight sacrifice in signal-to-noise ratio and convenience. In this system a signal is recorded on only half the width of the tape. After the full length of the tape has been recorded along one track, another recording can be made on the adjacent track. Thus playing time is doubled.

There is a 3-db increase in noise level in this arrangement, but this amount is usually unimportant. If you intend editing tapes extensively, as we'll discuss in detail later, the usual single-track system will probably be better for you. Noiseless splicing is somewhat trickier in twin-track tape and any cutting will, of course, also interrupt the unrelated signal on the adjacent track.

Playing time will also depend upon the

maximum reel size—and hence tape length—the machine can handle. Most home machines use the 7-inch reel, although some can accommodate only the 4- or 5-inch size, while more and more are using the professional size of 10½ inches. The serious hi-fi hobbyist should consider nothing less than 7-inch capacity.

Speaking of Heads

As we have already indicated, a 2-head machine has an erase head and a combination record-reproduce head, while the 3-head machine has separate erase, record and reproduce heads. Since the design requirements for recording and reproduction are somewhat different, the combination head must be in compromise.

The other advantage of separate heads is that the possibility of checking the quality of the recording on the tape even as it is being made. Although most 2-head machines provide for listening to the signal through speaker or headphones as it is being recorded, this is not the same thing as monitoring from the tape.

In one case the signal being heard is that being fed *into* the machine. In the other case the sound is actually a reproduction of the signal being played back from the tape at the *output* of the machine. This is an accurate indication of the way the tape will sound every time it is played.

The erase system may be either permanent-magnetic or electronic. Here there is no choice. Permanent-magnet erase is simply too noisy for hi-fi.

The hi-fi recorder must also have at least two separate input circuits. One of these should be high-impedance and low sensitivity for use with tuners, phono preamps or mixers. The other should be low-impedance, high-sensitivity, for use with a high-quality microphone.

Mikes and Speakers

Good microphones (*not* the kind usually furnished with tape machines) are almost always of the low-impedance type. This is desirable, to minimize hum pickup and high-frequency losses in long cable runs. The output of such a microphone is invariably low. Thus it is important to know that the gain of the recorder input circuit is adequate to handle such a mike.

Many home recorders have built-in loudspeakers and power amplifiers. These two elements are usually superfluous to the hi-fi system.

Provision should be made for a high-level, low-impedance output to permit the internal amplifier to drive an external loudspeaker. There should also be a low-level, high-impedance output to feed directly into the input of an external hi-fi power amplifier. •

WOW AND FLUTTER performance is determined partly by type and number of motors. As with disc turntables, there are three types used. In hi-fi, the 2-pole is useless, while hysteresis unit is best.

HYSTERESIS SYNCHRONOUS

2 POLE MOTOR

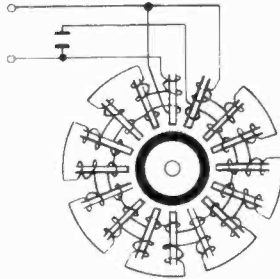
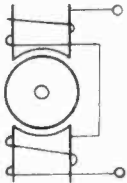

4 POLE MOTOR

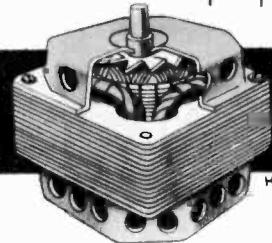
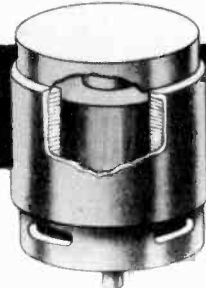
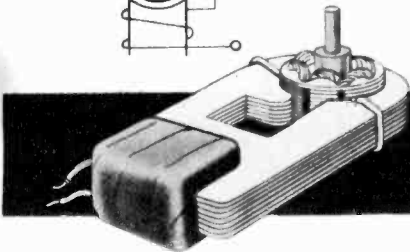
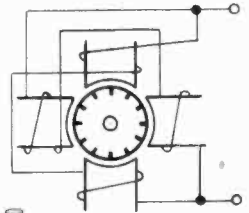

HOFFSCHMIDT

What Kind of Tape?

There is now a type to meet every requirement.

Here's how to choose to meet your specific needs

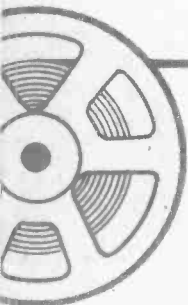

MOST of the bulk of magnetic tape has nothing directly to do with the actual recording of audio signals. The recording agent is a very thin coating of finely-powdered iron oxide, but most of the space is occupied by the base and the binder which holds the oxide onto it.

This base is nevertheless very important, and manufacturers have probably devoted at least as much time to its development as to the oxide. The base must be strong enough to resist stretching and breaking, although it is only $\frac{1}{2}$ -mil to $1\frac{1}{2}$ -mil in thickness (a mil is $\frac{1}{1000}$ inch) and $\frac{1}{4}$ -inch thick.

Paper has been used as a base material, but it is unsuitable for hi-fi. Therefore, let's confine this discussion to the plastic types. Two plastic materials are commonly used for magnetic tape. One of these is cellulose acetate and the other is polyester film. Polyester has the greater mechanical strength, but is also more expensive.

The original tape thickness, and still the safest in terms of resistance to damage, is $1\frac{1}{2}$ mils. A standard 7-inch reel can hold 1200 feet of this type. By decreasing the base thickness to 1 mil, it is possible to get half again as much tape in the same space, or 1800 feet on a 7-inch reel. This means an increase in playing

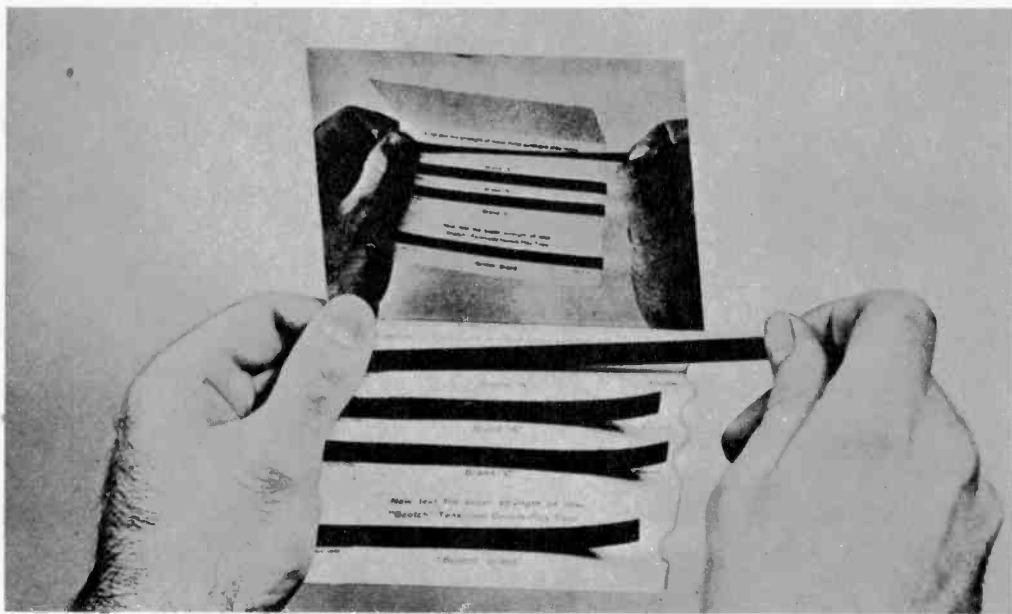

3-M Company photo

TEST KIT shown here is supplied to dealers by one major manufacturer of tape and affords a dramatic demonstration of the additional strength of tensilized $\frac{1}{2}$ -mil stock over the ordinary type base materials.

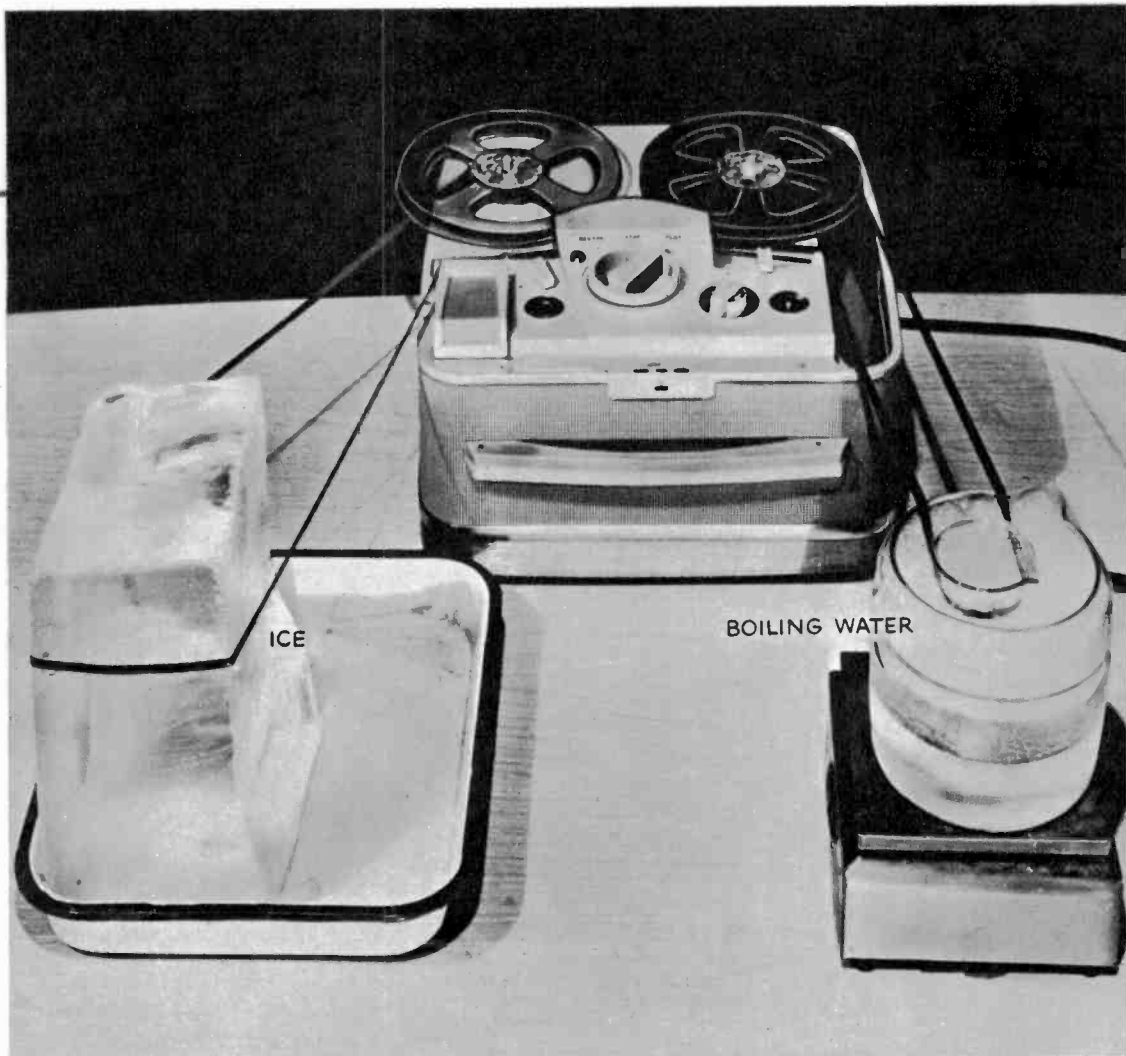

TAPE TORTURE shows how DuPont's new polyester film, Mylar, withstands extremes in temperature. Conditions illustrated cause no change in strength, flexibility, dimensional stability of the tape.

time of 50% without increasing reel size.

Carrying this miniaturization even further, all manufacturers now offer tape with a $\frac{1}{2}$ -mil base. This permits twice as much tape and twice as much playing time. The length for the 7-inch reel then becomes 2400 feet. The total playing time will depend not only on the tape length, of course, but also the operating speed.

The bar chart included here affords several interesting comparisons between the two common base materials. First, we can see that polyester tape is considerably stronger than acetate of the same thickness. It is also obvious, as would be expected,

that the thinner tapes are weaker. Acetate in the $\frac{1}{2}$ -mil size is so fragile, for example, that it is not used for recording tape.

The strength of polyester film is almost perfectly constant with changing humidity, while increasing humidity weakens acetate rapidly. Before deciding on a tape type for a given application, it is important to consider one more type of information presented in the chart.

Note that polyester film has a much higher breaking point than its stretching point, while with acetate the two are almost identical. Putting it the other way around, polyester will stretch much more



TAPES of the 1-mil-acetate type by four major manufacturers. The thinner tapes permit more tape to the reel and therefore more playing time. But this is accomplished with increase in fragility.

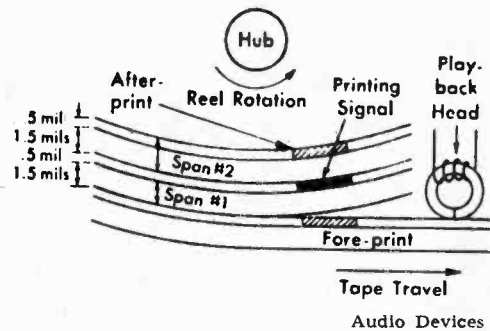
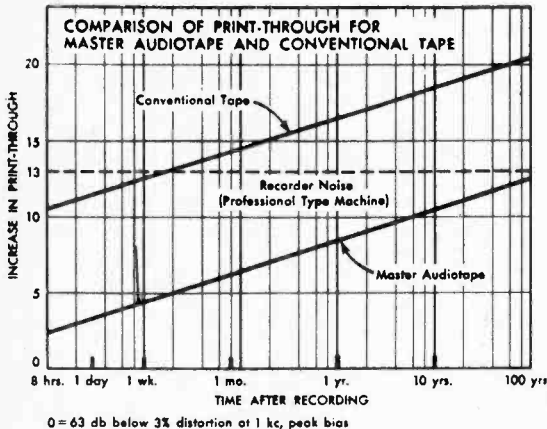

DRAWING above shows how print-through echoes occur between original recording and adjacent tape layers. Left, comparison of print-through rise with time as related to "pro" recorder noise.

easily than it breaks, while with acetate you have about a 50-50 chance of the tape breaking rather than stretching under strain.

As a practical matter what does this mean? Well, a broken tape can readily be repaired with a simple splice, and if it is done deftly the ear will never know the difference. But a recorded tape which has been stretched can be kissed good-bye. The pitch will drop and waver at the stretched point, and will always remain that way, for no method has yet been found for shrinking the tape to its original length.

The binder which holds the oxide to the base is a complex blend of resins and plasticisers. While it must hold the coating to the plastic, it of course must not cause adjacent layers of tape to stick to each other. The oxide and binder are in liquid form when they are applied to the plastic in a smooth coating 1/2-mil thick. Then it is quickly dried.

Coating Differences

The oxide coatings used by the several manufacturers are generally quite similar, but there are some differences. There are now three different grades of oxide used by manufacturers on 1 1/2-mil acetate stock.

These have been designated in the table as *economy*, *standard* and *deluxe*. The differences are largely in the fineness of the iron oxide particles and the smoothness of the coating. The more expensive types will have better frequency response, lower noise, and will cause less head wear.

Since the polyester base is more expensive than acetate, there seems to have been no reason to use less than the finest oxides with this material. Moving to the right along the table, we see next that Scotch tape is alone in a high-output type. This is a special oxide, with certain additives which give it a green color as opposed to the usual reddish-brown.

This oxide is more sensitive and therefore delivers a playback signal 6 to 12 db greater than red oxide for the same input signal. Because of the increased signal-to-noise ratio, it is particularly recommended by the manufacturers for dual-track and stereo recording, where less than half the width of the tape is used for a given signal. This tape is available on both acetate and polyester in the standard 1 1/2-mil thickness.

"Low-Print" Oxides

Next we come to one of the newest types

of tape, the "low-print" oxides. This type was developed to answer some of the problems of layer-to-layer magnetization or "print-through." This occurs when recorded tape is wound on the reel. Since all of the oxide particles are tiny magnets, they can under certain circumstances magnetize each other. When a fairly loud section of tape is adjacent to rather quiet pieces on either side of it, the quiet sections may become magnetized by the heavily-magnetized one.

The result in playback is "echo," which is heard both before and after the actual recorded sound. This may extend for a half-dozen layers or so, an effect which is particularly annoying before the record starts or during soft passages in the performance. The low-print formulations reduce the echo effect by 6 to 8 db, usually sufficient to bring it below the inherent noise level of the system.

"Half-Again" Tapes

Next we come to the 1-mil "half-again" tapes, which are available on both acetate and polyester from all major manufacturers. The 1/2-mil thickness is used with polyester only. A new type of polyester, which has been tensilized or fortified, is shown on the bar chart to be over half again as strong as the older type.

Which of these various types you will use will depend entirely upon the application. If you wish to make voice recordings for rehearsal or checking purposes, and if time is no problem, then your best bet is the cheapest available tape, the economy 1 1/2-mil acetate type. If you are more particular about quality, but your machine is not of the best, then probably the 1 1/2-mil acetate standard is for you.

The best all-around tape, in terms of quality, strength, playing time and economy, is the 1 1/2-mil acetate deluxe type, which the table shows is offered by all major manufacturers. If maximum record life, tape strength and quality are all important to you, then your choice would be the 1 1/2-mil polyester base tape.

Polyester film, which in the case of DuPont Mylar is actually a film form of Dacron, is better for long-life archival recording because, unlike cellulose acetate, it contains no plasticisers. When these plasticising agents in acetate evaporate, it becomes brittle and so prone to breakage that it can hardly be run through a tape machine without snapping into many pieces. With reasonable care, of course, acetate tapes may last indefinitely. We'll

discuss preserving your recordings in a later chapter, but for an extra margin of safety the polyester is superior to acetate.

The special high-output formulation has rather limited application, but when you really need it nothing else will do. Under conditions where the innate noise of the recorder is on the high side, or the recording circuits are rather weak, the extra sensitivity of HO tape may well save the day. Whether to use acetate or polyester will, of course, depend upon the same considerations as with other types.

Low-Print Limitations

The low-print tape is also a special-purpose formulation, with somewhat limited usefulness. But again, where it is needed it's needed badly. There has been many a time in professional work when such a tape would have prevented me from dropping otherwise good takes on the cutting room floor. But I've seldom felt the need of it in home recording. If print-through is a problem with you and your equipment, however, this is undoubtedly the answer.

Many hi-fi recordists have been hampered by the limited playing time of most home recorders. At the usual speed of 7 1/2 i.p.s., the standard 7-inch reel of tape will record or play for a half hour. This is simply not time enough to record a major work of music, a sporting event or TV spectacular.

The thinner tapes have come to the rescue, permitting more tape and consequently more playing time on the same reel size. This is done, of course, at the expense of increased fragility of the tape and perhaps somewhat increased print-through.

The former half-hour limit, for example, is extended to 45 minutes with 1-mil base or to 1 hour with 1/2-mil tape. The 1-mil size is available in both acetate and polyester from all major manufacturers. The weakest tape of all, as shown on the bar graph, is the 1-mil acetate. Let's see just what the risk is in using this tape.

The average tape machine exerts a pull of 6 to 9 ounces when playing or recording, and 10 ounces to 1 pound during stops and starts on fast forward and rewind. The 1-mil acetate base has a stretch point from 1.8 to 3.7 pounds and a break point from 2.5 to 3.9 pounds. Since the maximum pull is 1 pound and the minimum stretch point is 1.8 pounds, we have under the worst conditions a safety factor of nearly 2 to 1. Unless the tape gets unusually rough han-

how magnetic tape is made

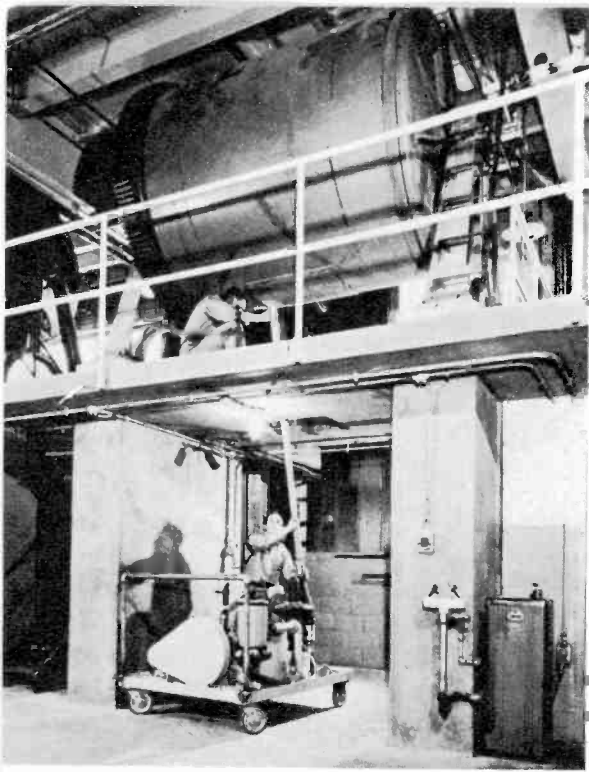

MIXING of treated iron oxide and the liquid binding agent takes place in ball mills, above.

TANKS, above right, store the mixture until it is piped to coater room and applied to tape backing.

COATED, 24-in.-wide tape goes through drying oven, right, visually inspected as it moves.

STORAGE AREAS are kept hospital-clean and the temperature and humidity completely constant.

MILLIONS of listening hours are represented below right. Next, tape will be cut, packaged.

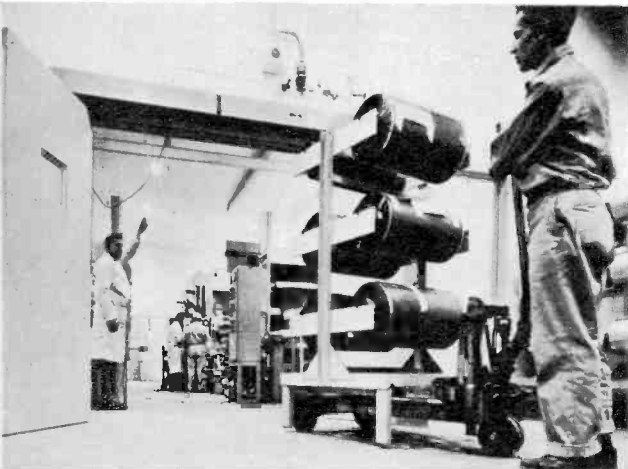
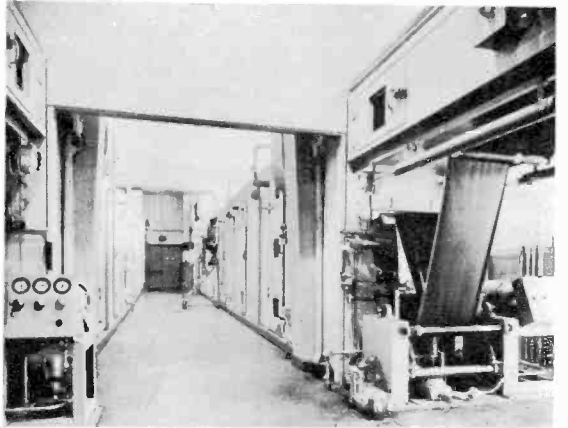
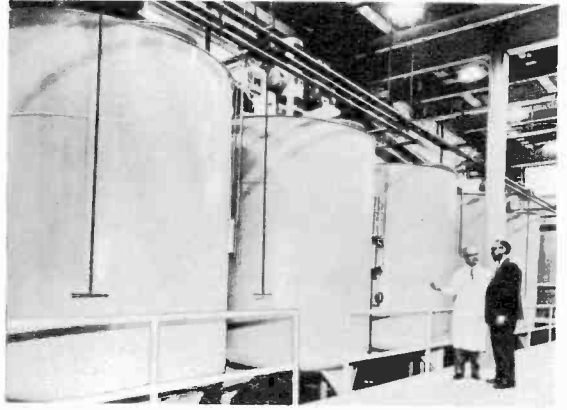



REELS, of 10½-in. size, are packed and demagnetized on continuous belt. Beneath table is an electromagnet that bulk-erases to provide signal-free tape for even most critical applications.

3-M Company photos

HEART-WARMING scene for the tape enthusiast: cases of magnetic recording tape line warehouse wall while awaiting shipment. European factories provide "Scotch" brand to countries in their areas.



| | 1 1/2-MIL ACETATE ECONOMY | 1 1/2-MIL ACETATE STANDARD | 1 1/2-MIL ACETATE DELUXE | 1 1/2-MIL POLYESTER | 1 1/2-MIL ACETATE HIGH OUTPUT |
|------------|---------------------------------|----------------------------------|--------------------------------|------------------------|-------------------------------------|
| AUDIO | | | PLASTIC BASE | MYLAR BASE | |
| IRISH | BROWN BAND 195 | SHAMROCK 300 | GREEN BAND 211 | | |
| SOUNDCRAFT | RED DIAMOND | HI-FI | PROFESSIONAL | LIFETIME | |
| SCOTCH | | | NO. 111 | NO. 111 AM | NO. 120 |
| SONORAMIC | | | STANDARD PLAY | | |

TAPE PLAYING TIME

FOR VARIOUS SPEEDS AND REEL SIZES

All tapes are standard 1 1/2 mil except as indicated

| REEL SIZE (in.) | TAPE LGTH. (feet) | SINGLE-TRACK PLAYING TIME FOR VARIOUS TAPE SPEEDS AND TAPE LENGTHS | | | | | DUAL TRACK PLAYING TIME | |
|-----------------------|-------------------------|---|-------------|-------------|-------------|-------------|----------------------------|-----------|
| | | TAPE SPEED—inches per second | | | | | 3 3/4 ips | 7 1/2 ips |
| | | 1 1/8 ips | 3 3/4 ips | 7 1/2 ips | 15 ips | 30 ips | | |
| 3 | 150 | 15 min. | 7 1/2 min. | 3 3/4 min. | 1 1/8 min. | 15 min. | 7 1/2 min. | |
| 3 | 225* | 22 1/2 min. | 11 1/4 min. | 5 3/8 min. | 2 1/8 min. | 22 1/2 min. | 11 1/4 min. | |
| 4 | 300 | 30 min. | 15 min. | 7 1/2 min. | 3 3/4 min. | 30 min. | 15 min. | |
| 4 | 450* | 45 min. | 22 1/2 min. | 11 1/4 min. | 5 3/8 min. | 45 min. | 22 1/2 min. | |
| 5 | 600 | 1 hour | 30 min. | 15 min. | 7 1/2 min. | 1 hour | 30 min. | |
| 5 | 900* | 90 min. | 45 min. | 22 1/2 min. | 11 1/4 min. | 1 1/2 hours | 45 min. | |
| 7 | 1200 | 2 hours | 1 hour | 30 min. | 15 min. | 2 hours | 1 hour | |
| 7 | 1800* | 3 hours | 90 min. | 45 min. | 22 1/2 min. | 3 hours | 1 1/2 hrs. | |
| 7 | 2400** | 4 hours | 2 hours | 1 hour | 30 min. | 4 hours | 2 hours | |
| 10 1/2 | 2400 | 4 hours | 2 hours | 1 hour | 30 min. | 4 hours | 2 hours | |
| 10 1/2 | 3600* | 6 hours | 3 hours | 90 min. | 45 min. | 6 hours | 3 hours | |
| 14 | 4800 | 8 hours | 4 hours | 2 hours | 1 hour | 8 hours | 4 hours | |
| 14 | 7200* | 12 hours | 6 hours | 3 hours | 90 min. | 12 hours | 6 hours | |

*Long play tape 1 mil film. **Double play tape 1/2 mil film. Chart courtesy ORRadio Industries, Inc.

ding by the operator, it should be quite adequate for most purposes.

With 1/2-mil polyester stock the story is even better. The minimum here is a 2-pound stretching point. Breaking point is higher, and tensilizing further improves the strength by about 80%.

There is now a tape type to meet just about every requirement. Factors to be weighed in making your choice will include:

1. Audio quality
2. Ruggedness
3. Long life
4. Sensitivity
5. Print-through
6. Playing time
7. Cost per foot

While each individual may have a certain brand preference, audio quality will for the most part be rather consistent throughout the various tape gauges, except for the 1 1/2-mil economy and standard types. Ruggedness and long life are now primarily functions of the base material, although in the earlier days there were binder problems.

Sensitivity will vary a few db among brands, with the high-output formulation being the most sensitive. Print-through is definitely inhibited by the low-print oxides. Playing time is determined by the operating speed and the tape length, which for a given reel size depends in turn upon the base thickness. Cost per foot varies widely. •

| | | | | | | |
|---------------------------------------|-----------------------------------|-------------------------------------|-----------------------|-----------------------|------------------------|------------------------------------|
| 1 1/2-MIL POLYESTER HIGH OUTPUT | 1 1/2-MIL ACETATE LOW-PRINT | 1 1/2-MIL POLYESTER LOW-PRINT | 1-MIL ACETATE | 1-MIL POLYESTER | 1/2-MIL POLYESTER | 1/2-MIL POLYESTER TENSILIZED |
| | MASTER PLASTIC | MASTER MYLAR | LR PLASTIC | LR MYLAR | SUPER- THIN | TEMPERED MYLAR |
| | | | LONG-PLAY 600-AB | LONG-PLAY 600 | DOUBLE- PLAY 7-2400 | FORTIFIED DOUBLE-PLAY |
| | | | HI-FI 50 | PLUS 50 | PLUS 100 | PLUS 100 X |
| NO. 120 AM | NO. 131 LOW-PRINT | | NO. 190 EXTRA-PLAY | NO. 150 EXTRA-PLAY | | NO. 200 TENSILIZED DOUBLE-PLAY |
| | | | | LONG PLAY | EXTRA-LONG PLAY | TENSILIZED DOUBLE-PLAY |

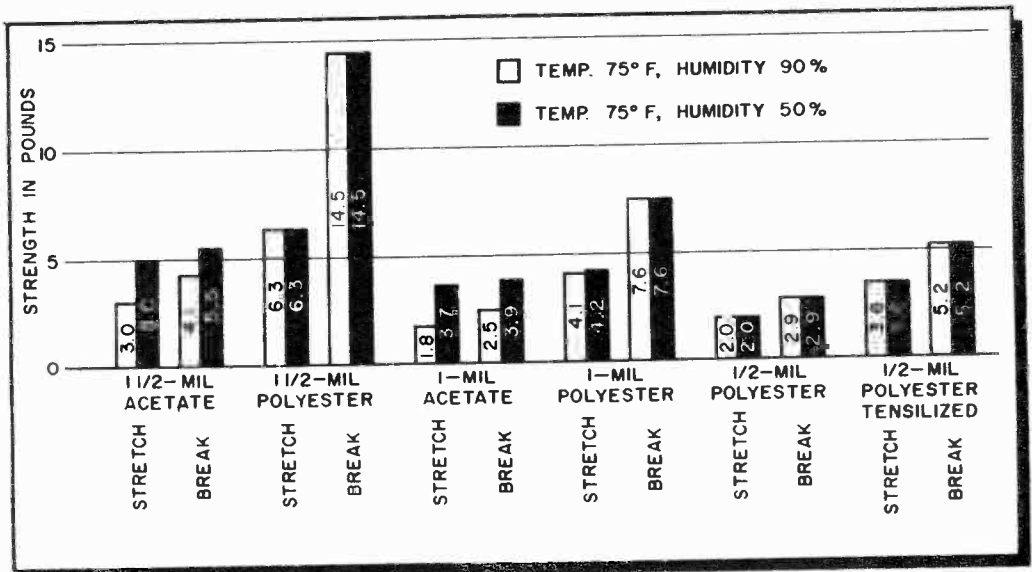

THIS CHART graphically demonstrates the stretch and break qualities of tapes of different base materials and thicknesses. Note that black bars designate pound-strength at the lower humidity.



THREE TAPES of the 1-mil polyester type. The 1-mil thickness is available with both polyester and acetate base from all major makers. Today, there are tapes to suit the needs of every recordist.

Accessories

Some will help you make more professional tapes more easily. Let's consider a few of them

IT SEEMS that every American industry which catches the public fancy, from automobiles to cameras to playing cards, soon gives birth to a secondary industry of gadgets, gimcracks and gewgaws. And tape recording is no exception. Far from it. In this field a lot of imaginations have been working overtime, and the result has been a number of truly clever and useful accessories. Let's have a look at some of them.

If you do any serious live recording at all, you soon realize that you are handicapped by the limitations of a single microphone input on your machine. It is often desirable to be able to mix several signal inputs, perhaps from several microphones,

BULK ERASERS, such as these Microtran and Amplifier Corp. models, work on 110 volts, erase quickly and thoroughly, will also demagnetize heads.



Grayson Tewksbury
photo

MIXERS eliminate the handicap of a single mike input on your tape recorder, providing multiple inputs for mikes, mike and tuner or mike and phono combinations with a volume control on each channel. Control on the tape recorder becomes a master volume control. These are popular Pentron and Revere models.

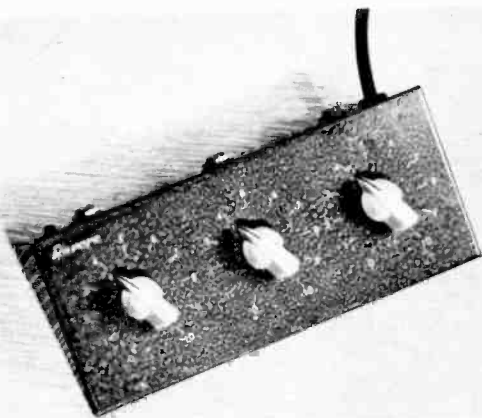

or a microphone and phonograph record, or mike and tuner, or any other combination.

Furthermore, it is desirable that the volume levels of each of these be individually controlled. The device which accomplishes this is called a *mixer*. It has multiple inputs and a volume control on each channel. Its output plugs into the input of the tape recorder and the volume control on the recorder then becomes a master gain control.

Sometimes it is useful to be able to record telephone conversations. Since telephone companies don't allow the direct connection of equipment other than their own on the lines, it is necessary to use an *inductive pickup*. When this little device is placed in the vicinity of the telephone cradle or receiver, the telephone equipment becomes the primary of a transformer, of which the pickup is the secondary. Then by inductive transformer action the audio on the phone line is picked up and can be fed directly into the recorder input.

When you buy a simple transport mechanism or tape deck, it is usually necessary to provide the electronic elements short of your own hi-fi power amplifier and speaker. These are often called *preamplifiers*, although they are actually much more than that.

The necessary functions include amplifi-

cation, erasing, bias, equalization and level indication for recording, and amplification and equalization for reproduction. Some so-called preamplifiers perform all of these tasks, while others are used only for recording or playback. And in the case of stereo systems, of course, the same facts hold true times two, once for each channel.

It is sometimes necessary or useful to have the tape recorder located at some point remote from the operator. This is easily done when you have a remote cable and switch. Most of these are operated by a foot pedal, but some have a hand-operated switch. And at least one has such a switch built into a microphone. Most of them stop and start only, but Ampro offers one which will remotely operate the rewind control as well.

We have already discussed the fact that by far the best results will be obtained when a VU meter is used for monitoring volume level. But it is usually a rather extensive job to add a meter to a machine which doesn't already have one. At least this was true until Amplicorp came along with a plug-in VU meter design which is really a honey.

This is a little self-contained battery-operated amplifier and meter. To use it, simply plug it into the phone jack on the recorder. No internal modification is necessary. It makes no difference where the jack is located on the machine, either, for

a swivel head on the meter permits it to be tilted for easy viewing from any angle.

The primary function of the phone jack, of course, is to allow plugging in of earphones. This provides for monitoring the recording when the machine is in the same room with a live microphone, and sound from the speaker would feed back. It also permits private listening to recorded tape.

Sometimes, as in classroom work, it is necessary for a number of listeners to be

able to hear recordings through earphones simultaneously. This problem is solved by an Audio Master unit called an *earphone aggregate box*. This has a cord which plugs into the single phone jack on the recorder, while a number of phone jacks are mounted on the box. Two models are available, one for eight sets of earphones, the other for twenty.

In cases where it is wanted to listen to a tape recorder in locations where no elec-

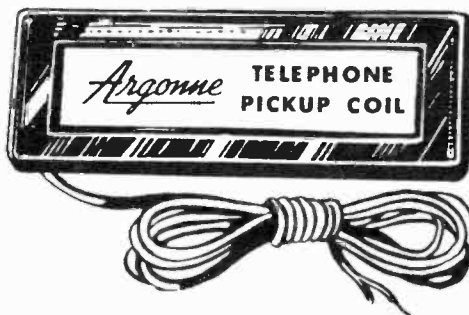

INDUCTIVE PICKUPS, when placed near telephone cradle or receiver, enable you to feed audio of the phone directly to input of your tape recorder. At right and below are Lafayette Radio, Microtran and American Geloso pickups.

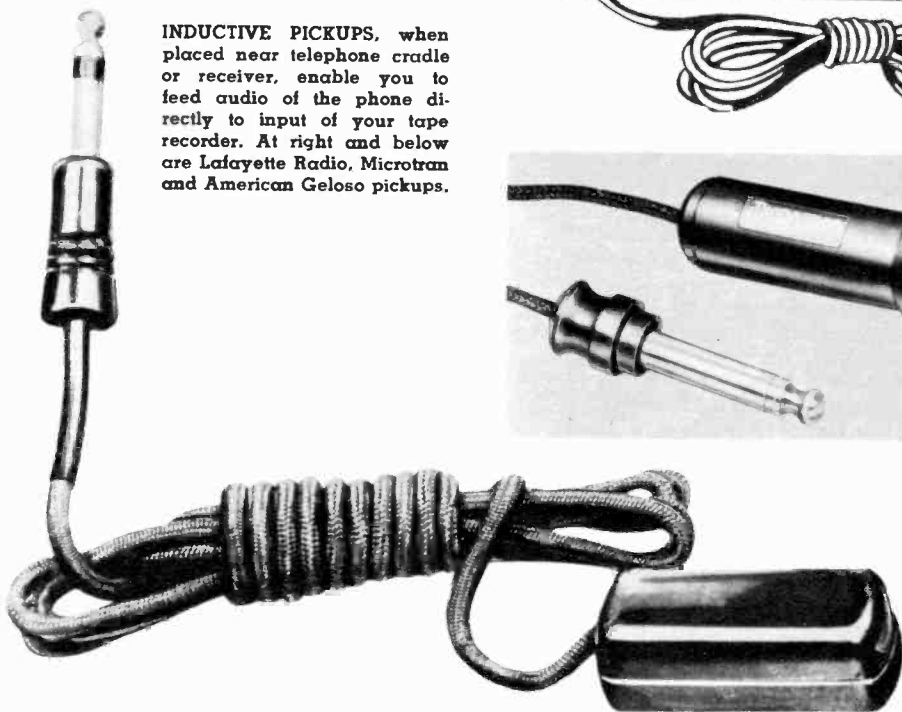
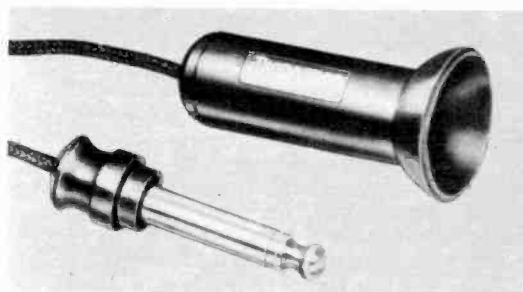

TAPE RECORDER PREAMP by Fen-tone affords complete record-playback preamplification including bias and erase, equalization for three common speeds, 3¾, 7½ and 15 ips.

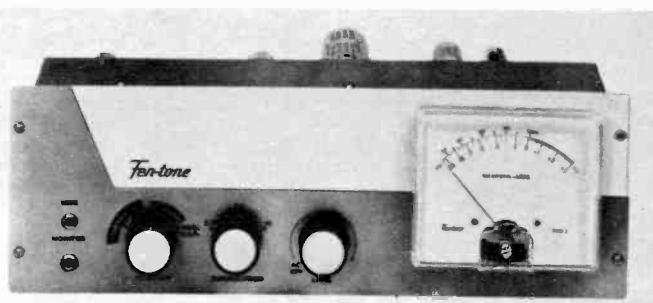

BELL PREAMP can also be used for recording and playback. An inch-long cathode indicator reveals volume level. Installs easily beneath Bell transport.

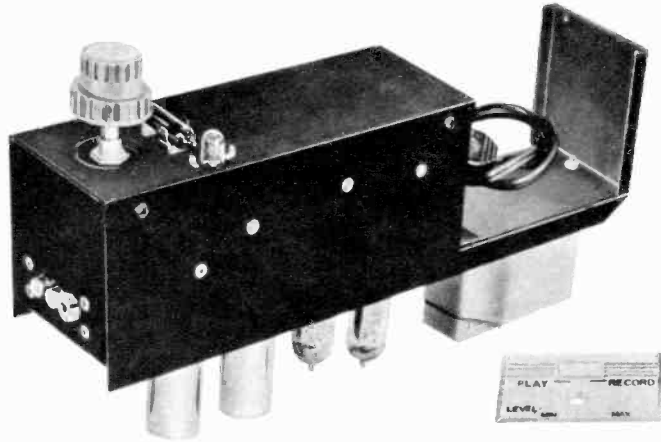

PENTRON preamps include the three-tube CA-11, left, which is for playback only and CA-13 model for playback and record. Controls of latter include gain control, safety interlock, hum adjustment.

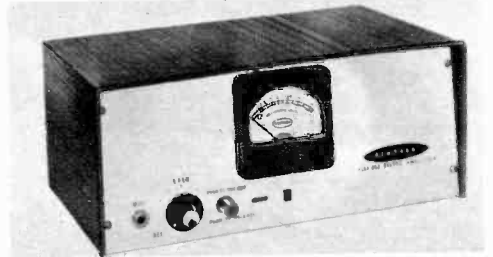
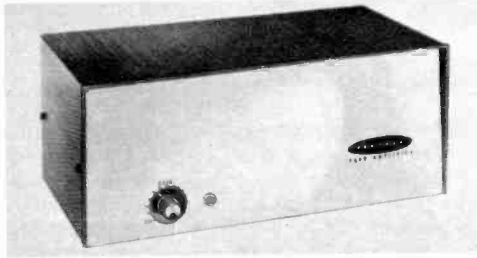

tric power is available, the recorder can be plugged into the nearest power source, and its signal fed to a remote battery-operated power amplifier. One such unit, by Amplicorp, has a self-contained speaker besides. Then all that is needed is a cable running from the battery amplifier input back to the output of the tape preamp. This could also be used with a phono preamp or tuner as well.

With stereophonic sound growing faster than anyone predicted, many tape recorder owners are wondering if their present equipment is obsolete. In most cases it definitely is not. We'll cover this in more detail in the stereo chapter later, but there are conversion kits and adapters available from most recorder manufacturers.

The Stereo-Magic conversion kit is one example, designed for some Pentron equipment. Another is the Steradapter, by the Dactrone Company. This is an attachment which will mount on the side of many recorders. The manufacturer also makes transistor booster amplifiers for use with it.

When you must make recordings where there is no practical means of plugging into an AC receptacle, then an auxiliary power unit is necessary. This will convert the DC power from a storage battery to the

higher voltage AC your recorder needs for proper operation. Two types of converters are available.

One of these is the vibrator pack, the sort of thing which has been used for many years on auto radios. The other is the motor-generator. This is a DC motor which drives an AC generator through a common shaft. The m-g set is more rugged and reliable than the vibrator, but it is also much bulkier and more expensive.

And if you're out in the field where no power is available, it's a cinch there won't be any handy table around either. You can avoid setting your machine on the ground, however, by carrying a collapsible field stand. This will keep the recorder protected, level and at convenient operating height.

It is often necessary to know how much tape will be needed to record a given length program, or to know how long a given tape will play. The chart in Chapter 3 will aid in estimating, but for a more precise calculation the Soundcraft Timing Chart is indispensable.

This is really a special form of slide rule which will tell the playing time of any length of tape from 1 to 3600 feet, at speeds from 1 7/8 to 15 i.p.s. The time range cov-

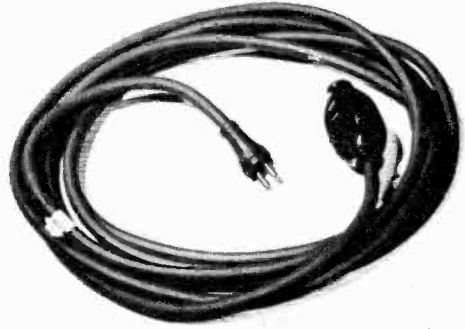
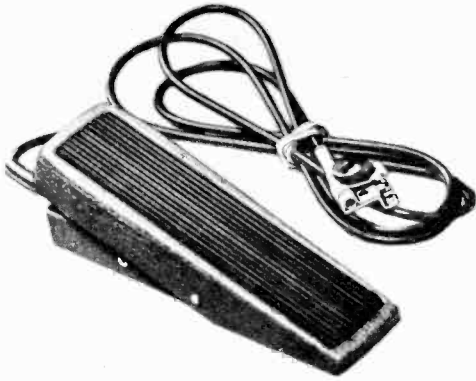

REMOTE CONTROLS are useful at times, enabling you to operate your tape recorder from a distant point. These foot and hand versions from Revere Camera will start and stop your machine. There are others to be had that will remotely operate the rewind control of your tape recorder as well.

VU METER, the best method of monitoring volume level, was all but impossible to add to a recorder until Amplicorp developed this plug-in number.

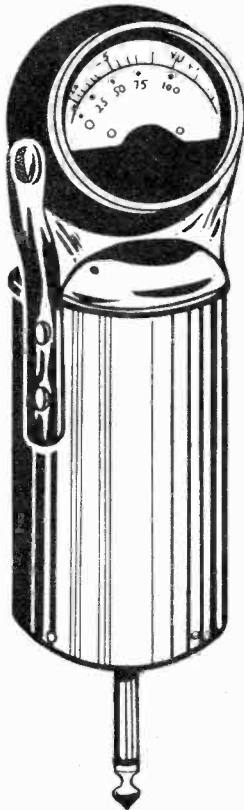

ered is from 1 second to 13 hours of play.

A handy means of synchronizing the projection of slides to a tape recorded commentary is offered in a unit by Revere. Any time there is a silent period on the tape of 4 to 8 seconds, the slide is changed. The silent time required to actuate the changer is adjustable. The tape can be recorded with the pauses cued in, or on a previously recorded tape the pauses can be added by cutting in blank tape of the right length at the appropriate points.

So much for the recorder. When we look at tape, it becomes obvious at once that an unusual amount of attention has been paid to the simple reel. Spill-proof reels, colored reels, easy-cue reels. These are just a few.

The no-spill reel is the brain child of the Irish tape people. It simply has two notches on opposite sides of the reel, allowing a rubber band to be secured and hold the tape in place. This eliminates the need for adhesive end tabs and prevents the wind from loosening.

The Audiotape C-Slot reel is claimed to be easier to load, and more positive in holding the tape end. In addition to the clear plastic types offered by all manufacturers, these are also available at no extra cost in four colors: red, yellow, green and blue. This is handy for filing tapes by musical type or any desired category.

The Ferrodynamics reel, called the V-Slot Selection-Finder, is slotted from the outer perimeter all the way into the hub. Permanent selection-finder numbers from 1 to 10 are molded along the edges of this slot to permit rapid location of the desired selection when playing back the tape.

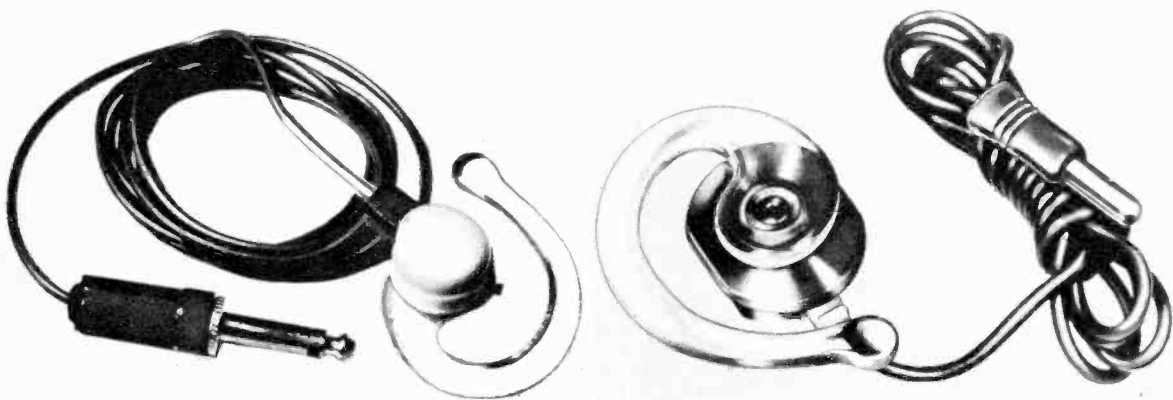

EARPHONES, which come in varied types, are a valuable accessory, permitting private listening and monitoring when machine is in room with a live mike and sound from the loudspeaker would feed back. The models pictured above are available from Revere and American Geloso and are modestly priced.

This idea is carried to a much greater extreme in the Geloso reel, where about $\frac{1}{3}$ of the rim area is cut away entirely. Selection-finding numbers are molded into one of the spokes, but since a part of the tape is accessible and bare all the way from the hub to the outermost layer, any desired point can easily be marked on the edge with a grease pencil.

Even at best, reels are somewhat inconvenient to use, and it has been the fervent wish of tape enthusiasts that a cartridge would become available, something which would make tape operation as simple as dropping a disc on a turntable.

Some progress is being made in this direction, one example being the Fidelipac. This is a continuous reel-type cartridge in which the tape is pulled from the center and, after passing the heads, is automatically wound on the outside of the reel. This process goes on continuously until the machine is stopped. The tape is completely contained in the plastic cartridge and is never touched by the user. The cartridge is simply placed on the recorder and the machine started.

The cartridge will operate satisfactorily from practically zero speed up to nearly 200 i.p.s., well over the maximum encountered in audio use. Unfortunately, this cartridge will operate on only a few types of machines, and with special tape. Nevertheless, there are a number of recorded tape libraries available in the Fidelipac cartridge. It is definitely a step in the right direction, and it is to be hoped that there will be further progress along these lines.

Getting back to the old-fashioned reels, another handy little gadget in spooling up

EARPHONE AGGREGATE BOX by Audio Master enables a number to hear via earphones simultaneously. Especially valuable for classroom use.



ANOTHER VERSION of the same accessory—and by the same manufacturer—is seen here. It has provisions for as many as twenty sets of earphones.



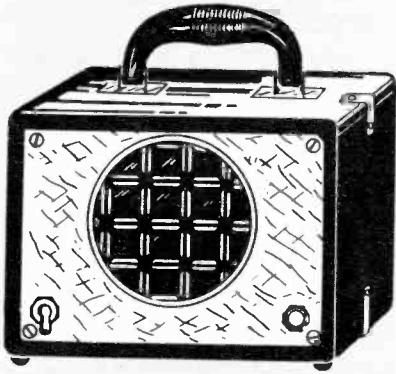

POWER AMPLIFIER, by Amplicorp, is battery operated for powerless area; has own speaker, too.

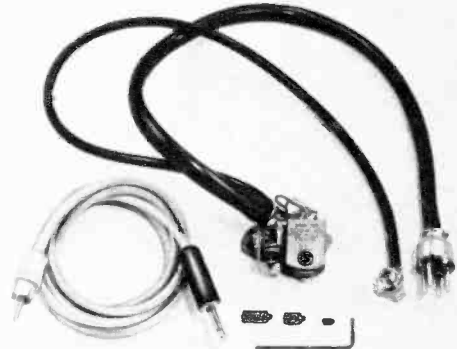

STEREO CONVERSION parts such as these by Wollensak-Revere make changeover more efficient.

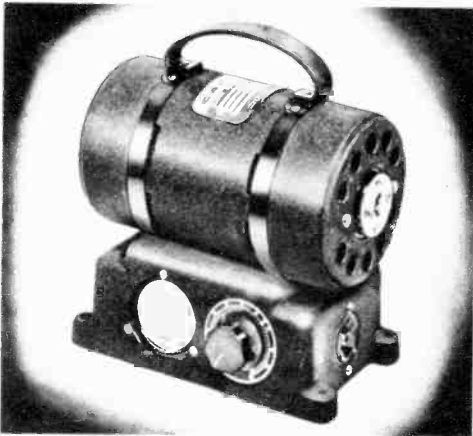

CONVERTER, by Carter, permits recorder use in cars, boats, converting battery power to 110 AC.



ATR INVERTER also changes battery power into 110 for tape, TV, and varied other purposes.

is the Robins tape threader. With the take-up reel on the spindle, the tape is simply placed against the hub and the threader slipped over the spindle. Then, with just a few turns of the threader crank, you are ready to play or record.

Since the tape ends have to take a certain amount of abuse in the threading process, it is wise to splice a length of tough leader tape to both the beginning and end of the magnetic tape to avoid destroying any part of the recording. Several varieties of leader tape are available.

For several years, the best leader tape was made of paper, because the early plastic types were noisy. But the perfection of anti-static agents has brought plastic leaders to the fore again. Most of them have timing markers on them as well,

usually spaced a handy 7½ inches apart.

A frosted surface is usually found on one side, which will accept writing by pencil or ball-point pen. Another method of identification is the color coding possible with Soundcraft Mylar-base leader tape. This is available in gold, red, white and blue.

Leaders are added to tape, undesired recorded selections deleted, sequence rearranged and breaks repaired by a process called splicing. The commonest method of doing this is by putting the two ends of the magnetic tape together so that they just touch, and then covering the joint with a piece of special adhesive tape.

This can be done by hand with no other tool than a razor blade or pair of scissors, but a splicer makes the job much easier.

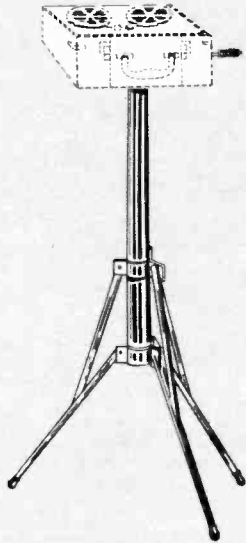

COLLAPSIBLE STAND for tape recorder use in the field will keep the machine protected, level and located at a convenient height: Amplicorp.

TIMING CHART by Soundcraft tells you how long a given tape will play as well as exactly how much tape you will need to record given program.

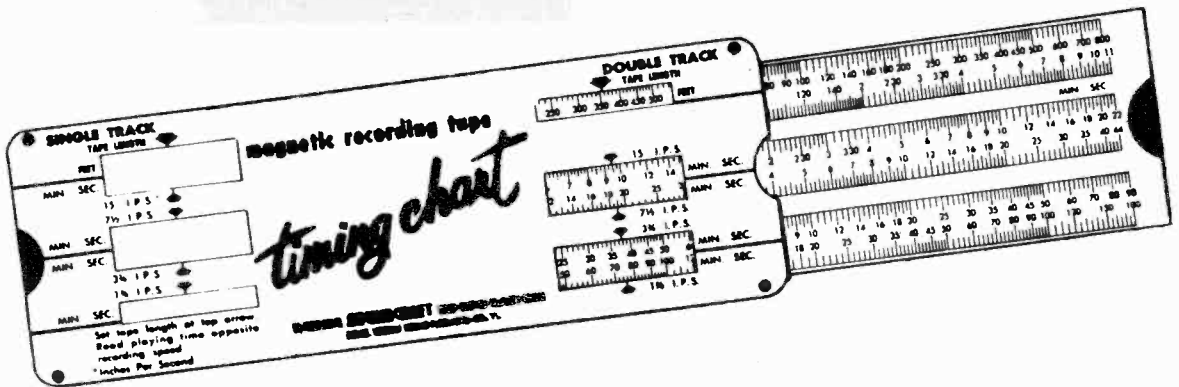

All splicers hold the tape in place while the patch is placed over the cut or break. Some of them then simply guide a hand-held cutting tool, such as a razor blade, for cutting the magnetic tape if necessary, and for trimming the splicing tape.

Some of the more elaborate ones also have a spindle for holding a spool of splicing tape, and some even dispense the tape already cut to size to just fit the splice. Others provide for undercutting both the splicing and magnetic tapes at the joint. That is, the trimming parallel to the edges of the magnetic tape is cut slightly concave, so that the tape becomes somewhat narrower at the splicing area. This reduces the possibility of binding or fouling as the splice passes head and guides and the loss in level is less than the human ear can de-

tect. (Canine recordists rarely complain.)

The other method of splicing tape is the heat weld, typified by the Prestoseal splicer. In this case, after the tape ends are butted together—or slightly overlapped if desired—they are held in place under pressure and heat is applied for just a few seconds. Some manufacturers have used this method for attaching paper leader to recorded tapes, and it is also useful for salvaging tape odds and ends, without adding the bulk and additional thickness of splicing tape.

If the patch-type splices are used, it is essential to use splicing tape especially designed for use with magnetic tape. It is true that almost any type adhesive tape will work in an emergency, but these makeshifts will cause trouble in time.

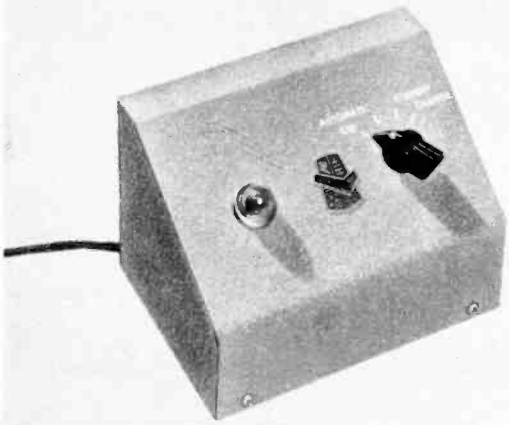

SYNCHRONIZER, made by Revere Camera, provides a handy means of synchronizing tape-recorded commentary, slide projection. (See text.)

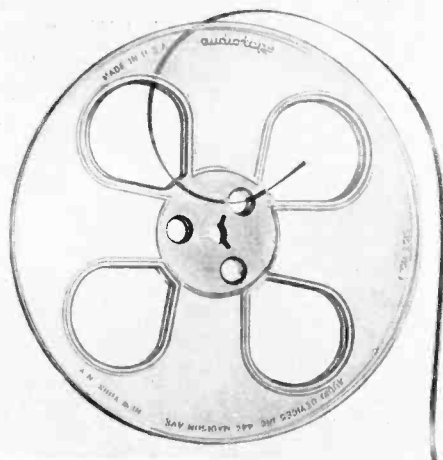

NO-SPILL REEL, made by Orradio, is notched on opposite sides to permit the use of a simple rubber band to hold the tape firmly in place.

C-SLOT REEL by Audiotape is said to be easier to load, more positive in holding tape end. It comes in four colors to ease filing by types.

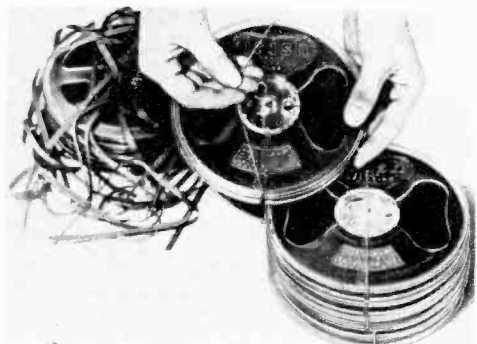

SELECTION-FINDING numbers are molded into a spoke of the Gelsos Model 102 reel for rapid location of a desired number when playing tape.

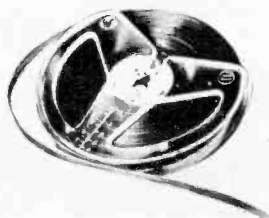

They will almost always ooze some of the adhesive material after a while. This causes burbles in the reproduction, and fouls the heads, guides, drive mechanism and reels. Thus the special white adhesive used in the several available brands of splicing tape is the only thing acceptable for permanent work.

When a tape has been severely overloaded in recording level, the eraser circuit in the recorder is often not powerful enough to clean the signal entirely off the tape. Then some of the old recording hangs on and can be heard at a low level, to mar the most recent recording.

When this occurs, the only answer is a more powerful eraser. This is an electromagnet which derives its power from any AC receptacle. When it is held adjacent to a reel of tape, it wipes the entire reel clean in a few seconds. Most brand-new tape now undergoes this treatment before the manufacturer ships it. This obliterates any stray magnetization the tape may have

picked up during manufacture, and it also lowers the background noise by 3 to 6 db.

Since one can't tell what is recorded on a tape by visual inspection, some other method must be found for identifying, indexing and filing. One means is the Irish reel tab, which slips under the reel edges and allows plenty of room for writing. Orradio offers these free to recordists, and at the end of the book we'll tell you how to get a supply. (See pages 132-135.)

Audiotape offers adhesive labels which may be pressed onto the side of the reel. The Scotch version of this idea has the labels in a continuous roll on a metal tear-off dispenser.

While any of these methods tells what material is on a given tape, none of them can tell very accurately where to locate a particular selection. This is the forte of the Tape-Indx, which use small adhesive tabs which are stuck to the tape backing and protrude above the edge of the wound tape.

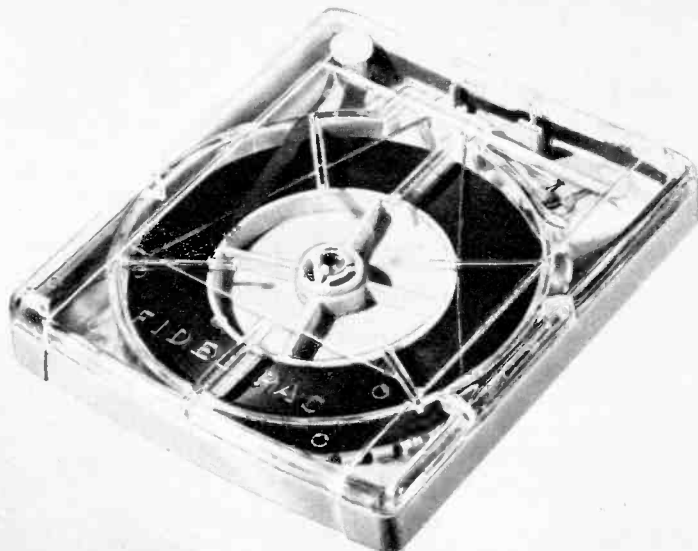

CARTRIDGE by Fidelipac requires special tape and will work only on certain machines. It is merely placed on the recorder; the tape itself is never touched by the user.

TAPE THREADER which slips over spindle of take-up reel, is a mighty handy accessory for spooling up. (See text.) A product of Robins Industries.

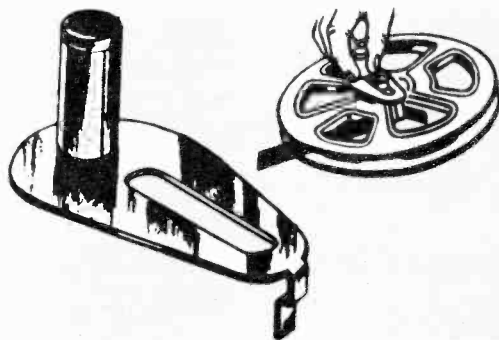

The shape of the tab provides a cam action so that the visible part lies flat for easy reading and lies back away from heads and guides, preventing binding or jamming. The tabs are printed in five colors for further subdivision: red, green, blue, orange and black.

The other part of the kit includes the conventional adhesive labels. These can be attached to the reel spokes, the outside of the tape box, or a handy little pocket secretary designed for the purpose.

Many tape enthusiasts feel that the cardboard boxes in which most tapes are supplied are not adequate protection for important recordings. A more durable package which is used by many recordists is the plastic-drum Stor-A-Tape made by Concertapes.

Another is the plastic container which is included with all new Sonoramic tapes. This is a very clever design, being a polystyrene box with a snap-fastened, hinged front which partially ejects the reel

when it is opened. The edges are flat, so the boxes may be stacked on edge just like books. They may also be hung on a wall by means of a dovetail slot in the back, which fits a mounting strip which is separately available.

Other tape manufacturers sometimes offer special storage packages, such as the Irish Collector's Cabinet and the Soundcraft Tape Chest. This type of cabinet is also available in the durable Revere Tape Filing and Carrying Case. This looks like a small piece of hand luggage.

Both Audio and Scotch offer corrugated shipping containers for mailing individual reels of tape. The carton folds around the standard sound recording tape box and is taped or tied shut. It provides added protection with minimum weight and is reusable. The Scotch line begins with the 4-inch reel size, and both brands have cartons for the 5-, 7- and 10½-inch reels.

Among the important routine maintenance procedures for tape recorders, the

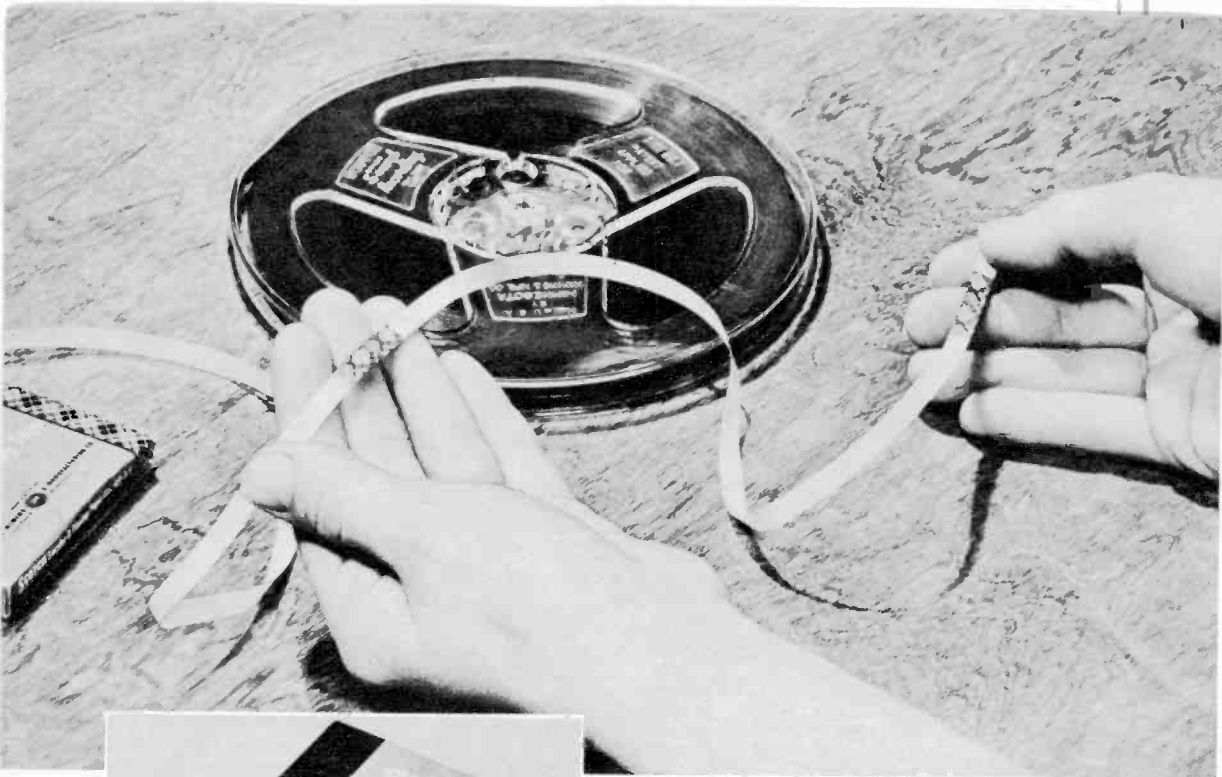

LEADER TAPE eliminates loss of any part of recording due to abuse tape-ends are subject to. Plastic types seen in the photos above and at left are Scotch and Audio brands respectively.

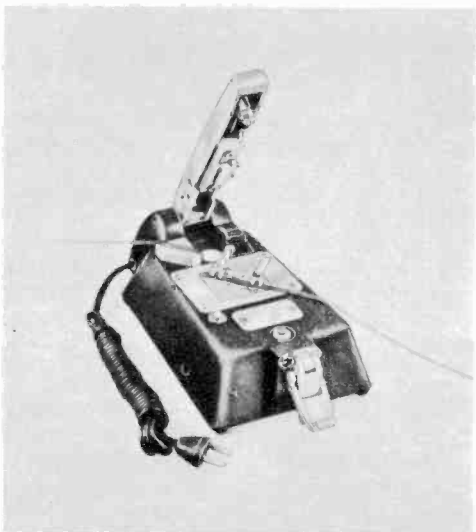

SPLICER above, made by Prestoseal, employs a heat weld after tape ends are butted together or overlapped. Ends are held under pressure.



OTHER SPLICERS available include these Robins models, the Gibson Girl and Gibson Girl Semi-Pro. named for rounded shape of their splices.

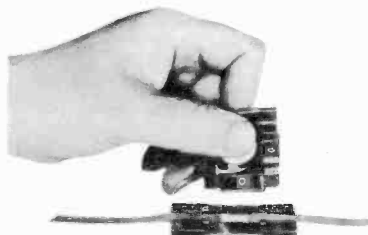

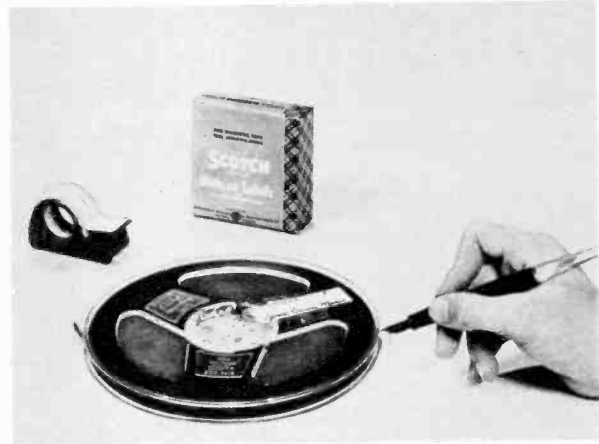

WRITE-ON LABELS are handy for identification of your recorded tapes. Scotch brand come on a continuous roll on a metal tear-off dispenser.

SPLICING TAPE has been especially designed for use with magnetic tape. Other adhesives will work, but should be limited to emergencies.

DATREL'S "Tape-Indx" enables you to locate a particular selection on a tape via small adhesives that stick and lie flat on tape's backing.

OTHER IDENTIFICATION labels available to the tape-recording enthusiasts include these manufactured by Audiotape. In each pack are 30.

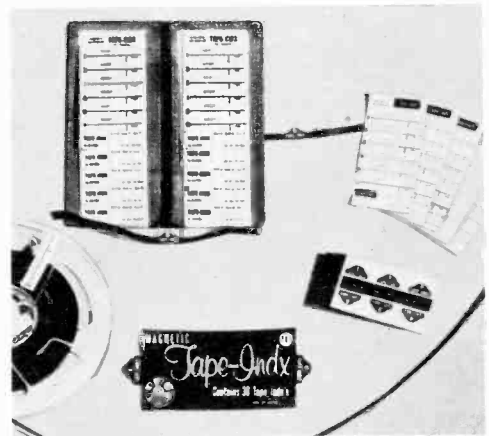
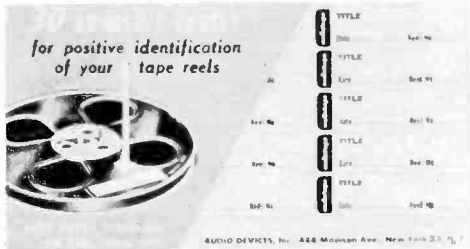

most important are periodic cleaning and lubrication.

Thus a specific cleaner is required which will act on the usual contaminants found in tape recording, but which will not harm the machine or tape. Such cleaners are formulated by Ampex and Audiotape. Another is the Long Life lubricant made by EMC Recording Corporation.

Among the contaminants to be found on the heads, guides and moving parts of a tape recorder are bits of oxide and binder, plastic shreds, dust, dirt, grease and oil. These can cause many types of mechanical and electrical malfunctioning, and the machine must be kept free of them.

There is also a silicone lubricant made under the Long Life label. This is recommended for use on the heads and guides, to effect the lowest possible friction during tape travel. It is also useful for loosening and cleaning sticky splices.

Alcohol is sometimes used for cleaning, but it is a rather poor solvent and consequently can't do a thorough job. Another common cleaner is carbon tetrachloride, but this sometimes attacks the resins which are used to cement head laminations or encapsulate components.

Occasionally the output of a tape machine will become noisy for no apparent reason. Even worse, it may be sometimes

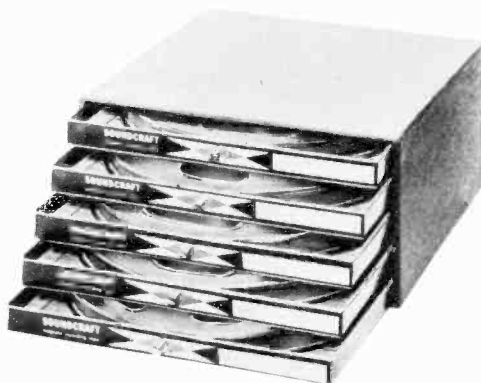
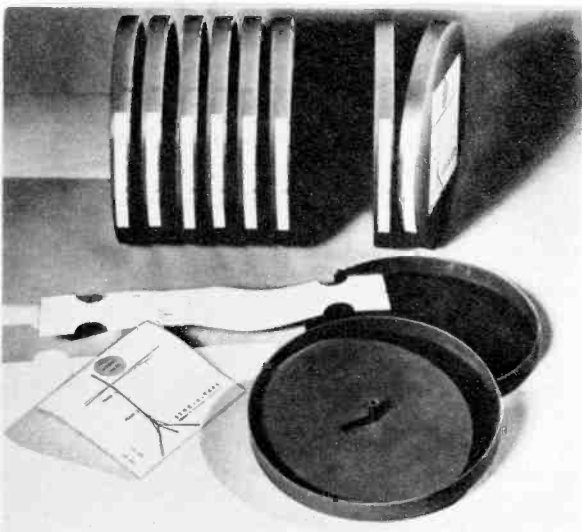

VARIED CONTAINERS for storage, protection, identification of treasured tapes include the "Stor-A-Tape" plastic drums by Concertapes; Soundcraft's Tape Chest with its pull-out drawers, above right; and the handsome luggage-type storage-carrying case made by Revere Camera.



COLLECTOR'S CABINET, made by Irish Tape, includes tape itself, leader stock, splicing tape, and twenty Irish "reel-tabs" as pictured above.

CORRUGATED CARTONS for mailing individual reels are another handy accessory. Those made by Scotch people begin with the four-inch-reel size.



AUDIOTAPE also has protective shipping containers for individual tape reels. Both lines include five-, seven-, and ten-and-a-half-inch sizes.

CLEANER-LUBRICANT KIT, made by EMC, includes a silicone lubricant, which is also very handy for loosening and cleaning splices that stick.



noted that good tapes will have noise recorded on them simply as a result of being played. When either of these conditions occur, it is time to suspect magnetization of one of the recording heads.

The head is supposed to be an electromagnet, without any permanent magnetization of its own. But if it does pick up any residual magnetism, it can be removed easily with the bulk tape eraser already described, or with the Audio Head Demagnetizer.

If tape is recorded on a machine with excellent frequency response and reproduced on another machine with equally good response, it is still possible that the



HEAD CLEANERS, such as this made by Robins Industries, should be used to remove contaminants from heads. Alcohol proves unsatisfactory.

HEAD DEMAGNETIZER, made by Audio, is useful for removing residual magnetism. Suspect such a condition if noise is recorded onto good tapes.

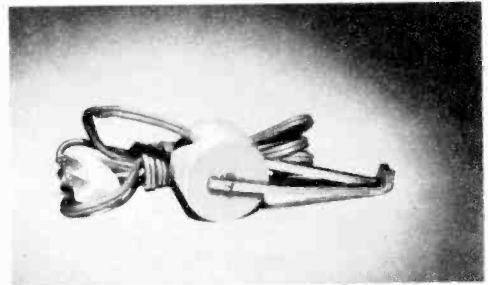

overall result may be lacking in high frequency response. The cause of this could very well be *azimuth misalignment*.

Unless the gaps on all of the recording and reproducing heads are at precisely right angles to the edges of the tape, reproduction will be considerably impaired. Tape heads are normally aligned at the factory, but if misalignment later occurs, it can be determined and corrected with the help of an azimuth alignment tape. One of these is available on Audiotape.

Now that we are familiar with the tools with which we have to work, let's set about incorporating a tape recorder into our hi-fi system. •

Adding Tape to Your Hi-Fi System

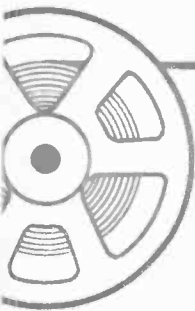

Any audiophile can integrate the two for maximum performance with simple materials and this dope

SINCE both tape recording and high fidelity are relatively young arts, there hasn't been time yet to integrate the two completely, but with a few simple materials and new connections any audiophile can do it himself. Many tape decks are now made as hi-fi components, and these will be discussed later, but first let's consider the problem of working a unitized tape recorder into an existing hi-fi system, so as to derive the maximum performance of which the recorder is capable.

Most tape recorders are rather simple devices, designed to record sound from a small crystal microphone, and to reproduce tapes made by this or other means. It includes all of the electronic devices necessary for these functions, plus a loudspeaker. This arrangement is far from the best for hi-fi fans for several reasons.

It doesn't provide for recording from other sources, such as radio, TV, records or other tape. Neither does it permit playing the tape through a good hi-fi amplifier and speaker system. The greatest weakness of such a recorder, in fact, is its puny audio amplifier and tiny speaker.

This same tape recorder, on the other hand, has all of the elements necessary for hi-fi recording and playback. It has the transport mechanism, the heads, the recording amplifier, the erase and bias oscillators, and playback preamplifier. And it will be quite a simple task for us to utilize these elements in our hi-fi system, while eliminating the others.

We have two problems to solve: getting signals from the hi-fi system into the recorder at a suitable level to be handled by the record amplifier, and getting signals from the recorder playback into the hi-fi system at a suitable level to be handled by the power amplifier. To understand this better, let's take a closer look at the electronic elements of a typical recorder.

The block diagram shows the basic *functions* performed by these elements. Very often some of these blocks do double duty. For example, as we already know, both recording and playback are often performed by a single head and preamp-control-amplifier chain. But it doesn't matter which arrangement is used on your recorder. The following discussion will apply in nearly all cases.

We can see from the drawing that, whether the amplifier chains are separate or double-duty, they have certain things in common. In each case there is a low-level amplifier (preamp) and a high-level amplifier (power amp), with a volume control between them. The volume control is thus a sort of gate or valve which determines how much of the signal from the preamplifier is fed to

RECORDER at the right, a Geloso model, is played through a Fisher high-fidelity console. A simple connector cord joins the machine to an external amplifier for either recording or playback, giving it increased fidelity.



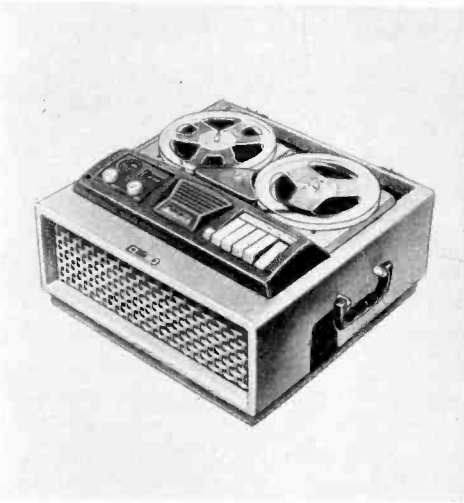

RECORDING and playback through a high-fidelity system are possible without modification of this Ampro tape recorder which features an amplifier by-pass.

THIS MACHINE by Pentron has input jack for connecting to hi-fi pre-amp; second output for external speaker only. Low-level output entails relatively simple modification.



power amplifier and succeeding speaker.

Now the signal level at the volume control is a "comfortable" one. That is, it could be carried over some distance by cable if necessary, without danger of the signal being so high as to cause cross-talk, or so low as to be susceptible to induced noise. Obviously, this would be a useful point to connect signals *both* to and from the hi-fi system.

We want, then, to introduce a signal into the recording amplifier from the hi-fi system *instead* of the microphone preamplifier. And for reproduction we want to send a signal from the playback preamp into the hi-fi power amplifier *instead* of the tape amplifier and speaker.

This means that in addition to connection at the proper point we also need a means of selective switching, unless the tape is to

be permanently connected into the hi-fi system. For maximum flexibility, the recording amplifier should be able to receive signals either from the hi-fi system or its own preamp. And the playback preamp should be able to feed either the hi-fi power amp and speaker, or its own internal audio system.

The tape recorders which are designed for integration into a hi-fi system will accomplish the connections through a conventional phono jack and patch cord arrangement, while the selection is handled through a function switch. The method we'll describe here does both the connecting and selection through the jack itself. It eliminates the complex wiring of a selector switch and is nearly as convenient in operation.

In order to make the installation, it will

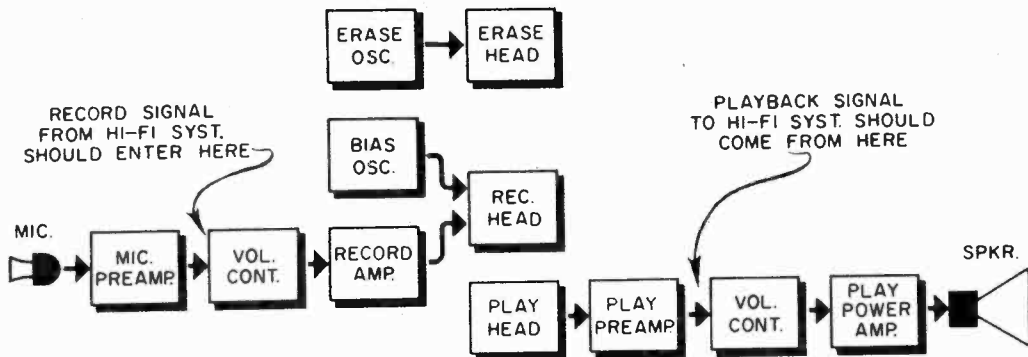

SIMPLIFIED block diagram of a tape recorder's electronic elements. Many machines have one head for playback and erase, one amplifier chain with switching arrangement for both record and playback.



THIS EKOTAPE model is correctly matched for recording from hi-fi, but for direct playback connection to setup, slight modification is needed.

be necessary first to remove the electronic elements of the recorder from the case. In some cases the electronic chassis is attached directly to the mechanical chassis. In others, the two chassis are separate, and plug-in cables connect the electronic elements to the heads.

If it is necessary to remove the transport mechanism, have blocks ready to support the four corners of the chassis, so that its weight need not rest on the motors, spindles or other fitted parts. Make sure that all mountings have been freed. Be especially careful of wires or cables which have been stapled to the wooden case. When all mounting fixtures are free, the unit should remove easily. Don't attempt to use force.

With the electronic unit removed and in a well-lighted place, the next step is to locate the volume control and identify its terminals. You will note three terminals fanning out in an arc around the edge of the control. One of these terminals will be seen to be connected to the metal chassis. It may go first to a terminal strip or to a tube-socket terminal being used as a tie point, but in any case it will be possible to trace a wire connection from one volume control terminal to chassis ground. We'll call this terminal 3, and it should be so marked with pencil on the back of the control.

The center terminal will be connected

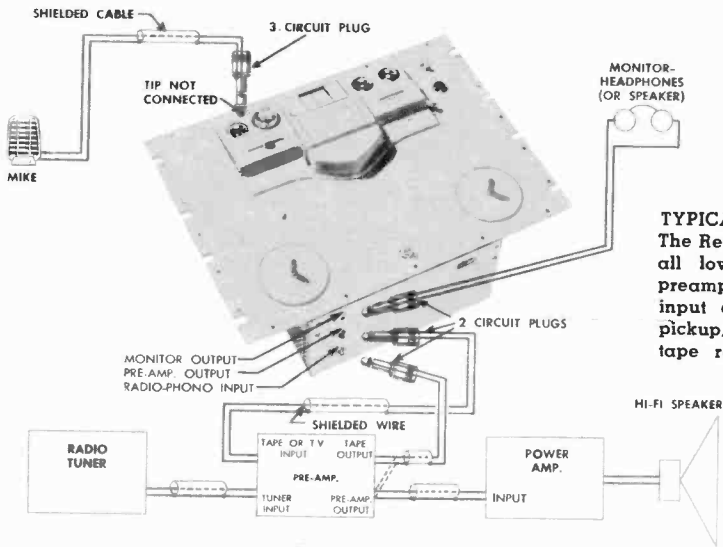

TYPICAL hi-fi hook-up of a tape deck. The Revere T-11 deck shown includes all low-level electronics. Its input preamp permits recording via direct input connection from mike, phono pickup, tuner, TV receiver, another tape recorder, or a hi-fi amplifier.



MECHANISM of the Bell RT-204, a complete three-motor tape recorder adaptable to stereo, is also available as a deck (photo, page 52). All modes of operation shown below are possible with this recorder, using only two input and two output jacks in any instance.

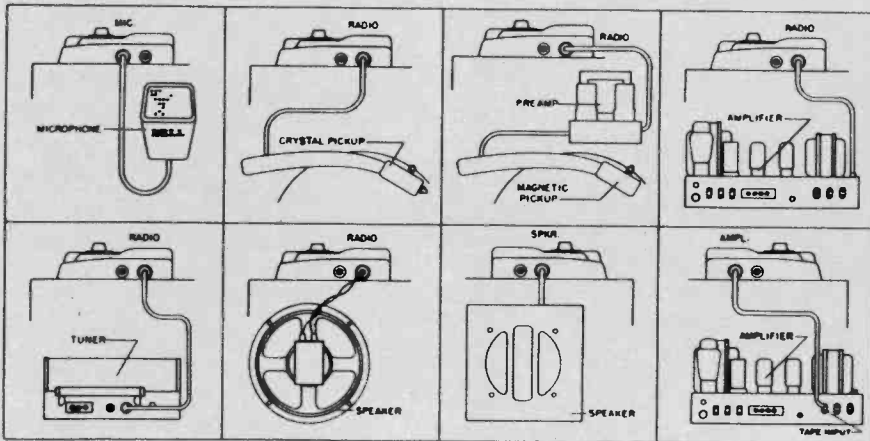

directly to a tube socket terminal. This we'll identify as point 2. The remaining terminal will connect to a condenser, which in turn goes to another tube socket terminal. This we'll call terminal 3.

If there is also a pair of terminals behind the three, these are for the on-off switch. Very often, this switch on tape recorders is coupled with the tone control instead. In any case, it is of no concern to us, nor is volume control terminal 2. Our work will have to do only with the two outer terminals, Nos. 1 and 3.

For each connection (record or playback), you'll need the following materials:

1—Single-closed-circuit, 2-conductor phone jack

1—Two-conductor phone plug to fit jack

1—Length insulated hookup wire

1—Length insulated phono cable, sufficient to reach from recorder to hi-fi amplifier

The jack is mounted at any convenient point on the case, chassis or escutcheon plate, where it will be accessible from the outside. The most convenient place, as far as wiring is concerned, is right next to the volume control. It is essential, however, that it not interfere with any of the existing wiring on the rear of the plate, nor with the operation of any of the controls on the front. Check this carefully before drilling any holes.

First let's consider the case of recording only from the hi-fi system. If the recorder has separate recording and playback level controls, it will be to the *recording* volume control to which the connections will be made. If the recorder uses the double-duty system, then the one single volume control common to both functions will be used.

Now as a last step before making the new connections, let's identify the three terminals of the jack. One of these will be seen to connect directly to the outer frame. This will be known as terminal 3. The other two terminals connect to a pair of contacts, which are closed when no plug is inserted, but which open up when the plug enters. The moving arm, which swings down to make contact internally when the plug is removed, and which swings up to make contact with the plug tip when it is inserted, will be called terminal 1. The remaining contact, which connects to terminal 1 when the plug is out and is open when the plug is in, should be labeled as terminal 2.

Now with the jack mounted and both volume control and jack terminals properly identified, the steps for interconnection are simple:

1. Unsolder the wire from terminal 1 of the volume control and solder it to terminal 2 of the jack.

2. Connect a short piece of hookup wire from terminal 1 of the jack to terminal 1 of the volume control. Solder the wire at each terminal.

3. Connect a short piece of hookup wire from terminal 3 of the jack to any convenient chassis ground point, such as terminal 3 of the volume control. Solder the wire at each end.

That's all there is to it. Three easy steps. Now the record amplifier will receive audio signals from its own preamp when there is no plug in the jack, and from any external source when it is plugged in. The recording volume control will continue to determine level as before.

For playback only from the tape recorder into the hi-fi system, the jack connection will be made at the playback volume control, or at the common volume control in the double-duty system.

1. Unsolder the wire from terminal 1 of the volume control and solder it to terminal 1 of the jack.

2. Connect a short piece of hookup wire from terminal 2 of the jack to terminal 1 of the volume control. Solder the wire at each terminal.

3. Connect a short piece of hookup wire from terminal 3 of the jack to any convenient chassis ground point. Solder the wire at each end.

You will observe that the procedure for playback is the same as for recording, except that the connections to terminals 1 and 2 of the jack are reversed. But the result in this case is that the playback preamp will now feed the internal playback amplifier and speaker when the plug is removed, and will play through the hi-fi sound system when the plug is inserted. The setting of the recorder volume control will have no effect on the hi-fi system level.

The procedures outlined preceding will work for both playback and recording only if the machine has separate playback and recording preamps, and separate level controls for each. For the double-duty system, where one amplifier chain performs both functions, two jacks are used, and both are inserted between the preamp and volume



RECORDING and playing back through a high-fidelity system of the Wollensak tape recorder are possible without further modification. Built-in speakers are silenced by merely plugging a cord into extension speaker closed-circuit jack.

DIAGRAMMED are connections for recording from hi-fi amplifier (A), playing back through hi-fi amp (B), and for recording or playing back through hi-fi system when amplifier-volume control chain is common to both functions (C).



TANCORDEX, a Lafayette Radio import for monaural or stereo recording and playback, has three motors, three heads. Blond or mahogany cabinet houses two-channel preamplifier. Stainless-steel-mounted deck is seen in detail below.

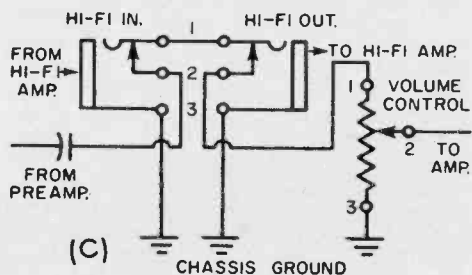
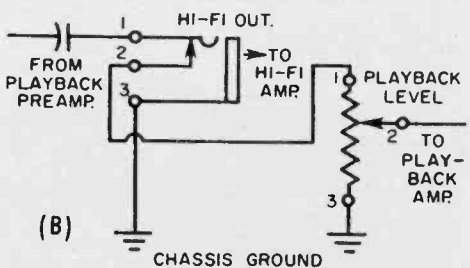
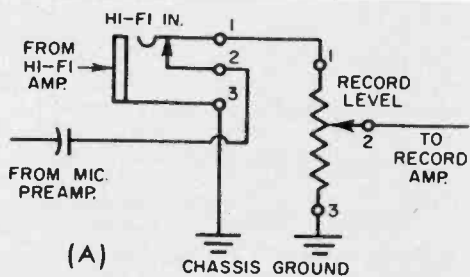
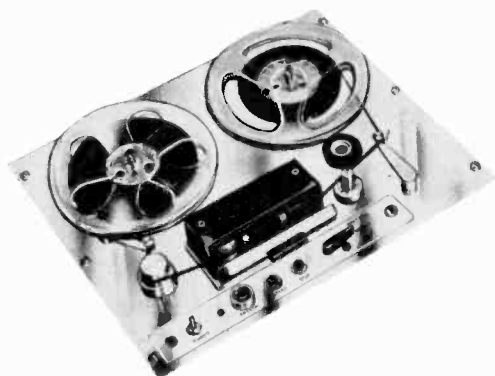

control. One jack, which will feed the preamp output to the hi-fi system for playback, will be known as *hi-fi out*. The other jack, which will accept the output from the hi-fi system and feed it into the tape recording amplifier, will be designated *hi-fi in*.

The wiring procedure is nearly as simple as with the single jack:

1. Unsolder the wire from terminal 1 of the volume control and solder it to terminal 2 of the *hi-fi in* jack.
2. Connect a short piece of hookup wire from terminal 2 of the *hi-fi out* jack to terminal 1 of the volume control. Solder the wire at each terminal.
3. Connect a short piece of hookup wire from terminal 1 of the *hi-fi in* jack to terminal 1 of the *hi-fi out* jack. Solder the wire at each terminal.
4. Connect a short piece of bare hookup wire from terminal 3 of the *hi-fi in* jack to terminal 3 of the *hi-fi out* jack and then to any convenient chassis ground point, such as terminal 3 of the volume control.

Solder the wire at all three terminals.

Since in this simplified dual system the jacks do the switching as well as the connecting, the signal path being determined by the position of the plug, it is important that the plug be inserted only when its particular function is desired. For example, if plugs are inserted into both the *hi-fi in* and *hi-fi out* jacks simultaneously, a recording signal will bypass the recorder completely, going in one jack and out the other.

Each phone plug has two terminals, for connection to each of the two conductors of the phono cable. After the insulation is stripped from the wires and the ends dressed, the braided outer conductor is connected to the terminal which goes to the body and shank of the plug. The center conductor of the cable is connected to the terminal which goes to the plug tip.

Now we still have the problem of connecting at the hi-fi amplifier end of the system. If your amplifier has tape jacks, the answer is simple. You will simply attach phono plugs to the remaining ends of the recorder cables, and plug from the *tape out* jack to the *hi-fi in* jack on the recorder. Similarly, a connection will be made from the *tape in* jack to the *hi-fi out* on the recorder.

If your amplifier doesn't have tape jacks, then you'll have to do another installation job. For both recording and playback, the circuit and procedure will be exactly the same as for the dual playback-record setup

just described for the recorder. The only difference will be in the labeling and functions. The jack shown on the drawing for the recorder as *hi-fi in* will become *tape in*, and that shown as *hi-fi out* will become *tape out*.

It is obvious that in hi-fi work, certain elements of the conventional tape recorder have limited usefulness, because they are duplicated in better quality by elements already in the hi-fi system. These elements are the microphone preamplifier, the playback power amplifier and the loudspeaker.

This fact has given rise in recent years to the hi-fi component concept in tape recorder design, and to the introduction of the *tape deck*. Already the term has two definitions, meaning in some cases simply a bare tape transport mechanism, while in others it is taken to include the erase, bias, record and playback preamp circuits. In any case it is definitely understood to be without the elements we have just mentioned as being superfluous, and without any sort of carrying case or cabinet as well.

The Revere T-11, for example, has all low-level electronics included as an integral part of the system, but with no high-level electronics or carrying case. Its top mounting plate is designed either for vertical installation in a 19-inch professional relay rack, or for horizontal mounting in home hi-fi furniture. It has an input preamplifier, enabling recording not only from the hi-fi amplifier, but also direct input connection from other devices such as a microphone, phono pickup, tuner, TV set or another tape recorder.

A somewhat different philosophy is followed by other manufacturers, such as Pentron, Bell and Viking. They offer the transport mechanism alone, plus a variety of electronic units. This provides maximum flexibility in the selection of equipment to perform any desired functions.

The number of possible combinations becomes rather large when we consider that in recording we have full-track monaural, half-track monaural, staggered stereo and stacked stereo. In playback there are, of course, an equal number of types. Then on top of that we have several speed possibilities. Now when we start mixing up recording only, playback only, recording types, playback types, and speeds, a considerable number of combinations is possible. Perhaps not every conceivable combination is available with existing equipment, but it is obvious that the widest possible flexibility is afforded by tape mechanism-plus-electronics buying.

THESE DRAWINGS show the Pentron components needed to add tape facilities indicated to an existing hi-fi system. 1. Monaural playback: tape mechanism and playback preamp. 2. Stereophonic playback and monaural record and play: mechanism, playback preamp and combined playback preamp-record amplifier. 3. Monaural record/play: tape mechanism and one preamplifier.

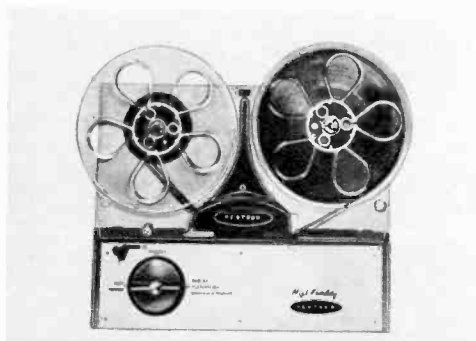
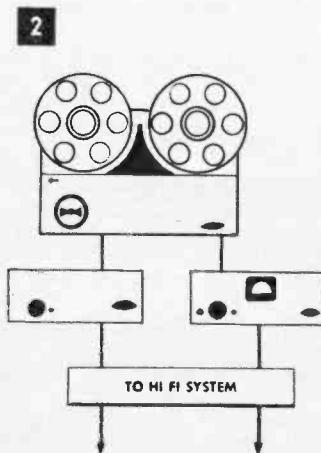
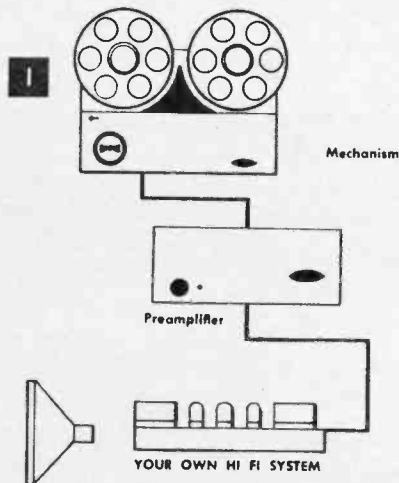

TAPE MECHANISMS, or decks, such as this Pentron model, are for use with separate electronic units, provide for greater flexibility of installation.

ROBERTS RECORDER-REPRODUCER could well be the focal point of your hi-fi system. It features a volume meter and hysteresis synchronous motor.

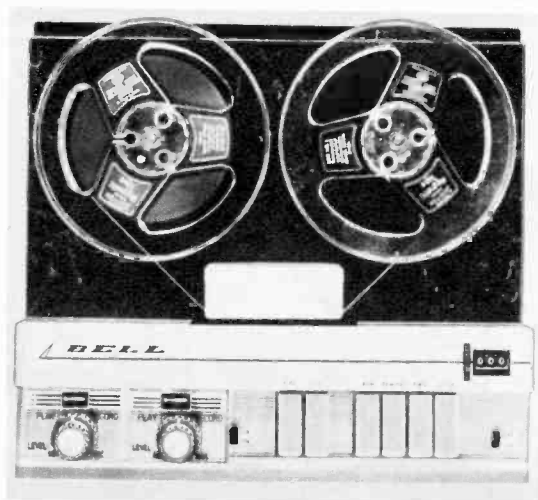

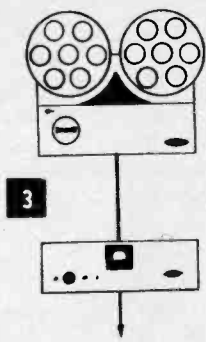

3

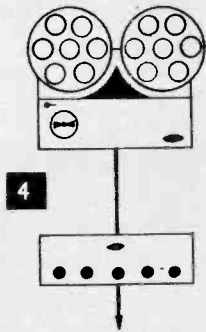

4

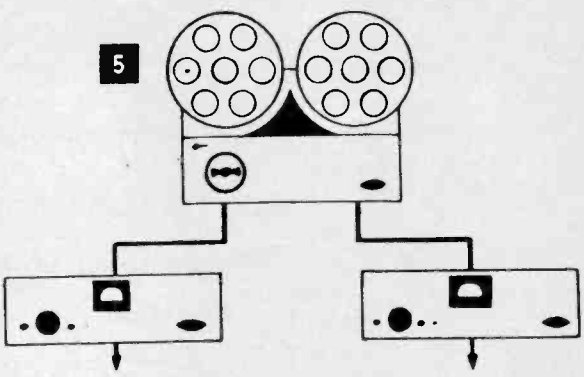

5

4. STEREO playback only: tape mechanism and preamplifier. 5. Stereo play/record and monaural play/record: mechanism, two playback preamp record amplifier combinations. The Pentron line includes mechanisms, or decks, for staggered stereo as well as in-line and staggered stereo.

A slightly different philosophy is seen in the imported Tancordex recorder. Most of the value has gone into an extremely fine transport mechanism, but it also includes a limited amount of electronics and a handsome wood cabinet. The only electronic element included is a stereo playback preamplifier plus tone and volume controls.

Thus it is possible to reproduce tapes in half-track with a single power amplifier and speaker, or in stereo with twin amplifiers and speakers. For monaural half-track recording, a recording amplifier with bias-erase oscillator must be added, and for stereo recording a second recording amplifier less the oscillator.

Still another approach to the integration of tape and hi-fi, particularly if your requirements are modest, is to buy a complete recorder of good quality, let that be the center of your hi-fi system, and build up the other components around it. Certain models of the Ampex, or the Tapesonic or Roberts will serve admirably for this purpose.

Each of these has a complete electronic system, including a fairly husky audio amplifier and an extended-range speaker. Furthermore it has input facilities for phono, tuner, TV, or other tape. Thus it could serve as the focal point of a fine little hi-fi system.

The Roberts, for example, is a complete sound reproduction unit, with amplifier, preamplifier and 5" x 7" extended-range

speaker. Overall response is reasonably flat from 40 to 15,000 c.p.s. Beyond this there are two features which make this recorder unique in its price range.

One of them is a VU meter for volume level indication. As we have already noted, the meter is far superior to any of the magic-eye or gas tubes. The second unusual feature is its hysteresis synchronous motor. Although only a single motor is used, the fact that it is hysteresis synchronous and its mechanical linkages are carefully designed, makes possible a wow-and-flutter content of less than 0.18%.

So whether we bring tape to hi-fi, or hi-fi to tape, the two belong together. And the proper wedding of the two will permit getting the optimum performance from both.

As we have seen, this can be accomplished by any of several methods. An existing complete tape recorder can be added to an existing hi-fi system by some simple circuit modifications to the recorder. A tape deck may be included in a hi-fi system simply by making the proper cable connections. Finally, an existing high-quality tape recorder system can act as the nucleus of a hi-fi setup. In this case, other sources such as phono, tuner and TV are connected to the recorder.

But this is only half the story. For the big excitement in audio today is stereophonic sound. To find out what it means to you, just flip the page. •

Stereo on Tape

It's the high-fidelity news story of the year and is coming along faster than anyone dared predict

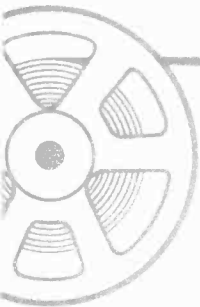

THE BIGGEST EXCITEMENT in all hi-fi today is stereophonic sound. Everywhere one goes, he hears stories of new stereo discs and new methods of stereocasting. All this obscures the fact that really good stereo has been with us for quite a while, and excellent stereo tapes for home use have been available for several years.

The illusion of depth and perspective in sound reproduction is a challenge which has intrigued audio engineers nearly as long as 3-dimensional pictures have engrossed photographers. And just as stereo photography uses two slightly different pictures, one for each eye, so does stereo sound use two or more separate audio channels.

"Stereophonic sound" is a rather redundant term, for the word *stereophonic* alone comes from two Greek words meaning *solid*

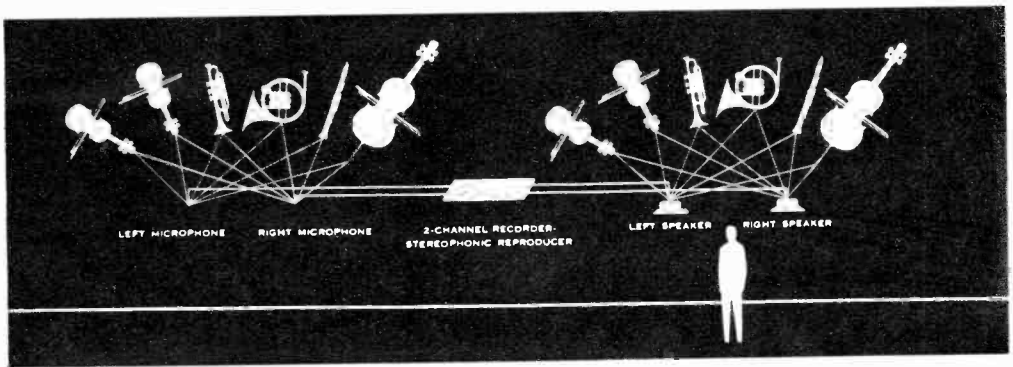

Drawing Courtesy of Ampex Audio

STEREO PRINCIPLE is demonstrated above. It spreads the orchestra before you, each instrument's sound seemingly emanating from the same source and direction "heard" by the recording mikes. Beautiful Bell home system, left, permits record and playback in monaural, record and playback in stereo with inline as well as tapes of the staggered or offset type.

sound. This term is just about perfect in describing the sensation of hearing the newest form of audio reproduction.

To understand the full meaning of stereo sound, and the reasons that audiophiles and music lovers are so enthusiastic about it, we have to know something about the way our hearing processes work. First of all, remember that your two ears are only a part of your sense of hearing, and that your brain also plays an active part in the process.

Although the ears collect all of the sound in the air surrounding them, the brain is actually able, within limits, to select only those sounds it wishes to hear. Thus you can carry on a conversation on a noisy street corner, or in a crowded room you can pick out the voice of one person even when everyone seems to be talking at once.

The physical reason for this is simply that you have two ears, or what is known as a *binaural* sense of hearing. Sounds reaching your two ears are just a little different in loudness and time, and you can therefore identify quite accurately the location from which a given sound originates.

The ordinary recording or broadcasting system, however, has no such discretion. The microphone picks up and transmits everything within its range without discrimination. Even if several microphones are employed, all of their signals are combined in a mixer and fed to a single channel. The result then is effectively one-ear or *monaural*.

Numerous and varied attempts have been made toward developing a truly bin-

aural sound reproducing system, and some of them have been quite successful from an engineering point of view. But it has only been in the past few years, with the burgeoning of hi-fi, that binaural and stereo systems have come into their own.

Nevertheless, way back at the turn of this century, when all recorded sound was heard from acoustical discs or cylinders, a system known as the *Polyphone* used dual styli, diaphragms and horns for a stereo effect. In 1925, when radio broadcasting was still in its infancy, station WPAJ in New Haven, Connecticut, was operating two transmitters simultaneously in a stereo system. And it is interesting to note that one of the latter-day pioneers of FM stereocasting, WGHF, is operating not many miles away from the site of these early experiments.

The Bell Telephone Laboratories were also hard at work on the problem in the 1930's, and they demonstrated their system to many thousands of visitors to the New York World's Fair. Around that same time the National Broadcasting Company was conducting similar experiments, with a pickup technique employing a dummy human head with a microphone placed in each ear. The mikes fed completely separate sound channels up to the ultimate listener, who had a split pair of headphones, one for each channel. This system has the striking effect of actually seeming to place the listener at the location of the dummy microphone head.

The two-mike technique with the dummy head is truly a binaural system,

SELF-CONTAINED stereo system is Pentron NL-2S, containing matched speakers, 5-watt amp output.

POPULAR member of the Ampro line is this model that has two heads for stereophonic playback.

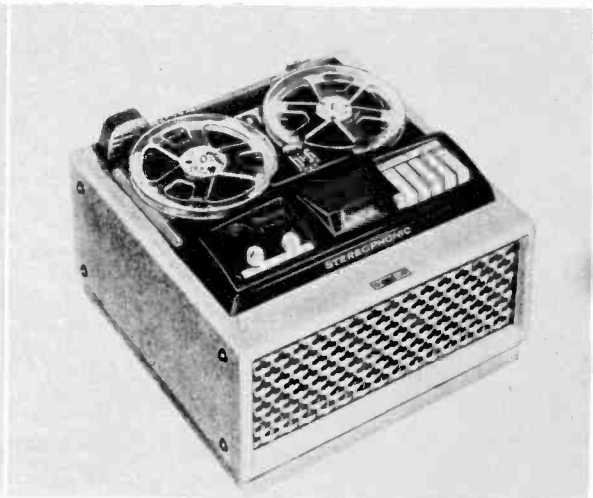

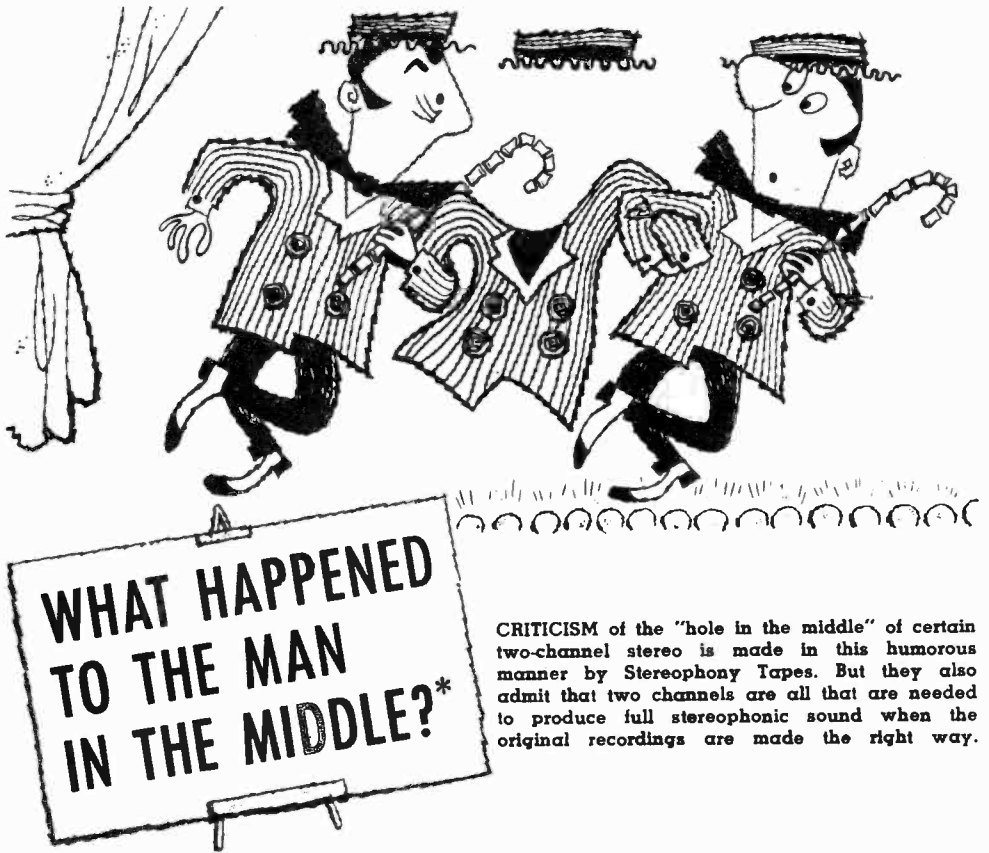

WHAT HAPPENED TO THE MAN IN THE MIDDLE?*

CRITICISM of the "hole in the middle" of certain two-channel stereo is made in this humorous manner by Stereophony Tapes. But they also admit that two channels are all that are needed to produce full stereophonic sound when the original recordings are made the right way.

and most authorities agree that this is the only one properly described as *binaural*. Although such a true binaural system provides tremendously exciting results, it does absolutely require the use of headphones. These are a nuisance to any but the most devoted music lover, they are hardly designed to inspire conversation, and the earphone mechanism is yet to be invented which equals a good speaker system in fidelity.

The next step then had to be in the direction of a loudspeaker stereo system, for people were simply not interested in anything requiring the use of earphones, a stereoptican or a space helmet. At this point the movie business got into the act, and it has been their tireless promoting of their stereo systems which has made possible the somewhat simplified stereo we have for home use today.

Just shortly before we had to turn our attention to other matters in December, 1941, there had been introduced two somewhat similar systems of loudspeaker stereo sound. One of these was *Fantasound*, used in the Walt Disney Picture, "Fantasia." As its name implies, the system was used

more for tricky and sensational effects than for realism.

The other approach to stereo at that time was the Stereophonic Sound-Film System of Bell Telephone Laboratories. As in *Fantasound*, the audio was photographically recorded on three separate tracks of a single strip of motion picture film, and was reproduced on three loudspeakers. It was never extensively employed in commercial theatrical films, for it had the same economic disadvantage as *Fantasound*, namely that a whole separate length of film was required in addition to the picture film. This contrasted with conventional practice, where the sound was optically recorded on a narrow track next to the picture on the same strip of film.

The postwar *Cinerama* system had the same disadvantage, but there it didn't seem so glaring. Since three separate films are used for the picture, the addition of a fourth one for the sound didn't seem so bad. After all, that's only one-third more film, instead of double the amount as in the earlier systems.

This was also a big step toward stereo tape in the home, for it was the first large-

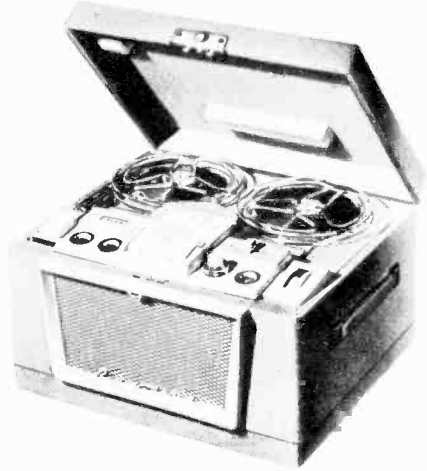
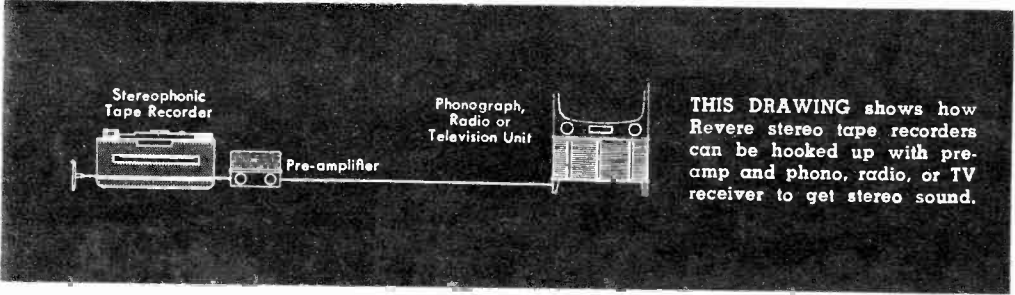

SHOWN HERE are two stereophonic tape recorders of the Revere line. Both are two-speed models and are said to have wow and flutter less than .3% at both speeds, overall distortion under .8%.

SECOND CASE of this Bell set-up contains second amplifier, remote speaker. Glow-light tube, inset, is used as a volume indicator on Bell's new DM-70. Top to bottom would mean no signal, average level, maximum for acceptable distortion.

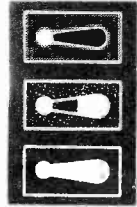

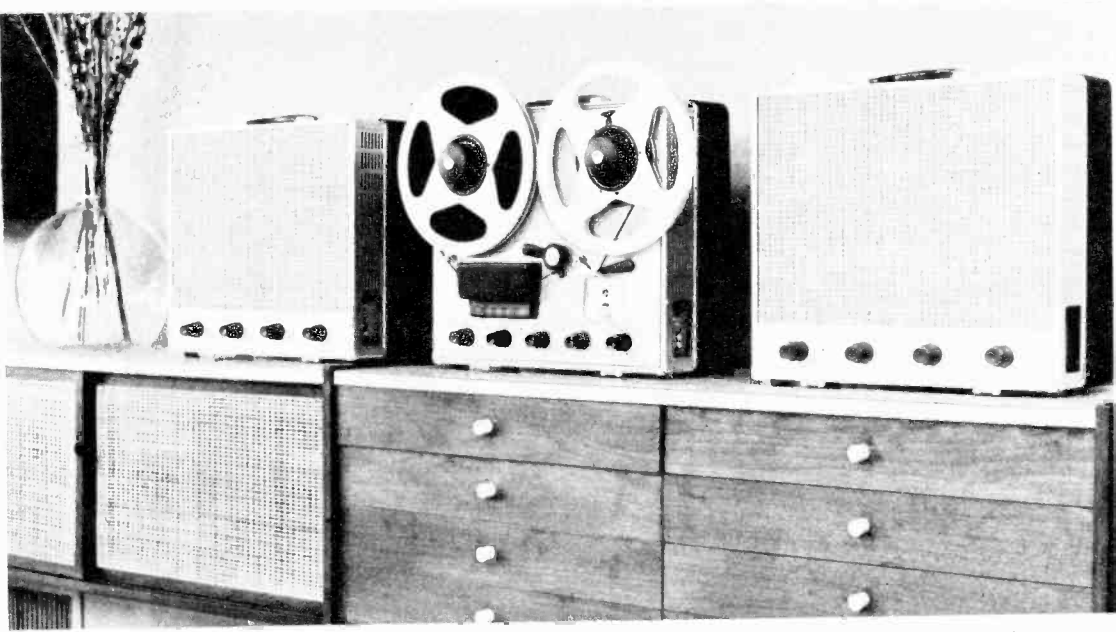

AMERICAN CONCERTONE "Globematic" Series 60 recorder is seen here, harmonizing perfectly with the cantilevered cabinets of the Robert Crons' living room. The attunement of decor is noteworthy.

scale use of magnetic stereo sound film. In a Cinerama presentation there are five loudspeakers behind the wide concave screen, along with two more "surround" speakers farther out along the sides of the theater, for a total of seven audio channels.

This was still a little too elaborate for the average Hollywood attraction, however, and so a scaled-down stereo system was included in the 20th Century-Fox Cinemascope process. This has three magnetic tracks on the same film with the picture, and is truly a remarkable example of efficient utilization of space. Every available mil of that film surface which is not being used for picture or sprocket holes is coated with magnetic oxide for recording.

It was now firmly established that magnetic recording of stereo was entirely feasible, and that the recording of more than one channel of information on tape was also possible. Dual-track recording had been with us for several years. The only difference now would be that instead of the two tracks being recorded consecutively as before, they would be recorded simultaneously in a two-channel stereo system.

And that is where we are right now, with two-channel stereo. You will immediately note some discrepancy here, for most of the professional activity has centered around systems of three channels or more. For the reasons for this, we have to go back once again to Bell Telephone Laboratories.

They reported in 1934 on some stereo experiments they had made, which tended

to prove that although the listener could tell the direction from which a sound was coming quite accurately with a two-channel system, it was only with a third channel that he could also discern distance or depth.

That being the case, you say, why don't we have three-channel stereo at home now, instead of just two? And there are a number of reasons for this. First, we must remember that these tests of a quarter-century ago were made only with the spoken voice, and were intended for determining the value of stereo in motion-picture dialogue. Their validity today as applied to music may be open to challenge.

Furthermore, recording techniques have progressed tremendously in recent years, and many tricks are being used to avoid the "hole in the middle," which has become a pet complaint of stereo's detractors. One of these tricks is the recording originally in three-track and then rerecording to two-track, with some of the middle signal being fed to each of the two tracks.

Another problem is the purely physical one. Professional systems using three tracks also use half-inch tape or 35mm film. It would be an extremely difficult matter to record good 3-track stereo consistently on quarter-inch tape, although considerable investigation is being carried on with that problem, and experimental recordings have been made on quarter-inch tape with as many as seven tracks.

But tape isn't the real bottleneck here. As it appears now, stereo with more than two tracks would be next to impossible on

how stereo recordings are made

IN RCA-Victor studios in New York City, engineer Ray Hall adjusts controls while recording an original stereo tape. The watcher is Roy McClay.

ORIGINAL binaural tape is then loaded onto a high-speed duplicating machine, which is known as a "master." Each of these feeds six "slaves."

RCA-Victor photos





"MASTER" is at the far left; engineer has just pressed button to start "slaves." Note conveyor.



CONVEYOR carries the stereo tapes to testers, foreground, who make selective tests of output.

COMPLETED stereophonic tapes are packed and shipped to a plant in the midwest for warehousing. This photo, taken in the tape vaults of the New York studios shows tapes from "master" machines being filed.





TABLETOP SYSTEM by Ampex features stereo tape reproduction as well as playback of both half-track and full-track monaural recorded tapes. A two-speed half-track tape recorder is included in system.

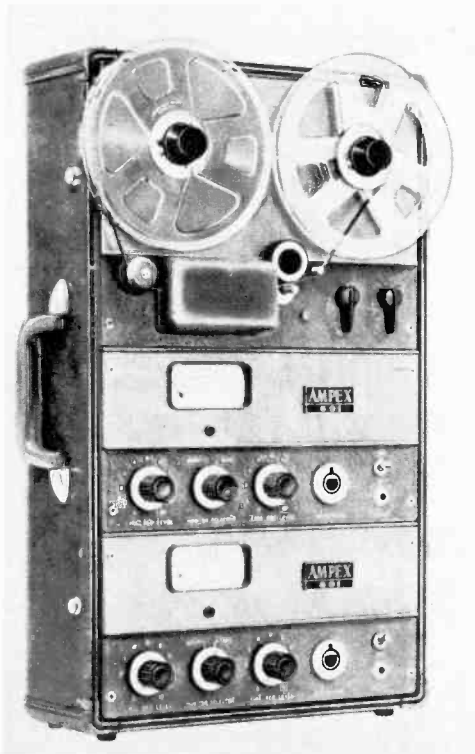

NEW AMPEX 601-2 enables you to record as well as reproduce stereo of professional quality. It requires a pair of matched speaker-amplifiers.

radio or phonograph records. Hence, if we are to have any standardization, we'd better be content to perfect the two-track system. It is really quite remarkable, and many music lovers who until now have been rather lukewarm in their enthusiasm for hi-fi, are presently embracing stereo with open arms.

And so probably will you, if you haven't already done so. Now you want to know just what to do about it. And what you do will depend largely upon what you have done about tape and hi-fi already. You naturally will want to make maximum use of equipment you already have, so we'll begin by describing what you need for stereo if you already have a good monaural hi-fi system.

A monaural tape recorder with a good transport mechanism can often be converted to stereo, with just a few simple replacements and additions. Going back a little bit, remember that there are four magnetic and electronic functions performed in the recorder:

1. Erase (oscillator and head)

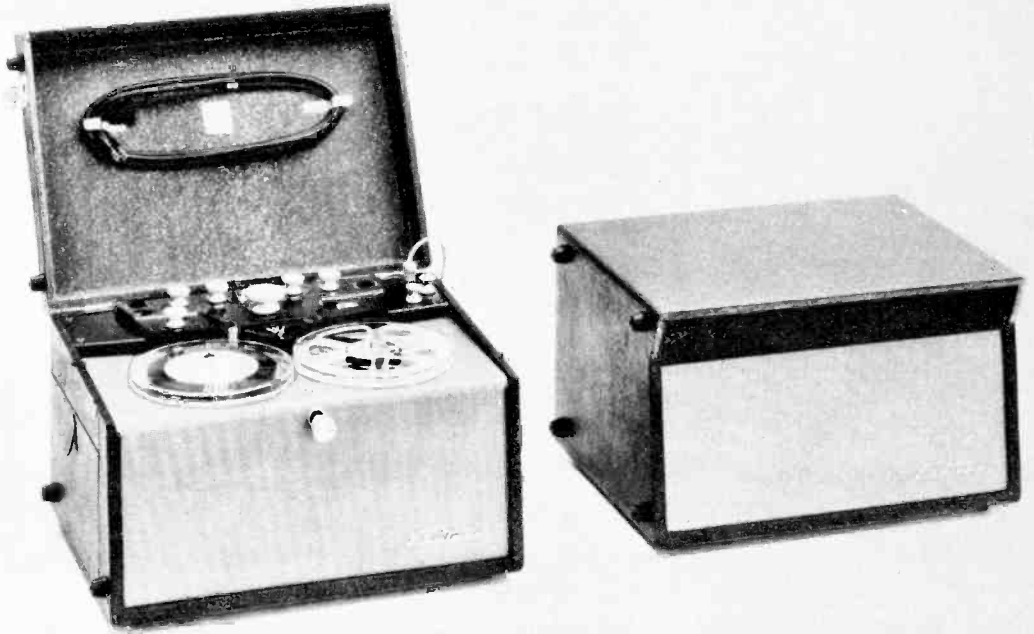

STEREO PLAYBACK only. monaural record and play are offered by the Ekotape 290. It has stacked stereo play head, half-track record head, separate erase. Companion contains speaker system, crossover.

2. Record (amplifier and head)
3. Bias (oscillator only, usually same as erase; same head is used as for record)
4. Playback (amplifier and head, either or both of which may be shared with record circuits)

Now let's see how much of this can be salvaged when we go to stereo. First, the erase system need not be disturbed if it already wipes the full width of the tape at a single pass. This is the case in full-track recorders, but it is not true in dual-track systems, where only half the tape width is erased at a time. Then the half-track erase head must be replaced by a full-track head, but no other change is necessary.

Since the record and bias are combined both in the amplifier and head, we'll consider them together. First, the head will have to go, for it is either full track or half track. What we need here now is a double-track head, one which will record separate signals on each half of the tape at the same time. The record-bias electronics, however, can be retained for one of the tracks, and

a second can be added for the other track.

If the original tape system was the two-head type, where the recording and playback were performed by the same components, these are all of the changes necessary except for a more elaborate switching arrangement. If the record and playback systems are separate, then a double-track playback head must be used as a replacement, and a second playback amplifier must be added.

Whether you modify existing tape equipment or start from scratch with new stereo gear, you will, of course, require the balance of a stereo setup for playback. This means two power amplifiers and two loudspeakers. As you probably already have one of each, the second two should preferably be of similar type, especially the loudspeaker.

If you don't yet have tape equipment, by all means give serious thought to stereo before making your final decision to buy. The first question facing you will be the choice between a complete recorder and a tape deck. Both are available in a variety

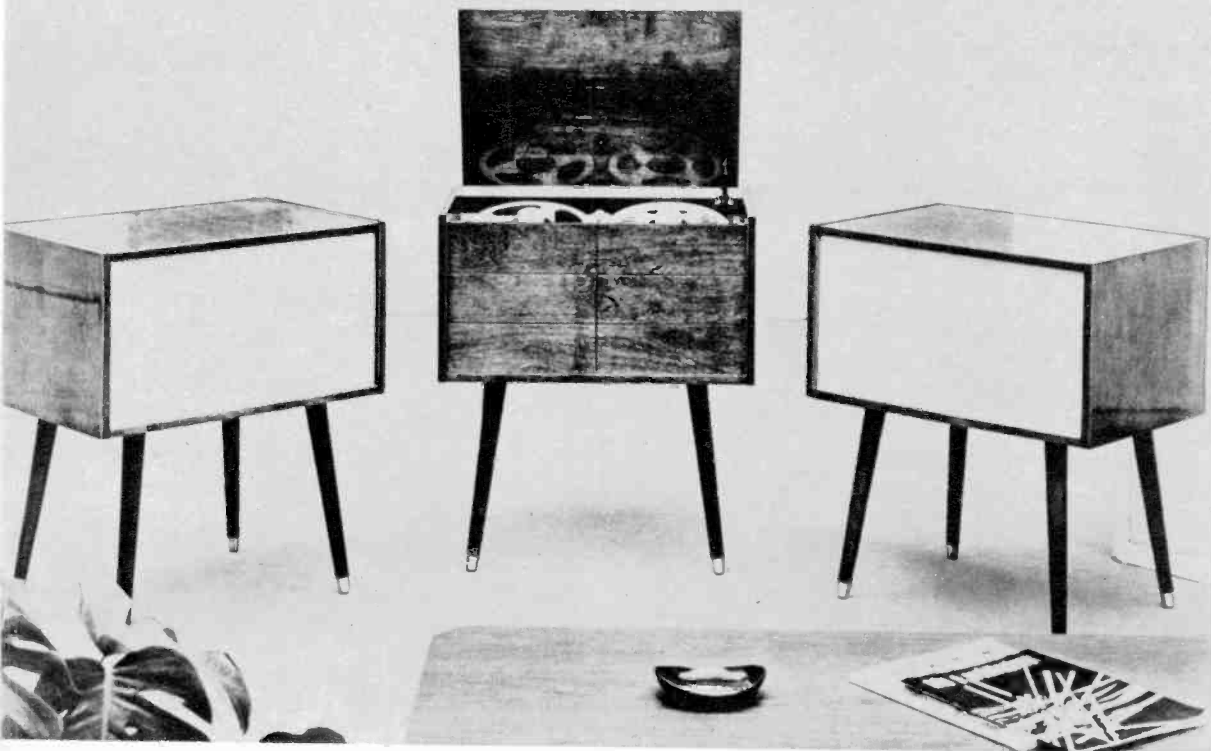

SHOWN HERE is the Concertone Custom Model 23-7 which consists of a stereo recorder in Acousti Craft cabinet and similarly encased amplifier-speaker units. Write to the manufacturer for further details.

of stereo models, the complete recorders including two playback amplifiers and two speakers. The pros and cons of decks and complete machines have been discussed elsewhere in this book, so we'll not elaborate on that here.

If you decide on a tape deck, you will immediately be confronted by a number of other questions. First, do you want to be able to record, or will playback only be sufficient for you? If you merely want to listen to recorded tapes as you do to phonograph records, there is no need to go to the additional expense of recording equipment at all.

On the other hand, even if you do get stereo playback, will monaural recording be sufficient for you? This will do the same as any other monaural recorder would do for you, and can be played back monaurally on your stereo playback equipment.

It will not, however, permit you to make live stereo recordings, or to record stereocasts off the air, or to rerecord stereo tapes or stereo discs. Stereo recording equipment is not at this writing available in as wide a variety as stereo playback gear,

simply because manufacturers underestimated the demand. Still, stereo recording is being outsold by monaural recording by about 10 to 1, so you won't be alone if you should decide that it isn't for you just yet.

Now we jump over to the playback side, and since we assume it will be stereo, you'll have to decide whether the heads will be stacked (in-line) or staggered (offset), or both. Here's the difference: it happens to be a lot easier to assemble a pair of stereo heads which have their gaps separated along the length of the tape by about $1\frac{1}{4}$ inches. With this type of construction the heads are said to be staggered.

When the two gaps are directly over one another, they are said to be stacked. Whichever method is used to record the tape is the one which must be used for playback. Staggered heads seem to be falling into disfavor despite their ease of manufacture, because it is difficult to maintain an accurate spacing between the gaps. When this accuracy is not within 0.0001 inch, the stereo effect is destroyed.

The staggered system is far from obsolete, however, and many pieces of equipment offer the choice of stacked or stag-

gered alignment at the flick of a lever. This permits maximum flexibility, for tapes recorded by either method can then be played correctly.

In some cases a common bias oscillator is used for both channels, while in others separate oscillators are used. In the latter case it is absolutely essential that both oscillators be set to precisely the same frequency. If they are not, there will be heterodyning between them and an audible beat note will be recorded on the tape. Then one of them must be adjusted for "zero beat," or until the note disappears.

The components of a tape deck arrangement for stereo recording and playback will thus include a tape transport, two recording preamplifiers (including bias and erase), and two playback preamplifiers. The physical arrangement of these elements may vary somewhat, however. There may be a common power supply for all of the electronic elements, or at the other extreme each of the four or more units may have its own supply.

There may be four or more separate chassis for each of the electronic units, or

a playback and recording preamplifier may be combined on a single chassis. Similarly, two playback or two recording preamps may be on the same chassis, and some manufacturers are known to be planning integrated electronics units which have all of the elements for stereo recording and reproduction on a common chassis.

The electronics chassis may include a front escutcheon panel and controls, the entire unit simply bolting onto the deck. In other cases the control panel is an integral part of the deck, and the electronics units are attached behind or below, with knockout plugs being removed for the control shafts.

With the chassis and controls mounted, there is then a simple plug-in connection between the heads and the amplifiers or oscillator. The interconnecting cables are plainly marked or color coded, so that there is no possibility of error. The preamplifier chassis have phono jacks built in for connection to the hi-fi system.

These connections are the same as for a monaural system, except that there are twice as many of them. There is the addi-

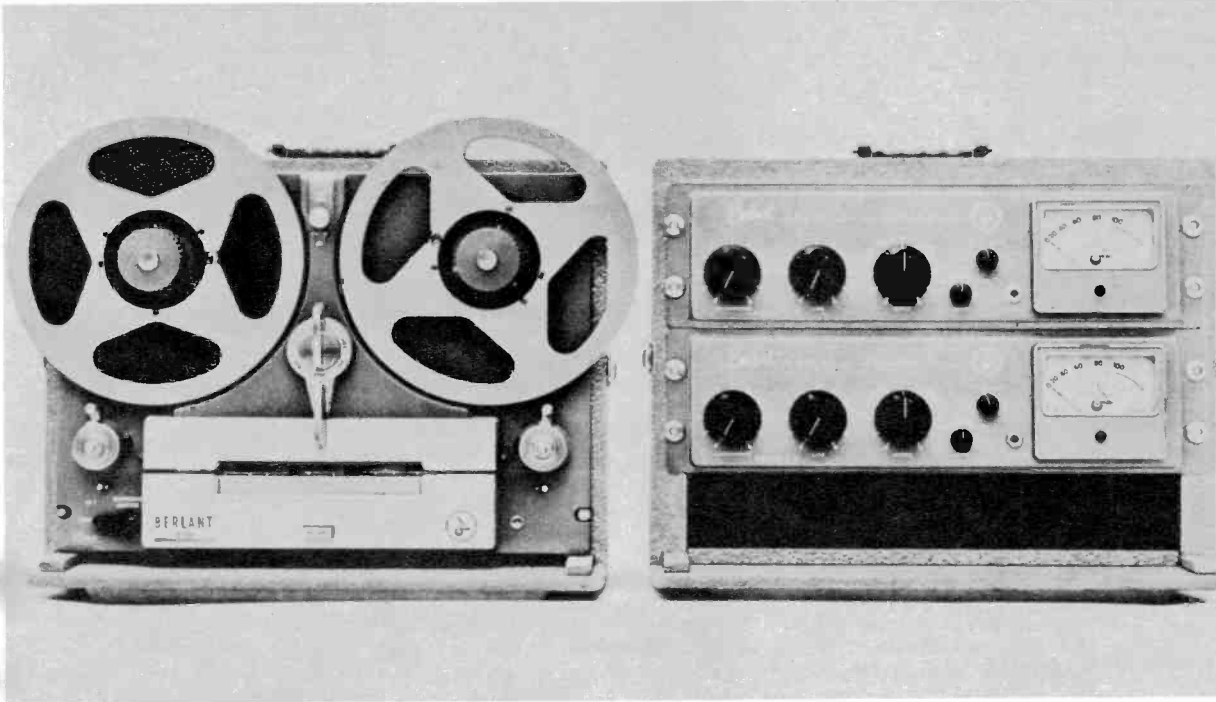

TWO-CHANNEL stereo playback modification of standard recorders by American Electronics adds playback electronics, stereophonic playback head, for playing full-track, half-track, two-channel stereo.



RCA-VICTOR'S STR66, which is for monaural record-play and in-line stereo playback, houses one speaker and amplifier with transport and the other in separate cabinetry.

tional problem, however, of being sure that the right-left orientation is correct. Although there is no standardized agreement as yet, it will be generally found that the upper heads are used for the left channel and the lower ones for the right.

This means that for recording the left-hand channel of your hi-fi system must feed into the left-hand channel of your tape recorder input. Similarly, the playback preamps feeding into the hi-fi system must go left to left, and right to right. Of course if you are a yoga enthusiast and enjoy listening to music standing on your head, then it is perfectly all right to do just the opposite.

Typical available equipment which has been labeled "stereophonic" varies widely. There is one stereo recorder which is simply a conventional monaural machine with a stereo playback head in place of a half-track monaural one. An output jack connects to one of the channels, which re-

quires an equalized preamplifier, power amplifier and speaker, all external to the machine. Internally the other playback channel has its own amplifying and speaker system.

The EMC player, as its name implies, is for playback only. In addition to the transport mechanism and stereo playback head, the electronics includes two playback preamplifiers, one power amplifier and one loudspeaker. This is an easy way to get started in stereo, for it permits playing stereo tapes in conjunction with any second amplifier and speaker, even those in a radio or TV set. Later, if a better speaker is acquired, it can be plugged directly into the power amplifier output of the player. Later yet, when a better amplifier is available, it can be plugged directly into the preamplifier jack.

While much stereo tape equipment packaging still clings to the luggage carrying-case styling, there appears to be some



THIS GERMAN recorder takes up to 70 sound tracks on tape that is $1\frac{3}{8}$ inches wide, or a little over 5 times as wide as the US standard.

trend toward incorporating the equipment into modern functional furniture. Notable steps in this direction have been made by Ampex and Concertone.

These pieces of equipment complete hi-fi stereo tape packages, with their own amplifier and speaker systems. The amplifiers are usually on the order of around 10 watts, and the speakers are similar to two-way bookshelf systems. Since they have input circuits for tuner, TV and phono, they can easily be the nucleus of a complete hi-fi system.

Some of the smaller recorders attempt to pack the entire stereo system into the single carrying case. This has several drawbacks, the most important one being insufficient spacing between the right and left speakers. A much better arrangement is the two-package system. One example of this is the Bell Porta-Pair, which has the transport mechanism, most of the electronics and one speaker channel in one

case. A second case has a matching power amplifier and speaker for the other channel. The Webster Ekotape uses a similar arrangement, except that all of the electronics is included with the recorder, and the extension unit houses a speaker only.

Notable among the deck-components arrangements in the popular-price field are the Pentron, Bell and Viking. The Pentron line includes three tape transport mechanisms, one for monaural, one for staggered stereo, and another for either stacked or staggered stereo.

There is also a choice of three preamplifier arrangements. One is a self-powered tape playback-only preamp. Two of these could be used for stereo reproduction, but there is also available a dual-channel stereo playback preamp, with separate equalization controls for each channel plus a master gain control.

The other preamp provides amplification, erase and bias for both recording and reproduction. It has an illuminated VU meter for level monitoring. Two of these will provide all of the electronics needed for a complete stereo tape system. Each preamplifier has its own case, and so is mounted independently of the transport mechanism.

The Bell tape mechanism is also available in a variety of arrangements of monaural and stereo. Each unit has three motors, as do professional machines. There are two basic preamplifier arrangements in this line, one for playback only and another for both playback and record.

Each of these units is complete with its own power supply, pilot lamps, and in the case of the record preamp, a volume indicator as well. The indicator used is the new European DM 70 glow light tube, wherein the length of a thin line of light in the tube indicates the volume level at any instant.

Provision is made for mounting each preamp below the deck of the transport mechanism, with the control shaft and lamps slipping through openings on an escutcheon plate. Power cables plug into receptacles on the mechanism, so that the power switch on the deck acts as a master control for all units.

Obviously, then, there is a wide variety of quality tape equipment to satisfy every taste. But whether stereo or monaural, there is a wealth of music on recorded tape for the home. To find out more about that, let's look in on the Recorded Tape chapter that follows. •

RECORDED TAPE provides another measure of enjoyment in the use of your tape recorder. Through it you can have the world's great artists providing matchless sound for you in your home, whenever you want them. Music on records is nothing new of course, but music of the greatest artists on tape, with a broad choice of repertoire, is new and rapidly expanding.

Today everybody who is anybody in the record and music business is well aware of the great importance of tape recording, and now all of the major companies and their artists are regularly preparing tape releases for home use. This has all come about just in the past year.

Nobody seems to know for sure just when the first recorded tape was made for the home. It is a matter of record, however, that a number of very small companies were toiling alone in the vineyards until the biggest of them all, RCA-Victor, joined the fold with a series of fifteen releases in the middle of 1954.

Then, much to everyone's surprise, everyone else in the record industry decided to leave hands off, evidently hoping that Victor and tape would fall flat on their respective faces. It didn't quite work out that way, however, although it took three long years to prove the point.

Finally, just a year ago, the rest of the record industry, almost en masse by strange coincidence, decided that it was time to field some tape entries of their own before Victor and the little guys ran off with the ball game. Today the Harrison catalog of recorded tape is still leaner than the Schwann LP record catalog, but it is growing faster.

Did this development mean the finish of the little fellow in recorded tape production? Not by a long shot. And here is one of the interesting differences between the LP record business

LEONARD BERNSTEIN conducts the New York Philharmonic on Columbia tapes.





SINATRA'S songs can be heard on Capitol tapes.



VOCALS by Doris Day are on tapes, by Columbia.



GISELE MACKENZIE is typical of the RCA-Victor tape recording stars. At the right are seen Zino Francescatti and Eugene Ormandy with the Philadelphia Orchestra. Their works are available on tapes bearing Columbia's label.



and the recorded tape business of today.

Most of the small operators in records today are in the cut-rate business, although there are some highly outstanding exceptions. And anyone who has bought cut-rate records knows from bitter experience that every one is a gamble.

Now let's see how the little fellow in recorded tape compares. He may not always be a saint, but he couldn't commit many of the sins of his disc counterparts even if he wanted to. In the first place, it is economically impossible to make a cheap recorded tape, for reasons which will be discussed in a moment.

This in turn has meant that he has had to maintain a standard of quality as high as the art permits. After all, getting skinned to the tune of a buck or buck-fifty a copy for junk records is one thing, but when you lay out seven to nineteen dollars for a reel of recorded tape, brother, it better be good. No, I doubt if there are many fast-buck boys in the recorded tape business.

There are many who will argue that the difference in price between an LP and a tape is entirely unreasonable. Perhaps you think so too. But after considering all of the factors, you may conclude that the higher price is justified.

It is clear that whatever the ultimate form of the record, the artistic production cost is the same. The featured artist, the musicians, the compositions, the arrangements and the studio rental will be the same in either case. The cost of selling should also be about the same.

Consider how a record is made. From the master tape it is rerecorded to a disc which is electroplated and then used to stamp out thousands of copies. Once the stamper is in the press, the entire cycle takes less than a minute for each record.

Every single tape, on the other hand, must be electrically rerecorded from the original master. It is true that the master and copy tapes are run off at higher than normal speed, that dual-track tapes have both tracks duplicated simultaneously,





KOSTELANETZ conducts, Sandburg reads for forthcoming Columbia tape, "A Lincoln Portrait."

and that a number of "slave" copying machines can rerecord from the master simultaneously. But despite these economies, it still takes considerably longer to make a recorded tape than an LP pressing. Hence the labor cost is greater.

But the difference in material cost is much more staggering. A chunk of vinyl compound sufficient to make a record costs only a few cents, but a reel of blank tape costs so much more that there is just no comparison at all.

What then is the advantage of tape? Well, there are several. We still cannot ignore the obvious superiority of tape in

quality of reproduction and less noise. Furthermore, tape wear is very much less. In fact, tape will give so many more plays than a record that in the long run it is your best buy.

Furthermore, tape is way out in front as far as stereo is concerned. The stereo disc has captured the public imagination and created a great deal of excitement, but as of this writing it still appears to be due for some shaking down. Stereo tapes, on the other hand, have been on the market for five years or more.

If you are interested in building a recorded tape library but do not yet have



PATTI PAGE is a popular Mercury tape artist.

a tape recorder or player, it is strongly recommended that you get equipment having at least the two speeds 3-3/4 and 7-1/2 i.p.s. The standard speed today is 7-1/2 i.p.s., and has been since the beginning of recorded tape. There is a good deal of development activity going on behind closed doors right now, however, aimed at getting the same quality on 3-3/4 inch tape. In fact, the catalogs already list a rather large number of tapes at this speed. This will not render obsolete your 7-1/2-i.p.s. library, of course, but it will ultimately bring down the cost of recorded tapes. •



GREAT Victor artists include Dennis Farnon, Julie Andrews, and Frankie Carle. Below is Sarah Vaughn, whose blues and spirituals are available on tapes bearing Mercury's label.



Taping Off The Air

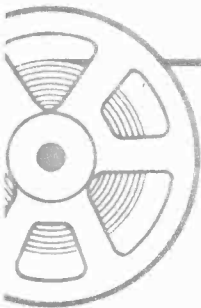

Television and FM and AM radio offer you excellent opportunities to record music of great artists



Unless otherwise indicated photos showing taping methods by Mike Bonvino, Fawcett Studios. Equipment courtesy of Hudson Radio, NYC.

Right: Ed Pryor photo

POPULAR MUSIC of top television programs such as the Perry Como Show on NBC are good bets for recordists. Know in advance what is available for proper planning. TV Guide, photo at right, is your best source of information. The Sunday newspaper supplements also serve.



THE REMARKABLE RESURGENCE in FM radio, plus the greatly improved audio work on many television shows, mean that there is more good program material for your permanent tape collection than ever before. And every bit of it comes to you absolutely free of charge. The only cost to you is that of the tape on which you will make your recordings.

To be sure of capturing these gems, you will need some diligence and planning. To begin with, you need good, accurate program schedules. The radio-TV log in your daily paper is hardly adequate, as it tells you very little more than the name of the program. You are left to your own device to determine who will be on a given show and what they plan to do.

For television, the bible is *TV Guide*. This always details highlights of the important shows, and in many cases includes the complete program format. After this comes *TV Guide's* most important competitors, the Sunday newspaper supplements. Many of these also outline the program content. They have the additional advantage that they usually include the schedules of the major radio stations as well, which the TV magazines cannot do because of their national character.

The best sources of radio programming information, however, are the program booklets published by many stations. The FM stations in particular have found this to be a good source of revenue, which means less advertising and more music.

Most program booklets are issued monthly, and give the title, composer and featured artists of every musical performance to be played, and the time at which each may be heard. Each booklet covers only the programs of its own station, of course, but it gives information which is available nowhere else. Furthermore, it is very likely published by a small FM station which is something less than highly profitable, and is most deserving of your support.

With information in hand concerning all of the coming radio and TV programs, you can check off the ones having performances which you will want to add to your permanent tape library. Then you might give the list a second going over to see if there is anything else you want to tape for temporary use, or anything which should be recorded just in case something worth saving occurs.

The next thing is to be sure that you have enough tape on hand. The tape timing chart will come in handy here. Instead of using it to determine how much playing time is on a given tape, now use it to find how much of the tape you normally use will be needed to handle all the time you want to record.

Once your supplies are provided for, you still have the problem of having them in the right place at the right time. There is nothing quite so frustrating as, say, recording a broadcast of the



Metropolitan Opera and having the tape run out right in the middle of the aria you wanted most. This can be avoided if you plan in advance to change reels during station breaks, commercials, or other stage waits which would only clutter up your tape anyway.

You actually have plenty of time if you plan to make the most of it. Remember that the quarter-hour show has an actual 11 or 12 minutes of entertainment, usually in one solid chunk, with commercial announcements before and after. The half-hour show has 22 to 24 minutes of entertainment, usually in two blocks, with commercial interruptions at the beginning, middle and end. Sometimes there is a third "opening hook" section which precedes the first commercial. The one-hour show ordinarily has 50 to 52 minutes of entertainment, in three or four segments. These averages apply only to the big-time network shows. The "participating" show, in which anyone can buy a spot announcement, may have a much lower ratio of entertainment to commercial time.

This is fine for all the times you can be present personally and attend to the recording details. But what about the night of the special jazz show on TV, and the missus has promised friends that you'll be at their party? You can't be both places at once.

You can still get the recordings you want, though, made in your absence through the medium of the time switch. One form of this is in the clock radio. If your program is on radio, this device is made to order. You'll find that the sepa-

rate time switch is more flexible, however.

The time switch is simply a clock very much like an alarm clock, except that instead of ringing it opens or closes a switch according to a preset time. Many of them have a-c receptacles built right into their cases, which are energized only at the times the clock closes the switch.

To prepare for a delayed recording you would first tune the radio or TV set to the station whose signal is later to be taped. Connect the receiver output to the recorder and set the machine for the proper level.

Then with all adjustments completed, and the tape machine running and recording, disconnect power from both the receiver and the recorder by pulling their plugs out of the receptacles. *Do not disturb any of the controls on either set.* Finally, set the time switch to the times it is to turn the receiver and tape machine on and off, allowing a couple of minutes lead time for warmup. Then plug both devices into the receptacles on the switch and forget it. When you return, your tapes will be made for you. All you'll have to do is rewind and play.

Television has earned the enmity of many hi-fi fans, for what were two very good reasons: there were very few musical shows on TV, and those we did get had very poor audio production. But those situations have largely changed for the better.

The TV producers have finally outgrown their preoccupation with their nice shiny new pictures, and have come to realize that audio is pretty important

A SAMPLING of the musical shows includes, left to right, ABC's Voice of Firestone, Howard Barlow directing; Lawrence Welk, ABC; Dinah Shore and Eddie Fisher on NBC; lovely Patrice Munsel, ABC.



after all. This point was driven home to them by the fact that technical failures involving picture did not lose them their audience nearly as fast as those involving sound. Loss of picture can be endured for quite a time as long as the audio is still all right. But silent pictures went out thirty years ago, and nobody seems anxious to turn back the calendar. Instead, they just turn to another channel, in droves.

So TV audio is pretty good today. But what about the programs? Well, it is true that there are not many music programs scheduled on a regular basis. The NBC Symphony is in limbo. Now a more recent casualty is the NBC Opera. But the picture isn't all bad.

The nearest thing to classical music which can be heard weekly is "The Voice of Firestone" on ABC. On the popular side there are such shows as "The Big Record" and "Hit Parade," both of which lean toward whatever happens to be the latest pop craze, but with a sprinkling of old standards as well.

The same format, using records for the

music, is used by a young man in Philadelphia on his "American Bandstand" and "Dick Clark Show." Many of the younger set are using this show to tape the records as new ones come up on the charts, and then they wipe the tape clean and start over when the record loses its popularity.

At the other extreme, there is only one regular jazz show on TV at this writing, that being "Stars of Jazz," also on ABC. Musicians picked for this one lean mostly toward the cool school. There have also been a number of special jazz shows on the several networks, and this appears to be something of a trend.

The ill-fated "Seven Lively Arts" gave jazz a good going-over just before it went off the air permanently. (No inference can be drawn from this. The dolorous word had come from on high before the jazz show was presented.) This, the all-star jazz shows, and the Benny Goodman Show have all been successful enough to encourage others to follow.

Right down the middle, between jazz and pops, we have the middlebrow music typified by the businessman's bounce of



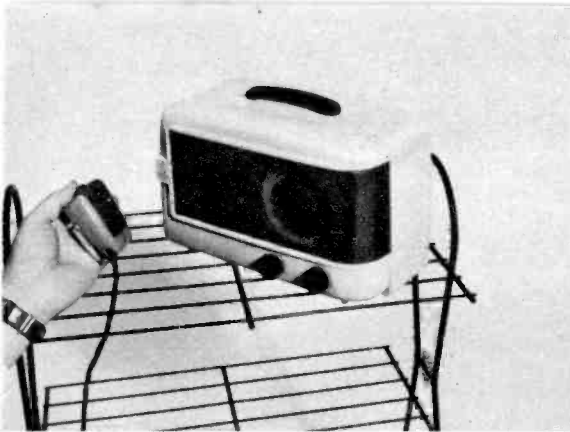

Ed Pryor photo

DON'T! Whether your radio is tomorrow's model or yesterday's, taping method shown is useless.

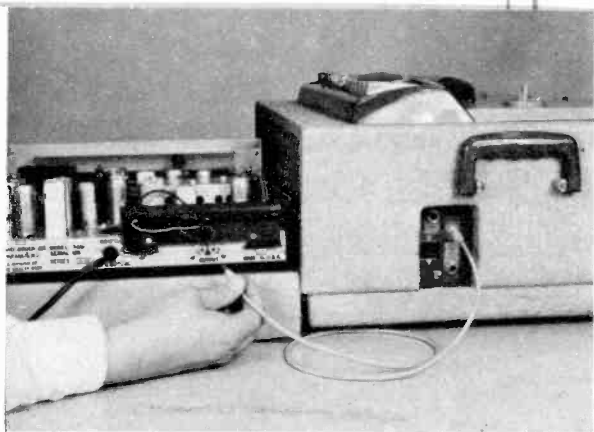

EVEN WITHOUT a hi-fi amp, you can tape off the air by connecting tuner output, tape input.

Lawrence Welk, now represented by two weekly network shows. Whatever one many think of the tastefulness of these arrangements, it would be difficult to deny that the musicianship of this group is probably the highest of any regularly constituted dance band in the business today.

Never to be forgotten in any listing of TV musical shows is the man who is in a class by himself, Liberace. This young man made a series of 113 films between 1953 and 1956, and he's been all over the TV airwaves ever since. The films have played in as many as 200 stations at once, and are currently booked in about 100, in some cases in their ninth rerun.

There are not very many more music-only shows than these, but the so-called variety shows often have musical numbers well worth recording. On Sunday evenings, for example, are the divertissements of Ed Sullivan, Steve Allen and Dinah Shore. Since Allen has a strong predilection for jazz, there is usually a good chance of some of it turning up on his show. And Miss Shore occasionally eschews the pop stuff and proceeds to prove once again that she is still one of the best blues singers around.

Arthur Godfrey still offers a lot of good music on his shows. Although his "Friends" have departed, there is still his across-the-board daytime show and the nighttime "Talent Scouts." The latter is usually bogged down with third-rate acts, has-beens or never-will-be's, but occasionally some really fresh and capable musical talent turns up.

Another daily show which often features top-quality guest musical talent is Dave Garroway's "Today." It seems incredible that any bunch of toolers can even hold their eyes open after a date at some club the night before, but the boys manage to do it consistently. This is one show you shouldn't overlook as a good

possibility for building up your tape library of small combos.

At the other end of the day, also on NBC, is Jack Paar's little clambake of an hour and a half or so. All kinds of oddball entertainment turns up on this show, but there is a very capable house band, a couple of affable singers, plus good guest talent.

There are many variety shows in which the star performer is a popular singer. These include Eddie Fisher, Perry Como, Pat Boone, Ernie Ford, Frank Sinatra, Patrice Munsel, Jimmy Dean and Betty White. Each of these can be depended upon to include some vocalizing by the star, plus performances by guest musical talent. Even some of the comedy shows include some good music as a change of pace. On the Red Skelton show, for example, more than one tape hobbyist adds to his collection the fine orchestral work of Dave Rose.

Not to be forgotten either are the many "spectaculars," which are usually musicals. Shows such as "Hansel and Gretel," "Annie Get Your Gun," "Hans Brinker" and "Jumbo" are worthy of anyone's library, in their entirety. Since they usually run 90 minutes in length, they can be recorded on one 1200-foot reel of either 1-mil or 1/2-mil tape, recorded dual-track at 7 1/2 i.p.s. The 1-mil tape will take a maximum of 48 minutes on each track, which doesn't allow much leeway in selection of the place to flip the reel. The 1/2-mil stock, on the other hand, with a total recording time of 128 minutes, does permit considerable room for the choice of a logical "side break."

So all right. We know there is quite a bit of material on TV which we'd like to have in our permanent tape library. Now the question is, how to get it there. Since the average TV set is simply not geared to hi-fi, this will take a little doing.

The most obvious method is simply to

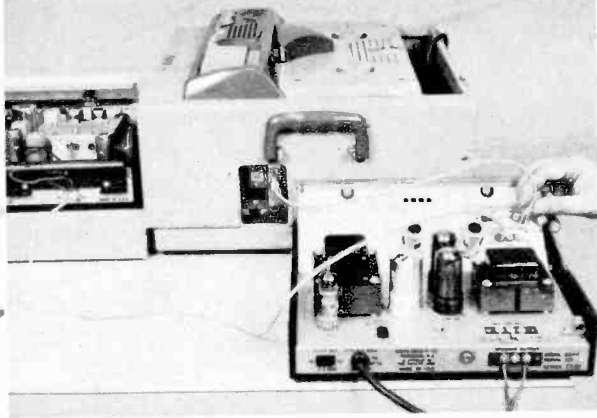

WITH HI-FI AMP. tuner feeds into amplifier which in turn connects to the tape recorder.

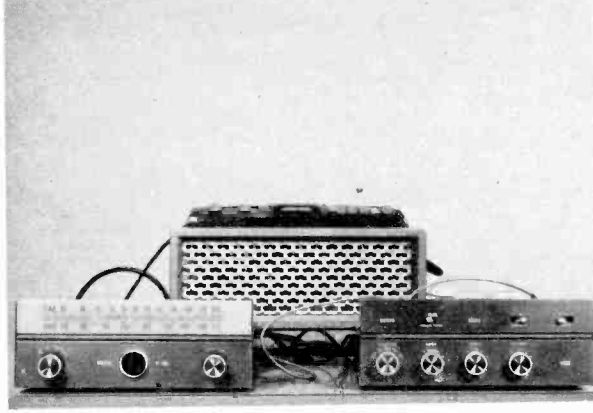

COMPLETE SETUP: AM-FM tuner, or separate units; hi-fi amplifier and the tape recorder.

hang a mike in front of the loudspeaker. Anybody who would do this will get just what he deserves. With the poor quality of the TV loudspeaker added to the poor quality of the average tape recorder microphone, plus any airborne noise in the room, the result is guaranteed to sum up as a very lousy job.

The method almost universally recommended by tape recorder manufacturers is better, but not much. It is an electrical connection rather than an acoustical one, but its greatest advantage is its simplicity. This is the setup where a phone plug is attached to one end of a cable, while alligator clips are attached to each conductor at the other end.

The clips are connected to the voice coil terminals of the loudspeaker, and the tape recorder will then receive whatever signals are fed to the loudspeaker, more or less. Besides not offering the best fidelity, this method may be dangerous with a TV set. Since there are sometimes two sets of coils on the speaker, one of them carrying high voltages, clipping on at the wrong place could do permanent damage either to you or your recorder.

The best place to pick up TV sound for a tape recorder is right at the output of the audio detector. It is important to emphasize audio here, for the composite video signal comprises both an a-m picture component and an f-m sound component on the same radio carrier. We are interested in getting the sound signal only, after the two have been separated and the audio has been detected.

This means that the logical connecting point is the volume control, rewired in exactly the same fashion as already described in the chapter on adding tape to your system. This is often much easier to accomplish in a TV set, however, because of a special circuit in many modern sets. By adapting it to recording use, we can avoid the inconvenience of reaching from

the back to the front of the set, or actually pulling the chassis out of the cabinet to get at the volume control terminals.

Many sets have a toggle switch and phono jack arrangement on the rear of the set, designed to permit playing a phonograph or tape recorder through the "superb" audio system of the TV set. Now no self-respecting audiophile would ever think of using that jack for its intended purpose, so there it lies, unused and just made to order for our recording purposes.

What we want to do with this circuit is just exactly the opposite of what its designer had in mind. As it is set up now, it permits feeding an external signal into the TV audio with the picture off. Now we want to take the sound portion of a TV broadcast out of the set before it reaches its own audio system, and feed it into our hi-fi system and/or tape recorder. And since we have already learned that the volume control is the key point for either one of these operations, we already have in this switch and jack the answer to our problem.

To understand more fully what must be done here, consider what the switch is doing at present. It is usually a 2-position toggle switch, with one setting marked TV, the other marked AUDIO. In the TV position the receiver operates as an ordinary television set. In the AUDIO position, both the TV picture and sound are killed, and whatever external signal is plugged into the jack will be heard through the TV set speaker.

But while both the picture and sound go dead, the set is still entirely operative and receiving television signals. The switch merely disconnects the voltage on the picture tube, and connects the audio amplifier to the jack, so that the output of the audio detector is no longer heard.

The switch which does this job is known as a double pole-double throw type. This

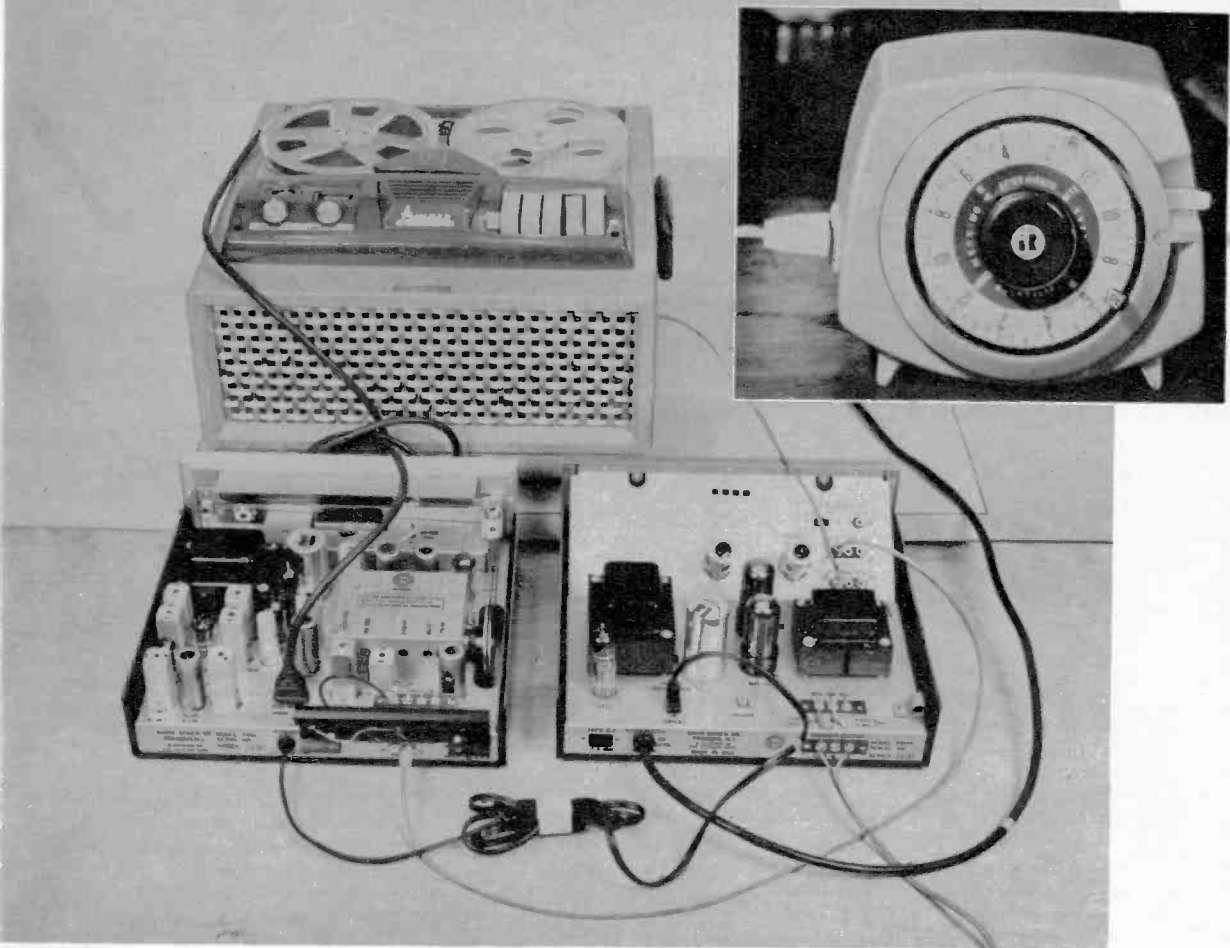

RECORD IN ABSENTIA with this setup. Power for recorder comes from tuner, tuner power from amplifier, amplifier power through a time switch (Lafayette model is shown). All controls are left on and adjusted; timer set, allowing time for warm-up, on departure. On return, enjoy playback.



Ed Pryor photo
STOP WATCH is one way of checking machine's speed, tape needed to record program off air.



SIMPLE CONNECTION here permits playback of taped air program through hi-fi amp and speaker.

means that two circuits are controlled by the switch, and that each of them will have a choice of two possible paths, depending upon the setting of the switch.

In this case the two circuits are (1) the picture-tube voltage, and (2) the audio amplifier input. The selection for the picture-tube circuit is either (a) high voltage, or (b) no voltage. The selection for the audio input is either (a) detector output, or (b) external circuit.

Now since we want to be able to see the TV show as well as record its audio, the first thing we must do is see to it that the picture is on at all times. That is, the picture-tube circuit should have high voltage regardless of the switch position. This is accomplished by adding the simple short circuit shown in the accompanying diagram. If it is ever desirable to kill the picture, this can still be done by turning down the brightness control on the front.

The audio part of the switch involves three factors: TV audio amplifier, TV detector output, and external circuit. But instead of letting the amplifier do the selecting, we now want the detector output to be the selector. That is, the detector output will be able to feed the internal audio system in the normal fashion, or the external system for hi-fi and recording. And this is done very simply by interchanging the positions of the detector and amplifier wires on the switch terminals.

As the diagram shows, the shell of the

phono jack is sometimes not connected directly to ground, but instead has a condenser in series. If hum is encountered after the changes are completed, this condenser is probably at fault. A direct short across the condenser to take it out of the circuit will usually clear the trouble. If a slight tingling is felt when the metal parts of either the TV, hi-fi or recorder are touched, this is an indication that they are electrically a few volts from ground. Try first reversing the a-c plug on the TV set. This nearly always takes care of it. If not, try reversing the other plugs in the system, one at a time until the right combination is found.

Tuning the TV set for the best picture should also present the best audio. But for recording work, it is better to tune by ear rather than by eye, for the least noise and distortion. Recording radio off-the-air will use the same connections as discussed for adding tape to the hi-fi system. If a receiver is used, a direct connection from its volume control to the tape input may be made. If tuners are used, they can plug directly into the tape recorder input, or into the hi-fi system in the usual fashion, in which case the usual feed from hi-fi to tape will be used.

Other sources of sound for your tape collection may be borrowed records or old 78-r.p.m. discs. To find out how to get them down on tape, refer to "Taping Your Records." ●

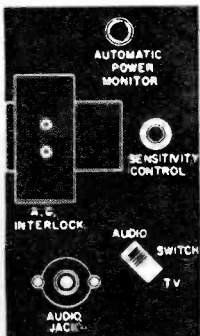

TV SETS such as Silvertone (diagram at left), which have jacks on back for feeding external signals into them, can easily be modified, as shown below, so television's audio can be fed to your hi-fi amplifier and tape recorder.

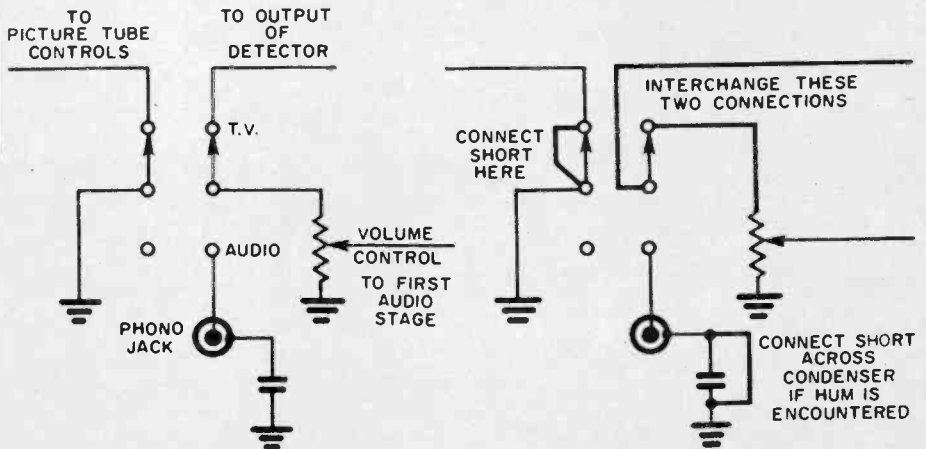

Living Sound

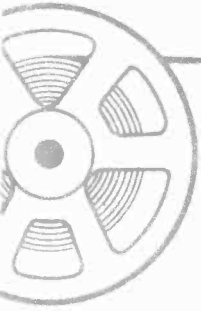

The tape art's highest form, it is an outlet for your artistic expression

"THIS PROGRAM has come to you *live*. . ." How many times every week do we hear such an announcement at the tag end of a TV show? This is the boast that tells us a certain program has immediacy, that we actually saw and heard it as it happened.

And when you make *live* recordings, you are working with the highest form of the tape art, the one which lets you give vent to your own creative expression. You yourself record it *as it happens*. Playing recorded tape is fine, but it is no more creative than running off someone else's movies. And recording off the air will help you enjoy the best programs many times over, but artistically it is no different from making a photographic copy of a picture in a magazine.

Live recording, on the other hand, lets you get into the act. You can write the performance if you wish, produce it, direct it, even perform in it. And then when you have your own production just the way you want it, you can record it on tape and hear it any time you please. And every time you listen, you'll have the renewed satisfaction of knowing that it is all your own creation.

But since this book isn't intended as a course in music or dramatics, our remarks here will be confined to the tools and techniques of making live recordings. And since live recording of hi-fi

LOW-COST CRYSTAL MIKE used by the young lady is adequate for speech recording, but cable length is limited and fi less than hi. Other is better grade crystal mike, Electro-Voice Model 951.

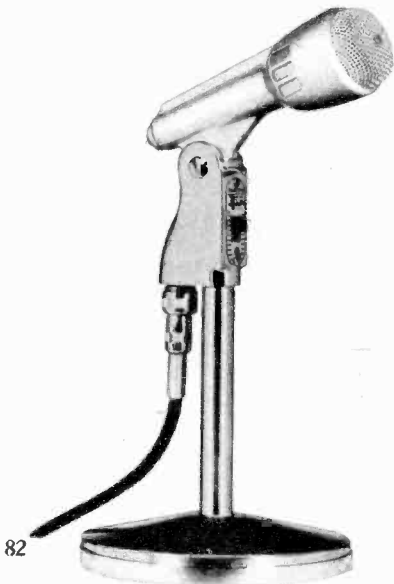



CORRECT TECHNIQUE for recording vocals with omnidirectional mike, Geloso tape recorder is demonstrated here. Excessive acoustic reflections from mirror might require her to move farther out however.

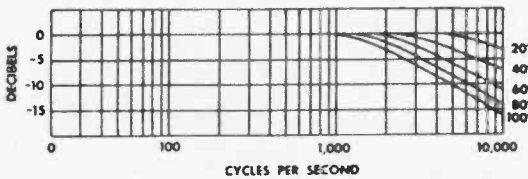

ATTENUATION EFFECT of extra cable length when installed on high-impedance mike. Graph shows loss in highs while the table shows the overall loss.

| CABLE LOSS | |
|---------------------------------|-------------------------|
| Cable Length in Feet | DB Loss in Level |
| 20 | .8 |
| 40 | 1.4 |
| 60 | 2.0 |
| 100 | 3.2 |
| 150 | 4.4 |
| 200 | 5.6 |

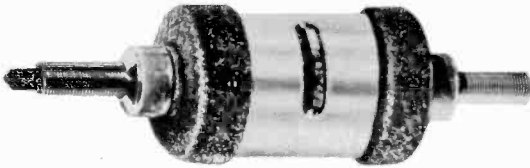

CABLE-TYPE transformer is handy for running long line, low-impedance mike to high-impedance amplifier. Low-impedance cables have two conductors and shield; note the three terminals below.



Shure Bros. photos and drawings

HIGH-IMPEDANCE SYSTEM, top right, limits cable length to 25 ft. for peak performance. Easy way to use low-impedance mike, cable, is to insert matching transformer near amplifier, center. More professional way places transformer in amplifier, bottom; a low-impedance microphone is required.

material is apparently not uppermost in the minds of home tape recorder manufacturers, we'll see that some of these tools are not of the best and will have to be adapted.

The Basic Tools

There are many ways of classifying our basic tools, the microphones, but it will be useful for us first to consider them on the basis of their *impedance*. We already know from hi-fi work that impedance has to do with the opposition of a device to the flow of alternating current. And we also know that two devices connected together should be of about the same impedance, or there should be some sort of matching device between them such as a transformer.

Any microphone will have a characteristic impedance determined by its physical makeup. And it happens that most mikes are inherently either *low impedance* (a few hundred ohms or less) or *high impedance* (tens of thousands of ohms). Since the input circuit of a vacuum-tube ampli-

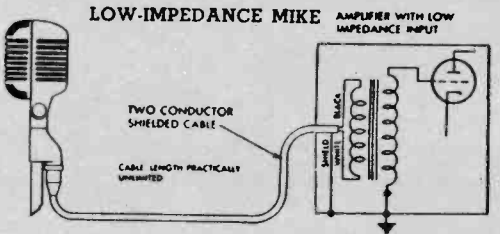
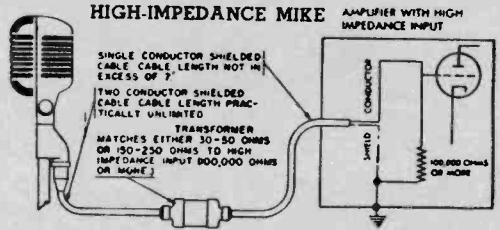
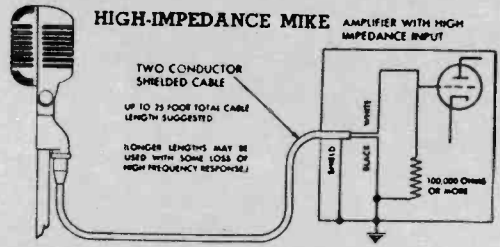

fier is characteristically high-impedance, it is convenient to connect a hi-Z mike directly to it.

This is the arrangement used with nearly all home tape recorders. A high-impedance mike is furnished which plugs directly into the recording amplifier input. It works, but there are several things wrong with it.

First, the mikes ordinarily furnished as part of a tape recorder package are usually of very poor quality. Secondly, the high-impedance method of connection severely limits the length of mike cable that can be used. As the illustrations show, there is an overall loss in level which must be made up by additional amplifier gain, but even worse there is considerable rolloff of the high frequencies as the cable length is increased. Furthermore, high-impedance cable is much more susceptible to induced hum and noise.

For these reasons it has been professional practice for many years to use low-impedance circuits exclusively for microphones. There is no single standard

impedance for these circuits. One school of thought favors a value of 30-38 ohms, another 150-250 ohms, while a third prefers 500-600 ohms. Each of these has certain practical advantages for the working broadcaster or recordist, but for our purposes low impedance can mean anything from 600 ohms on down.

Now let's see what practical significance this has to us in hi-fi tape recording. There are three elements involved here: the microphone, the mike cable, and the recorder input circuit. All of them are now hi-Z and must be converted to lo-Z.

Since the mike is also low-fi, it will have to be furloughed. We'll discuss its replacement possibilities later. The cable also will have to go. High-impedance mike cable is the same as phono cable, a single insulated center conductor surrounded by a braid conductor. The braid is supposed to act as a magnetic shield, but it also serves as one conductor in the circuit.

Low-impedance mike cable is two-conductor shielded. The two center wires provide both sides of the audio circuit, while the outer braid is grounded and acts as a shield only. It carries no audio currents.

Finally, there must be a matching device between the lo-Z cable and the hi-Z amplifier input. This is usually a mike-to-grid transformer, whose primary matches the low impedance of the cable while its secondary matches the amplifier input. There are two types of such transformers. One of them is mounted and connected permanently between the preamp grid and input jack. The other is connected into the mike cable itself at the end near the amplifier.

Mike Types

The earliest type microphone, the carbon mike, although inherently a low-impedance device, is also so low in fidelity as to preclude consideration for hi-fi recording work. Since it has excellent characteristics at speech frequencies, however, it is still used extensively in telephone and communications systems.

The mike included with most tape recorders is of the piezoelectric type, either crystal or ceramic. Thus it uses the same principles as the crystal or ceramic phono pickup. The sensitive material generates a voltage when it is subjected to physical stress, such as that caused by sound waves in air. These units are basically high-impedance devices, but their response is neither flat enough, nor good enough at the high end, to warrant their use in hi-fi work. Furthermore, high temperature or humid-

ity can hurt their performance even more.

The moving-coil or dynamic microphone also uses principles which are familiar in phono pickup work. It has a diaphragm which moves with the sound waves which strike it, and this motion is coupled to a coil made of a large number of turns of fine wire.

This coil is arranged, very much like the voice coil on a loudspeaker, between the poles of a permanent magnet. As the coil moves with the diaphragm, it cuts the magnetic lines of force between the poles. This in turn induces in the coil a varying voltage which is a replica of the wave motion of the air striking the diaphragm.

The dynamic mike is inherently low impedance. It is also probably the most improved in fidelity in recent times. Originally thought of as a simple, rugged mike, good for voice work such as public-address or sportscasting, it is now quite often used for hi-fi music. This type is now made in a wide range of qualities, so you should be sure that the one you buy is really hi-fi.

The old hi-fi standby is the ribbon or velocity mike. Its moving element is a very light piece of corrugated metal ribbon, set between the pole pieces of a permanent magnet. No diaphragm is used, as the ribbon itself moves with the sound waves, and so has induced in it an audio voltage.

Frequency response of this instrument is excellent, and it is still widely used in pro-

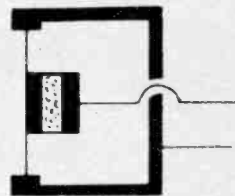

CARBON-BUTTON mike varies or modulates a supplied current, instead of generating voltage.

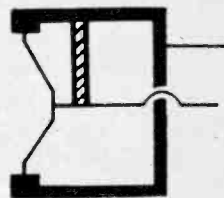

CRYSTAL or ceramic slabs in other mikes generate voltage when bent, twisted by sound waves.

fessional music pickups. It must be treated as the fine instrument it is, however, as the delicate ribbon is very sensitive to physical shock. Since the impedance of the ribbon is only a fraction of an ohm, a matching transformer is always used and is an integral part of the microphone. Its secondary impedance could be anything desired, but is usually about 250-500 ohms.

Another old-time microphone which has made a strong comeback is the capacitive or condenser type. In this one there is a diaphragm which acts as one plate of a condenser. When it moves, it varies the electrostatic charge and so produces a voltage across a resistor connected between the diaphragm and a source of polarizing voltage.

The audio voltage produced by this means is very feeble, and so there must be a preamplifier very close by. In older models, the preamplifier and high-voltage charging source were mounted within the microphone case itself. Current models

have these elements in a separate case, usually placed just a few feet away on the studio floor.

Performance of the condenser mike is excellent, and it is probably the most popular type for music work in broadcast and recording today. Impedance of the condenser itself is quite high, but the output of the associated preamplifier is usually low impedance for professional use.

Miscellaneous features of microphones include on-off switches, adjustment for altering the frequency response or impedance, and adjustment for altering the directivity pattern. The area surrounding it to which a microphone responds is a most important factor in the choice and use of a mike for a given application.

Directivity Characteristics

Generally, there are three basic microphone directivity characteristics. The mike is either sensitive in one direction only, in two opposite directions, or in all directions

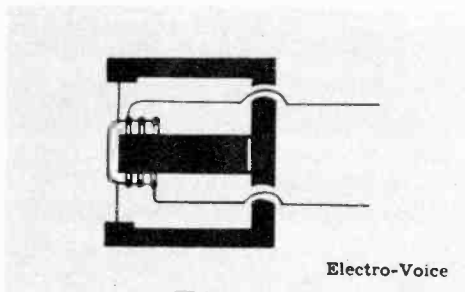

DYNAMIC or moving-coil mikes have a coil moving in magnetic field to generate a voltage. At right is Astatic Voque 988, a high-grade dynamic mike, typical of "new look" in this type.



TENOR RICHARD CROOKS records for RCA-Victor using a velocity microphone. Head turned away from live side is the best way to avoid blasting on reaching dynamic peaks.



MICROPHONES shown, left to right, are Astatic dynamic type of high or low impedance; Shure multi-impedance, velocity ribbon-element model 300; the Shure 556 dynamic, an old hi-fi standby of multi-impedance; and Fen-tone bi-directional velocity mike which is adjustable to any one of three impedances.

equally. These three characteristics are known respectively as unidirectional, bi-directional or omnidirectional.

These characteristics normally refer to the horizontal plane, that is, as they would appear when looking down on the microphone from directly over it. They also refer to the normal operating position of the mike. Obviously, if a microphone is tipped at right angles, its pattern is also, and the picture can change radically.

This being the case, it is not always possible to distinguish between the unidirectional and omnidirectional types, for the pattern will depend upon the way they are used. This two-way application is characteristic of many crystal, dynamic and condenser mikes.

One thing that can be said with finality is that the simple ribbon mike always has the figure-eight pattern. There are also hybrid mikes, consisting of more than one element, such as a two-ribbon, or a ribbon-dynamic, which have basically unidirectional heart-shaped (cardioid) characteristics. Many of these can be varied at will, to any of the three basic patterns, depending upon how much of each element is brought into play.

To use any of these microphones intelligently, we should have some knowledge of the nature of acoustics and of sound itself. For our purposes sound is a series of varying atmospheric pressures. When sound travels, the air itself doesn't travel from the source to the point of reception. Rather, it's like the bump or jerk that travels along the whole string of

freight cars when the engine in front of a train starts moving.

The difference is that, while the tug moved along in a straight line from engine to caboose, sound wave motion travels outward in an expanding sphere, sort of like an inflating balloon. As it does so, it will meet obstructions in its path, such as walls, the floor, ceiling, furniture and people.

At each of these meetings, some of the sound is either reflected or absorbed. If it is reflected, it starts out with another expanding bubble of sound pressures, different from when it arrived. The sum of all these reflections is known as *reverberation*.

A certain amount of reverberation is necessary for natural-sounding recordings, but too much of it becomes simply a ringing echo which destroys intelligibility. This is often the case when you try to make musical recordings in concert halls, auditoriums, classrooms, or even your own living room.

The problem then is to cut down the reverberation by increasing the absorption. This can be done by laying down carpeting, drawing drapes, or if the circumstances warrant, applying acoustical tile to the walls. A high ceiling is always an acoustical asset, unless it contains a large skylight, which may admit unwanted noises or be highly reflective. The mike stand should have a couple of extra layers of carpeting under it, so that the only vibrations received are those through the air, not through the floor.

The microphone is a delicate instru-

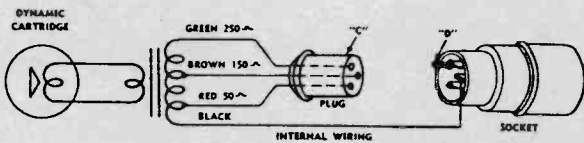
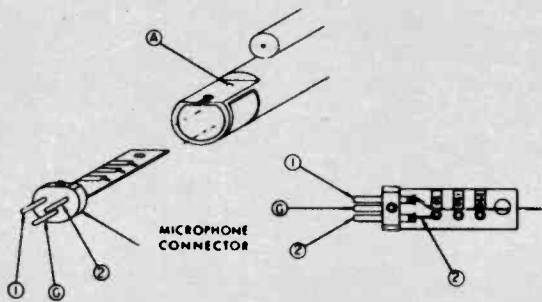

IMPEDANCE adjustment is made by pin-plug variations. Jumper wire (2) is switched to tap in some E-V mikes, left. Astatic selector entails rotation of plug around pin (D), diagram above.

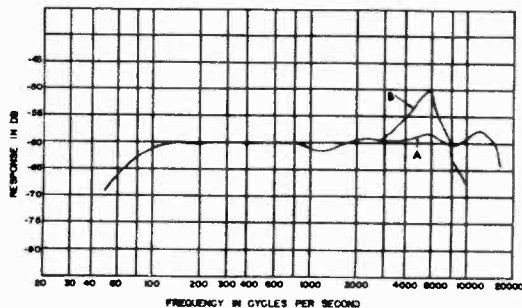
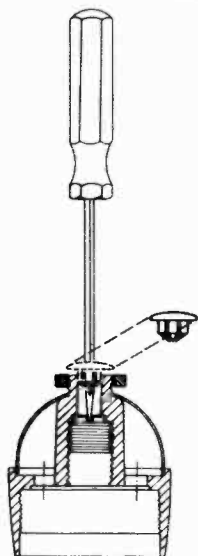

FREQUENCY RESPONSE of the Electro-Voice Lavalier model may be peaked in the "presence" range. Other microphones feature a high- or low-frequency roll-off for the purpose of special effects.

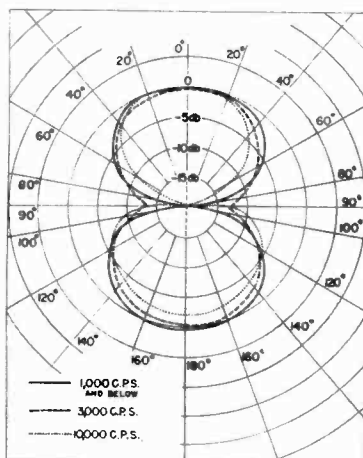

Shure Bros. Electro-Voice drawings

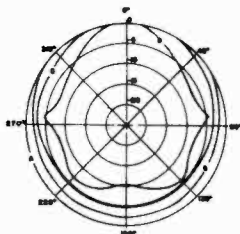

SCALE: 1 DECIBEL PER INCH
 A — 500 cps C — 5,000 cps
 B — 1,500 cps D — 10,000 cps

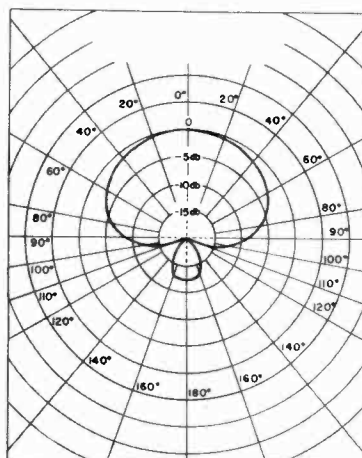

BASIC PICK-UP PATTERNS of microphones are bi-directional or figure 8, left; non- or omnidirectional, center; and the unidirectional or cardioid-type pattern as illustrated by these three drawings just above.

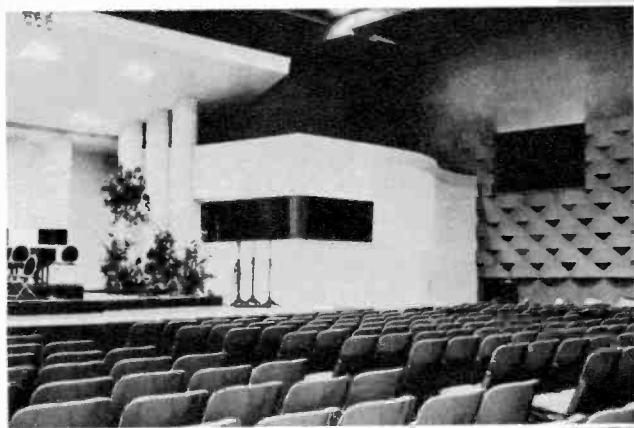

SUSPENDED unidirectional mikes were for overall pick-up, mikes on stands for presence when Toscanini directed from old NBC studio H. Gain intimate speech effect working in close on ribbon-type mike such as Shure 333 model pictured at right.



ment and should be treated accordingly. When setting up, route the cable where there is least likelihood of its being stepped on or tripped over. Hang the mike if possible, with the cable suspended up out of the way. Or a small carpet placed over the cable on the floor will help protect it. Don't check whether the mike is live by blowing into it. Instead just talk, or tap the case lightly with your fingernail.

Microphone Techniques

Good microphone technique is largely a matter of personal taste and judgment. If the sound is good, if you get the effect you want, then the mike placement is right, regardless of any abstract theories or past practice. By all means experiment with a variety of setups. This is the only way to become thoroughly familiar with your instrument and acoustical surroundings.

The most important thing in setting up a live recording session is to *use your ears*. This means that you must have a good monitoring system, comprising an amplifier and speaker, and your recording equipment must be located in another room separate from your studio, so that you can hear what you are getting, and experiment and make adjustments until you get what you want.

When recording speech, the mike should be one to two feet away from the lips of the speaker, and, if it is directional, pointed

directly at him. When recording dramatic skits involving several voices, the weaker ones should stand closer to the mike and the more powerful ones farther back. This in essence is the way of achieving *balance*.

The mike should be set at about the height of the speaker's mouth. When a mixed group is involved, some adjustments will have to be made.

If there is excessive hissing on the letter *s* or popping on the letter *p*, the speaker whose voice has such characteristics must get off mike just a little. He should align himself at an angle to it, so that he is speaking across the face of it. This will take just a little rehearsal to find the right location and technique to get rid of these distortions.

These techniques apply to ordinary conversational speaking. They must be modified somewhat for special effects. For a soft, intimate effect the speaker might work very close on mike. This is tricky, though, because it magnifies all of the breathing, nasal and throat sounds. A strong, declamatory style, on the other hand, will require the speaker to stand back.

Positioning the Performer

Similarly, in vocal recording the techniques employed will depend upon the singing style and the effect desired. The intimate, crooning voice might work very close in on mike, while a powerful operatic

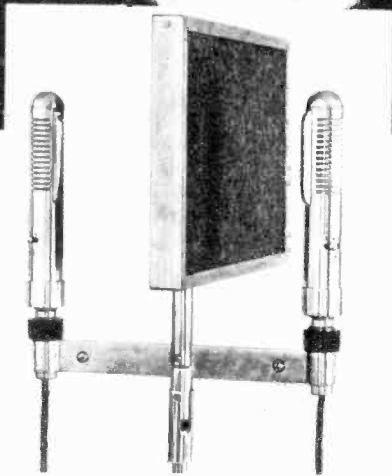

MAIN PICK-UP on orchestra was a high boom for this Columbia recording session. Soloist Sinatra and vocal group worked opposite sides of the velocity mike in right foreground. Unique Fentone stereo mike rig employs fiberglass panel for separation of the two individual channels.

Audio Devices drawings

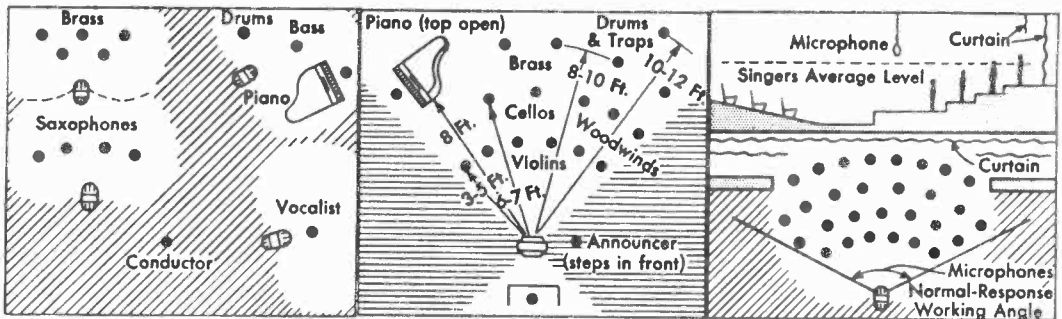

MICROPHONE SETUPS shown here are from left: a dance band with multiple unidirectional mikes; single bi-directional mike used by a medium-sized orchestra; and single suspended unidirectional mike used in a concert hall. Backdrops help hold down unwanted reflections from rear of concert hall.

speech recording

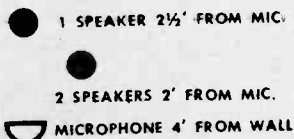

solo recording with accompanist



piano recording



Webster Electric drawings

DISTANCE from mike depends somewhat on speaker's vocal strength when recording dialogue. Mike-to-wall distance is shown since it affects bounce-back. Bi-directional, omnidirectional mikes should be farthest out. When recording vocal solo, piano accompanist is more distant for balance. Recording solo piano distance varies due to music type, acoustics. Shown is a good setup for most living rooms.

voice might have to work several feet away. Ordinary voices usually sound best in the 12-24 inch range.

Vocal groups are set up roughly the same as for a concert, with some modifications. When more than one voice has each part, as in a chorus or glee club, all of the like voices are grouped together. And, of course, the usual practice of placing the strong voices in the rear, weak voices in front, is followed.

The singers should be located so as to make maximum use of the sensitive coverage area of the particular microphone used. With an unidirectional mike, the conventional concert setup, with the entire group facing the microphone "audience" is best. With a bidirectional mike, the group should be split in two, with each unit facing the other around the two live faces of the mike. With an omnidirectional mike, they should be grouped in concentric circles around all sides of the instrument.

There is a little trick, which if performed subtly, will aid considerably in adding intelligibility to the lyrics. Select one singer from each voice group who has unusually good diction, and have him work just a little closer to the mike than the others. They shouldn't be so close in that their voices stick out like solos, but only enough to give a little more presence or bite to the words.

When there is also instrumental accompaniment involved, it is easier to use additional mikes and a microphone mixer. If no mixer is available, however, it is possible to group both the singers and instrumentalists around the single mike. The same general rules for balancing are

involved, and it will require a considerable amount of cut-and-try.

Piano recording technique varies widely, depending upon the type of music and effect desired from this versatile instrument. When a singer accompanies himself at the piano and only a single mike is used, it is usually placed to one side, so that the singer turns to face it. The piano lid is kept closed.

The mike must be on a stand or chair, never set on the piano itself. Vibrations transmitted to it through the case would be so strong and so distorted as to ruin the recording. When the mike is intended to pick up the piano alone, its placement depends upon acoustical conditions.

In dance band recording, for example, where the piano is primarily a rhythm instrument, the mike is usually hung on a boom under the lid and directly over the strings, perhaps a foot or so away from the hammers. For solo piano of the cocktail variety, a fairly intimate effect is desired, and a microphone distance of only three or four feet away from the strings is adequate.

For classical piano, a more open sound is usually desired. In a highly reverberant room, a distance of seven to eight feet is usually about right. In a noise-free, acoustically treated studio, the distance may be several times this amount.

Orchestral recording is often largely trial-and-error, even for professionals, because so much depends upon the type of music and the acoustic surroundings. The drawings show some arrangements which have been successful under average conditions. •

Taping Your Records

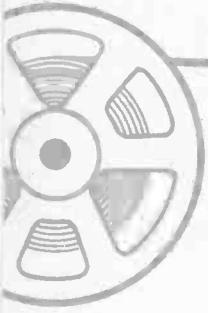

You can improve the sound of those old 78's and give it a new, long lease on life with these pro tricks

IN MOTION PICTURE work, dialogue is the first thing put on the sound track, sound effects and background music added later. Here they are being transferred to the magnetic track from special units. Warner Bros.

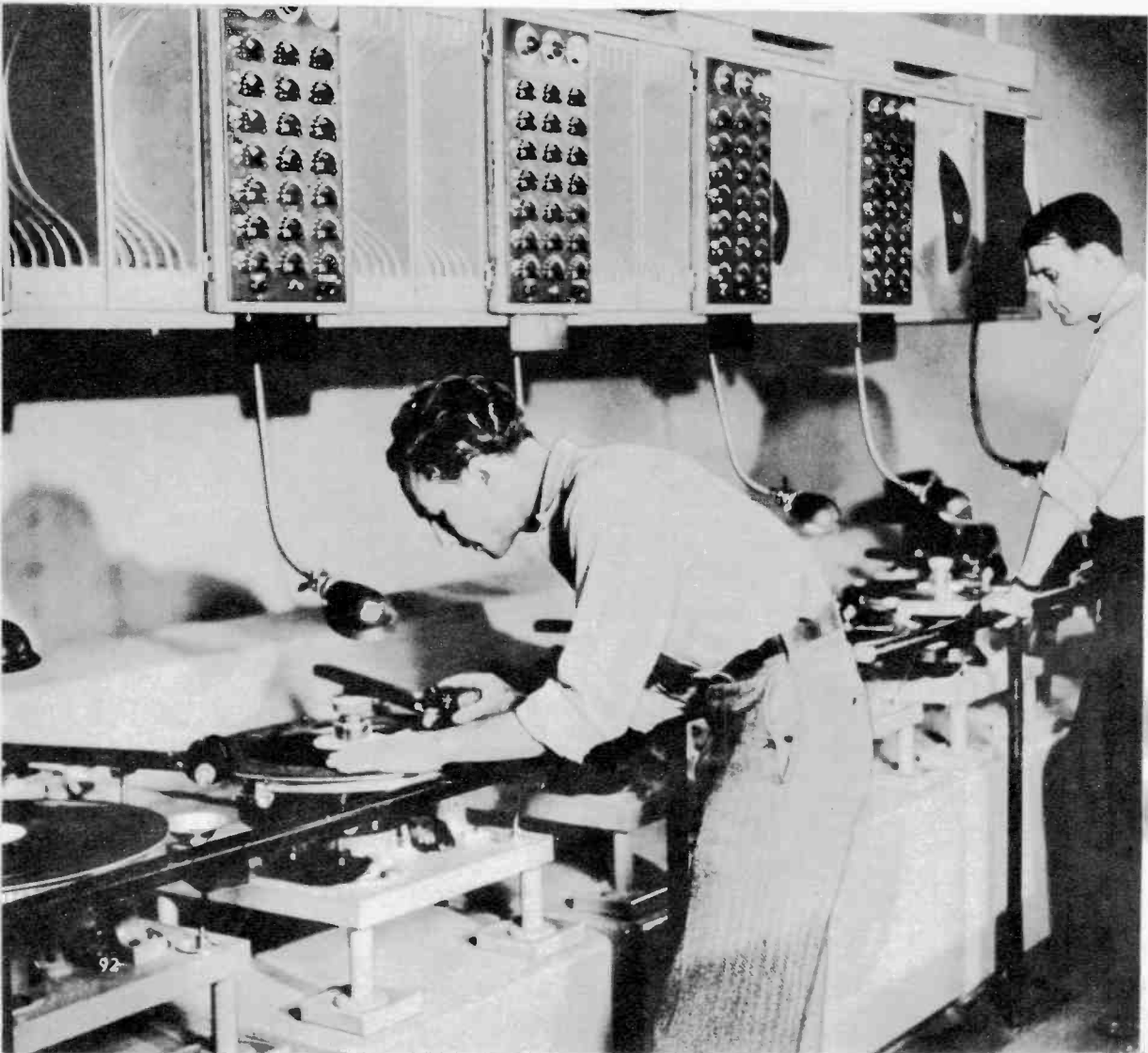

Unless otherwise noted, all photos are by Ed Pryor.

CLEAN record grooves as thoroughly as possible before re-recording. Detergent-type cleaner, which leaves no residue, is your best bet. Apply with pad of the puff type.



IF YOU have been interested in recorded music any length of time at all, you probably have a fairly extensive collection of 78-r.p.m. shellac records and are wondering just what to do with them. Some of them sound pretty awful on your hi-fi equipment, and yet it would be a wrench to part with them. None of your friends want them either, and yet it would be a downright shame to destroy them. What to do?

Many audiophiles are facing this dilemma, and some are selling them to record stores which specialize in 78's for reactionary collectors. Others give them away to friends or charity. Still others sail them across open fields like flying saucers, or drop them down dumb-waiter shafts. And some just let them lie around and gather dust.

Whichever of these alternatives suits your fancy, by all means dub your records to tape if the performances have any importance to you at all. And the chances are quite good that you can make the records sound better than they ever did on your old low-fi phonograph or on your present hi-fi system. Dubbing to tape is really quite simple, but you can do a much better job if you know a few professional tricks.

Begin by selecting the first record to be taped, and play it through your system in the usual manner. Adjust the volume to a comfortable level, and choose the compensator and tone-control settings you want on the tape. This is important.

You may as well begin by forgetting the company name on the label or any presupposition you have concerning the original recording characteristics. In the primeval days of recording, equalization was at best a rather hazy proposition. But you have a choice of several equalization curves on your phono pre-amplifier. Try them all. You also have tone controls. Use them.

Remember above all that it is your tape, and your ears are the ones to be pleased. Forget the abstract theories, and don't be afraid to experiment. Many of the ideas to be suggested here are unorthodox by usual standards, but they do work. Furthermore, they only have to work once, for once the sound you want is on the tape, it is there permanently if given proper care.

If you have a scratch filter on your amplifier, by all means use it when necessary. The same thing goes for the rumble

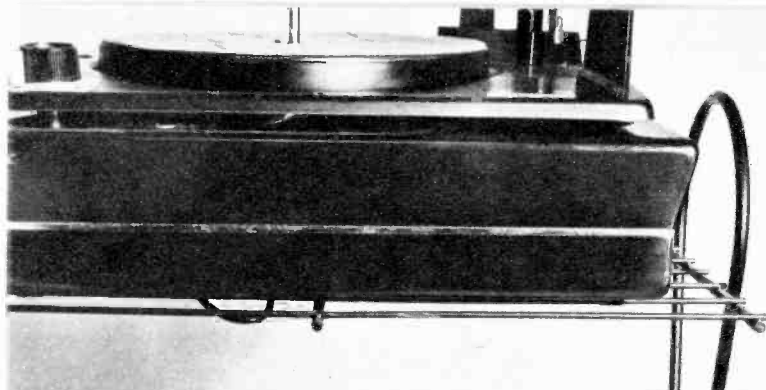

TONE CONTROLS, variable compensators and filters should be employed to the fullest. Strive for the sound most pleasing to your ears, not for theoretical perfection which might very well be based on misinformation anyway.



SOUND'S BEGINNING is found by slowly turning the record by hand and listening. This is not recommended for instantaneous "acetate" discs.



filter. And if you have presence controls or loudness controls, see what they can do for you as well. In short, try everything at your command which might improve the sound of your tape copy.

Make sure the disc is as clean as you can possibly make it before doing the re-recording. Don't use a spray for this. The record sprays are quite effective as anti-static agents, but they should never be used until the record is thoroughly free of dust. The best cleaner is the detergent type, with a puff-type cleaning pad that gets down into the bottoms of the grooves.

With all of the controls set for the sound quality you want and the level the tape can take, you are now ready to "cue up" the disc and make the actual transfer to tape. Cueing a record is done so that the first actual sound heard will be the be-

ginning of the performance, without any preceding surface noise, clicks, pops or scratches.

This is done by keeping the volume control fully closed until the very instant sound is to begin, and then opening the control up to the previously established setting. But how can you tell when sound begins if the volume is turned down? Well, it's not so impossible as it sounds. In fact, it's not even very difficult.

Cueing Records

There are a couple of ways of bringing records in on cue. The one used in broadcast work, because it is quick, is called back tracking. It is the less desirable method, however, because it is a little hard on the records when done repeatedly. In your taping, which is strictly a one-shot

INDICATE BEGINNING of modulation by one of methods shown here: With grease-pencil mark designating the location and number of turns from outside, or with slip of paper under disc at right degree of rotation.



proposition, there should be no harm in using it.

The first step is to place the pickup in the lead-in groove of the record, and then rotate the turntable by hand until the beginning of sound is reached. Then the turntable is rotated backwards (counter-clockwise) until the stylus is anywhere from a few inches to several turns ahead of the first groove modulation.

In broadcasting the pickup is often placed quite close to the beginning of modulation, the record held fast by hand, and the turntable started and permitted to skid under the stationary disc. Then when an announcement is completed, the record is let go to rotate with the table, the volume control is opened up, and music begins immediately.

It probably will be impossible for you

to do it in quite this way, however, because your turntable surface is purposely made non-skid with cork or rubber, as contrasted against the felt covering usually found on broadcast turntables. You can get around this by installing an intermediate layer between the turntable and the record.

Cut a disc out of a piece of smooth paper a little larger than the record or turntable, and punch a center hole in it, just like a record's. Any kind of varnished paper will work for this. Better yet, use an old photographic print if you have one large enough. Put the glossy side down against the turntable surface. The paper backing, which is somewhat rough, will be against the surface of the record when it is placed on top of the oversize disc.



FOR SKIDDING record prior to fade-in, place paper disc between the record and turntable. We used an old photo here, with glossy side down.



PAPER is held, keeping the record stationary as turntable turns. At proper moment, release paper to start record, bringing music in on cue.

Then when the turntable is started, the paper is held fast until the turntable and tape machine are up to speed. At this point, the paper and record are let go, and the volume control is quickly opened to the predetermined setting.

The other method of cueing involves counting the number of turns of unmodulated grooves before sound begins. First it is necessary to observe at what point in the revolution the sound begins. Note this by watching the position of the label as the record revolves and modulation begins. Then mark this position, using a grease pencil on the blank center of the record, or a slip of paper under the edge.

Finally, place the stylus in the outermost groove, at the angle of rotation indicated by the mark. Then count the number of whole revolutions the record makes before sound begins. Keep this in mind, or better yet mark it on the record. Now it is possible to bring the sound in on cue merely by setting the pickup in the correct groove and counting turns. No back tracking of the groove or slipping the disc is necessary. Where no split-second timing is necessary, as it is in broadcasting, this is by far the better method.

On many occasions, however, when attempting to play '78's on current hi-fi

equipment, you will encounter mechanical troubles which seemingly make it impossible to get anything resembling decent reproduction from the old discs. In these cases, a little more ingenuity is necessary.

Record Repair

Let's consider the case of scratched or cracked records. Sometimes a bad scratch can be toned down considerably merely by filling it up, using your grease pencil or a piece of soft wax or soap. Rub the wax over the scratch until there is obviously a build-up of material in the fissure. Then remove as much of the excess as possible, using the detergent and brush or puff. Finally, play the record a couple of times before recording to permit the stylus to work the wax into the gouges and polish it.

Even the fact that a record is cracked does not necessarily make it beyond salvation. It will often sustain a single play without causing a once-around tick, particularly if it is patched with adhesive tape on the reverse side. But when ticks can't be prevented, they can later be removed from the tape, as will be seen in the chapter on editing.

There will often be wow in old records, either due to the center hole being off



CENTER WEIGHT sometimes helps counteract warp of record. Be sure weight is small enough to permit tracking right to last music groove.



FILL SCRATCHES, cracks and gouges with a soft material like wax from a grease pencil. Be sure to remove all excess before you re-record.

center, or to its having been enlarged and gouged by an archaic changer. In either case, the center hole now *should* be enlarged considerably, so that you can move the record from side to side about the center post as needed.

With the oversize center hole, the disc is positioned to exact center by eye and ear. The visual part of the method consists of sighting along the end of the tone arm from pickup to pivot, and adjusting the position of the record until no back-and-forth lateral motion of the stylus is observed. At the same time listen carefully of course, particularly on sustained tones and reverberations. Before making the final disc-to-tape transfer, if there is any danger of the record slipping off center again, weight it down at the center or tape it down to the turntable at the edges.

You will be surprised to find that every trace of lateral wow will be capable of correction in nearly all cases. Very few records, even the oldest, have wow as an innate part of their modulation, due to speed inconsistencies in the original recording. But even when there is no wow in the original recording, and the record is perfectly centered, and the turntable speed is perfectly constant, there is still another possible source of wow.

This is *vertical* wow, resulting from warp in the disc which alters the distance the stylus must travel at various places on the record, and hence affects the constancy of stylus speed relative to the groove.

Vertical wow can be eliminated only by eliminating its source, the unevenness in the record surface. If the warp is convex, making the record look like an inverted dish, the only cure is some additional weight on top of the record in the center label area. If the record dishes upward in a concave warp, the cure is to tape down the edges to the turntable. If the warp is uneven, with hills and valleys giving the disc the appearance of a scallop, then weighting and taping may be necessary.

If all else fails and there is therefore nothing to lose, it may be possible to restore the original flatness by the application of heat. Remember that both shellac and vinyl are thermosetting plastics, which become records by being heated until soft and then stamped into shape in a record press. When they warp, that too is usually the result of a combination of heat and pressure.

It is therefore possible to undo the damage by the same means, a little heat plus gentle pressure. First place the record on a perfectly smooth surface



DAMAGED CENTER HOLE need not prevent you from re-recording a disc. Sight along the pickup arm, watching for side sway, while listening for wow. Keep adjusting record's position on turntable until perfectly centered.



HAYWIRE SCHEMES such as this are sometimes only way to get a light, high-compliance pickup to track old records. The cigarettes, directly over the cartridge, provide the additional weight that is necessary.

IDENTIFICATION of your tapes should be recorded onto them in addition to visual markings. Later on, you can easily edit out such announcements if you prefer. But you may find it a handy thing to have them there.

which is not heat-sensitive. A metal cookie sheet works very well. Place the record and pan in a medium oven or over a low burner for just a minute or two.

The thin shellac or plastic will become pliable at quite a low temperature, so you can work the record into reasonable flatness with your bare hands. Use no more pressure than necessary, and wait until the record has cooled and hardened again before attempting to play it.

Pickup Problems

You will often find that despite all of these precautions, 78-r.p.m. records simply will not track with your hi-fi pickup. This is understandable when you consider that the modern cartridge is designed specifically for microgroove applications, and its use for the older records is definitely a secondary consideration.

Phono pickups today employ much less stylus force and have much greater compliance than their forebears. Conversely, the old records you are attempting to rehabilitate by rerecording to tape, were intended to be played by a much heavier and stiffer cartridge. Hence in some cases the only way to get decent reproduction is to make the hi-fi cartridge behave like the old 78 cartridge as much as possible. This is done in two ways.

Greater stylus force can usually be obtained by a simple adjustment on the tone arm. Either the spring loading is lessened or a counterweight is shifted or removed altogether. Despite this the pickup will still sometimes show a tendency to take off and skate across the grooves, or to vibrate or resonate and distort.

At this point the only remedy is pure brute force. The pickup will simply have



ACTUAL RECORDING begins with recorder running, turntable started manually. Volume control fades up as your mark reaches the stylus. Various fades should be rehearsed before recording.



PAPER TABS are inserted when tape is stopped between selections for identification, future editing. They will drop out during rewind, so it may be more convenient to edit from the back.



to be loaded down and damped as well. This is done by the simple expedient of piling weight on top of it. I have seen a number of things used for this: a wallet, a pack of cigarettes, a stack of nickels or lead washers. This is not particularly good for the health of the record, stylus or pickup, but it usually works when all else fails.

Having gotten the record to play properly, with the sound quality you want and the starting point established, the correct recording level must be determined. Since there will be at least two volume controls in the circuit, one on the amplifier and one on the tape recorder, they should both be set similarly. That is, one should not be extremely high while the other is quite low.

Either of the volume controls can be used as the fader. Note its setting for the correct recording level, or mark it with a grease pencil. Now with all preparations concluded, you are ready to do the actual dubbing.

Cue up the record by whichever method you find most convenient. Turn your master fader all the way down, start the

recorder and press the record button. Start the turntable, and just as the first music groove approaches the stylus, turn up the volume fader to the predetermined setting.

Fading out the end of the record can be almost as tricky as the fade-in, especially if the noise level is high and the music soft. In these cases it is advisable to rehearse the ending and fadeout a few times, to determine just when it should be made, and how quickly or slowly the control should be rotated. The faded ending may sometimes be made less obtrusive by slowly turning down the treble control on the final soft notes, before the volume control is closed. Sometimes it is useful to listen to the ending with earphones, for the best fadeout.

All of this may seem to be a lot of bother for what is basically a simple process, but the results will speak for themselves. They will be those of a pro instead of a duffer. Taping your old 78-r.p.m. records will prolong their usefulness, and enable you to program them the way you want. •



RAISING MONITOR speaker level generally raises the recording level as well, so it sometimes becomes necessary to use earphones to obtain a graceful fadeout at the end of a particularly soft musical passage.

WHEN FINISHED re-recording, the tape should be visually identified by writing on a section of leader and splicing it in, or writing on tape itself with grease pencil. Add complete legend to the box as well.





ACCESS to the reproduce head gap is essential for tight editing. On some machines, access can be obtained by merely removing small shield that covers heads.



SOMETIMES entire top plate has to be taken off. It entails removal of knobs, screws. If there are piano-key controls, be careful: clearance at openings is slight.

All photos by Ed Pryor

How to Edit Tapes

It will improve them tremendously in most instances, and the portions you remove can be used over and over again

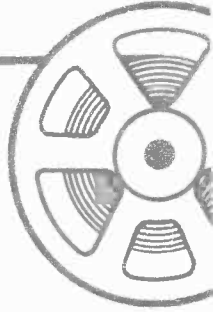

HOMEMADE TAPES, like home movies, can be improved immensely by just a little judicious pruning or editing. Still few movie-makers ever attempt it, and even fewer tape recordists have ever even considered it.

In the case of the amateur cinematographer there is some justification, for it comes hard to junk even one frame of that little ribbon which was bought with cold, hard cash. But the tape recordist has no such excuse, for every bit of tape he removes by editing can be reused for recording again and again.

It is entirely possible, however, that you would like to try some editing, but the conflicting stories you have heard leave you just plain confused. When you bought your machine, chances are the salesman told you that one of the wondrous advantages of tape is the ability to "just snip out" any mistakes. On the other hand you may have heard that the top tape editors in the country number a mere handful, and if the work is that tough you want no part of it.

These are the two extremes of the story, and the actual truth of the situation lies somewhere between. Tape editing, while more than just snipping out, is not really very difficult. You can do it too, if you really want to.

Tape editing consists of cutting out unwanted parts of a recording, or arranging parts in a different sequence, or both. To use a photographic analogy, the first type can be likened to cropping a picture. You see that by removing parts of the overall picture, the remaining composition becomes more compact, pleasing or forceful. By rearranging various parts of one or more pictures into a montage, you have created something new—you have synthesized a whole from selected parts.

Tape editing works much the same way. You can tighten up a dull performance and eliminate errors by judicious use of the splicer. In the same way you can synthesize something new, something which was never performed that way.

But this is as far as the analogy goes, for while the photographer is working with a visual medium and can see what he's working on, the tape editor cannot. He must rely upon his ears, more than his eyes, to tell his hands what to do. But as long as he understands a few fundamental principles, he can remove that mental roadblock between his ears and his hands.

To begin with, he must remember that recorded tape is really just a series of magnetic impulses, much as a movie film is a series of still picture frames. And the magnetic impulses responsible for each of the sounds he hears have a definite and immobile position on that tape. As long as that tape remains recorded, whenever it passes the reproduce head, the same magnetic impulses will produce the same sounds from

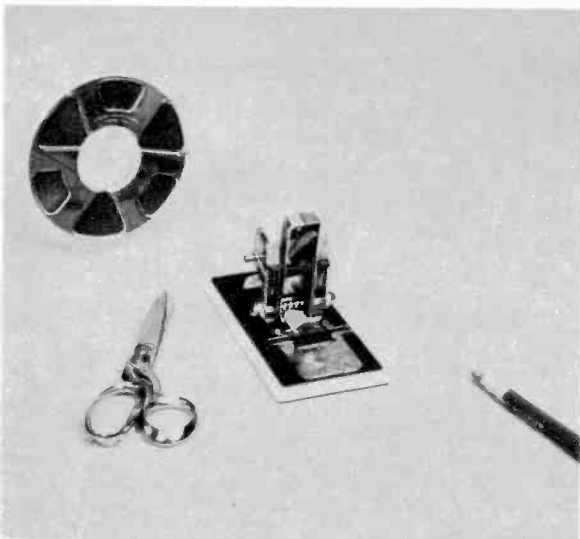

TOOLS of the editing trade: a china-marking pencil, a splicer or pair of scissors, and a roll of splicing tape. They're all you require.

the same place on the tape every single time.

Spotting Sound

And here we have our first and most important clue: magnetic impulses on a moving tape as it passes a *reproduce head*. It is this reproduce head which will enable us to relate the sound heard on the loudspeaker to the exact position on the tape of the magnetic impulse causing it. Once we have "spotted" the particular sound we're looking for on the tape, the toughest part of the editing job is done.

The reproduce head, as well as the erase and record functions are all in the small housing about midway between the two tape reels. This housing must be removed, as it is essential to be able to see the reproduce head while spotting. Since the tape moves from left to right during normal operation, the reproduce head is the farthest to the right.

If this same head is also used for recording, it will still be the farthest to the right. Upon close examination you will see a small vertical line running up through the middle of the head. As we know, this is called the *gap*. It is as the tape passes this fine hairline that sound is produced. Now it becomes evident just how accurate spotting is possible.

As the tape is played, and it reaches the point where a splice is to be made,

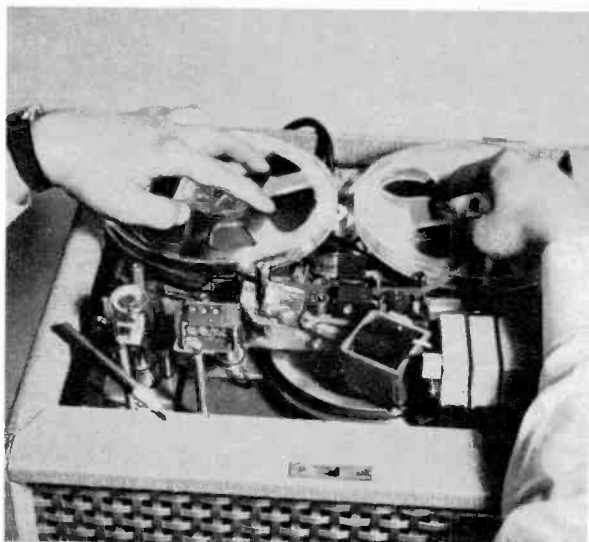

SPOTTING a particular cutting point is accomplished by rocking reels by hand, listening carefully to sound made as tape passes the head.

the stop button is pressed. Then the reels are turned back and forth by hand until the exact spot on the tape is found which is producing the sound in question. Then with the tape stopped with the splice point directly over the reproduce head gap, a mark is made on the tape at the gap. A grease pencil (china-marking) is best for this purpose, preferably yellow in color, although a small wax crayon or even a fountain pen may be used in a pinch.

Now let's consider a simple practical problem in tape editing. Suppose that you have a series of tape copies of a number of single phonograph records, which you wish to edit into a pleasing program of continuous music. You may want silent pauses of perhaps 3 to 5 seconds between selections, but as the tape was recorded the pauses are much longer and marred by switching clicks. The problem then is simply to tighten up the pauses and remove the noises, if any.

The first thing to do is play the tape near the end of the first selection. For the few seconds following, listen carefully for any noises. If any are heard, stop the machine and rewind the tape manually by turning the supply (left-hand) reel. As soon as the noise is heard again, stop turning, and with one hand on each reel move the tape rapidly back and forth across the reproduce head. When the noisy section of tape is fairly well cen-



WHEN the precise spot is found by ear, its position is directly over the head gap. You then mark it with a vertical line with grease pencil.

tered in the head area, cut off an inch or two either side of this point. It is not necessary to do very precise spotting in this work, as the only objective at the moment is to get several consecutive seconds of clean, quiet tape immediately following the end of music.

All this can be avoided, of course, by the insertion of tape known to be silent, such as erased magnetic tape or non-magnetic leader tape. The length of the silent tape is then calculated as the time of the pause in seconds multiplied by the operating speed of the machine in inches per second. As an example, a 5-second pause on a tape machine operating at $7\frac{1}{2}$ i.p.s. would equal $5 \times 7\frac{1}{2}$ or $37\frac{1}{2}$ inches.

Opening Cuts

So now we have the silent pause of some sort and of the correct length spliced to the end of the preceding selection. The final step is to bring in the next selection right at the end of the pause. This is accomplished by pulling the tape from the supply reel past the playback head until the beginning of the next selection is heard. Then the tape is rocked back and forth across the head until the precise point of the beginning of sound is spotted. It is then marked and cut at that point, and spliced onto the end of the silent pause tape.

Now let's consider a problem in editing

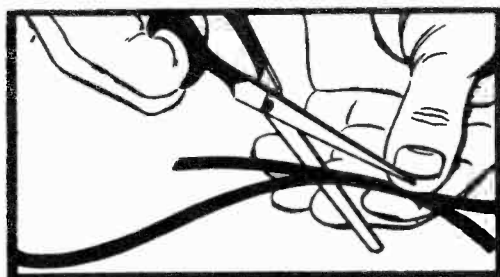

SPLICING without a splicer, cut at 45-degree angle with both pieces set perfectly parallel.



NEXT, you align and butt together ends of the tape with the uncoated or shiny side upward.



SMOOTH out the air bubbles after applying splicing tape. Don't use metal for the purpose.



AFTER the tape has been joined properly, you trim and undercut it slightly to avoid sticking.

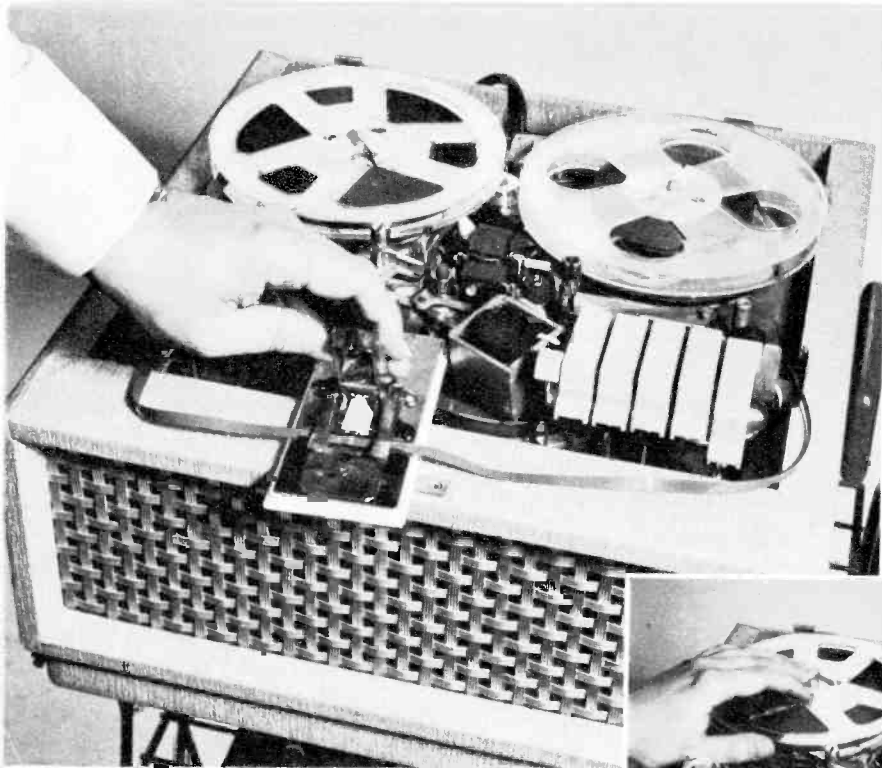

TAPE is cut exactly on pencil marks. Here the short section between faintly-seen marks will be deleted, requiring two cuts and a splice.

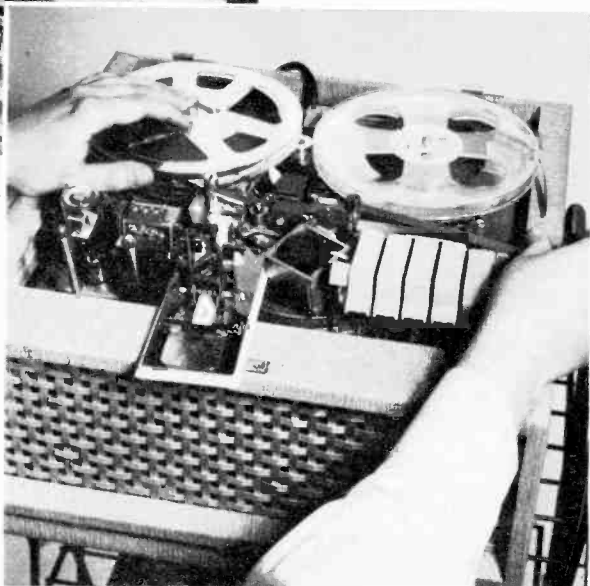

SHORTENING silent interval, run tape for as many seconds of silence as wanted. Halt tape, cut it. Pull from supply to next wanted section.

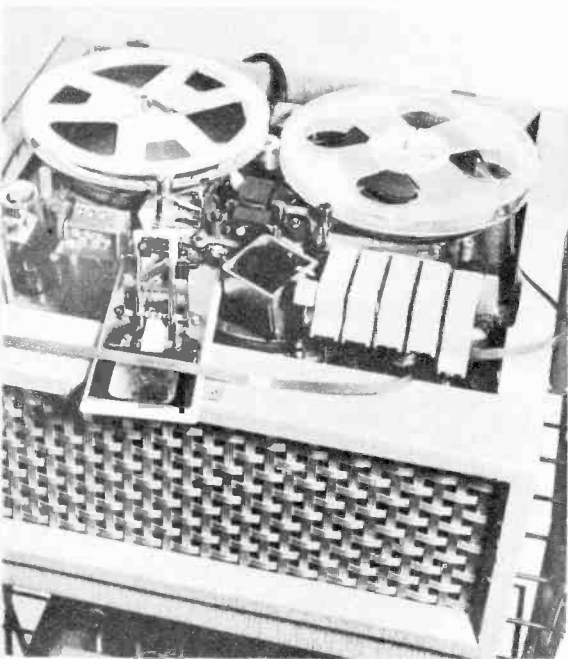

COMPLETED SPLICE is seen here. Deleted section should be held until check has been made. If mistake was made, deletion could be replaced.

speech. Suppose you have a tape of a child reciting a nursery rhyme, like this: "Mary had a little lamb, its fleece was Snow White and the—uh—oh, I forget—its—its—fleece was white as snow. And everywhere . . ."

It might very well be that you want that tape just as it is, because it's so cute. But let's assume you're a cold perfectionist, and as far as you're concerned those mistakes have to go.

The first thing to do is *analyze*, know in advance what you want to do. In this simple example the little reader went astray immediately after "was," and got back on the track on the word "fleece." Obviously, then, everything after "was" and before "fleece" must be cut out. But even this won't be sufficient, for we still have a repeat of the words "fleece was."

This is actually an advantage, however, for it means that we can cut at any convenient point in the "fleece was" area. Sibilants are particularly easy to spot on tape, and so we might decide to do our cutting right in the middle of a word. For example, the strong *s-s-s* sound at the end of "fleece" would be ideal. In that case we'd spot and mark the tape at *identical* points, just before the sibilant hiss at the end of "fleece."

After cutting, we would have from part one, "Mary had a little lamb its fleee . . ." And from part two we would have ". . . ce was white as snow. And everywhere . . ." Then when the two were spliced together, we'd have "Mary had a little lamb, its fleee/ce was white as snow. And everywhere . . ." But if the splicing is done correctly, it won't be discernible at all.

Although ticks and pops sound very big

to the ear, they actually last for only the briefest instant. When spotted on the tape, they are usually only a sixteenth-inch or so in length. It is important then that both the beginning and end of the noise be spotted and marked carefully.

Usually a short length of tape of this duration can be cut out and the tape spliced together without the splice being noticed. If the tempo of the music is very strict, however, the slight rushing of the beat may be detected by the sensitive musical ear.

Just how much tape is removed will depend not only upon the actual length of the noise modulation, but also upon the type of splice made. Some inexperienced editors argue that the diagonal splice is less likely to be heard than a right-angle one, but it can be demonstrated that this is not necessarily so.

In this case, where you are interested in deleting as little tape as possible, it is best to first try cutting the tape just as you have marked it, directly across its width. Only if this fails to do the job correctly should you try the more conventional diagonal splice.

Usually the angle of a diagonal splice is about 45 degrees, but some splicers permit cuts of anywhere between 30 and 90 degrees. Even smaller angles, sometimes just a few degrees, can be used for special effects. The 18-inch splice shown in the illustration was made with a straight-edge and a razor blade. Its purpose is to provide a montage or cross-fade effect between two sections of music. When one of the tape sections is blank, or leader, the effect will be a smooth fade-in or fade-out. •

EFFECTIVE for fade-outs, fade-ins, or cross-fades is the long splice seen here. Diagonals will be tightly joined and splicing tape placed over whole cut.

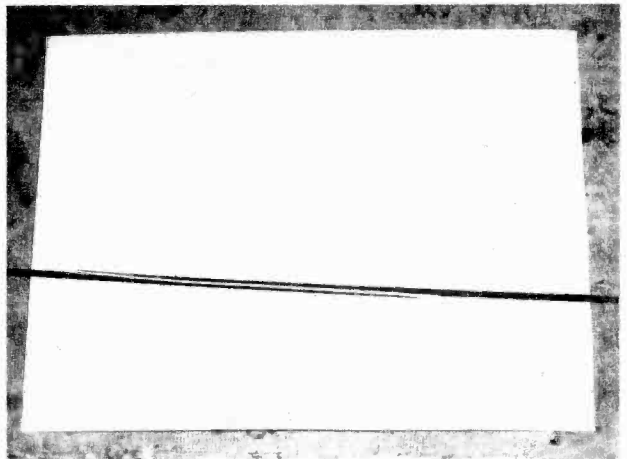

Make Your Own Sound Effects

Well-produced sound
will give your tapes
the true pro touch

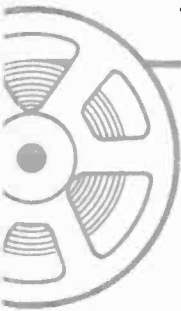

SOUND EFFECTS are the devices which complete the word-pictures on your recordings. They will give that professional touch to your tapes and set them apart and above everyday amateur efforts. A skit about Paul Revere's famous ride might be just another reading, but it will come *alive* when your listeners actually hear the hooves of the galloping horse, the wind rustling through the trees, the town clock tolling in the background, perhaps an occasional shot off in the distance, the sound of a hound baying the moon.

Many such sounds are now readily available on LP records, and in sound-effects record libraries which may be bought or leased. But the real fun and satisfaction comes in making (or faking) as many of them as you can yourself. Here's how.

Probably the most common sound needed for dramatic shows is just the opening and closing of a door. Professional sound-effects men take great pains to build this effect, but when they are all through they still have a real door in a real frame. Every home has several, but the trick is in using it correctly.

PROFESSIONAL sound effects men at NBC studios in New York City await earphoned cue to create the crash of a large tree toppling in a forest.

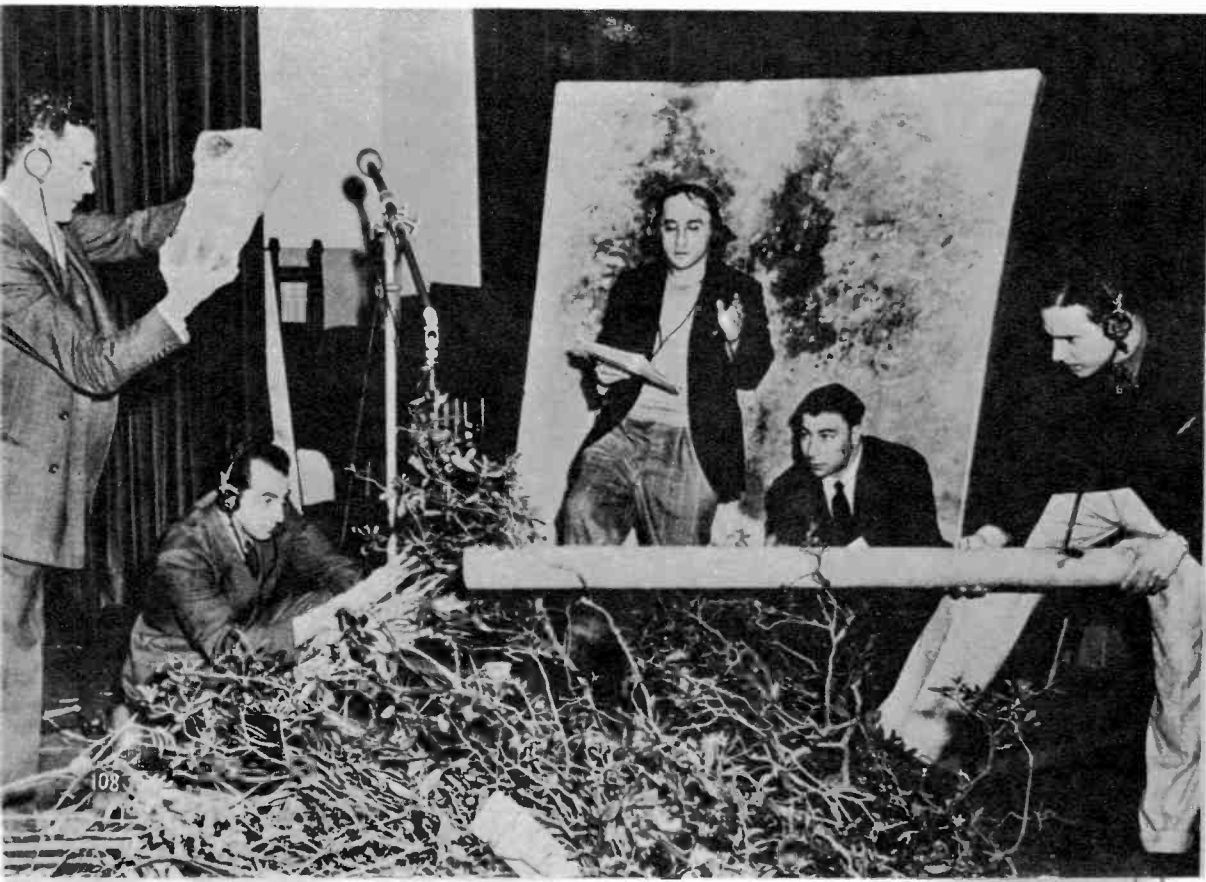



SOUND MEN like ABC's Bob Prescott often make use of recorded sound effects on a turntable.

The characteristic sound of a door opening or closing is in the latch and jamb, so the mike should be placed in this area. If the rooms are small, there will be a blast of air when the door is moved, so be sure to keep the mike out of the path of it or you'll get an effect you weren't looking for. And remember that it takes a while to walk through a door, so allow sufficient time for your audience to imagine this between the opening and closing.

A swinging door has a distinctive sound which comes from its spring hinges stopping it in the center of its arc. When a swinging door is released, it oscillates back and forth around this central point until it finally comes to rest. Once you have familiarized yourself with this sound, you can quite closely approximate it with an ordinary door.

Place the mike near one of the hinges this time. Then bat the door back and forth between the heels of each hand thumping against each side of it. The trick is to get the rhythm down pat so that the strokes

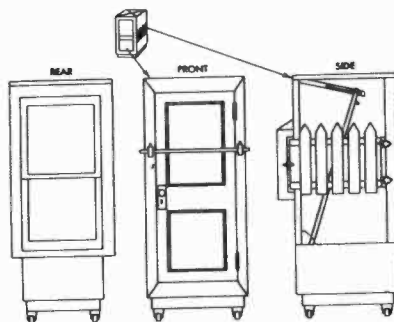

THIS GADGET is used to create the audible effects of certain doors, gates, hinges, bolts, latches.

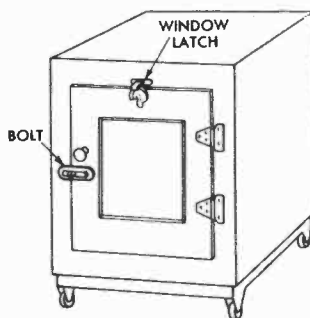

Drawings courtesy Audio Devices

INTERIOR cabinet sounds, including door, snap-lock, casters can be produced with this simple rig.

become ever shorter and faster until they finally stop dead.

There are many other everyday sounds which you can record live without artifice. These include such things as a drawer opening and closing, striking a match, writing with a pen, opening an envelope, and ice tinkling in a glass. These should not intrude on the telling of your story. Rather, the listener should be only half aware that he hears them.

Tape a Walk for Yourself

Unless your story is confined strictly to drawing-room conversation, you will have people going from place to place. And most of the time they will be going on foot. Hence you will need a wide variety of footsteps in your audio bag of tricks.

You will soon find that leather heels give a better effect than rubber ones. Actually walking on the floors or steps of your home will take care of most of the requirements for interior scenes. Usually the mike should be only a few feet above the

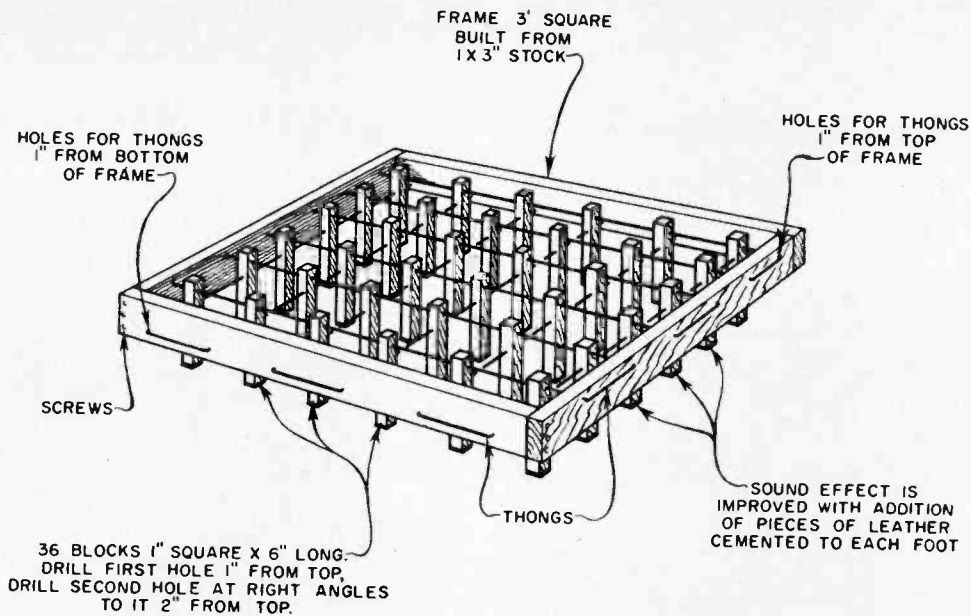

DRAMA ON TAPE often requires parade's cadenced beat. You can march the boys off to war, back again, down Fifth Avenue, or into their cells with this item which can be constructed easily.

floor. This means separate mikes for the dialogue and the effects.

The important thing to consider in the use of footsteps is the *viewpoint* of the listener. Do we hear someone walking into the scene or out of it? Are we walking along with the speakers? Or are we in a fixed position while we hear someone walking or running by? Each of these situations requires a different effect.

The continuous footsteps, indicating that the listener is strolling along with the players is one of the most difficult effects to produce. In the first place this almost certainly implies an exterior scene, with sidewalk or pavement underfoot. Since you probably haven't any concrete flooring around the place, this means you'll have to bring in a slab or flagstone for this effect. A tray about three feet square and six inches deep, lined with carpeting and half filled with stone, gravel or sand can be used for footsteps on those surfaces.

In any case the performer or sound effects man must mark time with his feet in this small area, while sounding like he is actually moving forward. This takes practice, but there are many radio and TV shows, and movies, too, which have proved that it can be done.

Footsteps in snow, mud or slush are done in miniature. It's easier on the shoes that way. For snow you need a small sack of cornstarch. The bag is best made of chamois skin, for the fine powder leaks

right through fabric and gets pretty messy. The little packet is bound at the top with a rubber band and held in both hands. Then it is alternately depressed with the thumbs in a walking rhythm. When the effect is held very close to the microphone, the result sounds highly realistic.

For footsteps in mud or slush, soak some crumpled newspaper in a large bowl or washtub. The consistency of the mud you want will determine the amount of water used. Then simulate the sound of walking, using the hands to squish on the wet paper. For slush, add the cornstarch bag, with one hand in the wet paper and one squeezing the bag. Don't discourage now. Remember you're doing this for art's sake.

For squeaky shoes, you can use either an old leather wallet or a piece of varnished paper such as is on some paper match books. Just twisting and squeezing the wallet close to the microphone will make a good leather squeak. Before using the match book, tear off the matches, staple and striking area. Then make a tight roll of the rectangular piece remaining. Squeeze it a little to flatten it, and then twist slowly. The sound is rather weak, so work close to the microphone.

For a group of marching men, you will need a gadget, which you can easily build yourself. The accompanying drawing shows how it is made, and you can easily put it together in an hour or less. To use it, just hold the frame at opposite corners

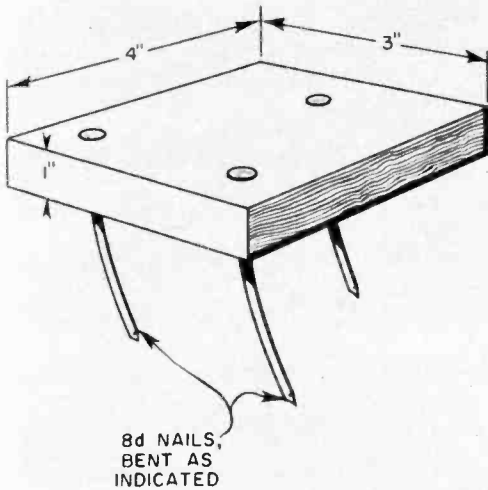

REALISTIC effects of skidding tires and train wheels are obtained from this box with nails.

and "pick 'em up and lay 'em down" in marching cadence. Let one corner strike slightly ahead of the other, so that your platoon isn't too perfectly in step. March them on a wooden table top or on a large piece of wallboard.

Squeals, Squeaks and Screeches

A little block of wood with three nails in it will provide the most beautiful auto or train skids you could ever want. As shown in the drawing, the nails should be in the form of a triangle and bent slightly in the direction of the apex.

Place the block with the points against a piece of glass, such as any handy window. Holding the block lightly against the glass, push it slowly in the direction of the apex of the triangle. You'll hear tire squeals so realistic you'll be looking for skid marks on the pavement.

You can get the same sound for a train by scraping your squeal block against a piece of slightly rough, unpainted metal, such as a garden spade. By changing the thickness of the wood, size of the nails, and size and thickness of the glass or metal, you can amass an entire catalog of eerie screeches.

Now from squeals we go to squeaks, which sound a little different and are created a little differently. The details of the gimmick are shown in the drawing. You can get some rosin to intensify the effect from any drug or music store. With

the proper manipulation of this gadget you can simulate squeaky doors, rusty hinges, or the creaking of a four-master before the wind.

Answering a telephone or replacing the receiver on the hook is easy. Any phone in your house will work for that. But a telephone seldom rings on cue, so you'll have to build your own ringing device. This also has a number of other uses, as we shall see.

The arrangement shown in the accompanying drawing has two bells mounted side by side, so that one clapper strikes only one gong, while the other clapper hits both. The effect is enhanced if the gongs are of slightly different sizes.

In addition to the obvious bell effects from this combination, it also has other possibilities. If you set the edge of a glass or a metal pan over the gong so that the clapper strikes the new item instead, almost any kind of vibrating sound is possible, depending upon what is placed in the path of the striker.

And speaking of strikers, you can imitate one of the deadliest of all, the dreaded rattlesnake. In this case you remove the gong from the single bell. Then attach to it a small bag formed from a piece of cellophane or tissue paper into which you have poured about a half-teaspoon of rice or BB shot. When you press the button and the clapper shakes that bag, you are assured of giving a case of the shivers to every member of your audience.

But in cartoon land all members of the animal world are friendly, even funny. And for their comic cavortings there has been devised a series of truly funny sounds never before heard by any of the little beasties, or by man either, for that matter. One of the funniest of these sounds is the "twang" or "boing."

A lot of these sounds are made with the old-fashioned jew's-harp, but that musical(?) instrument is rapidly vanishing from the American scene. It has even been deleted from the Sears Roebuck catalog. The other method for getting similar effects is the twang box, which you build yourself.

You begin with any old stringed instrument, such as a guitar, banjo or violin. If you haven't an old plunker to spare, any hobby book will tell you how to build one from cigar boxes or orange crates. Everything about the instrument remains as is except the finger board and strings.

The finger board is removed and replaced with a thin, supple slat, such as a piece of wide molding. Then the head

is attached to the slat, or at least enough of it so that one tuning key is operative. Then the "instrument" is strung in the usual fashion, but with only one string made of No. 8 piano wire. It is available in most hardware and music shops.

Now when the string is plucked, many weird sounds can be produced by varying the tension on the string rather rapidly. This is done by bending the new flexible finger board. The twang box can also be bowed. A violin bow can be used, but it's rather expensive, and the bow from a toy bow-and-arrow set will squawk just as lustily. Just make sure it has plenty of rosin on it.

Aquatic Effects

Water sounds are always an important dramatic element, especially rain on the roof. This can be imitated easily with a large salt shaker and a sheet of tissue paper. The salt is shaken or poured onto the paper, which is held at a downward angle, while the mike is placed very close to the underside of the paper. This arrangement can simulate anything from a gentle drizzle to a driving rainstorm, depending only on how fast the salt is poured and how steep the angle of the tissue-paper "roof."

Any seaside sequence must have the rolling surf pounding in the background, and this is quickly produced with just a round or oval hatbox and a couple of tablespoons of rice or BB shot. You simply dump the rice in the box and then slowly tilt the box back and forth. In this one the rhythm of the sea is the entire key. If you have that sound fixed in your mind's

SQUEAKS of varied types can be produced with this box and the help of some ordinary rosin.

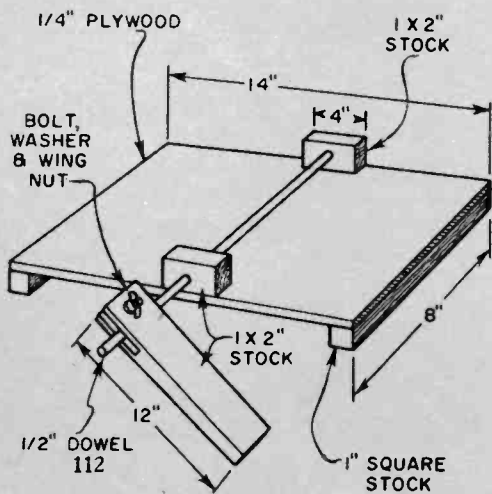

eye, some careful practice with your surf box will enable you to duplicate it with great accuracy.

One of the easiest ways of making the friendly gurgle of a little brook is the way Shep Fields used to create his "Rippling Rhythm" effect. Simply fill a water tumbler, or better yet a fish bowl, and blow into it with a couple of soda straws. This takes some practice, and you will find that the pressure can't be too high for a truly bucolic effect.

The best way to get a waterfall effect is to make one in miniature. Set up a few rows of bricks, staggered for a rough surface, and let water from a garden hose run off the top of them. Put some stones at the bottom so that the water splashes irregularly. Work the mike very close to the bottom of the falls and record at the highest possible level. This one is even more effective when the recorder is played back at half speed.

There are a couple of ways to get the sound of boiling water. One is simply to turn the kettle on and boil water. The other is a variation on the brook effect. By blowing a little harder on the straws, and letting some air escape from the side of your mouth for the steam effect, you'll be all ready for tea time. But if you need the effect for longer than a single breath, maybe you'd just better boil that water after all.

Now let's find some colder water and go for a swim. For a variety of water effects you'll find a large wash tub useful. You should line it with canvas or an old blanket before pouring water into it, as water splashing on metal has an unnatural sound.

DOORBELLS, phone, riveting machine, even a snake's rattle can be had from this. (See text.)

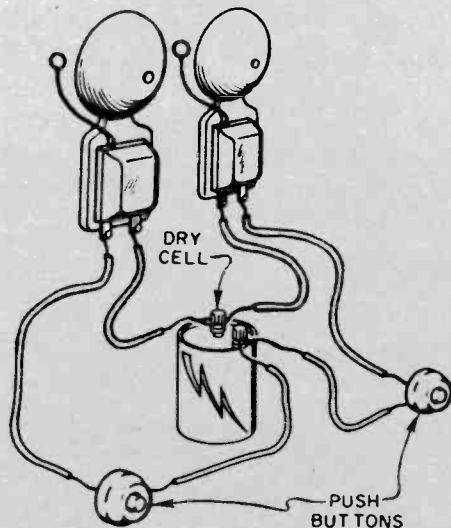



ABC SOUND MAN tensely awaits proper moment to produce. From the manually-operated tub-and-paddle device he gets any of several aquatic effects. Rig is standard equipment with major networks.

"Last one in is a nanny goat!" So take off your clothes, hold your nose and jump in feet first. Well, not exactly. In fact, we make the sound of diving in to water by pulling a bucket out of water.

The bucket is a toy one; even a large tin can will do. Submerge it in the tub and hold it upside down beneath the surface of the water. On the cue for the dive, very sharply pull the inverted bucket up out of the water. The effect will vary with the size of the can or bucket, but it is always quite realistic.

For swimming or general water sport, you just splash your hands around in the tub. Professionals often build a paddle wheel which can be rotated in the water. This multiplies the variety of effects, including, of course, a Mississippi steamer.

Another liquid effect, useful for both drama and comedy, is the milking of a cow. For this you need a seltzer bottle and a bucket or large pan. The seltzer water is just shot into the pail in a series of short squirts. If the sound is to be heard from the opening of the sequence, then of

course the bucket must be empty to begin with.

If the listener enters on the scene after milking has progressed a while, then there should be some water in the bottom of the pail. In this case, since water doesn't have the same consistency as milk, it has to be treated to make it "milkier." This is done by adding a couple of tablespoons of a mild detergent.

Charles Addams, Anyone?

The blood-and-gore sounds are always fun. Knifings, clubbings, fist fights, falling bodies—they're all here in a sort of do-it-yourself juvenile-delinquency kit.

First, let's have a nice clean knife job. Now for a job like this you've got to have a knife. And to hear that ripping of tender flesh you sink it into a head—of cabbage. But for heaven's sake be careful with that knife. After all, this is supposed to be a bloodless murder, you know. The sound is rather weak, alas, so work the mike in close. And for the final touch, be sure to embellish the effect with a good blood-curdling scream.

But perhaps you'd prefer to put your victim to rest by walking him into a booby trap such as Fibber McGee's closet. In this case, get your wash tub out again, without the water this time. Fill it up with any old metal junk you can find down in the basement or out in the garage. Tin cans, wrenches, short lengths of pipe, tire irons, brake drums, bottle caps, bed

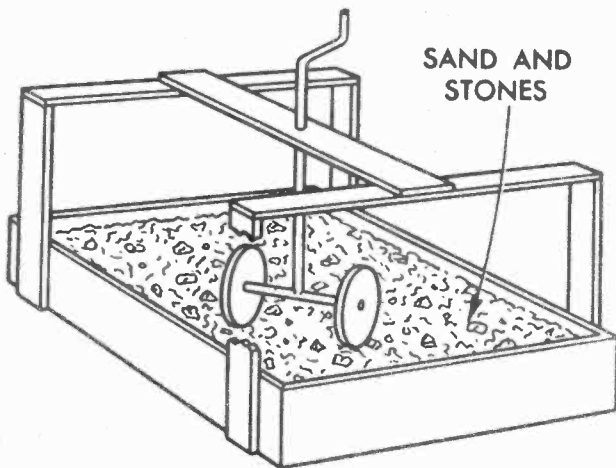
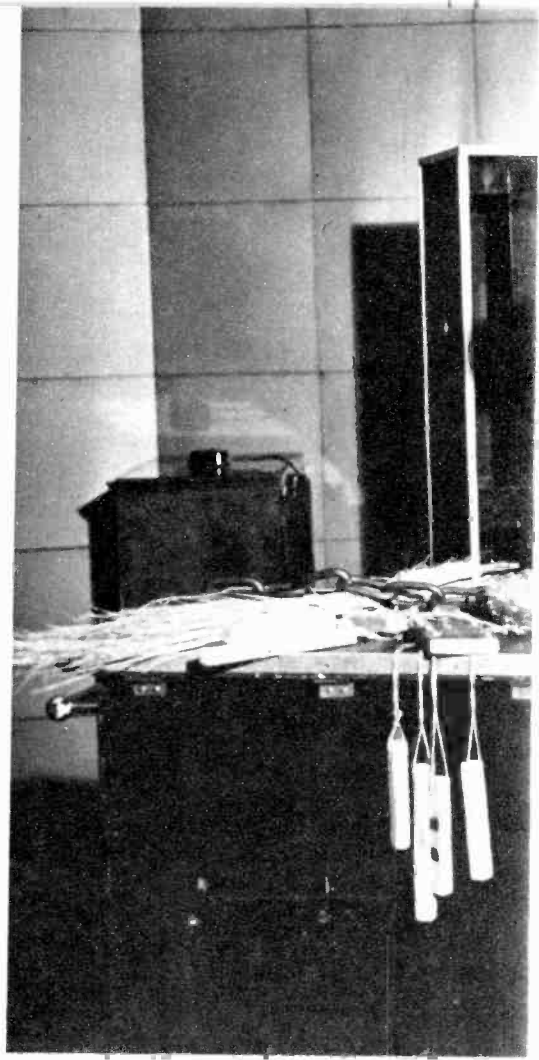

PROFESSIONALS go to great lengths for the proper effects, as evident in this NBC photograph. But you can get good effects simply, economically.

EXCELLENT sound effects of wagon or carriage wheels on a rough road can be obtained with the simple rig shown at left, filled as indicated.

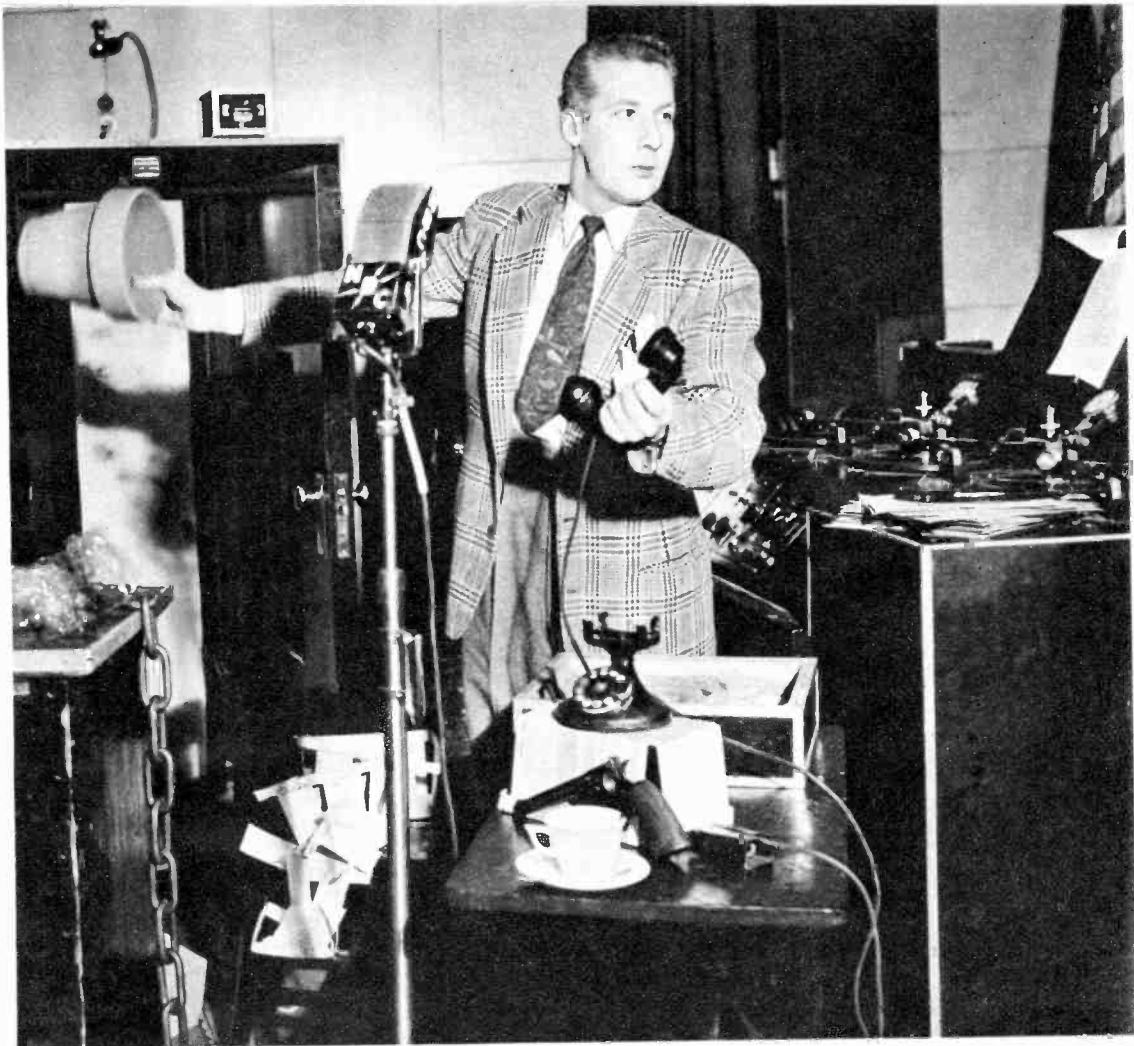

springs—anything you can find will contribute to an effective crash.

Begin by holding the tub up and shaking it violently. Then at just the right dramatic moment, turn it over and dump it, preferably on a concrete floor. Since this effect is a little less subtle than the previous one, the acting should be played down a little. Confine your actor to an understated expression of surprise and terror, such as a lower-case “oops!”

If your hero must run through a door which turns out to be closed, or is hanged from a yardarm which conveniently snaps off, or walks the plank which has been sawed almost in two, you'll need the nice crisp sound of splintering wood.

Berry boxes work fine for this. So do orange crates or strips of plywood. Just let your imagination go. You can even ram your fist through a berry box with hardly any danger at all. Well, if such

violence is your fate, you're certainly not afraid of a few slivers in your knuckles.

Gunshots are usually best produced by guns, provided the room is large enough. A small room will saturate quickly, however, and the crack of a pistol will sound more like a cannon's roar. If blank cartridges are too loud for your studio, then try a cap pistol.

If that's still too much, then the sound will have to be faked. This is done with a ruler, yard stick or flat curtain rod, which is slapped smartly against a cardboard carton. The effect is quite realistic, provided the rush of air preceding the slap isn't heard. This will depend upon the proper mike placement.

A roaring fist fight can be done with one person, although it's more effective with two or more. The technique is simply to hold a rubber sponge in one hand and smack it with the other fist. Of course the

accompanying vocal effects should include the huffing, puffing, grunts and groans.

Another handy way to eliminate friend villain from the picture is to give him a good clobbering. Your club should be a hammer or mallet, or, better, a toy baseball bat. Standing in for your victim should be a cantaloupe, either green or ripe, depending upon the hardness of his head. Or, if he's a big slob, use a watermelon. Then just do what comes naturally. Take that poor fruit and beat it to death.

Whatever method you use for disposing of Fogarty, his body is going to hit the deck with a resounding thud sooner or later. If you happen to be a burlesque comic, take a pratfall and record it. If not, save your sacrum and use your arms instead.

Sit down at a table with your arms up-raised vertically. Let the elbows land on the table first, and then let the arms swing down and fall askew on the table top. These thumps should be separated by a fraction of a second. Here again timing is most important, but after some practice you'll be able to close your eyes and see some ornery critter bite the dust every time.

Miscellaneous Effects

Every now and then, just for a little extra excitement, it's interesting to heave a brick—or maybe even your antagonist—through a plate glass window. The sound of crashing glass can be made only by crashing glass itself.

Most any glazier will be glad to give you all the scrap glass you want. He is no doubt loaded down with a pile of broken

sections which he'll only have to pay to have hauled away. If not, however, you can buy small sections, about 8x12 inches, which are entirely adequate. These are quite cheap, incidentally, when purchased in quantities.

You're working with the real thing now, not some artifice, so exercise extreme caution. Lay the glass on top of a waste basket or box which in turn is in the wash tub. Wear sun glasses or goggles, and gloves as well, and have everyone stand clear, especially children.

Strike the glass with a mallet or hammer, but use as little force as possible, so the pieces won't fly. For a more exciting effect, use two pieces. Strike the larger one first, and then while the pieces are still falling, break the second one.

The best thunder effect is made with the apparatus shown in the drawing, but there is another method which is much simpler. For this you need a basketball bladder or inflatable rubber ball, and a half-teaspoon of BB shot. The shot is poured through the stem, into the bladder, which is then inflated until the rubber is quite taut.

With the stem made airtight, the bladder is held very much as a basketball player would in lining up for a free shot. Then the wrists are snapped sharply upward, so that the shot is thrown up and then falls to the bottom. For the rumbling between thunderclaps, rock the shot around in the bottom of the ball. Amplification of the sound is very important here, for it is quite weak and the mike must be used close in.

Fire sounds are made in a number of

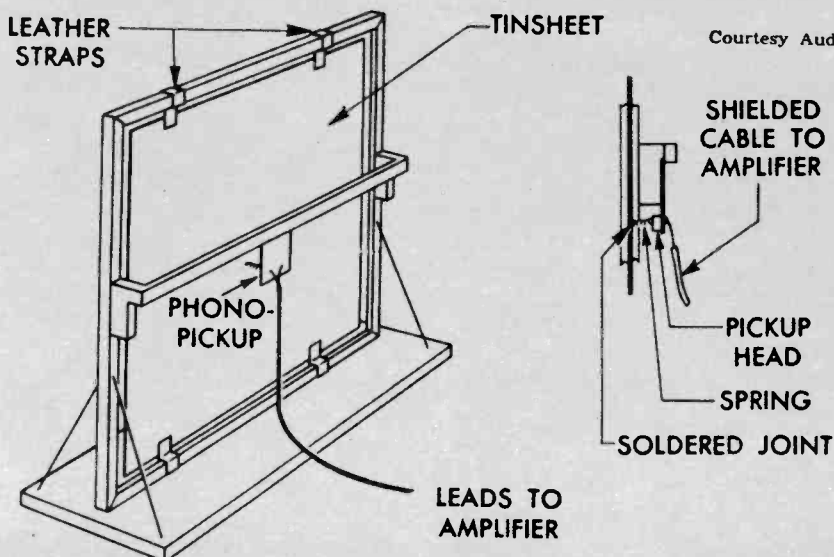



THUNDER is acquired for tape recordings by rigging a tin sheet with phono pickup, as at left.

BEATER, metal sheet, gun and blanks produce thunder and gunfire for NBC studio productions.

ways. For a cheery campfire or the crackle of logs in the fireplace, just crumple the cellophane off a pack of cigarettes. Knead it in the hands very close to the mike.

For a larger fire, go to a model supply store and get about a dozen bamboo strips, about $\frac{1}{4}$ -inch square and a foot long. Bundle them up, securing them in the middle with one rubber band. Hold one end of the bundle in each hand, and twist to make it snap and crackle. At the same time, try to manipulate a piece of cellophane as used for the smaller fire.

For an even larger fire, use the same technique with a berry box. Twist and crack it, and it will sound like a large building being consumed by flames. A real

holocaust, such as a forest fire, can be well simulated by frying bacon. The effect is enhanced by recording at one speed, say $7\frac{1}{2}$ i.p.s., and then playing back an octave lower at $3\frac{3}{4}$ i.p.s.

A slight variation of this technique yields a realistic imitation of Old Faithful or Vesuvius. In this case the original noise-maker is a bubbling coffee percolator. When this is played back at slow speed, your audience will run for the hills to avoid the steam on molten lava.

These are just a few of the many, many ideas concocted by professional sound effects men to fool the ear. You can duplicate nearly all of them with materials found right around home. •

Caring for Your Tapes

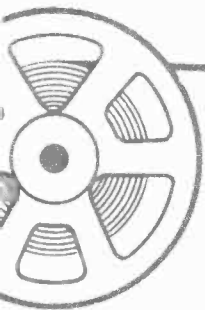

Learn these principles, follow these rules, and your precious tapes will have long, long lives

All photos by Grayson Tewksbury

THE POET may have been exaggerating just a little bit when he said "What I preserve can perish never"; but the life of your tapes and the recordings on them will be extended tremendously through just a few simple precautions. No one knows yet just how long a tape recording will last, but most of its ills are well known, and they include the following:

1. Induced noise
2. Accidental erasure
3. Print-through
4. Changing dynamic range
5. Inability to erase
6. Stretching or shrinking
7. Embrittling
8. Sticking
9. Shedding

The first two problems are due to the same cause, namely, a strong magnetic field in the vicinity of the tape. Permanent magnets and strong electromagnets will very likely cause noise and/or partial erasure if they come within a few inches of the tape. Under controlled conditions, as with the proper use of a bulk eraser, this effect is desirable. As we have already seen, a good eraser can demagnetize even the most stubborn recorded tapes, and can lower the inherent noise level by several db.

But under random conditions, quite the opposite is true. Generally, the fields necessary to produce erasure are so intense that the problem can readily be foreseen and avoided. Erasure doesn't usually occur unless the field is strong enough to exert a noticeable attraction for the tape, or to set it into vibration.

It would seem on the surface that accidental erasure would be easy to avoid, but there have been too many documented cases of tapes ending up in the cargo hold of a ship adjacent to the electric generator, or on an airplane near the radio transmitter, or in an office where there was a transformer vault directly downstairs.

So many things can happen that it is wise to take extraordinary precautions where important tapes are concerned. Never let any magnetic or current-carrying devices get near the tape, nor even an AC extension cord. If stray magnetic fields are known to be in the vicinity, or if they might be encountered when a tape is shipped, pack it in an aluminum film can, which will provide a measure of magnetic shielding.

The problem of layer-to-layer signal transfer or print-through was discussed briefly in an earlier chapter. One obvious way of minimizing it is through the use of the new low-print type tapes. Other means include keeping the recording level, temperature and humidity within limits.

There is another little trick which, once it is learned, is easy to use and will reduce the effects of printing somewhat. All American tape is wound on the reel with the oxide (dull side) in toward the hub, and all American machines are designed to handle tape wound this way with a counterclockwise payout and takeup.

It may be recalled, however, that the first German machines used an oxide-out wind. One of the advantages of this is that the preprint is a little lower in level than the after-print. This is desirable, since the after-print is normally masked by the reverberation of the sound which caused it, while the pre-print is likely to come at a relatively quiet section of the tape.

The reason the pre-print is stronger on oxide-in tape and the after-print is stronger on oxide-out tape is the fact that in each case the magnetizing signal must pass only through the tape base to get to the outer surface of the adjacent layer. The weaker printing, on the other hand, is due to the fact that the magnetizing signal must pass through the base plus the thickness of the coating.

It is possible to get this print-through

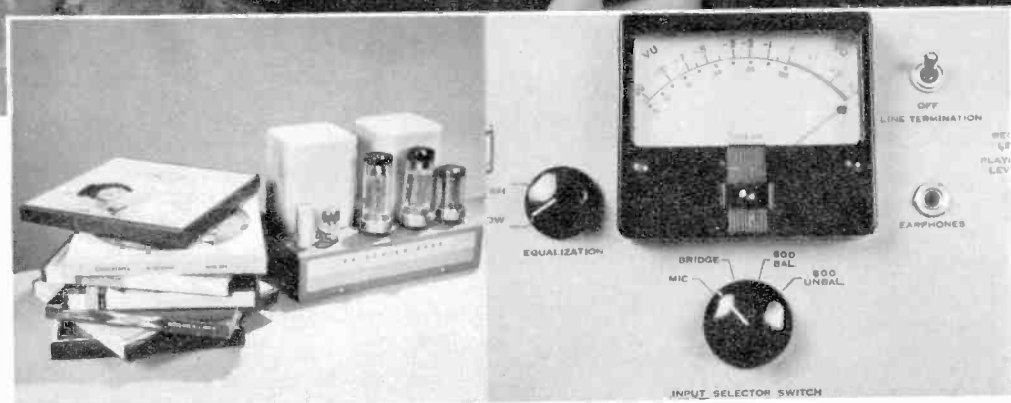

DON'T LEAVE your tapes in the bright sunlight of a window sill, or in other undue heat. Don't expose them to the magnetic field of a hi-fi amplifier, or even to that of an AC extension cord. Don't overload in recording. If it should happen, store the tape in moderate warmth after you have erased it.

advantage by using oxide-out winds on American machines. Here's how you do it. When a new tape is put on the machine, thread it up in the usual manner, except after the tape has cleared the capstan and right-hand guide, give it a half-twist so that it winds on the takeup reel oxide-out.

If the tape is to be rewound, do so in the usual manner, that is without further twisting. It will now be on the supply reel wound oxide-out. In subsequent playings, take a half-twist in the tape as soon as it leaves the supply reel. It will then pass with the oxide against the guides, heads and drive in the usual fashion. Then after it clears all these points, take another half-twist as before and wind up once again on the takeup side oxide-out.

Since the print-through path is important in determining its level, it is obvious that tape thickness is a factor. Print-through is relatively 4 db higher on 1-mil tape than on 1.5-mil, and decreasing the thickness to 0.5 mil increases the print-through 4 db again. The standard thickness tape is therefore much to be preferred for best signal-to-print-through performance.

When tape was first introduced, it was popularly supposed that any magnetic recording would in time lose its magnetism. There is no evidence to support this view,

however, and modern theory has it that the magnetic retentivity of recording tape is nearly infinite unless it is altered by magnetic means.

Still there have been observed some rather mysterious time effects. Volume peaks have been known to drop in level slightly, while the softer passages have been unaffected. The result is a distortion of the dynamic range. At the same time, the remainder of these peaks becomes increasingly harder to erase with the passage of time.

A loud note, which may be easily erased immediately after recording, may two or three months later require several times as much erase current to obliterate it. In fact, it may even be necessary to use an external bulk eraser to get it all. Even so, it may return during the excitation of a subsequent recording.

Heat has the effect of accelerating and accentuating this condition. Thus a roll stored for a few hours will exhibit the same effects as a roll stored for months at ordinary room temperature.

Conversely, a tape which is overloaded and difficult to demagnetize will tend to lose its "memory" faster if it is erased and then stored in a warm place. From these observations concerning print-through and erasure we can draw some conclusions concerning the handling of

OXIDE-OUT winding of tape cuts down print-through. Wind oxide-out with half twist on take-up side in recording, on both in playing back.

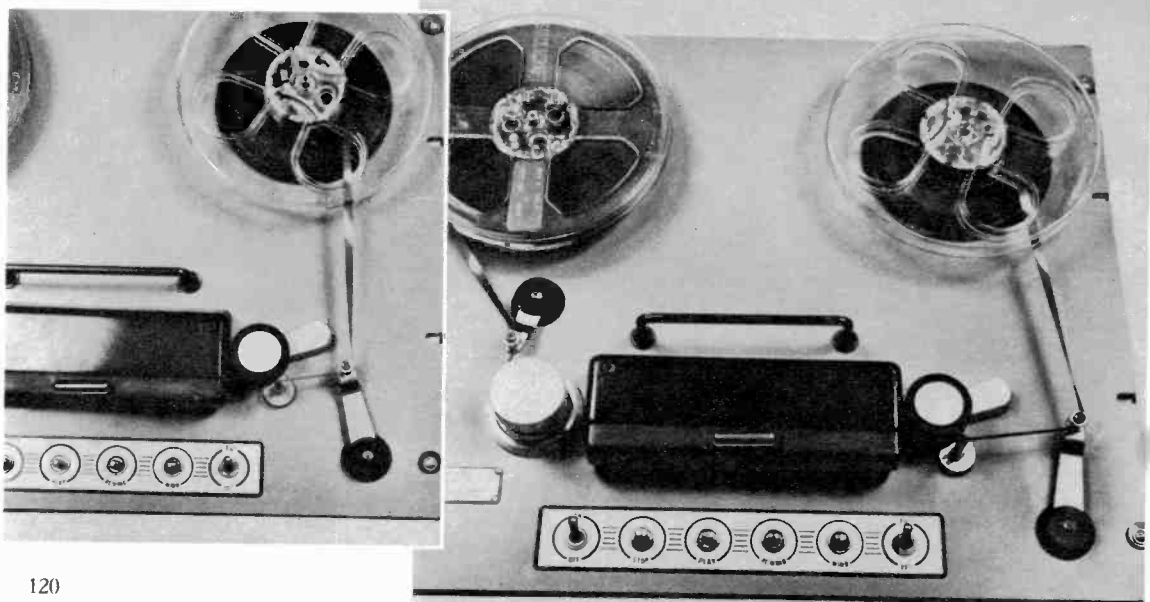

tape for long life and consistent service.

1. Use 1½-mil base
2. Use low-print oxide
3. Use oxide-out wind
4. Don't exceed recommended recording levels
5. Store recorded tapes in cool place
6. When a recording is no longer needed, erase the tape before storage
7. If a tape has been badly overloaded, store in a warm place after erasure

We have already seen that the ability of a given tape to withstand stretching or tearing is directly related to its thickness. Thus the thickest available tape, 1½-mil, is the toughest. It is also known that polyester base in any thickness is tougher than its counterpart in acetate.

Humidity will have a considerable effect on acetate, while affecting polyester hardly at all. High humidity will plasticize or soften acetate, while low humidity will make it brittle. Thus any storage method which involves the use of a desiccant or drying agent, such as silica gel or blotting paper, will have quite the opposite of the desired effect.

High temperatures will have several ill effects. First, heat will tend to soften the base, whether acetate or polyester. The coating will also soften, and there may be considerable friction developed if it is required to move past other plastic materials.

High temperature coupled with high humidity may cause adhesion between layers of tape. Extremely low temperatures, on the other hand, may loosen the bond between base and coating and allow them to separate.

Now in addition to the suggestions already given, we can offer the following rules for long-term storage:

1. Store reels in a container of some sort, to avoid dust contamination and physical damage
2. Use polyester base
3. Store at a relative humidity of 40-60%. If there are large humidity variations, store in sealed metal cans. Do *not* use a desiccant or humidifying agent
4. Store at a temperature of 60-70° F. If there are extreme temperature variations, allow the tape to return to room temperature before running on a machine
5. Tape should not be tightly wound on the reel, nor should it be rewound before storage
6. Occasional playing of the tape will flex it and improve its storage characteristics
7. Cleaning is not normally necessary, but if there is excessive dust, it can be removed by a gentle wiping with a dry cloth during rewinding. •

STORE your tapes in sealed metal cans, particularly where there is varying humidity. Heat will soften tape base as well as coating, increase danger of stretching. Stretch is always less desirable than a clean break which can be repaired. Clean excessive dust from tapes with a soft cloth during rewind.

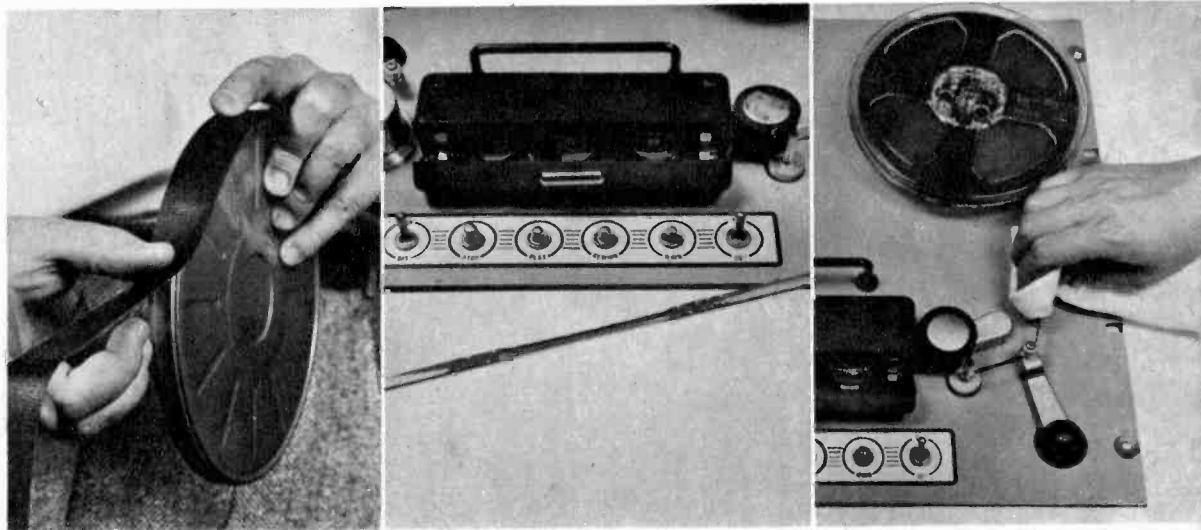

Recorder Maintenance

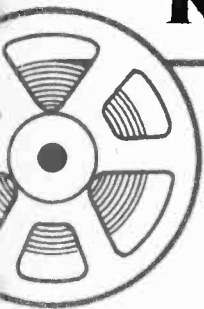

Give that fine machine the care it deserves and keep service costs to the minimum. Here's how

YOUR TAPE MACHINE is the most complex single piece of equipment anywhere in your hi-fi system. Any device, whether it be electronic, electrical or mechanical, requires some routine maintenance and is occasionally subject to trouble. The tape recorder is all three of these things at one and the same time, and therefore requires just that much more care.

One of the commonest complaints of careless tape recorder owners is that their machine has become old and tired, and just doesn't sound as good as it used to. In almost every instance the trouble with the machine can be traced back to preventive maintenance—or the lack of it. So first we'll discuss some of the procedures which should be followed on a regular schedule to keep your recorder in top condition.

RECORDERS are complex blends of the mechanical and electronic. Here the author explains tube complement of a fine Telectrosonic tape preamplifier.



Grayson Tewksbury
photo

Frequency Response and Distortion

To prevent deterioration in frequency response, and distortion, it is very important to keep the guides, capstan, idler wheel and heads free of contamination. As tape passes through the machine, minute quantities of dust, dirt, grease, oxide and binder are rubbed off and deposited on the parts of the machine over which the tape travels.

These deposits result in high-frequency losses, because they separate the tape from the head gap.

Even the thinnest layer of foreign material is enough to cause some loss in highs, and an accumulation can ultimately result in blocking out the highs altogether. On top of this, there can be changes in level which are wholly independent of frequency.

Since the tape is slit to its $\frac{1}{4}$ -inch width from wide jumbo rolls, there are always loose fragments of "sawdust" which readily adhere to the recorder parts. Some of this material is plastic base or binder, and therefore resinous and tacky. Some of it is iron oxide, magnetic and finely abrasive like jewelers' rouge. The combination gradually wears the metal laminates of the head, resulting in roughening and widening of the head gap. This, too, causes distortion.

The grease, oil and resinous components can also cause trouble at the capstan and idler wheel. Wow and flutter are often increased when these elements have become contaminated by materials deposited either by the tape or the fingers of the operator. There must be an absolutely firm, dry, non-slip contact at these points for proper tape motion.

All of these problems can be eliminated by the regular cleaning of the machine, to remove these contaminants before they cause trouble. We have already seen in a previous chapter that it is good practice to clean the tape itself with a soft cloth occasionally during rewind. It is also essential to keep the machine itself clean.

Much of the foreign matter is loose and can be readily removed by wiping with a soft cloth. The more stubborn accumulations must first be softened by a special solvent before they can be removed. It can be applied with a cotton swab or pipe cleaner, and should be wiped off as soon as it has done its job.

Since some of the head cleaning compounds have a bad effect on rubber, it is better to clean the idler wheel with alcohol or plain water. Never use a metal tool when cleaning the delicate parts of the recorder, as it may scratch the head pole

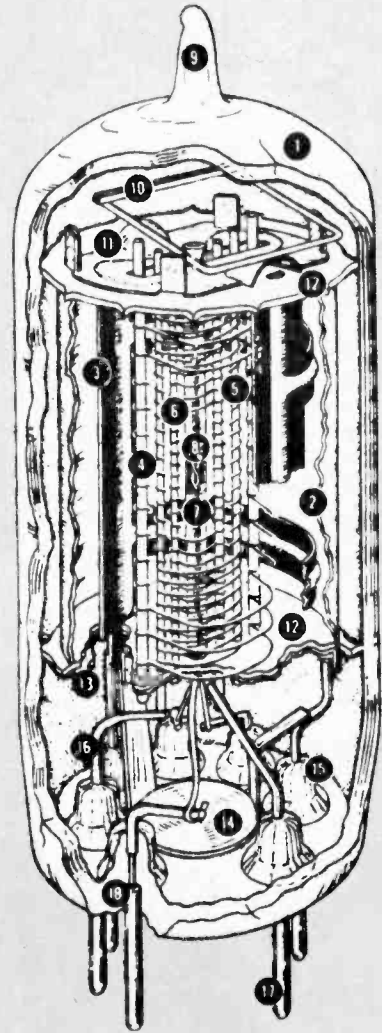

tube construction

CUTAWAY DRAWING by RCA shows internal construction details of typical "miniature" glass tube used in recorders' electronics. Sketch is two and one-half times actual size; component parts are as follows:

- | | |
|--------------------------------|--------------------------------|
| 1 Glass Envelope | 10 Getter |
| 2 Internal Shield | 11 SpacerShieldHeader |
| 3 Plate | 12 Insulating Spacer |
| 4 Grid No. 3 (Suppressor) | 13 Spacer Shield |
| 5 Grid No. 2 (Screen) | 14 Inter-Pin Shield |
| 6 Grid No. 1 (Control Grid) | 15 Glass Button-Stem Shield |
| 7 Cathode | 16 Lead Wire |
| 8 Heater | 17 Base Pin |
| 9 Exhaust Tip | 18 Glass-to-Metal Shield |

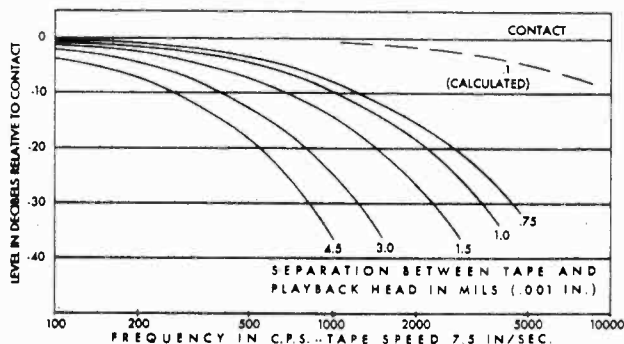
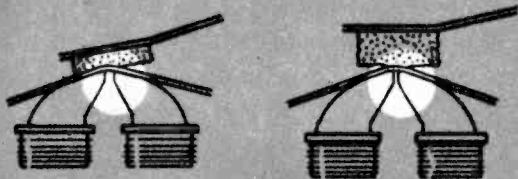

DRAWINGS above show gap depth of a new record-play head and that of a worn head, with increased wear on pressure pad; gap width of a new head and that of a badly worn head.

EMC Recordings

3-M Company

THE CURVES of the chart at left afford a graphic demonstration of the high-frequency losses encountered due to poor contact between magnetic tape and the record head.

pieces or roughen the rubber on the puck. This entire cleaning procedure should be followed after every 8 to 10 hours of running time.

While most professional recorders use high tension between the reels for good tape contact against the head, many amateur machines use lower tensions and have pressure pads holding the tape snugly in position. These pads are subject to wear and their springs may get out of adjustment.

The tension on the pressure pad springs can easily be adjusted with a screwdriver. The pressure on the tape should make for a good snug fit, but should not be so tight as to slow down the tape movement or cause undue abrasion against the head. If the pressure pad is worn too thin, it should be removed and a new one cemented in its place. If an exact replacement is not readily available, one can be cut from an old felt hat.

As the tape passes over the heads of the recorder, there is always some magnetic force attracting the tape coating to the heads. This attraction in effect frequency-modulates the tape. This may also be caused by the varying frictional forces the tape encounters as it passes over the heads and guides.

Whichever the cause, the result is that

the tape changes speed and sometimes even vibrates rapidly. The effect may be heard as wow, flutter, noise or squeal. The only cure is to minimize all of the frictions in the path of the tape.

One remedy is the use of a special silicone lubricant on all elements over which the tape passes. Another is the use of lubricated tape. Most of the better tapes today have a silicone lubricant included in their formulation. In some cases it may be necessary to ease off on the pad pressure just a little.

Other more serious causes can be maladjusted guides, worn heads, excessive tape tension or a sticking idler wheel. Most of these troubles can be corrected by slight adjustment or lubrication. Heads which have grooves worn in them, however, will have to be lapped smooth or even replaced if the wear has gone too far.

Head Alignment

Another common cause of trouble in tape recorders, which can result in serious frequency-response distortion, is maladjustment of the head azimuth. As we know, the key points in a tape recorder are the minute gaps between the poles on each of the heads. The standard setting for each of these vertical gaps is exactly at 90° to the edge of the tape.

SOME IDEA of the modern tape machine's complexity can be gained from this exploded view of a tape transport mechanism by Revere. This one has 126 parts. The need for periodic routine maintenance is evident.

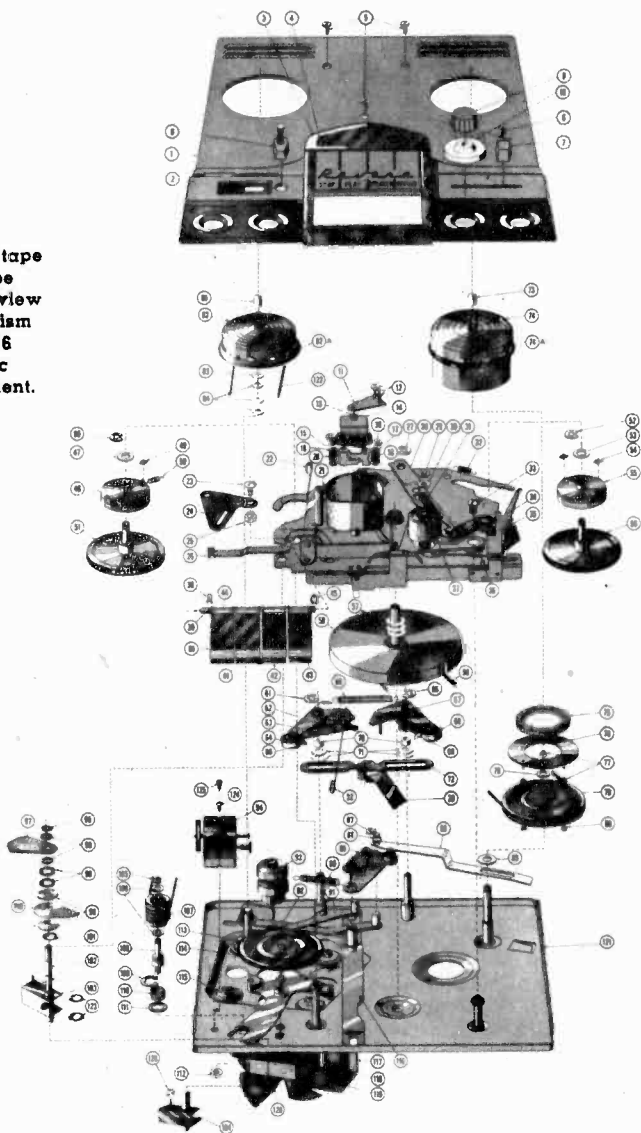

Azimuth alignment may not be important to you if your machine has a combination record-reproduce head, and if you never play any tapes other than those made on that same machine, and if the azimuth alignment hasn't slipped since you made some tapes which are still in your library of recordings.

But unless all three of these conditions prevail, then you should check and adjust the head gap alignment periodically. There is usually a single screw adjustment

on each head, and it is rather sensitive, for movement of only a small fraction of a degree can seriously affect the response.

To make this adjustment, you need a special azimuth tape and some sort of output indicator. Several alignment tapes are available, each of them containing simply a series of test tones recorded with a head which is known to have its gap at precisely right angles to the tape edge.

The output indicator can be any of those usually used for determining recording

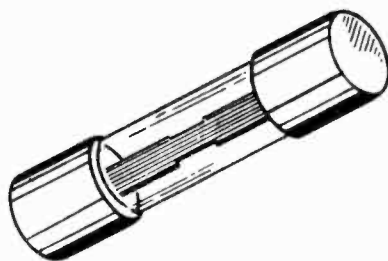
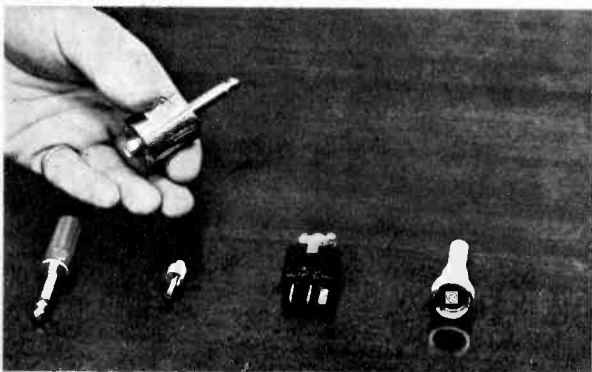

TYPICAL FUSE. If metal element is broken, the fuse must be replaced. Connectors commonly used are: phone plug, pin-to-phone adapter, pin plug, Jones plug, Amphenol screw-on in that order.

level, if they can be conveniently connected to the reproduce circuit of the system. Otherwise an external meter or other indicator is required. In a pinch your own ear will do a fairly good job, although you can't expect to get greater accuracy than within 1 to 3 db.

The procedure begins by playing the azimuth tape on the machine and adjusting the head for maximum output at the higher frequencies. The adjusting screw should then be locked in position by a lock nut or a drop of household cement. If the machine is of the two-head variety, that's all there is to it.

On three-head machines, the record head must be aligned as well. This requires some blank tape and a source of high-frequency tone, such as a test record, an oscillator, or a frequency tape played on a second machine. This tone is recorded on tape on the machine undergoing alignment. The output is observed as played back through the previously aligned reproduce head, and the record head adjusted for maximum output. Alignment of both heads is now complete.

Some tape machines have automatic head demagnetization. If yours doesn't, it is wise to demagnetize them manually at frequent intervals, before the accumulation becomes great enough to induce noise into important tapes.

Several powerful electromagnets are available for head demagnetization, all working on the same principle. The demagnetizer is held close to the head, thereby inducing a strong magnetic field into it. Then, with the power still on the demagnetizer, it is *slowly* drawn away from the head until, at some distance away the power is disconnected. Slow removal from the head is essential, for it is the

gradual diminution of the magnetic field which permits it to be reduced to zero in the head, with no residual magnetism.

Tape Speed

Since the speed of the tape machine is ultimately controlled by the power line frequency, which is highly reliable, it should be right on the nose unless there is some mechanical fault within the machine. Speed can be checked either with a strobotape, which works on the same stroboscopic principle as the phono strobodisc, or with a measured length of tape.

Test tapes have a precisely timed tone run and, when played on the recorder, are timed with a stop watch or at least one with a sweep second hand. Speed variation is often due to maladjustment, of the pressure pads, insufficient lubrication, or sticking guides.

There is also a wow-and-flutter test signal on this tape, by which it is quite easy to detect the variations, and even to count them, as they are usually cyclical. Then it is often possible to localize the trouble just by observing the moving parts on top of the machine. If the wow occurs once every revolution of the idler wheel, for example, it is almost certain that you will find a grease spot, a flat, or some other imperfection at one point on its surface. You would then clean, lubricate, or replace the offending part as indicated.

Often there is binding against one edge of the tape at some point in its travel. If this occurs on just part of the revolution of a reel, the reel is probably warped and should be straightened or retired from service. If it occurs consistently against one reel edge or the edge of a guide, then some adjustment is necessary.

Some means will usually be found for



TUBE CHECKERS, conveniently located at the corner drugstore, simplify maintenance, eliminate the need for purchasing your own costly test equipment. This one is at the obliging Jomar Chemists, Flushing, N. Y.

adjusting the height of the reel platform. Often this will be a set screw on the center shaft. The adjustment simply involves loosening the screw and positioning the platform so that the tape moves freely between the reel flanges, without binding at either top or bottom. The guides may be positioned in similar fashion.

Tube Tests and Lubrication

So much for the work topside. Now let's go below decks. Here on the electronics chassis we find the elements which are usually the first to cause trouble in any electronic gear. Those are the tubes. To forestall trouble at an embarrassing moment, the tubes should be checked periodically. Every 250 hours of use is a reasonable period, unless before that time there is a change of quality or an unusually high setting of the volume control is necessary. A tube checker should be high on the want list of any electronics hobbyist, but if you don't have one, there is surely a drug or variety store nearby which has one as a promotion device for selling TV tubes.

Although all recorders are carefully lubricated before they leave the factory, no lubrication is permanent, and it must therefore be replenished from time to time. A recorder in heavy-duty service should probably be lubricated once every three months, one in moderately heavy service every six months, and one in light service

about once a year. On an hourly basis, lubrication should be done after every 500 to 1,000 hours.

The first basic rule is not to overlubricate. Oil must be kept off all idlers, belts, drive wheels, clutches, and off any parts that might transfer oil to them. Excess lubricant should always be wiped from parts that have been lubricated.

The second basic rule is to use the right lubricant for the right part. Generally, oil is used on continuously rotating mechanisms and grease is used on sliding parts. The oil recommended by most recorder manufacturers is light and clear, usually of about No. 10 viscosity. The grease is a light machine or fiber grease.

Oil points will vary from one machine to another, and you should get a service manual for yours to be certain, but the points usually specified include motor bearings, flywheel bearings, pressure roller bearings, idler and capstan bearings, and reel spindle bearings. One drop of oil at each point is usually the standard specification.

Most oil cans are a little too generous for light machine work, but any of them can be converted to a one-drop type quite easily. Simply seal up the hole on the end of the spout with a little nail polish or household cement. When it has set, punch a new and smaller hole to the size you need with a pin or needle.

Grease points vary even more widely, but in general any remaining places where

clean, lubricate and adjust your recorder regularly by following these simple steps

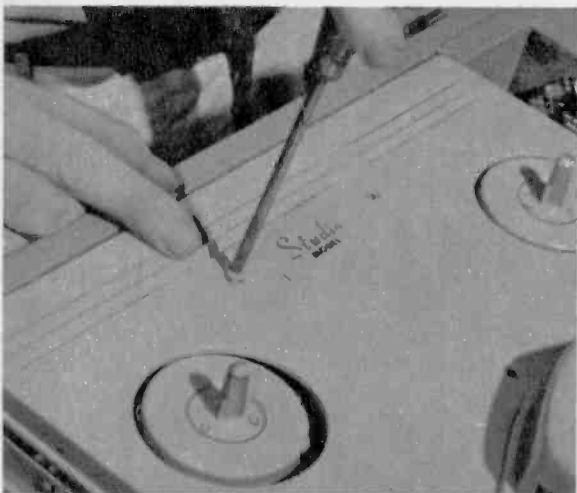

FIRST STEP is to remove cover plate, if heads, capstan and pressure pads are enclosed by it.

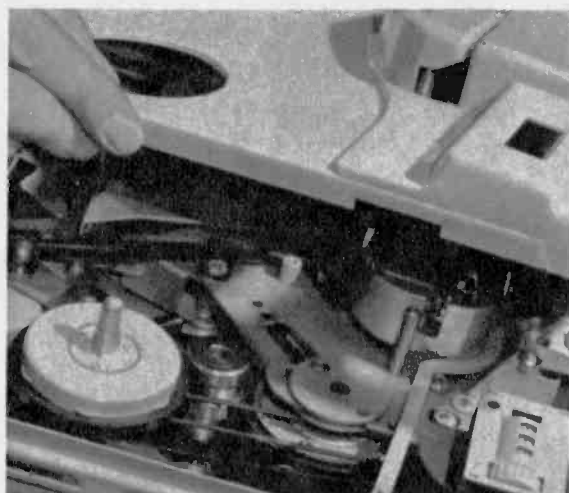

THIS IS accomplished by simply removing knobs and screws and lifting off the plate as shown.

Photos courtesy of 3-M Co.

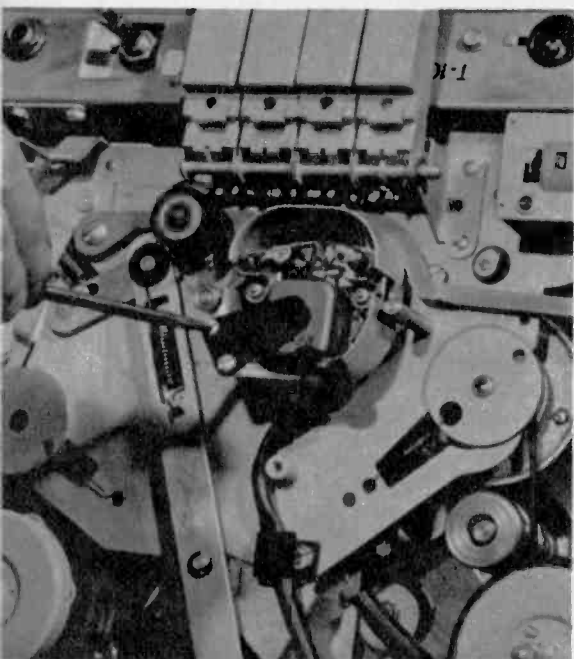

IF NECESSARY for access, remove flat spring that holds head in place. Note condition of pressure pad.

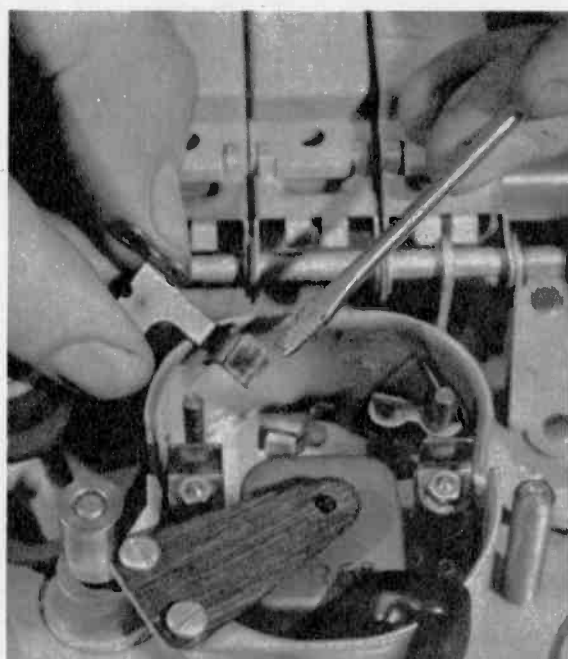

WORN PAD changes tape speed, causes distortion of sound by holding tape unevenly against head.

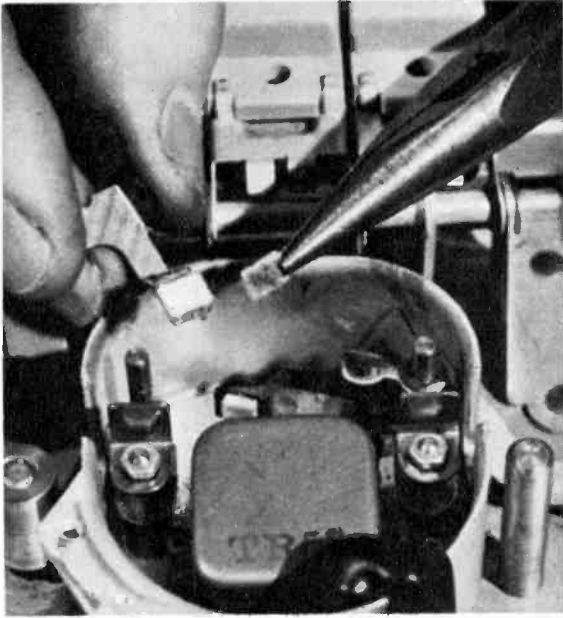

COMPARE new one, cemented in place. If pad pressure adjusts, set so that tape speed is right.

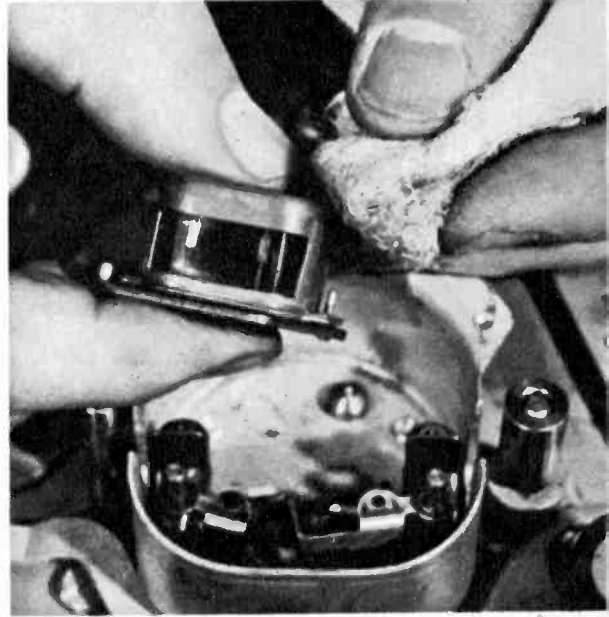

LIFT HEAD from plate, wipe its face, recording and erase gaps with lint-free cloth, head cleaner.



CLEAN CAPSTAN'S surface similarly and dry. Dirt causes uneven tape motion, wow, flutter.



SOME CAPSTANS have threaded mounts, permitting easy removal for changing speed, cleaning.

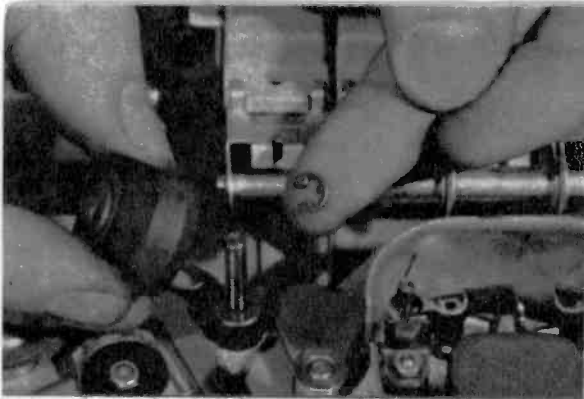

REMOVE PRESSURE ROLLER from bearing; oil bearing only with a thin grade of machine oil.



CLEAN ROLLER with head cleaner. Puck quickly accumulates oxide, binder residue from tape.



TAPE GUIDES must be cleaned same way. Never use oily cleaner on a part that touches the tape.

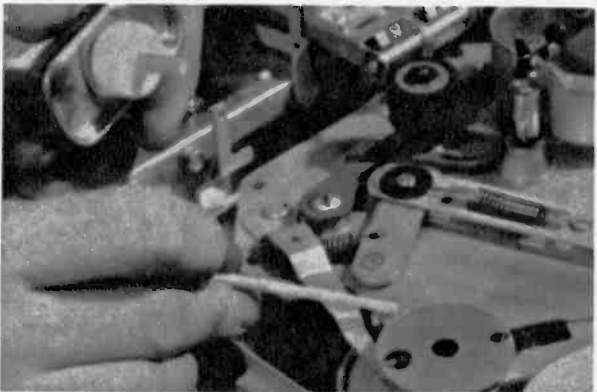

ROTATING or sliding parts can be lightly oiled. Remove oil that drips on capstan, pressure roller.

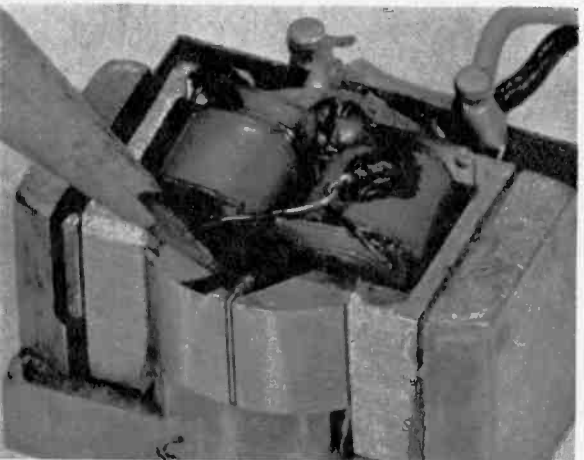

HEAD GAP (indicated by pencil) must be at exactly right angles to the tape for top fidelity.

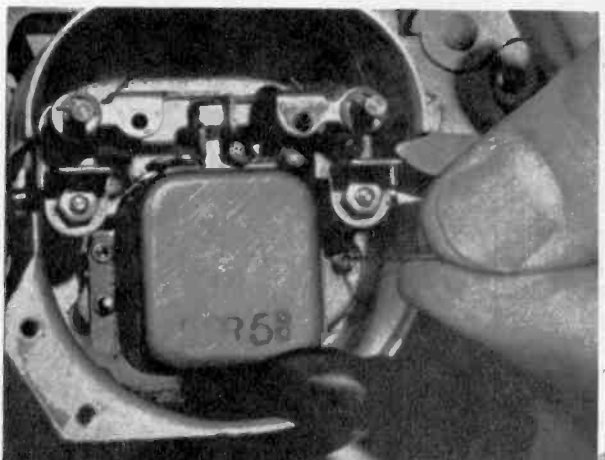

ADJUST azimuth alignment of head with a test tape on machine. Allen wrench is employed here.

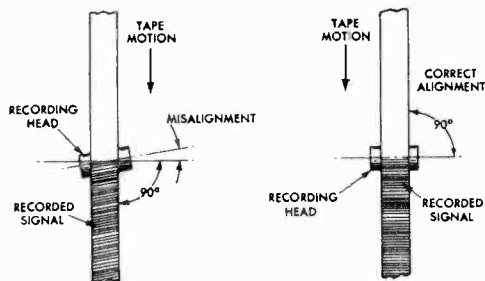

Audio Devices

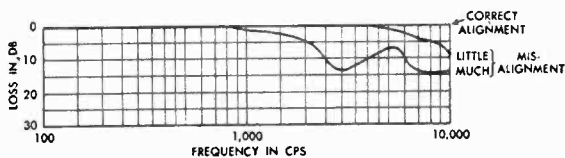

Typical Azimuth Misalignment Effects.

IMPROPER azimuth alignment of record, reproduce heads impairs high-frequency response as shown above. The sketch at the left shows proper and improper azimuth alignment of recorder's heads.

there is moving metal-to-metal contact, and which had been previously greased, should be lubricated again. These may include cams, sliding plates, shafts, pulleys, tie bars and levers. No more than a thin film of grease is required in any case.

Hum De Dum-Dum

There are several means of minimizing hum in a tape recorder. Although the power transformer is probably already located in the best possible position for minimum hum induction, further touching up of the orientation will sometimes help. This will involve loosening the transformer somewhat, and trying a few angles and positions of tilt to see if any of them reduce the hum. If so, make some spacers to fit under the base.

The next step involves minimum-hum phasing of the motor or motors. With the motors(s) unplugged, turn on the amplifier and set the volume control at about the midpoint in its range. Plug in the motor, observe the hum level, then unplug it, give the plug a half-twist and plug in again. Whichever direction gives the minimum hum should be used permanently. If there is more than one motor, the same procedure should be followed with each.

Common Troubles

Now we'll consider some common tape recorder troubles, and some of their causes and cures. This discussion will not cover all troubles, or all causes or all cures, but only those which can be handled easily.

The commonest of all, is failure of the motor to run or of the pilot lamp to light. This almost certainly means that power is not getting into the unit. Make sure that the power plug is in the wall receptacle, that there is no break in the cable and that both leads are connected at both ends, and that there are no blown fuses.

If the machine plays recorded tapes well, but its own recordings are distorted and

badly erased, the erase/bias oscillator tube is probably at fault. Check it.

If the motor runs and pilot lamp lights, but there is neither record nor playback, the trouble is probably either a rectifier or preamplifier tube. If there is some hum which can be varied with the volume control, more likely the culprit is the pre-amplifier.

If the machine records but does not play back, or replays but does not record, the trouble is probably the function switch if the amplifier is combined playback-record. If it is a three-head machine, the trouble is obviously isolated to whichever of the two amplifiers is malfunctioning.

If there are microphonic noises, where the set is sensitive to bumps or jars, the trouble is definitely within one of the tubes. Usually the trouble is in one of the first amplifier stages, where the sensitivity is greatest, but it can develop elsewhere. Starting with the input stage, try tapping the tubes lightly with the rubber-tipped end of a pencil. If this doesn't show up the offender, try replacing the tubes one at a time until the bad one shows up.

Excessive tape hiss might be due simply to insufficient level. Compare your recorded tapes against those made on other machines. Check the recording amplifier and oscillator tubes.

If the mechanism refuses to move the tape, or if the speed is too slow, look for stray tape wound around the capstan or spindles and binding. See that the brakes are releasing. Look for a spring that is broken or disconnected from the pressure roller or idler drive. Make sure the motor pulley is tight on its shaft. Check for belts which are loose, broken, grease-covered or out of place.

Your tape recorder is a complicated but well-made instrument. It will give you many more hours of faithful service if you provide it with good preventive maintenance regularly. •

One On The House

These consulting services, manuals,
building plans, and publications
are yours, absolutely free



THIS CHAPTER is being addressed to you because you are a very special person. You are a hi-fi tape recordist, and the manufacturers and distributors in this hobby of ours want to know you better, and they want you to become acquainted with them and their products.

Each of these offers is genuine and has been personally verified by a member of our editorial staff. There are no catches, no gimmicks. If a small service charge is requested, it is noted here. If not, you pay nothing, either now or later.

Please do not send your requests directly to us. We are not making these offers. We only hear of them—or in some cases suggest them—and pass the word along to you. In each case the concern making the offer is clearly listed.

Be sure when making your request that your information is complete and accurate. Print or type your name and address plainly, and be sure to specify the gift you are requesting by title or name, as some companies are making several offers.

Some of these offers have been made especially and exclusively for readers of **ALL ABOUT HI-FI TAPE RECORDING**. In order to be certain that you receive your gift promptly, it would be wise to mention this publication when you write.

As a final word, please don't ask for anything you can't use. If any of your friends should wish to have some of these gifts or services, they of course may do so, but each of these offers is limited to one request per letter.

Tape Recorder Diagrams

At deadline we learn that a new Heathkit is about to make its appearance, this time a complete tape recorder. And the longstanding policy of the Heath Company also applies here. You can receive free a schematic diagram and an outline of the electrical and physical specifications of the Heathkit tape recorder. Send your request to Mr. C. M. Edwards, Heath Company, Benton Harbor, Michigan.

Consulting Service

You may obtain answers to your questions concerning the choice of loudspeakers, either for a complete system or to supplement existing speakers. Or you may wish information on loudspeaker enclosures and their design for use with any Jensen speakers you now have or contemplate getting. If you have any problems concerning the application of Jensen hi-fi loudspeakers, write Mr. Karl Kramer, Jensen Manufacturing Co., 6601 South Laramie Avenue, Chicago 38, Illinois.



Microphone Book

Here is a new booklet which tells about the operating principles of various types of microphones, and how they may be used. It also tells how to select the right microphone for specific applications. These include not only hi-fi recording, but also sound effects, broadcasting, public-address, paging and ham radio. Your copy of *The ABC's of Microphones* will be sent you directly from Electro-Voice, Inc., Buchanan, Michigan.

Tape Strength Test Kit

Samples of three brands of 1-mil acetate-base tape are offered for comparison against "Scotch" tape with 1/2-mil tensilized polyester base. As shown in the photograph on page 22, you will find that the tensilized product is much more difficult to stretch. You can prove it for yourself by asking for the strength test kit from Minnesota Mining and Manufacturing Co., 900 Bush Avenue, St. Paul 6, Minnesota.



Master Tape Treasury

This is a listing of all monaural and stereo tapes of many of the small independent companies, such as Atlantic, Boston, Connoisseur, Elektra, Empirical, Esoteric, Livingston, Lyrichord, Musikon, Oceanic, Riverside, Tico and others. Recorded tapes are listed by musical type, composer and artist. Write to Livingston Audio Products Corporation, Livingston, N. J.

Free Home Trial

All Pentron tape recorders are available on a 10-day free home trial plan. See your local hi-fi dealer for details. Pentron also has an interesting brochure showing typical setups of tape mechanisms and preamplifiers for a number of monaural and stereo applications. Write for pamphlet PTCA757 from The Pentron Corporation, 796 South Tripp Avenue, Chicago 24, Illinois.

Tape Recording Magazine

This is the only periodical devoted exclusively to hi-fi magnetic recording. It features how-to-do-it articles, how-to-build-it, plus the latest in new products and doings in the world of tape. It also has a regular review section on recorded tape, including stereo. For a free copy of the very excellent *Hi-Fi Tape Recording*, write Mr. Mark Mooney, Tape Recording, Severna Park 10, Maryland.

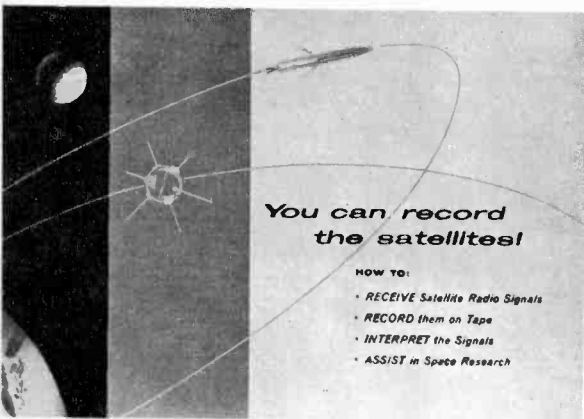

Recording The Satellites

This new brochure explains how you can participate in the IGY program by recording signals from the man-made satellites. Topics covered include the character of the signals, receivers for both AM and FM signals, how to know when the satellites will pass near you, how to record and time the signals, and how to interpret their meaning. Very well written, this pamphlet deserves a place in your library. It is available without charge from your Audiotape dealer, or for 10¢ to cover handling costs from Audio Devices, Inc., 444 Madison Avenue, New York 22, N. Y.

Recorded Tape Listing

Here is a bargain list of many recorded tapes of the leading manufacturers. A unique feature of this catalog is a brief description of each performance, as opposed to the usual listing simply by artist and title. Another plus is an illustrated article containing a lot of sound information on stereo. For your copy write Mr. J. W. Rubin, Allied Radio Corp., 100 North Western Avenue, Chicago 80, Illinois.

Oxide Test Kit

There is considerable controversy among tape manufacturers concerning the practice of polishing tape oxides after coating. Proponents claim reduced head wear, extended frequency range, fewer dropouts, and even less print-through. You can draw some conclusions of your own with this kit of tape samples. It also has a tape timing chart. Ask for *Which Tape Has The Smoothest Surface* from ORRadio Industries, Inc., Opelika, Alabama.

Stereo Product Listing

A catalog of leading stereo equipment, as well as tape and monaural hi-fi gear has recently been published. A complete description and photograph of each item is included. Information concerning a line of build-it-yourself kits which are available nowhere else is another feature of this book. Write for your copy to Mr. Lionel Zimmerman, Lafayette Radio, 165-08 Liberty Avenue, Jamaica 33, N. Y.

Tape Recording Glossary

An up-to-the-minute 12-page glossary of 99 tape and hi-fi terms is offered free upon request. This glossary gives concise, easy to understand definitions of terms commonly encountered in this field. Similar to the glossary in this book, it is in convenient 8½" x 11" form, suitable for punching and filing in a loose-leaf notebook. Write Minnesota Mining and Manufacturing Co., 900 Bush Street, St. Paul 6, Minnesota.



Recorded Tape Identification

The problem of identifying reels of recorded tapes is solved by the Irish Reel Tab. Now made in two sizes, they fit snugly beneath the edges of any 5- or 7-inch reel, regardless of how much tape is on it. Made of sturdy stock, they have plenty of room on both sides for writing or typing. For a free supply, write stating which size you want to Mr. Nat Welch, ORRadio, Inc., T-120 Marvyn Road, Opelika, Alabama.

A frank statement of high fidelity facts

ALTEC LANSING CORPORATION

Hi-Fi Factbook

One of the most forthright pieces of literature from any manufacturer is *A Frank Statement of High Fidelity Facts*. The title means what it says, and really lays it on the line concerning such euphemisms as "professional" and "laboratory standard." Other topics include electronic specifications, production quality, loudspeaker efficiency, the electrostatic speaker, and enclosures. Request this from Altec Lansing Corporation, 1515 South Manchester Avenue, Anaheim, California.

Audiocraft Magazine

This is the how-to-do-it magazine of home sound reproduction and tape recording. It regularly features articles on electronic construction, sound servicing, woodcrafting and system design. This magazine sells everywhere for 35¢, but our readers may obtain a copy free by writing Audiocraft, 4404 Publishing House, Great Barrington, Massachusetts.

How Records Are Made

An interesting booklet is offered, written in simple language and including photographs, describing the processes in the recording and manufacture of LP phonograph records. This shows how tape recording is the first step, even when the music ultimately ends up on disc. Write for Booklet FB, Somerset Records, Box 45, Swarthmore, Pennsylvania.

Technical Advice

The Technical Service Department of University Loudspeakers is ready at all times to answer consumer inquiries on loudspeakers, enclosures and systems. Hi-fi and tape enthusiasts are invited to avail themselves of this service without obligation. Write to Mr. Larry Epstein, University Loudspeakers, Inc., 80 South Kensico Avenue, White Plains, N. Y.

Choosing Your Tape

An interesting guide to tape selection is available, describing the various tape thicknesses, oxides, base materials and lengths. Also included in this colorful brochure is a tape timing chart. Ask for *Which Tape Type Are You?* from Minnesota Mining and Manufacturing Company, St. Paul 6, Minnesota.

Hi-Fi Plan Book

This booklet answers the important questions about how much to spend, suggested components, installation for best appearance, and where to buy a true hi-fi system. Ask for the BIC High Fidelity Plan Book from British Industries Corporation, Port Washington, N. Y.



Tape Head Replacement Manual

As we have already noted, poor performance of your recorder may be due to excessive head wear. Replacement is fairly simple, provided you use an azimuth tape for alignment. Complete technical data on replacement heads for all machines is tabulated in the Shure Replacement Manual. Similar information is included on phono cartridges as well. Write Shure Brothers, Inc., 222 Hartrey Avenue, Evanston, Illinois.

Complete Recorded Tape Catalog

The most complete listing of recorded tapes available is the Harrison catalog. The catalog has two sections, one for monaural and one for stereo tapes. Under these headings there are three subdivisions, listing the tapes by composer and artist, type of music, and manufacturer's name. This is published four times a year and is available from your music dealer. If he doesn't have it, send his name along with your own to Radio-Phonograph Research, Inc., 274 Madison Avenue, New York 16, N. Y. ●

Tape Terms

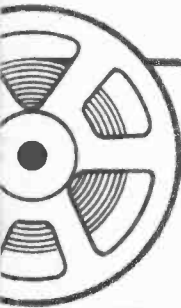

It will pay the serious audiophile to have a proper understanding of this tape-recording terminology

- A Wind**—Method of winding magnetic tape on the reel with the dull, oxide-coated side of the tape toward the inside. The wind almost universally used today. Recorder design determines whether A or B wind is normally used, but either type can easily be changed to the other simply by making a half-twist in the tape when winding.
- A-B Test**—Direct comparison of sound of two tape recorders made by simultaneously playing identical recorded selections on both machines and successively turning on the speaker of first one, then the other.
- Acetate Base**—The transparent plastic film which forms the backing for most of the magnetic recording tape made in the world today.
- Audible Tones**—Sounds with frequencies which the average human can hear and which range from about 30 to 15,000 cycles per second.
- Automatic Shut-off**—Special switch incorporated in some tape recorders which automatically stops the machine when the tape runs out, or in case of tape breakage.
- B Wind**—Tape wound with oxide out. Seldom used today, except as additional precaution against print-through.
- Bass Reflex Speaker Enclosure**—Type of extension loudspeaker cabinet frequently available as accessory item for tape recorders. Design employs a port or opening which greatly reinforces the bass, yet requires but a relatively small cabinet. Most commonly used in hi-fi systems.
- Bias**—A high-frequency alternating current fed into the recording circuit to minimize distortion.
- Binaural Recorder**—A tape recorder which employs two separate recording channels or systems, each with its own microphone, amplifier, recording and playback heads and earphones. Recordings using both systems are made simultaneously on a single magnetic tape on two parallel tracks, which, upon playback, reproduce the original sound with depth and realism unequalled by any other recording method. Use of headphones for listening is necessary for true binaural effect.
- Bulk Eraser**—An electromagnetic device used to erase an entire reel of magnetic tape at once without running it through a recorder. It uses a strong magnetic field which neutralizes any magnetic patterns on the tape.
- Capstan**—The spindle or shaft (often the motor shaft itself) which rotates against the tape and idler wheel pulling the tape along at a constant speed on recording and playback.
- Ceramic Microphone**—Inexpensive piezoelectric type microphone supplied with many tape recorders which employs a ceramic element to generate voltages. Extremely rugged, it requires more amplifier gain than does a crystal microphone.
- Crossover Network**—Filter circuits for a multiple loudspeaker system which separate highs and lows and feed each to the particular speaker designed to handle them.
- Crystal Microphone**—Inexpensive piezoelectric type microphone supplied with many tape recorders which employs a natural crystal, usually Rochelle salt, as its generator. As the diaphragm or slab moves, distorting the crystal, it is caused to generate electrical voltages. Should be handled with care, however, and never exposed to heat.
- Cycles Per Second**—The unit for measuring the frequency or pitch of any musical sound. Abbreviated cps.
- Decibel**—Abbreviated db, it is a relative measure of sound level or volume. It expresses the ratio of one sound intensity to another. One db is the smallest change in volume level that the average human ear can detect.
- Distortion**—Any difference between the original sound and that reproduced by a tape machine. Distortion takes on many forms, and although it can never be completely eliminated, it can be reduced to a minimum in a good recording and reproducing system. Tape today offers the maximum potential in distortion-free recording.
- Dual Track Recorder**—Usually a tape recorder with a recording head that covers half of the tape width, making it possible to record one track on the tape, then turn the reels over or reverse the machine and record a second track in the opposite direction. Sometimes called a half-track recorder.
- Dupe**—Sometimes called a dub or dubbing. A copy of a tape recording made by recording on one machine what another machine is playing. Tape recordings are easy to duplicate simply by re-recording and there is a minimum loss in quality from the original to the copy.
- Dynamic Microphone**—High quality electromagnetic type microphone which employs a moving coil in a magnetic field to produce varying voltages.
- Dynamic Range**—The ratio between the softest and loudest sounds a tape recorder or other device can reproduce, without undesirable noise or distortion. Usually measured in db.

Editing—Selecting certain sections of a tape recording, or of a number of different tape recordings, then splicing them together in the desired sequence. Magnetic tape is unsurpassed for editing purposes, since it can be easily cut and spliced without detection.

Electromagnetic Type Microphone—Microphone using an electromagnet to produce varying voltages. Includes ribbon or velocity microphones, dynamic or moving-coil type, and reluctance or moving-vane type.

Erasure—Neutralizing the magnetic pattern on tape by placing it in a strong, magnetic field, thereby removing the recorded sound from the tape. An erase head on the tape recorder does this automatically to any sound previously recorded on the tape just before the tape reaches the record head. A permanent magnet can also be used to erase magnetic tape, but this method is never used in high-quality recorders.

Equalization—Either boosting or decreasing the intensity of the low, middle or high tones of a recording during recording or playback or both. This compensation serves to correct any deficiencies in the recording system and to increase the signal-to-noise ratio.

Fast Forward Control—Provision on a tape recorder to run-tape rapidly through the machine.

Feed Reel—Reel on the recorder which supplies the magnetic tape. Also known as supply or payout reel.

Fidelity—A measure of the exactness with which any sound is duplicated or reproduced. Magnetic tape is presently regarded as the ultimate medium for high-fidelity sound reproduction.

Flat Response—The ability of a sound system to reproduce all tones—low and high—in their proper proportion. A high fidelity sound system might be specified as having an essentially flat response, plus or minus one db, from 30 to 15,000 cycles per second.

Flutter—Very short, rapid variations in tape speed causing similar variations in sound pitch or volume, not present in the original sound. A form of distortion.

Foot Switch—Electrical or mechanical foot pedal device for stopping and starting and sometimes rewinding a tape recorder without use of hands.

Frequency Range—The range between the highest and lowest-pitched sounds which a tape recorder or other sound system can reproduce at a usable output level.

Frequency Response—The output level of a recorder or sound system over a given range of frequencies. A more specific term than frequency range. Usually in the form of a curve plotted on a chart.

Gain—The ratio between the input level and output level of a piece of sound equipment. Gain is increased by means of an amplifier.

Gap—The tiny distance between the poles of the recording head, measured in mils. The head gap of most home recorders may range from 1 mil down to $\frac{1}{4}$ mil. The smaller the gap, the greater the high-frequency range of the tape recorder can be.

Head—The ring-shaped electromagnet across which the tape is drawn, and which magnetizes the iron-oxide coated tape in a series of patterns. Many tape recorders employ a combination record-playback head and also an erase head. Most professional machines employ a separate

Dr. Grabow

PRE-SMOKED PIPES

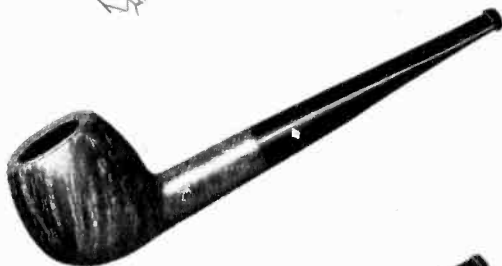

trademark of quality

Cool, sweet and mild from the first puff. No breaking-in because they're mechanically pre-smoked. All are hand-crafted of imported briar.

\$1.50 to \$10.00

DR. GRABOW PRE-SMOKED PIPES
GREENSBORO, N. C.

Write to Department SP for
free illustrated booklet

- playback head, which permits listening to the recorded sound a split second after it has been put on the tape.
- Head Alignment**—Positioning of the record-playback head on a tape recorder so that its gap is exactly perpendicular to the path of travel of the tape. Head misalignment will cause loss of high frequencies upon playback. Special head alignment testing tapes are available.
- Head Demagnetizer**—Device to eliminate any magnetism built up and retained in a recording head. Some tape recorders feature automatic head demagnetization.
- Identification Labels**—Pressure-sensitive labeling tape used for marking tape reels to indicate material recorded.
- Impedance**—A rating in ohms of the input and output of any electrical component, referred to in a general way as either high or low. Importance is that, in connecting any two components, the output and input impedances should be the same. Most home tape recorders use a high-impedance microphone and require a relatively short, shielded connecting cable. Low-impedance microphones used on professional recorders can use much longer cables with no appreciable loss in high frequencies.
- Index Counter**—An odometer type counter which makes it possible to note the location of any particular selection of a tape, thereby making it easier to find. Many late model tape recorders feature built-in index counters.
- In-Line Heads**—Arrangement of stereophonic heads on a tape recorder so that gaps are directly in line. One head is mounted directly above the other. Also called stacked heads.
- Input**—An electrical voltage fed into an amplifier, or the circuit to which that voltage is fed.
- Inverter**—Device to change one type of electrical current to another type. Frequently used to change 6-volt or 12-volt battery direct current to 110-volt alternating current for operation of a tape recorder in an automobile, boat or other vehicle.
- I.P.S.**—Abbreviation for tape speed in inches-per-second.
- Jack**—Receptacle for a plug connector leading to the input or output circuit of a tape recorder or other piece of equipment.
- Leader Tape**—Special non-magnetic tape which can be spliced to either end of a tape to prevent damage or breaking off of the magnetic tape ends and possible loss of part of the recorded material. Some types feature a marker every 7½ inches. Used as timing tape, therefore, it can be spliced between musical selections on a tape to provide a pause of a given number of seconds, depending on the tape speed.
- Level Indicator**—A device on the tape recorder to indicate the level at which the recording is being made, and which serves as a warning against under-recording or over-recording. It may be a neon bulb, a magic-eye tube, or a VU meter. Also known as a volume indicator or VI.
- Magnetic Tape**—A high-quality plastic (or paper) tape which has been precision-coated by the manufacturer with a layer of magnetizable, iron oxide particles. The result is a recording media that is subject to virtually no wear, can be erased and re-used, and offers the highest fidelity of reproduction possible today.
- Mailing Box**—Special durable carton designed to fit standard tape boxes for mailing.
- Mixer**—Device by which signals from two or more microphones or other sources can be fed simultaneously into a tape recorder at the proper level and balance.
- Monaural Recorder**—Standard type tape recorder which uses a single-channel system consisting of one microphone, amplifier and recording head, as opposed to a binaural or stereophonic recorder.
- Monitor Head**—Additional playback head featured on some tape recorders making it possible to listen to the material off the tape while the recording is being made.
- Motor Board**—Also called tape transport mechanism. The platform, or assembly, of a tape recorder on which the motor (or motors), the reels, the heads and controls are mounted. It includes those parts of the recorder other than the amplifier, preamplifier, loudspeaker and case.
- NARTB Curve**—Standard playback equalization curve set by National Association of Radio and Television Broadcasters.
- Output**—An electrical voltage coming from an amplifier and normally fed into a loudspeaker, or the electronic circuit at that point.
- Oxide**—Microscopically small particles of ferric oxide dispersed in a liquid binder and coated on a tape backing. Red oxide is most common, although high output magnetic tape employs a dark green oxide. These oxides are magnetically hard, that is, once magnetized they remain magnetized permanently, unless they are demagnetized by exposure to a strong magnetic field.
- Patch Card**—Sometimes called attachment cord. A short cord or cable, with a plug on either end (or with a pair of clips on one end) for conveniently connecting two pieces of sound equipment such as a phonograph and tape recorder, an amplifier and speaker, etc. Not used for 110-volt current.
- Playback Head**—Magnetic head used to pick up signal off a tape. Sometimes the same head as used for recording, but with circuitry changed by means of switch.
- Plug**—Circuit connector which is inserted into a jack.
- PM Speaker**—Loudspeaker using a permanent magnet in its voice coil.
- Polyester Backing**—Plastic film backing for magnetic tape used for special purposes where strength and resistance to humidity change are important.
- Portable Recorder**—Usually any tape recorder designed to be easily moved or carried about, but in most cases requiring an AC power supply. Some portable recorders, however, are self powered and use batteries or a spring motor; hence are completely portable.
- Power Amplifier**—An amplifier designed to operate a loudspeaker.
- Power Cord**—Cord for connecting the tape recorder to 110-volt AC current.
- Preamplifier**—An amplifier that raises extremely weak signal levels such as those from a microphone, magnetic playback head, or a phonograph pickup to a level usable by the power amplifier. Some tape recorders combine the preamp and the power amplifier. Others, especially the tape recorders designed for use in high fidelity music systems, may feature a separate preamplifier. In such cases the preamp includes an equalization circuit. In addition, the bias oscillator (necessary to record on tape)

Is often mounted in same unit with the preamp.

Pressure Pads—Felt pads mounted on spring-brass arms which hold the magnetic tape in close contact with the heads on some machines.

Pressure Roller—Also called capstan idler wheel or puck. A rubber-tired roller which holds the magnetic tape tight against the capstan by means of spring pressure to insure constant tape speed and prevent slippage.

Print-Through—Transfer of the magnetic field from layer to layer of tape on the reel.

Quick-Stop Control—Feature of some tape recorders making it possible to stop the movement of the tape temporarily without switching the machine off play or record position.

Raw Tape—A term sometimes used to describe tape that has not been recorded. Also called virgin or blank tape.

Recorded Tape—A recording on tape that is commercially available. Also called a pre-recorded tape. Sometimes any tape that has been recorded, whether commercially available or not.

Recording Noise—Noise induced by the amplifier and other components of the recorder, or tape hiss.

Reluctance Microphone—Inexpensive electromagnetic type microphone supplied with many tape recorders which is extremely rugged and durable but generally not as high quality as crystal or ceramic types. Employs a metal wand which moves in a magnetic field to produce varying voltages.

Rewind Control—Button or lever for rapidly re-winding tape from the take-up reel to the feed reel.

Self-Powered Recorder—Tape recorder containing its own power supply, either a combination of wet and dry cells to power the unit, or dry cells in conjunction with a spring-driven motor.

Signal-To-Noise Ratio—The ratio between the loudest, undistorted tone recorded and reproduced by a recorder and the noise inherent in the recording system itself. Normally measured in db.

Single-Track Recorder—A tape recorder which records only one track on the tape. Usually a full-track recording head is used which covers the full width of the 1/4-inch tape, although some machines use a narrower, half-track recording head which records a single track down the middle of the tape. Output of a full-track recording is theoretically double that of a half-track recording, a difference of only 3 to 6 db.

Splicing Block—Metal or plastic device incorporating a groove in which ends of tape to be spliced are inserted. An additional diagonal groove provides a path for sharp blade to follow in cutting the tape.

Splicing Tape—A special pressure-sensitive, non-magnetic tape used for splicing magnetic tape. Its hard adhesive will not ooze and consequently will not gum up the recording head, or cause adjacent layers of tape on the reel to stick together. Ordinary cellophane tape should not be used for splicing.

Stacked Heads—Arrangement of recording heads used for stereophonic sound where the two heads are located directly in line, one above the other.

Staggered Heads—Arrangement of recording heads used for stereophonic sound where the heads are located 1 1/4" apart. Stereo tapes recorded using staggered heads cannot be played

Spectacular New Tape System Components

PENTRON

• STEREO • MONAURAL

Select only the TAPE UNITS you want!

Pentron combines professional features and custom styling with building-block flexibility. Add components when you desire—from the simplest monaural system to the all-inclusive stereo systems.

3 MECHANISMS AVAILABLE Featuring —

Professional head assembly with removable pole piece
 • Mounts VERTICALLY, horizontally or at any angle • Simple single rotary control • 4 outputs plus 2 AC convenience outlets • Speed change lever at front panel • Automatic self-energizing braking.

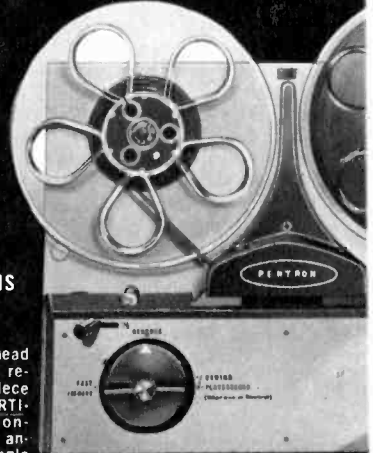

3 PREAMPLIFIERS

All CA units have same physical dimensions and require same cutout.



CA-11: Tape Playback only. Response: 20-20,000 cps. Signal-to-Noise: 55 db

CA-13: Tape Playback preamp and record amplifier. Response: 20-20,000 cps. Signal-to-Noise: 55 db



CA-15: Stereo Dual Channel Playback. Response: 20-20,000 cps. Signal-to-Noise: 60 db

PENTRON

799 S. Tripp Avenue
Chicago 24, Illinois

- brochure on tape components
- literature on portable recorders

Name _____

Address _____

City and State _____

on recorders using stacked heads, or vice versa.

Stereophonic Sound—Dimensional and directional sound reproduction achieved through use of two or more sound tracks, or channels, heard simultaneously through an array of two or more loudspeakers. In practice two channels are used, one on each track of a standard tape, with a recording head for each channel. Differs from binaural (which see) sound reproduction in microphone placement during recording and in using loudspeakers rather than headphones.

Take-up Reel—Reel on the tape recorder which accumulates the tape as it is recorded or played.

Tape Cartridge—Magazine or holder for a length of magnetic tape which can be slipped into a tape recorder and played without threading up. Usually the tape is an endless loop feeding out from the center and back onto the roll on the outside. Some cartridges employ two reels, one atop the other, but must be turned over at the end of the tape.

Tape Deck—Tape recorder designed for use in a high fidelity music system. Usually consists only of motorboard mechanism and does not include preamplifier, power amplifier, speaker or case.

Tape Guides—Grooved pins of non-magnetic material mounted at either side of the recording head assembly to position the magnetic tape on the head as it is being recorded or played.

Tape Loop—A length of magnetic tape with the ends joined together to form an endless loop. Used either on standard recorder, special message repeater type units, or in conjunction with a cartridge device, it makes it possible to play back a recorded message repetitively without rewinding the tape.

Tape Player—Unit for playback only of recorded tapes. Sometimes called a tape phonograph.

Tape Splicer—Device for splicing magnetic tape automatically or semiautomatically similar to a film splicer. Different models vary in operation, most using splicing tape, some employing heat and pressure.

Tape Threader—Device for easier threading of tape on the reel.

Telephone Pickup—Type of induction coil device which slips over a telephone receiver, or upon which entire telephone may rest, used to pick up both voices for recording on tape.

Threading Slot—Slot in recording head assembly coverplate into which tape is slipped in threading up the reels for use of the recorder.

Tone Control—Control knob on tape recorder amplifier used to vary bass and treble response to achieve most desirable balance of tone.

Volume—An acoustical, rather than electrical, measurement. Refers to the pressure of the sound waves in terms of dynes per square centimeter. The louder the sound, the greater the pressure. Most technicians prefer to talk in terms of decibels.

VU Meter—A volume unit meter which indicates the relative levels of the various sounds being recorded by measuring the electrical voltages.

Wow—Slow variations in tape speed causing similar variations in sound pitch or volume not present in the original sound. A form of distortion. •

Based on material prepared by Minnesota Mining and Manufacturing Co.

Where to Buy It

Products pictured or mentioned are by the following. Contact them direct

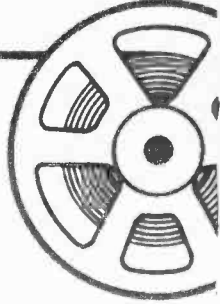

ALLIED RADIO CORPORATION
100 North Western Avenue
Chicago 80, Illinois

ALTO FONIC MUSIC SYSTEMS, INC.
935 Commercial St.
Palo Alto, California

AMERICAN ELECTRONICS, INC.
655 W. Washington Boulevard
Los Angeles 15, California

AMERICAN GELOSO ELECTRONICS, INC.
Manchester, New Hampshire

AMERICAN TELEVISION & RADIO COMPANY
Saint Paul, Minnesota

AMPEX AUDIO, INC.
1020 Kifer Road
Sunnyvale, California

AMPLIFIER CORPORATION OF AMERICA
398 Broadway
New York, N. Y.

AMPRO CORPORATION
154 Clarissa St.
Rochester 8, N. Y.

AUDIO DEVICES, INC.
444 Madison Avenue
New York 22, N. Y.

AUDIO-MASTER CORPORATION
17 East 45th St.
New York 17, N. Y.

AUDIOMATION LABORATORIES
7230 Clinton Road
Upper Darby 23, Pennsylvania

BELL & HOWELL
7100 McCormick Road
Chicago 45, Illinois

BELL SOUND SYSTEMS, INC.
555 Marion Road
Columbus 7, Ohio

BERLANT-CONCERTONE
9449 West Jefferson Boulevard
Culver City, California

DAVID BOGEN CO.
Box 500
Paramus, N. J.

BRITISH INDUSTRIES CORPORATION
80 Shore Road
Port Washington, New York

BROADCAST EQUIPMENT SPECIALTIES
Box 149
Beacon, New York

CARTER MOTOR COMPANY
2755 West George St.
Chicago 18, Illinois

COUSINO, INC.
2107 Ashland Avenue
Toledo 2, Ohio.

DATREL, INC.
520 Fifth Avenue
New York City

DEJUR AMSCO CORPORATION
45-01 Northern Boulevard
Long Island City 1, N. Y.

DICTAPHONE CORPORATION
420 Lexington Avenue
New York 17, N. Y.

E. I. DUPONT DE NEMOURS CO.
10th & Market Street
Wilmington 98, Delaware

EDUCATIONAL LABORATORIES, INC.
1048 Potomac St. N.W.
Washington 7, D. C.

ELECTRONIC APPLICATIONS
150 East 35th St
New York 16, N. Y.

ELECTRONIC TEACHING LABS
1818 M Street N.W.
Washington 6, D. C.

ELECTRO-VOICE, INC.
Buchanan, Michigan

EMC RECORDING CORPORATION
806 East 7th St.
St. Paul 6, Minnesota

ERCONA CORPORATION
551 Fifth Avenue
New York 17, N. Y.

FAIRCHILD RECORDING EQUIPMENT CO.
1040 45th Avenue
Long Island City 1, N. Y.

FEDERAL MANUFACTURING & ENGINEERING CO.
1055 Stewart Avenue
Garden City, N. Y.

FEN-TONE CORPORATION
106 Fifth Avenue
New York 11, N. Y.

THE FERRODYNAMICS CORP.
Lodi, New Jersey

FISHER RADIO CORPORATION
21-21 Forty-Fifth Drive
Long Island City, N. Y.

HEATH COMPANY
Benton Harbor, Michigan

HI-FI TAPE RECORDING
Severna Park, Maryland

INTERNATIONAL RADIO & ELECTRONICS
South 17th St. & Mishawaka Rd.
Elkhart, Indiana

INTERNATIONAL SCIENTIFIC INDUSTRIES
2374 East Highway 24
Colorado Springs, Colorado

NO REWINDING! with an AUDIO VENDOR

The Audio Vendor will repeat messages hour after hour without rewinding tape. Some of its uses are sleep-learning and education, memorization, and language drill. It is the only six-year time-tested message repeater. With no tools, and within a matter of seconds, any tape recorder will repeat messages with a Cousino Audio Vendor. Let us show you its many uses. Send for literature on new long play models and accessories. Advise make and model of your recorder.

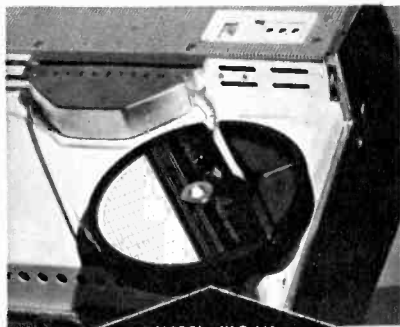

MODEL ULP-110
Up to 55 minutes **\$39.50**

MODEL U-300
20 seconds to 20 minutes **\$12.50**
(not shown)

PIONEERS IN TAPE CARTRIDGES AND ACCESSORIES



TAPE SPLICER
KIT
ONLY \$1.50

Ask your dealer first
COUSINO, INC.
2108 ASHLAND AVE.
TOLEDO 2, OHIO
Dealer Inquiries Invited

FAWCETT HOW-TO BOOKS

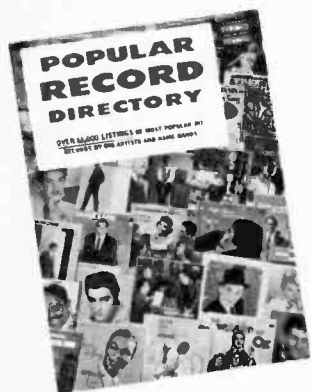

POPULAR RECORD DIRECTORY • Over 12,000 listings hit records, top artists, name bands. (No. 379)

Projects To Make For LIVING OUTDOORS • Barbecues, patios, terraces, pools, benches. (No. 378)

PETER BASCH PHOTOGRAPHS Beauties of World • Glamour, nudes, Europe, Far East, U. S. (No. 377)

Handy Man's TV REPAIR • Tubes, fuses, color, antennas, circuits, safety, accessories and combinations. (No. 376)

ASTROLOGY HANDBOOK • Predictions, history, planetary affinities, personal guidance. (No. 375)

PHOTOGRAPHY HANDBOOK • Nudes, aerial, news, multi-exposure, astronomy and salon section. (No. 374)

LANDSCAPING THE SMALL HOME • Shade trees, lawn, walls, terraces, flowers, shrubs. (No. 373)

LOW COST HOMES • 50 homes, plans available, financing, expanding, wiring, insulation. (No. 372)
Also available in hard cover edition at \$2.00 per copy.

Handy Man's CONCRETE and MASONRY Guide • Walks, foundations, patios, steps, laying brick. (No. 371)

BOATING HANDBOOK • Caulking, painting, hull repair, engine overhaul, fiberglass repair. (No. 370)

CANDID PHOTOGRAPHY • Nudes, glamour, theater, fashion, Camera Club News, salon section. (No. 369)

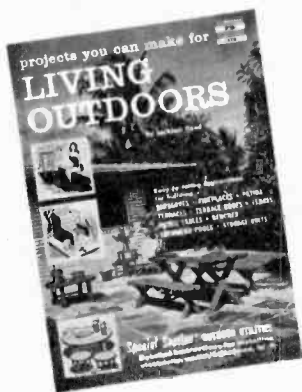

Sports Illustrated GOLF TIPS FROM TOP PROFESSIONALS • Abridged "Tips From the Top." (No. 368)

A GUIDE TO ASTRONOMY • Earth in space, Milky Way, Inter-Galactic space, telescopes, cameras. (No. 367)
Also available in hard cover edition at \$2.00 per copy.

OUTBOARD BOATING Handbook • New boats, motors, fiberglass boats, racing, trailers, houseboats. (No. 366)

ELECTRONIC PROJECTS You Can Make • Hi-Fi, radio, intercom equip., remote control, kits, alarms. (No. 365)

SPACE SATELLITES • Assembling, tracking techniques, Vanguard, race to space, Russia's Sputnik. (No. 364)

Peter Gowland's GLAMOUR TECHNIQUES • Nudes, studio glamour, lighting, underwater photos. (No. 363)

How To BUILD 20 BOATS • Outboard runabouts, duck-boat, sloops, ketch, inboard cruisers, etc. (No. 362)
Also available in hard cover edition at \$2.00 per copy.

Mechanix Illustrated ELECTRICAL REPAIR Handbook • Requirements, estimating, costs, wire, fuses. (No. 361)

How To INVEST YOUR MONEY • Income, safety, growth stocks, bonds, mutual funds, profit sharing. (No. 360)

Famous OLD CARS • Alfa Romeo, Auburn, Bentley, Cord, Bugatti, Cadillac, Duesenberg, Dupont, Stutz. (No. 359)
Also available in hard cover edition at \$2.00 per copy.

Mechanix Illustrated TV REPAIR and MAINTENANCE • Color TV, reception, interference, boosters. (No. 358)

To order direct, send 75c per copy for regular edition or \$2.00 per copy for De Luxe edition to: **FAWCETT BOOKS, Dept. 382, Greenwich, Conn.** Add 10c per copy mailing charge for all books. Specify title and number. Canadian orders cannot be accepted.

A FAWCETT
HOW-TO BOOK **75c**

AT YOUR LOCAL NEWSSTAND, LEADING DRUG STORE, SUPER MARKET, HARDWARE STORE AND BUILDING SUPPLY DEALER

JAMES INSTRUMENT LABORATORY
9110 South 52nd Court
Oak Lawn, Illinois

KARLSON ASSOCIATES, INC.
1610 Neck Road
Brooklyn 29, N. Y.

LAFAYETTE RADIO
165-08 Liberty Avenue
Jamaica 33, N. Y.

LIVINGSTON AUDIO PRODUCTS
Box 202,
Caldwell, New Jersey

MAGNECORD, INCORPORATED
Box 7186
Tulsa, Oklahoma

MICROTRAN CO., INC.
145 E. Mineola Avenue
Valley Stream, New York

MINNESOTA MINING & MFG. CORP.
St. Paul 6, Minnesota

NORTH AMERICAN PHILIPS
230 Duffy Avenue
Hicksville, N. Y.

ORRADIO INDUSTRIES, INC.
T-120 Marvyn Road
Opelika, Alabama

PENTRON CORPORATION
777 South Tripp Avenue
Chicago 24, Illinois

PREMIER ELECTRONIC LABORATORIES
382 Lafayette St.
New York 3, N. Y.

PRESTOSEAL MFG. CORP.
37-27 33rd St.
Long Island City, N. Y.

RADIO CORPORATION OF AMERICA
RCA Victor Division
Camden 2, N. J.

RANGERTONE, INC.
73 Winthrop St.
Newark 4, N. J.

REED RESEARCH, INC.
1048 Potomac St. N.W.
Washington, D. C.

REEVES SOUNDCRAFT CORPORATION
10 East 52nd St.
New York 22, N. Y.

REVERE CAMERA COMPANY
230 East 21st St.
Chicago 16, Illinois

ROBBINS INDUSTRIES
Bayside 61
Long Island, N. Y.

ROBERTS ELECTRONICS, INC.
1028 North LaBrea Avenue
Hollywood 38, California

SHURE BROTHERS, INC.
222 Hartrey Avenue
Evanston, Illinois

MARK SIMPSON MFG. CO.
32-28 49th St.
Long Island City, N. Y.

SOUND ELECTRONICS LABS.
1702 Wayne St.
Toledo, Ohio

STANCIL-HOFFMAN CORPORATION
921 No. Highland Avenue
Hollywood 38, California

SYMPHONIC RADIO AND ELECTRONIC CORP.
235 Jersey Avenue
New Brunswick, N. J.

TANDBERG
10 East 52nd St.
New York, N. Y.

TELECTROSONIC CORPORATION
35-16 37th St.
Long Island City, N. Y.

TRUYOX, LIMITED
Box 646
Livermore, California

VIKING OF MINNEAPOLIS
960 Aldrich Avenue, South
Minneapolis 20, Minnesota

V-M CORPORATION
280 Park St.
Benton Harbor, Michigan

J. C. WARREN CORP.
21 Hanse Avenue
Freeport, Long Island, N. Y.

WEBSTER-CHICAGO CORPORATION
5610 Bloomingdale Avenue
Chicago 39, Illinois

WEBSTER ELECTRIC
Racine, Wisconsin

WILCOX-GAY CORPORATION
Charlotte, Michigan

WOLLENSAK OPTICAL COMPANY
20 East 21st St.
Chicago 16, Illinois

MAGNETIC TAPE ERASER

A must
for
stereo
recording



Bulk
erasure
of both
stereo tracks

Erases recorded signals and noise from magnetic tape without rewinding. Spindle mounting of reel permits rapid coverage without missed spots. Noise level reduced below level of standard-erase heads. Restores tape to like new condition or better. Reel size range 5", 7", 10½". May also be used for demagnetizing record—playback—erase heads.

Model HD-11 Price \$27⁵⁰

TELEPHONE PICK-UP COIL

For transcribing telephone conversations with recorder or making messages audible on amplifier. May also be used as probe for locating sources of hum. More constant signal level than base mounted units. Suction-cup mounting on any telephone receiver. Supplied with 68" shielded cable, terminated with standard phone plug for recorder or amplifier.



Model HP-61

Price
\$7⁹⁵



Available from Electronic and Audio Distributors

MICROTRAN COMPANY
Inc.
Valley Stream, L. I., N. Y.

LOST in the HI-FI Jungle?



Looking for some straight answers before you spend your hi-fi dollars? You can get them in "How to Buy Hi-Fi" in the latest issue of **ELECTRONICS ILLUSTRATED**.

Learn how to deal with equipment salesmen; how to keep your hi-fi setup within your budget; whether to select consoles or components, and plenty more. There are other hi-fi articles in **EI**, too: build-it yourself items, exclusives on the latest kits, and the regular "Hi-Fi Clinic."

The new **ELECTRONICS ILLUSTRATED** also brings you other exciting features that put you in touch with the wonderful world of electronics, including:

Build a Safe Model Missile; Shortwave Listening
Careers in Astronautics; Transistor Experiments
Convert Your Radio to an Intercom; Electronic Brain

ELECTRONICS ILLUSTRATED

A Fawcett Publication—NOW AT YOUR LOCAL NEWSSTAND—25 CENTS



8 KEYS TO PERFECT SOUND



There's an Audiotape for every recording job — eight types, each with the famous quality and uniformity that give top performance on any recorder



PLASTIC-BASE AUDIOTAPE on 1½-mil cellulose acetate meets the most exacting requirements of the professional, educational and home recordist at minimum cost. Known the world over for matchless performance and consistent uniform quality. Series 51, in the red box.

AUDIOTAPE ON 1½-MIL MYLAR* — a premium-quality professional tape with maximum mechanical strength and immunity to heat and humidity. Will not dry out or embrittle with age. Series 71, in the green box.

"LR" AUDIOTAPE ON 1-MIL "MYLAR" — 50% more recording time per reel. Strong, super-durable polyester film base assures trouble-free operation even under extreme heat and humidity. Series 61, in the black-and-red box.

PLASTIC-BASE "LR" AUDIOTAPE provides 50% more recording time on low-cost 1-mil cellulose acetate base, affording maximum economy where high strength is not required. Series 41, in the blue box.

SUPER-THIN AUDIOTAPE on ½-mil "Mylar" gives twice as much recording time per reel as standard plastic-base tape. For long-play applications where tape tension is not excessive. Series 31, in the yellow box.

SUPER-THIN AUDIOTAPE ON TEMPERED "MYLAR" gives twice as much recording time per reel as conventional tape and is *twice as strong* as other double-length tapes. Will not stretch or break on any tape recorder — will not dry out or embrittle with age. Series 31 T, in the black-red-and-yellow box.

MASTER LOW PRINT-THROUGH AUDIOTAPE on plastic base — reduces print-through (magnetic echo) by 8 db. The finest, professional-quality recording tape. Base material, 1½-mil acetate. Maximum fidelity, uniformity, frequency response and freedom from noise and distortion... Series 51M, in the red-and-gold box.

MASTER LOW PRINT-THROUGH AUDIOTAPE on 1½-mil "Mylar" — print-through (magnetic echo) is reduced by 8 db. A super durable tape that meets the highest standards of performance. Withstands extreme temperatures and is virtually immune to humidity. Has maximum life under any conditions... Series 71M, in the green-and-gold box. *DuPont Trade Mark

audiotape
TRADE MARK
it speaks for itself

AUDIO DEVICES, INC., 444 Madison Ave., N. Y. 22, N. Y.
In Hollywood: 840 N. Fairfax Ave. • In Chicago: 5428 Milwaukee Ave.
Export Dept.: 13 East 40th St., N. Y., 16 • Cables "ARLAB"
Rectifier Division: 620 E. Dyer Rd., Santa Ana, Calif.

for high fidelity...today...and for years to come...

ONLY SOUNDCRAFT TAPES...

ONLY SOUNDCRAFT MICROPOLISHES TAPE!

Friction between recorder heads and non-polished tape surfaces is produced by tiny nodules...microns in size... which cause a loss of high frequency signals in recording, and even further loss in playback. Unless your tape surface is perfectly smooth when new...you've lost high frequency response before you start! Friction also causes dangerous head wear because recorder heads are forced to act as polishing surfaces! A truly smooth surface *must* be polished...and *no other tape*...ONLY SOUNDCRAFT TAPE is polished... MICROPOLISHED to guarantee high fidelity reproduction...to reduce head wear...to save the quality of the sound!

ONLY SOUNDCRAFT OXIDE FORMULATION IS PLASTICIZER-FREE!

Plasticizers, chemical agents used in other tapes to provide pliancy, eventually migrate into the atmosphere, leaving tape dry and brittle...old before its time! It is the oxide formulation on tape that carries the sound...and ONLY SOUNDCRAFT TAPES have the remarkable oxide formulation which eliminates antiquated plasticizers! You get complete tape stability...unequalled protection for your recordings! And when you buy SOUNDCRAFT TAPE on MYLAR* base you have double protection...lifelong preservation of your recordings!

* Dupont T.M.

PROFESSIONAL (Acetate)... professional applications—uniformity guaranteed. 7" reel—1200 feet.

RED DIAMOND (Acetate)... long, hard usage, economy. 7" reel—1200 feet.

ONLY SOUNDCRAFT OXIDE FORMULATION IS "UNI-LEVEL" COATED!

Variations in thickness of oxide coating cause distortion of low frequencies... a condition all the more dangerous because you can't see the variation. To insure faultless low frequency response through positive coating uniformity...insist on SOUNDCRAFT TAPES...the only tapes with oxide coating applied by the exclusive UNI-LEVEL process... you can hear the difference!

Because of these exclusive features, all SOUNDCRAFT TAPES offer complete uniformity...within a reel and from reel to reel...and can be freely interspliced without changes in volume!

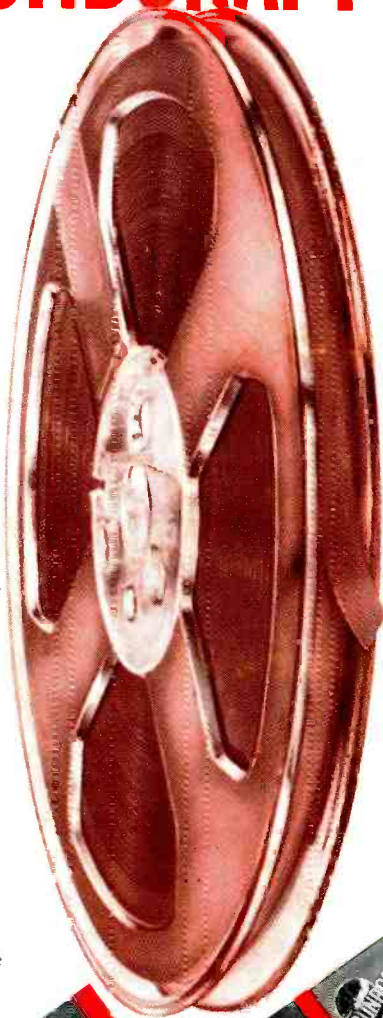

PLUS 50 (Mylar)... long play, strength, long term storage. 7" reel—1800 feet.

PLUS 100 (Mylar)... extra-long play—ultimate in double-length tapes. 7" reel—2400 feet.

LIFETIME (Mylar)... utmost strength, professional fidelity, permanence, accurate timing—lifetime guarantee. 7" reel—1200 feet.

REEVES **SOUNDCRAFT** CORP.

10 E. 52nd Street, New York 22, N. Y. • West Coast: 342 N. La Brea, Los Angeles 36, California

FOR EVERY SOUND REASON...REFUSE LESSER QUALITY...BUY ONLY SOUNDCRAFT TAPES!