

A FAWCETT  
75¢  
HOW-TO BOOK  
365

# electronic projects

you can make



- HI-FI EQUIPMENT • RADIOS • INTERCOMS
- TRANSISTOR GEIGER COUNTER • LIE DETECTOR
- HOW TO ASSEMBLE KITS • HAM TRANSMITTER
- BURGLAR ALARMS • REMOTE CONTROL
- HOW TO MAKE AN ETCHED CIRCUIT • BATTERY CHARGER
- TEST METERS • OSCILLOSCOPE

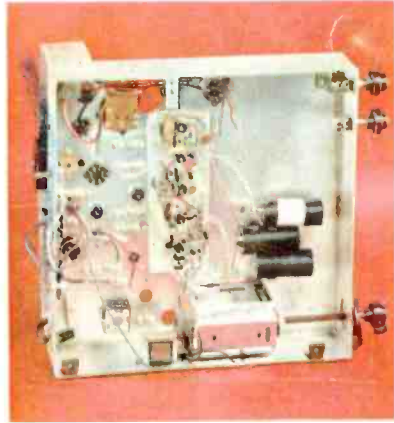

# Superior's New Model 70 UTILITY TESTER® FOR REPAIRING ALL ELECTRICAL APPLIANCES MOTORS • AUTOMOBILES • TV TUBES

As an electrical trouble shooter the Model 70:



- Will test Toasters, Irons, Broilers, Heating Pads, Clocks, Fans, Vacuum Cleaners, Refrigerators, Lamps, Fluorescents, Switches, Thermostats, etc.
- Will test all TV tubes for open filaments, interelement shorts, burned out tubes, etc.
- Measures A.C. and D.C. Voltages, A.C. and D.C. Current, Resistances, Leakage, etc.
- Will measure current consumption while the appliance under test is in operation.
- Incorporates a sensitive direct-reading resistance range which will measure all resistances commonly used in electrical appliances, motors, etc.
- Leakage detecting circuit will indicate continuity from zero ohms to 5 megohms (5,000,000 ohms).

As an Automotive Tester the Model 70 will test:

- Both 6 Volt and 12 Volt Storage Batteries • Generators • Starters • Distributors • Ignition Coils • Regulators • Relays • Circuit Breakers • Cigarette Lighters • Stop Lights • Condensers • Directional Signal Systems • All Lamps and Bulbs • Fuses • Heating Systems • Horns • Also will locate poor grounds, breaks in wiring, poor connections, etc.

Model 70 comes complete with 64 page book written in plain easy-to-understand language. Explains laws of electricity, how to proceed with repairs of appliances and automobile circuits, how to test TV tubes, etc.

Only **15<sup>85</sup>**

## SHIPPED ON APPROVAL NO MONEY WITH ORDER — NO C. O. D.

Try it for 10 days before you buy. If completely satisfied then send \$3.85 and pay balance at rate of \$4.00 per month for 3 months — No Interest or Finance Charges Added! If not completely satisfied, return to us, no explanation necessary.

**MOSS ELECTRONIC DIST. CO.**

Dept. D-395, 3849 Tenth Avenue, New York 34, N. Y.

Please rush me one Model 70. If satisfactory I agree to pay \$3.85 within 10 days and balance at rate of \$4 per month until total price of \$15.85 plus postage is paid. If not satisfactory, I may return for cancellation of account.

Name \_\_\_\_\_

Address \_\_\_\_\_

City \_\_\_\_\_

Zone \_\_\_\_\_ State \_\_\_\_\_



# BUILD 16 RADIO

## CIRCUITS AT HOME

with the New Deluxe  
PROGRESSIVE RADIO "EDU-KIT"

only  
**\$22.95**

### A Practical Home Radio Course

- Now Includes**
- ★ TRANSMITTER
  - ★ SIGNAL TRACER
  - ★ SIGNAL INJECTOR
  - ★ CODE OSCILLATOR
  - ★ No Knowledge of Radio Necessary
  - ★ No Additional Parts or Tools Needed
  - ★ Excellent Background for TV
  - ★ School Inquiries Invited
  - ★ Attractively Gift Packed

### WHAT THE "EDU-KIT" OFFERS YOU

The "Edu-Kit" offers you an outstanding PRACTICAL HOME RADIO COURSE at a rock-bottom price. The Kit is designed to train Radio & Electronics Technicians, making use of the most modern methods of home training. You will learn radio theory, construction practice and servicing.

You will learn how to build radios, using regular schematics; how to wire and solder in a professional manner; how to service radios. You will work with the standard type of punched metal chassis as well as the latest development of Printed Circuit chassis.

You will learn the basic principles of radio. You will construct, study and work with RF and AF amplifiers and oscillators, detectors, rectifiers, test equipment. You will learn and practice code, using the Progressive Code Oscillator. You will learn and practice trouble-shooting, using the Progressive Signal Tracer, Progressive Signal Injector, Progressive Dynamic Radio & Electronics Tester & S. You will receive training for the Novice, Technician and General Classes of F.C.C. Radio Amateur Licenses. You will build 16 Receiver, Transmitter, Code Oscillator, Signal Tracer and Signal Injector circuits, and learn how to operate them. You will receive an excellent background for Television.

Absolutely no previous knowledge of radio or science is required. The "Edu-Kit" is the product of many years of teaching and engineering experience. The "Edu-Kit" will provide you with a basic education in Electronics and Radio, worth many times the complete price of \$22.95. The Signal Tracer alone is worth more than the price of the entire Kit.

### THE KIT FOR EVERYONE

You do not need the slightest background in radio or science. Whether you are interested in Radio & Electronics because you want an interesting hobby, a well paying business or a job with a future, you will find the "Edu-Kit" a worth-while investment. Many thousands of individuals of all

ages and backgrounds have successfully used the "Edu-Kit" in more than 79 countries of the world. The "Edu-Kit" has been carefully designed, step by step, so that you cannot make a mistake. The "Edu-Kit" allows you to teach yourself at your own rate. No instructor is necessary.

### PROGRESSIVE TEACHING METHOD

The Progressive Radio "Edu-Kit" is the foremost educational radio kit in the world, and is universally accepted as the standard in the field of electronics training. The "Edu-Kit" uses the modern educational principle of "Learn by Doing." Therefore you construct, learn schematics, study theory, practice trouble-shooting—all in a closely integrated program designed to provide an easily-learned, thorough and interesting background in radio.

You begin by examining the various radio parts of the "Edu-Kit." You then learn the function, theory and wiring of these parts. Then you build a simple radio. With this first set you will enjoy listening to regular broadcast stations, learn theory, practice testing and trouble-shooting. Then you build a more advanced radio, learn more advanced theory and techniques. Gradually, in a progressive manner, and at your own rate, you will find yourself constructing more advanced multi-tube radio circuits, and doing work like a professional Radio Technician.

Included in the "Edu-Kit" course are sixteen Receiver, Transmitter, Code Oscillator, Signal Tracer, and Signal Injector circuits. These are not unprofessional "breadboard" experiments, but genuine radio circuits, constructed by means of professional wiring and soldering on metal chassis, plus the new method of radio construction known as "Printed Circuitry." These circuits operate on your regular AC or DC house current.

### THE "EDU-KIT" IS COMPLETE

You will receive all parts and instructions necessary to build 16 different radio and electronics circuits, each guaranteed to operate. Our Kits contain tubes, tube sockets, variable, electrolytic and paper dielectric condensers, resistors, tie strips, coils, hardware, tubing, punched metal chassis, Instruction Manual, wire, solder, etc.

In addition, you receive Printed Circuit materials, including Printed Circuit chassis, special tube sockets, hardware and instructions. You also receive a useful set of tools, a professional electric soldering iron, and a self-powered Dynamic Radio & Electronics Tester. The "Edu-Kit" also includes Code Instructions and the Progressive Code Oscillator, in addition to F.C.C.-type Questions and Answers for Radio Amateur License training. You will also receive lessons for servicing with the Progressive Signal Tracer and the Progressive Signal Injector, a High Fidelity Guide and a Quiz Book. You receive all parts, tools, instructions, etc. Everything is yours to keep.

### PRINTED CIRCUITRY

At no increase in price, the "Edu-Kit" now includes Printed Circuitry. You build a Printed Circuit Signal Injector, a unique servicing instrument that can detect many Radio and TV troubles. This revolutionary new technique of radio construction is now becoming popular in commercial radio and TV sets.

A Printed Circuit is a special insulated chassis on which has been deposited a conducting material which takes the place of wiring. The various parts are merely plugged in and soldered to terminals.



Reg. U.S. Pat. Off.

### FREE EXTRAS

- SET OF TOOLS
- SOLDERING IRON
- ELECTRONIC TESTER
- PLIERS-CUTTERS • ALIGNMENT TOOL
- WRENCH SET
- TESTER INSTRUCTION MANUAL
- HIGH FIDELITY GUIDE • QUIZZES
- TELEVISION BOOK • RADIO
- TROUBLE-SHOOTING BOOK
- MEMBERSHIP IN RADIO-TV CLUB
- CONSULTATION SERVICE • FCC
- AMATEUR LICENSE TRAINING
- PRINTED CIRCUITRY

### SERVICING LESSONS

You will learn trouble-shooting and servicing in a progressive manner. You will practice repairs on the sets that you construct. You will learn symptoms and causes of troubles in home, portable and car radios. You will learn how to use the professional Signal Tracer, the unique Signal Injector and the dynamic Radio & Electronics Tester. While you are learning in this practical way, you will be able to do many a repair job for your friends and neighbors, and charge fees which will far exceed the price of the "Edu-Kit." Our Consultation Service will help you with any technical problems you may have.

J. Statistis, of 25 Poplar Pl., Waterbury, Conn., writes: "I have repaired several sets for my friends, and made money. The "Edu-Kit" paid for itself. I was ready to spend \$240 for a Course, but I found your ad and sent for your Kit."

### FROM OUR MAIL BAG

Ben Valerio, P. O. Box 21, Magna, Utah: "The Edu-Kits are wonderful. Here I am sending you the questions and also the answers for them. I have been in Radio for the last seven years, but like to work with Radio Kits, and like to build Radio Testing Equipment. I enjoyed every minute I worked with the different kits; the Signal Tracer works fine. Also like to let you know that I feel proud of becoming a member of your Radio-TV Club."

Robert L. Shuff, 1934 Monroe Ave., Huntington, W. Va.: "Thought I would drop you a few lines to say that I received my Edu-Kit, and was really amazed that such a bargain can be had at such a low price. I have already started repairing radios and phonographs. My friends were really surprised to see me get into the swing of it so quickly. The Troubleshooting Tester that comes with the Kit is really swell, and finds the trouble, if there is any to be found."

### UNCONDITIONAL MONEY-BACK GUARANTEE

ORDER DIRECT FROM AD—RECEIVE FREE BONUS  
RESISTOR AND CONDENSER KITS WORTH \$7

- Send "Edu-Kit" Postpaid. I enclose full payment of \$22.95.
- Send "Edu-Kit" C.O.D. I will pay \$22.95 plus postage.
- Send me FREE additional information describing "Edu-Kit."

Name JOHN D. ECKLAND  
Address ANTIQUA RADIO REPAIR  
409A Addison Ave.  
Brooklyn, CA 11201

PROGRESSIVE "EDU-KITS" INC.  
497 Union Ave., Dept. 501AD, Brooklyn 11 N. Y.

# Electronic Projects you can make

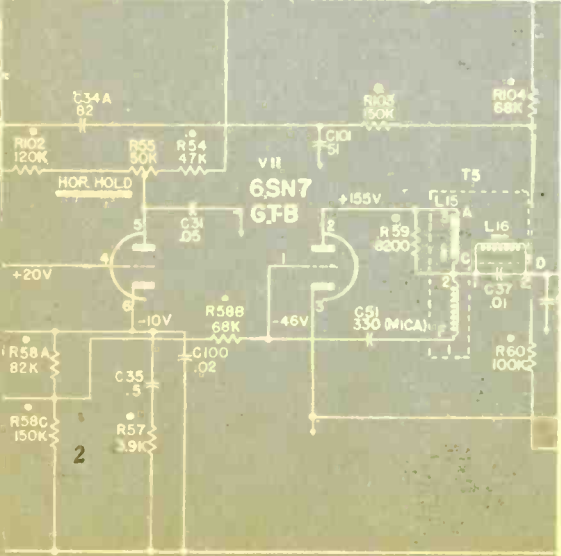
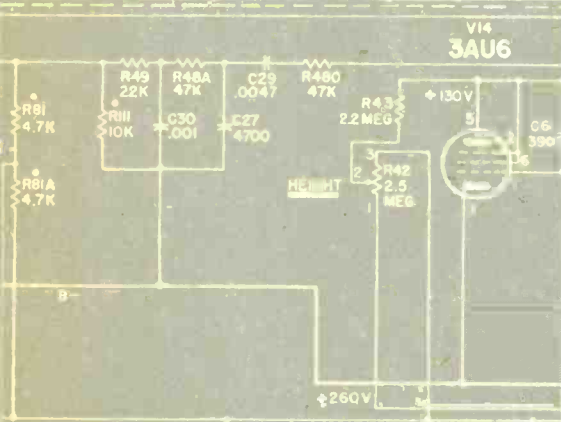
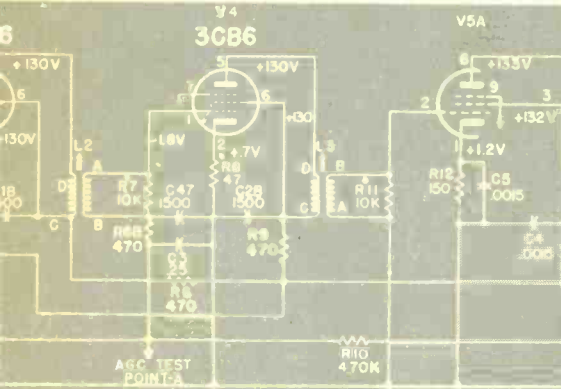
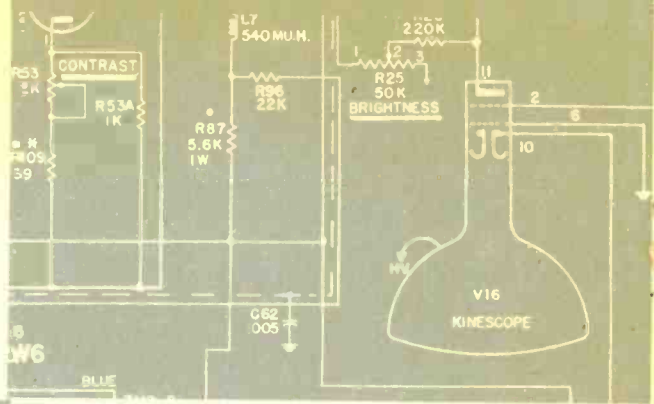

A FAWCETT BOOK • NUMBER 365  
 LARRY EISINGER • EDITOR-IN-CHIEF  
 GEORGE TILTON • MANAGING EDITOR  
 HAROLD KELLY • ART EDITOR

W. H. Fawcett, Jr. . . . . President  
 Roger Fawcett . . . . . General Manager  
 Ralph Daigh . . . . . Editorial Director  
 James B. Boynton . . . . . Advertising Director  
 Al Allard . . . . . Art Director  
 Ralph Mattison . . . . . Associate Art Director  
 Annette Packer . . . . . Production Director

FRED HONIG . . . . . EDITOR

SILVIO LEMBO . . . . . ASSOCIATE ART EDITOR  
 Nick Carlucci . . . . . Assistant Art Editor  
 Murray Cooper . . . . . Art Associate  
 Harold E. Price . . . . . Art Associate  
 Michael Gaynor . . . . . Art Associate  
 Larry Flanagan . . . . . Art Associate  
 John S. Selvaggio . . . . . Art Associate  
 Howard Katz . . . . . Art Associate  
 Mike Eastman . . . . . Art Associate  
 David Weiss . . . . . Art Associate  
 Bob Van Osten . . . . . Art Associate

Phyllis J. Goodman . . . . . Production Editor  
 Nancy Kay . . . . . Assistant Production Editor

ELECTRONIC PROJECTS YOU CAN MAKE, Fawcett Book 365, is published by Fawcett Publications, Inc., Greenwich, Connecticut. Editorial and Advertising Offices: 67 West 44th Street, New York 36, New York. General Offices: Fawcett Building, Greenwich, Connecticut. Gordon Fawcett—Secretary-Treasurer. Roscoe Fawcett—Circulation Director. Trademark of Fawcett Publications, Inc. Printed in U.S.A. Copyright 1958 by Fawcett Publications, Inc.

Cover photographs by Grayson Tewksbury



# FREE

LATEST  
**EICO**  
CATALOG

**EICO**®

33-00 NORTHERN BLVD.  
LONG ISLAND CITY 1, N. Y.

Show me HOW to SAVE 50% on Laboratory Precision test Instruments & Hi-Fi. Send FREE catalog & name of neighborhood EICO Distributor. F-58

SAVES YOU 50% on your  
**TEST INSTRUMENT & HI-FI COSTS**  
50 KITS & WIRED MODELS to choose from!

Name.....  
Address.....  
City..... Zone..... State.....  
Occupation.....  
Prices 5% higher on West Coast



Home, car, TV,  
appliance repairs:  
#540 NEWI  
READI-TESTER  
KIT \$12.95  
WIRED \$15.95



VACUUM TUBE  
VOLTMETER  
#221  
KIT \$25.95  
WIRED \$39.95



NEWI PEAK-to-PEAK  
VTVM  
#232 & UNI-PROBE  
(pat. pend.)  
KIT \$29.95  
WIRED \$49.95



1000 Ohms/Volt  
MULTIMETER  
#536  
KIT \$12.90  
WIRED \$14.90

You build EICO KITS in one evening — but they last a LIFETIME! OVER 1 MILLION in use today!



5" PUSH-PULL  
SCOPE #425  
KIT \$44.95  
WIRED \$79.95  
Lowest-priced  
professional Scope



NEWI COLOR &  
BLACK-&-WHITE  
S-MC TV  
SCOPE #460  
KIT \$79.95  
WIRED \$129.50



TUBE TESTER #625  
KIT \$34.95 WIRED \$49.95

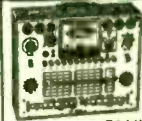

#666  
NEWI DYNAMIC  
CONDUCTANCE  
TUBE &  
TRANSISTOR TESTER  
KIT \$69.95 WIRED \$109.95

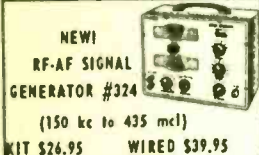

NEWI  
RF-AF SIGNAL  
GENERATOR #324  
(150 kc to 435 mc)  
KIT \$26.95 WIRED \$39.95



TV-FM SWEEP  
GENERATOR  
#360  
KIT \$34.95 WIRED \$49.95



MULTI-SIGNAL TRACER #145  
KIT \$19.95 WIRED \$28.95



1000 Ohms/Volt  
MULTIMETER  
#556  
(4 1/2" METER)  
KIT \$16.90  
WIRED \$23.50



6V & 12V  
BATTERY  
ELIMINATOR  
& CHARGER  
#1050  
KIT \$29.95 WIRED \$38.95

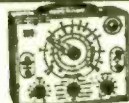

R-C BRIDGE & R-C-L  
COMPARATOR #950B  
KIT \$19.95 WIRED \$29.95



Test radio, hearing aid,  
flashlight, photo-flash,  
electronic equipment  
batteries:  
BATTERY TESTER  
#584  
KIT \$9.95 WIRED \$12.95



RETMA Res. Sub.  
Box #1100  
KIT \$5.95 WIRED \$9.95  
RETMA Cap. Sub.  
Box #1120  
KIT \$5.95 WIRED \$9.95

HIGHEST QUALITY HI-FI at the lowest prices...

only from **EICO**®



NEWI FM TUNER #HFT90  
KIT, less cover: \$39.95  
WIRED, less cover: \$45.95  
Cover: \$3.95 \*excise tax incl.



NEW  
MASTER  
CONTROL  
PREAMPLIFIER #HF61  
KIT \$24.95 WIRED \$37.95  
with Power Supply:  
KIT \$29.95 WIRED \$44.95



NEWI  
40-WATT  
Ultra Linear  
HIGH  
FIDELITY  
POWER AMPLIFIER  
#HF40 with ACRO TO-330 OUTPUT XFMS  
KIT \$72.95 WIRED \$99.95



NEWI  
50-WATT  
Ultra-Linear  
POWER  
AMPLIFIER  
#HF50  
with  
CHICAGO OUTPUT XFMR  
KIT \$57.95 WIRED \$87.95



NEWI  
20-WATT  
Ultra-  
Linear  
Williamson-  
type  
INTEGRATED AMPLIFIER  
#HF20  
KIT \$49.95 WIRED \$79.95



NEWI  
50-WATT  
Ultra-  
Linear  
INTEGRATED AMPLIFIER  
#HF52  
KIT \$69.95 WIRED \$109.95



NEWI 12-WATT Williamson-  
type INTEGRATED AMPLI-  
FIER #HF12  
KIT \$34.95 WIRED \$57.95



NEWI  
COMPLETE with  
FACTORY-BUILT  
CABINET-2-WAY  
HI-FI SPEAKER  
SYSTEM #HF51  
\$39.95



## CONTENTS

How To Work On Electronic Kits . . .	6
Radio And TV Symbols . . . . .	16
Superheterodyne . . . . .	20
Have Fun With A Lie Detector . . . . .	24
Utility Test Meter . . . . .	28
Multi-Band Receiver . . . . .	32
Signal Tracer . . . . .	36
Transistor Portable . . . . .	40
Remote Control Transmitter . . . . .	42
Remote Control Receiver . . . . .	47
Electronic Sentry . . . . .	50
Build Your Own TV Set . . . . .	52
Quiet Please . . . . .	56
Straighten Your Picture . . . . .	58
Signal Generator . . . . .	62
Sun-Powered Transistor Radio . . . . .	66
Balun Coil . . . . .	68
Low-Cost Ham Transmitter . . . . .	70
Tune Up With A S.W.R. Bridge . . . . .	78
Cathode Ray Oscilloscope . . . . .	82
Preamplifier And Control Unit . . . . .	86
Hi-Fi FM Tuner . . . . .	90
High Power Amplifier System . . . . .	92
Transistor Radio . . . . .	96
Transistor Power Supply . . . . .	100
Build An Etched Circuit Radio . . . . .	102
Foxhole Radio . . . . .	108
Transistor Geiger Counter . . . . .	110
3-Way Portable . . . . .	114
Photo-Electric Burglar Alarm . . . . .	118
Convert Your Radio to Short Wave . . . . .	124
Wading Pool Alarm . . . . .	128
30-Watt Basic Amplifier . . . . .	132
Code Practice Speaker . . . . .	136
Your Radio Is An Intercom . . . . .	138

## INTRODUCTION

**H**ALF the fun of electronics, especially if it's your hobby, consists of making the various components yourself. For years, enterprising electronic experimenters have been building their own radio receivers, amplifiers, etc. However, with today's more complicated circuits this would often involve having the knowledge of an electrical engineer plus an unlimited budget. This problem has been solved by the electronic kit manufacturers—the greatest boon to experimenters since Ben Franklin first flew his kite. Comparatively inexpensive, these kits include everything from printed circuits to rosin core solder. A fair understanding of English (to read the explicit instruction manuals) combined with a little patience will often be enough to construct the most complicated piece of equipment by even the beginner in this fascinating field. It's also quite profitable: the practical knowledge gained through the assembly of the various kits is probably the best education in electronics aside from a four-year course at M.I.T.

Many of the projects in this book are built from tested electronic kits; others are original. All of them are educational, entertaining and functional. None of them can be purchased as a finished component for at least double the price, which will not include the pleasure and satisfaction you'll derive from making it yourself.

*Paul Horij*  
EDITOR





THE MOST EXCITING HIGH-FIDELITY PERFORMANCES EVER OFFERED  
TO NEW MEMBERS OF THE COLUMBIA  RECORD CLUB

# FREE-ANY 3

OF THESE SUPERB HIGH-FIDELITY  
12" COLUMBIA  RECORDS

If you join the Club now—and agree  
to purchase 4 selections during  
the coming 12 months **day by day**



- ☆ You receive, at once, any 3 of these records—FREE. One is your gift for joining, and the other two are your Bonus records "in advance"
- ☆ After you have purchased only four records, you receive a 12" Columbia  Bonus record of your choice FREE for every two additional selections you purchase from the Club
- ☆ You enroll in any one of the four Club Divisions: Classical; Jazz; Listening and Dancing; Broadway, Movies, Television and Musical Comedies
- ☆ Every month you receive, FREE, a new issue of the Columbia  Record Club Magazine — which describes all forthcoming selections
- ☆ You may accept or reject the selection for your Division, take records from other Divisions or take NO records in any particular month
- ☆ Your only membership obligation is to buy four selections from the more than 100 to be offered in the coming 12 months. You may cancel membership any time thereafter
- ☆ The records you want are mailed and billed to you at only \$3.98 (original cast Musical Shows somewhat higher), plus small mailing charge
- ☆ You must be delighted with membership or you may cancel it by returning the free records within 10 days



## COLUMBIA RECORD CLUB Terre Haute, Indiana

**FREE — ANY 3 — MAIL ENTIRE COUPON NOW!**

COLUMBIA  RECORD CLUB, Dept. 473  
TERRE HAUTE, INDIANA

Please send me as my FREE gift the 3 records whose numbers I have circled at the right — and enroll me in the following Division of the Club:

(check one box only)

- Classical       Listening and Dancing       Jazz  
 Broadway, Movies, Television and Musical Comedies

I agree to purchase four selections from the more than 100 to be offered during the coming 12 months . . . at regular list price, plus small mailing charge. For every two additional selections I accept, I am to receive a 12" Columbia  Bonus record of my choice FREE.

Name  (Please Print)

Address

City  Zone  State

CANADA: Prices slightly higher. Address 11-13 Soho St., Toronto B2  
If you wish to have this membership credited to an established Columbia Records dealer, authorized to accept subscriptions, please fill in the following information:

Dealer's Name

Dealer's Address  85-2

© Columbia Records Sales Corp., 1967

CIRCLE 3 NUMBERS BELOW:

1. Eddy Duchin Story
2. Beethoven: 3 piano sonatas
3. Erroll Garner ("Caravan")
4. Gaité Parisienne; Les Sylphides
5. Easy To Remember—Luboff Choir
6. My Fair Lady—Orig. Broadway Cast
7. Brubeck and Jay & Kai
8. Gershwin Hits—Percy Faith
9. Sinatra—Adventures of the Heart
10. Ambassador Satch
11. Firebird; Romeo and Juliet
12. Day By Day—Doris Day
13. Johann Strauss—Waltzes
14. Lure of the Tropics—Kostelanetz
15. Ports Of Call
16. Oklahoma!
17. Levant Plays Gershwin
18. The Elgart Touch
19. The Great Melodies of Tchaikovsky
20. Sudden It's the Hi-Lo's
21. King of Swing—Benny Goodman
22. Brahms: Symphony No. 3
23. The Merry Widow
24. Wonderful, Wonderful—Mathis PE-1



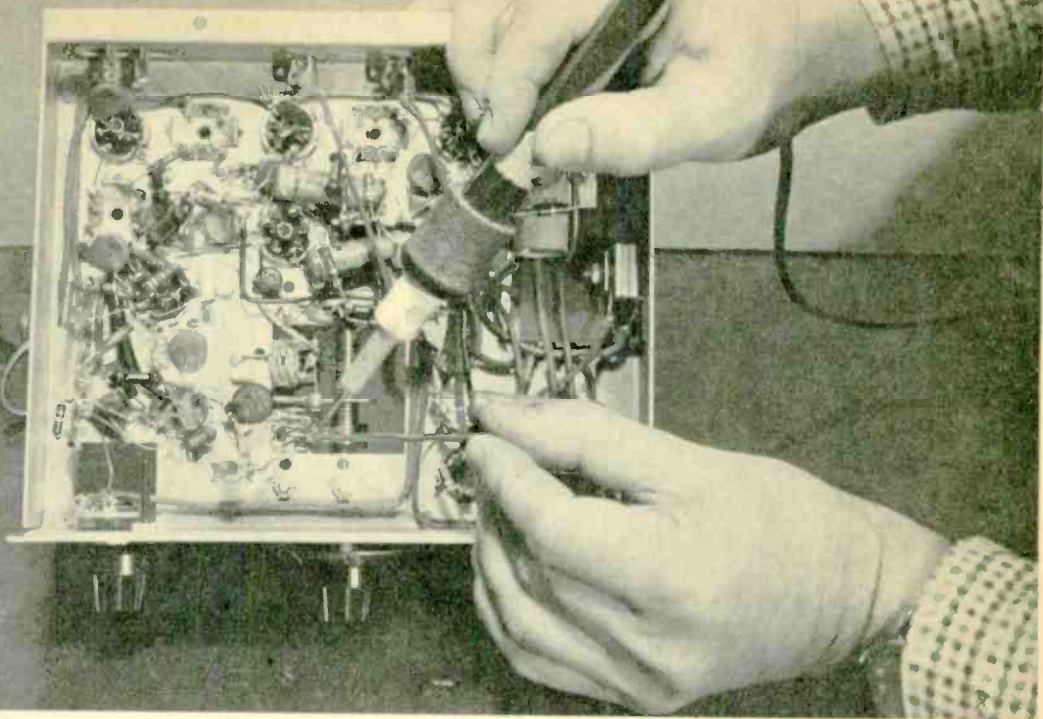

# How to Work on Electronic Kits

Get the most out of an electronic kit by proceeding with care and paying attention to details during assembly.

**PROCEED** slowly and use a clean, hot soldering iron.

There in a sentence you have the secret of success in electronic kit assembly. We should know, because we have put together no less than one hundred different kit projects during the past eleven years. All except a very few worked the first time they were turned on. The failures were due about equally to haste on our part and to errors in instructions or diagrams. The simplest item was a crystal set that took about fifteen minutes; the most complicated was a 30-tube television receiver that went up in smoke when plugged in.

If you're about to tackle your first project, you'll profit from a study of the suggestions contained in the accompanying photographs. •—Robert Hertzberg

Open box carefully by slitting the sealing strips with a sharp knife. Push knife in about ¼-inch.



LET DeVRY TECH PREPARE YOU IN  
SPARE TIME AT HOME AS AN

# ELECTRONICS TECHNICIAN



**NO PREVIOUS TECHNICAL EXPERIENCE  
OR ADVANCED EDUCATION NEEDED!**

Laborers and bookkeepers, store clerks, shop men, farmers, salesmen — men of nearly every calling — have taken the DeVry Tech program and today have good jobs or service shops of their own in Electronics. You don't have to quit your present job. If you are 17 to 55, see how you may get yourself ready for a future in the fast-growing Electronics field.

Whether you prepare at home or in our well-equipped Chicago or Toronto Laboratories, you get sound, basic training in both principles and practice. At home, you use educational movies. You build actual circuits and test equipment. You read simple directions, follow clear illustrations. When you finish, you are prepared to step into a good job in an excitingly different field. You may even start a service shop of your own. Mail coupon for free facts today.

### Live-Wire Employment Service



Puts you in touch with job opportunities—or helps you toward a better position in the plant where you are now employed.

### Draft Age?

We have valuable information for every man of draft age; so if you are subject to military service, be sure to check the coupon.

**SAMPLE BOOKLET FREE!**

We'll give you a free copy of an interesting booklet, "Electronics and YOU." See for yourself how you may take advantage of the opportunities in this fast-growing field.



**AN INDEX  
to a  
BETTER JOB,  
A BRIGHTER  
FUTURE**

Electronics

Radar

Guided  
Missiles

Television

Micro-Waves

Communications

Radio

Industrial  
Electronics

Computers

Automation  
Electronics

Remote Control  
Systems

Broadcasting

Your Own  
Service Shop

**MAIL TODAY FOR FREE FACTS**

"One of North America's Foremost Electronics Training Centers"



Accredited Member  
of National  
Home Study Council

**DEVRY TECHNICAL INSTITUTE**

CHICAGO 41, ILLINOIS

FORMERLY

DEFOREST'S TRAINING, INC.



**DeVry Technical Institute**

4141 Belmont Ave., Chicago 41, Ill., Dept. FEP-0

Please give me your FREE booklet, "Electronics and YOU," and tell me how I may prepare to enter one or more branches of Electronics as listed above.

NAME \_\_\_\_\_ AGE \_\_\_\_\_  
Please Print  
STREET \_\_\_\_\_ APT. \_\_\_\_\_  
CITY \_\_\_\_\_ ZONE \_\_\_\_\_ STATE \_\_\_\_\_

Check here if subject to military training

1090

DeVry Tech's Canadian Training Center is located at  
626 Roselawn Avenue, Toronto 12, Ontario



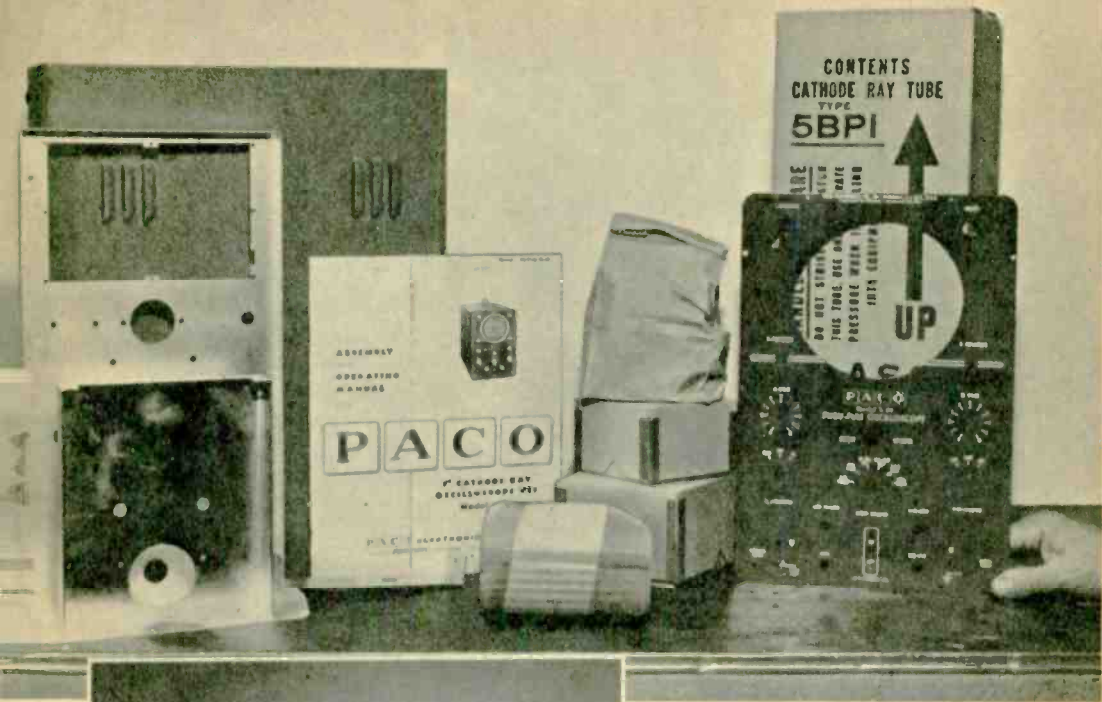

Above are the parts that came out of the oscilloscope kit (see page 82). The many components are in bags or boxes, the scope tube in its own container. Do not open any box at this time; instead, reach for instruction book and retire to favorite chair. Best investment of time you can make is to study instruction book from cover to cover. Look for correction notices, changes in parts list, notes about accessories, etc. Study the schematic circuit of the units plus the tube layout and general function of all the parts.



Make sure that every item shown in the parts list is actually on hand. Tear open all envelopes and spread out all packing material. With every item checked off, dispose of the boxes and packing material.



These men are getting practical training in . . .

# ELECTRICITY

## ELECTRONICS

### ON REAL

A.C. and D.C. Motors  
Generators  
Switchboards  
Controllers  
Appliances  
Electronic Units

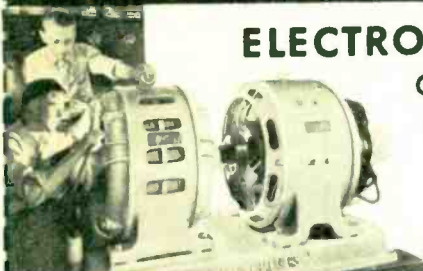

# Train in Great Shops of COYNE

in Chicago—Prepare for a better job and a real future in **TOP OPPORTUNITY FIELDS**. Train on real full-size equipment at **COYNE** where thousands of successful men have trained for nearly 60 years—*largest, oldest, best equipped school of its kind*—est. 1899. Trained instructors show you how, then do practical jobs yourself. No previous experience or advanced education needed. Employment Service to Graduates. **START NOW—PAY LATER**—Liberal Finance and Payment Plans. Part-time employment help for students. **GET FREE BOOK**—"Guide to Careers in **ELECTRICITY-ELECTRONICS** and **TELEVISION-RADIO**"—no obligation; no salesman will call. Vets and Non-Vets get vital facts now.

Coyne Electrical School 500 So. Paulina Street  
Chartered Not For Profit Chicago 12, Dept. 28-9C



# TELEVISION

## COLOR-TV

### ON REAL

Television  
Receivers  
Including Color TV  
AM and FM Radios  
Auto Radios  
Test Equipment

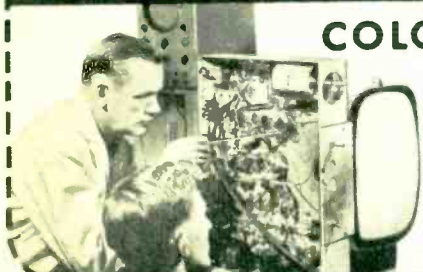

### MAIL COUPON TODAY!

**COYNE ELECTRICAL SCHOOL**  
500 S. Paulina St., Chicago 12, Ill., Dept. 28-9C

Send **BIG FREE** book and details of your training offer by return mail. I am interested in:

Electricity-Electronics  Television-Radio

Name \_\_\_\_\_

Address \_\_\_\_\_

City \_\_\_\_\_ State \_\_\_\_\_

**COYNE** offers  
**LOW COST**

# TELEVISION RADIO - COLOR TV

Training in  
Spare Time **AT HOME**



The future is **YOURS** in **TELEVISION!**

A fabulous field—good pay—fascinating work—a prosperous future in a good job, or independence in your own business!

Coyne brings you **MODERN-QUALITY** Television Home Training; training designed to meet Coyne standards at truly lowest cost—you pay for training only—no costly "put together kits." Not an old Radio Course with Television "tacked on." Here is **MODERN TELEVISION TRAINING** including Radio, UHF and Color TV. No Radio background or previous experience needed. Personal guidance by Coyne Staff. **Practical Job Guides** to show you how to do actual servicing jobs—*make money early in course*. Free Life-time Employment Service to Graduates.

## COYNE ELECTRICAL SCHOOL

A TECHNICAL TRADE INSTITUTE OPERATED  
NOT FOR PROFIT  
500 S. Paulina Street, Chicago 12, Dept. 28-H9

B. W. COOKE, Jr.  
President



Coyne—the Institution behind this training... the largest, oldest, best equipped residential school of its kind. Founded 1899.

### Send Coupon for Free Book

and full details,  
including easy  
Payment Plan.  
**No obligation, no  
salesman will call.**



### COYNE Television Home Training Division

500 S. Paulina St., Chicago 12, Ill.  
Dept. 28-H9

Send Free Book and details on how I can get  
Coyne Quality Television Home Training at  
low cost and easy terms.

Name \_\_\_\_\_

Address \_\_\_\_\_

City \_\_\_\_\_ State \_\_\_\_\_

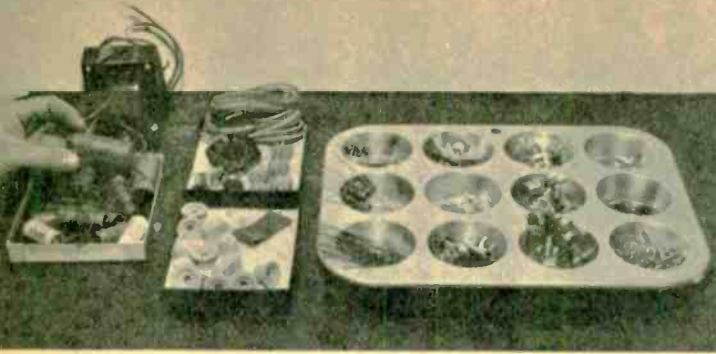

Sort out parts by categories and distribute them in various small containers so that they can be picked out conveniently as needed during the assembly and wiring work. A muffin tin borrowed from the kitchen is ideal for nuts, bolts and switches.

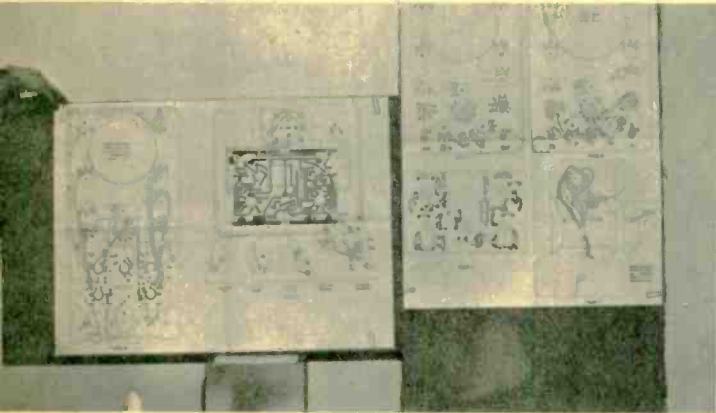

Full-scale working drawings are furnished with most kits. Clip these to pieces of wallboard, plywood or Masonite, and stand them up straight so that you can see them comfortably during any phase of assembly work.

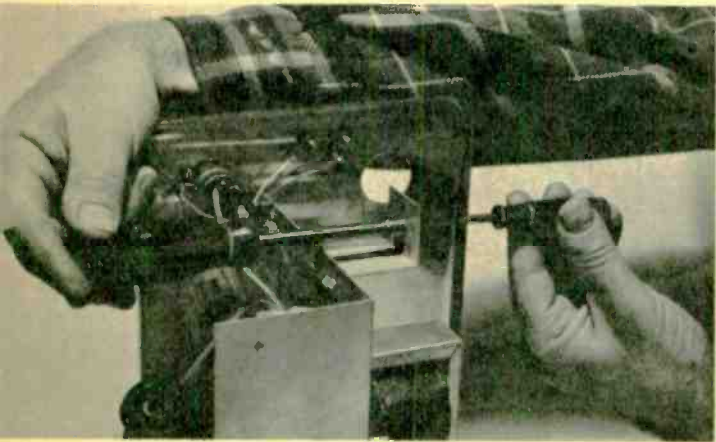

Almost all fasteners in electronic kits are 6-32 screws and 1/4-inch 6-32 hex nuts. In addition to a screwdriver a 1/4-inch socket wrench is an indispensable tool. Socket wrenches of 5/16- and 11/32-inch size are also useful for 8-32 and other hex nuts.

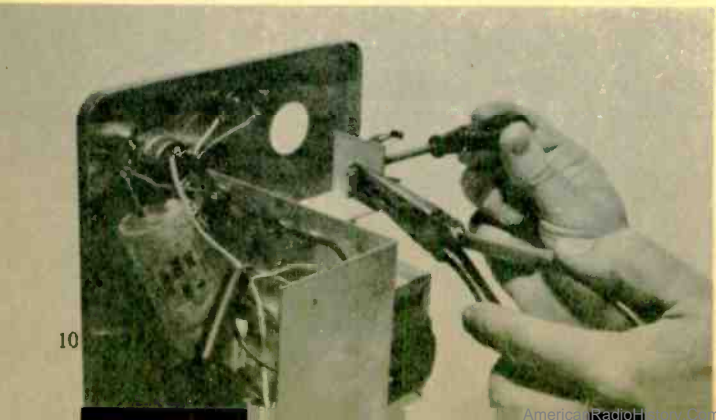

To start nuts in tight spots, hold them with a pair of long-nose pliers; but wherever possible do the final tightening with the aid of a wrench. Do not use these pliers for heavy squeezing or bending, or the slender nose will badly twist out of shape.



**RCA offers you the finest training at home in Radio-TV electronics, TV servicing, Color TV**

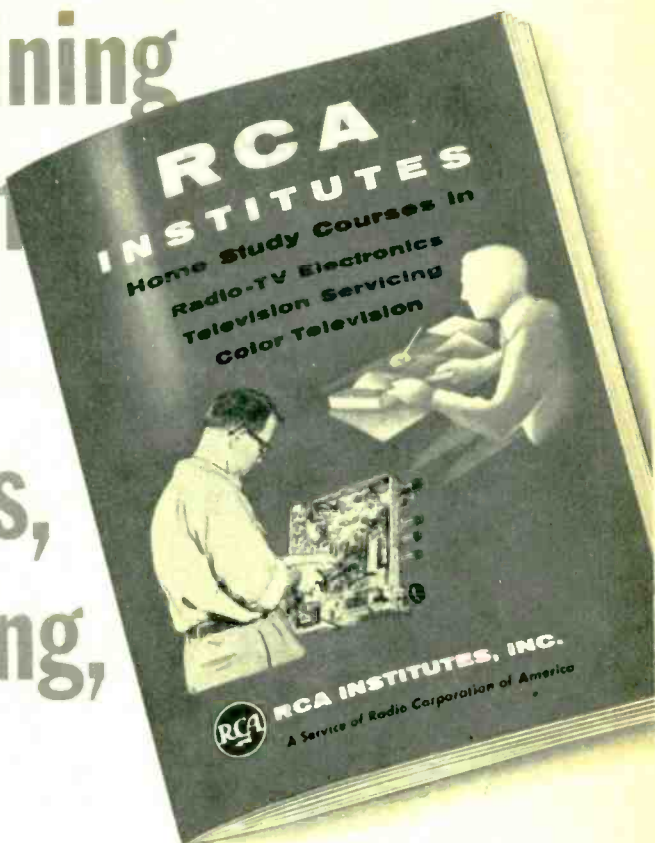

**SEND FOR THIS FREE BOOK NOW!**

Pay-as-you-learn. You need pay for only one study group at a time. Practical work with very first lesson. All text material and equipment is yours to keep. Courses for the beginner and advanced student.



**RCA INSTITUTES**  
 A SERVICE OF RADIO CORPORATION OF AMERICA  
 350 WEST FOURTH STREET, NEW YORK 14, N. Y.  
 In Canada — RCA Victor Company, Ltd.  
 5001 Cote de Liesse Rd., Montreal 9, Que.

RESIDENT SCHOOL courses in New York City offer comprehensive training in Television and Electronics. Day and evening classes start four times each year. Detailed information on request.

RCA Institutes, Inc., Home Study Dept. 30EP  
 350 West Fourth Street, New York 14, N. Y.  
 Without obligation, send me FREE 52 page CATALOG on Home Study Courses in Radio, Television and Color TV. No Salesman will call.

Name .....  
 Please Print

Address .....

City ..... Zone ..... State .....

KOREAN VETS! Enter discharge date .....

To save time, paste coupon on postcard



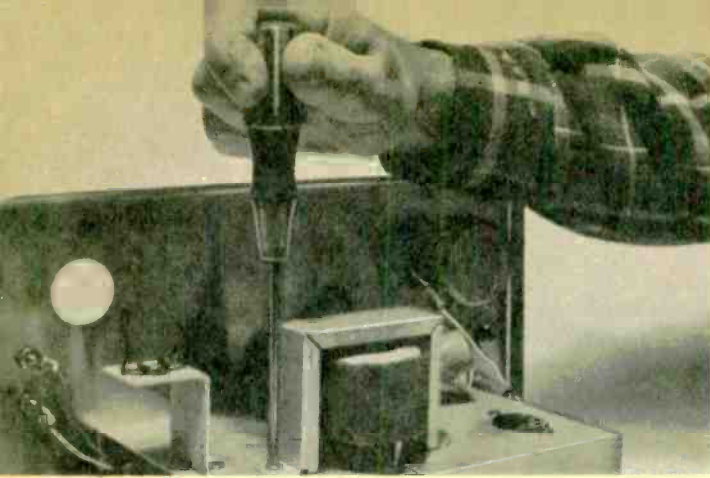

Pick a screwdriver whose blade fits and fills the heads of the screws and hold it in line with the latter when turning. A blade that is too thin will tend to slip and gouge out the slot. Three screwdriver sizes are usually needed for kits. Take samples of each screw size and match screwdrivers to them in the store.

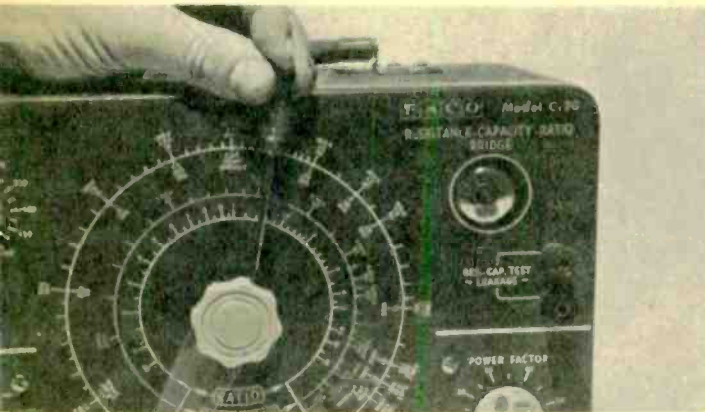

Headless set screws in knobs and dials require a very small screwdriver. You may have to file its end a bit to make it enter the threaded opening without any undue binding.

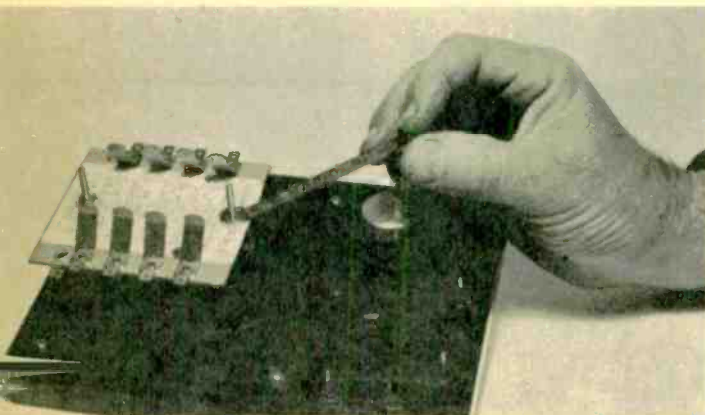

Miniature double-ended wrenches are usually identified as "ignition wrenches," are also a help in tight spots. They come in sets of six or eight and will accommodate nuts ranging from 13/64 through 7/16 in.

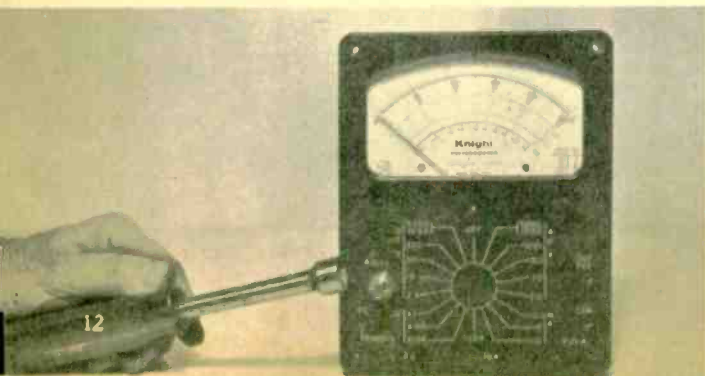

Volume controls, switches, phone jacks and similar parts are mounted with 1/2-inch or 9/16-inch hex nuts. To avoid damaging the panel invest in a set of socket wrenches in the above sizes. They do a quick and clean job.

Most wire used for connections in kits is of the "push-back" type; that is, the insulation can be rolled back without cutting. If it is not of this type, strip off insulation by cutting through lightly with side-cutting pliers; then pull off severed end. Practice on scraps so you can do this without nicking wire when working on the kit.



If wire does not lend itself to stripping with side-cutters, use common knife. Pare off insulation, with blade almost flat, to avoid cutting into the wire. If bared wire is dirty, clean it by scraping it very lightly with the BACK edge of your pocketknife.



Fasten wires to terminals, prior to soldering, by means of long-nose pliers. Avoid twisting with fingers as this usually puts a film of skin oil on the wire and makes soldering difficult. Use long-nose pliers only for holding, never for heavy bending.

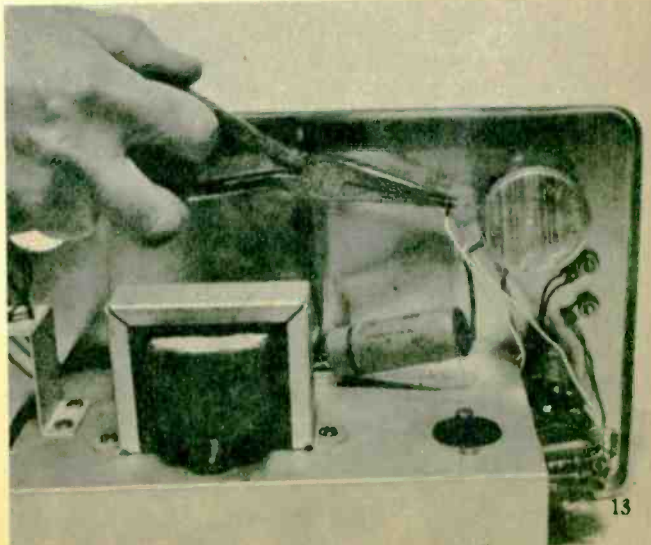

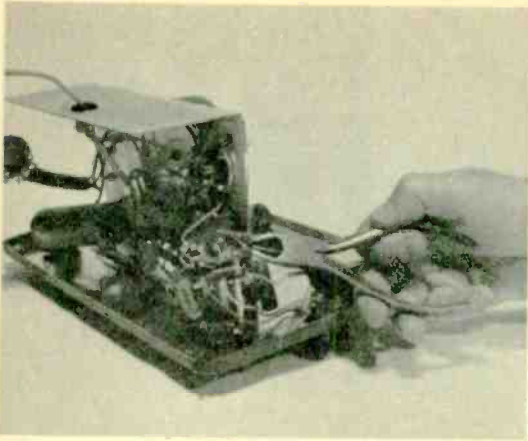

V-shaped nose of side-cutting pliers enables you to snip off wires close to soldering lug. Use these pliers only for working on copper wire.

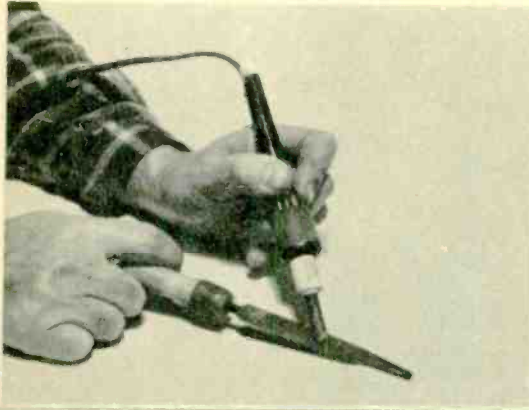

Soldering is very important part of kit work. Pencil-type iron, with interchangeable tips, is recommended. Light filing keeps tip smooth.

Entire trick of good soldering is to have both iron and joint clean. Use only rosin core solder. Avoid handling of wires with your fingers.

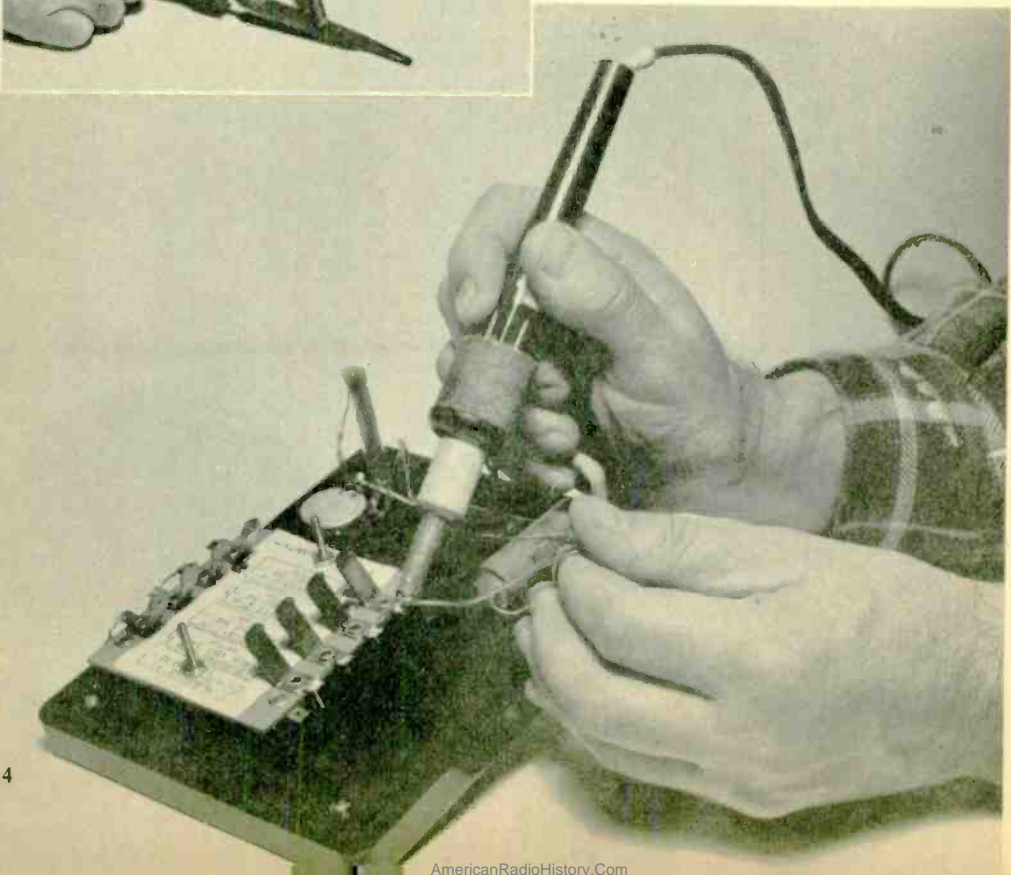



Wipe tip of iron frequently to keep it clean and shiny. Use rag or soft brass brush. Look closely for burned-out areas, and file flat.

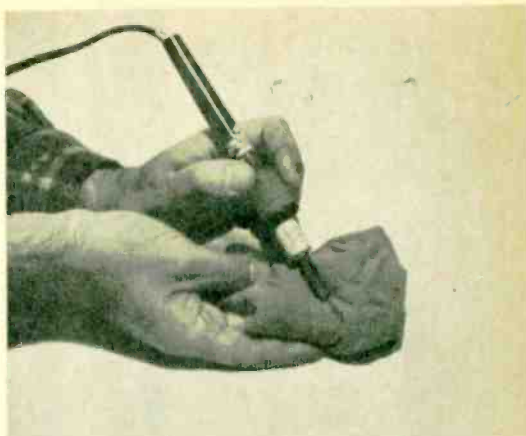

Many connections to miniature tube sockets will require a very slender iron. It's best to use a 1/8-inch diameter screw-in tip pencil iron.

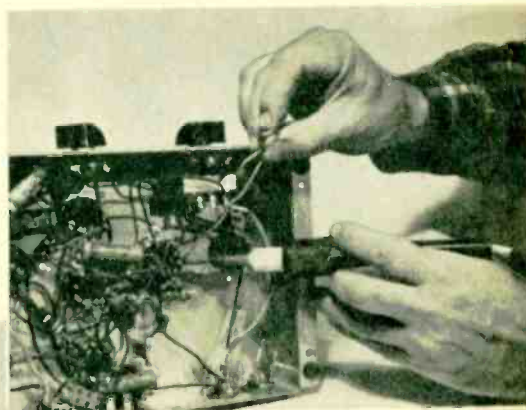

In open areas "gun" type irons are favored by many. They come to operating temperatures in a few seconds, are ideal for repair work.

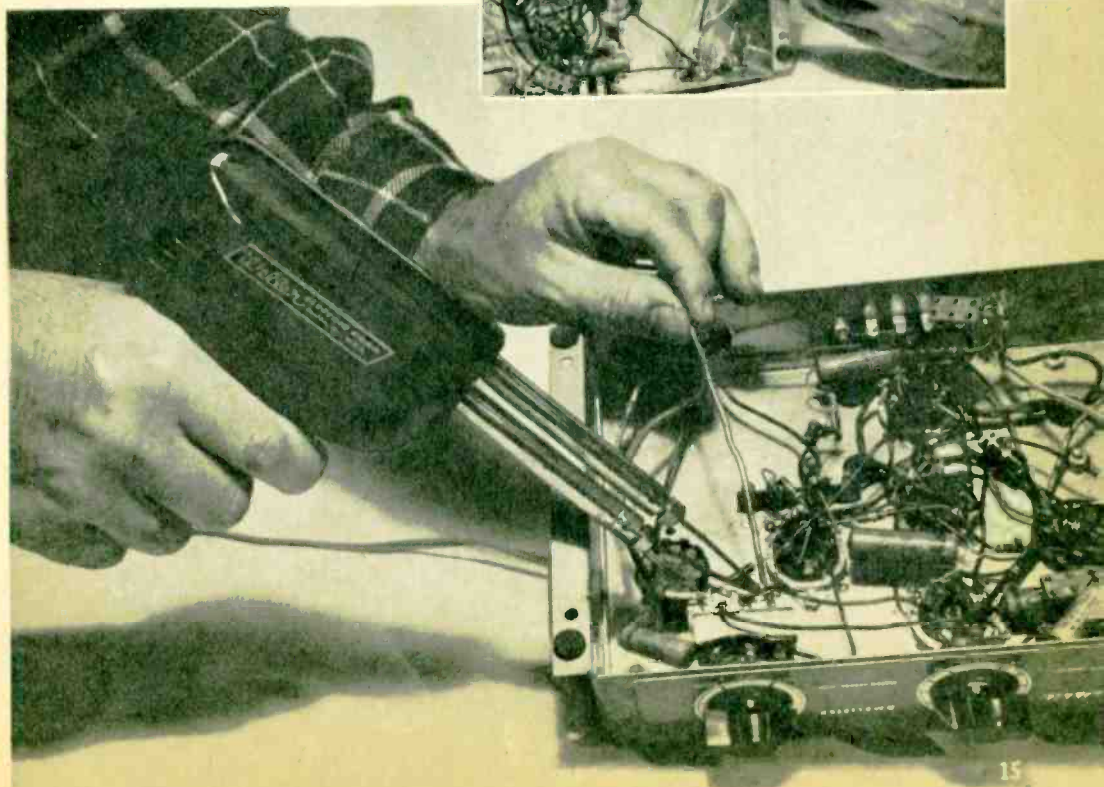

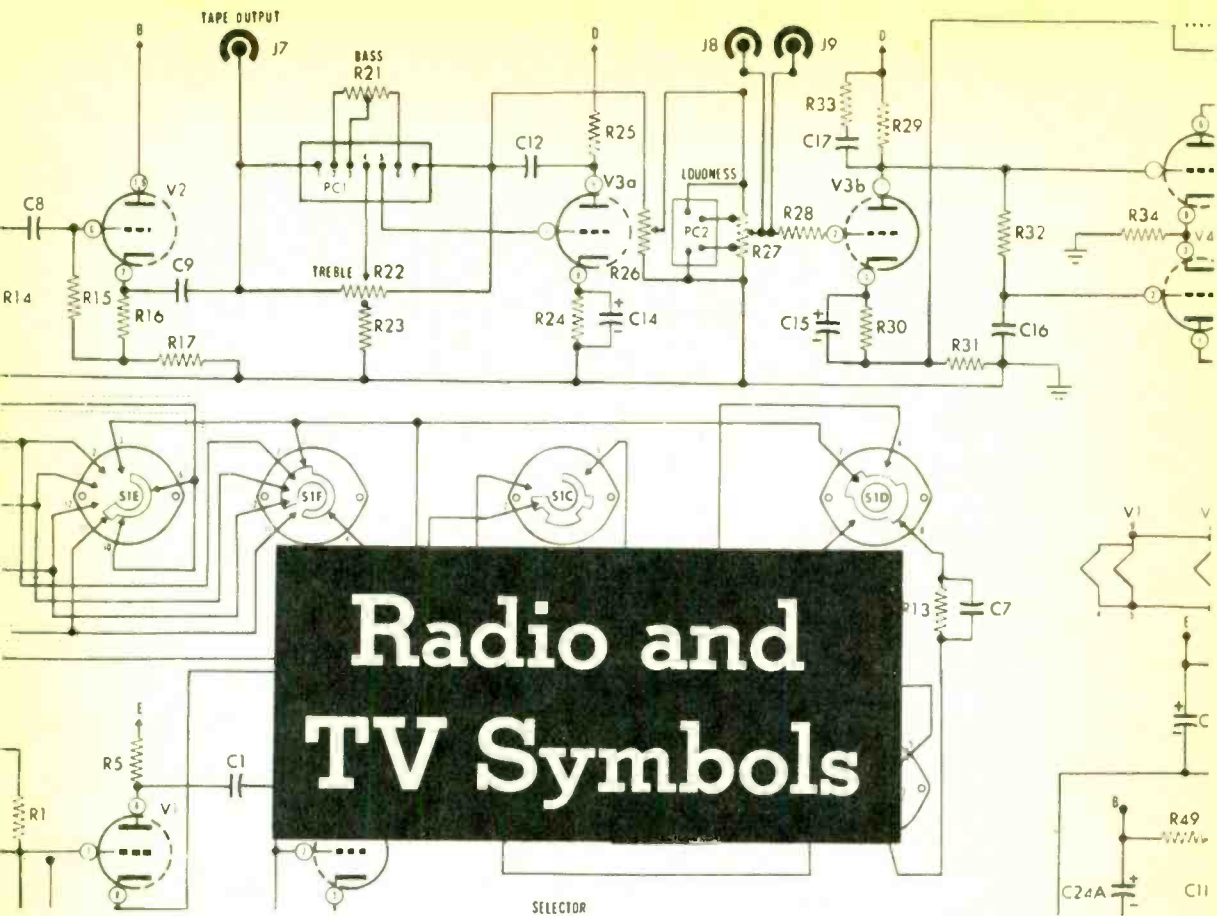

You can't understand schematic diagrams if you don't know the symbol language of the technician.

**T**HE symbols used to represent radio, TV and electronic components are of vital importance to the professional or amateur technician. Such symbols are used as a medium to convey information concerning circuits and principles, and since conveyed information can never be any more accurate or descriptive than the language used to communicate it, the technician owes it to himself and his fellow technicians to master the language of symbols. Many technicians who would never be guilty of writing "this here resistor," "the tube ain't no good," and similar violations of good grammar will flagrantly misuse and abuse the language of symbols.



In a recent small-scale survey conducted by the author, only 12 out of 25 technicians and engineers were able to draw the correct symbols for a list of 20 components. As might have been predicted, a large percentage of the errors involved the symbols

for components used less often than the ever-present resistor, capacitor and transformer. The symbols for neon bulbs, relays, phototubes, thyratrons, vibrators and microphones accounted for many of the errors. In some cases, a pictorial symbol was used. Since all technicians are not endowed with the same degree of artistic talent, pictorial representation invites misinterpretation.

The symbols shown in the accompanying drawings are based on current usage and the standards established by the American Standards Association. While it is not a complete listing of symbols, the charts do show those most frequently used.



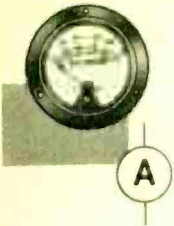
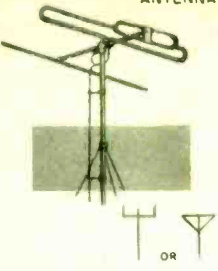
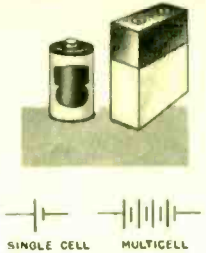
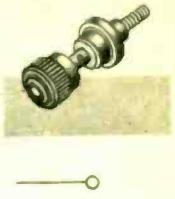
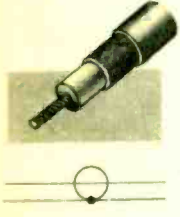
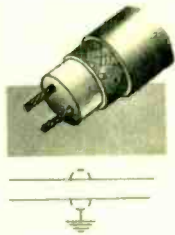

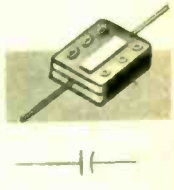
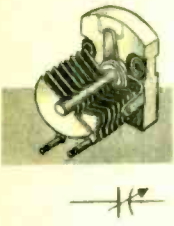
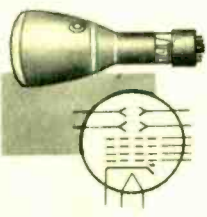
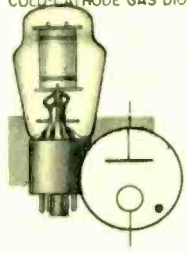
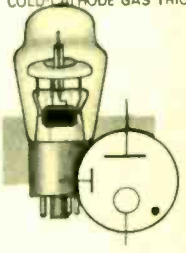
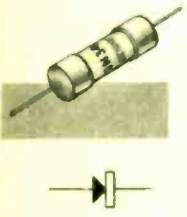
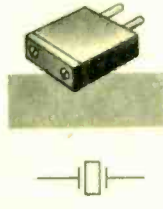
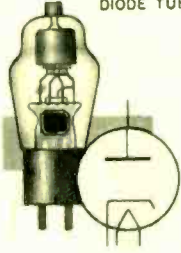
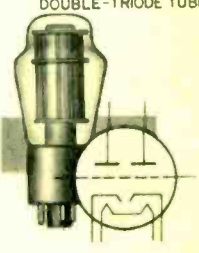
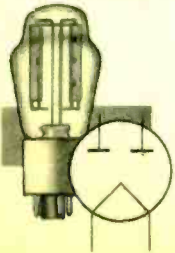
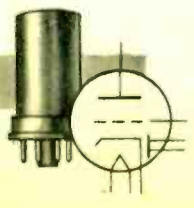
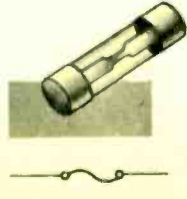
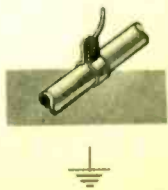

To simplify use of the charts, all components with the same initial letter in their names are grouped together. For example—under the letter A you will find ammeter and antenna; under B will be found battery and binding post, etc. •—Ed Bukstein

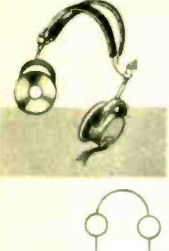

<p>AMMETER</p> 	<p>ANTENNA</p> 	<p>BATTERY</p> 	<p>BINDING POST</p> 
<p>CABLE (COAXIAL)</p> 	<p>CABLE (SHIELDED PAIR)</p> 	<p>CAPACITOR (ELECTROLYTIC)</p> 	<p>CAPACITOR (FIXED)</p> 
<p>CAPACITOR (VARIABLE)</p> 	<p>CATHODE RAY TUBE</p> 	<p>COLD-CATHODE GAS DIODE</p> 	<p>COLD-CATHODE GAS TRIODE</p> 
<p>CRYSTAL DIODE</p> 	<p>CRYSTAL (PIEZOELECTRIC)</p> 	<p>DIODE TUBE</p> 	<p>DOUBLE-TRIODE TUBE</p> 
<p>DUO-DIODE TUBE</p> 	<p>DUO-DIODE-TRIODE-TUBE</p> 	<p>FUSE</p> 	<p>GROUND</p> 

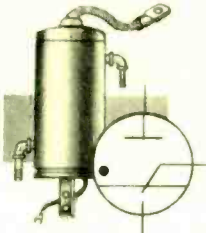
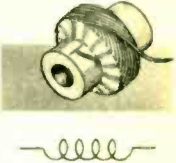
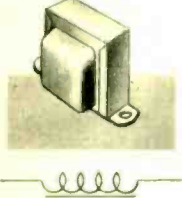
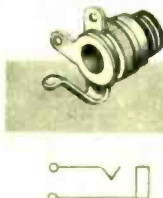
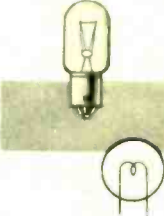
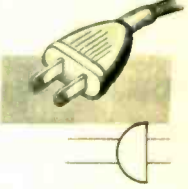
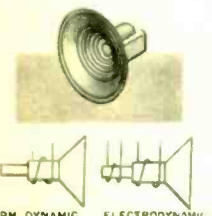
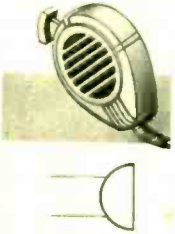
Continued . . .  
17

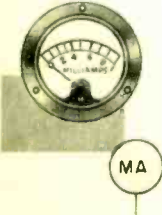
# RADIO AND TV SYMBOLS

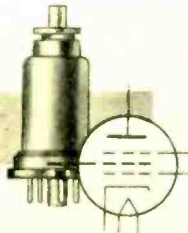
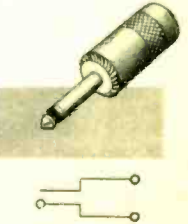
<p>HEADPHONES (DOUBLE)</p> 	<p>HEADPHONE (SINGLE)</p> 	<p>IGNITRON</p> 	<p>INDUCTOR (AIR CORE)</p> 
<p>INDUCTOR (IRON CORE)</p> 	<p>JACK</p> 	<p>LAMP</p> 	<p>LINE PLUG</p> 
<p>LOUDSPEAKER</p> 	<p>MICROPHONE (CARBON)</p> 	<p>MICROPHONE (CRYSTAL)</p> 	<p>MICROPHONE (MOVING-COIL)</p> 
<p>MILLIAMMETER</p> 	<p>NEON BULB</p> 	<p>PENTODE TUBE</p> 	<p>PHONE PLUG</p> 

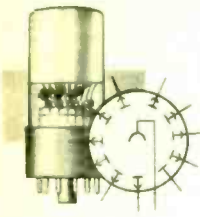
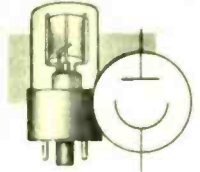
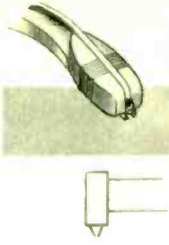
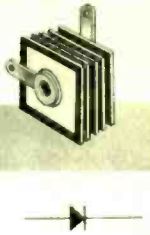
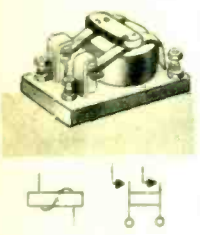
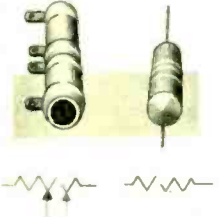
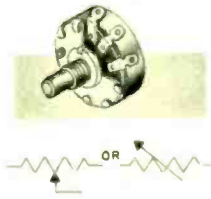
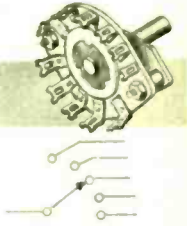
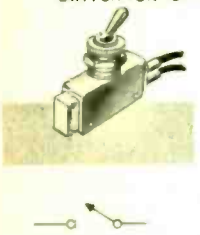
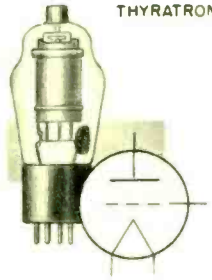
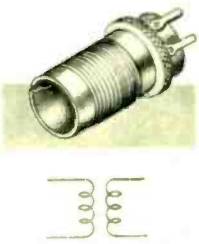
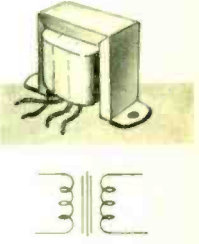
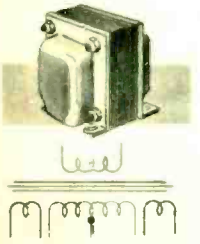
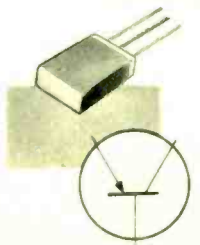
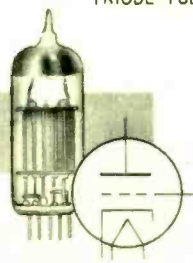
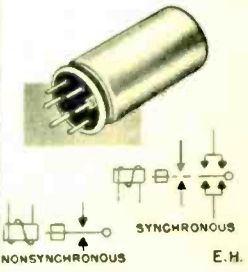

RADIO AND TV SYMBOLS

<p>PHOTOMULTIPLIER TUBE</p> 	<p>PHOTOTUBE</p> 	<p>PICKUP</p> 	<p>RECTIFIER (SELENIUM)</p> 
<p>RELAY</p> 	<p>RESISTORS (TAPPED AND FIXED)</p> 	<p>RESISTOR (VARIABLE)</p> 	<p>SWITCH (MULTIPOSITION)</p> 
<p>SWITCH (ON-OFF)</p> 	<p>THYRATRON</p> 	<p>TRANSFORMER (AIR CORE)</p> 	<p>TRANSFORMER (AUDIO)</p> 
<p>TRANSFORMER (POWER)</p> 	<p>TRANSISTOR</p> 	<p>TRIODE TUBE</p> 	<p>VIBRATOR</p> 



# Superheterodyne

The five-tube super-het is still the classic circuit,

a favorite of most amateur radio builders.

**T**HERE isn't a radio school in the world you can go to that does not include in its curriculum the five-tube superheterodyne. This classic receiver is of a basic design that has been varied many times over by many manufacturers.

Because the Arkay S-5E, made by Radio Kits Inc., 120 Cedar St., New York, N. Y., embodies the original circuit and completes this with a functional cabinet design, we have selected it for inclusion in this book.

In understanding the theory behind the five-tube superheterodyne, perhaps a bit of background material might be in order.

Before the advent of the superheterodyne circuit, the most popular receiver was the T.R.F., or Tuned Radio Frequency receiver. This ancient model boasted an array of knobs, each of which had to be tuned to a maximum signal point. The heterodyne circuit revolutionized the industry, permitting tuning with only one knob. An advertising genius added the word "super," and we have what we know as the superhet today.

Let's look at the schematic diagram. The first tube, a 12SA7 is a pentagrid converter, or mixer as it is more commonly known. The signals which constantly fill the air are





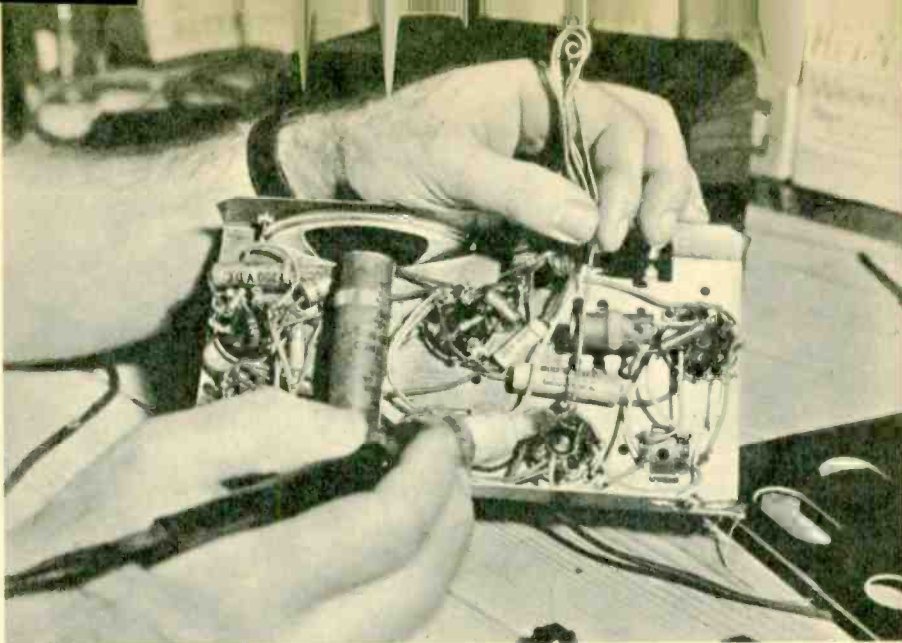

Follow the detailed instructions when soldering components in place. View above shows the bottom of one of the I.F. cans; these must be adjusted with plastic screwdriver.

After all connections are made, carefully insert the chassis into its plastic cabinet. Mounting bolts hold the unit from underneath. Note loop antenna attached to rear cover.

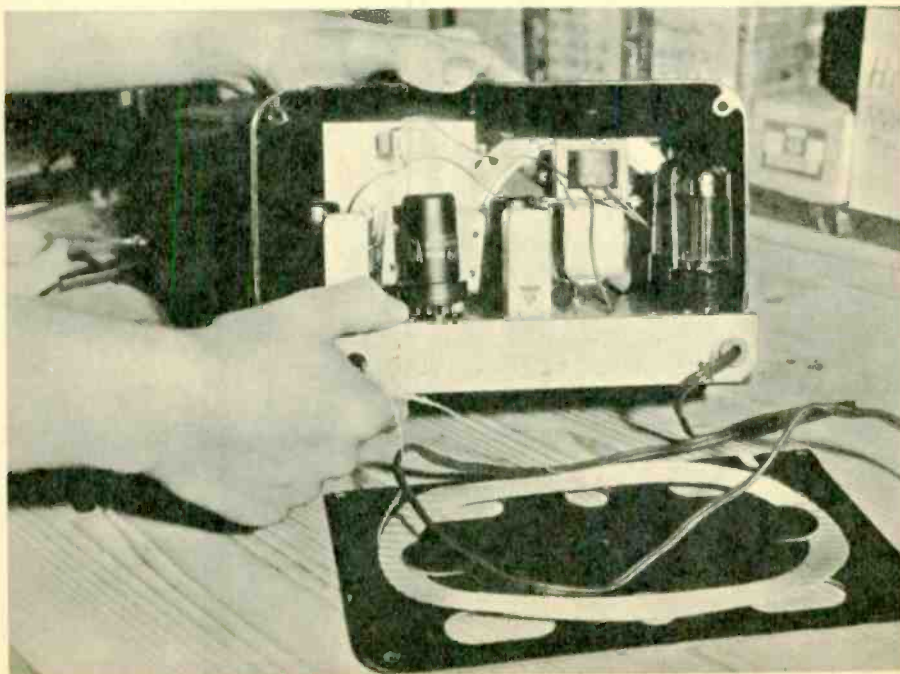



detector stage practically unaltered and goes on to the second half of the 12SQ7 tube where it receives amplification. The amplified audio signal is passed to the audio output stage, a 50L6 beam power amplifier. This tube serves only to boost the signal to a usable level, and the signal is then passed through the output transformer (T3) to the loudspeaker.

Volume of the unit is controlled by varying the amount of signal that is applied to the grid of the first audio amplifier. This potentiometer cannot of itself amplify a signal, but it can reduce the level of the signal taken from the detector and applied to the amplifier.

The only other function of the unit is the power supply. Adding the numbers of the tubes, we find that the total filament voltage is 121 volts. This permits operation directly from the AC lines which supply between 105 and 135 volts. Pilot lamp voltage is obtained by connecting the pilot lamp across the low voltage tap of the 35Z5 rectifier filaments. One side of the line is brought directly to the chassis through

the switch on the volume control; the other side of the line goes through the filaments which are also referenced to the chassis.

When you receive your kit, open the box carefully to avoid damaging the cabinet. If the box itself seems rather empty, it is because all the parts are packed inside the cabinet. Remove the packing material carefully and inspect each piece.

Read through the instructions carefully and then, studying the photograph (full-size) of the chassis, assemble the components as required. You will find several sheets of acetate plastic with the various steps in wiring included on each sheet. These sheets are to be laid over the photo of the chassis, and as you complete the wiring described on the first sheet, lay over the second sheet, and continue this process until the wiring is finished.

Place the tubes in the proper sockets and put the knobs on the shafts. Do not place the unit in the cabinet as yet. Now plug the receiver into a convenience outlet and turn on the switch which is part of the volume control. The tubes will light and after a short warm-up period the receiver should be able to bring in several stations.

You may want to make a few checks at this point. The alignment of the I.F. transformers has been taken care of at the manufacturer's factory, but most technicians feel they can always squeeze a little more out of an I.F. transformer by touching it up. To try this, a signal generator is needed, but you can do very little harm by using the "seat of your pants." Using a plastic screwdriver, first set the receiver to a local station, and then tune the I.F. transformers by inserting the screwdriver into the hole in the top of the I.F. shield can. Adjust slowly and carefully for increased volume.

After tuning each of the I.F. transformers, you may notice an improvement in sensitivity and selectivity. If you get a great increase in volume, you can lower the audio by rotating the volume control knob. Locate a station at the low end of the band, and check to see that the frequency is where it should be. Now repeat this process at the high end of the band. If the error is linear, you may only have to relocate the dial pointer on the condenser shaft. If any "tracking error" exists—if it is way off at both ends in opposite directions—you are able to compensate for this by adjusting the trimmer condensers on the tuning condenser. Use a plastic screwdriver, and lots of caution. •

—Byron G. Wels

The compact kit radio uses five vacuum tubes, is well worth its price. Assembly takes a few hours.

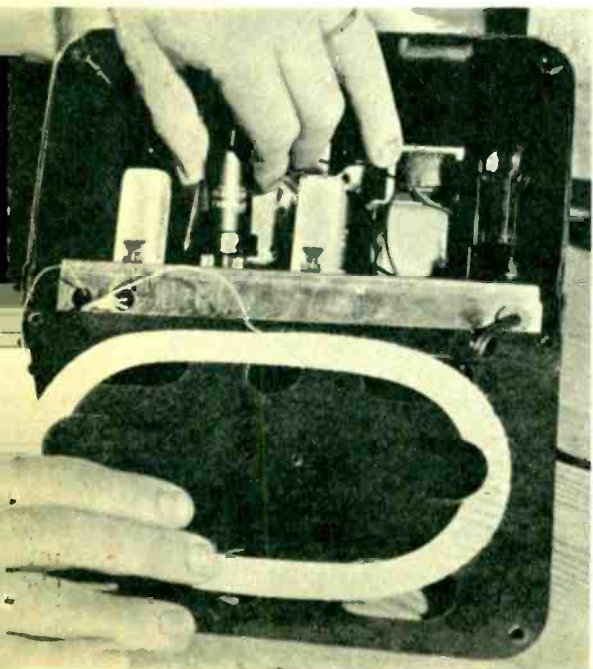

# Have Fun With a Lie Detector

Don't try to lie or to hide your emotions. This little "truth teller" will certainly give you away.



**I**F YOU really worked late in the office last night you have nothing to worry about if the wife wants to give you a little going over with the help of this lie detector. But, if you were out with the boys, played poker or told her that the smear on your collar is read ink—watch out! This little gadget will give you away.

When a person lies, no matter how slightly, certain physical changes such as

an increase in perspiration, body temperature, flow of blood, etc., take place. This increase or decrease in perspiration affects any electricity that may be passed across your body, your fingers in this instance. This change in electrical resistance is then registered on the instrument's meter.

You can have a barrel of fun with this device by using it as a kissing meter. To use for this osculatory purpose, fasten a



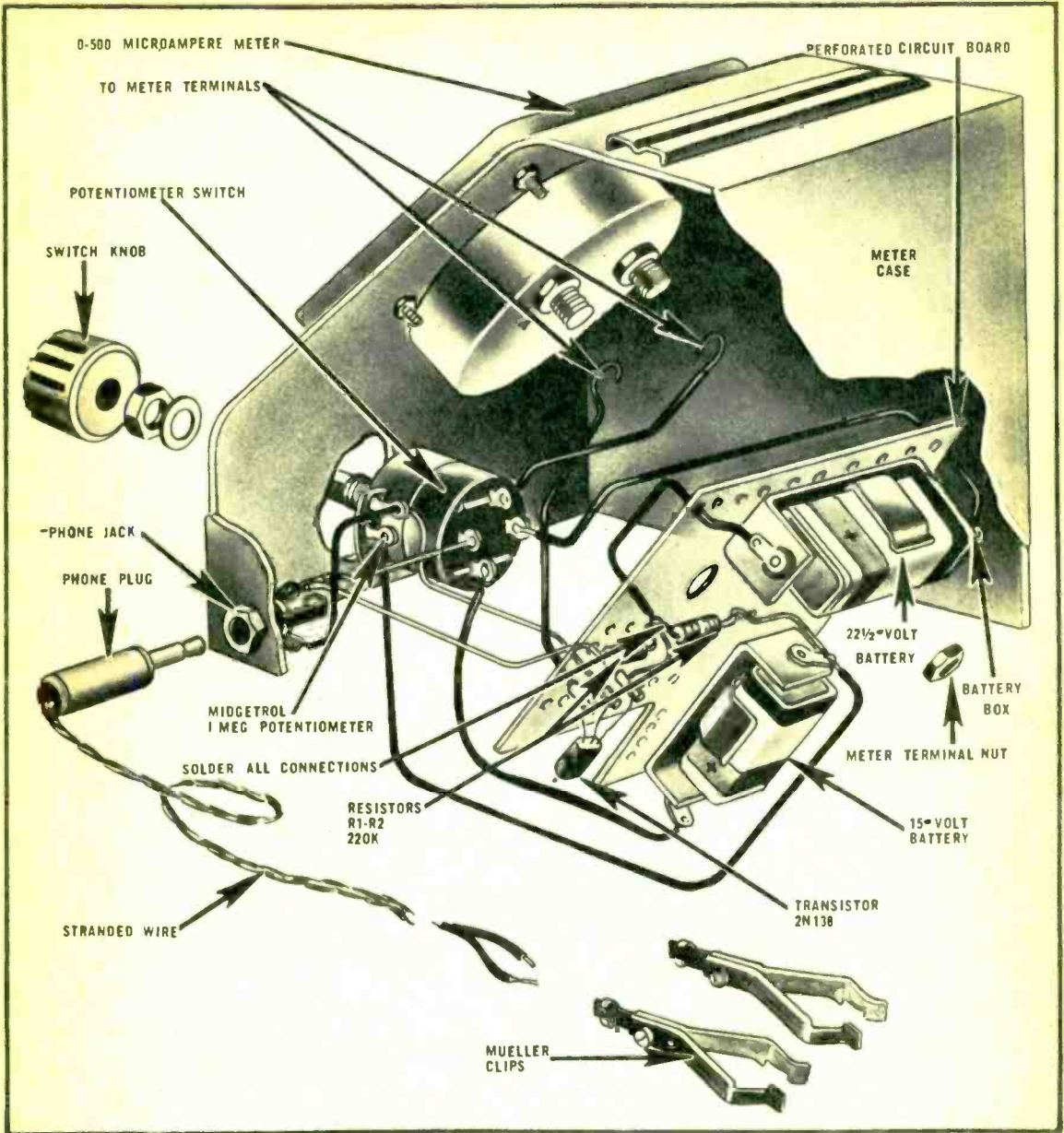

clip to the index finger of the man and the other clip to the corresponding finger of the female victim. When their lips touch, the needle will swing to a certain point on the dial. When tried with another partner or with other couples, the needle will invariably swing to another location, as obviously no two people have the same electrical intensity when kissing! It's all in fun so please don't accuse your partner of

being a cold fish if the needle doesn't swing as far as you expected it to. Our unit's circuit is similar to the Wheatstone bridge used in laboratory instruments for precise resistance measurements. However, for the home builder, there are several drawbacks to the Wheatstone system. The meter must be very sensitive and, therefore, expensive. A battery voltage of at least 45 volts is required.



No use trying to lie your way out. You can't beat meter which shows slightest emotional change.

With such a powerful battery there is a chance of burning out the meter if a short circuit occurs. In our system, with the addition of a transistor and another battery, the circuit is actually improved.

The transistor acts as an amplifier between the bridge and the meter. The 2N138 transistor amplifies the feeble current changes 140 times, making an expensive meter unnecessary. Low voltage batteries can be used. The current drain from the second battery is about .5 thousandths of an ampere. The second battery's current drain is about half that. The unit requires only one control and both switches are on this control.

All parts for our detector may be purchased from Lafayette Radio, 100 Sixth Ave., New York 13, N. Y., or from your local radio store. The case, ICA 3996, is made of very light steel and the builder using even a hand drill should encounter no trouble in drilling the various holes. First drill the  $\frac{3}{8}$ -in. hole for the control and the  $\frac{1}{4}$ -in. hole for the jack. Then, use the template provided with the meter as a guide for drilling its mounting holes.

Cut the circuit board to size and drill or ream the two holes to mount it on the meter. Flea clips are used to hold the

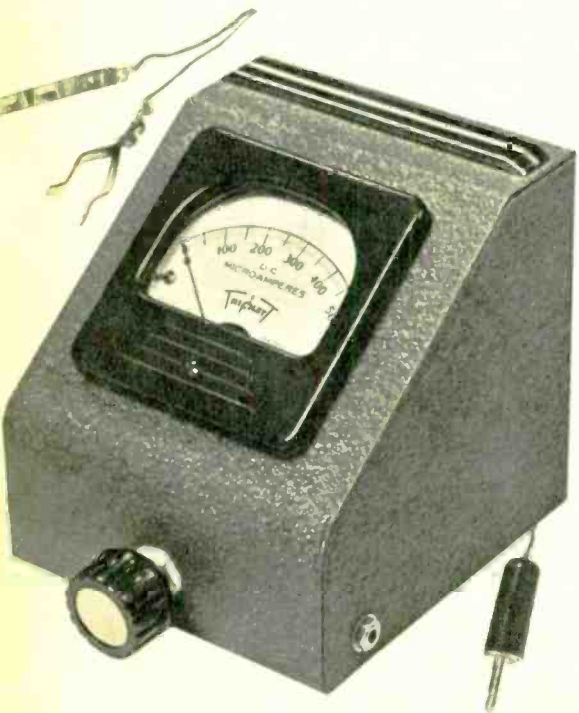

Front view of the unit shows meter and control.

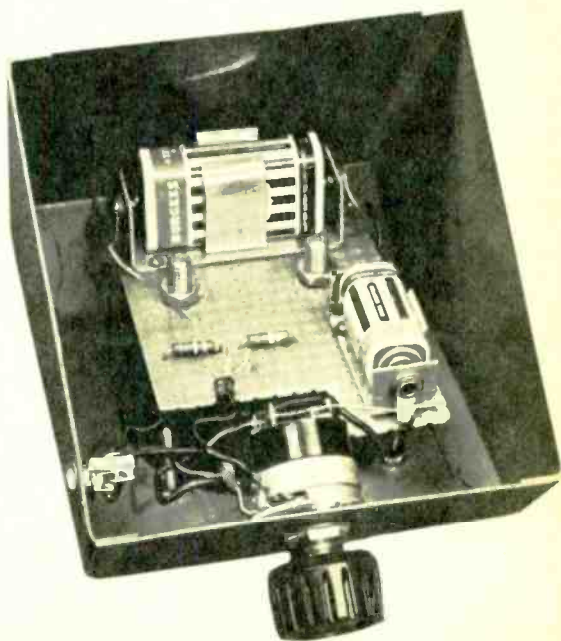

Note arrangement of batteries and transistor.



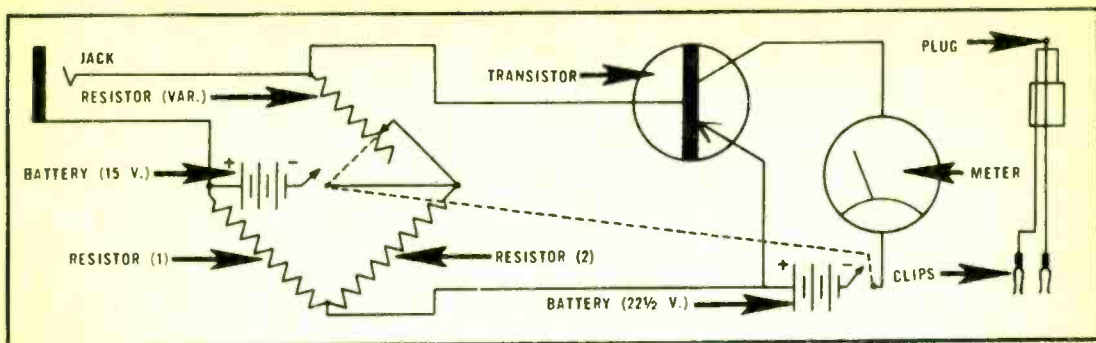

Schematic diagram of lie detector circuit.

transistor, but a socket (Lafayette No. MS-275) can be substituted. Attach the two battery holders and the resistors to the board. If desired, you may tie the batteries to the board and solder the wires directly to the terminals on the batteries. Follow the schematic carefully when wiring the unit. Make the leads from the board long enough to reach to the jack and the control. Once the meter is in the case, the other parts can be mounted in their proper places using the photo as a guide. Attach the switch to the control and wire it into the circuit. Wire up the rest of the circuit following the schematic carefully. Insert the batteries into the holders and the transistor into its flea clips. Check carefully to see that the polarity of the transistor and the batteries are correct; a reversed polarity can damage either the transistor or the meter.

To adapt the clips for our purpose, take the two Mueller No. 88 clips and remove the setscrews; twist the clip until it springs open. Now, replace the screws and wire the two clips to the plug with flexible wire.

Insert the jack into the plug but do not turn the unit on. Check once again for correct polarity of the batteries and the transistor and make sure that the control is wired correctly as shown in the drawing. Turn on the unit, holding the two clips together. The meter should stay at zero. If it does not, check the circuit against the schematic. Now, connect the clips to one finger on each hand. Turn the control until the needle on the meter rests at about mid-scale. The needle should drift as your body resistance changes slightly. If the unit passes all these tests, you are ready to try it out on a subject.

Connect the clips as before and balance the meter to mid-scale. Do not turn the

unit on unless there is some form of resistance between the two clips.

To use the meter properly, the subject must be asked a series of questions. It might sound something like this: "What is your name? Where do you live? Do you drink? Smoke? What did you do Saturday night?" etc., etc. Somewhere in this string of questions the subject should be asked something to which he is particularly sensitive. It may take a short time for the meter to give an indication but you will soon learn just what can be expected of the unit.

This detector makes an excellent demonstration unit for a psychology or law school class. But whether it is used for serious applications or just for some fun at your next party, it is a rewarding project for both builder and user. •—Tony Karp

## PARTS LIST

### ELECTRICAL

Quantity	
2	Resistors, 220 kilohm, 1/2 watt
1	Potentiometer, 1 meg; Mallory No. U-54 Midgetrol
1	Potentiometer switch, d.p.s.t.; Mallory No. US-27
1	Transistor, 2N138; Raytheon
1	Battery, 22 1/2-volt; Burgess No. U-15
1	Battery, 15 volt; Burgess No. U-10
1	Meter, O-500 microamperes; Triplett No. 327-T
1	Jack; Switchcraft No. 42A
1	Plug; Switchcraft No. 750
2	Clips; Mueller No. 88

### MECHANICAL

1	Meter case; ICA No. 3996
1	Circuit board; Lafayette No. MS-305
1	22 1/2 volt battery holder; Lafayette No. MS-177
1	15-volt battery holder; Lafayette No. MS-225
1	Knob; Lafayette No. KN-14
1	pkg. Flea clips; Lafayette No. MC-263
1	Lead wire, No. 24 stranded
4	Screws, No. 4-40x1/4"
4	Nuts, No. 4-40

# Utility Test Meter

The volt-ohmmeter is the basic tool of the worker in electronics. This unit, a kit, is easily assembled.

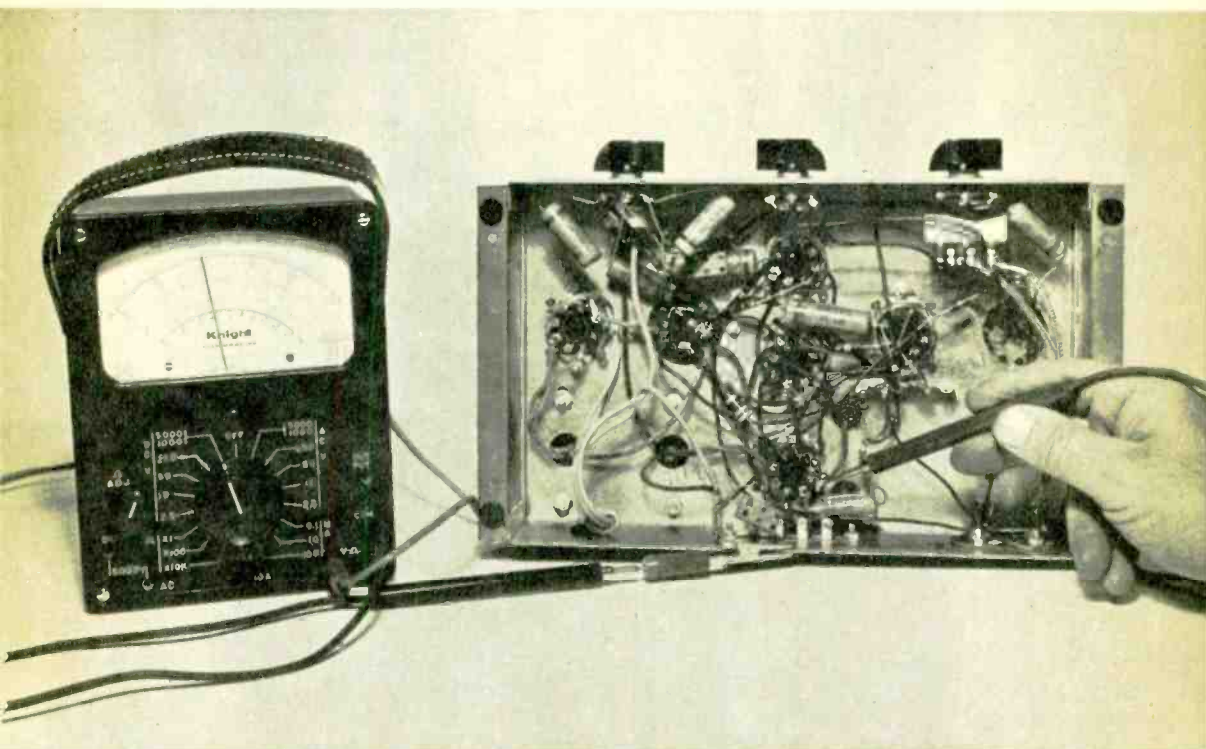

Are there 400 volts DC at a certain point in an amplifier circuit? Check by connecting negative test lead to amplifier chassis with alligator clip. Positive lead is touched to terminal of filter capacitor.

**T**HE most useful single test instrument for all electronic workers, from beginning "hams" to research engineers, is the multi-meter, generally known as the VOM. The latter is a contraction of "volt-ohmmeter," which pretty much describes the instrument's functions. It is also an ampere meter, or ammeter, but this application is not quite as important as the others in most circuit testing.

The heart of the VOM is a very sensitive direct-current ammeter, which in its bare state is capable of measuring extremely small currents. For example, in the typical Knight VOM pictured here, the meter is rated at 50 microamperes; that is, 50 millionths of an ampere, or .000050 amp. Through the use of various resistors con-

nected either in shunt or in series with the meter, the face of the instrument can be calibrated to read currents all the way up to 10 full amperes and voltages up to 5,000.

The current ranges are limited to direct current, as it is rarely necessary to measure small AC currents in ordinary electronic devices. The voltage ranges include both DC and AC. For AC voltage measurements, a rectifier is thrown into the circuit. This changes the AC into DC and permits the use of the basic DC meter movement.

For resistance measurement and continuity checking, several small flashlight batteries (contained in the case of the VOM) are added to the meter circuit, along with several resistors. The values of the



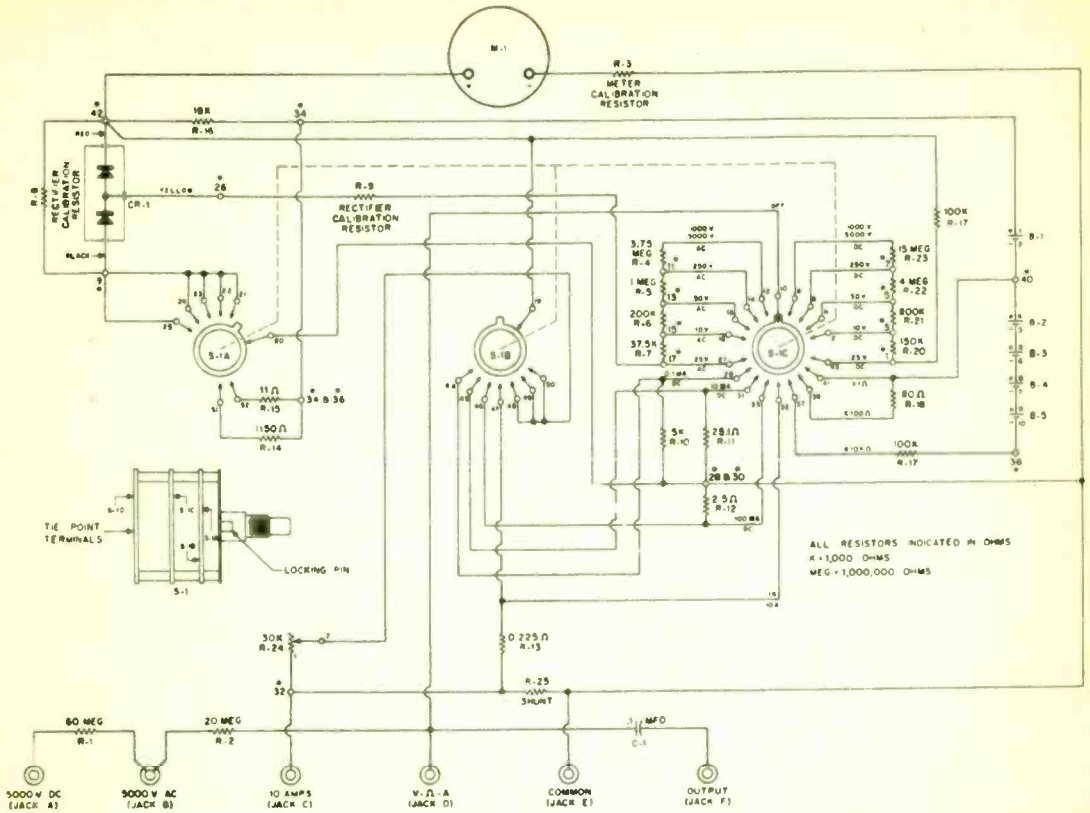

Schematic circuit diagram of the Knight VOM.

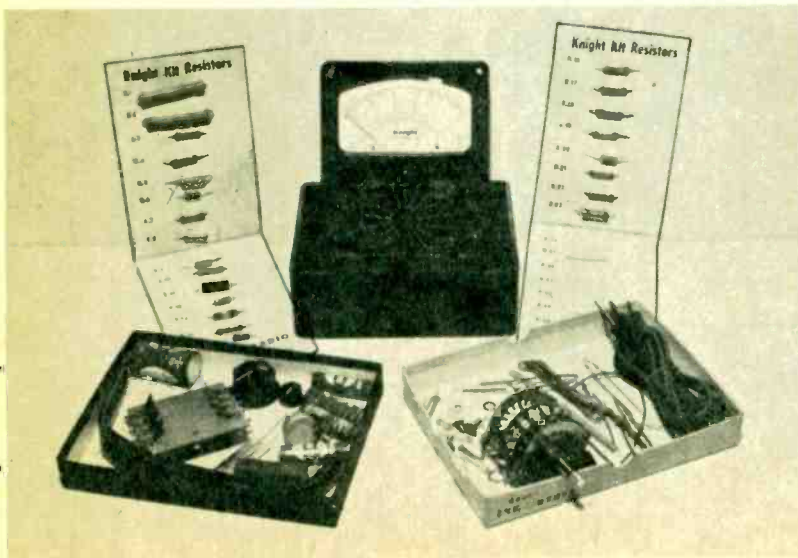

Excellent feature of VOM kit is mounting of resistors on cardboard strips, each identified by its R number. Meter is part of front panel (center of photo). Parts include supply of rosin core solder.

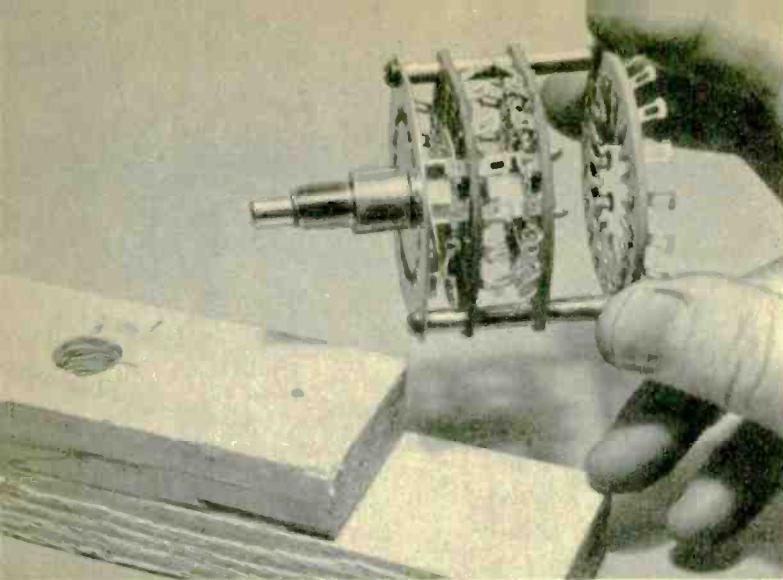

The function switch is easier to work on if it is supported upright. The jig shown at left consists of scrap lumber pieces with  $\frac{1}{2}$ -inch hole through center.



Insert shaft and mounting stud of switch in the hole. The unit now sits firmly, with each of the terminals readily accessible for easy soldering of all resistors.

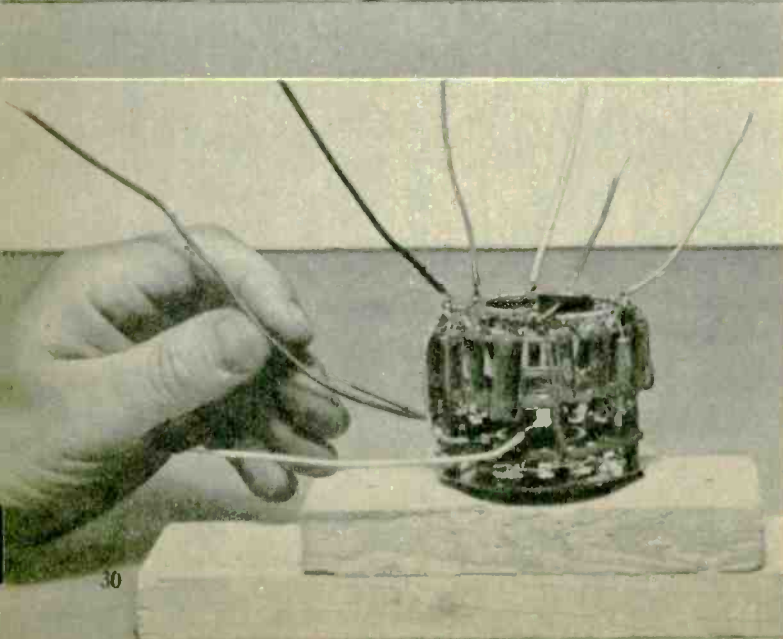

The resistors mount directly to switch terminals by their own pigtail leads. Long wires are connected later to back of meter panel when mounting the switch.



latter are such that when the test leads of the VOM are touched together, the meter needle reads 0. Any external resistance added to the circuit, by means of the test leads, causes the needle to read upward, on a scale marked "ohms."

Because the face of a VOM is printed with five or more scales, you must examine it carefully and interpret the correct one to match the setting of the function switch. In this VOM, for example, the switch has no less than eighteen positions, plus a choice of five connections for the two flexible test leads.

Suppose you start with an easy measurement, such as that of the line voltage in your house. This is supposed to be somewhere in the vicinity of 115 volts, so turn the function switch to AC V, and plug the test leads into the COM (for common) and V (for volts) jacks. Touch the test leads to the slots of an outlet, and watch the needle swing quickly about half way up the scale. Read the arc marked "250 AC." This has markings of 50, 100, 150, 200 and 250, with ten unmarked divisions between

each pair of numbers. Since the increase between numbers is 50, each unmarked division represents 5 volts. If the needle stops at the fourth line past the 100 mark, the voltage is 100 plus 4 times 5, or 120 volts.

To check a voltage that might be more than 250, turn the function switch to 1000. Read the 0 to 10 volt scale and *multiply* the result by 100. With practice, you'll quickly learn to obtain the correct readings of the needle.

The Knight VOM kit has been especially engineered for the newcomer to electronics, as it is usually the first piece of test equipment he acquires. Most of the connecting wires are precut to the right length, end-stripped, and identified by both color of insulation and overall length. Only a few short pieces of bare wire must be cut on the job. The major part of the work is the soldering of two dozen small resistors to the terminals of the function switch. Without rushing, we assembled and wired the meter from the kit in one sitting of four hours. •—Robert Hertzberg

Rear of finished VOM. Flashlight batteries for resistance measurement mount on plate over back of meter. Thumb points to variable resistor used for "zero-ing" meter for resistance measurement.

Meter has rich black case, sturdy leather strap.

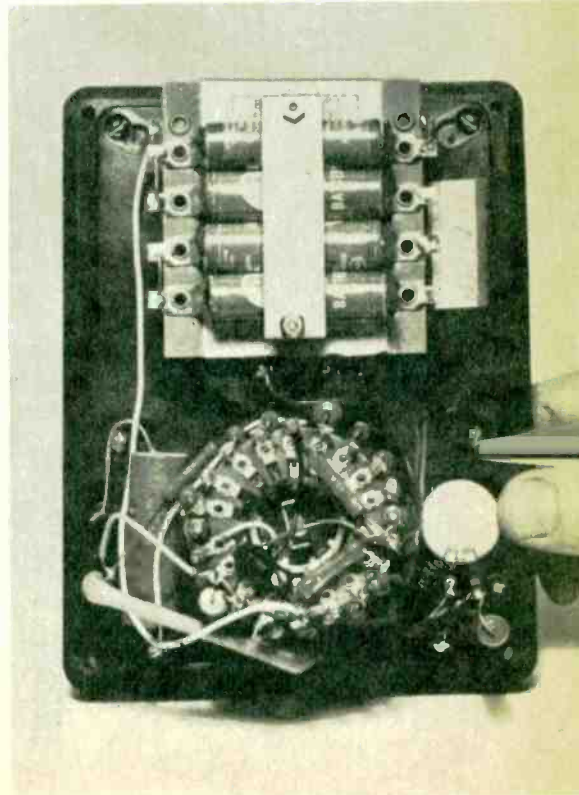
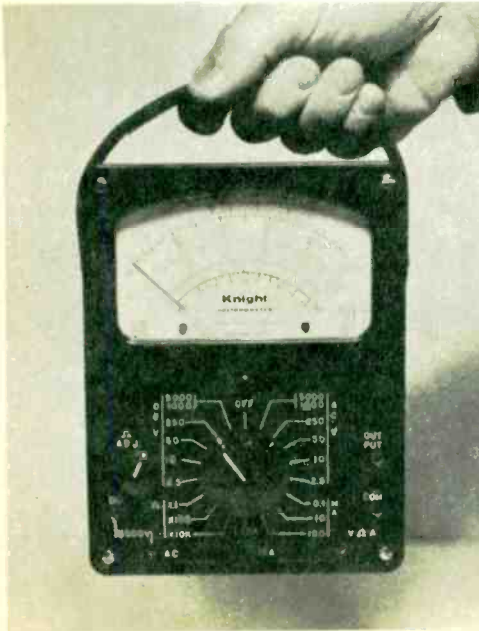

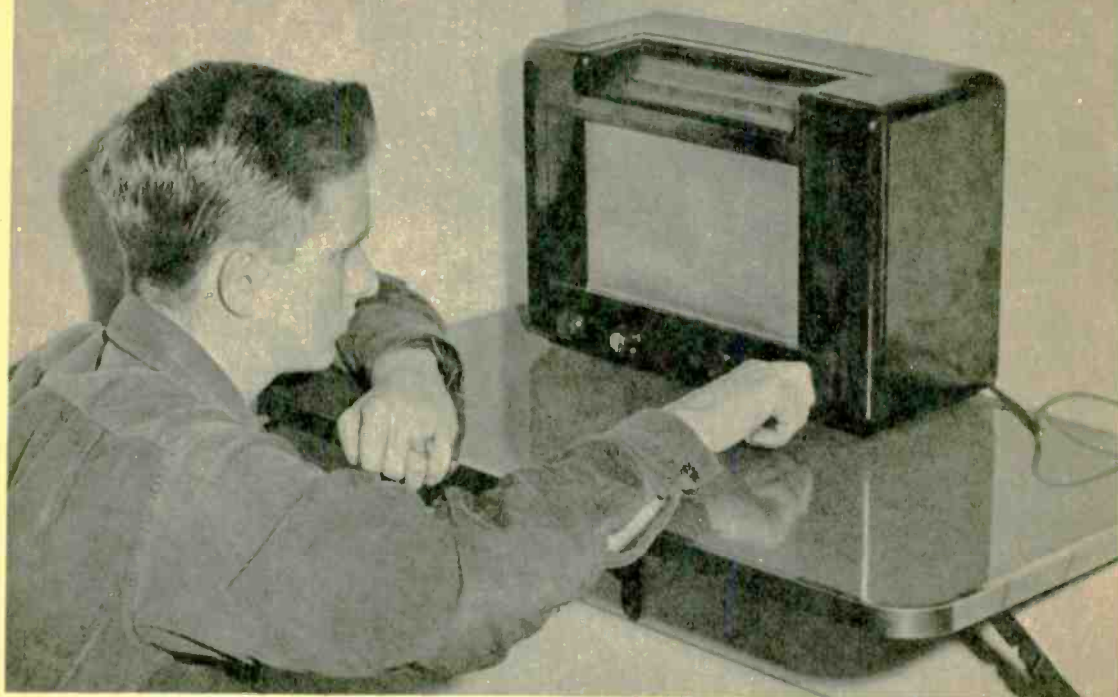

# Multi-Band Receiver

This handsome radio is a far cry from simple one-band receivers. It will cover a range of from 535 kilocycles to 18.0 megacycles.

**T**HE next normal step in progression after the basic five-tube superheterodyne or a super-het with one short-wave band, is this multi-band receiver. Covering the range of from 535 kilocycles to 18.0 megacycles, this ultra-flexible unit is very close to the ultimate in versatility.

Naturally, this set has more to it than the average small receiver. A more elaborate tuning mechanism, and more complex circuitry will offer far more knowledge to the builder and, of course, more gratification when the work is done.

When assembling this unit, use a little imagination where it is called for. While the drawing illustrates one type of dial mounting, the manufacturer has improved on this, and now furnishes separate

brackets for mounting the dial plate. In addition to the schematic diagram, several easy-to-read full-size pictorial drawings are supplied. Use a pencil to trace the wiring as you put it in, and you will not get into trouble.

This chassis is a large one. If you look carefully you will find one hole in the chassis for a socket and tube which are apparently missing. This "extra" hole is for the installation of a ballast tube, in the event that you operate from line voltages in excess of 130 volts.

While the coverage of the receiver is far in excess of what you will find in the simple five-tube superheterodyne, this extra band coverage is provided by a rather interesting switching circuit so that the re-



ceiver is still basically a five-tube super-heterodyne circuit.

You will notice by examining the schematic diagram that no antenna loop is included. An outdoor antenna is used instead plus a good ground connection. If we were to eliminate the switching circuits, we could for purposes of explanation, assume that this unit will only operate on one frequency. Let's select the broadcast band and follow the signal from the antenna. The signal is inductively coupled (coupled through a coil) to the grid of the mixer tube 14Q7. At the same time, another signal is injected into this stage by the oscillator portion of the circuit. The antenna coil and oscillator coils are both tuned by different portions of the same capacitor, which is operated by one tuning knob. This permits us to set the two signals always 455 kilocycles apart.

This 455 kc frequency is applied through an intermediate frequency transformer to the 14A7 I.F. amplifier. The 455 kc signal is brought to a higher level by this tube, so that the signal (much fortified by this amplification) can pass through the output I.F. transformer, and be applied to the

volume control and detector circuits. The detector is a part of the 14B6 tube, and the function of this stage is to actually convert the signal to direct current through a process of rectification. This results in the removal of the alternating component and leaves us with a direct current whose amplitude is varying. We apply this to the grid of the same tube in which we did our detecting, and amplify the signal once again.

From here, the boosted signal goes to a 50A5 amplifier tube, and after being increased still further, the signal is coupled through the output transformer to the six-inch loudspeaker.

The power supply portion of this set is fairly standard, consisting of a 35Y4 rectifier tube, which converts the alternating current in the house lines to a direct current. The filter system helps remove any last vestige of ripple from the direct current, and this is used to power the set.

Connecting the filaments in series (add the numbers) gives us a total voltage drain of 120 volts, which is what we will probably draw from house mains.

Now, let's go back and consider the

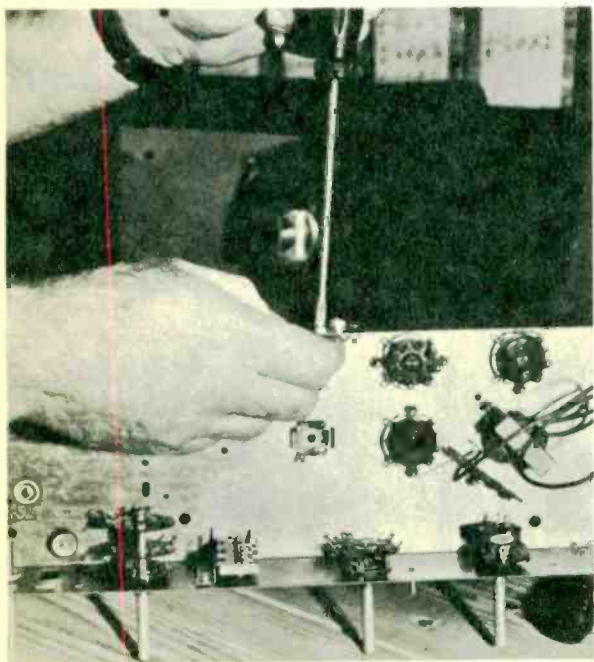

Attaching the phono jack. Underside view shows socket placement and front panel switch positions.

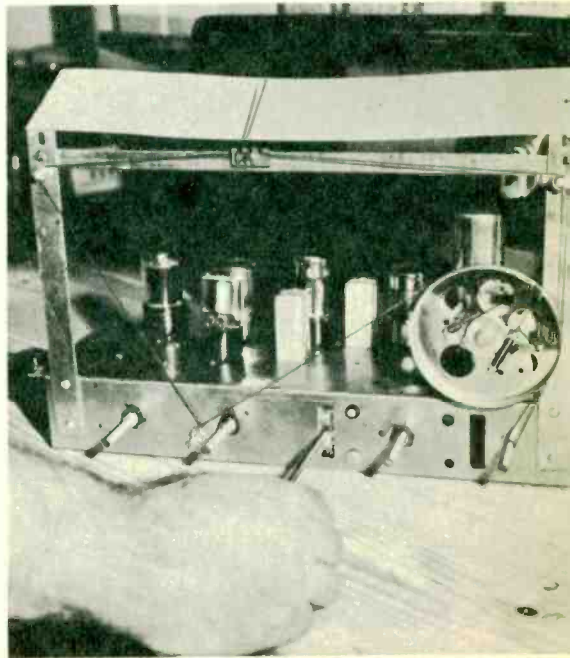

All final adjustments on the multi-band receiver should be made before the unit is placed in its case.

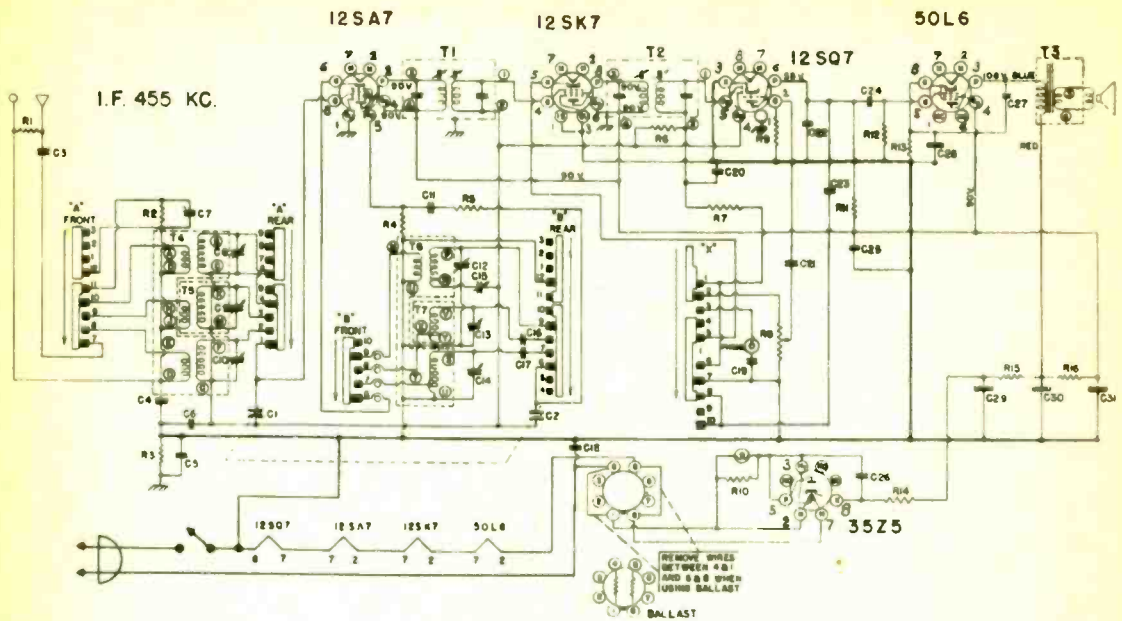

Use extreme care in tightening the metal clips which hold the dial glass to the plastic cabinet.

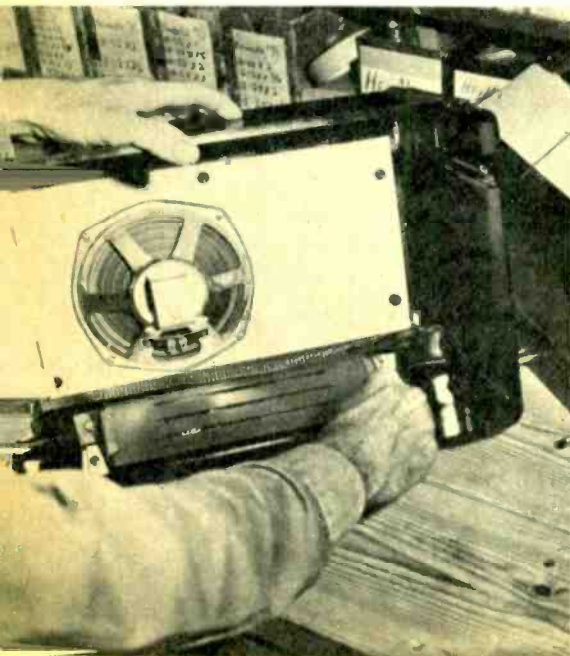

switching circuit that permits us to cover three separate tuning ranges. All that this switch actually accomplishes is to connect the right combination of antenna and oscillator coils across the condenser which tunes the signal, so that for each of the separate tuning ranges we always come up with an intermediate frequency of 455 kilocycles.

To make the unit more complete, a phonograph connector is provided at the rear of the chassis. This will permit you to play a crystal cartridge phonograph through the amplifier portion of the radio, or if you use an external preamplifier, a magnetic cartridge.

When the unit is finished, it is strongly advised that to benefit fully from the well-designed circuitry, you have the set aligned by a trained and equipped radio technician. To install the set, and put it into operation, a long antenna is recommended, and a good water-pipe ground.

Do not attempt to complete the job in one evening. Too many otherwise good jobs have been ruined by hasty work. We recommend that you take your time, and in addition to marking each connection and component on the pictorial diagram, locate the connection on the schematic diagram and attempt to determine its function in the circuit. In this way, you can learn while you wire the set. True, it will take longer, but it will be well worth it. •—Byron G. Wels



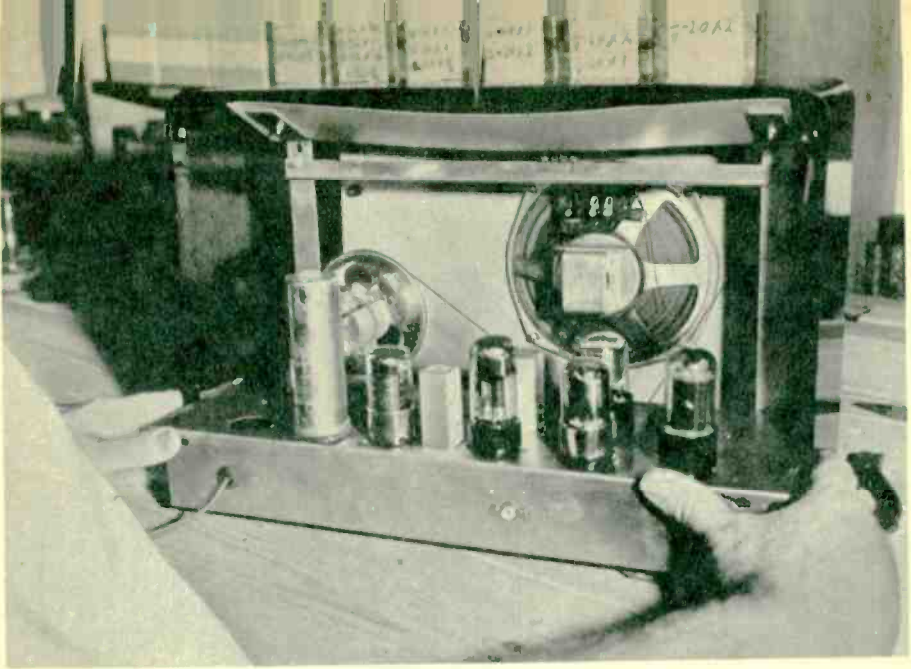

After all adjustments are made, dial face installed, etc., position the rubber mounting guides in the side channels. This will help to shock-mount the chassis.

Removing the rear cover makes all tubes readily accessible. Empty socket at left is used only for a ballast tube when unit is operated at more than 115 volts.

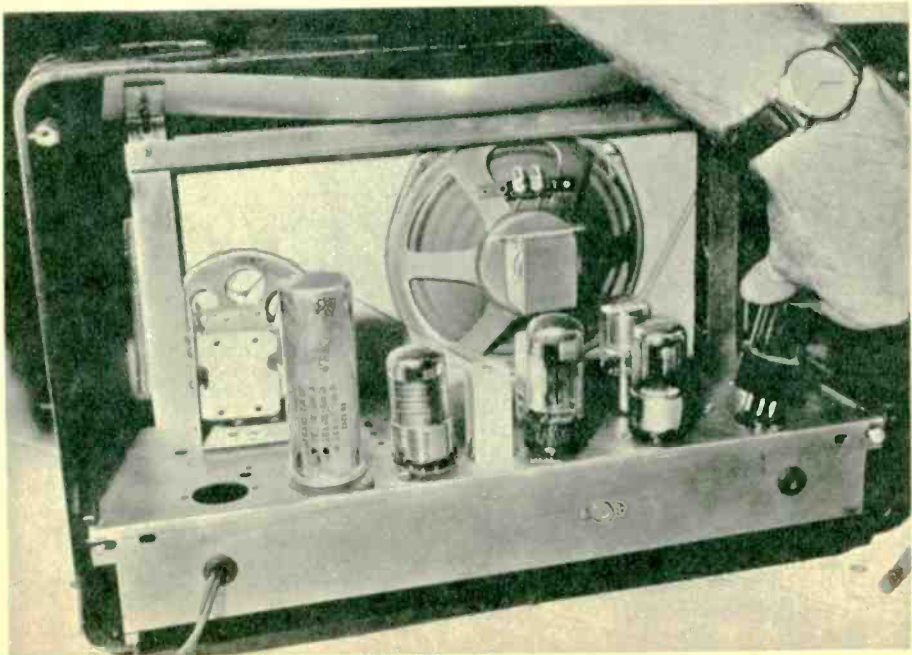

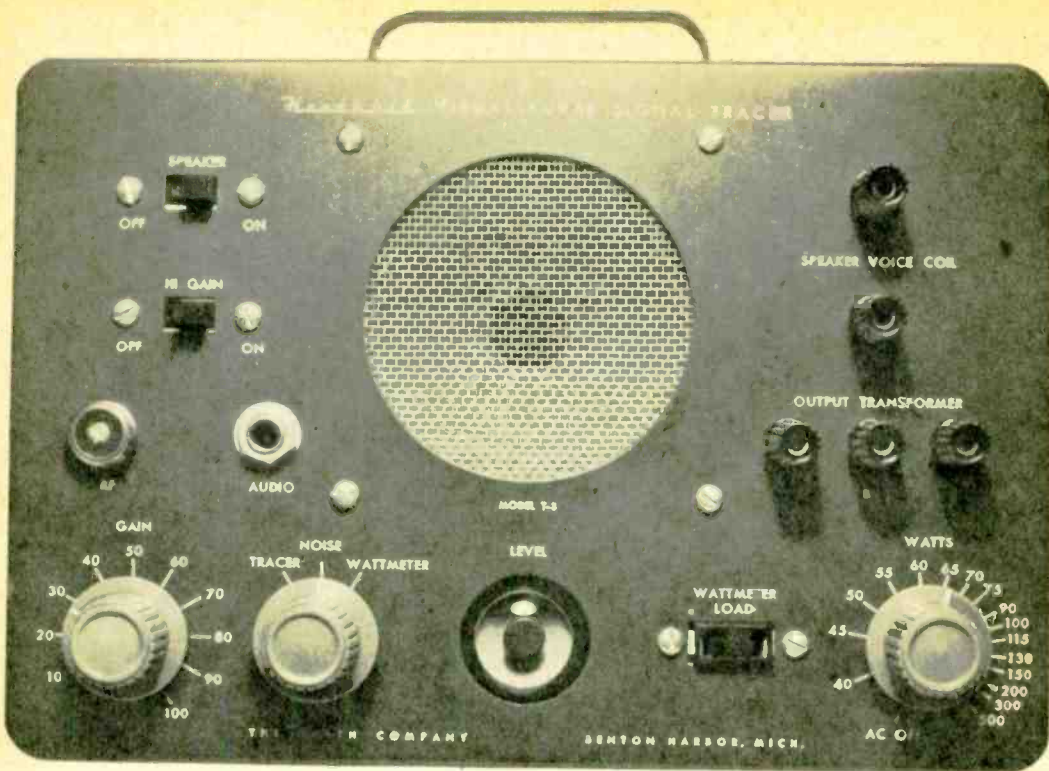

# Signal Tracer

Aural and visual indications are given by this test instrument. It checks R.F. and A.F. circuits, noise and power consumption.

**T**HE visual-aural signal tracer is one of the most versatile test instruments available to the electronic experimenter. Circuit-wise, it is simple and requires no bothersome adjustment or alignment. Physically, it is a compact unit, easy to build as a kit project.

The tracer is basically a high-gain, resistance-capacitance coupled amplifier, capable of responding to either audio-frequency or radio-frequency signals. Refer to the diagram, page 39, of a typical instrument, the Heathkit Model T-3. There are three stages of amplification, starting with a 12C8 tube and progressing through a 12SH7 and a 12A6 output tube. The power supply is conventional, using transformer T1 and a 6x5 rectifier.

A three-position function switch is marked TRACER, NOISE and WATT-

METER. In the TRACER setting, as shown in the diagram, either audio or R.F. signals can be fed in, depending on which input connector and probe are used. The audio unit is merely a straight probe like those used with voltmeters. The R.F. probe, however, is actually a detector or demodulator, and contains a diode rectifier, an isolating capacitor and two resistors. When the audio probe is used, the "HI-GAIN" switch is closed. This effectively short circuits the 12C8 stage, and anything picked up by the probe then actuates the 12SH7 and the 12A6.

An audio signal is heard in the loud-speaker of the tracer if the "SPEAKER" switch is closed, and it also causes a closing of the green screen of the 1629 "magic eye" tube. The degree of closing is an indication of the relative strength of the signal.



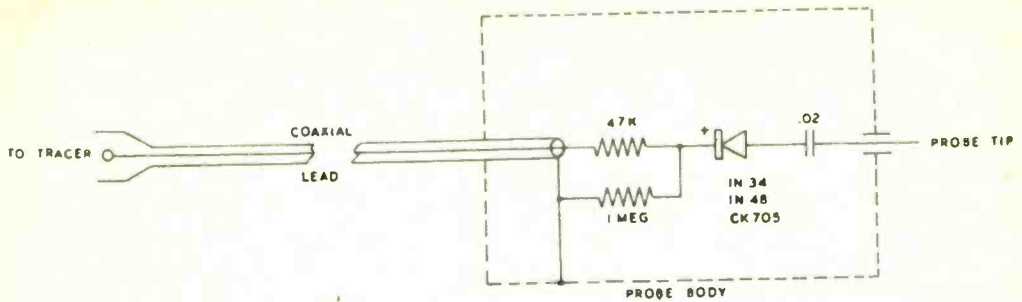

1. Underside of signal tracer; pencil points to the horizontal mounting of the magic eye tube. 2. Rear view of unit shows, at extreme left, the power transformer T1, with wattmeter transformer T2 next to it. 3. Audio probe of signal tracer has phone-plug fitting for connection to front panel. The R.F. probe, which contains a detector circuit in an aluminum housing (see drawing at top of this page for schematic diagram), plugs into front panel with a screw-on connector.

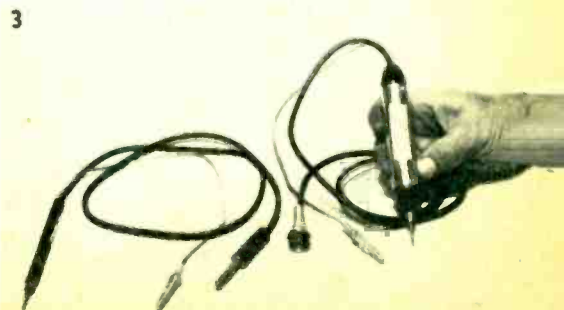
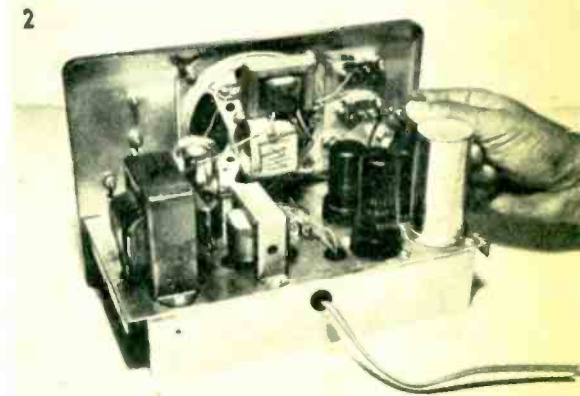
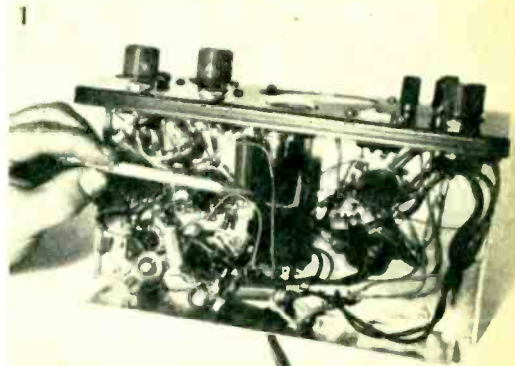

An R.F. signal also shows up on the eye. If it is voice modulated, it is heard from the speaker. Some types of R.F. signals convey intelligence in forms other than voice.

By touching the audio probe to audio sections of an inoperative receiver and the R.F. probe to R.F. sections, it is usually possible to determine in quick order just where the signals are blocked. The way to learn to use the tracer is, of course, to practice on a live set. Both inputs are protected by .005 mfd. blocking capacitors, so neither the tracer nor the receiver can be damaged by insertion of the probes in the "guts" of a live component.

With the function switch in the TRACER position, the instrument is an excellent "medium fidelity" amplifier for testing phono pickups, microphones, tuners, and

loudspeakers. The small speaker in the tracer is available independently for checking amplifiers or as a substitute for a suspected speaker in a receiver.

When the function switch is turned to the NOISE position, the signal tracer becomes a rather unique noise locator. Trace out the circuit to the No. 2 contact of the left section of the switch, and you'll note that this puts a DC voltage on the audio probe. The value runs between about 160 and 200, so caution is advised in handling the probe.

When the probe is free, only a faint background hum is heard from the speaker. When it is touched to a resistor, a transformer winding, or some other component that normally represents good continuity (with the circuit completed through the grounding clip of the probe), the speaker will emit a sharp crack when the contact is made, and another when it is broken. If the component's internal continuity is not 100% perfect, a frying or crackling sound will be heard. With the probed hooked to sections of wiring, a racket often reveals the presence and location of cold soldered joints, one of the most difficult of all

troubles to track down. Jiggling the suspected component or wire is helpful. Many innocent looking resistors and volume controls show up as faulty under this test.

Capacitors, which normally are "open" to DC, also respond to the noise test. Clip the prod to the ends of a suspected unit and shake it a bit. If it's OK, the tracer will remain silent, but if it's leaky the tracer will sound like a machine gun gone wild. You can do some very interesting and profitable experimenting with this noise feature of the instrument.

In the third setting of the function switch, the signal tracer acts as a wattmeter having a range of about 40 to 500 watts. The appliance to be checked is plugged in the wattmeter outlet. This puts it in series with a small transformer T2. The voltage developed across the secondary and the 50,000-ohm "WATTS" potentiometer is rectified by the diode plates of the 12C8 tube, and applied to the control grid of the 1629 magic-eye level indicator. The WATTS control is calibrated to read directly when the eye just closes without overlapping. The indications are surprisingly accurate. •—Robert Hertzberg

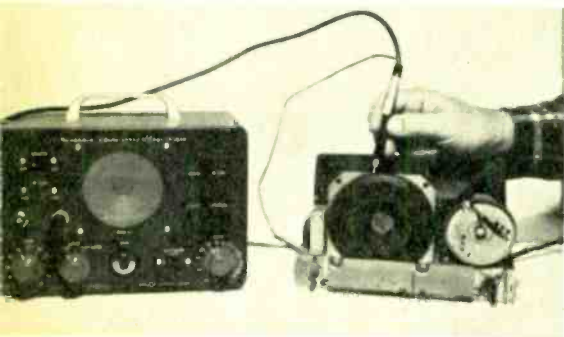

Audio probe used in speaker section of radio. Grounding wire, attached to probe, goes to chassis.

If you want to find out how much current your radio consumes, plug it into the unit as shown below.

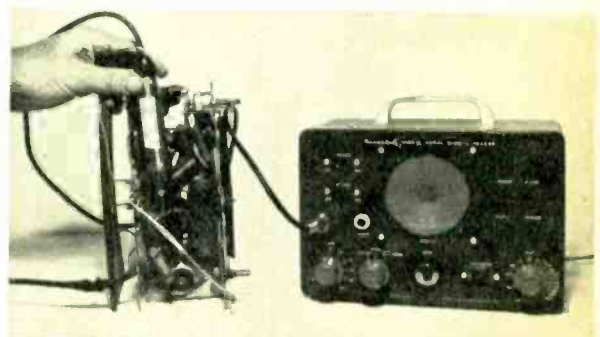

Typical application of R.F. probe on small receiver. Numerous components can be so tested.

Here, only the internal loudspeaker of the tracer is being used to check on this hi-fi amplifier.

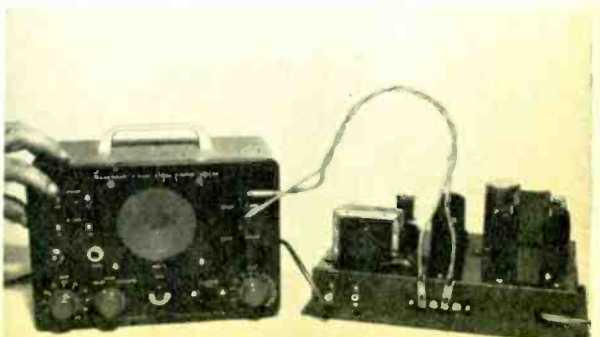



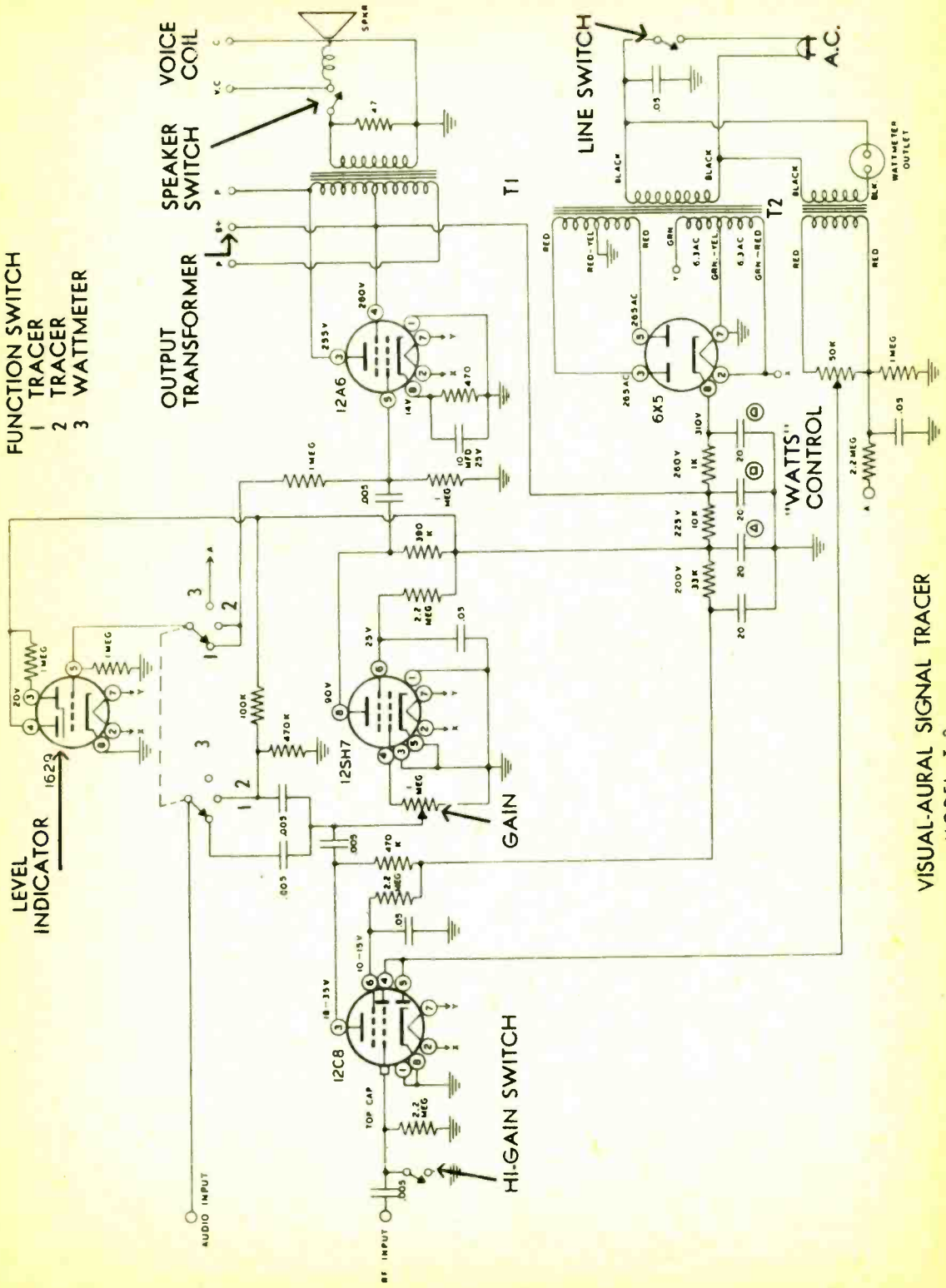

FUNCTION SWITCH  
 1 TRACER  
 2 TRACER  
 3 WATTMETER

LEVEL INDICATOR  
 1629

HI-GAIN SWITCH

GAIN

OUTPUT TRANSFORMER

SPEAKER SWITCH

VOICE COIL

T1

T2

"WATTS" CONTROL

LINE SWITCH

VISUAL-AURAL SIGNAL TRACER  
 MODEL T-3



# Transistor Portable

Easy-to-build-from-a-kit, six-transistor portable receiver combines smart looks with outstanding performance.

**T**HIS fine looking portable radio is in the height of fashion, and plays about as well as it looks. The top grain saddle leather case is trimmed in gold, and comes with the kit. There is nothing extra to buy.

Arkay, with this TR-6, utilizes typical circuitry. If you want to learn about transistorized portables, this is the perfect opportunity to do so.

As you can see in the photographs, there is quite a bit of material to pack into a small area. If you follow the directions, however, you will have no trouble in packing it in. Just remember that because of the size of some of the components, the connections are necessarily close together and care will have to be exercised in soldering. Again, use a small, clean and hot soldering iron to avoid accidentally burning neighboring components. You will notice that all parts are mounted on a flat metal plate which serves as a chassis,

so take care to mount your removable and replaceable parts, such as transistors, in such a way that opening the back of the case will give you access to them.

The transistors and their sockets each have three contacts. The socket contacts, however, are not equi-distant. Two of them are close together, with the third at the farther end. Follow carefully the steps outlined in the instruction book, so that you mount the sockets with the "lone" connector in the proper position. These sockets must be referenced, just as the keyway in a tube socket must be referenced, in order not to invalidate the wiring.

While it is true that this unit operates from batteries, you can allay your fears about constantly buying new batteries to replace old worn-out cells. The low current drain of the six transistors will increase battery life to the point where replacement costs are not a problem. •—Byron G. Wels





Follow instructions when soldering components in place. Always use rosin core solder, hot iron.



The unit uses a nine-volt battery. Horizontal rod across the top is a self-contained ferrite antenna.

To prevent battery short circuit, a rubber strip fits over the chassis edge of the Arkay TR-6.

Top grain saddle leather case is included with the kit. Fitting of knobs completes assembly.



# Remote Control Transmitter





## With the help of this low-cost transmitter you can remotely control anything from a model boat or plane to a garage door.

**I**F you wish to remotely control any moving device, from a garage door to a model plane, the Federal Communications Commission has set up a method permitting you to do so if you comply with some simple regulations.

It is first necessary to send to your local F.C.C. office for a form No. 505, which is the application for a Citizens Band Transmitter. It must be filled out and notarized, then sent back to the F.C.C. office, and in a short time you will receive your license to operate a transmitter in the Citizens Band, which is 27.255 megacycles.

This transmitter kit is constructed very simply, using a 3A4 pentode tube, which is triode connected. The oscillation takes place in the fixed-tuned grid circuit and is amplified by the tube, giving an output of approximately two to three watts.

In wiring this unit, follow the diagrams carefully, keeping all leads as short and as neatly dressed as possible. Be careful to remove the tube and crystal from the sockets while soldering. In mounting the variable condenser (C-1), take care not to mount the shaft to the chassis. While it may appear that this is the most con-

venient method, it will ground the shaft, which is actually connected to B+. This will cause a short-circuit. Rather, mount the condenser through the threaded inserts provided in the ceramic support. Allow sufficient clearance through the panel for the shaft of the condenser, thereby avoiding a short circuit.

You will find it necessary to saw or file the lower mounting stud of the antenna, to provide clearance for the battery bracket. While the mounting of the stand-off posts for the antenna is not critical, it will be a great convenience to separate them sufficiently so that the antenna itself can provide a carrying handle when the unit is not in use. In actual operation, however, do not attempt to hold the unit by the antenna as you will absorb most of the radiated energy.

In operation, we have a crystal controlled oscillator, with the 27.255 megacycle crystal controlling the frequency of the tube. An oscillator depends for proper operation on the fact that both the grid and plate circuits are tuned, setting up a feedback path.

You need not concern yourself in this

When inserting the crystal (which controls the frequency) try not to damage its fragile pins.

Carefully lining up the base pins, push the tube into its socket. Do not disturb coil position.

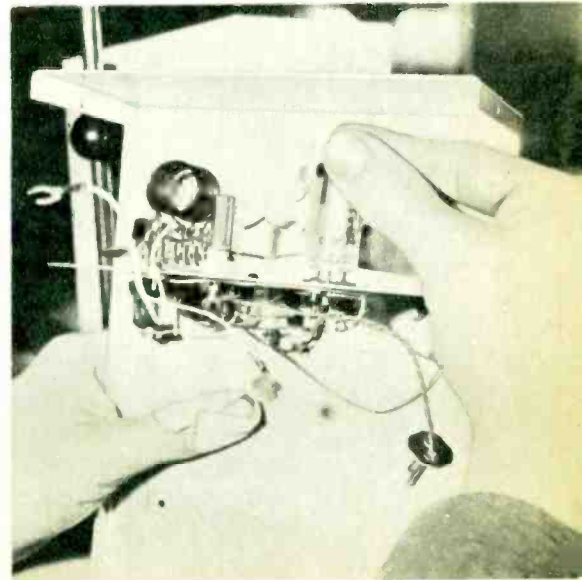
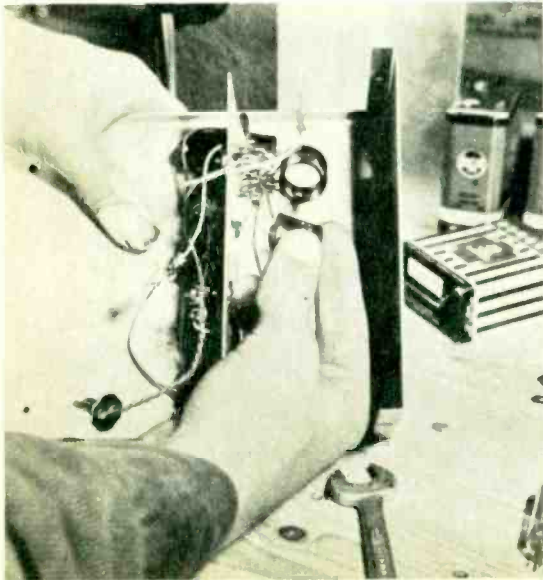

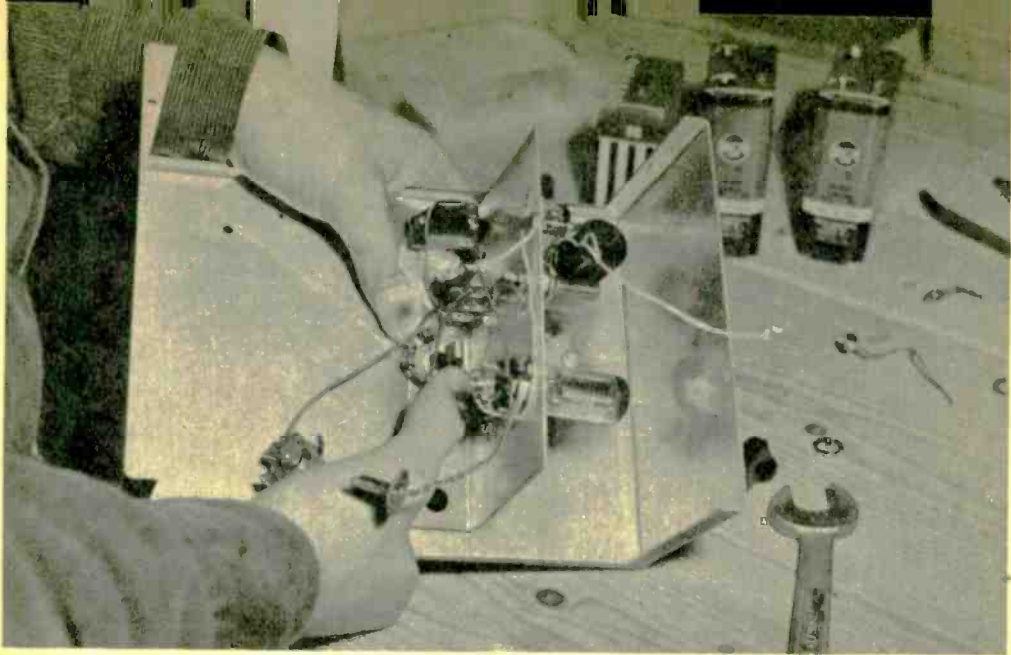

When wiring the control transmitter follow the diagrams in the instruction manual exactly, keeping all leads neatly dressed and as short as possible. Photo above shows installation of the jack.

unit about the tuning of the grid circuit, as the frequency at this point is crystal controlled. The plate circuit is tuned by the coil and variable capacitor. Plugging a meter into the jack provided on the front panel gives an indication of when the plate circuit is properly tuned. After you have finished the wiring, insert the meter lead into the jack, and turn the on-off switch to the ON position. Pressing the triggering button will give you an indication on the meter. You must now vary the tuning

capacitor until a MINIMUM (dip) is indicated on the meter. (Be sure that the antenna is fully extended.)

This push-to-operate switch is actually turning the plate voltage on and off, while leaving the filaments on as long as the on-off switch is ON. This permits an easy method of keying the oscillator without shutting the filaments each time, necessitating a warm-up period for each signal.

It is of importance that you place the coils in exactly the manner as prescribed

Schematic diagram of the transmitter is shown at right. Below, drawing of actual wiring layout.

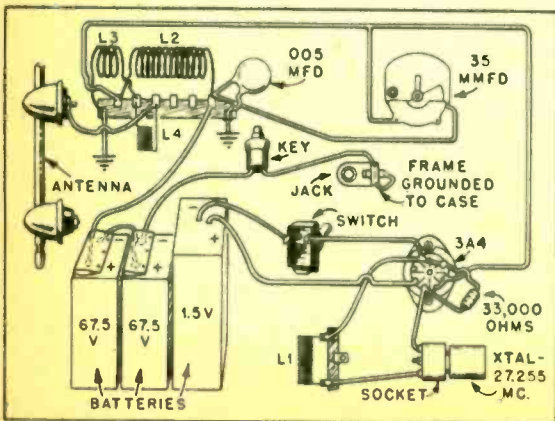
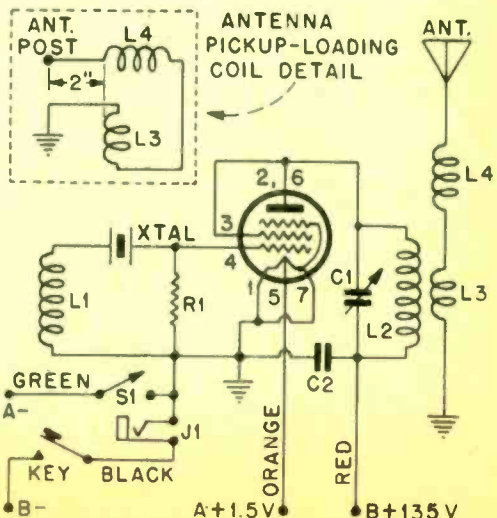



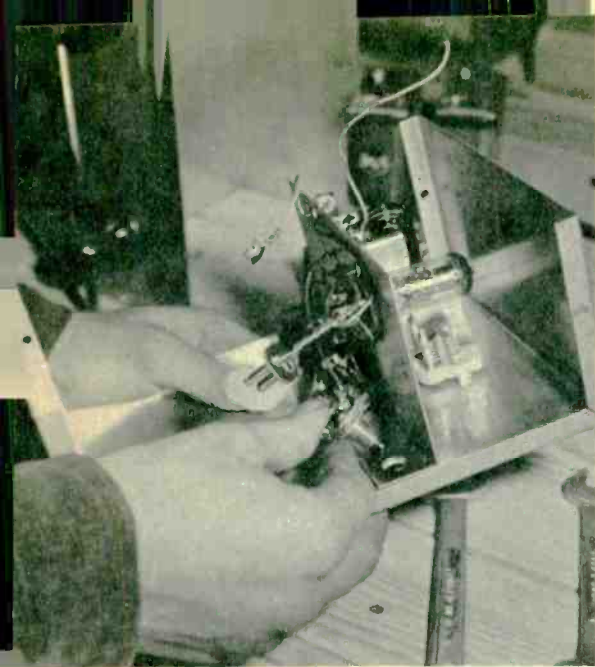

Chassis is held in position by the various controls which protrude through the front panel.

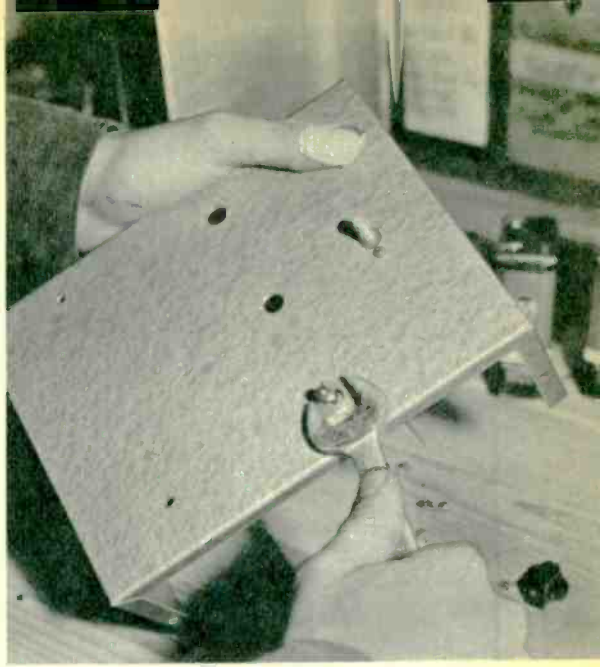

After inserting the switch from the inside, tighten its nut with a wrench. Case comes in silver finish.

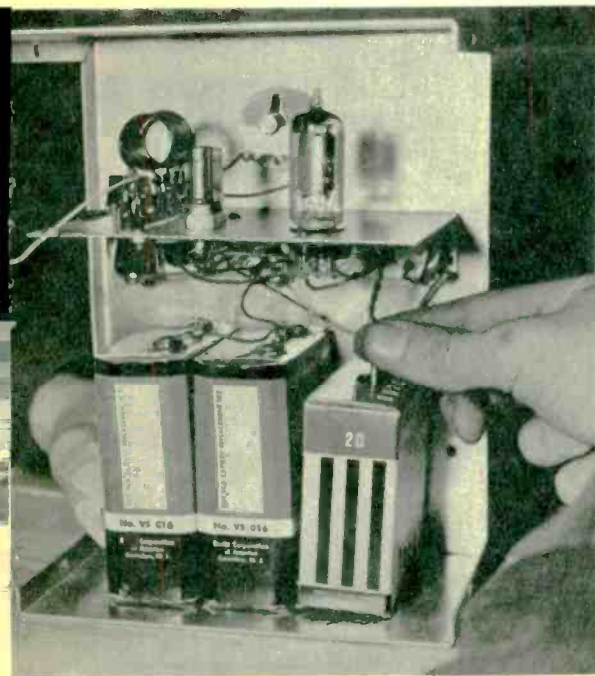

When installing the batteries, be certain that the correct battery attaches to the correct plug.

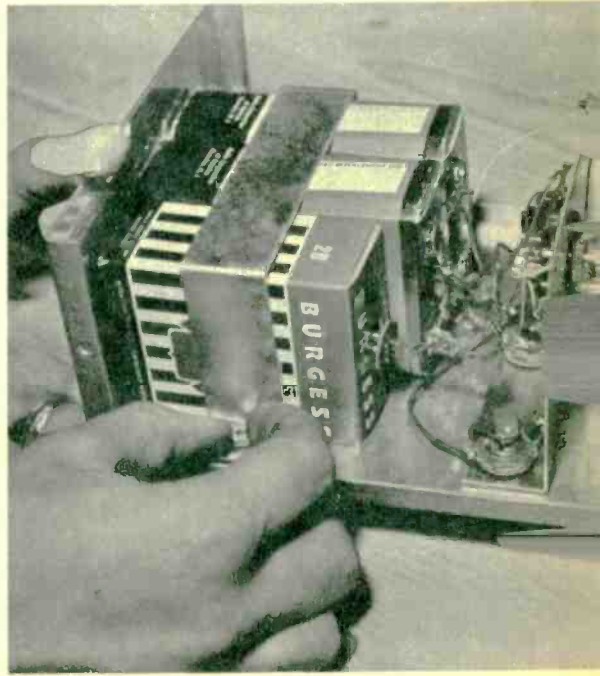

Do not pull the battery bracket too tight; it should hold snugly without leaving impression.

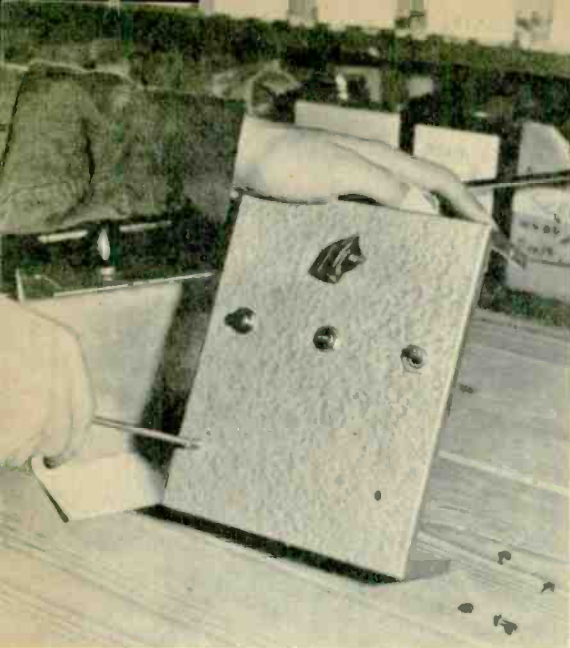

Battery brackets are fastened to the case from the outside, are held by two screws through panel.

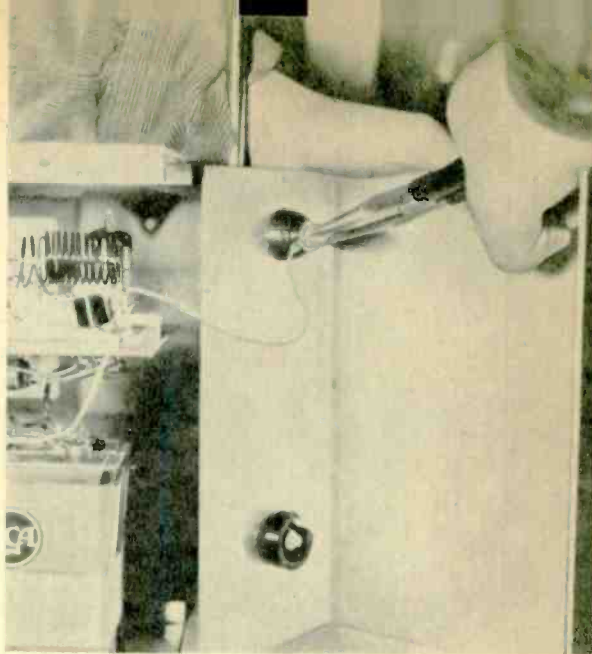

Use long-nosed pliers to shape wires around the antenna lead. Use heavy pliers to tighten nut.

in the instructions. You will notice that while two coils are mounted in the same axial line, another coil is mounted at right angles to these. Because of the closeness of the wiring it is necessary to avoid stray pick-up from one coil to the rest, while pick-up is required in the other two coils. Mounting at right angles will minimize this pick-up, while in-line mounting increases the chances for inductive transfer.

When you have completed the wiring, and have tested the unit to your satisfaction, you can greatly enhance the appearance by applying a few technical decals to the appropriate switches. When properly done, this gives the appearance of a commercially constructed unit. If you'd like to save a lot of work, you can buy a complete kit of parts, including the antenna and cabinet, from Lafayette Radio Co., 165-08, Liberty Ave., Jamaica 33, N. Y. The price is only \$14.95.

This transmitter will work in conjunction with the receiver and escapement described in the next chapter, to complete your remote control system. It will control the action of model boats and planes, and will serve in other ways around the house. One chap we know has installed a series of receivers to open his garage door, start his car, etc. One transmitter controls the entire operation. •—Byron G. Wels

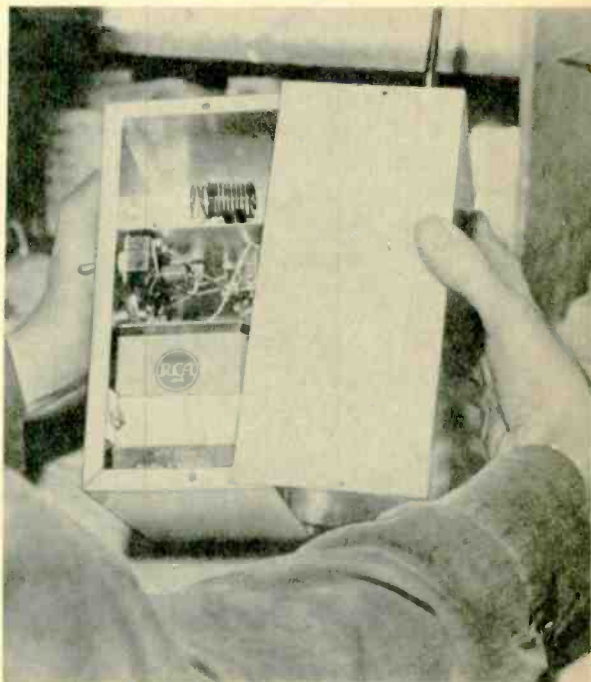

After unit is completely wired slip the cover in place and tighten the six self-tapping screws.



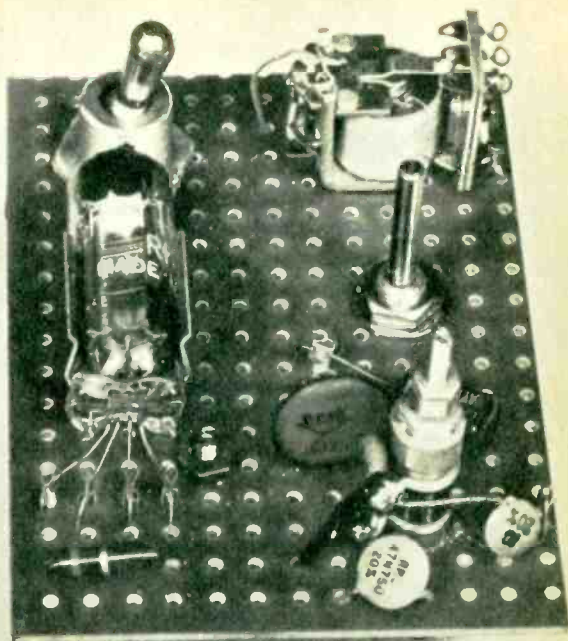
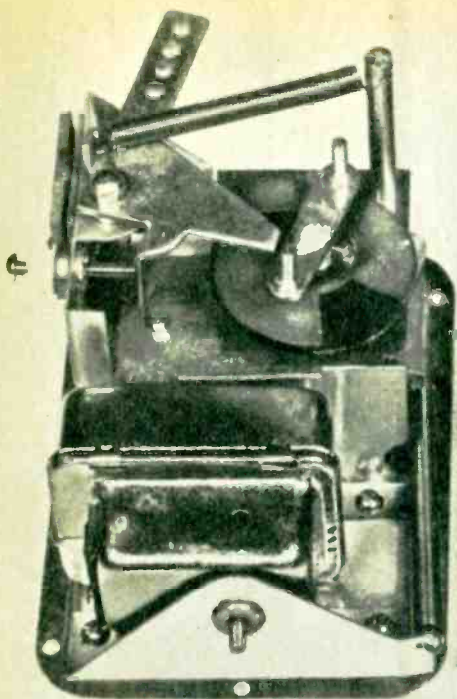

The two sections of receiver are shown above. Left, the escapement; right, the relay unit.

# Remote Control Receiver

As second half of the transmitter-receiver combination, this unit converts electrical signals into mechanical function.

**T**HIS receiver kit is the companion to the transmitter described in the previous chapter. The transmitter, as we know, has the ability to send out a controlling signal. The receiver is necessary to interpret these signals and convert them to electrical impulses which in turn control the escapement, a mechanical device which converts the signal from the receiver to a pre-specified action.

A remote control receiver must possess several important qualities in order to be successful: it must have good sensitivity, be small in size and light in weight; it will have to fit in a corner of a model airplane and not affect the balance; it will have to fit out of sight in the hull or cabin of a model boat. It may also be called

upon to do many, many things for the home experimenter.

This little plastic-mounted package from Lafayette fits all the above requirements, and is easy to wire, as well. The "flea-clip" mountings for the tube and transistor make changing these units a cinch, and the overall size is something you have to see to appreciate. The kit (KT-84) sells for \$11.75.

In wiring the receiver, again the old familiar caution: *follow the instructions!* Too many times, we kit builders are prone to forge blindly ahead, and wind up swearing at the manufacturers when the fault is really our own. We cannot blame the manufacturer for our failure to read instructions.

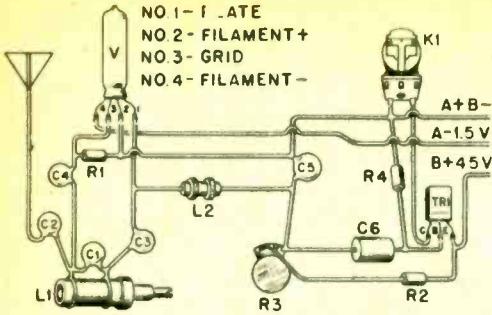

Above, pictorial wiring diagram of remote control receiver. Right, schematic circuit drawing.

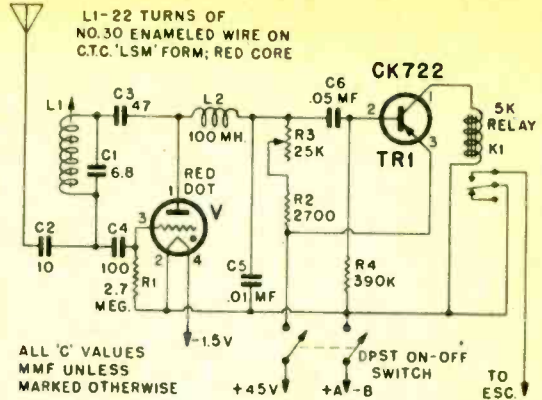

You will find that the screws which mount the tube clip will not pass through any of the holes in the mounting board. As the instructions say, "Drill out all mounting holes first." In drilling the perforated plastic board, incidentally, we tried several methods, and found that by far the best way to make the small holes is to first drill about a 1/8-inch pilot hole, and then try the screws for size. Number Six screws will require a larger drill, and for the fractional size holes required for the potentiometer, the coil form and the switch, try a 1/2-inch tapered reamer.

Be very careful, too, when removing the small relay from its plastic box. You must first remove the mounting screw on the bottom, which holds the relay to the box, and we advise caution here as this screw is made of a soft copper and the slot can easily be butchered. Naturally, exercise the same caution in mounting the relay to the plastic board. The relay has a small stud which fits snugly into one of the perforated holes, and thus keeps the relay aligned with only the one screw. You will also find it very easy to ruin the threads on this screw by over-tightening it; just pull the relay down snugly.

As we said previously, still another unit is required to put the system into operation. This "escapement," as it is called, is a controlled electro-mechanical device. There is really no point to building your own, as they are available at low cost, and come in several types. Basically, they control rudder action of either a boat or plane, and many types also have added switching circuits for other controls as well. These include starting and stopping motors, as well as reversing them completely: blinking lights on and off, etc.

While primarily designed for the operation of model aircraft and boats, you can easily apply this equipment to the remote radio controlled operation of any number of devices. Probably the most common application would be the opening of a garage door from the car. You must first prepare the garage door by obtaining an electric motor and gear reduction box. This will permit you to raise and lower the garage door by merely throwing a switch. It becomes a simple matter after this to put the electrical contacts of the escapement in parallel with the switch.

Leave the switch in the circuit in order to close the garage door again after the car is inside.

You can make the transmitter unit an integral part of the car, or even remotely locate it in the trunk compartment, with just a small control box containing the on/off switch and the press-to-operate switch. Mount the antenna outside the car, either on the fender or cowl, and the installation is complete.

You'll have lots of fun with the system, but remember that the citizens band is a privilege, and one that you can lose at any time. Don't be the one to cause everybody else to be deprived of this privilege. Other people will use the same facilities you do, so share the band freely. No testing of transmitters while somebody else is operating (this can be disastrous). Above all, no horseplay with the equipment in public. Wait your turn to operate, or go to a less crowded area. Don't be a poor sport.

Bear in mind, that the purchase of the equipment does not permit you to use it. The F.C.C. can demand to see your license at any time, so you'd better have one. It isn't hard to get. • *Byron G. Wells*



When wiring the unit apply heat sparingly. Small contacts are delicate, require little heat.

The most vulnerable part of the receiver is the relay. Solder lightly to avoid thermal shock.

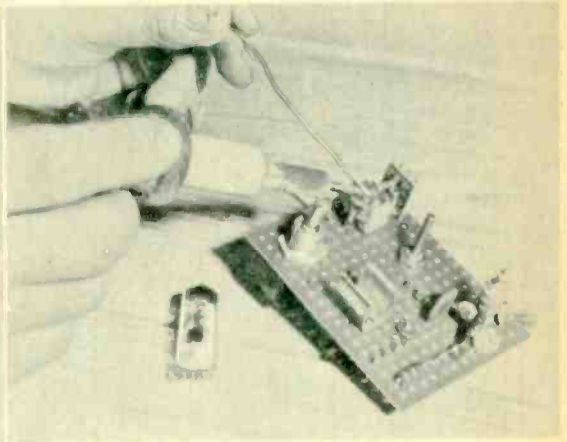
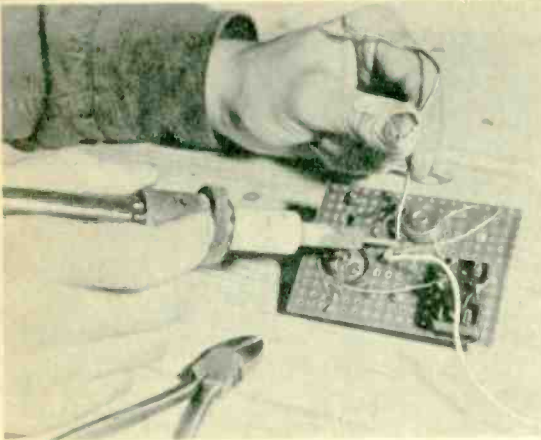

Vacuum tube leads may be soldered or may be attached by means of provided flea clips.

Source of action is the leader arm of the escapement. To the left is the motor which actuates it.

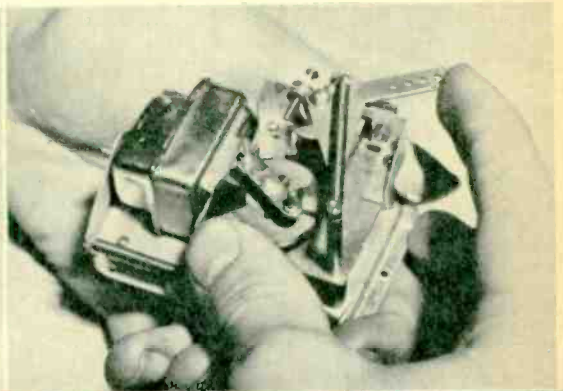
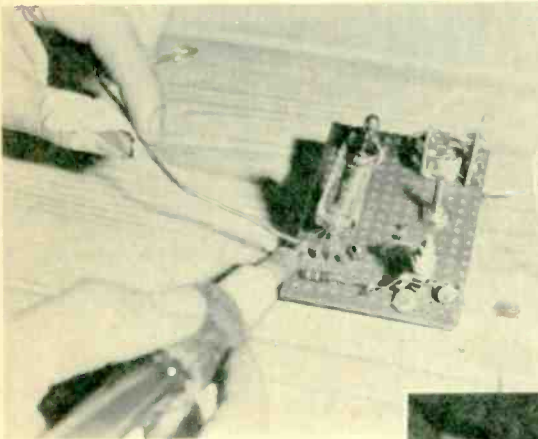

You can bench-test the unit after assembly by using the previously described remote control transmitter, as shown.

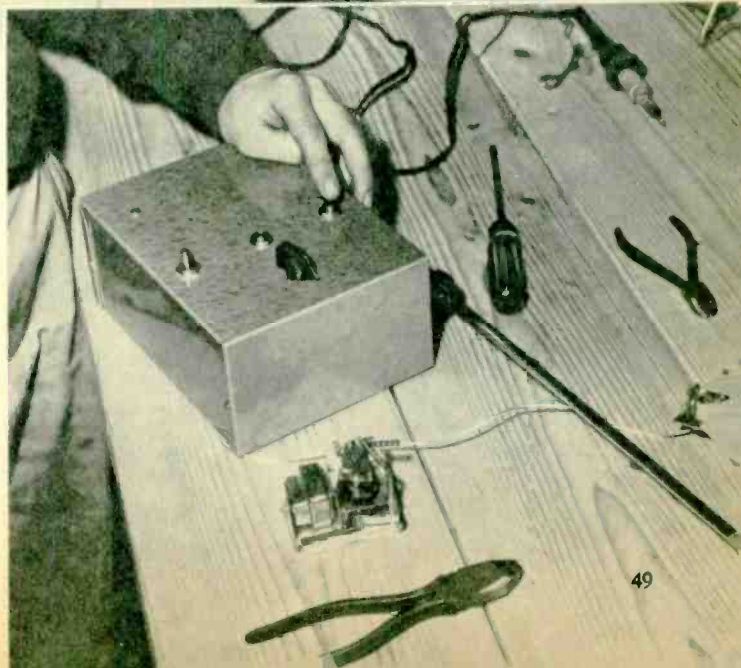

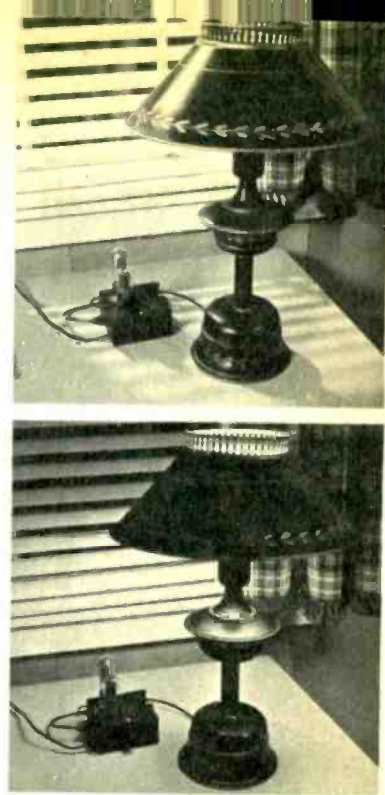

# Electronic Sentry

This photo-electric switch will scare off burglars by automatically turning lights on in your absence.

**H**AVE you ever gone away for a week-end or vacation and left a light burning in your house in order to keep thieves and vandals away? This electronic eye will turn the lights on and off for you, in your absence.

The unit is built around an RCA 868 Photo-tube. The reflector of the tube should be positioned facing the window, near the window, so as to catch the change of light values occurring outside the house. When the light intensity falling upon the photo cell drops below a pre-determined value, a relay is de-energized, closing the contacts to the auxiliary circuit, turning on the room lights. This happens toward evening when light outside starts to fail.

As dawn approaches, the outside light falling upon the cell will energize the relay, opening the contacts, thereby turning off the lamp or other electrical device connected to the unit.

The switch may also be used to control signs, hall lights, stair lights, ornamental lighting, in fact, any electrical device re-

quired to be turned on or off at nightfall. The relay contacts are rated at 5 amps., 110 volts, about 550 watts, and as long as their ratings are not exceeded, the unit may be used as is. However, if larger electrical loads are to be controlled, another 110 volt AC relay with heavier contacts should be controlled by the smaller plate current relay shown in the diagram.

When the line voltage is applied to the AC plug, electrons will flow from the cathode to the plate of the tube, through R1 and the plate circuit relay, whenever the plate of the 117N7 tube is positive. The potentiometer, R1, is adjusted so that with the photo-tube removed the relay is just released. Now, by placing the photo-tube into its socket, and exposing it to a small amount of light, current is allowed to flow through the photo-tube in a direction that makes the grid of the amplifier tube become positive. This allows more current to flow through the amplifier tube and relay, energizing the relay and closing the control circuit contacts. •—L. V. Vog



Unit is positioned with photo cell close to, and facing, window. Top photo shows daylight outside with lamp turned off. Below, the outside darkness, acting on photo cell, automatically turns on lamp.



Top photo at right shows assembled switch. Photo tube is mounted to the left of the 117N7 tube. Photo below shows underside. Note the knob of potentiometer R1, used to adjust the unit.

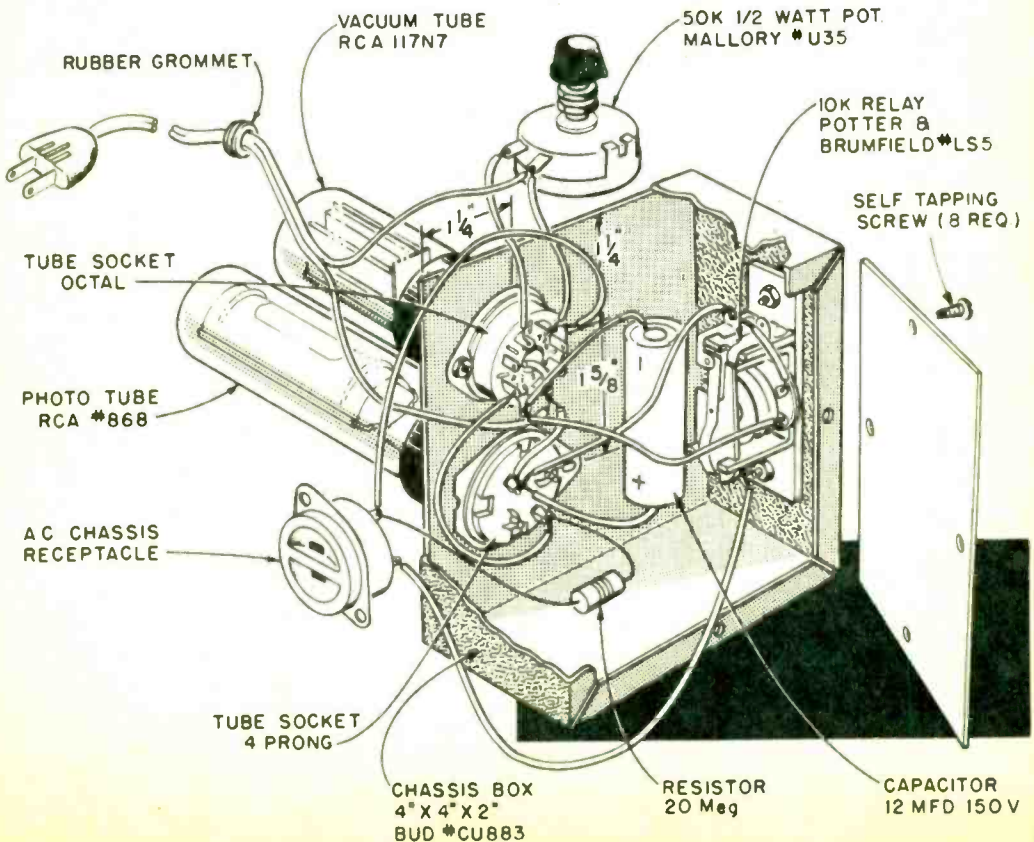
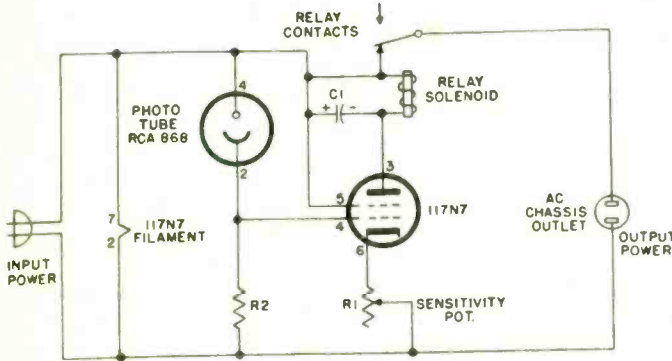
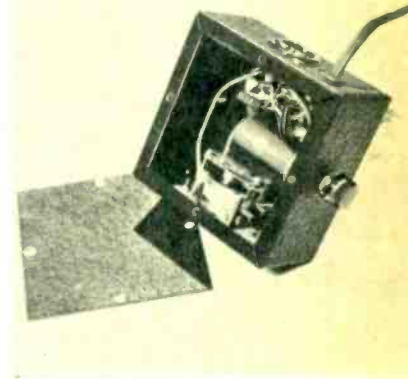

# Build Your Own TV Set

Even one of the more complicated electronic units, a television set, can be assembled by the beginner with the help of this kit.

Photo below shows the TV set completely assembled. Picture tube is not supplied with kit.

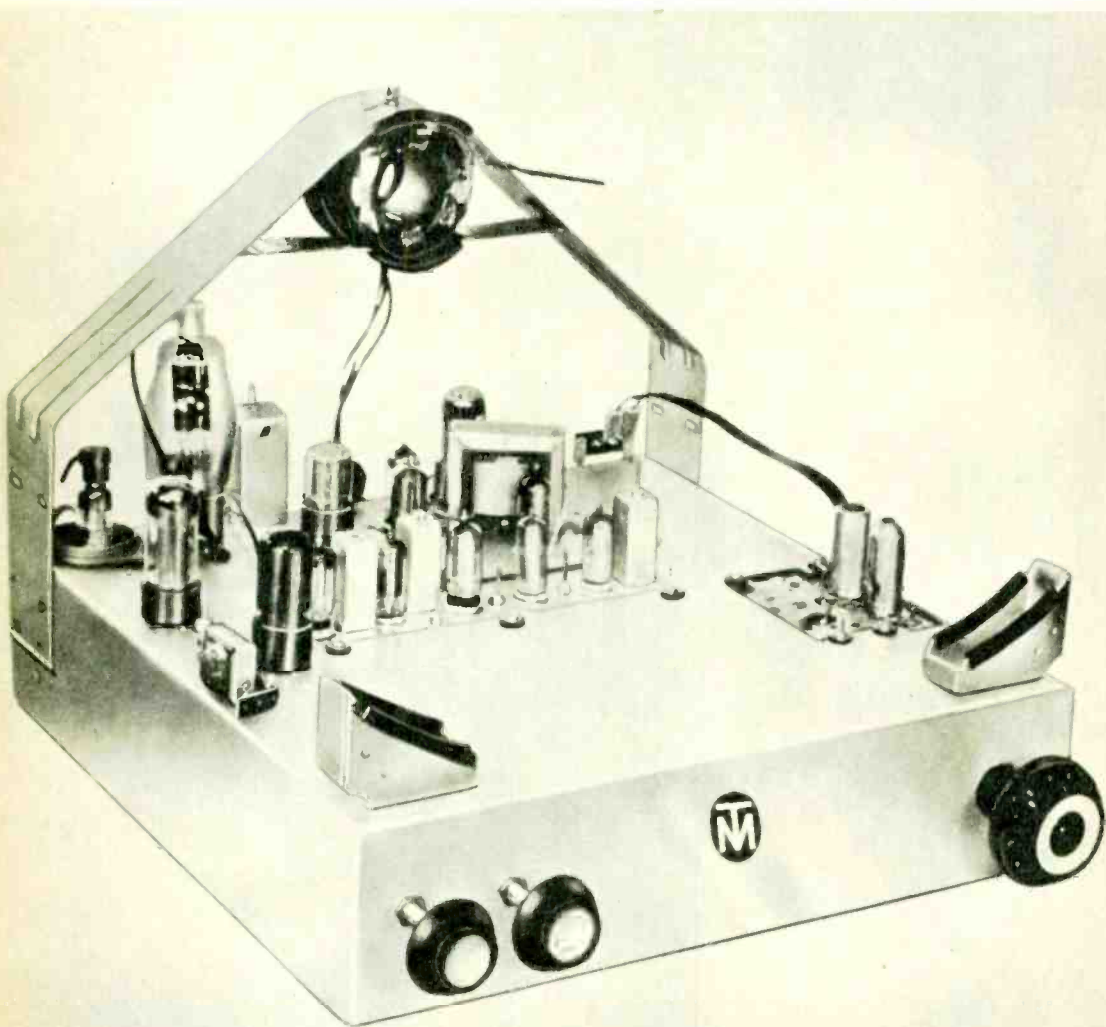



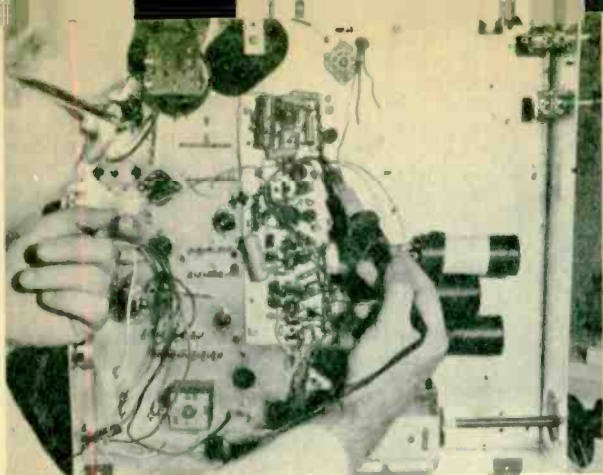

Time and critical adjustments are saved by obtaining the kit with the I.F. strip pre-wired.



All solder connections must be tight. Allow heat to flow thoroughly before removing the iron.

**O**BVIOUSLY, this is not as easy a kit to put together as the Foxhole Radio. But it is far more rewarding. As you look over the diagrams, and then study the test procedures, you may feel that in considering this kit as your next project you are biting off more than you can chew. Fortunately, this is not the case. Tech-Master is one of the oldest kit manufacturers in the business and they know how to lay out a chassis and instruction manual so that even a novice can get through the assembly.

One reason why this kit was selected is that many of the parts are already mounted to the chassis and you are faced only with the actual wiring. The wiring itself is broken down into groups. The I.F. strip, for example, is wired separately, as is the tuner. Final wiring involves connecting these separate boards to the chassis. Consisting of only seventeen tubes including the kinescope (picture tube), this modern TV chassis outperforms many commercial sets by a good margin.

As the picture tube is not supplied you have your choice of using either a 17-inch or 21-inch tube. The chassis includes three tube mounting supports, which are lined with cork and a strap to hold the tube to the chassis. The neck of the tube is supported in the deflection yoke by a large metal bracket at the rear of the chassis.

Installation of this chassis is extremely flexible. It can be mounted in any number of ways, depending on the type of cabinet you choose. There are many cabinet styles available, from consoles through table-top and, should you prefer, it's an easy matter to mount the chassis behind a wall, making a custom installation. You can get screens and masks from Tech-Master at slight additional cost.

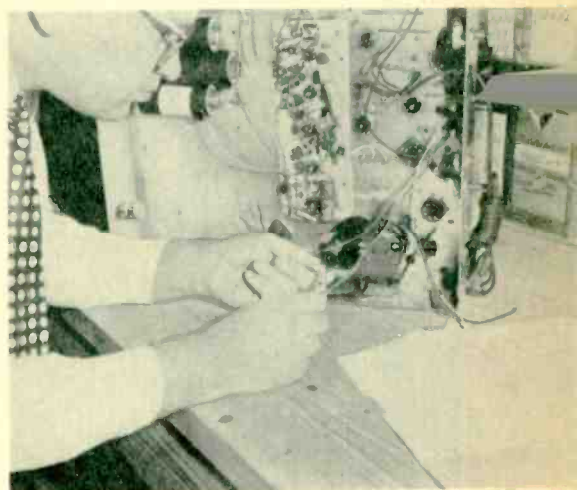

Mounting the vector-type socket for the rectifier tube. Refer continuously to the instruction manual.

Brackets are set, as shown, for 17-inch tubes, farther apart for larger 21-inch picture tubes.



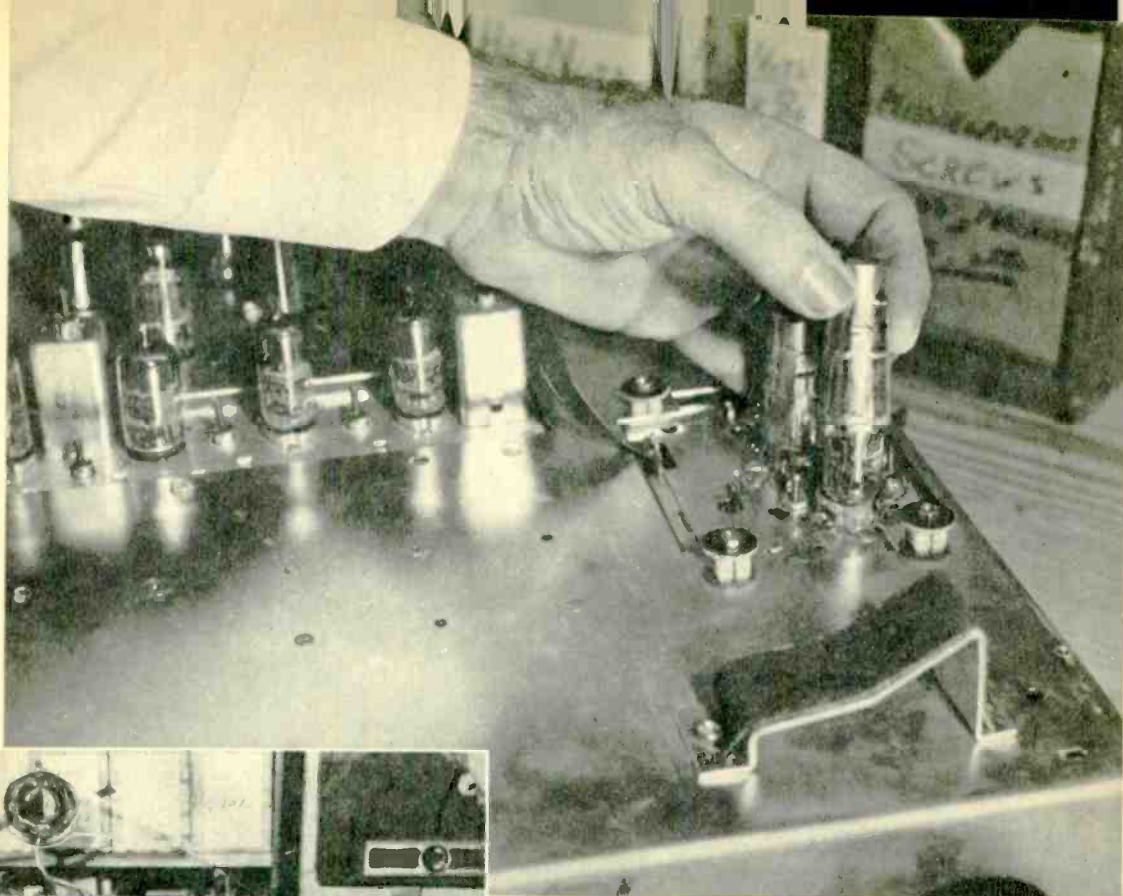

Metal shields are placed over the tubes in the tuner section of the set. Snap over socket base.

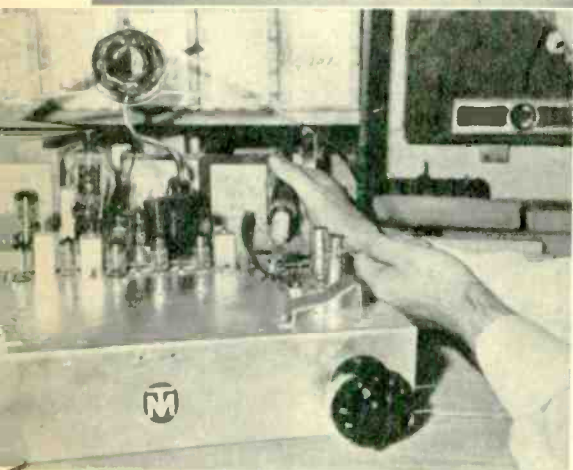

The yoke connects to chassis wiring by means of four-prong plug; this permits easy replacement.

Solder one part of the antenna lead to the tuner; the other end goes to connector at rear of unit.

Here is the correct method of carrying picture tube. It should NEVER be held by its narrow neck.

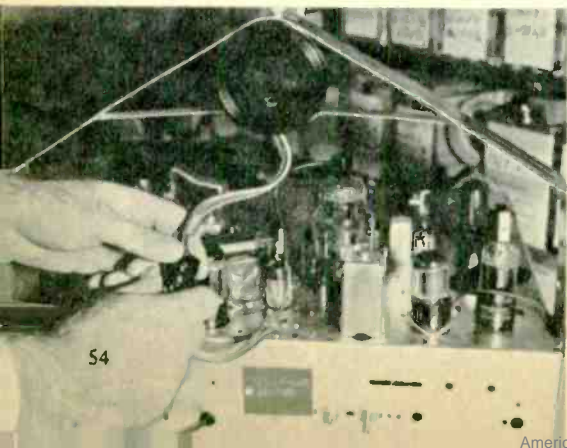



Looking at the schematic (not shown), we can see that Tech-Master has designed a classic circuit. While this may not mean very much at first glance, a little analysis will reveal some important advantages. First of all, by avoiding radical changes, Tech-Master gives us reliability through the use of time-proven circuits. Further, we can learn more about television in general by building the established type of receiver. Couple these facts with the use of the latest in TV tubes, such as the 5AM8, the 3AU6 and the 7AU7, we gain all of the advantages of new design without sacrificing the reliability and proven value of classic circuit parameters.

If you take the time and trouble to analyze this unit in separate stages, it becomes very clear. Of course, looking at any television schematic as a whole will appear complex; let's see what happens when we break it down and study it the proper way.

The filaments are connected in series. Many people will immediately pull their noses up at this as a purely economical measure. True, it eliminates the need for transformers but remember, too, that the only objection to a series string filament system is that a bit more warm-up time is required. As they are hooked up much in the same manner as Christmas tree lights, when one goes out, they all go out. This will prevent damage to other parts of the set as it will completely cease to function.

The antenna comes into the tuner circuit through a filter system, and the tuner works similarly to the tuners found in ordinary receivers. The 3BC5 and the 5J6 are the converter-oscillator and R.F. amplifiers. Tuning is accomplished by a drum-type tuner, in which all twelve channels are separately inductance-tuned and then switched to the final position. Fine tuning is accomplished by a variable condenser.

The signal is next passed to the 3CB6 I.F. amplifier. Another 3CB6 further amplifies the signal, and half of the 5AM8 is used for final I.F. amplification. The Video portion of the signal is then removed by the other half of the 5AM8, which is the video detector. This video signal is amplified in the 12BY7A video amplifier and applied to kinescope.

The audio portion is taken off at the same time the video portion is detected, and with its 4.5 megacycle carrier, is injected into the 3AU6 4.5 mc amplifier and goes from there to the 5T8 ratio detector. The carrier is removed in this stage, and the remaining audio frequency is amplified in the 12L6 audio output tube. From there it goes through the audio output transformer to the loudspeaker.

The synchronization amplifier, a 7AU7, amplifies the synch pulses and the second half of this stage separates the pulses. The vertical oscillator and synch limiter, a 3AU6, works in a balanced circuit with the height control and the vertical hold control, which keeps the picture from rolling. This stage feeds the vertical amplifier tube, a 12W6, which is connected inductively to the kinescope.

The signal which controls horizontal action of the picture is generated in the horizontal oscillator tube, a 6SN7GTB, and the horizontal hold control is affiliated with this circuit. This tube also serves as a phase detector. Horizontal amplification is handled by the 25CD6 horizontal output tube and the high voltage is rectified by the 1X2B half-wave rectifier. The only other tubes in the circuit are the 12AX4 horizontal damper tube and the kinescope.

You can get more information by writing to Tech-Master at 75 Front Street, Brooklyn 1, N. Y. The kit is the 5516 and costs \$99.50. •—Byron G. Wels

Picture tube is not supplied with the kit. You must purchase your own, of 17- or 21-inch size.

The extended clip from the yoke support bracket is designed to engage coating on back of tube.

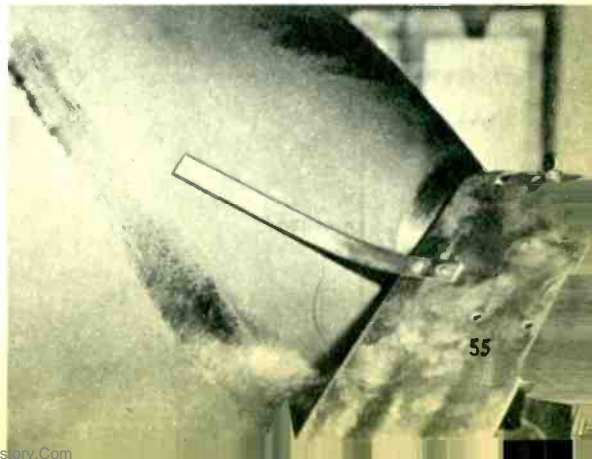

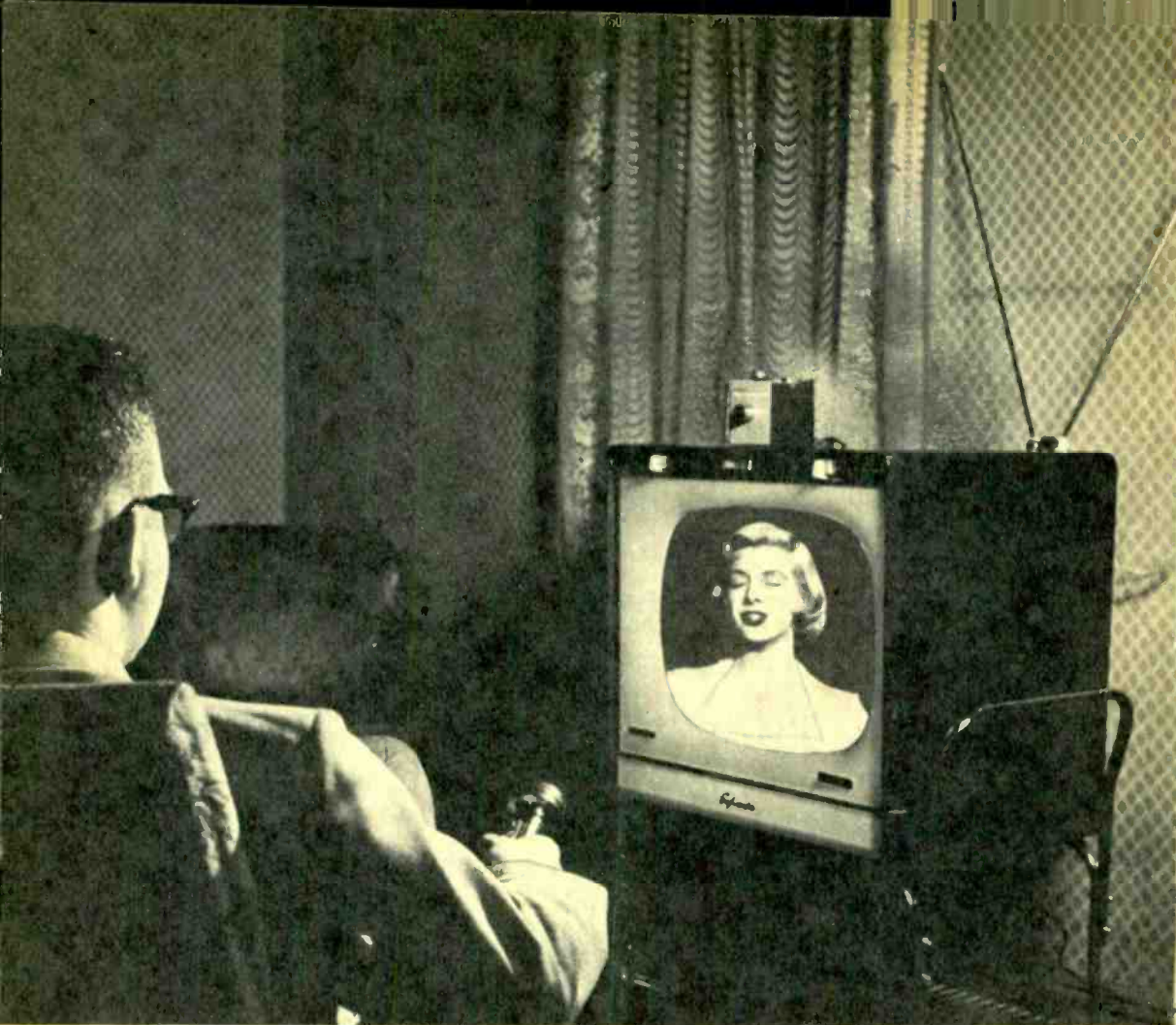

## "Quiet, Please!"

At a speed of 186,000 miles per second you can silence the sound in your television set.

**Y**EP, that's right! With a beam of light from a flashlight you can silence the voice of any tiresome announcer, groaning crooner or a raucous commercial. Aim the flashgun beam at your TV set—and lo and behold—blessed silence. Aim the beam again and you have the sound. Silence, 'swonderful!

The Allied Radio Corporation has available a photoelectronic relay kit which makes it possible for anyone to make a TV silencer. The kit has just about everything you will need. All you have to supply is a screwdriver, a pair of diagonal wire cutters and a soldering iron. The kit can be had from Allied for \$13.50; the ratchet impulse relay for \$7.90.

The book of instructions that comes with the kit is carefully detailed with a series of check boxes which enables you to mark off each operation as you complete it. You need not know anything about electronics. Even if you have never soldered before



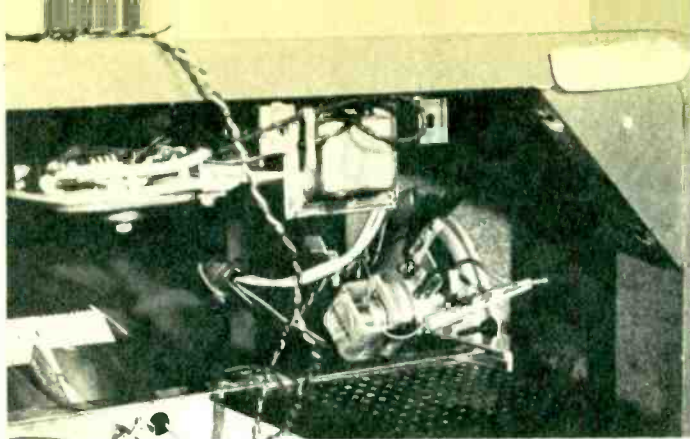

Relay wires connect to the terminals of loudspeaker.

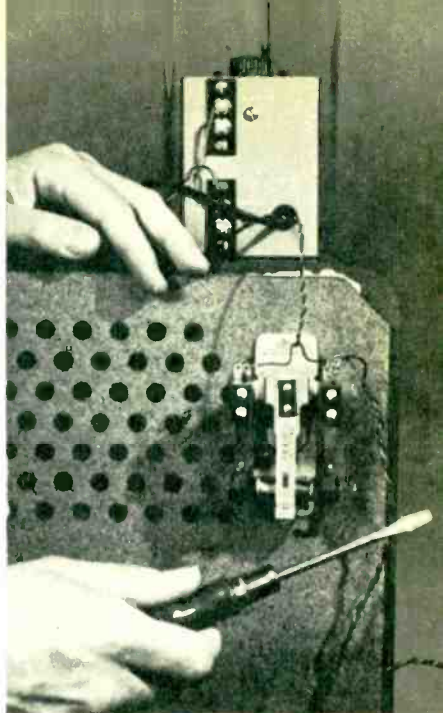

The relay switch is fastened to either side of rear panel. This switch is mounted on the outside to illustrate proper wiring connections.

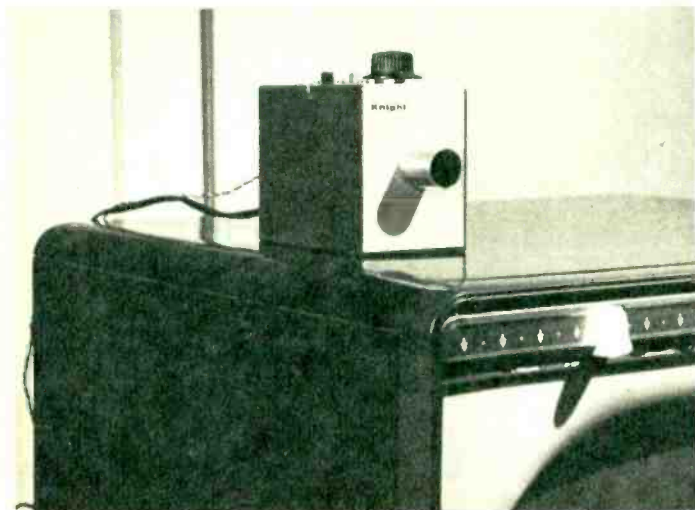

Electronic "eye" will be normally set on TV cabinet but will operate from any point in room provided it is accessible to the flashlight beam.

the booklet explains and illustrates how to make a good joint.

Various stages of progress in the assembly of the kit are shown in the accompanying photographs. The kit is foolproof—so much so that it's hard to make a mistake. The circuit uses a CL-3 cadmium selenide photocell and a 5696 thyratron vacuum tube. You really don't need the circuit diagram to wire this up; the instructions and pictures are all that are required.

Allied will also supply you with an impulse relay of the ratchet type. This is necessary in order to use the photoelectric relay for our purpose. The one we used is the double-pole, double-throw AP11A rated for six volts. The impulse relay is hooked up to the photo relay and then two wire leads are soldered to one set of contact terminals on the relay. The free ends of these wires are then connected in series with the speaker of the TV set.

Before working on the TV set, remove the wall plug from the outlet; there's no sense in taking even the slightest chance of getting a shock. Open the back of the set and locate the loudspeaker. More often than not the leads going to the speaker have small metal tips that slide into receptacles in the speaker itself. Slide one tip out and connect the relay in series. Close the back of the set, plug it in, and you're ready to operate.

Plug in the photoelectric relay to a 115-volt AC outlet and turn the switch to the ON position. Now, when we play the light beam on the "eye" and then remove it, the contacts open and the sound goes off. When we repeat the operation the sound returns.

Now during commercials we can talk among ourselves or read a newspaper without distraction; it's the greatest thing since television. •—*Emanuel Berger*

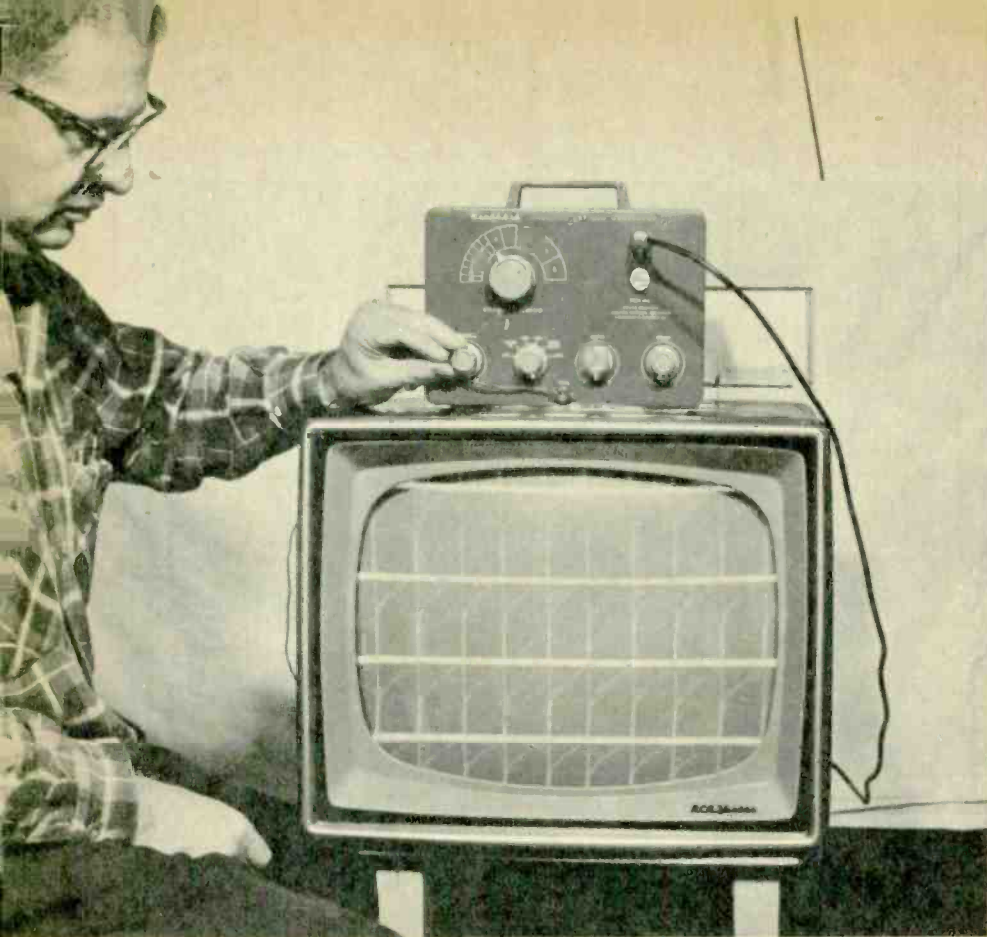

Pattern generator, shown here in finished form, resembles table-model radio set. Easy-to-read dials on unit enable the television repair man to make exact and accurate adjustments to set.

# Straighten Your Picture

Those bent television pictures can be straightened out with the help of a Linearity Pattern Generator; it's available in kit form.

**H**AVE you ever noticed, in visiting around, that the pictures on some television sets are sharp but distorted? Often the figures of people are too tall and thin, or they are fat and squat, and the edges of the screen appear to be rounded off like a ball. All these signs point to poor "linearity."

These conditions can usually be cured by careful adjustment of the back controls marked "horizontal size," "horizontal linearity," "vertical size," "vertical linearity," or words to that effect. The adjustments may interlock to some extent, but you can't hurt anything by making them.

It is not always easy to obtain a "normal" picture if a live program or a movie is on the air, because the images move around too much. The job is greatly simplified by the use of a special test instrument called a "linearity pattern generator." This is a miniature television station, but instead of transmitting pictures it creates horizontal and vertical bars, and a cross-hatch combination of them. Any misalignment of the receiver shows up instantly in the form of bent or misplaced bars. It then takes only a few minutes to correct the condition by manipulation of the controls on the set.

Although intended originally for pro-



Clothespin type clip is attached to output cable and is designed for quick, positive connection to antenna terminals of the television receiver under test.



Construction of the unit is simple. Tube V3 creates the vertical bars, V5 the horizontal bars. V4 is combination video amplifier, modulator, carrier oscillator.

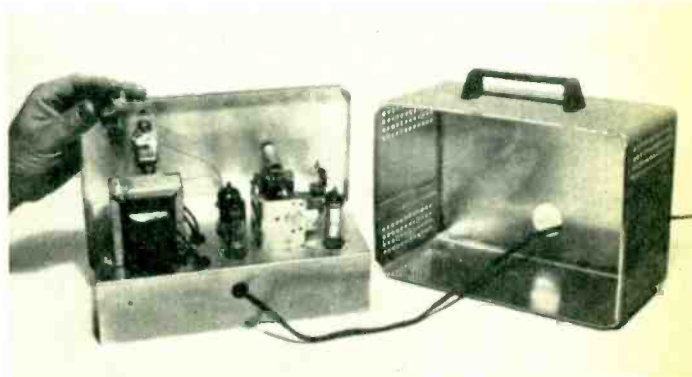

Output cable is connected directly to the antenna terminals at the rear of the television set. The regular antenna is disconnected at this stage.

Professional TV service technicians, the pattern generator has also been adopted enthusiastically by experimenters and do-it-yourself set owners. Equipment manufacturers are no longer surprised at this sort of thing.

A pattern generator that I have used with good results is the Heath Model LP-2. I started working on the kit at seven p.m. one evening and had it hooked up and working with a television set by ten. It uses five tubes, and represents about as much assembly and wiring effort as a standard table-model radio receiver.

The application of the generator is

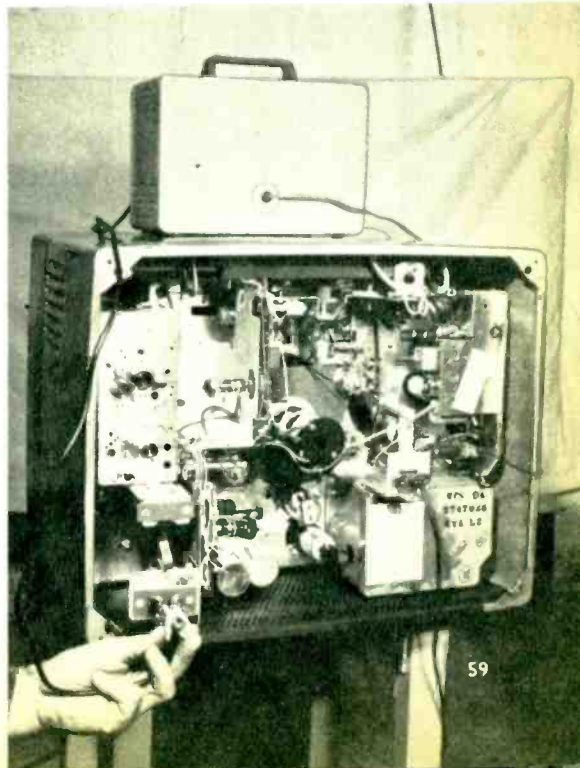

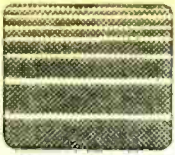

Horizontal bar pattern showing maladjustment of vertical linearity.

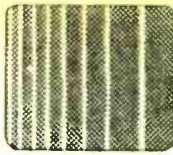

Vertical bar pattern showing maladjustment of horizontal linearity.

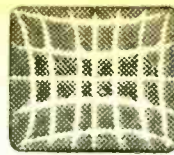

Crosshatch pattern above shows the effects of blooming

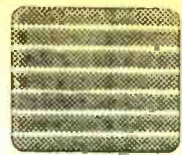

Horizontal bar pattern showing correct adjustment of vertical linearity.



Vertical bar pattern. Correct adjustment of horizontal linearity.

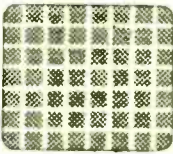

Crosshatch pattern. Correct adjustment of linearity controls, yoke and ion trap.

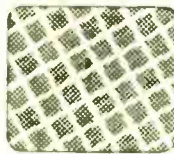

Crosshatch pattern showing the yoke positioning wrong.

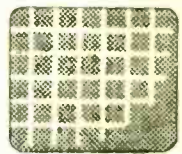

Crosshatch pattern. Neck shadow is caused by incorrect ion trap placement.

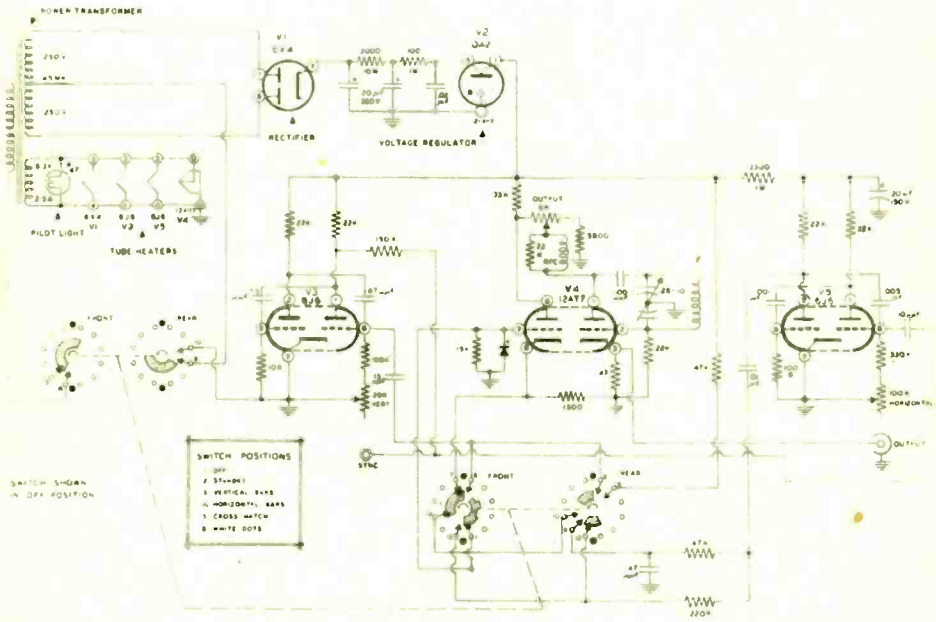

simple. The idea is to tune the TV set to an unused channel, so that actual TV signals won't interfere with the generator's test signals. The antenna is disconnected from the set, and the output cable of the generator is connected instead by means of a "clothespin" type clip. The receiver and the generator are allowed to warm up for at least fifteen minutes, to achieve stable operating condition. The various adjustments are definitely critical, and become impossible if either the receiver or the generator has a tendency to drift from its settings.

The generator "CHANNEL TUNING"

knob is turned to the same channel number of the TV set. Vertical, horizontal and cross-hatch patterns are then selected by means of the switch under the tuning knob. At first the patterns will bounce around like crazy, but with a little practice you can steady them down. It is very, very interesting to watch the bars bend and move as the set controls are twisted.

The instrument also produces a white dot pattern which is intended for adjustment of one particular function of color receivers. This feature is of interest to the relatively few service technicians who handle color sets. •—Robert Hertzberg



Actual on-the-screen photos of the patterns imposed by the generator are shown in three photos on this page. The even character of the lines indicate that the television receiver is properly lined up. At right is the first pattern: horizontal bar pattern.

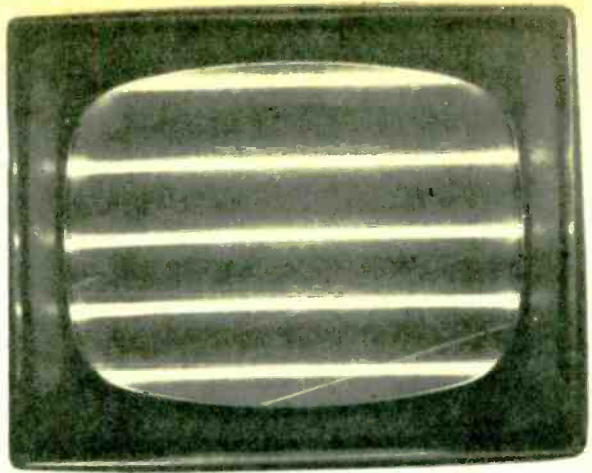

Next in line comes the vertical adjustment. A perfect pattern is shown in this actual test photo at right.

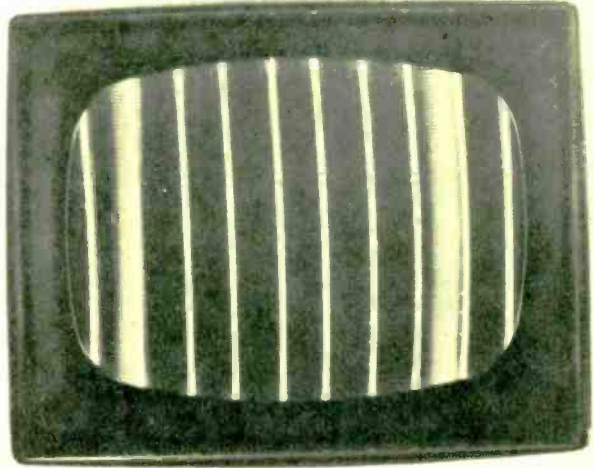

The last stage of test procedure is to check for both the horizontal and vertical patterns with the generator.

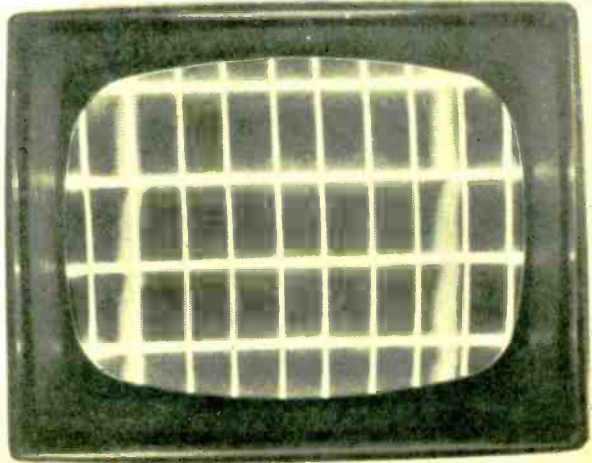

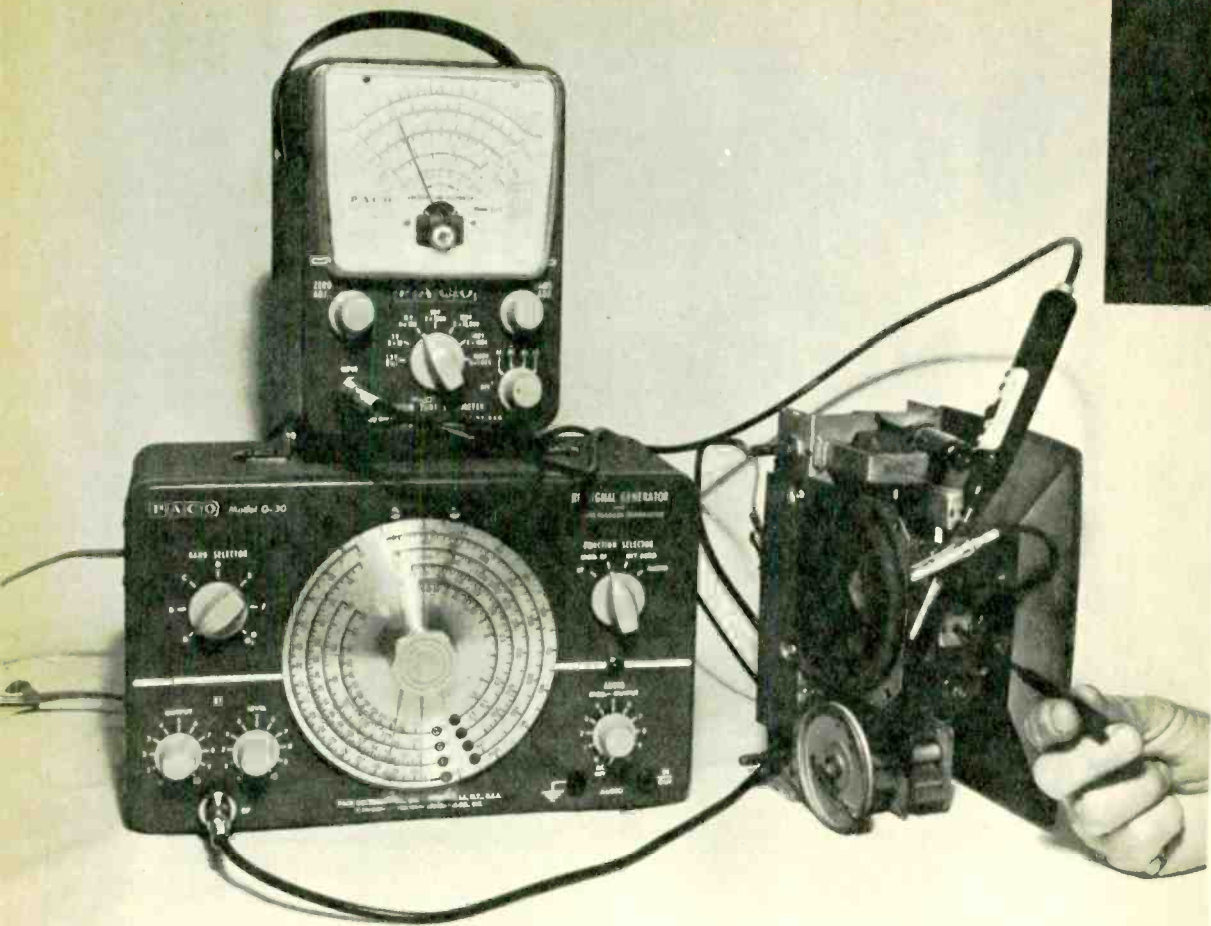

Above is a common use for the Paco signal generator: alignment of small table model radio. Cable from bottom left edge of generator connects to set's antenna terminals. Voltmeter sitting on top of generator is connected to loudspeaker's voice coil, giving various readings as the set's adjustments are varied as desired.



Left, the 400-cycle tone of the signal generator is taken from the connectors at the lower right corner of the front panel, for a test on a small high fidelity amplifier. After testing, a suspected tube was removed and found to be the main cause of trouble.



# Signal Generator

Producing a wide range of frequencies, this generator can be used to test various receivers and amplifiers.

AS an electronic experimenter gets deeper and deeper into the game, he begins to realize the need for a source of controllable signals of known frequencies. These signals are the prime requirement for the proper "alignment" of the circuits of AM, FM and television receivers, and are useful for trouble shooting. An instrument capable of producing such impulses is called a "signal generator."

In effect a signal generator is a small transmitter. However, because it has to produce signals of only very moderate strength, it is a very simple device, much smaller than even the lowest-power amateur transmitters. It lends itself very well to kit form. A representative generator is the new Paco Model G-30, which uses only two tubes and is assembled in two hours of easy work with a screwdriver, a socket

wrench and soldering iron as the only tools.

After assembling and wiring the basic Model G-30, the builder must calibrate it himself, using broadcast, short-wave and other stations of known frequency as reference points. The procedure is interesting, and in itself is educational. If he is relatively inexperienced in these matters, he can choose the Model G-30-PC. This kit includes a prewired and precalibrated coil assembly, accurately matched to the big 5½-inch tuning dial on the front panel.

The generator produces both unmodulated and 400-cycle tone modulated signals over the extremely wide frequency range of 160 kilocycles to 240 megacycles, in eight steps, as follows:

**Band A:** 160 to 520 kilocycles. Takes in the intermediate frequencies ("I.F.'s") of all regular broadcast receivers.

Closeup of front panel of the Model G-30 signal generator shows the controls. Variable frequency signals are taken from lower left-hand connector marked RF; a fixed 400-cycle tone comes from the lower right-hand posts marked AUDIO. The extra large dial is calibrated directly in frequencies for very easy reading.

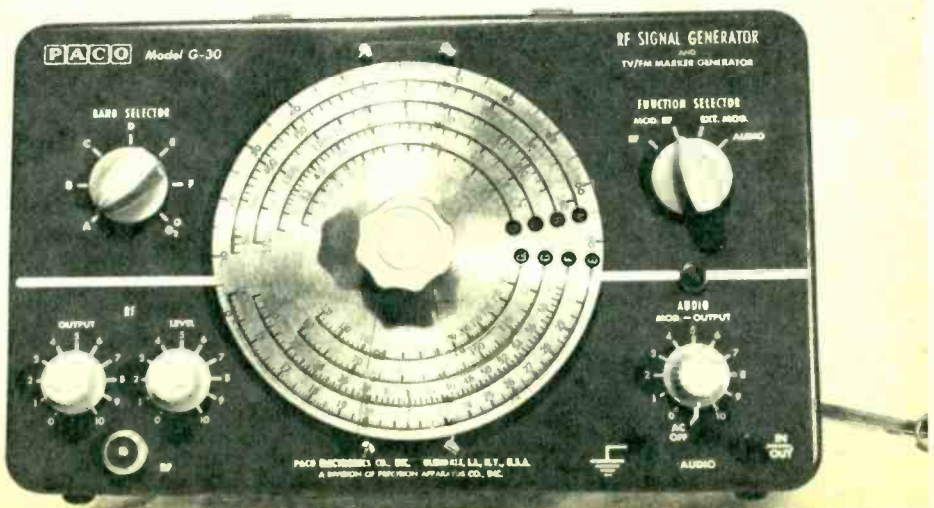

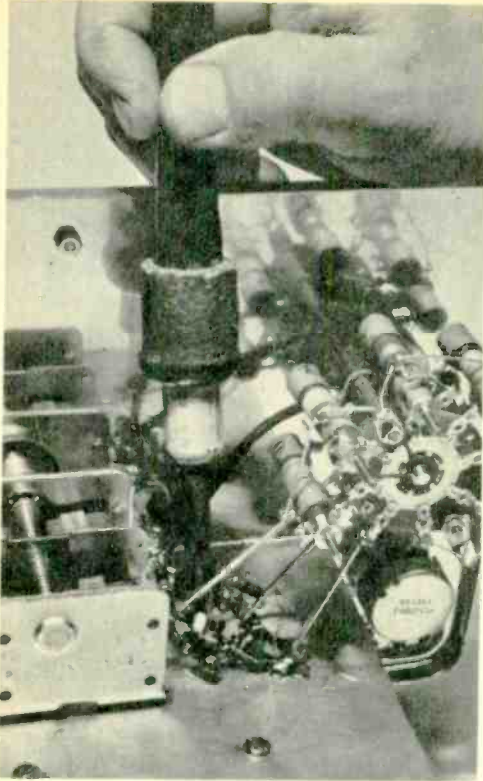

Socket for oscillator tube is mounted between the tuning capacitor (left) and the coil turret (right). A needle point iron is needed for soldering here.

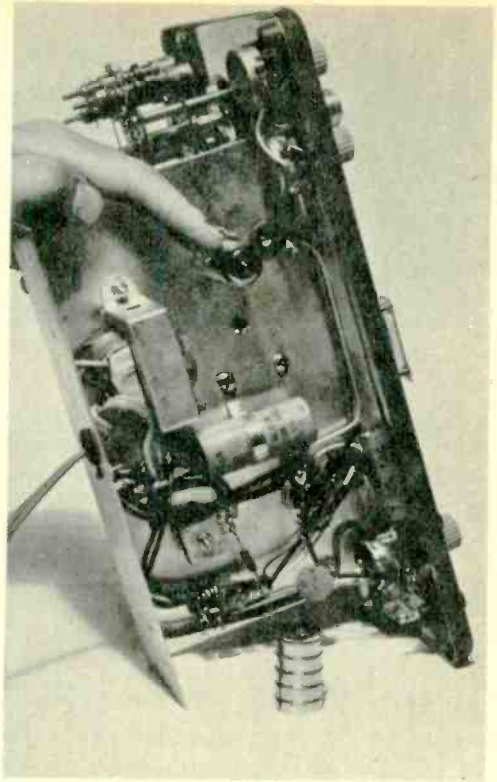

Oscillator tube hangs upside down on the underside of chassis. This unconventional method of mounting permits short leads from socket to coil.

The Paco signal generator is calibrated on its various frequency bands by means of adjustable slugs in the tuning coils. These tuning coils, shown below, are mounted directly to the BAND SELECTOR switch.

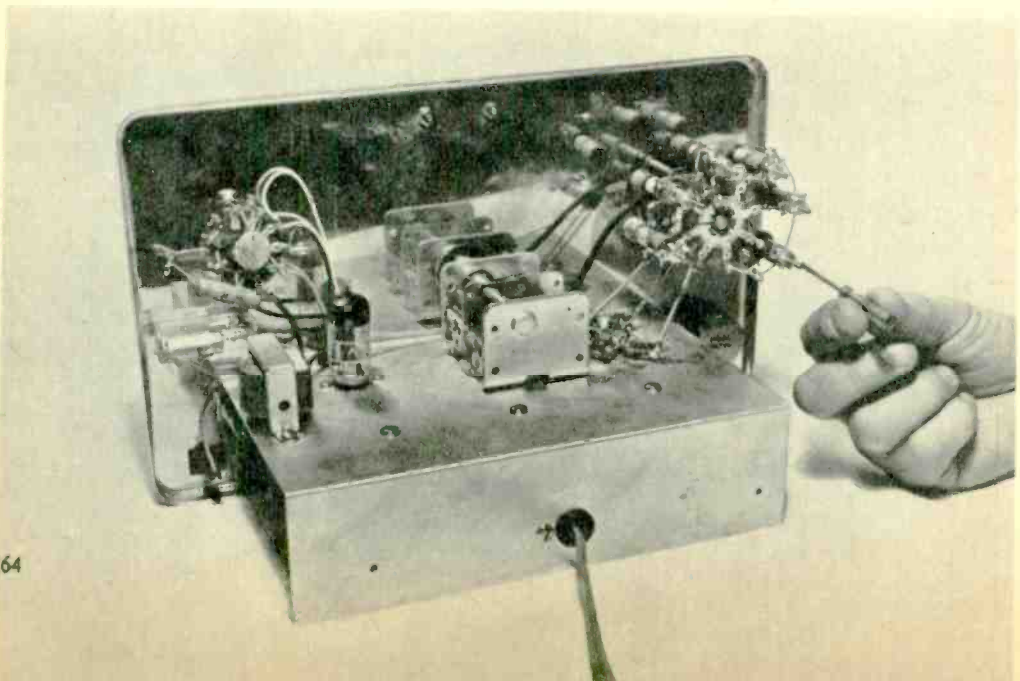



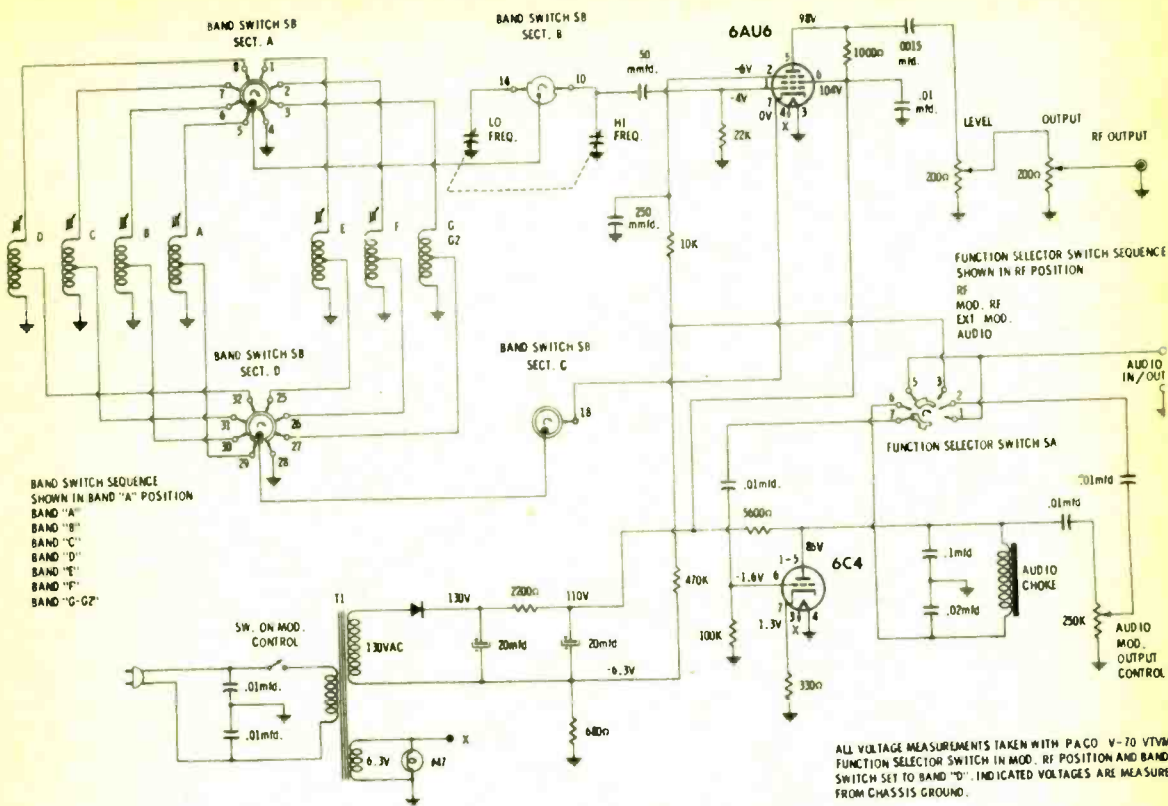

**Band B:** 520 to 1700 kilocycles. The full AM broadcast band.

**Band C:** 1.7 to 5.5 megacycles. Takes in the "medium" short waves, including police, marine, aviation and some amateur stations.

**Band D:** 5.2 to 16 megacycles. Takes in international broadcasting, two ham bands, and the important 10.7 megacycle frequency used in the I.F. circuits of FM receivers.

**Band E:** 15 to 30.5 megacycles. Takes in more broadcasting, ham and I.F. services.

**Band F:** 29 to 60 megacycles. Covers many FM two-way communication services and channel 2 of television.

**Band G:** 60 to 120 megacycles. Takes in TV channels 3, 4, 5, 6 and the important 88-108 megacycle FM broadcast band.

**Band G2:** 120 to 240 megacycles. Takes in some aviation frequencies, and TV channels 7 through 13.

The various bands are read directly on the large center tuning dial. This also has a 0-100 vernier calibration scale, which

permits the accurate recording of particular frequencies for special purposes.

In addition to these selectable frequencies, the Model G-30 also produces a fixed 400-cycle tone. This is highly valuable for testing and trouble-shooting hi-fi components, as well as the audio amplifier sections of radio and television receivers. The first time we used the generator we were able, within five minutes, to determine the cause of balky operation of an amplifier by connecting the 400-cycle output to the grid of the last tube. The tone came through the loudspeaker, but weakly and mixed with noise. Pressing the various connections at the tube socket with a Bakelite screwdriver, one was found to be caked with soldering flux. Wiggling the wire made the speaker rattle like thunder. Sure enough, it was a cold joint. A hot iron cooked out the flux, restored connection, and brought the amplifier to full volume.

This signal generator represents only a modest investment: about \$29 for the uncalibrated kit, and \$36 for the calibrated model. •—Robert Hertzberg

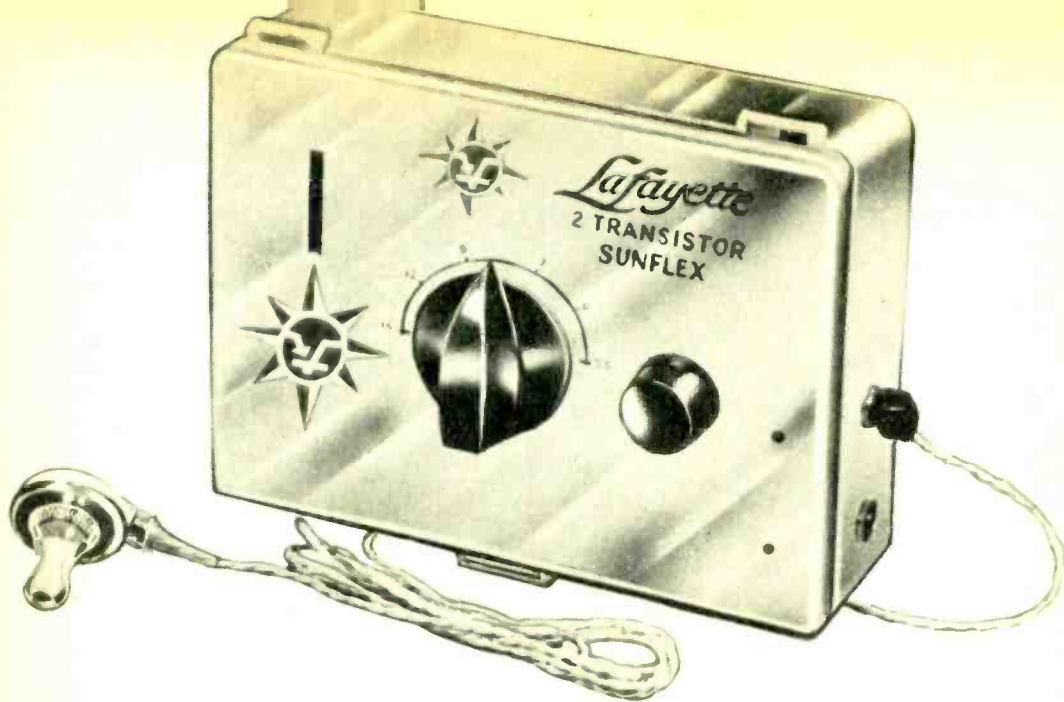

# Sun-Powered Transistor Radio

Whether operated on sun power or batteries, this midget receiver will give excellent performance.

**C**OMBINING the ultimate in transistor radio design with crystal radio efficiency, Lafayette has really gone all out with this unit. The radio, called Sun-Flex, is completely transistorized and uses one stage N-P-N, the other P-N-P. This symmetry makes for a highly sensitive unit. The germanium diode detector does not "rob" the use of one transistor but permits full amplifier operation of both transistors.

Here's the capper that makes the whole thing really worth while: it operates on the energy supplied by the sun. I know what the next question is. . . . "What do you do when it rains?" "What do you do at night?" Well, if it rains, or it's dark out, just unplug the earphones from the "sunlight" jack, and plug them into the "battery" jack. Yes, Lafayette has thought of everything. By merely plugging the earphones from one jack to another, we can use either the self-contained three-volt battery, or the sun batteries, also self-contained.

The principle of operation of the reflex circuit is quite interesting, and this is the first time we've seen it applied in transistor circuits. Vacuum tubes, generally, are voltage amplifiers and transistors are current amplifiers. The fact that this old application could be so well blended with a new idea helps to point up the interest.

The reflex circuit uses a single stage to perform a dual function. In this case, the transistors are first used as radio frequency amplifiers. The antenna picks up the signals which are applied to the transistors and amplified. These signals are, of course, tuned before being amplified so that only the station we want to hear will come through. The use of two transistors in a complementary circuit will increase the gain that is normally obtained from only a single transistor.

After being amplified, the signal is detected by the germanium diode. This little device functions by conducting the flow of electricity in one direction only. Ob-



vously, this one-way conduction serves to rectify the radio frequency coming through so that we are left only with the audio portion of the signal.

A portion of the signal, the audio frequency, is fed through the transistor circuit again, amplifying it before passing it through to the earphone. If this doesn't strike you as very spectacular, then consider the fact that the transistors are amplifying audio and radio frequencies at one and the same time!

There are certain disadvantages: reflex circuits have been known to overload when in strong signal areas. However, the complementary symmetry design applied in this particular kit eliminates this drawback completely.

Incidentally, if you've built any of these transistorized jobs, you may feel that for fringe areas an additional length of antenna is required which can be strung up where you commonly work. When you're at that spot, connect the antenna to the receiver. Lafayette makes this easy to do, as they have supplied a jack for external antenna connection. However, the reflexed complementary symmetry circuit has eliminated any real need for an external antenna. If there's any way to squeeze more out of a transistor, we don't know what it is. •—Byron G. Wells

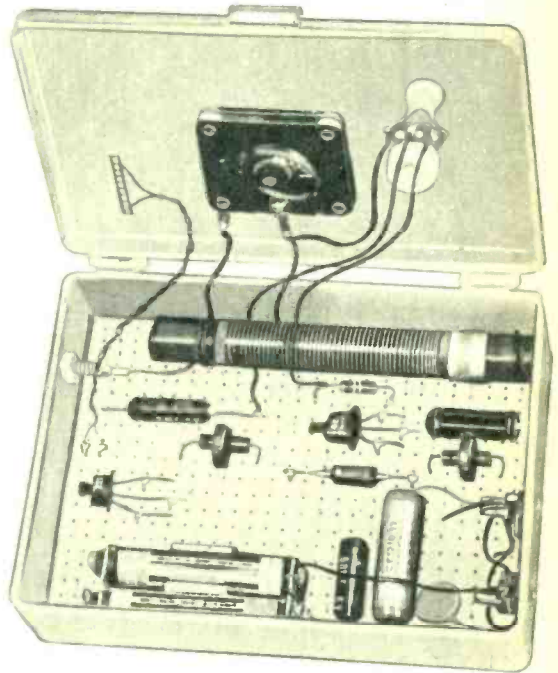

Internal view of the unit shows neat layout of components, with all the parts easily accessible.

Schematic diagram of sun power-battery receiver.

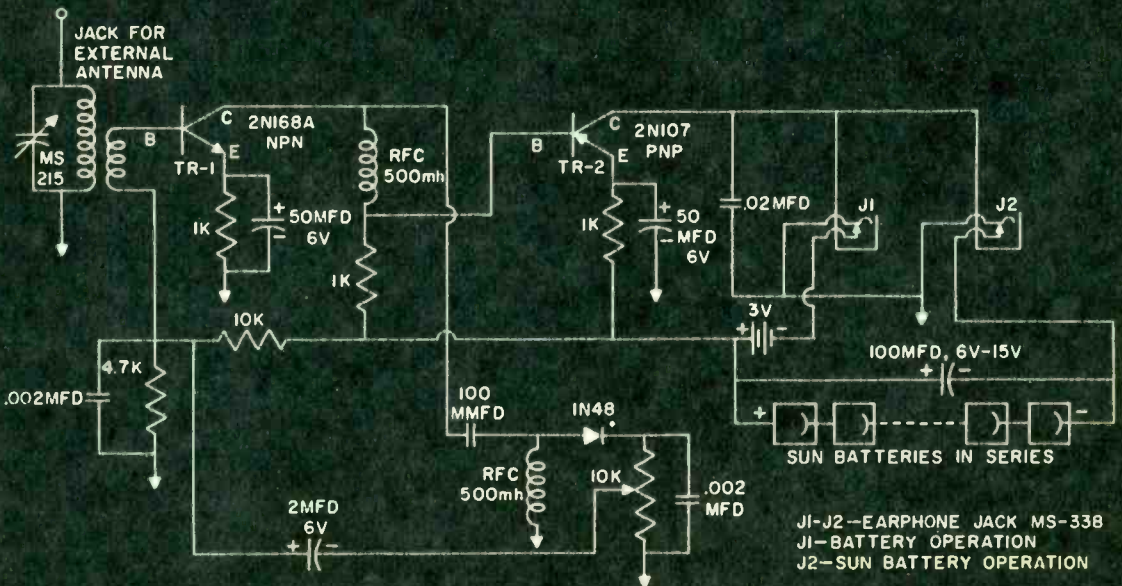

# Balun Coil

simplifies ham antenna operation

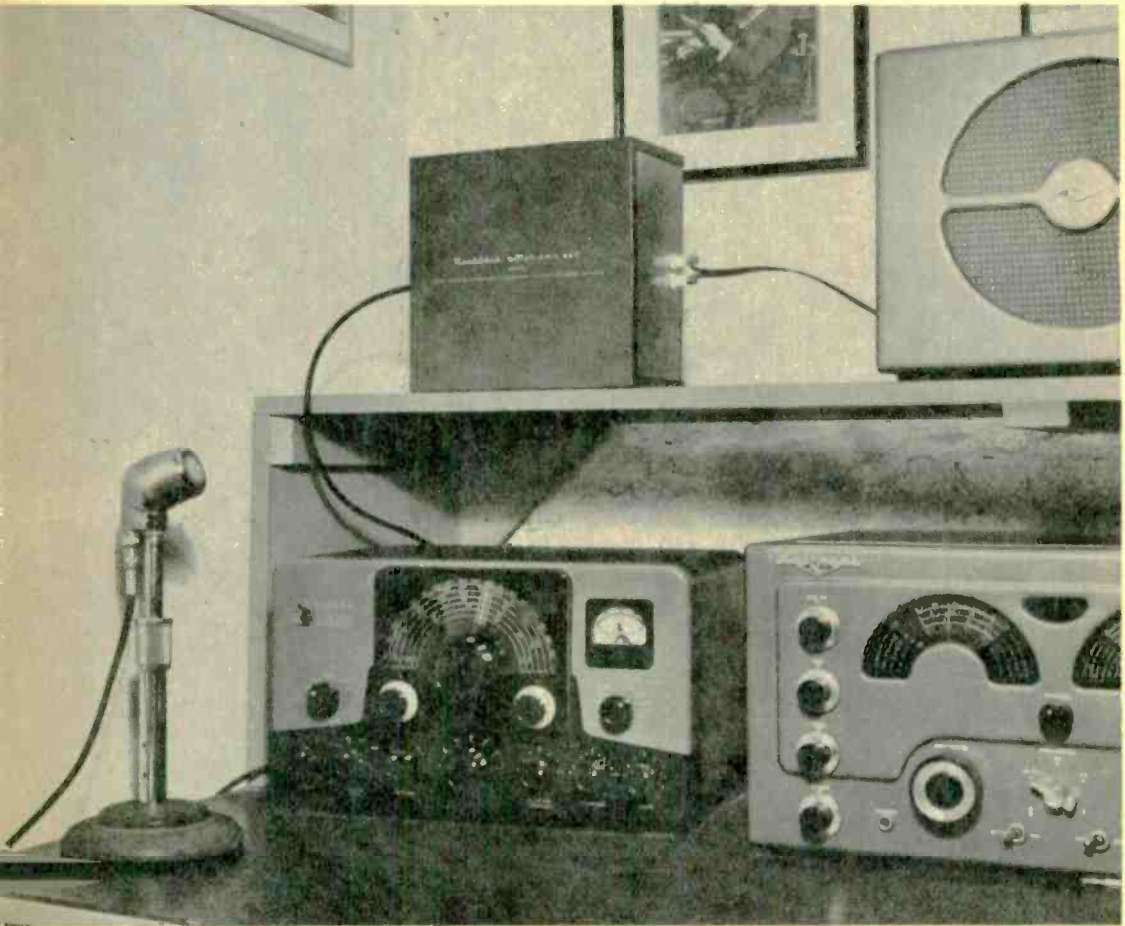

Above, actual installation of the balun at Station W2DJJ. It connects to a Johnson Viking transmitter by a three-foot coaxial cable, and to the outside antenna by piece of twin-lead visible behind loudspeaker.

Double-winding coils are mounted parallel inside can. They are wired for 4:1 ratio, 75 to 300 ohms. They can also be used 1:1 (75-ohm coax to 75-ohm twin-lead). At 4:1 coils are in series at right end, parallel at left. At 1:1, they are parallel at both ends. See diagrams on opposite page.

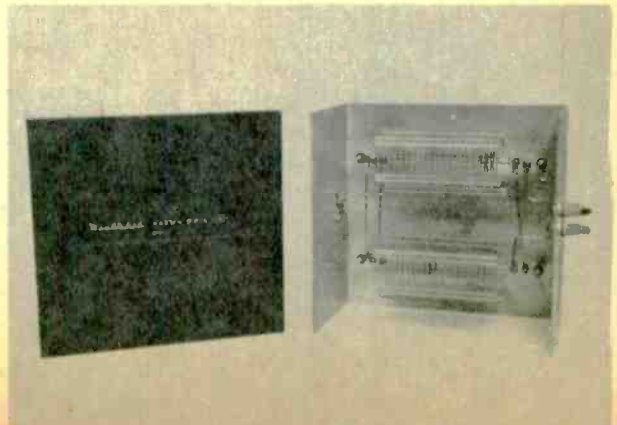



**A** STATION accessory that ham operators will find very useful when experimenting with antennas is a "balun" coil set. "Balun" is a coined word having the meaning "balanced to unbalanced." The expression relates to the common problem of operating transmitters with unbalanced coaxial type output into balanced antenna feed lines. The latter usually take the form of television "twin-lead," which is cheap and very easy to install, and therefore popular with hams.

Fortunately, a balun unit that works on the ham bands from 10 through 80 meters can be made both simple and foolproof. It consists only of two double-winding, air-spaced coils of heavy wire, connected to act as an impedance transformer. In its most usual application, the balun connects to the transmitter by a short length of

coaxial cable, and to the antenna by a piece of twin-lead as long as required. The nice part of this device is that it requires no adjustment of any kind. Just install it and forget it.

In the Heathkit Model B-1 balun, the coils are furnished all wound and ready to mount. As a kit project this is the easiest we have encountered: 25 minutes working time total. The coils are enclosed in a tight two-piece aluminum shield can, measuring 9 inches square and 5 inches deep. There is a coax fitting on one side, and two stand-off terminals on the other, for the twin-lead.

For experimental purposes, have the balun right on the operating table. For a permanent installation, it can be concealed under the table or mounted outside the house. •—Robert Hertzberg

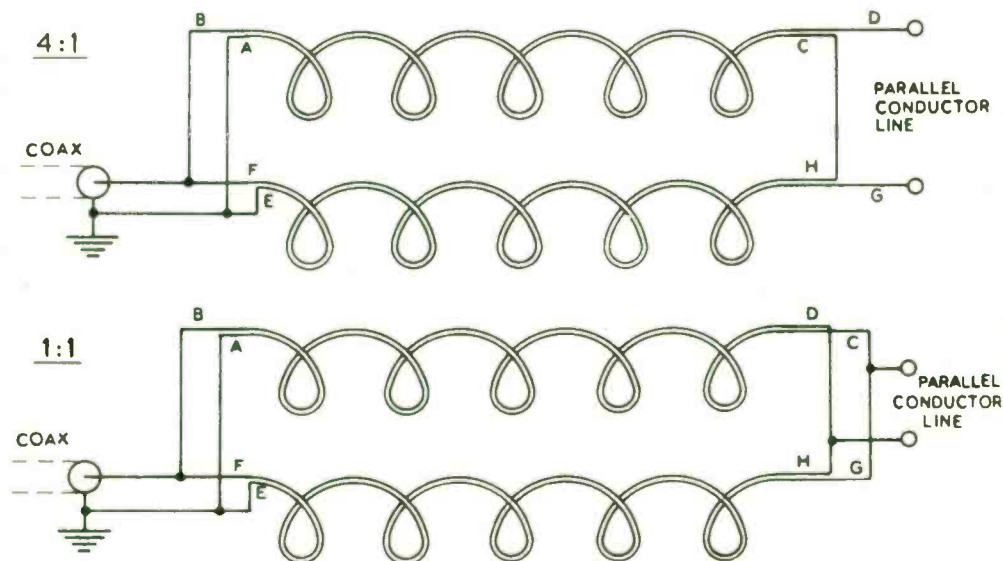

The transmitter signals enter here, by way of a coaxial cable, insulated from the aluminum can.

Signals leave the Heathkit balun at this end for the antenna, by way of a flat twin-lead wire.

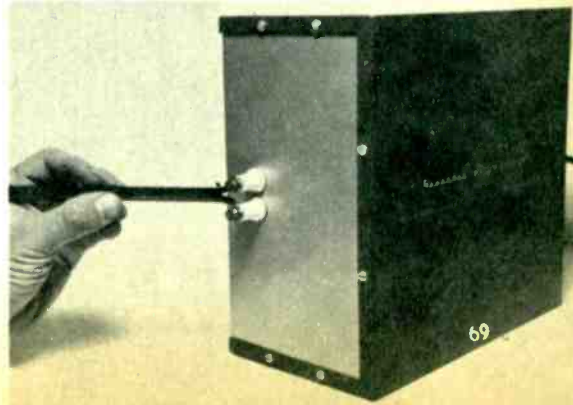
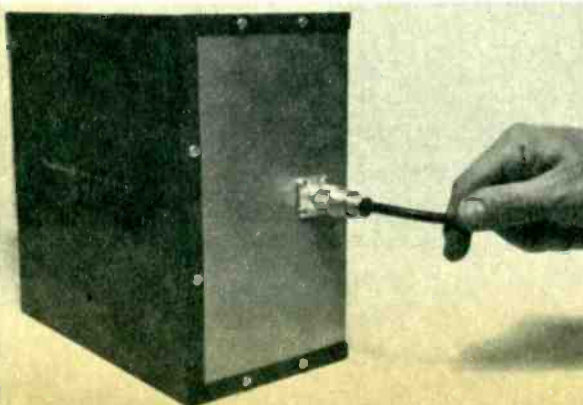



Station K2DUX. Equipment includes the DX-40 with mike and key, and a NC-183D receiver.

## Low-Cost Ham Transmitter

This compact, 6-tube amateur transmitter enables you to broadcast on the 10- through 80-meter bands.



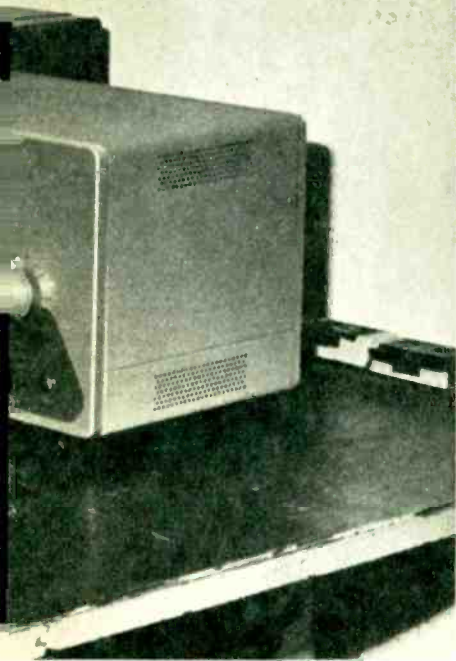

**A**RE you restricted to CW (radio telegraphy) at the present time but will soon be able to operate on phone (voice transmission) when you get your "General" class license? If so, you will be interested in the new Heathkit DX-40 transmitter. Covering the 10- through 80-meter bands, it is rated at 75 watts on CW and 60 watts on phone. Within its 13x8x9-inch cabinet is housed a carefully designed, compact six-tube lineup. This starts with a 6CL6 tube, operated in a Colpitts oscillator circuit which provides harmonic output for use on high frequencies. A small door in the rear of the cabinet gives access to three crystal sockets which can be switched into use by a four-position switch. The fourth position allows you to use an external VFO (variable frequency oscillator). Power to operate the VFO can be obtained directly from an accessory socket on the rear of the transmitter chassis. Another 6CL6 tube is used in the buffer stage and tunes to the second, third and fourth harmonics of the oscillator stage. The latter uses 160-, 80- or 40-meter crystals. The buffer stage is coupled to the final amplifier by a network which has a limited tuning range. This reduces the possibility of amplifying wrong harmonics.

Note in the schematic that the buffer has its own filament voltage supply. This feature prevents heater-to-cathode breakdown as this cathode is at 300 volts potential above the other tubes.

The final amplifier tube is a 6146, capacitance coupled to a network tank circuit. A 900-mmfd tuning capacitor is used for antenna loading. Microphone input can be traced through to the 12AX7 two-stage resistance-coupled speech amplifier, which feeds by capacitance coupling to a 6DE7

Block diagram shows the tube functions.

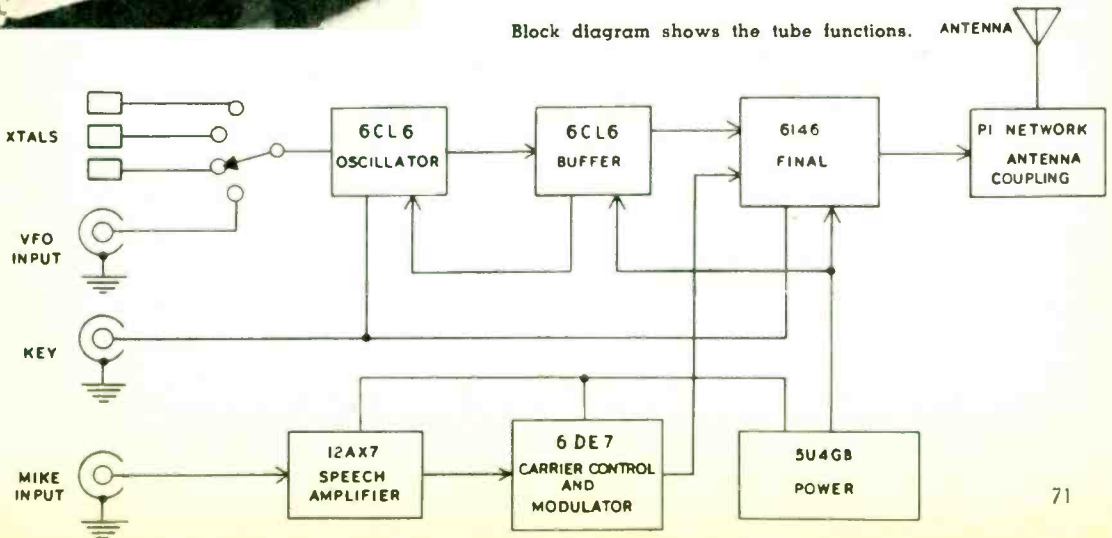



Complete layout of all parts removed from shipping box. Note the neatly punched chassis.

Soldering leads to rectifier tube socket. Preformed cable sits inside chassis edge.

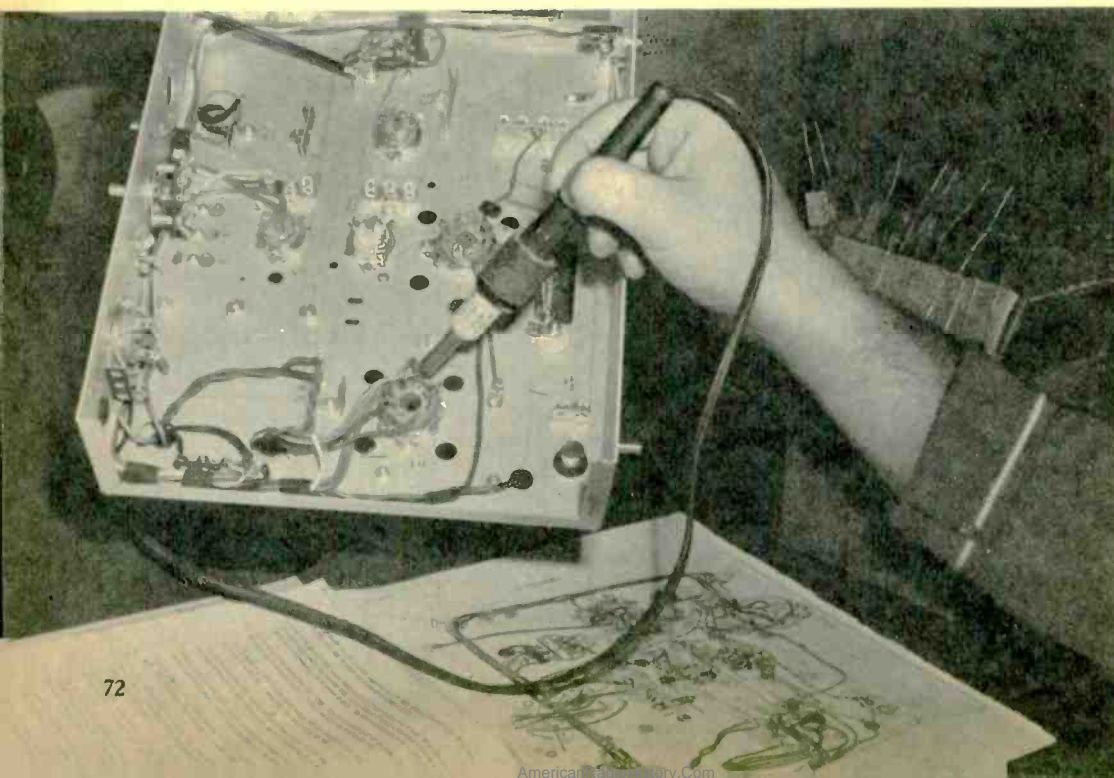





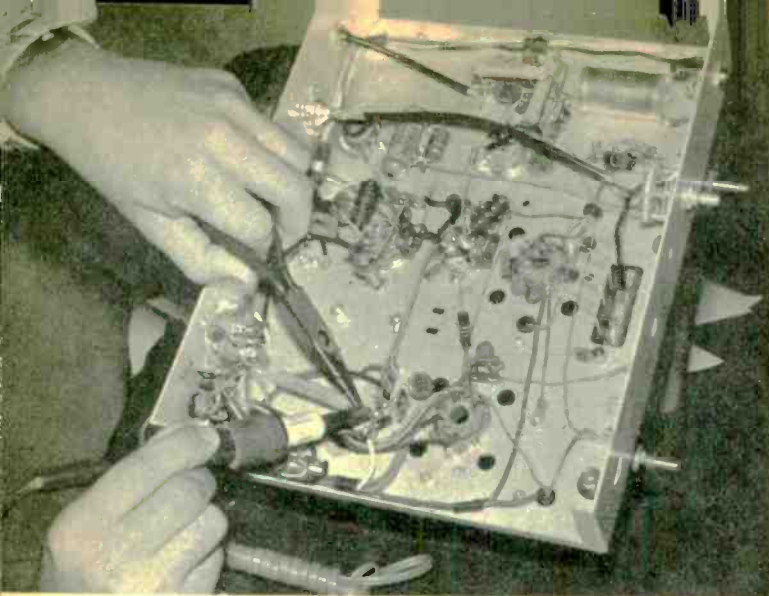

The assembly is about one third completed at this point. The resistor being connected supplies voltage to the accessory socket of the transmitter.

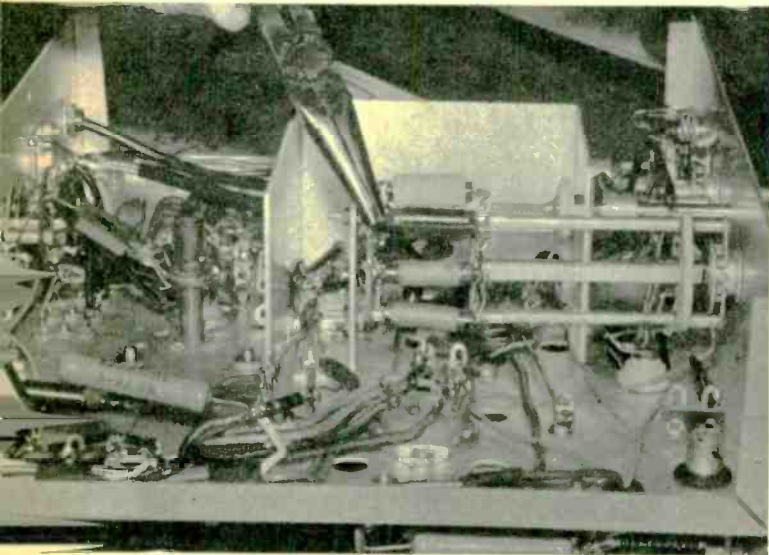

After the coil shield has been fastened to the chassis, the various coils must be checked to insure adequate clearance.

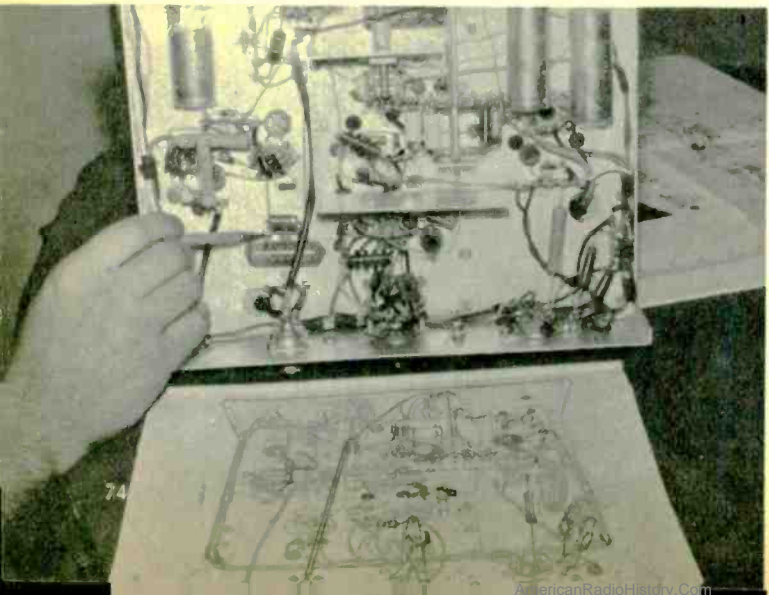

Double-checking the entire bottom chassis wiring starts with the microphone circuit. Always refer to instructions.



Continue checking point by point. In photo, right, pencil shows the coil assembly being given an accurate going over.

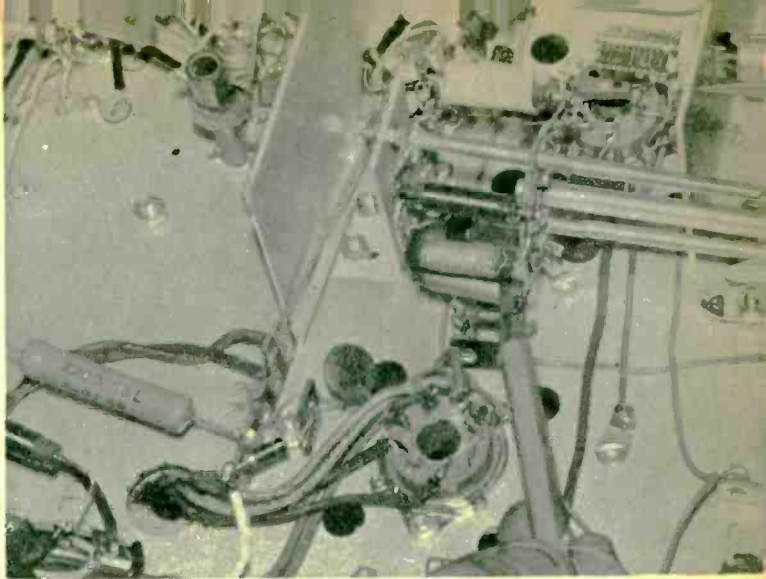

The filter unit is screwed to the rear edge of the chassis. The large unit sitting on the right is the power transformer.

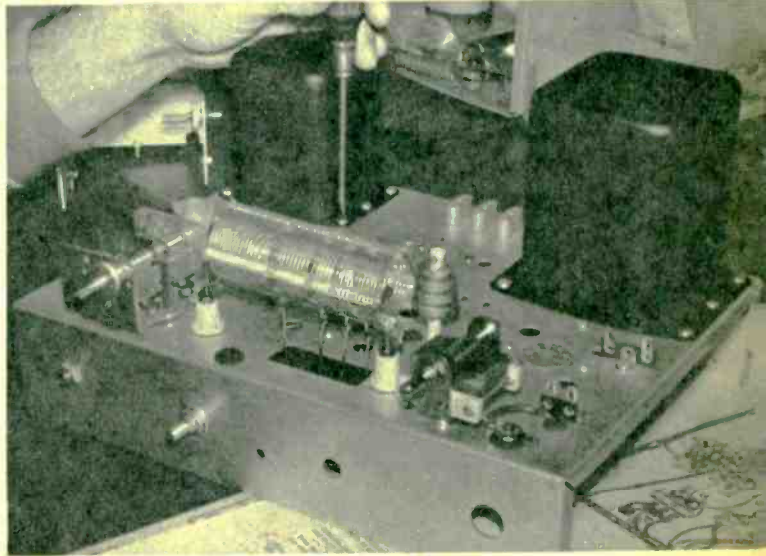

This view of the top of chassis shows the connecting of the plate choke and coupling capacitor to the final tank coil.

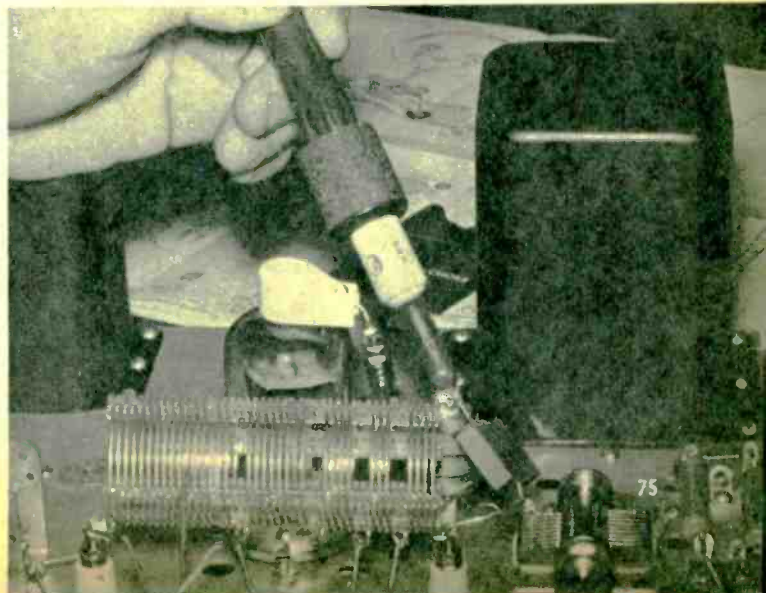



With the front panel and meter attached, the tubes and their shields are inserted into the proper sockets in preparation for the final testing stage.

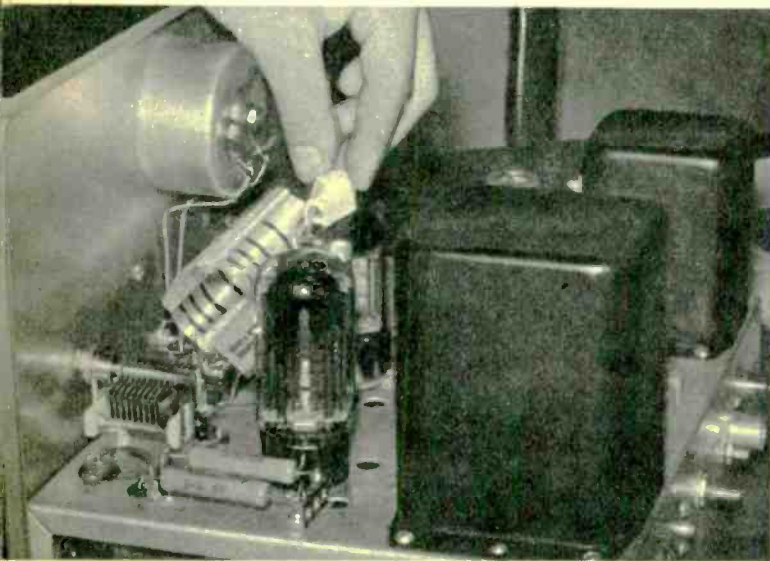

Just before placing the chassis in its cabinet it is advisable to check the fit of the final amplifier tube cap, as shown.

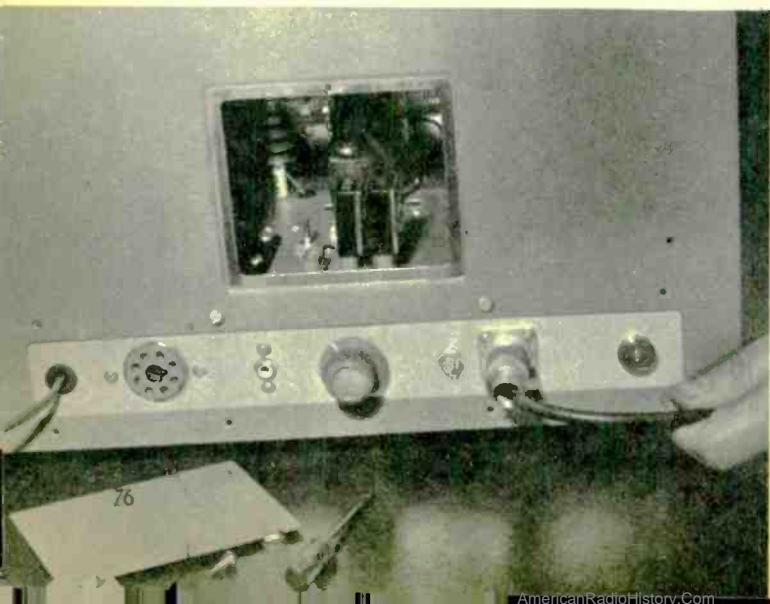

Prior to going on the air, remember to connect your antenna to the coax fittings and to insert crystals of the desired frequencies into the sockets, accessible through rear door.





Closeup of completed DX-40, ready for CW operation; key plugs directly into front panel.

twin triode having dissimilar rated plate dissipation of  $1\frac{1}{2}$  and 7 watts. The first section is used as a direct-coupled driver connected to the heavy triode section forming the modulator. The carrier wave is modulated by varying the screen voltage of the final tube, which is the direct resultant of the varying voice level through the modulator.

A 5U4GB tube is used in a full-wave rectifier and there are adequate filter capacitors; large bleeder resistors help regulate the output voltage under varying conditions. The total power consumed by the transmitter is only 175 watts, or slightly more than that required to light a large light bulb.

Some other features of the DX-40 include: a filter to prevent R.F. radiation to the power line; a five-position switch that allows you to turn on only the oscillator so you can spot your own signal on the band; a front panel D'Arsonval movement meter that indicates final grid or plate current; a drive control adjustment located in the center of the front panel for easy tuning.

The antenna output circuit will match pure resistive loads from 50 to approximately 1,000 ohms. An ideal antenna for apartment house dwellers and others with

space limitations is a Hertz end-fed single wire type.

We assembled the transmitter using a screwdriver, long nosed pliers, side cutting pliers and a 23-watt pencil soldering iron.

The mechanical assembly moves along very quickly with the aid of a screwdriver and a pair of long nosed pliers. A specially prepared wiring harness, included in the kit, saves many long minutes of stringing individual wires. We completed the DX-40 from the kit in four sittings as follows: 1. Major mechanical assembly, which took about an hour and a half; 2. Wiring on underside of the chassis, about seven hours; 3. Final top chassis assembly and wiring, about half an hour; 4. Putting chassis into cabinet, attaching knobs, etc., half an hour.

The DX-40 kit costs approximately \$65.00. This price includes all the tubes but not the following essential accessories: a telegraphy key and a microphone. This can be of the inexpensive crystal type; also there is no antenna system supplied; no crystals for frequency control, and no optional VFO. This can be added at any time after the transmitter is in operation. The latter is desirable because it enables you to shift frequencies rapidly within the band you are working. •—Paul Hertzberg

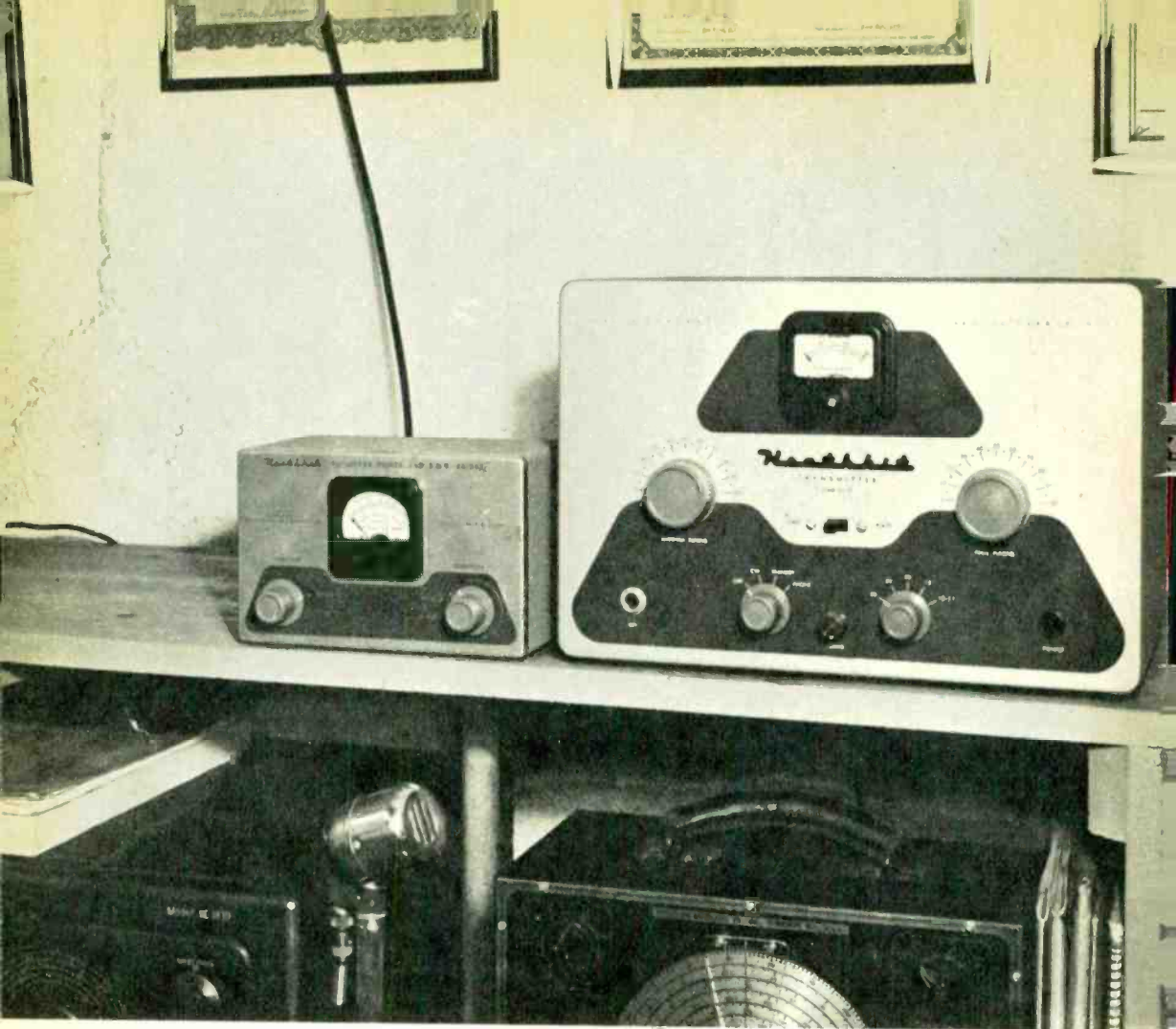

# Tune Up With a S.W.R. Bridge

**I**T IS easy to generate radio-frequency energy in a short-wave transmitter intended for ham radio operation. It is also easy to construct a good short-wave antenna out of inexpensive aluminum tubing or even ordinary wire. However, it is often not easy at all to feed the energy efficiently to the antenna, where it can whip off into space in the form of radio signals. In many installations, an appreciable part of the energy is wasted in heating up an improperly adjusted transmission line connecting the transmitter to the antenna.

It is important to know if the energy is being absorbed by the antenna or if all or part of it is bouncing back through the line. Fortunately, instruments that indicate line operating conditions are becoming available. Inexpensive in popular kit form,



Placed next to the short-wave transmitter on the operating table, the S.W.R. bridge (photo left) makes a useful, permanent addition to the ham station. Heavy wire rising from back of unit is coaxial cable to antenna. Transmitter (right) is a DX-35. S.W.R. bridge is valuable for checking operation of car antenna (photo below). Short jumper cable at left connects to antenna base through large hole in trunk, as photograph shows.

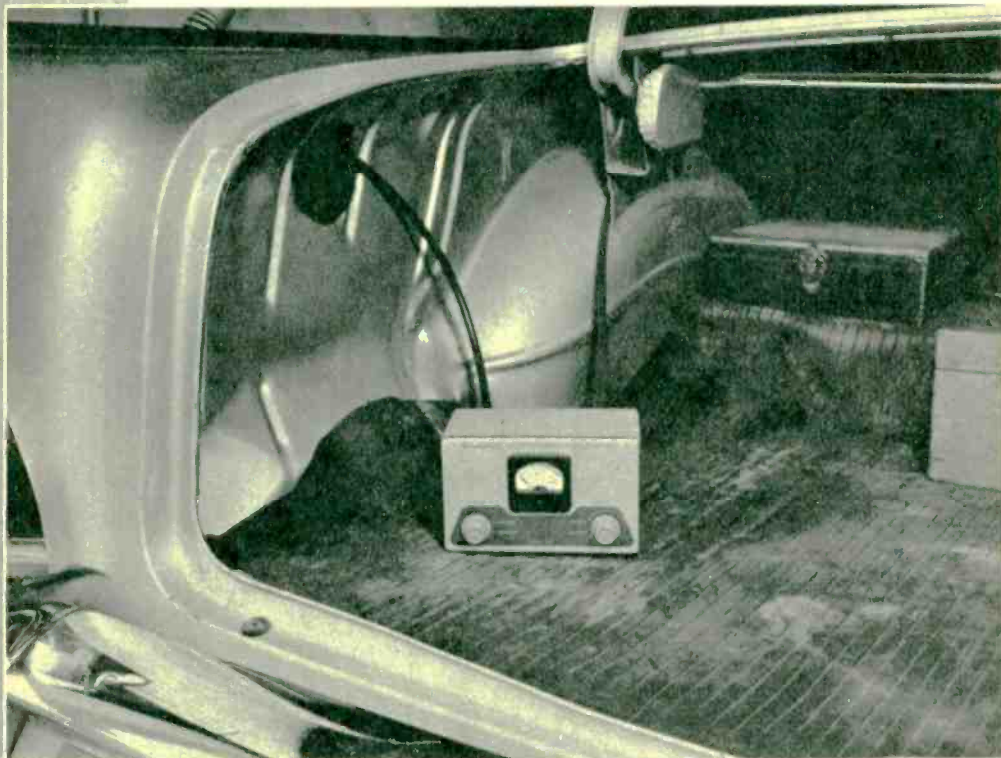

they enable even a beginner to understand just what's happening between his transmitter and the antenna on the roof. One of these is pictured herewith; it is the Heathkit Model BX-1 "Reflected Power and Standing Wave Ratio Bridge." The name is almost bigger than the actual instrument, which in finished form is only  $7\frac{1}{4}$  inches wide,  $4\frac{1}{2}$  inches high and 4 inches deep.

### Construction Simple

While the theory of operation of the S.W.R. bridge (for "standing wave ratio," see "The Radio Amateur's Handbook," 34th Edition, pages 320 and 513) is somewhat complicated, its construction and application are simple. Between the "input" and "output" connectors is a straight piece of  $\frac{1}{4}$ -inch copper tubing. By means of

three little square insulators, this is centered along a U-shaped aluminum trough  $\frac{3}{4}$  inch wide. The insulators also support two stiff copper wires, which lie parallel to and between the copper tubing and the inside surfaces of the aluminum trough.

To each wire is connected a tiny diode rectifier, a disc capacitor and a fixed resistor. Either combination is connected to a 0-100 microammeter through a single-pole, double-throw switch on the front panel. The latter also bears a sensitivity control for the meter, a 50,000 ohm potentiometer.

The input fitting of the S.W.R. bridge is connected to the antenna fitting of the transmitter by a short piece of coaxial cable. The antenna transmission line, removed from the transmitter, is transferred to the output fitting of the bridge. The

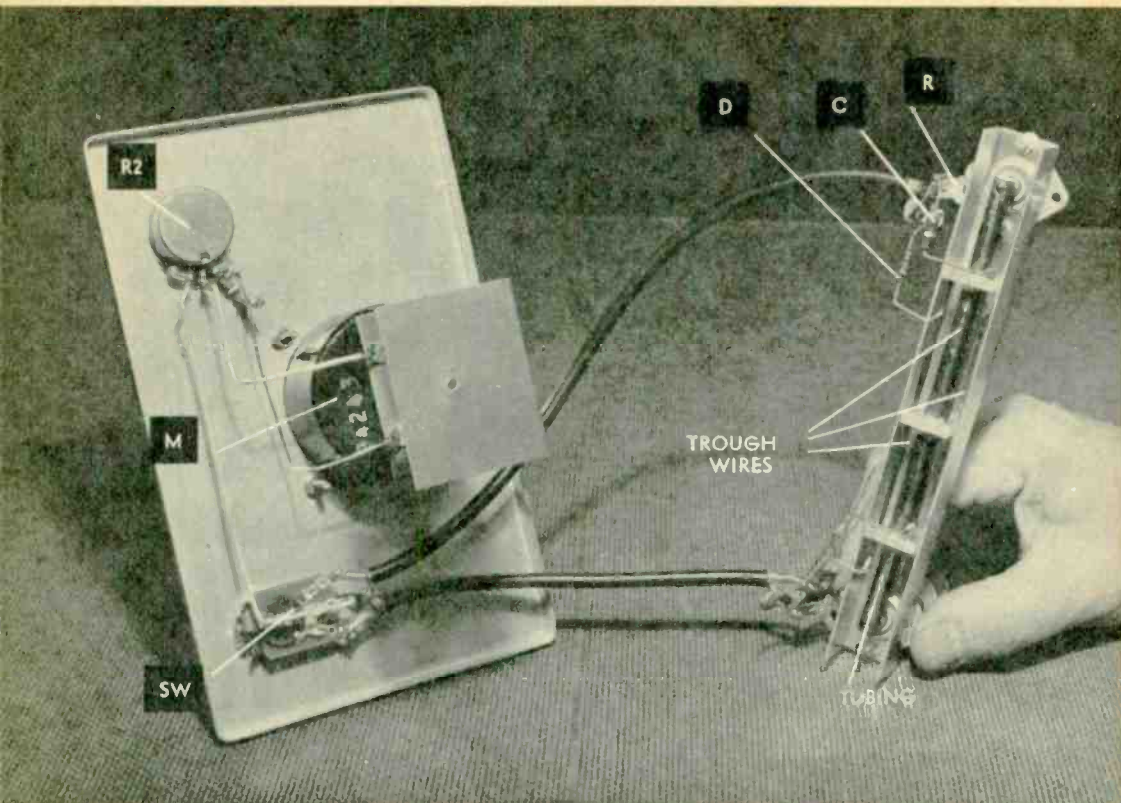

The transmission line from antenna and short jumper line to transmitter (photo below) are connected to back of bridge by screw-in coax fittings.

The "works" of the S.W.R. bridge (photo above) removed from case. The coaxial fittings for transmission line are on underside ends of the trough.

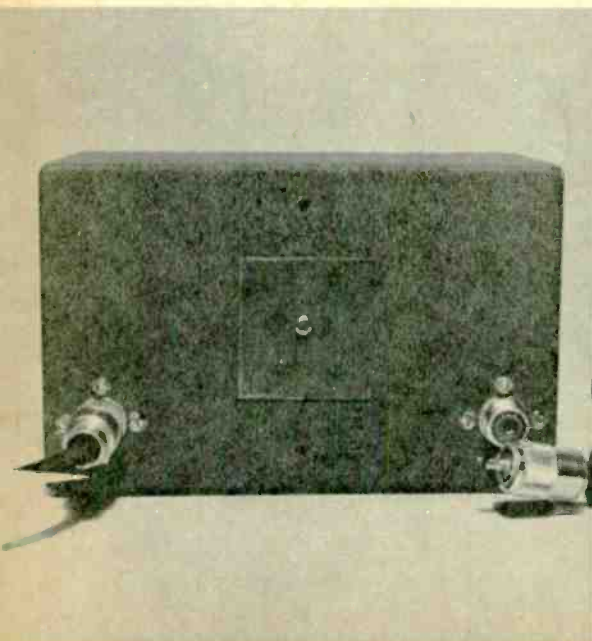

Details of front panel controls of S.W.R. bridge are shown in photo above. Diagram on the opposite page shows circuit arrangement of Heathkit Model BX-1 Reflected Power and S.W.R. Bridge.



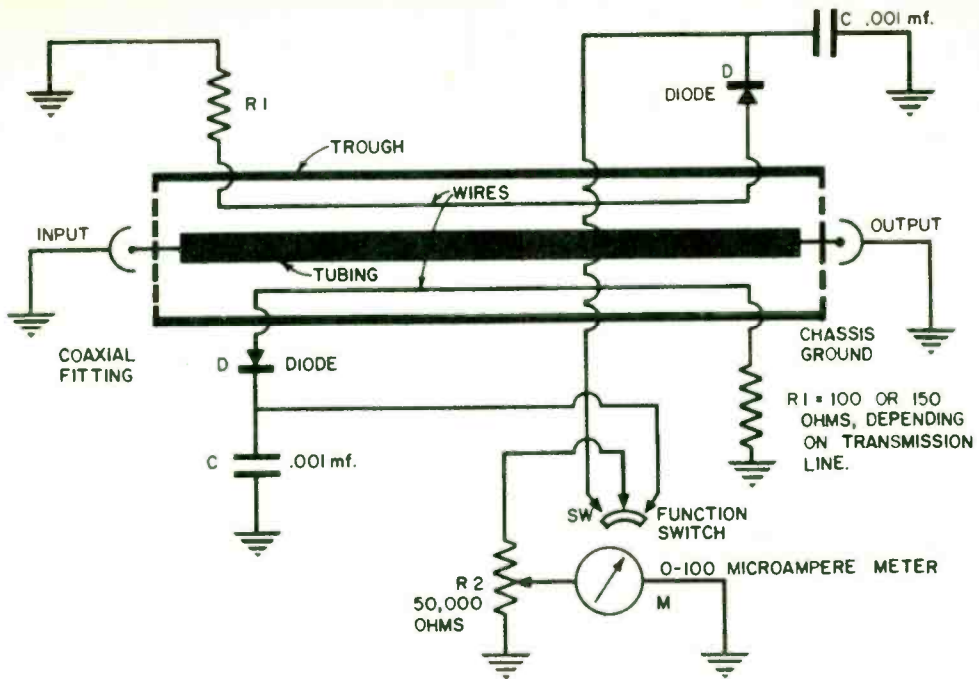

normal transmission line circuit is thus completed by the short copper tubing in the bridge.

Because of the combination of capacitive and inductive coupling between the parallel copper tubing, the copper wires and the aluminum trough, a small amount of the radio-frequency energy pushed through the transmission line by the transmitter is picked off by the wires and flows through the diode rectifiers. Changed into a rough form of direct current by the latter, the energy registers on the meter. The switch has two positions. In one, it shows the energy going *forward* from the transmitter to the antenna; in the other, the relative amount *reflected* back from the antenna. The smaller the ratio of reflected power to radiated power, the more efficient is the matching of the transmitter to the transmission line to the antenna.

### Indicator Not Corrector

A S.W.R. bridge is only an indicator, and in itself contains no means of correcting improper operating conditions it might reveal. The fault might lie in the antenna end of the transmitter, in the transmission line, in the method of terminating the latter at the antenna, or in the antenna itself.

The bridge is valuable because the relative readings of its meter instantly show the effect or lack of effect of any corrective measures that are undertaken. It eliminates guesswork in line and antenna adjustments, and enables the user to pump the maximum amount of energy from the transmitter into the antenna. Some losses in the line are inevitable, of course, but the bridge helps keep these losses at a minimum.

The bridge can be left permanently in the transmission line, and serves as a continuous monitor. If its reading changes appreciably from normal, a change in the antenna system surely has occurred. A connection might loosen or break off, or one element of the antenna might fall out of position; these are common happenings during stormy weather.

Since a S.W.R. bridge is self-contained and requires no outside source of power, it is just as useful in mobile installations as in fixed home stations; if anything, more so, because car antennas are of necessity small and pose special problems in tuning, and also because mobile transmitters are of low power to begin with and can't afford to waste much of it in mismatched circuits. •—Robert Hertzberg

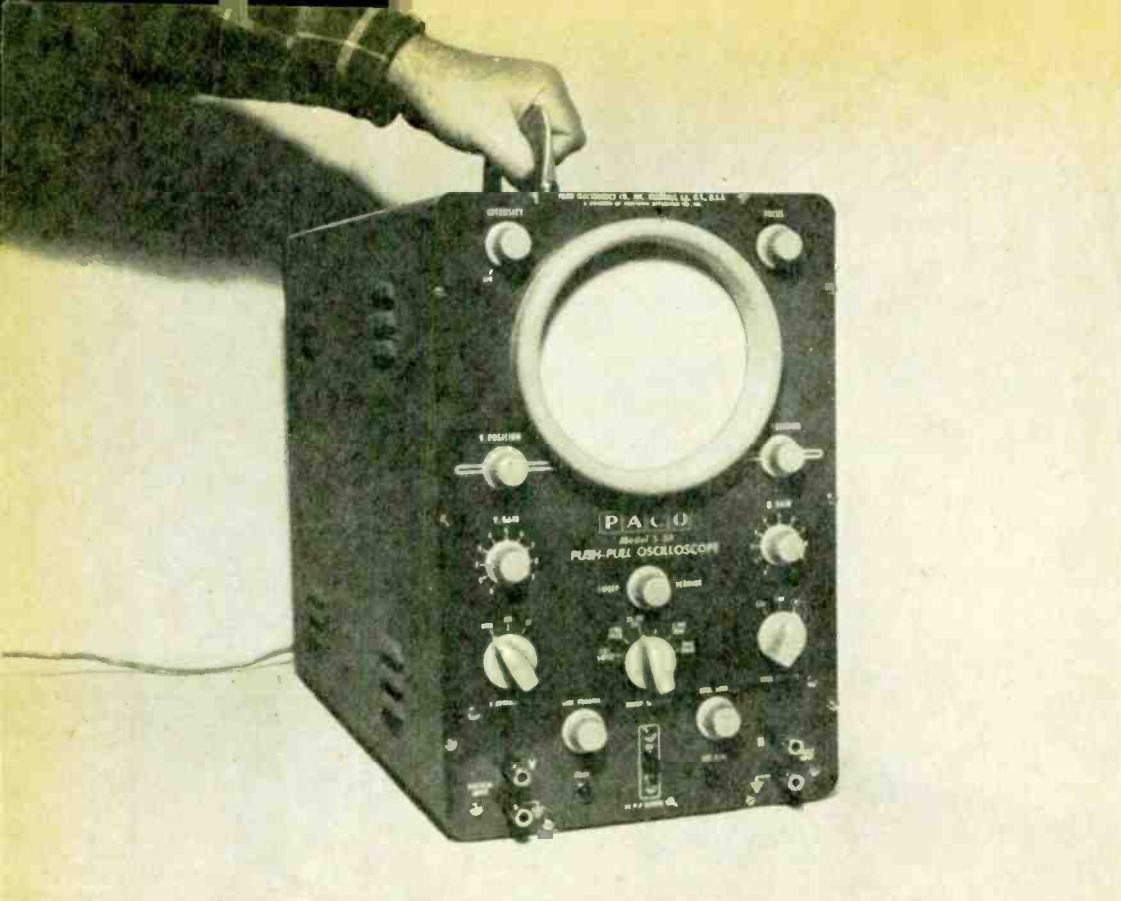

# Cathode Ray Oscilloscope

The most fascinating of all the electronic test instruments is a cathode ray oscilloscope. It can be easily built from a kit.

**O**F ALL the instruments used in electronics, the most interesting is without doubt the cathode ray oscilloscope. It has earned this status because it offers an instantaneous *visual* presentation of complicated voltages of all kinds found in radio, television and related electronic devices. It is one thing to imagine the action of AC in various circuits, and quite another thing to *see* it.

The physical behavior of numerous machines and devices can be portrayed on the scope screen if "transducers" are used to convert this behavior into electrical impulses of equivalent wave form. A common transducer is the microphone, which produces alternating current that follows the variations of voice or music impressed on it.

Hardly a decade ago, the C.R. scope was

an expensive instrument, found only in laboratories and used only by trained engineers. Today, a scope can be built in a couple of evenings from an inexpensive kit, and it is found on the workbenches of service technicians, experimenters and radio hams everywhere.

As a construction project, a scope is actually easier than most radio receivers. It looks impressive because the cathode ray tube itself is quite long and needs to be enclosed in a large cabinet. From the circuit standpoint, a scope consists essentially of two amplifiers (which are simpler than ordinary high-fidelity amplifiers), and a "sweep" oscillator. The latter is so named because it has the function of moving a sharp electron beam horizontally and uniformly across the screen. The voltage



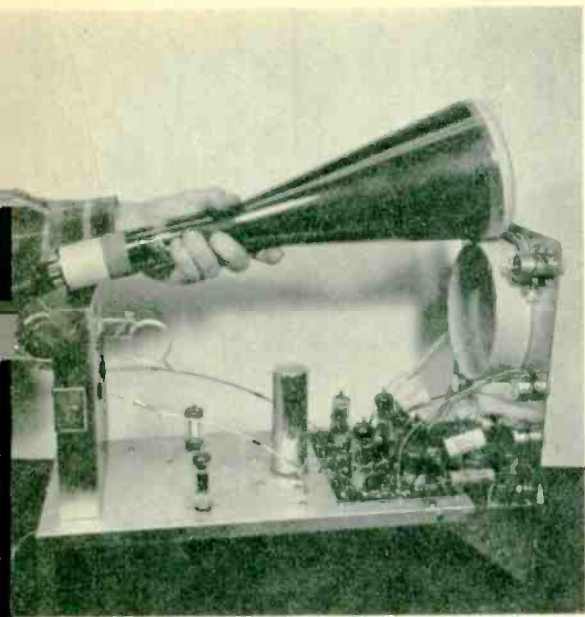

Long in proportion to its diameter, the cathode ray tube occupies upper section of chassis and case. Front panel has rubber ring for tube face.

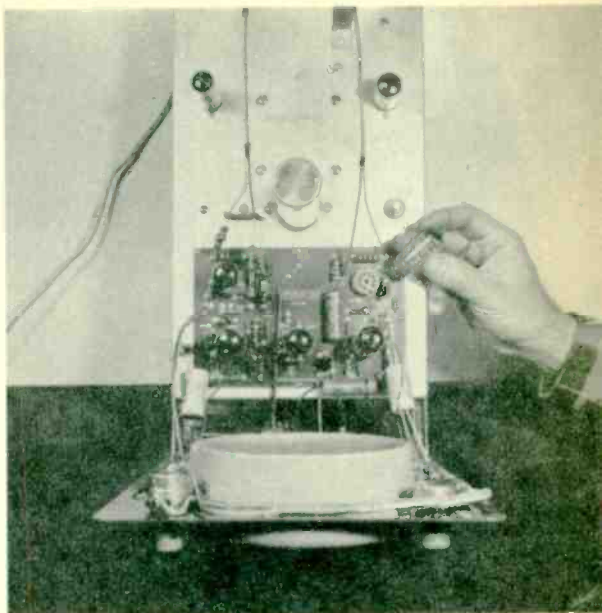

Top view of chassis, with cathode ray tube removed, shows the printed circuit board. Five miniature vacuum tubes are used in this unit.

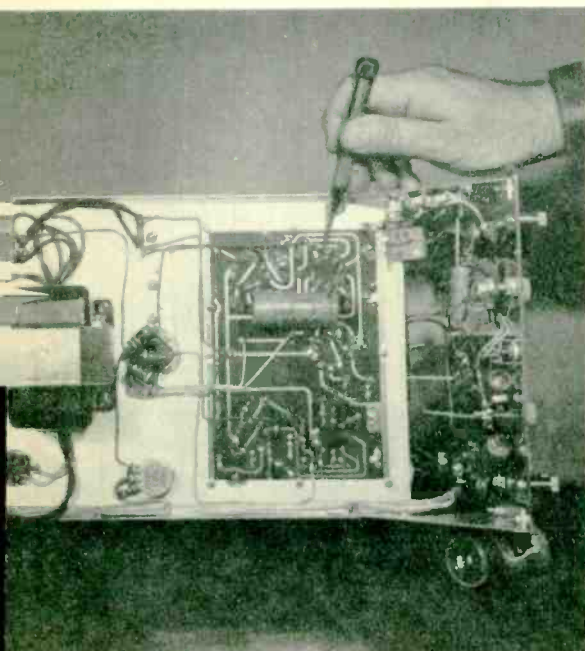

Bottom view of the Paco scope chassis. A scribe is being used here to remove the excess resin from between the lines of the printed circuit.

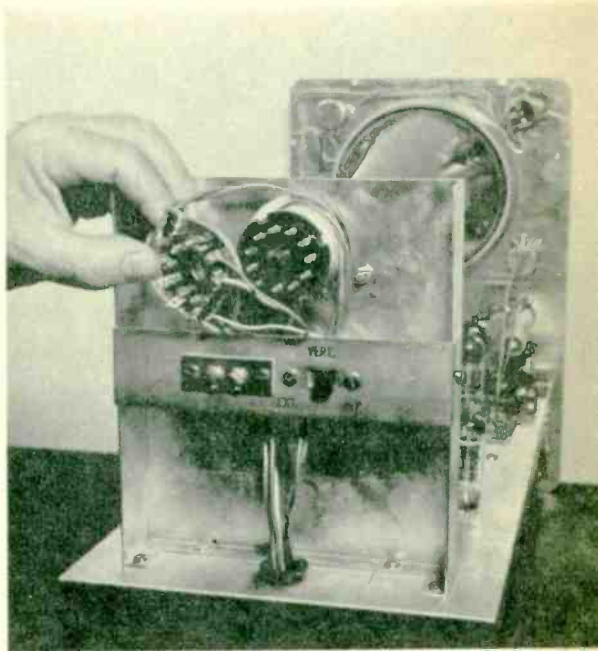

After the cathode ray tube is clamped in position, the socket for connections to pins can be placed over the latter. Photo above is rear view.



Photo of actual trace of ordinary 60-cycle AC as seen on scope face. This is classic "sine wave."



This zig-zag trace was obtained by hanging the vertical input leads near a fluorescent lamp.

to be "seen" is impressed on a pair of plates that influence this same beam in a vertical direction. The resulting interplay of the sweep and the input voltages, at right angles to each other, cause the latter to form their characteristic shapes as glowing lines on the screen.

Oscilloscopes having a five-inch diameter tube are more or less standard because vast quantities of high-grade tubes of this size are available as government surplus.

A representative modern scope kit, the Paco Model S-50, contains a five-incher. With this kit, the otherwise tedious job of mounting and connecting some 47 resistors, 28 capacitors and five-tube sockets is greatly simplified by the use of a printed circuit board. This is handled as a separate unit, and then installed in a large cutout in the main chassis. If you have assembled and wired several older scopes of conventional construction you can really appreciate the savings in time, temper and mistakes afforded by this arrangement.

A caution in connection with printed circuit boards; not just the one in this scope kit, but such boards in general: it has been my experience that the printed lines do not take solder as readily as they should. Make sure your iron is clean and free of pits, and that the solder itself is clean. Let the iron burn the rosin out well, and don't worry about rosin that melts

over to adjacent lines; you can scrape it off easily after it cools. (See photo.)

A presoldering treatment that we have found effective is a light alcohol rub over the board's surface, administered with a small brush of the fingernail type. Ordinary rubbing alcohol borrowed from the medicine chest cleans the printed lines and makes them amenable to soldering.

The finished oscilloscope, with its baleful eye staring at you, is a large handful. It measures 8 $\frac{1}{4}$  inches wide, 13 $\frac{1}{2}$  inches high, and 18 inches deep.

It would be misleading not to mention that a cathode ray oscilloscope must be studied extensively and used frequently. It is an *indicating*, not a *direct measuring* instrument. If you can read numbers, you can learn all there's to be known about a common volt-ohmmeter or vacuum tube voltmeter in about twenty minutes; the needle stops at a number and that's it. With a scope, however, you must learn to interpret the meaning of various traces on the screen by comparing them with others you have seen before or in the specialized books on the subject. This takes practice.

Especially recommended as a means of increasing the value of any scope for its owner is *Encyclopedia on Cathode Ray Oscilloscopes*, by Rider & Uslan, available from most firms that sell electronic supplies. •—Robert Hertzberg



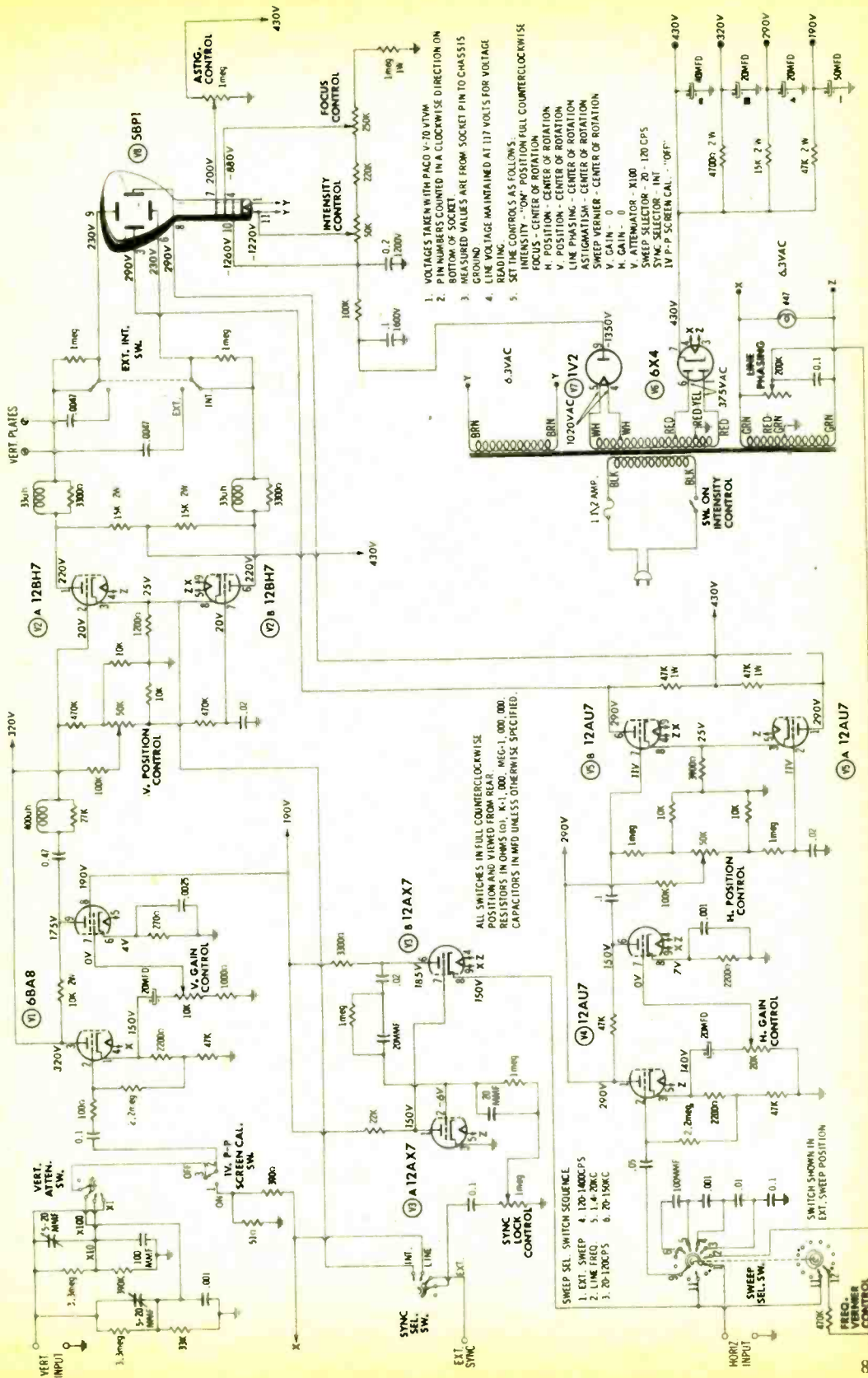

1. VOLTAGES TAKEN WITH PAID V-70 VTYM
2. PIN NUMBERS COUNTED IN A CLOCKWISE DIRECTION ON BOTTOM OF SOCKET
3. MEASURED VALUES ARE FROM SOCKET PIN TO CHASSIS
4. GROUND PLATE MAINTAINED AT 117 VOLTS FOR VOLTAGE READING
5. SET THE CONTROLS AS FOLLOWS:  
 INTENSITY - "0K"  
 POSITION FULL COUNTERCLOCKWISE  
 FOCUS - CENTER OF ROTATION  
 V. POSITION - CENTER OF ROTATION  
 LINE PHASING - CENTER OF ROTATION  
 ASTIGMATISM - CENTER OF ROTATION  
 SWEEP VERNIER - CENTER OF ROTATION  
 V. GAIN - 0  
 V. ATTENUATOR - X100  
 SWEEP SELECTOR - 20-120 GPS  
 SYNC SELECTOR - INT  
 1V P-P SCREEN CAL. - "OFF"

ALL SWITCHES IN FULL COUNTERCLOCKWISE POSITION AND VIEWED FROM REAR. RESISTORS IN OHMS (Ω), MEG-1,000,000. CAPACITORS IN MFD UNLESS OTHERWISE SPECIFIED.

- SWEEP SEL. SWITCH SEQUENCE
1. EXT. SWEEP 4-120-100G.P.S
  2. LINE FREQ. 5-1-4-200C.P.S
  3. 20-120C.P.S 6-20-150C.P.S

SWITCH SHOWN IN EXT. SWEEP POSITION



# Preamplifier and Control Unit

The heart of every good hi-fi system is the preamplifier control unit. It usually determines the performance of the other components.

**I**F you use a basic hi-fi amplifier system, you will require a preamplifier to go with it since a basic amplifier is completely devoid of operating controls. It is on the preamplifier that these controls are located, and this Eico unit does a man-sized job in this line.

Using a basic amplifier circuit, that is, one with no controls at all, you will require a preamplifier and control center. All controls, including bass and treble boost, preselection, compensation and filtering as well as volume and level controls are mounted on the preamplifier.

Electrically, the primary function of the

preamplifier was originally to amplify the lower signal from a magnetic type record pickup and bring it to the level of the older crystal cartridge, which can drive an amplifier without preamplification. As time went on, it was found to be more convenient to incorporate all amplifier controls right on the preamplifier chassis.

By selecting the correct input jack on the rear, and the correct switch position on the front, you can bypass the first stages of preamplification if you use a crystal cartridge. The magnetic or variable reluctance types use the preamplifier. The HF-61A will work well with any



When soldering the switches and the controls be careful not to have drops of solder falling into the chassis. If this should occur, remove them at once.

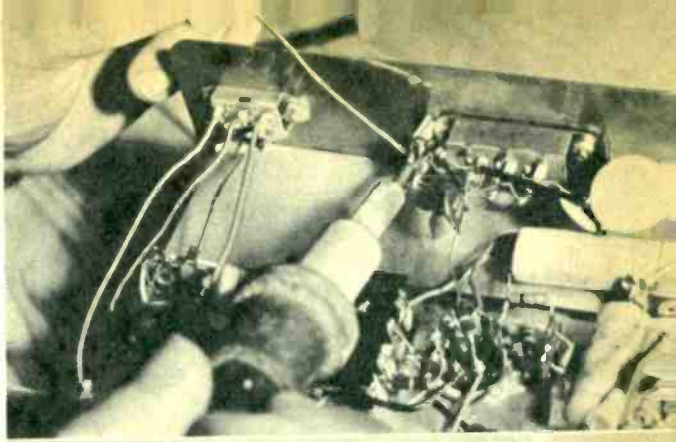

Carefully laid out circuits of the HF-61A are shown in this bottom view. Note the neat arrangement of wiring, which is designed as short and direct as possible.

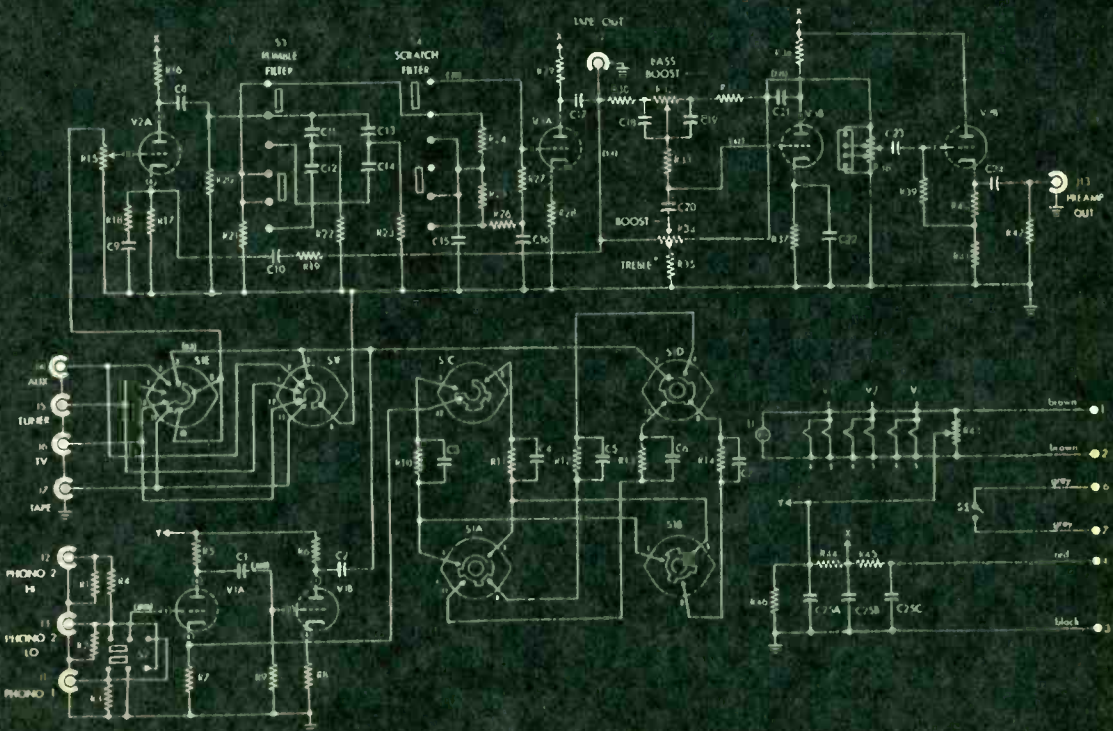
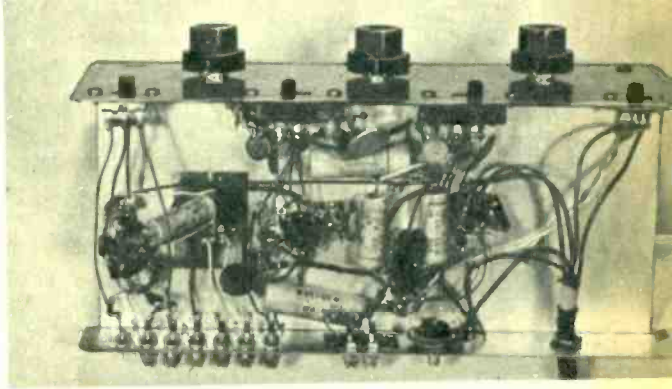

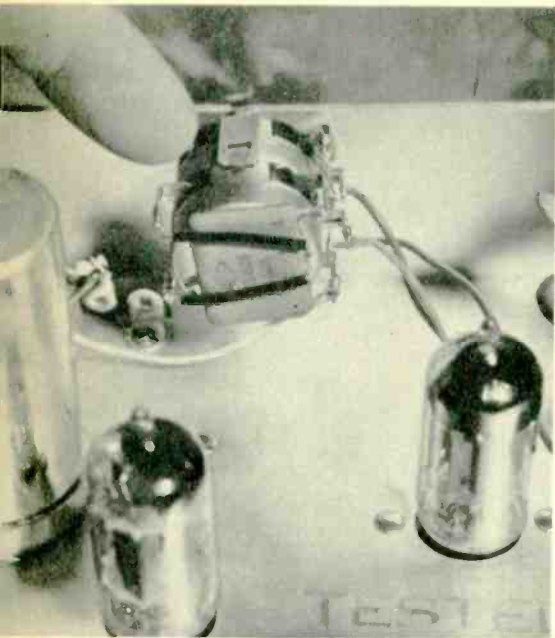

Printed circuitry has been used wherever possible. Finger, above, points to Central-Lab "compentrol."



Many of the tubes used are imported from Great Britain. Photo above shows the Mullard ECC-82.

This little reflector fits over the pilot light near the front panel, directing all light through the jewel.

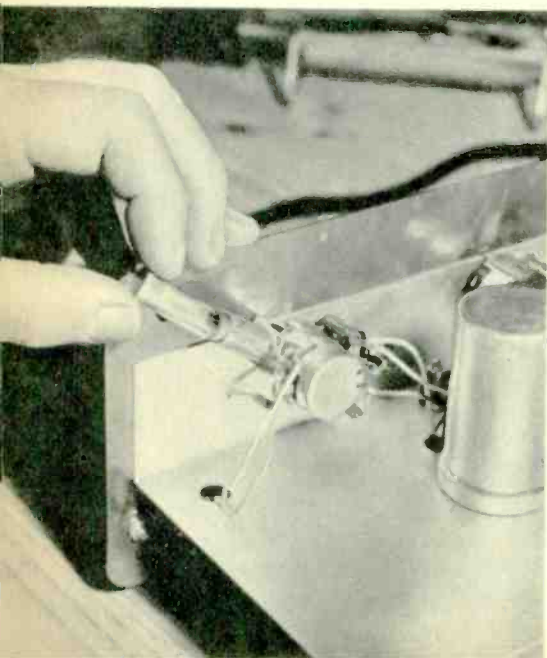

basic amplifier. When using the unit with an amplifier by a different manufacturer be certain to check that all voltages are brought-out to the correct pins on the octal socket at the rear. Failure to do this will damage the preamplifier.

The use of concentric controls gives a very uncluttered appearance, and the four slide switches release the other controls for active duty. A typical example of this improvement is the fact that the ON-OFF switch is independent of the other controls. This means that you can leave your amplifier set at one point and turn it off. When you turn it on again, the controls remain exactly as they were set when the unit was turned off.

Physically, the unit is mounted in a brown cover with an "eyebrow" extension over the top of the panel. It is ultra modern in appearance and functional in design. While you can mount this preamp in a console, you may think twice about the idea when you see the HF-61A. A chair-side table-top installation may prove to be far more agreeable.

This unit draws its power directly from the amplifier, although a preamplifier with a self-contained power supply is also avail-



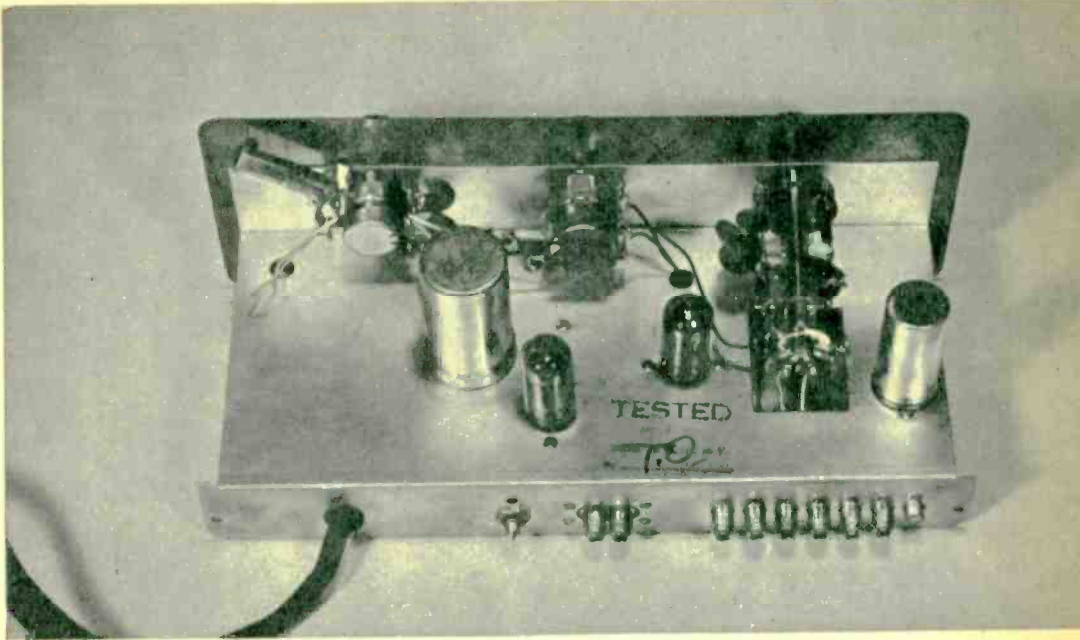

Inside view of control unit, cover removed, shows neat layout of tubes, making for easy access.

able at slightly higher cost. Bass and treble controls are concentric, as are the level and loudness controls. The selector switch has input choices of tape, TV, tuner, auxiliary, and equalization for Columbia, London, RIAA, American 78 and European 78.

A slide switch selects either of two phono positions, and another slide switch selects either flat, 50 or 100 rumble filtering. Moving further from left to right, the third slide switch supplies a choice of either 5 Kc, 10 Kc, or flat scratch filtration. Finally, the last of the slide switches is a two position ON-OFF switch. The red jewel above this switch lights up when the voltage is on, thereby precluding any possibility of accidentally leaving the system on when a record player with automatic shut-off is used.

You can get this unit in a great variety of ways. It comes wired and tested, with an internal power supply for \$44.95. In kit form, this model is \$29.95. Without the power supply built in, the unit costs \$37.95 wired and tested, and in kit form \$24.95. Ask for the HF-61A, from Eico at 33-00 Northern Boulevard, Long Island City 1, N. Y. •—Byron G. Wels

Making hum balance adjustment with screwdriver. Rear of preamplifier has various take-off points.

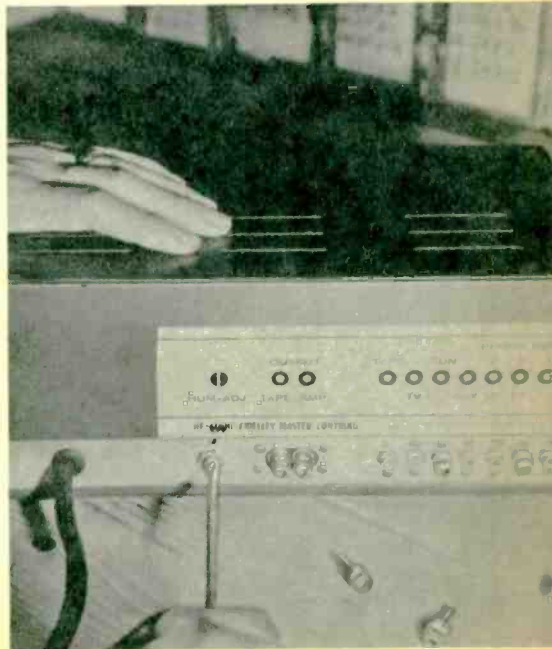

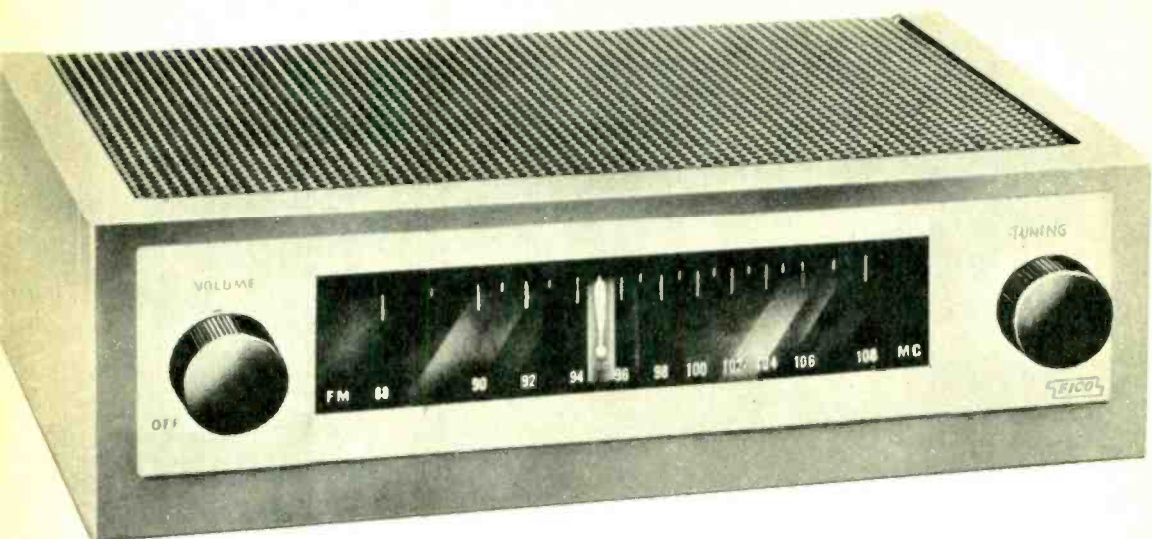

# Hi-Fi FM Tuner

Get static-free reception by building this compact, frequency modulation receiver unit.

**A**MONG the most advanced FM tuners on today's market, equal to or surpassing wired tuners up to three times the price, this unit reflects excellent design features.

The "front-end" of this kit (the most critical part) is completely wired and aligned, and housed in a cast aluminum-zinc box. This takes most of the "sweat" out of the work, and makes it comparable to the more costly units.

When we first saw this unit, it was at the Eico plant, and still "under wraps." We coaxed them into a quick peek and wouldn't leave until they had completely satisfied our curiosity. Taking a first look at the controls, we expressed disappointment at the fact that there was no AFC (automatic frequency control), but this was soon set to rights. It seems that many of the units that boast an AFC position will drift just as badly as those that do not have AFC, but this unit, with its highly stable oscillator needs no AFC at all, and as AFC adds distortion and prevents ac-

curate tuning in many cases, we're better off without it.

Using the ECC85/6AQ8 tube in a reflex circuit permits it to serve two important functions. In addition to working as a grounded grid amplifier, to boost the signal from the antenna, it serves as a converter-mixer tube as well.

The next tube in progression is, of course, a 6AU6 I.F. amplifier. This tube takes the signal from the converter, and after it has been passed through the input I.F. transformer, it is amplified and passed on to the next stage, another 6AU6 I.F. amplifier, where the signal is further amplified. In a good FM tuner, a sharp I.F. section is a prerequisite and, therefore, we amplify the I.F. signal once more in another 6AU6 tube, which also serves as a limiter. After the limiting action, a 6AL5 dual-diode is used as a detector; the output of this stage is fed through a 6C4 triode cathode follower to the output of the unit. It is this cathode follower stage which permits remote mounting of the tuner in relation to the



## BLOCK DIAGRAM MODEL HFT-90 FM TUNER

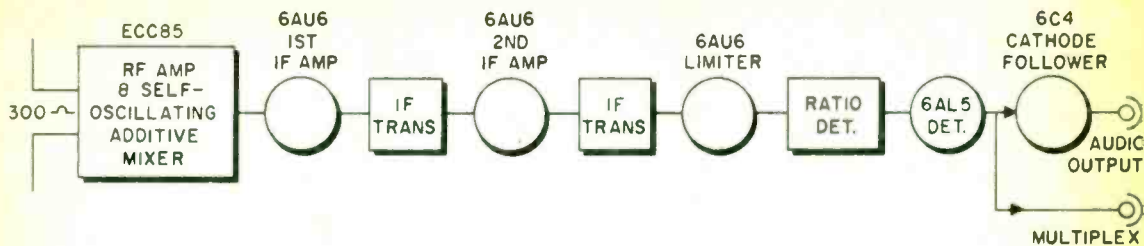

Underside view of chassis shows the zinc-aluminum can in which the prewired front end sits.

After all wiring is completed and checked against instruction book, insert tubes in their sockets.

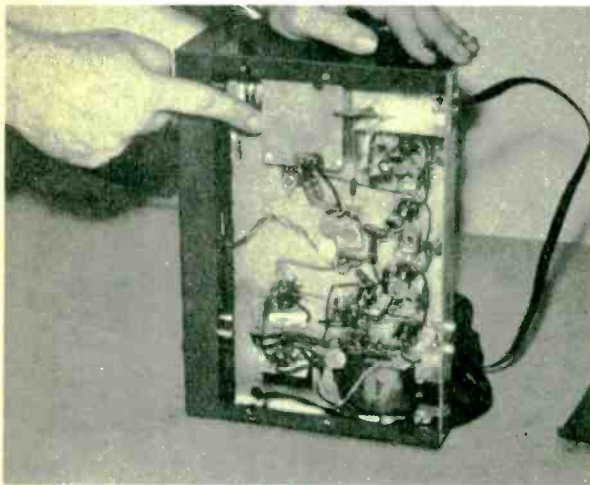

amplifier, with little or no line losses at all.

The DM-70 tuning indicator is fed a portion of the signal, so that when a station comes in, the added voltage causes an increase in brightness on the phosphor coating. The only other stage involved is the 6x4 rectifier tube. This is connected in a standard transformer operated power supply. Total drain of the unit in operation is only 40 watts. Cabinet dimensions are 3½x12x8¼ inches. The total weight is ten pounds.

Look at the photograph of this unit, and remember that your FM tuner will always be in full view. You will notice that the dial numbers are on the bottom. This is to facilitate tuning from above. See that exclamation point on the dial? That is the new DM-70 tuning eye. It travels across the dial as you tune, to indicate the position of the tuner. It glows with a soft, even green light, and when you come upon a station, it "blooms," giving indication of the presence of a station. The low silhouette makes for more attractive styling.

The model HFT-90 provides excellent reception even in fringe areas. It is the product of a year of intensive, meticulous engineering aimed at making it possible to obtain absolutely first-rate performance from a kit. Other features include fly-wheel tuning, automatic gain control, stabilized low limiting threshold for excellent performance from weaker signals, broadband ratio detector for improved capture ratio and easier tuning. Full wave rectification and heavy filtering are added to very low distortion and flat frequency response for superb audio quality.

Important construction aids include simplified dial-cord arrangement and a prewired tuning eye assembly. This extremely flexible design permits easy console installation with easy adaptability to different panel thicknesses. You may use the optional cabinet in console installations for additional shielding. In kit form the tuner costs \$39.95; wired and tested, \$65.95. The optional cover is \$3.95 extra. •

—Byron G. Wels

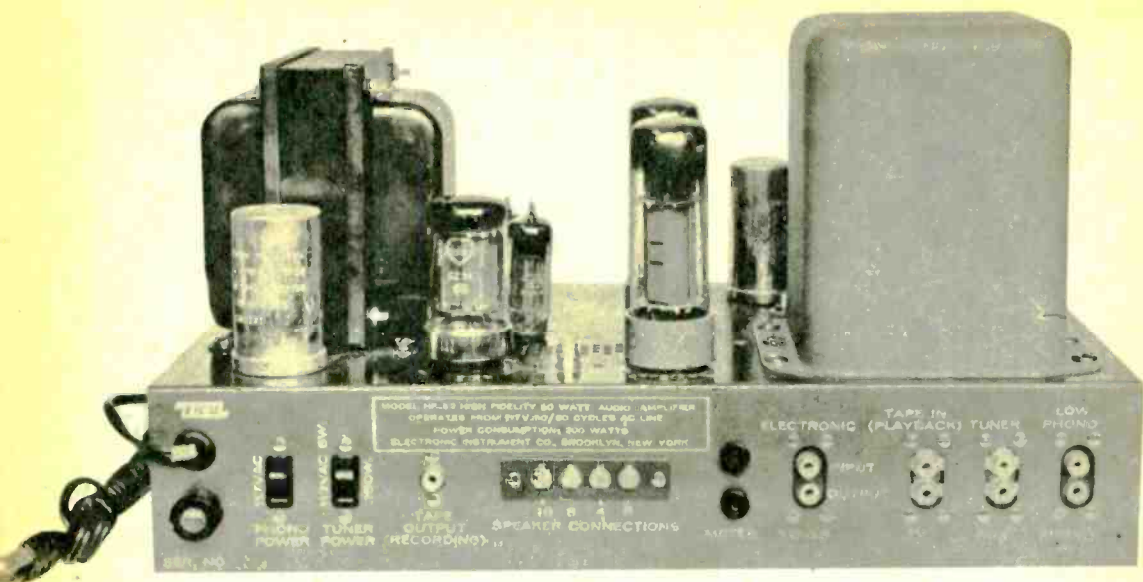

# High Power Amplifier System

The 50 watts of this self-contained amplifier-control unit are sufficient to power any high fidelity system.

**T**HE high power boys will like this one. It will make walls vibrate and windows rattle. It will have the neighbors screaming, and in no time at all, the police at your door.

Actually, loudness is no test of a high fidelity amplifier. That's why we ran laboratory tests on this job. Our hum and noise level tests showed that Eico was playing it cagey—we measured it to be even better than they claimed. We found one minor fault, and this was that the treble control was not flat at "O" on the dial, but at plus 1. This can be accounted for in the fact that we mounted the knob a bit off center, and it would take an ear calibrated in decibels to hear any difference.

We would sum the tests up by saying neither expense nor effort were spared in bringing the ultimate to the listener for the minimum in price. The output trans-

former is one of the heftiest we've seen in a long time, and investigation proved that it wasn't just a big can filled with tar and a little transformer inside. No, this is all output transformer, fully capable of handling the 50 watts rated, with 100-watt peaks.

If you wire this one from the kit, follow the steps carefully, checking each step as you go. To help you learn, as each wire is soldered in place, locate the wire on the schematic diagram, and go over it in red pencil. This is more than a mere double-check—it will serve to teach you what is accomplished with the wiring.

To understand the method of operation employed in this unit, you must first understand the function of a radio tube. A signal is applied to the grid of the tube, and as the signal becomes more positive, the grid is permitted to conduct more easily, causing a flow of more electrons to the plate. When



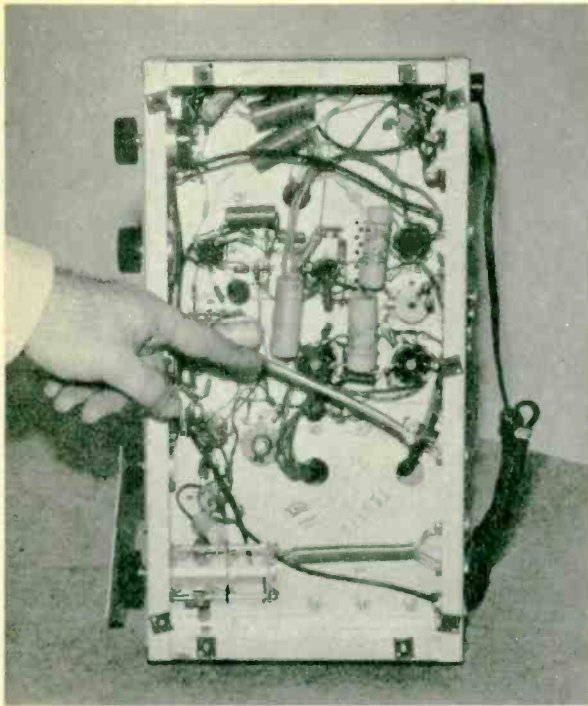

Shielded cables are used wherever necessary to bring wires from the front to the rear of unit.

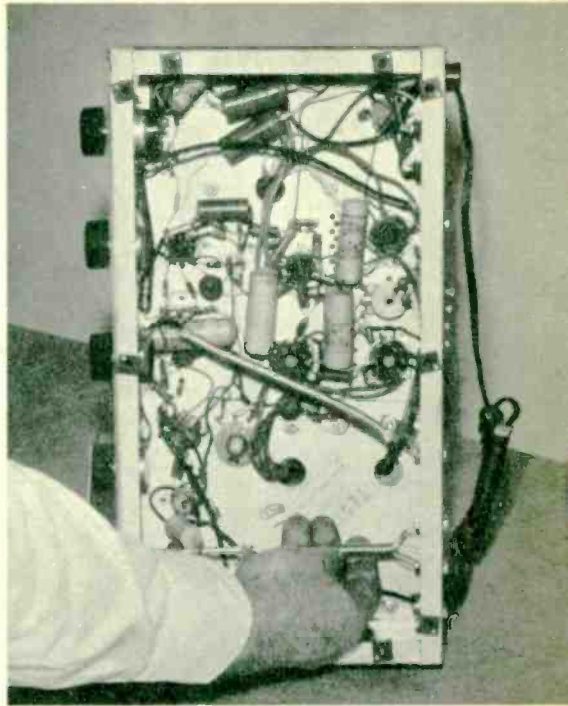

Another type shielding used on equipment consists of wire coils through which leads are passed.

The bottom plate, right, is held in position by ten machine screws which fasten into speed nuts.

the signal begins to go negative, the grid is brought closer to its cut-off point so that fewer electrons are permitted to flow to the plate. As we can see by analyzing this, the plate signal will very closely follow the signal applied to the grid, but two things will happen to it. It will become greatly amplified, and will also become inverted by 180 degrees.

This "phase inversion," as it is called, is a function of every vacuum tube and, frequently, where phase is critical as in an amplifier, we insert a tube in the circuit whose only function is to reinvert the phase so that it appears as it was applied when sent into the first amplifier stage. If there are three stages of preamplification, we can see that the signal will appear upside down as it is fed into the final stage. This stage will reinvert it to its proper position. Four stages of preamplification will result in an upside down signal coming

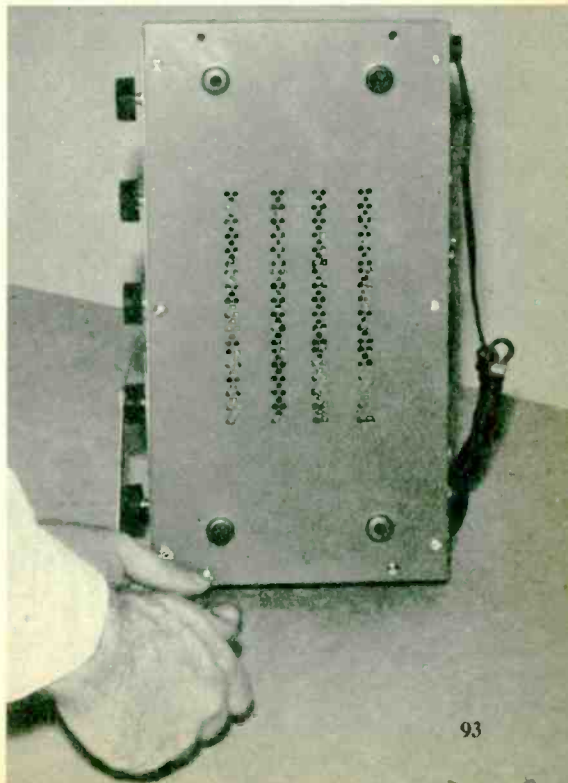



Tube positions are easily identified by callouts. Big transformer at right side of chassis is output transformer, capable of handling 50 watts. Note the various phone jacks and outlets located on the rear panel of the unit.

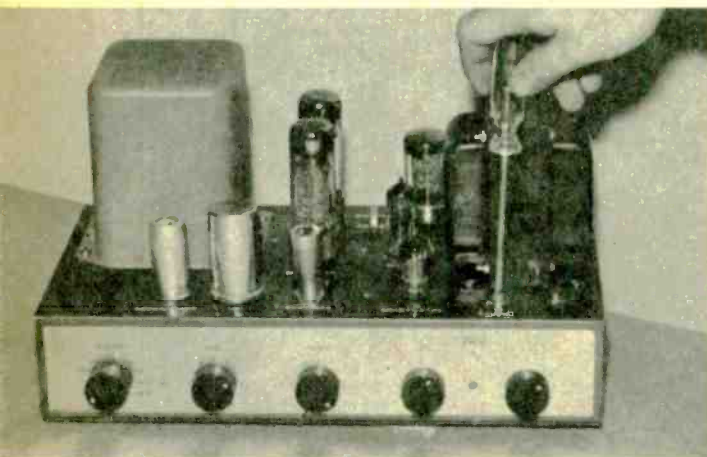

Hum balance adjustment is made when set is ready for use. This front view of amplifier shows panel dials. Left to right, selector knob, level control, loudness balance, separate calibrated bass and treble controls.

from the final amplifiers. We can correct this by using a phase inverter stage which does no amplifying, but feeds the signal directly to the final amplifiers upside down, so that it reappears right side up.

Obviously, this very simplified description is not complete, but will serve to help you understand the purposes of many actions taken in high fidelity amplifiers.

When mounting major components take extreme care not to damage the paint on the chassis. You can get a cover for this amplifier, but if you plan to use it exposed (for cooler operation), you will want it to look well. Screwdrivers are notorious paint scratchers, so exercise caution at all times.

After mounting the transformers to the chassis, cover them with masking tape. In the inverted position for wiring, the unit will rest on the transformers. To avoid unnecessary mutilation of the paint job, use the masking tape and then remove it when the unit is complete.

It will not be necessary to use a signal generator and oscilloscope as we did. You

don't have to do any more than hear this unit, and this will be a real thrill, even for the old die-hard audiophile.

There is a complete set of selector switch positions on the front panel with inputs for tape, TV, tuner, auxiliary, and equalization for Columbia, London, RIAA, American 78 and European 78. Two inputs for crystal and magnetic phonograph are on the back of the chassis, as are the tape output and electronic cross-over terminals, in case you want to bi-amplify. There are two power outlets also on the back. One for a phono motor, which is on as long as the amplifier is plugged in, and the other for a tuner, which shuts off when your amplifier is off.

Incidentally, should you decide to mount this amplifier in a console, an extra set of knobs with long shanks is supplied along with the unit at no extra cost.

This unit, HF-52, is supplied either in kit form, at \$69.95, or factory wired and tested at \$109.95. A matching decorative cover is available for \$4.50. •

—Byron G. Wels



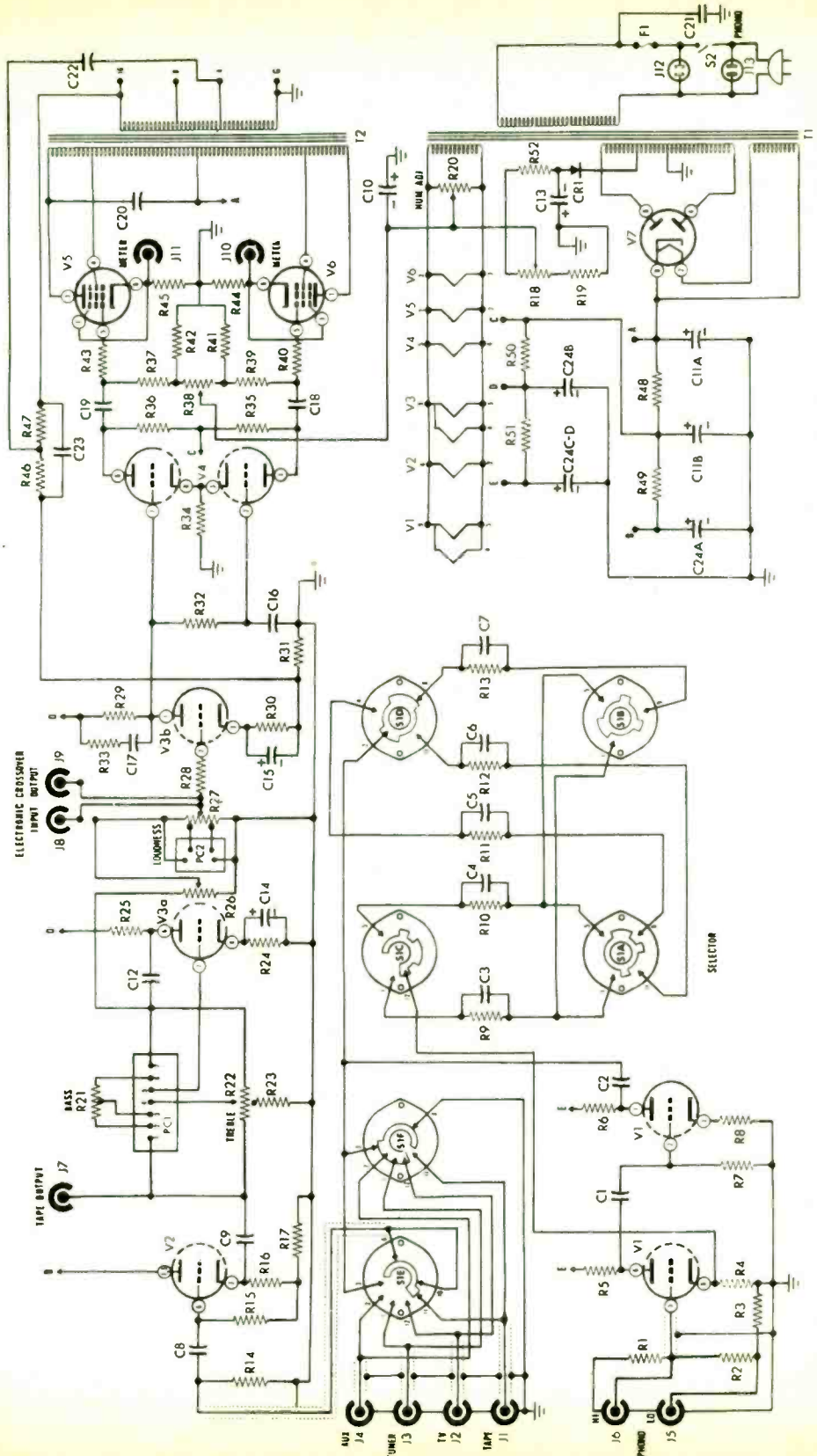

# Transistor Radio

It takes only about an hour to build this simple receiver.



The basic, one-transistor circuit has amazing power, will pull in even distant stations.

**I**F you start to assemble this transistor radio at seven o'clock you can, at eight, plug in the earphone and listen to programs! It's as simple and reliable as that. Even if you've never attempted radio construction before, you'll find the job easy and enjoyable. The secret lies in a carefully planned and tested layout with open, one-plane wiring. Add to this the fact that we've presented a full-size photograph, over which you can assemble and wire the parts, and you can't go wrong.

In the design of this set, special attention was paid to protection of the sensitive transistor against the heat of the soldering iron. The protective measure? No soldering of the transistor! You do all the assembling and soldering while the transistor is safely enclosed in its plastic container. Then, as the very last step, you merely wrap the three slender leads of the transistor under the heads of three small screws and tighten the latter.

The baseboard can be any smooth piece of wood equal in size to the full-size pho-

tograph. A scrap of shelving is fine; so is a piece of plywood  $\frac{3}{8}$  or  $\frac{1}{2}$  in. thick. Sand the edges lightly, then tear out the layout sheet and cement or tape it in place.

Begin by mounting the ground and aerial binding posts. In each case, pass a small wood screw through the hole in a soldering lug and through the hole in a post and tighten into the baseboard. Face the lugs to the right and pry them up a little so the wires will fit in their ends.

A flat piece of aluminum comes with the loopstick. Bend it carefully in the center to form an L bracket. Then face the leg with the large hole to the left and fasten the base leg with two wood screws. Mount the coil by putting the end with the threaded shaft through the large hole from the right, keeping the two soldering lugs on the coil form parallel to the baseboard. Press gently and the neck of the coil will lock in the hole. Next unravel and remove some loose, bare copper wire near the lugs and tighten a small black knob on the threaded shaft.



With its lugs facing the loopstick, mount the tuning capacitor with No. 4 wood screws, one in each corner. It is necessary to raise the capacitor about 1/4 in. above the surface of the base to allow the bottom of the shaft to turn freely. For spacers, use plywood, Masonite or a couple of hex nuts to each screw. Tighten a small black knob on the shaft.

Next four soldering lugs are installed. Tighten one, facing right, under a screw in the position marked "Tie Point." The other three are fastened loosely at the points marked "E," "B" and "C." These identify the connections of the transistor: E for emitter, B for base and C for collector.

The two small L brackets for the earphone jack are fastened to the baseboard with small wood screws and the earphone jack itself is secured to the brackets with 2x56 screws and nuts. Last to be installed is the battery holder, which is fastened in place with two small wood screws.

You're now ready for the wiring. For this you'll need a small soldering iron of the pencil type, a roll of rosin core solder, a pair of side cutting pliers, a pair of long-nose pliers and a small spool of No. 20 solid hook-up wire with plastic or push-back insulation. You can follow the wiring as indicated on the full-size photograph. In all cases, after cutting a wire to length, push back or trim off about 1/4 in. of the insulation from each end and bend the ends

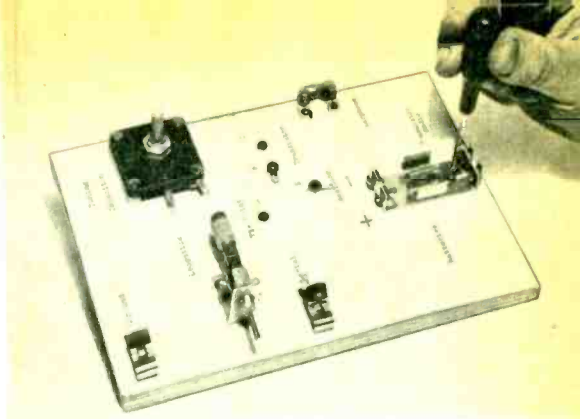

Paste graph paper on plywood board and mount all components as shown on the full-size layout.

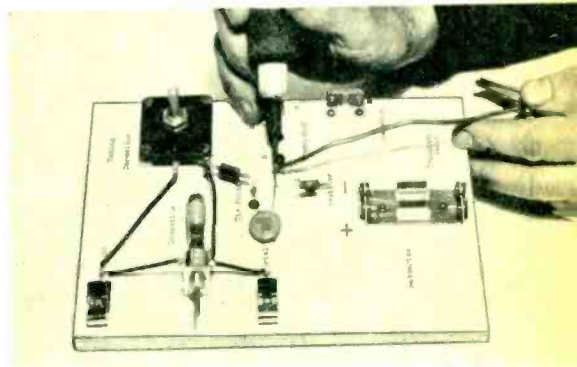

Receiver partially wired. Photo shows soldering of one capacitor and one resistor lead to lug B.

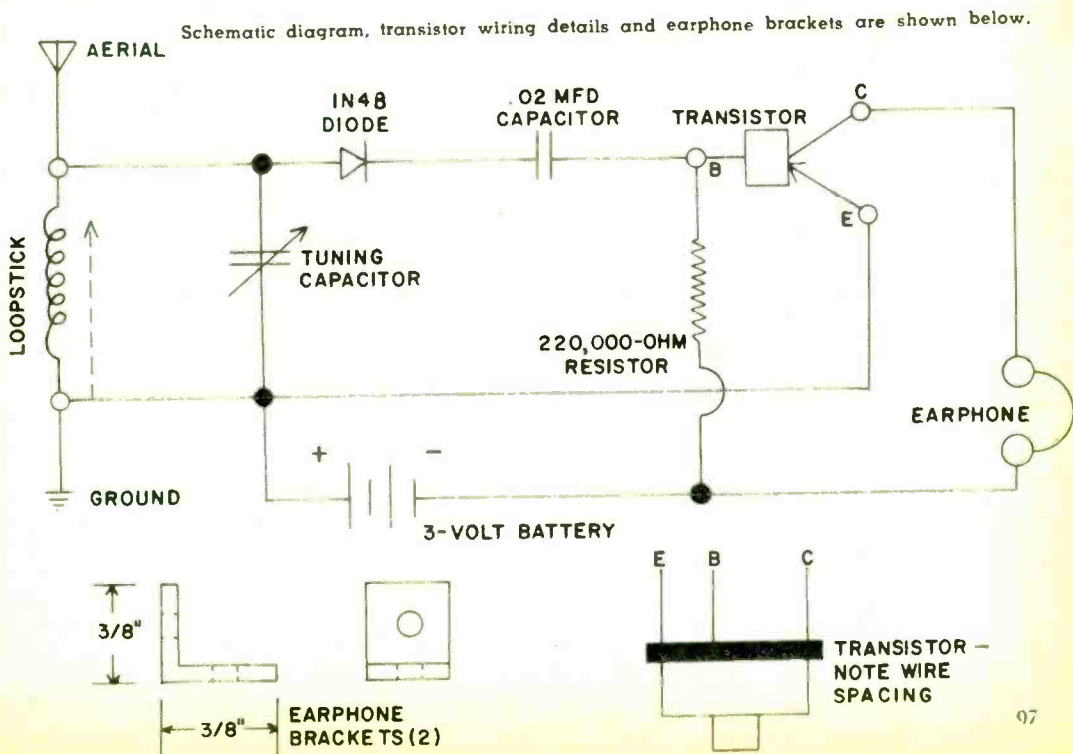

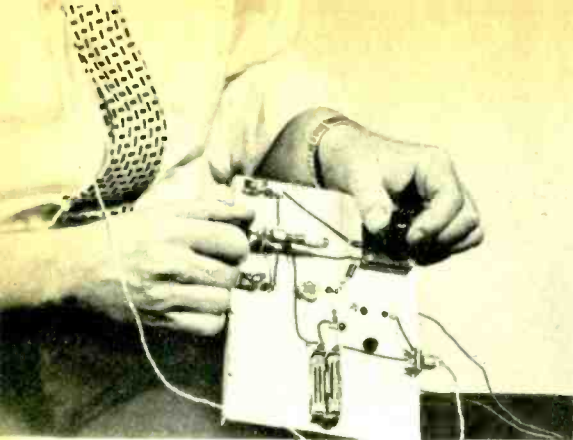

Tuning is accomplished by turning the capacitor and loopstick knobs until best signals appear.

to form small hooks to fit the holes in the soldering lugs.

Begin by soldering the points where there is only wire leading into a connection; that is, solder at the upper lug of the tuning capacitor, at the aerial lug, at the upper and lower lugs of the earphone jack and at the lugs at points E and C. Remember that the leads from the transistor are not soldered at points E, C or B and that the transistor is not introduced until all soldering is completed.

Next solder at the points where two insulated wires meet: the ground lug, the upper and lower lugs of the loopstick and the plus terminal of the battery holder.

You are now ready to tie in the 1N48 diode, the .02 mfd capacitor and the 220,000-ohm resistor. Cut the leads of the 1N48 diode to a length of  $\frac{1}{2}$  in. and bend down each lead carefully at right angles. This diode has a tapered body and one end marked with a dot. Take the lead from the unmarked, larger end and, with the lead from the lower lug of the loopstick, solder it to the lower lug of the tuning capacitor. Leave the other lead from the diode free for the moment. Then cut one lead of the .02 mfd capacitor to a  $\frac{5}{8}$ -in. length and cut the other to a length of  $1\frac{1}{4}$  in. Solder the short lead from the capacitor and the free lead from the diode to the lug at the Tie Point. Next cut one wire of the 220,000-ohm resistor to  $1\frac{1}{4}$  in. and bend it, at a right angle,  $\frac{1}{2}$  in. from the body. Solder this lead and the free lead from the .02 capacitor to the lug at point B. You can then bend up the resistor so that it is about  $\frac{5}{8}$  in. above the baseboard and solder the straight, uncut lead, with the lead from the lower lug of the earphone jack, to the minus terminal of the battery holder.

The transistor comes next. Examine it closely and note that two of its leads are

quite close together while the third is spaced away from the center wire. Form a loop at the end of each lead and catch them under the screws at points E, B and C in accordance with the identification drawing.

Finally, unscrew the cap of the earphone plug, pass the phone cord through it and solder the ends of the cord to the pins of the plug. The wire is thin, so do this carefully. Then replace the cap.

This radio receiver gets all its power from two small No. 7 penlight batteries connected in series to give three volts. Hold one battery up straight, its brass center cap up, and press it into the left hand holder. Turn the other around, with its center cap down, and put it into the right-hand holder. By actual measurement, the set requires only 180 millionths of an ampere, an extremely small current. In service, the batteries will last almost as long as they would if not used at all.

A small set of this kind requires an aerial. Just how long it must be depends on the location. Excellent results are obtained with 25 to 50 ft. of ordinary No. 18 wire hanging out the window, strung from a window to a fence or tree or even spread around the edges of a room. A ground connection sometimes helps, sometimes doesn't. Clip to any handy water pipe or radiator. Tuning is usually sharper without a ground connection, volume better with it.

To tune the set, merely turn the knobs of the tuning capacitor and the loopstick until the combination produces the best signals. The capacitor turns through 180 degree; the loopstick turns in and out about a dozen turns. You'll find after a little experimenting that you can leave the loopstick set in position and do all tuning with the capacitor. •—Robert Hertzberg

## PARTS LIST

- 1—Midget 365 mfd variable tuning capacitor, flat type,  $1\frac{1}{2}$  in. square
- 1—Loopstick
- 2—Small knobs to fit shaft of tuning capacitor and loopstick screw
- 1—Type 1N48 diode
- 1—Type 2N107 General Electric transistor
- 1—Disc type fixed capacitor, .02 mfd
- 1—220,000-ohm,  $\frac{1}{2}$ -watt resistor
- 1—Double holder for No. 7 batteries
- 2—No. 7 batteries
- 2—Single Fahnestock spring binding posts
- 1—Miniature earphone jack, flat type
- 1—Miniature earphone plug, to fit above
- 1—Dynamic earphone, hearing aid type
- 6—Soldering lugs, No. 6 hole
- 12—Roundhead wood screws for mounting parts, No. 4, about  $\frac{3}{8}$  in. long
- 4—Roundhead wood screws for mounting tuning capacitor, No. 4,  $\frac{3}{4}$  or 1 in. long
- 1—Spool of No. 20 solid insulated hook-up wire (only about 15 in. needed)
- 1—Wooden baseboard
- Aerial wire—Use balance of No. 20 wire or 25 to 50 ft. of bell wire or regular bare, stranded copper aerial wire with small insulators at ends.



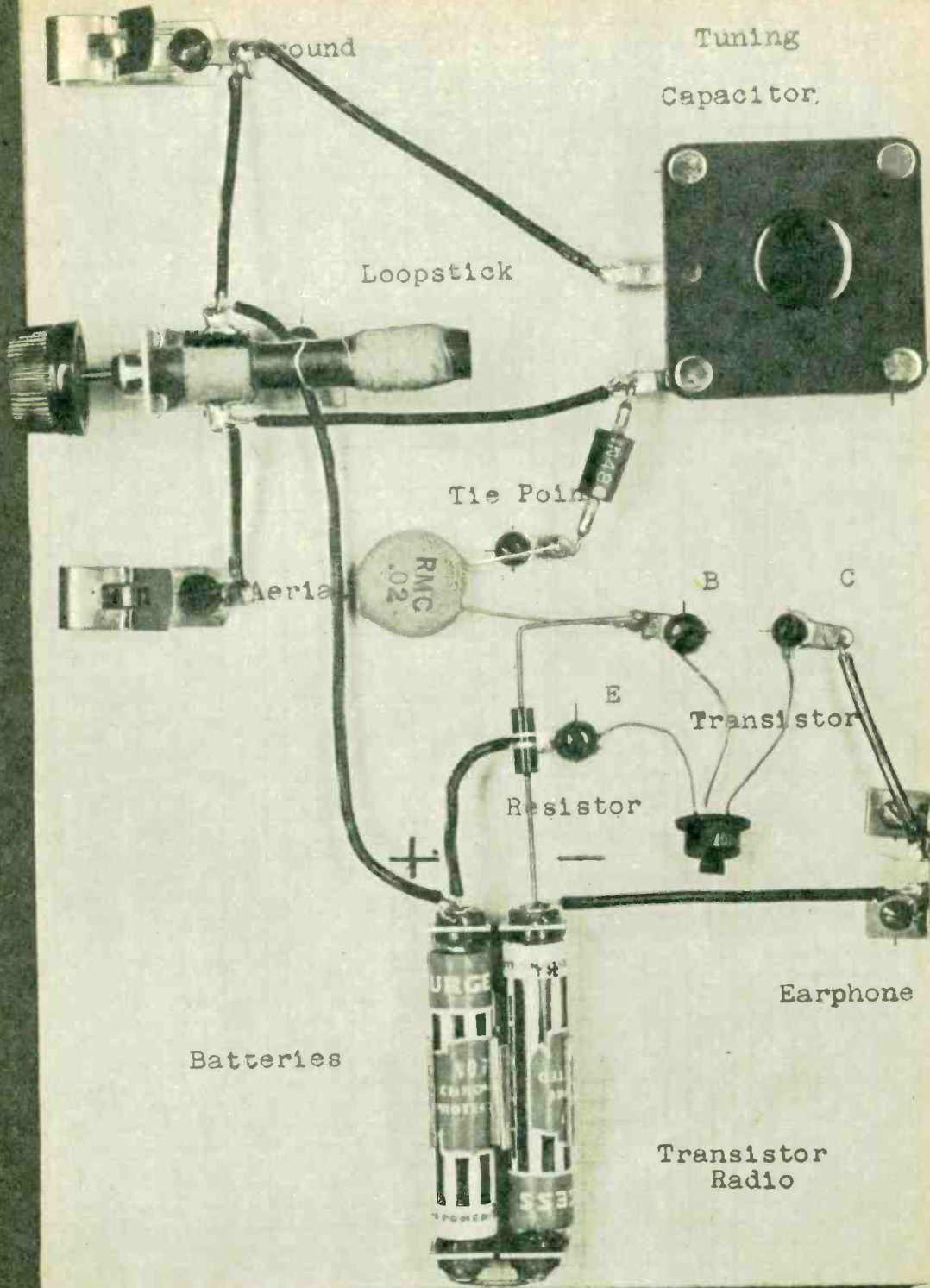

Actual size of receiver. This page may be torn out and pasted on a plywood board.

# Transistor Power Supply

This versatile unit gives smooth DC current, can also be used as a charger for car batteries or for electroplating small objects.

**W**ITH transistorised electronic equipment of many new types coming into general use, electronic technicians and experimenters are beginning to feel the need for a *low-voltage* direct-current power supply for bench purposes. By low voltage we mean the range from zero to about 16 volts. This takes in the many popular tran-

sistor portable radios, which require from 6 to 9 volts, and the new auto radios, using transistors alone or a combination of transistors and tubes. Not at all incidentally, such a "battery eliminator," as the device is generally called, is also extremely valuable for keeping a car storage battery fully charged, for running electric trains effi-

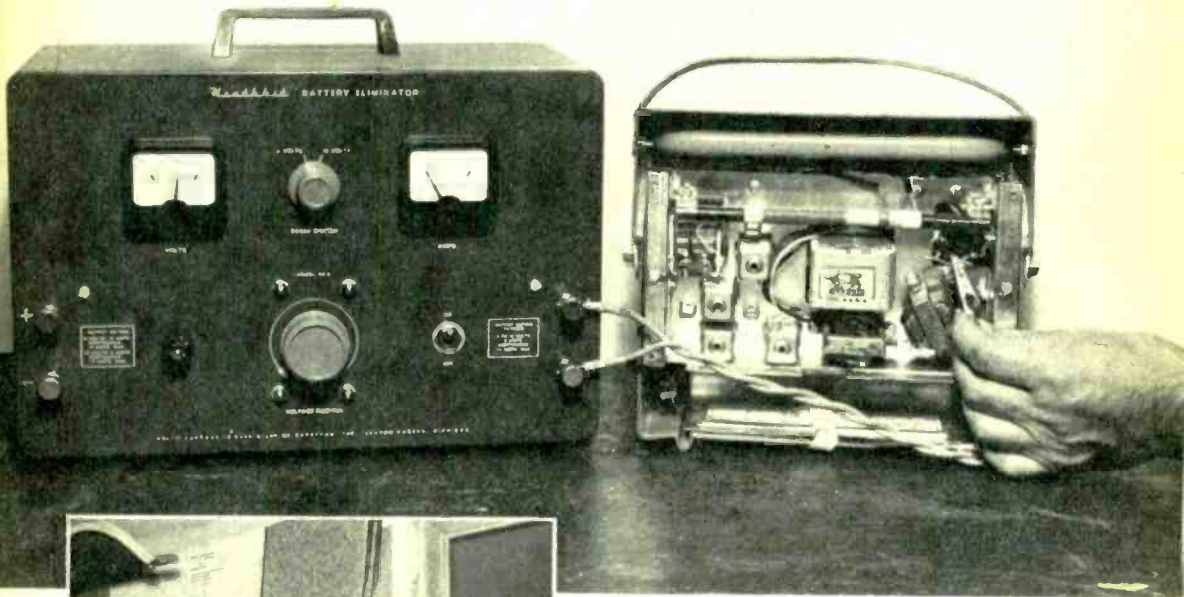

Above is actual set-up for testing of transistor portable (right). Filtered DC comes from pair of binding posts on right front edge of eliminator.



A real life-saver during the winter: the BE-5 used in the garage as efficient battery charger.



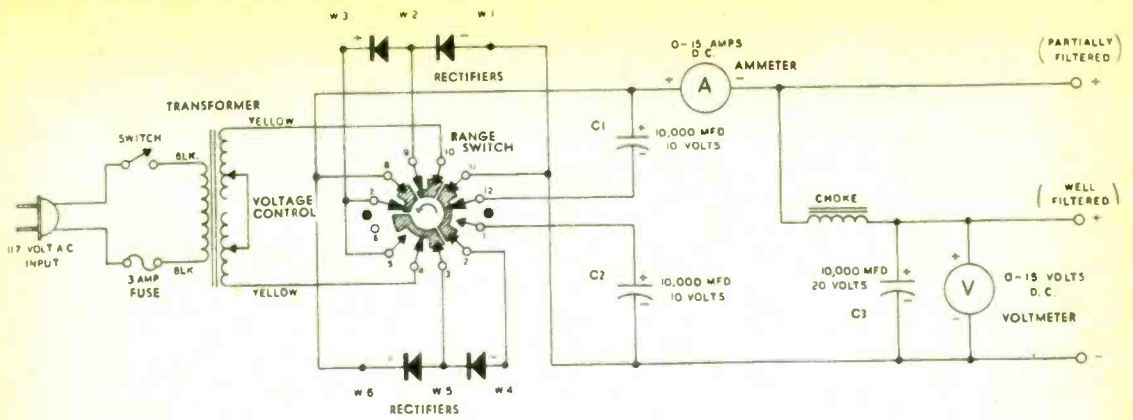

ciently, for electroplating small objects, and for other applications.

An ordinary battery charger is a source of low-voltage DC, but this is usually unfiltered, and when applied to a radio receiver of any kind it produces a terrific hum. A simple modification turns such a unit into a source of smooth DC. The Heath people, in their new Model BE-5 "battery eliminator," accomplish the trick by the addition of a brute-force filter to a standard dry-disc rectifier arrangement. This filter consists of a heavy-duty choke coil and three electrolytic capacitors having the enormous capacitance of 10,000 microfarads each. The usual filter capacitors in high-voltage power supplies, in the 100- to 500-volt range, run between 10 and 40 microfarads.

A choice of unfiltered or filtered output is available. For battery charging, electroplating, and other purposes not requiring velvet-smooth DC, the BE-5 can furnish up to 8 volts at 10 amperes continuously or 15 amperes intermittently, or up to 16 volts at 5 amperes continuously or 7.5 amperes intermittently. Filtered output in either voltage range is limited to 5 amperes because of unavoidable losses in the series-connected choke coil. This is more than enough for checking transistor equipment.

The actual current drain of most portable radios, for example, is measured in milli-amperes (thousandths of an ampere), rather than in full amperes.

As a kit construction project, the BE-5 is easy, despite its size and weight: 13 inches wide, 8½ inches high, 7 inches deep, and 20 pounds. Assembly and wiring took about two hours. The only minor difficulty encountered was in soldering wires to the lugs of the dry-disc rectifier. Although these were tinned, rosin-core solder rolled off them like water from a waxed surface. Rubbing the lugs very lightly with fine sandpaper and using a very hot 150-watt iron did the trick. If you don't have a big iron, we suggest clamping the wires to the lugs firmly with 8-32 machine screws, lock washers and nuts.

Permanently connected, a voltmeter and an ammeter read the output with good accuracy. Transistor radios don't take enough current to move the ammeter, but the voltmeter does register, and if the voltage is correct the current will take care of itself. The voltage control is a movable arm on the secondary of the power transformer. This changes the number of turns of wire in use, and hence also changes the step-down ratio of the primary to the secondary voltages. •—Robert Hertzberg

Inside chassis view of the Heathkit unit. Filter capacitors C1, 2 and 3 sit in holes at rear edge.

Bottom view. Last connection, to fuse socket, is soldered with a fast heating "gun" type iron.

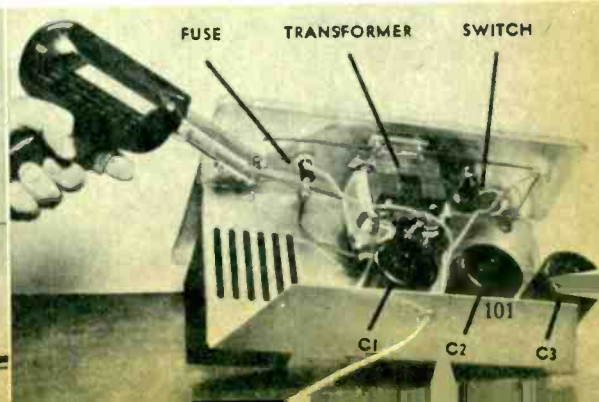
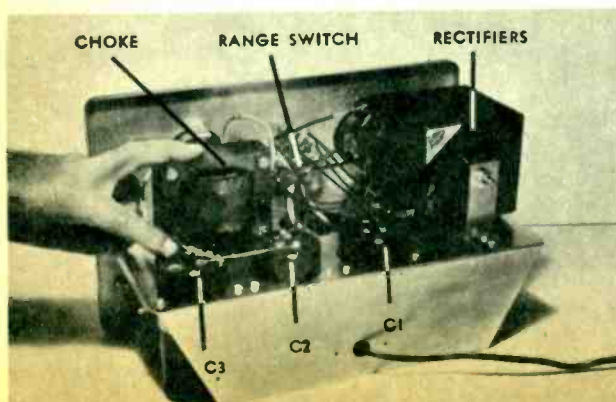

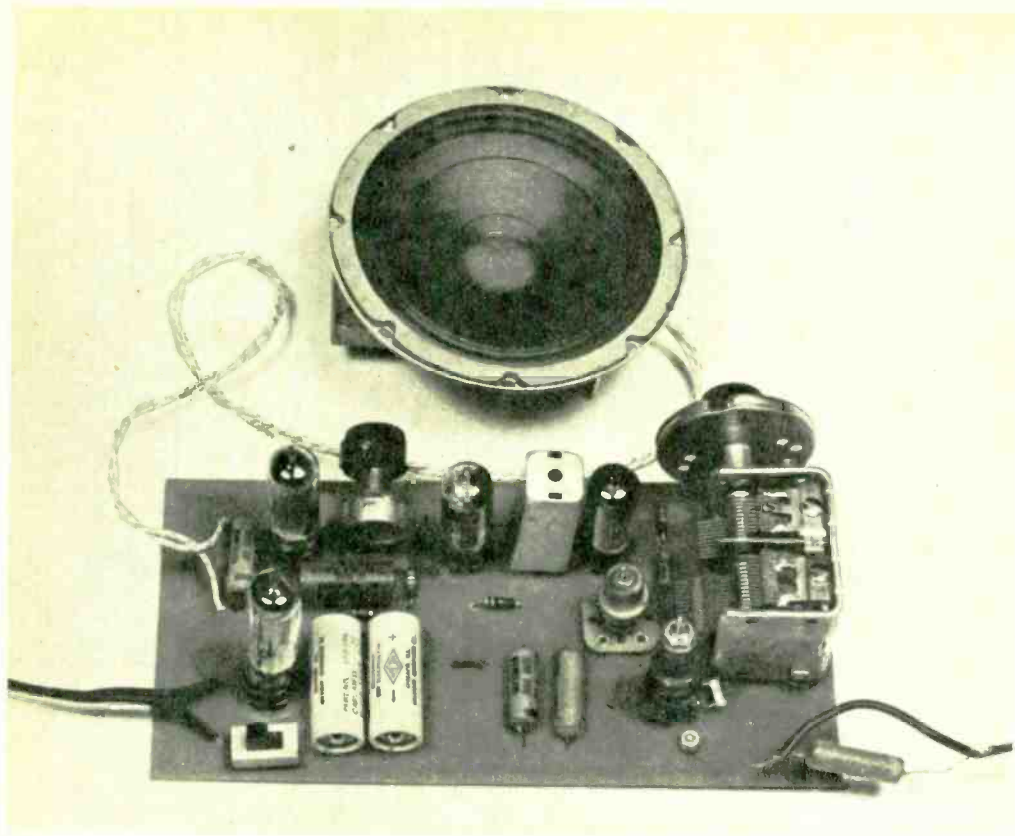

# Build an Etched Circuit Radio

You don't have to be an electronic wizard to master the secret of how to make your own etched circuit.

**I**N mass production the greater part of the time and cost involved in the assembly of electronic and electrical equipment consists of hand wiring the circuits. Elimination of hand wiring by the use of etched or printed circuits will often result in cutting production costs by as much as 50%. Although the techniques of etched circuitry are mainly of interest to people engaged in mass production of radio equipment, the processes involved are interest-

ing enough for our readers who want to construct just one set.

The circuit of our receiver (Fig. 2) was selected mainly because it contains few parts, has a simple basic circuit and the original model, wired in a conventional manner, gave good performance. Details of this receiver originally appeared in the publication of the National Radio Institute, Washington, D. C., of which the author is a consultant. If the reader has some other



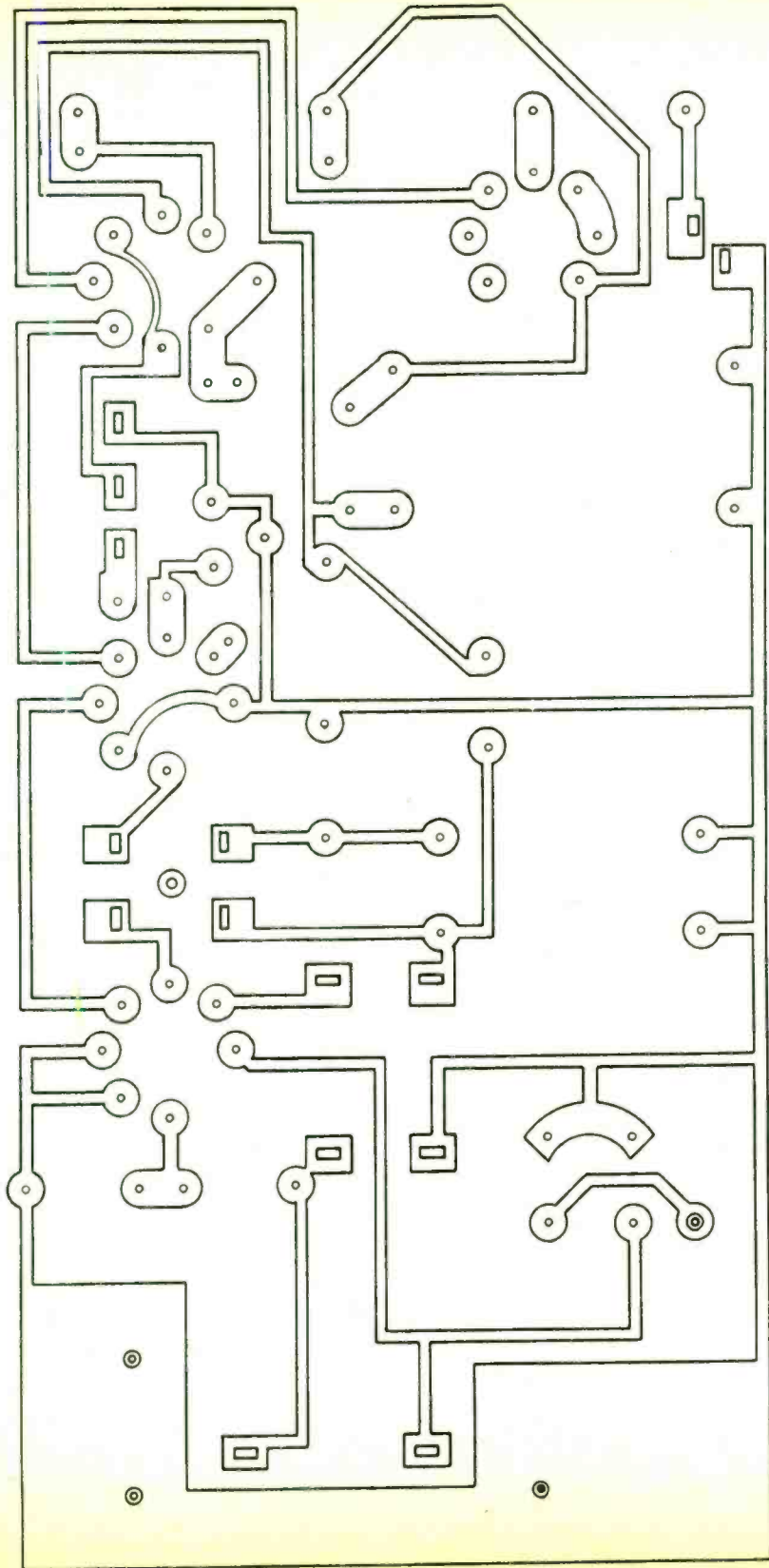

Figure 1. This is the full-size outline drawing of the etched circuit used for the receiver. The pattern on this page may be traced directly onto the copper sheet with the help of special carbon paper.

circuit he would like to use there is no reason why this should not be done. The instructions which follow, however, will apply only to our particular etched circuit.

Once a circuit is selected (the diagram, Fig. 1, is full scale and may be traced if desired), the next step should be the acquisition of all the parts. This is important since the circuit has to be drawn to fit the parts and if a particular part is not available to fit your circuit a lot of time will have been wasted.

The material used for the circuit work is called Natural XXXP-26 Dilecto; it is  $\frac{1}{16}$  inch thick insulating material and has a .0035 inch copper coating. The basic technique of etched circuitry consists of drawing the desired circuit with acid resistant ink onto the copper sheet which is bonded to the insulating material. After the unwanted copper has been removed by the etching process the ink is removed leaving the copper foil in the desired pattern.

Carbon paper is used to transfer the pattern from the drawing to the copper foil. Since ordinary typewriter paper is not suitable, "pencil carbon," coated on both sides, should be used. Do all your tracing with a 4H pencil. The carbon paper is placed onto the copper sheet after trimming it to size. The circuit drawing to be traced (Fig. 1) is placed on top of the carbon paper and all three sheets are firmly held together with Scotch tape.

When tracing use a straightedge to avoid wavy lines. After all vertical marks are copied finish up by tracing the circles. The

small circles inside the larger ones are centering marks so that the holes which are to be drilled later will appear in the proper positions. You can mark these center points by using a sharp pointed tool, punching right through the tracing and the carbon paper into the copper. Hit the marking tool only hard enough to mark the copper and be sure that you have the circle backed up with a solid board when locating these holes. When you remove the pattern lift it up from one end leaving the other end firmly taped in position. You can then raise up the carbon paper and make sure that all marks have been traced. If you find any omissions just pull the pattern back and retrace the missed lines.

The copper is now ready for inking. The ink used is acid resistant and may be applied with a small brush or ruling pen. It is important to completely cover all the copper that is to be preserved. The sharpness of the finished lines is determined by the sharpness of the ink work, so great care should be used to get a smooth, even line. Be sure to fill in the punch marks on the copper, located at the center of all circles, because the acid will attack anything not covered by the ink. After the ink work is completed, dry the plate under a lamp and examine it for errors by comparing it to our drawing of the inked copper sheet (Fig. 3). A hard eraser may be used to correct any error and corrections can be made by re-inking the circuit to its proper form.

Ferric chloride is used for etching the

Figure 2. Schematic diagram of the radio receiver's superheterodyne circuit.

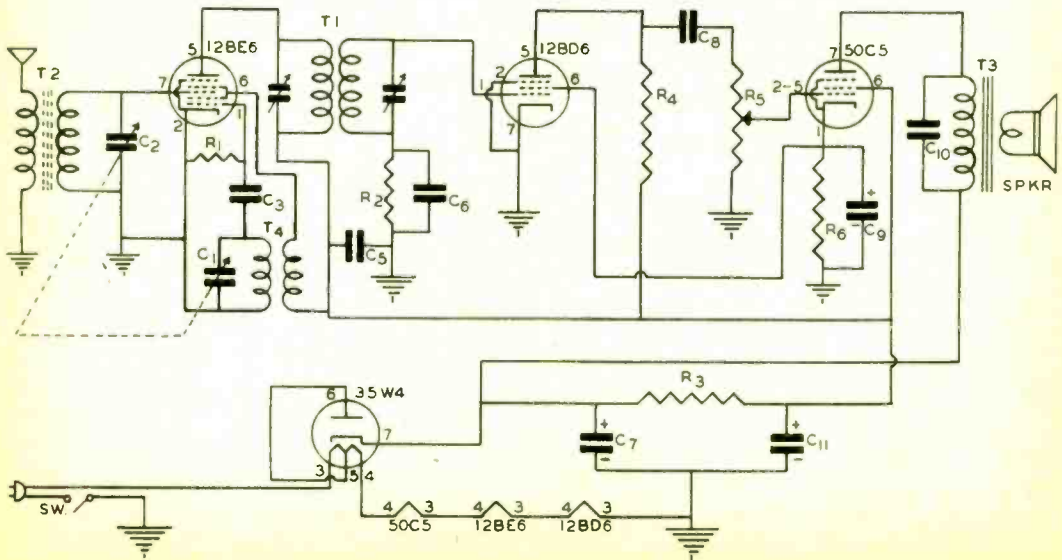



copper. It may be purchased in lump or liquid form, however, the liquid is easiest to use. Commercial engravers make use of it under the name of 42% Ferric Chloride. In its original form the material is quite thick and it should be cut by adding one pint of water to ½ gallon of ferric chloride. The acid will sting if it gets on your skin, therefore, it is best to wear rubber gloves and old clothes. A glass or enamel pan should be used to hold the acid. The etching action will be faster if the solution is warmed to 120° F. When the solution is ready place the board in the acid and gently work the board so that the surface which is to be removed has acid running over it continually. The agitation speeds up the etching process and only a few minutes are required. The surplus copper should disappear in less than 10 minutes. To protect the inked surface, it is desirable to have the etching action as fast as possible.

After the etching is completed remove the board and rinse it with clear water and dry it over a lamp. When dry the ink is removed from the copper with steel wool or pumice stone. When the ink is completely removed the board is ready for drilling and slotting.

Holes for tube socket pins and wire leads are drilled first with a No. 40 drill, using the punch marks previously made as a guide, then, enlarge them with a No. 45 drill. This drill is also used to bore the holes at the end of the slots used for the volume control connections, tuning con-

denser and I.F. transformer connections and oscillator transformer connections. The space between the holes at the end of the slotted area is removed with a small rat-tail file. Be sure to examine the board to see that all openings are made before you attempt mounting any of the parts.

Two wire jumpers are used on the circuit board and these should be installed first. The first jumper provides a means of getting B+ across the lead running from the No. 7 pin of the 12BD6 tube socket to the common return lead which goes to the "bus" which serves to connect all the returns to the switch terminal. This jumper is ½ inch long and a piece of push-back hookup wire is used to make the jumper. The second jumper is used to bring the screen voltage for the 12BD6 tube from the cathode of the 50C5 socket. Small ears project out from each of these points so that connection can be made. Use a 25-watt iron for soldering because excessive heat will loosen the copper from the base. *Always use rosin core solder.*

After jumpers are in place all tube sockets may be mounted by pushing the pins through the holes in the board from the top. Solder all connections of pins No. 1 and 5 first while holding the board down firmly against the socket which should rest on your worktable. Then, solder pins No. 3 and 7 to tighten opposite points. The remaining connections to the tube sockets are then soldered; repeat this process at each tube socket.

The remainder of the parts can be

Figure 3. This is the appearance of drawing made on the copper sheet after ink work is completed.

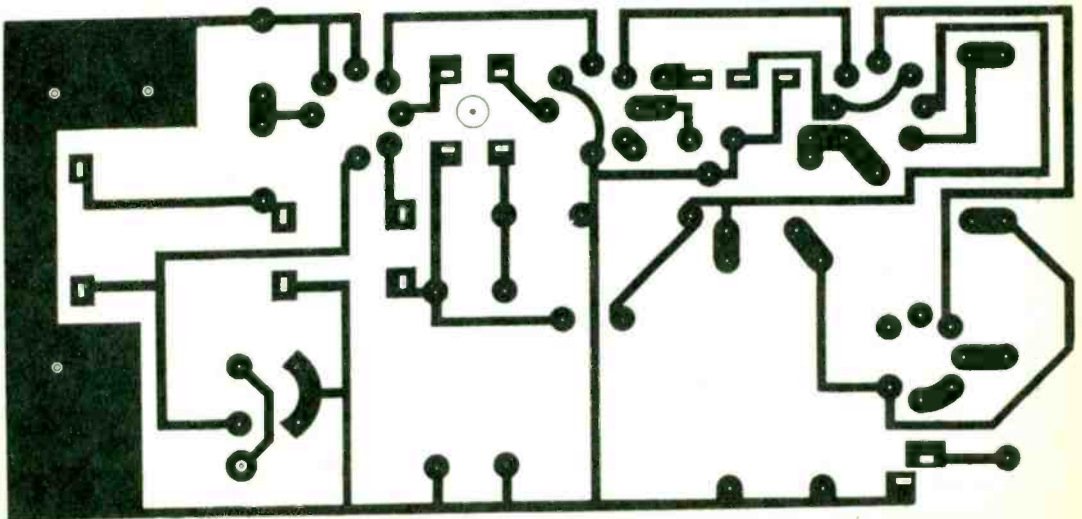

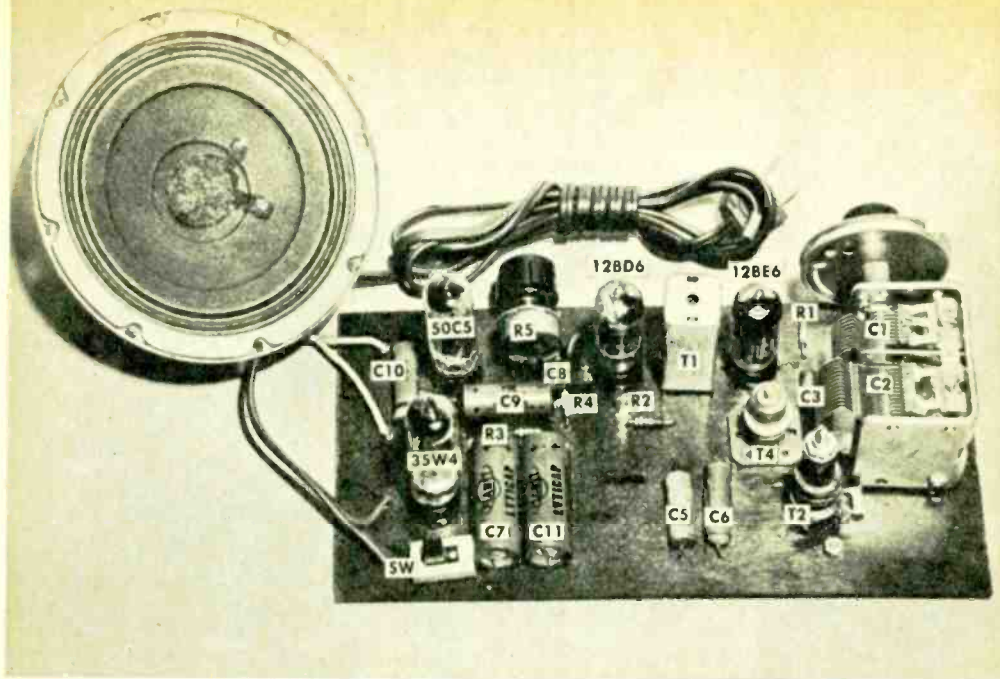

Figure 4. Top view of the receiver shows the location of all parts mounted on chassis board. The numbers shown correspond to the numbers on the parts list at the end of this article.

mounted in any order but it is easier to install the coils and tuning condenser after all other parts are mounted. Note: The circuit was drawn with the connections of the volume control reversed, therefore, maximum volume occurs in the full counterclockwise position of the control. The On-Off switch has ears for mounting to a conventional panel or chassis. The switch's ears may be cut off with a hacksaw while holding the switch upside down in a vise. In mounting the switch the terminals should be pushed through the holes and bent over sharply so that they are in contact with the copper coil before soldering. The power cord is connected by pushing the tinned ears of the leads through the proper holes. Be sure to put the lead down until the rubber is against the board; cut off all but  $\frac{1}{8}$  inch of the wire protruding on the pattern side of the board and solder the connection. The tubes can now be placed in their respective sockets, using the pictorial diagram (Fig. 4) as a guide.

The antenna should be connected to the 6-32 screw which comes through the board and it is a good idea to use a .005-mfd condenser in series with the antenna, since the antenna may be hot because the

ground return is connected to one side of the AC line and to the antenna post through the coil.

After the tubes have warmed up tune the condenser throughout its tuning range. If you have a high frequency local station in your area tune around on the high end of the dial where you know this station is operating. When the station comes in, adjust the antenna trimmer (mounted on top of the rear section of the gang) with a screwdriver for maximum signal strength, then go down to the low frequency end of the broadcast band and try to pick up a station. When you pick up a station at this point adjust the slug in the antenna coil for maximum volume. Repeat these adjustments several times at each end of the band until the receiver is operating normally. If you have a signal generator, however, the set can be aligned in a conventional manner.

The finished receiver can be mounted in any convenient way and may also be built into a cabinet. The same goes for the speaker. In certain cases, it will be found that reversing the line plug in the wall outlet will increase the volume.

The simple receiver described here is a good starting item to gain experience



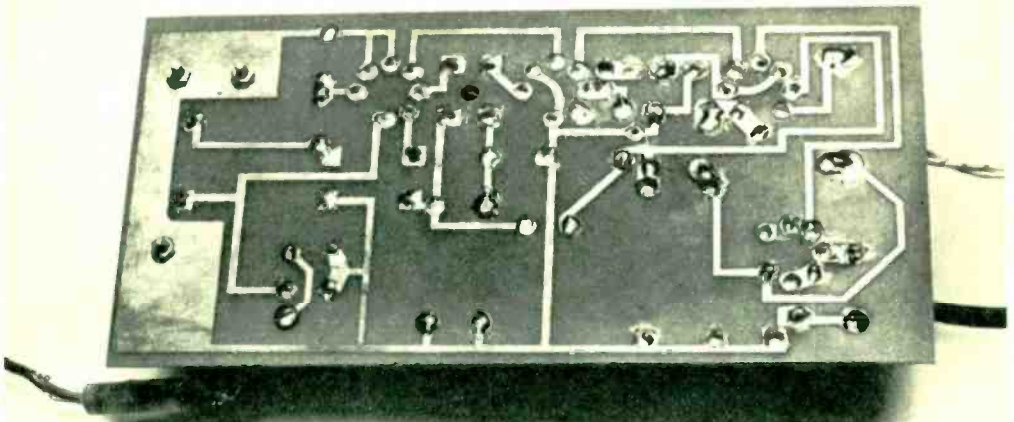

The completed printed circuit and all soldered connections are shown on this bottom view of set.

with etched circuit work. Phonograph amplifiers, capacity operated relays, phonograph oscillators and other units have been constructed using the methods described here. As time goes on materials for this type of work will become more readily available and many more home builders will be etching their own circuits.

The parts list at the end of this article shows all items that may be obtained from your local radio dealer or from the Allied Radio Corporation, 100 N. Western Ave., Chicago, Ill., or from Lafayette Radio, 100 Sixth Ave., New York, N. Y.

The other items such as the board, tube sockets, ink, and ferric chloride can be obtained from the following: board and tube sockets from Harcon Co., Brandywine, Md. The Harcon Co. will also supply an inked chassis ready for etching (if you don't want to do your own inking), for \$2.25 with tube sockets.

The ink is Superior, Trojan Grade, special marking ink, obtainable from R. A. Stewart & Co., 80 Duane St., New York 7, N. Y., at \$4.50 per pint. Ferric chloride is obtainable from engraving supply houses at about \$3 per gallon. A half gallon will be enough to etch many circuits. •

—Leo M. Conner

## PARTS LIST

### CONDENSERS:

C1-C-2	Sections of 2-gang Philmore #9045 tuning condenser
C3	50-mmf tubular ceramic condenser
C5	.005-mfd, 400V paper condenser
C6	.0005-mfd, 400V paper condenser
C7	20-mfd, 150V electrolytic condenser
C8	.01-mfd, ceramic disc type condenser
C9	10-mfd, 25V electrolytic condenser
C10	.01-mfd, 400V paper condenser
C11	20-mfd, 150V electrolytic condenser

### RESISTORS:

R1	22,000-ohm, 1/2-watt resistor
R2	3.3-megohm, 1/2-watt resistor
R3	2200-ohm, 1/2-watt resistor
R4	390,000-ohm, 1/2-watt resistor
R5	1-megohm volume control
R6	150-ohm, 1/2-watt resistor

### TRANSFORMERS:

T1	IF Transformer—Ambassador K—Trans. 455 kc
T2	Antenna Coil—Meissner #14-1056
T3	Output Trans. to match 50C5 plate to voice coil
T4	Oscillator Trans.—Meissner #14-4034

### SPEAKER:

I	5-inch PM dynamic speaker
---	---------------------------

### MISCELLANEOUS:

SW	Single pole—single throw slide type switch
1	5-ft. line cord and plug
2	round control knobs
3	6-32 spade bolts
1	6-32 machine screw
5	6-32 hexagonal nuts
4	tube sockets for etched circuit
1	4 1/2"x9"x1/16" copper-coated phenolic (chassis)

### TUBES

1	12BE6 tube
1	12BD6 tube
1	50C5 tube
1	35W4 tube



# Foxhole Radio

It may be hard to believe, but this very unorthodox "radio" actually does work.

**T**HE G.I. sits in his foxhole. War is mostly waiting, you know, and while he waits, he thinks. The ether around him is full of music, but he can't hear it because they didn't think to issue a radio along with the M-1 and steel helmet. American Inventive Genius, that old standby, comes to the fore with a blast of light.

This unit, dubbed the "foxhole radio," became so popular overseas that it was written up in such publications as *Stars and Stripes*, *The China-Burma-India Round-Up*, and similar journals.

Essentially, it consists of a crystal receiver, without a crystal. It's the most unorthodox radio you can imagine, and still, it served its purpose well. You can emulate with ease what many G.I.'s built under severe battle conditions. The requirements, of course, are simple. You need a piece of

wood (any ol' piece of wood), and the cardboard core of a toilet paper roll. You will also need a blued razor blade—not lacquer blued, but blued by heat quenching which puts a film of oxide on the blade. You'll also need a safety pin. Now for the hard part. You need a pair of earphones, and the approved method for obtaining these is to wander casually over to either a parked tank or an unguarded airplane, and very quickly and deftly unplug the nearest pair of earphones and shove them under your shirt. After this bit of "midnight requisitioning," high-tail it away from there.

Now you need wire . . . lots of wire. If you're really desperate you can take one of the two earphones apart, and carefully unwind the magnetic coil in it, but if you want both phones, you need another source



of wire. An old transformer, for example, will yield lots of wire.

Wind the toilet paper core full of wire. The amount of wire, and the total distributed capacity through the coil will determine the frequency of your receiver, but the unit has such a broad band that tuning is unnecessary. Now you must run a long antenna, and the longer the better. One hundred feet will be just about right, and the higher you can get it the better reception will be. Connect one end of this antenna to one end of the toilet paper coil, and drive your bayonet into the soft earth wall of your foxhole. Attach the other end of the toilet paper coil to this "ground." Connect one side of the earphones to the ground as well, and now we are ready to build the "detector unit."

Cut a small length of wire and connect

it to a safety pin. Another small length is connected to the razor blade, but first remove the bluing from a small portion of one end with some fine sandpaper, and, if tools are available, solder the wire to this cleaned part of the blade. Now connect the razor blade to the antenna side of the coil, and the safety pin to the open side of the earphones. That's all there is to it, except that a great deal of patience is now required.

You must probe round the blued surface of the blade with the "cat's whisker" safety pin, until you hit a sensitive spot. You'll know when you find this spot, as you'll hear the local radio broadcast.

If you are a collector of radio memorabilia, then this curiosity certainly deserves an honored place in your collection. •—Byron G. Wels

Below is the "schematic diagram" of the receiver. The detector is really an ordinary razor blade.

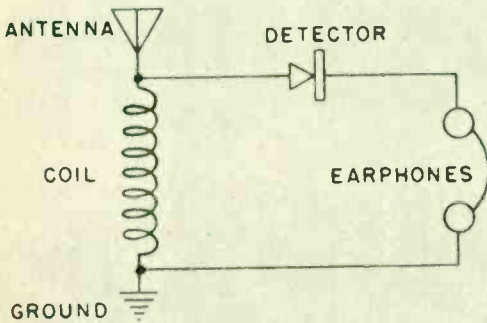

For best results solder connections. If you want to be "primitive," just twist leads around clips.

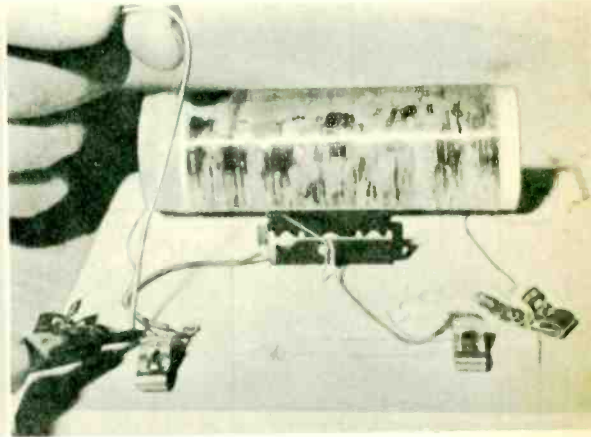

Radio is tuned with the detector, i.e., probing around razor blade with a section of safety pin.

Photo shows completed foxhole radio wired up and ready to go. One or two earphones can be used.

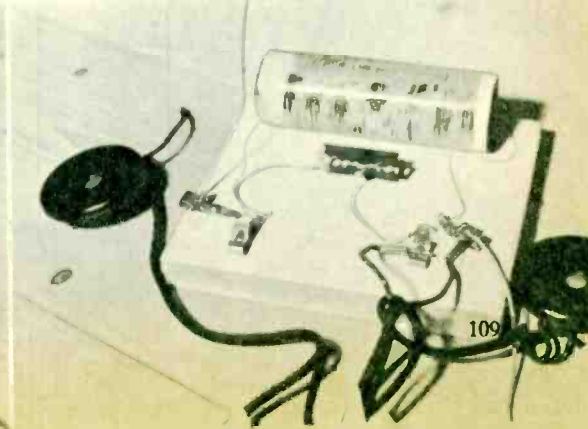
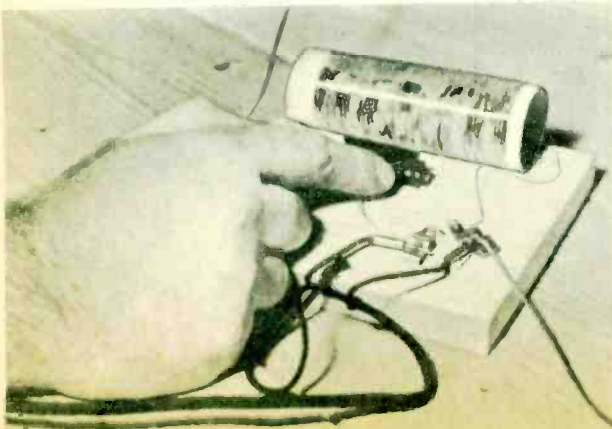

# Transistor Geiger Counter

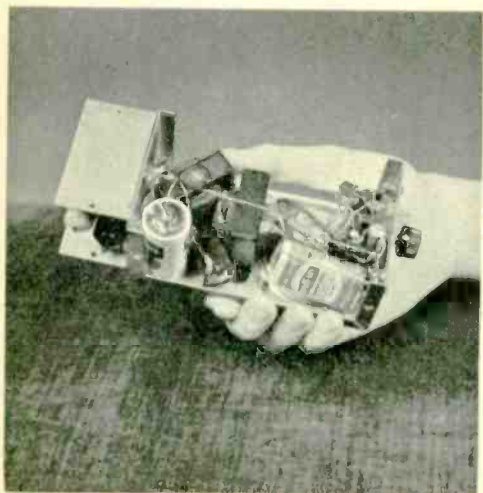

Geiger counter consists of two cases. The large case, cover removed, has speaker and batteries.

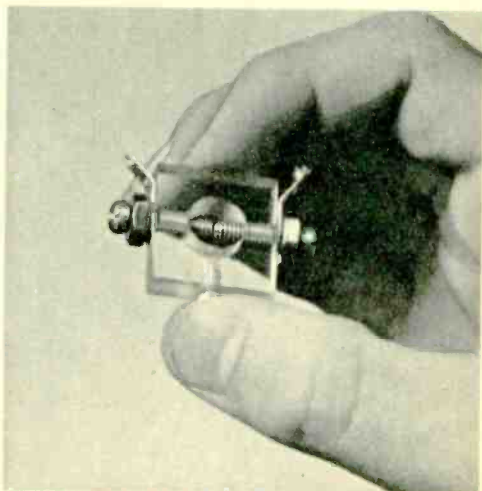

Unit uses a spark gap. Photo shows homemade model made from Lucite block, screws and nuts.



A loudspeaker, meter and neon light are used in this instrument to indicate radio activity. It's inexpensive and easy to construct.

SINCE the Geiger counter was first developed, many improvements have made it more economical and easier to build and use. From the earliest prototypes which were built into cumbersome cases and required heavy batteries, today's Geiger counter has become a compact and efficient unit.

One thing that has not improved much since the earliest models is the method of indication. Most Geiger counters priced low enough for the weekend prospector to afford, still use headphones. Many a man has returned from the field to nurse his sore ears. Since phones can do a good job of masking your ears from sounds outside of those made by the counter, the prospector is not always aware of the dangers around him. The mortality rate of weekend prospectors who have been bitten by rattlesnakes is very low but you still owe yourself that extra ounce of protection.

The counter described here has two methods of indication; it has its own self-contained loudspeaker amplifier and a neon light for use in high noise conditions. Yet it measures only 7x3x2 inches, making it just about the smallest loud-

speaker-Geiger counter ever built. A look at the photographs will convince you that there is no crowding of parts inside the case and even the inexperienced builder should be able to assemble it with ease. The reason for the use of two cases is quite simple. The high voltage has been isolated in the smaller box so that both batteries can be changed without any danger of high voltage shock. Another feature of this counter is its low cost. The whole unit can be assembled for about \$16.

The simplicity of the high voltage supply used can be seen in the schematic. When S1 is closed, a shot of current goes through the low impedance side of T1. When S1 is opened, high voltage is induced into the other side of T1 and a spark jumps the gap to C1. Every time a spark jumps the gap, about 100 volts are added to the charge held by C1. With this method it is possible to build up the 900 volts necessary to operate the Geiger tube. S1 has to be a snap-action switch so that sharp pulses of current can be fed into T1. The sharper the pulse, the more voltage will jump the gap.

When C1 is charged, it will operate the counter for about ten minutes, then S1

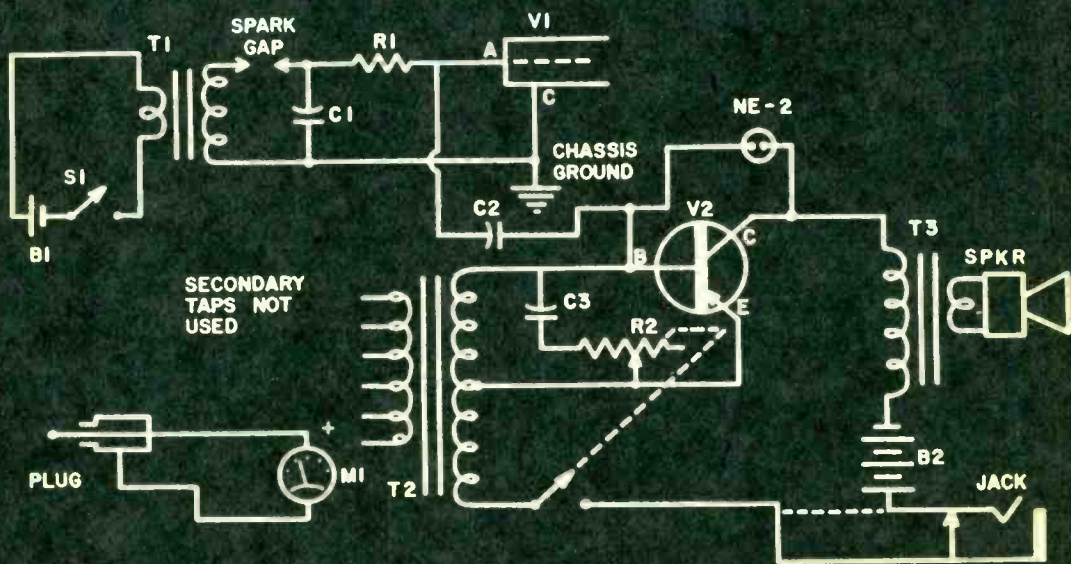

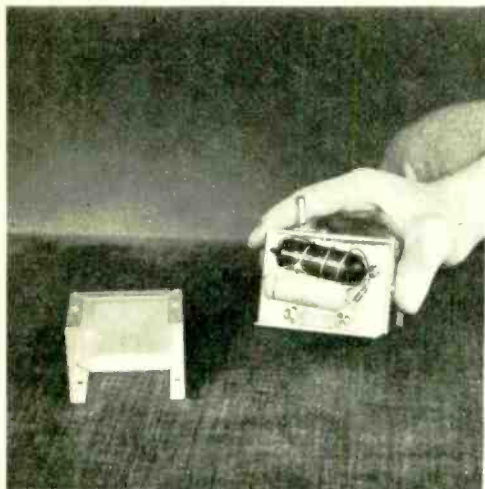

The smaller case contains the Luchte spark gap, the Geiger tube and the 1,600-volt C1 and R1.

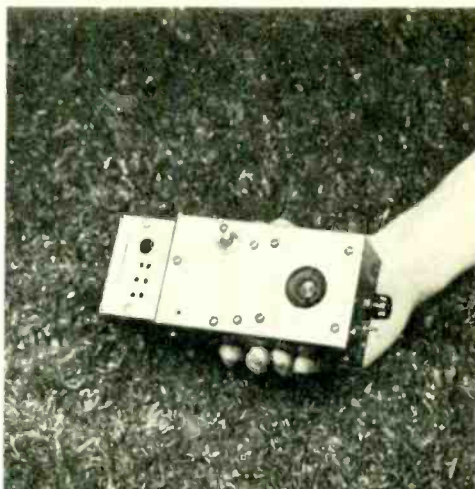

The loudspeaker cutout and S1 are seen above. Note spacing of the holes drilled in small case.

### PARTS LIST

- C1 Astron .03uf at 1,600 volts condenser
- C2 50uf Erie Ceramicon
- C3 30uf at 6 volts, Lafayette CF-104
- M1 Meter (0-25) milliamperes (optional)
- R1 10 megohms, ¼ watt
- R2 50 kilohm potentiometer with switch, Lafayette No. VC-31
- T1 Audio output transformer, 8,000 ohms to 8 ohms (Not critical)
- T2 Universal output transformer, Lafayette No. 101-01
- T3 Miniature audio output transformer, Lafayette No. AR-96
- V1 Raytheon CK1026 Geiger tube
- V2 CK722 or 2N107 Transistor
- S1 Walsco 2365-01 or microswitch
- B1 1½ volt size C flashlight cell
- B2 22½ volt battery, Burgess U-15
- ICA No. 29441 "Flexi-mount" case
- ICA No. 29435 "Flexi-mount" case
- SP Lafayette SK-66 speaker
- Miscellaneous
- 1 NE-2 light, terminal strips, wire, solder, etc.

must be pressed several more times to build up the voltage again.

The CK1026 Geiger counter tube is also a recent development. It has an unlimited life and cannot be damaged by over or reverse voltage. It is rugged and tiny enough to fit into the smaller box. One connection goes to the wire extending from the tube, the other to the outside of the tube.

To operate a loudspeaker, a four transistor amplifier would be needed, but it is possible to use a trigger circuit to operate a loudspeaker with just one transistor.

The circuit is actually a stabilized blocking oscillator. The pulse from the Geiger tube triggers this circuit sending about a ¼ watt through the loudspeaker. When the circuit is triggered, a high voltage pulse is produced between the collector and the base of the transistor. This can be used to light a small neon light (NE2). When the amplifier is in operation it draws only about .0025 watts until it is triggered. The result is that the battery will last for an extremely long time.

All the components on the parts list can be purchased from your local radio store or from Lafayette Radio Company, 165-08 Liberty Ave., Jamaica 33, N. Y.

Be sure to follow the schematic diagram carefully and use the photos as a guide to placement of parts in the two boxes. Exercise extreme caution when C1 is charged; you may live through a 900-volt shock



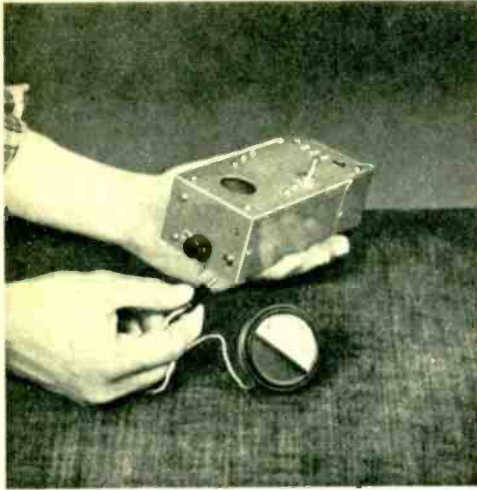

A meter, optional, is shown being plugged into the jack located next to the potentiometer.

but you won't forget it for a long time.

Drill several holes in the small box, as shown, to allow radiation to pass through. Three bolts are used to connect the two boxes. Two will also hold the Geiger tube and the third a terminal strip. Three smaller holes are also drilled so that connections can be made to the spark transformer and the single wire to the amplifier.

The speaker is now mounted in the box. The lugs on the transformer are bent around the frame of the speaker to form a single unit. Trim the two green wires on the transformer and solder them to the lugs on the speaker. Place the speaker in the box, being careful to leave clearance on both sides and mark the four holes. Then scribe an X between the four holes to use as a guide for the speaker hole. This should be about one inch in diameter and can be drilled or made with a chassis punch. The speaker is then mounted, using a small piece of grille cloth or plastic screening to cover the opening. For maximum volume, the hole can be left uncovered. Next, mount T2, R2, and the terminal strip as shown in the photo. Connect all the wires going to the terminal strip before soldering on the transistor. Drill a hole for the neon light and place a rubber grommet in it. Moisten the neon light slightly for easy insertion in the grommet.

Now, the rest of the amplifier can be wired by following the schematic. The leads on the transistor should be left about

one inch long and held with a pair of needle-nose pliers when soldering to prevent heat damage to the transistor. Check the wiring carefully before turning the unit on.

When the above steps have been completed, turn on the amplifier by rotating the shaft on R2. At a certain point, a large number of clicks will be heard in the speaker. Turn the shaft back to where the clicks cease completely and then touch any connection in the circuit with your finger. If a click is heard in the speaker, the amplifier is functioning correctly. If you do not hear a click, check the circuit of R2 and C3 to make sure they are connected correctly.

The next step is to mount T2 and S1 to the case; the photos show how they are placed. Be sure, however, to leave space for B1. Then the two boxes are bolted together. Follow the diagram carefully, making sure that the Geiger tube is securely mounted and is making a good electrical connection to the box. The spark gap can be purchased or made from a block of Lucite and two screws, as shown in the photo. Under the head of each screw is a nut and a terminal; adjust the gap between the two screws for the narrowest possible opening. Pass the two wires from the transformer through the chassis holes and connect one to the spark gap and one to the condenser as shown in the schematic. C2 and B1 should be soldered in now. Polarity is not important on B1.

Now the unit is ready to operate. Check all wiring before testing the unit. Operate S1 several times while watching the spark gap. If no spark jumps, move the two screws closer together. Space the two screws so that a spark jumps every time S1 is operated. Once this has been accomplished, turn on the amplifier and hold a radioactive sample next to the Geiger tube. Push S1 until rapid clicking is heard in the speaker. If no clicking is heard after S1 has been pressed thirty times, reverse the polarity of B1. It may be necessary to readjust R2 after the condenser has been charged the first time, but after that, no adjustment should be necessary. Just be sure to push C1 several times about every five minutes to keep the unit charged. The flashlight cell should be replaced every few weeks, but B2 should not need replacing for several months. •—Tony Karp

#### WARNING:

When C1 is charged it holds nine hundred to 1200 volts; be sure to exercise extreme caution.

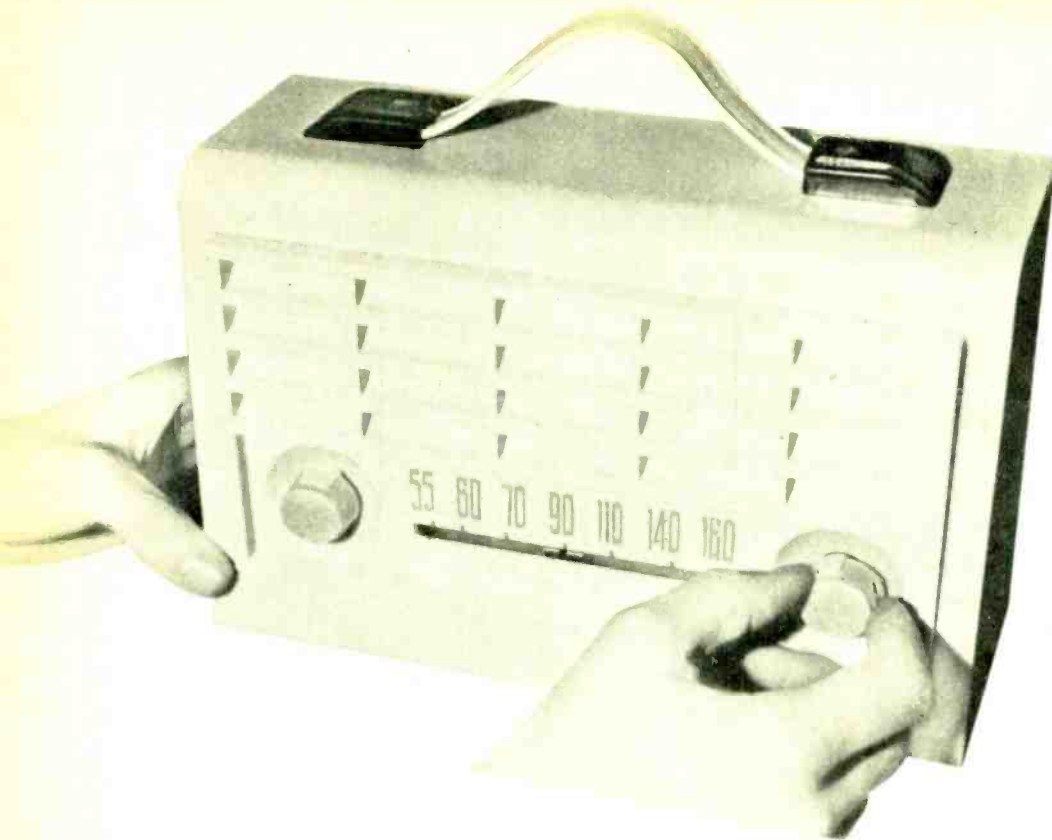

## 3-Way Portable

You can take this radio with you wherever you go.  
It operates on AC-DC house current or batteries.

**S**INCE the very earliest days of radio, man has tried to take his music with him. The first recorded knowledge of portability in radio receivers that we were able to trace dates back to the chap who had built an entire radio into a suitcase, and by connecting his ground wire to the side of the car, played his portable on the now disappeared New York elevated transit system. Needless to say, this caused quite a stir among his fellow passengers.

From this rather bulky unit, our concept of portability has been reduced through the briefcase radio, the portable cigar box receiver, to the currently popular pocket portables.

This 3W10P receiver from Arkay was not selected for its size. You can certainly buy and even build smaller ones. The

unit was chosen for this book because its circuit design embodies the classic in portable radios. If you want to learn, this will teach you.

This unit is a superheterodyne receiver, and it operates from AC-DC lines, or batteries. In either case, the operation of the various tubes is exactly similar, so let's begin by following the signal as it is brought in from the loop antenna.

The tuning capacitor is directly across the loop antenna. It tunes it so that of the many stations which fill the ether with radio signals only one is permitted to enter the 1R5 converter stage. This stage performs a dual function, acting as the oscillator as well. As the oscillator, it generates a frequency that "beats" against the incoming frequency to give us a resultant



frequency of 455 kc. As the oscillator is tuned by the same capacitor tuning shaft that tunes the main tuning capacitor, the oscillator frequency and the tuned frequency are always 455 kc apart. This 455 kc signal is passed from the converter-oscillator tube through the input I.F. transformer. It is amplified in the 1U4 I.F. amplifier, and this intermediate frequency is passed through the output I.F. transformer to the 1U5, which serves as a detector and audio frequency amplifier.

This process of detection consists of removing the 455 kc, and leaving only the information (music, talk, or what have you). This is accomplished by rectifying the high frequency (455 kc) and leaving the audio portion untouched. It is the small plate, attached to pin 4, that accomplishes this work.

The signal is then passed through the volume control to the grid of the 1U5, which amplifies the signal and functions to supply AVC voltage. It is the automatic volume control which prevents "blasting." This is accomplished by biasing the tube with a negative voltage so that when a

strong signal comes in, it is reduced before it can reach the speaker. A weak signal is boosted so that it becomes more audible. It is this AVC, incidentally, which functions in your car's radio to maintain an even level as the car passes through a tunnel.

Next stage is the audio amplifier 3V4. The signal is brought up to a greater level in this stage, and is passed through the audio output transformer to the loud-speaker.

The battery supply has two batteries. One is a 7½-volt "A" battery, which supplies voltage to the filaments of the tubes. The other is a 90-volt "B" battery which supplies the high voltage. In operating this equipment from power lines, a selenium rectifier is used which converts the alternating current to direct current, and a filter which removes any ripple that may exist after rectification. After filtering and rectifying, the line voltage has been dropped to approximately 90 volts, the same voltage as supplied by the "B" battery. Filament voltage is obtained by using a large resistor to drop the high input

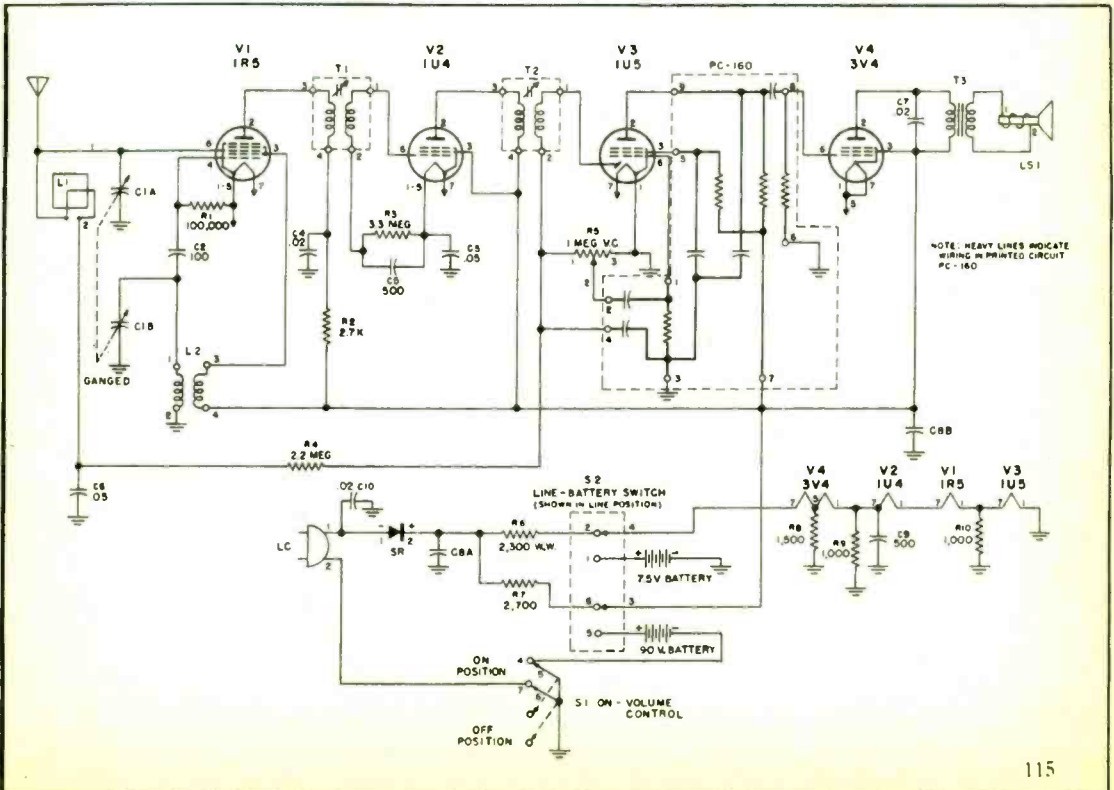

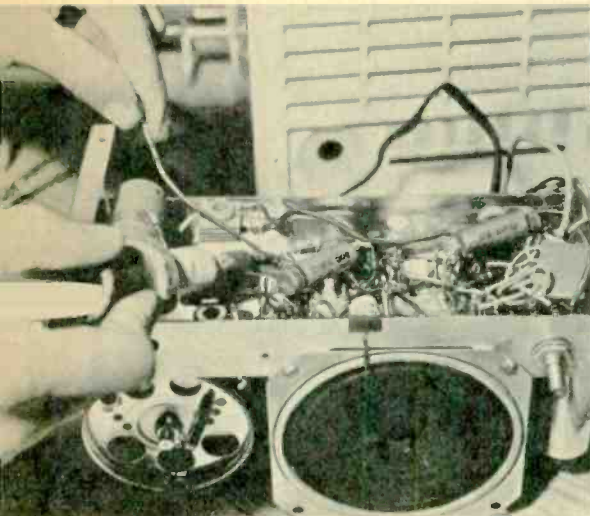

Soldering inside the 3W10P is not tricky. Space is plentiful for all internal wiring operations.

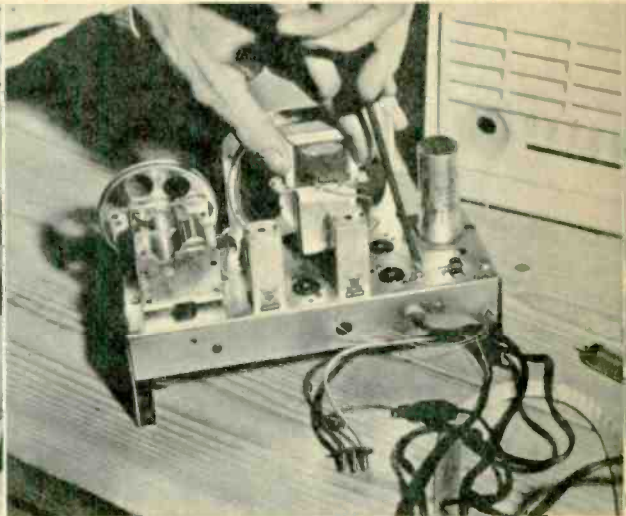

Change from AC to DC is simple. Selector switch is mounted on back of chassis, held by two bolts.

voltage to a more workable seven volts.

You will notice a switch on the back of this unit. It is used to select either AC or DC (battery) operation. Place it in the proper position for the type of operation you desire.

A great deal of time is saved by the use of the PC-160 printed circuit. This consists of an electronic network of resistors, capacitors, and conductors mounted to a ceramic base plate. This base plate is then equipped with external wire leads, and the

After internal wiring is completed mount the loudspeaker to chassis using bottom holes only.

Attach dial drive cord and test the control. Pointer should now travel across the front face of chassis.

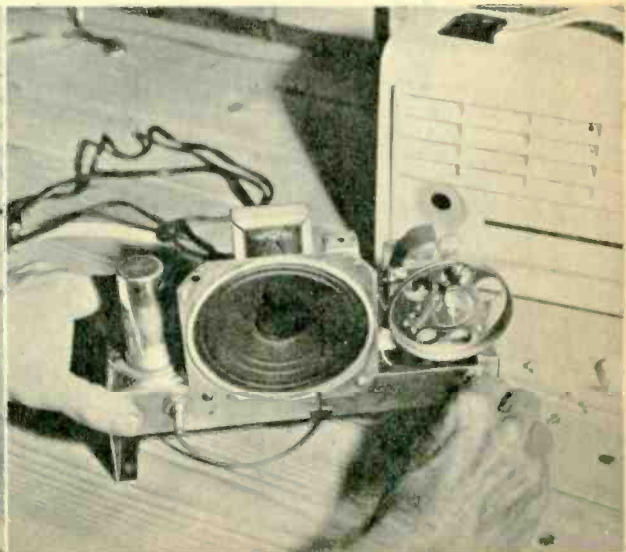
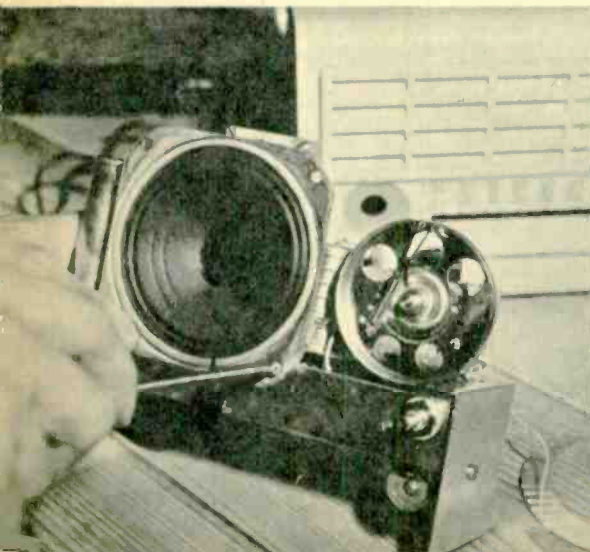



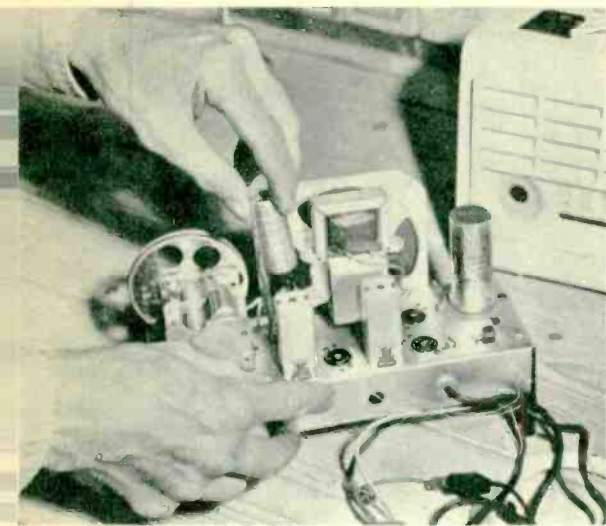

All parts are supplied with the kit. Place metal shield on tubes where required by instructions.

whole is sealed against moisture with an additional ceramic coating which is then fired.

Housed in an attractive plastic cabinet, this unit works from either AC or DC house current, or will operate directly

The receiver slips easily into its plastic case. Antenna (not shown) attaches to the rear cover.

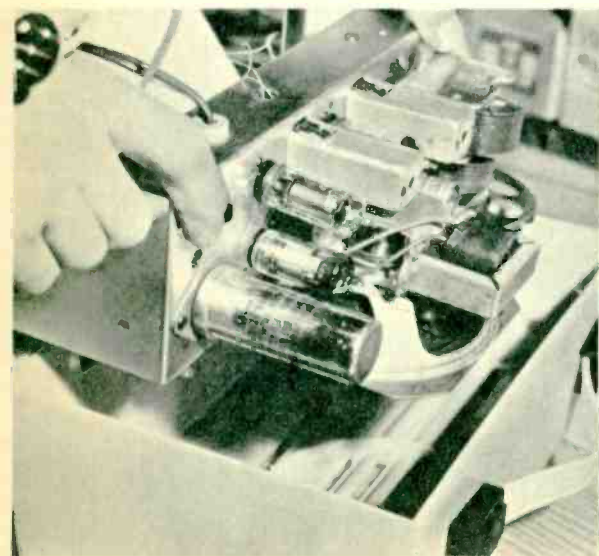

from batteries. The selectivity, which is, of course, the yardstick by which we measure most of our radios, is excellent, and the tone and volume are surprising. The radio has its own built-in antenna and seems to "suck" signals out of the air, giving outstanding reception even of usually hard-to-get distant stations. This is especially important for portable radios.

The entire chassis is wired up before the plastic case is put on. Your author, forging ahead on his own, attempted to mount the parts from the drawings without reference to the step-by-step instructions. This resulted in two broken fingernails, and a sadder but a wiser man. To avoid having to reach between the I.F. transformers to tighten the tube sockets in place, follow the instructions and mount the tube sockets first. Be sure to mount the small flange which is used to hold the tube shield in place; this shield must be mounted to the correct socket.

When installing the I.F. transformers, snap the small brass mounting clip first into the slot on one side of the transformer and then, using a screwdriver, ease the other end over the slot which is cut in the chassis; then snap the other side of the flange in place. Take special pains not to damage the lugs on the transformer, as the fine wire leads from the transformer are soldered to them. •—Byron G. Wels

This portable radio is designed to give you excellent reception of even quite distant stations.



# Photo-Electric Burglar Alarm

Here's an excellent device for protecting your home against unwelcome visitors. It's especially useful in farm areas.

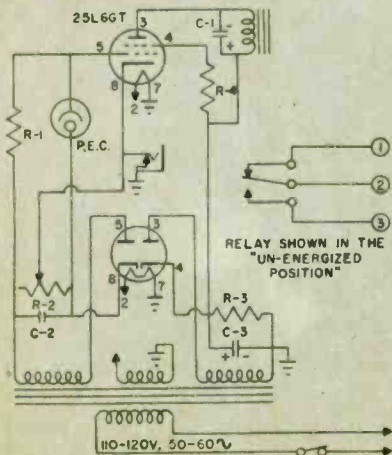
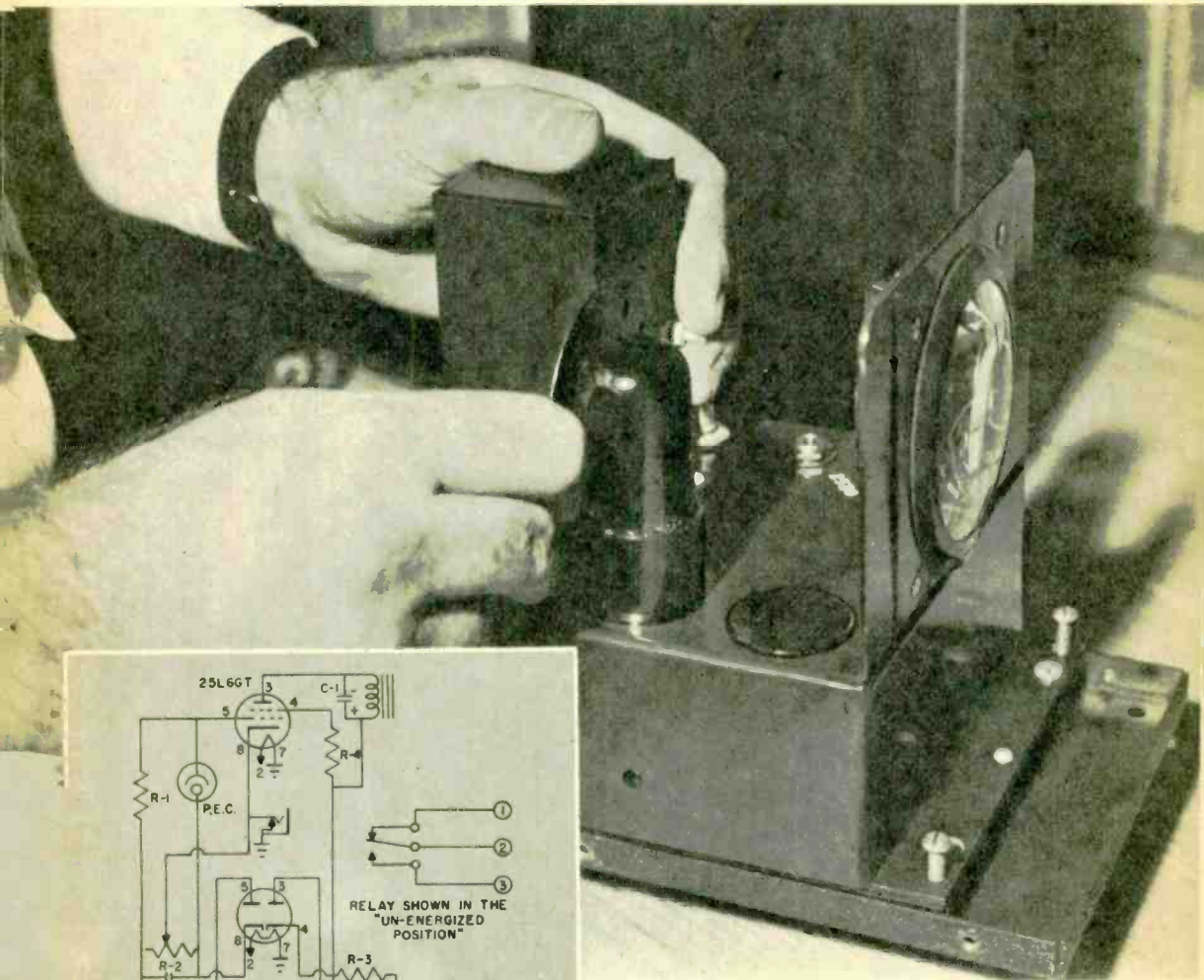

C-1 8 MFD. 150 VOLTS. R-1 51 MEG.  
 C-2 8 MFD. 475 VOLTS. R-2 50,000 OHM POT.  
 C-3 8 MFD. 475 VOLTS. R-3 22,000 OHM.  
 R-4 2,200 OHM.

The aperture on the disc in front of the photo cell can be varied to obtain desirable sensitivity of system. At left is the schematic diagram.





Terminals on the case enable you to make all the necessary electrical connections to light source.

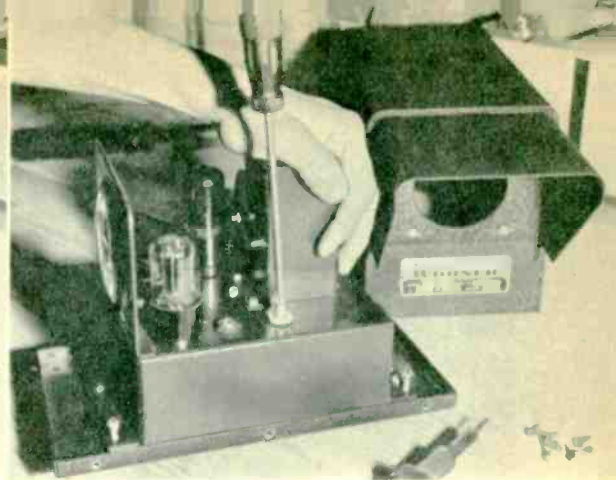

Careful adjustment of the bias control will increase usefulness of the unit. See photo above.

**O**RIGINALLY, we planned to include in this book a photo-electric system of our own design. As is common in such cases, we studied the available units on the open market, to see what design features were available. When we saw the Worner photo system, we stopped. Here was exactly what we planned to build, and many added features were included. For one thing, this unit comes in a completely weatherproof container and is fitted with pipe-mounting flanges for easier installation. A light shield is included to cut down on unwanted light and at a slight extra cost, mirrors are available which have adjusting screws for warping the mirror to a concave or convex form for focusing purposes.

There is nothing "magic" about photo-electric cells. We have devices that convert motion to sound (record player cartridges), that convert electricity to sound (loudspeakers), and electricity to light (electric lamps). Why not then, a device

that will convert light rays to electricity?

This is precisely what a photo electric cell does. When a concentrated light beam falls on the photo-sensitive surface of the cell, a small electric charge is generated which is amplified, and used to operate a relay, which in turn is used to switch the various controlled circuits on and off.

It is important, if the unit is to be operated at maximum efficiency, that the most intense light available be used. The Worner light source, designed for this purpose, is more than adequate, but you will have to lend your cooperation as well. You will have to be sure that the mirrors are not only focused to the ultimate point, but that all the components are properly aligned so that the most intense part of the light beam reaches the photo cell. The photo cell itself is designed to operate with even a minimum of light.

If you will follow the directions supplied with the unit, you should have ab-

View with rectifier tube removed shows the lens assembly. Large box is photo cell light shield.

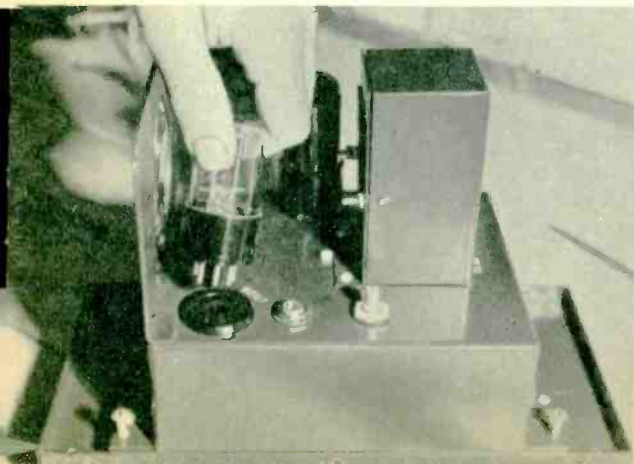

Four screws at the bottom of each unit are provided to enable you to make leveling adjustments.

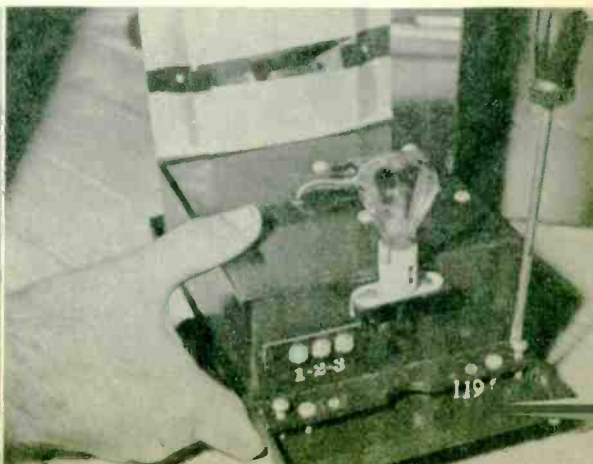

Follow instructions carefully when hooking up the unit. Below, external connections are made.

Part of kit is an alarm bell. Unit is housed in its own self-contained weatherproof container.

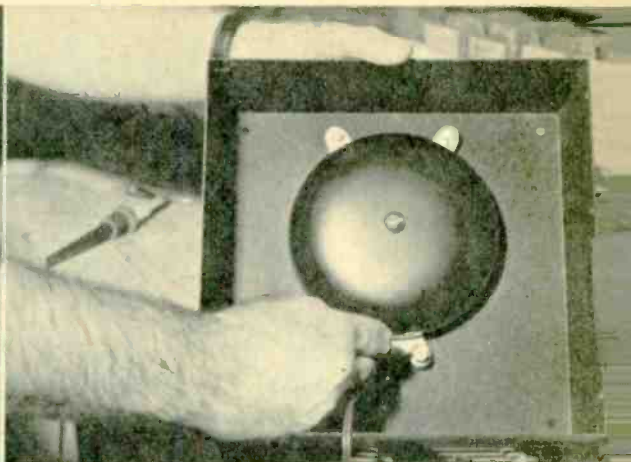
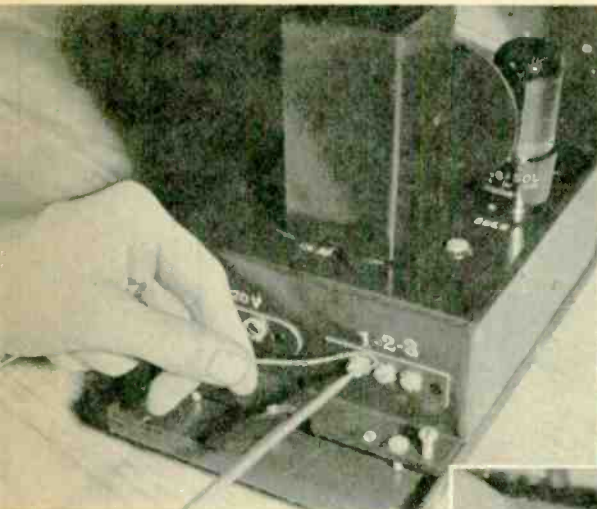

Mirrors are also supplied with the system. They can be adjusted to any angle, and can also be used in concave or convex position.

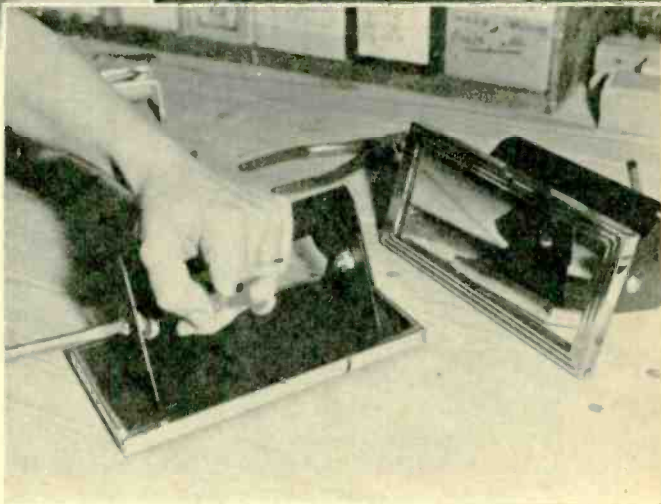

solutely no trouble. Just follow the instructions.

We formed a burglar alarm by surrounding our house with a light beam. We selected a rear corner of the house and mounted the light source box on one wall, the photo-cell on the other (see drawing). The two units point away from each other. At the three other corners we installed mirrors to reflect the light beam completely around the house from the light source to the photo cell. We then installed the control box outside the house, near the other units, and proceeded to follow the simple wiring instructions provided with the set.

We turn the system on every evening and thus far it has worked very well. Guests are surprised as they approach the

door to hear the alarm, and it shakes the neighbors up as well. We have learned to shut the unit off when we expect guests and, fortunately, we have not as yet had any unexpected company in the form of burglars; but should they come, we are ready.

Naturally, any application where a switch is used to activate an electrical device can be operated by this system. You can use it as an effective garage door opener, alarm, or signal. Other applications are truly limited only by your own imagination.

The Worner Photo-Electric System, Rankin, Illinois, is available in various ranges, extending up to 5,000 feet. The lower range units are, of course, less expensive. •—Byron G. Wels



At right is bird's-eye view of a typical house, with mirror and photo cell installation. Below, the light source positioned at one corner of the house. Dark wrinkle finish of case makes it hard to see at night.

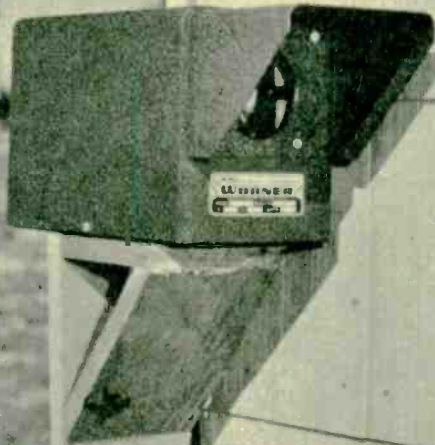
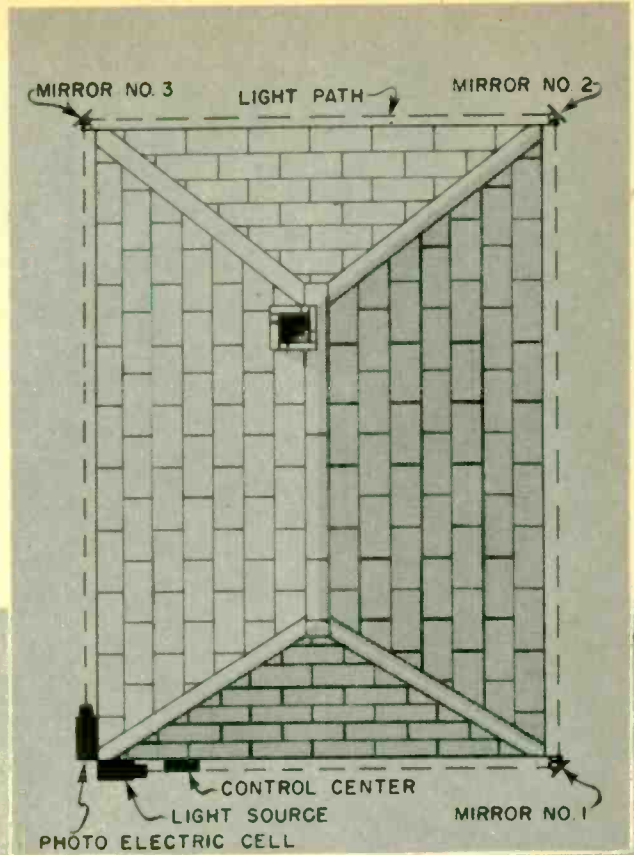

*continued . . .*

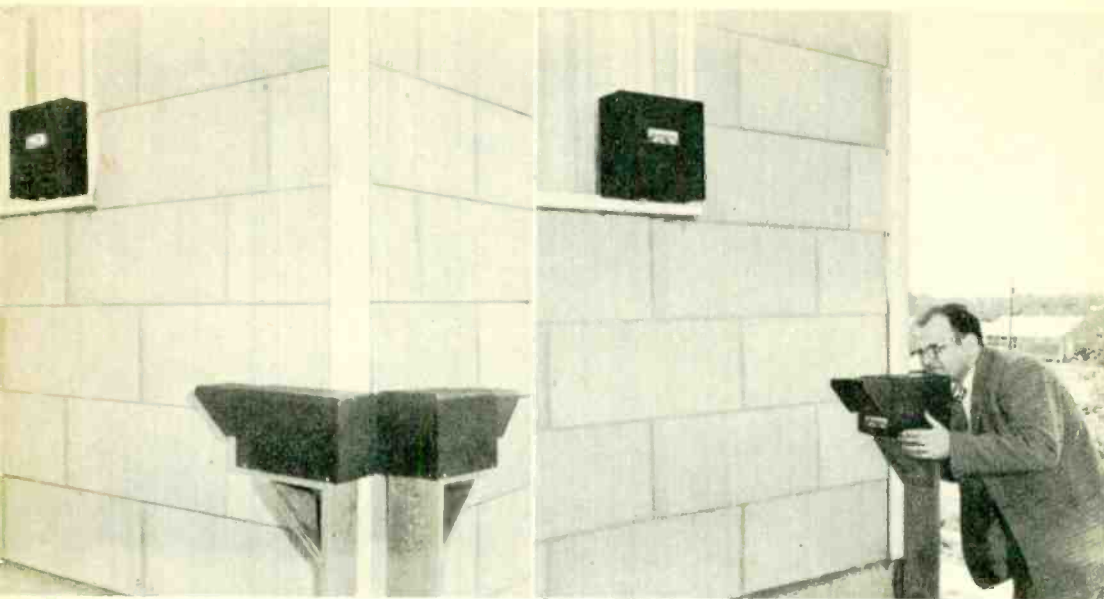

Above is part of the installation. Photo, above left, shows the light source pointing in one direction, the photo cell pointing in the opposite direction. The light beam is reflected by mirrors, photo below, around the four sides of house from the light source to the photo cell. If beam is broken, the alarm bell sounds.

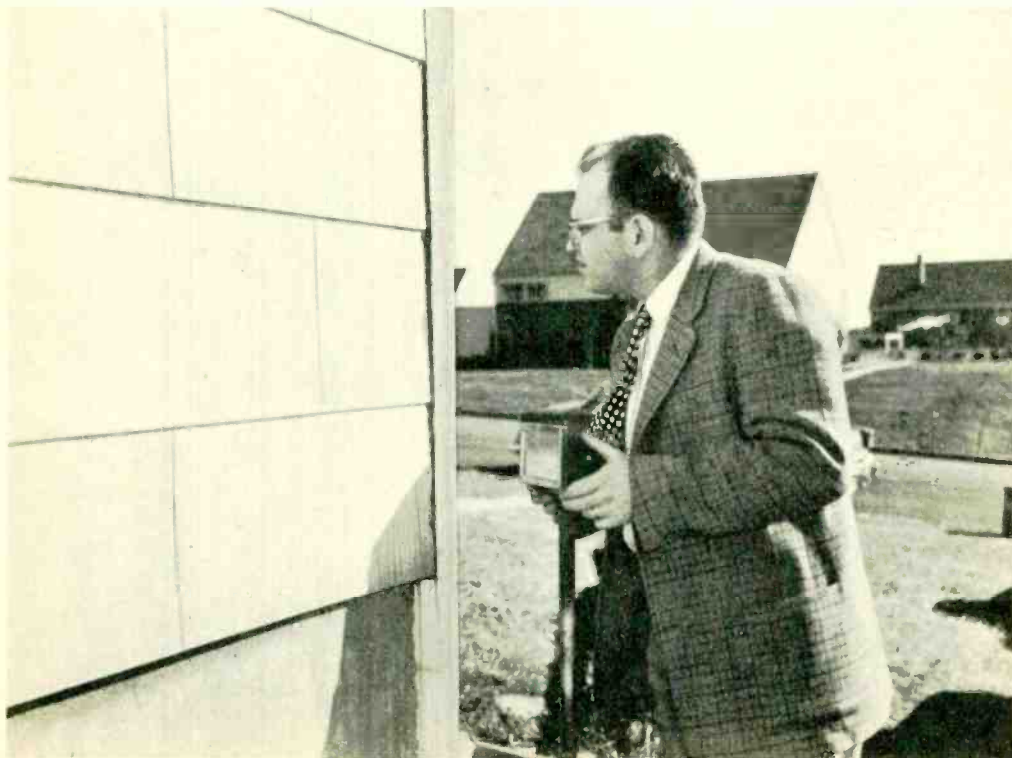



# Yours to Enjoy

## Electro-Voice®

### MODEL SP12B

#### 12" RADAX COAXIAL 2-WAY LOUDSPEAKER SYSTEM

The famous Electro-Voice SP12B RADAX coaxial speaker *economically* delivers the smoothest, widest range available in any loudspeaker in its price class. This is paralleled by its superb efficiency, which means full, distortion-free sound with *less* power from the amplifier. When these qualities are combined with the wide polar distribution afforded by the second RADAX cone element, you have fine listening pleasure—



**\$3500 NET**

(Capacity 20 watts; peak 40 watts)

### Compare these features!

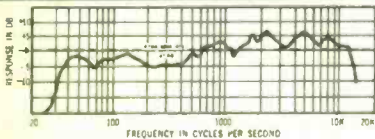

**RESPONSE CURVE**

**Usable Response Range**—25-16,000 cps.  
**Flat Response Range**— $\pm 6$  db 35-13,500 cps in recommended ARISTOCRAT folded corner horn enclosure.

**Highest Efficiency**—Lowest distortion with greatest sound energy output is the hallmark of SP12B superiority! This is the criterion of design excellence.



**POLAR CURVE**  
3 discreet frequencies

**Widest Polar Pattern**—Just see how completely the SP12B disperses the sound evenly throughout the entire listening area, and at all frequencies, too!

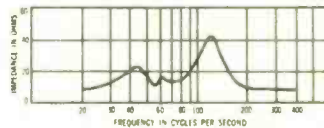

**IMPEDANCE CURVE**  
in ARISTOCRAT enclosure

**Ideal Impedance Characteristic**—Here is the impedance characteristic of the SP12B in the recommended ARISTOCRAT enclosure. Every design advantage has been exploited to attain greatest transfer efficiency from the amplifier over the widest range, *especially* at the difficult to attain, very-low frequencies.

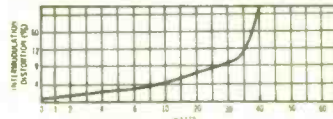

**IM Distortion vs. Power Input**

**Intermodulation Distortion**—Here is a plot of the distortion versus power input. Note the low distortion figure at usual room playing levels under 5 watts, and the sustained quality at even peak powers.

# Electro-Voice®

ELECTRO-VOICE, INC. BUCHANAN, MICHIGAN

Write Dept. 308 for the Electro-Voice Hi-Fi Fact Folder on speakers, enclosures, kits, and hi-fi microphones.

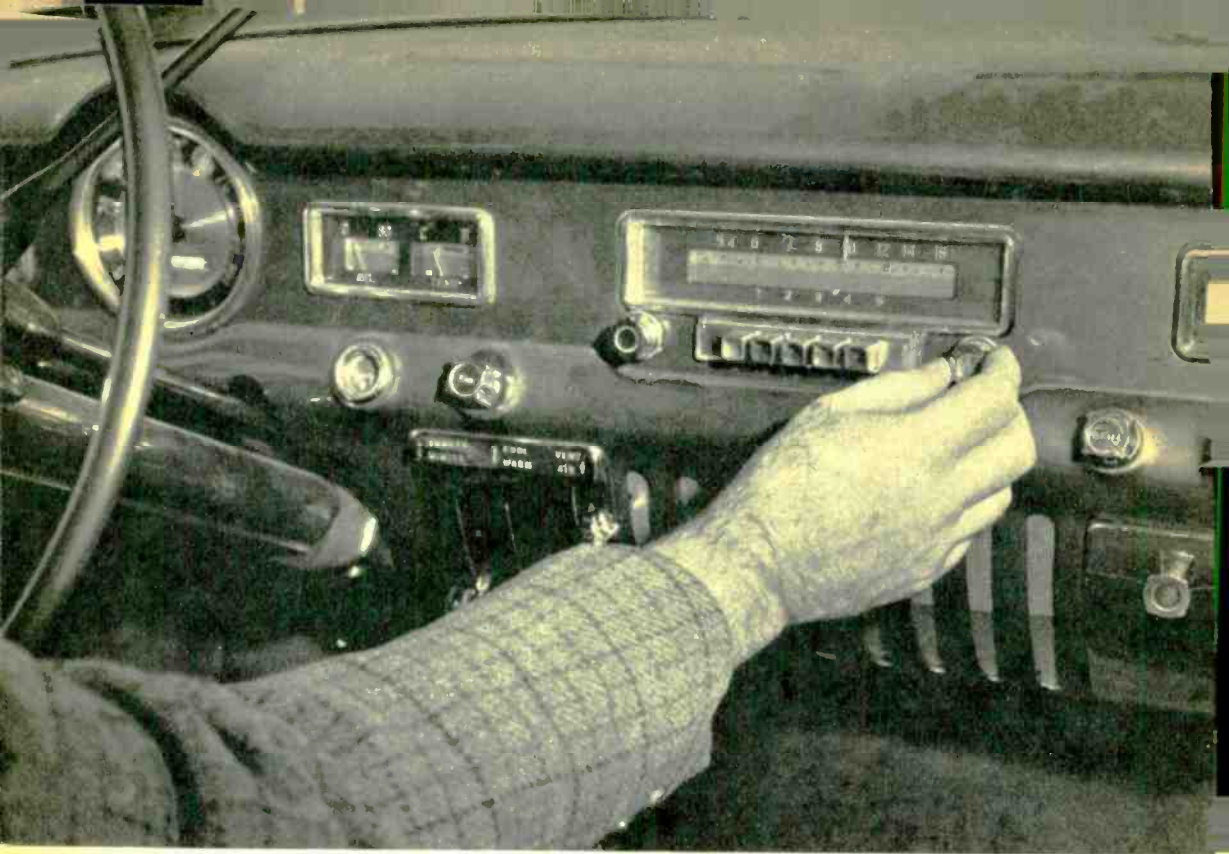

The short wave converter can be hidden out of the way, will not mar the car's appearance.

# Convert Your Radio to Short Wave

Installation of this simple gadget will enable you to pick up short wave broadcasts on your car's radio receiver.

**T**HIS compact little converter does a man-sized job! It has found widespread application among amateur radio operators who use this unit in conjunction with their car radios to receive short wave broadcasts. You may have even more use for it.

Are you a member of a volunteer fire department? Here's the way you can hear the fire calls either in your home or your car. Are you interested in press photography? You can hear police and emergency calls in your car or home. A member of the

Civil Air Patrol? This unit is for you, too!

The principle of operation is quite simple: essentially, the 6AK5 tube is inductively coupled to the antenna and acts as an RF amplifier. Its output feeds into the first grid of the 6J6, and the output of the crystal oscillator stage (the other half of the 6J6) is also applied to the first half of the 6J6. This stage acts as a mixer, combining the frequency from the R.F. amplifier and the frequency from the oscillator. The frequency of the crystal will determine the



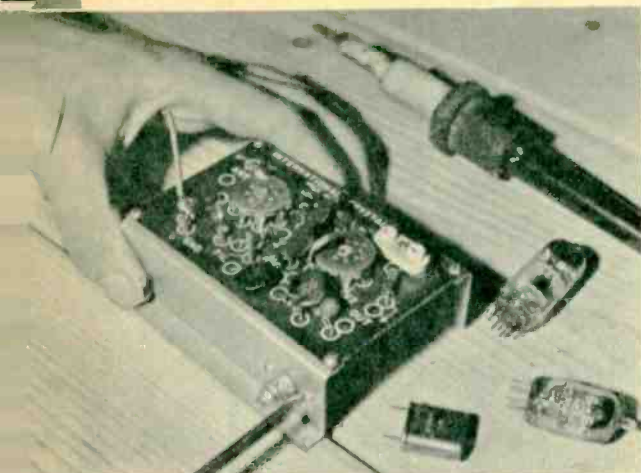

Parts are mounted to the chassis with lockwashers under nuts to prevent loosening by vibration.

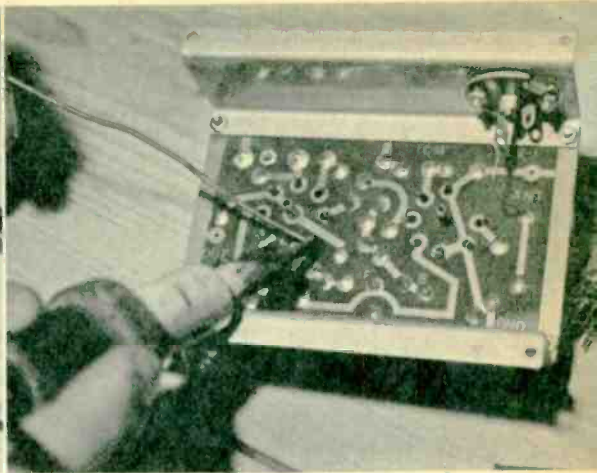

Unit has neatly printed circuit. Only a minimum of heat should be applied to avoid foil damage.

output frequency, which is applied to the antenna terminal of either a home broadcast or communications receiver, or an automobile receiver. As the unit is not tunable it can be hidden away in a glove compartment, or perhaps bolted to the car radio itself. In the home, it can often be hidden inside the cabinet of the companion radio.

A word of caution is in order here. In many communities it is against the law to have a receiver in a car that is capable of tuning fire department or police frequencies. Check in your own area before installing a unit of this sort; you may require a special permit.

Additional flexibility can be secured by wiring a simple switching circuit. Using a switch will apply or remove voltage to the converter, thereby saving the tubes when it is not actually in use; the same switch can be used to "short-circuit" the converter antenna circuit, permitting the antenna to go directly to the car receiver when the converter is unused.

The actual wiring of this unit is extremely simple. You will receive, as part of the kit, a printed circuit board. Whenever a component is to be placed, a small hole has been drilled. Simply follow the diagram and push the lead wires through the proper holes, from the top to the bottom. Solder them in place, applying the solder to the bottom. Clip the excess wire, and there you are!

The etched circuit board consists of a very thin metal strip which is bonded to a plastic base by special adhesives. Extreme

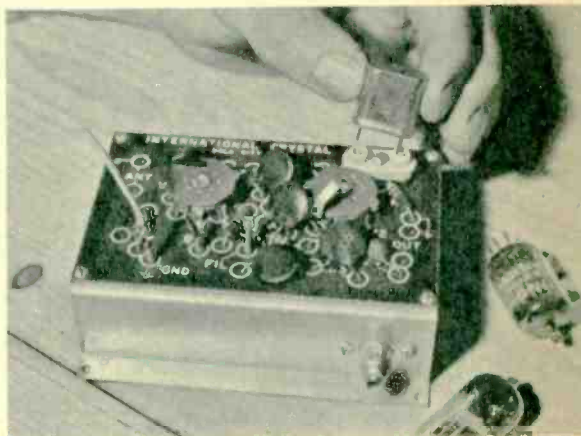

Heart of the converter is the crystal. Proper selection determines the frequency you listen to.

Note the small springs which keep the vacuum tubes firmly seated in their respective sockets.

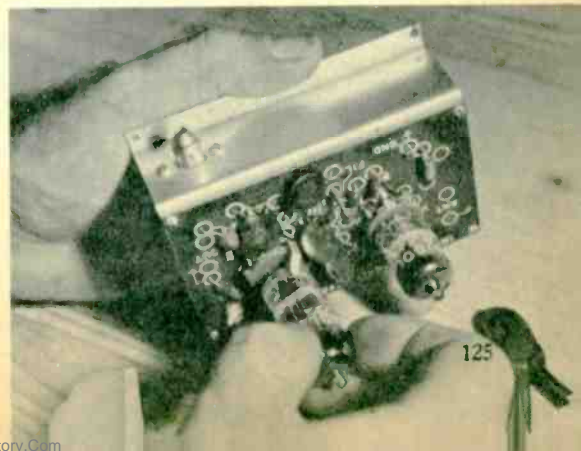

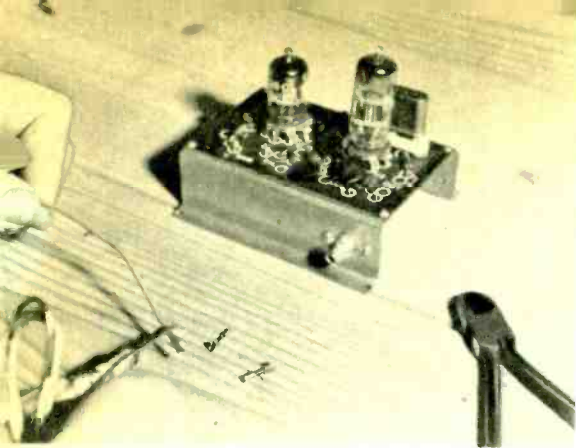

The connectors are prepared by first crimping them with small pliers; they are then soldered.

### SWITCHES

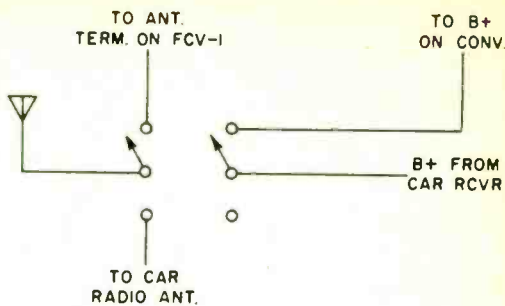

heat can break down the adhesive if the heat is applied for extended periods. This will result in the metal lifting away from the plastic base. The best way to avoid an accident is to use a small soldering iron, removing it from the joint as soon as the solder has properly flowed.

The metal strip is extremely thin and will conduct heat along its length. The plastic base is a poor conductor of heat, so that all the heat applied must be dissipated in the metal alone. You will find that the solder flows quickly and easily.

Attach the mounting brackets and then bolt the small coaxial-type phono connectors in place. Bring the bare wire leads from these to the proper point on the printed circuit board. Plug in the crystal. and install the unit wherever you choose.

You can actually improve reception by tuning the antenna to its critical length. Divide the operating frequency (in megacycles) by 300. This will give you the wavelength in meters, which can be then multiplied by 39.17 to give you the total length of your antenna in inches. If this works out to an ungainly length, remember that you can operate just as well with either a quarter or half wavelength.

Before ordering this kit—\$10.95—select a quiet place on your radio dial, and then write to International Crystals Co., 18 North Lee St., Oklahoma City, Oklahoma. Tell them what frequency you would like to listen to, and where on the radio dial you would like it to appear. They will select the proper crystal for you. •

—Byron G. Wels

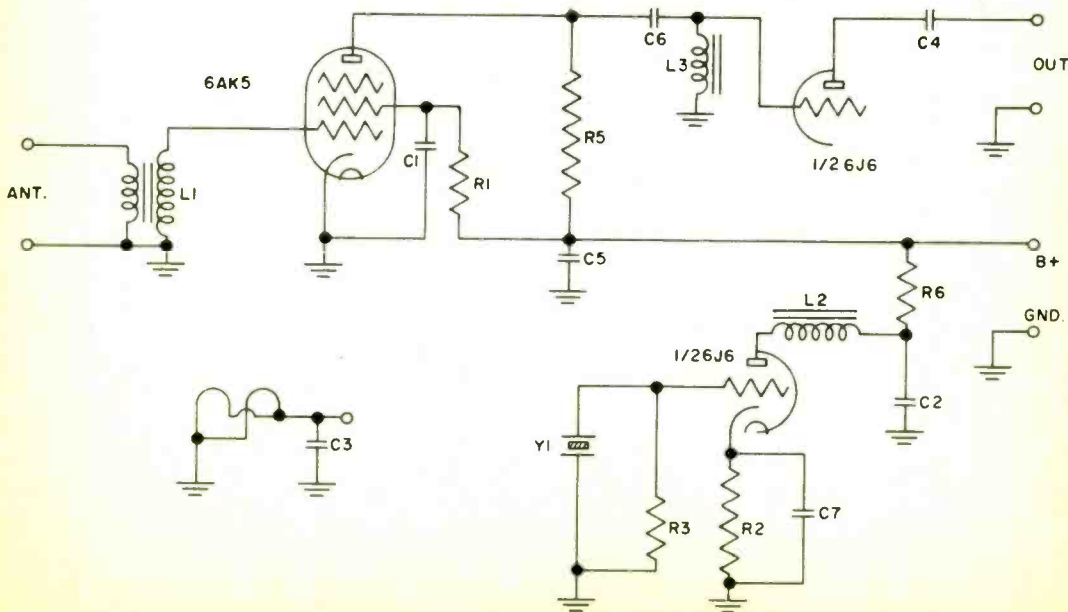



# Lafayette - ELECTRONIC PROJECT HEADQUARTERS FOR THE EXPERIMENTER AND HOBBYIST

Materials For The Following Projects Contained In This Book  
Are Available From Lafayette In Complete Kit Form

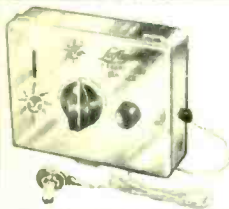

## "SUNFLEX" 2 TRANSISTOR REFLEX RADIO RECEIVER KIT

- FOR SOLAR OR FLASHLIGHT BATTERY OPERATION
- NPN-PNP CIRCUIT REFLEXED FOR 3 TRANSISTOR PERFORMANCE

An efficient miniature receiver kit for earphone operation. Works on 2 inexpensive penlight cells (3 volts) or in sunlight using solar batteries (not supplied). 1 mill current drain. Complete kit with detailed instructions. Size 4 1/4 x 3 3/4 x 1 1/8". Shpg. wt., 1 lb.

KT-132—"SUNFLEX" KIT (less earphones).....Net 11.95  
MS-260—Super Power Dynamic Earphone.....Net 3.95



## "HELIODYNE" SUBMINIATURE SOLAR SILICON BATTERY

- MOST EFFICIENT TYPE OF SUN BATTERY

Generates electrical energy from sunlight or other light source. Rated 3.2 volts at 2 milliamps. Ideal for "Sunflex" receiver. 1-1/16 x 3/32".

MS-420—"HELIODYNE" SILICON SOLAR BATTERY  
Net 6.65

## PHOTO CELL RELAY KIT



A super-sensitive Cadmium Sulphide Photo-cell Relay Control Kit for critical applications such as burglar alarm systems, door openers, and in countless industrial uses. Operates directly from 110V AC line. Single pole double throw relay contacts rated at 5 amps. A 5823 cold-cathode tube permits instantaneous operation at low illumination levels. Kit complete with all parts and detailed instructions. Size 3 x 4 x 5". Shpg. wt., 4 lbs.

KT-81—PHOTO CELL RELAY KIT  
Net 11.50



## FM-AM STEREO TUNER KIT

Highly sensitive and flexible hi-fi tuner for stereophonic or standard reception of FM and AM broadcasts. Outstanding design and circuitry assure noise-free, distortion-free, drift-free operation and also protects you against obsolescence. Size 1 3/4 x 1 1/8 x 4 1/2". Shpg. wt., 18 lbs. Supplied complete with 2 printed circuit boards for easy construction. All parts plus metal cover, step-by-step instruction manual with schematic and pictorial diagrams.

KT-500—FM-AM STEREO TUNER KIT.....Net 74.50

## LORENZ REMOTE CONTROL TRANSMITTER KIT



A highly efficient R/C transmitter designed to operate on the license-free "Citizens Band" frequency of 27.255 MC. which requires only filing of FCC form 505 (supplied with kit). Activated R/C receiver for remote control of planes, boats, cars, etc. Tops for value and dependable performance. Shpg. wt., 4 lbs.

KT-87—COMPLETE KIT. Less Batteries  
Net 14.95  
1-RCA VS069—Battery.....Net .53  
2-RCA VS016—Batteries 2.45 ea.....Net 4.90

## TRANSISTORIZED R/C RECEIVER KIT

- WEIGHS 1 OZ.
- 100% SUBMINIATURIZED!

The mighty mite of the R/C field. Designed for compactness and sturdiness to withstand severe vibration and shock. Operates on 27.255 MC "Citizens Band". A perfect mate for Lafayette Model KT-87 R/C transmitter. Uses one 1.5V and one 45V battery, with size depending upon size of model. Super-sensitive and efficient. 2-1/16 x 1 1/4 x 1-11/16".

KT-84—COMPLETE R/C RECEIVER KIT  
Net 11.75



## 4 TRANSISTOR TELEPHONE PICKUP AMPLIFIER KIT



- FOR GROUP LISTENING OF PHONE CONVERSATIONS

Extra-sensitive 4 transistor telephone pickup amplifier with "Class B" push-pull output for efficient speaker operation. Merely requires pickup coil under or near phone. Also may be used as high gain amplifier for phono and mike.

Easy-to-follow Instructions. Size 4 1/2 x 4 1/4 x 4 1/4". Shpg. wt., 3 lbs.  
KT-131—Complete Kit Less Battery & Pickup Coil.....Net 17.95  
BATTERY RCA VS305 (9V).....Net 1.30  
MS-16—Telephone Pickup Coil.....Net 2.95

## TRANSISTOR SPEAKER OPERATED CODE PRACTICE OSCILLATOR KIT



- FOR GROUP CODE PRACTICE
- VARIABLE PITCH CONTROL

Ideal code practice oscillator for group and class-room code practice with speaker operation. Well designed transistor audio circuit with variable signal tone control. Compact and attractive. Housed in 3-1/16 x 2 1/4 x 1 1/4" sound box designed for superior speaker performance. Complete kit with simple detailed instructions. Shpg. wt., 1 lb.

KT-118—COMPLETE KIT—Less Key Net 7.95  
MS-510—KEY for KT-118. Shpg. wt., 1/2 lb.....Net 1.25

## 4 TRANSISTOR INTERCOM KIT



- EFFICIENT 2-STATION INTERCOM
- SAFE BABY SITTER—NO SHOCK

All-purpose 4 transistor Intercom and Baby Sitter. Master has volume control and switch. Instantaneous operation with insignificant battery drain. No hum, no shock, no fire hazard. Two station unit complete with 50 ft. of cable. Shpg. wt., 3 lbs.

KT-113—COMPLETE INTERCOM KIT Net 19.95



## AUDIO CONTROL CENTER HI-FI PREAMP KIT

- EXTRA CHANNEL FOR CONTROL OF STEREO TUNER

Highly flexible preamp which cannot become obsolete. Features DC on all filaments, 2 cathode follower outputs, 24 positions of equalization, tape head input and printed circuit construction. Complete with all parts and detailed instructions. Size 12 1/2 x 9 1/4 x 3 1/4". Shpg. wt., 10 1/2 lbs.

MODEL KT-300—KIT.....Net 39.50

## 6 TRANSISTOR SUPERHET RECEIVER KIT

- SENSITIVE, SELECTIVE, POWERFUL
- 100% SUBMINIATURIZED



This transistor set provides superior commercial quality. Circuitry features 6 transistors and diode, matched loop, oscillator coil and IP's and transformer coupled push-pull audio. Speaker and earphone jack for private listening. Complete kit includes detailed instructions. Size 4 1/2 x 3 1/4 x 1 1/8". Shpg. wt., 3 lbs.

KT-110—Complete Kit—Less Battery and Case.....Net 29.95

BATTERY RCA VS300.....Net 1.23  
Burgess P6.....Net .77  
MS-330—Brown leather case with carrying strap.....Net 2.95  
MS-366—Sensitive Matching earphone.....Net 1.29

## 3 TRANSISTOR SUPERHET POCKET RADIO KIT

- A TRUE POCKET SUPERHET RECEIVER—NO EXTERNAL ANTENNA
- NO EXTERNAL GROUND



A truly sensitive, super-selective pocket superhet receiver. Features matched components, built-in ferrite antenna, compact circuitry and commercial appearance. Complete kit with detailed instructions. 4 1/2 x 2 1/4 x 1-1/16". Shpg. wt., 1 lb.

KT-116—Complete Kit, less earphone  
Net 16.95

MS-260—Super Power Dynamic Earphone.....Net 3.95  
or MS-368—Sensitive Economy Dynamic Earphone.....Net 1.44

## "GENIAC" THE ELECTRIC BRAIN KIT

• COMPUTES, "REASONS" COMPOSES MUSIC  
Build 33 brain machines to test intelligence, play games, solve puzzles, compute and reason. No soldering required. Includes 200 page book and 64 page instruction manual. 16 1/4 x 11 1/4". Shpg. wt., 5 lbs.

KT-78—GENIAC KIT.....Net 17.95

100 SIXTH AVE. NEW YORK, N.Y.  
PLAINTFIELD, N. J., 139 W. Second St. BOSTON 10, MASS., 110 Federal St.  
BRONX 50, N. Y., 542 E. Fordham Rd. NEWARK 7, N. J., 14 Central Ave.  
Include postage with order.

Lafayette Radio  
Dept. P 30

165-08 Liberty Ave.  
JAMAICA 33, N. Y.



Photos at right show the alarm in various stages of construction. Solder electrical connections to avoid weather damage. Float arm is threaded into the toggle bracket and held in place with a lock nut. After all wiring connections are made replace cover and install unit next to wading pool.

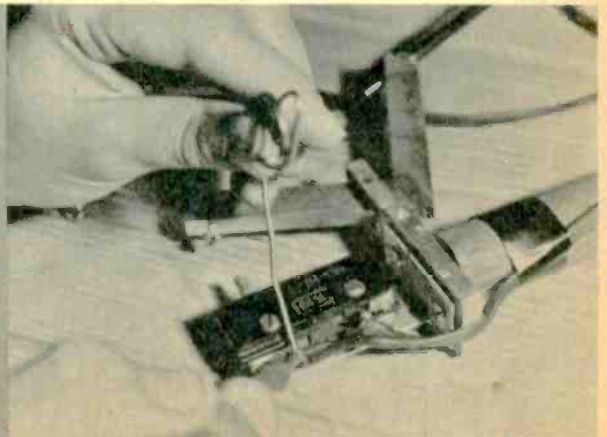



# Wading Pool Alarm

Inexpensive and simple to construct, this warning device is a real lifesaver for the busy housewife.

A WADING pool for the kiddies is really wonderful on a hot summer day. However, it isn't always the panacea it pretends to be, as many a housewife is driven to distraction with running out to the back yard to see if the children are all right.

Our alarm device is not completely foolproof. It is not an "Electric Lifeguard" by any means. If you give the children permission to use the pool, we will assume that you will also watch them; if you forbid them to use the pool, this alarm will serve to tell you if your orders are violated. and should a child get into the water deliberately or accidentally, a bell will sound in the house. The rest is, of course, up to you.

The unit is an open circuit system which is not actuated until the water level rises appreciably. This means less wear and tear on the electrical system. The electrical source is a six-volt dry battery; this eliminates any danger from electrical shock. Because of the electrical open circuit, the battery should last a long time. Batteries do fail, however, so a test switch is built in to determine if the battery is still good. Parts are readily available, and unit costs far less than it will be worth.

The method of operation is simplicity itself. A stake is driven into the ground, alongside the pool. Suspended from the stake is an ordinary toilet bowl float with its threaded rod. An actuating paddle is made out of sheet aluminum and mounted to the other end of the rod.

Next, a microswitch is fitted with a small cable-clamp and wing nut. This is slipped over the stake and placed so that the switch will be actuated by the paddle when the ball float rises. This completes the outside circuit.

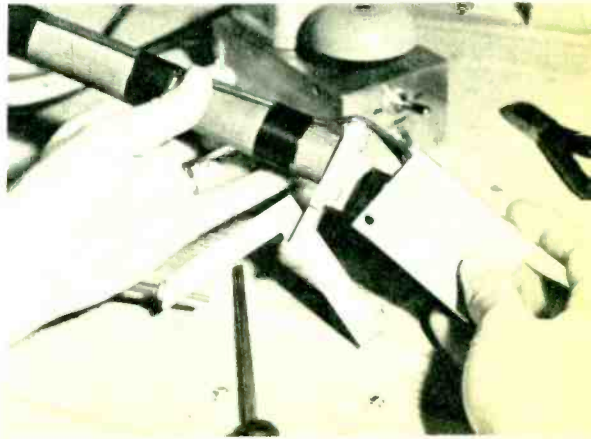
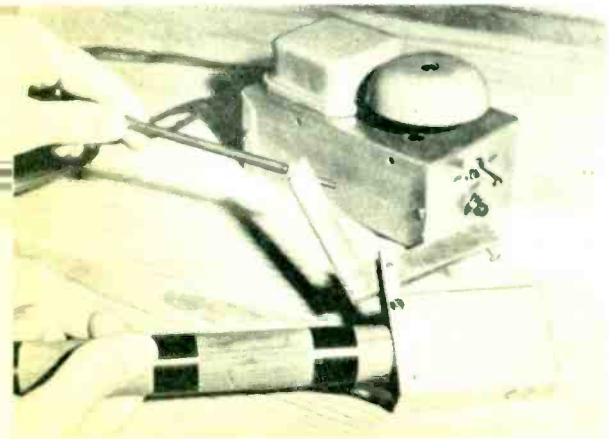



The bell of the wading pool alarm can be tested by installing a simple press-to-test switch unit.



Cut-off switch on alarm bell enables you to have pool in use without bell ringing. See schematic.

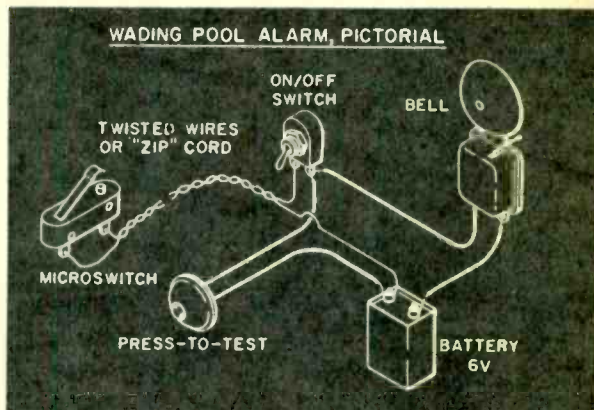
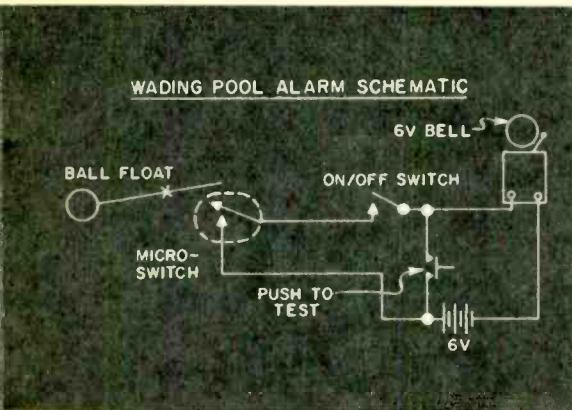

Installation of alarm. Adjust float arm so that slight water rise will not ring bell.







Attach the bell on a wall in your kitchen near window. This makes checking easy when bell rings.

A pair of twisted wires are brought from the switch into the house. Here we have a six-volt battery and a bell. The two wires from the outside switch are connected, one to the battery and one to the bell; polarity of the battery is not important. The open connections on both bell and battery are wired together. Now add a simple push type switch as used on your front doorbell. Connect this switch to the contacts of the outside switch wires.

To set the unit up, fill the pool to its normal level. Now ask your child to sit in the pool. Adjust the float ball so that it will rise when the child is in the pool. Loosen the wing nut holding the switch and raise or lower the switch so that it closes with the child in the water, and opens when he gets out. Tighten the wing nut, and the installation is complete.

To put the unit into use, you will observe that when the child gets into the water, the bell rings. If you desire to test the battery, press the test button and the bell should ring again. If it does not, this will indicate a bad battery.

You can add a disabling switch very easily, so the circuit is put out of commission when the children have your permission to enter the pool. This is done by adding a small switch in series with one of the wires coming from the pool. With the switch closed, the unit will work. With the switch open, the unit is disabled.

You needn't be afraid to leave this switch on at all times when children are not to be near the pool, as no battery current is used except when the bell sounds. •—Byron G. Wells

## build these amazing ALLIED knight-kits

**IT'S EASY  
IT'S FUN—  
and you save!**

You'll marvel at how easy it is to build KNIGHT-KITS. You always know what you're doing with "Step and Check" instructions and wall-size diagrams. You'll be thrilled by KNIGHT-KIT performance—you'll be proud of your work—and you'll save money!

### 2-Transistor Pocket Radio Kit

It's fun to build this pocket-size radio—enjoy loud, clear local broadcast-band reception wherever you go! Completely self-contained with built-in ferrite loop antenna—no external antenna or ground needed. Printed circuit board for easiest assembly. Efficient reflex-type circuit operates for months and months on long-life alkaline battery supplied. Miniature earpiece provides remarkably fine tone. With all parts, including plastic-impregnated case, earpiece, battery and transistors. 1½ lbs.

**\$14.65**

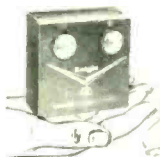

### 5-Transistor Superhet Portable Radio Kit

Handsome, easy-to-build personal portable with every ultra-modern feature: 5 transistors (up to 200 hours playing time from 9v. battery supplied); printed circuit for easy building; big 3½" speaker; push-pull audio output, built-in ferrite loopstick antenna. Sensitive reception of AM broadcast with exceptional tone. In ultra-smart high-impact ivory plastic case with gold trim; only 7½ x 3½ x 1½". All parts, case, transistors, battery and instructions. 2 lbs.

**\$29.95**

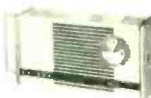

### 83 Y 766. Portable Radio Kit

**Famous 2-band "Space-Spanner"**  
Thrilling bandswitching receiver. Selects exciting short wave, 6 to 18 mc (foreign, amateur, aircraft, police, marine); and full standard broadcast. Sensitive regenerative circuit; 4" PM speaker; beam-power output. Easy to build. All parts supplied including smart-looking gray pyroxylin-covered case. For AC or DC. 6 lbs.

**\$17.95**



### 2-Way Intercom Kit

It's easy and inexpensive to build your own 2-station intercom! Use it in home or office. Makes ideal "baby sitter." Extra high gain—delivers full output from only a whisper. Complete with 50 ft. cable, master and substation in antique-white cases, tubes and all parts. For AC-DC. 7 lbs.

**\$14.75**



**FREE**

## 1958 ALLIED CATALOG

Send for our 404-page Catalog showing the complete line of KNIGHT-KIT Hobby, Hi-Fi, Amateur and Test Instrument Kits. See everything in Electronics: Hi-Fi, recorders, Amateur gear, test instruments, parts, tubes and tools. **FREE**—send for it!



World's Largest Electronic Supply House

## ALLIED RADIO Our 37th Year

ALLIED RADIO CORP., Dept. 101-8  
100 N. Western Ave., Chicago 80, Ill.

Send **FREE** 404-Page ALLIED Catalog

Send the following KNIGHT-KITS:

- 83 Y 262.       83 Y 249.      \$ \_\_\_\_\_ encl.  
 83 Y 766.       83 Y 295.

(All prices Net F.O.B. Chicago)

Name \_\_\_\_\_

Address \_\_\_\_\_

City \_\_\_\_\_ Zone \_\_\_\_\_ State \_\_\_\_\_

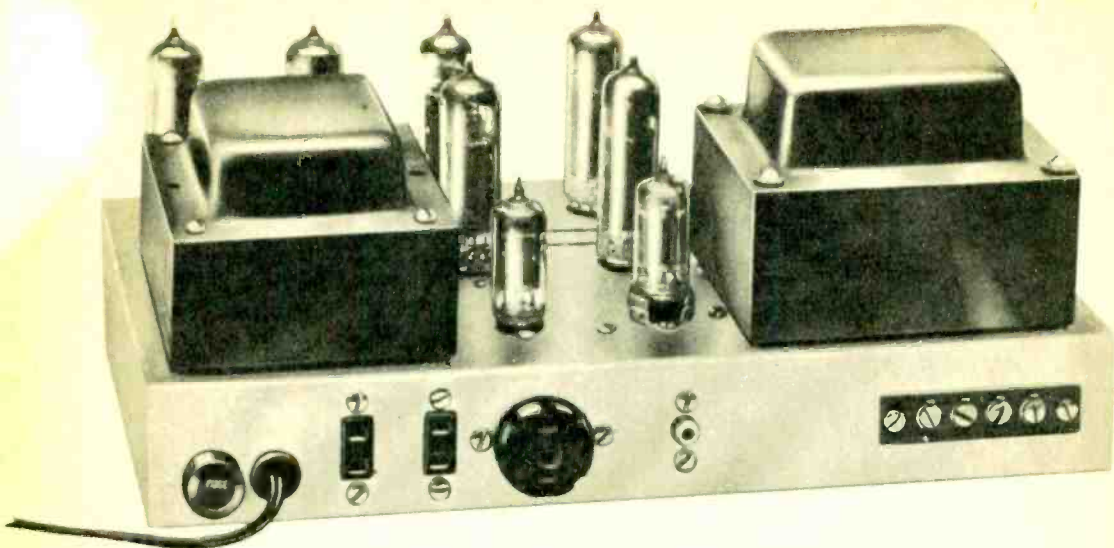

## 30-Watt Basic Amplifier

Designed for the audiophile, this amplifier has very low hum level, excellent response characteristics.

**H**ERE is the moderately powered high-fidelity amplifier which works in conjunction with a preamplifier. This unit can be tucked away behind a bookcase, in a closet or in a console. As all the operating controls will be on the preamplifier there is no need to make adjustments on the amplifier, which can be out of sight.

Perhaps one of the most important tests for an audio amplifier is the hum level. We connected this amplifier to a good speaker system and turned the preamplifier gain wide open. We couldn't hear any hum at all.

Not satisfied with this aural test, the output was observed on an oscilloscope, and at full amplifier output, the hum level was barely visible. Not enough to measure.

We talked about hiding this unit. There really is no need to do this as the amplifier looks rather well. What's more, the power take-off plug on the rear of the unit will supply power to the matching Eico preamplifier.

That this unit is designed to operate with a preamplifier is obvious at first glance. There are no operating controls on the set and no input terminals, other than those which interconnect the HF-30 with its associated preamplifier-control unit.

All the tubes in this unit, except for the 6AV6, are British imports, and you will recall that it was the British who pioneered in high fidelity work with such circuits as the Williamson.

The HF-30 uses four EL84 output tubes in a push-pull parallel circuit, and an output transformer with extensively interleaved windings and grain-oriented steel laminations. One of the finer features of this unit is the fact that the chassis layout leaves everything accessible to the user. Tubes are easy to reach and even a panel-mounted fuse is employed to eliminate the necessity for tipping the chassis end-up to change the fuse.

On the rear of the chassis are two convenience outlets, one of which is "live" just as long as the unit is plugged in. The



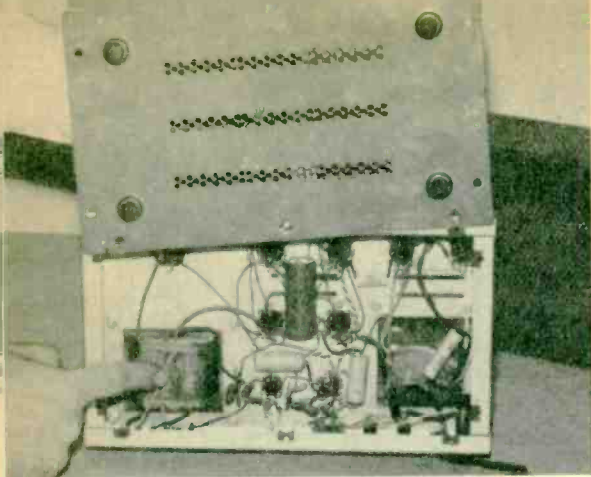

The extremely large output transformer, visible on bottom of unit, causes no overload distortion.

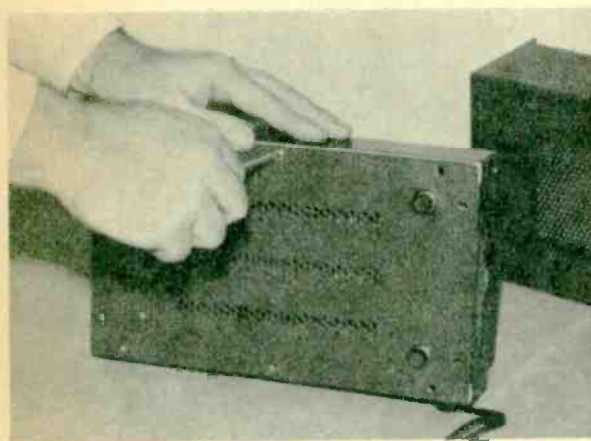

Bottom plate of amplifier is held with screws, fastening to speed nuts. Note ventilation holes.

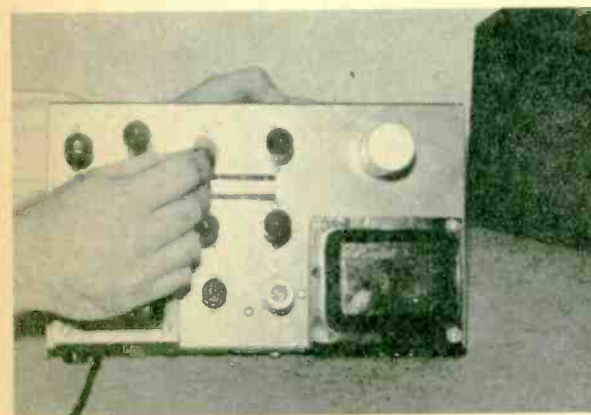

Top view shows neat layout. This efficient unit works in conjunction with control preamplifier.

## Interesting, Pictorial **FREE BOOKLET**

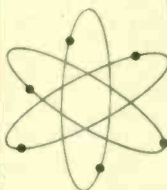
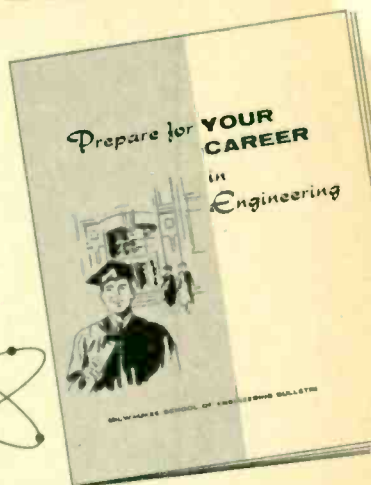

to help you decide on  
your career in

## **ELECTRONICS RADIO-TV COMPUTERS**

Here is a graphic story about preparing for your career as an engineer or engineering technician in electronics, radio, television, computers, etc. Booklet tells about:

- Wide variety of job opportunities
- Courses offered, degrees you can earn
- Pictures of the Milwaukee School of Engineering and its facilities
- Recreation and fraternities
- Scholarships; part-time work

—plus other interesting and informative facts to help you make a sound decision on your career.

MS-90

**Milwaukee School of Engineering**  
— dedicated to serving young men and industry

**SEND COUPON TODAY!**

**Milwaukee School of Engineering**  
Dept. EP-258, 1025 N. Milwaukee St., Milwaukee, Wis.

Please send me free new booklet  
"Prepare for Your Career in Engineering"

I'm interested in \_\_\_\_\_  
(name of course)

Name \_\_\_\_\_ Age \_\_\_\_\_

Address \_\_\_\_\_

City \_\_\_\_\_ Zone \_\_\_\_\_ State \_\_\_\_\_

I am  I am not eligible for veterans educational benefits. (discharge date) \_\_\_\_\_

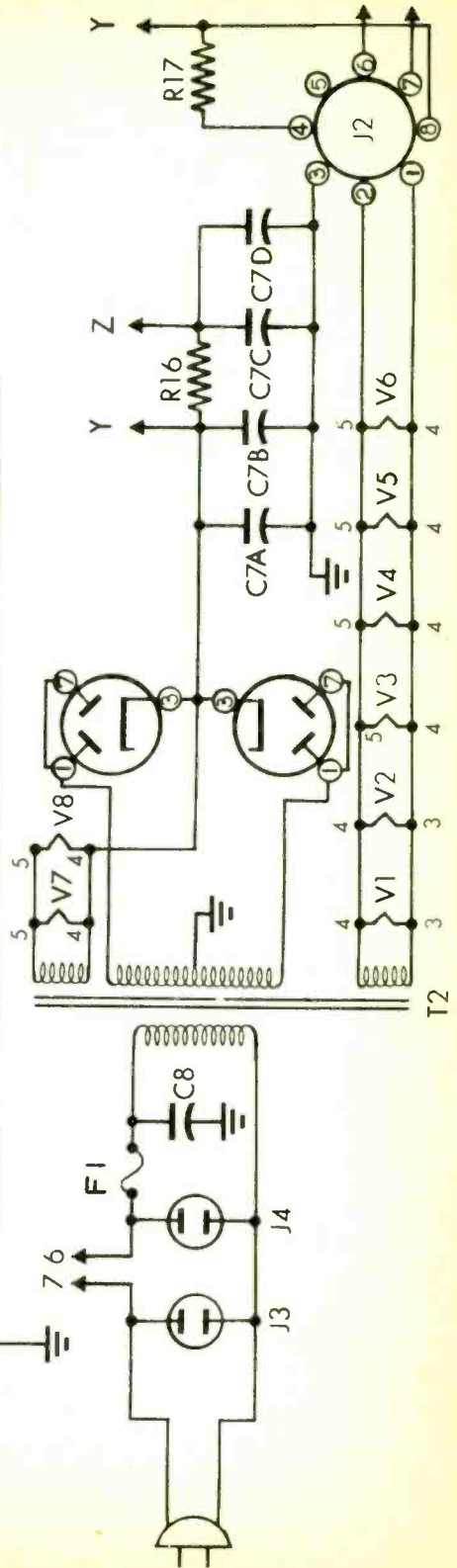
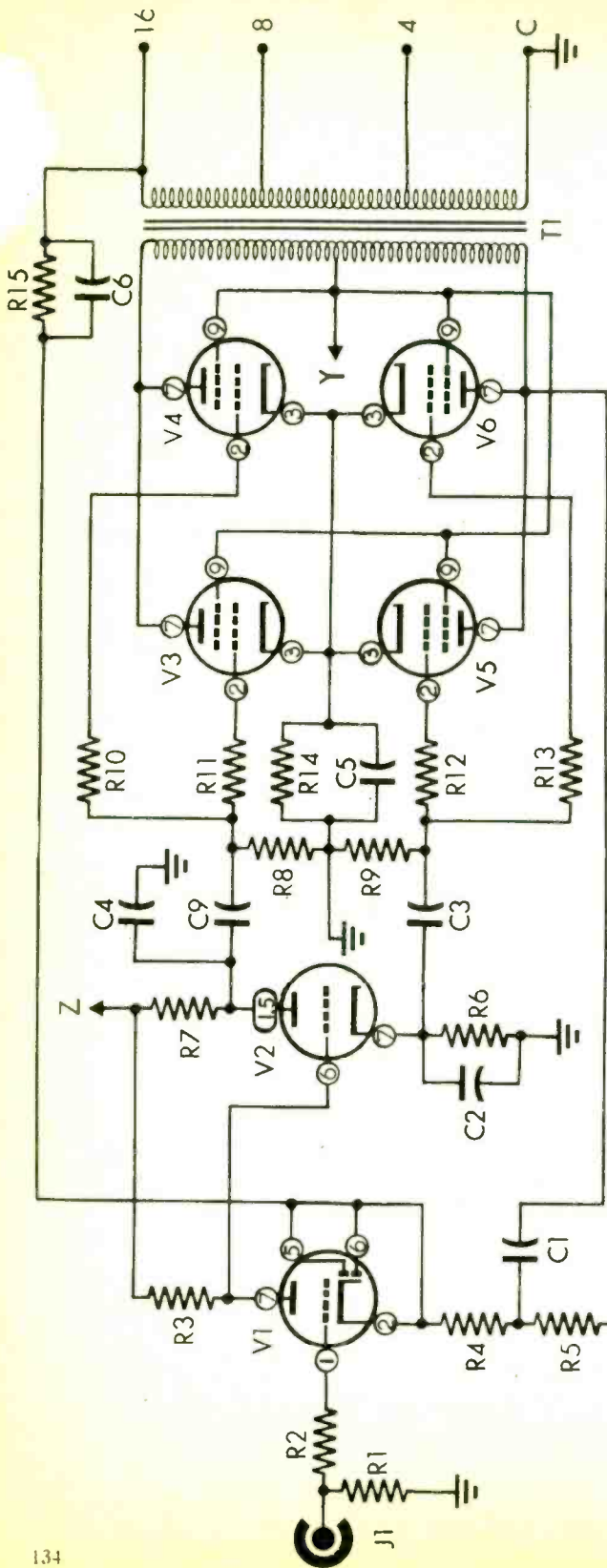





After wiring, place tubes in their sockets. All the tubes, except the 6AV6, are British imports.

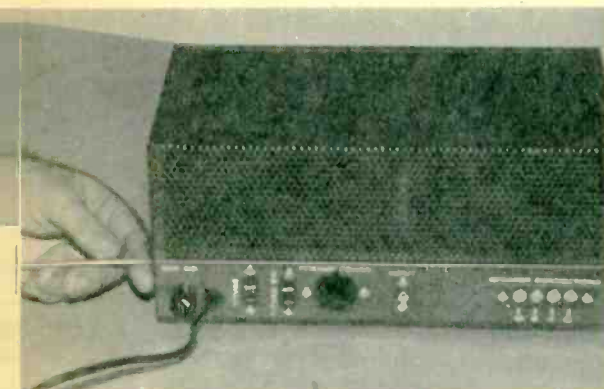

Rear view shows speaker terminals and power outlets. Perforated cover gives good ventilation.

other is "live" only when the ON-OFF switch on the preamplifier is in the ON position. This permits you to operate other equipment such as tuners, tapes, record players, etc., and have them wired directly into the amplifier circuit.

An eight-prong socket is provided on the rear of the chassis, which permits connection of a preamplifier control unit.

This amplifier has been designed to maintain its excellent characteristics under speaker load (including electrostatic types) as well as the resistive load normally used for testing. Phase corrections have been provided at both extremes of the audio spectrum to insure stability under all conditions and to insure that variations in components and construction will not affect the performance.

Stability is maintained on all speaker taps with loads ranging from zero to infinity. The overload characteristics are excellent and the HF-30 will remain stable under all conditions. It is sold either wired for \$62.95, or in kit form for \$39.95. •

—Byron G. Wels

## HERE'S THE CATALOG

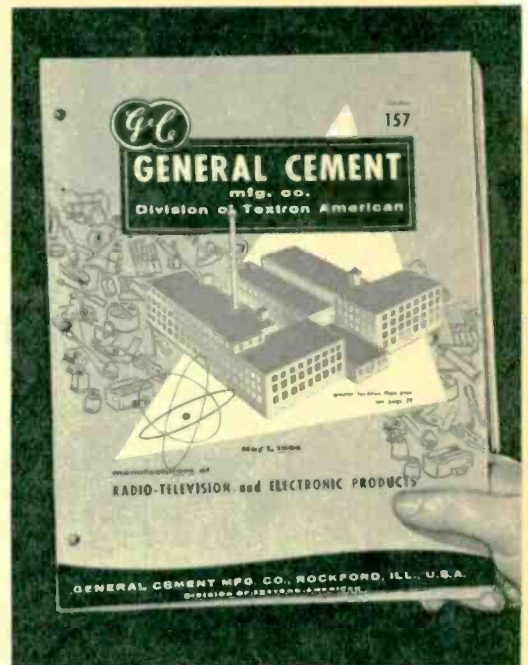

## that has 1000's of Electronic Tools and Components You Need!

**The Big Illustrated 80-Page G-C Radio-Television-Electronic Products Catalog . . . Containing**

Jacks • Plugs • Switches • Knobs • Resistors  
Alignment Tools • Cements & Thinners  
Cleaners & Solvents • Lubricants & Coatings  
Paints & Varnishes • Belts & Cables • Grille  
Cloth & Screen • Hardware . . . All kinds  
. . . many others

**SEND POSTCARD TODAY** for your free G-C Catalog . . . look for the G-C Displays at Radio-TV-Electronic Distributors and Dealers Everywhere!

## General Cement Mfg. Co.

Division of Textron Inc.

400 South Wyman Street • Rockford, Illinois

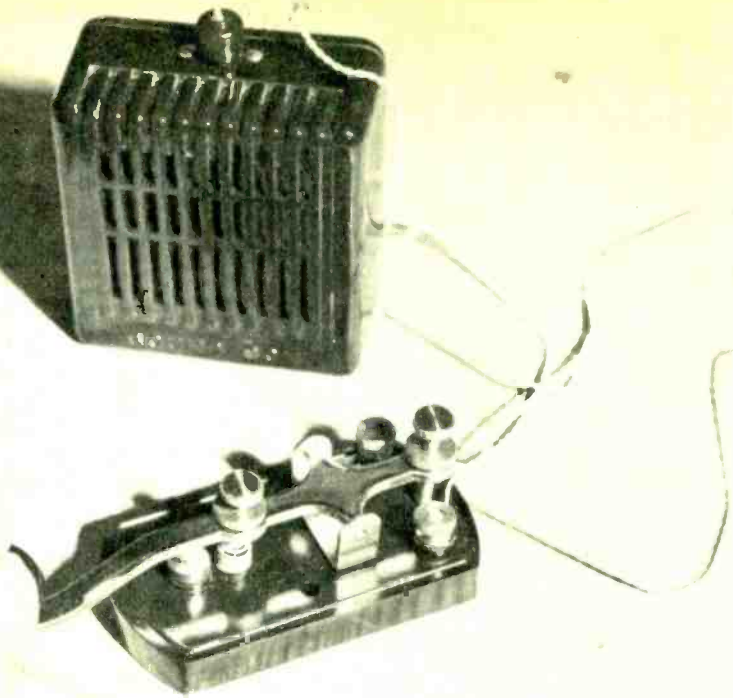

# Code Practice Speaker

**T**HIS miniature code practice oscillator actually operates a small loudspeaker with surprising volume. If you find yourself in the position of wanting to experiment (successfully) with the new transistors and at the same time have a practical, useful code practice instrument, this is the kit for you.

There are very few components involved which accounts for the small size of the completed unit. All parts are supplied, including a plastic cabinet which houses everything except the key. As all components are mounted to a pre-punched chassis, this becomes merely an interesting evening's work.

There is, of course, a great temptation to lunge ahead and by looking at the pictorial diagrams, begin to bolt parts in place. Nothing could be more unproductive. You will soon find it necessary to refer to the instructions (which is what you should have done in the first place) and will find that everything must be unbolted. This very carefully planned project requires that nuts be used as additional spacers in some cases, and access to various controls is difficult unless certain components are wired prior to final assembly.

In addition, there is included with the kit, an addenda sheet. Again we say, read

first and then work. This will save lots of grief.

You can follow the schematic diagram which is not the least bit tricky. Remember that to avoid damaging the transistors it is wise to first clip the transistor leads so that they are only one-quarter inch long. While this will necessitate the use of a transistor socket, it guarantees that the transistor itself will not be damaged by excessive heat from the soldering iron.

When soldering to the transistor socket, the wiring between the base and emitter terminals is very close and liable to short circuit. If you will observe the socket from the bottom you will see that these pins are not centered in the plastic but are set one on each side. A little pressure, judiciously applied, will spread these pins even further apart making the connection a safer, surer one. Under no conditions should you attempt to make a bulky, wrapped joint; rather tin the contacts first, make a hook in your wire lead, and apply solder sparingly. Trim excess wire with wire cutters. Be sure that the transistor is *not* in its socket during soldering operations.

This kit (KT-118) is available from Lafayette Radio, 165-08 Liberty Avenue, Jamaica 33, N. Y. The price, less key, is \$8.95. •—Byron G. Wels



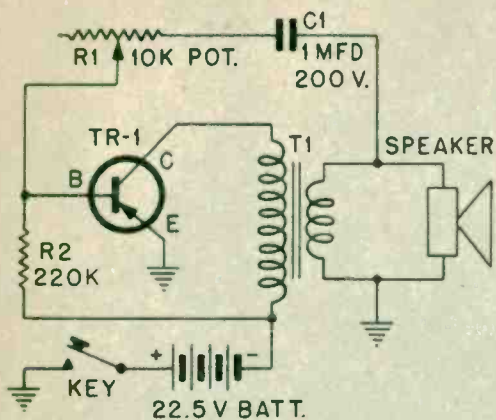

Finger points to small transistor that does all the work. Note the neat design of this kit unit.



Insert the plug into the code oscillator and you are ready to operate merely by depressing key.

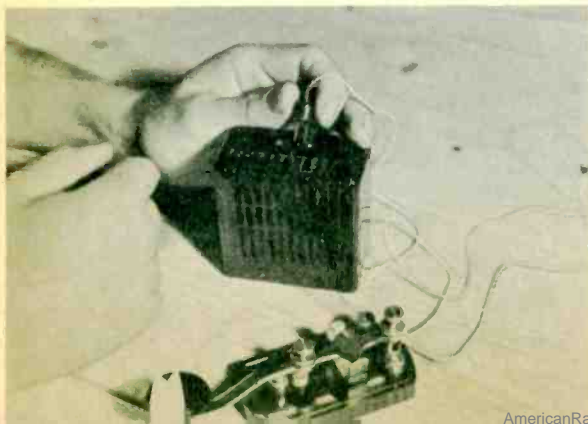

# Dr. Grabow

## PRE-SMOKED PIPES

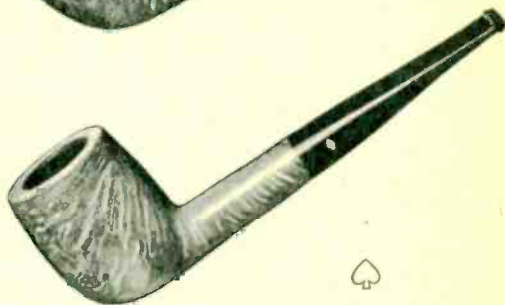

trademark of quality

Cool, sweet and mild from the first puff. No breaking-in because they're mechanically pre-smoked. All are hand-crafted of imported briar.

\$1.50 to \$10.00

DR. GRABOW PRE-SMOKED PIPES  
GREENSBORO, N. C.

Write to Department SP for  
free illustrated booklet

# Your Radio is an Intercom

Do you want a ready-made intercom? Here is all you need to build yourself a perfect unit.

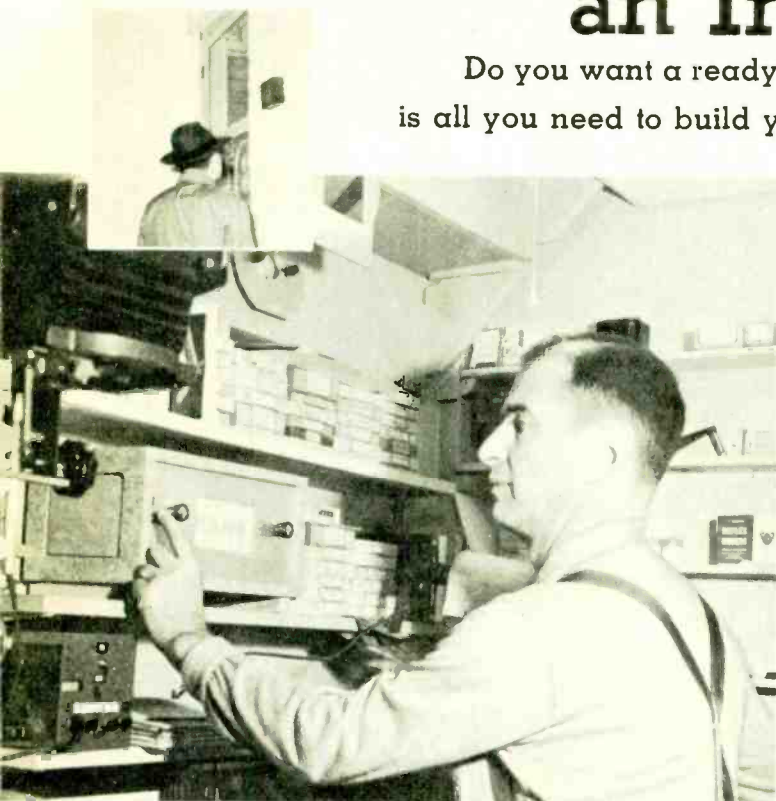

Music while you work and instant communication with the front door or any other part of the house. Author presses switch, above, to talk into intercom. Inset, top left, shows the loudspeaker mounted at the front door in a metal case.

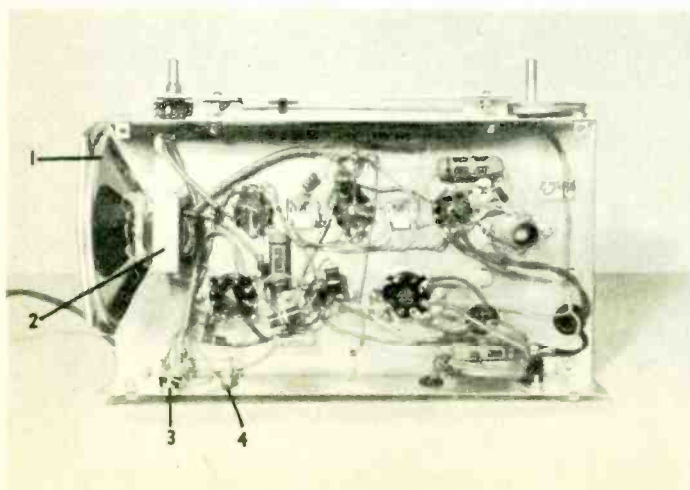

Underside view of Heathkit BR-2 chassis. Loudspeaker 1, and its transformer, 2, are at extreme left. Upper transformer wire is cut to produce ends A and B shown in diagram. The phono-radio switch is 3, the phono jack is shown by No. 4.

Photo right. Newly installed intercom transformer snuggles closely next to loudspeaker and tube. Connecting leads go through hole in chassis. This transformer location can be varied on your own radio set.



**I**F YOU own a radio or television receiver that has a "phono input," you can double its usefulness by making it work also as an intercom. You need only four parts costing a total of about \$4.35 if you buy them new, and you have to cut into only a single, easily accessible wire in the set itself.

In a house or an apartment, the combination radio-intercom quickly becomes an important step-saver and security measure for the housewife. With the "remote" loud-speaker at the front door, she can answer the bell without moving out of the kitchen, where she normally keeps a radio set going during the day. Or, she can readily check on a baby in a bedroom, if the remote speaker is placed there. Actually, any number of remotes can be installed in and around the house, with a suitable selector switch added to the radio set to enable the user to talk-listen with any one of the others at a time.

The proprietor of a small store or shop can use the radio-intercom to greet customers or other visitors when he is busy momentarily in the back. I fixed up one unit for my basement photo darkroom, hooked to both the front door and the kitchen upstairs. If I'm home alone when the house bell rings, as it does invariably about ten seconds after I have opened a roll of film, I can determine in an instant who the caller is and I can tell him to wait or go away. Also, I can communicate with my wife upstairs without having to scream through a light-tight door.

The "phono input" jack on the back of the radio or TV chassis is intended pri-

# "TAB"

OUR TWELFTH YEAR

That's a Buy !!!!

NEW PREAMP & 60 WATT HIFI AMPLIFIER



U-Build-It Preamp & Amplifier Mark-60. 20 to 40,000 cycles at 60 watts with minimum distortion. Bass & Treble Tone Controls, 5 point Record Selector, Phono-Pickup Selector, Signal Selector, Tape Recorder Input, 25 lb. Hi-Fi Output Transformer feeds 4, 8 or 16 ohm speakers & electrostatic units also, 2 power outlets. The Newest, Latest and Finest design easily built with professional look. Kit.-----\$69

Cover Grille Cabinet ----- \$ 7.50  
Mark-60 Assembled ----- \$100.00  
Mark-50 Finest Hi-Fi 50 Watt Amplifier Kit 20 to 100,000 cycles. Easy to build. Beginner can build. Uses printed circuit, complete, compact. Rugged design, full output 30 Watts with lowest distortion. Tubing 6AN8-2, EL34, 5U4GB U-BUILD KIT \$57. Professional Wired ----- \$68

U-BUILD! NEW TEST EQUIPMENT KITS! U-BUILD!

TIK VTVM KIT \$24; TSK SCOPE 5" KIT \$42  
RES/CAP BRIDGE KIT \$19; T&K TUBE TESTER KIT \$34  
TKH Hi-Fi 2 WAY SPEAKER KIT \$24; T&K TUBE TESTER 7" KIT \$76  
TKD DYNAMIC TUBE & TRANSISTOR TESTER KIT \$68  
AM-FM TUNER \$29; 12 Watt Amp & Pre-Amp \$26  
FM Tuner \$24; Five Tube Superhet \$18  
BC & SW Radio \$19; 10 Watt Amp & Pre-Amp \$22  
Transistor Portable \$34; Transistor personal portable \$30  
Write to "TAB" all parts for "ELECTRONIC PROJECTS" in this book!

ELECTRONIC FLASH! 400-II "TABLITE" \$25  
AC & BATTERY OPERATION

Assembled & ready to work! Not a Kit. Latest features SUPER CIRCUIT-Low cost flash less than 3% c. inbuilt AC & Batteries all in one case, powerful compact. Guide # Color 60-64W 200+ Recycles 3 sec. includes 60W5 \$24/525mfd/450WV Flash cond. Special \$25 \* Batteries not included. Two (2) 240V \$5.50  
New Photoflash Condens. Low Leakage \$25 mfd/450WV/53WSecs. Gtd Famous Mir. ----- \$3 @ 2 for \$9. 6 for \$24  
"TAB" PHOTO ELECTRONIC FLASH BOOK ----- 50c  
ILLINOIS PHOTOFLASH HANDBOOK ----- 50c



NEW "TEKSEL" SELENIUM RECTIFIERS

FULL WAVE BRIDGE-ONE YEAR GTD.  
18VAC 14VDC-1 Amp. \$1.40; 2A \$2.00; 3A \$2.90;  
4A \$3.50; 6A \$3.95; 10A \$5.85; 12A \$7.20.  
36VAC 28VDC-1 Amp. \$2.80; 2A \$3.40; 3A \$4.10;  
4A \$6.40; 6A \$7.70; 10A \$11.35; 12A \$14.25.  
18 VOLT 8 AMP 120 PARTS PACKAGE, CONTAINS BRIDGE RECTIFIER & 18 to 24V/8A 3 lb. TRANS. 115 VA INPUT. \$20 Value. Delivers 14 to 20 VDC. Ideal R.R. ---SPECIAL \$11

NEW VARIABLE 0 to 6 & 12 VOLT/12 AMP  
"TABPAK" DC Power Supply

Battery Eliminator, Charger, Model RR. Plates Aircraft. Marine or any DC requirement. Extra Hvy. duty Selenium Rectifier, 2 meters V & A. Designed for cont. service & up to 20 amps intermittent overload. Ripple below 100%.  
MODEL T612V12AC ----- \$33.00  
MODEL T612V12ACC Ripple 0.5% at 5A. ----- \$40.00



FREE! WRITE TODAY FOR OUR NEW CATALOG

KITS! Each "TAB" Kit Contains The Finest Selection

Kit 35 Precision Resistors	Kit 35 Power Resistors
Kit 10 Switches	Kit 75 Mica Condensers
Kit 75 Resistors 1/2/1/2W	Kit 5 Crystal Diodes
Kit 150 Carbon Resistors	Kit 250 ft. Hook Up Wires
Kit 45 Panel Lamps	"TV" Repair Book
Kit 12 Electrolytic Cond's	Kit 100 Fuses, ass'd all types
Kit 15 Volume Controls	Kit 100 Ceramic Condensers
Kit 35 Tube Sockets	Kit 150 Coil Forms
Kit 65 Tubular Condensers	Kit 5 Crystals & Holders
Kit 500 Lugs & Eyelets	Kit 65 Inductors & Coils
Kit 10 Bathtub Oil Cond's	Kit 5 Microswitches
Kit 5 lbs. Surprise Package	Kit 10 Wheat Lamps
Kit 10 Transmit Mica Cond's	Kit 3 Transistor Xfmr's
Kit TV Fluid Cleaner	Kit TV Knobs
Kit Encapsulation Fluid	Kit 3 Output Transf.
Kit 40 Insulators	

Order Ten Kits  
We Ship Eleven!!!

ONE EACH ABOVE  
KIT ONLY

99c

NEW POCKET AC-DC MULTITESTER  
1000 Ohms Per Volt (Postpaid 48 States)

"TAB" 27E Only \$7.49 ea.

Finest precision Hi-accuracy VOM. Reads AC & DC Volts: 0.15-150-1000V. DCMA: 0-150 Ma. OHMS: 0-100K. Size 1 1/4" D x 4 1/2" L x 3 1/4" W. Features: 1% Precision resistors, extra long meter scales. Complete w/batteries & test leads. Ideal for Ham, Experimenter and Beginner.



# "TAB"

TERMS: Money Back Gtd (cost of mds only) \$5 min order F.O.B. N.Y.C. Add shpg charges or for C.O.D. 25% Dep. Prices shown subject to change.

111FEC Liberty St., N. Y. 6, N. Y.

Phone RECTOR 2-6245



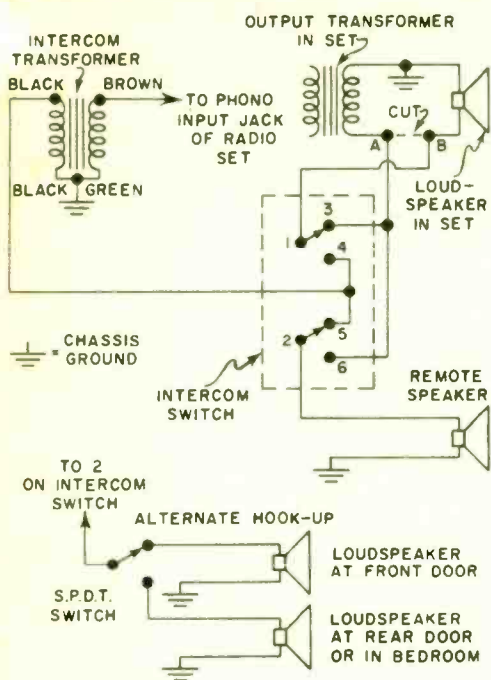

marily for the connection of a crystal-type cartridge of a record player. A "radio-phonograph" changeover switch is usually found on the rear apron of the chassis, or less often, on the front panel of the set.

The new parts needed for the conversion are as follows:

One intercom switch, double pole, double throw, spring return. Centralab No. 1464 or equivalent. About 90 cents.

One intercom transformer, voice coil to grid input. Stancor No. A-4744 or equivalent. About \$1.85.

One permanent magnet loudspeaker, 4 or 5 inches. Make or style immaterial. About \$1.50.

One phono pin plug. About 10 cents.

The specified makes of switch and transformer are the ones most generally available from electronic supply firms.

The hook-up is simple. First examine the loudspeaker. In practically all sets this has a small "output transformer" mounted in its frame. Between one side of the transformer and the actual paper cone of the speaker are two short leads, usually of bare, tinned wire. One is grounded to the chassis. Cut the *other* wire, leaving two ends marked A and B in the diagram. Now

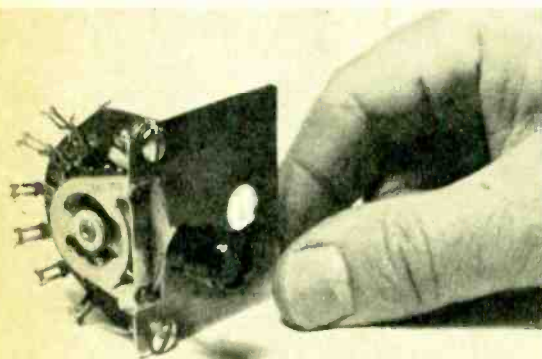

Special push-to-talk intercom switch has been fitted with small aluminum plate to go over mounting stud of the volume control in radio set.

Below left. The same lockwasher and nut that hold volume control of this set also support push-to-talk switch. This is suitable also for other sets.

Top right. Slot drilled and filed in front panel allows switch handle to pass through. The switch can also be mounted on the outside of a cabinet.

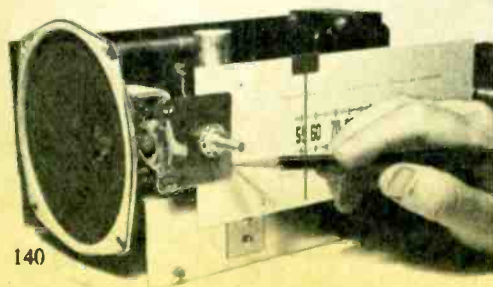

Bottom right. The finished receiver has the intercom switch at extreme left next to volume control. Study your own set carefully before cutting panel.



examine the switch closely. It has two contact arms, indicated as 1 and 2, and four contact points, 3, 4, 5 and 6. The contact arms are under spring pressure in such a manner that when the switch is in its normal position, arm 1 closes against point 3, and arm 2 against point 5. When the switch is pressed downward, arm 1 moves to point 4, and arm 2 to point 6. When the switch is released, it springs back by itself to 1-3, 2-5 connections.

The intercom transformer's primary leads are black, the secondary brown and green. The green and either black lead are hooked together to ground. The other black goes to the junction of switch points 4 and 5. The brown by itself is connected to a length of wire having the phono pin plug at its other end, and this plug goes into the phono jack on the radio set.

The remote loudspeaker (without any intermediate transformer) is connected by any standard lamp cord or bell wire. One wire goes to arm 2 of the intercom switch, and the other is grounded. We have run remotes as far as 75 feet from the radio set, with good results.

With the phono-radio switch on the radio set in the radio position, and the intercom

## EVERYBODY'S TALKING ABOUT **ELECTRONIC PROJECTS**

... AND SO ARE WE!



**MECHANIX ILLUSTRATED**, the How-To-Do Magazine, always brings its readers (more than a million) the very latest news of exciting developments in electronics... **PLUS** step-by-step, easy-to-follow instructions for building radio transmitters and receivers, hi-fi players, television sets, Geiger counters, home sentry systems, public address units, lie detectors, unique family telephone hook-ups, radio-controlled models and many other fascinating projects. For the best in electronics plans and projects always buy...

# **MECHANIX ILLUSTRATED**

Another Great FAWCETT Publication

**25c** a copy

**\$3** a year



switch left alone, the intercom transformer is in effect not connected. Trace the wires from A and B to 1 and 3 on the intercom switch, and you'll see that A and B are closed by the latter. The radio or TV set then functions in its normal manner. It is playing nicely, and the front bell rings. You flip the phono-radio switch to phono, press down on the intercom switch, and talk into the loudspeaker,

"Who's there, please?"

Release the switch, and the startled caller's voice will come back at you.

"Where are the microphones?" you may be asking at this point. There aren't any separate mikes, as such; the loudspeakers do the trick. It isn't generally realized that a common loudspeaker is a two-way affair. It produces sound if a varying electronic signal is fed into it, and it produces a varying electronic signal if sound is fed into it.

When the intercom switch is up, the remote speaker connects through the intercom transformer to the amplifier section of the radio set, and any sound that hits the remote is thus reproduced by the set's

speaker. When the intercom switch is depressed, the two speakers are swapped around. The simplicity of the arrangement is beautiful!

If you want one speaker at the front door and another at a side door, or elsewhere in a house, all you need is a single pole, double throw toggle switch, connected as shown on the diagram. For more than two remote speakers, you need a rotary switch of suitable contact point capacity.

Mounting the intercom switch and the intercom transformer is a mechanical job, the details of which depend on the particular radio or television set. The receiver shown in the accompanying illustrations is the popular Heathkit Model BR-2. With only a little squeezing I was able to mount the switch alongside the volume control. A drilled-out slot in the panel takes care of the switch arm. The transformer fits nicely behind the loudspeaker.

The remote speaker should be protected in a metal or wooden box, with a screened front. Suitable enclosures can be purchased, or you can readily knock one together of plywood. •—Robert Hertzberg

This is the location of the phono-radio switch on the back apron of the Heathkit receiver. The phone input jack is next to it. Arrangement shown is typical of most home radio receivers.

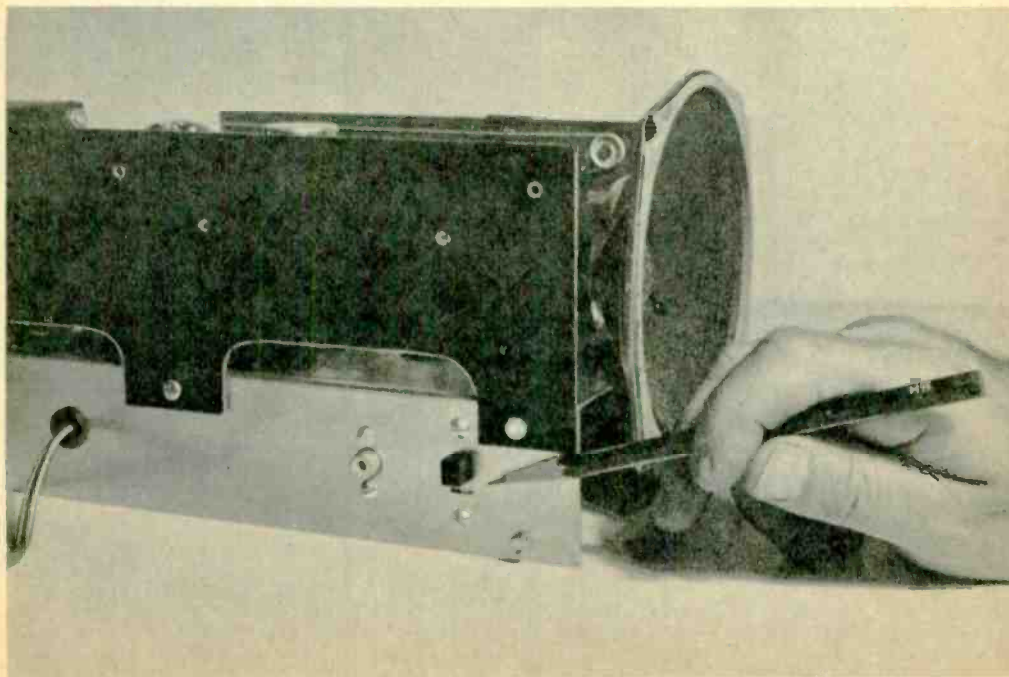



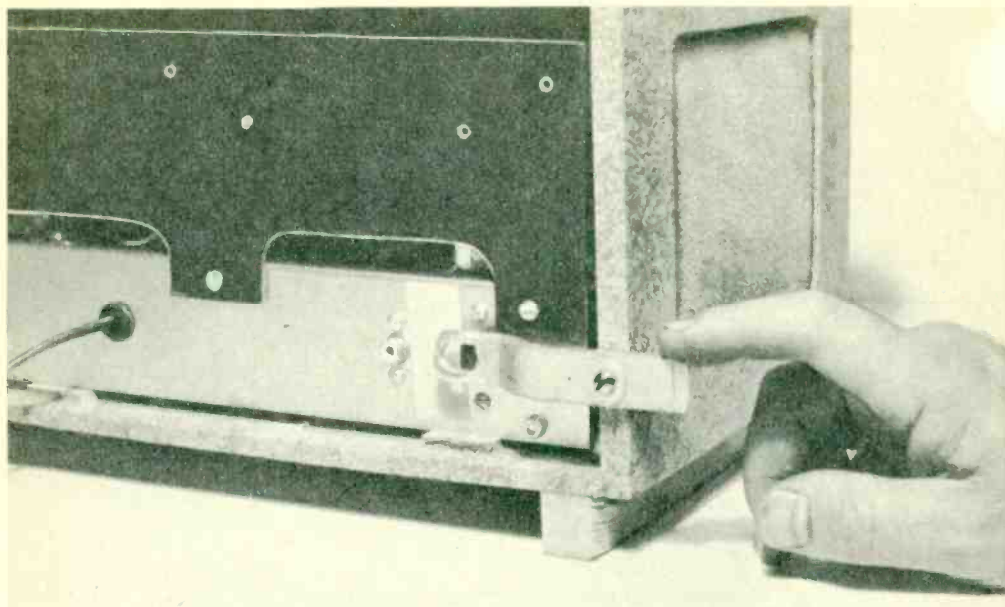

If phono-radio switch is not readily accessible from front, when set is placed on shelf or other tight spot, add a simple finger lever made from a 1/2-inch aluminum sheet, as shown. The wood screw acts as pivot.

# Learn Code

THE *Candler* WAY IS THE *Champion* WAY!

prepare  
yourself for  
your big  
opportunity

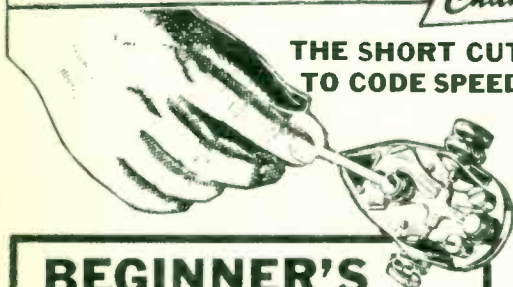

THE SHORT CUT  
TO CODE SPEED

## BEGINNER'S CODE COURSE

Especially designed for the beginner. Teaches the basic principles of code operation scientifically.

Here's your chance to learn quickly and easily . . . to get maximum speed and proficiency in code . . . right in your own home. You can save time and money learning the fundamentals of code sending and receiving and the principles of fast, efficient operating with the world-famous CANDLER SYSTEM.

Picture yourself at your own transmitter . . . sending out radio code, messages that will be received around the globe. Yes, operators are waiting to communicate with you today, tonight or any time. The knowledge of the world . . . intimate friendships you will gain . . . may help you in your business, may be a stepping stone to success.

Wouldn't you like to be the invaluable link with the outside world in time of disaster? Or to serve in a national or local emergency? Be ready for service when the opportunity arises! Learn telegraphy now—the Candler way.

For 46 years the CANDLER SYSTEM has trained beginners for all telegraphing requirements, all operator licenses, highest ratings, and FCC specifications, both amateur and commercial. The record of famous amateurs and expert operators who learned the Candler way is proof of what the Candler System offers you. Send for details today.

CANDLER SYSTEM, Dept. 28, P. O. Box 928, Denver 1, Colorado

# FAWCETT HOW-TO BOOKS

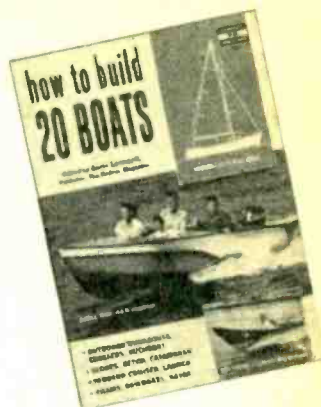

**SPACE SATELLITES** • Assembling, tracking techniques, Vanguard, race to space, Russia's Sputnik. (No. 364)

**Peter Gowland's GLAMOUR TECHNIQUES** • Nudes, studio glamour, lighting, underwater photos. (No. 363)

**How To BUILD 20 BOATS** • Outboard runabouts, duck-boat, sloops, ketch, inboard cruisers, etc. (No. 362)

**Mechanix Illustrated ELECTRICAL REPAIR Handbook** • Requirements, estimating, costs, wire, fuses. (No. 361)

**How To INVEST YOUR MONEY** • Income, safety, growth stocks, bonds, mutual funds, profit sharing. (No. 360)

**Famous OLD CARS** • Alfa Romeo, Auburn, Bentley, Cord, Bugatti, Cadillac, Duesenberg, Dupont, Stutz. (No. 359)  
Also available in hard cover edition at \$2.00 per copy.

**Mechanix Illustrated TV REPAIR and MAINTENANCE** • Color TV, reception, interference, boosters. (No. 358)

**SALON PHOTOGRAPHY** • Glamour, famous faces, nudes, children, animals, salon section. (No. 357)

**101 Remodeling Ideas For BASEMENT AND ATTIC** • Studs, ceilings, floors, doors, windows, stairs. (No. 356)

**Lucian Cary on GUNS** • Skeet and traps, roll ammo, scopes, varmint sniping, antique arms. (No. 355)  
Also available in hard cover edition at \$2.00 per copy.

**Handy Man's PLYWOOD PROJECTS** • Easy-to-build desks, beds, cabana, boat; storage units. (No. 354)

**Low Cost HI-FI** • AM-FM tuners, pickup arms, kits, turntables, amplifiers and recorders. (No. 353)

**How to BOWL BETTER** • Rules, footwork, straight, hook and curve ball, scoring, team play (No. 352)

**Mechanix Illustrated HOME REPAIRS** • Furniture, plumbing, masonry and electrical repairs (No. 351)

**Peter Basch's PHOTO STUDIES** • Pin-ups, portraits, nudes. Over 230 glamour photos. (No. 350)

**Home Workshop FURNITURE PROJECTS** • TV table, storage units, garden furniture, finishes. (No. 349)

**Photographing The FEMALE FIGURE** • Poses, action, props, lighting, techniques, portraits. (No. 348)

**ELECTRONICS GUIDE** • Kits, receivers, hi-fi, amplifiers, tape recorders, "ham" radio, gadgets. (No. 347)

**GOOD PHOTOGRAPHY** • New! Multiple nude, outdoor glamour, children, documentary, salon. (No. 346)

**Mechanix Illustrated POWER TOOLS HANDBOOK** • Portable, stationary tools. Set up shop, safety. (No. 345)

**HOW TO MAKE CERAMICS** • Molds, glazes, airbrush, potter's wheel. Vases, bowls, tiles, plates. (No. 344)  
Also available in hard cover edition at \$2.00 per copy.

**HOW TO REPAIR** washing machines, clothes dryers, refrigerators, vacuum cleaners, fans, mixers, etc. (No. 342)

To order direct, send 75¢ per copy for regular edition or \$2.00 per copy for hard cover De Luxe edition to: FAWCETT BOOKS, Dept. 365, Greenwich, Conn. Add 10¢ per copy mailing charge for all books. Specify books by title and number when ordering

A FAWCETT  
HOW-TO BOOK 75¢

**AT YOUR LOCAL NEWSSTAND, LEADING DRUG STORE, SUPER MARKET, HARDWARE STORE AND BUILDING SUPPLY DEALER**



Prepare for a Good Paying Job — Or Your Own Business

Learn PRACTICAL RADIO-TV  
with 25 BIG KITS

of equipment I send you while  
you train with me . . . for valuable  
shop bench experience . . .

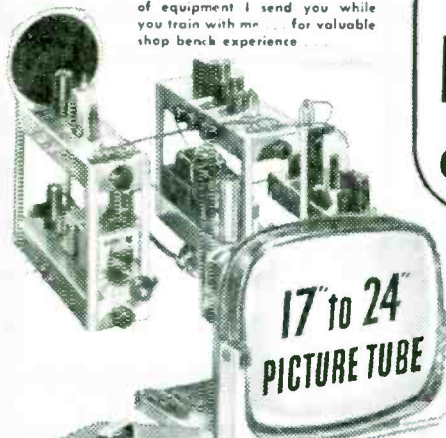

The new Sprayberry Training Television receiver, built and tested in sections

I now offer this fine modern oscilloscope.

You build this powerful 2 band Superhet radio receiver.



You build the new Sprayberry Tester . . . 18-range Volt-Ohm-Milliammeter readings

Average cost per lesson  
ONLY \$3.42  
Including Kits and Equipment

"I Will Train You at Home in  
**RADIO-TELEVISION**  
on Liberal No Obligation Plan!"

New Equipment! New Lessons! Enlarged Course! The true facts are yours in my big new catalog . . . YOURS FREE . . . JUST MAIL COUPON!



Frank L. Sprayberry  
Educational Director

I can train and prepare you in as little as 10 months to step into the big opportunity Radio-Television service field. Train *without* signing a binding contract . . . without obligating yourself to pay any regular monthly amounts. You train entirely at home in spare hours . . . you train as fast or as slowly as you wish. You'll have your choice of THREE SPRAYBERRY TRAINING PLANS . . . planned for both beginners as well as the more experienced man. Get the true facts about the finest most modern Radio-Training available today . . . just mail the coupon for my big new 56 page fact-filled catalog plus sample lesson—both FREE.

**Train the Practical Way—with Actual Radio-Television Equipment**

My students do better because I train both the mind and the hands. Sprayberry Training is offered in 25 individual training units, each includes a practice giving kit of parts and equipment . . . all yours to keep. You will gain priceless practical experience building the specially engineered Sprayberry Television Training Receiver, Two-Band Radio Set, Signal Generator, Audio Tester and the new Sprayberry 18 range Multi-Tester, plus other test units. You will have a complete set of Radio-TV test equipment to start your own shop. My lessons are regularly revised and every important new development is covered. My students are completely trained Radio-Television Service Technicians.

**NEWEST DEVELOPMENTS**

Your training covers U.H.F. Color Television, F.M. Oscilloscope Servicing, High Fidelity Sound and Transistors.

See for Yourself . . . Make Your Own Decision  
. . . Mail Coupon Today!

The coupon below brings you my big new catalog plus an actual sample Sprayberry Lesson. I invite you to read the facts . . . to see that I actually illustrate every item I include in my training. With the facts in your hands, you will be able to decide. *No salesman will call on you.* The coupon places you under no obligation. Mail it now, today, and get ready for your place in Radio-Television.

**SPRAYBERRY ACADEMY OF RADIO-TELEVISION**

1512 Jarvis Ave., Dept. 200-B, Chicago 26, Illinois

**Mail This Coupon For Free Facts and Sample Lesson**



SPRAYBERRY ACADEMY OF RADIO-TELEVISION  
1512 Jarvis Ave., Dept. 200-B, Chicago 26, Illinois

Please rush all information on your ALL-NEW Radio-Television Training Plan. I understand this does not obligate me and that no salesman will call upon me. Include New Catalog and Sample Lesson FREE.

Name \_\_\_\_\_ Age \_\_\_\_\_  
Address \_\_\_\_\_  
City \_\_\_\_\_ Zone \_\_\_\_\_ State \_\_\_\_\_

# Learn Radio-Television

## Servicing or Communications by Practicing at Home in Spare Time

N.R.I. SENDS kits with which you practice building circuits common to Radio and TV sets. You LEARN-BY-DOING to locate Radio-TV troubles. As part of N.R.I. Servicing Course, you build Vacuum Tube Voltmeter and AC-DC receiver. Use VTVM to conduct experiments. Earn extra money fixing sets in spare time.

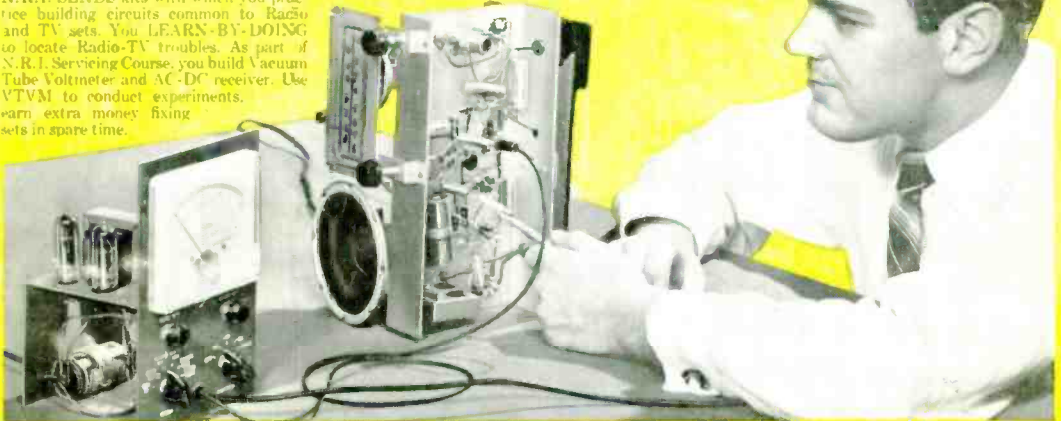

**RADIO-TV BROADCASTING** (see above) offers important positions as Operators and Technicians. **RADIO-TV SERVICING Technicians** (see below) needed in every community. Their services are respected, their skill appreciated.



## Fast Growing Field Offers You Good Pay, Success, Bright Future



**J. E. SMITH**  
Founder

Bigger than ever and still growing fast. That's why Radio-TV has special appeal to ambitious men not satisfied with their job and earnings. More than 4,000 Radio and TV stations. More than 150 million home and auto Radios, 40 million TV sets. Color TV promises added opportunities. For the trained man, there are good jobs, bright futures in Radio-TV Servicing or Broadcasting. Training PLUS opportunity is the ideal combination for success. So plan now to get into Radio-TV. The technical man is looked up to. He does important work, gets good pay for it. Radio-Television offers that kind of work. NRI can supply training quickly, without expense of going away to school. Keep your job while training. You learn at home in your spare time. NRI is the OLDEST and LARGEST home study Radio-TV school. Its methods have proved successful for more than 40 years.

### Added Income Soon - \$10, \$15 a Week in Spare Time

Soon after enrolling, many NRI students start to earn \$10, \$15 a week in spare time fixing sets. Some pay for their training and enjoy extra luxuries this way. Some make enough to start their own Radio-TV shops. NRI training is *practical*—gets quick results. Easy to understand, well illustrated lessons teach you basic principles. And you LEARN-BY-DOING by practicing with kits of equipment which "bring to life" things you study.

### Find Out What NRI Offers

NRI has trained thousands for successful careers in Radio-TV. Study fast or slow—as you like. Diploma when you graduate. Mail coupon now. Paste it on a postcard or mail in envelope. **ACTUAL LESSON FREE.** Also 64 page catalog that shows opportunities, shows equipment you get. Cost of NRI courses low. Easy terms. **NATIONAL RADIO INSTITUTE, Dept. 88W7, Washington 16, D. C.**

### N.R.I. TRAINED THESE MEN FOR SUCCESS



"I was repairing Radios by 10th lesson. Now have good TV job." **M. R. LINDEMUTH,** Fort Wayne, Ind.



"Doing spare time repairs on Radio and TV. Soon servicing full time." **CLYDE HIGGINS,** Waltham, Mass.



"I had a successful Radio repair shop. Now I'm Engineer for WHPE." **V. W. WORKMAN,** High Point, N.C.



"There are a number of NRI graduates here. I can thank NRI for this job." **JACK WAGNERS,** Lexington, N. C.



### SEND FOR BOTH FREE

**National Radio Institute**

Dept. 88W7, Washington 16, D. C.

Mail me Sample Lesson and 64-Page Catalog FREE. (No salesman will call. Please write plainly.)

Name \_\_\_\_\_ Age \_\_\_\_\_

Address \_\_\_\_\_

City \_\_\_\_\_ Zone \_\_\_\_\_ State \_\_\_\_\_

Accredited Member National Home Study Council



**VETERANS** Approved Under G. I. Bills