

**ELECTRONICS  
HOBBYIST**

# ELECTRONICS HOBBYIST

## Let The SUN Power Your Projects!

10 TIPS FOR QUICKIE PROJECTS  
IDEAS FOR SIMPLE RADIOS





# Lab Test C&E HOBBY HANDBOOKS For Yourself

In case you're not all that familiar with us, we're *not* a publication for electrical engineers and other wizards. *No way*. C&E HOBBY HANDBOOKS are expressly for people who like to build their own projects and gadgets—and maybe get a little knee-deep in tape, solder and wire clippings in the process.

In fact, we have a sneaking suspicion that our readers like us because they think we're just as bug-eyed and downright crazy over great new project ideas as they are. And I guess they're right!

C&E HOBBY HANDBOOKS thinks of you who dig electronics as the last of a special breed. It's more than just the "do-it-yourself" angle—it's also the spirit of *adventure*. In this pre-packaged, deodorized world, building your own stereo system, shortwave receiver, darkroom timer or CB outfit is like constructing a fine-tuned little universe all your own. And when it all works perfectly—it really takes you to another world.

**C&E HOBBY HANDBOOKS knows the kinds of projects you like—and we bring 'em to you by the truckload!**

Ever hanker to build a sharp-looking digital clock radio? Or to hook up an electronic game to your TV? Or an easy-to-build photometer that makes perfect picture enlargements? Or a space-age Lite-Com so you and the family can talk to each other on a light beam? We've got it all to get you started.

Has your sound system gone blooey just when the party's going

## Get switched on

great? Do you shudder when your friendly neighborhood electrician hands you the bill? C&E HOBBY HANDBOOKS can help.

Of course, we can't make you a master electrician overnight. But we can show you the fundamentals of repair plus maintenance tips.

### IF YOU'RE NEW TO ELECTRONICS YOU GET A "BASIC COURSE"!

It gives you the complete, ground-floor lowdown on a variety of important electronics subjects. For example—Understanding Transistors ... How radio Receivers Pull in Signals ... Cathode Ray Tubes Explained ... How Capacitors Work ... Using Magnetism in Electronics. And more!

#### ENJOY GREAT ARTICLES LIKE THESE

- How to Build Your Own Transformer
- How to Select the Right Shortwave Receiver
- The Burgeoning World of Micro-computers
- Quickdraw Rickshaw—The Electric Car that Really Gets Around
- What's Really Wrong with FM Radio?
- How to Power-Up Your Antique Radio
- The Vanishing Vacuum Tube
- How to Customize Your CB Antenna
- Those Incredible TV Sets of the Future
- Listening in on the Forgotten Continent
- DXing Endangered Species
- Sandbagging—CB Fun Without a License
- The World's Worst Hi-Fi Components

#### TRY A FEW ISSUES AND EVALUATE OUR ...

• **HOW-TO-DO-IT HELP.** Tips and pointers that add up to money saved. For example—tuning up your tape player ... all about radios ... whys and hows of turntables ... care and feeding of speakers.

• **EXCITING DISCOVERIES.** Whatever your particular interest in electronics, you'll be entering a world of discovery in the pages of C&E HOBBY HANDBOOKS





# ELECTRONICS HOBBYIST

**THE STAFF**  
**PUBLISHER**  
**Don Gabree**

**ASSOCIATE PUBLISHER**  
**H.M. McQueeney**

**CREATIVE COORDINATOR**  
**Tony DeStefano**

**SECRETARY/TREASURER**  
**Lillian Beck**

**CONTROLLER**  
**William Aronson**

**EDITOR**  
**Hank Scott**

**ART DIRECTION**  
**Newgraphics, Inc.**

**ASSOCIATE ART DIRECTOR**  
**Joe DeStefano**

**MARKETING MANAGER**  
**Jordan Malmed**

**COVER ART**  
**George Mattel**

**ADVERTISING SALES**  
**C&E Hobby Handbooks, Inc.**  
 300 W 43rd Street  
 New York, N.Y. 10036  
 (212) 397-5200

**EAST COAST**  
**Worldwide Publications**  
 (201) 231-1518

**WEST COAST**  
**J.E. Publishers Representative**  
 (213) 467-2266

ELECTRONICS HOBBYIST Volume 8, Number 5, a quarterly publication published by C&E Hobby Handbooks, Inc. Editorial and Business offices 300 W 43rd Street, New York, N.Y. 10036, (212) 397-5200. PERMISSIONS: Material in this publication may not be duplicated or reproduced in any form without permission. Requests for permission should be directed to—Don Gabree, C&E HOBBY HANDBOOKS, INC. 300 W 43rd Street, New York, N.Y. 10036 (212) 397-5200, ISSN 0364-9067.

ADVERTISING OFFICES: New York, 300 West 43rd Street (212) 397-5200 or (201) 231-1518. Los Angeles, J.E. Publishers Rep. 6855 Santa Monica Blvd., Los Angeles, CA 90038 (213) 467-2266.

EDITORIAL CONTRIBUTIONS must be accompanied by return postage and will be handled with reasonable care; however, the publisher assumes no responsibility for the return or safety of manuscripts, artwork or photographs. All contributions should be addressed to: PUBLISHER, C&E HOBBY HANDBOOKS, 300 W. 43rd Street, New York, N.Y. 10036.

C&E Hobby Handbooks Inc. a division of J.Q. Adams Productions. Second Class Entry applied for. Copyright © 1985 by C&E HOBBY HANDBOOKS, Inc.

## CRYSTALS

32.768khz	1.85
1.0mhz	3.85
1.8432	3.85
2.0	2.85
2.097152	2.85
2.4576	2.85
3.2768	2.85
3.579545	2.85
4.0	2.85
5.0	2.85
5.0688	2.85
5.185	2.85
5.7143	2.85
6.0	2.85
6.144	2.85
6.5536	2.85
8.0	2.85
10.0	2.85
10.738635	2.85
14.31818	2.85
15.0	2.85
16.0	2.85
17.430	2.85
18.0	2.85
18.432	2.85
20.0	2.85
22.1184	2.85
32.0	2.85

## OSCILLATORS

1mhz	9.6768	19.6608
2.4576	10.000	20.000
2.7648	10.240	20.100
3.120	13.230	23.6725
3.6864	14.000	24.000
4.000	14.31818	25.000
4.032	14.175	28.636
4.9152	14.7456	26.824
5.000	15.000	29.498
5.0688	16.000	30.000
6.000	16.257	32.000
6.336	16.384	35.488
7.168	18.000	40.000
8.000	18.432	50.000
9.216	18.6624	80.000
9.218	19.3536	

### PRICE EACH

1	\$18.95
10	\$13.95
25	\$9.95

## DIP SWITCHES

MS4	\$ .78
MS6	.88
MS8	.95
MS10	1.25

## I/C SOCKETS

8 pin ST	12	20 pin ST	28
14 pin ST	14	24 pin ST	29
16 pin ST	16	28 pin ST	39
18 pin ST	19	40 pin ST	48

**800-341-4468**



### World Distributors, Inc.

709 N. Memorial Parkway  
 Huntsville, Alabama 35801  
 (205) 539-0441



TLX 810-726-2135/810-726-2174

**TERMS: Shipping & Handling Charge \$2.50**  
**Min. Charge Order \$15.00**

# KeproClad

by Kepro Circuit Systems, Inc. T.M.

## At Home Professional Quality Fine Line PCB's.

Introducing an easy, inexpensive, step by step method for the home production of professional quality printed circuit boards without a major equipment investment—KeproClad, by Kepro, makers of quality industrial equipment and supplies. KeproClad was designed for the home user who needs professional results with:

### A Simple Circuit Board;

Use KeproClad unsensitized copperclads. These boards come in 2 popular sizes with 1 sided foil, a marking pen, all for a suggested retail price as low as \$3.50.

### A Fine Line Detailed Board;

Use KeproClad photosensitized copperclads. Available in 2 sizes with 1 or 2 sided foil. These copperclads use the latest technology of negative acting dry-film photoresist. This material is rugged, yet holds extremely fine detail. It comes with a pre-measured amount of developer and sells for as little as \$3.90 (suggested retail).

Other KeproClad products such as a photo reversal kit for making negative film, etch, tin plating solution and photoflood lamps are all available at your local distributor. (For the distributor nearest you, call or write:

**KEPRO CIRCUIT SYSTEMS, INC.**  
 630 Axminster Drive., Fenton, MO 63026-2992  
 In MO 314-1630 Toll Free 800-325-3878



# ELECTRONICS HOBBYIST

4-Editorial 5-Ask Hank 6-New Products 8-Book Reviews

10-Hobbyist's Text Bench

14-Construction Quickie

16-Keeping Your Hobby Costs Down

19-Simplex-A-Thing

20-Special Tools

23-That Blinking Light

26-Understanding Logic Circuits

31-Cat's Whisker

33-HI-AMP Meter

34-Sun-Powered Radio

38-Solar Cell Tester

40-Circuit Board Etching

42-Digital Capacitance Meter

48-Big Boost

49-Diode Digest

50-Photometer

53-Projects to Have Fun With

58-Oscar: The Audio Freak

61-Electronic Pendulum

62-Burglar Alarm

63-Smart Power Supply

65-Dwell/Tachometer

69-BCL/SWL Antenna Tuner

71-Wire Wrap Breadboard

75-One Tube Regenerative Receiver

79-RS232 Switcher

81-LED Weathervane

85-Third Ear

89-Telephone Projects

92-Dashboard Digital Temperature Gauge





# ELECTRONICS BOOK CLUB

The Best Source for Hobbyists and Professionals  
for Over 19 Years!

Time- and Money-Saving Advice . . .  
Practical Troubleshooting & Repair Tips . . .  
State-of-the-art Technology . . . Hundreds  
of Projects . . . Plus, Exceptional Savings

## Take Any 4 Books for Only \$2<sup>95</sup>

Values to  
~~\$90.80~~

Join Now, Get a Utility Apron FREE!



1593  
List \$13.95



1542  
List \$21.95



1699  
List \$19.95

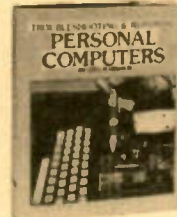

1539  
List \$21.95

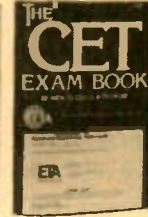

1670  
List \$14.95



1599  
List \$21.95



1875  
List \$21.95



1583  
List \$19.95



1393  
List \$14.50 (paper)



1431  
List \$17.95

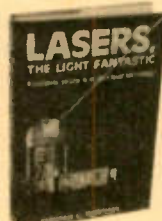

1108  
List \$15.95



1183  
List \$18.95



1765  
List \$21.95



1777  
List \$21.95



1492  
List \$14.95



1211  
List \$12.95 (paper)



1820  
List \$16.95



1616  
List \$19.95



1605  
List \$19.95



1932  
List \$17.95



1690  
List \$19.95



1604  
List \$24.95

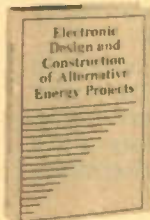

1672  
List \$18.95



1218  
List \$18.95



1665  
List \$15.95 (paper)



1740  
List \$18.95

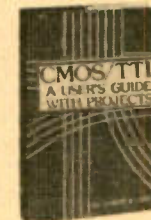

1650  
List \$19.95



1577  
List \$19.95

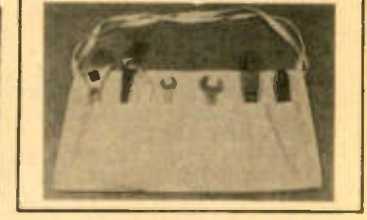

FREE Utility Apron

## 7 very good reasons to join the Electronics Book Club

- **Big Savings.** Save 20% to 75% on books sure to increase your electronics know-how
- **No-Risk Guarantee.** All books returnable within 10 days without obligation
- **Club News Bulletins.** All about current selections—mains, alternates, extras—plus bonus offers. Comes 13 times a year with hundreds of up-to-the-minute titles to pick from
- **Automatic Order.** Do nothing and the Main selection will be shipped automatically! But . . . if you want an Alternate selection—or no books at all—we'll follow the instructions you give on the reply form provided with every News Bulletin
- **Bonus Books.** Immediately get a Dividend Certificate with every book purchased and qualify for big discounts of 60% to 80%
- **Exceptional Quality.** All books are first-rate publisher's editions selected by our Editorial Board and filled with useful up-to-the-minute information



## ELECTRONICS BOOK CLUB

P.O. Box 10, Blue Ridge Summit, PA 17214

Please accept my membership in the Electronics Book Club and send the 4 volumes circled below, plus, my FREE utility apron, billing me \$2.95 plus shipping and handling charges. If not satisfied, I may return the books within ten days without obligation and have my membership cancelled. I agree to purchase 4 or more books at reduced Club prices (plus shipping/handling) during the next 12 months, and may resign any time thereafter.

1108 1183 1211 1218 1393 1431 1492 1539 1542  
 1577 1583 1593 1599 1604 1605 1616 1650 1665 1670  
 1672 1690 1699 1740 1765 1777 1820 1875 1932

Name \_\_\_\_\_ Phone \_\_\_\_\_

Address \_\_\_\_\_

City \_\_\_\_\_

State \_\_\_\_\_ Zip \_\_\_\_\_

Valid for new members only. Foreign applications will receive ordering instructions. Canada must remit in U.S. currency. This order subject to acceptance by the Electronics Book Club.



# OUR PROJECT PARADE

Projects, projects, projects! It seems that we never get enough projects to print, and you never get enough projects to build. Somewhere in the middle is a gap that needs filling.

ELECTRONICS HOBBYISTS is just what the gap ordered! Well, it is for the readers. Where else can you get a magazine packed with projects covering a good portion of the interests we all have. In particular, we present two articles on using sun power to excite you. One is flashing light and the other is a radio. The concept of using the sun to power a circuit is not new. Also, it is infrequently used where in many instances it is a viable alternative for a power source.

Consumer electronics will see an influx of solar-powered devices in the years ahead. The paper-thin pocket calculator is here, and the price is right. A transistor radio may take too much current to be powered by a solar-cell array, but the cells can contribute power thereby extending the useful life of the battery. Or, should rechargeable batteries be used, the obvious need not be detailed here.

Solar cells are getting better and cheaper. You'll find that their applications will be affecting your life style

and your hobby. So get in the practice of working with solar sells. And, when you do, let us know about it. Our readers are the source of almost all our projects. When you have assembled a project that you find useful, let us know about it. Not only will we publish it under your byline, we'll present you with an honorarium (that's money folks). For now, get down to the workbench and get started with the projects in this issue.

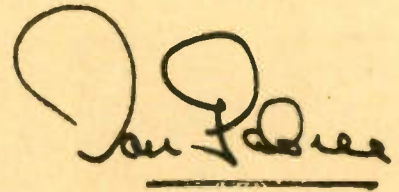

Don Gabree,  
—Publisher

**AMAZING**  
SCIENTIFIC and ELECTRONIC  
**DEVICES**

**LASER DEVICES**

- LC5 BURNING CUTTING CO2 LASER \$15.00
- RUB3 RUBY LASER RAY PISTOL 15.00
- LR3 IR LASER RIFLE/PISTOL 10.00
- LGU3 VISIBLE RED LASER RIFLE 10.00
- LHP/LLD LASER LIGHT XMTR/RCVR SYS 10.
- LHC2 BEGINNER simulated VISIBLE LASER 5.

**SCIENTIFIC & ELECT**

- TCL3 SOLID STATE TESLA COIL 35KV 6.00
- BTC3 250 THOUSAND VOLT TESLA COIL 9.00
- BTC5 1.5 MILLION VOLT TESLA COIL 15.00
- MVM3 125 THOUSAND VOLT DC SUPPLY 8.00
- IOG3 ION RAY FORCE FIELD GUN 8.00
- MEG1 MILLION WATT 500 JOULE SOURCE 10.

**ULTRASONIC ACCOUSTICAL**

- PPF1 PHASOR PAIN FIELD GENERATOR 15.00
- PSP3 PHASOR SHOCK WAVE PISTOL 7.00
- IPG5 POCKET PAIN FIELD GENERATOR 7.00
- RAT2 RAT AND PEST ELIMINATOR 6.00
- HT9 HIGH FREQ. LISTENING OVICE 8.00

**SECURITY & PROTECTION**

- DEVI DEVASTATING OVICES 10.00
- PPG1 PHASOR PROPERTY GUARO 15.00
- MFT1 MINI VOICE XMTR 2-3 MILE 7.00
- INF1 INFINITY TRANSMITTER 15.00
- PSW3 PHASOR BURNING STUN WAND 8.00
- PG1 PARALYZING WAND 10.00

WE STOCK ALL PARTS NECESSARY FOR CONSTRUCTION OF THE ABOVE PROJECTS.

• CATALOG CONTAINING HUNDREDS MORE OF ALL NEW AMAZING and FASCINATING PLANS. EASY TO BUILD KITS AND ASSEMBLED ITEMS \$1.00. CATALOG INCLUDED FREE WITH ANY OF THE ABOVE PROJECT PLANS. SEND CASH. CHECK. MO. VISA. MC TO:

**INFORMATION UNLIMITED**  
P.O. BOX 716, DEPT. CE AMHERST, NH 03031

## WANTED: PROJECTS

How would you like to find your home-brew project in the next issue of ELECTRONICS HOBBYIST or in one of its sister publications? It's all up to you! Build your project for yourself—it should have a real purpose. Then, if you think it is good enough to appear in one of the Hobby Handbooks, let us know about it.

Write us a short letter describing your project. Tell us what the project does. Provide us with a schematic diagram and a few black-and-white photographs of the project—photos are important. Once we read your letter, we'll let you know, one way or the other, whether we would like to purchase your article describing the project. Send your letter to:

**DON GABREE, PUBLISHER**  
**C&E HOBBY HANDBOOKS**  
300 WEST 43RD STREET  
NEW YORK, N.Y. 10036







## Ask Hank, He Knows!

Got a question or a problem with a project—ask Hank! Please remember that Hank's column is limited to answering specific electronic project questions that you send to him. Personal replies cannot be made. Sorry, he isn't offering a circuit design service. Write to:

**Hank Scott, Editor**  
**C & E HOBBY HANDBOOKS INC.**  
300 West 43rd Street  
New York, N.Y. 10036

### What Do I Need

My Dad says that I should take a computer course during my senior term in High School so that I would be ahead of others in my freshman class in college. My answer to him is that the college will teach what I need to know. I could better use the time to advance my education by taking an extra math or science course. What's your opinion?

—B.M., Baltimore, MD

*First off, colleges don't teach, they tell you what you need to know, suggest the books you should study, and provide the testing. You, dear friend, must learn by self-education. And, one educational tool you should have at your back and call is the knowledge of how to operate a computer using a basic DOS with CP/M, or anything like it. There was a time when Dad sent you off to college with a new portable typewriter. The new student tool is the computer with printer. You should be able to operate a basic word-processing system so that the first paper you have to prepare does not cause a severe trauma—simple traumata (that's the plural off trauma) are enough!*

### Penny Wise, Pound Smart

I picked up a bunch of printed-circuit boards dumped by a local electronics plant. Not all the parts are good because some of the boards are rejects, and most others are boards that have been used and tossed out, because of defects or replaced by updated boards. Many of the parts are not identified, that's no hassle for me. Now, what is a way of getting the parts off the board with little, if any, loss of parts during the process?

—F.G., Fresno, CA

*Take the boards out to the back yard. Get an old bucket or two. Use a propane torch to heat up the back of a board until the solder just melts*

*and whack the board over the bucket. Most of the parts will fly into the bucket. Since solder from future whacks will splatter over the parts now in the bucket, remove them before continuing. I once did this with the help of two friends. With three buckets and with me whacking away we had stripped dozens of boards in no time at all. Very few parts have their leads bent down so that there was almost no work for our solder-sucker iron. Do it out-of-doors because the smell can foul up the house. Also, switch off from board to board, because the board can get too hot to hold should you try to strip one board completely.*

### Big Difference

For hobby projects purposes, can you tell me the differences between the 2N2222 and the 2N2222A?

—K.L., Austin, TX

*Eh!*

### Audio—Big Deal

I hear so much talk about this amplifier and that turntable with so-and-so cartridge that delivers such good sound compared to the Dog Mk II, etc. I can't hear the difference, and I'm still a young person with good ears. Why all the fuss over audio specs?

—D.D., West Palm Beach, FL

*We are not all equal, so that what I can discern may not be what you can! If you can't hear the difference between a \$500 system and that of a \$5000 system—good for you! Keep in mind that the person who can hear the difference may have ears equal to yours. You see, although we all hear, we do not listen alike. You can train yourself to hear the subtle differences that separate a cheap system from an expensive system. No, you don't train yourself so that you can spend more money. You train your ears to hear the melodic undertones in a score that*

*were placed there cleverly by the author. Frankly, if you want the top 40's, ho hum!*

### I've Noticed...

Hank, at times you are a bit snobbish in your replies. Is this for effect?

—J.K., Chicago IL

*Yes. Ho hum!*

### Confused

I always mess up when I connect a light-emitting diode into a circuit. Who can remember from the longer lead and flat edge to determine the anode from the diode. What do you suggest, Hank?

—R.D., Greenwich, CT

*Since you usually work in the same area or bench top, draw a side view of a LED with two leads, one longer than the other and the flat edge next to the shorter lead. Now label the longer lead "Anode" and the shorter, "Cathode." That should do it. If you travel around a lot, then inscribe the same diagram on the inner sole of one of your shoes. If someone is around when you have to resort to the diagram, claim that you have a pebble in your shoe. It's a good idea. I wrote inside my shoes, "T-G-I-F." That is to remind me that "Toes Go In First"*

### Alarm System

What is the best type of inexpensive burglar alarm to have in a home?

—D.T., Waco, TX

*The perimeter alarm is the best for the least bucks to my way of thinking. Be sure the system activates a 12-inch gong that'll shake your teeth loose. The foil used on the windows tell the thief that you got something working for you and that he is better off going next door. For those of you who believe that a big dog is best, remember to buy a pooper-scooper!*



# NEW PRODUCTS PARADE

## MODULAR TELEPHONE CRIMPING TOOLS & PLUGS

MOUSER ELECTRONICS announces two new crimping tools and plugs for modular telephone installation.

The ME382 crimping tool is compact and lightweight, yet its durable design makes it ideal for use where quick, solid crimps are a must. This crimping tool delivers fast, easy attachments of modular type connectors to 4 wire stranded or tinsel cable. It lets you attach modular connectors, as you need them. This tool eliminates the need for stocking complete cords and cables with connectors attached.

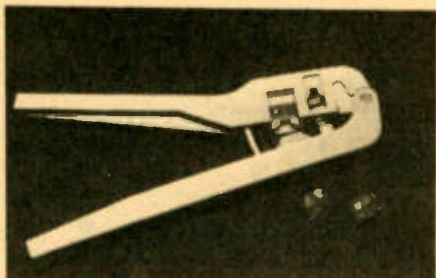

It features a built-in wire cutter/stripper that allows you to repair existing cable or make new cables to any length. The ME382 comes in two styles, for pre-wire use and for handset use. Also available are crimp style modular plugs for use with either style crimping tool.

Both are available from stock. Write or call for FREE catalog. MOUSER ELECTRONICS, 11433 Woodside Avenue, Santee, CA. 92071 (619) 449-2222

## MINIATURE SOLID STATE RELAYS

A quality solid state relay in a miniature, PC-mounting design is available from Mouser Electronics. The model ME433-SK541100 relay has all the quality features of higher-priced, solid-state types. It has an opto-coupler input, Triac output, and switches on at zero crossover voltage. Designed for low power

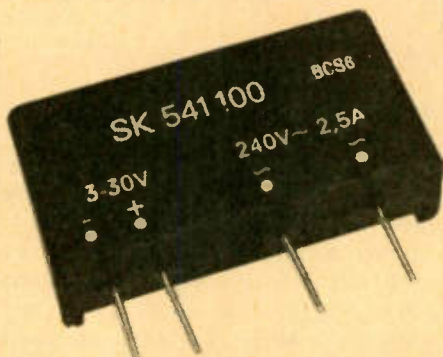

consumption, the relay has a permanent current maximum of 2.5 A. It can handle an overload of 90 A (10mS) and remains energized at less than 50 mA. The relay also consumes little board surface space. It's 1.575-in. long and only .39-in. wide.

The relay has an input resistance of 1500 ohms. Its nominal operating voltage is 3-30-volts, pickup voltage is 3-volts, and the release voltage is .8-volt. It has an input/output isolation of 2500-volts AC. The relay is priced as low as \$11.54 in quantities of 50. For a free catalog, write Mouser Electronics, 11433 Woodside Ave., Santee, CA. 92071. Telephone (619) 449-2222.

## ONE-PIECE LED MOUNTING CLIP

A new economical LED mounting clip, the ME352-0002, features a new one-piece design which eliminates the need for a retaining ring. Molded extrusions firmly hold the LED, while the unit itself snaps through a panel or PCB in one motion. It saves both material cost and assembly time.

The clip is molded of black phenolic resin and accommodate all standard T-1 3/4-in. LED's. It measures .315 in. in diameter and extends .25-in. beneath the mounting surface. The unit mounts in a



.275-in. hole. The clip is priced as low as .035 cents in quantities of 1000. Write or call for a free catalog! Mouser Electronics, 11433 Woodside Avenue, Santee, CA. 92071. Telephone: (619) 449-2222.

## PROFESSIONAL AUDIO POWER AMPLIFIERS

ILP Electronics, a supplier of high-fidelity power amplifier modules and torodial power transformers, has introduced the MOSFET Series of power amplifiers for state-of-the-art music reproduction. Both models in the series are available factory assembled or in kit forms.

The MOSFET series features ILP modular amplifiers in a 19-in. rack size, combined with ILP torodial power transformers. These amplifiers are totally user-serviceable, and make easy-to-build kits. Serv-

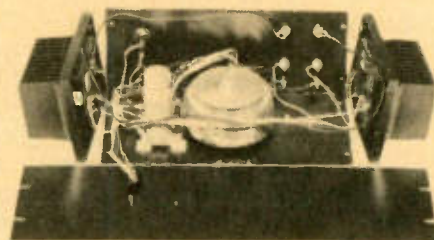

ice, if ever required, simply consists of replacing a module by a few solder connections.

ILP Mosfet Amplifier Modules provide faster slew rate, no cross-over distortion, and greater thermal stability compared to normal amplifiers. The integrated heatsink ensures long-term reliable operation. ILP Mosfet amplifiers have the ability to operate into complex loads without the need for any special protection circuitry. ILP Mosfet amplifiers also provide a high damping factor for superior amplifier/speaker interface.

ILP torodial power transformers operate with reduced noise compared to normal transformers. They are smaller in size and weight,



operate with greater efficiency, and at lower temperatures.

Model RM80 has 800-watts per channel output and features a twin power supply using a dual-wound toroidal transformer with electro-stating shielding. The unit is remarkably lightweight at 21 pounds due to the use of toroids and the efficient amplifier heatsink design. Price \$675 assembled, \$575 kit. Model RM70 provides 120-watts RMS per channel output and weighs 16 pounds. Price \$475 assembled, \$375 kit.

ILP Products are distributed by Gladstone Electronics, Inc., 1585 Kenmore Ave., Buffalo, NY 14217. Telephone: (716) 874-5510.

### SPELLING CHECKER FOR TYPEWRITER

The first spelling-checker for a portable electronic typewriter belongs to Smith-Corona. Called Spell-Right I, it can detect misspellings and typos of 35,000 of the most commonly used words. Spell-Right II, a more advanced version, checks up to 50,000 words, and is programmable for up to 300 more words of the typist's choice. Spell-Right can check for more words than the average person's vocabulary. According to the World Book Encyclopedia, the average American has a vocabulary of 10,000 words but when typing with Spell-Right I, a typist is able to detect misspellings or typos of 35,000 words.

The Spell-Right feature will immediately alert the typist to possible misspellings or typos with an audible beep. For example, with a typo such as "jumpd," Spell-Right will signal the typist as soon as the key for the letter "D" is struck.

Spell-Right II expands the number of words in the Spell-Right dictionary to 50,000. Furthermore, it allows the typist to add 300 specialized words, such as medical words, or proper names not found already in the Spell-Right II dictionary. A 16-



character display featured on the selected Smith-Corona electronic portable typewriter models designed to accommodate Spell-Right II will also allow the typist to look-up the correct spelling of a word if desired.

Spell-Right I, with a suggested retail price of \$69.95, will be available at authorized Smith-Corona typewriter and office machine dealers, mass merchandisers, cataloguers and department stores. Spell-Right II will be available at a suggested list price of \$99.95.

For additional information contact: Smith-Corona, 65 Locust Ave., New Cannan, CT 06840. Telephone: (203) 972-1471.

### MINIATURE METRIC SOCKET SET

A 10-piece Metric Socket Wrench/Nut Driver Set (58-0165) has been added to the Acu-Min Line of precision, miniature hand tools manufactured by Moody Tools, Inc. The set contains five metric socket wrench/nut driver blades, sizes: 2.0mm, 2.5mm, 3.0mm, 3.5mm, and 4.0mm. The metric sockets have hardened, plated steel and are fully assembled with five solid-locking, chuck-type, knurled, plated steel handles with swivel-tops. Metric



sockets are ideal for the repair and adjustment of imported electronics and industrial equipment containing miniature metric fasteners.

This 10-piece Metric Socket Wrench/Nut Driver Set, which has a suggested retail price of \$14.95, is packaged in a compact vinyl storage pouch. For more information, write to: Moody Tools, Inc., Dept. 851, 42-60 Crompton Avenue, P.O. Box 230, East Greenwich, RI 02818.

### NON-CONTACT TEMPERATURE MEASUREMENTS

Simpson is offering non-contact infrared temperature probe. The Model IR-10 converts Simpson (or other) DMM or VOM to a direct reading, non-contact temperature tester. The IR-10 can be used to measure temperature of hazardous materials, fragile objects, live circuits, rough or uneven surfaces or moving objects.



The Simpson IR-10 is supplied with 0.95 emissivity discs, adapters for different DMM/VOM inputs jacks, alkaline battery and operator's manual. Price is \$395.00, and the IR-10 (Catalog No. 00853) is available from Simpson distributors worldwide. Simpson Electric Company, 853 Dundee Avenue, Elgin, IL 60120-3090. ■



# NEW BOOK REVIEWS

## Managers and Computers



Here's a fresh approach in explaining the world of computers to business managers and executives. You'll find it in the book *Real Managers Use Personal Computers* by Dick Heiser. The text provides information every manager needs to operate a personal computer effectively. Author Dick Heiser presents the facts on buying and using a personal computer in an informal style that includes charts, illustrations, pictures, and cartoons.

The text begins with an overview of where and how personal computers fit into business managements and proceeds to an explanation of specific computer applications and their benefits. One chapter discusses in detail the process for buying a computer system, and the book ends with insights into the future of computers in business.

Dick Heiser is eminently qualified to write a book on computers in business management. After graduation from Rice University, he worked as a technical representative and later as a computer systems analyst and programmer. He bought his first personal computer in 1973 and, two years later, started The Computer Store in Los Angeles, California, the world's first retail store for computers. He used personal computers to manage the store profitably before selling it in 1982. In both public and private courses, Mr. Heiser has also taught hundreds of business managers to use personal computers. Currently, he uses an IBM PC and an Apple II

for the applications described in his book.

This book is publishing by Que Corporation, 7960 Castleway Drive, Indianapolis, IN 46250. It sells for \$14.95, is paperback bound and has 260 pages. Write to Que for their catalog of computer titles, or telephone: 317/842-7162. Paperback, 260 pages, \$14.95.

## Here Comes XENIX



The topic is hot: XENIX, Microsoft's popular implementation of UNIX. Endorsed by IBM and Tandy as an excellent choice for their computers, XENIX is predicted to be the operating system of the future for multiuser microcomputer systems. *Understanding XENIX: a Conceptual Guide* by Paul Weinberg and James Groff (a 240-page, paperback book) is for anyone seeking technical or market insights into the XENIX system. As the subtitle indicates, the book provides a solid conceptual overview as Weinberg and Groff answer such questions as: What is XENIX?, What are XENIX's major features and benefits?, How does XENIX compare to MS-DOS and to UNIX?, How do XENIX-based multiuser systems compare to networks of PC's for office applications?, What is the role of XENIX in the microcomputer marketplace today? In the future?

Helpful charts, diagrams, and illustrations enhance this lucid, easy-to-understand book. The visual shell, a menu-driven features that simplifies XENIX operation for novice users, is explained, as are

multiuser operations, test-processing tools, and portability and compatibility with other systems.

*Understanding XENIX: A Conceptual Guide* is available in bookstores and computer stores in North America and most of the free world. To order directly from Que, call 1-800-428-5331 and ask for a sales representative. It sells for \$19.95.

Both Paul Weinbergs and James Groff are experienced writers. Mr. Weinberg's technical articles on UNIX software and performance measurement appeared in *PC Magazine*, *Mini-Micro Systems*, and *Unique*. Mr. Groff's articles on the UNIX system and UNIX networking were published in *Electronics*, *Systems and Software*, and *Mini-Macro Systems*.

## Semiconductor Spies



SYBEX Computer books has just released *Espionage In The Silicon Valley* by John D. Halamka (240 pages, \$14.95, hard cover) in which the author investigates the five major kinds of espionage and also reveals startling new evidence, previously unpublished, raising questions of CIA, KGB and corporate involvement. Included is a special chapter on the Polish connection.

Five different case histories are presented, illustrating the five major kinds of espionage. The first is the James Harper case, a tale of foreign agents infiltrating US high-tech industries. The second is the Larry



Lowery case, a tale of blackmarket chips and mayhem. The third is the Peter Gopal case, a tale of trade secrets stolen for American competitors. The fourth is the Anatoli Maluta case, a tale of transshipment to the Soviet bloc. The last is the Hitachi case, a tale of trade secrets stolen by foreign competitors. Previously unpublished facts are included that raise questions about the CIA, KGB and America's largest corporations. Incriminating evidence is shown in photographs, diagrams, and confidential memos. A special 8-page insert of photos is included.

This title is intended not only for follows of the microcomputer industry but also for anyone intrigued by true-life stories. The title is especially appropriate for professionals in the computer industry who want a concise and factual yet fascinating account of espionage in the most technologically advanced region of the world. SYBEX is at 2344 Sixth Street, Berkeley, CA 94710, telephone: (415) 848-8233.

### Hidden Satellite Signals



The Hidden Signals On Satellite TV by Thomas P. Harrington and Robert B. Cooper, Jr. is the first book that completely covers the entire field of non-video satellite services carried on the domestic satellites. These services include: stereo subcarriers, telephone channels, world news and press services, teletext and other VBI systems, single channel per carrier (SCPC) systems, plus other data

systems.

Hidden Signals deals with all phases of this expanding side of the satellite business: the systems, how they work, who uses them, how they are received, and how the services can be utilized. The entire book is devoted to this area, and is a complete works in this field to enable a person to thoroughly understanding the latest developments and put this knowledge to use.

Hidden Signals is a must for the new entry into the satellite field, as well as the person who is now in the trade. The book is straight forward, easy to read and understand, 180 pages, containing many diagrams, photos and other pertinent information.

Available for \$14.95, plus \$2.00 shipping and handling from Universal Electronics, Inc., 4555 Groves Road, Suite 3A, Columbia Ohio 43232. Phone: (614) 866-4605.

### Do-It Yourself Burglar Alarm Catalog

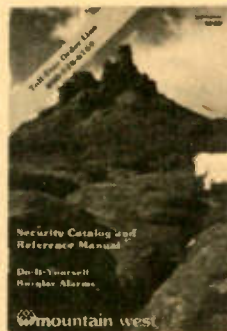

Readers interested installing their own burglar on fire alarm systems will appreciate the Mountain West catalog of alarm supplies. Each pre-packaged system is especially designed for a different application, whether by homeowners, businesses, or industrial users. Readers may also design their own system from the selection of hard-to-find components offered.

The catalog's 96 pages are packed with a variety of essential items, ranging from the most

sophisticated controls and sensors (sound detectors, motion detectors, smoke detectors, etc.) to the tools and test equipment (relays, wire, drills, etc.) so necessary to a reliable installation. Related security equipment covers computer security, business security, vehicle security, access control, and surveillance/countersurveillance.

A free copy of the Mountain West catalog may be obtained by simply writing to Mountain West Catalog, 4215 N 16 Street, P.O. Box 10780, Phoenix, AZ 85064-0780, or telephone: 1-800-528-6169.

### Spreadsheets and More



54 VisiCalc Models by Robert Fast presents solutions to common problems in finance, statistics, and mathematics.

These VisiCalc solutions are called templates, because they are working, reusable examples of VisiCalc applications. In other words, someone who doesn't know anything about the VisiCalc program can center the template and use it to perform the intended application over and over again. Templates can also serve as models to modify and customize.

Readers will find sample problems and their solutions, as well as complete listings of the VisiCalc instructions needed to solve these problems. In addition, the book provides frequent, practical examples of the use of almost all the VisiCalc Instructions and features. The 277-page, softcover book sells for \$15.95. Published by Osborn/McGraw, 2600 Tenth Street, Berkeley, CA 94710.



# THE HOBBYIST'S TEST BENCH

This guide to selecting the right gear for troubleshooting and experimenting will give you an idea of what's available in the field of equipment for the hobbyist

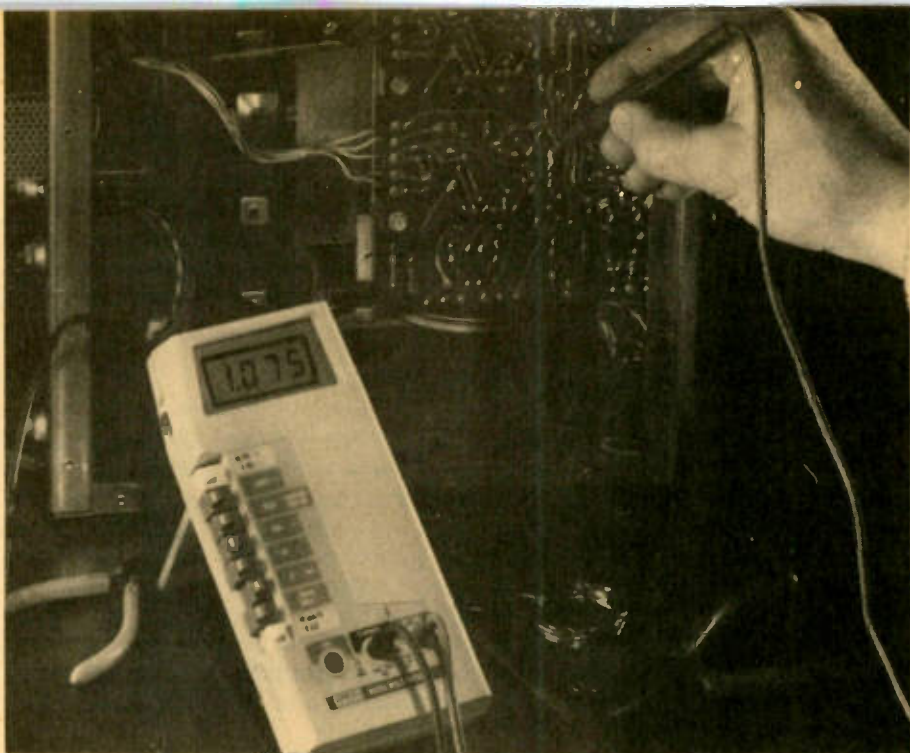

□ The day of the "screwdriver mechanic" is long past in electronics. Troubleshooting the complicated and delicate circuits of today requires much more sophisticated equipment than the screwdriver and ohmmeter that were once enough. The trick, for the electronics hobbyist, is selecting reliable and accurate test equipment at a reasonable cost.

The key to success in equipping a hobbyist test bench at a rock bottom price is to always keep in mind two important facts: A) Only a few basic instruments will handle most hobbyists needs; B) You don't need laboratory-standard equipment, because you're not building space labs for NASA. For example, most hobbyists will rarely have need for a voltmeter with 0.01% accuracy, so why spend several hundred dollars for an instrument you might only need once? Unless you intend to contract out for laboratory services, you don't need a scope with vertical delay line, sweep delay, dual sweep or plug-in amplifiers.

**What You Really Need.** Let's take a look at the test bench instruments that will satisfy most hobbyists's needs.

Leading the list is an ordinary 20,000-ohm, 50,000-ohm, or 100,000-ohm volt-ohm-milliammeter. Its common worst-case tolerance of 3% for DC measurements and 5% for AC measurements is more than adequate for typical use. If you need better than this, you should make measurements with a scope rather than a digital meter.

The VOM, as the meter is more often called, measures AC and DC voltages, resistance from "0" to several megohms, DC current from microamperes to about 10 amperes, and sometimes OUTPUT, which is nothing more than the AC function in series with a DC blocking capacitor that permits the user to measure AC in the presence of DC without the DC affecting the meter's reading.

Just about any type of VOM can be used by the hobbyist, although models with meter scales measuring approximately 5 inches, and with at least three resistance ranges (Rx1, Rx10, or Rx100 and Rx1000), are the most convenient.

About the only measurements the VOM cannot handle are instantaneous and pulse waveforms; these require an oscilloscope.

As a basic measuring instrument for hobbyists the VOM is recommended over a digital meter because the VOM can "track" a slowly varying voltage, current, or resistance. A digital meter "jumps" from one value to the next. The ability to literally see an incremental change in value is

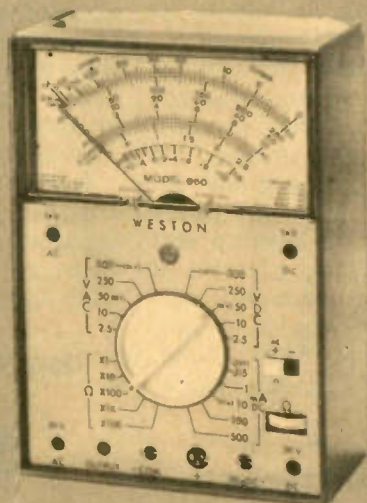

A good VOM like this Weston 660 is basic to the well-equipped test bench. Meters with a needle movement can actually be used to "track" any incremental changes in voltage as they occur. This is good for troubleshooting.



For absolute accuracy in measurements, you need a digital multi-meter, or DMM. Its readout shows the exact figure, indicated by LEDs or LCDs. No meter movement can duplicate the DMM.



often more important to the hobbyist than the precision of a digital meter.

When you require absolute accuracy, say to resolve the difference between 4.85 and 5.25 VDC, there is no low cost substitute for the digital multimeter, or DMM. Depending on how much you spend, DMM accuracy will typically range between 0.05% and 1%; this contrasts with VOM accuracy, which is usually in the 1% to 5% range for hobbyist-grade equipment.

The DMMs have virtually the same measurement functions as the VOM, the primary difference being that the measurements are indicated by a digital readout rather than a meter movement.

DMMs use either an LED or LCD display. As a general rule of thumb, the LCD display is used in the lower

cost meters because, with its low current requirement, it serves nicely for a battery power supply that lasts almost the shelf life of the battery. DMMs with LED displays generally require a 120 VAC power source. When battery powered, they usually use NiCads, which require frequent recharging.

Whether LCD, LED, portable or bench model, DMMs usually have the same functions. Within a given type, higher price generally reflects greater accuracy and a larger, more readable, display.

**The Oscilloscope.** Once you get beyond the stage of puttering with simple experimenter type projects, the most valuable test instrument is the oscilloscope. Most of today's equipment has some form of pulse circuitry, and the only way you can test or measure most pulse-type circuits is to actually *look* at the waveform. The way you look at a waveform is with an oscilloscope, or "scope" as it's usually called in the trade.

While those laboratory type scopes with plug-in amplifiers that go well into the RF region, and digital CRT display, are both attractive and impressive, their price is similarly just as impressive. Yet few hobbyists need a laboratory grade scope. At most, you scope will need just a few of the less expensive "laboratory" features. Primarily, a *calibrated time-base* is an absolute requirement, even for the beginning hobbyist. Particularly when dealing with digital circuits, you must know the timing of an event, and how often it occurs.

The time base, or *horizontal sweep* as it's often called, is calibrated in CRT graticule divisions. For example, if there are 10 horizontal divisions, one of the sweep speeds, or time base, might be *1 sec./div.*; which means that it takes the sweep 1 second to traverse 1 division, or 10 seconds for the whole 10 divisions. When each division is precisely 1 cm., you might see the time base calibrated in centimeters; for example, *1 sec./cm.*

Calibrated time bases are always switch selected, with a potentiometer adjustment for selecting sweep speeds in between switched values. Note, however, that the time base calibrations are valid only when the potentiometer is set to a "calibrated" position.

While not as important to the hobbyist as a calibrated time base, a *calibrated vertical input attenuator* is a decided convenience. Similar to the calibrated time base, the vertical attenuator is calibrated in volts per division or centimeter, and there is a variable attenuation adjustment. Scopes with vertical inputs calibrated in *gain*—X1, X10, X100—are better than those having just a continuously variable input attenuator. However, you'll need some form of calibration reference voltage—which is often built into the scope—if you want precise voltage measurements.

As for the scope's frequency range, anything that will handle home TV will generally be more than adequate for the hobbyist. A vertical frequency response 3 dB down at about 4 MHz or higher will be sufficient. Often, scopes intended primarily for TV servicing will have switch-selected sweeps specifically calibrated for the vertical and horizontal TV receiver sweep in addition to the standard time base.

If you plan on using the scope to examine modulated RF waveforms into the HF-VHF range (above 5 MHz), say for an amateur transmitter, you'll need a *direct plate* scope input. This is a set of input terminals that connect directly to the CRT plates without passing through an amplifier en route.

**Variable Power Supply.** The next item to consider for your test bench is either a variable voltage power supply or a signal generator. On the assumption most hobbyists will be experimenting with solid-state circuits of all types, we'll

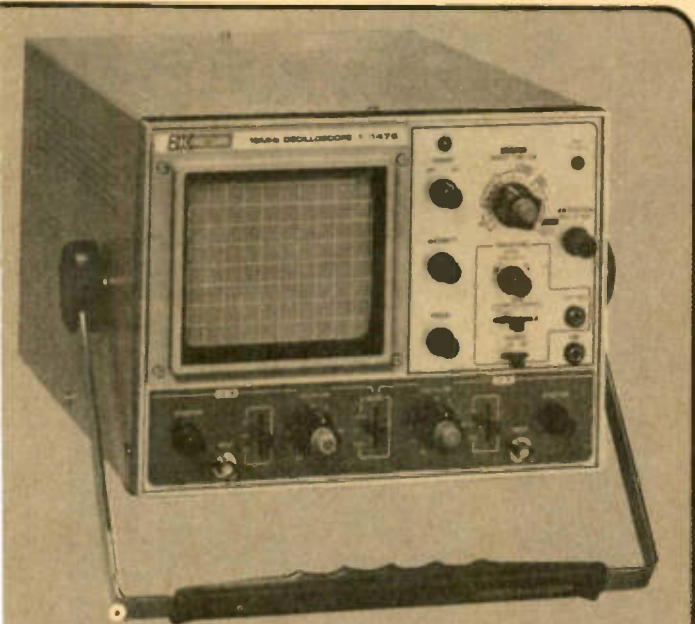

As your interests become increasingly sophisticated, you will probably find frequent use for an oscilloscope such as this unit from B & K Precision.



Probes like this one from Global Specialties are a must for digital experimenters.



# Hobbyist's Test Bench

opt for the power supply first.

Solid state circuits and equipment appear to use an almost infinite selection of operating voltages. Unless you have an endless assortment of battery types, the best way to power an experimental circuit, or any battery powered equipment, is by using a *protected* variable voltage power supply. First off, a range of about 0-30 volts will handle almost all of the experimenter's voltage needs. Secondly, since current-carrying capacity is what really costs money, figure a maximum output current of 1-2 amperes. Even a 500 mA output will handle most experimenter needs.

Protection means the way whereby the power supply protects itself or the circuit it is powering. One characteristic of solid-state circuits is that they usually short circuit. If there is no protection in the power supply, the supply would attempt to deliver full current *into* the short. A supply with basic protection will automatically start to reduce the output voltage when the current starts to exceed the rated maximum output voltage or the voltage programmed by the user. If the supply senses an excessively low impedance approaching a *dead short* the output voltage might be reduced to zero.

An even more convenient protection is *user programmed* maximum current. In this instance, the power supply has both voltage and current adjustments. After the user programs the desired output voltage, he short circuits the supply's output terminal and then sets the current adjustment for the *maximum* desired value. If the circuit or equipment that's powered attempts to draw more than the programmed current, the supply automatically shuts down the output voltage. Of all the power supplies available, the type with programmable maximum output current is usually the most valuable for the hobbyist.

If you intend to work only with digital circuits then a *digital power supply*, meaning one with a fixed, regulated 5 volt output, will probably handle almost all your needs at a relatively modest cost.

**The Logic Probe.** Speaking of digital equipment, many consider the *logic probe* the most important tool for the digital experimenter. Basically, the logic probe simply tells the user whether a test point in a digital circuit is HIGH (1) or LOW (0). Usually the indicator is an LED built into a hand holdable probe; when the LED lights up, the test point is HIGH; when the LED is out, the point is LOW.

The input impedance to a logic probe is often on the order of several megohms (it is always "high impedance") so there's no "loading" of the circuit being tested. Most probes also have several sensitivity ranges, to accommodate the various reference voltage levels in RTL, TTL, DTL, CMOS, MOS and microprocessor circuits.

While the basic probe indicates either HIGH or LOW, the more sophisticated models can "catch a pulse"; meaning they have memory. For example, if the circuit is LOW but a transient pulse has occurred, the logic probe will "catch the pulse" and indicate the pulse even though the circuit has returned to LOW. Some probes require the memory to be manually disabled for the next pulse, others automatically clear when the probe is lifted off the circuit.

**The Signal Tracer.** One of the least esoteric but most convenient pieces of test gear is the *signal tracer*. This device can track a signal almost from the antenna, through RF and IF amplifiers, through the AF amplifier, and up to the speaker. With a tracer, an advanced hobbyist, or a technician who is familiar with what AF and RF circuits should



The Mura Clamprober is a handy variant of the VOM. It is pocketable and gives results.



Something like this Logic Monitor from Global Specialties is a must when precise measurements of faulty microprocessor chips are called for.



A status symbol among hobbyists and a primary tool for the professional, there is no substitute for an accurate frequency counter.

be doing, can knock hours off a difficult servicing or troubleshooting job. The signal tracer is basically a very high gain audio amplifier with a switch-selected RF probe—actually an RF detector probe.

The straight AF amplifier can trace a minute signal from a magnetic phono pickup, a microphone, or a receiver's detector. Where the signal stops is where the trouble is.





Smaller frequency counters like this one from Optoelectronics, Inc. are all the counter that most hobbyists will ever be in a position to need.

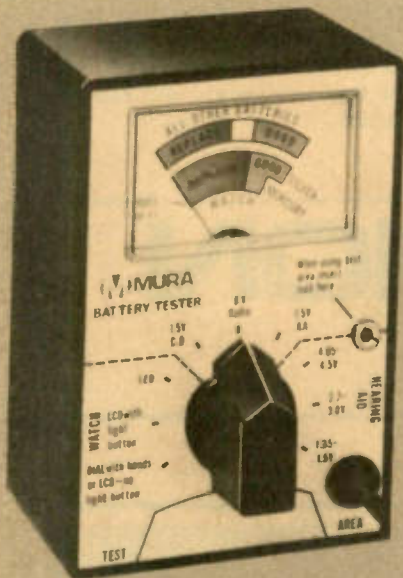

This Mura Battery Tester is a handy device, especially if you spend a lot of time around portable solid state equipment. Its color-coded scale is set up to give a quick reading of the most popular battery voltages.



In experiments or projects involving complicated circuitry, it is often important to know the exact capacitance of components; this capacitance meter is the ticket.

Similarly, with the RF probe switched in ahead of the AF amplifier, a signal can be tracked through a receiver from the first RF amplifier. (If the received signal isn't strong enough for detection, feed in a stronger "local" signal from a signal generator.)

Even SSB and FM signals can be tracked with what is otherwise an AM RF detector probe. SSB and FM will be

highly distorted; but again, where the signal fails to pass is where the trouble is.

As a general rule, signal tracers provide access to their own speaker terminals so the tracer's speaker can be used as a substitute for the speaker of the receiver or amplifier being tested. Also, many signal tracers have a built in AC wattmeter; if you suspect some equipment is defective you can measure how much power it draws and compare the figure against the equipment's specifications.

If you're into any kind of experimentation or service of radio communications gear it's almost certain that you will need a signal generator. Generally, the low cost "service grade" signal generator is more than adequate, unless your work is almost entirely restricted to FM or TV equipment.

The typical service grade generator provides a variable RF output level in the range of about 100k Hz to 50 MHz on fundamental frequencies, with harmonics providing usable test signals to above 150 MHz. The RF signal can be unmodulated (CW, for *continuous wave*), or modulated, either by a 400-1000 Hz internal oscillator, or by an external AF signal through terminal connections. The internal oscillator's signal, whose level is adjustable, is available at the same set of terminals, so it can be used as a separate AF test signal (say, for troubleshooting amplifiers).

The type of modulated test signal depends on whether the generator is tube or transistor (one is not necessarily better than the other). Tube generators can generally be AM modulated to 30%-50% by the internal oscillator—30% is the standard test value for AM receivers.

Transistor generators can generally be modulated to 80% to 100%. Only if you have specific reason to test the adjacent channel rejection of CB (Citizens Band) receivers will you need modulation capability greater than 30%. (More than 30% modulation usually adds big bucks to the cost of a signal generator.)

**The Frequency Counter.** Everyone wants a frequency counter. It is probably the most common status symbol in electronics. However, unless you're a Radio Amateur or an RF experimenter, money spent for a counter is probably better invested in some piece of general purpose test equipment. Glamor aside, you'll have very little use for a counter in digital, audio or general electronic experimentation.

But, as we said, if you're into RF you need one; and it will probably turn out to be one of the most important instruments on your bench. The counter has no low cost equal when it comes to troubleshooting oscillators, multipliers and frequency synthesizers. There are even experimenters who signal trace RF amplifiers with a small homebrew sensing coil attached to a counter.

Counters come in many shapes, sizes and styles. As a general rule, however, there are two basic types: those with the reference crystal in a heated, temperature-compensated oven, and those with an unheated crystal as the time base reference. The accuracy of any counter is that of the reference crystal oscillator, plus or minus 1 count. Those which have heated crystals simply provide a higher, more stable accuracy, as required for precise transmitter frequency measurements. Unless you are a service technician who must certify the output frequency of VHF or UHF radios or AM, FM and TV transmitters, there is no good reason why you need spend the extra several hundred dollars for a counter with a crystal oven.

A low-priced general purpose frequency counter will generally cover from about 50 to 100 MHz. If you need coverage above this maximum it is usually less expensive to connect an accessory *prescaler* ahead of the counter. The prescaler is a device that multiplies the frequency counter



## Hobbyist's Electronics Test Bench

reading by a factor of X10 or 100(X). (Most prescalers have only the 10X mode.) The maximum counter range then becomes that of the prescaler. For example, a 144 MHz oscillator that is prescaled 10X would be indicated as 14.4 MHz—the user must “move” the decimal one place to allow for the prescaler's 10X factor. It's all very convenient but it does not mean that a counter with a 50 MHz maximum frequency can be prescaled to 500 MHz. If the prescaler has a maximum range of 200-MHz, then that's it for the whole system. Feeding in, say, a 400 MHz signal will produce an erroneous “reading.”

Almost all hobbyist and service grade counters have a 1-megohm input impedance, which allows the device to be bridged across most RF circuits because RF circuits are usually of relatively low impedance. For hi-Z circuits, the 1-megohm impedance allows convenient use of a pickup coil or telescopic whip antenna. A few service-grade, and almost all lab-grade, counters have a 50-ohm input in addition to the 1-megohm input. The 50-ohm input is a bit difficult for the hobbyist to use because it often has a maximum input power of ¼-to-½-watt and tends to load down the circuit being tested. However, all generally available prescalers have 50-ohm inputs; so take extra care when using a prescaler.

Keep in mind that a frequency counter is not a *general use counter*. A frequency counter indicates frequency, di-

rectly in Hz, kHz or MHz. A *general purpose counter* indicates directly in both *frequency* and *time*. In addition to the frequency calibration, it will be calibrated in, perhaps, *seconds*, *milliseconds*, and *microseconds*. It can time the period between events, the period of one or more events or the ratio in time between events. It can also be *gated* to time a specific event. As you might well imagine, a general purpose counter costs a bundle.

The typical hobbyist counter is available with either an AC power supply, a battery power supply with built-in or optional AC adapter, or with a rechargeable NiCad battery power supply. It is a general rule—perhaps Murphy's Fifth Corollary—that batteries are discharged when they are needed most. Unless you need a frequency counter for use away from the AC power, get a counter with a built-in AC power supply. There's no point in paying for a battery pack if you don't need it.

We've covered the instruments that are most commonly found on the typical experimenter's test bench. Naturally, as you develop specific interests, you will also accumulate test gear specifically intended for that interest. For example, if you get deeply involved with the technical nitty-gritty of high fidelity sound, you will most likely find that you need a low distortion audio signal generator and a distortion meter. If you get heavily into RF transmitters, you'll probably want a bi-directional power meter and a kilowatt 50-ohm dummy load, or maybe a 200-watt dummy load with built in direct-reading power meter.

But regardless of what direction your interests take in the future, the basic hobbyist test equipments will remain the foundation of your test bench. ■

# CONSTRUCTION QUICKIE

## Digital Goes Linear

Digitally-oriented ICs are best at their intended On-Off tasks, but can be persuaded into linear operation if care is taken. CMOS lends itself better than TTL for linear operation, but good by-passing and layout is essential to avoid pickup and exotic self-oscillations. The 4009 CMOS hex-inverter sections can be biased as shown below. A typical single stage yields a gain of about 5. The triple combination can give a gain of 100 with care. These circuits could be useful where a high-impedance input circuit does not quite have sufficient amplitude to operate the digital gate. ■

### PARTS LIST FOR DIGITAL GOES LINEAR

- C1, C2—0.1- $\mu$ F ceramic capacitor, 15 VDC
- IC1—4009 hex buffer
- R1, R2, R3—1,000,000-ohm, ½-watt resistor
- R4—500,000-ohm linear-taper potentiometer
- R5—5,000,000 to 10,000,000-ohm, ½-watt resistor

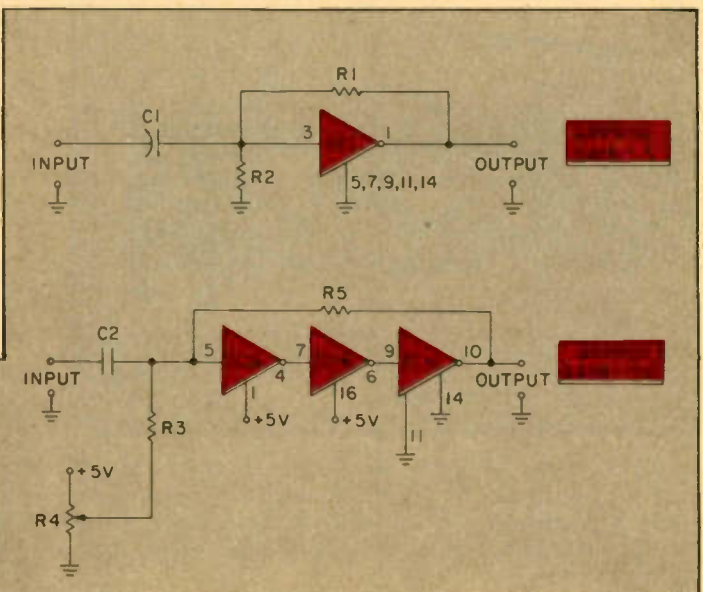



# KEEPING YOUR HOBBY COSTS DOWN

Dollars can get you anything, but not everything! Smart buys will mean more gadgets and gear for less bucks. We tell you how.

by Herb Friedman

Whether you're buying just a handful of components for a do-it-yourself project, a hi-fi system, a video tape recorder, a home computer, a table radio, or some electronic gizmo that wasn't even invented until last month, in most instances what you get won't be worth what you pay for it. Not that you will necessarily get inferior goods; rather, you will simply be paying more than the item or service is worth.

Instead of the price of electronic equipment and service representing a true cost/value ratio, it often conceals multiple levels of profits for multiple levels of ownership, company mismanagement and losses for ventures totally unrelated to the normal purpose of the business, governmental quotas to protect certain industries, astronomical charges for repairs because "We're the only place that has the parts," postage and "handling fees" for warranty repairs which actually cost more than the repair itself and...well...the list of unrelated costs that now go onto the price of anything electronic is almost endless. Generally, consumer costs have become "whatever the traffic will bear."

But there are ways in which the *you*, the consumer, can save *big bucks* when buying such things as electronic parts, a video tape recorder, a computer, a TV antenna installation, just about anything. The way to cut costs to rock-bottom is to take advantage of distress and surplus merchandise, seasonal sales, contract service, and, most important, new models.

Let's take a look at some of the things you can do to get the most bang for a buck — how to squeeze almost anything into your budget. But keep in mind that we don't suggest that our recommendations are necessarily the right way for every situation; rather, they are meant only as a guide to help *you* determine how you can get the most for *your* money.

## Building it Yourself

First things first, let's look at "homebrew projects:" the gizmos and gadgets you build for yourself. For illustration, let's assume you're into photography and you'd like to have a bare bulb electronic flash unit, the kind of thing that makes your flash pictures look as if they were taken under natural lighting. You dig out the General Electric flashtube manual from under the dust at your local library, and there it is: a complete schematic and parts list for line-powered bare-bulb flash tube.

Only problem is, when you add up the cost of the parts it



comes out to more than a commercial electronic flash would cost. You have learned the first lesson of modern home construction: The individual cost of the components ranges from twice to greater than five times the cost of commercially built equipment. Just a small metal enclosure for a hand-sized project will set you back around \$5 before you purchase any other components. A toggle switch for power control? Maybe a \$1.50 if you use a large one. If you're building a small project and need a miniature switch it's about \$2.50. Transistors? The general replacement at Radio Shack will cost you more than \$1; the same item under its own JDEC number will cost between 25 and 50 cents. An LED for an indicator lamp?; maybe 2-for-\$1. We could go on and on, but you probably have gone down the road of disappointment before. Worse yet, it's likely often you have gone to great effort and expense to obtain the components for a particular project only to discover that one single component, the one without which the project won't work is unavailable. You have maybe \$10, \$20 or more invested in components and you can't get the most important part.

If you're really into home construction and want to build things at rock-bottom cost the way to do it is to get out of the "all new" rut. Start thinking "surplus." For almost every item commercially manufactured there are truckloads of components left over that the manufacturer wants to turn into immediate cash by selling them "in bulk" to a surplus



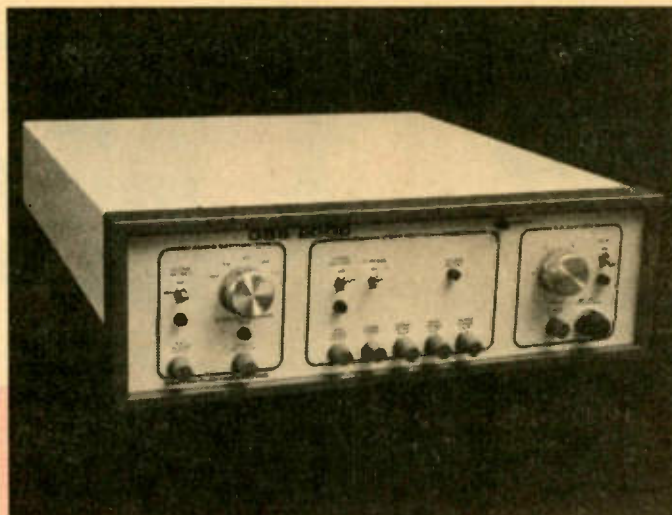

Watch out for the prices on home video equipment. Those prices are going through the roof because there is a large demand for them right now. It may be wise to hold off purchase until a dull buying season like July when everyone is out-of-doors and not interested in viewing tapes and satellite programs. Prices may come down during sales.

distributor. It's all prime stock, but it's no longer needed. It's out there in the marketplace at anything from 50% to 75% below what it sells for as "standard stock." For example, miniature toggle switches similar to the one sold for \$2.49 at Honest Harry's Electronic Flea Market and Pet Store can be purchased from a surplus distributor for \$1 to \$1.25—the exact price depending on the particular dealer. Remember the electronic flashtube we wanted to build? A "standard stock" blister-packaged flashtube will set you back about \$7.50. The same tube, surplus, wrapped in tissue paper can be purchased from a surplus distributor for \$2.50.

Transistor prices got you down? Why pay extra for a so-called *universal* or "*direct*" replacement? You can purchase "the real stuff" from surplus distributors for about 25% of the "universal price." In fact, you pay about the same price if you purchase the real stuff from a prime source—meaning an authorized distributor for the part.

The truth of the matter is that the marketplace is literally drowning in surplus components. Except for a specific esoteric part, you can find virtually anything you need at bargain prices. But don't get trapped by "postage and handling fees." Often, the store makes more profit on these charges than they do on the components. To keep "postage and handling" charges from escalating into a major expense, consolidate all your purchases so you order from only one source. If possible, specify only UPS (United Parcel Service) delivery. It's the fastest, least expensive, most dependable way to ship; and every package is automatically insured for up to \$100. If anyone has an insurance fee when shipping an under \$100 package via UPS better ask yourself if this is the kind of operation you want to do business with. If the store has a flat charge of 10% of the total bill, that works out to \$10 per hundred. People have had relatively heavy computer equipment worth many hundreds of dollars shipped via UPS for less. Unless you're buying lead fishing sinkers, or iron weights for a bell bar, 10% of anything

should raise some questions in your mind. (It might be reasonable, but then again, it might not.)

#### Hi-Fi at the Lowest Cost

If you live outside the larger cities there is rarely any discounting of Hi-Fi components, or anything else for that matter. If you have the confidence to purchase mail order you can easily save yourself from 20% to 30% or more on name brand high fidelity components, TV, video recorders, just about anything. Surprisingly, the greatest discounts are from camera dealers, the great ones in New York City that go by names such as 47th Street Photo, Competitive Camera, and Focus Camera and Electronics. These are very reliable mail order houses that stand behind everything they sell, and they sell the best-known brands. People come from all over the world to purchase their camera and electronic equipment from these dealers, so you know their prices must be right. Most of them advertise in the Metropolitan and Entertainment sections of the Sunday edition of the New York Times newspaper. If you're ready to spring for relatively expensive equipment it will pay you to search out where you can purchase the Sunday edition. Maybe a friend living in one of the major metropolitan areas will mail you the advertisements. The savings can be very large, so it's worth lots of extra effort to check the advertisements.

Another money-saver for high fidelity enthusiasts is the twice a year sales when the fidelity industry introduces new models. Overnight, a vast supply of components becomes "last year's model," sold off at a substantial reduction from the usual selling price. If you can wait for the sales, which are generally around September and January-February, you can often get components you never thought you could afford. You might not have the largest possible selection because a line of components you're interested in might not be on sale—there might be no new models in a particular line—but if you're willing to compromise on a feature or two, or perhaps on the brand—maybe substitute Pioneer for



Kenwood equipment or viceversa—you can easily save between 20% and 50% of the discounted price—what is called “the New York price.”

There's also a time to purchase video tape recorders. Selected new models—usually those at the low priced end of the line—are introduced around Washington's birthday. That's the time you can get some great prices on both last year's models and the latest versions. Often, the dealer will also throw in a handful of tapes, or maybe a year's worth of free movies.

If you want to cut costs on maintaining a video cassette recorder consider a service contract. Experts rarely recommend taking out a service contract on any home appliance. Unless you get stuck with a “lemon” you won't even break even with a service contract. Video recorders are something else. Almost any repair you can think of is time-consuming. Many authorized repair stations now charge nominally \$75/hour for service, plus parts. The video heads for one popular recorder costs \$225. A single replacement of heads can cost almost as much as the recorder. While the machines are much better made than they were a few years ago, they still break down, and they are expensive to fix.

If the dealer has a service contract that 100% guarantees parts and labor take it. \$50 is not an unreasonable fee considering that major service companies charge more. But keep in mind that a parts-only guaranty is almost worthless; except for the heads, labor is the big expense. Also, make certain the dealer's service contract is renewable after the second year. That's when you're going to have problems if you give the machine heavy service, and if he bails out and doesn't renew the authorized service shop might not sell you a service contract if you didn't have an “authorized service contract” for the first year or two.

If the dealer does not provide his own “carry-in” service warranty buy the best machine you can get. What's the best machine? The one for which there is an authorized service agency in your town. All the VCRs are good: many come from the same factory. If your machine does break down, you don't want to have to worry about packaging the machine and shipping it someplace on the other end of the

country—paying for shipping costs both ways. The “best” VCR is the one for which there is nearby carry-in service.

### Snow All Year

Does everything on your TV look like it's coming from the Winter Olympics in Yugoslavia? You know, the one where everything was seen through a white blur because it snowed all the time. If so, you're probably ready for a new antenna system. Antenna systems do age and run down. Moisture gets into the transmission line, antenna connections corrode, some elements fall off, the mast gets loose. If you haven't priced a TV antenna installation better sit down first. The last time we inquired it ran about \$150 to \$200 to install the equivalent of what we could purchase at the local Radio Shack for about \$25.

There is nothing mysterious about a TV antenna installation. Unless you're out in the deep fringe area where repositioning the antenna a foot in either direction can make the difference between a decent picture or none at all, just about anything will work as long as it uses coaxial transmission line and the installation resembles the antenna installation used by your neighbors. If their antenna is 40 feet above the ground that's where your's belongs. If theirs points NNW, that's where you point your antenna. The secret to good reception is to purchase an antenna that's “milage rated.” If you live 25 miles from the TV broadcast antenna you need a receiving antenna rated for at least 25 miles. If you live 40 miles from the TV antenna you need a receiving antenna rated at least 40 miles. The ratings such as “local,” “fringe,” and “deep fringe” mean nothing unless something also specifies the milage sensitivity, which isn't “official” anyway. Radio Shack antennas are milage rated, so that's really a good place to start.

Often, a TV antenna that's been up many years will droop, appear to be ready to fall down, and obviously in need of replacement. However, check the antenna carefully. Often, the drooping is caused by the rusted U-bolts which secure the antenna to the mast and the mast to the wall brackets. The U-bolts are iron and rust thru rather quickly. New U-bolts, which are available from auto supply stores and muffler shops, will make your antenna system stand tall once again.

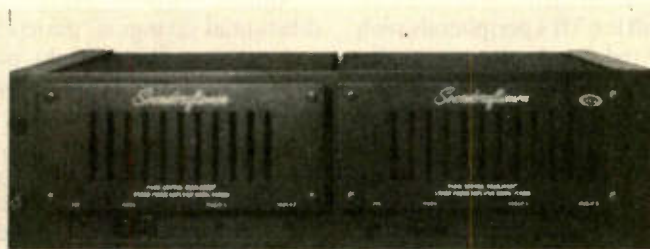

Audio electronic equipment designed for the super audiophile is very expensive. At times, you will have to **shoot dice** to pick up a used unit. Remember, the unit is often out of warranty! Better than shooting dice is to look for last year's model on sale. This is still a brand new product sold in a sealed carton. Often, the price drops out the bottom for some audio models because the new models are now on the marketplace. Also, some products are discontinued, and the manufacturer wants to get them off the shelves quickly.





The best buy of a personal computer is determined first by your current and future needs. Don't start looking at the price tag until you are sure the computer will provide the features you require. The best buy available may be too expensive should it prove to be insufficient to your needs.

the transmission line is more than five years old it's probably got more losses than a gambler in Las Vegas. A transmission line is relatively inexpensive, so replace it. Between the new transmission line and new mounting brackets you might end up with picture quality the equal of a whole new antenna system, and it will probably save you at least \$100 compared to what the local TV shop would charge you.

### Cutting Computer Costs

There is almost no such thing as a discount on personal computers. No matter how the advertisements twist and turn the computer itself is generally "full list." It's peripherals such as printers which are discounted, and often a really substantial discount is offered as a "complete package" consisting of a computer and the printer, or the computer, a printer and some other peripheral such as an extra disk drive. In the New York "discount" stores, there are some notably excellent prices on well-known computer printer packages, such as a Kaypro computer with an Epson or Comrex printer, or an IBM PC with two disk drives and monitor for the usual price of the same system with one disk drive. However, be very wary of packages with unknown or little known printers. They might be quite good, but some of them use special ribbons (that's where they make their profit) that aren't all that available outside the larger cities.

Also be wary of computer packages which include a software bundle worth empty-up dollars. Is the bundled software really worth anything to you? If you need a personal computer only for applications software and never

intend to write any programs, both a BASIC interpreter and a BASIC compiler, which might be worth nearly \$500, has no value at all to you. Similarly, a package of expensive word processing software is also worthless if you intend to use some other word processing program, as is keyboard reconfiguring software if you have no expectation of reconfiguring your keyboard. Bundled software packages always appear to be a fantastic value until you ask yourself "Do I really have use for it?"

### Summing UP

Almost without exception, there is a way to make substantial savings is "patience." If you don't have to run out and get something "right now," if you can wait to shop around, wait for the special sale days such as Columbus Day and Washington's Birthday, if you have the confidence to trust in mail order purchases, you can easily average savings of 20% to 50%, particularly if you outside a metropolitan area, for the rule of thumb is "The farther you live from a large city, the higher the price for appliances and equipment of any kind." One final note of caution, however. Never, but never, pay for any mail order purchase by check. It's your money out there in the marketplace and it's your problem if something goes wrong with the sale. Instead, use a credit card. If something goes wrong and you don't get the merchandise you ordered, or you get the wrong merchandise, it's usually the bank's problem. Also, a personal check takes two weeks to clear before the seller will ship to you. With a credit card purchase your order will probably be on its way to you in one to three days.



# SIMPLEX-A-THING

Remote telephone signaling helps avoid missing those important phone calls

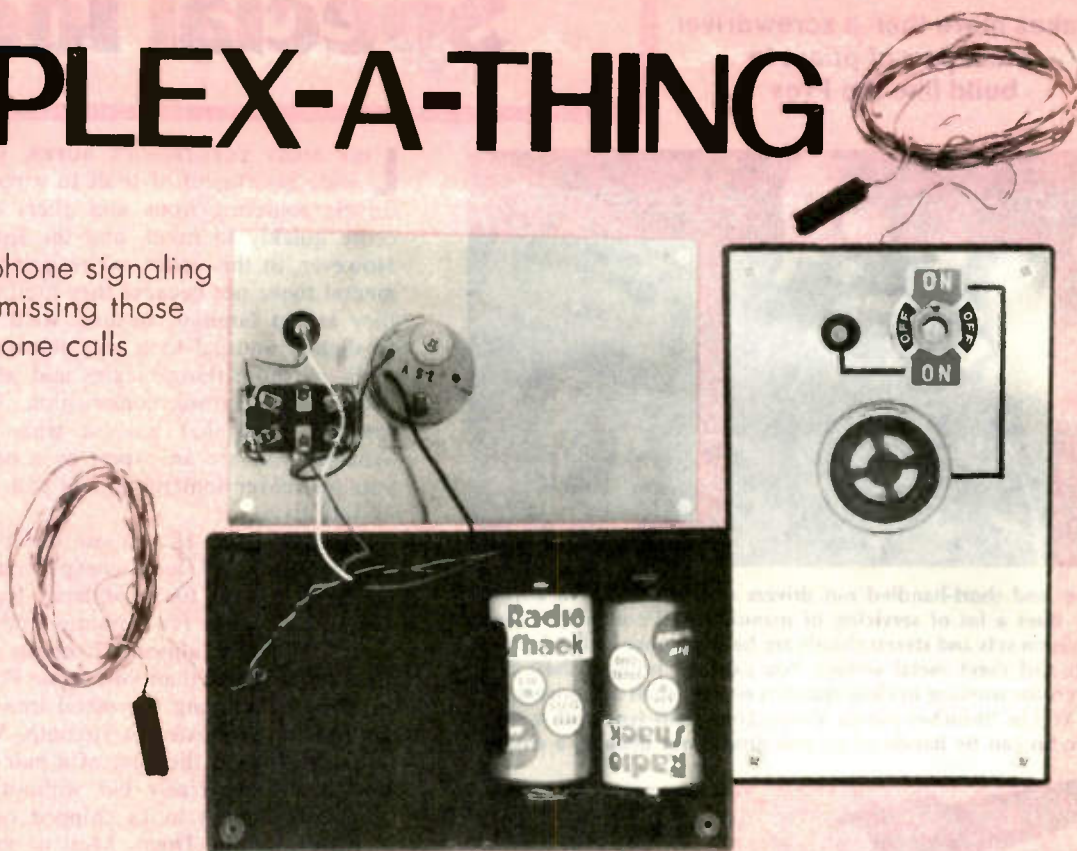

**Y**OU WON'T MISS any more phone calls when out of hearing range of your telephone, if you add this simple remote signalling unit which alerts you to incoming calls by means of either a buzzer or blinker light. The unit is self powered for easy placement in any room in your home, or even outdoors where there are no AC outlets.

Now that you are permitted to own your own phone, you don't have to worry about the legality of add-on convenience devices, so long as you don't

upset the phone company's circuits. This unit won't bother Ma Bell one bit because it is *not* electrically hard-wired to the telephone lines, and therefore cannot possibly cause voltage drops that could be detected at the phone company switching station. This gadget simply senses the normal ringing of the telephone with a magnetic reed switch placed near the telephone ringer armature. When the phone rings, the armature generates a strong electro-magnetic field, which trips the reed switch.

The switch is triggered even if you turn the regular telephone bell off to provide completely silent signalling by means of a blinker light.

**Construction.** Solder a 14-inch-long insulated wire to each end of the reed switch and terminate these leads with a phone jack. Insulate the switch body before installation in the telephone, by means of a plastic sleeve or with electrical tape.

Open the telephone and remove the bell-clapper arm back to where it joins the armature-coil assembly.

Have someone call you on another dialer mechanism by gently lifting it off its mount. Find the ringer armature located just behind the dialer. You can recognize the armatur by following the telephone so that the regular bell rings. With the reed switch plugged into the signalling unit, and the selector switch thrown to the buzzer position, gradually move the reed switch close to the ringer armature. When the buzzer beeps in time with the telephone bell, the reed switch is correctly placed. If the buzzer sounds continuously, even when the phone stops ringing, back the reed switch off a little. In the telephone shown here, mounting was achieved easily by simply faping the reed switch to a large capacitor.

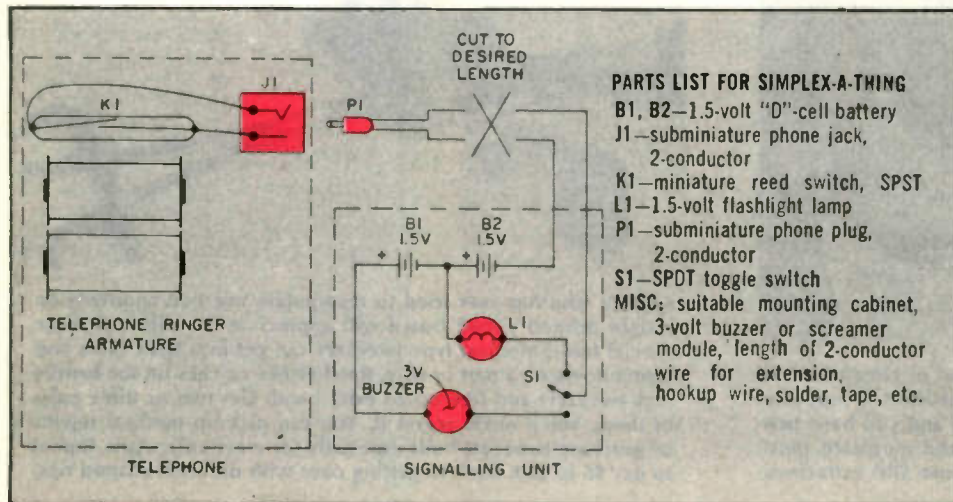



# Special Tools for

It takes more than a screwdriver and a pair of pliers to build like the Pros

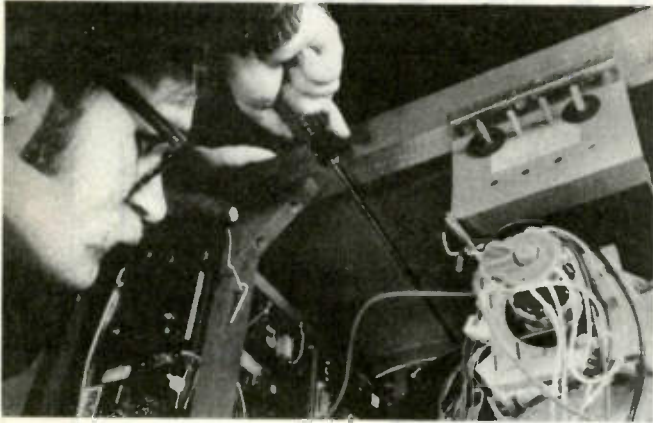

Long- and short-handled nut drivers can be a boon to anyone who does a lot of servicing of manufactured equipment. Most television sets and stereo chassis are held together by hex-headed bolts and sheet metal screws. You can buy midget, short-shaft drivers for working in close quarters or long shaft nut drivers like the Xcelite 20-incher shown above. Long-shaft type with a magnetic tip can be handy when you drop a nut deep in a chassis.



In addition to a good soldering iron like this one from Ungar, for putting electronic components together, it is a good idea to get some special desoldering heads so you can undo your errors. Rectangular head is for heating heads DIP pins so that the connections all melt at once. Round heads are for ICs packaged in cans.

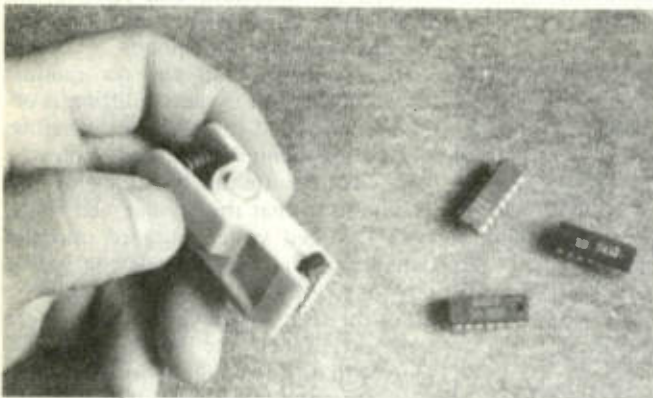

Getting integrated circuit DIP chips in and out of circuit boards and solderless breadboards has to be one of the most deceptively difficult tasks faced by the hobbyist. One slip and you have two parallel rows of eight holes in your thumb, and mutilated pins. To avoid this there are a number of easy-to-use DIP extractors.

**L**IKE MOST ELECTRONICS BUFFS, you probably possess a wide assortment of tools to support your hobby. Screwdrivers soldering irons and pliers are familiar items that come quickly to mind, and the list could go on and on. However, in this article we're going to ignore these fundamental tools, not because they are unimportant, but because they are so familiar. Instead, we'll be considering a group of slightly unusual tools and unusual variations of common tools—all those thingamagigs and whatchamacallits that are peculiar to electronic construction. The emphasis will be on low-cost tools that have a wide range of applicability. Whether you are an expert or a beginner, it is likely that you'll discover something new and useful in this collection of tool trivia.

**Buy the Best.** If you use cheap tools, the chances are your project will look cheap, and take longer to build. Eighty-eight-cent tin snips from Hong Kong usually don't last more than a few minutes under normal use, and the same applies to almost all cheap tools. Look for *forged* steel tools rather than *cast* iron. Forging is important; this involves hammering the metal into shape which aligns the molecules for maximum strength. Where a hinge is under stress, such as at the joint of a pair of wire cutters, see that the parts move freely but without any play in the joint. Avoid metal that looks chipped or has a flaking surface.

**Where to Buy Them.** Most of the tools shown on these pages are available in electronic or electrical supply stores. The metal-working tools should be found in any well-stocked hardware or auto-supply store. Keep on the lookout for new tools that will make your hobby easier, and your projects looking professional. ■

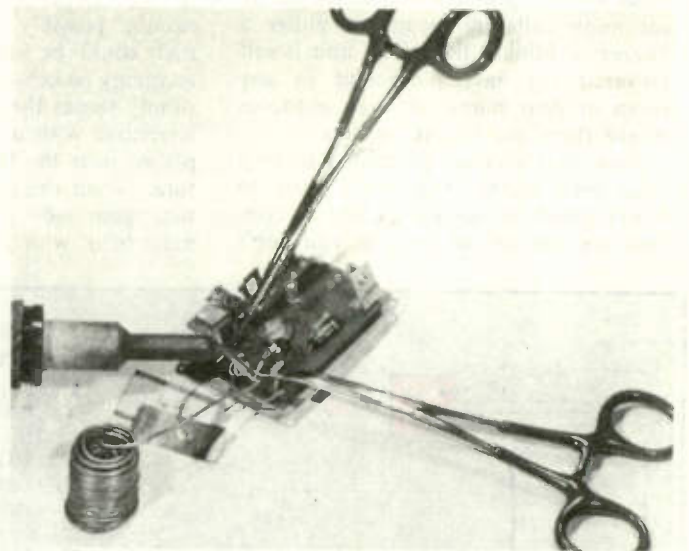

Anyone who has ever tried to manipulate microcomponents on a tight printed circuit board will appreciate the value of these special tools. Medical type tweezers can get into tight spots and clamp down on a part or wire. Ratchet-like catches on the handle lock tweezers and free up an extra hand. Get two or three pairs of them, you'll never regret it. You can pick up medical rejects or purchase tweezers built especially for electronic work. Expect to pay \$5 to \$10. Look to getting ones with different shaped tips.



# the Hobbyist

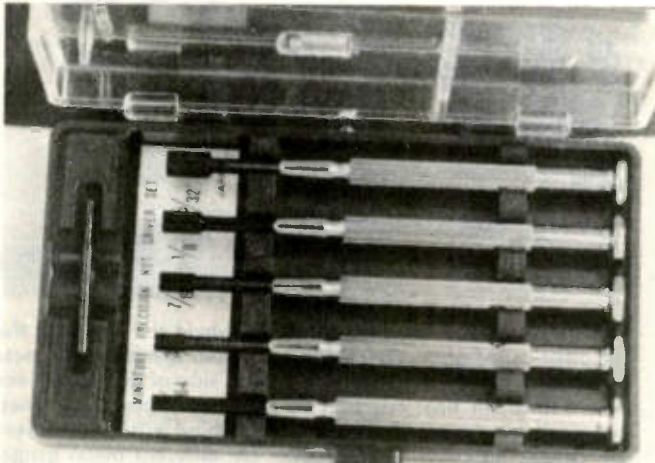

Jewelers' style nut drivers are typical of a style of midget screw drivers and nut drivers that are available in many hobby stores, electronic supply outlets and hardware stores. The top end of the handle spins so that you can twist the handle without having to let go. This is very handy when working on tiny components. Don't use a metal jewelers' screwdriver as an alignment tool.

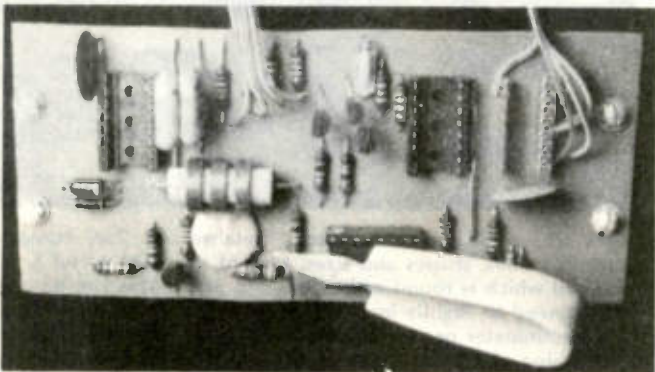

Heat sinks are indispensable, especially for the beginner who's skill with a soldering iron often leaves something to be desired. A heat sink will draw the excess heat of a soldering iron away from a delicate component. When soldering, clamp the heat sink between joint to be soldered and body of the transistor.

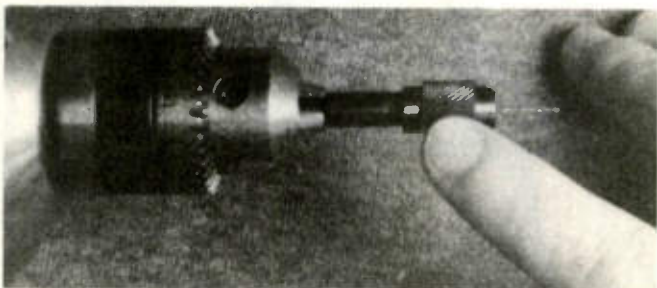

The standard, printed circuit board, component lead hole is smaller than the smallest drill in most drill kits. The drill size needed is a Number 67 and this will slip out of the average drill chuck. To solve this problem, buy a chuck reducer like the one shown above. It will easily hold a Number 67 drill and in turn fit into a normal chuck. Be careful, however, the drill is fragile.

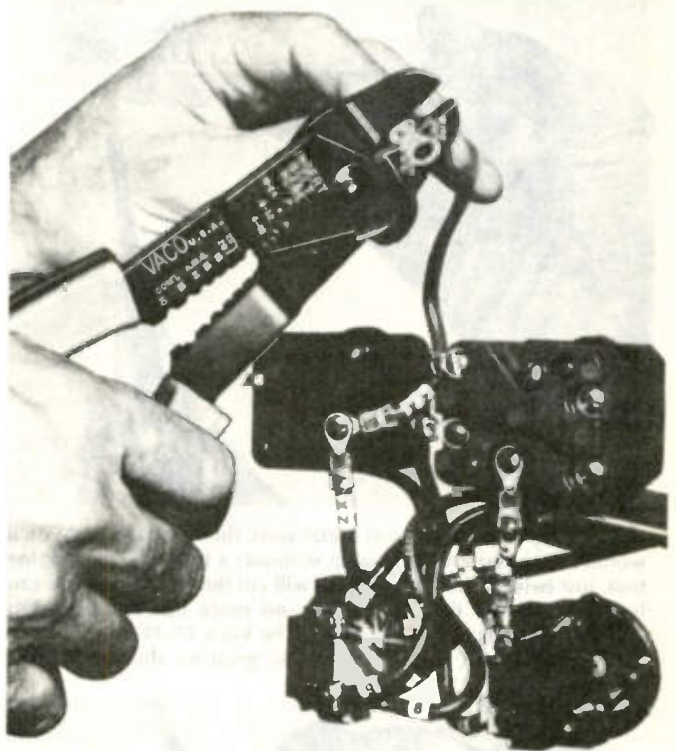

There is just no point in soldering on terminal lugs when there is a neater, cleaner and easier way to connect them—by crimping. Crimping is where the thick metal of the terminal lug is crushed over the wire end. If done properly, this technique is strong, permanent and has no electrical ill effects. Crimping is a recommended technique for high current connections as is demonstrated in the above photo. The crimping tool shown, from Vaco, is also a wire stripper/cutter and a bolt cutter. Crimping kits are available for assembling different types of pin connectors.

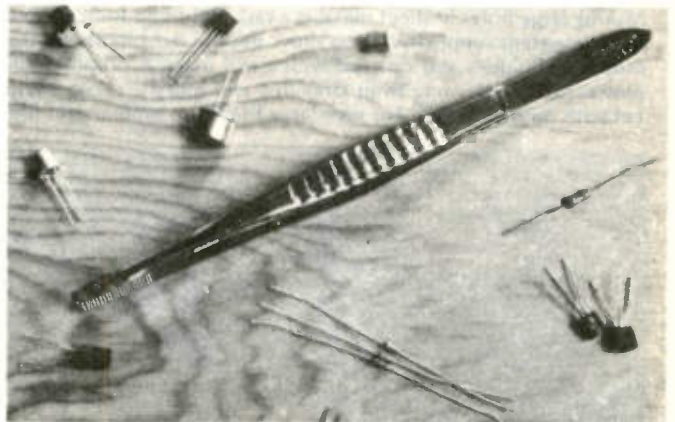

A plain old-fashioned pair of splinter pullers is about the most indispensable of the special tools. It lets you recover parts lost in almost inaccessible nooks and crannies of electronic gear. Pick up a handful of them in different sizes and styles. The type with the bent tips are particularly useful. Be careful around integrated circuits, however, tweezers are metal, and they will conduct static electricity that damages these microcomponents.



# Special Tools/Metalworking

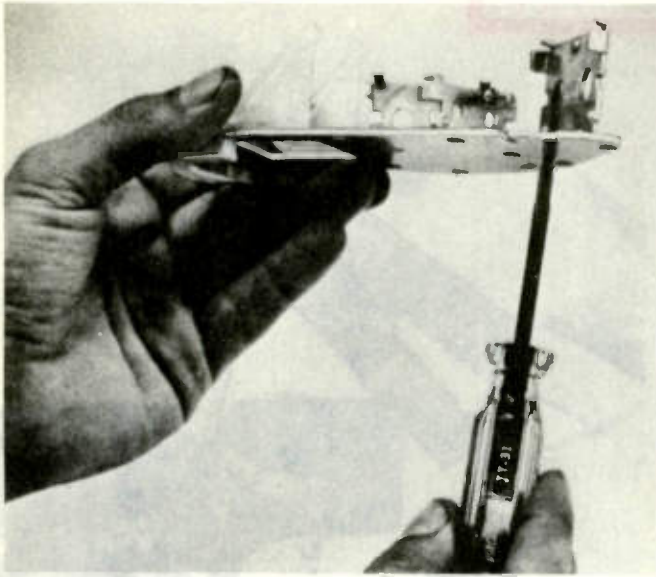

If you pride yourself on neat metal work then here's a tool you'll wonder how you ever got along without: a three-in-one tapping tool. Just twist it into a hole and it will cut threads so that you can bolt directly into the sheet metal—no more fiddling with nuts and lock washers in close quarters. The Vaco TT-31 threads holes for 6-32, 8-32, and 10-24 bolts. Works great on aluminum plate.

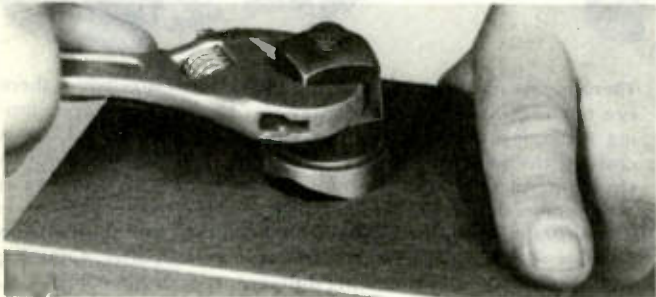

Making large holes in sheet metal is a task that often fools people by its apparent simplicity. If you don't use the right tools and the proper techniques you can end with a real mess. A proper hole-punch such as this one from Greenlee will make a clean, sharp cut with no bent edges. For very large holes use nibbler and file.

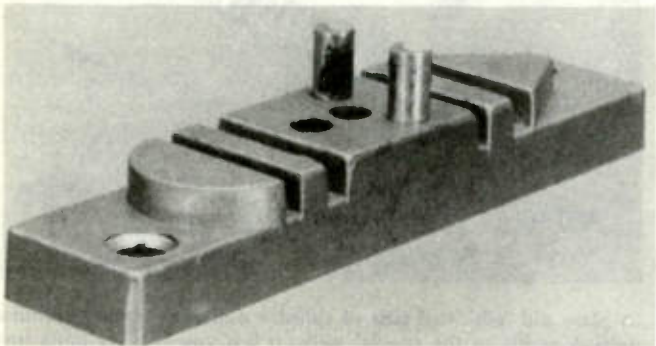

For bending thick wire and the wire leads of components a bending jig is a useful piece of equipment. It will speed assembly of projects and kits that have a lot of resistors, plus save a great deal of wear and tear on your finger tips. You can buy one or make your own of hardwood and some strategically placed nails.

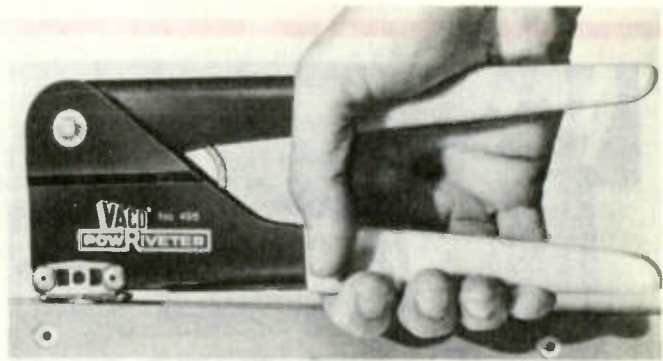

This Vaco Pow Riveter is typical of hand-held riveting tools that are often called pop-riveters. These will join two pieces of metal without having to get a tool to the other side of the work piece. This is great for final assembly of complex-shaped cases where you can't get a hand in to put a nut behind a bolt. Pop rivets are cheap and come in many sizes for different metal gauges.

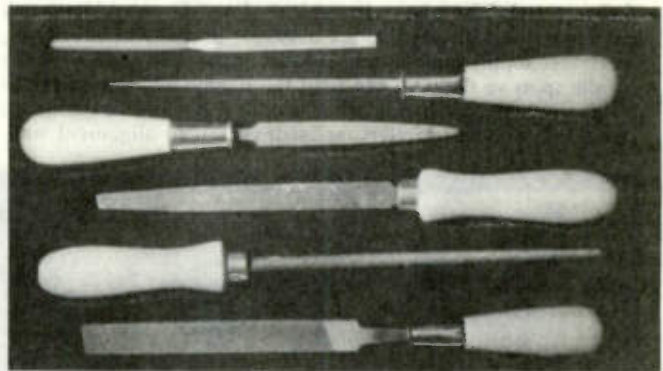

Files are essential for any serious metalworker. They come in various grades, shapes and sizes. One of the most useful is the Rat Tail which is round and tapers to a point. This can be used if you need to slightly increase the size of a drill hole to install a potentiometer or switch. A flat or half-round file is good for smoothing of the edges of a hole cut by a nibbler or hack saw.



The nibbler is just about the greatest electronics hobbyist invention since the screwdriver. With this device you can cut metal, plastic and printed circuit boards with ease. A nibbler literally nibbles its way through various materials by biting away small chunks of whatever is being cut. The working head will fit into a quarter-inch drill hole. A good nibbler can be had for under \$10.



# THAT BLINKING TUBE

By Homer L. Davidson

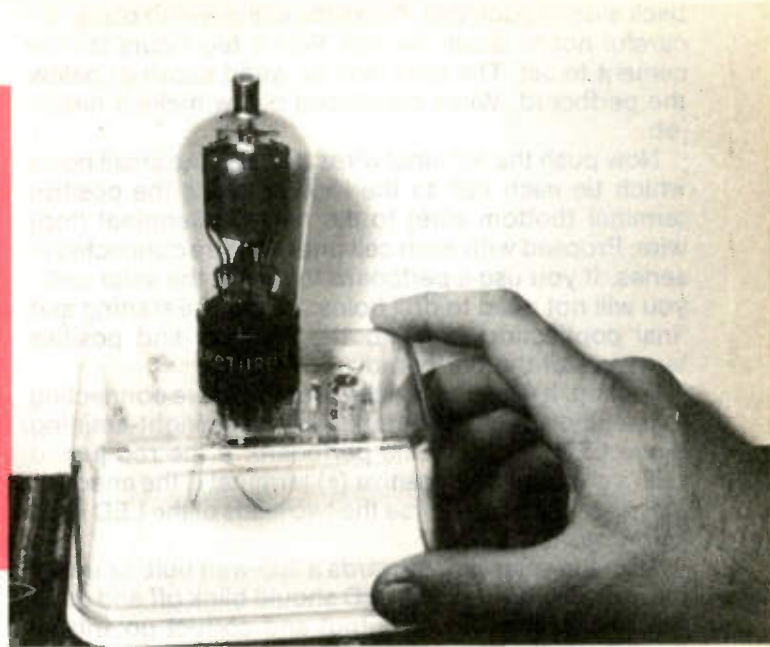

You can build the Blinking Tube project using a surplus or defective transmitting or TV tube. Not only is the Blinking Tube attractive and unusual to look at, it is functional and may bring back a few memories of the good old days in broadcasting. Just dig out one of those old tubes (it doesn't have to be a good or working tube), and put it back to work. The Blinking Tube will keep blinking off and on until you remove it from the light.

That Blinking Tube project is constructed around an old vacuum tube, integrated circuit and light-emitting diode. The flashing circuit consists of a LM3909 IC with only five other components. The project runs on solar power so batteries are not required. Four solar-cell pieces wired in series keeps the Blinking Tube doing its thing for years under the sun or an ordinary reading light. The circuit is shown in Fig. 1.

The parts are inexpensive, including the solar-cell pieces. Actually, these five solar-cell pieces were purchased at \$1.00 each. Look around the junk box, you may find a few of the parts that can cut down the total cost.

**Circuit Construction.** The small light-emitting diode (LED) flashing unit is built upon a small piece of printed-circuit board. Actually, it is easier to use a piece of perfboard. Cut the board from a piece of scrap material or a larger piece. A 4-inch by 1¼-inch piece will fit nicely against the back side of a clear plastic container used to house the unit. All components are mounted upon the small board. The photos show the author's PC board construction; however, we suggest the perfboard construction, because it is easier.

Any container that will pass light and house the unit will do. The author used a clear plastic refrigerator container to mount the tube and chassis board. The plastic container is made up of strong thick plastic sides with a plastic sealing lid which serves as attractive feet. The plastic container is found at most K-Mart or shopping center stores under the trade name of Superseal.

**Mounting the Parts.** Mount capacitors C1 and C2 into position. Connect two 6-inch wire leads to terminals. These two leads connect to the bottom tube pins for the light-emitting diode LED inside the tube socket. Now solder the IC socket in place. Make sure excessive solder does not bridge terminal pins.

**Solar Cell Construction.** The solar cells are wired in series to acquire the correct working voltage (Fig. 2). Use either a piece of stranded hookup or #30 wrapping wire to connect the cells together. Attach a 2-inch piece of wire to the top and bottom side of each cell. Keep the soldered connection on the bottom side (+) as flat as possible for easy mounting. The top side wire (-) should be soldered to a large cross bar area. Clean off the cell area with the blade of a pocket knife. Be real careful not to break the cell in pieces. Pull each wire upward on each cell.

Each cell is laid out upon the small perfboard for clearance. After determining where the wires will connect, place a dab of silicone rubber cement on the

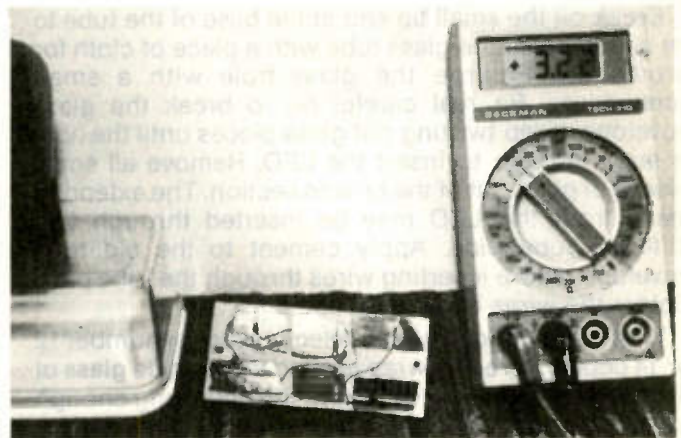

With no load applied to the terminals of the series-connect solar cells, measure the voltage output. The meter should register approximately 3.2-volts DC.



back side of each cell. Press the cell down in place. Be careful not to break the cell. Wait a few hours for the cement to set. The cells may be wired above or below the perfboard. Wires connected below make a neater job.

Now push the terminal wires through the small holes which tie each cell to the next one. Tie the positive terminal (bottom wire) to the negative terminal (top) wire. Proceed with each cell until they are connected in series. If you use a perfboard to mount the solar cells, you will not need to drill holes. Solder the starting and final connecting wires to the negative and positive terminals of the perfboard.

Testing. It's best to test the project before connecting to the tube assembly. Temporarily solder light-emitting diode LED1 leads to the perfboard. If the red jumbo LED's are used, the positive (+) terminal is the anode or long lead. Simply reverse the two leads of the LED if the light does not blink.

Turn the solar cells towards a 100-watt bulb or under the sun. Right away the LED should blink off and on. If not, check the voltage output and correct polarity of the solar cells. The correct voltage should be around 3 volts. Total current consumption should be less than .5 mills of current. Low or improper voltage may be caused with a poor soldered connection of each cell or the cells may be wired up backwards. Take a voltage check across each cell to determine the voltage loss. Check the circuit components when correct voltage is found at pins 4 and 5 of IC1.

Tube Preparation. After selecting the tube you wish to mount upon the plastic base, the outside glass envelope must be removed so the LED can be placed inside. First remove the plastic center piece if one is found at the tube base. Break off the glass tip end of the sealed tube. This will let air enter the tube so it will not implode when the glass envelope is removed. The glass bulb may be removed with a sharp glass cutter or hot soldering iron.

Sometimes with older tubes, the glass envelope is already loose in the plastic base and is very easily removed. Apply the soldering iron to each tube pin and melt out the solder. Quickly flip the tube base downward throwing out excess solder. After all solder is removed the glass-envelope will pull right out of the tube base.

Break off the small tip end at the base of the tube to let air in. Grasp the glass tube with a piece of cloth for protection. Enlarge the glass hole with a small screwdriver. Be real careful no to break the glass envelope. Keep twisting out glass pieces until the hole is large enough to insert the LED. Remove all small pieces of glass out of the broken section. The extended leads from the LED may be inserted through two different tube pins. Apply cement to the old tube envelope before inserting wires through the tube pins. Solder the wires inside the tube pins.

With more difficult tubes, select a piece of number 12 or 14 copper wire and wrap around the outside glass of the tube at the base area. Leave the ends long enough to go into the soldering gun assembly. The copper ends can be brought together around the tube base with a piece of long nose pliers (Fig. 3). Now turn the soldering gun on for a few minutes until the copper

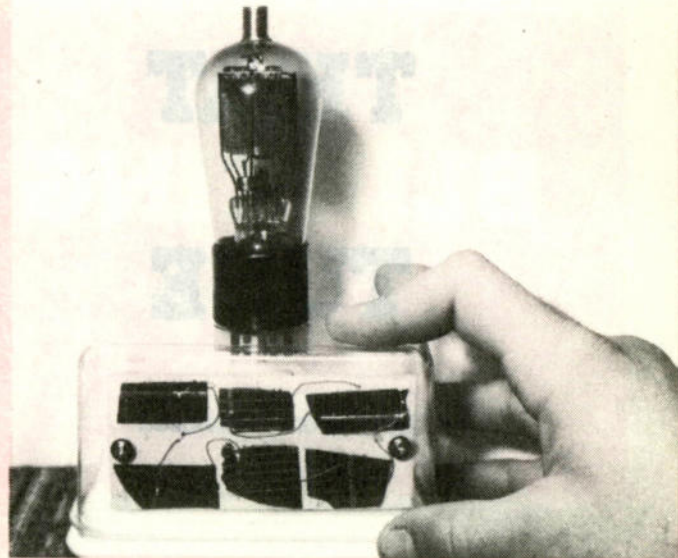

Here is the completed Blinking Light project viewed from the sunny side, that is, where the light should stick the solar cells to get the light-emitting diode blinking.

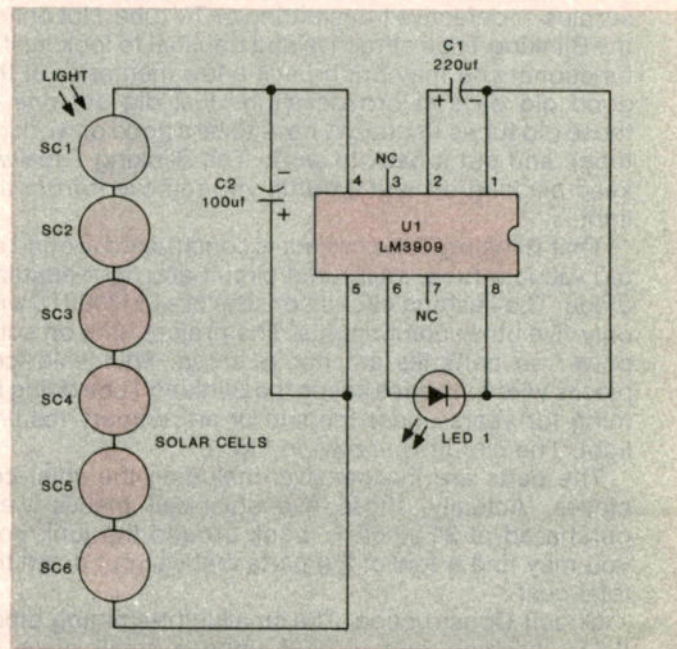

#### PARTS LIST FOR BLINKING TUBE

- C1—220-uF, 16-WVDC, electrolytic capacitor
- C2—100-uF, 16-WVDC, electrolytic capacitor
- SC1-6—solar cell pieces, 6 required for a current of 40 mA or more
- LED1—Light-emitting diode, red
- U1—LM3909 integrated circuit
- MISC.—Perfboard or printed circuit materials (your choice), wire, hardware, old vacuum tube, tube socket, solder, etc.

Fig. 1. Here is the simple schematic diagram of the Blinking Tube. Six solar cells (SC1-SC6) are wired in series and placed in a strong light or the sunlight to power the unit.



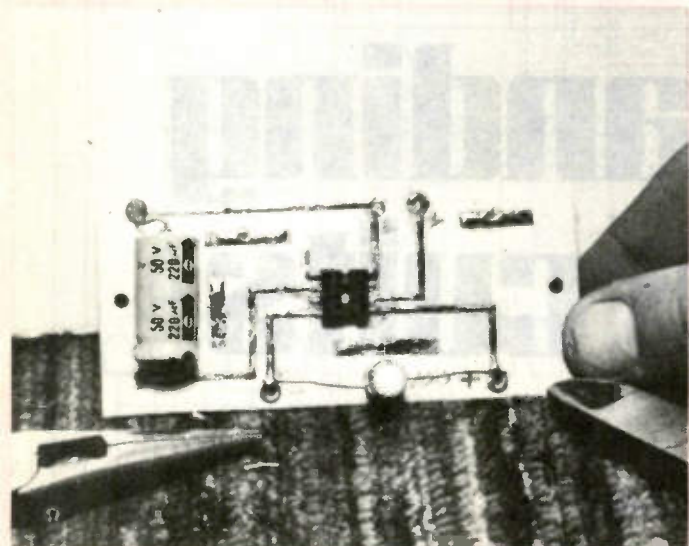

The author's printed-circuit board layout is simple and illustrates the editor's view that a perfboard layout is better. Should you decide to make several units, you may want to make several printed-circuit boards if you use a photo-copying method.

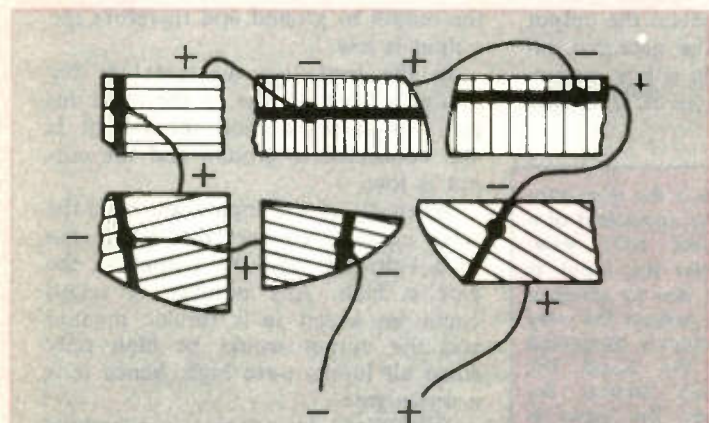

Fig. 2. Connect all the solar cells in series. The stranded wire may be connected from cell to cell (watch polarity carefully) by soldering directly to the cells. Do not use too much heat. Keep wire size down for flexibility.

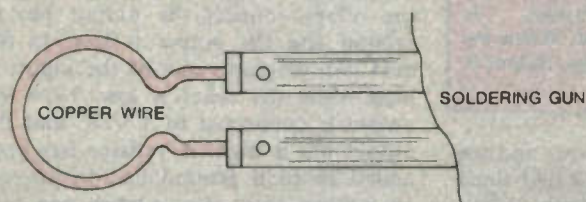

Fig. 3. A piece of solid copper wire (AWG 12 05 14) is placed around the tube's glass at its base. The wire ends are inserted into the terminals of soldering gun. When heat is applied, quickly unplug the gun, and dip the entire heated glass area under cool water. The glass will break cleanly at the heated area.

Solar-cell pieces are available from:

Chaney Electronics, Inc.      John Meshma, Jr., Inc.  
P.O. Box 27038                  P.O. Box 62  
Denver, CO 80227              East Lynn, MA 01940

Edmund Scientific  
Edscorp Building  
Barrington, NJ 08007

wire is red hot. Dip the whole assembly under a water faucet. The outside glass bulb will snap into right where heat was applied with the soldering gun.

If the glass does not break, apply more heat from the soldering gun. Some older tubes have a thicker glass than others. Do not pry or push down on the glass of the tube. You may shatter the whole glass bulb. With the hot copper ring the glass bulb will snap into when running water is applied upon it.

Pull the tube assembly from the glass envelope. The LED may be mounted about halfway up the tube assembly. Bend the LED terminals at right angles so when it blinks the light is more visible. A dab of clear silicone rubber cement will hold it in place. Solder two small wires to the LED terminals. These wires may be insulated and fed behind the tube elements so they are not visible from the front side. Use #26 or #28 enamel wire. Feed the wires through the bottom glass envelope.

Before the tube base is glued to the glass envelope take a continuity test of the LED connection and wiring with the ohmmeter. Use the low-ohm scale for continuity measurements. Now mix up a batch of 5-minute epoxy and cement the glass envelope the plastic tube base. Make sure the plate assembly is straight up and down inside the tube base.

Tube and Chassis Mounting. Although, the plastic container is quite heavy in construction, place a piece of stock 2 +multi 4 wood inside the container before drilling out the hole for the tube socket. Also, the plastic hole may be cut out with the soldering iron tip. Ream out the hole with a round pigtail file. Drill two small holes for the tube socket mounting holes. Bolt the tube socket in place.

The old tube may be mounted directly upon the plastic base instead of in a tube socket. Simply drill the holes large enough to take all the pins of the tube base. Cement the bottom side of the tube base with epoxy or rubber silicone cement to the plastic top. Let the cement set up for a couple of hours. Make sure the LED is pointing towards the front of the plastic container. The two leads from the flashing LED may be soldered directly to the correct tube pins and perfboard circuit.

The perfboard may be bolted to the rear side of the plastic container with a hole in each end. Use plastic spacers to hold the chassis away from the plastic container to prevent damage to the solar cells. Connect two hookup wires from the perfboard to the LED wires of the tube socket.

Operation. Place a 100-watt bulb towards the rear of the plastic container letting light strike the solar cells. The LED should start to blink. If not, reverse the leads to the tube socket pins. Check the voltage across C2 if LED1 does not blink. LED1 should start to blink with a 2-volt power source. Double check all wiring connections. Check the polarity of C2.

That blinking tube will keep on blinking as long as light is applied to the solar cells. Just set it in a window and let it blink away. A faster blinking rate may be changed by substituting C1 with a 100-µF capacitor or increasing the voltage source with another solar cell. Increase the value of capacitor C1 to slow down the blinking rate. When used under a reading lamp the rate of blinking decreases as the unit is pulled away from the light. ■



# Understanding Logic Circuits

by Gordon Sell

A simplified look at how logic circuits "think"

**T**HE FIRST MISTAKE made by people trying to explain digital logic is their insistence on name dropping. They confuse a reasonably simple subject with technical terms such as CMOS, TTL, PMOS and so on and so on. There's plenty of time to learn about these later, but first we must learn what a digital logic circuit is.

A digital logic circuit is, for all intended purposes, a *solid state relay network*. After a statement like this there are probably a few engineers out there grinding their teeth and pulling out their hair, but this basic definition will help you more than any explanation of "electron movement through silicon substrates."

All digital logic circuits can be broken down into combinations of three basic *logic gates*. These gates receive information in the form of one or more inputs of a high- or a low-voltage level—usually +5 volts DC and 0 volts (ground potential). Depending on what type of gate it is, an appropriate voltage level appears at the output. The three basic gates are called NOT, AND and OR. Their operation can be simulated by using plain old-fashioned mechanical relays.

**NOT Gates.** Now we will see where the relays come into action. Look at the diagrams of the NOT gate. When there is no input voltage the relay is not energized and the relay contact connects the output to the high voltage level. In other words, a low input is inverted by a NOT gate. When a high voltage level is applied to the input the

relay energizes and connects the output to ground potential. The gate has inverted the high input to a low output. No matter what the input is, it is NOT the output.

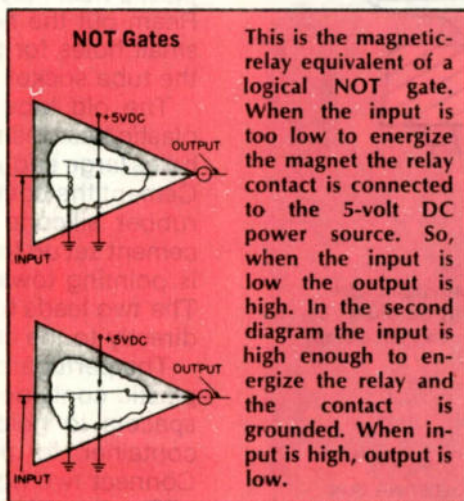

The next two gates, the AND and OR gates, are a bit more complicated since they have two or more inputs. When you think of them try to think of the AND gate as a *series* gate and the OR gate as a *parallel* gate. This may not be clear yet but it will help you to keep things straight in the future.

**AND Gates.** In order for the output of an AND gate to be high all inputs must be high. If any of the inputs are low the output will be low. Look at the first of the AND gate diagrams. Both inputs are low and neither relay is energized. The relay contacts connect

the output to ground and therefore the output is low.

In the next two diagrams we try putting a high on one or the other inputs. In each situation the output is still connected to ground and the output is low.

When all of the inputs are high the relay contacts connect the output pin to 5 volts DC and the output of the gate is high. Any number of relays could be added in a similar manner and the output would be high only when all inputs were high, hence it is a series gate.

**OR Gates.** An OR gate is a parallel gate and its output is high if any of its inputs are high. In the first diagram all the inputs are low and none of the relays are energized. The contacts of the relays connect the output pin to ground and the output is low. In the next two diagrams one of the inputs is high while the other is low. Now the output is connected to 5 VDC and the output pin is high. A resistor has been added to each ground line to prevent an internal short circuit when one contact is on high while the other is low. In the last sketch both relay contacts are connecting the output to the high-voltage source, and the output is high. As with the AND gate, any number of relay circuits could be added in this parallel format. If any number of inputs are high then the output will be high.

Now we have learned how our three basic digital logic gates work. Of course, in an actual logic circuit the relays are



### AND Gates

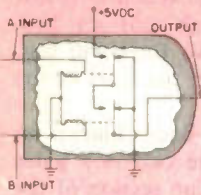

When both inputs to an AND gate are at a low level, as is shown in the first diagram, the relays are de-energized. Each set of contacts connects the output to ground.

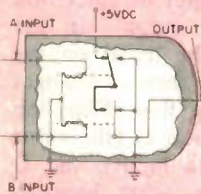

In the second diagram input A is at a high voltage level (typically 5 volts DC) and the upper relay is energized, yet the output is still low.

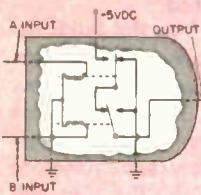

Now, in the third diagram, we put a high on the B input. The lower relay is energized but the output pin is still grounded.

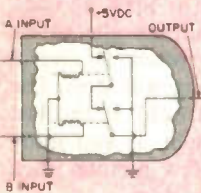

In the last diagram we see what happens when both inputs are high. The two relay contacts connect the output to 5 VDC. The output will be high only if both inputs are high.

### OR Gates

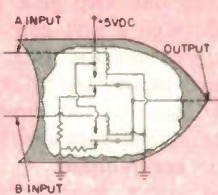

In the relay-equivalent circuit of an OR gate we have added a couple of resistors to prevent an internal short circuit. Note that when both inputs are low both relay contacts connect the output to ground.

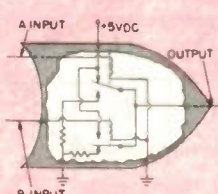

In the second OR gate diagram the upper relay is energized by a high voltage level at the A input. This connects the output to the 5 VDC contact of the relay.

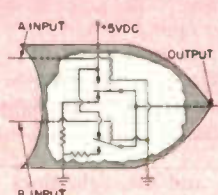

In the third diagram the B input is high while A is low. Again you can see by tracing out the current flow that the output will be high.

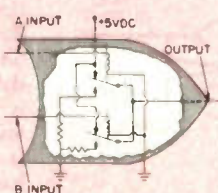

By now the last diagram should need little explanation. Both relays are energized and the output is connected to 5 VDC through both relay contacts.

Making an exclusive OR gate is a little more tricky. It comprises two NOT gates, two AND gates and an OR gate. Study the diagram of this gate and see what happens. When both inputs are the same the two NOT gates cause each AND gate to receive a high and a low. They will, in turn, put a low on each input of the OR gate and its output will be low. Now, if we put different signals into the two inputs the NOT gates will criss-cross the signal levels so that one AND gate receives two lows and the other two highs. This will put a high on the OR gate's input and its output will also be high. To make this and exclusive NOR gate we just add a NOT gate to the final output.

**Flip Flops.** You now have a pretty-good understanding of how digital logic circuits work, but there is one more type of device that needs some explaining—the flip-flop. The best way to understand about flip flops is to think back to your childhood when you used to play a game called “Red Light—Green Light.” One kid was “it” and the others could only sneak up on him when he turned his back and said “green light.” If he said “red light,” everyone had to freeze in whatever positions they were in before he turned around and stay that way until he gave another “green light.” A flip flop works just like that. When the circuit gets the “red light” its output freezes at whatever level is on the input at that moment. An actual flip flop may have a few more frills but if you remember red light, green light you should have no problems with these handy devices.

To see how a flip flop works we have to put our collection of logic gates together in a more-complex fashion. There are actually two main sections in a flip flop, the gating network and the flip flop itself.

First, let's take a look at the gating network. There are two inputs—the data input and the latch (red light—green

replaced by integrated circuit transistors that switch the levels from high to low, but the inputs and outputs are the same.

**Combinations.** By now you are probably asking why this article has ignored all the other gates you've probably heard about—the NAND and NOR gates for example. The reason is that these and all other logic gates are combinations of the three basic gates. A NAND gate is really a NOT/AND gate since it is a combination of the two. In the diagram of the NAND gate you will see that it is an AND gate whose output is inverted by a NOT gate. For example: When any of the AND gate's inputs are low the output is low, but now the input of the NOT gate is low so its output is high. If all AND gate inputs are high then the input to the NOT gate is high and its output is low. Therefore the output of a NAND gate is high unless all inputs are high, and then the output would be low. The output of a NAND gate is always the opposite of an AND gate if the inputs are identical.

A NOR or NOT/OR gate works in much the same way except that its output is the opposite of an OR gate. A NOT gate is added to the output of the OR gate turning the lows to highs and the highs to lows. A NOR gate's output

will be high when both inputs are low, and its output will be low when one, or both, are high.

**Exclusive Gates.** Two more important gates are the exclusive OR and exclusive NOR gates. The exclusive OR gate has a low output when the inputs are either all high or all low. If one input is high and the other low then the output is high. An exclusive NOR gate, as you might have guessed, has a high output if the two inputs are the same and a low output if they are not the same. An exclusive OR or NOR gate can only have two inputs.

Exclusive Gates are special combinations of logic gates. Use your knowledge of the three basic gates to see how the exclusive OR gate and exclusive NOR gate operates. First, see what happens when both inputs are low; then make A high and B low; then B high and A low; then try it with both A and B at a high level. See how the two gates are opposites.

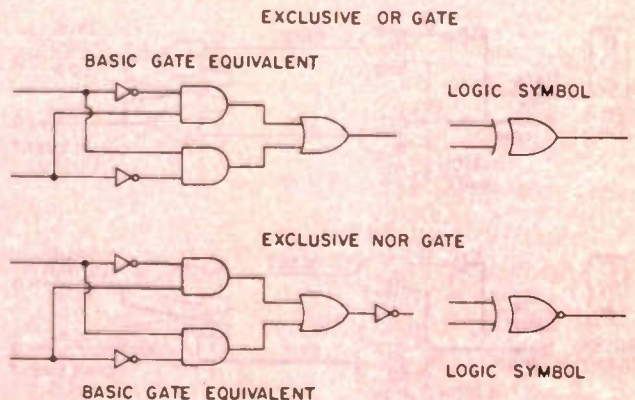



# Digital Logic

light) input. Now, consider what happens under green-light conditions when the latch input is high. This input is connected to one input on each of 2, two-input AND gates. (Refer to the gat-

ing network diagrams). The data input is split into two lines, one goes straight into one AND gate and the other goes through a NOT gate to put the opposite signal on the other AND gate. These two inputs are referred to as D and  $\bar{D}$  ("data bar" is how " $\bar{D}$ " is said), D being the data and  $\bar{D}$  being its opposite or compliment.

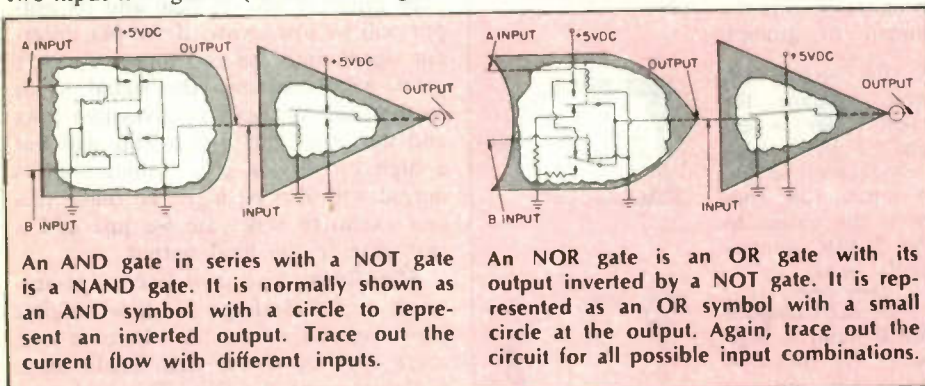

An AND gate in series with a NOT gate is a NAND gate. It is normally shown as an AND symbol with a circle to represent an inverted output. Trace out the current flow with different inputs.

An NOR gate is an OR gate with its output inverted by a NOT gate. It is represented as an OR symbol with a small circle at the output. Again, trace out the circuit for all possible input combinations.

The outputs of the AND gates are called set and reset. When D is high, set is high and reset is low. When D is low then reset will be high and set low. The levels on these two lines will toggle back and forth with the level of the input data.

The set and reset lines, known as S and R, feed into the two NOR gates that make up the flip flop section of the circuit. The second input of each NOR gate is fed by the output of the other NOR gate. As the levels on the S and R inputs change then so changes the output of the flip flop. Flip flop outputs are referred to as Q (the value equal to the true data input) and  $\bar{Q}$  its compliment. Now, what happens when the light turns red?

Applying a low level to the latch input changes things around considerably. Both AND gates now have a low on one of their inputs. No matter what other signals they may receive, their outputs will both be low and therefore the R and S inputs to the flip flop will be low. If the flip flop is toggling back and forth, with the outputs alternately going high and low, when R and S both go low the toggling will stop. The outputs Q and  $\bar{Q}$  will hold at the last value before the red light. If you study these diagrams for a few minutes then it will all become very clear.

The heavy lines represent high voltage levels and the light lines represent low levels.

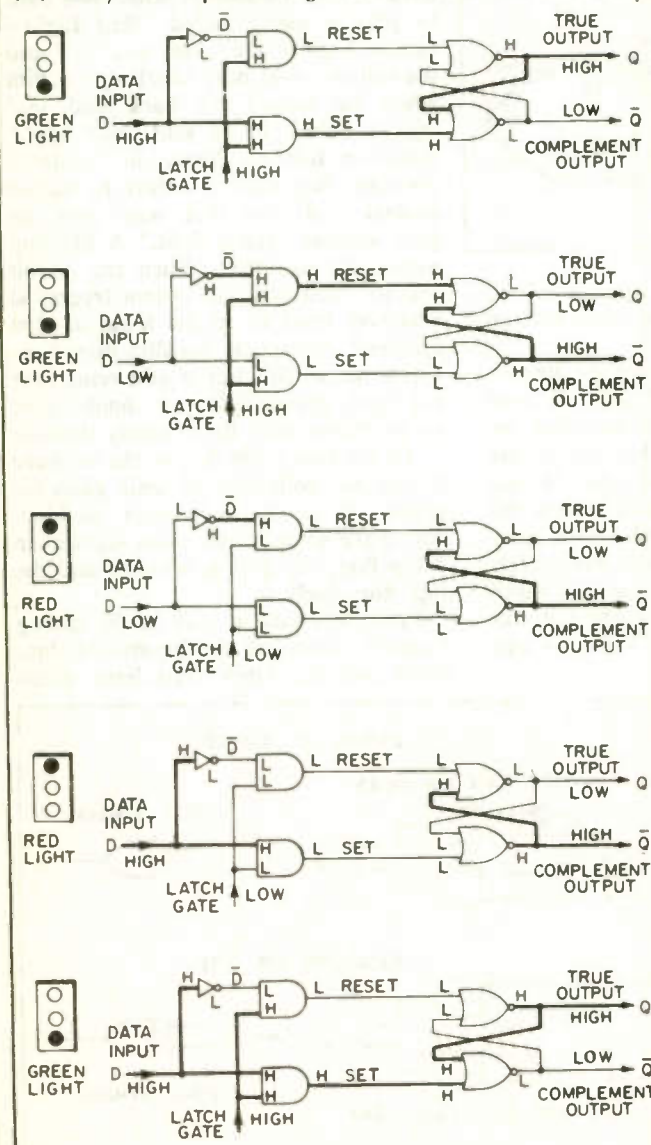

Under green - light (latch input high) conditions with a high data input, the set line is high and the reset low. The true output is high and it is fed back to reinforce the set line's data input.

A low data input will toggle the set and reset lines to their opposite levels. Now the compliment output is high and it reinforces the reset line.

Changing the latch input to a low voltage level causes both AND gates to have a low output on set and reset. The compliment output, however, still keeps a high on the reset NOR gate and the true output is still low.

If the data input now toggles to a high value it will have no effect on either the true or the complimentary outputs. The flip flop is now latched tight.

In this diagram we return the high voltage level to the latch input. The circuit is now free to toggle back and forth with the incoming signal.

## Basic Logic Symbols

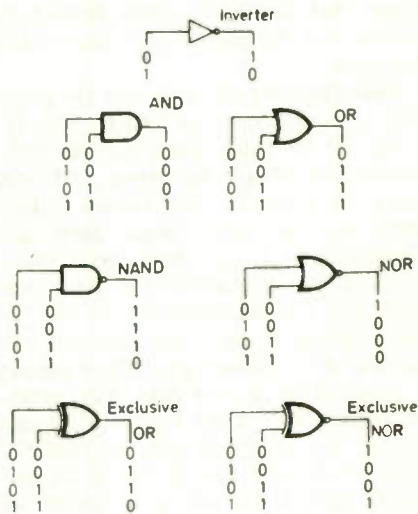

Above are all the elementary gates but this time we have used the common logic level indications of "0" for Low and "1" for High. This type of chart is called a truth table.

Once you have learned how all these different logical circuits operate you will be able to work out some more complicated arrangements, and perhaps even spend some time researching the differences between TTL, CMOS and all those other little digital details. ■



# Transistor Logic Demonstrator Circuits

**N**OW THAT YOU fully understand the ins and outs of basic digital theory, (well, it made sense to us anyway) you're probably itching for a bit of hands-on experimenting to see if what we've said really works, and how it applies to the projects you're eagerly waiting to build. The following four quickie demonstrator projects can be assembled in a snap with parts you probably already have cluttering up the junk box. You might want to leave these demonstrators assembled as you build the IC projects, to serve as a logic guide for checking out and troubleshooting the projects in their final phases.

The size of these demonstrators also serves as an indicator of just how far the electronics industry has advanced in the space of just a few years, in

terms of miniaturization of components, and component groups. Imagine what it would be like to build even the most rudimentary of our 99 Integrated Circuit projects, if each and every gate had to be hand-fabricated and wired point-to-point! By the time the builder got done with the making of the ersatz ICs, he or she wouldn't feel much like tackling the construction project for which they were intended. On this scale of construction, the Apollo spacecraft would have had to be as big as a Navy destroyer to contain all of the electronics necessary for the lunar voyage! While you may gripe about Detroit's shrinking cars, and your favorite restaurant's shrinking portions, be thankful for shrinking circuits!

Don't forget about the energy crisis either! Just because you're not quee-

ing up in mile-long lines for gasoline, don't think that electrical power is all that free and easy to come by. These circuits require the full output of a nine volt transistor battery to make them operable. Their equivalents in IC form use, in many cases, half the voltage, and only one-tenth the current. In practice, the efficient use of energy by the new types of integrated circuits can allow them to be powered by some of the less conventional, and ostensibly cheaper, sources of electricity, such as small photocells, thermo-chemical body-heat generators, and the like. In fact, if electrical consumption in industry was reduced the way it has been for and by the new ICs, we probably wouldn't need all of the new generating facilities currently being planned and fought over today!

## AND Logic Demonstrator

□ In digital logic, an AND statement is true only if all parts of the logic leading to it (its inputs) are all true. If we take "true" to mean "on", a logic state we define as "1" (and not true = off = 0), we can see that a series switch configuration is a good way to illustrate the AND logical statement.

In integrated circuit logic, instead of actual mechanical switches, transistors are used as switches. Specifically, this circuit demonstrates the action on a "two-input AND gate." Only if both switches are on will the L.E.D. turn on. Similarly, you can expand the demonstrator to demonstrate as many inputs to an AND gate as you have switches to connect in series.

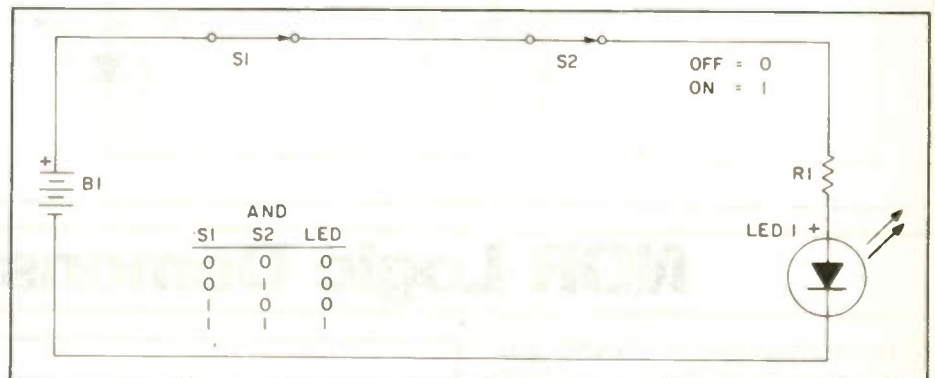

Once again, we present the "truth table" of this particular circuit which will tell you exactly what's happening and when. Truth tables are often used in digital design, and can be indispensable. Depending on the device they can be quite long.

### PARTS LIST FOR LOGICAL "AND" DEMONSTRATOR

- B1—9VDC battery
- LED1—Light emitting diode
- R1—470-ohm resistor, ½-watt
- S1, S2—SPST switch

## NAND Logic Demonstrator

□ NAND is logic shorthand for "Not And." So a NAND gate has an output of 1 only when an AND gate would not. Compare the right column (results, or output) of an AND gate truth table to that for the NAND gate

above and you will see that they are exactly opposite.

Here, the L.E.D. will turn on only if the two switches are *not* both turned on. Be careful that the series combination of S1 and S2 can short

out only the L.E.D. and not R1 as well or your battery will not last more than a few seconds. R1 limits the current drain on the battery to about 20 milliamperes.



### PARTS LIST FOR LOGICAL "NAND" DEMONSTRATOR

- R1—470-ohm resistor, ½-watt
- S1, S2—SPST switch
- B1—9 VDC battery
- LED1—Light emitting diode

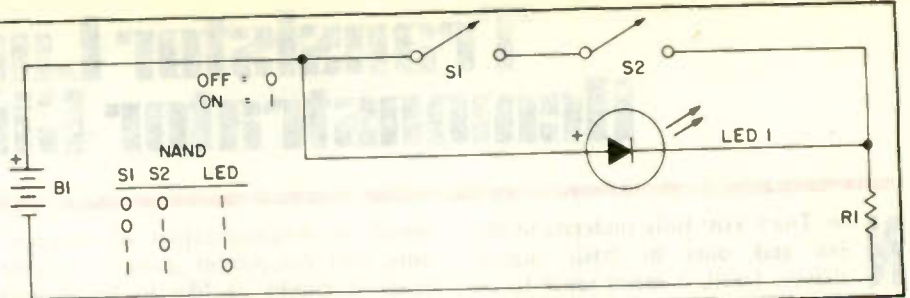

## OR Logic Demonstrator

□ In digital logic, an OR statement is true if any one of the statements leading to it is true. Parallel switches are a good analogy for the OR logic function. If any of the parallel switches are on (=true="1"), the L.E.D. turns on. While this circuit demonstrates the operation of a "two-

input OR gate," you may add as many parallel switches as you like to demonstrate the action of "wider" OR gates.

OR gates are very widely used in alarm circuits, for example, where an alarm should be sounded whenever anything occurs at any one of the

several inputs. The chart of numbers is known as a "Truth Table." The columns at the left identify the states of the various inputs, the column at the right the state of the output. Compare the results (right column) of this Truth Table with the results of other types of logic and you will see why digital logic systems can be so versatile.

The nice thing about this circuit is that it's so visual. You'll find that it's so much easier to understand digital logic when you can watch what's happening rather than reading about it.

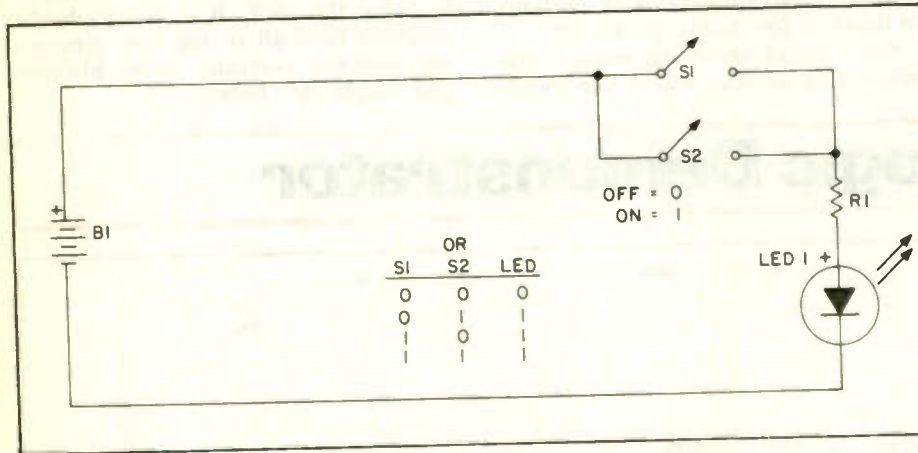

### PARTS LIST FOR LOGICAL "OR" DEMONSTRATOR

- B1—9 VDC battery
- LED1—Light emitting diode
- R1—470-ohm resistor, ½-watt
- S1, S2—SPST switch

## NOR Logic Demonstrator

□ Just as the output of a NAND gate is the opposite of that for an AND gate, this NOR gate produces results opposite those of an OR gate.

LED1 will turn on when neither S1 nor S2 are on.

A NOR gate is a good way to handle a failsafe system in which a circuit cannot operate unless all systems are "go"; in other words, if any of the inputs are on, the system cannot be.

This truth table compares the operation of different types of logic gates:

Think of 0=off=not true,  
1=on=true

Digital logic is certainly in the forefront of modern electronics. Circuits such as this NOR Demonstrator can

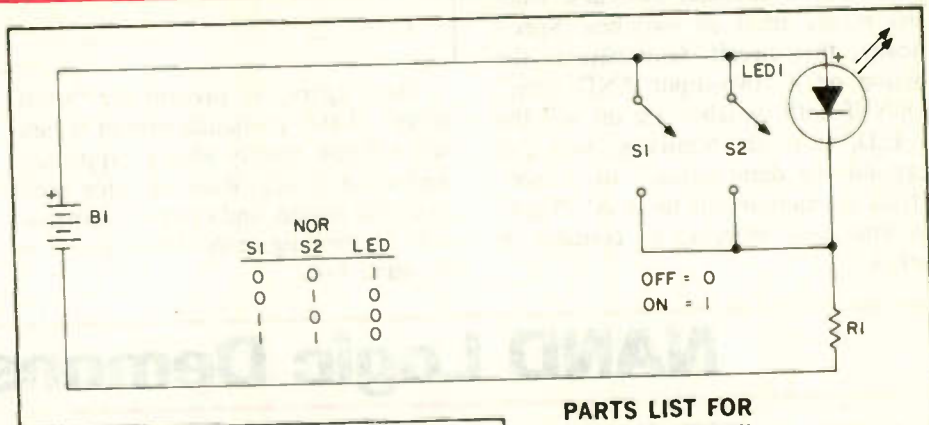

### PARTS LIST FOR LOGICAL "NOR" DEMONSTRATOR

- B1—9 VDC battery
- LED1—Light emitting diode
- R1—470-ohm resistor, ½-watt
- S1, S2—SPST switch

help to prepare you in understanding complex circuitry. The principles you learn remain the same as in actual digital circuitry—only the method of achieving demonstrable results changes.



# CAT'S WHISKER RECEIVER

Build this update of the classic crystal set

**B**UILDING A CATSWHISKER crystal set can be lots of fun. The only problem with this type of construction project is the radio's poor selectivity. The weaker stations are usually drowned out by the stronger ones. If you live close to a broadcast station, that station might come in over a good portion of the tuning range. We are faced with this difficulty because a single tuned circuit is limited in its ability to discriminate against unwanted signals. By increasing the Q (quality factor) of the inductor in the tuned circuit, and adding another, we can improve selectivity sharply. This article will tell you how to build a crystal set that will do a much more efficient job of separating radio stations. This set will have the clarity and tone that is associated with crystal radios.

This selective set will only detect the signals that your antenna picks up. This means that you will need a good antenna of 100 feet in length, at least 25 feet high, plus a good ground system. You will then be able to pick up signals with greater strength from longer distances. You will also need a good set of headphones of at least 2,000-ohms impedance.

**Exploring The Circuit.** Two tuned circuits are used, each being a combination of inductance and capacitance. The two tuned circuits form a band-pass filter, passing the signal to which it is tuned. This signal reaches the crystal detector. All signals outside the range of the tuned circuit are rejected. This results in the desired selectivity.

**Mechanics of Building.** To get started building the receiver, look over the parts list, and gather up the parts you will need. To help you find the parts you may not have in your junk box, we have included sources for the parts listed in the Parts List. Start construction with the base board, which is approximately 8-inches x 10-inches by 3/4-inch thick. You can stain and varnish the board, and glue small felt or

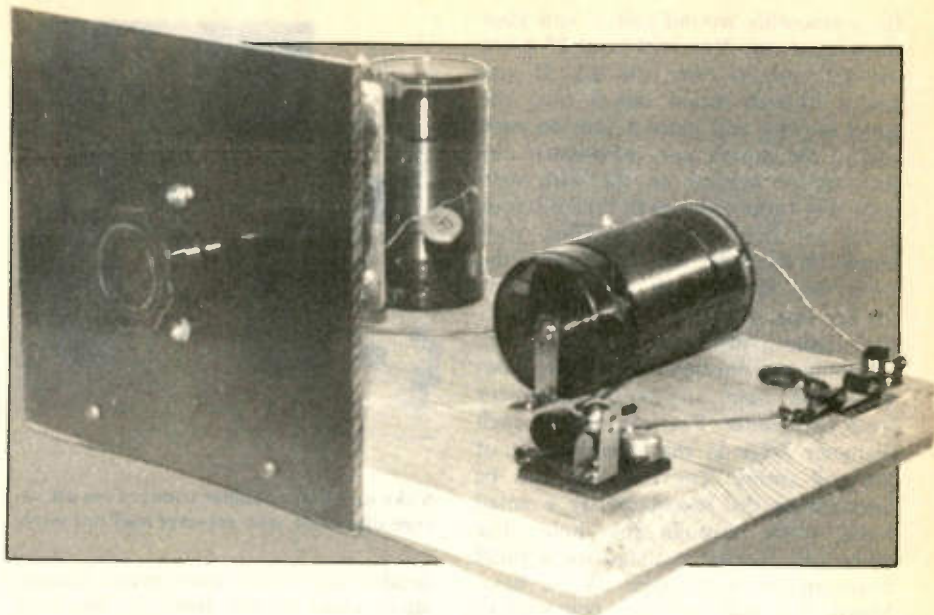

rubber cushions under each corner of the bottom. The panel should be 6-inches x 6-inches, and can be made of 1/16-inch sheet aluminum, 1/8-inch tempered masonite, or formica laminated to tempered masonite. Drill two holes in the lower part of the panel for two screws to hold it upright on the baseboard. In the exact center of the panel, drill a 1/2-inch hole for the shaft of the tuning capacitor, and also drill the holes to mount the capacitor to the panel. Fasten the panel to the baseboard with two screws. Mount the dual variable tuning capacitor on the panel, and install the tuning pointer or knob.

**Winding The Coils.** You are now ready to wind the two coils. Both coils are exactly alike and wound in the same way. The coil forms are made from plastic pill bottles from your local drugstore. They are 2-inches in diameter and 3 1/2-inches high. Use care in drilling the coil forms as the plastic

is very brittle, and may crack if drilled carelessly. If you like, you may heat a large needle and push it through the plastic to make the holes. To tie the wire ends to the forms, and hold the coils in place, you will need two 1/16-inch holes for each wire end. Make these about 1/2-inch apart and lace the wire ends thru each hole several times to hold them firmly in place. Drill two holes along the open edge of the form, then move up 3/4-inch and drill two more holes, this set of holes is for the ends of L-2. Now move up 1/8-inch and drill two more holes, and then two additional holes at the closed end of the form. This set of holes is for the ends of L-1. Drill both forms alike. An old trick to make the winding easier is to dip both coil forms into melted candle wax. This creates an adhesive surface for the wire. Now carefully wind the coils, keeping the spool of wire under controlled tension

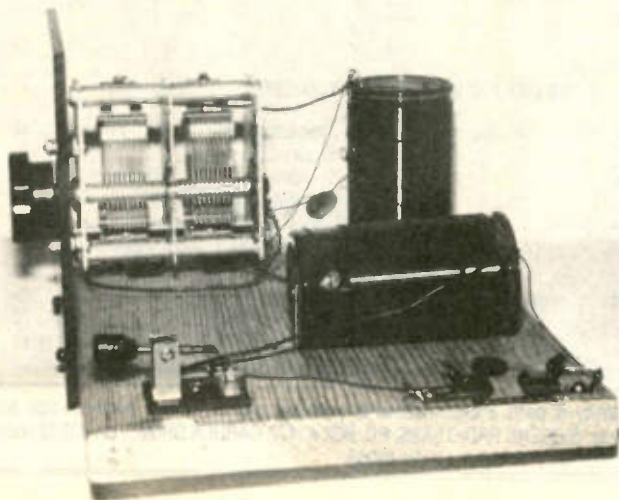

Easy to build, this cat's whisker receiver has two large inductors that must be hand wound. Be very careful when you do this to insure a quality inductor. A wood or other non-conducting base is best for the receiver, so that its components can be isolated.



for a smoothly wound coil. Count your turns carefully. You will need 25 turns on L2 and 90 turns on L1. If you put a 3/4-inch wood dowel thru the spool of wire and place a foot on each end of the dowel, you can control the pressure or tension on the wire with your feet (you might even take off your shoes for this exercise). Using your hands to wind the wire by turning the form and laying each turn alongside the last one, you can, with a little practice, make a professional looking coil.

Mount the finished coils on the baseboard, at right angles (90 degrees) from each other. You can drill 1/8-inch diameter holes in the solid bottom of the coil forms. The first coil can be fastened to the baseboard by a small wood screw through this hole. The other coil can be mounted on the baseboard at an angle and then mounted on the baseboard. You will have one coil with its axis vertical, and the other with its axis horizontal. This orientation prevents inductive coupling between the coils. The secret behind the sharp selectivity of this radio, is the high Q factor of 2 separate coils. Any coupling between them diminishes Q, and degrades the radio's ability to pick out weak stations.

**Setting Up The Rest.** Next mount the four binding posts, terminals, or Fahnstock clips in place. Two for the antenna and ground, and two for the

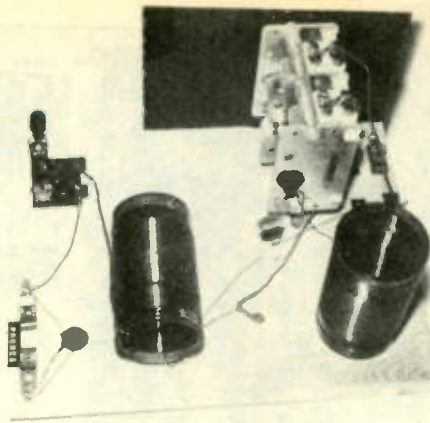

Make sure that all solder connections are secure otherwise your receiver may not work.

headphones. Place your crystal detector stand close to the front of the baseboard, at the end not covered by the panel. This will allow you to adjust the cat's whisker to its most sensitive point. This explains why the panel is shorter than the baseboard. Now, start wiring the parts according to the schematic diagram. Note that the connections to the coil should be made as shown. For example, the top of L2 goes to the antenna terminal, and the bottom of L2 goes to the ground terminal. The top of L1 goes to the single section of the variable capacitor stator.

and the bottom of L1 goes to C3. Follow the same game plan on the other coil, as shown in the schematic, and you should have no problems.

If you purchase a crystal detector stand, it will have two terminals and a cup for the mounted Galena crystal. Put the mounted crystal in the holder or cup and carefully adjust the cat's-whisker to lightly touch the surface of the crystal, not the metal of the mount.

**Cheating For Fun.** Because it is sometimes difficult to find the most sensitive point on a Galena crystal we can make a Gimmick, as is shown in the drawing. The clips and diode are called out in the parts list. The Gimmick is a sort of cheater, as it merely consists of a Germanium Diode connected to two alligator clips.

**Testing.** After the set is completely wired, double check to be sure all the suggestions have been followed, and that the wiring is correct. Connect the headphones, the antenna, and ground to the proper points. Clip the Gimmick across the detector stand, and tune the capacitor until you hear one station loud and clear. Now, remove the Gimmick and adjust the cat's whisker until you hear that station again. You are all set to listen to distortion free, pure radio programs.

Many radio experimenters are building crystal radio receivers. There is a desire to go back to the simpler times, before life became so fast paced and hectic. A crystal radio requires no outside power, and is the most energy efficient device you can build. It operates only on the power provided by the broadcasting station. We believe you will derive a great deal of satisfaction from building your radio ■

From the schematic, it can be seen that this project is a snap. There are only a few parts that are needed to put this nifty little receiver together.

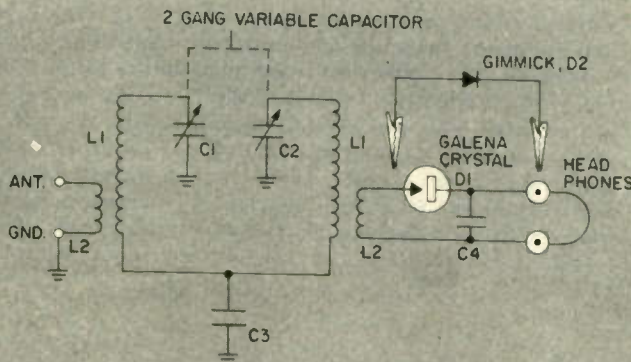

#### PARTS LIST FOR SELECTIVE CRYSTAL SET

- C1, 2—365-pF, dual section, variable tuning capacitor
- C3—.02-uF ceramic capacitor
- C4—.002-uF ceramic capacitor
- D1—Galena crystal detector, mounted on stand
- D2—1N34 or 1N48 germanium diode for Gimmick
- L1—90 turns of No. 22 or No. 24 magnet wire on 2-inch diameter x 3 1/2-inch long coil form
- L2—25 turns, same construction parameters

as L1, separated from L1 by 1/8-inch, wound in same direction as L1.

Misc.—Headphones (over 2000-ohm impedance), baseboard—8 x 10 x 3/4-inches, panel—6 x 6-inches (1/8-inch thick tempered masonite, or 1/16-inch thick aluminum), knob or pointer for tuning capacitor, two plastic pill bottle coil forms (2-inch diameter x 3 1/2-inch high), 2 spools of No. 22 or No. 24 magnet wire, 4 binding posts or Fahnstock clips, 2 alligator clips.

For information on the availability of parts and/or material to build this project, send a business-size, self-addressed, stamped envelope to: MODERN RADIO LABS, P.O. BOX #1477, GARDEN GROVE, CA 92642 and/or ANTIQUE RADIO PARTS, P.O. BOX #42, ROSSVILLE, IN 46065.

COIL FORM

DRILL 8 HOLES  
1/16-IN. DIA.

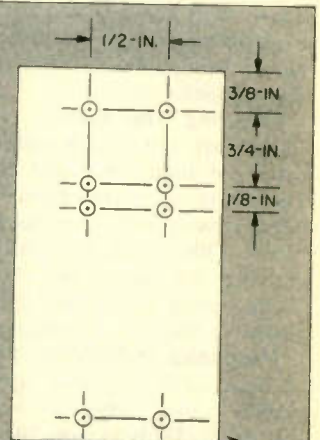

WHERE NEEDED FOR END OF COIL WINDING

Drill the holes in the base as is shown in this diagram for best performance.



Keep up with current events by expanding your meter's amp-ability

# HIGH-AMP METERS

WITH THE RISING COST of test equipment it is advantageous to be able to perform several operations with one meter. For instance a DC milliammeter can be converted to read higher values of current by adding a shunt to bypass the bulk of the current around the delicate meter. By following a few simple steps a milliammeter can be converted to read 10 to 20 amps or more. The first step is to determine the internal resistance of the meter. From this you can calculate the shunt resistance needed and the type of material to be used.

To find the internal resistance of the meter, construct the test circuit illustrated here. The 4700 ohm resistor is used to limit current and serves no other purpose. Start with the power supply set to zero volts, leaving S2 open and S1 closed. Slowly increase the current flow by varying R3 until the meter needle moves to full-scale deflection. Without touching the setting of R3, close S2 and adjust R2 until the meter reads half of full scale. According to Ohm's Law the resistance of the meter and of R2 are now equal. Open switch S2 and measure the resistance across R2. This value will be equal to the internal resistance of the meter.

**Shunt.** Precise shunt resistance is important for accurate current readings and must be chosen carefully. With the shunt connected across the meter, most of the current is diverted past the meter. This is the theory behind a small meter being able to read high currents. The shunt can be a wire, steel or copper bar, or almost any material that will offer the proper resistance. To determine the needed shunt resistance we will consider an example. If we want a 0 to 10 milliammeter to be able to read full-scale for a current of 10 amps. Therefore 10 mA will flow through the meter when 9.990 Amps are diverted through the shunt. If the meter resistance was 100 ohms, using Ohm's Law the voltage across this parallel circuit is found by using the following equation:

$$E = (\text{Current}) \times (\text{Resistance}) \\ = (0.01 \text{ amps}) \times (100 \text{ ohms}) \\ = 1 \text{ volt}$$

Using the calculated voltage and

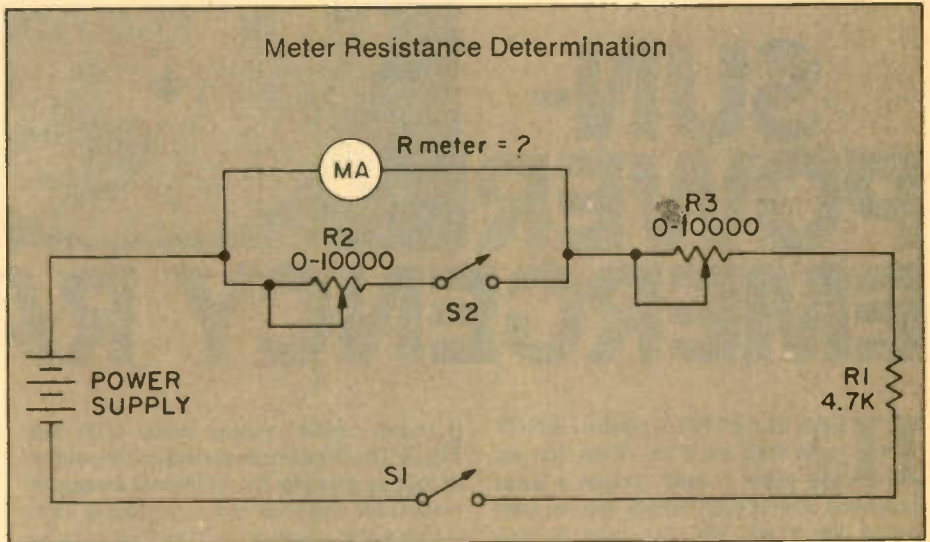

To determine the internal resistance of a meter construct a circuit like the one illustrated above. If you don't have the parts in your junk box then check an electronics surplus outlet.

A shunt resistor bypasses the bulk of the current around the meter while allowing a regulated amount to pass through the meter's coil and give an accurate reading. A shunt can be a resistor or a measured length of wire. Make sure it will handle the current.

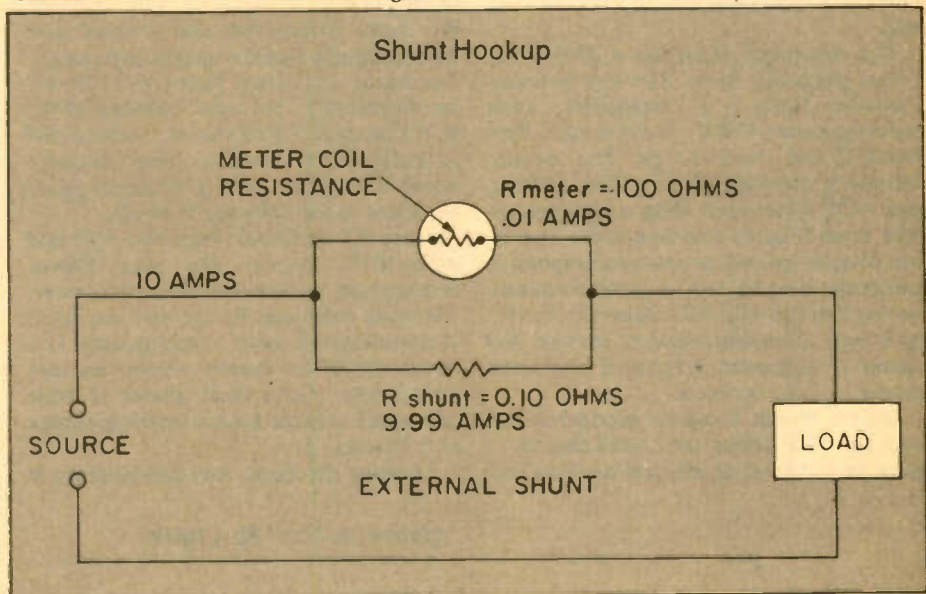

solving Ohm's Law for resistance the proper shunt can be found. This derivation is shown below:

$$\text{Resistance} = \frac{\text{Voltage}}{\text{Current}} \\ = \frac{1 \text{ Volt}}{9.990 \text{ Amps}} \\ = .1001 \text{ Ohms}$$

In this case the milliammeter would be capable of giving a readout directly in amperes.

By following these few simple steps you will greatly expand the versatility of your test equipment. It will increase your ability to handle a greater variety of test and trouble shooting situations. ■



By Homer L. Davidson



# SUN-POWERED EMERGENCY RADIO

**H**ERE IS A LITTLE EMERGENCY radio that has a lot of zip and go. The radio is built around a linear integrated circuit (IC) which can be purchased for \$2.00. You can tune in your favorite AM broadcast station with excellent audio quality driving a single earphone. This portable radio is easy to assemble, with only a few parts and is solar powered. You do not ever have to replace batteries in this radio for it is powered with three small solar cells.

The emergency radio has a ZN414 IC, which physically looks like any ordinary transistor. Inside is a 10-transistor, tuned radio-frequency (TRF) circuit using a Ferrante C.D.I. technology. The circuit includes a complete RF amplifier, detector and AGC system providing a high quality AM tuner (Fig. 1). Excellent audio quality can be achieved and current consumption is extremely low. In fact, a local broadcast station tuned in with full volume the little IC pulls only .05 milliamperes of current. No set-up or alignment is required and parts mounting is no problem.

**How It Works.** To obtain good selectivity with any TRF device, the ZN414 chip (IC1) must be fed from an efficient antenna coil

(L1) and capacity tuning section (C2). See Fig. 2. The ferrite rod antenna coil should be as long as possible. No additional antenna is needed for this solar radio. On strong local stations the antenna or container may be turned to lower the signal if needed. Sometimes a strong radio station may take up a large share of the tunable band.

The desired station is selected by L1 and C1. This RF signal is fed into the input terminal (2) of IC1 (Fig. 2). Here the tuned RF signal is amplified and detected with excellent audio signal at output terminal (1). The stator (stationary) plates of C1 should be connected to the input terminal of the IC1. Capacitor C4 couples the audio signal to audio driver transistor. Here the audio signal is amplified with a single earphone piece tied to the collector terminal.

Since IC1 and audio transistor (Q1) pull very little current, the ideal power arrangement is provided with solar power. The small radio may be operated out doors in the sunlight or under a reading lamp. You never have to worry about battery replacement. Three small pieces of solar cells wired in series have a working voltage of 1.32 volts.

**Locating the Parts.** Any combination of

L1 and C1 which cover the AM broadcast band may be used. C1 should be of the miniature type and several sources are listed in the Parts List. L1 may be a commercial broadcast ferrite rod antenna or a home wound job as given later. Both the IC and AF transistor may be obtained from Circuit Specialists, Inc. of Scottsdale, Arizona. Practically any NPN low-voltage transistor may be used to drive the earphone. You may find the small fixed capacitors and resistors in the Parts List.

**Winding the Coil.** Choose the largest diameter ferrite core and length that is handy. Many of these antenna coils are found in radio part stores, in grab bag bargains or may be purchased individually. A 3/8 x 4-inch length core is ideal to wind the wire upon (Fig. 4). It does not matter if the core is flat or round. The length of this core can only be 4-inches long to fit inside the large Old Spice® deodorant stick container. The longer ferrite core may be cut off with a hacksaw.

Select a 24 or 28 enameled covered wire to

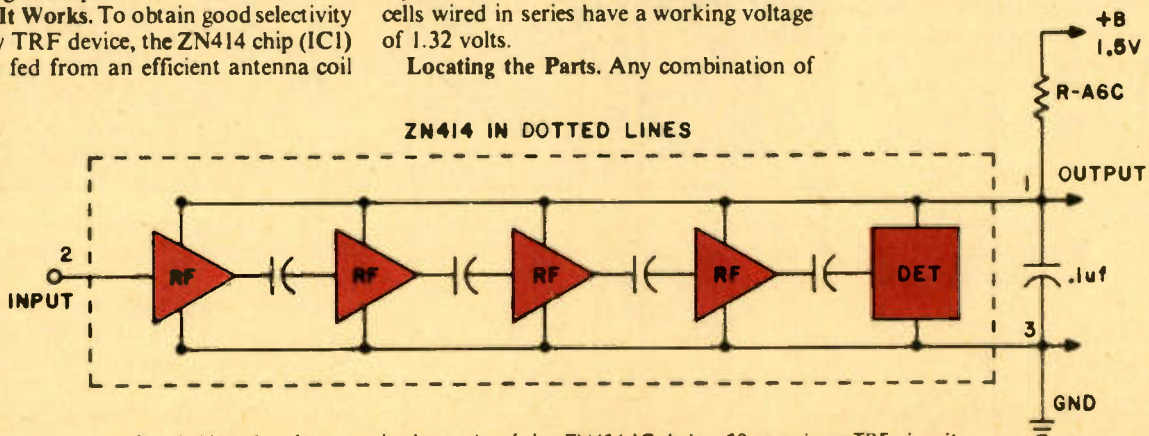

Fig. 1. Here is a front-end schematic of the ZN414 IC. It is a 10-transistor TRF circuit.



## PARTS LIST FOR SUN-POWERED EMERGENCY RADIO

C1—365-uF variable tuning capacitor (ETCO type 185-VA, ETCO Electronics Corp., North Country Shopping Center, Rt. 9 North, Plattsburg, NY 12901, or Circuit Specialists type A1-232—address below)  
 C2—.01-uF, 100-WVDC ceramic capacitor  
 C3, C4—.1-uF, 100-WVDC ceramic capacitor  
 IC1—ZN414m (Available from Circuit Specialists, Inc., P.O. Box 3047, Scottsdale, AZ 85257—\$2.00)  
 L1—Ferrite antenna coil to match 365-uF

variable capacitor or wind your own on a ferrite stick 4-inches long and  $\frac{3}{8}$ -inch in diameter. Refer to text. Wire is required.  
 Q1—ECG123A, SK3044, or any low-power NPN audio transistor  
 R1, R3—100,000-ohm,  $\frac{1}{2}$ -watt, 5%  
 R2—470-ohm,  $\frac{1}{2}$ -watt, 5%  
 R4—15,000-ohm,  $\frac{1}{2}$ -watt, 5%  
 SC1, SC3—Solar cells (purchase low-priced broken cells or crescent-type cells from: Edmund Scientific, 101 East Gloucester Pike,

Barrington, NJ 08007  
 John Meshna, Jr., Inc., P.O. Box 62, East Lynn, MA 01804  
 Poly-Paks, Inc., P.O. Box 942, S. Lynnfield, MA 01940  
 Solar Pump, P.O. Box 27885, Denver, CO 90227

Misc.—Crystal (high-impedance) earphone, hookup wire, winding wire (see text), foam chassis, solder, empty deodorant container, etc.

complete the coil assembly. Place a layer of scotch or masking tape at one end holding the wire tight against the ferrite rod. Close wind (CW) the coil next to each turn until the full 72 turns are completed. Tape down the last few turns to keep the wire from coming loose. The entire antenna coil may be covered with scotch tape, if desired. Better still, lay down a narrow bead of RTV cement. Leave about 8 inches of extra wire at each end to solder to the variable capacitor (C1).

The antenna coil may be wound with #30, AWG Kynor wire-wrap wire. Not only is this wire ideal to connect the solar cells together, it may be used as hookup and antenna coil wire. Since the wrapping wire is covered with a coat of plastic it may be close wound directly upon the ferrite iron core. The plastic must be removed from each end for soldering. Scrape off with the pocket knife or burn back the insulation with the solder-iron tip.

**Preparing Chassis.** All small parts including the solar cells are mounted upon a piece of styrofoam material. Select and cut a piece of foam  $\frac{3}{4}$ -inch thick, 4 $\frac{1}{2}$ -inches long and 1 $\frac{1}{4}$ -inches wide. This will let the pieces of foam fit snug against the inside of the round plastic container. The foam chassis may be cut from regular  $\frac{3}{4}$ -inch foam stock or discarded packing pieces. Pieces of foam packing may come from radio, stereo, TV sets and small appliance boxes. The small

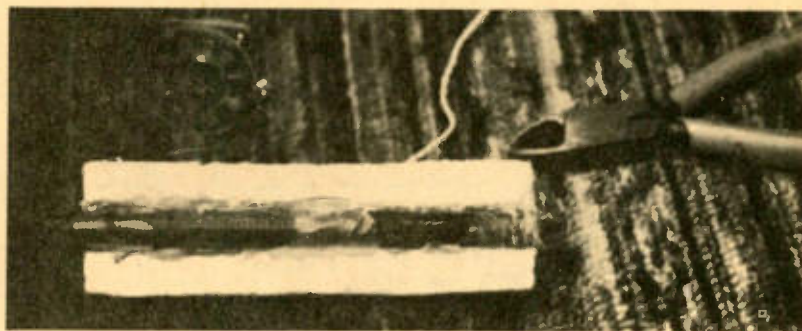

The antenna coil is mounted down inside the V slot of the foam chassis at the bottom side.

solar radio mounts inside a large plastic stick deodorant container.

Cut a large "V" groove down the middle area of the bottom side to mount the ferrite antenna coil. Do not mount the antenna coil until all other wiring and mounting of parts are completed. The small radio component will mount to the front top piece and the three solar cells are cemented to the back area of the top side of the foam chassis.

**Mounting and Wiring Up Parts.** All small parts are mounted as they are wired into the circuit. These parts are kept in a 1- x 1 $\frac{1}{2}$ -inch area. The small resistor and capacitors are wired to IC1 and transistor Q1 terminal before mounted upon the foam chassis. Both the IC and transistor are mounted upside down so the terminal are easily accessible. Use the sharp point of the

soldering iron to melt out the foam so the wiring and part will lay flat upon the foam chassis. Small holes may be poked through the foam with an ice pick or the stiff end of a fixed resistor.

Connect capacitor C3 (.1) across the output and ground terminals (1 & 3) of IC1. Solder a four-inch piece of hookup wire to the same ground connection. This ground wire will go through a hole in the foam and serve as a ground connection for emitter terminal of Q1. Connect the .01 capacitor (C2) to the ground terminal. Now connect a 8-inch piece of hookup wire from the top side of C2 which will later connect to C1. Wrap one end of R1 (100K) to this junction and output terminal (1) of IC1. Solder all terminal connections after these connections are wrapped together.

Solder one end of C4 (.1-uF) capacitor to the output terminal (IC1) with R2. Try to keep all parts in a one-inch width area as they are soldered up. Connect the other end of Capacitor C4 to the base terminal of Q1. Place R1 resistor across the base and collector terminals of Q1. Tie R3 to the collector terminal and BM common at R2. Pull the common ground wire up through the foam chassis, cut off and solder to the emitter terminal of Q1.

The crystal earphone connection may be tacked in momentarily to check out the radio. After the small radio is working leave about 4-inches of earphone cord and tie a knot so the plastic end piece will keep the strain off the wired circuit if the earphone



All components are mounted upon a piece of foam 1 x 1 $\frac{1}{2}$  x  $\frac{3}{4}$ -inches thick.



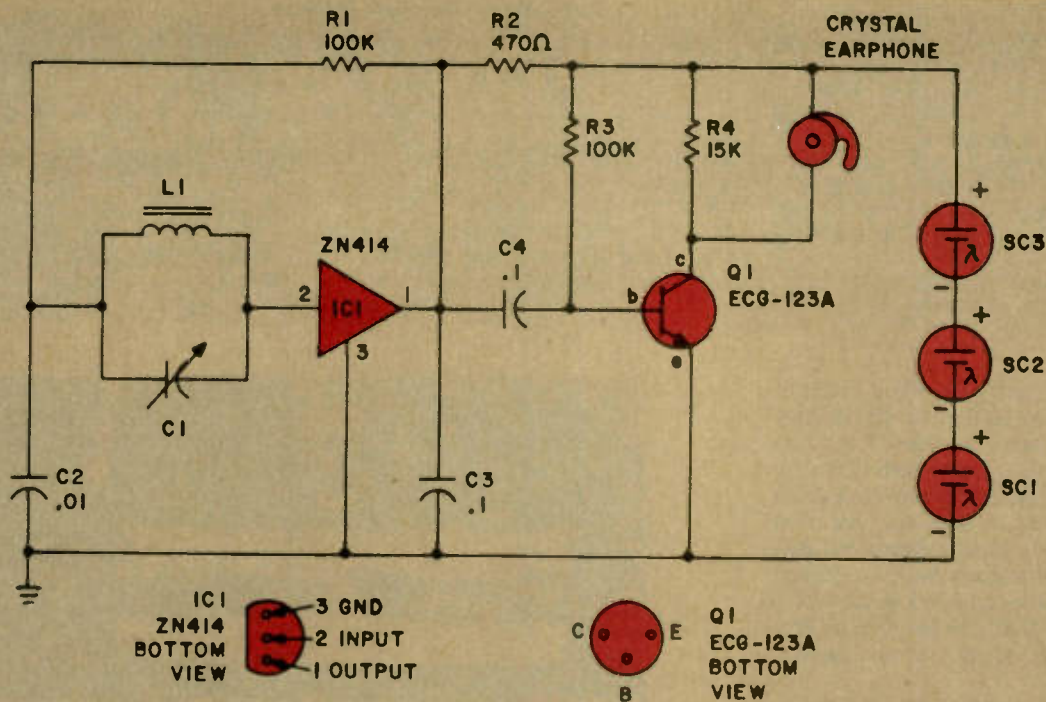

Fig. 2. The actual solar radio circuit with IC1 and Q1. The volume is sufficient to drive a crystal earphone.

cord is jerked or pulled. If the earphone comes with a plug, you may install an earphone jack in the plastic end piece. Here the earphone plug was cut off and soldered directly into the circuit. Burn back the plastic wire coating with the iron tip. Scrape the flexible Litz wire of each earphone cable with a pocket knife. Trim each end before trying to solder into the radio.

**The Solar Cells.** The small solar cells may be pieces of broken cells wired in a series hookup. These cells may be purchased in a broken cell lot as given in the Parts List. Since the cells must be mounted close together they are wired and connected together before mounted. Use plastic wrapping wire or single strand of hookup wire to connect the cells together or Krynor Wrapping wire. Simply cut a piece of flexible hookup wire six inches long and unwind each strand of copper wire for cell hookup wire.

Remember, the top part of the solar cell is

negative with the bottom or silver side as the positive terminal (Fig. 4). Start with solar cell SC1 and solder a lead to the bottom side (M). Cut the lead off just long enough to connect to the top side of cell SC2. Select a T or bar area of a broken solar cell to make the top connection. Now connect another piece of hookup wire to the bottom side of cell SC2 and connect to the top side of cell SC3. Cut two pieces of cell hookup wire three inches long to connect these cells to the radio circuit. Solder the negative terminal to the top side of cell SC1 and the other connecting (positive) wire to the bottom of side of cell SC3. (Refer to figs. 4 and 5.)

Double check the wiring of the solar cells before mounting upon the foam chassis. If a small VOM is handy select a 2-volt range and measure the voltage across the two connecting wires with a 100-watt bulb placed above them. Do not allow the cell to get hot. A total of 1.3 volts should be measured with proper cell connections. The

meter may read backwards if test probes are connected wrong. Notice which lead is positive upon the meter. This positive terminal lead is soldered to R3 and the crystal earphone connection (Fig. 5).

After the solar cells are connected together and tested mount them upon the end of the foam chassis. To keep wires and cells down below the foam surface melt out the exact area with the tip of the small soldering iron. Likewise, melt out mounting area for the IC1, Q1 and larger capacitors into the foam area. Cement the solar cells in place with rubber silicone (RTV) cement. Let the cement set up for a couple of hours. A dab of rubber cement may be placed upon larger components to hold against the foam after the radio, is operating.

**Preparing Case.** A large, plastic, discarded Old Spice® Deodorant Stick is used to house the small IC radio. Select the largest, about 5-inches long. Remove the used up deodorant end piece and throw it

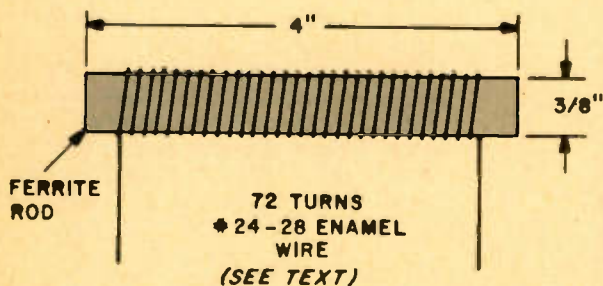

Fig. 3. Wind 72 turns of number 24 or 26 wire upon a 4 inch ferrite iron core. Cut the rod to 4 inches in length.

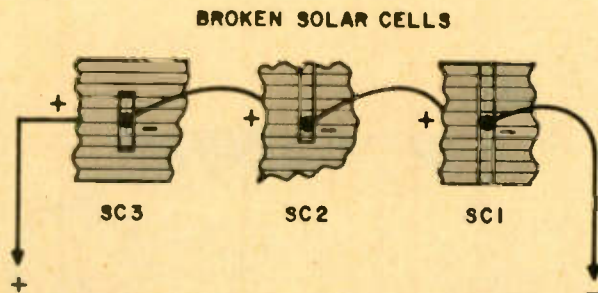

Fig. 4. The three small solar cell pieces are wired together before cemented upon the foam chassis. Burn out a portion of the back chassis so the cells with wires will mount flush with the top of chassis.



away. Drill a 1/8-inch hole in the plastic screw end piece. Cut out a piece of flat plastic to fit in the open end of the container. Drill a 5/16-inch hole in this piece before placing inside of container.

The plastic round end may be cut with a small saw or soldering iron tip. File and cut the piece of plastic to fit inside the end opening. Remove any burr edges so the capacitor will fit flat against the plastic end piece. Use airplane or similar glue to cement the round plastic to the container. Let the cement set before mounting the small capacitor.

**Finishing Up.** Now mount the large antenna coil. Turn the foam chassis over and place a layer of rubber silicone cement in the grooved area. Refer to the photos. Push the antenna assembly down into the slotted area. Keep the coil end flat with the front of the foam chassis. Make sure the antenna coil connecting wires are underneath the antenna and pulled out towards C1. Let the cement set up before connecting one end of coil to terminal 2 of IC1 and junction of C2 and R1.

Leave approximately 8 inches of hookup wire from the radio circuit to connect to the variable tuning capacitor. This capacitor will mount directly ahead of the foam chassis into the hole of the plastic end piece. The variable capacitor is fed through the small plastic hole and tightened with the small lock nut. Keep the extra hookup wire to the bottom side of chassis and capacitor so they will not bind up the tuning capacitor. Check to see if the plastic end piece will screw up against the body of the container. Place a layer of rubber cement on top and bottom sides of foam chassis to hold against the plastic container after making sure the radio is working.

**Testing.** Before firing up the Sun-Powered Emergency Radio, go over each soldered connection and component at least twice. Check off each part upon the schematic diagram. Make sure the soldered connections are tight with a good connection. Be careful, do not leave the hot iron-tip too long upon IC1 or Q1 terminals. Too much heat may damage the small components. Use a pair of long nose pliers as a heat sink.

Now, place a 100-watt bulb close to the radio. Measure the voltage at the two solar-cell output terminals. You should have between 1.1 to 1.3 volts. No voltage indicates a dead short across the cells or the cells are not turned towards the light, also, your inter-solar-cell connections may be open. Disconnect one lead and take another voltage measurement. Double check the wire connections of each cell. Suspect a wire or wrong connection if the voltage returns. Go over the wiring once again.

Place the blade of a pocket knife or screwdriver upon the input terminal (2) of IC1. You should hear a small hum or loud click in the earphone. If a click is heard check the wiring to the antenna and variable tuning capacitor (C1). A wire may break off while mounting the radio chassis.

**Operation.** The Sun-Powered Emergency Radio may be operated under a reading lamp or in the sun. Remove the cap from the end so more light will strike the solar cells. Now slowly rotate the dial until a station is heard. Move the small radio at different angle to increase the volume of the station. Several local stations should be heard over the entire broadcast band. Powerful local stations may be heard with the end cap screwed in place.

Increase the resistance of R2 when a whistling noise is heard on several stations at

different portions of the broadcast band. This squealing noise may occur at any point indicating swamp out of the AGC signal. Try a 1000-ohm resistor for R2. Keeping extreme light from the solar cells may help in accurate station tuning. Turning the small radio case towards or away from loud local stations may help in locating a weaker one. To locate and tune in weaker or more distant stations remove the end cap for stronger light upon the solar cells.

This little radio may tune in those long distance stations after the local ones are off the air. Some strong local stations may sign off when the sun goes down, letting the radio pick up the weaker stations. These far away stations may be selected late at night. Slowly rotate the dial to a weaker station, turn the radio until the station is loudest.

**Conclusion.** Be careful when soldering IC1 and Q1 into the circuit to prevent overheating. Select the correct terminal of IC1 and Q1 before soldering up. Mark the solar cell front area with a dot or line so that area will be turned towards the lights. Check the solar-cell polarity before connecting into the circuit. Double check all wiring before firing up the radio. Mount IC1 and Q1 with a dab or rubber silicone glue to hold in place after the radio is checked out. Remember to keep the solar cells turned toward the sun or light at all times. Strong broadcast stations may be turned down in volume by keeping cells covered with the plastic end piece and rotating the antenna away from the station. Weak stations may be tuned in by turning the radio towards the weak station with a stronger light source. Although the small Sun-Powered Emergency Radio will not blast your ears, easy-private listening can be had without ever changing batteries—just use that internal solar power at no cost. ■

Fig. 5. Here is a pictorial drawing showing how the parts are mounted and wired into the circuit.

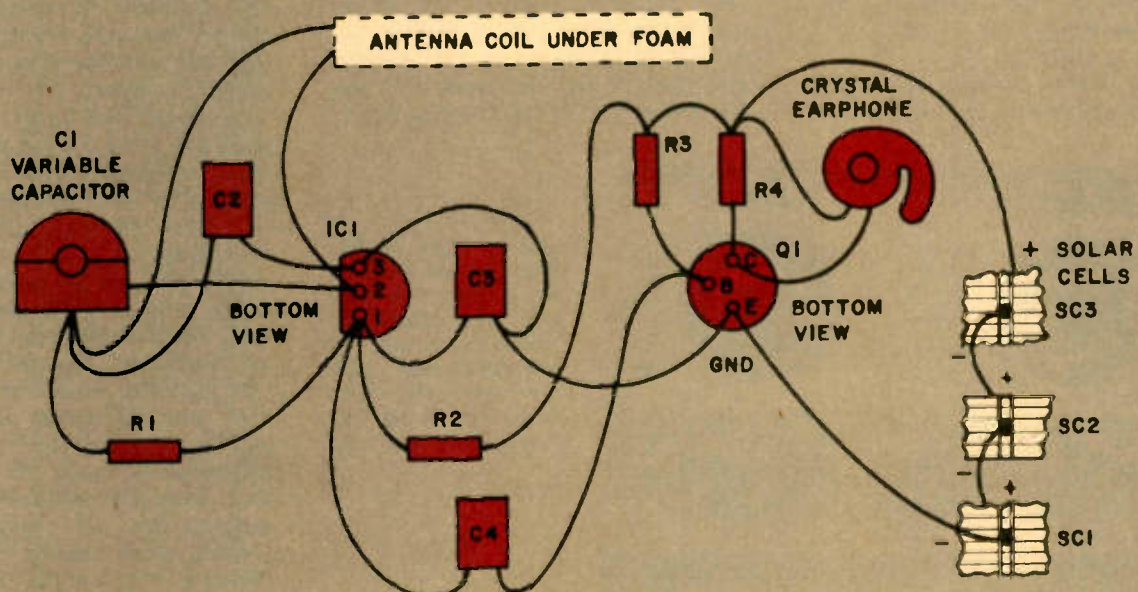



# Solar Cell Tester

Measure photovoltaic characteristics with this unique meter

**P**HOTOVOLTAIC SOLAR CELLS may hold the promise for the future, but you can experiment with them today. Before utilizing the units in a project, it's necessary to know their capabilities.

All makers list a maximum output current rating, with some listing of power levels for a given light source (usually 100 mw/cm<sup>2</sup>).

So what? You need to know what it will do for you—under your parameters, your light source, and your load! How? With a handy-dandy solar cell tester.

**The Rating Game.** Silicon cell output varies with the light level, and with the load as well. If a cell is too heavily loaded, the power drops appreciably. Glance at the power graph. Notice it peaks when the voltage across the cell is 460 millivolts.

This is where the manufacturer tests his units, to determine *maximum performance*. He uses variable load, placed across the cell. With no load, the solar generator exhibits an open circuit voltage higher than its working voltage. As the load is increased (more current), the potential across the junction drops.

At one point, the current begins to dip along with the voltage—thus further reducing power. The maker sets the resistance so the voltage across the cell under test is optimum.

Figure 1, shows a simple circuit for performing just such a test. One meter

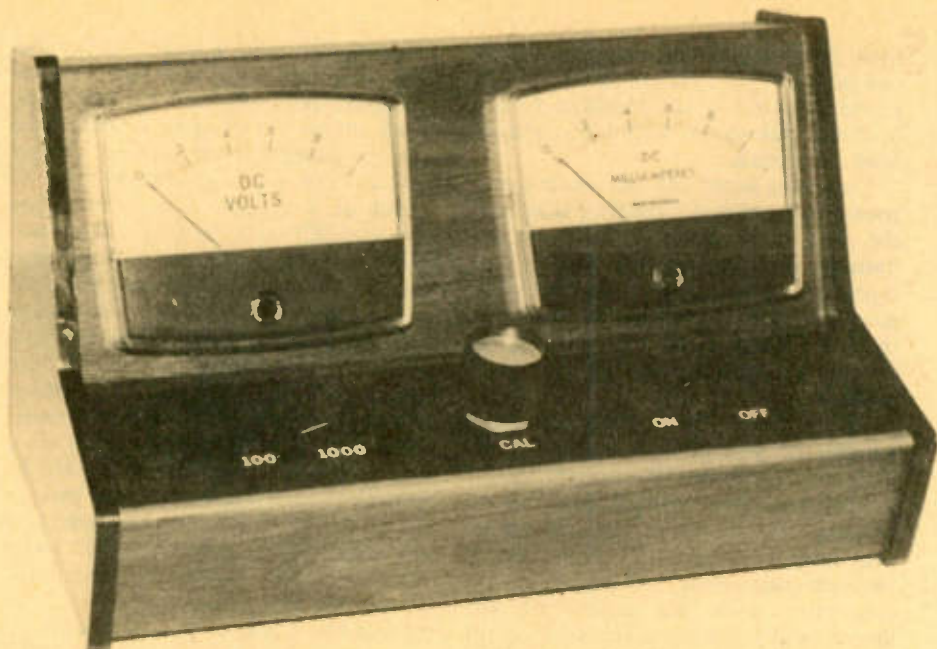

monitors current . . . the other voltage. Adjusting the variable resistor to the peak power voltage (460 mv) will net you the device's current! But, the output current differs from cell to cell, necessitating a corresponding change in resistor value. That's fine if you're testing one or two units, but how do you efficiently check 20, or 50, or ??? With a dynamic variable load; one that adjusts itself to the correct voltage.

**About The Circuit.** The easiest way to achieve a dynamic variable load (DVL) is using a transistor. In figure 2, the solar cell is connected across the emitter and collector. As current is metered through the base, the VCE changes—loading the cell accordingly.

Now, add a feedback loop, an amplifier, a couple of meters, and we have a professional solar cell checker.

The feedback resistor, R<sub>2</sub>, determines the amplifier gain, while the non-inverting input monitors the voltage across the cell and compares it to the reference voltage at the inverting input.

**Let's Make One.** The tester can easily be duplicated, using any method of construction available to you: perf-board, PC board, point to point, etc. You'll notice, a PNP transistor is used for the load, making the ground positive in respect to the cell's input voltage. That's because the silicon cell has a *positive* backing, with the front contacts *negative* polarity.

The IC amplifier is a 741, but any stable operational amplifier should suffice. Don't forget the external compensation, should your choice require it. The only requirement—output current. As the transistor reaches higher current levels, the HFE (gain) decreases accordingly, requiring more base current through the transistor.

The sink transistor (Q1) may be any silicon PNP capable of passing 1 amp safely and able to dissipate about 1 watt. No heat sink is required.

My test instrument was designed to measure 1 ampere, but you can make it any range you desire by changing R<sub>m</sub>. If you use a 0-1 ma meter with an internal resistance of 50 ohms, follow the chart for your selected value. If it is 100 ohms, double that figure—it'll be close enough to be accurate.

Connect R<sub>1</sub> and R<sub>2</sub> to the VCC power supplies as shown. The power supplies should be tracking—or, at least regulated. Otherwise, the reference voltage at the inverting input will shift, throwing off your calibration setting. (Actually, I've even used two 9 volt batteries and had good results. If the cells are within reasonable tolerance, the shift is negligible. But, for precision, a well regulated power supply is a *must*.)

**Using It.** Connect the cell under test to the input leads, observing polarity.

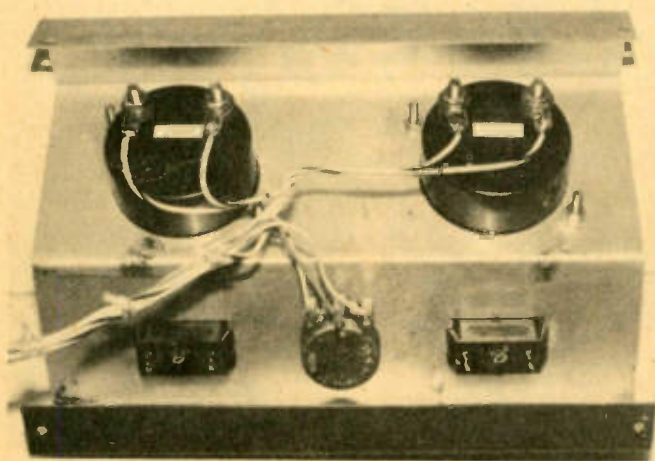

Looking down at the Solar Cell Tester. Chassis, meters, switches, and the calibration control can be seen. If you look carefully, you will notice the wire shunt (R<sub>m</sub>) across the panel-meter on left.



# Solar Cell Tester

Illuminate the surface with the light it will be subjected to (sunlight, desk lamp, etc.) and set the CAL control for the voltage—in most cases .46 volts. The current of the cell will be displayed on the other meter—don't forget your multiplication factor!

The tester will adjust to any cell automatically, regardless of the output current of the load.

A nice feature about the instrument is you can change the calibration to give you the output voltage at a specific current. Twist the calibration knob to your current value, then read the volt-

age. Of course, it won't regulate at that current value as it does voltage, but you will know the output voltage under the actual operating conditions.

Obtain some solar cells you intend to use for your next solar project. Using your photovoltaic tester, you can now design your load to yield maximum power output. ■

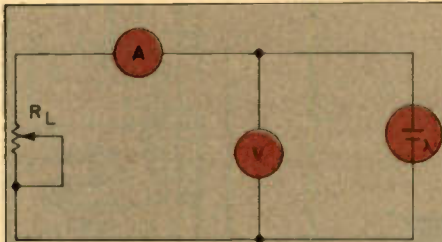

The diagram above shows the basic circuit. The voltmeter shows cell voltage, while Ammeter (A) indicates the load, which can be adjusted by potentiometer, called RL.

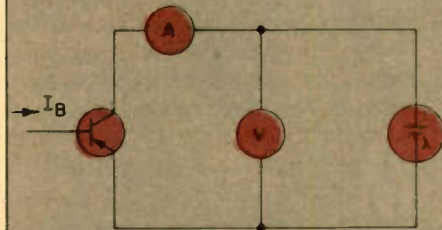

In above diagram, the same output voltage can be obtained at different loads. This is accomplished by placing the calibration potentiometer in the transistor's base.

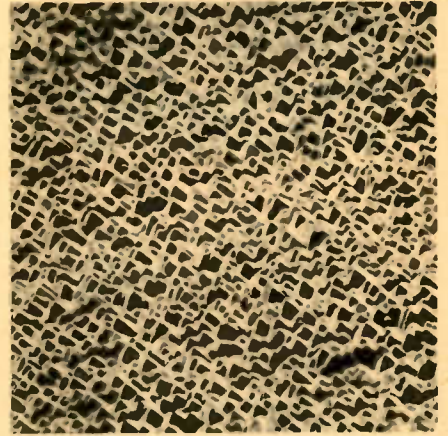
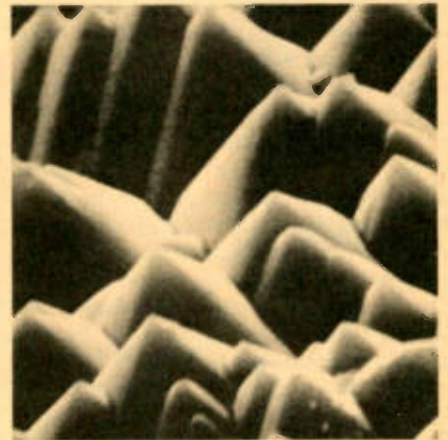
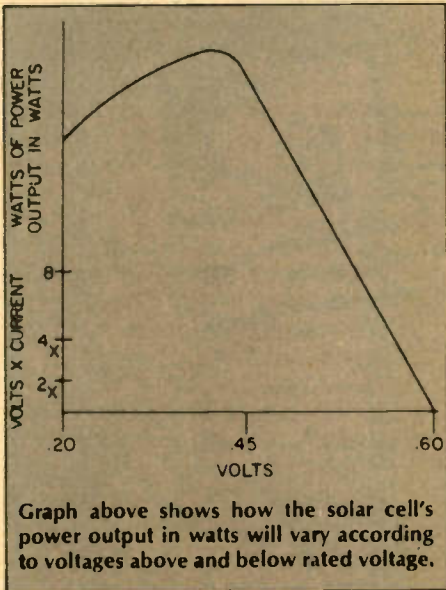

Photo above shows 400 times magnification of a photovoltaic silicon cell surface.



With cell surface magnified 4,000 times, tetrahedrons or peaks stand out sharply.



Graph above shows how the solar cell's power output in watts will vary according to voltages above and below rated voltage.

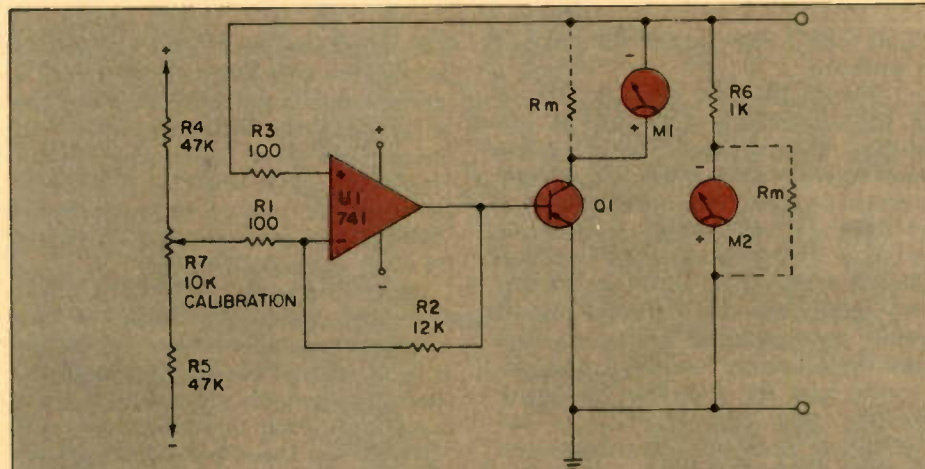

## PARTS LIST FOR PHOTOVOLTAIC TESTER

- M1, 2-0-1 ma panel meter (Radio Shack #270-1752)
- Q1—transistor, ECG 129, or equivalent
- R1—resistor, 100 ohms, ½ watt, 10%
- R2—resistor, 12,000 ohms, ½ watt, 10%
- R3—resistor, 100 ohms, ½ watt, 10%
- R4-5—resistor, 47,000 ohms ½ watt, 10%

- R6—resistor, 910 ohms, ½ watt, 1%
- R7—(VR1) potentiometer, 10,000 ohms
- U1—integrated circuit 741,1458, etc., operational amplifier

Note: The Radio Shack meter listed has 100 ohms internal resistance.

WHAT'S YOUR R <sub>m</sub> VALUE ?		
X1	0-1	NONE
X10	0-10	5.00 10.00
X100	0-100	.500 1.00
X1000	0-1000	.050 .100
	RANGE (MA)	OHMS

TOP VALUE IS FOR METER WITH 50 OHMS, BOTTOM IS FOR 100 OHMS.

R<sub>m</sub>, or meter shunt value is determined by the meter's internal resistance. Using a shunt we can multiply the meter's face value by 10X, 100X, or 1000X. As we increase the multiplied range, the resistance value of the shunt (R<sub>m</sub>) goes down.



# CIRCUIT BOARD ETCHING

A step-by-step guide to making project boards

**W**HILE PERFORATED PROJECT BOARDS, or perf boards, are relatively cheap and easily obtained, a circuit board etched for its particular usage will provide neater, more professional results. Projects with the circuitry foundation of an etched board will be less prone to vibration damages as well as have greater impact resistance—in all, an etched board provides sturdier construction and greater safeguards.

In addition to the quality of construction, in contrast to perf boards, etching lessens the chances of undesirable oscillations caused by crossed or jumpered output signal wires producing feedback in sensitive component elements. Also, electrical noise interference caused by spurious radiations in the circuit's environment are more easily suppressed as a result of the close proximity of ground and voltage supply leads. Decoupling capacitors can easily span supply and ground distribution lines with correct board layout.

Only the etching process will be discussed in this article. The actual circuit board layout should be considered carefully and fully in advance.

**Materials.** The materials required for board etching can be found in nearby electronic retail stores, and the supplies, once purchased, should last through a number of etchings. A list of the materials needed includes:

1. Copper Clad Board.
2. Etchant Solution.
3. Resist Pen.
4. Shallow Pan.
5. Heat Source.
6. Template.
7. Drill Bits.

1. **Copper-Clad Board.** For good results on initial etchings, use boards with copper coating on one side only. A little experience is best before attempting double-sided boards. As for board dimensions, any convenient thickness or size will do depending upon the individual project. Copper-clad boards can easily be cut to fit exact measure-

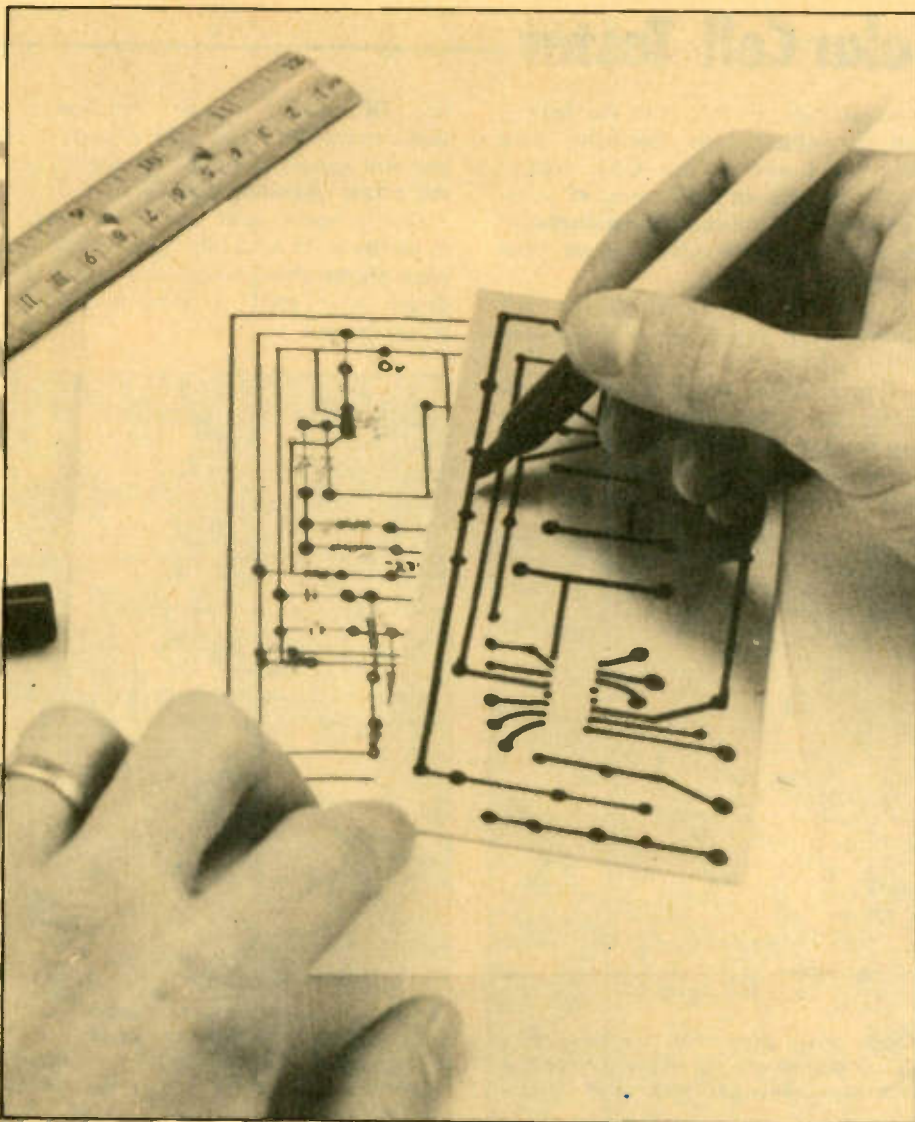

ments with a fine-toothed saw such as a hacksaw.

2. **Etchant Solution.** There is a variety of etchant solutions currently on the market, both in crystal form and already mixed. An inexpensive, pre-mixed solution of ferric chloride is good for a starter; it conveniently provides a uniform end product. Although the solution used during an etching (several boards may be etched at once) cannot be reused, the bottles of solution commercially available contain enough fluid for a number of board projects.

3. **Resist Pen.** Most electronic retail outlets have on stock pens specially designed for circuit board etching. However, most discount or five-and-dime stores sell the Sanfords Sharpie pen, or one like it, guaranteed to write on metal, plastic, etc. for one-quarter to one-half the price of the special resist pens. Both types give good service.

4. **Shallow Pan.** Do not use metal

pans to etch in, because the etchant will act on the pan metal. Instead, use a glass or plastic pan close to board size to conserve the etchant solution. An inexpensive set of plastic photographic developing trays would be a good investment for etching projects. Photographic trays are available in a variety of sizes.

5. **Heat Source.** A thermostatically controlled heat lamp would be the ideal heat source to be used during the etching process. However, an ordinary 60-watt light bulb suspended near the solution pan will accomplish the same thing for less expense. A droplight with a 60-watt bulb works well. Use a plastic photographic darkroom thermometer for temperature checking. In fact, with warm (60°F or above) air temperature, simply placing the plastic tray in warm water will provide the needed heat during the etching process.

6. **Template.** A template, or exact board layout, can be hand drawn. Often



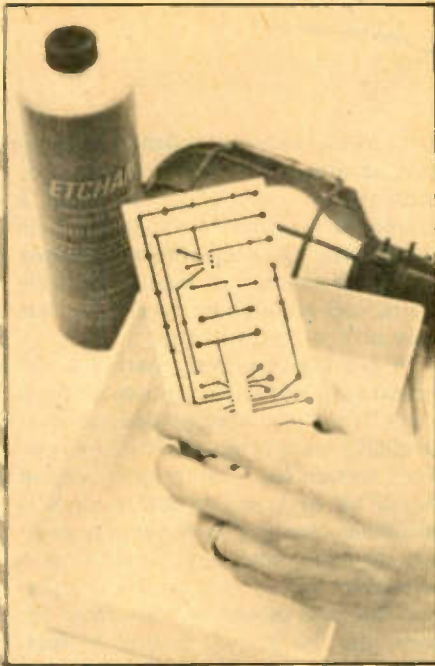

This photo shows all of the vital items needed to etch custom-made circuit boards.

Some practice is needed to etch involved circuit boards like this one, but even a board of this complexity is within reach of hobbyist who is willing to learn etching.

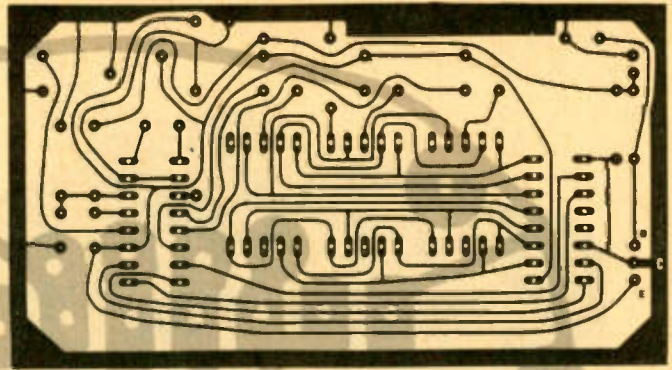

it is provided in electronic project plans.

7. Drill Bits. For board projects, get drill bits size 1/16-inch and 1/32-inch. Bits in these sizes can be found in most hardware or hobby stores.

**Marking The Board.** A board layout, or template, provided with an electronic project may already be drawn in reverse. This is necessary, since circuit designs are drawn from the component side of the board, leaving the copper clad rear of the board an exact reverse.

If the design to be etched onto the circuit board is an original hand drawn layout, though, a reversed drawing can be easily accomplished by placing a carbon ink side up beneath the drawing and retracing the lines of the layout topside. When the carbon is removed, an exact reverse remains on the back of the original drawing. This carbon reverse is the template for etching. Before transferring the template drawing to the copper clad board, *lightly* rub the copper with a steel wool pad, then rinse and dry. Cleaning the board in this way permits the resist ink to adhere better.

Taking the template, punch small holes in the paper at each connection point. Place the template over the copper and use the resist pen to mark each connection point through the holes. Remove the template. If the circuit is simple, draw the rest of the template drawing onto the board. If lines are complicated, use a ruler as straightedge.

To get the most accurate results using

the resist pen, store the pen with its tip down for several hours prior to use. When drawing on the copper, use long smooth lines and stop marking only at connecting points, otherwise there will be fine lines in the resist ink that will cause hairline cracks in the finished product. Do not back-up while marking or retrace lines for best results. Wide lines can be drawn by using the side of the pen point. Two lines drawn side by side can produce a wide area, but generally the end product is better using one mark. When mistakes occur, erase with a pencil eraser. Store the resist pen point down to prevent the point from drying between usages.

**Etching.** The etchant itself is an acid and therefore handle the solution with care. Take the same precautions necessary when handling any acid. Do not store the fluid where it is accessible to children. If during the etching process the solution splashes into the eyes, flush the affected area with water immediately and see a physician. Avoid body contact with the fluid and wash well if the etchant touches skin.

Pour only enough etchant needed to cover the resist marked board to a depth of 1/8-inch or slightly greater into the shallow tray. Use the etchant solution in a well ventilated room, and avoid breathing the fumes. Place the heatlamp or light bulb near the solution to raise the fluid temperature to approximately 100°F—the exact degree of temperature is not critical. Carefully slide the board into the etchant, copper side up. Gently agitate the solution every few minutes. By using the proper temperature of near 100°F, the etching should be completed within 15 minutes or so. Keep a close eye on the board and remove immediately upon completion of the etching. Tilt the pan carefully to one side to determine if all unwanted copper is gone.

The etching process can be undertaken with success using no heat source if the etchant solution temperature is above 60°F. The process takes approximately one hour with no applied heat,

but the results are not as certain.

**Finishing The Board.** After the etching process has been completed, pour off the solution and rinse the board well under running water. Do not pour the used solution back into the solution bottle with unused etchant—this contaminates the entire contents of the bottle. To remove the resist ink, *gently* rub with a steel wool pad. Rinse, then dry the etched board.

Drill holes for connection wires with a 1/16-inch drill bit. For transistor or other component leads, use a bit size of 1/32-inch. To use these tiny bits in an ordinary hand drill, wrap the bit shank with masking tape before inserting it into the drill.

During etching, hairline cracks may form in critical paths on the board. Repair these cracks with solder before attaching components to the board.

The etched circuit board is now ready for whatever project you have in mind. ■

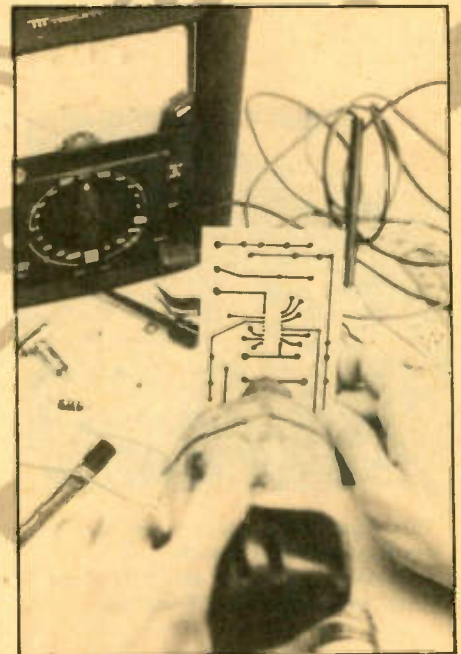

The final step is drilling holes to mount components. Use a 1/16- or 1/32-inch bit.



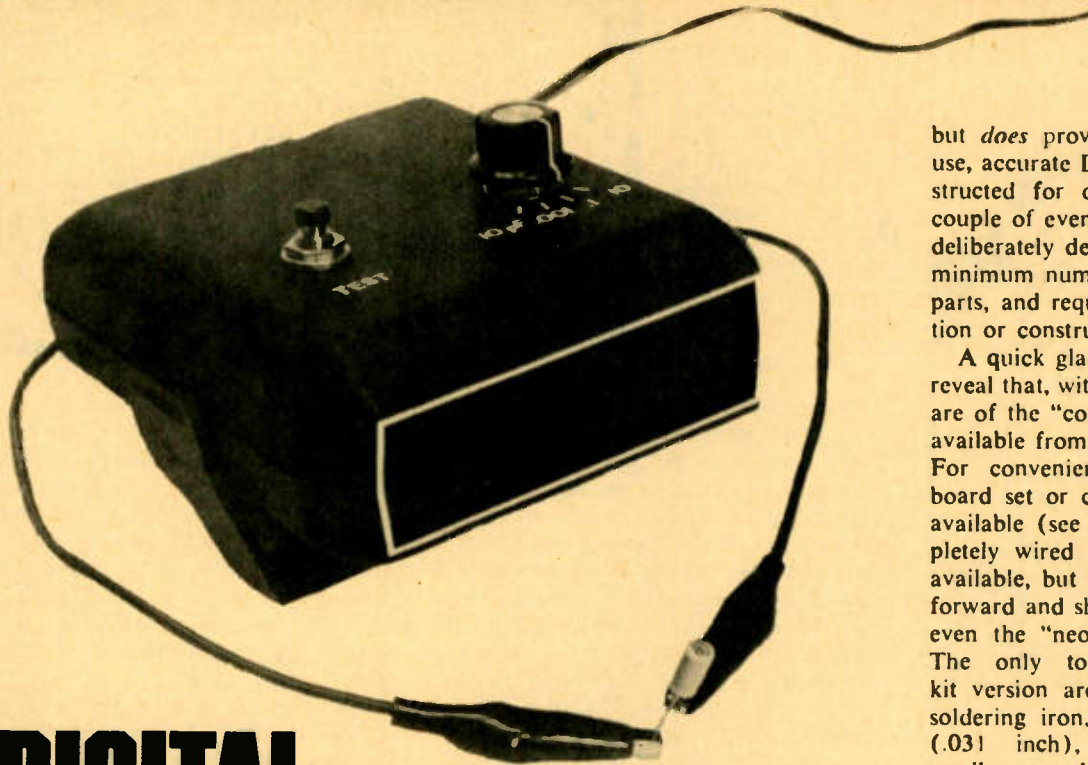

# DIGITAL CAPACITANCE METER

Bargain meter lets you measure those mystery Caps



This digital capacitance meter is a cinch to use; just clip the leads to the capacitor, select the right range and push the TEST button.

**W**ith the proliferation of increasingly sophisticated test equipment, it's quite easy to lose sight of one's *real* test needs. An excellent case-in-point is the digital capacitance meter. Many commercially available designs provide for auto-ranging, auto-null, and have eliminated the "push-to-test" requirement. Furthermore, they frequently boast of accuracies up to .1%! These features might be great for professional laboratory or manufacturing requirements. But, really now, when was the last time you needed to verify a capacitance value to .1%?

Enter our Digital Capacitance Meter (DCM). It does *not* have auto-ranging, nor auto-null, nor auto-test, and does *not* approach .1% accuracy,

but *does* provide a reliable, easy-to-use, accurate DCM which can be constructed for only about \$55 and a couple of evenings' work. It has been deliberately designed with an absolute minimum number of readily available parts, and requires no special calibration or construction skills.

A quick glance at the parts list will reveal that, without exception, all parts are of the "common, garden variety," available from a multitude of sources. For convenience, a printed circuit board set or complete kit of parts is available (see the parts list). A completely wired and tested unit is also available, but construction is straightforward and should be considered for even the "neophyte" project builder. The only tools required for the kit version are a fine-tipped 25-watt soldering iron, small diameter solder (.031 inch), wire cutter/stripper, small screwdriver and long-nosed pliers.

**DCM Design.** For clarity, DCM circuit operation may be divided into a capacitance measurement task and a display task (see the block diagram).

The capacitance measurement system consists of U1a, U1b and U2a. U2, a 556 timer, contains two independent 555-type timer functions: U1a functions as a monostable oscillator; U1b functions as a 10-kHz astable oscillator. Depressing the TEST switch triggers the monostable. The test capacitor (Cx) is part of the timing circuit, and thus, the duration of the monostable output is dependent upon the value of Cx. One pole of the RANGE switch selects the resistance portion of the monostable timing circuit to match the anticipated range of Cx. See the chart for a 556 monostable time-delay nomograph.

Capacitance measurement is based upon gating, via U2a, the 10 kHz astable output with the monostable output signal. That is, 10 kHz astable pulses will appear at the output of U2a only for the length of time that the monostable output is *high* (triggered state). Thus the number of pulses at the output of U2a is a function of the capacitance being tested.

The display system performs the remaining major task; that is, to convert the gated number of pulses to a recognizable numeric display form. For simplicity, this task is accomplished by a series of TTL decade di-



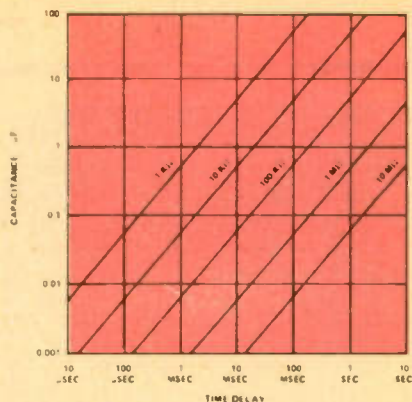

This is a 556 timer nomograph to be used for determining the delay achieved when a certain capacitor is used with the appropriate calibration resistance.

viders, BCD to 7-segment decoders, and 7-segment LED displays. U3 through U7 are wired as decade dividers, additionally providing BCD outputs for the 7-segment decoders U8 through U10. The DCM Functional Diagram illustrates an example of the timing countdown to the displays. We will use it to facilitate understanding of the counting system.

**Test Example.** In the example, a 10uF capacitor is measured on the X.1uF range. With this test capaci-

tance, and assuming a calibration resistance of 110k-ohms, a one-second monostable output duration will be produced at pin 3 of U1a. (See the 556 nomograph assuming a 110k-ohm calibration resistance.) When the TEST switch is depressed, pin 3 of U2a produces 10,000 "pulses" since we gated the 10kHz astable output for one second. U3 and U4 collectively divide by 100, thus presenting 100 pulses to the next three dividers. U5, U6, and U7 also each divide by 10, and in addition, provide BCD outputs to U8 through U10. In the example, U5 "counts" 100 pulses, U6 counts 10 pulses, and U7 counts 1 pulse. When each divider counts 10 pulses it resets to a zero-count state and outputs a trigger pulse to the next divider stage.

Since U5 counts a number of pulses evenly divisible by 10, its BCD output to U10 is a binary-coded zero (ie: 0000). U6 also counts pulses evenly divisible by 10 and thus outputs a BCD zero to U9. U7 counts one pulse, and outputs a BCD 1 (ie: 0001) to U8. Since U7 does not count up to 10, no output pulse is produced at pin 11. U7 controls the most significant digit of the display, and thus must provide a "flag" to the operator if the maximum display count has

been exceeded. This flag exists in the form of an output pulse at pin 11 if count 10 is reached, indicating an overflow condition. This pulse triggers a flip-flop, U2b and U2c, which turns on all segments of all displays via the "lamp test" function of U8, 9 and 10. This alerts the operator to advance the RANGE switch to the next higher position.

U8 through U10 convert BCD information to the 7-segment format used by the displays. In the first example, U10 processes its incoming data (0000) to produce a logic high level for segments a,b,c,d,e and f of the least significant digit. This allows those segments to illuminate, forming the number zero. U9 likewise causes a zero to appear on its associated display digit. U8 processes its incoming BCD 1 to illuminate segments b and c, forming the number 1. The result, reading from the most-to-least significant digits, is 100 which, times the X.1uF range position, yields a capacitance reading of 10uF.

The TEST switch actually performs three functions. The function previously discussed (triggering the monostable oscillator) is accomplished by providing a brief logic low level at pin 2 of U1a. Before the monostable is actually triggered, however, two "housekeeping" chores must be taken care of. First, all dividers (U3-U7) must be reset to zero. This is accomplished by providing a brief logic high level, via U2d, to the "master reset" connections at all divider pins 2 and 3. Second, a brief logic low must be provided as a reset to the flip-flop U2b-c to reset the display digits in the event of an overflow during the previous measurement.

Monostable triggering is delayed by the C1, C2 circuitry to allow completion of these tasks. U1a requires a voltage level of one-third or less of the supply voltage in order to trigger. C2 is discharged from 5 volts through R37 via a low potential available for a brief time from C1 and the TEST switch. A second monostable oscillator, U12, is provided as a buffer for

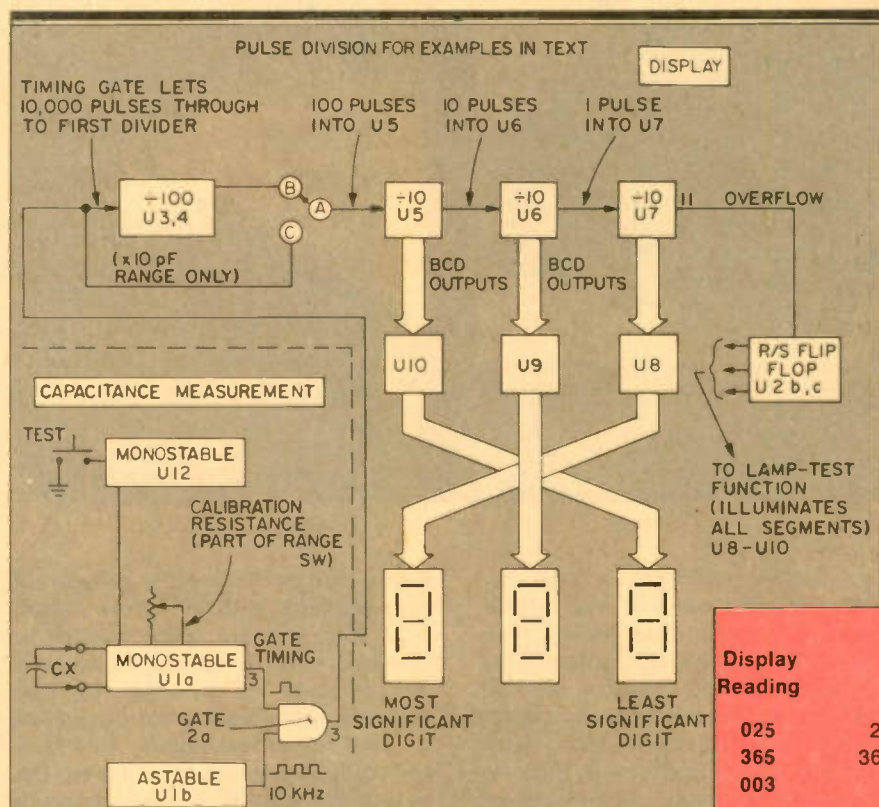

Display Reading	SAMPLE METER READINGS			
	10 pF	.001	.1	10
025	250 pF	.025 uF	2.5 uF	250 uF
365	3650 pF	.365 uF	36.5 uF	3650 uF
003	30 pF	.003 uF	.3 uF	30 uF

Use this diagram to help you understand the sample capacitance reading described in the text above. A 10 uF capacitor and the .1 range are used for this example. The display will read 100.

The above chart shows sample values when various one, two or three digit numbers appear on LED display panel.



the TEST switch, providing a switch "debounce" function.

**Construction.** Construction of the DCM is straightforward when using the PC board layout shown. While point-to-point "perf board" construction is feasible, you would probably wish you had opted for the PC method long before you completed the project. Study the parts layout and orientation before starting construction, and decide upon a "method of attack" for inserting the components. Although individual styles differ, the following sequence should work well. The idea here is that by sequencing the parts installation according to the height of the components, several like-components can be inserted on the board before the board is inverted and the parts soldered in place. This should speed things up a bit. As mentioned earlier, use only .031 diameter (or smaller) solder.

First, install the wire jumpers on the main board as indicated in the

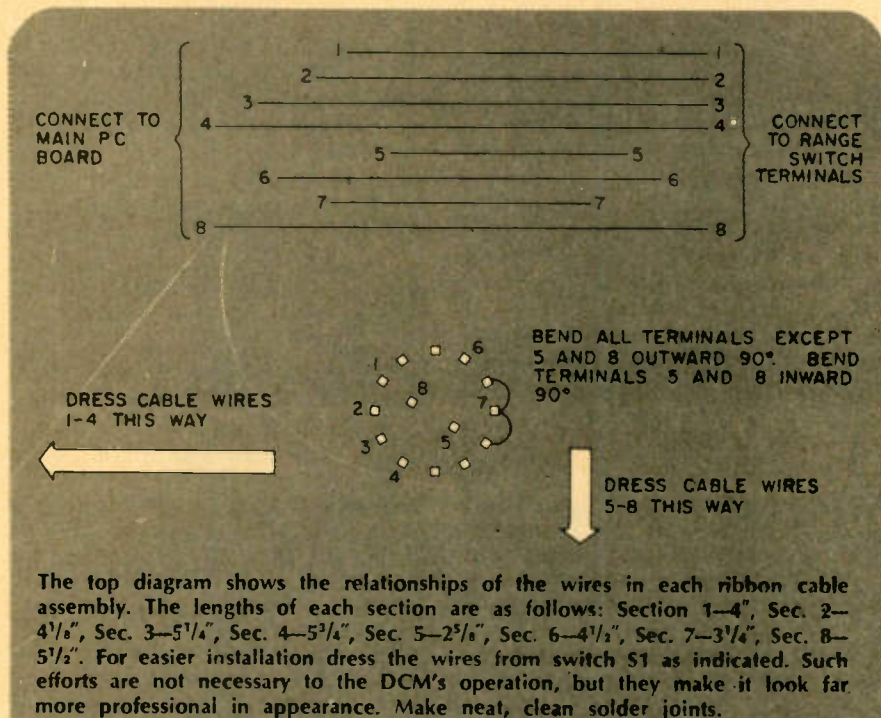

An interior view of a completed DCM. Note the nut and bolt used to dissipate heat from the voltage regulator, the use of IC sockets, and the way the LED current limiting resistors are soldered to the board behind the display panel.

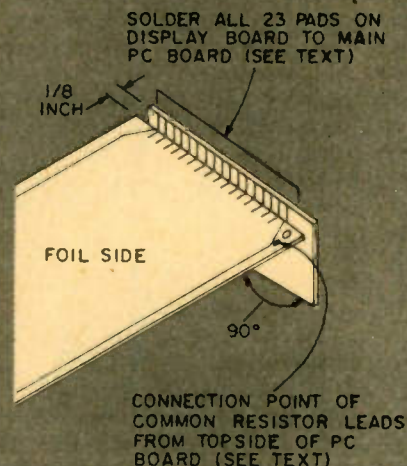
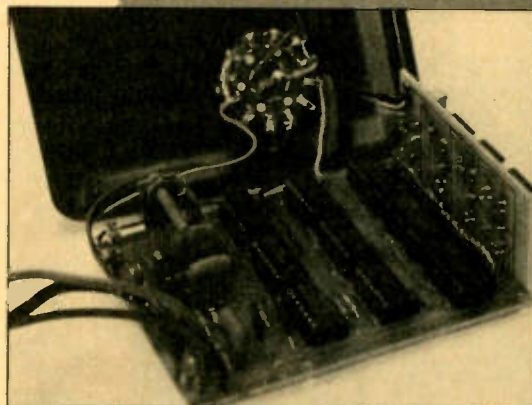

The display board and main board are soldered together in the orientation shown here. Make solid but neat joints.

parts location diagram. (This is probably the most difficult portion of the construction, so take your time and doublecheck the jumper placement.) Next, install the horizontal-mount fixed resistors, slightly bending the leads after insertion to avoid mispositioning when the board is inverted for soldering. (It is helpful, for subsequent troubleshooting identification, to orient the resistors so that all the first bands point in the same direction. It looks neater, and makes identification a lot easier.)

After soldering them in place, trim the leads flush with the solder "blobs." Next, install the IC sockets on the

main board, *making sure* that the notch, or dot, on one end of the socket is positioned as shown. This will facilitate proper orientation of the IC's when they are installed after all soldering is completed. Do not install IC sockets on the display board when using the cabinet described in this article, as there would be insufficient clearance to the front panel.

Next, install the capacitors, perhaps beginning with the mylar types (C1 through C7), then C8, C9 and C10.

Be careful to observe the polarity of capacitors C8 and C9 before soldering. The trimmer pots should be mounted with the adjustment side facing the center of the board for ease of calibration. Observe the orientation of U11 before installation. U11 does not really require heat-sinking for this circuit, but a 6-32 x 1 1/2 inch screw and nut may be added to more evenly distribute the heat when using a small cabinet. It might be useful to note that the heat-sink tab is at circuit



## DIGITAL CAPACITANCE METER SCHEMATIC

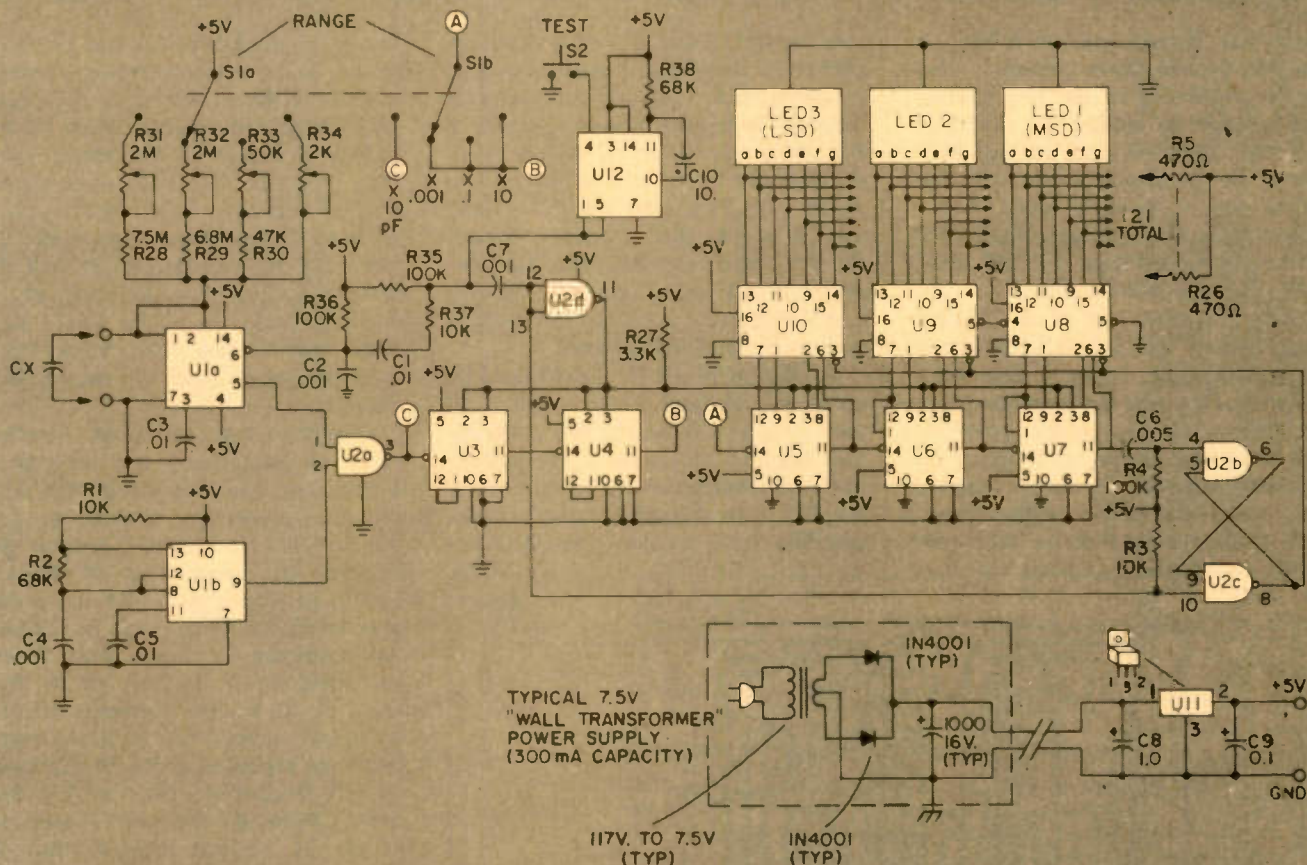

### PARTS LIST FOR DIGITAL CAPACITANCE METER

C1, C3, C5—.01uF, mylar capacitor  
 C2, C4, C7—.001uF, mylar capacitor  
 C6—.005uF, mylar capacitor  
 C8—1uF, tantalum capacitor  
 C9—.1uF, ceramic disc capacitor  
 C10—10uF, electrolytic capacitor  
 LED1 through LED3—DL704 7-segment LED display, common cathode  
 R1, R3, R37—10,000-ohm, 1/4 watt, 5% resistor  
 R2, R38—68,000-ohm, 1/4 watt, 5% resistor  
 R4, R35, R36—100,000-ohm, 1/4 watt, 5% resistor  
 R5 through R26—470-ohm, 1/4 watt, 5% resistor  
 R27—3,300-ohm, 1/4 watt, 5% resistor  
 R28—7.5-megohm, 1/4 watt, 5% resistor  
 R29—6.8-megohm, 1/4 watt, 5% resistor  
 R30—47,000-ohm, 1/4 watt, 5% resistor  
 R31, R32—2-megohm, 1-turn trimmer pot, vertical PC mount  
 R33—50,000-ohm, 1-turn trimmer pot, vertical PC mount

R34—2,000-ohm, 1-turn trimmer pot, vertical PC mount  
 S1—2-circuit, 4-position rotary switch (GC 35-377 or similar)  
 S2—SPST momentary contact switch  
 U1—556 dual timer integrated circuit  
 U2—74LS00 Quad NAND gate  
 U3 through U7—74LS90 decade counter  
 U8 through U10—74LS48 BCD to 7-segment decoder  
 U11—LM340T-5 5-volt regulator  
 U12—74121 monostable multivibrator  
 Misc.—Cabinet 4" x 4 1/2" x 1 5/8" minimum, with bezel and red filter (Radio Shack 270-285 or similar), IC sockets, knob, clip leads, PC board, 26 AWG solid hookup wire. AC power supply—7.5 volt, 300 milli-amp., wall-plug-in type (Herald BA-46A or equivalent).  
 Don't use just any "9V AC battery eliminator." It must have sufficient current handling ability; and, to avoid need for an elaborate heat sink, 7.5 V should

be used (as available on many "multi-voltage" models).

For information on the availability of parts and/or other material to build this project, send a business-size, self-addressed, stamped envelope to: PVP INDUSTRIES, INC., P.O. BOX #35667, TUSCON, ARIZONA 85740. Be sure to mention the "Project" by name.

ground potential, and thus makes a handy place to hang a test clip for troubleshooting purposes.

The LED displays and U12 should

now be installed on the display board, being careful that the orientation dots face the same direction. The display jumpers shown may be formed either

by bending the appropriate LED lead over to the pad, or by using hookup wire. Join the two PC boards by first studying their positioning and the pad



# Digital Capacitance Meter / Measures those unknown caps

orientation. Scotch tape and a book or two may be helpful in obtaining temporary positioning of the two boards, long enough to solder the first few pad-sets. There should be  $\frac{1}{8}$  inch overlap of the display board over the pattern side of the main board. Apply solder to the pads, allowing the solder to freely flow and form a  $\frac{1}{16}$ " thick bead over the pad surfaces.

Next, place one end of all 21 470-ohm resistors (R5 through R26) into the proper holes. Apply a long strip of Scotch tape across the upward-facing leads to maintain proper positioning. Invert the board, and solder all 21 leads. Cut off the excess lengths, then turn the board right-side-up. After final straightening of the resis-

tors, solder these 21 leads together (either by bending the lead on appropriately-spaced resistors or using a separate bare hookup-wire). Install a wire from one end of the resistor array through the board to the appropriate solder pad as shown. Stop at this time, take a break, then carefully inspect the work you have done thus far. Re-check for properly oriented components, and make sure that soldering is neat with no solder-bridges.

At this point all PC board components should have been soldered in place. (If you have any left over, install them at this time.) All that remains is connecting the two switches, the test leads, the power supply wires and the wire jumper connected be-

tween the display board and the main board. Select a reasonably short path-length for the switch wires, depending on your chosen cabinet design. Either individual leads or flat-ribbon cable may be used. Test leads were chosen for this project in lieu of binding posts since all diverse physical capacitor designs can be accommodated with the test leads. You may, however, prefer binding posts. In either case, keep these lead lengths short to minimize residual capacitance in the X10pF range.

**Checkout and calibration.** Double-check all connections and component orientation. Do *not* install the IC's into the sockets yet. Instead, plug-in the wall transformer and observe the display. All segments of all displays should be illuminated, forming a display of all 8's. If they are not illuminated, unplug the supply immediately and determine the cause. (If at least *some* of the display segments are on, the power supply and on-board regulator are functioning. If all segments are off, check to see that you installed a wire from the common connection of the 21 vertical resistors through the PC board to a +5 volt pad.) The wall supply case should remain luke-warm after 10 minutes of operation in this mode. (If the supply case becomes hot, chances are you chose an insufficiently-rated AC supply.) If everything appears alright, disconnect the supply and install the IC's, being careful to observe proper orientation in the sockets.

Reconnect the supply. Depress the TEST switch in each of the RANGE switch positions, observing the display each time. (Do not connect a test capacitor yet.) The X10pF range

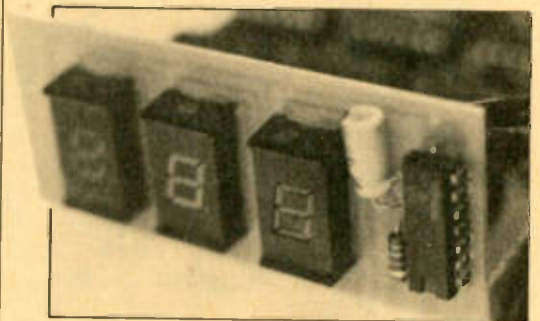
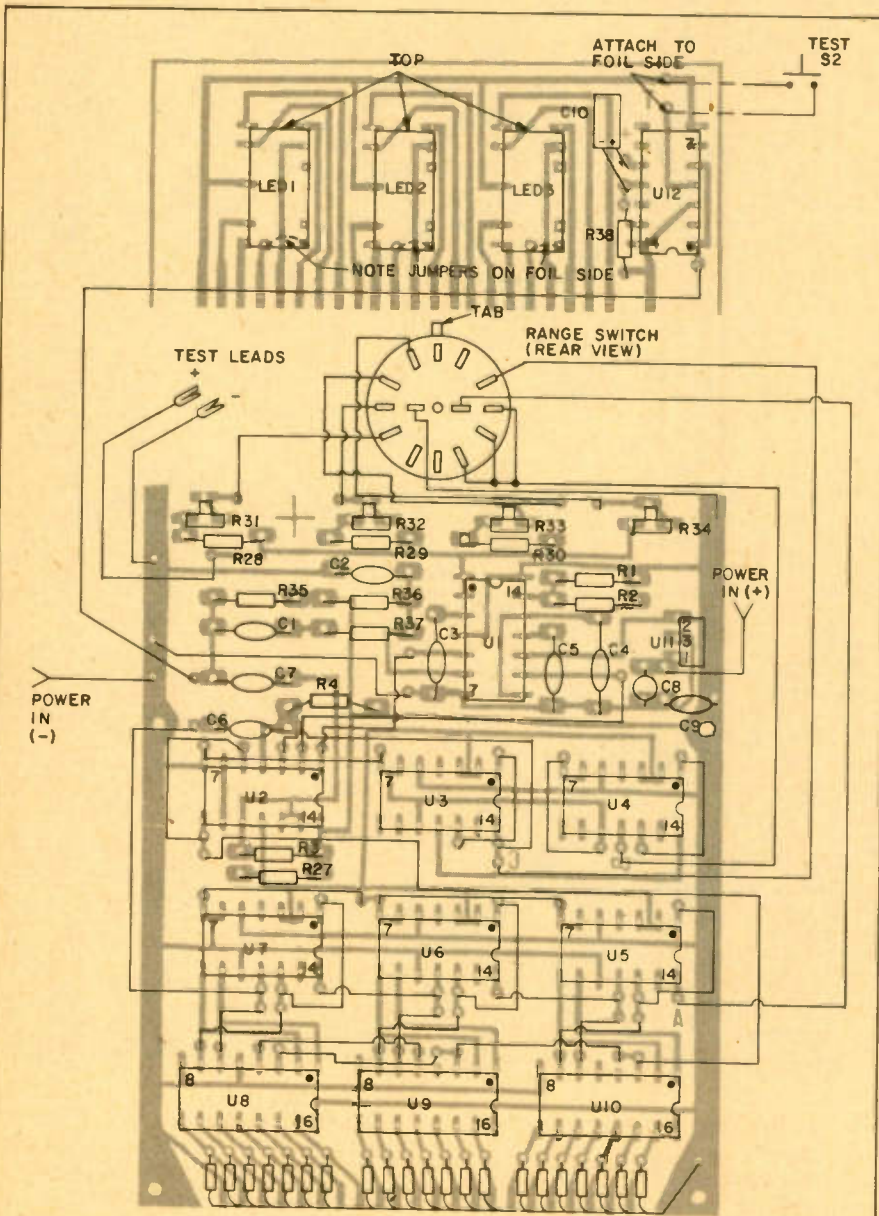

Orient the LED displays as shown above and in the parts location diagram to the left. Note how C10 is bent over on its side and how U12 is mounted without a socket to allow adequate clearance around the case's red display bezel.



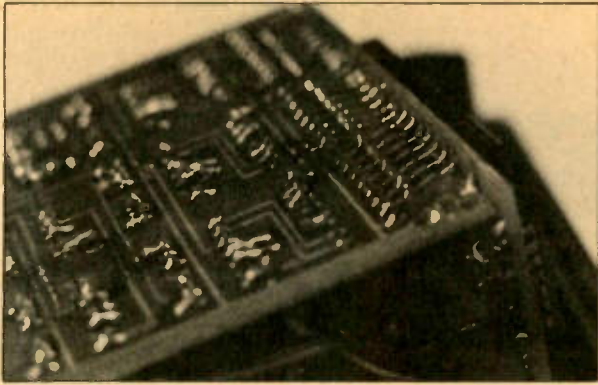

This close-up detail photo shows how the display panel is connected to the main circuit board. This is a complex circuit board, so be careful soldering.

should produce a low single-digit reading corresponding to the residual input circuit capacitance. The other range positions should produce a single-digit zero reading. (This design employs leading zero display suppression to enhance readability.)

Calibration is quite simple, consisting of adjusting the appropriate range trimmer pot for a display reading corresponding to a known test capacitance. Only one capacitor need be used for each range, as the 556's response is extremely linear; but, for accuracy, choose a value for each range that causes all three displays to be lit (eg.: on the X.001uF range, choose a capacitor between .1uF and .999uF). If you have access to an accurate capacitance meter you won't need to obtain premium tolerance caps. Simply measure your selected-value "junkbox" capacitors on this other meter, then calibrate the DCM accordingly. If these means are not available, you will have to use several capacitors of known "nominal" value for each range, and average all of the readings.

**Operation.** As stated above, accuracy is enhanced by selecting a scale that will produce a two or, preferably, a three digit display. It is best to perform several tests of each capacitor, as an occasional transient pulse (or in some cases, a marginal capacitor) can cause spurious readout counts. Accuracy is also improved by allowing a few seconds "settling time" between measurements; otherwise, the next measurement may produce a slightly lower count. The practical lower limit of measurement on the X10pF scale should be considered 100pF; although with a little experience, and remembering to subtract the residual reading for this scale (ie: TEST switch depressed with no capacitor connected), low capacitance values can be measured with reasonable accuracy. The upper capacitance limit is 9,990uF, obtained on the X10uF range.

I have found that connecting a wire from the ground lead to the AC outlet cover retaining screw will improve the stability of low capacitance values when measured under high noise conditions.

An overflow condition (steady 888

display) indicates either that the capacitance being measured exceeds the selected RANGE position or may indicate a shorted or excessively leaky capacitor. Leaky capacitors will cause a "suspiciously high" reading. For example, if a 10uF electrolytic (+100, -0 tolerance) reads 100uF, odds are you've got a "leaky-lytic"!

A power switch was deliberately left out of the design. The remaining lit segments when the DCM is not being used serve as a reminder that the wall supply is still plugged in. As with any electronic device employing a wall supply, turning off the power switch, if provided, would still *not* remove power from this supply. Thus, for maximum safety, unplug the supply.

Your efforts in carefully constructing the DCM will be rewarded by many years of dependable service. ■

Full-size photo-etching template.

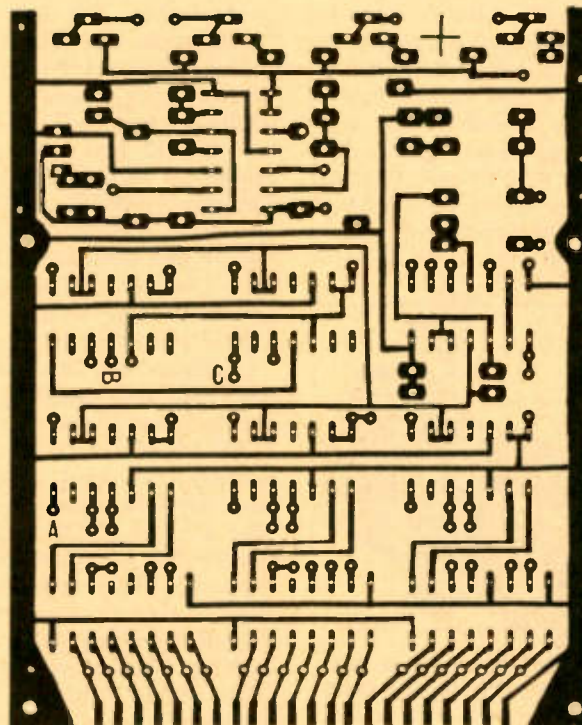
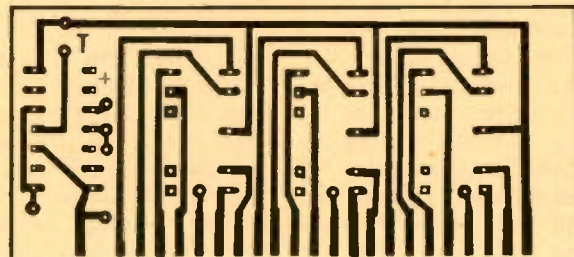



# BIG BOOST

This inline preamp puts more punch in your mike

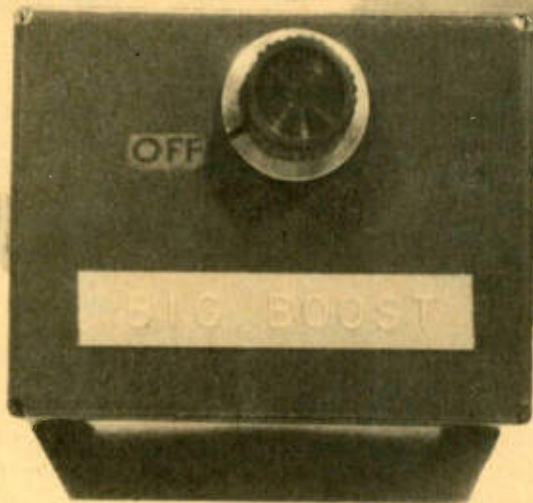

**W**HEN THE VOCALIST can't make it over the bass player, or the lead guitar gets buried behind the rhythm section, or the audience can't tell the keyboard player is really tickling the ivories, that's the time you need a big boost in preamplification between the performers and the amplifiers. And that's just what you'll get from Big Boost, a self-contained mike/guitar/keyboard preamp you can plug directly into the amp, or into the mike or instrument itself.

**Big Features.** Though the Big Boost is a simple one-transistor project, it has several features specifically intended for rock or dance band use, or just for straight vocal amplification. First off, the Big Boost contains its own battery power supply, a standard 9-volt transistor radio battery operating at only 1 mA drain. Next, it is virtually overload immune; whether driven by a mike or the signal from an electric guitar pickup (about 0.1-volt) the output signal is

not driven into clipping. As for gain, it's a whopping 25 dB, almost "ruler flat" from 100 Hz to about 20kHz. If you need extra bass for a keyboard, simply change C1 to 0.1- $\mu$ f. Finally, the whole device is assembled in a palm-sized metal cabinet, and using a Switchcraft phone plug-to-phone plug adaptor, you can plug the Big Boost directly into an amplifier input. Or, because it's also unusually light, you can plug the preamp into the guitar or keyboard so the volume control is directly at the instrument.

**Assembly.** The unit shown in the photographs was assembled inside of a 2 $\frac{3}{4}$  by 2 $\frac{1}{8}$  by 1 $\frac{5}{8}$ -inch Mini-Box. Admittedly, it's a tight fit, but it can be done if input and output phone jacks J1 and J2 are installed  $\frac{1}{8}$ -inch off-center on each end (make certain they are offset to the same side). This should leave just enough clearance for battery B1 on one side. Rotate J1 and J2, and bend their lugs if necessary, until you are certain the battery will fit with the Mini-Box's cover in place.

Potentiometer R5 is the volume control, and the miniature type specified in the parts list must be used if you want to get everything in a miniature cabinet. You must be certain R5 will not interfere with insertion of plugs into J1 and J2. It might appear that there's lots of room, but there really isn't. To avoid problems, it's best to insert a dummy plug into both J1 and J2 while marking R5's mounting spot.

R1 is supplied with a DPDT switch, S1a and S1b. Take note that some types have only two wire lugs for each switch

section, the third connection being a rivet through which the builder sticks the component lead before soldering. Don't think something is wrong with the potentiometer because each switch section has only two lugs. Remember, the third connection for each switch is a solder-rivet.

No terminal strip is needed for assembly. All components are self-supported by simply twisting them together and soldering. If you keep the connecting leads as short as possible, the assembly will be sufficiently rigid to take the most rugged handling without shorts or "sound dropouts." It will all squeeze in nicely if the resistors used are  $\frac{1}{4}$ -watt units, and the capacitors are the miniature mylar printed circuit type (both leads from the same end) available from Radio Shack.

As with the mounting of R5, double-check that inserting a plug into J1 or J2 does not touch any wire or compon-

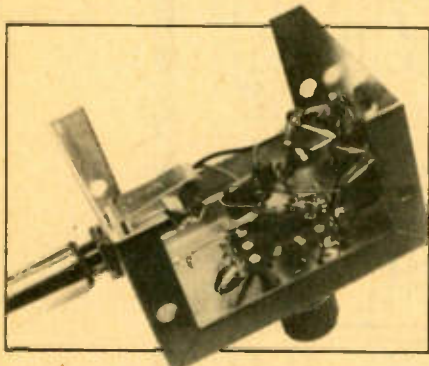

Use the jacks and volume control leads to wire up your amp point-to-point. Parts layout is not critical with this project.

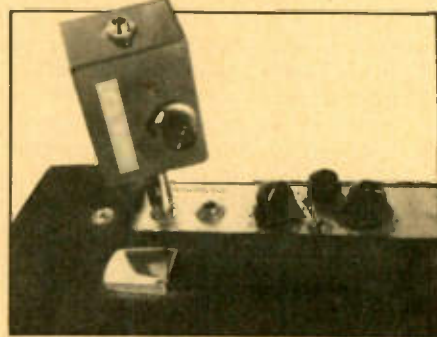

Use of the double male phone plug allows placement of the preamp at the amp's control head or right at mike stand.



# BIG BOOST

ent. Again, your best bet is to wire the project with dummy plugs installed.

**Checkout.** Install a battery, rotate R5's shaft until you hear the power switch click, and then check the voltage from Q1's collector to the cabinet. It should be about half the battery voltage (4 to 5-volts). If it's excessively high, around 8-9 volts, or excessively low, 1-2 volts, you have either made a wiring error or substituted an improper transistor for the specified Q1.

Connect a mike or an electric instrument's output to the Big Boost input and connect the preamp's output to your main amplifier's input. Advance R5 as you speak into the mike or play the instrument. The volume should increase as R5 is advanced. If it doesn't, you have wired S1a/S1b incorrectly. Note that when R5 is fully counterclockwise (off) the battery is disconnected and J1 is connected through S1a directly to J2. When R5 is advanced, closing S1, the battery is connected and S1a connects the preamp's output via R5's wiper to J2.

**Plug to Plug.** While you can use patch cords to connect the Big Boost to your equipment, it's usually a lot more convenient and less of a hazard if the Big Boost is right at the amplifier input. Professional musicians do this by us-

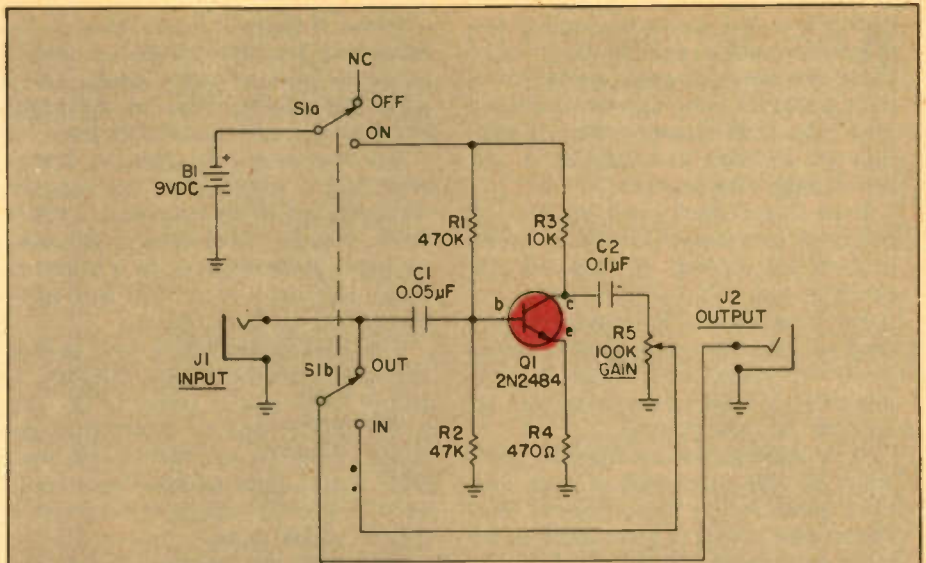

## PARTS LIST FOR BIG BOOST

- |   |  |
|---|--|
| B1—9-volt transistor battery                        | R3—10,000-ohm, ¼-watt resistor, 10%  |
| C1—0.05- $\mu$ F, 15 VDC mylar capacitor (see text) | R4—470-ohm, ¼-watt resistor, 10%   |
| C2—0.1- $\mu$ F, 15 VDC mylar capacitor             | R5—100,000-ohm audio taper potentiometer with built-in DPDT switch (Radio Shack part #271-216 or equiv.) |
| J1, J2—¼-inch standard phone jack                   | S1—DPDT switch (part of R5)  |
| Q1—PN2484 NPN transistor                            | Misc.—cabinet, wire, battery clip, knob, phone plug: (female-to-male) adaptor, etc.                      |
| R1—470,000-ohm, ¼-watt resistor, 10%                |  |
| R2—47,000-ohm, ¼-watt resistor, 10%                 |  |

ing a special *phone plug-to-phone plug* adaptor sold at music instrument shops. You can use the adaptor for either the input or output. If desired, you can

plug the Big Boost directly into an electric guitar or keyboard output jack, and then use a regular patch cord to the amplifier's input. ■

# DIODE DIGEST

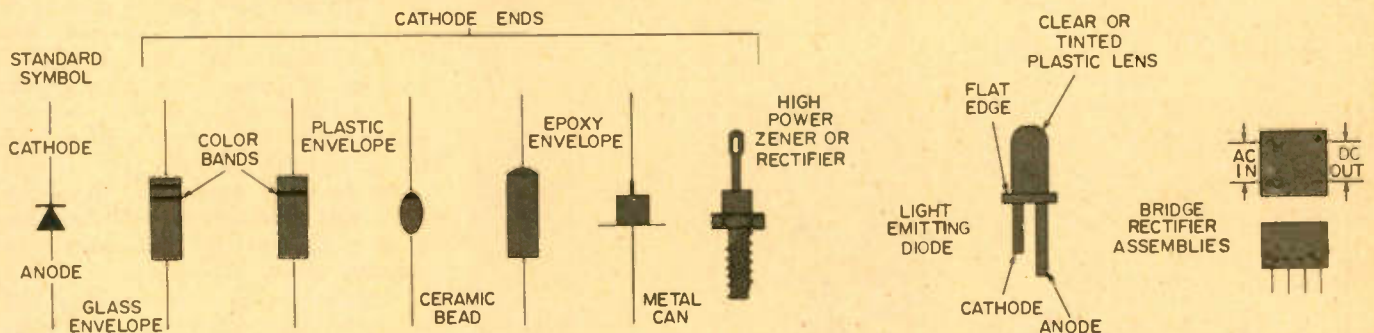

**I**T MAY SOUND SILLY, but it seems that a lot of people still don't know which end of a diode is up. A letter we received recently from O.M.S. of Guilford, Connecticut illustrates this point. He writes:

*"I have been trying for the last three months to purchase a power supply that I can use to power a walky-talky from house current. I've finally given up and decided to build my own. I have a transformer that converts 110 VAC to 12.6 VAC, some large filter capacitors salvaged from an old television, and some 'bargain bag' diodes I purchased from a discount store. The diodes are black, unmarked, and have one rounded end. Can I use them,*

*or will I have to shell out for ones with known values?"*

Of course, we couldn't be sure of just exactly what he had in hand, but from the description, and basing our guess on the chart, we were pretty sure that these were epoxy-encapsulated rectifiers, with probably about a 100 to 200-PIV rating. These would fill his needs if our guess was right. Although we haven't heard any more from that gentleman, we assume he didn't blow himself up. By tearing out the chart and pasting it up inside the cover of your spare parts box, you can have a handy reference guide for identifying the leads and types of whatever diodes happen to find their way into your hands. ■



**W**ITH A LITTLE BIT OF time and effort, anyone with a well equipped dark-room can turn out good prints. However, problems come up when someone gives you a 36-exposure roll, all with different densities and asks for a full set of wallet-size prints.

Even if you don't mind the cost of test strips and wasted prints, it will take at least an evening to bang out 36 prints to your satisfaction.

But if you use a Photometer to determine exposure and paper grade, you'll cut wasted paper to an absolute minimum and total processing time to an hour for 36-exposures.

If a stabilization machine is used, you'll be able to develop a black and white prints in less than a minute. The Photometer allows a good print to be made with every attempt.

Unless you're making artistic prints suitable for exhibition, good tonal balance is any print with white highlights and jet black coloration. It doesn't matter how black the print is, it can be a spot, but the eye expects to see black. If there is no black, the print appears flat (lacking in contrast).

**Dense Negatives.** Pure white highlights and jet black detail are determined by various paper grades (#1-#5). The density range of the negative determines which grade to use.

The Photometer, by analyzing a negative that is projected by the enlarger (it is not fooled by condensed or diffused enlarger illumination) indicates the paper grade required by a negative. It can be used to determine lens aperture for an exposure time.

The Photometer has a row of five red light emitting diodes (LEDs), a yellow LED and a green LED. The green LED is used for determining exposure. Centered in a white target area, there is a 1/8-inch diameter photoresistor that is small enough to represent a spot on a final print.

Projecting the negative, adjust the enlarger for the desired print size, focusing on the easel with the lens diaphragm wide open and place the Photometer on the easel with the photoresistor under an area of maximum light transmission (minimum density). Adjust the Photometer's CAL (calibrate) control until just the five red

LEDs are clearly lit and glowing.

Move the Photometer so the photoresistor is under the minimum transmitted light (maximum density). Count the number of red LEDs that remain lit; that's the standard paper grade for the negative. If two red LEDs are lit, the negative calls for a #2 paper.

The yellow LED checks the contrast reading. After you make the initial reading, which should take no more than a few seconds, return the photoresistor to the point of maximum light and adjust the CAL control so the yellow LED just lights.

**Rock Control.** Rock the CAL control a few times to be certain its at the setting that just lights the LED. Move the photoresistor back to the point of minimum light and count the number of lit red LEDs. If the number remains the same the contrast is in the approximate center of standard contrast range.

If the next higher red LED lights during the yellow test, the contrast range is closer to the top of the initial lower range. For example, if the first test lit two red LEDs and the yellow test lights three, #3 paper should be used or #2 with slightly extended development. Almost a #3 is the same as using Polycontrast #2½ or #3 photographic filters.

(Note. Variable contrast filters are not the equivalent of standard paper grades. It all depends on the filter and the particular type of variable contrast paper being used. Crossindex the measured contrast range with the specified range for variable contrast filters from the manufacturer's data sheet.)

**Constant Exposure.** The green LED allows setting the aperture for a constant exposure time. Make a good print using your favorite exposure time: 10, 15 or 20 seconds. Without touching the enlarger adjustments, place the photoresistor under maximum light and adjust the EXP (Exposure) control until the green LED just snaps on.

Set the EXP controls so the green LED goes from off to on. The Photometer is now set for what you consider proper exposure.

Assume you have used a 10-second exposure. You rack up the next negative, compose, focus, and make the contrast measurement. (Remember, the lens is wide open.) Place the photoresistor under maximum light transmission, the same spot used for the contrast calibration, and slowly step down the lens until the green LED lights.

That's the right amount of light for a 10-second exposure. Because of memory in the photoresistor, you cannot rock the lens's diaphragm for the green LED adjustment. The diaphragm must

# PHOTOMETER

You will make the grade and get good exposure with the photometer

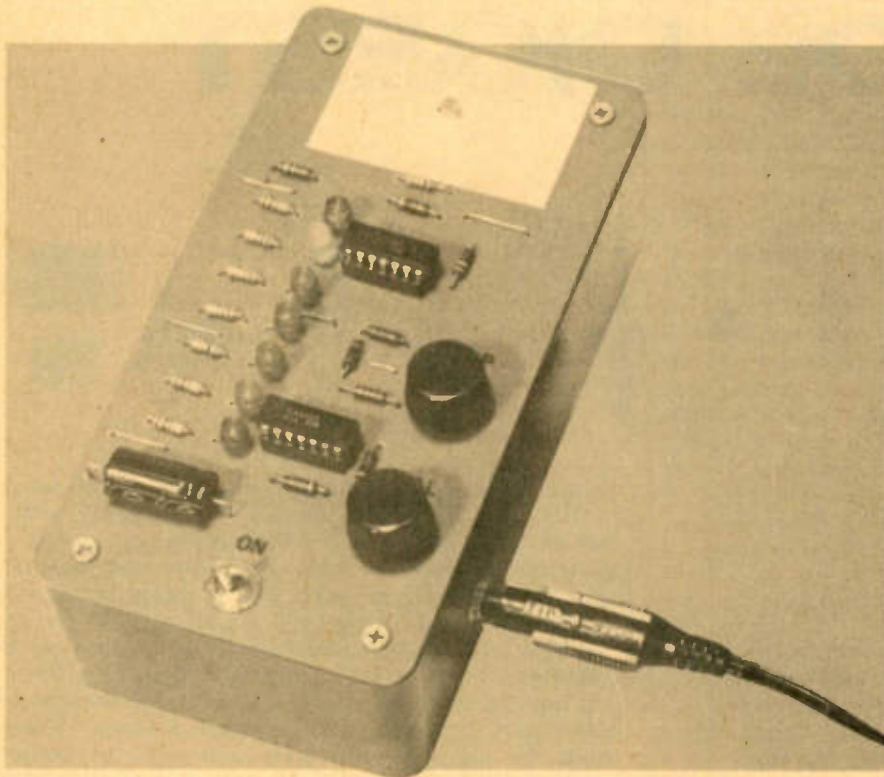



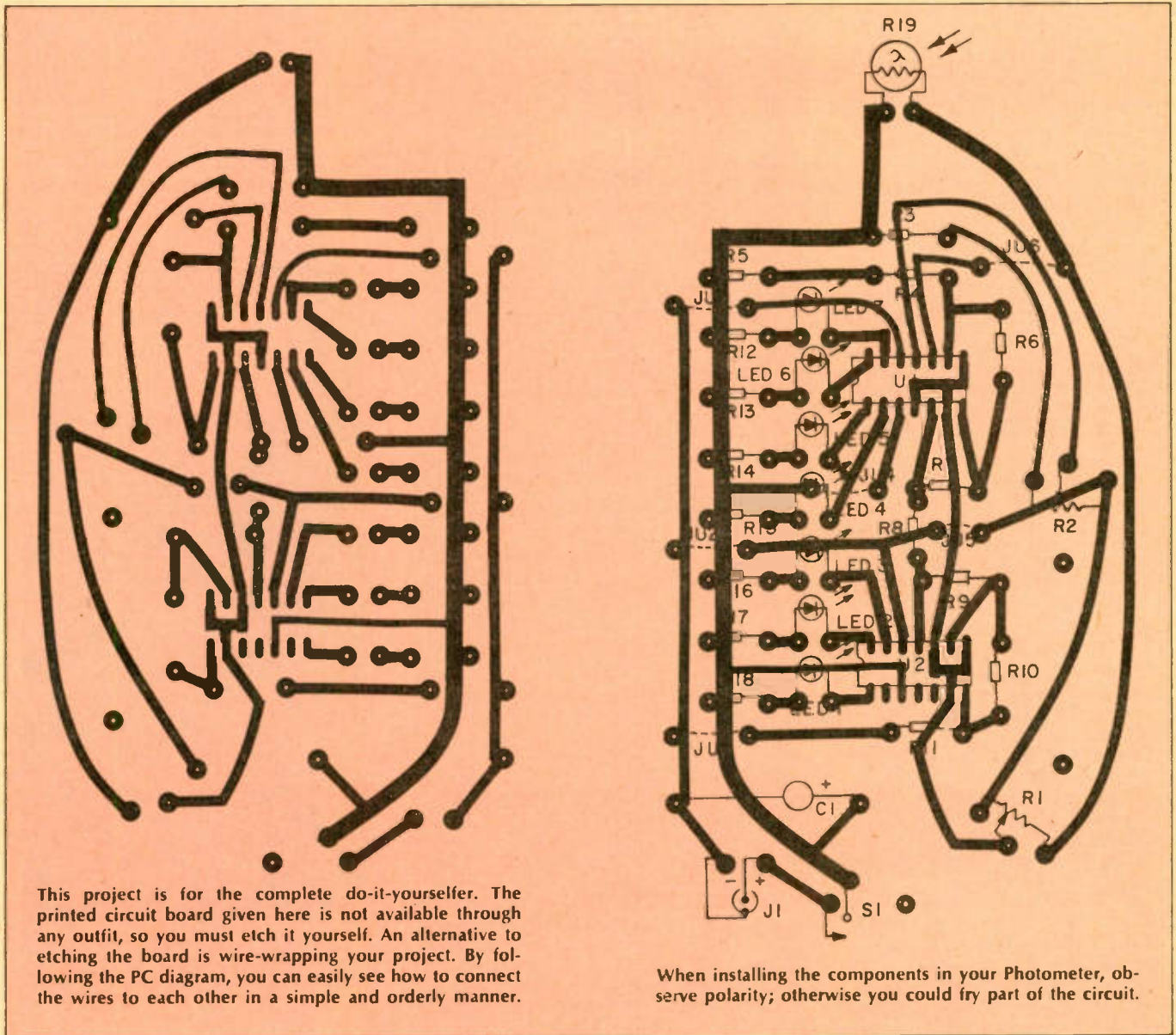

be started from the wide open setting (the same one that is used for the contrast measurement).

If the lens is adjusted beyond the setting where the green LED snaps on go back to maximum light for 3-5 seconds for a precise adjustment.

The entire project, except for the power supply, is built on a printed circuit board that also serves as a cabinet cover. The power supply can be any 9 volt AC adapter. Any current rating greater than 100 mA will work well.

**Critical Parts.** There are three critical parts in assembling the Photometer: the cabinet, whose height establishes the operating parameters for photoresistor R19; the photoresistor itself, which is a

version specifically designed for linearity and EXP control R1, which must be as close as possible to 50,000-ohms.

All other components are common tolerance and substitutions can be made as long as the tolerance, where specified in the parts list, is not reduced.

The cabinet *must* be 2¾-3 inches high. No substitute can be used for R19; any other photoresistor will give the user completely erroneous contrast measurements.

**Socket To U1.** Sockets are suggested for U1 and U2. They prevent butchering of the PC board if you must remove an IC. The ICs are installed with pin #1 facing the LEDs.

Before installing R19, cement a white

target approximately 1¾ by 2-inches to the PC board and punch-through the holes for R19. Then install R19 so its top is ¼" above the PC board. If you must bend R14's leads, brace them with long-nose pliers directly behind the photo-resistor—the pliers should actually touch PR1. (Careful, R19 tends to be fragile when bending its leads.)

Finally, install J1 and connect it to the PC board. Double-check the polarity of the 9 volt adapter. Some have the plug tip *negative*; if so, be certain you connect J1's tip to the negative foil on the PC board.

**Check it Out.** Under normal room lighting, set CAL control R1 fully counter clockwise. Set EXP control R2



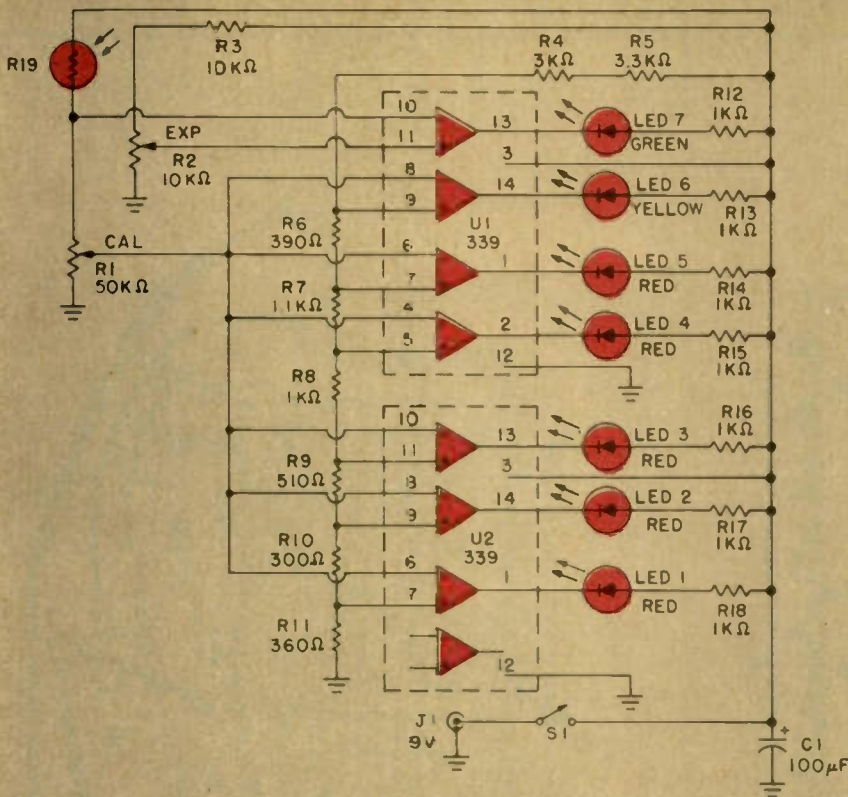

**PARTS LIST FOR PHOTOMETER**

- C1—100-µF, 35-VDC electrolytic capacitor
- J1—Jack to match power adaptor
- LED1-LED5—Red light emitting diode (LED) fresnel lens
- LED6—Yellow LED
- LED7—Green LED
- R1—50,000-ohm potentiometer, linear taper (see text) all resistors are ¼-watt, 5% except potentiometers)
- R2—10,000-ohm potentiometer, linear taper
- R3—10,000-ohm resistor
- R4—3,000-ohm resistor
- R5—3,300-ohm resistor
- R6—390-ohm resistor
- R7—1,100-ohm resistor
- R8—1,000-ohm resistor
- R9—510-ohm resistor
- R10—300-ohm resistor
- R11—360-ohm resistor
- R12-R18—1,000-ohm resistor
- R19—Photoresistor, Custom Components PRL9
- S1—SPST mini-switch
- U1, U2—Quad Comparator LM339 Integrated Circuit
- Misc.—Cabinet, 9-volt power adaptor, IC sockets, PC material, solder, wire, hardware, etc. (Photoresistor PRL9 is available for \$5 plus \$2 postage and handling per order from Custom Components, Box 153, Malverne, NY 11565, N.Y. State residents must add sales tax. No foreign orders except Canada. Canadian orders must be in \$US.)



This photoresistor is the heart of the Photometer. Be sure you get the right one.

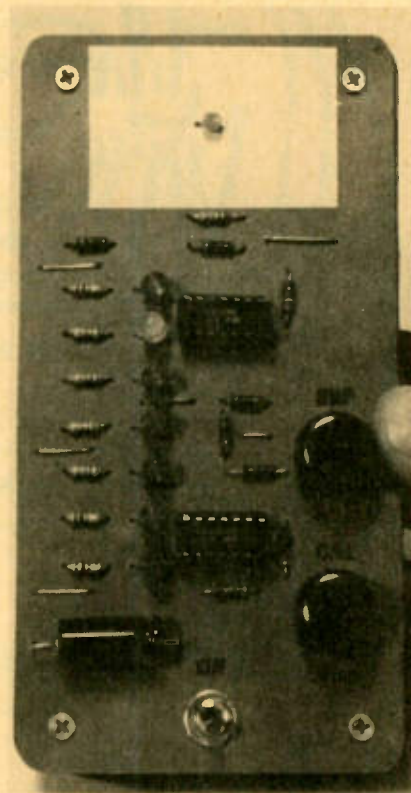

The Photometer is compact and easy to use. Photometer's circuit is totally exposed and allows easy removal of circuit parts.

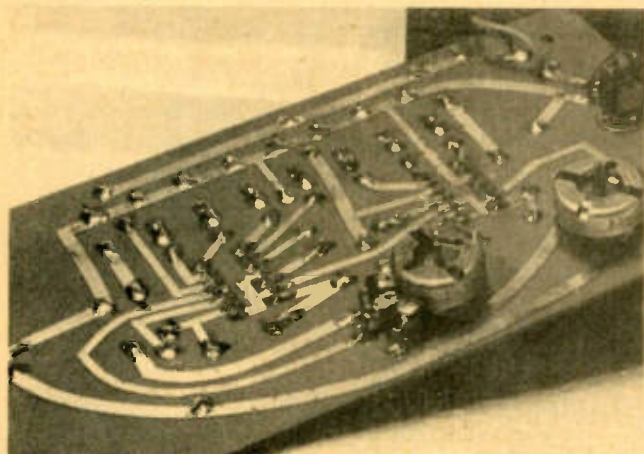

Two potentiometers and an On/Off switch are connected to the back of the PC board. The battery is connected to the case.

fully clockwise. Turn the Photometer on. Cover R19 with your thumb; all LEDs should be out.

Advancing CAL control R1 should cause the red and yellow LEDs to light one at a time. Adjusting EXP control R2 anti-clockwise should cause the green LED to turn on.

If you don't get this response, there is a wiring error or a defective component. (Note: Under full room illumination, with no covering of R19, the green LED can remain lit through R2's range of adjustment: this is normal.)

With your Photometer operating, you can spend less time and money in the dark and more time in the light doing what you want to do: taking pictures. ■



# Projects to Have Fun With

by Hank Scott

It's difficult to be serious in every phase of life. From time to time we have to back off and put some fun into our lives—especially our hobbies. We can expect no difference in thought with the electronics experimenter. Once in a while it pays to build a project that will reward us with pure fun. So, with that in mind, here are a few good ideas that you should know about.

## COIN TOSS

For just the price of a pushbutton switch (S2), one circuit can be converted to another, and you can flip electronic coins as long as you want until the battery drains dead! See Fig. 1. When the button of S2 is depressed, the circuit is a squarewave multivibrator running at about 800 Hz. Release the button and the circuit becomes a stable one-shot device that has only one transistor conducting. Under this condition, one of the light-emitting diodes (LED1 and LED2) will be on. The symmetry of the circuit indicates that the 800-Hz squarewave will have a 50-percent duty cycle. That is, the squarewave will be high for one half of the time, and low for the remaining half. Thus, when S2 is released, the transistor that was on will continue to conduct.

You could expect 50 heads for every 100 "tosses!" But,

that will only occur when potentiometer R7 is so set that all unbalances in the circuit are equaled. With R7 set to some unbalance, the number of heads versus tails will be other than 50-50. The device could be adjusted for 60-40 splits, or other desired ratios. Don't try this with friends who become upset when they discover that you hoodwinked them!

If you want to slow down the free-running frequency to as low as one Hertz or less, increase the value of C1 and C2 equally to 10 microFarads. Of course you will be able to see the light-emitting diodes switch on and off so that releasing S2 can control the indication read out of either heads or tails. In this case, use a remote switch so the player cannot see the readout until after he releases the switch.

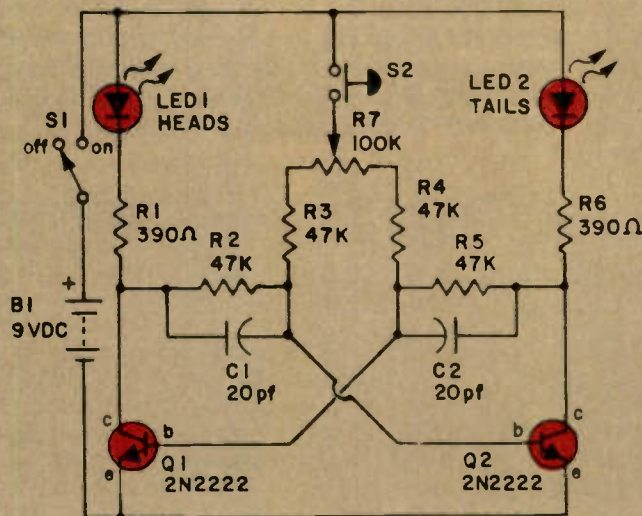

Fig. 1.

### PARTS LIST FOR COIN TOSS

- B1—9 volts DC, transistor-radio battery
- C1, C2—22-picaFarad disk capacitor
- LED1-LED2—Light-emitting diode, 20 mA, one red, one yellow or green
- Q1, Q2—2N2222, 2N2222A or BC108 PNP audio-switching transistor
- S1—SPST-on-off Switch, any suitable type
- S2—Normally open, single-pole pushbutton switch
- (All fixed resistors are 5%, 1/4-watt fixed units unless otherwise indicated)
- R1, R6—390-ohm resistor
- R2, R5—47,000-ohm resistor
- R7—50,000-ohm linear-taper potentiometer



# CASINO WHEEL

A simple counter-display circuit can be adapted to a game of chance for up to seven players, with a built-in provision to insure that "The house never loses." See Fig. 2. Note that all seven display segments, like the previous circuitry, have only one connection. Three outputs (pins 8, 9, 10) now go to the decimal point, via isolating diodes D1, D2,

and D3. This gives the "House" a 3 out of 10 chance to take all bets. The clock should be set to provide a rapidly flickering display when the push-button switch is depressed. When the player holds down the switch for a few seconds and releases it, one of the segments, or the decimal point will remain lighted...and the odds are on the point!

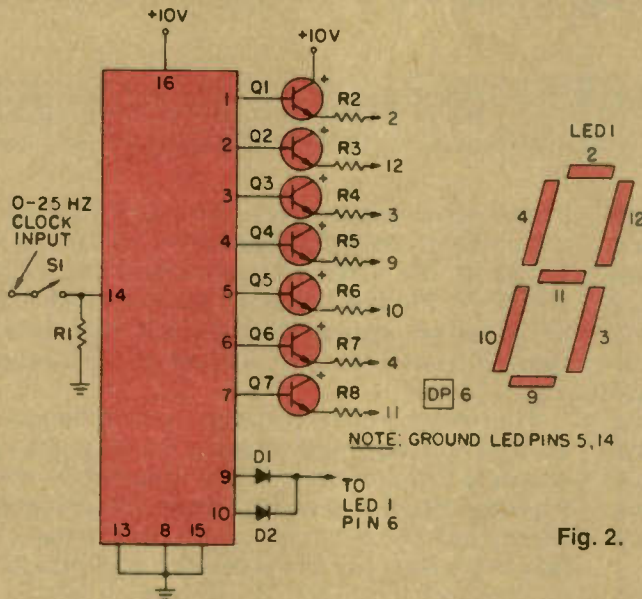

## PARTS LIST FOR CASINO WHEEL

- D1, D2—IN4148 diode
- 1C1—4017 CMOS decade counter
- LED1—DL-750, 7-segment display
- Q1 through Q7—2N4401
- R1 through R8—1,000-ohm, 1/2-watt resistor
- S1—SPST Momentary-contact switch.

Fig. 2.

# DIODE QUIZ

This innocuous-looking little circuit (See Fig. 3) will provide a good indication of how well you really understand the rectifier diode and the light-emitting diode. Your task is to determine which of the five LEDs will light up when 6.3 volts AC is applied to the circuit. We won't give you the answer; to find that out, just breadboard the circuit. However, we will supply you with a couple of hints. First, the forward voltage

drop of a rectifier diode is approximately .8 volt, while that of an LED is about 2 volts. Naturally, rectifiers conduct current in one direction only. LEDs will light up only when their anodes (arrows) are 2-volts more positive than their cathodes (bars). Finally, you can expect to find 3 LEDs lit and 2 LEDs dark. Pencil sharpened? OK, begin.

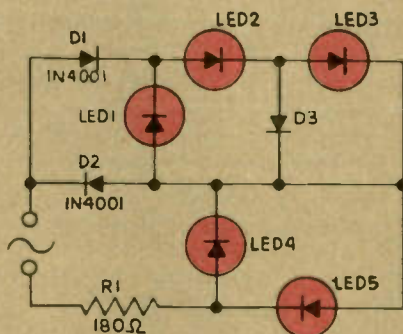

Fig. 3.

## PARTS LIST FOR DIODE QUIZ

- D1, D2, D3—1N4001 rectifier diode
- LED1, LED5—Red light-emitting diode
- R1—180-ohm, 1/2-watt 10% resistor



# ESP TESTER

The closest encounter most of us ever have with psychic phenomena probably comes from inlaws with the uncanny knack for dropping by just as dinner is served. If you'd like to delve somewhat deeper into the world of the unknown, or if you just want an intriguing party game, give this ESP tester a try. See Figure 8.

Testing requires three persons—a Tester, a Sender and a Receiver—each one of whom has access only to a part of the circuitry. The Tester has S5, LED5 and LED6. By pressing and releasing S5, he causes the random lighting of one LED out of the set consisting of LEDs 1, 2, 3, and 4. Each LED of this set is identified in some way—usually by a geometric symbol like a star or triangle alongside it. The

Sender, who views only these four LEDs, seeks to telepathically transmit the identify of the lit LED by mentally "broadcasting" a picture of the symbol linked with the LED.

The Receiver, whom we hope is monitoring the correct channel, indicates his response by pushing one of the four switches (S1 through S4) at his disposal. S1 corresponds to LED 1 and is marked with the same geometric symbol. Likewise, S2 corresponds to LED2, and so forth. If the Receiver makes the correct choice, the Tester sees LED5 light up. One the other hand, if the Receiver's choice is wrong, or if he gets cute and pushes several buttons simultaneously, the Tester is notified of an error by the lighting of LED6.

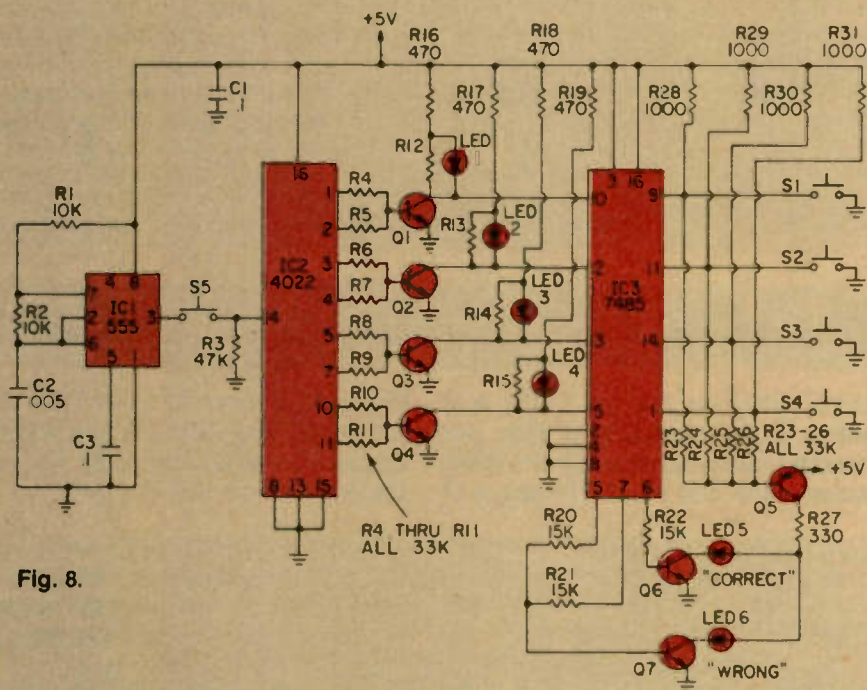

Fig. 8.

## PARTS LIST FOR ESP TESTER

- |  |   |
|--|---|
| C1, C3—0.1-uF ceramic disc capacitor           | (all resistors 10%)                           |
| C2—0.05-uF mylar capacitor                     | R1, R2—10,000-ohm, 1/2-watt resistor          |
| IC1—555 timer integrated circuit               | R3—47,000-ohm, 1/2-watt resistor              |
| IC2—4022 CMOS octal counter integrated circuit | R4-R11, R23-R26—33,000-ohm, 1/2-watt resistor |
| IC3—7485 4-bit magnitude comparator            | R12-R15—4,700-ohm, 1/2-watt resistor          |
| LED1-LED6—light emitting diodes                | R16-R19—470-ohm, 1/2-watt resistor            |
| Q1-Q4, Q6, Q7—2N3904 NPN transistor            | R20-R22—15,000-ohm, 1/2-watt resistor         |
| Q5—2N3906 PNP transistor                       | R27—330-ohm, 1/2-watt resistor                |
|  | R28-R31—1,000-ohm, 1/2-watt resistor          |



# WILD WEST DRAW

Okay, pardner, the first one to push the button lights the light on his side, and blocks the other light from turning on. You can yell "draw" by closing S1. But instead of a switch, you can find a trickier way of closing the contacts. Try rolling a steel ball bearing down a channel with the

contacts on the bottom. When the ball completes the circuit, go for your trigger buttons. Or you can just leave S1 closed. Once both "triggers" (S2 and S3) are released, this game is automatically set to be played again.

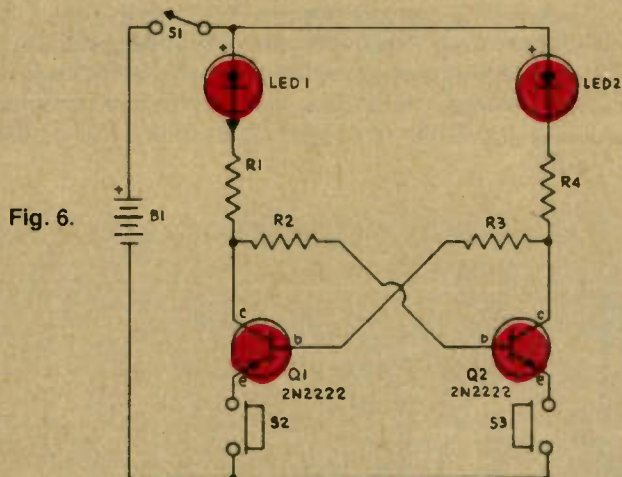

## PARTS LIST FOR WILD WEST DRAW

- B1—6-15 VDC Battery
- LED1, LED2—Light emitting diodes
- Q1, Q2—NPN transistors (2N2222 or similar)
- R1, R4—150-390-ohms, 1/2-watt, 10% resistor
- R2, R3—22,000-56,000-ohm, 1/2-watt, 10% resistor
- S1—SPST switch (see text)
- S2, S3—Normally open momentary or micro, switches

# CHASE LIGHTS

The rippling or chase effect on the ten LEDs is a beautiful and interesting sight, especially if they are mounted atop a nice wooden case and placed in the living room. A nice conversation piece. See Fig. 5. The speed of

the ripple or chase is controllable via R1 and R2, where a smaller R1 and R2 makes the ripple go faster. The "on" of each LED overlaps perfectly with no momentary "off," so the ripple travels very smoothly.

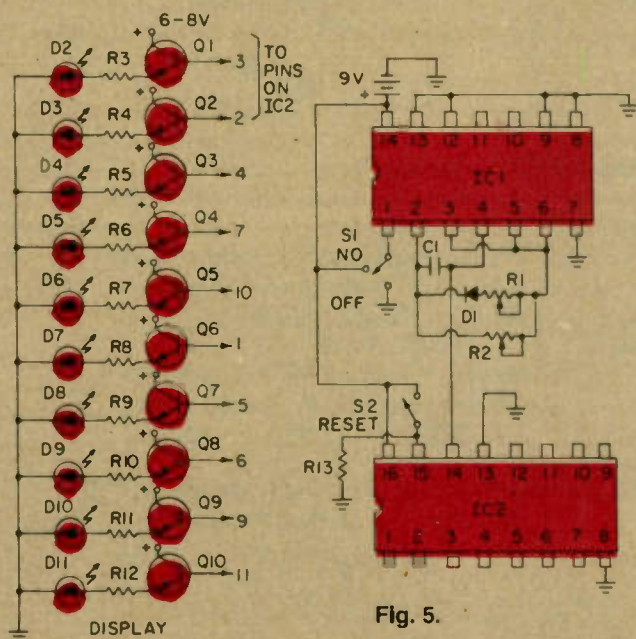

## PARTS LIST FOR CHASE LIGHTS

- C1—0.01-uF ceramic capacitor, 15 VDC
- D1—1N4401 diode
- D2 through D11—small LED
- IC1—4011 quad NAND gate
- IC2—4017 diode counter
- Q1-Q10—2N4401
- R1—10,000,000-ohm linear-taper potentiometer
- R2—500,000-ohm linear-taper potentiometer
- R3 through R12—1,000-ohm, 1/2-watt resistor
- S1—SPDT slide switch
- S2—SPST momentary-contact pushbutton switch
- R13—100,000-ohm, 1/2-watt resistor



## FOR MAGICIANS ONLY

"As anyone can plainly see, the LED (D1) flashes rather rapidly," you say to an unsuspecting guest. "But in fact, the flashes are an optical illusion. Just hold this white paper in front of the LED and look at the light through the paper. You will see that in fact the LED is not flashing, at least not until you remove the paper." Refer to the paper as an Oppulan-

optical filter (no such thing) to add some mystery to what is happening in front of his eyes. Your guest will be the victim of optical confusion. The trick lies in the fact that the LED flashes only as long as its light shines on Q1. See Fig 4. Put the paper between D1 and Q1 and the LED shines continuously.

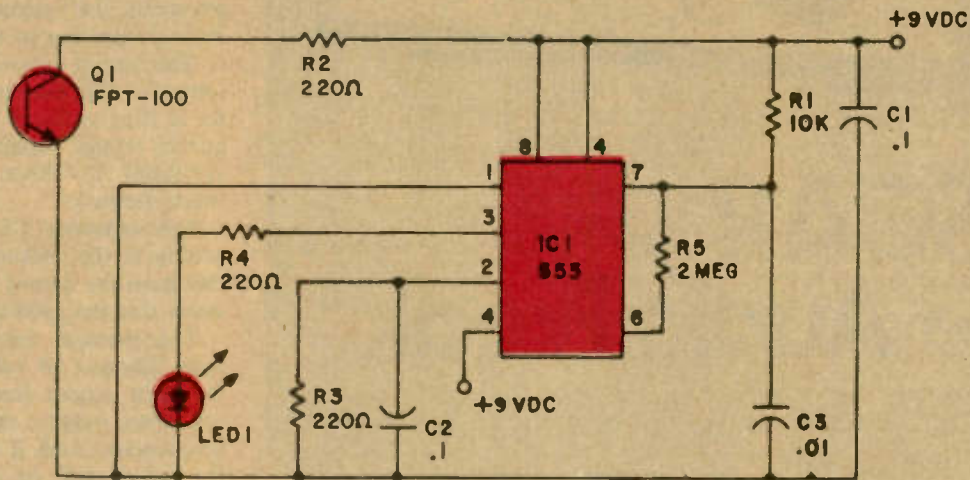

Fig. 4.

### PARTS LIST FOR MAGICIANS ONLY

- |                                      |                                      |
|--------------------------------------|--------------------------------------|
| C1, C2—0.1-μF ceramic capacitor      | R1—10,000-ohm, ½-watt, 10% resistor  |
| C3—0.01-μF ceramic capacitor         | R2, R4—220-ohm, ½-watt, 10% resistor |
| IC1—555 timer integrated circuit     | R5—2-Megohm, ½-watt, 10% resistor    |
| LED1—Large light-emitting diode, red |                                      |
| Q1—FPT100 phototransistor            |                                      |

## It's Fun to Have Fun.

If you assembled just two of our game gadgets and used them to brighten your life or the lives of your friends, we did our job just right. What? You say you have a few simple circuits that you conjured up; good! Send them off to the Editor; you may become a successful, published author.





# OSCAR, The Audio Freak

A handy audio oscillator for the electronics hobbyist

There's nothing quite as useful as an audio oscillator for testing defective audio or amplifier circuits. An audible signal, or the lack thereof, is proof positive as to whether or not a circuit is behaving as it should. Unfortunately, a good, stable variable oscillator can run into hundreds of dollars—far more than all but the wealthiest hobbyist can afford to spend.

Oscar is an inexpensive, easy-to-build oscillator with a frequency range from 30-Hz all the way up to 25-kHz and an almost flat response over the whole range. It uses a unique circuit: a Wien network with a photocell and 1.5-volt bulb coupled to maintain frequency stability. A compact unit (ours fits easily into a 5¼-inch by 4-inch by 2-inch box) Oscar will drive into a low impedance load, and is powered by a 9-volt transistor radio battery. Those parts that you don't have in your junk box can be found at the local Radio Shack or other well-stocked electronics supply house convenient to you.

**Easy Assembly.** Assembling Oscar is quite simple. All of the components—except for the variable potentiometers R2a, R2b and R3, the switch, LED and 9-volt battery—are mounted

on an etched PC board. Our Oscar is rather fancy, mounted in a two-toned enameled aluminum box with vents and rubber feet, but any Bud or other box of approximately 6-inch by 4-inch by 2-inch dimensions will serve as a housing.

Oscar's heart is a Radio Shack LM386 low-voltage audio amplifier, an IC "bug" giving 20dB of gain without external components. Amplifier output feeds directly into a Wien network which determines the output frequency. From there the signal is fed back into the positive input of the amplifier.

The 150-kohm resistor (R6) in series with the input serves two purposes: it reduces the signal from the Wien network to the amplifier input to a satisfactory level. And, together with the input impedance to the amplifier, it provides an impedance which doesn't affect the audio frequency determined by the Wien network components. The oscillator's frequency is varied by changing the setting of the ganged potentiometers R2a, R2b.

The 5,000-ohm switched variable potentiometer serves as an ON-OFF switch in the circuit and volume adjustment control.

Thus far we have listed the components for a pretty straightforward amplifier circuit. The following components—a photocell (R4), 1.5-volt bulb (L1) and a 100,000-ohm preset linear potentiometer are what make for Oscar's uniqueness.

**Circuit Theory.** The photocell (R4) is a Radio Shack RS 276-116 or equivalent, with a 5-megohm to 100-ohm resistance range. It will be coupled to a Radio Shack 1.5-volt at 15ma. miniature bulb. The theory behind this circuit is that the light output of a bulb filament varies proportionately to applied voltage. The light output from this bulb is closely coupled to the photocell, the resistance of which varies in proportion to the light shining on it. This circuit ensures that, with proper setting of R1, the output of the oscillator is held constant over its entire frequency range, despite frequency gain variations in either the amplifier or Wien network.

The capacitor C5 blocks DC from getting to the photocell, and C6 blocks DC from the output. The LED lets you know that the oscillator is running.

The thermal time constant of the bulb filament is sufficient to prevent the light output from "following" the waveform output, except at the lowest frequencies. And, if R1 is carefully set, the circuit will be stable even at the lowest frequencies.

**Make it Light-Tight.** The only tricky spot in assembling Oscar is making the bulb/photocell unit. While the sketch should make this procedure clear, there are several points worth stressing. One—the most important—is that the unit must be absolutely light-tight when assembled. The fit between the bulb base and sealing grommet, and of the heat-shrinkable tubing over the entire assembly, is critical. Also, the tip of the bulb should just clear the surface of the photocell. The whole assembly then mounts on the PC board, supported on the photocell leads.



This photo shows the soldering connections at the rear of OSCAR's front cabinet panel.



# OSCAR

While there are very few components on the PC board, it is necessary to pay close attention to the mounting and placement of these. Make sure that the polarities of the electrolytic capacitors are correct and that the amplifier IC "bug" is the right way around.

The PC board itself should be raised 1/2-inch or so above the bottom of the housing to prevent the soldered joints from shorting. This can be done by drilling two pieces of squared-off plastic to pass the shafts of the bolts attaching the PC board to the housing.

The frequency adjusting potentiometers R2a, R2b should be wired so that rotating the shafts clockwise REDUCES the resistance in the circuit. Reducing the resistance causes the oscillator frequency to rise in accordance with the formula:

$$f = \frac{1}{2\pi RC}$$

where  $R = R2 + R3$  and  $C = C1$  or  $C2$ , as selected by the range switch S1.

**Turning it on.** At this point Oscar is just about ready to be buttoned up and turned on. The final step is turning the center rotor of R1 all the way to ground. Now connect the battery, put the top cover on, attach a pair of 1000-ohm or greater headphones and turn Oscar on.

With S1 on the upper frequency range, turn the ganged pots R2a, R2b all the way counterclockwise for maximum resistance in the circuit. A sound—a distorted 600-Hz—should be heard in the headphones.

Let Oscar run for a minute or so to condition the photocell to the light. Now adjust R1 until the distortion just disappears. An oscilloscope makes this easier: adjust R1 for an output waveform that is just short of clipping.

To make life easier for yourself, remember to drill a 1/4-inch hole in the oscillator housing opposite the center rotor of R1 to allow a screwdriver blade access for adjustments.

Vary the output frequency by turning the ganged potentiometers R2a, R2b. Turn to the upper end of the frequency range—25-kHz, well beyond your hearing range—and allow a few seconds for the oscillator to stabilize there. Turn back to the audible signal range to make sure that the circuit is still oscillating. If it's not, turn R1 carefully towards ground until the oscillation starts up again.

Now that the upper frequency range is adjusted, switch to the lower range.

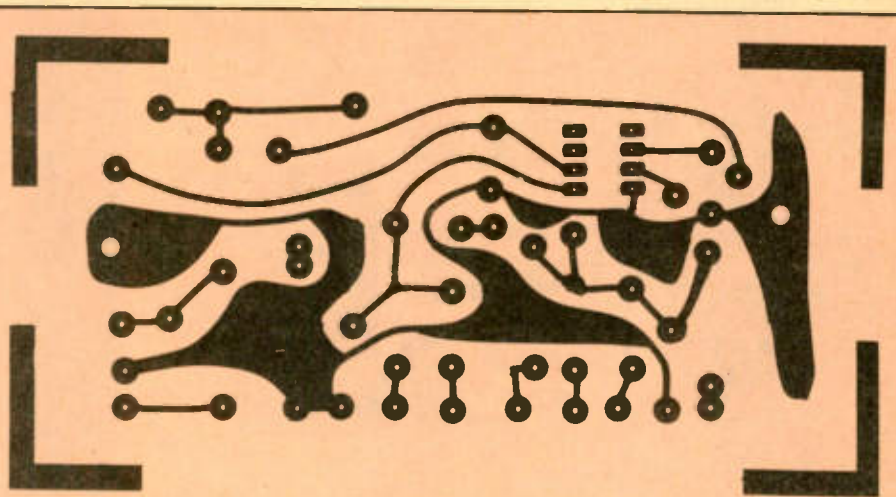

This is the circuit board template, appearing here in its exact size. For those who feel that their skills are not up to board etching, there is a complete kit listed below.

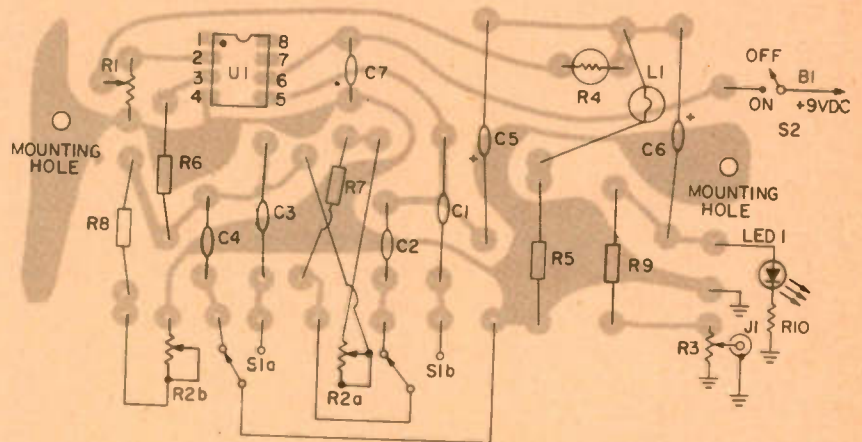

The parts placement is such that nearly any available cabinet which can easily hold the PC board is suitable for OSCAR. This cabinet leaves plenty of room for all components.

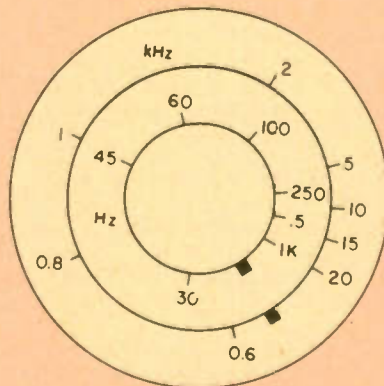

Trace this exact size oscillator range diagram or cut it out and use on the face of the oscillator. It is calibrated exactly for the dual frequency ranges available.

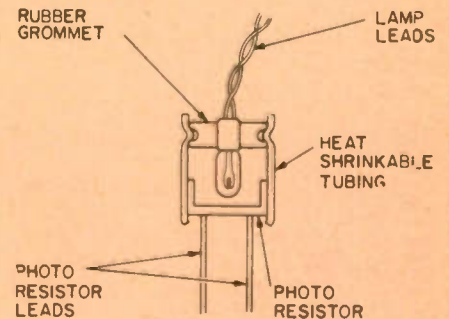

NOTE: GROMMET AND HEAT SHRINKABLE TUBING MUST BE BLACK.

It is very important that the photocell and bulb tandem arrangement be light free.



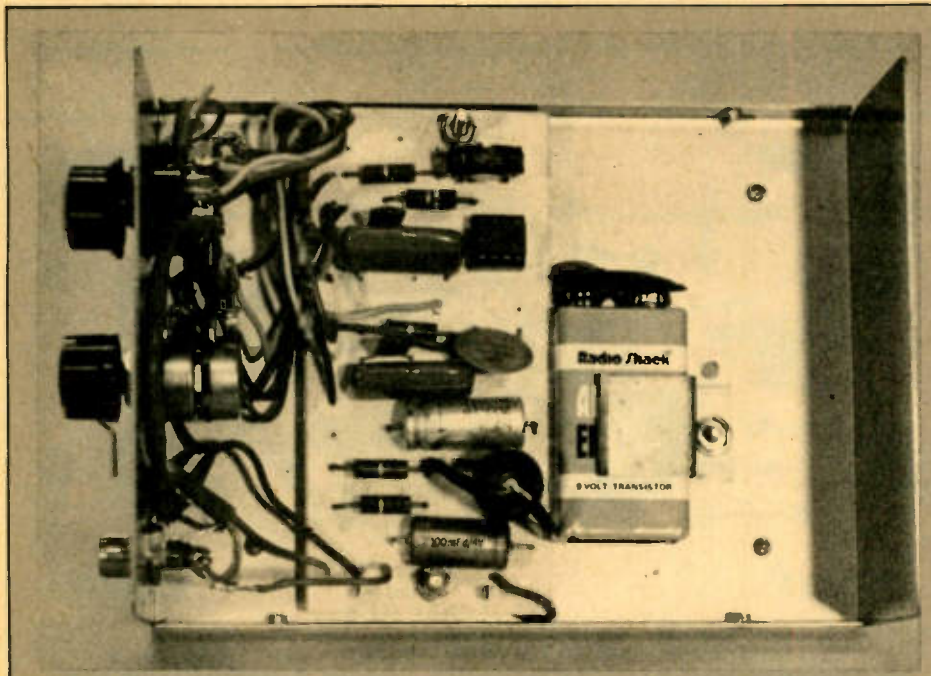

This foil side down parts overlay shows the exact placement of all the components on the circuit board. Care is required in soldering and placing components with precision.

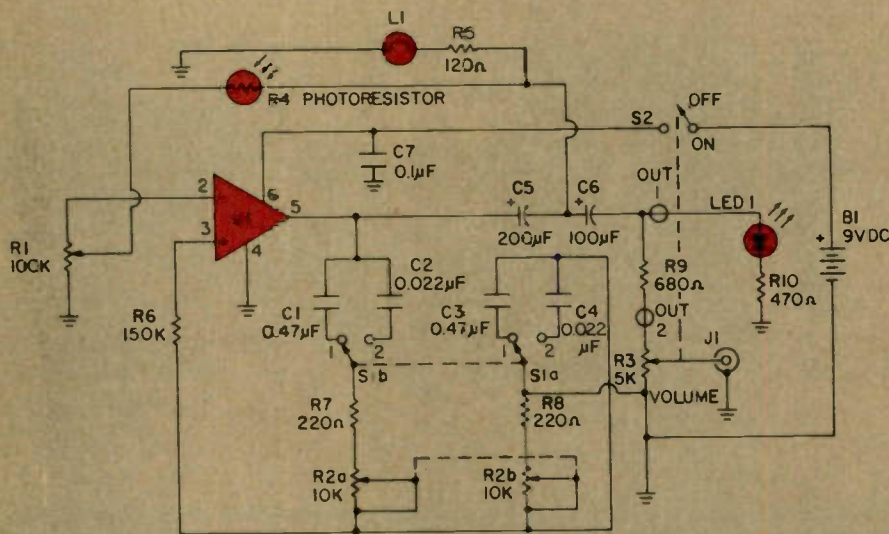

#### PARTS LIST FOR OSCAR

- |  |   |
|--|---|
| B1—9-volt transistor radio battery                               | R4—Photoresistor, 5-megohm to 100-ohm range (Radio Shack 276-116 or equiv.)   |
| C1, C3—0.47- $\mu$ F, 50-VDC capacitor                           | R5—120-ohm, 1/4-watt resistor   |
| C2, C4—0.022- $\mu$ F, 50-VDC capacitor                          | R6—150,000-ohm 1/4-watt resistor  |
| C5—200- $\mu$ F, 16-VDC electrolytic capacitor                   | R7, R8—220-ohm, 1/4-watt resistor   |
| C6—100- $\mu$ F, 4-VDC electrolytic capacitor                    | R9—580-ohm, 1/4-watt resistor   |
| C7—0.1- $\mu$ F ceramic capacitor                                | R10—470-ohm, 1/4-watt resistor  |
| J1—Shielded phono jack (Radio Shack 274-346 or equivalent)       | S1—DPDT slide switch  |
| L1—Miniature bulb, 1.5-volt 15-mA                                | U1—LM 386 Op amp Integrated Circuit (Radio Shack 276-1731 or equiv.)  |
| LED1—Small red Light Emitting Diode                              |   |
| R1—100,000-ohm linear preset potentiometer for PC board mounting | MISC.—Box, PC board, 2 1-inch roundhead machine screws with nuts and washers, IC socket (8-pin), 9-volt battery clips, wire, knobs, sheet metal screws and assorted hardware as needed. |
| R2a, R2b—10,000-ohm linear ganged potentiometers                 |   |
| R3/S2—5,000-ohm linear potentiometer with ON-OFF switch          |   |

At the bottom end, about 30-Hz, the frequency amplitude may vary at a very slow rate. If that is the case, give the circuit a little more negative amplitude by turning R1 up slightly from ground. Some experimentation with R1 settings should yield a compromise position giving the best overall performance for both frequency ranges. When this is attained, the oscillator output should be constant within  $\pm 1$ dB over the whole frequency range.

**Troubleshooting Oscar.** If this output stability cannot be achieved, the ganged potentiometer R2a, R2b is probably at fault. The cheaper varieties track poorly; some may have worse than a 50% difference between the tracks in places. Before throwing out the old one and replacing it, try swapping the R2a and R2b leads around to see if this improves performance.

If the output frequency response is still unsatisfactory, change the 120,000-ohm resistor (R5) in series with the bulb one value up or down. Readjust R1 as before.

While you were making all those adjustments in the lower frequency range the LED should have been winking away at you. This indicates that the oscillator is running and that it has stabilized after a frequency change. You will notice that, in the upper range, the LED stays on steadily. This is because the human eye can't assimilate light oscillations above a certain frequency, so the high-speed flashings appear as a steady light.

Oscar is somewhat sensitive to variations in voltage, especially to low voltage. Serious clipping will result if the voltage drops below eight volts, but the oscillator will operate at up to 14 volts with only an adjustment of R1. If left with the power off for long periods of time, the R1 setting will probably have to be adjusted.

Oscar is a handy piece of test equipment well within the budget and building capabilities of any electronics hobbyist. It's a natural for shooting a signal into misbehaving audio or amplifier circuits: just attach a probe or even two leads to the output jack and you're ready to delve into the innards of recalcitrant circuits.

Other possible—and somewhat more farfetched—uses for Oscar are: as an audiometer, offering the bored hobbyist a hearing test at the bench; or, hooked to a high-powered amplifier and speaker, as a device to scare crows off the backyard garden patch.

Usefulness, low cost and ease of assembly makes Oscar both an interesting project and a welcome addition to any hobbyist's workbench.

For information on the availability of parts and/or other material to build this project, send a business-size, self-addressed, stamped envelope to: ICCUM ELECTRONICS, ROUTE #3, P.O. BOX #271B, STRUDO, OKLAHOMA 74078. Be sure to mention the "project" by name.



# Electronic Pendulum

Simulate the sensuous swing of a pendulum.

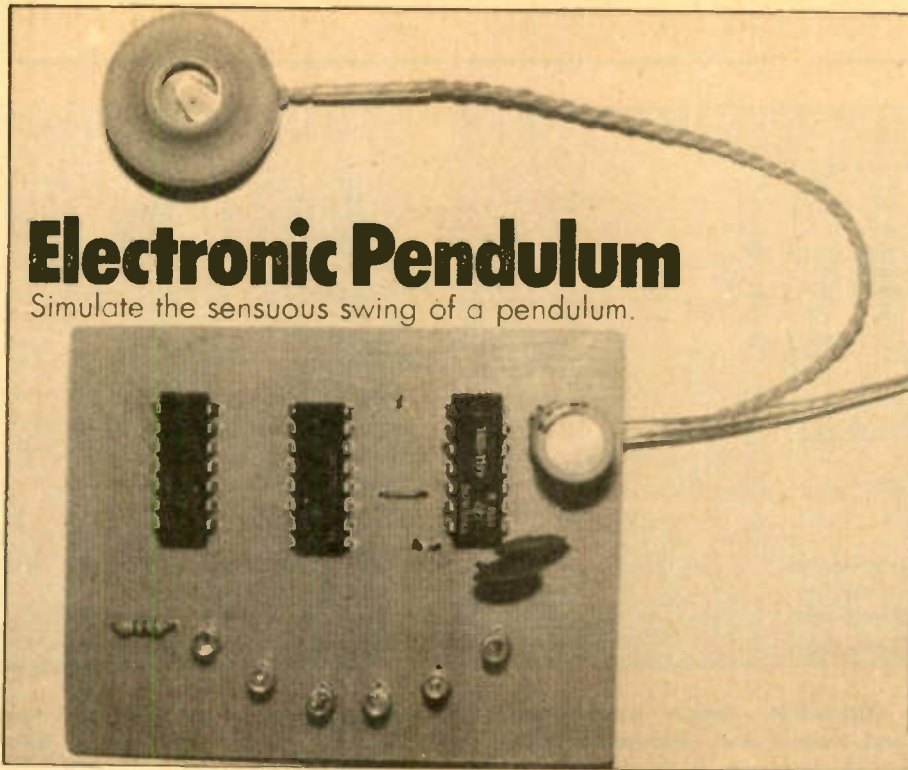

EVERYONE LIKES THE GRACEFUL SWING of a grandfather clock's pendulum. The motion and tick-tock sound are pleasing to the senses and reinforce the idea that the clock is working. Here is a quick and easy project which duplicates the motion of a pendulum electronically and if desired, the sound as well. Parts cost should run about \$4-5 and if you use the PC layout in this article construction time will be a couple of hours.

**The Circuit.** The pendulum operates by having an LSTTL oscillator drive a CMOS 4017 decade counter with decoded outputs. The CMOS chip has ten output lines, 0 through 9, each in turn going "high" after a clock pulse appears on pin 14. Now if you took those outputs and used them directly to light LEDs the result would be a series of bulbs illuminating in sequence 0 to 9 and then going back to 0. But a pendulum doesn't work like that, it swings to the right then to the left. Its electronic counterpart would retrace its path something like 0, 1, 2, 3, 4, 5, then 5, 4, 3, 2, 1, 0, 1, . . . One could use an up-down counter, changing its direction at each end of the count to achieve the above pattern, but there is a simpler way to approximate a pendulum's motion for the hobbyist.

Let's use six bulbs, labelling them A to F. Remember, the counter chip has ten output lines. If we allow some of the lamps to be lit by two outputs instead of just one, we can get oscillatory motion for free, so to speak. Let's see how. Look at Fig. 1. If we let bulb A be turned on by output line 0, bulb B by output 1 or 9, C by 2 or 8, D by 3 or 7, E by 4 or 6, and F by output line 5, the desired result is produced. You can see this easily if you count from 0 to 9 and repeat this modulo ten (base ten) sequence over and over using Fig. 1 for your guide.

Be sure to notice that L1 is inserted in its PC board holes the reverse of the since the LEDs are activated by a "low" or ground signal. Also note that pins 15 and 13 of the 4017 must be at 0 volts for the CMOS chip to count.

**Construction:** The two boards on the other page show the respective orientation of the parts. C2, C3 and S are optional, depending on an audible click with the pendulum swing. This circuit can also easily be wire-wrapped, beginners may wish to do this since the PC layout is somewhat tight and could be difficult for you to reproduce easily.

The schematic shows how this is done. Note the use of the circuit's NOR gates other LEDs. Failure to invert it will not harm anything, but it won't light. Sound output for the unit is provided

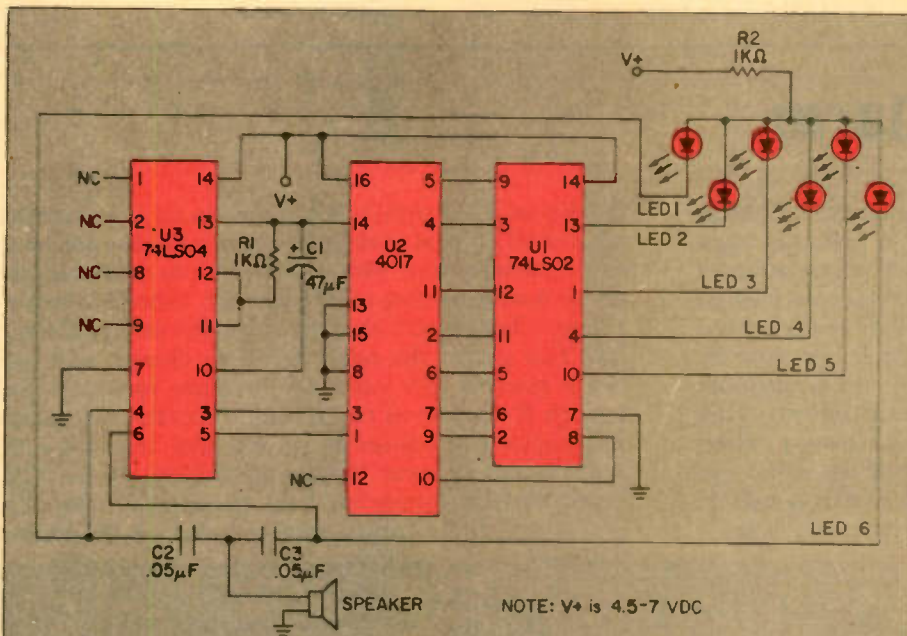

## PARTS LIST FOR ELECTRONIC PENDULUM

- LED 1-6—light emitting diode, red
- R1, 2—resistor, 1,000 ohms, ¼ watt, 10%
- S—crystal earphone
- U1—74LS02, quad NOR gate
- U2—4017, CMOS counter
- U3—74LS04, hex inverter
- Misc.—jumper wire, PC board, solder

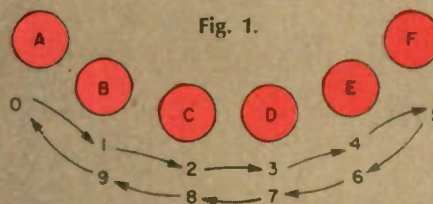

As you see, Electronic Pendulum's circuit is simple and straightforward. Just beware of solder bridges. Note the sequence of firing for the six light emitting diodes.



## Electronic Pendulum/Swing to the beat of this LED metronome

Six LEDs are the center of the Electronic Pendulum. Watch polarity when you install them otherwise you could ruin hours of hard work.

A small printed circuit board, such as the one given for Electronic Pendulum requires good soldering skills. Try to be careful.

by a crystal earphone fed by LED1 and LED6. This arrangement gives plenty of noise in a quiet room, but if desired, more volume can be obtained using an audio amp like the LM386. You will have to experiment with the circuit components to get the proper loudness.

**Operation:** Simply connect power and ground and Electronic Pendulum should start up. It should be easy to add this project to an existing clock or incorporate it into a new design. Voltage to the board should not exceed 7 V, as the 74LS chips will fail, but

V+ can dip to about 4.5 V if you don't mind dim lamps. The circuit draws less than 10 mA so drain from existing supplies will be minimal. Adding a red plastic filter in front of the lamps will improve the illusion of oscillatory pendulum motion. ■

## Burglar Alarm

□ This burglar alarm circuit uses one integrated circuit and operates from a 6 volt battery. It is activated upon the breaking of a circuit. Since the sensing loop operates in a high impedance circuit, there is virtually no limit to the length of wire you can use. You can protect every window and door in your house. Practical operation by using four D cells for power is accomplished through the use of a four-section CMOS integrated circuit which draws only a few microamperes from the battery. Thus, battery life will be equivalent to its shelf life unless the alarm is activated. The heart of the circuit is a pair of NOR gates connected in a bistable configuration called a

flip-flop or latch circuit. When the circuit is in standby, pin 1 of IC1 is held to almost zero volts by the continuous loop of sensing wire. This causes pin 3 to assume a voltage of 6 volts, cutting off Q1 and Q2. When the sensing circuit is broken, C1 charges to battery voltage through R2. This causes the latch circuit to change state and pin 3 goes to zero volts. B1 becomes forward-biased through R4 and turns on Q2 which operates the buzzer. The circuit will remain in an activated state once the alarm is set off, even though the broken circuit is restored. A reset switch has been provided to return the latch circuit to its original state and shut off the alarm.

**PARTS LIST FOR HOME BURGLAR ALARM**

- C1—0.1- $\mu$ F ceramic capacitor, 15 VDC
- C2—0.1- $\mu$ F ceramic capacitor, 15 VDC
- C3—0.47- $\mu$ F ceramic capacitor, 15 VDC
- D1—1N4148 diode
- IC1—4001 quad NOR gate
- Q1—2N4403
- Q2—2N4401
- R1, R3—100,000-ohm, 1/2-watt resistor
- R2—4,700,000-ohm, 1/2-watt resistor
- R4, R5—10,000-ohm, 1/2-watt resistor
- R6—100-ohm, 1/2-watt resistor
- S1—SPST momentary-contact pushbutton switch
- V1—6 VDC buzzer



**W**hen working with various electronic projects, it's easy to get carried away with too many current-eating components, which can overload a power supply. Our Smart Power Supply solves this problem with its built-in LED ammeter, which always tells you what the current draw is.

The supply delivers a regulated 5 and 8-volt output at up to 1-amp, and you'll never be in the dark as to how much current is being drawn. 4 LEDs display the amount of current being utilized by the load. Each LED lights respectively to show the level of current being drawn. For example, if  $\frac{3}{4}$  of an amp (.75) is being used, the first three LEDs (".25", ".50", and ".75") will all glow to show that a current of at least  $\frac{3}{4}$  of an amp is flowing. Best of all, the current measuring resistance is an unprecedented 0.1-ohm! What's more, the cost for the ammeter portion of the circuit is only about \$5. That's way less than you'd pay for a good mechanical meter.

The 5-volt output is ideal for all of your TTL IC projects, while the 8-volt output may be selected for CMOS circuits, and other, higher-power requirements. The total cost for the whole supply, including the bargraph ammeter, is about \$15-20, depending on your buying habits, and choice of parts suppliers.

**How it Works.** IC4 is supplied by an accurate reference voltage of 5-volts by IC3. IC4 is a quad op amp used in a quad comparator configuration.

The 4 op amps (comparators) in IC4 are each fed a separate reference voltage by the divider network made up of R1-R4 and R5-R8. These comparators in IC 4 are very sensitive, and they can detect extremely small voltage differences and compare them.

Let's take the first op amp comparator as an example. Its inputs are pins 2 and 3, and its output is pin 1. The reference voltage appearing at pin 3 is compared to the voltage coming into the first comparator at pin 2. When  $\frac{1}{4}$  of an amp or more is flowing thru R10, .025-volts or more (0.1-ohms times  $0.25A = .025V$ ) appears across R10, which is enough voltage to equal pin 3's reference voltage, thus turning on the first op amp. The output of this op amp is at pin 1, so LED1 turns on to signify that at least  $\frac{1}{4}$  of an amp is being drawn. In a like manner, the other LEDs turn on or off with the changing current. The rest of the circuitry makes up a basic voltage-regulated power supply.

**Construction.** All of the circuitry, except ICs 1 and 2, can be mounted on a small piece of perfboard. These two ICs must be mounted to the cabinet. In operation, IC1 and IC2 will get hot

when the supply is run at higher currents, and they may shut down if the heat is not carried away. The back of the cabinet is the best place to mount ICs 1 and 2, for it allows a large heat dissipating area, while keeping the rest of the cabinet cool to the touch. When mounting ICs 1 and 2, smear heatsink grease between the IC cases and the cabinet, then bolt the ICs down tightly. Connect three long wires to IC1 and 2. These will be connected to the main circuit board later.

If the transformer that you wish to use has a center tap, cut it off or tuck it away. You won't need it. Bolt T1 down to the cabinet. Use heavy gauge (#16) wire for all line voltage connections, and carefully wrap all AC line connections with electrical tape. Use a

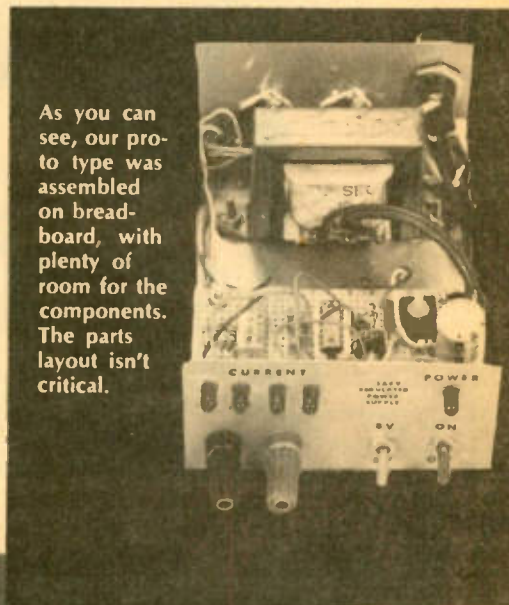

As you can see, our proto type was assembled on bread-board, with plenty of room for the components. The parts layout isn't critical.

# The Smart Power Supply

Keeps tabs automatically on current and voltage levels

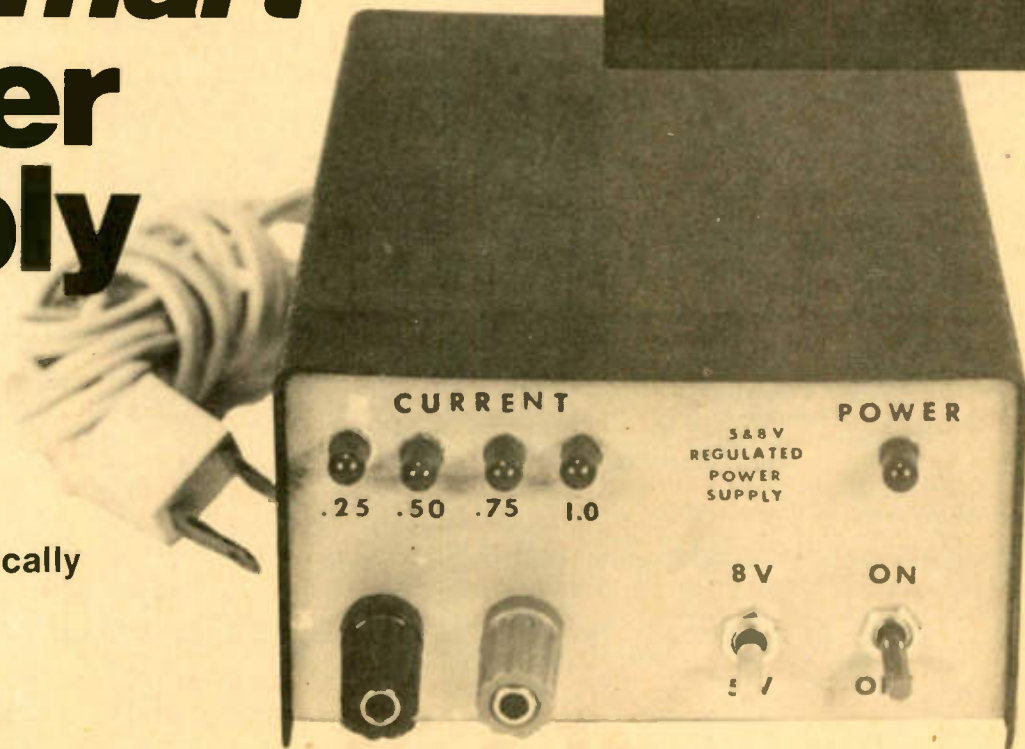



# Smart Power

grommet around the line cord exit hole in the chassis to protect the cord from the heat that will be there due to ICs 1 and 2. Tie a knot in the line cord just inside the cabinet hole to prevent it from being pulled out.

IC3, unlike ICs 1 and 2, can be mounted on the perf-board because it will not get hot in operation. You should use a 14-pin socket for IC4. In-

stall IC4 only after all of your wiring to the socket is complete.

Be careful not to make any solder "bridges" between socket pins, as they are close together. When you install IC 4 in its socket, make sure that you observe the correct orientation with regard to pin 1.

After you've installed the circuit board, attach the wires from ICs 1 and 2 to their proper places on the board. Connect the wires to the display LEDs last, and make sure that you observe polarity on each LED. Be careful not

to let the LED leads short against the metal cabinet.

**Operation.** Carefully inspect your wiring on the circuit board, especially the wiring to IC4's pins. This is a very important step, as one misplaced wire here can produce some real odd-ball systems. If everything appears to be in order, turn the unit on. The "power" LED (LED5) should glow.

Connect a voltmeter to the output jacks. Depending on what position switch S2 is in, the voltmeter will read 5 or 8 volts. Throwing S2 to its other position should cause the voltmeter to read the other of the two voltages that the supply delivers.

To test the ammeter section, connect a circuit to the output jacks. With the supply set for 5-volts, a TTL IC circuit would be good for this test.

If the circuit that you hooked up draws more than 1/4 amp, then one or more of the display LEDs will go on to show you how much current is being drawn.

**Conclusion.** You shouldn't worry about overloading the power supply, as fuse F1 will limit current draw to a peak of about 1.3-amps momentarily, before acting, and we deliberately overloaded several times in a row, with no damage occurring to the circuitry.

You might wish to attach a solderless breadboard to the top of the cabinet, to act as a permanently-powered breadboard for your experiments, or to construct an output voltage switcher for powering several projects alternately. ■

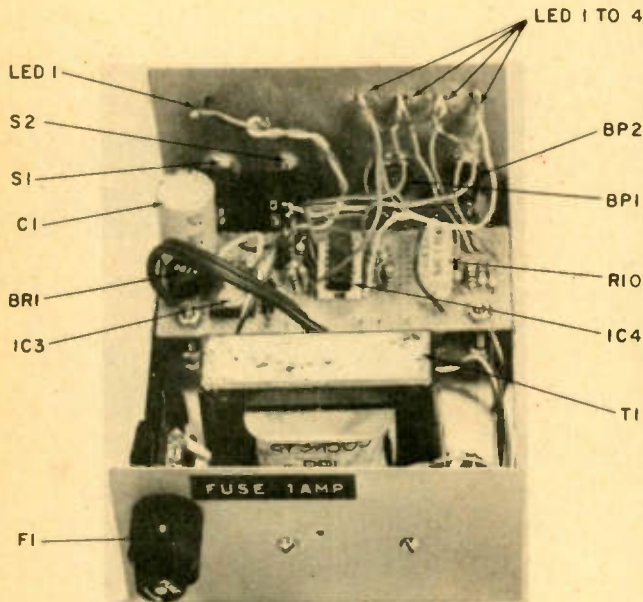

Again, parts layout is not critical in this power supply, but feel free to use our idea of where things should go. It's always a good general design idea to keep the power transformer as far away from the rest of the circuitry as cabinet size or practicality permits. Suspend the board above chassis.

## PARTS LIST FOR THE SMART POWER SUPPLY

- BP1, BP2—5-way insulated binding post
- BR1—bridge rectifier rated @ 50 PIV 2-Amperes
- C1—1,000- $\mu$ F, 24-VDC electrolytic capacitor
- F1—3AG 1-Amp fuse
- IC1, IC3—7805 linear voltage regulator
- IC2—7808 linear voltage regulator
- IC4—LM324N quad op amp
- LED1 through LED5—large, red LED rated @ 20 mA.
- R1—2,000,000-ohm, 1/4-watt resistor
- R2—1,000,000-ohm, 1/4-watt resistor
- R3—660,000-ohm, 1/4-watt resistor
- R4—500,000-ohm, 1/4-watt resistor
- R5, R6, R7, R8—10,000-ohm 1/4-watt resistor
- R9—180-ohm, 1/4-watt resistor
- R10—0.1-ohm, 5-watt resistor (Radio Shack #271-128)
- R11, R12, R13, R14—100-ohm, 1/4-watt resistor
- S1—SPST switch
- S2—SPDT switch
- T1—transformer with primary rated @ 120-VAC/secondary @ 12.6-VAC, 2-Amperes

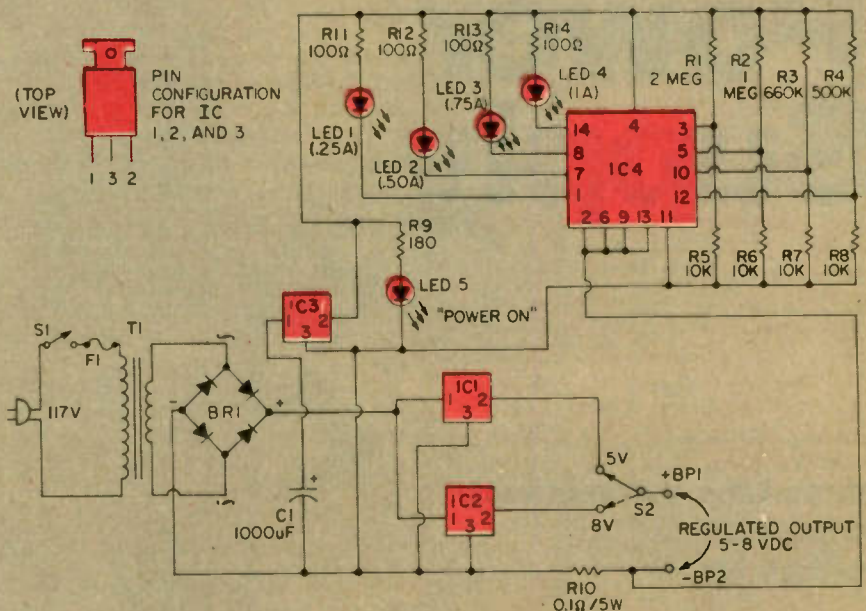



# Build a budget DWELL/TACHOMETER

Saves money on tune-ups!



**O**UTSIDE OF A GOOD SET of wrenches, the most commonly called for automotive tool is the dwell/tachometer. When tuning up an engine, there's no substitute for the kind of accuracy a dwell/tach can bring to your engine adjustments. A commercial version of this apparatus might run as high as \$25.00. With some judicious parts buy-

ing, you should be able to do the job for roughly half of that figure. In addition, our dwell/tachometer gives you an additional feature not found on any but the most expensive commercial units: a DC voltmeter, which is highly useful in checking a car's electrical system and, in particular, the ignition.

Most of the parts used in the construction of this instrument will probably be found in the electronics hobbyist junk box. The meter is a common 1 mA DC movement. If desired, other meter movements may be used by simply changing circuit values to accommodate a more or less sensitive meter.

**Construction.** Most of the circuitry of the instrument is built on a printed circuit board, which mounts all components except the front panel switches and meter. The PC board is mounted

to the rear of the meter by means of the two meter studs. This type of construction allows the entire circuit of the instrument to be contained in one module, and allows ease of assembly and service if ever necessary. The components layout as seen from the parts side of the board is shown in Fig. 1, and the printed circuit layout as seen from the copper side of the board is shown full size in Fig. 2. If you are going to use a physically different meter than that specified in the parts list, be sure to take into account the center-to-center stud distance when laying out the printed circuit board.

Fig. 3 is an illustration of a meter scale which can be used for the instrument. This scale has two ranges; 0 to 1500 RPM, and 0 to 60 degrees dwell. To change the 0 to 1 milli-

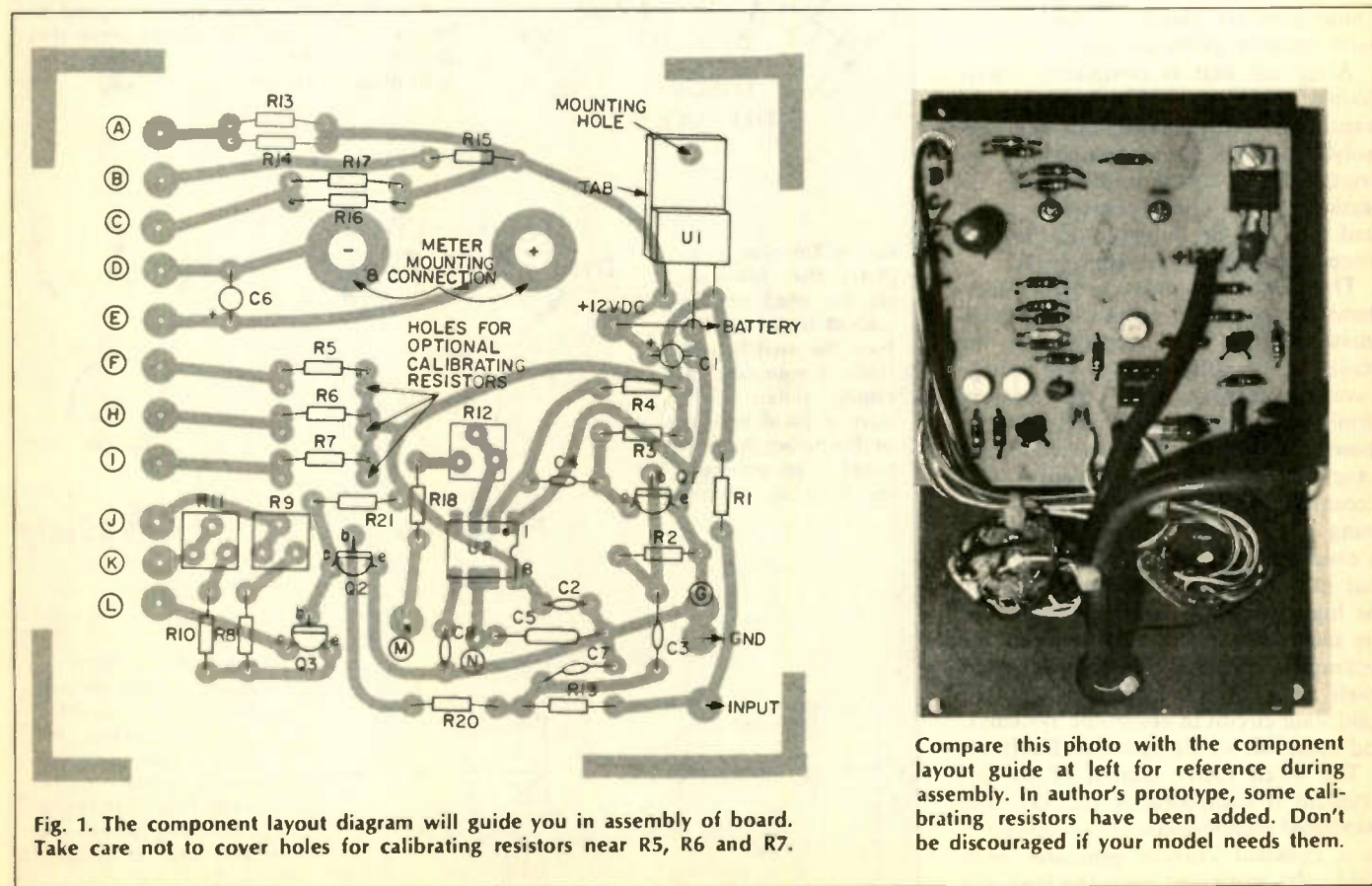
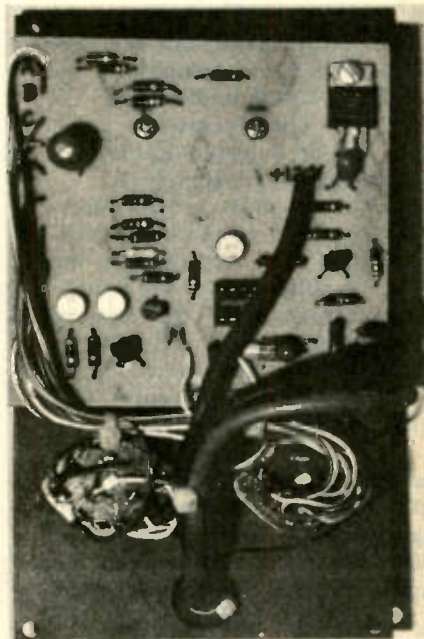

Fig. 1. The component layout diagram will guide you in assembly of board. Take care not to cover holes for calibrating resistors near R5, R6 and R7.



Compare this photo with the component layout guide at left for reference during assembly. In author's prototype, some calibrating resistors have been added. Don't be discouraged if your model needs them.



# DWELL/TACH

ampere scale on the meter, remove the plastic front of the meter and carefully remove the two small screws which hold the scale in place. You can then paste the scale of Fig. 3 over the back side of the meter scale and put it into place over the meter movement. Be careful not to disturb the meter needle during this operation, since it is very fragile. Fig. 4 can be used as a front panel label which provides the FUNCTION and CYLINDER lettering.

The instrument is connected to the automobile ignition system with three wires, as shown in Fig. 6. Be sure to use different colors to help prevent misconnections when the instrument is placed in use. Rubber covered test lead wire is ideal for the purpose, and comes in several colors besides red and black. Alligator clips and boots can be placed on the ends of the wires for the connections to the automobile.

Connections between the printed circuit board and front panel switches are indicated on the schematic diagram and printed circuit layout by a group of 14 letters, A through N. Three additional wires are used for the three operating leads of the instrument. These connections are clearly marked on the parts location guide diagram.

After the unit is completely wired, double check to make sure that the transistors, integrated circuits, and electrolytic capacitors are mounted to the printed circuit board in the correct direction. These components are polarized and will be damaged if they are placed into the circuit improperly.

**The Circuit.** In order to best understand the operation of the dwell/tachometer circuit, it is necessary for the reader to be familiar with the voltage waveform appearing at the primary terminal of the ignition coil. This is shown in Fig. 5. The basic voltage waveform is a rectangular pulse with a considerable amount of ringing on the rising edge of the pulse. This ringing is caused by the sudden cut-off of current in the ignition coil, and results in the high voltage generation which fires the spark plugs. The duty cycle of the rectangular pulse is determined by the dwell angle of the ignition points (or solid state circuit in electronic systems), and must fall within specified limits for

The dwell meter section of the instrument is composed of Q2, Q3, and associated components. Q3 is connected as a constant current generator with eight-volts impressed upon the base and

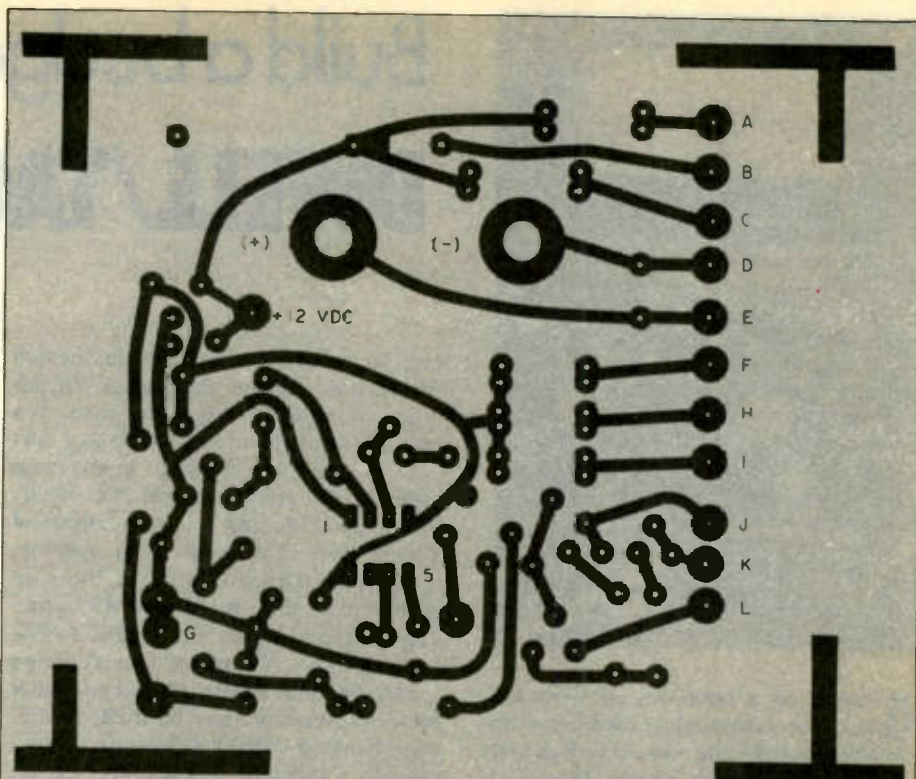

Fig. 2. This is the full-scale etching guide for the Dwell/Tachometer's printed circuit. DO NOT etch the board until you know the center-to-center distance of the studs.



Fig. 3. This is a full-scale template for use on the meter face. It is designed to be used with the GC Electronics movement described in the parts list, but will likely fit other meter faces just as well.

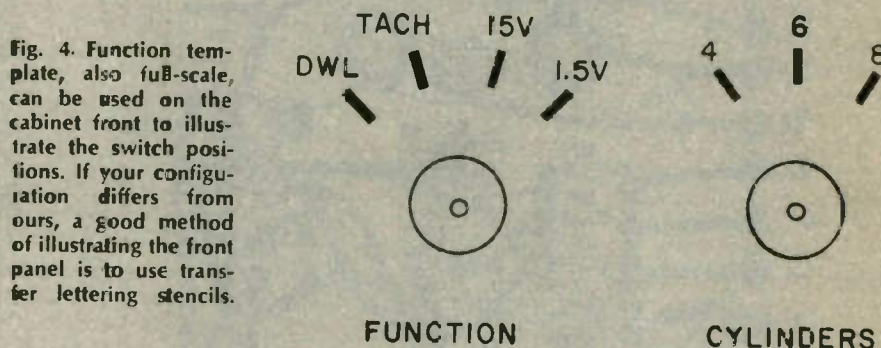

Fig. 4. Function template, also full-scale, can be used on the cabinet front to illustrate the switch positions. If your configuration differs from ours, a good method of illustrating the front panel is to use transfer lettering stencils.

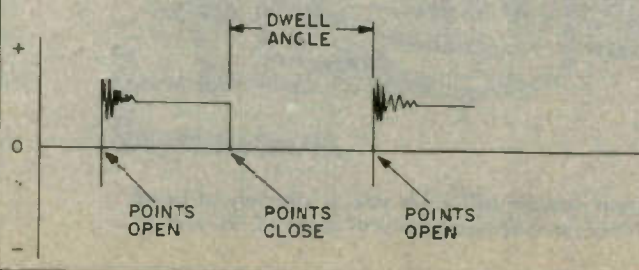

Fig. 5. A waveform diagram of the voltage across the ignition points illustrates exactly what happens during operation, and what it is that you're measuring when you use the instrument.



the meter placed in the collector circuit by the FUNCTION switch. The value of resistance placed in the emitter of Q3 determines the collector current of the transistor, and is adjusted so that the meter reads the full dwell angle (45 or 60 degrees) when the sensing lead of the instrument is shorted to ground. Q2 acts as a switch which controls the base of Q3, and causes Q3 to either be on or off, depending upon the state of the ignition points. When the points close, Q2 is cut off and Q3 passes its calibrated constant current through the meter. When the points open, Q2 is forward

biased and saturated by the voltage appearing across the points. This cuts off Q3 and the meter current is zero. Since this action takes place much faster than the meter needle can follow, the meter reading is the average of the two conditions, and is the actual dwell angle measurement.

The tachometer section of the instrument makes use of the fact that the meter of spark plug firings per second is directly related to the RPM of the engine. Q1 is used as a buffer transistor between the ignition system and the trigger input of a 555 timer IC which is connected as a one-shot

multivibrator. Each time the ignition circuit produces a positive-gain pulse, U2 generates an 8-volt pulse of 2500 to 5000-microseconds duration, depending upon the number of cylinders of the engine under test. The output of U2 is fed to the meter through a calibrating potentiometer. C6 acts as a filter to smooth out the pulses to nearly pure DC, and provides a steady meter reading which is engine RPM.

The voltmeter section of the unit consists of R13, R14, R16 and R17. These components are used as multiplier resistors so that full scale meter current is generated when either 15

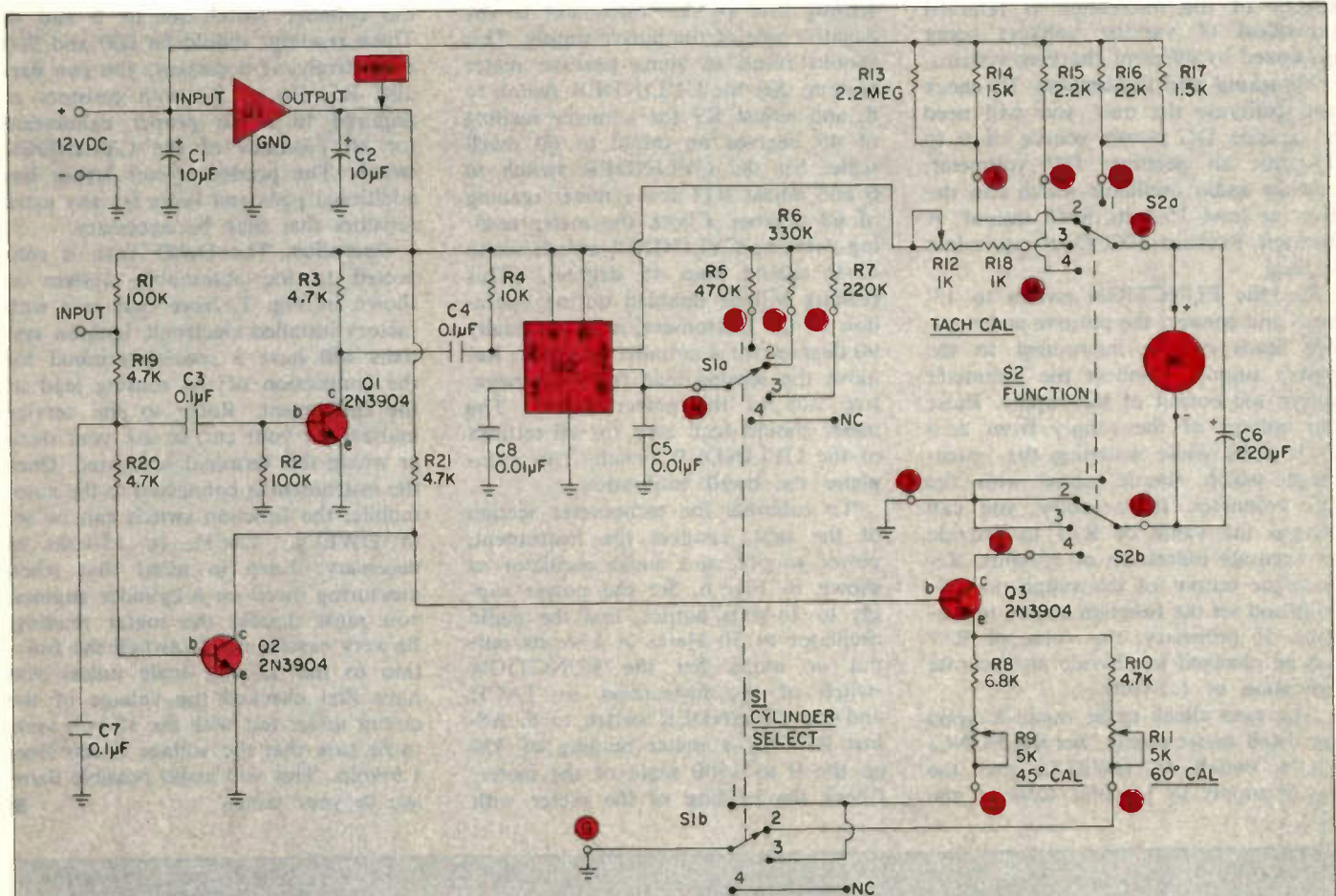

#### PARTS LIST FOR DWELL/TACH

C1, C2—10-µF, 25-VDC electrolytic capacitor  
 C3, C4, C7—0.1-µF, 25-VDC ceramic capacitor  
 C5—0.01-µF, 25-VDC tubular capacitor  
 C6—220-µF, 6-VDC tantalum capacitor  
 C8—0.01-µF, 50-VDC disc capacitor  
 Q1, Q2, Q3—2N3904 NPN silicon transistor (or equivalent)  
 R1, R2—100K, ¼-watt resistor, 10% (all resistors 10% tolerance unless otherwise noted.)  
 R3, R10, R19, R20, R21—4.7K, ¼-watt resistor

R4—10,000-ohm, ¼-watt resistor  
 R5—470,000-ohm, ¼-watt resistor  
 R6—330,000-ohm, ¼-watt resistor  
 R7—220,000-ohm, ¼-watt resistor  
 R8—6,800-ohm, ¼-watt resistor  
 R9, R11—5,000-ohm linear taper potentiometer (PC mount)  
 R12—1,000-ohm linear taper potentiometer (PC mount)  
 R13—2,200,000-ohm, ¼-watt resistor  
 R14—15,000-ohm, ¼-watt resistor

R15—2,200-ohm, ¼-watt resistor  
 R16—22,000-ohm, ¼-watt resistor  
 R17—1,500-ohm, ¼-watt resistor  
 R18—1,000-ohm, ¼-watt resistor  
 S1, S2—2-pole, 4-position rotary switch, GC Electronics #E2-166, or equivalent  
 U1—LM340T-8, 8-volt regulator integrated circuit  
 U2—555 timer integrated circuit  
 Misc.—0 to 1 mA DC ammeter movement, GC Electronics #D1-912, or equivalent, cabinet, solder, alligator clips, knobs, etc.

For information on the availability of parts and/or other material to build this project, send a business-size self-addressed, stamped envelope to: NICCUM ELECTRONICS, ROUTE #3, PO BOX #271B, STROUD, OKLAHOMA 74079. Be sure to mention the "Project" by name.



# DWELL/TACH

1.5-volts is fed to the power leads of the instrument. The function switch of the unit connects the proper resistors into the circuit as necessary for a full scale voltmeter reading of either 5 or 1.5-volts.

U1 is a fixed, 8-volt regulator IC which provides the power to operate the dwell and tachometer sections of the unit. Since the circuit derives its power from the battery and alternator of the automobile under test, the 8-volt regulator ensures that the calibrated accuracy of the instrument is retained regardless of varying voltages being generated by different charging systems.

**Checkout and Calibration.** To check and calibrate the unit, you will need a variable DC power source of 0 to 15-volts, an accurate DC voltmeter, and an audio oscillator which can deliver at least 15-volts RMS output. A Hewlett/Packard 200CD or equivalent is ideal.

Set the FUNCTION switch to 15-volts and connect the positive and negative leads of the instrument to the power supply. Connect the voltmeter across the output of the supply. Raise the voltage of the supply from zero to 15-volts while watching the instrument, which should agree with the DC voltmeter. If necessary, you can change the value of R14 to provide an accurate indication of 15-volts. Reduce the output of the supply to 1.5-volts and set the function switch to 1.5-volts. If necessary, the value of R17 can be changed to provide an accurate indication of 1.5-volts.

The next check to be made is upon the dwell meter circuit. Set the FUNCTION switch to DWELL, and the power supply to 14-volts. Connect the

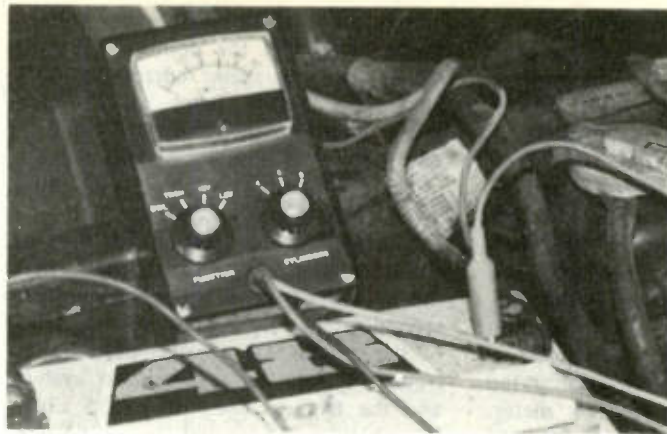

Here the Dwell/Tach's voltmeter function is being utilized to test a battery. If you look closely, you'll see that the meter is reading a nominal 12-volts.

sensing lead of the instrument to the negative side of the power supply. This should result in some positive meter reading. Set the CYLINDER switch to 8, and adjust R9 for a meter reading of 45 degrees on the 0 to 60 dwell scale. Set the CYLINDER switch to 6 and adjust R11 for a meter reading of 60 degrees. Check the meter reading with the CYLINDER switch set to 4. It should read 45 degrees. (This reading will be doubled during operation of the instrument, and is actually 90 degrees for 4 cylinder engines). Remove the sensing lead from the negative side of the power supply. The meter should read zero for all settings of the CYLINDER switch. This completes the dwell calibration.

To calibrate the tachometer section of the unit, connect the instrument, power supply, and audio oscillator as shown in Fig. 6. Set the power supply to 14-volts output, and the audio oscillator to 30 Hertz at 15-volts output or more. Set the FUNCTION switch of the instrument to TACH and the CYLINDER switch to 8. Adjust R12 for a meter reading of 450 on the 0 to 1500 scale of the meter. Check the reading of the meter with

the cylinder switch set to 6 and 4. These readings should be 600 and 900 respectively. If necessary, you can parallel R5, R6 or R7 with resistors as required to attain proper calibration for all positions of the CYLINDER switch. The printed circuit layout has additional pads and holes for any extra resistors that may be necessary.

**Operation.** The Dwell/Tach is connected to the automobile system as shown in Fig. 7. Note that cars with factory installed electronic ignition systems will have a special terminal for the connection of the sensing lead of the instrument. Refer to the service manual for your car, or ask your dealer where this terminal is located. Once the instrument is connected to the automobile, the function switch can be set to DWELL, TACH, or 15-volts as necessary. Keep in mind that when measuring dwell on 4 cylinder engines, you must double the meter reading. Be very careful not to switch the function to the 1.5-volt scale unless you have first checked the voltage of the circuit under test with the 15-volt scale to be sure that the voltage is less than 1.5 volts. This will avoid possible damage to your meter. ■

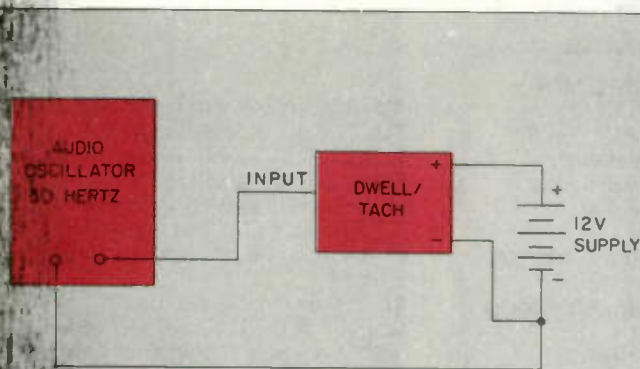

Fig. 6. This is the wiring setup utilized for final calibration. A well-regulated 12-volt power supply is a necessity here. Alternatively, you can use the car's battery if it is fully charged.

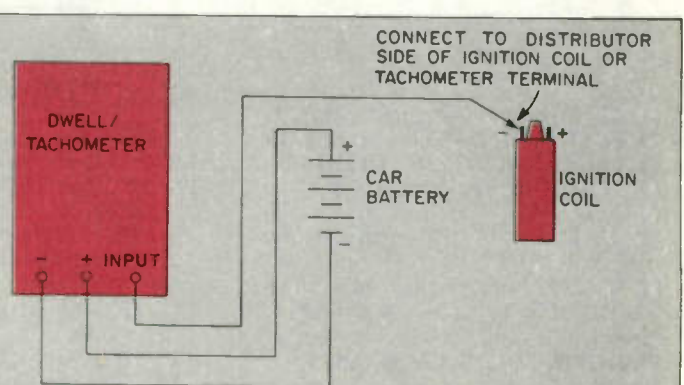
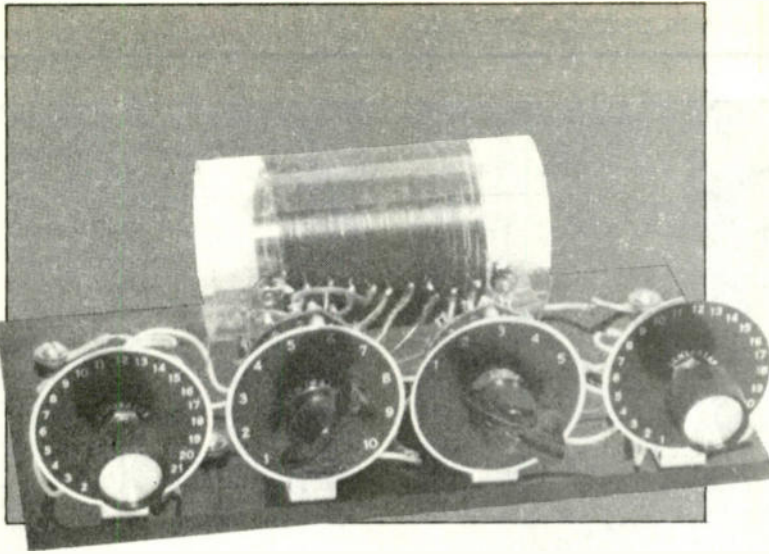

Fig. 7. This is a schematic representation of the manner in which Dwell/Tachometer is connected to car's ignition system. No other connections needed to use all of meter's functions.



# BCL-SWL ANTENNA TUNER

A perfect match for your antenna



**P**EAK PERFORMANCE in a receiver antenna is achieved when it is cut to the proper length for a particular radio band. Since most receivers are used for multiband operation, every antenna is a compromise. However, this compromise is not necessary.

Antenna tuners used with transmitting antennas provide a proper match between the antenna and transmitter for maximum transfer of RF power. A tuner can also be used to match the receiver input to an antenna for efficient operation over the radio bands.

**A SWL Tuner.** A receiver antenna tuner that may improve your reception is our BCL-SWL Antenna Tuner. The tuner is designed to cover the broadcast band as well as the short waves and it is laid out in breadboard style for easy construction.

The random length single wire antenna, fed to the receiver at one end, has a great range of impedance changes over the radio spectrum. At the low frequency end the impedance is low. At the opposite end it can be several thousand ohms.

Receiver input impedances vary from 50 to 300-ohms. The antenna tuner's basic circuit is a pi-network that can be adjusted to match the antenna's impedance to the receiver's input impedance. This insures maximum reception.

The tuner's antenna input (J1) impedance and output impedance is adjusted by tuning C1 and C6. (Refer to Schematic 1.) Additional capacity (C2-C3-C4-C5) is paralleled across C6 by switch S2 to better match the receiver input impedance (J3). The taps on coil L1 are selected by S1 enabling the circuit to be resonant at the desired frequency band.

The antenna tuner is built on a 8-

inch by 4½-inch by ¼-inch section of plastic. (Refer to the base-plate drawing for lay-out dimensions of the tuner components). The tuning capacitors and switches are installed on metal brackets approximately ½-inch wide by 1½-inch high, with a ½-inch foot.

Cut the base-plate to size and mark the component locations. Coil L1 is wound on a 3¾-inch (long) by 2-inch (outside diameter) plastic tube. The thickness of the tube is not critical, but it must be rigid enough for winding the coil. The plastic tube we used has a ¼-inch wall.

**A Big Lug.** A solder lug terminal is mounted ½-inch from the tube's ends. Make a 100 turn coil with number 28 enameled magnetic wire, tapped every

10 turns. Twist the wire together ¼-inch out from the tube, as it is wound, to make the taps.

Put a drop of solder on the wire to keep the tap stiff and pointing outward from the tube. Connect the coil ends to the lug terminals. Make sure the enamel on the wire is carefully removed (with sandpaper) before making connections.

Mount L1 on the baseplate with ½-inch spacers. (The taps should face toward the front of the tuner.) Install the remaining components on the baseplate and wire up the tuner as shown in Schematic.

Temporarily connect a clip-lead between the external antenna (J1) and the receiver antenna terminal (J3).

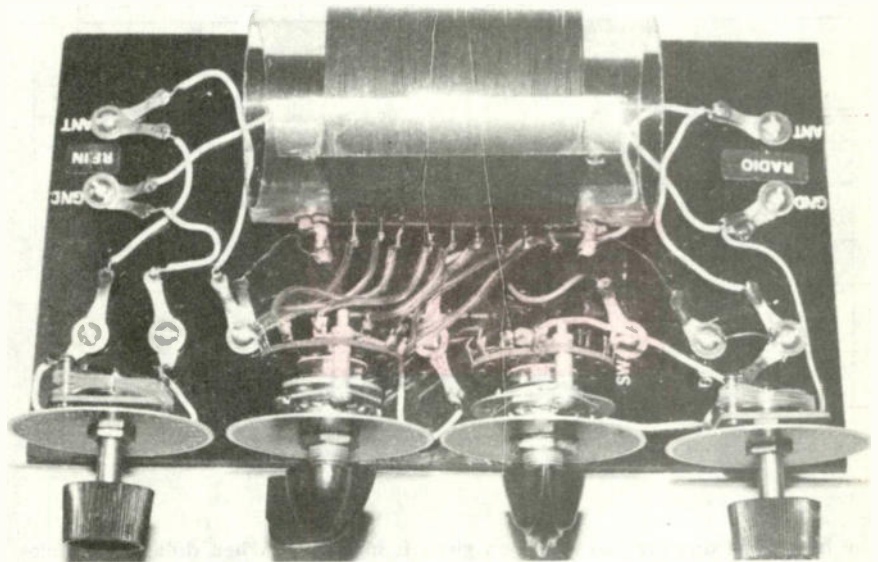

The self wound induction coil, L1, is tapped at nine different points. By doing this, the operator is able to change the inductance of the coil and properly match an antenna to the frequency that a set is receiving. Can be used for SW.



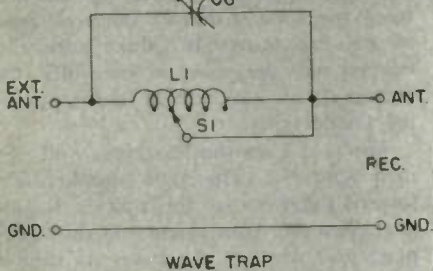
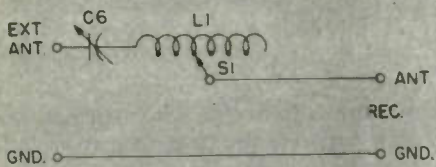
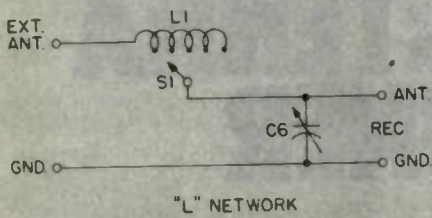

Schematic 1. The upper schematic describes the layout of the antenna tuner. It is comprised entirely of capacitors and inductors. Schematic 2A-C. These three schematics show the hobbyist various things that can be done with the BCL-SWL Antenna Tuner. Try some of the applications yourself.

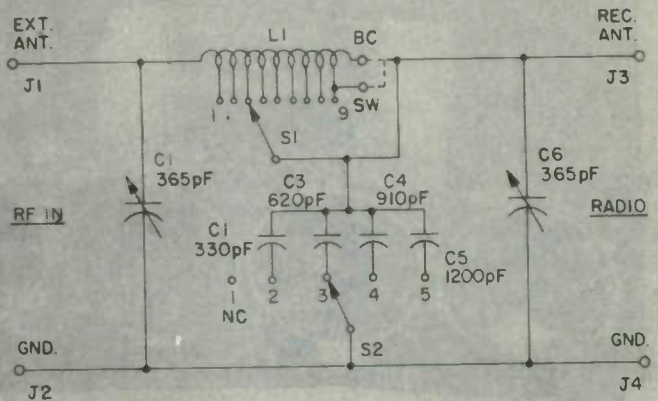

**PARTS LIST FOR BCL-SWL ANTENNA TUNER**

- C1, C6—365-pF subminiature variable capacitor
- C2—330-pF capacitor
- C3—620-pF capacitor
- C4—910-pF capacitor
- C5—1200-pF capacitor
- L1—See Text
- S1—Single pole, 10 position rotary switch
- S2—Single pole, six position rotary switch
- Misc.—8-inch by 4½-inch by ¼-inch section of black plastic, 3¾-inch long by 2-inch diameter plastic tube, #28 enameled magnetic wire, 6-32 machine screws, washers, dial plates, hookup wire and solder lugs, metal brackets for mounting switches, hardware, etc.

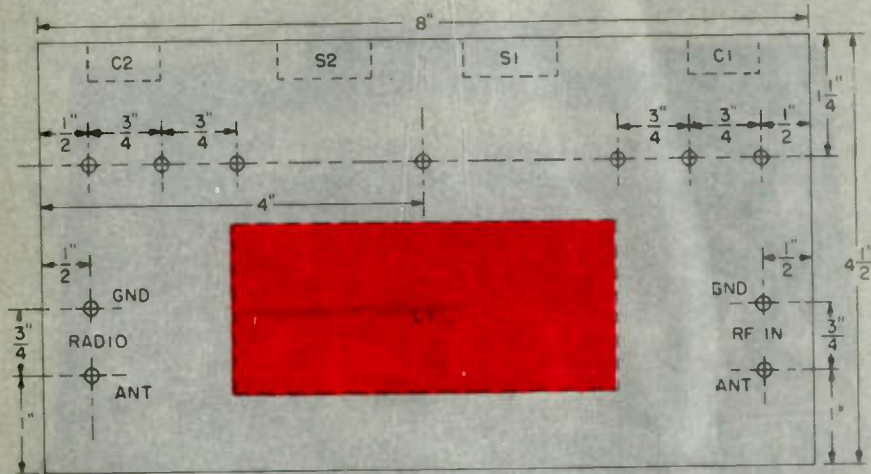

The base plate drawing that has been given is half scale. When drilling out holes, be sure to carefully observe drilling locations. Any sort of material can be used for the base providing that it is a nonconducting material such as wood or plastic.

Tune the receiver to a radio station and remove the clip-lead. If no stations are heard, tune up on the received background noise. Connect the tuner jumper to either BC or SW position.

Set C1 and C6 to mid-range position. S1 to position 1 (minimum inductance tap) and S2 to position 1 (minimum capacity). Set S1 to each position while listening to the receiver. At each S1 position, switch S2 through the five capacity ranges and tune C1 and C6 as necessary for maximum received signal.

**Effective Experiments.** You can also use the tuner components for various experiments (refer to Schematics 2A-C and reconnect components):

- 1) **L Network**—Set S1 through its positions and tune C6.
- 2) **Series Tuning**—Tune C6 and switch S1 through its positions for maximum signal strength.
- 3) **Wave Trap**—Tune C6 and switch S1 as necessary to tune out an interfering station.

With this sort of versatility, you can really go far with the BCL-SWL Antenna Tuner.



# WIRE-WRAP BREADBOARDING

New construction technique unites the best features of printed circuit and solderless breadboard construction

**F**OR THE LAST FEW YEARS, there have been two major methods of circuit board construction dominating the hobbyist field: etched printed circuit boards, and solderless breadboards. Both have their respective advantages and disadvantages. The printed circuit offers compactness and ease of actual assembly of components onto the board. However, the initial startup cost for the hobbyist can be expensive, when the cost of materials necessary for the production of a printed circuit board is added up. Additionally, there is the time involved in the design of a printed circuit, where component shapes and sizes often dictate departures from simply transferring the flow of the schematic onto the board.

However, the finished product is rugged and, if designed with care, usually compact in size.

**To Solder or Not.** Solderless breadboards, on the other hand, offer the hobbyist the opportunity to literally transfer a schematic on paper to a physical working circuit by utilizing point-to-point construction. Spring-

loaded terminals allow the insertion of component leads without trimming, thereby extending their value in that they remain completely reuseable in other circuits at a later time. However, the drawback with solderless breadboards is that they lack permanency in the sense that components can become dislodged from their terminals due to careless handling and through exposure to the elements, if not used in a controlled environmental setting (meaning that you'll require a heavy degree of weather-proofing if the circuit is to be used anywhere outside the home).

**The Best of Both.** This brings us to the relative newcomer in the hobbyist construction field, the wire-wrapped breadboard. We use the term "relative newcomer," because in fact wire-wrapping as a method of connecting

components together on a circuit board has been around for close to twenty years, but was mainly used only in industrial applications before printed circuitry came into widespread acceptance, bringing with it miniaturized components. Many of you will recall the advertisements of the Zenith Television Corporation in the early 1960's, extolling the virtues of their completely hand-wired television receivers. If you still have one about the house, a quick gander at the chassis will reveal the presence of wire-wrapped connections, running from point to point between tube sockets and tie points for such components as capacitors and larger resistors. And those sets really did last.

Through the good offices of the OK Machine and Tool Company, and Vector Electronics, we've illustrated a fair cross section of the tools and accessories necessary and available to the hobbyist for wire-wrap construction.

**Made for You.** Perhaps the primary reason for the emergence of wire wrapping on the hobbyist level has been the increase in complexity of the pro-

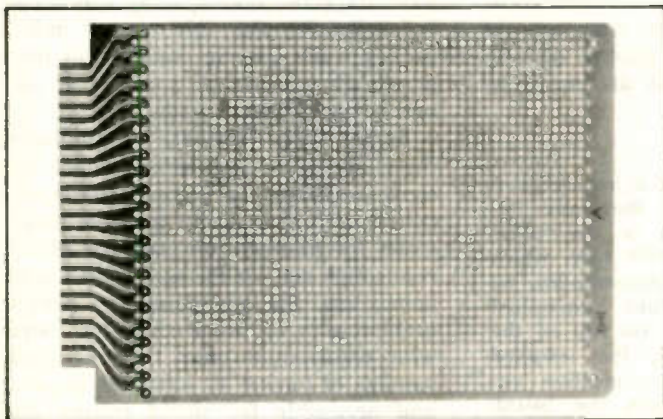

An excellent example of a "basic" matrix board is this model 3662 Plugboard™ from Vector. In addition to the edge-pin terminals, this model has hole spacing which accommodates that of DIP ICs.

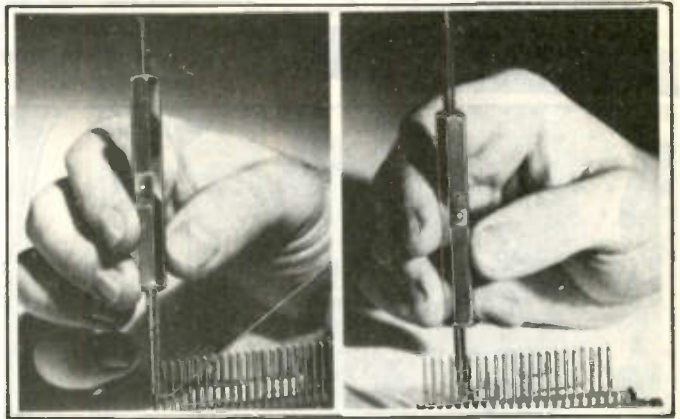

A basic wrap tool, such as OK's WSU-30 allows the user to wrap and unwrap connections with ease. The built-in wire stripper is seen in the middle of the tool in both photographs above.



# WIRE-WRAP

jects available for the hobbyist to build. One can literally build her or his own microcomputer from scratch these days, and the complexity of the circuitry involved dictates that the medium upon which the circuit is constructed be flexible enough to allow rearrangement of components and connections as modifications (and yes, sometimes mistakes) are made, yet it must be rigid enough to allow the circuit to be put to practical use. Let's face it—the days of the electronics project as a conversation piece are almost gone. Today's hobbyist builds for more pragmatic reasons, and

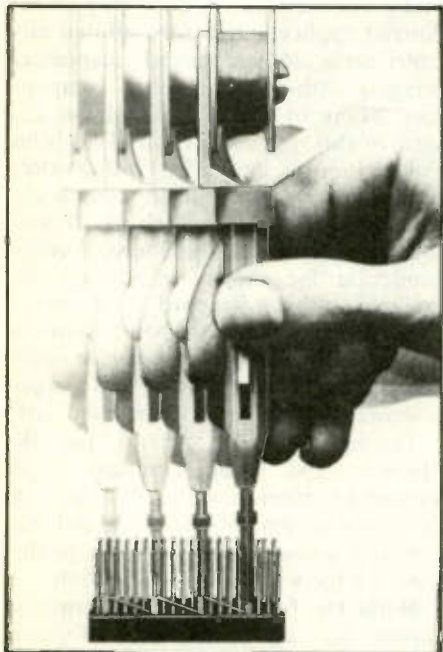

If you're willing to spend a few more dollars for convenience, OK's "Just Wrap" tool has a built-in wire dispenser, allowing for one-handed operation.

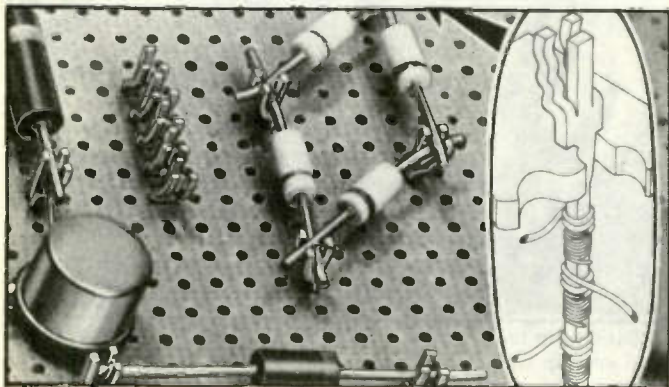

A further improvement upon the basic terminal is the "Klip-wrap"™ type, which can accommodate up to three component leads on top of the board, the wrapped wire connection underneath the board. These are used on the larger, unetched perforated matrix boards.

it has become necessary to apply the latest technology to keep up with the demands of the hobbyist builder. Therein lie the advantages of wire-wrapping.

**What You'll Need.** The basics you'll require for wire-wrapping are: the wrapping tool, wire (usually the wrapping tools can accommodate anything

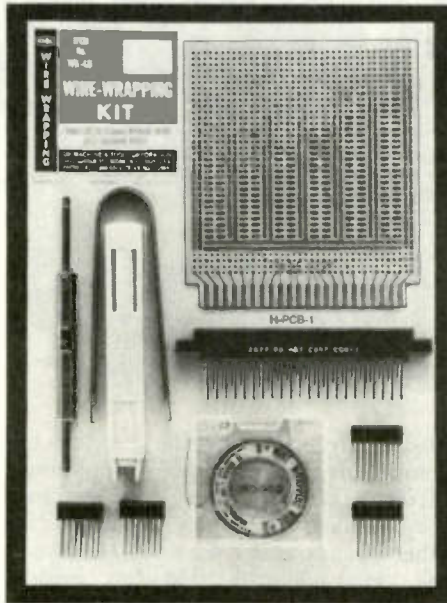

A good starter kit is OK's WK-4B, which contains all you'll need to begin to execute your projects in wire-wrapped formats. Make sure the terminals you buy are the correct diameter for your boards' holes.

from #22 to #30 gauge insulated wire), a perforated matrix board, and the terminal posts upon which to wrap both component leads and interconnecting leads (meaning jumpers).

A basic wrapping tool, such as OK's WSU-30, allows the user to strip insulation from the wire, wrap connections with one end, and unwrap connections (just as quickly) with the other end. As you can see from the photos, connections between terminals are made by

stopping the wrap on one terminal, stretching the unbroken wire to another terminal, and then wrapping again. As your proficiency increases, you'll find that this process can take less than a second, and that you'll be producing the kind of tight mechanical connection that can stand by itself or take solder just as easily. (Everyone who has ever read about or been instructed on proper solder techniques has heard about the necessity for a "good mechanical connection" underlying the solder joint. There is no better example of that connection than a wire-wrapped junction.)

The base for your wire-wrapped circuitry can be as simple as a regular, perforated phenolic board, or something as esoteric as an epoxy/glass copper-clad board. The simpler perforated boards require that you merely insert wire-wrap terminals at the points where component leads meet on the board, and then simply wire up the junctions. Some of the more expensive boards available (and there are none in the hobbyist category that would be considered prohibitively expensive even for the most budget-minded builder)

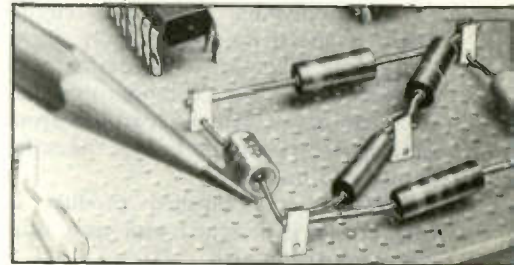

Vector offers push-in flea clips which are extremely suitable for pre-wrap circuit testing. They can be crimped and soldered for permanent use as well.

have staggered hole spacing which can accommodate the DIP (dual in-line package) pin spacing required for integrated circuits (or IC sockets) at certain areas on the boards.

**Some Nice Touches.** Additionally, there are many specialized board designs available for computer-type circuitry, with special end terminal accessories for mating with standard ribbon connectors and/or PC card 44-pin edge connectors. For breadboarding peripheral circuitry for home computers, wire-wrap construction offers the unique advantage of having all junctions exposed and accessible for signal tracing and logic testing with probes. Any of you who have ever attempted to force a



probe tip into a standard solderless breadboard hole in order to trace a pulse will no doubt appreciate this.

The more complex copper-clad boards which we referred to earlier also allow the builder to create "hybrid" circuit boards, utilizing the copper traces for standard printed circuit assembly of some components, while still being able to insert terminals through

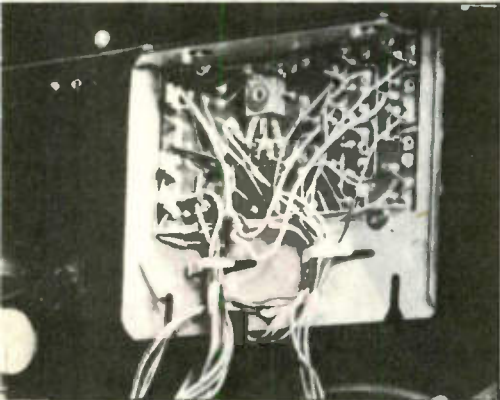

The high-voltage circuit board of this mid-1960's TV shows the use of wire-wrapped terminals combined with printed circuits. This type of hybrid can be built using the type of matrix boards seen on this page.

the same holes or busses for the flexibility of rapid changeover of certain other components. This allows for much experimentation with differing component values without having to rip up an entire board, (something of a nuisance if the circuit is a functional, in-use item already installed in a cabinet or another piece equipment) while still maintaining the physical integrity of the circuit's other connections.

**Where to Get Them.** If the possibilities we've presented here appeal to you, then by all means do some further investigating on your own, either at your local electronics supplier, or by contacting the manufacturers directly. OK Machine and Tool Company, one of the largest hobby supplier of wire-wrapping tools and accessories, has a free catalog available, which can be had by writing them at: 3455 Conner St., Brooklyn, NY 10475, or by circling number 40 on the reader service coupon. A listing of one of the widest assortments of matrix boards available to the hobbyist can be obtained by writing to: Vector Electronics Company, 12460 Gladstone Avenue, Sylmar, CA 91342, or by circling number 79 on the reader service card. ■



If you decide to go into wire-wrapping in a big way, a battery-operated wrapping tool can be a real time and work-saver. Interchangeable bits accommodate all wire sizes commonly used for wire-wrap construction.

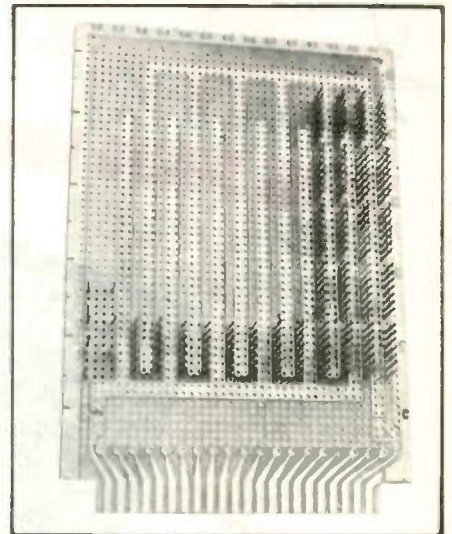

This Plugboard™ (model 3682-4) has etched copper bus strips for soldering as well as holes for wire-wrap terminals. This allows you to build rugged, yet flexible circuitry for virtually any electronic application.

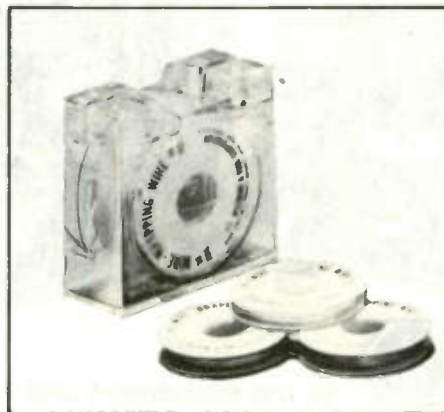

Buying your wire in a dispenser will keep it handy and always ready for use. Some dispensers have built-in cut/strip mechanisms, which make them all the more useful. Most types of dispensers are refillable.

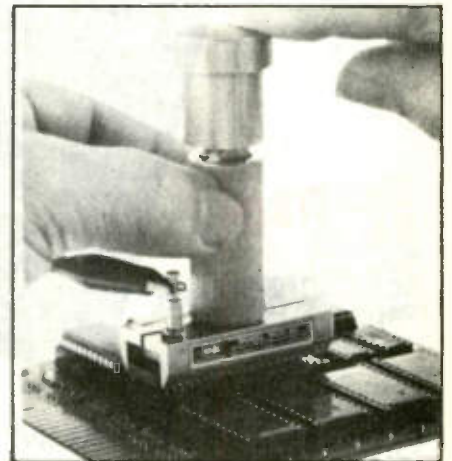

For safe and sure removal of delicate CMOS (as well as other types) ICs, an insertion tool is recommended. OK's MOS-40 has a lug for grounding the tool, this prevents damage caused by static electrical charges.

Vector's "Any DIP"™ Plugboard is designed specifically for S-100 microcomputer accessory circuitry. It comes complete with a built-on heatsink for power supply voltage regulator chips.

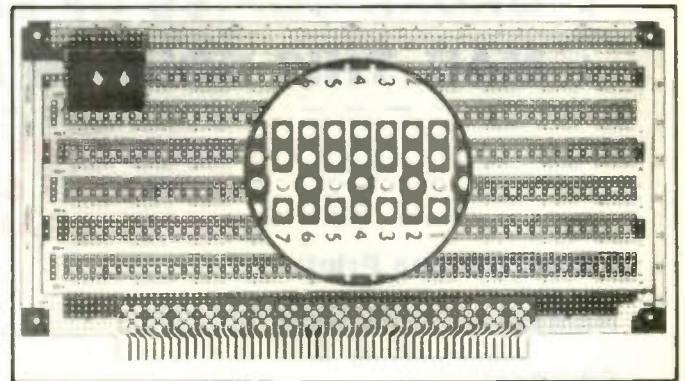



Get switched on

# THE FUN WAY TO LEARN ELECTRONICS

Lab Test  
C&E HOBBY  
HANDBOOKS  
For Yourself



**LEARN ABOUT ELECTRONICS:**  
Electricity and Magnetism,  
Inductance and Capacitance

**NEWEST SOLID STATE TECHNIQUES:**  
Thermistors, Op Amps,  
IC Learning Aids

**SECRETS OF RADIO:**  
Phase and Frequency Facts,  
AVC, Superhet Circuitry,  
Power Supplies, Antennas

**ALL ABOUT COMMUNICATIONS:**  
Low Frequencies, FM, TV,  
Microwaves, Satellites

"PLUG IN"  to the excitement and satisfaction of

## C&E HOBBY HANDBOOKS

- ★ RESERVE YOUR COPIES OF FUTURE ISSUES...
- ★ ORDER COPIES OF BACK ISSUES...
- ★ MAIL THIS COUPON FOR DETAILS...

**TO: WORLDWIDE PUBLICATIONS INC.**  
**P.O. BOX # 5206**  
**NORTH BRANCH, N.J. 08876**

EH-85

**FROM: (Please Print)**

**Name:** \_\_\_\_\_

**Address:** \_\_\_\_\_

**City & State:** \_\_\_\_\_ **Zip:** \_\_\_\_\_



# One-Tube Regenerative Receiver

Build this broadcast receiver from the early days of radio

**M**ANY EXPERIMENTERS NEW to electronics have never worked with tubes. This is unfortunate because while transistors don't require large amounts of power, and ICs can cram huge circuits into dust grains, the vacuum tube has an aesthetic advantage over solid state components. In addition, the tube's elements are physically large and the principles involved are simpler and easier to understand. So, here is a one-tube broadcast band regenerative receiver project. The finished radio is much superior to the beginner's crystal set, yet is not much more difficult to build. It only requires a modest antenna (20 feet or so) and a good ground to perform well. Incidentally, the circuit is a real oldtimer. Lee De Forest and E. H. Armstrong simultaneously discovered it around 1912, and were involved in a long patent dispute over it.

**Theory.** For those of you who don't remember those two gentlemen, I'm going to give a bit of theory about vacuum tubes and this particular radio. I apologize to those of you who are well versed on these subjects, and beg your indulgence.

The simplest tube is a diode (di-two, ode-element), which is a hairpin of tungsten wire surrounded by a cylindrical metal tube. Both are sealed in a glass bulb from which all the air has been pumped. Connecting a battery across the *filament* wire causes it to glow red hot (much like an ordinary incandescent lamp) and the electrons in the wire are given enough energy to boil off into the vacuum.

If a battery's plus terminal is connected to the metal cylinder (the *plate*) and its minus terminal is connected to the filament, a current of these electrons (electrons have a negative charge) will flow through this plate circuit. *No* current, however, will flow if the plate battery is connected backwards, because electrons cannot leave the plate's surface (see Fig.1). Although

this diode will function as a rectifier (one-way valve) or as a rudimentary radio detector, it is good for little else.

Around 1906, Lee De Forest changed this by adding a small twist of wire in between the filament and the plate. This *grid* can be used to control a large power (in the plate circuit) with a small power (in the grid circuit). Here's how: putting a negative voltage on the grid diminishes the plate current, because electrons traveling from filament to plate are repelled by the electrons sitting on the grid. Remember, like charges repel; see Fig. 2. There's a smooth relationship; many electrons on the grid cause a very weak plate current, or  $I_p$ , and only a few sitting there allow a stronger plate current. Figure 3 is a graph of just such a relationship. In this case, no plate current flows when the grid voltage is negative seven volts. Of course, the tube (a triode) is still a rectifier, but now it amplifies, too!

Okay, first diode, then triode, now radio: our simple receiver consists of a tuner, a radio frequency (or RF) amplifier, a detector, and an audio amp.

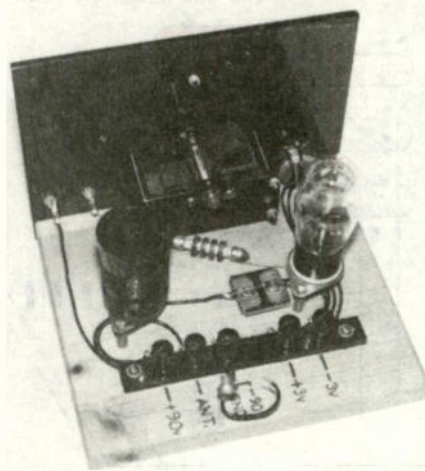

All of the receiver's components are mounted in full view on the spacious rear board.

Our versatile tube is both detector and amplifier. The tuner is the parallel combination of L2 and C1. Here's the scheme: many different RF signals exist at the antenna input (see Fig. 4), and are coupled to L2 through the antenna coil, L1. The LC tuner (L2 and C1) looks like a short circuit for all frequencies but one, and this one is sent through C2 and R1 to the grid of V1. They make V1 act like a detector by fixing it so two signals appear: the rapidly varying RF signal (1 MHz or so) and a slowly changing audio signal (200 to 5000 cycles or so). Pretending for a moment that R2 is fully shorting L3, we see electrons flowing from ground, through V1, where they pick up the two signals in an amplified form, and then flow either through C3 to ground or through L4, the earphones. The 90 volt plate battery (which supplies all the electrons' energy) and thence to ground. Note, however, that the RF signal goes through C3 because that capacitor is too small to pass the low audio frequencies, and conversely the audio travels through L4 (an *RF choke*), which presents an open circuit to the high radio frequencies. Thus an amplified version of the audio that was once impressed on the RF carrier wave appears in the earphones.

So, what's L3 for? Well, I wasn't telling the whole truth when I said our LC tuner selected only *one* frequency. It tuned in on *mostly* one frequency, but some others sneaked in, too. The width of this tuning curve (see Fig. 5) determines the selectivity, or station selection ability of our radio. This bandwidth, depends on the Q, or quality factor, of the LC combination. A high-Q circuit has thick wires, no energy losses, and consequently a sharp tuning curve. Unfortunately, the Q of our L2, C1 combination is low, and *that's* why a small amount of RF energy in the plate circuit has to be fed (via L3) back into the grid circuit to account for



# One-Tube Receiver

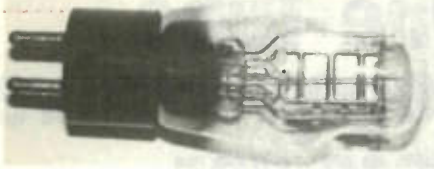

While a Type 30 tube was used in the author's set, any tube in the table is good.

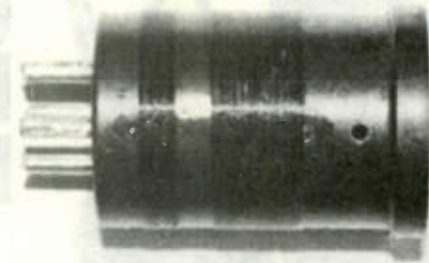

Coil forms such as this one are becoming rare items, so you may have to substitute.

energy losses there.

Feeding more and more energy back (turn R2 clockwise) forces the Q sky high, along with the selectivity. The RF amplification increases, too. When we feed more energy into the tuner than is lost, the tube starts oscillating, or producing its own RF signal, at the frequency the tuner is set for. This is undesirable, because it distorts the signals and reduces the set's gain. Obviously, the best setting for R2 is where the tube almost oscillates (see Fig. 6). Now that some of the fundamentals are clear, we discuss next building a real live regenerative receiver.

## Triode Type Tubes

Remarks	Tube type	Filament Voltage
4 pin	199, 299	3 V
4 pin	201-A, 301-A	5 V
4 pin	30	3 V
5 pin	227, 327	2.5 V AC
8 pin octal	1LH4	1.5 V
8 pin octal	1G4GT	1.5 V
8 pin octal	1H4GT	1.5 V
8 pin octal	6C5	6.3 V AC
8 pin octal	1/2 6SN7	6.3 V AC
8 pin octal	6J5	6.3 V AC

This table gives a list of the tubes that may be used in the regenerative receiver.

**Finding the Parts.** Unfortunately, few electronics shops stock battery tubes (some don't stock any tubes at all!) so here are some hints: a type 30 tube (called for in the parts list) is not necessary. Any of the tubes in the tubetable could be used, but just be sure to use the right filament voltage and the right pin diagrams when you wire. Obviously you will need an appropriate socket, and you may have to up the plate voltage on some tubes to obtain

sufficient regeneration. Those tubes marked AC can use alternating current for their filaments because the actual electron emitter is a metal sleeve (called a cathode) insulated from the filament. Without it, hum would be too loud. These types will, of course, use DC as well, but to save the batteries, you would use a transformer to run the filament, and connect the cathode to top of L3 and to R2.

Enough about tubes. Plug in coil forms are hard to find (I don't know if they're still made) but they can be had if you scrounge enough. More on that later. You can salvage the coil wire from an old power transformer by pulling the laminations apart and unwinding the core—number 30 wire is about sewing thread size. The wire, along with the tuning capacitor, earphones, dials and tube sockets, came from my junk box, but any of these items could be purchased commercially (note: don't try to use low impedance hi-fi earphones or the crystal type, either. These won't work). Any wood will do for the base (pine is easy to work with) and the front panel doesn't have to be fancy black plastic: plywood, fiber-

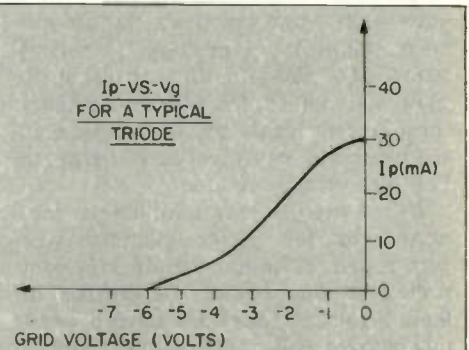
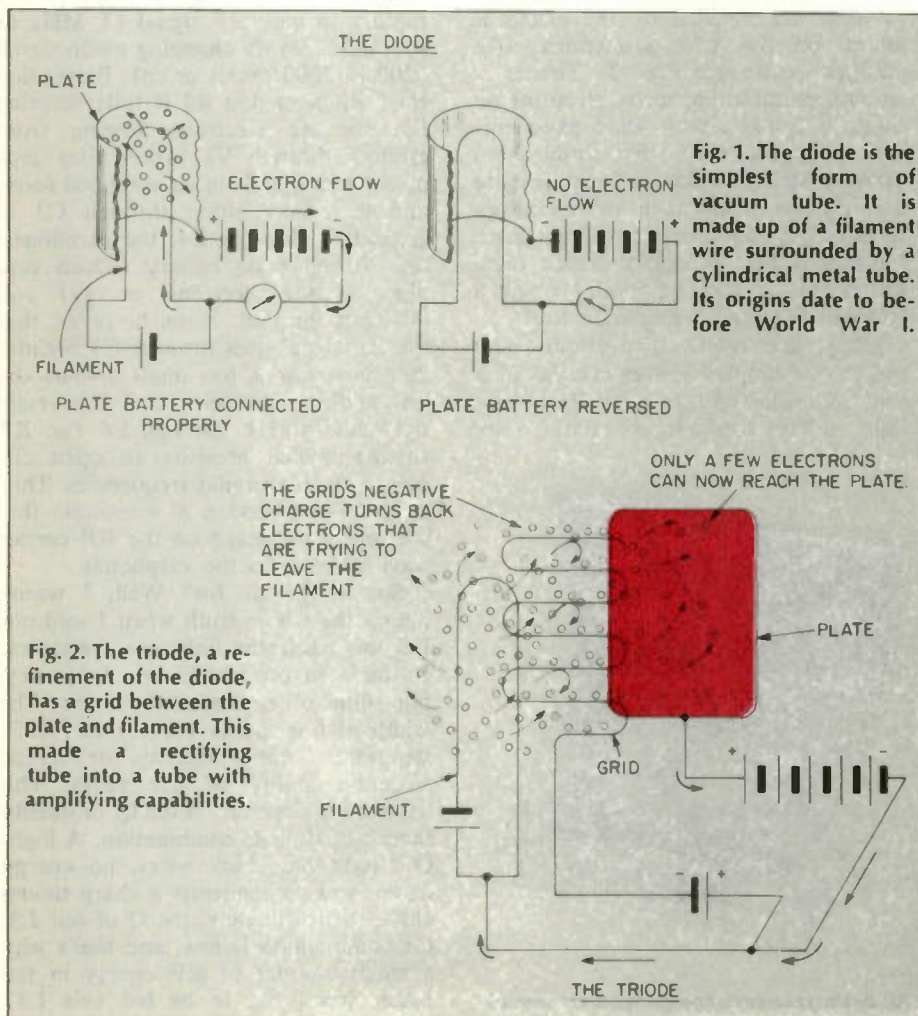

**Fig. 3.** This graph shows the relationship between the grid voltage and plate current.



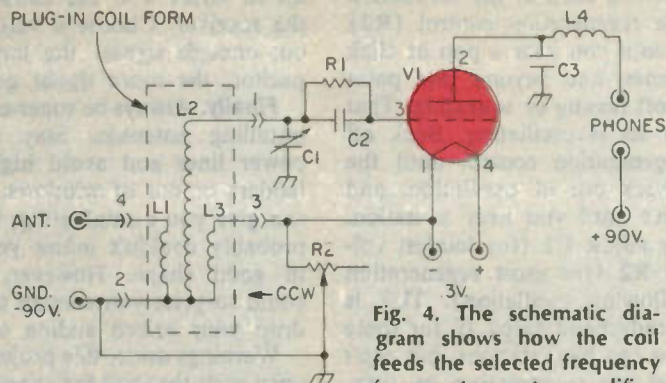

Fig. 4. The schematic diagram shows how the coil feeds the selected frequency from antenna to amplifier.

**PARTS LIST FOR REGENERATIVE RECEIVER**

- C1—350 pF, variable capacitor
- C2—250 pF, mica capacitor
- C3—470 pF, disc ceramic capacitor
- L1—11 turns, No. 30 enameled wire, close wound on 1½-inch coil form
- L2—55 turns, same construction parameters as L1
- L3—12 turns, same construction parameters as L1
- L4—2.5 mH RF choke
- R1—2,000,000-ohm resistor, ½ watt, 10%

- R2—1,000-ohm variable resistor, ½ watt or more
- V1—type 30 vacuum tube or similar, see Tube Table
- Misc.—Wood base 7-in. x 8-in. x ¾-in., black acrylic front panel 8-in. x 6-in. x ¼-in., 1 large knob, 1 small knob, 7 binding posts, 14 prong plug-in coil form, No. 30 enameled wire, hook-up wire, 2 sockets (4 pin), 4 spacers (¾ inch long), wood screws, machine screws, solder lugs, batteries, ear-phones (hi-Z type), antenna, ground.

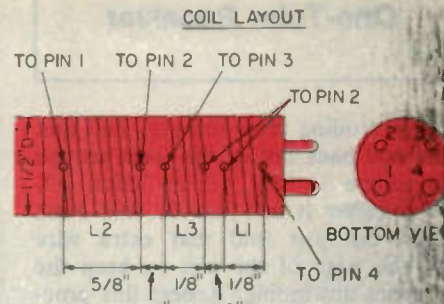

Fig. 7. The coil winding guide shows the wiring configuration of the important coil.  
 L1—11 TURNS #30 ENAMELED WIRE  
 L2—55 TURNS #30 ENAMELED WIRE  
 L3—12 TURNS #30 ENAMELED WIRE  
 NOTE: ALL COILS ARE CLOSE WOUND IN THE SAME DIRECTION.

Fig. 7. The coil winding guide shows the wiring configuration of the important coil.

a strip of plastic, and used the wood screw-spacer technique. Then wire according to the schematic. You probably won't need any tie points, because you can always solder an extra length of wire to a too-short lead, and slip spaghetti over the connection.

Do try to keep the wire between the grid and the C2, R1 combination very short. It tends to pick up noise. Finally, mark each binding post with its proper function.

**Winding the Coil.** As I said before, plug-in coil forms are becoming scarce, so if you can't get one (try to, because it makes the coil winding easier), you can substitute many things in its place. Tissue rollers, wood dowels, plastic tubing, or anything non-metallic will work, and it doesn't have to be exactly 1½-inch in diameter if you're willing to experiment some. If the form is too narrow, you'll have to wind more turns than I've indicated, and if it's wider, less wire will be needed. If you're not sure how much to wind onto L2 (L1 and L3 aren't too critical), wind on extra, because it's easier to remove turns than to add them.

Start by marking and drilling the form as I've indicated (see Fig. 7), proceed by winding the required number of turns. Scrape (using fine sandpaper) the insulation off the end of your wire, run it through the bottom-most hole you drilled on the form, insert and solder it into pin. 4. If your form is plastic, hold the pin in the middle with a pair of pliers to prevent the heat from softening the plastic. Wind 11 turns, clip the wire (leaving enough to make the other connection) and insert it into pin 2, via the hole in the form's side. Don't solder it, but just cut off the wire, leaving about ¼

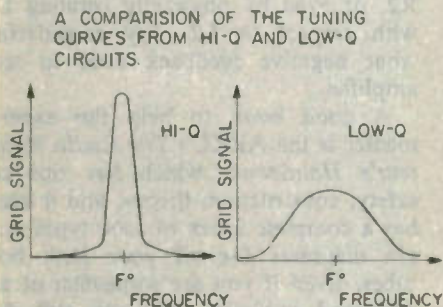

Fig. 5. The width of the tuning curve is the determining factor in set's selectivity.

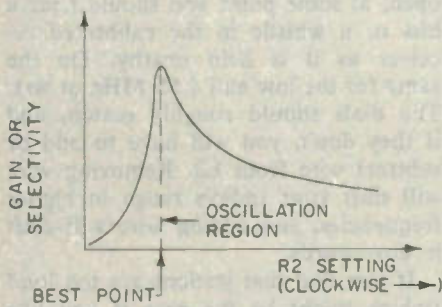

Fig. 6. Too much oscillation is undesirable; R2 must be set to give the minimum.

board or metal would all work. My panel, however, was free, courtesy of the local plastic distributor (they even cut it to size!) and it only took a bit of abrasive paper to clean up the edges. The filament, or A battery, can be anything from number six dry cells to storage batteries to flashlight cells soldered together. The B, or plate battery, is a rather esoteric item, and while some stores still stock them, a substitute might be 9 volt transistor (yuch!) radio batteries soldered in series, or a myriad of worn out flashlight cells. Plate current (Ip) is only about 6 mA.

**Construction.** Now that all the parts are at hand, begin by cutting and finishing the wood base. A quick sanding and a coat of linseed oil or shellac will give it a glossy surface, but avoid paint, as paint often has metallic pigments that could short out connections. Then, mark and drill the front panel to fit your particular way of mounting R2,

C1, and the binding posts for the ear-phones. Some capacitors have threaded holes on their bottoms, so you may have to fashion an L bracket to hold it to the front panel, or mount it from the base using spacers. Drill three holes ⅜-inch up from the bottom of the panel to fasten it to the base. In all cases, be sure to drill slowly and carefully to avoid splitting the plastic as the bit pops through. Drill pilot holes on the front of the base, and screw the front panel on. After mounting C1, R2, and the earphone connectors, mount the knobs and tube sockets. I mounted my sockets by passing a 1¼-inch long wood screw through each of the socket's holes, and slipping a ¾-inch long spacer over each. Then I screwed the whole thing to the base about halfway between the front and the back, to allow room for wiring. At the back edge of the base, mount the binding posts or clips for the batteries, ground, and antenna. Once again, I mounted all the posts on



## One-Tube Receiver

inch protruding from the pin. Pull that same end back out of the form so you can scrape 1/2-inch of insulation off, and re-insert it into pin 2. Still don't solder, but just fold that extra wire over the edge of the pin, to keep the coil from unwinding. Repeat this process for the remaining coils and pins, soldering in pins three and one, and folding two more wires over the edge of pin two. Eventually, you will have three bare wires sticking out of pin two. That's when you can solder them all in place, at once. Finally, add a bit of coil dope to the whole thing to keep it from loosening up and unwinding (clear nail polish works well). Plug the coil into place, and the tube, too, while you're at it.

For those of you who are using a substitute coil form, just run the ends of the windings out of one end of the coil, and secure the coil to the base using L brackets or spacers.

**Operation.** Check the wiring against the schematic for errors. If all looks okay, attach only the filament battery. If you can see it, the tube's filament will glow orange red. If not, re-check the wiring. Don't connect the B battery if there's any chance that 90 volts will wind up across the filament—some of these battery tubes like the 99 are very fragile in this respect. Assuming all looks well, connect earphones, an antenna, and a ground. Finally, connect the B battery; doing this should

cause a decided click in the earphones.

Turn the regeneration control (R2) clockwise until you hear a pop or click in the phones, and beyond that point will be a soft hissing or squealing. That means the set is oscillating. Back off on the regeneration control until the set pops back out of oscillation, and tune around until you hear a station. Alternately adjust C1 (for loudest volume) and R2 (for most regeneration without allowing oscillation). This is where a steady hand helps. If, for some reason, you can hear stations, but can't seem to get any regeneration, by turning R2 back and forth. If the signals are *loudest* when R2 is counter-clockwise, you may have accidentally reversed the leads to L3, producing negative feedback, instead of positive. Try switching the leads.

Now is the time to see if your coil covers the broadcast band properly. Using a calibrated AM receiver set to the high end (1.6 MHz) of the band, make your regenerative radio oscillate, and tune C1 until its plates are mostly open; at some point you should hear a hiss or a whistle in the calibrated receiver as it is held nearby. Do the same for the low end (.55 MHz or so). The dials should roughly match, and if they don't, you will have to add or subtract wire from L2. Removing wire will shift your radio's range to higher frequencies, and adding wire will shift it downwards.

If you find that stations are too loud (which might be the case if you live nearby several transmitters) you can reduce the overload on the RF amp. by inserting a small (10-75 pF) capaci-

tor in series with the antenna lead, at the receiver. Choose a value that cuts out enough signal: the larger the capacitor, the more signal gets through.

**Finally.** Always be super-careful when installing antennas. Stay away from power lines and avoid high dives off ladders or out of windows. B batteries can give you a small sting, but 90 volts probably couldn't injure you if you're in good shape. However, that sting could surprise you enough to make you drop your prized audion to the floor.

Warnings aside, this project has many open ends that beg for experimentation: filament current might be varied with a low value (10-20 ohms) rheostat to provide volume control. The antenna coupling could be varied with a 150 pF variable capacitor in series with the antenna lead. Many different triodes are usable, or even tetrodes (double grid tubes) can be used. The coil may be re-wound for other bands, although the value of C1 might have to be lowered. Regeneration can be accomplished by varying C3 and eliminating R2, or even by physically rotating L3 with respect to L2. Try considering what negative feedback does to any amplifier.

A good book to help the experimenter is the ARRL's *The Radio Amateur's Handbook*, which has tips on safety, construction, theory, and it even has a complete index of tube types and pin diagrams for all your junk box tubes. Even if you are somewhat of an advanced hobbyist, you can still delight in an antique technology as you listen to the radio by the glow of your venerable vacuum tube. ■



**Here's GOOD NEWS...** the up-dated  
White's Radio Log is available.  
**Enjoy Your Radio Hobby**

AN UP-TO-DATE DIRECTORY OF NORTH AMERICAN  
AM, FM AND TV STATIONS INCLUDING A SPECIAL  
SECTION ON WORLD-WIDE SHORTWAVE STATIONS

Only \$6.35 (ppd)  
**SEND FOR YOUR  
COPY TODAY!**

CLIP AND MAIL COUPON TODAY TO:

**WORLDWIDE PUBLICATIONS INC.**

P.O. BOX #5206, NORTH BRANCH, N.J. 08876

NAME: \_\_\_\_\_

ADDRESS: \_\_\_\_\_

CITY: \_\_\_\_\_

STATE: \_\_\_\_\_ ZIP: \_\_\_\_\_



ONE OF THE PROBLEMS you're likely to encounter as you expand your personal computer system is finding sufficient RS-232 serial outputs. Most small computers provide either no serial outputs, or just one; although there might be relatively expensive add-on serial interfaces available.

For example, the Heathkit H-8 computer is normally supplied with one serial output for a CRT control terminal. If you want to use a serial printing terminal, you must disconnect the CRT and substitute the printing terminal. Either that, or you have to purchase a relatively expensive multi-port serial card which permits simultaneous connection of up to four serial devices.

The Radio Shack TRS-80 computer doesn't even have a serial output; it was designed for a parallel printer. With an expansion interface and optional serial I/O, the user winds up with only one serial port left. If both a serial printer and communications modem will be used, it becomes a matter of juggling connections to accommodate each device.

Apple computers accept easy to plug in serial I/O cards, but these aren't cheap. If you want to use two or more serial devices, either you purchase an extra card or it's back to rearranging connections.

The least expensive way to equip your computer with two serial connections—assuming they both won't be needed at the same time—is to provide some form of passive electrical switching. While commercial RS-232 switchers can cost almost as much as a serial interface, you can build a serial switcher for personal computers at a rock-bottom cost using switches and parts easily available at most electronic shops.

You can build the Switcher cheaply because, for most applications, only four (or fewer) connections are used. You don't need a device that can switch all 25 terminals of a D-25 microperipheral connector.

**The Standard.** RS-232 connections are standardized, and were originally intended to accommodate communications via terminal and/or computers through modems and telephone lines. For example, one of the RS-232 connections is called a *ring detector*. If the modem detected a ring, it would signal the associated computer to answer the "call" through the modem.

Another RS-232 connection was intended to be controlled by the incoming signal. If the incoming line signal was too noisy, the modem sig-

naled the computer that "garbage" was coming down the line. Yet another connection signaled the associated computer that the modem was still in a dial-out mode, or had not yet established a communications link with the other end of the circuit.

With only a few exceptions, the RS-232 control signals aren't needed or used by personal computers. In fact, if you're using RS-232 for a printer all you might need are the signal in, signal out, and signal common (ground) connections.

**Common Connections.** In Fig. 1 we show all the RS-232 connections commonly used. The terminal connections are those of a D-25 connector, which is standard for all RS-232 equipment.

You should be able to plug any RS-232 connecting cable into any RS-232 socket. The arrows indicate the direction of signal flow; for example, Terminal 2 labeled TRANSMITTED DATA means the signal from a computer or terminal keyboard. Terminal 3 labeled RECEIVED DATA is signal into the computer or printer.

Think about this for a moment: if you were to connect two terminals together, they could not "talk" to each other because both would be transmitting on Terminal 2 and receiving on Terminal 3. The 2 and 3 connections on one terminal would have to be reversed; i.e., they must be connected to receive from Terminal 2 and transmit on 3.

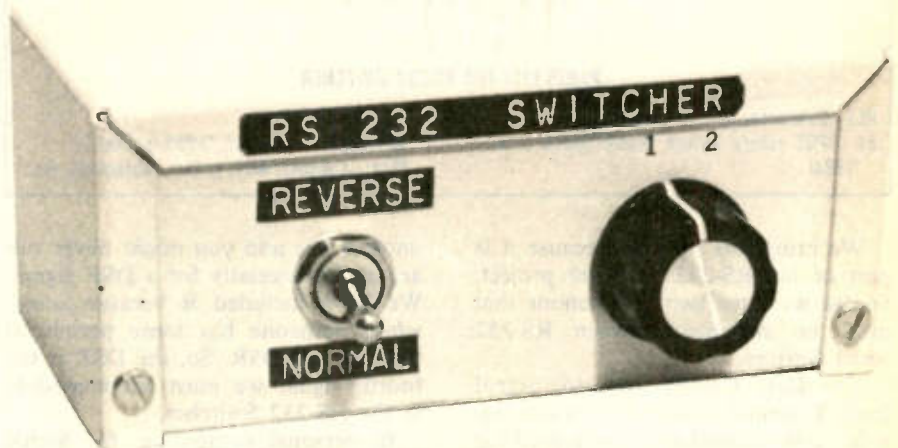

## RS-232 Switcher

Increase available serial ports with this inexpensive, easy-to-build switcher

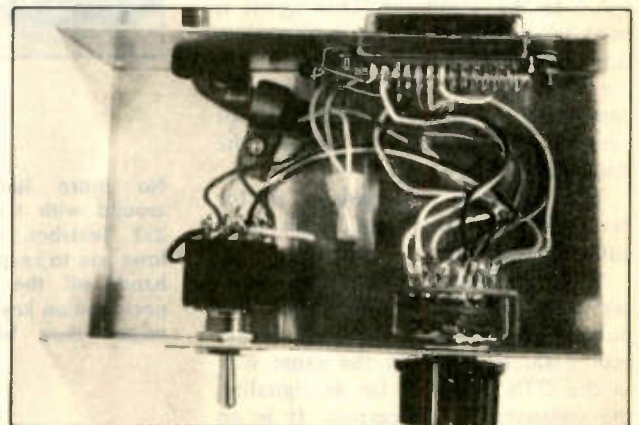

The RS-232 switcher is an easy project to build and use. It has no printed circuit board and very few connections. All you have to do is to connect up a couple of switches to a plug and you are in business. Your TRS-80 will be more useful.



# RS-232 Switcher/This handy device is a life saver when you run out of ports

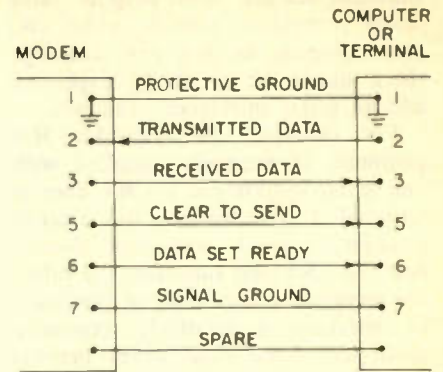
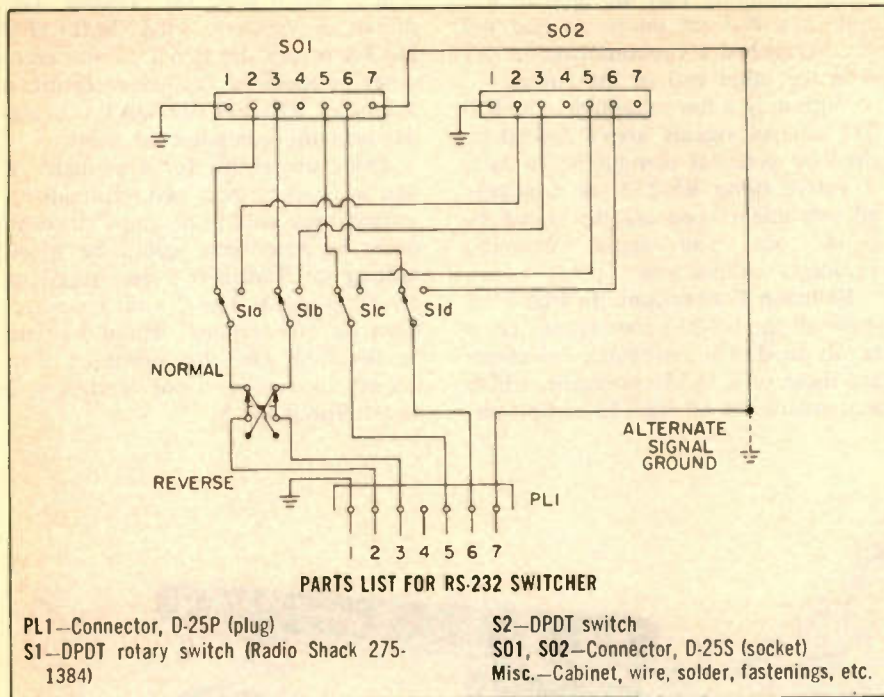

Fig. 1. Connection diagram illustrating how modem is connected to computer or terminal. It's fairly straightforward.

We bring this up now because it is part of the RS-232 Switcher project. So far we have two connections that must be switched between RS-232 serial devices.

The Data Carrier Detector signal from Terminal 8 is one of those signals we mentioned previously used for "communications;" it is almost never needed for personal computing and can be dispensed with.

The Clear To Send, or CTS as it is more often called, flows from Terminal 5 to the computer. This signal is often used by printers and modems to tell the computer that the device is ready to accept data. It is one of the required signals, so it is the third RS-232 signal that we will use.

**Terminal To Computer.** The Data Set Ready, or DSR, flows from Terminal 6 to the computer. This signal is used to indicate that the communications unit, such as a modem, is not in the test, talk, or dial mode and has completed any special timing functions necessary to establish a call on the phone line.

This signal is not used at all for personal computers that don't have auto-dial modems.

Some equipment rebuilders, however, use this line to signal the computer that the printer is ready to accept data. It works in the same way as the CTS signal as far as signaling the computer is concerned. It is an

unusual use and you might never run across the necessity for a DSR signal. We have included it because *some-where* someone has some peripheral that sends a DSR. So, the DSR is the fourth signal we must accommodate in the RS-232 Switcher.

In personal computing, the Signal Ground is often connected to the protective ground. It's not the best of ways to do things, particularly on long cable runs in areas of relatively high electrical noise. Don't be too surprised

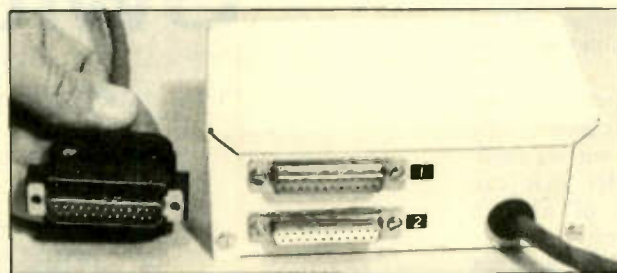

No more fumbling around with the RS-232 Switcher. It allows you to keep your hands off the serial ports and on keyboard where they belong.

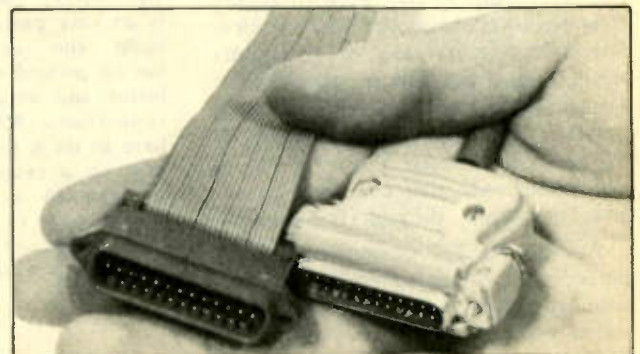

to find that some equipment has only one ground wire.

Two signals we don't show (for clarity) are the Data Terminal Ready, or DTR, and the Ring Indicator, or RI. The DTR (Terminal 20 if used) is a signal to the communications device (modem) to connect to the communications channel (phone line). The RI is a signal from the communications device (modem) that the device is receiving a carrier from a remote data set.

A signal sometimes referred to in articles, but rarely used, is the Request To Send (Terminal 4). It is a signal to the data communication equipment that controls the direction of data transmission. It is not used in personal computing gear at all. If you

*(Continued on page 96)*

Two serial ports are available for use with this switcher. Many home computers only offer one or sometimes no serial output. Instead of having to plug and unplug a port, all that needs to be done is to flip a single switch.



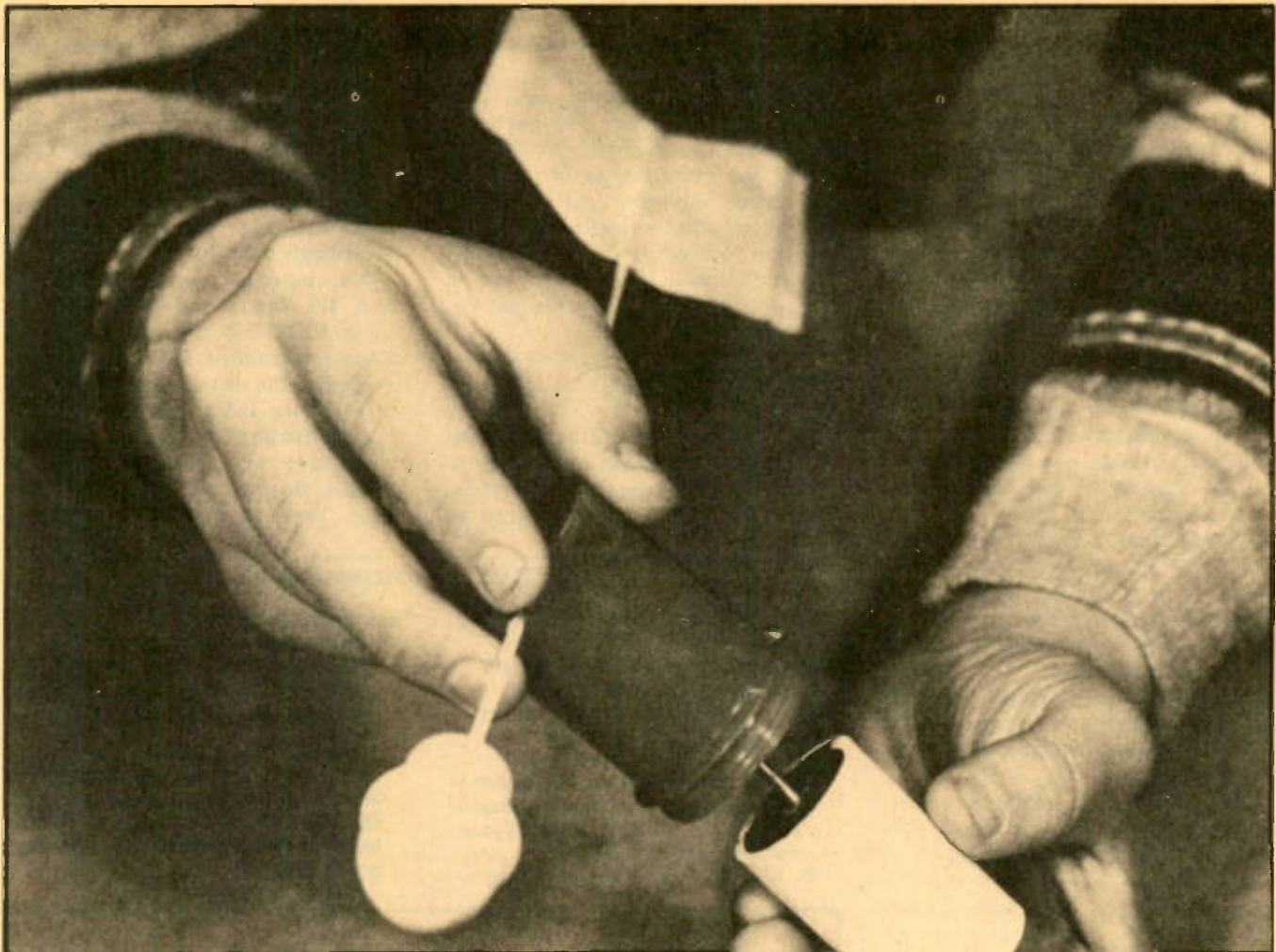

# LED WEATHER VANE

Lets You Know Which Way to Bend With the Breeze

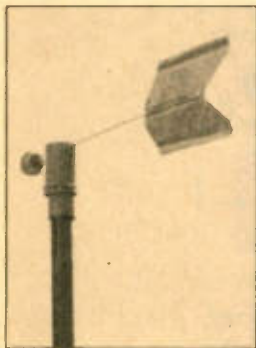

The LED weather vane should be mounted high above a roof and clear of any obstructions that might distort the flow of the wind.

**W**HETHER YOU ARE A PILOT, farmer, sailor, kite flyer or just plain curious about tomorrow's weather so you can go to the beach, this low-cost electronic weather vane will tell you which way the wind blows. All you need are two readily available IC chips, some variable resistors, LEDs, and a handful of junk-box parts to put it together.

By learning how the weather changes with the shifting winds you can learn to predict what is going to happen over your head over the next few hours, rather than trusting that last night's six-o'clock forecast was accurate. We don't have the space to teach you meteorology here, but there

are plenty of books available on that fascinating subject. Or, you can ask an old-time sailor or farmer to tell you some of the tricks of weather watching.

**Wind Direction.** Essentially, measuring the direction of the wind is a simple and ancient process. Although there are a couple of methods (the airsock, so familiar at small airports, and the vane), only the vane is suited for our needs.

A vane is fabricated from a flat sheet of material. A pivot point is selected. The material is cut (or fashioned, as in the case of the weather-cock rooster) so that one surface about the pivot has considerably more



## LED Weather Vane/Tells you which way the wind blows

area than the other.

The vane is placed into the wind. Now as the air strikes the surfaces, a force is developed. A greater force is exerted on the larger area. This imbalance of forces causes the vane to twist, seeking an equilibrium; this occurs when the vane is pointing into the oncoming wind. When people talk about wind direction they always refer to the direction the wind is coming from. In other words a northwest wind is blowing out of the northwest towards the southeast. The weather vane would be pointing northwest. To translate this into usable information a transducer is used.

A transducer converts the outside world into a more appropriate form. For us, a potentiometer is the logical choice. By connecting the vane to the control shaft, it will rotate in accordance to wind direction.

When a voltage is applied across it, the wiper becomes a voltage divider with the resultant voltage relative to the shaft position.

**The Circuit.** But voltage is a very abstract value and in its raw form doesn't lend easily to interpretation of wind direction. So, we incorporate a decoder of sorts. (The two circuits will analyze the voltage as it comes from the sensor; the conversion is merely for our sake.)

The input voltage is converted to a display representative of a compass (the standard used to indicate wind direction). The decoder and display consists of two ladder-type LED driver ICs—the ones so popular with graphic power and tuning displays. U1 and U2 are LM 3914s connected in cascade. They are programmed with a jumper from pins 9 to 11 for dot display.

When a voltage is presented at the input (pin 5), a LED corresponding to that voltage will light. By matching the potentiometer range to that of the display, we represent 16 positions of the shaft, which is the number of compass points associated with wind direction.

Arranging the LEDs in a circle completes the concept, giving us the visual effect of a compass. There are, however, a few not so obvious points about the circuit.

Each IC carries a complement of eight LEDs instead of its capacity of 10. In the case of U1, it was necessary to eliminate the topmost indicator, pin 10. A curious thing occurs

with this device when the input voltage exceeds full scale. The last LED will remain constantly lit. We are cascading the two units to increase the number of indicators and unless additional circuitry is incorporated, this situation would prove intolerable. Two indicators at the same time would be confusing. Eliminating this pin circumvents the problem.

In the case of U2, we want the last LED to light. To understand the reasoning behind this we must look at the potentiometer. The resistance element isn't continuous; it has a break in it. When the wiper reaches this position, the output voltage (input as seen by

the decoder) goes high.

In this situation, the only lamp to light is the last one LED16. What was a problem for the first series of indicators becomes a solution for the upper set. The remaining LEDs are accordingly distributed.

The circuit also has two adjustments to it. R6 controls the input voltage of U2 so LED9 can take over after LED 8 has extinguished. R5 is necessary to overcome the initial voltage required to begin the ladder process.

**Constructing The Sensor.** Since the wind vane will undoubtedly be less familiar than the electronics, let's start there. Begin by obtaining a steel bev-

### PARTS LIST FOR WIND DIRECTION INDICATOR

LED1-LED16—Jumbo, red light emitting diodes  
 R1—22,000-ohm, ½-watt, 10% resistor  
 R2—3,300-ohm, ½-watt, 10% resistor  
 R3, R4—1,000-ohm, ½-watt, 10% resistors  
 R5—200-ohm, trimmer potentiometer  
 R6—1,000-ohm, trimmer potentiometer  
 R7—2,000-ohm precision linear potentiometer, 360-degree-free rotation (Bourns model 6538 or 6638 preferred—next choice Bourns 6537 or 6637).  
 U1, U2—LM 3914 dot/bar display driver in-

tegrated circuit  
 Misc.—cabinet, prescription vial (1½" x 2½"), coat hanger, bezel, beverage can (vane), P.C. board, counterweight, epoxy, hardware, wire, etc.

For information on the availability of parts and/or other material to build this project, send a business-size, self-addressed, stamped envelope to: DANOCINTHS, INC., P.O. BOX #261, WESTLAND, MICHIGAN 48185. Be sure to mention the "Project" by name.

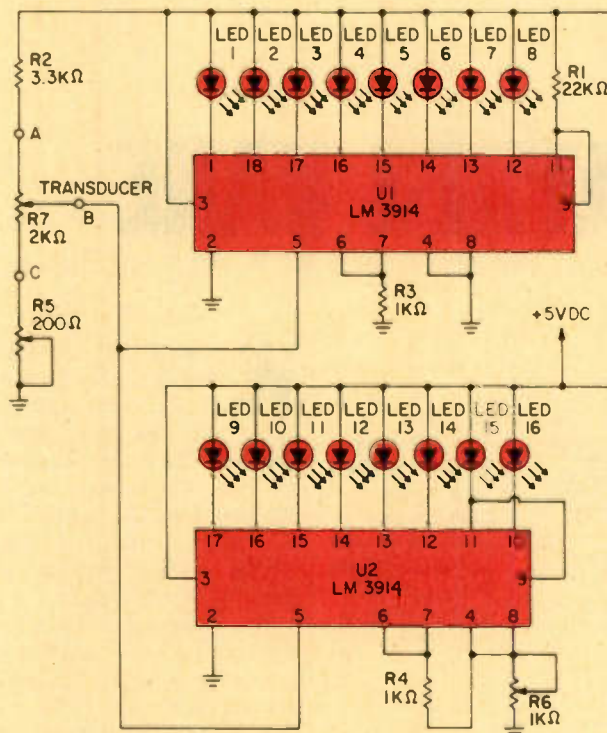



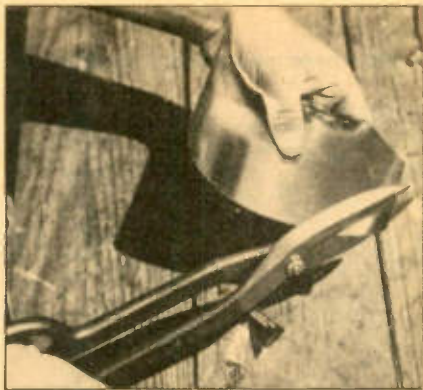

Use tin snips to cut the sheet metal to the appropriate shape (see next page).

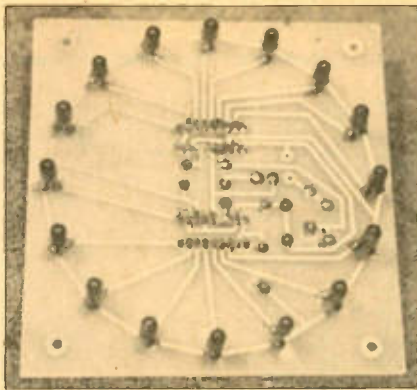

LEDs mount on the foil side of the printed circuit board (see text instructions).

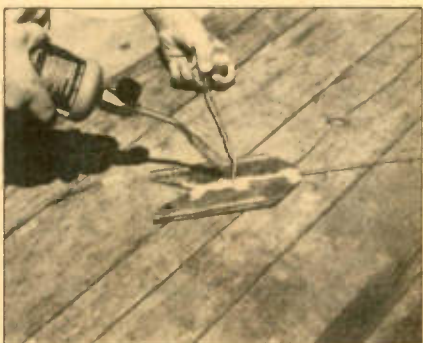

Use a blowtorch to solder the vane to the rod. Beware of dangerous fumes released from the tin plating by heat.

erage can. But be wary, most containers nowadays are aluminum and won't work for our application. However, almost all canned teas come in steel, as do some colas. With an opener, remove the top and bottom; next cut down the seam with a pair of tin snips. Don't attempt to flatten the metal.

Remove the outside edge with the snips, then smooth the metal. Shape the vane according to the template. This isn't a necessary step—merely aesthetic. A rectangle will work equally well.

Rigidity is given to the finished piece by bending three grooves into

the metal. Lay the vane over a thin metal rod along the designated lines and run a piece of wood over it. A notch in the end of the wood will impart a deeper groove.

Cut out a 10-inch section of coat hanger. Remove the paint and solder it to the center groove of the vane. This must be done in a well ventilated area. The stannous fumes are poisonous!! Avoid inhaling any fumes coming from the tin plating, which will vaporize as soon as you apply heat.

A counterweight is necessary to remove lateral pressure from the potentiometer bearing. It can be fabricated in a number of ways; ours is the decorative end from a curtain rod, along with a short piece of coat hanger filled with solder.

Here's where it all comes together. Obtain a plastic prescription vial, one about 1½ inches in diameter by 2½ inches deep. The plastic bottle will serve to keep rain and dirt out of the sensor pot as well as provide a convenient method of assembly.

Drill two 7/64-inch holes near the bottom. Locate them so a single piece of wire will pass through the center, barely clearing the bottom. Drill a hole in the center (1/8 inch of the bottom just large enough to accept the potentiometer shaft. It should be a snug fit. Push the support wires from the vane and counterweight into the side holes and adjust the length of the counterweight until the system is in balance.

**Epoxy It.** Epoxy will hold everything together, but first you must provide the rheostat shaft. Take the drill bit used to make the hole and cover it with a light vegetable oil coating. Place it shank end down into the hole. Line up everything and fill the bottom of the vial with a layer of fast-setting epoxy just thick enough to cover the support wires. Make absolutely sure the drill bit is straight up and down, lest you develop a wobble when the casting is dry.

After the epoxy has set remove the drill. Now, set aside to harden overnight.

The transducer pot is mounted inside a ¼ inch plastic coupling. Let's pause for a moment and examine the sensor pot. It's a special precision pot, in that the resistance element has 340-degrees of electrical contact. An ordinary control has only about 260, maybe 290, degrees of resistance path.

Attach three wires to the potentiometer and seat it into the coupling with silicone adhesive. Avoid getting

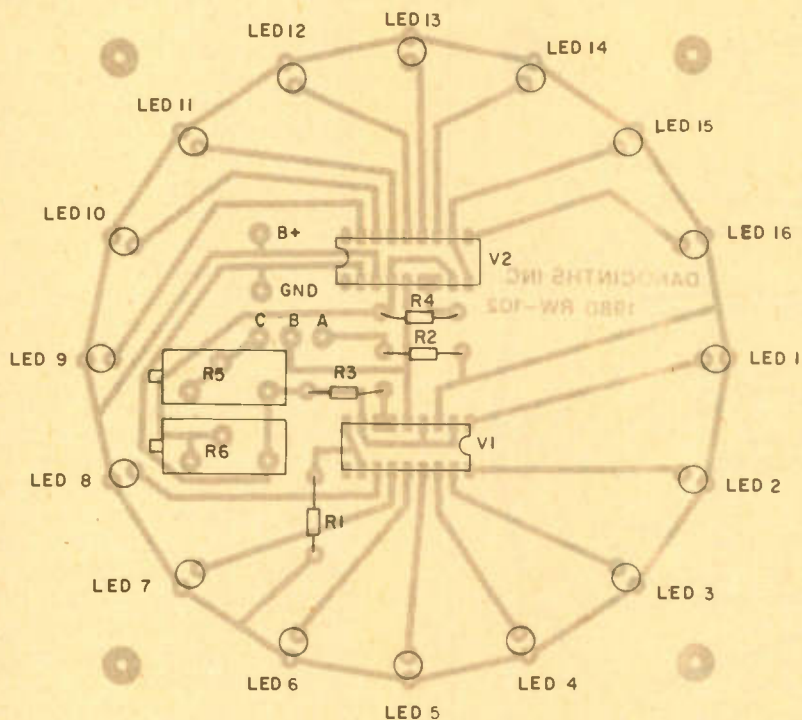

The above diagram shows where the parts are installed on the printed circuit board. Be sure to mount the LEDs on the foil side with cathodes on the outside ring. The flat edges of the LEDs should face the middle of the board.



# LED Weather Vane/Tells you which way the wind blows

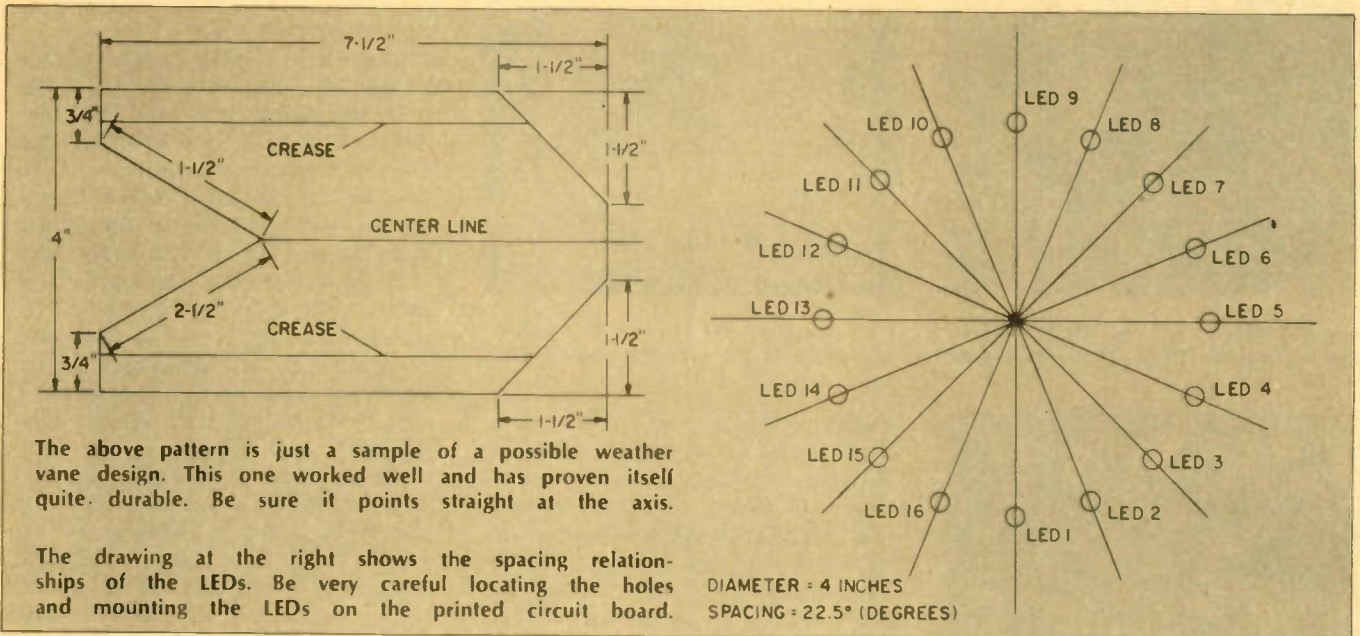

any on the shaft or bearing. The coupling is glued to a section of 3/4 inch water pipe, which becomes the support.

Slip the vane assembly over the pot shaft and glue with Crazy Glue or equivalent. (Here's a hint: Slide the

vane assembly on the shaft and push down all the way. Apply a drop of glue to the exposed shaft and immediately move the assembly upward about 1/4 to 3/8-inch. This eliminates the possibility and frustration of the adhesive running down the shaft and

into the bearing.)

**Assembling The Display.** As previously discussed, we arrange the LEDs in a circle, thus mimicking a compass. We'll start by drilling the required sixteen holes in the cabinet; the reason will become very apparent later when you arrange the indicators.

A full-sized layout of the LED positions is on these pages. Remove (or trace) the template and fasten it to the front panel of the cabinet with tape. With a center punch locate each hole to be drilled. Drill the holes with 13/64-inch bit to accommodate the jumbo LED called for.

Obviously the best way to locate and properly space the LEDs is with a printed circuit board. The LEDs solder to the clad side of the PC board, while the components assume the conventional position. But before soldering in place, read the following.

Since it's highly unlikely you'll be able to eyeball the LEDs into place sufficiently close to match the drilled holes, use this procedure. Begin arranging the LEDs on the board two at a time, LED 1 and LED 9 first (observe polarity). Place the board in the cabinet, adjustments up, and the LEDs into their respective holes. The lamps lead length is adjusted so the base is 1/4-inch from the board.

Gently remove the assembly and without disturbing the relative positions of the indicators, solder them in place. Repeat this procedure, two at a time, until all are secured. You'll

*(Continued on page 96)*

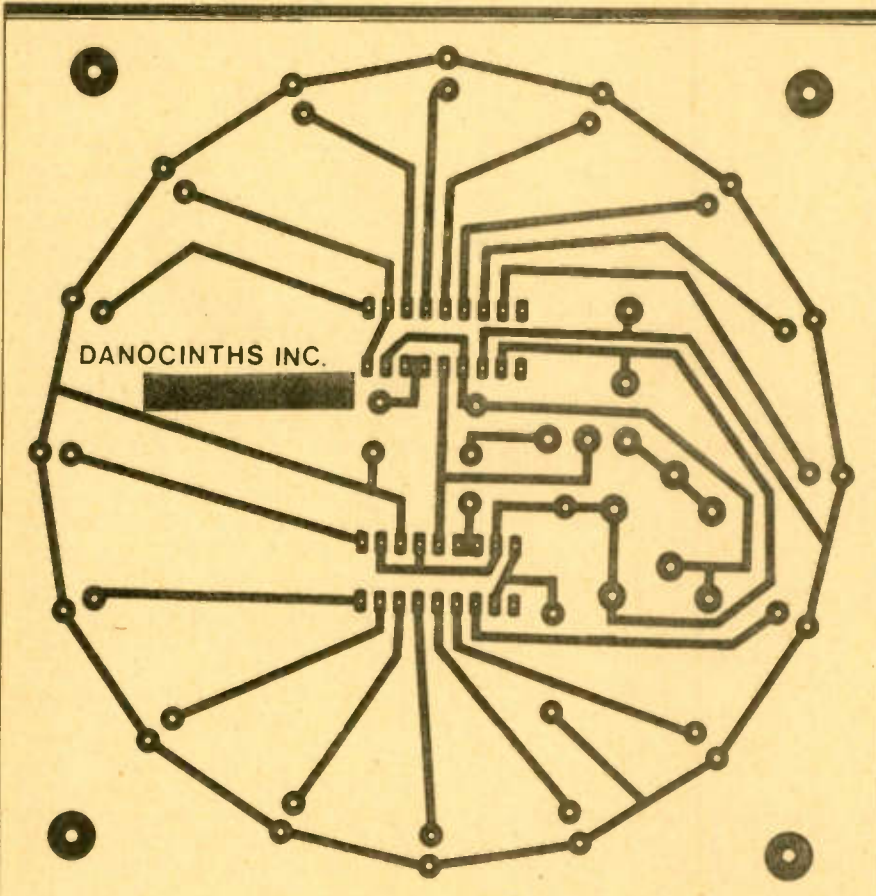



**F**OR MANY CREATURES on this earth, two ears are the norm. The two-eared arrangement does more than allow listening to your mother-in-law and wife at the same time. Thanks to some special neural circuitry (which, among other things, performs phase and magnitude comparisons between left and right ear signals) a two-eared individual can quite accurately tell where a sound is coming from. You know how marvelously well the present system works, but think of the possibilities afforded by a third ear.

Wait a second now, no one is advocating surgery as a hobby (à la Frankenstein). The *Third Ear* in this instance is a versatile, electronic, sound-actuated control system. It can spy on your friends, mind the phone, babysit, thwart would-be burglars and much more. Later on, the *Third Ear's* applications will be explored in detail, but first let's examine its circuit.

**The Circuit.** The heart (better yet, the eardrum) of the *Third Ear* is a tiny module, the ETCO S-210U sound trigger. This little device originally formed the nervous system of an electronic turtle. The species is now extinct, unfortunately, but its innards are available as a great surplus bargain. As you can see from the schematic, the S-210U contains a crystal microphone, a transistor amplifier, and an SCR. The module's black lead goes to the minus side of a battery, while the red and green leads will be shorted together in this application. The shorted leads connect to one side of a low-resistance load (like a relay), and the opposite end of the load goes to battery positive. Sound picked up by the microphone is amplified by the transistor and fed to the SCR's gate. If the sound is sufficiently loud, the SCR latches in a conducting state, thus drawing a relatively large current through the connected load. Power must be removed in order to turn off the device again.

A more versatile system should operate in either of two modes, latch or pulse. After the first triggering impulse of sound, the latch-mode system remains active. A pulse-mode system, on the other hand, remains active only for some pre-determined time interval after triggering. It then returns to its inactive state, where it rests until re-triggering occurs. Then, the process repeats itself.

**Construction.** Adding pulse-mode capability to the S-210U is a simple matter. All it takes is some auxiliary circuitry to sense the latching of the SCR and to unlatch it again after a user-selected time delay. Unlatching an SCR can be accomplished by opening

# the **3**rd **E**ar



## This electronic servant will jump at the snap of your fingers

a switch in series with the anode or closing a switch to short the anode and cathode together. The latter method is the one used in the *Third Ear*, but before getting any further into that, there are a few easy modifications that must first be made to the S-210U.

The pictorial diagram shows the four necessary modifications in detail. First, remove the 5000-ohm trimmer by unsoldering it. This device is unusual in that it has two mounting pins, not three. Wire a 2500-ohm potentiometer in series with a 680-ohm resistor so that the net resistance is a minimum

(680 ohms) when the pot is fully clockwise. The two wires from the pot/resistor combination should be soldered into the holes vacated by the 5000-ohm trimmer. This new pot will function as the *Third Ear's* sensitivity control (with maximum sensitivity in the clockwise position).

The second modification requires that the 0.1-uF disc capacitor in the upper left-hand corner of the S-210U be unsoldered. In the holes vacated by the capacitor, install and solder a jumper of bare, solid hookup wire.

The third step is to cut the red wire



# 3rd EAR

in the lower lefthand corner completely off at the point where it joins the PC board.

Finally, unsolder the 32- $\mu$ F electrolytic capacitor from the board, and replace it with a similar unit having a higher working voltage; 16 VDC or higher. In general, your replacement may have a value anywhere between 22 and 47- $\mu$ F, with 33- $\mu$ F being about optimum. Remember that since you are dealing with electrolytic devices, the orientation must be correct. In the pictorial you can see that capacitor positive (+) must be pointing upward.

Now, let's see how the modified S-210U mates with the rest of the circuitry in our *Third Ear*. As the schematic diagram shows, the green and black leads of the module are its only connections to the external circuitry. Capacitor C2 bypasses the module's supply leads in order to keep the sensitivity high, while R1 isolates C2 to reduce its effects on the performance of the rest of the circuit. Whenever the module's SCR latches into conduction (due to sonic triggering), current will be drawn through relay K1 and the LED1/R2 combination. As a result, the normally open relay contacts will close, and the LED will light simultaneously. These two conditions will persist as long as the SCR remains latched.

Note how switch S3 selects either the normally open (N.O.) or normally closed (N.C.) contacts of K1. This allows a load to be turned on or off, respectively, when the circuit is activated. Diode D1, connected across K1's coil, is normally reverse-biased (not conducting). When the SCR is forced to unlatch, however, K1's coil generates an inductive kickback voltage which could cause trouble if D1 were not there to clip it.

In order to see how unlatching is accomplished, let's assume that the SCR in the module is initially unlatched, and that mode switch S2 is closed in its "pulse" position. Since the SCR is not conducting, the voltage at the green lead of the module must be high (about 7 volts above ground). This potential drives sufficient current through R3, D2 and D3 into the base of transistor Q2 to ensure that Q2's collector is conducting current heavily. This prevents the voltage on C3 from rising, and nothing of interest happens.

Suppose, however, that a sound triggers the module into conduction. The

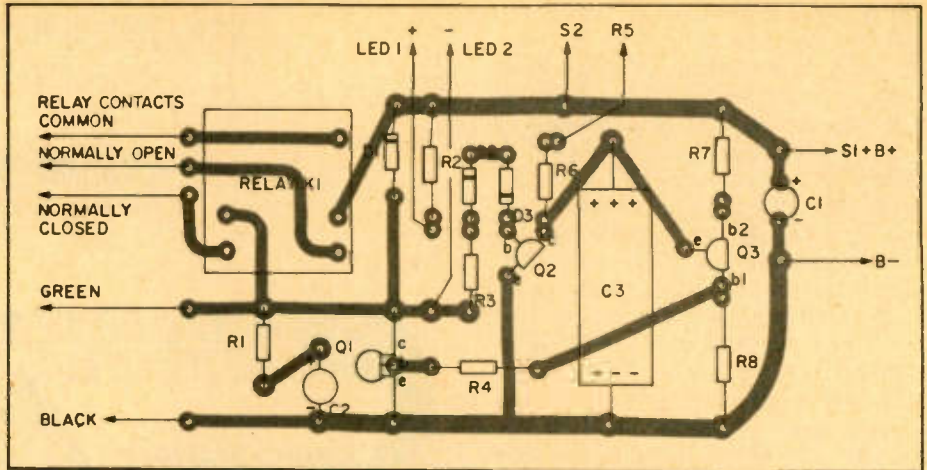

This is the component-side view of the main printed circuit board. The foil pattern is on the reverse side. If your K1 relay has mounting tabs you may have to make some holes.

potential of the green lead drops to less than one volt, which is less than the 2-volt minimum needed to turn on the D2/D3/Q2 combination. Consequently, Q2's collector no longer conducts current, and the potential across capacitor C3 rises as charging occurs through R5 and R6. The rate of ascent is controlled by potentiometer R5; higher resistance causes the potential on C3 to climb more. Eventually, the voltage on C3 will reach a critical level, at which point unijunction transistor Q3's emitter-to-base 1 impedance will break down to a very low level. This rapidly discharges C3 and causes the appearance of a voltage spike across resistor R8.

This voltage spike drives current through R4 into the base of transistor Q1. As a result, Q1's collector conducts current heavily, thus shorting the module's green and black leads together.

This deprives the SCR of anode current, causing it to unlatch. Because the voltage spike lasts only a brief instant, less than 0.1 second, Q1 soon loses base drive and ceases to conduct. When this happens, current can no longer activate K1 or LED1, and both will remain off until another sound triggers the module. As you can see, the circuit has returned to the state it was in at the beginning of this discussion.

If mode switch S2 had been opened to its "latch" position, no current would have been able to flow through R5 and R6 to charge C3. Since the charging of C3 is an essential part of the unlatching process, it is clear that the module would have remained latched indefinitely. In fact, in the latch mode, the only way to reset the circuit to its inactive state is by opening power switch S1 for at least five seconds.

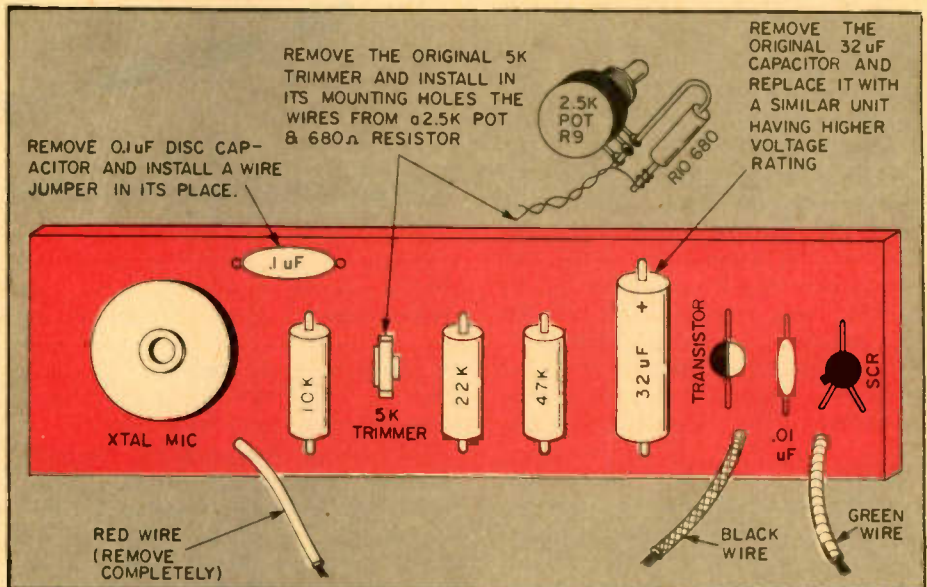

This pictorial diagram shows all the modifications that are needed on the S-210U module. The 32  $\mu$ F capacitor should be replaced by one with a 16-VDC or higher voltage capacity.







# 3rd EAR

thermore, any leakage within C3 will exert yet another influence on the time delay; the leakier the capacitor, the longer the charging time. With this in mind, it is wise to use a new, high-quality electrolytic capacitor for C3.

**Power Supply.** Power for the *Third Ear* comes from five "D" cells in series, yielding 7.5 volts. Electrolytic capacitor C1 keeps the power supply's impedance low. Inactive, the *Third Ear* draws only 2 milliamps, but current consumption jumps to 22 mA when the circuit is active. At these small rates of discharge, "D" cells will last a long time. Some readers might prefer to see the *Third Ear* powered by an AC supply; however, transformers hum at 60 Hz, and the *Third Ear* is sensitive enough to be triggered if a transformer is mounted inside its case. If you want to use an AC supply, a 6- to 9-volt DC unit will work well, but it *must not* be mounted inside the *Third Ear's* case.

**Construction.** Construction is easy because you don't need to worry about the layout; anything will do. A PC board is not absolutely necessary, but if you like to give your projects that professional look, use the PC patterns provided.

You should test LED1's sensitivity before wiring it into the circuit. Bargain LEDs especially may not be sensitive enough to be used here. Hook your LED in series with a 1000-ohm resistor, and connect the combination to a 7.5 VDC source. (Get the polarities right.) If you do not obtain an easily visible red glow, try another LED. Red LEDs are more sensitive than green or yellow ones, so stick with red.

When wiring duration control R5, make sure you obtain maximum resistance in the fully clockwise position. This will then give you a maximum time delay.

When building your *Third Ear*, you

The printed circuit board for The *Third Ear* is easy to make. You can use this template for a photographic copy or just duplicate the pattern with a resist pen.

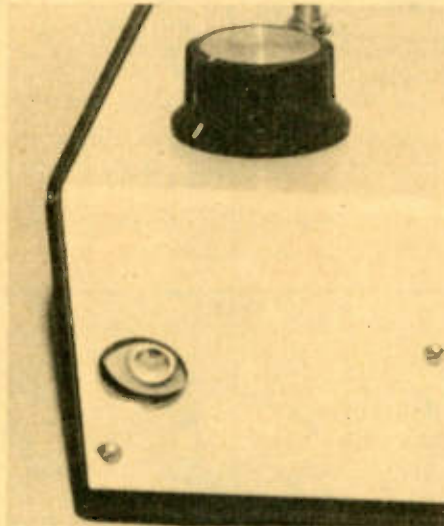
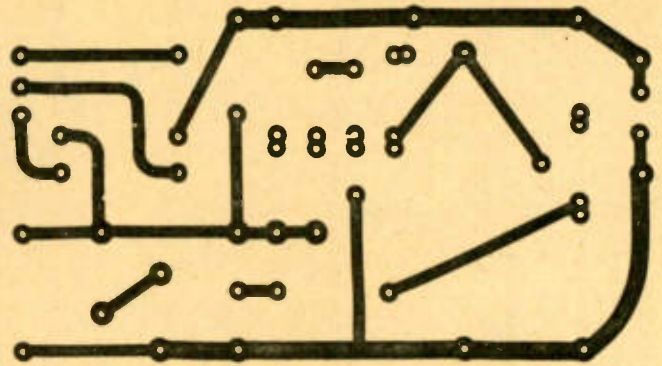

Make a three-quarter-inch diameter hole in the front panel of the cabinet or wherever you want to put the microphone. Adjust the sensitivity so that it triggers correctly.

would be better off with slide switches. When a toggle is snapped quickly, the click of the switch can activate your system, regardless of the sensitivity setting. Slide switches require very little operating force and are practically silent.

The contacts of relay K1 are rated for a load of up to one ampere, which is more than adequate for most applications. Sometimes, however, you may wish to control a high-power load, such as a flood lamp. One method of doing

this would be to substitute a relay with a higher contact rating for K1, but high-current, good-quality relays are expensive. Besides that, all relays arc, especially with high-power loads, so a relay's lifetime under such conditions is limited. A cheaper, better solution is the high-power interface. Note that the triac controls the AC load, but the relay contacts control the triac. In this way, the relay contacts carry only the small gate current of the triac, and your *Third Ear* remains isolated from the AC line (and shock hazards) by the relay. Choose a triac with a current rating high enough for your load, and heat sink it. Mount the triac and heat sink in a well-ventilated plastic case to prevent accidental shocks.

**Checking it Out.** After construction is complete, you should check out the operation of your project. Set your *Third Ear* into the pulse mode, with R5 set for a minimum duration, and sensitivity control R9 placed at the midpoint of its range of rotation. Now, turn on power switch S1. LED1 should flash momentarily as power is applied. Snap your fingers directly in front of the microphone, and note the length of time that LED1 remains lit.

Next, rotate the duration control to maximum. Snap your fingers, and again make a note of how long LED1 stays illuminated.

Finally, turn the power switch off, and flip S2 to the latch mode. After five seconds, re-apply power. Snapping your fingers should now cause the LED to light and stay lit for as long as power is applied. You can do some experimenting with the sensitivity control, too. In the prototype, operation at maximum sensitivity was impossible because even the faintest ambient noise would trigger the circuit.

The applications for the *Third Ear* are only limited to the uses your imagination can find, and with its switching flexibility, it can control almost anything you may wish to operate around the home or office.

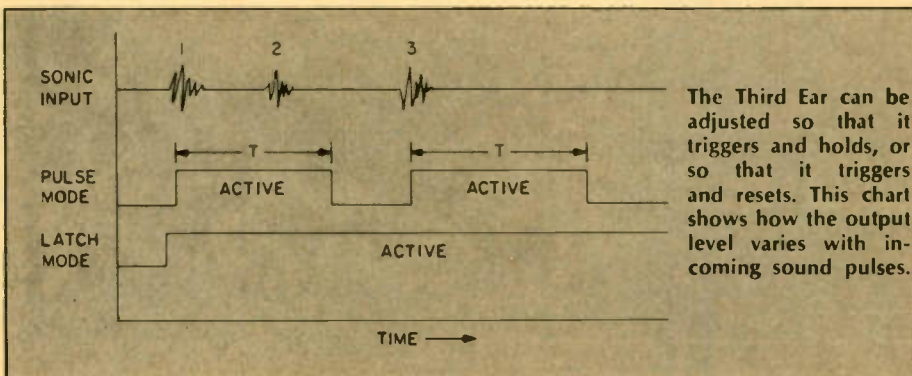



# TELEPHONE IDEAS

Telephone projects are the rage today, because they add features to your telephone system that would normally cost many bucks more from the big Bell. The projects are simple to assemble. A hint: Always restore the phone line or telephone to its original hookup should the project fail to work. This way you will not disconnect your phone service.

## SIGHT-FOR-SOUND PHONE ALARM

The hard-of-hearing may not hear a telephone ring, or a sleeping child should not be awakened by a ringing telephone. This simple Sight-for-Sound Phone Alarm can do the job for you! What rings your telephone is a 20 Hertz AC signal at anywhere from 60 to 120-volts, depending on your phone company. That same bell-ringing signal can be used to light an LED with the circuit shown here, without significantly loading the telephone line. Capacitor C1 provides DC isolation to help foolproof this project. The .1 value shown works, but you may want to increase it to .5 microFarads. Use a mylar capacitor (like the Sprague *Orange Drop* series) rated at 250-450 working volts or more.

Why so high? The telephone company keeps its line clear of ice and other trouble by daily sweeping a pulse of high voltage through the system. Too low a working voltage could mean trouble for them, and that is absolutely the last thing you want to use. We might even suggest connecting to the telephone lines only temporarily to verify circuit operation. This will help avoid accidents and trouble. Diodes D1 through D4 act as a full-wave bridge to deliver the AC ringing voltage as DC to LED1. Series resistor R1 limits this current through the circuit. If the LED1 glows too brightly, you can reduce the intensity by slightly increasing the resistance of R1.

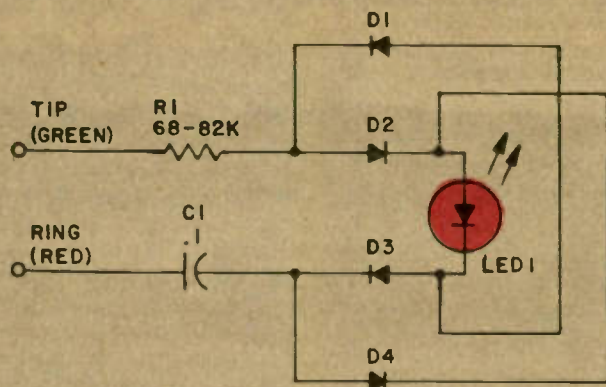

### PARTS LIST FOR SIGHT-FOR-SOUND PHONE ALARM

- C1—.1- $\mu$ F 100-WVDC capacitor
- D1, D2, D3, D4—Diode, 1N914 or equivalent
- LED1—Light emitting diode, any color
- R1—82,000-ohm,  $\frac{1}{2}$ -watt, 10% resistor



# TELEPHONE VOICE PICKUP

□ You can pick up and amplify the voice signals from your telephone by using this simple IC circuit and a small pickup coil. The circuit has sufficient output to drive a loudspeaker. One section of a quad op amp is used as a high-gain voltage amplifier. This increases the relatively low output of the pickup coil (a few millivolts) to a

sufficient level to drive the loudspeaker. The circuit draws about 60 milliamperes from a 12 volt power source. You can purchase a ready made pickup coil or construct one yourself using about 200 turns of fine enamel wire wound around an iron core. Place the pickup near the telephone receiver for best results.

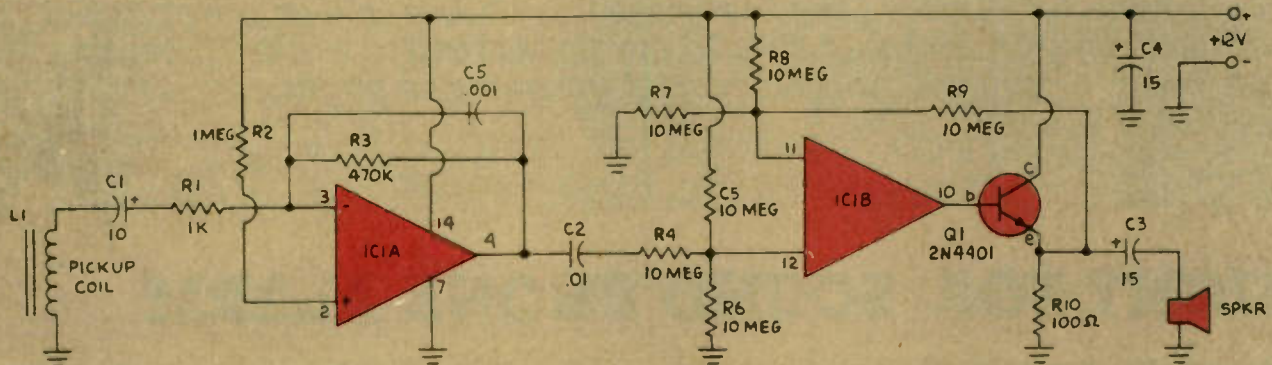

## PARTS LIST FOR TELEPHONE VOICE PICKUP

**C1**—10-uF, 25-WVDC electrolytic capacitor

**C2**—0.01-uF, 15-WVDC ceramic disc capacitor

**C3, C4**—15-uF, 15-WVDC electrolytic capacitor

**C5**—.001-uF, 15-WVDC ceramic disc capacitor

**IC1**—3900 quad amplifier

**L1**—Inductance pickup coil (see text)

**Q1**—2N4401

**R1**—1000-ohm, ½-watt 10% resistor

**R2, R4**—1,000,000-ohm, ½-watt 10%

resistor

**R3**—470,000-ohm, ½-watt 10% resistor

**R5, R6, R7, R8, R9**—10,000,00-ohm, ½-watt 10% resistor

**R10**—100-ohm, ½-watt 10% resistor

**SPKR**—8-ohm PM type speaker

# HI-Z 'PHONE BOOSTER

Quite often the audio output from small, home-brew projects is just barely sufficient to produce a recognizable signal in standard experimenter magnetic earphones. Yet a handful of surplus components will provide enough gain to turn that

whisper sound into a roar.

Specifically intended for use with magnetic earphones of from 1000 to 5000 ohms impedance, the HI-Z 'Phone Booster can do double-duty as an audio signal tracer. Transistor Q1 can be any PNP of the

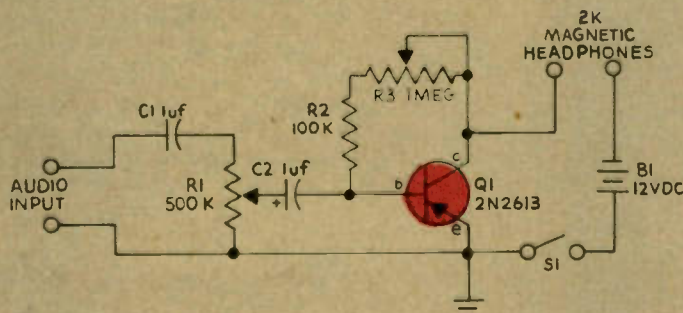

## PARTS LIST FOR HI-Z 'PHONE BOOSTER

**B1**—Battery, 12 volts (two RCA VS068 in series or equivalent)

**C1**—0.1-uF capacitor, 15-WVDC or better

**C2**—1-uF electrolytic capacitor, 15-WVDC or better

**Q1**—PNP transistor, 2N2613 or equivalent

**R1**—500,000-ohm audio taper potentiometer

**R2**—100,000-ohm, ½-watt, 10% resistor

**R3**—1-Megohm potentiometer, any taper will do







**N**O MATTER WHAT TIME OF YEAR it may be, from the arctic blasts of a Buffalo winter to the swelter of St. Louis in August, you've probably had the unfortunate experience of having your car's engine overheat. Whether it's due to a malfunctioning water pump, a broken fan belt, frozen coolant, or a leaky radiator hose, the bottom line is that it's one All-American pain in the neck when it happens. Regular and thorough automotive maintenance will prevent this most of the time. However, when the unexpected happens, a temperature gauge can forewarn you of impending disaster—and possible engine damage, *before* the engine overheats.

It's unfortunate that most car manufacturers do not see fit to offer gauge packages (except at outrageous optional prices) on their vehicles. The few that do, offer mostly uncalibrated units which are no more helpful than a dummy light—they tell you only that you're *in* trouble, not that you're *about* to be. The following is our answer to this dilemma.

**Features.** This relatively simple and inexpensive temperature gauge offers three-place digital readout of Fahrenheit temperatures in the car's engine from a low of 0° to a high of about 250° (well above where your engine is likely to start melting). About the only type of engine with which this gauge may not work would be the small, 4-cylinder diesels now found in Volkswagens and some other imports. These engines normally operate at higher temperatures than gasoline engines, and may have an effective heat range outside the limits of this gauge. Check with your dealer or manufacturer for the nominal operating temperatures of your car's engine just to make sure.

Use of our gauge will not interfere with factory-installed gauges or dummy lights, and we suggest that they be retained as a back-up system. In addition, our gauge is easy on energy, with a maximum current consumption of 160 mA or less.

**Circuit Operation.** Spike protection (spikes result from turning inductive devices on and off) for the LM340T-5 (U1) is provided by capacitor C1 and diodes D1 and D2. Transients ("noise") on the 5-volt line are suppressed by capacitor C2 and the LM340T-5.

A positive potential between pins 11 (+) and 10 (-) of U2 is converted by the CA3162E into a BCD (binary coded decimal) output which reflects that difference. The CA3161E is the control element that actuates the 7-segment display. For an example of a typical cycle of switching action, assume that the display is displaying "2."

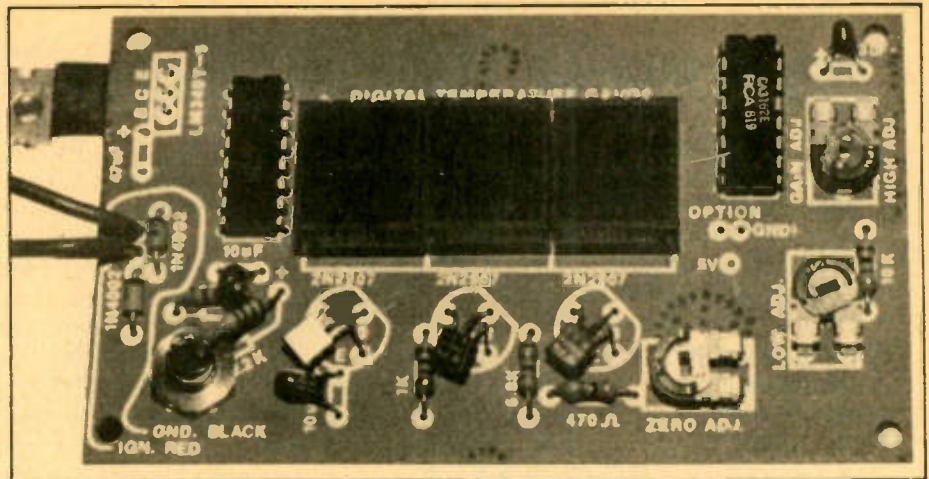

# Dashboard Digital Temperature Gauge

This is the 1's place or least significant digit. The instant pin 5 activates the PNP switching transistor of the least significant digit, the BCD for "2" is generated in the CA3162E. The BCD code leaves pins 2, 1, 15, and 16, and enters pins 7, 1, 2, and 6 of the CA3161E decoder driver (U3). The CA3161E then takes that BCD code and activates (lights) those segments of the 7-segment display forming a "2." In reality, an optical illusion is being created for the eye. At any given time, only one display (digit) is actually on. Because of the brain's image retention of the eye's sensing capacity, all displays appear to be on simultaneously. The same cyclic sequence occurs with the two remaining displays.

As a final note on operations, we should touch on the matter of cyclic conversions or comparisons made each second (note the point marked OPTION on the schematic). With the OPTION point left disconnected, the comparison (or display update rate) is set at 4 Hz. We feel that this is probably the most pleasing to the eye and the least distracting. With the OPTION point grounded, the comparison rate goes up to 96 Hz. The result of this is that the display will appear to be unstable as the numbers fluctuate at the more rapid rate. As a result, and depending upon where in the line of the driver's vision the gauge is mounted, it may tend to be a distraction. This is the common bugaboo with

all digital gauges, especially tachometers and speedometers, which can undergo rapid changes in readout as data input from the engine changes. Experiment yourself, but you'll probably agree that the 4 Hz rate is decidedly the most attractive of the two choices.

**Sensing Probe Operation.** The response to temperature change of a silicon diode is linear as it reflects a rise or fall. As the temperature rises across the diode's PN junction, the forward voltage developed across it drops. This would make it seem that diodes could be interchanged with no effect on readings. Unfortunately, such is not the case. While the rise and fall responses to temperature changes are for all practical purposes uniformly linear, the *base starting points are not*. Because of this, *calibration must be repeated* if the sensing probe diode is replaced.

Note that resistors R1 and R2 form a voltage divider network that has a one-volt (approximate) drop across R2. The one-volt is dropped across R3 and R7 in series with the temperature-sensing diode (the probe). The latter two resistors limit the current to the temperature-sensing diode. The forward voltage drop that is developed across the temperature-sensing diode is now applied to the negative input terminal, pin 10 of U2. As the temperature rises, the forward voltage drops linearly. The inversion resulting from the rise or fall is compensated for by applying the forward voltage to the negative input,



# Temperature Gauge

which is pin 10 of U2:

Let's illustrate the action described in the preceding paragraph. Assume for each degree of Fahrenheit change there is a corresponding 1.0 mV change. Assume, also, that at 32° F, there is a 0.55-volt or 550 mV forward voltage drop. The CA3162E (U2) "looks" at the positive input (pin 11) and the negative input (pin 10), and then generates a BCD code reflecting that difference, transmitting this to the display by means of the CA3161E (U3). If the positive input, pin 11, is 32 mV greater than the negative input, pin 10, or reads a total of 582 mV, then the CA3162E will

"see" a difference of 32 mV and the 7-segment displays will display "032." As the temperature increases, the difference becomes wider. At 212° F, the voltage at the negative input would be 370 mV. Therefore, the voltage difference between pin 11 (positive) and pin 10 (negative) would be 212 (582 mV - 370 mV = 212° F). Since the tolerances of diodes tend to vary somewhat, we have only stated an approximate maximum reading range for our temperature gauge. The temperature at which your gauge will cease to function linearly will be determined by the quality of the individual diode used in the construction of the probe.

**Assembly.** After etching your PC board, (or receiving one from Digital World) check the finished product for foil bridges and other imperfections

which might create difficulty during assembly and calibration. Leaving installation of U2 and U3 for later, install all other components on the board, following the component placement guide. Be sure to observe polarity with respect to diodes, electrolytic and tantalum capacitors and the LED displays. Make sure that when J1 is installed, the outer shell is given a good ground by soldering it to the large foil area on the board.

We strongly suggest that you make use of IC sockets when installing U2 and U3. These two chips are highly sensitive to static electrical damage caused by handling without insulated tweezers. In addition, stray AC from the tip of your soldering iron (not to mention excessive heat) can also cause irreparable damage to the chips.

With all components installed, make a final check of the board against the component layout diagram as a precaution. If the final check is positive, proceed to wire in the 2 leads for the 12-volt power source. The unit is now ready for calibration.

**Probe Assembly.** As mentioned earlier, the probe itself is simply a 1N4002 diode which is wired across one end of a length of RG58A/U coaxial cable. Check the diagram to obtain proper diode polarity and for details on its construction. Be certain that you have a length of cable that is sufficient to pass through the firewall and reach the point at which you are planning to install the gauge. You should avoid having to splice the coax at any point to add length. Moisture entering under the outer insulator of the coax will cause rapid deterioration and result in inaccurate or erratic temperature readings from the gauge.

Obtain a new intake manifold bolt (or stud) from your automotive dealer or parts supply house. Placing the bolt carefully in a bench vise (take care not to damage the threads), drill a 5/16-inch diameter hole down the center of the bolt, stopping 1/8-inch from the bottom. Solder the diode's anode to the center conductor, and the cathode to the braided shield (see diagram). Now, mix the epoxy that will be used to anchor the probe in the hole. Use of a slow-setting type will allow you more time in setting the depth of the probe.

Now attach one terminal of an ohmmeter to both the shield and the center conductor of the coax at the free (gauge) end. Ground the other ohmmeter terminal to the bolt. You will use the ohmmeter to make certain that the soldered diode connections do not contact the sides of the bolt hole, creating an unwanted short.

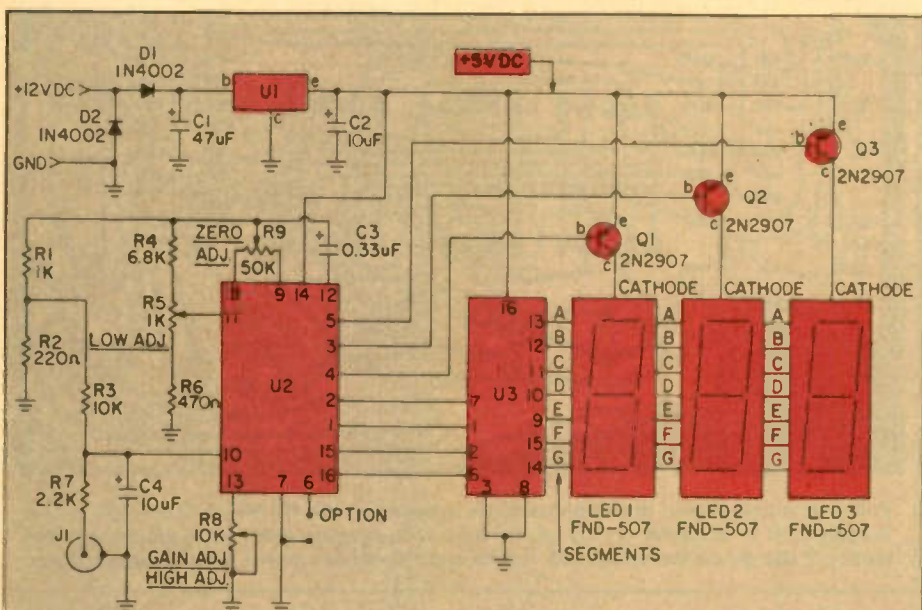

## PARTS LIST FOR DIGITAL TEMPERATURE GAUGE

- C1—47-µF, 25-VDC electrolytic capacitor
- C2, C4—10-µF, 16-VDC tantalum capacitor
- C3—0.33-µF, 35-VDC tantalum capacitor
- D1, D2, D3—1N4002 diode
- J1—RCA-type phono jack
- LED1, 2, 3—FND-507 7-segment, common cathode display
- P1—RCA-type phono plug
- Q1, Q2, Q3—2N2907 PNP transistor
- Note: All resistors rated ¼-watt, 5% tolerance unless noted otherwise.
- R1—1,000-ohms
- R2—220-ohms
- R3—10,000-ohms
- R4—6,800-ohms
- R5—1,000-ohm trimmer potentiometer
- R6—470-ohms

- R7—2,200-ohms (see note below)
- R8—10,000-ohm trimmer potentiometer
- R9—50,000-ohm trimmer potentiometer
- U1—LM340T-5 voltage regulator integrated circuit
- U2—CA3162E dual slope/dual speed BCD encoder
- U3—CA3161E BCD decoder/display driver

Misc.—5 to 10-foot length of RG58A/U coaxial cable, epoxy glue, red plexiglass stock, solder, spacers, hookup wire, replacement intake manifold bolt for probe assembly (obtainable from your new car dealer), etc.

Note: During the calibration procedure, it may be impossible to calibrate for the high end unless the value of R7 is lowered to 1,500-ohms, or even 1,000-ohms. Select the highest value of resistance for R7 that allows full scale calibration (212° F).

For information on the availability and prices on parts and printed-circuit board for this project write to Digital World, P.O. Box 5508, Augusta, GA 30906. Be sure to enclose a business-size, stamped, self-addressed envelope.



Fill the hole halfway with the epoxy mixture. Some of this will be forced out as the probe is inserted, but it can be wiped away easily. Force the probe all the way in until it stops. At this point, the ohmmeter should be showing a completed circuit. Gently begin withdrawing the probe until the ohmmeter shows that the circuit is broken. Secure the coax in this position until the epoxy sets, continuing to check to see that there is no reading on the ohmmeter. Let the assembly dry for at least 24-hours before checking once again to see that the probe is not in contact with the bolt. If the process is successful, you may now proceed with the installation of the probe on the manifold.

If, due to the design of your car's manifold (or a reluctance on your part to remove a manifold bolt) you do not wish to follow the recommended installation procedure, we can suggest an alternative. Simply secure the probe to the side of the engine block with the epoxy. Prepare the area first with a thorough cleansing before applying the epoxy. Apply a coat of epoxy sufficient to coat the metal entirely within the intended installation area. Allow this to set until very tacky. Next, observing the same anti-short procedures as described above, embed the diode in the semi-hard epoxy, and cover with more epoxy to completely enclose the probe and coax end in it.

While this method is obviously the easier of the two, you will experience some loss of sensitivity and accuracy (we estimate somewhere between 5 and 10%, depending upon how close you can get the diode to the engine wall without creating electrical contact). Whether you accept the trade-off between accuracy and ease of installation is up to you, and should be determined primarily by your degree of mechanical expertise. If you doubt your ability to remove, modify and re-install the manifold bolt, have someone else do it for you, or else use the external attachment.

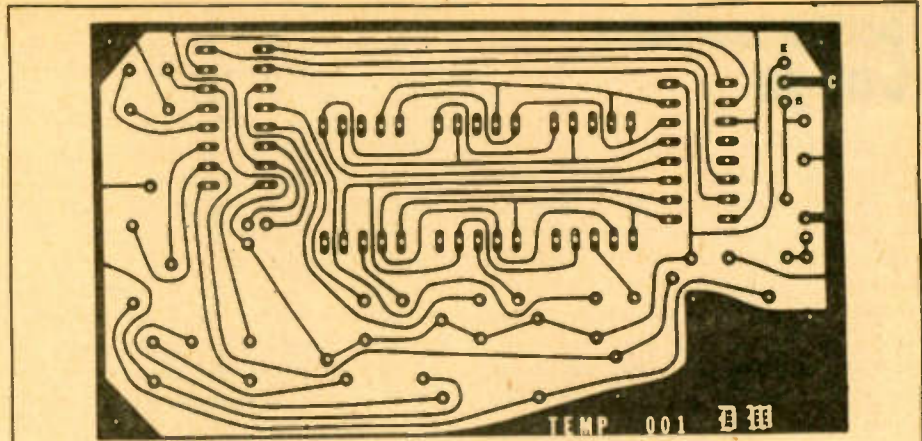

Here is the full-scale etching template for the printed circuit board. See the parts list for ordering information on a ready-to-go board if you don't etch your own.

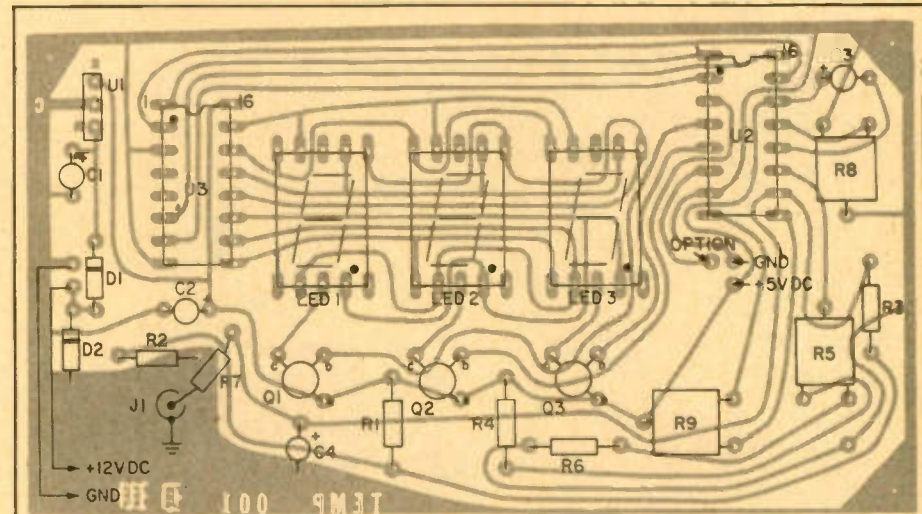

Follow this component layout guide when assembling the PC board. Note that in this diagram, U1 is installed on top of the board. Depending upon your space requirements, it can go on top or bottom, but be careful not to reverse the pin connections.

**Troubleshooting.** As an initial check prior to calibration, apply a DC voltage of between 10 and 16-volts (preferably 13.8-VDC) to the power input of the gauge, after having connected the probe to the gauge via J1. You should obtain some reading on the dis-

plays, and all three should be lit. If this is not the case, and all displays are unlit, check the connections to the power source, and check to see that R9's wiper is centered. Furthermore, check to see that all components have been installed properly on the board

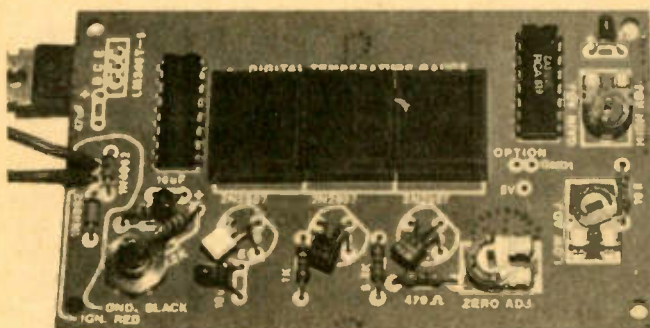

This photo shows the completed board ready for installation in a car. Jack J1 may be reversed for flush mounting on the dash.

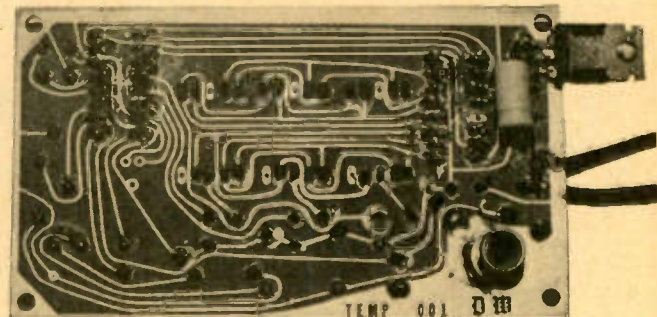

The foil side of the completed board shows U1 mounted from the underside. If pins are reversed, U2 and U3 will be ruined.



# Temperature Gauge

with respect to polarity, especially D1 and D2. Improper orientation here will prevent power from reaching the rest of the circuit. If these steps fail to alleviate the problem, make a physical inspection of the printed circuit board for foil or solder bridges that might be creating shorts. Before removing any solder bridges in and around the ICs, remove the ICs from their sockets to avoid heat and AC current damage.

**Calibration.** Assuming that all bugs have been removed from the circuitry by means of the troubleshooting section (or by virtue of your expertise having obviated the need for troubleshooting in the first place), apply power to the circuit and begin the calibration procedures. At this point, we should note that the accuracy of your gauge will be determined by the degree of calibration exactness that you apply here. Take your time.

To zero the gauge (as you would with a mechanical meter movement),

temporarily ground pins 10 and 11 of U2 to circuit ground, and adjust the wiper of R9 very slowly until all displays read zero. Disconnect the temporary ground on U2. Center the wiper of R8, and place the probe in ice water for a full five minutes (to compensate for thermal inertia). At the end of five minutes, slowly adjust R5 until the display is reading "032."

Next, immerse the probe in boiling water for five minutes, and at the end of this time, adjust R8 for a reading of "212." Of course, this adjustment is made on the basis of the sea level boiling point of water. Check the boiling point for your locality's altitude, and adjust R8 accordingly. Repeat the low and high end adjustments at least once more to compensate for any interaction among the two adjustments. Again, patience here will pay off in a more accurately operating instrument.

**Installation.** Select an appropriate position for the gauge, and install it by whatever convenient means suits your car and the position you have selected. Use a red plexiglass screen across the opening in the cutout for the displays. Red, although it probably doesn't seem logical at first thought, will offer the highest contrast display background.

Next, install the modified manifold bolt (containing the probe) on the cylinder head. Obviously, in order to protect the coax at this point, it should be coiled into a tight loop to avoid putting undue stress on it during rotation. After the bolt has been properly retorqued, route the coax directly away from the engine towards the fender. This will avoid close contact with hot engine parts and high-voltage ignition leads, either of whose presence in close proximity to the coax could cause deleterious effects.

Locate a point in the firewall where accessory wires are passed through grommets to the passenger compartment, and feed the coax through at this point. Should you be unable to locate or utilize existing holes, locate a point on the firewall clear of obstacles both in the engine compartment and passenger compartment (behind the dash) and drill a 3/8-inch hole through. After passing the coax through the hole, apply silicone cement to the area to provide a weatherproof seal. Water has a nasty habit of travelling along lines, through holes, and onto irreplaceable carpets and ruining them if sufficient precautions are not taken.

Trim any excess coax so that it runs to the gauge in as direct a manner as possible from the firewall, and install P1. Plug P1 into jack J1, and connect the power leads (preferably to the horn

fuse for V+, and to a good chassis point for ground).

**Conclusion.** Some of you are no doubt questioning the wisdom of center-drilling so fragile a component as a manifold bolt, especially on older cars, where the original bolts may be either rust or heat-seized. If, when removing the original bolt to replace it with the probe-carrying bolt, you should happen to break the bolt off, do not become alarmed. This happens commonly during carburetor and gasket overhaul and replacement at car dealers and service stations. They are capable of drilling the remaining piece of the bolt out for you quite easily, leaving you free to install the new bolt.

We have selected this method of probe installation to insure the most accurate readings allowable. Other methods, such as insertion of the probe in the coolant itself, would tend to violate the pressure integrity of the car's systems, leaving open the possibility of leakage and fluid loss at a later time. Additionally, encasing the probe in the necessary waterproofing material would result in an unacceptable loss of sensitivity.



Here's a closeup of the probe assembly. Anode is soldered to the coax center wire.

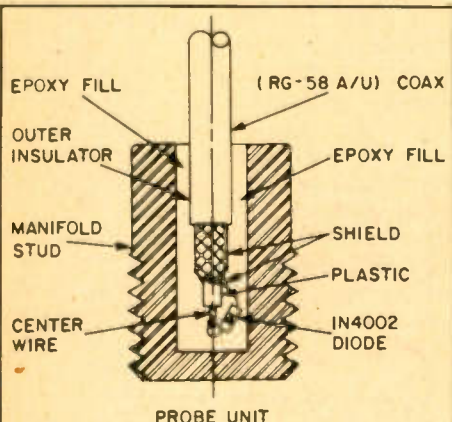

This is a cutaway of the probe assembly mounted in the manifold stud.

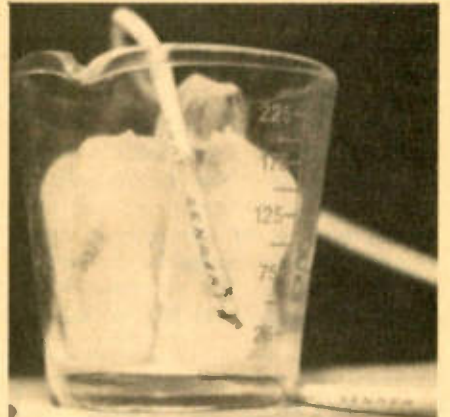

Use a setup like this for the low end calibration of the temperature gauge. See text.



Allow 5 minutes in boiling water to compensate for thermal inertia in the diode.



## RS-232 Switcher

(Continued from page 85)

run across it in some piece of surplus gear, forget about it. Unless you're experimenting with a rather esoteric data communicator, you will probably never run across an RTS signal.

**Building The Switcher.** The RS-232 switcher is assembled in an aluminum cabinet, 5¼ by 3 by 2½ inches. As a general rule, the connecting sockets are "female" (D-25S) and the input cable connector is "male" (D-25P).

Do NOT get this arrangement confused if you have a Radio Shack TRS-80. For some reason, Radio Shack decided the whole world would use their parallel printer, and the serial interface would only be used with a modem having its own "female" connector. So the output plug provided by Radio Shack is "male," instead of the more common "female."

If you want a universal switching unit, assemble it as shown and make up a "female-to-female" D-25 adaptor cable for your TRS-80 computer. (As a matter of interest, when Radio Shack decided to sell D-25 connectors, they sold only the male, which does not mate with their own computer connection.)

Switch S1 can be any type of DP-DT, although to avoid the possibility of damage to some peripherals, it should be *break-before-make*. This means one set of terminals is completely disconnected before the second set is connected. For example, when switching from socket S01 to S02, all

connections from S01 will be opened before S02 is connected.

Do NOT use a *make-before-break* switch, because it would connect S02 before S01 was disconnected. This would result in the devices connected to S01 and S02 being connected together for a brief instant as the switch was operated. Normally this would not create a problem, but the well-known Murphy's Law clearly states that out there *somewhere* are two peripherals that will be totally wiped out if connected together.

Switch S2 is the signal reversing switch mentioned earlier. In the REVERSE mode it takes the signal from Terminal 2 of S01 and S02, puts in on PL1's Terminal 3, and vice versa. It is used when the computer or terminal can function in two different modes.

For example, the TRS-80 serial interface can be used to communicate with a modem (normal connection), or the TRS-80 itself can be used as a terminal. For the TRS-80 to receive at a terminal, it must "see" an arriving signal on Terminal 2, and send it on Terminal 3. This is not the "normal" arrangement. Radio Shack provides a reversing switch inside the expansion interface on the serial interface board.

Unfortunately, in order to operate the switch, the user must disconnect the display, remove four screws and a trap door, move the switch, and reinstall everything. It's easier to have the reversing switch on the RS-232 Switcher—at the very least you don't have to take anything apart.

Connections to S01 and S02 should be No. 20 or 22 solid wire. Try to

avoid the use of stranded wire because a single loose strand too small to be easily seen can short-circuit adjacent terminals. If you must use standard wire, make certain you first twist and tin the ends of the wires. To reduce the possibility of shorts remove no more than ¼-inch insulation

**Wiring Is Critical.** Wiring is somewhat tight, and insulation can be damaged by the soldering iron so the following assembly procedure is suggested. First, connect to S01 and S02, starting with the Terminal 7 and keep the soldering iron on the lower terminal side. For example, when connecting to 7 place the soldering iron between 7 and 6. In this way you won't be reheating a completed connection.

Wire the bottom connector (S02) first, then the wires from S2, then those from S01 (top connector), then the PL1 cable.

The protective grounds from Terminal 1 go to a solder lug under the socket's mounting screw(s). In some installations the protective ground—the wire from the chassis of computer or peripheral—is also used as the signal ground. If so, also connect the Signal Ground, Terminal 7, to the solder lug. If you are using separate protective and signal grounds, twist the Terminal 7 wires from S01, S02, and PL1 together, solder, and insulate the connection with plastic tape.

To use the RS-232 Switcher, just connect everything together and set S2 for NORMAL. If your situation requires reversed signal connections, simply set S2 to REVERSE, and that's all there is to using the RS-232 Switcher. ■

## LED Weather Vane

(Continued from page 80)

notice this gets easier as it goes along!

The power supply is also constructed on a PC board. Transformer T2 mounts on the board. U1 must be provided with a heat sink, since it will supply the current for the readout.

**Wire Wrap.** Wire wrap posts are soldered to the board to supply the voltages. Although we use only the 5-volt line for this particular board, the finished project will require all the sources (notice all but one are regulated).

Ease the completed display board into the mating panel holes. A dab of silicone glue around a couple of the LEDs will secure it in place. The power transformer (T1) mounts to the bottom of the chassis. Along side the

transformer resides the power supply board, which is held in place with plastic circuit board guides fastened to the bottom. Wires interconnecting the voltage sources may be wire wrapped or soldered, as you prefer. A feed through terminal strip attached to the back provides connection to the outside world.

The wind vane is mounted atop a ¾-inch plastic water pipe (schedule 40 or similar) and the wires are channeled through the center. The pipe is then secured with conventional mounting hardware to a convenient location.

The calibration is performed in two steps. With a voltmeter on pin 5 of the IC, rotate the pot so voltage is at a minimum. Now adjust R5 to light LED1. Rotate the control until LED8 just extinguishes. If indicators LED9 through LED16 light during this procedure, ignore them. However, should

the vane rotate the opposite direction of the moving display, reverse the outside leads from the sensor pot.

With LED8 off, adjust R6 until LED9 lights. Further rotation of the potentiometer will consecutively light the remaining lamps until the cross-over point is reached; the gap in the resistive strip. LED16 should light at this point. If the spacing of the indicators seems uneven, you can juggle the value of R2.

Now point the vane due north and rotate the support pipe so that the north indicating LED is lit. Turn it loose and you're in business! ■

## We are winning.

Please support the

 AMERICAN CANCER SOCIETY®



**NRI Trains You At Home—As You Build Your Own IBM-Compatible Computer**

# GET THE KNOW-HOW TO REPAIR EVERY COMPUTER ON THIS PAGE.

## Learn the Basics the NRI Way—and Earn Good Money Troubleshooting Any Brand of Computer

The biggest growth in jobs between now and 1995, according to Department of Labor estimates, will occur in the computer service and repair business, where demand for trained technicians will actually double.

You can cash in on this opportunity—either as a fulltime corporate technician or an independent serviceperson—once you've learned all the basics of computers the NRI way. NRI's practical combination of "reason-why" theory and "hands-on" building skills starts you with the fundamentals of electronics, then guides you through advanced electronic circuitry and on into computer electronics. You also learn to program in BASIC and machine language, the essential languages for troubleshooting and repair.

## You Build—and Keep—a Sanyo MBC-550-2

The vital core of your training is the step-by-step building of the 16-bit Sanyo MBC-550-2 computer. Once you've mastered the details of this state-of-the-art machine, you'll be qualified to service and repair virtually every major brand of computer, plus many popular peripheral and accessory devices.

With NRI training, you learn at your own convenience, in your own home. You set the pace—without classroom pressures, rigid night-school schedules, or wasted time. You build the Sanyo MBC-550-2 from the keyboard up, with your own personal



IBM is a Registered Trademark of International Business Machine Corporation.

Epson is a Registered Trademark of Epson America, Inc.

Apple and the Apple logo are Registered Trademarks of Apple Computer, Inc.

Compaq is a Registered Trademark of COMPAQ Computer Corporation.

© 1984 AT&T Technologies, Inc.

using machine language. You'll also prepare the interfaces for future peripherals such as printers and joysticks.

## 100-Page Free Catalog Tells More

Send the postage-paid reply card today for NRI's big 100-page color catalog on NRI's electronics training, which gives you all the facts about NRI

courses in Micro-computers, Robotics, Data Communications, TV/Video/Audio Servicing, and other growing high-tech career fields. If the reply card is missing, write to the address below.

# AND MORE.

NRI instructor and the complete NRI technical staff ready to answer your questions or give you guidance and special help whenever you need it.

Praised by critics as the "most intriguing" of all the IBM-PC compatible computers, the new Sanyo uses the same 8088 microprocessor as the IBM-PC and features the MS/DOS operating system. As a result, you'll have a choice of thousands of off-the-shelf software programs to run on your completed Sanyo.

Your NRI course includes installation and troubleshooting of the "intelligent" keyboard, power supply, and disk drive, plus you'll check out the 8088 microprocessor functions,



Your NRI course includes the Sanyo MBC-550-2 Computer with 128K RAM, monitor, disk drive, and "intelligent" keyboard; the NRI Discovery Lab™, teaching circuit design and operations; a Digital Multimeter; Bundled Spread Sheet and Word Processing Software worth \$1500 at retail—and more.

**NRI** SCHOOLS  
McGraw-Hill Continuing Education Center  
3939 Wisconsin Avenue, NW  
Washington, DC 20016



We'll Give You Tomorrow.



# BUILD 20 RADIO AND ELECTRONICS CIRCUITS

Reg. U. S. Pat. Off.



Training Electronics Technicians Since 1946

## PROGRESSIVE HOME RADIO-T.V. COURSE

### Now Includes

- ★ 12 RECEIVERS
- ★ 3 TRANSMITTERS
- ★ SQ. WAVE GENERATOR
- ★ SIGNAL TRACER
- ★ AMPLIFIER
- ★ SIGNAL INJECTOR
- ★ CODE OSCILLATOR
- ★ No Knowledge of Radio Necessary
- ★ No Additional Parts or Tools Needed
- ★ Solid State Circuits
- ★ Vacuum Tube Circuits

### YOU DON'T HAVE TO SPEND HUNDREDS OF DOLLARS FOR A RADIO COURSE

The "Edu-Kit" offers you an outstanding PRACTICAL HOME RADIO COURSE at a rock-bottom price. Our Kit is designed to train Radio & Electronics Technicians, making use of the most modern methods of home training. You will learn radio theory, construction practice and servicing. THIS IS A COMPLETE RADIO COURSE IN EVERY DETAIL. You will learn how to build radios, using regular schematics; how to wire and solder in a professional manner; how to service radios. You will work with the standard type of punched metal chassis as well as the latest development of Printed Circuit chassis. You will learn the basic principles of radio. You will construct, study and work with RF and AF amplifiers and oscillators, detectors, rectifiers, test equipment. You will learn and practice code, using the Progressive Code Oscillator. You will learn and practice trouble-shooting, using the Progressive Signal Tracer, Progressive Signal Injector, Progressive Dynamic Radio & Electronics Tester, Square Wave Generator and the accompanying instructional material.

You will receive training for the Novice, Technician and General Classes of F.C.C. Radio Amateur Licenses. You will build Receiver, Transmitter, Square Wave Generator, Code Oscillator, Signal Tracer and Signal Injector circuits, and learn how to operate them. You will receive an excellent background for television, Hi-Fi and Electronics.

Absolutely no previous knowledge of radio or science is required. The "Edu-Kit" is the product of many years of teaching and engineering experience. The "Edu-Kit" will provide you with a basic education in Electronics and Radio, worth many times the low price you pay. The Signal Tracer alone is worth more than the price of the kit.

### THE KIT FOR EVERYONE

You do not need the slightest background in radio or science. Whether you are interested in Radio & Electronics because you want an interesting hobby, a well paying business or a job with a future, you will find the "Edu-Kit" a worth-while investment. Many thousands of individuals of all

ages and backgrounds have successfully used the "Edu-Kit" in more than 79 countries of the world. The "Edu-Kit" has been carefully designed, step by step, so that you cannot make a mistake. The "Edu-Kit" allows you to teach yourself at your own rate. No instructor is necessary.

### PROGRESSIVE TEACHING METHOD

The Progressive Radio "Edu-Kit" is the foremost educational radio kit in the world, and is universally accepted as the standard in the field of electronics training. The "Edu-Kit" uses the modern educational principle of "Learn by Doing." Therefore you construct, learn schematics, study theory, practice trouble shooting—all in a closely integrated program designed to provide an easily-learned, thorough and interesting background in radio. You begin by examining the various radio parts of the "Edu-Kit." You then learn the function, theory and wiring of these parts. Then you build a simple radio. With this first set you will enjoy listening to regular broadcast stations, learn theory, practice testing and trouble-shooting. Then you build a more advanced radio, learn more advanced theory and techniques. Gradually, in a progressive manner, and at your own rate, you will find yourself constructing more advanced multi-tube radio circuits, and doing work like a professional Radio Technician.

Included in the "Edu-Kit" course are Receiver, Transmitter, Code Oscillator, Signal Tracer, Square Wave Generator and Signal Injector Circuits. These are not unprofessional "breadboard" experiments, but genuine radio circuits, constructed by means of professional wiring and soldering on metal chassis, plus the new method of radio construction known as "Printed Circuitry." These circuits operate on your regular AC or DC house current.

### THE "EDU-KIT" IS COMPLETE

You will receive all parts and instructions necessary to build twenty different radio and electronics circuits, each guaranteed to operate. Our Kits contain tubes, tube sockets, variable, electrolytic, mica, ceramic and paper dielectric condensers, resistors, tie strips, hardware, tubing, punched metal chassis, Instruction Manuals, hook-up wire, solder, selenium rectifiers, coils, volume controls, switches, solid state devices, etc.

In addition, you receive Printed Circuit materials, including Printed Circuit chassis, special tube sockets, hardware and instructions. You also receive a useful set of tools, a professional electric soldering iron, and a self-powered Dynamic Radio and Electronics Tester. The "Edu-Kit" also includes Code Instructions and the Progressive Code Oscillator, in addition to F.C.C. Radio Amateur License training. You will also receive lessons for servicing with the Progressive Signal Tracer and the Progressive Signal Injector, a High Fidelity Guide and a Quiz Book. You receive Membership in Radio-TV Club, Free Consultation Service, Certificate of Merit and Discount Privileges. You receive all parts, tools, instructions, etc. Everything is yours to keep.

Progressive "Edu-Kits" Inc., P.O. Box #238, Dept. 528 EN, Hewlett, N.Y. 11557

Please rush me free literature describing the Progressive Radio-TV Course with Edu-Kits. No Salesman will call.

NAME .....

ADDRESS .....

CITY & STATE ..... ZIP .....

### PROGRESSIVE "EDU-KITS" INC.

P.O. Box #238, Dept. 528 EN, Hewlett, N.Y. 11557

### FREE EXTRAS

#### • SET OF TOOLS

- SOLDERING IRON
- ELECTRONICS TESTER
- PLIERS-CUTTERS
- VALUABLE DISCOUNT CARD
- CERTIFICATE OF MERIT
- TESTER INSTRUCTION MANUAL
- HIGH FIDELITY GUIDE • QUIZZES
- TELEVISION BOOK • RADIO TROUBLE-SHOOTING BOOK
- MEMBERSHIP IN RADIO-TV CLUB: CONSULTATION SERVICE • FCC AMATEUR LICENSE TRAINING
- PRINTED CIRCUITRY

### SERVICING LESSONS

You will learn trouble-shooting and servicing in a progressive manner. You will practice repairs on the sets that you construct. You will learn symptoms and causes of trouble in home, portable and car radios. You will learn how to use the professional Signal Tracer, the unique Signal Injector and the dynamic Radio & Electronics Tester. While you are learning in this practical way, you will be able to do many a repair job for your friends and neighbors, and charge fees which will far exceed the price of the "Edu-Kit." Our Consultation Service will help you with any technical problems you may have.

### FROM OUR MAIL BAG

Ben Valerio, P. O. Box 21, Magna, Utah: "The Edu-Kits are wonderful. Here I am sending you the questions and also the answers for them. I have been in Radio for the last seven years, but like to work with Radio Kits, and like to build Radio Testing Equipment. I enjoyed every minute I worked with the different kits: the Signal Tracer works fine. Also like to let you know that I feel proud of becoming a member of your Radio-TV Club."

Robert L. Shuff, 1534 Monroe Ave., Huntington, W. Va.: "Thought I would drop you a few lines to say that I received my Edu-Kit, and was really amazed that such a bargain can be had at such a low price. I have already started repairing radios and phonographs. My friends were really surprised to see me get into the swing of it so quickly. The Trouble-shooting Tester that comes with the Kit is really swell, and finds the trouble, if there is any to be found."

### SOLID STATE

Today an electronics technician or hobbyist requires a knowledge of solid state, as well as vacuum tube circuitry. The "Edu-Kit" course teaches both. You will build vacuum tube, 100% solid state and combination ("hybrid") circuits.

### PRINTED CIRCUITRY

At no increase in price, the "Edu-Kit" now includes Printed Circuitry. You build a Printed Circuit Signal Injector, a unique servicing instrument that can detect many Radio and TV troubles. This revolutionary new technique of radio construction is now becoming popular in commercial radio and TV sets.

A Printed Circuit is a special insulated chassis on which has been deposited a conducting material which takes the place of wiring. The various parts are merely plugged in and soldered to terminals.

Printed Circuitry is the basis of modern Automation Electronics. A knowledge of this subject is a necessity today for anyone interested in Electronics.