

ELECTRONICS HOBBYIST

SPRING-SUMMER 1974 \$1.25

by the Editors of ELEMENTARY ELECTRONICS

Projects Anybody Can Build

- IC Regen Receiver
- Compass Galvanometer
- Solid-State Flashlight
- FET VHF Converter
- Hand-Powered Static Generator
- Automatic Night Light
- Outdoor Speaker System
- Portable FM Broadcaster

- SCA Music Adapter

Plus Projects for the Pros

- Digital Timepiece
- Scrambled Hotline
- Better Battery Tester
- Sound Pollution Tipster



Boosts Shortwave Signals
See page 39



Tells the Time and Date
See page 19

Scrambles Phone Conversations
See page 43

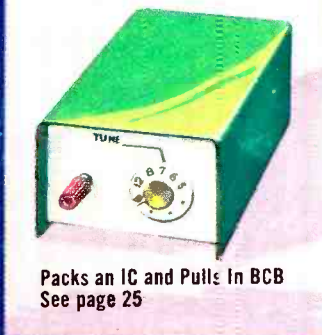

Packs an IC and Pulls In BCB
See page 25

Detects Sound Pollution Level
See page 89

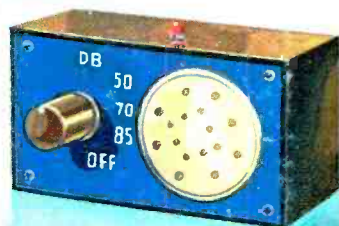

Earn Hundreds of Dollars More

With the S&M Supersensitive Photo Meters

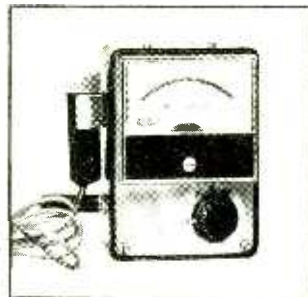
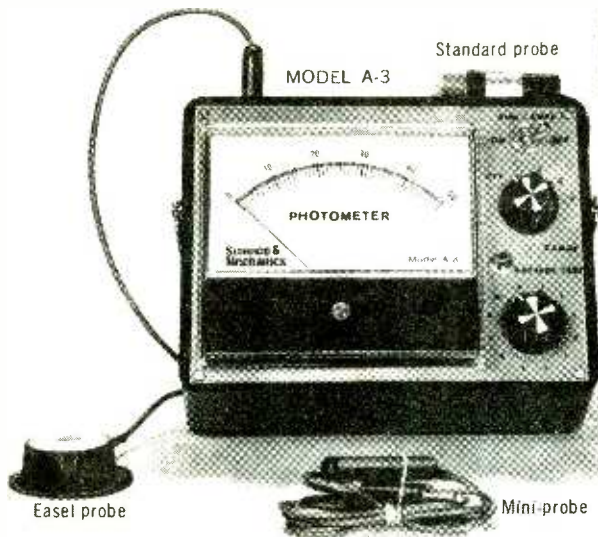

MODEL 102



Exposure computer

Use the MODEL A-3 DARKROOM METER with dial lights to become a darkroom PRO. It is EASY to use at the enlarger with the $\frac{3}{8}$ in. high EASEL probe to determine accurate exposures for B & W or color photography.

Use the A-3 to improve your darkroom skills; to eliminate waste of prints, chemicals and time; to standardize your work for increasing productivity and earning by HUNDREDS OF DOLLARS.

Use the MODEL 102 LIGHT METER with STANDARD probe to determine exposures from dawn to twilight, to moonlight! SPECIAL FEATURES? Four sensitivity ranges; EV-EVS-LV settings; ASA settings from 3 to 25,000; f stops from 0.7 to 90; exposure times from 1/15,000 sec. to 8 hours.

Use the A-3 or Model 102 as a densitometer to find the highlights and shadow densities of your negatives and the CORRECT paper for printing.

OTHER APPLICATIONS? Ground-glass, slides, photomicrography, holography and MORE!

These marvelously accurate and extremely sensitive battery-powered Meters use plug-in probes. Each is supplied here with the probe of your choice, exposure computer, carrying case and manual. This is your opportunity to use one free for 10 days without obligation. Mail the coupon today.

SCIENCE & MECHANICS
Instruments Division, Dept. 362
229 Park Avenue South
New York, N.Y. 10003

Send the S & M Photo Meter with probe indicated, computer, case and manual. Complete instructions supplied to make your own densitometer. If not satisfied, I may return the Meter within 10 days for a complete refund. (Add 10% for Canadian and Foreign orders; N.Y.C. residents add 7% for sales tax.)

- Darkroom Model A-3 @ \$79.95 with
- Light Meter Model 102 @ \$57.50 with
- Standard probe; Easel probe; or
- Mini-probe.
- $\frac{3}{8}$ in diameter Standard probe @ \$7.50
- $\frac{3}{8}$ in. high Easel probe @ \$7.50
- $\frac{3}{8}$ in. diameter Mini-probe @ \$7.50
- Send more information
- Check or money order enclosed, ship ppd.
- Company Purchase Order attached.

NAME _____

ADDRESS _____

CITY _____

STATE _____ ZIP _____

Why a Sylvania home training program may be your best investment for a rewarding career in electronics



In the Master TV/Radio Servicing Program, you build and keep the all solid-state black and white TV set, the color TV set, the oscilloscope and multimeter shown above.

1 LEADER IN ELECTRONICS TRAINING

Over the years, Sylvania Resident Schools have trained thousands of men and women for key positions in the electronics field. Now, through Sylvania Home Training, you can receive the same high-quality career training at home. In your spare time. While you hold your present job.

2 AUTOTEXT TEACHES YOU ELECTRONICS RAPIDLY, EASILY.

AUTOTEXT, offered exclusively by Sylvania, is the proven step-by-step method of home training that can help you learn the basics of electronics quickly and easily.

3 CASSETTE SYSTEM

This innovative learning-by-hearing approach is a special option that adds an extra dimension to AUTOTEXT. It's almost like having an instructor in your own home. As you play the cassette tapes, you'll have an instructor guiding you through your AUTOTEXT lessons. Explaining the material as you read it. All in an easy-to-understand, conversational tone.

4 SPECIALIZED ADVANCED TRAINING

If you're already working in electronics or you have previous training, you can start on a higher level without wasting time on work you already know.

5 PERSONAL SUPERVISION THROUGHOUT

All during your program of home study, your exams are reviewed and your questions are answered by Sylvania instructors who become personally involved in your efforts and help you over any "rough spots" that may develop.

6 HANDS-ON TRAINING

To give practical application to your studies, a variety of valuable kits are included in many programs. In Sylvania's Master TV/Radio Servicing Program, you will actually build and keep an all solid-state black and white TV set, and a color TV set. You also construct an oscilloscope which is yours to keep and use on the job.

7 FCC LICENSE TRAINING MONEY BACK AGREEMENT

Take Sylvania's Communications Career Program — or enter with advanced standing and prepare immediately for your 1st, 2nd, or 3rd class FCC Radio Telephone License examinations. Our money-back agreement assures you of your money back if you take, and fail to pass, the FCC examination taken within 6 months after completing the course.

8 CONVENIENT PAYMENT PLANS

You get a selection of tuition plans. And, there are never any interest or finance charges.

SYLVANIA 231-402-0
TECHNICAL SCHOOL

Sylvania Technical School
Home Study Division
909 Third Avenue
New York, N.Y. 10022

Please send me FREE illustrated career catalog. I understand that I am under no obligation.

Name _____
Address _____
City _____
State _____ Zip _____
Age _____
Veterans: Check here

ELECTRONICS HOBBYIST

CONTENTS

PROJECTS

SPRING/SUMMER 1974

- 19 *Build this Electronic Clock—uses just a handful of parts*
- 24 *So You Want to Design a Simple Transistor Amplifier Stage*
- 25 *There's a TRF in that IC—amazing BCB reception from a special IC*
- 29 *Heath Metal Locator—checks out underground unknowns*
- 34 *Antiquing an Old Tube into Antiquity*
- 35 *Build a Better Battery Tester*
- 39 *Super DXer—antenna terminal supercharger for SWLs*
- 43 *Scramble Phone—it exterminates the little buggers*
- 48 *Compass Galvanometer—sensitive electron flow detector*
- 51 *Gen Trace—substitute or trace signals with one IC*
- 57 *Build a LED Flashlight—low light is better than no light*
- 59 *Sim Com—tune the VHF low band on your AM radio*
- 65 *Automatic Headlighter—two-transistor headlight timer*
- 68 *Put that Clock Radio Back on the Job*
- 71 *Look Again to the Loop—BCB listeners, build your own loop antenna*
- 75 *Super Booster—to pull in AM broadcasters*
- 80 *Signal Shifter—trick your UHF TV converter into tuning the cops*
- 81 *Roto Stat—Science Fair sparkler*
- 87 *Hobbyist Night Light—light sensor controls dial-lamp night light*
- 89 *Sound Pollution Tipster—noise level indicator*
- 93 *Basket of Sound—outdoor speaker built with garden supplies*
- 97 *Super SCA Adapter—mono and lo-fi on FM?*
- 103 *Magic Mike—broadcast voice to your FM radio*

QUICK AND EASY PROJECTS

- 28 *Krunchometer*
- 31 *Head Amp for those Mini Sound Projects*
- 50 *Instant Patch Box*
- 58 *Vacuum Tube Filament Continuity Tester*
- 67 *Build an RF Sniffer*
- 70 *Groove Booster—integrated circuit phono preamp*
- 92 *A Regulated Nine—a substitute for your 2U6s*

GOOD STUFF TO CHECK OUT

- 6 *Ask Hank, He Knows*
- 9 *Hey, Look Me Over*
- 12 *Literature Library*
- 15 *Reader Service Page*
- 18 *Cartoon Page*
- 106 *Reader Service Page*
- 110 *Classified Ads*

COVER PAINTING BY JOE RACK

SPECIAL INTRODUCTORY OFFER!

Now get **ELEMENTARY ELECTRONICS** sent to your home all year long for **ONLY \$2.67!** Order Now and Save!

* * * For beginner or expert EE is valuable * * *

Written by experts—you get a practical understanding of IC circuits . . . semi-conductors . . . power supplies . . . networks . . . transistors . . . pulse circuitry, much more! Get general rules

of electronics, develop trouble-shooting techniques, know how to calculate changing effects. **TRY THIS NO-RISK SUBSCRIPTION OFFER TODAY!**

**PROJECTS
IN
EVERY
ISSUE**

•
**CB
RADIO**

•
**SHORT-
WAVE**

•
**NEW
PRODUCTS**

•
**BASIC
ELECTRONICS
COURSE**

•
**PRODUCT
LAB
TESTS**

PUBLISHER'S DISCOUNT SAVINGS CERTIFICATE



Good for **\$2.78** off the newsstand price of **ELEMENTARY ELECTRONICS** up to



- Enter my trial subscription for 1 year (6 issues) of Elementary Electronics, for only \$2.67. (regularly by subscription \$3.95).
 I prefer 1½ years (9 issues) for \$3.97 (on the newsstand \$6.75).
 New Subscription Renewal Subscription

Name _____
(please print or type clearly)

Address _____

City _____ State _____ Zip _____

SEND NO MONEY, WE'LL BILL YOU LATER

You must seal (staple, scotch tape or glue) before mailing. Dept. P5002

FOLD HERE



BUSINESS REPLY MAIL

First Class Permit No. 790 (Sec. 34.9 P. L. & R.) New York, N.Y.

ELEMENTARY ELECTRONICS

P.O. Box 2600

Greenwich, Connecticut 06830

Dept. P5002

**CUT OUT
AND MAIL
TODAY!**



• THE SHOPPING CENTER FOR ELECTRONICS
(our catalog index of Mfrs extends from ADC to XCELITE)

• HOBBYISTS . . . EXPERIMENTERS . . . SERVICE
TECHNICIANS . . . ENGINEERS •



Your Satisfaction is Our Target

Top Name Brands . . .
Low Prices

AMPLE STOCKS—including
those hard-to-find Parts

whether you want a 15¢ capacitor,
a \$50 FET-VOM, or a \$450 stereo
system—you can get it at EDI!

Send for your FREE catalog Today.



RUSH FREE CATALOG

Name _____

Address _____

City _____ State _____ Zip Code _____

ELECTRONIC DISTRIBUTORS INC.
Dept. TA-2, 4900 Elston Chicago, Ill. 60630

CIRCLE NO. 5 ON PAGE 15 OR 106

WRITE
NOW FOR

McGEE'S
BIG SPEAKER CATALOG

1001 BARGAINS IN

SPEAKERS—PARTS—TUBES—HIGH FIDELITY
COMPONENTS—RECORD CHANGERS—
Tape Recorders—Kits—Everything in Electronics
1901 McGee Street, Kansas City, Missouri 64108

CIRCLE NO. 14 ON PAGE 15 OR 106

PARTS! CORNELL TUBES!

Send For
CORNELL'S
New Color
Catalog

48 Pgs. New Items

CORNELL

33¢ per
tube

36¢ per
tube

ORDER FREE
IF NOT SHIPPED
IN 24 HOURS!

4219 E UNIVERSITY AVE. SAN DIEGO, CALIF. 92105

CIRCLE NO. 6 ON PAGE 15 OR 106

**YOU'RE THE SOLUTION
TO WATER POLLUTION**

SPRING/SUMMER 1974 EDITION

ELECTRONICS HOBBYIST

Dedicated to America's Electronics Hobbyists

Editor-in-Chief

JULIAN S. MARTIN, WA2CQL/KMD4313

Technical Editor

PETER L. DEXNIS, WA3LOQ

Project Editor

STEPHEN B. GRAY

Service Editor

JEFFREY APTER

Workbench Editor

HANK SCOTT

Citizens Band Editor

KATHI MARTIN, KA1Ø614

Art Director

JIM MEDLER

Cover Art Director

IRVING BERNSTEIN

Art Editor

RALPH RUBINO

Advertising Director

DAVID J. MILLER

Production Director

CARL BARTEE

Production Manager

GERTRUD BORCHARDT

Assistant Production Manager

MARYLYN BONILLA

Instruments Division Manager

WILFRED M. BROWN

Newsstand Circulation Director

DON GABREE

Subscription and Marketing Director

ROBERT V. ENLOW

President, Chairman of the Board (1957-1972)

B. G. DAVIS

President and Publisher

JOEL DAVIS

Vice-President and General Manager

LEONARD F. PINTO

Vice-President and Treasurer

VICTOR C. STABILE, KBPØ681



ELECTRONICS HOBBYIST is published Semi-Annually by Davis Publications, Inc. Editorial business offices: 229 Park Ave. South, New York, N.Y. 10003. Advertising offices: New York, 229 Park Avenue South, 212-OR 3-1300; Chicago, 520 N. Michigan Ave., 312-527-0330; Los Angeles: J. E. Publishers' Rep. Co. 8732 Sunset Blvd. Back issues available at New York office prepaid \$1.25 per copy. Copyright 1973 by Davis Publications, Inc.

ELECTRONICS HOBBYIST



**ASK HANK,
HE KNOWS!**

Weak Leads

I was building an RCA Digital Display IC project kit No. KC4011. The IC leads broke and I wondered if you knew where I could get a replacement? The IC number is RCA KD-2127-303.

—R.E., Brooklyn NY
ICs are not noted for their strong leads. In fact, I find daisy petals show a questioning lover a tougher pull than an IC can. As for a replacement, go back to the store where you purchased the kit. The chances are the store carries the RCA IC line. If not, then write to Circuit Specialists Co., Box 3047, Scottsdale AZ 85257. They will help you.

Back to the Reference Book

How do I determine the number of gilberts an electromagnetic coil has?

—B.V., Chicago IL
Determine the number of turns of wire the coil has and multiply that by the current in amperes, and then by a constant 1.257 to get gilberts. The Handbook of Electronic Tables (a Tab Books publication) gave me the answer to this one.

Color Me Blue

I have a resistor (I know it's a resistor because the resistance is almost zero) that I can't measure on my ohmmeter accurately. You see, it is practically a short circuit. The color code is black, brown, black, red. What the heck is it?

—L.M., Ashland WI
It is a resistor, you can be sure. It is a one-ohm job rated at 2% tolerance. When the first band is black, the first digit is zero. The sec-

Hank Scott, our Workshop Editor, wants to share his project tips with you. Got a question or a problem with a project you're building—ask Hank! Please remember that Hank's column is limited to answering specific electronic project questions that you send to him. Sorry, he isn't offering a circuit design service. Write to:

**Hank Scott, Workshop Editor
ELECTRONICS HOBBYIST
229 Park Avenue South
New York NY 10003**



**93
FAMOUS
BRANDS!**
**240
BIG PAGES!**
**MANY
IN FULL
COLOR!**

**SAVE on the NEWEST
and BEST in famous-
name product lines . .**

A superstore of electronics at your fingertips
• Stereo/4-Channel Sound Systems • Tape Recorders and Accessories • Radios • Phonos • Kits • Amateur and Shortwave Gear • Citizens Band • Antennas • Police/Fire VHF-UHF Radios • Electronic Calculators and Timepieces • Security • Test Equipment • 1000's of Parts, Tubes, Batteries, Wire, Hardware

Exclusive TELEDYNE and OLSON Audio Products

mail this coupon today



Olson Electronics Dept. CS
260 S. Forge St., Akron, Ohio 44327

Send me my FREE 1974 Olson Catalog

Name _____ Apt. _____

Street _____

City _____ State _____ Zip _____

Send a Catalog to my friend

Name _____ Apt. _____

Street _____

City _____ State _____ Zip _____

CIRCLE NO. 10 ON PAGE 15 OR 106

EXPERIMENTER

International EX Crystal and EX Kits



OX OSCILLATOR
\$2.95

OX OSCILLATOR Crystal controlled transistor type. Lo Kit 3,000 to 19,999 KHz Hi Kit 20,000 to 60,000 KHz (Specify) **\$2.95**

MX-1 TRANSISTOR RF MIXER A single tuned circuit intended for signal conversion in the 3 to 170 MHz range. Lo kit 3-20 MHz. Hi kit 20-170 MHz. **\$3.50**

SAX-1 TRANSISTOR RF AMP. Amplifier to drive MX-1 mixer. Lo kit 3-20 MHz. Hi Kit 20-170 MHz. **\$3.50**

PAX-1 TRANSISTOR RF POWER AMP. A Single tuned output amplifier to follow the OX oscillator. 3,000 to 30,000 KHz **\$3.75**



EX CRYSTAL
\$3.95

EX CRYSTAL Available from 3,000 KHz to 60,000 KHz. Supplied only in HC 6/U holder. Calif. is $\pm 0.2\%$ when operated in International OX circuit or its equivalent. (Specify frequency) **\$3.95**

BAX-1 BROADBAND AMP. May be used as a tuned or untuned amplifier in RF and audio applications 20 Hz to 150 MHz. **\$3.75**



CRYSTAL MFG. CO., INC.
10 NO. LEE • OKLA. CITY, OKLA. 73102
Write for **FREE** Catalog

CIRCLE NO. 4 ON PAGE 15 OR 106

Ask Hank, He Knows

ond band (brown) is one, and the third band (black) is the multiplier, which is one in this case. The fourth band is for tolerance. Red is 2%. The others are: Brown, 1%; orange, 3%; yellow, 4%; gold, 5%; silver, 10%; and no color indicates 20% tolerance.

A Hot Wire

I have a reel of wire from a wire recorder, but no wire recorder to play it on. Do you know of any way I can hear that recording?

—W.H., Simi Valley CA

You got me! Wire recorders predate me. I was playing highschool football when Hitler made use of this gadget during WW II. However, maybe one of our readers can help. If so, please write direct to William Hyde, 2606 Luray Circle, Simi Valley CA 93065.

The Hole Truth

Drills up to one-half inch are fine for small chassis holes, but after that I use circle saw cutters and they don't work too good. Can you help, Hank?

—W.S., Kansas City MO

Seems you never heard of the famous Greenley punches. In the old days every experimenter had a set to punch holes for 7- and 9-pin miniature tubes and 8-pin octals. I've never owned one, but I hear they make a punch for meters—that's up to 3-inches diameter. I also have a set of square punches made in Japan. Don't know where you can buy a set today, but look in the parts catalogs.

No Cheap Way Out

I built a SCA adaptor from plans in ELEMENTARY ELECTRONICS some time ago and it works fine. However, one of my dining customers tells me I'm in for a lot of trouble if I use it in my place of business. Why? I made it!

—S.L., Atlanta GA

Sorry, but your customer is right, SCA offers a service to business. If you as a private citizen want to enjoy the music from SCA, it's okay. But share it with your customers and you're in for trouble. The law is on the side of the radio station transmitting the SCA program. Listen to your customer and remove the SCA adaptor from the store.

Don't Do It

If I were to get an old WWII surplus walkie-talkie, could it be converted to Citizen's Band use?

—C.W., Buffalo IL

That's right, don't do it. First off, considering the cost of parts today, it would be cheaper

AUTO AIDS

Do-It-Yourself—Save Time, Money, Gas.

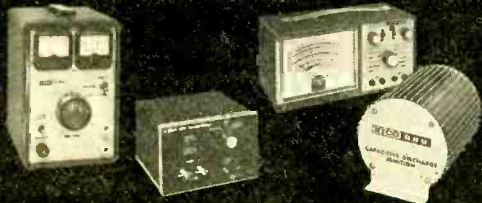

EICO 1064 Dual purpose Battery Eliminator and Charger incorporating an extra low ripple filter circuit. Ideal for servicing and powering 6-12 volt auto and marine equipment. **\$64.95 Kit \$84.95 Wired**

EICO 1080 200 watt Solid State Power Inverter and Battery Charger. Converts 12 volts DC to 117V AC current. For use in cars, mobile homes and boats to operate recorders, appliances, etc. **Kit \$44.95 Wired \$59.95**

EICO 888 Portable Universal Engine Analyzer. Keeps your car or boat engine in tip-top shape. Complete with "How-to-Use" tune-up and troubleshooting manual. **Kit \$54.95 Wired \$79.95**

EICO 889 Solid State C-D Ignition System adds power to any engine. Boosts gas mileage up to 20%. Points and spark plugs last up to 5 times longer, instant cold weather starting. **Kit \$29.95 Wired \$39.95**

FREE 32 PAGE EICO CATALOG

For latest catalog on EICO Test Instruments, Stereo, EICOCRAFT Projects, Environmental Lighting, Burglar/Fire Alarm Systems, and name of nearest EICO Distributor, check Reader Service Card or send 25c for First Class mail service.

EICO, 283 Malla Street, Brooklyn, N.Y. 11207



CIRCLE NO. 2 ON PAGE 15 OR 106

to pick up an inexpensive car-battery-operated CB rig for under \$75, and have three channels to work. Also, since you asked the question, I assume you don't have the measurements laboratory to go with your work shop. You see, you've got to check out and certify the rig to meet FCC requirements before you go on the air. See what I mean? It's cheaper to buy in this case!

Pops the Question

If I set up the correct electromagnetic radio field, can I cure acne?

—H.U., Baltimore MD

I never saw a dead man with pimple problems. What are you trying to do, become a teenage quack? If soap and water plus diet does not help you (it didn't help me when I was young), see your family doctor. Follow his advice and use those tank circuits on 20 meters.

Transistor Substitution

Where can I locate information pertaining to Japanese-manufactured transistors?

—J.L., Philadelphia PA

Howard W. Sams and Tab Books both publish a transistor guide for all American and most foreign types. Also, HEP (Motorola) and Radio Shack have substitution guides for their replacement line. Check them all out. I prefer the HEP Booklet.

QSL Swapper

Hi, Old Man. I'd like to swap my QSL cards for yours. What do you say?

—D.W., Rego Park NY

No. I forward QSL cards to only those I contact on the air. And since I have been working 2 meters for the past year, I have no exciting DX requests for my QSL. Just as well, I'd rather spend the time answering letters.

Stop—Help Needed

I have a pocket-size tape recorder that I would like to fit with an automatic end-of-reel stop circuit. How can I do it?

—G.F.P., Los Altos CA

My first impulse is to tell you to forget the idea, but—why not? First, remember that anything you add to the recorder should not interfere with the normal action of tape against tape head. Also, try not to add magnetic parts that come near the tape heads or tape. Now, install a "micro" lever-action switch on the recorder's front panel near the tape path. Next add a copper wire shaft to the lever so that it rest against the taut tape. Slip a plastic pulley over the copper wire so that as the tape passes by the pulley will rotate, reducing the friction on the tape. The taut tape should hold the switch action closed. When the tape ends and passes completely onto the take-up reel, the spring action of the switch will automatically open the

ROTATE, TILT, TIP VISE

Puts the work where you want it

Serious modeling is an exacting art requiring more than patience and hard work.

The serious modeler realizes the value of precise tools... like PanaVise®. PanaVise is a meticulously designed, highly precisioned and incredibly flexible work positioning system.

It turns your work every way but loose. All its units are designed to allow you complete work positioning flexibility. The locking unit on each base rotates 360°, each vise head and attachment rotates 360° and each vise head and attachment tilts 180°.

It moves—you don't. No more bending or crouching in awkward positions while you work. PanaVise adjusts your work to you. The number of ways you can use it is limited only by your imagination.

You can get the basic set (consisting of the standard height base and vertical jaw vise head) for only \$19.95. Add other units from the complete system of 4 bases and 7 vise heads as you need them. Available at better model, hobby and craft shops throughout the world. Write Colbert Industries for a free catalog.

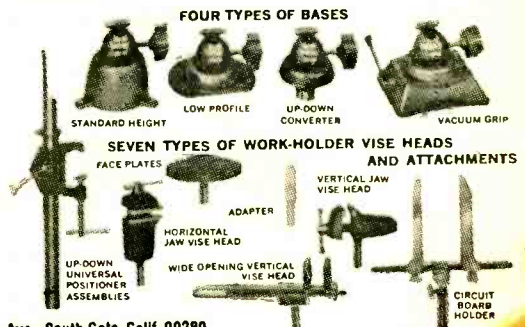
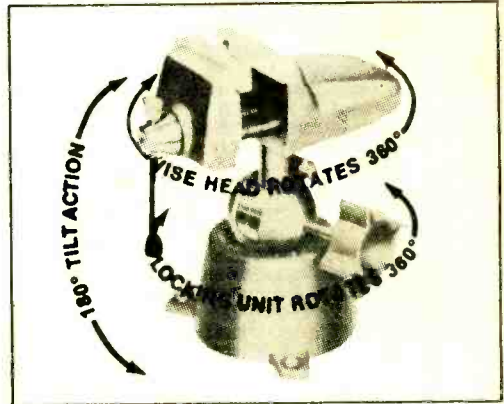

PANA VISE®

COLBERT INDUSTRIES, 10107 Adella Ave., South Gate, Calif. 90280

CIRCLE NO. 11 ON PAGE 15 OR 106

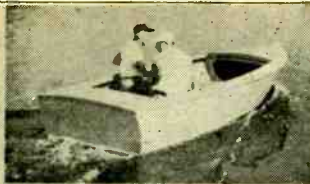

Sea Lark

all purpose,
inboard-powered runabout

SHEET 1 OF 2

CRAFT PRINT **228**

**BOAT
BUILDER**

**BUILD
THE
REAL
THING
!**



OTHER BOATS YOU CAN BUILD

12' Fiberglass	1.00
14' Fiberglass	1.50
16' Fiberglass	2.00
18' Fiberglass	2.50
20' Fiberglass	3.00
22' Fiberglass	3.50
24' Fiberglass	4.00
26' Fiberglass	4.50
28' Fiberglass	5.00
30' Fiberglass	5.50
32' Fiberglass	6.00
34' Fiberglass	6.50
36' Fiberglass	7.00
38' Fiberglass	7.50
40' Fiberglass	8.00
42' Fiberglass	8.50
44' Fiberglass	9.00
46' Fiberglass	9.50
48' Fiberglass	10.00
50' Fiberglass	10.50
52' Fiberglass	11.00
54' Fiberglass	11.50
56' Fiberglass	12.00
58' Fiberglass	12.50
60' Fiberglass	13.00
62' Fiberglass	13.50
64' Fiberglass	14.00
66' Fiberglass	14.50
68' Fiberglass	15.00
70' Fiberglass	15.50
72' Fiberglass	16.00
74' Fiberglass	16.50
76' Fiberglass	17.00
78' Fiberglass	17.50
80' Fiberglass	18.00
82' Fiberglass	18.50
84' Fiberglass	19.00
86' Fiberglass	19.50
88' Fiberglass	20.00
90' Fiberglass	20.50
92' Fiberglass	21.00
94' Fiberglass	21.50
96' Fiberglass	22.00
98' Fiberglass	22.50
100' Fiberglass	23.00

DOLPHIN

A 16 foot fiber-glass designed for those who enjoy their work about the water.

CRAFT PRINT **62**

**BOAT
BUILDER**

228. SEA LARK is an all-purpose in-board runabout that's safe, dependable, and economical to operate. It takes engines up to 25 hp for speeds to 20 mph. Its large, open cockpit and side-mounted controls make it an excellent fishing rig. L.O.A., 14'6"; beam, 5'6". **\$6.00**

62. DOLPHIN is small and light enough to be transported anywhere by trailer, yet it will accommodate two persons for extended cruising or a party of four on day trips. Plywood is used throughout, and the hull is designed to get the most from modest power. L.O.A., 16'; beam, 5'9". **\$5.00**

Boat Builder, 229 Pk. Ave. S., NY, NY 10003
Enclosed is \$_____ SATISFACTION
GUARANTEED.

- Craft Print #228, \$6
 Craft Print #62, \$5
(add 50¢ for postage and handling)

NAME _____ (please print)

ADDRESS _____

CITY _____ STATE _____ ZIP _____

EH 1/22

**MAKE
IT
WITH
CRAFT
PRINTS
AND
SAVE
!**

Ask Hank, He Knows

circuit, because there is no tape to hold the pulley in place.

FM From AM?

How can a crystal-controlled oscillator be frequency controlled?

—L.B., Boise ID

The frequency of a crystal-controlled oscillator is determined by the resonant frequency of the crystal and the reactance of the crystal circuit. So, it is easy enough to connect a variable-capacitance diode across the crystal circuit and vary the diodes capacitance with a varying DC voltage. The frequency of the circuit will vary slightly in step with DC changes. That's FM, boys.

Almost Had it Perfect

I got troubles. I installed a MATV system in my house and it doesn't work. As soon as I connected my TV the reception was lousy. The same is true for the MATV outlets I installed upstairs and in the den. What gives?

—G.H., Macon GA

I didn't print all of your letter to save space, but I did give enough clues so that our readers can see the fault you built in. Unterminated MATV outlets breed ghosts and signal loss. The more, the unmerriest. Pick up some type F connectors and install 75 ohm resistors in them. Ground one end of the resistor and the other serves as the center terminal as done with coax cables. Terminate each unused MATV outlet with these dummy loads and your one-and-only-TV will get a good signal. When you get another set, remove the dummy load and connect the set. See, it's easy!



NEW PRODUCTS

This Piano is a Lightweight

Now from *Earth*—the portable electronic piano that really strikes up the band. Ideal for the traveling musician, this portable, lightweight twenty-five pound electronic piano may be plugged into any size amplifier for the reproduction of true piano sound. Equipped with three tabs for sound changes, the piano is able to create a variety of sound



effects from honky-tonk to harpsichord. Small in size, this new piano measures only three feet long and six inches high. At a suggested retail price of \$499, the new *Earth* piano features a sixty-one note keyboard with a booming bass section. Designed in a walnut grain finish, this sturdy electronic piano is attractive for any room in the house, and will stand up to extensive wear and tear. For more information, circle No. 52 on Reader Service Coupon.

Peg Panel Storage

Portable-type molded plastic storage bins hold all sorts of small parts, materials, tools or equipment on pegboard backwalls at the

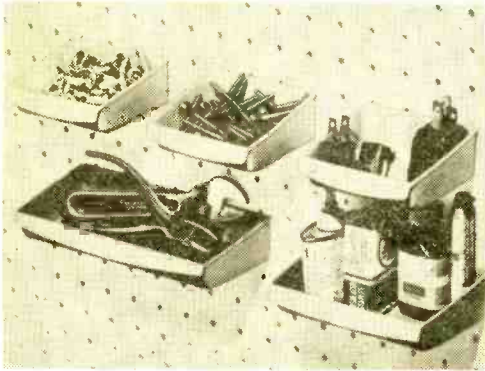

hobby or tool bench. Made by Merrymaid Plastics Corporation, Peg Panel Bins are available at local hardware and department stores priced at 98¢ per set. They are made in three (3) convenient lengths . . . 3½, 5 and 7-in. They are 1½-in. deep and 3½-in. wide. Each has molded-in hooks that fit standard pegboard holes. They're molded in flame red and avocado green. Peg Panel Bins are recommended for holding electronic or electrical

parts, screws, washers, nails, model parts, art tools or materials . . . a myriad of small items. They're ideal for use at the hobby or work bench, tool room, crafts room or sewing room, to name a few. For more information, circle No. 56 on Reader Service Coupon.

Electronic Air Purifier

The new Heathkit GD-1003 electronic air purifier removes up to 99% of all pollens and mold spores and up to 95% of all other airborne contaminants, regardless of size or concentration. It easily cleans the air in a 400 sq. ft. room, and the completely self-

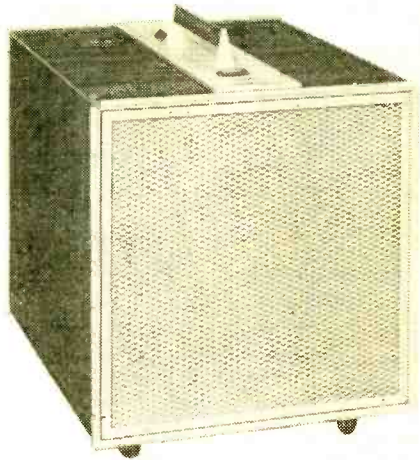

contained unit can be handily carried from room to room and plugged into any 120 VAC outlet. The amazing efficiency of the GD-1003 is accomplished by a powerful 2-stage clean-

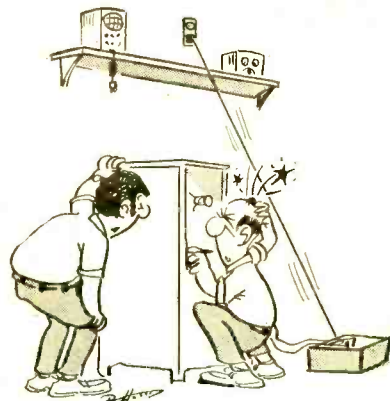

"I told you the voltmeter was dropping!"

NEW

TO: Electronics Hobbyist readers from the Editor of **HI-FI STEREO BUYERS' GUIDE**

"When you play your recordings you want the best hi-fi components you can get. HI-FI STEREO BUYERS' GUIDE tells you what they are, and whose equipment to buy. In addition to useful, authoritative articles on hi-fi componentry, every issue includes a new products Show Case, unbiased Tested in the Lab reports on quality hi-fi components, and Record and Tape Reviews on the Classics and Pops."

Let HI-FI STEREO BUYERS' GUIDE into your music life right now. Published four times a year, every issue is jammed full of information to aid you in a fuller enjoyment of your records and tapes.



Make certain you get each exciting issue by taking advantage TODAY of a special MONEY-SAVING introductory offer. Instead of receiving four issues; a full year subscription at the regular \$5.00 rate, you receive an extra issue, an immediate saving to you of \$1.25. Just mail the coupon below, with your payment, to: HI-FI STEREO BUYERS' GUIDE, P.O. Box 2600, Greenwich, Conn. 06830.

PAY CASH & SAVE UP TO \$2.50

HI-FI STEREO BUYERS' GUIDE,
P.O. Box 2600
Greenwich, Conn. 06830

Special Introductory offer for Electronics Hobbyist Readers.

Okay! Enter my subscription to HI-FI STEREO BUYERS' GUIDE at the money-saving cash payment rate below:

One year (4 issues) PLUS ONE BONUS ISSUE. I enclose payment of \$5.00 and save \$1.25 off the newsstand and regular subscription rate.

DOUBLE MY SAVINGS! I prefer a two year subscription (8 issues) PLUS TWO BONUS ISSUES, a total of 10 issues. I enclose \$10.00 and save \$2.50 off the regular rates. B409

Enclosed is \$ _____

Name _____ (please print)

Address _____

City _____ State _____ Zip Code _____

ing cycle—an 8,000 volt initial ionizing stage, followed by a 4,000 volt collecting stage. A two-speed switch allows movement of large volumes of air in the "high" position and provides whisper-quiet continuous operations in the "low" position. Cleaning is easy—simply flip off the rear grille screen, lift out the collector cell and wash in plain detergent and water. The activated charcoal deodorant filters also slip out easily for replacement when needed. Price \$139.95. Get all the facts by circling No. 1 on Reader Service Coupon.

One Station FM Receiver

Fixtune Electronics announces a new FM table receiver with a crystal-controlled front end and integrated circuitry that assures a frequency accuracy of .01%. This one station



radio does not require tuning because it is preset to receive only your choice of station, without drift or noise. Sensitivity is better than 3 μ V and S/N is 60 dB. This new model features walnut wood finished cabinet, air suspension type speaker, separate tone control, telescopic antenna, and external antenna connection for fringe area reception.

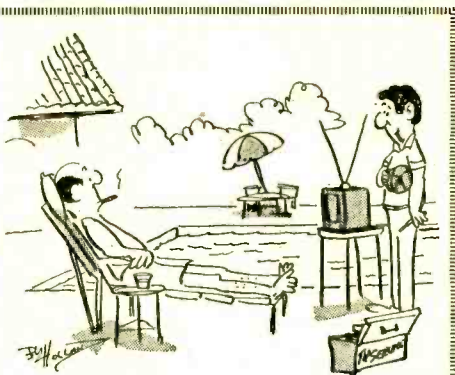

"Sorry, Doc, your battery passed away."

PRODUCTS

Price about \$75. Full color catalog sheet available from Fixtune Electronics, One West 30th Street, New York, NY 10001, or circle No. 50 on Reader Service Coupon.

Save A Fuse & Speaker

The Hartley Speaker Sentry is an electronic control that limits the power dissipated in the speaker by utilizing a closed loop feedback circuit. If the power reaching the speak-

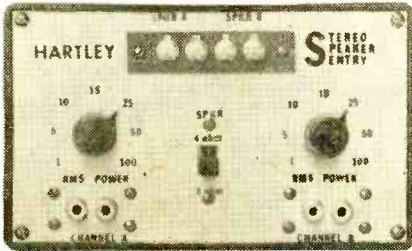

ers exceeds a preset level, between 1 and 100 watts rms, the input signal to the amplifier is reduced automatically to the desired level across the speakers. This self-powered all-solid-state component takes only milliwatts of power from the amplifier. The Hartley Speaker Sentry reacts much faster than the common fuse, responding to an overload condition within a fraction of a millisecond. This is the best way to give you peace of mind where your speakers are concerned. Priced at just \$35. For additional details, circle No. 53 on Reader Service Coupon.

Tap Connections With Just a Squeeze

An exclusive design 3-Way Vaconector by Vaco acts as a tap connector, pigtail connector, or an inline connector. Easy to use by simply pushing wire to be tapped into slot at side of connector. Tapping wire is then inserted into hole at end of connector (inspec-

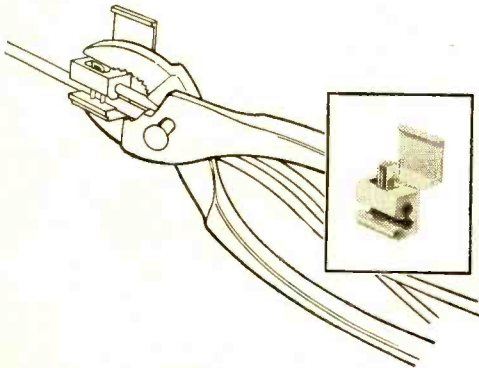

tion window allows user to make sure tapping wire inserts past metal clip). Metal clip is then squeezed with pliers until flush with top of connector body. Hinged cover snaps closed to insure complete insulated connection with no cutting or stripping of wires. Exclusive features include double insulation grip for extra pullout resistance and inspection window to insure correct positioning of tapping wire. Vaconectors come in 3 sizes and are color coded as follows: 18-14 AWG (blue), 14-12 AWG (yellow), and a combination 18-14 and 14-12 (brown). Priced at about 79¢. Available in bubble paks on pegboard racks throughout the country. For further information, circle No. 58 on Reader Service Coupon.

Electronic Oral Thermometer

A scientific development gives the kids a break and makes it easier for parents, doctors and nurses to take temperatures faster, safer, more accurately and hygienically than with the old fashioned mercury filled glass thermometer. The revolutionary Electronic Oral Thermometer is also much easier to read. It gives clear readings in 15 seconds, with big

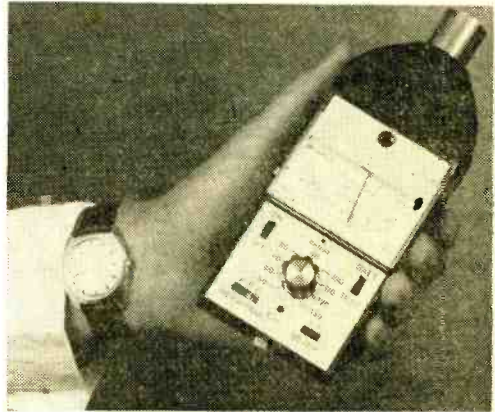

numerals ranging from 90° to 98.6°F in 1/2° and 1/4° from 99 to 106°. A disposable cover is simply placed over the flexible probe which is put under the patient's tongue. Then it's simply a matter of flicking a switch to calibrate and then flicking the "on" switch to get a temperature reading in 15 seconds without having to squint or hold the instrument up to the light. The new Electronic Oral Thermometer costs only \$25.00 postpaid and is available by mail from Edmund Scientific Co., 380 Edscorp Bldg., Barrington NJ 08007. For more information and big catalog, circle No. 60 on Reader Service Coupon.

(Continued on page 13)



LITERATURE LIBRARY

101. Kit builder? Like weird products? EICO's 1974 catalog takes care of both breeds of buyers at prices you will like.
102. International Crystal has a free catalog for experimenters (crystals, PC boards, transistor RF mixers & amps, and other comm. products).
103. See brochures on Regency's 1974 lineup of CB transceivers & VHF/UHF receivers (public service/business bands—police, fire, etc.)
104. Dynascan's new B&K catalog features test equipment for industrial labs, schools, and TV servicing.
105. Before you build from scratch, check the Fair Radio Sales latest catalog for surplus gear.
106. Get Antenna Specialists' cat. of latest CB and VHF/UHF innovations: base & mobile antennas, test equipment (wattmeters, etc.), accessories.
107. Want a deluxe CB base station? Then get the specs on Tram's super CB rigs.
108. You want Xcelite's new ratchet socket wrench set the moment you lay eyes on it. It has eleven sockets from 3/16 inch through 1/2 inch. The set includes a reversible ratchet handle with two spinner extensions—2 inches regular and 5 3/4 inches.
109. Bomar claims to have C/B crystal for every transceiver . . . for every channel. The catalog gives list of crystal to set interchangeability.
110. A Turner amplified mike helps get the most from a CB rig. This free brochure describes line of base & mobile station models.
111. Midland's line of CB (base and mobile) equipment, and marine transceivers and accessories are illustrated in a new 4-color 24-page folder. There's also a separate 8-page, 4-color flyer on scanners.
112. EDI (Electronic Distributors) has a catalog with an index of manufacturers' items literally from A to Z (ADC to Xcelite). Whether you want to spend 29 cents for a pilot-light socket or \$699.95 for a stereo AM/FM receiver, you'll find it here.
113. Get all the facts on Progressive Edu-Kits Home Radio Course. Build 20 radios and electronic circuits; parts, tools, and instructions included.
114. Olson Electronics' 244-page fully-illustrated 1974 catalog carries leading national brand products in all electronics categories.
115. Trigger Electronics has a complete catalog of equipment for those in electronics. Included are kits, parts, ham gear, CB, hi fi and recording equipment.
116. Get the HUSTLER brochure illustrating their complete line of CB and monitor radio antennas.
117. Teaberry's new 6-page folder presents their 6 models of CB transceivers (base and mobile): 1 transceiver for marine-use, and 2 scanner models (the innovative "Crime Fighter" receiver and a pocket-size scanner).
118. Burstein-Applebee's 1974 catalog has 276 pages of radio/TV electronics bargains. Selling for \$2, it is offered free to our readers.
119. Besides Browning's colorful leaflet on their Golden Eagle Mark III base station, their packet includes other surprises. The SST transceiver is claimed to have unparalleled design in the CB world. The LTD is pictured in actual size on a card for you to test on your car's dash. Specifications are given for both the SST and LTD. All literature is in full color.
120. Edmund Scientific's new catalog contains over 4000 products
- that embrace many sciences and fields.
121. Cornell Electronics' "Imperial Thrift Tag Sale" Catalog features TV and radio tubes. You can also find almost anything in electronics.
122. Radio Shack's 1974 catalog for electronics enthusiasts has 180 pages, colorfully illustrated—a complete range (kits & wired) of hi-fi, CB, SWL equipment and parts.
123. It's just off the press—Lafayette's all-new 1974 illustrated catalog packed with CB, hi-fi components, test equipment, tools, ham rigs, and more.
124. Mosley Electronics reports that by popular demand the Model A-311 3-element CB beam antenna is being reintroduced. Send for the brochure.
125. RCA Experimenter's Kits for hobbyists, hams, technicians and students are the answer for successful and enjoyable projects.
126. B&F Enterprises has an interesting catalog you'd enjoy scanning. There are geiger counters, logic cards, kits, lenses, etc.
127. Avanti antennas (mobile and base for CB and VHF/UHF) are fully described and illustrated in new catalog.
128. A new free catalog is available from McGee Radio. It contains electronic product bargains.
129. Semiconductor Supermart is a new 1974 catalog listing project builders' parts, popular CB gear, and test equipment. It features semiconductors—all from Circuit Specialists.
130. Heath's new 1974 full-color catalog is a shopper's dream—chockful of gadgets and goodies everyone would want to own.

ELECTRONICS HOBBYIST

Box 886

Ansonia Station

New York, N.Y. 10023

Please arrange to have this literature whose numbers I have circled at right sent to me as soon as possible. I am enclosing 25¢ to cover handling. (No stamps, please).

S/S 1974



- 101 102 103 104 105 106 107 108 109 110,
111 112 113 114 115 116 117 118 119 120
121 122 123 124 125 126 127 128 129 130
131 132 133 134 135 136 137 138 139 140
141 142 143 144 145 146 147 148 149

Indicate total number of booklets requested
Sorry, only 12 circled items maximum.

Are you a subscriber to this magazine? Yes No

NAME _____

ADDRESS _____

CITY _____

STATE _____ ZIP _____

Not Valid After July 31, 1974

NEW PRODUCTS

How Loud is Loud

A rugged new, hand-size, easy-to-read-and-operate Sound Level Meter (SLM), designed to economically determine sound pressure levels and to help pinpoint "noise pollution"



sources in industrial and other environments, has been introduced by the Triplet Corporation. The Triplet Model 370 is intended for rapid survey and periodic checks in such noise environments as those found in factories and offices, for measuring automotive, halls, studios and auditoriums, hospitals, household appliances, and other worlds of sound. The lightweight Model 370 has an operational range of from 40 dB to 140 dB in nine steps, features an omni-directional lead-zirconate-titanate ceramic microphone and selectable A, B, and C weighted response, and provides switch selectable "fast" and "slow" meter response. Complete with batteries and instruction manual, the Triplet Model 370 Sound Level Meter, Catalog #3130, is priced at \$250. Available accessories include leather carrying case and neck strap, microphone caps, wind screens, and a rugged molded carrying case for the SLM, a calibrator and other ancillary equipment. For further information on the Triplet Model 370 SLM and accessories, circle No. 43 on Reader Service Coupon.

Shelves to Order

System Plus is the new easy do-it-yourself shelf idea from PMI. A low cost easy shelf system is now available to the consumer for of-

Use Coupon on Left!

131. E. F. Johnson's 1974 full line of CB transceivers and accessories equipment is featured in a new 16-page brochure. A 4-color folder on monitor scanner line is also offered.

132. If you want courses in assembling your own TV kits, National Schools has 10 from which to choose. There is a plan for GIs.

133. Get the new free catalog from Howard W. Sams. It describes 100's of books for hobbyists and technicians—books on projects, basic electronics and related subjects.

134. Sprague Products has L.E.D. readouts for those who want to build electronic clocks, calculators, etc. Parts lists and helpful schematics are included.

135. The latest edition of Tab Books' catalog has an extensive listing of TV, radio and general servicing manuals.

136. Leader's catalog features "Instruments to Believe In." They have a complete line for industry, education and service, featuring oscilloscopes/vectorscopes, many generators, accessories, etc.

137. Pace Communications has a packet of information for you. The "Citizens two-way radio" answers all the questions from how to operate one to how much they will cost to operate. A booklet on Pace's scan/monitors to keep you informed is included.

138. Pearce-Simpson has a booklet, "Citizens Band Radios & Scanners," which pictures and describes the various models in this line. A section on CB antennas is included.

139. For the latest information on CB transceivers by Courier, send for their literature.

140. Featured in Siltronix's brochure are single sideband/AM citizen band transceivers, pictured and described with extra features and specifications listed. VFO sliders for monitoring are pictured as well as export models of linear amplifiers.

141. Lee Electronics Labs has an inexpensive circuit analyzer, which is featured in this catalog.

142. Available from Royce Electronics (a new name in electronics manufacturing) is a 16-page catalog for CB'ers. See their base and mobile transceivers, accessories and test instruments.

143. A set of Abraxas/4 speakers contains a rugged 12-inch long-throw woofer with a 22-oz. Alnico magnet, a 5-inch sealed-back rub-

ber-damped midrange, and two 3-inch dome tweeters from Designers Audio Products.

144. For a packetful of material, send for SBE's material on UHF and VHF scanners, CB mobile transceivers, walkie-talkies, slow-scan TV systems, marine-radios, two-way radios, and accessories.

145. For CB'ers from Hy-Gain Electronics Corp. there is a 50-page, 4-color catalog (base, mobile and marine transceivers, antennas, and accessories). Colorful literature illustrating two models of monitor-scanners is also available.

146. Robyn International has 4-color "spec" sheets for each model of their CB (base and mobile) transceivers and monitor-scanner lines.

147. Telex's 4-page, 2-color folder illustrates their new line of boom microphone head-sets for CB'ers and hams, as well as their line of communications headphones.

148. American Trading Corp. offers you two catalogs in 4-color. One features their Electronics 2000/Contact CB, pictured with descriptions and specifications. Their Monitor/Scanner, Surveyor Model 4H 4U, is featured in the second catalog.

149. Cush Craft has a catalog on Citizens Band Antennas for every purpose. The Ringo base antenna is featured, as is the new Superfire 8-element horizontal/vertical power beam.

NEW PRODUCTS

fice furniture, library, hobbyist or furniture supplier with System Plus. System Plus is excellent for organizing or storage of test



equipment, station gear or hi-fi. The design allows anyone to assemble a completely designed area in only a few minutes. System Plus is free-standing, easily moved or redesigned as requirements may change. Color coordinated fittings with shelves that can be painted, stained or left natural gives System Plus a professional custom appearance in any area used. The shelves are made of particle (compressed chips) board, and three sizes are available, 12-in. x 12-in., 12-in. x 16-in., and 12-in. x 32-in. Fittings are available in four colors, red, white, blue, and gold. More information from PMI is yours for the asking by circling No. 67 on Reader Service Coupon.

For Wheels

Once someone has become accustomed to good stereo sound, he wants it everywhere: his car, boat, camper, trailer, and virtually every other vehicle available. And the Sanyo F8412 Tachrad AM/FM stereo car radio system is designed to do the job. The F8412 stereo system is still another improvement on Sanyo's tachrad styling which resembles a racing car tachometer for the face of the radio. Included is an acoustically matched

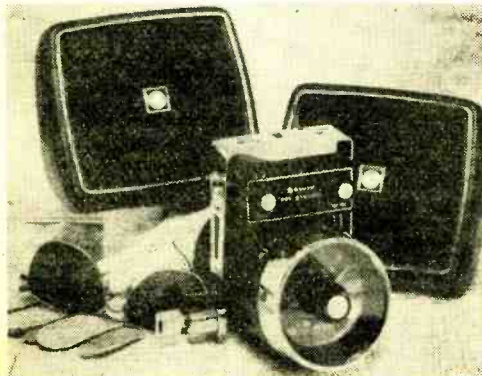

pair of high fidelity speakers for in-door or rear-shelf mounting. The system has special features such as tone control, lighted dial, windshield antenna and a locking system with a key. It may also be connected to an existing antenna. The F8412 is priced at \$135.95. For more information, circle No. 72 on Reader Service Coupon.

Multimeter Kit

A new 3½ digit multimeter kit has been introduced by Nobex Electronics. The result of intensive research, development, engineering and testing, the new instrument contains



many innovative features. One of these innovations is apparent when the box is opened. The exclusive package has been engineered so that all components are in separate tray compartments according to assembly sequence. Thus, building procedure is simplified and the kit is self-contained at all times through completion. Accuracy of 0.5% is assured by oven control making the Nobex multimeter as reliable as many high priced industrial instruments. Full details and specifications are contained in a color brochure available from the manufacturer. To get your copy, circle No. 71 on Reader Service Coupon.

Big Stick

Channel Master has introduced a new telescoping antenna mast constructed of its extra-strength "Golden Duratube" special process steel. The product also features new Contour Guy Rings whose unusual type of construction eliminates sharp, wire-fraying edges. Previously available only in straight 5 and 10-foot lengths, "Golden Duratube" now comes in 20, 30, 40 and 50-foot telescoping lengths. Tests show that Duratube is 50% stronger than high-carbon masting of the same gauge, is more resistant to wind stress, and does not get coated with "white rust." The unique Contour Guy Rings, resembling inverted saucers, are made of aluminum. They rest on the swaged shoulder of the

ELECTRONICS HOBBYIST

READER SERVICE PAGE

• The Editor of **ELECTRONICS HOBBYIST** offers readers an easy way to get additional information about products and services advertised in this issue. Also, if you would like more information about any new product mentioned in our new products column, it's yours for the asking. Just follow the instructions below and the material you requested will be sent to you promptly and at no cost.

• The coupon below is designed for your convenience. Just circle the numbers that appear next to the advertisement or editorial mention that interests you. Then, carefully print your name and address on the coupon. Cut out the coupon and mail to **ELECTRONICS HOBBYIST**, Box 886, Ansonia Station, New York, N.Y. 10023. Do it today!

Void after JULY 31, 1974

S/S 1974-

ELECTRONICS HOBBYIST
Box 886, Ansonia Station, New York, N.Y. 10023

Please arrange to have	1	2	3	4	5	6	7	8	9	10
literature whose num-	11	12	13	14	15	16	17	18	19	20
bers I have circled at	21	22	23	24	25	26	27	28	29	30
right sent to me as	31	32	33	34	35	36	37	38	39	40
soon as possible. I un-	41	42	43	44	45	46	47	48	49	50
derstand that this is a	51	52	53	54	55	56	57	58	59	60
free service offered by										
the magazine.										

Name (Print Clearly) _____

Address _____

City _____

State _____

Zip Code _____

NEW PRODUCTS

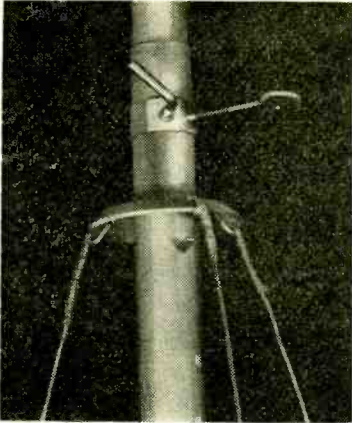

mast, and cannot ride up or bind the adjacent telescoping sections. This allows the mast to be firmly guyed before the antenna is finally oriented. For more details and dealer locations, circle No. 70 on Reader Service Coupon.

Looks and Sounds Good

The *Advent/2*, a new low-cost loudspeaker system designed for high performance-per-dollar, is housed in a molded thermo-set

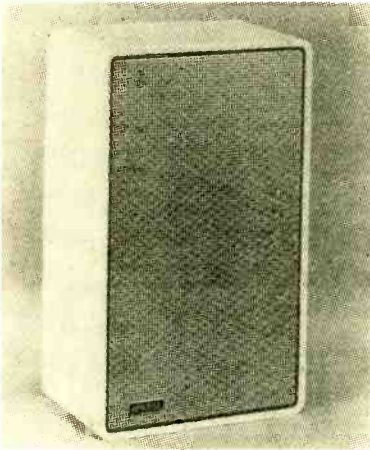

plastic cabinet, uses drivers associated with speakers of twice the cost to produce wider range, higher efficiency, and greater power handling than other systems in its price class. The aim is more fully satisfying sound from lower-cost complete stereo systems than ever before. The system employs an acoustic suspension woofer and two direct radiator tweeters, arranged in an acoustic array that provides maximum dispersion with no interference effects between drivers. System resonance is 58 Hz. The nominal crossover point

is 1500 Hz, and the impedance is 8 ohms. Recommended minimum power is 10 watts per channel. The suggested retail price of the *Advent/2* is \$58.00. Dimensions are 11½ x 19 x 7¼-in. deep. For more data, circle No. 73 on Reader Service Coupon.

Voltage Indicator

Procon has recently introduced a Voltage Indicator that plugs into any standard wall outlet. It provides an instant warning when the power falls below a safe level for operating household appliances. The attractive unit has

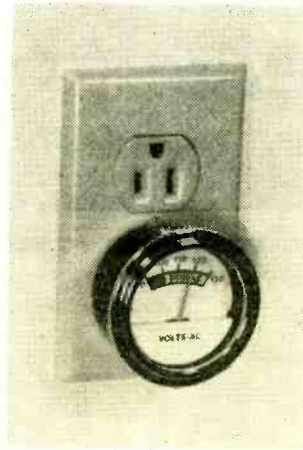

a color coded dial which indicates *Lo*, *Normal*, and *Hi* readings. It can be moved throughout the home or left plugged into one convenient outlet for constant monitoring of incoming power. Two models are available, the *Voltage Guard* for household use at \$7.95 and the *Voltage Monitor* with 1% accuracy for precision applications at \$12.95. Both are post-paid. For information, circle No. 74 on Reader Service Coupon.

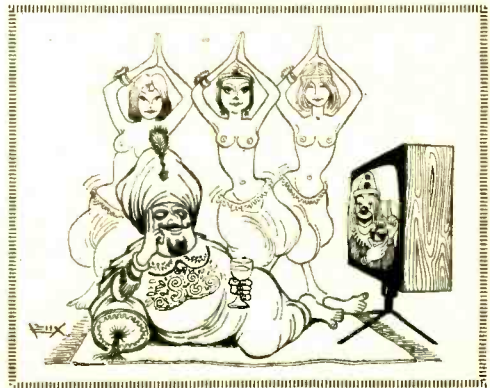

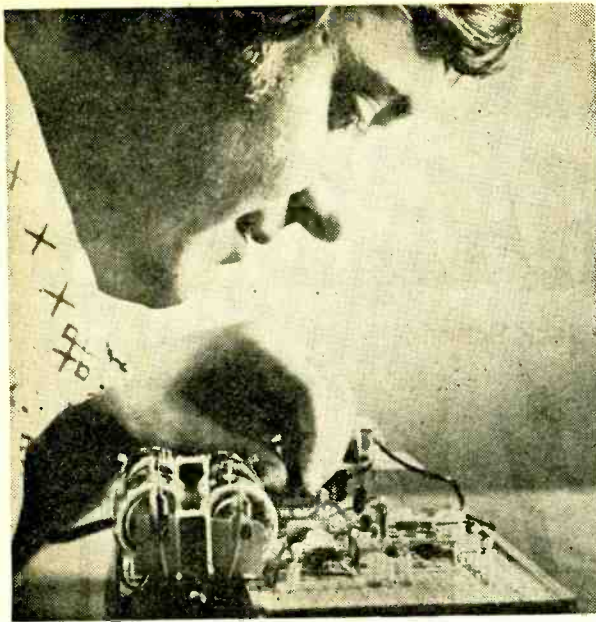

You Learn to Make Money ...with CIE's Electronics Laboratory!

Now you can learn Electronics by performing more than 200 practical, skill-producing experiments...with authentic industrial components...at home...in your spare time.

You learn by doing! This 161-piece Laboratory includes the up-to-date equipment you'll need — such things as an IC (integrated circuit), printed circuit board, FET (field effect transistor), photovoltaic cell, DC motor, microphone, multimeter, soldering iron and power supply.

You put theory into *practice* right in your own home... in your spare time...while you go right on pulling down your present pay. It's CIE's exciting space-age "Electronics Technology with Laboratory" program... a unique combination of CIE's special AUTO-PROGRAMMED® Lessons and laboratory equipment. It is the *practical* way to learn Electronics!

Prepare for a High-paying Career

You see, when you "learn by doing," you're *ready to do*...you're *armed* with the know-how to meet the challenges of a high-paying career in Electronics... prepared to go after an exciting, relevant job in a growing field such as medical technology, pollution control, radio and TV broadcasting, computers...just to name a few. Once you have some experience, you can make \$12,000 a year or more.

But that's not all! When you successfully complete your Electronics Laboratory course, you'll get a CIE Diploma. And, you'll be able to pass the Government FCC examination or *be entitled to a full refund of all tuition paid!* CIE's Money-Back Warranty is valid during the completion time allowed for your course.

Send today for CIE's 2 FREE BOOKS about opportunities in Electronics. For your convenience, we will try to have a representative call. Mail reply card or coupon to CIE...or write: Cleveland Institute of Electronics, Inc., 1776 E. 17th St., Cleveland, Ohio 44114.

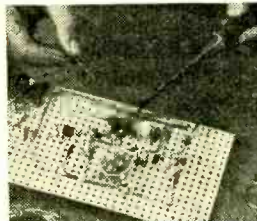

You learn how to construct circuits and connect them with a soldering iron, which is part of your CIE laboratory equipment. This "hands on" experience is extremely valuable.

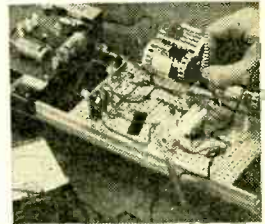

Testing and troubleshooting are an important part of your learning experience. Your laboratory has a precision multimeter to diagnose electronic troubles quickly and accurately.

APPROVED UNDER G. I. BILL

All CIE career courses are approved for educational benefits under the G.I. Bill. If you are a Veteran or in service now, check box for G.I. Bill information.

CIE Cleveland Institute of Electronics, Inc.

1776 East 17th Street, Cleveland, Ohio 44114
Accredited Member National Home Study Council

Please send me your 2 FREE BOOKS—The CIE school catalog, "Succeed in Electronics" and "How To Get a Commercial FCC License".



Name _____ (Please Print)

Address _____

City _____

State _____ Zip _____ Age _____

Veterans and Servicemen:

Check here for G.I. Bill information.

EB-12

CIRCLE NO. 3 ON PAGE 15 OR 106



HOBBY HAZARDS

by Jack Schmidt

PARTS

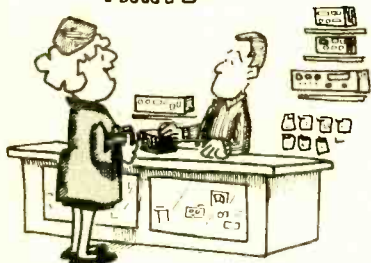

"It's his birthday, and I'd like to surprise him with some of those colored things you put in those black boxes..."



"The radio store didn't have a 12-volt tube, so I got you two 6-volt ones..."



"You must have won some kind of contest... you just got a special delivery letter from the FCC!"



"Why don't you use the phone, the way other women do?"

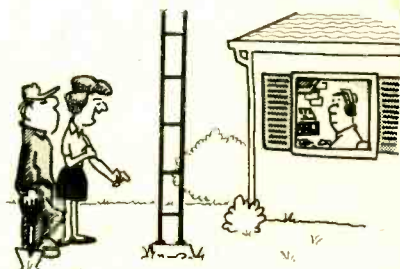

"This looks like a good spot for the tree!"

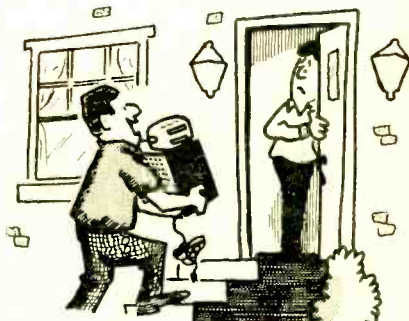

"Hi! Your wife told my wife you're good at this electronic stuff, and I thought you could take a look at..."

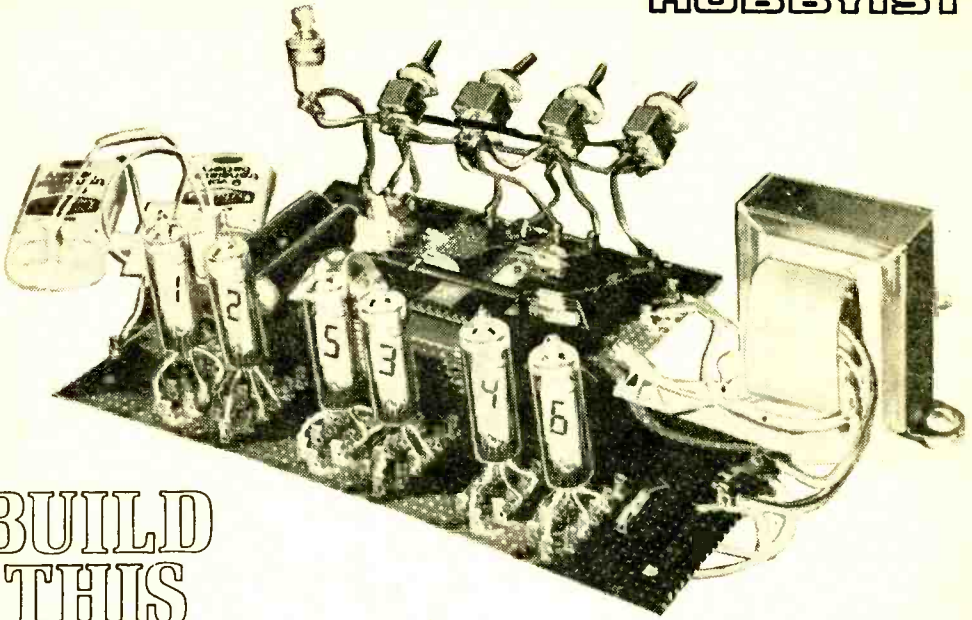

BUILD THIS ELECTRONIC CLOCK

Turn a few parts into the darndest digital calendar-clock you've ever seen!

by C. R. Lewart

You can see the advantages of a digital clock! Particularly this one! It has big, bright, bold numerals that display time, date, and your electronic interest and skill to all who view it. And as you would expect, we turn a complex electronic instrument—the digital clock—into a very elementary electronic project!

How did we do it? By putting together the ideal marriage of a popular clock-on-a-chip IC (integrated circuit) and a new fluorescent-anode type display tube that can be driven directly by an IC.

What does that mean to you? A set of twenty driver transistors you don't need; extensive wiring on a high-priced circuit board you don't need; an extra high-voltage power supply for cold-cathode display tubes you don't need. And there's more.

Convert to a 24-hour clock in a snap. Flip a switch on the rear panel to convert your clock immediately to a 24- or 12-hour time display. Plus, a pair of ordinary 9-volt transistor radio batteries keep things ticking electronically while you move from one outlet to another or until a power interruption or brownout is over. This little trick is done with a built-in oscillator that feeds the counter until 60 (or 50) Hz voltage is restored. Yep! there's even a switch that gives the correct time from either a 50 or 60 Hz power line.

As You Can See, the electronic clock described here was designed to provide a large number of features and make construction simple.

ELECTRONIC CLOCK

Eight of the ten connections made to each display tube are shown opposite this page in the shaded area. For example, the SA segment of a display tube (pin connection 9) is connected to pin nine of all the display tubes as well as to IC 1 pin 15 and R13. Only grid G (pin 5) of each tube has a separate connection to the integrated circuit. For display tube DS 1 it is IC 1 pin 3; for DS 2, it is IC 1 pin 4, et cetera.

Q1
BOTTOM VIEW

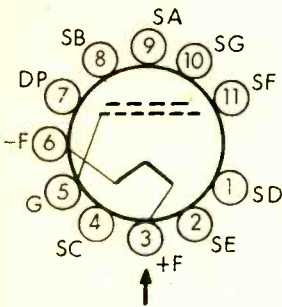
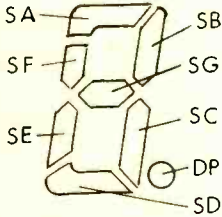
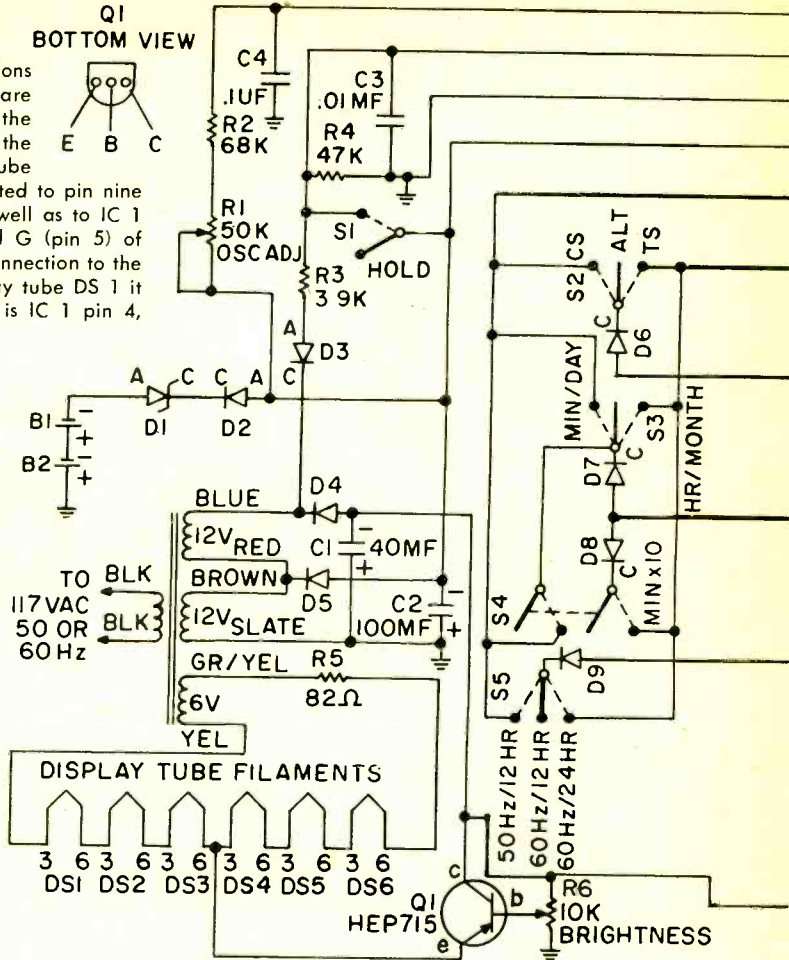
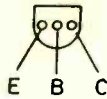

NL-8051
BASE CONNECTION
(BOTTOM VIEW)

NOTE: For full brightness only without control, remove transistor Q1 and Potentiometer R6, and install jumper from terminals c to e of Q1 shown in diagram.

PARTS LIST FOR DIGITAL CLOCK

- B1, B2—9-volt transistor portable battery (Eveready 216 or equiv.)
- C1—40 μ F, 50 VDC electrolytic capacitor, subminiature type, value not critical
- C2—100 μ F, 35 VDC electrolytic capacitor, value not critical
- C3—0.01 μ F capacitor
- C4—0.1 μ F capacitor
- C5—100 pF ceramic disc capacitor
- Note: Capacitors C3, C4, and C5 can be voltage rated at 100 VDC or better.
- D1—Zener diode, 6-volt (HEP-Z0214 or equiv.)
- D2, D4, D5—Silicon power diode, 1N4001 (HEP-154 or equiv.)
- D3, D6, D7, D8, D9—Silicon signal diode, 1N914 (HEP-156 or equiv.)
- DS1-DS6—Fluorescent display tube, National NL-8051 (write to National Electronics, Inc.,

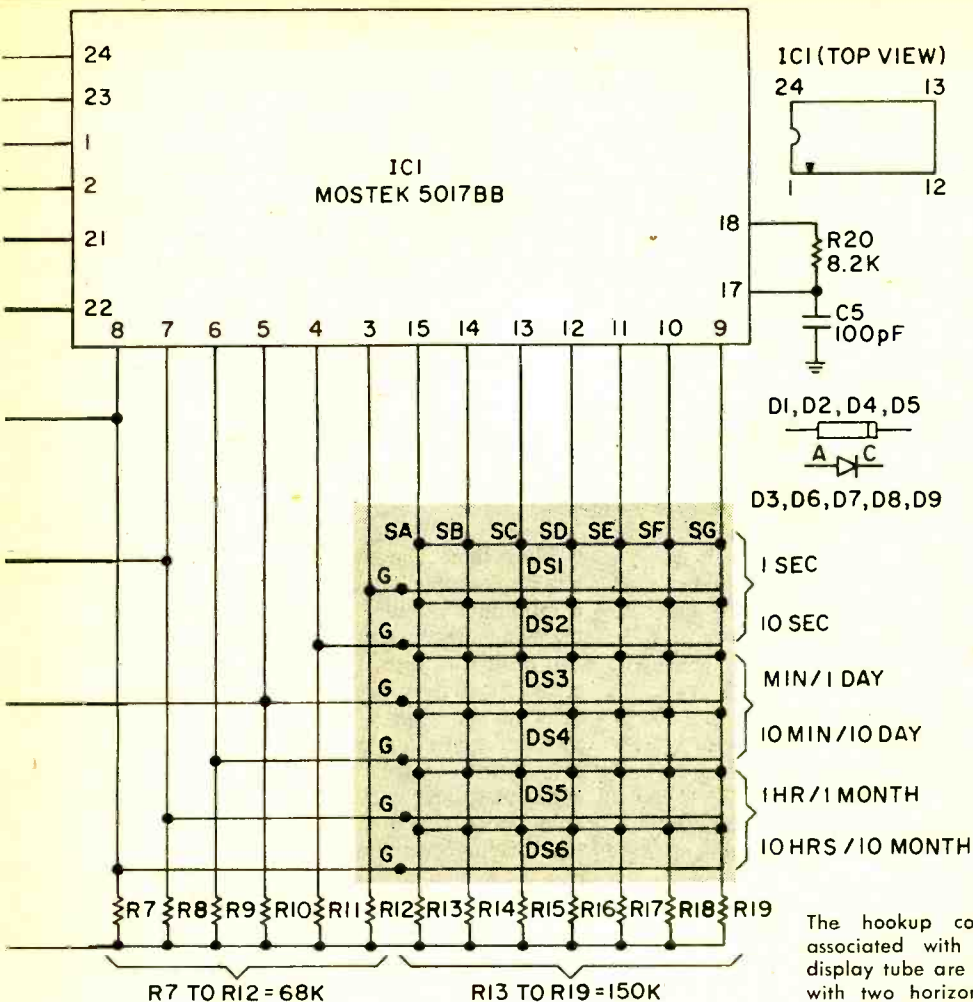

- Box 269, Geneva IL 60134 for name and address of nearest local dealer; or write to Circuit Specialists Co., Box 3047, Scottsdale AZ 85257 enclosing \$5.00 for each unit required, shipped postpaid.
- IC1—Mostek 5017BB (available from Circuit Specialists Co., Box 3047, Scottsdale AZ 85257 for \$24.95 postpaid)
- Q1—2N3906 (HEP-715 or equiv.)
- R1—50,000-ohm potentiometer
- R2, R7 through R12—68,000-ohm, 1/4-watt resistor
- R3—39,000-ohm, 1/4-watt resistor
- R4—47,000-ohm, 1/4-watt resistor
- R5—82-ohm, 1/4-watt resistor
- R6—10,000-ohm potentiometer, miniature type (Lafayette 32-22528 or equiv.)
- R13-R19—150,000-ohm, 1/4-watt resistor
- R20—8,200-ohm, 1/4-watt resistor
- S1—Spst, normally open pushbutton switch, miniature type preferred (Lafayette 99-62184 or equiv.)

The hookup connections associated with a given display tube are indicated with two horizontal lines immediately above and below the DS1 to DS6 reference designation in the shaded area. The upper line for each display tube shows the seven segments (SA to SG); the lower, the G terminal. Refer to the NL-8051 base connection diagram at far left.

- S2, S3, S5—Spst, neutral center subminiature toggle switch (Radio Shack 275-325 or equiv.)
- S4—Dpdt subminiature toggle switch (Radio Shack 275-1546 or equiv.)
- Note: Although switches S3 and S4 should have been specified as spring-return-to-neutral-position types, they were not because they are difficult to obtain. If not available, make substitution.
- T1—Filament transformer: 117 VAC to 12V, 12V and 12VCT (each isolated) (Stancor P8362 or equiv.)
- Misc.—24-pin IC socket with solder tabs (Allied 746-0906 or equiv.), 3-in. x 8-in. x 6-in. aluminum cabinet, wire, blue or green plastic light shield, etc.

ELECTRONIC CLOCK

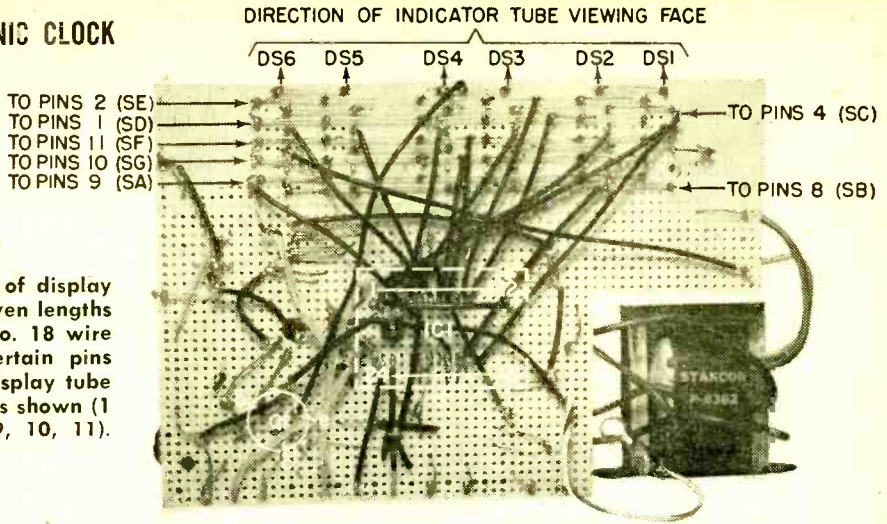

Underside of display board. Seven lengths of bare No. 18 wire connect certain pins of each display tube together as shown (1, 2, 4, 8, 9, 10, 11).

Let's go over the list of features:

A display of time (hours, minutes, and seconds) alternates with the date (month and day of the month).

At the flip of a switch, the display changes from a 12-hour to a 24-hour mode.

A stand-by battery operates the clock during power failures (most other clocks reset to zero even during momentary power failures).

A simple adjustment of the seconds display is provided, with a hold button to stop the counting and a 50/60 Hz switch to speed up the counting by 20 percent.

Display intensity can be adjusted.

Multiplexing of the display tubes (a sequencing time-system) eliminates a "rat's nest" of wires (display is seen without annoying flicker or blanked-out digits).

An economy model cuts out seconds display, brightness control, battery switchover, 50/60 Hz and 12/24-hour switchable features, if you wish.

A handsome face for your finished clock



More Info. The construction of the clock was kept simple by selecting an IC requiring a minimum number of connections and by choosing fluorescent display tubes which can be driven directly by the IC. The complete circuit uses, in addition to its IC brain, four to six display tubes, a power transformer, only a single transistor (if you want brightness control), twenty resistors, five capacitors, and nine diodes. If you don't care about the seconds display, you omit two display tubes with associated components. Compare this clock to a well-known digital clock kit with over twenty transistors and over fifty resistors! Anybody even moderately handy in electronic construction should have no difficulty building the clock in a few hours.

How Does It Work. The MOS integrated circuit consisting of over a thousand transistors divides the 50 or 60 Hz line frequency into seconds, minutes, hours, days, and months. A decoder on the same IC operates the individual segments of the display tubes, which are operated in multiplex mode. This means that the IC sends signals to the first display tube, then the second, and so forth, and then starts with the first tube again. This mode of operation simplifies the wiring to the IC, since all like segments in the display tubes can be wired in parallel and connected to a single pin on the IC. Therefore, seven pins on the IC control the segments of all the display tubes. Just four or six other pins on the IC (one per tube used) control individual tubes with a connection to their control grids.

Additional logic on the IC provides for

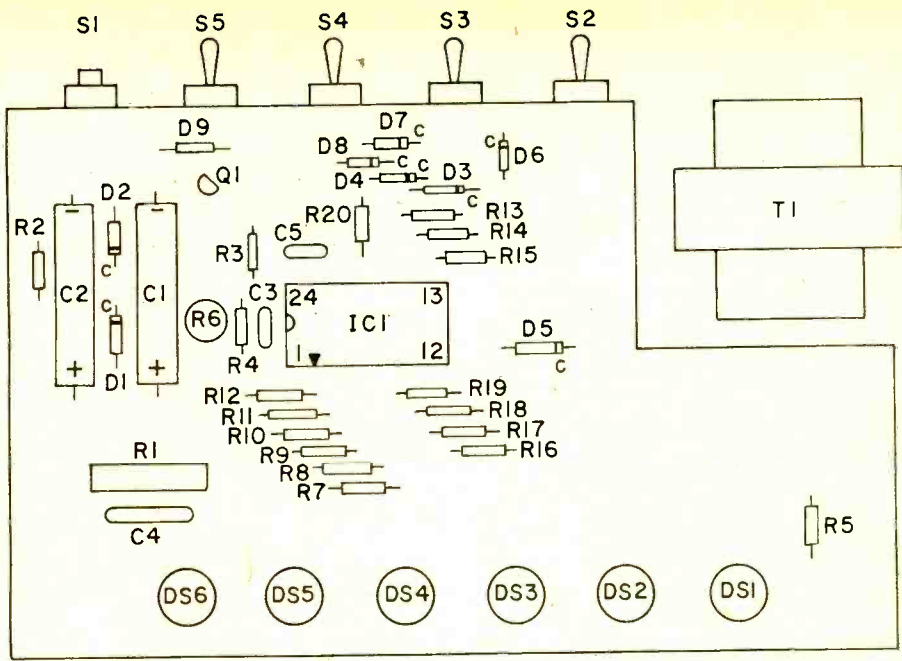

alternate time/date and 12/24-hour display. When the AC power line is disconnected, the stand-by battery takes over and an internal oscillator controlled by C4, R1, and R2 substitutes for the line frequency. To conserve power, the display tubes are *not* lighted during the stand-by operation, but the clock runs as usual.

Display tube mounting using push-in clips. Stagger the eleven clips as shown and strap like pins together with bare wire on underside of board. See photo on opposite page.

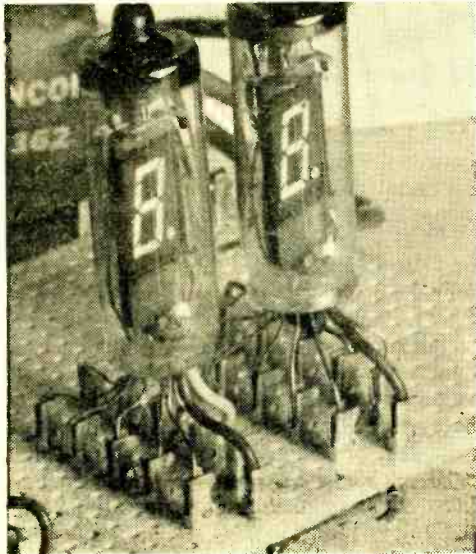

Top of the board showing a suggested location of all discrete components that are used in this circuit. Resistors R7 through R19 are grouped as shown to facilitate their connections to the integrated circuit.

Construction Hints. Use approximately a 4½-in. x 6-in. piece of perfboard or vectorboard with holes spaced at 0.1-in. Insert the display tube leads into push-in terminals and run parallel wires between the display segments. Use a socket for the IC, but do not insert the IC before all the construction is finished. Be careful in handling the IC before inserting it. Static electricity may damage it. The clock case has to be grounded to the wire connected to pin

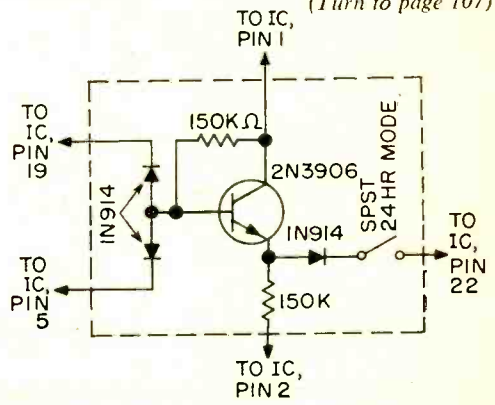

December display circuit for 24 hour clock fans. Transistor 2N3904 base is same as Q1.

SO YOU WANT TO DESIGN A SIMPLE TRANSISTOR AMPLIFIER STAGE!

by David J. Waters

Want a quick, easy method to determine what component values to use when you insert an additional transistor amplifier stage in your equipment? The common emitter arrangement shown in the diagram can be used with a reasonable amount of simplicity, stability, and dependability. It has both voltage and current gain.

Get Started. It is simple to select the correct values for the components in this circuit. Suppose we have the common variety of a silicon transistor with a beta of over 20 to be used as a small signal class A amplifier stage.

Under these conditions we want about 1 mA in the collector circuit. Let's use an emitter voltage somewhere between 1/2 and 2 volts, say 1 volt. The emitter resistor R_e value will then be 1 volt/1 mA = 1000 ohms.

Since the base is automatically at 0.7 volt for a silicon transistor—close to 0.3 volt for germanium—the 1 volt emitter sets the base at 1.7 volts.

The current in the divider network of R_1 and R_2 should be 1/2 or more times as high as the collector current, which was selected at 1 mA. The divider current, then, is 0.5 mA. Use a 6-volt collector supply, for example. To obtain the resistance values of the divider network simply divide the 6 volt collector supply by the divider current of 0.5 mA. The answer, 12,000 ohms, is the total divider resistance value. Since R_2 is at

1.7 volts/0.5 mA = 3400 ohms, it follows that R_1 must be 12,000 minus 3400 or 8600 ohms.

This leaves only the collector resistor R_c to find. Any resistance should be used that gives the required collector voltage to drive the next stage. The collector voltage should be kept at least 1 volt over the emitter voltage; about 3 volts would be a logical output. The value of resistor R_c can then be easily calculated by $6 - 3 \text{ volts} / 1 \text{ mA} = 3000 \text{ ohms}$.

Lest You Forget. A few things worth remembering: A signal at the base affects the collector current. A positive voltage for an NPN transistor or a negative voltage for a PNP applied to the base raises the collector current. The common emitter configuration inverts the input signal 180° at the transistor output. The common emitter current gain, beta, is usually given in the manufacturer's data sheet but may quite easily be figured by the equation:

$$\text{Beta} = \frac{\text{alpha}}{\text{one minus alpha}}$$

Thus, if alpha is given at 0.98, beta would be:

$$\text{Beta} = \frac{1 - .98}{.98} = \frac{.02}{.98} = .49$$

As a general rule alpha is approximately between .9 and .99; beta is usually between 10 and 1000. The negative number (minus sign) indicates signal phase inversion.

Final Tip. Now you have an inside track on designing simple, one-stage transistor amplifiers. If your computations call for an 8,600 ohms resistor, select the nearest standard resistance value. The two nearest values are 8,200 and 9,100 ohms. Either value is usable in the circuit (the 8,200 being the closer) since they are within 6% max. of the computed value. You'll find $\pm 10\%$ change in computed values to have little effect on the circuits operation. Start designing, today! ■

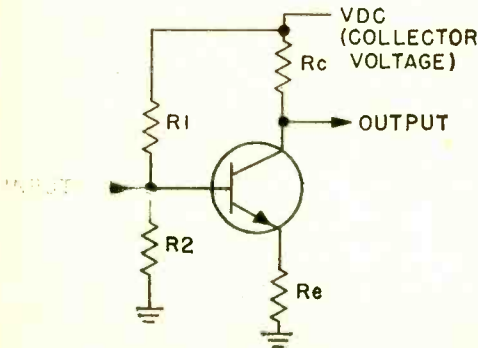



There's a TRF in that IC

by C. R. Lewart

Building yesterdays radio with the excitement of today!

□ Back in the days when everyone who built electronic projects as a hobby used vacuum tube circuits, there was a project in the RCA Receiving Tube Manual for a wide range, low distortion receiver for the AM broadcast band that used what was called an "infinite impedance detector." This one-tube project gave hi-fi buffs a simple receiver that could detect the full response of local AM stations, some of which did broadcast wide frequency programming in spite of the usually quoted 5 kHz audio cutoff of AM stations. But, plagued with poor sensitivity and selectivity, it became more convenient to build one of the \$29.95 AM tuner kits of the day than to erect a 50-foot longwire antenna and deal with the bleedover of other local stations. With this project e/e shows you how to overcome those old time problems with an IC circuit that's simple, sensitive and selective.

TERRIFIC TRF-IC

This is the author's original model, built on a small perf board with a ferrite rod and coil L1 salvaged from an old transistor radio. You can do that or use one of the units suggested in the parts list.

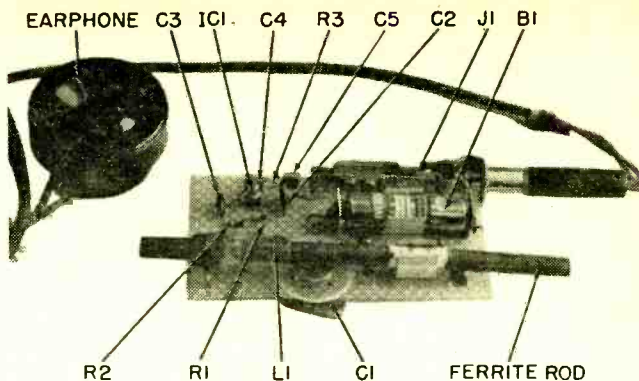

There is a way today for you to get a full measure of low-distortion sound from your local AM station, and at the same time gain experience in building one of the oldest circuits around—the TRF (tuned radio frequency) radio. As a bonus, you work with an integrated circuit, one of those amazing supersmall bits of etched silicon that do big jobs. Here the IC is a small three-lead unit that looks like a transistor but actually contains ten. Inside, an RF signal (the station you tune) is amplified and detected with enough output to directly drive high-impedance headphones. There is even an automatic volume control built in, so you don't have the problem of blasting and fading as you tune signals of different strengths.

That brings up the other fascinating thing about this receiver—its selectivity, or ability to separate stations crowded along the dial. With a high-Q ferrite antenna we could pick up eight separate stations in downtown NYC—a real feat for a TRF! A quick glance at *White's Radio Log* shows no less than seven

full-power 50,000-watt AM stations listed for New York City. An ordinary TRF circuit would be swamped by the high-power locals, allowing only one or two stations to be heard.

Actually, compared to an average superheterodyne-type pocket transistor radio, the audio quality of our receiver is considerably better, and its sensitivity and selectivity closely approach the superhet. The radio drives high-impedance earphones with sufficient volume for personal listening; with additional amplification it can of course be used to drive a loudspeaker.

The Circuit. The heart of this simple radio is a newly-developed integrated circuit, the ZN414, made and developed by Ferranti Limited of Great Britain. It amplifies the RF signal, demodulates it, and provides automatic gain control (AGC). Selectivity is the result of the input circuit—a high-Q (200 or more) ferrite antenna and tuning capacitor that work into the high input impedance of the IC.

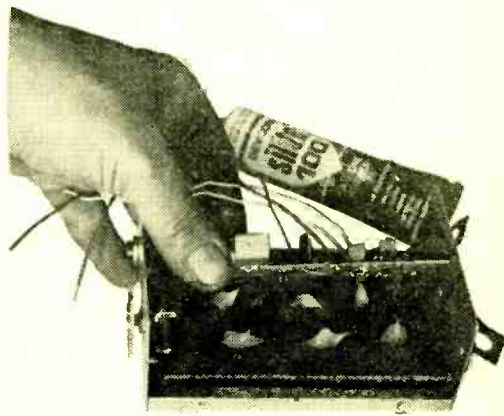
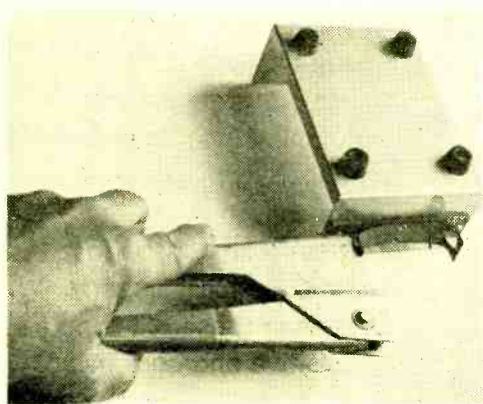

Increasing the appearance of basic perfboard construction is simple with one of the good looking cases available to hobbyists. A well stocked workshop (left) can make a neat job easy as you attach the Miller coil holder. And dabs of adhesive hold perf-to-fiberboard.

Your three options for listening include a one-transistor earphone amplifier. Use it with less sensitive phones. Actually, even 8-ohm hi-fi phones work at reduced volume when connected directly to cap C5. Connecting C5 and ground to the input of your hi-fi, quad or stereo will give you well defined clean sound from BCB locals +1.5 VDC

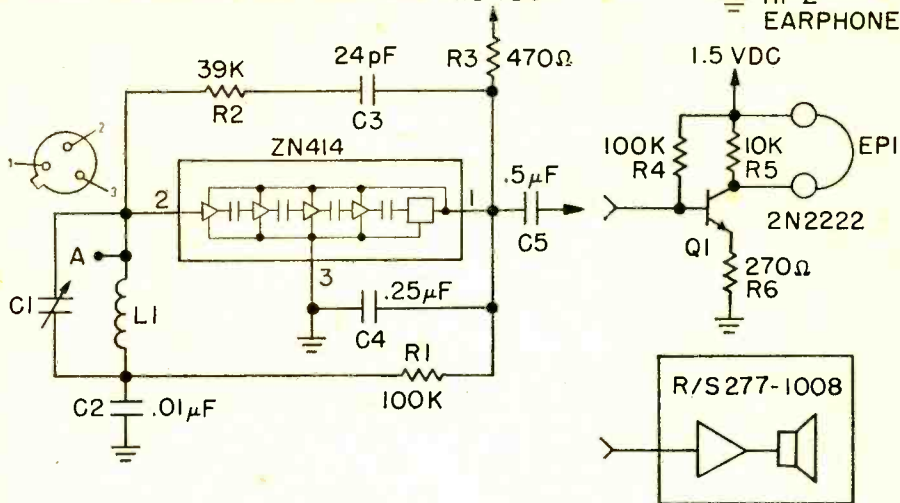

PARTS LIST FOR THE TRF-IC

B1—1½ volt AA cell
 C1—365 pF variable capacitor (Calectro A1-232 or equiv.)
 C2—0.01 uF (10,000 pF) disc capacitor, 12 VDC or better
 C3—24 to 27 pF disc capacitor, 12 VDC or better
 C4—0.22 to 0.25 uF capacitor, 12 VDC or better
 C5—0.5 uF capacitor, 12 VDC or better
 EP1—2000-ohm impedance earphone (Calectro J4-825 or equiv.)
 IC1—Integrated Circuit ZN414 (Available from Circuit Specialists Co., P.O. Box 3047, Scottsdale AZ 85257 for \$4.95. Postage is included.)

*Optional parts required only if single-stage audio amp is to be constructed.

L1—Ferrite rod antenna coil for broadcast band, J. W. Miller type 2001 (Lafayette Radio 32-82027 or equiv. is identical to author's unit)

PA1**—Optional amplifier and speaker

Q1*—Transistor, NPN, 2N2222
 R1—100,000-ohm, ¼-watt resistor
 R2—39,000-ohm, ¼-watt resistor
 R3—470-ohm, ¼-watt resistor
 R4*—100,000-ohm, ¼-watt resistor
 R5*—10,000-ohm, ¼-watt resistor
 R6*—270-ohm, ¼-watt resistor

Misc.—Battery holder, hookup wire, solder, epoxy glue, etc.

**Optional amplifier/speaker unit required only if earphones are not used.

Construction. Try to follow the parts layout as shown. Long connections may cause feedback whistles and poor reception. Of special note, C4 must be soldered as close as possible to the integrated circuit. Sensitivity with the ferrite antenna should be sufficient for most broadcast band stations. If you do want to pull in the weak ones, attach a couple of feet of free-hanging wire to point A shown on the schematic. The radio will operate with proper selection of a smaller tuning capacitor (C2) at frequencies between approximately 200 kHz and 4 MHz! This

would include, in addition to the broadcast band, the weather band, the marine band, and the end of the 49 meter short-wave band. I was able to receive, using just a ferrite antenna, a German and a Canadian station in the 49 meter band, and I could hear the marine operator around 2.5 MHz.

The Editor's Modification. The original circuit board for the super-transistor radio was heywired on a perfboard with all connections made there. Phone jack, tuning capacitor, antenna coil—every part was mounted on the board without regard for

TERRIFIC TRF-IC

appearance. However, there comes a time when every project must be mounted in a box so that it can be used and be durable.

The super-transistor radio board is suitable for mounting inside an aluminum case. However, the antenna coil must be mounted on the outside of the case. The phone jack was mounted so that the phone plug could be inserted without any problem. The tuning capacitor was also mounted on the front panel for the purpose of having its dial accessible for tuning. The antenna coil (ferrite core) was mounted on the outside of the box simply because the box itself would shield the antenna from electromagnetic radiation. So, the easiest way for me to proceed was just to remove these parts from the perfboard and mount them on the front and back panels as the photos indicate. Leads were then connected to the perfboard, and the perfboard in turn was cemented to the bottom of the box. Since the bottom of the box is metallic, with metal screws jutting up because of the rubber feet mounting, a 1/4-in. masonite board was cut and inserted into the box so that the leads on the bottom of the perfboard would not touch the metal case.

There was one particularly important mounting problem. The tuning capacitor is isolated from ground as the schematic diagram indicates. However, the mounting shaft of the tuning capacitor connects to one of

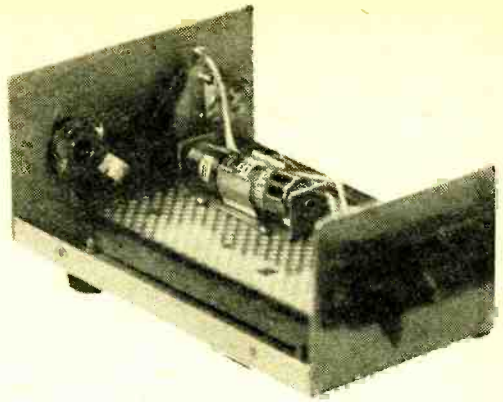

Just a single 1½ volt cell powers this set for at least 90 days—even if you operate for 24 hours a day! What would a D cell do?

the plates of the capacitor. Therefore, mounting this tuning capacitor directly to the front panel would short out a part of the circuit and make the receiver totally inoperative. To avert this problem, two washers were cut from this magazine's cover. The holes were punched out with a paper punch. A piece of spaghetti tubing was cut about 1/16-in. long to make a large "rubber band" spacer that would fit over the shaft threads. This insures that the side of the shaft and the capacitor mounting threads would not touch the hole in the box. The two washers went on either side of the surface of the box so that the capacitor nut and rear mounting would not touch. Sound difficult? It's not, because it only took about five minutes to do. ■

Hook Up a Krunchometer Today

□ Your oscilloscope sits unused on the test bench during parties when it can provide yeoman service as a Krunchometer to entertain your guests. Set-up is easy!

Set the vertical gain control of the oscilloscope for zero gain. Adjust the horizontal sweep control to about 20 Hz. Set the intensity and focus controls to give a nice clean, fairly bright trace. Now stand back about 15 feet from the face of the oscilloscope and crunch on a raw carrot or spaghetti (yuck!) while watching the trace on the oscilloscope. No connections are needed between the oscilloscope and the crunching observer. Note the wave that is generated on the oscilloscope trace and you will find the greater the crunch, the greater the amplitude of the wave.

Don't expect to see the wave on the oscilloscope unless you are the one doing the crunching. This seemingly "magical" property of the Krunchometer can be verified by everyone who takes part in the crunching.

How does it work? While you are watching the oscilloscope trace, your eyes see a flying spot which makes the oscilloscope trace. You do not see this trace as a flying spot, but as a solid line because of the eye's image persistence of 1/15th of a second or less. As you are crunching the eyes are being bounced up and down causing the flying spot to trace on the retina of the eye a wiggly line. This wiggly line you see is what I call a Krunchometer. The Krunchometer works best when carrots are in season.
—Glynn G. Gillette

go
treasure
hunting
with the...

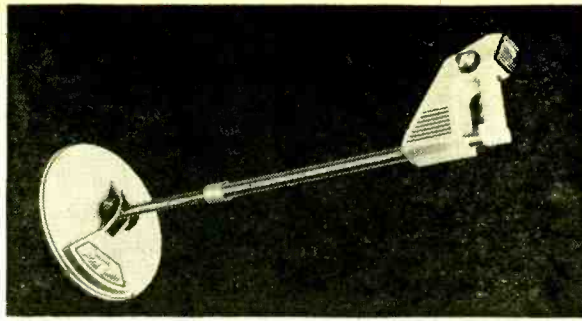

Heathkit GD-348 Deluxe Metal Locator

Those of us fortunate to grow up near an ocean or lake remember the *scroungers* who made their appearance at the end of summer. Equipped with large screens and a shovel, the scroungers would sift through acres of sand to find the coins lost by summer's sun-lovers. Today, it's unusual to see anyone hoisting mountains of sand to find "Captain Kidd's treasure," for the modern treasure hunter need merely walk along carrying a metal locator, waiting for the "beep" that denotes coins—or a stale sandwich wrapped in aluminum foil—lying under the sand.

Fact is, the modern electronic metal locator does a lot more than provide pocket money for some youngster willing to spend a day in the sun. Electricians use it to locate wires buried in walls, floors and ceilings, your water company uses it to locate your water and sewer pipes or the water and gas cut-off valves, and real treasure seekers with "secret" maps purchased from a *desert rat* in a bar use it to find the mythical cities of gold. (Ever wonder why these *desert rats* don't buy their own metal locator and find the cities of gold for themselves?)

Of course, there are those who use a metal locator just for fun; to find old relics of ships or from ships washed ashore in some famous hurricane of way-back-when; to locate antiques buried under some farmer's *south forty*; or to zero-in on the remnants of an ancient people in an archaeological dig.

What Makes It Beep! There are two types of metal detectors available to the hobbyist at reasonable cost. The least expensive of the two is the *heterodyne* or BFO (beat frequency oscillator) type which is little more than a toy. The other is the *balanced induction* type, represented by "professional" models such as the Heathkit Model GD-348 Deluxe Metal Detector.

The search coil of a balanced induction metal locator is actually two coils. One coil is stimulated by a pulse modulator, producing a 100 kHz output that is modulated at a 500 Hz rate. The second coil in the search head is positioned in such a manner that there is no coupling between the two coils (whatever leakage exists is balanced out). The second coil's output is connected to a

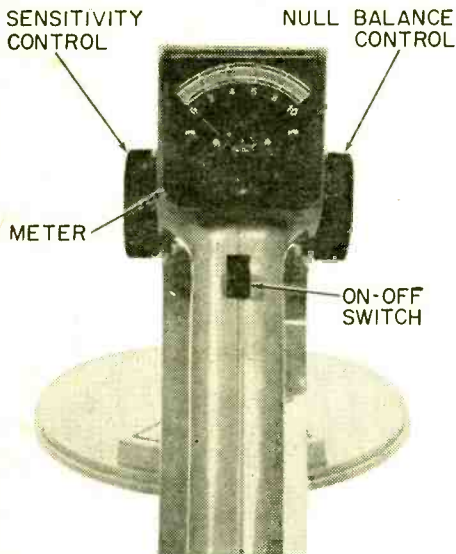

Control head of the GD-348 where a tone and a visual indicator help pinpoint metals. Circle No. 1 on the Reader Service Page.

DELUXE METAL LOCATOR

detector, amplifier, meter and audio output.

When the search head passes over metal, the inductive balance between the two coils is upset and part of the modulated 100 kHz signal is coupled into the second coil. This signal is rectified, amplified and heard in a loudspeaker, or phones, as a tone of approximately 500 Hz. Simultaneously, a meter indicates the degree or amount of energy coupled into the second coil. With proper control adjustment the higher the meter reading the, larger the metal object, or the closer the object to the "center" of the search coil.

The most convenient part about the induction balance system is that the user doesn't have to fiddle with oscillators that drift in the hot sun or listen for minute changes in tone frequency. Induction balance is generally set to work on-off. Dead silence means no metal. Any tone or meter reading means the presence of metal.

About the Kit! Though the Heathkit GD-348 uses the more complex induction balance metal detection system is it actually easier to use and operate than most, if not all, BFO detectors. The adjustable-position search coil is mounted on the end of a telescopic shaft which resembles one leg of a photographic tripod. At the top end of the shaft is a plastic housing that doubles as a handle (or grip). The housing contains

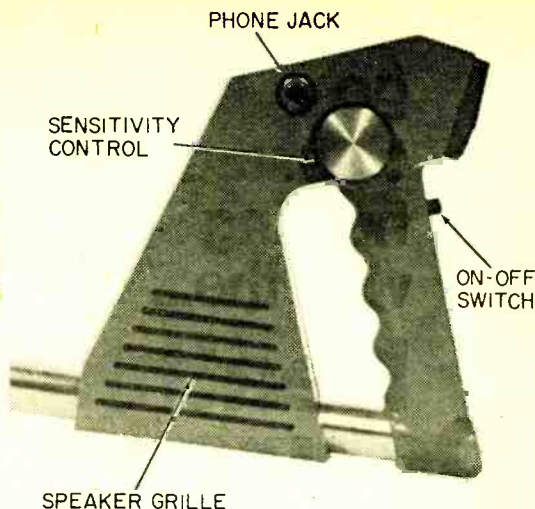

A plastic handle serves as the housing for electronic circuits used in the balanced-induction system; headphones can be used.

the amplifying electronics, a sensitivity control, a null control (to cancel leakage between the coils in the search head) a headphone jack, a loudspeaker and a "calibrated" meter. The headphone jack is wired in such a manner that the internal speaker is automatically disconnected when the phones are plugged in.

The sensitivity control serves to attenuate the effects of large areas or masses of metal, thereby allowing almost pinpoint "centering" of the located metal under the search head. If no sensitivity control was provided, if maximum sensitivity was always provided as it is in many other metal locators, large metal objects could give a false "centering", and would not be found directly under the search head's area of highest sensitivity.

To Operate. In typical use the user grabs the handle moulded into the plastic housing and walks along with the search head positioned parallel to the ground (an inch or so above the ground). As long as there is no metal under the search head there is no meter reading and no sound from the internal speaker or headphones. As the search head passes over metal a tone will appear in the speaker (or phones), while the meter starts to indicate a value higher than zero. As the search head's point of maximum sensitivity passes over the metal the tone volume and meter reading peaks out, and then starts to decrease as the search head is moved beyond range of the metal. Though maximum sensitivity occurs when the metal

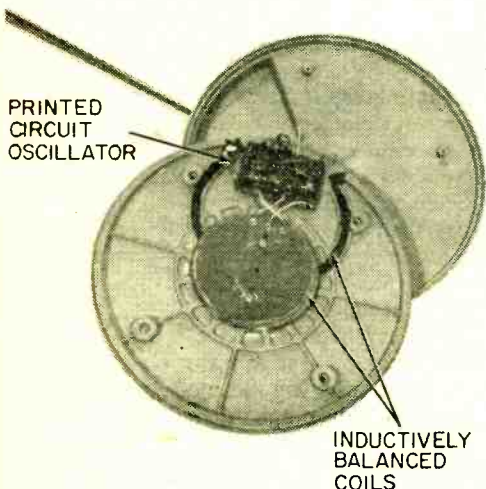

Inductively balanced coils in the search head are factory installed and adjusted. Builders assemble and install PC assembly.

is approximately under the center of the search head, it is still a good idea to locate the *precise center* using a dime as the "treasure" and then to mark the *precise center* on top of the search head with a dot of bright nail polish or white paint. It's a lot easier to find small coins when you know their exact position within 1/2-in.

Building the Kit. The most critical part of the assembly, which is the positioning of the coils in the search head, is done for you at the factory; the coils are positioned properly and supplied cemented and mounted in place. The transistorized electronics is divided between two small printed circuit assemblies. One, containing the oscillators and driver for the search coil is mounted directly inside the search head and is connected to the audio and meter printed circuit assembly which is mounted in the plastic housing (and handle) at the top of the telescopic shaft. The connecting wires for the two printed circuit assemblies pass through the telescopic shaft so they are fully protected against damage. Though the printed circuit boards represent *simple, no problem* construction, there are a few points

where the connecting wires must be snaked through difficult or tight quarters, and Pop will have to figure on giving junior some assistance with the final assembly.

Somewhat unusual, you will find that even though power is provided by a 9-volt transistor radio battery, there is a Zener voltage regulator in the power supply circuit. The regulation insures that performance remains constant as the battery is used, or if the battery is subjected to wide extremes of ambient temperature variations, as might occur if the metal detector was moved from a cool shade into the hot sun. By providing voltage regulation Heathkit insures the user will not be confused by meaningless variations in the tone's level or meter reading.

Summing up. There is no better way to locate metal at a reasonable instrument cost other than with the *induction balance* system used in Heath's GD-348 Deluxe Metal Detector (\$89.95). By providing both a user adjustable sensitivity and search head balance (null) Heathkit insures the user obtains the optimum level of performance possible. For additional information circle No. 1 on the Reader Service Coupon. ■

HEAD-AMP FOR THOSE MINI-SOUND PROJECTS

□ Quite often the audio output from small projects is just barely sufficient to produce a recognizable signal in standard experimenter magnetic earphones. Yet a handful of surplus components will provide enough gain to turn that whisper sound into a roar. Specifically intended for use with magnetic earphones of from 1000 to 5000 ohms impedance, the Head-Amp can do double-duty as an audio signal tracer when troubleshooting.

Transistor Q1 can be any PNP of the

2N2613 variety. Even the 10-for-a-buck kind will work. Volume control R1 should have an audio taper. Distortion control R3 can have any taper. Make certain C2's polarity is correct; the positive terminal connects to volume control R1 (wiper terminal). Adjust distortion control R3 for best sound quality. If you use a jack and plug to connect your headphones to this amp, you can eliminate on-off switch S1 because power is removed whenever the headphones are disconnected. ■

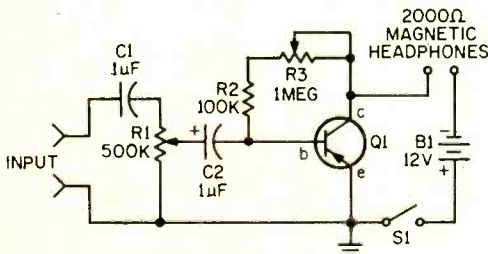

It takes two to stereo, and four to quadeo. Construction is easy, just use one battery and combine all ground connections in one chassis.

PARTS LIST FOR HEAD-AMP

- B1—Battery, 12 volts (two Eveready 5105 in series or equiv.)
- C1—0.1 uF capacitor, 15 VDC or better
- C2—1 uF capacitor, 15 VDC or better
- Q1—PNP transistor, 2N2613 or HEP-632 or equiv.
- R1—500,000-ohm audio taper potentiometer with on/off switch S1
- R2—100,000-ohm, 1/2-watt resistor
- R3—1 megohm potentiometer, any taper, no switch required.

Use it all as you get ready for a new career:

\$1,500.00 WORTH OF TWO-WAY RADIO ELECTRONIC COMMUNICATIONS EQUIPMENT

Bell & Howell Schools announces a new learn-at-home program in two-way radio that gives you "hands on" experience with commercial-grade equipment! For free information mail the postage-free card today.

You need "hands on" experience with a real, commercial-band FM transceiver and actual commercial-grade test equipment—to take full advantage of growing opportunities in electronic communications.

Two-way radio communications is a healthy growth area in electronics. And it's lucrative. Almost two million commercial two-way radio systems now serve as vital communications links for trucks, planes, boats and taxis. And the FCC requires each system to have its equipment serviced regularly by a licensed technician. That's where you come in. But you need career-oriented training—plus your FCC license.

Knowing how to put an amateur radio kit together won't help when you're "on the job"—servicing two-way radio systems for aircraft or advising trucking companies about their land-mobile communications system. For that, you need "hands on" experience with the real thing. This unique new Bell & Howell Schools learn-at-home program gives you just that. You can work with the equipment by attending one of our special "help sessions" or by dropping by one of the Bell & Howell resident schools. If neither of these plans is convenient, you can have the equipment shipped to your home in return for a \$100 deposit, which is refundable when you return the equipment.

Find out more about this exciting new Bell & Howell Schools program. There's no obligation.

**For free information,
mail attached card today!**



Let Bell & Howell Schools help you get ready for an exciting career or business of your own in two-way radio electronic communications!

Bell & Howell Schools has helped thousands of people prepare for careers—and businesses of their own—in electronics. You can have absolute confidence in the thorough training you get.

Expert instructors at Bell & Howell Schools plan each program to answer a single question: "What qualifications will you need to take advantage of *actual career opportunities* in electronics?" They then build each program to give you those exact qualifications.

To get ready for a business of your own in two-way radio, you need: 1) career-oriented training; 2) FCC License; 3) "hands on" experience with commercial-grade equipment. Bell & Howell Schools now offers this new at-home training program that gives you all three. (See FCC License Warranty on attached card.)

JUST LOOK AT ALL THE EQUIPMENT YOU'LL WORK WITH DURING YOUR TRAINING PROGRAM WITH BELL & HOWELL SCHOOLS!

Commercial-Band FM Transceiver... exactly the kind of two-way radio you'll service throughout your career.



Deviation Meter

... model favored by many working technicians to check modulation of transmitted signal.

Frequency Meter

... highly sensitive instrument used to check signal frequency within precise tolerances established by government standards.

Power Output Meter

... meter used almost universally by trained and licensed technicians to check power output—or wattage—of signal.

Alignment Generator

... a custom-designed unit you use to generate test signals for transceiver alignment.

FCC REGULATIONS GIVE YOU THE OPPORTUNITY TO START YOUR OWN BUSINESS!

The Federal Communications Commission requires that all commercial two-way communications systems be checked and serviced by a licensed technician at regular intervals.

As a Bell & Howell Schools graduate, you'll have the technical know-how you need. With your FCC license, you could go out and eventually build your own business—signing contracts with companies that use two-way radio. FCC regulations could mean security and regular income for you!

BELL & HOWELL SCHOOLS OFFERS YOU THESE SPECIAL ADVANTAGES:

Help Sessions Scheduled regularly at the Bell & Howell Schools and in many other cities throughout the U.S. and Canada. Top instructors give you personal help and expert advice.

National Career Placement Center Helps you locate a job in the field of electronics that fits your background and interests. Use this unique service *any time* after you complete your program—and throughout your new career.

Veterans' Benefits We are approved by the state approval agency for Veterans' Benefits.

Student Financial Aid We are an eligible institution under the Student Loan Program.

EXCLUSIVE ELECTRO-LAB® ELECTRONICS TRAINING SYSTEM!

To make sure you get practical experience with instruments used daily by professionals, we've integrated into your program three precision instruments you assemble yourself:

Design Console Use this to rapidly "breadboard" circuits without soldering.

Oscilloscope Offers bright, sharp screen images, 3-way jacks for leads, plugs.

Transistorized Meter Registers current, voltage and resistance.



DETACH AND MAIL POSTAGE-FREE CARD TODAY! OR WRITE:

An Electronics Home Study School
DEVRY INSTITUTE OF TECHNOLOGY



ONE OF THE
BELL & HOWELL SCHOOLS

4141 Belmont, Chicago, Illinois 60641

531

*Electro-Lab® is a registered trademark of the Bell & Howell Company.

Antiquing an Old Tube into Antiquity

by Art Traufer

Many antique radio collectors have one or more early battery radios in their collections which have bayonet shell-type sockets made for O1A type tubes. The O1A tubes require 5 volts on the filament and draw a hefty .25 amps each. Since these tubes were out of production many years ago and are becoming hard to find, it is desirable to use more modern tubes having lower filament voltages and less "A" battery drain. One such tube is the type 30 tube, which requires only 2 volts on the filament at only .060 amps!

Type 30 tubes have the same four pin arrangement as the old O1A tubes. However, the 30's base is smaller in diameter than the O1A's base and it also does not have the metal pin for use in bayonet sockets. The 30 tubes were made for use in "push-in" type sockets.

To use a 30 in an O1A bayonet socket it isn't necessary to make an adapter or to "re-tube" an O1A base with a 30 glass envelope. All you have to do is build up the diameter of the 30 base so that it fits the bayonet socket and then put small metal

pins in the base.

How To Do It. Buy a 12" length of Crown Line PCV-1120 1" white plastic pipe at a plumbing supply house, or buy any other plastic pipe having an inside diameter the same (or slightly larger) than the diameter of the 30 tube base. Be sure the outside diameter is the same (or slightly smaller) than the opening in the O1A bayonet tube socket.

Saw off a 1" piece from the plastic pipe, then file the tough sawed edges smooth and glue the 1" piece on the base of the 30 tube. If the plastic fits a little too loose on the tube base simply wrap a turn or two of *Mystik* cloth tape around the tube base before you apply the glue. Let the glue harden.

If the modified 30 base now fits a little too loose in the O1A bayonet socket wrap a turn or two of the cloth tape around the base.

To complete the job fasten a small metal pin in the base. To do this drill an undersize hole through the plastic and into the tube base and then twist in a machine screw

(Continued on page 109)

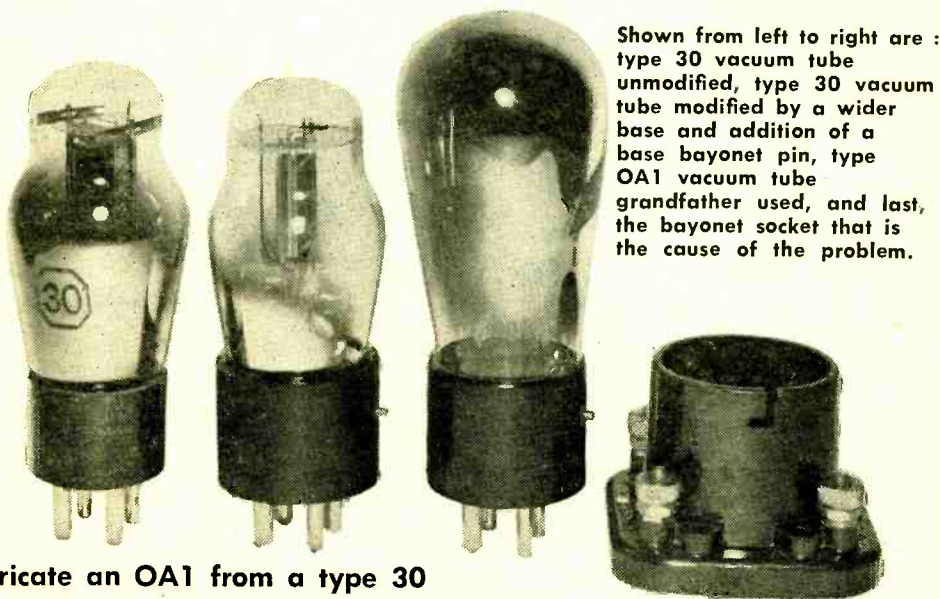

Shown from left to right are : type 30 vacuum tube unmodified, type 30 vacuum tube modified by a wider base and addition of a base bayonet pin, type O1A vacuum tube grandfather used, and last, the bayonet socket that is the cause of the problem.

Fabricate an O1A from a type 30 tube and keep your ancient rig on the air!

BUILD...

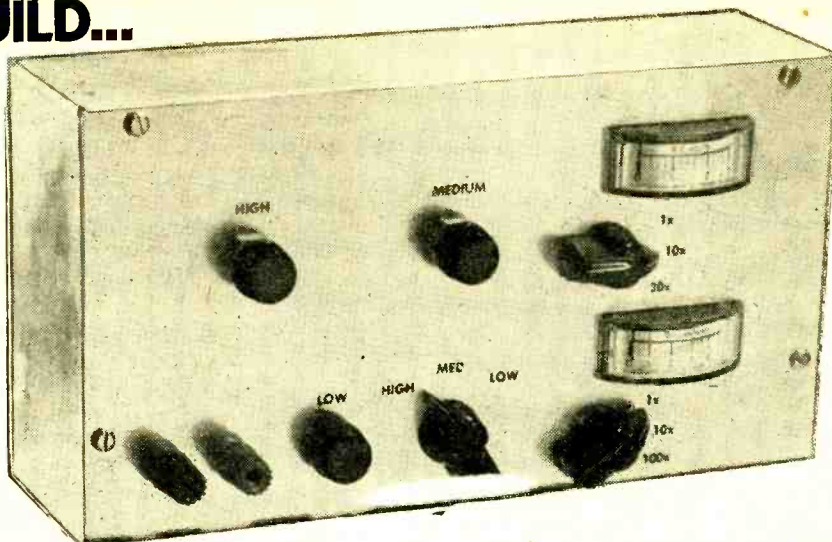

A BETTER BATTERY TESTER

by Marshall Lincoln

EACH OF US today uses a surprising number of batteries in daily living—more of them than we realize until we sit down to count all the battery-operated devices we have in home and shop. But how many of us have a good way to test all the various sizes and kinds of batteries we use, to learn when each should be replaced (or in some cases, recharged)?

Mostly, we must rely on the old method of using a battery until it seems to be getting weak, and then replace it. If we want to be cautious, we may replace it sooner than necessary “just to be sure,” and never really know if the old battery was really worn out.

Sometimes we may keep a couple extra batteries on hand for the most important devices in the household. These may go dead on the shelf before we get around to using them. So, the next time, we put off buying a replacement until we need one and then find the store is out of the size we need. Any way you look at it, we wind up with a feeling that “there must be a better way.”

Naturally, There Is. It's through use of a battery tester that will check all the many types of batteries we have in the house. And to do the job right, it must do more than just measure the voltage—it must also put the correct *load* on the battery while measuring the voltage.

The little testers you find on the counter at an electronics parts store do this in a limited fashion. It's easy enough to build a similar tester to check just one or two types of batteries this way for yourself. But with so many different types of batteries in common use today, these simple testers still don't do the complete job. What you need is a battery tester with a built-in load which can be adjusted to suit any common type of battery which you are likely to have. The better battery tester illustrated here does just that, and yet is not much more complex than a simple tester which may work with only a few selected types of batteries.

Using commonly-available components and inexpensive, yet suitably accurate meters, this battery tester enables you to test just about any household or workshop battery you're likely to encounter, from the little button cells used in hearing aids and photographic exposure meters, up through medium-voltage radio “B” batteries.

A Terminal Voltage? This tester has both a voltmeter and a milliammeter, and so it enables you to check the battery voltage while at the same time observing the amount of current being drawn from the battery. By adjusting the tester so it draws the amount of current for which the battery is rated by the manufacturer, you can quickly see if its

Battery Tester

terminal voltage drops significantly under this load.

Three rheostats, of different resistance values, are used in the tester to give you continuously-variable control of the load placed on the battery. This is the key to use of this better battery tester—it gives you the ability to easily impose the proper load on the battery so you can observe the effect this load has on the battery's terminal voltage.

Each of the tester's two meters has three ranges, selected with a rotary switch just below the meter. Voltage ranges are 0-3, 0-30, and 0-60 volts. Current ranges are 0-5, 0-50, and 0-500 mA.

Three rheostats give you a selection of load resistance from zero to 20,000-ohms. Only one rheostat is used at a time, with S1 used to select the rheostat in use. By covering the load resistance range with three rheostats whose resistance values overlap, this tester allows you to select a medium or low resistance setting with greater precision than if a single rheostat were used for the load.

Overrated Rheostats. When you look at the parts list, you may be surprised at the power ratings of these rheostats—they range from 12½ watts up to 50 watts. Why such a high power dissipation rating for the load resistors to be used on household batteries, which don't produce nearly that much power?

These high power ratings are needed to give you the flexibility to test a wide range of batteries. The power rating on a rheostat applies only to the full resistance of the rheostat. When you turn the slider to a lower resistance point, as you will do when

using this tester, the power rating of the portion of the rheostat which is being used is reduced accordingly.

You certainly won't be sucking 50 watts of power out of the batteries you test, but you need rheostats heavy enough to safely dissipate lesser amounts of power when set for less than their full resistance.

In using the tester, you'll adjust a rheostat used as a load on the battery being tested until the milliammeter shows you this load is drawing from the battery the amount of current for which it is rated. To determine this "load current," refer to the accompanying battery table, which covers many of the commonly-used batteries you're likely to encounter, or refer to a battery manual from the manufacturer of the batteries you use.

For example, the normal full rated load current for a 1.5-volt size "D" flashlight cell is shown as 150 milliamperes. To test such a cell on this better battery tester, follow this procedure.

1. Plug a pair of test prods into the two banana jacks at the lower left corner of the tester. Set the voltmeter range switch to "1x" (for the 0.3 volt range) and the milliammeter range switch to "100x" (for the 0-500 mA. range).

2. Set the load range switch to "low." This will select load resistor R3.

3. Touch the positive test prod to the positive battery terminal and the negative test prod to the negative battery terminal. Turn the "low" rheostat control (R3) until the milliammeter shows you are drawing 150 milliamperes from the battery, and as you do this, also watch the voltmeter. If it continues to indicate nearly 1.5 volts as the current flow is adjusted upwards until it reaches 150 milliamperes, the cell is in good condition, since you can see it is supplying

S1, S2, S3 are SP3T, Centralab 1461

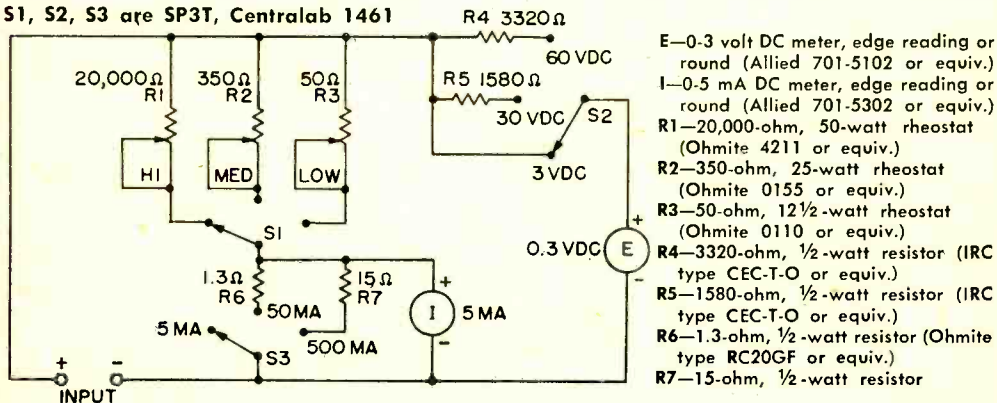

BATTERY TEST REFERENCE CHART

Maximum Current (mA)	Manufacturer Type Number					Type and Application
	RCA	Burgess	Eveready	Ray-O-Vac	NEDA	
1.5 Volts						
25	VS034A	Z	915	7R	15E	AA flashlight cell
80	VS035A	1	935	1C	14F	C flashlight cell
150	VS036	2	950	2D	13F	D flashlight cell
20	VS073	NE	904	716	910	Key chain lights & novelties
20	VS074	7	912	4D0	24F	AAA flashlight cell
25	VS334	930	1015	15	15	Transistor radios AA size
80	VS335	130	1035	14	14	Portable radios C size
150	VS336	2R	1050	2LP	13	Portable radios D size
25	VS734	920	815BP			Photoflash AA size
80	VS735	120	835BP			Photoflash C size
150	VS736	220	850			Photoflash D size
200	VS1074	AL-7	E92	MN-2400	24F	Alkaline AAA size
300	VS1334	AL-9	E91	MN-1500	15A	Alkaline AA size
500	VS1335	AL-1	E93	MN-1400	14A	Alkaline C size
500	VS1336	AL-2	E95	MN-1300	13A	Alkaline D size
4.5 Volts						
250	VS067	F3	736	A3	3	Portable "A"
6 Volts						
250	VS040C	F4M	509	941		Lantern service spring terminals
25	VS068	Z4	724	A2	2	Portable "A"
500	VS317	TW1	731	918	918	Lantern service binding posts
7.5 Volts						
70	VS065	C5	717	9	9	Portable radio "A"
50	VS129	B5	713	8	8	Portable radio "A"
80	VS315	D5	707	26	26	Portable radio "A"
9 Volts						
9	VS300A	P6	226	1600	1600	Transistor radios
150	VS301	D6PI	2506	1601	1601	Transistor radios
15	VS305	N6	246	1602	1602	Transistor radios
30	VS306	D6	276	1603	1603	Transistor radios
20	VS322	M6	266	1605	1605	Transistor radios
8	VS323	2U6	216	1604	1604	Transistor radios
7	VS327	L6	206		1611	Transistor radios
80	VS330	C6X	2356N		1612	Transistor radios
12 Volts						
250	VS342	TW1S	732			Lantern service
13.5 Volts						
10	VS304	XX9	239	1900	1900	Transistor service
15 Volts						
1.5	VS704	Y10	504		220	Photoflash BC units
22.5 Volts						
2.5	VS084	U15	412	215	215	Photoflash BC units, transistor service
30 Volts						
2.5	VS085	U20	413	A210	210	Transistor radios
45 Volts						
40	VS014	A30	W359	206	206	Portable radio "B"
25	VS015	Z30	738	205	205	Portable radio "B"
4	VS086	U30	415	213	213	Portable radio "B"
50	VS112	5308	762S	709	709	Portable radio "B"
70	VS344	B30	484	207	207	Portable radio "B"

Battery Tester

its rated load current without a significant drop in voltage. However, if the voltmeter shows you the voltage dropped excessively as the current was adjusted upward to the value that's normal for this particular cell, then you know the cell is weak.

Incidentally, if you compare battery ratings published by different manufacturers of similar battery types, you may find a few variations in ratings. However, the versatility of this battery tester permits you to operate it to fit virtually any ratings to be found for low and medium voltage batteries.

Some batteries that have just a little life left will produce their rated load current for a short time before their terminal voltage begins to drop off. So, even if the cell tests good at first, hold the test prods in place for a minute or so and watch the voltmeter closely. If the voltage begins to drop off, you know the cell may be all right for short periods of operation, but that it is nearing the end of its useful life.

For Unknown Loads. In describing the test procedure for a size "D" flashlight cell, it was said to use the *low* resistance rheostat load. That's because the author, who designed this tester, knew from his calculations which load to use. Many times though, you may not be sure which rheostat to use, so just follow this simple rule. Start a test using the *high* rheostat (R1) set for its highest resistance, and work down from there. This is easy to do if you wire the unit so each rheostat will be set for maximum resistance when it is turned fully counter-clockwise as viewed from the front of the panel.)

In making a test, turn the resistance knob to the right, which will reduce the resistance, as you seek a setting that will produce on the milliammeter an indication of the current for which the battery is rated.

If you find you must turn the rheostat nearly fully clockwise to obtain the amount of current you want to draw from the battery being tested, you will find it's very hard to set the rheostat precisely enough to hold the milliammeter steady. This will happen because you will be attempting to work with a very tiny portion of the rheostat's full resistance range.

When this happens, the thing to do is set

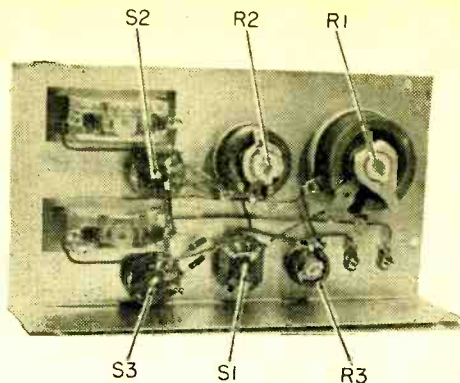

Once parts are assembled mechanically, it's a fast and simple matter to wire a tester. Choose a panel meter that fits your design.

the load selector switch (S1) to *medium* and try again, using the medium rheostat (R2). If the same thing occurs with R2, then set S1 to *low* and use the low rheostat (R3).

As a general rule, you'll find the high rheostat will be used on tests requiring fairly low amounts of current from low voltage batteries, and the low rheostat will be used for high amounts of current from low and medium voltage batteries. The medium rheostat will be used to conveniently bridge the gap between these two general categories. However, because of the wide variety of voltage and current combinations now available in the many battery types, it's not practical to set an iron-clad rule to determine which rheostat to use in every case. So, just follow the procedure of starting with a high resistance and working down until you reach the proper load for the battery you're testing.

Construction. Building the battery tester is very simple and straightforward, as you can see from the photos. Any type of metal or plastic utility box may be used. The one shown here is a 5 x 9½ x 2¼-in. steel converta-box, which is a little easier to work with than the more common mini-box.

Drill ⅜-in. holes for the switches and rheostats. Drill large enough holes for the two binding posts to accommodate fiber shoulder washers so the binding post mounting screws will be insulated from the metal panel, and cut rectangular holes for the meters.

One or two evenings should be sufficient to complete the unit, and then you'll have a battery tester that we think you'll be proud to own and wise to use. ■

a DX central project

SUPER DX_{ER}



Our outboard rig makes QSL waves—
adds 20 dB minimum gain
to any shortwave receiver

CAN YOU REMEMBER back to the early days of TV—back to the mid and late 1940's—when the Jones' who had the only TV in the neighborhood would strain to clean-up a snowy, flickering picture by adjusting a “booster” that sat on the top of their 12-in. phosphor cyclops?

Well, more often than not, those outboard boxes, with their 6J6's in push-pull tuneable circuits, didn't amount to the proverbial hill-of-beans! Those World War II vintage tubes were not well suited to the new-fangled wide-band requirements of TV. But later on as the technology advanced, and more powerful transmitters were built, good, solid pictures became the rule.

Unlike old TV boosters, today a good booster for short wave receivers, a preselector, can be designed with all the advantages of the latest solid-state devices—and, to boot, can be simple and very easy to build. It's the easiest way to turn any receiver into an even hotter signal sniffer. You use a booster (a very high gain RF amplifier) between the antenna and the receiver antenna terminals. A good one will also provide sharp image rejection by adding a relatively hi-Q circuit to the receiver input. Image signals (that often take the pleasure out of receivers with low frequency single-conversion IF amplifiers by jamming desired signals) vanish as if by magic when passed through a hi-Q booster or preselector. In short, a top quality super booster such as the SUPER DXER, will add another dimension of performance to any shortwave receiver.

What It Can Do. The SUPER DXER provides from 20 to 40 dB of signal boost—the exact amount is determined by the particular input characteristics of your receiver.

Figuring on 6 dB per S-unit, that's an increase of better than 3 to 6 S-units. In plain terms, the SUPER DXER will bring in stations where all your receiver will pick up running barefoot is its own noise.

The SUPER DXER's input is a diode protected FET (field effect transistor); the protection diodes are built into the FET so that excessively strong input signals, and even static discharges, will not destroy Q1. Since the FET input impedance is many thousands of megohms, there is virtually no loading of the L1/C1 tuning circuit; its “Q” remains high and provides a very high degree of image-signal attenuation.

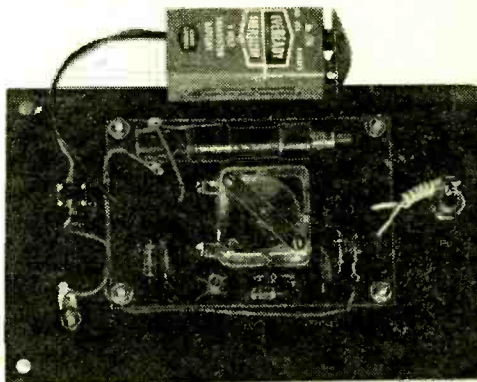

Add an extra 20+ dB gain to your shortwave receiver. Simple kit-of-parts is available. You supply just the outer case and a knob. Note: Wrap J1 ground wire as shown above.

The SUPER DXER output circuit is a low impedance emitter follower, and it will match, with a reasonable degree of performance, just about any receiver input impedance. As long as your receiver has two antenna terminals, one “hot” and one ground, you can use the SUPER DXER.

SUPER DX'ER

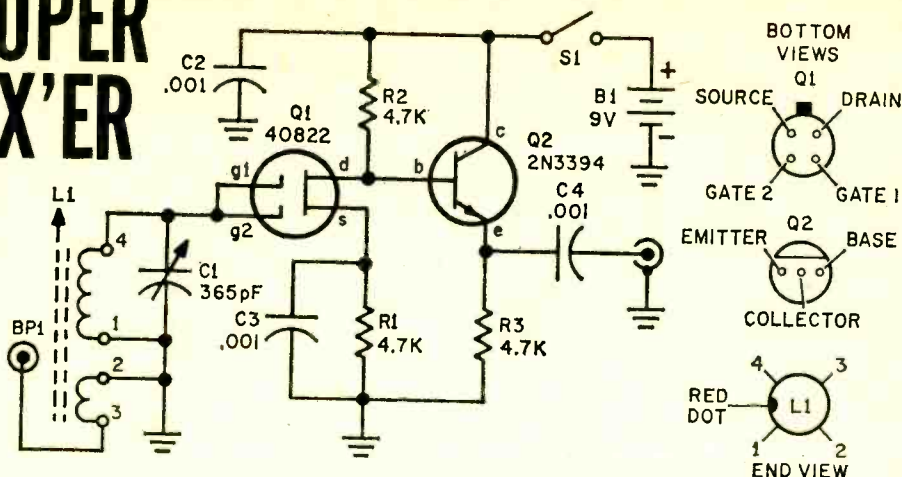

PARTS LIST FOR SUPER DXER

B1—9-volt battery (Eveready 216 or equal) and connector
 BP1—Insulated binding post
 C1—365 pF tuning capacitor, subminiature
 C2, C3, C4—0.001 uF ceramic disc, 25 VDC or better
 J1—RCA type phono jack
 L1—5-20 MHz antenna coil, Custom Components SW-520
 Q1—MOSFET, RCA 40822

Q2—NPN transistor, 2N3394
 R1, R2, R3—4700-ohms, 1/2-watt resistor
 S1—Switch, SPST (power on-off)

A kit of all the above components including the printed circuit board is available from the Electronic Hobby Shop, Box 587, Brooklyn, N.Y. 11202. Price of \$19.92 includes postage. Canadians add \$2. New York State residents must add sales tax. No foreign orders. Allow 6-8 weeks for delivery. Postal Money Order speeds delivery.

Optimum performance will be obtained if your receiver is equipped with an antenna trimmer. Just as the antenna trimmer peaks the receiver for use with any type of antenna, so too does it add something extra when matching the SUPER DXER.

Set Bandpass. The SUPER DXER has a tuning range of slightly more than 3-to-1 between 5 and 21 MHz. That means if the low end is set to 5 MHz, the upper limit will be slightly higher than 15 MHz (3 times 5). If the lower limit is set at 7 MHz, the upper frequency limit will be slightly higher than 21 MHz. Since the slug in tuning coil L1 is adjustable, you can select any operating range between 5 and 21 MHz.

SUPER DXER, though a very high gain device, is absolutely stable if built exactly as shown and described. There will be no spurious oscillations or response. It is possible that changes in the component layout or construction will result in self-oscillation at certain frequencies; hence, make no modifications or substitutions unless you are qualified.

Getting Started. Your first step is to prepare the printed circuit board. Using steel wool and a strong household cleanser such

as Ajax or Comet, thoroughly scrub the copper surface of a 2¼-in. x 3¼-in. copper-clad board. Any type will do—epoxy or fiberglass; the type of board is unimportant. Rinse the board under running water and dry thoroughly.

Cover the copper with a piece of carbon paper—carbon side against the copper—and place under the full-scale template we have provided. Secure the PC board in position with masking tape. Using a sharp pointed tool such as an ice pick, indent the copper foil at each component mounting hole by pressing the point of the tool through the template and carbon paper. Next, using a ball point pen and firm pressure, trace the foil outlines on the template.

After all foil outlines have been traced, remove the PC board from under the template and, using a resist pen, fill in all the desired copper foil areas with resist. Make certain you place a dot of resist over the indents at each of the corner mounting holes. Pour about one inch of etchant into a small container and float the PC board—copper foil down—on top of the etchant. Every five minutes or so gently rock the

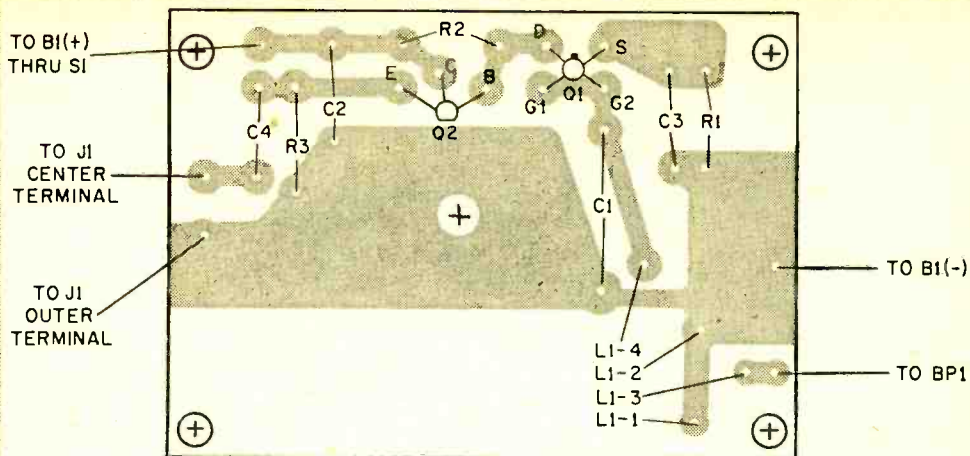

For exact part placement on PC board, see diagram above. View is from component (top) side of your Super DXer board. Layout below shows a completed Super DXer. Pins 3 and 4 of the dual winding coil L1 are shown in an end view for clarity.

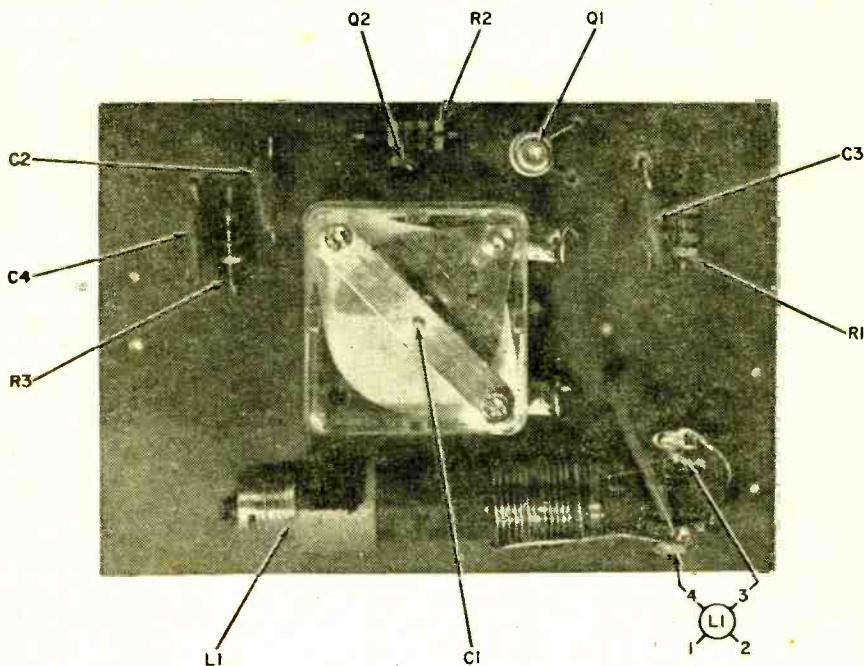

container to agitate the etchant. After 15 or twenty minutes check the PC board to see if all the undesired copper has been removed. When every trace of the undesired copper is gone, rinse the board under running water, and then remove the resist with steel wool or a resist "stripper."

Continue. Drill out all the mounting holes marked by an indent with a No. 57, 58 or 59 bit—this includes the corner mounting and C1 mounting holes. Then

drill the corner mounting holes for a #6 screw, and use a $\frac{3}{16}$ -in. bit for the C1 mounting hole.

Install tuning capacitor C1 first. Tuning capacitor C1 should be the type provided in the kit of parts. It has a plastic dust cover and a long shaft. Do not use the type supplied with a short shaft to which a tuning dial for the broadcast band can be attached. Remove the mounting nut and ground washer from C1's shaft. Then make

SUPER DX'ER

certain the shaft's retaining nut is tight. It is usually supplied loose. Discard the ground washer and secure C1 to the PC board with the mounting nut. Then install tuning coil L1. Make note of two things about L1. The terminal end of L1 has a large *red* dot (ignore any other marks). L1 must be positioned so the red dot faces the bottom edge of the PC board—the edge closest to the coil. Also note that the lug connected to the top of the fine-wire primary is adjacent to the bottom of the heavy-wire secondary. When the red dot is facing the edge of the PC board, both these lugs are against the board. Solder the lugs to the matching holes in the PC board. Use the shortest possible length of wire to connect the remaining primary (fine-wire) terminal to the antenna input printed foil. Connect the remaining L1 terminal (heavy wire) to its matching hole with solid, insulated wire—form a right angle bend in the wire so it doesn't touch L1. Now mount the remaining components.

Orienting Q. Note that Q1 is positioned properly when the small tab on the case faces the nearest edge of the PC board. Also note that the round edge of Q2 faces the nearest edge of the PC board. The flat edge of Q2's case should face C1.

Because the printed copper foil faces the front panel when the assembly is mounted in the case, and is therefore inaccessible for soldering, the connecting wires to front panel components should be installed at this time. Solder 6-in. solid, insulated wires to

the antenna, output and output ground, and + 9V foils. Solder the negative (usually black) wire from the battery connector to the ground foil.

The SUPER DXER is mounted in a standard plastic or Bakelite case approximately 6 $\frac{3}{8}$ -in. x 3 $\frac{3}{16}$ -in. x 1 $\frac{7}{8}$ -in. The front panel must be aluminum. If the cabinet is not supplied with an aluminum panel, obtain an optional or accessory metal panel. Do not use a plastic panel.

Drill a $\frac{3}{8}$ -in. hole in the center of the front panel. Position the PC assembly over the hole with C1's shaft fully inserted through the hole, and mark the locations for the four PC board mounting screws. Drill the panel and temporarily secure the PC board to the panel. Then locate the positions for power switch S1, antenna input binding post BP1 and output jack J1. Make certain J1 is as close to the PC board output terminals as is possible—within 1 $\frac{1}{2}$ -in.

Remove the PC board and drill the holes for the panel components. Power switch S1 can be any inexpensive SPST type such as a slide switch. Install the panel components and then the PC board. To prevent the copper foil on the underside of the PC board from shorting to the panel place a $\frac{3}{8}$ -in. plastic or metal spacer, or a stack of washers, between the PC board and the panel at each mounting screw. Connect the panel components to the appropriate wires extending from the PC board and the SUPER DXER is ready for alignment.

Alignment. Prepare a length of 50 or 52 ohm coaxial cable (such as RG-58) that will reach from the SUPER DXER's output jack to the receiver antenna input terminals.

(Continued on page 109)

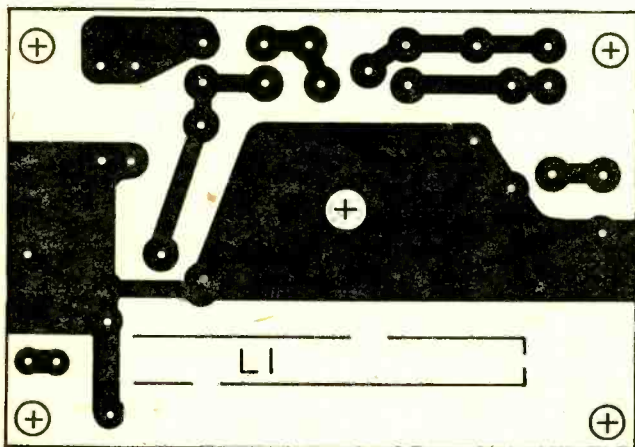

Exact PC board size. Transfer image to copper clad board using carbon paper. This is the bottom (copper) side of your board. Mount it to the front panel with $\frac{1}{4}$ -in. spacers between board and panel at each mounting screw. Secure the battery to the back of the cabinet with tape.

SCRAMBLE PHONE



**This double-duty unit
can also unscramble
2-way radio calls**

by Charles D. Rakes

Demand ultimate privacy in your telephone conversations? If so, a secure phone link can be yours with these three easy and exciting steps. 1. Place your call with Ma Bell's instrument. 2. When your party answers, switch to your special scrambler phones. 3. A soft buzz in the ear piece says your security phone link is operational. Your line is secure. Conduct your call in complete privacy no matter how many ears are party-line-listening!

All it takes is a pair of **ELECTRONICS HOBBYIST** Scramble Phones. And with this double duty unit, you can try your hand at decoding scrambled conversations that are sometimes heard on radio receivers covering the VHF high band (148-176 MHz). The basic scrambler circuit (available in kit form, see parts list) can be simply modified for radio by removing two fixed resistors and replacing them with a dual-potentiometer.

Wait a minute! Before your soldering iron overheats, let me say that this scrambler will decode information that is encoded in the *single inversion* mode only. The highly sophisticated scramblers that are sometimes

used today can not be decoded with this decoder, but in many areas the single inversion system is still in use and may be decoded with our unit.

How It Works. IC-1 and the associated circuitry form a stable audio tone generator which feeds a buffer amplifier, Q1 and Q2. The tone output is taken from the emitters of the transistor pair to supply a carrier voltage for a balanced modulator made up of four diodes—D1 through D4—and T1 and T2. If the two transformers and the four diodes are perfectly matched (which is almost impossible to achieve and not necessary in any case) no carrier will appear at the input or output of T1 or T2. In a practical circuit, a small amount of unbalance will occur and produce a low-level carrier tone at the input and output of the balanced modulator. This tells you your scramble phone is working.

A telephone carbon mike and ear piece are connected to the low impedance winding of T1, with a three volt battery supplying the necessary mike current. When the mike is spoken into, the carrier voltage is allowed to pass, in part, through transform-

SCRAMBLE PHONE

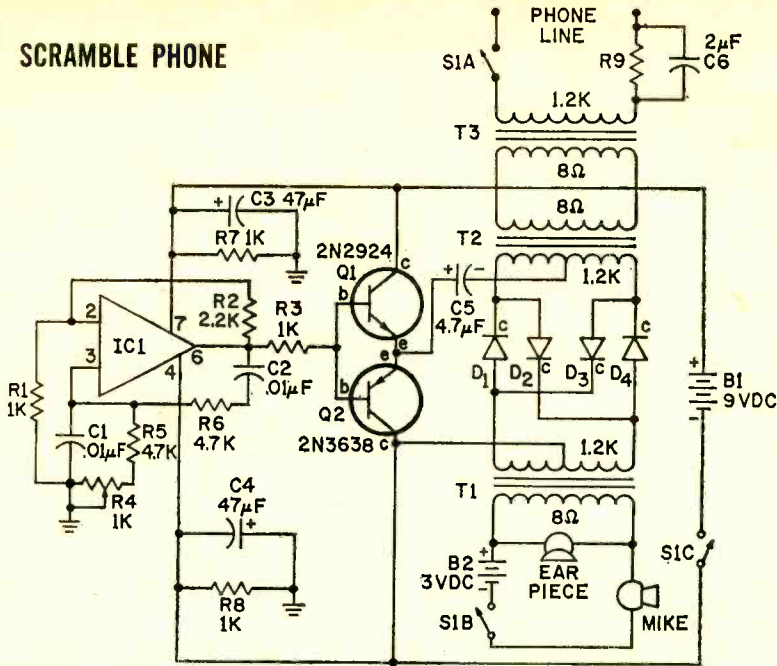

PARTS LIST FOR SCRAMBLE PHONE

B1—9-volt battery, Eveready 216 or equiv.
 B2—3-volt battery, two AA penlight cells in series
 C1, C2—0.01 μ F polystyrene capacitor, 100 VDC or better
 C3, C4—47 μ F electrolytic capacitor, 25 VDC or better
 C5—4.7 μ F electrolytic capacitor, 25 VDC or better
 C6—2 μ F paper or mylar capacitor, 50 VDC or better
 D1 to D4—Diode, 1N914, HEP-156
 IC1—Integrated circuit, Signetics N5741K or equiv.
 Q1—NPN transistor, 2N2924, HEP-724
 Q2—PNP transistor, 2N3638, HEP-716
 R1, R3, R7, R8—1000-ohm, $\frac{1}{2}$ -watt resistor
 R2—2,200-ohm $\frac{1}{2}$ -watt resistor

R4—1000-ohm potentiometer
 R5, R6—4,700-ohm, $\frac{1}{2}$ -watt resistor
 R9—Limit line current to 25mA (see text)
 S1A, S1B, S1C—Phone hook switch (see text)
 T1 to T3—Small transistor audio transformer; 8-ohm primary, 1,200-ohm center taped secondary.

Misc.—Surplus telephone (see Lafayette, Radio Shack, EDI, BA catalogs), battery holders, hardware, knob, wire, solder, etc.

An etched and drilled printed circuit board is available for \$4.95 (includes postage and handling). A complete kit of all parts that mount on the PC board, plus the drilled board and R4 are available for \$17.95 (one kit) and \$32.95 (two kits). Add one dollar (Canadians add \$2) for handling when ordering the complete kit(s). Postal Money Order speeds shipment. Order from KRYSTAL KITS, Highway 102 East, Bentonville AR 72712.

ers T2 and T3, and on to the telephone network. The only purpose of T3 is to match the impedance offered by most telephone lines.

Trim potentiometer R4 is used to make a fine frequency adjustment of the oscillator so that two scrambler units may be synchronized to the same carrier frequency. Both oscillators must be operating at the same frequency to produce the best decoded speech quality. This control is referred to as the speech *clarity* control.

The best overall carrier frequency range to use for speech scrambling is between 2 kHz and 3.5 kHz.

Listening In. If the scramble phone is to be used for only receiver speech decoding, then only one unit is required. The operation is much the same as for telephone encoder/decoder purposes, with the exception that it is used only as a decoder. The carrier oscillator is made variable so the decoder may be synchronized to the same carrier frequency as is used in the encoder. The output of the receiver is connected to the 8-ohm winding of T2 (T3 is not required for this use) and the decoded information is developed across the 8-ohm winding of T1. A small speaker may be connected across this winding, or a low impedance ear-

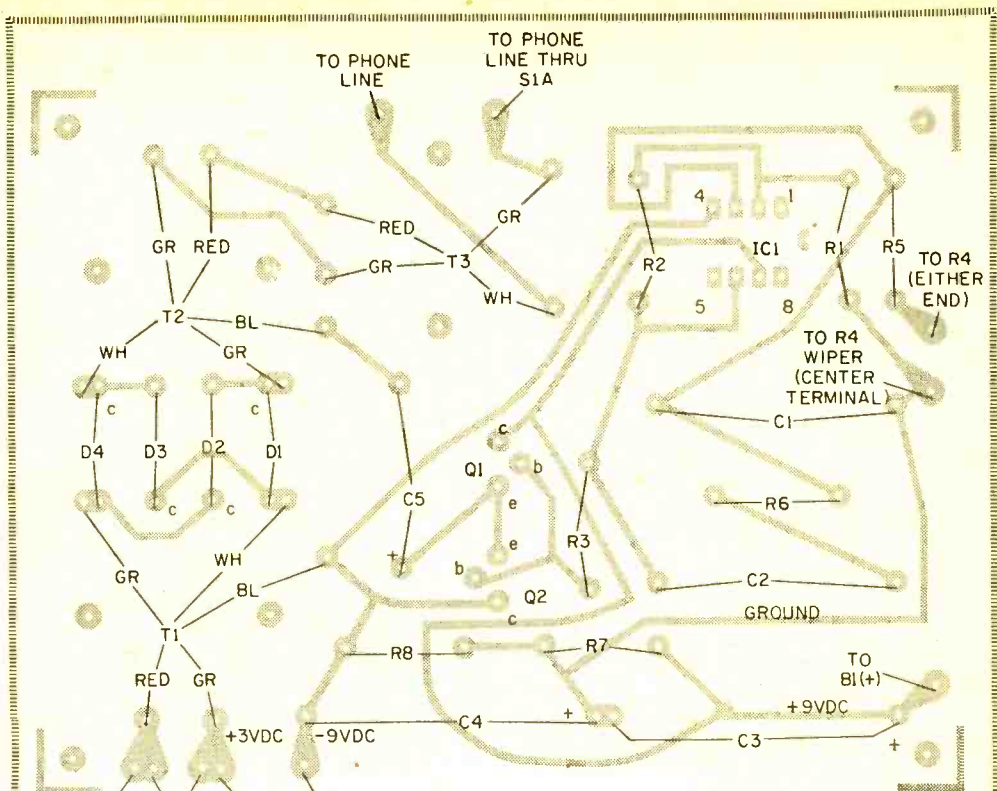

For exact part placement on PC board, see diagram above. View is from component (top) side of board. Layout below shows a completed scrambler board.

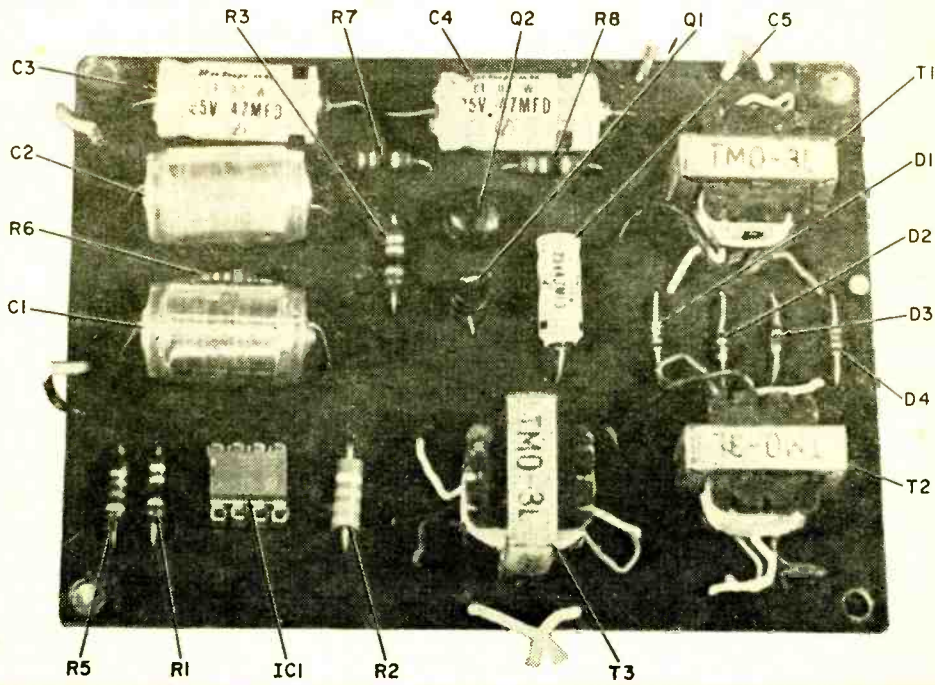

SCRAMBLE PHONE

MODIFICATION 1.

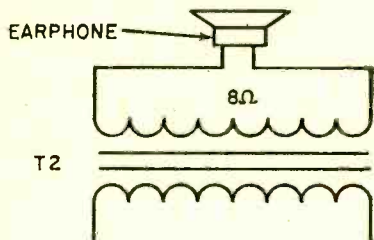

REMOVE T3, ADD EARPHONE

MODIFICATION 2.

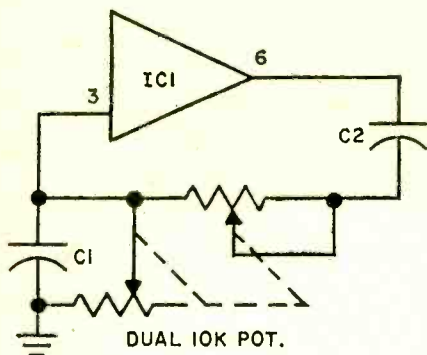

ADD DUAL POT, REMOVE R4, R5 AND R6.

MODIFICATION 3.

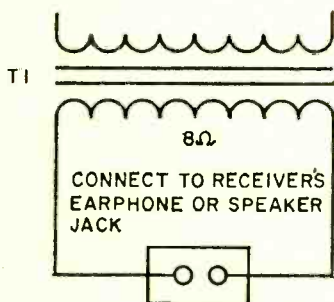

REMOVE PHONE HANDSET AND 3-VOLT BATTERY, ADD TERMINAL STRIP

It is possible to decode some older scrambler systems heard on 2-way radio bands. However, this single inversion mode circuit will not work with multi-inversion systems also in use. Dual pot is Allen-Bradley CJK1N200P103U or equiv.

phone will do for monitoring the decoded speech. No mike or 3-volt battery is necessary for decoding operations.

Putting It Together. The circuit layout isn't critical and any suitable scheme can be followed, but the layout shown for the PC board would be a good one to use. No matter what construction plan is used, PC board or bread board, extra care should be taken when connecting the IC, diodes, and transistors to the circuit. Care should also be taken when connecting the three transformers, so that the low and high impedance windings are not reversed.

The size of the PC board allows the

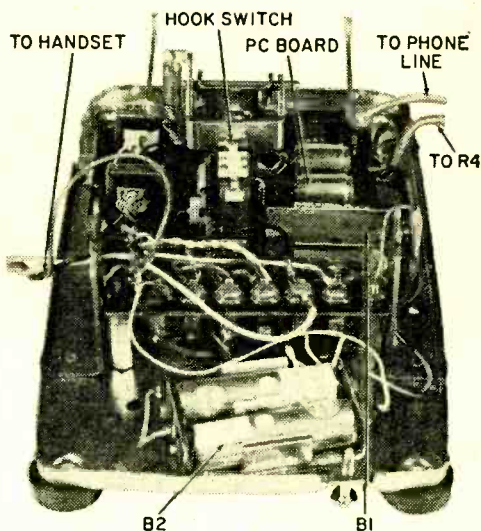

Inside completed Scramble Phone. Surplus phones are available from a number of mail order firms as well as their local stores.

scrambler to be mounted in the base of a standard telephone. All parts located inside the phone, with the exception of the hook switch, can be removed to make the construction job an easy one. Check the pictures when mounting the board and batteries.

In some telephones, the hook switch contains enough switch contacts to function as the three switches, S1A, S1B, and S1C; but if you have one that does not contain enough contacts, a separate switch must be added to switch the battery power. For the scramble phone to automatically bridge the telephone line when the handset is off-hook, at least one section of the hook switch must be used for S1A.

If a dial telephone is selected, the dial may easily be removed and replaced with a

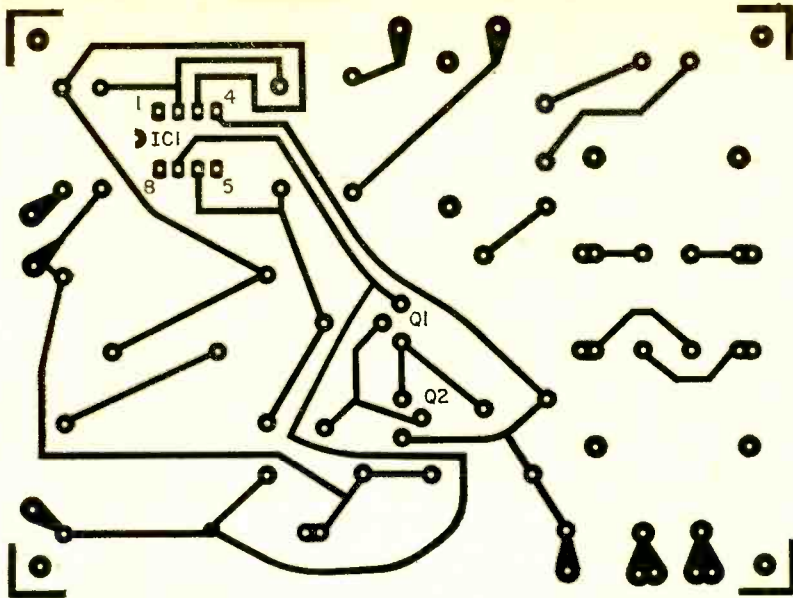

The Scramble Phone's PC board is shown in exact size. Transfer its image to copper-clad board using a piece of unused carbon paper. The copper-clad board is the bottom surface of the printed circuit board. Parts are mounted thru holes from above.

metal or plastic plate. The *clarity* potentiometer can be mounted at any convenient location on the phone's base plate, but be very careful not to let any component interfere with the mechanical operation of the hook switch.

Scrambling A Phone. Connect the two scramble phones together (phone line outputs connected to each other) but separated by at least twenty feet. Lift either of the hand sets and you should hear a low level tone; talk into the mike and you should hear your own unscrambled voice in the ear piece. This reception of your own voice is normal and occurs when using a standard telephone; it is called the *sidetone*.

Have a friend or another member of your family talk over the scramble phone. If your reception isn't clear or sounds like Donald Duck, adjust the *clarity* control for the best voice quality. This simply puts the two oscillators on the same frequency.

Scrambler Hook-Up. This job is a simple one. All that's required is to parallel the output of transformer T3 with the telephone lines. But before doing so, make the following tests. If you are in doubt about which two wires on the telephone terminal block are the telephone circuit, take a DC volt meter and check between pairs until 24 to

48 volts is measured. This test must be performed with the telephone on hook. The second important check to make before connecting the scrambler phone determines the line current. This test is made as follows. Set the VOM to measure DC current on the 50 or 100mA range, and place the meter in *series* with a lead from the high (1.2 K) impedance winding of T3. Pick up the phone. If the circuit current is greater than 25mA, then the resistor/capacitor network C6 and R9 must be added in series with the scrambler phone and the telephone circuit. This should reduce the circuit current to a value close to 25mA, but if not, adjust the value of R9 (start with a 1000-ohm, 1/2-watt resistor) until this current value is reached.

Security Link-Up. After connecting one of the scrambler phones at your location and another at the home of a friend, dial his number with your standard telephone. When the party answers and agrees to go to the scrambler mode, pick up your scramble phone, and have your friend do the same. You can now continue your conversation in complete secrecy. If either of the scrambler oscillators should drift in frequency, just set the *clarity* pot for the best possible voice quality. ■

COMPASS GALVANOMETER

by T. A. BLANCHARD

Many electrical measuring instruments today are based on the design of the d'Arsonval *String Galvanometer*, but substitute a needle-suspended coil riding on jeweled bearings for the hanging coil employed in the original precise lab instrument.

The galvanometer is not often used to measure quantity of current flowing in a circuit, but rather to indicate the polarity and presence of small currents by comparison to null methods. The compass galvanometer (made from the illustration at right) can be used with a Wheatstone bridge to indicate null points.

The d'Arsonval instrument suspends a small coil between the pole faces of a permanent *horseshoe* magnet. When a current flows through the coil it becomes an electro-magnet and its *like* poles repel the *like* poles of the horseshoe magnet, thus causing the coil to turn on the connecting wire. The strength of the current through the coil determines the extent of the coil's rotation.

A small pointer attached to the moving coil registers on a curved dial, or a tiny mirror is attached to the galvanometer string. A beam of light is aimed at the mirror, bouncing the beam off to a wall screen or chart to give great magnification of tiny current changes in a darkened room.

Making A Simple Galvanometer. A small amount of insulated magnet wire, any Boy Scout pocket compass and a 2¼ x 3½-in. scrap of plywood is what you need to make the compass galvanometer. Cut a strip of cardboard ¾-in. wide and 3¾-in. long. Score the cardboard ¼ in. from each end, with a dull knife blade and crease so the cardboard form resembles a C or bridge shape. Now glue the cardboard to the edges of the wood base. Do not use tacks!

Bind the cardboard with a rubber band until glue or cement dries. Wind 25 turns

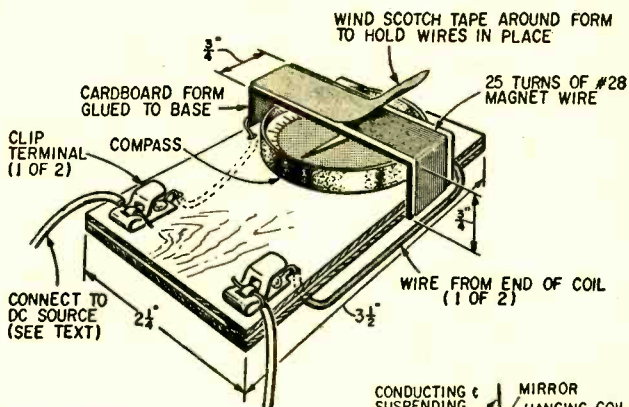

Easy to build, the compass galvanometer (above) can be assembled in an hour at practically no cost. At right is hanging coil galvanometer used in labs.

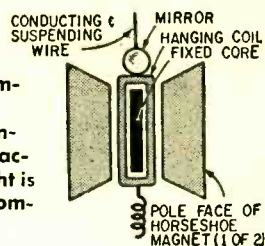

of #28 magnet wire around the cardboard. Heavier wire and fewer turns will work, too, with a slight drop-off in sensitivity.

Scotch tape is wound around the finished coil to keep the wire turns in place. Connect the ends of the coil to screw terminals or clips. Slip the compass under the coil in a position where its needle comes under the coil and parallel to the coil turns.

Connect the galvanometer in series with a flashlight battery and bulb, a buzzer or a toy motor, etc. When the circuit is closed, the compass needle will be drawn so that it is at right angles to the coil. A slow swing of the needle indicates the circuit is drawing little current. A rapid swing denotes an increase in current flow.

To show how sensitive this simple galvanometer is, connect what appears to be a dead flashlight cell across the terminals, immediately breaking the circuit. The compass needle will spin at a merry clip, indicating there is still some life in the "dead" cell.

Send for your new FREE Heathkit catalog

Whatever your interest, you're sure to find a kitbuilding project just for you in the new '74 Heathkit Catalog. You'll find color TVs, stereo and 4-channel equipment, amateur communications gear, home protection devices, auto tune-up instruments, calculators, electronic organs, marine electronics, educational kits, service & lab instruments... hundreds more! A few of our latest kits are shown below. Each kit includes a comprehensive assembly manual that reduces even the most complex operation to a simple step-by-step procedure. The coupon below will get you in on the fun and the savings — with your FREE '74 Heathkit Catalog.

World's largest selection of electronic kits. A kit for every interest, every budget... starting as low as \$5



Solid-State Lamp Dimmer \$7.95*



Photoelectric Lamp Switch \$5.00*



Weather Station \$89.95*



4-Channel AM-FM Receiver \$249.95*



Portable 12V B&W TV \$129.95*

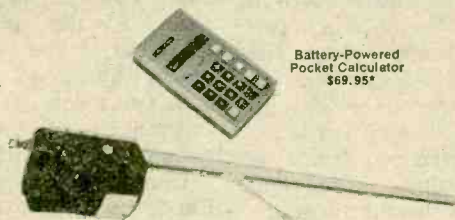

Battery-Powered Pocket Calculator \$69.95*



Deluxe Garage Door Opener \$139.95*



Electronic Spinnet Organ \$1045*



Ultrasonic Cleaner \$54.95*



Indoor/Outdoor Digital Electronic Thermometer \$59.95*



Electronic Air Purifier \$139.95*

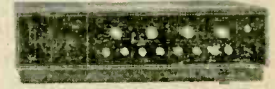

Professional Audio Oscilloscope \$199.95*



180-Watt AM-FM Stereo Receiver \$379.95*

See them all at your Heathkit Electronic Center — or send for FREE '74 Heathkit Catalog

HEATHKIT ELECTRONIC CENTERS
Units of Schlumberger Products Corporation
ARIZ.: Phoenix; CALIF.: Anaheim, El Cerrito, Los Angeles, Pomona, Redwood City, San Diego (La Mesa), Woodland Hills; COLO.: Denver; CONN.: Hartford (Avon); FLA.: Miami (Hialeah), Tampa; GA.: Atlanta; ILL.: Chicago, Downers Grove; IND.: Indianapolis; KANSAS: Kansas City (Mission); KY.: Louisville; LA.: New Orleans (Kenner); MD.: Baltimore, Rockville; MASS.: Boston (Wellesley); MICH.: Detroit; MINN.: Minneapolis (Hopkins); MO.: St. Louis; NEB.: Omaha; N.J.: Fair Lawn; N.Y.: Buffalo (Amherst), New York City, Jericho, L.I., Rochester, White Plains; OHIO: Cincinnati (Woodlawn), Cleveland, Columbus; PA.: Philadelphia, Pittsburgh; R.I.: Providence (Warwick); TEXAS: Dallas, Houston; WASH.: Seattle; WIS.: Milwaukee.

HEATH
Schlumberger

Heath Company, Dept. 26-1
Benton Harbor, Michigan 49022

Please send my FREE 1974 Heathkit Catalog.

Name _____

Address _____

City _____ State _____ Zip _____

* Mail order prices; F.O.B. factory. CL-491R

CIRCLE NO. 1 ON PAGE 15 OR 106

INSTANT PATCH BOX

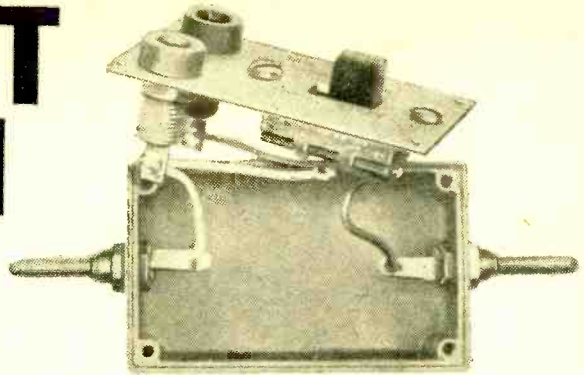

Speed up
substitutions with this builders aid

by James A. Fred

The INSTANT PATCH BOX is one of the little luxuries that simplifies electronic experimenting and makes it more enjoyable. Haywire lash-ups often get the job done, but feedback, oscillation, or inaccurate meter readings sometimes make the end results worthless. This little blue box provides a shielded, no-nonsense method of substituting resistance, capacitance, or inductance into a circuit with a minimum of problems.

Essentially, the INSTANT PATCH BOX consists of a small metal box with a cover in which are mounted a SPST slide switch, two banana jacks, and two banana plugs. The box is the smallest that will do the job and keep distributed capacitance and inductance to a minimum. The circuit is extremely simple as you can see from the schematic diagram. A voltage is fed into one banana plug and either through the switch or through the component plugged into the banana jacks. The switch allows conduction through the plugged-in compo-

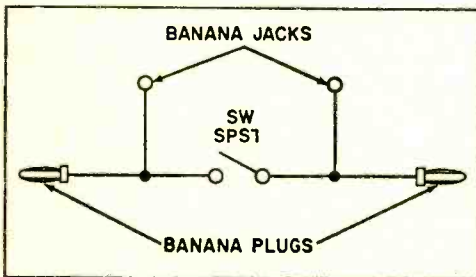

nent, or provides a shorted path across the banana jacks.

You will not find a parts list with this

article since you should select parts to fit your needs. Check your junk box for parts on hand, and pick up what you can't find at your local electronics shop.

When . . . you have built the instant patch box, what can you do with it? Let us suppose for a minute you have an experimental circuit you are working on. You are trying to determine the correct size bias resistor to use. Connect the box into the circuit with the banana jacks and alligator clips. You can now plug different size resistors into the banana jacks and short out the jacks if you wish. All this is possible without touching a soldering iron to the circuit. Once you get into the habit of using this builders aid, you may wonder how you got along without it!

Construction is simple. Secure the parts listed, make the proper size holes, and mount the parts. There is only one precaution to take and that is to be sure to use insulating washers when mounting the ba-

This almost too easy circuit gives you the option of (1) adding an extra component to your haywire circuit or (2) shorting across the component at the flip of a switch. You can vary the terminals to suit your needs.

nana plugs. They must not short to the metal box.

Incidentally, you don't have to use the same combination of input plugs or component jacks that I did. You can use 5 way binding posts, BNC connectors, tip plugs and jacks, or other types of hardware. Just be sure and use connectors that are compatible with your other test equipment. ■

GEN-TRACE



Beginner's IC Project

Build this troubleshooting test unit that generates and traces signals

by Edward A. Morris, WA2VLU

Two of the most widely and easily used troubleshooting techniques popular today are the signal-substitution and the signal-tracing methods. Especially helpful on dead sets, these methods can be used on a wide variety of communications, entertainment, and industrial electronic equipment—just about everything, in fact, from the All American 5 BCB receiver to servo amplifiers! And best of all, you can put these two most practical troubleshooting techniques to work for you without having to invest in a yard or two of fancy, expensive test equipment.

Gen-Trace is both a broad-band signal generator and an audio signal tracer, all in one package. Output of the signal generator is a 1000-Hz square wave. Its fast rise-fall times produce harmonics extending well beyond 100 MHz (most garden-variety signal squirters poop out after only a few MHz). The buffered out-

put of the generator is short-circuit proof and is frequency-stable when driving low-impedance loads. Maximum output is 2 volts peak-to-peak.

The signal-tracer portion has a maximum gain of about 50 dB, more than enough for tracing through the circuit of most any device, even when dealing with small signal levels. When the RF demodulator probe (described later) is connected, the unit can be used to trace through RF and IF amplifiers. Audio output of Gen-Trace is about 5 mW, enough to drive a miniature headphone of the variety supplied with transistor radios. It won't burst eardrums, but it's more than adequate for most applications.

Gen-Trace is a self-contained, all-in-one compact package. It's small enough ($3\frac{3}{4} \times 3 \times 2\frac{1}{8}$ -in.) to drop into your tool kit for field work. Simple and non-critical to build, it will take about 3 hours to

GEN-TRACE

construct. Best of all, building it won't flatten your wallet, since parts run to just over ten dollars.

How It Works. *Gen-Trace* is built around a single Motorola MC798P RTL (resistor transistor logic) integrated circuit (IC). It replaces half a dozen transistors and a dozen resistors, all at a cost of \$1.08. That represents a savings well over \$3.00 at current prices.

Signal Generator Function. Integrated circuit IC1 is comprised of six inverters, each similar to an ordinary single-stage transistor amplifier. Two of the inverters, INV1 and INV2, are cross-coupled by capacitors C1 and C2 to form an *astable multivibrator*. The output frequency of the multivibrator is established by the time constants of R1/C1 and R2/C2; output of the multivibrator is a 1000-Hz square wave, which is coupled to the input of inverter INV3. Resistor R3 and inverter INV3 isolate the multivibrator from load variations at the output terminals and thus help ensure frequency stability.

The output of this buffer inverter is coupled to potentiometer R4, the generator's level control, by capacitor C3. The controlled output level is then coupled to output jack J3 via capacitor C4.

Signal Trace Function. Normally the inverters making up the integrated circuit are

used as *on/off* switches. Thus the output has two possible states, *on/off* or *positive voltage/no voltage*. While this is exactly what's needed for the square-wave generator function, it leaves a bit to be desired for use in the audio amplifier section. In order for the inverters to amplify audio signals without excessive distortion, suitable operating bias has to be provided for the inverters.

Audio input signals introduced at jack J1 are fed to the gain control, potentiometer R5, by capacitor C5. The audio at the wiper arm of the control is then coupled to the input of the first amplifier, inverter INV6, by capacitor C6. Inverter INV6 is biased for class A amplifier service by resistor R7, producing a voltage gain for this stage of about 20.

The amplifier output of INV6 is coupled to the input of INV5, which, with R6, is identical to the first amplifier. Overall audio output is fed to the headphone jack J4 by capacitor C8.

Two AA cells connected in series to provide about 3 volts make up the power supply for the instrument. The supply is decoupled at low and high frequencies by capacitors C9 and C10, respectively.

Mechanical Construction. Mechanical layout isn't critical and can be varied to fit the particular housing used. Beginners starting their first IC project, however, should not attempt to crowd the layout into a small housing. More experienced experimenters can, if they wish, go whole hog. It's possible to build the entire instrument in an alumi-

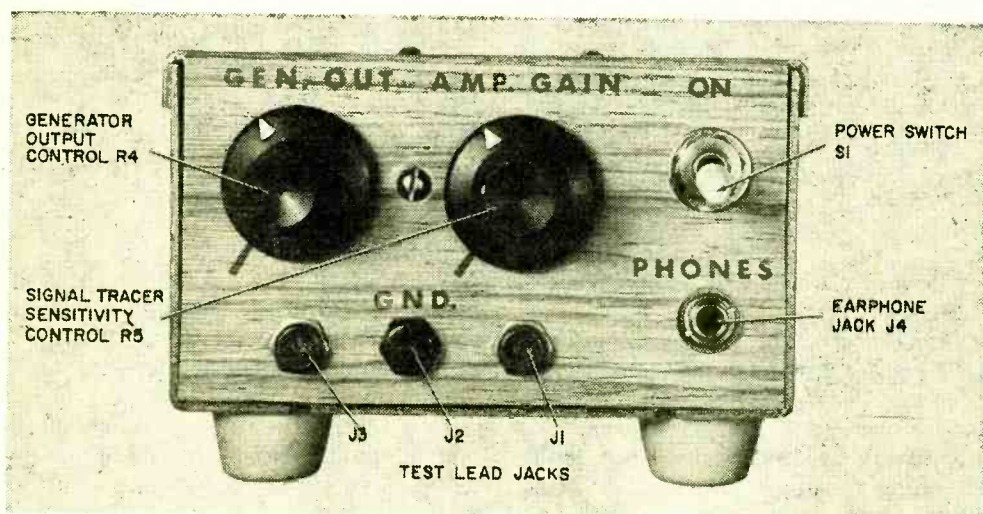

If hassling with your electric drill doesn't catch your fancy, S1's hole can be omitted by mounting substitute spst switch on rear of sensitivity control R5.

PARTS LIST FOR GEN-TRACE

- B1** 2 AA size mercury or alkaline cells (Lafayette 32-46857 or equiv.)
C1, C2, C9 0.1- μ F, 75-VDC miniature ceramic capacitor (Lafayette 33E69089 or equiv.)
C3, C6, C7, C8 10- μ F, 35-VDC miniature electrolytic capacitor (Radio Shack 272-1025 or equiv.)
C4, C4 5- μ F, 35-VDC miniature electrolytic capacitor (Radio Shack 272-1024 or equiv.)
C10 100- μ F, 35-VDC miniature electrolytic capacitor (Radio Shack 272-1028 or equiv.)
IC1 RTL integrated circuit (Motorola MC 789P or HEP573)
J1, J3 Red nylon tip jack (Amphenol 350-29200 or equiv.)
J2 Black nylon tip jack (Amphenol 350-29200 or equiv.)
J4 Subminiature phone jack (Lafayette

- 99E62119 or equiv.)
R1, R2 8200-ohm, $\frac{1}{2}$ -watt resistor
R3 1800-ohm, $\frac{1}{2}$ -watt resistor
R4 5000-ohm potentiometer, linear taper (Lafayette 33-1122A or equiv.)
R5 5000-ohm audio taper potentiometer (Lafayette 33-11216 or equiv.)
R6, R7 27,000-ohm, $\frac{1}{2}$ -watt resistor
S1 Dpdt miniature toggle switch, used as spst (Lafayette 99-61624 or equiv.)
 1 2 cell battery holder (Keystone 140 or equiv.)
 1 $3\frac{3}{4} \times 3 \times 2\frac{1}{8}$ -in. aluminum chassis (LMB 135 or equiv.)
 1 3000-ohm impedance earphone with $\frac{1}{8}$ -in. dia plug (Lafayette 99E25405 or equiv.)
 Misc. Rubber feet, wire, solder, perfboard (H or P pattern), knobs, push-in terminals, contact vinyl, press-on lettering (Datak or equiv.), etc.

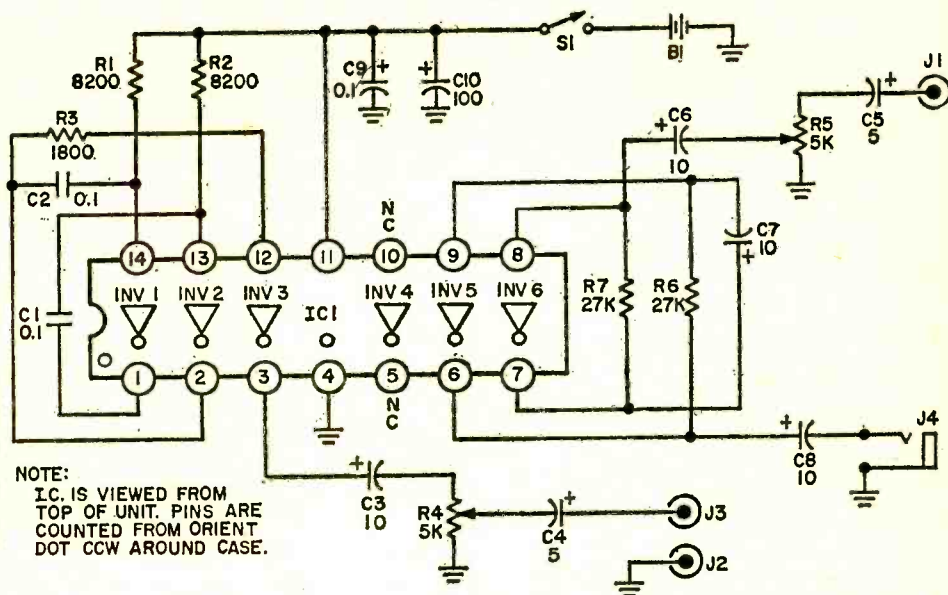

NOTE:
 IC1 IS VIEWED FROM
 TOP OF UNIT. PINS ARE
 COUNTED FROM ORIENT
 DOT CCW AROUND CASE.

num cigar tube by using sub- and micro-miniature components and controls!

The layout presented in this description is tailored for the housing specified in the Parts List and should provide suitable facilities for most applications of signal tracing or as a signal source. By following the mechanical details and dimensions shown, our layout can be used with a minimum of effort.

Lay out and center punch all of the holes to be drilled, according to the mechanical layout. The holes may be de-burred with a

pocket knife, file, or tapered reamer.

After completing the mechanical work on the housing, you're ready to spray-paint it or cover it with a contact adhesive vinyl material (Contac or equiv.) such as used on the model. Regardless of how much care is taken during all other phases of construction, the finished project will still look amateurish unless the housing is properly finished and lettered.

A little extra time spent on the appearance of the housing can work wonders. And while this doesn't necessarily improve the

GEN-TRACE

performance of the instrument, it makes it look more professional. It takes it out of the typical, run-of-the-mill, homebrew category.

If you elect to spray-paint the housing, care should be taken to ensure that it's clean and oil-free. A film of oil on the surface will prevent the paint from forming a good bond on the aluminum surface.

Spray on several light coats of a good quality paint. Two light coats work out much better than a single, heavy coat. Heavy coats tend to sag and run, spoiling the final finish. Allow each coat enough time to dry thoroughly before applying the next, as directed on the spray can.

A somewhat easier and faster way to finish the housing is to cover it with a contact adhesive material. This material is available in a variety of solid colors and wood tones similar to the material used on our model.

Covering the case with vinyl is very easy. Work with each half of the case separately. Cut a section of material large enough to

the material on the sides, or they can be removed with a pin prick through the vinyl. For the best adhesion press the vinyl firmly against the case.

After the case has been spray-painted or vinyl-covered, transfer lettering should be applied to really jazz up the appearance of *Gen-Trace*. If you are applying the transfer lettering over a painted finish, make very sure that the finish is thoroughly dry before adding the letters. A slightly tacky painted finish will tend to grab and hold all letters on the transfer sheet. After placing the letters where required, several light coats of a clear acrylic spray should be applied to protect the lettering from wear and abrasion. Remember to spray the protective finish with a light touch. A heavy coat will dissolve the lettering.

Electrical Construction. With the exception of S1, J1, J2, J3, J4, R5, and B1, all components are mounted on a small piece of perforated vector board. Boards with either H or P pattern are especially suited for IC projects. These hole patterns fit the IC's lead layout perfectly so that no extra holes have to be drilled.

Begin the electrical construction by wiring the circuit card according to the schematic diagram. Detailed parts placement can be determined from our photos. All wiring is effected by using small gauge bare copper wire, with insulated tubing added where necessary (crossovers of wiring or other parts) to prevent shorts. The IC is mounted by passing its leads through the pattern

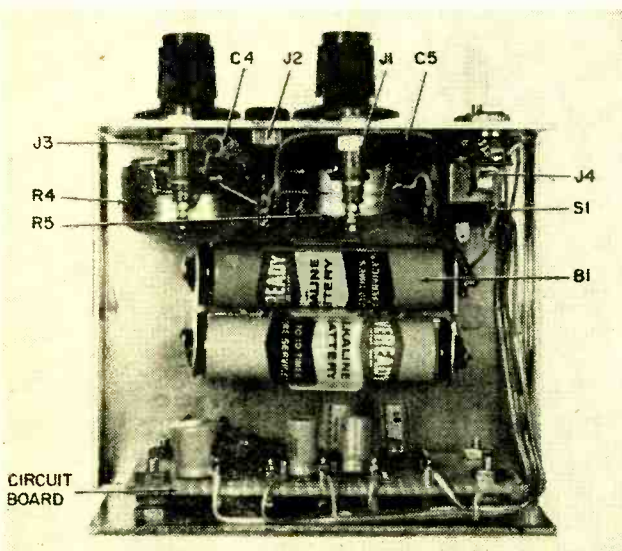

This prototype of Gen-Trace looks, works like instrument costing far more. For added versatility, substitute universal binding posts for tip jacks J1 through J3.

completely cover each half of the case. Lay the piece you have cut with the finish side down on a flat surface. Remove the paper backing and press the material over the surface of the housing. Fold material over the sides and trim off the excess with a sharp knife or razor blade. Small air bubbles should be rolled out before turning under

of holes in the board, bending them outward on the wiring side and cutting them off, leaving about a 1/4-in. tab for soldering circuit wiring. Connections to the IC are lap soldered to conserve space, reduce strain on the IC's leads, and to help prevent shorts between adjacent pins.

Soldering connections to the IC's leads

should be completed as quickly as possible. Use a low-wattage (under 50 watts) soldering iron with a small, well-tinned soldering tip. Soldering guns should not be used—they are just too big, both in heat and in size, for this sort of work.

We anchored other components in place with miniature eyelets, though you may prefer to use push pins. The ones used on the model had an 0.062-in. outside diameter. If you use the P pattern vector board, it'll be necessary to drill out the board's 0.042-in. holes to the proper size. The eyelets may be staked in place, if desired, with the aid of an automatic centerpunch. Support the eyelets' head on a rounded 1/8-in. diameter steel rod held in a vise. Center-punching the eyelet from the opposite side will flare the eyelets' skirt while fastening it in place.

Component leads can then be inserted through the eyelets and soldered in place to complete a circuit connection. The leads are then clipped to about 1/8-3/16 in. The small protruding lead then serves as a suitable soldering terminal.

Depending on what type of test leads you may already have in your shop, you may wish to substitute jacks in your project that are compatible to these leads in place of the ones used in the model as J1, J2, J3. RCA phono jacks can be used to advantage if you prefer to use shielded input and

output cables. Likewise, J4, the phone jack, may be changed to mate with the type of plug on the earphone you are using.

After completing the wiring of the electronic card, it's best to recheck your work against the schematic for possible wiring errors. Check too for shorts and poor solder connections. Pay particular attention to pins 4 and 11 on the IC. Make certain that pin 11 connects to the battery positive through the switch S1, and that pin 4 goes to ground.

Install the completed and checked card in the housing using 4-40 x 3/4-in. bolts. Additional nuts or spacers are used under the card to raise it 1/4 to 3/8-in. from the housing to avoid shorts.

Mount potentiometers R4, R5, switch S1, the battery holding clip, and the various jacks in their respective locations. A dab of red paint (your wife's nail polish will be perfect) on the battery clip serves admirably to indicate the positive terminal of each battery. This will help you remember the correct way to insert the batteries.

Capacitors C4 and C5 are soldered in, supported only by their leads. Wire in the remaining connections between the electronics card and the various potentiometers, jacks, switch, and battery clip.

Checkout. When construction is completed, insert a pair of AA size cells into the battery holder. Be sure to observe correct polarity. Connect a medium- or high-

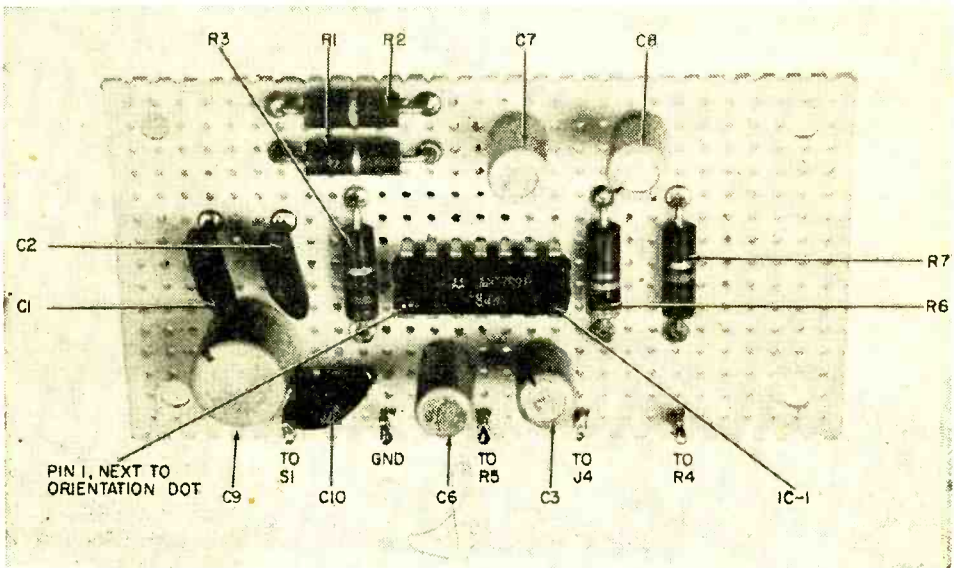

Note how IC mounting tabs slip perfectly into Vector type-H pattern perfboard. You could buy IC socket if you don't want to solder directly to IC mounting tabs as seen here. Normal axial lead electrolytics can be substituted for printed-circuit types.

GEN-TRACE

impedance headphone across the generator's output by plugging it into J4. Turn the instrument *on* and advance the level control. A clear tone in the phone will confirm proper operation of the signal generator.

To check out the operation of the signal trace section, couple the output of the generator (J1) into the input of the signal trace (J3). Again the tone will be heard if all is operating properly.

Should trouble develop in either section, check the wiring to that section. If the trouble appears to be in the signal generator

section, check the wiring to inverters INV1, INV2, INV3. If the trouble appears to be in the trace portion of *Gen Trace*, check INV5 and INV6. A failure of both sections could indicate reversed battery polarity, or wiring to pins 4 and 11 on the IC.

Add an RF Probe. The signal tracer can be used to check through audio stages without any special test leads. But it cannot be used to check RF, IF, and mixer stages. The usefulness of the signal tracer can be extended by the addition of an RF demodulator probe. The drawing for a suitable RF probe details a circuit for one we designed to be used with *Gen-Trace*.

In most applications, additional gain will
(Continued on page 108)

Extending usefulness of *Gen-Trace's* easy with RF demodulator probe. Solder all parts close to perf-board; line interior of probe with cardboard for short-circuit protection. Carefully separate inner conductor from cable shield; gently pry inner conductor through shield with pair of tweezers. After tinning, run grounded end of capacitor, diode, GND clip to cable braid. Inverter I4 boosts demodulator sensitivity. Solder 27k resistor across IC1 terminals 5, 10. Capacitor rating's not critical—10 μ F @ 35 VDC's sufficient.

RF DEMODULATOR PROBE

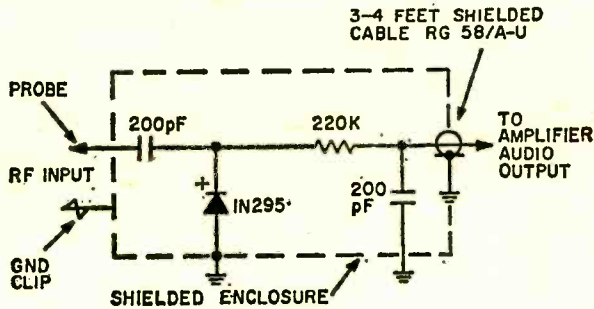

CIRCUIT ADDITION FOR RF PROBE

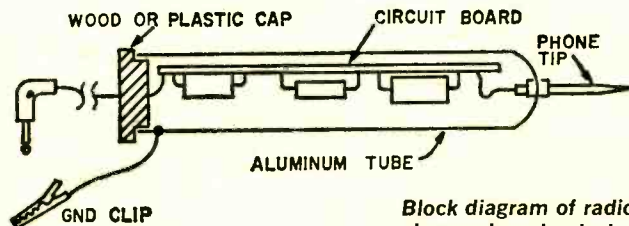
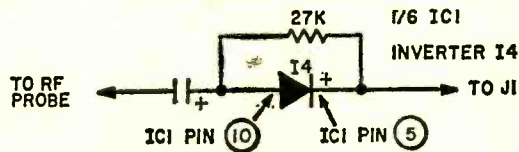
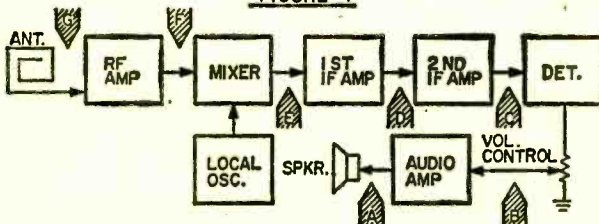
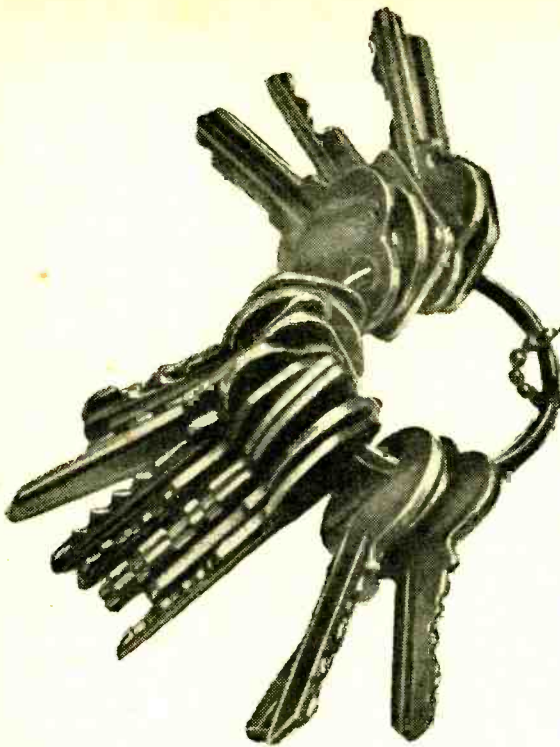

FIGURE 1

Block diagram of radio shows where to start testing when set dies. Connect leads from J1, J2 across speaker; tip of probe from J3 makes contact with input element of each successive stage, working back to antenna terminals.





Build a LED Flashlight

for Your Key Chain

by Thomas R. Fox

A miniature flashlight, attached to a key chain, is an extremely useful device. The trouble is, most key chain flashlights use standard filament light bulbs, which are notorious current hogs and have rather short lifetimes. Because of its minute size, almost unlimited lifetime and very low current consumption, the LED (Light Emitting Diode) is, to date, the best device to use in such a flashlight.

The LED is a revolutionary new solid state lighting device that has no filament to heat up and burn out. Instead, it produces a 'cold light' like fireflies do. It is basically a forward-biased diode composed of gallium arsenide instead of the more usual silicon or germanium. Since it generates most of its

light in a narrow bandwidth, the LED is only a step away from being a LASER. Also, its nearly monochromatic properties, the color of the LED is quite unusual and many have a rubylike appearance. See light chart.

Many types of LED's are suitable for such a miniature flashlight. Motorola's MLED600 is a good choice to use in a miniature flashlight since it provides a high light output at a low voltage—1.55 volts is enough to turn it on.

The power supply B1, for the device is two 1.35-volt mercury button cells connected in series to give a total voltage of 2.7 volts. This voltage is then dropped to 2.3 volts by the addition of a 15-ohm resistor. With normal use, these mercury cells should

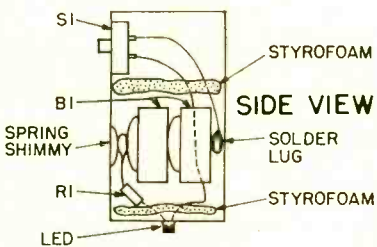

PARTS LIST FOR LED FLASHLIGHT

- B1—1.35-VDC mercury button cell, 2 required (Mallory RM-635TR2, or any pair of cells thin enough to fit the plastic toothbrush tube you use)
- LED—Motorola MLED600, HEP-P2000 or equiv.
- R1—15-ohm, 1/2-watt resistor
- S1—Subminiature, momentary-contact s.p.s.t. pushbutton switch (GC Electronics 34-002 or smaller)
- Misc.—Toothbrush plastic container, solder lugs, wire, styrofoam, silver paint, etc.

LED Flashlight

The visible light spectrum shows the colors we see and the narrow band of light the LED generates.

last at least a year. Assuming 20 seconds of use a day, the batteries in the LED flashlight might last as long as their shelf life.

Building It. The case for the LED flashlight can be made from the plastic container in which a toothbrush comes. Either the heavy-weight plastic container or the flexible one can be used.

Cut this plastic container 1 1/4-in from the bottom and save the cover. You now have the case.

Follow the wiring diagram to complete construction. Styrofoam is used as an insulating material and the specified piece of sheet metal is used as a spring shimmy to get a good connection between the solder lugs and the batteries. Since you can't solder to the batteries directly, pressure contact is required.

Before fastening the cover, check out the flashlight to see if everything is working properly. If the LED lights when the switch is pressed, fine; if not, reverse the batteries or solder lugs. LED's, unlike common incandescent lights, are polarized. If it still doesn't work, check battery contacts, mercury cells, switch and LED in that order.

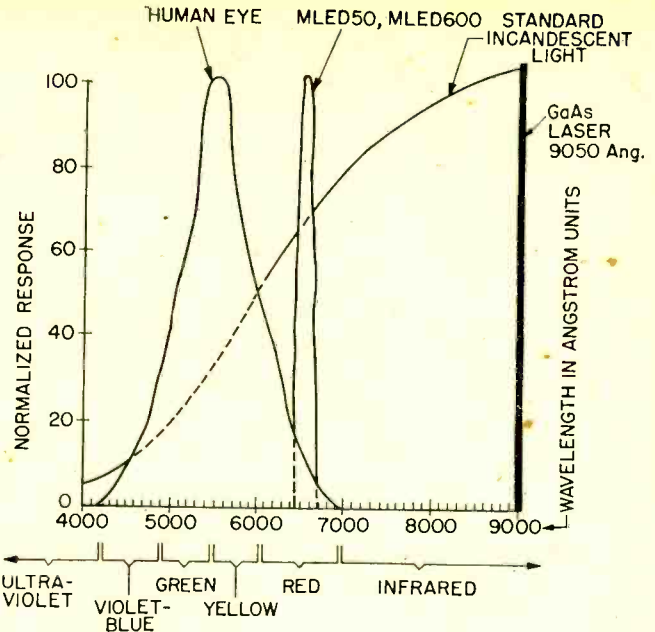

If everything works okay, finish construction by drilling a small hole in the cover. Put a small piece of styrofoam between the batteries and LED. From the inside of the cover, stick the LED through the hole you drilled. Fasten the cover (it might need to be cut down to size) to the case using small sheet metal screws (or even glue, since the batteries rarely need to be replaced). To appear professional, paint the plastic case with aluminum paint. For the final touch, drill two small holes in the bottom of the case and string a key chain through the holes.

Total cost of this ultra-modern miniature flashlight can be as low as \$3.50 including batteries, and it weighs less than 0.5 ounce. ■

Quicky Vacuum-Tube Filament and Continuity Checker

□ Most tube failures are caused by open filaments, so you can save a lot of time when troubleshooting radios and TV sets by using this instant tube checker. Simply plug a tube into the matching socket; if the filament is

okay, lamp I1 will light. If you have any odd-ball tubes that use sockets other than the standard three shown, simply build them into the checker. The continuity test leads allow you to check TV picture tubes. ■

PARTS LIST FOR TUBE CHECKER

- B1—6-VDC lantern battery
- I1—#40 pilot (Calectro E2-437 or equiv.)
- SO1—8-pin octal socket
- SO2—7-pin socket
- SO3—9-pin socket

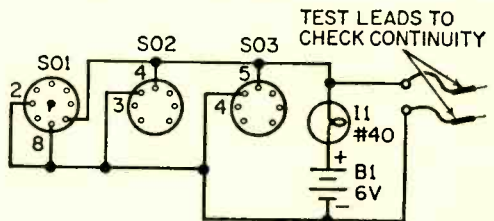

build



SimCon...

... the 1-FET converter that puts you where the real action is
by Edward A. Morris, WA2VLU

BY NOW, JUST about everyone who dabbles in electronics knows where the real action is. That's right—it's on the so-called emergency bands. Here's where you can listen in on the day-to-day communications of your local and state police and fire departments. Here, in fact, is where you can tune in on the drama of everyday life.

Our SimCon (for simplicity converter), designed to be used in conjunction with an auto radio, brings you close to the action. The converter can be used to receive any 1-MHz band between 25 to 55 MHz. No modifications to the radio it's used with are necessary and the converter even employs the same antenna.

Aside from the more casual listeners, some of the more serious types—rural volunteer firemen, say—will also be able to put the converter to good use. SimCon enables the volunteer fireman or Civil Defense worker to receive directions and information while en route, eliminating a possible stop at a central meeting point.

SimCon is packaged in a small attractive, vinyl-clad housing. It's compact enough to be mounted unobtrusively under the dash, and there's no chance in the world of it posing a threat to your knees.

Cost? About \$14.00 builds it. Construction time should be under 4 hours (say two evenings' work). Sound good? Read on.

How It Works. First, let's take an overall look before we go into circuit details. Our SimCon uses a field effect transistor, Q1, as a mixer. The input to the FET consists of two signals. One is the RF input signal we wish to receive; the other is generated by a crystal-controlled oscillator, consisting of transistor Q2 and its associated components. The two signals, which differ in frequency, are mixed by the FET.

(Continued overleaf)

SimCon

Among the FET's output products is a signal which is identical to the signal we wish to receive, except that its frequency is the difference frequency between the original frequency and the local oscillator frequency. By picking the proper frequency for the local oscillator, we can receive this new difference frequency on a BCB radio.

For a more detailed look, let's start at the beginning. With switch S1 on, power is applied to the circuit, and the converter is placed between the antenna and the receiver. RF input signals are coupled to the resonant circuit consisting of coil L2 and capacitor C1 by the antenna input coil L1. The desired signals are applied to the gate of Q1; undesired signals falling outside L2/C1's bandpass are rejected.

The FET is operated with its gate negative with respect to its source terminal. Bias is provided by the voltage drop of the source drain current across resistor R1. With the source positive with respect to ground and the gate at DC ground potential, the gate is negative with respect to the source terminal. The source resistor is bypassed for RF by capacitor C3.

Local Oscillator. Along with the desired RF input signal at the gate of the mixer, we also need a signal from the local oscillator (LO).

Graph gives some idea of how AM radio is able to detect FM signals. Secret is to detune receiver slightly so incoming signal falls on slope of radio's selectivity curve. Signal can then be detected and amplified.

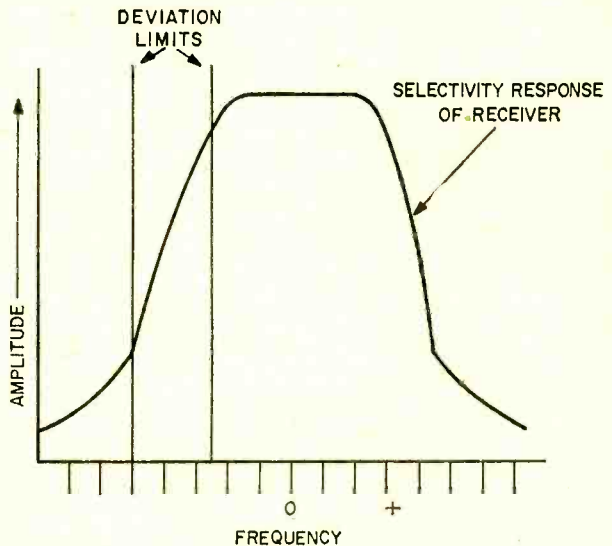

The LO signal is generated by transistor Q2 and its associated components. Most hams will recognize the circuit as that of a Clapp oscillator, widely used as a VFO. The version used here is its solid-state, crystal-controlled twin.

Operating bias for Q2 is provided by the voltage divider formed by resistors R2 and R3. The collector of Q2 is placed at RF ground by bypass capacitor C4. Frequency control is accomplished by X1, operating in

its series mode. Positive feedback, necessary for oscillation, is controlled by the ratio of the values of capacitors C6 and C7.

Emitter resistor R4 raises the impedance of Q2's emitter above RF ground, as is necessary for proper feedback and circuit operation. The RF output appears across the emitter resistor and is injected into the gate circuit of Q1 by coupling capacitor C2.

We now have two RF signals at the gate of the mixer: the signal we wish to receive, and the injection voltage from the local oscillator. As a result of the mixing action in the FET, one of the mixer's outputs will be the difference frequency of the two input signals. If we choose our local oscillator frequency properly, the difference frequency will fall in the standard broadcast band. This output appears at the drain terminal of the mixer, and is coupled to the output of the converter, output jack J2, by coupling capacitor C5.

The converted signal is then received and detected by the radio it's used with. At this point we may have some readers scratching their heads, wondering how a diode detector

in the auto radio is going to cope with FM-modulated stations in the emergency and business bands.

Slope Detection. Key to this problem is a little trick called slope detection. To receive FM transmissions, the auto radio is tuned a bit off to one side of the desired station. This places the received signal on the slope of the receiver's selectivity curve. Frequency deviation (FM modulation) is then converted into a varying-amplitude sig-

nal, which is detected and amplified just like an ordinary AM signal!

Though this method of detecting FM signals negates some of the benefits of FM, it is satisfactory for general use. It also has the advantage that no modifications are necessary to the radio it is to be used with.

Mechanical Construction. The author chose to construct his model in a small aluminum box chassis. The circuit layout isn't critical, however, so you have considerable freedom in picking your layout and packaging technique. Even so, a metal enclosure should be used to ensure proper shielding. And if you've had little or no previous ex-

perience in HF/VHF layout and construction, you'd do well to follow the general layout used by the author just to be on the safe side.

Construction is simple and goes easily. Begin by laying out the pattern of holes to be drilled in the case. A small T-square can come in handy here. Spot the holes with a centerpunch to ensure accurate placement of the drilled holes. The rectangular cutout for switch S1 is most easily made by first scribing the outline of the cutout onto the box. Then drill a connecting pattern of 1/16-in. holes just inside the scribed outline. Remove the material in the center, and fin-

PARTS LIST FOR SIMCON

- B1—9-V battery (Eveready 216BP or equiv.)
- C1—Dipped silver mica capacitor (Elmenco DM-10 or equiv.—see text and Table 1)
- C2—10-pF, 500-V dipped silver mica capacitor (Elmenco DM-10 or equiv.)
- C3, C4—0.0022- μ F, 1000-V miniature ceramic capacitor (Erie display card # A 23 or equiv.)
- C5, C6—100-pF, 500-V dipped silver mica capacitor (Elmenco DM-10 or equiv.)
- C7—62-pF, 500-V dipped silver mica capacitor (Elmenco DM-10 or equiv.)
- J1, J2—Motorola auto radio jack (Lafayette 11E66024 or equiv.)
- L1—3 turns #26 plain enameled wire, close wound over ground end of L2—see text
- L2—7 1/2 turns #26 wire close wound over 1/4-in. dia. form, ferrite slug tuned

- (Miller 20A687RB1 or equiv.)
- L3—2.5-mH RF choke (Miller 6302 or equiv.)
- Q1—HEP-802 transistor (Motorola)
- Q2—HEP-55 transistor (Motorola)
- R1—4700-ohm, 1/2-watt resistor
- R2—33,000-ohm, 1/2-watt resistor
- R3—47,000-ohm, 1/2-watt resistor
- R4—2200-ohm, 1/2-watt resistor
- S1—3-pdt slide switch (Lafayette 99E-6166 or equiv.)
- X1—Crystal—see text and Table 2 for instructions on calculating frequency. Available from Z-Tech Enterprises, P.O. Box 70EH, Hauppauge NY 11787, \$4.95 postpaid. Money order, speed delivery. Specify series resonant 3rd overtone crystal, type ZTE-1.
- 1—5 1/8 x 3/8 x 1 5/16-in. aluminum case
- Misc.—Crystal holder, battery holder, perforated board, push-in terminals, solder, hardware, wire, vinyl covering material, press-on lettering, etc.

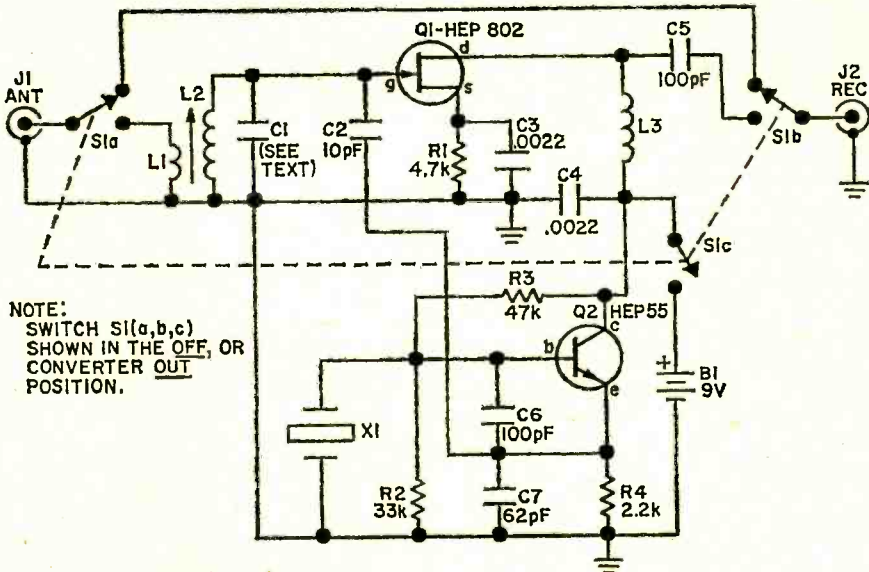

NOTE:
SWITCH S1(a,b,c)
SHOWN IN THE OFF, OR
CONVERTER OUT
POSITION.

SimCon

ish the sides of the cutout with a small file.

After the mechanical work has been completed, the case can be spray painted or covered with vinyl contact adhesive material, as was the author's model. The vinyl material looks great and is easier to apply than spray paint. A wide variety of wood grain and solid tone patterns are available.

In either event, the case should be thoroughly cleaned before it's covered or painted. Hot water and soap will do a good job. Rinse well, then dry thoroughly.

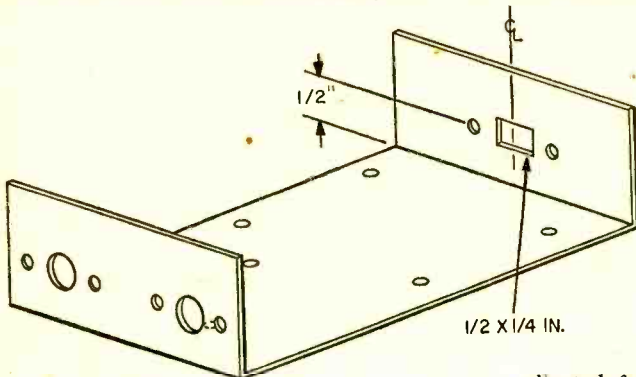

Chassis for SimCon is cinch to prepare. Hole at far end is for switch S1; two holes at near end are for jacks J1 and J2.

To cover the case with vinyl, first remove the paper backing from the vinyl material. Place the material adhesive side up on a flat surface, then place the case on the material. Alternately press each side of the case onto the material, and trim excess material with razor blade or pocket knife. Remove entrapped air bubbles by working them out to the edge of the material. In stubborn cases, try puncturing the vinyl by pricking the bubble with a small needle. For maximum adhesion and permanence, press the vinyl firmly against the case. Remove the material over the various holes and cutouts with a sharp knife blade.

Press-on lettering can then be applied to the case to lend a finished, professional appearance to the project. Follow the manufacturer's directions in applying the lettering. To protect the lettering from abrasion, spray on several light coats of a clear acrylic spray.

Electrical Construction. With the exception of switch S1, the input and output jacks, and the battery, all components are mounted on a small section of perforated

epoxy-glass board. Miniature push-in terminals are used to mount various components, as well as to serve as wiring terminals. Wiring is point-to-point, using small gauge bare wire, and is carried out on both sides of the board. Care should be taken to use short, direct leads whenever possible.

The general components layout can be determined from our photos. Though not exactly wide open, the layout shown allows even the beginner enough room to work.

Transistors Q1 and Q2 are soldered directly into the circuit. No special precautions are necessary: just a bit of solid-state-oriented common sense. Use a small (under 50 watt), well-tinned iron, and complete the job quickly. Beginners should perhaps use a heat sink on each lead while soldering.

Coil L2 can be store-bought or home brew, depending on how ambitious you feel. If you opt for the home-brew version, wind 7½ turns of #26 plain enameled wire, close wound, over a ¼-in. dia. ferrite slug tuned form. Position the coil on the form so that the ferrite slug can be adjusted from fully in, to fully out of the coil. Coil L1 consists of 3 turns of #26 plain enameled wire close wound over the cold (ground) end of coil L2.

Selecting Frequencies. Both the value of capacitor C1 and the frequency of the crystal will depend on what frequency(s) you want the converter to cover. Refer to the table at right to calculate the crystal frequency; the table above specifies the value of

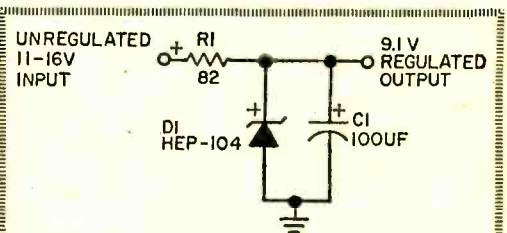

PARTS LIST FOR AUXILIARY POWER SUPPLY

- C1—100-uF, 25-V miniature electrolytic capacitor (Sprague TE or equiv.)
- D1—9.1-V, 1-W, 10% Zner diode (Motorola HEP-104 or equiv.)
- R1—82-ohm, 1-watt resistor
- Misc.—Wire, solder, hardware, push-in terminals, perforated board, etc.

	25/35 MHz	35/45 MHz	45/55 MHz
C1	33 pF	15 pF	10 pF

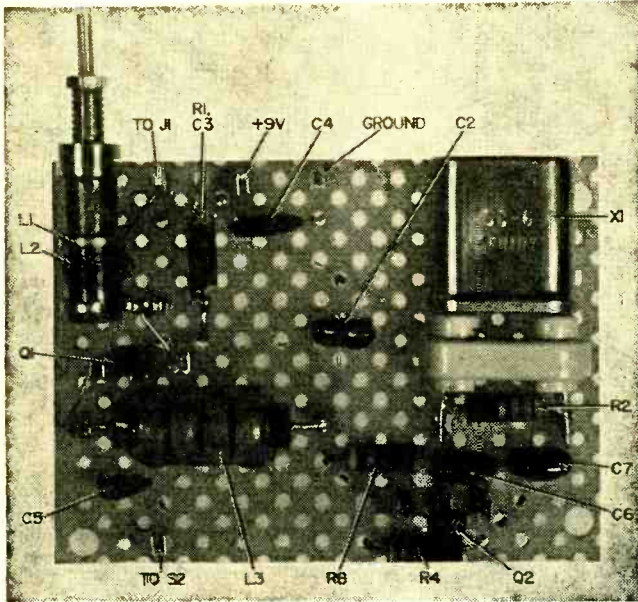

SimCon's perfboard, all wired up and ready for mounting in chassis. Since wiring is carried out on underside of perfboard, board must be spaced from chassis with nuts when mounted. Note that L1/L2 and L3 appear at right angles to each other.

Q2 (capacitor C4) is wired in close to the collector terminal and with short leads for proper circuit action.

After the electronics card has been wired according to the schematic diagram, recheck your work for possible errors and shorts. Remember, it's a rare builder who can

honestly boast that he never ever makes a wiring mistake.

Final Assembly. Prior to installing the electronics card in the case, first mount switch S1, the battery clip, and jacks J1 and J2. The jacks specified in the Parts List will match most all auto-radio antenna systems.

When installing components with nuts and bolts, take care not to pull the vinyl material. The easiest way around this is to tighten up on the nut from the rear while holding the screw head in a fixed position with a screwdriver.

Mount the electronics card with 4-40 x 3/4-in. bolts and matching nuts. Space the card about 3/8 in. from the chassis using additional nuts to achieve the correct spacing. Take care to prevent possible shorts between wiring on the underside of the electronics card and the chassis.

Though not shown in the schematic diagram, an extension cable is needed to connect the output of the converter to the input of the auto radio. A short length of RG-58 coaxial cable can be used; however, better results will be obtained by using a length of

Calculating the Crystal Frequency

For spot frequency operation:

$$F_{XTAL} = F1 - F2$$

where F_{XTAL} is the frequency of the crystal to be ordered.

F1 is the spot frequency to be received.

F2 is the frequency (between .54 and 1.6 MHz) where you wish to receive the converted frequency on your radio.

For 1 MHz band operation:

$$F_{XTAL} = F1 - 0.55 \text{ MHz}$$

where F1 is the frequency of the lower edge of the 1 MHz band to be covered. The lower edge of the 1MHz band to be covered will appear at 0.55 MHz, and the upper edge at 1.55 MHz on the auto radio.

SimCon

low capacitance auto antenna lead-in cable. Terminate both ends with Motorola plugs.

Alignment. Connect the output of the converter to the input of the receiver, using the extension cable. If a signal generator is available, connect its output, through a 15-pF capacitor, to the input of the converter. Set the radio where you want the spot frequency to appear at, or to the center of the band if you want 1-MHz coverage. Set the generator approximately on frequency, then vary it a bit to obtain maximum signal output from the auto radio. Peak coil L2 for maximum output. Reduce the generator output and repeak L2. Continue the procedure until no further improvement is noted.

If a signal generator isn't available, connect the auto antenna to the converter. Tune L2 for maximum noise output from the receiver. Further improvements can be made by peaking L2 with the aid of an on-the-air signal.

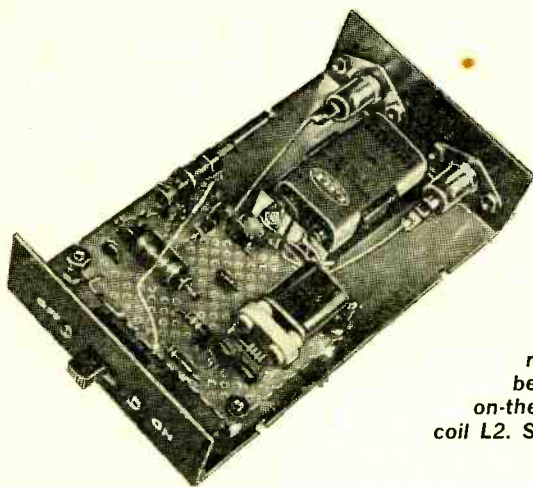

Operation and Use. Best results will be obtained if the auto antenna is extended to its maximum length. The auto radio's push-button selector can be taken advantage of and pre-set to frequencies of most interest. This is most handy when you want to switch frequencies rapidly.

In some locations, where the converter is used to receive only one frequency and a strong local broadcast station lies close to the converter's output frequency, the broadcast station may ride through and interfere with the desired station. The interference can be reduced by connecting a trap be-

tween the antenna and the input to the converter. Tune the trap until the offending station disappears or is greatly attenuated.

This type of interference can be prevented by picking a quiet spot on the broadcast band for the converter to work into, and picking the crystal for the local oscillator accordingly.

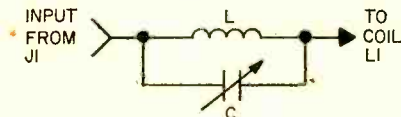

Interference trap for SimCon. L is Miller 2002 antenna coil or equivalent in parallel with 25-280 pF mica trimmer capacitor.

If desired, the converter can also be used with a portable radio. For temporary operation, good results can be obtained by wrapping several turns of insulated hookup wire around the portable's case, close to the radio's ferrite antenna. Connect one end of the wire to the hot (center conductor) output of jack J2.

A more permanent connection would involve wrapping 10-15 turns of #26 plain enameled wire, close wound, around the ferrite antenna rod inside the portable's case. The connection could be brought out through a small jack installed in the set's case.

Completed SimCon with perfboard neatly mounted on chassis, battery B1 installed, switch S1 mounted at front of chassis, jacks J1 and J2 at rear. As explained in text, unit is best aligned with signal generator, but on-the-air signal can also be used to peak coil L2. Signal should be weakest one on band.

Auxiliary Power Supply. Though the self-contained battery supply will be adequate for most uses, there are those—like the volunteer fireman or Civil Defense worker—who may want a more dependable source of power. Batteries have a habit of giving out when they are needed most. For these reasons we have included a Zener-regulated power supply (see page 60) which operates directly from the vehicle's 12-VDC electrical system. Note that the supply cannot be used with positive-ground electrical systems; this requires reversing the polarity of both D1 and C1. ■

Automatic Headlighter

Don't end your trip in a fall!

By William P. Dodd, Jr.

THE night may be dark and dismal when you pull in your driveway, but thanks to your Automatic Headlighter you'll have no trouble seeing the way to your doorstep. This automatic headlight timer is a two-transistor circuit that keeps your headlights illuminated for 60 seconds after you leave your car. A simple ten-dollar project (all new parts), it's connected in parallel with your existing auto headlight switch and is operated by a single pushbutton. The timer has been field-tested for over a year and has been proven extremely reliable. It is for installation in a 12-Volt negative ground electrical system, but installing the unit in positive ground systems is a snap for hobbyists.

THE HOW OF IT. When the driver depresses pushbutton switch S1, timing capacitor C1 charges to 12 volts and turns on transistor Q1, which drives power transistor Q2 into conduction. This, in turn, energizes the relay which has its contacts connected in parallel with the headlight switch. The relay will stay energized until C1 discharges to the Q1 turn-off level. The lights-on period is determined by the value of C1, R1, and the characteristics of transistor Q1. With values shown on the schematic, about 60 lights-on seconds are provided.

WHAT TO DO Construct the timer in a small 3½-in. x 2½-in. x 1½-in. mini-box where all components except the relay and pushbutton switch S1 are mounted on a 1½-in. x 1½-in. printed circuit card. The circuit card may be made by any of the conventional methods.

Special attention must be given in mounting some of the components on the printed circuit card. Capacitor C1 must be mounted with its + terminal connected to R1. Also, special attention must be given to spacing the transistors at least ¼-in. away from the circuit card to avoid overheating during soldering. Two insulated washers are used to mount power

AUTOMATIC HEADLIGHTER

transistor Q2 to the printed circuit board.

Interconnecting wires from the circuit board should each be at least 4-in. long. They can be cut to proper length just before wiring in the mini-box. Mount RY1 and S1 in the mini-box, with heavy gauge (#14) wires soldered to the relay terminals as shown on the schematic. Make these wires about 24-in. long and mark "+" and "Lights" for easy identification during installation. The last step is to mount and connect the printed circuit card in the mini-box.

Under the Dash. The protruding mounting screw of RY1 may be used to mount the timer under your dash, or make a bracket of your own design for your particular automobile and installation. Just make sure the timer chassis is well grounded to the dashboard frame before proceeding.

At the headlight switch, find the wire coming from the headlamps and select a

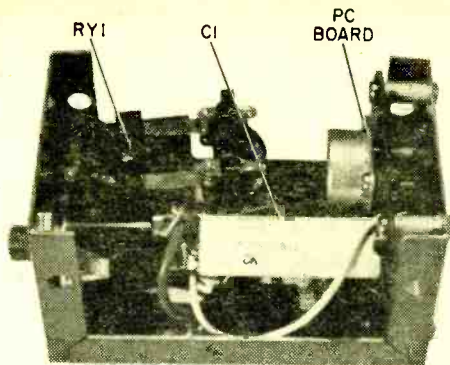

With the relay mounted on left, PC board at right, all parts fit conveniently into the 3¼-in. x 2½-in. x 1½-in. minibox case.

convenient point (probably a wire right on the switch) to tap into the 12-Volt battery power. You can locate these two wires by checking for voltages with a VOM at the headlight switch. A +12-Volt battery wire will be the only wire that will read +12 volts with the headlight switch in the *off*

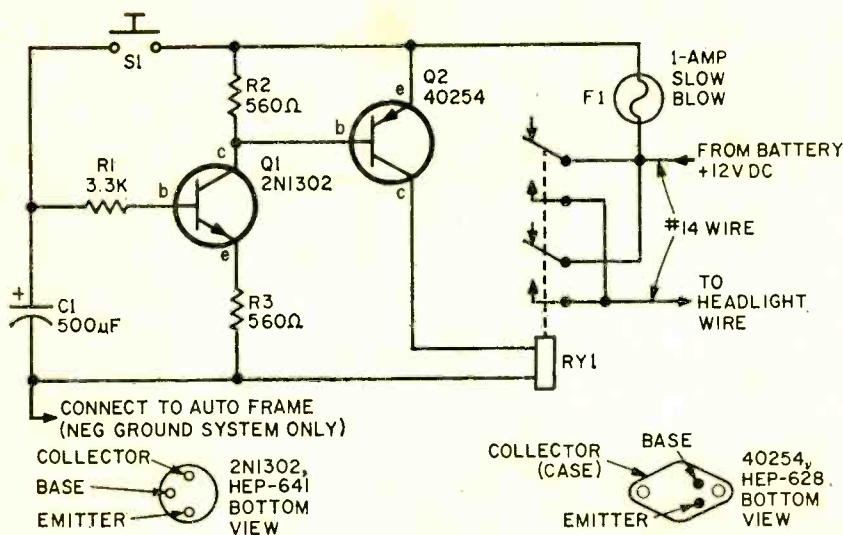

PARTS LIST FOR AUTOMATIC HEADLIGHTER

C1—500 μ F electrolytic capacitor, 15 VDC or better

Q1—NPN transistor, 2N1302, HEP-641

Q2—PNP transistor, RCA 40254, HEP-628

R1—3,300-ohm, ½-watt resistor

R2, R3—560-ohm, ½-watt resistor

RY1—Relay, DPDT, 10-amp contacts, 12 VDC coil resistance at least 100-ohms, Potter and Brumfield type MR11D or equiv. (BA stock no.

19A387, Lafayette stock no. 30-20047 or Allied type KN105-2C-12D.)

S1—SPST pushbutton switch, normally open (time-start switch)

Misc.—3¼-in. x 2½-in. x 1½-in. case, 1-amp SB fuse with pigtail leads, #14 wire, hook-up wire, printed circuit material, hardware, solder, etc.

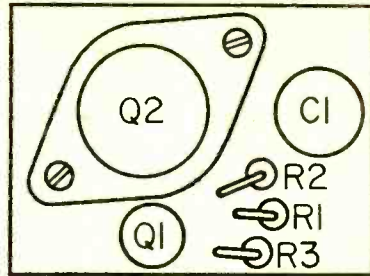
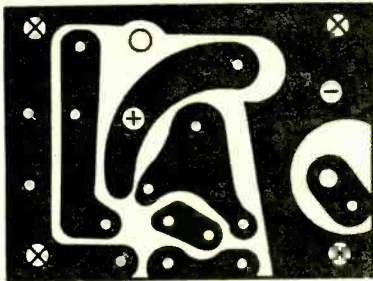

Actual size copper (bottom) side of your board on left and component (top) side on right.

position. The wire that reads +12 Volts only when the headlights are on is the other correct one; it normally runs directly to the

Modifications Anyone? If more than 60 seconds delay is desired, a larger capacitor can be installed in place of C1. For example, a 1,000 μ F capacitor will give two minutes or more of time delay. If you wish, a 10K trimmer resistor in series with R1 will allow exact adjustment of the time interval.

Several fixed timing periods such as 60, foot dimmer switch. After locating these wires and marking them "+" and "Lights," disconnect the battery cable at the battery so there will be no accidental shorts. Remove 1/2-in. insulation from the two underdash headlamp and battery wires you have located. Now connect each timer wire to the corresponding automobile headlamp and battery wire. Wrap electrical tape over the exposed wires and arrange them in an out-of-the-way spot under the dash. Reconnect the + battery cable and the timer is ready for use.

30 and 15 seconds can be chosen with a switch wired to select different discharge resistors connected in parallel across capacitor C1. All of these modifications combined would give a longer delay period and a vari-

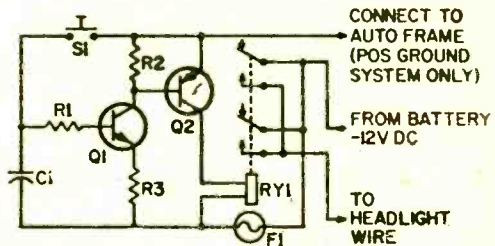

Use this schematic in positive ground cars only. There are no connections made to the normally open contacts of the relay. Use the same printed circuit board. All of the necessary changes are made around a board.

able delay with your choice of lights-on times.

Positive Ground? To modify the basic timer for a 12-Volt positive ground system, do not ground the printed circuit board to the chassis. Instead, use insulated standoffs when mounting the circuit board in the mini-box. Ground the "+" point on the circuit card to the chassis using a solder lug mounted under one standoff. Run a wire from the circuit card negative points to the relay. Operation will be identical to negative ground systems. ■

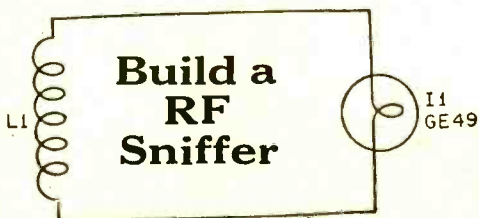

The easiest way to start servicing low power ham transmitters is to first localize

where the power gets lost. An RF Sniffer made from an ordinary #49 pilot lamp and a few turns of wire will instantly indicate if there's RF in a tank circuit. Carefully, so you don't get near the high voltage, bring the sniffer close to the tank coil. If RF is present, lamp I1 will glow—no glow, no RF. Coil L1 can be any diameter from about one-half to one inch or greater. Use about 10 turns for 80 meters, 5 turns for 40 and 20 meters and 3 turns for 10 meters. □

Put that Clock



By F. J. Bauer W6FPO

When the clock radio blows, it is hardly worth your while trying to find out why the radio chassis quit. Unless the trouble is something obvious like a bad electrolytic capacitor or output transistor, why not replace the AM radio chassis with a new one? If you have a portable transistor radio with a broken case or a bad speaker, you can use it as a replacement chassis by making a simple change in the clock radio power supply. If you have no spare transistor radio, you could install a code practice

oscillator in place of the radio. It will not awaken you to music, but it will wake you up with the tone of your choice.

Radio-Fix-It. If you decide to replace the AM radio chassis with working unit, it is a good idea to retain the tuning capacitor and audio gain control of the original clock radio. The original knobs may then be used without the bother of having to mate them to replacement control shafts. The only catch is that the tuning capacitor of both receivers should be electrically identical for proper tuning.

Simply remove the mounting plate with the controls on it from the defunct chassis and wire the assembly to the replacement chassis after removing the old tuning capacitor and gain control. The additional lead lengths make no difference in the performance of the replacement set. Also, the modification will not affect tuning dial settings noticeably, since these receivers have only an approximate tuning scale. However, play it smart, keep the leads reasonably short. This completes the mechanical job of adapting the replacement AM chassis to the cabinet.

Many clock radio chassis run on a 15-VDC supply instead of the usual 9 VDC for portables. If your replacement chassis is designed for 9 VDC, you may still use the

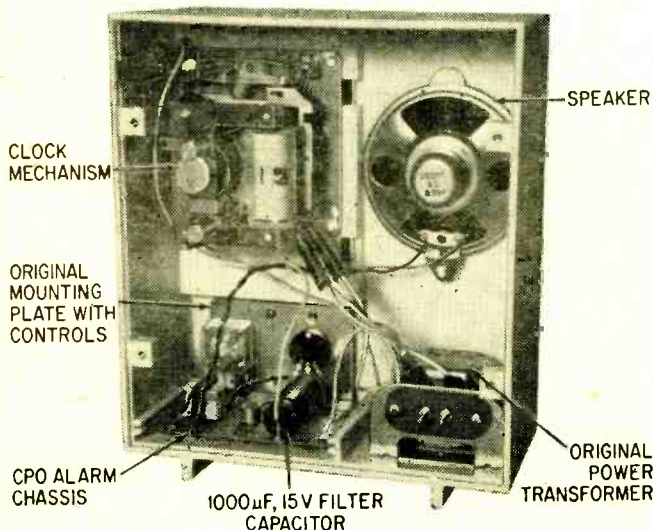

Here's a great way to salvage a good clock that caught radio failure! The Rx includes either a new transistor radio chassis or your own home-built one-transistor tone generator. Either way, your sack-time terminator doesn't sound quite as harsh when you revamp it yourself. Or does it?

Radio Back on the Job...

original power transformer in the clock radio, but it will be necessary to add a dropping resistor in the DC filter circuit of the power supply. See the *Power Supply* schematic diagram. Experiment with the value of the series dropping resistor, R1, until the voltage to the chassis is about 9 VDC. Start with, say, 1000 ohms and *gradually decrease* the resistance value until the proper voltage is obtained with the AM radio volume set at minimum. A convenient way to do this is to use a potentiometer. There is no danger of damaging the potentiometer since the power dissipated is only a fraction of a watt. Remove the potentiometer from the circuit and replace it with a one-watt fixed resistor that closely approximates the potentiometer setting. Insert the fixed resistor into the circuit and recheck the voltage.

Now check the performance of the receiver at normal volume. The power supply voltage will drop on volume peaks, but not enough to cause serious distortion.

Add A Tone. If you have no suitable AM chassis available as a replacement, why not install a code practice oscillator instead? Its

dulcet tone will awaken you just as readily as any local radio station would. A suggested circuit for the CPO, using a minimum of parts, is shown in the *CPO* schematic diagram. The oscillator requires 3 volts, or so, for proper operation and a series dropping resistor, R1, in the filter circuit should be selected as described previously to give this output voltage.

The 5000-ohm potentiometer, R2, should be adjusted for a pleasing tone and, if you prefer, replaced with a fixed, 1/2-watt resistor of the nearest standard value. In some cases, it may be necessary to add a capacitor, C2, across the primary of T2 to get the tone you want, since the frequency of oscillation of the oscillator depends to a degree upon the characteristics of the transformer used. Do not use a capacitor larger than .25 μ F. It may result in unstable oscillation and low output. After the capacitor is permanently installed readjust R2 for a pleasing tone and check the oscillator for prompt starting.

That's all there is to giving the old clock radio a new lease on life. Pleasant dreams! ■

A BUILD IT FAST PROJECT

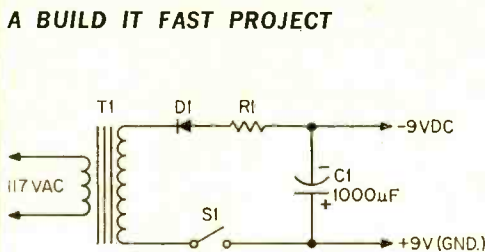

PARTS LIST FOR POWER SUPPLY

- C1—1000- μ F 15-VDC electrolytic capacitor. (Use capacitor in clock radio or replace.)
- D1—Diode rectifier, 200 PIV, 1A (Use unit in clock radio or replace.)
- R1—1/2-watt resistor (See text for selecting value)
- S1—SPST switch (Alarm switch in clock movement)
- T1—Power transformer (Use unit in clock radio or replace with 115-VAC primary; 12-VAC, 1.2-A secondary.)

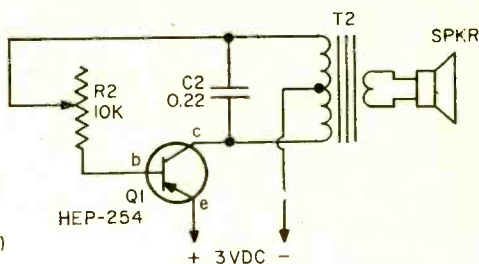

PARTS LIST FOR CPO

- C2—0.22- μ F, 100-VDC disc or tubular capacitor.
- Q1—Audio transistor, PNP, 2N427, 2N396, SK3004, HEP-2, HEP-254, etc.
- R2—5000 or 10,000-ohm potentiometer, taper not critical.
- SPKR—Use original unit in clock radio or replace with speaker with same physical dimensions.
- T2—Audio output transformer, 500-ohms CT primary; 3.2-ohms secondary (Lafayette 33-85580 or equiv.)

Groove Booster

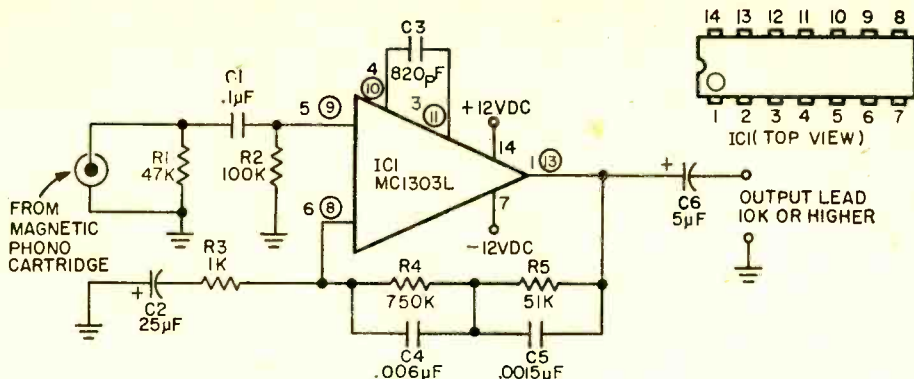

Using a dual operational amplifier IC, the Groove Booster will provide a fully equalized 1 V rms output from standard phono magnetic pickups. The terminal numbers which are circled on the schematic are the connections for one of the two independent stereo amplifiers on the single IC chip. The uncircled numbers are the terminals for the stereo second IC. Power supply terminals #14 and #7 are common to both stereo amplifiers. Note that the power supply is ± 12 volts to ground. Two 6 volt batteries in series can be used for each side of the power supply. If batteries are used, connect 25 μ F capacitors from

pins 7 and 14 to ground—and get their polarity correct. ■

PARTS LIST

- C1—0.1 μ F, 3 VDC
- C2—25 μ F, 3 VDC
- C3—820 pF, 500V VDC disc
- C4—0.006 μ F, 100V VDC disc
- C5—0.0015 μ F, 100V VDC disc
- C6—5 μ F, 25 VDC
- IC1—Motorola MC1303L
- R1—47,000-ohms, 1/2-watt
- R2—100,000-ohms, 1/2-watt
- R3—1,000-ohms, 1/2-watt
- R4—750,000-ohms, 1/2-watt
- R5—51,000-ohms, 1/2-watt

Keep a Light Flashing in the Window

□ The night is dark, rain is falling and the parking lot is dismal. Where the heck is your car? That's easy—right over there under that twinkling star! Well, it's not a star but one of those 3-volt thermal-blink lights found in so many kids toys.

You, too, can be fortunate if you plan in advance. In fact, plan for others. Build a blinking light for your doorway or driveway, if all the houses on your street are similar. This way visitors can look for the twinkling star and find you pronto.

Hyman Wallin of Silver Spring, Maryland did just that and sent a sample to the Editors of *ELECTRONICS HOBBYIST*. He soldered the bulb directly to a terminal strip yanked from a defective transistor battery. Next, he snapped it to a two-cell battery holder that mated the snap terminals on the battery strip. It's that easy. Mr. Wallin used C cells, but anything larger will be good and last longer. You can cement an alligator clip for fastening purposes. Lights out!
—Emmett Fluffin

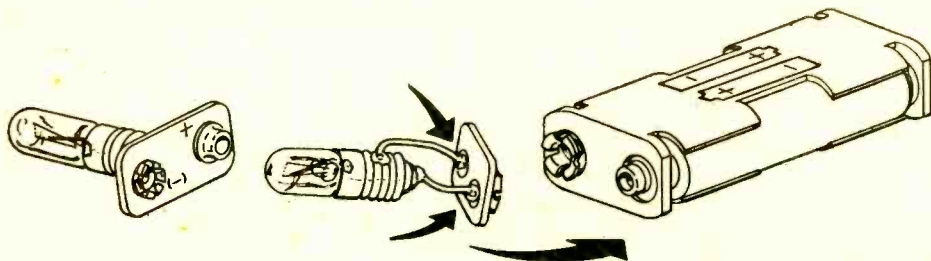

Broadcast Band DXers...

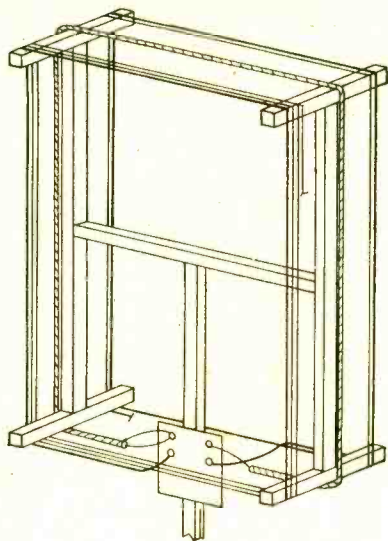

LOOK AGAIN TO A LOOP

Build this rotatable antenna. Nulls out beat interference. Helps track down tough dog BC band DX.

by Steve A. Money G3FZX

HAVE YOU TRIED DXing the BC band yet? If not, then maybe you're missing out on a whole section of the DXing hobby. It can be more interesting than short wave DXing although the stations are not usually as far away. The more distant stations are certainly much harder to log than the big international short wave broadcasters but are often much more interesting to listen to.

In another year or two we shall be coming to the minimum of the current cycle of sunspot activity. At this time reception on the higher frequency band, such as on short wave, becomes poor. On the lower BC band frequencies the opposite is true and the band really starts to come to life from the DX point of view.

Many of the stations you are likely to hear will be from the North American continent. With a little more careful listening however South America and the other continents. An advantage of working on the BC band is that nearly all of the programs will be in English so you can put all those foreign phrase books back on the shelf. Some Canadian stations broadcast in French and most programs from Mexico are in Spanish but these should not be too difficult to sort out.

Listening Hints. The best time to listen for BC band DX signals is during the winter months. Signals tend to be weaker in the

summer and often there will be a high level of noise from electrical storms which makes reception difficult. Generally the more distant stations will become audible as darkness falls and reception of DX should be possible until dawn. Conditions often vary from one night to the next so that one can never be sure what surprises are in store at the start of a night of listening. Maybe this is one of the things that makes BC band DXing so fascinating.

Apart from a reasonable receiver and an effective antenna all you need is a lot of patience. What sort of antenna? Well that piece of wire strung up across the shack may be OK for logging the local station but it's not going to be so hot for DX reception. Because there are so many stations using the BC band it will be found that there are often two or more stations coming in on the same frequency. The result is a confusing jumble of signals with one or other of them coming out on top as the rest fade out. Listening under these conditions can be very tedious and the identification of the individual stations can be almost impossible. On the short waves it is possible to get over this by using a directional type antenna such as a rotary beam.

BCB Beam Problems. Rotary beam antennas come rather large when they are designed for operation on the lower frequency BC band. If we take a mid band frequency

LOOK TO THE LOOP

of 1 megahertz then the length for a half wave antenna element works out at some 500 feet. Imagine a three element beam on that sort of scale. The mind boggles. Now if you just happened to own a ranch out in the wide open spaces of Kansas or Wyoming and had a few hundred dollars to pay for the erection of one or two towers, then you too could have yourself a full size BC band beam antenna. I guess most of us ordinary mortals who live in or near the city can always dream of such things. Usually the back lot in a city house or apartment is so small it's difficult to swing a baseball bat let alone erect any fancy antenna system. Apart from that, the neighbors might not appreciate the aesthetic beauty of a 500 foot antenna tower casting a shadow over their house!

In Britain the BC band enthusiasts face very much the same problems. An added difficulty is that in many city owned houses and apartments, the erection of an antenna, even for TV or FM radio reception, is forbidden. With a certain amount of native cunning however, a way round these problems was soon discovered and now even the guy in a high rise apartment block can listen to DX.

Back in the old days of radio, before transistors and ferrite rod antennas were even thought of, the so called portable radios used battery operated tubes. In those old type radios the antenna consisted of a large coil of wire wound around the inside of the case. This type of antenna is called a loop or frame antenna. In most of these radios the loop antenna was made less than a foot square and was not too sensitive, but it did have a directional pick up pattern. For DX-ing it seemed that a bigger version of the old loop antenna, in combination with a modern communications receiver, might prove to be quite effective. In practice it was found that a loop antenna four feet square would give good signal pick up and provide remarkable directional properties when it was properly coupled into the receiver.

The Loop Works? The easiest way to understand the operation of a loop antenna is to consider it as just one square turn of wire mounted vertically. The signal is usually taken out by breaking into the bottom side of the turn. Figure 1 shows the general idea. Now when a radio signal passes through the

loop it will cause a voltage to be induced into each of the vertical sides of the turn. These two voltages will be roughly equal in amplitude.

Suppose the loop is set up so that it is facing broadside on to the direction from which the signal is coming. The two sides of the loop will now be at exactly the same distance from the transmitter antenna. This means that the voltages induced in them will be exactly the same and in phase with one another. Each of these voltages will try to make a current flow around the loop. Since the two currents will be trying to flow around the loop in opposite directions, they will cancel one another out. As a result no current actually flows around the loop and no signal is transferred to the receiver.

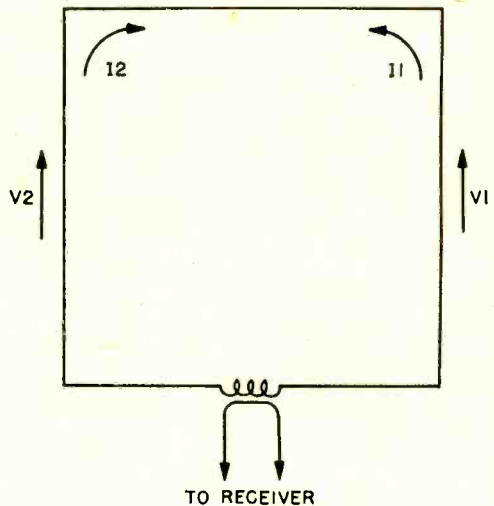

Figure 1 shows currents in an operating loop facing the signal. Currents induced, equal in magnitude but oppositely in phase, cancel to cause an antenna null point.

If the loop is now turned so that it is end on to the direction of the signal, one side will be nearer to the transmitter than the other. Although radio waves travel at the speed of light, it will take a short time for the wave to travel from one side of the loop to the other. As a result the signal induced in the far side of the loop will lag behind that in the near side. There is now a phase difference between the two voltages induced in the loop and the currents that they produce will not cancel out completely as they did before. As a result there will now be some current flowing around the loop and this current will cause a signal to be transferred to the receiver.

The position of the loop at which the signal is cancelled out is usually quite sharply defined. If the loop is rotated only a few degrees in either direction from this position the signal rapidly rises towards its maximum level. Thus although a station in a particular direction may be almost completely cancelled out, other signals coming in from points only a few degrees off in direction will be almost unaffected. By using this type of antenna at least some of the advantages of a rotary beam antenna can be obtained.

Practical Loop Antennas. So far we have assumed that there is only one turn on the loop. In practice a single turn does not give a lot of signal pick up. Greater output can be readily obtained by simply increasing the number of turns so that the antenna becomes a short coil. In this case the signal pick up increases directly with the number of turns used. The size of the turns is also important. Pick up is directly proportional to the area enclosed by the loop coil.

A further increase in the signal output from the antenna can be achieved by tuning the loop to resonance. This can be done by connecting an air spaced variable capacitor across the ends of the loop winding.

A loop antenna which has sides 24 inches long will need a winding of 13 turns. The turns should be spaced $\frac{3}{8}$ inch apart so that the total width of the winding will be about 4 inches. If the loop size is increased so that the sides are 4 feet long, then only 9 turns will be required. In this case the turns should

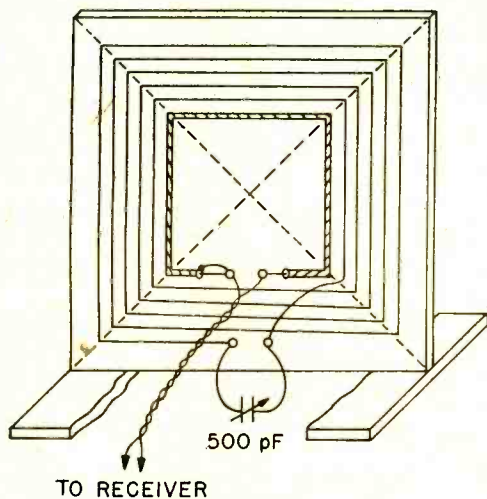

Figure 2. Simple 2 or 4-foot loop is built on plywood. Center pickup loop is coax connected to twisted pair lead-in shown.

be set $\frac{3}{4}$ -inch apart to give a total coil width of 6 inches.

The tuning capacitor should be an air spaced type with a maximum capacitance of 500 pF. If a capacitor of only 365 pF is used, it may not be capable of tuning the whole BC band. With the smaller tuning capacitor it is necessary to switch a 150 pF fixed capacitor in parallel with the main tuning capacitor when stations at the low frequency end of the band are being received.

Receiver Coupling. It is not practical to couple the ends of the loop winding directly to the receiver input since under these conditions the loop will not work properly.

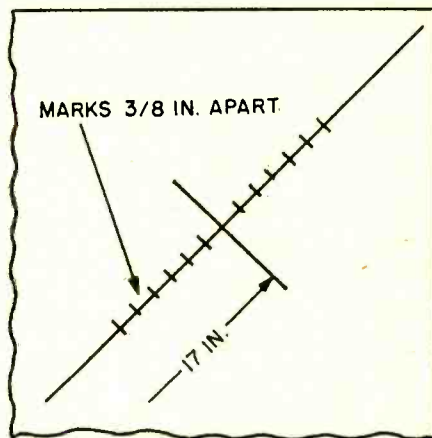

Figure 3. Tap in 13 nails at each diagonal of your 2-foot/side loop as shown. Then wind a thirteen turn spiral of #20 wire.

The easiest method of coupling is to use a link coil. One extra turn is wound alongside the main winding and the ends of this coupling turn are taken to the receiver input terminals.

Better performance is obtained if the link turn is made from a length of RG-11U or similar coaxial cable, using the center conductor as the link turn. One end of the cable's outer braid should be joined to the grounded end of the link turn. The cable shield will act as an electrostatic screen between the main loop and the link turn. This arrangement improves the directional effect of the antenna. The feeder cable used to join the link turn to the receiver input terminals may be either a twisted pair or another length of coaxial cable.

Some kind of support frame will be required to hold the loop winding in place. The actual construction method used will

LOOK TO THE LOOP

depend upon your skill in the woodwork shop.

Making The Support Frame. A very simple method of construction is as shown in Figure 2. Take a sheet of plywood some six inches larger than the size of loop desired. For a 2 foot square loop the board will need to be 2 feet 6 inches square and at least a 1/4-inch thick. For a four foot square loop the board should be at least 3/8-inch thick.

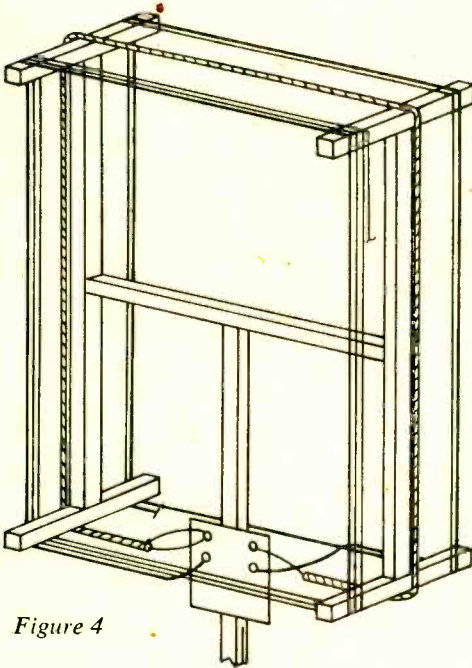

Figure 4

Deluxe "H" frame model for home builders shows center conductor of coax pick-up loop connected to lead-in terminals. Tuning cap connects to bottom terminals.

Mark out the diagonals across the board. Now mark off points 17 inches from the center along each of the diagonals. Still working along the diagonals, mark off 12 points 3/8-inch apart, six on each side of the 17 inch mark as shown in Figure 3. Repeat the pattern at each of the corners. Drive a panel pin or small nail part way into the board at each of the marked points. You should now have a total of 52 pins in the board.

For the loop winding you will need about 120 feet of #20 stranded plastic-covered hook up wire. Start at the bottom and wind

a turn around the inner set of pins. Now work out in a spiral winding turns around the other pins until there are 13 turns on the board. As you go along, anchor the wire in place by bending the pins down over it. Join the two free ends of the winding to a pair of terminals or binding posts near the bottom of the board. Put four more pins in the board near the inner set of pins and wind the link turn around them. Fix the link turn in place and take its ends to another pair of terminals. The tuning capacitor can now be mounted on the board and connected across the main winding. Finally the feed cable should be connected from the link turn to the input of the receiver.

For Carpenters Only. A rather more ele-

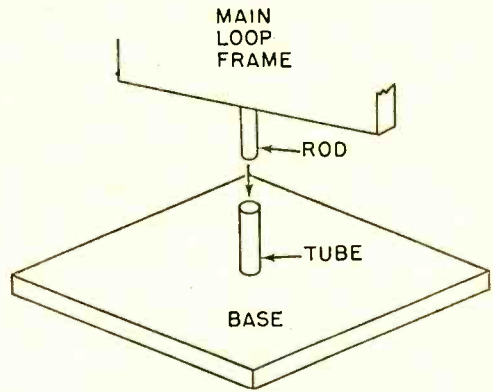

Simple indoor rotating system for your loop can help lower interference from stations on top of the one you are tuning.

gant method of construction is as shown in Figure 4. In this case the support frame is in the shape of an "H" and is made up from 1 inch by 1 inch timber. The joints may be either half lap or mortise and tenon according to your skill at woodwork. At the tip of each arm of the "H," a spreader of 1-inch x 1-inch timber is fixed on to hold the winding in place. Cut 13 "V" shape notches along the outer edge at 3/8-inch intervals.

Using The Loop Antenna. Actually, using the loop is simplicity itself. First of all tune the receiver to the station or channel you want to listen to. Now peak up the signal to maximum by adjusting the loop tuning capacitor. If there is some interference from another station then rotate the loop until it is reduced to a minimum. It only remains for me to wish you happy hunting and maybe one day you will achieve Heard-All-States on the BC band! ■

Super Booster

Add this devilishly simple RF booster to any Broadcast Band rig, and watch the once dead BC Band come alive—by Lars Jorgensen

Imagine your receiver's broadcast band dial jammed from end to end with a solid wall of signals! Pip-squeek stations that normally can't be heard with headphones *can* come booming into your shack at S9. A dream? Nope! That's just the kind of performance you'll get with Electronics Hobbyist's Super Booster.

Here's a preamplifier specifically designed for BC DX'ers. Whether you live in a concrete and steel tower, or out in the boondocks with plenty of space for a long-wire antenna, the Super Booster will dig out signals you've never heard before. The average gain of Super Booster is almost 42 dB—that's 7 S-units "extra" sensitivity!

As shown in our figure, the booster can function either as an "electronic antenna", with signals received only by loopstick antenna coil L1, or as a pre-amplifier, with long-wire antenna signals coupled to L1 through L2. Coil L2 is supplied as part of the specified antenna loopstick; you have no coil winding problems.

Signal voltage appearing across L1 and C1 is coupled to Field Effect Transistor Q1 which provides approximately 20 dB gain on top of the L1/C1 resonant gain. The output of Q1 feeds

transistor Q2, connected as an emitter-follower. This transistor stage provides an additional 10 to 15 dB power gain, and also provides a low-impedance output for connection to the relatively low impedance receiver input.

Though intended for direct connection to a receiver's antenna input terminals, CW's super Booster can also be used with "loop antenna radios" by connecting the booster's output to a loopstick antenna (a duplicate of L1), and then positioning this loopstick near the radio. We'll show how both connections are used.

The total current drain of Super Booster is less than 2 mA. Power is provided by a standard 9V transistor radio battery. The 2U6 type will last at least 3 months, even under heavy service. An "activator" type battery can last a year or more. With such low power consumption, there is no reason to build an external AC power supply for Super Booster.

—Construction. Though the circuit appears very simple, extreme care must be taken in the circuit board preparation. Reason is, the very high gain can cause total instability if a single component, or printed foil-circuit is out of position. We suggest that no attempt be made to

use point-to-point wiring; use a PC board which is an exact copy of the supplied template. The board can be of type XXXP; there is no need for a more expensive board.

Make *no* component substitutions; Q1 and Q2 should be the specified types. Through the circuit might work with some "general purpose replacement type NPN and MOS tran-

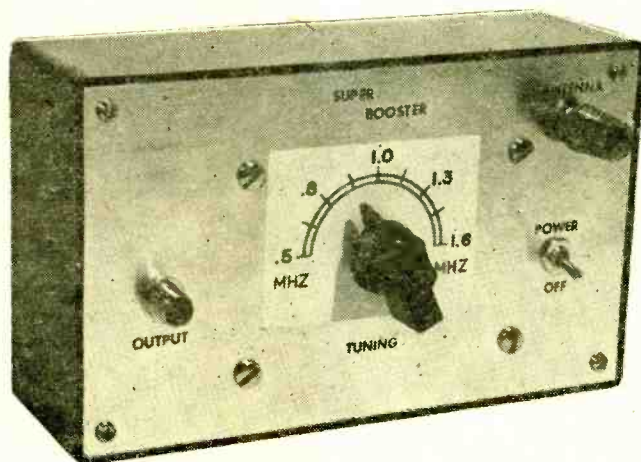

SUPER BOOSTER

Placement diagram for SB's parts. If the output is fed to an AC/DC-type rig, disconnect the link and ground J2's cold end separately.

sisters," it probably won't work with other dime-a-cheapies. Worse yet, it might work only on very weak signals while distorting on strong signals.

The specified components will provide distortion-free performance on signals as high as 80,000 μ V. You can expect Super Booster to provide its great performance until the battery voltage falls below 6 volts.

The circuit board and a *very short* connection to output jack J2 are the only critical assemblies. You may make mechanical modifications to Super Booster as long as the general layout approximates the unit shown in the photographs. Any cabinet can be used; the PC board has a built-in hand-capacitance shield. For maximum stability, though, a metal front panel will reduce the possibility of RF instability caused by the signal being fed into the receiver radiating back into the booster's input

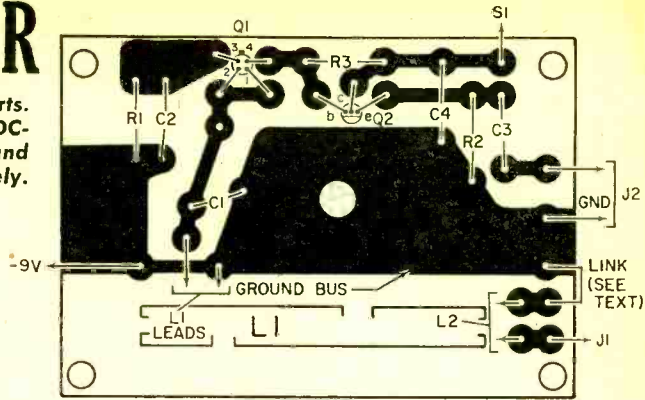

—Making the PC Board. Cut a piece of copper-clad board to the size of the template and scrub the copper surface clean with a strong household cleanser such as Ajax. Or, use steel wool and a liquid detergent. Place a piece of carbon paper (carbon side towards the copper) over the board and tape the board under the template. Next, find a sharp pointed instrument, such as an ice-pick or scriber, and indent the copper foil at each component mounting hole by forcing the point of the tool through the template and into the copper. Use only hand pressure, not a hammer. Then, using a ball

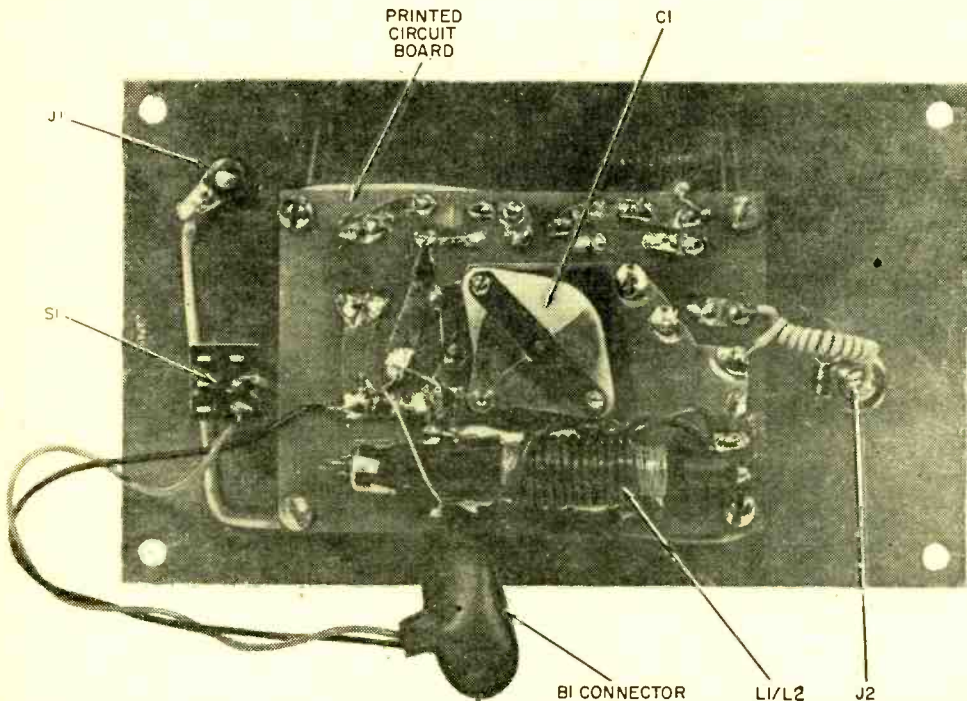

This is Super Booster's printed circuit board drawn full-size. If you make your own PC board, follow this pattern exactly; RF instability, or regeneration, could result if you don't. Our diagram shows where the various components are mounted on this PC board. Follow the layout carefully.

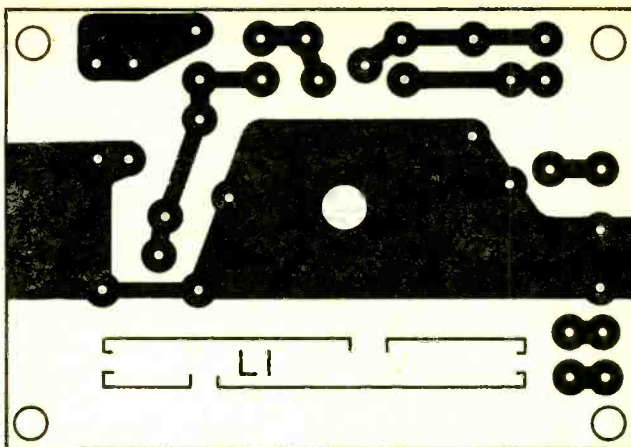

point pen, trace the outline of each foil area.

Remove the board, discard the carbon paper, and fill in the outlines with a resist pen such as supplied in the Allied Radio Shack printed circuit board kits. Allow about 15 minutes for the resist to dry and then immerse the board under at least 1/4" of etchant.

When all the excess copper is dissolved—about 45 minutes later—rinse the board thoroughly and remove the resist with a cloth moistened in rubber

cement thinner or by scrubbing with steel wool.

All of Super Booster's component mounting holes, except the one for tuning capacitor C1, are drilled with a number 58, 59 or 60 bit. Capacitor C1 requires a 5/16" mounting hole. The holes in the corner of the PC board, used for mounting the completed PC assembly, should clear #4 or #6 screws—which-ever you prefer.

The PC board is best assembled in the following manner: install capaci-

PARTS LIST FOR SUPER BOOSTER

- B1—9 volt transistor radio battery (Burgess type 2U6 or equiv.)
- C1—365 pF subminiature poly-type variable capacitor
- C2,C3,C4—0.05 μF, 50 VDC disc ceramic capacitor
- J1—5-way universal binding post
- J2—RCA-type phono jack
- L1—loopstick antenna
- L2—loopstick antenna (optional for radios without antenna terminals—see text)
- PL1—RCA-type phono plug—see text
- Q1—dual gate mosfet n-channel transistor (RCA 40600)
- Q2—bipolar npn transistor (G.E. 2N 3394)

- R1—1,000-ohms, 1/2-watt composition resistor, 10% tolerance
 - R2,R3—4,700-ohms 1/2-watt composition resistor, 10% tolerance
 - S1—single pole, single throw switch
- A complete set of components, including J1,J2, S1,B1, and an undrilled printed circuit board is available for \$14.90 (includes postage) from the Electronic Hobby Shop, Box 192, Brooklyn, N.Y. 11235. Add \$1 for antenna loopstick L3 if needed. Canadian add \$2 extra. New York state residents must add sales tax. No foreign orders, please. Speedy service offered when postal money order accompanies order. Otherwise allow 6-8 weeks for delivery.

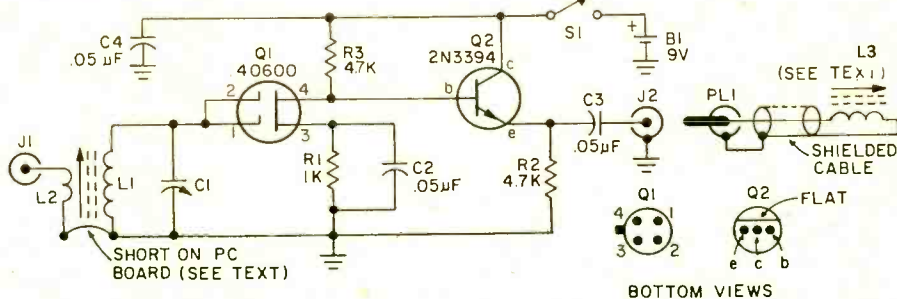

SUPER BOOSTER

tor C1 first, then all other components except Q1. Then push Q1's leads through the holes in the PC board and solder them home. Finally, solder the two power leads to their respective points if you intend to check out the booster before installation in the cabinet.

Note that Q1 is supplied with a shorting clip around all the leads. *This clip must be left in position until the booster is completed and ready for operation.* If the clip is removed, a high static voltage from the tip of the soldering iron, or a voltage generated through normal handling, might destroy Q1.

Position transistor Q1 so that the tab sticking out from the case faces the nearest edge of the PC board. Position transistor Q2 so that the round side of the case faces the nearest edge of the PC board; the flat side faces the far edge of the PC board.

Note that there are no crossed leads for Q1 and Q2. When they are oriented so the tab and round end are properly aligned, the transistor leads will plug straight into the board.

Note that L2's leads have individual printed foil connections. Normally, one foil is connected to the boosters' ground through a shorting wire. The remaining foil connects to antenna jack J1. If, for some reason, you prefer a separate antenna ground, open the shorting wire and install a "ground" jack on the panel. Connect the proper foil to the ground jack.

Because the components are mounted on the side of the pc board facing the cabinet panel, stand-offs must space the board away from the panel. You'll find, however, that C1's tuning shaft will be too short to pass through the panel for application of a tuning knob. But the cure's simple enough; simply cut off a section of shaft from an old potentiometer and epoxy-cement the section to C1's shaft. Or, use a plastic extension sleeve (such as the type supplied for "insulated shaft" potentiometers); the sleeve is rigid to support a knob.

The loopstick coil is cemented to the board with General Electric's RTV Silicon Rubber adhesive. Use no other

brand or type of adhesive. Other brands, such as Dow-Corning's Silastic, are conductive at RF frequencies, and will ruin the electrical properties of the coil.

Check that the foil area outlined on the board has the indicated "breaks". You don't want a closed loop. If you forgot and made a closed loop, cut four breaks as indicated with a knife or hand grinder. Apply a thin layer of Silicon Rubber adhesive inside the marked coil area and press L1-L2 into the adhesive. Make certain L1's connection terminals are parallel to the board, with L2's leads away from the board. Then allow sufficient time for the adhesive to dry.

We suggest you check out the PC assembly before it is installed in a cabinet. Remember to remove Q1's shorting clip! Simply pull on the end of the clip with long nose pliers and the clip will unwind from around Q1's leads.

Connect a DC milliammeter rated at 5 mA or higher between the battery's positive terminal and the board's positive foil. Connect the battery's negative terminal to the board's negative foil. The meter should indicate slightly less than 2 mA. If the meter indicates 1 mA or less, or more than 2.5 mA, check for a component mixup or incorrect installation of Q1 and Q2. If the meter reading is correct, disconnect power and install the board in a cabinet.

We recommend a plastic cabinet with aluminum panel such as shown in the photographs. The plastic cabinet allows direct signal pickup by the loopstick, which will be more than adequate for most DX'ing. Keep antenna jack J1 as far as possible from coil L1. Keep output jack J2 as close as possible to the board's output terminals. The power and antenna input leads should be flat against the panel.

Make up a short, shielded output lead by wrapping a solid-conductor, insulated wire around another wire. Keep the wrap turns against each other. Using the shortest possible length of this shielded wire, connect J2 to the board's output terminals. Make certain the "ground" wire goes from J2's ground lug to the ground foil.

Adjust L1's slug clockwise with a small screwdriver until only $\frac{1}{4}$ " of the slug's adjusting screw sticks out of the coil form. The other end of this screw,

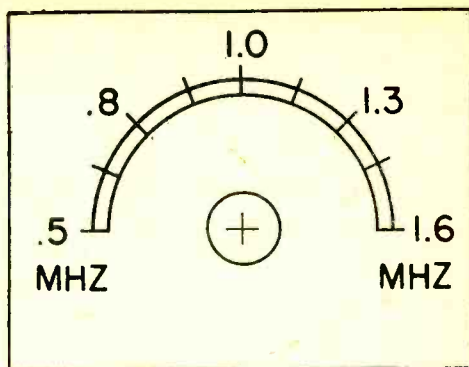
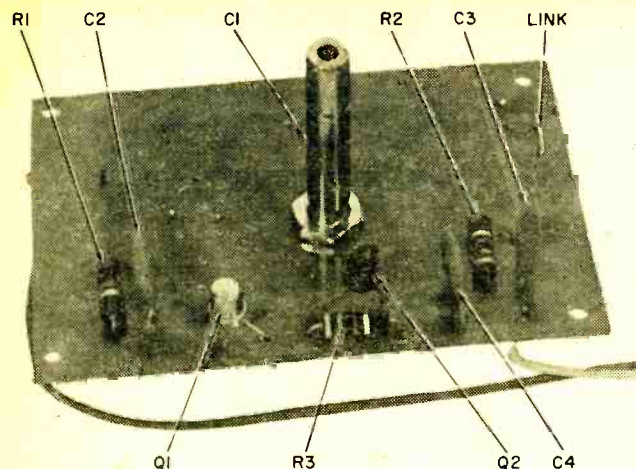

Here's what finished PC board looks like before it's mounted to front panel with standoffs. Tuning dial faceplate can be used as is; just paste it down!

the slug itself, will protrude about $\frac{1}{4}$ " out the end of the form. The slug is generally secured with wax, so the first turn or two might require a little extra force; don't be afraid to adjust the slug if it "feels" tight.

Make up a connecting lead to go from output jack J2 to the receiver's antenna terminals. Any shielded wire or coaxial cable can be used. Install a phono plug on one end. For least signal attenuation, the lead should not exceed 15 inches.

If the Super Booster will be used with a transistor radio having a built-in loop antenna and no external antenna terminals, connect the free end of the output lead to a loopstick antenna—merely an exact duplicate of L1! If the loopstick has an antenna winding, such as found on the specified loopstick, simply unwind the few turns and connect the output lead to the coil's solder terminals. Position this coil on the radio's case opposite its built-in antenna and tape the coil in position.

—Using Super Booster. Turn on both the receiver and booster and tune in the desired station. Adjust tuning capacitor C1 for maximum signal strength or highest S-meter reading. As a general rule, the direct signal pickup by L1 will be more than adequate. If greater sensitivity is needed, connect 6 to 15 feet of wire to antenna jack J1. If you have the space needed for an outdoor longwire antenna, take note that the signal level into the receiver can be so high as to overload the receiver.

If there is a strong local station in

your area, it is possible that its signal strength will be so greatly boosted that it might swamp the receiver when listening to a weak signal on the other end of the dial. If this occurs, simply detune the booster away from the strong local until its interference is gone. While this might sacrifice some gain on the desired station, the actual loss will be slight.

It is possible that the booster's output might radiate back into the input (particularly when using a loopstick coupling coil). You'll know when this happens—the booster breaks into self-oscillation—as evidenced by receiver blocking, or signals being tuned in and then "lost" when C1 is adjusted. If this happens, position the booster as far away from the receiver as possible. And, keep an external antenna, if used, well away from the receiver and the booster's output. Do this, and under normal conditions, there should be no instability.

Under certain conditions Super Booster will provide an additional benefit which should not be construed as improper operation. Some inexpensive rigs are highly prone to marine band "image" interference when signals at the high end of the BC band are received. The booster, by providing tuned pre-selection, will eliminate or suppress these images while providing signal amplification. Do not assume the loss of image interference means reduced sensitivity; actually, the desired signal will be getting full boost while the image signals are squashed. ■

UHF ACTION BAND... SIGNAL SHIFTER



by Morrie Goldman
WA9RAQ

**Clever
nothing-to-build
technique puts
UHF action band signals
on any 30-50 MHz
low band FM monitor**



IF YOU already own a low band 30-50 MHz Action Band (public service) monitor and would like to tune the UHF public service band as well, here's a simple solution: Just connect the output of a standard UHF TV converter to the antenna input of your low band monitor. Since a UHF television converter must cover a broad frequency range (470-890 MHz) and since its IF output is also broad, it is possible to tune-in UHF Action Band (450-470 MHz) signals on a low band monitor.

A Little More Detail? Most TV converters are designed with an IF output on channel 5 or 6; a few use 2 or 3. Whenever the converter is fed into a lower frequency IF, the tuning range of the converter is effectively shifted lower (the dial calibration moves up). While tuning a UHF TV converter connected to a TV set, you may have already noticed the effect. If your converter's IF output is adjusted for channel 6 and you switch to channel 3 or 4, the cali-

bration moves up. There is a limit to this of course, but it is far enough below 450 MHz to make a hook-up like this work the way we want it to.

The connections are simple. We just substitute the low band monitor receiver for the normal TV set connections. With a converter output of channel 5 or 6, tune your monitor to about 49 MHz. If your converter's output is channel 2 or 3, try around 40 MHz. Now tune your UHF converter slowly around channel 17. If there is UHF activity in your area, you should be hearing it.

Final Hook-Up. A regular UHF TV antenna should prove suitable in most areas. Of course, an outdoor antenna is preferred. At my home in Chicago, many UHF stations (including police, taxi, radiotelephone, etc.) are "solid copy" using just a low-cost UHF converter, regular UHF TV antenna, and either of my two low band monitors, one of which is an \$18 portable! ■

Roto-Stat

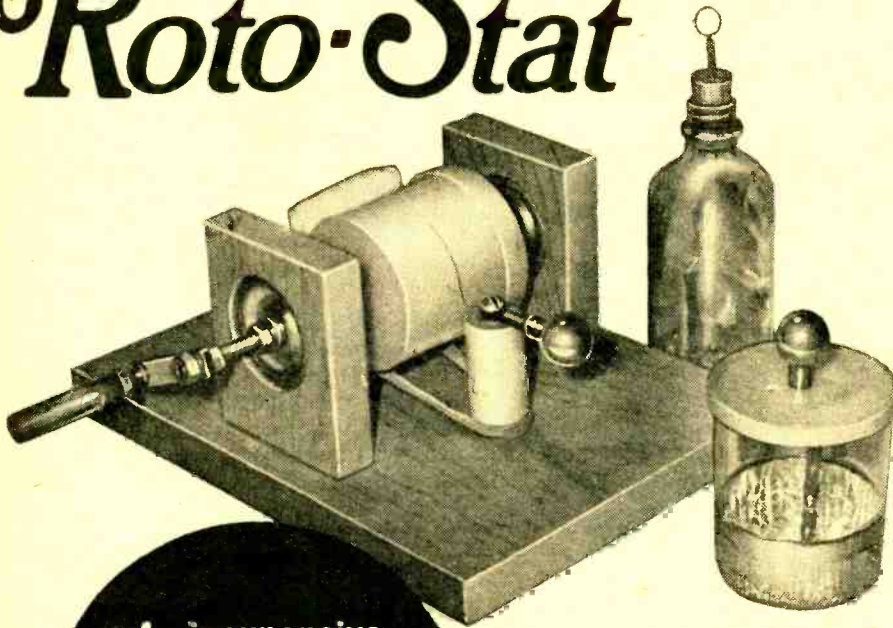

**An inexpensive
efficient
hand-powered
electrostatic
generator**

From the earliest days of experimenting with electrostatic electricity—say in the 4th Century B.C., when Plato mentioned the wonderful attracting power of amber—electrostatic electricity was produced by laboriously rubbing glass rods or other electrostatic producing objects with dry fur or cloth. In 1663, in Germany, Otto von Guericke used a large ball of sulphur to generate electrostatic electricity by rotating the sulphur ball and rubbing it with his fingers. In 1706, in England, Francis Hauksbee employed rotating glass globes and cylinders to generate static

by Charles Green
W6FFQ

Roto-Stat

electricity, and he used a metallic conductor to collect the generated static electricity from the generator.

In 1744, in Germany, J.H. Winkler invented a mechanical rubbing device to use in place of rubbing the glass cylinder with the fingers. His *rubber* used a leather-covered cushion pressed against the rotating globe. In America, in 1747, Ben Franklin used an electrostatic generator in some of his electrical experiments; it contained a rotating glass cylinder with a mechanical *rubber*.

Even in this day and age, electrostatic experiments still fascinate the avid experimenter. You can perform electrostatic electricity experiments by building and using our Roto-Stat electrostatic generator, instead of generating the electrostatic charges by hand-rubbed glass or plastic rods. Our Roto-Stat, designed for easy construction, uses a plastic cosmetic or similar jar in place of a glass

ball or cylinder. The generator is built on a $\frac{3}{4}$ -in. white pine base and uses a wool cloth *rubber* and a copper wire electrostatic collector that's formed round the jar.

How It Works. Turning the generator handle rapidly in a clockwise direction causes the wool cloth to rub against the plastic jar's surface. The friction of this rubbing releases electrons which electrostatically charge the jar's surface. As the jar is rotated, the pickup wire mounted on the ceramic standoff collects electrostatic charges from its surface and conducts them to the metal ball output electrode. A Leyden jar can be charged by contacting its terminals to the metal ball output electrode and ground. (For complete construction details for a Leyden jar and an electroscope see *Ben Franklin's Leyden Jars*, Dec./Jan. 1970 SCIENCE AND ELECTRONICS.)

Plastic Power. We used a plastic jar $2\frac{3}{4}$ -in. high x $2\frac{3}{4}$ in. diameter with plastic screw top for the rotating element of our Roto-Stat. If another size plastic jar is used, scale the dimensions of your unit proportionately. Since different types of plastic vary in their ability to generate electrostatic electricity,

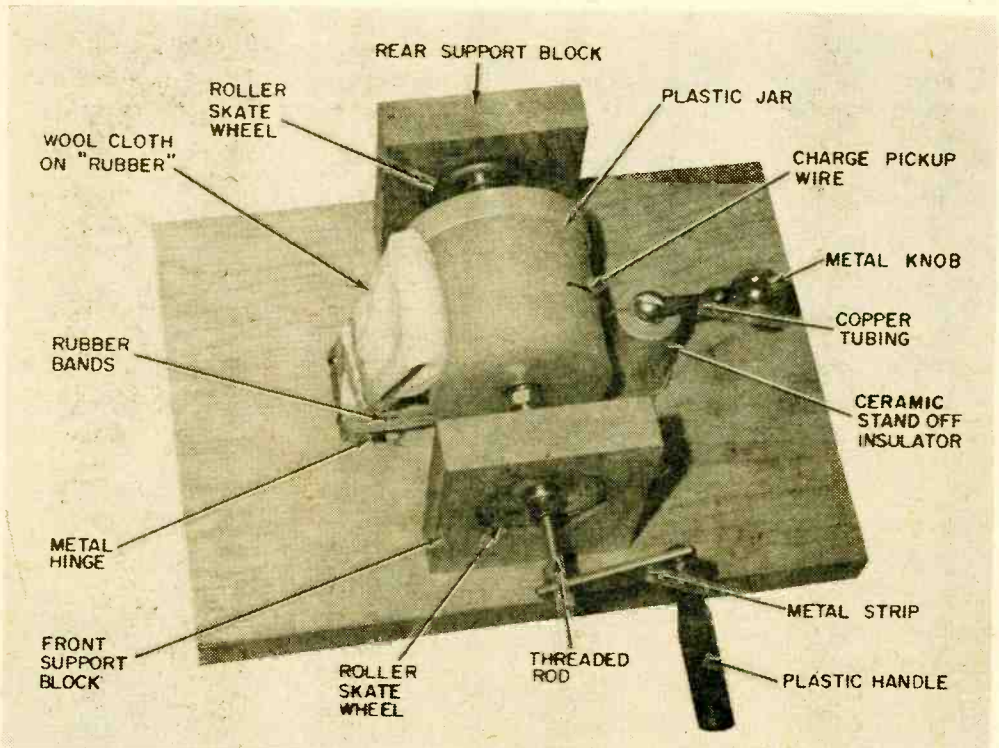

Our Roto-Stat electrostatic generator, though not as huge as original ones built in early 18th Century, is quite efficient. From details in photo and drawing you can build it.

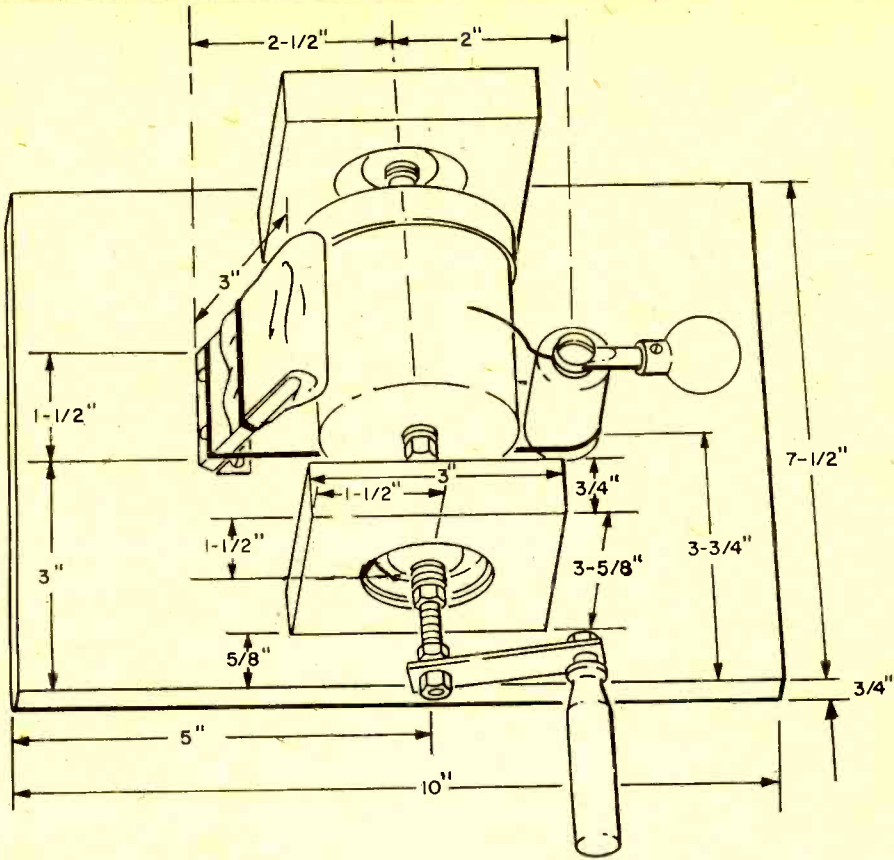

MATERIALS LIST FOR ROTO-STAT

- 1—Ceramic (L5 glazed) standoff insulator, threaded at both ends, 2-in. high x 1-in. dia. (JAN type NSSWO416, E.F. Johnson 135-503, or equiv.)
- 1—Hard rubber or plastic handle, 2-in. long x 1/2-in. dia. (we used handle from radio aligning tool)
- 1—1 1/2 x 1/2-in. metal hinge
- 1—Plastic jar with screw-on or snap-on plastic lid, 2 3/4-in. high x 2 3/4-in. dia. (you may also want to use this size for Leyden jar and electroscope—see text)
- 2—Metal knobs, approx. 7/8-in. dia. (available as automobile dash control or seat control knobs at auto parts stores)
- 1—2 1/4 x 1/2 x 1/8-in. metal strip for mounting handle
- 1—NE2 neon lamp
- 2—Roller skate wheels, ball bearing (available as replacement wheels at toy stores and toy counters in department stores)
- 1—Threaded metal rod, 8-in. long x 1/4-in. dia.
- Misc.—1 1/2 x 4-in. wool cloth strips, wood screws, nuts and washers for threaded rod, cement, rubber bands, #18 to #22 bare copper wire, 3/4-in. thick pine for base, etc.

test the jar you've selected by rubbing it with a wool cloth and noting whether the jar attracts small pieces of paper when the jar is moved over them. If it doesn't, try a jar made of different plastic material.

Any type of soft wood can be used for the base. Just make sure that the wood is clean and dry. The dimensions given in our drawing are approximate, to serve as a guide. Any size generator unit can be built, but for best results it's suggested you follow

the general layout of our unit.

Begin construction by cutting a 7 1/2 x 10-in. base of 3/4-in. thick pine or other soft wood, then cut two 3 5/8 x 3 x 3/4-in. wood blocks. Roller skate wheels, available as replacements at most hardware or bicycle shops, are used as driveshaft bearings. Cut a hole in each wood block to fit roller skate wheel used for this purpose. The hole in each block of our unit is made just large enough to force-fit the wheel into the hole in the

Roto-Stat

block. Duco cement or Elmer's Glue is used to hold the wheel securely in place. You may prefer to use long sheet metal screws through the sides of the mounting blocks to hold the wheel.

Cone Or Cylinder. Drill holes in the center of the bottom of the plastic jar, and also its lid, to fit the $\frac{3}{8}$ -in. threaded metal rod. Cut and drill a conical wood section to fit inside the plastic jar if the jar isn't straight-sided (if it is, then you'll need a wooden cylinder), extending from the jar bottom to the jar lid for internal support. A clearance hole for the metal rod, which serves as the axle for the jar, is drilled through the center of this wooden block.

Mount front supporting block on the base as shown in our drawing. We used two wood screws through the base to hold the block to the base. Insert threaded metal rod through jar and skate wheel bearing and hold them in position on the rod with a nut and washer top and bottom of the jar and on either side of the bearing mounted in the

wood block. Don't tighten the nuts now; you'll probably reposition the jar.

Position the rear block-mounted bearing on threaded metal rod with a nut and washer on both sides of the bearing. Adjust spacing of nuts on the metal rod so that the jar is in the center of the base as shown in photos and drawing. Position the rear wood block so that metal rod and jar can turn freely without binding, and fasten this block in position to the base with wood screws. Make sure that about $1\frac{3}{4}$ in. of metal rod projects out from the front bearing for attaching the metal strip that holds the handle, then tighten nuts against the jar and bearings.

Plastic Handle. We made the plastic handle from an alignment tool and bolted it to a $2\frac{1}{4} \times \frac{1}{2} \times \frac{1}{8}$ -in. metal strip with washers to allow the handle to rotate freely. Fasten a $3 \times 1\frac{1}{2} \times \frac{1}{4}$ -in. piece of plywood to a hinge, and mount the hinged plywood section to the wood base adjacent to one side of the jar. Mount a 2-in. high x 1-in. diameter ceramic standoff to the base on the opposite side of the jar as shown in our drawing and photos.

Mount a small unpainted metal knob onto a piece of copper tubing, flatten the free end of the copper tubing, and mount it on

About Leyden Jars and Electrosopes

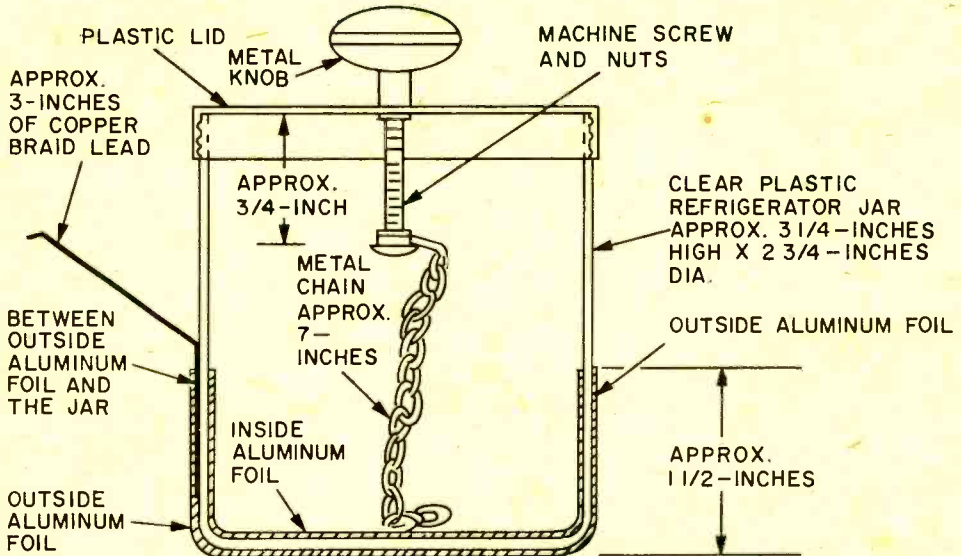

Even though we used materials found either in kitchen or bathroom this Leyden jar can store electrostatic charge generated by our Roto-Stat, so be sure it's discharged when stored.

the ceramic standoff. Also fasten a length of #22 or larger copper wire to the ceramic standoff and bend it so that it curves around the jar for a length of about 1½ in. but doesn't touch it. Position the wire approximately 1/16 in. away from the jar's surface and cut off the excess length of wire. Small rubber bumpers are fastened to each of the corners on the bottom of the base.

Fold a piece of clean, dry wool cloth over the top end of the hinged plywood piece, holding the cloth in place by means of a rubber band. Clean the surface of the jar carefully. Place several rubber bands around the base of the ceramic standoff and stretch them round the bottom of the hinged plywood section so that the wool cloth that is folded over its free end will be seated firmly against the side of the jar.

Rotate the jar by turning the handle, making sure that the jar turns freely, but with a slight resistance from the wool cloth *rubber*, and that the pickup wire does not touch the surface of the jar. Do not touch the surface of the jar or the wool cloth after the jar has been cleaned, because of the possibility of transferring moisture on your hands to either or both.

Experiment 1. Before performing any ex-

periment, make sure that both the cloth on the *rubber* and the jar's surface are clean and dry. If necessary, expose both cloth and jar to the rays of a heat lamp to dry up any moisture. These experiments may not work as well, or may not work at all in a humid area, since a dry environment is necessary for best results. We suggest you perform them in an air-conditioned room if at all possible for driest atmosphere.

Rotate generator handle rapidly in a clockwise direction, and hold the electroscope so that its electrode makes contact with generator's metal ball. Observe that the electroscope leaves deflect away from each other. This indicates that the electrostatic generator is operating and producing an electrostatic output voltage.

Experiment 2. Connect the outer foil of a Leyden jar to ground or a large metal object, and bring the Leyden jar top electrode in contact with the generator metal ball. Rotate generator handle rapidly in a clockwise direction for a few minutes, then move the Leyden jar away from the generator. Make sure you do not touch Leyden jar top electrode with your fingers. Carefully disconnect the Leyden jar outer foil lead from the ground. Then move the outer foil lead very

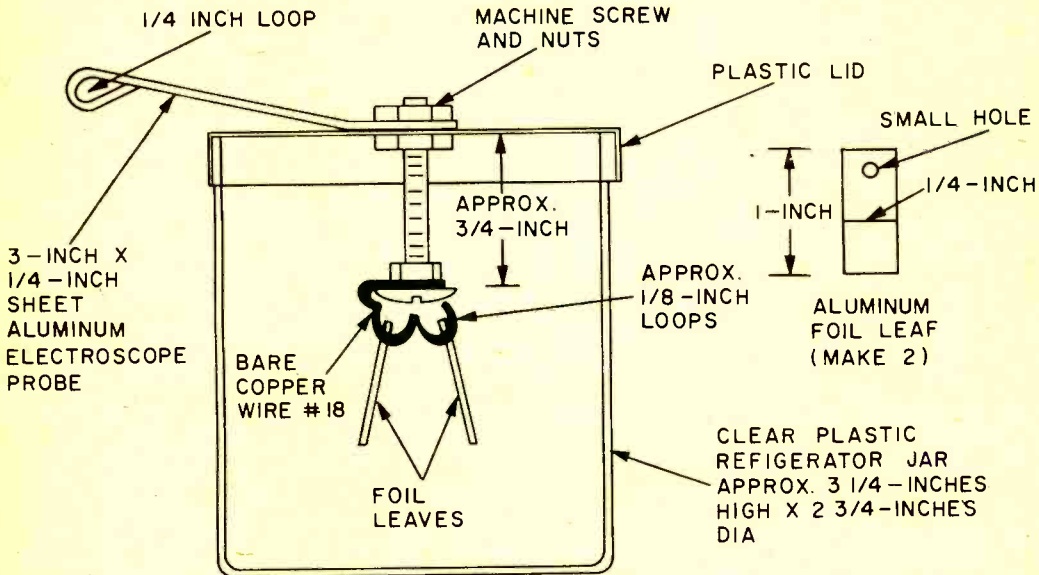

You'll want an electroscope to reassure you that your Roto-Stat is actually generating current before you start each experiment. It's easy to build and well worth the effort.

Roto-Stat

close to the top electrode. Note that a small spark will jump between the top electrode and the outer foil lead of the Leyden jar. This indicates that the Leyden jar was charged with the electrostatic output voltage from the generator.

Repeat the experiment, except connect a VTVM (preferably with a high voltage

clockwise direction, and momentarily bring one lead of an NE-2 neon lamp in contact with the generator metal ball while you hold the other lamp lead. The neon lamp should flash momentarily, indicating that the generator is operating.

Move one of the neon lamp leads around the surface of the rotating plastic jar. Note that the neon lamp flashes, indicating the electrostatically charged areas.

Remove the neon lamp lead from the jar, rotate generator handle rapidly for a minute, and then stop. Now move neon lamp lead

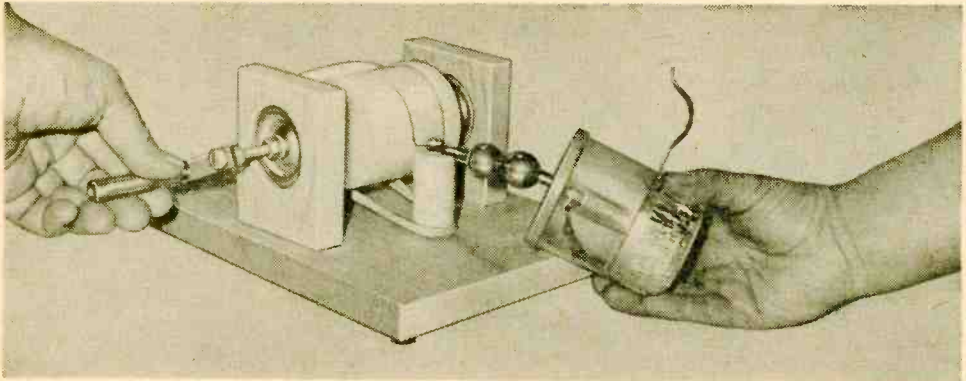

Here's how to hold your Leyden jar when you charge it from your Roto-Stat. Keep two metal balls in constant contact while turning handle to generate charge.

probe) between the Leyden jar outside foil and its top electrode, after Leyden jar has been charged. Fasten one lead to ground strap and touch top electrode with the other lead of the VTVM. Observe that the VTVM momentarily indicates a large negative voltage. This shows that the generator has a negative electrostatic output voltage.

Experiment 3. This experiment requires a dimly lit area in order to best see the neon lamp. Rotate generator handle rapidly in a

around on the surface, noting that the neon lamp still flashes, indicating that the electrostatically charged areas on the plastic jar will remain active for a period of time after the surface of the jar is excited by rubbing.

Try different types of cloths for the rubber in place of the wool cloth and compare their operation with that of a wool cloth. Note rotation speed affects size of charge. You can also try different configurations of the wire collector. ■

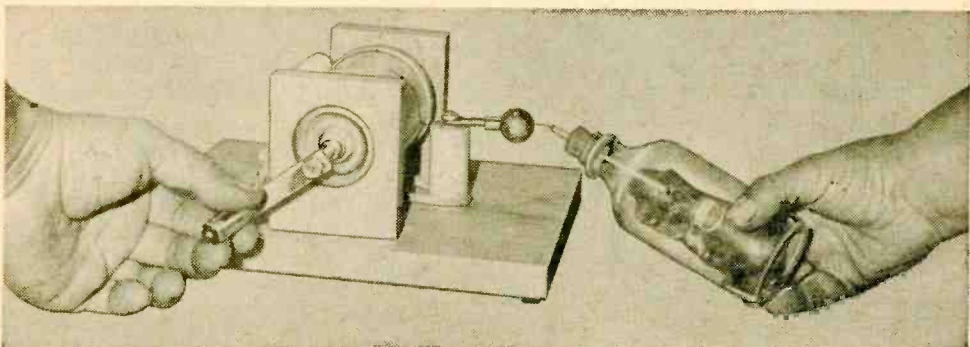

If there's a doubting Thomas amongst those you're showing your Roto-Stat, prove it's generating by placing Electrostat's collector against Roto-Stat's output ball.

Get out of the dark with the . . .

HOBBYIST'S NIGHT LIGHT

Night
Trips
This Light
So You
Don't

by Steve Daniels, WB2GIF

A bedside light is always a nice thing to have around. It keeps you from falling over wastebaskets, shoes, and other obstacles that might be scattered around. It's even nicer when you build it yourself. The Hobbyist's Night Light is a lamp that responds to large changes in ambient light and switches itself on whenever the light level goes below a point that you select.

A Light Response. In this circuit, light is detected by a cadmium-sulphide photocell which varies its resistance in *inverse* proportion to the light striking it. This simply means that, in the evening when the light gets dimmer and dimmer, the photocell resistance slowly increases. When the resistance of the photocell becomes greater than the total resistance of R1 and R5,

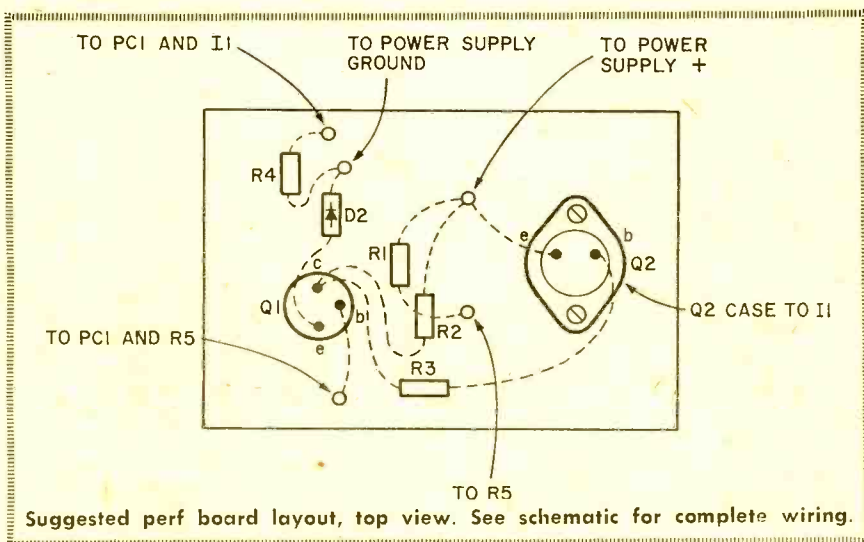

SOUND POLLUTION TIPSTER



THERE'S BEEN a lot said lately about high-level sound and your ears. Much of the publicity and controversy centers around today's pop music with its electronic sound reinforcement and big-bass. But if loud sounds can be harmful, as experts say, just where does the danger cease? What about medium level sounds we come in contact with every day?

Quite recently the City of New York completed a study about noise. Some of the results are quite disquieting! Not only can noise levels in the city cause hearing loss, they can interrupt enough sleep to cause fatigue and possible personality changes. In addition, Massachusetts has

Blow the whistle on noise with this simple, portable detector; it measures local environmental noise levels with a flashing light emitting diode.

By Herb Cohen

just outlawed snowmobiles with a sound level of more than 82dB (decibels) and after July 1973, the ceiling is just 73dB.

What's a dB? In terms of sound, a dB describes the smallest increase or decrease that an ear can hear. Pile one dB on top of another and pretty soon you'll have a genuine ear splitting sound. At levels approaching 120dB you actually begin to *feel* the sound; at slightly higher levels, the threshold of pain occurs.

Would you like to know if you're living and working or playing in a danger zone? For about twenty dollars in parts and an evening of soldering fun you can build a noise pollution tipster to find out. It's a lightweight portable sound-level meter that uses the latest technology and comes straight from an electronic experimenters workbench. Based on data from the New York and other studies, we've built our tipster to flash when the sound intensity reaches certain minimum values. They are 50dB, 70dB, and 85dB.

For an idea of what some typical levels are, a whisper at 5 feet is about 35dB, a normal conversation is about

TIPSTER

60dB, a full symphony orchestra at front row center can average 94dB. The New York City subway is about 100 dB.

How-it-Works. The mike voltage is sent to a three-position divider, this selects the different dB levels that are amplified by the I.C.

The I.C. is an operational amplifier, the 741C. Here it is used as a 40dB audio amp. The amplifier gain is set by R8 and R6. The I.C. output is coupled to Q1, another audio amplifier, which adds another 30dB of gain to give us a total of 70dB.

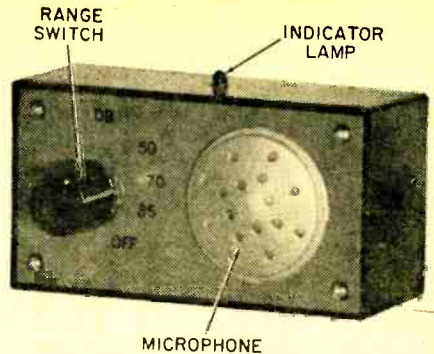

Source	Average dB
Air conditioner	55
Alarm clock	60
Blender—electric	93
Can opener—electric	78
Clothes dryer—automatic	64
Dishwasher	69
Doorbell	100
Drill—1/4" portable	70
Fan—12" portable	70
Fan—vent	63
Fan—wall exhaust	90
Furnace blower	100
Garbage disposer	78
Hair dryer	77
Knife sharpener	78
Mixer—electric	85
Pots and pans	73
Radio	78
Sander—belt	91
Sander—disc	93
Sander—orbital	70
Saw—8" radial	92
Saw—sabre	76
Sewing machine	64
Shaver—electric	85
Shower	78
Sink drain	86
Telephone ring (6 1/2 ft.)	78
TV	68
Vacuum cleaner	85
Washing machine—automatic	64
Water faucet	68
Whisper (5 ft.)	10

It should be noted that we are not talking about a linear scale when we discuss dB. We are talking about a measurement technique that uses logarithmic ratios. It means that each time a sound intensity doubles, the new sound measurement is just 3dB greater than before. For example, doubling the intensity of a 50dB sound level will increase the value to 53dB, not 100. This technique must be used because there is such a great difference between loud and soft sounds. By using a logarithmic system, the number describing the difference can be small. Why say an increase of 4,000,000 times when it's easier to convert to the logarithmic notation and say a 66dB increase?

From here we go to a driver that fires the Light Emitting Diode on negative-going pulses. The LED draws about 25 milliamps on peaks, enough for viewing without placing an excessive drain on the battery.

Construction. In order to make the unit as compact as possible a 1 5/8-in. x 4-in. x 2 1/8 in. box is used. The circuitry is mounted on perf. board and secured to the box using double-backed adhesive tape. The battery is mounted the same way. Be sure to ground

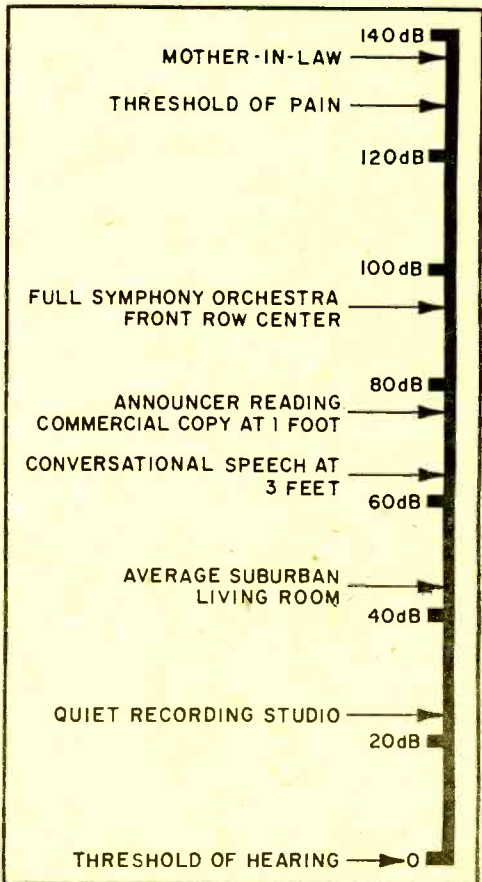

Our sound pollution tipster may not be as fancy as commercial units, but it doesn't cost 800 dollars either!

the aluminum panel and switch frame; also check which lead on the mike is common to the mike case and be sure it goes to ground. To mount the Light Emitting Diode, drill $\frac{1}{8}$ in. hole and ream it out until the LED fits snugly. Cement in place.

Scat! Cat. What do the three levels mean? Try the 85 dB level in the plant. If you listen to a sound level above 85dB for 8 hours a day over a period of time your hearing can be permanently damaged. You should be able to map out safety and danger areas. The

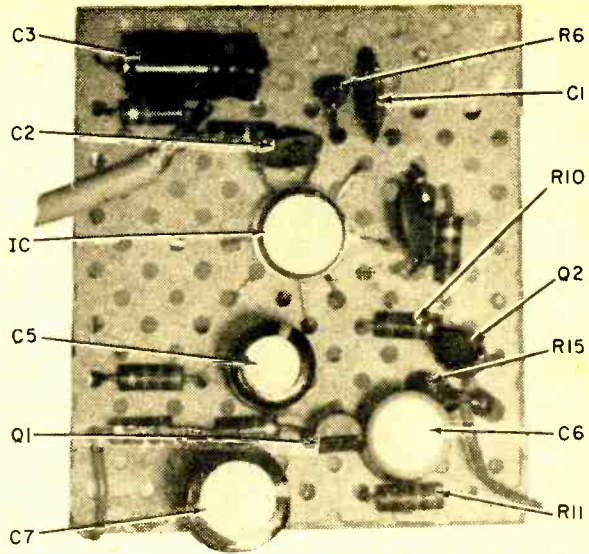

Most parts mount on this perf. board. Put R1, 2, 3 on switch S1, mount LED to case.

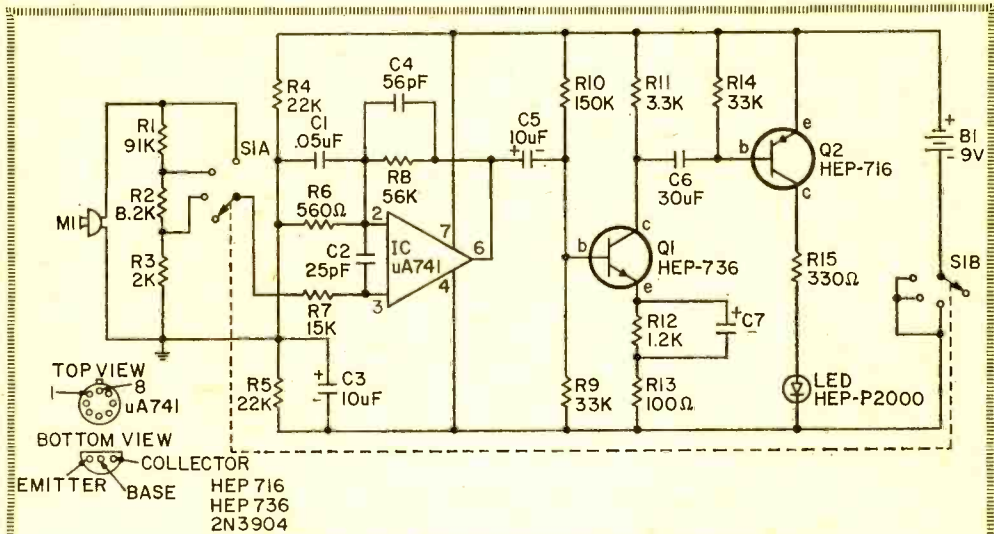

PARTS LIST FOR SOUND POLLUTION TIPSTER

- B1—9-volt battery, Eveready 216 or equiv.
- C1—0.05 μ F disc capacitor, 15 VDC or better
- C2—25 pF disc capacitor, 15 VDC or better
- C3—5–10 μ F, 15 VDC electrolytic capacitor
- C4—56 pF disc capacitor, 15 VDC or better
- C6—30 μ F, 10 VDC electrolytic capacitor
- C7—150 μ F, 15 VDC electrolytic capacitor
- IC1—Operational amplifier, type 741 (Radio Shack No. 276-010, Fairchild uA 741, etc)
- LED—Light emitting diode, Motorola HEP-P2000
- M1—Microphone, crystal (Lafayette Radio 99-45130 or equiv.)
- Q1—NPN transistor, 2N3904, HEP-736 or equal
- Q2—PNP transistor, HEP-716
- R1—91,000-ohm, $\frac{1}{2}$ -watt resistor, 5%
- R2—8,200-ohm, $\frac{1}{2}$ -watt resistor

- R3—2000-ohm, $\frac{1}{2}$ -watt resistor, 5%
- R4, 5—22,000-ohm, $\frac{1}{2}$ -watt resistor
- R6—560-ohm, $\frac{1}{2}$ -watt resistor
- R7—15,000-ohm, $\frac{1}{2}$ -watt resistor
- R8—56,000-ohm, $\frac{1}{2}$ -watt resistor
- R9, 14—33,000-ohm, $\frac{1}{2}$ -watt resistor
- R10—150,000-ohm, $\frac{1}{2}$ -watt resistor
- R11—3300-ohm, $\frac{1}{2}$ -watt resistor
- R12—1200-ohm, $\frac{1}{2}$ -watt resistor
- R13—100-ohm, $\frac{1}{2}$ -watt resistor
- R15—330-ohm, $\frac{1}{2}$ -watt resistor
- S1—Switch, 3-pole, 4-position (Mallory No. 3234J)

Misc.—Hardware, knobs, perforated board, push-in clips, wire, solder, etc.

TIPSTER

50dB level is for testing your bedroom at night. Place the meter on your bed and switch to 50dB. If the LED stays on, or goes on periodically from vent noises, pipe gurgles, traffic noise, or a loud-mouth alley cat, your bedroom is too noisy for sleeping. The 70dB level is the point that will jolt a sleeper into wakefulness. Try this level on your desk at work. If the light goes on periodically, you probably have trouble concentrating.

Take Steps. To get an idea of what some typical dB levels for familiar sounds are, check the table. To help you reduce home noise pollution, here are some suggestions. Appliances make a lot of noise; refrigerators hum, washers rattle, and dryers whirl, so the kitchen and utility room are good places to start.

Try to use only one appliance at a time because the noise level is accumulative. When shopping for a new appliance, choose the one that makes the least noise, and let manufacturers know that this is an important factor in your purchase. Fiberglass padding for plumbing, and cork or rubber pads under major appliances can lower the noise levels. Consider installing thick, perforated sound-absorbing wall panels in noisy areas such as the laundry room.

In another part of the home, acoustical tiling, padded carpeting and lots of upholstered furniture will absorb noise. Weather

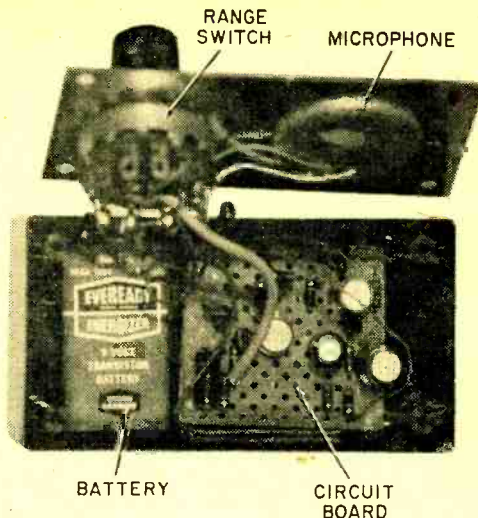

Solder leads to battery and save space. Microphone, LED mount to case with glue. Battery makes tight fit, watch for shorts.

strip an exterior door facing a noisy street. If you are building or remodeling, insist on solid inside doors and soff weather stripping at the tops and sides. Ask for fiberglass-lined heating and air ducts, which cost no more than metal ducts, to eliminate racket coming through them. Similar practices can line water pipes to cut down the noise. You can even use stereo headphones for listening to stereo, hi-fi and other home electronic entertainment units. Stereophones, which operate without the loudspeakers, bring the sound only to the listener's ears. ■

● A REGULATED NINE

Providing 9 volts at approximately 250 mA, this lab-type power supply will handle many experimenter projects. Actually, T1 can be a 6.3-V imported filament transformer since they usually give approximately 12 V peak at less than 500 mA output. Change the Zener diode to 12 or 6 volts (and possibly the value of R1) and you get a regulated 12- or 6-volt supply.

For 12 volts DC you must use a 12-V filament transformer. Filtering is very good since the electrical filter capacitor equals the value of C2 times the gain of Q1. It can add up to thousands of μF . In this case, about 10,000 μF . ■

PARTS LIST

- C1—500- μF , 25-VDC electrolytic capacitor
- C2—100- μF , 15-VDC electrolytic capacitor
- D1—Motorola HEP-175 50-PIV diode bridge rectifier
- D2—Motorola HEP-104, 9.1-V Zener diode
- Q1—Motorola HEP-240, 10-watt npn transistor
- R1—560-ohm, 1/2-watt resistor
- T1—12-V filament transformer (see text)

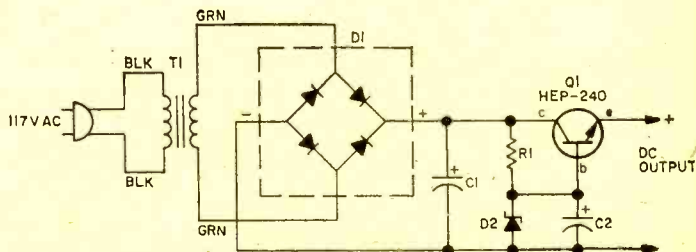

easy-to-build... Basket of Sound

**Our redwood speaker
opens the outdoors
to Beethoven or Rock.
Build it with an
inexpensive planter box
from your local
garden nursery**

by Herman F. Johnson

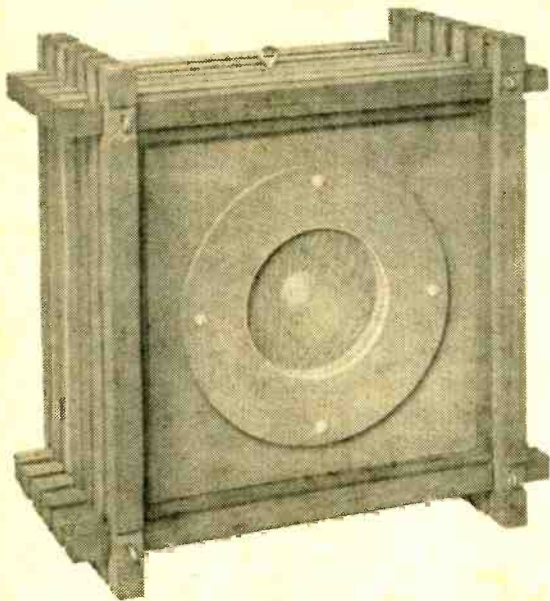

Would you like something different in a loudspeaker? Here is one like none other. It is so radically different from those oiled walnut, small box speakers we usually encounter, it may be compared to the commercial varieties only by its size. In appearance, it is equally at home in a small listening room or in a 4-channel arrangement around a swimming pool. Or, hang it beneath the eaves of your house, preferably at an inside corner, to enhance the low frequency response.

Everyone likes small size loudspeakers because of their portability. When you attempt to build one from scratch however there is rarely enough room inside to hold a screwdriver! Finishing an enclosure to suit one's decor can also be quite a problem. But one way to avoid construction difficulties, yet build a better-than-average small speaker, is to start with a pre-assembled box or two (or four). That way most of your effort is simply fitting a speaker baffle.

Green Thumb Ground Supply. One type of box that is suitable for a speaker enclosure can be found in your garden nursery store. The redwood planters. They are sturdily built to hold soil for a number of years. Redwood is less susceptible to warping than other forest materials, and planter boxes are usually made of $\frac{3}{4}$ -in. board securely joined. The planter employed in this application has side walls that are $\frac{5}{16}$ -inch thick, and the bottom is a $\frac{3}{4}$ -inch solid board. Inside dimensions are $9\frac{3}{4}$ -in. square by 6-in. deep. About an inch of the

Basket of Sound

depth is lost when speaker mounting pieces are installed, but a sufficient volume of about 480 cubic inches remains available for the speaker.

Construction. It is a good idea to inspect the inside areas of the box to determine if there are any crevice openings along the inside corners. Seal these openings while running a bead of caulking full length along all the mating surfaces. Silicone rubber is ideal for this purpose, though other non-hardening caulking may be used. It is important that a speaker enclosure be made airtight to insure adequate low frequency sound.

Pencil-line the perimeter inside the box $\frac{3}{4}$ -in. from the edge of the open end with an adjustable square. This will locate the front face of the cleats after you cut them to length (piece numbers 1 and 2 in the drawing). Fit the cleats in place for a snug fit. Then pencil-line the perimeter once more using the inside edge of the cleats as a guide. These locator lines are a help when you are ready to glue the cleats in place. Plastic resin glue is the best bonding agent for this purpose, it is stronger than the wood when dry. You will find sufficient room to drive one inch long nails through the cleats to compress the glued joints and hold them in place.

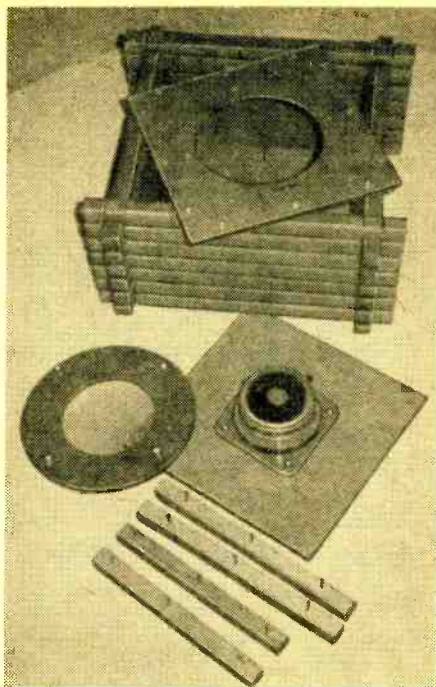

Your redwood planter comes completely put together ready to be turned into one great indoor/outdoor speaker. Sounds great, too!

Gate the Drain Source. All planter boxes have at least one drain hole in the bottom. Install a terminal strip over the hole and caulk this opening on the inside after a length of speaker hook-up wire has been installed. However, if you intend to use the

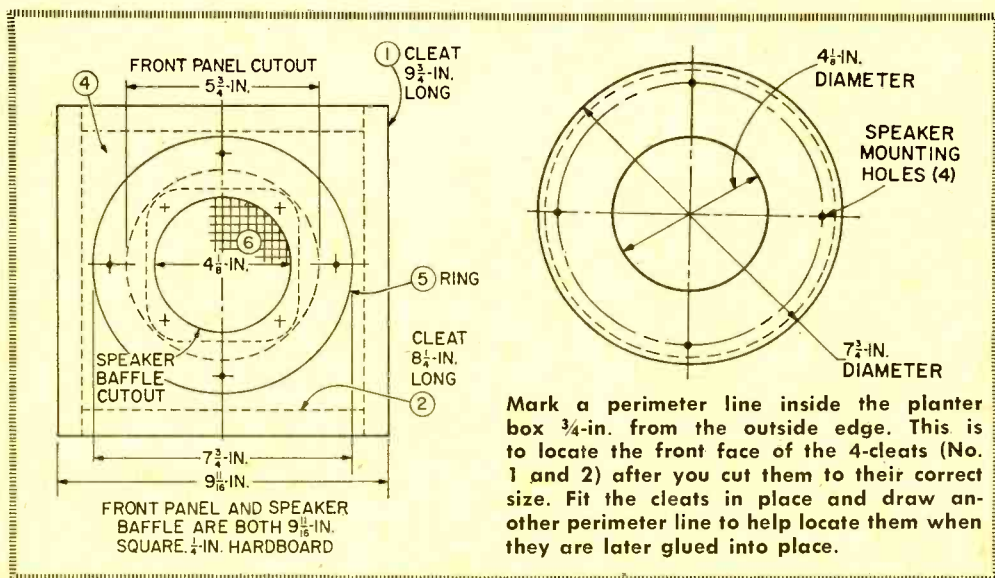

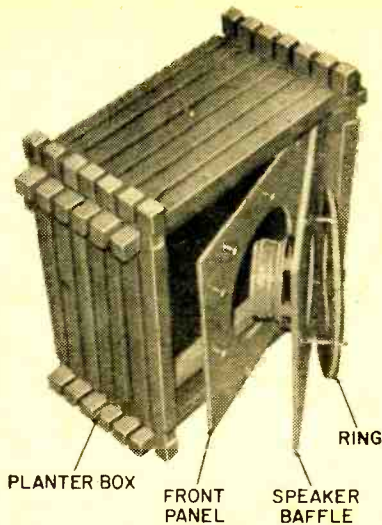

Fan-out view of front area illustrates how simple construction really is. Front ring is added to improve enclosure's appearance.

speaker outdoors, it is best to plug the drain hole with a wood dowel or a cork. Then designate a side as the underside and drill a 1/4-in. hole about two inches from the open end for hook-up wire.

Standard 1/4-inch hardboard is ideal for mounting the speaker to the front face of the planter. This material has a smooth flat surface on the front and a waffle-like pattern embossed on the back. Note in the photograph that the speaker is mounted with three parts—front panel, speaker baffle, and a front facing ring (piece numbers 3,4 and 5 respectively). Mark the hole locations and cut-outs on the smooth face and make the cuts. Your front panel should make a snug fit inside the box, but your speaker baffle should fit loosely in the opening. It is a good idea to clamp these two parts together when drilling the four outside mounting holes. Then, all four holes in the front panel should be redrilled to fit the tee nuts.

Speaker Mountings. Locations for the four machine screw holes in the speaker baffle should be templated from the speaker's frame with the speaker centered over the 4 1/8-inch diameter cut-out, while holes in the ring can be templated from the four holes in either the front panel or the speaker baffle. The flat heads of the screws should be flush with the surface of the hardboard. When assembling these parts note that tee nuts are pressed into place on the embossed side of the front panel. The front panel is then glued and screwed to the cleats (embossed side toward cleats). Your speaker is back-mounted to the smooth surface of the baffle. This provides a seal without the use of a gasket. Note that the speaker baffle covers all of the flathead wood screws in the front panel. The ring has been added for esthetic reasons, to cover flat head screws and bolts and to secure the fiberglass cone protector screen. Only four round head screws are exposed at the front.

Before the front panel is permanently installed, fill the inside cavity with 5 layers of one-inch fiberglass. The front two layers should be cut out in the center to clear the magnet structure of the speaker. High compliance speakers operate most efficiently in small enclosures when damped with fiberglass. *(turn page)*

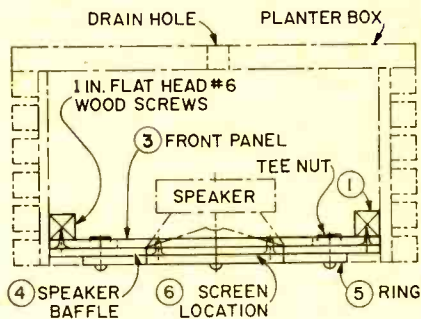

Planter box drain holes should be plugged to prevent turning your enclosure into a bird's nest if you put it to use outdoors.

OPTIONAL FINISHING

If the speaker is to be used outdoors, it is advisable to give all of the hardboard pieces a coating of resin sealer. A pleasing front appearance can be had by coating the embossed surfaces of the speaker baffle and the ring with a color-toned penetrating sealer to match the prefinished planter. If the redwood color is not appealing, you can paint-decorate all of the outside surfaces, or give it a coating of charcoal resin sealer to obtain a dark, woody finish.

Basket of Sound

For ease of handling or support for hanging the speaker, predrill a hole, centered on the top surface, to receive a 1/8-in. screw eye, or install four small screw eyes since wire hangers are furnished with the planter listed in the Bill of Materials.

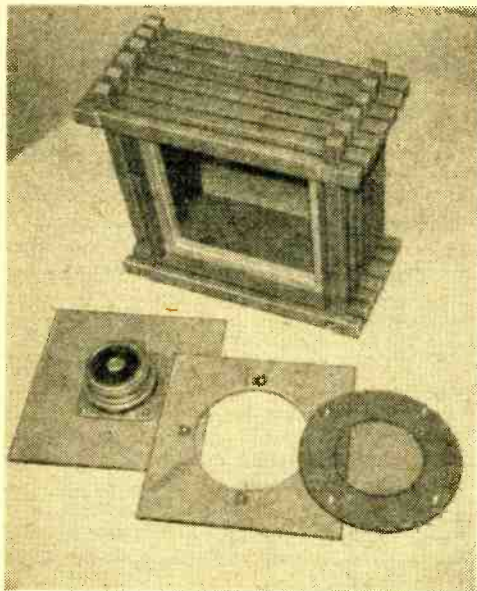

Ready for final assembly. An Altec 405A speaker with its smooth frequency response and weatherproofing treatment is suggested

Sound Source. Dimensions given in the drawing will fit a 4-inch Altec 405A. There are several high compliance 4 or 5-inch full range speakers available that can be expected to operate with satisfaction in this application. However, the Altec speaker is recommended for this system if it is to be used outdoors. It is a speaker that has gained wide acceptance among audiophiles who demand fine music and voice reproduction in their automobiles since its high efficiency provides low frequency output and smooth frequency response equal to many larger speakers. And, a water-resistant cone prevents distortion during periods of high humidity. Smooth distribution is provided by its shallow cone and aluminum center dome. High efficiency in a speaker is very important when it is necessary to connect it at a location that is likely to be up to 125 feet from the source of audio power. Do not use antenna lead-in wire; the wire size is too small. A 1/4-in. diameter #16 gauge vinyl-jacketed cable such as Belden 8471 is recommended for outdoor cable runs. It may be used up to 125 feet with less than 15 percent loss of audio power.

Tie a knot in the cable or build up its diameter by tightly wrapping rubber tape about a foot from the end, then solder the speaker terminals and caulk the inside where the cable enters the enclosure. Push the baffle-speaker assembly into the front panel opening and insert the four round head screws and tighten them. Now you're ready to lie back and enjoy good listening from your own hanging basket. ■

Bill of Materials for Basket of Sound

Key to Drawing	Description
1	Fir cleat, 3/4-in. x 3/4-in. x 9 1/4-in. Two required.
2	Fir cleat, 3/4-in. x 3/4-in. x 8 1/4-in. Two required.
3, 4, 5	Masonite hardboard, 1/4-in. thick. Three square feet required.
6	Grill cloth. One square foot required.
	8-32 Tee nut. Four required.
	8-32 x 1/2-in. flat head machine screw. Four required.
	No. 6 x 1-in. flat head wood screw. Ten required.
	Fiberglass damping material. Four square feet of 1-in. material required.
	8-32 nut and washer. Four required.
	Redwood planter, No. HB1-12 or similar. (Distributed to garden nurseries by Germain's, Inc., 4820 50th Street, Los Angeles CA 90058)
	Altec 405A 4-in. wide range speaker. (Altec-Lansing, 1515 South Manchester Avenue, Anaheim CA 92803)

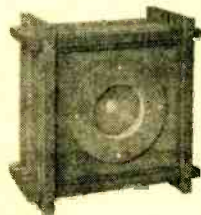

SUPER SCA ADAPTOR

by
Herbert Friedman



Hot Enough For DXing

You can build a Super SCA detector that's powerful enough for DXing! It's a two-IC circuit in an *amplifier* and *phase locked loop* detector configuration. And it's superior to many other PLL detector circuits because it has an IC amplifier to boost and *lift* the relatively weak 67 kHz sub-carrier signal from the FM signal. That makes it a must for fringe areas.

But let's go back to what SCA is. When a Subsidiary Communication Authorization (known as SCA) is granted to an FM station by the FCC, that station is permitted to transmit a second program *in addition* to its regular program by a special method of modulation. A standard FM radio, even a stereo radio, cannot detect these special broadcasts. The regular listening audience hears only the standard mono or stereo programming. In fact, there is no way of even telling whether or not a station engages in SCA programming. That is, not without a special SCA adaptor that you can build!

If you think you'd like to tune to these hidden broadcasts, we've provided this special project. Special because its high sensitivity permits reception of SCA signals that other low cost adaptors miss.

What You Can Hear. For some time now, SCA has been used to transmit educational programs and continuous weather reports to specialized audiences; however, it is *primarily* used for background music—the type heard in restaurants and shopping centers. For example, in the New York City area there are FM stations with SCA programming in light popular music, while others specialize in music of India and Greece.

Best of all, this pleasant, interesting music is never interrupted by an endless barrage of commercials or the patter of an announcer in love with his own voice.

How it's done. SCA programming is transmitted by a 67 kHz FM sub-carrier that is impressed on the main FM carrier. When a station broadcasting SCA is received by a standard FM tuner, the SCA sub-carrier is simply wiped out—the listener has no idea it exists. To receive SCA, the FM tuner's output is usually passed through a filter that wipes out everything except the SCA sub-carrier and its modulation. When the sub-carrier is demodulated, the output is only the SCA program; to the SCA listener, the standard programming doesn't exist.

Until recently it took a lot of expensive hardware to receive SCA programs: a very sensitive receiver and a rock-steady detector. (A good receiver is needed because the SCA carrier is only 10% of the total FM signal.) Though many low cost SCA



Adaptor above is teamed with Rotel RT-620 AM/FM tuner and Dynaco SCA-80Q amplifier

SUPER SCA ADAPTOR

adaptors have been available in project or wired form, most had a tendency to burp, gargle or distort on the very weak signal level of the SCA.

While the radio-astronomy crowd had a great weak-signal detector known as the phase locked loop, it was also true that the astronomical phase lock detector was astronomical in price. But thanks to modern solid-state techniques, the Signetics Corpor-

ation has come up with a phase locked loop detector specifically intended for SCA detection that is priced well under ten dollars.

Available in the standard 8 pin round and 14 pin DIP IC packages, the Signetics SE/NE565 requires virtually no external hardware for SCA detection. Most important, since the phase lock detector automatically locks on the incoming SCA carrier frequency, the Signetics SE/NE565 will demodulate SCA subcarriers of either 65 kHz or 67kHz without adjustment; whichever subcarrier frequency the broadcasting station uses will be received equally

PARTS LIST FOR SUPER SCA ADAPTOR

- B1,B2—6-volt battery, RCA VSO68 or equiv.
- C1,C9—470 pF disc capacitor, 15 VDC or better
- C2—47 or 50 pF disc capacitor, 15 VDC or better
- C3—0.005 uF disc capacitor, 15 VDC or better
- C4,C7—0.1 uF disc or Mylar capacitor, 15 VDC
- C5,C6—100 uF electrolytic, 15 VDC or better
- C8—7 or 10 pF disc capacitor, 15 VDC or better
- C10,C11—0.001 uF disc or Mylar, 15 VDC
- C12,C14—0.02 uF disc, 15 VDC or better (see text)
- C13,C17—0.05 uF disc or Mylar, 15 VDC or better
- C15,C16—2000 uF electrolytic capacitor, 15 VDC or better
- IC1—Integrated circuit amplifier, NE531T (Signetics). Write to Circuit Specialists Co., Box 3047, Scottsdale AZ 85257 for IC prices.
- IC2—Integrated circuit PLL, NE565A (Signetics)
- R1,R5,R6—4700-ohms, 1/4-watt resistor, 5%
- R2,R4—47,000-ohms, 1/4-watt resistor, 5%
- R3—470-ohm, 1/4-watt resistor, 5%

- R7—1800-ohm, 1/4-watt resistor, 5%
 - R8—5000-ohm potentiometer, PC board mounting
 - R9,R10,R11—1000-ohms, 1/4-watt resistor, 5%
 - SR1 to SR4—Silicon diodes, HEP-154 or equal
 - S1—Toggle or slide switch, SPDT
 - T1—Small filament transformer, 12.6 volt center tapped
 - Misc.—6 x 3 1/2 x 2-in. case, printed circuit material, etchant, RCA phono jacks, push-in clips, hardware, wire, solder, etc.
- The printed circuit board for the Super SCA project is available direct from Electronics Hobby Shop, Box 192, Brooklyn NY 11235 for only \$5.95 (includes postage and handling). Canadian shipments add \$2 extra. New York state residents must add sales tax. No foreign orders, please. Postal money orders will speed delivery of Super SCA PC board. Otherwise allow 6-8 weeks for delivery.

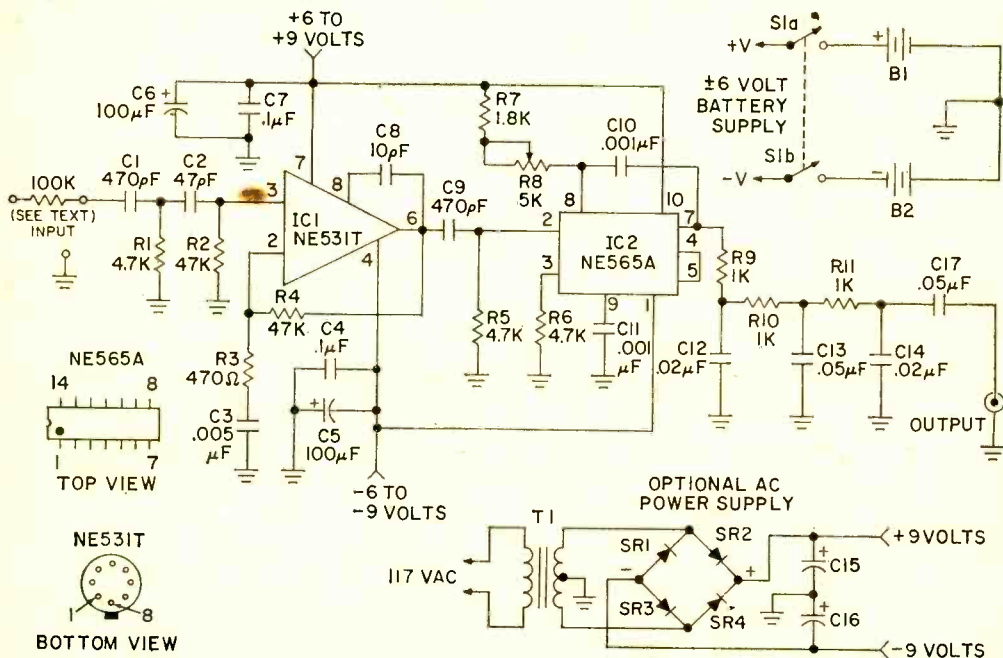

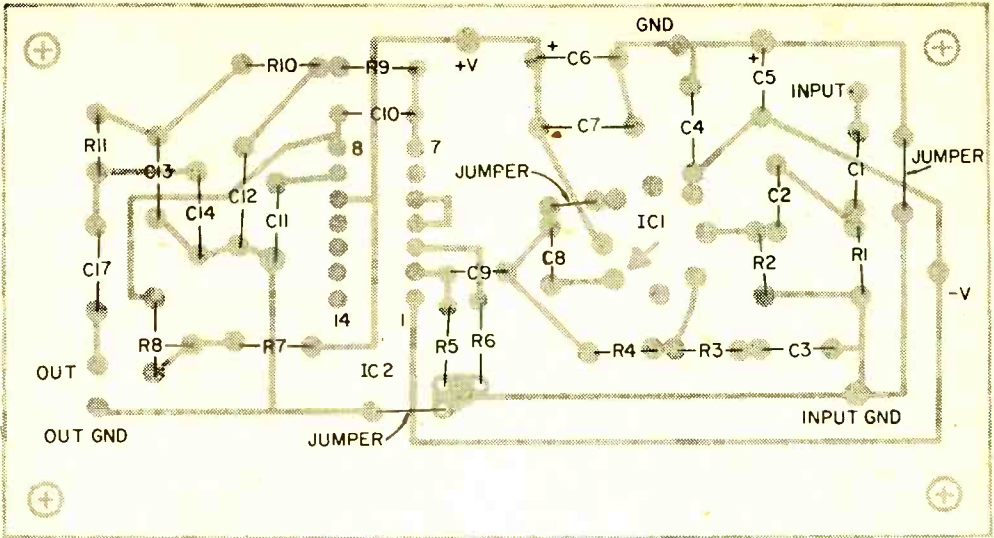

JUMPER WIRES

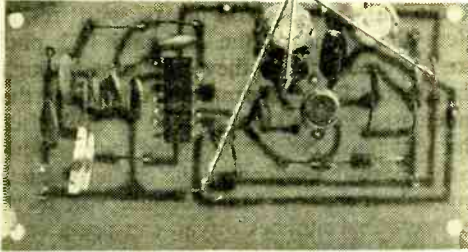

Strong backlighting, left, shows printed circuit wiring through a completed circuit board. Layout above and photo on next page show where to place components.

well with this unit.

Combination Gets Results. Unfortunately, the phase lock detector requires at least 80 mV for good reception, and this means that usually only one or two stronger or local SCA stations can be received. To make our SCA adaptor the best there is, we have combined the phase lock detector with a high gain operational amplifier. The result is

a Super SCA Adaptor that can receive SCA programs on a real cheap FM tuner and an indoor rabbit-ear antenna.

Another plus feature for our Super SCA Adaptor is that no large filter coils are needed to suppress the main channel program. Even SCA programming on stereo stations is received cleanly and with no trace of stereo hash. And because large, bulky coils are not needed, the entire adaptor can be assembled on a 2 1/4-in. x 4 1/4-in. printed circuit board for which we provide the template.

Because our adaptor gain is high, it must be assembled on a PC board exactly as

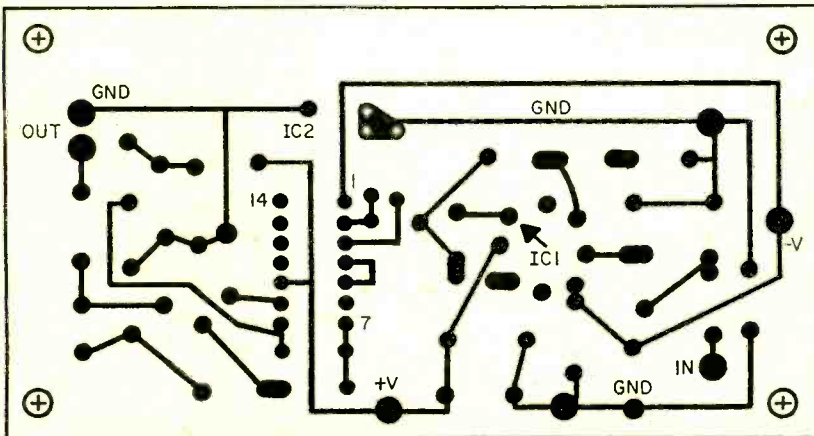

Exact PC board size. Transfer image to copper clad board using carbon paper. This is the bottom (copper) side of your board.

SUPER SCA ADAPTOR

described to insure complete stability.

Some Tech Talk. The signal from your FM tuner's detector before de-emphasis is applied to operational amplifier IC1 through a high pass filter consisting of C1, C2, R1 and R2. The filter's rollover frequency is 60 kHz, which removes a substantial part of the main channel information. Frequency response of the amplifier is tailored by the feedback loop through R3 and C3 to further suppress main channel information. IC1's output is fed through high pass filter C9 and R5 to IC2, the phase lock loop detector. IC2's output is passed through a low pass filter consisting of C12, C13, C14, R9, R10 and R11 which provides de-emphasis and noise suppression. The output level at C15 is about 50 to 100 mV, depending on the signal, and can be fed to your hi-fi or utility amplifier.

Since SCA frequency response is limited to 7 kHz, just about any amplifier can be used.

Note that the adaptor requires a bi-polar power supply in the range of ± 6 to ± 9 volts. The power supply can be either batteries or a power line bridge rectifier using a center-tapped 12 volt filament transformer as shown on the schematic. Since the adaptor requires only about 10 mA of current, any small transformer can be used.

How to Etch a Circuit. Your first step is to prepare the PC board. Since the board must be precise, we suggest you work directly from the supplied template rather than through an intermediate tracing. Cut a section of any type copper clad board to 2 1/4-in. x 4 1/4-in., clean the copper surface with a strong household cleanser such as Ajax or Comet and place a piece of carbon paper, carbon side towards the copper, on the board. Tape the board under the template and, using a sharply pointed tool such as a scribe, indent the copper foil at each component mounting hole by pressing the point of the tool through the template into the foil. (Each indent will serve to mark the hole's location when the board is drilled.) Using a ball point pen and firm pressure, trace the outline of the foil areas.

Continue. . . . Remove the board from under the template, discard the carbon paper and, using a resist pen such as the Kepro RMP-700, available from Allied Radio, fill in the foil areas with resist. Note that some of the IC1 and IC2 pins are not used, though they must pass through the board. Place a drop of resist over the indents so you'll know where to drill after the unwanted copper is etched away. Similarly, mark the indents at the corner mounting hole locations. Make certain you mark IC1 terminal number 8; you can use a drop of resist.

Immerse the PC board under at least 1/4-in. of etchant for about 45 minutes and then inspect the board. If all the unwanted

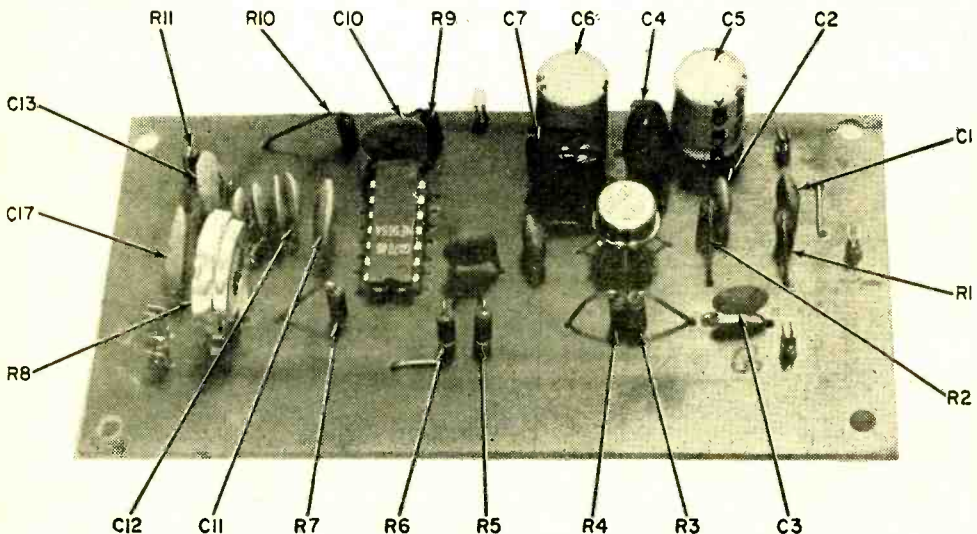

Completed circuit board. Resistor R8 easily adjusts frequency of PLL to 67 kHz.

copper has not been etched away, re-immerses the board in five minute intervals until all the copper not protected by resist has been removed. Then rinse the board under running water and remove the resist by scrubbing briskly with a steel wool pad such as Brillo.

Using a #56 drill bit, drill the holes for the connecting terminals (push-in terminals) and trimmer potentiometer R8. Drill the corner mounting holes to clear a #4 or #6 screw and drill the remaining component holes with a #58, #59 or #60 bit.

You Can Buy the Board. You don't have to make a printed circuit board for the Super SCA—you can buy one. The Electronics Hobby Shop is offering the PC board completely etched ready for drilling and assembly. This beats trying to copy the author's board layout exactly, and the mess and expense of etching copper.

Mount the Components. Install IC1 and IC2 before any other components. Note that the IC1 lead opposite the case tab is number 8. Insert the leads (begin with number 8) and push IC1 toward the board until there is about 3/8-in. between IC1 and the board. Solder the wires and cut off the excess.

Hold the PC board so you are looking at the top with IC1 to the left. Hold IC2 so the notch is away from you and insert IC2's leads into the matching holes. *Doublecheck the notch before soldering.* It is correct if the distance from the notch to the edge of the PC board is greater than that of the unnotched end to the opposite edge of the PC board. If all is okay, solder IC2.

Install trimmer potentiometer R8 and solder. Make certain you use sufficient soldering heat to flow solder to R8's terminals.

Then install the three wire jumpers and, finally, the remaining components taking extreme care that the polarity of capacitors C5 and C6 is correct. Note that C5 has the positive lead connected to ground.

While capacitors C12 and C14 are indicated as 0.02 μF , they are not the easiest to obtain in miniature size. You can substitute two parallel-connected 0.01 μF capacitors. Simply twist their leads together and insert them into the matching holes. Do not tin the twisted leads prior to soldering as they will not fit into the holes if tinned.

Set-up and Checkout. Either a bi-polar battery power source or a standard bi-polar power supply can be used. Since there is

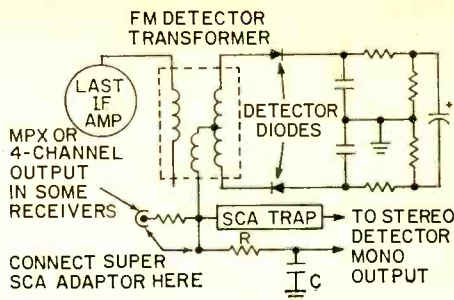

Always connect SCA adaptor before de-emphasis network R, C as shown above. Most tuners, receivers do have an MPX jack for a home SCA, or 4-channel use.

essentially no difference in performance between a $\pm 6\text{ V}$ and $\pm 9\text{ V}$ power supply, use whatever you have available. For long-term battery life we suggest Burgess type Z4 6 volt batteries (or their equivalent).

The Super SCA adaptor connects to your mono FM tuner or receiver detector *before* the de-emphasis network. If you connect after the de-emphasis network, you will find the 67 kHz subcarrier has been filtered from the signal, so you will get nothing but noise from the adaptor. The figure shows a typical FM detector output, the de-emphasis network and the correct connecting point for the adaptor. Since it is possible the adaptor might load down the detector for normal FM reception, we suggest a switch be installed, so the adaptor can be removed from the circuit for normal FM listening.

The adaptor is most conveniently connected through a phono jack installed in the tuner's rear apron, though you can use a direct wire connection.

Note that if you have one of the older mono FM tuners with an "MPX output" you already have the correct connection as the MPX output is the non de-emphasized detector output. Similarly, if you have a modern FM Stereo tuner with a "4-channel decoder" or a "quadrasound decoder" output you also have the correct connection; they are also non de-emphasized detector outputs.

Connect the tuner's detector output to the adaptor with the shortest possible length of shielded cable or ordinary zip cord, or install the adaptor directly in the receiver if there is sufficient room. Connect the adaptor's output to any high gain amplifier; for example, the microphone input of your hi-fi amplifier, or a utility amplifier is fine, or maybe an old tape recorder. (See page 102)

SUPER SCA ADAPTOR

R8 Locks Loop. Tune in a station you know is transmitting an SCA program (a call to your local station should get you the info.) and adjust trimmer potentiometer R8 for best sound quality. Normally, the reception will be almost completely garbled, then fade into a clean signal as R8 is adjusted, then fade into garbling again as R8 is further adjusted. Set R8's wiper so it is approximately midway between the two points of garbled sound. Usually, the best sound will occupy a broad part of the R8 adjustment range, so don't try to be too fussy.

If you don't know which station(s) are transmitting SCA, set R8 to the mid position and tune every station very carefully and slowly. When you hear anything that sounds like distorted music, try adjusting R8; if it is real SCA, it will turn *clean* as R8 is adjusted. Some stereo stations might cause sound bursts that you think are SCA.

If adjusting R8 doesn't bring in a clean signal, it's not SCA. Note that once R8 is adjusted there is no stereo hash interference on SCA signals. Hash will only be heard from non SCA signals.

Problems? The high sensitivity of this system may require desensitizing procedures; in the event you cannot receive *any* SCA stations, you either have none in your area or you have made a construction error. If the non-SCA program from the tuned-in station is heard breaking through the SCA programming, follow the suggestions in our troubleshooting box. If your adaptor doesn't work at all, beg, borrow or steal an oscilloscope and check input and output waveforms as shown in the scope photos. Just be sure to return the scope so we don't get in trouble with John Law for inciting a felony!

What's Your Beef? Here are some hints to help you steer clear of trouble—straight toward your musical enjoyment and SCA DXing!

☞ *If your problem is a weak signal re-*
(Continued on page 107)

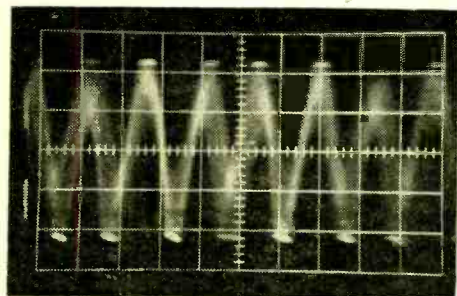

A

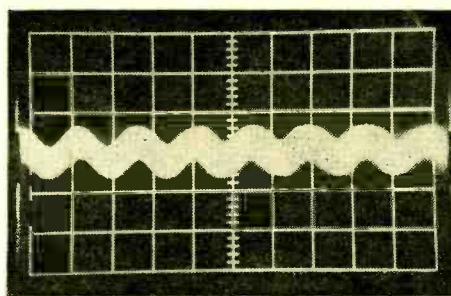

B

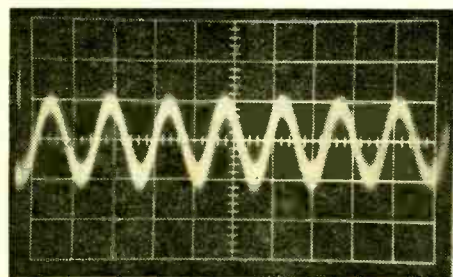

C

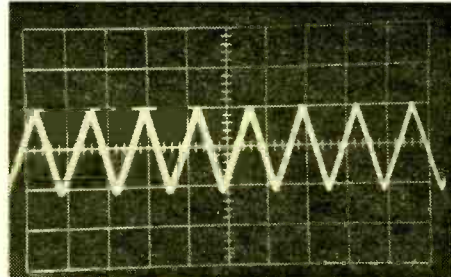

D

Oscilloscope patterns quickly locate any possible difficulty. You can use a general purpose scope since the signals are under 100 kHz. With "triggered" scopes, set the time base to 10 μ sec/cm. Photos B and C are input and output of IC1, the 67 kHz amplifier. If signal is clipped as in A, main channel program may break through—see text for cures. Normal IC2 pin 9 waveform at D. Vert. sens: B, 20mV/cm; C, 1V/cm.

MAGIC -MIKE

Use it with any FM set
connected to your PA!
No mike line needed!

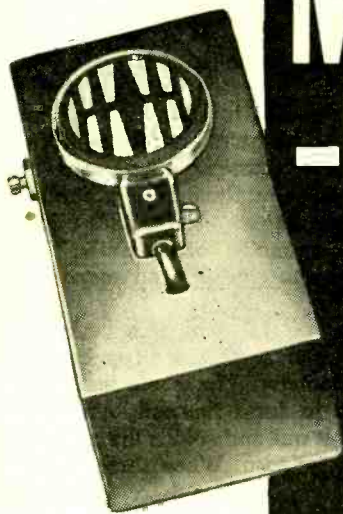

by Steve Daniels
WB2GIF

When the FCC opened the FM band to permit legal use of low-powered transmitters for wireless microphones, telemetering and for measurement, they opened a Pandora's Box for many an experimenter. Within the short space of time after the FCC relaxed their regulations, there was a flood of flea-power devices on the market. Some were good, some bad, but most had one basic inherent problem. Body capacity affected the tuning of the device, which, in turn, affected its usefulness.

No doubt about it. For a speaker or performer to be completely free of a fixed position—dictated mostly by the best location for a floor microphone in a PA system—is probably the dream of all would-be orators and very-off-Broadway thespians. So, as soon as the new wireless microphones were introduced, there was a rush to try them out.

It didn't take long before it was discovered that this ideal device was not so ideal. Problem was, when tuned up on the bench, the little devils worked perfectly. But, after the bench tune-up, when concealed in the clothing of a voluptuous young chick, or, for that matter, an uninteresting looking gentleman, the tuning was off.

Just by walking or breathing, the signal quality, as well as its output level changed,

and so at times there was poor sound. Or, no sound at all! This is very disturbing for any performer whose roller-coaster voice levels causes the audience to loose a tomato/egg barrage!

Simple Magic. Our *Magic-Mike* certainly solves the tuning problem and so ultimately solves the major drawback of this equipment. You may well ask what makes *Magic-Mike* so different, especially when we note that a commercially-produced transistorized oscillator is used to generate the signal? Secret is, we added an FET (Field Effect Transistor) buffer stage to the output of the commercial unit. That isolated the tuned elements of the oscillator from the antenna and thereby eliminated the problem of body capacity disturbing the tuning of the oscillator. This buffer stage is comprised of components R1, C1, C2, L2 and Q1. These are wired as an RF amplifier. Transistor Q1 is an *n* channel FET operating in a positive ground circuit which may appear to be a bit unusual.

Microphone Making. Sure, you could wind coils and assemble transistors, resistors and capacitors together into a basic oscillator. But if you're like us—a little on the lazy side—it's much simpler, and cheaper, to buy a commercially-built unit to start your proj-

MAGIC MIKE

ect. We used an Archer model 277-205 FM Wireless Microphone. It's available through *Allied Radio Shack* sales outlets. The module's easier to work with if you use just the printed circuit board without the housing.

Start your module mashery by prying off the bottom plate of the Archer module and removing the printed circuit board with its components from the housing. We mounted this circuit board, along with a $\frac{3}{4}$ X $1\frac{3}{8}$ -in. piece of perfboard (on which the buffer stage components are mounted) and the battery, microphone element and power switch into a 4 X $2\frac{1}{8}$ X $1\frac{5}{8}$ -in. bakelite utility case supplied with aluminum cover panel.

Drill mounting holes for the switch, the microphone, the antenna, the circuit board, and the battery clamp in the plastic utility case. You can see the arrangement we used in the photos. The layout isn't critical; however, we suggest you use the basic arrangement shown in the photos to simplify the construction project.

The crystal lapel microphone was fitted with a metal spring clip that can be bent to pass through a hole in the bakelite face of the utility cabinet. The clip's then crimped to hold the microphone in position. A scrap of aluminum was pressed into service as a battery clamp, holding it tightly inside the case.

The perfboard is mounted on two 6-32

machine screws with $\frac{1}{4}$ -in. spacers raising it off the surface of the case. The printed-circuit board is suspended from the perfboard by soldering a stiff solid wire lead and capacitors C1 and C2 to circuit connecting points between them.

Buffer Stage Assembly. Drill mounting holes in the perfboard to match the spacing of the mounting bolt holes you drilled in the plastic case. Mount three push-in pins on the free end of the perfboard for mounting and making connections to the FET (Q1). Resistor R1 is mounted between the pins that connect to the *gate* (*g*) and *source* (*s*) pins of Q1.

Next comes coil L2, which is made by winding 3 $\frac{1}{2}$ turns of #22 bare copper wire on a $\frac{3}{16}$ -in. diameter. Use a $\frac{3}{16}$ in. diameter dowel rod to form the coil. After it's wound, spread it out and solder the antenna lead to the center turn. When these operations have been completed remove the dowel rod and discard it. After winding the coil the turns should be spread apart so that total length of the coil is $\frac{5}{16}$ -in.

Solder coil L2 directly to the leads of capacitor C2 and cut off any excess coil lead wire. One end of C2 is connected to the drain (*d*) of Q1, and the other end is soldered to the 9V plus terminal on the printed circuit board that connects to the center tap of the coil (L1) on this circuit board. Except for the minus battery lead which is run from one side of the power switch to the *source* (*s*) terminal of Q1, the buffer stage is now finished.

The only other connections required to complete the project are your microphone and the plus battery leads. The shielded microphone cable supplied is cut to a length of about 2-in. Skin back the shielding about $\frac{1}{2}$ -in. Then connect the center lead of this cable to the proper tab on the Wireless Mike module printed circuit board. The shield of the mic cable is soldered to the ground bus at this same end of the pc board.

The 9V battery connector is soldered to the assembly so that the red wire (plus lead) is connected to the tab on the printed circuit board where you connected C2. The black lead (minus lead) is soldered to one side of the power switch.

Now that the hard (?) work has been completed, there's little left to do. Fasten the perfboard assembly and printed circuit board to the case. Then mount S1 into the hole you drilled for it, insert the battery and you're ready to test *Magic-Mike*.

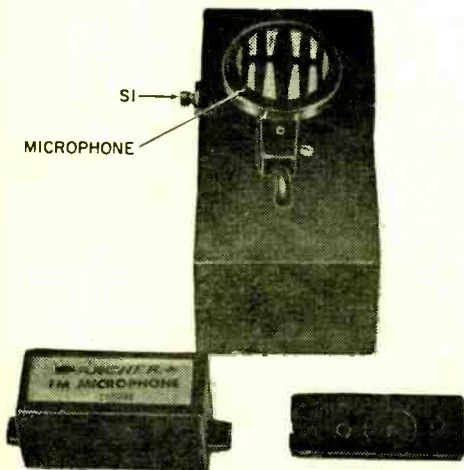

Heart of our Magic-Mike is FM wireless mike module shown with its cover on. We removed pc board from case to make easier assembly.

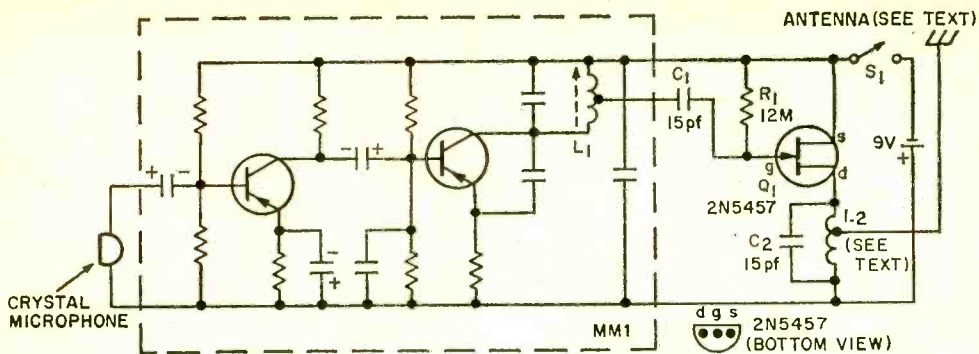

PARTS LIST FOR MAGIC-MIKE

- B1**—9V Battery (Eveready 216 or equiv.)
- C1, C2**—15 pF, 1000V ceramic disc capacitor (Lafayette 32F01514 or equiv.)
- L2**—3½ turns #22 bare copper wire (see text)
- MM1**—FM wireless microphone module (Radio Shack 277-205 or equiv.—see text)
- Q1**—*n* channel FET, Motorola MPF103 or HEP 801 or 2N5457
- R1**—12,000,000-ohm, ½-watt carbon resistor

- 1**—4 X 2½ X 1½-in. plastic mini utility box with aluminum panel (Lafayette 99F80780 or equiv.)
- 1**—Battery connector (Calectro F3-052 or equiv.)
- 1**—Crystal lapel microphone (Calectro Q4-189 or equiv.)

Misc. Wire, solder, bolts, nuts, spacers, perboard, push-in terminals, aluminum strip for battery clamp, etc.

One thing not mentioned—the antenna discussed above—is soldered to the center tap of coil L2. It should be made from a piece of #22 stranded wire about 18-in. long. You might try points other than the exact physical center of coil L2 as the final connection point for the antenna. A spot a little ahead or perhaps behind the midpoint may produce a better signal.

So okay, already, how does a smart operator like you groove on *Magic-Mike*? Just follow the

instructions that come with the Archer module! We haven't changed the module's basic how-it-works principles. All we've done is to provide a means of eliminating one of the principle drawbacks inherent in all of these units. Namely, the problem of a chick's body capacity broadly detuning the oscillator. ■

It's easier to follow our layout although circuit isn't critical. If you want to make it small enough to hide in performer's clothes go ahead and try it. The case we used may be a little too deep.

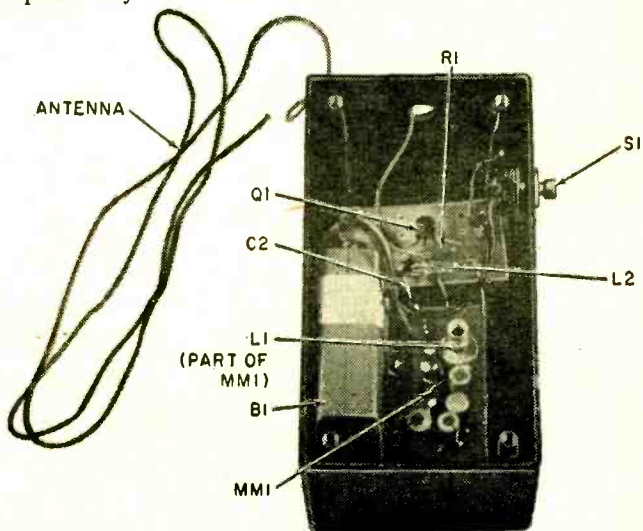

ELECTRONICS HOBBYIST

READER SERVICE PAGE

• The Editor of ELECTRONICS HOBBYIST offers readers an easy way to get additional information about products and services advertised in this issue. Also, if you would like more information about any new product mentioned in our new products column, it's yours for the asking. Just follow the instructions below and the material you requested will be sent to you promptly and at no cost.

• The coupon below is designed for your convenience. Just circle the numbers that appear next to the advertisement or editorial mention that interests you. Then, carefully print your name and address on the coupon. Cut out the coupon and mail to ELECTRONICS HOBBYIST, Box 886, Ansonia Station, New York, N.Y. 10023. Do it today!

Void after JULY 31, 1974

S/S 1974-

ELECTRONICS HOBBYIST
Box 886, Ansonia Station, New York, N.Y. 10023

Please arrange to have	1	2	3	4	5	6	7	8	9	10
literature whose num-	11	12	13	14	15	16	17	18	19	20
bers I have circled at	21	22	23	24	25	26	27	28	29	30
right sent to me as	31	32	33	34	35	36	37	38	39	40
soon as possible. I un-	41	42	43	44	45	46	47	48	49	50
derstand that this is a	51	52	53	54	55	56	57	58	59	60
free service offered by										
the magazine.										

Name (Print Clearly) _____

Address _____

City _____

State _____

Zip Code _____

Super SCA Adaptor

Continued from page 102

sulting in high frequency noise. Change C12 and C14 to 0.05 μ F.

☞ If your problem is background breakthrough from the main program.

This problem is caused by clipping (white lines on waveform A). Simply change C1 and C9 to approximately 300 pf. This will attenuate the subcarrier and clean up the breakthrough on very strong signals, though very weak signals may get lost (well you can't win or hear em all!).

A second and simple corrective procedure is to put a 100,000-ohm resistor in series with the input from the FM radio. This effectively cuts down on the input signal to eliminate overload.

☞ If your problem is an inoperative adaptor (even after you've checked

components, made sure power supply polarity and receiver connection are correct), you must determine at what point in the circuit your signal is at fault or is lost.

The three oscilloscope traces show what you can expect to get if you are tuned to an SCA station. Photo B is the input, IC1 pin 2; note the presence of a 67 kHz carrier. Photo C is IC1 pin 6; note the very strong 67 kHz carrier. Photo D is IC2 pin 9, the phase lock detector's voltage controlled oscillator triangular wave output.

If you don't get photo B, the trouble is the connection between the tuner and the adaptor. If you get photo B but not photo C, the trouble is in the IC1 circuit. If you get photo C but not photo D, the trouble is in IC2.

If you don't get photos C and D, there is most likely a major fault in the assembly; we have specifically designed the adaptor so a defective IC cannot disable another IC. ■

Digital Clock

Continued from page 23

1 of the IC, as shown in the schematic, otherwise stray RF fields may cause the clock to run fast or slow. You may want to put a piece of green or blue plastic in front of the display tubes for better appearance.

Clock Operation. Selection of various modes of clock operation and setting of time and date are all controlled with only four toggle switches mounted on the back of the cabinet. Switch S2 *cal set, alt-off, time set* is used to command the IC to receive the time or date; in the center-off

position, the time (for eight seconds) and the date (for two seconds) are alternately displayed. Switch S3 *min/day, off, hour/month* is used to set minutes or days in one position, and hours or months in the other position. Its normal operating position is center-off. Switch S4 *min. x 10, off* advances only the tens of minutes display. Switch S5 *50 Hz, 12 H, 24 H* selects between 24 hours at 60 Hz operation, 12 hours at 60 Hz (center position) and 12 hours at 50 Hz. The 50 Hz operation and the hold button, S1, are used to adjust the seconds display to coincide with the WWV time signal. Always set the calendar first, and then the time, since advancing the calendar could change the time from p.m. to a.m. ☞

"What have I been telling you? Hear that? There—now you can hear all that loud thumping and screaming!"

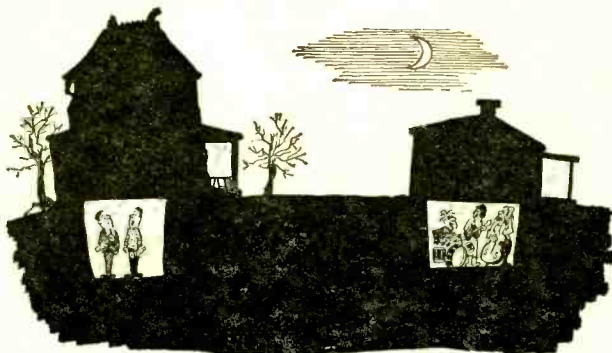

Also, notice that when the clock is operated in the 24-hour mode, it will indicate zero for the month of December, instead of 12. If you plan to operate the clock in the 24-hour mode and would like the correct month indication for December, you will require an additional switch, an additional transistor, two diodes, and two resistors, as shown in the schematic.

Adjustments. There are only two adjustments: R6 controls the brightness of the display, and R1 determines clock accuracy during battery operation. Adjust brightness control R6 to your liking. A good way to adjust R1 is to listen to WWV and disconnect the clock from the power line for one minute at a time. Depending on whether the clock is then slow or fast after reconnecting it to the power line, you turn R1 one way or the other.

The clock assumes that all months have

31 days, so don't forget to advance the date indication on February 28 (or 29 if it's Leap Year) to March 1, otherwise you'll wind up with February 31, which is a pretty unlikely date! Do the same thing with April 30, changing it to May 1, and so on with June, September, and November. ■

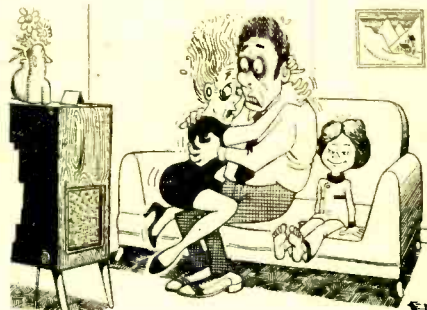

GenTrace

Continued from page 56

be required when using the RF probe, due to the very low level of the signals involved. The schematic for the RF probe also outlines how the unused inverter INV4 of IC1 is used to provide the required additional gain when the RF probe is used.

An aluminum tube, used to protect a deluxe cigar or one used to dispense solder, or an old penlight case makes an ideal housing for the RF probe. Mount the capacitors, resistor, and diode on a narrow strip of perfboard. When placing this assembly inside the aluminum tube, make certain that these components aren't shorted against the metal tube. If you can't scrounge a cigar case, try a scrap of aluminum tubing and make either wood or Bakelite end pieces. You'll need a phone tip plug for the probe's contact point.

How You Use Gen-Trace. A typical method of troubleshooting a dead set using *Gen-Trace* as a signal generator would be to start at the speaker leads' output (point A in our drawing). A signal injected here will check the speaker for proper operation. The level of tone signal heard in the speaker, while quite low, will provide the proper indication that speaker is OK.

As you work back through the circuit from that point, at each successive stage

you should note an increase in level of the tone heard originally in the speaker (points B, C, D, etc. on the drawing). The wide-band noise produced by the harmonics of the 1000-Hz square wave make it possible to trace the signal through the IF, mixer, and RF stages. The harmonics extend to well beyond 100 MHz, making it useful in checking FM receivers and TV sets (on the lower channels) up to the antenna input.

When you come to a point where the signal disappears completely, or is greatly attenuated, you know you've pinpointed the defective stage. Let's say when you come to point E, the signal first heard in the speaker drops out here and the responses at points A, B, C and D are all good. This indicates that the first IF amplifier is the source of the trouble, though there's a possibility that the trouble may possibly be in the mixer output.

Troubleshooting with the signal tracer is just opposite that used to check through a set using the signal generator. In signal tracing, you start at the input and work toward the speaker.

Caution: Don't connect the signal generator or the signal tracer to a point that's at a DC potential higher than the DC voltage ratings of capacitors C4 or C5; if necessary, connect a 0.01- μ F capacitor rated at 1000 WVDC in series with the test lead. The capacitors specified the *Gen-Trace* are adequate for most equipment using transistors or integrated circuits that operate on relatively low voltages. ■

Antiquing an Old Tube

Continued from page 34

about $\frac{3}{32}$ -in. in diameter letting the screw cut its own threads in the hole. Clip off the screw leaving about $\frac{1}{8}$ " projecting from the base and then file the clipped end of the pin smooth.

Caution: Do not drill too deep into the tube base or you might strike the glass inside the base and ruin the tube. Use a depth marker on the drill so you will not drill too deep.

Who Has It? Possible sources for type 30 tubes or other battery tubes having the same type bases as the 30s and having low filament voltages and low filament drain:

George Haymans, WA4NED, Box 468, Gainesville GA 30501. George has a

good stock of new type 30 tubes at this writing. Write him for prices. He also has type VT-25 tubes which are similar to type 30s.

Barry Electronics, 512 Broadway, New York NY 10012

Cornell, 4213 University Ave., San Diego CA 92105

Steinmetz, 7519 Maplewood, Hammond IN 46324

Transelectronic, Inc., 1306 40th St., Brooklyn NY 11218

United Radio Co., 56 Ferry St., Newark NJ 07105

Zalytron, 469 Jericho Turnpike, Mineola NY 11501

A purist collector may say that you are cheating when you substitute a 30 for an O1A job. Maybe so, but your restored ancient receiver will be operative, and if you're lucky, you may uncover an O1A. ■

Super DXer

Continued from page 42

Solder a standard phono plug to one end. Take care that you do not use ordinary shielded cable such as used to interconnect hi-fi equipment; coaxial cable is a must.

Connect the coax between the SUPER DXER and your receiver. Rotate the C1 shaft fully counterclockwise and install a pointer knob so that the pointer extends to the left (9 o'clock position). Connect your antenna to binding post BP1. Then, set L1's

ceive nothing—neither signal nor noise. The panel markings complete the adjustments.

Pull 'em In. To prevent self-oscillation, you must keep the antenna wire as far as possible from the coaxial output cable. To receive a signal, set C1 to the approximate desired frequency and then tune-in the signal on the receiver. Finally, peak C1's adjustment for maximum signal strength as indicated on your receiver S-meter, or listen carefully for an increase in speaker volume. Keep in mind that, if the signal is sufficiently strong to begin with, the receiver AVC will "absorb" the SUPER DXER's boost.

A kit of all the DXer's components including the printed circuit board is available from the Electronic Hobby Shop, Box 192, Brooklyn, N.Y. 11235. Price of \$19.98 includes postage. Canadians add \$2. New York State residents must add sales tax. No foreign orders. Postal Money Order speeds delivery to your doorstep.

slug so the *bottom* of the screwdriver slot is level with the very *top* of L1. This will provide a frequency range of approximately 5 to 15 MHz. If you back out the slug $\frac{1}{4}$ -in., the frequency coverage will be from approximately 7 to 21 MHz. You can use any in-between slug adjustment.

Turn on the receiver and booster, and set the receiver tuning to 5 MHz, or whatever frequency you selected for the "bottom end." Adjust C1 for maximum received signal or noise and mark the panel accordingly. Repeat the procedure at approximately 7, 10, 14 and 15 (or 20) MHz. The panel markings are important because the SUPER DXER tuning is so sharp it must be preset to near the desired frequency or you'll re-

and the speaker volume will probably remain the same, though the S-meter reading will increase. SUPER DXER's boost will be most apparent on very weak signals, digging out those signals below the receiver's usual threshold sensitivity, making them perfectly readable.

Don't worry about strong signals overloading your SUPER DXER; it is virtually immune to overload even from excessively strong signals. However the booster's output can be so high as to overload the input of some budget receivers. If this occurs simply reduce the booster's output by detuning C1 just enough to drop the overall signal strength below the receiver's overload value. Happy DX'ing. ■

CLASSIFIED Market Place

Classified Ads 75¢ per word, each insertion, minimum 15 words, payable in advance. For information on Classified ads—to be included in our next ELECTRONICS HOBBYIST—write to R. S. Wayner, Classified Ad Manager, 229 Park Ave. South, N. Y. 10003.

ADDITIONAL INCOME

WIN \$1,000,000.00 in the New Jersey State Lottery. Rush \$3.00 for complete details and instructions. Satisfaction Guaranteed. Davidson's, Box 274-SM, Belleville, Illinois 62222.

Extra Income! Complete Information in Your Area—No experience Necessary. Details 25¢. Oyewole, Box 4577A, N.Y. 10017.

Stuff Envelopes \$25.00—Hundred. Immediate earnings. Beginners Kit \$1.00 (refundable). Turner, Box 553A, Bronx, N.Y. 10472.

AGENTS WANTED

WATERGATE Items! Big Sellers! Easy money! Personalized Free. Edison, B125, Miami, Fla. 33151.

AUTO PARTS & ACCESSORIES

AIRMASTER Gas Saver. Fits All Cars. \$14.95. Airmaster, Lenora, Kansas 67645.

BLUEPRINTS, PATTERNS & PLANS

NEW CRAFT PRINT CATALOG—choose from over 100 great easy-to-build plans. Send \$1.25 (completely refunded with your first order). BOAT BUILDER, (CP Div.)—229 Park Avenue South, New York, N.Y. 10003.

BOOKS & PERIODICALS

WIRETAPPING Expose! Your Privacy invaded. Details \$1.00. (Refundable). Don-Q, Box 548, Seattle, Washington 98111.

JESUS Books, Christ Books, The Mateo Company (SM-14), Box 932, Moorhead, Minnesota 56560.

BUSINESS OPPORTUNITIES

I made \$40,000.00 Year by Mailorder! Help others make money! Start with \$15.00—Free Proof! Torrey, Box 318-T, Ypsilanti, Michigan 48197.

MAKE Magnetic Signs. Big Profits. Details. Universal, Lenora, Kansas 67645.

FREE BOOK "2042 Unique Proven Enterprises." Beat inflation with fabulous, successful "Little Knowns." Work Home! Haylings-Ell, Carlsbad, Calif. 92008.

HERBALISM! The home gold mine! Free lesson, Seeds, Herbalism Institute-D, Box 968, Glendora, Ca. 91749.

HOW To Make Money Addressing, Mailing Envelopes. Offer Details 10¢. Lindbloom Services, 3636 Peterson, Chicago 60659.

BUSINESS OPPORTUNITIES—Cont'd

1000% PROFIT Bronzing Baby Shoes In Your Home. Free Honest Facts. NBC-DG, Gower, Missouri 64454.

\$25,000 YEARLY—sparetime. Guaranteed mailorder system! Start with \$7.00. Rush 25¢ (refundable) Mears, 5363 Essex, Alexandria, Virginia 22311.

\$1000 MONTHLY possible from your own home. Write Jordan, Box 884, Dept. DC11, Visalia, Calif. 93277.

ADDRESSERS and Mellers Wanted. Details 25¢. Shields Enterprises, Macungie, Penna. 18062.

DO Simple Addressing-Mailing. Receive \$12.95 orders. Keep \$8.00 profit. Details Free! Quality, Box 9-DC, East Rockaway, New York 11518.

\$26.00 HUNDRED Addressing Envelopes. Details Send \$1.00 and stamped addressed envelope. Keen, Box 9995DC, San Diego, Calif. 92109.

IMPORT-MAILORDER OPPORTUNITY FREE AT OUR RISK AND EXPENSE FOR ONE FULL YEAR. Earn \$15,000 or pay nothing. Details, Northeast Imports, World Trade Division, Box 111H1, Fremont, N. H. 03044.

BUY IT WHOLESALE

BELT BUCKLES, WESTERN Trophy, Turquoise, Silver Dollar, Horses, Bronco, etc. \$3.00—\$5.00 Retail. Send for dozen samples—\$12.00. 6 dozen \$65.00. Zelco Mfg. Box 1934, Studio City, Calif. 91604.

COINS, CURRENCY & TOKENS

4 BUFFALOS \$1.20. 1929S, 1930S, 1934D. 1937S. Rongo, 1265 81st Street, Brooklyn, New York 11228.

DO-IT-YOURSELF

MAKE any window a one-way mirror, you look out, nobody looks in. (11 1/2 x 16") Plastic \$3.00 Palmer, P. O. Box 12445DC, P. C. Ala. 36867.

BUILD Sewer Pipe Wine Rack. Illustrated instructions \$1.00. Minipix, Box 2578, New Brighton, Minnesota 55112.

EDUCATION & INSTRUCTION

"LOGIC newsletter design and construction, sample copy, \$1.00. Logic Newsletter, POB 252, Waldwick, N. J. 07463."

COLLEGE Degrees At Home! Complete Directory Accredited Universities offering Correspondence Courses, \$2.00. Research, Box 48533D, Los Angeles, Calif. 90048.

EDUCATION & INSTRUCTION—Cont'd

HIGH SCHOOL DIPLOMA for adults. Earn State Diploma. Accepted by Civil Service, business, colleges. Low cost. No tedious study. Money-back guarantee. Details: H-S Programs, Suite 25 22,1221 Avenue of Americas, New York, N. Y. 10020.

ORDINATION. Details Free. Ministry of Service, Box 526, Seymour, Texas 76380.

ACUPUNCTURE TRAINING Home Study Course! Tsang, Box 219W, Toronto, Canada M6M 4Z2.

COLLEGE degrees via Mail. Free Information! West Gulf, Box 3199, Dept. D-1, Pasadena 91003.

BIG profits in publishing. Learn how. Details free. Stevenson Enterprises, 4808 Santa Monica Ave., San Diego, Ca. 92107.

\$2.00 BRINGS Book. How To Have Confidence and Power. Specialty Gift House, 53 Locust St., West Haven, Conn. 06516.

MATHEMATICS cassette tapes correlated with printed texts. A new series narrated by a college mathematics professor: Computer: Number Bases \$6.95. Sets and Flowcharts \$6.95. Algebraic Expressions \$5.95. Statistics \$7.95. Gambling Theory \$7.95. Sets and Numbers \$5.95. Send Check or Money Order, WILLIAMSVILLE PUBLISHING COMPANY, INC. Dept. VA, Box 237, Williamsville, New York 14221.

ELECTRONIC EQUIPMENT & SUPPLIES

SACRIFICE prices on Electronic Component systems. Send for catalog, 25¢ postage. RLH Electronics, Box 8908, Shreveport, La. 71108.

EMPLOYMENT INFORMATION

EXCITING Overseas Jobs. Directory \$1.00. Research Associates, Box 889-CE, Belmont, California 94002.

FARMS, ACREAGE & REAL ESTATE

GOVERNMENT LANDS DIGEST. A Monthly review of government Real Estate offerings throughout the U.S.A. Free subscription information! DIGEST, Box 25561-DP, Seattle, Washington 98125.

FOR INVENTORS

PROSECUTE Your Own Patent Application! All Material Necessary—Write: Inventors Service, Box 3574, Washington, D.C. 20007.

MORE

**YOU'LL MAKE
MONEY**

**SAVE MONEY TOO—
BY READING and ANSWERING
THESE CLASSIFIED ADS**

CLASSIFIED MARKET PLACE

(Continued from page 97)

FOR INVENTORS—Cont'd

NEEDING Assistance? INVENTION DEVELOPMENT FOUNDATION, 155 Kent, Ottawa, Canada K1P 5P3.

FOR SALE—MISCELLANEOUS

HILARIOUS Professional SWL satire tape: Radio Morania! Hour reel or cassette (specify) \$3.85. A DX'ers must! Custom Production Studios, Box 146, Ishpeming, Mich. 49849.

HEARING AIDS

HUGE SAVINGS! BUY DIRECT! Eliminate dealer markups. 20 days FREE Trial. Terms arranged. No salesman will call. LLOYD'S-79, Rockford, Illinois 61108.

HYPNOTISM

HYPNOTIZE STRANGERS in 30 Seconds! Most powerful hypnotic device ever created! Complete easy instructions included. Guaranteed only \$2.00. From: WORLD-31C1, 3047 University, San Diego CA 92104.

HYPNOTIZE STRANGERS in 30 SECONDS. Most powerful hypnotic device ever created! Instructions included. Only \$2.00 (Guaranteed). ORDER TODAY! James Green, R. D. 1, Dept. 1D1, Evans City, Pennsylvania 16033.

IMPORTS—EXPORTS

MAILORDER IMPORTS. Report reveals foreign drop-ship sources. World Traders digest. Ideal mailorder items. \$1.00. Witt Enterprises. 4023 Kendall Lane, Waco, Texas 76705.

INVENTIONS WANTED

WE either sell your invention or pay cash bonus. Write for details. Universal Inventions, 298-3 Marion, Ohio 43302.

LOGIC

LOGIC NEWSLETTER. Design Theory. Construction. Sample copy \$1.00. Logic Newsletter, POB 252, Waldwick, N.J. 07463.

MAGIC TRICKS, JOKER NOVELTIES & PUZZLES

WOW! Largest selection. Newest, best tricks, jokes. Giant 150 page catalog 25¢. Abracadabra-HE. Colonia, New Jersey 07067.

VENTRILOQUISM—Profitable Hobby or Career! FREE INFORMATION! Dummy Catalog 25¢ Maher, Box 9037DC, Denver, Colorado 80209.

MISCELLANEOUS

SEE THRU WALLS! New secret two-way super spy device! Instructions included. Guaranteed, only \$2.00. World-1B31, 3047 University, San Diego, Ca. 92104.

MONEYMAKING OPPORTUNITIES

AIR CONDITIONING, "ECONOMIC COMFORT", "TECHNIQUES in Getting You Into A More COMFORTABLE Home". Send \$5.00 pnd. to: KIDWELL ENTERPRISES, P.C.M.H. Park, Box 6, Pryor, Oklahoma 74361.

\$1,000 INTO \$1,000,000 in Ten Years. Simple Plan. Send \$3.00. Suite 401, Investment Building, Pittsburgh 15222.

STORIES FOR MOVIES NEEDED. If accepted, we write screen-plays. SEND self addressed stamped envelope and \$2.00 for handling. International Pictures Corp., 1040 N. Las Palmas, Hollywood, Calif. 90038—Stories, etc., not accepted will be returned.

GUARANTEED Home Income raising chinchillas. 25¢ Chinchilla. 11DC2. Port Richey, Fla. 33568.

JOIN "Money-Getters Guild" 25¢. Russell Advertising, Box 612-D, New Philadelphia, Ohio 44663.

HOMEWORKERS \$185.00 Weekly. Send 25¢ + stamped self addressed envelope. Odyssey, Box 12560DC, Philadelphia, Pennsylvania 19151.

MAKE YOUR Classified Ad Pay. Get "How to Write A Classified Ad That Pulls." Includes certificate worth \$2.00 towards a classified ad in this publication. Send \$1.25 (includes postage) to R. S. Wayner, Science & Mechanics, 223 Park Avenue South, New York, N.Y. 10003.

\$40.00 DAILY possible tying fishing flies at home. Details 25¢. Flyco, Box 481-EE, Albany, Oregon 97321.

\$6.00 HOUR Possible Part-Time Men. Women! show Free Sample. Take Orders for Popular Engraved Metal Social Security Plates. Send Your Name, S-S Number for Free Personalized Sample, Kit. Lifetime Products, Box 25489-A, Raleigh, N.C. 27611.

COLLECT COINS FOR PROFIT! ONE ROLL of 1926S BUFFALO NICKELS are NOW WORTH \$13,000.00! CHECK YOUR CHANGE! LIST of VALUABLE coins. HOW to start WHERE to sell coins. Booklet SM12 75¢. J. D. Clarke, 101-D Clark Street, #8, Brooklyn, New York 11201.

SELECTED 100 MONEYMAKING OPPORTUNITIES. Send \$1.00. Fulk, 7003 Birch Drive, Cocoa, Florida 32922.

FORTUNES in Land! Amazing profits! Acreage, lots few dollars on Signals. Five other fast \$100,000 profit plans. Money-machine brain training! Easy borrowing. Everything \$3.00. Fortune-Builders, FDPE-1, Box 25, Marshall, Texas 75670.

YOU Can Make \$4.00 profit on every \$5.00 sale. Details 25¢. Oyewole, Box 4577A, N.Y. 10017.

OF INTEREST TO WOMEN

\$25.00 DAILY Possible addressing-stuffing envelopes Typewriter-longhand, also Clipping News items at home Information; Send stamped addressed envelope. Ame-7, Box 310, Le Mars, Iowa 51031.

OPTICAL GOODS—TELESCOPES

EYEGLASSES Wholesale—Free Catalog. A-Z Optical Company, Box 175, Dept. 28, G. Bay Station, Brooklyn, N.Y. 11255.

PERSONAL

CONTRACEPTIVES FOR MEN—By Mail Samples and Catalogue—\$1.00. POPLAN, Box 2556-DCG-10, Chapel Hill, N.C. 27514.

BECOME Ordained Minister. Free information. Church, Box 324, Daytona Beach, Florida 32015.

JAPANESE introductions! Girls' photographs, descriptions, brochure, details, \$1.00. INTER-PACIFIC, Box 304-SC, Birmingham, Michigan 48012.

SINCERELY interested in Marriage? Fourteen Years experience. Social Introduction Service. Box 1547, Eugene, Oregon 97401.

HOW would you like to Receive 100 letters daily each containing \$1.00? Plan plus Six Formulas \$1.00. Rush Dollar to: Turner, Box 553A, Bronx, N.Y. 10472.

GET \$12.00 Orders in every mail—keep \$8.00 on each order for yourself. Details 25¢. Turner, Box 553A, Bronx, N.Y. 10472.

PHOTOGRAPHY—PHOTO FINISHING

SAVE HUNDREDS OF DOLLARS! !! Make your own S&M Densitometer. Send \$3.00 for detailed drawings and instructions. A must for successful photography in your darkroom. Order direct from: S & M Instruments, Dept. EE1, 229 Park Avenue South, New York, New York 10003.

RADIO & TELEVISION

TV TUBES 36¢ each. Send for Free 48 page color catalog. Cornell, 4217-W University, San Diego, California 92105.

BUILD Distance Crystal Sets. 10 Plans—25¢; Handbook 18 different—50¢; 20 different—50¢. Catalog 25¢. Refundable. Laboratories, 1477-G, Garden Grove, Calif. 92642.

NEW TV Filter. Reduces outside noise, interference. Improves reception. Easy installation. \$1.98. Request catalog. I-EH, Mark Anthony's, 3841 Hammel, Los Angeles, California 90063.

SURPLUS EQUIPMENT

GIANT 120 Page Canadian Surplus Catalog \$1. Etco, Dept. DG, Box 741 Montreal.

For Greater Classified Savings . . . Results . . . and Profits . . .

Place your ad in one of our SPECIAL COMBINATIONS: Business Group, Science & Mechanics, or Davis Combination. Each Combination is designed to give your ad the largest audience available. For further information write to R. S. Wayner, Classified Ad Manager, Davis Publications, Inc. 229 Park Avenue South, New York, N.Y. 10003.

THERE IS NO CHARGE FOR THE ZIP CODE—PLEASE USE IT IN YOUR CLASSIFIED AD

NRI FIRSTS make learning Electronics fast and fascinating—to give you priceless confidence

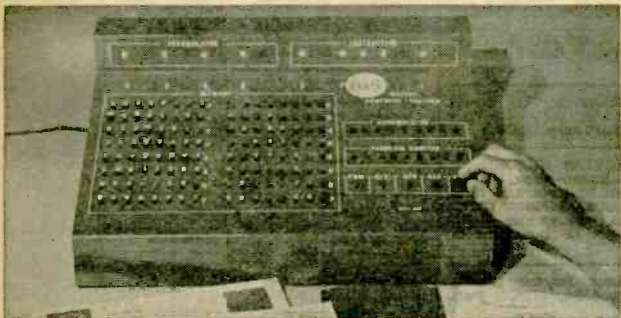

FIRST to give you a complete programmable digital computer, with memory, you build yourself... to learn organization, operation, trouble-shooting and programming. This remarkable computer is one of ten training kits you receive with the new NRI Complete Computer Electronics Course.

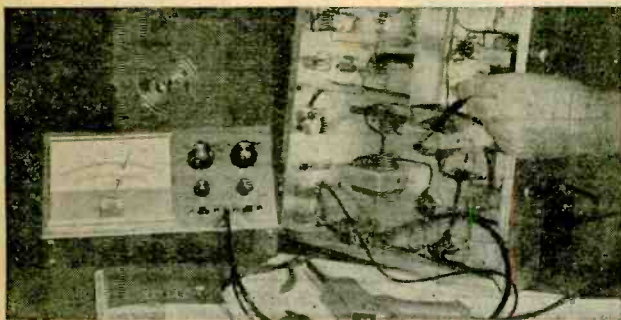

FIRST to give you true-to-life experiences as a Communications Technician. Every fascinating step you take in NRI Communications training, including circuit analysis of your own 15-watt, phone/cw transmitter, is engineered to help you prove theory and later apply it on the job. Studio equipment operation and trouble shooting become a matter of easily remembered logic.

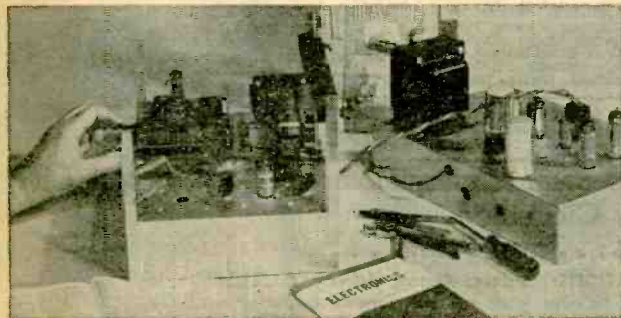

FIRST to give you completely specialized training kits engineered for business, industrial and military Electronics Technology. Shown is your own training center in solid-state motor control and analog computer servo-mechanisms. Telemetry circuits, solid-state multivibrators and the latest types of integrated circuits are included in your course.

The NRI color TV and digital computer kits are the latest in a long line of "firsts" for NRI. For more than fifty years, NRI has been providing unique 3-dimensional home-study training that has helped hundreds of thousands of students reach their goals quickly and easily.

What NRI provides is a combination of kits and bite-size texts that give you hands-on experience while you are learning. The texts average only 40 pages each, and they are fully illustrated. You are taken step-by-step from the first stages into the more advanced theory and techniques... with an expert instructor ready at all times to provide valuable guidance and personal attention. (The level of personal attention provided is more than you would receive in many classrooms.) Once you've grasped the fundamentals, you move with confidence and enthusiasm into new discoveries in the fascinating world of electronics.

You start out with NRI's exclusive Achievement Kit, containing everything you need to get moving fast. Lessons have been specifically written so that experiments build upon one another like stepping stones. You can perform a hundred experiments, build hundreds of circuits... as you learn to use the professional test equipment provided, building radios and TV sets, transmitter or computer circuits. It's the priceless "third dimension" in NRI training... practical experience.

Train with the leader—NRI

Compare training kits, texts, techniques and overall training... and you'll find that you get more for your money from NRI. Whatever your reason for wanting more knowledge of Electronics, NRI has an instruction plan that will meet your needs. Choose from major programs in Advanced Color TV Servicing, Complete Computer Electronics, Industrial Electronics and the other special courses designed to meet specific needs. With NRI home training, you can learn new skills while you're still working at your present job... and turn yourself into the man in demand.

GET FACTS ABOUT GI BILL

If you have served since January 31, 1955, or are in service now, check GI line on postage-free card.

Send for free NRI catalog

MAIL THE POSTAGE-FREE CARD FOR THE FREE NRI CATALOG IN THE FIELD OF YOUR CHOICE. YOU WILL BE UNDER NO OBLIGATION. NO SALESMAN WILL CALL.

If the card has been used, write direct to:



NRI TRAINING

3939 Wisconsin Ave.
Washington, D.C. 20016

NOW you can train at home building a NEW 25" DIAGONAL Solid State Color TV engineered by NRI for learning and trouble-shooting

So much better for learning TV servicing than any hobby kit, because NRI designed and created it as an educational tool.

Unlike hobby kits which are designed for creating a TV set as the end product, NRI built its exclusive 25" Diagonal Solid State Color TV kit as a real training kit. You can introduce and correct defects . . . for trouble-shooting and hands-on experience in circuitry and servicing. The kits include a wide-band oscilloscope, color bar crosshatch generator, transistorized volt-ohmmeter and other valuable equipment that can soon have you earning \$5 to \$7 an hour servicing color sets in your spare time.

Handsome woodgrain cabinet, at no extra cost. (Offered only by NRI)

New square-cornered Sylvania picture tube

100% solid state chassis

6-position detented UHF channel selector



Modular construction with plug-in circuit boards

Automatic degaussing

Automatic fine tuning

Automatic color control

Automatic tint control

