

ELECTRONICS HOBBYIST

FALL-WINTER 1970 \$1.25

PROJECTS EVERYONE CAN BUILD

One-Tube
Superhet
BCB Receiver —
page 73

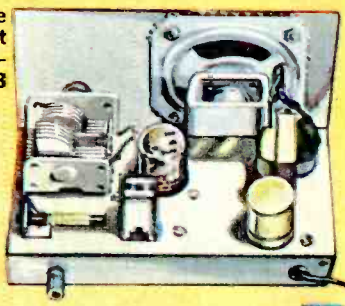

Treasure-Metal Locator — page 19

Projects you can
build in one
evening... projects
that'll bring you
more pleasure...
projects you
can make this
weekend... projects
that bring fun
to learning...
projects you can only
enjoy by building...

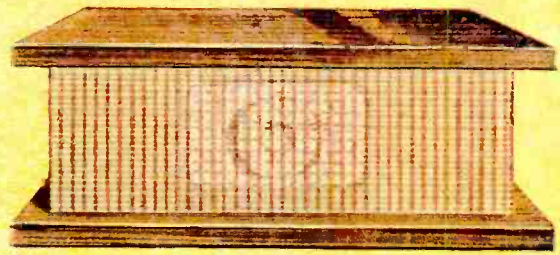

Hi-Fi Speaker System — page 47

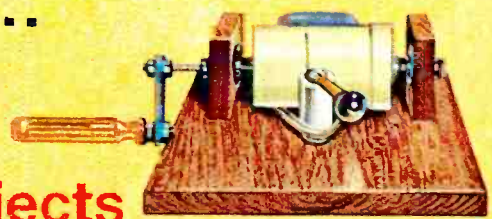

Science Fair Project — page 79



Stroboscope — page 43

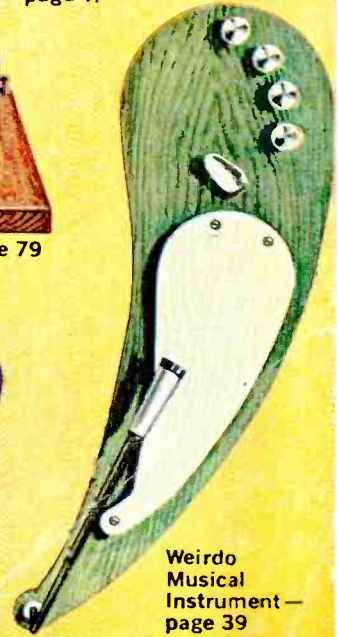

Weirdo
Musical
Instrument —
page 39

Much more, compiled and presented by
the staff of ELEMENTARY ELECTRONICS

NEW 1970 CRAFT PRINT CATALOG



The new 1970 Craft Print Catalog has over 100 great easy-to-build plans . . . Sail boats . . . recreational travel trailer . . . Biplane . . . and many home projects you can order. With the 70 Craft Print Catalog you can get top mailage from your own craft skills . . . outstanding design . . . utility value . . . and ease of construction. Each Craft Print is fully illustrated . . . step-by-step construction procedures . . . and complete material list.

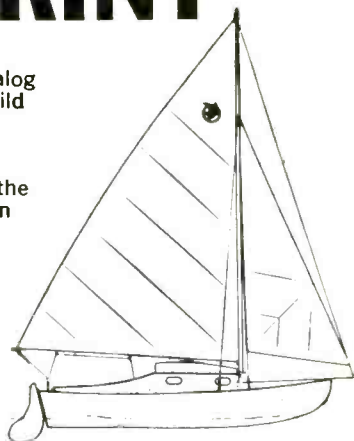

Here are just 3 of the many great Craft Prints Plans included in the catalog.



255. MINIMAX. For minimum cost and maximum performance you can't beat "Minimax." Actually, it was built in one day at a cost of less than \$30.00. It will carry two persons, take outboard motors ranging from 3 hp to 15 hp, and has a watertight air compartment that will support 900 lbs. even with the cockpit completely filled with water. As to performance, it will plane a 165 lb. man up to 15 mph with a 3 hp motor. With motors of 10 hp or more, "Minimax" just about rides on the engine's cavitation plate. Length, 8'; beam, 48"; weight, 68 lbs. Full size patterns No. 347 are available for "Minimax."



334. EAA BIPLANE. Completely modern in design, but based on the traditional one-man flying machine of yesteryear, is the EAA Sport Biplane. It's a real plane, adaptable to home construction at a cost of less than \$2000 (with a used engine). She can carry a 230 lb. pilot at a rate of climb of 700' per minute to a ceiling of 11,500'. With an 85 hp engine, she can attain a speed of 130 mph. (Plans are \$10.)

106. PETREL. As a sailboat, "Petrel" fulfills the greatest possible variety of uses in one model. It can be built as an open cockpit racing craft, or as a cabin cruiser with accommodations for overnight trips and shelter on fishing excursions. Cockpit seats four. Either model is constructed from the same basic design, and possesses unusual seaworthiness, stability, trim attractive lines, speed, and ability to handle well. Construction is easy and inexpensive, utilizing marine or exterior grade plywood. An outboard of up to 6 hp can be used for auxiliary power. Due to the simplified construction, ordinary carpenter's tools and only average skill are required to build this boat. Length, 16'; beam, 6'; depth, 23" amidships; draft with fixed keel, 24"; draft with centerboard down, 30"; weight 650 lbs.

AMAZING OFFER

All Craft Prints are unconditionally guaranteed; if you are not completely satisfied you may return them and your money will be promptly refunded.

To order Craft Print or Catalog use the handy order form below.

MAIL TODAY

SCIENCE & MECHANICS / Dept. CP-28
CRAFT PRINT DIV.,
229 Park Avenue South, New York, N.Y. 10017
Please send me _____ copy(s) of the 1970 Craft Print Catalog for only \$1.00 ea. . . . COMPLETELY REFUNDED WITH FIRST ORDER.

Please send me the following Craft Print Plan(s).

Craft Print(s) #255 _____ @ \$3.00 each

Craft Print(s) #334 _____ @ \$15.00 each

Craft Print(s) #106 _____ @ \$3.00 each

Enclosed is \$ _____

A FREE Catalog is included with each Craft Print Order. Sorry No C.O.D. orders accepted.

NAME: _____

ADDRESS _____

CITY _____ STATE _____ ZIP _____

SAVE! SPECIAL OFFER: Order 2 or more sets of Plans and you can deduct 10%—from the total price.

**Without NTS
training
you've only
scratched
the surface in
electronics...**

NTS digs deep into electronics. Proof? Look at the close-up at the left. It's the first transistorized digital computer-trainer ever offered by a home study school.

Fascinating to assemble, the NTS Compu-Trainer® introduces you to the exciting world of computer electronics. Its design includes advanced solid-state NOR circuitry, flip-flops, astable multivibrators and reset circuits. Plus two zener and transistorized voltage-regulated power supplies. The NTS Compu-Trainer can perform 50,000 operations per second, and is only one of many ultra-advanced kits we offer to give you incomparable, in-depth career training.

NTS... THE FIRST HOME STUDY SCHOOL TO OFFER LIVE EXPERIMENTS WITH INTEGRATED CIRCUIT KITS

With NTS Project-Method Home Training, you build a computer sub-system using the new, revolutionary integrated circuits. Each one, smaller than a dime, contains the equivalent of 15 resistors and 27 transistors.

With Project-Method, kits are carefully integrated with lesson material. All our kits are real equipment—not school-designed versions for training only. Project-Method was developed in our giant resident school... and proven effective for thousands of men like yourself. It's the practical-experience approach to learning. Gets you going in a hurry!



■ **COMMUNICATIONS**

This Transceiver is included in Communications courses. It's yours to build... to easily prepare for F.C.C. License exam... To become a fully-trained man in communications.

■ **COLOR TV, 295 SQ. IN. PICTURE**

Included in Color TV servicing courses. Building this advanced receiver gets you deep into color circuitry—advances you into this profitable field of servicing—the easy way. Color is the future of television, and your future, too!

■ **INDUSTRIAL & COMPUTER ELECTRONICS**

New ideas, new inventions, are opening whole new fields of opportunity. Electronic control systems, computers, are being applied to great numbers of manufacturing processes every day. We train you for this new field, fast! With advanced control systems devices, a new 5" oscilloscope, and the NTS Compu-Trainer. Modern, quick and easy training prepares you to enter this brand-new world like a pro.



GET THE FACTS! SEE ALL NEW KITS AND COURSES OFFERED IN THE NEW NTS COLOR CATALOG. SEND THE CARD TODAY! No obligation. No salesman will call.

Classroom Training At Los Angeles. You can take classroom training at Los Angeles. NTS occupies a city block with over a million dollars in facilities devoted exclusively to technical training. Check box on coupon.

NATIONAL TECHNICAL SCHOOLS

WORLD-WIDE TRAINING SINCE 1905

4000 So. Figueroa Street Los Angeles, Calif. 90037

APPROVED FOR VETERANS



Accredited member:
National Home Study Council
National Association of
Trade and Technical Schools.



ELECTRONICS HOBBYIST



Unicord Organ
Page 55

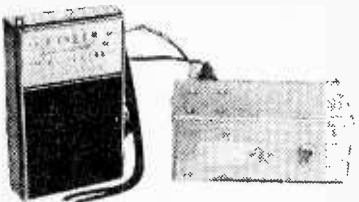

TLPS Power Supply
Page 52

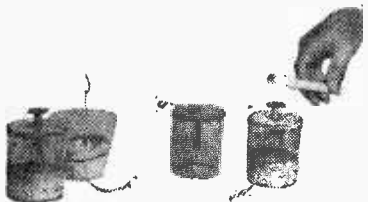

Leyden Jars
Page 87

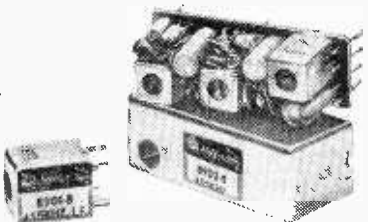

The 100Xer
Page 29

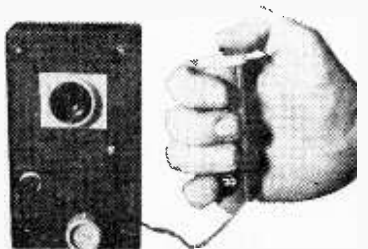

Sonopulse Timer
Page 107

THE FUN PROJECTS

- 19 Treasure Witcher Metal Locator
- 39 VibraVox Musical Instrument
- 43 Penny-Pincher Stroboscope
- 55 Unicord Organ
- 77 Visulert Telephone Alarm
- 93 Radio from the Roaring '20s
- 104 Interval Screamer
- 107 SonoPulse Timer

FOR THE AMATEUR SCIENTIST

- 25 Magnetic Beam Balance
- 79 Rotostat Static Generator
- 87 Leyden Jars

COMMUNICATION PROJECTS

- 29 The 100Xer Receiver Restorer
- 54 Double Timer
- 61 Station Blazer SWL Preamp
- 69 Semi-Pro 2-Meter Converter
- 73 The Unicorn—One-Tube BCB Receiver
- 85 Beginner's CPO
- 97 \$10 Aircraft Receiver

IN CASE YOU LIKE TO LISTEN

- 38 Horn Speakers
- 47 Polar Plus Speaker System

FOR MR. FIX-IT

- 52 TLPS Power Supply
- 65 Universal Regulated Power Supply
- 60 Grin and Tin
- 92 Soldering Clip Tips

SHORTIES FOR EVERYONE

- 8 New Products
- 17 Literature Library
- 18 As the Wife Sees It
- 68 Power Failure Alarm

Free

Print



World's Largest Electronic Kit Catalog over 300 kits for every interest...save up to 50%

Join the millions who have discovered that they can *build* a better product than they can buy... have fun... & enjoy substantial savings in the process. No special skills are required to assemble Heathkit electronics...just follow our simple step-by-step instructions. Send for your free Heathkit catalog now...and discover the fun & satisfaction of building the best.

- NEW Solid-State Color TV
- Deluxe Tube-Type Color TV
- Stereo/Hi-Fi Components
- Transistor Organs
- Home Equipment
- Shortwave Radios
- Amateur Radio Equipment
- Musical Instrument Amplifiers
- Automotive Electronics
- Marine Electronics
- Trail Bikes
- Test & Lab Equipment
- Home Study Courses
- Scientific Instrumentation
- Radio Control Electronics

**SEND FOR
YOUR FREE
COPY TODAY!**



HEATH COMPANY, Dept. 26-9
Benton Harbor, Michigan 49022
Please send FREE Heathkit Catalog

Name _____
Address _____
City _____ State _____ Zip _____

CL-390

Olson ELECTRONICS FREE Catalog

Fill in coupon for a FREE One Year Subscription to OLSON ELECTRONICS' Fantastic Value Packed Catalog — Unheard of LOW, LOW PRICES on Brand Name Speakers, Changers, Tubes, Tools, Stereo Amps, Tuners, CB, and other Values. Credit plan available.

NAME _____
ADDRESS _____
CITY _____ STATE _____
GIVE ZIP CODE _____

If you have a friend interested in electronics send his name and address for a FREE subscription also.

OLSON ELECTRONICS
542 S. FORGE STREET, AKRON, OHIO 44308

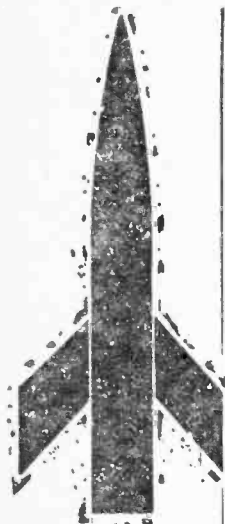

Keep up to date with **SCIENCE & MECHANICS**

Science & Mechanics—the only magazine that keeps you right up to date on developments in space technology, weapons, automobiles, medicine, boats, planes, tools, new products, and exciting world events.

Keep up to date. Make sure of your home delivered copy by returning the coupon today.

SCIENCE & MECHANICS, Dept. 289
229 Park Ave. S., N. Y., N. Y. 10003

12 issues \$4; 24 issues \$8; 36 issues \$12. Foreign:

Add \$1 a year.)

Please enter my _____ year(s) subscription.

I enclose _____ Bill me, (No stamps)

Name _____

Address _____

City _____ State & Zip _____

FALL/WINTER, 1970 EDITION

ELECTRONICS HOBBYIST

Dedicated to America's Electronics Hobbyists

Editor-in-Chief

JULIAN M. SIENKIEWICZ, WA2QQL/KMD4313

Managing Editor

RICHARD A. FLANAGAN, KQD2566

Technical Editor

CHARLES S. HARRIS

Service Editor

HELEN PARKER

Art Editor and Associate Art Director

JIM MEDLER

Art Director

JOSEPH A. D'AMATO

Cover Art Director

IRVING BERNSTEIN

Advertising Director

DAVID J. MILLER

Production Director

CARL BARTEE

Production Manager

GERTRUD BORCHARDT

Assistant Production Manager

MARILYN VARGAS

Instruments Division Manager

WILFRED M. BROWN

Circulation and Marketing Director

ROGER G. CAVANAGH

Chairman of the Board

B. G. DAVIS

President and Publisher

JOEL DAVIS

Vice-President and General Manager

LEONARD F. PINTO

Vice-President and Treasurer

VICTOR C. STABILE, KBPO681

Cover illustration
by
Joe Rak



ELECTRONICS HOBBYIST is published Semi-Annually by SCIENCE & MECHANICS PUBLISHING CO., a subsidiary of Davis Publications, Inc. Editorial business offices: 229 Park Ave. South, New York, N.Y. 10003. Advertising Offices: New York, 229 Park Ave. South, 212-OR-3-1300; Chicago, 520 No. Michigan Ave., 312-527-0330; Los Angeles, J. E. Publishers' Rep. Co., 213-653-5841; Long Island, Len Ostien, 9 Garden St., Great Neck, N.Y., 516-487-3305; Southwestern advertising representative, Jim Wright, 4 N. 8th St., St. Louis, 314-CH-1-1965.

Copyright 1970 by Science & Mechanics Publishing Co.

ELECTRONICS HOBBYIST

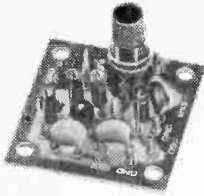

**MXX-1 Transistor
RF Mixer \$3.50**

A single tuned circuit intended for signal conversion in the 3 to 170 MHz range. Harmonics of the OX oscillator are used for injection in the 60 to 170 MHz range.

Lo Kit 3 to 20 MHz
Hi Kit 20 to 170 MHz
(Specify when ordering)

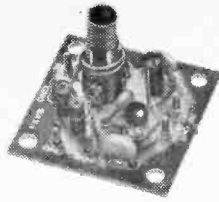

**SAX-1 Transistor
RF Amplifier \$3.50**

A small signal amplifier to drive MXX-1 mixer. Single tuned input and link output.

Lo Kit 3 to 20 MHz
Hi Kit 20 to 170 MHz
(Specify when ordering)

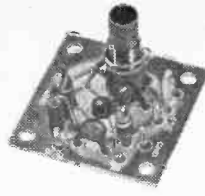

**PAX-1 Transistor RF
Power Amplifier \$3.75**

A single tuned output amplifier designed to follow the OX oscillator. Outputs up to 200 mw, depending on the frequency and voltage. Amplifier can be amplitude modulated. Frequency 3,000 to 30,000 KHz.

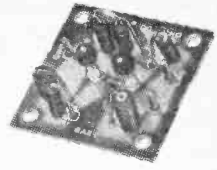

**BAX-1 Broadband
Amplifier \$3.75**

General purpose unit which may be used as a tuned or untuned amplifier in RF and audio applications 20 Hz to 150 MHz. Provides 6 to 30 db gain. Ideal for SWL, Experimenter or Amateur.

For The Experimenter!

International EX Crystal & EX Kits

OSCILLATOR / RF MIXER / RF AMPLIFIER / POWER AMPLIFIER

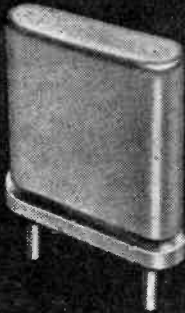

Type EX Crystal

Available from 3,000 to 60,000 KHz. Supplied only in HC 6/U holder. Calibration is $\pm .02\%$ when operated in International OX circuit or its equivalent. (Specify frequency)

\$395

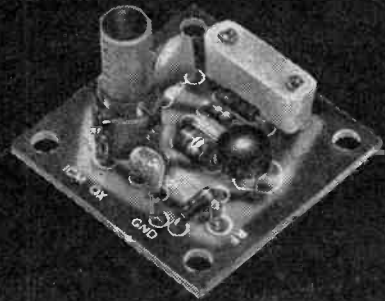

OX Oscillator

Crystal controlled transistor type. Lo Kit 3,000 to 19,999 KHz
Hi Kit 20,000 to 60,000 KHz
(Specify when ordering)

\$295

Write for complete catalog.



CRYSTAL MFG. CO., INC.
10 NO. LEE • OKLA. CITY, OKLA. 73102

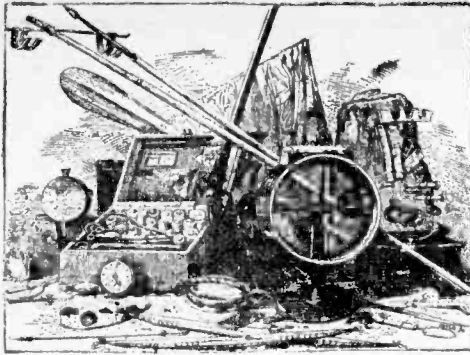

NEW PRODUCTS

HERE'S A CAR THAT WON'T POLLUTE!

Heathkit has something for the new generation of radio-controlled model car racers. Called the Spectre, the car is 1/8-scale and measures 19 3/4 in. in length. The snap-on body is a sin-



Heathkit Spectre R/C Car Model

gle piece of white high-impact plastic, and the car reaches scale speeds of up to 200 mph. The Spectre features independent front-wheel coil spring suspension with adjustable toe-in and caster, live rear axle, chrome plated steel chassis, and rubber tires for nylon "mag" type wheels. The sidewinder-type engine mount accepts any 0.15-0.23 cubic inch R/C engine. There's an adjustable centrifugal clutch, gear train with a 5.5:1 ratio, automatic brake. The Heathkit GD-101 Spectre car kit includes the car body, chassis, wheels and tires, 4-oz. fuel tank and tubing, equipment case, centrifugal clutch and gears, axles, servo linkages and mounting tape, all hardware, decals, numbers, and a manual. Mail order price of the GD-101 is \$49.95 FOB. For more details write Heath Co., Benton Harbor, Mich. 49022.

DIAL YOUR SPEED CONTROL

Unlike conventional halfwave controls the Solid-State Motor Speed Control from Dremel Mfg. Co. gives controlled full-wave output.



Dremel Motor Speed Control

Motor Speed Control comes with an *on/off* switch and built-in pilot light. 3-wire grounding cord, and overload protector with manual reset button. The unit can be used with all universal (brush type) motors and fixed-load, shaded-pole motors. Speed can be dialed from zero to full rpm. Also, Motor Speed Control can double as a temperature control on soldering irons or guns to provide just the right heat. Price is \$16.95. More information can be obtained from Dremel Mfg. Co., Box 518, Racine, Wis. 53401.

HELLOOOO OUT THERE

For those of you who don't want a permanent hunch from trying to do something (change the baby, take notes) while cradling the telephone, here's a telephone amplifier. Model FTA-4, from Fanon Electronics. The FTA-4 is a desk-top instrument that consists of a receiving and transmitting unit, and a small, powerful 2-in. diameter extension speaker. The unit measures 9 1/2 x 4 x 2 1/2 in. and weighs less than 4 lb. The amplifier can be lowered to a whisper for privacy, or raised to fill a room to carry on a telephone conference. The FTA-4 is turned *off* simply by removing the telephone



Fanon Telephone Amplifier

handset from the cradle. A 4-transistor, battery-powered circuit eliminates the need for a line cord, so it's completely portable. A 9-volt battery is included with the unit, the price of which is \$24.95. For additional information write Fanon Electronics, 100 Hoffman Pl., Hillside, N.J. 07205.

"MOST ADVANCED RECEIVER TO DATE!"

Lafayette's new LR-1500TA AM/FM-stereo receiver puts out a big fat 220 watts (IHF) \pm 1 db at 4 ohms. The unit has an electronic tuning circuit which Lafayette calls Acri-Tune, three front-end silicon FETs, and FET tone controls. Elsewise, there's fuseless automatic overload protection circuit, automatic stereo/mono switching, 4-gang FM tuning capacitor, four IF stages, wide-band ratio detector, center channel

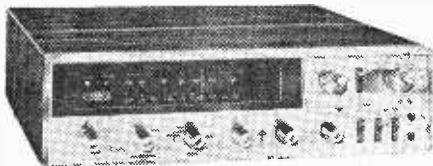

Lafayette AM/FM-Stereo Receiver

output, built-in AM/FM antennas, off/on muting control, loudness compensator, low and high filters, dual system speaker control (main/remote, or both simultaneously), front and rear panel tape output jacks, and much, much more. The LR-1500TA sells for \$299.95. For more details, write Lafayette Radio Electronics Corp. 111 Jericho Tpk., Syosset, N.Y. 11791.

TAKE SINATRA FOR A RIDE

Selectron International calls their new AIWA Model TPR-2010 the *Touch 'n Go*. The unit, which is smaller than a cigar box, combines a solid-state receiver with a cassette tape player



AIWA Touch 'n Go FM Receiver/Cassette

(it measures only 7 1/2 x 8 x 2 1/2 in.) "Touch 'n Go" describes the controls: a flick of the finger converts from FM-stereo to cassette. The AIWA TPR-2010 mounts with quick-attach, under-the-dash brackets. A 4-prong connector, head cleaner, and fuse are supplied with the unit. Price of *Touch 'n Go* is \$109.95; for more dope

(Continued on next page)

FREE 1971
50th
ANNIVERSARY
CATALOG 710

Serving The Public Since 1921



Over
460
 Pages

Your Most Comprehensive Buying Guide to Everything in Electronics for
 • Home • Industry • Laboratory
 from the "World's Hi-Fi & Electronics Center"

Complete electronics catalog for the hobbyist and experimenter. Widely used by leading electronic magazines in their construction articles. Featuring thousands of products at money-saving prices.

Lafayette Radio Electronics
 P.O. Box 10 Dept. 47090
 Syosset, L.I., N.Y. 1191

Send me the FREE 1971 Catalog 710 47090

Name

Address

City State Zip

NEW PRODUCTS *****

write Selectron International Co., Inc., 4215 W. 45th St., Chicago, Ill. 60632.

LIGHTS OFF, EVERYBODY!

No more dead batteries from forgetting to turn off your headlights. Lights Off, from PRS Products Company, is a simple electronic monitor which requires no tools to install. The cigarette-pack size monitor is installed by pushing

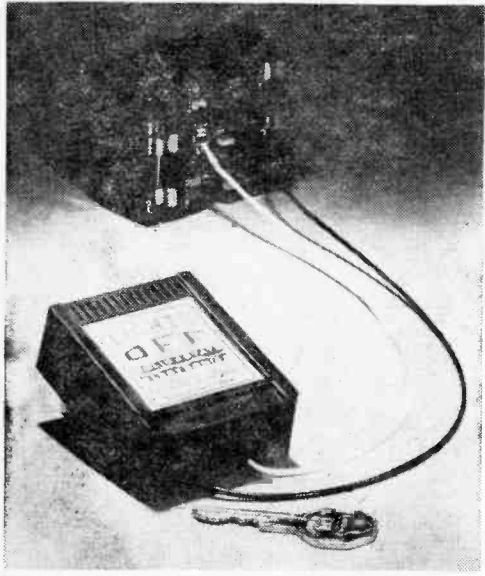

PRS Lights Off Headlight Warning Monitor

two special terminals into the vehicle's fuse-block. The solid-state circuit monitors the lighting system and buzzes when lights are *on* but ignition is *off*. Fits all American car models from 1963 through 1970. With a 30-day warranty, Lights Off sells for \$3.95. Write for a brochure from PRS Products Co., Box 222, Huntington Beach, Calif. 92648.

NO MO' BREADBOARDIN'

Heath Company has just introduced the EU-53A Stack-n-Patch, a technique for circuit design and teaching which is faster and easier than conventional breadboarding. Stack-n-Patch consists of a desk-top chassis, a power patch card,

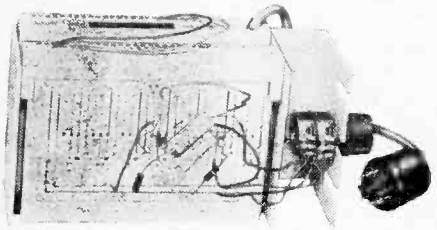

Heath Company Stack-n-Patch

and a component patch card. You pick your choice of power supply and connect it to the power patch card, stack the component and power patch cards in the chassis, and patch components or hookup wire into the component card. The special connectors on the cards make a tight, electrically stable connection just by inserting the wire into the connector. The 177 connectors on the component patch board are arranged according to common circuit board practice. Price of the EU-53A Stack-n-Patch is \$37.50, and Heath says they've a goodly selection of power supplies to use along with it. For details write Heath Co., Dept. 139, Benton Harbor, Mich. 49022.

LOW ON IMPEDANCE

Shure Brothers have a new omnidirectional dynamic microphone, the Vocal Sphere Model 579SB. The state that its uniformly omnidirectional pickup pattern minimizes unnatural voice coloration that occurs when the speaker

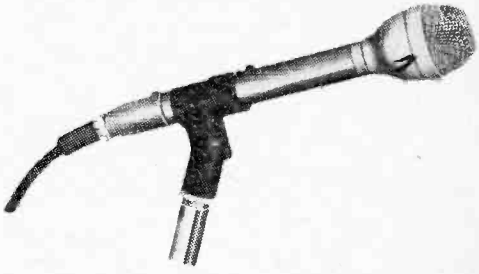

Shure Vocal Sphere Microphone

moves from side to side in front of the mike. Built-in wind and pop filters render the Vocal Sphere useful for intimate, close-up situations. The shock-mounted, isolated cartridge reduces mechanical noises. Price of the Vocal Sphere 579SB is \$75.00. For additional information write Shure Brothers Inc., 222 Hartrey Ave., Evanston, Ill. 60204.

PUT TOGETHER 60 WATTS OF STEREO

Last time out, we reported on the Heathkit AR-29 AM/FM/FM-stereo receiver, which puts out 100 watts. Now for those of you who don't need all those watts, here's the AR-19, a 60-watt job, and naturally it's more moderately priced. The AR-19 features the same advanced FET, IC design as the AR-29. There

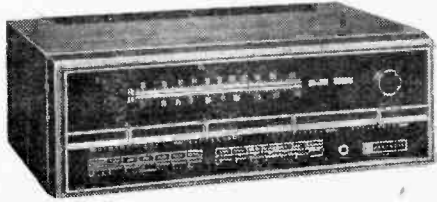

Heathkit AR-19 AM/FM/FM-Stereo Receiver

are five integrated circuits for a total of 57 transistors and 35 diodes. Frequency response is from 6 to 35,000 Hz with less than 0.25% harmonic distortion at any power level (Heath says this is the lowest distortion of any receiver in this power class). For the ease and comfort of the kit builder, all eight circuit boards snap in and out in seconds. This also means that later checking of circuits can be done with a minimum of dismantling. The factory-assembled FM tuner has a 2.0- μ V sensitivity. Unit has necessary output terminals to connect a second pair of stereo speakers for use in another room, or you can connect three speaker systems—right, center (mixed), and left. With Heath's Black Magic panel lighting no dial or scale markings show til the set is turned on. Price of the AR-19 is \$225.00. For more dope, write the Heath Co., Benton Harbor, Mich. 49022.

SOLID SOLID-STATE TEST GEAR

RCA Electronic Components has a new portable all solid-state VOM, the Master Volt-Ohmyst, which can be operated either from internal batteries or from a 117-VAC power line. The Master VoltOhmyst (RCA order number WV-510A) measures DC voltage from 0.01 to 1500 volts, direct current from 0.01 milliamperes to 1.5 amperes, AC voltage from 0.2 to 1500 volts, AC peak-to-peak voltage of complex waveforms from 0.5 to 4200 volts, resistance values from 0.2 ohms to 1000 megohms. Seven overlapping ranges are provided for AC, resistance, and current measurements, and eight ranges are provided for DC voltage measurement. Accuracy for all voltage and current

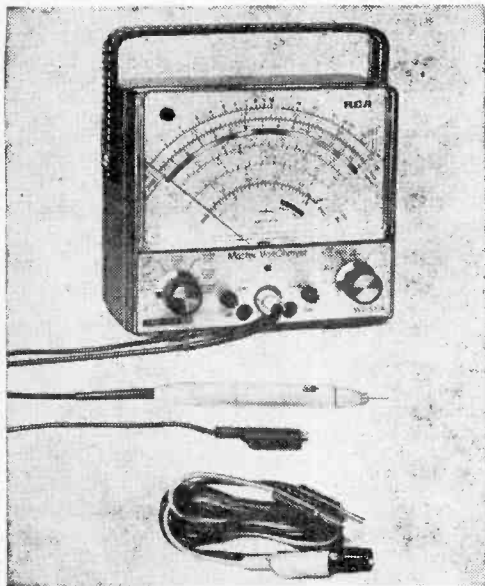

RCA WV-510A Master VoltOhmyst

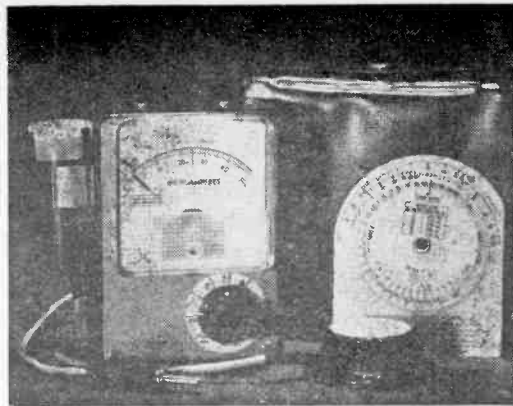

NOW, BETTER THAN EVER the new and improved S&M supersensitive photo meter

Here is a precision instrument that meets the highest standards of any meter available. It offers consistently accurate readings at very low light levels, which, if required, can be converted to ft.-candles from a graph supplied. Researchers, scientists, educators and hobbyists have confirmed that this meter can read light levels as low as 0.000245 ft.-candles.

The S&M Supersensitive Photo Meter uses the newest Clairex Corp. CL-505L Cadmium Sulfide Light Cell to measure light levels from twilight to bright sunlight at ASA speeds of 3 to 25,000. A new $\frac{3}{8}$ " high easel type probe and also a miniature probe are now available as accessories. The Computer included gives F stops from .7 to 90; lists exposure time from 1/15,000 sec. to 8 hrs.; 4 range selection; EV-EVS-LV settings; weighs only 10 ounces.

Used extensively in Photo Labs, Physics and Research Labs, Hospitals, High Schools, Universities and numerous industries. Also used with movie or still cameras, microscopes and telescopes and IS A MUST FOR PHOTOMICROGRAPHY.

FREE BOOKLET included on Photomicrography

\$57.50	\$2.00	Additional Exposure Computer	\$2.00
No. 102—with carrying case and Exposure Computer	carrying case only	Easel Probe	\$7.50

SCIENCE & MECHANICS—INSTRUMENTS DIVISION—Dept. 245, 229 Park Avenue South/New York, N.Y. 10003
Enclosed is \$ Please send me the new S&M Supersensitive Photo Meter. I understand that if I am not completely satisfied, I may return the meter within 10 days for a complete refund.

- No. 102—\$57.50 Carrying case only—\$2.00 Easel Probe \$7.50
 Additional Exposure Computer—\$2.00

Add 10% for Canadian and foreign order. New York City residents add 6% for N.Y.C. sales tax.

Name _____ (PLEASE PRINT)
Address _____
City _____ State _____ Zip Code _____

A Complete Course in ELECTRONIC COMPUTERS for only \$2.95!

You get all the basics you need — at your own pace — whether you're entering the exciting computer field or your work is affected by computers. This giant book has all the latest, step-by-step learning aids; nearly 200 diagrams and circuits; full data on digital and analog computers — covering math background, servomechanisms, digital computer logic, programming, control and communication. PLUS handy glossary, self-review tests, summaries. All at a fraction more than a penny a page!

A Complete Course in ELECTRONICS for only \$1.95!

From fundamental electronic principles and devices right through their application in operating circuits, this famous, bestselling book covers everything — with major sections on electron tubes and transistors, amplifiers, oscillators, radio, TV, radar and electronic navigation, high fidelity, detection systems. With 227 diagrams and circuits — 191 big pages.

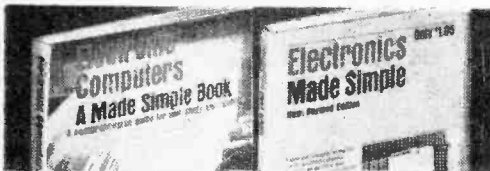

UNCONDITIONALLY GUARANTEED!

Elementary Electronics Book Club
Dept. DE-7
229 Park Avenue South, New York, N.Y. 10003

Please send me ELECTRONIC COMPUTERS @ \$2.95
 ELECTRONICS MADE SIMPLE @ \$1.95

I'm enclosing my check or money order for the price of each book ordered, plus a 15¢ shipping charge. If I wish, I may return the book(s) within two weeks for a prompt refund.

NAME _____

ADDRESS _____

CITY _____ STATE _____ ZIP _____

Offer available in U.S. only.

NEW PRODUCTS *****

functions is $\pm 3\%$ of full-scale reading. Dimensions of the WV-510A, less handle are $6\frac{7}{8} \times 5\frac{1}{4} \times 3\frac{1}{8}$ in.; weight is $3\frac{1}{2}$ lb. Price is \$128.00 and you can get further technical information from Commercial Engineering, RCA Electronic Components, Harrison, N.J. 07029, or from RCA test equipment distributors.

AMBIDEXTROUS SYSTEM

Lafayette's new LSC-888 combines a solid-state stereo modular phono with an 8-track tape system—a happy combo! The LSC-888 brings together a Garrard 4-speed automatic record changer, an 8-track tape system, a 20-watt solid-state amplifier, and a pair of acoustically matched speaker systems. The record changer has tubular tonearm with stereo turnover car-

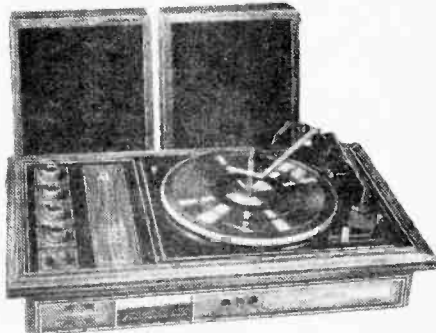

Lafayette LSC-888 Stereo Phono and Tape System

tridge and diamond needle; plus cueing control. The amplifier controls include balance, bass, treble, volume, selector; there's also an automatic shut-off switch, a front panel stereo headphone jack, and an auxiliary input jack for tuner or tape recorder. Speakers are 8 in. There's a tinted plastic dust cover and a 45 rpm spindle. Control unit measures $23\frac{1}{2} \times 4 \times 14$ in.; speakers, $15 \times 10 \times 4\frac{7}{8}$ in. Price of the LSC-888 is \$149.95, and for more specs write to Lafayette Radio Electronics, 111 Jericho Tpke., Syosset, N.Y. 11791.

TUNING FORK WITH ELECTRONIC BRAIN

With the new Schober Electronic Tuning Fork you can tune any musical instrument, except a piano, which requires a process known as "stretching." Fork provides 12 steady tones, middle C through the B above it. Pitch accuracy is within 5 cents (5% of a semitone). A special knob sets the scale a $A=440$ but permits resetting to anything between about 435 and 445. The tones have harmonics, making the zero-beat tuning technique easier and permitting the fork to be used directly to tune instruments in higher and lower octaves. Housed in a strong wooden case, $5\frac{1}{2} \times 7 \times 3$ in., it operates on two 9-volt transistor radio batteries and has its own built-in speaker. A volt-

(Continued on page 14)

THE AMAZING WORLD OF SOUND

ASTRO-COM TELEPHONE-AMPLIFIER

Transforms any ordinary telephone earpiece into a unique sound-control amplifier! It's a space-age electronic concept that assures the maximum in hearing range and comfort... attaches instantly and securely to any phone with a simple, snug-fitting band. Carry it in your pocket... or in purse, it's that portable! Especially suited for high-noise factory and office areas. And, it's a low-cost practical answer to public phone distractions. What's more, the hard-of-hearing, and elderly folks find it a definite aid, while guaranteeing privacy!

Precision-built for reliable performance, the ASTRO-COM amplifies any normal speaking voice up to five times. Complete with easily adjustable fingertip touch volume control.



Amplification: More Specification than 30db
Circuitry: 4 transistors
Case: High Impact Polystyrene
Battery: For best results, use Saxton #B-103 battery or equivalent. Battery life expectancy—25 hours.

only \$995
(less battery)

"SKY-SPY" NOW!! Add A New Dimension To Listening... Up!

Complete SKY-SPY only! \$1695
(less batteries)



Amazing... excitingly new! "SKY-SPY" allows reception from planes within a range of 75 miles; even permits reception from the aircraft tower itself within a 15 mile range.

Hear how aircraft are instructed to land, weather conditions, delays in launchings, etc....

This unique device uses 1.52 hearing aid batteries... giving it a 65 hour life span.

ASTRO-COM WRIST RADIO Transmitter

- Broadcasts your voice to any FM receiver within 50 feet in any direction.
- No wires! Powerful tiny silver oxide battery good for hours of broadcasting!
- Great for party fun; kids' games; keeps you in touch with playroom, bedroom, or sick room.
- Complete with replaceable silver oxide battery, nylon strap, rugged case, "whip" antenna, and tuning device.
- Electronic components designed by Saxton first in miniature electronic equipment.

SPECIFICATIONS: Frequency Response: 300 to 6,000 Hz.; POWER: 5 MW input; RANGE: Up to 50 feet, depending upon conditions; Frequency: FM broadcast band, (tunable ± 3 megacycles through 88 megacycles); Audio Sensitivity: Normal voice at approximately 10 feet; Case: High impact polystyrene-electronics encapsulated in epoxy; Weight: 4 ozs.

SPECIAL INTRODUCTORY PRICE ONLY \$1400

THE BIG EAR

"HOMES IN" on faint sounds up to 100 feet away... twice as far over water.

Exclusive cordless Broadcast Accessory also available—increases sensibility tenfold.

- USE INDOORS OR OUTDOORS— from baby sitting to bird watching.
- ENTERTAINING, PRACTICAL AND INSTRUCTIONAL for young and old.
- THE LATEST IMPALID STATE CIRCUITRY.
- PROTECTIVE DEVICES to listen for intruders at night.

The "BIG EAR" is an amazing electronic device which is completely portable. Basically it combines the principle of a parabolic microphone, a high gain amplification system and stethoscope earphone for intimate listening.

The "BIG EAR" comes complete with its own sturdy adjustable tripod base for convenient use anywhere... operates for hours on standard 9 volt-transistor battery.

Complete with Stethoscope \$1995 earphones ONLY (less batteries)

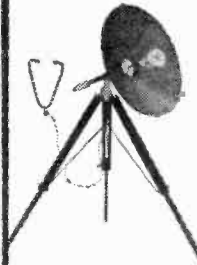

BIG EAR BROADCAST ACCESSORY

Plug in our exclusive cordless Broadcast Accessory and convert Big-Ear into a group entertainment listening device. The "Big-Ear Broadcaster" let you broadcast sound to any FM receiver up to 30 feet away. With it you hear everything, without connecting wires with 30 times amplification.

Stay indoors and listen to bird calls and animal sounds. Place it in a baby's room or near the baby carriage or use it as a sick room monitor.



BROADCASTER COMPLETE ONLY \$1495 (less batteries)

EYEGGLASS RADIO

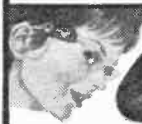

Clips to your glasses, receives the whole AM broadcast band, can be used wherever you go 'cause it weighs a few ounces. Comes with ear-phone plug for privacy, convenient on-off and tuning knobs. Includes 1.5v. hearing aid batteries for many long hours of listening pleasure.

only \$1595

D & D SALES CO. DEPT. WS-9

60 E. 42nd Street
New York, N.Y. 10017

Please send me the following items on a full money back GUARANTEE, if I'm not completely satisfied.
I enclose my check (or money order) for \$_____

ITEM	NUMBER OF UNITS	UNIT PRICE	TOTAL PRICE
BIG EAR		\$19.95	\$
BROADCASTER		14.95	
PHONE AMPLIFIER		9.95	
SKY-SPY		16.95	
WRIST RADIO		14.00	
EYE GLASS RADIO		15.95	

Plus Postage & Handling 1.50 Per unit

New York State Residents add appropriate tax

TOTAL AMOUNT ENCLOSED

NEW PRODUCTS *****

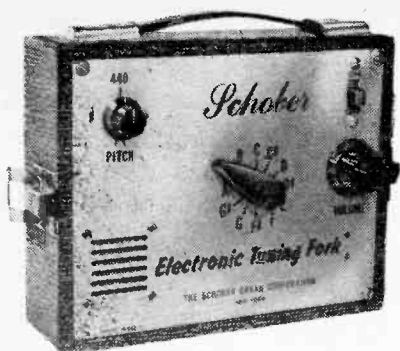

Schober Electronic Tuning Fork
 age regulator maintains pitch accuracy during the entire life of the batteries—about 18 hours continuous operation and several times that in normal use. The fork is factory-calibrated for pitch accuracy; price is \$49.95. For detailed descriptive sheet write The Schober Organ Corp., 43 W. 61st St., New York, N.Y. 10023.

8-TRACK OR 4? BE ADAPTABLE!

Panasonic adds another item to its line of car stereo accessories by introducing a cassette adaptor pack which allows you to play a 4-track stereo cassette in any Panasonic 8-track tape player. Designed specifically for the car, it fits into an 8-track tape player like an ordinary stereo cartridge and plays cassette tapes

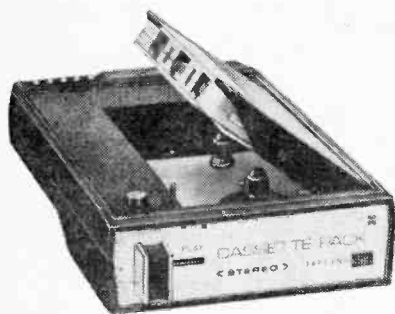

Panasonic CJ-980 Cassette Adapter Pack

instantly. A panel light automatically switches on to signal the end of a tape. The cassette adaptor pack, Model CJ-980, comes with a leatherette carrying case and polishing cloth, and is priced at \$39.95. For more details write Panasonic, 200 Park Ave., New York, N.Y. 10017.

SLAM-BANG HAM BAND BOX

Allied has a new, moderately-priced 80- to 10-Meter ham band receiver that, they say, not only has highly satisfactory performance, but, also, clean, attractive styling that will please your XYL. Model A-2516 features a deluxe filter for highly selective AM, CW, and SSB

reception on all ham bands between 3.5 and 29.7 MHz. This includes 80, 40, 20, 15, and 10 Meters, as well as the WWV signal on 10 MHz. Unit has a crystal-controlled first local

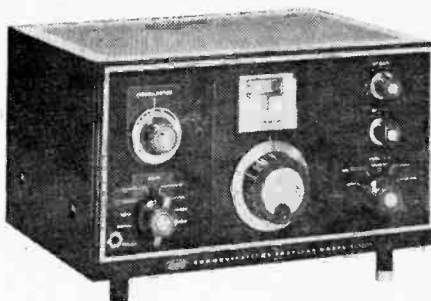

Allied A-2516 Ham Receiver
 oscillator and a solid-state VFO-type second oscillator with negligible frequency drift. The VFO circuit has output terminals for use as a transmitter VFO. The mechanical IF filter provides a 1.5-kHz bandwidth at 6 dB down, 6 kHz at 60 dB down. Sensitivity is 1.5 μ V for 10 dB signal-to-noise ratio at 14 MHz. Image ratio and IF rejection are better than 40 dB at 14 MHz. Price is \$169.95 and for more specs you can write to Allied Radio Corp., 100 N. Western Ave., Chicago, Ill. 60680.

CARRY-O THE STEREO

Heathkit has a new portable stereo phonograph, the GD-109. It has 18 watts output, a deluxe record changer, and full-range speakers. Each 4½-in. speaker can be lifted off the changer cabinet and placed up to 5 ft away. The 9-watt per channel solid-state amplifier is combined with a preassembled, 4-speed automatic record changer—a Maestro—which tilts

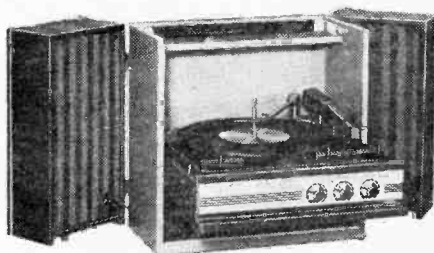

Heathkit GD-109 Portable Stereo Phonograph

up and locks for portability. The GD-109 features a ceramic stereo cartridge having 30 dB separation; diamond stylus pressure is a low 3½ grams. Controls include volume, tone, and balance, and there's a 45-rpm adapter. Cabinet is wood with plastic-coated covering and the price is \$74.95. For additional information, write the Heath Co., Benton Harbor, Mich. 49022.

Repairing or refinishing any kind of furniture ?

1. You need *The Furniture Doctor* — George Grotz's famous, encyclopedic compendium of practical information . . . with easy-to-follow directions and tricks of the trade that use commonly available materials . . . all presented with more than 90 illustrations and the author's usual hilarious anecdotes in the Yankee manner! Hardcover, \$5.95



32 easy ways to get out of refinishing ?

4. You'll find them in *Decorating Furniture with a Little Bit of Class*, together with some cheap ways to furnish an apartment in a hurry out of a Goodwill store, a Salvation Army emporium, or a St. Vincent de Paul Society; faking techniques; lazy man's tricks of the trade; and some extra stuff thrown in. \$1.95



Want to refinish the quick and easy way ?

2. *Instant Furniture Refinishing and Other Crafty Practices* is for you. It's newer and bigger than Grotz's own *From Gunk to Glow* — with professional trade "recipes" organized for amateur craftsmen, including how to get a "new look" without refinishing; how to remove paint cheaply and easily; how to "antique." \$1.95



Looking for antiques in the middle-price-range ?

5. *Antiques You Can Decorate With* is the Furniture Doctor's own practical, Yankee-shrewd guide to what they are, where to find them, how much to pay for them, how to refinish, and how to avoid fakes. With 400 drawings that cover the whole gamut of old pieces, from beds to wall things. Hardcover, \$4.95



Staining, shellacking, varnishing or waxing ?

3. Using bleach, linseed, lemon oil, or polish? Grotz's *Staining and Finishing Unfinished Furniture and Other Naked Woods* is the one eye-opening, pioneering manual that tells the truth about using them all — which to use, when, how to prepare surfaces, and how always to get that expensive, quality, finished look. \$1.95



In the market for Victorian furniture ?

6. *The New Antiques: Knowing and Buying Victorian Furniture* is the one, up-to-date, illustrated guide that will help you identify, appraise, and refinish American Victorian furniture. Covers Gothic, Renaissance, Art Nouveau, all other important styles. Includes up-to-date Price Guide on all pieces. Hardcover, \$5.95



THE FURNITURE DOCTOR HAS THE ANSWERS!



Molly Malone Cook

— — — MONEY-BACK GUARANTEE! — — —

Science & Mechanics Book Club
Dept. D1-107
229 Park Avenue South, N.Y., N.Y. 10003

Please send me the books by George Grotz, the Furniture Doctor, checked below. I'm enclosing my check or money order for the price of the books (plus 25¢ shipping charge if my order totals less than \$4.95). I understand I may return book(s) ordered within two weeks for a full refund if not completely satisfied.

1. (\$5.95) 2. (\$1.95) 3. (\$1.95)
 4. (\$1.95) 5. (\$4.95) 6. (\$5.95)

NAME.....

ADDRESS.....

CITY..... STATE..... ZIP.....
Offer available in U.S. only.

NEW PRODUCTS *****

VEHICULAR VANE

Avanti has three new tunable antennas for vehicular applications, featuring base-loaded and ruggedized construction. Model numbers apply as follows: SS-27, 27 to 33 MHz; SS-34, 34 to 40 MHz; SS-45, 40 to 50 MHz. All three have taper ground stainless steel whips and can be tuned to exact frequency. Loading coil is finned to aid heat dissipation and potted in epoxy for water proofing. Nominal impedance is



Avanti SS Series Mobile Antenna

50 ohms; power handling, 100+ watts. The antennas come with their own integral mounts, 20 ft of RG-58/U cable, and PL259 connectors, and are guaranteed for one year. Components are heavy chrome-plated brass and are compatible with the new Avanti no-hole trunk lip base. Price of any of the models is \$21.25. For more information write to Avanti Research & Development, Inc., 33-35 W. Fullerton Ave., Addison, Ill. 60101.

TWO CAN LISTEN AS CHEAPLY AS ONE

This new device from Robins Industries, called Twinfone, lets two persons in on a phone call. It has no moving parts and requires no electricity. One end of Twinfone slips over the earpiece, while a length of tubing carries the sound to another earpiece. What you have is the convenience of an extension phone without the expense of a second telephone instrument. A

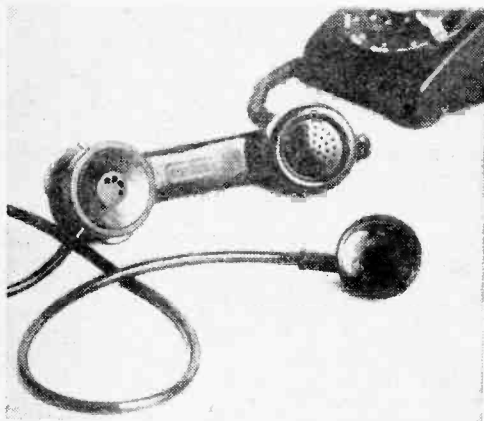

Robins Twinfone

business associate can join in a call, a secretary can listen to take notes, or, both parents can chat simultaneously with a child away from home. Twinfone also helps the hard-of-hearing by amplifying the sound when the extra earpiece is held to the other ear. Twinfone is priced at \$4.98, and you can get more dope

from Robins Industries Corp., 15-58 127th St., College Point, N.Y. 11356.

CORDLESS BRILLIANCE

Campers, boaters, outdoor lovers, patio partyers, and just plain folk who have a power failure now and then will welcome the Porta Lite from Marathon Battery. Attractively styled, it's powered by a 6-volt No. 896 Marathon battery, molded from polyethylene in green or blue, and its No. 1651 bulb provides up to 100 hours of intermittent light. The shade can be moved up or down and there's a hang-up loop. Price is \$10.99 and for complete information contact Marathon Battery Co., Box 1246, Wausau, Wis. 54401.

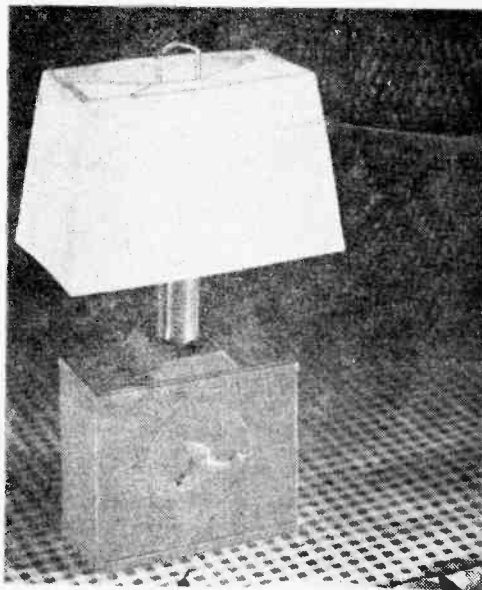

Marathon Battery Porta Lite

QUICK-MOUNT FLUSH SPEAKER

Those Poly-Planar people have come out with a new quick-mount speaker/grille assembly, model G51P. It's designed to permit customized surface or flush mounting with a minimum of effort by means of newly engineered mounting brackets and grille. The G51P requires only 7/8-in. mounting depth—great for custom-mounting in walls, ceilings, furniture, doors, under eaves. With its new brackets, no cutout of the mounting surface is required, and the brackets form a natural sound chamber. Unit can be mounted in a few minutes. The Poly-Planar G51P has a power handling capacity of 5 watts, frequency range of 60 Hz to 20 kHz and input impedance of 8 ohms. Size of grille is 6 x 10 in., it comes in ivory, walnut, and black, and sells for under \$11.00.

(Continued on page 112)

LITERATURE LIBRARY



1. *Allied's* catalog is so widely used as a reference book that it's regarded as a standard. The surprising thing is that it's free!
2. Now, get the all-new 512-page, fully illustrated Lafayette Radio 1970 catalog for CB gear, test equipment, ham gear, tools, books, hi-fi components, etc.
3. Get all the facts on *Progressive Edu-Kits Home Radio Course*. Build 20 radios and electronic circuits; parts, tools and instructions included.
4. *Olson's* catalog is a multi-colored newspaper that's packed with more bargains than a phone book has names.
5. *Edmund Scientific's* new catalog contains over 4000 products that embrace many interests and fields.
6. Bargains galore, that's what's in store! *Poly-Paks Co.* will send you their latest 8-page flyer.
7. Before you build from scratch, check the *Fair Radio Safes* latest catalog for surplus gear.
8. Get it now! *John Meshna, Jr.'s* new 96-page catalog is jam packed with surplus buys.
9. Troubleshooting without test gear? Get with it—let *Accurate Instrument* clue you in on some great buys.
10. *Burstein-Applebee* offers a new giant catalog containing 100s of big pages crammed with savings.
11. Now available from *EDI (Electronic Distributors, Inc.)*: a catalog containing hundreds of electronic items.
12. *C. B. Hanson's* new Automatic Control records both sides of a telephone call automatically.
13. Discover how to drive nuts and screws, ream, scribe, pierce holes with *Xcelite's* Series 99 handles and interchangeable blades.
15. *Custom Alarms* reveals how inexpensive professional alarms can really be. Circle 15 for exclusive catalog.
18. Here's a free 20-page booklet that tells you how to improve your TV pic and a do-it-yourself approach to installing a *Master Antenna TV (MATV)* system. *Mosley Electronics* will wing it your way.
19. *RCA Experimenter's Kits* for hobbyists, hams, technicians and students are the answer for successful and enjoyable projects.
20. Get your copy of *E. F. Johnson's* new booklet, "Can Johnson 2-way Radio Help Me?"
22. Kit builder? Like wired products? *EICO's* 1970 catalog takes care of both breeds of buyers.
23. No electronics bargain hunter should be caught without the 1970 copy of *Radio Shack's* catalog.
26. Get with 1970's hi-fi jet set. *H. H. Scott* sets the pace with their fantastic line of audio components, some in kit form too!
42. *Heath's* new 1970 full-color catalog is a shopper's dream. Its 116 pages are chuck full of gadgets and goodies everyone would want to own.
45. CBers, Hams, SWLs—get your copy of *World Radio Labs' 1970* catalog. Circle 45 now!
48. *Hy-Gain's* new CB antenna catalog is packed full of useful information. Get a copy.
74. Get two free books—"How to Get a Commercial FCC License" and "How to Succeed in Electronics"—from *Cleveland Institute of Electronics*.
100. You can get increased CB range and clarity using *B&K's* hot "Cobra" transceivers.
107. Want a deluxe CB base station? Then get the specs on *Tram's* super CB rigs.
111. Get the scoop on *Versa-Tronics' Versa-Tenna* with instant magnetic mounting.
114. Prepare for tomorrow by studying at home with *Technical Training International*. Get the facts on how you can step up in your present job.
116. Pep-up your CB rig's performance with *Turner's M+2* mobile microphone.
127. *National Schools* will help you learn all about color TV as you assemble their 25-in. color TV kit.
130. Bone up on CB with the latest *Sams* books. Titles range from "ABC's of CB Radio" to "99 Ways to Improve your CB Radio."
136. You can become an electrical engineer *only* if you take the first step. Let *ICS* send you their free illustrated catalog describing 17 special programs.
137. For success in communications, broadcasting and electronics get *First Class FCC* license. *Grantham School of Electronics* will show you how.
140. Take a gander at *Cornell Electronics' latest* catalog. It's packed with bargains like 6W4, 12AX7, 5U4, etc., tubes for only 33¢.
141. CB antenna catalog by *Antenna Specialists* makes the pickin' easy.

ELECTRONICS HOBBYIST

Dept. 970A

229 Park Avenue South

New York, N.Y. 10003

Please arrange to have this literature whose numbers I have circled at right sent to me as soon as possible. I am enclosing 25¢ to cover handling. (No stamps, please.)



1	2	3	4	5	6	7	8	9	10
11	12	13	15	18	19	20	22	23	26
42	45	48	74	100	107	111	114	116	127
130	136	137	140	141					

Indicate total number of booklets requested
Sorry, only 20 circled items maximum.

NAME _____

ADDRESS _____

CITY _____

STATE _____ ZIP _____

As the Wife sees it

By Jack Schmidt

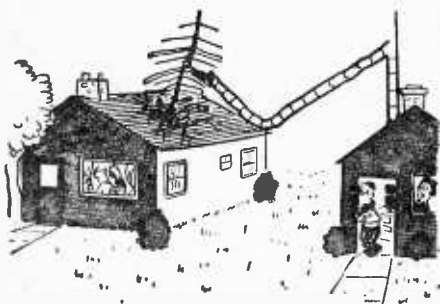

"Don't make a big thing of it—just go over and tell them you want your antenna back!"



"Well, Marconi, there goes the hard cash you saved by wiring it yourself!"

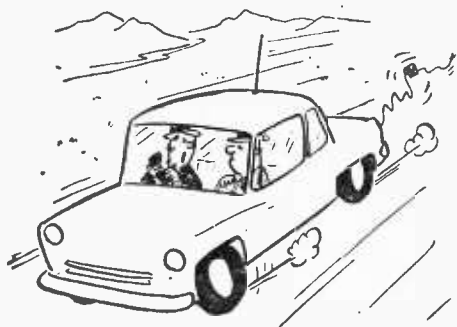

"It's your wife . . . she says you forgot to disconnect the battery charger this morning!"



"I hate to disturb him, Albert, he's doing a very important bench test!"



"Special Delivery for a Mr. KMD4313."



"Fred, the man is here to fix the color TV!"

TREASURE WITCHER

If these headphones give you a buzz, dig where you hear the tone unless you think the ground is bewitched

by Charles D. Rakes

HUNTING treasure or water pipes? Then you must, without delay, build our TREASURE WITCHER. With this super-sensitive solid-state instrument you'll greatly improve your odds of finding that long-forgotten treasure that could be only a few feet below the earth's surface. But, you say, why build the WITCHER?

Simple. With the TREASURE WITCHER you'll be able to locate large metal objects at greater depths than with a metal locator of the beat-frequency type. A large metal chest or a wooden box filled with metal—gold coins, say—will easily be detected several feet beyond the range of beat-frequency type units. Dig knowing where to dig? If so, read on and learn how you can duplicate this handy treasure finder.

Theory of Operation. No magic, but only simple facts are all you'll need to



TREASURE WITCHER

explain the operation of this sensitive metal locator. Two separate units are required in its makeup: a simple transmitter and a receiver, both of which use a loop coil in their tuned circuit. The loop coil also functions as a highly directional antenna.

When the two loop antennas are at right angles to each other, the signal coupled from the transmitter to the receiver is at a minimum and the meter will read zero. But bring a metal object within range of the WITCHER and the transmitted RF field will be distorted. Result is a small amount of RF energy will be reflected to the receiver loop. Picked up and amplified, it will be detected and indicated by the meter and heard on the earphones.

Transmitter Operation. As shown in Fig. 1, transistor Q1 and its associated components, L1, C1, C2, C3, R1, R2, and R3 form an oscillator. The operating frequency, which is in the RF range, is determined by the loop and the three capacitors. The three resistors are used to set the operating bias and output level of the oscillator.

Unijunction transistor Q2 operates as a relaxation oscillator and produces a low-frequency audio tone. This audio signal is coupled to the base of Q1 through C4 and modulates the RF oscillator (Q1). The modulated signal can then be received by a conventional receiver circuit, that extracts the signal that tells where the treasure is.

Receiver Operation. The receiver circuit (Fig. 2) is designed around a very high-gain, linear IC (integrated circuit) that contains three separate high-gain amplifiers, which, when connected in a cascade amplifier configuration, realize a gain of 129 dB.

The first IC amplifier stage is connected together with the tuned circuit as an RF amplifier, which is used to increase the minute signal available at the receiver's loop antenna to a level that can be demodulated into a useful audio signal. The network composed of D2, C7, and R3 performs the demodulation. The demodulated signal appears across gain control potentiometer R3 and is directed to the second amplifier stage through the pot's wiper. This audio signal is once more amplified by the remaining IC amplifier stage. The output is directed to the meter circuit and supplies an audio tone for the earphones, which plug into jack J1.

PARTS LIST FOR TRANSMITTER

- | | |
|--|---|
| B1—9-V transistor battery (Eveready 216 BP or equiv.) | R3—1000-ohm, ½-watt resistor |
| C1—50-pF to 380-pF midget trimmer (Lafayette 34E68337 or equiv.) | R4—180-ohm, ½-watt resistor |
| C2—3300-pF mica capacitor | R5—47,000-ohm, ½-watt resistor |
| C3—10,000-pF mica capacitor | S1—Spst miniature toggle switch (Lafayette 99E61624 or equiv.) |
| C4, C5—0.1-µF, 200-V tubular capacitor | 1—6 ¹ / ₁₆ x 5 ⁵ / ₃₂ x 2 ⁵ / ₁₆ -in. plastic case (Allied 42A7886 or equiv.) |
| L1—34 turns of #22 enamel wire closewound outside of case | 1—6½ x 5-in. cover (Allied 42A7888 or equiv.) |
| Q1—2N2924 transistor (GE) | 1—2 ⁷ / ₈ x 7 ⁸ / ₁₆ -in. perfboard |
| Q2—2N2646 unijunction transistor (Motorola) | 1—48-in. aluminum conduit |
| R1—150,000-ohm, ½-watt resistor | 1—Battery holder (Keystone 203P or equiv.) |
| R2—39,000-ohm, ½-watt resistor | Misc.—Hex spacers, hardware, wing nut, spring, solder, hookup wire, etc. |

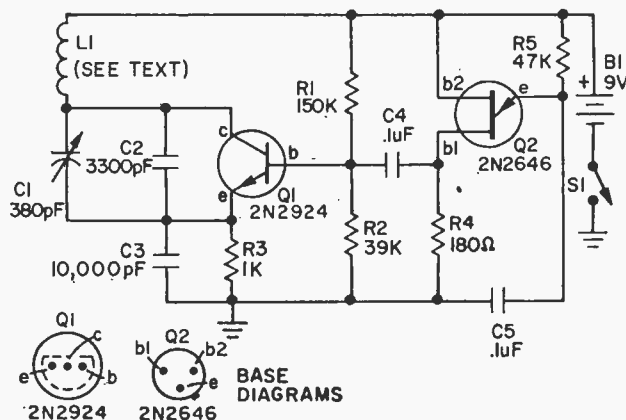

Fig. 1. Transmitter schematic details separate unijunction relaxation oscillator modulating npn transistor RF oscillator to produce the tracer's search signal.

TREASURE WITCHER

as illustrated in our photos.

Transmitter Checkout. The transmitter can be checked to determine if both of the oscillators are working by turning it *on* near an AM broadcast radio and tuning the radio until you pick up a signal with a steady audio tone. The tone will sound like a high-speed buzz saw and will be easily recognized.

Receiver construction can follow the same basic steps as those for the transmitter, except that all circuit parts are located on

Fig. 5A. Photo right shows how transmitter parts are arranged within housing. Note that all components except battery are on perf-board.

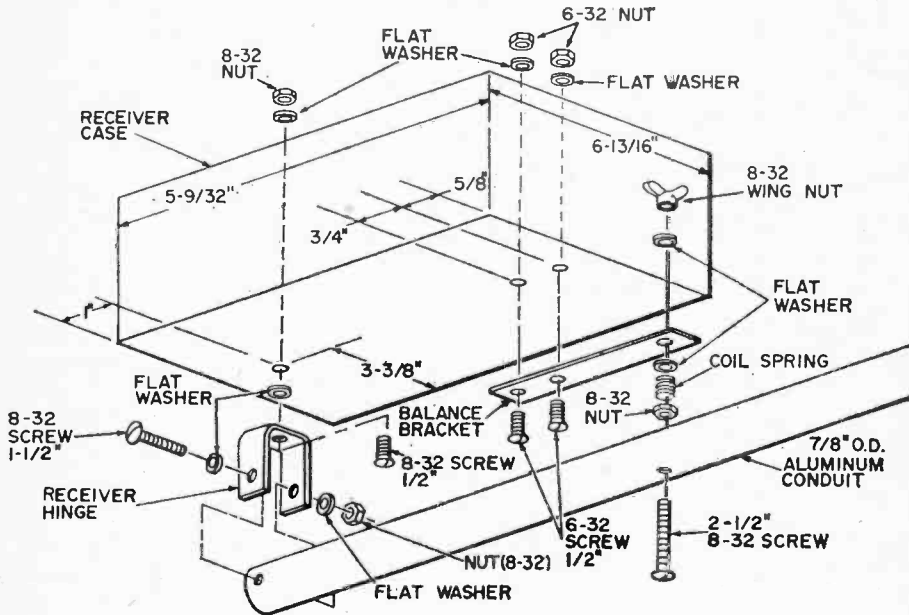
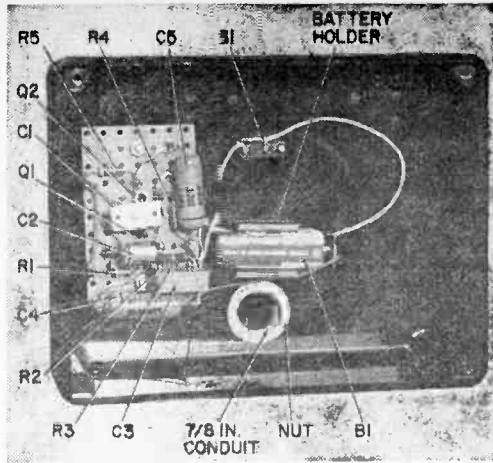

the cover instead of the case. Construction is done in this manner for ease of wiring and to take advantage of the structural strength of the case in mounting the receiver to the aluminum conduit.

The receiver will function best if construction matches our model (see Fig. 5). The metal case of the gain control (R3) must be connected to the negative circuit. This can be done by soldering a wire to the control's case and to the circuit ground. As for the loop coil, it should be wound to match the transmitter loop exactly (see

Fig. 5B. Photo right details receiver layout on box lid. Two contact connector used to separate receiver from loop for servicing.

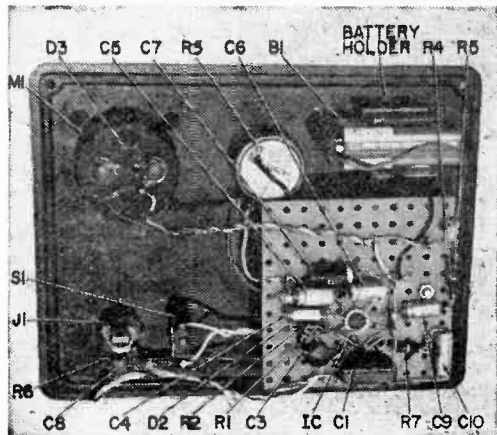

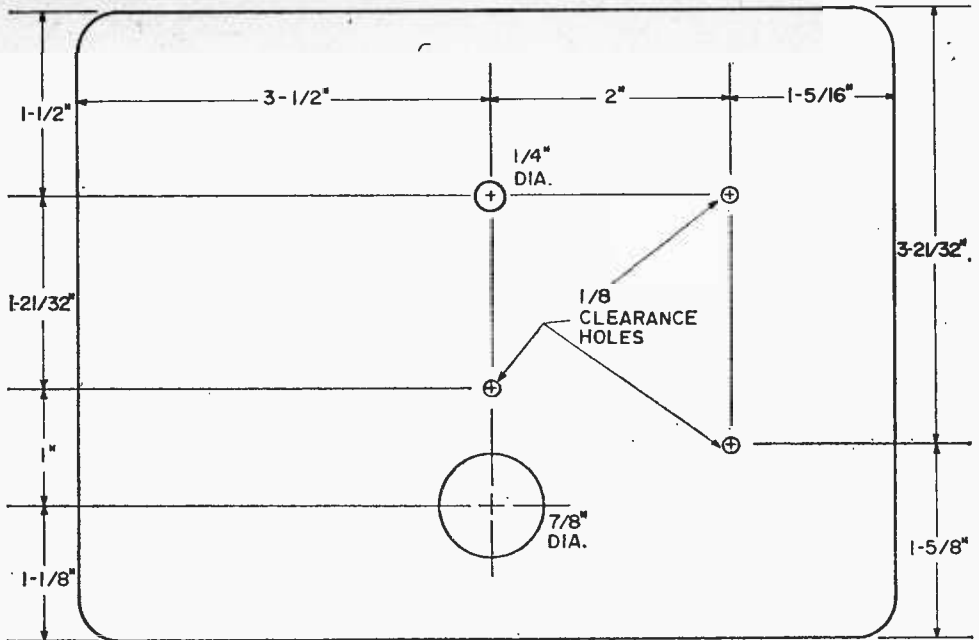
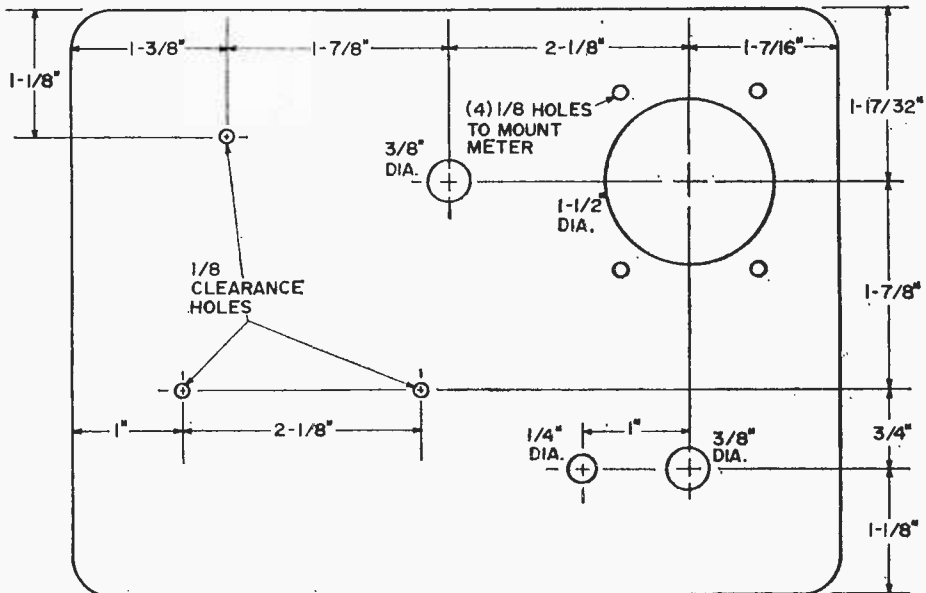

Fig. 3 (above) information for drilling the box to house the transmitter circuit card battery and power switch. Card is raised above bottom by extra nuts on mounting bolts. Complete receiver is mounted on its box cover. Drilling details are shown below. Opposite page (center), Fig. 6 details drilling and mounting details for receiver. Note hinged mount for receiver box. This allows receiver loop to be oriented to null the receiver before starting search.

Fig. 4). A plug and socket are used in the receiver to link the circuit to the loop antenna.

After the receiver has been completed, it's necessary to tune the transmitter to the receiver tuned frequency. To do this, first turn the two units *on* and place them several feet apart. Next, slowly tune transmitter trimmer capacitor C1 until the receiver's meter indicates a maximum current. If for any reason the transmitter will not tune to



TREASURE WITCHER

Fig. 4. Drill both transmitter and receiver boxes as shown for loop leads. Wrap coils with tape for support and protection.

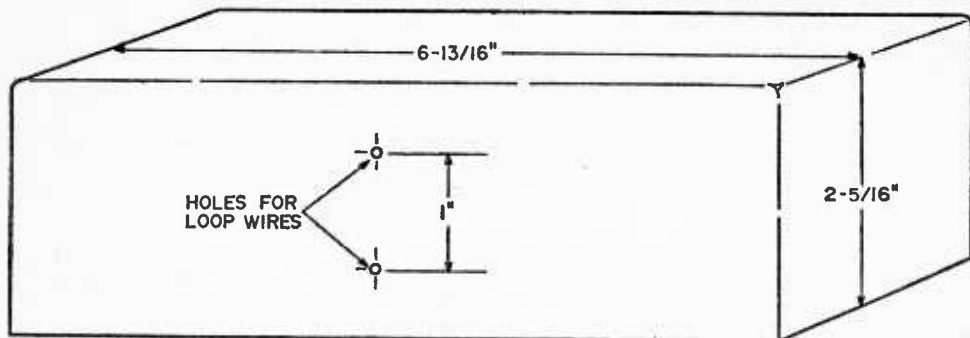

the receiver frequency, then try smaller or larger values for C2. After making a capacitor change carefully re-tune the trimmer until a maximum meter reading is obtained. With the units properly tuned the receiver should be capable of receiving the transmitter at a distance of at least 25 ft.

The WITCHER, when properly tuned, will be operating near 180kHz, but the frequency can vary by as much as 20 kHz without affecting the overall performance of the locator.

Final Assembly. The transmitter case is held on to the aluminum conduit with two nuts. As shown in our photo, the conduit goes through the case. The nuts are home-made and can be fabricated by taking a coupling (threaded to fit conduit) and cutting it into two parts. The two nuts must be filed flat so that an equal bearing surface will support the case without causing breakage.

The receiver case is connected to the balance bracket with two 6-32 screws and

matching nuts (see Figs. 6 and 7). The receiver hinge is mounted to the opposite side of the case with an 8-32 screw and nut. The receiver is then hinged to the aluminum conduit with a 1/2-in. 8-32 screw, two flat washers, and a nut. This screw, washer, and nut combination should be tight but with enough play to allow the balance adjustment to be made smoothly.

A 2 1/2-in. 8-32 screw is bolted to the aluminum conduit below the balance bracket and held in place with a washer and nut. A coil spring and flat washer separates the conduit and balance bracket. On top of the bracket is a flat washer and a wing nut which function as a balance adjustment. The handle (see Fig. 7) is made of conduit and should be shaped to match our photos and drawings. A 2 3/4-in. 8-32 screw, washer, and nut mount the handle to the conduit.

Putting It to Work. Turn both units on and set the receiver gain control to mid-position. (Continued on page 116)

Fig. 7. Dimensions and drilling information for aluminum conduit main support bar, handle and hinge parts for receiver.

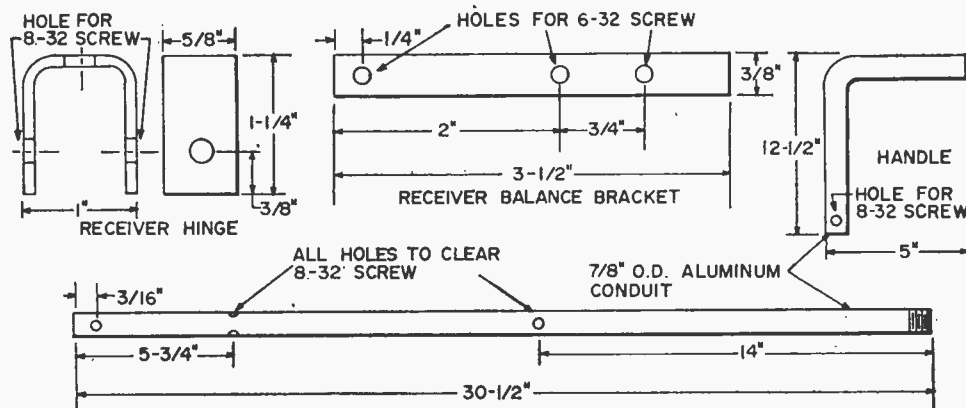



magnetic BEAM BALANCE

by Thomas R. Sear WA6HOR

***How much does
the wing of that fly
in the window weigh?***

How many times have you wondered about that statement that the lowly ant can tote a load more than twenty times greater than his own weight? And, still on that theme, just how much does an ant weigh? Or, as a matter of interest, how does one go about weighing an ant without having to invest a lot of hard-earned cash in a delicate chemical balance? If not the ant, perhaps you have been curious about the weight of a fly's wing, or the weight of one whisker from your new mustache, or, for that matter, any number of things that, for most practical purposes, are so

Magnetic Beam Balance

infinitesimally light in weight that they simply can't be weighed on standard scales.

What is needed to weigh items with such small mass is a very expensive, very sensitive and delicate laboratory beam balance. However, sensitive electrical meters and reliable current sources are relatively low in cost and within easy reach of the average experi-

menter. And, with just a little mechanical dexterity and ingenuity, you can produce an ultra-sensitive device to meet your needs for weighing extremely lightweight objects at a modest cost.

How It Weighs. Our Magnetic Beam Balance or MBB, though quite sensitive, is really a very simple device. If you're familiar with the conventional moving-coil meter movement, you know that its pointer is deflected in direct proportion to the amount of current flowing through its mov-

PARTS LIST FOR MBB

- C1—100- μ F, 15-VDC electrolytic capacitor (Allied 46A6633 or equiv.)
- D1—200-PIV, 750-mA silicon rectifier (Allied 24A9692 or equiv.)
- F1—Panel-mounting fuse holder (Allied 57A-3001 or equiv.) with type 3AG, 1/4-A, 250-V fuse (Allied 57A3111 or equiv.)
- I1—Panel mounting pilot lamp assembly (Allied 60A7781 or equiv.) with 12-V, bayonet base lamp (Allied 60A7361 or equiv.)
- M1—0-100- μ A, DC meter (Allied 52E8197 or equiv.—see text.)
- M2—0-50- μ A, DC meter (Lafayette 99E50429 or equiv.)
- R1—10-ohm, 1/2-watt resistor
- R2—22,000-ohm, 1/2-watt resistor
- R3—2700-ohm, 1/2-watt resistor
- R4—1000-ohm, 1/2-watt resistor
- R5, R7, R8—180-ohm, 1/2-watt resistor
- R6—100-ohm, 1/2-watt resistor
- R9—1000-ohm, 2-watt potentiometer, linear

- taper (Lafayette 30E80082 or equiv.)
- R10—10,000-ohm, 2-watt potentiometer, linear taper (Lafayette 30E80140 or equiv.)
- R11—50,000-ohm, 2-watt potentiometer, linear taper (Lafayette 30E80181 or equiv.)
- R12, R13—50,000-ohm, 2-watt potentiometer, linear taper (Lafayette 30E80249 or equiv.)
- S1—5-posit toggle switch (Lafayette 34E33026 or equiv.)
- S2—3-pole, 4-position rotary switch (Lafayette 30E40185 or equiv.)
- T1—Filament transformer: primary 117-V, 50-60-Hz; secondary 12.6-V @ 1.5-A (Allied 54A4136 or equiv.)
- 1—8 x 12 x 3-in. aluminum chassis (Lafayette 12E82128 or equiv.)
- 1—8 x 12-in. aluminum chassis base (Lafayette 12E83050 or equiv.)
- Misc.—Hookup wire, hardware, solder, knob, rubber feet, etc.

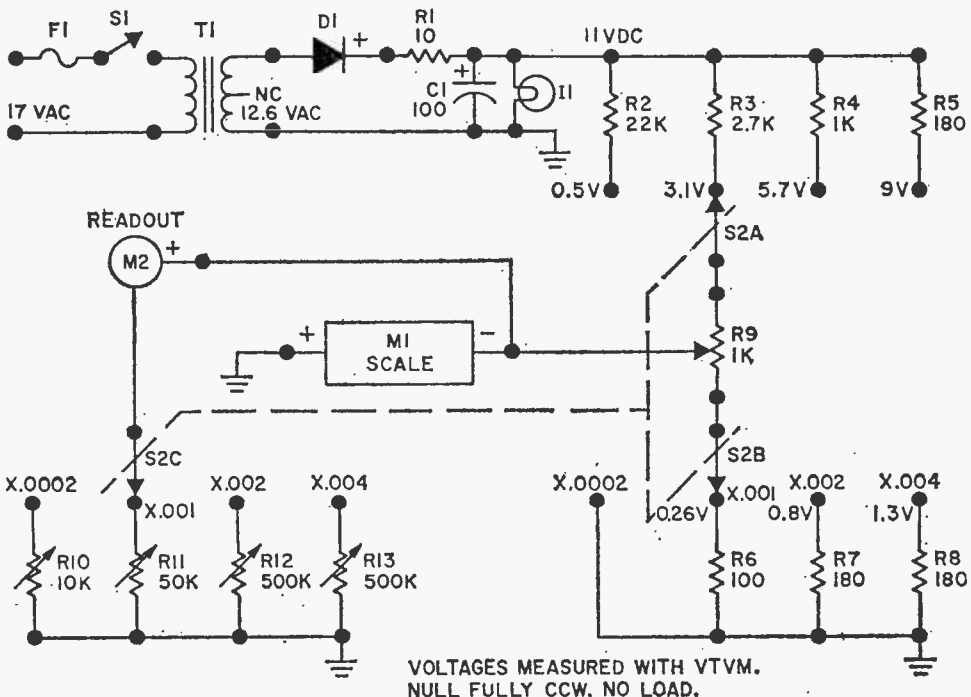

ing coil, which is attached to the pointer. The coil is suspended in a fixed magnetic field and is mounted on jeweled pivot bearings to reduce friction to a minimum. Except for the pull of the hair-spring, used to return the pointer-and-coil assembly to an established zero point when no current is flowing, this assembly has very little mass. As a result, it's easily deflected from the zero position by small increments of current flowing through the coil.

What we have done is to mount a moving-coil meter movement (M1) 90 deg. off its normal mounting axis so that the pointer is in a horizontal rather than the normal vertical position. The tip of the pointer has been modified so that it can serve as a platform on which the object to be weighed can be placed. In addition, we added limit pins to restrict movement of the pointer over a narrow range after first mechanically adjusting the normal zero-rest position to mid scale. An arbitrary true zero is established by placing a mark on the meter face plate that is midway between these two limit pins.

This meter movement is wired in series with a relatively constant source of DC, a potentiometer to adjust the current flow, and a microammeter which acts as a voltmeter to measure the amount of voltage developed by the flow of current during the weighing process.

Standard Weighing Charts. The fly's wing, mustache hair, or whatever low-mass object is to be weighed, is placed on the weighing platform. This, of course, causes physical displacement of the pointer below the newly established zero rest point. When the null potentiometer (R9) is adjusted to

restore the pointer to the arbitrary true zero point, a reading is taken on M2. What actually has occurred is that the electromagnetic force, created by the current flowing through the moving coil, is adjusted so that when the pointer (weighing platform) is back to the zero point, it just balances the mass of the material being weighed. By correlating current readings with standard weights a chart can be prepared so you know exactly what weighs what.

You can purchase sets of standard weights having very small mass from most laboratory supply houses (e.g., Edmund Scientific, Fisher Scientific). These can be used to establish your weighing chart. Tabulate the current reading you get for each increment of the standard weights in creating your chart. You can, of course, combine individual weights to arrive at a weight equal to the unit increment you have established for your chart. The MBB is designed to be adapted to many weight ranges by changing the range of the electrical readout. The range switch switches the appropriate multiplier into the circuit to permit higher current readings. These represent heavier weights, as read on meter M2.

Building the MBB. We housed our MBB in an 8 x 12 x 3-in. aluminum chassis fitted with a bottom plate. We used aluminum to make it easier to cut out the openings for the two meters. The overall layout isn't critical. The one we used, however, is very convenient for interwiring the components, so we suggest you follow it—unless you feel that you would prefer to design a layout more adaptable to your specific applications of the MBB.

The only part of the construction that does test your dexterity is the modification to the moving-coil meter movement to convert it to a weighing platform.

Making the Weighing Platform. Once all of the holes have been drilled in the chassis, the parts have been mounted and wired and you have completed everything but the installation and hookup of M1, you should proceed to modify the meter so that it can be used as your weighing platform.

We purposely selected a meter that has the protective glass cover mounted separately in the bezel in order that it could be removed easily without destroying the bezel. The glass must be permanently removed to provide access to the weighing platform.

Incidentally, the cost of the meter specified in the Parts List is quite high when pur-

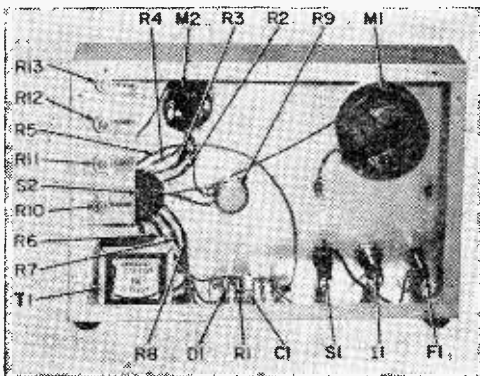

View of MBB innards showing simple layout. There's plenty of room here to make a neat wiring job; note that most resistors and capacitors are supported by their own leads.

Magnetic Beam Balance

chased new and used just for this one project. Since you'll have to remove the protective glass from the meter bezel and also bend the pointer, the instrument will probably be unsatisfactory for any other project you may want to try. Therefore, we suggest you try to pick up a used one in order to hold the cost of the project down.

Since the calibrated scale that comes with the meter is meaningless for our MBB, we suggest you remove the scale and replace it with a blank piece of metal or plastic of the same thickness and shape as the original; alternatively, you can reverse the original scale so that its blank side is facing out. Make a mark in the center of the arc that the pointer follows when moving across the scale. Cut two pieces about 1/2-in. long from an ordinary straight pin and cement one about 1/2 in. above and below the center mark.

Before replacing the bezel on the meter case, move the lever that controls the zero positioning of the pointer assembly until the pointer rests mid-scale when no current is flowing. Incidentally, when putting the scale back onto the meter movement take care that the pointer can move freely between the two limit pins that have been installed on the face plate.

The final step before mounting and wiring this meter is to bend the pointer so that the arrow head on its free end is perpendicular to the face plate. This then becomes the

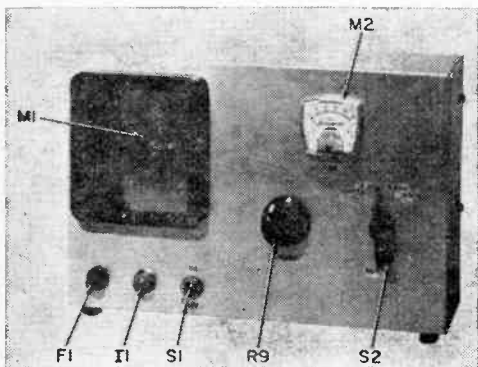

Business side of MBB shows M1 containing platform to hold material to be weighed. Always make certain that platform and material do not rub against M1's faceplate.

platform on which material to be weighed is placed. Make certain that the arrowhead platform doesn't rub against the face plate, otherwise any readings you make will be inaccurate.

Adjusting the MBB. Now that you've completed construction and checked for any wiring errors, you're ready to adjust the assembly to ensure accuracy in weighing. A VTVM (or the Hi-Fet Voltmeter described in the January/February 1970 *ELEMENTARY ELECTRONICS*) should be used for these adjustments as you will be dealing with critical circuits that could be affected by the relatively low resistance of a conventional VOM. Before applying power to the MBB, place the null control (R9) in a full counterclockwise position and set potentiometers R10, R11, R12, and R13 at midpoint. Remember, always begin every new range adjustment with the null control in the full counterclockwise position.

Connect the VTVM between the arm of R9 (+) and the chassis (-) of the MBB. Use a low voltage scale of the VTVM. Set the range switch (S2) to the X.0002 position, turn *on* the power and adjust the null control until the VTVM reads 0.29 VDC. Then adjust R10 until M2, the 50- μ A meter, reads full scale. You may find some interaction between R9 and R10; if so juggle the two until you get the VTVM reading of 0.29 V with M2 reading full scale.

Once you've adjusted this range, proceed to the X.001 range and follow the same steps—except that the VTVM should now read 2.0 V and you will adjust R11 along with R9 instead of R10. You can expect the same possible interaction between R9 and R11 that you experienced between R9 and R10.

The other two positions of the range switch are adjusted in exactly the same manner. When adjusting the X.002 range the VTVM should read 4.1 volts and when adjusting the X.004 range it should read 8 volts. R12 is used for the X.002 range and R13 is used for the X.004 range. Once each range has been adjusted and the VTVM has been disconnected, it's a good idea to move the range switch to each position to make certain that M2 can be set to full scale by rotating R9, the null control, for each range switch setting.

Using MBB. Now that you have adjusted the various ranges, how do you use MBB to weigh a fly's wing or an ant or any other

(Continued on page 116)

Be a magician — changeo — presto —
make that budget SW receiver
perform like the best

the

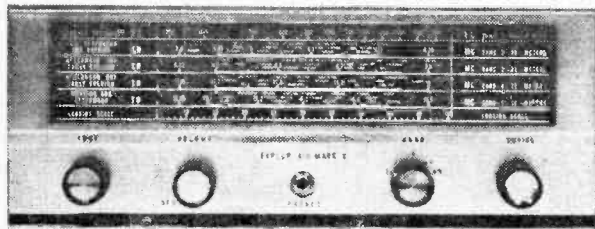

100Xer

by Herb Friedman
W2ZLF/KB19457

WOULD YOU like to give your budget shortwave receiver a swift kick in the antenna input? You can — by making its selectivity so sharp you can knock an interfering CW signal over the cliff into never-never land, and at the same time raise its sensitivity so high that it may be almost unusable. Nope! You don't have to buy a new super-gold-plated receiver — all you need do is tuck our little 100Xer into the innards of your present budget SW receiver and you'll pick up at least 40 dB (100X) gain and an additional 18 dB or so of selectivity at 10 kHz.

Our 100Xer is basically the Miller solid-state IF strip, a sub-miniature assembly providing two complete stages of IF amplification and a detector. Hold on! Don't leave us now! If you've gone through these articles before with their "open the case and change an itty-bitty lead" or "add four widgets to the IF," fear not. Our 100Xer can be dropped into your receiver without having to make advanced engineering changes, without loss of AVC, or needing to ride every station with an RF gain control. You won't lose the receiver's BFO, nor will you have to build a new BFO.

Most difficult task you'll have will be making a printed circuit

100Xer

board. Roughly speaking, figure on about one evening's work and approximately \$15.00 to effect a super-colossal improvement in budget receiver performance. (We keep saying "budget receiver" because the AVC action of a gold-plated receiver would mask any improvement made by the 100Xer, and, in addition the noise level would be brutal.) The only prerequisite for adding the 100Xer is that your receiver have a 455-kHz (or 456 kHz) IF. The 100Xer will not work with a set having another IF.

is our 100Xer will work with either positive or negative grounds.

The Miller 8902B basic module affords roughly 40 dB of amplification and has a bandwidth of 18 kHz at 20 dB down. When a sub-miniature IF coil is used ahead of the module, the gain is approximately 40 dB with a bandwidth of 12 kHz at 20 dB down. Because of the rather sharp improvement in selectivity we suggest the module be used with the Miller 8901B IF coil. Even though some projects still use it, note that the 8901 coil is not a direct replacement for the 8901B; therefore, make certain you get the B model. Both the IF module input and the 8901B input are each

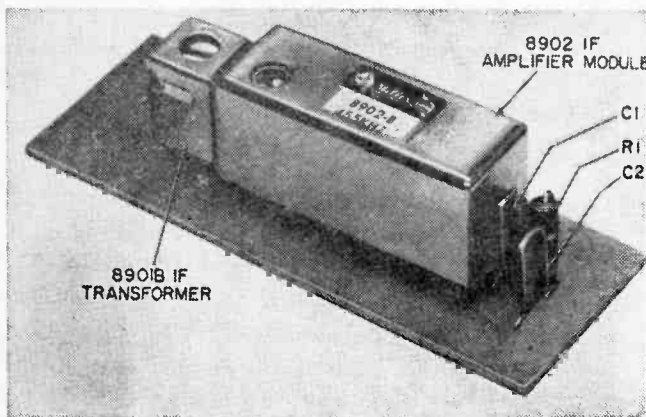

Completed assembly makes small, neat package, easily installed. Aside from printed circuit board, Miller IF module, and transformer, just three other parts are needed: R1, 4700 ohm, 1/2W resistor; C1, 0.005uF, 75V ceramic capacitor; and C2, which for tube type sets is a 0.01uF, 75V ceramic capacitor and for transistor sets is a 10uF, 6V electrolytic capacitor. The 100Xer assembly is only 1-1/16 x 3-in.

The circuit of the Miller module is shown in the schematic. Note that there is nothing tricky or unusual about it. It's a straightforward two-stage IF amplifier with a detector. And you forget voltage polarity, or if npn or pnp transistors are used. Reason

approximately 47 ohms. They can be connected directly to almost any detector output transformer without upsetting the original receiver circuit.

First step in construction is to make a small printed circuit board which will hold

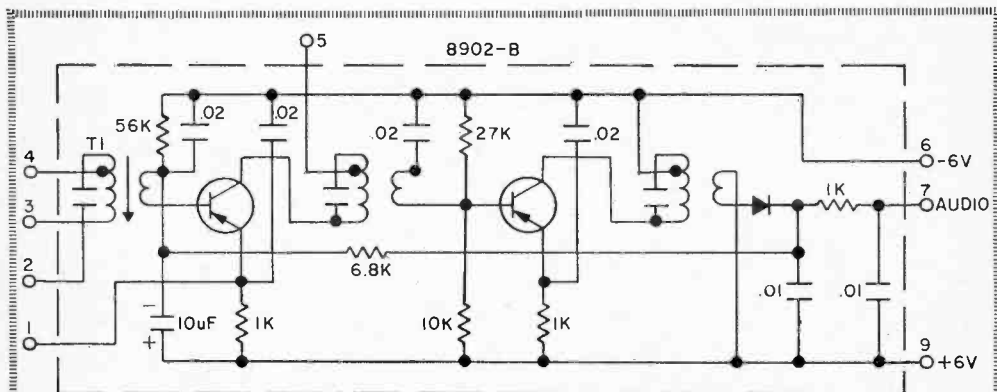

Circuit diagram of Miller model 8902B IF module. Note that this unit consists of conventional transistorized stable 2-stage amplifier tuned to 455kHz and a detector.

the IF coil, the IF module, and the three external components we have added, as shown in the block schematic. The board arrangement is critical. Do not make it larger or change the foil leads layout as either could cause receiver-disabling instability. Make the board this way . . . please!

Making the PC Board. Cut a piece of XXXP Bakelight or epoxy glass board with foil on one side to a $1\frac{1}{16}$ x 3-in. size. Scrub the foil clean with a piece of soapless steel wool and place a piece of carbon paper face down on the foil. Slip the board, with carbon paper, under the full-scale template shown and tape it securely under the template.

Next, using a sharp-pointed instrument such as an awl or ice pick, push through the template at the center of each circle until an indent is pressed into the copper foil, in order to identify lead holes. Make certain every lead hole is indented, as well as the hole for the unused transformer pin, and the mounting tabs on the cases for transformer and the IF module. Next, using a ball pen, trace the outline of all foil circuit ribbons onto the foil.

Remove the template and carbon from the PC board. Using a Kepro resist pen (which has a wick tip, and is available from Allied Radio), not a resist ball pen, fill in the outlines traced on the foil with resist. It's best to make the ribbons as thin as possible to ensure they won't touch one another and short—they needn't be thick. So you'll know where to drill after etching, make certain you place a dot of resist over all of the indents including the ones for the unused coil lead and the tabs for the cases. Use as little resist as possible to make very small markers for drilling centers. Print the terminal code letters on the foil as they appear in the template.

Let the resist dry thoroughly for a minimum of 10 minutes, then immerse the board in etchant to a depth of at least 1 in. for about 30 minutes, or as long as it

takes to remove all the unwanted copper foil. Agitate the etchant frequently to be sure of complete removal of the unwanted copper. When all unwanted foil has been removed, rinse the board under running water and then dissolve the resist with resist solvent (or nail polish remover) or by rubbing over it with steel wool.

You are now ready to drill the holes. Use a #58 drill for the component and transformer leads' hole. Use a #44 drill for the holes for the module and transformer case tab holes, and a #52 drill for the holes for the T-28 push-in terminals used for external connections.

Installation. When the *100Xer* is installed in a receiver having a negative ground, which is the case for all tube-type receivers and some transistor models, connect a wire jumper from hole E to hole G on the newly-made printed circuit board. Hole G is one of the tab holes for the case of the module. When the receiver has a positive ground, connect an insulated wire on the foil side of the board from hole E to the push-in terminal used for the + battery connection. (Note: the 8901B transformer must be used in transistor receivers, but not necessarily with tube-type models.)

When the *100Xer* is installed in the receiver the original AVC circuit is not disabled. In addition, the 8902B module has its own AVC. During reception of CW or side-band signals, the receiver's original AVC is normally disabled. The 8902B module's AVC stays on, but this creates no unreasonable problems.

You should understand the AVC circuit thoroughly before making any attempt at installing the *100Xer*. As shown in schematics depicting typical detector circuits, whether tube or transistor, the last IF transformer feeds a detector diode (which may be either a separate solid-state diode or the diode part of a tube) that rectifies the RF. A capacitor extracts the modulation and couples it to an AF amplifier, and

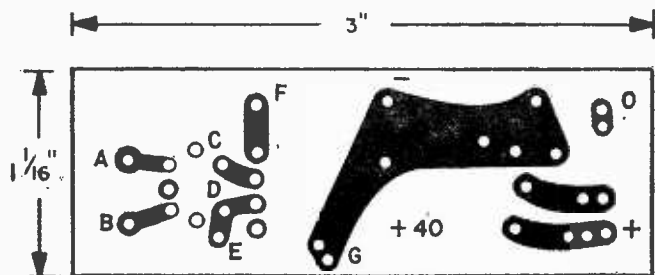

Once you've traced outlines of circuit ribbons onto foil side of a circuit board by placing ordinary carbon paper between this full scale pattern and circuit board, fill outlines with resist, allow it to dry, then etch as directed in text to complete board for assembly.

100Xer

an RC filter network smooths the DC rectifier output for AVC control.

When the 100Xer is installed you modify only the modulation take-off point. The AVC connections are not modified in order that AVC for the receiver's original IF and RF amplifiers is maintained. Note from the tube-type receiver schematic that the receiver's volume control is the load for the detector; therefore, the AVC voltage is developed across the volume control. The receiver's normal AF output is disconnected

equal to that of the volume control. Resistor R_y is this added resistor, as shown in the schematic for the completely modified detector circuit.

Don't be concerned about a "detected" signal feeding another IF amplifier, since budget receiver, modified as detailed in this article, works well. Everything remains as is, except for the original audio connection.

Special Note. In some transistor receivers the gain of the 100Xer is so high it might cause the receiver to be unstable, depending on where you mount the 100Xer. If you should experience instability because of this, remove the 8901B coil from the circuit by connecting jumpers from A to C and from

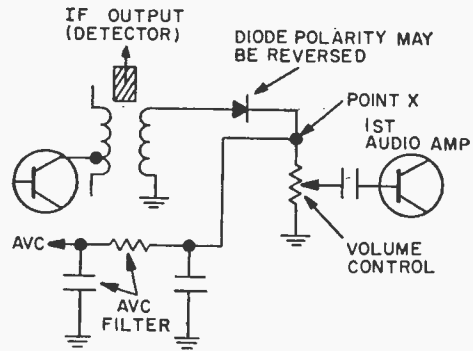
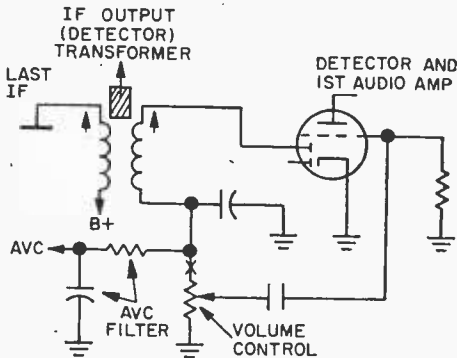

Left, circuit for IF, Detector, 1st audio portion of tube type receiver; right, same portion of transistorized receiver. Note audio take-off point and how AVC voltage is developed.

from the volume control at point X and the volume control is connected to the output of the 100Xer.

For proper receiver operation, a fixed resistor must be installed from point X to ground when the 100Xer is installed. The resistance value of the resistor should be

B to D on the PC board.

Install the 100Xer as close as possible to the receiver's last IF transformer. Cement it to the chassis or any convenient spot with two or three drops of GE's RTV adhesive, making certain that the foil doesn't short out against the chassis. A very important word

This schematic details how you connect 100Xer to IF output of your SW receiver. Be sure to replace volume control with fixed resistor (R_y) having same total resistance as control. Volume control is disconnected at X and reconnected between output of 100Xer and 1st audio stage of your receiver.

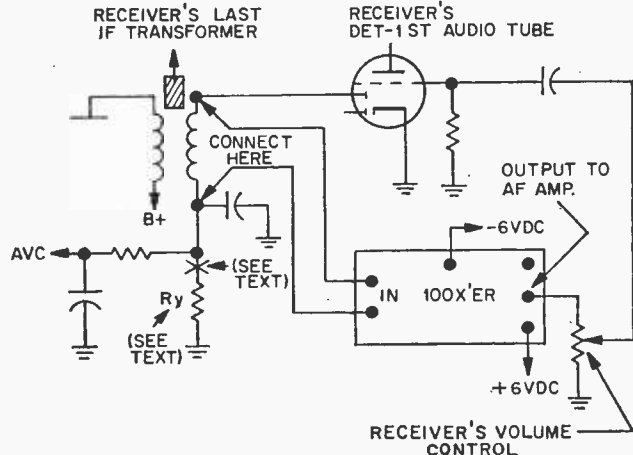

of warning: do not use Silastic or anything other than RTV. Though they look the same, in reality RTV adhesive will not affect tuned circuits even if it should run onto the 100Xer terminal while Silastic, etc., will create a dead short to RF.

Allow at least 24 hours for the RTV to dry and then connect the 100Xer as shown in the schematic for the modification.

The Power Supply. The 100Xer requires 6 volts maximum at 2 mA. You can get it the easy way by using a 6-V battery and a separate battery switch (a Burgess type Z4 battery will work for hundreds of hours). We suggest this arrangement when modifying transistor receivers since it's the easiest

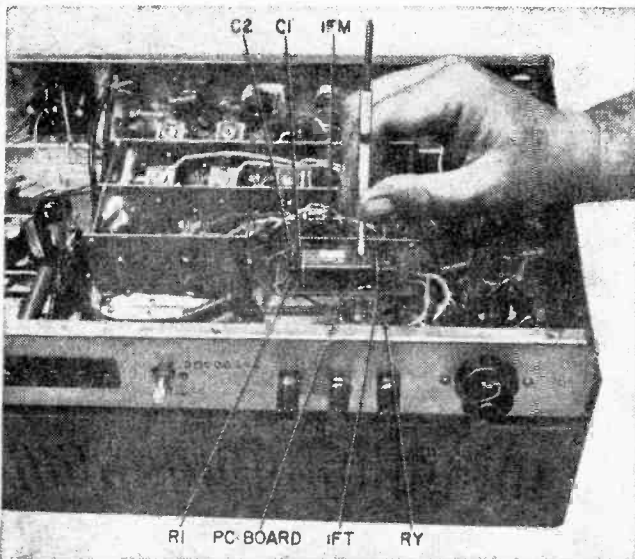
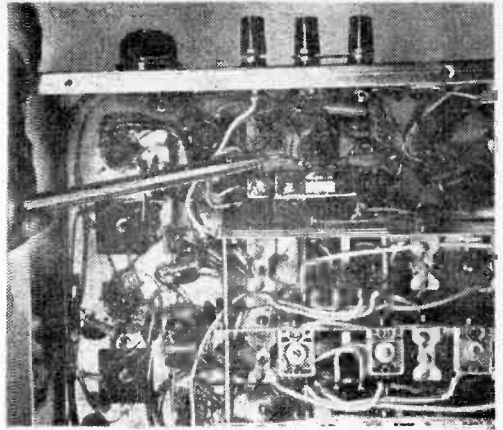

Complete assembly is small enough to be tucked on chassis of your SW receiver as close as possible to last IF transformer of set. It's easy to fasten assembly there—just use RTV adhesive. It cements board of 100Xer to set's chassis.

Once you have wired 100Xer in accord with schematic on opposite page, you are ready to check alignment. To get maximum benefit from 100Xer, even though module and IF transformer are factory aligned, go through steps outlined.

PARTS LIST FOR 100XER

- C1—0.005- μ F, 75-VDC ceramic capacitor
- C2—0.01- μ F, 75-VDC ceramic capacitor or 10- μ F, 6-VDC electrolytic capacitor (see text for correct choice)
- D3—Zener diode, 6.1V, 180mW (see text)
- R1—4700-ohm, 1/2-watt resistor
- Ry—See text for resistance value
- 1—Miller 8901B, 455-kHz IF transformer
- 1—Miller 8902B, 455-kHz IF amplifier

- and detector module
- 1—1/6 x 3-in. piece XXXP Bakelite or epoxy glass circuit board with copper foil on one side only (see text for etching instructions)

Misc.—GE RTV cement, solder, etchant, resist, Kepro RMP-700 resist pen, hookup wire, small glass dishes to hold etchant, steel wool, etc.

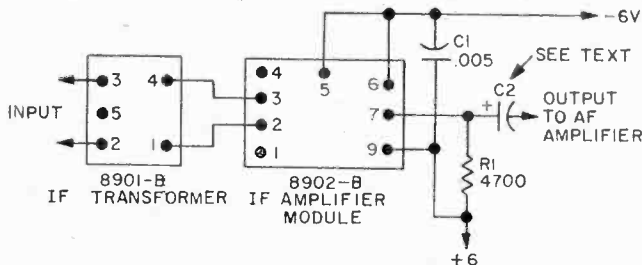

100Xer

way and doesn't require tapping into the receiver's PC board. If the receiver has a 6-volt power supply—which is very unusual—you can tap directly onto this battery supply.

For tube receivers a Zener regulator circuit as shown in schematic for low-voltage regulator is suggested. Zener diode D3 can

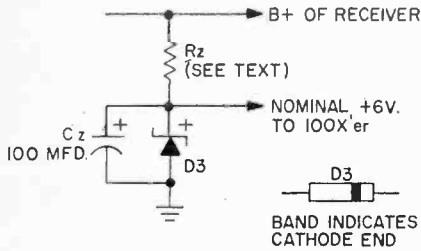

To get 6 VDC required for 100Xer, use bleeder resistor and Zener diode to regulate voltage as discussed in text.

be any 6-V Zener having the lowest possible power rating, say 180 mW. The object is to keep the total current, both the Zener's and the 100Xer current which flows through Rz, as low as possible to keep Rz's heat dissipation down. Allow about 4 mA for D3, added to the 2 mA 100Xer current, the total current through Rz, will be 6 mA. It's most important the Zener be rated no more than 6.1 V maximum. If necessary, use a Zener rated below this value, but as close as possible to 6 V.

The value of Rz is determined by the voltage of the receiver's B+. Carefully measure the B+ and note the voltage. For illustration, assume this is 250 V. The drop across Rz will be 250 V, less the 6V of the Zener drop, or 244 V. Since there will be 6 mA current through Rz (4 + 2), the value of Rz from Ohm's Law ($R = E/I$) is: $R_z = 244 \text{ V} / .006 \text{ A}$, which is 40,000 ohms. Use a standard resistance as close to 40,000 ohm as possible, which, in this instance, would be a standard resistance value of 39,000 ohms.

Power-handling capacity for this resistor should be at least twice the power dissipated in Rz. Again, from Ohm's Law ($P = I^2R$), the power dissipated by Rz is: $P = 0.006^2 \times 40,000 \text{ ohms}$ which is 1.44 watts. Twice 1.44 is approximately 3 watts, so use the next highest value, a 4-watt resistor, or two

2-watt resistors, each 80,000 ohms, connected in parallel.

Because you might be using "bargain" Zeners make certain you have the proper voltage across S3 before connecting to the 100Xer. (The Zener you use may not pass enough holding current.) If the voltage across the Zener is higher than the rated voltage, raise Rz's resistance in small increments by seriesing a resistor until you reach the rated voltage across D3. Once you are certain that the voltage is correct, you can safely connect the 100Xer.

Regardless of the type of power supply, capacitor Cz must be used or the 100Xer will actually reduce the overall receiver gain. Even if you use a battery supply capacitor, Cz must be connected across the 100Xer's power terminals.

Alignment. The 100Xer will be in almost perfect alignment unless you displace the receiver's original detector transformer. To check, or to peak align, connect a signal generator tuned to 455 kHz to the input of the receiver converter or mixer, set the generator's output level till you barely hear the tone from the receiver's speaker, and adjust the receiver's detector transformer, the 8901B, and the IF module for maximum audio output. Make certain that you keep reducing the generator output to the lowest possible level as you reach the peak in adjustments of each unit.

Using the 100Xer. The 100Xer does not affect a standard BFO; you use the BFO in your receiver as you always have. For CW and sideband reception disable the receiver's AVC (the 100Xer's built-in AVC is always operative) and adjust the RF gain for usable signal level. In some receivers the AVC is automatically disabled when the BFO is switched on—that's fine. For phone reception you use the receiver's AVC.

With the 100Xer the overall receiver gain when running wide open is very high and the hiss level similarly will be high. However, when a signal is received, the AFC of both the receiver and 100Xer becomes operative and you will actually hear the noise level drop down behind the signal. So don't worry about a high noise level.

The overall selectivity will also be very high, producing sideband cutting of phone signals—tending to make the signal bassy. That's the price paid for super-selectivity. On CW you should be able to drop all but zero-beat interference over the "selectivity cliff." ■

10 Reasons why RCA Home Training is

your best investment for a rewarding career in electronics:

Transistor experiments
on programmed breadboard—
using oscilloscope.



1 LEADER IN ELECTRONICS TRAINING

RCA stands for dependability, integrity and pioneering scientific advances. For over a half century, RCA Institutes, Inc., has been a leader in technical training.

2 RCA AUTOTEXT TEACHES ELECTRONICS FASTER, EASIER

Beginner or refresher — AUTOTEXT, RCA Institutes' own method of Home Training will help you learn electronics faster, easier, almost automatically.

3 THOUSANDS OF WELL PAID JOBS ARE OPEN NOW

RCA Institutes can help you qualify for a rewarding career if you have an interest in electronics. Every year, thousands of well paid electronics jobs go unfilled just because not enough men take the opportunity to train themselves for these openings.

4 WIDE CHOICE OF CAREER PROGRAMS

Select from a wide choice of courses and career programs ranging from basic Electronics Fundamentals to advanced training including Computer Programming and Electronics Drafting. Each

Career Program begins with the amazing AUTOTEXT method.

5 SPECIALIZED ADVANCED TRAINING

For those working in electronics or with previous training, RCA Institutes offers advanced courses. Start on a higher level. No wasted time on material you already know.

6 PERSONAL SUPERVISION THROUGHOUT

All during your program of home study, your training is supervised by RCA Institutes experts who become personally involved in your efforts and help you over any "rough spots" that may develop.

7 VARIETY OF KITS, YOURS TO KEEP

At no extra cost, a variety of valuable specially engineered kits come with your program—yours to keep and use on the job.

8 TRANSISTORIZED TV KIT AND VALUABLE OSCILLOSCOPE

You will receive in most career programs a valuable oscilloscope. Those enrolled in the TV Program or courses receive the all-new Transistorized TV Receiver—exclusive with RCA. Both are at no extra cost.

9 TWO CONVENIENT PAYMENT PLANS

Pay for lessons as you order them. No contract obligating you to continue the course. Or, you can take advantage of RCA's convenient monthly payment plan.

10 RCA GRADUATES GET TOP RECOGNITION

Thousands of graduates of RCA Institutes are now working for leaders in the electronics field; many others have their own profitable businesses... proof of the high quality of RCA Institutes training.

RCA INSTITUTES, INC.

Dept. 231-009-0, 320 West 31st St., N.Y., N.Y. 10001

Canadians: These same RCA courses are available to you in Canada. No postage. No customs. No delay. Your inquiry will be referred to our school in Canada.

All courses and programs approved for veterans under new G.I. Bill.

CLASSROOM TRAINING ALSO AVAILABLE. FREE CATALOG ON REQUEST.

ACCREDITED MEMBER National Home Study Council

Construction of Oscilloscope.



Construction of Multimeter.



RCA

FALL-WINTER, 1970

If Reply Card Is Detached—Send This Coupon Today

RCA INSTITUTES, INC.

Home Study Dept. 231-009-0
320 West 31st Street
New York, N.Y. 10001

Name _____

Address _____

City _____

State _____

Zip _____

Check here if interested in Classroom Training



HORN SPEAKERS

by Art Trauffer



Here's a quickie way to blend the old and the new. Build a transistor radio into the base of an old-fashioned horn loud-speaker and you've got the makings for some real good conversation.

Your friends will do a double-take when they hear *soul* from the 60s coming out of a 1920ish speaker. Just latch onto a horn salvaged from an attic, barn, auction, or second-hand store, and you've won half the battle.

Next trick is to build a transistor radio into the hardwood base. We've used a "Build-In" Radio Shack model 12-1150 which has six transistors, its own volume control and switch, and a 2¼-in. PM speaker. This go-go accessory should be just right for your installation. Of course, the size of the radio and the base might depend on the exact model horn you wind up with.

We used black walnut stock about ¾-in. thick to make a base measuring 6¾ x 5¾ x 1½ in. The open-bottom box was put together with small nails and wood glue. It was then sanded smooth, given a coat of walnut stain, and rubbed to a shining finish with soft facial tissues.

The Radio Shack chassis is enclosed in plastic and can be mounted on the side of the base with short flathead machine screws. (Angle brackets or epoxy cement might also be used.) Cement the speaker or mount it with brackets, right over the opening cut into the base. This is where sound will be fed out through the horn.

A metal angle bracket keeps the 9-V battery in place. After the components are wired according to the schematic, all you need do is attach rubber feet to each corner

(Continued on page 116)

BILL OF MATERIALS FOR HORN SPEAKER

1—"Build-In" transistor radio (Radio Shack 12-1150 or equiv.)

1—9-V battery (Burgess 2U6 or equiv.)

2—Short flathead 6-32 machine screws

Hardwood base:

1—6¾ x 5¾ x 5/16-in. piece

1—1-3/16 x 5/16-in. piece, about 25 in. long (for sides)

Misc.—Speaker horn, 4 small rubber feet, metal stock for angle brackets (optional), flange or fittings (see text), battery connector; volume control, PM speaker, knobs (if not supplied with radio), solder, hardware, etc.

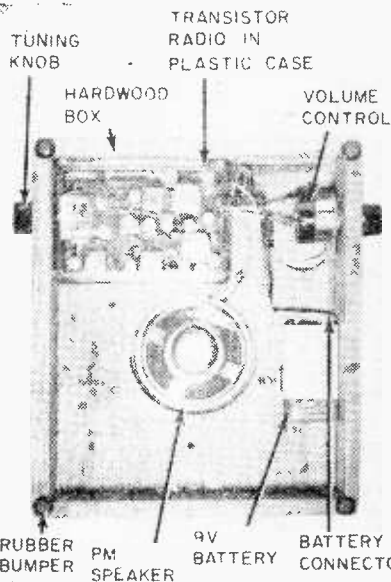

Man, it's easy to put together in one evening, and anyone can do it. Photo above is practically a wiring diagram.

Vibra Vox

The all solid-state musical instrument that defies tradition

by Charles D. Rakes

Vibra Vox is the psychedelic wonder of the age. With it you thrill all your "be-in" friends, terrorize and/or frustrate your neighbors by creating weird discordant musical sound effects, and, with perseverance you may even learn to play tunes on it. This oddball electronic instrument is a completely solid-state device, producing all those unusual sounds. It can be played by any member of your family, or for that matter, by any bystander brave enough to spread the five fingers of his left hand over the five "touch contacts." The Vibra Vox's teardrop shape has a practical aspect in addition to having an aesthetic decorative appeal. Playing the instrument is facilitated by providing ample space to group the five "touch contacts" in one convenient place, and in addition, it contains the balance of the components comprising the (continued)

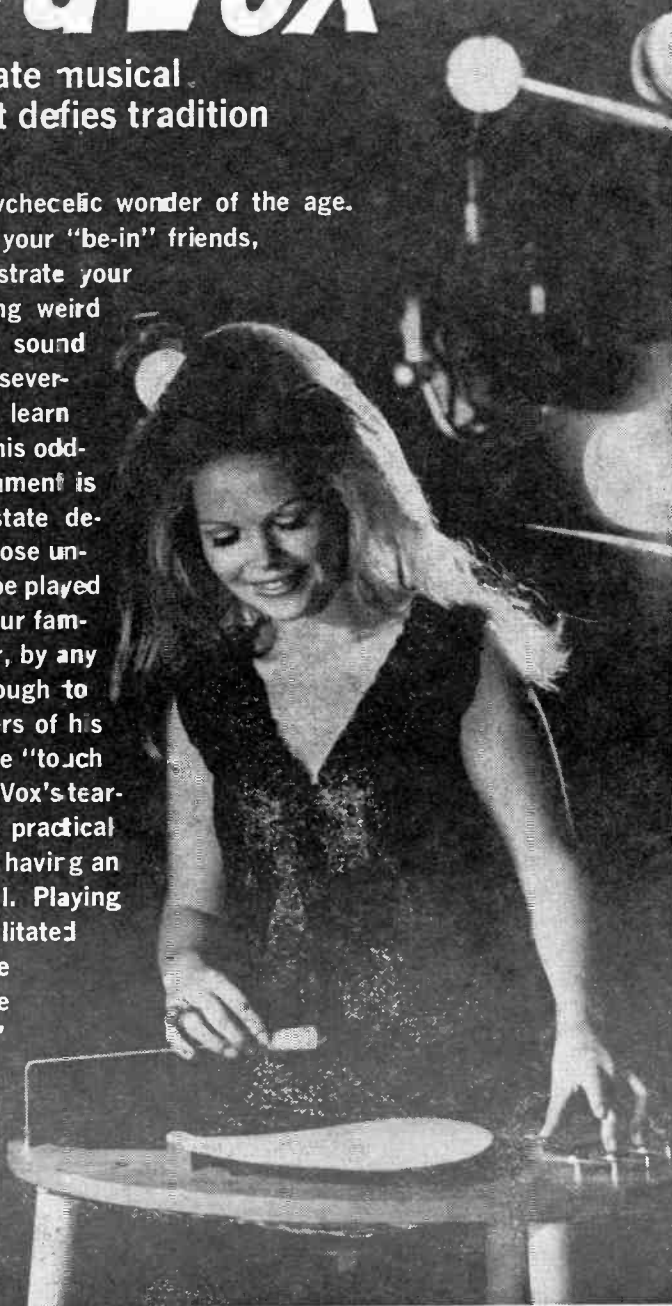

Vibravox

complete instrument without making it a bulky piece.

Essentially, the five "touch contacts" make it possible for the player to cause transistors to switch circuits for the specific functions of both tone generation and vibrato when

playing this creation. The frequency of any of the tone ranges selected is continuously variable, in three stages, from 130 Hz to over 2000 Hz by manipulating a "shift lever" while playing the VibraVox.

Just in case the self-contained amplifier/speaker combination doesn't have enough power output to shake the rafters of your pad, an output jack connected ahead of the built-in amplifier/speaker lets you feed the

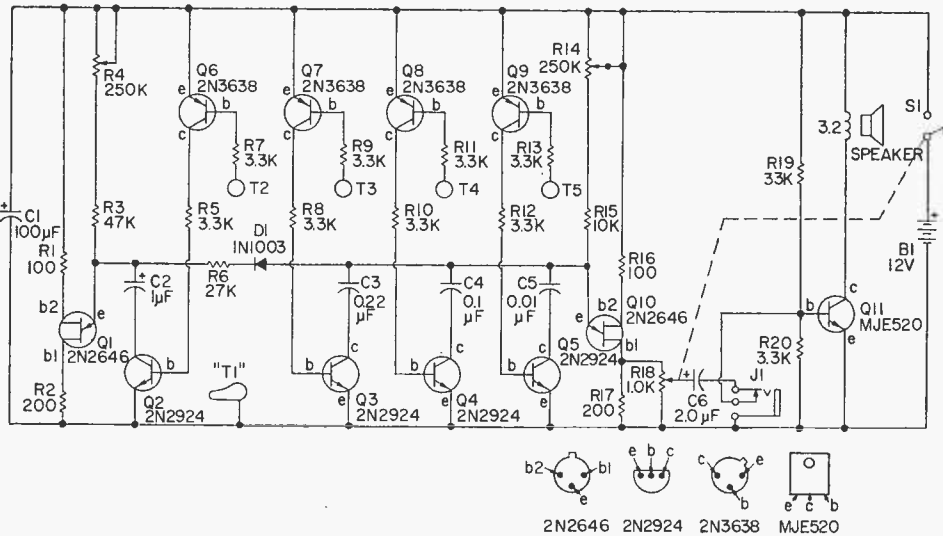

PARTS LIST FOR VIBRAVOX

- BI—12-V battery, made of 8 1½-V cells (Burgess type 930 or equiv.)
 C1—100- μ F, 15-V electrolytic capacitor (Allied 43A6633 or equiv.)
 C2—1- μ F, 50-V electrolytic capacitor (Allied 43A1784 or equiv.)
 C3—0.22- μ F, 200-V tubular paper capacitor (Allied 43A5146 or equiv.)
 C4—0.1- μ F, 200-V tubular paper capacitor (Allied 43A5122 or equiv.)
 C5—0.05- μ F, 200-V tubular paper capacitor (Allied 43A5121 or equiv.)
 C6—2- μ F, 50-V electrolytic capacitor (Allied 43A6642 or equiv.)
 D1—Motorola type 1N4003 silicon diode (Allied price 60¢)
 J1—Closed circuit phone jack (Allied 16A3467 or equiv.)
 Q1, Q10—GE or Motorola type 2N2646 unijunction transistor (Allied price \$2.10)
 Q2, Q3, Q4, Q5—GE npn silicon transistor type 2N2924 (Allied price \$1.53)
 Q6, Q7, Q8, Q9—Raytheon type 2N3638 silicon, planex, epoxy transistor
 Q11—Motorola silicon power transistor type MJE520 (Allied price \$1.38)
 R1, R16—100-ohm, ½-watt resistor
 R2, R17—200-ohm, ½-watt resistor

- R3—47,000-ohm, ½-watt resistor
 R4—250,000-ohm potentiometer, linear taper (Allied 46A1623 or equiv.)
 R5, R7, R8, R9, R10, R11, R12, R13, R20—3300-ohm, ½-watt resistor
 R6—27,000-ohm, ½-watt resistor
 R14—25,000-ohm potentiometer, linear taper (Allied 46A1620 or equiv.)
 R15—10,000-ohm, ½-watt resistor
 R18—1000-ohm potentiometer, linear taper with switch (Allied 46A5301 or equiv.)
 R19—33,000-ohm, ½-watt resistor
 S1—Switch, mounted on R18 (Allied 46A5359 or equiv.)
 2—4-cell battery holder (Allied 18A5904 or equiv.)
 1—6 x 9-in. oval speaker, 3.2-ohm voice coil (Allied 16A3467 or equiv.)
 Misc.—Four 1-in. dia. chrome-plated drawer pulls, one tear-drop chrome-plated drawer pull (available at Montgomery-Ward), ¾ x 9¼ x 27 in. wood for base, 6 x 12 x ¼-in. plywood or hardboard, three 6 or 29-in. legs and angled mounting brackets, ¼-in. drill rod for shift lever, gear shift knob, ½-in. spacers, perf board, push-in terminals or flea clips, hookup wire, solder, screws, bolts, nuts, etc.

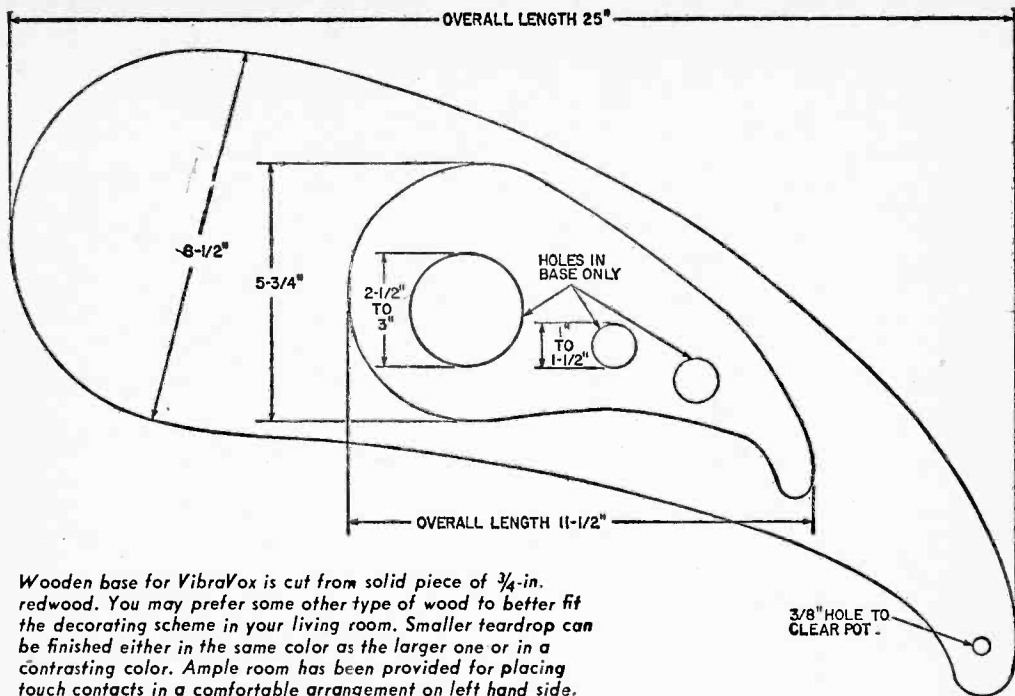

Wooden base for VibraVox is cut from solid piece of $\frac{3}{4}$ -in. redwood. You may prefer some other type of wood to better fit the decorating scheme in your living room. Smaller teardrop can be finished either in the same color as the larger one or in a contrasting color. Ample room has been provided for placing touch contacts in a comfortable arrangement on left hand side.

$\frac{3}{8}$ " HOLE TO CLEAR POT.

output of the VibraVox to your hi-fi amp and speakers. Friends, enemies and innocent bystanders had better come prepared — be sure they have earplugs with them.

The How of It. The tone generator is an

effected by electronic switching accomplished by finger contact between touch contacts T1 and T3, or T4 or T5.

What happens is that body resistance between the fingers touching T1 and any one

This operating side view of VibraVox shows how all controls are conveniently placed to facilitate playing the instrument. Touch keys, mounted to left, are arranged at time of assembly to comfortably fit the span of the player's hand. Frequency shift lever, mounted on right side of instrument, has lever extending to left.

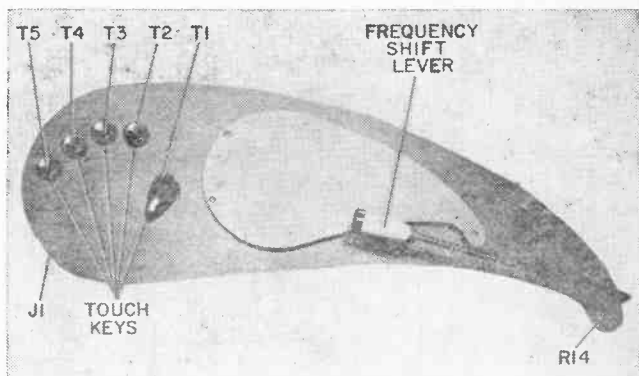

FET relaxation oscillator having three ranges to cover the overall range of the VibraVox. The basic frequency of each range is established by the capacity of the particular range capacitor (C3, C4, or C5) switched into the oscillator circuit, plus the total amount of resistance that is in the circuit (determined by the position of the arm of potentiometer R14, which is mechanically coupled directly to the shift lever. Range selection is

of the other touch contacts causes the respective transistor connected to that contact to conduct, which starts the second transistor connected to it conducting. This, in turn, causes current to conduct through the base B1 of UJT (Q10). The junction voltage at the emitter of this transistor is clamped almost to ground and current through the transistor then decreases and the transistor is driven to cut-off. (Turn page)

Vibravox

The capacitor connected to the emitter begins to recharge and the cycle is repeated. The repetition rate, which actually determines the frequency of the tone generator output, is established by the RC time constant (R14 plus either C3, C4, or C5), thus developing an audio voltage at base b1 of Q10, which is amplified by Q11 and heard over the speaker. If an external amplifier-speaker is used the audio output at base b1 is fed to the input of the external amplifier combination to which it may be connected.

Output level, power switch, and vibrato rate controls are mounted in a convenient place on the under side of the base of the VibraVox.

By glancing at the VibraVox schematic you will note that the group of components producing the vibrato effect (Q1, R1, R2, R3, R4, C1, Q2, and Q6) make up a sep-

proportionately smaller (approximately 5¾ x 11½ in.) is made to be placed over the speaker openings in the base but separated from it by ¾-in. high wooden spacers, made from scraps remaining from the forming of the base, shaped to fit the ends of this cover. Cut and drill all of the holes indicated on the layout drawings.

The four finger-touch contacts and the thumb-touch contact are metal drawer knobs. The three-tone range and the vibrato contacts are round metal drawer pulls and the thumb contact is a tear-drop shaped metal drawer pull. Before mounting these touch contacts be sure they are clean and free of protective lacquer or shellac used to preserve the polish of the metal. The touch contacts should be located at the left of the speaker, on the widest part of the base, arranged to fit your hand comfortably for playing the VibraVox. Solder lugs placed under the heads of their mounting screws enable good electrical contact to be made to the knobs. Power switch, output level and vi-

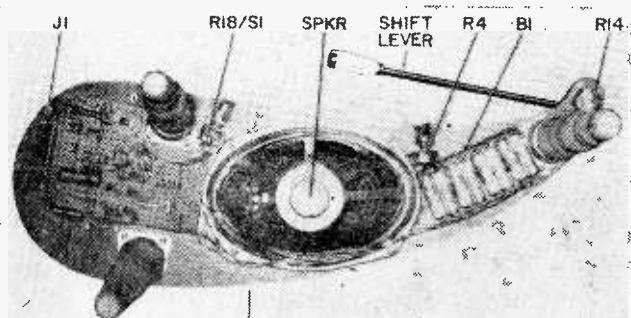

Bottom view of VibraVox clearly shows location of various sections of complete instrument. Oval speaker provides larger cone to improve overall response of instrument. Batteries are easily replaced by merely slipping old ones out of carrier and slipping new ones in. This type of battery holder makes it easy. All electronics with exception of frequency and volume controls and vibrato rate control, are mounted on single perf board.

arate oscillator and electronic switcher, identical in circuitry to the tone generator oscillator and its switchers, except that the RC time constant values for the oscillator are not the same in order that they might produce a much lower frequency output. The vibrato oscillator frequency range is continuously variable from 2 Hz to 20 Hz, depending on the setting of R4. This low frequency signal modulates the output of the tone generator oscillator at a rate dependent on the output frequency of the vibrato oscillator.

Building It. The complete unit, including the batteries to operate the oscillator, amplifier, and electronic switching, is mounted on a piece of redwood (or other wood of your preference) 8½ x 25 x ¾ in. formed into the shape of a tear drop. A smaller piece of ¼-in. plywood (or hardboard) cut so that it's a mirror image of the base tear drop, but

brato rate controls are mounted on angle brackets fastened to the underside of the base. The range control (R14) is mounted on the narrow end of the base so that the potentiometer shaft sticks up through the top of the base far enough to fasten a shaft coupler to it for joining the shift lever to the potentiometer shaft.

All the components making up the tone generator and vibrato oscillators, as well as the amplifier, with the exception of R4, R14, R18, J1, S1, the speaker and battery B1, are mounted on a 6¼ x 4¾-in. piece of perf board. A 2 x 3-in. corner of the board is notched out to accommodate the mounting of a metal leg support to the wooden base. Three ½-in. spacers are used to raise the perf board from the base to which it is fastened to permit wires to pass under

(Continued on page 115)

pennypincher's STROBOSCOPE

by Stan Tennen

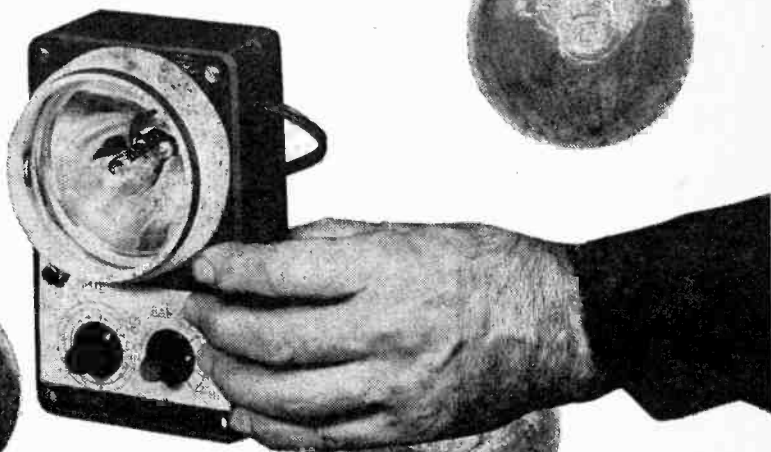

□ Stroboscopes have been around for a long time. They are used in photography and science to stop motion, in auto shops to tune up your ignition, and generally to measure rotating speeds. They let you see what's happening on rapidly moving or vibrating machinery of all kinds. But don't look at a strobe — it might stop your brain, too!

Actually, the danger isn't all that great unless you're an epileptic or fail to take some simple precautions. The problem arises because your brain has a strobe of its own. One of the brainwave frequencies, called the alpha-rhythm, can become synchronized to the flashing strobe light if the frequencies are close enough. Most people have alpha-rhythms of between about 6 and 14 Hz; therefore, only these frequencies might be troublesome to an average person. Psychedelic light shows usually use flash rates above or below this band to prevent the possibility of harm.

If you're watching a strobe and become dizzy or ill at ease, close your eyes and turn the light off or walk out. And don't ever show a strobe-light flashing at low frequencies (less than

STROBOSCOPE

about 40 Hz) to an epileptic; it can bring on a seizure.

Most people, luckily, aren't susceptible and can look at strobelight flashing at exactly their alpha-rhythm without any ill effect or discomfort. Many see different flashing colors at their alpha frequency. If you want to find out about stroboscopes, what they can do for you, and what kinds of fun you can have with one, this simple, easy-to-build, and inexpensive unit is for you.

How It Works. The stroboscope consists of four sections: a 300-V power supply, an unijunction relaxation oscillator clock, a high-voltage trigger using a silicon-controlled rectifier, and a Xenon flashtube discharge circuit.

The *power supply* is a conventional voltage doubler operating directly from the AC line. On the positive-going part of the 117-V, 60-Hz input, capacitor C1 is charged to about 150 VDC through rectifier D1 (D2 does not conduct and C2 does not charge). On the negative swing, D2 conducts, charging C2 to 150 VDC (D1 does not conduct). Since C1 and C2 are in series with respect to the rest of the circuit, the potential to which each is charged adds and about 300 VDC is available.

The *internal clock* provides timing pulses for the SCR trigger when S2 is closed. Q1 transistor functions as a relaxation oscillator; C4, C5, or C6 charge via R2 and R7 to determine the RC time constant. When C4, C5, or C6 has charged sufficiently to turn the unijunction *on*, the capacitor discharges through the emitter base 1 circuit and a pulse appears across R6. The cycle then repeats, producing a sawtooth voltage at the emitter and a continuous series of timing pulses across R6.

Alternately, when S2 is open, a repetitive signal applied to T2 through J1 will be rectified by D3. Capacitor C4, C5, or C6 will trigger the unijunction as above and produce pulses at R6 in time with the signal. Because of the polarity of D3, T2 does not provide an alternate discharge circuit for C4, C5, or C6.

The *silicon-controlled rectifier trigger* is a scaled-down transistorized automobile ignition. Capacitor C3 is normally charged to about 300V. But when a timing pulse appears across R6, SCR1 conducts, discharg-

ing C3 through the "primary" of "ignition transformer" T1. This produces a 5-kV trigger pulse for the Xenon lamp. Meanwhile the SCR is turned *off* by the back emf induced in T1; this allows C3 to recharge and the cycle to repeat.

The 5-kV trigger pulse causes an initial ionization of the Xenon gas in the flashtube. Capacitor C7, C8, or C9, charged during the *off* period to 300 V via R5, discharges through the Xenon tube. Result is a short intense burst of light.

Construction. Almost all components are mounted directly to the top of the perforated board and supported by their leads. Resistor R5 is the only part mounted under the board; R7 S2, T2, D3, and J1 are mounted on the back of the front panel.

To begin construction, first cut the perfboard to fit the Bakelite case and mount the four $\frac{3}{8}$ -in. bushings at the corners. The four rubber feet screw into the bottom of the bushings through the case. Drill four holes in the case so they will line up with the standoffs. Also drill a hole for the line cord strain-relief feed-through. Drill three holes in the perfboard to accept the three contact pins from flashtube base (a socket may be hard to find and may mount the tube too high to fit your reflector properly), and a hole to support T1 (it fits through the board to save space and is glued in place under the board—orient terminal 3 close to the flashtube trigger strap).

If the selector switch you use has all its terminals on its bottom, you'll also have to drill holes through the perfboard to mate with these. The switch is held in place by its bent-over terminals. (If your switch cannot be mounted this way, mount it on the front panel with R7 S2 and J1 and run leads to the perfboard.)

Safety First. Only one lead is critical. The high-voltage lead (5-kV trigger pulse) from terminal 3 of T1 to the external metal trigger strap on I1 must be as short as possible and must not touch any component the perfboard, or the reflector. The 5-kV *could* be dangerous and any contact other than at the flashtube could shortcircuit or reduce the pulse, and I1 might not trigger reliably. Except for this, layout and lead dress are completely non-critical. Be sure the mesh electrode of I1 is connected to ground.

Also for safety's sake, use a plastic case and take care that none of the screws or metal parts of R7/S2 or S1 contact the

circuitry (except J1 which is isolated by T2). Reason for these precautions is that the stroboscope operates without isolation from the AC line. (If you wish, an isolation transformer, such as Lafayette 33E75029, can be used. Just wire it to R1 and the junction of C1 and C2 where the line cord is shown connected. Wire R1 to D1 and D2 and move SIC to one of the primary leads of the transformer. You'll probably need a larger case for this minor modification.)

The case of SCR1 is the anode connection. Carefully solder a lead to it, using as little heat as possible to prevent damage. The case is well tinned and this isn't difficult. The long lead is the cathode and the short lead is the gate connection for the SCR recommended in Parts List.

Now mount the components to the perf-board by running their leads through the holes and bending them over. Large parts can be soldered to flea clips for added

PARTS LIST FOR PENNYPINCHER STROBELIGHT

- C1, C2—30- μ F, 150-VDC electrolytic capacitor
- C3—0.02- μ F, 400-VDC mylar capacitor, $\pm 10\%$ tolerance
- C4—1- μ F, 100-VDC mylar capacitor
- C5—0.2- μ F, 100-VDC mylar capacitor
- C6—0.04- μ F, 100-VDC mylar capacitor electrolytic
- C7—8- μ F, 350-VDC electrolytic capacitor
- C8—2- μ F, 350-VDC electrolytic capacitor
- C9—0.25- μ F, 400-VDC mylar capacitor
- D1, D2—750-mA, 200-PIV silicon rectifier (any general purpose type having these ratings, or better, will do.)
- D3—1N34A diode
- I1—Xenon flashtube (Sylvania R4307 or equiv.) Available from Ionics Inc., 65 Grove St., Watertown, Mass. 02172
- J1—RCA-type phono jack, single-host mount
- R1—10-ohm, 8-watt wire-wound resistor
- R2—1.5-megohm, $\frac{1}{2}$ -watt resistor
- R3—100,000-ohm, 2-watt resistor
- R4—56,000-ohm, $\frac{1}{2}$ -watt resistor
- R5—4500-ohm, 10-watt wire-wound resistor
- R6—47-ohm, $\frac{1}{2}$ -watt resistor
- R7—10-megohm, $\frac{1}{2}$ -watt carbon poten-

tiometer, linear taper (IRC/CTS type Q11-143 complete with 76-1 spst. switch or equiv.)

S1—3-pole 4-position rotary switch

S2—Spst switch (part of R7)

SCR1—Silicon-controlled rectifier (Moto-rola 2N4155 or equiv.)

T1—Photoflash trigger autotransformer (UTC PF-7 or equiv.) Available from Cramer Electronics, 85 Wells Ave., Newton, Mass. 02159

T2—Input transformer: primary, 200K; secondary 1K (Lafayette 99E60345 or equiv.)

1— $6\frac{1}{4} \times 3\frac{3}{4} \times 2$ -in. Bakelite case with Bakelite front panel (Lafayette 19E-20016 or equiv.)

1—Perforated circuit board to fit case (Lafayette 19E37010 or equiv.)

1—3-in. dia. plastic reflector assembly (taken from Ray-O-Vac L295 flashlight or equiv.)

4— $\frac{3}{8}$ -in. high bushings to raise circuit board

Misc.—Knobs, rubber feet, line cord with AC plug, strain-relief feedthrough for cord, screws, nuts, wire, solder, glue, etc.

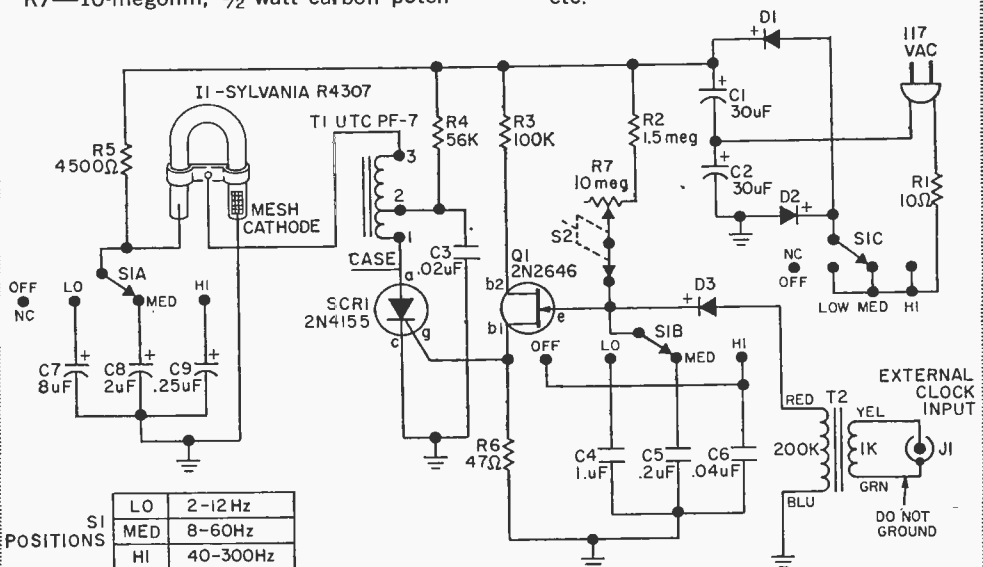

STROBOSCOPE

support. Use regular solid hookup wire for point-to-point wiring beneath the board.

Finishing Up. Finally, mount the reflector, J1, R7/S2, T2, and D3 to the back of the front panel. Almost any plastic reflector will do. Make certain you cut a large enough hole at its apex so it won't touch I1 or any of the leads; cut a mating hole in the Bakelite panel and glue or screw the reflector assembly to it. Doublecheck that it will be properly positioned over I1 before cutting. Drill a hole to clear the shaft of switch S1, a hole for jack J1, and a mounting hole for potentiometer R7 with shaft-actuated switch S2 attached to its rear.

Diode D3 is supported by its leads on the terminals of S2 (a dpst switch such as IRC/CTS type 76-2 has two extra leads and may be convenient instead of the spst 76-1 specified.) The case of input transformer T2 is soldered to the side of R7 for support; alternately, it can be glued to the back of the panel. Observe the color code on the schematic when wiring T2. Note that it is used backwards—the 1k secondary is used as the primary winding and the 200k primary becomes the secondary. If you don't plan to use an external clock, omit J1, T2, D3, and S2. These low-cost parts can always be added later if you change your mind for any reason.

Adjustment and Calibration. Switch S1 turns on the stroboscope and selects the frequency range desired. Rheostat R7 is a vernier for each range; in its extreme counter-clockwise position, it opens S2, disabling the internal clock, for external operation via J1. The Pennypincher's Strobe flash ranges are nominally *Lo*—2-12 Hz; *Med*—8-60 Hz; *Hi*—40-300 Hz.

However, the unijunction transistor may have a substantial effect on the higher frequencies on *Hi* range and the lower frequencies on *Lo* range. (If the unijunction is leaky or has an unusually high turn-on voltage the upper frequencies will be limited; if it has high emitter/base-1 resistance, the lower frequencies won't trigger the SCR gate.) The circuit will function with almost any low-cost unijunction but a Motorola 2N4870 or 2N4871 may not allow frequencies over 200 Hz in this circuit.

Capacitors C4, C5, and C6 determine the ranges. Smaller values give higher frequencies; larger values give lower frequencies;

(Continued on page 113)

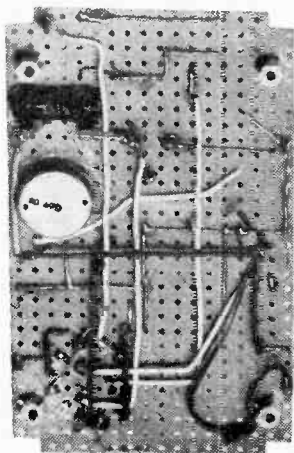
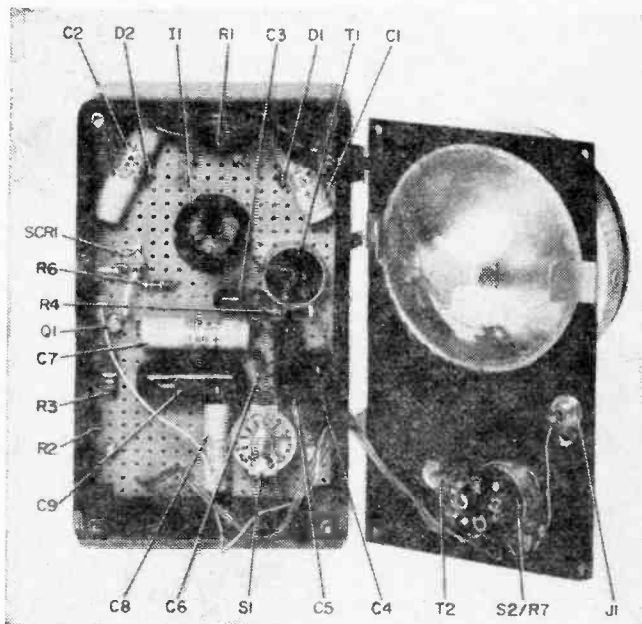

Innermost secrets of our Pennypincher's Stroboscope are revealed here in all their glory. Removing cover from box exposes all components except R5, which is mounted on bottom of circuit board and is shown in our photo of bottom of board. Controls and reflector are mounted on box cover. Be sure to provide sufficient clearance between reflector and I1. Because voltages are relatively high we suggest you use plastic case similar to one we used.

Everybody loves
to make a speaker system!
So try our . . .



POLAR-PLUS

by Charles Green, W6FFQ

YOU KEEP HOPING, as do most audiophiles, that someone will come up with a design for a better speaker system, whose reproduction approaches the natural tone of the original performance, yet is simple enough that you can make it at a reasonable cost. You should be able to build our Polar-Plus speaker system for about \$10.00 (depending on local prices for plywood, etc.). Make two, and the speakers for your new stereo system will cost less than one of the conventional budget-priced speakers.

Vast changes in technology have developed over the past few years. The space age, with men walking on the surface of the moon, has brought new materials to the foreground that replace older established ones. Traditionally, speaker cones have been made of paper. Now, one of the space-age materials, compacted bead-structure expanded polystyrene plastic, has been used in our Polar-Plus speaker system to make a

Polar-Plus

radically different type of speaker. We used this new type of speaker in our compact speaker enclosure, which was designed especially for it.

Plastic Speaker. The Poly-Planar speaker's *modus operandi* is the same as a conventional paper cone type permanent magnet, moving coil dynamic speaker. But, except for the moving coil-PM structure, the Poly-Planar speaker differs radically from the conventional. A plastic, foam-like, flat panel, made rigid with a special surface skin treatment, replaces the conventional paper cone,

diaphragm and permanent magnet, which, by the way, along with the voice coil, is the only metal in the speaker. The model P-5 Poly-Planar was housed in our enclosure, which has been designed to conserve space and yet provide sufficient baffling to compensate for the roll-off at the low end of the spectrum. Poly-Planar P-5 speaker mechanism measures 4½-in. wide by 8½-in. long by 1⅜-in. deep. The manufacturer states that its frequency range is from 60 Hz to 20 kHz with a power handling capability of 5 watts maximum, and that its sensitivity is 80 dBm for 1W electrical input. Input impedance of the Poly-Planar is 8 ohms.

Enclosure. We designed a simple bass-reflex enclosure for the P-5 Poly-Planar.

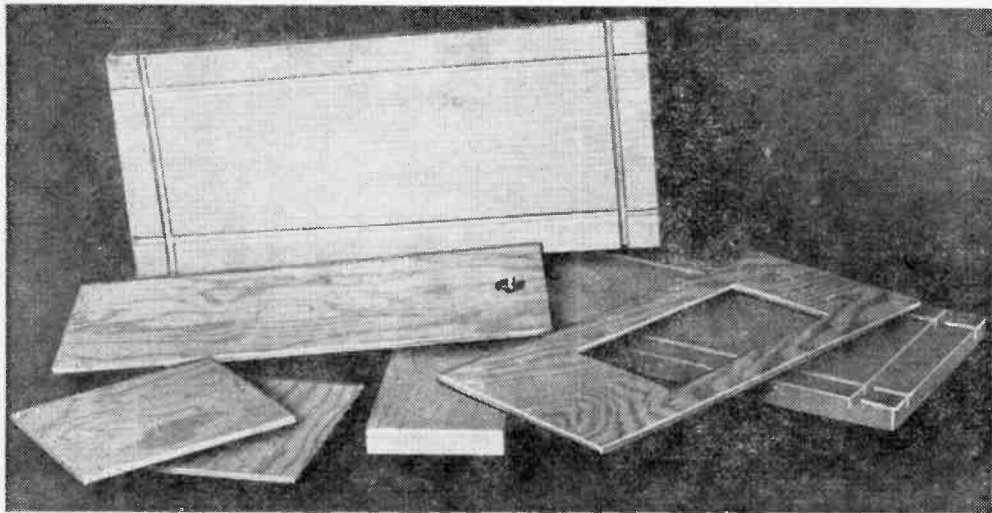

Here's how all plywood needed for Polar-Plus looks after you've cut it to sizes specified in list of materials. Sand two ¾-in. pieces to a satin smooth finish since grille cloth doesn't cover them and they finish best when smooth.

making the speaker a very compact unit. The Poly-Planar speaker used in our Polar-Plus enclosure is less than one inch in depth.

The speaker's plastic panel diaphragm is made from expanded polystyrene, and, since the expanded material is largely air, the weight of this plastic panel is very low. The manufacturer states that the flat rectangular panel, acting as an air piston, moves a greater volume of air than a paper cone of an equivalent size. This accounts for the superior low frequency response.

The Poly-Planar speaker also employs a plastic frame, molded from the same material as the panel so that both will have the same coefficient of expansion, to support the

This enclosure is 17¾-in. high by 7½-in. wide by 7½-in. deep.

The un baffled P-5 was found to resonate at approximately 120 Hz. The enclosure port opening was adjusted to lower the low frequency resonance point to approximately 76 Hz.

The small size of the enclosure makes it adaptable for either bookshelf or floor locations. The efficiency of the speaker system makes it ideal for operation from low audio power-output equipment having a maximum output of 5 watts.

Construction. The enclosure for Polar-Plus is made from ¼-in. plywood panels glued to ¾-in. white pine end pieces. Start

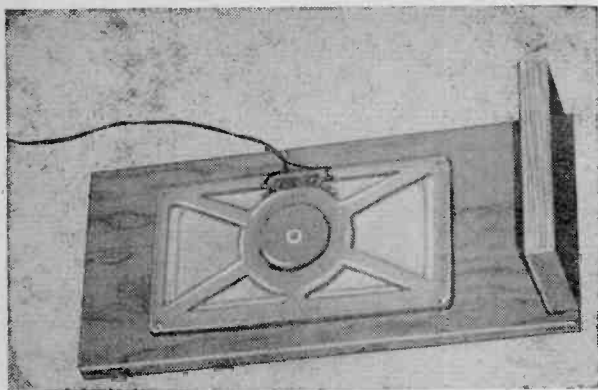

Here's how Poly-Planar speaker mounts on baffle (E). Piece D is fastened to bottom of E so that it's just 1-in. above bottom panel B, forming with side panels A, 1-in. port.

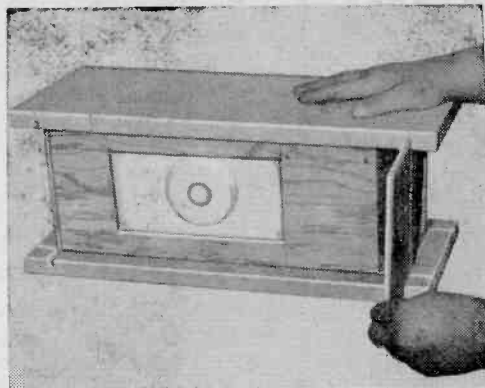

Once you've set side panels A and baffle E in place and glued them you're ready to finish enclosure by sliding bottom and top B in place. Seal joints with glue for tight fit.

the construction by cutting all of the wood panels to the sizes specified in the drawing.

Position the cut-out for the speaker so that the bottom of the speaker frame will be 4 in. up from the bottom of the front panel (E), and centered within its width. After the speaker opening is cut out, locate and drill the four speaker-mounting holes in this panel. After mounting the speaker on the front panel, we used a glue gun to seal the plastic frame of the speaker to the inside of the wooden panel (E). Then fasten the 5½-in. long section of piece D to the bottom of this panel with wood screws and glue. Since the front panel is 6½-in. wide, and piece D is 5½-in. wide, it should be centered so that

there will be ½ in. of clear space at each end at the bottom of the front panel.

Solder lengths of stranded hookup wire approximately 24-in. long to the speaker terminals. Drill a hole and mount a phono jack (J1) approximately 1 in. up from the bottom of the rear panel (C).

Cut a groove ⅛-in. wide and ⅜-in. deep, 1 in. in from the edge around the periphery of both side panels (A) on their inner surface. (A total of four grooves on each panel.) Make sure that the grooves are straight and parallel to each edge.

Place one of the side panels (A) on your workbench with the grooves facing up, and position front panel E in the groove so that

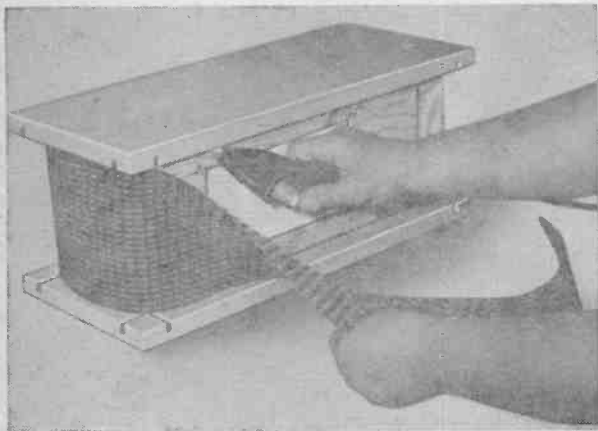

Electric glue gun serves two purposes here. It glues various panels to side pieces and is also used to glue grille cloth around outside of enclosure. See text for details.



We finished two sides in dark brown stain that blends well with grille cloth and makes white pine look like walnut. Newspaper wrapped around sides protects grille cloth.

Polar-Plus

its top edge is flush with the bottom edge of the groove at the top of panel A. The bottom edge of the front panel E (with the D section fastened to it) should be 1 in. from the top edge of the bottom groove. Glue the front panel to the side panel groove.

Next, position the rear panel (C) in the groove on this side panel (A) so that its ends are flush with the bottom edge of the top

each other. Glue the second side panel (A) in place. Slide the top and bottom panels (B) into their respective grooves on both side panels (A) and glue them in place. It may be necessary to sandpaper the edges of the various panels so that they will fit snugly in the grooves. Seal off all joints with glue so that there is no leakage of air at the seams.

Cut the grille cloth to size so that one piece can completely surround front, rear, top, and bottom panels, and glue it in place around the panels, thus covering all surfaces except for the two side panels. Make sure

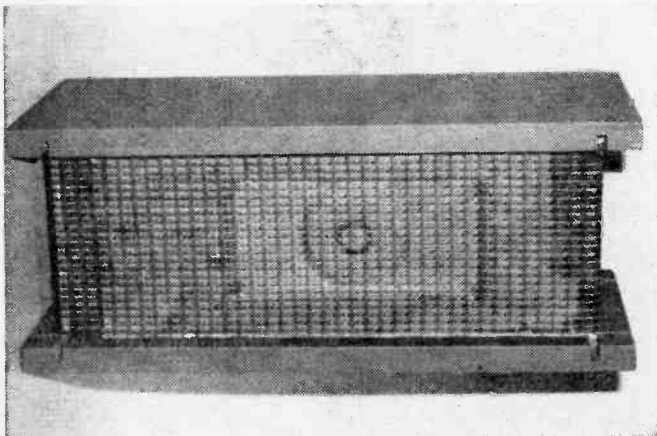

Here's how your Polar-Plus speaker will look from front when you've completed construction. Two of these make an ideal pair for bookshelf or floor placement of your stereo system.

groove and top edge of the bottom groove. Glue the rear panel in this groove. At this stage of construction, connect the speaker wires to the terminals of jack J1, making certain that you allow some slack in the wires. Glue or staple the wires to the inside to prevent movement and rattles.

Carefully position the other side panel (A), so that the front and rear panels that have been glued to one side panel (A) fit into the grooves of this second side panel (A) and that the side panels are parallel to

the grille cloth fits snugly around the phono jack. We removed the jack temporarily from the unit, cut a small hole in the grille cloth for the wires and remounted the phono jack over the cloth after it was glued to the rear panel.

The side panels (A) are stained or painted to blend with the color of the grille cloth. Carefully cover the grille cloth with newspaper before painting or staining the side panels to keep paint or stain from getting on the cloth. ■

And here's the back of Polar-Plus. Back looks almost identical to front except for jack used to make connections between Polar-Plus and your amplifier. Decorate speakers to suit your own scheme.

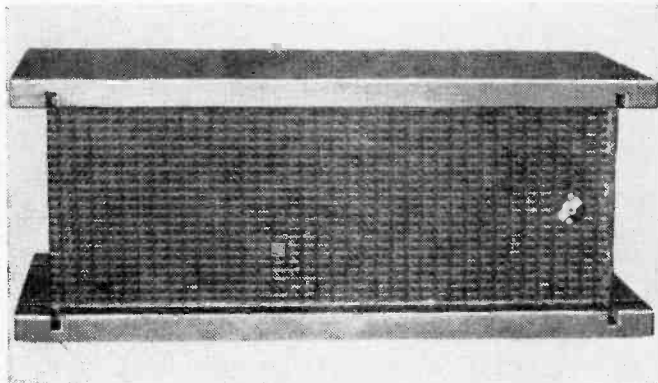

BILL OF MATERIALS FOR POLAR-PLUS SPEAKER

- A— $17\frac{3}{4}$ x $7\frac{1}{2}$ x $\frac{3}{4}$ -in. white pine (2 required—see text regarding grooves to be cut into each panel)
 B— $5\frac{3}{8}$ x $6\frac{1}{2}$ x $\frac{1}{8}$ -in. plywood (2 required)
 C— 15 x $6\frac{1}{2}$ x $\frac{1}{8}$ -in. plywood (1 required) (see text on mounting speaker)
 D— $3\frac{3}{4}$ x $5\frac{1}{2}$ x $\frac{3}{4}$ -in. white pine (1 required)

- E— 14 x $6\frac{1}{2}$ x $\frac{1}{8}$ -in. plywood (1 required)
 J1—Phono jack (Lafayette 32E64587 or equiv.)
 SPKR—Model P-5 Poly-Planar speaker (Lafayette 21E56024 or equiv.)
 Misc.—Grille cloth, paint or wood stain, glue, wood screws, hook-up wire, staples

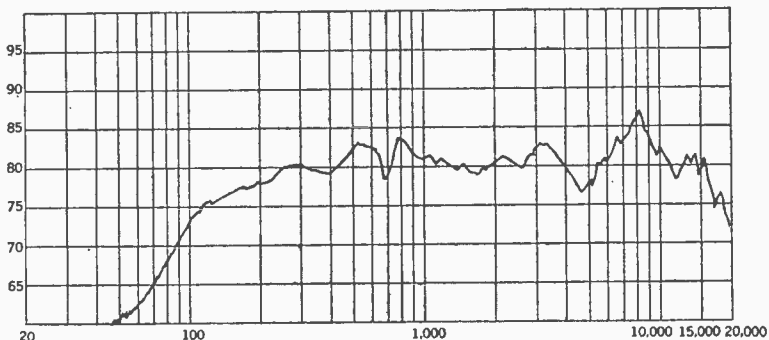

Curve above shows wide range of Poly-Planar 5. At right we've removed one side (A) of enclosure to show placement of parts. A pair of Polar-Plus's are connected to a Midland AM/FM-stereo receiver. One's been set upright to show they work both ways.

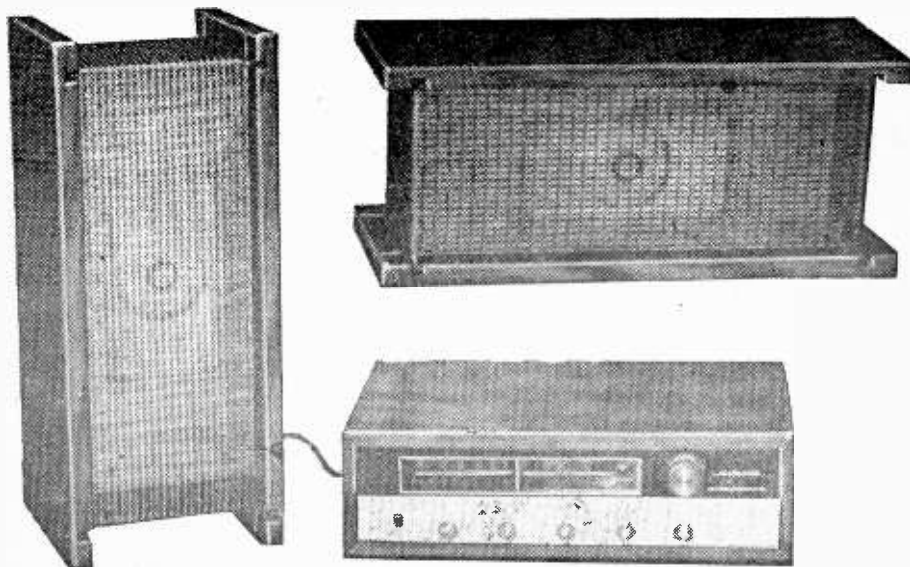
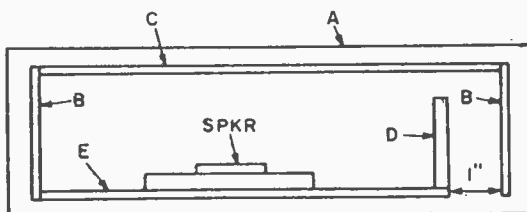

TLPS...

Build our TLPS for a happy home and

by Donald A. Smith, W3UZN

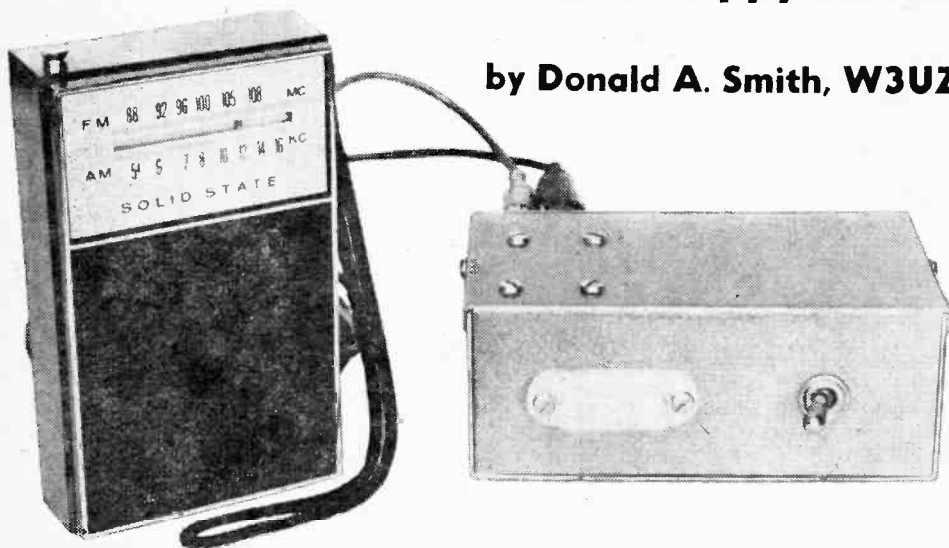

ARE YOU TIRED of continually buying new 9-V batteries for Junior's transistor radio because he insists on using his sets excessively (like maybe 16 hours a day) in the house, where, most likely, more than one line-powered receiver that's capable of reproducing rock music can be found? From the number of inquiries we get in the mail there must be a vast number who are tired of this and would gladly spend an evening on our simple construction project to rid themselves of this chore.

As you may have guessed from the title, we're going to show you how easy it is to get out of that rut by building our TLPS (transistor line power supply). It's simple and easy to build, provides ample, well filtered, regulated 9 VDC to power the receiver directly from the line without concern of damaging it by excessive high voltage, a condition easily encountered with poorly regulated power supplies.

How It Works. The nominal 117-V, 60-Hz line power is reduced to 12 VAC by T1.

Diode D1 rectifies this AC voltage and capacitors C1 and C2, along with R1, act as a brute force filter to remove most of the AC ripple. Resistor R1 serves another purpose too. It acts as a voltage dropping resistor to bring down the 12 VDC from the rectifier to 9 VDC, and to limit the current flow through the Zener diode regulator when the load is removed. If, by chance, you require 12 VDC instead of the 9-V output featured in our supply, two minor component changes are all that's required to effect the change in output voltage: 1) change resistor R1 from 220 ohms to 100 ohms, and 2) change the Zener diode from the 9-V HEP-104 to a 12-V HEP-105.

Construction. The photos show two different styles of construction for the TLPS; one an open chassis, and the other housed in a minibox similar to an LMB #138. You can use either one, or, for that matter, mount it in whatever type of housing suits your particular application. The parts layout isn't critical, so make it in whatever form you

power supply

declare your independence from batteries

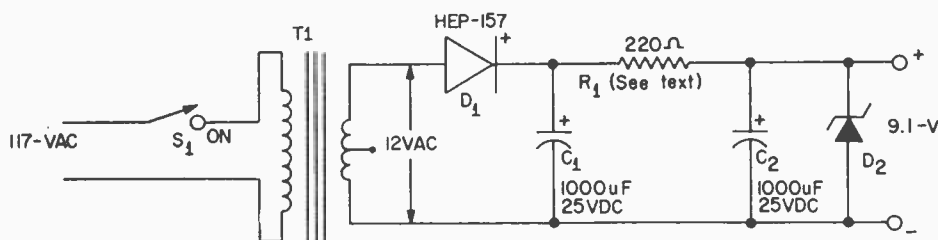

PARTS LIST FOR TLPS

C1, C2—1000- μ F, 25-VDC electrolytic capacitor (Cornell-Dubilier BR1000-25 or equiv.)
D1—400-PIV, 1-A silicon rectifier (Motorola HEP-157 or equiv.)
D2—9.1-V, 1-W Zener diode, (Motorola HEP-104 or equiv.—see text)
R1—220-ohm, $\frac{1}{2}$ -watt resistor (see text)

T1—Power transformer; 117-V 50-60 Hz pri., 12-V secondary (Stancor P-8130 or equiv.)
Misc.—Suitable box (LMB #138 as shown or Premier AMC 1006), wire, multipoint tie strips, 2-conductor, jacketed cable, solder, connectors (see text), hardware, etc.

prefer. The use of multi-point tie strips for mounting filter capacitors, diodes, and resistor R1 is an excellent way to do the job. You may prefer binding posts or banana jacks to connect to the output if the supply is to be used for general transistor projects. You could extend the output to a length of 2-conductor cable, terminated in a connector made from the terminal board removed from a discarded 9-V battery so you can plug the power supply directly into the device being powered by it.

A word of caution: be sure the capacitors, diodes, and output terminations are correctly polarized before soldering them into the circuit. Because of the simplicity of this project, you shouldn't encounter any problems, just double-check your wiring for accuracy before plugging the supply into a wall outlet. Now you can let them use their sets to their hearts' content and not be pestered by run-down batteries again. ■

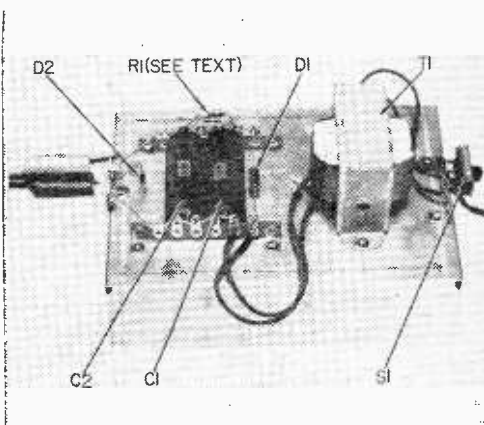

This version built on a conventional chassis instead of in a minibox as the one shown on opposite page. Since circuit isn't critical build it to fit your needs. Tie strips hold parts neatly in place.

DOUBLE-TIMER

by Frank Deems

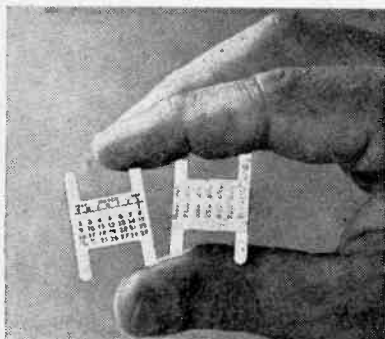

Outdated wristwatch calendar (left) is basic ingredient in our DoubleTimer. Actual chart (right) is typewritten, then copied with camera and close-up lens. Print, which should be exact size of wrist calendar, is held securely in place with epoxy cement.

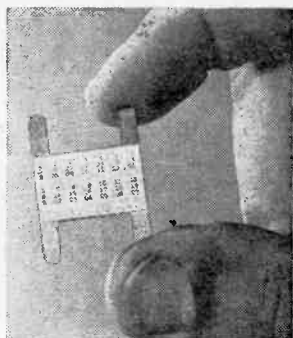

THOSE little clip-on calendars that wrap around a watchband are mighty handy gadgets. But telling the day of the month doesn't need to be their only function in life. They also can be put to work to help keep track of at least two time zones.

Active people, such as radio operators, pilots, and traveling businessmen, often need to know the time of day simultaneously in two locations. One of those wristwatch calendars can be easily modified to handle this assignment with ease.

Greenwich Mean Time is frequently used by ham operators and by pilots, since it serves as a universal time recognized in all parts of the world. Nor is it affected by local time zones and changes from standard to daylight saving time. Businessmen also need

such convenience. But they generally want to know the time at their home office, plus some distant location, such as a district office or an important customer's plant.

Two On One. Our double-timing watchband can provide this convenience without the necessity of carrying two watches, or of buying a high-priced watch with an adjustable outer dial bezel for the second time zone. With this modified watchband, any wristwatch serves to tell the wearer the time in two places—any two places in the world!

Heart of the system is a simple chart which you affix over an outdated clip-on wrist calendar. The chart compares local time with GMT (or with any other time zone you may wish to use). You use the watch normally for local time, but refer to the chart to convert local time instantly to GMT, and vice versa.

The chart shown in the photos was prepared for use in the Mountain Standard
(Continued on page 64)

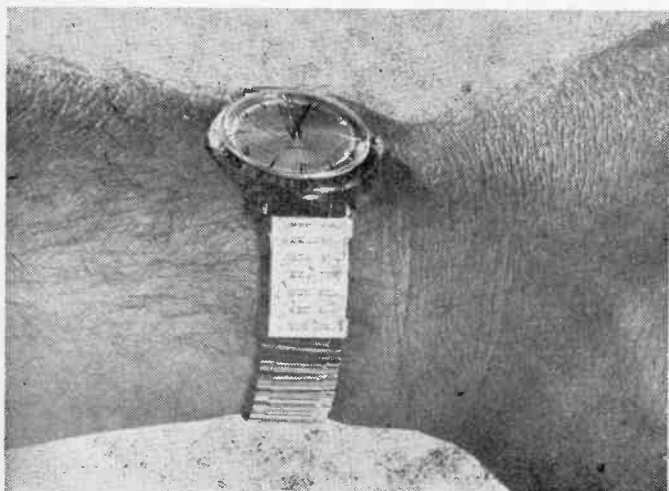

Completed DoubleTimer makes useful addition to any watchband. Varnish or clear Krylon spray protects it from wear; edges of print should ideally be beveled with fine sandpaper after epoxy has dried but before protective coating is applied to prevent them from snagging on shirtcuffs.

the UNICORD

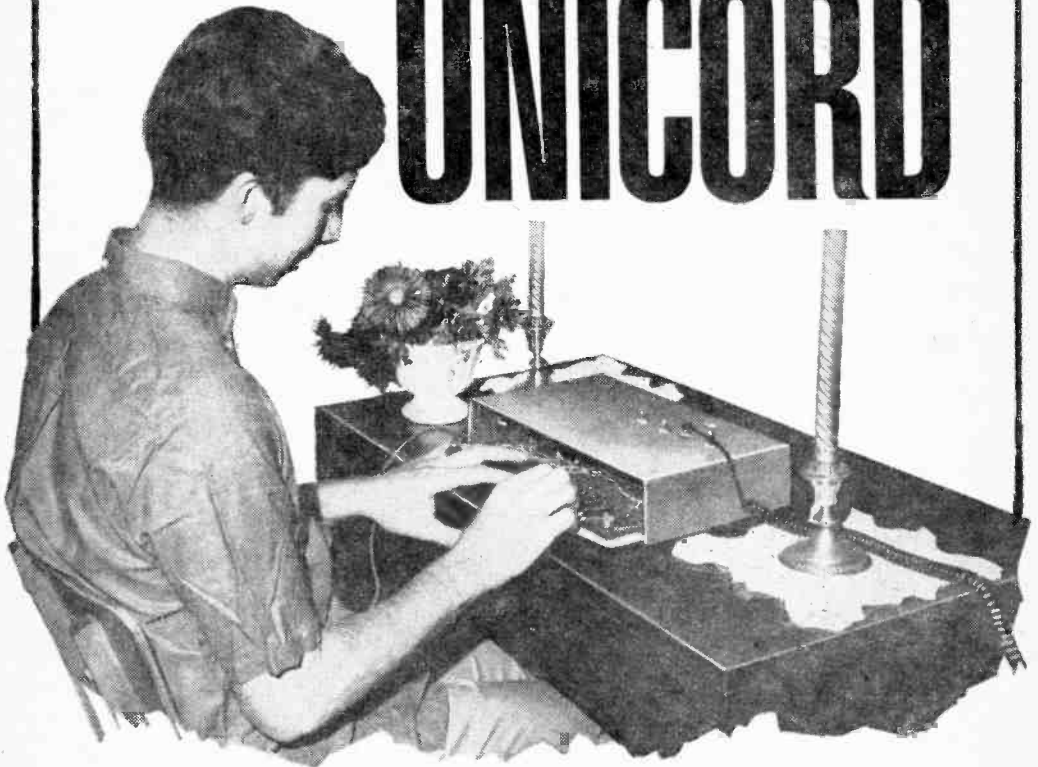

You can build this multiple chord organ with tremolo for less than \$30

by Steve Daniels, WB2GIF

You're sick of those circuits for electronic organs that work great but let you play only one note at a time? You can't afford the bread for a "Mighty Wurlitzer," but you still want to be able to play chords? Well then, our Unicord is just what the doctor ordered. Employing unijunction transistors, it can be built for about 30 bucks. And, best of all, you can play complex chords up to a maximum of five notes over a range of better than an octave. In addition, it has tremolo that can be switched *on* when you want it and a switch to give you bass boost or brilliance at will. Output of Unicord can be fed to any phono input on a radio or TV, PA or hi-fi amplifier, tape player, etc.

How It Does It. Commercially built electronic console organs are designed with separate divider or generator stages for each note in

the UNICORD

order to provide flexibility and range. That is why you pay hundreds of dollars for these instruments. Our Unicord is built around a basic module containing five tone generators with circuitry that derives three notes from each generator. Frequencies of these notes are adjustable by means of three variable resistors. You can play no more than one of each of three derived tones from each generator at any one time. However, this has proven to be a minor problem when the notes are properly distributed between generators, since the organist can combine the output of more than one generator to make up chords.

Since all of the tone generators are identical electronically, the technical description for one applies to all. Reference to the schematic diagram for the complete module, and also the separate basic generator schematic, will make it easier to understand the following functional description of Unicord's circuit.

Depressing a key applies B+ to its respective unijunction generator circuit. Referring to the basic generator schematic, this charges capacitor C through its associated resistor R1 until the peak point voltage of its UJT is reached. At this point the 2N2646 UJT now starts to conduct current through its base b1. The junction voltage at the emitter is clamped almost to ground. The current through the transistor then decreases and the transistor is driven to cut-off.

Capacitor C now begins to recharge and the cycle is repeated. The repetition rate,

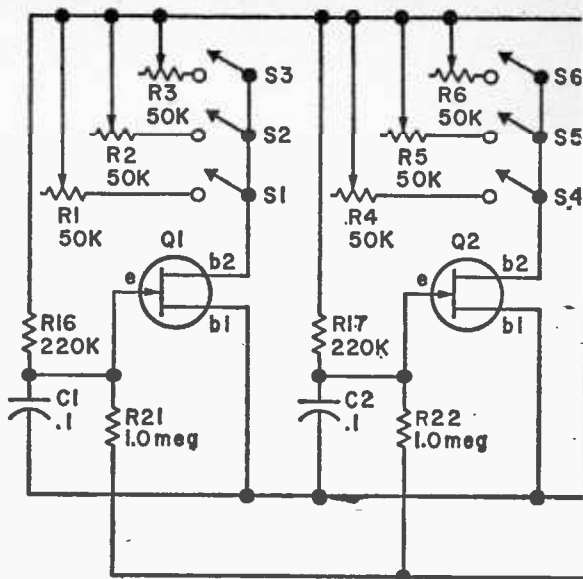
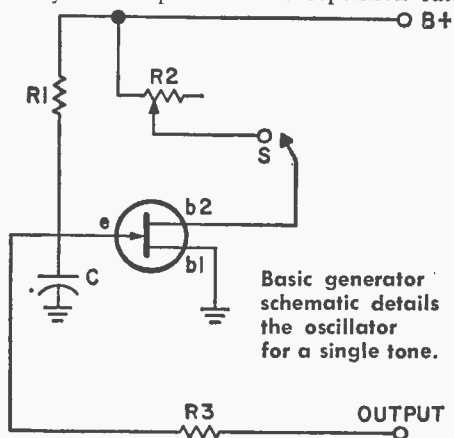

PARTS LIST FOR UNICORD

- C1 through C5—0.1- μ F, 600-V tubular capacitor (Allied 43E232 or equiv.)
- C6—1000- μ F, 25-V electrolytic capacitor (Allied 43E5864 or equiv.)
- C7—500- μ F, 15-V electrolytic capacitor (Allied 43E6268 or equiv.)
- C8—5- μ F, 15-V electrolytic capacitor (Allied 43C6624 or equiv.)
- C9—100- μ F, 15-V electrolytic capacitor (Allied 43C6633 or equiv.)
- C10—0.001- μ F, 150-V tubular capacitor (Allied 43C1636 or equiv.)
- D1, D2—1-amp silicon diode (Allied 24C9572 or equiv.)
- I1—6-V, 50-mA miniature screw base incandescent bulb (H.H. Smith #2418-26)
- J1—Open circuit phone jack (Allied 47E4955 or equiv.)
- PC1—Clairex photocell type CL604L (Allied 60E7465 or equiv.)
- Q1-Q5—2N2646 unijunction transistor
- Q6—GE-10 general purpose transistor
- Q7—2N2160 unijunction transistor
- R1 through R15—50,000-ohm trimpot (Allied 46E3674C or equiv.)
- R16 through R20—220,000-ohm, $\frac{1}{2}$ -watt resistor
- R21 through R25—1.0-megohm, $\frac{1}{2}$ -watt resistor
- R26—20,000-ohm, $\frac{1}{2}$ -watt resistor
- R27—50,000-ohm, linear taper potentiometer with switch (Allied 46C5523)

which actually establishes the frequency of the note, is determined by the RC time constant. End result is an audio voltage, developed at the emitter and coupled to the output buss through the high resistance iso-

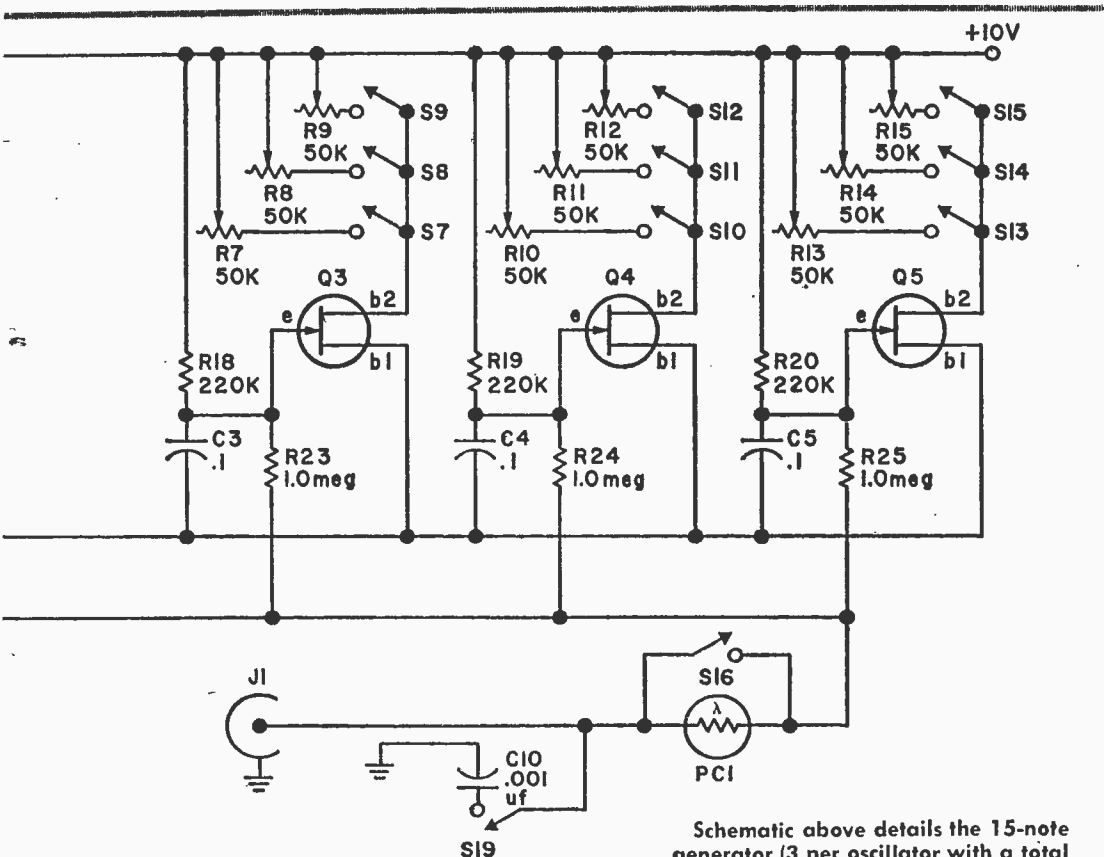

Schematic above details the 15-note generator (3 per oscillator with a total of 5 oscillators). Schematic below is for tremolo unit. Lamp I1 of tremolo unit excites photocell PC1 of generator unit.

- R28—33,000-ohm, 1/2-watt resistor
- R29—22,000-ohm, 1/2-watt resistor
- R30—33-ohms, 1/2-watt resistor
- S1 through S15—Keys (switches) for playing notes—see text
- S16, S19—Spst toggle switch (Allied 47E4955 or equiv.)
- S17—Spst toggle switch (Allied 56E5604 or equiv.)
- S18—Spst switch mounted on R27 (Allied 46C5359 or equiv.)
- T1—Power transformer, 117-V, 50-60 Hz pri; 12.6 VCT, 2-A sec (Allied 54E4200 or equiv.)
- I—Lamp holder for miniature screw base G-3 1/2 lamp (Allied 60E8077 or equiv.)
- Misc.—10 x 13 1/2 x 3/4-in. plywood for base, sheet aluminum or tin cans for keys, plastic discs for key tops, perfboard, flea clips, wire, solder, 19 3/4 x 11-in. piece of sheet iron or aluminum, 1/2-in. spacers, etc.

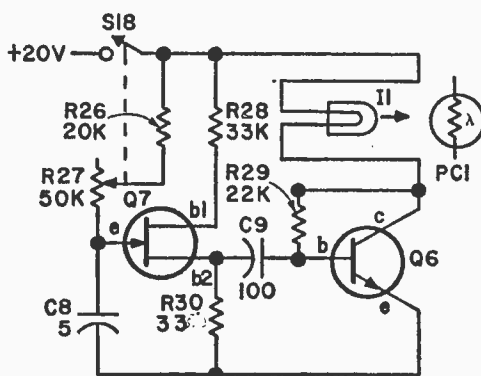

lating resistor R3. So much for the generation of a tone.

Tremolo is produced by energizing a photocell with pulsed light. Lamp I1 is driven by a low-frequency oscillator similar to the tone

generator oscillator. Negative pulses from base b1 of oscillator Q7 are coupled to a common-emitter, fixed-bias amplifier Q6, which has lamp I1 connected in its collector circuit. Transistor Q6 is cut-off whenever re-

the UNICORD

verse bias pulses are applied to its base, thus raising and lowering current flow through I1, causing I1 to proportionally increase and decrease in illumination.

These variations, in turn, increase and decrease the output of the photocell. And since the photocell is in series with the output of the tone generator, the generator output is varied at the same rate. This variable output produces the tremolo effect. Tremolo is disabled by closing switch S16, which shorts out the photocell.

Bass boost/brilliance switch S19 inserts a 0.001 μ F capacitor between the output buss

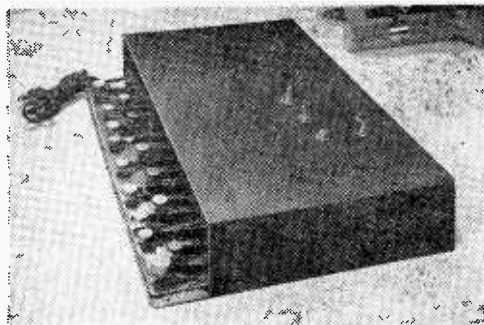

The completed Unicord shown with its cover in place. Cover adds class over solder joints.

of aluminum or tin cut from a tin can. The natural keys are 2½-in. long and the sharp keys are 1½-in. long. Keys are formed so that the front half is elevated near the rear portion. When the keys are screwed to the

THE UNICORD TUNING CHART

Musical Note	Frequency (Hz)	Musical Note	Frequency (Hz)
(Middle) C	261.63	(Middle) G#	414.90
C#	277.20	A	440.00
D	293.66	A#	465.00
D#	310.55	B	493.88
E	329.63	C	523.25
F	349.23	C#	554.40
F#	370.41	D	587.32
G	392.00		

and ground to produce the equivalent of a bass boost by filtering out higher harmonics. The output has more brilliance when S19 is open and has the bass boost effect when this switch is closed.

On Being an Organ Builder. The basic 5-tone, 15-note generator is mounted on 10 x 13½ x ¾-in. piece of plywood, along with the 15 keys and required power supply. All of the keys are made from 7/16-in. strips

wood base at their rear, the elevated front accounts for the spring return action; this occurs whenever the organist removes his finger from the key. Cement plastic discs (not over ½-in. in diameter) on top surface of the front of each key. An insulator prevents hum being introduced by body contact through organist's finger.

Place 9 wood screws in a straight line, spaced ⅞-in., center-to-center, ¾-in. from the front edge of the base board and 6 wood screws in between the 9, 1¾-in. from the front edge as shown in our photo. Before tightening these screws connect together, with bare wire, groups of three (starting from your left when facing the board) and extend these busses by connecting insulated wire leads approximately 5 to 9-in. long which will be connected to the generator later on during the construction. Mount each key to the board with wood screws. Screws should be placed in a straight line, 2¾-in. from the front edge of the board on ⅞-in.

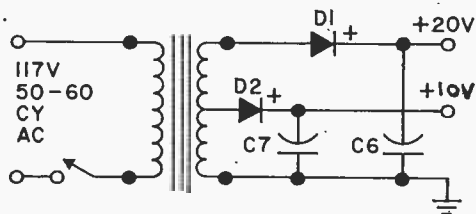

Instead of dropping resistor, dual voltage power supply provides 10 VDC for tone generators and 20 VDC for tremolo unit.

Cover bent from a single sheet of thin aluminum or steel. If metal brake not handy, place aluminum between two hard surfaces to make bends.

centers. Fasten a soldering lug under each screw for making connection between the key and the tone generator before tightening the key to the board.

The power transformer, diodes, and filter capacitors that make up the power supply are mounted the rear left-hand corner of the base board. The perf board, containing the electronic circuitry, is mounted in the remaining space on the base board.

All components for the generator, the tremolo circuit and bass boost, with the exception of switches and tremolo control, are mounted on a 7 1/4 x 5 1/4-in. piece of perf board. Follow the layout we use as detailed in our photo. In hooking up the keys use as

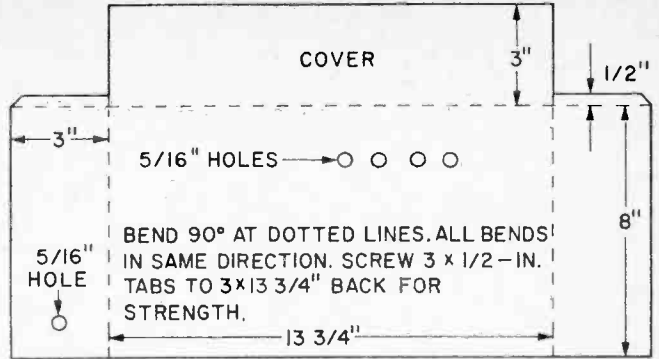

many different colors of wire as are available. This will help identify the various notes when you are tuning the organ.

Use flea clips or push-in terminals for terminating circuit to external parts such as tremolo control, power, and bass/brilliance switch not mounted on the perf board. We used flea clips for each base h2 lead of the UJTs for connecting them to the keys. Take care when soldering the diodes and UJTs: if

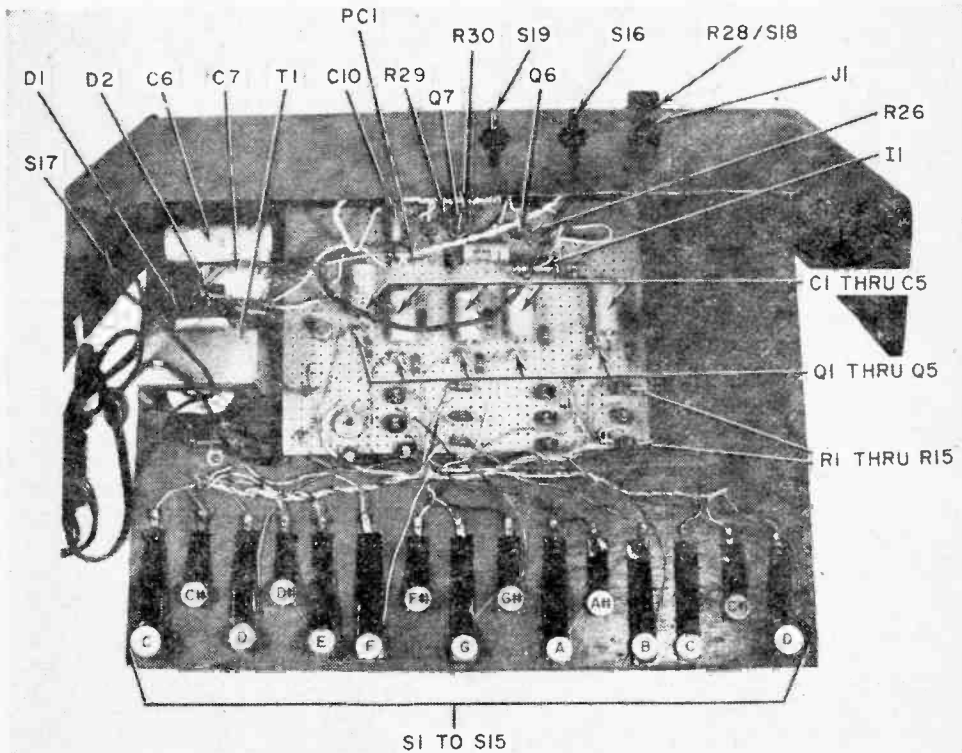

Unicord opened to show location of components. All keys are mounted on 7/8-in. centers. Note that natural and sharp keys are alternated except between E and F, and B and C.

the UNICORD

possible use an alligator clip as a heat sink temporarily clipped to each lead during the soldering. Separate the photocell about 2 in. from the lamp in the output of the tremolo circuit.

When mounting the perf board to the base board use 1/2-in. spacers to raise it above the base board. Do not fasten it down until the unit is completely wired and tested. It will be easier to adjust the trim pots if the perf board is free to be moved around during this operation.

A suitable cover for the entire assembly can be made from a 19 3/4 x 11-in. sheet of metal, either aluminum or sheet iron. Notch out the two corners, leaving a 1/2 x 3-in. tab to be fastened to the back of the cover with sheet metal screws; these tabs will strengthen the cover. Bend the sheet as shown in the drawing to form a box-like cover.

On Being an Organ Tuner. The easiest way to tune the organ, especially for those who have a musical ear, is to compare the organ output signal with the desired note produced by a musical instrument known to be in tune. A piano, guitar, violin, banjo, ukelele, or accordion will be ideal as any one of these instruments has had each of its notes tuned to specific frequencies, which can be repeated as often as desired. If none of these instruments is available, an accurately calibrated audio oscillator will serve just as well. The accompanying chart tabulates the correct frequency for each note.

● GRIN and TIN

● When a soldering iron having a removable solid copper tip held in place with a setscrew begins to lose its heating ability due to the filament aging, here's what you can do. Loosen the setscrew, remove the tip, and place it in the barrel backwards. File the newly-exposed surface of the tip lightly to clean off scale, then heat

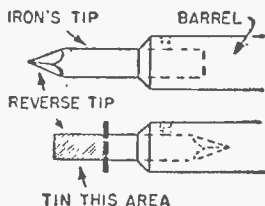

Once you have determined that the tone generator and tremolo are working properly, and you do get an output from the Unicord when each key is depressed, you are ready to tune it. The Unicord should be fed into the high impedance input of your amplifier. The photo of the Unicord with cover raised has the specific note assigned for each of the keys indicated for each key. When tuning, hold down a key so that the Unicord output will be heard while you strike the same note several times on your musical instrument.

Here is where that good musical ear comes into play—compare the tone of the Unicord note with that of the musical instrument and adjust the trimpot associated with the key being tuned until the note from the Unicord is identical to the note of the instrument. Repeat this operation for all 15 keys and then you are ready to try your hand at being an organist.

If you should use an audio signal generator as your standard tone source instead of a musical instrument, you first set the audio generator to the frequency for the note you are tuning (determined from the chart), feed the output of the audio generator as well as the output from the Unicord, to an input of your amplifier and then proceed to make the same tuning adjustments described for tuning with a musical instrument. For those purists who are extremely sensitive to true tone, or those who may have a "tin ear," you can use a frequency counter on the output of the Unicord, if one is readily available.

Now that it's properly tuned you can idle away the hours playing your favorite chords to your heart's content. Our guess is you'll be loath to find a project that's half as much fun as your Unicord. ■

the iron and tin the tip with a thin layer of solder. When you place the tinned portion of the tip back into the barrel, more efficient heat conduction will result and the iron will operate at or near its original heat output.

● For a neater job of soldering a wire or cable to a lug, build a dam around it with a pipe cleaner as shown. This idea is particularly good for automotive or radio jobs, where precision is necessary.—V. H. LAMOY.

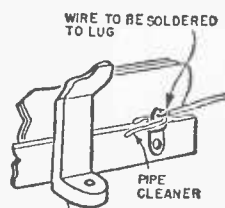

Station **BLAZER**

Build our six-buck preamp in one evening and convert your so-so SWL receiver into a red-hot number.

By Edward A. Morris, WA2VLU

CHANCES are, if your general-coverage SWL or ham receiver cost much under \$100.00, it's lacking sufficient RF gain. Fact is, many of the more inexpensive receivers lack an RF stage altogether! If you're ever going to get out of the novice league when it comes to pulling in the rare ones, you'll have to correct the situation. You *could* go out and plunk down \$250.00 to \$600.00 for an all-band, do-everything, super-deluxe receiver. Thing is, there aren't too many of us who can afford to go that route.

As you may suspect by now, there's another answer—our Station Blazer. Station Blazer is a wide bandwidth RF amplifier that provides 12-15 dB of signal gain. That's an increase of about two S units. Station Blazer covers 3 to 30 MHz in one giant step. No tuning or signal peaking is necessary and the only control is an *on/off* switch.

All that signal helping gain is provided by a mere handful of parts. Total cost should run under \$6.00, and that's for a fancy version. Construction is simple and goes quickly. It's a one-evening project.

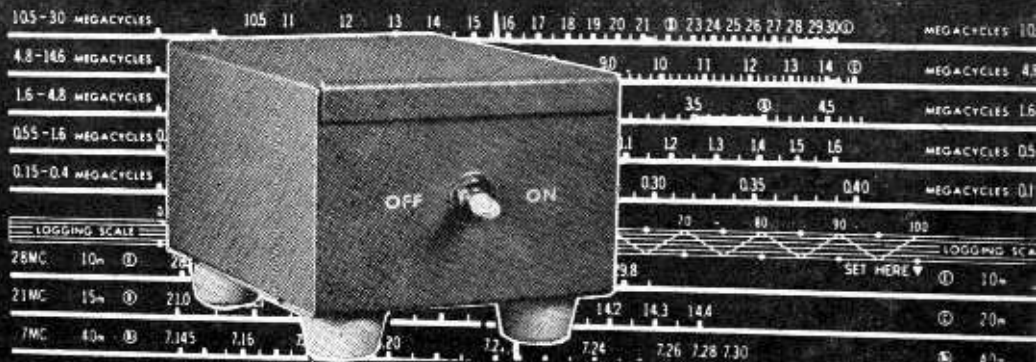

Station BLAZER

Schematic diagram shows how simple our Station Blazer is to build and how few components can be put together to make a very efficient preamp thanks to the FET.

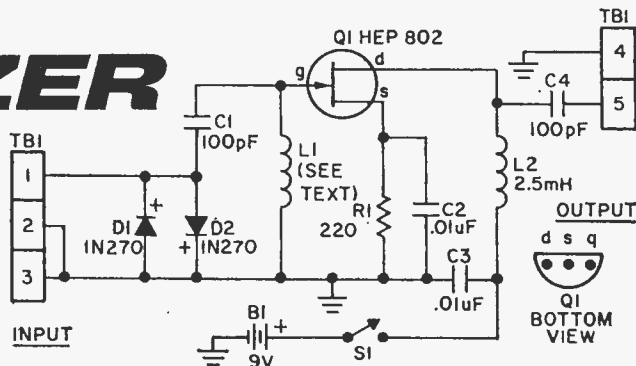

PARTS LIST FOR STATION BLAZER

B1—9-V battery (Eveready 216BP or equiv.)
 C1, C4—100-pF, 25-VDC disc ceramic capacitor
 C2, C3—.01 uF, 25-VDC disc ceramic capacitor
 D1, D2—1N270 diode (RCA)
 L1—See text
 L2—2.5-mH choke (National R-50-2.5 or equiv.)
 Q1—HEP 802 field-effect transistor (Motorola)
 R1—220-ohm, 1/2-watt resistor
 S1—Spst miniature toggle switch (Lafayette 99E61624 or equiv.)
 TBI—5-terminal screw terminal board

1—3/8-in. dia. x 1-in. long ferrite rod taken from a ferri-loopstick antenna (Lafayette 32E82019 or equiv.—see text)
 1—3 1/4 x 3 x 2 1/2-in. interlocking chassis (LMB-135 or equiv.)
 1—Battery holder made from 1/2 x 1 1/4-in. scrap aluminum
 1—Circuit board, copper clad on one side
 Misc.—Push-in terminals, vinyl covering material, rubber feet, hardware, solder, hook-up wire, RG8/u coaxial cable, etc.

How It Works. RF signals from the antenna are coupled from terminal 1 of terminal strip TBI to the gate of field-effect transistor Q1 via coupling capacitor C1 (see Fig. 1). Coil L1 provides a DC return path to ground for the gate but blocks RF.

Transistor Q1 is biased for normal amplifier operation by resistor R1 in the source

ground leg of the circuit. Capacitor C2 bypasses R1, preventing degeneration and loss of amplifier gain. The amplified signals appear at the drain of the transistor and are coupled to terminal 5 of TBI by capacitor C4.

Diodes D1 and D2 are connected across the input. Normally they don't affect circuit operation. They do come into action, how-

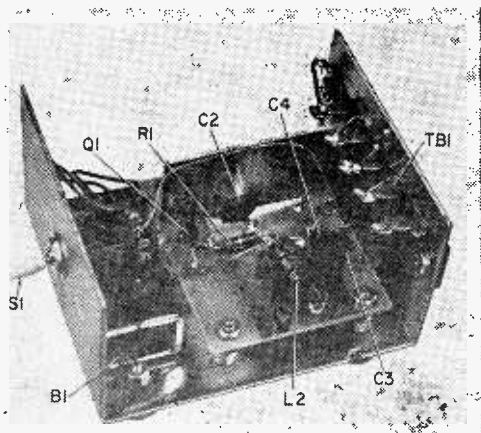

You can see how well the Station Blazer's laid out, with all components mounted on one sided copper foil board. Good HF wiring practices must be used for it to work.

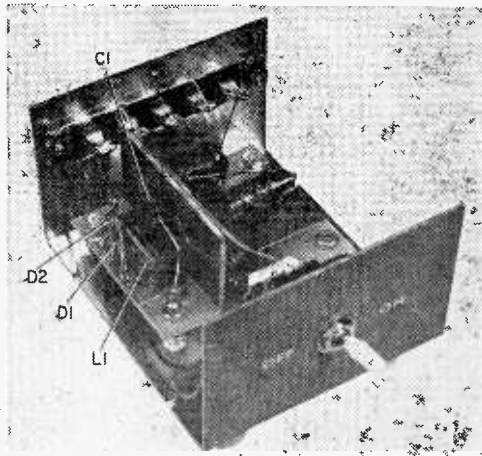

You can see that all it takes to run our Station Blazer is just one control—the power switch on the front panel turns it on or off. It's easy to build and fun to use.

ever, to protect the FET from high voltages generated by lightning and static discharges as well as high-power transmitters located nearby. They conduct only on high-level inputs, grounding the signal, and thus protecting the FET from possible damage.

Begin construction by marking the chassis with the mounting positions of switch S1, terminal strip TB1, the circuit board and

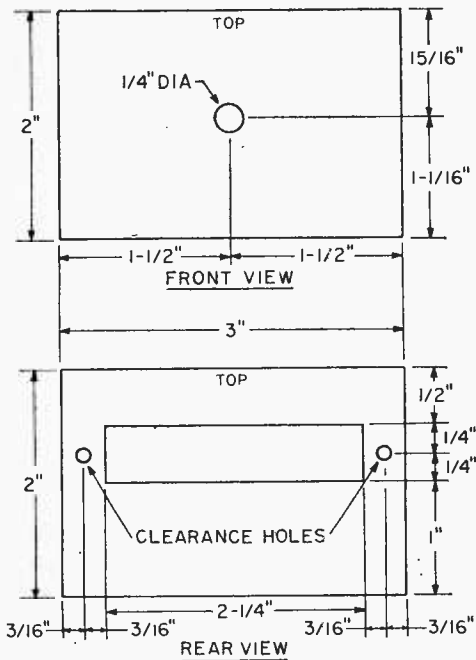

Drilling instruction for the minibox that houses our Station Blazer. If you don't have a hand nibbler available cut out the large openings by drilling and filing.

rubber feet (see Figs. 2 and 3). Once the parts layout has been determined, spot and center punch the holes to be drilled, then drill and deburr all holes. The cutout for the terminal strip is most easily made with a hand nibbler. With the necessary holes drilled and all other mechanical work on the case completed, finishing the case is the next step. The author's model was covered with a contact adhesive vinyl material. This type of material is widely available in a variety of colors and patterns.

Electrical Construction. The exact electrical layout isn't critical, as long as proper hf layout and wiring techniques are kept in mind. Remember the FET has lots and lots of gain. Couple this with its high input impedance, and you can see where sloppy layout and wiring can get you in trouble! Poor-

ly wired, Station Blazer will act more like an oscillator than an amplifier, and this we can do without.

The general component layout can be determined from our photos. Most of the parts are mounted on a copper-clad board. Take care to use short, direct leads. Note that coils L1 and L2 are mounted at right angles to one another. This is done to reduce inductive coupling between input and output. Further isolation is provided by shielding the input from the output circuit with a section of copper-clad board.

With the exception of the lead from Q1's gate to L1, all wiring is carried out on the component side of the board. Two strips, along opposite edges of the board, should be removed to provide insulated areas for push-in terminals and mounting nuts. To remove the strips score the material with a hobby knife and pull off the unwanted copper areas.

Transistor Q1 is soldered directly into the circuit. Precautions should be taken to prevent Q1 from damage due to excessive heat while soldering. This means that your old 250-watt lead melter is definitely out! Use a small (under 50 watts) well-tinned iron, and complete the job as quickly as possible. The source and drain leads are interchangeable. The gate leads, however, isn't interchangeable with any of the other leads and must go to L1 and C1.

Coil L1 is home-brew. Start with a 3/8 x 5-in. ferri-loopstick antenna (see Parts List) and unwind the turns. Cut off a 1-in. long section of rod and wind it with 40 turns of #26 PE wire closewound. Cement the turns

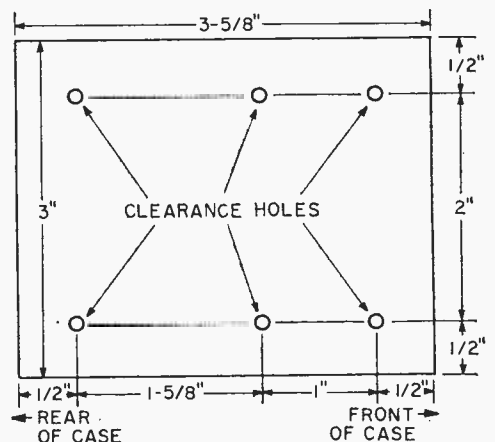

Drill the bottom of the minibox as shown to mount the circuit card and the battery holder. Be sure all holes are de-burred.

Station BLAZER

in place with Q-dope or Duco cement. The low-frequency coverage of Station Blazer can be extended down to 0.5 MHz by winding L1 with 150 turns on a 1½-in. long ferrite rod, closewound in 3 layers. Some loss of gain at the higher frequencies will result, however.

After the electronic card has been wired, check it against the schematic for possible errors and shorts. Mount the card in the case using 4-40 x ½-in. screws. Space the card about ⅜ in. off the chassis, using additional nuts under the board on the screws. Complete the few final connections between the card and the input/output terminals, battery B1, and switch S1.

Using It. All that's left to do is to connect

your receiver's input terminals to Station Blazer's output and your antenna to the input. Station Blazer is connected to your receiver using a short length (under 3 ft.) of RG-8/U coaxial cable.

For best results, a good ground is a necessity. However, when connecting ground wires to systems containing an AC/DC receiver you must use special precaution because a lethal shock hazard is present. The best procedure to follow is to first isolate the receiver from the power line using a 1:1 transformer.

All set? Snap in the 9-V battery and turn your Station Blazer on. Never knew there were so many signals, eh? Gain improvement is most noticeable on weak signals, about S1 or so. Boosted to a more respectable S3, these stations are much more readable. Best of all, signals you never even suspected of existing before can now be copied and logged.

Happy DXing! ■

Doubletimer

Continued from page 54

Time zone, and goes like this:

L	1	2	3	4	5	6	7	8	9	10	11	12
D	20	21	22	23	00	13	14	15	16	17	18	19
N	08	09	10	11	12	01	02	03	04	05	06	07

However, it can be modified for use in any time zone you prefer. The horizontal lines following the letter *L* indicate hours in local time. The lines following the *D* (for day) indicate GMT when local time is between 6 a.m. and 6 p.m. And, the lines following *N* (for night) indicate GMT hours when local time is between 6 p.m. and 6 a.m.

The cart was typewritten on a white card, then copied with a camera using a close-up lens. A print was made to the exact size of a wristwatch calendar, and glued to an old calendar with epoxy cement.

After the cement dried, the edges were beveled with fine sandpaper, then two coats of varnish applied to protect the surface of the chart from wear and smudges.

Using It. With such a chart attached to your watchband, use it this way:

✓ To convert local time to GMT, first look at the watch dial reading local time. Let's say it reads 8:32 and it's in the evening. Locate 8 in an *L* line on the chart. You see it's opposite 3 in the *N* line and 15 in the *D*

line. Since it's night time, disregard the *D* line and use the *N* line. This tells you that 8 p.m. local time (in the Mountain Standard Time zone, for which this chart was prepared) is 0300 GMT. Add to this the number of minutes shown on your watch dial and you have 0332 GMT.

✓ To convert GMT to local time. Suppose a ham in Europe told you he'd be on the air at 1700 hours GMT, and you want to listen for him. Look at the chart for 17. You see it's opposite 10 and in the *D* line. This tells you local time will be 10 o'clock in the daytime, or 10 a.m.

What could be simpler?

For use in other time zones, set up your chart this way: 0000 GMT equals 8 p.m. in EDT, 7 p.m. in EST and CDT, 6 p.m. in CST and MDT, 5 p.m. in PDT, and 4 p.m. in PST. Once you have this key hour filled in, the rest of the chart follows logically.

If at first glance the chart seems complicated, never fear. After you've used it a few times, you'll marvel at how simple . . . and handy . . . it is to use.

Now, with any inexpensive watch, you can carry GMT (or some other time zone) with you all the time. And of course if you still want to know the day of the month, you can wear a conventional clip-on calendar for the current month, plus your GMT conversion chart on a separate clip-on.

Sure beats carrying a sun-dial around, doesn't it? ■

UNIVERSAL REGULATED POWER SUPPLY

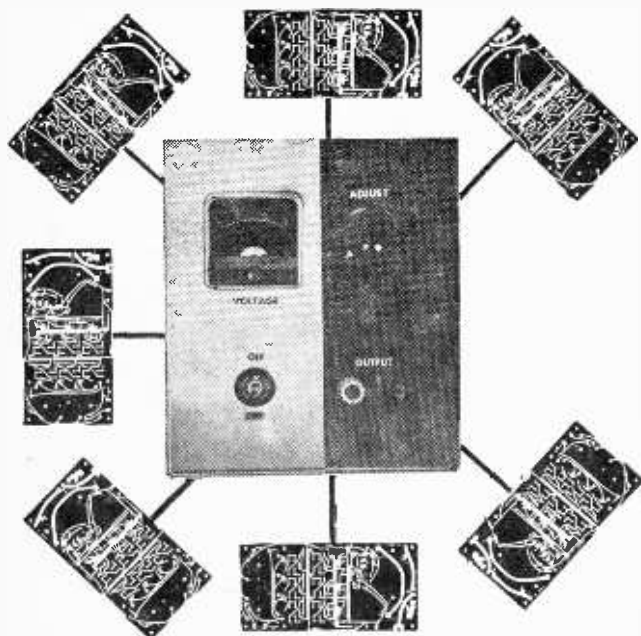

Reliable
current-
and
voltage-
regulated
low-
voltage
supply
powers
experiments
using
solid-
state
devices

by Herb Cohen

Many solid-state projects require a reliable source of low voltage power. Therefore, why not equip your shop with one or more DC power supplies having both current and voltage regulation to provide the necessary reliable low voltage power needed for various projects?

Best way to acquire this power source is build your own. As a starter, try the power supply detailed on the following pages. It's designed to have a 10-volt output at a maximum of 300 mA that is both voltage and current regulated.

Voltage Limiting. Reference battery, B1, maintains a voltage flow through R9, R10 and R11 to the negative side of the power supply, which is at zero potential. Therefore, the gate of the FET (Q1) is positive and Q1 is turned *off*. This being the

UNIVERSAL REGULATED POWER SUPPLY

PARTS LIST

- B1—9-V transistor radio battery (Lafayette 32E48077 or equiv.)
 BP1—Red binding post, accepts banana plug or phone tip (Lafayette 99E61202 or equiv.)
 BP2—Black binding post, accepts banana plug or phone tip (Lafayette 99E61210 or equiv.)
 C1—500- μ F, 25-VDC electrolytic capacitor (Lafayette 34E55243 or equiv.)
 C2—0.01- μ F, 100-VDC paper tubular capacitor (Lafayette 34E67057 or equiv.)
 C3—100- μ F, 25-VDC electrolytic capacitor (Lafayette 34E85682 or equiv.)
 C4—30- μ F, 16-VDC electrolytic capacitor (Lafayette 34E85505 or equiv.)
 D1, D2, D3, D4, D5, D6—750-mA, 400-PIV diode (Lafayette 19E50021 or equiv.)
 D7—5.6-V, 250-mW Zener diode, IR type 1N708 or Motorola HEP 603
 M1—0-1-mA, 1 9/16-in. square meter (Lafayette 99E50528 or equiv.)
 Q1—FET, Motorola MPF 155

- Q2, Q4—Npn silicon transistor, Motorola HEP 54
 Q3—Pnp Silicon transistor, Motorola HEP 57
 Q5—Npn silicon transistor, RCA 40316
 R1, R4, R8—560-ohm, 1/2-watt resistor
 R2—9100-ohm, 5%, 1/2-watt resistor
 R3—1000-ohm, 1/2-watt resistor
 R5—2.7-ohm, 1/2-watt resistor
 R6—1.0-ohm, 1/2-watt resistor
 R7—1500-ohm, 1/2-watt resistor
 R9—220,000-ohm, 1/2-watt resistor
 R10, R12—500,000-ohm, subminiature, printed circuit type potentiometer (Lafayette 99-E614678 or equiv.)
 R11—500,000-ohm, linear taper potentiometer with spst switch S2 (Lafayette 33T1277 or equiv.)
 R13—75,000-ohm, 5%, 1/2-watt resistor
 R14—3300-ohm, 1/2-watt resistor
 S1—Spst toggle switch (Lafayette 34E33026 or equiv.)
 S2—Spst switch (part of R11)
 T1—Filament transformer: primary 117 V, 50-60 Hz; secondary 12.6 V @ 2 A (Lafayette 33E81191 or equiv.)
 1—AC line cord (Lafayette 12E39011 or equiv.)
 1—6 x 9 x 5-in. aluminum utility box with removable sides (Lafayette 12E83530 or equiv.)
 1—Battery connector for 9-volt transistor radio battery (Lafayette 99E62879 or equiv.)
 Mics.—Bolts, nuts, screws, insulated sleeving, push pins, perf board, grommets, hook-up wire, solder, press-on-letters, etc.

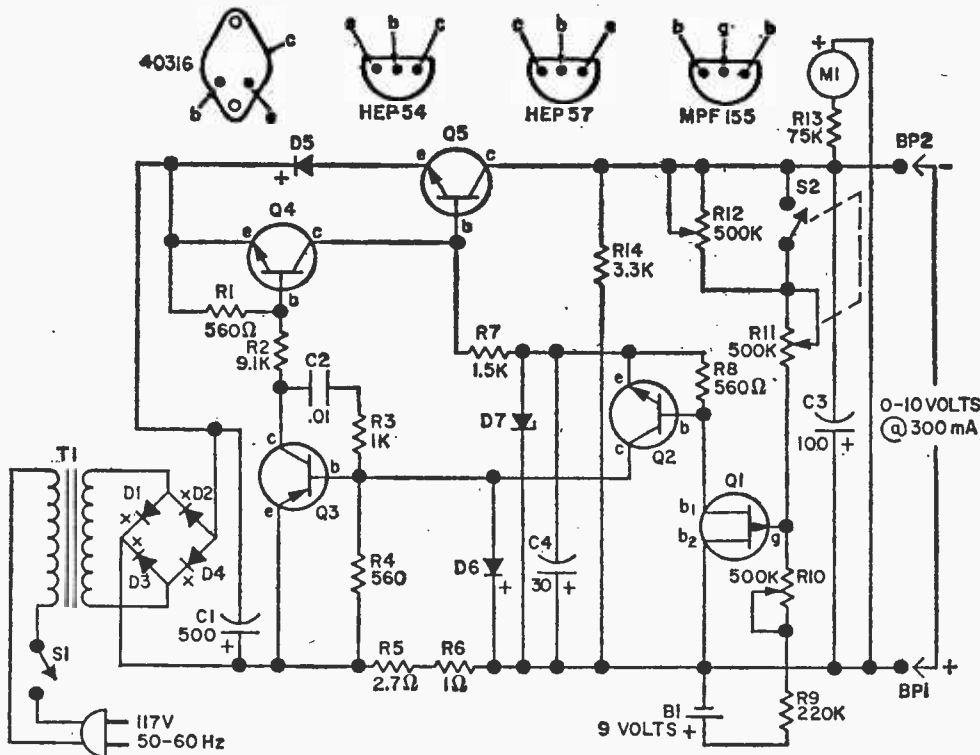

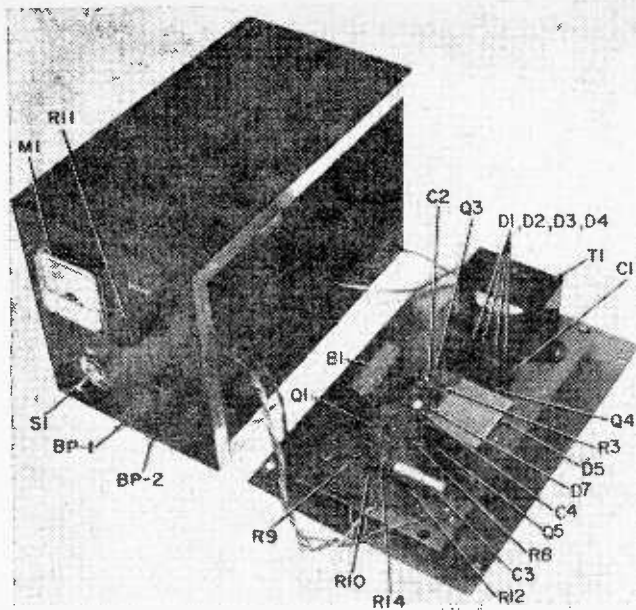

Here's what's inside our regulated supply. Note accessibility of components on circuit board. Because power transformer is relatively heavy, it needs extra support to prevent board from cracking.

case, no current flows through R8 and the base of Q2, so Q2 is also turned off. With Q2 off, no current flows and therefore Q3 is turned off. This effectively turns off Q4.

Transistor Q4 bypasses the base current of Q5, the series pass transistor that regulates the output voltage, and turns it off. With Q4 turned off, Q5 gets all of its base current and turns on, which causes the negative side of the power supply to rise off zero voltage. As this voltage rises, the gate of Q1 becomes less positive, and at a pre-set voltage, Q1 starts to conduct. The series pass transistor Q5 is now controlled and holds the voltage at the pre-set level.

The output voltage is controlled by programming series network R12, R11, R10—which serves as a sensitivity network. When R11 is turned on S2 is closed, shorting out R12, and R11 controls the output voltage. Its range is controlled by R10. When R11 is set at minimum resistance, S2 opens and R12 will control the voltage. (See paragraph on adjustments for correct setting of R12 and R10.)

When Q2 is turned on, it compares the voltage to that of D7, the Zener diode. The difference between the two voltages determines the amount of conduction of Q3. As the output voltage increases, the base voltage of Q3 increases, turning it on even more. This reduces the base current of Q4, which, in turn, reduces the conduction of Q5, thus reducing the output voltage. If the output

voltage drops, Q3 begins to turn off, which turns on Q4 and Q5, increasing the output voltage. In essence, we have a feedback amplifier that tries to maintain constant output voltage irrespective of the load.

Current Limiting. In this supply, current limiting will start at 250 mA and output current won't exceed 300 mA with a full short across the output. That's a good safety feature.

Current limiting is effected through R5, R6, and D6. A load placed across the output draws the current through R5 and R6. Normally the base of Q3 is -0.5 V with respect to its emitter, and D6 is reverse biased. When current through R5 and R6 reaches 250 mA, D6 is forward biased and conducts current into the base of Q3, turning it on hard. Q3, in turn, turns on Q4, which controls current through Q5, the series pass transistor. Q1 and Q2 no longer control the output, being overridden by the current sensing circuit R5, R6, and D6. When the excessive load is removed, D6 is reverse biased again the voltage regulators Q1 and Q2 take over again.

Building The Supply. A 6 x 5 x 5 x 9-in. (HWD) aluminum utility cabinet with removable sides houses the power supply. The voltmeter (M1), switch S2, potentiometer R11, and output binding posts BP1 and BP2 are mounted on one of the 5 x 6-in. ends of the cabinet as shown in the photos. All other components are mounted on a piece of perf board that is fastened to one of the removable 6 x 9-in. sides. It is raised from the metal side by $\frac{1}{4}$ -in. bushings to prevent shorts in the wiring on the under side of the circuit perf board.

If possible, use two additional mounting

UNIVERSAL REGULATED POWER SUPPLY

screws and bushings to add support to the perf board where the relatively heavy power transformer is mounted. (We lost a perf board because this additional support had not been included in the model.)

Push pins should be used for mounting and connecting components. They make it easier to replace defective components and tend to reduce heat damage from soldering. Spray paint the outside of the cabinet in a distinctive color and use press-on letters to mark the various facilities and controls on the front panel. You may want to add a carrying handle to the top to facilitate moving the power supply.

Be sure all diodes and electrical capacitors are properly polarized and all transistors are correctly connected before soldering them into the circuit.

Adjustments. R10 and R12 are set during construction and normally are not adjusted again. Therefore we used miniature

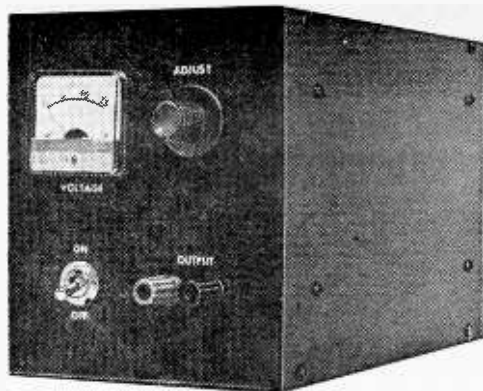

Output and control panel of this compact, utilitarian, low-voltage, regulated power supply usable either in experiments or as primary supply for operating equipment.

potentiometers that mount directly to the circuit board. R9 is a standard-sized, panel-mounted potentiometer complete with switch that's mounted on the front panel since it is the means to adjust output voltage and should be readily accessible.

R10 is adjusted so that output is zero volts when R11 is at minimum resistance and 10 volts with R11 at maximum resistance.

When S2 is open (R11 at minimum resistance), R12 is adjusted so that output voltage is 9 volts. ■

Power Failure Alarm

Never fear again that a power failure will knock out your electric alarm clock—not to mention your freezer. The instant the juice fails, the Power Failure Alarm's raucous buzz let's you know about it, even in the wee hours of the morning.

To keep current consumption (and operating costs) at rock bottom, a very sensitive relay is used for K1. As long as AC power is supplied, K1 is activated and the buzzer contacts are held open. When power fails, K1's contact springs back, completing the battery connection to the buzzer.

Relay K1 is a "model radio-control" type with a pull-in current of approximately 3 mA—almost no power. ■

POWER FAILURE ALARM

- B1—6V dry-cell battery
- C1—25- μ F, 150-VDC capacitor
- D1—500-mA, 200-PIV silicon diode
- K1—3000-5000 ohm sensitive relay coil
(see text)
- R1—10,000-ohm, 1/2-watt resistor
- 1—6-VDC commercial home buzzer

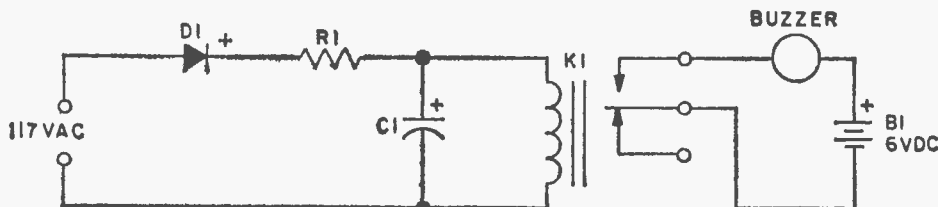

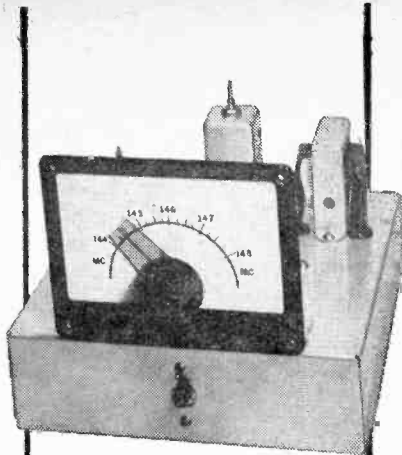

Photo By Moto



**Our
2-Meter
Converter
Puts your
BCB Receiver
On the
Beam**

**BY Charles Green
W6FFQ**



WHY not become part of the friendly round tables, net activities, and leisurely conversations prevalent on the 2-Meter ham band throughout the U.S.? This band, extending from 144 to 148 MHz, is quite different in character from the lower-frequency ham bands with their fast QSOs and heavy QRM.

The MARS and CAP nets at the edges of the band and the Civil Defense nets within the band make interesting listening. Traffic nets pass messages from other bands for local delivery and experimental transmissions of all kinds are common in it.

You really don't have to spend a fortune for a receiver in order to join the listeners on the 2-Meter band. Our SemiPro, a 2-tube converter used in conjunction with a BCB receiver, converts the 2-Meter signals for reception at the high end of the broadcast band.

Circuitry. In reality, SemiPro is a conventional superheterodyne front end, consisting of an RF amplifier, an oscillator, and a mixer; its RF output signal at 1650 kHz will be amplified and detected by a standard BCB receiver it must be connected to. As a matter of fact, if your BCB receiver is a super (as are most modern BCB receivers), you wind up with a double-conversion 2-Meter superhet. Double conversion achieves the higher gain and selectivity normally associated only with high-performance, professional communications equipment. This accounts for SemiPro's high performance on 2-Meters when coupled to a superhet BCB receiver.

How It Works. The 2-Meter signals picked up on the antenna are fed through J1 to the

SemiPro

primary of L1, a broadband coil. Its secondary feeds the cathode of V1, a grounded-grid amplifier.

These amplified signals are tuned by L2 and C3A and coupled to the grid of V2A mixer stage via R2 and C4. The other half of V2 (V2B), the oscillator stage, is tuned by L4 and C3C to produce an RF output signal that is always 1650 kHz above the incoming signal frequency. The oscillator (V2B) output is coupled to the mixer (V2A) grid by C5 and the resulting heterodyne signal output is fed to the tuned circuit comprised of L3 and C7 and thence via J2 to a BCB receiver that has been tuned to 1650 kHz.

A built-in power supply furnishes both heater and B+ voltages for operating the converter.

Building the SemiPro. Because this is a high-frequency circuit, wiring and layout are critical. Therefore we suggest you follow our layout as shown in our photos.

SemiPro is built on a 7 x 7 x 2-in. aluminum chassis with a 3 $\frac{3}{4}$ x 4 $\frac{3}{4}$ -in. heavy aluminum panel for mounting the dial, centered on the top front edge. Mount the dial to the panel and temporarily couple the ganged tuning capacitor (C3A, C3C) to it with an insulated flexible-shaft coupling. Cut the tuning gang shaft so that when this

capacitor is permanently mounted on the chassis, the front of the gang is 2 in. from the front of the chassis. Remove all but one rotor plate from each section of the ganged capacitor before permanently mounting it.

Locate and drill mounting holes in the chassis and shim the gang with nuts, spacers, or washers so that it's aligned with the dial and doesn't bind when tuning. Drill a $\frac{1}{4}$ -in. hole in the chassis adjacent to each stator

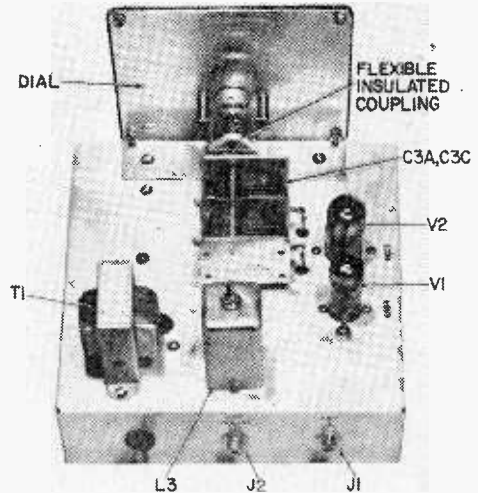

Since we are dealing in high frequencies parts layout is important. This view clearly indicates top of chassis orientation.

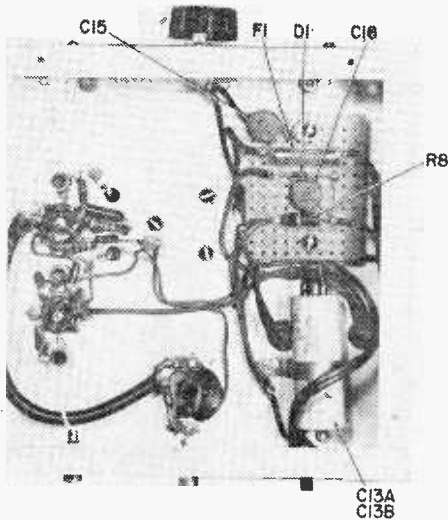

Except for the power transformer, which is mounted on top, all other parts of power supply are below chassis as shown here.

connecting lug. Bend these lugs so that they are centered over the holes, to keep connecting leads underneath the chassis as short as possible.

Locate the rest of the parts, keeping the same relative spacing between them, especially the tube sockets and the tuning capacitor, as shown in our photos. Coil L3 is mounted inside the shield can. Leads to it and capacitors C7, C8, and C9 are connected through a $\frac{7}{8}$ -in. hole in the chassis directly under the shield can.

Mount coils L1, L2, and L4 and associated resistors and capacitors around the sockets for V1 and V2 so that leads will be as short as possible. Connect center leads of sockets for V1 and V2 to chassis ground. Ground C6 and C12 to center post of V1 and be sure ground lugs are placed between mounting bushings and chassis when fastening L1, L2, and L3 to ensure short ground leads.

Remove tuning slug originally supplied

PARTS LISTS FOR SEMIPRO

C1, C6, C12, C14—1000-pF, 500-V ceramic disc capacitor

C2, C10—10-pF, 500-V, npo ceramic disc capacitor

C3A/C3B/C3C/C3D with trimmer capacitors—6.6 to 23 pF, two-gang variable capacitor (J.W. Miller 1461-2, see text for modification)

C4, C11—27-pF, 500-V ceramic disc capacitor

C5—Gimmick capacitor (see text)

C13A, C13B—50-50 uF, 150-V tubular electrolytic capacitor

D1—1N2071 silicon diode, 600 PIV, 750 mA

F1—½-A, 250-V fuse type 3AG (solder pigtails to ends for mounting and connecting)

J1, J2—RCA type phono jack (Switchcraft 3501F)

L1—0.108 mH to 0.180 mH RF coil (J.W. Miller 20A157RB1)

L2, L4—0.88 mH to 0.120 mH RF coil (J.W. Miller 20A107RB1) (J.W. Miller 30-202-5 brass tuning slug to modify L2—see text)

L3—Oscillator coil (J.W. Miller A-5496-C mounted inside J.W. Miller S-33 shield)

P1, P2—RCA type phono plug (Switchcraft 3501M)

R1—330-ohm, ½-watt resistor

R2, R5—12-ohm, ½-watt resistor

R3—1,000,000-ohm, ½-watt resistor

R4—22,000-ohm, ½-watt resistor

R6—47,000-ohm, ½-watt resistor

R7—2700-ohm, ½-watt resistor

R8—1200-ohm, 2-watt resistor

RFC—1.72 mH RF choke (J.W. Miller RFC 144)

S1—Spst slide switch (Continental-Wirt GF1123 or equiv.)

T1—Power transformer: primary 117-V, 50-60 Hz; secondaries 125V @ 15 mA and 6.3V @ 0.6A (Stancor PS8415 or equiv.)

V1—Type 6AB4 tube

V2—Type 6KE8 tube

1—7 x 7 x 2-in. aluminum chassis (Bud AC405 or equiv.)

1—3¼ x 4¼ x ¼-in. sheet aluminum with 1-in. mounting flange for mounting dial to chassis (see text and photos)

1—Flexible coupling (Millen 39001 or equiv.)

1—7-pin miniature tube socket with mounting plate (Cinch-Jones 7EB or equiv.)

1—9-pin miniature tube socket with mounting plate (Cinch-Jones 9EB or equiv.)

1—Vernier dial (J.W. Miller MD-4 or equiv.)

Misc.—Perfboard, push-in terminals, ground lugs, tie strips, rubber grommets, plastic spaghetti tubing, hookup wire, solder, hardware, press-on letters (Datak or equiv.) RG-59/u, coax cable, etc.

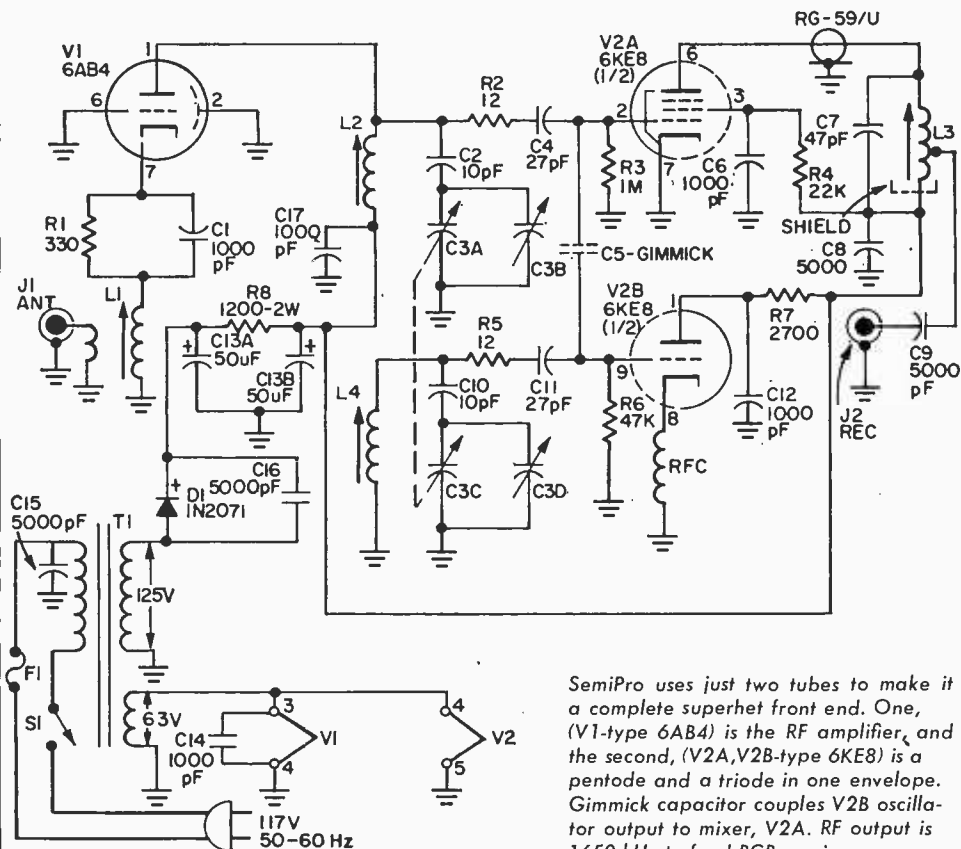

SemiPro uses just two tubes to make it a complete superhet front end. One, (V1-type 6AB4) is the RF amplifier, and the second, (V2A,V2B-type 6KE8) is a pentode and a triode in one envelope. Gimmick capacitor couples V2B oscillator output to mixer, V2A. RF output is 1650 kHz to feed BCB receiver.

SemiPro

with L2 and replace it with a brass slug (J. W. Miller 30-202-5). Primary for L1 is made by a single loop of wire wound around the coil, with one end connected to ground lug and the other directly to J1 (make as direct as possible).

Gimmick capacitor C5 is made by twisting two short lengths of hook-up wire into three twists and connecting one end of each lead to pins 2 and 9 of V2 respectively. The other ends of these leads are not connected. Capacitors C2 and C10 are connected to C3A and C3C tuning capacitor by short lengths of insulated bus wire.

With the exception of T1 and C13A and C13B, the balance of the power-supply components are fastened to a 1¾ x 2¼-in. piece of perboard which is mounted under

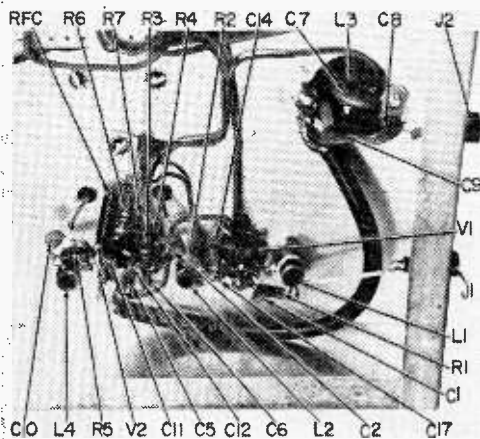

Short leads and good grounds are a must at high frequencies. Its best to use this layout to assure success of your SemiPro.

the chassis adjacent to T1. Transformer T1 is mounted on the top left hand (from the rear) corner of the chassis with leads fed through grommets to the rest of the power-supply components inside the chassis pan. Keep heater leads from T1 and B+ leads from power supply as far away from the RF circuits as possible.

A short length of RG-59/U coaxial cable is used to connect V2A plate to L3. Be sure the shield is grounded to the chassis at both ends of the cable.

Alignment. Once you have double-checked the wiring for accuracy and have allowed the tubes and other components to warm up,

you are ready to align your SemiPro for optimum results. A short length of RG-59/U coax cable is used between J2 (output jack) of the converter and the antenna and ground terminals of your BCB to interconnect the two. If your BCB receiver doesn't have antenna and ground terminals but does have a ferrite rod antenna, loop several turns of hook-up wire connected to the center contact of J2. If by chance your BCB receiver is an AC/DC set of the so-called "hot chassis" variety, make certain that there's no direct electrical connection between the two chassis to avoid placing the chassis of the converter at a dangerous electrical potential. Best way to prevent this is to place a small capacitor (0.01 μ F) in series with the grounding lead.

Tune the BCB receiver to a clear frequency at or near 1650 kHz. If the receiver doesn't tune that high, pick a clear spot as close as possible to the high-frequency end of its tuning range. You'll need a signal generator to be sure the converter's RF output is properly tuned to the high-frequency spot used on the BCB receiver. Connect the signal generator to the stator lug of C3A (mixer tuning capacitor) and chassis ground of the SemiPro. Adjust L3 of the converter for maximum signal output from the BCB receiver.

Once this has been done, disconnect the signal generator from C3A and connect it to J1 on the converter. Set trimmer capacitors C3B and C3D of the ganged variable capacitor on the converter to minimum capacity (screws backed out nearly full length) and turn the dial of the SemiPro to not quite full capacity (at 144 MHz on dial in photo). Set the signal generator for a 144-MHz modulated signal output and then adjust L2 and L4 tuning slugs for maximum signal output on the BCB receiver.

Next, turn dial on SemiPro to almost minimum capacity of tuning gang C3A/C3C (148 MHz on dial in photo), set the signal generator for a modulated output signal of 148 MHz, and adjust trimmer capacitors C3B and C3D for maximum output on the receiver. Repeat these adjustments to be certain optimum alignment has been reached.

At this point we calibrated the dial and marked it with press-on letters. We set the signal generator at each of the frequencies marked on the dial and noted the spot where they tuned to maximum on the SemiPro dial. Since the MARS and CAPS nets are at the extreme edges of the band we calibrated

(Continued on page 116)

THE UNICORN

by Robert E. Kelland

Want to try another construction project that will provide you with the most for the least?

Like the unicorn, a mythical beast having a single horn in the center of its forehead, our Unicorn has a single tube located in the center of its chassis. This single-tube superhet broadcast receiver has sensitivity and selectivity that is comparable to superhets having several tubes and, when using just a short indoor antenna, will give reasonable speaker volume on local stations.

Employing one type 6M11 Compactron and a 1N34A diode as the only active elements, our Unicorn includes: RF, oscillator, mixer, detector, and audio stages. In other words, all the working elements of conventional multi-tube or transistor superhet receivers without the higher cost for several tubes, etc. It's not a TRF or a regenerative set, it's a *true* superhet.

How It Works. The single 6M11 Compactron, having two triode and one pentode sections in a single glass envelope fitted with a 12-pin base, actually is three separate tubes. V1A, the pentode section, is used as

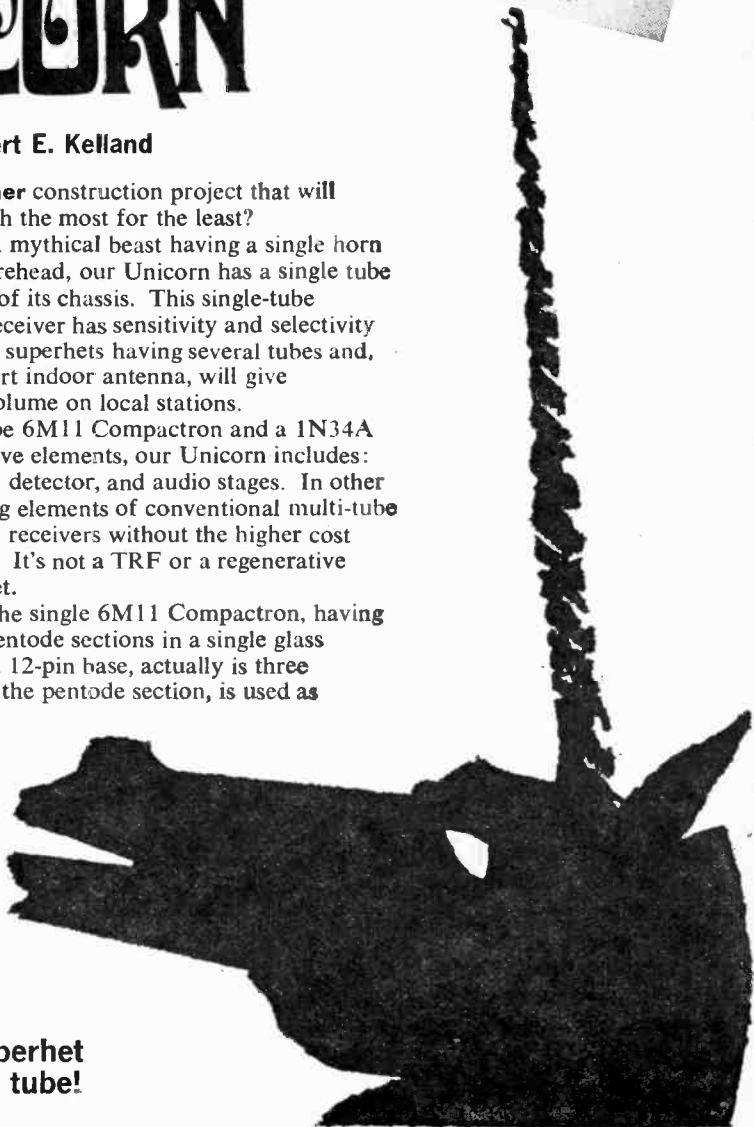

No kidding,
a complete Superhet
using just one tube!

UNICORN

RF amplifier, oscillator, and mixer. V1B, one of the triodes, serves as the IF amplifier, and V1C, the other triode, is the audio amplifier/power output stage of the Unicorn. A 1N34A diode is the detector.

RF signals fed into the receiver from the antenna are selected by the tuned RF circuit (L1, C3A), which inherently doesn't have the selectivity required to easily separate the closely spaced AM broadcast stations. The superheterodyne circuit effects the higher selectivity by developing a narrow band signal to be amplified by the IF stage, which is tuned to a specific frequency. (455 kHz in the Unicorn). The local oscillator signal is mixed with the broadly tuned RF signal and produces a resultant (heterodyned) narrow band signal which is fed to the IF amplifier. The sharply tuned IF transformer (T1) rejects all but the narrow band heterodyned signal and feeds it into tube V1B.

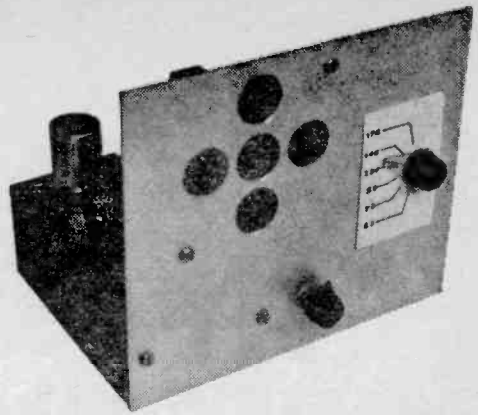

Front view of the Unicorn shows clean lines and simple panel layout. No attempt was made to provide an artistic masterpiece, just a utilitarian layout.

When the RF section of the receiver is tuned to a station, the oscillator is also tuned because both tuning capacitor rotors are on a common shaft. This is commonly called oscillator tracking. This ensures the heterodyned signal will always be at 455 kHz, the

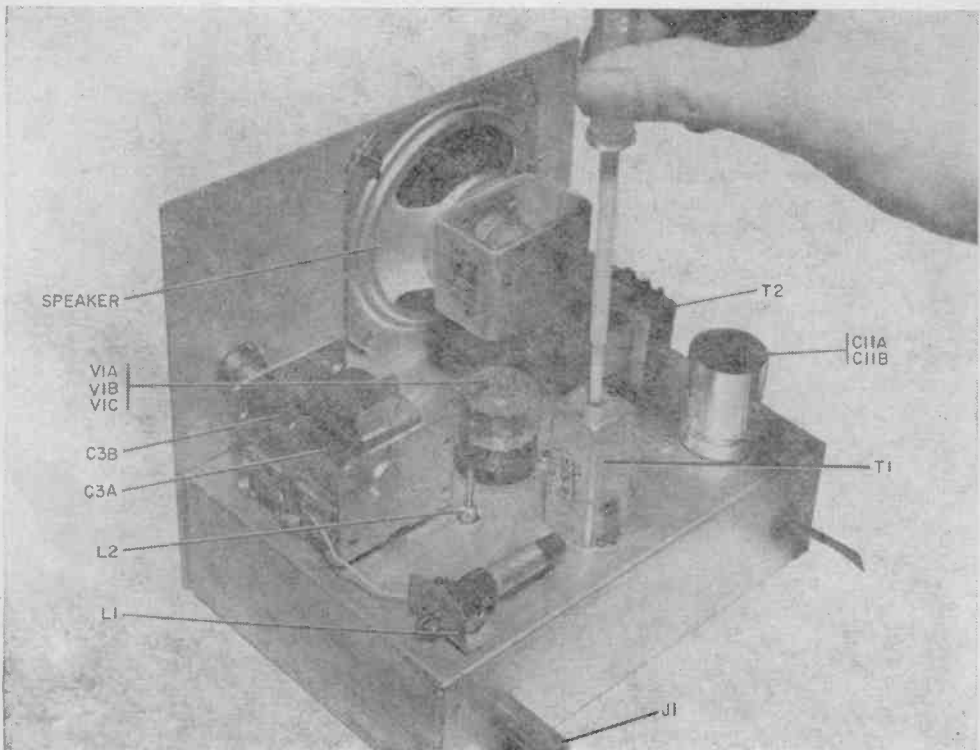

Rear view of chassis shows locations of the various parts on the top of the chassis pan. A simple right angle bracket is used to mount L1 to the chassis. It can be made from aluminum channel $\frac{1}{2} \times \frac{1}{2}$ -in. IF transformer T1 tuning slug is being adjusted for maximum signal. Use a plastic tuning tool for this.

working frequency of the IF transformer.

The 455 kHz amplified output signal of the IF stage is detected by diode D1 and the audio portion is extracted and fed to the remaining triode section where it is amplified and fed to the speaker so it can be heard.

The Unicorn contains its own 117 VAC power supply. The 6.3 VAC for the 6M11 filament is obtained from the low voltage winding of power transformer T3. Direct

current for the receiver is provided by the packaged bridge rectifier D2 and filtered by capacitors C11A and C11B and resistor R7.

Let's Build It. The complete receiver, with the exception of the speaker, is built in and on a 5 x 7 x 2 in. aluminum chassis. The speaker is mounted on the front panel, which is a 6 x 7 x 1/16-in. sheet of aluminum. We didn't attempt to make the front panel an artistic masterpiece. You may want to

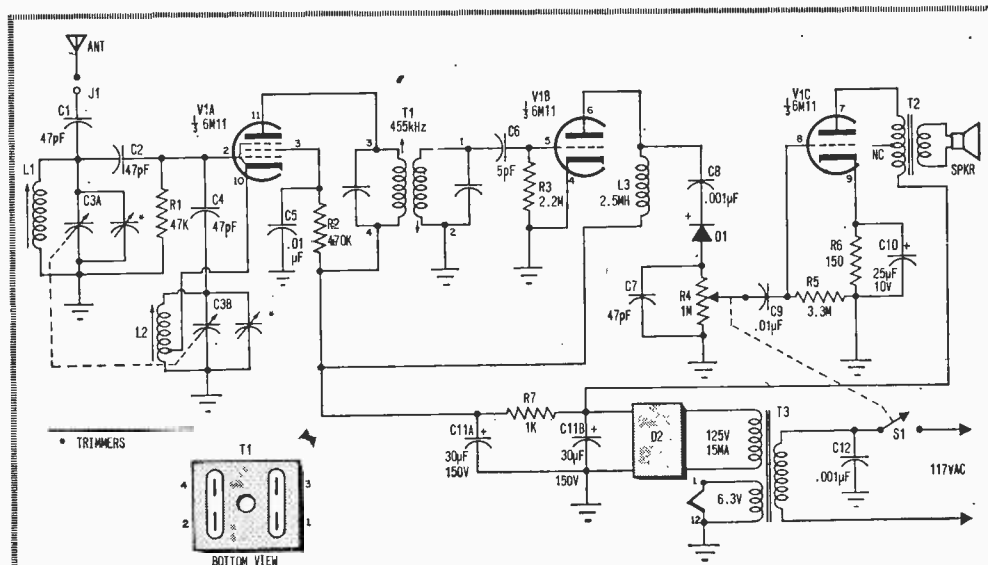

PARTS LIST FOR UNICORN

C1, C2, C4, C7—47-pF, 1000-V ceramic disc capacitor (Lafayette 32T0160 or equiv.)
 C3A, C3B—2-gang variable capacitor, front section 10.5-pF to 365-pF, rear section 7.6-pF to 132-pF (Lafayette 32T1101 or equiv.)
 C5, C9—0.01-uF, 600-V ceramic disc capacitor (Lafayette 33T2337 or equiv.)
 C6—5-pF, 1000-V ceramic disc capacitor (Lafayette 32T0147 or equiv.)
 C8, C12—0.001-, 1000-V ceramic disc capacitor (Lafayette 33T2311 or equiv.)
 C10—25-uF, 12-V electrolytic capacitor (Lafayette 34T8502 or equiv.)
 C11A, C11B—30-30-uF, 150-V electrolytic capacitor (Lafayette 34T7572 or equiv.)
 D1—1N34A diode
 D2—Bridge rectifier, 400 PIV working volt, 1.5 A, 280 VRMS (Erie FWR3004A or equiv.)
 J1—Binding post (Lafayette 99T6121 or equiv.)
 L1—High Gain Loopstick antenna coil for use with 365-pF variable capacitor (Lafayette 32T4106 or equiv.)
 L2—Universal oscillator coil (Lafayette 34T-8704 or equiv.)
 L3—2.5-mH RF choke (Lafayette 32T5118 or equiv.)

R1—47,000-ohm, 1/2-watt resistor
 R2—470,000-ohm, 1/2-watt resistor
 R3—2,200,000-ohm, 1/2-watt resistor
 R4/S1—1,000,000-ohm potentiometer, audio taper, with spst switch
 R5—3,300,000-ohm, 1/2-watt resistor
 R6—150-ohm, 1/2-watt resistor
 R7—1000-ohm, 1/2-watt resistor
 S1—Part of R4
 T1—IF transformer, 455 kHz (Lafayette 32T-0946 or equiv.)
 T2—Universal output transformer (Lafayette 33T7503 or equiv.)
 T3—Power transformer, 117-VAC pri., 125-VAC @ 15 mA sec., and 6.3-VAC @ 0.6 A sec. (Lafayette 33T3405 or equiv.)
 V1A, V1B, V1C—GE type 6M11 Compactron multi-section tube
 1—5 x 7 x 2-in. aluminum chassis (Lafayette 12T8195 or equiv.)
 1—Compactron socket (Lafayette 33T8701 or equiv.)
 1—4-in. speaker, 3.2 ohm V.C. (Lafayette 99T6268 or equiv.)
 1—AC line cord (Lafayette 12T3901 or equiv.)
 Misc.—Hardware, hookup wire, solder, knobs, perforated metal 1/16-in. aluminum sheet, grommets, tie strip, etc.

UNICORN

make yours more attractive by restyling the dial plate and/or the speaker grille.

We made our speaker grille by punching four 3/4-in. holes in the simple pattern shown in the photo, using a standard chassis punch, and backed them up with plain perforated metal to protect the speaker cone. (It was all we had in the stock pile at the time we built Unicorn.) We made the dial plate by lettering a 1 3/4 x 2 3/4 in. piece of white plastic sheet in black letters for the tuning calibration points.

It is suggested that for best results you follow our layout as detailed in the photos, to maintain short leads where we found them necessary, and to advantageously position parts for ease in wiring and to reduce inter-coupling problems.

All of the major components with the exception of T3 and D2 are mounted on top of the chassis. T3 is mounted on the left front apron inside the chassis. Bridge rectifier D2 is also inside the chassis mounted on

a 5-terminal plus grounding lugs at each end tie strip.

Potentiometer unit R4/S1 is centered on the front apron inside the chassis with the control shaft protruding out front for the control knob. The antenna coil (L1) is mounted on top of the chassis by employing a small right angle bracket.

After all wiring has been completed, double-check it for accuracy against the schematic before inserting the power cord into an outlet and turning on the power.

Alignment. Now that you are reasonably certain that you have wired up the set correctly, insert the Compactron in its socket, turn on the receiver, and allow it to warm up a few minutes before starting the alignment. The first step in aligning is to tune IF transformer (T1) to 455 kHz. To do this accurately, feed a 455 kHz modulated signal from a signal generator to the grid of V1A (pin 2). Temporarily short out the oscillator tuning section (C3B) of the two-gang variable tuning capacitor. Adjust the tuning slug of T1 for maximum signal level at the speaker. It's preferable to use an out-

(Continued on page 114)

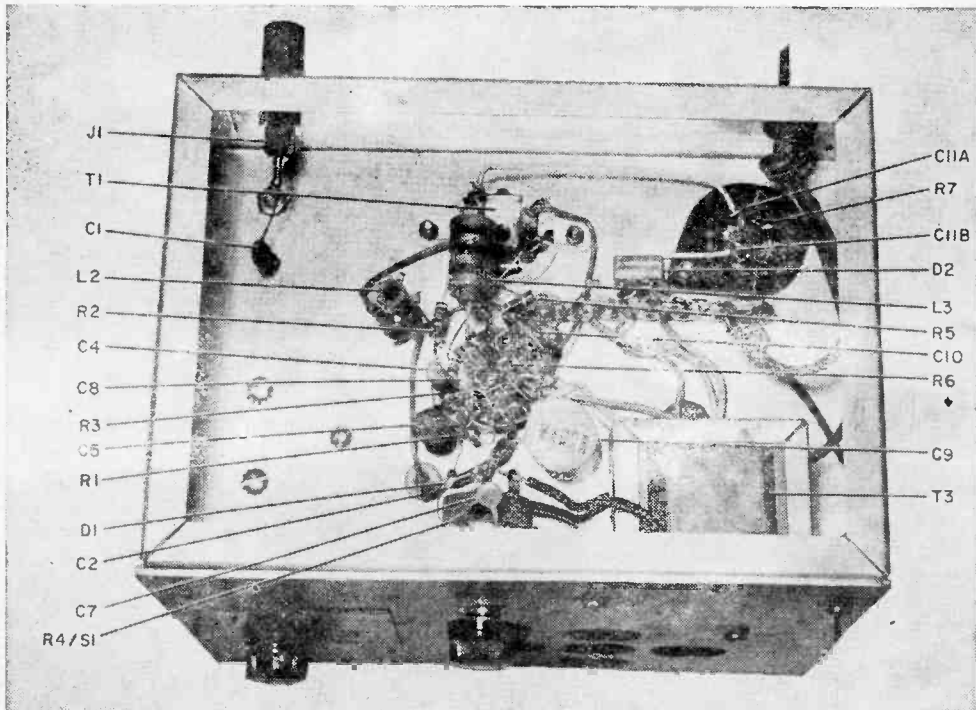

Bottom view of chassis with all components located on the underside identified. It is suggested that you follow this layout in order that all leads will be as short as possible and you'll have a minimum amount of wiring. In most cases the parts are wired from point to point with their leads.

VISULERT

ADD A FLASHING LIGHT TO YOUR TELEPHONE BELL

by Robert S. Kelland

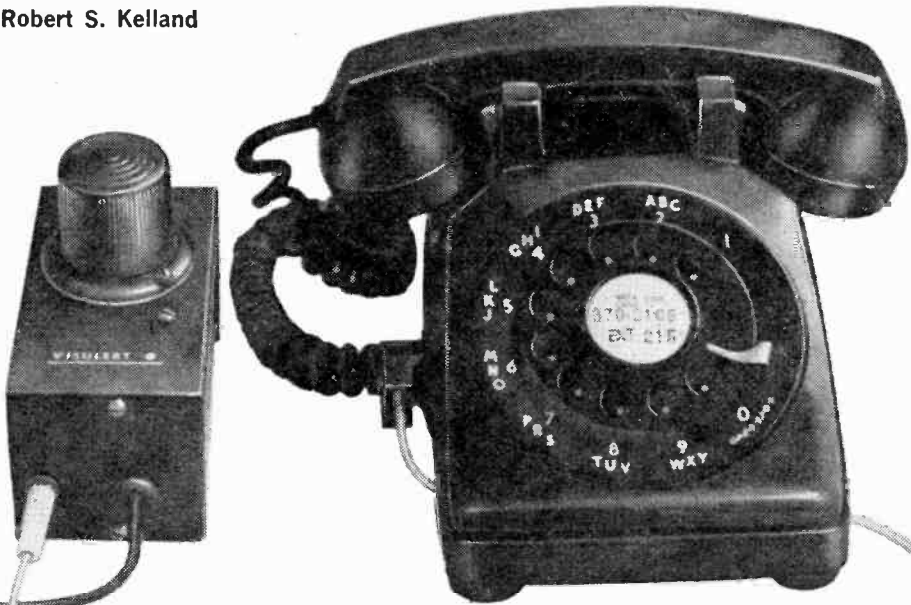

ARE there times when you'd like to turn down the telephone bell so that baby or grandma can nap, and yet you need to know when that important call comes in? Because high platform noise overrides the normal telephone bell, and you're skeptical of the effectiveness of so-called loud ringers, do you have need for another means of alerting the shipping clerk to take a telephone call? Or, perhaps you know a deaf person who can't hear the phone bell at all.

Our Visulert, a small, self-contained, easily constructed telephone accessory, solves all these problems. And the beauty of it is that you don't have to connect it directly to the telephone lines, a no-no rule of most telephone companies.

An inductive pickup coil ordinarily used for recording phone messages, placed on or under a telephone, picks up just the ringing pulses by magnetic induction and feeds them to an am-

VISULERT

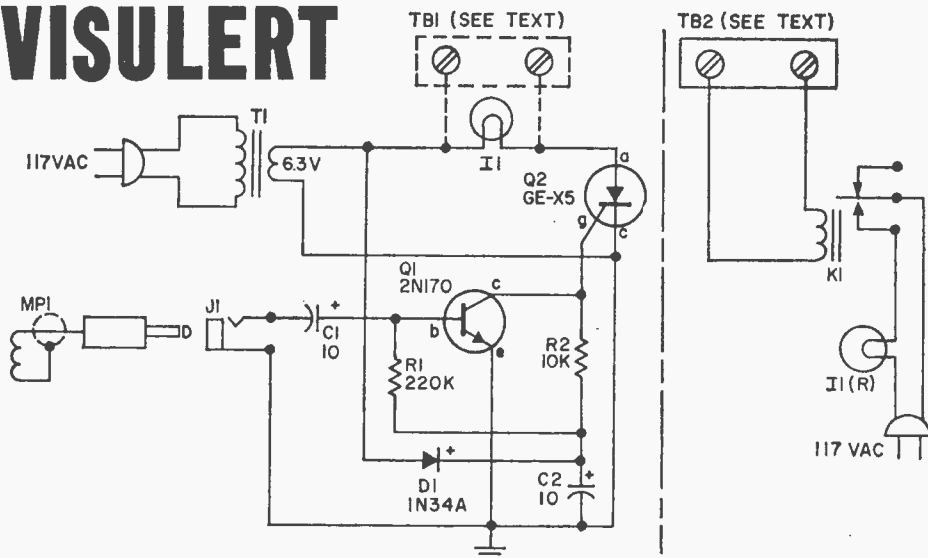

PARTS LIST FOR VISULERT

- C1, C2—10- μ F, 35-VDC miniature electrolytic capacitor (Radio Shack 272-1025 or equiv.)
- D1—75-PIV, 50-mA silicon diode, type 1N34A
- I1—Panel-mounting pilot lamp assembly with clear plastic dome lens (Lafayette 99E63406 for miniature bayonet base lamp 32E66194 or equiv.) (note: our model was adorned with the addition of a large plastic lens salvaged from a toy fire engine)
- J1—Miniature phone jack (Lafayette 99E63141 or equiv.—includes matching plug)
- MP1—Inductive pickup coil assembly (Radio Shack 44-533 or equiv.)
- Q1—GE 2N170 npn germanium transistor
- Q2—GE X5 silicon-controlled rectifier
- R1—220,000-ohm, $\frac{1}{2}$ -watt resistor
- R2—10,000-ohm, $\frac{1}{2}$ -watt resistor
- T1—Filament transformer; primary 117 V, 50-60 Hz; secondary 6.3 V at 1.2 A (Radio Shack 273-050 or equiv.)
- T2—4 x $2\frac{1}{4}$ x $2\frac{1}{4}$ -in. aluminum minibox (Lafayette 12E83704 or equiv.)

- 1—AC power cord (Lafayette 12E39011 or equiv.)
- 1—2 point + ground lug tie strip (Lafayette 32E12073 or equiv.)
- 1—5 point + ground lug tie strip (Lafayette 32E12131 or equiv.)
- Misc.—Hookup wire, solder, hardware, spray paint or pressure-sensitive vinyl sheet (Contact or equiv.), grommets, etc.
- If remote lamp is used add following:
- I1(R)—50 to 250W, 117V lamp bulb in porcelain Edison base lamp socket, $3\frac{1}{4}$ -in. diameter base (Lafayette 13E1359 or equiv.—mount on outer surface of junction box or cover panel of suitable box used)
- K1—Spdt miniature ruggedized remote control relay (Lafayette 99E60915 or equiv.—mount on inner surface of box cover panel)
- 1—Pane for box (Lafayette 19E37010 or equiv.)
- 1— $6\frac{1}{2}$ x $5\frac{1}{4}$ x $2\frac{1}{4}$ -in. Bakelite Box (Lafayette 19E20016 or equiv.)
- 2—2-contact screw terminal strip (Lafayette 32E644488 or equiv.) (TB1, TB2)

plifier in the Visulert. This amplifier triggers an SCR that switches a lamp *on* and *off* in step with the pulsing of the ringing signal.

How It Works. Provided magnetic pickup MP1 is properly located within the ringer's magnetic field an electrical voltage is induced in the coil of MP1 whenever the ringer of a telephone is energized. This voltage is fed via jack J1 to the base of transistor Q1. The resulting amplified signal output on the collector of Q1 is coupled to the gate of silicon controlled rectifier Q2 and triggers it *on* whenever the signal appears on its gate. Lamp I1 is turned *on*

each time Q2 is triggered *on* and remains *on* until Q2 is triggered *off* by a drop in the induced signal level. Since the ringer voltage is pulsating, the Visulert will flash its lamp *on* and *off*, following the ringer pulses.

Building Visulert. Our model is housed in a standard 4 x $2\frac{1}{4}$ x $2\frac{1}{4}$ -in. aluminum minibox. Though the layout isn't critical, you will speed up your construction time by following our layout as shown in our photos.

All of the components are mounted either directly on the minibox or to tie strips, which
(Continued on page 111)

Roto-Stat

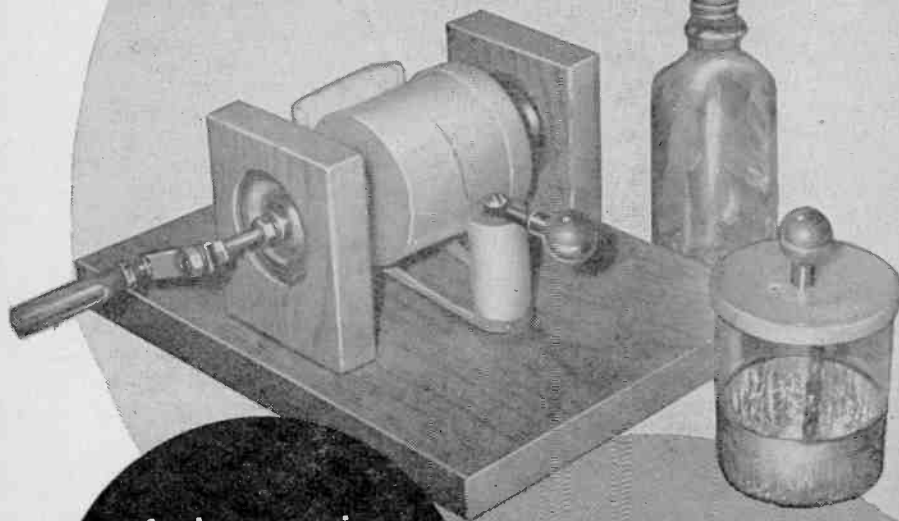

**An inexpensive
efficient
hand-powered
electrostatic
generator**

From the earliest days of experimenting with electrostatic electricity—say in the 4th Century B.C., when Plato mentioned the wonderful attracting power of amber—electrostatic electricity was produced by laboriously rubbing glass rods or other electrostatic producing objects with dry fur or cloth. In 1663, in Germany, Otto von Guericke used a large ball of sulphur to generate electrostatic electricity by rotating the sulphur ball and rubbing it with his fingers. In 1706, in England, Francis Hauksbee employed rotating glass globes and cylinders to generate static
(Turn page)

**by Charles Green
W6FFQ**

Roto-Stat

electricity, and he used a metallic conductor to collect the generated static electricity from the generator.

In 1744, in Germany, J.H. Winkler invented a mechanical rubbing device to use in place of rubbing the glass cylinder with the fingers. His *rubber* used a leather-covered cushion pressed against the rotating globe. In America, in 1747, Ben Franklin used an electrostatic generator in some of his electrical experiments; it contained a rotating glass cylinder with a mechanical *rubber*.

Even in this day and age, electrostatic experiments still fascinate the avid experimenter. You can perform electrostatic electricity experiments by building and using our Roto-Stat electrostatic generator, instead of generating the electrostatic charges by hand-rubbed glass or plastic rods. Our Roto-Stat, designed for easy construction, uses a plastic cosmetic or similar jar in place of a glass

ball or cylinder. The generator is built on a 3/4-in. white pine base and uses a wool cloth *rubber* and a copper wire electrostatic collector that's formed round the jar.

How It Works. Turning the generator handle rapidly in a clockwise direction causes the wool cloth to rub against the plastic jar's surface. The friction of this rubbing releases electrons which electrostatically charge the jar's surface. As the jar is rotated, the pickup wire mounted on the ceramic standoff collects electrostatic charges from its surface and conducts them to the metal ball output electrode. A Leyden jar can be charged by contacting its terminals to the metal ball output electrode and ground. (For complete construction details for a Leyden jar and an electroscope see *Ben Franklin's Leyden Jars*, Dec./Jan. 1970 SCIENCE AND ELECTRONICS.)

Plastic Power. We used a plastic jar 2 3/4-in. high x 2 3/4 in. diameter with plastic screw top for the rotating element of our Roto-Stat. If another size plastic jar is used, scale the dimensions of your unit proportionately. Since different types of plastic vary in their ability to generate electrostatic electricity,

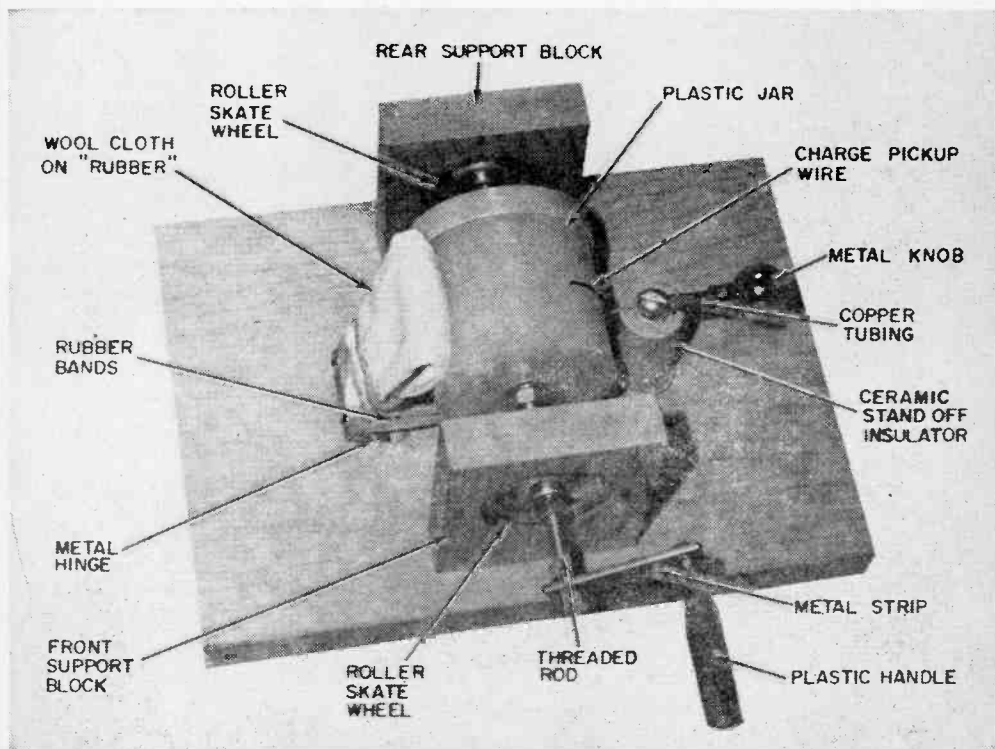

Our Roto-Stat electrostatic generator, though not as huge as original ones built in early 18th Century, is quite efficient. From details in photo and drawing you can build it.

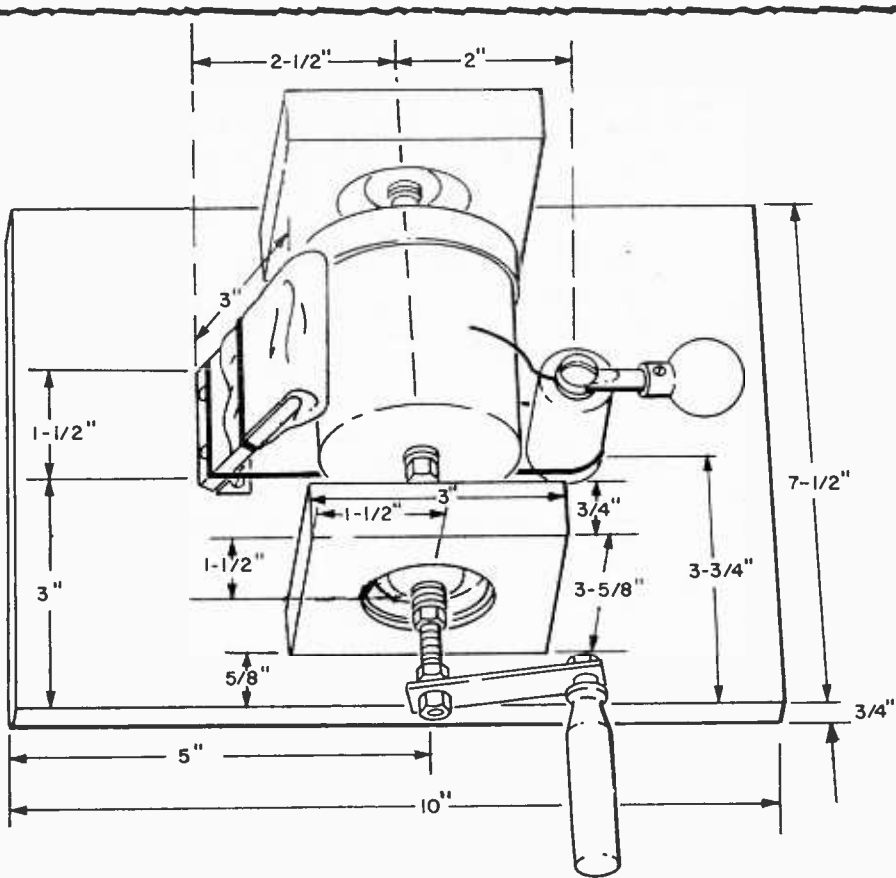

MATERIALS LIST FOR ROTO-STAT

- | | |
|---|--|
| 1—Ceramic (L5 glazed) standoff insulator, threaded at both ends, 2-in. high x 1-in. dia. (JAN type NS5WO416, E.F. Johnson 135-503, or equiv.) | knobs at auto parts stores) |
| 1—Hard rubber or plastic handle, 2-in. long x 1/2-in. dia. (we used handle from rodio aligning tool) | 1—2 1/4 x 1/2 x 1/8-in. metal strip for mounting handle |
| 1—1 1/2 x 1/2-in. metal hinge | 1—NE2 neon lamp |
| 1—Plastic jar with screw-on or snap-on plastic lid, 2 3/4-in. high x 2 3/4-in. dia. (you may also want to use this size for Leyden jar and electroscope—see text) | 2—Roller skate wheels, ball bearing (available as replacement wheels at toy stores and toy counters in department stores) |
| 2—Metal knobs, approx. 7/8-in. dia. (available as automobile dash control or seat control | 1—Threaded metal rod, 8-in. long x 1/4-in. dia. |
| | Misc.—1 1/2 x 4-in. wool cloth strips, wood screws, nuts and washers for threaded rod, screws to fit ceramic insulator, cement, rubber bands, #18 to #22 bare copper wire, 3/4-in. thick pine for base, etc. |

test the jar you've selected by rubbing it with a wool cloth and noting whether the jar attracts small pieces of paper when the jar is moved over them. If it doesn't, try a jar made of different plastic material.

Any type of soft wood can be used for the base. Just make sure that the wood is clean and dry. The dimensions given in our drawing are approximate, to serve as a guide. Any size generator unit can be built, but for best results it's suggested you follow

the general layout of our unit.

Begin construction by cutting a 7 1/2 x 10-in. base of 3/4-in. thick pine or other soft wood, then cut two 3 5/8 x 3 x 3/4-in. wood blocks. Roller skate wheels, available as replacements at most hardware or bicycle shops, are used as driveshaft bearings. Cut a hole in each wood block to fit roller skate wheel used for this purpose. The hole in each block of our unit is made just large enough to force-fit the wheel into the hole in the

Roto-Stat

block. Duco cement or Elmer's Glue is used to hold the wheel securely in place. You may prefer to use long sheet metal screws through the sides of the mounting blocks to hold the wheel.

Cone Or Cylinder. Drill holes in the center of the bottom of the plastic jar, and also its lid, to fit the $\frac{3}{8}$ -in. threaded metal rod. Cut and drill a conical wood section to fit inside the plastic jar if the jar isn't straight-sided (if it is, then you'll need a wooden cylinder), extending from the jar bottom to the jar lid for internal support. A clearance hole for the metal rod, which serves as the axle for the jar, is drilled through the center of this wooden block.

Mount front supporting block on the base as shown in our drawing. We used two wood screws through the base to hold the block to the base. Insert threaded metal rod through jar and skate wheel bearing and hold them in position on the rod with a nut and washer top and bottom of the jar and on either side of the bearing mounted in the

wood block. Don't tighten the nuts now; you'll probably reposition the-jar.

Position the rear block-mounted bearing on threaded metal rod with a nut and washer on both sides of the bearing. Adjust spacing of nuts on the metal rod so that the jar is in the center of the base as shown in photos and drawing. Position the rear wood block so that metal rod and jar can turn freely without binding, and fasten this block in position to the base with wood screws. Make sure that about $1\frac{3}{4}$ in. of metal rod projects out from the front bearing for attaching the metal strip that holds the handle, then tighten nuts against the jar and bearings.

Plastic Handle. We made the plastic handle from an alignment tool and bolted it to a $2\frac{1}{4} \times \frac{1}{2} \times \frac{1}{8}$ -in. metal strip with washers to allow the handle to rotate freely. Fasten a $3 \times 1\frac{1}{2} \times \frac{1}{4}$ -in. piece of plywood to a hinge, and mount the hinged plywood section to the wood base adjacent to one side of the jar. Mount a 2-in. high x 1-in. diameter ceramic standoff to the base on the opposite side of the jar as shown in our drawing and photos.

Mount a small unpainted metal knob onto a piece of copper tubing, flatten the free end of the copper tubing, and mount it on

About Leyden Jars and Electroscopes

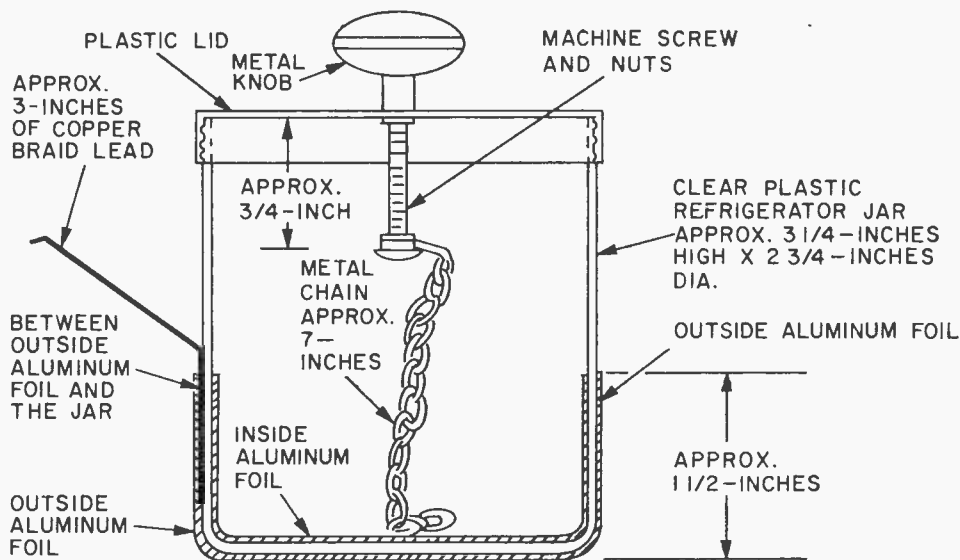

Even though we used materials found either in kitchen or bathroom this Leyden jar can store electrostatic charge generated by our Roto-Stat, so be sure it's discharged when stored.

the ceramic standoff. Also fasten a length of #22 or larger copper wire to the ceramic standoff and bend it so that it curves around the jar for a length of about 1½ in. but doesn't touch it. Position the wire approximately 1/16 in. away from the jar's surface and cut off the excess length of wire. Small rubber bumpers are fastened to each of the corners on the bottom of the base.

Fold a piece of clean, dry wool cloth over the top end of the hinged plywood piece, holding the cloth in place by means of a rubber band. Clean the surface of the jar carefully. Place several rubber bands around the base of the ceramic standoff and stretch them 'round the bottom of the hinged plywood section so that the wool cloth that is folded over its free end will be seated firmly against the side of the jar.

Rotate the jar by turning the handle, making sure that the jar turns freely, but with a slight resistance from the wool cloth *rubber*, and that the pickup wire does not touch the surface of the jar. Do not touch the surface of the jar or the wool cloth after the jar has been cleaned, because of the possibility of transferring moisture on your hands to either or both.

Experiment 1. Before performing any ex-

periment, make sure that both the cloth on the *rubber* and the jar's surface are clean and dry. If necessary, expose both cloth and jar to the rays of a heat lamp to dry up any moisture. These experiments may not work as well, or may not work at all in a humid area, since a dry environment is necessary for best results. We suggest you perform them in an air-conditioned room if at all possible for driest atmosphere.

Rotate generator handle rapidly in a clockwise direction, and hold the electro-scope so that its electrode makes contact with generator's metal ball. Observe that the electroscope leaves deflect away from each other. This indicates that the electrostatic generator is operating and producing an electrostatic output voltage.

Experiment 2. Connect the outer foil of a Leyden jar to ground or a large metal object, and bring the Leyden jar top electrode in contact with the generator metal ball. Rotate generator handle rapidly in a clockwise direction for a few minutes, then move the Leyden jar away from the generator. Make sure you do not touch Leyden jar top electrode with your fingers. Carefully disconnect the Leyden jar outer foil lead from the ground. Then move the outer foil lead very

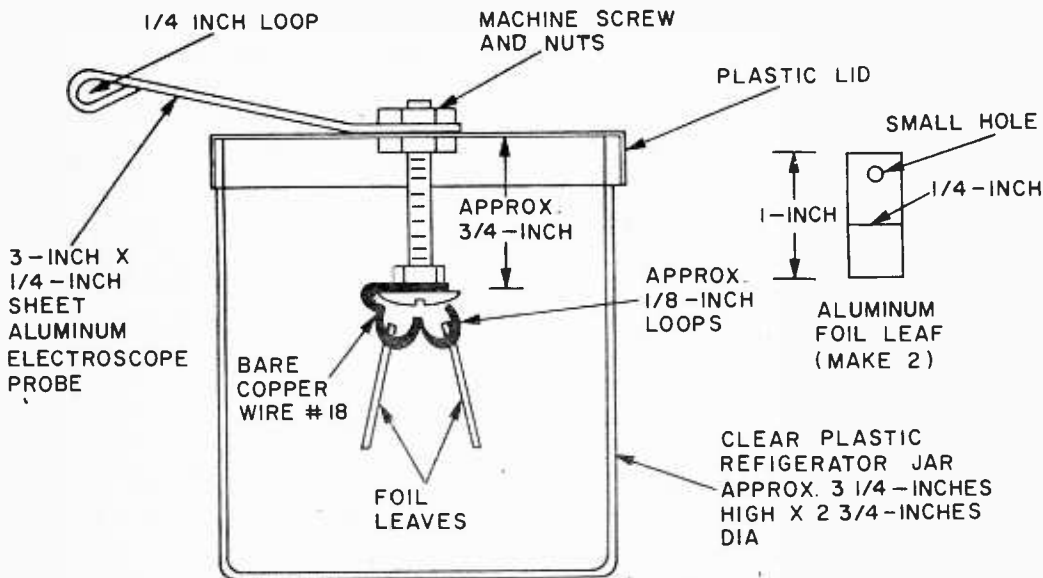

You'll want an electroscope to reassure you that your Roto-Stat is actually generating current before you start each experiment. It's easy to build and well worth the effort.

Roto-Stat

close to the top electrode. Note that a small spark will jump between the top electrode and the outer foil lead of the Leyden jar. This indicates that the Leyden jar was charged with the electrostatic output voltage from the generator.

Repeat the experiment, except connect a VTVM (preferably with a high voltage

clockwise direction, and momentarily bring one lead of an NE-2 neon lamp in contact with the generator metal ball while you hold the other lamp lead. The neon lamp should flash momentarily, indicating that the generator is operating.

Move one of the neon lamp leads around the surface of the rotating plastic jar. Note that the neon lamp flashes, indicating the electrostatically charged areas.

Remove the neon lamp lead from the jar, rotate generator handle rapidly for a minute, and then stop. Now move neon lamp lead

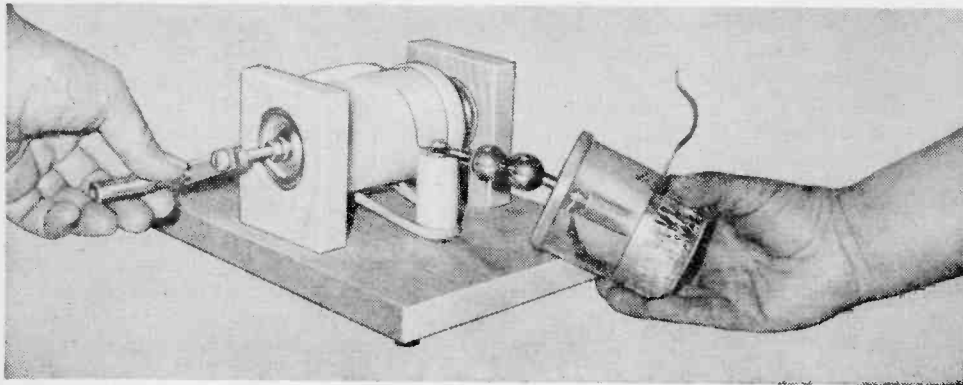

Here's how to hold your Leyden jar when you charge it from your Roto-Stat. Keep two metal balls in constant contact while turning handle to generate charge.

probe) between the Leyden jar outside foil and its top electrode, after Leyden jar has been charged. Fasten one lead to ground strap and touch top electrode with the other lead of the VTVM. Observe that the VTVM momentarily indicates a large negative voltage. This shows that the generator has a negative electrostatic output voltage.

Experiment 3. This experiment requires a dimly lit area in order to best see the neon lamp. Rotate generator handle rapidly in a

around on the surface, noting that the neon lamp still flashes, indicating that the electrostatically charged areas on the plastic jar will remain active for a period of time after the surface of the jar is excited by rubbing.

Try different types of cloths for the *rubber* in place of the wool cloth and compare their operation with that of a wool cloth. Note rotation speed affects size of charge. You can also try different configurations of the wire collector. ■

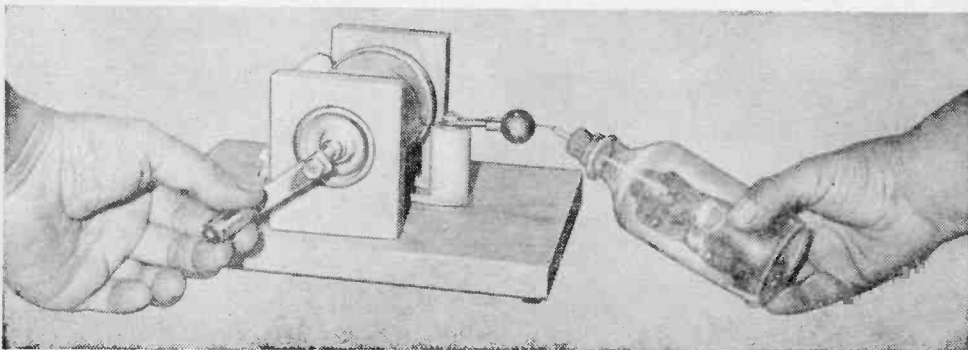

If there's a doubling Thomas amongst those you're showing your Roto-Stat, prove it's generating by placing Electrostat's collector against Roto-Stat's output ball.

BEGINNER'S

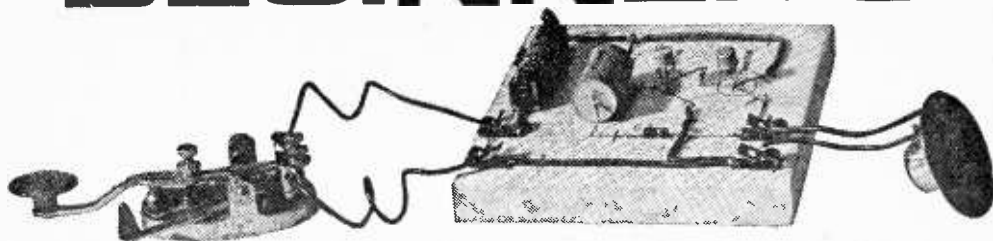

CPO

Learn as you build with a circuit that'll clue you in on what oscillators are all about
/ by Wayne Kiser, WA9VKP

□ Getting started in electronics is almost always an exciting experience—almost, we say, because that first step can be so complicated that the poor beginner becomes confused and discouraged.

Here's a simple project that will make that first step easy for you or someone you may teach. Schematic symbols are the language of this new adventure. But how hard it is for the newcomer to relate symbols to the parts they represent! Reason is that parts placed on a chassis or on a printed circuit board don't look much like the neat drawings in a book. Even so, a simple schematic like that of an audio oscillator can help form the mental links necessary.

Tail Chasing. What's an oscillator? An

oscillator can result when part of the output voltage is fed back into the input of practically any amplifier. The same effect results when a dog chases his tail. He goes round and round but doesn't get anywhere. In the case of the oscillating circuit, however, this changing voltage can be fed into a speaker, causing sound. The circuit we show here is that of a typical audio oscillator. And to understand it better, we suggest you draw the schematic on a board (see Parts List) right now, studying the symbols and the hookup of the circuit as you do so.

Here's how it works: when the key is closed, current flowing through the 12,000-ohm resistor (R1) into the base-emitter junction of the npn transistor (Q1) causes a

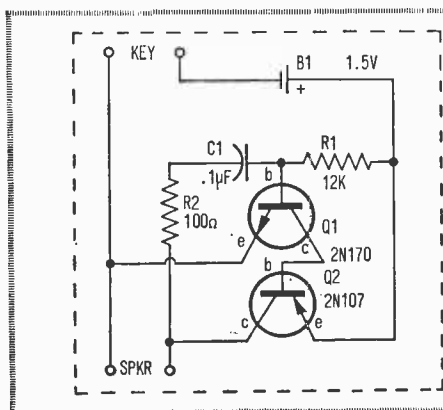

Schematic for Beginner's CPO. It's best to buy parts first, arrange them as per schematic, then draw schematic on wood block.

PARTS LIST FOR BEGINNER'S CPO

- B1—1.5-volt penlight battery (Eveready 1015 or equiv.)
- C1—0.1- μ F capacitor
- Q1—2N170 transistor
- Q2—2N107 transistor
- R1—12,000-ohm, 1/2-watt resistor
- R2—100-ohm, 1/2-watt resistor
- 1—5 1/2 x 5 1/2 x 3/4-in. wooden block
- 4—Fahnestock clips
- 1—Telegraph key
- 1—Miniature PM speaker
- Misc.—Wire, solder, staples, battery holder, etc.

BEGINNER'S CPO

collector-emitter current to flow. But since the collector current of Q1 must flow through the base-emitter junction of the pnp transistor (Q2), Q2 is similarly turned *on* and *its* collector-emitter current flows through the speaker voice coil.

When current begins to flow through the speaker, a voltage is developed across it. Result is that the terminal connected to the collector of Q2 becomes more positive than the terminal connected to the key. This positive voltage is coupled through the 100-ohm resistor (R2) and the 0.1- μ F capacitor (C1) back to the base of Q1, causing additional base-emitter current to flow in both transistors. This is the tail chasing, because additional collector current flows, and this in turn causes additional voltage to be developed across the speaker.

Repeat Performance. This cumulative action continues until the capacitor is fully charged. At this point, the like charges on both sides of the capacitor begin to repel and the voltage at Q1's base becomes more negative. This decreases current flow in the collector of the npn transistor (Q1), and this in turn causes the collector current of the other transistor to decrease as well. Eventually, the voltage across the speaker reaches zero. When this happens, current again flows through R1 into the base-emitter junction of Q1 and the cycle begins all over again.

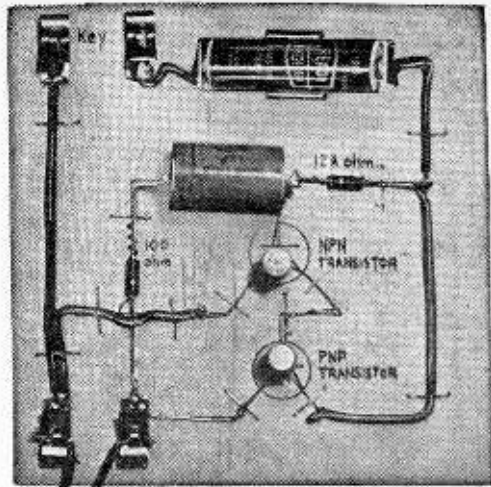

Completed CPO, with speaker connected, but less key. Staples hold most parts in place; Fahnestock clips and battery holder are nailed to board. Parts replace symbols in this schematic.

Study the appearance and construction of the few parts used. By now you should know what each part is and how it works. When explaining the workings of components to other people who haven't much previous knowledge, though, be extra careful not to give too much information at one time.

The final step is to place the parts on the schematic you drew earlier and solder the connections. The wires can then be stapled directly to the wooden block.

Connect the speaker and the key, and the oscillator is ready for work. The completed project can be useful in learning the code, or, through use of transistor sockets instead of direct connections, for testing which transistors are npn's and which are pnp's. ■

Handy, Self-Polarizing Connector

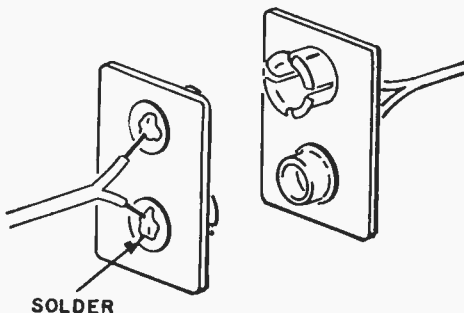

□ Next time you're in need of a two-post connector for a pair of speaker leads or a quick-disconnect plug for a transistor-equipment power supply, give this idea a try. Just pull a couple of dead 9-V transistor radio batteries out of your wastebasket and carefully remove their terminal strips. Put what's left back in the wastebasket again and take a good look at the handy, self-polarizing connector you've just concocted. Plug one into the other, solder up the appropriate leads, and give yourself a pat on the back for good old ingenuity. No reason to color-code for polarity, either—this one is self-polarizing, remember? —Bob Stephens ■

EXPERIMENTING WITH... BEN FRANKLIN'S

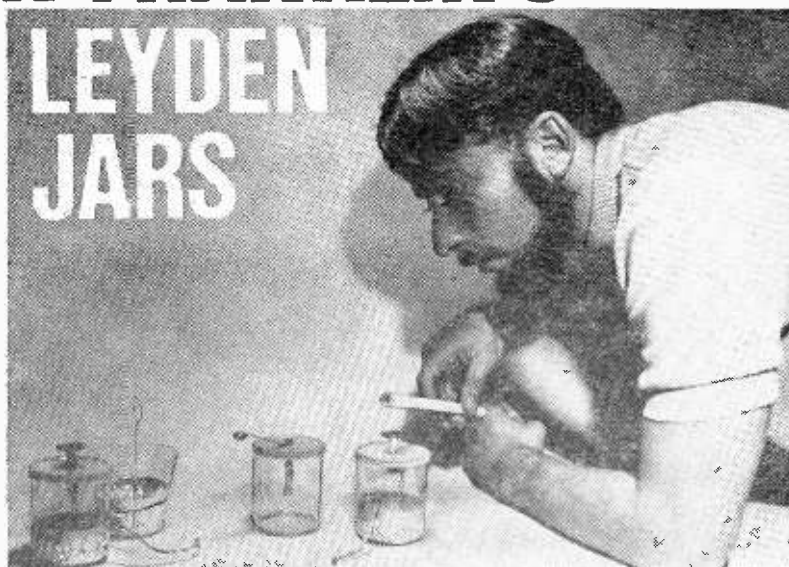

Discover how capacitors work by duplicating some original experiments performed in the 18th Century.

Many people like to think of Benjamin Franklin as one of the founding fathers of our country. As one of the signers of the Declaration of Independence, he is regarded as a great statesman and humanitarian. In addition, "Old Ben" was considered one of the leading scientists of his era and was as well known for this in Europe as he was in America.

That is why, when the Continental Congress searched for a man of prestige to send to France to ask for assistance in the American War for Independence, they chose ol' Ben Franklin.

Franklin's original experiments with static electricity contributed to world-wide recognition of his scientific ability. His analysis of the principles of the Leyden Jar was the result of one of his great experiments.

The earliest known apparatus capable of storing an electrical charge was labeled a Leyden Jar, the forerunner of present-day capaci- (Continued overleaf)

by
Charles Green
W6FFQ

BEN FRANKLIN'S LEYDEN JARS

tors. The first Leyden Jar was made by Pieter van Musschenbroek, in the town of Leyden in the Netherlands.

It consisted of a glass jar, filled with water with outer surface wrapped in metal foil. Electrical connections to the water was made by a wire touching the water. Other versions employed metal shot or metal foil inside the glass jar.

Benjamin Franklin's experiments proved that the electrical charge is actually stored in the glass, and not in either the inner or outer foils. You can confirm Franklin's discoveries by following our plans for building a Leyden Jar and an Electroscope and then use them in the experiments outlined, which closely follow Franklin's original ones.

Constructing a Leyden Jar. We made our Leyden Jar by covering the inner and outer surfaces of a clear plastic refrigerator food storage container with ordinary aluminum foil. We used one 2½-in. high by

2¾-in. diameter, fitted with a snap-on lid although the size is not important. This is a convenient size for construction and for handling during the experiments. The foil was formed to the jar to a height of approximately 1½ in. from the bottom and held in place with Scotch tape.

A piece of copper braid, or braided shielding from shielded wire, about 3-in. long is held in contact with the outer foil by slipping it between the outer foil and the side of the jar before taping the foil. Check to be sure that the braid makes good electrical contact with the foil.

A metal drawer knob, mounted in the center of the lid, to which a length of metal chain is fastened, is used to connect to the inner foil.

Constructing an Electroscope. The electroscope is an elementary indicator of an electrical charge. We used the same type and size of clear plastic refrigerator container for the electroscope as was used for the Leyden Jar.

A short length of #18 bare copper wire was formed to contain two open loops about ⅛-in. in diameter and was then fastened to the head of a ¾-in. long machine screw by means of a nut and washer. The bolt was then mounted in the center of the jar lid. A 3-in. length of sheet aluminum, ¼-

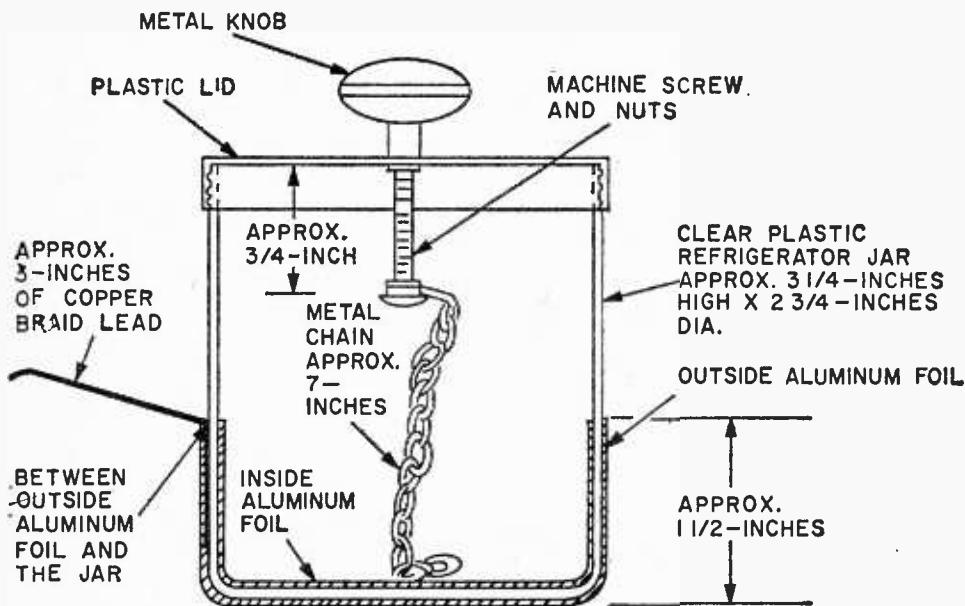

OUTSIDE ALUMINUM FOIL

A trip to the kitchen will reward you with almost all the raw materials needed to assemble a workable Leyden Jar. Dimensions are not critical, but try to duplicate author's prototype.

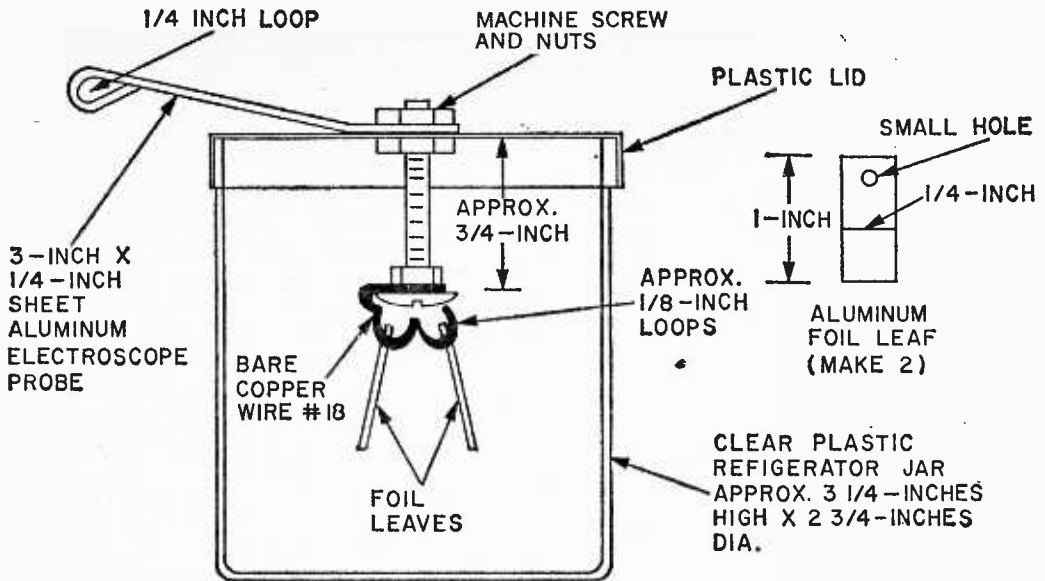

Details for building the Electroscope, a primitive indicator of electrical charge on a body. It, too, is made from kitchen materials and odd items from your workbench.

in. wide, is mounted to the outside surface of the lid under the locking nut for this bolt. Form a 1/4-in. loop on its free end to use this strip as a probe. Cut two pieces of aluminum foil 1-in. long and 1/4-in. wide. Punch a clearance hole near the top of each piece so that each can be hung separately on one of the loops previously formed in the copper wire that is fastened to the jar cover.

Assembly for Dielectric Experiments.

A clear plastic drinking cup (2 3/4-in H x 3 1/2-in dia), with tapering sides, plus aluminum foil muffin baking cups are the principal materials needed for this experiment.

The cup for the inside conducting plate is cut to a height of 1/2 in. Make 1-in. loops in a piece of #18 gauge bare copper wire and bend one of the loops to form a right angle on one end so that the wire will be perpendicular to the bottom of the muffin foil cup when fastened there. Total length should then be approximately 4 in. Tape this looped end to the bottom inside the cup making certain that a good electrical contact between the wire loop and the cup is maintained.

The outer foil cup is cut to a height of about 1 1/4 in. Form the cups to the inner and outer surfaces of the plastic glass so that they fit snugly but can still be easily removed. This is a necessary physical requirement of the experiment. Make two

exact pairs of cups for inside and out.

The accompanying drawings and photos detail the construction of these devices as well as showing how they are used in experiments.

Emulating "Old Ben." Now that the construction work is finished, let's conduct some experiments to prove Old Ben's theory and also to learn more about the action of a capacitor.

These experiments must be made in a very dry environment; they will not work under conditions of high humidity. If at all possible work in an air-conditioned area. Make certain that the rubbing cloth is completely dry and discard it for a fresh one frequently to avoid its becoming dampened by moisture from your hands. Drive off excess moisture by heating the cloth in an oven.

The experiment is begun by holding a plastic or glass rod firmly in one hand and vigorously rubbing its free end with a cloth. Immediately upon stopping the rubbing, touch the free end of the rod to the metal knob of the Leyden Jar. Repeat this action about a dozen times. Each time the rod contacts the knob electricity flows from the rod to the jar, building up the charge in the jar. Be careful not to touch the end of the rod you have rubbed with your finger as this will discharge it.

You test the jar for its charge by bringing

BEN FRANKLIN'S LEYDEN JARS

the copper braid connected to the outside foil near the metal knob in the center of the lid. A spark will be seen to jump between the braid and the knob as the braid is brought close to the knob. An NE2 neon lamp can be used for this indication by connecting one lead to the braid and touching the knob with the other lead. The lamp will light momentarily. It is possible to store enough electrical energy in the jar to create an electrical charge of sufficient magnitude to shock you, so be careful not to touch the jar with your fingers.

One Leyden Jar Experiment. Franklin charged his Leyden Jar with static electricity produced by vigorously rubbing a glass rod with a dry cloth. He repeatedly rubbed the rod to full charge and then touched it to

the metal knob in the lid of the Leyden Jar.

The vigorous rubbing of the rod with the cloth transfers some electrons from the rod to the cloth, thus making the rod more positive and the cloth more negative. Franklin is credited with using the words positive and negative to designate differences in polarity. A plastic rod can be used in place of a glass one. When using a plastic rod, however, electrons are transferred from the cloth to the rod and therefore the polarity is reversed.

You can use an old tooth brush handle, or an aligning tool, or a swizzle stick, or glass or plastic stirring rod.

The electroscope you built can be used to indicate the charge on the Leyden Jar. Bring the probe of the electroscope in contact with the knob of the jar. The foil leaves will move apart indicating that the jar is charged. The distance that the leaves move apart will be proportional to the amount of charge. You can prove this by varying the amount of the charge you place on the jar (change the number of times you touch the rubbed rod to the knob on the jar). Discharge the

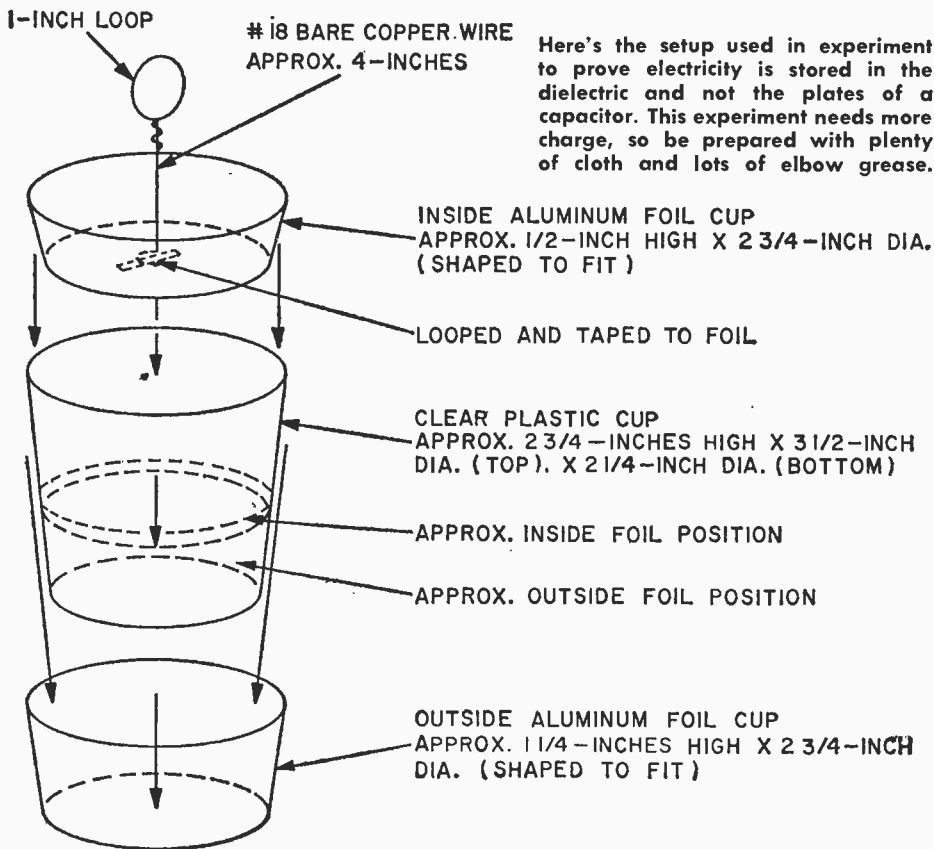

Here's the setup used in experiment to prove electricity is stored in the dielectric and not the plates of a capacitor. This experiment needs more charge, so be prepared with plenty of cloth and lots of elbow grease.

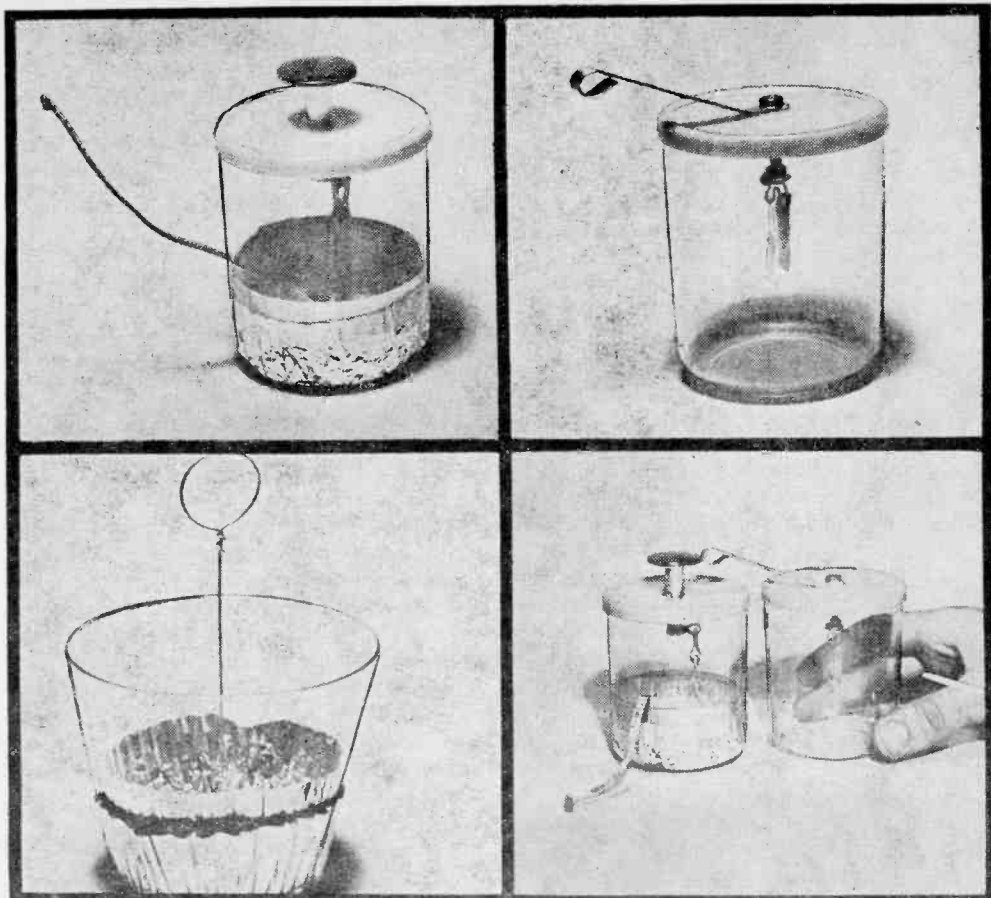

Top left and right photos show constructed Leyden Jar and electrostatic probe, respectively. Bottom photos show capacitor (left) used in the experiment and Leyden Jar (right) coming in contact with electrostatic probe to detect electrical charge. These simple electrical charge instruments were the exotic test gear used by Ben Franklin back in the 18th Century.

electrostatic probe just before contacting the jar with its probe, each time, by first grounding the probe.

A Dielectric Test Experiment. Experiments on Leyden Jars were conducted by many scientists. However Benjamin Franklin was the first to determine exactly how the Leyden Jar stored electricity. His findings became the basis for the development of the capacitors we use so profusely in electronic and electrical equipment today.

Franklin proved that the electrical charge is stored in the jar (the dielectric) rather than on the conductors (the plates) by carefully removing the inner and outer conductors after charging his Leyden Jar.

We can reproduce this experiment by setting up the material we prepared earlier, described in the previous paragraph on page

69 headed: Assembly for Dielectric Experiment.

Place the plastic drinking cup in the foil cup formed for the outside of the glass and place the foil cup, with the copper wire lead taped to it, inside the glass. Charge the assembly in the same manner as the Leyden Jar was charged. The success of this experiment is dependent on as large a charge as possible. Have extra cloths available to activate the rod that charges the assembly more times than when charging the Leyden Jar. Take care not to touch the lead wire from inner cup, or the plastic cup.

When you have charged the assembly, carefully lift out the center foil cup, using plastic photographic print tongs, and set this foil cup aside.

Now is when the second set of foil cups

BEN FRANKLIN'S LEYDEN JARS

you made previously is used. With the plastic tongs pick up the foil cup from this second set of cups and carefully place it in the plastic cup. Then, still using the plastic tongs, lift the plastic cup containing the second inner foil cup from its original outer foil and place it in the outer foil cup of the second set you made.

At this point bring the probe of the Electrostatic Voltmeter in contact with the wire loop taped to the inner foil cup. You will note that the Electrostatic Voltmeter's leaves separate, indicating that the assembly is still charged. Now discharge the Electrostatic Voltmeter.

Recharge the assembly and then carefully remove the inner foil cup again. Holding the assembly by the outer foil cup only, tip the plastic cup so that the probe of the Electrostatic Voltmeter comes in contact with the lower

BILL OF MATERIALS FOR THE LEYDEN JAR ELECTROSCOPE AND DIELECTRIC EXPERIMENT ASSEMBLY

- 2—Clear plastic refrigerator jars approximately 3 1/4-inches high x 2 3/4-inches in diameter
- 1—Clear plastic drinking cup approximately 2 3/4-inches high x 3 1/2-inches in diameter (top) and tapered to approximately 2 1/4-inches in diameter at the bottom
- 1—Plastic or glass rod
- 1—Plastic photographic print tongs
- Misc.—Cloths (wool or cotton), household aluminum foil, aluminum foil baking cups (muffin size), metal knob (drawer knob—see text), machine screws and nuts, metal chain, copper braid, scotch tape, #18 solid copper wire, etc.

inside section of the plastic cup. Observe that the leaves of the Electrostatic Voltmeter separate, indicating a charge on the plastic cup even though the inner metal foil conductor has been removed. You may have to move the probe of the Electrostatic Voltmeter around to locate a spot where you get best foil separation. ■

The center foil of the capacitor has been carefully removed to permit sampling the charge on the dielectric with the electrostatic voltmeter. Move probe about to locate the greatest charge.

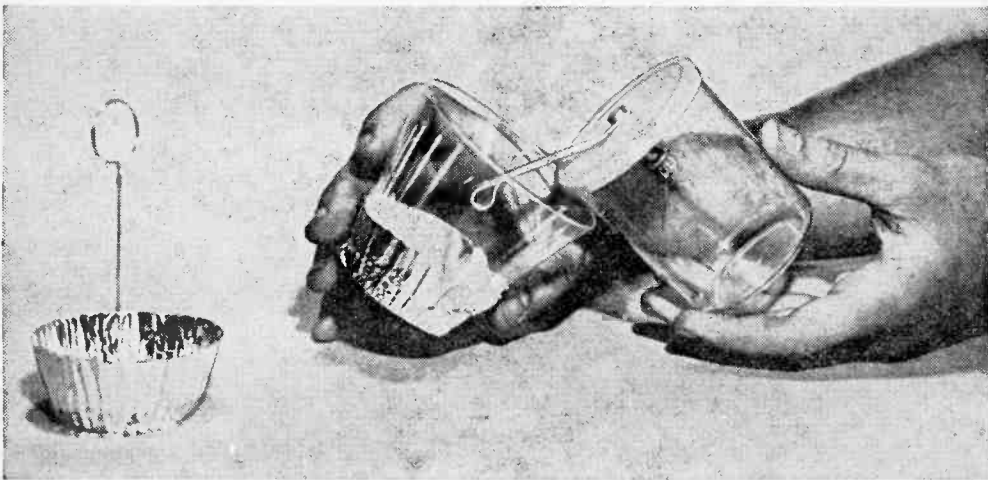

SOLDER CLIP TIP

● You'll have no trouble keeping track of rosin core solder when working on kits. Just purchase a trouser clip at a bicycle store, slip it over the iron cord and wind some solder around clip so it can't come off.

—Joe Gronk

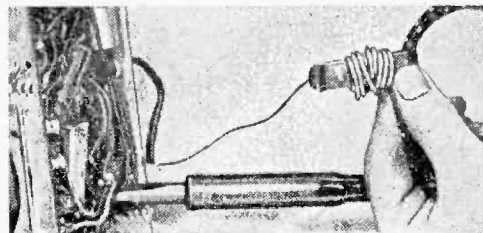

RADIO FROM THE ROARING



by Art Trauffer

Build an authentic Book Condenser Crystal Set

HERE'S a radio construction project that's just the reverse of what you'd expect. In this one, instead of making the coil and buying the variable tuning capacitor, we'll show you how to make a variable capacitor for use with a commercially made coil. You've got to admit that this is a project with a twist!

The variable capacitor we're going to show you how to build is called a book condenser. Its plates are hinged like the pages in a book, and capacitance is varied by increasing or decreasing pressure on the supports of the plates, which, in turn, increase or decrease spacing between the insulated plates—thus varying the capacity. Though this is a unique approach to varying capacity of a tuning capacitor, unfortunately we can't claim to be its innovator. Way back in the early 1920s, Crosley Radio Corporation (now a division of AVCO Corp. and renamed AVCO Electronics Div.) patented a design for and manufactured book condensers. These were used in the then famous Crosley Model 50, better known as the *Crosley Pup*, a one-tube broadcast band radio receiver.

Our *Book Condenser* is quite similar in basic design to the Crosley condenser. It's

also easy to build, since it uses hardwood blocks, aluminum foil, tissue paper, etc., all materials normally found around the house.

The coil, a major component of the radio you'll wind up building upon completion of the condenser, is a standard ferrite cored variable loopstick used in many commercial radio sets, and therefore easily procured as a replacement part.

The How of It. Either the coil or the tuning capacitor shunted across it must be capable of having its parameters varied in order to tune across the band for which the combination has been designed. In this project the capacitance of the tuning condenser is varied by moving the plates closer together without shorting them, for maximum and moving them further apart for minimum capacitance. As the plates are brought closer together capacitance increases; as they are separated it decreases. That's all there is to it. The mechanical construction we've adopted is quite simple and therefore it's easy to make our variable book capacitor.

Making the Book Condenser. Two plates, one fixed in position and the other hinged so that it can be moved closer or farther

RADIO FROM THE ROARING 20's

away from the fixed one, is how we achieve variation in capacity. The plates for the condenser are made by carefully cementing aluminum foil to one side of each of two wooden blocks. The two blocks are mounted so that the foil sides face one another. A piece of unused airmail stationery, placed between the foil, insulates them.

The thickness of the paper determines maximum capacity—the thinner the paper the higher the capacity. That's why we've specified airmail stationery. This is just about the correct thickness for the plate sizes used to give our *Book Condenser* the capacity required to tune the loopstick coil over the broadcast band. The sizes of the blocks and mechanical details are shown in our photo and in the materials list.

Plate Connections. Be sure to leave a tab of aluminum that can be folded over the edge of the wooden block to make connections to the plates. After the cement has dried, fasten a soldering lug to the tab with

a wood screw, making certain that the eyelet of the solder lug is held tightly against the foil by the head of the screw.

The foil must be as flat as possible, so be sure all air bubbles are pressed out before the cement dries and be careful not to tear the foil. A good cement to use is Pliobond. Since wood is more porous than the metal foil, spread the cement on the foil first and then on the wood. Press the foil to the wood immediately after spreading the cement on the wood.

A good way to ensure that the foil will be cemented smoothly is to first place the foil on a table top or other hard, smooth surface, facing *up* the side on which the cement has been spread, and then pressing down the cemented side of the wood block to the cemented side of the foil. After the cement has dried, trim excess foil to the size of the wood blocks. Cement the paper insulator, which has been cut slightly larger than the foil, to the hinged end of the large wooden block that is fixed in position.

When mounting the hinges hold the two wooden blocks together in a vise, or clamp, to ensure correct movement of the small wooden block.

IN THE BEGINNING WAS CROSLY'S BOOK CONDENSER

The Crosley book-type variable condenser consists of two molded insulating plates coated with metallic foil and hinged together at one edge so that they can be swung toward or away from each other like the leaves of a book. A cam, mounted on a shaft passing through a bearing in the condenser frame, and provided with a knob and dial, offers the mechanical means of adjusting this condenser. A thin sheet of mica is mounted between the plates in order that the capacity may be sufficiently high without making the plates excessively large, and so there will be no danger of short-circuiting no matter how close together the plates are pressed.

—Crosley Radio Corp., 1923

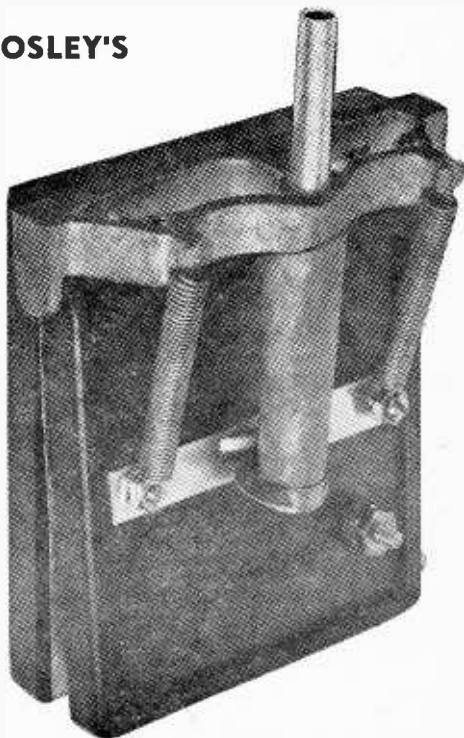

In this case innovation is the mother of invention. On the previous page we showed how one manufacturer, Crosley, made their commercial Book Condenser from metal and molded insulation. We've duplicated it with wood and aluminum foil. This top view of a complete radio shows its construction as well as location of all major components.

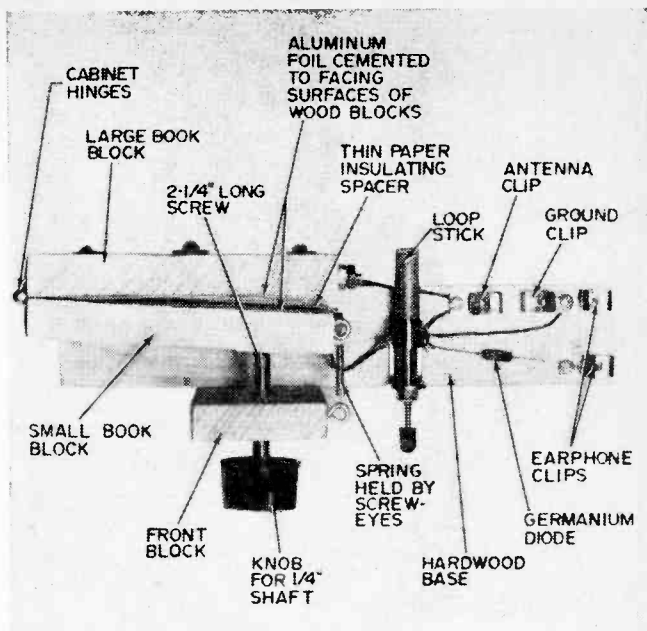

A screw or threaded rod, approximately 2 1/4 in. long and having fairly heavy threads, is threaded through the Front Block to exert pressure on the metal strip fastened to the small wooden block. Turning the knob clockwise causes the screw to change the length of the screw that projects beyond this Front Block. This in turn moves the Small Book Block closer to the Large Book Block.

When the screw is turned counterclockwise, the part of the screw that moves the Small Book Block is shortened. The Small Book Block is pulled away from the Large Book Block by the spring stretched between the Front Block and the Small Book Block. Small screw eyes, one in the free end of the Small Book Block and one in the end of the Front Block that is adjacent to the free end of the Small Book Block, hold this spring in position.

Now the Coil. Remove all but 80 turns of wire from the loopstick coil to adjust its inductance to permit tuning the broadcast band with the capacitance of our Book Condenser. Mount this coil assembly on a 1 x 1 x 1/2-in. metal bracket with the ferrite core adjusting screw facing the front of the radio and fasten a small knob on the adjusting screw. You may find slight changes in the position of the core will improve the performance of the receiver.

Connect the Book Condenser, coil, and crystal diode as shown in the schematic.

Enjoying Book Condenser Radio. Since there are no amplifier stages in this radio,

Just in case top view may not reveal all intimate details of construction of our Book Condenser we've included this oblique view. It's really a very crude approach by comparison with commercially produced ones even though they were made way back when radio was in its infancy.

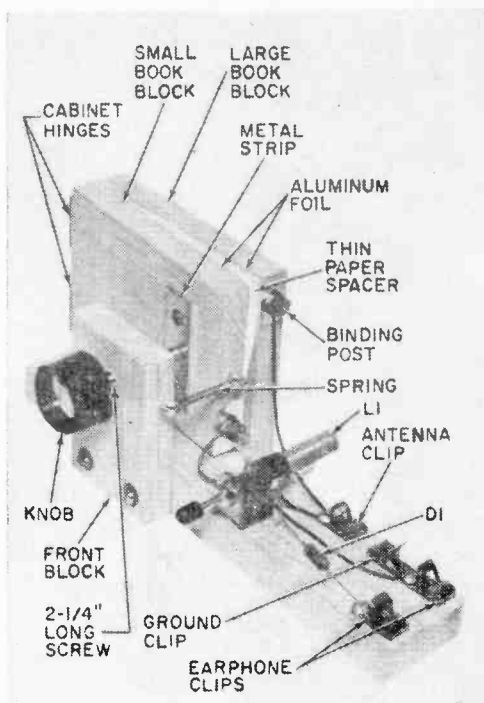

RADIO FROM THE ROARING 20's

BILL OF MATERIALS FOR BOOK CONDENSER RADIO

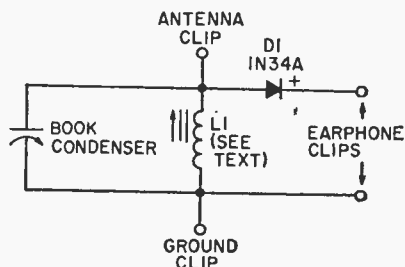

Back in the beginning we had solid-state radios but then they were called crystal sets. Note simplicity of circuitry.

- D1—Germanium diode, type IN34AS, IN60, IN82A, or IN295
- L1—Variable loopstick (Lafayette 32E41064 or equiv.)
- 4—Fahnestock clips, medium size (Lafayette 32E71028 or equiv.)
- 1—Base, hardwood, $8\frac{1}{2} \times 1\frac{1}{2} \times \frac{3}{4}$ in.
- 1—Block, hardwood, $3 \times 2 \times \frac{1}{2}$ in.
- 1—Small book block, plywood or hardwood, $4 \times 3 \times \frac{1}{2}$ in.
- 1—Large book block, plywood or hardwood, $4 \times 3\frac{3}{4} \times \frac{1}{2}$ in.
- 2—Brass cabinet hinges, 1 x 1 in. (usually available with required brass flathead screws)
- 1—Long screw, $\frac{1}{4}$ -28NF x $2\frac{1}{4}$ or equiv.
- 1—Brass or polished steel metal strip, $2 \times \frac{1}{2}$ in.
- 1—Spring, 1 in. long x $\frac{3}{16}$ in. diameter
- 1—Knob for $\frac{1}{4}$ -in. shaft
- 2—Screw eyes, $\frac{1}{2}$ -in.
- Misc.—Aluminum foil, paper spacer, $\frac{1}{2}$ -in. round head brass wood screws, $\frac{1}{4}$ -in. round head brass wood screws, washers, wire, glue, solder etc.

it's important to use a long antenna and good water-pipe ground in order to collect as much signal as possible for the set. Since the output is high impedance, you must use either high-impedance magnetic or crystal headphones on the output.

Because the Book Condenser Radio has a simple single tuned circuit, it will not tune

sharply, and therefore will receive only those stations whose signal strength is high and that are widely separated from other nearby stations. Strong local signals will be received best. If you are located near several powerful stations, this simple, broad-tuning receiver will make an ideal AM tuner for your hi-fi system. ■

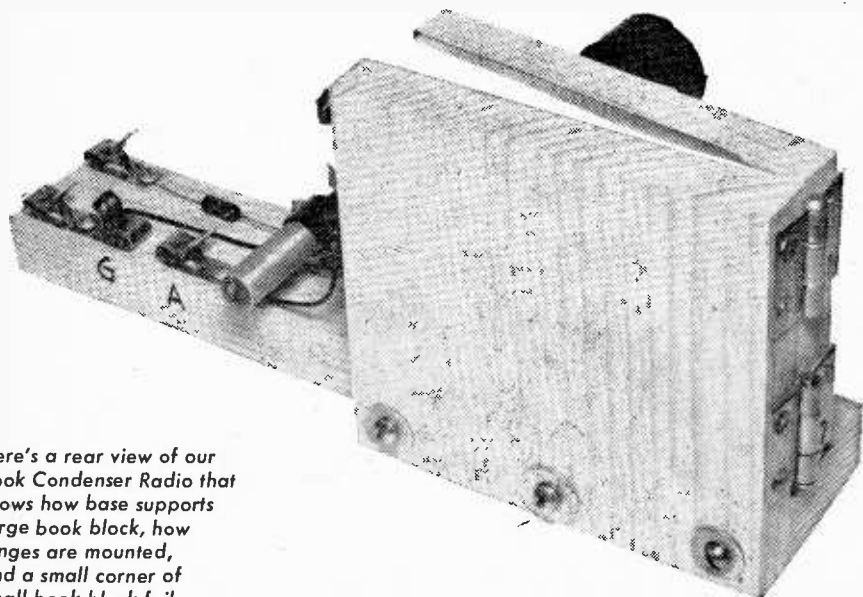

Here's a rear view of our Book Condenser Radio that shows how base supports large book block, how hinges are mounted, and a small corner of small book block foil.

TEN BUCK AIRCRAFT RECEIVER

A SLIGHT MODIFICATION TO AN EICO EC-1400
AND VOILA—YOU EAVESDROP ON BOTH PILOTS AND TOWER

D ID YOU SAY you'd like to listen to the tower of your nearby airport? You can, you know, with just a few simple modifications to an FM receiver so that it will tune to the airport frequencies and let you virtually ride along in the cockpit with the pilot and crew. Of course, you must live near an airport in order to hear the control tower and the aircraft; you won't hear anything if you're 20 miles from the runway, unless by chance you should be under the holding pattern. However, if you're within ten miles, this simple aircraft receiver conversion will put you on top of the action.

What You Need. Our Ten Dollar Aircraft Receiver is basically an Eicocraft FM radio which is a three-transistor set consisting of superregenerative detector and two stages of AF amplification. To convert this set to an aircraft receiver involves only stretching the tuning coil, or cutting one turn off it, depending on how your particular



\$10 AIRCRAFT RECEIVER

receiver now tunes, plus the addition of an antenna isolation capacitor to prevent a long antenna from blocking the regen detector with excessive signal level.

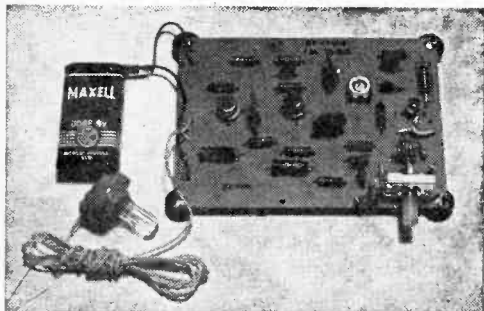

You start by building this FM set from an Eico EC-1400 kit. Once it's operating you're ready to make necessary modifications.

Getting Started. First step of the conversion project is to build the Eicocraft EC-1400 FM Radio exactly as described in the instructions for the kit. You cannot do the conversion until you are certain the original circuit is working. The EC-1400 is supplied with a pre-drilled printed circuit board and you need only to mount the components by pushing their leads into the matching holes and solder them to the circuit board.

Mounting Capacitors. However, for the conversion project capacitor C2 must be moved. Therefore, when you solder it in to

test the original circuit do not trim the leads too close to the circuit board as indicated in the kit's instruction sheet; leave the leads about 1/2-in. long and don't fold them flat against the circuit board—C2's leads should be left sticking out straight from the board. Also, it's recommended that you cement tuning capacitor C3 to the top of the circuit board. Tuning the high frequencies used by aircraft requires a capacitor that is physically stable in its mounting on the circuit board. The two wires that normally connect the tuning capacitor to the PC board don't provide an adequately rigid mounting. After C3 has been installed as described, place a few drops of General Electric RTV Silicon Adhesive (don't overdo the cement) under trimmer capacitor C3. Press C3 into the adhesive, but not so hard that the adhesive squishes out, and let it set for 24 hours. Finally, remember that capacitor C13, which is connected across C3, will be removed for the aircraft conversion; in the initial construction just tack-solder it across C3's terminals—don't wrap C13's wires around C3's terminals.

No Power Switch Needed. Though the FM radio's schematic and pictorial diagrams show a power switch, none really is needed since the battery can be easily unplugged from its terminals. Connect the red wire of the battery connector to the + connection on the circuit board and the black connector wire to the - connection on the board.

Checking Reception. Set the trimming potentiometer R1, so that the slider adjusting notch faces the top of the PC board.

Plug-in the battery connector to a fresh battery and, by listening to the phone supplied with the kit you should hear a rushing sound. Adjust tuning capacitor C3 fully clockwise (maximum capacity) and then adjust this tuning capacitor counter clockwise until you hear an FM station. If

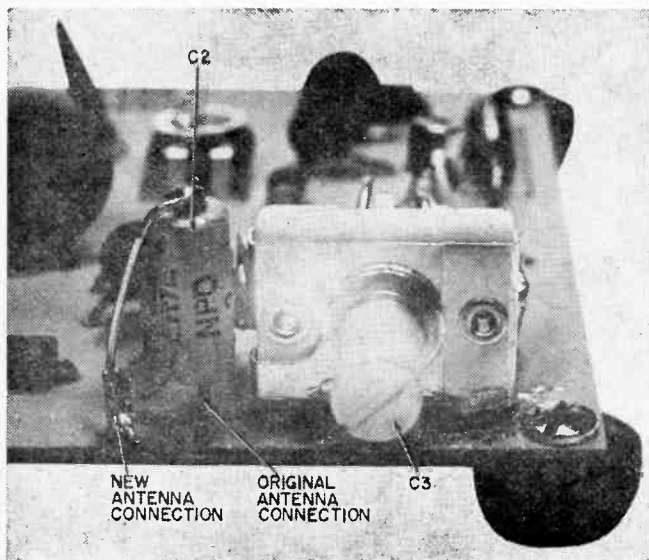

Use original antenna connection to mount C2 and install a push-in terminal nearby as new antenna terminal. C3 is cemented to circuit board to make its mounting sturdier for higher frequencies.

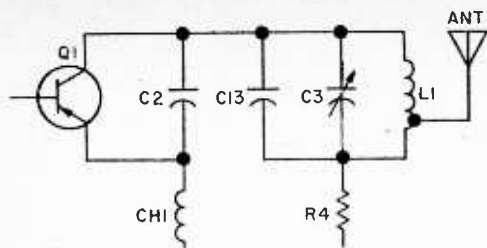

Above, circuit for kit before modification. Below, circuit modified by removal of C13 and repositioning of C2.

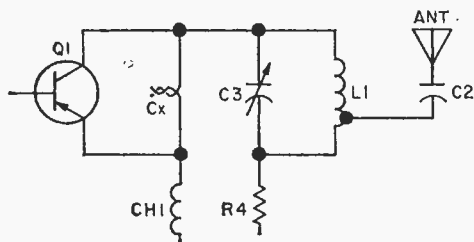

you can't pickup a station connect your TV antenna or a long wire to the FM radio's antenna lead; it needs a lot of signal. If you can hear any sound the radio is ready for conversion. Note that the regen detector is an AM detector and uses slope detection to receive FM signals: therefore, even when working correctly, on FM signals the sound level in the earphone will be very low. However, since aircraft radio communications uses AM modulation the sound level on the control tower and aircraft transmissions will be loud on this receiver. If the radio doesn't

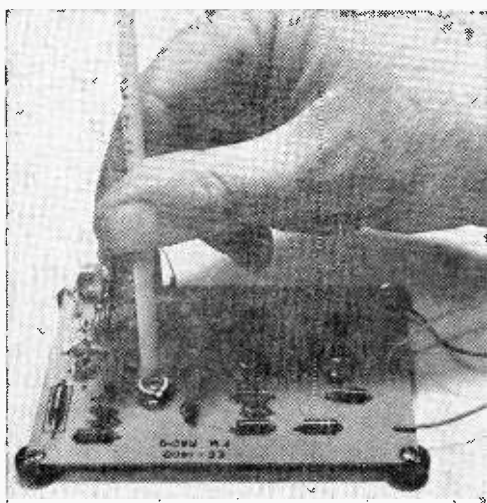

With modifications finished, set can be aligned either on airways signals or, if signal strength is low, from signal generator.

work, check your assembly for a possible error in wiring.

Converting To Aircraft Band. Being careful to use as little soldering iron heat as possible, remove C2 and set it aside. A "gimmick" capacitor (Cx) will replace C2. Cut two pieces of #20 or #22 solid insulated wire about 3/4-in long and connect one end of each to the holes where C2 had been connected. Now twist them together one full turn (caution, be sure that they are insulated from one another electrically) and cut away any excess wire left hanging after the one turn twist. Use a #49 or #50 bit to drill a hole just off the edge of the circuit board about 1/4-in from the present antenna hole (marked C).

Make certain that you do not drill into any of the printed circuit wiring copper

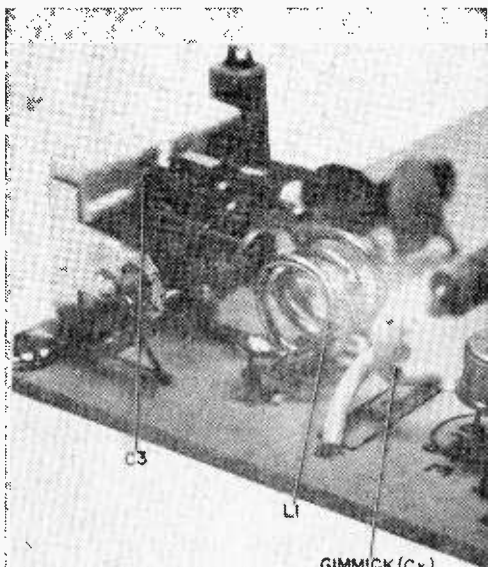

After it's replaced by gimmick, C2 is used to couple antenna to set. L1 may have to lose one turn to cover airways bands.

strips. Insert a flea clip or T-28 type push-in terminal in the added hole and connect C2 between this terminal and the old antenna connection (marked C). Your antenna will now connect to this new terminal (see photographs).

Coil Modification. In order to extend the tuning range of the EC-1400 FM radio to cover the aircraft band it will be necessary to modify tuning coil L1. Grasp both ends
(Continued on page 110)

Join "THE TROUBLESHOOTERS"

They get paid top salaries
for keeping today's
electronic world running

Suddenly the whole world is going electronic! And behind the microwave towers, push-button phones, computers, mobile radio, television equipment, guided missiles, etc., stand

THE TROUBLESHOOTERS

—the men needed to inspect, install, and service these modern miracles. They enjoy their work, and get well paid for it. Here's how you can join their privileged ranks—without having to quit your job or go to college in order to get the necessary training.



JUST THINK how much in demand you would be if you could prevent a TV station from going off the air by repairing a transmitter...keep a whole assembly line moving by fixing automated production controls...prevent a bank, an airline, or your government from making serious mistakes by servicing a computer.

Today, whole industries depend on Electronics. When breakdowns or emergencies occur, someone has got to move in, take over, and keep things running. That calls for one of a new breed of technicians—The Troubleshooters.

Because they prevent expensive mistakes or delays, they get top pay—and a title to match. At Xerox and Philco, they're called Technical Representatives. At IBM they're Customer Engineers. In radio or TV, they're the Broadcast Engineers.

What do you need to break into the ranks of The Troubleshooters? You might think you need a college degree, but you don't. What you need is know-how—the kind a good TV service technician has—only lots more.

Think With Your Head, Not Your Hands

As one of The Troubleshooters, you'll have to be ready to tackle a wide variety of electronic problems. You may not be able to dismantle what you're working on—you must be able to take it apart "in your head." You'll have to know enough Electronics to understand the engineering specs, read the wiring diagrams, and calculate how the circuits should test at any given point.

Learning all this can be much simpler than you think. In fact, you can master it without setting foot in a classroom...and without giving up your job!

For over 30 years, the Cleveland Institute of Electronics has specialized in teaching Electronics at home. We've developed special techniques that make learning easy, even if you've had trouble studying before. Our AUTO-PROGRAMMED® lessons build your knowledge as easily and solidly as you'd build a brick wall—one brick at a time. And our instruction is personal. Your teacher not only grades your work, he analyzes it to make sure you are thinking correctly. And he returns it the same day received, while everything is fresh in your mind.

Always Up-To-Date

To keep up with the latest developments, our courses are constantly being revised. This year CIE students are

NEW COLLEGE-LEVEL COURSE IN **ELECTRONICS ENGINEERING**

for men with prior experience in Electronics. Covers steady-state and transient network theory, solid state physics and circuitry pulse techniques, computer logic and mathematics through calculus. A college-level course for men already working in Electronics.

getting new lessons in Laser Theory and Application, Microminiaturization, Single Sideband Techniques, Pulse Theory and Application, and Boolean Algebra.

In addition, there is complete material on the latest troubleshooting techniques including Tandem System, Localizing through Bracketing, Equal Likelihood and Half-Split Division, and In-circuit Transistor Checking. There are special lessons on servicing two-way mobile radio equipment, a lucrative field in which many of our students have set up their own businesses.

Your FCC License—or Your Money Back!

Two-way mobile work and many other types of troubleshooting call for a Government FCC License, and our training is designed to get it for you. But even if your work doesn't require a license, it's a good idea to get one. Your FCC License will be accepted anywhere as proof of good electronics training.

And no wonder. The licensing exam is so tough that two out of three non-CIE men who take it fail. But our training is so effective that 9 out of 10 CIE graduates pass. That's why we can offer this famous warranty with confidence: If you complete a license preparation course, you get your FCC License—or your money back.

Mail Card for 2 Free Books

Want to know more? Send for our 44-page catalog describing our courses and the latest opportunities in Electronics. We'll send a special book on how to get a Government FCC License. Both are free—just mail the bound-in postpaid card. If card is missing, use coupon below.

ENROLL UNDER NEW G.I. BILL

All CIE courses are available under the new G.I. Bill. If you served on active duty since January 31, 1955, or are in service now, check box on card or coupon for G.I. Bill information.

CIE Cleveland Institute of Electronics

1776 East 17th Street, Cleveland, Ohio 44114

Cleveland Institute of Electronics

1776 East 17th Street, Cleveland, Ohio 44114

Please send me without cost or obligation:

1. Your 44-page book "How to Succeed in Electronics" describing the job opportunities in Electronics today, and how your courses can prepare me for them.
2. Your book on "How To Get A Commercial FCC License."

I am especially interested in:

- | | | |
|--|---|--|
| <input type="checkbox"/> Electronics Technology | <input type="checkbox"/> Broadcast Engineering | <input type="checkbox"/> First Class FCC License |
| <input type="checkbox"/> Electronic Communications | <input type="checkbox"/> Industrial Electronics | <input type="checkbox"/> Electronics Engineering |

Name _____ (PLEASE PRINT)

Address _____

City _____ State _____ Zip _____

Check here for G. I. Bill information.

EB-6



INTERVAL SCREAMER

IT'S DIABOLIC, IT'S ELECTRONIC, IT'S DELAYED INSANITY

by Steve Daniels, WB2GIF

HAVE YOU HAD occasion to wish for some oddball happening to liven up a dull party or uninteresting meeting? Or perhaps you wanted to get even with the boss, or a teacher, or fellow worker for his past disregard of your talents, knowledge, and capability?

Our Interval Screamer should be just the thing to help you even the score. What is it? What does it do? How does it do it? How can you use it?

Well, it's an innocent looking black box that could easily be misconstrued for a desk radio, an intercom, or an extension speaker. Don't you believe it.

Most people are curious and have an uncontrolled urge to flip a switch whenever they confront a device having toggle and/or pushbutton switches exposed. This means that if

our little innocent looking Screamer is casually tossed on a desk or table top, you can be sure someone will pick it up and flip a switch. Will their face be red—because when the switch is flipped that innocent looking black box lets out a continuous scream and, unless you know how to stop it, it just keeps on wailing!

In short order everyone will have been wakened from their stupor. And if you don't get hold of the gadget quickly someone may just toss it out a window as the only means to restore peace and tranquility. Well, we've told you what it is, what it does, and how to use it, so now—

How It Works.

Actually what we have is a solid-state electronic timer combined with a solid-state electronic siren having concealed controls for stopping



Interval Screamer

the action and resetting the device for the next curious one who isn't yellow.

By referring to the schematic you will note that SCR1 is in series with the positive battery supply lead to the timing circuit, which consists of Q1, C1, R1, and the coil of K1. Also, SCR2 is in series with the positive battery supply feeding the siren through the normally closed contacts of relay K1.

When S4 is closed it applies bias to the gate of SCR2, which immediately energizes the siren. If S2 is closed first, starting the timing action, K1 will be energized and will disconnect the siren. When C1, in the timing circuit, becomes fully charged, Q1 is reverse biased and is *cut off*. This drops out relay K1 and the siren is activated. Since our innocent switch flipper doesn't know the secret we defy him to turn *off* the siren.

You ask what is the secret? But of course! It's S3, the momentary switch that can be

operated only by inserting a pointed pencil, pin, paper clip, or whatever is convenient, through one of the holes in the perfboard that covers the bottom of the plastic case. The timing delay, predicated on the value of the components shown in the schematic, is approximately 40 seconds. This can be varied by changing the value of resistor R1, plus or minus 10%.

Building the Beast. Our model was built in a black molded plastic box $3\frac{3}{4} \times 6\frac{1}{8} \times 2$ in. (available from Radio Shack). We used this one because a speaker grille was molded in the box and we were too lazy to drill holes for one. You may use any suitable box that's handy (even an empty cigar box). First chore is to drill holes in the box for mounting the speaker, S2, S4, and the circuit board. Next make S3 (from the blades of an old phone jack or phosphor bronze strip) and mount them on the perfboard bottom supplied with the box. The two leaves or strips are mounted so that one end of each is over the other and making contact with it, thus making up a normally closed (NC)

PARTS LIST FOR INTERVAL SCREAMER

- B1—6 type AA 1.5-V penlight cells
- C1—100- μ F, 6-V electrolytic capacitor (Allied 43A1753 or equiv.)
- K1—Sigma relay type 11F1500G/Sil (Allied 41D5070 or equiv.)
- Q1—Motorola HEP 250
- R1—56,000-ohm, $\frac{1}{2}$ -watt resistor
- R2, R3—22,000-ohm, $\frac{1}{2}$ -watt resistor
- SCR1, SCR2—Silicon-controlled rectifier GE 10EY1
- S1—See text
- S2—Spst normally open pushbutton switch (Lafayette 99E62184 or equiv.)
- S3—See text
- S4—Dpdt toggle switch used as spst switch (Lafayette 99E62124 or equiv.)

- 1—Plastic battery holder for B1 (Radio Shack 270-384 or equiv.)
- 1—Battery connector (Allied 18A5307 or equiv.)
- 1— $3\frac{3}{4} \times 6\frac{1}{8} \times 2$ -in. molded plastic box with perfboard bottom (Radio Shack 270-097 or equiv.—see text)
- 1— $2\frac{1}{2}$ -in., 8 to 10-ohm speaker (Lafayette 99EG60972 or equiv.)
- 1—Siren module (Lafayette 19E55053 or equiv.)
- Misc.—Hookup wire, solder lugs, solder, perfboard, flea clips or push pins, $\frac{1}{4}$ -in. bushings, bolts, nuts, leaves from old phone jack or phosphor bronze strip, etc.

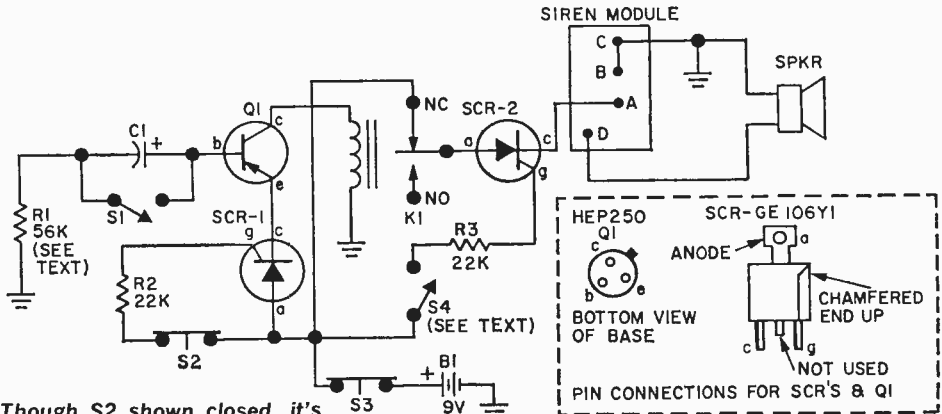

Though S2 shown closed, it's NO; S3 is NC as shown.

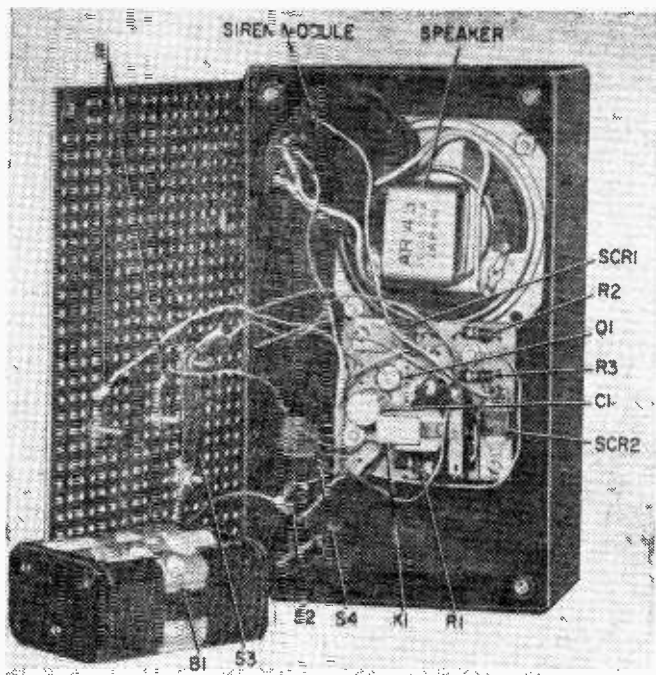

Above, be sure to leave enough room for battery holder when locating circuit board. Below, pencil operates hidden S3. See text for application of S3.

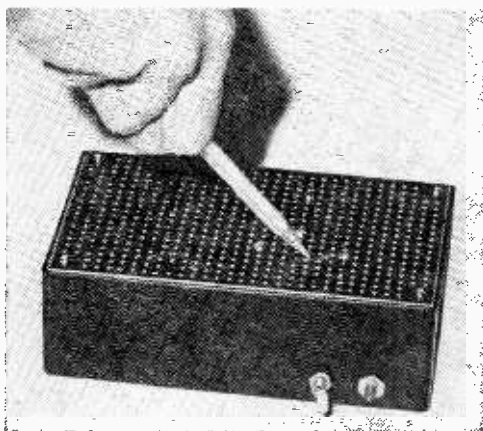

switch that can be opened by inserting a pointed object through a hole in the mounting board for the purpose of separating the two leaves. (See photo.)

Make a hole slightly larger than the perf opening so that a pencil or ball-point pen or toothpick can be inserted to open the contact leaves of the switch.

Switch S1 is made by placing two nickel-plated 6-32 bolts approximately 1/2 in. apart

adjacent to S3. Space between bolts that make up S1 should be such that a key or paper clip or short scrap of bare wire can be placed momentarily between them to short out C1, the leads of which are connected to the two bolts.

Though we placed S1 and S3 on the bottom perfboard, you may want to locate them elsewhere in your Screamer. Remember, though, they are far less conspicuous on the bottom of the box even though it may be a little more difficult to conceal your operating them, which would reveal the secret of how to silence the Screamer.

Fasten the siren module in place with epoxy cement where the module contacts the sides of the plastic box. To be certain module does not jar loose use cement both

at the bottom and top extremities of the points of contact.

A 2 x 2-in. piece of perfboard is used as the circuit board and contains the SCRs and the timing components. Even though we didn't use them for this project, it is suggested that you mount and wire components via push pins and/or flea clips. It makes a neater circuit board and facilitates replacement of parts. Also, since anyone can make a wiring error, this type of construction makes it easy to spot and correct goofs.

Layout isn't critical and needn't be the same as ours. The components we selected are relatively inexpensive and are readily available from most parts suppliers. If you should use different ones be certain that their characteristics are similar to the ones we used. Our layout does lend itself to simplifying the wiring and mounting in the box we chose.

The relay we selected is mounted by a single bolt screwed through the perfboard into a threaded mounting stud on the relay.

Before fastening the SCRs to the board, shorten the gate and cathode leads to about one-third their original length. Use a soldering lug under the bolt that passes through the anode tab for mounting the SCR, to connect to the anode.

(Continued on page 110)

SonoPulse Timer

by Steve Daniels, WB2GIF

WOULDND'T YOU RATHER listen to a dulcet tone when timing a science project, or in the darkroom timing exposures and/or development, or when timing sports events, or any timing you may require, rather than to have to use a stop-watch? You can, you

Use our beeping timer in timing your darkroom or sports events and check the text for a test of your understanding of electronic circuits!

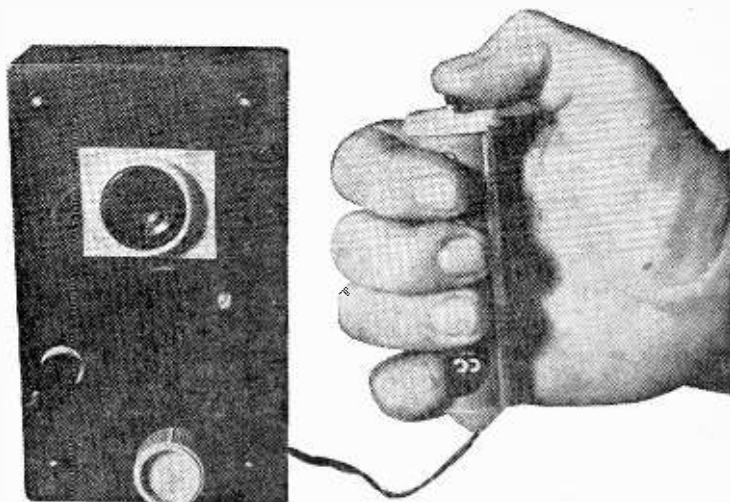

know, by building an electronic timer, and you can build our SonoPulse timer for about \$12.00.

Why bother, you say. Well, for one thing, think of the pleasure and experience you will have building this intriguing solid state device; for another, particularly when in the darkroom, you are not forced to strain your eyes concentrating on the face of a dimly illuminated (safe light) clock. And, if you use a foot switch to trigger the SonoPulse, both hands will be free to perform other necessary functions during the timing process.

The SonoPulse employs one unijunction transistor (UJT) and one *pnp* general purpose transistor, plus five resistors, two electrolytics, a 9-v transistor radio battery, and an interesting new solid state miniature audible-signal device that emits a pleasant beep tone, develops a husky signal (approx. 50-80 dB). Although the audible signal unit draws just a couple of mA, it's all

SonoPulse Timer

housed in a neat 6 x 3½ x 2-in. plastic instrument case. The timing pulses can be varied from one every ¾ of a second to 3.5 pulses per second.

How It Works. The UJT (Q1) is connected as a conventional relaxation oscillator wherein C1 and C2 charge—but wait a minute—how can these capacitors be charged when the ends of the series connection are both returned to the positive side of the battery? And if, as stated above, this is a series string of two electrolytic capacitors, each having definite plus and minus connections, how do you account for the two negative leads being connected together and floating, with each positive lead connected through resistors to the positive side of the battery?

The prime reason this manuscript was published by the Editors was the open chal-

lenge the schematic diagram presented to those who wish to find out how the circuit works. Take a good look at the schematic diagram and tell us honestly that you know how the circuit operates. If your answer is affirmative, then dollars to doughnuts you are either a genius or you're just fooling yourself. Before you read on any further, the Editors suggest that you copy the diagram onto a piece of paper and sit down with others who understand schematic diagrams and see if you can dope out exactly how this circuit works. You'll be surprised to discover how complicated a simple circuit can be.

Here is a simple explanation of how the capacitors are charged. Since the collector-to-base junction of Q2 is the equivalent of a diode and has diode leakage, the mystery should be solved. What is required to charge these capacitors is a negative reference point, which in this circuit is the collector-to-base junction. When the firing point of the emitter of the UJT (Q1) is reached, C1 and C2 discharge through the UJT and produce a negative pulse at the base of Q2, causing it

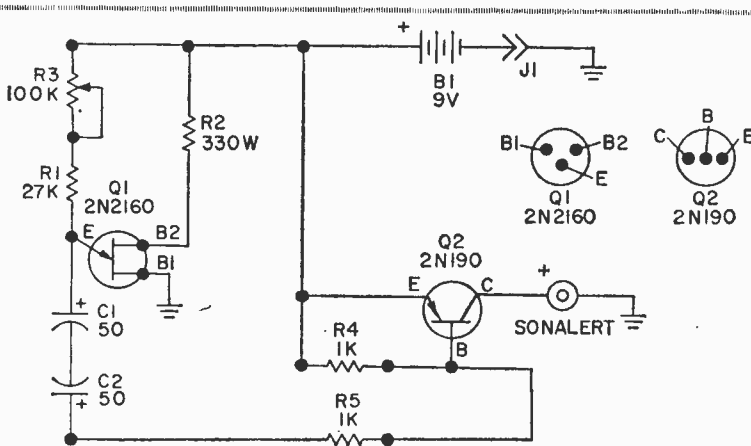

PARTS LIST FOR SONOPULSE

- B1 9-V transistor radio battery (Eveready 216 or equiv.)
- C1, C2 50-μF, 16-V electrolytic capacitor (Lafayette 34E85521 or equiv.)
- J1 Open circuit phone jack (Lafayette 99E62135 or equiv.)
- Q1 GE unijunction transistor type 2N2160
- Q2 GE transistor type 2N190
- R1 27,000-ohm, ½-watt resistor
- R2 330-ohm, ½-watt resistor
- R3 100,000-ohm, linear potentiometer (Lafayette 33E11404 or equiv.)
- R4, R5 1000-ohm, ½-watt resistor

- S1 Switch, single-pole momentary, normally open, pushbutton (Lafayette 99E62184 or equiv.)
- 1 6⅜ x 3 3/16 x 1⅞- in. bakelite box with aluminum panel (Lafayette 99E62721 or equiv.)
- 1 Keystone # 203P battery holder
- 1 Battery connector (Lafayette 99E62879 or equiv.)
- 1 Mallory "Sonalert" electronic audible signal device (Lafayette 12E74018)
- Misc. Bolts, nuts, ½-in. spacer, perf board, flea clips, knob, etc.

The works of our SonoPulse timer. Though layout isn't critical this parts arrangement assists in hooking up the unit. The UJT and the unique audible alarm device help make this compact package a reality.

to conduct. Capacitors C1 and C2 are connected "back-to-back" to produce, in effect, a bipolar capacitor since both open ends of that series connection are positive with respect to ground while idling between charges.

How to Build It. A review of the photos reveals the simplicity of construction. The layout is not critical. We mounted all of the components, with the exception of the audible signal unit, the jack to which switch S1 is connected, and the battery, on a 2 x 2-in. piece of perf board which, in turn, was mounted within the housing by one bolt and 1/2-in. spacer. The audible unit is mounted in the base of the plastic case, centered in the upper half, by drilling a single 1 3/16-in. hole in the base of the case. You may use a chassis punch, circle cutter or nibbling tool to cut this hole.

The timing control is mounted centered in the lower half of the base and the jack to which the starting switch is plugged for connection to the circuit is mounted on the case wherever it will be most convenient. (Our unit has it mounted in the base near the timing control.) A blank piece of aluminum covers the plastic case and serves as a bottom plate.

We used flea clips in the perf board as intake-off points for the potentiometer, battery and jack connections. You may want, also, to use flea clips to mount and connect the transistors and other parts, which makes it easier to replace the parts that may become defective. Although we held the battery in place with a simple clip bolted to the side of the plastic case, you may prefer using a battery holder.

As you can see in the photo, we used a miniature pushbutton switch which we mounted in a discarded container from sol-

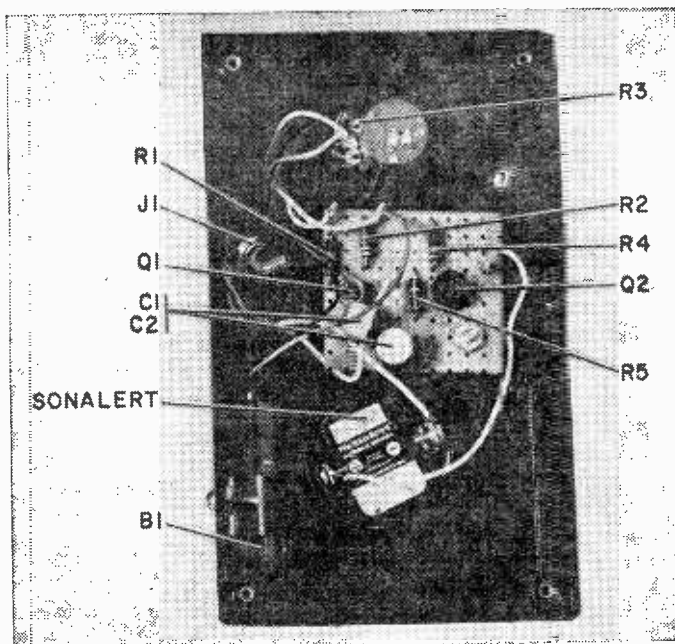

der for S1. It serves the purpose well. However, should you prefer a foot-operated switch you may improvise one or buy a commercially built foot switch. You can easily make one by mounting the miniature push-button switch in a rubber, hollow door wedge (available from hardware or variety stores).

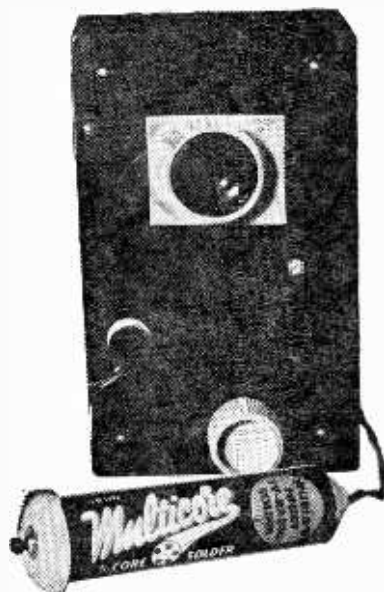

Operating side of the SonoPulse timer. Note the simplicity of controls that make it easy to use.

We purposely have not specified the length of the pair of wires between the switch and SonoPulse. Make it a convenient-to-use length. You may use zip cord, 2-conductor jacketed cable, or twisted hook-up wire. If you use a double-pole switch in place of the single pole, the extra contacts can be used to turn *on* or *off* the enlarger or device being timed. You can best see this technical point by referring to the schematic diagram.

Using SonoPulse. When completed you will hear a pleasant beep tone burst, repeated continuously as long as switch S1 is closed. The repetition rate is controlled by potentiometer R3. The fastest pulse rate is attained at full counter-clockwise (minimum

resistance) rotation of R3; the slowest is full-clockwise (maximum resistance) rotation.

We did not take the time to locate calibration points on our model. You will find the SonoPulse timer more useful if you do calibrate the control. This can be done easily by using a stop-watch. Just start the watch at the beginning of a count of 10 (or 20 if you prefer) beeps and stop it at the end of the count. Divide the total elapsed time registered on the stopwatch by the number of beeps counted (10 or 20) to arrive at the time duration between beeps. These various settings of R3 at the time the count is made will become your calibration marks. ■

\$10 Aircraft Receiver

Continued from page 99

of the coil and stretch it approximately $\frac{1}{8}$ to $\frac{1}{4}$ -in. If necessary, simply fold outward the turn at each end. Adjust tuning capacitor C3 fully clockwise until you pick up a station on the high end of the FM band. A slight additional counterclockwise adjustment should bring in the the aircraft frequencies loud and clear. If the range of tuning capacitor C3 is such that you can't tune above the FM band, remove one turn from the right side of the coil (the side farthest from the tap).

Remove the turn by cutting this end of the coil about $\frac{1}{8}$ -in above the circuit board and unwinding one turn. Then solder the free end of the coil to the piece left in the board when the cut was made. Don't try to unsolder the coil from the board as you may permanently damage the coil.

Aligning Aircraft Band. If you still have no luck tuning in the aircraft frequencies, try aligning the tuning range by using a signal generator to spot the correct setting for C3. Set C3 fully clockwise and position the antenna wire near the signal generator output, or the output of a grid-dip oscillator, either of which has been tuned to 120 MHz. Then back-off C3 $1\frac{1}{2}$ turns. If you don't tune through the 120 MHz test signal within $1\frac{1}{2}$ turns of C3 try squeezing the coil together in small increments until you can tune in the 120 MHz test signal within the $1\frac{1}{2}$ turns range of C3. Once you have either an aircraft or test signal tuned in, then, using an alignment screwdriver, adjust the trimmer-potentiometer (R1) for maximum signal strength.

Note that though the radio will work on FM band with the antenna connected directly to the antenna terminal on the circuit board, it will not work on the aircraft band unless the antenna is connected through 2pF capacitor C2. —Joe Gronk ■

Interval Screamer

Continued from page 106

Different colors of hook-up wire will simplify final hookup of the Screamer. Remember, before soldering the SCRs, the transistor and C1, be certain that they are correctly wired. The circuit board should be raised from the box with $\frac{1}{4}$ -in. spacers.

Operating the Screamer. Now that the wiring has been checked and all the construction has been completed, you're ready

to practice the various methods of operating the Screamer. This way, you'll be ready to stop it after some curious person has turned it *on*—and to do so before he tosses it out the window, or at you.

To turn *on* the Screamer flick *on* S4. To turn the thing *off* when started this way open S4 and press S3, then reset the Screamer by shorting the bolt contacts you made to serve as S1.

Got the operation down pat? OK, then rush off to that dull party and wait for the fun to start after you've tossed your Screamer on a table to tempt some unsuspecting switch flipper. ■

Visulert

Continued from page 78

support them away from the metal to prevent shorts. Before soldering electrolytic capacitors and diodes, check to be sure that you have them properly polarized. Also, doublecheck that connections to Q1 and Q2 are correct before soldering to avoid application of too much heat, if you must unsolder and resolder them, since excessive heat can damage solid-state devices. In fact, we recommend that you use an alligator clip as a heat sink by temporarily clipping it to each lead being soldered.

Remote Lamp. In the event you require a brighter lamp than the standard bulb listed, or want the lamp located on a wall or site outside the area of the telephone—where it can be universally observed—make the following modification. Remove the bulb and connect the leads to terminal strip TB1 for connecting the remote lamp control leads. Mount a 6.3-VAC relay, a standard 110-V lamp socket, and TB2 in a container suitable for the remote location. Wire it as shown in the schematic. By using low voltage (6.3 VAC) the interconnecting remote control leads can be small-sized insulated wire. The 6.3 V that is switched by the SCR (Q2) to turn the low voltage lamp on and off will now be used to operate the remote relay, which will, in turn, control 117 VAC to the larger lamp bulb.

Checking Out Visulert. After doublechecking your hookup for possible errors, shorts, or cold soldered connections, plug the power

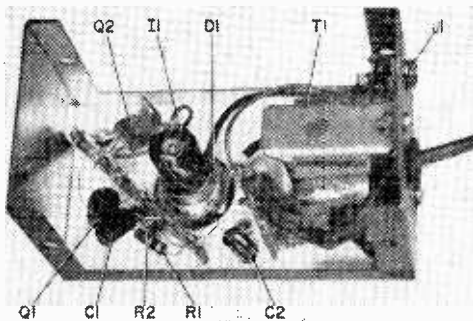

You can see how all of unit's parts are mounted either to tie strips or directly to mini-box in this opened up view of Visulert.

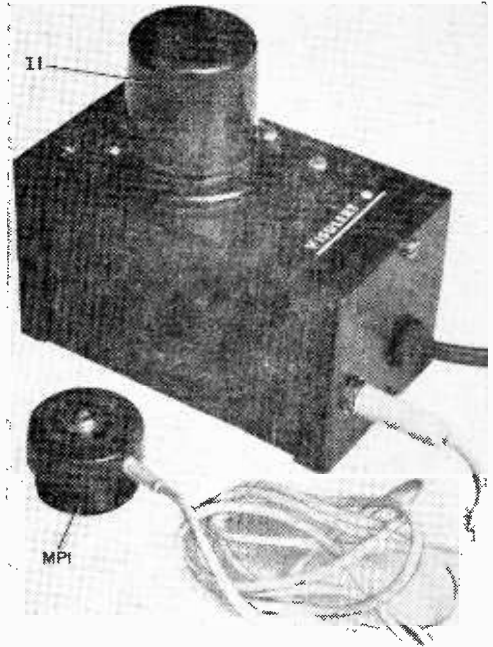

We used conventional round magnetic phone pickup. You may have a flat version available that can be conveniently placed under phone.

cord into an AC outlet, and plug magnetic pickup MPI into J1. Now bring the pickup near power transformer T1. If the unit is working correctly the radiated AC field around the transformer will produce a signal in the magnetic pickup device, triggering the SCR (Q2) to turn on lamp I1. Each time you move the pickup close to the transformer, the lamp will be lit; as you move MPI away from T1's magnetic field, the lamp will go out. When this checkup has been completed you can close up the mini-box and place Visulert in service.

Using Visulert. The suction cup on the pickup coil we used serves a dual purpose. It permits you to easily orient MPI into the magnetic field of the telephone ringer and also holds it in position once the ideal location is found. If the pickup you use is one of the flat types, place it under the phone near the exit of the handset cable.

Regardless of the type, you'll have to move the pickup around the base of the phone to locate the magnetic field of the ringer. Remember, of course, the only time you can locate the pickup is when the phone is ringing. Reason is that Visulert's operation is dependent upon the relatively high magnetic field of the ringer to develop a control signal to fire the SCR. ■

New Products

Continued from page 16

For more information write the Magitran Co., Moonachie, N.J. 07074.

MOD, MOD MODULAR

Here's a hot combo from Lafayette Electronics, the LSC-45 stereo modular hi-fi phono system. It combines a Garrard 4-speed automatic record changer, a 20-watt solid-state stereo amplifier, and a pair of acoustically



Lafayette LSC-45 Stereo Phono System

matched speaker systems. The record changer has tubular tone arm with stereo turnover cartridge and diamond LP needle, plus cueing control. It will play 7-, 10-, and 12-in. records at 16 $\frac{2}{3}$, 33 $\frac{1}{3}$, 45 and 78 rpm. Amplifier controls include Balance, Bass, Treble, Volume, Selector, Automatic Shut-off Switch, front panel stereo phone jack, auxiliary input jack for tuner or tape recorder. The speakers are 8 in. and you get a plastic dust cover, 45-rpm spindle, and speaker cable. The LSC-45 has walnut veneer cabinetry and the price is \$99.95 for all. Write for further specs to Lafayette Radio Electronics, 111 Jericho Tpke., Syosset, N.Y. 11791.

SWITCHED-ON SASER BEAM

The Saser Beam antenna line, says Mosley Electronics, cuts through CB interference like a laser cuts through steel. Model DMS-3D is a deluxe 12-element Saser Beam, a combination of two MS-3D beams stacked, and features the sturdy construction of a beam plus the choice of polarization usually found only in the quad design. Each of the six horizontal and six vertical elements has two high "Q" coils, so powerful they can be used on a 10-meter ham antenna. A double "T" matching system provides balanced feed horizontally and vertically. A turn of the dial of the polarization switching control, located at the transceiver, permits selection of polarization. Complete with

color-coded parts and instructions, the DMS-3D is priced at \$198.41. For complete specs, write Mosley Electronics Inc., 4610 N. Lindbergh Blvd., Bridgeton, Mo. 63042.

GET YOUR SIGNALS STRAIGHT!

EICO's Model 150 solid-state signal tracer is just what the doctor ordered for troubleshooting AM, FM and TV receivers as well as hi-fi and PA systems. There are two separate probes for testing both radio and audio frequency circuits. Results are judged from an audible output from an 8-ohm speaker or visually from a built-in meter. The unit has 400-mW continuous power output; power requirements are 105-132 VAC, 50-60 Hz, 5 VA. Handy-dandy size is 7 $\frac{1}{2}$ x 8 $\frac{1}{2}$ x 5 in., weight a mere 6 lb. Model 150 sells for \$49.95 in kit form, \$69.95 wired. For more info write to EICO Electronic Instrument Co., Inc., 283 Malta St., Brooklyn, N.Y. 11207.

CLEANER HEADS WILL PREVAIL

Robins Industries has come out with what they call "a pair of new combos and a couple of singles." The combos include the Test-N-Clean cassette Model THC-6 and cartridge Model THC-8, both listing at \$2.80. They'll remove accumulated oxide, grime and foreign matter and test heads for both alignment and stereo balance between channels. For gentler head cleaning, there's the lintless, non-woven polyester cloth Head-Kleen cassette Model THC-4, which sells for \$3.00. Finally, there's the Head-Kleen cassette Model THC-7, which cleans by means of polishing tape and sells for \$2.50. For more information write to Robins Industries Corp., 15-58 127th St., College Point, N.Y. 11356. ■



Pennypincher's Strobe

Continued from page 46

cies. (With external clocking, C4, C5, and C6 provide filtering and smoothing.) If the frequency ranges don't overlap or aren't correct, change C4, C5, or C6. If you try to increase the highest frequency in any range much above its nominal value, however, the flashtube may not trigger reliably because C7, C8, or C9 will not be able to recharge fast enough.

Do *not* appreciably increase the values of C7, C8, C9. Not only will this reduce the highest frequencies available, but, since more energy will be dissipated in I1, its life will be reduced and R5 will overheat. Fortunately, for almost all applications, the higher frequencies are more a convenience than a necessity. The strobe will stop motion with lower frequencies at a sub-harmonic of the motion with no loss of effectiveness. (You might even eliminate the *Hi* range to save cost and space or if you cannot get a 4-position switch for S1.)

Almost any SCR with a breakdown voltage of at least 300 VDC can be used in place of the 2N4155. General Electric C22C or C22D SCRs work just fine. Even the lowest current units are usable, since the average current is only a few milliamperes.

There is one circuit precaution. Sometimes at high frequencies the flashtube may overheat and fail to shut off when C7, C8, or C9 has discharged. It can glow dimly, receiving current through R5. If this occurs turn the unit *off* for a few seconds and operate at a lower flash rate for a while. If you don't R5 will overheat and the flashtube life may be reduced.

After the unit is checked out and operating you are ready to calibrate the flash rate. On *Lo* range just count the number of flashes in, say, 10 seconds, and divide by 10 to get the number of flashes-per-second. On the *Med* or *Hi* ranges, it's easiest to watch a strobe disc on a hi-fi turntable. When the bars stop moving, the strobe is flashing at 60 Hz or a harmonic or sub-harmonic of 60 Hz. A little experimentation will tell if the strobe is flashing at 15, 30, 60, 120, 180, or 240 Hz.

If you don't have a hi-fi and a strobe disc, just look at a small electric fan or other household appliance with an AC-only motor. The fan blades will stand still at the

same frequencies as the strobe disc. (Don't use an AC/DC motor with brushes; it probably won't be synchronized with the 60-Hz line.)

Using It. First, try some simple experiments in a darkened room with a friend. Turn the strobe *on* (the *Lo* range is best) and watch your friend clapping hands while you vary the flash rate. When you get it just right you will hear the hands clapping, but you won't see them touch! It's eerie.

Next, clap *your* hands. They'll seem to touch. But watch yourself clap in a mirror. You'll hear the sound and feel your hands touch, but you won't see them touch and you won't believe it.

Spin a short piece of string with a weight on the end (or a yo-yo) and watch what happens. Try bouncing a ball or playing catch.

If the flash rate is very low (say about 3 or 4 Hz) and you move about rapidly, you will bump into things and the world will look like an old silent movie. But be careful and if you or your friend feel dizzy, turn the strobe *off* or use it only in a lighted room.

On the *Lo* range, if you connect the external input to the distributor lead on the ignition coil in your car, the strobe will

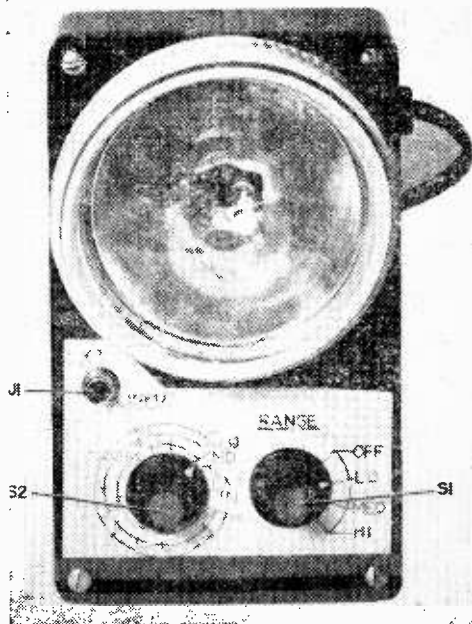

Simplicity of operation is exposed in this view of the front panel. All controls are readily available in easy reach.

work as a timing light—though it will flash when all cylinders fire instead of only the no. 1 cylinder.

Connect it to your hi-fi's speaker, play some music with a pronounced beat, and watch it flash in time with the music. Try different ranges. Connect the external input to the earphone jack on a battery operated transistor radio (so the radio's speaker is disconnected). Turn up the volume. On the Hi range you may be able to understand the sound of the flash (so to speak).

Use the strobe to stop motion. Look at a fine stream of water from a faucet. If you are sharp of eye, you will see the individual droplets in mid-air.

Still Life. Watch a plucked string on a musical instrument. When the strobe is flashing exactly at the same frequency (or exactly at a harmonic), the string will stand still. If the frequency is very slightly higher or lower, the string will move in slow motion—you will be seeing the beat note between the strobe and the musical string. If you don't know the note being played when the motion is stopped by the light, just read the calibrated strobe dial. You can analyze vibration modes or tell how fast machinery is going the same way. The

stroboscope makes an excellent no-contact, no-connection tachometer.

Measure your car's idling speed by stopping the motion of the radiator fan (the fan has to be connected to the crankshaft, of course).

A single-flash photographic strobelight (or a flashbulb) will stop motion for photography but the stroboscope will let you take multiple-exposure stop-motion pictures. Use high-speed black-and-white film (such as Polaroid 3000 or Kodak Tri-X) and a fast lens. If you set the camera to take a one- or two-second exposure (or a time exposure) while using the flashing stroboscope as the only light, you will get multiple pictures of anything moving during the exposure. Try different flash rates, exposure times, and subjects. Take a picture of a ping-pong ball in flight or of someone walking or waving his arms.

If you know the time between strobe flashes (1/flash rate), you can calculate the speed of motion from the distance between images in the multiple exposure.

With a little imagination you will think of dozens of other uses. And for fun, you can always hold a psychedelic party—just try dancing in strobelight! Groovy, man! ■

The Unicorn

Continued from page 76

put meter to measure the output level. However, if one is not available, trust the judgment of your ears.

After peaking T1, remove the temporary jumper from C3B and set the tuning capacitor at the midpoint of its rotation. Adjust the signal generator to produce an output signal at 1000 kHz and feed the signal, loosely coupled, to the antenna post (J1).

Adjust the tuning slug of the receiver's oscillator coil (L2) until you get output at the speaker. Then adjust the trimmer capacitor on C3B for maximum signal output.

Without making any change in the setting of the signal generator, adjust the trimmer capacitor on the RF section of the tuning capacitor (C3A) for maximum output at the speaker. Also, adjust the tuning slug of the antenna coil (L1) for maximum output. Now go back and do it again—you'll hear the improvement.

Before changing the position of the rotor

of the ganged tuning capacitor, place a mark on the panel to identify this position as a reference point when adding markings to the dial plate.

Calibrating the Dial. Set the signal generator first at 550 kHz and then at 700, 900, 1200, 1400, and 1700 kHz successively and tune the dial of the receiver for maximum signal at each of these frequencies, marking the spots of maximum signal for each frequency, to be used for the calibration points of the dial.

For Your Listening Pleasure. Disconnect the signal generator and connect a 10-ft. indoor antenna (a 10-ft. length of hookup wire stretched out will do) to J1. Tune the receiver to a broadcast station, set the volume control so that the station is just audible and touch up all tuning slugs and trimmers of the RF section of the receiver for maximum volume. You may find a slight readjustment of the IF transformer (T1) and oscillator coil (L2) tuning slugs and also the trimmer of the oscillator portion of the tuning capacitor (C3B) at this point may improve the output. Now sit back and listen to your heart's content. ■

Vibravox

Continued from page 42

it. We used push pins to mount and connect the various components on the perf board. A word of caution: do not overheat the leads to the transistors and diode or the

control, is mounted centered on the small end of the tear drop base. To conveniently operate the frequency shifting variable resistor a "shift lever" is made from a length of drill rod, bent at a right angle about 3 in. from one end and mechanically coupled to the shaft of the control and equipped with a gear shift knob at the other end to make it easy to operate.

Heart of VibraVox is the electronic tone generator and vibrato generator shown here. Note that all of components are mounted on a piece of perf board, except for various controls which are distributed in convenient locations on base-board. Basic layout isn't critical; however, one shown here does place components advantageously for interwiring.

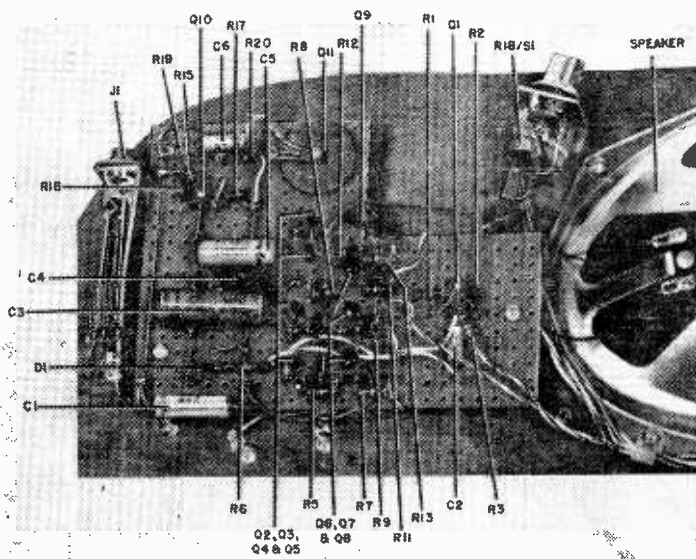

electrolytic capacitors. Excessive heat damages them. It is suggested you use an alligator clip as a temporary heat sink when soldering these parts, temporarily clipping it to the lead being soldered. One other word of caution, be sure you have the transistors properly oriented before soldering and be sure that polarity of electrolytic capacitors and the diode is correct. You get only one chance, so taking precaution to doublecheck your wiring before soldering is well worth the time spent.

Cut a copper or aluminum disc about 1½-in. in diameter to serve as a heat sink for the power transistor.

Batteries are held in two, four-cell battery holders fastened to the under side of the base as shown in the photos. The unit can be fitted with three short legs (6 in. long) for table top mounting and playing or with three long legs (29 in.) to make it self supporting, yet high enough from the floor to be able to sit in a chair when playing it.

Resistor R14, the frequency shifting con-

Playing the VibraVox. Be seated in front of the VibraVox, with the larger end, containing the touch contacts, at your left. Turn on the power switch, place the thumb of your left hand on the thumb-touch contact and one finger on any of the range contacts to develop the tone range desired. The right hand is used to shift the lever back and forth to vary the tone generator frequency through its span to achieve the tones desired. By moving the finger so different range contacts are touched to select a range and shifting the tone tuning lever you will produce tones that, when properly selected, will develop a tune. To create the vibrato effect place another finger on the touch contact for the vibrato oscillator (T2) and adjust its frequency control (R4) for the desired rate of vibrato. Remember, like any other instrument, it takes practice to play it, so if a delightful melody is to be produced, all we can say is practice-practice. Why not get your start in electronic music by building VibraVox?

Magnetic Beam Balance

Continued from page 28

lightweight object? It's very simple—just place the object to be weighed on the weighing platform, being careful that it doesn't rub against the meter's face plate. Turn the power switch *on* and adjust the null control until the pointer, which has been forced down against the lower limit pin by the weight of the object, is just balanced in the middle of its excursion from minimum to maximum between the two limit pins. Take a reading on M2. Since there is a direct correlation between the weight of the object being weighed and the amount of current required to balance the pointer, the M2 readings can be converted directly to weight units. ■

Treasure Witcher

Continued from page 24

tion. The receiver should respond to the transmitter by giving a meter indication and producing an audio tone in the earphones. Start with the balance bracket at its upper limit of adjustment and slowly turn the wing nut clockwise until the meter reading drops near zero. Then raise the gain and re-adjust the balance until a minimum meter reading is again obtained.

If a plastic handle is used over the conduit, as in the author's model, a slight unbalance will occur when the wing nut is touched. With care, however, a balance adjustment can be easily accomplished.

Hitting the Road. If everything checks out AOK then you're ready for a trial run with your WITCHER. If you haven't previously used a transmitter-receiver metal locator, a little practice may be in order. Place coffee cans, pie pans, or any good-sized metal object on the ground and use the WITCHER to locate the metal objects to get a good idea of its operation. (Actually, the unit is more sensitive when the balance adjustment is set where the meter will read up scale a division or two—this adjustment should be made away from any metal.)

If treasure hunting isn't your brew, then perhaps locating buried water, gas, or other hidden pipes will be more up your alley. Use your WITCHER and enjoy it! ■

Horn Speakers

Continued from page 38

of the wood base. This'll help protect polished surfaces.

To mount the horn on the base you'll have to shop around for flanges, fittings, etc., that will allow you to join the neck of the horn to the box. If you want the horn to mount flush on the base (like the author's models), you'll have to disassemble the magnet assembly in the horn and then bolt the horn in place with fairly large wood screws. Be sure to mount a small speaker inside the horn if you choose the flush installation. ■

SemiPro

Continued from page 72

the SemiPro from 143.75 to 148.25 MHz.

A final adjustment before disconnecting the signal generators; set the generator for a 145 MHz output signal and the SemiPro dial to the 145 MHz calibration. Adjust L1 for maximum signal output on the BCB.

Operating SemiPro. Since propagation of 2-Meter signals is line of sight and doesn't follow the curvature of the earth, an outdoor antenna erected as high as possible.

At the personal preference of the ham operator, his signals may be either horizontally or vertically polarized. Suitable antennas are listed for both types in most parts suppliers' catalogs. A ground-plane antenna is used for vertical polarization and a halo or beam antenna for horizontal polarization. You may find a conventional TV antenna suitable for stronger signals. Always use a coax cable matched to the impedance of the antenna as a lead-in from the antenna.

A last word, a tip on tuning the SemiPro: tune the dial slowly, else you can easily pass over signals due to the high selectivity. Once you have a signal try slight rocking of the BCB dial as a bandspread for best results. Another tip—the 2-Meter band is generally more active during evening hours and on weekends, since most 2-Meter enthusiasts can't take time from their work to participate in the pleasure of hamming on the 2-Meter band during working hours. Once the boss's yoke is lifted the boys really hop to it for the pleasure of keeping the rig going strong making QSLs whenever they raise signals. ■

CLASSIFIED Market Place

**FOR BIGGER PROFITS! NEW CAREER OPPORTUNITIES!
READ AND REPLY TO THESE CLASSIFIED ADS**

Classified Ads 65¢ per word, each insertion, minimum 10 words, payable in advance. For information on Classified ads—to be included in our next **ELECTRONICS HOBBYIST**—write to C. D. Wilson, Mgr., Classified Advertising, 229 Park Avenue South, New York, N. Y. 10003.

ADDITIONAL INCOME

UP To \$151.00 Profit A Race Day With \$2.00 Stakes And Wonderful Pencil! World's Top Horse Race Computer. \$4.000 Latest Checkable. Fabulous Results Supplied. Have Fun—Plus Profits—RH-D1. 5715. Carmel, Calif. 93921.

BOOKS & PERIODICALS

ADULT Books and Magazines. Write for free Brochure, Catalog. Badger Distributors, 921 Ohio Street, Oshkosh, Wis. 54901.

CATALOG of all Science & Mechanics Craftprints. Send 25¢ to cover postage to Craftprint Div., Science & Mechanics, 229 Park Ave. South, New York 10003.

BUSINESS OPPORTUNITIES

I made \$40,000.00 Year by Mailorder! Help others make money! Start with \$10.00—Free Proof! Torrey, Box 318-T, Ypsilanti, Michigan 48197.

FREE Book "999 Successful, Little-Known Businesses." Fascinating! Work home! Plymouth 411-J, Brooklyn, N.Y. 11218.

MAILORDER: Prepare your own catalog for \$8/1000. Free Proof! Obie-MBI, Brooklyn, N.Y. 11219.

\$10,000 PER Year in your own **SECOND-HAND BUSINESS**. Free Information. Empire, 146 Main, Rio Nido, Calif. 95471.

DO IT YOURSELF

BURGLAR-proof your automobile ignition (or any device) electronically! Illustrated plans including PC, \$5.00. Information, 25¢. Logan, 403 Lakewood Circle, Virginia Beach, Va. 23451.

GIFTS THAT PLEASE

BEAUTIFUL Green Glazed Ceramic Tree With Lights. Sample \$14.95. Em-EI Studios, 10 Vesper Hill, Trumbull, Conn. 06611.

INVENTIONS WANTED

WE either sell your invention or pay cash, bonus. Write for details. Universal Inventions, 208-30, Marion, Ohio 43302.

MISCELLANEOUS

ADULT Books, Magazines! Full Color Catalogue—200 photographs! 25¢ (hauling). State Age, Clifton's, Box 1068-9M, Saugus, Calif. 91350.

MONEYMAKING OPPORTUNITIES

MAKE BIG MONEY raising Chinchillas for us. Information 25¢. Keeney Brothers, New Freedom, Pa. 17349.

OVER \$16.50 an hour. Spare Time at home! Rubber Stamp industry needs small manufacturers. We furnish all equipment and know-how! Particulars Free! Write: Roberts, 1512 Jarvis, Room CR-107-C, Chicago 60626.

MAKE Your Classified Ad Pay. Get "How To Write a Classified Ad That Pays." Includes certificate worth \$2.00 towards classified ad in this publication. Send \$1.25 TO C. D. Wilson, Science & Mechanics, 229 Park Avenue South, New York, N.Y. 10003.

OF INTEREST TO WOMEN

\$350.00 MONTH Addressing! Details. Mail Stamped Addressed Envelope and 25¢. Write Happy, Box 1161-DV, Battle Creek, Mich. 49016.

PERSONAL

ELIMINATE Debts Without Borrowing! Particulars Free. Helper, 10639 Riverside, No. Hollywood, California 91602.

FREE! Men, Women Ordained Immediately! No questions asked. Free Church, Box 4039-S, Hollywood, Fla. 33021.

STOP smoking in 6 weeks. Count Down Cigarette Holder. Turn dial inhale less smoke. Check, M.O. \$5.40. Palmerlee Gift House, 310 Metropolitan Bldg., Detroit, Michigan 48226.

THE MAGIC OF THINKING BIG! The book that gives YOU the secret of thinking and acting in the manner that brings success. \$2.00 + 50¢ postage and handling. Write to: GOLDEN THOUGHT ENTERPRISE, 216 EAST SMITH STREET, DEPT. DC, MILWAUKEE, WISCONSIN 53207. WISCONSIN residents add 4% sales tax.

RADIO & TELEVISION

THOUSANDS and thousands of types of electronic parts, tubes, transistors, instruments, etc. Send for Free Catalog. Arcturus Electronics Corp., EME, 502-22nd St., Union City, New Jersey 07087.

"DISTANCE Crystal Set Construction" Handbook—50¢. "Coil Winding"—50¢. Catalog, Laboratories, 2612-EH Butano, Sacramento, Calif. 95821.

RADIO & TV tubes 35¢. Free Catalog. Cornell, 4217 West University, San Diego, California 92105.

RECEIVING & INDUSTRIAL TUBES. TRANSISTORS. All Brands—Biggest Discounts. Technicians, Hobbyists. Experimenters—Request Free Giant Catalog and Save! Zalytron, 469 Jericho Turnpike, Mineola, New York 11501.

TRANSISTOR PROJECTS: simple, high-performance circuits for all applications. Free catalog: EDI, 1918C 49th Street E., Palmetto, Fla. 33561.

EXCITING Listening! Police—Fire—Emergency calls on your broadcast radio \$19.95 up's. Also crystals—receivers, Scanners, dualband, High/Low. Brochures 10¢. Saleh Company, Woodsboro 39, Texas 78393.

TOP-SECRET! Classified frequencies: spies, NASA, military, many more—\$1.00. EDIC, 1918C 49th Street E., Palmetto, Fla. 33561.

BLACK and White Television Converted To Color. Patented system. Do it yourself kit. Write for free brochure. Bele Electronics Corp., 111 N.E. Second Ave., Miami Fla. 33132.

GET SMART! Know your antenna! "Easy Ways To Improve TV Reception" \$1.00 (no stamps): GJM Electronics, Dept. E, Box 218, Goleta, California 93017.

C. B. BUYERS' Guide—A new magazine for the buyers of Citizens Band Electronic Equipment. Send \$1.25—includes Postage to C. B. Buyers' Guide, 229 Park Avenue South, New York, New York 10003.

TIPS FOR THE HOME, ETC.

PRACTICAL tips for home, garden and workshop are in "1001 How-To Ideas." Send \$1.00 for your copy includes Postage. To 1001 How-To Ideas, 229 Park Avenue South, New York, New York 10003.

FOR GREATER CLASSIFIED PROFITS, RESULTS AND SAVINGS

Place your ad in one of our **SPECIAL COMBINATIONS**: Business, Science & Mechanics, or Davis Combination. Each Combination is designed to give your ad the largest audience available. For further information write to C. D. Wilson, Manager, Classified Advertising, Science & Mechanics, 229 Park Avenue South, New York, N.Y. 10003.

Discover the ease and excitement of learning Electronics with programmed equipment NRI sends you

When you train at home with NRI, you train with your hands as well as your head. You learn the WHY of Electronics, Communications, TV-Radio the NRI pioneering "3-Dimensional" way. NRI training is the result of more than half a century of simplifying, organizing, dramatizing subject matter, and providing personal services unique for a home study school. You get the kind of technical training that gives you priceless confidence as you gain experience equal to many, many months of training on the job.

NRI—The 53 Year Leader in Electronics Training

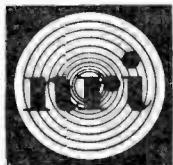

APPROVED UNDER NEW GI BILL

If you served since January 31, 1955, or are in service, check GI line in postage-free card.



*Earn \$5 or more an hour
spare or full time in*

TV-RADIO SERVICING

Color Television has arrived. Sales are soaring, along with the continuing popularity of other home entertainment equipment like portable radios, tape recorders, hi-fi sets, phonographs and auto radios. TV-Radio servicing is one of your best routes to spare-time earnings, a good paying job or a business of your own. NRI not only trains you quickly and expertly, but also shows you how to get started in Servicing soon after you enroll, earning as you learn. NRI trains you in today's methods of installing and repairing all Electronic equipment for the home—including booming Color TV. You even build, experiment with and keep to enjoy your own solid-state radio and your choice of black-and-white or Color TV receiver. Like thousands of others, you can be earning \$5 or more an hour extra in spare time starting soon.

*There's money and
success awaiting you in*

BROADCASTING— COMMUNICATIONS

The experience you gain from intensely practical NRI training in Complete Communications equals as much as two years of training on the job. With NRI, you can train for a choice of careers ranging from mobile, marine and aviation radio to TV broadcasting and space communications. You learn how to install, maintain and operate today's remarkable transmitting and receiving equipment by actually *doing* it. You build and experiment with test equipment, like a VTVM you keep. You build and operate amplifier circuits, transmission line and antenna systems, even build and use a phone-cw transmitter suitable for transmission on the 80-meter amateur band. Whichever of five NRI Communications courses you choose, you prepare for your FCC License exams, and you *must pass your FCC exams or NRI refunds your tuition in full.*

*Move ahead in America's
fast growing industry as*

ELECTRONICS TECHNICIAN

Electronics touches everyone's lives. This vast field of opportunity is open to you with NRI training. Industrial/Military Electronics training—like all NRI courses—prepares you quickly, thoroughly the practical "hands on" way. You build with, and learn to understand the functions of, today's miracle solid-state components like printed circuits, diodes and transistors. You build and experiment with Electronic circuitry used in automation, data processing, ultrasonics, telemetry. Whatever your interest in Electronics, NRI training can fill your needs. Prove to yourself what nearly a million NRI students could tell you ... that you get more for your money from NRI. Check the postage-free card and mail it today for your FREE NRI Color Catalog. No salesman will call. NATIONAL RADIO INSTITUTE, Electronics Division, Washington, D.C. 20016.

YOU GET MORE FOR YOUR MONEY FROM NRI— Build, test, explore, discover. Everything you see here is included in one NRI course—including Color TV. Other courses equally complete. And you'll be surprised at the low tuition costs. Text for text, kit for kit, dollar for dollar—you get more for your money from NRI.



BUILD YOUR OWN 20 RADIO

and Electronics Circuits

PROGRESSIVE HOME RADIO-T.V. COURSE

Now Includes

- ★ 12 RECEIVERS
- ★ 3 TRANSMITTERS
- ★ SQ. WAVE GENERATOR
- ★ SIGNAL TRACER
- ★ AMPLIFIER
- ★ SIGNAL INJECTOR
- ★ CODE OSCILLATOR

- ★ No Knowledge of Radio Necessary
- ★ No Additional Parts or Tools Needed
- ★ EXCELLENT BACKGROUND FOR TV
- ★ SCHOOL INQUIRIES INVITED
- ★ Sold In 79 Countries



Reg. U.S. Pat. Off.

Training Electronics Technicians Since 1946

YOU DON'T HAVE TO SPEND HUNDREDS OF DOLLARS FOR A RADIO COURSE

The "Edu-Kit" offers you an outstanding PRACTICAL HOME RADIO COURSE at a rock-bottom price. Our course is designed to train Radio & Electronics Technicians, making use of the most modern methods of home training. You will learn radio theory, construction practice and servicing. THIS IS A COMPLETE RADIO COURSE IN EVERY DETAIL. In a professional manner; how to service radios. You will work with the standard type of Dunched metal chassis as well as the latest development of Printed Circuit chassis. You will learn the basic principles of radio. You will construct, study and work with RF and AF amplifiers and oscillators, detectors, rectifiers, test equipment. You will learn and practice code, using the Progressive Code Oscillator. You will learn and practice Troubleshooting using the Progressive Signal Tracer, Progressive Signal Injector, Progressive Dynamic Radio & Electronics Tester, Square Wave Generator and the accompanying instructional material.

You will receive training for the Novice, Technician and General Classes of F.C.C. Radio Amateur Licenses. You will build Receiver, Transmitter, Square Wave Generator, Code Oscillator, Signal Tracer and Signal Injector circuits, and learn how to operate them. You will receive an excellent background for television, Hi-Fi and Electronics. Absolutely no previous knowledge of radio or science is required. The "Edu-Kit" is the product of many years of teaching and engineering experience. The "Edu-Kit" will provide you with basic education in Electronics and Radio, worth many times the low price you pay. The Signal Tracer alone is worth more than the price of the kit.

THE KIT FOR EVERYONE

You do not need the slightest background in radio or science. Whether you are interested in Radio & Electronics because you want an interesting hobby, a well paying business or a job with a future, you will find the "Edu-Kit" a worthwhile investment. Many thousands of individuals of all

ages and backgrounds have successfully used the "Edu-Kit" in more than 79 countries of the world. The "Edu-Kit" has been carefully designed, step by step, so that you cannot make a mistake. The "Edu-Kit" allows you to teach yourself at your own rate. No instructor is necessary.

PROGRESSIVE TEACHING METHOD

The Progressive Radio "Edu-Kit" is the foremost educational radio kit in the world, and is universally accepted as the standard in the field of electronics training. The "Edu-Kit" uses the modern educational principle of "Learn by Doing." Therefore you construct, learn schematics, study theory, practice trouble shooting—all in a closely integrated program designed to provide an easily-learned, thorough and interesting background in radio. You begin by examining the various radio parts of the "Edu-Kit." You then learn the function, theory and wiring of these parts. Then you build a simple radio. With this first set you will enjoy listening to regular broadcast stations, learn theory, practice testing and trouble-shooting. Then you build a more advanced radio, learn more advanced theory and techniques. Gradually, in a progressive manner, and at your own rate, you will find yourself constructing more advanced multi-tube radio circuits, and doing work like a professional Radio Technician.

Included in the "Edu-Kit" course are Receiver, Transmitter, Code Oscillator, Signal Tracer, Square Wave Generator and Signal Injector Circuits. These are not unprofessional "breadboard" experiments, but genuine radio circuits, constructed by means of professional wiring and soldering on metal chassis, plus the new method of radio construction known as "Printed Circuitry." These circuits operate on your regular AC or DC house current.

THE "EDU-KIT" IS COMPLETE

You will receive all parts and instructions necessary to build twenty different radio and electronics circuits, each guaranteed to operate. Our Kits contain tubes, tube sockets, variable, electrolytic, mica, ceramic and paper dielectric condensers, resistors, tie strips, hardware, tubing, punched metal chassis, instruction Manuals, hook-up wire, solder, selenium rectifiers, coils, volume controls and switches, etc.

In addition, you receive Printed Circuit materials, including Printed Circuit chassis, special tube sockets, hardware and instructions. You also receive a useful set of tools, a professional electric soldering iron, and self-heating Dynamometer and Electronics Tester. The "Edu-Kit" also includes Code Instructions and the Progressive Code Oscillator, in addition to F.C.C. Radio Amateur License training. You will also receive lessons for servicing with the Progressive Signal Tracer and the Progressive Signal Injector, a High Fidelity Guide and a Quiz Book. You receive Membership in Radio-TV Club, Free Consultation Service, Certificate of Merit and Discount Privileges. You receive all parts, tools, instructions etc. Everything is included.

Progressive "Edu-Kits" Inc. 1189 Broadway, Dept. 507EN, Hewlett, N. Y. 11557

UNCONDITIONAL MONEY-BACK GUARANTEE

Please rush my Progressive Radio "Edu-Kit" to me, as indicated below: Check one box to indicate choice of model

- Deluxe Model \$31.95.
- New Expanded Model \$34.95 (Same as Deluxe Model plus Television Servicing Course).

Check one box to indicate manner of payment
 I enclose full payment, Ship "Edu-Kit" post paid.
 I enclose \$5 deposit, Ship "Edu-Kit" C.O.D. for balance plus postage.
 Send me FREE additional information describing "Edu-Kit."

Name _____
 Address _____
 City & State _____ Zip _____

PROGRESSIVE "EDU-KITS" INC.
 1189 Broadway, Dept. 507EN Hewlett, N. Y. 11557

FREE EXTRAS SET OF TOOLS

- SOLDERING IRON
- ELECTRONICS TESTER
- PLIERS-CUTTERS
- VALUABLE DISCOUNT CARD
- CERTIFICATE OF MERIT
- TROUBLE-SHOOTING MANUAL
- HIGH FIDELITY GUIDE + QUIZZES
- TELEVISION BOOK + RADIO
- MEMBERSHIP IN RADIO-TV CLUB
- CONSULTATION SERVICE + FCC AMATEUR LICENSE TRAINING
- PRINTED CIRCUITRY

SERVICING LESSONS

You will learn trouble-shooting and servicing in a progressive manner. You will practice repairs on the sets that you construct. You will learn symptoms and causes of trouble in home, portable and car radios. You will learn how to use the professional Signal Tracer, the unique Signal Injector and the dynamic Radio & Electronics Tester. While you are learning in this practical way, you will be able to do many a repair job for your friends and neighbors, and charge fees which will far exceed the price of the "Edu-Kit." Our Consultation Service will help you with any technical problems you may have.

FROM OUR MAIL BAG

J. Statistis, of 25 Poplar Pl., Waterbury, Conn., writes: "I have repaired several sets for my friends, and made money. The "Edu-Kit" paid for itself. I was ready to spend \$240 for a Course, but I found your ad and sent for your Kit."
 Ben Valerio, P. O. Box 21, Maikna, Utah: "The Edu-Kits are wonderful. Here I am sending you the questions and also the answers for them. I have been in Radio for the last seven years, but like to work with Radio Kits, and like to build Radio Testing Equipment. I employed every minute I worked with the different kits; the Signal Tracer works fine. Also like to let you know that I feel proud of becoming a member of your Radio-TV Club."
 Robert L. Shuff, 1534 Monroe Ave., Huntington, W. Va.: "Thought I would drop you a few lines to say that I received my Edu-Kit, and was really amazed that such a bargain can be had at such a low price. I have already started repairing radios and phonographs. My friends were really surprised to see me getting into the swing of it so quickly. The Trouble-shooting Tester I received with the Kit is really swell, and finds the trouble, if there is any to be found."

PRINTED CIRCUITRY

At no increase in price, the "Edu-Kit" now includes Printed Circuitry. You build a Printed Circuit Signal Injector, a unique servicing instrument that can detect many Radio and TV troubles. This revolutionary new technique of radio construction is now becoming popular in commercial radio and TV sets.

A Printed Circuit is a special insulated chassis on which has been deposited a conducting material which takes the place of wiring. The various parts are merely plugged in and soldered to terminals.

Printed Circuitry is the basis of modern Automation Electronics. A knowledge of this subject is a necessity today for anyone interested in Electronics.