

ELECTRONICS HOBBYIST

SPRING-SUMMER \$1.00

By the Editors of ELEMENTARY ELECTRONICS and RADIO-TV EXPERIMENTER

A Parade of PROJECTS

For Home, Car, Science Fair,
HAM-CB-SWL Radio, Test Bench,
Audio/Hi-Fi, and just fun!

ONE-EVENING PROJECTS

- Broadcast Boomer with FET
- Groovy Directional Mike
- 3-Buck Battery Booster
- Rovin' Recorder for Wheels

PROJECTS FOR WEEKENDS

- Portable Guitar Amplifier
- Sensitive Metal Locator
- All-Band SW Preselector
- In-Car CB Converter



Slides come alive with our

SUPERMATIC SYNCHRONIZER

Program your own shows, add commentary, even mood music with this exciting accessory that actually reverses slides at will—automatically!

EICO Makes It Possible

Uncompromising engineering — for value does it!
You save up to 50% with Eico Kits and Wired Equipment.

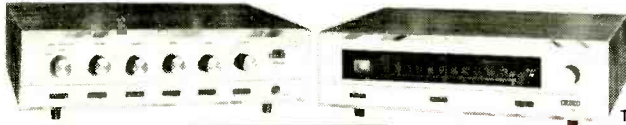

Cortina Stereo

THE VERDICT IS IN. High fidelity authorities agree:

Cortina's engineering excellence, 100% capability, and compact dramatic esthetics all add up to Total Stereo Performance at lowest cost.

NEW



A Silicon Solid-State 70-Watt Stereo Amplifier for \$99.95 kit, \$139.95 wired, including cabinet. Cortina 3070

NEW

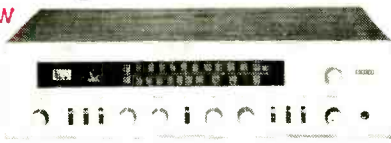

A Solid-State FM Stereo Tuner for \$99.95 kit, \$139.95 wired, including cabinet. Cortina 3200.

A 70-Watt Solid-State FM Stereo Receiver for \$169.95 kit, \$259.95 wired, including cabinet. Cortina 3570.

NEW Silicon Solid State 150-Watt Stereo Amplifier designed for audio perfectionists. Less than 0.1% harmonic distortion, IM distortion. Less than 0.6% at full output. Controls and inputs for every music source. \$149.95 kit, \$225.00 wired including cabinet. Cortina 3150.

NEW 70-Watt Solid State AM/FM Stereo Receiver for \$189.95 kit, \$279.95 wired including cabinet. Cortina 3770.

Eicocraft

The newest excitement in kits.

100% solid-state and professional.

Fun to build and use. Expandable, interconnectable. Great as "jiffy" projects and as introductions to electronics. No technical experience needed. Finest parts, pre-drilled etched printed circuit boards, step-by-step instructions.

EC-100 Electronic Siren \$4.95, EC-101 Electronic Burglar Alarm \$6.95,
EC-102 Electronic Fire Alarm \$6.95, EC-200 Electronic Intercom \$5.95,
EC-300 Audio Power Amplifier \$5.95, EC-400 Electronic Metronome \$3.95,
EC-500 Tremolo \$9.95, EC-600 Electronic Light Flasher \$3.95,
EC-700 Electronic "Mystifier" \$4.95, EC-800 Photo Cell Nite Lite \$4.95,
EC-900 Power Supply \$8.95, EC-1000 Code Oscillator \$2.50,
EC-1100 FM Wireless Mike \$9.95, EC-1200 AM Wireless Mike \$9.95,
EC-1300 Electronic VOX \$8.95, EC-1400 Solid State FM Radio \$9.95,
EC-1500 Solid State AM Radio \$8.95, EC-1600 Electronic Bongos \$7.95



6 EXCITING NEW PROJECTS

EC-1700 Ham/CB Vox \$8.95,
EC-1800 Electronic "TOX" \$8.95,
EC-1900 "Treasure Finder" \$9.95,
EC-2000 Electronic Organ \$9.95,
EC-2100 Electronic "Eye" \$9.95,
EC-2200 Electronic "Magic" Switch \$9.95



Color n' Sound



Add a new dimension to your music system. Introducing the first inexpensive solid-state electronic system which provides true synchronization of color with sound. Watch the music you love spring to life as a vibrant, ever shifting interplay of colors.

Simply connect to speaker leads of your Hi-Fi system (or radio). Kit can be assembled in several hours — no technical knowledge or experience necessary. Kit \$49.95, Wired \$79.95.

Automotive

EICO 888—Car/Boat Engine Analyzer.

For all 6V/12V systems; 4, 6, 8 cyl. engines.

Now you can keep your car or boat engine in tip-top shape with this solid-state, portable, self-powered universal engine analyzer. Completely tests your total ignition/electrical system.

Complete with a Tune-up & Trouble-shooting Manual. Model 888; \$49.95 kit, \$69.95 wired.

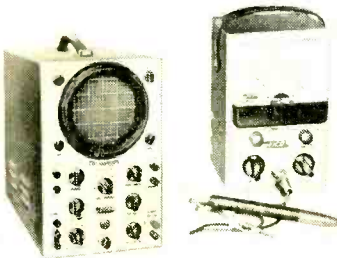

Model 232 Peak-to-Peak VTVM. A must for color and B&W TV and industrial use. 7 non-skip ranges on all 4 functions. With exclusive Uni-Probe.® \$34.95 kit, \$49.95 wired.

Test Equipment **EICO**®

100 best buys to choose from.

"The Professionals"

—laboratory precision at lowest cost.

Model 460 Wideband Direct-Coupled 5" Oscilloscope. DC-4.5mc for color and B&W TV service and lab use. Push-pull DC vertical amp, bal. or unbal. input. Automatic sync. limiter and amp. \$99.95 kit, \$149.95 wired.

FREE 1969 CATALOG

EH-59

EICO Electronic Instrument Co., Inc.
283 Malta Street, Brooklyn, N.Y. 11207

Send me **FREE** catalog describing the full EICO line of 200 best buys, and name of nearest dealer.

Name

Address

City

State Zip

**Without NTS
training
you've only
scratched
the surface in
electronics...**

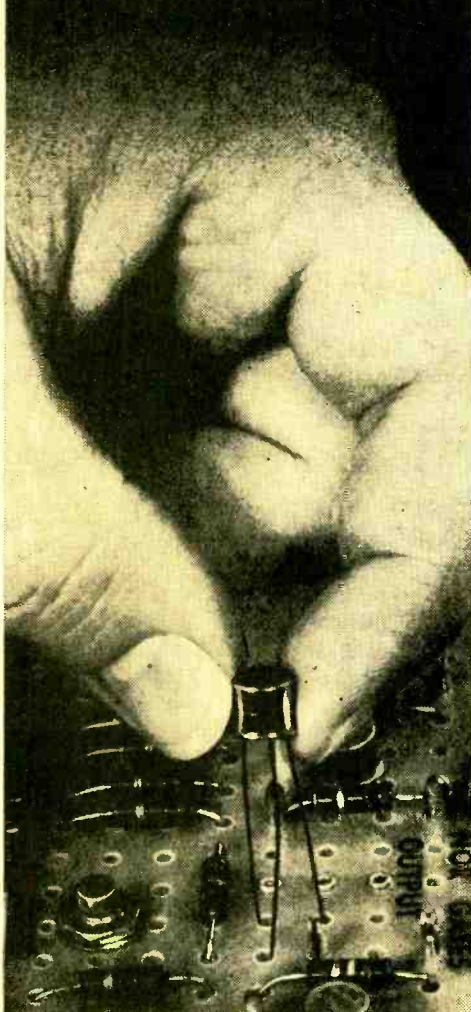

NTS digs deep into electronics. Proof? Look at the close-up at the left. It's the first transistorized digital computer-trainer ever offered by a home study school.

Fascinating to assemble, the NTS Compu-Trainer® introduces you to the exciting world of computer electronics. Its design includes advanced solid-state NOR circuitry, flip-flops, astable multivibrators and reset circuits. Plus two zener and transistorized voltage-regulated power supplies. The NTS Compu-Trainer can perform 50,000 operations per second, and is only one of many ultra-advanced kits we offer to give you incomparable, in-depth career training.

NTS... THE FIRST HOME STUDY SCHOOL TO OFFER LIVE EXPERIMENTS WITH INTEGRATED CIRCUIT KITS

With NTS Project-Method Home Training, you build a computer sub-system using the new, revolutionary integrated circuits. Each one, smaller than a dime, contains the equivalent of 15 resistors and 27 transistors.

With Project-Method, kits are carefully integrated with lesson material. All our kits are real equipment—not school-designed versions for training only. Project-Method was developed in our giant resident school... and proven effective for thousands of men like yourself. It's the practical-experience approach to learning. Gets you going in a hurry!



■ **COMMUNICATIONS**

This Transceiver is included in Communications courses. It's yours to build... to easily prepare for F.C.C. License exam... To become a fully-trained man in communications.

■ **25" COLOR TV**

Included in Color TV servicing courses. Building this advanced receiver gets you deep into color circuitry—advances you into this profitable field of servicing—the easy way. Color is the future of television, and your future, too!

■ **INDUSTRIAL & COMPUTER ELECTRONICS**

New ideas, new inventions, are opening whole new fields of opportunity. Electronic control systems, computers, are being applied to great numbers of manufacturing processes every day. We train you for this new field, fast! With advanced control systems devices, a new 5" oscilloscope, and the NTS Compu-Trainer. Modern, quick and easy training prepares you to enter this brand-new world like a pro.



GET THE FACTS! SEE ALL NEW KITS AND COURSES OFFERED IN THE NEW NTS COLOR CATALOG. SEND THE CARD TODAY! No obligation. No salesman will call.

Classroom Training At Los Angeles. You can take classroom training at Los Angeles. NTS occupies a city block with over a million dollars in facilities devoted exclusively to technical training. Check box on coupon.

NATIONAL  SCHOOLS

WORLD-WIDE TRAINING SINCE 1905
4000 So. Figueroa Street Los Angeles, Calif. 90037
ACCREDITED FOR VETERANS



Accredited member:
National Home Study Council
National Association of
Trade and Technical Schools.



ELECTRONICS HOBBYIST



DX Devil SW Booster
Page 39

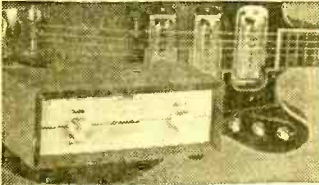

Universal Reverb Add-On Unit
Page 63

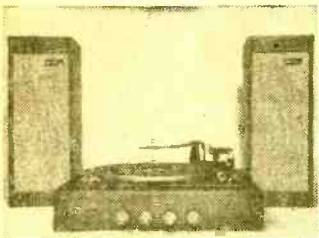

Date Pacer Hi-Fi System
Page 73

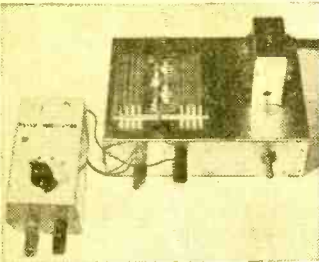

Power Supply & Reg Unit
Page 81

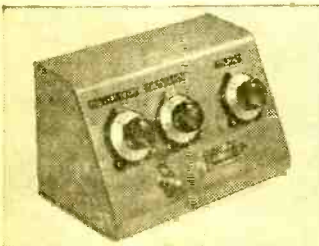

Simple Pot Computer
Page 43

COVER PROJECT

- 19 Supermatic T/S Synchronizer

ONE-EVENING PROJECTS

- 37 Ceramic Pickup Equalizing Preamp
- 46 CB Skyhook Mit Sock
- 47 1-FET BCber—*broadcast boomer with FET*
- 56 Decibel Decimator
- 67 Wall Phone Wireless
- 70 Little Joule—*experimenter's vari-volt*
- 81 Charger & Spender
- 84 Mighty Mickey-Mike
- 89 3-Buck Battery Booster
- 91 Sound Sipper—*groovy directional mike*
- 93 Electronic Foot Stomper
- 101 Rovin' Recorder for Wheels

PROJECTS FOR WEEKENDS

- 23 Hi-Power Crowd Getter
- 30 Super Snoop—*caseworker for cars*
- 33 Gold Grabber—*sensitive metal locator*
- 39 DX Devil—*all-band SW preselector*
- 43 Computer Goes to Pot
- 49 Travelin' Happening—*portable guitar amplifier*
- 59 Rev-Buster—*dwell tachometer*
- 63 Universal Reverb
- 73 Date Pacer—*low-cost stereo music center*
- 77 The CB Grabber—*in-car CB convertor*
- 85 CB Band Buster
- 95 Touchomatic—*instamatic silent switcher*
- 98 Mini Mix—*IC mike mixer*
- 103 Triple Threat—*3-in-1 CB accessory*

FOR THE QUICKIE READER

- 8 Workbench Brainstorms
- 16 Literature Library
- 22 Plug with Forked Tongue
- 22 Color-Code Your Transistors
- 38 A Safe Connection
- 38 Polystyrene Tubing Insulates Chokes
- 88 Crystal Is as Crystal Does

MAIL
ORDER

SHOPPING MART

UNUSUAL
VALUES

A selection of products available by mail for readers of Electronics Hobbyist
All merchandise sold on a money-back guarantee. Order Direct by Stock No. Send check or M.O.

SEE MUSIC IN ACTION

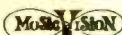

Dramatic Breakthrough In Audio-Visual Enjoyment

Actually see favorite musical selections translated into fantastic patterns of beautiful color—each individual note creating its own unique, twisting, radiating shape—each shape dancing and prancing, swirling and swirling in perfect time with the music. Easily attached to stereo, radio, tape recorder. Send 25¢ in coin for 16-page booklet—#9006GT. No. 85,151GT—WALNUT CABINET MODEL \$99.50 FOB
No. 71,030GT—8" SET \$45.00 Ppd.
No. 71,009GT—8" DO-IT-YOURSELF KIT \$22.50 Ppd.

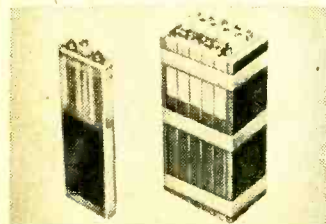

Nickel-Cadmium Battery Bargain!

Terrific value—slightly used gov't surplus. Lightweight 5 cell, 6 volt, 4 amp-hour battery with almost unlimited life. Extremely high current output. Recharges in 1 hour with Edmund kit. Won't deteriorate when left discharged. Minimum maintenance—few drops of water per year. Rugged, shock-and-vibration resistant nylon case. Delivered partially charged, filled with electrolyte. 3 1/2" x 2" x 6", 2 lbs.
Stock No. 70,942GT (battery)... \$15.00 Ppd.
CHARGER KIT
Stock No. 70,807GT... \$8.00 Ppd.

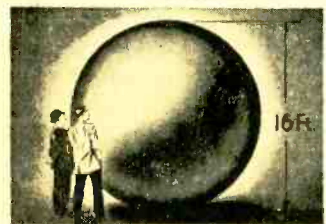

Giant Weather Balloons

Available in big 8' and 16' diameter. Create a neighborhood sensation. Great backyard fun. Exciting beach attraction. Blow up with vacuum cleaners or auto air hose. Filled with helium (available locally) use balloons high in sky to attract crowds, advertise store sales, announce fair openings, etc. Amateur meteorologists use balloons to measure cloud heights, wind speed, temperature, pressure, humidity at various heights. Photographers can utilize for low-cost aerial photos. Made of heavy duty neoprene.
Stock No. 60,568GT... 8' DIAM. \$2.00 Ppd.
Stock No. 60,632GT... 16' DIAM. \$7.00 Ppd.

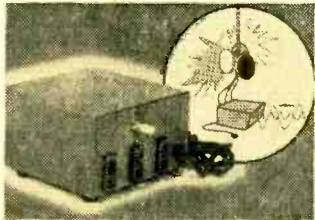

New! Low-Cost Color Organ

Accompany music with colored lighting that changes in hue and intensity. Create tremendous variety of unusual and beautiful effects. Simply plug in 3 diff. sets of colored lights and place near audio source. Notes picked up by interior "mike" determine which colored lights go on—loudness determines intensity. Surprising number of commercial, display and home uses—control lighting in pools and fountains, window and holiday decorations, great for parties. Tough, compact unit with light intensity control. 4 3/4" x 2 1/4" x 4 1/2". 1 lb. 6 oz.
Stock No. 1900GT... \$39.95 Ppd.
4 CHANNEL DE LUXE 2,000 watt.
Stock No. 71,103GT... \$195.00 Ppd.



No Hands... With Headlight Glasses

Two powerful beams give "hand free" illumination directly in front of you. Tough, lightweight—wear 'em like a pair of specs. Use 2 regular "D" batteries (not included). Perfect for model makers, machinists, inspectors, assembly lines... any close-up work requiring torch lighting. Battery case with on-off switch fits in shirt pocket. Bulbs included.
Stock No. 60,725GT... \$5.00 Postpaid



New Low-Cost Ultrasonic Cleaner

Top-quality 1/2rd pint unit for only \$39.95. Cleans dirt, grime completely, quickly, safely. Small delicate parts, precision electronic items, lab instruments, jewelry, coins, even dentures, sparkle like new. Operates on regular house current—American-made. Solid state generator with automatic turn-off. Power regulating knob. No shocks. No radio interference. 6" x 4" x 1 1/2" stainless.
Stock No. 71,003GT... \$39.95 Ppd.
1/2 GAL. INDUSTRIAL SIZE.
Stock No. 85,126GT (37 lbs.)... \$249.95 FOB

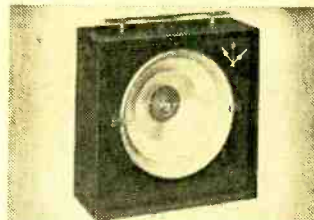

Top Quality Low-Cost Strobe

Genuine electronic strobe creates psychedelic or old-time movie effects. Terrific for parties, experiments... for combos, night clubs, dances, exhibitions. Best party ice-breaker ever—"freezes" the action and "unfreezes" guests. Practical too—check action of moderate-speed machinery. Xenon lamp gives one million flashes. 6 1/2" diam. reflector. Uses reg. 110-120 volt A.C. current. Handsome solid walnut cabinet, 9 1/2" x 9 1/2" x 4". Send for Bulletin #75—describes other startlingly new unique lighting effects.
Stock No. 70 989GT... \$79.95 Ppd.

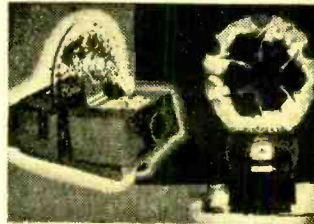

NEW! PROJECTION KALEIDOSCOPE

A low-cost unit with 9" diam. liquid wheel. Projects variety of color patterns which do not repeat. Specially designed wheel, 3" projection lens and Edmund Visual Special Effects Projector make it all possible. Easily operated. Large screen image at short projection distance perfect for photo backgrounds, light shows, parties, dances, etc. Front or rear projection. Incl: 1 RPM 115 V Motor, motor bracket, instructions.
Stock No. 71,121GT... \$94.50 Ppd
MULTI-COLORED GLASS WHEEL
Stock No. 71,122GT (9" Diam.) \$15.00 Ppd.

GIANT FREE CATALOG

148 Pages! More than 4,000



UNUSUAL BARGAINS!

Completely new. Packed with huge selections of lenses, prisms, optical instruments, parts and accessories, 100's of charts, illustrations. Many hard-to-get surplus bargains. Enormous variety of telescopes, microscopes, binoculars, magnets, magnifiers, photo components, etc. America's #1 source for research labs, engineers, scientists, inventors, experimenters, hobbyists. Write for Free Catalog GT.

Name _____
Address _____
City _____
State _____ Zip _____

ORDER BY STOCK NUMBER • SEND CHECK OR MONEY ORDER • MONEY-BACK GUARANTEE

EDMUND SCIENTIFIC CO. 300 EDSCORP BUILDING BARRINGTON, NEW JERSEY 08007

Olson



*** FREE**

Fill in coupon for a **FREE** One Year Subscription to **OLSON ELECTRONICS'** Fantastic Value Packed Catalog—Unheard of **LOW, LOW PRICES** on Brand Name Speakers, Changers, Tubes, Tools, Stereo Amps, Tuners, CB, and other Values. Credit plan available.

NAME _____
ADDRESS _____
CITY _____ STATE _____
GIVE ZIP CODE _____

If you have a friend interested in electronics send his name and address for a **FREE** subscription also.

OLSON ELECTRONICS

481 S. Forge Street Akron, Ohio 44308

SPRING/SUMMER, 1969 EDITION

ELECTRONICS HOBBYIST

Dedicated to America's Electronics Hobbyists

Editor-in-Chief
JULIAN M. SIENKIEWICZ, WA2CQL/KMD4313

Managing Editor
RICHARD A. FLANAGAN, KQD2566

Technical Editor
CLIFFORD L. FORBES, KBQ8535

Art Editor
JIM MEDLER

News Editor
HELEN PARKER

Art Director
ANTHONY MACCARRONE

Cover Art Director
IRVING BERNSTEIN

Associate Art Director
JOHN YUSKO

Art Associate
JACK GOLDEN

Advertising Director
JIM CAPPELLO

Production Manager
CARL BARTEE

Production Assistant
MARILYN VARGAS

Instruments Division Manager
WILFRED M. BROWN

President and Publisher
B. G. DAVIS

*Executive Vice-President
and Assistant Publisher*
JOEL DAVIS

Vice-President and Editorial Director
HERB LEAVY, KMD4529

Vice-President and Production Director
LEONARD F. PINTO

Vice-President and Treasurer
VICTOR C. STABILE, KBP2681

IT COSTS ONLY
1/100 OF 1¢ MORE
PER SOLDER JOINT
TO KNOW YOU ARE USING THE
WORLD'S FINEST CORED SOLDER



New Easy
Dispenser
Pak
60/40
18 S.W.G.

Latest PC
(Printed
Circuit) Pak
60/40 Extra Thin
22 S.W.G.—.028"

each only 69¢ per package at your dealer

ERSIN **Multicore** FIVE-CORE SOLDER

MULTICORE SALES CORP., WESTBURY, N.Y. 11590



Cover illustration
by
Joe Rak



ELECTRONICS HOBBYIST, Spring/Summer, 1969 Edition, is published Semi-Annually by SCIENCE & MECHANICS PUBLISHING CO., a subsidiary of Davis Publications, Inc. Editorial, business offices: 229 Park Ave. South, New York, N.Y. 10003. Advertising Offices: New York, 229 Park Ave. South, 212-OP 3-1300; Chicago, 520 No. Michigan Ave., 312-527-0330; Los Angeles, J. E. Publishers' Rep. Co., 213-653-5841; Atlanta, Pirnie & Brown, 3108 Piedmont Rd. N.E., 404-233-6729; Long Island, Len Osten, 9 Garden St., Great Neck, N.Y., 516-487-3305; Southwestern advertising representative, Jim Wright, 4 N. 8th St., St. Louis, 314-CH-1-1965.

Copyright 1969 by Science & Mechanics Publishing Co.

Here's a new, complete ICS course in TV Servicing that costs less than \$100.

With the first two texts, you can repair 70 percent of all TV troubles.

You need no previous experience to take this complete, practical course in TV Repairing.

You don't even have to know a vacuum tube from a resistor. Yet in a matter of months, you can be doing troubleshooting on color sets!

Course consists of 6 texts to bring you along quickly and easily. 936 pages of concise, easy-to-follow instruction, plus 329 detailed illustrations. You also receive a dictionary of TV terms geared directly to course material so you'll understand even the most technical terms.

Instruction is simple, very easy to grasp. Photos show you what a TV screen looks like when everything is normal, and what it looks like when trouble fouls it up. The texts tell you how to remedy the problem, and why that remedy is best.

Quizzes are spotted throughout the texts so you can check your progress. At the end of the course,

you take a final examination. Then you get the coveted ICS® diploma, plus membership in the ICS TV Repairman Association.

By the time you've finished the course, you should be able to handle tough, multiple TV problems, on color sets as well as black and white.

This new TV Servicing and Repair Course has been approved by National Electronic Associations for use in their Apprenticeship program. Because of its completeness, practicality and price, it is the talk of the industry. The cost is less than \$100—just slightly over ½ the price of any comparable course on the market today.

Remember, the sooner you get started on your course, the sooner you'll be turning your spare time into real money. Fill out the coupon and mail today. We'll rush you complete information at no obligation to you.

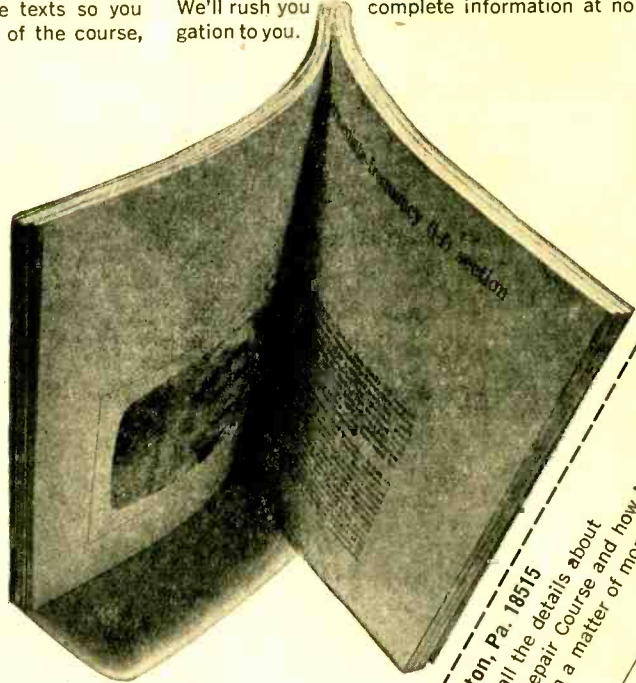

ICS, Dept. J94844, Scranton, Pa. 18515

Yes, I would like to have all the details about your new TV Servicing/Repair Course and how I can break into TV work in a matter of months.

Name _____
Street _____
City _____
State _____
Zip _____

Can't find the key to electronics?

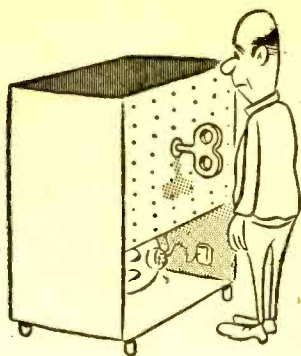

—then get your electronics cool with this introductory offer to the two leading electronics magazines! Use coupon:

DAVIS PUBLICATIONS, INC. GG-69
229 Park Ave. S./New York, N.Y. 10003

Yes! I want to find the key to electronics.

Begin my subscription to both RADIO-TV EXPERIMENTER and ELEMENTARY ELECTRONICS at your special low-subscription rate of \$7.00

Bill me later. Check enclosed.

Name

Address

City State..... Zip.....

(Outside U.S.A. & Canada add \$1.50 pstge. & hndlg.)

—Now, both of these fine magazines will be delivered to you at the special subscription rate of just \$7.00 . . . save \$2 from newsstand price.



ELEMENTARY ELECTRONICS

The magazine that serves up electronics theory in pleasant spoonfuls and reinforces the knowledge you gain with exciting and useful projects.

RADIO-TV EXPERIMENTER

The magazine dedicated to the hobbyist—the man who wants to obtain a fuller and broader knowledge of electronics through the applications of his hobby.



WORKBENCH BRAINSTORMS

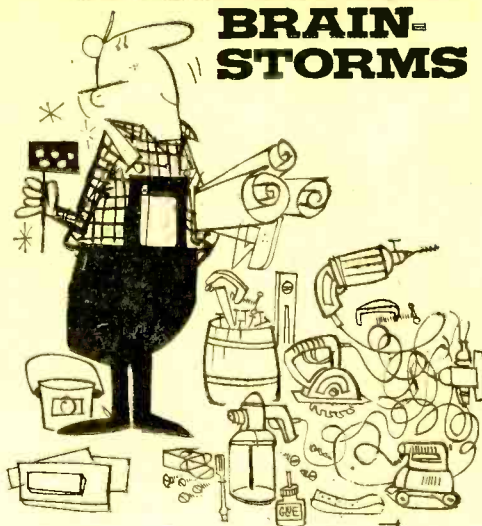

SPEAKER PHASE REVERSER

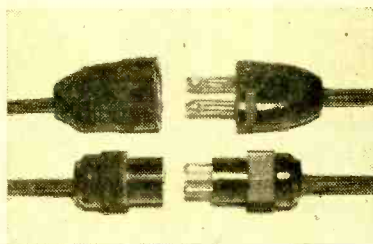

Here's a quick and easy way to flip the connections to the speakers in a stereo setup. Our photo shows two types of connectors that can be used in the speaker wiring; one is a standard AC plug and socket, the other is an automotive type. Both types are un-polarized so that reversing speaker phase can be accomplished by simply reversing one of the plugs.

CONNECTIONS THAT WON'T QUIT

A great new goody to fix up those cable plugs so they just won't quit is this thermogrip glue-gun that uses a hot-melt polyethylene-based adhesive. Operation of the gun is simplicity itself: just plug it in, let it warm up, then apply the nozzle to the area to be sealed or the wires to be immobilized. Then, press down on the solid-stick sealant and it'll flow out

(Continued on page 10)

FREE! World's Largest Electronic Kit Catalog

● **Deluxe Color TV** . . . the sets you've read about that give better performance yet cost no more; three models: 295, 227 & 180 sq. in. rectangular; exclusive built-in self-servicing aids. Custom, wall, or cabinet installation. New optional wireless remote controls, and new Heathkit antenna line.

● **Transistor Organs** . . . deluxe 19-voice and low cost 10-voice Thomas models in kit form — save up to \$500. Also VOX "Jaguar" combo organ at \$200 savings.

● **Electric Guitar Amplifiers and accessories**...amps, "fuzz" booster, microphones and speakers.

● **Portable and Table Radios and Phonographs** . . . AM, FM, short-wave radios . . . mono or stereo phonographs.

● **Stereo/Hi-Fi Components** . . . stereo receivers (including the famous Heathkit AR-15), amplifiers, tuners, speakers, turntables.

● **Amateur Radio Gear** . . . world's most popular line . . . SSB transceivers, transmitters, receivers, accessories.

● **Citizen's Band Radio** . . . fixed and mobile transceivers, walkie-talkies.

● **Test and Lab Instruments** . . . a complete line for home & hobby, shop, educational and industrial use. Newly designed and styled.

● **Scientific and Educational** . . . Berkeley Physics Lab, Malmstadt-Enke instrumentation including Analog/Digital equipment, kits for home & classroom study.

● **Marine Electronics** . . . radiophones, RDF, depth sounder, fuel vapor detector.

● **Photographic Aids** . . . Heath/Mitchell Fotoval® and Colorval® darkroom computers for perfect B&W and color printing; electronic photo timer.

**New . . . Over 300 Kits
For Every Interest . . .
Save Up To 50%**



MAIL COUPON NOW!

- **Biggest Selection** . . . Over 300 Kits
- **Up to 50% Savings**
- **Easiest To Build**
- **World Famous Easy-To-Understand Construction Manuals**
- **Highest Quality Components**
- **Best Performance**
- **Unique Creative Satisfaction**
- **Pride Of Achievement**
- **Free Technical Consultation**
- **Easy Credit Terms**

HEATH COMPANY, Dept. 26
Benton Harbor, Michigan 49022

Please send **FREE** Heathkit Catalog

Name _____
(please print)

Address _____

City _____ State _____ Zip _____

CL-339

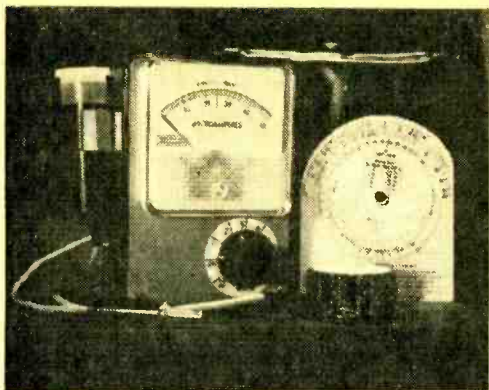

NOW, BETTER THAN EVER the new and improved S&M supersensitive photo meter

Here is a precision instrument that meets the highest standards of any meter available. It uses the newest Clairex Corp. CL-505L Cadmium Sulfide Light Cell to measure light levels from twilight to bright sunlight at ASA speeds of 3 to 25,000. A new 3/4" high easel type probe and also a miniature probe are now available as accessories. The Computer included gives F stops from .7 to 90; lists exposure time from 1/15,000 sec. to 8 hrs.; 4 range selection; EV-EVS-LV settings; weighs only 10 ounces.

Used extensively in Photo Labs, Physics and Research Labs, Hospitals, High Schools, Universities and numerous industries. Also used with movie or still cameras, microscopes and telescopes and IS A MUST FOR PHOTO-MICROGRAPHY.

FREE BOOKLET included on Photomicrography

SCIENCE & MECHANICS—INSTRUMENTS DIV. EH-69
229 Park Ave., S., New York, N.Y. 10003

Enclosed is \$_____. Please send me the new S&M Super-sensitive Photo Meter. If I am not satisfied, I may return the meter within 10 days for a complete refund.

(Prices subject to change without notice.)

Model 102 Photo Meter

- \$36.95 with standard probe + carrying case
- Microscope Adapter \$5.00
- Add'l. Computer \$2.00
- Add'l. Standard Probe \$7.50
- \$2.00 carrying case
- 3/8"-mini Probe \$7.50
- Easel Probe \$7.50

Add 10% for Canadian and foreign order. New York City residents add 5% sales tax. (No Stamps)

Name _____ (please print)
 Address _____
 City _____ State _____ Zip _____

Tape this ad to the back of your TV or Radio Set

ALL TV-RADIO RECEIVING TUBES \$1.50

- ALL BRAND-NEW, First Quality. All Types Available
- Orders Shipped First Class Same Day Rec'd.
- Unconditionally Guaranteed.
- 24 Month Warranty.

Send \$1.50 for ea. tube + 50¢ postage & handling of entire order. FREE: Write for TV Test Chart and Tube List to Dep't EH-S9



UNIVERSAL TUBE CO. Cape May, N.J. 08204

WORKBENCH BRAINSTORMS

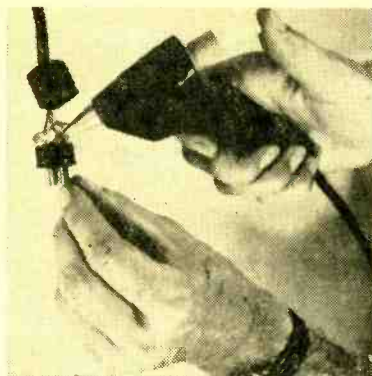

the nozzle. In only sixty seconds, the glue has set to about 90 percent full strength. When set, it's non-flammable, has good insulating properties, and is resilient so it won't break.

STOP A SHORT TODAY

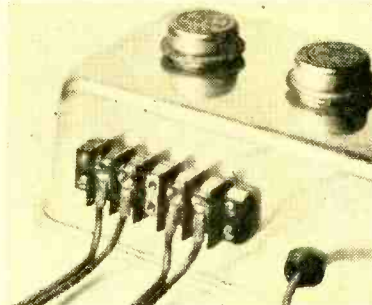

When building your own transistorized power amplifiers, like this one using a cake pan for heat sink and chassis, take a tip from manufacturers and mount a barrier terminal strip for the speaker connections. This will help prevent shorts which can damage or destroy the output transistors. The response time of transistors is faster than that of fuses, and this is one good way to take care of the problem.

AVOID BURIED CONDUCTORS

When drilling holes in floors or walls, you may accidentally slice through a buried cable conduit or water pipe. This simple setup lets you drill to your heart's content without danger of a nasty shock, blown fuse, or a face full of water. The hookup consists of a battery and door-bell hooked in series. The other side of the battery goes to the metal case of the

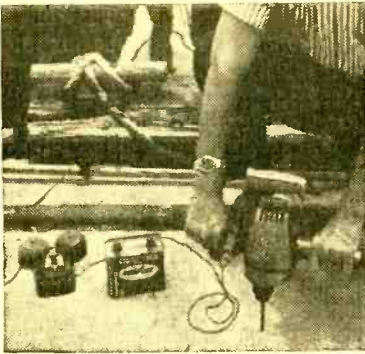

drill, and the remaining connection of the doorbell is hooked to any cold water pipe. Then if the drill bit hits conduit or a pipe, the circuit is completed, and the bell rings.

ROUND HOLE, ROUND PEG

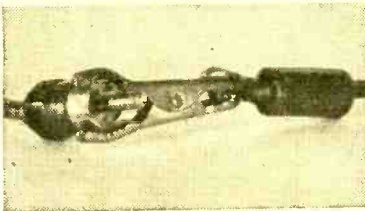

The trouble with alligator clips is that they were designed for grabbing wire and small flat terminals. Try using them on larger objects and zip—they slip right off. Here's an idea you can try. Bend both jaws of a clip round with long-nose pliers. Then watch how they grip tight on phono plugs, dial lamps, transistor cases, and other "slippables."

TAPE IT! BLOW IT! PULL IT!

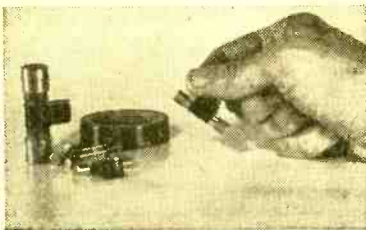

Did you ever notice how big your fingers get when you pull a cartridge fuse, 3AG size to 30-amp job, from its clips? Even with the power off we worry about a shock. Shake your fears! Wrap some $\frac{3}{8}$ -

New 1969 LAFAYETTE CATALOG

FREE!

Over
500
Pages



**NOW
OFF
PRESS**

Complete electronics catalog for the hobbyist and experimenter. Widely used by leading electronic magazines in their construction articles. Featuring thousands of products at money-saving low prices.

AM, FM, and Multiband Radios • Auto Battery Chargers and Inverters • Automotive Test Equipment • Cameras and Accessories • CB Transceivers • Drawing and Drafting Supplies • Electric Guitars, Amplifiers, Organs and other Musical Instruments • Fire and Burglar Warning Systems • Ham Equipment • Hi-Fi and PA Equipment • IC's and Experimenter Kits • Ignition and RF Interference Filters • Intercom Systems • Magnet & Mineralogy Kits • Marine Electronic Equipment • Microscopes and Telescopes • Miniature Amplifier and Tuners • Mobile, Base, and TV Antennas • Modules and Do-It-Yourself Kits • Police and Fire Receivers • R/C Transmitters and Receivers • Tubes • Relays • Science, Educational and Computer Kits • Speaker Enclosure Kits • Tape Recorders • Telephone Recorder and Answering Devices • Test Equipment • Timers • Transistors • Walkie-Talkies

Lafayette Radio Electronics
P.D. Box 10 Dept. 47029
Syosset, L.I., N.Y. 11791

Send me the FREE 1969 catalog 690.

47029

Name

Address

City

State

Zip



Keep up to date with **SCIENCE & MECHANICS**

Science & Mechanics—the only magazine that keeps you right up to date on developments in space technology, weapons, automobiles, medicine, boats, planes, tools, new products, and exciting world events.

Keep up to date. Make sure of your home delivered copy by returning the coupon today.

SCIENCE & MECHANICS EH-69
 229 Park Ave. S., N. Y., N. Y. 10003
 12 issues \$4; 24 issues \$8; 36 issues \$12. (Foreign: Add \$1 a year.)
 Please enter my _____ year(s) subscription.
 I enclose \$ _____ Bill me.
 Name _____ (Please Print)
 Address _____
 City _____ State & Zip _____

The Latest Hi-Fi Buyers' Guide "is great!"



This is a magazine with a difference, designed to help you, the buyer, pick the hi-fi components that are right for you. It's packed with test reports on stereo equipment of all kinds, reports that tell you exactly how each and every piece of equipment chalked up when put through its paces in our lab.

You'll find the Fall/Winter 1968 Hi-Fi BUYERS' GUIDE on your newsstand. Or if he's sold out send \$1.25 plus 25¢ postage to:

Hi-Fi BUYERS' GUIDE
 229 Park Avenue South / New York, N.Y. 10003

WORKBENCH BRAINSTORMS

plastic tape around the fuse body with the ends forming a tab about $\frac{3}{4}$ -in. long. Now yank tab for instant out!

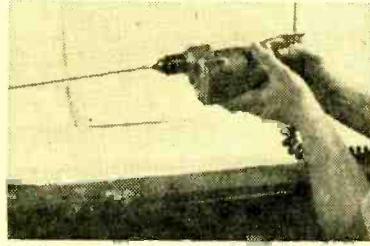

Next time a kit manual tells you to twist lengths of red and black wires into a twisted pair, here's what you do! Secure an eye hook or a hooked nail in your drill's chuck. Tie the wires to the hook, and clamp the other ends in a vise. Zap the drill's switch trigger for a short blast and watch the twisted pair form. Lengths up to 10 feet can be paired. Don't over do it or you'll kink the cable.

DOWN WITH FINGER POKING

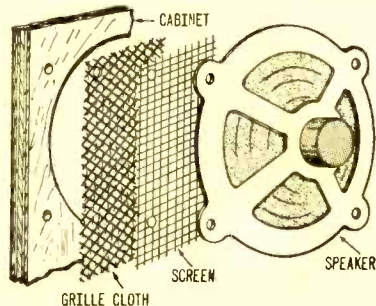

One sure way to destroy a loudspeaker is to poke a hole through it. An easy way to prevent this type of cone damage is to place a metal screen between the speaker and grille cloth. Besides adding protection for the delicate speaker cone, the added steel or aluminum screen will prevent unsightly pushed-in or torn grille cloths.

NO-COST VOLUME GETTER

At parties, dances, or other get-togethers, more volume can be had from that little transistor radio without resorting to complicated solutions. Simply attach a cheer-leader type meg-



aphone to the radio with rubber bands or tape as shown, with the megaphone's mouthpiece centered over the radio's speaker. The end result is double or triple the volume.

NO HANG NAIL FOR IRON

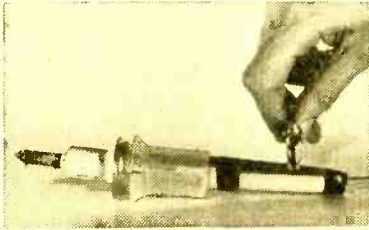

Rust, grime, dirt, and films on component leads and terminals may be too tough for the rosin and heat of soldering. A phone plug ground lead may resist solder unless the contact area is filed. Make this soldering job easy by taping a small nail file to your iron's handle. The next time you'll need a file to clean a terminal—the tool will be in your hand.

GIVE A KNOB A JOB

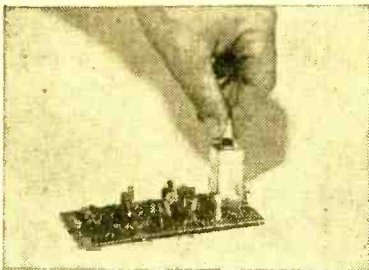

About the toughest job during alignment is turning threaded shafts on slug-tuned coils. Make the job easier on yourself by slipping a solderless connector on the coil's shaft and twisting tight. These electrical solderless con-

NEW ALLIED 1969 CATALOG & BUYING GUIDE

FREE

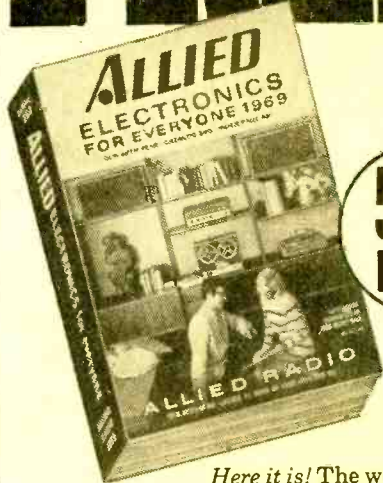

**536
PAGES**

Here it is! The world's most famous catalog of electronic equipment featuring hundreds of new and exclusive items and special Allied values.

536 pages—including a complete Electronic and Hobby Kits Catalog—picturing, describing, and pricing thousands upon thousands of items. The most complete inventory ever assembled of Hi-Fi, Radios, Tape Recorders, CB, Electronic Equipment, Parts and Tools...all at money-saving low prices.

NO MONEY DOWN—UP TO 2 YEARS TO PAY!

- BIG SAVINGS ON THE BEST IN ELECTRONICS FOR EVERYONE**
- Stereo Hi Fi • Electronic & Hobby Kits • Tape Recorders & Tape
 - CB 2-Way Radios • Walkie-Talkies • FM-AM & AM Radios
 - Shortwave Receivers • Portable TV • Phonographs • Transistors
 - Intercoms & P.A. • Automotive Electronics • Test Instruments
 - TV Antennas & Tubes • Power Tools, Hardware
 - Amateur Equipment • Tubes • Parts, Batteries, Books

WRITE FOR YOUR COPY TODAY!

ALLIED RADIO, Dept. 181
P.O. Box 4398, Chicago, Ill. 60680

Send me your free catalog for 1969

PLEASE PRINT

NAME _____
 First Middle Last

ADDRESS _____

CITY _____

STATE _____ ZIP _____

Yours FREE

this valuable guide to
MONEY-MAKING OPPORTUNITIES
with your NO RISK TRIAL
subscription to the new
INCOME OPPORTUNITIES
Newsletter

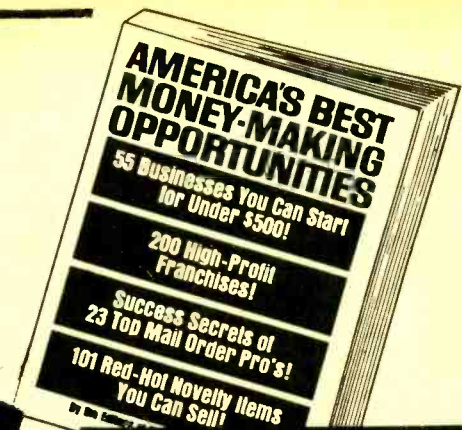

**NOT FOR SALE at any price...
 but you can get a copy FREE
 by returning the coupon below.**

HUNDREDS OF IDEAS that can mean big money for you assembled by **INCOME OPPORTUNITIES** staff in a special report can be yours **FREE** when you mail the coupon below accepting a **NO RISK** Charter subscription to the new **INCOME OPPORTUNITIES** Newsletter—the new confidential reporting service that brings you exclusive reports of new business breakthroughs **FAR IN ADVANCE** of any other source.

YOUR FREE SUCCESS GUIDE contains these powerful profit-makers:

- Success secrets of millionaire mail order professionals!
- 200 high-income, low investment opportunities!
- 55 Businesses you can start right now for under \$500 investment!
- 101 Red-hot novelty items you can sell for phenomenal commissions!

EACH MONTH this exclusive confidential newsletter reporting service will bring you exclusive advance news of opportunities in every area... always with the names and addresses of the sources so that you can take full advantage of money making opportunities and can go into action immediately long before anyone else has even heard of them.

OUR NATIONWIDE STAFF of reporters and the editors of **INCOME OPPORTUNITIES**, the world's leading magazine in this field, are in constant touch with **EXCLUSIVE** sources of inside information about unusual opportunities of increasing your income... and this information is rushed to subscribers in fast-reading newsletter format... together with special in-depth reports of information you can get nowhere else.

YOU TAKE NO RISK WHEN YOU SUBSCRIBE SINCE YOU MUST BE 100% SATISFIED

To get your **FREE** exclusive report on **AMERICA'S BEST MONEY-MAKING OPPORTUNITIES**, all you need do is mail the post card facing this ad or the coupon below to enter your **NO RISK** trial subscription to the new **INCOME OPPORTUNITIES** Newsletter. The cost is less than 5¢ a day... and a single idea you get from it can be worth many times the cost of a year's subscription.

THESE SPECIAL REPORTS are included with your subscription as an **EXTRA VALUABLE BONUS**

22 MAIL ORDER FIRMS THAT WILL PUT YOU IN BUSINESS! Top-notch, reputable firms... each with a profit-producing mail order program. Choose your own hours... work full- or part-time.

33 SELECT FRANCHISES FOR UNDER \$5,000! Choice franchises selected to return maximum profit for an investment within your means. Restaurants, automotive, stores, and many, many more!

25 HOME-BASED, SPARE-TIME MONEYMAKERS For anyone who would want additional income—laminating specialty mail order, secretarial services. Full details on how to get customers and how to price your product for profit!

DIRECT SELLING DIRECTORY! Leaders in the direct selling field—Saladmaster, Tupperware, Stanley, and many others help put you on the path to financial independence selling nationally known products... and earning commissions of up to \$1,000 monthly!

20 FASTEST GROWING RETAIL BUSINESSES! Survey and report of independent businesses which are currently booming—coin-op car wash, beauty/wig salons, poodle grooming parlors... economic indicators to help you make the wisest choice for a profitable business!

AND REMEMBER... THIS SUCCESS GUIDE IS NOT FOR SALE, anywhere else, AT ANY PRICE!

TO GET YOUR FREE report on **AMERICA'S BEST MONEY-MAKING OPPORTUNITIES**, mail the coupon below to enter a **NO RISK** Charter subscription to the new **INCOME OPPORTUNITIES** Newsletter—the confidential report that brings you exclusive advance news of money-making opportunities month after month.

HUNDREDS OF EXCLUSIVE IDEAS YOU CAN USE TO MAKE MORE MONEY

THE REASON we want to send you this valuable report on **AMERICA'S BEST MONEY-MAKING OPPORTUNITIES** as a **FREE** gift with your **NO RISK** subscription to **INCOME OPPORTUNITIES** Newsletter is we know that once you become a reader you will never want to be without it.

22 MONEY-MAKING HOBBIES! Hobbies are not only for fun, but can be profitable as well! Here's how to turn your coin/stamp collecting, your tropical fish or even your own art and craft items into a substantial secondary source of income!

HERE'S THE EXCLUSIVE VALUABLE INFORMATION

You'll find in your **FREE** copy of **AMERICA'S BEST MONEY-MAKING OPPORTUNITIES**:

55 BUSINESSES YOU CAN START FOR UNDER \$500!

Proven profit makers which offer independence and financial security... many can be started on a part time basis... with addresses for obtaining detailed information.

200 HIGH-PROFIT FRANCHISES!

Selected franchise profit-making opportunities with initial investment of under \$5,000... covers all major areas such as: services... products... schools... sports and recreation... stores... vending machines... cosmetics... health aids and much more.

SUCCESS SECRETS OF 23 TOP MAIL ORDER PROS

The inside success stories behind the big mail order money makers... and full details you can use to get into the big mail order field.

101 RED HOT NOVELTIES FOR SALESMEN How to get your share of the multi-billion dollar advertising specialties industry which offers unlimited opportunities to salesman.

SEND NO MONEY NOW to get your **FREE** Money-Making Opportunities Report.

Enter my Charter **NO-RISK** subscription to the new **INCOME OPPORTUNITIES** Newsletter including 6 special reports listed above and send me **FREE** the exclusive report: **AMERICA'S BEST MONEY-MAKING OPPORTUNITIES**. The cost is \$1.50 per month payable annually or semi-annually.

Bill me Annual Basis Semi-Annual Basis

I understand I may cancel my subscription at any time and will receive a **FULL REFUND** with no questions asked for all issues still due me at that time. The cost of my subscription is **TAX DEDUCTIBLE** as a business expense.

NAME _____ (Please PRINT—it prevents errors)

STREET ADDRESS _____

CITY _____ **STATE** _____ **ZIP CODE** _____

CHECK HERE TO GET AN EXTRA MONTHS' SERVICE FREE. Enclose your payment of \$18.00 now and save us bookkeeping costs and we'll add an extra month to your subscription. **SAME NO RISK GUARANTEE.** You may cancel your subscription at any time for a **FULL PROMPT REFUND** for all undelivered issues.

Mail to:
INCOME OPPORTUNITIES Newsletter
 229 Park Avenue South, New York, N.Y. 10003

EH-S/S

WORKBENCH BRAINSTORMS

nectors are available at the hardware counter in five-and-dimes. A drop of epoxy will make the knob stick forever on shafts that need frequent twisting.

A LIGHT MIKE STAND

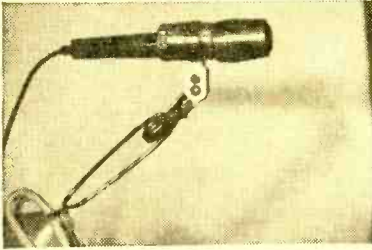

Makes no matter whether you are a pro or amateur tape recordist, you'll always have need for a clip-on mike stand. To make one quickly just snap out the electrical works from the rear of an electrical socket on a clip-on photoflood holder. Slip the mike into the empty socket shell—a few wraps of tape will give the mike a snug fit.

BASS-REFLEX AUTO SPEAKER



When installing that rear-seat speaker in your car, mount the speaker on bushings as shown in our drawing. The bushings should be about 1/2-in. long. This creates a port for the speaker's backwave, thereby reinforcing the bass. Another advantage is that the fragile speaker cone is less subject to damage from excessive air pressure created when the trunk lid is slammed shut.

• Like what you've been reading? Well, there's more of the same coming your way in every issue of **RADIO-TV EXPERIMENTER!** Just pick up a copy today and thumb to our regular column, *Imagineering Design Tips*. See you there! ■

LEARN ELECTRONIC THEORY

BY BUILDING THESE STEP-BY-STEP KITS

Embark now on an exciting step-by-step journey toward the assembly of a highly professional eight-transistor or five-tube radio. Enjoy the personal pride and accomplishment of assembling your own radio . . . and learning a great deal about basic electronics and radio theory. Graymark, leader in kits for instructional classroom use, here offers two of these radio kits to the public. Each comes complete with all parts and fully illustrated/easy-to-follow instruction manual. All parts are fully warranted. Send coupon below for fully illustrated color brochure.



COMACHO

"COMACHO" EIGHT-TRANSISTOR RADIO. Kit provides basics of superheterodyne transistor theory operation. Builds into an attractive printed circuit-board radio, mounted in plastic case. Compares favorably with more expensive units. Earphone included. \$19.95 each.

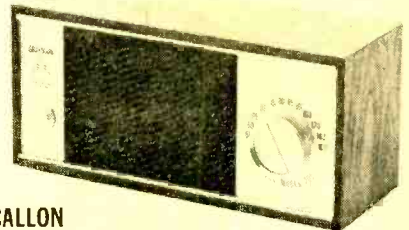

SCALLON

"SCALLON" FIVE-TUBE RADIO. Easy-to-understand kit approach to superheterodyne circuitry. Assembles into a distinctive table-type radio. Tubes, contemporary walnut cabinet included. \$21.95 each.

Send order today to:

Graymark

ENTERPRISES, INC.

P.O. Box 54343 • Ter. Annex, • Dept. 108

Los Angeles • Calif. 90054

Send Kits Checked

COMACHO (\$19.95 ea.) SCALLON (\$21.95 ea.)

Send Postpaid. Enclosed find check/money order for full amount. (Calif. Res. add 5% total purchase)

Send C.O.D. I will pay full amount, plus postage.

Send illustrated color brochure.

Name _____

Address _____

City & State _____

Zip _____

LITERATURE

★ Starred items indicate advertisers in this issue. Consult their ads for additional information and specifications.

LIBRARY

CB—AMATEUR RADIO— SHORTWAVE RADIO

100. You can get increased CB range and clarity using the "Cobra-23" transceiver with speech compressor—receiver sensitivity is excellent. Catalog sheet will be mailed by *B&K Division of Dynascan Corporation*.
141. Newly-designed CB antenna catalog by *Antenna Specialists* has been sectionalized to facilitate the picking of an antenna or accessory from a handy index system. Man, *Antenna Specialists* makes the pickin' easy.
102. No never mind what brand your CB set is, *Sentry* has the crystal you need. Same goes for ham rigs. Seeing is believing, so get *Sentry's* catalog today. Circle 102.
130. Bone up on the CB with the latest *Sams* books. Titles range from "ABC's of CB Radio" to "99 Ways to Improve your CB Radio." So Circle 130 and get the facts from *Sams*.
107. Want a deluxe CB base station? Then get the specs on *Tram's* all new Titan II—it's the SSB/AM rig you've been waiting for!
101. If it's a CB product, chances are *International Crystal* has it listed in their colorful catalog. Whether kit or wired, accessory or test gear, this CB-oriented company can be relied on to fill the bill.
96. Get your copy of *E. F. Johnson's* new booklet, "Can Johnson 2-Way Radio Help Me?". Aimed for business use, the booklet is useful to everyone.
129. Boy, oh boy—if you want to read about a flock of CB winners, get your hands on *Lafayette's* new 1969 catalog. *Lafayette* has CB sets for all pocketbooks.
103. *Squires-Sanders* would like you to know about their CB transceivers, the "23'er" and the new "55S." Also, CB accessories that add versatility to their 5-watters.
46. Pick up *Hallcrafters' new* four-page illustrated brochure describing *Hallcrafters' line* of monitor receivers—police, fire, ambulance, emergency, weather, business radio, all yours at the flip of a dial.
116. Pep-up your CB rig's performance with *Turner's M+2* mobile microphone. Get complete spec sheets and data on other *Turner* mikes.
48. *Hy-Gain's* new CB antenna catalog is packed full of useful information and product data that every CBER should know. Get a copy.
111. Get the scoop on *Versa-Tronics' Versa-Tenna* with instant magnetic mounting. Antenna models available for CBERs, hams and mobile units from 27 MHz to 1000 MHz.

45. CBERs—get your copy of *World Radio Labs 1969 CB Catalog No. 2*. You've got to see to believe *WLR's* special CB bonus offers. This is the catalog for big CB buyers.

50. Get your copy of *Amphenol's "User's Guide to CB Radio"*—18 pages packed with CB know-how and chit-chat. Also, *Amphenol* will let you know what's new on their product line.

54. A catalog for CBERs, hams and experimenters, with outstanding values. Terrific buys on *Grove Electronics' antennas, mikes and accessories*.

ELECTRONIC PRODUCTS

143. Bring new life to your hobby. Exciting plans for new projects—let *Electronics Hobby House* give you the dope. Circle 143. now.

★42. Here's colorful 116 page catalog containing a wide assortment of electronic kits. You'll find something for any interest, any budget. And *Heath Co.* will happily sent you a copy.

★44. Kit builder? Like wired products? *EICO's 1969 catalog* takes care of both breeds of buyers. 32 pages full of hi-fi, test, CB, ham, SWL, automotive and hobby kits and products—do you have a copy?

128. If you can hammer a nail and miss your thumb, you can assemble a *Schober organ*. To prove the point, *Schober* will send you their catalog and a 7-in. disc recording.

126. *Delta Products* new capacitive discharge ignition system in kit form will pep up your car. Designed to cut gas costs and reduce point and plug wear. Get *Delta's* details in full-color literature.

66. Try instant lettering to mark control panels and component parts. *Datak's* booklets and sample show this easy dry transfer method.

109. *Seco* offers a line of specialized and standard test equipment that's ideal for the home experimenter and pro. Get specs and prices today.

ELECTRONIC PARTS

★135. Get with ICs! *RCA's* new integrated Circuit Experimenter's Kit KD2112 is the first of its kind and should be a part of your next project. Get all the facts direct from *RCA*. Circle 135.

140. How cheap is cheap? Well, take a gander at *Cornell Electronics' latest catalog*. It's packed with bargains like 6W4, 12AX7, 5U4, etc., tubes for only 33¢. You've got to see this one to believe it!

★2. Now, get the all-new 512-page, fully illustrated *Lafayette Radio 1969* catalog. Discover the latest in CB gear, test equipment, ham gear, tools, books, hi-fi components and gifts. Do it now!

144. Hear today the organ with the "Sound-of-Tomorrow," the *Melo-Sonic* by *Whippany Electronics*. It's portable—take it anywhere. Send for pics and descriptive literature.

★1. *Allied's* catalog is so widely used as a reference book, that it's regarded as a standard by people in the electronics industry. Don't you have the 1969 *Allied Radio* catalog? The surprising thing is that it's free!

8. Get it now! *John Meshna, Jr.'s* new 46-page catalog is jam packed with surplus buys—surplus radios, new parts, computer parts, etc.

23. No electronics bargain hunter should be caught without the 1969 copy of *Radio Shack's* catalog. Some equipment and kit offers are so low, they look like misprints. Buying is believing.

★5. *Edmund Scientific's* new catalog contains over 4000 products that embrace many interests and fields. It's a 148-page buyers' guide for *Science Fair* fans.

★106. With 70 million TV and 240 million radios somebody somewhere will need a vacuum tube replacement at the rate of one a second! Get *Universal Tube Co.'s Troubleshooting Chart* and facts on their \$1.50 flat rate per tube.

★4. *Olson's* catalog is a multi-colored newspaper that's packed with more bargains than a phone book has names. Don't believe us? Get a copy.

7. Before you build from scratch check the *Fair Radio Sales* latest catalog for electronic gear that can be modified to your needs. *Fair* way to save cash.

6. Bargains galore, that's what's in store! *Poly-Paks Co.* will send you their latest eight-page flyer listing the latest in available merchandise, including a giant \$1 special sale.

10. *Burstein-Applebee* offers a new giant catalog containing 100s of big pages crammed with savings including hundreds of bargains on hi-fi kits, power tools, tubes, and parts.

11. Now available from *EDI (Electronic Distributors, Inc.)*, a catalog containing hundreds of electronic items. *EDI* will be happy to place you on their mailing list.

120. *Tab's* new electronics parts catalog is now off the press and you're welcome to have a copy. Some of *Tab's* bargains and odd-ball items are unbelievable offers.

TOOLS

78. Do more jobs with fewer tools. Double duty sets contain midget nut and screwdrivers plus special piggy-back handle that gives midgets the power and reach of standard drivers. *Xcelite's* the name—get their catalog 166.
118. Secure coax cables, speaker wires, phone wires, etc., with *Arrow* staple gun tackers. 3 models for wires and cables from 3/16" to 1/2" dia. Get fact-full *Arrow* literature.

TELEVISION

70. Need a new TV set? Then assemble a *Heath* TV kit. *Heath* has all sizes. B&W and color, portable and fixed. Why not build the next TV you watch?
- ★127. *National Schools* will help you learn all about color TV as you assemble their 25-in. color TV kit. Just one of *National's* many exciting and rewarding courses.

SCHOOLS AND EDUCATIONAL

142. *Radio-Television Training of America* prepares you for a career—not a job. 16 big kits help you learn as you build. 120 lessons. Get all the facts today!
- ★74. Get two free books—"How to Get a Commercial FCC License" and "How to Succeed in Electronics"—from *Cleveland Institute of Electronics*. Begin your future today!
136. "Power Engineering," a new 32-page, illustrated brochure by *ICS (International Correspondence Schools)* describes seven *ICS* Power Engineering courses that may open a new career for you. Get a copy today!
114. Prepare for tomorrow by studying at home with *Technical Training International*. Get the facts today on how you can step up in your present job.
- ★137. For success in communications, broadcasting and electronics get your First Class FCC license and *Grantham School of Electronics* will show you how. Interesting booklets are yours for the asking.

138. For a complete rundown on curriculum, lesson outlines, and full details from a leading electronic school, ask for this brochure from the *Indiana Home Study Institute*.
105. Get the low-down on the latest in educational electronic kits from *Trans-Tek*. Build light dimmers, amplifiers, metronomes, and many more. *Trans-Tek* helps you to learn while building.
3. Get all the facts on *Progressive Edu-Kits Home Radio Course*. Build 20 radios and electronic circuits; parts, tools and instructions come with course.

HI-FI/AUDIO

134. Discover *PlayTape*—America's newest tape cartridge and tape players. Units priced at under \$17 with cartridges at 45-disc prices. *PlayTape* has one of America's largest recorded libraries.
139. *Altec Lansing* covers both ends of the audio market—microphones and loudspeaker systems. *Altec* supplies the facts—you do the asking. Circle 139 now!
19. *Empire's* new 16-page, full-color catalog features speaker systems in odd shapes for beautiful room decor. Also, rediscover *Empire's* quality turntable line and cartridges.
26. Always a leader, *H. H. Scott* introduces a new concept in stereo console catalogs. The information-packed 1969 Stereo Guide and catalog are required reading for audio fans.
85. Write the specs for an ideal preamp and amp, and you've spelled out *Dynaco's* stereo 120 amp and PAS-3X preamp. So why not get all the facts from *Dynaco!*
119. *Kenwood* puts it right on the line. The all-new *Kenwood* FM-stereo receivers are described in a colorful 16-page booklet complete with easy-to-read-and-compare spec data. Get your copy today!
131. Let *Elpa* send you "The Record Omibook." It's a great buy and *Elpa* wants you to have it free. Your records will thank you when the mailman delivers it.

17. Mikes, speakers, amps, receivers—you name it, *Electro-Voice* makes it and makes it good. Get the straight poop from *E-V* today.
27. 12 pages of *Sherwood* receivers, tuners, amplifiers, speaker systems, and cabinetry make up a colorful booklet every hi-fi bug should see.
99. Get the inside info on why *Koss/Acoustech's* solid-state amplifiers are the rage of the experts. Colorful brochure answers all your questions.

TAPE RECORDERS AND TAPE

123. Yours for the asking—*Elpa's* new "The Tape Recording Omibook." 16 jam-packed pages on facts and tips you should know about before you buy a tape recorder.
31. All the facts about *Concord Electronics Corp.* tape recorders are yours for the asking in a free booklet. Portable, battery operated to four-track, fully transistorized stereos cover every recording need.
32. "Everybody's Tape Recording Handbook" is the title of a booklet that *Sarkes-Tarzian* will send you. It's 24-pages jam-packed with info for the home recording enthusiast. Includes a valuable table of recording times for various tapes.
34. "All the Best from Sony" is an 8-page booklet describing *Sony-Super-scope* products—tape recorders, microphones, tape and accessories. Get a copy before you buy!
35. If you are a serious tape audiophile, you will be interested in the all new *Viking/Telex* line of quality tape recorders.

HI-FI ACCESSORIES

112. *Telex* would like you to know about their improved *Serenata* Headset—and their entire line of quality stereo headsets.
104. You can't hear FM stereo unless your FM antenna can pull 'em in. Learn more and discover what's available from *Finco's* 6-pages "Third Dimensional Sound."

<p>ELECTRONICS HOBBYIST Dept. SS9</p> <p>229 Park Avenue South New York, N.Y. 10003</p> <p>Please arrange to have the literature whose numbers I have circled sent to me as soon as possible. I am enclosing 25¢ 1 to 10 items; 50¢ for 11 to 20 items to cover handling. (No stamps, please.)</p> 	<input type="checkbox"/> Indicate total number of booklets requested										
		1	2	3	4	5	6	7	8	10	11
		17	19	23	26	27	31	32	34	35	42
		44	45	46	48	50	54	66	70	74	78
		85	96	99	100	101	102	103	104	105	106
		107	109	111	112	114	116	118	119	120	123
		126	127	128	129	130	131	134	135	136	137
		138	139	140	141	142	143	144			
		NAME _____									
		ADDRESS _____									
	CITY _____										
	STATE _____					ZIP _____					

CLASSIFIED Market Place

FOR BIGGER PROFITS! NEW CAREER OPPORTUNITIES!
READ AND REPLY TO THESE CLASSIFIED ADS

Classified Ads 65¢ per word, each insertion, minimum 10 words, payable in advance. For information on Classified ads—to be included in our next **ELECTRONIC HOBBYIST**—write to C. D. Wilson, Mgr., Classified Advertising, 229 Park Avenue South, New York, N. Y. 10003.

ADDITIONAL INCOME

MONEY—Sparetime Opportunity Panelists At Home Wanted By New York Researcher. Leading research firm seeking people to furnish honest opinions by mail from home. Pays cash for all opinions rendered. Clients' products supplied at no cost. For information write: Research 669, Mineola, N. Y. 11501. Dept. 633-EH.

FREE! Details on Essential Item for Every Store and Business. Adcco, Box #31, Station "A," Vancouver, Canada.

MAKE Your Classified Ad Pay. Get "How to Write a Classified Ad That Pays." Includes certificate worth \$2.00 toward classified ad in S & M. Send \$1.25 (includes postage) to C. D. Wilson, Science and Mechanics, 229 Park Avenue South, New York, New York 10003.

AUTHOR'S SERVICE

PUBLISH your book! Join our successful authors: publicity advertising promotion, beautiful books. All subjects invited. Send for free manuscript report and detailed booklet. Carlton Press, Dept. SMH, 84 Fifth Avenue, New York 10011.

BOATS, MOTORS & MARINE SUPPLIES

BOAT Bailer—Automatic. For Small Craft \$4.95. More Information: Write De Persia Automatic Bailer, Grand Haven, Michigan 49417.

FOR Consistent Fun, Excitement and Expert Advice, subscribe to "Camping Journal." Only \$4.98 for 12 Issues. Write Camping Journal, 229 Park Avenue South, New York, N. Y. 10003.

BUSINESS OPPORTUNITIES

I MADE \$40,000.00 Year by Mailorder! Helped others make money! Start with \$10.00—Free Proof! Torrey, Box 318-T, Ypsilanti, Michigan 48197.

FREE Book "990 Successful Little-Known Businesses." Fascinating! Work home! Plymouth 311-R, Brooklyn, N. Y. 11218.

CATALOG of all Science & Mechanics Craftprints. Send 25¢ to cover postage and handling to Craftprint Div., Science & Mechanics, 229 Park Avenue South, New York, N. Y. 10003.

EARTHWORMS

BIG Money Raising Fishworms and Crickets. Free Literature. Carter Farm-O, Plains, Georgia 31780.

EDUCATION & INSTRUCTION

FCC License and Associate Degree correspondence/residence courses. School bulletin free. Grantham Institute of Electronics, 1505 N. Western Ave., Hollywood, California 90027.

EARN Your Degree in Electronics Engineering. Highly Effective Home Study Courses In Electronics Engineering Technology And Electronics Engineering Mathematics. Free Literature. Cook's Institute Of Electronics Engineering, P. O. Box 36185, Houston, Texas 77036. (Established 1945.)

INVENTIONS WANTED

WE either sell your invention or pay cash bonus. Write for details. Universal Inventions, 298-30, Marion, Ohio 43302.

MAGIC TRICKS, JOKER NOVELTIES & PUZZLES

FREE! World's Leading Catalog 1995 Novelties, Jokes, Tricks, Scientific Gadgets, Hobbies. Johnson-Smith, D-395, Detroit, Michigan 48224.

MISCELLANEOUS

ROOT BEER Formulas: Instructions \$3.00. Tomarch, 1114-41st, Brooklyn, New York 11218.

HIGHER Income—Security and Power. 256 Page Book—Thinking Big—reveals secrets that make Men rich. Money Back Guarantee. Book #WB-123. Send \$2.00. Tobin Enterprises, 425 B Street, Petaluma, California 94952.

QUART dried hops \$1.00, with 101 recipes—Homebrewing, Winemaking, Hop-breads, Sourdoughs, and supplies catalogue. Nichols Nursery, Northpac, Albany, Oregon 97321.

STOP theft, vandalism. Send \$5.95 for high voltage property protector. Effective. Non-lethal. Satisfaction guaranteed. Catalog 20¢. Franks Scientific Co., P.O. Box 156, Martelle, Iowa 52305.

MONEYMAKING OPPORTUNITIES

1000% PROFIT Bronzing Baby Shoes. Free Literature, Box 11069, Kansas City, Missouri 64119.

FREE! The World's Leading Money-making Magazine. How and when to earn a Second Income, develop a Spare-time Business, get into Profitable Franchising, become a successful Agent. For your free copy—write Income Opportunities, 229 Park Avenue South, New York, N. Y. 10003.

MUSIC & MUSICAL INSTRUMENTS

ELECTRONIC device writes music as you play. Details \$1.00. Musac, P.O. Box 722, Logansport, Indiana 46947.

PERSONAL

DO We Have All The Bible? A Candle, Box 2325, Lehigh Valley, Penna. 18001.

RADIO & TELEVISION

THOUSANDS AND THOUSANDS of types of electronic parts, tubes, transistors, instruments, etc. Send for Free Catalog. Arcturus Electronics Corp., MRT, 502-22nd Street, Union City, N. J. 07087.

KITS, Metal Detector \$5.95. Audio Telescope \$5.95 Others. Lectronix, Box 42, Madison Heights, Mich 48071.

BUILD Distance Crystal Sets. 10 plans—25¢; 18 different—50¢; 20 different—50¢. Catalog Laboratories, 12041-EH Sheridan, Garden Grove, Calif. 92640.

3600 VOLT rectifier 65¢. 1200 volt electric shock module \$5.95. 14"x12" fiberglass epoxy printed circuit boards \$3.95. Radio jammer \$7.95. Radio jammer plans \$1.50. TV jammer \$7.95. TV jammer plans \$1.50. Catalog 20¢. Franks Scientific Co., P.O. Box 156, Martelle, Iowa 52305.

TIPS FOR THE HOME, ETC.

PRACTICAL tips for home, garden and workshop are in "1001 How-To Ideas." Send \$1.00 for your copy includes Postage, to 1001 How-To Ideas, 229 Park Avenue South, New York, N. Y. 10003.

THERE IS NO CHARGE FOR THE ZIP CODE—PLEASE USE IT IN YOUR CLASSIFIED AD

**For Greater Classified Profits
why not try the new combination classified ad medium**

Your classified ad will appear in **SCIENCE & MECHANICS MAGAZINE** as well as in a minimum of four other **SCIENCE & MECHANICS PUBLICATIONS**. Write now for information to C. D. Wilson, Manager, Classified Advertising, **SCIENCE & MECHANICS**, 229 Park Avenue South, New York, N. Y. 10003.

**Build it,
Program it,
Forget it!**

**Our
SUPERMATIC T/S SYNCHRONIZER**

No doubt about it . . . there's an art to making home slide shows interesting! Of course, a little science can also help, which explains why we've designed this unique two-way slide synchronizer circuit. Like any other synchronizer, it links your tape recorder with your slide projector, automatically advancing the slides in step with a taped narration. But unlike any other unit, it will also reverse the slides. The only requirement is that your projector be equipped with a two-way (forwards and back-

**gives with
the
greatest
slide shows
you
ever saw!**

By **RON MICHAELS**

wards) hand-held remote control unit.

Backwards slide selection sounds nutty until you think about it. When you do, you'll have no trouble imagining the various visual special effects you can achieve by cycling your projector backwards as well as forwards.

The synchronizer circuit will work with any stereo tape recorder. One channel contains the taped narration; the other channel contains the electronic control signals that auto-

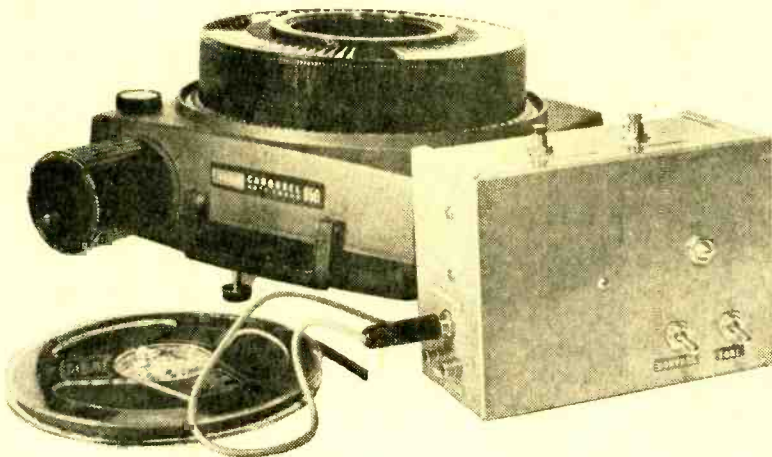

SUPERMATIC T/S SYNCHRONIZER

Circuit of Supermatic T/S Synchronizer. Though Synchronizer will work with any stereo tape recorder, it's ideally suited for those with preamp outputs.

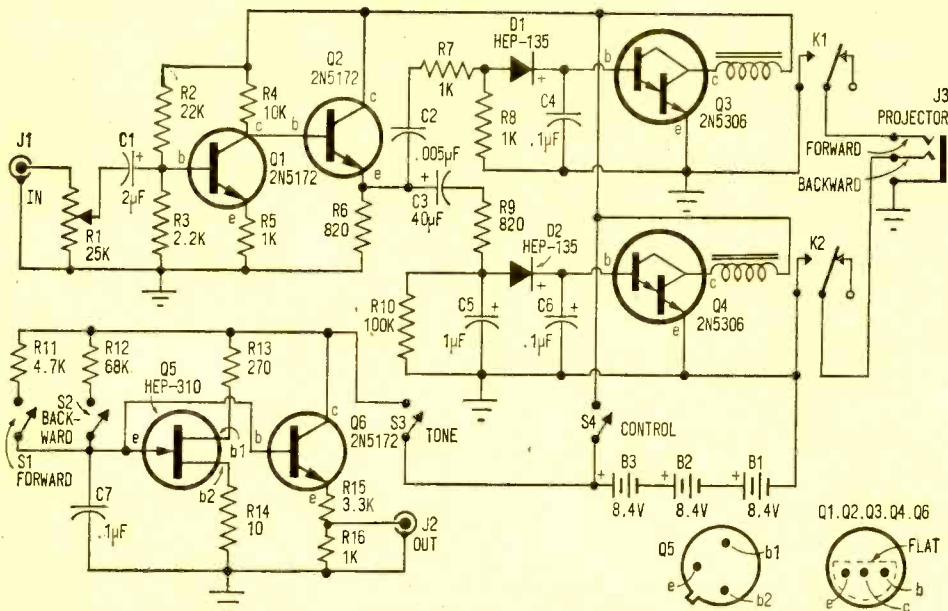

matically cycle the projector via the synchronizer circuit.

How It Works. The circuit consists of two independent tone-operated relay circuits. One (built around transistor Q3) responds to a tone of 1000 Hz (this cycles the projector one slide forward); the other (built around transistor Q4) responds to a tone of 100 Hz (this cycles the projector one slide backwards). Each of these circuits is made up of a frequency-selective filter network and a relay driver/amplifier transistor (actually a dual transistor mounted inside a single case).

Both circuits are driven by a two-transistor tone amplifier stage formed by transistors Q1 and Q2.

In operation, the circuit monitors the output of the "control" channel—it can be either left or right—of the recorder. When it "hears" either a high- or low-frequency tone, the appropriate relay closes and activates the changer mechanism in the projector.

Where do the tones come from? You

place them on the control channel at the same time you record the narration on the other channel. To do so, you simply activate the two-frequency tone generator built into the circuit. This generator consists of uni-junction transistor Q5 (which is wired in a relaxation oscillator circuit) and output transistor Q6. By pushing either one of the two pushbutton switches (S1 or S2), you generate either the high- or low-frequency tone. The generator has its own power switch (S3), since it is not used when the control circuit is working, and vice versa.

The circuit will work best with a tape recorder that has a preamplifier output jack. This way, the preamp output signal of the control channel can be fed directly to the synchronizer circuit. Though the circuit will work with the input connected (via a shielded lead) across the speaker terminals of a tape recorder's power amplifier, the volume control usually must be turned up rather high in such cases. Further, the control signals themselves will be audible. Therefore, if possible, it's best to disconnect

PARTS LIST FOR SUPERMATIC T/S SYNCHRONIZER

- B1, B2, B3—8.4-V mercury battery (Mallory TR146X, Burgess H-146 or equiv.)
 C1—2- μ F, 15-VDC electrolytic capacitor
 C2—.005- μ F, 15-VDC disc capacitor
 C3—40- μ F, 15-VDC electrolytic capacitor
 C4, C6, C7—.1- μ F, 100-VDC paper capacitor
 C5—1- μ F, 15-VDC electrolytic capacitor
 D1, D2—Silicon diode (Motorola HEP-135 or equiv.)
 J1, J2—Phono jack
 J3—Two-circuit audio jack
 K1, K2—Spdt general-purpose relay; 2500-ohm coil, 7 mA pull-in current (Ohmite GPRX-82T or equiv.)
 Q1, Q2, Q6—Silicon transistor (GE 2N5172)
 Q3, Q4—Darlington transistor (GE 2N5306)
 Q5—Unijunction transistor (Motorola HEP-310)
 R1—25,000-ohm, linear-taper potentiometer
 R2—22,000-ohm, $\frac{1}{2}$ -watt resistor
 R3—2200-ohm, $\frac{1}{2}$ -watt resistor
 R4—10,000-ohm, $\frac{1}{2}$ -watt resistor
 R5, R7, R8, R16—1000-ohm, $\frac{1}{2}$ -watt resistor
 R6, R9—820-ohm, $\frac{1}{2}$ -watt resistor
 R10—100,000-ohm, $\frac{1}{2}$ -watt resistor
 R11—4700-ohm, $\frac{1}{2}$ -watt resistor
 R12—68,000-ohm, $\frac{1}{2}$ -watt resistor
 R13—270-ohm, $\frac{1}{2}$ -watt resistor
 R14—10-ohm, $\frac{1}{2}$ -watt resistor
 R15—3300-ohm, $\frac{1}{2}$ -watt resistor
 S1, S2—Spst pushbutton switch
 S3, S4—Spst toggle switch
 Misc.—3 x 5 x 7-in. aluminum chassis box, perf board, push-in terminals, battery connectors, two-circuit plug for J3, angle bracket, wire, solder, hardware, etc.

box with room to spare. Note the parts placement as shown in our photos. All components (except the panel-mounted controls, relays, and jacks) are wired on a piece of perforated phenolic chassis board, using push-in terminals as soldering points.

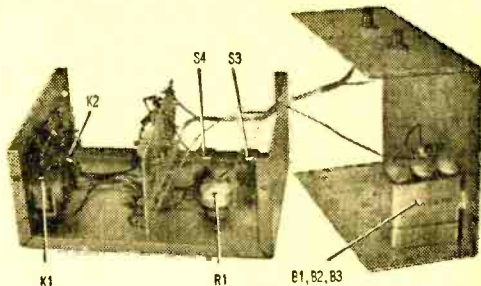

Three 8.4-V mercury batteries are taped together, then glued to bottom of case. Relays are positioned at one end of case; perf board in center; switches S3, S4, and potentiometer R1 at front.

Work carefully, and be sure to observe polarity when you mount the diodes and the electrolytic capacitors. And solder quickly, with a miniature-tipped iron when you mount the semiconductor components—these are easily damaged by excessive heat.

We chose a battery supply rather than AC-operation for two reasons:

1) The relatively low current drain makes battery power economical. A set of batteries should last through well over a year of slide shows.

2) The use of batteries simplifies hum pick-up problems and eliminates complex grounding requirements.

Note that you must use the 8.4-V mercury batteries called for in the Parts List.

If you wish, you can mount the batteries in individual holders. Considering their long service life, though, it's just as effective to tape the three batteries together into a single battery pack and cement it in place with a dab of contact cement. Use snap-on connectors to wire the batteries to the circuit. At replacement time, simply break loose the cement bead and install a new set.

The relay contact wiring shown in the diagram will control Kodak *Carousel* projectors as well as others using a three-wire control system. Essentially, the mechanism cycles forwards or 'backwards' when either the forward or backward (i.e., reverse) control wire is connected—for a brief time—to a common control wire.

Easiest way to connect the device to your projector is to buy an extra hand-held control unit and cut off the hand-switch assem-

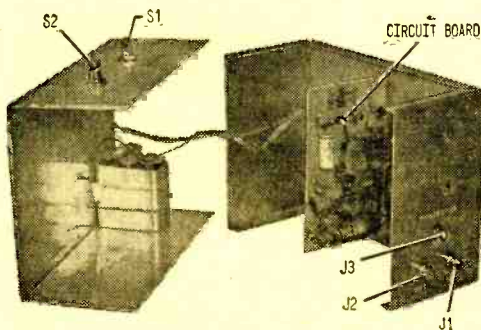

Entire unit is housed in 3 x 5 x 7-in. aluminum chassis box, with majority of components mounted on single perf board. Pushbutton switches S1 and S2 in tone generator are mounted on top of case.

the speaker and temporarily replace it with a dummy load resistor having approximately the same value as the speaker's nominal impedance (generally 4 ohms). Do *not* use this resistor if the circuit is connected to the preamp output.

Building It. The entire circuit can be housed in a 3 x 5 x 7-in. aluminum chassis

SUPERMATIC T/S SYNCHRONIZER

bly. Use an ohmmeter or continuity checker to determine which wire in the cable controls forward motion, which controls backwards motion, and which is the common. Do this by connecting the ohmmeter across different pairs of wires leading into the switch unit as you press the buttons.

Next, connect the cut end of the cable to a three-conductor (two-circuit) audio plug so the appropriate cables are routed to the appropriate relay contact terminals as indicated on the diagram.

Using It. To record the control signals, connect the device's output jack to either your recorder's mike or line input, for the channel you've chosen as control channel. Set the recorder's input gain control for this channel high enough so that the tones just overload the recorder (the distortion lamp comes on, or the vu meter reads in the yellow-red region, when you press either S3 or S4). Note: be sure to use shielded cable between recorder and synchronizer.

As you record the narration on the other channel, press either S1 or S2 to place a forward or reverse command on the tape, as desired. Hold the switches down for slightly longer than the time you would hold down the buttons on the hand-held control unit if

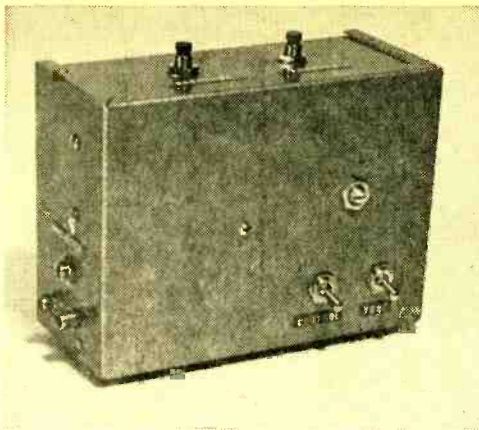

Completed Synchronizer, ready for connection to tape recorder and slide projector. Control immediately above two switches on front is R1; note that author used screwdriver-adjust model.

you were working the projector yourself.

To control the projector, connect the synchronizer's jack to the control channel's output (as described above), and plug the projector's control cable into the three-conductor panel-mounted jack, J3.

Incidentally, input control R1 is provided for use with tape machines that don't have output level controls. If your machine has one, simply set R1 for maximum resistance (minimum attenuation) and bring up the output level until the circuit activates the projector reliably. If the machine doesn't have an output control, set R1 to minimum resistance and back off its setting until the synchronizer works properly. □

PLUG WITH FORKED TONGUE

● Polarize your hi-fi and test gear to be sure they're properly grounded. The ground slot on an AC outlet is wider than the other, so make the ground prong on the line cord plug wider, too! Just snip the ground prong with a heavy-duty cutter as shown—the prong will spread. But, be sure you have the ground prong before you snip! —L. Grant

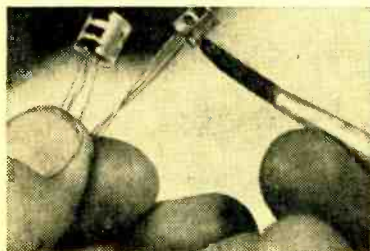
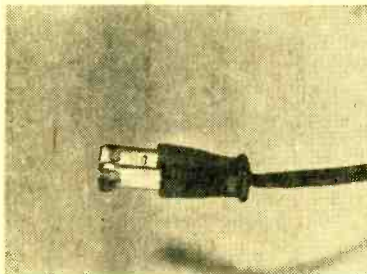

COLOR CODE YOUR TRANSISTORS

● A few drops of dope will let you identify transistors as you do resistors—the color code is the same. Use hobby-type dope or quick-dry enamel on the transistor case. A red dot on top means "2N". The next 3 or 4 colors give the numbers that follow the 2N prefix, like 2N1177.

—J. Lamb

High Power Crowd Getter

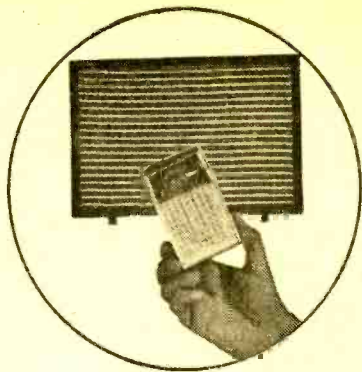

One transistor radio plus this IC booster
spell more bark in the beat

By Herb Friedman, W2ZLF/KB19457

☐ Pocket radios are everywhere. You get AM, FM, even SW coverage anywhere you wander. And the little box fits lickety-split into pocket, purse, beach bag, picnic basket, or what have you.

Trouble is, while transistor radios are getting smaller and smaller, the sound is often not what it should be. The mini levels provided by these transistor units are fine for small rooms and private listening. But try making the scene with the group, and you'll find they're just too pooped to pop.

Take on our Crowd Getter, however, and you can bet your surf parties will zoom like never before. This amplifier/speaker combo will raise any transistor's whisper to an ear-shattering blast that'll gather all the bees to the honey and make your party the success it should be.

Only One IC. The Crowd Getter is a complete booster amplifier housed in a commercially made remote-speaker cabinet (the speaker comes with the cabinet). The amplifier consists of a single IC (integrated circuit) which contains the preamp, driver, and power-output stages. The amplifier shown in our photos is powered by a 6-volt battery which provides about a 1/2-watt output—roughly equivalent to an old vacuum-tube table radio at full volume. If you substitute a 9-volt battery the sound will be substantially louder, though it might be difficult to

fit the larger battery into the speaker cabinet.

Both the IC-amplifier and the battery mount on the back panel of the speaker cabinet, making the Crowd Getter as portable as your transistor radio. In fact, you might even consider attaching a handle to the cabinet.

To use the Crowd Getter, simply connect a cord from the radio's earphone jack—thereby disabling the speaker—to phono jack J1. Volume must be controlled by the radio's volume control, since no control has been included in the amplifier.

Building The Bomb. While connections can be made directly to Q1's leads via flea-clip terminals, to avoid excessive heat from soldering, we suggest you use a transistor socket as shown. Note that though Q1 has 12 leads, a 10-pin socket is used. A 12-pin socket is not only difficult to obtain, it is also expensive. On the other hand, a low-cost 10-pin socket is available in Motorola's HEP line of components. And if you follow our layout, construction will actually be easier using the 10-pin socket.

First step is to remove the back cover of the speaker enclosure and unsolder the speaker wires connected to phono jack J1 on the cover. Next, assemble the amplifier on a section of perf-board measuring approximately 2 x 3 in. Flea-clips or push-in terminals are tie points. *(Turn page)*

Hi-Power Crowd Getter

Drill a 5/16-in. hole for Q1's socket about 1/4 in. from one end of the perf-board. Note that the socket is *keyed* with a small point; the key should face the closer end of the

exactly one-half the total length of the remaining Q1 leads. Place the socket in the perf-board hole, then insert Q1 into the socket.

The Q1 lead directly opposite the case's key is 12. Looking at the bottom of Q1, the lead next to 12 in a clockwise direction is 1. On the socket, the pin opposite the key is 10. The next pin in a clockwise direction is 1.

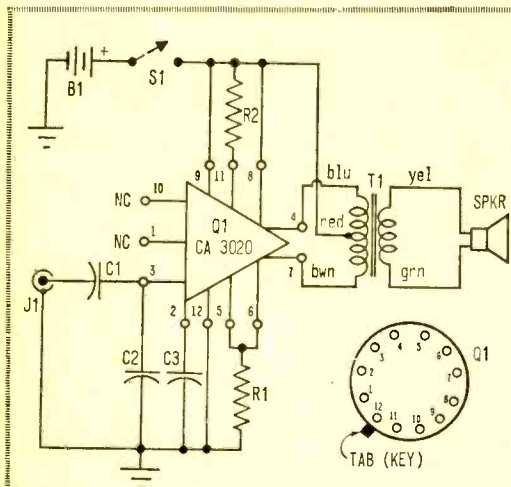

PARTS LIST FOR CROWD GETTER

- B1—6-volt battery (Burgess Z4 or equiv.)
 - C1—.1- μ F, 10-VDC capacitor
 - C2—.01- μ F, 10-VDC capacitor
 - C3—.22- or .25- μ F, 10-VDC capacitor
 - J1—Phono jack (supplied with speaker)
 - Q1—Integrated circuit (RCA CA3020)
 - R1—0.82- or 1-ohm, 1/2-watt resistor
 - R2—1000-ohm, 1/2-watt resistor
 - S1—Spst toggle switch
 - SP1—Speaker in enclosure (Lafayette 99H4550 or equiv.)
 - T1—Output transformer, 8 ohms (Lafayette 33H8571 or equiv.)
 - Misc.—Battery holder (Keystone #175 or equiv.), 10-pin socket for Q1 (Motorola), phono plug, plug for earphone jack, patch cord, perf-board, push-in terminals, wire, solder, hardware, etc.
- Note—A kit (#IC-5) containing the CA3020 and 10-pin socket is available from Custom Components, Box 352, Alden Manor, Elmont, N.Y. 11003. Price is \$4.50, including postage and handling.

Integrated circuit is from RCA. While IC has 12 leads, a 10-pin socket is used for economy. Leads 11 and 12 are bent out from case, so remaining leads align with socket terminals.

perf-board. Bend leads 11 and 12 of Q1 straight out from the case—at right angles to all the other leads. Make certain leads 11 and 12 don't touch Q1's case. Now cut off

This might sound somewhat complicated, but it's not. When Q1's 10 lead is lined up with the socket's 10 pin, all of Q1's leads will fall into line. Just take an extra moment or so

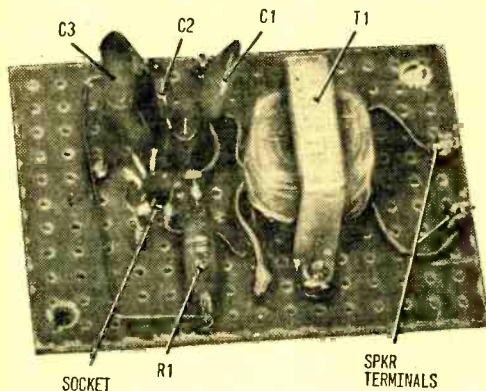

Most components mount on top of perf-board and should be tack-soldered to Q1's socket. Do not attempt to wrap the leads as a socket terminal might become shorted. Leads 1 to 10 of Q1 are cut to about half length.

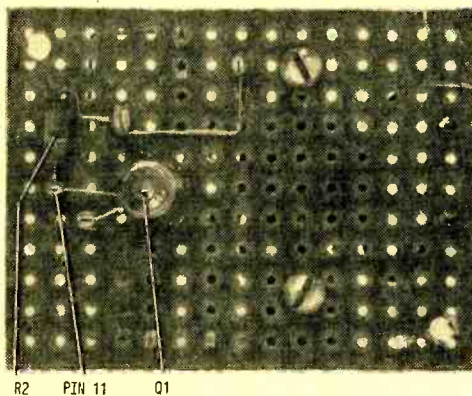

Q2 (IC) and R2 are mounted on bottom of perf-board assembly. Leads 11 and 12 of Q1 are brought out at right angles to case. They are about 1/2 in. long in order to prevent heat damage to unit while soldering.

to check Q1's installation, because you won't get a second chance if you make an error.

Press Q1 down firmly into the socket, then cement the socket to the perf-board using ordinary hobby or household cement. Don't cement the socket before Q1 is installed, for just a drop of cement in a pin will make the socket useless.

Mount transformer T1 on the socket terminal side of the board, as shown in photo. Position T1 about 1 to 1½ in. from Q1, then install the remaining components. All connections to Q1's socket are *tack-soldered*; don't try to wrap wires around the socket's terminals.

Installation. Install the amplifier on the back cover so the input terminals are in line with phono jack J1. To avoid crushing Q1 on the underside of the perf-board, use a ½- or ¾-in. spacer between the amplifier and the cover at each mounting screw.

Install power switch S1 near the amplifier. It can be installed in any of the ⅜-in. holes pre-drilled in the cover. Finally, install bat-

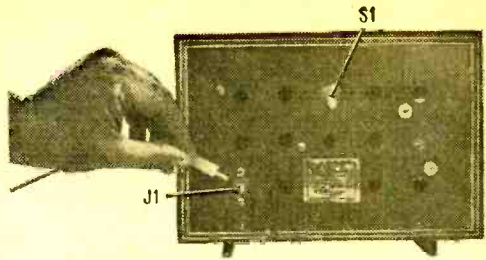

Connect shielded patch cord between transistor radio's earphone jack and J1. S1 turns on power, but volume is controlled by radio.

A heat sink is not needed for a 6-volt power source.

To finish up, connect the speaker wires to T1's secondary terminals, route the leads away from the amplifier's input connections, then install the speaker enclosure's back cover. Your Crowd Getter is now ready for use.

A Final Note. Make up a patch cord with a phono plug on one end and a plug

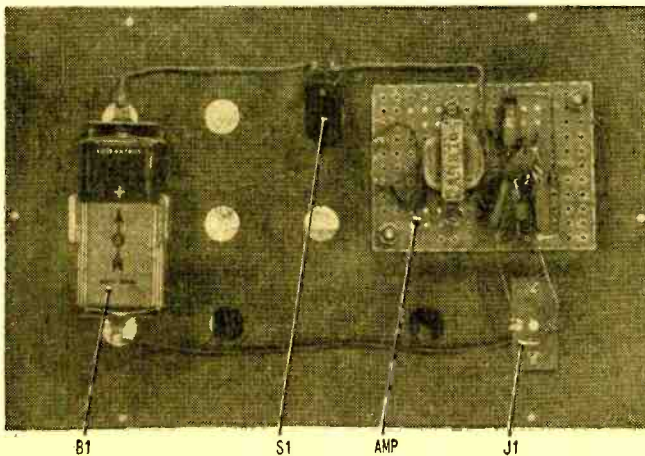

Amplifier, power switch (S1), and battery holder are mounted on back cover of speaker enclosure. Phono jack (J1) is supplied with speaker. Make sure perf-board is mounted on cover with either ½- or ¾-in. spacers so that case of Q1 will not be damaged.

tery holder for B1. Though B1 is a 6-volt battery, it will fit a standard D-cell holder such as the Keytone #175. For slightly higher power output a 9-volt battery can be substituted, though it must be rated for at least 100 mA. Don't use a transistor radio 9-volt battery like the 2U6. The 2U6 won't last more than a couple of hours.

Warning. Q1's supply voltage must not exceed 9 volts. To avoid damage, mount a heat sink on Q1 when using a 9-volt battery.

on the other that matches the earphone jack of the transistor radio. Then connect the radio. Turn on the amplifier and turn on radio. Adjust the radio's volume control for the desired level. Do *not* turn on the radio first and then patch it into the booster, as the Crowd Getter requires only a very minute input level (patching in the radio when the volume is up might damage Q1).

So there you are. Have fun, and good listening! ■

**Someone
should develop
an easy way
to learn
electronics at
home**

**RCA Institutes
did!**

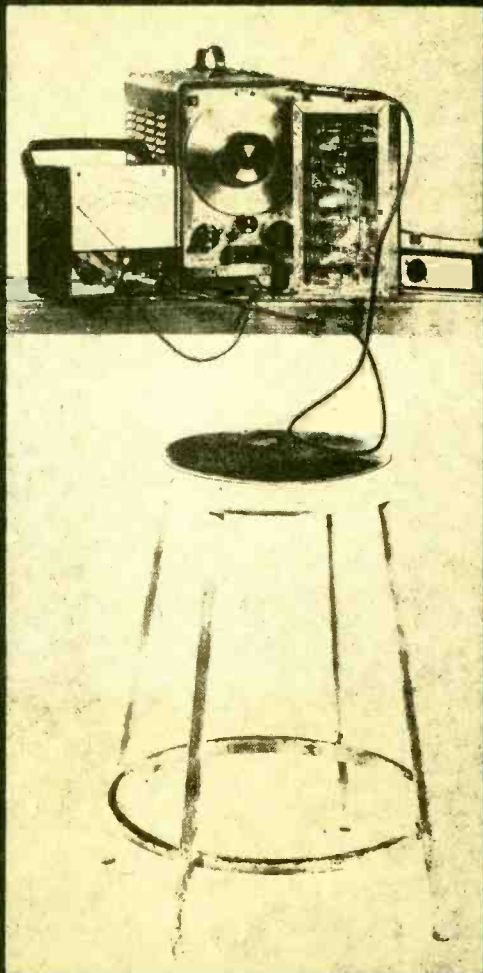

Here is a whole new approach to learning electronics at home! RCA Institutes, one of the nation's largest schools devoted to electronics, has developed a faster, easier way for you to gain the skills and the knowledge you need for the career of your choice. Here for the first time is a student-proved, scientifically designed way to learn. If you have had any doubts in the past about home training in electronics—if you have hesitated because you thought you might not be able to keep up—or that electronics was too complicated to learn—here is your answer! Read how RCA Institutes has revolutionized its home training ideas!

**NEW CAREER PROGRAMS
BEGIN WITH "AUTOTEXT"
INSTRUCTION METHOD!**

**Start to learn the field of your
choice immediately!
No previous training or
experience in electronics
needed!**

With this new revolutionized method of home training you pick the career of your choice—and RCA Institutes trains you for it. RCA's Career Programs assure you that everything you learn will help you go directly to the field that you have chosen! No wasted time learning things you'll never use on the job! The Career Program you choose is especially designed to get you into that career in the fastest, easiest possible way!

And each Career Program starts with the amazing "AUTOTEXT" Programmed Instruction Method—the new, faster way to learn that's almost automatic! "AUTOTEXT" helps even those who have had trouble with conventional home training methods in the past. This is the "Space Age" way to learn everything you need to know with the least amount of time and effort.

CHOOSE A CAREER PROGRAM NOW

Your next stop may be the job of your choice. Each one of these RCA Institutes Career Programs is a complete unit. It contains the know-how you need to step into a profitable career. Here are the names of the programs and the kinds of jobs they train you for. Which one is for you?

Television Servicing. Prepares you for a career as a TV Technician/Serviceman; Master Antenna Systems Technician; TV Laboratory Technician; Educational TV Technician.

FCC License Preparation. For those who want to become TV Station Engineers, Communications Laboratory Technicians, or Field Engineers.

Automation Electronics. Gets you ready to be an Automation Electronics Technician; Manufacturer's Representative; Industrial Electronics Technician.

Automatic Controls. Prepares you to be an Automatic Controls Electronics Technician; Industrial Laboratory

Technician; Maintenance Technician; Field Engineer.

Digital Techniques. For a career as a Digital Techniques Electronics Technician; Industrial Electronics Technician; Industrial Laboratory Technician.

Telecommunications. For a job as TV Station Engineer, Mobile Communications Technician, Marine Radio Technician.

Industrial Electronics. For jobs as Industrial Electronics Technicians; Field Engineers; Maintenance Technicians; Industrial Laboratory Technicians.

Nuclear Instrumentation. For those who want careers as Nuclear Instrumentation Electronics Technicians; Industrial Laboratory Technicians; Industrial Electronics Technicians.

Solid State Electronics. Become a specialist in the Semiconductor Field.

Electronics Drafting. Junior Draftsman, Junior Technical Illustrator; Parts Inspector; Design Draftsman Trainee Chartist.

SEPARATE COURSES

In addition, in order to meet specific needs, RCA Institutes offers a wide variety of separate courses which may be taken independently of the Career Programs, on all subjects from Electronics Fundamentals to Computer Programming. Complete information will be sent with your other materials.

2 CONVENIENT PAYMENT PLANS

RCA Institutes offers a unique tuition plan that lets you progress at your own pace. You only pay for lessons as you order them. You don't sign a contract obligating you to continue the course. There's no large down-payment to lose if you decide not to continue.

However, if you desire, RCA Institutes also offers a convenient monthly payment plan.

VALUABLE EQUIPMENT

You receive valuable equipment to

keep and use on the job—and you never have to take apart one piece to build another.

New—Programmed Electronics Breadboard. You now will receive a scientifically programmed electronic breadboard with your study material. This breadboard provides limitless experimentation with basic electrical and electronic circuits involving vacuum tubes and transistors and includes the construction of a working signal generator and superheterodyne AM Receiver.

Multimeter and Oscilloscope Kits At No Additional Cost. You will receive with most RCA Institutes Career Programs the instruments and kit material you need to build a Multimeter and Oscilloscope. The inclusion of both these kits is an RCA extra.

**CLASSROOM TRAINING
ALSO AVAILABLE**

RCA Institutes maintains one of the largest schools of its kind in New York City where classroom and laboratory training is available in day or evening sessions. You may be admitted without any previous technical training; preparatory courses are available if you haven't completed high school. Coeducational classes start four times a year.

JOB PLACEMENT SERVICE, TOO!

Companies like IBM, Bell Telephone Labs, GE, RCA, Xerox, Honeywell, Grumman, Westinghouse, and major Radio and TV Networks have regularly employed graduates through RCA Institutes' own placement service.

**SEND ATTACHED POSTAGE PAID CARD
FOR COMPLETE INFORMATION, NO
OBLIGATION.**

All RCA Institutes courses and programs are approved for veterans under the new G.I. Bill.

Accredited Member
National Home Study Council

IF REPLY CARD IS DETACHED—SEND THIS COUPON TODAY

RCA INSTITUTES, Inc., Dept. EZQ-19
320 West 31st Street, N.Y., N.Y. 10001

Please rush me FREE illustrated catalog. I understand that I am under no obligation.

Name _____ Age _____
(please print)

Address _____

City _____

State _____ Zip _____



SUPER SNOOP

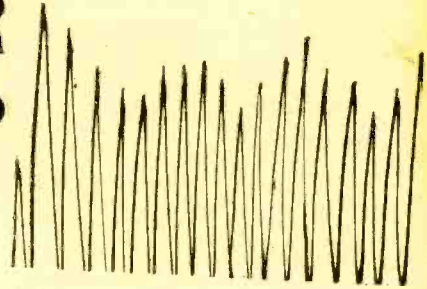

Great gadget ferrets out those hidden sounds of impending disaster in your ailing buggy.

By Alexander Prokop

Are you a perfectionist? One of those guys that practically goes around the bend if your car has a well-concealed clatter, squeak, or rumble? Have you tried in vain to ferret out a little sound that to your sensitive ear bespeaks impending doom, only to find that neither you nor your local mechanical genius can put a finger on the buggy's hangup? Well, take heart, for the author understands, sympathizes, and has for you an answer to the source of your trepidations; a goody that'll check your transmission at 80 mph or your generator bearings at 30. It can tell you if your clutch is slipping on those five-G take-offs, or locate the source of a mysterious thump, clunk, squeak or rattle. Sound like the Super Snoop is for you? Well, read on, MacDuff.

Heart Of Super Snoop. The heart of the little beastie is a crystal transducer originally designed as a mouth-organ pickup. This pickup was found to be highly sensitive to vibrations of all sorts. As shown in the photos, the pickup is attached with a clamp

to the part or area you want to check out.

By virtue of picking up sounds only from the item to which it's attached, Super Snoop will tell you what's going on there without confusing you with extraneous noise. This selective pickup allows you to easily localize the source of the problem. Combined with a little training of the ear, the heap can be given a complete physical in a matter of a dozen or two minutes.

Pickup Construction. The first step in making Super Snoop is to visit your local hardware store and purchase a C-clamp as pictured in the photos. Most stores carry the bar handle type; however, if you can find one whose clamp screw and handle are one solid piece your task is simplified.

Now drill a hole as indicated with a No. 29 or .136 drill through the clamp and tap a (8-32) thread for the crystal mount. Next, if you have bar handle type clamp, wrap electrical tape around the handle so that it can't wiggle and generate extraneous noise in your pickup to confound your ear.

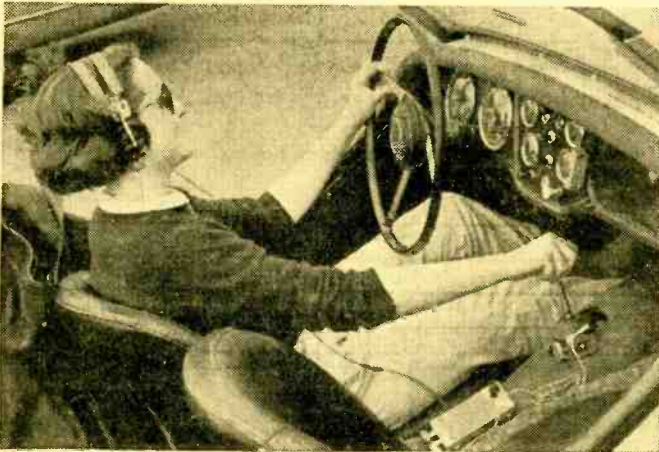

The young lady is checking out her sports-car's transmission with the aid of Super Snoop. Here the transducer is attached right next to the gearshift lever with the C-clamp mount.

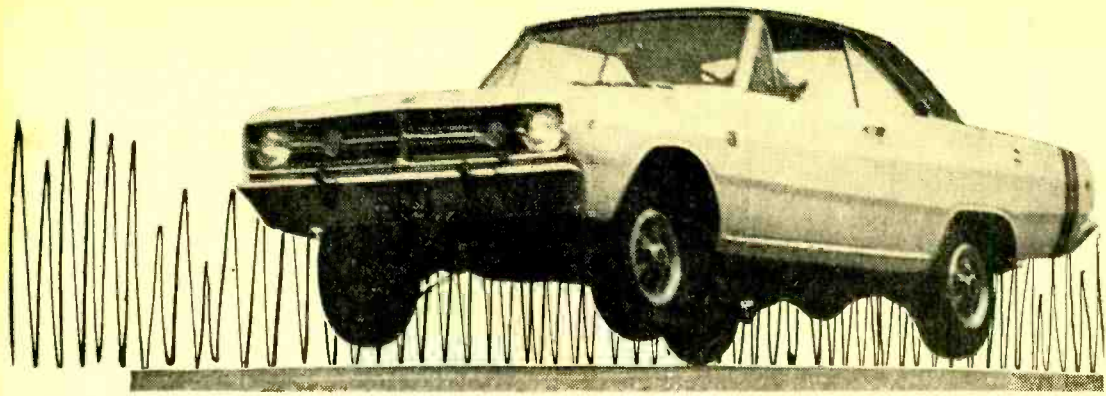

Add an 8-32 screw with a washer and the clamp is completed. The crystal transducer can be fastened to the clamp at any time with a screwdriver to complete the pickup. While the pickup is of a sturdy nature, care to prevent mechanical and water damage should be observed as with any sensitive device.

Amplifier—Buy Or Make. Construction of the amplifier should pose no problem as parts layout is not critical and requires no shielding other than the pickup cable.

For the softy who doesn't feel up to making his own amplifier, there are several ready-made, high-gain amplifier modules on the market that are ready to go with the addition of a battery, such as Radio Shack's Super High Gain Amp # 277-251. The amplifier will get knocked around a good deal and placing it in a firm plastic box with padding will insure trouble-free operation for years to come.

If you decide to build your own, the layout shown may be altered as box dimensions

demand. Use transistor sockets if you can, and take care to observe polarities on the electrolytic capacitors (C1, C2, C3) when wiring. When perf-board wiring is completed, install it in the plastic box, wire in the phono sockets, volume control, and switch. Then, power the rig with two 9-volt transistor radio batteries in series, and place a voltmeter from ground (B-) to the test point in the schematic diagram. Turn on the amplifier, and adjust potentiometer R8 for a reading of 2 volts on the voltmeter. This completes the only adjustment necessary.

Resistor R2 and capacitor C5 comprise a tone control which has been fixed for a nearly flat response to 15 kHz. By lowering the value of R2, the response will eliminate the higher frequencies. The entire sound spectrum is equally informative over the amplifier's range and a flat response is normally most desirable in tracking down and identifying sources of noise in autos and other applications.

Finally, splice eight feet of shielded cable

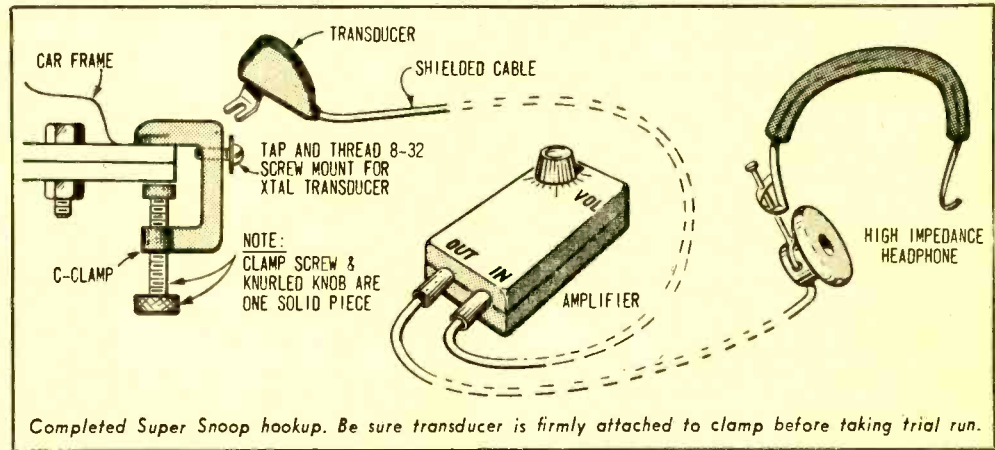

Completed Super Snoop hookup. Be sure transducer is firmly attached to clamp before taking trial run.

Super Snoop

to that extending from the crystal pickup for a total of about 12 feet. Solder on a phone jack and plug into the amplifier's input, add a pair of 500-ohm phones and Super Snoop is ready for some super snooping.

Case History. Perhaps an actual application will best serve as an illustration. Re-

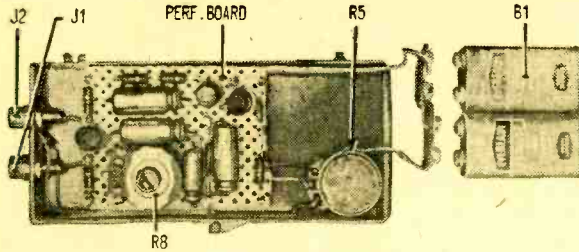

Perf-board construction of Super Snoop's amplifier speeds assembly and simplifies layout. Parts arrangement isn't critical and can be modified to suit individual preference.

cently, a '59 Buick Le Sabre produced a deep rumbling sound from under the floor when accelerating but otherwise ran quietly. The first suspect was the transmission. Placing the C-clamp pickup on the immediate frame supporting the transmission, the subsequent test run revealed the rumble heard inside to

be a sharp ringing sound, not unlike the banging of a thin metal tube, distinctly different from the soft whine of the transmission.

The transmission was cleared of suspicion but what about the noise? A careful inspection revealed a dent in the exhaust pipe next to the transmission. The pipe was moved away as far as possible and the car was taken on a second run. The rumble was gone and with it all the worries.

Auto Diagnosis. A good trackdown pro-

cedure is to place the pickup on the frame near a suspected noise to obtain a better idea of its position after analyzing its sound.

Repeat this process until the offending part is identified. With a little practice and careful interpretation, Super Snoop will
(Continued on page 109)

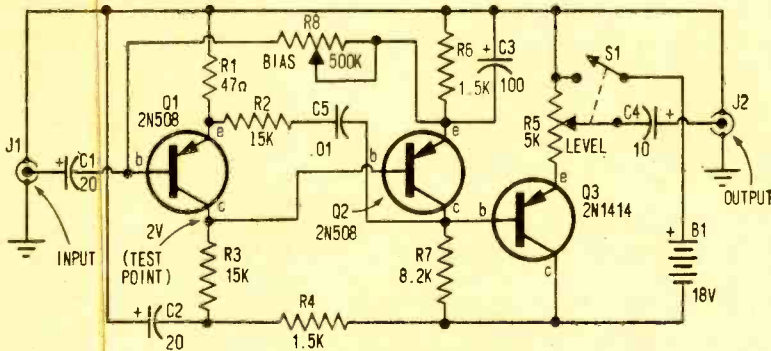

Schematic of Super Snoop amplifier. R8 is used to set bias level of Q1 for maximum linear gain.

PARTS LIST

- | | |
|--|--|
| B1—9-volt transistor batteries, two in series (Eveready 216 or equiv.) | R5—5000-ohm potentiometer (with S1 attached) |
| C1, C2—20uF, 20-VDC miniature electrolytic capacitor | R7—8200-ohm, 1/2-watt resistor |
| C3—100-uF, 20-VDC miniature electrolytic capacitor | R8—500,000-ohm potentiometer |
| C4—10-uF, 15-VDC miniature electrolytic capacitor | S1—Switch mounted on R5 |
| C5—.01-uF, disc capacitor | Q1, Q2—2N508 transistors |
| J1, J2—Phono jacks, RCA type | Q3—2N1414 transistor |
| R1—47-ohm, 1/2-watt resistor | X1—Crystal transducer, "harmonica mike" (Radio Shack 33-115 or equiv.) |
| R2, R3—15,000-ohm, 1/2-watt resistors | |
| R4, R6—1500-ohm, 1/2-watt resistor | |
- Misc.—3-in. C-clamp, transistor sockets, perf-board, 8-ft. shielded cable, pastic box, wire, solder, etc.

Gold Grabber

By Charles Green, W6FFQ

There may be ore on that shore,
so build our treasure tracker
and take a sec to know for sure

■ Has your girl ever complained about a lost earring just as you're about to leave the beach and make your way home? Have the kids ever buried their favorite pail under inches of what looks like a murky quicksand?

Well, now for the first time, ELECTRONICS HOBBYIST has come up with a metal locator that'll help you solve problems like these. And it'll throw some fun and fortune into the bargain as well. For
(Continued overleaf)

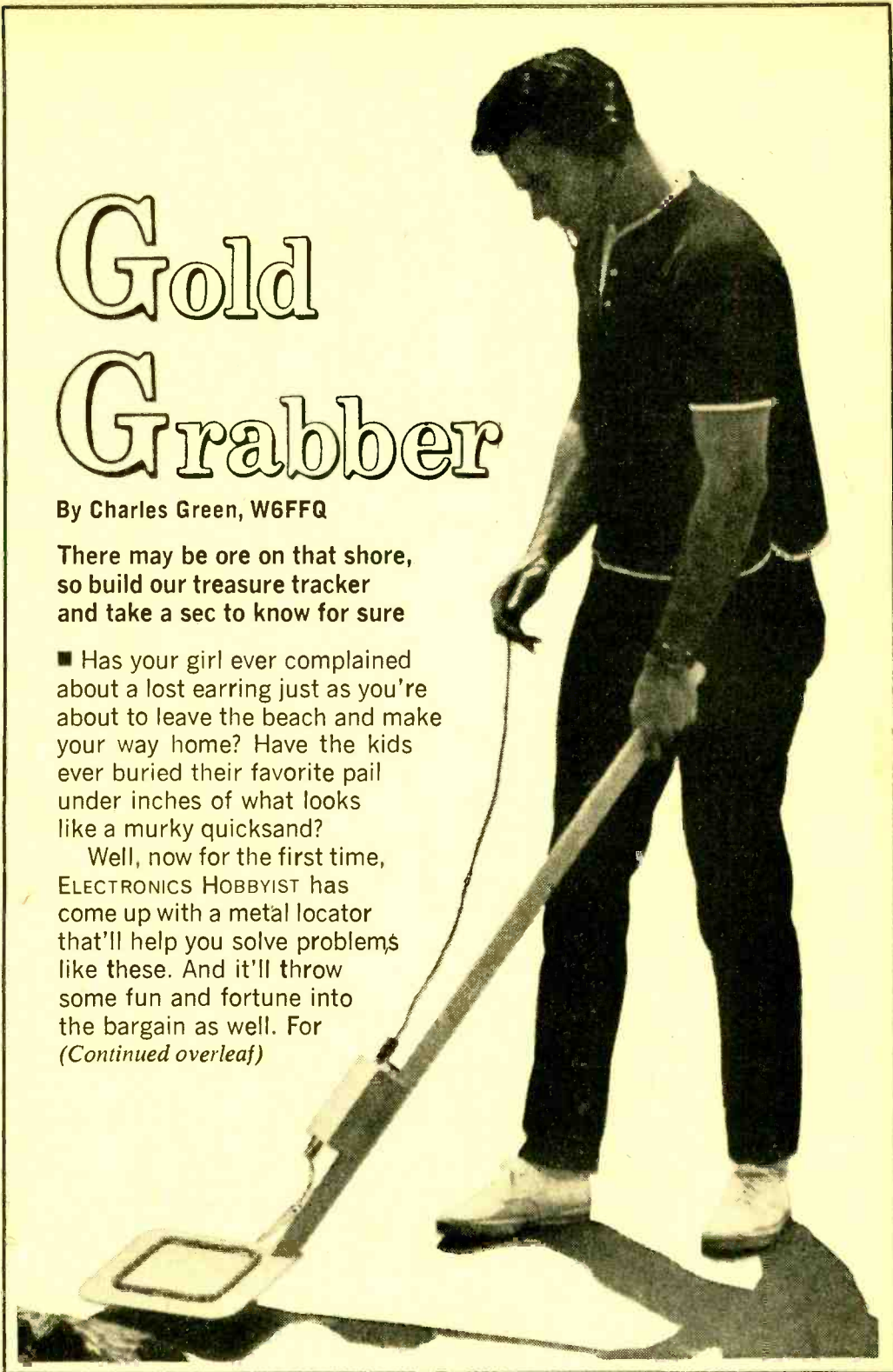

Gold Grabber

whether it's minor disasters like the ones mentioned, or just a natural lust to go out adventuring. Gold Grabber will keep you busy like nothing you've ever seen.

Pieces of Eight. Lucky folks down in the Caribbean or in the California and Central America areas can go looking for the gold coins and relics which abound on some of the exotic beaches and landscapes. And the battlefields of Civil War fame are hunting grounds that should keep any buff busy for days on end.

You can also use Gold Grabber to find buried cables and conduits; to make up games for the youngsters so they can have fun looking for hidden objects; or just to help out a friend in need of a metal locator. In fact, every reader will be able to come up with countless ideas that'll increase the value of his instrument a thousandfold.

Easy Operation. Gold Grabber consists of a search loop and locator unit mounted on a wooden handle. Since the locator unit is all-solid-state and powered by a mercury

battery, it is light enough to permit easy operation as a search tool. (As you can see from the photos, there are two versions of Gold Grabber—one jazzed up by the editors, and one constructed by the author. You choose the one best for you. But stay away from ferrous material! Brass screws will do, but epoxy glue would be best.)

Most metal locators are complex to build, but Gold Grabber has a simplified design that makes for easy construction. The simplified circuit, of course, is not designed for great depth penetration in the earth. But metallic objects lying close to the surface should be no problem.

Two FETs (field-effect transistors) and a conventional transistor are used in an RF beat-frequency, metal-detector circuit which does not require any complex test equipment for initial adjustment.

The Circuit. Q1 (an n-type FET) is connected to L1 and C1 in a Hartley oscillator circuit operating at a frequency of approximately 500 kHz. The source electrode of Q1 is connected to a tap on L1 to obtain the RF feedback needed in this circuit. The C2/R1 combo form the gate-leak self-bias for Q1.

Layout shown below allows plenty of space for components. Check clearance of pot R6, and make sure that green index dot of L2 shows on top of coil. Parts must be anchored securely.

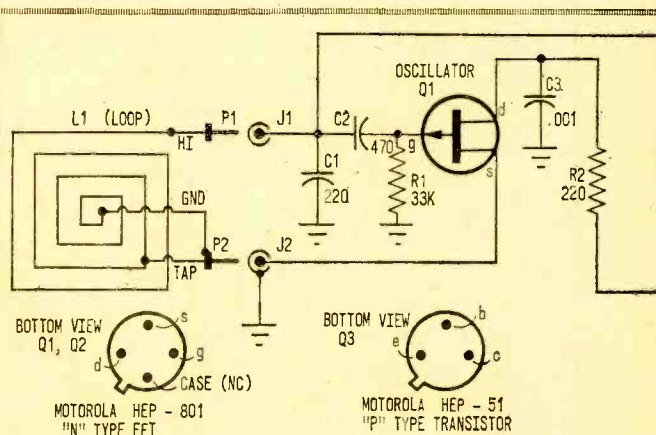
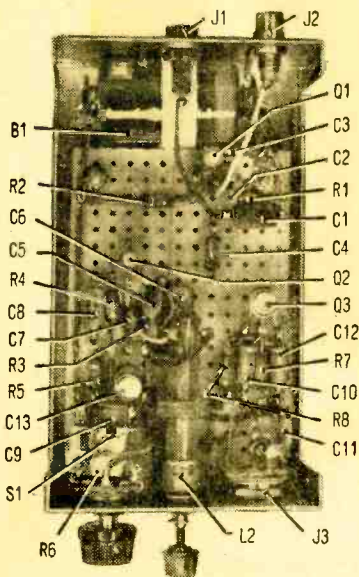

- B1—8.4-V mercury battery (Mallory TR-286 or equiv.)
- C1—220-pF mica capacitor
- C2, C3, C7—470-pF, 50-V disc ceramic capacitor
- C4—10-pF, 50-V tubular ceramic capacitor
- C6—470-pF mica capacitor
- C8, C5, C10, C12—5-uF, 15-V electrolytic capacitor
- C9, C11—.005-uF, 50-V disc ceramic capacitor
- C13—10-uF, 15-V electrolytic capacitor
- J1—phone pin jack

L1 is an external loop which radiates the oscillator RF energy. A small portion of this RF is coupled via C4 to the oscillating detector circuit of Q2. Note that Q2 is connected in a Hartley circuit similar to Q1, except that the gate leak is much larger, and the detected output is taken from the drain electrode.

Resonant circuit L2/C6 is tuned to a frequency very close to the operating frequency of the Q1 oscillator, thereby producing an audio beat-note signal from detector Q1. This audio signal is coupled through C8 and low-pass filter R5/C9 to volume control R6. The audio signal from R6 is amplified by the circuit of Q3 and direct-coupled to J3 and a pair of external 2000-ohm earphones.

When RF energy radiated from external loop L1 is absorbed by a nearby metallic conducting surface, the Q1 oscillator circuit changes its frequency. This change in frequency also changes the beat-note frequency of the Q2 detector circuit, thereby changing the frequency of the audio signal heard in the earphones.

On Your Way. The Gold Grabber has two major assemblies: the external loop, and the oscillator/amplifier mounted in a 5¼ x

3x2⅞-in. aluminum box. We'll start with the locator unit in the box.

Best way to begin construction is to install two 1¼-in. machine screws spaced two inches apart and centered on the long side of the box. The screws extend out from the bottom of the box and are used to mount the box to the loop assembly. Use serrated washers with the nuts to prevent any movement.

Cut a section of perforated wiring board to approximately 2⅝x4 in. and mount it as shown in the photo with machine screws and nuts. Position it ⅜ in. above the box bottom. Install two ground lugs as shown in the photo, and use serrated washers as required.

Mount the components on the sides of the box as shown, using washers to prevent movement. Position R6 to stay clear of the top cover and mounting screws. Battery B1 is fastened to the side of the box with a tape-covered aluminum strap. Position L2 so that its green index dot is on top of the coil.

Insert the push-in terminals, and mount the parts on the wiring board as shown in the photo. Make your connections with short, stiff leads to prevent movement. There

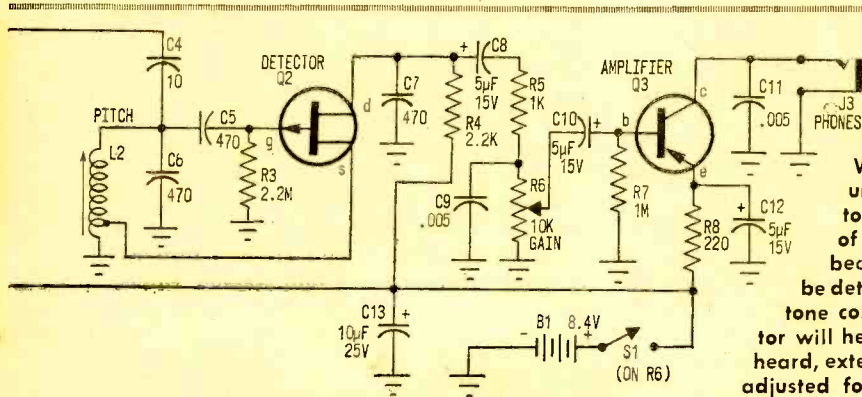

When working with units, it's important to adjust tuning slug of L2 so that change in beat-note frequency can be detected quickly. Audio tone comfortable for operator will help. If beat note isn't heard, external loop L1 must be adjusted for correct frequency.

PARTS LIST FOR GOLD GRABBER

- J2—Phono jack
- J3—phone jack
- L1—Loop (see text)
- L2—Tapped oscillator coil (Miller X-5496-C or equiv.)
- P1—Phone tip plug
- P2—Phono plug
- Q1, Q2—HEP-801 FET (Motorola)
- Q3—Pnp-HEP-51 pnp transistor (Motorola)
- R1—33,000-ohm, ½-watt resistor
- R2, R8—220-ohm, ½-watt resistor
- R3—2,200,000-ohm, ½-watt resistor
- R4—2200-ohm, ½-watt resistor

- R5—1000-ohm, ½-watt resistor
- R6—10,000-ohm, audio taper potentiometer (with S1)
- R7—1,000,000-ohm, ½-watt resistor
- S1—5pst switch (part of R6)
- 1—5¼x3x2⅞-in. aluminum box (LMB-780 or equiv.)
- Misc.—⅛-in. masonite, ⅞-in. OD aluminum tubing, ¼-in. wooden dowel, #22 plastic-insulated hook-up wire, hardware, perf board and push-in terminals, knob to fit L2 tuning screw (optional) and knob for R6, 2000-ohm earphones, wire, solder, etc.

Gold Grabber

is no electrical connection to the case leads of Q1 or Q2, but the leads should be connected to push-in terminals to help support the FETs. Make sure that all parts and wiring are anchored down, or performance of the Gold Grabber will be affected. Use spaghetti over the leads of Q1, Q2, and Q3 to prevent shorts.

Looping The Loop. Fasten four nails in a 6-in. square of a piece of scrap wood. The nails should protrude approximately 1 in. Wind 10 turns of #22 plastic-covered wire (Belden 8530 or equiv.) around the square, and connect a length of wire at this point for the tap. Continue winding until there are 25 turns forming the square loop.

Carefully remove the nails and wire loop from the scrap, tape the corners of the loop with plastic tape, and connect a length of wire to the start of the loop (ground end). This done, wrap it tightly around one-half of the loop spaced approximately in $\frac{1}{4}$ -in. turns. Tape the end to the loop. Then connect another length of wire to the ground end of the loop and wind it around the remaining side of the loop in the same way. Tape the end to the loop, making sure it does not short to the other length of wire.

Cut the three-loop leads to approximately 5 in. and connect them to P1 and P2 as shown in the schematic. Twist the leads of P2 together. Make sure the loop is firm, but use tape sparingly to hold it together.

Now cut a 10-in. square of tempered $\frac{1}{8}$ -in. hardboard and round the corners as shown in the photo. Center the loop on the board, and mark hole locations about an

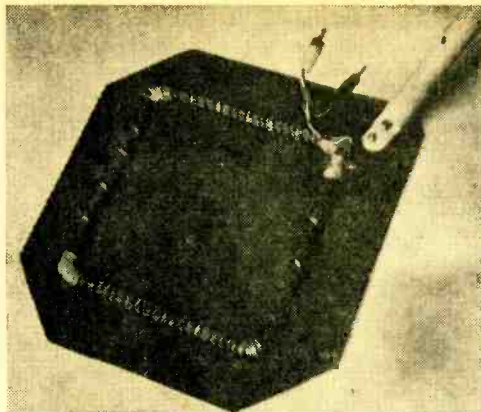

Loop should first be constructed on a piece of scrap wood, with three connections for Hi, Tap, and Gnd. Two wires from ground lead are wrapped around opposite sides of loop.

inch apart on both sides of the loop. Drill the holes and lace the loop onto the board with insulated tubing or fish line. Make sure the loop is tightly secured.

Hold On Tight. Cut one end of a 15-in. length of $\frac{3}{4}$ -in. wood dowel at a 45-deg angle and fasten it to the end of the loop board with two machine screws and nuts (brass screws are a must).

Mount the aluminum box on the wood dowel approximately 3 in. up from the loop board. You can use a 44-in. length of $\frac{7}{8}$ -in. OD aluminum tubing for a handle, and fasten it to the dowel approximately 3 in. behind the box with two machine screws. (Since the tubing can be of any convenient length, you can make it as long as desired.)

Plug It In. To test the Gold Grabber, connect the loop to J1 and J2, plug a pair of 2000-ohm earphones into J3, and turn R6 full clockwise for maximum volume. Adjust
(Continued on page 109)

Photos of author's unit show slight variations from model on cover. Brass screws are a must, as use of any ferrous materials will affect metal locator's performance greatly.

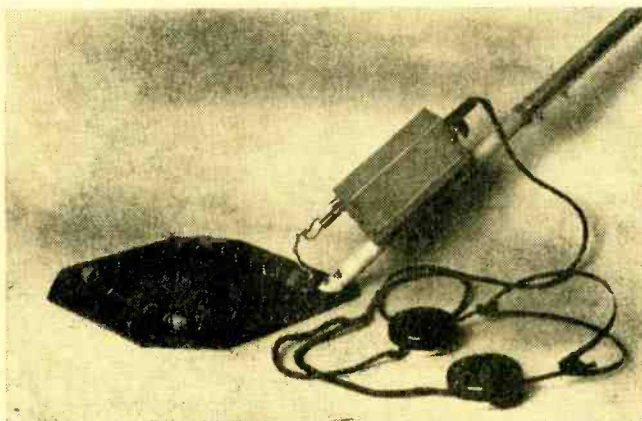

Flat amplifiers are great but you must have a flat input signal. Here's how to match that pickup.

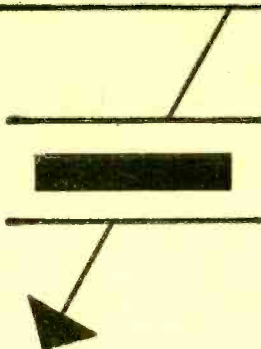

Ceramic Pickup EQUALIZING PREAMP

by Jay Copeland

■ One of the problems with home-made phono amplifiers is that they are invariably *flat*—good circuit design can make even the cheapest transistor audio amplifier flat to within ± 3 db throughout the usable portion of its frequency curve. You would think this feature would be desirable, but it's not necessarily so when you take a *hard* look at the signal supplied by the phono pickup. The unequalized output voltage curve for a typical ceramic cartridge extends from 50 to 10,000 cps, peaks at about 300 cps, and falls about 6 db per octave at 50 cps and 15 db per octave at 10,000 cps. Also, the impedance of a ceramic pickup decreases as the frequency is increased. On top of this non-linear characteristic the signal is

further complicated by the record manufacturers. Recordings are deliberately made with reduced amplitudes at low frequencies, a relatively flat middle frequency range, and increased amplitudes at high frequencies.

Therefore, a carefully designed preamplifier circuit is needed to boost the low-frequency signals, reduce the highs and match the ceramic pickup's impedance. And all of these things must be done before passing an equalized audio signal to the frequency-*flat* amplifier.

Fortunately, the recording industry had decided on a recording equalization standard (R.I.A.A.) and the characteristics of ceramic pickups are almost universally identical with respect to frequency response and im-

PARTS LIST FOR EQUALIZING PREAMP

C1—.01-mf. disc capacitor (voltage not critical)
C2—.0033-mf. disc capacitor (voltage not critical)

C3—10-mf., 6-WVDC electrolytic capacitor

Q1—2N1091 npn transistor, RCA (Alternates are 2N440, 440A, 635, 636, 636A, 1005, 1006)

R1—220,000-ohm, 1/2-watt resistor 5%

R2—33,000-ohm, 1/2-watt resistor 5%

R3—10,000-ohm, 1/2-watt resistor 5%

R4—4,700-ohm, 1/2-watt resistor 10%

I—Perf-board cut to 2 3/4" x 2 1/2" approx.
Misc.—Flea clips, bare and insulated wire, solder, etc.

Estimated cost: \$3.50

Construction time: 1 1/2 hours.

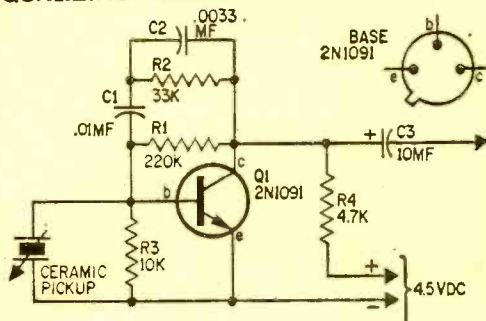

Equalized output is taken across C3 and the negative lead of the DC power input.

Layout of the components on the perforated circuit board is not at all critical—but watch ground connections if you take power from amplifier.

pedance output. Now, a preamplifier can be designed to *straighten* the frequency-output curve from a ceramic pickup's signal prior to being fed to a *flat* amplifier.

How it works. The schematic diagram for the ceramic-pickup preamplifier appears to be a basic common-emitter type using an *npn* small-signal transistor—except for the collector-base network (resistor R2 and capacitors C1 and C2). Resistors R1 and R3 provide fixed base bias. The amplifier's input impedance is made smaller than the pickup's impedance and Q1's current gain is made to vary inversely to the velocity response of the R.I.A.A. recording characteristics.

The negative feedback characteristics of the collector-base network do the equalizing—C1 is the effective circuit element for frequencies between 30 and 500 Hz (cps); R2 between 500 and 2000 Hz; and C2 above 2000 Hz.

The large amount of negative feedback reduces distortion and permits the use of low operating current in the collector circuit. This is essential for a low-noise output signal. The fact that no equalizing network is connected in series with the base also helps reduce noise.

The low input impedance of the preamplifier permits hookup to all available ceramic pickups on the market today. Remember, unlike a vacuum-tube amplifier circuit, this transistor preamplifier depends on

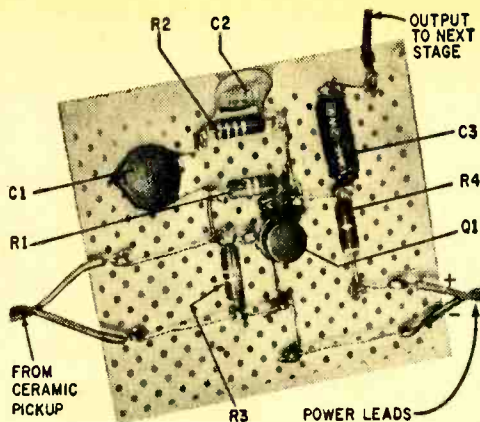

the apparent input impedance mismatch for proper audio equalization.

Putting It Together. Parts layout, shown in photo, closely matches the schematic diagram. All resistor, capacitor and transistor leads terminate at flea clips. If you prefer not to use flea clips, make all connections by passing leads through perf-board holes and soldering underneath perf-board. Twisted wire leads can be used to connect to ceramic pickup and amplifier input terminals. Shielded cables should be substituted if hum level is high. Also, it may be necessary to connect a 10-mf. 6-volt electrolytic capacitor across the power supply leads (watch polarity) if preamp taps power from phono's power supply.

Installation is not critical. Keep leads short and locate perf-board away from heat. A classical recording (with violins) can serve as a test record. Play the recording before and after modification—use your amp's *AUX* input. ■

A Safe Connection

- When making a wire connection for your projects, cut two one-inch pieces from a half-inch rubber tube. Split these and put one around

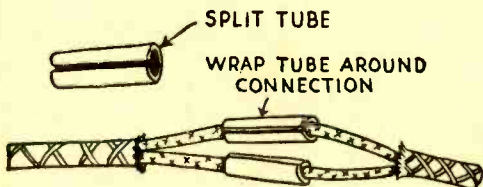

each wire at the connection point. Then wrap some plastic electrical tape over all, and it makes a neat, safe job. This idea is not suitable for power or lamp cords.

Polystyrene Tubing Insulates Chokes

- To protect the metal ends of an RF choke from accidental contacts in a crowded radio chassis saw a lengthwise slot on one

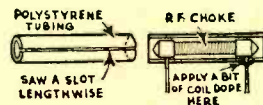

side of a length of polystyrene tubing, and slip it over the RF choke. For straight-wound chokes, 1/2 in. O.D. tubing is about right, but for pie-wound chokes use larger tubing. Coil-dope or speaker-cement applied to wire leads where they enter tubing keeps tubing from slipping off choke. Or, heat the ends of the tubing and pinch them shut. Use color code to indicate value.

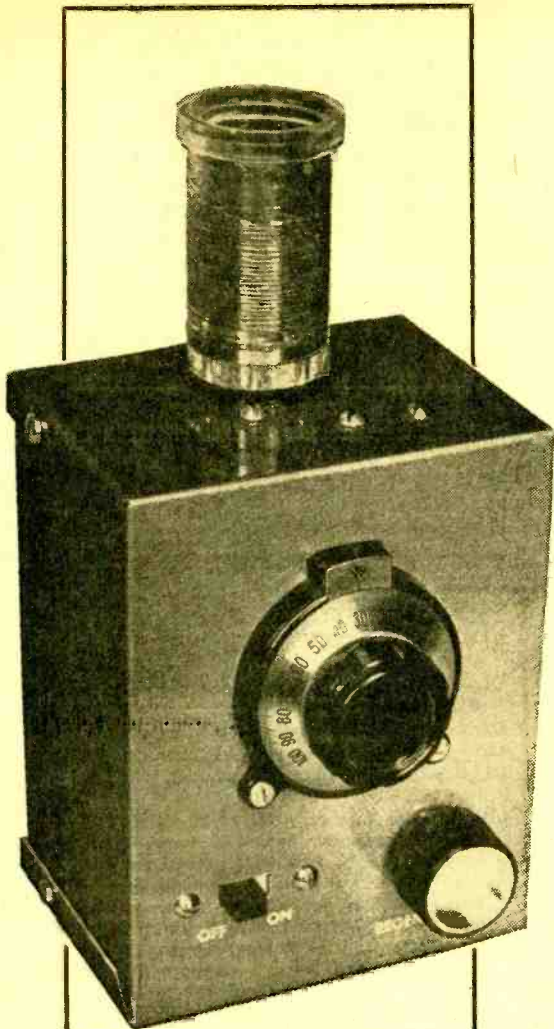

Put the bite on weak signals by building this devil device that'll turn you on with real DX sound

DX DEVIL

By Hartland B. Smith, W8VVD

Is your shortwave set plagued with puny signals, excessive fading, or CW birdies that chirp across your favorite stations? Do you find that signals repeat themselves about 900 kHz away from where they're supposed to be on the dial?

If you must reluctantly answer yes to any of these questions, then the sooner you build our DX Devil the sooner you can enjoy improved reception from 4 to 30 MHz. This remarkably simple gadget easily boosts nebulous DX transmissions about 40 dB (that's $\times 10,000$)! It'll make a lazy S-meter climb as much as 6 or 7 S-units. Further, it'll force the receiver's AVC (automatic volume control) to work much better, thereby minimizing very deep, quick fades that often cause annoying momentary dropouts.

No Secret. The DX Devil is an old-fashioned idea dressed in brand new clothes. It's a battery-powered regenerative preselector built around a high-gain field-effect transistor (FET).

The device acts as a single stage of tuned radio-frequency amplification which may be connected between the antenna feed and the input terminals of your receiver. It not only boosts weak signals before they reach the first stage in the receiver, but it also adds selectivity (*Continued overleaf*)

DX Devil

to reject unwanted signals that might otherwise interfere with a desired transmission.

Many shortwave sets, especially those selling for less than \$75, contain no tuned RF stage ahead of the mixer or first detector. Consequently, these receivers often lack both sensitivity and front-end selectivity.

These deficiencies show themselves in two very obvious ways. First, only the more powerful nearby stations come through with really adequate strength. Peanut whistles and DX from the other side of the globe can usually be heard, if at all, only very weakly. Second, the dearth of selectivity ahead of the mixer is evidenced by numerous unwanted birdies, or images.

More Rejects. On the higher frequencies, above 10 MHz, inexpensive superhet receivers often have a habit of picking up the same signal at two points on the dial. This can be a real problem when a 14-MHz ham rides in on top of a 15-MHz shortwave broadcaster, or a fellow on the low end of 28 MHz clobbers another fellow near the high end.

With some sets the situation is reversed. That is, a 15-MHz signal will stomp all over the 14-MHz ham, and the fellow at the top end of 28 MHz will also come in at the low end of the band. In either case, the unwanted

signals you hear in the wrong places are images created by the heterodyning process. A preselector ahead of the receiver will provide additional selectivity that will either reduce or completely eliminate these images.

Because it is regenerative, the DX Devil boasts almost as much gain and selectivity as you would normally expect to obtain from a complicated two-stage preselector without regeneration. Coil L1 includes a feedback winding between pins 3 and 4 which causes the circuit to oscillate when a full 9 volts is applied between the source and drain electrodes of transistor Q1.

Regeneration control R2 makes it possible to reduce the drain voltage until the unit operates just below the point of oscillation. This is the region of maximum amplification and selectivity.

The cost and complexity of band switching are eliminated in the DX Devil through

PARTS LIST FOR DX DEVIL

B1—9-volt transistor battery (2U6, 216 or equiv.)

C1—15-409-pF variable capacitor (Allied 4383524—see text)

C2, C4—.05- μ F, 10-V disc ceramic capacitor

C3—.001- μ F, 500-V disc ceramic capacitor

D1, D2, D3, D4—Silicon or germanium diodes (see text)

L1—Series of three coils: (1) 14-30 MHz: Pri. 3 turns, closewound, Sec. $4\frac{1}{4}$ turns, $\frac{5}{8}$ -in. long, tapped $\frac{1}{4}$ turn from ground end; (2) 7-14 MHz: Pri. 3 turns, closewound, Sec. 11 turns, 1-in. long, tapped $\frac{1}{2}$ turn from ground end; (3) 4-7 MHz: Pri. 3 turns, closewound, Sec. 22 turns, $1\frac{1}{8}$ -in. long, tapped $\frac{1}{4}$ turn from ground end. All coils wound with #28 Formvar insulated wire on $2\frac{1}{4}$ x $1\frac{1}{4}$ -in. polystyrene plug forms (Allied 47B6696 or equiv.)

Q1—Motorola MPF-107 field-effect transistor (available from Newark Electronics, 500 N. Pulaski Rd., Chicago, Ill. 60624)

R1—1000-ohm, $\frac{1}{2}$ -watt resistor

R2—5000-ohm, linear potentiometer

RFC1—2.5- μ H RF choke

S1—3PDT slide switch

TS1—4-screw terminal strip

1—4-lug terminal strip with grounded lug

1—5 x 4 x 3-in. aluminum Minibox

1—5-prong tube socket (Amphenol 7855 or equiv.)

Misc.—Knob, vernier dial, screws, nuts, spacers, battery plug, wire, solder lugs, solder, etc.

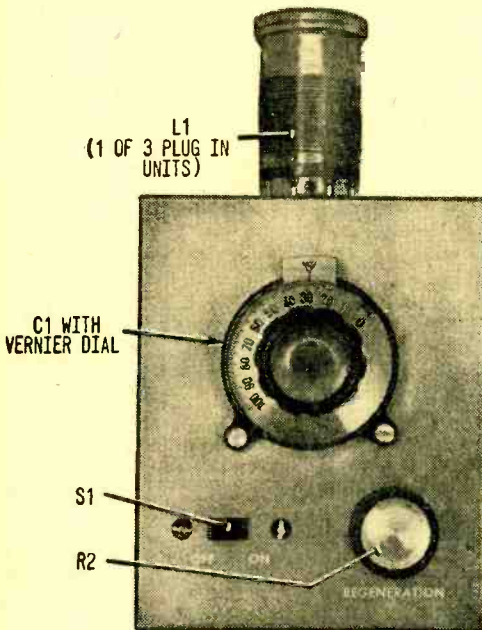

DX Devil preselector boosts signal levels as much as 40 dB at frequencies from 4 to 30 MHz. Three plug-in coils which cover frequency range mount in 5-prong socket at top of unit. When regeneration control (R2) is set just below point of oscillation, tuning of C1 is very sharp. Vernier dial permits careful adjustment by operator so that desired station can be received at maximum strength. Improved performance will be especially noticeable at higher frequencies.

use of plug-in coils. Wiring the preselector is relatively easy because there are so few components inside the uncluttered chassis. All in all, the device is a fine project for the fellow who's looking for an inexpensive, easily built gadget that will markedly improve the performance of his receiver.

Construction. The first order of business is to modify C1. Cut $\frac{3}{8}$ in. off the shaft and remove 11 of the rotor (movable) plates. Start at the rear of the capacitor and slowly bend backward one plate at a time, then carefully pull it out of the brass shaft. When you are finished, there should be six rotor plates remaining in the capacitor.

When operating at maximum gain, the unit tunes very sharply, and you must employ a vernier dial. The actual method of mounting C1 will depend on the type of dial you buy. In the prototype, C1 was supported on two 1-in. spacers through which

were passed two 6-32 screws. Self-tapping screws can be employed if you have no way of threading the holes which are factory drilled in the capacitor frame.

Mount the coil socket after you have installed C1 and the dial. Then drill holes for R2, S1, and the three-terminal mounting strip. Carefully file the slot for S1 so that the knob slides back and forth without binding. Mount TS1 on the rear cover of the Minibox.

Plastic-coated, solid #20 hookup wire is recommended for all leads except those running to TS1 and the battery connector. In these cases, insulated stranded wire is preferable. Solder the gate terminal of Q1's socket directly to pin 2 of L1's socket and cut the leads of the disc capacitors and R1 as short as possible. Wire R2 as shown, so that it is at minimum resistance when the regeneration control knob is turned fully clockwise.

Three Coils. Wind the coils on $2\frac{1}{4} \times 1\frac{1}{4}$ -in. polystyrene forms. While it is true that large-diameter wire makes the most efficient coils, #28 Formvar insulated wire is much easier to work with, and you'll find it provides results that are entirely satisfactory.

Closewind the primaries, and space the secondaries so that the winding lengths are approximately as specified in the Parts List. When soldering the coil prongs, don't let them get too hot. Otherwise, the form will melt and the prongs will tilt askew. Use an iron with lots of heat, but apply it to the pins for only a short period of time. After each coil has been completed, coat it thoroughly with Q-dope or polystyrene cement.

The top end from a discarded 9-volt battery can serve as a power plug. Tape the preselector's battery to the bottom of the Minibox.

Diodes D1, D2, D3, and D4 must be used if you have a radio transmitter in the house. The purpose of these diodes is to short out dangerously high voltages which might otherwise reach the

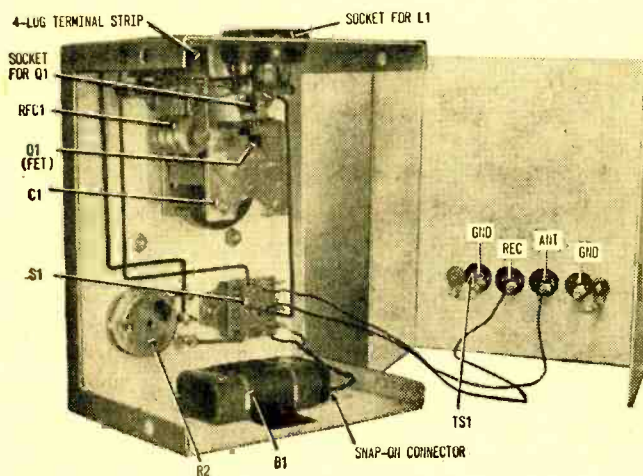
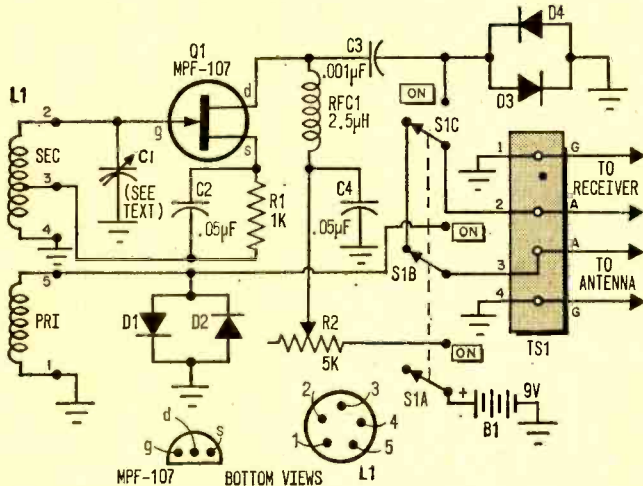

DX Devil

transistor and burn it out. They will also protect Q1 from static discharges resulting from nearby lightning strokes.

The diodes offer a fairly high resistance to the tiny signal voltages present on the antenna feed, but they break down to form a direct short whenever they are subjected to more than a few volts of RF energy. Just about any low-cost silicon rectifier will do the job. The ones in the photo below are inexpensive 750-mA, 400-PIV units. Type 1N34A germanium diodes will also prove satisfactory. The diodes can be omitted if you have no transmitting gear and live in an area with few thunderstorms.

Adjustment. After carefully checking for wiring errors, plug in Q1 and the battery. Run twinlead or a coax between the receiver's antenna connector and terminals 1 and 2 of TS1. Attach the feed from a doublet antenna to terminals 3 and 4.

If you use coax at either point, attach the shield braid to the G terminal and the center conductor to the A terminal as marked on the schematic. If you run twinlead to the receiver, be sure to connect the wire on terminal 1 of TS1 to the ground terminal. If you use a single wire rather than a doublet, connect it to terminal 3 and then run a lead from terminal 4 to an earth ground.

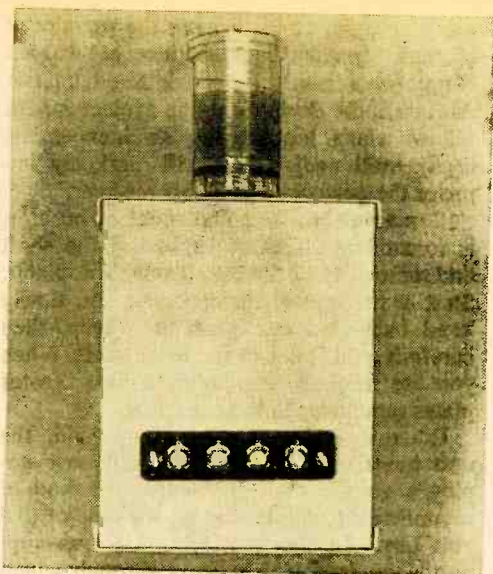

Input and output leads attach to terminal strip as follows: from left to right, Gnd—Ant—Rec—Gnd.

Snap the back on to the Minibox and fasten it in place with sheet metal screws. The unit won't work unless you do this, because there must be a good electrical connection between the two halves of the case.

Tune the receiver to a 4-MHz signal, preferably one from an AM station, and plug in coil 3. Turn on S1 and set R2 in its maximum clockwise position. Tune C1 back and forth. You should hear some birdies (extraneous signals) in the receiver. These indicate oscillation in the preselector.

Rock C1 while turning the regeneration control counter-clockwise. You should finally reach a setting of R2 where the birdies disappear, and a point on C1 where the 4-MHz signal is much louder when S1 is on than when it is switched off.

Feedback. The small portion of coil which appears between pins 3 and 4 is the feedback winding. It causes the circuit to be regenerative. Because of variations in transistor gain, as well as antenna and receiver input impedances, it may be necessary to modify the coil a bit to provide optimum (Continued on page 108)

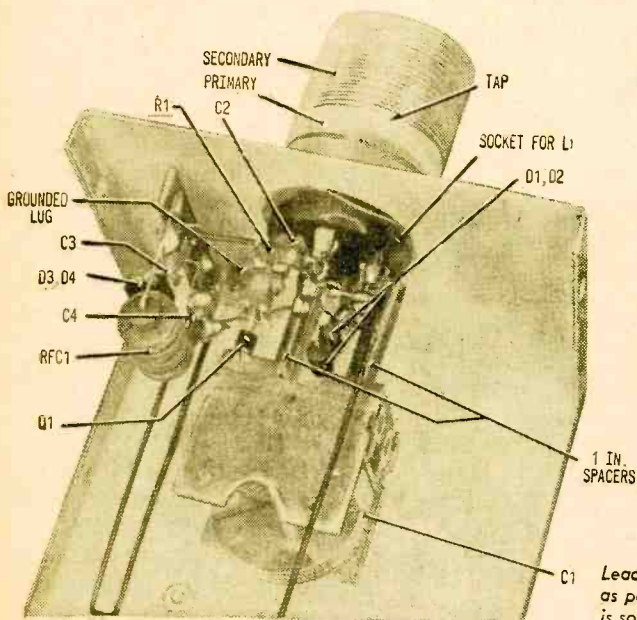

Leads to L1's socket should be as short as possible. Gate terminal of Q1's socket is soldered directly to pin 2 of L1.



Computer goes to Pot

Build our Electronic Slide Rule with ordinary radio parts and then you will discover the vast, interesting world of analog computers

According to at least one humorous dictionary, an engineer "is a man who multiplies two by two and says that the answer is *approximately* four." The reason for the word "approximately" is that our engineer probably used a slide rule—a popular mechanical analog computer—when he made his calculation. And the very nature of all analog computers is that all of the answers they produce are approximate—some more than others.

You can make your own electronic analog computer—our Electronic Slide Rule—that'll knock out simple multiplication and division problems accurate to ± 3 digits out of every 100. No, it will not replace your slide rule, but it's great for simple rapid estimations and checking. Before we show you how to build our Electronic Slide Rule, let's peek into the electronics of the gadget.

Voltage Analog. An ordinary potentiometer will help us see how a number can be converted into a voltage analog. Fig. 1 shows a simple circuit of a potentiometer, R1, connected in series with a battery, B1. Rotating the dial on the shaft of R1 causes the pot wiper to "pick off" a voltage proportional to the dial setting.

In Fig. 1 the dial is calibrated from zero to one, and the voltage supplied by the battery is 1.0 volt. Thus, in this particular instance, the dial setting indicates the voltage

at the wiper of the pot. A voltmeter connected at the output terminals of this circuit will indicate the setting of the dial—0.5 V would mean that the dial is set at 0.5. The voltage is an analog voltage, since it may represent a dial quantity of 0.5 acre, quart, or even light year.

Multiplying. In Fig. 1, a voltage analog for the number 0.5 was developed at the wiper of R1. It can also be said that the supply voltage across R1 was multiplied by

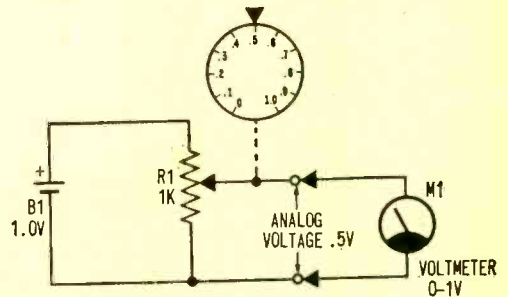

Fig. 1. Hypothetical circuit showing how potentiometer can convert number into voltage analog. Dial calibrations represent any desired quantity.

0.5. Thus, 1 V times 0.5 will be 0.5 V. If a voltage other than 1 V were supplied by B1 in Fig. 1, we would be multiplying the supply voltage by the dial setting.

This apparent ability of potentiometers to multiply can best be seen in Fig. 2. Battery

Pot Computer

B1 supplies 1 volt across pot R1. Dial A is set at 0.5 so that analog voltage A developed at the wiper of R1 (0.5 volt) is applied across pot R2. Dial B is set at 0.8 so that the voltage at the wiper of R2 will be only 0.8 times the voltage across R2, or simply 0.5×0.8 . The voltage developed at the wiper of R2 is appropriately called analog voltage A · B, and voltmeter M1 will indicate this voltage to be 0.4—the product of 0.5 and 0.8.

Null Readout. In Fig. 2 the voltmeter presents a load across the resistive network—this introduces errors. One way to eliminate this loading effect is to replace the voltmeter with a null indicator. It's nothing more than inexpensive center-reading ammeter hooked up as shown in Fig. 3 (more properly called a galvanometer). When the voltage on the wiper of R3 is equal to the voltage on wiper R2, no current will flow through the galvanometer. So, a calibrated dial is added to the shaft of R3 which is read when the galvanometer is zeroed. Now all it takes to get an answer for any multiplication problem is to rotate the dial on R3 until the galvanometer is zero and the dial is read.

Another way to reduce loading error is to isolate the pots from each other by the use of isolation amplifiers. This is important because the pots are interconnected and one will load one another. Sounds like a big task but it's quite simple. Fig. 4 shows you how.

Transistor Q1 draws only a few microamperes from the wiper of R1, which is used to supply an identical voltage from the wiper

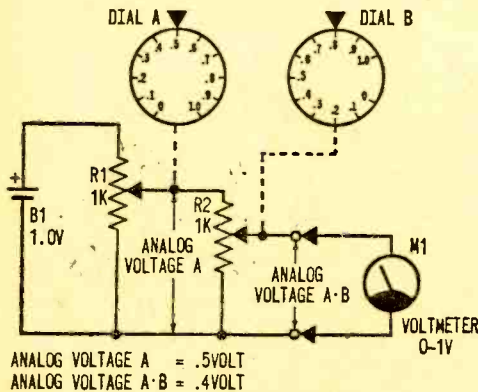

Fig. 2. Addition of second potentiometer to hookup in Fig. 1 results in circuit which can multiply. Voltmeter M1 now indicates analog voltage $A \times B$ rather than analog voltage A only.

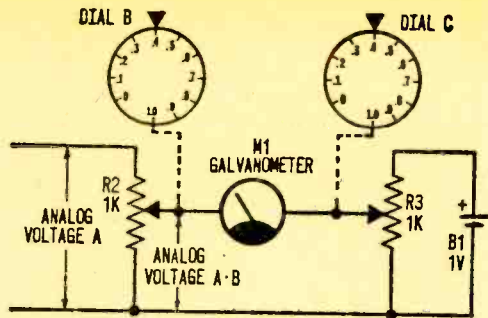

Fig. 3. Adding pot R3 and moving battery B1 reduce loading error inherent in circuit of Fig. 2.

of R1 to the top of R2. This could have been done with a wire, but the isolation effect of Q1 removes any loading effect R2 could have on R1. The story is the same for Q2. The nulling circuit is connected across emitter resistors R2 and R6. The galvanometer functions as previously explained. However, a series damping resistor, R7, is added to prevent slamming the needle at its extremes when the voltage drops across R2 and R6 are significantly different. The original unit used a 10K resistor, but it was later changed to 2200 ohms for snappier indications.

Building It. The Electronic Slide Rule is housed in a sloping aluminum box. A piece of perforated phenolic chassis board is used as the sub-chassis with push-in terminals used as wiring points. The circuit is very simple (see Fig. 4), and parts positioning is absolutely non-critical.

The sub-chassis is supported in place by an angle bracket at its bottom, and by the three vernier drive mechanisms that hold the potentiometer shafts at the top. Mount the 6-volt battery inside the rear panel of the case in a battery holder.

You may want to replace the on-off toggle switch (S1) with a pushbutton type. If so, mount the pushbutton on the top of the unit so the case will not move when the button is pressed.

Calibration. Turn all three vernier dials to zero (their set screws are still loose, so the pot shafts can turn freely). Then, turn the pot shafts of R1, R2, and R3 fully counter-clockwise. Tighten the set screws.

Now, turn switch S1 on and observe M1's pointer. It will move ever so slightly. Possibly, you may be able to eliminate the pointer's movement by resetting R2's shaft position a smidgeon. Maybe not! Now, adjust all dials to read 1.0 (that's the top of the dial). With the unit on, adjust R5 until the galvanometer is zeroed. If the galvanom-

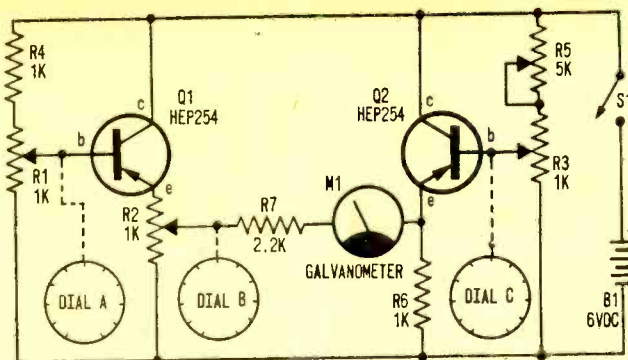

Fig. 4. Complete circuit of the Electronic Slide Rule. Since Q1 and Q2 are both emitter followers, their primary purpose is isolation, not amplification. Potentiometer R5 serves as zero-adjust control—see text for details on calibration procedure.

PARTS LIST FOR ELECTRONIC SLIDE RULE

- B1—6-volt battery, size not critical (9-volt batteries may be used)
 M1— ± 100 μ A balance DC ammeter, pointer centered on scale (Lafayette 99H5034 or equiv.)
 Q1, Q2—HEP254 transistor (Motorola)
 R1, R2, R3—1000-ohm, linear-taper potentiometer
 R4, R6—1000-ohm, $\frac{1}{2}$ -watt resistor
 R5—5000-ohm potentiometer (any taper)
 R7—2200-ohm, $\frac{1}{2}$ -watt resistor (see text)

- S1—Spst toggle switch or pushbutton switch, normally open (see text)
 3—Vernier dial, $1\frac{1}{2}$ -in. dia. (Lafayette 99H6031 or equiv.)
 1—Sloping panel utility box, $4\frac{1}{2} \times 4\frac{1}{2} \times 7$ -3/16-in. (Premier ASPC-1203, Lafayette 12H8072 or equiv.)
 Misc.—6 x $6\frac{1}{2}$ -in. perf-board (size approx.), metal bracket, battery holder, several flea clips, hardware, solder, wire, etc.

eter zeroed when the dials were set at zero, the calibration procedure is now complete. However, if the dials were set at zero and the meter read $\frac{1}{2}$ division to the left, set the dials to 1.0 and adjust R5 till the meter deflects $\frac{1}{2}$ division to the right. This is a simple averaging technique that will make the dials' mid-range readings fairly accurate.

Using It. Well, by now you should know how to multiply on the Electronic Slide Rule. Set dial A (Multiplicand) to any number, dial B (Multiplier) to any number, and

dial C (Product) will read the correct product of these two numbers when the meter is nulled. It's that simple. Next—here's how you divide. The number you wish to divide is cranked onto dial C. The number which will do the dividing is cranked onto dial B. Then adjust dial A until the meter nulls and the answer is taken from dial A. Notice that the sequence for dividing is in reverse dial setting, as was multiplication.

Have fun with the Electronic Slide Rule, but remember that your wood or metal slide rule is still quicker and more accurate. ■

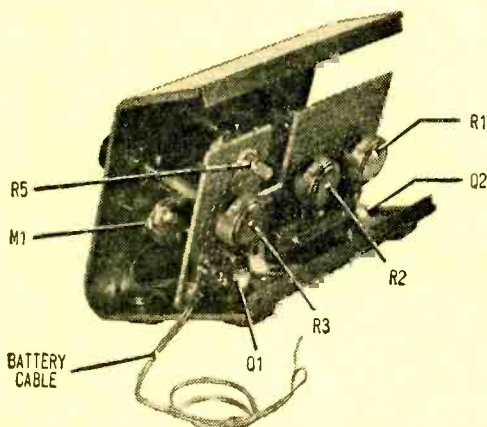

Rear view of Electronic Slide Rule. Angle bracket holds sub-chassis in place; pot R5 is at upper left.

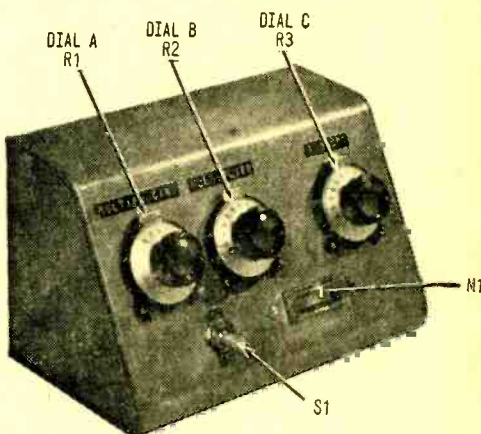

Front view of Slide Rule in its finished form. Unit can multiply or divide without circuit changes.

CB SKYHOOK mit sock!

By Elmer Carlson

Socket-2-me, CB baby, with a whip that rises in seconds and stays up for months

■ A low-cost, center-loaded R/C antenna makes a good CB skyhook for cliff dwellers and temporary installations anywhere. Field-tested on the outskirts of a big city's concrete jungle, this convenient whip belts out good signals from a near ground-level base station to any mobile unit over a four-mile area.

Whether you're just anxious to get some use out of your newly-arrived license, or Mother Nature has leveled your roof-mount in one blustery blast, you'll find this whip can fill in better than you ever expected. There are no coax losses, mismatches, etc. All five watts (or whatever) pour right into the ol' radiator.

R/C or CB? The beauty of this project is the convenience of a ready-to-go, center-loading coil antenna available from Lafayette Radio for \$2.99, plus postage (by mail: 111 Jericho Tpke., Syosset, N.Y. 11791). Though advertised for R/C (radio control), it's good for frequencies in the CB band and will work fine. And those five watts certainly won't melt a tubular antenna; you need much more power for that. Even the center-loading coil will stand up under the strain of CB transceiver power and will match all CB rigs.

Three Plus Two. Believe it or not, you

don't have to build anything. All you do is drill five holes—three in a scrap of phenolic (or any insulating material), and two in the rear edge of the top of the CB transceiver cabinet. This set-up allows the antenna to be mounted just behind the cabinet rim. (The author attached his unit to the rear of an Olson "Sidebander.")

The holes drilled into the cabinet should be smaller than those drilled through the perforated phenolic. As shown in our photo, the perforated phenolic is attached to the cabinet of transceiver with self-tapping screws. This eliminates the need for opening the cabinet. Sheet-metal screws have deeper threads and will hold better in the thin metal.

When drilling those two screw holes be careful that you don't spray metal chips over the inside of the transceiver. Drill at a low speed—even if you have to use the ol' egg-beater. The use of a slow drilling speed is especially important with tube-type trans-
(Continued on page 108)

PARTS LIST FOR CB SKYHOOK

- 1—Center-loaded R/C antenna (Lafayette 99H9098 or equiv.)
- 1—1 3/8 x 1 3/4-in. piece of perforated phenolic
- 1—Banana plug
- 1—Solder lug
- 2—1/2 x 6 Parker-Kalon binderhead sheetmetal screws
- 1—12-in. length of AWG-18 plastic-covered hookup wire
- 1—1/2-in. 6-36 roundhead machine screw (if not supplied with antenna)
- Misc.—Solder, wire, 1/4-in. spacers (if needed), etc.

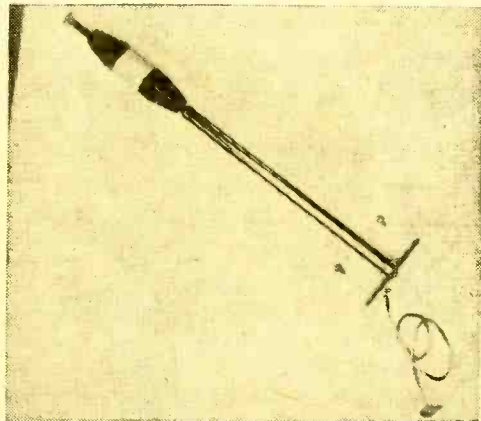

Center-loading whip extends to 54 in. Use length of stranded hookup wire for lead.

1-FET BCBer

*Built around one
of those new-
fangled FETs,
this broadcast
set is modern as
the day is long*

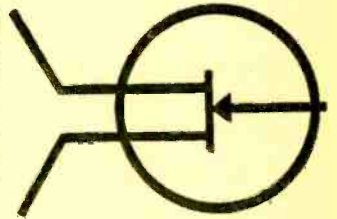
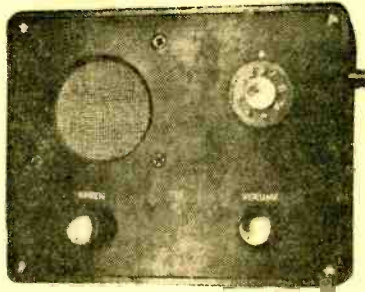
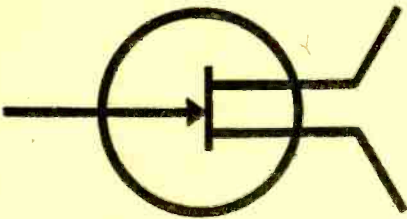
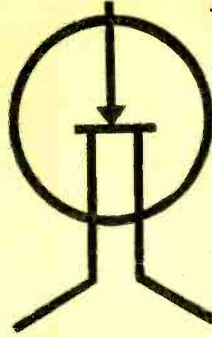

One of the most important developments in electronics has been the transistor, and one of the newest wrinkles in solid-state devices is the Field Effect Transistor. The FET has operating characteristics very similar to that of a vacuum tube. It is controlled by voltage, as opposed to a transistor that is controlled by current. Because of this, the FET does not load tuned circuits and can give better performance in simple receivers than a transistor. You can gain practical experience in FET circuit operation by building our 1-FET broadcast band receiver.

How It Works. The signal from the antenna is tuned in the L1A-C1 tank circuit, and fed through the gate leak (R1-C2) to the gate of Q1. The signals are detected between the source and gate (the PN junction acts like a diode) and a portion of the amplified signal is fed back to the gate through the coil L1B, for regeneration which is controlled by R2. T1 is used to couple the detector to the amplifier.

The amplifier is a ready-made job available from Radio Shack. Because of its low cost and to ease assembly, this amp was chosen, though any comparable unit could be used.

Construction. Care must be taken in construction as the bakelite panel and case are rather brittle and liable to crack under pressure. Follow the layout shown in the

photos for approximate hole location. Placement of the front panel controls can be rearranged to suit if desired.

The battery holder is made from an aluminum strap mounted on the volume control (R6). The coil (L1A) is mounted on a small aluminum bracket which also mounts on the volume control (R6) as shown. This bracket should be grounded with a connection to a large solder lug on the coil to reduce the effect of hand capacitance. Serrated washers should be placed under the pots and the tuning capacitor, next to the panel, to prevent them from turning.

Speaker Mount. The speaker is mounted under solder lugs on four mounting screws attached to the front panel. Place a small piece of grille cloth in front of the speaker to protect the cone. The amplifier board is mounted, using solder lugs for brackets, on two mounting screws. It should be mounted so that the component side is away from the speaker and the connection to the battery lead is on top. This will enable ground connections to be made to the mounting screws. A 1½ x 2½-in. perforated board is also mounted on solder lugs. This board will be used to mount the detector components.

The green wire of the amplifier is connected to the wiper arm of volume control (R6) while the red wires lead to the switch (S1). The black lead on the same side goes to a solder lug on the nearest mounting

1-FET BCBer

Follow layout of parts as shown in photo approximately for quick and easy assembly of this little BCBer. The AMP is a ready made unit that can be had at nominal cost from Radio Shack and the only wiring is the detector and interconnection. The FET detector circuit is constructed on a perf-board mounted on the bakelite front-panel.

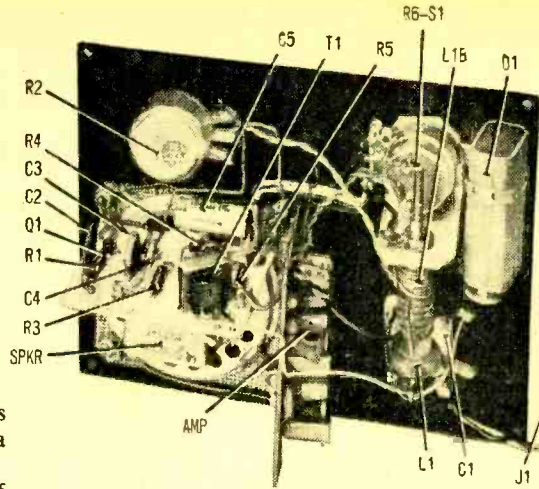

screw to provide a ground. The output leads go to the speaker with the black lead as a ground.

L1B is formed by wrapping 8 turns of hookup wire around L1A.

The detector circuit is wired from the schematic and should present no problem. Keep RF-carrying wires away from other wires to prevent signal attenuation. When

everything is wired, check for mistakes and then insert the battery for a test run. Switch the receiver on and check operation by turning the regeneration control clockwise; the
(Continued on page 107)

PARTS LIST FOR THE 1-FET BCBer

- AMP—4-transistor, 100-milliwatt, audio amplifier (Radio Shack 27-1240 or equiv.)
- B1—9-volt battery (Radio Shack 23-464 or equiv.)
- C1—10-365 pF miniature variable capacitor (Lafayette 99C6217 or equiv.)
- C2—100-pF ceramic disc capacitor
- C3—47-pF ceramic disc capacitor
- C4—470-pF ceramic disc capacitor
- C5—100- μ F, 15 volt, electrolytic capacitor
- J1—Phono jack (Radio Shack 274—346 or equiv.)
- L1A—Antenna-stage broadcast band coil (J. W. Miller A-5495-A or equiv.)
- L1B—8 turns of #22 hookup wire (see text)
- Q1—N-channel field effect transistor (Motorola MPF103 or equiv.)
- R1—3,300,000-ohm, 1/2-watt resistor
- R2—2500-ohm linear taper potentiometer
- R3—330-ohm, 1/2-watt resistor
- R4—1800-ohm, 1/2-watt resistor
- R5—1000-ohm, 1/2-watt resistor
- R6—5000-ohm audio taper potentiometer
- S1—S.p.s.t. switch on R6
- T1—Input transformer—20,000-ohm primary, 1000-ohm secondary (Midland 25-618, Ar-gonne AR-104, or equiv.)
- 1—6 3/4 x 5 1/4 x 2 1/4-in. bakelite case and panel (case, Lafayette 19C2002; panel 19C3702 or equiv.)
- SPKR—8-ohm, 2 1/2-in. dia. speaker.
- Misc.—2 1/2 x 1 1/2-in. perforated board, aluminum bracket and clamp, solder lugs, push-in terminals, mounting screws, wire, solder, etc.

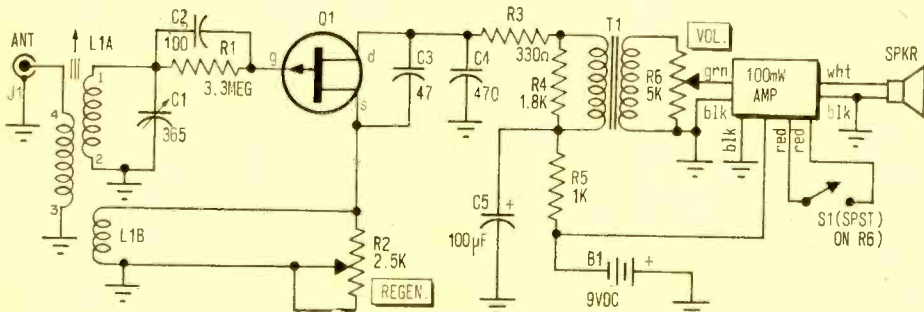

Wire the BCBer using the schematic above. Coil L1B is the regeneration winding; if it is connected backwards the receiver will not oscillate. If this happens, just reverse the leads.

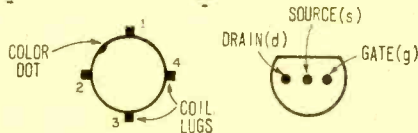

TRAVELIN' HAPPENING

By Herb Friedman, W2ZLF



In-case add-on amp lets you and your guitar swing in on the action most any old time and place

Hey man, next time the gang has a blast at the beach or a picnic at the wood-side, there's no need to let the folk singers and their hollow boxes steal the limelight just because your guitar needs an amplifier and there's no power plug out in the boonies.

For just a few bucks and an evening's work you can build a battery powered amplifier right into your guitar's case. It takes up next to no room, doesn't interfere with proper seating of the guitar in the case, and doesn't take up any of the compartmented storage space.

As shown in the photographs, the whole installation can be tucked up in the corner of the case—a generally unused part. Of course, you must have a square case; a form fitted case can accommodate just a few picks and a sandwich, certainly not an amplifier.

Megawatt It's Not. Our Travelin' Happening is not going to crush anyone's ears under a wall of sound. Fact is, it's just about as loud as a good portable phonograph, and any more power would require a battery too heavy to be really portable.

Installation in your guitar's case is a snap because only four components are used, not including the battery. There's a speaker assembly, input jack, volume control, and a completely assembled transistorized amplifier rated at 3 watts. Add the battery and your electric guitar can be used anywhere, anytime.

The complete wiring is shown in the schematic. Resistor R1 is optional, though its use is recommended. Some guitar pickups require a 22,000-ohm termination for proper sound quality. However, if you find the amplifier appears to lack gain, R1 can be reduced to 10,000 ohms.

Low Power Pickup. Some low-output guitar pickups may require the total elimination of R1 for maximum power output. We suggest you first assemble the amplifier with R1; then make modifications if required.

The speaker cannot be a cheap replacement type. Music reproduction requires a speaker capable of handling peak power cleanly. Therefore, if possible, use a so-

Travelin' Happening

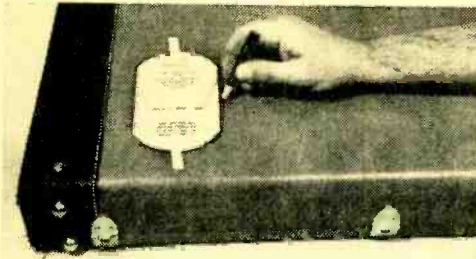

1 Taping the speaker grille template to the outside of guitar case is the first step. Then draw outline on case with grease pencil or china marker.

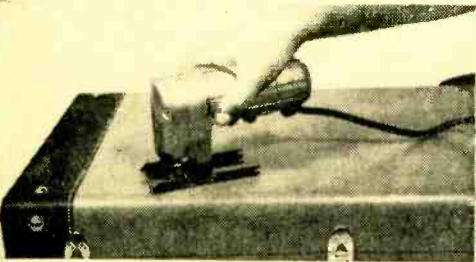

2 Drill a starting hole in case inside outline. Using a saber saw, or a keyhole saw, cut out the speaker hole and sand off any ragged edges.

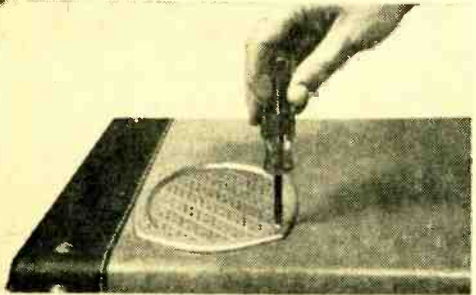

3 Using the speaker grille as a template, drill the speaker mounting holes. Now mount the speaker and grille with the supplied screws and nuts.

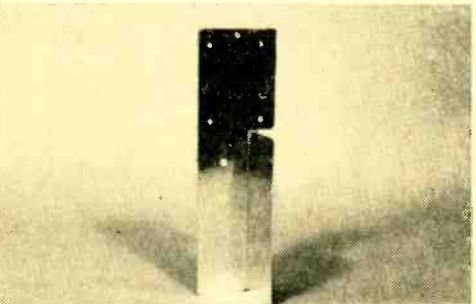

4 Make a mounting plate as shown from scrap aluminum. The bent piece is used to hold the battery against the case as shown in photo nine.

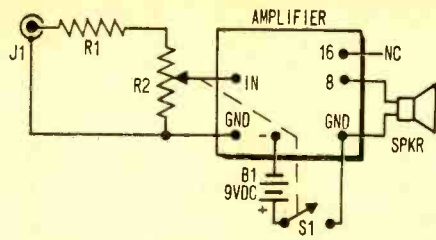

Wiring up Travelin' Happening is a snap. Be sure to hook up the two ground connections as shown; tying them together will cause oscillation.

PARTS LIST

- Amp.—3-watt audio amplifier module (Lafayette 99H9132 or equiv.)
- B1—9-volt battery (Burgess C6X or equiv.)
- R1—22,000-ohm, 1/2-watt resistor (see text)
- R2—10,000-ohm audio-taper potentiometer with switch
- S1—S.p.s.t. switch, (part of R2)
- SPKR—8-16-ohm 6x9 in. oval transistor auto speaker (Lafayette 32H2204 or equiv.)
- Grille—See text
- Misc.—Wire, solder, screws, etc.

called music speaker; the music rating will generally insure higher efficiency and lower distortion than a "standard" speaker of equivalent size.

If you're pressed for space, the 6 x 9-in. universal transistor replacement speaker specified in the parts list will prove adequate.

The amplifier output impedances are 8 and 16 ohms; don't use a 3.2- or 4-ohm speaker. The transistor replacement type shown in the photographs provides—through two 20-ohm voice coil windings—impedances of 10, 20 or 40 ohms. Use the 10-ohm connections as shown in the accompanying speaker instructions and connect the unit to the amp's 8-ohm terminals.

Doin' It. The speaker grille is the type used for automobile rear-speakers. They are available in chrome or Hammettone Grey; use whichever style complements the guitar case's color. The speaker cutout template is part of the grille's plastic bag. Cut along the outline with scissors, tape the outline to the outside of the guitar case, and then trace the outline with a grease pencil or China Marker. You might mark the speaker-grille mounting holes at the same time.

Drill a 1/2-in. hole inside the outline and then use a saber or keyhole saw to cut out the speaker opening. Install the grille and speaker before proceeding with the instal-

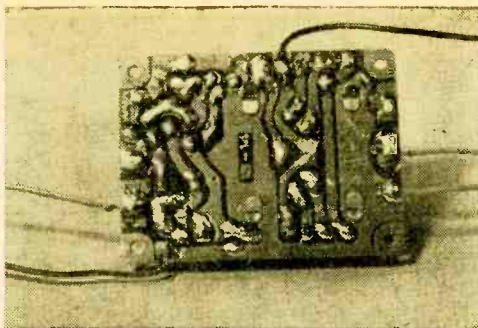

5 The amplifier is a ready made unit and just has to be wired to the battery, volume control and input jack as shown in the schematic.

lation. Since space is at a premium, you'll need the speaker in position in order to position the amplifier and associated components. Take care you don't puncture the speaker when installing the amplifier.

Amp Mount. The amplifier is mounted on a formed aluminum plate (from scrap aluminum or a chassis bottom plate) along with the input jack J1, and volume control R2. While each guitar case will probably require a customized installation, the photographs show the general idea.

Cut the aluminum plate so that a portion the exact length and height of the battery can be bent at right angles to the plate. When the plate is mounted, the upright plate section will press the battery against the side of the case as shown. When the case's cover is closed, the battery will be sandwiched between the case and the plate, assuring a rigid battery mounting.

The amplifier must be mounted to the aluminum plate on stand-offs to avoid shorting the printed circuit terminals to the grounded plate. Because the amplifier connections are made directly to the printed wiring on the bottom of the board, the connecting leads must be soldered in before the amplifier is mounted to the plate.

Ground Where Shown. The input ground lead must be soldered to the PC board exactly where shown in the supplied amplifier instructions. The positive battery connection—through power switch S1—should be soldered to the same point as the ground (common) speaker lead. Under no circumstances should the positive battery lead be soldered to the same point as the input ground lead.

J1 and R2 are mounted on the aluminum plate in any convenient location, though they

(Continued on page 107)

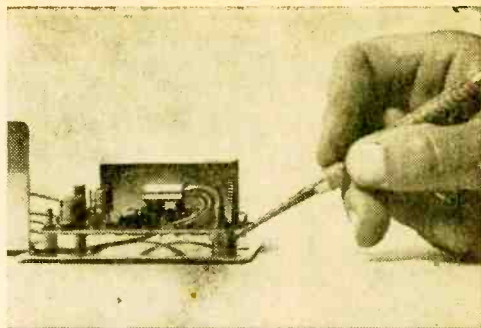

6 The amplifier circuit board is mounted on the aluminum plate with stand-offs as shown to keep the printed wiring from shorting out.

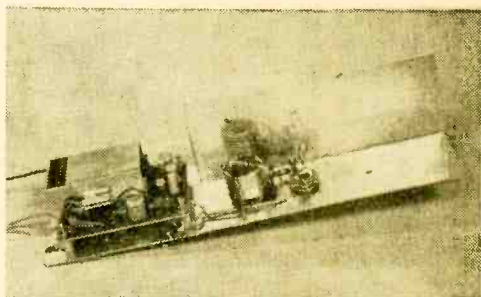

7 The volume control and input jack are now installed on the mounting plate as shown and are then wired to the amplifier (see text).

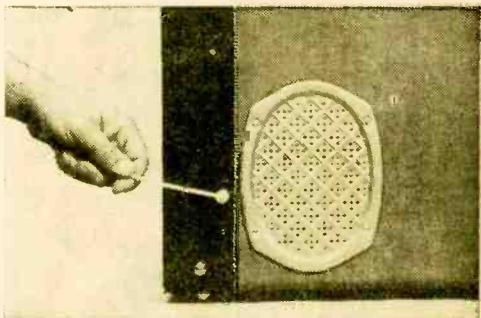

8 Two half-inch holes must be laid-out and drilled in the guitar case to allow access to the input jack and the volume control.

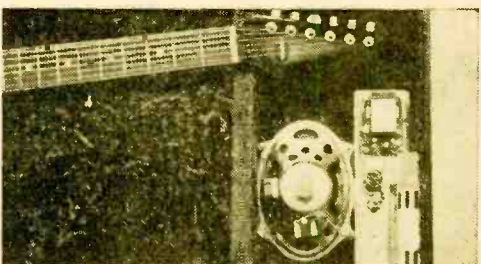

9 Finish up by securely mounting the amplifier assembly in the guitar case and install the battery. Now you're ready to sound off any time, any place.

Join "THE TROUBLESHOOTERS"

They get paid top salaries
for keeping today's
electronic world running

Suddenly the whole world is going electronic! And behind the microwave towers, push-button phones, computers, mobile radio, television equipment, guided missiles, etc., stand

THE TROUBLESHOOTERS

—the men needed to inspect, install, and service these modern miracles. They enjoy their work, and get well paid for it. Here's how you can join their privileged ranks—without having to quit your job or go to college in order to get the necessary training.



JUST THINK how much in demand you would be if you could prevent a TV station from going off the air by repairing a transmitter...keep a whole assembly line moving by fixing automated production controls...prevent a bank, an airline, or your government from making serious mistakes by servicing a computer.

Today, whole industries depend on Electronics. When breakdowns or emergencies occur, someone has got to move in, take over, and keep things running. That calls for one of a new breed of technicians—The Troubleshooters.

Because they prevent expensive mistakes or delays, they get top pay—and a title to match. At Xerox and Philco, they're called Technical Representatives. At IBM they're Customer Engineers. In radio or TV, they're the Broadcast Engineers.

What do you need to break into the ranks of The Troubleshooters? You might think you need a college degree, but you don't. What you need is know-how—the kind a good TV service technician has—only lots more.

Think With Your Head, Not Your Hands

As one of The Troubleshooters, you'll have to be ready to tackle a wide variety of electronic problems. You may not be able to dismantle what you're working on—you must be able to take it apart "in your head." You'll have to know enough Electronics to understand the engineering specs, read the wiring diagrams, and calculate how the circuits should test at any given point.

Learning all this can be much simpler than you think. In fact, you can master it without setting foot in a classroom...and without giving up your job!

For over 30 years, the Cleveland Institute of Electronics has specialized in teaching Electronics at home. We've developed special techniques that make learning easy, even if you've had trouble studying before. Our **AUTO-PROGRAMMED®** lessons build your knowledge as easily and solidly as you'd build a brick wall—one brick at a time. And our instruction is personal. Your teacher not only grades your work, he analyzes it to make sure you are thinking correctly. And he returns it the same day received, while everything is fresh in your mind.

Always Up-To-Date

To keep up with the latest developments, our courses are constantly being revised. This year CIE students are

NEW COLLEGE-LEVEL COURSE IN **ELECTRONICS ENGINEERING**

for men with prior experience in Electronics. Covers steady-state and transient network theory, solid state physics and circuitry pulse techniques, computer logic and mathematics through calculus. A college-level course for men already working in Electronics.

getting new lessons in Laser Theory and Application, Microminiaturization, Single Sideband Techniques, Pulse Theory and Application, and Boolean Algebra.

In addition, there is complete material on the latest troubleshooting techniques including Tandem System, Localizing through Bracketing, Equal Likelihood and Half-Split Division, and In-circuit Transistor Checking. There are special lessons on servicing two-way mobile radio equipment, a lucrative field in which many of our students have set up their own businesses.

Your FCC License—or Your Money Back!

Two-way mobile work and many other types of troubleshooting call for a Government FCC License, and our training is designed to get it for you. But even if your work doesn't require a license, it's a good idea to get one. Your FCC License will be accepted anywhere as proof of good electronics training.

And no wonder. The licensing exam is so tough that two out of three non-CIE men who take it fail. But our training is so effective that 9 out of 10 CIE graduates pass. That's why we can offer this famous warranty with confidence: If you complete a license preparation course, you get your FCC License—or your money back.

Mail Card for 2 Free Books

Want to know more? Send for our 44-page catalog describing our courses and the latest opportunities in Electronics. We'll send a special book on how to get a Government FCC License. Both are free—just mail the bound-in postpaid card. If card is missing, use coupon below.

ENROLL UNDER NEW G.I. BILL

All CIE courses are available under the new G.I. Bill. If you served on active duty since January 31, 1955, or are in service now, check box on card or coupon for G.I. Bill information.

CIE Cleveland Institute of Electronics

1776 East 17th Street, Cleveland, Ohio 44114

Cleveland Institute of Electronics

1776 East 17th Street, Cleveland, Ohio 44114

Please send me without cost or obligation:

1. Your 44-page book "How to Succeed in Electronics" describing the job opportunities in Electronics today, and how your courses can prepare me for them.

2. Your book on "How To Get A Commercial FCC License."

I am especially interested in:

- | | | |
|--|---|--|
| <input type="checkbox"/> Electronics Technology | <input type="checkbox"/> Broadcast Engineering | <input type="checkbox"/> First Class FCC License |
| <input type="checkbox"/> Electronic Communications | <input type="checkbox"/> Industrial Electronics | <input type="checkbox"/> Electronics Engineering |

Name _____ (PLEASE PRINT)

Address _____

City _____ State _____ Zip _____

Check here for G. I. Bill information.

EB-3

By Herb Friedman

Decibel

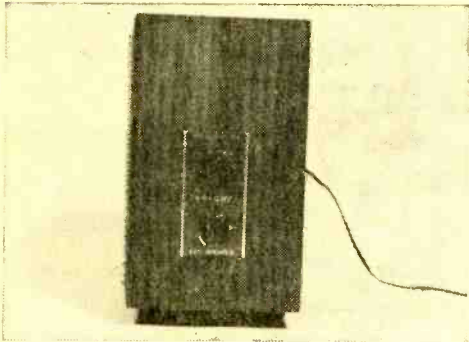

Two controls on side of Duo-Remote extension speaker allow adjustment of both the TV and remote speaker volume.

■ Do loud TV commercials take the pleasure out of your evening idiot-box viewing? Do you find extended lectures on sweaty armpits cause nausea? How about that rock singer with the booming voice who turns out to have a flea's whisper on TV, requiring a walk to the box to crank up the sound, and another walk to turn the sound level down when the M.C. comes back? Whatever the annoyance, it can be overcome with a remote TV speaker and remote volume controls placed next to your favorite armchair.

Adding a remote speaker and remote volume control for both the main TV speaker and the remote unit is an easy installation since virtually everything is supplied pre-wired in Lafayette Radio's Duo-Remote TV Speaker. As shown in the schematic, the Duo-Remote Speaker consists of all components inside the dotted line—and these are supplied pre-assembled in an attractive walnut-finished cabinet.

Control By The Twos. Note that two controls are provided: R1, which controls the level of the main TV speaker, and R2, which determines the remote speaker's sound level. R1 is a specially constructed potentiometer with a *full off* position—the sche-

matic, in fact, shows the wiper in the *off* position. When installed, R1 completely disconnects the TV speaker, substituting R1 and R2 as the load for the TV receiver's output transformer. Since R2 and its associated remote speaker are connected across R1, the TV sound output appears across R2, with the remote speaker level determined by the position of R2's wiper.

The Duo-Remote Speaker requires a 3-wire connection to the TV receiver's speaker circuit in order to obtain control over both the main and remote speaker level. For convenience and maximum flexibility—like allowing the TV receiver to be "pulled" for servicing—a plug and jack arrangement such as shown in the schematic is suggested.

Note that J1 is a special version of the standard 3-circuit phone jack, having a through connection on the tip terminal. When connected as shown, removing the plug (thereby disconnecting the remote speaker) automatically restores the original TV speaker circuit. A further refinement as shown in the photos, is the use of a telephone type

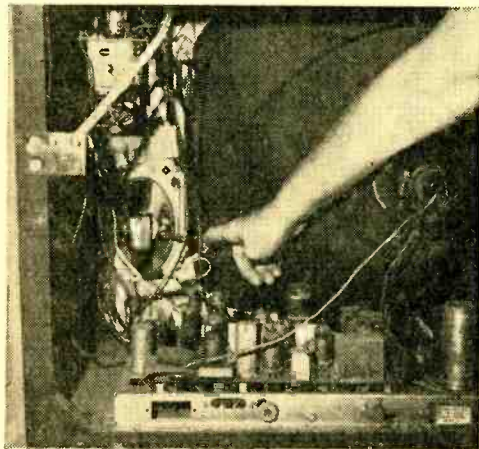

First step is to remove one of the leads going to the speaker in the set.

When loud commercials give you the boob-tube blues, this neat and easy remote TV sound control will rest those weary ears.

Decimator

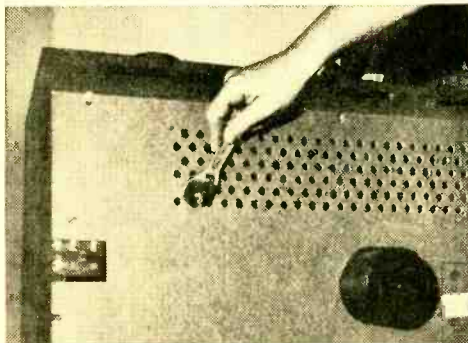

Remote speaker jack can be mounted in one of the ventilation holes in back of set, or $\frac{3}{8}$ -in. hole can be drilled to suit.

jack and wall plug at the remote speaker location, allowing the remote speaker to be unhooked at its location during housecleaning, etc.

Do in' It. The first step is to pull the TV power plug and remove the back of the cabinet. Locate the two wires leading from the audio output transformer to the speaker and



Telephone extension jack is mounted on baseboard near desired location of remote unit.



disconnect *one* of them at the speaker terminal. Now install J1 on the back of the television receiver. Generally, the back cover has a series of $\frac{3}{8}$ -in. ventilation holes and J1 can be installed directly in a handy one, with no drilling required.

If there are no ventilation holes, you will, of course, have to drill a $\frac{3}{8}$ -in. hole for J1 in any convenient location. If the back is metal, J1 should be insulated for safety by using a set of fiber shoulder washers between J1 and the metal cover. After J1 is mounted, wire it up as shown in the schematic. Try to use the shortest possible leads and route them away from IF and RF circuits.

Now put the TV cover back and apply

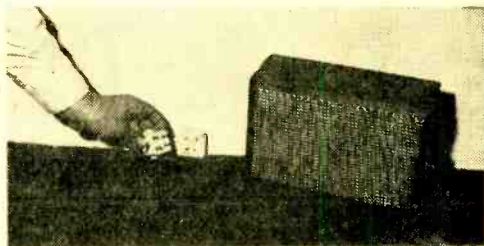

Matching telephone plug connected to Duo-Remote allows unit to be readily disconnected for housecleaning.

power. After the set warms up you should hear the program sound if no plug is in J1. If you don't hear the TV, better check for an error in wiring. If the sound is coming through, insert an unwired 3-wire phone plug in J1; the sound should be cut out. If it doesn't, check again for a wiring error.

Final Installation. If you want a quick-and-dirty finish, simply connect P1 to the existing Duo-Remote wiring as shown. Insert P1 to J1 and the installation is complete. However, since the wire supplied with the Duo-Remote unit is very thin and easily broken, a more permanent installation can

Decibel Decimator

be made by using standard #18 or #20 three-wire cable stapled to the moulding with an outlet plug at the speaker location.

Determine where the remote unit goes, then staple the 3-wire cable to the moulding with a round-staple stapler (the type used by electricians or telephone installers). If you have a tackless wall-to-wall carpet installation, the wire can often be pressed into the space between the carpet and the moulding.

Plug in P1 at the TV end of the cable and install a telephone-type jack (four connections) at the seating area. Connect the three wires of the cable to three of the four tele-



Decibel Decimator all hooked up and ready to go. With a little use, you'll find this inexpensive job's quite a step-saver.

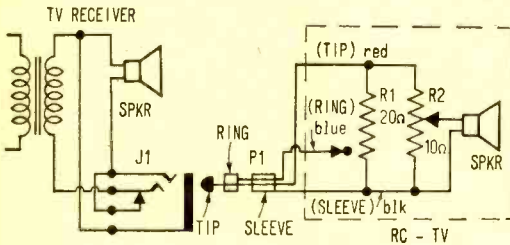

Wire up the jack on the back of the set according to the schematic. The extension speaker, in the dotted lines, is pre-wired.

PARTS LIST

- J1—3-conductor jack (Switchcraft type 13B or equiv.)
- P1—3-conductor phone plug (Switchcraft type 267 or equiv.)
- 1—RC-TV Duo-Remote Speaker (Lafayette 99-H4596)
- 1—4-contact wall-mount telephone plug and socket (see text)
- Misc.—Wire, solder, staples, etc.

phone jack terminals and connect the matching plug to the cable from the Duo-Remote Speaker.

Usin' It. With P1 plugged into J1 and the telephone plug into the telephone jack, set the *main speaker* control on the Duo-Remote to maximum volume (full clockwise) and the *remote speaker* control to off (counterclockwise). Turn on the TV receiver and set the TV sound slightly louder than normal—the volume can then be set to a comfortable level with the *main speaker* control on the Duo-Remote. To kill the main speaker from the Duo-Remote, simply rotate the *main speaker* control counterclockwise. The level at the remote speaker can be adjusted at any time—either with the main speaker *on* or *off*—to any desired volume with the remote speaker control. Now when your ears are assaulted by unwanted TV sounds, you can fight back with but a flick of the wrist.

Pens Make Handy Probes

● A worn out ballpoint pen with an all-plastic barrel makes a handy all-around probe for your multimeter or other test gear. Simply disassemble the pen as shown. Then drill a hole at the top end for the test-lead wire. On some pens, you can force the little button on top of the barrel out and run the wire through there, obviating the need to drill a hole. Then simply solder a piece of flexible test-lead wire to the filler and assemble the pen.

—Kevin Green

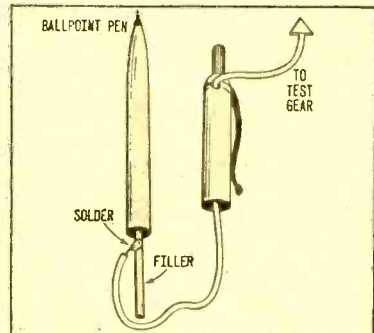

REV-BUSTER

This
mighty
monitor
puts your
car

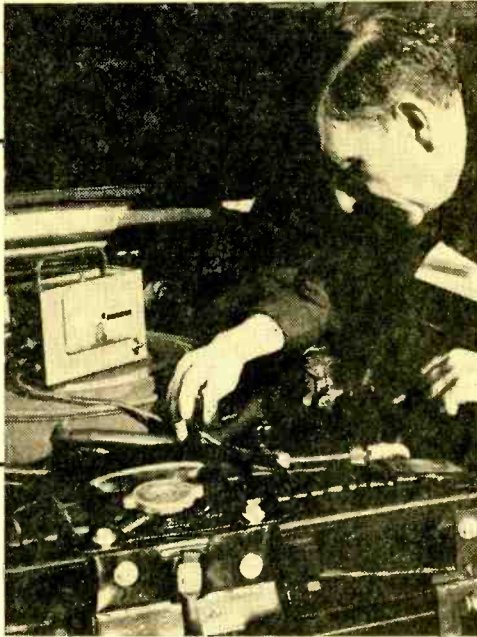

on the
go-go-GO
and
saves you
money, too!

By Ron Michaels

Round and round it goes . . . but just how fast is your engine's crankshaft turning? Engine rpm—or revolutions per minute—is something you must know when you service any engine. And a tachometer like the Rev-Buster is just the device to tell you rpm and a few other things as well.

You'll use your Rev-Buster as a guide when you adjust engine idle or when you monitor a voltage regulator setting. You can use it to check automatic transmission shift points and to adjust engine speed prior to tuning the ignition system. (All of these techniques are explained in any good auto service manual.)

As a bonus, the Rev-Buster also measures *ignition point dwell*, a technical term that indicates the percentage of time the ignition points are closed as the engine turns. This is a convenient gauge to use when setting point gap.

In case you've been too busy to do any servicing lately, remember that the ignition points in your car's engine are a pair of switch contacts that are periodically opened and closed by a rotating camshaft inside the distributor. Each time the points open, current flowing through the primary winding of your car's ignition coil is interrupted, and a

high-voltage pulse is induced in the coil's secondary. This pulse is routed to the appropriate spark plug by the distributor and a spark flashes across the plug's gap.

For most efficient engine operation, the points must be open (i.e., producing a spark) each time the compressed air and fuel mixture inside one of the cylinders is ready to be ignited. This adjustment can be made in two ways.

The hard way is to use a point setting gauge to attain maximum gap between the points when they are fully open—a rather laborious task. The easier way is to use a dwell meter to measure the length of time the points remain closed, and adjust the points until the dwell reading agrees with the specified value listed in your car's service manual.

How It Works. The tachometer is basically a pulse counter circuit. It counts high-voltage pulses supplied to the engine by the ignition system. The rate of these pulses—the number of pulses per minute—is directly proportional to engine rpm, and the Rev-Buster's panel meter can be calibrated to read engine rpm directly. We'll say more about this shortly.

Heart of the pulse counter circuit is an

REV-BUSTER

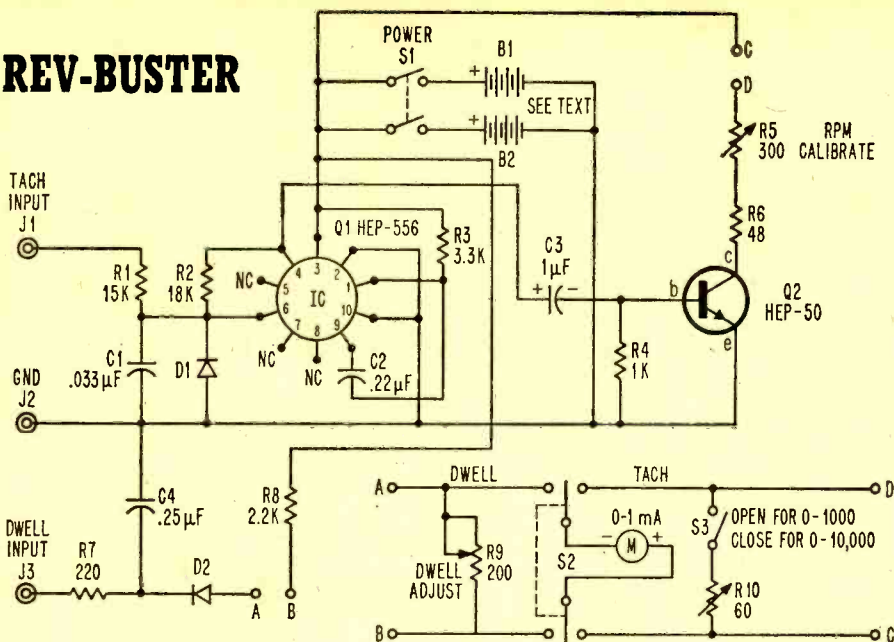

IC (integrated circuit) that functions as a *one-shot multivibrator*. The job of the multivibrator is to take the rough, ragged, non-uniform pulses produced by the ignition system and transform them into smooth, uniform output pulses. One output pulse comes from every input pulse.

These output pulses go on to transistor Q2, which functions as a meter amplifier. The net result is that the greater the rate of the ignition pulses supplied to Q1 (IC), the greater the rate of the output pulses, and the greater the reading on the panel meter.

The meter circuit is equipped with a switch-operated shunt resistor R10 to provide two rpm ranges: low rpm (0 to 1000) and high rpm (0 to 10,000). For most applications, the low range is more practical. But the high range is useful for checking transmission shift points and ignition tuning curves. Note that the instrument can also be used when you're out on the road—just run long test leads from the engine compartment through the firewall.

Ignition pulses are produced across the ignition points as they open and close. To measure rpm or dwell angle, you connect the Rev-Buster's test leads between the *hot* terminal on the distributor (the terminal connected via a slender wire to the ignition coil) and *ground*.

The dwell meter circuit is similar to a simple ohmmeter but with a few important modifications. While we want current to flow through the points and into the panel meter when the points are closed, we don't want the

Layout is designed for efficient servicing. Access to control R5 is through grommet on back of panel.

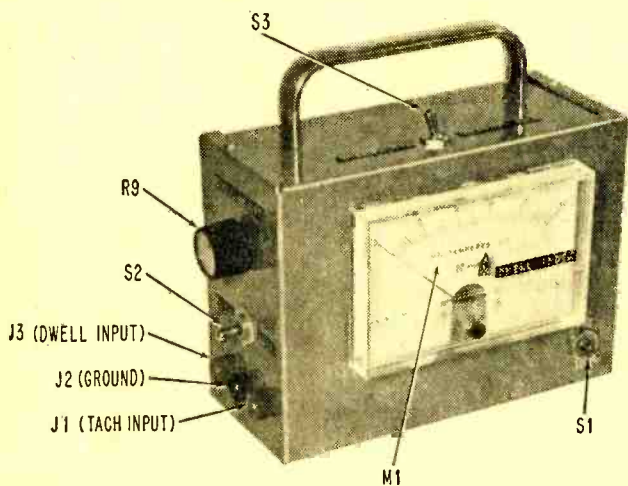

PARTS LIST FOR REV-BUSTER

B1, B2—Four 1.5-V pen cells in holder (see text)
 C1—0.033- μ F, 200-V capacitor
 C2—0.22- μ F, 200-V capacitor
 C3—1- μ F, 10-V electrolytic capacitor
 C4—0.25- μ F, 200-V capacitor
 D1, D2—300-V silicon rectifier (GE 1N1695 or equiv.)
 J1, J2, J3—Banana jacks (2 red, 1 black)
 M1—0-1 mA, DC panel meter (Allied 52B-7209 or equiv.)
 Q1—Integrated circuit (Motorola HEP-556)
 Q2—Npn transistor (Motorola HEP-50)
 R1—15,000-ohm, $\frac{1}{2}$ -watt resistor
 R2—18,000-ohm, $\frac{1}{2}$ -watt resistor
 R3—3300-ohm, $\frac{1}{2}$ -watt resistor
 R4—1000-ohm, $\frac{1}{2}$ -watt resistor
 R5—300-ohm, hum-adjust potentiometer

R6—48-ohm, $\frac{1}{2}$ -watt resistor
 R7—220-ohm, $\frac{1}{2}$ -watt resistor
 R8—2200-ohm, $\frac{1}{2}$ -watt resistor
 R9—200-ohm, linear potentiometer
 R10—60-ohm, hum-adjust potentiometer
 S1—Dpst toggle switch
 S2—Dpdnt toggle switch
 S3—Spst toggle switch

Misc.—5 x 7 x 3-in. aluminum chassis box, small chassis box for calibrator, AC line cord, 2 10k resistors (for calibrator), binding posts (red and black), test leads (red and black), alligator clips, banana plugs, mercury batteries (optional), carrying handle, perf board, push-in terminals, $\frac{1}{4}$ -in. insulators, grommet, decals, tape, hardware, wire, solder, etc.

ignition system to force current backwards through the meter when the points are open.

Silicon rectifier D2 accomplishes this by blocking current flow whenever the input voltage rises above 5.3 V—a condition that exists whenever the ignition points are open. Capacitor C4 bypasses any high-voltage pulses that appear across the test leads before they can do damage to the meter circuit. This same function is performed in the tach circuit by the network composed of R1, D1, and C1.

Building Tips. Most of the circuitry is wired on a 4 x $\frac{3}{4}$ -in. piece of perf board. Push-in terminals are used as wiring points. All board components are mounted on the top surface, except calibration control R5 which is mounted to the bottom so that it can be reached through a hole in the rear of the cabinet.

The cabinet is a 5 x 7 x 3-in. aluminum chassis box. The carrying handle is just a convenient accessory. Mount the panel me-

ter and power switch S1 on the cover. The input jacks, hi/low range switch S3, function switch S2, and dwell adjust control R9 also go on the cover, as shown in the photos. The PC board should be mounted with $\frac{1}{4}$ -in. insulated spacers to keep the board away from the inside of the case.

Generally, the parts layout isn't critical, but be sure to double-check the orientation of the IC when you mount it (a ring of push-in terminals makes a fine socket). The tab is under pin 12. In the schematic, the pin diagram represents the IC when viewed from the bottom.

Also, you should note the correct polarity of the silicon rectifiers and the electrolytic capacitor. Take care not to overheat the semiconductor components when you solder their leads in place (alligator clips make good heat sinks).

The power supply consists of two independent battery holders. Each holder has four pen cells wired in series, and they are paralleled when the power switch S1 is on.

This arrangement helps maintain a constant supply voltage (6 V), an important consideration, since calibration accuracy depends on the power supply voltage.

You can eliminate one of these battery holders by using only

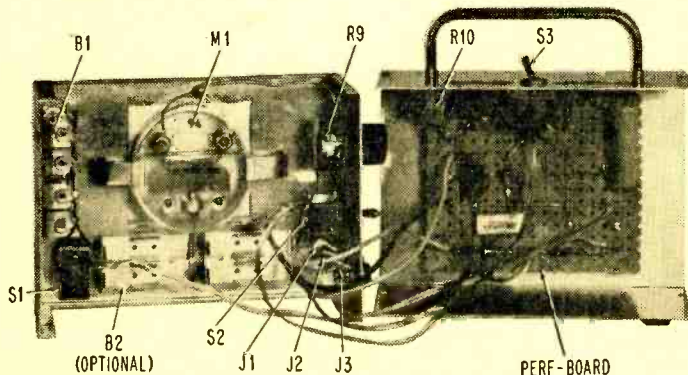

Two battery holders are mounted inside case, but only one was used (see text).

REV-BUSTER

mercury cells in just one holder instead of conventional cells. Mercury cells maintain a relatively constant output voltage throughout their lives, but at a substantially greater cost.

Make your test leads from two 48-in. lengths of insulated wire—one red, the other black. Mount alligator clips at one end and banana plugs at the other.

Calibration and Use. To use the instrument just examine the function labels shown in our photos. For a tachometer, flip S2 to

brator using any line cord from your junk box. Two 10k resistors are wired in series with both leads from the AC cord. The leads should go to black and red binding posts, with all components mounted in a tiny aluminum chassis box for safety. The resistors serve to lower the line voltage before it is applied to the tach input.

The tach automatically clips off the bottom half of the 60-Hz sine wave so that pulses are applied to the circuit at a rate of exactly 60 pps. This 60-pps rate represents different values of rpm, depending on the type of engine you are working with.

The ignition system of an 8-cylinder engine produces 60 pps when the crankshaft is turning at 900 rpm. A 6-cylinder engine turns at a rate of 1200 rpm, a 4-cylinder engine at 1800 rpm.

(Continued on page 107)

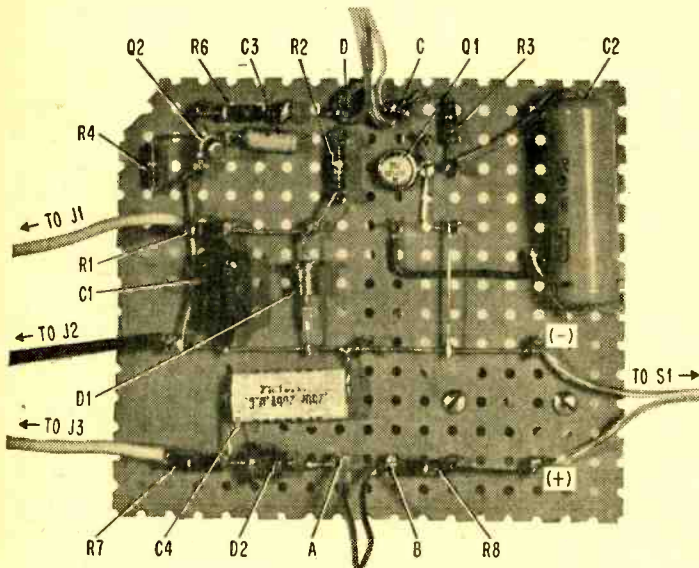

At left is top of perf board. Wiring almost corresponds to schematic. Below is underside of board. Calibration control R5 aligns with hole on panel.

TACH, flip S3 to desired rpm range, and plug your test leads into the appropriate jacks; the ground lead goes to the center jack (black), while hot lead for TACH is at right—use the jack at left only for DWELL.

Connect the test leads between the hot terminal on the distributor and ground. For a *negative ground* (the most common) ignition, connect the ground lead (black) to a ground point in the car, and the hot lead (red) to the distributor. For *positive ground* ignitions just reverse the leads.

For a dwell meter, flip S2 to DWELL, plug your test leads into the appropriate jacks, and connect the leads as you did before.

Calibrating the tach requires a stable signal source of known frequency. The most convenient is the 60-Hz power line in your home. To use it, you simply build a cali-

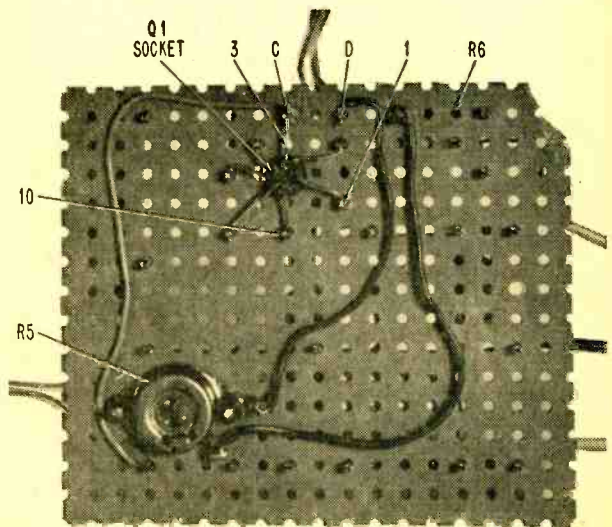



UNIVERSAL REVERB REVERB

Guitar kicks with
sound on the rebound

By Herb Freidman
W2ZLF/KBI9457



Hottest item going these days for the in-crowd guitar pickers is Olson Electronics' RA-844, a twenty buck add-on reverberation device that can make a twenty-dollar amplifier (or even your hi-fi amp) sound like a \$200 guitar amplifier. You simply plug the electric guitar to the RA-844's input jack, connect the reverb amp to the guitar amp (or the hi-fi), and you can make the guitar sound like it's at the bottom of a five-story cavern.

Or, if you don't go for overpowering echo, you can add just a smidgen of reverb to make the overall sound very bright (like they do down at the local radio station.)

(Continued overleaf)

REVERB

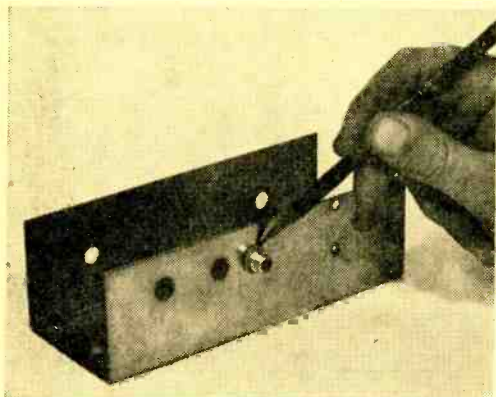

After the reverb unit has been disassembled, the keying jack hole is drilled and the jack installed. Note that the jack is insulated from chassis with fiber washers.

You can even use the RA-844 reverb amp with a dynamic mike to put a little pizzazz on a vocalist.

Few Bucks, Big Buy. Sound like a great buy for twenty bucks? You're right, it is; that's why it's so big with the in-crowd. Only problem is that the reverb amp cannot be keyed in and out while playing. If you want to change back and forth from reverb to "dead strings," you have to stop playing and shut down the depth (reverb) control. But if you're willing to go for a few extra dollars and about an hour's work, you can

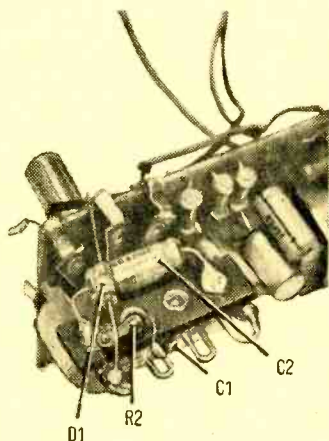

All components of the keying circuit mount on a 4-lug terminal strip which is soldered to the back of the depth control.

add a switch (keying) jack to the reverb amp so it can be keyed in and out with a foot switch as you play.

The foot switch modification for the reverb amp is shown in the schematic. The components to be added are shown in the dotted line. The reverb amp components show only the parts value. To understand what the modification does, let's take a quick run through the circuit of the basic reverb amplifier itself.

The guitar pickup feeds into the input jack—its level controlled by the 10K volume control—and is amplified by transistor Q1. The unmodified (no reverb) signal is tapped off Q1's collector through a capacitor and the 470K resistor, and is again amplified by Q4. (The loss through the 470K resistor compensates for Q4's gain.) The guitar's signal is then fed to the output jack—which is connected to the guitar amplifier's input jack.

Springy Sound. Now go back to Q1's collector. Note that the guitar's signal is also fed through the transformer and is amplified by the push-pull amplifier (Q2 and Q3) and is then fed to the reverb unit. The heart of the reverb unit is a spring that literally *bounces* the signal back and forth, just like the echoes in a canyon (when you holler hello-o-o-o).

The output from the reverb unit—which now consists of "echoes," or reverberation—is fed through the *Depth Control* into Q4, where it mixes with the direct guitar signal.

When the *Depth Control* is closed, only the direct guitar signal passes through Q4 and there is no reverberation. As the depth control is advanced and more reverb signal is mixed with the direct sound, the total effect at the output jack varies from no reverb, to slight "liveness," to cavernous reverberation.

The Keying Circuit. If one attempted to

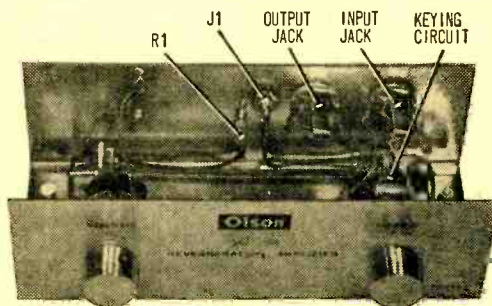

Completed modification of the Olson reverberation amplifier. R1 is soldered directly to the keying control jack.

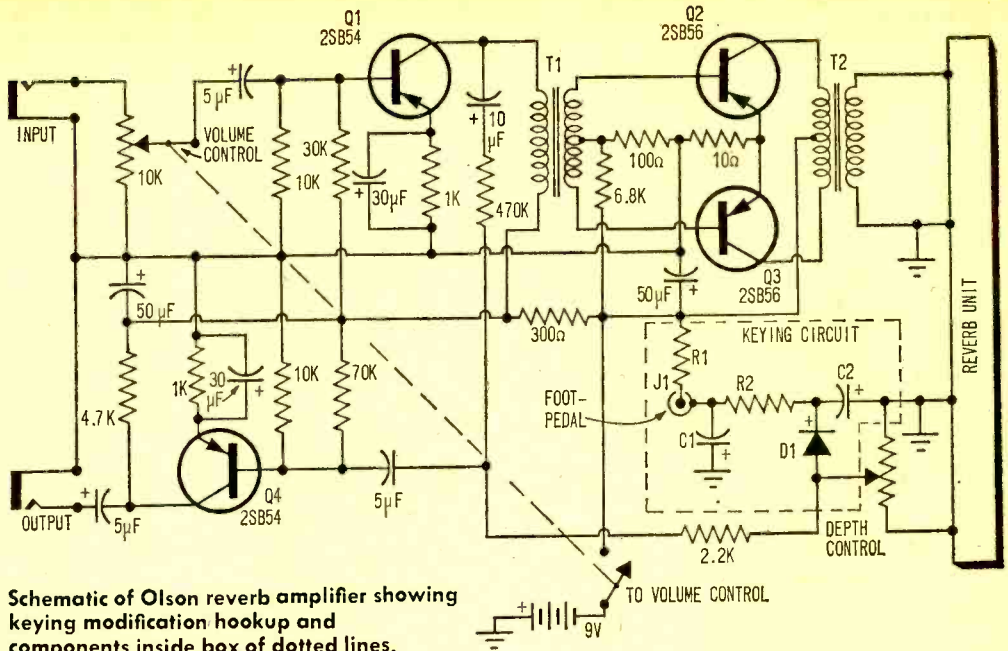

Schematic of Olson reverb amplifier showing keying modification hookup and components inside box of dotted lines.

key the reverberation in and out by disabling the power supply to the class B amplifier, the sudden change in load on Q1's collector transformer will cause a drastic change in level of almost 20 dB at the output jack, so this technique is out. If a foot switch was used to short-circuit the reverb signal across the *Depth Control*, not only would there be the possibility of severe hum and noise pickup in the control leads, but there would be severe clicks and pops as the effect was switched in and out.

To avoid clicks and pops, our modification uses delayed diode keying of the reverb signal that shorts (or restores) the reverb signal from the *Depth Control's* wiper contact to ground. With the delayed reverb signal taking approximately one second to key in and out, there is virtually no noise when keying the reverb effect—at most a slight sound well under the music level when the reverb is keyed out. We could entirely eliminate the slight thump but the circuit would get unnecessarily complex; when you're playing a gig no one will hear the thump anyway.

When jack J1 is open, the reverb amp functions normally, since diode D1 is non-conducting (D1 is very slightly back biased by the leakage through Q4's base-input capacitor). When J1 is closed, the battery voltage is applied to the C1-R1-C2-D1 circuit through R1. At the instant J1 is closed by a foot switch, C1, being uncharged, drops

PARTS LIST	
1—	Reverb Amp—Olson RA-844, available from Olson Electronics Corp., \$19.95
C1, C2—	300- μ F, 3-VDC miniature electrolytic capacitor
D1—	1N34A diode (don't substitute)
J1—	Phono jack
R1—	20,000-ohms, $\frac{1}{4}$ -watt resistor
R2—	2,200-ohms, $\frac{1}{4}$ -watt resistor
1—	Foot-switch (Linemaster T515 or equiv.)
1—	Phono plug
1—	Terminal strip, 4-lug
Misc.—	Wire, solder, etc.

the voltage at the C1-R2 junction and lets it build up slowly, thereby forward biasing diode D1. D1 conducts, shorting the reverb signal to ground through C2.

When J1 is opened, interrupting the battery voltage, C2 discharges through D1 slowly (1 second) giving a slow fade-in of the reverb effect. Because of D1's natural "break-over" voltage, the echo effect is never 100-percent disabled. There is a slight residual effect that adds a smidgen of liveness; you won't know it's there unless you're a golden-eared pro. (Again, it would unnecessarily complicate the installation to get rid of the reverb effect entirely.)

Installing The Keying Circuit. Completely remove the guts of the reverb unit as a single assembly by unscrewing the input and output jack mounting nuts, the volume and depth control mounting nuts, and the reverb unit's two mounting screws. Scribe a pencil

REVERB

line along the edge of the input and output jack's trim plate and the edge of the battery holder. Drill a 9/16-in. hole exactly midway between the two lines (there is virtually no extra clearance so make certain the hole is centered before you drill). Install a single-mounting-nut type phono jack in the hole.

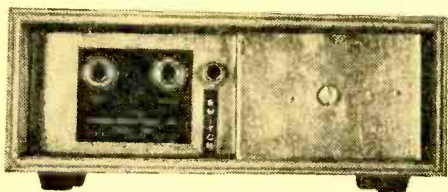

Rear view of completed modification showing keying control jack where foot switch is plugged in.

Be sure it is insulated from the chassis with shoulder washers.

Thoroughly clean the back of the depth control with some kind of contact cleaner, or radio-cement solvent, and solder a small terminal strip to the back of the depth control as shown in the photographs. The control cover will not take solder if it is not thoroughly clean. If possible, use a miniature terminal strip as supplied in the Allied Radio Terminal Strip Kit.

Install C1, C2, R2 and D1 on the strip as shown in the photographs. We used very small 300- μ F capacitors to keep things neat; these capacitors as specified in the parts list are somewhat expensive. You can, if you want to cut costs, substitute any cheap capaci-

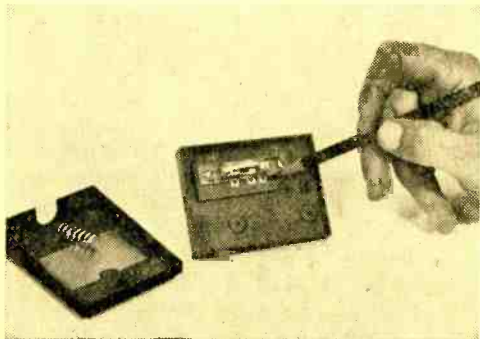

Foot switch is disassembled so cable and plug can be attached. Be sure to connect cable to the right two contacts.

tor as long as the voltage rating is three volts or more. In addition, C1 and C2 can be reduced to 100 μ F, though the keying thump will be somewhat louder than with the bigger capacitors.

Finally, connect a 10-in. wire to the circuit-side power terminal on the volume control and re-assemble the reverb amp.

Cut the 10-in. lead just long enough to reach jack J1 and connect R1 between the jack (either terminal) and the lead; insulate the R1/wire joint with tape or spaghetti. Connect the remaining J1 terminal to the C1-R2 junction. Make certain the leads to J1 do not interfere with the reverb unit's spring.

Switching Feet. We suggest the foot switch listed as it's inexpensive, though just about any switch will work. Disassemble the foot switch and connect a length of ordinary lamp cord (or any two conductor cord) to the two switching terminals. The switch has s.p.d.t. terminals, so make certain you select



With the modification finished and the reverb amp plugged into guitar and amplifier, you're ready to make with the great wild sounds of the seventies.

the right two—check for the right ones by having a close look or with an ohmmeter. Now, to finish up the job, connect a phono plug to the free end of the lamp cord being careful not to melt the cord insulation when soldering and causing a short circuit.

Connect the switch to J1, the guitar to the input jack, and the guitar amp to the output jack. Key the switch so the reverb effect is off and adjust the guitar, reverb volume, and amplifier volume controls for desired sound level; then key the echo effect in and adjust the depth control for the desired reverb effect. As you play, you can key the reverb effect in-and-out as desired. Try St. Louis Blues or Kansas City with reverb. Man, it's the greatest! ■

WALL PHONE WIRELESS

By Art Trauffer

Mr. Bell doesn't get to meet Mr. Marconi in this project, but you can try to bring them together in spirit. You can put a modern transistor radio into what looks like ye olde telephone. Besides serving to dress up the decor of your home, it's great as a conversation piece. It's functional, too . . . if you get tired of talking about it, you can sit back and listen. And the listening is good. The larger speaker and the larger enclosure

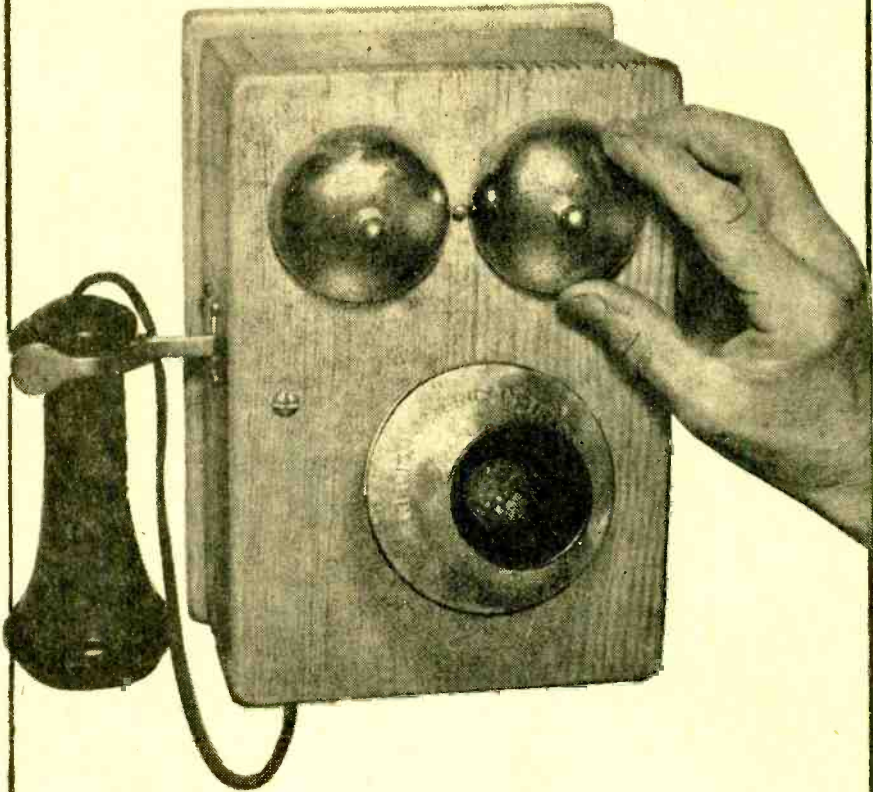

used here (compared to most small transistor radios) do much to enhance sound quality. And for a change, the left bell is the *on/off* and volume control, while the right bell is the station selector. Other parts are for show.

You can try your hand at finding some practical and some not-so-practical applications for the other telephone parts. For example, if the receiver hook is equipped with a switch, you can use it to turn the radio *on* and *off*, or you can use it to switch the sound from the speaker to the telephone receiver. What can be done with the various parts depends upon imagination and a desire for the unusual.

Old wood wall phones of various styles and sizes are available from

Wall Wireless

several firms. If you prefer, you can construct your own. All of the parts, including the receiver, hook, and bells, can be purchased separately. However, for your convenience, some of the sources for complete units are listed. Construction isn't difficult, and there's more than enough room inside the box to hold all the components.

Most of the old phone boxes were made of solid oak, but you can use clear pine. It is easier to work with, and while pine won't take the same abuse as hardwood, it does serve the purpose. Use glue and small finishing nails to hold the box together.

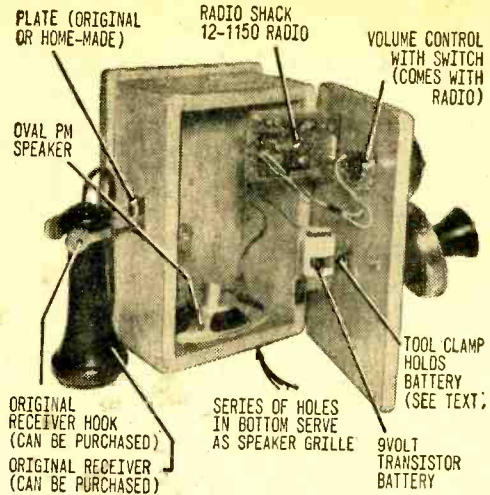

The 9-V battery is held in place by a small metal clamp. A group of small holes directly under the speaker permits passage of sound. Be sure to check clearance of all parts before securing them in place.

At left, front panel overlaps top, bottom, and sides slightly. Center the panel and carefully mark exact hinge positions. You will have to do an accurate job of aligning panel closing screw to its bracket—it may be easier to substitute a magnetic door catch.

Completed unit (below) can be hung on a nail or screwed into wall. One or two holes in back panel is all you need. You can mark broadcast band frequencies on tuning bell and mark the off position on other control bell.

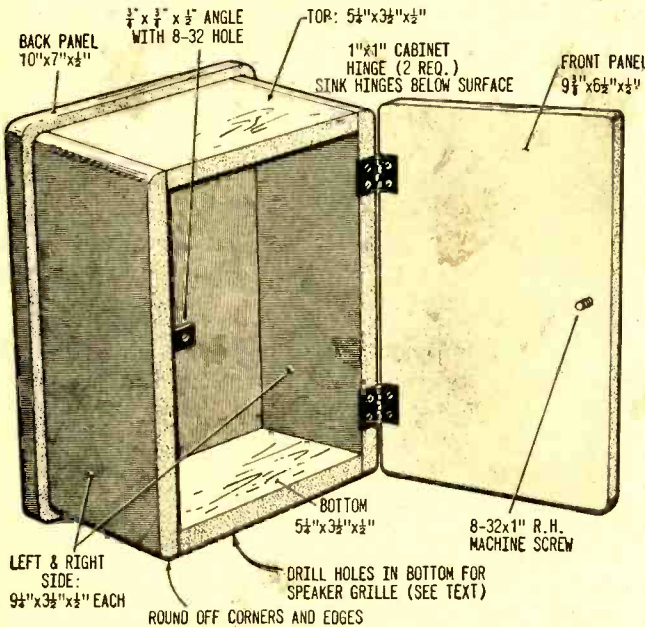

Countersink the nails and fill in with plastic wood. Then round off all the corners and outside edges. Sand the exterior surfaces and finish with a coat of oak stain, rubbed with a cloth or wad of facial tissue. Finally, apply a couple of coats of clear varnish to all the surfaces to seal the wood and to protect the finish.

Mount the transistor radio on the front panel of the box as shown in the photo and illustration. Fasten a bell to the station-tuner shaft. When mounting the radio use screws that are just long enough. If they are too long, you could cut into the circuit board and other wiring.

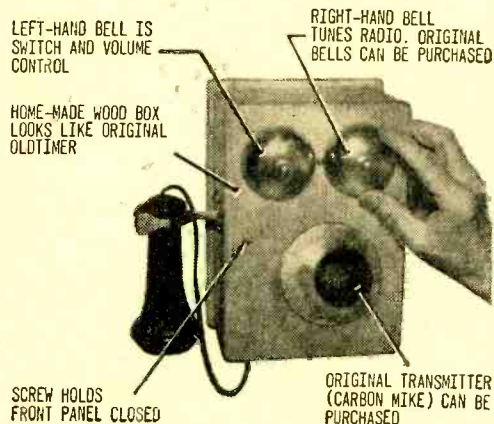

Important—length of screws should be just long enough to penetrate the thickness of front panel and radio's case. Excessive length can cause short circuits and other damage. Tuning shaft should be centered in panel opening. After mounting bell, check for smooth operation.

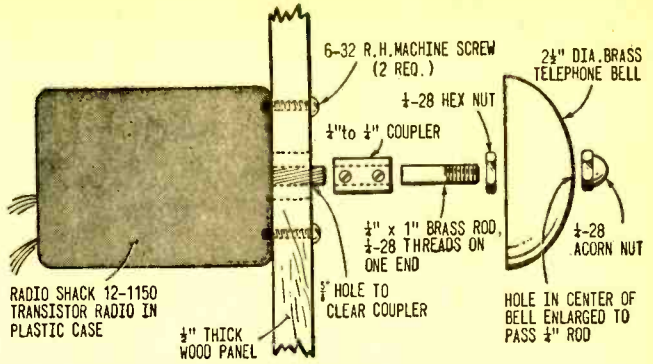

MATERIALS LIST FOR WALL PHONE WIRELESS

ELECTRONICS PARTS

- 1—Transistor radio (Radio Shack 12-1150 or equiv.)
- 1—3 x 5-in. speaker
- 1—9-V transistor radio battery

CABINET MATERIALS

- 1—10 x 7-in. back panel (see text)
- 1—9 3/8 x 6 1/2-in. front panel
- 2—9 1/4 x 3 1/2-in. side panels
- 2—5 1/4 x 3 1/2-in. top and bottom
- 2—1 x 1-in. brass cabinet hinges (with 8 brass, flat-head wood screws)
- 1—3/4 x 3/4 x 1/2-in. brass angle (front panel lock)
- 1—8/32 x 1-in. brass round-head machine

screw (front panel lock)
Misc.—Small finishing nails, glue, etc.

TELEPHONE PARTS

- 2—2 1/2-in. dia brass telephone bells
- 1—Transmitter (carbon mike) with mounting bracket and screws
- 1—Receiver, with cord
- 1—Receiver hook with mounting bracket

HARDWARE

- 2—1/4 x 1/4-in. couplers with set screws
- 1—1/4 x 3/4-in. brass rod
- 1—1/4 x 1-in. brass rod
- 2—1/4-28 brass hex nuts
- 2—1/4-28 acorn nuts

Use a coupler and small rod to mount bell on shaft of volume control and switch assembly. Drill an undersized hole in panel to obtain a tight grip on volume control's threaded shank. The shank isn't long enough to go all the way through panel. If you insist on putting a nut on the shank, you will have to do a very careful job of countersinking to avoid punching too large a hole through panel.

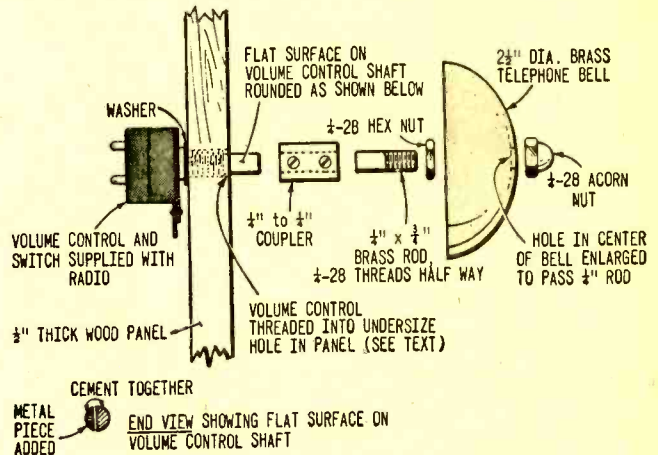

OLD WOOD WALL TELEPHONES AND PARTS SOURCES

A-M TELEPHONE CO.

Turtle Lake, Wis. 54889

MR. & MRS. G. BILLARD

21710 Regnart Rd., Cupertino, Calif. 95014

BURDEN SALES CO.

814 "O" St., Lincoln, Neb. 68508

CONTINENTAL TELEPHONE SUPPLY CO.

49 W. 46th St., New York, N.Y. 10036

DELTA ELECTRONICS

Box 2262, Dallas, Tex. 75221

ORA HARDACRE

555 S. Harbor Blvd., Anaheim, Calif. 92805

R. L. LOVELACE & SONS

Old Nauvoo Antiques, Nauvoo, Ill. 62354

SURPLUS SAVINGS CENTER

Waymart, Pa. 18472

TELEPHONE ENGINEERING CO.

Lincoln Bldg., Simpson, Pa. 18407

TELEPHONE REPAIR & SUPPLY CO.

1760 W. Lunt Ave., Chicago, Ill. 60626

Little Joule

THE EXPERIMENTER'S VARI-VOLT

By James A. Fred

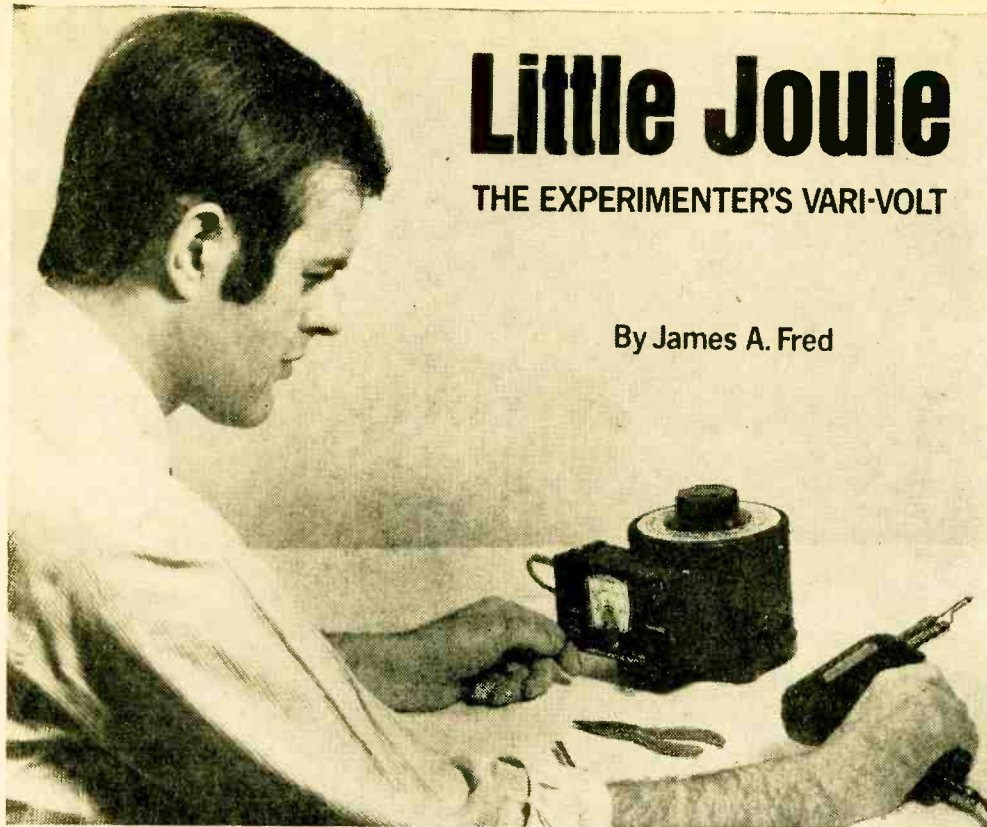

Inexpensive metered variable-voltage transformer lets you dial power.

One thing most home-electronic workshops don't have is a variable voltage transformer. The high purchase price is enough to keep most experimenters from buying one, though most probably understand the need for one in their shops.

Trade names for this device range from *Variac* by General Radio, *VT* by Ohmite, *Volt-Pac* by General Electric, to *Powerstat* by Superior Electric. But whatever the trade name, it is basically a transformer with one winding on a circular iron core that operates as an autotransformer.

The line voltage is applied to a portion of the winding. The voltage used is taken from the winding by use of a sliding contact on the bare wire track on top of the winding. The last 25-percent of the winding has a voltage induced into it from the part of the winding to which the line voltage is applied. Thus, we can increase the line voltage to 140 volts and tap off any amount from 0 to 140 volts with the sliding contact.

Fortunately, Radio Shack has an inexpen-

sive variable voltage transformer on the market. By adding an AC voltmeter, plugs, on/off switch, and a fuse to the basic transformer, you have an extremely versatile and useful addition to the shop. We call it our Little Joule.

Uses for Little Joule range from controlling the heat of a soldering iron to just the right temperature, to varying the input voltage to a power supply so the exact desired voltage appears at the output. Other applications include slowly increasing voltage applied to an untried project from zero thereby avoiding a smoking catastrophe, and controlling the speed of an electric drill to suit the material being worked on. Sound good? Here's how.

Getting Started. When you have all the parts we've listed, you are ready to begin construction. Lay out the holes in the aluminum box and drill or punch them. If you like, you can label the receptacles. But since the switch has an indicator plate, the fuse holder is labeled, and the AC meter marked

At right, bottom half of the chassis box is attached to the transformer with two screws through the section of casing that was formerly used to hold the AC receptacle.

with its range, no other markings are needed.

If you have an unpainted box, carefully clean it with steel wool and spray it with a coat of zinc chromate. Wet-sand the zinc chromate, then spray on two coats of your favorite paint. If you add decals or press-on letters, spray the box with a clear finish to protect the lettering.

While the paint is drying, take the variable transformer apart. Remove the two screws from the plastic casing of the transformer and cut the blue wire, black wire, and the core wire. Take out the fuse holder, switch, and line cord—save fuse for use later in the construction of Little Joule.

Now cut a $\frac{7}{8}$ -in. piece off the bottom of the plastic casing. This piece will fasten to the side of the lower box half. Remove the set screw from the knob on the transformer and lay it aside.

Next remove the four screws that hold the perforated metal cover to the base. Carefully unsolder and remove the blue wire from the side of the transformer winding. Solder a piece of #18 stranded hook-up wire ten in. long to the core wire.

Transformer Wiring. Remove the black wire from the center terminal and replace it with a piece of #18 hook-up wire six in. long. Now replace the perforated cover and knob. Fasten the $\frac{7}{8}$ -in. piece of plastic casing

First step to building Little Joule is to prepare the control box. The large holes can be made with a chassis punch or hand nibbler. After holes are made and all ragged edges smoothed and deburred, the chassis box should be primed with zinc chromate, wet-sanded and then painted to suit to obtain a neat, professional appearance of the finished unit.

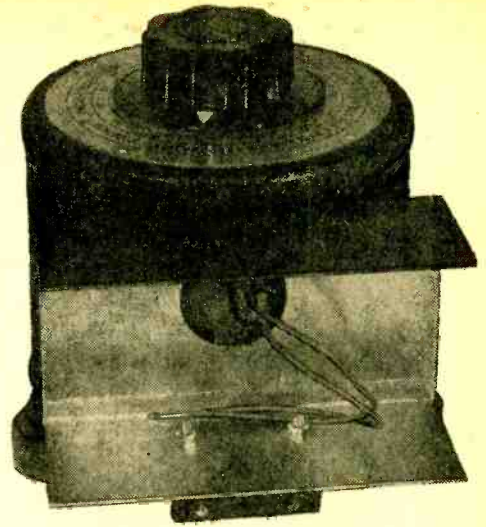

to the lower box half with two 6-32 screws and hex nuts. Fasten the plastic piece to the original holes with the screws you previously removed. Feed the wires you soldered to the transformer through the rear of the lower box half before screwing tight.

You are now ready to build up the top half of the box. Mount the two AC receptacles, the fuse holder, pilot light, switch, and meter, in that order. Be sure to use salvageable

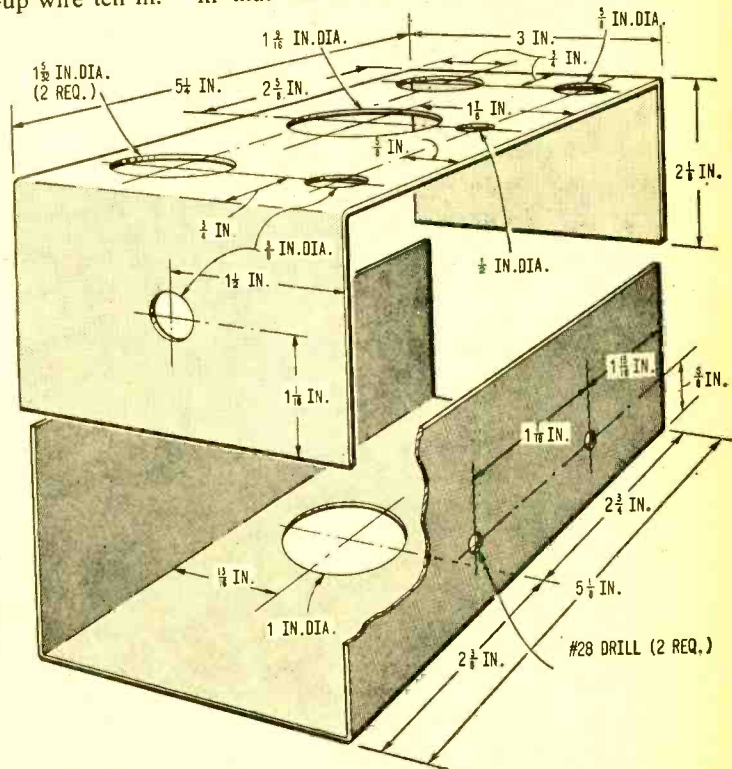

Little Joule

Right, the transformer wires have to be lengthened to reach their tie-points in the control box. Be sure to use wire of adequate gauge to carry the rated 5 Amps.

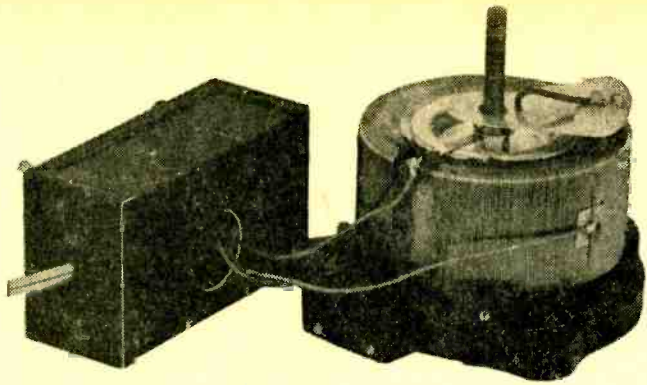

Below is the schematic of Little Joule. Note that J2 provides a fixed output since it's hooked directly across the AC line.

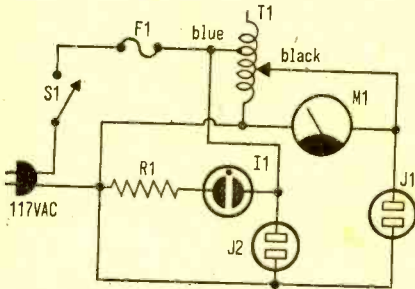

PARTS LIST FOR LITTLE JOULE

- F1—5-A fuse and holder (Supplied with T1)
- I1—Neon pilot light assembly (Radio Shack 272-328 or equiv.)
- J1, J2—Standard AC receptacle (Amphenol 61-F, Allied Radio 47B0677 or equiv.)
- M1—150-VAC voltmeter (Radio Shack 22-016 or equiv.)
- R1—Resistor supplied with pilot light I1
- S1—S.p.s.t. 117-VAC, 5-A toggle-switch (Supplied with T1)
- T1—Variable voltage transformer (Radio Shack 273-043 or equiv.)
- 1—5¼ x 3 x 2½-in. aluminum chassis box (Bud 3006A, Radio Shack 77-0683 or equiv.)
- Misc.—Line cord and plug, rubber grommet, wire, solder, etc.

parts. Use #18 stranded hook-up wire on all connections except for the meter and pilot light: here you can use #22 solid hook-up wire. Do not solder either connection on the variable-voltage receptacle or the end connection on the fuse holder.

Connect and solder the wire from the side of the transformer to the end of the fuse holder. Solder the wire from the solder lug on the transformer to the copper-colored terminal on the variable receptacle.

Twin Receptacles. Note that the left hand receptacle is wired to the line voltage and isn't variable as the right hand receptacle is. Splice a 6-in. length of wire to the other core wire on the transformer. Insulate this solder joint with a length of sleeving. Solder this wire to the white terminal on the variable receptacle.

If you have carefully followed the directions, you are ready to put the front of the aluminum box onto the bottom half fastened to the transformer. Set the knob to zero volts and the switch to off. Plug the line cord into a wall outlet and turn on the toggle switch. As you turn the transformer knob, the meter reading should begin to increase. You should have close to 150-VAC no-load voltage on your meter at full knob rotation. With a full 5-A load, the meter reading of your Little Joule should be about 140 volts. ■

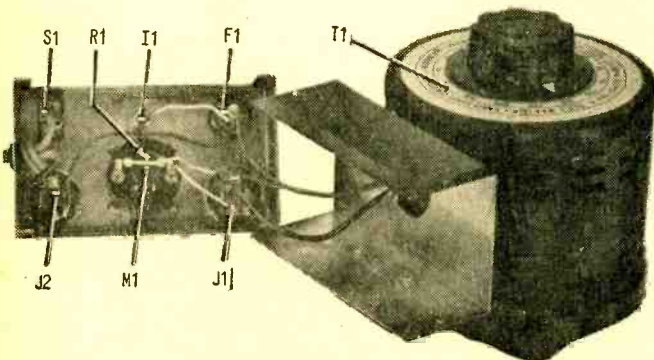

When the various parts have been installed in the top half of the chassis box, wiring up the control box is a quick task. Since the circuit carries up to 5 Amps, be sure to get a good mechanical and solder joint on all connections.

make music with...

DATE PACER

By Bill Britton

mmmmmm! Love that sound,
Daddy! But tell me: did you
really make it yourself?

■ You say you're lazy—and you're just 'bout broke, but you want hi-fi to make a good impression on *you-know-who*? Tell you what we're gonna do! We're gonna let you in on a little secret—good audio reproduction doesn't have to be sky-high in price. Most of the cost in those high-priced units is for skilled labor, rent on large factories, sales promotions, and don't forget *markup*. The Editors in cooperation with the author have come up with a you-build-it project called the *Date Pacer* hi-fi system, using preassembled components. We think it's the *greatest* even at twice the price.

For The Price! If you've been looking around for a low-cost *good quality* stereo music center—just a record changer with an integrated (built-in) amplifier and real speaker enclosures—you know such a thing can't be bought over the counter.

Do you really think you can get first class high fidelity for under \$100? For this price or a bit more you can buy "hi-fi"—a one-piece stereo player with attached speakers, not over three feet apart. You might as



DATE PACER

well have mono! What's that? You can get one in a real pretty wooden cabinet—with open-back speaker enclosures for "wide sound dispersal" (and no bass at all) and it's only \$160. Do you think it will be any better than the one your friend picked up for a C-note? Well, it sounds pretty good—except that the amplifier has a tendency to shatter on the sound peaks. Give up?

Don't! You can get a really good quality *low-cost* stereo music center by building your own. But you'll have to use the components the Editors of *RADIO-TV EXPERIMENTER* specify. Then you'll not only have a good-sounding system—you'll have top-quality, real-walnut styling—not a plastic box or a laminated plastic or painted finish.

Patter on Date Pacer. The Date Pacer you-build-it project is essentially a semi-kit—just like those from a kit manufacturer. The only difference is *you* buy the items separately and save some more money. All the components are ready to connect together. You don't have to do a thing to the speaker systems, record changer or amplifier. You simply put a few holes into the walnut base, mount the amplifier, solder a few connections and you're finished.

Remember, the overall sound quality is determined by *all* the components. These units were specifically selected for good sound balance and competitive price. If you make any substitutions and it doesn't sound as well as you hoped you only have yourself to blame—you've been warned.

The speakers are Lafayette Radio's Minuette II (99HO-171W). They come completely assembled—even to the brilliance level control. All you do is connect speaker wires.

To make your shopping easier the record changer is Lafayette's Model 400 (21HO-155W). All you do is take it out of the box and set it in the cutout in the walnut base (21-0203W) that matches the changer. The only thing left for you to do is solder the leads

from the stereo/mono ceramic cartridge.

It's an Amperex. The heart of the system is the amplifier, an Amperex PCA-3B-18-1—a completely assembled printed-circuit board. Just solder on a few leads—from the ceramic cartridge, to the speaker terminals and from the power transformer.

To avoid size and voltage problems, and make shopping easier, use the Lafayette (19-0918) power transformer. It's only \$2.95. You won't find this transformer listed in the catalog—but order it anyhow. Lafayette is stocking this item just for readers of *RADIO-TV EXPERIMENTER*.

The PCA-3B-18-1 amplifier is rated at 4-watts per channel. We know that won't break any windows but you won't play it at full volume for long. Because even if the neighbors or the family doesn't complain you'll turn it down because it's uncomfortably loud. But the power output is equal to, or greater than, most budget-priced stereo record players—and the Date Pacer sounds a lot better, too!

The amplifier's input sensitivity is rated as 1.6 volts—good for ceramic pickups. You won't be able to use a magnetic pickup with this amplifier.

All the controls you need are mounted right on the printed-circuit board. So you'll have to make provisions for *Bass*, *Treble*, *Balance* and *Volume* control shafts in the side of the walnut base. Connections to the amplifier are made at easy-to-find *solder*

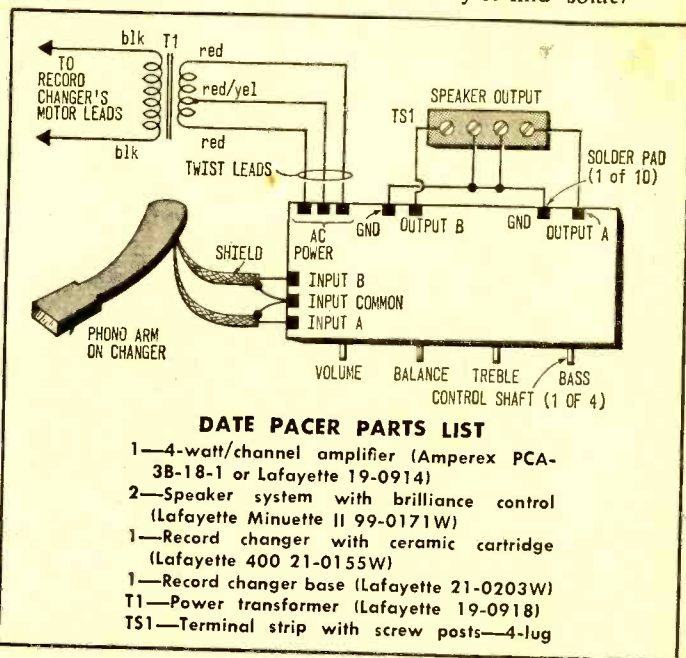

pads, pre-tinned spots on the printed-circuit board approximately $\frac{1}{4}$ -in. square.

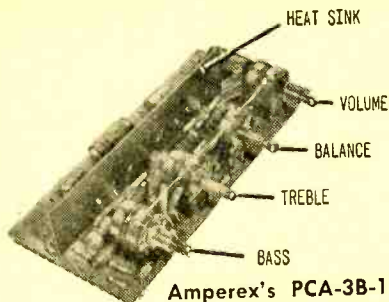

Amperex's PCA-3B-18-1 amp is pre-wired and rarin' to go.

Assembly. First step is to mount the amplifier in the walnut base for the record changer. Position the amplifier so the bottom of the printed circuit board is exactly flush with the bottom edge of the walnut changer base. Mark a horizontal line, across the front of the walnut base, to indicate where the controls will line up. Next, make a center line exactly midway between the sides of the base. This is the center of the front panel. Now go ahead and lay out the positions of the controls as shown in the photo. Make all marks lightly. You don't want them to show or otherwise ruin the beauty of the walnut finish.

Before you do any drilling, check the position of the marks by holding the amplifier close to the walnut base. Each control shaft should line up with one of the marks. If they don't, check your layout again.

Use the marks on the horizontal line as your drill guide. Once you've double checked you can make the marks easier to see. Mark them darkly with a pencil or even use a scribe or ice pick. Don't slip and scratch the walnut finish.

Now drill the holes. If you're using power wood bits be careful—the wood is thin, and you'll have to be content with the $\frac{3}{8}$ -in. bit. The next standard power wood bit size is too large.

If you're using a brace and auger bit pick the next larger size. The same goes for regular twist bits—but to be safe (to prevent the drill from wandering) drill an $\frac{1}{8}$ - or $\frac{3}{16}$ -in. pilot hole before using the large drill. Use the same size drill for all holes.

Once the holes are drilled check to see that the controls fit through the holes. If they don't fit exactly right don't try to force

the control shafts through the holes. There's a good chance that all you'll do is crack the printed-circuit board. It's best to use a rattail file and file away some of the wood on the side of the hole.

Set the amplifier aside temporarily, and mount the power transformer with 8-32 machine screws *through the side of the base*. Do not try to mount the power transformer with wood screws from the inside as the wood isn't thick enough to hold the screw. Stand the base upright on its back and mount the power transformer in the lower left corner so that the red and yellow leads face out; the two black leads will be between the transformer and the base's mounting board. Install speaker terminals TS1 on the rear apron of the base and then mount the amplifier using flat washers under the control-shaft-bushing nuts.

Now Comes the Wiring. Twist together three 24-in. lengths of wire, two red and one black. Connect one end of each of the red wires to the power transformer's red leads. Solder and insulate the connections with tape or shrinkable tubing. Connect the black wire to the power transformer's red/yellow lead—solder and insulate. Run the twisted wires along the inside edges of the base to the amplifier and connect to the amplifier's AC power. Solder pads as shown in the pictorial diagram. Staple, tape or cement the wires to the base so they don't flop around.

Twist together three 15-in. leads of *three* different colors, one being black. Connect the black lead to the two GND solder pads for each speaker. Connect the other end of the black wire to the *two* inside TS1 terminals. Connect the remaining two wires to each speaker-output solder pad and its matching TS1 terminal. (Connections are shown in

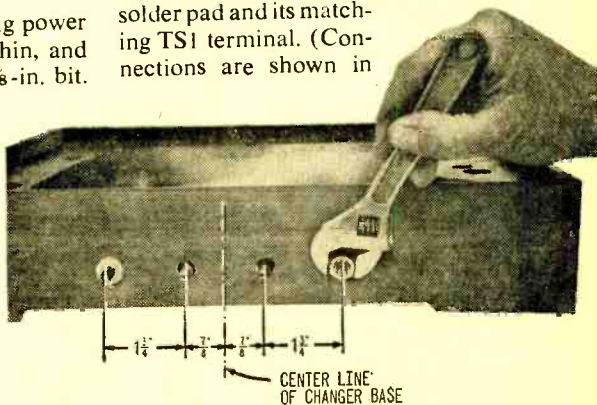

Nuts on control shafts secure amplifier to base. Take care not to mar base when drilling holes.

DATE PACER

moved when the changer shuts itself off.

Connect the black leads from power transformer T1 directly across the motor. Scrape the insulation off each motor lead and connect the leads using a T-splice. Solder and insulate the joint. Now, whenever the motor is powered to operate the record changer, the amplifier will be powered to deliver sound from the Date Pacer.

Did It, Dad! The Date Pacer is now completed. Simply connect the speakers to the matching TS1 terminals and you're ready to play your records—either mono or stereo. As a starter, we suggest you run the speakers' brilliance control wide-open to get a good picture of the overall sound quality. You can

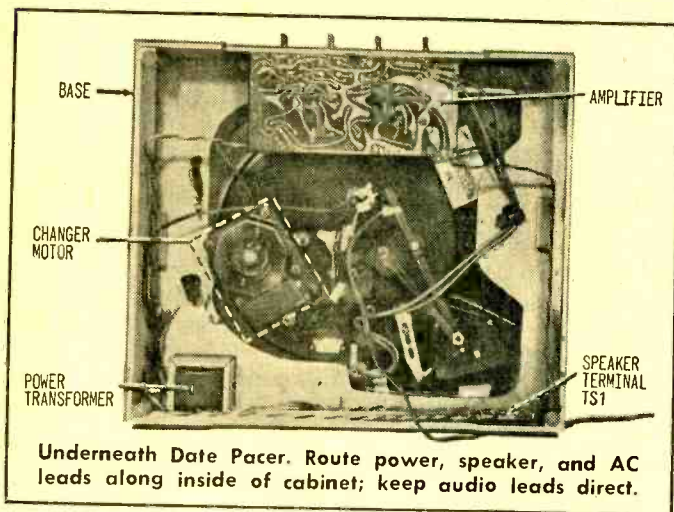

Underneath Date Pacer. Route power, speaker, and AC leads along inside of cabinet; keep audio leads direct.

later adjust them to your sound quality preference and the conditions within your room.

the schematic diagram.) Staple, tape or cement the wires to the inside of the base. The leads from the stereo cartridge are pre-wired. Run them to the corresponding amplifier input terminals; leave some slack, but cut off the excess. Unwrap the shield from each cable and attach both shields to the input common solder pad. Connect the left and right center conductors to the matching Input A and Input B solder pads, respectively.

Finally, connect the power-transformer primary winding. Note that the changer has an automatic power shut-off. When the last record is played, the power is automatically removed from the motor. The power transformer must be connected so that it also receives its power when the changer is turned on, and so it automatically has the power re-

later adjust them to your sound quality preference and the conditions within your room.

Unlike some budget stereo centers which can drive to excessively-distorted high-volume levels, the Date Pacer has only enough gain to maintain reasonably undistorted sound; you cannot shatter your ears with distortion. This feature is a function of the cartridge output voltage, and is one reason we suggest no substitutions be made for the specified components.

Where to Obtain the Components. The changer, walnut base, power transformer and speakers are available from Lafayette Radio. The Amperex amplifier is available from Amperex dealers. If you cannot obtain an amplifier locally it can be obtained direct from Lafayette Radio—simply specify catalog no. 19HO914. ■

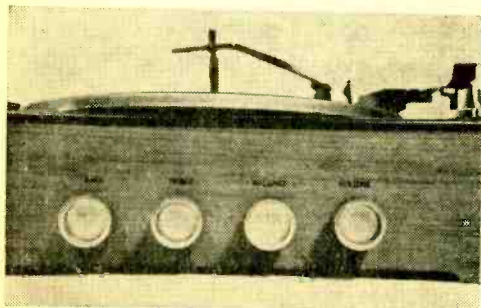

Front-panel labels are ordinary Technicals; gold-plated knobs complement walnut finish.

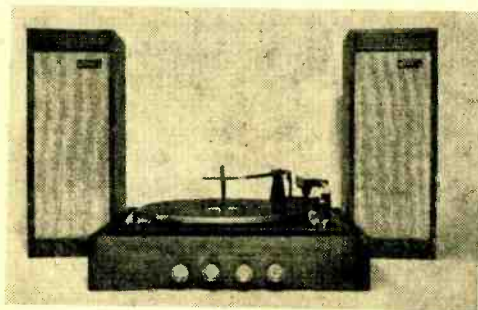

Completed Date Pacer is a project you'll take real pride in. And the sound? It's fantastic!



The CB Grabber

A hot little 1-transistor converter
that lets you tune CB signals
on any AM set—any time, anywhere!



By Charles Green, W6FFQ

■ Here is a double-fun project, the fun of building a simple solid-state converter and the fun of listening to the activity on the Citizens Band. Tabbed the CB Grabber, the one-transistor converter will work with any BC-band receiver tuned to 1550 kHz, or any quiet spot near this frequency. The converter tuning dial is tunable to cover all 23 channels for easy operation.

The BC receiver together with the CB Grabber forms a dual-conversion receiving system to separate the CB stations for better listening. No changes are required in the BC receiver, and the CB Grabber is powered with a self-contained battery.

It is easy to build the converter. Most of the resistors, capacitors and coils are mount-

ed on the top of a perf-board box using breadboard construction.

Operation. The CB Grabber can be operated with almost any BC-band receiver that can be tuned to the converter output frequency (1550 kHz). The converter can even be connected to a battery-operated receiver for portable use.

If the BC band receiver does not have terminals for an external antenna and ground, wind 5 turns of hook-up wire around the receiver loopstick and connect the turns to J2 on the CB Grabber with either coax or twisted pair wire.

Do not make any direct connections to the "hot chassis" type of AC/DC receiver—use .005- μ F ceramic disc capacitors in series

CB Grabber

with each lead to the converter to prevent electrical shock.

For best results, use a rooftop CB whip fed with coax to J1 and a good external ground. Strong signals may be received with an inside antenna. Even a TV antenna can be used with some results.

For long or continuous use, a larger external 9-volt battery can be connected to the converter in place of the internal 9-volt battery.

How It Works. CB signals are coupled from the antenna (via coax connector J1) to tap 1 on L1. Refer to the schematic diagram. Coil L1 and C1-C2 are a broadly tuned circuit centered at 27 MHz. The signals are coupled from tap 2 on L1 to the

low-impedance base circuit of Q1. Transistor Q1 is also a tuned oscillator—look at its collector circuit in the schematic diagram. The oscillator circuit (L2, C3, C4, C5 and C6) is varied in frequency by tuning capacitor C3 and trimmer C5. Ceramic tubular capacitor C4, in series with C3, limits the capacitance variation possible with C3. Output frequency is set by C5 and L3.

The tuning capacitor adjusts the oscillator frequency to about 1550 kHz above the frequency of the incoming CB signals. This frequency difference is actually the first IF of this dual-conversion setup. (The second IF is that inside the broadcast receiver.) The first IF generated, in the collector circuit of Q1, is coupled (via L3 through J2) to the BC-band receiver input.

Battery B1 supplies power to the circuit—switch S1 controls it.

Construction. The converter, as shown in the illustrations, is built on a 6x3¼x2-in.

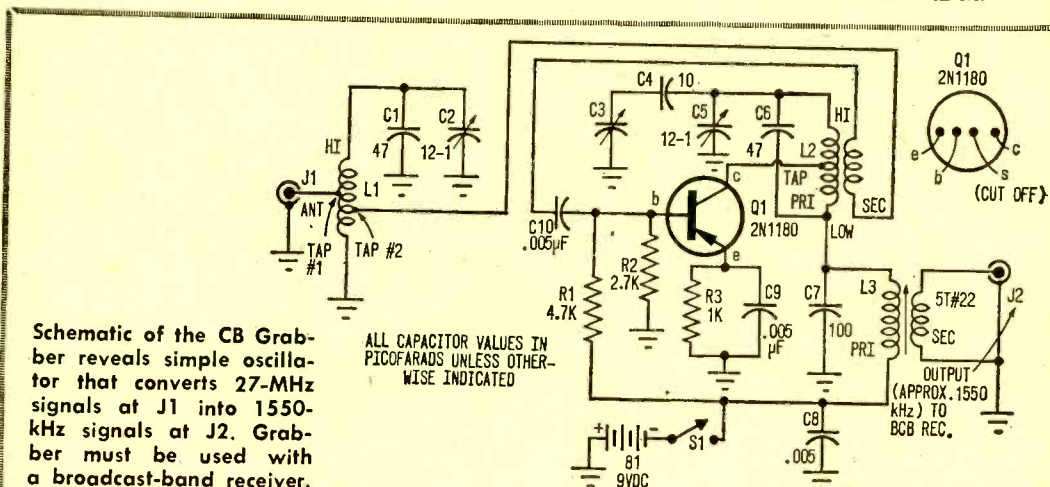

PARTS LIST FOR THE CB GRABBER

- B1—9-volt battery (see text)
- C1, C6—47-pF, ceramic disc capacitor, NPO
- C2, C5—1-12 pF, mica trimmer capacitor (ARCO 420 or equiv.)
- C3—1-15 pF variable capacitor, modified—one rotor blade removed (E. F. Johnson 149-1)
- C4—10-pF ceramic tubular capacitor, NPO
- C7—100-pF ceramic disc capacitor, NPO
- C8, C9, C10—.005- μ F ceramic disc capacitor
- J1, J2—Phono jacks, one-hole mounting (Radio Shack 274-346 or equiv.)
- L1—10 turns AWG 18 solid wire, ½-in. dia., spaced to 1-in., tapped at 1 turn and 3 turns from ground end (see drawing and text)
- L2—Primary, 9 turns AWG 18 solid wire, ½-in. dia., spaced to 1 in., tapped ¾ turns from low end (see drawing and text); sec-

- ondary, 2 turns AWG 18 solid wire, ½-in. dia., spaced to 3/10-in. and covered with plastic sleeving (positioned ¼-in. from L2 primary cold end (see text and drawing).
- L3—Adjustable antenna coil (J. W. Miller 6300), modified, 5 turns AWG 22 hook-up wire wound as secondary winding (see text and drawing)
- Q1—2N1180 transistor (RCA)
- R1—4700-ohm, ½-watt resistor
- R2—2700-ohm, ½-watt resistor
- R3—1000-ohm, ½-watt resistor
- S1—S.p.s.t. toggle switch (Radio Shack 275-602 or equiv.)
- 1—6 x 3¼ x 2-in. phenolic box and perf-board (Radio Shack 270-097 or equiv.)
- Misc.—Push-in terminals for perf-board, aluminum for brackets, wire, solder, battery connector, machine screws and nuts, etc.

phenolic box with a perforated phenolic board top. Most of the resistors, capacitors and coils are mounted on the perf-board using push-in terminals. The tuning capacitor is mounted at the front of the box and input and output connectors J1 and J2 are mounted at the rear. A few easy-to-make aluminum brackets are used. The 9-volt battery, B1, is mounted inside the box.

To start construction, remove the perf-board panel from the box and set it aside. Drill a 1/2-in. hole through the center of one side of the phenolic box. This hole is for S1. When mounting S1 use an internal-tooth lock washer between the switch body and the phenolic case. Using the internal-tooth lock washer this way prevents the switch from turning easily after the nut has been tightened (not too tight) on the shaft.

Any 9-volt battery that will fit into the box can be used. Here a NEDA 1604 was mounted to the rear of the box with the leads

connected to S1 and brought out through a hole in the rear of the box. The larger the battery, the longer it will last (the 8.4-volt mercury batteries will last longer than carbon-zinc types). Make sure the battery is mounted securely and that there is at least 1/2-in. clearance to the bottom of the perf-board panel.

Watch Where You Put It! The sizes of the mounting brackets for the tuning capacitor and jacks are not critical, but their placement is critical. The tuning capacitor C3 should be mounted so that its bottom is approximately 1/4-in. above the perf-board. The jacks J1 and J2 should be mounted approximately 1/4-in. above the perf-board also. Position the tuning capacitor and jack brackets exactly as shown in the photo. The brackets are mounted with two screws and nuts for each bracket in holes drilled in the box front and rear sides. For easier tuning, remove one plate from the rotor of tuning capacitor C3.

Lay out and mount parts, soldering them to push-in (flea-clip) terminals, as shown in the illustration. Parts placement is critical because of the high operating frequency of the converter.

Before mounting Q1, locate and cut off the shield lead, as shown in the base diagram for the transistor on the schematic diagram. Wire the components as shown in the schematic diagram and photos. Do not connect the leads from the battery and S1 to the circuit wiring until all of the other wiring is completed and checked. Keep the wiring straight and as short as possible. Connect the taps on the coils as shown in the diagrams. Use stranded wire with a little slack bent in for the connections to C3 and the push-in terminal. This minimizes any microphonics while tuning C3. Make sure that the L2 secondary turns are wound in the same direction as the L2 primary turns.

Alignment. Tune your BC-band receiver to a quiet spot on the dial as near to 1550 kHz as possible. Don't tune too close to any strong signal, as this will interfere with the operation of the CB Grabber—especially if

Drawings at left and below give full details for winding coils L1 and L2; see photo on next page for placement of secondary winding on L3. Location of components on perf-board can also be seen on this photo as well as on the pictorial below.

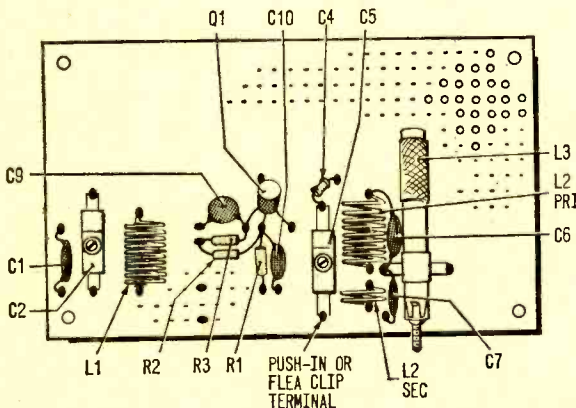
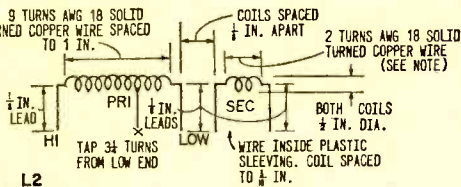
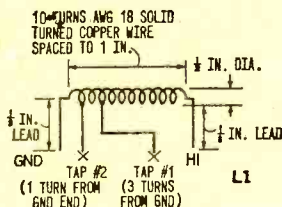

CB Grabber

the BC-band receiver does not have a shielded input with antenna and ground connections.

Connect a signal generator to J1 and connect the output from J2 to the BC-band receiver (see earlier text covering *Operation*). Adjust the signal generator output frequency (about 1550 kHz) for maximum output from the BC-band receiver. Now set S1 to ON and adjust the tuning slug in L3 for maximum tone output from the BC-band receiver.

Rotate the tuning capacitor almost to its full capacitance position. Set the signal generator output frequency to 27 MHz. Now alternately adjust trimmer capacitors C2 and C5 until you hear the 27-MHz tone-modulated signal from the BC-band receiver. Adjust the trimmers for maximum tone output. If necessary push together or stretch apart the turns of coil L1 and the primary of L2.

Make sure the oscillator is operating at a frequency *above* the incoming CB frequency. Tune the signal generator for the IF image signal—it should be near to the 30-MHz calibration on the signal generator. If an image frequency cannot be found tune the signal generator to about 25.5 MHz. Should the signal be heard at this point you must retune trimmer C5. Readjust C5, turning the adjusting screw to increase the oscillator frequency—readjust the signal generator to check the frequency of the oscillator in the CB converter.

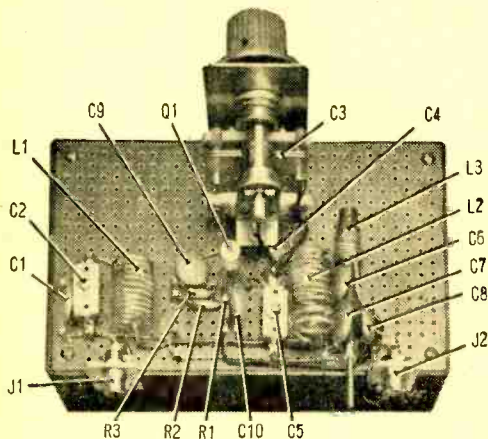

Here's the completed CB Grabber, all hooked up and rarin' to go. Needed: an antenna into jack J1, a lead to a BCB set from jack J2.

CB CHANNELS AND FREQUENCIES

Channel	Freq. (MHz)	Channel	Freq. (MHz)
1	26.965	13	27.115
2	26.975	14	27.125
3	26.985	15	27.135
4	27.005	16	27.155
5	27.015	17	27.165
6	27.025	18	27.175
7	27.035	19	27.185
8	27.055	20	27.205
9	27.065	21	27.215
10	27.075	22	27.225
11	27.085	23	27.255
12	27.105		

For those willing to beg, borrow, or buy an accurate RF signal generator, here are exact frequencies in MHz for all the 23 CB channels.

After adjustment with the signal generator, connect an antenna to J1 and loosely couple the signal generator to the converter by connecting a lead from the generator output alongside the coil L1. Set the tuning capacitor C3 to its full capacitance position and adjust the signal generator to 26.965 MHz. Tune C3 slightly for the signal, if necessary, then adjust the signal generator to 27.255 MHz and tune C3 to near minimum capacitance until you hear the signal. If you cannot spread the CB band out like this, increase the value of C4.

An uncalibrated dial was used for the CB Grabber, but a cardboard calibrated dial can be used with the channels indicated. You can style the dial or the entire CB Grabber to suit your needs.

No Sig Gen? If you do not have a signal generator, connect an antenna to J1 and vary C2 and C6 for loudest signals in the CB frequencies. As a starter you can use a CB handie-talkie. Have someone hold down the *Transmit* switch while you make adjustments. Move the transceiver further and further away as you make the adjustments. Have your helper hold the *Transmit* switch down for 10 or 15 seconds then wait several minutes before repeating adjustments. This gives others a chance to make use of the frequencies. After your helper has moved 20 or 30 feet away from the converter and you can still hear the transmissions loud and clear you'll have to rely on CBers' broadcasts for a signal. This may be a tedious process since these signals are on and off. But a signal generator is best. ■

You start with Charger (for a good, solid source of 12 VDC), then add Spender (for well-filtered and regulated 3, 6, 9, or 12 VDC). You end with a pair that's the cat's meow for car, home, and workbench!

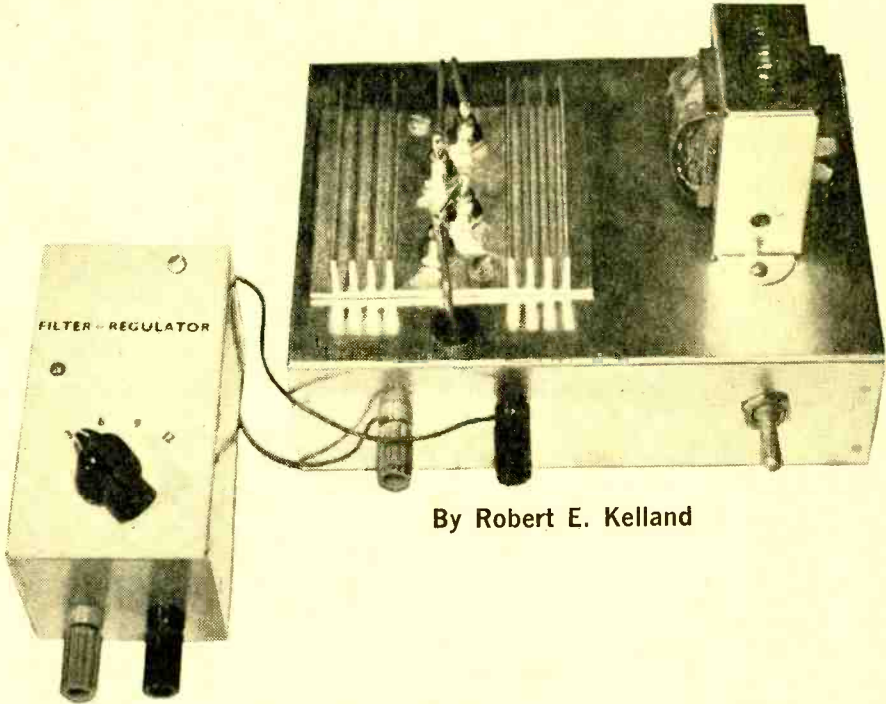

By Robert E. Kelland

Charger & Spender

■ Here are two projects that can be put to very good use in the car or on the workbench. *Charger*, a car battery trickle-booster, is built around an inexpensive silicon diode rectifier kit that comes complete with all mounting hardware and heat sink. Charger can supply up to about 1.2 amps to a 12-volt car battery. That's just enough to keep a lead-acid battery up to full charge during the cold winter months. *Spender*, a filter-regulator unit, gives 3, 6, 9, or 12 volts of low-ripple DC—a must for transistor experimenting and servicing. Spender draws its raw DC voltage from the output of Charger, filters it, and then breaks up the DC into the four Zener regulated voltages.

Charger. Charger is constructed separately on a standard 5 x 7 x 2-in. aluminum chassis so that it may be moved conveniently to its working location. The circuit is a conventional full-wave bridge rectifier supplied by the stepped-down 12.6-VAC from a filament transformer. Complete mounting instructions are supplied with the rectifiers. Note that no part of Charger's circuit is grounded. This prevents shorting Charger's output should it come in contact with the automobile body if the car has a positive-ground battery circuit. *(Continued overleaf)*

Charger & Spender

The rectifier diodes are stagger-mounted on the heat sink to evenly distribute the unwanted heat and to provide optimum mounting room. Before following the kit-supplied instructions to assemble the diodes and heat sink, use the diode mounting holes in the heat sink to locate the proper punch points on the aluminum chassis. Punch out $\frac{5}{8}$ -in. holes (there are four diodes) so that both the studs and soldering lugs of the diodes clear the chassis. The heat sink is attached to the chassis with two small machine screws.

Any filament transformer that can deliver 1.2 amps AC at approximately 12.6 volts may be used. If the transformer has a secondary winding center tap, cut it short and insulate the end with tape. Jacks J1 and J2 are the insulated type and should be color-coded to help avoid incorrect battery connections.

The wiring of Charger is straightforward. The underside of the chassis is wide open for working and should not present any obstacles. Be sure to use at least AWG-18 insulated hookup wire for all connections. Before testing Charger, double check to see that no part of the circuit makes contact with the chassis. An ohmmeter check between each diode and the chassis is an easy way to check the effectiveness of the mica washers and the plastic spacers.

Spender. The full-wave rectified output from Charger is used by Spender to provide four common low DC voltages used to power transistor circuits.

All parts for Spender are arranged in a 4 x 2 $\frac{1}{4}$ x 2 $\frac{1}{4}$ -in. aluminum chassis box. The dual-section filter capacitor (C1A-C1B) takes up the most of the room in the box. The capacitor is mounted lugs up in a capacitor mounting ring. Be sure the capacitor you buy will fit the chassis box.

If you can't get a dual, can-type electrolytic small enough to fit the chassis box, two tubular capacitors 1000 μ F, 25 volts each may be used. An additional 2-lug terminal strip will be needed for solder connections.

Even though Spender supplies four output voltages, only two zener diodes are used in this voltage-divider output circuit. With this arrangement, plenty of current (at least 20 mA on all voltages) is available with only a few tenths-of-a-volt variation in voltage from no load to full load. Wiring is fairly tight in the chassis box, so be sure to use

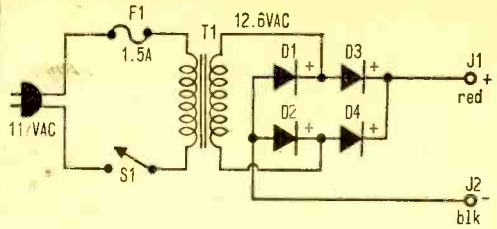

PARTS LIST FOR CHARGER

- D1-D4—Rectifier diode—part of Battery Charger kit, includes heat sink and mounting hardware (Radio Shack 276-1266)
- F1—1.5-amp, 3AG fuse (Radio Shack 77-2764 or equiv.)
- J1, J2—5-way binding post, 1 black, 1 red (Radio Shack 274-736 or equiv.)
- S1—S.p.s.t. toggle switch (Radio Shack 275-602 or equiv.)
- T1—1.2-amp, 12.6-volt filament transformer (Radio Shack 273-1505 or equiv.)
- 1—Fuse holder, 3AG-size (Radio Shack 270-364 or equiv.)
- 1—Chassis, 5 x 7 x 2-in. (Lafayette 12H8195 or equiv.)
- Misc.—AC line cord, rubber grommets, machine screws and hex nuts, wire, solder, etc.

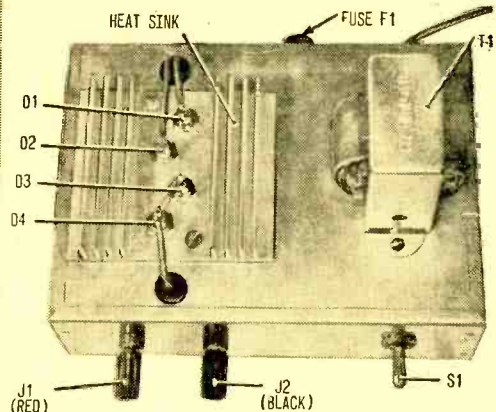

Top and bottom views of Charger, showing parts placement. Diodes run cool as cucumbers due to high conductivity of heat sink.

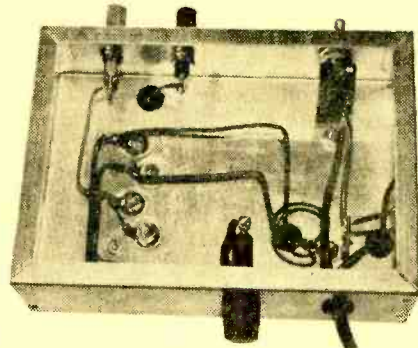

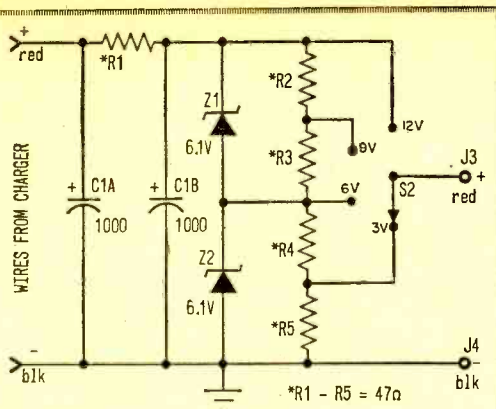

PARTS LIST FOR SPENDER

C1A, C1B—1000/1000- μ F, 25/25-volt dual electrolytic capacitor, can type or use two 1000- μ F, 25-volt tubular type with wire leads (Radio Shack 272-1718 or equiv.—see text.)

J3, J4—5-way binding post, 1 black, 1 red (Radio Shack 274-736 or equiv.)

R1-R5—47-ohm, 1-watt resistor

S2—S.p. 4-t. rotary switch, non-shorting type (Mallory 3215J or equiv.)

Z1, Z2—6.2-volt, 1-watt Zener diode (GE Z4XL6.2, Radio Shack 276-561 or equiv.)

1—Chassis box, 4 x 2 1/4 x 2 1/4-in. (Radio Shack 77-0680 or equiv.)

Misc.—Knob, 3-lug terminal strip, machine screws, wire solder, decals, etc.

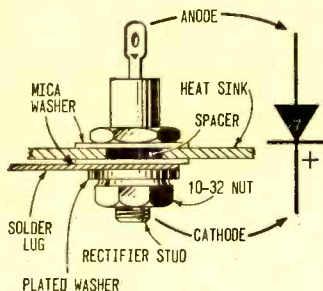

Above, mounting details for diodes D1-D4. Below, Spender with its cover removed.

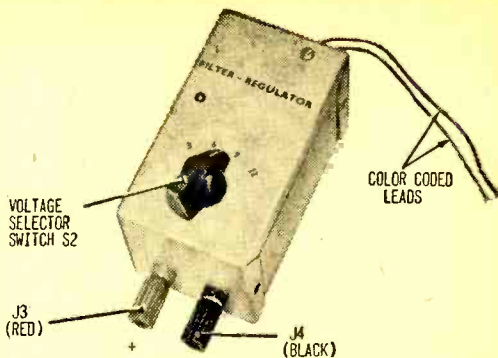
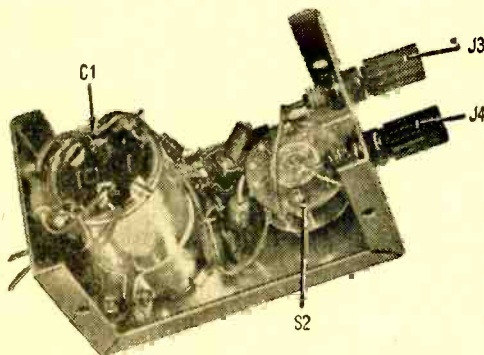

Spender makes neat package in its Minibox.

spaghetti and dress leads neatly to avoid shorts. Use a heat sink when soldering the zener diodes in the circuit.

Using Charger. Only 12-volt car batteries can be connected across Charger. To be real safe, remove the cables from the car battery before the Charger is placed across it. Connect the positive lead from Charger to the positive battery terminal and the negative lead to the negative battery terminal. If not marked otherwise, the positive battery terminal will have a slightly larger diameter than the negative terminal. Still not sure? Then use a DC voltmeter to pick out the positive terminal.

To bring the battery up to full charge, the above setup should be left powered overnight, and longer if necessary. If a hydrometer is available, check the specific gravity of the battery electrolyte. A reading between 1.260 and 1.280 indicates a fully-charged cell. Lacking a hydrometer, the battery may be considered fully charged when bubbling (gassing) of the electrolyte is noticeable. If the charging is done indoors provide ventilation to rid the area of expelled battery gases.

A trickle charger is intended primarily to "top up" batteries in a relatively good state of charge. However, an almost fully discharged battery can be brought back to full charge if Charger is left connected to it long enough. For a 60 ampere-hour battery, charge time can be 50 hours or more. And that's a small battery for a small compact car.

You can also use Charger to pep up 9-volt transistor radio batteries with complete success. The current drain varies from about 200 mA to somewhat below 100 mA while charging, so do not keep the battery on charge for long periods. Single cells and

(Continued on page 107)



MIGHTY MICKEY- MIKE

Nifty junk-box capacitor checker makes a handy addition to any experimenter bench.

By Jerry Emanuelson

■ Just about every experimenter worth his salt finds himself in the position now and again where he'd willingly give his Aunt Matilda's right arm for a simple way to check capacitance.

Well here's the dope on a simple little unit that'll do just that and it'll only cost you a couple of bucks to build.

Have a look at the schematic and you've got the essentials. The circuit is set up so that an AC meter simply measures the AC resistance, or reactance, of the unknown capacitor. A simple calculation turns the reading into capacitance value. The completed Mickey Mike will measure capacitance from 500 μF to 1 μF with an accuracy of between 10 to 20 percent.

Construction. The unit can be breadboarded and used with a multimeter as shown, or it can be built into a meter case with its own meter for a more sophisticated job. If you use a separate meter, either use an AC meter or a DC meter with a rectifier. Also get a meter with a sensitive movement or you won't have much luck measuring low capacitance values. Using a separate meter will allow you to calibrate the unit's dial di-

rectly, using capacitors of known value.

If you want to use the Mickey-Mike with your VTVM or VOM, the meter should have an AC input resistance of at least 10,000 ohms per volt.

Pushbutton switch S1 is used to protect the meter in case the capacitor shorts and also to reduce shock hazard caused by the more than 100 volts across the capacitor.

Using Mickey Mike. When the unit is finished, hook up a capacitor—but be sure any capacitor you want to check is rated at more than 100 volts, and don't try to measure capacitors in excess of 1 μF . Also, don't attempt to measure electrolytics.

Now set switch S2 so that a reading of less than 12 volts is seen on the multimeter. Then calculate capacitance as follows:

Capacitance (μF)

$$= 2.3 \times \text{Volts} \times .1 \quad (\text{Range A})$$

$$= 2.3 \times \text{Volts} \times .01 \quad (\text{Range B})$$

$$= 2.3 \times \text{Volts} \times .001 \quad (\text{Range C})$$

$$= 2.3 \times \text{Volts} \times .0001 \quad (\text{Range D})$$

For example, on range B, and the multimeter reads 4.4 volts: $C = 2.3 \times 4.4 \text{ Volts} \times .01 = 10.12 \times .01 = \text{approximately } .1 \mu\text{F}$. ■

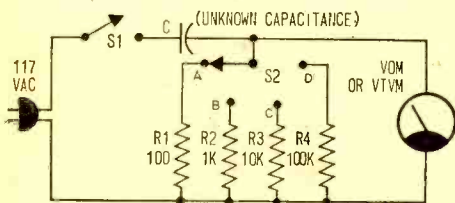

Simple circuit of Mickey Mike does bang-up job of measuring value of most capacitors.

PARTS LIST

- R1—100-ohms, 1/2-watt resistor
- R2—1000-ohms, 1/2-watt resistor
- R3—10K, 1/2-watt resistor
- R4—100K, 1/2-watt resistor
- S1—S.p.s.t., normally-open pushbutton switch
- S2—Single-pole, 4-position rotary switch
- Misc.—Wire, solder, line cord, etc.

Estimated cost: \$2.00

Construction time: 1 hour

CB BAND BUSTER

By Herb Friedman KB19457

Break the CB sound barrier
with this booming mike preamp

□ If you think you're losing some of that precious CB power along the uncertain and sometimes sorry road leading from mike to antenna, chances are you're right! All CB transceivers have certain design characteristics built into them. Thing is, what the designers had in mind doesn't always work out when you're operating the rig.

Take this business of power, for example. Our Band-Buster is a mike pre-amplifier designed to make your signal top dog on the CB bands. It does this job handsomely by taking advantage of a couple of built-in transceiver characteristics which are flexible enough to permit Band-Buster to take over the reins and boost your talk power.

Two Tricks. First of all, CB transceivers are designed for *average* voice levels. The overall modulator gain is fixed so that a person speaking at an average

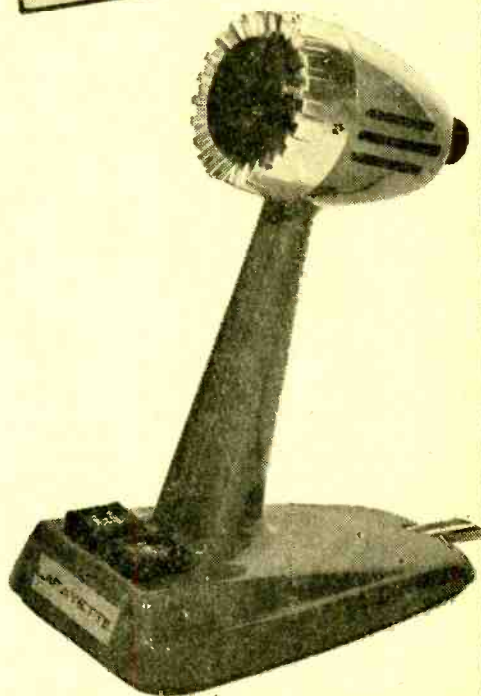

CB Band Buster

voice level—and at an average distance from the mike—will be able to modulate the transmitter 100%.

This is a good idea, but just who has an average voice, and what is an average mike distance? Your voice might just be somewhat weaker than average, or maybe you hold the mike 12 inches away rather than the more usual 6 inches. If this is true, your rig's modulation might never make it out of the basement.

The second factor to be considered is that nearly all modern transceivers limit modulation of the carrier to 100%. This means that even if you shout the modulation won't exceed 100% (or 90%, if that happens to be the rated maximum level).

Some manufacturers make good use of this limiting feature by providing a *range boost* or DX boost circuit. This is simply additional amplification that boosts the level of modulation, while depending on the limiting feature to prevent overmodulation. In other words, more output power is obtained, but distortion is kept to a minimum.

With all this in mind, we can appreciate how the CB Band-Buster takes advantage of modern transceiver design. The mike preamplification increases your talk power to above average levels, while the built-in 100% modulation limit ensures that there will be no distortion of the transceiver output. Your voice will hit the front end with full force, but the unit's design will make sure that you don't overmodulate. Just turn up the volume and get all the advantages of a speech clipper!

FET Does It. A quick look at the schematic should convince you that your Band-Buster will do the job that you thought couldn't be done. The sock-it-to-me feature here is obviously Q1—an N-channel FET (field-effect transistor) that has a high input resistance and will therefore accept a high-impedance source like a ceramic or crystal mike.

Since the FET has an input impedance of tens of megohms, the mike's load will only be that of input resistor R1. Here R1 is 2.2 megohms, which is the usual load for a mike. However, if the mike you're using calls for a different value, R1 can be changed without affecting total performance.

Nominal gain for the Band-Buster is

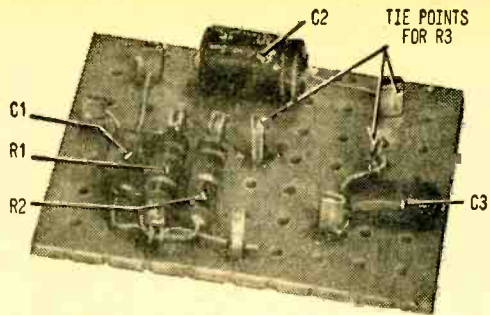

Components mount on top side of board. Capacitors C1 and C3 are flush to conserve space.

10 dB, while the frequency response is almost ruler-flat from 20 to 15,000 Hz. Even with high-output mikes, distortion is almost unmeasurable. Just make sure your transceiver's modulation is limited to 100% and you'll get all the talk power you want.

Though the preamplifier can be built into a small aluminum cabinet, it can also be installed directly in the microphone case, or even in the mike's base. Our photos show a custom installation in a good-quality CB base-station mike available from Lafayette Radio (see Parts List).

While the same installation techniques can be used with other microphones, the exact procedure will depend on the particular mike you choose. However, the perf-board assembly should be used in all instances. It's just a question of where to place the assembly and the volume control, whether it be in the microphone head or in the base.

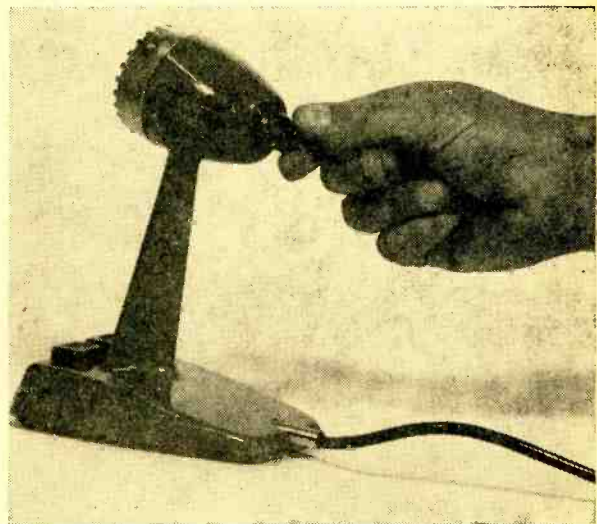

Band-Buster's output level is set by adjusting R3—a miniature volume control with switch.

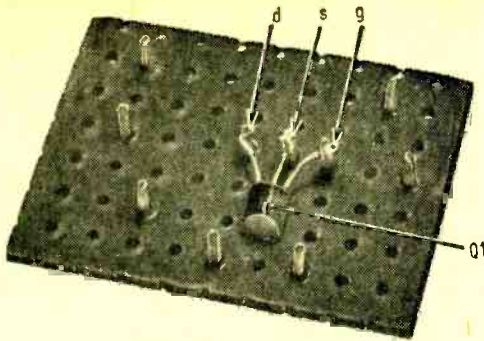

In author's model, Q1 (FET) mounts on underside of board. This side is covered with tape.

Perf Package. The Band-Buster assembly is wired on a 1¼ x 1½-in. section of perforated wiring board. Flea clips are used as tie points. To keep the assembly as small as possible, all components must be mounted flat on one side of the board. In the author's model, the FET is mounted on the *underside* with its flat side against the board. (The cover version shows Q1 mounted on the same side with other components.)

Mount and tack-solder all topside components, then install Q1 using full-length leads. To avoid heat damage, use a heat sink (such as an alligator clip) on Q1's leads when soldering. If you're going to install the Band-Buster in the mike case, volume control R3 must be the miniature type specified. A standard potentiometer and switch will probably not fit into any ordinary case.

The volume control's connecting leads are soldered to points A, B, and C in the sche-

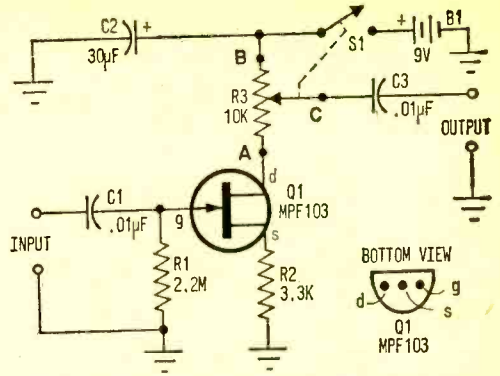

FET has high input resistance to match high-impedance mike. Value of R1 depends on mike.

PARTS LIST FOR CB BAND-BUSTER

- B1—9-V battery (Burgess 2U6 or equiv.)
- C1, C3—.01-µF, 10-VDC disc capacitor
- C2—30-µF, 10-VDC electrolytic capacitor
- Q1—N-channel field-effect transistor (Motorola MPF103 or equiv.)
- R1—2,200,000-ohm, ½-watt 10% resistor
- R2—3300-ohm, ½-watt 10% resistor
- R3—10,000-ohm miniature potentiometer with spst switch (Lafayette 32H7364 or equiv.)
- S1—Spst switch (on R3)
- Misc.—High-impedance mike (Lafayette 99H-4607 or equiv.), battery connector, perf board, flea clips (Vector T28, Lafayette 19H8302 or equiv.), solder, wire, hardware, etc.

matic. Shielded connections should not be necessary as either a metal cabinet or the metal microphone case will do the job. However, if the mike's case is plastic and the Band-Buster is installed within, keep R3's leads as short as possible. Even then, it might be necessary to use shielded leads.

The photos show how the Band-Buster was installed in the Lafayette mike. First, the front of the mike was removed and the microphone element was eased out of the case. Then the two connecting leads were unsoldered (excessive heat could ruin the element, so use a small soldering iron). Be sure to note which is the hot (insulated) lead. Finally, a ¼-in. hole was drilled in the back of the microphone case for volume control R3.

The control was then pre-wired to the perf-board assembly. The back of the perf-board (the FET side in the author's model) was covered with a layer of tape to prevent the tie points which stick through the board from shorting to the mike case. Finally, the original mike connecting leads were soldered to the Band-Buster *output* and new leads

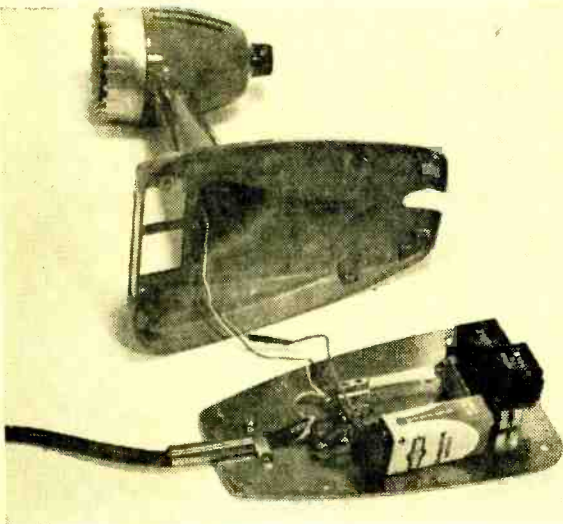

Here, battery is mounted in base of mike. You may have to tape battery to outside of case.

CB Band Buster

were connected between the mike element and the preamp *input*. The entire assembly was then eased into the case.

Battery in Base. The pre-wired B+ lead from S1 (on the back of R3) was fished down to the microphone base, where it was connected to battery B1's positive terminal. The battery's negative terminal was connected to the case to act as the system ground for both the mike and the switching leads. It required quite a bit of customizing to fit the battery into the base. We suggest that if the battery doesn't go into the base easily, you run the battery connection out of the unit and tape the battery to the case. You should get many months of service from your battery as the Band-Buster uses only 500 μ A.

Best results are obtained if a modulation meter is used when you are adjusting or using the Band-Buster. First place the microphone at a comfortable working distance, then advance R3 (turning power *on*) until your rig peaks at 100% modulation. If your transceiver has built-in limiting you can give a little extra gain to obtain some of the bene-

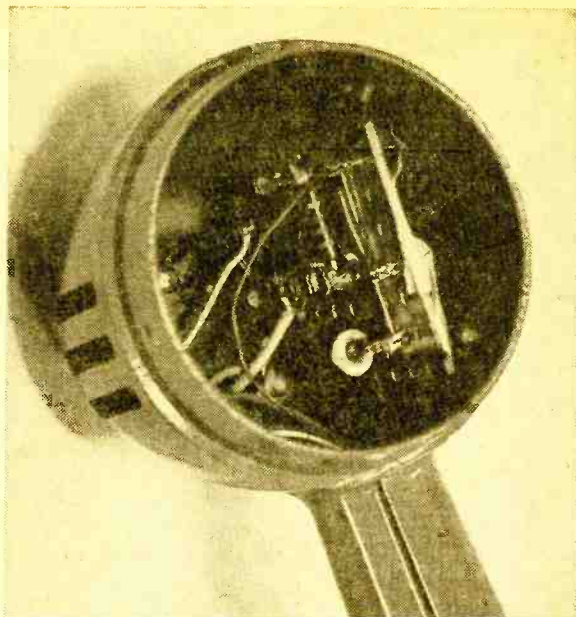

Band-Buster assembly mounted in mike case. Only volume control R3 takes hardware.

fits of speech clipping. Use a grease pencil, marking pen, or a piece of tape to mark the setting of R3's knob so that it can be easily reset whenever you use the mike. ■

Crystal Is as Crystal Does

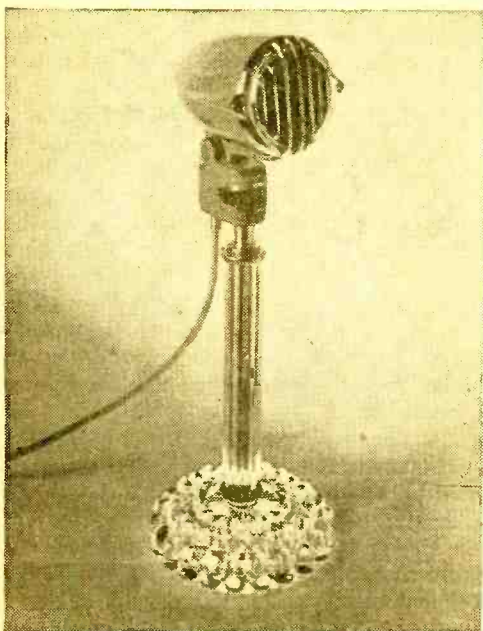

■ Here's a mike stand that ought to bedazzle the shack of any lady ham or CBer. These crystal desk stands are made from discarded glass table lamps and cost next to nothing. A quick trip to a store, rummage sale, or perhaps your own attic should turn up just the lamp you need.

Remove the line cord and socket from the lamp. Since both lamp threads and mike threads are usually $\frac{5}{8}$ -27—which is standard for most pipe, the mike will screw onto the stand in a jiff. Most radio stores carry adapters and converters should you need to make any modifications.

Small bits of felt or rubber cement on the bottom of the stand will protect surfaces from nasty scratches. And should your mike have connections in the mounting socket, don't panic. Just run your mike cable through the pipe in the lamp and attach the cable to the connector on top. A rubber pad under the base can be hollowed out so the cable will come out flush, natch.

—Art Trauffer ■

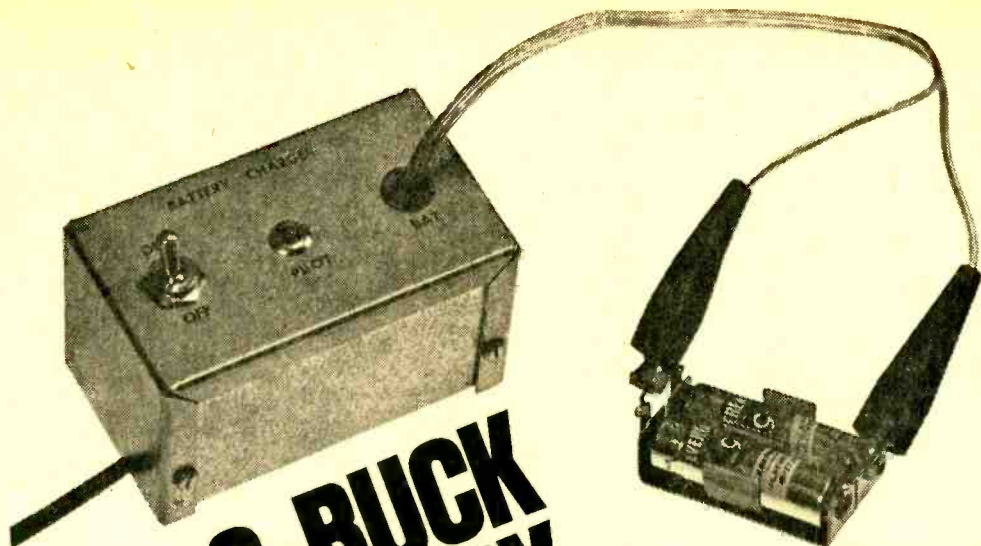

3-BUCK BATTERY BOOSTER

By James I. Randall

One mighty module packs a wallop that'll empty your battery box pronto

■ These days, with all the transistorized equipment around, batteries are common as bikinis. Flashlights, toys, electric toothbrushes, and tools add up to this charged-up bonanza with a rapidity that's beyond belief. As a result, every household's parts box usually has enough batteries to fill a mini-sized boxcar.

Trouble is, most of these batteries are either dead as a dodo, or they'll pump out only a few last spurts of current before fading away into oblivion. To clear out your parts box and juice up half the gizmos that are lying around your house, just take on our 3-Buck Battery Booster and you'll be on your way.

Our Battery Booster is a simple, low-cost trickle charger that you can build in one evening. It will increase the useful life of your batteries considerably. Overnight, it will recharge any small dry cell that has a rating from $1\frac{1}{2}$ to $22\frac{1}{2}$ volts. This range

should cover most of the equipment you use, and the batteries can be used over and over again.

Magic Module. Heart of the 3-Buck Battery Booster is a solid-state module that measures only $\frac{5}{8}$ in. in diameter and $\frac{1}{4}$ in. high. It contains all the circuitry needed to electronically trickle charge your batteries at a safe and constant 3-mA rate.

Just add a line cord and plug, and two short lengths of wire to connect the module to the battery. The schematic diagram shows how the author added a toggle switch and a pilot light. These are convenient and add little of the cost of the charger, but they are not required.

Our photos show both the completed battery charger in use—charging two Penlite cells in parallel—and an interior view of the wiring and parts layout. This model was built into a $2\frac{1}{4}$ x $2\frac{1}{4}$ x 4-in. aluminum Minibox which was later painted with a

BATTERY BOOSTER

copper-colored Krylon spray. After the decals were in place, three final coats of clear Krylon plastic spray were added. Of course, any kind of case will do just as well. But if it's metal, be sure to insulate the 117-VAC connections with tape or spaghetti to avoid possible shorts.

Off and Charging. To operate your Battery Booster, connect the test leads shown as J1 and J2 to the battery (or batteries) to be renovated. Be careful to observe the correct polarities. Plug in the charger and turn on the power. The pilot lamp should then light up.

It is advisable to leave the Booster on overnight, or for at least 12 hours. After the battery is fully charged, first unplug the unit, then disconnect the leads from the battery.

If you have a milliammeter and a voltmeter, you may want to test the operation of the charger before using it. A simple test circuit is illustrated. With the charger connected to a 9-V transistor radio battery (Eveready 216 or equiv.) the milliammeter should indicate a constant charging current of 3 mA, and the voltmeter should show about 10V. (Incidentally, this test circuit could be made a permanent part of the Booster if you'll be charging 9-V cells exclusively.)

For charging C and D cells, or Penlite batteries, you can use holders like the one shown in the lead photo. This allows you to charge several batteries at once.

Many factors influence the rate of charging a small battery. Age, composition, quality, and type of service all play a part. In

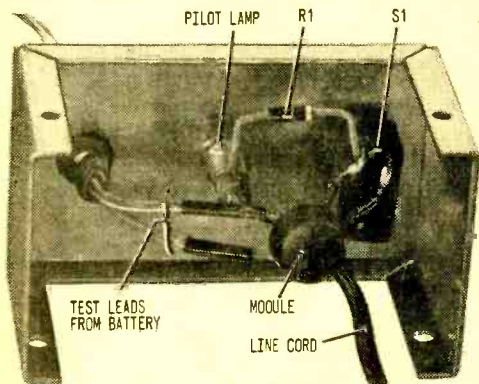

Interior view of author's unit with bottom part of Minibox removed. As explained in text, S1, R1, and pilot lamp are optional.

general, you should be able to renovate any small dry cell so that its normal life is extended 10 times. While mercury batteries have been known to explode during charging, this is very unlikely due to the low charging rate of your Battery Booster.

The unit has successfully recharged ordinary zinc-carbon, alkaline, mercury, and even nickel-cadmium batteries. Storage batteries, however, cannot be renovated with this type of charger. So that's it. Keep the Booster blasting during those chilly fall and winter evenings and your parts box will be empty in a jiff.

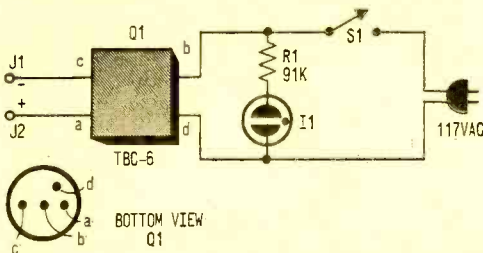

Schematic diagram for the 3-Buck Booster is simplicity in itself. Unit can charge most any battery with an output up to 22V.

PARTS LIST FOR BATTERY BOOSTER

- I1—110-VAC neon lamp assembly (Lafayette 99H6226 or equiv.)
- J1, J2—Test clips (Mueller 45C, Lafayette 32H3502 or equiv.)
- Q1—Charger module (Cordover TBC-6)
- R1—91,000-ohm, 1/2-watt 5% resistor
- S1—Spst toggle switch (Lafayette 99H6150 or equiv.)

Misc.—Zip cord, AC plug, strain-relief plug, test leads, insulators for test clips (Lafayette 32H3528C, red or black), 2-cell battery holders, 2 1/4 x 2 1/4 x 4-in. Minibox (see text), spaghetti, grommets, decals, wire, solder, hardware, etc.

Note—the battery charger module is available from Carl Cordover & Co., 104 Liberty Ave., Mineola, N.Y. 11501. Price is \$1.50 including postage and handling. Elsewhere, the module is available at most Lafayette Associates Radio Stores for \$1.00.

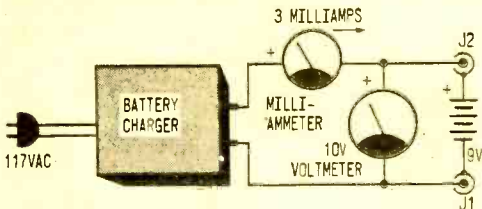

Test circuit shown above will tell you whether your Battery Booster is operating properly. Unit pumps 3 mA into 9-V cell.



Sound Sipper

By Elmer C. Carlson, KOD1752

This audio project was not conjured up in a malt shop but you may need to visit a sundae supermart to pick up plastic straws!

■ *They're free!* That's right! All the basic materials needed for making a lightweight directional baffle for your recorder's microphone are free. All you need is a handful of plastic drinking straws, a plastic sleeve and a few small rubber bands, and *voila*—*Sound Sipper*.

Get Started. To assemble *Sound Sipper* you'll need about a dozen plastic drinking straws, more or less depending on the microphone's housing diameter. Use plastic straws—paper straws crush and don't return to their original shape.

You'll have to cut all of the straws except one which will be used full length. Put the uncut straw aside. With a sharp single-edge razor blade cut $\frac{1}{4}$ -in. off the first plastic straw. Cut $\frac{1}{2}$ -in. off the second; $\frac{3}{4}$ -in. off the third, and so on. Don't throw away the cut-off ends. Some of those longer pieces may be used as the "short" ends—those near the base of the microphone housing. Altogether, this version of *Sound Sipper* used 20 sections. But, you can use almost any mike with slight modification.

To make it easy on yourself, lay out the cut straws on a strip of masking tape as shown in the photo (see next page). The strip of masking tape keeps the straws from rolling all over and keeps them in their size-places position to make the job of assembling *Sound Sipper* easier.

For a temporarily-mounted *Sound Sipper* all you need is a few rubber bands looped around the upper parts of the baffle. About three rubber bands are all you need to keep the straws in their places. A couple of wraps of masking tape around the base completes the assembly. See what we mean? *It's Free!*

A Better Way. To make your *Sound Sipper* permanent you had better cement the polyethylene straws together. But, polyethylene is not the easiest plastic to cement. The Editors recommend you use Pliobond. Probably there are other cements, even some special-purpose cements, that will do a good job with polyethylene. But none of the other commonly available cements worked well when tested. (Continued Overleaf)

Start Sound Sipper's baffle with a core of seven straws as shown in the drawing. The longest straw, the uncut one, goes in the middle. The other six go around the long straw in the center. It won't matter which way the spiral of straws runs.

Cementing the straws together takes the longest part of the construction time. That's because you have to work in layers—longest straws first. Let one layer dry and then cement on another layer. Rubber bands do a good job of holding the drinking straws together while the cement sets.

Now comes the task of fitting the baffle onto the microphone. The straw assembly fits flush against the microphone grille with the end of the spiral pointing along the axis of the microphone. A white polyethylene sleeve salvaged from an empty deodorant bottle fits about the microphone housing and the straws. This plastic serves as a hood to mount the straws on the microphone. Stiff, durable cardboard can be used, or acetate, or other stiff plastic material. Use Pliobond to cement the straws to the white plastic hood. Rubber bands secure Sound Sipper to the mike unless you wish to make it a permanent attachment, then cement it, too!

Some Tests. Without connecting a sen-

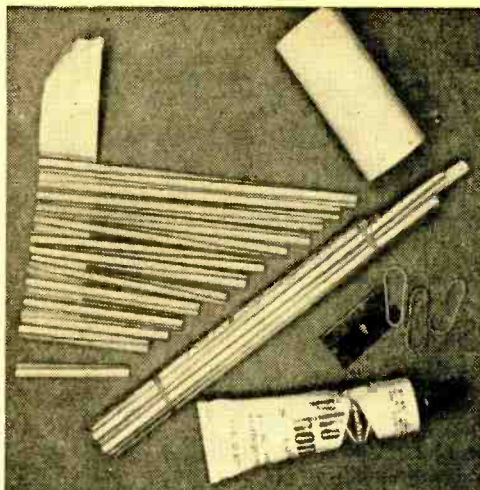

Here's what your workbench will look like part way through the construction. Straws are kept in place by sticking them to some masking tape. Other construction items are Pliobond cement, razor, rubberbands and white plastic hood. See photo below.

clatter of the office machines wasn't annoying any longer.

Outdoor tests proved much better than those conducted indoors. The reason was there were no walls to bounce the noise around the room. However, if used in a crowd such as a screaming football mob it is wiser to head for open spaces on the sidelines, if possible.

To make more accurate tests of the effectiveness of your Sound Sipper use a constant tone audio signal. Try 400 Hz from a modulated signal generator picked up by a radio. With a constant tone it will be easy to make relative measurements just using the recording level meter on the tape recorder. In time, you could plot a pickup pattern for Sound Sipper's microphone baffle that you assembled.

Sound Sipper doesn't make a pencil-sharp pickup like the pro jobs do. It can't compete with those parabolic dishes or yard-long baffles. But, it will reduce background noise considerably. What's more, you can stuff Sound Sipper in your pocket—it'll bend but won't break. And if you lose it, you won't cry over the cost. Just head back to the maltshop and pick up some more straws. ■



Here's the Sound Sipper all finished and ready to snoop out the sounds you want in.

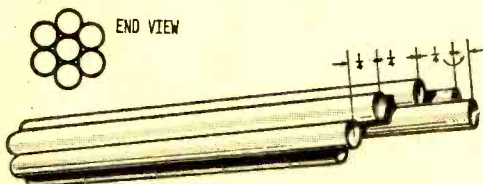

Like all projects, it's important to get a good start. The first seven straws are the most critical in forming the spiral.

sitive meter into the tape recorder circuitry you won't notice much difference in sound pickup over a 45° segment of space in front of the microphone. For best appraisal of Sound Sipper just tape record a quarter-minute with and without Sound Sipper in place in a slightly noisy room.

The first test of Sound Sipper was made in an office using a portable radio as a sound source. Just tune in a news broadcast. Without Sound Sipper the microphone picked up much of the noise of the typewriters and adding machines. The office noise made it difficult to hear the audio from the radio set at low volume.

With Sound Sipper in place the voice from the radio came out much clearer on the second part of the recording. The constant

Electronic Foot Stomper

By
Herb Friedman
W2ZLF/KBI9457

*Why not beat time
the Space-Age way—
use electronics to
save your achin' feet.*



Because they cost next-to-nothing (use junk-box components), and can be assembled by a five-year-old, electronic metronomes have always been a favorite *one-night project* with experimenters. They *always* work, and are great for elementary school Science Fairs, primarily because while other science fair projects just sit and stare at the parents, a metronome at least will *tic-tic-tic*.

But an *electronic tic-tic* can be more than a child's toy. Dress it up in a fancy box, select component values that get the *tics* to vary continuously through the 40 to 208 beat-per-minute range, and you've got a nice, and thoughtful, gift for a musical friend. And *your* cost (less the box, speaker and battery) comes to less than \$3.50.

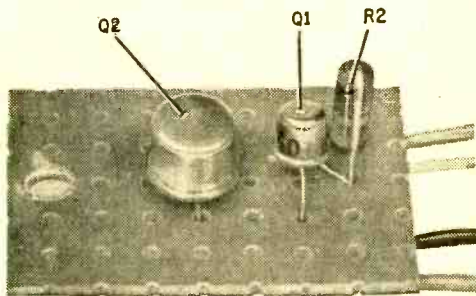

Whole circuit is contained on a perforated circuit board. Only other component on the board is C1—that's on other side. If you like, C1 can be mounted on this side, too.

Electronic Is Better. What's the advantage in an electronic metronome? Well there's tone quality and long-term convenience, to name just two. The ordinary arm-buster used by musical students requires winding, and it's five-to-one the spring will run out long before the last note of the Hungarian Rhapsody. And the usual *tack-tack* of the spring-wound arm buster is often more annoying than the clown who interrupts every fifth note to comment on the musician's abilities. On the other hand, the metronome shown in the schematic diagram produces a soft *thock-thock* sound, similar in characteristics to a muted tom-tom drum, a very pleasant beat to play along with.

The basic metronome circuit shown could cost you under \$3.50—providing you use only the components listed in the Parts List and shop carefully. Do not attempt to improve performance by using industrial grade components as a tantalum capacitor is not going to improve anything over the lowest-priced C1 specified. Same thing with transistors Q1 and Q2. With the specified transistors the output sound is a soft *thock-thock*; using better or less expensive transistors will result in the usually annoying electronic metronome *tic-tic* sound—like someone driving a nail into your ear. However, if you like *tic-tic* substitute the *least expensive* audio-grade transistors you can get (like 20 for a dollar); and while you can

Foot Stomper

substitute for the specified R1, R2 and C1 values, keep in mind that the timing will not correspond to a standard metronome.

Circuit Board. Assemble the electronics on a section of perforated phenolic-board about 1 inch x 1 inch. If you don't have a scrap of perf-board lying about use any piece of stiff fibre board or plastic and drill your own holes with a #52 or 1/16-inch drill. (Don't be fussy about the hole size, as long as the component doesn't fall through, the hole is the right size.)

Solder terminals are not needed. As

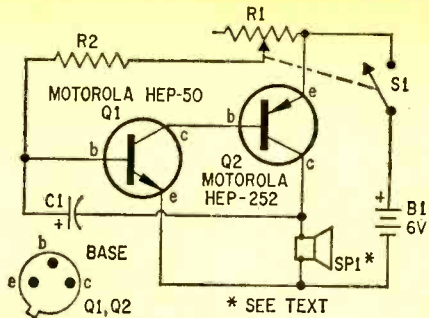

Direct-coupled transistor circuit has few components and requires only a scrap of phenolic board to mount them on. Speaker SP1 is the largest item and S1-R1 mounts on the side of the speaker enclosure.

PARTS LIST

- B1—6-volts (Burgess Z4 or equiv.)
 - C1—2-mf., 6-volt electrolytic capacitor (Lafayette 99C6003 or equiv.)
 - Q1—Transistor, npn (Motorola HEP-50 or equiv.)
 - Q2—Transistor, pnp (Motorola HEP-252 or equiv.)
 - R1—1,000,000-ohm potentiometer with switch S1 (Lafayette 32C7287)
 - R2—100,000-ohm, 1/2-watt resistor
 - S1—S.p.s.f. switch (part of R1)
 - SPKR—Speaker (see text)
 - Misc.—Perforated phenolic board, battery holder, mounting hardware, wire, solder, etc.
- Estimated cost: \$3.49
Construction time: 1 hour

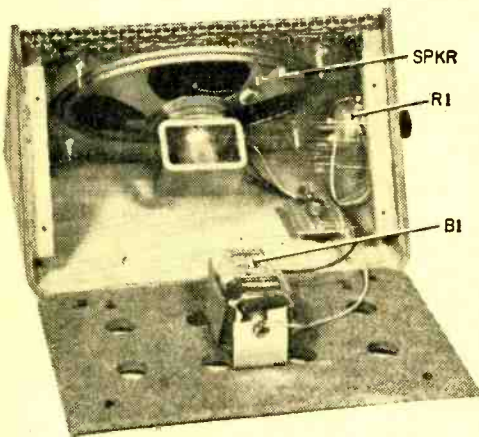

Inside view of Foot Stomper shows speaker, battery, R1 and perforated circuit board. Battery holder is mounted on the bottom cover of the speaker cabinet.

shown in the photographs, just pass the leads through the holes, twist once, and solder.

The completed metronome consists of the phenolic board assembly, the external R1, the battery and the speaker. The speaker can be anything you've got lying around with a 3.2-, 4- or 8-ohm voice coil. Any six-volt battery will do—the smaller the better. So little current is drawn the battery should last almost as long as its shelf-life.

Box It. For a little *ritzy* styling, you can use the inexpensive wood grain speaker enclosure shown. The cabinet is purchased complete with speaker, volume control and wire. Remove the existing speaker-level control and install R1 in its mounting hole. Using a single screw, with a 1/4 inch spacer or stack of washers between the board and the cabinet, install the metronome circuit

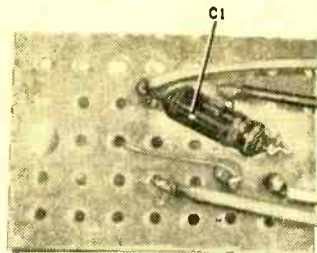

Bottom view of circuit board shows C1 and connections to speaker and B1.

board in the cabinet close to R1.

Mount the battery holder (if one is used) on the speaker cabinet's removable base. Finish the wiring and your "Oh, how thoughtful" gift is ready for presentation.

If desired, you can install a calibrated dial under R1's knob to indicate the actual beat. Slip a piece of stiff cardboard under R1's mounting nut and then compare the electronic beats against a standard metronome—indicate the correct timing on the cardboard. ■

Your instamatic silent switcher allows you to switch at least a kilowatt of power with almost no pressure at all. In fact, this nifty device wants only the right touch—just a light touch!

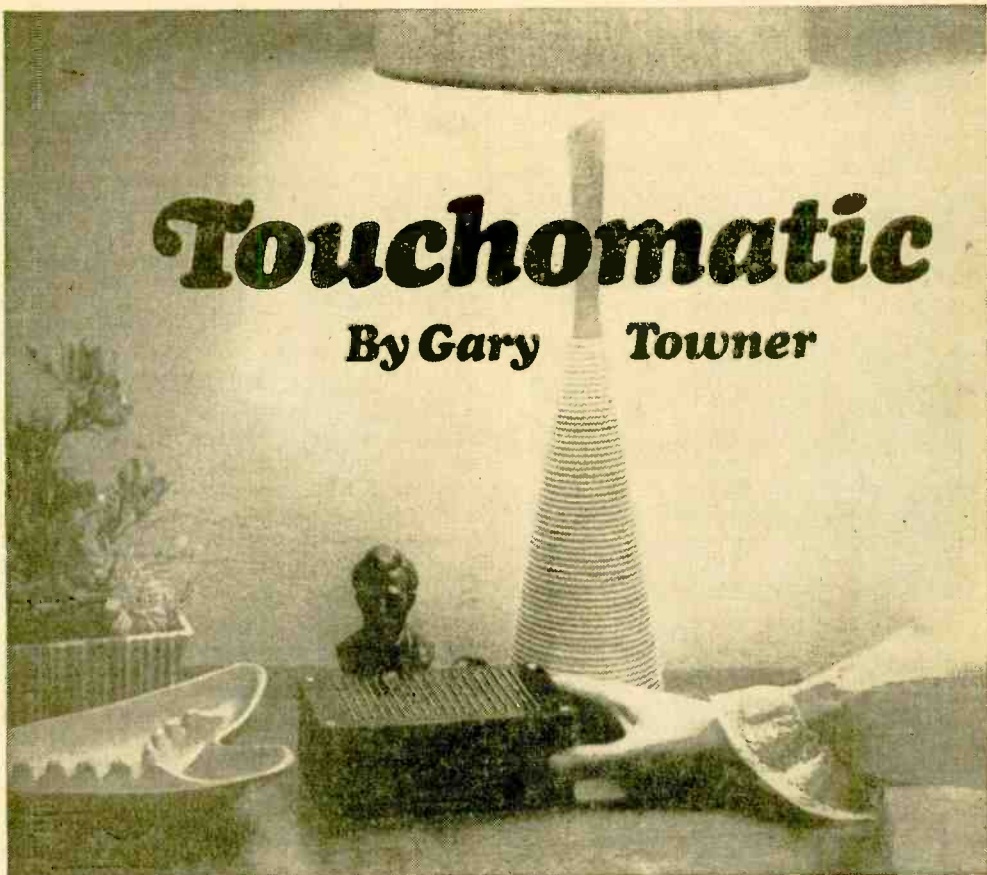

Touchomatic

By Gary Towner

Ever get tired using heavy, bulky switches for equipment that takes a lot of power? Well, snap on the Touchomatic and see that there is, indeed, a better way!

Ever get tired of having to leave the room to turn out the lights or having to get up from your chair to switch on the TV? Then give in and build the Touchomatic for a touch that will really tell. Its applications are limitless. You can even control the power input to your ham or CB shack from one central point with this snappy control box.

Anyone can have magic fingers with this do-all switch. And with the heavy-duty relay that's included, just under a 1000 watts of resistive power can be controlled. No modifications to your present equipment need be made, and operation is safe and

reliable. But if you're the kind of fellow who touches all bases, you can even add an isolation transformer to make sure that the AC line voltage stays in its place.

A Working Model. Taking a look at the schematic, you can see that R1, the touchplate (TP), R2, C1, and NE1 would form a basic relaxation oscillator if it were not for 1000-ohm resistor R3. With the addition of R3, a pulse-generating circuit is formed.

When someone touches the touchplate (TP), the resistance of his finger across points A and B is added in series to the combination of R1 and R2, and capacitor C1 begins to charge. When the voltage across C1 is finally sufficient to fire NE1, C1 will begin to discharge.

When NE1 fires, it produces a short be-

Touchomatic

tween its terminals. Since R3 is connected across C1, they are effectively in series after NE1 fires. A voltage spike will then be passed by C2 and this will act as a positive triggering pulse. The pulse is fed to both SCR gates; SCR2 conducts, thereby closing relay K1. With a finger no longer on the touchplate, no more pulses are forthcoming because the C1 charge path is open.

The next contact with the touchplate will produce a pulse which triggers SCR1. SCR2 is now turned off by capacitor C3 which was charged by current passing through R6 and

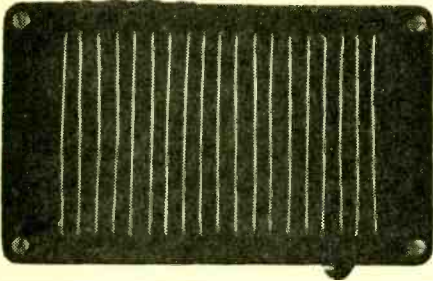

Author's design for touchplate is shown above. Touching any combination of two wires connecting points A and B (see schematic, above right) will trigger relay. Underside of cover (below) shows wiring layout for touchplate. Leads from A and B are connected to solid wires in alternate rows.

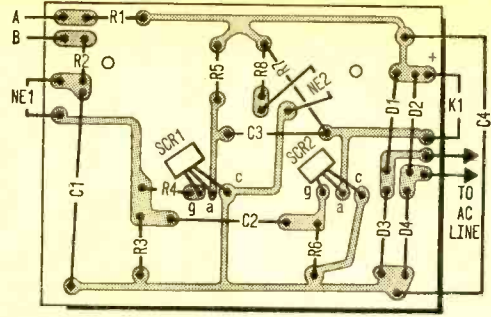
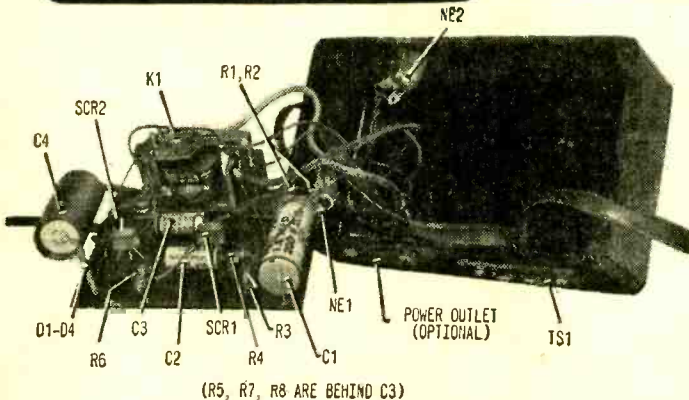
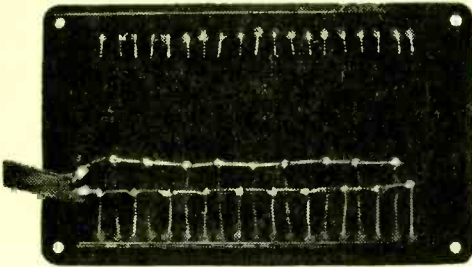

Heavy lines show how components mount on top of PC board. Relay K1 fits between two holes at top of board, covering R5, R7, and R8. A perf board and flea clips or push-in terminals will also work fine.

SCR2. The firing of SCR1 in this way places a negative voltage across SCR2 which momentarily drops the relay current to a point below the holding current value of SCR2. (Holding current is the minimum current an SCR requires to remain in a conducting state once its gate voltage is removed.)

With SCR2 turned off, the relay will open and SCR1 will turn off due to the large resistance in series with its anode. Starved in this way, SCR1 turns off because of a forced lack of holding current.

Construction. Due to such high sensitivity, one might expect the parts layout to be critical. This just isn't so. If you follow the photos and pictorial you shouldn't have any trouble.

Together R1 and R2 offer excellent isolation from the AC line. A transformerless power supply is used. But as said before, an isolation (power) transformer might be a good idea, particularly if you want to be certain that you're always on the safe side.

The actual form of the touchplate is pretty much up to you. The model shown was constructed by drilling holes in the box lid and placing solid wire in alternate positions

Circuit board removed from plastic case. Parts layout corresponds to wiring pictorial at top of page. While NE2 mounts on case in a panel light assembly, NE1 is connected to board with heavy wire soldered to terminals of bulb. A #51 neon lamp having wire leads might be more convenient. If perf board is used, parts layout will be basically the same. Optional power transformer should fit into plastic case.

Note that touchplate (TP) is connected to circuit with 300-ohm twinlead at points A and B. These two points are located on terminal strip TS1. With this design, an external input (i.e., from a switch) would connect to screw terminals of TS1. Twin lead is also used to connect points A and B at TS1 to PC board. Since R1 and R2 offer only minimal isolation from AC line, and diodes D1-D4 could short out, an isolation transformer is recommended for beginners.

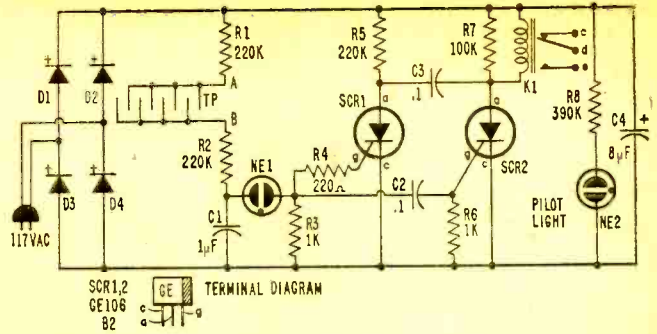

PARTS LIST FOR TOUCHOMATIC

- C1—1- μ F, 200-VDC capacitor
- C2, C3—0.1- μ F, 400-VDC capacitor
- C4—8- μ F, 450-VDC electrolytic capacitor
- D1, D2, D3, D4—10B2 silicon rectifier
- K1—110-VDC, spdt, 8000-ohm power relay (P&B MR5D, Allied 41 E 6760 or equiv.)
- NE1, NE2—#51 neon bulb
- R1, R2, R5—220,000-ohm, $\frac{1}{2}$ -watt resistor
- R3, R6—1000-ohm, $\frac{1}{2}$ -watt resistor
- R4—220-ohm, $\frac{1}{2}$ -watt resistor
- R7—100,000-ohm, $\frac{1}{2}$ -watt resistor
- R8—390,000-ohm, $\frac{1}{2}$ -watt resistor
- SCR1, SCR2—GE 106B2 silicon controlled rectifier
- Misc.—Plastic box and cover, touchplate (see text), panel light assembly for #51 neon bulb, 2-screw terminal strip, optional chassis-mounting AC outlet (Allied 47B0830 or equiv.), zip cord, 300-ohm twinlead, PC board or perf board (optional), rubber feet, spaghetti, wire, solder, hardware, etc.

so that touching any combination of two different leads (A and B) will close the relay. The wire should be rugged and spaghetti should be used to insulate one group of wires from the other (A from B).

Applications. Your touchplate needn't be the end of the line for the Touchomatic. While the basic Touchomatic hookup is shown (Fig. A), other hookups can be made to points A and B via terminal strip TS1. Figs. B and C show circuits for a burglar alarm and hall light system.

The hall light system—as well as similar circuits—requires only low-current wires and switches, and the whole system is switched on or off at any one control point. These are just starting points for people who want to experiment—just use your imagination.

Last but not least! Touchomatic can be one hell of a devilish device. Just leave a sign next to it saying DO NOT TOUCH. Then hook up points A and B to whatever gimmick you can think of, and watch your panic button go to work on an unsuspecting victim! Yikes!

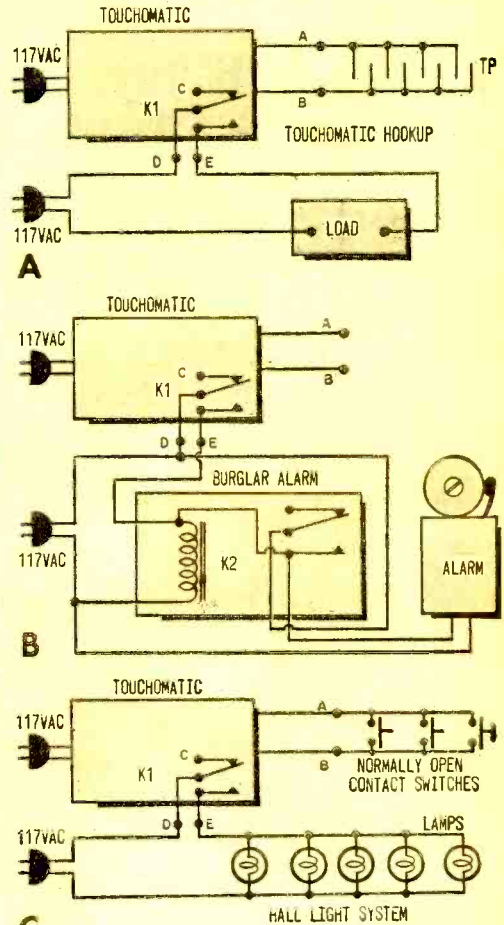

Basic Touchomatic hookup is shown above in Fig. A. While relay K1 is a spdt model, only two contacts (d and e) were used by author. However, experimenters may wish to use contact c for some kind of indicator to show that switch is off, etc. Fig. B is design for a burglar alarm, and contains an external relay K2 to control current to alarm and to provide a latching circuit so that alarm cannot be switched off. Builder might want to add a switch so that relay may be de-energized at his command. Finally, Fig. C illustrates typical lighting circuit where external switches connected in parallel can control lights at any one point.

By James Fred

Mini Mix

Little mixer with big performance using the first low-cost experimenter's IC

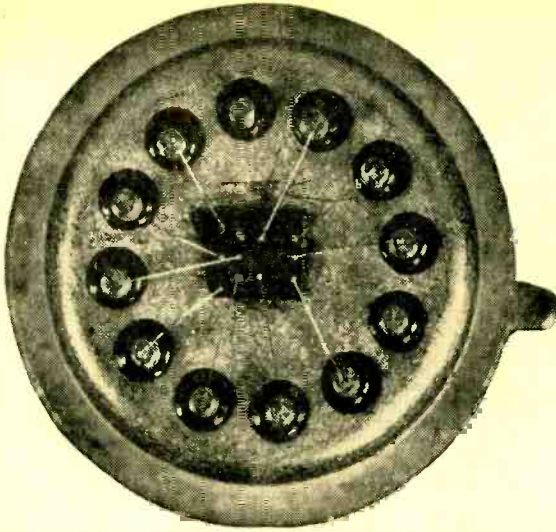

■ Integrated circuits, or IC's as they are now called, are the epitome of electronic technology today. A typical integrated circuit consists of a 25-mil square of semiconductor material with a number of transistors, diodes, resistors, and, in some cases, capacitors deposited thereon. These components are interconnected and packaged in a small transistor can or other container with external leads for circuit connection.

One of the first integrated circuits available to the experimenter was the Westinghouse WC183. It's available as the WC183G in a ten lead plastic package or as the WC183T in a TO5-style transistor can.

The WC183 is a general-purpose low-level audio amplifier consisting of an 8 transistor

balanced circuit with internal DC feedback. It is fabricated on a silicon chip about 20 mils square.

The photograph shows the silicon chip and interconnections to the hermetic glass sealed leads. (The photograph is highly magnified to show it more clearly.) The circuit is shown in the diagram and consists of a 3-stage class "A" amplifier followed by a class "B" output stage. Note that the amplifier must be used in a push-pull output arrangement and not as two separate amplifiers.

Gobs Of Gain. Under ideal laboratory conditions, the overall circuit gain of the IC is given as 90 dB with a 4.5 volt power source. (90 dB represents a voltage gain of



Mini Mix is compact professional looking unit that's easy to build using IC whose tiny "chip" contains circuit at right.

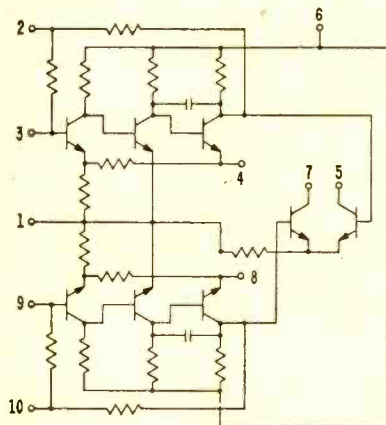

PIN NUMBERS REFER TO G PACKAGE

something in the area of 39,000 times.)

In the circuit shown, with 50,000 ohms input impedance, undistorted voltage gain of 20 times (26 dB) was obtained. This is adequate gain for most applications.

Mini Mix has an output transformer that will provide a 75- or 150-ohm output impedance. This will enable you to use microphone cables up to 100 ft. long between the mixer and the power amplifier. Of course, the power amplifier must have a low impedance input.

Mini Mix has two inputs with individual gain controls. Two microphones can be connected, their gains controlled individually and their outputs mixed in the output stage of the IC amplifier. The 50,000-ohm impedance of most crystal microphones is a good match to the 40,000-ohm input impedance of the IC amplifier. The gain controls are also 50,000 ohms and won't degrade the input impedance.

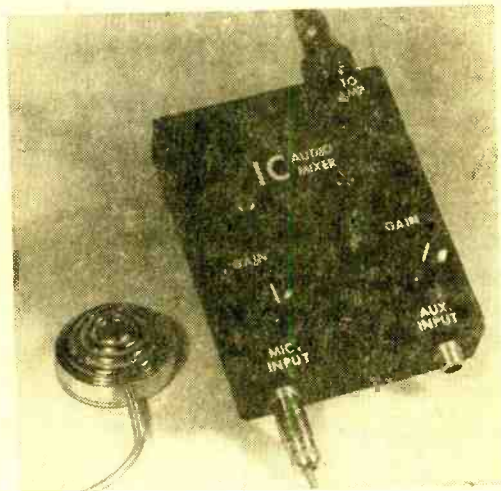

Completed Mini Mix all hooked up and ready to go. Unit's small size and good performance makes it welcome anywhere.

Making Mini Mix. The entire mixer is self-contained in an aluminum box $3\frac{1}{4} \times 4 \times 1$ in. It can easily be held in one hand or slipped into a jacket pocket. The box is made from a miniature aluminum chassis with a homemade aluminum cover. The input and output connectors, gain controls, and amplifier assembly are mounted on the chassis.

The cover has four rubber feet attached and is actually the bottom of the box. The two box halves are carefully cleaned with steel wool and sprayed with two coats of

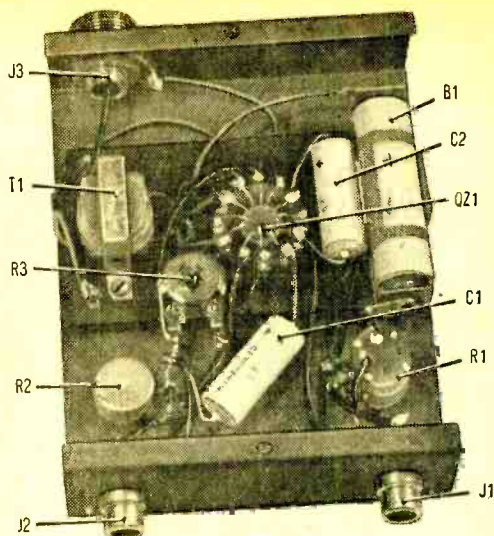

Internal layout of unit is simple and uncluttered thanks to IC. Most components including IC mount on phenolic board.

zinc chromate. They are then wet sanded and spray-painted with flat black lacquer. The decals are applied and a clear flat spray is given to protect the lettering.

Sans Socket. The IC has 12 leads on .200-in. diameter centers. IC sockets are difficult to find and expensive to buy so the alternate method of mounting shown in the photo was used. A center clearance hole $11/32$ in. in diameter is made in a phenolic board and a circle of twelve holes .093-in. diameter is drilled around it. The phenolic board is laid out and drilled approximately as shown and the turret terminals and two short stand-offs are staked into place. The TO5 IC can is inserted in the hole upside down and the leads are attached to turret terminals staked into the .093 holes.

The standoffs on the bottom of the board are for mounting board to chassis. The battery holder is riveted in place and the output transformer is held in place by two 2-56 screws and nuts. Two 2-56 screws hold the box halves together. The two additional turret terminals near the transformer are for the secondary leads that provide the two different output impedances.

The connectors and the IC board assembly are mounted into the box half and then the wiring is installed. It is not necessary to use shielded wire since all the leads are short and the unit is completely shielded.

Buss wire, number 22, was used with plastic insulating sleeving where necessary

Top of Mini Mix is miniature aluminum chassis and bottom is made from sheet aluminum to fit.

for circuit wiring. The IC can is pushed into the mounting hole in the phenolic board and the leads crimped to the terminals as shown.

The locating tab on the IC can should be positioned as shown. Additional leads are fastened to the terminals before being soldered. Use extreme care when soldering so as not to overheat the IC junctions.

Sink The Heat. Each turret terminal should be held with needle nose pliers to draw off the excess heat from soldering.

The output transformer has a tapped secondary. One wire is connected to ground and the other two to turret terminals. A wire from the output connector can then be soldered to either terminal to get either 75 or 150 ohms output impedance.

The miniature trimmer resistor is used to control the gain of the circuit. It can be set to its maximum value unless distortion oc-

curs. The battery should be installed after all the wiring is completed and checked for errors.

Try-Outs. After the unit is completed, it can be tested by connecting one or two crystal microphones to Mini Mix and connecting its output to the low impedance input of an audio amplifier. If an audio signal generator and oscilloscope is available, a check can be made for distortion. Our unit was free of distortion at normal input levels. Mini Mix will work nicely when connected to just about any public address amplifier. ■

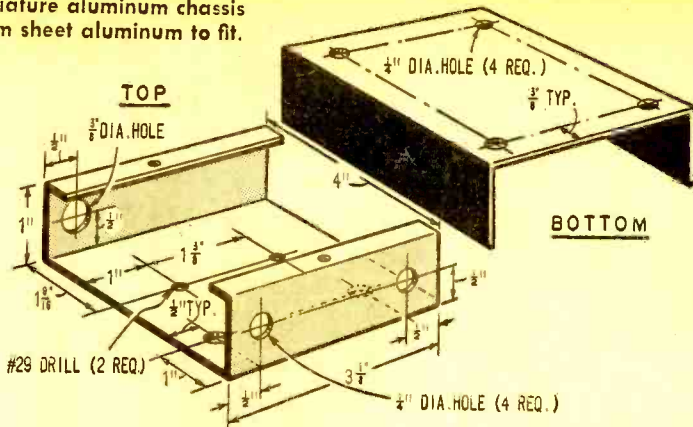

PARTS LIST FOR MINI MIX

B1—Mercury battery, 4.2 volts (Mallory TR153, Allied Radio 18B5938, or equiv.)

C1, C2—100-uF, 15-VDC electrolytic capacitor (Mallory MTA110E15 or equiv.)

J1, J2—phono jacks (Radio Shack 274-346 or equiv.)

J3—Microphone connector (Keystone 505 or equiv.)

QZ—Integrated circuit (Westinghouse WC-183T, available from Tridac Electronics Corp., Box 313, Alden Manor Br., Eimont, N. Y. 11003 for \$8.95 postpaid, N. Y. State residents add appropriate tax.)

R1—50,000-ohm variable resistor with switch (Lafayette 32C7367 or equiv.)

R2—50,000-ohm variable resistor (Lafayette 32C7359 or equiv.)

R3—5000-ohm miniature trimmer resistor (Mallory MTC-53L1 or equiv.)

S1—Switch on R1

T1—Transistor output transformer (Argonne AR163, Lafayette 33C8554 or equiv.)

2—Knobs (Mallory 1910K or equiv.)

1—Battery holder for mercury battery, B1 (Keystone Electronics 137 or 106, Allied Radio 18B5909, or equiv.)

1—Miniature chassis (Bud CB1617, Allied 4ZA7816 or equiv.)

2—Standoffs, 1/4-in. high, threaded 6-32 (Keystone 1591-2 or equiv.)

14—Turret terminals (Keystone 1502-2 or equiv.)

Misc.—Phenolic board, 6-32 screws, 2-56 screws and nuts, buss wire, insulating tubing, sheet aluminum, etc.

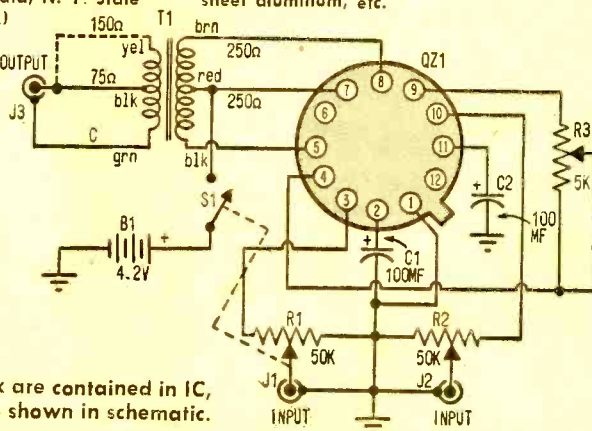

Most components in Mini Mix are contained in IC, remaining parts are wired as shown in schematic.

If doin' 70 on the ol' freeway
can't keep you from being bored,
take a gander at this cozy setup
and start taping those blues away

Rovin' Recorder

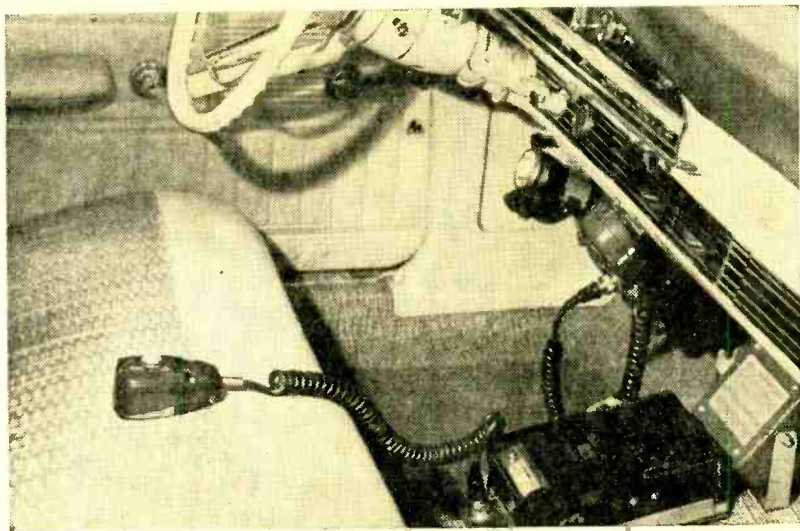

By Frank Deems

■ Here is a simple accessory you can build in one evening to extend the usefulness of your portable tape recorder. It'll transform any battery-powered unit into a Rovin' Recorder for your car, and a Rovin' Recorder can very well prove one of the handiest devices you've ever owned.

Hams and CBers will find this accessory useful for keeping notes to be written later in their log books. Businessmen can dictate letters; public speakers can organize speech notes. Housewives can complete their shopping lists or leave messages for the car's next driver. The uses are endless!

Your Own Rig. A special bracket for the recorder is the answer. The bracket must be designed to fit the requirements of your recorder and your car, but the unit shown in our photos can be considered typical of the many cassette models available.

Though dimensions and construction details will differ from one bracket to another, keep in mind when building the bracket that it must hold the recorder securely, and in a position where it may be conveniently operated by the driver. This can be accomplished by mounting the bracket on the

transmission hump of the car and using suitable cables and connectors so the recorder can be operated with a push-to-talk mobile mike.

For my Rovin' Recorder, I use a Norelco Carrycorder with a simple bracket that I built in a couple of hours using a piece of $\frac{1}{8}$ -in. Masonite and three scrap pieces of soft aluminum. The Masonite was cut $\frac{1}{8}$ in. wider than the recorder, and about $1\frac{1}{2}$ in. longer. The extra length of Masonite provides space for a mike connector.

This was necessary since the mike I wanted to use didn't have the right connectors for the recorder, and I wanted to keep the original connector on the mike so it could be used as a spare for my two-meter ham mobile rig. Another advantage was that the coiled mike cord could be pulled out to its full length without pulling the plugs from the recorder.

Snug Fit. The pieces of aluminum were cut to appropriate size with a hacksaw and bent at right angles so they could be attached to the Masonite to hold the recorder safely in place. Epoxy cement was used to attach the aluminum braces, and they were care-

Rovin' Recorder

fully spaced to fit snugly against the sides of the recorder. Edges and corners were filed smooth before they were cemented in order to make the unit more attractive and prevent accidental cuts.

Next, a hole for the mike connector was cut in the bottom portion of the Masonite board. I used the same type connector that would go on the front panel of a radio. The connector will have four leads: two for the

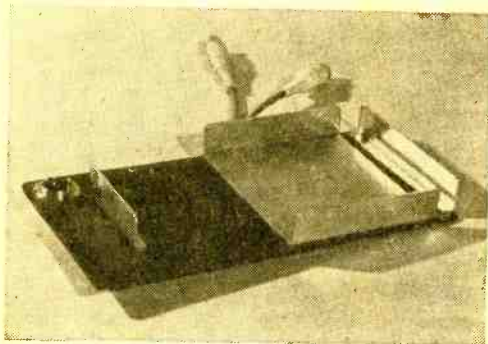

Top view of recorder bracket. Braces are made of aluminum scrap. Connector up front accommodates mobile mike with push-to-talk switch.

push-to-talk function, and two for the audio output.

These wires were cut long enough to allow the plugs to be inserted or removed from the recorder easily, yet not so long that they would disturb the driver. A short length of lamp cord was used for the push-to-talk switch, while a piece of coax carried the audio signal to the recorder.

Many radio and hi-fi stores carry connectors needed for the wide variety of recorders on the market. If you have trouble locating the right connectors for your foreign-made recorder, write to Switchcraft, Inc., 5555 N. Elston Ave., Chicago, Ill. 60630 for a catalog covering their line.

After you have your own bracket completed and have bench-tested it with your recorder, you're ready to mount the unit on the transmission hump, where it will be easiest to operate while you're driving. Climb out of the car and check underneath to make sure the area is clear of brake lines, the gas line, electrical wiring, etc., before you start drilling holes!

The bracket should be narrow enough so

that only two screws are necessary to hold it securely to the transmission hump. If you're not so fortunate, you can stabilize it by using additional screws, or by shaping some wood blocks to fit under the Masonite so that they press against the sloping sides of the hump. Glue these to the bottom side of the Masonite with wood glue or epoxy.

Slow Speed. Use flat-head, sheet-metal screws, drilling through the Masonite first, then carefully drilling through the hump in exactly the right locations. Make the holes in the Masonite large enough for the screws to drop through without the threads engaging. Then counter-sink the holes so the screw heads will be flush with the surface.

Use a smaller drill for the hump so that the screw threads will engage the metal. You'll probably need screws at least $\frac{3}{4}$ in. long. If you have an SCR speed control for your electric drill, here's a good place to use it. This way you can avoid pulling up an awkward lump of the padding under the floor mat.

After the bracket is attached, use a sharp knife to cut a piece of $\frac{1}{4}$ -in. foam rubber so it fits snugly between the aluminum braces. This will serve as a protective pad to prevent vibration and road shocks from damaging your recorder as you drive along.

All that remains is to put the recorder in the bracket, connect the mike, drive away, and watch that traffic! ■



Bracket on transmission hump is ready for installation of recorder. Connector cables underneath are fastened to Masonite with a cable clamp. This prevents any strain on connector's terminals. Speaker at right and mike above are for two-meter mobile rig.

Great little goodie that'll snuggle right up to your rig and make for CBing with a vengeance.

By Ed Morris, WA2VLU

TRIPLE THREAT

TRIPLE THREAT



With today's crowded CB and Ham bands, you're just plain hurting if your rig's transmitter or antenna aren't putting out their best for you. Getting through the gobs of QRM takes just about everything you can muster—from a few more milliwatts to another ½-dB antenna gain. If your rig is letting you down, you'll want to know so's you can do something about it. If you don't, the end results will be decreased operating range, and fewer QSOs.

How are you going to find out? Simple, build our whiz-bang Triple Threat, a combination 0 to 5-watt RF power meter, field strength meter, and modulation monitor, all wrapped up in one small, neat package. It's just the thing that'll keep your rig's transmitter and antenna doing the very best they know how for many a CB season to come.

Not only is Triple Threat fun and easy to build (a beginner can do the job in 4-5 hours), but it's inexpensive as well. The total cost is under thirteen bucks, and that's using all new parts throughout.

The input impedance to the RF power meter is 52 ohms—compatible with almost all CB and Ham rigs—and it can be used up to 50 MHz. The field strength meter can be used way up to 150 MHz, as can the modulation monitor.

RF Power Meter. The RF power to be measured is coupled across a dummy load consisting of resistors R2-R6. Notice that the total resistance of this resistor hookup is about 52 ohms. In addition, resistors R5 and R6 serve as an RF voltage divider.

The RF voltage dropped across resistor R5 is applied to germanium diode D2. Here

Triple Threat

the RF voltage is rectified and converted to direct current. The DC is then filtered by the action of capacitors C2 and C3. Resistors R7 and R8 aid in this filtering action and are also the calibration resistors, controlling the amount of current flowing through meter M1. The rectified and filtered RF voltage is then read by meter M1, which is calibrated in RF watts.

Field Strength Meter. Radio-frequency signals picked up by the antenna are coupled across choke L1, which is a high impedance to ground for these signals. The RF voltage developed across L1 is rectified by diode D1 and filtered by capacitor C1. Potentiometer R1 is a variable voltage divider, and is the sensitivity control.

The output from the wiper arm of R1 is sent to meter M1 through switch S1. M1 will then read the relative strength of the RF signal. Capacitor C4 is an RF bypass capacitor for the meter.

To monitor modulation quality when using Triple Threat as either a power meter or a field strength meter, plug in a medium impedance (500- to 5000-ohms) headset into jack J1. This disconnects the meter, and connects the output directly to the headset so you can hear what's happening.

Mechanical Construction. Triple Threat is built in a standard 4 x 2½ x 1½ in. aluminum chassis box. Begin mechanical construction by laying out the holes to be drilled with the aid of a T-square. Center-punching the spots to be drilled will result in a more accurate and neater job. The larger holes may be cut by first drilling a pilot hole, then enlarging it with a tapered reamer to the proper size. A hand nibbler will make quick work of the cutout required for the meter. After the mechanical work on the case has been completed, the holes should be de-burred.

Before the case can be painted, it should be properly prepared by cleaning the aluminum surface. First make sure that the case is clean. Remove all traces of surface dirt and oil by washing with soap and water.

Several light coats of primer may then be applied to provide a good base for the finish

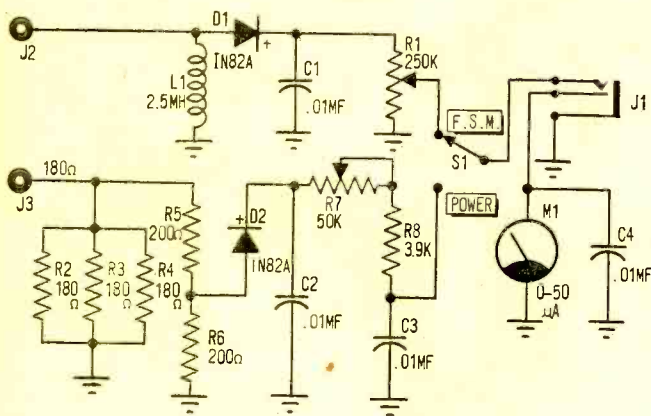

Schematic of Triple Threat shows simple, straightforward design that gives you the features you need without the headache of undue complexity. Pot R7 is the set-and-forget power calibration control; R1 is the front panel field strength sensitivity control.

PARTS LIST FOR TRIPLE THREAT

C1, C2, C3, C4—0.01- μ F, 1000-VDC ceramic disc capacitor

D1, D2—1N82A germanium diode

J1—Miniature closed-circuit jack (Lafayette 99C6211 or equiv.)

J2—Pin-jack, RCA type, single hole mounting (Lafayette 99C6234, Radio Shack 274-295 or equiv.)

J3—UHF-type chassis connector, 50-239 SH, single hole mounting (Lafayette 42C6907, Radio Shack 278-201 or equiv.)

L1—2.5-mH RF choke (National R-50 or equiv.)

M1—50-microampere miniature panel meter (Lafayette 99C5049 or equiv.)

R1—250,000-ohm potentiometer, linear taper

(Mallory type UL-46 or equiv.)

R2, R3, R4—180-ohm, 2-watt, 5% resistor. (Do not substitute)

R5, R6—200-ohm, ½-watt, 5% resistor. (Do not substitute)

R7—50,000-ohm potentiometer, linear taper (Mallory type MCL-546 or equiv.)

R8—3900-ohm, ½-watt resistor

S1—S.p.d.t. subminiature switch, toggle type (Lafayette 99C6126, Radio Shack 77-0670 or equiv.)

1—Aluminum chassis box, 4 x 2½ x 1½-in. (Lafayette 12C8369 or equiv.)

Misc.—Wire, solder, nuts, bolts, ground lugs, paint, decal lettering, etc.

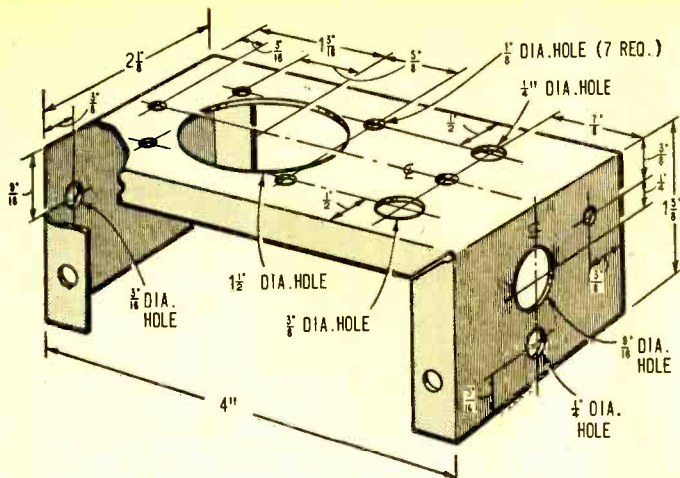

Aluminum chassis box provides plenty of working space but keeps unit compact. While operation of Triple Threat may not be impaired by changing layout, top performance is assured by sticking with design.

coats. When you are ready to apply the final finish coats, use a light touch, as several thin coats will produce a better and longer lasting finish than one or two heavy ones.

After the paint has been allowed to thoroughly dry, suitable transfer lettering can be applied. Transfer lettering, such as that put out by DATAK and others, is both inexpensive and easy to apply. It also usually results in a neater job than decals. In either case, be sure to follow the manufacturer's instructions when applying. An overcoat of clear spray will protect both the lettering and the paint job.

Preparing the Meter Face. Working on a clean surface free from dirt, and in an area free from lint, carefully pop off the plastic face plate of the meter. Using non-magnetic tools, remove the two screws holding the meter scale to the body of the meter.

Spray paint the reverse side of the meter scale white. Exactly copy the actual size pre-calibrated scale included in this article. Use rubber cement to bond the scale to the side of

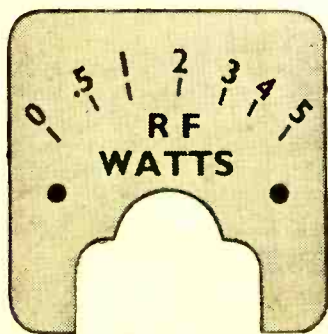

Using the recommended meter makes dial face above exactly the right size. The non-linear scale is pre-calibrated to match circuit operation; final calibration is made at any power level.

the meter scale plate which you have just painted. Carefully reassemble the meter.

Although the layout for Triple Threat is not critical, best results will be obtained, especially with the power meter section, if the reader follows the layout presented. The more advanced reader should feel free to modify to suit his own needs best.

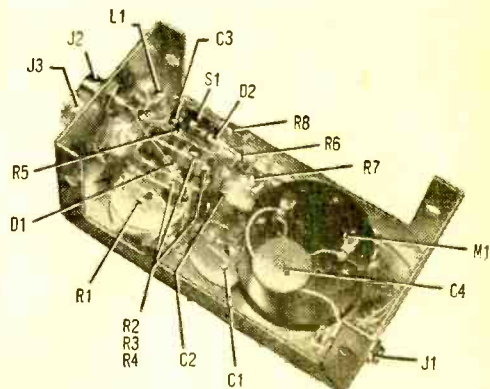

Internal view of completed Triple Threat indicates careful planning of layout. Resistors R2, R3, R4 are hooked in parallel to provide load for transmitter.

Begin the electrical construction by mounting potentiometer R1 and RF connector J3. When wiring in resistors R2 to R6, follow the photographs for parts placement and positioning.

Next mount meter M1 along with switch S1 and potentiometer R7.

Wire in the remaining circuitry as per the schematic diagram. When soldering diodes D1 and D2 into the circuit, be sure to use a heat sink to preclude possible damage resulting from excess heat. Use a low wattage soldering iron with a well tinned tip. Use the

Triple Threat

minimum amount of heat necessary to form a good connection.

When you are finished with the wiring of the set, go back and recheck your work. Pay particular attention to the polarity of meter M1 and the diodes D1, D2.

Final Checkout. Place switch S1 in the Field Strength position. Turn the sensitivity control completely counterclockwise. Plug a short antenna (12 to 18-in.) into J3. Key your transmitter and increase the sensitivity by turning R1 until a mid-scale reading on Triple Threat is obtained.

Plug in a medium impedance (500- to 5000-ohms) headset into jack J1. Key your transmitter again and speak into the microphone. You should now be able to monitor your modulation in the headsets.

If a down-scale reading is obtained, reverse the leads to diode D1. If no meter reading is obtained, or if the monitor is inoperative, recheck your work against the schematic, and look for possible shorts.

Now with an ohmmeter, measure the resistance from the center connector of J3 to ground. It should be about 52 ohms. Connect your transmitter, (not exceeding 5 watts output) to J3 with a short length of coax. Set potentiometer R7 to maximum resistance. Key the transmitter and gradually reduce the resistance of R7 until you obtain a half-scale reading. If the meter reads backwards, reverse the leads to diode D1.

Calibration. The calibration procedure for the power meter portion of the Triple

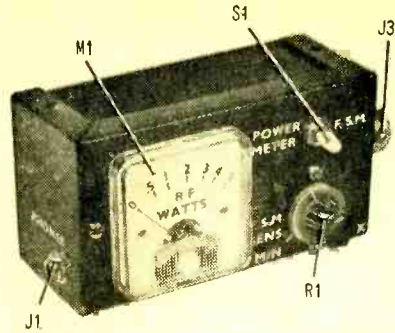

Tidy, professional appearance of Triple Threat front panel makes it nice to have around and a pleasure to use.

Threat, while not complicated, does require the use of a calibrated RF power meter.

The actual calibration procedure is to adjust calibration potentiometer R7 to match readings on the Triple Threat with those obtained from the RF power meter being used as the standard.

Connect your rig (not exceeding 5 watts output), to the meter being used as the standard. Key your transmitter and note its output on the standard. Now connect your rig, being careful not to change the tuning, to Triple Threat. Key your transmitter again and adjust Triple Threat's calibration control to match the meter reading of the standard.

Let's say the standard says your rig is putting out 2.5 watts. Simply adjust calibration potentiometer R7 so that your Triple Threat reads the same. Only one point of calibration is necessary to calibrate the entire range of the meter. The calibration point should, however, be between 1 and 3.5 watts for best overall accuracy. ■



All hooked up and ready to go, Triple Threat isn't ashamed to be seen in the best of company. Unit's overall good looks and handy features makes it good side kick for any rig in the shack. Here it's shown snuggling up to a Lafayette HB-525 CB rig.

1-FET BCber

Continued from page 48

unit should break into oscillation. The most sensitive and selective operation will be obtained with the regen control set just below the point of oscillation.

Operation. For local stations use 25 feet of hook-up wire for an antenna. To improve the reception of weaker stations, use an outside antenna and a ground.

Tune C1 for signals while adjusting R2. If there is too much regeneration, the circuit will oscillate and stations will come in as whistles. If whistles occur, turn R2 back below the point of oscillation. C2 may then have to be readjusted.

Rev Buster

Continued from page 62

To calibrate your tach, first adjust R10, the $\times 10$ shunt resistor. Flip S3 to the 0-1000 rpm position, connect the calibrator, and adjust R5 (a temporary adjustment) until the meter reads exactly full scale (1.0 mA). Then flip S3 to the 0-10,000 rpm position and adjust R10 until the meter reads exactly 1/10 of full scale (0.1 mA).

Now decide which type of engine you want to calibrate for. For an 8-cylinder engine, flip S3 to 0-1000 rpm, and adjust R5 for a reading of 900 rpm (0.9 mA). For a 6- or 4-cylinder engine, set S3 at 0-10,000 rpm and adjust R5 for a reading of 1200 rpm (0.12 mA) or 1800 rpm (0.18 mA), respectively. The above procedures automatically calibrate both ranges.

The dwell meter is calibrated *before every application*. Touch the test prods together and adjust R9 for full-scale deflection. That's all! Note that your dwell meter is calibrated differently than most—it's calibrated directly in percentage of point dwell—0 to 100%.

The conventional calibration is in terms of *degrees of dwell*. This is because the distributor's points are closed for a specific number of degrees of the cam shaft's rotation. If the correct dwell figure for your car is listed in terms of degrees, just use the method described in the table below to con-

vert to percentage. Consult your service manual for the correct dwell angle figure.

Number of cylinders into 360° (full shaft rotation) gives dwell and gap values for each cylinder.

4 cylinders = 90°

6 cylinders = 60°

8 cylinders = 45°

For instance, for a 6-cylinder engine, if dwell angle for your car were 36° (i.e., 36° dwell plus 24° gap equals 60° per cylinder), percentage would be $36/60$, or 60%. This is a reading of 0.6 on meter.

Travelin' Happening

Continued from page 51

should be as close as possible to the amplifier. If they are mounted more than three inches from the amplifier, use shielded cable for the connections to the amp.

Drill two $\frac{1}{2}$ -in. holes in the guitar case in J1 and R2's locations. If the case is wood, R2's shaft will protrude through the case while J1 will be recessed about $\frac{1}{8}$ -in. The $\frac{1}{2}$ -in. hole, however, will permit the guitar's jack to fit past the wood case into J1.

The amplifier can be secured to a wood case with just two screws.

If the case is thin hardboard, drill $13/32$ -in. holes opposite J1 and R2 and secure the amplifier assembly to the case with J1 and R2's mounting nuts. Connect the battery and Travelin' Happening is ready to go. ■

Charger & Spender

Continued from page 83

lower-voltage batteries may be "charged" in a similar manner if suitable voltage dropping resistors are used.

Using Spender. Operation is simple, but the following points should be noted: observe polarity when connecting Spender to Charger. When uncertain about correct voltage needed for an experimental circuit, always start at the 3-volt position and switch up, if necessary. Under no circumstances should current exceed 60 mA. Do not attempt to charge a battery through the Spender. If you power two transistor units with Spender at the same time, it would be wise to place an electrolytic capacitor (1000 μ F, 15-VDC) across J3-J4 to eliminate any unwanted cross coupling between units. ■

DX Devil

Continued from page 42

results with your particular installation.

If you hear no birdies even when R2 is fully clockwise, you need a little more coil between pins 3 and 4 of L1. Add a turn or two. On the other hand, if you still hear birdies with R2 at its full counterclockwise position (maximum resistance), there is too much coil between pins 3 and 4. Shorten this winding a bit. In rare cases, it may even be necessary to operate the preselector with only a short jumper between pins 3 and 4 of the coil form.

DX Devil is most sensitive when R2 is set just below the point of oscillation. When operated in this manner, the tuning of C1 will become extremely sharp. Carefully adjust the capacitor for maximum strength of the desired station.

Coil 3 will cover both the 4-MHz and 7-MHz amateur bands and all the frequencies in between. Once you have this coil working correctly over its entire range, make similar checks with Coil 2 (7 MHz to 14 MHz) and Coil 1 (14 MHz to 30 MHz).

Performance. The improvement in reception which can be achieved with the aid of your DX Devil varies inversely with the quality of the companion receiver. The worse your set is, the more startling will be the results. Tests on a pre-World War II receiver showed that 28-MHz amateur signals could be lifted from inaudibility to 100% copy, and weak signals boosted to S-9 plus. Annoying images were almost completely suppressed. Unreadable holes in fluttery 15- and 17-MHz shortwave broadcasts were either eliminated or drastically reduced.

Even when connected to the author's modern, 13-tube double superhet, performance on 28 MHz was improved. Weak signals became much more readable, and the S-meter jumped 20 to 30 dB with the pre-selector switched on. Because the average receiver is more efficient at lower frequencies, results weren't quite so spectacular from 4 to 7 MHz. However, the S-meter went up and lots more signals were heard with true armchair copy.

Though the SWBC bands are more crowded today than ever before, broadcasts have never been more fascinating. Hook up the Devil to your catch-all receiver, and you'll DX like crazy. ■

CB Skyhook

Continued from page 46

ceivers. High-speed drilling will cause more vibration, and there's a better chance of damaging delicate vacuum tubes. A little oil on the self-tapping screws will make it easier to set them in their holes.

In the Middle. Alternatively, you can mount the whip right in the center of the transceiver cabinet. Doing so might give you a little better ground-plane effect, but you probably won't be able to notice the difference. Then, too, it would also mean extra hardware.

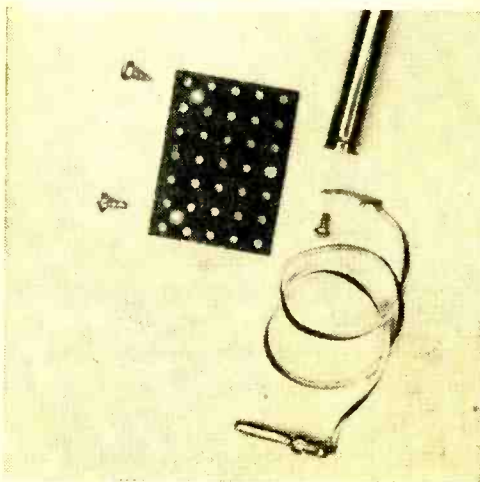

Solder lug and wire are attached to whip from underside of phenolic. Phenolic is then screwed down on top of cabinet at rear.

If you do decide to mount the antenna in the center of the cabinet, you'll need a set of four ¼-in. spacers to raise the phenolic above the cabinet surface. Then the lug and the screw at the bottom end of the antenna will clear the cabinet.

To connect the antenna to your rig, strip the ends of an 8- to 12-in. length of hookup wire. Solder one end to a solder lug and the other to a banana plug. You don't need an insulator on the shank end of the plug unless, of course, there's a chance for it to short out.

That's just about it. How much quicker can you get? All that's left is to mount the whip on the cabinet of the CB transceiver, and get on the air.

So go to it, and don't be shy about using this CB skyhook to get on the air—fast! ■

Super Snoop

Continued from page 32

prove to be a valuable aid in automobile and mechanical diagnosis.

A few points on safety should be observed and remembered. When tracing those squeaks or merely listening to your transmission switch gears, take care that the pickup cable is safely clear of moving parts capable of snagging it on the road and producing a dangerous situation by distracting your attention from driving. Use tape to hold the cable secure to the car body and areas where the cable cannot be strung through.

Similarly, when listening in the phones, keep in mind that a little recognized but important driving aid is removed—your hearing. So be cautious! The best safety measure is to let a friend drive and you can listen with a great deal more attention.

Gold Grabber

Continued from page 36

the tuning screw of L2 until you hear a loud beat note. Further adjustment of L2 should cause the beat note to pass through the zero-beat point and back to an audio note again.

If a beat note cannot be heard with adjustment of L2, check the voltage on the gate leads of Q1 and Q2. The voltage should be measured with a VTVM. Our unit measured -3.5 V at the gate of Q1 (across R1) and -10 V at the gate of Q2 (across R3). The exact voltages are not critical, since they will vary with a particular FET.

If there's a negative voltage on the gates of Q1 and Q2, indicating that the circuits are oscillating, but a beat note is not heard, change the number of turns of L1 until the frequency of the Q1 oscillator circuit is close enough to the detector circuit of Q2 to zero beat.

Finally, move a section of aluminum foil towards the loop. The beat note should change frequency and indicate the presence of metal.

Using It. Practice operating Gold Grabber by burying several sections of aluminum foil a few inches under the ground in locations with differing types of soil and gravel. Hold the metal locator close to the surface of the earth and adjust the tuning slug of L2 to a convenient audio pitch.

Wide World Of Super Snoop. Super Snoop can be used to detect worn brakes, frozen bearings, chipped gears, and a variety of other problems. It can also be used for listening to walls in 007 fashion; just place the pickup on any attachable wall-framing such as a door jamb, and conversations from the other side are easily monitored. Plaster walls, as far as sound sensitivity is concerned, are the best type of walls. If there is no framing on the wall, remove the transducer from the C-clamp and tape it to the wall. This method may be better in some cases for picking up conversations.

Finally, one last application of Super Snoop is its use in producing sound effects, such as water running through the pipes, marbles being dropped in empty metal pails, or salt being poured onto a card table. The possibilities are endless, and the results make Super Snoop a worthwhile addition to anybody's family. Happy snooping! ■

Pass the loop over the area until you hear a sudden change in the audio tone, then dig for the aluminum foil targets. Practice with different audio tones until your ear is accustomed to the change in audio pitch that denotes a metal object.

The sensitivity of Gold Grabber is dependent on the surface area of the metal, its depth below the surface, and the composition and moisture content of the earth.

The energy radiated by the loop will be absorbed by the earth in various degrees, depending on the mineral content, etc. The larger the surface of the metal and the closer it is to the surface of the earth, the easier it is to locate. Gold Grabber was able to find a 3x3-in. square of aluminum foil under several inches of gravel and earth. You can do better! Get out there and start grabbing. ■

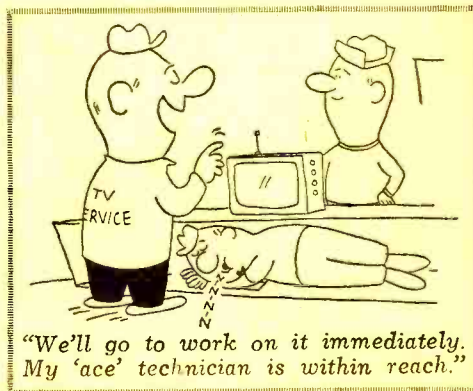

You get more for your money from NRI—

America's oldest and largest Electronic, Radio-Television home-study school

Compare. You'll find—as have so many thousands of others—NRI training can't be beat. From the delivery of your first lessons in the remarkable, new Achievement Kit, to "bite size," easily-read texts and carefully designed training equipment . . . NRI gives you more value.

Shown below is a dramatic, pictorial example of training materials in *just one* NRI Course. Everything you see below is included in low-cost NRI training. Other major NRI courses are equally complete. Text for text, kit for kit, dollar for dollar—your best home-study buy is NRI.

APPROVED UNDER NEW GI BILL

If you served since January 31, 1955, or are in service, check GI line in postage-free card.



12 WAYS TO TRAIN AT HOME WITH NRI

**Television-Radio Servicing
Industrial Electronics
Communications**

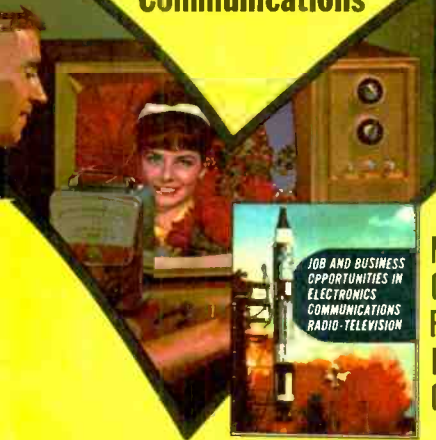

JOB AND BUSINESS
OPPORTUNITIES IN
ELECTRONICS
COMMUNICATIONS
RADIO-TELEVISION

**MAIL
CARD
FOR
FREE
CATALOG**

***NRI EQUIPMENT GIVES YOU
PRICELESS CONFIDENCE***

**check
your choice**

**NATIONAL
RADIO INSTITUTE**
Washington, D.C. 20016



Please send me the NRI catalog checked.
(No salesman will call. Please print.)

- TV-Radio Servicing (with color) • Industrial Electronics • Complete Communications • FCC License • Math for Electronics • Basic Electronics • Electronics for Automation • Aviation Communications • Marine Communications • Mobile Communications.
- Advanced Color TV Servicing (not for beginners)
- Electrical Appliance Servicing (Including small gas engines, air conditioning, refrigeration).

Name _____ Age _____

Address _____

City _____ State _____ Zip _____

CHECK FOR FACTS ON NEW GI BILL

ACCREDITED MEMBER NATIONAL HOME STUDY COUNCIL



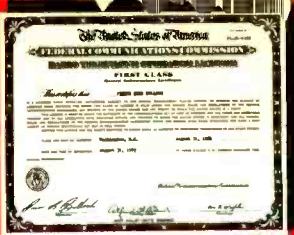

**EARN
YOUR
FCC
LICENSE
—OR GET
YOUR
MONEY BACK ON ANY NRI
COMMUNICATIONS COURSE.**



**TRAIN AT
HOME WITH
THE LEADER**

**80 page catalog NRI
sends you is filled with
facts and color photos.**

NO SALESMAN WILL CALL

MAIL CARD

NO STAMP NEEDED



**NATIONAL RADIO INSTITUTE
3939 Wisconsin Avenue
Washington, D. C. 20016**

BUSINESS REPLY MAIL
POSTAGE WILL BE PAID BY

NO POSTAGE NECESSARY IF MAILED IN THE UNITED STATES

**FIRST CLASS
PERMIT
No. 20-R
Washington, D. C.**



GET A FASTER START WITH NRI'S NEW EXCLUSIVE ACHIEVEMENT KIT

The day your enrollment is received your Achievement Kit will be on its way to you. It contains everything you need to make an easy, fast start in the Electronics training of your choice. This attractive, new starter kit is an outstanding, logical way to introduce you to home-study the way NRI teaches it . . . backed by a dedicated staff and the personal attention you should expect of a home-study school. It is your first special training aid . . . designed to make your adventure into Electronics absorbing, meaningful. Your Achievement Kit contains your first group of lesson texts; rich vinyl desk folder to hold study material; the industry's most complete Radio-TV Electronics Dictionary; valuable reference texts; lesson answer sheets; envelopes; pencils, pen; engineer's ruler—even postage. No other school has anything like it.

OVER 50 YEARS LEADERSHIP
IN ELECTRONICS TRAINING



LEARNING BECOMES AN ABSORBING ADVENTURE WITH NRI TRAINING KITS

What better way to learn than by doing? NRI pioneered and perfected the "home lab" technique of learning at home in your spare time. You get your hands on actual parts and use them to build, experiment, explore, discover. Electronics come alive! NRI invites comparison with training equipment offered by any other school. Begin NOW this exciting, practical program. It's the best way to understand the skills of the finest technicians—and make their techniques your own. Whatever your reason for wanting to increase your knowledge of Electronics . . . whatever your field of interest . . . whatever your education . . . there's an NRI instruction plan for you, at low tuition rates to fit your budget. Get all the facts about NRI training plans, NRI training equipment. Fill in and mail the attached postage-free card today.

NATIONAL RADIO INSTITUTE, Wash-
ington, D.C. 20016.

Accredited by the Accrediting Commission
of the National Home Study Council

BUILD-TEST-EXPLORE-DISCOVER. All this is yours — from Achievement Kit to the only Color TV specifically designed for training — when you enroll for NRI's TV-Radio Servicing course. Other courses are equally complete. But NRI training is more than kits and "bite-size" texts. It's also personal services which have made NRI a 50 year leader in the home-study field. Mail the postage-free card today.



BUILD YOUR OWN RADIO

CIRCUITS AT HOME with the New Improved only \$26.95

PROGRESSIVE RADIO "EDU-KIT"®

A Practical Home Radio Course

- Now Includes
- * 12 RECEIVERS
 - * 3 TRANSMITTERS
 - * SQ. WAVE GENERATOR
 - * SIGNAL TRACER
 - * AMPLIFIER
 - * SIGNAL INJECTOR
 - * CODE OSCILLATOR
- * No Knowledge of Radio Necessary
 - * No Additional Parts or Tools Needed
 - * EXCELLENT BACKGROUND FOR TV
 - * SCHOOL INQUIRIES INVITED
 - * Sold In 79 Countries



Reg. U. S. Pat. Off.

Training Electronics Technicians Since 1946

YOU DON'T HAVE TO SPEND HUNDREDS OF DOLLARS FOR A RADIO COURSE.

The "Edu-Kit" offers you an outstanding PRACTICAL HOME RADIO COURSE at a rock-bottom price. Our Kit is designed to train Radio & Electronics Technicians, making use of the most modern methods of home training. You will learn radio theory, construction practice and servicing. THIS IS A COMPLETE RADIO COURSE IN EVERY DETAIL. In a professional manner; how to service radios. You will work with the standard type of punched metal chassis as well as the latest development of Printed Circuit chassis. You will learn the basic principles of radio. You will construct, study and work with RF and AF amplifiers and oscillators, detectors, rectifiers, test equipment. You will learn trouble-shooting, using the Progressive Signal Tracer. Progressive Signal Injector. Progressive Dynamic Radio & Electronics Tester, Square Wave Generator and the accompanying instructions.

You will receive training for the Novice, Technician and General Classes of F.C.C. Radio Amateur Licenses. You will build Receiver, Transmitter, Square Wave Generator, Code Oscillator, Signal Tracer, Signal Injector circuits, and learn how to operate them. You will receive an excellent background for television, Hi-Fi and Electronics.

Absolutely no previous knowledge of radio or science is required. The "Edu-Kit" is the product of many years of teaching and engineering experience. The "Edu-Kit" will provide you with a basic education in Electronics and Radio, worth many times the low price you pay. The Signal Tracer alone is worth more than the price of the kit.

THE KIT FOR EVERYONE

You do not need the slightest background in radio or science. Whether you are interested in Radio & Electronics because you want an interesting hobby, a well paying business or a job with a future, you will find the "Edu-Kit" a worth-while investment. Many thousands of individuals of all ages and backgrounds have successfully used the "Edu-Kit" in more than 79 countries of the world. The "Edu-Kit" has been carefully designed, step by step, so that you cannot make a mistake. The "Edu-Kit" allows you to teach yourself at your own rate. No instructor is necessary.

PROGRESSIVE TEACHING METHOD

The Progressive Radio "Edu-Kit" is the foremost educational radio kit in the world, and is universally accepted as the standard in the field of electronics training. The "Edu-Kit" uses the modern educational principle of "Learn by Doing." Therefore you construct, learn schematics, study theory, practice trouble shooting—all in a closely integrated program designed to provide an easily-reinforced, thorough and interesting background in radio. You begin by examining the various radio parts of the "Edu-Kit." You then learn the function, theory and wiring of these parts. Then you build a simple radio. With this first set you will enjoy listening to regular broadcast stations, learn theory, practice testing and trouble-shooting. Then you build a more advanced radio, learn more advanced theory and techniques. Gradually, in a progressive manner, and at your own rate, you will find yourself constructing more advanced multi-tube radio circuits, and doing work like a professional Radio Technician.

Included in the "Edu-Kit" course are Receiver, Transmitter, Code Oscillator, Signal Tracer, Square Wave Generator and Signal Injector Circuits. These are not unprofessional "breadboard" experiments, but genuine radio circuits, constructed by means of professional wiring and soldering on metal chassis, plus the new method of radio construction known as "Printed Circuitry." These circuits operate on your regular AC or DC house current.

THE "EDU-KIT" IS COMPLETE

You will receive all parts and instructions necessary to build twenty different radio and electronics circuits, each guaranteed to operate. Our Kits contain tubes, tube sockets, variable electrolytic, mica, ceramic and paper dielectric condensers, resistors, tie strips, hardware, tubing, punched metal chassis, Instruction Manuals, hook-up wire, solder, selenium rectifiers, coils, volume controls and switches, etc.

In addition, you receive Printed Circuit materials, including Printed Circuit chassis, special tube sockets, hardware and instructions. You also receive a useful set of tools, a professional electric soldering iron, and a self-powered Dynamic Radio and Electronics Tester. The "Edu-Kit" also includes Code Instructions and the Progressive Code Oscillator, in addition to F.C.C. Radio Amateur License training. You will also receive lessons for servicing with the progressive Signal Tracer and the Progressive Signal Injector, a High Fidelity Guide and a Quiz Book. You receive Membership in Radio-TV Club, Free Consultation Service, Certificate of Merit and Discount Privileges. You receive all parts, tools, instructions, etc. Everything is yours to keep.

Progressive "Edu-Kits" Inc., 1186 Broadway, Dept. 504EN, Hewlett, N. Y. 11557

UNCONDITIONAL MONEY-BACK GUARANTEE

Please rush my Progressive Radio "Edu-Kit" to me, as indicated below. Check one box to indicate choice of model

- Regular model \$26.95.
 - Deluxe model \$31.95 (same as regular model except with superior parts and tools plus valuable Radio & TV Tube Checker).
- Check one box to indicate manner of payment
- I enclose full payment. Ship "Edu-Kit" post paid.
 - Ship "Edu-Kit" C.O.D. I will pay postage.
 - Send me FREE additional information describing "Edu-Kit."

Name _____
 Address _____
 City & State _____ ZIP _____

PROGRESSIVE "EDU-KITS" INC.
 1186 Broadway, Dept. 504EN, Hewlett, N. Y. 11557

FREE EXTRAS

• SET OF TOOLS

- SOLDERING IRON
- ELECTRONICS TESTER
- PLIERS-CUTTERS
- VALUABLE DISCOUNT CARD
- CERTIFICATE OF MERIT
- TESTER INSTRUCTION MANUAL
- HIGH FIDELITY GUIDE • QUIZZES
- TELEVISION BOOK • RADIO TROUBLE-SHOOTING BOOK
- MEMBERSHIP IN RADIO-TV CLUB: CONSULTATION SERVICE, FCC AMATEUR LICENSE TRAINING
- PRINTED CIRCUITRY

SERVICING LESSONS

You will learn trouble-shooting and servicing in a progressive manner. You will practice repairs on the sets that you construct. You will learn symptoms and causes of trouble in home, portable and car radios. You will learn how to use the professional Signal Tracer, the unique Signal Injector and the dynamic Radio & Electronics Tester. While you are learning in this practical way, you will be able to do many a repair job for your friends and neighbors, and charge fees which will far exceed the price of the "Edu-Kit." Our Consultation Service will help you far exceed the price of the "Edu-Kit." Our Consultation Service will help you win any technical problems you may have.

FROM OUR MAIL BAG

J. Stataitis, of 25 Poplar Pl., Waterbury, Conn., writes: "I have repaired several sets for my friends, and made money. The 'Edu-Kit' paid for itself. I was ready to spend \$240 for a Course, but I found your ad and sent for your Kit."

Ben Valerio, P. O. Box 21, Magna, Utah: "The Edu-Kits are wonderful. Here I am sending you the questions and also the answers for them. I have been in Radio for the last seven years. I like to work with Radio Kits, and like to build Radio testing Equipment, I enjoyed every minute I worked with the different kits; the Signal Tracer works fine. Also like to let you know that I feel proud of becoming a member of your Radio-TV Club."

Robert L. Shuff, 1534 Monroe Ave. Huntington, W. Va.: "Thought I would drop you a few lines to say that I received my Edu-Kit, and was really amazed that such a bargain can be had at such a low price. I have already started repairing radios and phonographs. My friends were really surprised to see me get into the swing of it so quickly. The Trouble-shooting Tests that comes with the Kit is really swell, and finds the trouble, if there is any to be found."

PRINTED CIRCUITRY

At no increase in price, the "Edu-Kit" now includes Printed Circuitry. You build a Printed Circuit Signal Injector. You build a servicing instrument that can detect many Radio and TV troubles. This revolutionary new technique of radio construction is now becoming popular in commercial radio and TV sets.

A Printed Circuit is a special insulated chassis on which has been deposited a conducting material which takes the place of wiring. The various parts are merely plugged in and soldered to terminals.

Printed Circuitry is the basis of modern Automation Electronics. A knowledge of this subject is a necessity today for anyone interested in Electronics.

Be creative and thrifty too!

SAVE WITH EICO KITS AND WIRED EQUIPMENT.

NEW "TREASURE HUNTER" KIT

Find metals, pipes several inches underground. EICO TH-30 Solid State Treasure Hunter locates iron, steel, tin, gold, silver, copper etc. Beep pitch increases as you near object.

Battery operated. \$29.95

NEW "BULLHORN" KIT

Carries your voice up to 400 feet. EICO BH-16 Solid State Bullhorn. 2 1/2 lbs. light, is perfect for all outdoors, camping, sports. Battery-operated. \$15.95.

NEW EICOCRAFT

The electronic science project kits

COLOR IMAGES

Electronic Art in Motion

"CHROMA-CUBE"

Classic white 18" Cube features a fantastic audio-responsive light display.

"CELESTIAL LITES"

Constantly flowing color images move in rhythm to music. 24" x 24" x 6".

"LIGHT FANTASTIC"

Translucent dome provides 3-dimensional world of ever changing light patterns in response to music. 38" high.

NEW cortina2 STEREO KITS

The lowest-priced component quality high fidelity!

EICO 3780 50-Watt Silicon Solid State FT AM-FM Stereo Receiver. Kit \$109.95, Wired \$169.95

EICO 3300 Silicon Solid State FET AM-FM Stereo Tuner. Kit \$69.95, Wired \$109.95

BEST INSTRUMENTS

Equipment guaranteed for 5 years!

Kit \$59.95, Wired \$79.95.

Kit \$69.95, Wired \$94.50.
er. Kit \$49.95, Wired \$69.95.
enerator.

EICO CATALOG

atalog describing the full EICO
y, and name of nearest dealer.

State _____ Zip _____

Inc. 97 **EICO**

NOW YOU CAN SEE THE MUSIC YOU HEAR.

Sound n' Color

Color Organs, Translators, Strobes



COLOR ORGANS

The new dimension to music pleasure.

EICO all electronic solid-state Audio-Color Organs transform sound waves into moving synchronized color images.

MODEL 3450 Giant (30" x 12" x 10") 4-Channels. Kit \$79.95, Wired \$109.95.

MODEL 3445 (24" x 12" x 10") 4-Channels. Kit \$64.95, Wired \$99.95.

MODEL 3440 (10" x 15" x 16") 3-Channels. Kit \$49.95, Wired \$79.95. Other models to choose, from \$19.95 and up.

TRANSLATORS

The electronics you need to create audio-stimulated light displays.

MODEL 3460 1 Channel. Kit \$24.95, Wired \$39.95.

MODEL 3465 3 Channel. Kit \$39.95, Wired \$69.95.

STROBE LITES

Burst of white light flash in cadence of each beat of audio.

Model 3470 Adjustable Rate. Kit \$29.95, Wired \$44.95

Model 3475 Audio Actuated. Kit \$39.95, Wired \$69.95.



AUTOMOTIVE



EICO 889 Solid State Capacitive Ignition System.

Boost gas mileage up to 25%, life of points, plugs to 100,000 miles. Kit \$29.95, Wired, \$39.95.



EICO 888 Solid State Universal Engine Analyzer. Tunes and troubleshoots your car/boat engine, the totally professional way. Kit \$49.95, Wired \$69.95.