

ELECTRONICS HOBBYIST

1968 EDITION \$1.00

GOOF-PROOF PROJECTS For Home, Car, Darkroom,
Ham-SWL-CB Radio, Lab,
Science Fair, Audio-and Fun!

ONE-EVENING PROJECTS

Shotgun Signal Generator

Auto Siren Burglar Alarm

Snooper's FM Hideaway Microphone

PROJECTS FOR WEEKENDS

6 Receivers-tuning 13 kHz to 172 MHz

7 Test Instruments for Bench & Lab

4 Quickie Projects for Better CBing

VHF Receiver tunes

- Police • Fire • Aircraft
- Weather • Utilities

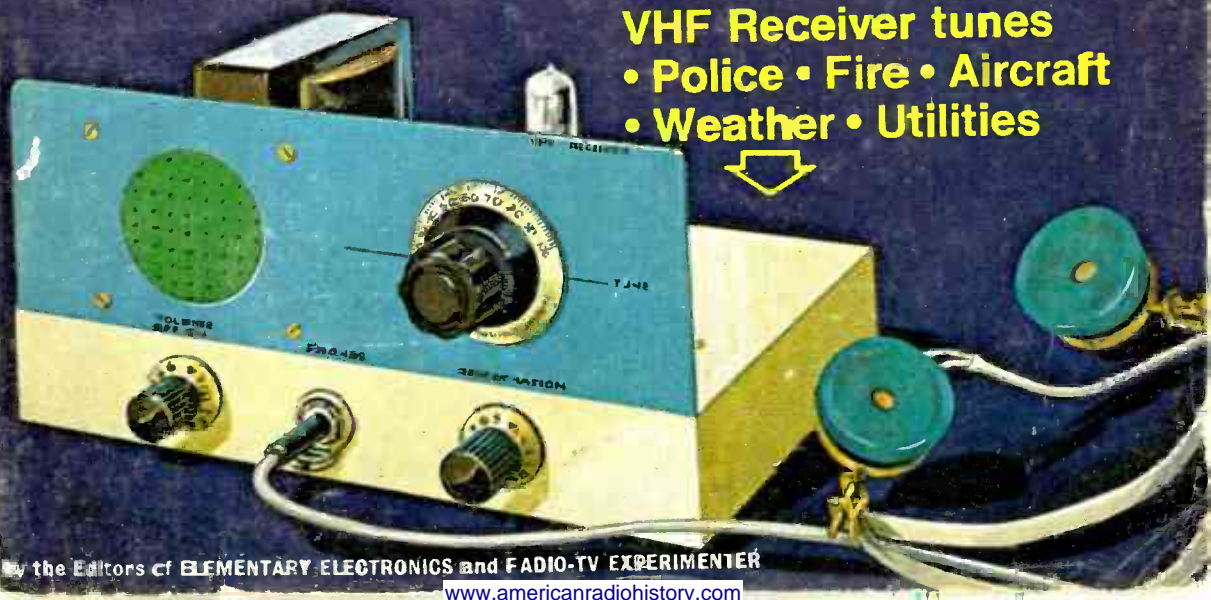

EICO Makes It Possible

Uncompromising engineering—for value does it!
You save up to 50% with Eico Kits and Wired Equipment.



Cortina Stereo

Engineering excellence, 100% capability, striking esthetics, the industry's only **TOTAL PERFORMANCE STEREO** at lowest cost.

A Silicon Solid-State 70 Watt Stereo Amplifier for \$89.95 kit, \$129.95 wired, including cabinet. Cortina 3070.

A Solid-State FM Stereo Tuner for \$89.95 kit, \$129.95 wired, including cabinet. Cortina 3200.

A 70-Watt Solid-State FM Stereo Receiver for \$159.95 kit, \$239.95 wired, including cabinet. Cortina 3570.

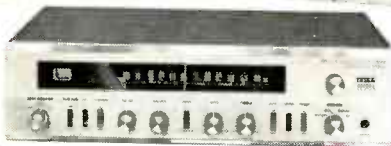

Eicocraft

The newest excitement in kits. 100% solid-state and professional. Fun to build and use. Expandable, interconnectable. Great as "jiffy" projects and as introductions to electronics. No technical experience needed. Finest parts, pre-drilled etched printed circuit boards, step-by-step instructions.



Electronic Siren \$4.95, Burglar Alarm \$6.95, Fire Alarm \$6.95, Intercom \$3.95, Audio Power Amplifier \$4.95, Metronome \$3.95, Tremolo \$8.95, Light Flasher \$3.95, Electronic "Mystifier" \$4.95, Photo Cell Nite Lite \$4.95, Power Supply \$7.95, Code Oscillator \$2.50, FM Wireless Mike \$9.95, AM Wireless Mike \$9.95, Electronic VOX \$7.95, FM Radio \$9.95, AM Radio \$7.95, Electronic Bongos \$7.95.



Citizen's Band

Two years ahead! Model 7923 All Solid-State 23-Channel 5W Transceiver. 4 exclusives: dual-crystal lattice filter for razor-sharp selectivity; efficient up-converter frequency synthesizer for advanced stability; precision series-mode fundamental crystals; Small: only 3"H, 8"W, 8 1/4"D. \$189.95 wired only. The best buy in tube-type CB—"Sentinel-Pro" 23-channel dual conversion 5W Transceiver \$169.95 wired only.

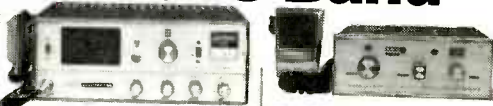

EICO Trans/Match (Model 715) is a professional test set designed for complete checking of ham and CB equipment. Kit \$34.95; Wired \$49.95.

Truvohm

Professional Portable Multimeters by EICO. The industry's greatest V-O-M values. Designed, made to Eico's high standards of professionalism. Each complete with batteries & test leads. Backed 100% by famous EICO warranty.

- Model 100A4, 100,000 Ω /V, \$34.95.
- Model 30A4, 30,000 Ω /V, \$19.95.
- Model 30A3, 30,000 Ω /V, \$15.95.
- Model 20A3, 20,000 Ω /V, \$12.95.
- Model 4A3, 4000 Ω /V, \$8.95.
- Model 1A1, 1000 Ω /V, \$5.95.



Automotive

EICO 888—Car/Boat Engine Analyzer.

For all 6V/12V systems; 4, 6, 8-cyl. engines.

Now you can keep your car or boat engine in tip-top shape with this solid-state, portable, self-powered universal engine analyzer. Completely tests your total ignition/electrical system.

Complete with a Tune-up & Trouble-shooting Manual. Model 888; \$44.95 kit, \$69.95 wired.

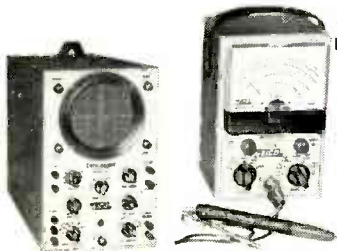

Model 232 Peak-to-Peak VTVM. A must for color and B&W TV and industrial use. 7 non-skip ranges on all 4 functions. With exclusive Uni-Probe. \$29.95 kit, \$49.95 wired.

Test Equipment

100 best buys to choose from.

"The Professionals" —laboratory precision at lowest cost.

Model 460 Wideband Direct-Coupled 5" Oscilloscope. DC-4.5mc for color and B&W TV service and lab use. Push-pull DC vertical amp., bal. or unbal. input. Automatic sync limiter and amp. \$109.95 kit, \$149.95 wired.

FREE 1968 CATALOG

EICO Electronic Instrument Co., Inc. 131-01 39th Ave., Flushing, N.Y. 11352

Send me FREE catalog describing the full EICO line of 200 best buys, and name of nearest dealer.

Name _____
Address _____
City _____
State _____ Zip _____

Cast your ballot for a successful future!

253 I.C.S. COURSES



I.C.S. is the oldest, largest correspondence school. Over 200 courses. Business, industrial, engineering, academic, high school. One for you. Direct, job-related. Bedrock facts and theory plus

practical application. Complete lesson and answer service. No skimping. Diploma to graduates. Send for the 3 free booklets offered here and find out how I.C.S. can be your road to success.

ACCOUNTING
Accounting for Business Programmers
Accounting (Canadian)
Auditing Business Law
Cost Accounting
C.P.A. Review
Estate & Trust Accounting
Executive Accounting
Federal Tax
General Accounting
Industrial Accounting
Junior Accounting
Legal Accounting
Office Accounting
Personal Income Tax Procedure
Practical Accounting
Public Accounting
Small Business Accounting
Starting & Managing a Small Bookkeeping Ser.

ARCHITECTURE AND BUILDING
Arch. Drawing & Designing Architecture
Building Contractor
Building Estimator
Building Inspector
Building Maintenance
Carpenter-BUILDER
Carpentry & Millwork
House Planning & Interior Design
Mason Painting Contr.
Reading Arch. Blueprints
Review in Arch. Design & Practice
Review of Mech. Systems in Buildings

ART
Amateur Artist
Commercial Art
Commercial Cartooning
Illustrating with Options:
— Magazine
— Advertising Layout
— Illustration
Interior Decorating
Oil Painting for Pleasure
Show Card & Sign Prod.
Show Card Writing
Sign Painting & Designing
Sketching & Painting

AUTOMOTIVE
Automatic Transmission Specialist
Automobile Body
Rebuilding & Refinishing
Automobile Electrical Tech.
Automobile Engine Tune-Up

Automobile Technician
Automotive Mechanic
Diesel-Gas Motor Vehicle Engines

BUSINESS
Advertising
Basic Inventory Control
Business Administration
Canadian Business Courses
Condensed Bus. Practice
Direct Mail & Mail Order Advertising
Industrial Psychology
Magazine & Newspaper Advertising
Managing a Small Store
Marketing
Marketing Management
Marketing Research
Modern Exec. Management
Office Automation
Office Management
Purchasing Management
Retail & Local Advertising
Retail Bus. Management
Retail Merchandising
Retail Selling
Systems and Procedures Analysis

CHEMICAL
Analytical Chemistry
Chemical Engineering
Chemical Engineering
Chemical Laboratory Tech.
Chemical Process Operator
Elements of Nuclear Energy
General Chemistry
Instrumental Laboratory Analysis

CIVIL ENGINEERING
Civil Engineering
Construction Eng'g Tech.
Technology
Highway Engineering Tech.
Principles of Surveying
Reading Highway Bl'pts
Reading Structural Blueprints
Sanitary Engineering Tech.
Sewage Plant Operator
Structural Eng'g Tech.
Surveying and Mapping
Water Works Operator

COMPUTERS
COBOL Programming
Fortran Programming for Engineers

Programming for Digital Computers
Programming the IBM 1401 Computer
Programming the IBM SYSTEM, 360 Computer

DRAFTING
Aircraft Drafting
Architectural Drafting
Design Drafting
Drafting Technology
Electrical Drafting
Electrical Eng'g Drafting
Electronic Drafting
Introductory Mech. Draft.
Mechanical Drafting
Pressure-Vessel and Tank Print Reading
Sheet Metal Layout for Air Conditioning
Structural Drafting
ELECTRICAL
Electric Motor Repairman
Electrical Appliance Ser.
Electrical Contractor
Electrical Engineering (Power option or Electric option)
Electrical Engineering Tech.
Electrical Instrument Tech.
Industrial Electrical Tech.
Power Line Design and Construction
Power Plant Operator (Hydro or Steam option)
Practical Electrical
Practical Lineman
Reading Elec. Blueprints

ENGINEERING (Professional Refresher Courses)
Chemical Civil Electrical
Engineer-in-Training
Industrial Mechanical
ENGLISH AND WRITING
Better Business Writing
Free Lance Writing for Fun & Profit
Introductory Technical Writing
Modern Letter Writing
Practical English
Short Story Writing

HIGH SCHOOL
High School Business
High School (Canadian)
High School College Prep. (Arts)
High School College Prep. (Engineering & Science)

High School General
High School Mathematics
High School Secretarial
High School Vocational
LANGUAGES
(Edited by Berlitz)
French German
Italian Spanish

LEADERSHIP
Basic Supervision
Industrial Foremanship
Industrial Supervision
Modern Woman as a Supervisor
Personally Development
Personnel-Labor Relations
Supervision

MATHEMATICS
Advanced Mathematics
Mathematics and Mechanics for Engineering
Mathematics and Physics for Technicians
Mathematics and Physics for Engineering
Modern Elementary Stat.

MECHANICAL
Aircraft & Power Plant Mechanics
Hydraulic & Pneu. Power
Industrial Engineering
Industrial Management for Engineers
Industrial Eng'g Tech.
Industrial Instrumentation
Machine Design
Mechanical Engineering
Quality Control
Safety Eng'g Tech'ggy
Tool Design Value Analysis
Vibration Analysis and Control

PETROLEUM
Natural Gas Production & Transmission
Oil Field Technology
Petroleum Production
Petroleum Prod. Eng'g
Petroleum Refinery Oper.
Pipeline Engineering Tech.

PLASTICS
Design of Plastic Products
Plastics Technician

PLUMBING, HEATING, AIR CONDITIONING
Air Conditioning
Air Conditioning Maint.
Domestic Heating with Oil & Gas
Domestic Refrig. Heat'g

Heating & Air Conditioning with Drawing
Industrial Air Conditioning
Industrial Heating
Pipe Fitting Plumbing
Plumbing & Heating Est.
Practical Plumbing
Refrigeration
Refrigeration & Air Cond.

PULP AND PAPER
Paper Machine Operator
Paper Making
Pulp & Paper Engineering
Pulp & Paper Making

SALESMANSHIP
Creative Salesmanship
Real Estate Salesmanship
Sales Management
Salesmanship

SECRETARIAL
Clerk-Typist Commercial
Engineering Secretary
Legal Secretary
Medical Secretary
Professional Secretary
Shorthand Stenographic
Typewriting

SHOP PRACTICE
Drill Operator
Foundry Practice
Industrial Metallurgy
Lathe Operator
Machine Shop Inspection
Machine Shop Practice
Machine Shop Practice & Toolmaking
Metallurgical Eng'g technology
Milling Machine Operator
Multicraft Maintenance Mechanic
Practical Millwrighting
Reading Shop Prints
Rigging
Tool Eng'g Tech'ggy
Tool Grinder Toolmaking
Turret Lathe Operator
Welding Engineering Tech.
Welding Processes

STEAM AND DIESEL POWER
Boiler Inspector
Industrial Building Eng'r
Power Plant Engineering
Stationary Diesel Engines
Stationary Ireman
Stationary Steam Eng'g

TEXTILES
Carding
Carding and Spinning

Dyeing & Finishing
Loom Fixing Spinning
Textile Designing
Textile Mill Supervisor
Textile Technology
Warping and Weaving

TRAFFIC
Motor Traffic Management
Railway Rate Clerk
Traffic Management

TV-RADIO-ELECTRONICS
Color Television Principles & Servicing
Communications Techn'gy
Electronic Fundamentals
Electronic Fundamentals (Programmed)
Electronic Fundamentals with Electronic Equipment Training
Electronic Instrumentation & Servo Fundamentals
Electronic Principles for Automation
Electronics and Applied Calculus
Electronics Technician
First Class Radiotelephone License
Fundamentals of Electronic Computers
General Electronics
General Electronics with Electronic Equip. Trng.
Hi-Fi Stereo and Sound Systems Servicing
Industrial Electronics
Industrial Electronics Eng.
Industrial Electronics Engineering Technician
Numerical Control
Electronics & Maint.
Practical Radio-TV Eng'g
Practical Telephony
Principles of Radio-Electronic Telemetry
Principles of Semiconductor-Transistor Circuits
Radio Servicing with Equipment Training
Radio & TV Servicing
Radio & TV Servicing with Equipment Training
Second Class Radiotelephone License
Sound Systems Specialist
Telephony Electronics and Radio Communications
TV Receiver Servicing
TV Technician

Clip coupon here... take your first step to real success! I.C.S., Scranton, Penna. 18515



Accredited member, National Home Study Council.
Convenient payment plan.
Special Canadian courses in French and English.
Approved for veterans under the new G. I. Bill.
Special rates to members of the U. S. Armed Forces.

INTERNATIONAL CORRESPONDENCE SCHOOLS Dept. N2331A, Scranton, Penna. 18515

(In Hawaii: P.O. Box 418, Honolulu. Canadian residents mail to Scranton, Penna. Further service handled through I.C.S. Canadian Ltd.)

Without cost or obligation, rush me your famous "Success Package"—(1) "How to Succeed" booklet, (2) sample lesson demonstrating I. C. S. method, (3) catalog for program of study I'm interested in:

Mr. _____ (Print name of course. See list.)
Miss _____ Age _____
Mrs. _____
Address _____
City _____ State _____ Zip Code _____
Occupation _____ Employed by _____ Working Hours _____ A.M. to _____ P.M.

ELECTRONICS HOBBYIST

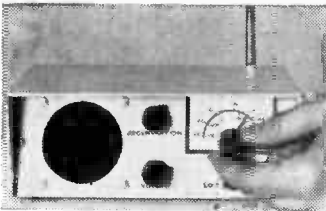

Stratospheric Super Sleuth
Page 39

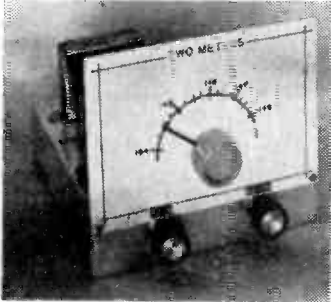

2-Meter Super Squared 3
Page 89

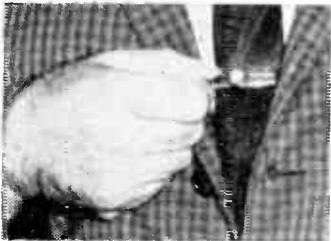

FM Hideaway Microphone
Page 55



Dynamic Curve Tracer
Page 36

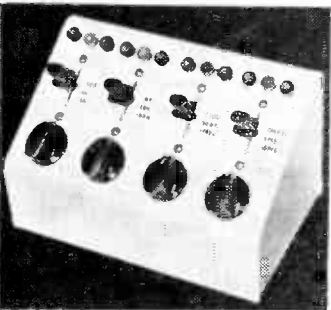

Con-Cover Pot Box
Page 74

FUN PROJECTS FOR HOME AND HOBBY

- 55 Spy in the Tie
- 76 Party Line Listening
- 81 Auto Siren Sentry
- 102 Dim View on a Dark Subject
- 105 Electronic Foot Stomper
- 107 Telephone Broadcaster

HAM-SWL-CB RADIO

- 23 Multiband VHF Receiver
- 39 Stratospheric Super Sleuth
- 51 BCB 2 for Beginners
- 54 CB's Coax-Cobra
- 62 Build 1-Tube Bottom Scraper
- 67 Dipperette-1 SW Semi-Convertor
- 70 Quick-n-Easy CB Dipole
- 85 CB Signal Center
- 89 Super Squared 3 For Hams
- 93 CB Squeaker

SCIENCE FAIR

- 19 Building Tesla's Famous Coil
- 43 Experimenter's Simplex Motor
- 104 Compass Galvanometer

TEST BENCH AND LAB

- 31 Square Maker Duo
- 36 Dynamic Diode Curve Tracer
- 74 Pot Box
- 78 Solid State Cube Tester
- 80 Add a Flip-Flop to Your Meter
- 97 Shotgun Signal Generator
- 100 Stop Test and Listen
- 110 Mighty Mickey-Mike
- 111 50-Cent Transistor Tester

AUDIO AND HI-FI

- 27 Stereo Broadcaster
- 48 Rubber-Mount Treble Speaker
- 49 Ceramic Pickup Equalizing Preamp
- 66 Make a Mini-Mike
- 71 Whiskey Barrel Speaker System

FOR THE QUICKIE READER

- | | |
|---------------------------------|-------------------------------|
| 6 A Message From the Editor | 50 A Safe Connection |
| 7 New Products | 50 Tubing Insulates Chokes |
| 13 Stand Stops Transistor Drop | 84 Solder Silences Noisy Tube |
| 13 Save-a-Lead Breadboard Block | 84 Color-Coding Wires |
| 14 Question Bee Bonanza | 88 Raz-Ma-Taz Relay |
| 48 Extending Component Leads | 112 Literature Library |

IT COSTS ONLY
 1/100 OF 1¢ MORE
 PER SOLDER JOINT
 TO KNOW YOU ARE USING THE
 WORLD'S FINEST
 CORED SOLDER



New Easy
 Dispenser
 Pak
 60/40
 18 S.W.G.

Latest PC
 (Printed
 Circuit) Pak
 60/40 Extra Thin
 22 S.W.G.—.028"

each only 69¢ per package at your dealer

ERSIN *Multicore* **FIVE-CORE SOLDER**

MULTICORE SALES CORPORATION, WESTBURY, N.Y. 11590

now there are **3** time & tool-saving double duty sets

New PS88 all-screwdriver set rounds out Xcelite's popular, compact convertible tool set line. Handy midgets do double duty when slipped into remarkable hollow "piggyback" torque amplifier handle which provides the grip, reach and power of standard drivers. Each set in a slim, trim, see-thru plastic case, also usable as bench stand.

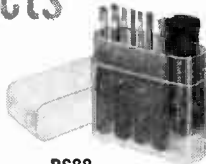

PS88
5 slot tip,
3 Phillips
screwdrivers

PS7

2 slot tip,
2 Phillips
screwdrivers,
2 nutdrivers



PS120
10 color
coded nutdrivers



XCELITE INC. • 128 BANK ST., ORCHARD PARK, N. Y.

Please send free literature N563.

name _____
address _____
city _____ state & zone _____

1968 EDITION ELECTRONICS HOBBYIST

Dedicated to America's Electronics Experimenters

Editor-in-Chief

JULIAN M. SIENKIEWICZ, WA2CQL/KMD4313

Managing Editor

RICHARD A. FLANAGAN, KQD2566

Technical Editor

W. KRAG BROTHBY, KQD2828

Art Editor

JIM MEDLER

Editorial Assistant

HELEN PARKER

Art Director

ANTHONY MACCARRONE

Associate Art Director

EUGENE F. LANDINO II

Cover Art Director

IRVING BERNSTEIN

Art Associate

BARBARA GABRIEL

Advertising Manager

JIM CAPPELLO

Production Director

LEONARD F. PINTO

Production Manager

CARL BARTEE

Assistant Production Manager

MICHELLE WOLFFS

Kit Division Manager

WILFRED M. BROWN

President and Publisher

B. G. DAVIS

Executive Vice-President

and Assistant Publisher

JOEL DAVIS

Vice-President and Editorial Director

HERB LEAVY, KMD4529

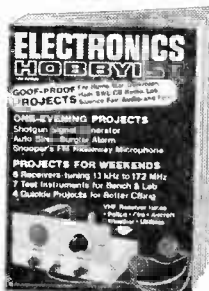

Cover illustration
by
Joe Rak



ELECTRONICS HOBBYIST, 1968 Edition, is published annually by SCIENCE & MECHANICS PUBLISHING CO., a subsidiary of Davis Publications, Inc. Editorial, business offices: 505 Park Ave., New York, N.Y. 10022. Advertising Offices: New York, 505 Park Ave., 212-PL-6200; Chicago, 520 N. Michigan Ave., 312-527-0330; Los Angeles, 1709 W. 8th St., 213-483-3582; Atlanta, Pirnie & Brown, 3108 Piedmont Rd. N.E., 404-233-6729; Long Island, Len Osten, 9 Garden St., Great Neck, N.Y., 516-487-3305; Southwestern advertising representative, Jim Wright, 4 N. 8th St., St. Louis, 314-CH-1-1965.

Copyright 1968 by Science & Mechanics Publishing Co.

LAFAYETTE Solid State CB 2-Way Radios

COMSTAT 9 5-WATT CITIZENS BAND
TRANSCEIVER KIT

23-Channel Tuneable Receiver!

Only **54⁹⁵**
No Money Down

42 - 0915WX



EASY-TO-FOLLOW INSTRUCTIONS

- ★ 9-Crystal-Controlled Transmit and Receive Channels
- ★ Built-in 115VAC; 12VDC with Optional Power Supply
- ★ High-Efficiency 7-Tube Circuit
- ★ Complete With Parts, Wire, Solder, Instructions and Mike

LAFAYETTE "EXPLOR-AIR"
4-BAND RECEIVER KIT

Covers Amateur • International • Maritime • Aeronautical
WWV Time Signals Plus Standard AM Broadcast Band

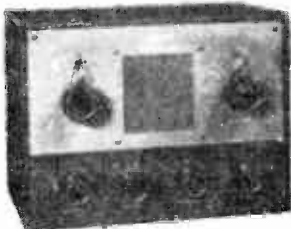

Less Cabinet

22⁹⁵

Made in U.S.A.

19 - 0905

- ★ Built-in Equalized Preamplifiers
- ★ Virtually Every Control Needed In A Stereo System
- ★ Easy-To-Build—All Parts, Wire, Solder and Instructions Included
- ★ Inputs for Magnetic or Ceramic Phono, AM/FM Tuner and Auxiliary

5 WATTS OF POWER
YOU CAN HOLD
IN YOUR HAND!

3 Channels

Only **79⁹⁵**
No Money Down
with leather
shoulder strap



Dyna-Com 5

99 - 3087L

- ★ 13 Transistors, 6 Diodes
- ★ 7-Stage Transmitter
- ★ Superheterodyne Receiver
- ★ Mechanical Filter
- ★ 3 Crystal Controlled Transmit and Receive Channels for all 23 CB Channels

LAFAYETTE MODEL KT-630
30-WATT STEREO AMPLIFIER KIT

Build Your Own Stereo Amplifier!



Made in U.S.A.

Only **44⁹⁵** Less Case
No Money Down

21 - 0930WX

- ★ Complete Band Switching from Front Panel
- ★ Bandsread Tuning
- ★ Built-in 4" Speaker
- ★ Prewound Coils For Greater Selectivity



Mail This
Card Today
For Your
FREE!

512 PAGES
1968 Lafayette Catalog 680

Shop At The "World's"
Hi-Fi & Electronics Center"
For The Widest Selection Of:

- Stereo Hi-Fi • CB 2-Way Radios • Walkie-Talkies • FM-AM & AM Radios • Shortwave Receivers • Portable TV • Amateur Equipment • Intercoms & PA • TV Antennas & Tubes • Power Tools, Hardware • Tubes, Transistors • Parts, Batteries, Books

Lafayette Radio Electronics

Dept. 24-8, P.O. Box 10 Syosset, L. I., N. Y. 11791

Send me the Free 1968 Catalog 680 24-8

Name

Address

City

State

Zip

A message from the Editor



Julian M. Sienkiewicz
KMD4313
EDITOR

THE ENTHUSIASTIC reception accorded the first issue of the *ELECTRONICS HOBBYIST* brings us back this year with a brand-new edition that promises to go one better than its illustrious predecessor. As before, we've packed the issue from cover to cover with enough construction projects to stagger the mind of even the eagerest of eager beavers. They range in complexity from a simple, two-diode wave shaper (*Square Maker Duo* on page 31) to a 3-tube, 2-meter receiver (*Super Squared 3 For Hams* on page 89); in size from a flea-proportioned FM wireless mike that is actually concealed in a tie clasp (*Spy in the Tie* on page 55) to a Tesla Coil that has poop enough to deliver sparks of the 50,000-volt variety (*Building Tesla's Famous Coil*, page 19). And as for the areas they cover, you'll find the projects run the gamut from shortwave to longwave, from experimenting to servicing, from doorbells to dipoles. In fact, if it's electronic, you name it, and you'll no doubt find it represented here.

Though complete construction details accompany every project, you as a builder are free to redesign and implement the basic configuration to suit your own tastes and requirements. And while you're necessarily on your own when you undertake to make such changes, a little improvisation can go a long way toward adding even more fun and satisfaction to almost any project.

But remember: you must follow our schematic diagrams, pictorials, parts lists, and instructions to the letter if you want to be assured that your project will work. As we've said, any changes you make may result in a unit more to your liking, but no one cares for a unit that plain doesn't work. The moral: know what you're doing or *don't do it*.

Have fun!

Yours for happy hobbying,

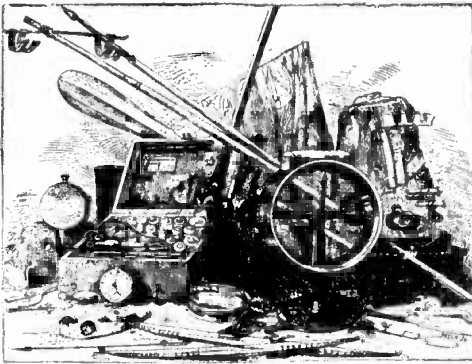

NEW PRODUCTS

Noise Killing Bubbles

Introduction of an entirely new line of noise suppression accessories in attractive bubble packs is announced by Estes Engineering Co. The new Electro-Shield line includes kits for Ignition Suppression, Alternator Filtering w/ Shielding, DC Power Line Filters as well as Universal Suppression packages. These units will permanently reduce engine noise, thereby providing improved long-range communications and increased reliability. Dealers in the mobile 2-way communications field will be interested in the new eye-catching merchandising board, holding up to 24 assorted bubble packs, plus literature racks illustrating the entire Electro-Shield line of products. The immediate benefits of Electro-

(Continued on page 10)



Man, here's one product display from Estes Engineering that caught the Editor's eye.

NEW ALLIED 1968 CATALOG & BUYING GUIDE

FREE

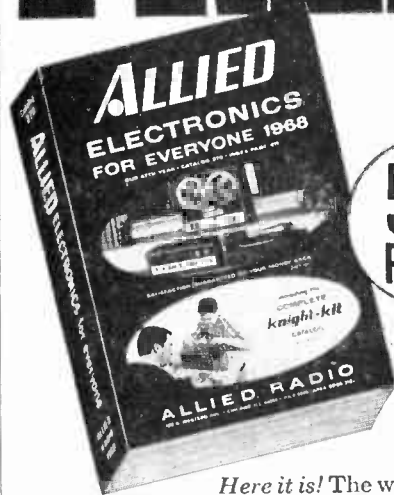

**518
PAGES**

Here it is! The world's most famous catalog of electronic equipment featuring hundreds of new and exclusive items and special Allied values.

518 pages—including the complete Knight-Kit Catalog — picturing, describing, and pricing thousands upon thousands of items. The most complete inventory ever assembled of Hi-Fi, Radios, Tape Recorders, CB, Electronic Equipment, Parts and Tools... *all at money-saving low prices.*

NO MONEY DOWN — UP TO 2 YEARS TO PAY!

BIG SAVINGS ON THE BEST IN ELECTRONICS FOR EVERYONE

- Stereo Hi-Fi • Famous Knight-Kits® • Tape Recorders & Tape
- CB 2-Way Radios • Walkie-Talkies • FM-AM & AM Radios
- Shortwave Receivers • Portable TV • Phonographs • Transistors
- Intercoms & PA • Automotive Electronics • Test Instruments
- TV Antennas & Tubes • Power Tools, Hardware
- Amateur Equipment • Tubes • Parts, Batteries, Books



WRITE FOR YOUR COPY TODAY!

ALLIED RADIO, Dept. 50A

P.O. Box 4398, Chicago, Ill. 60680

Send me your free catalog for 1968

NAME Please Print

ADDRESS

CITY

STATE

ZIP CODE

12 NEW KITS FROM HEATH...

For The Whole Family . . .

New Deluxe "227" Color TV

Exclusive Heathkit Self-Servicing Features. Like the famous Heathkit "295" and "180" color TV's, the new Heathkit "227" features a built-in dot generator plus full color photos and simple instructions so you can set-up, converge and maintain the best color pictures at all times. Add to this the detailed trouble-shooting charts in the manual, and you put an end to costly TV service calls for periodic picture convergence and minor repairs. No other brand of color TV has this money-saving self-servicing feature.

Advanced Features. Boasts new RCA Perna-Chrome picture tube for 38% brighter pictures . . . 227 sq. in. rectangular viewing area . . . 24,000 v. regulated picture power . . . improved phosphors for brilliant, livelier colors . . . new improved low voltage power supply with boosted B+ for best operation . . . automatic degaussing . . . exclusive Heath Magna-Shield to protect against stray magnetic fields and maintain color purity . . . ACC and AGC to reduce color fade and insure steady, flutter-free pictures under all conditions . . . preassembled & aligned IF with 3 stages instead of the usual 2 . . . preassembled & aligned 2-speed transistor UHF tuner . . . deluxe VHF turret tuner with "memory" fine tuning . . . 300 & 75 ohm VHF antenna inputs . . . two hi-fi sound outputs . . . 4" x 6" 8 ohm speaker . . . choice of installation — wall, custom or optional Heath factory assembled cabinets. Build in 25 hours.

Kit GR-227, (everything except cabinet) . . . \$42 dn., as low as \$25 mo. . . 114 lbs. . . **\$419.95**

GRA-227-1, Walnut cabinet . . . no money dn., \$6 mo. . . **\$59.95**

GRA-227-2, Mediterranean Oak cabinet (shown above) . . . no money dn., \$10 mo. . . **\$94.50**



Kit GR-227
\$419.95 (less cabinet)
\$25 mo.

New Remote Control For Heathkit Color TV

Now change channels and turn your Heathkit color TV off and on from the comfort of your armchair with this new remote control kit. Use with Heathkit GR-227, GR-295 and GR-180 color TV's. Includes 20' cable.



Kit GRA-27
\$19.95



Kit GR-295
\$479.95
(less cabinet)
\$42 mo.

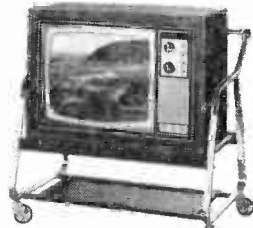

Kit GR-180
\$349.95
(less cabinet & cart)
\$30 mo.

Deluxe Heathkit "295" Color TV

Color TV's largest picture . . . 295 sq. in. viewing area. Same features and built-in servicing facilities as new GR-227. Universal main control panel for versatile in-wall installation. 6" x 9" speaker.

Kit GR-295, (everything except cabinet), 131 lbs. . . \$48 dn., \$42 mo. . . **\$479.95**

GRA-295-1, Walnut cabinet (shown above), 35 lbs. . . no money dn., \$7 mo. . . **\$62.95**

Other cabinets from \$94.50

Deluxe Heathkit "180" Color TV

Same high performance features and exclusive self-servicing facilities as new GR-227 (above) except for 180 sq. in. viewing area.

Kit GR-180, (everything except cabinet), 102 lbs. . . \$35 dn., \$30 mo. . . **\$349.95**

GRS-180-5, table model cabinet & mobile cart (shown above), 57 lbs. . . no money dn., \$5 mo. . . **\$39.95**

Other cabinets from \$24.95

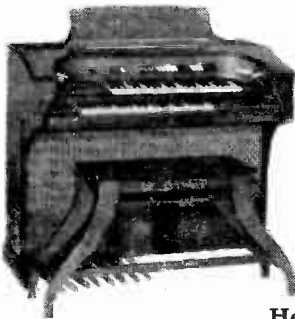

FREE 40-Lesson Record Course With Either Heathkit / Thomas Organ! A \$50 Value! Includes four 33 1/3 rpm records, music book & leatherette album.

Kit TO-67
\$995
(including bench)
\$200 dn.,
as low as \$29 mo.

Heathkit® / Thomas "Paramount" Theatre Organ

Save Up To \$500! Build in 80-100 hours. All Thomas factory-made parts . . . 15 manual, 4 pedal voices; instant-play Color-Glo; all-transistor circuit; 200 watts peak power; 2-speed rotating Leslie plus main speaker system with two 12" speakers; 44-note keyboards; horseshoe console with stop tablets; 28-note chimes; 13-note bass pedals; repeat & attack percussion; reverb; headset outlet; assembled walnut finish hardwood cabinet & bench; and more. 265 lbs. 7", 33 1/3 rpm demonstration record 50c.

America's Lowest Cost Solid-State Organ

Kit GD-325B
\$394.90
\$40 dn., \$34 mo.

Save Up To \$205! Instant-play Color-Glo; 10 voices; 13-note bass pedals; repeat percussion; 37-note keyboards; 75-watt peak power; vibrato; assembled walnut cabinet & bench. 172 lbs. 7", 33 1/3 rpm demonstration record 50c.

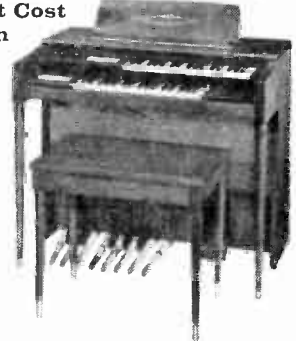

Exclusive Band Box Percussion

Automatically or manually adds 10 percussion voices to any Heathkit/Thomas organ. Build & install in 12 hours.

Kit TOA-67-1, no money dn., \$14 mo. . . **\$145.00**

Exclusive Playmate Rhythm Maker

Adds 15 fascinating rhythms to any Heathkit/Thomas Organ. Requires Band Box percussion (above) for operation.

Kit TOA-67-5, no money dn., \$18 mo. . . **\$189.90**

USE COUPON TO ORDER NOW!



TO-68
\$349.95
 \$35 dn., \$30 mo.

NEW! VOX "Jaguar" Transistor Combo Organ By Heathkit

Save Up To \$150 on the world's most popular combo organ with this new Heathkit version. Features the most distinctive sound of any combo organ. Has a special bass output that gives a brilliant stereo bass effect when played through a separate or multi-channel amplifier, 4 complete octaves, vibrato, percussive effects and reversible bass keys. Includes hand crafted orange and black cabinet, fully plated heavy-duty stand, expression pedal and waterproof carrying cover and case for stand. Requires a bass or combo amplifier like Heathkit TA-17 (opposite page).

Kit TO-68, 80 lbs. . . . \$35 dn., \$30 mo. **\$349.95**

NEW! Deluxe Solid-State Combo Amplifier & Speaker System . . . Choose Kit Or Factory Assembled.

Amplifier
 Kit TA-17
\$175
 \$17 mo.
 (Assembled
 TAW-17 \$275)

Speaker System
 Kit TA-17-1
\$120
 \$11 mo.
 (Assembled
 TAW-17-1 \$150)

Special
 Combination Offer
 Amplifier & Two
 Speaker Systems
 Save \$20
 Kit TAS-17-2
\$395
 \$40 dn.
 \$34 mo.
 (Assembled
 TAW-17-2 \$545)

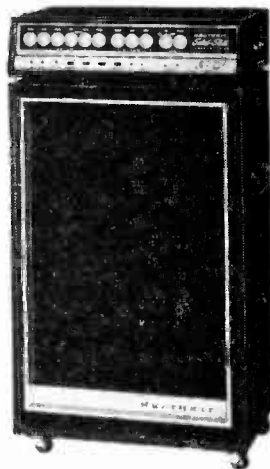

All the "big sound" features every combo wants . . . tremolo, built-in "fuzz", brightness, reverb, separate bass and treble boost and more. Delivers a shattering 120 watts EIA music power (240 watts peak power) through two TA-17-1 speakers . . . or 90 watts through one TA-17-1 speaker. Features 3 independent input channels, each with two inputs. Handles lead or bass guitars, combo organ, accordion, singer's mike, or even a record changer. All front panel controls keep you in full command of all the action.

Speaker system features two 12" woofers, special horn driver and matching black vinyl-covered wood cabinet with casters & handles for easy mobility.

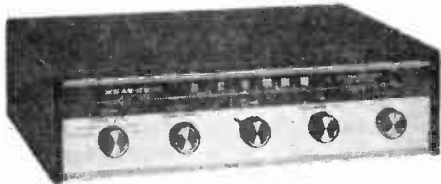

Kit AR-17
\$72.95
 (less cabinet)
 \$8 mo.

NEW! Lowest Cost Solid-State Stereo Receiver

Features wide 18-60,000 Hz response @ ±1 db at full 5 watts RMS power per channel . . . 14 watts music power . . . inputs for phono and auxiliary . . . automatic stereo indicator . . . outputs for 4 thru 16 ohm speakers . . . adjustable phase for best stereo . . . flywheel tuning . . . and compact 9 3/4" D. x 2 3/4" H. x 11 3/4" W. size. 12 lbs. Optional factory assembled cabinets (walnut \$7.95, beige metal \$3.50).

Kit AR-17, (less cab.) 12 lbs. . . . no money dn., \$8 mo. . . **\$72.95**
 Kit AR-27, 7-Watt FM Mono Only Receiver (less cab.)
 9 lbs. . . . no money dn., \$5 mo. **\$49.95**

Kit IM-17
\$19.95

NEW! Solid-State Portable Volt-Ohm-Meter

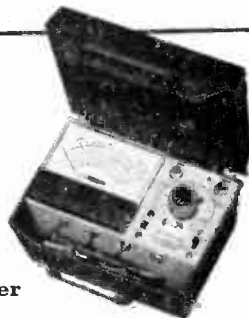

So Handy, So Low Cost we call it "every man's" meter. Just right for homeowners, hobbyists, boatowners, CBers, hams . . . it's even sophisticated enough for radio & TV servicing! Features 12 ranges . . . 4 AC & 4 DC volt ranges, 4 ohm ranges; 11 megohm input on DC, 1 megohm input of AC; 4 1/2" 200 uA meter; battery power; rugged polypropylene case and more. Easy 3 or 4 hour kit assembly. Ideal gift for any man! 4 lbs.



NEW FREE 1968 CATALOG!

Now with more kits, more color. Fully describes these along with over 300 kits for stereo/hi-fi, color TV, electronic organs, electric guitar & amplifier, amateur radio, marine, educational, CB home & hobby. (Mail coupon or write Heath Company, Benton Harbor, Michigan 49022.)

HEATH COMPANY, Dept. 26-1
 Benton Harbor, Michigan 49022
 In Canada, Daystrom Ltd.

Enclosed is \$ _____, including shipping.

Please send model (s)

Please send FREE Heathkit Catalog.

Please send Credit Application.

Name _____

Address _____

City _____

State _____

Zip _____

Prices & specifications subject to change without notice

CL-312

Olson



*** FREE ***

Fill in coupon for a **FREE** One Year Subscription to **OLSON ELECTRONICS' Fantastic Value Packed Catalog—Unheard of LOW, LOW PRICES on Brand Name Speakers, Changers, Tubes, Tools, Stereo Amps, Tuners, CB, and other Values. Credit plan available.**

NAME _____
 ADDRESS _____
 CITY _____ STATE _____
 GIVE ZIP CODE _____

If you have a friend interested in electronics send his name and address for a **FREE** subscription also.

OLSON ELECTRONICS
INCORPORATED

792 S. Forge Street Akron, Ohio 44308

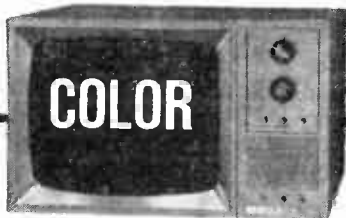

**NEW CONAR All-Channel
 COLOR TV KIT \$366.00**

Model 600UK

- Easier to build because it's designed for learning
 - Complete with cabinet—nothing else to buy!
- Tops for quality, simplicity of design, ease of building, the new CONAR 600 gives you the latest advances in the art of color TV receiver construction. In addition to 21 tubes, this all-channel receiver incorporates a transistor UHF tuner, transistor noise cancellation circuit and 16 solid-state diodes. Separate gun killer switches and a cross hatch generator are built in. All hardware is engineered for accessibility. Attractive bronze-tone steel cabinet with durable wood-grained vinyl covering.

For information write Dept. AR8C

CONAR instruments

DIVISION OF NATIONAL RADIO INSTITUTE
 3939 Wisconsin Ave., Washington, D.C. 20016

WRITE FOR FREE CONAR CATALOG

NEW PRODUCTS☆☆☆☆☆☆☆☆☆☆☆☆☆☆☆☆

Continued from page 7

Shield products makes them highly recommended for Police and Fire vehicles. Ham operators, CB operators, truck fleets and other users of 2-way radio communications. For further information and prices, write Estes Engineering Co., 543 W. 184th St., Gardena, Calif. 90247.

Hot Hertz Grabbers

Jerrold has come out with two recently developed lines of 300-ohm outdoor antennas. The 82-channel VUfinder and the VHF-TV/FM ColorPeak series are high-gain periodic types with unusually flat response across the full frequency range. They provide strong, clear signals even in difficult reception areas. The five Jerrold VUfinder models, for local to deep fringe applications, can be converted for coaxial lead-in by using an 82-channel matching transformer

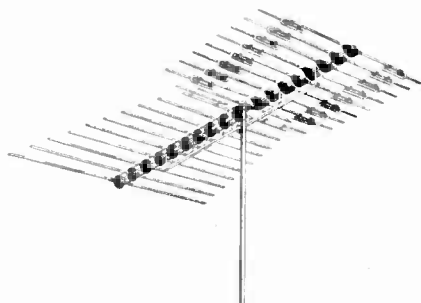

Jerrold's 82-channel ColorPeak TV Antenna

model MUV-374. VUfinders are shipped with Jerrold model FS-1314 frequency separators to split VHF from UHF for separate inputs into TV sets. VUfinder prices range from \$17.95 to \$79.95. The seven ColorPeak models, for local to deepest fringe use, can also be converted for coaxial-lead-in through use of a VHF matching transformer, model TO-374A. List prices range from \$15.95 to \$79.95. Both highly efficient types have excellent front-to-back ratios. They are finished with Jerrold's corrosion-resistant Golden Armor Coating. "Cycloc" insulators provide superior strength at assembly points. Further information about VUfinder and ColorPeak antennas can be obtained from Jerrold Electronics Corp., 401 Walnut St., Philadelphia, Pa. 19105.

Breadboarder's Resistor Pack

Only 1/50th the size of ordinary resistor substitution boxes, the Resistor Pack provides a selection of 20 resistor values in the mini-shape shown in the photo below. Any of the 20 resistance values can be used in combination where the circuitry requires more than one resistor at a node, as in voltage divider or parallel

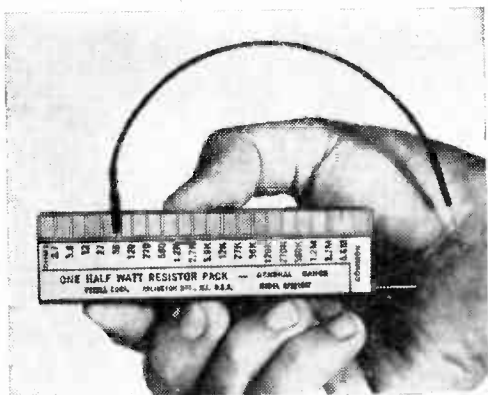

Vytell Corp. Resistor Pack

networks. The Resistor Pack includes twenty 1/2-watt, 10% resistors, each with one lead connected to a common bus. The other lead is available for use with the push-on connector assembly furnished with the Pack, or with standard miniature clip leads. Construction allows visual inspection of resistor condition without disassembly through the clear thermoplastic housing. The Resistor Pack comes in three resistance ranges for general, low and high resistance applications. Other ranges on special order. For more info write for Bulletin 501.1, Vytell Corp., Box 92, Arlington Heights, Ill. Price of Pack is \$3.49.

It's a Grabber!

This "third hand" seizer/plier will give every assembler a surgeon's skill and precision in coping with tiny, miniaturized parts. The ALLIS-SEIZER is made of surgical stainless steel and features a medical locking device for clamping, permitting use of the instrument as a heat sink as well as holding microminiatures and fine wires securely for soldering. Several types are available: straight or curved nose with or with-

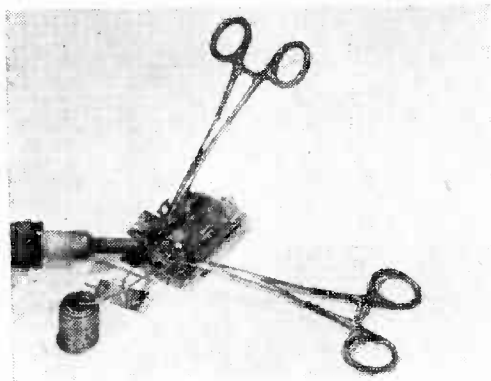

Allis Industries AllisSEIZER

will '69 be the year of the **SKID-PROOF** car?

Neither rain, nor snow, nor sleet, nor what-have-you may bother the valiant postman, but it sure has had all kinds of unfortunate effects on the man behind the wheel, plus his passengers, not to mention his vehicle! Soon, the threat of skidding on slippery pavement may be no more than an unhappy memory, and it's all due to another one of those little black boxes! The February issue of S&M reports on the brand new computerized braking systems that respond automatically to even the most adverse road conditions—removing one of the greater hazards of driving today. And these remarkable devices may well be available on the 1969 model cars!



Don't miss the February issue of S&M, on your local newsstand NOW!

SCIENCE & MECHANICS

EH 68

505 Park Ave., N. Y., N. Y. 10022

12 issues \$4; 24 issues \$8; 36 issues \$12. (Foreign: Add \$1 a year.)

Please enter my _____ year(s) subscription.

I enclose \$ _____ Bill me.

Name _____
(Please Print)

Address _____

City _____ State & Zip _____

Handy Stand Stops Transistor Drop

□ Modern transistor radios are rugged, but it doesn't really help their performance to be dropped repeatedly. Here's a nifty, quick way to prevent just such occurrences from happening too often. The simple stand shown is just a metal U clamp tacked onto a wooden disc.

The disc is jigsawed from 1/2-in. stock or anything else you happen to have on hand. Give the disc a quick sanding and then either varnish it, or give it a shot of paint.

The U clamp is bent from a piece of 2 x 3 1/2 in. sheet tin or aluminum.

The metal is easily bent in a vise or by using blocks and clamps. Be sure to make the bottom of the U the right width to accommodate your radio. Bend the two top edges of the U clamp out a little and then sand or file the edges and corners smooth. Attach the U clamp to the disc with a couple of flat-headed tacks and you're all set. Slip the radio in the stand when at home—slip it out when you're on the go. ■

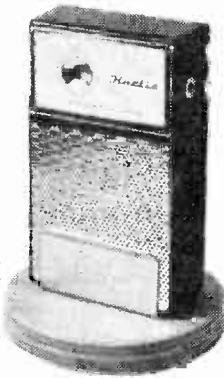

Save-a-Lead Breadboard Block

□ Experimenting with transistor modules, such as the Cordover series, is likely to cause great big headaches. Why?—well, if you've been doing it you undoubtedly found that the little leads

of stiff wire coming out of the black epoxy blob have a tendency to break off, consequently ruining an otherwise good unit. Worse, the lead always seems to break right at the blob where you can't get hold of it. If you've got one of these solid-state goodies around, take ten minutes and mount it as shown—

the module you save might be your own.

The module mount is made from a 5-in. square piece of wood, about 1-in. thick. Using the module as a template, draw its outline on the wood block. Jigsaw the mounting hole and press the module into the block, securing it with a little cement. Mount a Fahnestock clip for each lead on the wood block. Stick the leads under the clip's mounting screw. Label each clip and you're ready to experiment all you like. ■

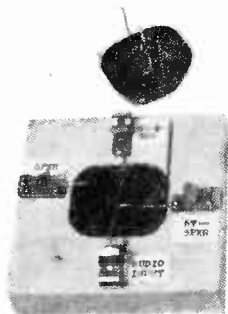

FREE Catalog

OF THE WORLD'S FINEST
ELECTRONIC GOV'T
SURPLUS BARGAINS



HUNDREDS OF TOP QUALITY ITEMS— Receivers, Transmitters, Microphones, Inverters, Power Supplies, Meters, Phones, Antennas, Indicators, Filters, Transformers, Amplifiers, Headsets, Converters, Control Boxes, Dynamotors, Test Equipment, Motors, Blowers, Cable, Keys, Chokes, Handsets, Switches, etc., etc. Send for Free Catalog—Dept. EH.

FAIR RADIO SALES

P. O. Box 1105 • Lima, Ohio 45802

How to Write a Classified Ad That Pulls

Deluxe 48 page booklet—only \$1 per copy. And, with the booklet, you get a \$2 credit towards your payment of your classified ad in RADIO-TV EXPERIMENTER. Send \$1 now to 505 Park Avenue, New York, N.Y. 10022.

TAKE A BREAK...AND PICK UP THE 1968 CB YEARBOOK NOW!

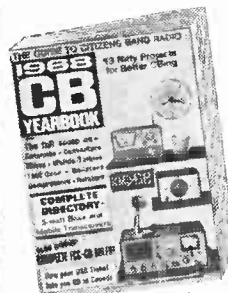

Just \$1 at your local newsstand or ask us to send you a copy!

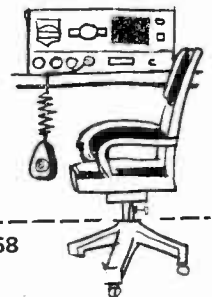

136 pages of great CB chit-chat

CB YEARBOOK EH68
505 Park Avenue
New York, N. Y. 10022

Yeah! Send me a copy of the 1968 CB Yearbook and make it snappy. Enclosed find \$1.25 to keep the mail-room boy in fish-n-chips.

Name

Address

City State Zip

QUESTION BEE BONANZA

The Editors of RADIO-TV EXPERIMENTER and ELEMENTARY ELECTRONICS bring to the readers of ELECTRONICS HOBBYIST the knowhow of electronics experts. Whenever space permits, questions sent to the Editors are answered in RADIO-TV EXPERIMENTER and ELEMENTARY ELECTRONICS. To get your question answered in an early issue, send it to The Editors, in care of one of the above magazines you read regularly. The address: 505 Park Avenue, New York, New York, 10022.

Radio Heaven Maybe

I'm an SWL and tune in mostly on 25 meters. There, I occasionally hear a sound that might be produced by trumpets and a French horn. It is of about three bars duration and repeats itself indefinitely. What is it?

—M. G. Z., McKeesport, Pa.

We don't know, but why don't you write lyrics for it—it just might make the top-ten. Can our readers help us out?

FM Is Not AM

Please tell me how to modify my FM receiver front end to extend its range from 108 MHz to about 122 MHz.

—L. J. H., Chattanooga, Tenn.

While it could be done, you wouldn't benefit since there are no FM stations up there, only AM aviation stations—which your set would not demodulate.

Wasted Watts

I have an old TV set that was given to me which I use only as a phono amplifier. I would like to make it more compact by eliminating the picture tube. However, I learned that it is in series with the rest of the set and the amplifier section won't function without it. Can I replace the tube with something smaller and still use the set as a phono amplifier.

R. T., Harrisburg, Pa.

You're burning up a lot of kilowatt-hours of power running a whole TV set and making use of only two or three of its tubes as a phono amplifier. If the set draws 160 watts and you get one watt of audio out, you've got a mighty inefficient lash up. Since you can buy a comparable amplifier in kit form for as little as \$10.95, why don't you have the trashman take away that old TV set?

BCB Traps

On my shortwave receiver I pick up AM BCB stations between 1.7 and 2.2 MHz (mc). What causes this and is there any remedy?

—C. W., Albany, New York

Yours is a common trouble encountered with receivers with too much gain or inadequate front-end selectivity which causes intermodulation. Try a shorter antenna. If this doesn't solve the problem, connect a wave trap across the antenna and ground terminals or add an RF gain control as shown in the diagram, or do both. Tune C1 to eliminate a specific BCB signal. Adjust R1 to provide just enough gain to receive the signal you want.

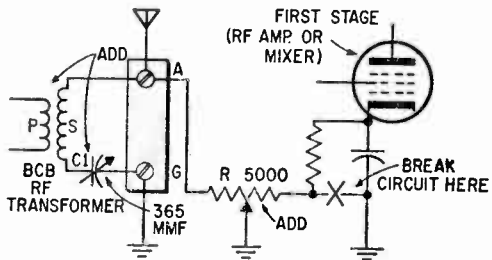

Q-Multiplier Coil

While building a Q multiplier I came across a part in the schematic, a variable coil labeled "tune to IF of radio." My IF is 455 kHz but I have been unable to locate such a part. I have been advised to use half of an IF transformer. Is this right?

—P. G., Ann Arbor, Mich.

You can use an IF transformer by disconnecting the capacitor from across the coil you do not intend to use. You might be able to buy a ready-made coil from Hammarlund Manufacturing Company, Mars Hill, N. C. Ask for the price and availability of a quadrature coil for an FM-50A.

AC-Line Filtering

I need circuits for power line filters to cut out noise caused by neighbors' vacuum cleaners, etc. I get the noise on AC radios but not on transistor portables at the same locations.

—C. L. D., Homestead, Florida

A noise filter circuit is shown in the diagram. The chokes can consist of bell wire wound for two or three inches on a half-inch diameter form. I have the same problem in my steel-

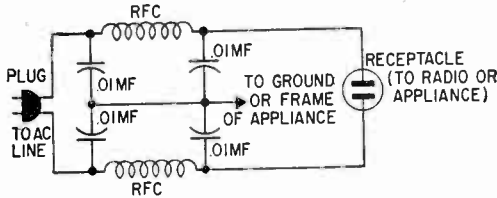

framed New York City apartment where radio signal pickup is poor and noise level is high. My transistor radios don't pick up the noise. You might try a Viking (830 Monroe Street, Hoboken, N. J.) Model 958 line filter (\$12) designed for CATV system use, connected between a radio and an AC outlet. It is supposed to provide 60 dB of attenuation. Radio noise is best suppressed at the source.

Shortwave Converter

I have a Zenith AM radio. Can you give me a circuit for a shortwave converter to use with it?

—R. A. R., Hayward, Calif.

You can use a separate pentode (V1) and a triode (V2) or a combination pentode-triode tube such as the 6GH8 connected as shown in the diagram. Coils L1 and L2 are wound on the same plug-in coil form. Coil L3 is also a plug-in coil. You'll have to wind your own or select

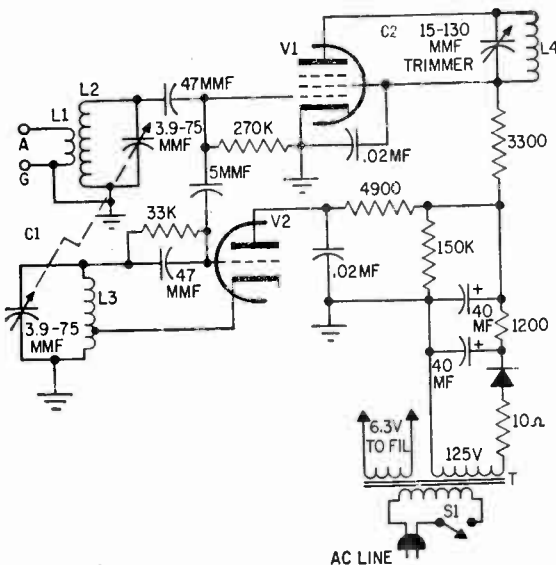

Can't find the key to electronics?

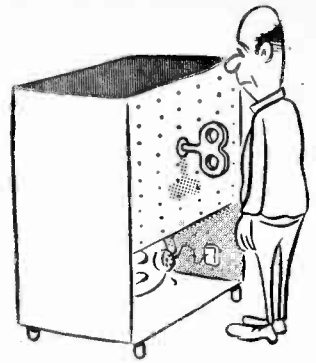

— then get your electronics cool with this introductory offer to the 2 leading electronics magazines! Use coupon:

DAVIS PUBLICATIONS, INC. EH68
505 Park Avenue/New York, N.Y. 10022

Yes! I want to find the key to electronics.

Begin my subscription to both **RADIO-TV EXPERIMENTER** and **ELEMENTARY ELECTRONICS** at your special low-subscription rate of **\$7.00**

Bill me later. Check enclosed.

Name

Address

City State..... Zip.....
(Outside U.S.A. & Canada add \$1.50 pstge. & hndlg.)

— Now, both of these fine magazines will be delivered to you at the special subscription rate of just **\$7.00** . . . save \$2 from newsstand price.



ELEMENTARY ELECTRONICS

The magazine that serves up electronics theory in pleasant spoonfuls and reinforces the knowledge you gain with exciting and useful projects.

RADIO-TV EXPERIMENTER

The magazine dedicated to the hobbyist—the man who wants to obtain a fuller and broader knowledge of electronics through the applications of his hobby.



QUESTION BEE BONANZA

non-plug-in coils for the shortwave bands you want to cover from a J. W. Miller catalog. Radio parts stores in Oakland and San Francisco should have the catalog and many of the coils.

Coil L4 is a BCB loop antenna which should be placed close to your AM radio, assuming it too uses a loop. Set the radio to a clear spot on the dial around 1500 kHz. Tune in shortwave stations with C2 and adjust C1 for best reception.

Marines Have Landed

What kind of an antenna should I use to pick up long wave, CB and marine band stations? I can't pick up 2-3 MHz band marine signals with present antennas.

—A. A., Rochester, Minn.

You're about 150 miles from the Great Lakes but not too far from the Mississippi. You should be able to receive marine signals at night, but not necessarily in the daytime when range is limited to about 50 miles over water, and there is land to cross. For all but CB, use a long wire antenna and a ground. For CB, use a 9-foot vertical wire or regular CB antenna.

Not So Hot

My stereo receiver uses four EL95 tubes. After 15 minutes of operation the plate of one of the tubes glows orange and gets very hot. Any tube in the same socket does the same. The set sounds O.K. Is this normal?

—T. W., Calumet City, Illinois

There probably is distortion in one of the stereo channels and you're not noticing it if there is a defect in your receiver. It could be a leaky coupling capacitor which allows positive DC to reach the grid of one of the tubes (see diagram), causing it to draw excessive plate current. It is possible that the screen of the affected tube is glowing instead of the plate. This would happen if one side of the output transformer is open, as shown in the diagram.

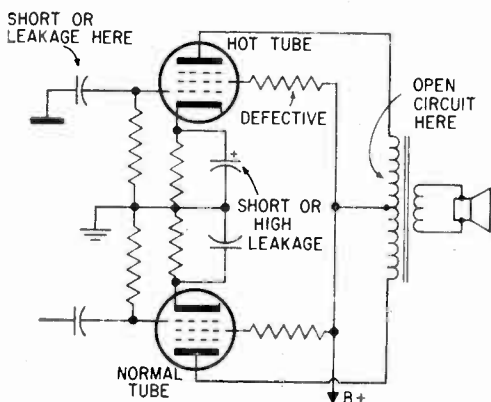

So You're the One!

I own a Sibley AF-950 receiver. It covers the AM, FM and SW (4-12 MHz) band. When I tune in the FM band on certain frequencies (104-105 MHz) my favorite television and the family's TV picture and sound just go off on Channel 9. Is there anything wrong with the radio receiver?

—A. S., Chicago, Ill.

Sounds like the trouble is caused by radiation from your receiver's local oscillator. Move it further away from the TV sets. Also, think of using a coax TV antenna lead-in. Frankly, there may be something wrong with your TV antenna and lead-in wire. Check it today!

6-Volt Recharger

Can I recharge a 6-volt ignition battery using a charger as shown in the schematic?

—D. T., Mayo, Fla.

Yes. To get the full scoop, write for a copy of *Using the Secondary Capacity of Primary Cells* from Dynamic Instrument Corp., 115 E. Bethpage Road, Plainview, New York.

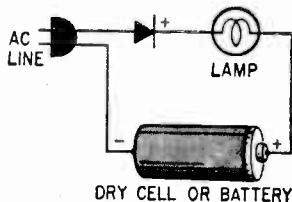

Meter Protection

I would like to install a Lafayette Meter Guard or an International Rectifier MP-100 meter protection rectifier to my VOM. Are they really effective? How should I install one?

—G. D., Montreal, Que.

Yes, they protect the meter from excessive voltage drop across the meter movement and from reversed polarity voltage. The meter protectors usually are furnished with installation instructions. Protectors are not all the same and installation procedures may differ.

BCB Skywire

I would like to know how to improve the BCB reception of a Knight-kit Star Roamer receiver. I am in a dorm and a long wire is impossible.

—W. H. P., Troy, N. Y.

Try using the power line as an antenna as shown in the diagram. Reverse AC plug to see which side gives best reception. Don't overlook the signal pickup abilities of bed springs, and combination storm-screen windows (or

other metal frame windows) or the rain down-spout and gutter. For safety, use the capacitor when making the connections—someone else might get the same idea.

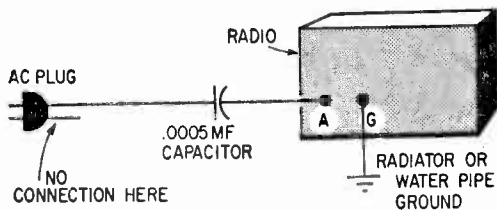

Have Whip?—Better Travel

I have a four-band Radionette which was made in Norway. Using a 10-foot whip antenna outside of the window of my third floor apartment, I can get Holland, Japan, Australia and the Voice of America and that's about it. My building is 12 stories high and made of steel and concrete. How can I upgrade my receiver?

—E. A. B., San Francisco, California

Your antenna is in a shielded, electrically noisy area. You're doing well, considering the circumstances. For better shortwave reception, get a professional communications receiver and install a doublet antenna on the roof of the building, feeding it through coaxial cable. In an apartment building in a big city, you can't expect outstanding reception.

What is It?

What transistor can I substitute for a T1X-882?

—F. T., Ronan, Mont.

We couldn't find it listed in Datedex or in industrial catalogs. You can probably get the exact type or substitute from Allied Electronics, the industrial division of Allied Radio, at 100 North Western Avenue in Chicago by mail order. Often special-batch or experimental transistors are given company numbers—the manufacturer will often provide exact data or indicate a suitable replacement.

It'll Cost Ya!

My CB radio has crystal holders for only six channels. Can you give me a circuit for modifying it so I can transmit and receive on all 23 channels by turning a dial instead of having to change crystals?

—R. R., Medford, Mass.

You can use the channel selector switch used in the Knight-kit Safari III connected as shown in the diagram. Order spare part No. 437-157 from Allied Radio Corp., 100 N. Western Ave., Chicago, Ill. 60680. You will have to add crystals and crystal sockets.

Before you put the rig on the air, have all

THE SUPERSENSITIVE DARKROOM METER

S & M MODEL A-3

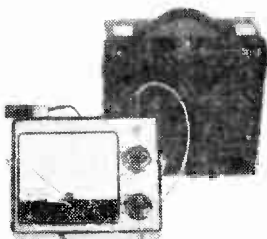

\$44.50
in kit form*

\$49.50
fully
assembled*

*Carrying Case
included

Here is a precision instrument that meets the highest standards of any meter available today. The S & M A-3 uses the newest cadmium sulfide light cell to measure light levels from twilight to bright sunlight at ASA speeds of 3 to 25,000. This supersensitive darkroom meter is successfully used with movie or still cameras, microscopes, telescopes and it can also be set up for use as a densitometer.

The computer gives F stops from .7 to 90 and lists exposure time from 1/15,000 sec. to 8 hours; 4 range selection; EV-EVS-LV settings. The unit is also equipped with a large (4½") illuminated meter, paper speed control knob and a new battery test switch.

The S & M A-3 darkroom meter is ideal for darkroom and studio applications where accuracy is a necessity. It's available fully-assembled from the factory, or in easy to assemble kit form.

SCIENCE & MECHANICS — Kit Division
505 Park Ave./New York, New York 10022

EH-68

Please send the A-3 Supersensitive Darkroom Meter as checked below. I understand that if I am not satisfied, I may return the meter within 10 days for a complete refund. Add 10% for Canadian and foreign orders. N.Y.C. residents add 5% for sales tax.

- \$44.50 — in kit form \$49.50 — fully assembled
 Check or money order enclosed, ship post paid. Enclosed \$3.00 deposit, ship balance COD, plus postage and COD charges.
 A-3 Extra Carrying Case — \$4.95

NAME _____ (Please print)

ADDRESS _____

CITY _____ STATE _____ ZIP CODE _____

QUESTION BEE BONANZA

the channel frequencies measured by a licensed operator at a two-way mobile radio shop. Otherwise, you might operate off frequency and be inviting a citation from the FCC.

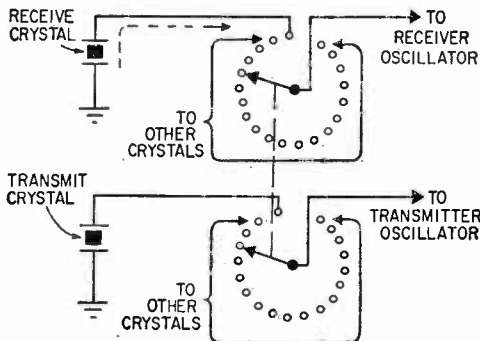

BCB DX Booster

I get a kick out of monitoring distant AM BCB stations on my table radio. How can I boost receiving range? What kind of antenna can I use?

—D. L. H., Memphis, Tennessee

Your radio probably has a built-in loop antenna if it was manufactured after 1940. To avoid having to open up the set, you can fasten an external flat loop antenna (salvaged from a discarded radio) to the back of the set, connected to an external antenna and ground as shown in the diagram. The signals picked up by the antenna will be inductively coupled from the external loop to the internal loop. Adjust the distance between the loops for best reception.

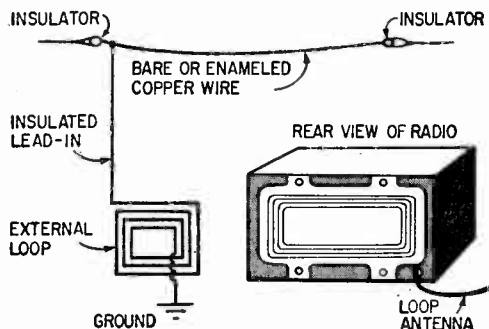

Shame, Shame

I would like to know where I can buy or order Amperite delay relays and at what prices.

—L. E. M., Chicago, Ill.

At Allied Radio, 100 N. Western Ave., on your town's west side or directly from Amperite Co., 600 Palisade Ave., Union City, N. J. 07087.

BCI from Thermostat

The aquarium heater in our house causes annoying noise in my radio receiver as the thermostat cuts in and out. I have tried many different commercial static eliminators, but none have worked. What should I do?

—M. E. B., Jacksonville, Ill.

Capacitors should be connected directly to the thermostat but there is no room and there is danger of lousing up the heater and cooking the fish. Get a new heater with built-in radio interference filters.

Not Impossible—Not Easy

Is there any way I can convert my Lafayette HE-15 to operate in the 6-meter ham band?

—P. D., Woodhull, New York

You can take turns off the receiver antenna, mixer and oscillator coils and the transmitter RF amplifier output coils, or select new coils from the J. W. Miller Co. catalog (5917 South Main Street, Los Angeles, California 90035). Operate the RF amplifier as a doubler, using crystals operating at half the output frequency. Use a dip meter to determine when the coil turns are correct. This would make a good construction project article. How about a reader writing one?

Solid-State UHF Converter

Is there such a thing as a transistorized UHF converter for TV?

—J. J. McC., Cambridge, Mass.

The Blonder Tongue BT-44 is solid state and sells for less than \$15.00. Your Boston parts distributors should have them available.

What's SHF?

When wading through old magazines I ran across the term SHF. Is it or isn't it real and, if it is, what are its frequency and applications?

—R. D. L., Parchment, Michigan

SHF means Super-High Frequency. It is the portion of the radio spectrum above UHF and extends from 3000 to 30,000 MHz (mc). Most microwave systems and radars operate in the SHF bands.

That's Not Right

I have a Knight Star Roamer on which I get radio and TV instead of shortwave. What can I do about it?

—J. S., Denver, Colorado

You must be very close to BCB and TV stations. Try a shorter antenna. Nevertheless, you should be able to detect shortwave stations between the spurious responses from nearby stations.



By Kenneth A. Wright and Wallace Kern



Building Tesla's Famous Coil

Science teachers, amateur scientists, magicians, and many electronics hobbyists will find *ELEMENTARY ELECTRONICS'* *Tesla Coil* an interesting project both to build and to perform experiments with. Readily demonstrating the principles of radio and electricity, the "giant coil" may also lead to an interest in Dr. Tesla, whose work is little known by most beginning science students. Few, in fact, have heard of Nikola Tesla, or of the work he has done. But many experts believe Tesla was as great as Edison—or even greater—in his contributions to science.

Tesla's Contributions. During Dr. Tesla's time, in the late 19th century, only direct current (DC) was used commercially, (turn page)

BUILDING TESLA'S COIL

though there was some knowledge of alternating current (AC). Tesla was the first person who investigated the practical uses of alternating currents to any great extent.

A few years after he came to the United States (1884), Tesla worked out several possible systems of alternating-current machinery, dynamos, motors, transformers, and distribution systems for which he was granted 45 patents between 1887 and 1893. In 1891, George Westinghouse purchased some of Tesla's systems and used them at the 1892 Chicago World's Fair to supply all the electrical power needed.

Dr. Tesla proposed a 7500-kilowatt transmitting plant producing RF currents at 100-million volts. One of the chief uses for this transmitted energy would be to illuminate "isolated" homes. The energy would be collected by a terminal a little above the roof of each house.

He actually built a generator similar to the one he proposed and lit 300 electric bulbs 25 miles from his laboratory. He started to build a transmitting station—probably the world's largest Tesla Coil—on a site near New York City before World War I, but ran out of funds.

A Tesla Coil. This high-voltage RF generator is more commonly known as a Tesla Coil, although the actual construction hardly resembles the original apparatus of Dr. Tesla. The Tesla Coil is a dynamic demonstrator of electrical principles, and a crowd pleaser as a science fair project. It can be built for much less than the estimated cost—

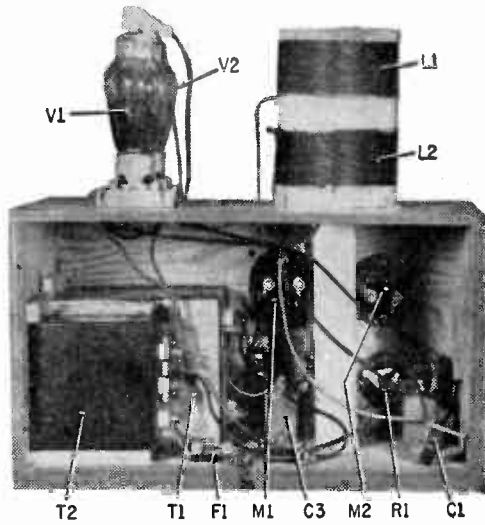

Rear view of Tesla Coil shows location of major components. Layout isn't critical. Leads to coil, vacuum tubes and bypass capacitors should be kept as short as possible.

if you can shop around the "bargain counters" in parts stores. All the materials used in building the unit pictured here were from war-surplus components. (The parts list gives stock, over-the-counter parts. Admittedly, new parts are expensive, so some wise shopping may be in order.) The Tesla Coil is very easily built and it gives good results. Sparks several inches long may be obtained from the coil at voltages on the order of 50,000 volts.

Circuitry. The apparatus consists basically of a plate-tuned oscillator, as can be seen in the schematic diagram. Practically any transmitter-type triode vacuum tube will serve in the oscillator.

One of the things considered in selecting a tube was that it have a plate voltage rating of about 1500 volts. The higher the voltage, the more spectacular the experiments that may be performed with the apparatus. The second factor considered was that it have a fairly-high power output (of about 150 watts or more). Two 811A transmitting triodes met the specifications. Both of them are used, in

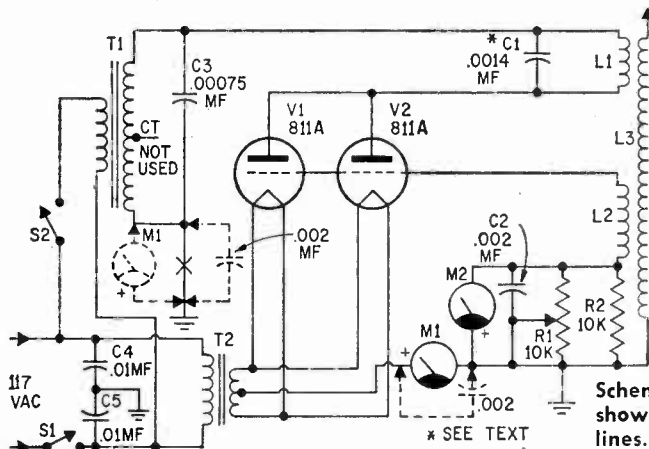

Schematic diagram of the Tesla Coil shows alternate connections in dotted lines. Circuit is quite flexible.

PARTS LISTS FOR TESLA COIL

- C1—.0014-mf., 3000-volt DC, ceramic-disc or mica capacitor.
(two or more capacitors in parallel—see text)
.0004-mf., (400-mmf.) Centralab DD30-401 or equiv.
.001-mf., (1,000-mmf.) Centralab DD30-102 or equiv.
- C2—.002-mf., (2,000-mmf.) 3000-volt DC, ceramic disc capacitor (Centralab DD30-202 or equiv.)
- C3—.00075-mf., (750-mmf.) 3000-volt DC, ceramic disc capacitor
- C4, C5—.01-mf., 600-volt DC, molded tubular capacitor
- F1—6-ampere, glass cartridge fuse
- L1—26-turns, AWG-14, enameled wire (see text)
- L2—26-turns, AWG-14, enameled wire (see text)
- L3—2100-turns, AWG-26, enameled wire (see text)
- M1—0-300 milliamperes DC, (Shurite 550, 850, 950 or equiv.—see text)
- M2—0-150 volts DC, (Lafayette 99R5040 or

- equiv.—see text)
- R1—10,000-ohm, 50-watt, wirewound potentiometer
(Ohmite Type J-0332 vitreous-enameled rheostat)
- R2—10,000-ohm, 10-watt, wirewound resistor
- S1, S2—5-p.s.t. toggle switch
- T1—Plate transformer, 1840-volt, 250-ma secondary (Allied-Knight 63U700 or equiv.)
- T2—Filament transformer, 6.3-volt, 10-ampere secondary (Allied-Knight 61Z418 or equiv.)
- V1, V2—Vacuum tube, type 811A
- 2—4-pin, low-loss, ceramic tube socket (Amphenol 49-R554, Johnson 123-209-1, or better)
- 1—Lead-in bushing (E. F. Johnson 135-53 or equiv.)
- Misc.—Magnet wire, hookup wire, coil forms, wooden cabinet, wood screws, machine screws, solder, etc.
- Estimated cost: \$50.00
- Estimated construction time: 8 hours

parallel, to deliver a total output of about 300 watts of RF power.

Supply Transformers. A high-voltage-secondary transformer (delivering about 1840 volts at about 250 milliamperes) is used as the AC plate-voltage supply. In the schematic diagram, a 0.00075-uf by-pass capacitor is placed across the high-voltage secondary to prevent the high-frequency current from going through the transformer and out the AC power line.

The filament-transformer secondary supplies 6.3 volts, and 4 amperes are needed for each tube. Since the cathodes in these tubes are directly heated, the current from the plates must flow through the filament transformer to the filament. This is best accomplished by connecting the B- to the center tap of the filament winding, making a complete circuit as shown.

Coil Winding. Plate coil L1 is 26 turns of AWG-14 enameled magnet wire on a thoroughly wax-impregnated, 4 1/4-in. diameter cardboard form (phenolic or plastic can also be used). The grid coil (L2) is wound above L1, on

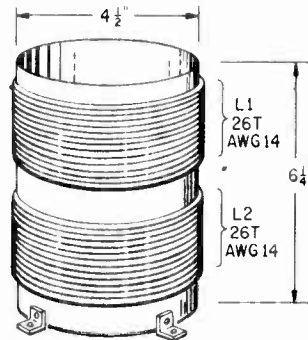

Grid and plate coils are wound with same size wire. Large diameter wire increases "Q" of grid inductance and that of plate tank L1-C1. Low resistance coils have less internal losses and higher output.

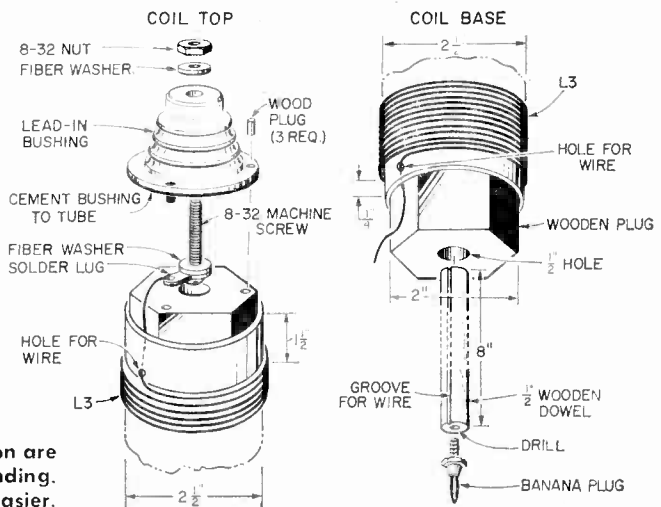

Details of coil construction are important to fabrication and winding. Plug-in coil makes storage easier.

BUILDING TESLA'S COIL

the same form, in the same direction, and with the same number of turns of AWG-14 wire as L1. Both coils must be given two coats of good insulating varnish. Brackets are put on the bottom of the form to mount it on the wooden cabinet.

To complete the resonant circuit (L1-C1), the value of C1 was calculated so the circuit oscillated at about 500 kiloHertz (kilocycles). From experimentation it was found that the circuit used here oscillates best with a capacitance of about 0.0014-*uf* (.001-*uf* and .004-*uf* in parallel) with a corresponding frequency of about 500 kHz.

The output coil (L3) consists of 2100 closely-wound turns of AWG-26 enameled wire on a thoroughly wax-impregnated 2¼-in. diameter cardboard form about 36-in. long. Three coats of insulating varnish were put on the windings. One end of the winding of the coil is connected to the terminal of a cone-shaped standoff insulator. A

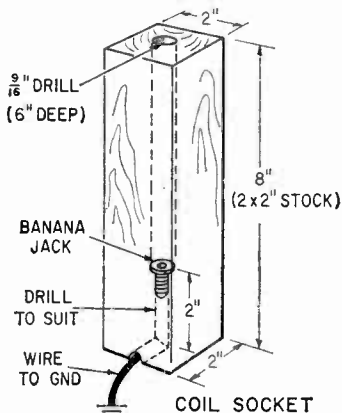

Wood block forms socket for plug-in coil L3. Six-inch deep hole accepts dowel which takes strain off jack and plug.

wooden plug is fitted to the inside of the bottom portion of the coil with a dowel inserted in a hole drilled in the plug to mount the coil and make the ground-end connection. Shellac the wood to keep out moisture.

A box, with the back open, should then be constructed. Both triode tubes are mounted on top of the box along with L3—mounted concentrically with L1 and L2. Both transformers (T1 and T2) are mounted inside the box at one side.

AC Input. Two 0.01-*uf* capacitors, con-

nected from each side of the AC-line input to ground, prevent any high-frequency oscillations from escaping to the power lines. The transformers are protected with a 6-ampere fuse as shown in the schematic diagram—a circuit breaker can be used.

Power Switching. Two switches are mounted on the front panel of the box. Plate transformer (T1) can not be turned *on* with S2 unless the filament transformer (T2) is *on*. This protects the tubes. For your own safety, it is wise to ground the apparatus to a waterpipe on some other ground.

In order to set R1 correctly, a DC voltmeter (M2) is wired across it to measure the grid bias. A DC milliammeter (M1) is also connected between the center tap of the filament transformer and ground to indicate the total plate and grid currents.

With the circuit completely wired—and double-checked for wiring mistakes—S1 may be turned *on* for filament warmup. After approximately 30 seconds, the plate-power transformer T1 is turned *on* and the apparatus is in operation.

Control R1 is adjusted for a grid bias of about 115 volts—the plate-current meter should read about 200 milliamperes. With the proper control adjustments some sort of brush discharge from the insulator terminal should be clearly visible.

With a variety of capacitors on hand, C1 can be changed in total capacitance until the brush discharge is maximum. With this condition maximum oscillation is obtained. (Maximum oscillation will vary somewhat with coil construction.) It was noticed that

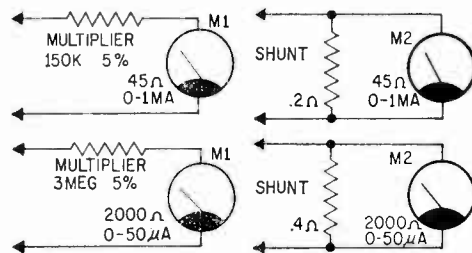

Even 0-1 milliampere or 0-50 microampere meters may be used to measure plate current and grid voltage in the Tesla Coil circuit if proper multiplier or shunt is added.

whenever the incorrect values of either R1 or C1 are used, the brush discharge was not as great.

The plates of the tubes must be watched at all times to make certain that their color does not get brighter than their normal dull-red. (Continued on page 116)

multiband VHF RECEIVER

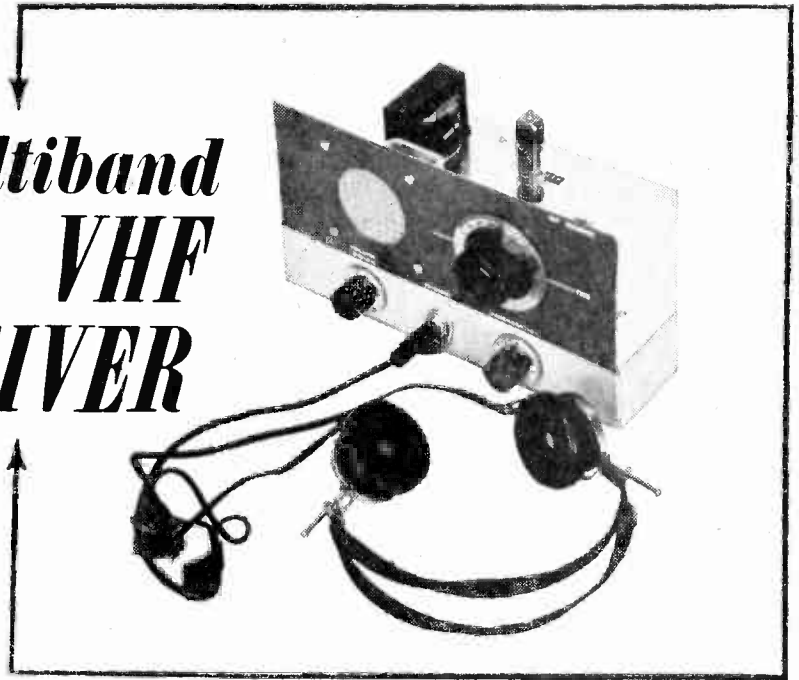

Tune in where the action is—hear the drama of everyday life—live—as it happens. Then relax with FM music.

by Charles Green, W6FFQ

■ The VHF spectrum is more popular, to SWLs, than ever. Even the 10-meter Ham band is starting to show life as the sunspot activity increases. Radio paging services are busy around 40 MHz (mc.) and the always popular 6-meter Ham band is active at 50 MHz. In addition, there are fire, police, ambulance, veterinarians (and other special emergency services), aircraft and the 2-meter Ham band—and even FM broadcast to round out the variety of listening fare in the VHF band.

You can listen in on the VHF activity with this multiband receiver. The simplified circuit uses only two tubes and easy-to-make plug-in coils. The superregenerative detector and grounded grid RF stage do not need any alignment or complicated adjustment. Its construction requires a minimum of shop tools and the audio stages drive the speaker to room volume. The unit incorporates a built-in AC power supply with a silicon rectifier.

About the Circuit. Signals, from the antenna connected to J1, are coupled by C1 to the cathode of V1A—a grounded-grid RF amplifier. RF choke L8, in series with the cathode bias resistor (R1), minimizes circuit loss at the higher frequencies. The amplified RF signal is coupled through C3 to J2 and the plug-in coils L1-L5. C5 tunes the coils—C4 sets the overall bandwidth.

V1B is a superregenerative detector with C6 and R4 establishing the squegging frequency. S1 switches RF chokes L6 and L7 for the “hot cathode” oscillating circuit of V1B. L7 is used for plug-in coils L1 and L2, and L6 is switched in for the other coils. R3 controls the superregen action of the circuit by varying the B+ voltage to the plate of V1B.

The detected audio signals are fed via the squegging-frequency filter (R6, C8 and C9) to the volume control (R7). V2A amplifies the audio signal and C12 couples the resultant audio to the grid of V2B. V2B is the

VHF RECEIVER

audio-power-amplifier stage and is connected to the speaker through output transformer T1 and phone jack J3. The speaker is automatically disconnected when phones are plugged into J3. High-impedance phones are driven by audio signals through C14.

If low-impedance phones are on hand they can be used by grounding the output transformer secondary as indicated on the schematic—C14 is not used and should be disconnected.

The operating voltages for the receiver are supplied by T2 and the silicon rectifier D1, with R12 and C15A-B filtering the B+ power.

Construction. For easy construction, a 7 x 11-in. piece of aluminum is used for the front panel. A 2¼-in. hole is cut or punched for the speaker opening. Mount the components as shown in the photos. Keep the parts

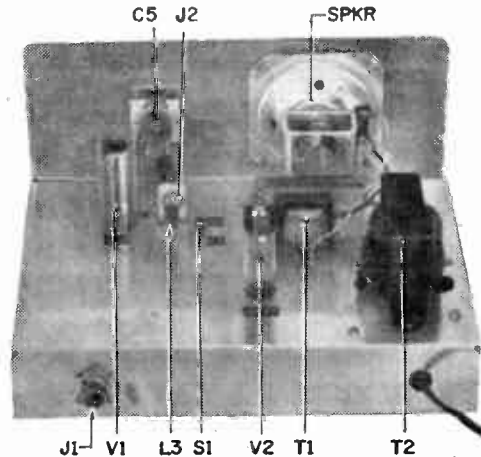

spaced as shown. The plug-in connector for the coil (J2) is mounted on an aluminum bracket approximately 1 in. high by ¾ in. wide. Use a single hole mounting type jack with ceramic insulation.

MULTIBAND VHF RECEIVER PARTS LIST

- C1, C6—47-mmf., 100-volt ceramic disc capacitor
- C2—4-mf., 150-volt miniature electrolytic capacitor (value not critical)
- C3—4.7-mmf., 1000-volt ceramic disc capacitor
- C4—24-mmf., mica capacitor
- C5—35-mmf., variable capacitor (Hammarlund HF-35 or equiv.)
- C7—200-mmf., capacitor (two 100-mmf., disc capacitors used in parallel)
- C8, C17—.001-mf., 1000-volt ceramic disc capacitor
- C9, C12, C14, C18—.005-mf., 1000-volt disc capacitor
- C10—5-mf., 6-volt miniature electrolytic capacitor
- C11—100-mmf., 1000-volt disc capacitor

- C13—.05-mf., 600-volt paper Mylar capacitor
- C15A, B—50-, 30-mf., 150-volt dual electrolytic capacitor with leads (Sprague TVA Atom 2450, Allied 15U244 or equiv.)
- C16—.01-mf., 1000-v., ceramic disc capacitor
- D1—Silicon rectifier—minimum ratings 500-1000 ma, 400-600 PIV (RCA SK-3017 or equiv.)
- F1—1 amp, 3AG fuse and fuse holder
- J1—Coax receptacle, chassis mounting type (SO-239 or equiv.)
- J2—RCA-type phono jack, single-hole mounting with ceramic insulation
- J3—Closed circuit phone jack
- L1, L2, L3, L4, L5—See text
- L6, L8—.82-microhenry RF choke (J. W. Miller RFC-220 or equiv.)

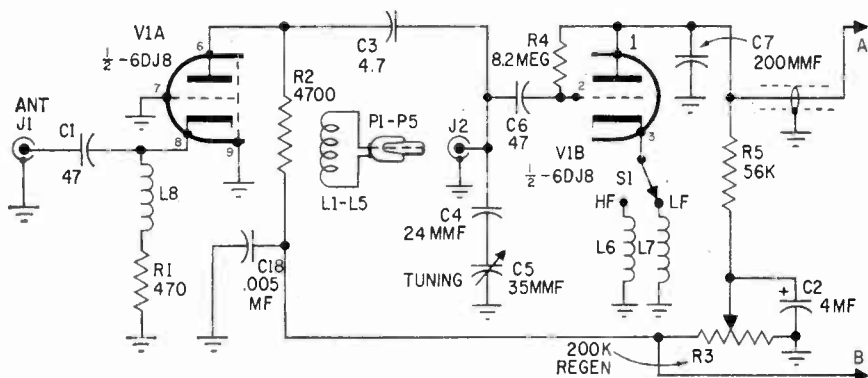

Top-chassis view (left) indicates location of most of the major components in the VHF receiver.

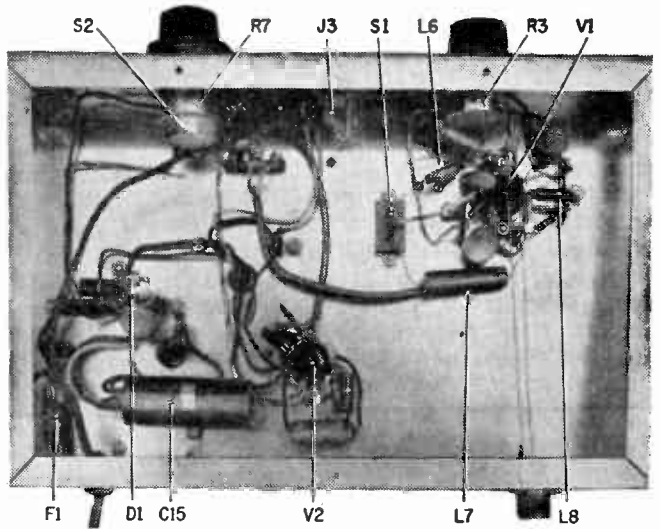

Under-chassis view (right) of VHF receiver shows there is little crowding. Leads to socket of V1 are kept short.

Keep the connections short in the RF and detector stages (V1) as is done in wiring all high-frequency construction projects. Run the wires to J1 about a quarter inch apart and keep the RF chokes L6 and L7 away

from the chassis. Use rubber grommets in the wire fed through chassis holes and lock washers in mounting the terminal strips to prevent movement.

The coils are wound with AWG-16 insulat-

- L7—24-microhenry (J. W. Miller RFC-28 or equiv.)
- P1-5—RCA-type phono plugs to fit J2 (for coils see text)
- R1—470-ohm, 1/2-watt resistor
- R2—4700-ohm, 1/2-watt resistor
- R3—200,000-ohm, linear taper, potentiometer
- R4—8.2-megohm, 1/2-watt resistor
- R5—56,000-ohm, 1/2-watt resistor
- R6—82,000-ohm, 1/2-watt resistor
- R7—1-megohm, audio taper, potentiometer (with S2)
- R8—8,200-ohm, 1/2-watt resistor
- R9—390,000-ohm, 1/2-watt resistor
- R10—470,000-ohm, 1/2-watt resistor
- R11—220-ohm, 2-watt resistor
- R12—1800-ohm, 2-watt resistor

- S1—S.p.d.t. slide switch
- S2—S.p.s.t. switch (part of R7)
- SPKR—3.2-ohm, 3-inch PM type
- T1—Output transformer; 5000-ohm pri., 3.2-ohm sec. (Allied Radio 59D2069 or equiv.)
- T2—Power transformer; 125-vac., 50-ma; 6.3-vac., 2-A sec. (Merit P13045, Allied 54D1411 or equiv.)
- V1—6DJ8 or ECC88 vacuum tube
- V2—6BM8 vacuum tube
- Misc.—AC line cord, 7x11x2-in. aluminum chassis with mating bottom plate and 6x11-in. aluminum plate (used for front panel), rubber grommets, hardware, etc.

Estimated cost: \$24
Construction time: 5 hours

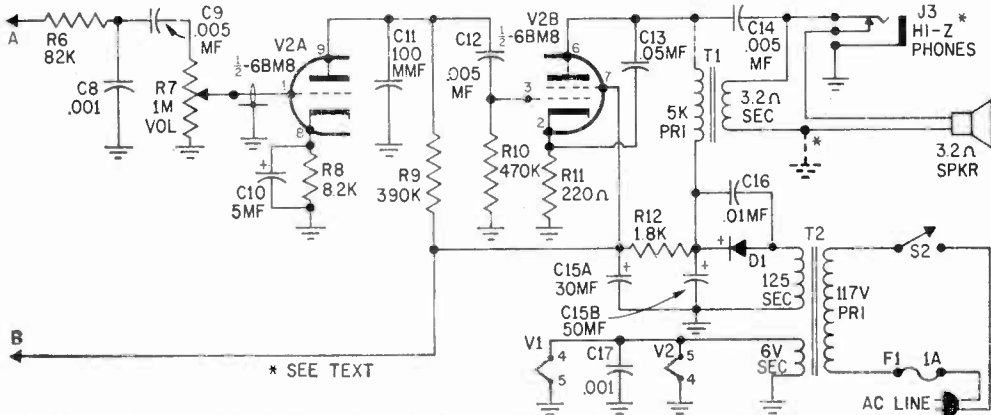

VHF RECEIVER

ed solid wire soldered to RCA-type phono plugs to fit J2. The dimensions of the coils are only approximate, as their frequency coverage will depend on the wiring inductance and capacitance of your particular receiver. Experiment with different numbers of turns for each band until you get your desired coverage. Different colors of plastic tape can be used to identify the coils and bands. Even the amount of tape will affect the frequency

services are on the air intermittently—only when they are transmitting a particular message. Some mobiles are on the same frequency as their base stations and you'll be able to hear *both* sides of the conversation. Others, like taxicabs, transmit on one frequency and listen on another.

What You'll Hear. Coil L1 will tune the CB and 10-meter bands. During the work-day CB will be busy with business calls—10-meter hams will be comparatively quiet until late afternoon.

Police, ambulance, veterinarians, etc., make good use of the frequencies covered

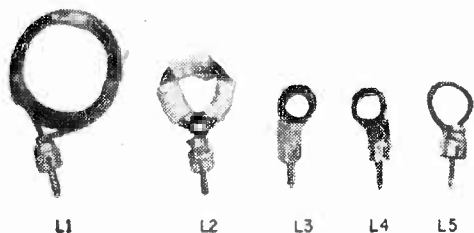

TABLE OF COIL WINDING DATA

Coil	Turns	Diameter	Frequency Range	Color
L1	5	1 1/4-in.	26 to 33 MHz	Red
L2	5	5/8-in.	42 to 52 MHz	Yellow
L3	4	3/8-in.	82 to 108 MHz	Grey
L4	2	3/8-in.	116 to 150 MHz	Black
L5	1	1/2-in.	140 to 185 MHz	—

All coils wound with AWG-16 solid, insulated wire.

The above plug-in coils are tuned with C5. As indicated in the Table of Coil Winding Data the coils do not provide continuous coverage—there are gaps in coverage between all coils except L4 and L5. Coverage can be adjusted slightly by spreading or squeezing the turns together.

range of the coils, use only enough to hold the wire turns together. Use care when soldering the coils to the plugs to prevent internal shorts in the plugs.

Operation. Plug in L3, the 4-turn coil (FM-broadcast band), and apply power to the receiver. Allow the unit to warm up for a few minutes, and set S1 to HF position. Turn the volume and regeneration controls to maximum (full clockwise position). You should hear a loud hissing noise from the speaker.

Connect an antenna to the antenna jack J1. A TV antenna is good for FM reception, but a 6-foot length of insulated wire will work for nearby stations. Tune C5 for a station. This will be an FM station on this band, so tune to one side of the station until you can hear the signal clearly. (This is known as slope detection of FM signals by an AM receiver.)

Adjust the regeneration control and volume control for best reception of the signal. You will find it necessary to retune a little as the regeneration control is adjusted. Practice will make operation of the receiver easier. Try the other coils in J2 and check reception. Remember—the 2-way mobile

by L2. Hams are from 50 to 54 MHz (mc).

L3 tunes the FM broadcast band. Aircraft messages are tuned with L4 but don't overlook the possibility of hearing a satellite

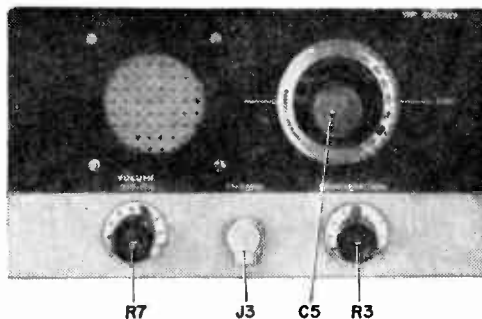

Front panel of the completed receiver is professional looking. Tuning knob for C5 can be replaced with a vernier drive for easier tuning on the communications bands.

around 137 or 149 MHz. L5 should tune in Channel-7 TV sound around 180 MHz. Below that you'll hear boats and more land mobile. If you're more than 10 miles from a commercial waterway forget the boats. ■

Stereo Broadcaster

by
Herb Friedman
W2ZLF/KBI9457

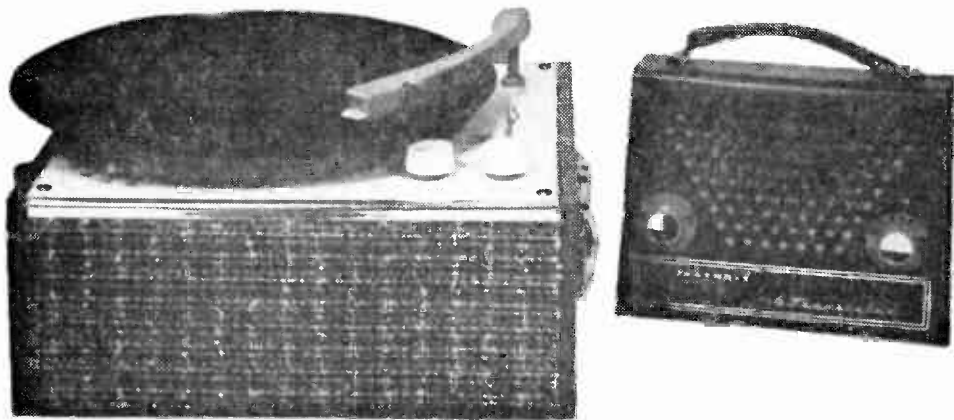

It doesn't take a lot of money and long wires to convert to stereo.

Tired of hearing one-dimensional music from your record player? Want the *big full* sound of stereo, and without the disadvantages of a large heavy box and out-board speakers? Then convert your present record player to a stereo broadcaster and enjoy the option of mono or stereo listening.

The stereo broadcaster is basically your present portable record player modified to provide stereo sound via a standard or portable AM radio. Inside the cabinet you place a small wireless broadcaster which radiates the right (or left) stereo channel. The record player itself provides either the left (or right) channel or mono. Want to take the player to a record party? Just pack it up as you usually do and use it as a straight mono player, or get the stereo channel through your friend's radio. Whether mono or stereo, the player is still the same small, light package. And there are no extension speakers or "rat's nest" of the interconnecting cords to worry about.

Modifications are easy to make, with only standard commercial components used. And since only five connections are required, a trouble-free conversion can be made by anyone to any record player.

Start With The Arm. First step is to replace the existing mono tone arm with a

stereo model. As with the wireless broadcaster, we suggest you use the exact component specified in the Parts List. If your record player has a two- or three-tube amplifier, with at least two tubes used as amplifiers (don't count rectifier tubes such as a 50DC4, 35Z5, or 35W4), use a 1-volt output stereo arm—the Sonotone model T20T1-S. If your player has but a single audio tube, it will require a higher input voltage; in this case, use the 2-volt output arm, the Sonotone model T20T-2. Either arm can be ordered through your local electronics parts distributor.

To replace the arm, simply disconnect the two leads from the existing arm at the amplifier (connections may be soldered or the clip-on type), and remove the single nut retaining the arm's pivot-post. Before installing the stereo arm, mount a d.p.d.t. switch near the hole for the pivot-post. This switch will be used to provide either a stereo or mono output, and it will automatically apply power to the broadcaster when it is set to the *stereo* position.

After the switch is installed, mount the tone arm. Select one of the two shielded leads and cut it short so it just reaches the stereo/mono switch (S1) with a little slack. Connect the center conductor of this lead

Stereo Broadcaster

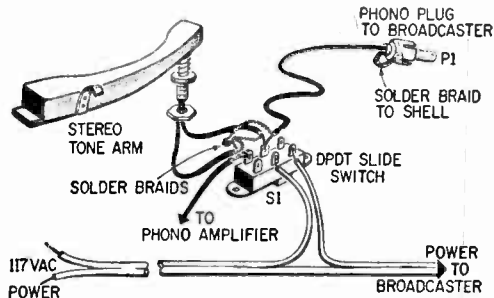

Pictorial diagram of flip-over arm and switch (above) can be easily compared to the schematic (top, right). Leads from the cartridge are delicate. Handle them with care and don't overheat while soldering.

PARTS LIST

- P1—Phono plug
- S1—D.p.d.t. slide switch
- 1—Stereo tone arm and cartridge (Sonotone T20T1-S—Lafayette 99R1024 or equiv.) (See text)
- 1—Radio broadcaster Phono oscillator (Lafayette 99C0177 or equiv.)

Estimated cost: \$6.50

Construction time: 2 hours

to any end terminal on S1, making certain the shield does not short to the center conductor. Connect one end of the shielded lead that was cut away to the switch terminal and wrap the two shields together. This done, connect the free end of the lead to the normal amplifier input.

Similarly, cut into the remaining lead from the arm and connect to the center switch terminal that corresponds to the corner terminal previously used, as shown in the illustration. Solder a phono plug (P1) to the free end of the lead, and wrap and solder together all the shields from the two arm leads. Temporarily set the completed motor and tone arm board aside until the wireless oscillator is installed.

Installing The Oscillator. We specifically recommend the Lafayette model 99C0177 Radio Broadcaster/Phono Oscillator for the wireless broadcaster. This model has the chassis insulated from the AC power line, and will not create a shock hazard by placing "hot" mounting screws on the outside of the record-player cabinet. (Other model broadcasters might have a "hot" chassis.)

Note that the schematic supplied with the

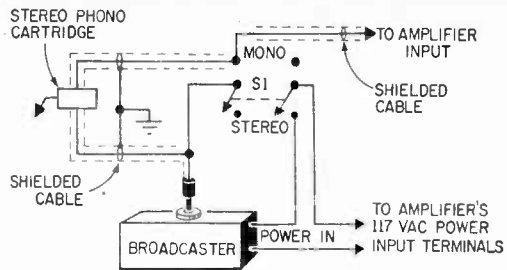

Schematic diagram is easy to follow—even for a beginner. If you get confused you can take a quick peek at the pictorial diagram just to the left of it.

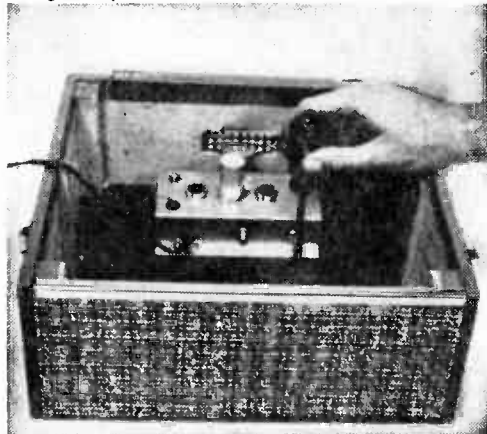

Lafayette broadcaster is mounted in box near the ventilating holes. If holes haven't been made for ventilation, add them. Ventilation won't hurt these units and will help prolong their operating life.

Lafayette broadcaster isn't correct (it shows a chassis "ground," which really doesn't exist). Just make certain that on the unit you receive the "ground" connection from the input jack isn't touching the chassis.

Before connecting or installing the broadcaster, check that the record player's amplifier doesn't use a "hot" chassis. Connect a small 117-V lamp, say 15 watts, between the amplifier chassis and a good electrical ground—the metal receptacle box or a cold water pipe being two good bets. Insert the player's power cord and turn the power switch on. If the lamp lights, the chassis is "hot." If the lamp doesn't light, reverse the power plug and try again. If the lamp fails to light either way, the amplifier chassis is isolated from both sides of the AC line and you'll have no problems. If the lamp lights under any condition the chassis is "hot." And since the tied-together shields of the phono arm will provide a common "ground" connection to the broadcaster, the broadcast-

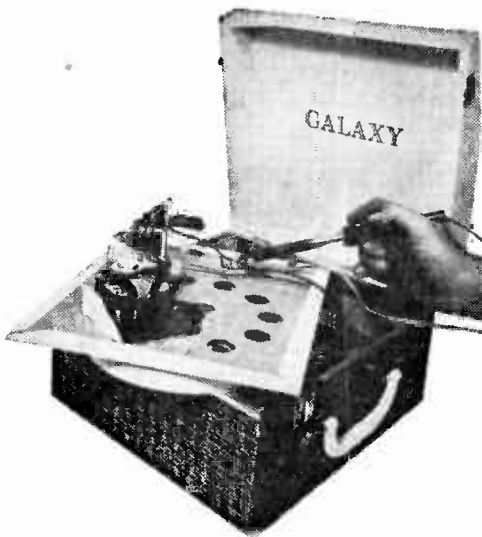

After the d.p.d.t. switch is mounted make the connections to S1, P1 and the stereo tone arm. Keep the iron clean and well tinned.

er's mounting screws *must* be insulated with tape to prevent a serious shock hazard.

Mount the broadcaster in the base of the player, as near as possible to ventilation holes, if there are any. The broadcaster can be mounted as shown in the photographs, or with the chassis vertical, if there isn't sufficient depth inside the record-player cabinet to provide clearance between the tubes and the motor-board.

Uncoil the antenna wire and staple it to the back of the cabinet. The wire supplied will radiate a sufficiently strong signal for a distance of about four feet. If you want greater separation between the player and radio speakers, add about five feet to the antenna and pass the free end through one of the ventilation holes so it can dangle behind the player.

Phasing The Phono Cartridge. After the broadcaster is installed, but before the 117-VAC power connection is made, temporarily assemble the player. Make certain that the amplifier is connected to the speaker, and that the stereo lead from the phono arm with the phono plug is connected to the phono jack on the broadcaster.

Set stereo/mono switch S1 to the *stereo* position and play a mono record. While the record is playing, set S1 to the *mono* position (both cartridge leads shorted together).

If there is no change in the music, or a very slight increase in sound level, all is okay. But should the sound level take a

sudden drop when S1 is set to *mono*, one set of cartridge leads must be reversed. Select either lead and reverse the shield and "hot" terminal connections. The terminals appear to be soldered but they're not. Grasp the terminal lightly with long-nose pliers and gently pull the terminal back; the terminal sleeve will slide off the connecting pin. Now remove the motor-board so the power connections can be made to the broadcaster.

Broadcaster Power. The broadcaster power leads must be phased to prevent severe hum. Temporarily connect the broadcaster's linecord to the record player's AC power input terminals. Note, as shown in power connections schematic, that some phono motors are not connected directly to a 117 VAC source. Newer players use the phono motor to drop the voltage for the heaters of a single amplifier tube. The motor is connected and is rated for approximately 75 VAC. Do not connect the broadcaster's

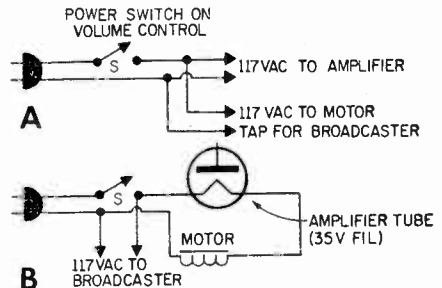

Diagrams of the two common AC-power input circuits show where to connect Broadcaster power leads. If you're in doubt use a VOM or a test lamp.

linecord in parallel with the motor if your player utilizes the series circuit shown. Make certain the linecord is connected to the 117-VAC input.

Apply power to the player and turn the volume control full up. With the phono arm lead plugged into the broadcaster you should hear little or no hum. If you hear a severe hum reverse the power leads of the broadcaster.

After the correct power lead phasing is obtained, cut open *one* of the linecord wires and connect it to S1 as shown in the pictorial diagram. When S1 is set to *stereo*, power is applied to the broadcaster. When S1 is set to *mono*, power is removed from the broadcaster.

Setting The Frequency. Place a radio near the player, set S1 to *stereo*, and play a record. Tune the radio to a clear channel

Stereo Broadcaster

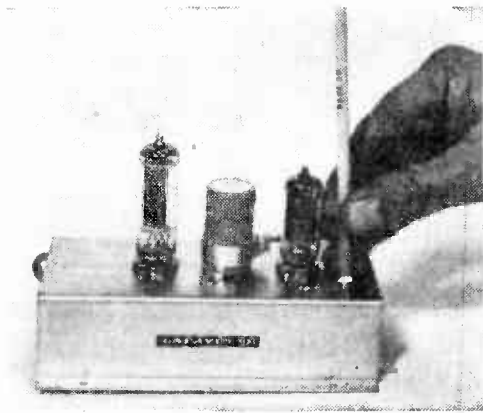

Setting the frequency is simple—just turn a threaded rod until you hear the sound loud-and-clear on the AM radio's speaker.

near the high end of the band and adjust the broadcaster's frequency adjustment—the oscillator coil slug—until you hear the music from the record. The broadcaster is supplied with an output frequency of approximately 1700 kHz. You may use this frequency or tune your own.

The Big Stereo Sound. Place a stereo record on the turntable, set S1 to *stereo*, and allow a minute or two for the broadcaster to warm up. Meanwhile, place a radio to the left or right of the player, and tune in the radio signal. Soon as you spin the platter you'll hear the stereo—one side through the radio. If you get severe distortion through the radio channel you'll have to make a minor modification to the broadcaster.

To do so, replace the existing 2-megohm input resistor with two 1-meg resistors in series, and connect the input to broadcaster

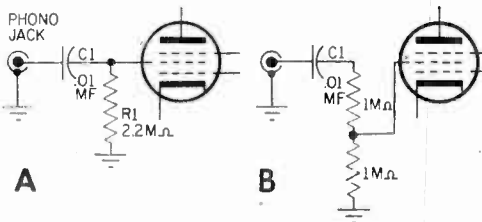

The original input circuit to broadcaster (A) can be modified for high-output cartridges with the voltage divider at B. A 2-meg potentiometer can be used, too.

to the junction of the two 1-meg resistors. The distortion is due to overload of the oscillator/modulator and the series voltage divider will reduce the input voltage by half, thereby reducing the overload distortion.

Speaker Phasing. If both speaker cones don't move in and move out in unison you won't have a very good stereo effect with stereo records. The easiest way to check for stereo phasing is to play a mono record with the stereo settings. If you listen at a point that is just about halfway between the speakers (and the volume is about equal), the sound should seem to come from a point between the two speakers. If the sound seems to come from some other direction, you'll have to switch the leads to either the speaker in the AM radio you're using for the stereo channel or switch the leads to the speaker in the record player. Since you have the record player apart during construction, the best place to switch leads would be in the record player.

If you plan on doing a lot of traveling with your new stereo setup and using whatever AM radio is at hand, it's best to add a speaker-phasing switch to the record player. All it takes is another d.p.d.t. switch and a couple short lengths of wire as shown in

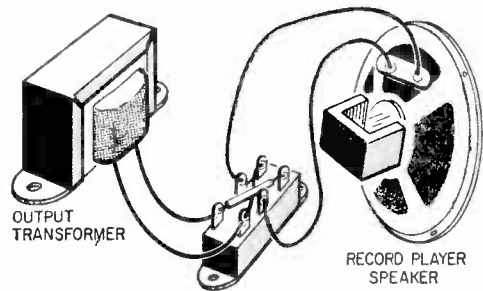

Speaker reversing switch can improve phasing when you use a strange AM radio. If you use the same radio all the time you can switch leads to record-player speaker.

the *speaker reversing pictorial diagram*. With the speaker-phasing switch wired into the circuit, you can simply flip it back and forth to find out which position affords the more pleasing stereo effect.

Broadcast Both Channels. Of course, if you want to broadcast both stereo channels, all you have to do is replace the phono amplifier with another broadcaster. Tune this second AM broadcaster to another quiet spot on the dial and you can have stereo anywhere in the house from any two AM radios. ■

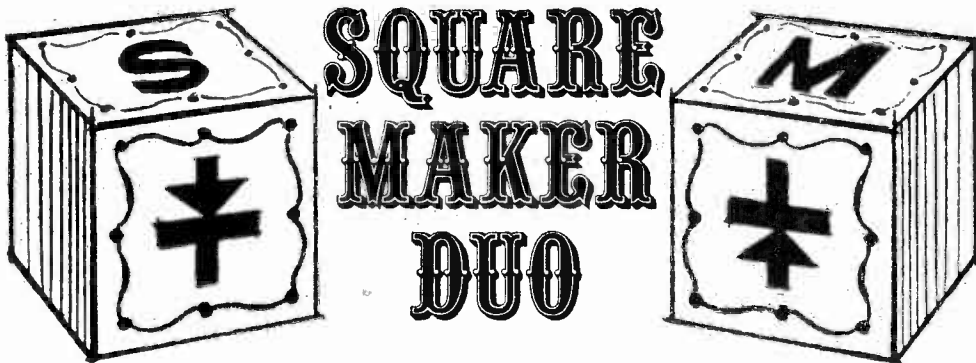

Our ducky little Duo will put you
in great shape any time your wave needs are square

By James A. Fred

It's a well accepted fact that square wave testing is about the only way to realistically check hi-fi amplifiers. Many ways have been devised to make square waves, most of them elaborate and fairly expensive. The most popular way seems to be to start with a sine wave, then clip and shape it into a square wave with various circuit configurations. For the experimenter in need of an occasional square wave or two, traditional methods are pretty complicated and the net result is that he usually does without them. But now, for a few bucks and fewer hours, you can convert the sine-wave output of your oscillator into a good, healthy square wave that's just what the doctor ordered.

The little device we are about to describe does the job in short order and fine shape. Two Amp-Gate diodes are used. These diodes are especially processed to start conducting at a signal level of 1.5-volts rms.

No batteries are needed to bias the diodes to this level, and all we need do is to supply a sine wave source of more than 2-volts rms and the diodes will automatically clip it to a square wave. Wave shape will not be as perfect as a big expensive generator, but for the price it can't be beat.

If you have trouble finding Amp-Gate diodes on your dealer shelves, substitute silicon diodes in their place such as the 1N137A or 1N200 to 1N209 series. These diodes conduct at about 0.5 volt so your square wave will not be as high in amplitude. You can buy a surplus diode package of 10 from most mail order parts houses for under a buck and have eight left over for other projects in the making.

Feeding Square Maker. If your audio signal source puts out less than 2-volts rms, you can use an amplifier to build the signal up to this level. The oscillograph drawings

All you need to make neat little square waves is our Square Maker Duo and a signal generator capable of two to six volts rms output; the higher output will result in almost perfect little squares.



SQUARE MAKER DUO

shown are traces taken from the face of an oscilloscope used by the author to check Square Maker's operation. They show what to expect at 1 and 10 kHz. With a 2-volt rms input signal at 1000 Hz, you will get about 1-volt rms output. If you can get 6.5 volts rms out of your oscillator, you will get nearly a perfect square wave at 1.25 volts output.

There are very few parts used and the assembly takes very little time. The aluminum shell of the mike connector comes complete with a phenolic banana plug strip. You use the strip by drilling out the banana plugs and mounting the 5-way binding posts in the same holes. Amp-Gate diodes have heavy wire leads which are formed and soldered to the 5-way binding posts. Use long nose pliers as a heat sink when soldering the diodes since all semiconductors can be damaged by excess heat. Use No. 2 bare

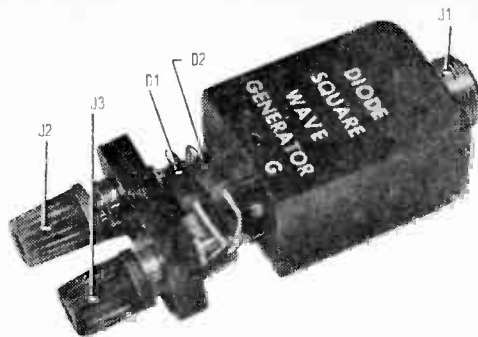

Construction of Square Maker in mike-connector cover makes handy, neat little unit.

the scope face with a grease pencil. Now connect the scope to the output signal. If the amplifier is linear, then the output signal will be greater in amplitude, but when attenuated, it will be the same shape. If the input and output pattern aren't the same, there is distortion in the amplifier that may have to be tracked down. In any case, however you use it, Square Maker Duo will serve you well for years to come whenever your needs are square. ■

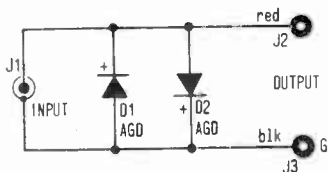

Schematic shows unit is a clipper circuit producing essentially square waves by flattening peaks of sine wave.

PARTS LIST

- D1, D2—Amp-Gate diodes (Mallory AGD, Radio Shack 276-660 or equiv.)
- J1—Microphone connector (Keystone 509, Radio Shack 274-1561 or equiv.)
- J2, J3—1 red and 1 black 5-way binding post (Lafayette 99C6233, Radio Shack 274-333 or equiv.)
- T—Banana-plug strip (Keystone 651 or equiv.) modified as described in the text
- 1—Aluminum shell (Keystone 4484 or equiv.)
- Misc.—Wire, solder, etc.

wire and insulating tubing to connect the microphone connector and the binding posts.

Using Square Maker. To use Square Maker, you simply insert it between the signal generator (audio) and the input to the amplifier under test. Use an oscilloscope to monitor the input signal and trace it on

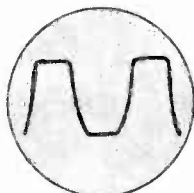

1 VOLT RMS OUTPUT AT 1kHz

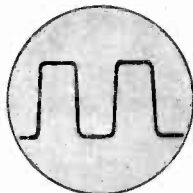

1.25 VOLT RMS OUTPUT AT 10kHz

Scope patterns produced by Square Maker with 2-volt and 6.5-volt rms input.

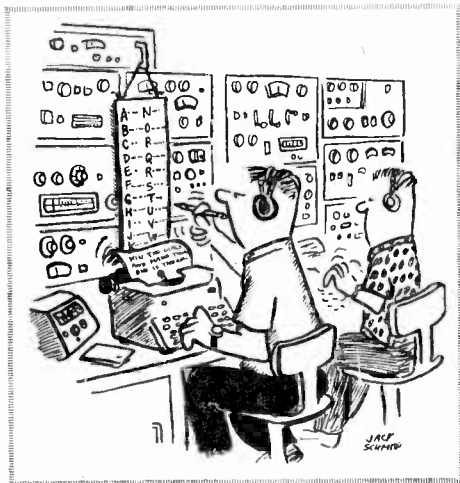

10 Reasons why RCA Home Training is your best investment for a rewarding career in electronics!

1 LEADER IN ELECTRONICS TRAINING

RCA stands for dependability, integrity and pioneering scientific advances. For over a half century, RCA Institutes, Inc., has been a leader in technical training.

2 RCA AUTOTEXT TEACHES ELECTRONICS FASTER, EASIER

Beginner or refresher — AUTOTEXT, RCA Institutes' own method of Home Training will help you learn electronics faster, easier, almost automatically.

3 THOUSANDS OF WELL PAID JOBS ARE OPEN NOW

RCA Institutes can help you qualify for a rewarding career if you have an interest in electronics. Every year, thousands of well paid electronics jobs go unfilled just because not enough men take the opportunity to train themselves for these openings.

4 WIDE CHOICE OF CAREER PROGRAMS

Start today on the electronics career of your choice. On the attached card is a list of "Career Programs", each of which starts with the amazing AUTOTEXT method. Look the list over, pick

the one best for you and check it off on the card.

5 SPECIALIZED ADVANCED TRAINING

For those working in electronics or with previous training, RCA Institutes offers advanced courses. Start on a higher level. No wasted time on material you already know.

6 PERSONAL SUPERVISION THROUGHOUT

All during your program of home study, your training is supervised by RCA Institutes experts who become personally involved in your efforts and help you over any "rough spots" that may develop.

7 VARIETY OF KITS, YOURS TO KEEP

At no extra cost, a variety of valuable specially engineered kits come with your program—yours to keep and use on the job.

8 FROM RCA INSTITUTES, INC. TRANSISTORIZED TV KIT AND VALUABLE OSCILLOSCOPE

All students receive a valuable oscilloscope. Those enrolled in the TV program or courses receive the all-new Transistorized TV Receiver—both at no extra cost and only from RCA.

9 UNIQUE TUITION PLAN

You progress at your own pace. You only pay for lessons as you order them. There's no long-term contract or large down-payment to lose. Even if you decide to interrupt your training, you don't lose a single cent.

10 RCA GRADUATES GET TOP RECOGNITION

Thousands of graduates of RCA Institutes are now working for leaders in the electronics field; many others have their own profitable businesses... proof of the high quality of RCA Institutes training.

SEND ATTACHED CARD TODAY FOR FREE DESCRIPTIVE BOOK

All courses and programs approved for veterans under new G.I. Bill.

CLASSROOM TRAINING ALSO AVAILABLE. FREE CATALOG ON REQUEST.

Canadians: These same RCA courses are available to you in Canada. No postage. No customs. No delay. Your inquiry will be referred to our school in Canada.

RCA INSTITUTES, INC. Dept. EZ-48

320 West 31st St., N.Y., N.Y. 10001

ACCREDITED MEMBER National Home Study Council



The Most Trusted Name In Electronics

Transistor experiments on programmed breadboard — using oscilloscope.



Construction of Oscilloscope.



Construction of Multimeter.

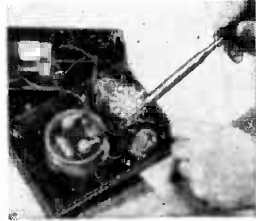

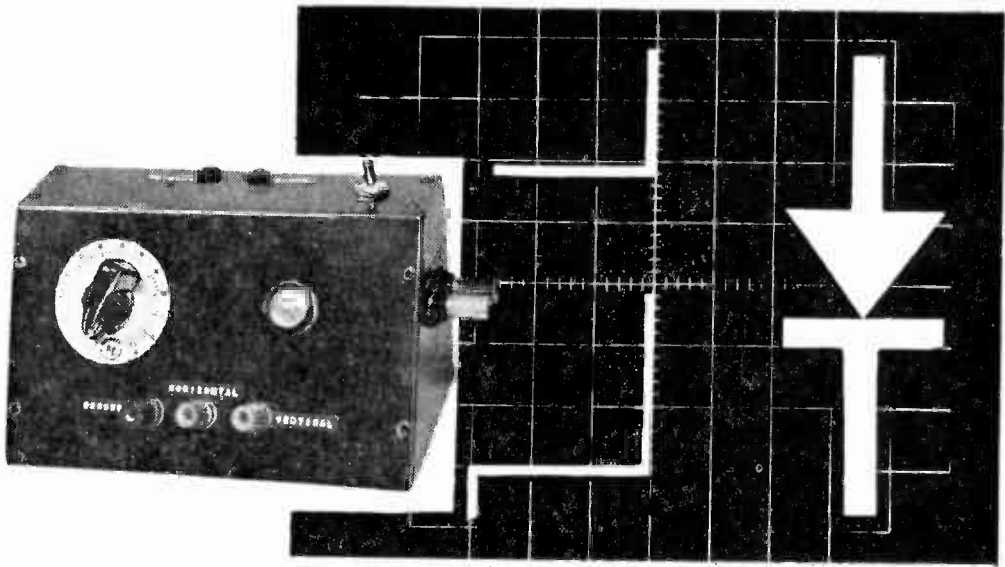

DYNAMIC DIODE CURVE TRACER

Don't guess! See at a glance the exact characteristics of that unmarked or suspected-defective diode. Use the same methods that are used to classify new diodes.

by Henry Schneider

■ If you're a typical experimenter or service technician, you've got a box of diodes—accumulated over many years—filled to overflowing. And if it's like anyone else's diode collection the markings have about as much meaning to you as the double-talk on Radio Moscow. It's a sure bet that if you start to use them, somewhere along the line you're going to connect a 50-PIV (PRV) diode into a 600-volt circuit.

But there is a way to check diodes, even if they haven't the faintest trace of a marking. Not only can you check the characteristics of silicon and germanium diodes, but Zeners as well. Throw together the dynamic *Diode Curve Tracer*—in about one hour construction time—and you'll be able to reproduce visually the dynamic characteristics of most of the diodes you'll run across. And best of all, you'll be able to tell whether those 500-for-a-buck surplus Zeners are any good, and if so, exactly what their breakdown characteristic is.

The *Diode Curve Tracer* must be used with a scope—any inexpensive type will do if it is calibrated properly. With it we trace the characteristics of the diode we are testing.

The Underlying Theory. The ideal semiconductor diode would have zero resistance to forward current and infinite resistance to reverse current flow. (The line to the right of the zero point or Fig. 1 would

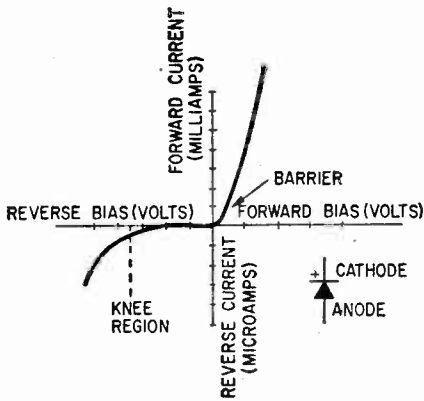

Fig. 1. Typical characteristic curve of a common diode shows forward and reverse current and bias (applied) AC voltages.

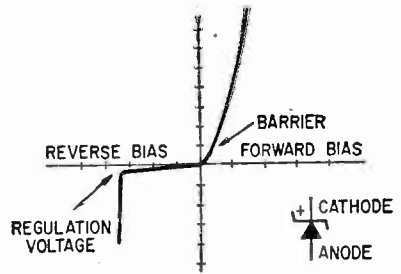

Fig. 2. The knee region of Zener diodes is a sharp bend to give a definite regulation voltage point. A curved knee just wouldn't work.

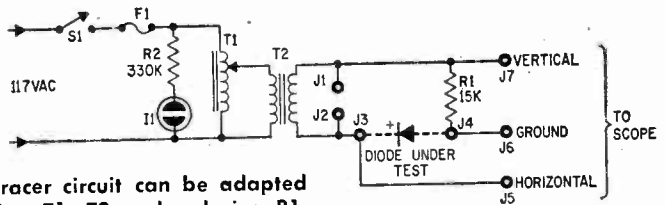

Fig. 3. Dynamic Diode Curve Tracer circuit can be adapted to high-current tests by changing T1, T2 and reducing R1.

go straight up and the line to the left of it go straight across—horizontally.) But in all semiconductor diodes there is some forward resistance and a much greater reverse resistance. You will readily see from the figure that the more vertical the forward curve is, the more efficient the diode is and the less power loss it has. And, of course, the flatter the reverse voltage line, the less reverse leakage there is. The curve at the dashed line is the *knee area*, and indicates the maximum reverse voltage the diode will stand. Beyond that point it will probably avalanche and burn out.

The Zener diode (Fig. 2) is designed to take advantage of this breakover point. It is so designed that it can avalanche (within limits). When placed in a properly designed circuit it limits the output voltage to the rated value of the Zener diode.

Putting It Together. The Dynamic Diode Checker can be built in virtually any cabinet you've got around—the model shown is assembled in a home-brew instrument-type cabinet but you can substitute a standard aluminum cabinet or even a wooden box. The only precaution necessary—if you use a metal cabinet—is to double check that no part of the circuit wiring touches the enclosure (for safety's sake.) A metal cabinet is just that—a cabinet. It is not a common ground.

PARTS LIST

- F1—1.5 amp. fuse
- I1—Neon pilot lamp (NE-51 or equiv.)
- J1, J2, J5, J6, J7—5-way binding posts (3 red, 3 black)
- J3, J4—Banana jacks, panel insulated (see text)
- R1—15,000-ohm, 2-watt resistor
- R2—330,000-ohm, 1/2-watt resistor
- S1—S.p.s.t. toggle switch
- T1—1.75 amp. variable autotransformer (Ohmite VT2, Knight 64Z938, Standard 175BU or equiv.)
- T2—Isolation transformer (Triad N54M or equiv.)
- 1—Sloping panel cabinet 4-1/2x4-1/4x 7-3/16-in. (Premier ASPC-1203 or equiv.)
- Misc.—Pilot light socket, fuse holder, tie strip, decals, wire, solder, etc.

Estimated cost: \$25

Construction time: 1 hour

Any component layout can be used—it's not critical. J1, J2, J3, J4, J5, J6 and J7 are insulated, 5-way binding posts. The diode test jacks (J3 and J4) in the model shown are banana jacks, so that a clip jig can be used; but for general use, connecting to J3 and J4 might be more convenient if they too are 5-way binding posts. With paint or other color coding, be sure to mark J3 as the *cathode* end of the diode. (Jack J4 is the *anode* connection.)

J1 and J2 are provided only for convenient AC voltage measurement and so the auto-

DYNAMIC DIODE CURVE TRACER

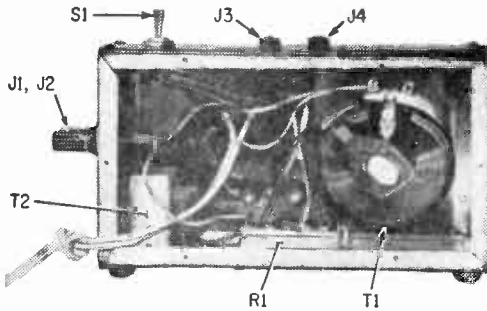

Rear view of Curve Tracer shows components mounted inside cabinet. Larger cabinet is needed for high-current version of tester.

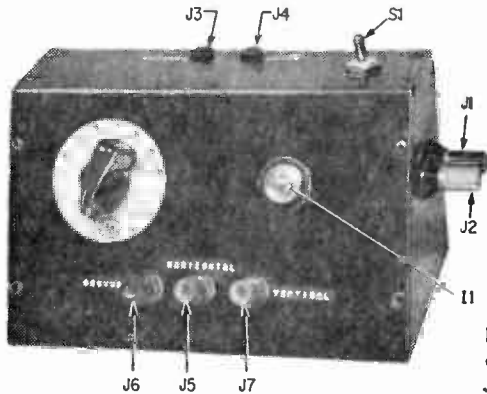

Front panel of the Curve Tracer has only one control—T1. Scope connections (J5, J6 and J7) can be placed on side or rear.

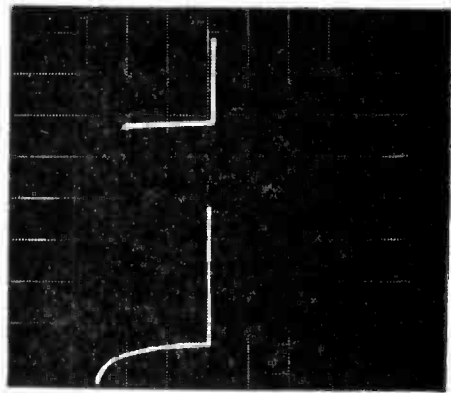
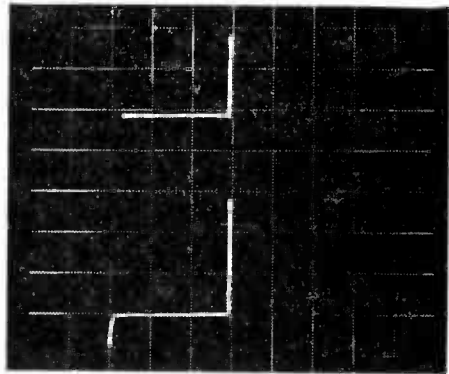

Fig. 4. Actual scope traces of typical diodes. The lower trace in each photo shows the overdriven and regulating current flow in rectifiers and Zeners.



transformer, T1, can be used for other purposes—they may be eliminated if you don't feel you'll need T1 for other purposes.

While T2 is an isolation transformer and may appear to be unnecessary, it does isolate the tracer from the AC power line, and should *not* be eliminated.

Using The Tracer. To test a diode, calibrate the horizontal sweep of the oscilloscope with an exact voltage per centimeter (or inch) and set the vertical gain at a value that will keep the whole curve on the screen of the scope. Connect checker to scope. Connect the diode between the cathode and anode terminals (observing polarity!). Turn on the checker and advance the variable control slowly until the diode curve approaches the knee region. Examples of a germanium diode under test are shown in Fig. 4.

As the curve approaches the knee read the

horizontal voltage. This is the peak inverse rating of the diode. In the case of Zener diodes, proceed the same as with ordinary diodes until you reach the breakover point.

You then read the voltage of the horizontal line. This gives you the voltage value the Zener will control at. The cleaner the reverse breakover, the better the quality of the Zener.

Note that the curve traced on your scope may be reversed from left to right when compared with the illustrations. It is important to observe the *cleanness* of the curve to judge the quality of the diode under test. Be sure to use a reliable calibration voltage. If you are reading the calibration voltage in RMS, remember that the scope is indicating it in peak-to-peak values. You only have to calibrate the horizontal—you need not read the vertical values. ■

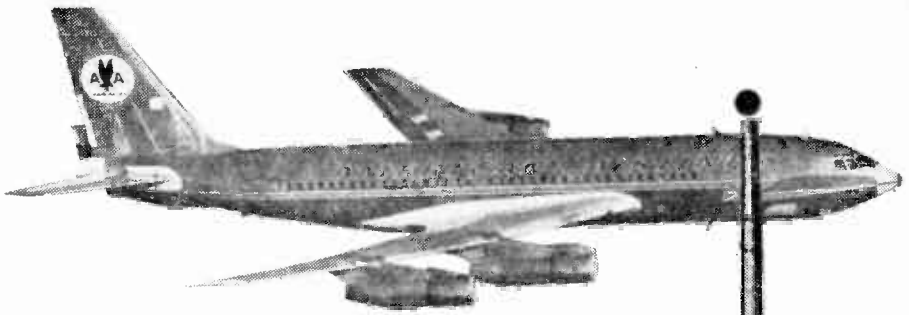

- a tonic for tired SWLs
- a hotline to NASA and the mysteries of the space age
- your passport to the unbelievable chaos of the crowded skyways
... that's our

STRATOSPHERIC SUPER SLEUTH

a self-powered VHF eavesdropper tuning a world you've never heard!

By Charles Green, W6FFQ

If SWLing doesn't pack the thrills per Hertz (cycle?) it once did, chances are you're due for a change of scene. Sure, you'll miss Radio Moscow . . . and that OA2 on 20 meters . . . and WWV . . . and the local CB folderol—or will you? Let's face it—wouldn't you rather give a listen to jet pilots and control towers, NASA satellites and other space gear, aircraft and Civil Air Patrol and maybe even 2-meter hams? All you have to do is step up to where the action is—in the VHF world above 100 MHz. *(Continued overleaf)*

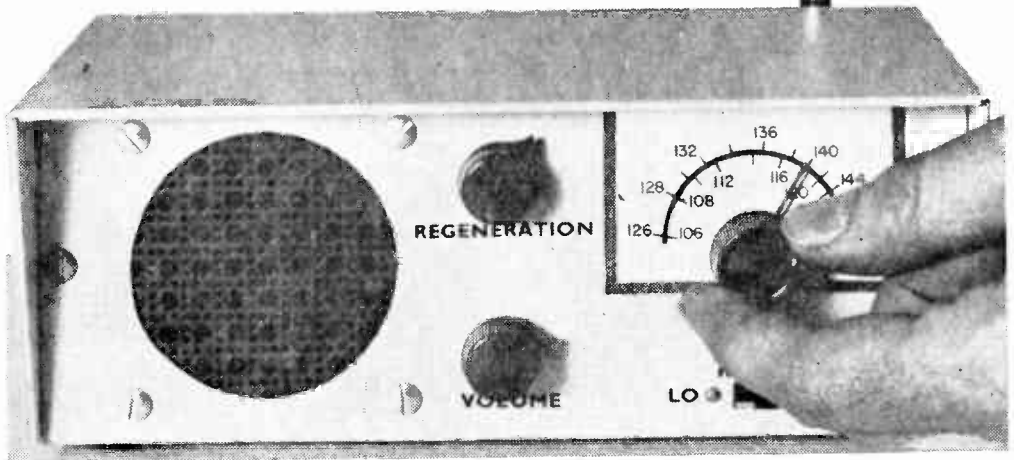

STRATOSPHERIC SUPER SLEUTH

Drawings show method of mounting tuning capacitor (at left) as well as size and placement of all chassis holes.

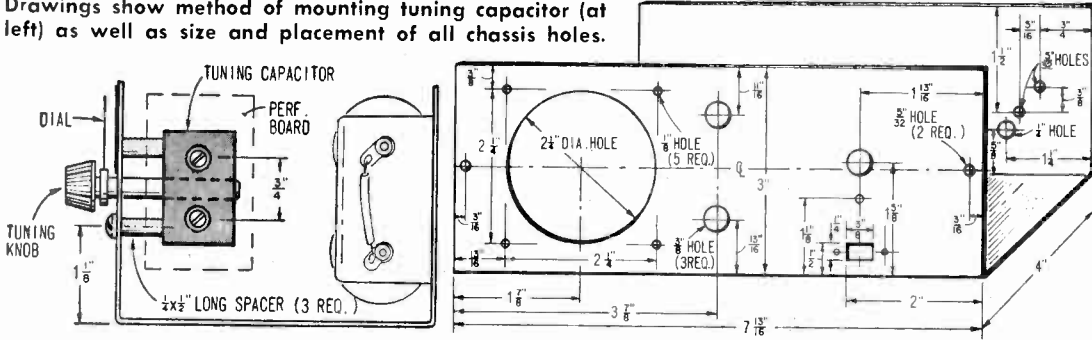

SUPER SLEUTH PARTS LIST

- B1—4 1 1/2-volt "D" cells
- C1—.01 mf, 25 V ceramic disc capacitor
- C2—5 mmf, 25 V ceramic disc capacitor
- C3—.001 mf, 25 V ceramic disc capacitor
- C4—6.5 to 13 mmf tuning capacitor (Lafayette 32C0917)
- C5—470 mmf, 25 V ceramic disc capacitor
- C6, C8—.05 mf, 100 V plastic film capacitor
- C7—100 mf, 15 WVDC electrolytic capacitor
- C9—5 mf, 15 WVDC electrolytic capacitor
- J1—Phono jack with RF insulation (Switchcraft 2505F or equiv.)
- L1—1.72 uh RF choke (J.W. Miller RFC-144; Lafayette 34C8973)
- L2—LO band coil (106-128 MHz, 2 turns No. 20 wire, 1/4-in. diam. x 1/4-in. long, with 1/2-in. leads—see text)
- L3—HI band coil (126-150 MHz, 1 turn No. 20 wire, 3/8-in. diam., with 1/2-in. leads—see text)

- Q1—2N1788 transistor (Sprague)
 - R1, R2, R7, R9—1000-ohm, 1/2-watt resistor
 - R3—2700-ohm, 1/2-watt resistor
 - R4—25,000 ohm, linear-taper potentiometer
 - R5—4700 ohm, 1/2-watt resistor
 - R6—2200 ohm, 1/2-watt resistor
 - R8—25,000 ohm, audio-taper potentiometer with SPST switch
 - S1—SPDT slide switch
 - S2—SPST switch (on R8)
 - SPKR—2 1/2-in., 8-ohm speaker
 - Misc.—4-transistor audio amplifier (Radio Shack 277-1240), two dual D-size battery holders, perf board and push-in terminals, cowl-type minibox (BUD SC-2132 or equiv.), 52-in. telescoping whip antenna (Radio Shack 21-1156 or equiv.), sheet aluminum for antenna bracket, spacers, etc.
- Estimated cost: \$25.00
Construction time: 5 hours

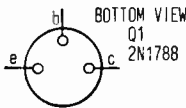
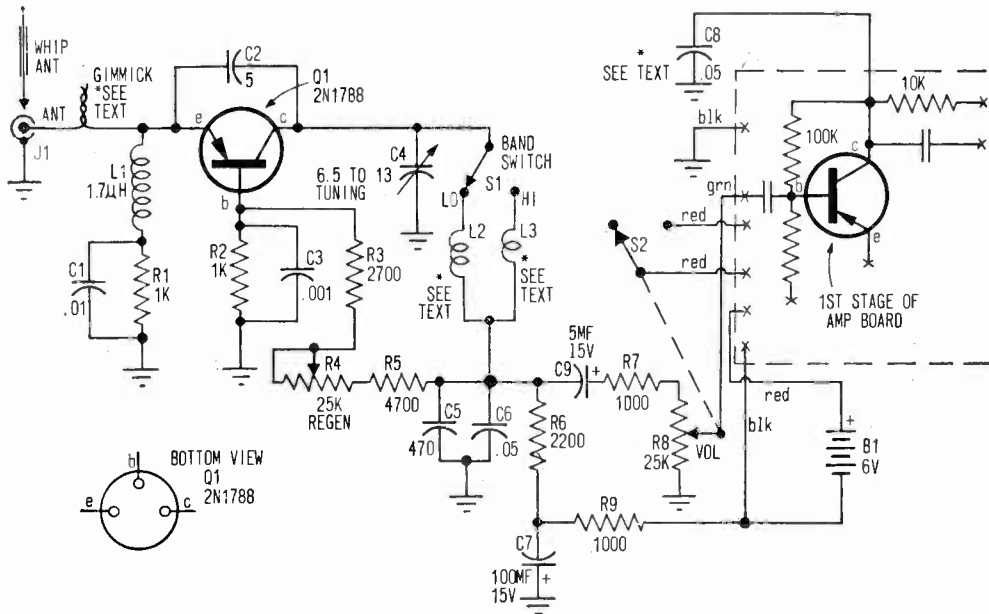

The thing that makes that big step possible is our Stratospheric Super Sleuth, one of the neatest little VHF receivers ever devised. And don't shy away because you think its construction will be a grind, because it isn't. A single perf-board mounted right on the tuning capacitor holds the handful of components that make VHF reception possible; the balance of the rig consists of a ready-made audio amplifier (transistorized, of course), plus a speaker and four flashlight batteries. The unit even carries its own telescoping whip antenna.

The Circuit. A glance at the schematic reveals that the receiver actually tunes two bands—106 to 128 MHz and 126 to 150 MHz—depending on the setting of band-switch S1. A high-frequency transistor (Q1) is used in a superregen detector circuit, and the transistorized audio amplifier drives a 2½-in. speaker. A built-in battery makes this compact unit perfect for portable operation.

Tracing the circuit, signals received at J1 are coupled through the gimmick capacitor to the emitter of Q1; capacitor C2 provides RF feedback for the superregenerative detector circuit, which is tuned by C4 and L2 or L3 (switched by S1). The superregenerative operation is controlled by R4 and the detected signals fed through C9-R7 to R8. This potentiometer, in turn, controls the audio input to the amplifier unit and the 2½-in. speaker. Four D-cells are connected in series to supply 6 volts to the receiver and amplifier circuits.

Construction. Our model was built in a

cowl-type, 3- x 8- x 5-in. aluminum mini-box. The major assemblies are mounted on the front and rear panels, with the amplifier on the box bottom. Since C4's shafts are concentric for vernier action, they cannot be cut. Therefore, we used ½-in. spacers to mount C4 behind the front panel and keep the tuning knob a convenient distance from the panel surface. Countersink the front-panel mounting screw holes for C4, and use flat head screws to provide a flat surface for the dial.

After you cut the speaker hole, install a section of perforated aluminum to protect the speaker cone. Use serrated washers between controls R4 and R8 and the inside of the front panel to prevent movement. We used rubber faucet washers as spacers to mount the amplifier. These washers will conform to the module's irregular surface and won't short the conductors as metal spacers might.

The detector circuit is built on a 1¼- x 2½-in. section of perf board, which is then mounted on the bottom of C4 with spacing

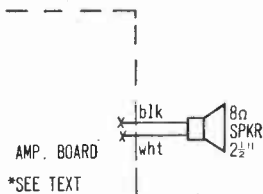
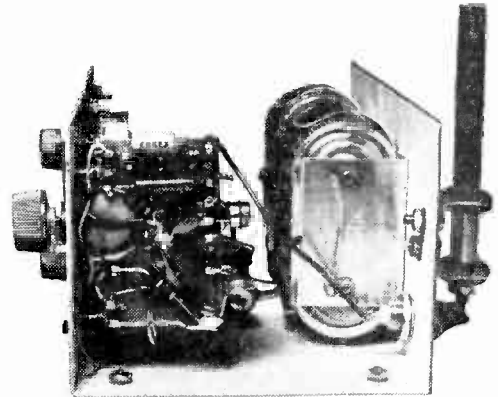

Schematic diagram at left shows superregen circuit and necessary connections to factory-wired audio amplifier; as explained in text, addition of

capacitor C8 to amplifier circuit was required to bypass detector quench frequency. Photo and drawing at right show placement and wiring of perf board which holds bulk of Super Sleuth's components. Because of VHF frequencies involved, all leads must be kept as short as humanly possible. For same reason, dimensions given for coils L2 and L3 are only approximate, and you may have to cut-and-try a bit before these coils tune their required range.

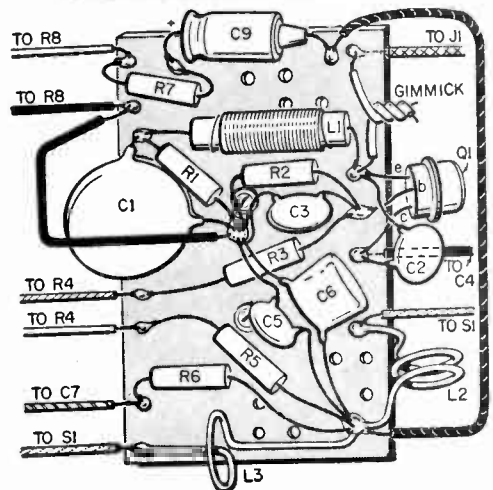

STRATOSPHERIC SUPER SLEUTH

Rear view of Super Sleuth, showing method of mounting whip antenna as well as location of speaker, potentiometers R4 and R8, and tuning capacitor C4. Screws along chassis rear support battery holders.

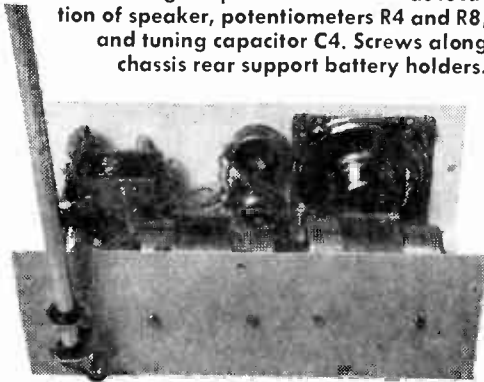

Front view of Super Sleuth, showing front-panel layout and placement of flashlight cells. Home-brew dial can be prepared after receiver has been aligned; pointer here is piece of bus wire.

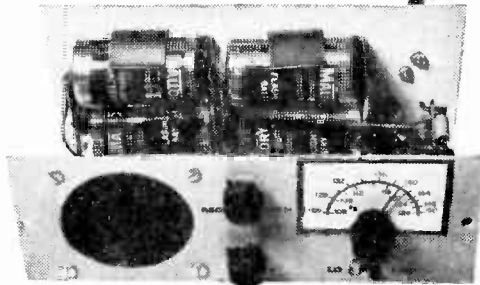

washers. As with all high-frequency circuits, the wiring here should be short and direct as possible. Dimensions for coils L2 and L3 are only approximate, since their frequency coverage will depend on the exact wiring layout of your receiver. To make the coils, wind the specified number of turns of No. 20 bus wire around a 1/4-in. drill for L2 and a 3/8-in. drill for L3. The gimmick capacitor is made of 4 turns of No. 22 hook-up wire, with the ends separated to prevent shorting.

Bend a suitable piece of scrap aluminum into a U bracket to support the whip antenna. We mounted the antenna in rubber grommets fitted into holes cut in the bracket ends. Jack J1 should be a phono jack with good quality plastic insulation to minimize RF losses.

To add bypass capacitor C8, find the junction of the 100k and 10k resistors (at the collector of the first transistor stage) in the amplifier (check the circuit diagram supplied with the amplifier). The addition of C8 is necessary to prevent the detector quench frequency from overloading the amplifier.

The dial on our model is a 1 3/4 - x 2 3/4 -in. section of white cardboard, with an inked 1/8-in. border. We made the pointer with a length of bus wire inserted in a fiber washer reamed to fit snugly over the outside concentric shaft of C4.

Calibration and Operation. Install the batteries in the receiver and set S1 to the LO band position, pull the whip antenna out

to full length, and turn the volume control (R8) full clockwise. Adjust the tuning control to full capacity position (full CCW) and rotate the regen control (R4) until you hear the characteristic superregen hiss in the speaker.

Set a signal generator to 106 MHz (modulated output) and loosely couple it to the receiver antenna by connecting the generator output to an 18-in. lead placed along the rear of the receiver. Squeeze or lengthen L2 until you hear the generator signal in the speaker. Adjust the volume control for a comfortable listening level and calibrate the LO band dial to 128 MHz with the generator. You may have to readjust the regen control as the tuning control is advanced up the dial.

After the LO band is calibrated, set the signal generator frequency to 126 MHz and squeeze or lengthen L3 until you hear the generator signal in the speaker. The regen control may have to be readjusted for best reception. Calibrate the HI band dial to 150 MHz with the generator.

Next, disconnect the generator and tune the receiver for signals. For strong stations, the whip antenna will be OK, but for weak-signal reception an external ground-plane antenna may be required. A TV antenna will also suffice for horizontally polarized signals.

Shortening the whip antenna to about 18-in. will usually improve reception at the higher frequencies. Practice in adjusting the regen control as you tune the receiver will make reception of weaker signals easier. ■

By Jorma Hyypia

EXPERIMENTER'S SIMPLEX MOTOR

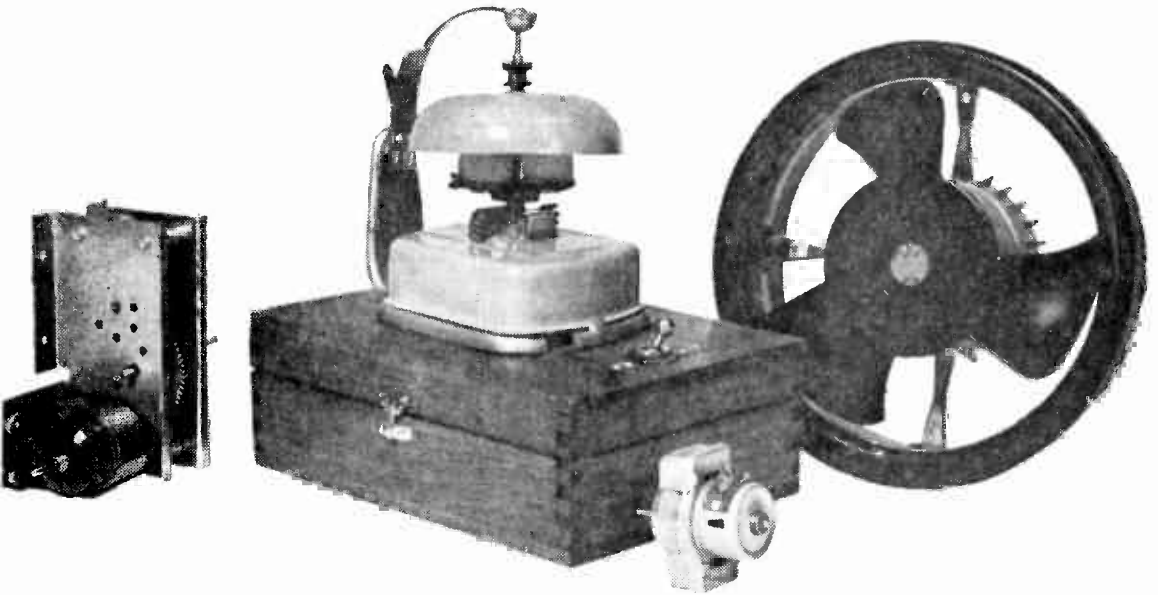

You can make this novel DC motor in a few hours from an ordinary door bell, a magnetic cabinet-door catch and two discarded ballpoint pen ink tubes. Parts will cost you about two dollars—nearer three if you buy the box for holding three dry cells. The motor is ideal for demonstration purposes because it can be partly dismantled, in seconds, to reveal all working parts. It is also an attention-getting novelty suitable for display on your desk, in the den, and elsewhere.

Materials. The component parts for this motor are available in every town or community, and you need only simple hand tools to make the conversion from door bell to motor.

You could probably use almost any make of doorbell since they are all pretty much alike; however coil sizes are not all the same and you may have to do some redesigning if you use parts other than those specified.

The bell butchered here was picked up in a local hardware store. It's an Edward 2½ inch Nubel Exposed Gong, 6-8 volts AC, 3-6 volts DC, Catalog No. 740, made by the Edwards Co., Inc., Norwalk, Conn.

I swiped a magnetic cabinet-door catch from our kitchen cupboard, so I can't specify a particular brand or model number. But here's what to look for. Find a catch with the magnet poles spaced $\frac{3}{4}$ in. apart and oriented perpendicular, *not* parallel, to the long axis of the case. This spacing and orientation of the poles relate perfectly with the coils to be used, greatly simplifying construction. The catch shown has a plastic case measuring about $2 \times \frac{7}{8} \times \frac{1}{2}$ in. The width is quite important; it should not be greater than $\frac{7}{8}$ in. or you will have trouble fitting the catch inside the doorbell case unless you take it apart. If you can't find a comparable catch, try using a small alnico horseshoe or U-magnet (sold in hardware

EXPERIMENTER'S SIMPLEX MOTOR

stores). The poles should be about $\frac{3}{4}$ in. apart. Stay away from children's toy magnets—no poop at all in them.

Two ballpoint-pen ink tubes are used to make a low-friction ball-bearing armature shaft. Use the *thin*, $\frac{1}{8}$ in. diameter tubes, not the thick type. If you don't have used tubes on hand, your local stationer can probably save a couple for you when he refits customers' pens with refills. If you use unused tubes, heat them to make the ink flow out before using them for this purpose.

The wooden box used to house three D-size dry cells was obtained from a handcraft supply store for 80 cents. A box with inside measurements about $5 \times 3\frac{1}{2} \times 1\frac{1}{2}$ in. is ideal.

Dismantle Doorbell. Begin the project by carefully dismantling the various parts of the doorbell; you will use *all* parts except

one terminal screw, so try not to damage any parts.

Remove the gong by drilling away the rear of the rivet holding it on the mounting bracket. The two coils are mounted on an angle bracket projecting from the base; hacksaw this off near the base so that the coils remain fastened together as a unit. Pry the clapper off its rear mount taking care to leave the bronze flat spring still attached to the clapper arm. Remove both terminal screws—saving the insulated internally-threaded metal piece that takes one of the bolts. (You will use this as a handy wing nut.) Several small lugs will remain projecting from the base; hammer these flat.

Armature Shaft. The ball-bearing armature shaft is made from the ballpoint pen ink tubes as shown in Detail Drawing A. Carefully remove one of the tip sections from one tube. Use a very small file to file away some of the main ink tube just adjacent to the small collar (next to the thin section holding the ball). In this way the terminal section can be removed intact. You will

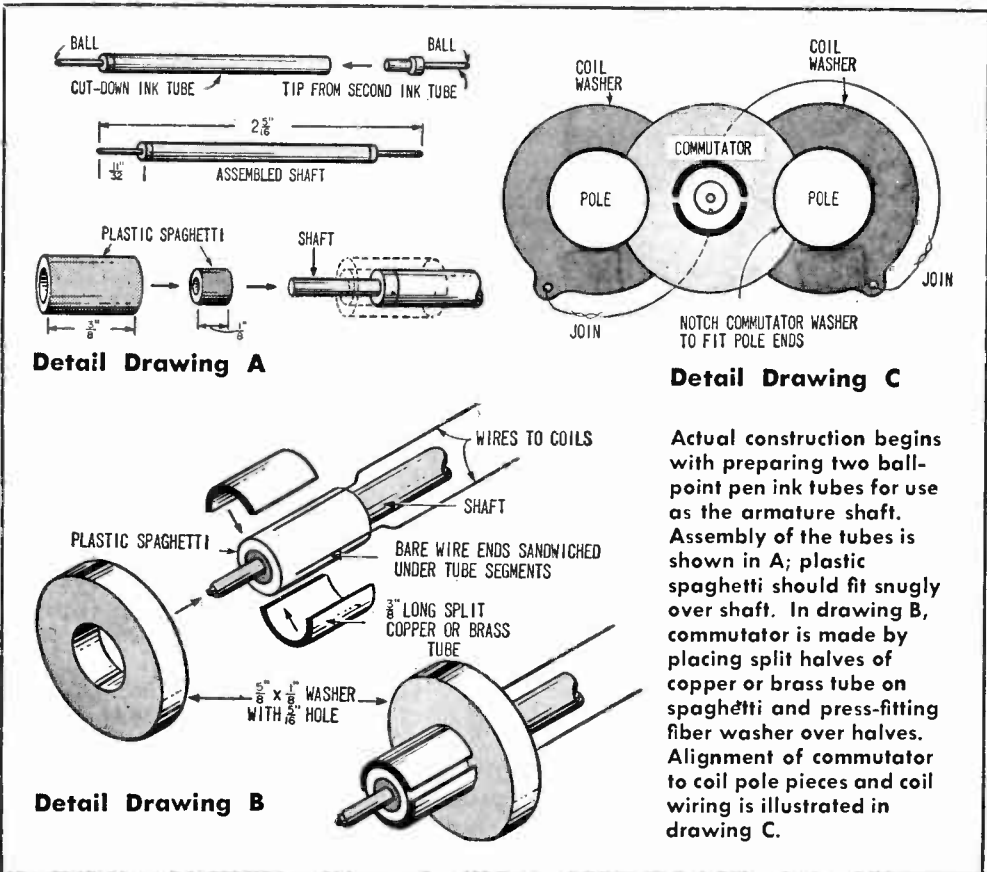

probably damage the tip if you try to pull the section out by force.

Cut the main section of the other ink tube to such length that the entire unit—with a ball section fitted on each end—will measure about 2- $\frac{5}{16}$ inches. Start the second tip into the open end of the tube by hand, tapering the tip sleeve slightly with a file if necessary. Slide the end of the discarded tube (from which the tip was removed) over the tip so that it butts against the collar. By tapping lightly on the other end with a hammer, you can force the tip into the end of the tube. Take care to keep all parts aligned as perfectly as possible.

Before proceeding with construction of the commutator, test the fit of the shaft between the two coils. It may be necessary to file a small semi-circular notch in the center of the metal bracket holding the coils together in order to obtain perfect alignment of the shaft with the coils. Very small indentations also had to be filed into the fiber washers at each end of the coils—to give enough clearance for the shaft to pass be-

tween the coils. If you do this carefully, the fit will be so snug that the shaft will stay in place without soldering, using cement or other means of attachment. A very small jeweler's rattail file is very handy in this fitting job. Remove the shaft for the next step.

Commutator Assembly. The commutator sleeves are made by hacksawing a $\frac{3}{8}$ in. long, $\frac{5}{16}$ in. diameter copper or brass tube lengthwise down the middle. Tubing can be obtained from hobby supply shop if you don't have it on hand.

One end of the bearing shaft is built up with two pieces of plastic spaghetti (Detail Drawing A) to the proper diameter to support the split commutator. The smaller-diameter tube is first slipped onto the thin end of the tip to thicken it to $\frac{1}{8}$ in.—the same diameter as the main body of the tube. The larger piece of spaghetti (plastic tubing) slides over the smaller spaghetti and the main tube. The larger-size spaghetti used here was obtained from inside an aerosol spray can. (Turn page.)

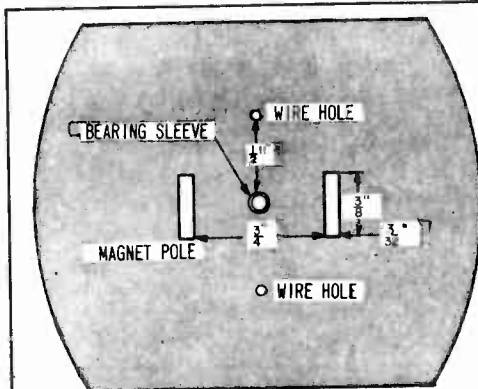

Detail Drawing D

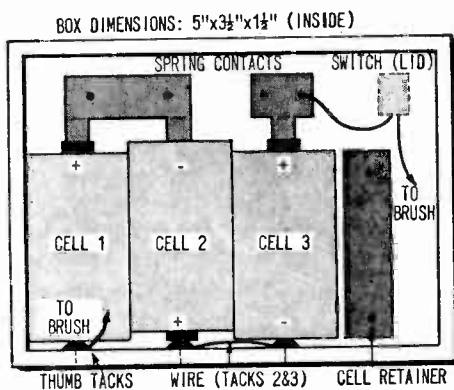

Detail Drawing E

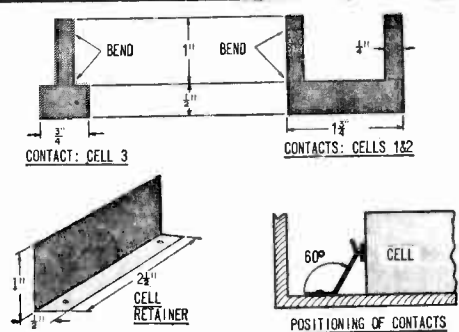

Detail Drawing F

Drawing D is the layout of holes cut in the doorbell cover to accommodate magnet poles, bearing sleeve and armature wires. Pole slots' size and position may have to be changed to suit magnet used. Drawing E gives cell arrangement, polarity and wiring. Cells are held in place by the spring contacts, which, along with the cell retainer, are fastened to the base with thumbtacks through the small holes indicated by black dots. Spring contacts are made of any light gauge sheet metal formed as illustrated in F.

EXPERIMENTER'S SIMPLEX MOTOR

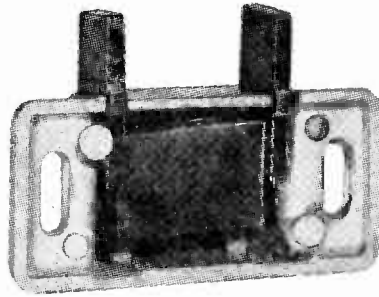
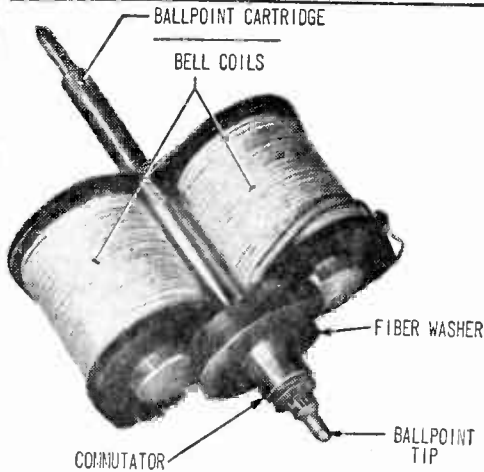

Completed armature assembly at left is ready for installation as soon as base and bearing assembly is finished. Efforts should be made to balance armature on shaft for optimum results. Field magnet above is made from magnetic door catch modified by extending pole pieces through slots to bring them closer to armature.

(Warning: puncturing an aerosol can may be hazardous unless done properly. First relieve *all* pressure through the nozzle. Then turn the can upside down, cover with a thick rag, and puncture the bottom with an awl or nail. You can now remove the bottom safely with a can opener. *Don't use cans containing hazardous chemicals such as insecticides*; used hair spray cans are plentiful.)

Procure a $\frac{1}{8}$ in. thick, $\frac{5}{8}$ in. diameter fiber washer having a $\frac{3}{16}$ in. diameter hole. This washer is slipped over the assembled commutator (as shown in Detail B) to hold the parts together. The fit should be quite tight. Before assembling, sandwich the bared ends of two pieces of solid (single-strand) bell wire under the commutator sleeves.

Notch the retaining fiber washer with a rattail file (Detail C) to fit between the two metal poles projecting from the coils. This simple expedient keeps the coil unit from swivelling on the shaft.

After fitting the shaft back onto the coil unit, connect the wires leading from the commutator segments to the coil wires as shown in Detail C. Your armature is now completed.

Magnet and Brushes. Five holes are cut into the top of the doorbell cover (Detail Drawing D). The long slots are made just large enough to permit the extended ends of the door-catch magnet to project through

the cover for about $\frac{5}{16}$ in. The small holes on the sides are just large enough for insulated solid conductor bell wire.

A bearing sleeve is soldered in the exact center, between the two magnet poles. This sleeve is $\frac{1}{8}$ in. long, with an inside diameter just large enough to take the end of the armature shaft without binding or lateral wobble. *Do not cut a hole into the lid at this point* because the ball tip of the armature shaft must rest on the cover, inside the sleeve.

Pry the rear plate off the door catch. Slide both the magnet pole pieces about halfway out of the case and secure into this new position—use masking tape or cement. The original plate probably won't go back on; it can be discarded.

Place the modified catch inside the cover so that the pole pieces (ends) project out as shown. This brings them closer to the coils for more efficient operation of the motor. There is no need for special mountings to hold the catch inside the cover; the magnetic attraction of the magnet to the steel cover is sufficient to keep it in place.

See whether or not the cover can be replaced on the doorbell base, using the original snap lugs. You may have to carefully peen a concavity (dent) into the center of the base plate to provide a little more room for the magnetic catch. If this doesn't work, cut out enough metal from the base to make room for the catch.

Brushes. To make the two commutator brushes, wind small springlike coils near the ends of two pieces of solid bell wire. Allow about 1 in. of the bared end to project sideways from the springs to contact the commutator. About three or four turns of wire around the discarded ink tube will form a spring long enough to bring the bared ends to the proper height to contact the commutator.

Slide the wires through the holes snugly, and form a flat loop on each so that it lies against the inside of the cover top; tape to the top to keep the spring from turning. Properly adjusted, these springs will provide just the right amount of pressure against the commutator for good contact without excessive drag. The free ends of the wires can be brought out through a hole in the side of the cover for connection to external batteries, or they can be passed down into the box, if used.

Armature Bracket. The photograph shows how the bell clapper is used as a bracket to hold the upper end of the armature shaft. First bend the arm (which originally held the gong) into a vertical position; it should be about $\frac{3}{4}$ in. from the cover, and extend to a height of about 2 in.

Drill a hole through the bronze spring attached to the end of the clapper; bolt it to the hole in the gong arm using one of the doorbell terminal screws and a wing nut shaped from the small metal piece to which

the terminal screw was originally attached.

Before fastening the clapper in place, drill a small hole into the strike knob on the end of the clapper. This should be just wide and deep enough to hold the tip of the armature shaft without binding.

When the clapper is in place, bend the soft metal into a curve to bring the shaft hole into the proper position. The springiness of the clapper makes it easy to remove and install the armature at any time.

Install the armature and connect to three D-size dry cells for a test run. You may have to fiddle with the wire brushes a bit to make proper contact, but once adjusted they will function very well. Most of the time the motor will start on its own when the current is turned on; a slight turn of the armature may be required once in a while.

Gong Flywheel. The motor works without the flywheel which is used mainly to make the motor look more interesting and to protect the armature from damage. The motor will start up a little more slowly because of the added weight, but it soon builds up to a very respectable speed. Also, the flywheel will continue to spin for some time after power is removed.

Drop a $\frac{5}{8}$ in. diameter conical washer made from a faucet gasket onto the shaft so that it rests on the coil bracket. Place the gong into position. A retainer is made by thrusting a $\frac{3}{16}$ in. length of $\frac{1}{8}$ in. diameter plastic tubing inside a $1\frac{1}{2}$ volt dry-cell

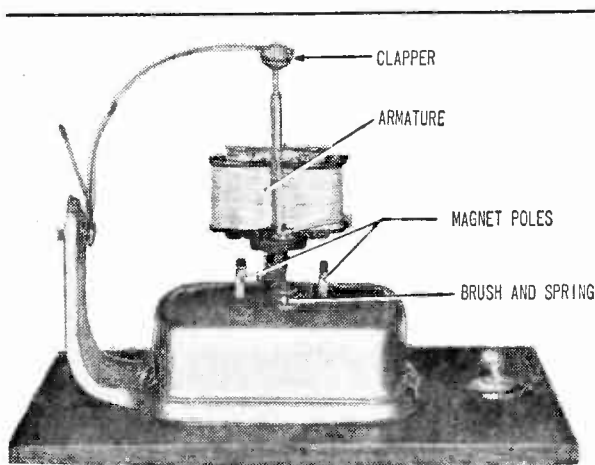

Completed motor assembly above, minus gong flywheel, is ready for a test spin. At right, internal view of base box shows arrangement of power supply.

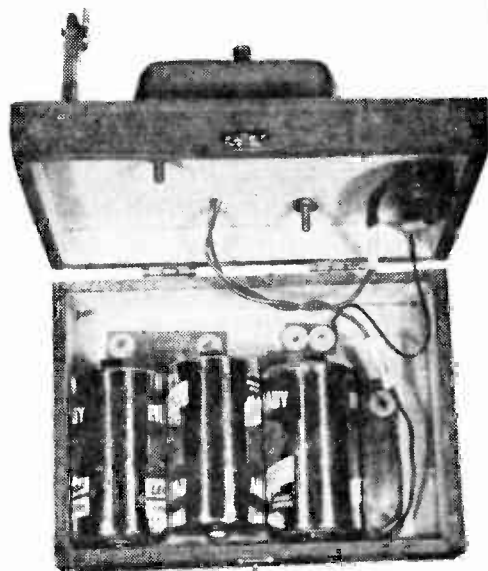

EXPERIMENTER'S SIMPLEX MOTOR

terminal nut. Allow about $\frac{1}{16}$ in. of the tube to project from the end of the nut.

This should provide a snug sliding fit on the shaft. The projecting bit of plastic tubing goes into the hole in the gong which is otherwise a bit over-sized for the shaft. The gong should be centered on its shaft, and tight enough so that it cannot wobble as it rotates. This arrangement permits quick and easy removal of the flywheel at any time.

Box Fittings. You can make your own battery box, or obtain one (at low cost) from a handicraft supply store; these unfinished boxes are intended for decorating—to make jewelry boxes and the like. A box with hinges and a small clasp is ideal.

Place three D-size dry cells in the front of the box as shown in Detail E and mark the position of the terminals on the inside wall of the box. Wind a few turns of the bared ends of bell wire around the pins before pushing into place. The wire from tack 1 is connected to one of the wires leading from the commutator brushes. Tacks 2 and 3 are joined with a short length of wire. Use metal tacks, of course, removing any paint if necessary.

A double-pronged contact, fashioned from sheet metal, connects the opposite ends of cells 1 and 2. A single pronged contact to cell 3 has a wire attached which connects to the switch. Dimensions of the battery-

box contacts, and the method of bending for proper positioning are given in Detail F. A sheet metal "cell retainer" keeps the cells from rolling about in the box.

The toggle switch is mounted in the top of the box as shown in the photograph—not in the corner as it seems to be indicated in Detail Drawing E.

A light mahogany stain, followed by a coat or two of varnish converts the battery box and motor assembly into an attractive showpiece.

Suggested Modifications. Instead of using the simple *on-off* switch, you may want to install a cross-over reversing switch to run the motor in either direction at will. If you are satisfied with a single direction of rotation, have the commutator work *with* the wire brushes, not against them by switching the battery leads if necessary.

If your motor isn't perfectly balanced, and the speed seems a bit excessive for smooth rotation, try adding a small variable resistance as a speed control.

Of course you can cheat a bit. You can use a cigar box or a file-card box if you have a suitable one around. You don't have to go to all that work in making the contacts for the battery box—you can buy ready made ones listed in most catalogs or use a 6-volt battery with screw terminals.

You'll have a lot of fun building this motor and showing it off to others. And you may discover—as I did—that this novelty motor will even "ring the bell" with your wife; she will probably consider it "cute" enough for display in almost any part of the house! ■

Extending Component Leads

- After the same components have been soldered into several different experimental circuits which then have been dismantled, the length of the

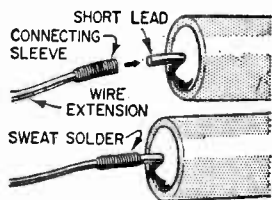

leads gradually becomes shorter until the parts are no longer usable. You can extend such leads for further use by splicing on a 2-in. length of bare wire about the same diameter as the component lead. Wrap several turns of #22 or smaller bare wire tightly around the larger wire, near one end, to form a connecting sleeve.

Scrape both wires clean or remove any enamel coating with solvent. Then push it up until it extends partly beyond the end of the wire. Insert the short component lead into the end of the sleeve and sweat-solder it, using resin sparingly. ■

Rubber-Mount Treble Speaker

- Rubber suction cups are ideal shock-mounts for treble loudspeakers. They make good mechanical mounts and acoustically isolate the speaker frame from cabinet panels which tend to accentuate the bass frequencies. Attach the cups to the speaker frame with screws (get the kind of cups having threaded inserts or screws) and to the cabinet panel with rubber or service cement. ■

Flat amplifiers are great but you must have a flat input signal. Here's how to match that pickup.

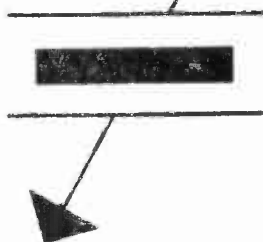

Ceramic Pickup EQUALIZING PREAMP

by Jay Copeland

■ One of the problems with home-made phono amplifiers is that they are invariably *flat*—good circuit design can make even the cheapest transistor audio amplifier flat to within ± 3 db throughout the usable portion of its frequency curve. You would think this feature would be desirable, but it's not necessarily so when you take a *hard* look at the signal supplied by the phono pickup. The unequalized output voltage curve for a typical ceramic cartridge extends from 50 to 10,000 cps, peaks at about 300 cps, and falls about 6 db per octave at 50 cps and 15 db per octave at 10,000 cps. Also, the impedance of a ceramic pickup decreases as the frequency is increased. On top of this non-linear characteristic the signal is

further complicated by the record manufacturers. Recordings are deliberately made with reduced amplitudes at low frequencies, a relatively flat middle frequency range, and increased amplitudes at high frequencies.

Therefore, a carefully designed preamplifier circuit is needed to boost the low-frequency signals, reduce the highs and match the ceramic pickup's impedance. And all of these things must be done before passing an equalized audio signal to the frequency-*flat* amplifier.

Fortunately, the recording industry had decided on a recording equalization standard (R.I.A.A.) and the characteristics of ceramic pickups are almost universally identical with respect to frequency response and im-

PARTS LIST FOR EQUALIZING PREAMP

- C1—.01-mf. disc capacitor (voltage not critical)
 - C2—.0033-mf. disc capacitor (voltage not critical)
 - C3—10-mf., 6-WVDC electrolytic capacitor
 - Q1—2N1091 npn transistor, RCA (Alternates are 2N440, 440A, 635, 636, 636A, 1005, 1006)
 - R1—220,000-ohm, 1/2-watt resistor 5%
 - R2—33,000-ohm, 1/2-watt resistor 5%
 - R3—10,000-ohm, 1/2-watt resistor 5%
 - R4—4,700-ohm, 1/2-watt resistor 10%
 - 1—Perf-board cut to 2 3/4" x 2 1/2" approx.
 - Misc.—Flea clips, bare and insulated wire, solder, etc.
- Estimated cost: \$3.50
Construction time: 1 1/2 hours.

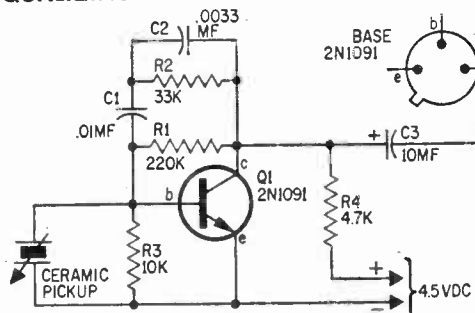

Equalized output is taken across C3 and the negative lead of the DC power input.

Layout of the components on the perforated circuit board is not at all critical—but watch ground connections if you take power from amplifier.

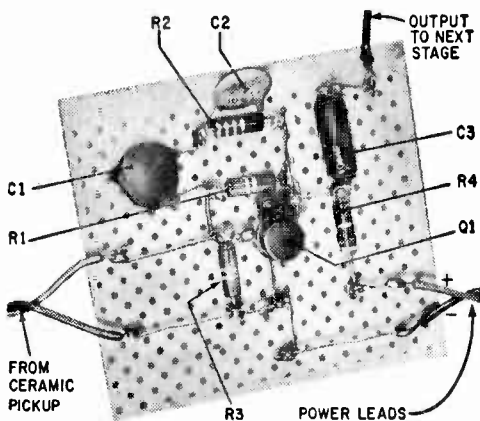

pedance output. Now, a preamplifier can be designed to *straighten* the frequency-output curve from a ceramic pickup's signal prior to being fed to a *flat* amplifier.

How it works. The schematic diagram for the ceramic-pickup preamplifier appears to be a basic common-emitter type using an *npn* small-signal transistor—except for the collector-base network (resistor R2 and capacitors C1 and C2). Resistors R1 and R3 provide fixed base bias. The amplifier's input impedance is made smaller than the pickup's impedance and Q1's current gain is made to vary inversely to the velocity response of the R.I.A.A. recording characteristics.

The negative feedback characteristics of the collector-base network do the equalizing—C1 is the effective circuit element for frequencies between 30 and 500 Hz (cps); R2 between 500 and 2000 Hz; and C2 above 2000 Hz.

The large amount of negative feedback reduces distortion and permits the use of low operating current in the collector circuit. This is essential for a low-noise output signal. The fact that no equalizing network is connected in series with the base also helps reduce noise.

The low input impedance of the preamplifier permits hookup to all available ceramic pickups on the market today. Remember, unlike a vacuum-tube amplifier circuit, this transistor preamplifier depends on

the apparent input impedance mismatch for proper audio equalization.

Putting It Together. Parts layout, shown in photo, closely matches the schematic diagram. All resistor, capacitor and transistor leads terminate at flea clips. If you prefer not to use flea clips, make all connections by passing leads through perf-board holes and soldering underneath perf-board. Twisted wire leads can be used to connect to ceramic pickup and amplifier input terminals. Shielded cables should be substituted if hum level is high. Also, it may be necessary to connect a 10-mf. 6-volt electrolytic capacitor across the power supply leads (watch polarity) if preamp taps power from phono's power supply.

Installation is not critical. Keep leads short and locate perf-board away from heat. A classical recording (with violins) can serve as a test record. Play the recording before and after modification—use your amp's *AUX* input. ■

A Safe Connection

- When making a wire connection for your projects, cut two one-inch pieces from a half-inch rubber tube. Split these and put one around

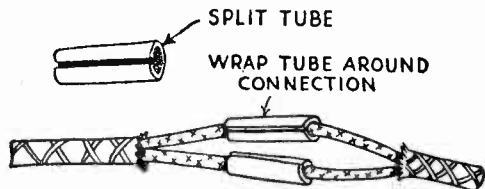

each wire at the connection point. Then wrap some plastic electrical tape over all, and it makes a neat, safe job. This idea is not suitable for power or lamp cords.

Polystyrene Tubing Insulates Chokes

- To protect the metal ends of an RF choke from accidental contacts in a crowded radio chassis saw a lengthwise slot on one side of a length of polystyrene tubing, and slip it over the RF choke.

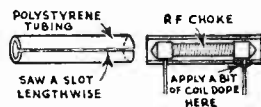

For straight-wound chokes, $\frac{1}{2}$ in. O.D. tubing is about right, but for pie-wound chokes use larger tubing. Coil-dope or speaker-cement applied to wire leads where they enter tubing keeps tubing from slipping off choke. Or, heat the ends of the tubing and pinch them shut. Use color code to indicate value.

By Robert E. Kelland

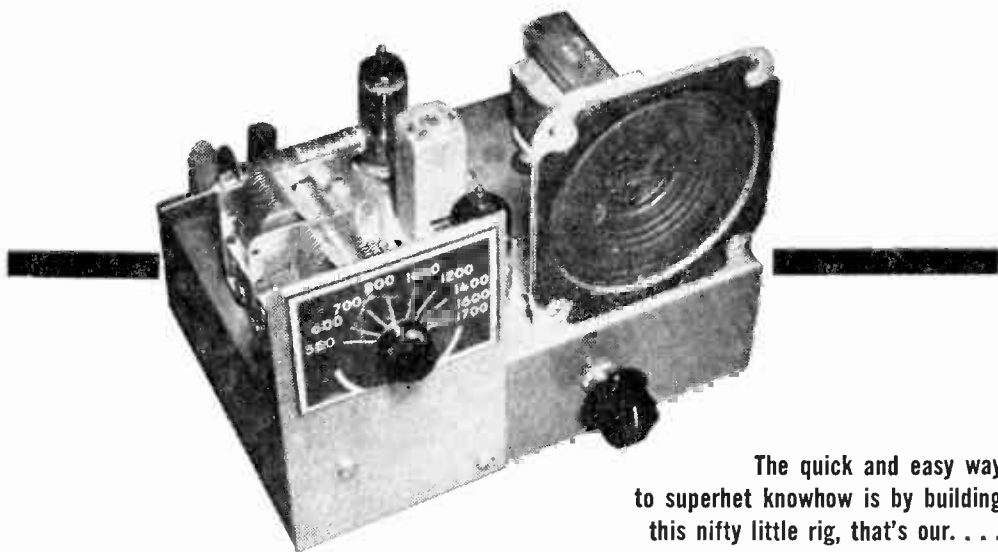

The quick and easy way to superhet knowhow is by building this nifty little rig, that's our. . . .

BCB 2 for Beginners

■ A regular superhet can be a pretty complicated way to grind your teeth in the realm of receivers. That's because you need a bevy of parts and plenty of spare time for construction. There's also the disheartening fact that it's simply cheaper to buy a standard four tube job than it is to build one.

But here's a little rig that'll get you initiated into the ranks of experimenters who find the superhet old hat, and it'll do so without making you float a loan at the local shark's. On top of that, the BCB 2 will stand you in good stead for years to come as a handy, reliable little BCB grabber.

What's really unusual about this rig is the fact that though it's got but two tubes, it's actually a full-fledged superhet. Most radio experimenters are well aware of the inherent drawback of a simple TRF broadcast radio. The selectivity (ability to separate stations) of TRF jobs tends to keep them confined to the experimenter's bench. The BCB 2 overcomes this drawback by in-

corporating the superheterodyne principle.

Two To You. A look at the schematic diagram reveals the combination of circuits used. The loopstick antenna coil (L1) and the tuning capacitor C1A do the usual job of tuning in the frequency desired. The signal selected is passed to the grid of the 6BE6 pentagrid mixer tube. At the same time, the local-oscillator tuning-capacitor C1B, and coil L2 are together generating their own radio frequency signal which is 455 kHz higher than the station frequency. The oscillator signal is coupled to another grid in the 6BE6.

The station signal and the local oscillator signal mix in the 6BE6 and the output frequency in the plate circuit is the difference between the two frequencies, or 455 kHz. The new frequency carries the same audio components as the original station carrier frequency. The primary of the intermediate frequency (IF) transformer is tuned to this frequency and it couples the signal to its

BEGINNERS' CBB 2

secondary, which is also tuned to 455 kHz.

The triode section of the 6BL8 has the dual job of demodulating the radio signal and of giving some audio boost. Grid-leak detection was found to give good audio reproduction in this circuit. The final stage further amplifies the audio signal and passes it on to the speaker.

Here's How. Use a 5 x 7 x 2 in. chassis and plan your layout from the photographs. The IF transformer mounts in an adapter plate which in turn mounts in a 1½-in. chassis hole. When purchasing the two-gang tuning capacitor (C1A, C1B) and oscillator coil (L2), be sure to check that they are matched (see Parts List). The antenna coil (L1) is a standard unit and will match most capacitors after some slug adjustment. If you live close to broadcasting stations you can forget about the ground jack (J2) since it isn't necessary for normal reception. The 3½-in. speaker is mounted on the chassis with two right-angle brackets. If you have a larger speaker it would be best to mount it in the radio cabinet and then bring the voice-coil leads to the radio.

All RF wiring (on the left of the IF transformer—see schematic) must be as neat as possible. Short leads and direct connections are necessary. The detector and audio stages are less critical and layout modifications can be made to suit your cabinet design. The volume control and switch can be moved almost anywhere along the front apron. The output transformer (T2) used in the model is a universal type, but almost any transformer with between 5k- and 10k-ohms primary impedance will be satisfactory. For best performance, the secondary impedance should match that of the speaker's voice coil.

Something For Nothing. A substantial increase in IF gain is accomplished by adding regeneration to the detector stage. This is done by winding four turns of #28 insulated hookup wire next to the secondary of the IF transformer as a tickler coil. Normally this winding will not cause the detector to go into oscillation. And since the detector operates at a fixed frequency, tuning won't affect the amount of feedback.

To get to the IF coils, unbend the little tabs on the bottom of the transformer that holds the cover to the base. Carefully lift off

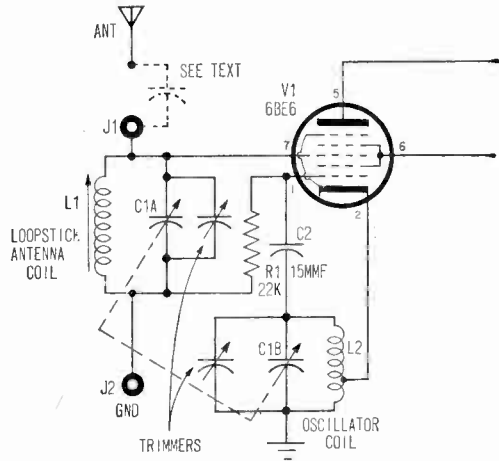

PARTS LIST

- C1A, C1B—Tuning capacitor, two-gang BCB superhet type
 C2—15-pF disc or tubular capacitor
 C3—100-pF disc capacitor
 C4—25-mF, 12-VDC electrolytic capacitor
 C5—.01-mF disc capacitor 400 volt
 C6A, C6B—20-20-mF, 150-150-volt dual electrolytic capacitor
 D1—Silicon rectifier diode, 400-PIV, 400-mA
 J1, J2—Binding posts (Radio Shack 274-736 or equiv.)
 L1—Loopstick antenna coil with adjustable slug (Radio Shack 270-1430 or equiv.)
 L2—Three-terminal (tapped) broadcast oscillator coil (Lafayette 34C8713 or equiv.)
 R1—22,000-ohm, ½-watt resistor
 R2—2200-ohm, ½-watt resistor
 R3—15,000-ohm, ½-watt resistor
 R4—1-megohm, audio-taper potentiometer with s.p.s.t. switch (S1)
 R5—82-ohm, ½-watt resistor
 R6—2200-ohm, 1-watt resistor
 R7—3.3-megohm, ½-watt resistor
 S1—See R4
 T1—455-kHz intermediate-frequency (IF) transformer, universal replacement type, with adapter plate (Lafayette 32C0946 or equiv.)
 T2—Audio output transformer (Lafayette 33C-3701 or equiv.)
 T3—Power transformer, 125-V at 25-mA, 6.3 V at 1A (Lafayette 33C8096 or equiv.)
 V1—6BE6 tube
 V2—6BL8 tube
 Spkr—3½-in. square speaker, 3.2-ohm voice coil impedance (Lafayette 32C0927 or equiv.)
 1—5x7x2-in. aluminum chassis
 Misc.—7-pin socket, 9-pin socket, terminal strips, 3x4 ½-in. aluminum plate, hardware, knobs, hookup wire, line cord and plug, solder, etc.
 Estimated cost: \$18.00
 Construction time: 8 hours

the cover and wind the tickler directly next to the secondary of the transformer, taking care not to damage the fine IF coil wire.

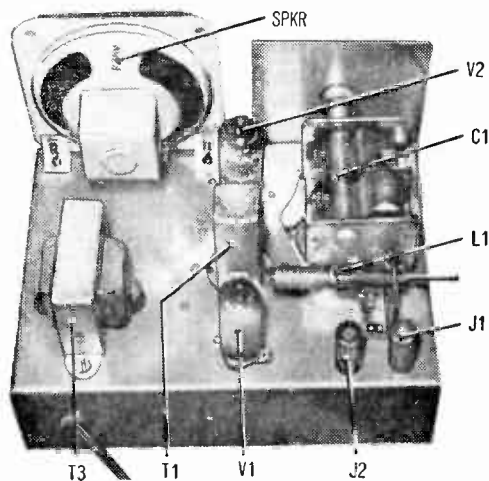
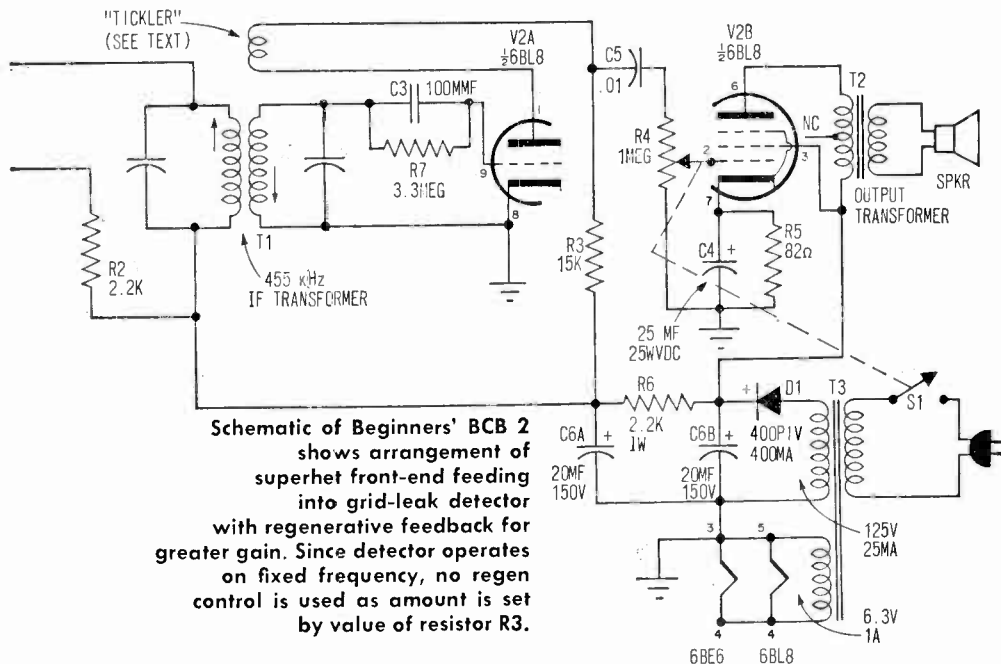

Topside layout of parts is straightforward and tidy. Use author's photos as guide for layout of your own BCB 2.

File little notches in the base of the transformer, place the tickler leads in them, and cement in place. Replace the cover and you're ready to hook up the tickler (see schematic). Bear in mind that if the tickler is connected backwards it will decrease gain instead of increasing it. If this happens in your case, just reverse the connections.

If the detector breaks into oscillation as a result of the tickler, increase the value of

the plate load resistor (R3) until oscillation stops.

Firing Her Up. After the tubes warm up, check for proper audio operation by touching your finger to the grid (pin 9) of the 6BL8. A loud hum should be heard which may be increased and decreased by the volume control. If this checks out, connect a short antenna (not more than 6 ft. long) and try tuning for a station. If you are lucky, you will pick up local stations. However,

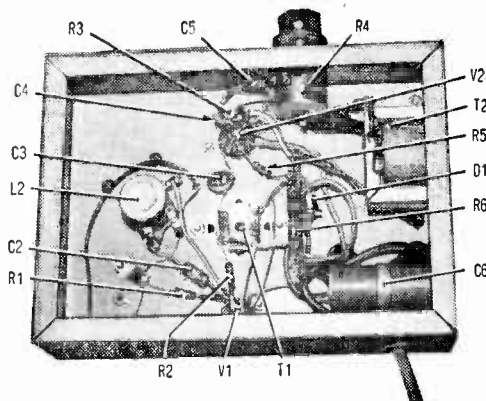

Completed wiring of BCB 2 shows few parts and wide-open spaces, making construction and assembly a snap.

BEGINNERS' CCB 2

your set will likely require alignment before satisfactory results are obtained.

To align the IF transformer, a modulated RF signal from a signal generator is needed. If a generator is available, connect it to the antenna jack through a 200-pF capacitor. Connect a VOM or a VTVM set on a low AC voltage range across the speaker terminals. Set the tuning capacitor to the high end of the broadcast band (plates fully open) and tune the generator to produce a modulated 455-kHz output. Adjust the slugs in the IF transformer (top and bottom) for maximum output as indicated on the voltmeter. The remainder of the alignment procedure can be done by "ear."

Set the tuning capacitor to a position where a station should be. A look at another radio tuned to the station desired will give you an idea of where to set the capacitor. Adjust the slug in L1 and the trimmer capacitor on C1B until the station is heard. If successful, tune for other stations and note their relative levels. Some retouching of the oscillator trimmer and antenna coil, along with the antenna trimmer capacitor (on C1A) will be needed to get optimum performance right across the band.

Antenna Hookup. If you use a long an-

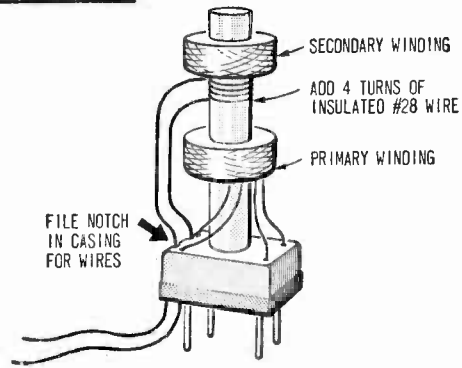

Regenerative feedback is supplied by adding tickler coil to IF transformer. Care must be taken not to damage IF coil wires.

tenna it may be necessary to connect a small coupling capacitor between the antenna and the antenna jack to prevent the mixer from blocking and distorting the signal. As a final step, a suitable dial must be made to agree with the capacitor tuning. A simplified dial which includes only the local stations in your area is easiest to make, or you can do as the author did and salvage a dial from a junked CCB receiver.

But however you finish off your CCB 2, you've got a superhet under your belt and a neat little rig that's nice to have around. ■

CB'S COAX-COBRA

□ You may think it would be easy to fabricate a whip antenna from some wire strung up from a tree—and it is! But, if you're going to all that trouble, why not make the Coax-Cobra? It takes a few minutes to knock together from a 16-ft. or longer length of coax, and it'll outperform any whip you could assemble.

Take the required length of RG-58A/U cable, and strip the black outer coating and metal braid a distance of 8 ft. 3 in. from one end. Make a loop at this end by folding over 2 in. and taping. Now, measure 7 ft. 4 in. down from where the stripping ended and make 4 turns (loops) 5 in. in diameter, wrapping the loops with plastic electrical tape to hold them in place. That's about all there is to it—just measure off the distance between the loops and your rig, cut the cable, attach a PL-259 (Amphenol 83-1SP plug and 83-168 adaptor), connect to the rig, and the Cobra is ready to sing.

If you go camping with a transistorized CB, our Coax-Cobra is just the antenna you should have rolled up in your pack to replace the stunted antenna stick your rig now uses. (By the way, take a peek at page 70.) ■

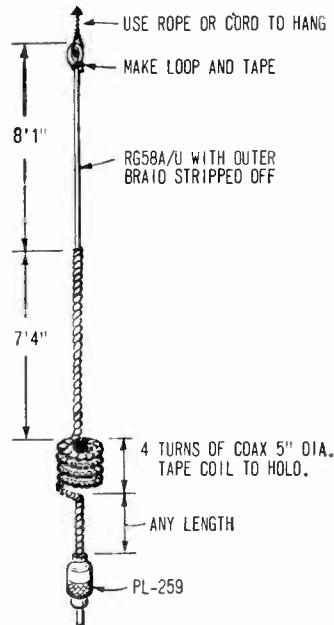



SPY IN THE TIE

Counter snooping is a game anyone can play if you keep your shirt on—and tie, too!

by Lars Jorgensen

■ Privacy is almost a thing of the past. Nearly every day the papers detail some new horizons in eavesdropping, from the phone company listening in to subscriber's conversations to executives bugging the rank-and-file employee's washroom. And of course, in this modern era of recording tape and the scissors, even the most innocuous of conversations can be *rearranged* into the most disarming of evidence. What to do? Nothing. You can scream and the most you'll get is a few sympathetic words from your Congressman, but not much else; for the *polizei* you complain to are up to their ears in wiretaps and bugs, the Feds have a sorry record of eavesdropping prosecutions, the phone company has been getting away with it for at least 30 years, and your Congressman's indignation dies with yesterday's headlines.

About the only thing *you* can do is *fight to protect the truth*; make certain that what's used against you isn't the result of some brilliant tape editing. Make certain that when you tell your neighbor "I need some money for termite poison" it doesn't come out "I poison for money."

And you can easily protect yourself with the Tie-Spy—known in the trade as an 007 FM mike. Just clip on the Tie-Spy and your words are broadcast to a nearby FM receiver, where it can be transferred to tape in an *unedited* version of what was said.

As shown in the photographs, the Tie-Spy consists of an miniature, very-short-range

FM transmitter and a microphone that appears to be a high-class diamond-studded tie-pin. You simply clip the mike to your tie (naturally you're out of luck if you wear bow ties), place a battery in the transmitter, and you're on the air. A nearby confederate can monitor your conversation on an FM portable and handle the recording.

Construction. The unit shown is housed in a plastic case approximately $2\frac{1}{8}$ x $1\frac{1}{4}$ x $1\frac{3}{4}$ inches. Actually it can be made smaller by using subminiature components. But to keep the price down to rock bottom, we have used standard components available from Allied and Lafayette Radio (among others). If you want to squeeze it into an olive by all means do so, just use the equivalent miniature values—nothing is really critical except the coil.

In a similar vein, the sound quality is exceptionally "tinny"—*readable* but "tinny." This is due to the low-impedance loading of the high-impedance crystal tie-clip mike we used to keep costs down. If you want to go for a few extra bucks get a better mike, a low impedance job—say a dynamic type from 500 to 5000 ohms. You can even try a small transistor radio speaker, or might even add a matching transformer. As we said, nothing is really critical.

The electronics is assembled on a $1\frac{5}{8}$ x $2\frac{1}{16}$ inch section of perf-board. If you slightly round-off the corners the perf-board will just fit into the plastic case.

Start assembly by mounting tuning capacitor C5 and oscillator/antenna loading coil L1. L1 is made as follows: Cut off a three foot section of AWG-18 solid enameled wire and *tensilize* it by clamping one end in a vise and pulling on the free end until the wire goes “dead slack”—unless this is done the coil will unwind when you release tension.

Using a 3/8-inch drill bit as the form, wind seven closewound, tight turns. Remove the coil from the form and stretch the first three turns so the distance from the “start” to the third turn is exactly 3/8 inch. Scrape a small bit of insulation from the start of the third turn (actually what we call the second turn), and solder about an inch of wire to this tap. As shown in the schematic, the tap connects to the “top” of C5 while the “start” of

frequency of use. Since there is no standard battery holder you have to make your own. The battery holder is simply two L-brackets fashioned from scrap aluminum (an old Minibox) or copper. The L-brackets are mounted to the board with 2-56 machine screws. Connection is made to the clips by soldering directly to the *head and nut*. Note that the negative clip has a hook at the end. The battery’s negative terminal is slightly

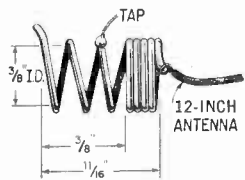

Coil is quite critical since it determines the transmitting frequency. It must be right on the button.

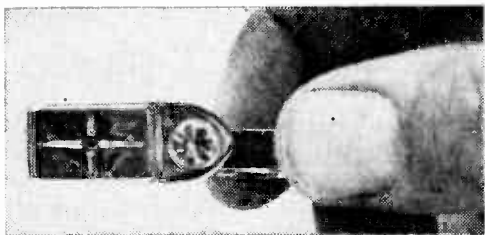

While the tie-bar may not be the most in men’s jewelry it does the job—it’s the microphone that counts the most right here.

recessed into its case, so to insure connection you must form an 1/8-inch “hook” which will bite into the negative battery terminal.

The Mike and Antenna. The mike is supplied with a mini-plug. Cut off the plug, un-braid the shield—forming a *tinned* twisted lead with no free strands—and solder the mike cable directly to a ground terminal and the input to C1. The antenna consists of 12 inches of very-thin stranded wire—AWG-22 or thinner—soldered to L1’s free end.

the coil connects to Q2’s collector. The free end of the coil will be connected later to the antenna.

Drop the unit into the plastic case, leaving the hinged cover open. Mark the points where the mike and antenna leads will pass through the case. Remove the transmitter and quickly press a hot soldering tip into the edge of the case at marks for the mike and antenna leads. The case will melt under the iron, forming the openings for the two leads. Don’t press down hard or you’ll go right through the case. . . . If desired, melt a hole opposite the adjusting screw of C5—so you can change frequency without actually

Flea clips or Vector T28 push-in terminals are used for tie points and supports. To mount the C5-L1 assembly, push in a set of terminals directly under C5’s solder tabs and install a very short support lead from C5’s tabs to the terminals.

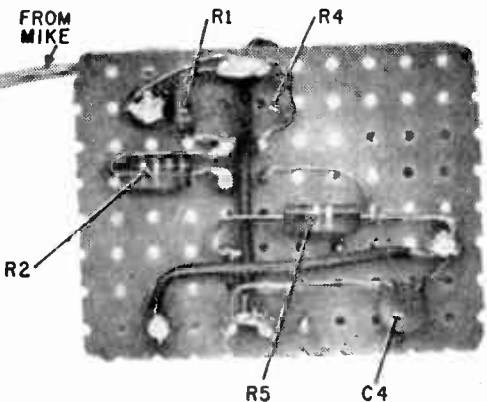

To insure frequency stability C6 should be the silver mica type or its equivalent. Space gets a little tight on top of the board so miniature resistors (1/10 or 1/8 watt) and capacitors are suggested. The components on the bottom of the board can be “standard” size (1/4-watt resistors, etc.).

Either 1/10 or 1/2-watt resistors can be used here on under side of perf-board.

We can only be certain the project will work with the transistors specified in the parts list, do not substitute another type for the specified Q1 and Q2.

Battery Power. The power supply has no *on-off* switch. To start the transmitter you simply clip in the battery. To turn the unit off you remove the battery. The specified battery will give an average of 35 hours service, depending on the “freshness” and fre-

PARTS LIST

- B1—7-volt mercury battery, Mallory (Allied 55J886 or equiv.)
 C1—2-mf, @ 6-volt DC
 C2—10-mf, @ 12-volt DC
 C3, C4—500-mmf ceramic disc
 C5—2.7-30 mmf, trimmer capacitor (Arco 461 or equiv.)
 C6—5-mmf silver mica
 L1—see text
 M1—Tie-Clasp Microphone, (Lafayette 99C-4567 or equiv.)
 Q1—Transistor, Motorola HEP 52 (from Allied)
 Q2—Transistor, Motorola HEP 251 (from Allied)
 R1—4700-ohm, 1/10-watt resistor
 R2—330,000-ohm, 1/10-watt resistor
 R3—10,000-ohm, 1/10-watt resistor
 R4—47-ohm, 1/10-watt resistor
 R5—100,000-ohm, 1/10-watt resistor
 R6—470-ohm, 1/10-watt resistor
 Misc.—Plastic cabinet, (Lafayette 13C3801); perf-board; terminals, wire, solder, L-brackets, machine screws, nuts, etc.

Estimated cost: \$7.00
 Construction time: 2 hours

removing the transmitter from the plastic case.

Checkout. Insert the battery into the clips—get the polarity right—close the case, place an FM receiver near the transmitter, and place the mike near the receiver's speaker. As you tune the receiver you can't miss the transmitter's frequency, the feedback will be unbearable. To change the transmitter's frequency, adjust C5 until there is no interference from strong FM-broadcast stations.

Protecting yourself. To use the Tie-Spy, clip the mike to your tie, place the transmitter in your trouser's side pocket, and run the

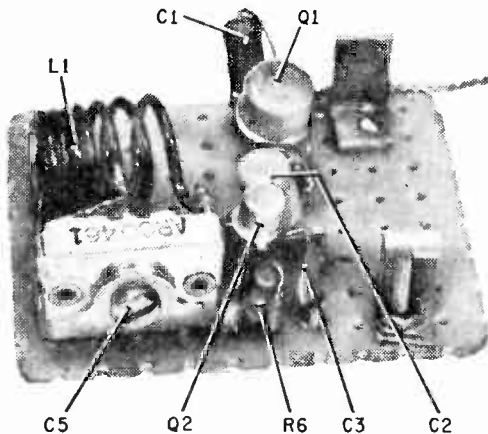

Tight-wound portion of L1 is a loading coil for the short antenna—the spread portion tunes with C5. Leads that connect to the base, emitter and collector of Q2 should be kept as short as possible (a normal VHF wiring technique). Those to Q1 aren't as critical. Transparent plastic box protects delicate parts—specially L1 and C5—from damage.

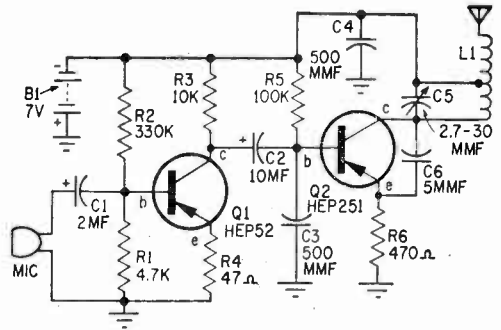

Circuit is simple but you must remember that wiring at 100 MHz is critical—all leads to Q2 and L1-C5 must be kept short to get proper operation on the FM band.

antenna around your waist under your belt or under the back of your shirt, or wherever you prefer. The effective transmitter range will be about 25 to 50 feet. Don't try to speak directly into the mike as the gain is very high and the modulation will severely "pop"—the gain is designed to pick up voices from one to three feet. Naturally, the better the mike the better the reproduction.

A Note of Warning. The transmitter *must* operate between 88 and 108 MHz (mc) and it must not interfere with a commercial broadcast signal. And the transmitter must be certified by an electronics technician that it has no spurious emissions and conforms to FCC requirements. For more details concerning wireless-mike FM transmitters we suggest you write to the FCC, Washington, D.C. 20554 and request Bulletins 11 and 12 concerning FCC rules pertaining to license-free, low-power transmitters. ■



Join "THE TROUBLESHOOTERS"

They get paid top salaries
for keeping today's
electronic world running

Suddenly the whole world is going electronic! And behind the microwave towers, push-button phones, computers, mobile radio, television equipment, guided missiles, etc., stand THE TROUBLESHOOTERS—the men needed to inspect, install, and service these modern miracles. They enjoy their work, and get well paid for it. Here's how you can join their privileged ranks—without having to quit your job or go to college in order to get the necessary training.

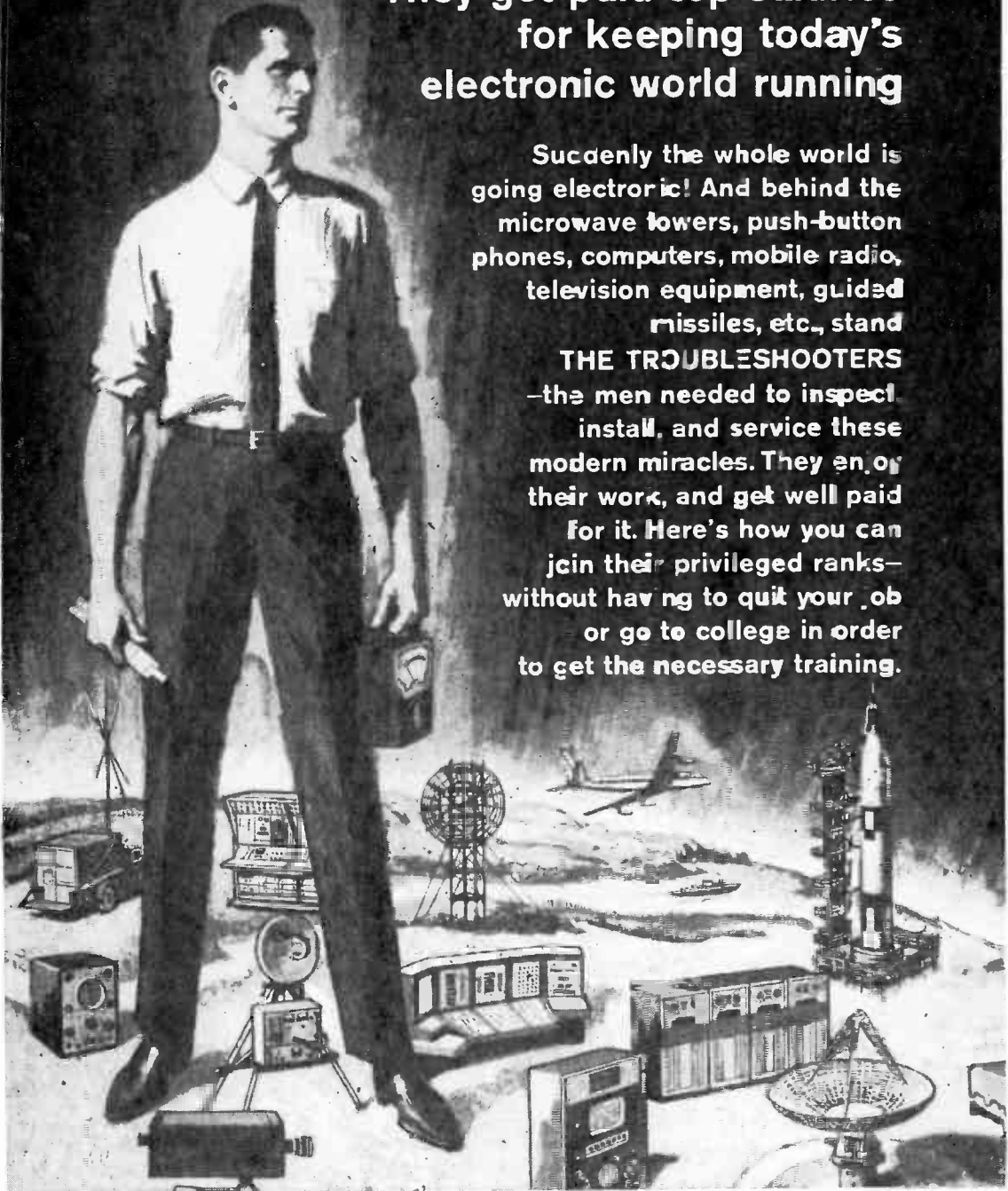

JUST THINK HOW MUCH in demand you would be if you could prevent a TV station from going off the air by repairing a transmitter...keep a whole assembly line moving by fixing automated production controls...prevent a bank, an airline, or your government from making serious mistakes by repairing a computer.

Today, whole industries depend on electronics. When breakdowns or emergencies occur, someone has got to move in, take over, and keep things running. That calls for one of a new breed of technicians—The Troubleshooters.

Because they prevent expensive mistakes or delays, they get top pay—and a title to match. At Xerox and Philco, they're called Technical Representatives. At IBM they're Customer Engineers. In radio or TV, they're the Broadcast Engineers.

What do you need to break into the ranks of The Troubleshooters? You might think you need a college diploma, but you don't. What you need is know-how—the kind a good TV service technician has—only lots more.

Think With Your Head, Not Your Hands

The service technician, you see, "thinks with his hands." He learns his trade by taking apart and putting together, and often can only fix things he's already familiar with.

But as one of The Troubleshooters, you may be called upon to service complicated equipment that you've never seen before or *can't* take apart. This means you have to be able to take things apart "in your head." You have to know enough electronics to understand the engineering specs, read the wiring diagrams, and calculate how a circuit should test at any given point.

Now learning all this can be much simpler than you think. In fact, you can master it without setting foot in a classroom and without giving up your job!

AUTO-PROGRAMMED™ Lessons Show You How

For over 30 years, the Cleveland Institute of Electronics has specialized in teaching electronics at home. We've developed special techniques that make learning easy, even if you've had trouble studying before.

For one thing, our AUTO-PROGRAMMED™ lessons build your knowledge as you'd build a brick wall—one brick at a time. Each piece rests securely on the one that came before it.

ENROLL UNDER NEW G.I. BILL

All CIE courses are available under the new G.I. Bill. If you served on active duty since January 31, 1955, or are in service now, check box on reply card for G.I. Bill information.

In addition, our instruction is personal. When your teacher goes over your assignment, no one else competes for his attention. You are the only person in his class. He not only grades your work, he analyzes it to make sure you are thinking correctly. And he returns it the day it's received so that you can read his comments and corrections while everything is fresh in your mind.

Always Up-To-Date

To keep up with the latest developments, our courses are constantly being revised. This year CIE students are getting new lessons in Laser Theory and Application, Microminiaturization, Single Sideband Techniques, Pulse Theory and Application, and Boolean Algebra.

In addition, there is complete material on the latest troubleshooting techniques including Tandem System, Localizing through Bracketing, Equal Likelihood and Half-Split Division, and In-circuit Transistor Checking. There are special lessons on servicing two-way mobile equipment, a lucrative field in which many of our students have set up their own businesses.

Your FCC License—or Your Money Back!

Two-way mobile work and many other types of troubleshooting call for a Government FCC License, and our training is designed to get it for you. But even if your work doesn't require a license, it's a good idea to get one. Your FCC License will be accepted anywhere as proof of good electronics training.

And no wonder. The licensing exam is so tough that two out of three non-CIE men who take it fail. But CIE training is so effective that 9 out of 10 of our graduates pass. That's why we can offer this warranty with confidence: *If you complete one of our license preparation courses, you'll get your license—or your money back.*

Mail Card for 2 Free Books

Want to know more? Mail the postage-paid reply card bound here. We'll send our 40-page catalog describing our courses and the latest opportunities in Electronics. We'll also send a special book on how to get a Commercial FCC License. Both are free. If the card is missing, just send us your name and address.



Cleveland Institute of Electronics

1776 E. 17th St., Dept. EB-1, Cleveland, Ohio 44114

Accredited Member National Home Study Council
A Leader in Electronics Training... Since 1934



build our 1-TUBE BOTTOM SCRAPER

Here's a one-tube receiver project that has been designed especially for eavesdropping on the Navy's super-powered CW stations that operate in the vicinity of 20 kHz(kc). Whether you're interested in high-speed code practice with 5-letter cipher groups, want to copy the latest news flashes in plain English, or merely want to set your watch by good ol' Naval Observatory time signals, it will pay you to have a receiver that tunes to the fantastically-long wavelengths in the neighborhood of 15,000 meters.

Just think of it, a half wave antenna for this range is almost 5-miles long! Of course you won't need one that long to pick up signals satisfactorily. In Michigan, where the author lives, a hundred feet of wire and

a good ground provide excellent reception, day or night, of NAA in Maine; NSS, Maryland; and NPG on the west coast. As a matter of fact, that's why Uncle Sam uses such long waves. They offer consistently good reception all over the world so that even submerged nuclear subs on the other side of the globe can get their latest orders without difficulty.

About The Circuit. The receiver consists of a regenerative detector that tunes from 13 to 28 kHz plus a single stage of audio amplification. A self-contained power supply furnishes DC for the tube.

You tune to different VLF stations by varying the position of the slug in L1, a TV horizontal-oscillator coil which is paralleled

Bottom Scraper was built on chassis without panel or cabinet. If you want a more impressive receiver, unit can be housed in a small sloping-front enclosure.

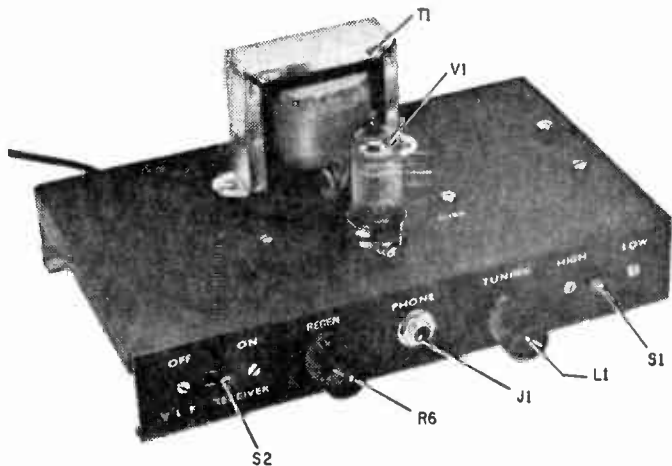

By Hartland B. Smith, W3VVD



... and tune in the unbelievable subbasement of radio!!!

by C1. An extra capacitor, C2, may be switched across coil L1 to provide sufficient tuning range—to cover the entire band from 13 to 28 kHz. Schematic diagram is located on page 49.

In the antenna circuit, choke L2 passes very-low frequencies, but offers a high impedance to strong local broadcast signals. It prevents them from reaching the grid of V1A where they would be detected and cause unwanted interference.

Potentiometer R6 is the regeneration control which varies the screen voltage of V1A. When this voltage is set at the proper level, V1A oscillates to provide the beat note required for reception of CW signals.

The detector's output is coupled, via C4,

to the grid of V1B where the audio signal is amplified. The plate circuit of this stage is capacitance-coupled to high-impedance headphones plugged into J1.

The half-wave rectifier power supply furnishes approximately 150-volts DC to the plates of tube V1. The filament winding of transformer T1 supplies 6.3 volts AC for the heater.

Construction. Most articles tell you to carefully follow the layout of the original and to avoid parts substitutions. This receiver is different. You can employ just about any layout that suits your fancy, without degrading the performance of the set. As a matter of fact, the short, direct leads usually required in RF circuits are of little

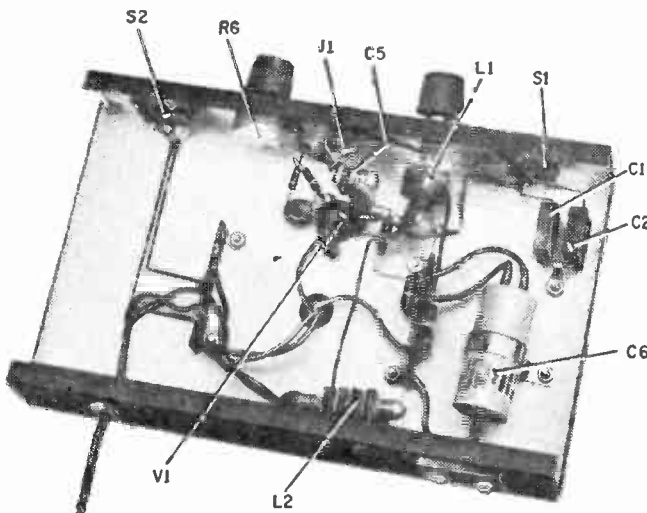

Bottom view of chassis of Bottom Scraper shows there is plenty of room, so smaller chassis could be used without affecting operation. Other frequencies below 540 kHz can be tuned if additional capacitors are switched by a multi-position S1.

Bottom Scraper

consequence in a unit that operates at or near the audio frequency range.

With the exception of L1, C1, and C2, component values may vary by as much as 50% from the figures specified, with little or no effect on the receiver's operation. As a result, this gadget is a natural for construction from junk box parts.

The threaded brass adjustment shaft of L1 is too small to accept knobs designed for 1/4-in. shafts. A short length of plastic rod

or wooden dowel is cemented over the end of the shaft so that an ordinary knob can be fastened to it. Since L1 was not designed by the manufacturer for constant tuning, it will pay you to apply a small amount of Lubriplate or Vaseline to the threads in order to minimize friction and wear.

Operation. Attach an antenna at least a hundred feet long to the ANT terminal of TS1 and a good cold-water pipe ground to the other terminal. Screw the slug of L1 fully counterclockwise (all the way out of the coil) and open S1 (*HIGH* setting). Plug a pair of headphones into J1 and turn S2 *on*.

After V1 has warmed up for a minute or two, advance R6 until you hear a hissing

Pictorial diagram can be used by the beginner to successfully wire the Bottom Scraper. See schematic for proper polarity of D1.

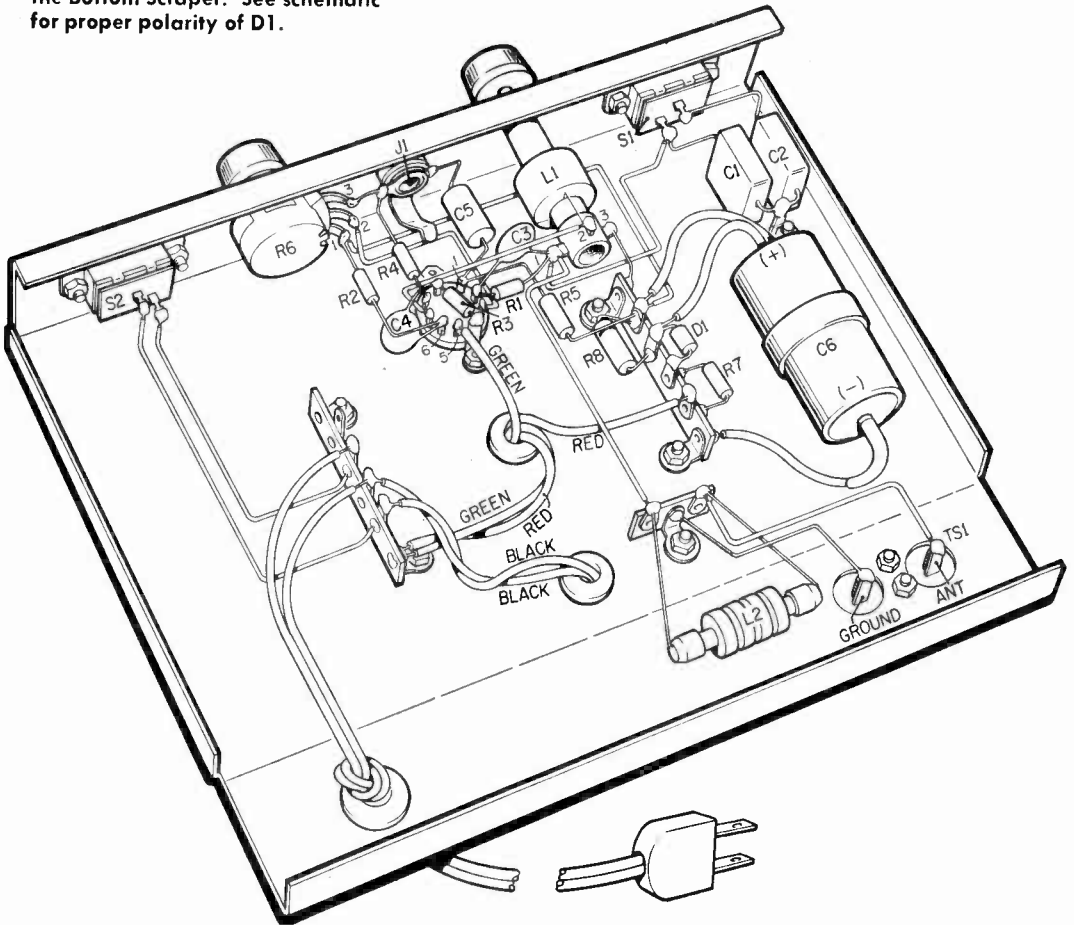

noise in the phones, which denotes that V1A is oscillating. Slowly turn the knob of L1 clockwise. As you do this, you should hear two or three different CW stations. Peak L1 and R6 for optimum reception of the desired signal. A regenerative receiver isn't very selective, so don't be surprised if you can hear the other stations faintly in the background when you are tuned to a signal.

With S1 open, the tuning range is approximately 20 to 28 kHz. With it closed, the range is 13 to 20 kHz. You'll hear a whistle when the slug is all the way into L1 and S2 is closed. This is because the detector in the Bottom Scraper is actually oscillating at 13 kHz, a frequency which all but the

oldest foyeys are easily capable of hearing.

Back the slug out a bit and the whistle will disappear. NAA, the lowest-frequency signal you'll pick up, operates just beyond the audible range. Therefore, the oscillation produced by the detector at this frequency won't bother you—at least not unless you have the supersensitive ears of an Airedale or Dachshund.

For best results, always operate the receiver with R6 set close to the point where oscillation just commences. Advancing the regeneration control too far will not only reduce sensitivity, but may even cause the oscillator to take off at an audio rate, producing an uncomfortably loud howl. ■

Schematic diagram reveals simplicity of 1-tube VLF receiver.

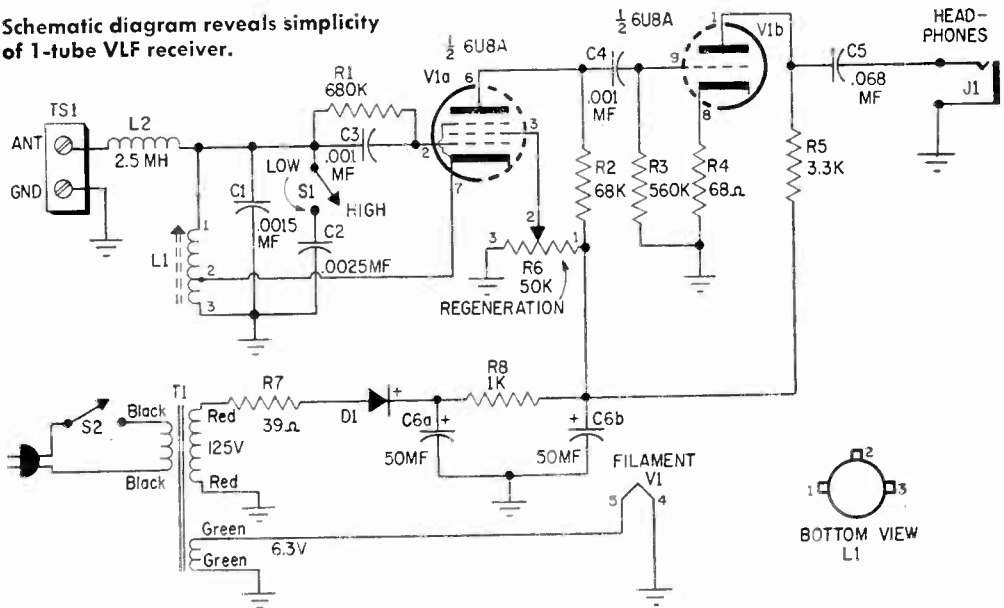

LONG-WAVE RECEIVER PARTS LIST

C1—.0015-mf. silver mica capacitor
 C2—.0025-mf. silver mica capacitor
 C3, C4—.001-mf. ceramic disc capacitor
 C5—.068-mf., 200-volt tubular capacitor
 C6—50-, 50-mf., 150-volt dual electrolytic capacitor
 D1—500-ma., 400-piv., silicon diode rectifier (IN2070 or equiv.)
 J1—Open circuit phone jack
 L1—16-42 millihenry TV horizontal-oscillator coil (J. W. Miller 6211 or equiv.)
 L2—2.5 mh. RF choke
 R1—680,000-ohm, 1/2-watt resistor
 R2—68,000-ohm, 1/2-watt resistor
 R3—560,000-ohm, 1/2-watt resistor
 R4—68-ohm, 1/2-watt resistor
 R5—3300-ohm, 1-watt resistor
 R6—50,000-ohm linear taper potentiometer

R7—39-ohm, 1/2-watt resistor
 R8—1000-ohm, 1-watt resistor
 S1, S2—S.p.s.t. slide switch
 T1—Power Transformer. Pri.: 117 volt, 60 Hz; Sec.: 125 volt, 50 ma.; 6.3-volt, 2-amp (Knight 54A1411 or equiv.)
 TS1—2-screw terminal strip
 V1—6U8A tube
 2—4-terminal insulated tie strips
 2—Knobs
 1—9x5 1/2 x 1 1/2-inch aluminum chassis
 1—9-prong miniature tube socket
 Misc.—Solder lugs, wire, solder, 6-32 machine screws and nuts, power cord and plug, rubber grommets, etc.

Estimated cost: \$14.00
 Construction time: 3 hours

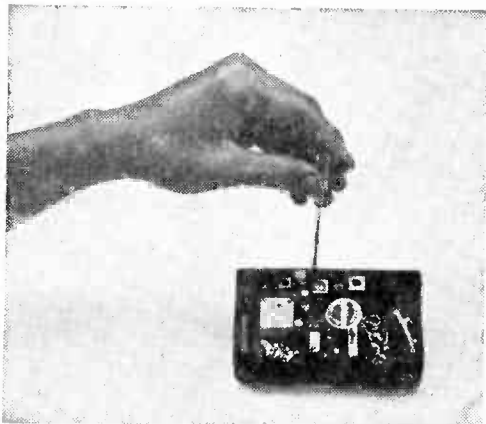

Start by removing back of radio and unscrewing circuit board.

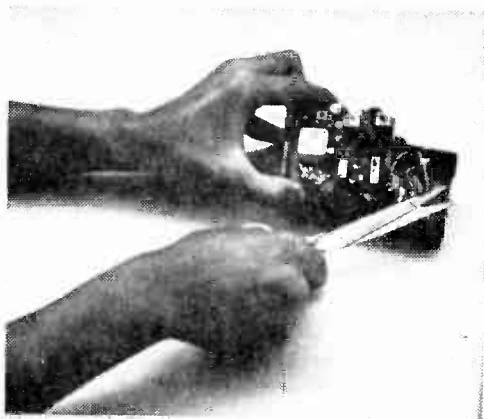

Cut wires and remove circuit board, leaving only speaker and its wires.



MAKE A MINI-MIKE

☛ If you've an old, broken-down transistor radio just waiting to be thrown away, grab onto it before it's too late. The reason: it can be turned into a great little all-purpose, low-impedance mike. To make your Mini-Mike, just follow our photo sequence.

If the impedance is too low for your purposes, you can try salvaging the audio output transformer. By hooking the speaker to the secondary and using the primary as the output, the output impedance will be increased to approximately 250 ohms.

Miniature transformers with higher impedance ratios are also available from parts houses.

—Ronald Tom ■

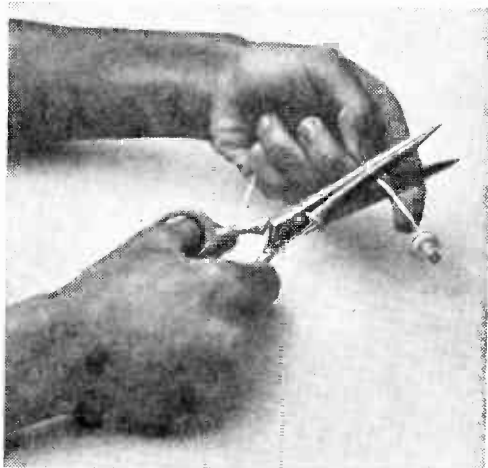

Clip earphone from cord and plug—this plug size is often used in portable tape recorders.

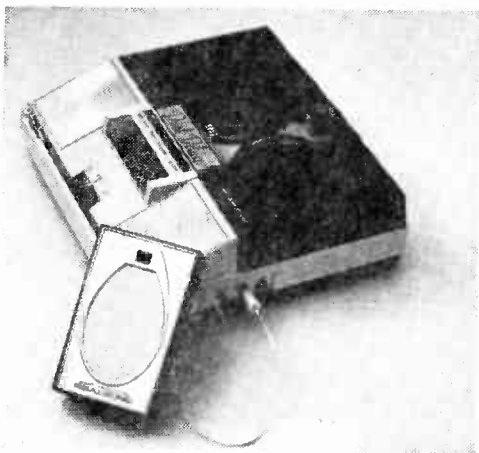

* Snap back of case on, plug into your recorder, and you're all set to go with this all-purpose Mini-Mike.

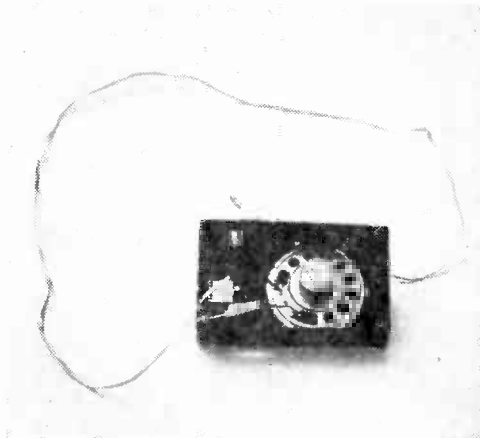

☞ Carefully strip cord wires, solder to speaker wires, then tape. Make a strain loop to prevent pulling speaker wires off.

DIPPERETTE-1

It takes two to tango and the Dipperette-1 is a wall flower unless a GDO and BCB receiver pitch in to play!

■ So maybe you're not really an SWL. But you still have an occasional hankering to fire up a rig and tune a few shortwave stations just to see what's happening. Or maybe you're a grade-A diddler just looking for something short and sweet to get your meat-hooks into. In any case, if you've got a Grid Dip Oscillator and an AM radio floating around looking for a cause, we've got



Hookup may be odd, but the results are just great! GDO fits inside the Dipperette-1; output lead wraps around the AM receiver.

a goody that'll put you smack-dab in the middle of Shortwavesville.

The Dipperette-1 is the epitome of simplicity and consists of what is really just a mixer circuit. A Grid Dip Oscillator is used as the local oscillator. The net result is a nifty little shortwave converter that'll zap a healthy SW signal into any standard AM radio.

With only a short indoor antenna, stations from all over the world are easily picked up and then amplified through the broadcast radio. Selectivity and sensitivity are quite good. The Grid Dip Oscillator (GDO) (such as the EICO Model 710 in our photos) is essential for operation of this unit. Since most serious radio experimenters are in possession of a GDO, this requirement shouldn't be a problem. *(Turn page)*

DIPPERETTE 1

An attraction to the beginner is that no alignment or tedious adjustment is required after the converter is put together. Another note before you start collecting parts: a separate source of power is needed; otherwise, a larger chassis should be used and a self-contained power supply constructed. A schematic for a suitable power supply appears at the end of this article.

The Ways Of Dipperette. Signals picked up in the antenna are coupled to tuned circuit L2/C1. With band switch S1 in the LOW position, the tuning range is approximately 3 to 7.5 MHz. In the HIGH position, stations operating on frequencies between 6 and 18 MHz, are heard. The signal selected is placed between one grid and ground of the pentagrid converter tube (V1). Coil L3 serves as a transformer secondary winding, which receives radio frequency signals from the GDO (now functioning as a local oscillator).

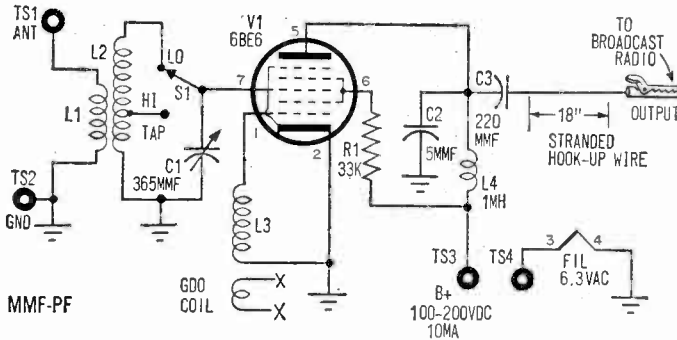

Take a good look at the schematic diagram—it's very much like the front end of a superhet. GDO coil is not part of circuit, it belongs to the grid dip oscillator that serves as the local oscillator.

PARTS LIST

- C1—365- or 410-pF variable capacitor
- C2—5-pF, 200-VDC disc ceramic capacitor
- C3—220-pF, 600-VDC mica or disc ceramic capacitor
- L1, L2, L3—(see text)
- L4—1-mH radio frequency choke
- R1—33,000-ohm, 1/2-watt resistor
- S1—S.p.d.t. slide switch (Radio Shack 275-315 or equiv.)
- TS1, TS2, TS3, TS4—2-lug, screw-type terminal strip (Radio Shack 274-345 kit or equiv.)
- V1—6BE6 tube
- 1—Case with aluminum cover (Radio Shack 270-627 or equiv.)
- 1—#16 AWG enameled copper wire
- Misc.—7-pin tube socket, knob, alligator clip, hookup wire, hardware, solder, etc.

Estimated Cost: \$4.00 (less power supply)
Construction Time: 2 hours

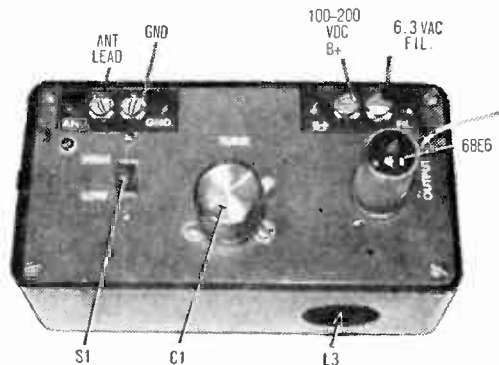

The Dipperette-1 makes a neat looking package and in a small space provided an external power source is used. The High-Low switch and Tune knob are coarse adjustments—the GDO tuning knob provides the fine tune adjust.

tor). The plug-in coil of the GDO is the primary of the transformer.

The signal from the GDO is placed between another grid in the 6BE6 and ground. The two RF signals present in the tube combine to produce two new signals containing the same audio information, but at entirely different frequencies from those injected at the grids. The first new frequency is equal to the sum of the received signal frequency and the GDO signal frequency. The second consists of the difference between the two frequencies.

Without adding further complications, we simply adjust the GDO to a frequency such that the difference between the station frequency and the GDO frequency produces a difference frequency which lies in the standard broadcast band. This new frequency (it still contains the same audio components as did the shortwave frequency) is coupled to the broadcast radio and processed in the normal way.

A short piece of wire from the converter placed near the antenna of the broadcast radio handles the coupling. More about tun-

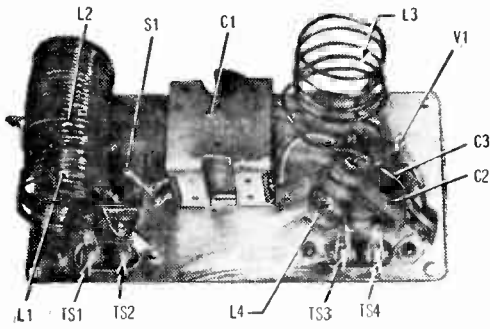

Follow parts layout if you are a novice. Note RF choke (L4) at right angles to coil L3—this avoids pickup from the GDO.

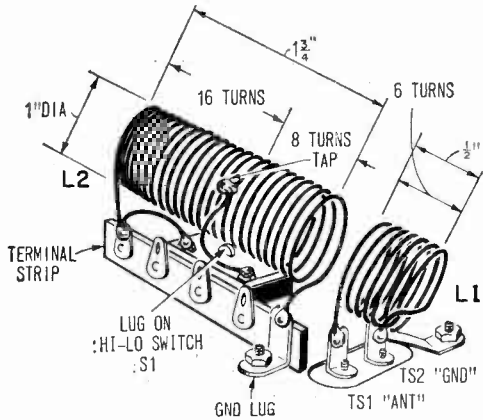

Coils L1 and L2 are wound close with #16 AWG enameled copper wire. Terminal strips support coils prior to mounting.

ing and operating the unit is covered later.

Building Dipperette. A small plastic case measuring about 6 x 3 x 2 in. and a matching aluminum cover was used in the model. If you plan on building the power supply on the same chassis, it will be necessary to obtain a larger chassis plate and housing. If intended for temporary use, careful breadboarding of the circuit will be OK.

Follow the photographs to get an idea of the relative positioning of the tuning capacitor, terminal strips, slide switch, and the 7-pin tube socket. Coils L1 and L2 were wound on an old metal octal tube envelope, which happens to give the proper diameter. Detailed winding data is given in the sketch. L2 mounts on an ordinary terminal strip and is self-supporting. The leads of L1 are soldered directly to the lugs of terminal strip TS1-TS2, and the coil is then positioned in line with, and very close to, the grounded end of L2.

The author used double cotton covered

wire for L3 to insure against easy baring of the wire and possible short circuits, but the same enameled wire used to wind L1 and L2 will do just fine. The exact position of L3 is made so that the coil of the GDO will enter L3 when placed in the access hole made in the plastic case (see photos). The access hole must be large enough to accept the coil diameter of your GDO.

The remainder of the wiring is pretty well routine, with the exception of the radio frequency choke (L4). Locate the choke as far away from L3 as is physically possible and position it so that its windings are at right angles to the windings of L3. As a final point, remember that this is an RF circuit, so keep leads short and direct to prevent unwanted oscillations.

Using Dipperette. Connect the power supply and a short indoor antenna. Let the radio, converter, and GDO warm up for several minutes so the circuits become stabilized. Switch to the HIGH frequency band and plug in a GDO coil to match this frequency range (the 7.5-18 MHz coil for the

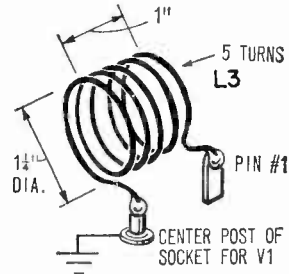

Coil L3 is wound with #16 AWG wire with an 1 1/4-in. diameter to allow most GDO coils to pass within the coil.

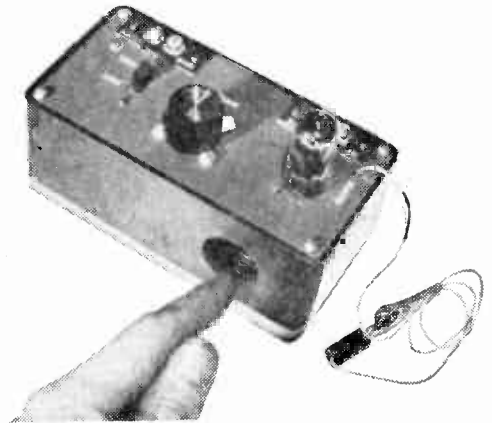

A 1-in. access hole is made in the case for entry of the GDO coil. The hole lines up with L3 inside the case.

EICO 710). Turn the GDO switch to *OSC* and set the converter tuning capacitor about mid-range. Adjust the broadcast receiver to a clear spot in the upper half of the band. Clip the converter's output lead near the broadcast radio's antenna or, if you're using a transistor radio, wrap the output lead around the radio once or twice.

Now, tune the GDO until you hear stations. Top up the station desired by adjusting Dipperette's tuning capacitor. The GDO tuning will be quite coarse, but adjustment of the broadcast dial will provide the fine tuning. The sensitivity of the complete system depends to a large extent on the sensitivity of the broadcast radio, but chances are you'll be amazed at the results of this unit. For the *LO* frequency band, the same tuning procedure is followed. An outside antenna and ground will be needed for best reception on this band.

Don't be surprised if the same station is picked up at two different spots on the GDO

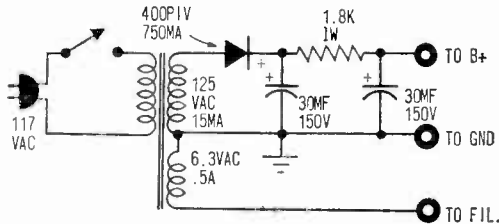

Here is a diagram for a fairly simple power supply that is line-isolated. Parts values aren't critical; plate-supply voltage can be from 90 to 150 volts DC. If the transformer you use has only a 12-volt filament winding, then substitute a 12BE6 for the 6BE6 in the Dipperette-1.

dial. This situation (image, you know) can easily arise as illustrated by the hypothetical example below:

CASE 1	CASE 2
GDO Freq. 13,000 kHz	11,000 kHz
Stn. Freq. 12,000 kHz	12,000 kHz
Diff. Freq. 1,000 kHz	1,000 kHz

It takes some practice to become proficient in tuning the converter, and accurate logging of stations by frequency is a bit difficult. However, for general purpose listening you can't beat the Dipperette-1—especially in view of its cost and simplicity. ■

HERE'S A CB DIPOLE YOU CAN SET UP TODAY

□ It's always handy to have some form of homebrew, temporary CB antenna around the place. Then you can take the base rig and its skyhook with you on a trip, or you can press the temporary wire into use if something should happen to your regular roof topper. Here is a simple coax dipole you can put together to serve as an emergency or temporary base antenna.

Cut two 8-ft., 8-in. lengths of #16 or #19 hard-drawn copper wire (leave a little extra as you will have to waste about 2 in. of each piece making connections). Take three glass or porcelain insulators and connect them as shown in the diagram at right. Next, take *more than* 8 ft. of RG-58A/U coax, and strip one end, exposing the braid and inner conductor. The braid gets soldered to one side of the antenna, the center (inner) conductor to the other side. You can then connect a PL-259 connector to the free end of the coax for hooking to your set—however, make certain that the coax runs at right angles to the antenna for at least 8 ft.

Want a quick camp-site antenna for portable CB rigs? Take a peek at the bottom of page 54. ■

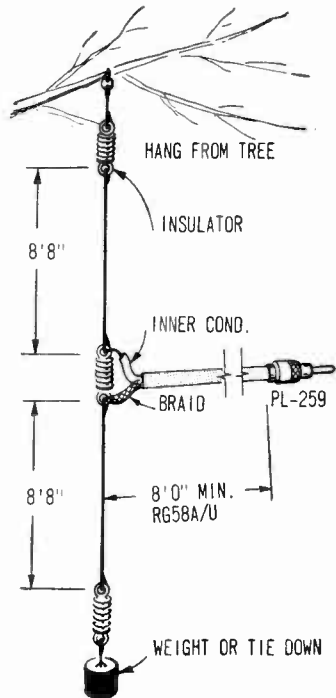

Greatest little conversation piece since the blue-nosed monkey, this simple project is also guaranteed to make your guests sit up and listen with both ears. For want of a better term, we call it our

WHISKEY BARREL SPEAKER SYSTEM



By Bob Foy

A whiskey-barrel speaker system? And why not? A speaker baffle, after all, has but two or three functions in life. One is to hold a speaker. The second is to prevent its front and back waves from intermingling and thereby cancelling each other. The third is to add, not detract, from room decor (and here's where many an enclosure falls flat on its side-panel, looking for all the world like a box someone mistakenly left on a shelf). Significantly, a whiskey barrel shines on all three counts.

In addition to a suitable speaker, all you'll need is a 5-gallon fir or a 6-gallon-oak whiskey keg to make your own whiskey-barrel speaker system. You'll find it (*them* for stereo, since you'll obviously need two in this case) capable of delivering some excellent sound, and you'll also find it on the inexpensive side when compared with commercial boxes. But perhaps the most outstanding thing about having your own whiskey-barrel speaker system is the fact that it's a

first-class eye-catcher and conversation piece. In short, it's just the thing to set off your bar or bookshelf.

Look up a cooperage dealer or a barrel manufacturer in the Yellow Pages of your telephone directory. A 5-gallon fir keg costs about \$4.00; the 10-gallon size runs a dollar or so more. For white oak, made in the 6-gallon size, you'll probably have to put out around \$13.00. If you live near one of these barrel makers, you're in clover and should be able to get your barrel with little trouble. But don't despair even if you live a distant piece from the madding throngs of the Big City. Most of the manufacturers will sell you a barrel and send it to you by motor freight. The extra effort put out in finding your barrel is nothing compared to the fun you'll have building your own whiskey-barrel enclosure.

Speaker Cut-Out. Once you've obtained your barrel, the first thing to do is saw out a circle in one end. You have a choice of

WHISKEY-BARREL SPEAKER SYSTEM

ends, since one has the spigot bung in it. (If you want to leave this intact, simply use the other end.) For a sawing pattern, use a 5½-in. diameter kitchen bowl for an 8-in. speaker, a 10½-in. diameter for the 12 incher. Place it upside down on the face you have chosen and run a pencil around it. Don't worry if the circle isn't perfect. Once the speaker is set in and the grille cloth put on, no one will ever know the difference.

Removing the Bottom. The next step is to knock out the bottom face of the barrel. This piece must be kept intact since it's going to be drilled a little later on in the proceedings. Loosen the inner hoop nearest the bottom end (opposite from the speaker cut-out you have just made). A special hoop hammer can be used to advantage here, but if you don't happen to have one around a screwdriver will work almost as well.

Force the screwdriver gently between the hoop and the barrel, while tapping lightly on the screwdriver handle. It won't take much to loosen this hoop. Now let it slip partway down the barrel body, but don't let it fall all the way off. The next step will be to loosen the bottom hoop and remove it. The middle hoop, slipped down a bit toward the bottom, will hold the barrel in shape while you do more work.

Drilling the Bottom. With the bottom stave now taken off, tap gently on the barrel face. It should slip easily from its groove. If it is still tight, loosen up on the middle hoop a bit more.

With the bottom end removed, you may now plot out the locations of the holes. The number of holes drilled is important for the best sound. The following numbers are recommended for speakers with a resonance of 40 to 100 Hz (cycles).

- 5-gallon fir—64 holes
- 6-gallon white oak—80 holes
- 10-gallon fir—128 holes
- 11-gallon white oak—160 holes

Leave about ½ in. between holes and use a ¼-in. wood bit for this part of the job. No particular pattern is necessary, so don't worry if a couple of holes are not exactly in line.

Speaker. You'll need a good quality 8-in. speaker if you have been working on the



Though the 64 holes in barrel pictured above have been drilled in a neat pattern, this is not essential for good sound. Terminal block is for making connections to speaker.

smaller barrel, a 12-incher for the 10 and 11-gallon size. Two good bets for whiskey barrel enclosures are Lansing's 8-in. and Jensen's SG 88. Get the best speaker you can afford and you'll be happier with the sound.

Bolt the speaker to the lip of the cut-out using four flathead 2 x ¼-in. bolts and nuts. Remember to countersink the heads in the barrel lip so that grille material may later be smoothly fastened down.

Filler. Once the speaker has been securely bolted to the front cut-out, you'll need about four feet of spun glass about 2 feet wide. This is an excellent absorbent material for echo and costs only about 15¢ a foot. Roll this into a loose bundle and fit it inside the barrel.

Replacing the Bottom. Replace the bottom face now just the reverse of the way

Keg and Barrel Manufacturers

- John Eppler Co., 1202 S. Sharp St., Baltimore, Md. 21230
- Sweeney Cooperage, Ltd., 1341 N. Northlake Way, Seattle, Wash.
- Fleischmann Distilling Corp., Ewing Rd., Owensboro, Ky. 42301
- L. W. Clark, Inc., Box 220, Clarksville, Ark.
- Edwin Bell Cooperidge Co., S. 17th and Hopkins, Pittsburgh, Pa. 15203

George Martin, owner of Bali Hi-Fi in Bellevue, Wash., says he thinks he just may have originated the idea of putting barrels to work as speaker baffles (though he admits there's good chance he may have read of someone else doing it at some time or other). In any case no one has put more TLC (tender loving care) into his barrel-baffles than Mr. M., shown here with a 5-gallon fir barrel which he built for use with a Model SG-88 8-in. Jensen speaker.

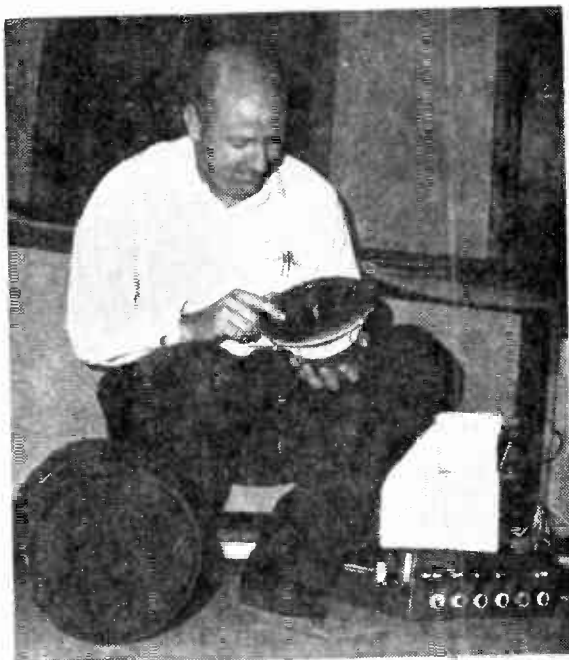

you removed it, slipping the hoops back into position and pounding them into place. The two speaker leads may now be brought through the two extra holes you drilled and anchored to a terminal.

Grille. Natural cane or black are excellent materials. Fasten the grille over the speaker cut-out with small nails which may be driven into the supporting lip of the barrel. The last step in the construction of your whiskey-barrel speaker is winding about two feet of 1/2-in. manila hemp around the inside cir-

cumference of the barrel—over the grille. The rope can be nailed down or made secure with a good epoxy cement. The rope doesn't do much for sound—only looks.

Fir barrels can be sanded down and stained a deep red or mahogany. For white-oak barrels, rub a 50-50 combination of boiled linseed oil and turpentine into the smoothly sanded staves for a fine rich finish.

And that's it! For only a few dollars and very little work you now have a unique and efficient speaker enclosure.



Readying whiskey barrel for speaker is so simple even the pretty miss in our photos found it no great shakes. An ordinary kitchen bowl can be used to trace out the circle, and pulling out the spigot exposes an ideal hole for inserting a saber saw.

POT BOX

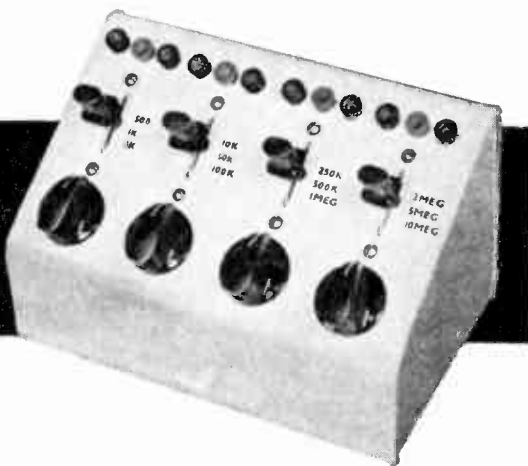
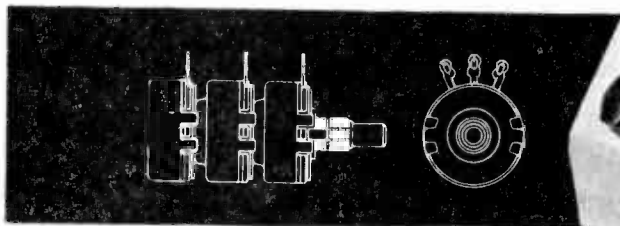

by Jack Brayton

Flip a switch, twist a wrist—the resistance you want, when you want it.

■ If there's one thing the experimenter almost never has it's the correct pot (potentiometer in Webster's) for the circuit he's building or fixing. Those pots in the junk box always seem to be either noisy, dirty, broken, or their values are simply wrong for the project at hand.

Sure, you can manage (after wasting time searching) to find a pot that works in the circuit you're breadboarding. But can you find another one with a slightly-higher or lower-resistance value to locate the circuit's outside limits? Are you sure your final choice is well within those limits? You can do all these things, simply, easily, with the *Pot Box*. You can also temporarily replace a few of those fixed resistors with pots—to see how the circuit would act if these fixed units were higher, or lower in resistance value. Since the *Pot Box* has twelve overlapping ranges you can have *continuous* coverage from a few ohms to 10 Meg.! Still another advantage is that individual range switches allow up to four pots to be used *simultaneously*.

Cost is not prohibitive—the complete, 4-section, 12-range unit costs only about \$22.00 to build. Even this price can be cut by \$5.00 or more simply by eliminating one of the lesser used sections at the high or low end. Using 3-position, double-pole slide switches will also reduce costs by about

TABLE OF POTENTIOMETER RANGES

R1a—500	R2a—10K*	R3a—250K*	R4a—2Meg.*
R1b—1K	R2b—50K	R3b—500K*	R4b—5 Meg.
R1c—5K	R2c—100K*	R3c—1 Meg.*	R4c—10 Meg.

*Indicates values available in log (audio) tapers.

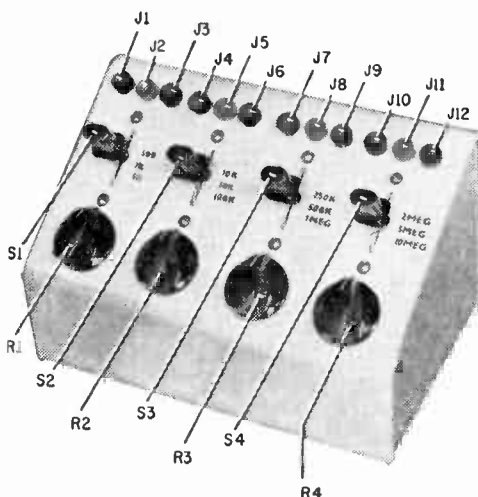

Each group of three jacks is for one potentiometer. Lever switches select one of the wafers of each triple-section unit.

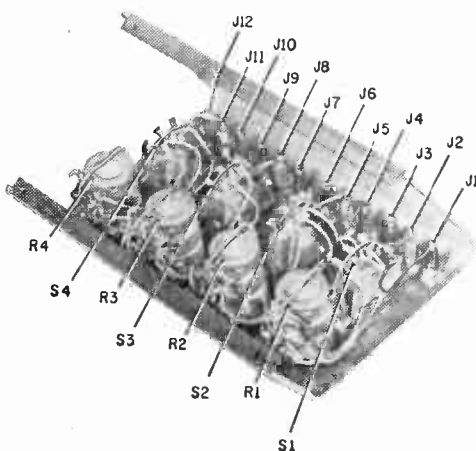

75¢ for each of the sections. (Use Continental-Wirt G338; Allied 35Z032.)

Its Secret. Its secret is simple and neat. Triple-section controls are used which means only four knobs are on the panel even though twelve potentiometer values are available at the jacks. As we've already mentioned, low-cost, double-pole, lever-type range switches are utilized to connect the four triple-section potentiometers to the various output jacks.

PARTS LIST FOR POT BOX

- J1-J12—Tip jacks (or banana jacks) (H. H. Smith 1515 or equiv.)
- R1a, b, c—500-ohm, 1,000-ohm, 5,000-ohm, triple-section potentiometer (Allied 46D1892C—type 45-D501-MD102-MD502-16)
- R2a, b, c—10,000-ohm, 50,000-ohm, 100,000-ohm, triple-section potentiometer (Allied 46D1892C—type 45-D103-MD503-MD104-16)
- R3a, b, c—250,000-ohm, 500,000-ohm, 1,000,000-ohm, triple-section potentiometer (Allied 46D1892C—type 45-D254-MD504-MD105-16)
- R4a, b, c—2,000,000-ohm, 5,000,000-ohm, 10,000,000-ohm, triple-section potentiometer (Allied 46D1892C—type 45-D205-MD505-MD106-16)
- S1-S4—3-p.d.t., positive-action, non-shorting lever switch (Centralab 1454 or equiv.)
- 1—Sloping-panel utility cabinet, 7-in. wide (Bud C1609—steel; AC1613—aluminum, or equiv.)
- 4—Knobs for ¼-in. round shaft
- Misc.—Wire, solder, machine screws and nuts, panel marking decals, paint, etc.

Estimated cost: \$22.00

Construction time: 4 hours

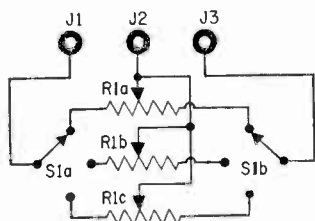

ALTERNATE PARTS LIST

(For Log-Tapered Audio Controls)

- R2a, b, c—10,000-ohm, 50,000-ohm, 100,000-ohm, triple-section potentiometer (Allied 46D1892C—type A103-MD503-MA104-16)
- R3a, b, c—250,000-ohm, 500,000-ohm, 1,000,000-ohm, triple-section potentiometer (Allied 46D1892C—type 45A254-MA504-MA105-16)
- R4a, b, c—2,000,000-ohm, 5,000,000-ohm, 10,000,000-ohm, triple-section potentiometer (Allied 46D1892C—type 45-A205-MD505-MD106-16)

Parts. All of the parts, except the controls, are standard and widely available. The four controls are from Allied's *industrial catalog* and may be ordered (\$3.00 each) using the stock and type numbers shown in the Parts List. It's important to note that the *stock* number merely indicates a triple-section control while the *type* number indicates the placement and resistance values used to make up the control. Thus, *both* the stock and

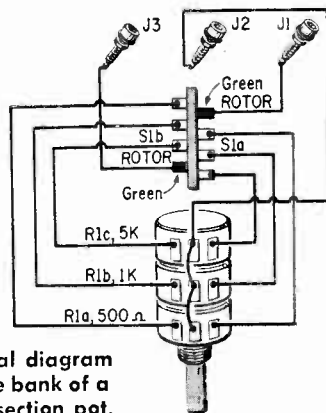

Pictorial diagram for one bank of a triple-section pot.

type numbers must be clearly written on the order.

Linear instead of logarithmic (log) tapered pots are specified in the Parts List because tapered pots do not come in all of the values needed. However, if you do a lot of audio or related work and want log-tapered pots in as many values as possible, simply substitute the stock and type numbers shown in Alternate Parts List when ordering the controls. The values marked with an asterisk (*) in the table would then be log tapered pots.

Construction. Of course, construction is started by laying out the sloping panel of the utility box on ¼-inch graph paper as shown. Then cut it out; tape it to the front panel; center punch the holes; and, finally, drill them. The switch slots are started in the ¼-inch center holes and are sawed with a keyhole hack saw. A thin, flat file is used to smooth the edges and widen the slots slightly.

The parts are mounted as shown in the illustrations. You can't mount the switches wrong (upside down) since their terminals are symmetrical, the same in either position. Furthermore, the rotor terminals are identified by a green dye.

Wiring. Wiring is simple and easy because each of the four sections are wired exactly the same. The schematic diagram shows the

(Continued on page 116)



PARTY LINE LISTENING

It takes only a few hours to install a modern radio in the case of an antique telephone, but you'll end

□ Time was when telephones came in wooden boxes with cranks and earpieces. Mounted on the wall at some level or other, the then new-fangled creations could be utilized only with a preposterous amount of stretching or stooping—and only if the party line wasn't engaged.

Today, most of these phones have gone the way of the Stanley Steamer, though a few still lurk in attics and antique shops (the one in the photos was picked up at a country sale for a five-dollar bill). And though their days as telephones are over, such oldies can be returned to service in a way grandpop would never have dreamed of—as a conversation-inspiring cabinet for a table radio.

Strip Treatment. The old oak wall telephone in the photos took its first steps toward its new role when it was dusted, then given the strip treatment. All of the old wiring and small parts were removed from the inside of the main case, leaving only the box and the exterior paraphernalia.

The front-hinged lid of the telephone came off when we removed the screws from

one side of the three brass hinges. We then cleaned up the main cabinet and the wooden back, removing a variety of grease, pencil marks, and stains. What we didn't touch, of course, were the dents and scratches (remember, we wanted this to be an antique!).

Almost any long and narrow radio chassis could have gone into the telephone cabinet. The type or age of the radio really made precious little difference as long as the radio worked and would fit in the main compartment. Though we were tempted at one point to use a small, battery-powered transistor job, we eventually settled on a new G-E T1220A AM/FM table model (which, incidentally, uses an AC/DC circuit).

Trial Run. Once the etched circuit board had been removed from the radio's plastic case, we temporarily lined up the chassis and marked the mounting holes for its controls. Since we wanted to mount the dial plate separately, we cut it free from the cabinet with a hacksaw blade. Having smoothed off the rough edges, we laid the dial on the side of the telephone case, carefully traced around it, then slid the radio chassis into

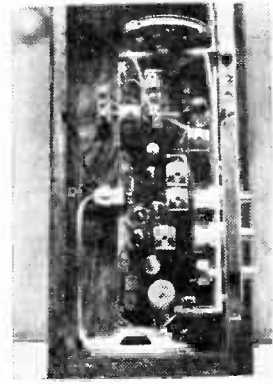
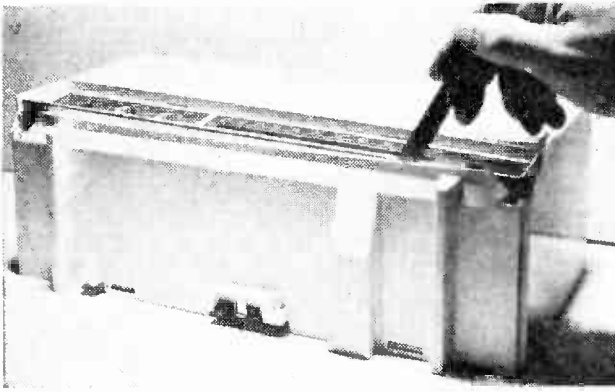

Slide-rule dial in radio author used was permanently affixed to plastic cabinet, so author carefully sawed it out with hacksaw blade. Dial could then be fitted into cutout in telephone box.

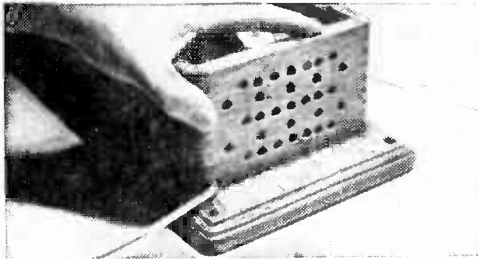

Photos above show how radio was positioned in telephone box; view at left shows $\frac{3}{8}$ -in. holes in one end of box for speaker grille and line cord. Varnish was later applied to telephone box to spruce up its appearance.

up with plenty to talk about and a lot to listen to.

By HOMER L. DAVIDSON

position. Fortunately, we found there would be plenty of room to mount the chassis in the telephone compartment and also to fasten it to the dial.

Masking tape was placed on the marked edge of the antique cabinet to serve as a guide line for the dial cutout and to protect the case against possible mars and scratches. We then drilled two $\frac{1}{2}$ -in. holes on opposite ends of the masked area to start a small saber saw. Since the oak case was very hard, we were careful not to feed the power saw too fast.

Plastic Grille. We mounted a 4-in. speaker at the bottom of the telephone case, having first drilled several $\frac{3}{8}$ -in. holes and then covered them with a small piece of plastic screening. The line cord was passed through another $\frac{3}{8}$ -in. hole at the speaker end of the cabinet, and a knot was tied in the cord at a point just inside the cabinet to secure it against accidental stress.

Next, we replaced the circuit board in the cabinet and marked the chassis mounting holes on the wooden base. This done, we removed the chassis and drilled two $\frac{1}{8}$ -in.

mounting holes. Wood screws and spacers were used to fasten the chassis to the telephone base.

With the plastic dial in the new opening, we drilled two mounting holes at either end so the dial could be fastened to the telephone cabinet. The dial was mounted in place and the radio chassis was then bolted to the dial itself.

Finishing Touches. With the project almost completed, we then soldered the wires from the output transformer to the speaker voice-coil terminals and taped the FM antenna wire to the inside of the telephone cabinet. After the radio had been mounted and tested, we sealed the dial in place by squirting rubber seal around the dial.

Later, we removed the telephone bells, front mouthpiece, and hand phone hanger from the cabinet and spray-painted them with black enamel. When they were dry, we remounted them in position, then touched up the telephone cabinet proper with two coats of varnish. And last of all, we sat back for some real modern-time Party Line Listening! ■

Solid State

C U B E

Tester

Be a square when you get 'round to testing tubes for a hard-to-find open heater in those series-filament chassis

by Robert E. Kelland



■ The title of this article may lead you astray, as it infers the use of semiconductor devices in a unit that tests "cubes"! But if you look a little closer at the photos you should quickly spot the intended use.

Well, anyway, in case you didn't figure it out after taking a good look; the *tester* is "carved" out of a solid block (cube) of wood and it is an inexpensive, knock-about, tube-filament continuity tester. The tester operates on ordinary line voltage, which lights the neon-lamp good-bad indicator.

Construction. Cut the cube from a good piece of 2 x 2-inch stock—watch for knots and coarse grain when making the selection. Sand all sides smooth and round the edges.

Three sockets are needed; a 7-pin miniature, a 9-pin miniature and an 8-pin octal. It's okay to use salvaged sockets from old projects, but if you want a neat, uniform appearance in your tester, pick up sockets of the same style and color. Inexpensive wafer-type sockets work nicely but molded sockets are sturdier.

Determine the diameter of the tube-socket mounting holes for the sockets you intend to use, and select the wood bits to match. Generally, molded octal sockets require 1 1/8-inch mounting holes; 7-pin miniature 5/8-inch mounting holes; and 9-pin miniature require 3/4-inch holes.

All holes are drilled in the *centers* of the sides involved. Only one side remains blank. First, drill the hole for the line cord and neon lamp with a 1/4-inch bit. (A drill press will help ensure against accidental veering, but if you use a portable electric drill or a brace and bit, extreme care must be taken to keep the holes straight.) The 5/8-inch hole is bored for the 7- and 9-pin sockets, and then the hole for the 9-pin socket is enlarged with a round file until the socket fits. But, if you have the proper-size bit, use it to avoid whittling time.

The last hole, the one for the octal socket, is drilled *half-way* through the cube, the side opposite remains solid. Use a 1-inch wood bit, and then enlarge the hole with a round file or pen knife to take the octal socket if you can't get hold of an 1 1/8-inch bit. Give the cube a final smoothing with fine sandpaper, and spray paint it with several coats of enamel or clear varnish.

Wire the sockets and indicator lamp as shown in the schematic diagram. You'll have to solder leads (about 2 inches long) to the sockets and do the final connections inside the 1 1/8-inch hole for the octal socket. Carefully insulate all bare leads and solder joints to prevent shorts. Use plastic tubing and electrical tape.

Completion. Finish the job by maneuver-

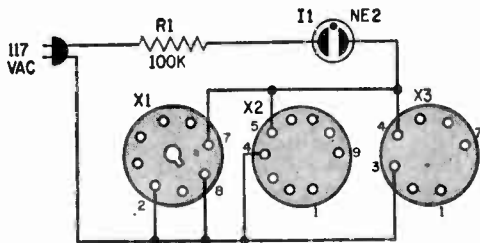

The circuit (above), is simple but you must remember it won't check all of the tubes—filaments on many 5-volt rectifier tubes are pins 2 and 8.

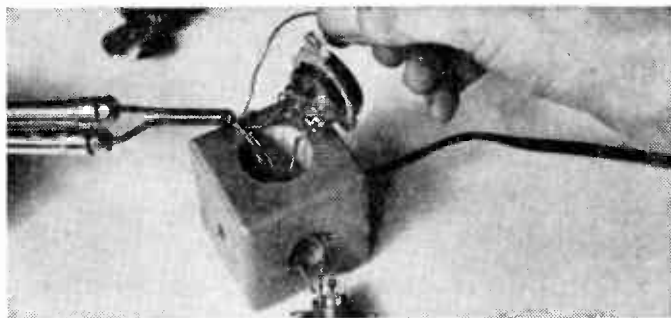

Wiring can be quite a chore for an all-thumbs wirer in the close confines of the wooden block—nothing is to prevent you from using a plastic case or a standard chassis box to hold the circuitry. Add a pair of metal strips to test fuses and lamps.

ing the NE2 lamp down into the 1/4-inch hole provided for it and push it in place. To prevent breakage the tip of the lamp should be kept below the surface of the side. Before mounting the sockets, check the tester for proper operation. Don't do so, though, until you make a final check on your wiring to detect any short circuits. Plug in a vacuum tube that is known to be good, and the NE2 should glow. Removing the tube will cause the NE2 to extinguish. If all is OK, go ahead and secure the sockets with small roundhead wood screws.

A Final Note. The tester will check most common tubes for open filaments. There are some tubes not used in series-filament circuits which have different pin connections to the filament element, so, if in doubt, check with a tube manual. ■



PARTS LIST

I1—NE2 neon lamp
 R1—100,000-ohm, 1/2-watt resistor
 X1—8-pin octal socket
 X2—9-pin miniature tube socket
 X3—7-pin miniature tube socket
 1—Line cord and plug
 1—Block wood 2x2x2 inches approx.
 Misc.—Enamel or varnish, plastic electrical tape, stranded hookup wire, solder, wood screws, sandpaper

Estimated cost: \$0.80
 Construction time: 2 hours

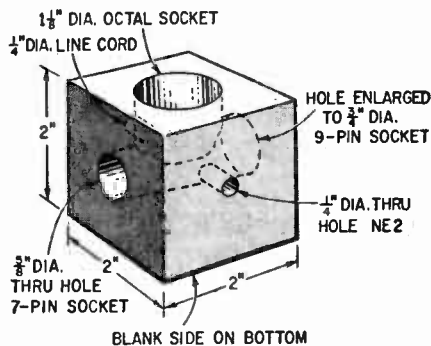

If you're not sure of your carpentry, drill the 1/4-in. holes from each side to the center and drill the 1 1/8-in. hole past center to be sure of having all other holes bore into it.

One worthwhile use for that blank side of the wooden cube would be for a 7- and 9-pin tube-pin straightener. Bent pins can be the cause of bad or poor contact in tube sockets. The oxide coating on heat-darkened tube-base pins also contribute to poor operation.

Add a Flip-Flop to Your Meter

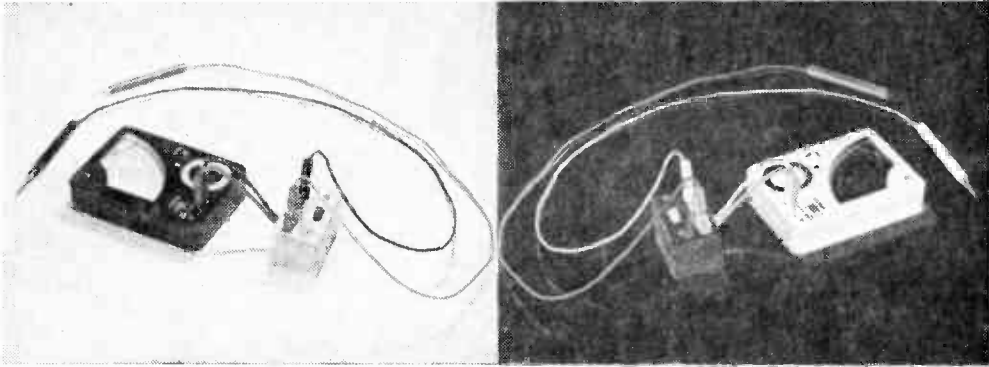

Make your troubleshooting less trouble—build a low-cost test-lead reversing switch for your VOM and VTVM.

by Marshal Lincoln, W7DQS

■ VOM's, multimeters, pocket voltmeters, and all their brothers and cousins come in a thousand shapes and sizes these days. But though priced to fit any purse and purpose, many of them lack a very handy feature which you yourself can add in an hour or less. This is the Meter Flip-Flop, or, by a more descriptive name, a *polarity-reversing switch*. Some testers have this feature built in, but a surprising number of VOM's, many of them rather expensive models, do not.

To be sure, for AC voltage or resistance measurements, the lack of such a switch poses no problem. But when measuring DC, it's amazingly easy to accidentally connect the meter backwards into the circuit under test. This immediately throws the meter off scale—*downscale*, which means you then have to reverse either the test prods on the circuit under test, or reverse the pins plugged into the meter.

With the handy Meter Flip-Flop, you just leave the clips on the test leads where they

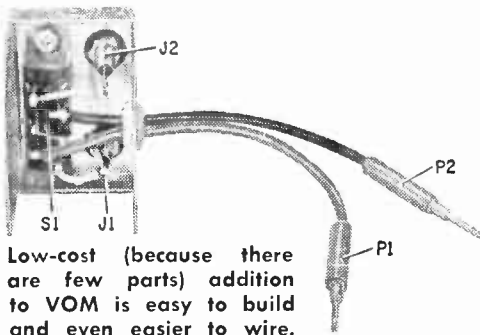

Low-cost (because there are few parts) addition to VOM is easy to build and even easier to wire.

PARTS LIST

- J1, J2—Tip or banana jack (to match meter leads)
- P1, P2—Pin tip or banana plug (to match meter jacks J1, J2)
- S1—D.p.d.t. switch (slide, see-saw, or toggle type)
- 1—Chassis box, 2 1/4 x 1 1/2 x 1 3/8-in. (LMB type M00, Burstein-Applebee 20A458, or equiv.)
- Misc.—Test-lead wire, hookup wire, solder, grommet, machine screws and nuts, etc.

Estimated cost: \$1.50

Construction time: 1 hour

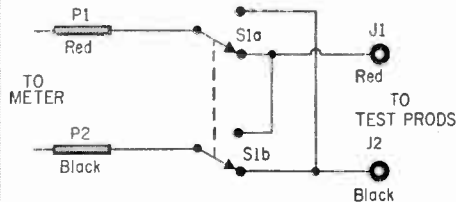

Simple circuit, shown in schematic form, can be used for other purposes like reversing battery connections powering a permanent-magnet motor.

are, flip the switch, and go right ahead with your work. The switch reverses the polarity of the test prods with respect to the meter.

Construction, shown in the photos and wiring diagram, is very simple, with nothing critical involved. A d.p.d.t. switch, two jacks and two plugs of the type used by your own meter and test prods, some hookup wire,

(Continued on page 116)



AUTO SIREN SENTRY

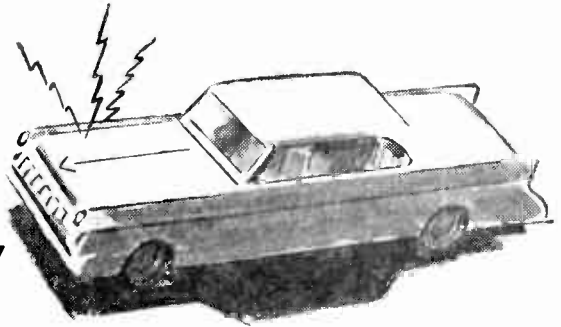

by Herb Friedman W2ZLF / KBI9457

Let electronics stand guard when you leave your wheels unattended!

■ You almost could give odds that in the next few months someone you know will have his car stolen or broken into. Fact is, auto break-in and theft is fast becoming the *All American Sport*, for you've not only got professional thieves to contend with, you've got the local hoods who believe any shiny new car *belongs* to them.

Insurance? Next to worthless! You can never get back the true value of your car since most insurance policies are limited to actual cash value (ACV), meaning you get about what it's worth on a legitimate trade-in. Whether it's spotless and smooth-running, or it has a one-lung engine and mashed fenders, it's still worth the same ACV. Contents stolen or damaged? Not covered by

can buy. The Auto Alarm fights theft and break-in two ways. Firstly, it sticks out like Jayne Mansfield at a Boy Scout meeting. Right there on the fender is a *key switch* which in any man's language means "*Watch Out*," this car is wired for sound.

Secondly, the instant anyone tries to open a door, the hood or the trunk, a *screaming siren* fills the neighborhood; and it can only be turned off with a key. Unlike other theft alarms which shut off when a door is closed or if the trip switch is taped down, the Auto Alarm cannot be silenced other than with the alarm's key or ripping loose the connections. Keep the wires hidden and friend thief will take off on foot before he can find the wires. No thief is going to try driving around with a siren roaring under the hood. Police take a dim view of a "civilian" car with a siren.

How It Works. The schematic diagram shows how the siren and locking circuits work. M1, an electronic siren module, in conjunction with speaker SPKR, comprise the *siren*. The positive voltage input is fed through S1, a key-lock switch, to the module. R1 is simply a dropping resistor for the module which works best with a 6- to 10-volt input.

The negative battery connection to the siren module is made through normally closed pushbutton switches, like those used to turn on courtesy lights when a door is opened (these switches are indicated by the dotted lines in the schematic).

Trace the circuit through. Note that when a door is opened, the associated switch connects terminal 2 of terminal strip TS1 to ground—completing the power connection to the module and the siren "sounds off." Also note that when terminal 2 is grounded



This version of the Auto Siren Sentry is completely protected by the aluminum box. Perforated phenolic protects speaker cone.

car insurance! That CB rig, camera, or luggage (filled with vacation clothes) is completely lost if you don't have separate theft insurance—the *expensive* kind.

But invest about \$17 and an hour's work installing the *Auto Siren Sentry* and you've got just about the best theft "insurance" you

AUTO SIREN SENTRY

relay K1 is energized, pulling down K1's armature or wiper contact. When the moving contact touches this normally open terminal (#2) it parallels the door and trunk switches and "permanently" grounds the relay and the module's ground connection—the siren keeps sounding even if the door is closed (opening the switch). The only way K1 can be released—to turn off the *Auto Siren Sentry*—is to interrupt the positive battery connection by opening key switch S1.

Protecting The User. Since key-switch S1 is mounted on the fender—and you want it there for all to see—it protects the user against the embarrassment which might be caused by the siren going off as he attempts to leave the car (which will happen if the alarm switch is mounted inside the car). After the user leaves the car, the alarm is set by turning S1 to *on*. Before getting into the car, the driver then turns S1 to *off*. Naturally, if S1 is mounted inside

the car the alarm will sound whenever the driver enters the car. Mount the key switch out on the fender for your own peace of mind.

Construction. Actually, there isn't much involved in building the *Auto Siren Sentry*. The siren module is an *EICOCRAFT* Siren Module Kit—type EC-100, which can be assembled in a matter of minutes. There is but a handful of components which are mounted on a pre-punched and "component position marked" printed circuit board. However, assemble only the board itself, do not make the external connections given in the instructions as the *Auto Siren Sentry* uses a simpler external wiring than that given with the module.

After the module is completed, connect a 10-inch length of black wire to terminal *G*, loop the wire under the board and solder the end to *F*. Connect a 1-inch length of bare wire to *C*. Connect a bare-wire jumper from point *A* to point *B*. Then connect two wires of the same color to *D* and *E*, the speaker terminals. Note that the board shows the battery connection to *A* and *B*; ignore these instructions. In the *Auto Siren Sentry* the positive battery connection is the

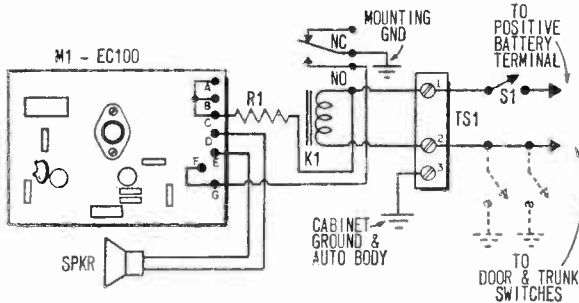

Noisemaker of the *Auto Siren Sentry* is the Eico EC100 (M1) module that drives the speaker. Relay K1 keeps siren sounding.

PARTS LIST

- K1—S.p.d.t. relay (Potter and Brumfield R55D-12VDC, Allied 41D5504—P & B R55D-6VDC Allied 41D5896 or equiv.)
- M1—Siren Module (EICOCRAFT EC-100 or equiv.)
- R1—10-ohm, 5-watt resistor (see text)
- S1—Key-lock switch (Lafayette 33C6401 or equiv.)
- SPKR—Weatherproof speaker (Lafayette 44C-5201 or equiv.)
- TS1—Terminal strip (see text)
- 1—3 x 5 x 7-in. aluminum chassis box
- Misc.—Wire, solder, mounting hardware, solder lugs, etc.

Note: The EC-100 Siren kit is available from Custom Electronics, P.O. Box 124, Springfield Gardens, N. Y. 11413. Price is \$4.95 plus 35¢ postage and handling.

Estimated cost: \$17.00
Construction time: 2 hours



Inexpensive key-lock switch set in fender advertises burglar alarm. Presence of lock alone will give some theft protection.

short bare wire at *C* while the negative battery connection is the black wire going to *F* and *G*.

After all cabinet holes are cut in the main section of a 3 x 5 x 7-inch aluminum cabinet,

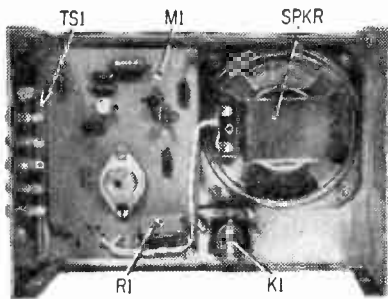

Internal view of *Auto Siren Sentry* shows location of major components. Much smaller box can be used if speaker is outside.

mount the siren module as shown in the photographs, on the bottom as close as possible to one side; use stand-offs between the board and the cabinet to avoid shorting the printed-circuit wiring. The stand-offs as well as the necessary mounting hardware are supplied with the module.

The speaker is a three-inch waterproof type. The speaker specified in the Parts List is supplied in a metal cabinet having an integral gimbal bracket. If the speaker is installed as shown, in an aluminum cabinet, place a piece of perforated phenolic board in front of the speaker, to prevent possible

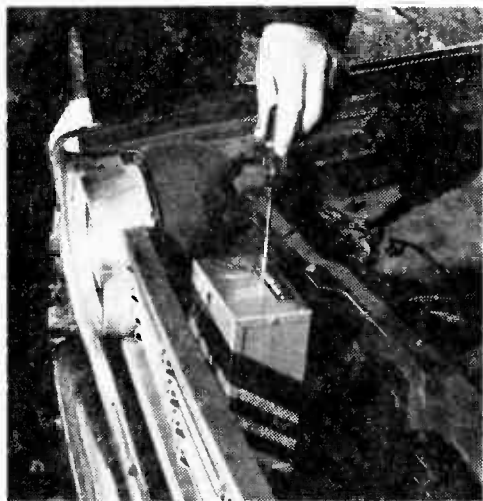

Once *Auto Siren Sentry* is attached to the body, leads to switches can be connected. Protect leads from accidental breakage and possible tampering through grille openings.

damage to the cone. (If desired, the speaker can be used in the cabinet supplied.) Mount the speaker cabinet near the radiator, facing outwards, and connect the speaker leads from the module to the terminals on the speaker cabinet.

The wiper contact on *K1* is *automatically grounded* when the relay is mounted in the cabinet—the wiper contact is connected directly to the frame of *K1*.

While only a three-lug terminal strip is required if the speaker is mounted in the aluminum cabinet, we show a five terminal type in the photographs to illustrate the arrangement when an external speaker is used. The speaker would connect to the two terminals shown unused. To reduce the possibility of wiring errors, place the battery connections on opposite ends of *TS1*, as shown, with at least the switch terminal in between.

Install the *Auto Siren Sentry* on any

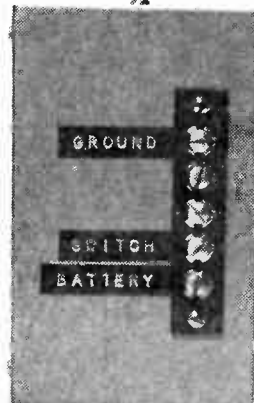

The two unused connections of the terminal strip (*TS1*) are used for external speaker leads. A grommet can be used instead of a strip—just make wires long enough to reach switches.

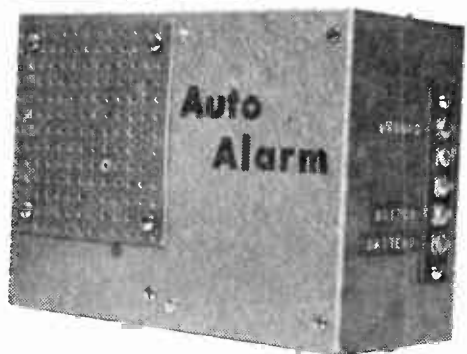

convenient surface under the hood. Just make certain the alarm doesn't project above the hood line or you won't be able to close the hood.

Installing The Switches. Any existing door switch automatically becomes part of the *Auto Siren Sentry* when the wire from terminal 2 of *TS1* is connected to the cour-

AUTO SIREN SENTRY

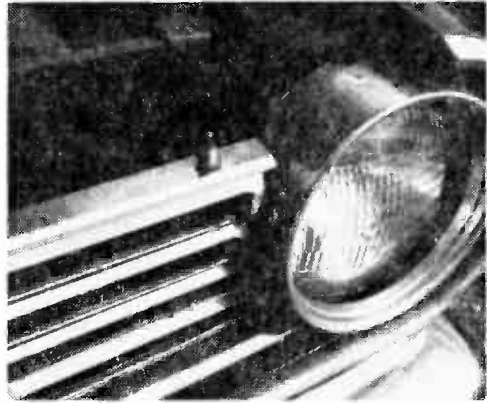
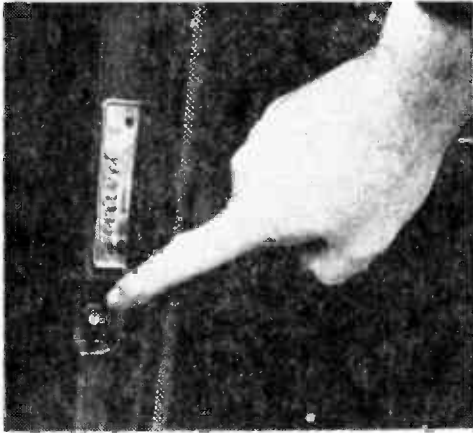

Hood switch prevents tampering with Auto Siren Sentry although someone familiar with your system could conceivably disable it fast.

Courtesy-light door switches become part of the Auto Siren Sentry burglar alarm system.

tesy light circuit. These switches are the self grounding type, always switching the ground lead of the courtesy lights: therefore, when you look at these switches you will see only *one* connecting wire. All other switches which may be added should be of the same type, self grounding, with their leads connected to the wiring of any of the original door switches. Additional switches for the hood, trunk or rear doors can be purchased from your car dealer at nominal cost.

The key switch should be installed so some smart "cooky" can't jump the terminals. If the switch is installed in the part of the fender that faces the tire anyone can reach under the car and jump the terminals,

making the alarm inoperative. Install the switch on part of the *double fender*. Part of each fender, near the door, is shielded by the sides of the firewall, and access to the space between the fender and firewall is only through a small area which is exposed when the door is open. Place the switch so that its terminals are in the concealed space.

Positive Grounds. The circuit shown is for cars with the more common *negative* ground battery. If your car uses a positive ground battery simply reverse the connections to siren module terminals C and G.

6-Volt Systems. If your car uses 6-volts eliminate R1—use a direct connection from terminal 1 of TS1 and use the alternate 6-volt relay specified in the parts list. ■

Solder Silences Noisy Tube

- When a tube in a radio, TV, amplifier or other device becomes microphonic and produces an undesirable howl or ringing sound from the speaker, don't throw the tube away. Wrap the glass envelope with several turns of solder or heavy uninsulated copper wire. The added weight and support of the wire weight will often damp out vibrations that cause annoying oscillations. ■

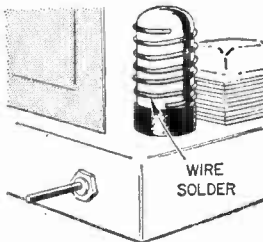

Color-Coding Wires

- When you need some color-coded wires for a circuit and only plain-colored wires are on hand, color-code your own. To do this, wrap lengths of the wire around a mailing tube, broom handle or other suitable form, and paint diagonal lines across the coil with different-colored paints. Apply the paint sparingly with cotton swab or piece of cotton on the end of a match. Tape holds coil in place. Using two or three colors you can code every wire your insert into a project or kit. ■

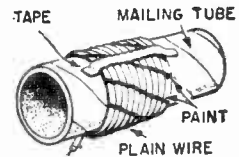

CB

Signal Center

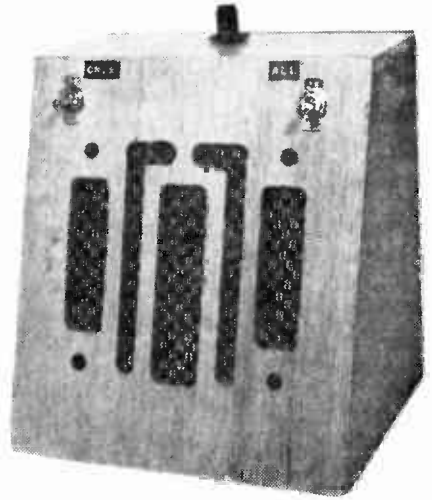

Let this dual voice coil speaker reduce much of the clutter from your desk and free your operating position for important work.

by Herb Friedman, W2ZLF / KB19457

■ If your CB operations consist of something more than sitting back and chewing the fat on 11 meters, your operating position is probably jammed to the edges of the desk with gear. Perhaps a radio to fill the silent voids between calls, maybe a second transceiver to cover the H.E.L.P. channel if you're involved in a REACT operation, possibly a public-service receiver for police and fire calls if you're part of an *emergency net*.

Yet, as important as all the auxiliary equipment might be, rare is the professional communications center that buries the operator under a mountain of equipment. Generally, the signal from secondary equipment is fed from a remote location, such as a closet, to a speaker at the operating position; and even the primary equipment might be remote controlled. In fact, in some of the really complex communications centers there is but a single speaker at the operating position, with a special electronic switch rapidly "cutting" the speaker into several circuits, so that a single speaker carries two or more signal circuits.

While electronic switching is somewhat expensive, there is still an inexpensive way for the CB'er to get more than one signal out of a single speaker; thereby freeing the operating position from the clutter of some of the receiving equipment.

One pathway to a clutter-free communications center is through the *CB Signal Center*. The Signal Center has but a *single* 6-inch speaker, yet the speaker can be con-

nected to *two* separate receivers (or transceivers) at the same time. The levels can be preset so that one signal source is reproduced at a background level—such as music from a radio—while the second signal, say from a CB transceiver, comes in much louder and overrides the background signal.

Either signal circuit can be totally disabled, or if desired, the level from each receiver can be controlled directly at the Signal Center. The total flexibility of the Signal Center depends on how much you want to build in. In fact, total signal control can be built into the Signal Center so that all equipment can be placed in a closet. All you'll need is a remote (long cord) cable for the push-to-talk microphone.

How It Works. The heart of the signal center is a dual-voice-coil speaker, Utah's model SP6D-M1. As shown in the diagram below, each voice coil is completely in-

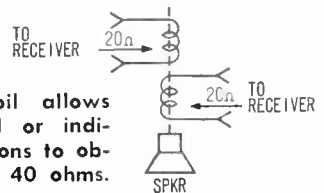

Dual voice coil allows series, parallel or individual connections to obtain 10, 20 or 40 ohms.

dependent of the other, and each voice coil can be connected to an individual receiver.

If the speaker is connected to two radios, the two separate radio programs will be reproduced. If one voice coil is connected to

CB Signal Center

a radio and the other connected to a CB transceiver, both the radio program and the CB signals will be heard.

Add the appropriate switching and volume control facilities shown in the *Signal Center* schematic and the *Signal Center* can control all the volume and program switching adjustments.

The schematic of the *Signal Center* shows two possible connections you can utilize. The connections for REC 1 has provisions for controlling the volume at the speaker. With the volume control of REC 1 set $\frac{3}{4}$ to full open, the volume is adjusted at the speaker by the L-pad (R1)—a speaker-level volume control that provides proper impedance match to the receiver's output transformer.

If you don't need volume control at the speaker, you can use the circuit shown for REC 2; a switch to cut the speaker in and out (S2) and a load resistor (R2).

If you have no need to completely disable either signal source the switches can be eliminated. Of course, an L-pad can be used in both circuits to provide individual remote volume control.

Why The Load Resistor. If an L-pad is

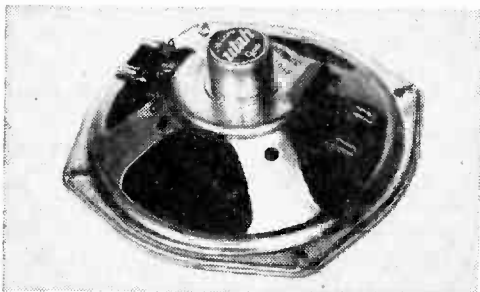

Utah multi-impedance speaker has plug-in terminals (above) while speaker in AC/DC set (see below) uses typical solder connection.

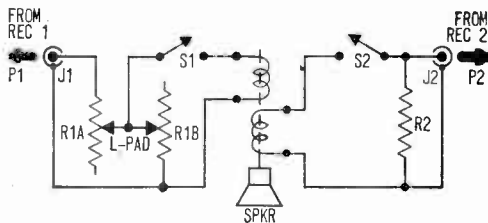
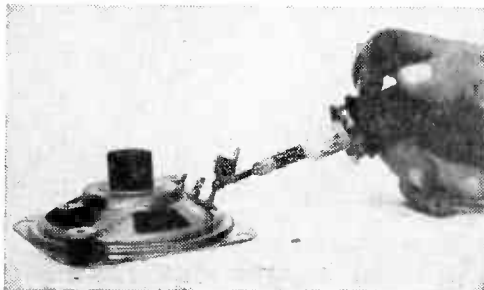

Signal Center schematic diagram shows two methods of connecting to the receivers. A load resistor (R2) can be used in place of the pad (R1) or two pads can be wired in the circuit.

PARTS LIST

- J1, J2—Phono jack
- P1, P2—Phono plug to match J1, J2
- R1—L-pad; 4-ohm for 3.2- or 4-ohm circuits; (Lafayette 33C1376 or equiv.) 8-ohm for 6- or 8-ohm circuits (Lafayette 33C1378 or equiv.)
- R2—Load resistor (see text)
- S1, S2—5-p.s.t. switch
- SPKR—6-in. dual-voice-coil speaker (Utah SP6D-M1, Lafayette 32C2205 or equiv.)
- 1—Speaker enclosure
- Misc.—Terminal strips, lugs, solder, hookup wire, speaker wire, etc.

Estimated cost: \$9.50

Construction time: 1 hour

not used, the load resistor, R2, *must* be used to provide the correct terminating impedance for the receiver. This is because the impedance of each of the speaker's voice coils are 20 ohms. For 5-watt CB transceivers and table radios (which normally use a 3.2-ohm speaker) R2 is 3.9 ohms at two watts. (The 3.9-ohm resistor in parallel with the 20-ohm speaker provides a total impedance of approximately 3.2 ohms.) For 6 to 8-ohm speaker circuits R2 should be 10-ohms at 2 watts.

Resistor R2 isn't needed when an L-pad is used as the pad will "compensate" for the 20-ohm speaker voice coil mismatch as long as the L-pad isn't set "wide open." Just keep the L-pad backed-off slightly from full-open and you'll have no mismatch problems at all.

Keep in mind that the matching resistor does "eat up" some output level, and the receiver's volume control will have to be advanced slightly from the usual setting to obtain the "normal" speaker level.

Building the Signal Center. The unit shown in the illustrations incorporates the circuits shown in the large schematic; an L-pad control on REC 1 and a matching resistor for REC 2. It is housed in a 6-inch wooden speaker baffle.

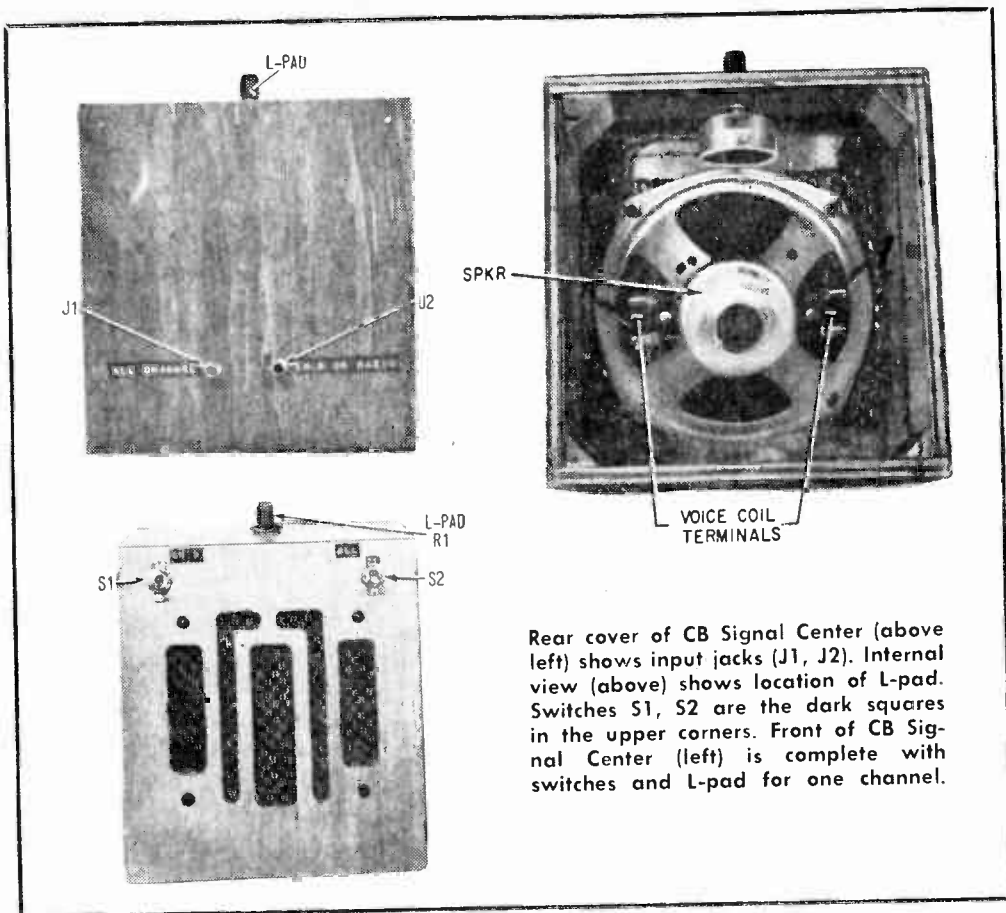

Rear cover of CB Signal Center (above left) shows input jacks (J1, J2). Internal view (above) shows location of L-pad. Switches S1, S2 are the dark squares in the upper corners. Front of CB Signal Center (left) is complete with switches and L-pad for one channel.

While a metal enclosure might look more *pro*, keep in mind that a wood baffle produces a superior sound, with none of the metallic “ring” common to metal enclosures (you’ll be surprised how good your transceiver sounds when you get the speaker out of the metal coffin).

If your speaker baffle doesn’t come complete with a back panel cut one from a piece of plywood. If the speaker sounds *boxy* or hollow with the back on, simply drill two or three ½-in. holes in the back panel.

Install input jacks J1 and J2 on the back panel. If you don’t use an L-pad solder the load resistors (R2) directly across the jacks. The load resistor (not shown in the photographs) is wired directly across the solder terminals of J2. Connect about 12 inches of two-wire zip-type (thin parallel) speaker wire to each of the jacks and then set the panel aside.

Temporarily mount the speaker—so you can judge the clearance for the switches. Mark the locations for the switches in the

upper corners, then remove the speaker and drill the holes for the switches. If you use L-pads they can be installed on the top of the baffle as shown in the photographs.

Mount the switches, the L-pad, do as much wiring as possible, and then install the speaker. Complete the speaker wiring and connect the leads from the back panel. Finally, use four wood screws to hold the back in place.

Connecting the Receivers. If both speaker circuits are to be connected to CB or communications receivers make up a patch cord with a phono plug at one end (for J1 and J2) and a plug at the other end that matches the headphone or remote speaker jack on the receiver. Simply plug the one end of the cord into the Signal Center and the other into the receiver.

If the receiver doesn’t have a headphone or remote speaker jack, or if you’re connecting to a radio, you’ll have to make a slight modification to that speaker circuit,

Disconnect the leads at the radio’s (or

CB Signal Center

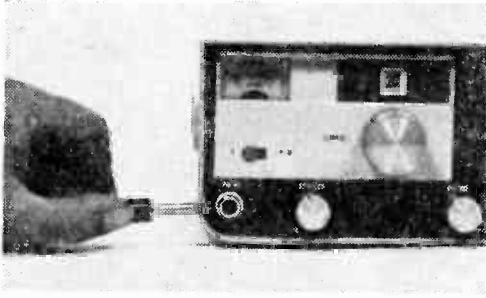

Often it is just a matter of inserting a plug into a jack to connect the BCB receiver or CB rig to the CB Signal Center speaker circuit.

receiver's) speaker, and as shown in the photographs, solder a terminal strip to one speaker terminal. Re-install the speaker but connect one of the leads to the speaker to the insulated terminal (disabling the internal speaker). Then solder a length of zip or

speaker wire to the speaker terminal having the output transformer lead, and to the insulated terminal.

If the receiver or radio doesn't have a power transformer, and is the so-called AC-DC type, you must make certain you don't bring out a "grounded" speaker lead as this might create a shock hazard by making the shell of P1 or P2 one side of the AC power line. As shown in the photograph, check that one speaker terminal is not connected to the speaker frame—with the frame, in turn, connected to the radio's chassis (this is common in many radios). If you do find a ground strap, or a direct connection between the speaker terminal and the frame, make certain it is this connection that is opened and connected to the insulated terminal strip.

Finally, label the switches and jacks so you'll know what is what and get rid of the junk at the operating position. Unlike 30 years ago, the sure sign of a professional operation is a completely clear desk, not a wall of dials, meters and cabinets. ■

RAZ-MA-TAZ RELAY

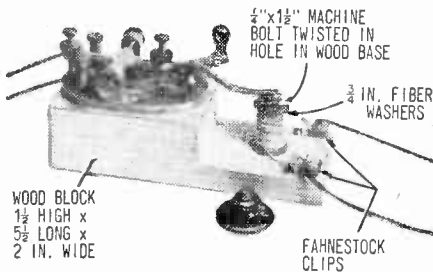

□ So you're fiddling around in the shop one day and you need a relay—just a simple, regular old relay. You know—clunk, on—clunk, off. Well, if you've got an old code key sitting around not earning its keep, you've got the answer just a'lookin' for a problem.

Practically any lever-type transmitting key can be put to good use as a handy-dandy experimenters' relay. You simply mount an iron core electromagnet under the key lever as shown in the photo. Here's how.

First, make the wood block to the size shown. Cut the part that holds the coil and clips down to about 1/2 in. thick.

To speedily construct the magnet, slip two

3/4 in. diameter fiber washers on to a 1/4 in. x 1 1/2 in. long iron machine bolt. Drill a 3/16 in. hole in the wood block directly under the head of the bolt and twist the bolt into the hole. Screw it down until you've got about 1/4 in. between the head of the bolt and the head of the key. Now wrap the space between the fiber washers with #24 cotton-covered enameled magnet wire. The two ends go to the Fahnestock clips as shown.

Fasten the key in the right position on the block. Then adjust the key screw adjustments for about 1/8 in. key travel, making sure that the keying contacts 'make' when the key is pulled in by the magnet. Adjust the key-tension spring for just enough zing to return the key.

This coil should be good for about six volts—but for other voltages you'll have to add or subtract coil wire to suit.

If the key lever happens to be made of brass, just screw an iron bolt into the threaded head of the key for the magnet to grab hold of.

Since most keys have both a 'make' and 'break' contact, what you end up with is a fully adjustable, single-pole double-throw raz-ma-taz relay. ■

SUPER SQUARED 3 FOR HAMS

This rig is the cat's meow if you're hurtin' for a sensitive, selective little mini-meter grabber.

■ There's happy listening for you on two. That's because ever-increasing popularity of 144 to 148 MHz is making for gobs of activity up there in mini-meter land. And for good reason, too.

If you thought the high frequency bands, like two meters, were deadly dull, think again. Fact is, better understanding of what's going on up there in the ethereal heights of radiodom, improved high frequency technology, plus overcrowding of the lower frequencies all combine to make this band ever more popular.

For local rag-chews, as well as longer distance band-opening contacts, more and more hams are populating the two-meter portion of the radio spectrum. One big reason is it's the only ham band where novice-class licensees can operate phone, and it's a popular technician-class band as well.

You can listen in on the fun on two meters with our Super Squared 3-receiver. The unit is easy to build and doesn't need elaborate test equipment to get it operating. The way-out (Continued overleaf)

By Charles Green, W6FFQ

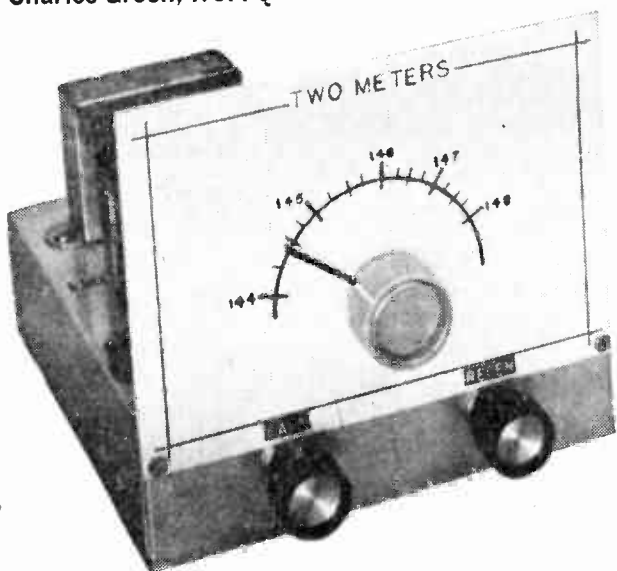

Super Squared 3 is just the receiver if you're ready to step up to 2 meters. This hot-shot uses a superhet front-end for good selectivity and a superregen detector for excellent sensitivity. Two stages of audio provide poop for driving a speaker or headset.

SUPER SQUARED 3

design of Super Square's circuitry includes a superhet front-end driving a superregen detector providing unusually good selectivity and *lotsa* gain. The audio section, using two stages, will drive an external speaker. The receiver is built on a 7x7x2-in. aluminum chassis, with a built-in AC supply.

How It Works. Let's have a look at the schematic diagram. A two-meter antenna connected to J1 delivers signals through the coax to a two-turn link on L1. The coil L1 is broadly tuned to the 2-meter band with the wiring and tube capacity. Signals are coupled via C1 to the grid of V1A and mixed with the oscillator output of V1B. V1B is tuned approximately 12 MHz below the incoming signals and coupled to the grid of V1A via the gimmick capacitor. The resultant 12 MHz signal output is coupled from the plate of V1A to the cathode of the superregenerative second detector V2A by coupling capacitor C7.

Potentiometer R7 controls the regenerative action of the circuit by varying the B+ voltage to V2A. The detected signals are fed through the low pass filter R8, C11 to minimize overloading of the audio stages by the detector's quench voltage. The audio signals are coupled via C10 to the audio gain control R13 and the first audio amplifier stage of V2B.

The amplified audio signal is coupled through C14 to the grid of V3 and further amplified. Output transformer T1 couples the audio to an external 3-ohm speaker connected to J2. The necessary power for the receiver circuits are supplied by transformer T2, diode D1, and the B+ filter consisting of R14, R15 and C17A, B, C.

Putting SuperSquare Together. Lay-out the 7x7x2-in. aluminum chassis as shown in the photos. Easiest way is to tape a sheet of graph paper on the chassis, and mark the holes to be cut. Remove the paper before mounting components on the chassis. Space the parts as shown and follow the parts placement shown in our unit. As in all high frequency circuits, the wiring and component placement is critical. Keep the RF wiring as short as possible. Use sleeving over bare leads.

The author used a 5x7-in. heavy cardboard front panel with aluminum foil cemented to its back for shielding. This makes

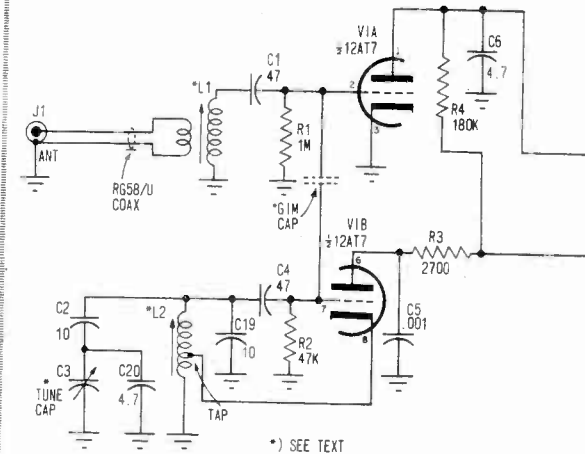

Schematic of Super Squared 3 shows low-noise triode mixer feeding superregen detector.

PARTS LIST FOR

- C1, C4, C8—47-mmF, 500-volt Ceramic tubular capacitor (Erie 315-005U2M470K or equiv.)
- C2, C19—10-mmF, 500-volt ceramic tubular capacitor (Erie 301-000C0H110C or equiv.)
- C3—15-mmF, variable capacitor; 2 rotor and 1 stator blade, modified by removing 1 rotor blade (see text) (E. F. Johnson 149-1)
- C5, C11, C18—.001-mF, 1000-volt ceramic disc capacitor (Erie 801-000X5F0102K)
- C6, C20—4.7-mmF, 500-volt ceramic tubular capacitor (Erie 301-000C4H479C or equiv.)
- C7—22-mmF, 100-volt ceramic tubular capacitor (Erie 390-000X5P0220K or equiv.)
- C9, C13—100-mmF, 500-volt ceramic tubular capacitor (Erie 315-005X5U101K)
- C10, C14—.01-mF, 1000-volt ceramic disc capacitor (Erie 871-000Z5U0103M)
- C12—5-mF, 15-volt miniature electrolytic
- C15—5-mF, 15-volt miniature electrolytic
- C16—.02-mF, 1000-volt ceramic disc capacitor (Erie 841-000Z5U0203M)

for easy inking of the front panel dial and lettering. An aluminum front panel can be used as well, with decals for the dial. The panel is mounted with two sheet metal screws to the chassis and two nuts on the threaded bushing of C3.

Before mounting C3, remove one rotor blade by carefully twisting it with a pair of long nose pliers. Install a ground lug under the rear mounting foot of C3 and a washer under the front foot to keep it level. Solder the ground lug to the rear rotor terminal of C3 and connect C20 between the lug and

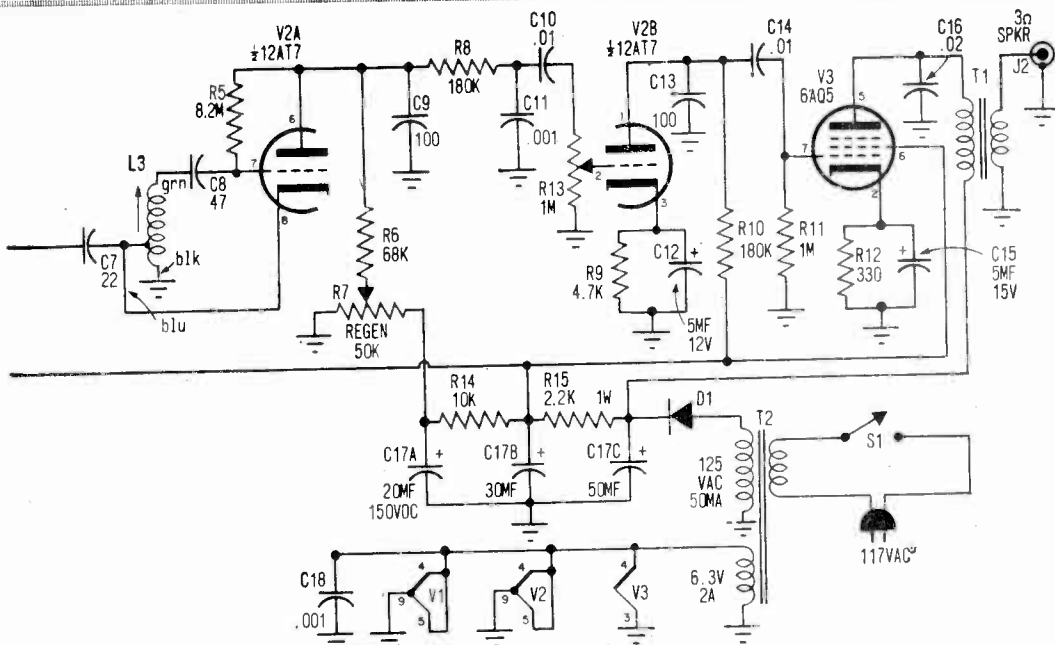

SUPER SQUARED THREE HAM RECEIVER

C17A, B, C—20-30-50-mF, three section 150-volt electrolytic capacitor

D1—Silicon rectifier, 400 PIV, 750 mA (Erie 1N2070, Radio Shack 276-1110 or equiv.)

J1—ANT jack, phono socket with RF type insulation

J2—SPKR jack, RCA-type phono jack

L1—0.15- μ H coil (J. W. Miller 20A157RBI, Allied 50D0367 or equiv.)

L2—4 turns No. 22 wound on J. W. Miller coil form A000RBI (Allied 54D3908) tapped at one turn from bottom (see text)

L3—Oscillator coil (J. W. Miller B-321-C or equiv.)

R1, R11—1-megohm, $\frac{1}{2}$ -watt resistor

R2—47,000-ohm, $\frac{1}{2}$ -watt resistor

R3—2,700-ohm, $\frac{1}{2}$ -watt resistor

R4, R8, R10—180,000-ohm, $\frac{1}{2}$ -watt resistor

R5—8.2-megohms, $\frac{1}{2}$ -watt resistor

R6—68,000-ohms, $\frac{1}{2}$ -watt resistor

R7—50,000-ohms, linear taper, potentiometer

R9—4,700-ohms, $\frac{1}{2}$ -watt resistor

R12—330-ohms, $\frac{1}{2}$ -watt resistor

R13—1-megohm, audio taper, potentiometer with s.p.s.t. switch (S1)

R14—10,000-ohms, $\frac{1}{2}$ -watt resistor

R15—2,200-ohms, 1-watt resistor

S1—S.p.s.t. switch (part of R13)

T1—Output transformer; 5,000-ohm primary to 3.2-ohm sec. (Allied 54A2064 or equiv.)

T2—Power transformer; 125-VAC, 50-mA; 6.3-VAC, 2-A secondaries (Allied 54A1411 or equiv.)

2—Terminal boards (Erie 3976-205-2)

V1, V2—12AT7 tube

V3—6AQ5 tube

1—7x7x2-in. aluminum chassis

Misc.—2- 9-pin sockets, 1- 7-pin socket, cardboard for dial, rubber grommets, AC line cord, one and three lug terminal strips, wire, solder, etc.

Estimated cost: \$30.00

Estimated construction time: 8 hours

stator terminal, keeping the leads short.

Erie terminal boards were used to mount most of the parts. These terminal boards have connecting jumper strips which are left connected or removed as necessary. The terminal boards are mounted away from the chassis with $\frac{1}{2}$ -in. metal spacers. Install ground lugs on the mounting screws as shown. The unused terminals around the AC line input connections to the terminal board were removed.

Wind two turns of hookup wire around the base of L1 (see drawing) and solder

one end to the center conductor of a length of RG-58/U coax and the other end to a ground lug. Connect the coax to J1. Make sure the coax shield is connected to the chassis at both ends.

Wind L2 as shown in the drawing and solder the #22 bus wire to the coil terminals positioned to the dimensions indicated. Space the coil wire so the turns do not short. Use the serrated washers under both the mounting nuts and coil form body to prevent movement of both coils. Make the Gimmick capacitor by connecting two lengths of hook

SUPER SQUARED 3

Most circuit components of Super Squared 3 are mounted on terminal boards for easy assembly and rugged construction. Leads in RF section must be kept short at these frequencies.

up wire to pins 2 and 7 of V1 and twisting them together two turns. Cut off the excess wire.

Firing It Up. After you have completed construction, plug in the tubes, and allow the receiver to warm up for a few minutes. Connect an external 3- to 4-ohm speaker to J2, and set the Gain control (R13) to maximum clockwise position (full gain).

Adjust the tuning screw on top of L3 to about 1/4-in. out. Exact adjustment is not necessary. This will provide an IF of about 12 MHz. Install another nut on the L3 screw to lock it into position. Rotate the Regen control (R7) clockwise until you

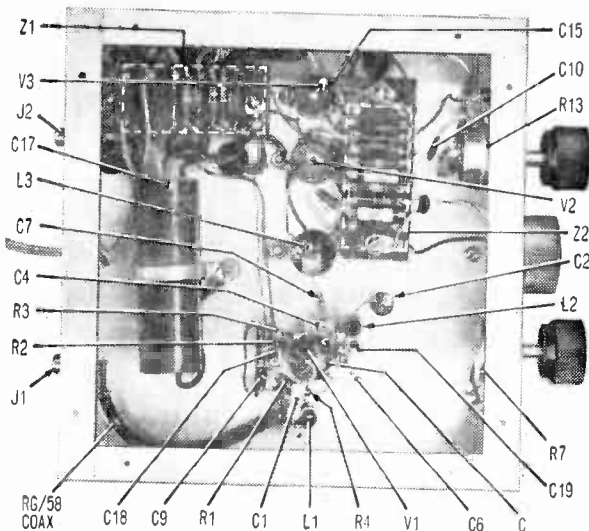

hear the characteristic superregenerative hiss from the speaker. Set the tuning capacitor (C3) to full capacity.

If you happen to have a signal generator that covers from 144 to 148 MHz, connect it

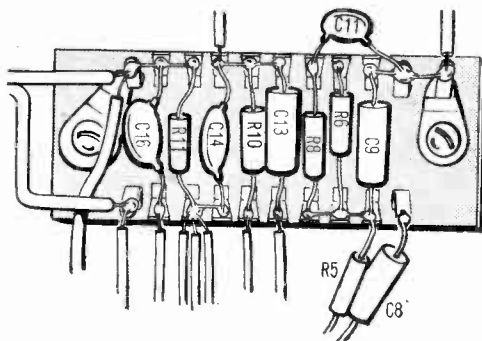
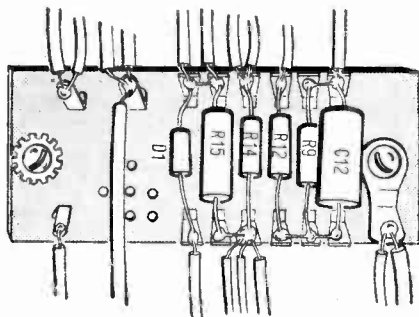

Terminal boards can be pre-assembled before mounting in chassis. Remainder of wiring is then readily completed.

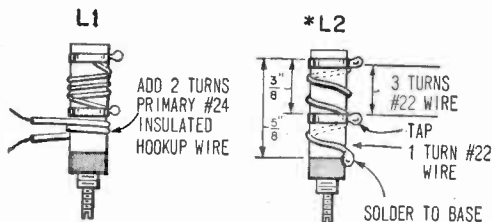

*SEE TEXT

Coil L1 is pre-wound, you just add primary. Coil L2 is wound on coil form. Complete details are given in text.

to J1 and set it for 144 MHz modulated output. Adjust L2 until you hear the signal in the speaker. Set the signal generator to 145 MHz and tune C3 until you hear the signal in the speaker. Reduce the output of the signal generator until you can just hear the signal above the background hiss, then adjust L1 for maximum signal. Re-adjust C3 around the signal as you adjust L1 for best reception. Use the lock nuts supplied with the coils to keep adjustments from shifting. Calibrate the dial.

If you don't have a signal generator, set the L1 and L2 screws to approximately 1/4-in. out from the top of the coil. Connect a good two-meter antenna to J1 and listen for signals. Receiving conditions are generally better at night, as the band is more
(Continued on page 114)

CB SQUEAKER

by Homer L. Davidson

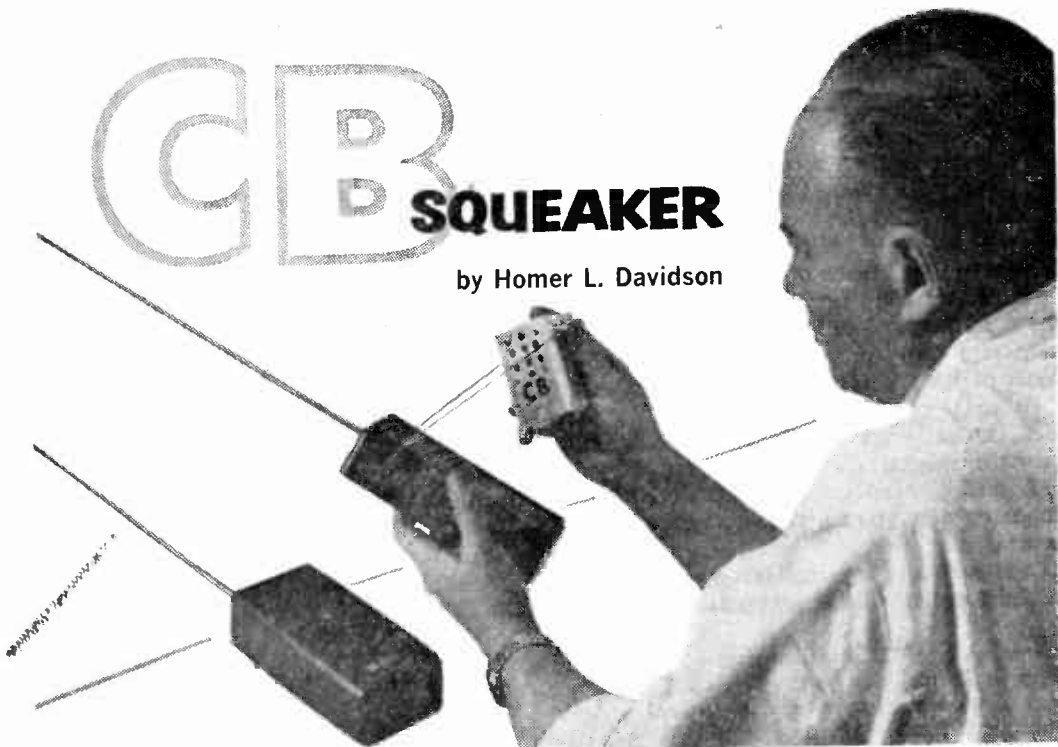

Want more distance from a pair of those low-priced hand-talkies? Well, build this little audio-signal generator to modulate those hand-held rigs and you can tune 'em up for maximum milliwatt range.

The main trouble with 100-milliwatt rigs is that they were never tuned to one another even though they are designed to operate on the same CB channel. Although sold in pairs they're never tuned together as a pair. Of course dropping them every other week hasn't helped much either.

Now you can get a pair of walkie-talkies perking as good as new. Probably better than new if you use our easy-to-build CB Squeaker. Just zero in the receiver of one unit on the transmitter tone-modulated frequency of the other. Why, you can even do the job all alone!

Just place the output speaker of the CB Squeaker face-to-face with the speaker used as a microphone in the walkie-talkie. It can be held in place with a rubber band. A special clip or just a C-clamp can be used to hold the push-to-talk switch in. The tone signal coming from the one-inch speaker of the CB Squeaker takes the place of some one talking. A constant-level audio signal is transmitted to the receiver of the other CB unit whose receiver you are going to tune for maximum output from the speaker.

Circuitry. A single unijunction transistor and a couple of resistors, a capacitor, a speaker and a 9-volt battery cover the components. There are no expensive chokes or transformers used—just a resistance-capacitance (R-C) circuit with that one transistor. And that resistance (or capacitance) can change the tone of the audio generator.

A unijunction is not like those common, everyday transistors. It's a lot different—it can't even be compared to a vacuum tube circuit (the nearest would be a thyatron, probably). In the CB Squeaker it's connected into a relaxation-oscillator circuit.

When switch S1 is closed R2, Q1 and the speaker (SPKR) form a voltage divider across the battery. At the instant the switch is closed the emitter of Q1 is at zero volts and it is held there by a capacitor C1. The charge on C1 keeps the emitter junction of Q1 reverse-biased and no current flows.

As C1 charges the voltage across it builds up at the emitter of Q1. When the charge on C1 reaches some point around 6 volts the emitter junction becomes forward-biased—This reduces the internal resistance of Q1

CB SQUEAKER

and the voltage drop across it. The charge stored in C1 is discharged through the speaker until the voltage across C1 is too low to forward-bias the emitter-to-base-1 junction. The internal resistance of Q1 increases and the capacitor (C1) begins to charge again. The cycle repeats over and over—the repetition rate (frequency) determined by the values of R1 and C1. Increasing the value of either R1 or C1 will slow down the repetition, lowering the frequency of the tone from the speaker. For R1 don't go below 4.7K and C1 can be increased to 1 mf. No matter what you do, you won't get a sine wave signal.

Construction. Any small box can be used. It doesn't matter whether it's plastic or metal.

Internal view of CB Squeaker shows location of parts. R2 is hidden by the tie strip. Placement of parts is not critical. Actual connections can be seen in pictorial diagram on the next page.

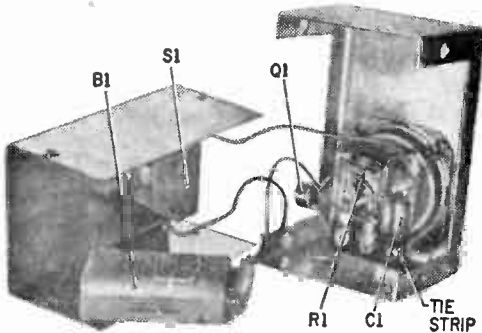

Lay out the speaker mounting holes by placing the speaker in its position and mark the holes in each corner as well as the outline of the speaker. Within the outline of the speaker, holes must be drilled to allow the signal tone to come through. Space the holes as evenly as possible—eight 1/4-in. should be enough but you can use more holes if you want.

The four holes for the speaker mounting should be 1/8-in. for pop rivets or 4-40 machine screws and nuts—use flathead machine screws to prevent scratching the front of the CB handi-talkie. The speaker side of the chassis box should be smooth for best transfer of sound energy between the speaker in the audio generator and that used as a microphone in the transceiver.

If you use a toggle switch you'll need a 1/2-in. hole to mount that and another 1/8-in. hole for the 2-terminal tie strip. The locations are shown in the photograph.

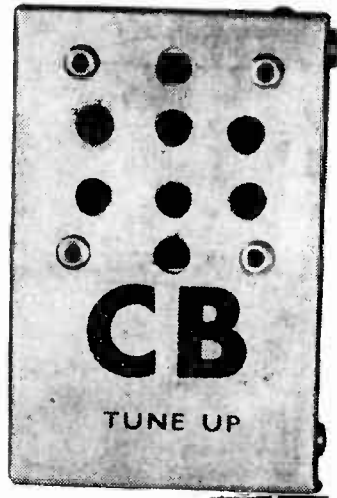

PARTS LIST

- B1—9-volt battery (Eveready 216 or equiv.)
- C1—0.1-mf., capacitor (see text)
- Q1—Unijunction transistor (GE 2N2160 or equiv.)
- R1—10-000-ohm, 1/2-watt resistor
- R2—470-ohm, 1/2-watt resistor
- S1—S.p.s.t. toggle, slide or see-saw switch.
- SPKR—1 1/2-in., 10-ohm speaker (Lafayette 99C6035 or equiv.)
- 1—3 1/4 x 2 1/8 x 1 3/8-in. chassis box (Premier AMC-1001; Bud CU-3001-A or equiv.)
- Misc.—Battery connector, wire, solder, spaghetti tubing, machine screws and nuts (or rivets), etc.

Estimated cost: \$5.00

Construction time: 1 hour

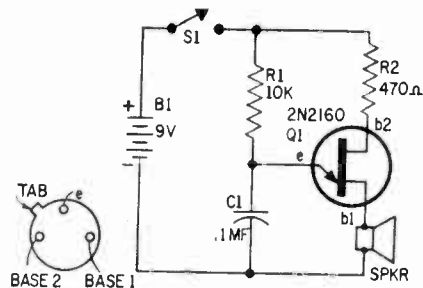

Schematic diagram is simple and easy for a beginner to compare to the pictorial diagram to the right—an easy way to learn symbols.

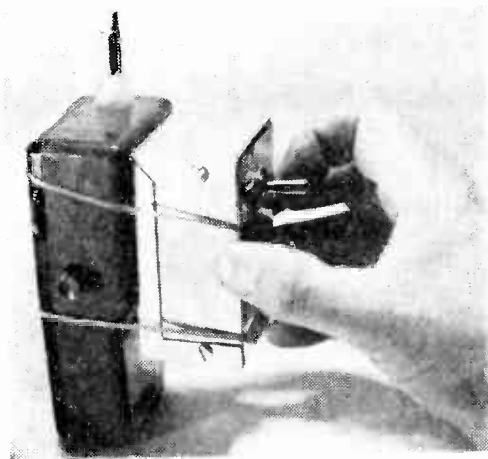

Assembly. Mount the tiny speaker first. Attach the 2-terminal tie strip above it and then mount the toggle switch in the cover. All of the smaller parts are mounted by their leads as they are soldered into the circuit. The 1-inch PM speaker and the 2-terminal tie strip can be mounted either with machine screws and nuts or with pop-rivets—using a special tool.

Wiring the Circuit. The gadget is very simple and sweet to wire—only six components must be connected together, as shown in the schematic diagram and illustrations.

Connect the *base-1* lead of Q1 to one terminal of the voice coil of the speaker SPKR. Use a 1-in. length of plastic tubing (spaghetti) to cover the bare lead. If you don't have small-diameter spaghetti use the insulation slipped off a piece of hookup wire.

Slip 1-inch length of spaghetti over the *base-2* lead of Q1. Connect the *base-2* lead to one pigtail lead of R2 after the lead of R2 has been shortened to about 1/2-in.

Pictorial diagram makes it easy for just about anyone to build CB Squeaker.

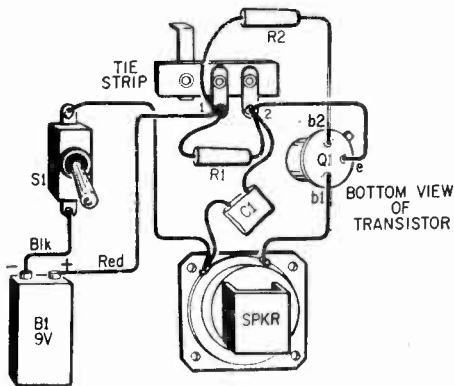

Pair of rubberbands hold lightweight CB Squeaker in place on transmitting unit while you retune the receiver (left). U-shaped strip of metal (below) will press push-to-talk switch for tests.

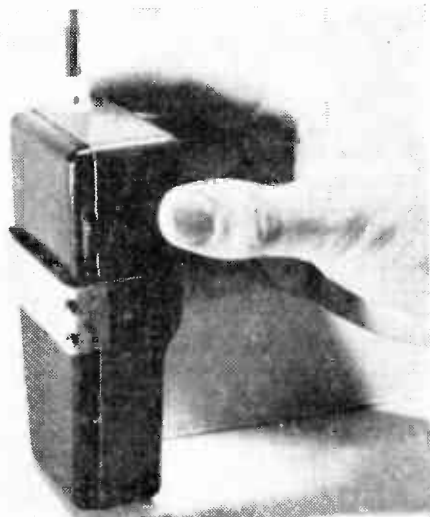

Cover R2 and the connection to *base-2* with a short length of larger-diameter spaghetti.

Connect the remaining lead of R2 to *terminal-1* of the tie strip. Just hook the end of the pigtail lead in the solder lug. Do not solder.

Connect one pigtail lead of R1 to *terminal-1* of the tie strip. Do not solder.

Connect the red (+) battery-connector lead to terminal-1 of the tie strip and solder. Make sure leads of R1, R2 and the battery connector are properly soldered.

Hook one lead of C1 around *terminal-2* of the tie strip. (Two miniature .05-mf capacitors are wired in parallel to obtain the necessary value of 0.1 mf.) Do not solder.

Wire the remaining lead of R1 to *terminal-2* of the tie strip. Do not solder.

Connect the emitter lead of Q1 to *terminal-2* of the tie strip. Solder the leads of C1, R1 and Q1 to the tie strip. Use a heat sink, or the jaws of a pair of pliers, on the emitter lead of Q1 to prevent damage to the unijunction transistor since the lead is less than an inch long.

Hook the free end of C1 to the remaining voice-coil terminal. Do not solder.

Connect one end of a 4-inch length of hookup wire to the same voice-coil terminal as C1 and solder both C1 and the end of the hookup wire.

Solder the other end of the 4-inch length

CB SQUEAKER

of hookup wire to one terminal of the battery *on-off* switch (S1).

Solder the black (-) lead of the battery connector to the remaining terminal of S1.

Now check the wiring at least once. Check each connection to make sure they are soldered properly. Cold solder joints may prevent the oscillator from operating.

Clip the battery to the connector and flip the battery switch *on*. Listen for a low-level tone coming from the speaker. During normal operation the unijunction-transistor oscillator should draw about 2.5 milliamperes.

Tone Modulation. Now you're all set to tune up those ailing handi-talkies. With the speaker side of the audio generator covered with plastic tape or adhesive backed weather stripping (so you don't mar the plastic case of the handi-talkie) you can attach the test unit to the handi-talkie with a large rubber-band or two.

To radiate a *weak* signal do not extend the antenna fully on the hand-held CB unit that is transmitting. The antenna on the unit being tuned *must* be extended fully since this often affects the tuning of the receiver.

You must keep the CB rig transmitting

while adjustments are being made so you'll have to have someone hold the push-to-talk button in or you'll have to make a holder to do the job. You can take a scrap of thin sheet metal and form it into a U-shaped holder. A large C-clamp can also be used. Just make sure you pad the metal and smooth the edges to prevent damage to the plastic cases.

Now with the back of the transceiver removed (some units have access holes in the back cover), and the receiver adjust previously located you can proceed with the tune up. Make all adjustments with the proper alignment tool—whether it's just a plastic screwdriver or a special hexagonal alignment tool. Using hardened steel tools on the soft ferrite cores will end up "chewing" the molded slot or hexagonal hole to a point where adjustments are impossible.

Adjust the slug in the coil for loudest tone from the speaker of the CB handi-talkie. On single-coil superregenerative rigs (about three transistors) you will find that the point of maximum tone output is very sharp—adjust very slowly. Tune past the point of loudest tone and then come back. Repeating this adjustment several times helps to find the critical point.

Repeat the process for the other handi-talkie—tune the receiver of the rig that had just been used for transmitting. You'll find that by making only this one adjust on each of the rigs will improve reception—sometimes you can actually double the previous communication range.

Remember, only tune up the receiver portion of the CB unit. Do not touch the transmitting coils unless you have at least a 2nd Class Radiotelephone license.

When working on larger (4- to 6-transistor handi-talkies) you'll find separate receiving and transmitting coils. There are also IF transformers that should be adjusted for maximum sensitivity and selectivity.

Use a Meter. If you want to be extra critical you can hookup an output meter across the speaker and tune for maximum indication on the meter. The main thing is to keep the signal from the transmitting CB rig as weak as possible. Reduce the amount of transmitting antenna that is extended or put more distance between you and the other rig. If you want to receive weak signals (signals from a distance) you'll have to tune the receiver with an equally weak signal. And the weaker the signal the more critical the tuning. ■

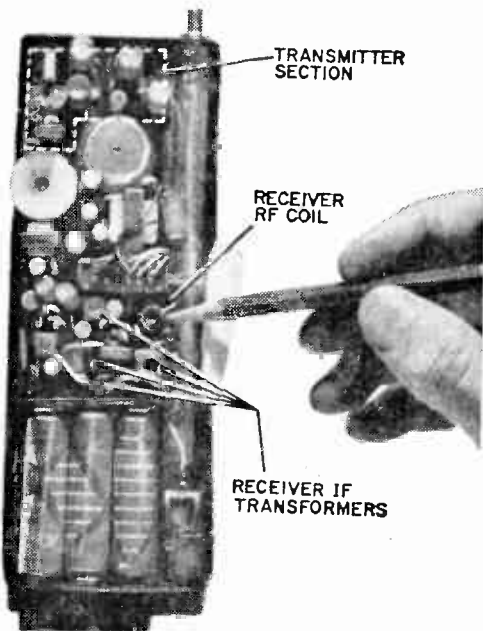

Avoid trouble with the FCC—keep hands off the transmitter stage.

Shotgun Signal Generator

**Blast-through audio, IF, RF
and video troubleshooting!**



Robert E. Kelland

■ Noise gets through where signals fail to get. And it's a simple matter to generate noise. All you need is an arcing contact and all sorts of frequencies are generated. How do you generate this noise? Just dig out that old, unused code-practice buzzer and convert it into a *noise generator*. If your buzzer is in operating condition it will cost as little as fifty cents to complete the job. Before the circuit and construction details let's see what a noise generator is, and where it can be useful.

Remember the Spark Gap? Basically, the output of the noise generator consists of a fundamental frequency, in the audio range, plus an infinite number of harmonic frequencies. However, the harmonic frequencies are not harmoniously related to produce a melodious tone—far from it. Instead, the output (when reproduced) will be heard as *noise*. This noise will easily pass through audio, RF and IF circuits *without any tuning or adjusting*—the reason why this noise is useful. The noise generated by

Shotgun Signal Generator

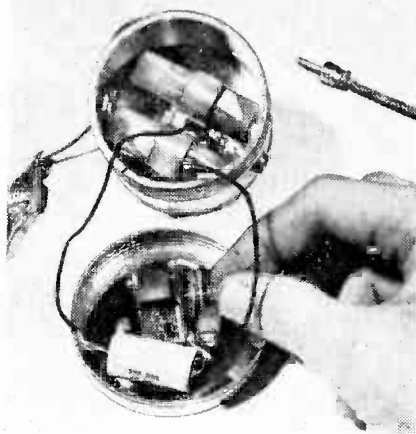
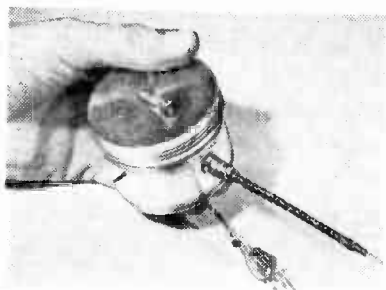

Completed signal generator is easily held in one hand (top left) and can be conveniently moved from point to point in a circuit (bottom left). Extended use may call for some minor touch-up of the unit's tone— if so, remove the top portion of the container (above), depress the switch, and make the necessary adjustments.

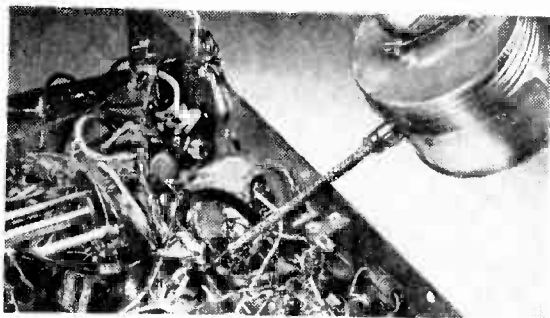

the buzzer can be heard on VHF receivers, tuned to over 100 mHz (mc.) when the signal is injected at the antenna.

Specific Uses. Although we have already hinted at a number of possible applications in the preceding paragraph, the following list is worthy of study:

- Testing AF amplifiers
- Testing RF amplifiers
- Testing IF amplifiers
- Testing video amplifiers
- Testing complete systems (e.g. radio receivers)

Testing speakers

The noise generator will test all of these and others not listed which you may think of by yourself.

In short, the noise generator is an *untuned* signal generator that will *quickly* test numerous electronic circuits *for operation*. The generator will not show up amplifier distortion, improper tuning or alignment, or other pertinent details; it will simply let you know if the amplifiers are amplifying. Special audio and RF generators are needed to ascertain the other facts.

Standard signal injection and signal tracing methods are used in conjunction with noise generators. To find a defective stage you start injecting at the output stage and

work towards the input until the defect is found.

Construction. The container used in the model shown in the photos is a cut-down mailing *can* measuring 2½ inches diameter and 2 inches high. Any similar or larger dimensioned can may be used. If a screw-on cover container can't be found, a push-on type will do provided you secured it with self-tapping screws.

Follow the pictorial diagram and the photos for construction types. The buzzer serves as its own template to drill the two mounting holes and the access hole for the switch.

The switch is made from a 1x¼-inch strip of spring brass. Bend and drill the switch as shown in the diagram. Sweat-solder the switch to the outside of the cover so that the self-tapping screw (switch contact) will pass freely through the previously drilled access hole.

The phono jack is mounted half way up the side of the container and is soldered directly to the can. An additional hole is required for the battery clamp and ground lug retaining screw. The battery clamp is formed from a 2x½-inch strip of aluminum. The batteries should be connected and soldered before they are clamped in. Because

of space, a battery holder is not used—it will be necessary to solder in new batteries when they need replacing.

Only two wires interconnect the cover to the body of the can. The first wire is from the positive side of battery B1 to the adjusting screw on the buzzer, and the second from the ungrounded terminal of the phono jack J1 to capacitor C1. Incidentally, if you use the same size can as the author, you should select the smallest size capacitor possible, otherwise you may have a tight fit. (Don't use a capacitor with a breakdown voltage less than 600 volts.)

Test Prod. Shield of the test prod can be braid removed from a piece of coaxial cable or thin tubing (from an indoor TV antenna). Solder the braid at the ends to prevent fraying. The ground lead can be a 12-inch length of AWG-20 hookup wire if a length of test-lead wire can't be found. You can solder it directly to the can, if it isn't aluminum, but a solder lug (secured to the bottom of the can by the battery-clamp screw) that will grip the insulation will prevent the ground lead from breaking frequently. Attach a clip to the other end of the lead.

PARTS LIST

B1—2 size AA penlight batteries, 1½ volts each
 C1—.05-mf., 600-volt capacitor (see text)
 J1, P1—RCA-type phono jack and plug
 1—Code practice buzzer (Lafayette 99R2556 or equiv.)
 1—Metal container, 2½" diameter, 2" high (see text)
 Misc.—Shielding braid, AWG 12 insulated copper wire, scrap metal, screws and nuts, hookup wire, alligator clip, soldering lugs, solder, etc.

Estimated construction cost: \$2.00
 Estimated construction time: 1 hour

When finished, check your wiring against the schematic diagram.

Test the noise generator with the cover removed so that you can set the tone-adjusting screw. Depress the switch and adjust the screw for the highest-frequency, most consistent sound possible. Put on the cover (be careful that the interconnecting wires do not jam the buzzers' armature) and the noise generator is ready to go to work.

A final test can be made by touching the prod to the antenna of a radio—a loud signal should be heard at the speaker if everything is OK. ■

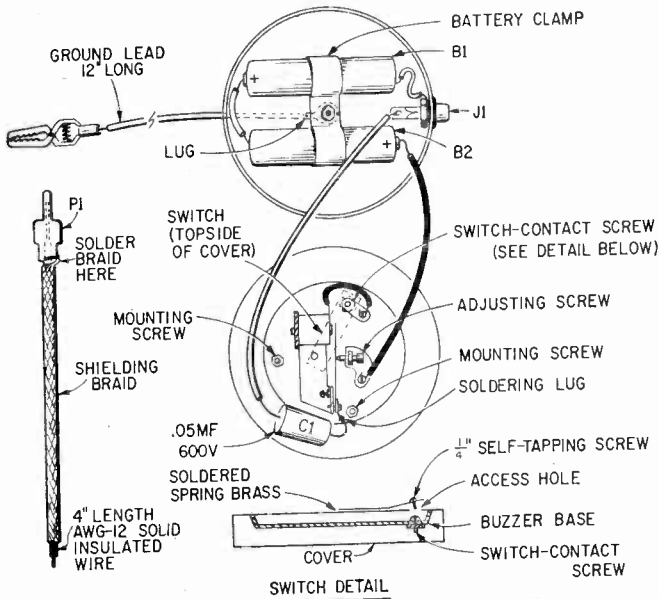

Pictorial diagram (at left) shows how parts are arranged in top and bottom sections of circular container. Batteries should be wired in series.

Schematic diagram (at right) reveals extreme simplicity of noise-generator's circuit. Ground lead (not shown) is connected to cover by battery-clamp screw.

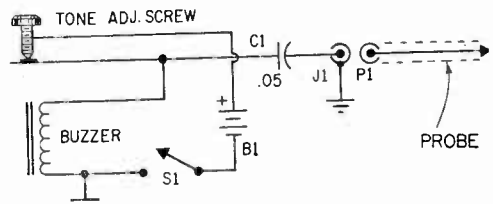

STOP TEST AND LISTEN

No need to take your eyes off the points of your test leads when you test for continuity—use the *Sonalert* as an indicator.

Whenever a new electronic gadget comes out, which isn't often, I like to buy one and see how many projects I can make using it. Recently I found an advertisement for a *Sonalert* described as a "solid-state tone signaler." It provides an audio tone at 2500 Hz (cps). At 6-volts dc it only draws 3 ma. The output level was described as being 68 to 80 db depending on the battery voltage. I secured a *Sonalert* and was quite intrigued with its possibilities.

The *Sonalert*, a metal chassis box, a 9-volt battery, a telephone jack, and two 5-way binding posts can be combined to make a code-practice oscillator and continuity

checker. Test leads are necessary for continuity checking and a telegraph key for code practice.

Construction. The smallest size aluminum chassis box is used. You'll have to use a larger box if you want to put the battery inside. A battery clip is used to hold the battery—either on the end or inside the box. A battery connector, with leads, connects the battery to all the other components inside the assembly.

No special precautions are needed in wiring or building this unit. The *Sonalert* can easily be mounted in a 1-5/32-inch round hole. Paint and decals will turn your home-

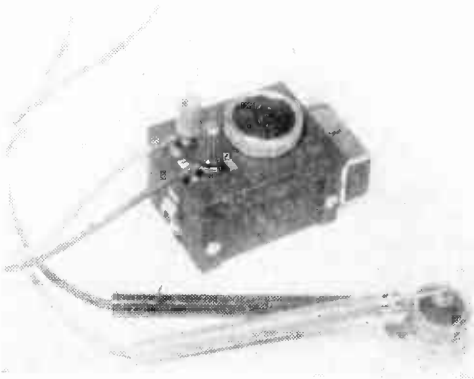

Just about any lead will fit into those 5-way binding posts used on this tester.

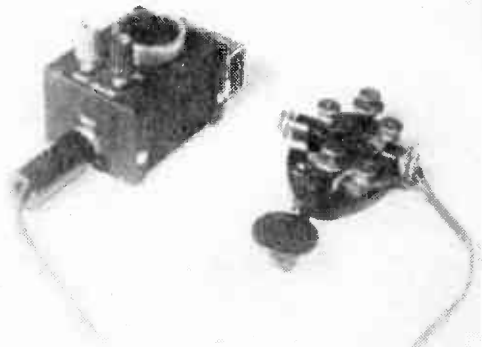

Phone jack wired in parallel to binding posts is mostly for code practice key.

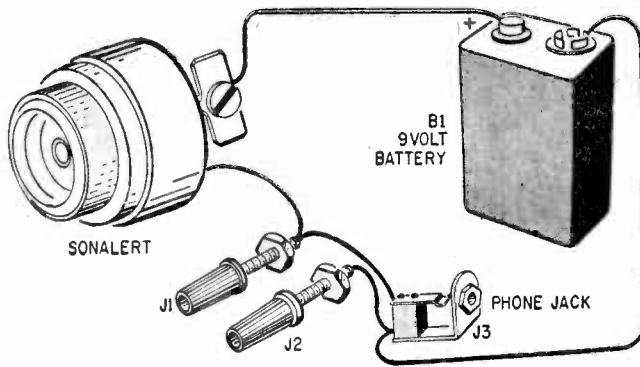

Pictorial diagram (left) shows the complete simplicity of this miniature continuity tester. Battery is clipped on outside (below) to eliminate need for opening case once construction has been completed. Make sure to insulate J1 and J2 from the metal chassis box using the fiber washers that come with them.

PARTS LIST

- B1—9-volt transistor radio battery
- J1, J2—5-way binding post—1 red, 1 black (Lafayette 99R6233 or equiv.)
- J3—Phone jack (Mallory SCIA or equiv.)
- SC1—Sonalert (Mallory SC-628) —Allied 60-A-8983, price \$5.50)
- 1—Chassis box 2 3/4 x 2 1/8 x 1 1/8 in. (Bud CU2100A or equiv.)
- Misc.—Solder lugs, rubber feet, grommet, battery connector, wire, solder, test leads, phone plug, telegraph key, etc.

Estimated cost: \$8.00
Construction time: 1 hour

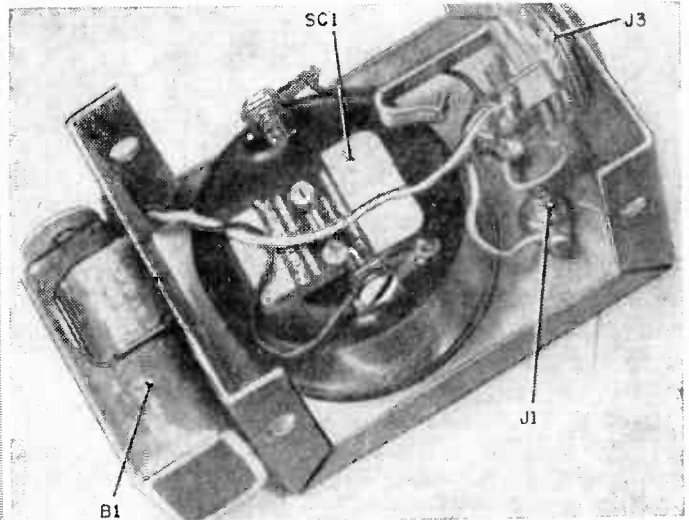

made job into a professional looking device.

For Code Practice. To use the Sonalert as a code-practice oscillator simply plug a telegraph key into the phone jack using a phone plug on the key wires. Pressing the key will produce a 2500-cycle tone which nearly simulates the sound of commercial radio code signals. The Sonalert responds very quickly when keyed so that you should have no trouble learning the Morse code for a radio amateur license.

Circuit Tracing. With test leads connected to the binding posts you can check the circuitry of all low-resistance devices by listening to the Sonalert tone as the test prods are touched to the points under test. Among the low-resistance devices found in the home that can be checked are fuses, light bulbs, line cords, electrical appliances and even radio- and TV-tube filaments. Some indication of the resistance in the test circuit can be noted by the change in volume of the *Sonalert*. With a 9-volt battery resistances up to 3000 ohms can be indicated. Any higher

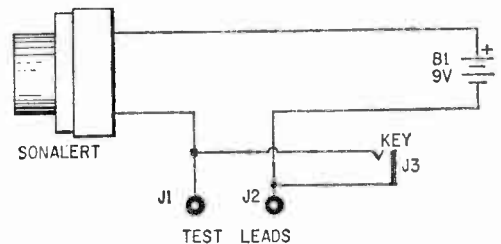

It is easy for the beginner to compare schematic with pictorial diagram (top).

resistance will keep the Sonalert from sounding off.

This device can be used in absolute safety by any member of your household—young or old.

A Precaution. The device to be tested must be disconnected from the 117-volt line. The *Sonalert* applies only 9-volts DC and draws only 3 ma. with the test leads shorted. All-in-all this piece of simple equipment makes a very useful handy tester for the home or workshop. ■

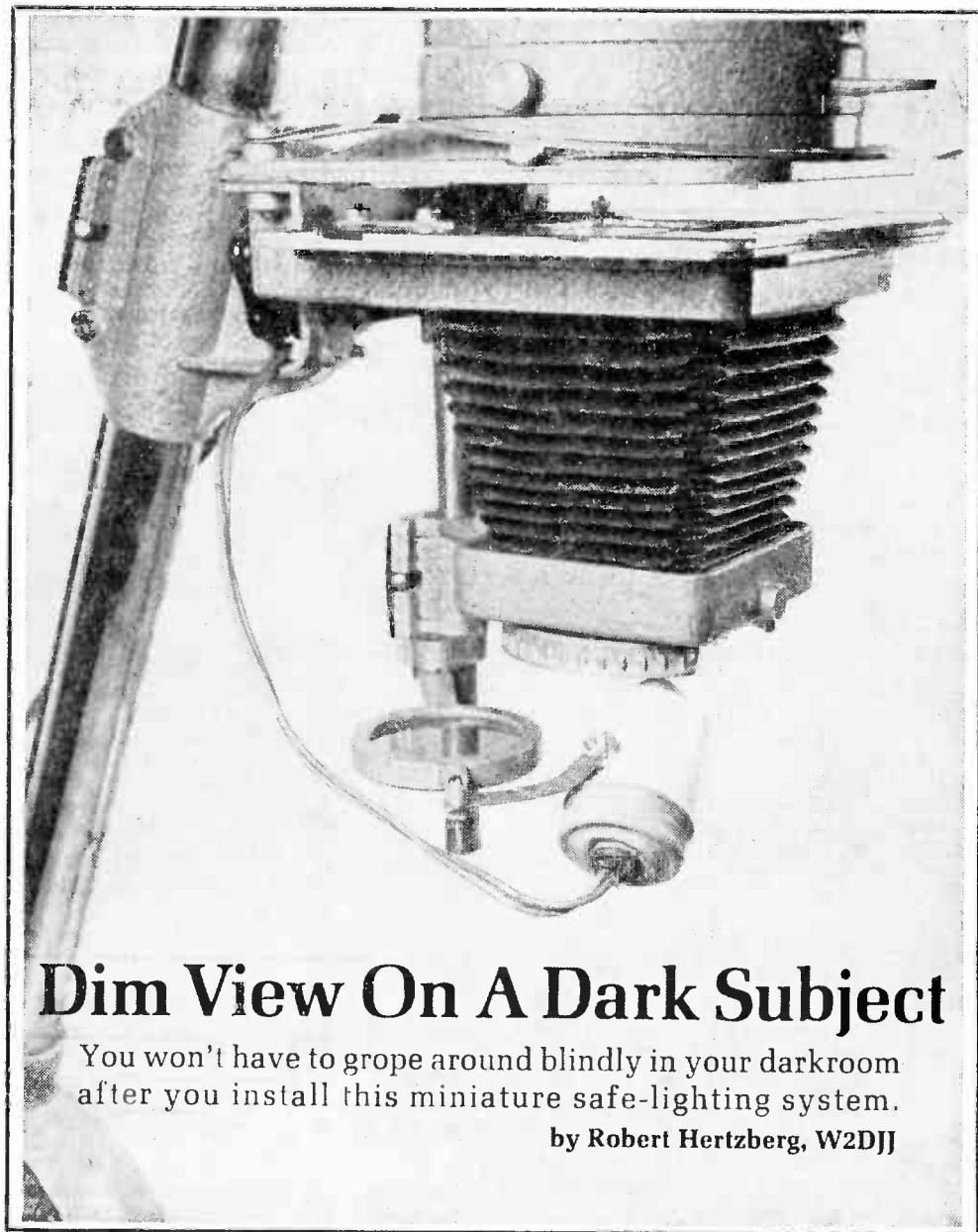

Dim View On A Dark Subject

You won't have to grope around blindly in your darkroom after you install this miniature safe-lighting system.

by Robert Hertzberg, W2DJJ

Why fumble around in your photo darkroom trying to read the markings on an enlarger lens or a print timer? The time you spend in your darkroom will be much pleasanter if you install a very simple lighting system using a few inexpensive parts, most of which can be salvaged from an experimenter's "junk box." Even if bought new they cost little.

The actual sources of illumination are a couple of pilot-light assemblies with red jewels and No. 47 miniature bayonet-base lamps.

These fit neatly inside 35-mm film cans. The holes for them are made in the can with an ordinary penknife, the metal being very soft aluminum. One can is mounted on the pivoted safe-light arm of the enlarger by a short piece of brass or aluminum, which is bent to throw the light upward to the rim of the lens. The usefulness of the filter is not impaired at all; the whole assembly swings back and forth smoothly. The other can is mounted over the face of the print timer, pointing downward.

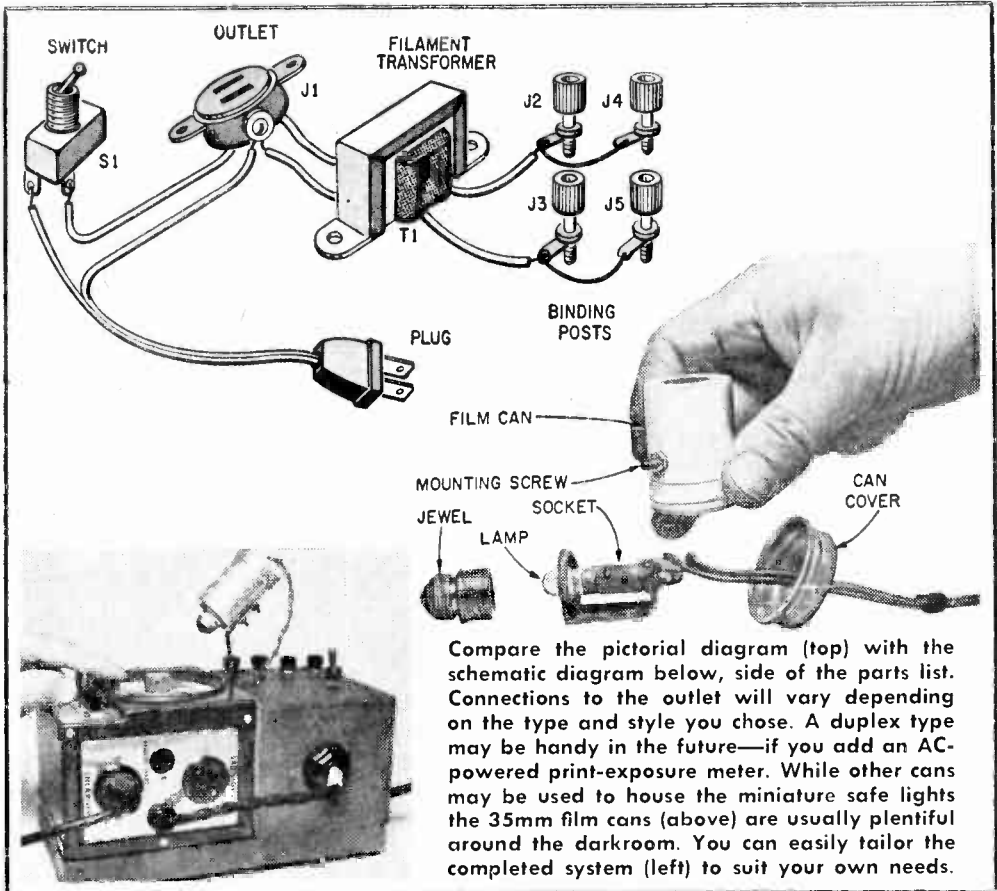

Compare the pictorial diagram (top) with the schematic diagram below, side of the parts list. Connections to the outlet will vary depending on the type and style you chose. A duplex type may be handy in the future—if you add an AC-powered print-exposure meter. While other cans may be used to house the miniature safe lights the 35mm film cans (above) are usually plentiful around the darkroom. You can easily tailor the completed system (left) to suit your own needs.

PARTS LIST

- J1—Outlet (Female power receptacle)
- J2-J5—Binding posts, insulated
- S1—Toggle switch, s.p.d.t.
- T1—6.3-volt, 1-amp. sec; 117-volt pri filament transformer (Lafayette 33R3702 or equiv.)
- 2—Pilot lamp assemblies—red jewel (Lafayette 33R6109 or equiv.)
- 2—#47 pilot lamps
- Misc.—Film cans, wire, solder, wood stock, glue and nails, machine screws, etc.

Estimated cost: \$2.50
Construction time: 1 hour

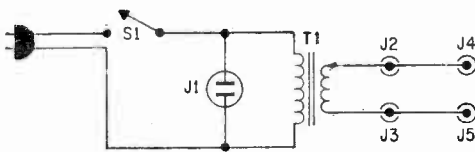

The lamps are powered by a 6.3-volt filament transformer which is enclosed in a small wooden box at one end of a board used for a base—the front portion of the base supports the timer itself. The various dimensions of the box are adjusted to suit the size of the timer. The top of the box holds a line switch and four binding posts; the right side, a single AC outlet—for the timer's AC plug.

The light for the timer dial connects to one pair of binding posts, the enlarger-lens light to the other. Lamp cord is fine for the

purpose. A single pair of posts would serve just as well, since the lamps are in parallel, but the extra pair is handy if still another light is wanted, perhaps to illuminate a clock face or a paper safe. There is absolutely no shock danger from the low-voltage wiring powered by the filament transformer.

Placed next to the enlarger, the timer-transformer unit is very convenient to operate. The bright red jewels end all squinting, yet do not fog the fastest black-and-white enlarging papers. ■

COMPASS GALVANOMETER

by T. A. BLANCHARD

Many electrical measuring instruments today are based on the design of the d'Arsonval *String Galvanometer*, but substitute a needle-suspended coil riding on jeweled bearings for the hanging coil employed in the original precise lab instrument.

The galvanometer is not often used to measure quantity of current flowing in a circuit, but rather to indicate the polarity and presence of small currents by comparison to null methods. The compass galvanometer (made from the illustration at right) can be used with a Wheatstone bridge to indicate null points.

The d'Arsonval instrument suspends a small coil between the pole faces of a permanent *horseshoe* magnet. When a current flows through the coil it becomes an electromagnet and its *like* poles repel the *like* poles of the horseshoe magnet, thus causing the coil to turn on the connecting wire. The strength of the current through the coil determines the extent of the coil's rotation.

A small pointer attached to the moving coil registers on a curved dial, or a tiny mirror is attached to the galvanometer string. A beam of light is aimed at the mirror, bouncing the beam off to a wall screen or chart to give great magnification of tiny current changes in a darkened room.

Making A Simple Galvanometer. A small amount of insulated magnet wire, any Boy Scout pocket compass and a 2¼ x 3½-in. scrap of plywood is what you need to make the compass galvanometer. Cut a strip of cardboard ¾-in. wide and 3¾-in. long. Score the cardboard ¾ in. from each end, with a dull knife blade and crease so the cardboard form resembles a C or bridge shape. Now glue the cardboard to the edges of the wood base. Do not use tacks!

Bind the cardboard with a rubber band until glue or cement dries. Wind 25 turns

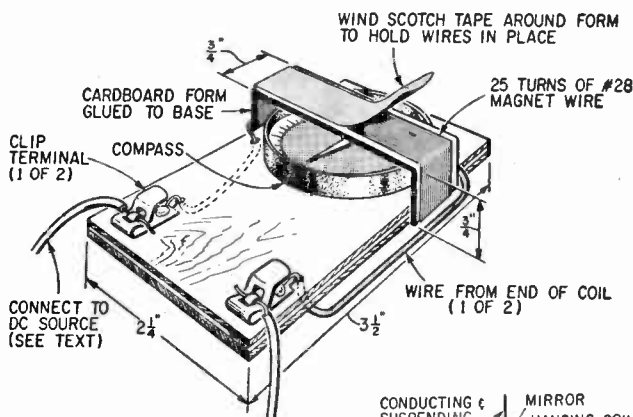

Easy to build, the compass galvanometer (above) can be assembled in an hour at practically no cost. At right is hanging coil galvanometer used in labs.

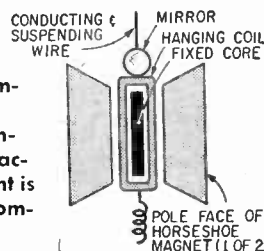

of #28 magnet wire around the cardboard. Heavier wire and fewer turns will work, too, with a slight drop-off in sensitivity.

Scotch tape is wound around the finished coil to keep the wire turns in place. Connect the ends of the coil to screw terminals or clips. Slip the compass under the coil in a position where its needle comes under the coil and parallel to the coil turns.

Connect the galvanometer in series with a flashlight battery and bulb, a buzzer or a toy motor, etc. When the circuit is closed, the compass needle will be drawn so that it is at right angles to the coil. A slow swing of the needle indicates the circuit is drawing little current. A rapid swing denotes an increase in current flow.

To show how sensitive this simple galvanometer is, connect what appears to be a dead flashlight cell across the terminals, immediately breaking the circuit. The compass needle will spin at a merry clip, indicating there is still some life in the "dead" cell.

Electronic Foot Stomper

By
Herb Friedman
W2ZLF/KBI9457

*Why not beat time
the Space-Age way—
use electronics to
save your achin' feet.*



Because they cost next-to-nothing (use junk-box components), and can be assembled by a five-year-old, electronic metronomes have always been a favorite *one-night project* with experimenters. They *always* work, and are great for elementary school Science Fairs, primarily because while other science fair projects just sit and stare at the parents, a metronome at least will *tic-tic-tic*.

But an *electronic tic-tic* can be more than a child's toy. Dress it up in a fancy box, select component values that get the *tics* to vary continuously through the 40 to 208 beat-per-minute range, and you've got a nice, and thoughtful, gift for a musical friend. And *your* cost (less the box, speaker and battery) comes to less than \$3.50.

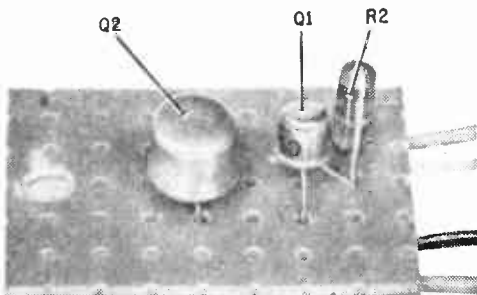

Whole circuit is contained on a perforated circuit board. Only other component on the board is C1—that's on other side. If you like, C1 can be mounted on this side, too.

Electronic Is Better. What's the advantage in an electronic metronome? Well there's tone quality and long-term convenience, to name just two. The ordinary arm-buster used by musical students requires winding, and it's five-to-one the spring will run out long before the last note of the Hungarian Rhapsody. And the usual *tack-tack* of the spring-wound arm buster is often more annoying than the clown who interrupts every fifth note to comment on the musician's abilities. On the other hand, the metronome shown in the schematic diagram produces a soft *thock-thock* sound, similar in characteristics to a muted tom-tom drum, a very pleasant beat to play along with.

The basic metronome circuit shown could cost you under \$3.50—providing you use only the components listed in the Parts List and shop carefully. Do not attempt to improve performance by using industrial grade components as a tantalum capacitor is not going to improve anything over the lowest-priced C1 specified. Same thing with transistors Q1 and Q2. With the specified transistors the output sound is a soft *thock-thock*; using better or less expensive transistors will result in the usually annoying electronic metronome *tic-tic* sound—like someone driving a nail into your ear. However, if you like *tic-tic* substitute the *least expensive* audio-grade transistors you can get (like 20 for a dollar); and while you can

FOOT STOMPER

substitute for the specified R1, R2 and C1 values, keep in mind that the timing will not correspond to a standard metronome.

Circuit Board. Assemble the electronics on a section of perforated phenolic-board about 1 inch x 1 inch. If you don't have a scrap of perf-board lying about use any piece of stiff fibre board or plastic and drill your own holes with a #52 or 1/16-inch drill. (Don't be fussy about the hole size, as long as the component doesn't fall through, the hole is the right size.)

Solder terminals are not needed. As

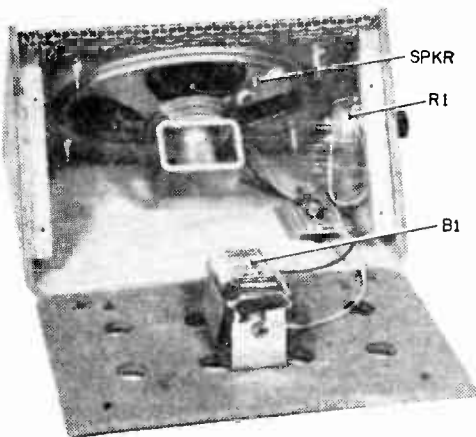

Inside view of Foot Stomper shows speaker, battery, R1 and perforated circuit board. Battery holder is mounted on the bottom cover of the speaker cabinet.

shown in the photographs, just pass the leads through the holes, twist once, and solder.

The completed metronome consists of the phenolic board assembly, the external R1, the battery and the speaker. The speaker can be anything you've got lying around with a 3.2-, 4- or 8-ohm voice coil. Any six-volt battery will do—the smaller the better. So little current is drawn the battery should last almost as long as its shelf-life.

Box It. For a little *rizy* styling, you can use the inexpensive wood grain speaker enclosure shown. The cabinet is purchased complete with speaker, volume control and wire. Remove the existing speaker-level control and install R1 in its mounting hole. Using a single screw, with a 1/4 inch spacer or stack of washers between the board and the cabinet, install the metronome circuit

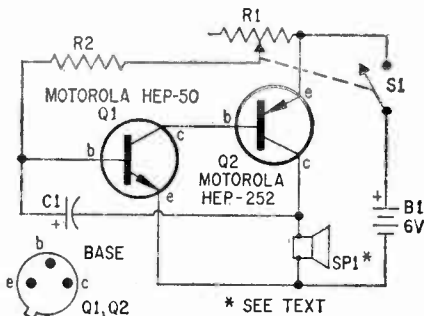

Direct-coupled transistor circuit has few components and requires only a scrap of phenolic board to mount them on. Speaker SP1 is the largest item and S1-R1 mounts on the side of the speaker enclosure.

PARTS LIST

- B1—6-volts (Burgess Z4 or equiv.)
 - C1—2-mf., 6-volt electrolytic capacitor (Lafayette 99C6003 or equiv.)
 - Q1—Transistor, npn (Motorola HEP-50 or equiv.)
 - Q2—Transistor, pnp (Motorola HEP-252 or equiv.)
 - R1—1,000,000-ohm potentiometer with switch S1 (Lafayette 32C7287)
 - R2—100,000-ohm, 1/2-watt resistor
 - S1—S.p.s.t. switch (part of R1)
 - SPKR—Speaker (see text)
 - Misc.—Perforated phenolic board, battery holder, mounting hardware, wire, solder, etc.
- Estimated cost: \$3.49
Construction time: 1 hour



Bottom view of circuit board shows C1 and connections to speaker and B1.

board in the cabinet close to R1.

Mount the battery holder (if one is used) on the speaker cabinet's removable base. Finish the wiring and your "Oh, how thoughtful" gift is ready for presentation.

If desired, you can install a calibrated dial under R1's knob to indicate the actual beat. Slip a piece of stiff cardboard under R1's mounting nut and then compare the electronic beats against a standard metronome—indicate the correct timing on the cardboard. ■

TELEPHONE BROADCASTER



Group listening to telephone conversations may not be an everyday necessity for you but this multi-purpose unit can also be used as a BCB transmitter, phono oscillator or electronic baby sitter.

by Herb Friedman, W2ZLF/KBI9457

■ Chances are that somewhere, sometime, you've made a business telephone call and was bothered by a hollow ringing quality. Nope, for a change Ma Bell didn't goof; you were hearing the feedback from a speakerphone, a device (being used more and more these days) that lets a roomful of eavesdroppers listen to a telephone call.

And while *you* probably don't have need to have a group derive pleasure from hearing how a mortgage foreclosure threw widows and orphans out of their home, *you* probably can get extra service out of the phone through group listening. Junior away at college? Don't run up the long distance charges while he talks to one at a time—let *all* hear what he's got to say. Planning a party with the gang? No need to make an infinite number of calls; get everyone around the phone at once.

The cost of group listening? A lot—if you feel like paying Ma Bell a monthly fee. But for less than \$10 (possibly less than \$5) you can throw together, in one evening, a *telephone conversation transmitter* that will rebroadcast the phone conversation through

the nearest AM radio. And as an extra, when not in use, give the transmitter to the kids for use as a wireless microphone.

What It's Made Of. The *heart* of the telephone transmitter is a prewired *baby nurse transmitter module* (\$3.50) that contains a broadcast-band oscillator and an audio amplifier and modulator. Simply connect a 6-volt battery and a telephone pickup coil or a microphone and you're in the broadcast business. Anything picked up by the coil or microphone is broadcast to the nearest radio. The broadcast range depends primarily on the length of the antenna connected to the module. Use an antenna about a foot long and the range is about three feet. Use a ten-foot antenna and with a strong wind, a clear sky, and a lot of luck you'll get about 100 feet.

Putting It Together. The telephone transmitter is housed in a standard 3½ x 2¼ x 5-inch aluminum cabinet but any similar-sized plastic or wooden box can be used. Position the module as close as possible to the top of the cabinet, as shown in the photographs. Note that the underside of the

TELEPHONE BROADCASTER

module has an access hole for the frequency adjustment screw. Drill a hole in the front of the cabinet so you'll be able to change the module's frequency. (The frequency adjustment is necessary to avoid "jamming" a broadcast station.)

Jack J2, the antenna connection, is a banana jack; a tip jack can be substituted. Connect the module's green lead (the antenna wire) to J2, using as short a length as is possible.

Power switch S1 can be any s.p.s.t type. Since the module draws only 3 to 4 milliamperes, the battery will give almost full shelf life under typical usage, and the power leads from the module can be soldered directly to battery B1's terminals—saving the cost of a switch.

Take extreme care that only *one* module lead touches or is connected to the cabinet—generally, it's one of the two input leads, the one connected to J1's frame lug. (Input jack J1 is a phono jack.) Make certain neither battery connection touches the cabinet by wrapping a turn or two of tape around the battery terminals.

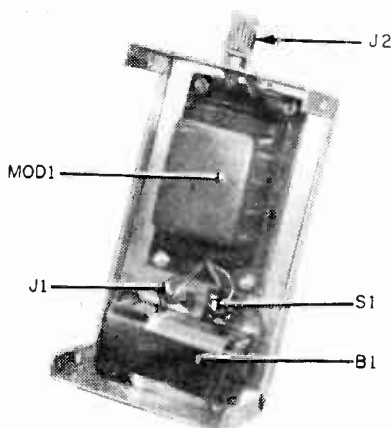

Inside view of Telephone Broadcaster shows all small parts of unit.

For *telephone transmitter* use, about 12 or 15 inches of antenna will be adequate. Cut off a section of metal coathanger, scrape away about a half inch of paint from one end, and solder or clamp this end in a banana plug. For wireless microphone use, either use a long telescopic antenna (such

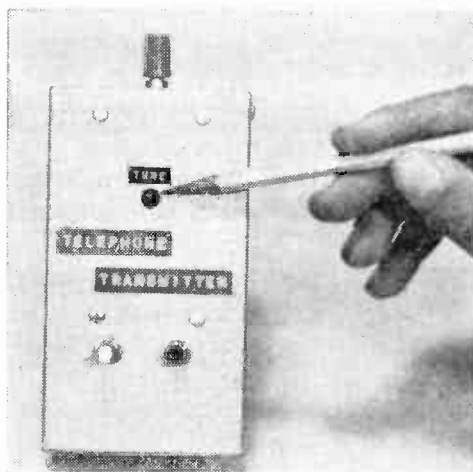

Tuning adjustment is used to shift Telephone Broadcaster's frequency away from those strong local stations.

as sold as replacements for CB handie-talkies) or a long length of wire.

Tuning Up. Place a radio within a foot of the transmitter, flip S1 *on* and tune the radio for the "carrier"—as evidenced by a pronounced *hush* or quieting of receiver noise. Then apply modulation either from a microphone or telephone pick-up coil. Best fidelity will generally be obtained if the radio is tuned slightly into one sideband—off the center carrier. If the module comes equipped with instructions illustrating the use of a

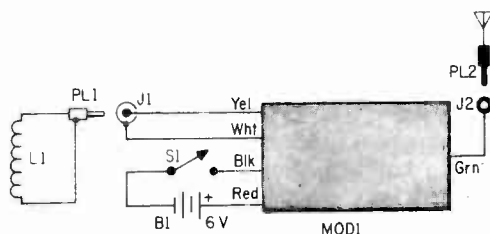

PARTS LIST

- B1—6-volt battery (Burgess Z4 or equiv.)
- J1—Phono jack (see text)
- J2—Insulated 5-way binding post
- L1—Telephone pickup coil (Lafayette 99C1034 or equiv.)
- MOD1—Wireless Baby Nurse Module (Lafayette 19C0120 or equiv.)
- PL1—Phono plug (to match J1)
- PL2—Banana plug (to match J2)
- S1—S.p.s.t. slide or toggle switch (see text)
- Misc.—Cabinet, antenna, wire, solder, machine screws, nuts, etc.

Estimated cost: \$7.50

Construction time: 1 hour.

volume control, forget it. There generally isn't enough input signal to warrant a volume control.

Using A Pick-Up Coil. As a general rule, the most a telephone signal pickup will be obtained if the coil is placed along the sides of the phone—generally the right side. On a wall phone, the pickup can be positioned either on the side or in front, directly under the dial.

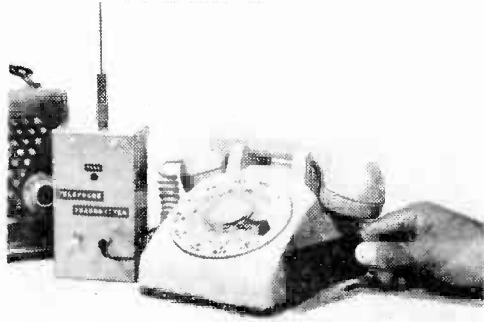

Complete setup above shows Broadcaster, telephone and pickup coil. Try coil on sides and under the base of the phone.

Where To Buy the Module. The *baby nurse transmitter* module is available from most mail order houses such as Lafayette and Olson Radio, or from local distributors. Regardless where it's obtained it's the same

unit if it has the plastic case shown in the photographs. While other "sealed" modules are available, we cannot be certain they will work with a pickup coil as we have tried only the plastic housed model shown.

Pinching Pennies. You can shave the estimated cost by quite a bit if you're willing to sacrifice a few of the conveniences in the construction.

You don't have to have an aluminum chassis box to house the components—try a plastic box like those sold for sandwiches or refrigerator storage.

For an antenna you can use a length of wire, a straightened out wire coathanger; a discarded telescoping curtain rod or an arm from an indoor TV antenna. And it can be connected permanently instead of using a jack and plug. Machine screws are a lot cheaper than jacks and plugs.

While the inexpensive phono jack and plug set can be bought for about a dime, every dime counts—so you could wire the pickup coil right into the circuit. Just tie a knot in the wire to prevent it from pulling out the hole and breaking the connections.

Another dime can be saved by eliminating slide switch S1—but having the transmitter on all the time could cause interference. Not only on the broadcast band but on your SWL receiver as well as FM and TV. So it's best to use the switch or remove the 6-volt battery when the unit is not being used. ■

Most difficult part of wiring the Broadcaster is soldering. Only five parts are inside the cabinet with a total of seven solder connections—plus the plug for L1 and the antenna. You can solder right to the ends of B1 without ruining the 6-volt battery. Make sure to insulate J2 from the cabinet with fiber washers.

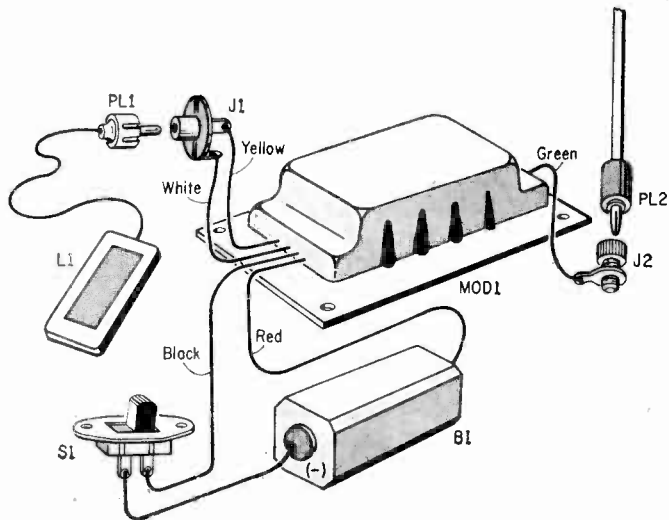



MIGHTY MICKEY- MIKE

Nifty junk-box capacitor checker makes a handy addition to any experimenter bench.

By Jerry Emanuelson

Just about every experimenter worth his salt finds himself in the position now and again where he'd willingly give his Aunt Matilda's right arm for a simple way to check capacitance.

Well here's the dope on a simple little unit that'll do just that and it'll only cost you a couple of bucks to build.

Have a look at the schematic and you've got the essentials. The circuit is set up so that an AC meter simply measures the AC resistance, or reactance, of the unknown capacitor. A simple calculation turns the reading into capacitance value. The completed Mickey Mike will measure capacitance from 500 μF to 1 μF with an accuracy of between 10 to 20 percent.

Construction. The unit can be breadboarded and used with a multimeter as shown, or it can be built into a meter case with its own meter for a more sophisticated job. If you use a separate meter, either use an AC meter or a DC meter with a rectifier. Also get a meter with a sensitive movement or you won't have much luck measuring low capacitance values. Using a separate meter will allow you to calibrate the unit's dial di-

rectly, using capacitors of known value.

If you want to use the Mickey-Mike with your VTVM or VOM, the meter should have an AC input resistance of at least 10,000 ohms per volt.

Pushbutton switch S1 is used to protect the meter in case the capacitor shorts and also to reduce shock hazard caused by the more than 100 volts across the capacitor.

Using Mickey Mike. When the unit is finished, hook up a capacitor—but be sure any capacitor you want to check is rated at more than 100 volts, and don't try to measure capacitors in excess of 1 μF . Also, don't attempt to measure electrolytics.

Now set switch S2 so that a reading of less than 12 volts is seen on the multimeter. Then calculate capacitance as follows:

Capacitance (μF)

$$= 2.3 \times \text{Volts} \times .1 \quad (\text{Range A})$$

$$= 2.3 \times \text{Volts} \times .01 \quad (\text{Range B})$$

$$= 2.3 \times \text{Volts} \times .001 \quad (\text{Range C})$$

$$= 2.3 \times \text{Volts} \times .0001 \quad (\text{Range D})$$

For example, on range B, and the multimeter reads 4.4 volts: $C = 2.3 \times 4.4 \text{ Volts} \times .01 = 10.12 \times .01 = \text{approximately } .1 \mu\text{F}$. ■

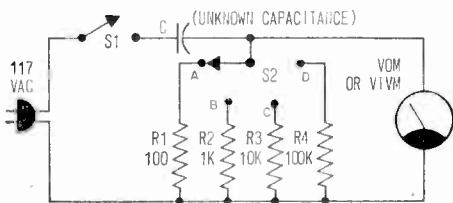

Simple circuit of Mickey Mike does bang-up job of measuring value of most capacitors.

PARTS LIST

- R1—100-ohms, 1/2-watt resistor
- R2—1000-ohms, 1/2-watt resistor
- R3—10K, 1/2-watt resistor
- R4—100K, 1/2-watt resistor
- S1—S.p.s.t., normally-open pushbutton switch
- S2—Single-pole, 4-position rotary switch
- Misc.—Wire, solder, line cord, etc.

Estimated cost: \$2.00

Construction time: 1 hour

Shorts, open junctions, collector-to-base leakage, even amplification can be charted for almost any transistor using little more than a reliable VTVM and a little something you might call "know-how."

50 CENT TRANSISTOR TESTER

By A. A. Mangieri

While it's nice to have a fancy transistor checker to indicate gain and leakage, you don't have to pass over a pile of dollars to just find out if that transistor is usable or dead. Much information on the condition of a transistor can be had using nothing more than a VTVM and a resistor. One simple amplification test shows whether the transistor can amplify, and also reveals shorted and open transistor junctions. Another collector-to-base leakage test spots leaky and drifting transistors. These tests are used when the transistor tester is not on hand or when a quick test bench check of transistor condition is needed.

Those Tests. Amplification and leakage tests use an ohms range—giving resistance readings well up on the scale to insure that the test voltage is not too low. To avoid calculations, resistance readings are used as guidelines to transistor condition although leakage currents can be calculated from an Ohm's law formula.

Current flow in the ohms test lead of the typical VTVM (for any indicated resistance on any range) may be calculated using the formula

$$I = Vb / (Rx + Rc)$$

where Vb is the ohmmeter-circuit battery voltage, Rx is the measured or indicated resistance, and Rc is the center-scale resistance reading of the selected ohms range.

Voltage across the ohms test leads, which is also across the transistor under test, varies from Vb (usually 1.5 volts with the test leads

open) down to zero with the test leads shorted. This voltage varies uniformly with meter-pointer position, not indicated resistance. It is exactly $Vb/2$ (half of Vb), or .75 volt, when the meter pointer is at mid-scale.

Amplification. For the amplification test, connect the circuit as shown, but less S1 (or the clip lead). Set the ohms-range selector on the VTVM to $R \times 10$ ohms. This range passes up to 15 milliamperes current with test leads shorted. The indicated resistance

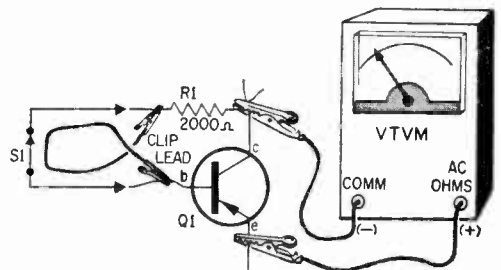

Two components—a 2.2K resistor (shown as 2000 ohms) and a s.p.s.t. switch (shown as a clip lead)—suffice for amplification tests.

should be above 5000 ohms—near full-scale. A very much lower reading indicates a leaky or shorted transistor. Connect the clip lead or switch S1 to connect R1 to the base of Q1. This supplies base current to the transistor. The indicated resistance should then drop to a value much lower than 2000 ohms (the value of R1). Usual values are 30 ohms or so for high-gain transistors to 200 ohms or so for low-gain transistors. If little
(Continued on page 114)

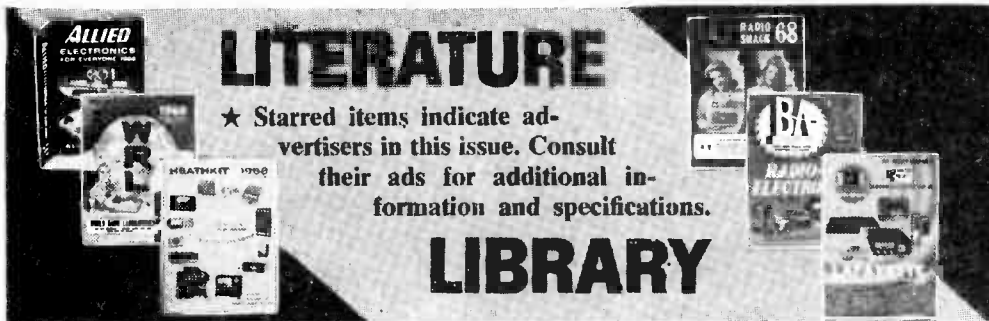

LITERATURE

★ Starred items indicate advertisers in this issue. Consult their ads for additional information and specifications.

LIBRARY

CB—AMATEUR RADIO— SHORTWAVE RADIO

★129. Boy, oh boy—if you want to read about a flock of CB winners, get your hands on *Lafayette's* new 1968 catalog. *Lafayette* has CB sets for all pocketbooks.

122. Discover the most inexpensive CB mobile, Citi-Fone II by *Multi-Elnac Company*. Get the facts plus other CB product data before you buy.

50. Get your copy of *Amphenol's* "User's Guide to CB Radio"—18 pages packed with CB know-how and chit-chat. Also, *Amphenol* will let you know what's new on their product line.

121. Going CB? Then go *CB Center of America*. Get their catalog and discover the big bonus offered with each major product—serves all 50 states.

107. Want a deluxe CB base station? Then get the specs on *Tram's* all new Titan II—it's the SSB/AM rig you've been waiting for!

116. Pep-up your CB rig's performance with *Turner's* M+2 mobile microphone. Get complete spec sheets and data on other *Turner* mikes.

48. *Hy-Gain's* new CB antenna catalog is packed full of useful information and product data that every CBER should know. Get a copy.

111. Get the scoop on *Versa-Tronics' Versa-Tenna* with instant magnetic mounting. Antenna models available for CBers, hams and mobile units from 27 MHz to 1000 MHz.

45. Hams, CBers, experimenters! *World Radio Labs* 1968 catalog is a bargain hunter's delight. Get your copy—it's free.

115. Get the full story on *Polytronics Laboratories' latest CB entry—Carry-Comm*. Full 5-watts, great for mobile, base or portable use. Works on 12 VDC or 117 VAC.

100. You can get increased CB range and clarity using the "Cobra" transmitter with speech compressor—receiver sensitivity is excellent. Catalog sheet will be mailed by *B&K Division of Dynascan Corporation*.

54. A catalog for CBers, hams and experimenters, with outstanding values. Terrific buys on *Grove Electronics' antennas, mikes and accessories*.

★93. *Heath Co.* has a new 23-channel, all-transistor, 5-watt CB rig at the lowest cost on the market, plus a full line of CB gear. See their new 10-band AM/FM/Shortwave portable and line of shortwave radios.

101. If it's a CB product, chances are *International Crystal* has it listed in their colorful catalog. Whether kit or wired, accessory or test gear, this CB-oriented company can be relied on to fill the bill.

96. If a rugged low cost business/industrial two-way radio is what you've been looking for, be sure to send for the brochure on *E. F. Johnson Co.'s* brand new Messenger "202."

103. *Squires-Sanders* would like you to know about their CB transceivers, the "23'er" and the new "55S." Also, CB accessories that add versatility to their 5-watters.

46. A long-time builder of ham equipment, *Hallcrafters* will send you lots of info on ham, CB and commercial radio equipment.

ELECTRONIC PRODUCTS

128. If you can hammer a nail and miss your thumb, you can assemble a *Schober* organ. To prove the point, *Schober* will send you their catalog and a 7-in. disc recording.

126. *Delta Products* new capacitive discharge ignition system in kit form will pep up your car. Designed to cut gas costs and reduce point and plug wear. Get *Delta's* details in full-color literature.

★42. Here's a colorful 108-page catalog containing a wide assortment of electronic kits. You'll find something for any interest, any budget. And *Heath Co* will happily send you a copy.

★44. Get your copy of *EICO's* colorful 36-page catalog on 200 "best buys" products. Ham radio, CB, hi-fi, test gear, both wired and kit, are illustrated.

★125. Need TV camera kit, touch control lamp, hi-fi component, test unit or shop gear? Then you need *Conar's* latest catalog. Born from NRI, *Conar* has become a major supplier of electronics hobbyist parts.

66. Try instant lettering to mark control panels and component parts. *Datak's* booklets and sample show this easy dry transfer method.

109. *Seco* offers a line of specialized and standard test equipment that's ideal for the home experimenter and pro. Get specs and prices today.

ELECTRONIC PARTS

★1. *Allied's* catalog is so widely used as a reference book, that it's regarded as a standard by people in the electronics industry. Don't you have the 1968 *Allied Radio* catalog? The surprising thing is that it's free!

★2. The new 1968 Edition of *Lafayette's* catalog features sections on stereo hi-fi, CB, ham gear, test equipment, cameras, optics, tools and much more. Get your copy today.

102. Before you buy your next *xtal*, get ahold of *Sentry's* 1968 catalog. *Sentry* lists the best in precision quartz crystals and communications goodies. Check off 102 now!

8. Get it now! *John Meshma, Jr.'s* new 46-page catalog is jam packed with surplus buys—surplus radios, new parts, computer parts, etc.

23. No electronics bargain hunter should be caught without the 1968 copy of *Radio Shack's* catalog. Some equipment and kit offers are so low, they look like misprints. Buying is believing.

5. *Edmund Scientific's* new catalog contains over 4000 products that embrace many interests and fields. It's a 148-page buyers' guide for Science Fair fans.

106. With 70 million TV and 240 million radios somebody somewhere will need a vacuum tube replacement at the rate of one a second! Get *Universal Tube Co.'s* Troubleshooting Chart and facts on their \$1 flat rate per tube.

★4. *Olson's* catalog is a multi-colored newspaper that's packed with more bargains than a phone book has names. Don't believe us? Get a copy.

★7. Before you build from scratch check the *Fair Radio Sales* latest catalog for electronic gear that can be modified to your needs. *Fair* way to save cash.

6. Bargains galore, that's what's in store! *Poly-Paks Co.* will send you their latest eight-page flyer listing the latest in available merchandise, including a giant \$1 special sale.

10. *Burstein-Applebee* offers a new giant catalog containing 100s of big pages crammed with savings including hundreds of bargains on hi-fi kits, power tools, tubes, and parts.

11. Now available from *EDI (Electronic Distributors, Inc.)*: a catalog containing hundreds of electronic items. *EDI* will be happy to place you on their mailing list.

120. *Tab's* new electronics parts catalog is now off the press and you're welcome to have a copy. Some of *Tab's* bargains and odd-ball items are unbelievable offers.

117. Harried by the high cost of parts for projects? Examine *Bigelow's* 13th Anniversary catalog packed with "Lucky 13" specials.

SCHOOLS AND EDUCATIONAL

★61. *ICS (International Correspondence Schools)* wants to send you a 64-page booklet on the most often asked questions on preparing for an electronics career. You also get "How to Succeed" and a sample *ICS* lesson.

★74. Want to whiz through circuit problems in seconds without pencil and paper? Then get the facts on an amazing electronics slide rule and course from *Cleveland Institute of Electronics*.

114. Prepare for tomorrow by studying at home with *Technical Training International*. Get the facts today on how you can step up in your present job.

59. For a complete rundown on curriculum, lesson outlines, and full details from a leading electronic school, ask for this brochure from the *Indiana Home Study Institute*.

105. Get the low-down on the latest in educational electronic kits from *Trans-Tek*. Build light dimmers, amplifiers, metronomes, and many more. *Trans-Tek* helps you to learn while building.

★3. Get all the facts on Progressive Edu-Kits Home Radio Course. Build 20 radios and electronic circuits; parts, tools and instructions come with course.

HI-FI/AUDIO

124. Now, *Sonotone* offers you young ideas in microphone use in their new catalog. Mikes for talk sessions, swinging combos, home recording, PA systems and many more uses.

26. Always a leader, *H. H. Scott* introduces a new concept in stereo console catalogs. The information-packed 1968 Stereo Guide and catalog are required reading for audio fans.

85. Write the specs for an ideal preamp and amp, and you've spelled out *Dynaco's* stereo 120 amp and PAS-3X preamp. So why not get all the facts from *Dynaco*!

119. *Kenwood* puts it right on the line. The all-new *Kenwood* stereo-FM receivers are described in a colorful 16-page booklet complete with easy-to-read-and-compare spec data. Get your copy today!

15. *Acoustic Research* would like to send you literature on their speaker systems and turntable. It's "must have" literature before you buy.

16. *Garrard's* Comparator Guide turns you in on the new Synchro-Lab turntable/changer series. Discover how *Garrard* locks on to the correct disc speed.

17. Mikes, speakers, amps, receivers—you name it, *Electro-Voice* makes it and makes it good. Get the straight poop from *E-V* today.

19. *Empire* has made exceptional advances in speaker cabinet design you should read about. Also, *Empire's* successes in the turntable and cartridge fields are worth discovering.

27. 12 pages of *Sherwood* receivers, tuners, amplifiers, speaker systems, and cabinetry make up a colorful booklet every hi-fi bug should see.

95. Confused about stereo? Want to beat the high cost of hi-fi without compromising on the results? Then you need the new 24-page catalog by *Jensen Manufacturing*.

99. Get the inside info on why *Acoustech's* solid-state amplifiers are the rage of the experts. Colorful brochure answers all your questions.

TAPE RECORDERS AND TAPE

123. Yours for the asking—*Elpa's* new "The Tape Recording Omnibook." 16 jam-packed pages on facts and tips you should know about before you buy a tape recorder.

31. All the facts about *Concord Electronics Corp.* tape recorders are yours for the asking in a free booklet. Portable, battery operated to four-track, fully transistorized stereos cover every recording need.

32. "Everybody's Tape Recording Handbook" is the title of a booklet that *Sarkes-Tarzan* will send you. It's 24-pages jam-packed with info for the home recording enthusiast. Includes a valuable table of recording times for various tapes.

33. Become the first to learn about *Norelco's* complete Carry-Corder 150 portable tape recorder outfit. Four-color booklet describes this new cartridge-tape unit.

34. "All the Best from *Sony*" is an 8-page booklet describing *Sony-Super-scope* products—tape recorders, microphones, tape and accessories. Get a copy before you buy!

35. If you are a serious tape audiophile, you will be interested in the all new *Viking/Telex* line of quality tape recorders.

HI-FI ACCESSORIES

112. *Telex* would like you to know about their improved *Serenata* Headset—and their entire line of quality stereo headsets.

98. Swinging to hi-fi stereo headsets? Then get your copy of *Superezz Electronics' 16-page* catalog featuring a large selection of quality headsets.

104. You can't hear FM stereo unless your FM antenna can pull 'em in. Learn more and discover what's available from *Finco's* 6-page "Third Dimensional Sound."

TOOLS

★78. Need pliers to hold, bend or cut fine wires? Check *Xcelite's* new line of miniatures shown in Catalog 166 along with a complete selection of regular pliers and snips.

118. Secure coax cables, speaker wires, phone wires, etc., with *Arrow* staple gun tackers. 3 models for wires and cables from 3/16" to 1/2" dia. Get fact-full *Arrow* literature.

TELEVISION

★70. Need a new TV set? Then assemble a *Heath* TV kit. *Heath* has all sizes, B&W and color, portable and fixed. Why not build the next TV you watch?

127. *National Schools* will help you learn all about color TV as you assemble their 25-in. color TV kit. Just one of *National's* many exciting and rewarding courses.

97. Interesting, helpful brochures describing the TV antenna discovery of the decade—the log periodic antenna for VHF and UHF-TV, and FM-stereo. Get it from *JFD Electronics Corporation*.

ELECTRONICS HOBBYIST
Dept. 1968
505 Park Avenue
New York, N. Y. 10022

Please arrange to have the literature whose numbers I have circled sent to me as soon as possible. I am enclosing 25¢ for 1 to 10 items; 50¢ for 11 to 20 items to cover handling. No stamps, please.

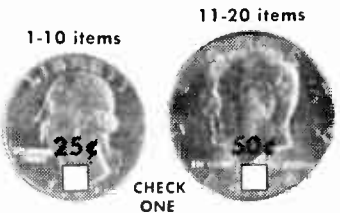

maximum number of items = 20

Indicate total number of booklets requested

	1	2	3	4	5	6	7	8	10	11
15	16	17	19	23	26	27	31	32	33	
34	35	42	44	45	46	48	50	54	59	
61	66	70	74	78	85	93	95	96	97	
98	99	100	101	102	103	104	105	106	107	
109	111	112	114	115	116	117	118	119	120	
121	122	123	124	125	126	127	128	129		

NAME (Print clearly) _____

ADDRESS _____

CITY _____

STATE _____ ZIP _____

Super Squared 3

Continued from page 92

active then. Adjust L2 (with C3 at full capacity) to a point just below the activity on the band. Tune C3 to a station and adjust L1 for best reception.

Getting The Mostest. For best reception, you'll need a good outside two-meter antenna. For vertically polarized signals, a ground plane antenna is a good bet. Use coax to feed the antenna to the receiver. For horizontally polarized signals, a two-meter dipole, beam, or TV antenna will work. For strong local signals, an 18-in. whip connected to J1 will be OK.

In addition to two-meter hams, CAP and MARS nets are usually in operation at the ends of the band. Also, in many communities, civil defense has two-meter nets within the ham band. Adjust the Regen control for best reception of each signal. If you hear strong 12-MHz signals leaking through, adjust the tuning screw of L3

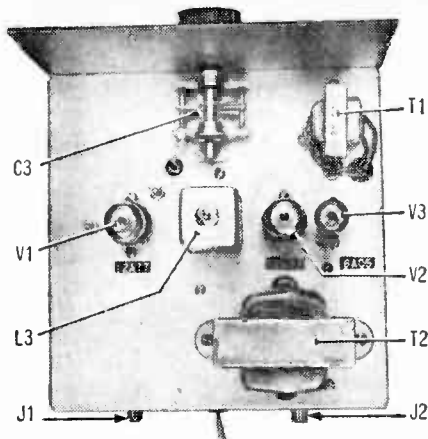

Layout of Super Square is neat and clean, with plenty of working room. Finished rig makes attractive addition to any shack.

(local oscillator) for a quiet frequency.

To sum it all up, what you'll find is what lots of others have found—there's a hot time to go to town with the Super Squared 3. ■

50¢ Transistor Tester

Continued from page 111

or no resistance change is noted upon applying base current, the transistor can be assumed to be defective.

Base Leakage. The next test checks *I_{cbo}*, the collector-to-base leakage current with emitter open, in terms of resistance or current if desired. Excessive *I_{cbo}* leakage biases or shifts the transistor operating points upwards to higher collector currents—leading to excess heating, large-signal distortion and other effects. A transistor with higher-than-normal *I_{cbo}* leakage may or may not operate properly depending on the particular circuit and other factors.

Switch the VTVM to the R × 10K-ohm range. Maximum test current on this range is 15 microamperes with leads shorted. Open S1 and connect the positive-voltage ohms lead to the base. The indicated resistance should fall in the upper third of the scale corresponding to a test-lead current of five microamperes or less. Most transistors will read higher than one megohm on this ohms range—the lower the resistance measured,

the higher the leakage current to be expected.

A high-leakage transistor will indicate near zero ohms on the R × 10K-ohms range. An appreciable downward drift of the meter pointer indicates unstable leakage current leading to transistor drift. No sharp division line exists, but resistance readings well below 200K at these test voltages indicate higher-than-normal leakages for low-power transistors. Silicon transistors, which have extremely-low *I_{cbo}* leakages, will read near infinity on the R × 10K range.

These tests and resistance guidelines were established by checking a number of low-power germanium junction transistors including not only good but also defective transistors to insure their rejection. Although infrequently, a transistor passing these tests may fail to operate properly in the circuit (at normal voltages) if the transistor has an abnormally-rising *I_{cbo}* leakage current with an increase in collector voltage.

When running these tests, do not inadvertently set the ohms range to R × 1 ohm. This range supplies about 150 milliamperes of test current—which could damage some converter-mixer type transistors. And just reverse all polarities shown and mentioned when checking *npn* transistors. ■

CLASSIFIED Market Place

**FOR BIGGER PROFITS! NEW CAREER OPPORTUNITIES!
READ AND REPLY TO THESE CLASSIFIED ADS**

Classified Ads 60¢ per word, each insertion, minimum 10 words, payable in advance. For information on Classified ads—to be included in our next **ELECTRONIC HOBBYIST**—write to C. D. Wilson, Mgr., Classified Advertising, 505 Park Ave., N. Y., New York 10022.

ADDITIONAL INCOME

TURN your Mailbox into a goldmine. Catalog 25¢. La Dera, 1104 San Antonio Drive, Long Beach, Calif. 90807.

MAKE Your Classified Ad Pay. Get "How To Write a Classified Ad That Pulls." Includes certificate worth \$2.00 towards classified ad. Send \$1.00 to C. D. Wilson, Science & Mechanics, 505 Park Ave., New York, N. Y. 10022.

AUTO PARTS & ACCESSORIES

MAKE Hot Coffee, Cocoa, Soup, Tea in your own car. Complete details. S. A. Wimberly Co., 119 Willow Street, Dept. D-11, Redwood City, Calif. 94063.

AUTO TRAILERS & SUPPLIES

MOR/RYDE Rubber Suspension. No Maintenance. Deluxe Ride. Mor/Ryde, Box 579, Elkhart, Indiana 46514.

BOOKS & PERIODICALS

FREE Illustrated Catalog! Unusual Adult Books! Sondreal, 225 Granby St., Norfolk, Va. 23510.

BUSINESS OPPORTUNITIES

I MADE \$40,000.00 a year by Mailorder! Helped others make money! Start with \$10.00—Free Proof! Torrey, Box 318-T, Ypsilanti, Michigan 48197.

FREE BOOK "990 Successful Little-Known Businesses." Fascinating! Worth home! Plymouth 211-R, Brooklyn, N. Y. 11218.

EARTHWORMS

BIG Money Raising Flshworms and Crickets. Free Literature. Carter Farm-O, Plains, Georgia 31780.

EDUCATION & INSTRUCTION

FCC License and Associate Degree correspondence/residence courses. School bulletin free. Grantham Institute of Electronics, 1505 N. Western Ave., Hollywood, California 90027.

EARN Your Degree In Electronics Engineering. Highly Effective Home Study Courses In Electronics Engineering Technology And Electronics Engineering Mathematics. Free Literature. Cook's Institute Of Electronics Engineering, P. O. Box 36185, Houston, Texas 77036. (Established 1945.)

EMPLOYMENT INFORMATION

"HOW To Get A Better Job." Effective, easy to follow instructions. Full refund if not satisfied. \$2.00. Career Aids, Box 415, Dunellen, N. J. 08812.

GIFTS THAT PLEASE

FREE. Beautiful Gift Catalog. Henry's Gifts, 1500 Joliet, Plainview, Texas 79072.

FREE Gifts With Order! Send for color catalog now! Jerome Associates, 11 Gothic, SM-1, Novato, Calif. 94947.

HOBBIES & COLLECTIONS

NEW! Groovy Psychedelic Color, Poster-of-the-month-club. \$3.00 Membership gifts, two posters Free! Tide Lines, 1632 Milton Road, Napa, Calif. 94558.

HYPNOTISM

SELF-Hypnosis—let's you use amazing, proven power for learning, working, feeling, living better. Free literature. Smith-McKinley, Box 3038, San Bernardino, Calif. 92404.

INVENTIONS WANTED

WE either sell your invention or pay cash bonus. Write for details. Universal Inventions, 298-30, Marion, Ohio 43302.

MISCELLANEOUS

WINEMAKERS Catalog — Samples — Recipes—25¢. Kraus, Box 451-U, Nevada, Missouri 64772.

THERE is no charge for the Zip Code. Please use it in your Classified Ad.

MONEYMAKING OPPORTUNITIES

YOU are important! Amaze family, friends, five ways to develop profitable leisure time. \$4.95. Tide Lines, 1632 Milton Road, Napa, Calif. 94558.

PERSONAL

BILL Problems? Poor credit no trouble. Not a loan company. Send for free application. Automatic Acceptance, 318DC Broadway Blvd., Reno, Nev. 89502 or 307DC Pocasset Ave., Providence, R. I. 02909.

IT'S easy to stop smoking with our Swedish Formula. Thousands already have. Send \$1.25 today! Antaramian, Box 2389, San Diego, Calif. 92112.

PETS—DOGS, BIRDS, RABBITS, HAMSTERS, ETC.

REGISTERED Bloodhound Pups Black and Tan or Tawney Red. Write for details. Fred Grandall, Kingman, Kansas 67068.

PROFITABLE OCCUPATIONS

\$25.00 AN Hour Possible Learn Furniture Touch-up. Illustrated Guide \$4.98. Peg Enterprises, Box 243, So. Holland, Ill. 60473.

START Profitable Business in spare time. Investigate many money-making opportunities. Send 10¢ for sample copy of Income Opportunities Magazine, 505 Park Ave., New York, N. Y. 10022. Dept. S.

RADIO & TELEVISION

CANADIANS—Giant Electronic Catalogs. Ili-Fi. Shortwave, Ham, CB. Rush \$1.00. ETCO, Dept. EX, Box 741, Montreal, Canada.

RECORDERS, SOUND EQUIPMENT & SUPPLIES

CHALLENGE Your Sound System with the most demanding music ever put on record and tape. Write: Concert Recording, Lynwood, Calif. 90262.

SEEDS, PLANTS & NURSERY STOCK

1,000 NURSERY Items: Many unusual items—Grafts, Seedlings, Trees, Shrubs, Evergreens, Hedging, Vines, Tree and Evergreen Seeds. Propagation Supplies, Pots, Watering Devices. Free Catalog. Mellinger's, 2322 West South Range Rd., North Lima, Ohio 44432.

SONGWRITERS

POEMS Wanted for musical setting and recording. Send poems. Free examination. Crown Music, 49-SC, West 32, New York 10001.

STAMP COLLECTING

FREE 50 Stamps including Cayman Islands, Southern Rhodesia, San Marino, Approvals. Moublow, 2000-4C Maple, Costa Mesa, Calif. 92627.

START YOUR OWN BUSINESS

UP To 90¢ Profit On Each \$1.00 Sale. Details 25¢. Carpenter, 2907-C West 39th Place, Chicago, Ill. 60632.

For Greater Classified Profits why not try the new combination classified ad medium

Your classified ad will appear in **SCIENCE & MECHANICS MAGAZINE** as well as in a minimum of four other **SCIENCE & MECHANICS PUBLICATIONS**. Write now for information to C. D. Wilson, Manager, Classified Advertising, **SCIENCE & MECHANICS**, 505 Park Ave., New York, N. Y. 10022.

Tesla's Coil

Continued from page 22

Because each builder will want to use parts he has available, it is inadvisable to give specific instructions. Even substitutions for meters M1 and M2 may be made by using their proper shunt or multiplier. Though cardboard forms, shellac, and AC-fed oscillators may seem haywire today, the use of more deluxe components and circuitry is not justified for the average experimenter.

Of course you can build a lower-power

version of the Tesla coil for a lot less money. But with less power available the experiments will be limited and many may be impossible to perform. Lower power will give less brush discharge.

Experiments with the unit will reveal the many fascinating and spectacular demonstrations which can be performed—such as lighting fluorescent and neon tubes without wire connections. In fact, the energy of the discharge is sufficient to ignite candles and paper, or to drive a pin-wheel balanced on the discharge point. Even the smallest Tesla coil never fails to astound and interest on-lookers with feats such as these. ■

Pot Box

Continued from page 75

wiring of a single section and all remaining sections are wired exactly the same.

The last step is checking the wiring and solder joints. Also, if an ohmmeter is available, it's a good idea to check the resistance values for each switch position to make sure the controls are connected to the output jacks in the order listed in the table.

Having built the Pot Box it's certain that you'll never have a potentiometer shortage around your shop. ■

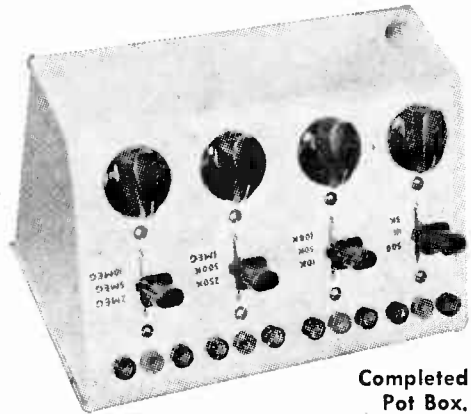

Completed Pot Box.

Meter Flip-Flop

Continued from page 80

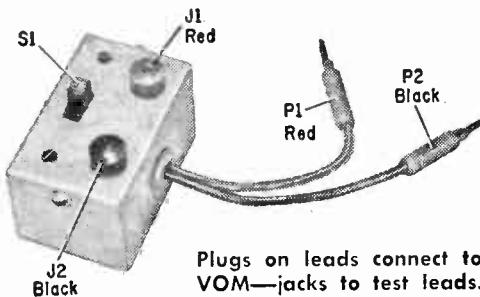

A slide switch is used in the unit shown in the photos, but a toggle, sec-saw, or rotary switch can be used if you wish. If you build your unit in a metal box, as shown here, be sure to use insulating shoulder washers when mounting the two jacks.

For frequent use, or for ease in carrying your test equipment, you can attach the

switch box to the side or bottom of your VOM with screws and nuts. Or, it may be kept as a separate unit, connected to the meter only when making DC measurements. In either case, you will find it a very handy addition to your multimeter. ■



BUILD YOUR OWN

CIRCUITS AT HOME

with the New Improved

PROGRESSIVE RADIO "EDU-KIT"®

A Practical Home Radio Course

Now Includes

- ★ 12 RECEIVERS
- ★ 3 TRANSMITTERS
- ★ SQ. WAVE GENERATOR
- ★ SIGNAL TRACER
- ★ AMPLIFIER
- ★ SIGNAL INJECTOR
- ★ CODE OSCILLATOR

- ★ No Knowledge of Radio Necessary
- ★ No Additional Parts or Tools Needed
- ★ EXCELLENT BACKGROUND FOR TV
- ★ SCHOOL INQUIRIES INVITED
- ★ Sold In 79 Countries

\$20



Training Electronics Technicians Since 1946

YOU DON'T HAVE TO SPEND HUNDREDS OF DOLLARS FOR A RADIO COURSE

The "Edu-Kit" offers you an outstanding PRACTICAL HOME RADIO COURSE at a rock-bottom price. Our Kit is designed to train Radio & Electronics Technicians, making use of the most modern methods of home training. You will learn radio theory, construction practice and servicing. THIS IS A COMPLETE RADIO COURSE IN EVERY DETAIL.

You will learn how to build radios, using regular schematics; how to wire and solder in a professional manner; how to service radios. You will work with the standard type of punched metal chassis as well as the latest development of Printed Circuit Chassis.

You will learn the basic principles of radio. You will construct, study and work with R.F. and A.F. amplifiers and oscillators, detectors, rectifiers, test equipment. You will learn and practice the use of the Progressive Code Oscillator. You will learn and practice trouble-shooting, using the Progressive Signal Tracer, Progressive Signal Injector, Progressive Dynamic Radio & Electronics Tester, Square Wave Generator and the accompanying instructional material.

You will receive training for the Novice, Technician and General Classes of F.C.C. Radio Amateur Licenses. You will build Receiver, Transmitter, Square Wave Generator, Code Oscillator, Signal Tracer and Signal Injector circuits, and learn how to operate them. You will receive an excellent background for television, Hi-Fi and Electronics.

Absolutely no previous knowledge of radio or science is required. The "Edu-Kit" is the product of many years of teaching and engineering experience. The "Edu-Kit" will provide you with a basic education in Electronics and Radio, worth many times the low price you pay. The Signal Tracer alone is worth more than the price of the kit.

THE KIT FOR EVERYONE

You do not need the slightest background in radio or science. Whether you are interested in Radio & Electronics because you want an interesting hobby, a well paying business or a job with a future, you will find the "Edu-Kit" a worth-while investment. Many thousands of individuals of all

ages and backgrounds have successfully used the "Edu-Kit" in more than 79 countries of the world. The "Edu-Kit" has been carefully designed, step by step, so that you cannot make a mistake. The "Edu-Kit" allows you to teach yourself at your own rate. No instructor is necessary.

PROGRESSIVE TEACHING METHOD

The Progressive Radio "Edu-Kit" is the foremost educational radio kit in the world, and is universally accepted as the standard in the field of electronics training. The "Edu-Kit" uses the modern educational principle of "Learn by Doing." Therefore you construct, learn schematics, study theory, practice trouble shooting—all in a closely integrated program designed to provide an easily-gained, thorough and interesting background in radio. You begin by examining the various radio parts of the "Edu-Kit." You then learn the function, theory and wiring of these parts. Then you build a simple radio. With this first set you will enjoy listening to regular broadcast stations, learn theory, practice testing and trouble-shooting. Then you build a more advanced radio, learn more advanced theory and techniques. Gradually, in a progressive manner, and at your own rate, you will find yourself constructing more advanced multi-tube radio circuits, and doing work like a professional Radio Technician.

Included in the "Edu-Kit" course are Receiver, Transmitter, Code Oscillator, Signal Tracer, Square Wave Generator and Signal Injector Circuits. These are not unprofessional wiring and soldering on metal chassis, plus the new method of radio construction known as "Printed Circuitry." These circuits operate on your regular AC or DC house current.

THE "EDU-KIT" IS COMPLETE

You will receive all parts and instructions necessary to build twenty different radio and electronics circuits, each guaranteed to operate. Our Kits contain tubes, tube sockets, variable, electrolytic, mica, ceramic and paper dielectric condensers, resistors, tie strips, hardware, tubing, punched metal chassis, Instruction Manuals, hook-up wire, solder, selenium rectifiers, coils, volume controls and switches, etc.

In addition, you receive Printed Circuit materials, including Printed Circuit chassis, special tube sockets, hardware and instructions. You also receive a useful set of tools, a professional electric soldering iron, and a self-powered Dynamic Radio & Electronics Tester. The "Edu-Kit" also includes Code Instructions and the Progressive Code Oscillator, in addition to F.C.C. Radio Amateur License training. You will also receive lessons for servicing with the Progressive Signal Tracer and the Progressive Signal Injector, a High Fidelity Guide and a Quiz Book. You receive Membership in Radio-TV Club, Free Consultation Service, Certificate of Merit and Discount Privileges. You receive all parts, tools, instructions, etc. Everything is yours to keep.

PRINTED CIRCUITRY

At no increase in price, the "Edu-Kit" now includes Printed Circuitry. You build a Printed Circuit Signal Injector, a unique servicing instrument that can detect many Radio and TV troubles. This revolutionary new technique of radio construction is now becoming popular in commercial radio and TV sets.

A Printed Circuit is a special insulated chassis on which has been deposited a conducting material which takes the place of wiring. The various parts are merely plugged in and soldered to terminals.

Printed Circuitry is the basis of modern Automation Electronics. A knowledge of this subject is a necessity today for anyone interested in Electronics.

FREE EXTRAS

• SET OF TOOLS

- SOLDERING IRON
- ELECTRONICS TESTER
- PLIERS-CUTTERS
- VALUABLE DISCOUNT CARD
- CERTIFICATE OF MERIT
- TESTER INSTRUCTION MANUAL
- HIGH FIDELITY GUIDE • QUIZZES
- TELEVISION BOOK • RADIO TROUBLE-SHOOTING BOOK
- MEMBERSHIP IN RADIO-TV CLUB: CONSULTATION SERVICE • FCC AMATEUR LICENSE TRAINING
- PRINTED CIRCUITRY

SERVICING LESSONS

You will learn trouble-shooting and servicing in an engaging experience. You will practice repairs on the sets that you construct. You will learn symptoms and causes of trouble in home, portable and car radios. You will learn how to use the professional Signal Tracer—the unique Signal Injector and the dynamic Radio & Electronics Tester. While you are learning in this practical way, you will be able to do many a repair job for your friends and neighbors, and charge fees which will far exceed the price of the "Edu-Kit." Our Consultation Service will help you with any technical problems you may have.

FROM OUR MAIL BAG

J. Statitis, of 25 Poplar Pl., Waterbury, Conn., writes: "I have repaired several sets for my friends, and made money. The "Edu-Kit" paid for itself. I was ready to spend \$240 for a Course, but I found your ad and sent for your Kit."

Ben Valerio, P. O. Box 21, Magna, Utah: "The Edu-Kits are wonderful. Here I am sending you the questions and also the answers for them. I have been in Radio for the last seven years, but like to work with Radio Kits, and like to build Radio Testing Equipment. I enjoyed every minute I worked with the different kits; the Signal Tracer works fine. Also like to let you know that I feel proud of becoming a member of your Radio-TV Club."

Robert L. Shuff, 1534 Monroe Ave., Huntington, W. Va.: "Thought I would drop you a few lines to say that I received my Edu-Kit, and was really amazed that such a bargain can be had at such a low price. I have already started repairing radios and phonographs. My friends were really surprised to see me get into the swing of it so quickly. The Trouble-shooting Tester that comes with the Kit is really sweet, and finds the trouble, if there is any to be found."

Progressive "Edu-Kits" Inc., 1186 Broadway, Dept. 502EN, Hewlett, N. Y. 11557

— UNCONDITIONAL MONEY-BACK GUARANTEE —

Please rush my Progressive Radio "Edu-Kit" to me, as indicated below:

Check one box to indicate choice of model

- Regular model \$26.95.
- Deluxe model \$31.95 (same as regular model, except with superior parts and tools plus Radio & TV Parts Jackpot worth \$15.)

Check one box to indicate manner of payment

- I enclose full payment. Ship "Edu-Kit" post paid.
- Ship "Edu-Kit" C.O.D. I will pay postage.
- Send me FREE additional information describing "Edu-Kit."

Name

Address

PROGRESSIVE "EDU-KITS" INC.

1186 Broadway, Dept. 502EN, Hewlett, N. Y. 11557

LEARNING TV-RADIO, ELECTRONICS IS FAST, INTERESTING WITH NRI

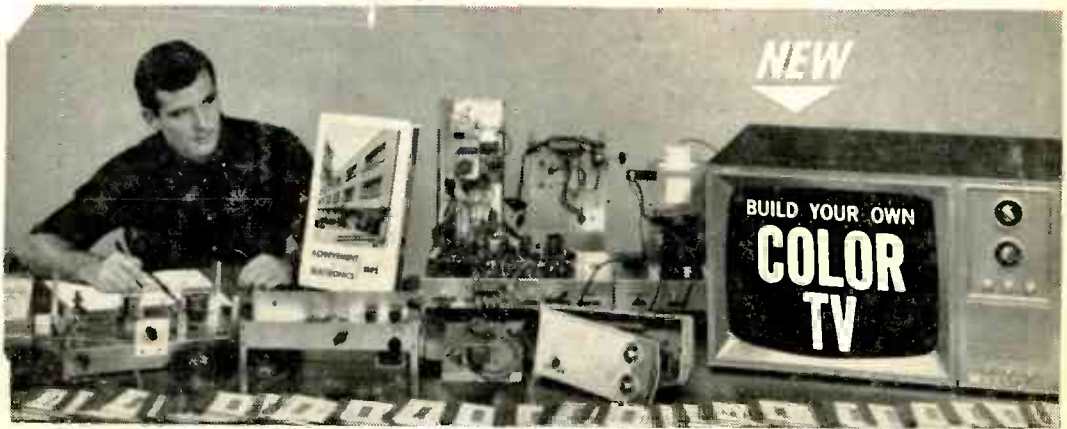

All the material you see above is included in a typical NRI home-study course. Other courses are equally complete. But NRI training is more than kits and texts. It's unique personal services which have made NRI the 50-year leader in training at home for fast growing TV-Radio, Electronics.

Choose From 12 NRI Training Plans

NRI has a training plan to fit every interest, every need in TV-Radio, Color TV and Electronics. Be your own boss in a TV-Radio servicing business or make \$4 to \$6 an hour fixing sets in spare time. Or be a part of the Electronics "revolution" in business and industry. Or get into the fascinating fields of broadcasting-communications. Or take part in missile, rocket, satellite or other government programs. An understanding of computers may be necessary in your work. Perhaps you want to "brush up" on math, electronic terms or basic principles. Whatever your interest, you'll find an NRI course tailored to your needs.

Revolutionary "3-Dimensional" Method

NRI makes training at home easy, interesting. Catalog gives you complete information. Read about the exclusive Achievement Kit NRI sends you, about custom designed training equipment NRI gives you at no extra cost, about NRI's unique "bite-size" lesson texts.

The demand for skilled technicians is great and growing. Discover how you can be a part of the Electronics Age—starting soon. Mail coupon now for free NRI Catalog. NATIONAL RADIO INSTITUTE, Electronics Division, Washington, D. C. 20016. No salesman will call. No obligation.

EARN YOUR FCC LICENSE OR YOUR MONEY BACK

Five NRI Communications courses include FCC License preparation. Mail the coupon. Find out how quickly and easily you can earn your First Class FCC License by training at home with NRI. You MUST get your license or NRI refunds your tuition in full. 87% of NRI graduates pass their FCC exams. Send for free NRI color catalog now. Mail coupon below. No obligation. No salesman will call.



MAIL FOR FREE CATALOG

NATIONAL RADIO INSTITUTE
Electronics Div., Washington, D.C. 20016 37-018

Send me your FREE Catalog (No salesman will call).

- | | |
|--|--|
| <input type="checkbox"/> TV-Radio Servicing (with color) | <input type="checkbox"/> Marine Communications |
| <input type="checkbox"/> Advanced Color TV | <input type="checkbox"/> Mobile Communications |
| <input type="checkbox"/> Industrial Electronics | <input type="checkbox"/> Basic Electronics |
| <input type="checkbox"/> Complete Communications | <input type="checkbox"/> Math for Electronics |
| <input type="checkbox"/> FCC License | <input type="checkbox"/> Electronics for Automation |
| <input type="checkbox"/> Aviation Communications | <input type="checkbox"/> Electrical Appliance Repair |
- CHECK FOR FACTS ON GI BILL

Name _____ Age _____

Address _____

City _____ State _____ Zip Code _____

ACCREDITED MEMBER NATIONAL HOME STUDY COUNCIL



Over 50 years of leadership in Electronics training

AVAILABLE UNDER NEW GI BILL—
If you served since Jan. 31, 1955, or are in service, check GI line in coupon.